

Demonstration of membrane distillation on textile waste water: assessment of long term performance, membrane cleaning and waste heat integration

Noel Dow¹, Jesús Villalobos García², Leslie Niadoo², Nicholas Milne¹, Jianhua Zhang¹,
Stephen Gray¹, Mikel Duke^{1*}

¹Institute for Sustainability and Innovation, College of Engineering and Science, Victoria
University, P.O. Box 14428, Melbourne, Victoria, 8001, Australia

²Australian Textile Mills, Wangaratta, Victoria, Australia

*Corresponding author at: College of Engineering and Science,

Victoria University, PO Box 14428, Melbourne, Victoria 8001, Australia

Tel.: +61 9919 7690; fax: +61 9919 7696.

E-mail address: mikel.duke@vu.edu.au (M. Duke).

Abstract

This work reports outcomes of a pilot trial and practical assessment of direct contact membrane distillation (DCMD) towards achieving zero liquid discharge at a textile manufacturing plant. Treatment of textile wastewater is difficult due primarily to the complexity of textile processing and the wastewater produced. Combined effluent from the site, either untreated or treated with the site's existing flocculation and biological processes, were considered as the feeds to the MD testing. Initial bench scale studies found rapid membrane wetting appeared avoided by the novel use of foam fractionation on the untreated effluent, or by using the conventionally treated effluent. The trial was conducted on treated effluent using fractionation on a side stream within the MD process, and no wetting was observed over the entire 3 month trial duration. The flux of the 6.4 m² membrane module started at 5 L/m²/h and declined to 2 L/m²/h after more than 65 days. Caustic cleaning effectively restored flux to 4 L/m²/h. A 41-fold increase in feed concentration was verified by sulphate measurements, increasing from 567 mg/L to 23,000 mg/L. After concentrating in the hot cycle, all ammonia entering the DCMD plant from the feedwater was found to evolve into the permeate, but non-volatile sulphate rejection was >99.9%. Water recovery at the end of the trial was 91.6%. A plant integration assessment found that zero liquid discharge would be feasible if saline waste streams were isolated and reverse osmosis processes were coupled with MD harnessing waste heat. MD application to current and future treatment scenarios with waste heat integration to textile processing appears viable.

Introduction

Textiles manufacturing is a large industry globally that generates significant quantities of wastewater. It is also one of the longest and most complicated industrial chains [1], making wastewater treatment and resource efficiency a complicated task. The complexity is due to the range of materials and processes used in textile manufacturing. For example, textile processors can produce fabrics made from synthetic, cotton and/or wool where waste water is produced during their processing by scouring, carbonizing, dyeing, sizing, desizing, wool felting, bleaching, mercerizing, printing and finishing [2]. Not all processes are used at all plants and some steps may be skipped or combined. Different fibre types, textile end uses, market demands and internal company policies drive the selection of processes at individual sites. While this is a major reason for the highly variable nature of effluents overall from any textile processor, effluent from a single site can also significantly vary over short spaces of time due to the batch-wise nature of textile processing. In terms of volume, scouring, dyeing and finishing generate most of the wastewater in textiles processing [2]. While many approaches have been considered to treat waste waters from each operation separately, these will be unique to each plant.

Treatment of the combined effluent may instead be considered and can offer conveniences over treatment of individual streams which may only work for specific operations. However combined effluent treatment solution must be versatile enough to handle the variations particular to the overall operation of any textile site and capacity to work under general combined effluent characteristics. The contaminants in wastewater from the textile industry carry organics [3] including polyacrylates, phosphonates, sequestering agents such as EDTA, deflocculation agents, antistatic finishing agents, carriers from disperse dyeing, fixing agents from direct dyeing, preservatives, auxiliaries from finishing steps in particular water-, fire- and moth-proofing, pesticides/insecticides from raw wool and cotton, latex from carpet manufacturing and non-ionic surfactants, such as nonyl-phenol ethoxylate (NPE) used in wool scouring. Many of these present a significant issue as they can be highly toxic and difficult to remove from wastewater [3]. There is also moderate salt content from alkali washes/scouring, neutralization and dye baths.

Current approaches to treat combined effluent include biological (anoxic, anaerobic and aerobic), coagulation/flocculation and oxidation, and are generally effective for treatment of textile wastewater organics [2, 4]. Adsorption is also useful for removing colour. Membrane treatment is being considered, including (in order of decreasing pore size) microfiltration, ultrafiltration, nanofiltration and reverse osmosis. Membrane microfiltration and ultrafiltration sees some application for pre-treatment but must be followed by more separation stages for complete treatment [5] such as nanofiltration and reverse osmosis. Nanofiltration is typically considered to remove dyes from wastewater to allow for recycling and can pass monovalent ions such as sodium [6]. Reverse osmosis on the other hand rejects between 90 and 99.99% of dissolved solids including sodium, as well as organics [7] and its application is more suited to desalination in working towards zero liquid discharge to reduce brine volumes. All membrane processes require a need for concentrate disposal [8], and need to reduce this concentrate volume as much as possible to enable convenient disposal. Saline

concentrates from desalination can require further concentration via a thermal technique like multiple effect evaporation (MEE) and mechanical vapour recompression (MVR). Achieving zero liquid discharged by biological treatment, membrane processing and more recently MEE/MVR has been practiced in textile plants to eliminate the problematic discharge of waste water to inland environments [9], but energy costs for the thermal processes are very high. A technique that can reduce thermal energy use by harnessing existing plant energy sources is membrane distillation [10].

Membrane distillation (MD) is a thermal desalination technology. It utilizes a hydrophobic membrane that prevents the passage of liquid water and entrained solids while permitting the passage of water vapour and other volatiles. A temperature difference across the membrane drives the process by vaporizing water on the hot side, passing the vapour through the membrane and then condensing it on the cold side. The effect is largely insensitive to salt concentration making it suitable for zero liquid discharge application. MD can operate at lower temperatures than other thermal techniques, with results from Australian pilot trials showing operation can occur at 30°C to 40°C albeit with low flux and high thermal energy consumption [11]. The size of the unit is also smaller with respect to conventional thermal techniques due to the decreased vapour space requirement that arises from the high mass transfer area per unit volume of the membrane process.

A number of studies have been performed looking at the cost of MD versus traditional technologies including other thermal processes [12, 13]. These show that MD becomes favourable where it can harness a waste heat source and thermal efficiency is less of a concern [11]. Therefore, the focus of most emerging research in this field is to utilize MD in an industrial environment where waste heat is abundant. Many industrial sites involve a source of thermal energy, where boilers are run on sites to provide a steam/hot water service. The spent heat needs to be exhausted and can be passed through an MD process to gain a water treatment function. MD has been investigated for the treatment of wastewaters from a range of industrial processes that have major heat sources including power stations [11], dairy production [14], food manufacturing [15] and metal forming wastewater [16] (with an additional focus towards acid recovery). While heat sources may be available, a key challenge in operating MD over longer term is managing membrane fouling. While fouling leads to a decreased flux due to pore blockage, fouling, in either the organic or inorganic form, also decreases the hydrophobicity of the membrane, leading to wetting (a condition where liquid water and any contaminants are able to pass through the membrane) [17]. This means that fouling must not be allowed to become too severe. There are many studies featuring application of MD to the textile industry to assess performance and membrane fouling as well as innovative processes such as MD hybrid with photocatalysis [16, 18-27]. These have been primarily laboratory scale treatment of synthetic dye effluents rather than real textile wastewater streams, but provide valuable insight into practical application. For example, that dye-membrane interactions are likely to be complex and difficult to predict, and dye concentrations of up to 45 g.L⁻¹ have been reported in the final effluent [27].

Both fouling and wetting is a concern for MD application to textile effluents, primarily due to the use of surfactants [28]. Approaches to avoid wetting by surfactants have been explored by the use of hydrophilic alginate coatings on hydrophobic PTFE membranes which prevented PTFE wetting from surface active oils, fats and surfactants during MD [29-31]. However correct pre-treatment of a textile waste water, such as widely used existing biological treatments, can digest surfactants and potentially lead to sustainable MD operation. One proposal included the addition of calcium and/or magnesium [32], although the effectiveness of this approach is likely to be limited and could actually enhance the potential for inorganic fouling. Another proposal has been to use vacuum MD to generate a submerged membrane distillation bioreactor [33]. This approach was seen as feasible as the EPS from biofouling was found to less readily wet the membrane compared with other organic substances. However, a more novel non-biological approach is to consider using simple foam fractionation to remove surface active substances which often attach to hydrophobic MD membranes and cause wetting. Foam fractionation has been considered previously for separation of biomolecules (proteins) [34], dyes, metals and chemical recovery [35] but so far it has not been considered for removing the membrane wetting surface active compounds for MD. Conventional biological treatment and/or foam fractionation may therefore serve as a suitable pre-treatment to a standalone MD operation.

Cleaning is also an important part of effective membrane plant fouling management. Typically in membrane processes, inorganic foulants can be removed by washing with product water or acid (hydrochloric or citric) leading to complete recovery of flux [36-40]. Partial reversal of organic fouling by humic substances has been shown using water and complete recovery was achieved with a subsequent clean with 0.1 M NaOH [41]. Other organic fouling formed during the treatment of an RO brine has been removed with relatively good success using 2.5 wt% NaCl in NaOH (approx. pH 9) [42]. Sodium hypochlorite is also utilised in removing organic matter from filtration membranes [43, 44] and may be suitable for MD. However experience on cleaning MD membranes after treatment of real textile wastewater is limited, and more work is needed to demonstrate effective cleaning for practical longer term operation.

While intensified membrane based textile effluent treatment for the future vision of the industry have been conceptualised [22] and costed [45], a trial showing MD performance on real textile wastewater over sufficient time is needed. This work, therefore, considers application of MD to a representative textile industry combined effluent. The more widely applied conventional hydrophobic membranes will be used, so to avoid membrane wetting the innovative concept of foam fractionation treatment will be applied. MD testing will be validated in two scenarios prior to the pilot trial. The first scenario considers the future intensified treatment vision of textile water treatment where MD is applied more directly to the site's effluent [22], while the second scenario considers MD applied to existing operations where effluent from plants utilise biological treatment. The latter scenario is not expected to

have a significant membrane wetting issue due to the effectiveness of biological treatment to digest surfactants. The objective was to perform a practical demonstration of MD technology over a number of months of operation for the scenario which provides the best membrane performance and minimal wetting risk. Then undertake membrane cleaning to remove fouling and restore membrane flux with a view for presenting much needed experiences in MD application, especially for the water needs of the textile industry. The thermal energy performance will then be considered in an assessment on how MD may be integrated into the at the textile facility to recover clean water and reduce waste liquid volumes.

Experimental

MD feed waters tested

The feed water used for the MD testing in this work came from Australian Textile Mills, located in Wangaratta, Victoria. The existing water treatment utilised by the site shown in Figure 1 follows a conventional treatment approach, where the site's combined effluent is first collected into a balance pit prior to being treated by flocculation, anaerobic and aerobic digestion, and settling prior to discharge. The three locations for sample collection were; 1) directly from the site's combined discharge into the balance tank, labelled 'Untreated MD feed', 2) the same sample but after foam fractionation in the laboratory, labelled as 'Fractionated MD feed' and 3) after the site's combined discharge wastewater treatment just before release to the receiving waters, labelled as 'Treated MD feed'. To understand the variability of the site's combined untreated discharge, samples of the 'Untreated MD feed' were collected at several times and tested by bench-scale MD. The site's effluent quality varied significantly depending on mill operations, so for this work the sample used for the study on 'Untreated MD feed' was from samples collected during typical operations producing "average" quality wastewater featuring combined visible characteristics of foaminess and colour from dyes.

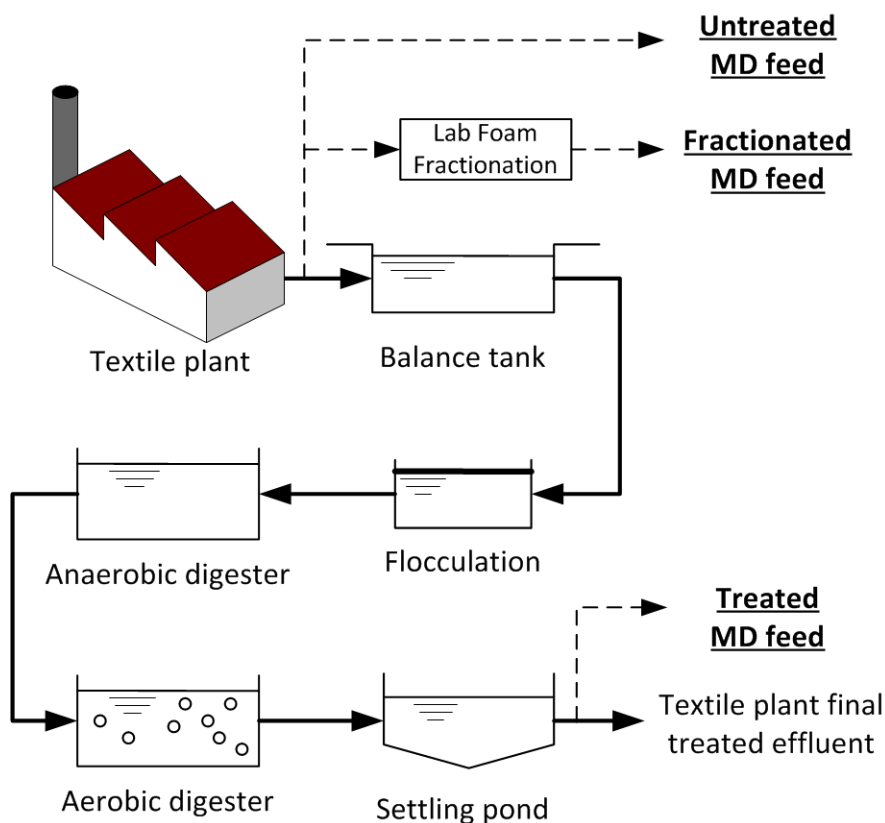

Figure 1: Current full scale textile plant combined discharge treatment train where the flow from the site’s treatment system is finally released via ‘Textile plant final treated effluent’. Locations in this train where the three types of water fed to the MD testing in this work, labelled as ‘Untreated MD feed’, ‘Fractionated MD feed’ and ‘Treated MD feed’, indicated with dashed lines.

Foam Fractionation

Textile effluent collected from the ‘Untreated MD feed’ sample point was subjected to an alternate treatment of foam fractionation for selected experiments to produce the ‘Fractionated MD feed’. The foam fractionator in this work was a ProSkim-G216 protein skimmer (obtained from Aqua One through an aquarium retailer) and was modified to use externally supplied compressed air. Foam fractioning involved flowing feed water down a column while simultaneously contacting it with rising finely dispersed air bubbles. The action of the gas bubbles captured surface active materials, raising them to the top of the water column, as a foam layer. The foam layer was then captured in a foam trap and removed. The fractionator was configured to treat 5 L the Untreated MD feed sample over 6 hours in a batch-wise process. The foam depleted water eluting from the bottom of the column used for MD testing is labelled as ‘Fractionated MD feed’ in Figure 1.

Bench testing

Bench scale DCMD was carried out using a system with a module containing 0.0163 m² of active membrane area. The apparatus was similar to that reported elsewhere [46]. The membranes installed into the module were similar to those utilised previously [11], which were supplied by Ningbo Chanqi, China, and featured a highly hydrophobic polytetrafluoroethylene (PTFE) active membrane layer with nominal 0.5 µm pore size bonded to a polypropylene (PP) scrim support. Cycle flow rates of both hot and cold cycles were both 800 mL/min corresponding to a cross flow velocity of 0.15 m/s. Hot and cold cycle temperatures were controlled at 60°C and 20°C respectively. Feed sample of 3.9 L was placed into a graduated concentrate tank which was pumped through a stainless steel coil immersed in a programmable water bath, through the module and returned to the concentrate tank. The cold cycle was pumped from a vessel placed on a data-logged balance through a coil immersed in a refrigerated water bath, through the module and returned to the cold cycle vessel. Temperatures of the module inlet and outlet for both hot and cold side were monitored using thermocouples attached to a data logger. Pressure indicators were installed on the module inlets to ensure pressures applied to the module matched that of pressures to be experienced by the membrane in the pilot plant, and did not exceed liquid entry pressures of water into the hydrophobic membrane (between 100 kPa and 120 kPa). Clean brine tests on the fresh membrane were first conducted on 1,000 mg/L NaCl solution (Chem-supply, Gillman, South Australia) which was rinsed and purged prior to feeding with the industry samples. 'Untreated MD feed' from the site (Figure 1) was either run directly by DCMD or after first treating with the foam fractionator (i.e. 'Fractionated MD feed'). 'Treated MD feed' from the site was run directly by DCMD without foam fractionation.

Monitoring of permeate electrical conductivity (EC) of the DCMD's cold cycle was used as a means to indicate the occurrence and degree of membrane wetting. However as EC rise also occurs when volatile components such as ammonia and carbon dioxide pass through an intact membrane [11], a specially modified apparatus was used to repeat the tests which enabled visualisation of the membrane surface facing the hot cycle during DCMD operation. A video camera was installed to record the membrane appearance as DCMD was performed, where wetted membranes show obvious changes in appearance (a transition from opaque to transparent) as well as a rise in permeate EC.

Pilot testing

The pilot plant was installed on site at Australian Textile Mills. Figure 2 shows the simplified flow diagram of the pilot plant, and Figure 3 shows an image after installation on site. The DCMD system and membrane module were constructed by Victoria University using a custom made design, featuring a 6.38 m² membrane module consisting of 14 layers of 2 m long, 0.35 m wide with a height of 0.3 m. In this module design, water is directed by internal manifolds along the 2 m side of the module in order to flow across the shorter 0.35 m width

of the module to maximise flux performance. The module was mounted onto the pilot plant that was equipped with pumps to drive the two DCMD cycles (the hot cycle which circulates the concentrate, and the cold cycle which circulates collected permeate), sensors for temperature, cycle flows and EC, which were logged and controlled by a programmable logic controller (dataTaker DT80 obtained from Thermo Fisher Scientific). The system sourced heat from the site's steam condensate return line, which contained water of 80°C to 90°C, fed to the hot cycle heat exchanger. This was not a source of waste heat, but served as a source of thermal energy for the trial. However, during the trial real waste heat sources were investigated and considered as part of the final integration assessment. DCMD process cooling was provided by a fan forced ambient air cooler during winter but required supplementary water cooling during summer to maintain target temperatures in the MD cold cycle. The flow rates of the cycles were initially set at the maximum rating of 45 to 47 L/min for the two centrifugal pumps, corresponding to a superficial cross flow velocity of 0.041 m/s.

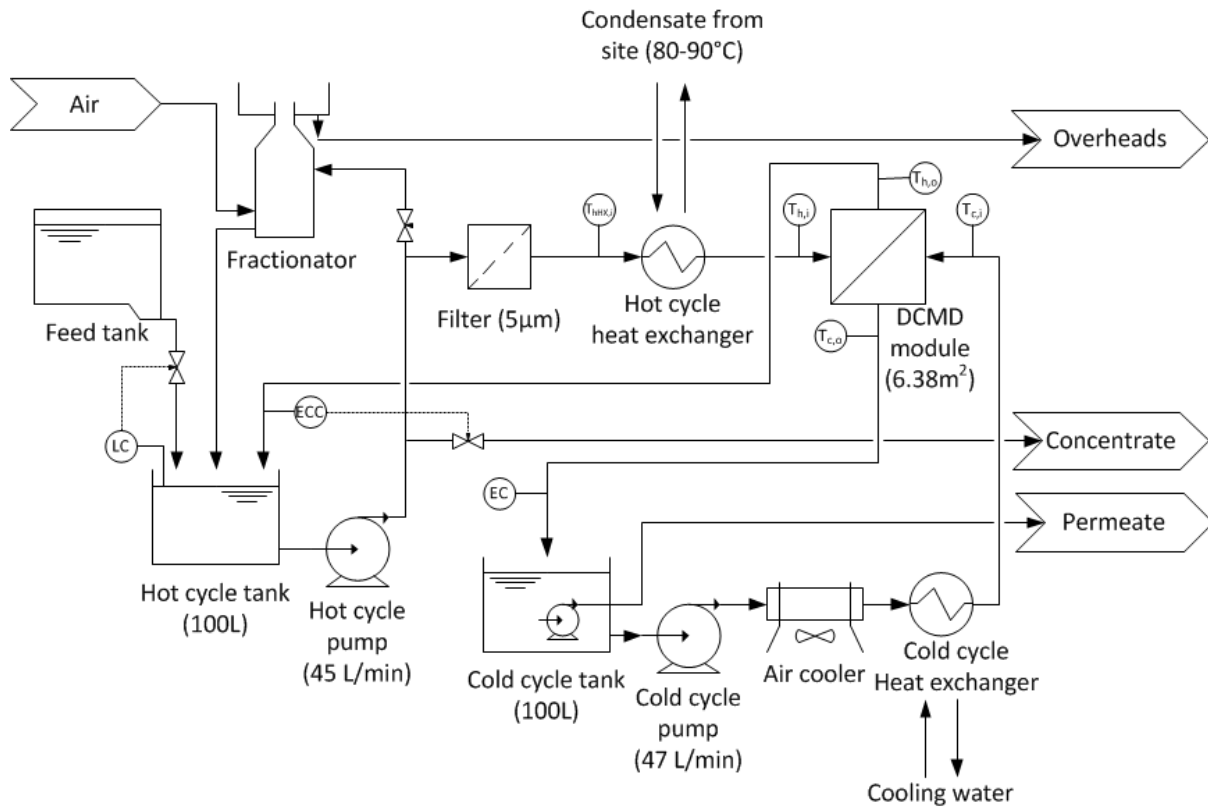

Figure 2: Process flow diagram of the DCMD pilot plant.

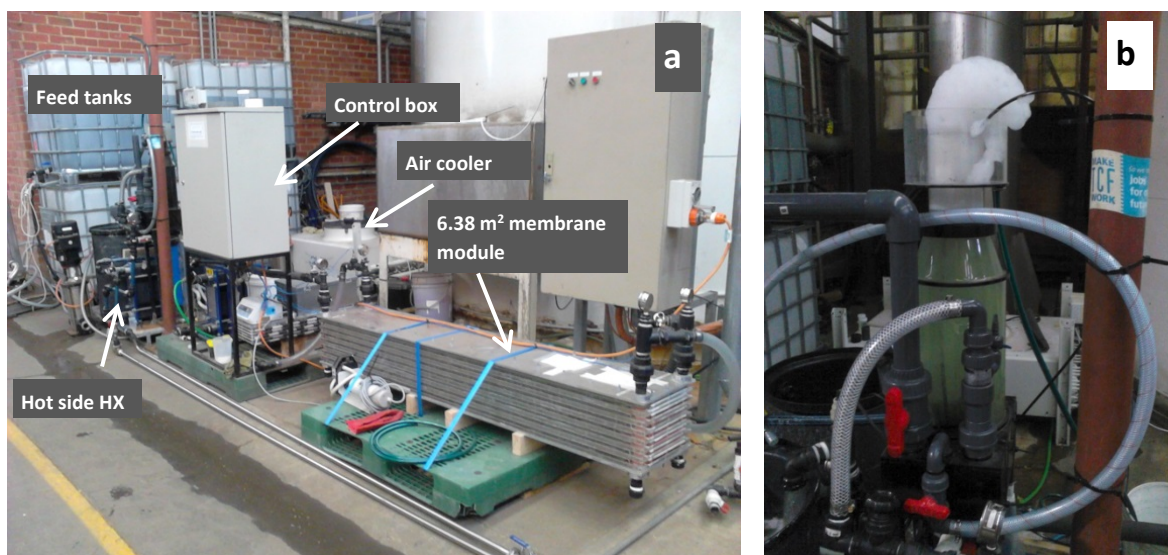

Figure 3: Photo of installed pilot plant (a) and a close up view of the installed foam fractionator in startup mode (b). In steady state operation the foam collapsed and drained into a collector.

Due to the large concentrating effect of the MD process running for many months, it was considered likely that compounds responsible for membrane wetting would reach critical concentrations at some time in the hot cycle. Therefore fractionation was conducted continuously on a side-stream of the hot cycle as shown in Figure 2 to remove surface active organics. A protein skimmer (Reef Octopus 3000 Protein Skimmer obtained from an aquarium supplier) was modified to better operate as a foam fractionator (external air source fitted, and a higher inlet water location to affect a longer region of exchange between down-flowing water and up-flowing air). The installed fractionator is shown in Figure 3 under operation where foam can be seen to be eluting from the top. After optimisation of the fractionator's control parameters (hot cycle liquid and air flow rates, and column liquid level), steady-state operation was achieved where the foam collapsed in the foam trap and drained to a collection container.

The DCMD pilot plant was operated 24 hours per day for 5 days per week to reflect the operations of the textile plant. Prior to weekend shutdowns, DCMD plant hot and cold cycles were rinsed with tap water and stored until startup on the following Monday. The plant was operated predominantly this way over a three month trial period, where in some cases longer shutdown occurred as a result of the operation of the site. ‘Treated MD feed’ shown in Figure 1 was used as the feed for the DCMD pilot plant. Several 1,000 L container samples of this feed were collected every week which were stored at the trial location. Each 1,000 L container was filtered through 200 μm mesh before being fed to the pilot plant's hot cycle tank controlled by a level float valve.

The volume of treated water produced by the DCMD pilot plant was recorded by periodic pumping out of the cold cycle tank through a flow counter calibrated in litres. The membrane's permeate production rate was determined over the time interval from the previous pump out, and membrane flux calculated from the membrane area, as was reported previously [11]. In this same work, the overall mass transfer coefficient, C_m , was calculated to enable better understanding of the membrane fouling over time which will also be utilised here. C_m conveniently minimises variations in supplied heat that are reflected in membrane flux, and shows variations due to fouling as well as changing conditions such as cycle flow rate. C_m is given by [46]:

$$C_m = \frac{J}{\Delta p_{vap}} \quad (1)$$

Where Δp_{vap} is the vapour pressure drop between the bulk solutions flowing across the membrane (i.e. an overall representation of pressure drop not accounting for temperature polarisation) and determined by the log mean pressure drop, for counter current systems it is determined by [46]:

$$\Delta p_{vap} = \frac{(p_{h,i} - p_{c,o}) - (p_{h,o} - p_{c,i})}{\ln \frac{(p_{h,i} - p_{c,o})}{(p_{h,o} - p_{c,i})}} \quad (2)$$

where subscript 'h' designates the hot cycle channels of the module, 'c' the cold cycle channels to the module, 'i' is the membrane module inlet port and 'o' is the membrane module outlet port (four ports in total). The vapour pressures were determined using the Antoine equation, which has been previously applied to determine vapour pressure differences in MD systems [46].

Membrane cleaning

A key part of this trial was the validation of cleaning techniques to restore lost flux. The summary of the cleaning solutions and the routines are presented in Table 1. The steps were carried out in this order with a DCMD performance test using clean brine feed after each step to assess effectiveness. Deionised (DI) water cleaning was employed due to its known effectiveness to remove mineral scale [38, 47], while the use of caustic and chlorine based cleaners was adopted from wider industry knowledge in their use for removing organic fouling.

Table 1: cleaning routines utilised at end of pilot trial to assess cleaning effectiveness.

Step	Type	Description
1	Warm caustic clean	1.5 wt% NaOH at 55°C for about 45 minutes
2	Ambient chlorine clean	0.1 wt% NaClO (as free Cl ₂) at ambient temperature for 30 minutes
3	DI water	DI water pumped through hot side MD module channels until no increase in electrical conductivity measured. Leave to soak overnight.
4	Repeat warm caustic clean	1.5 wt% NaOH at 55°C for about 60 minutes. Spent solution rinsed out with warm water.

Water quality characterisation

Water quality indicators were measured during bench-scale testing and throughout the plant trial using the following techniques: total organic carbon was measured by thermal decomposition TOC/TIC/TN analyser using carbon NIR detection (Shimadzu TOC-V, Kyoto, Japan), metallic cations were analysed on a ICP-OES (Shimadzu ICPE-9000, Kyoto, Japan), ammonia was measured by the phenate method at the trial site using prepared reagents and Spectroquant instrumentation (Merck-Millipore), and sulphate was measured by a turbidimetric method also using Spectroquant instrument and reagents.

The measure of membrane separation was determined from concentration values measured in the DCMD pilot plant streams labelled as ‘concentrate’ and ‘permeate’ in Figure 1. The values are presented by calculation of the rejection parameter [48], R , for the relevant water quality component:

$$R = \frac{C_{conc} - C_{perm}}{C_{conc}} \quad (3)$$

where C is the concentration, ‘ $conc$ ’ represents the value of the concentrate stream pumped out of the hot cycle tank and ‘ $perm$ ’ represents the value of the permeate stream pumped out of the cold cycle tank.

Energy assessment

The waste heat requirement was calculated per unit of clean water permeated, defined by the specific thermal energy consumption, or $STEC$, (kWh/m³) as follows:

$$STEC = \frac{\dot{m}_{hot} C_p (T_{h,i} - T_{hHX,i})}{JA} \quad (4)$$

where \dot{m}_{hot} is the hot cycle flow rate (kg/s), C_p is the specific heat capacity of the feed water (4.18 kJ/kg/K), $T_{hHX,i}$ is the inlet temperature of the hot cycle waste heat exchanger (°C) and $T_{h,i}$ is the temperature of the hot cycle inlet to the MD module (°C). The temperature difference represents the thermal energy entering the MD process via the hot cycle.

Results and discussion

Initial water characterisation

The characteristics of the two wastewaters collected from the locations shown in Figure 1 were analysed and the results are shown in Table 2. The ‘Untreated MD feed’ sample had a near neutral pH and an EC expected for this type of saline effluent. The water was blue coloured, cloudy and foamy indicating the presence of dyes and surfactants. Although water quality varied greatly depending on mill operations, this sample was considered typical for normal site operations and used for the preliminary DCMD bench testing. The ‘Treated MD feed’ sample was similar in pH, but about half the EC (salinity) than the ‘Untreated MD feed’ (averaged) as a result of the multiple process trains and intermediate holding tanks of the site’s existing water treatment plant shown in Figure 1. This sample was analysed more completely, and showed a TOC of 26 mg/L which has been reduced as a result of upstream flocculation and biological treatment (original ‘Untreated MD feed’ TOC >100 mg/L). The major ions present were Na^+ , Cl^- and SO_4^{2-} , which is typical of textile industries. The sum of all ions (including Ca^{2+}) is 1,660 mg/L, which is similar to the value of 1,420 mg/L estimated by converting the EC of 2.22 mS/cm to total dissolved solids using the standard factor of 0.64. Ammonium was also present in the ‘Treated MD feed’, which is used in mill operations, but is also likely to evolve from the anaerobic stage of the train shown in Figure 1. The standard deviation of ammonium measurements taken over the duration of the 3 month trial period included in Table 2 shows the ammonium concentration was highly variable (46% of the average value), as compared to the much more stable pH and TOC readings which showed lower standard deviation values (5% and 8% of the averages, respectively). This was mainly due to slowly rising ammonia in ‘Treated MD feed’. Meanwhile SO_4^{2-} showed high variability (standard deviation 31% of average), where it showed declining concentration over the trial time. The trends may possibly be due to seasonal variation, for example the trial started in winter and finished in warmer spring weather. The ‘Treated MD feed’ and ‘Untreated MD feed’, along with the ‘Fractionated MD feed’ were then tested in the DCMD bench system.

Table 2 Water quality characteristics of the two samples used as feed for either the bench or pilot DCMD system. ‘Treated MD feed’ average values for pH, TOC, NH_4^+ and SO_4^{2-} , and variabilities determined by the standard deviation taken for numerous samples (n=36, 10, 10 & 13 respectively) over the entire 3 month trial period where at least one sample was taken in

each week of continuous operation. All other values determined from single measurements of the initial sample.

	pH	TOC (mg/L)	NH ₄ ⁺ (mg-N/L)	EC (mS/cm)	Na ⁺ (mg/L)	Ca ²⁺ (mg/L)	Cl ⁻ (mg/L)	SO ₄ ²⁻ (mg/L)
Untreated MD feed	7.7			4.00				
Treated MD feed	7.7 ±0.4	26 ±2	8.5 ±3.9	2.22	409	37	650	531 ±169

DCMD Bench testing of textile combined waste waters

DCMD performance in terms of membrane flux and cold cycle (i.e. permeate) EC of the bench scale tests on the ‘Untreated MD feed’ samples is shown in Figure 4b. Clean brine reference tests for both membranes prior to exposure to the samples are also shown as a single point at 0h run time. For the ‘Untreated MD feed’, we see an initial flux of 50 L/m²/h, a rise from its clean brine value of 39 L/m²/h, which rapidly declined to 20 L/m²/h after about 2.5 hours of operation. The jump in actual flux would be unusual if the membrane was intact, as usually fluxes on wastewater samples will be lower than the clean brine value. However, when considering the EC as well, a sharp rise occurred which is evidence of membrane wetting and allowing some hot cycle liquid, consisting of the original feed water, to transport through the membrane into the cold cycle consisting originally of deionised water. This may explain why flux appeared to increase at first, where vapour transport was overtaken by liquid transport. Flux then declined as the membrane started to become blocked by foulants in the sample. Wetting was confirmed by the visual observation apparatus as shown in Figure 5, where the original opaque white PTFE membrane rapidly became transparent revealing the permeate flow spacer. Therefore direct MD treatment of the ‘Untreated MD feed’ representing untreated combined effluent taken directly from the textile plant prior to the site’s treatment process was not suitable.

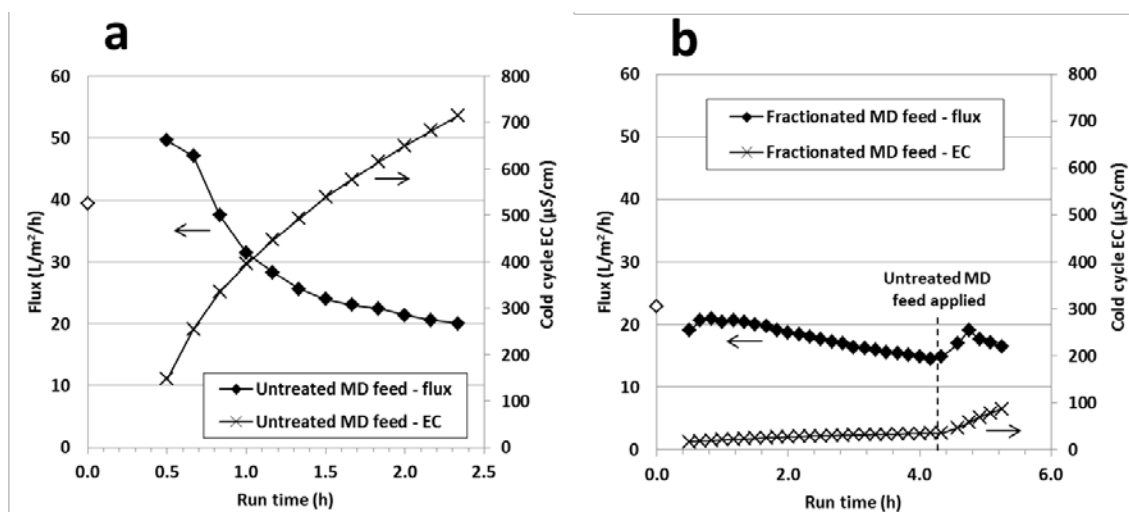

Figure 4: MD performance of (a) ‘Untreated MD feed’ and (b) ‘Fractionated MD feed’. Hollow symbols at 0h run time show the relevant clean brine flux. The dashed line in (b) indicates the time when ‘Untreated MD feed’ was added to the hot cycle tank. Hot and cold cycle temperatures were 60°C and 20°C respectively.

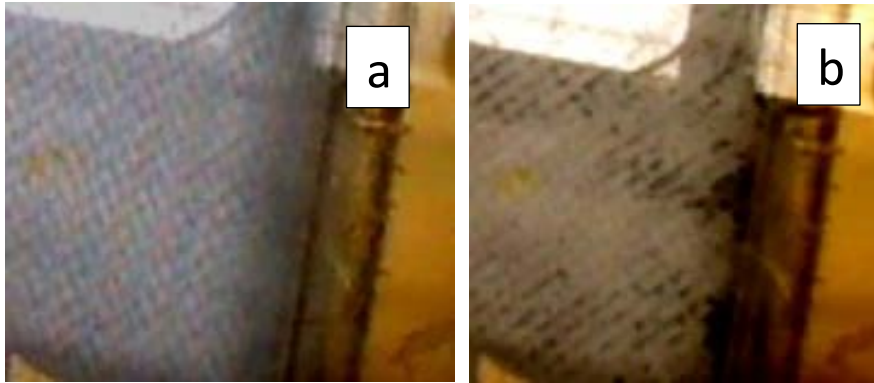

Figure 5: Images of a membrane before (a) and after wetting (b) in *in-situ* monitoring rig when testing ‘Untreated MD feed’ as received (unequal lighting due to sun-light changes). The images were cropped to draw attention to areas of transparent wetted membrane seen as dark spots in the image.

On the other hand fractionation of the sample prior to DCMD, shown from testing ‘Fractionated MD feed’ in Figure 4b, appeared more suitable. The initial clean brine flux of 23 L/m²/h declined slightly to 20 L/m²/h upon introduction of the sample, and continued to decline to 15 L/m²/h after just over 4 hours of concentrating the sample. The EC rose slowly during this test, starting at 17 μS/cm and rising to 36 μS/cm over this interval, but this still represents excellent quality permeate. In order to confirm using this membrane specimen if the fractionation was effective, the original sample of ‘Untreated MD feed’ was introduced again to the concentrate tank, and like the membrane fed directly with this sample, both apparent flux and EC rose sharply indicating wetting. Therefore it appears fractionation of the ‘Untreated MD feed’ effectively removed wetting surfactants and thus led to a suitable DCMD operation.

The effective operation of DCMD was also tested on the bench apparatus on effluent obtained after conventional wastewater treatment, represented in Figure 1 as ‘Treated MD feed’. The results are shown in Figure 6. As the performance was more stable compared to testing ‘Untreated MD feed’, testing was run for longer, concentrating the liquid in the hot cycle reservoir for 52 hours. This was achieved by topping up the reservoir with original sample after sufficient volume was treated. The top up intervals are shown with the dashed vertical lines. The clean brine flux was 25 L/m²/h, and remained unchanged upon introduction of the sample and for the duration of the run. The water recovery (ratio of the

permeated water volume to the fed water volume) reached 91% by the end of the full run. Hot cycle EC increased to 6.2 mS/cm, while the cold cycle EC initially was stable, but showed an increasing trend during each interval (cold cycle volume replaced with deionised water in each run). Instead of being evidence of wetting, this moderate cold cycle EC rise was more likely due to volatile ammonia and carbon dioxide (from carbonates) transport through the membrane which has been seen in previous pilot trial on ion exchange regeneration waste which was pH neutralised using sodium bicarbonate. The transport of ammonia through MD membranes [11] can also be utilised as a means to remove ammonia from wastewaters [49].

Based on the results of DCMD of both water samples representing the two scenarios referred to in the Introduction, being MD application to future intensified treatment plants [22] ('Untreated MD feed') or to conventional treatment plants ('Treated MD feed'), the latter case was considered for the pilot trial. This decision was made based on the more sustained fluxes, even when recovery extended to practically high values, when the system was fed with the 'Treated MD feed'. Further, the second scenario is more relevant to current textile wastewater treatment practice where MD may be immediately adopted, but can be later adapted to work in the first scenario when future intensified plants are realised by the industry.

Although the pilot trial was operated with the 'Treated MD feed' water, the fractionation process that was found to be effective when treating the 'Untreated MD feed' (Figure 4a) was also installed on the pilot plant to assist with removal of surface active materials, including surfactants and biomolecules [34, 35, 50], that would otherwise concentrate at high water recoveries. Thus, fractionation was expected to minimise the membrane wetting risk when operating over the long trial period.

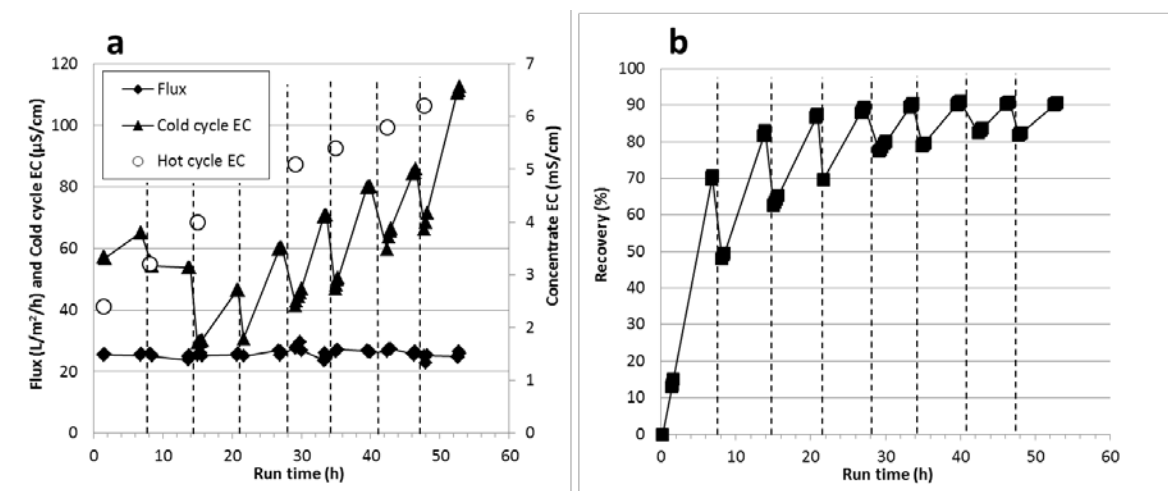

Figure 6: DCMD of 'Treated MD feed', (a) flux profile and cycle EC, and (b) water recovery. Dashed vertical lines show experiment restart which involved top up of hot cycle tank with original feed and replacement of cold cycle with fresh deionised water. Feed initial

volume = 3.9 L, cold cycle initial volume = 1 L, hot and cold cycle flows = 800 mL/min, hot cycle temperature = 60°C, cold cycle temperature = 20°C. Clean brine flux before sample introduction = 24.8 L/m²/h.

Pilot testing

Clean water initial performance validation

Prior to commencing the trial, the pilot plant was tested on clean Na₂SO₄ solution to assess baseline water flux performance prior to introduction of the selected waste water. The average flux determined over a 5 hour test was 5.4 L/m²/h and the C_m determined by Equation 1 was 131 L/m²/h/bar. However, temperature was variable, with the hot side $T_{h,i}$ measured at 48°C +/- 8°C while the cold side $T_{c,i}$ was measured at 27°C +/- 2°C. Hot and cold cycle flow rates were both 50 L/min, which corresponds to superficial cross flow velocities of 0.046 m/s. Higher fluxes would be expected for DCMD systems, which can easily reach 20 L/m²/h for a similar membrane [46]. Indeed high flux was observed for the bench testing of clean brine shown in Figure 6, where the hot cycle temperature was similar but cold cycle temperature slightly warmer. However, the most significant influence on the flux is likely to be the cross flow velocity, which is more than 3-fold faster in the bench system (0.15 m/s). On our previous smaller scale pilot trial using the same membranes, a fresh membrane C_m of 211 L/m²/h/bar was measured [11] with a cross flow velocity of 0.09 m/s, double that of the present work. Therefore, although C_m was lower than previous work, this was attributed to different cycle temperatures and cross flow conditions (which can lead to different temperature polarisation impacts on the calculated C_m), leading to the conclusion the pilot plant was operating effectively under these conditions.

Trial performance

The flux results over the full 3 months of the trial are shown in Figure 7a. Flux varied considerably between 2 L/m²/h and 8 L/m²/h over the entire period. The sharper variations were due to the rapid changes in heat supply temperature and flow from the site's condensate return line, which limited the amount of heat supplied to the pilot plant due to the inability to accept temperatures greater than 60°C. This shows how the MD system is sensitive to available heat, and how it can easily vary its production according to available temperatures. The variations of the four port inlet/outlet temperatures of the module are shown in Figure 7b. Some of the variability in the available temperature was resolved after day 40, when the source of steam condensate to the concentrate heat exchanger was modified. Previous to this change flow and temperature of the condensate varied considerably in very short time periods (~minutes) depending on mill operations, whereas after the change condensate flow was constant and independent of steam usage, although condensate temperature continued to vary. Following day 40, flux (Figure 7a) and temperature profiles (Figure 7b) were higher and

more consistent reflecting the ability to utilise more condensate with the reduced effect from high temperature spikes.

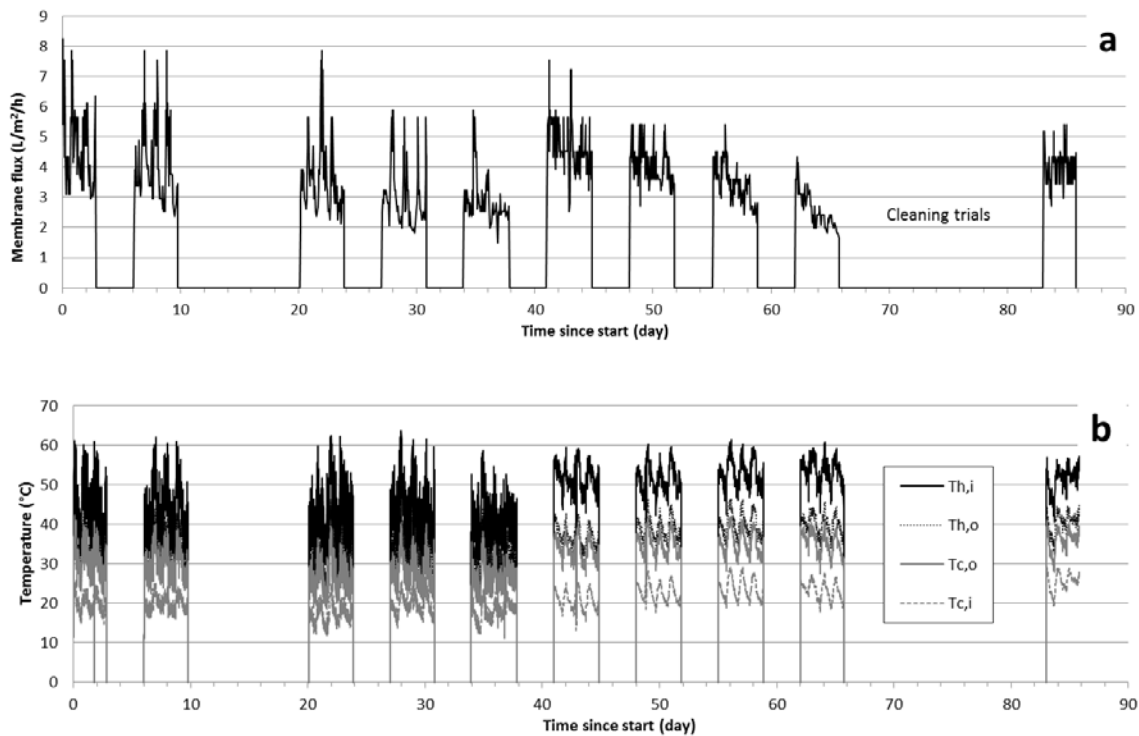

Figure 7: Pilot trial flux results (a) and temperature profile at the four DCMD module ports (b) over 3 months of DCMD fed with ‘Treated MD feed’ from the textile plant. x-axis in days elapsed including pause periods due to site shutdowns (weekends and site maintenance).

Another change in flux occurred more gradually over time, for example, the flux just after the heat supply upgrade from day 40 was around 5 L/m²/h, but declined to 2 L/m²/h just before the cleaning trials on day 66. After cleaning the flux returned to 4 L/m²/h. This gradual decline was, therefore, likely due to membrane fouling. By the end of the trial, the plant had permeated 20 m³ of water, and produced 1.8 m³ of brine concentrate, equating to a total recovery of 91.6% and therefore produced a highly concentrated solution rich in components that may adhere to the membrane surface. The composition of the water and more detailed analysis of the cleaning routines were investigated.

DCMD pilot plant water quality analysis

Figure 8 shows the EC of the hot and cold cycle tanks measured over the trial period, representing the concentrate and permeate streams shown in Figure 2 respectively. As the pilot plant recovery was controlled by hot cycle EC (Figure 2), stable plateaus are seen after setting the hot cycle EC value at various times during the trial to gradually increase plant water recovery. At the end of the 3 month trial (day 86), hot cycle EC had reached 61 mS/cm

which was 27-fold more than the initial feed (Table 2). Cold cycle EC also rose over time, generally reflecting the hot cycle EC rise which is to be expected as rejection across the membrane is a quotient of hot cycle solution concentration. Cold cycle EC reached 204 $\mu\text{S}/\text{cm}$ by the end of the trial, where the permeate product drawn from this cycle is lower than the EC of most drinking water supplies. However as observed during bench tests (Figure 6), the likely reason for rising EC was due to ammonium and possibly carbonate. Therefore testing for the volatile ammonia contaminant was carried out along with testing for non-volatile species.

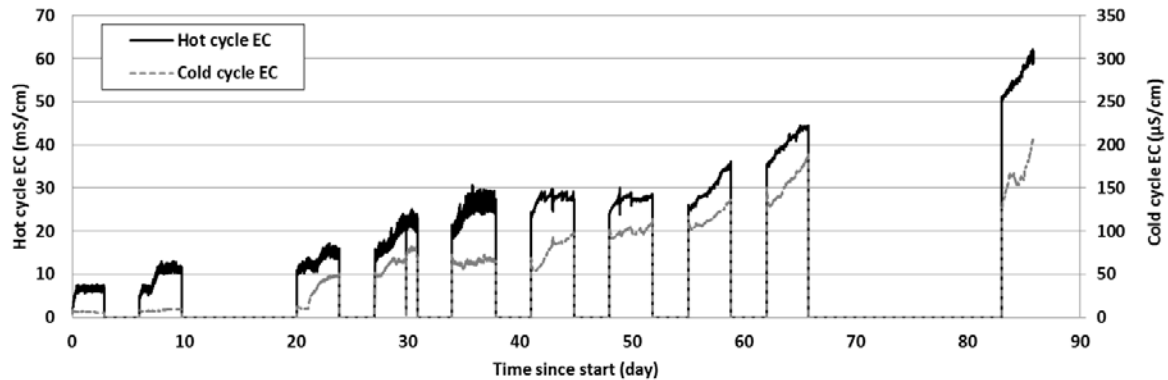

Figure 8: Hot cycle (concentrate) and cold cycle (permeate) EC over the 3 month trial period

In order to confirm the membrane intactness where EC can be influenced by volatile ammonia, rejection of non-volatile sulphate was analysed as shown in Figure 9. The rejection relative to the incoming ‘Treated MD feed’ (system rejection), and the rejection relative to the hot cycle (membrane rejection), were calculated from the data. The membrane rejection always remained above 99.9% as expected for high performing MD membranes. However because the liquid became concentrated in the hot cycle, the rejection as compared to the incoming ‘Treated MD feed’ was slightly lower. At the end of the trial when the components in the hot cycle were at their highest concentrations, indicative non-volatile sulphate rejection decreased to 95%, which is calculated from 22 mg/L of sulphate in the cold cycle where the incoming ‘Treated MD feed’ sulphate was 460 mg/L at that time (usually 531 mg/L as shown in Table 2). Therefore the MD system provided a very high degree of salt rejection, producing a high quality distillate even at very high concentration factors.

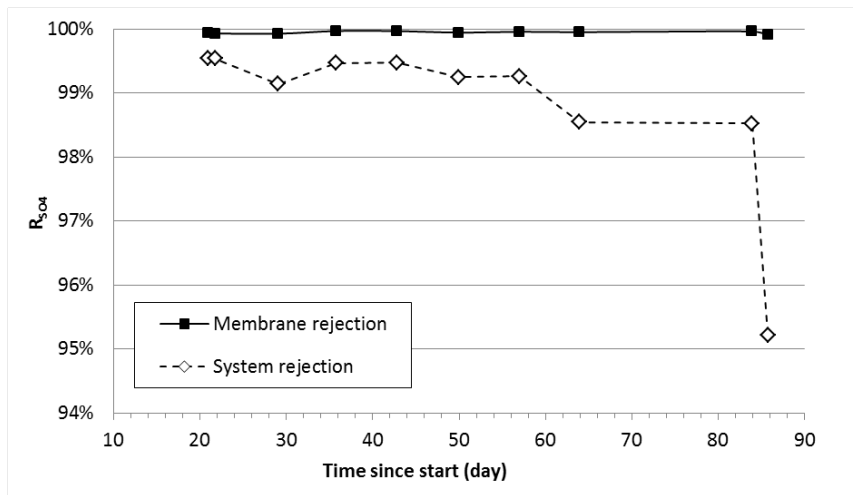

Figure 9: Rejection of sulphate, R_{SO_4} , of the system (based on incoming ‘Treated MD feed’) and the membrane (based on the hot cycle) over the trial duration.

The sulphate and TOC concentrations in the hot cycle are shown in Figure 10. These rose significantly during the trial as they were both predominantly retained by the membrane. Sulphate is expected to rise in proportion to the volume of water removed due to its high solubility and high membrane rejection (Figure 9). For instance, the 23,000 mg/L sulphate measured at the end of the trial is equivalent to 34,000 mg/L as sodium sulphate, which has a solubility in water at 60°C of 453,000 mg/L. At the end of the trial, sulphate was 43-fold more concentrated than the average value of the original ‘Treated MD feed’ shown in Table 2. The TOC rise on the other hand was slightly less, being 34-fold more concentrated at the end of the trial than the average value in ‘Treated MD feed’. This lower proportionate increase in TOC could be expected due to the removal of organic matter from the foam fractionation. The membrane retained TOC as it was measured in the cold cycle at less than 1 mg/L.

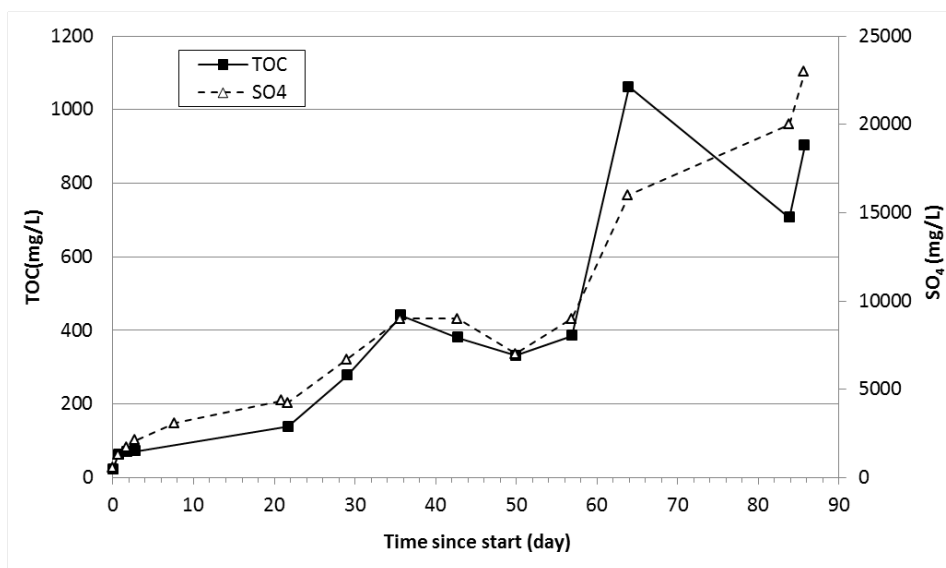

Figure 10: TOC and sulphate in the hot cycle during the trial

The analysis of the MD hot cycle and the fractionator overheads taken at three separate times is shown in Table 3. The overheads had a proportionately higher TOC than the MD hot cycle, showing it was effective at removing organic matter. Prior work on foam fractionation to remove enzymes from fermentation [34] and model protein in solution [50] showed that it can work in waste water treatment to remove surface active components such as biomolecules often present in the biologically treated effluent, which was the feed in this MD trial. With regards to the other components (minerals) shown in Table 3, there was little change in the proportions showing they were entrained into the foamed product and no separation occurred, so TOC was being selectively removed supporting the earlier finding that TOC increase was less than sulphate. So while TOC continued to accumulate as the trial progressed, the proportion of surface active organics that can be removed by fractionation were still able to be removed. Table 3 shows the organics in the hot cycle continue to rise, while the concentration in the overheads shows no trend indicating that organics that were not surface active accumulated in the hot cycle, while the surface active organics coming from the ‘Treated MD feed’ continuously added to the hot cycle, left via the fractionator overheads. Further, as the principle of operation preferentially separates surface-active components [34] there was an expectation that membrane wetting biomolecules or residual textile surfactants would partition into the overheads phase. The main control parameter, air and liquid flow rates, underwent simple optimisation to achieve proof of principle for TOC removal shown in Table 3. However, a dedicated investigation into the novel use of foam fractionation for MD pre-treatment is required, where factors known to affect performance include temperature, gas flow rate and pH [34].

Table 3: Water quality characteristics from samples of concentrate (from MD hot cycle) and fractionator overheads, taken on days 1, 2 and 8.

Sample	Day	pH	TOC (mg/L)	EC (mS/cm)	Na ⁺ (mg/L)	Ca ²⁺ (mg/L)	Cl ⁻ (mg/L)	SO ₄ ²⁻ (mg/L)
Concentrate	1	8.5	69	6.47	1,230	50	1,000	1,710
	2	8.8	72	6.68	1,260	51	900	2,120
	8	8.7	140	13.1				
Overhead sample from trial	1		453	5.48	1,220	50	900	1,880
	2		197	6.58	1,300	50	900	1,560
	8	9.3	266	9.2				

The increasing cold cycle EC observed in Figure 8 was attributed to ammonium, which is analysed more closely in Figure 11a which shows the ammonium concentrations of the

‘Treated MD feed’, hot cycle and cold cycle. Unlike TOC and sulphate, ammonium in the hot cycle did not continue to accumulate and actually dropped suddenly after day 42. The reason for this is unknown, but may be due to a change in chemistry of the ‘Treated MD feed’ sourced from the textile mill’s water treatment plant over time. Ammonium of the ‘Treated MD feed’, however, increased slowly from 6.8 mg-N/L to 13 mg-N/L towards the end of the trial. As mentioned earlier, the rise in ammonium may be due to the increasing ambient temperatures or other aspects of the upstream waste water treatment plant (Figure 1). However what is interesting to note here is that cold cycle ammonium was almost identical to incoming ‘Treated MD feed’ ammonium, which indicates no ammonia rejection by the DCMD system and any added ammonium evolves via the cold cycle. This could be expected since most of the time the membrane total production rate was close to the ‘Treated MD feed’ flow rate (overall recovery as mentioned earlier of 91.6%). While ammonium present in the permeate product may limit its reuse as clean water, the capacity of the system to instead capture ammonia from the wastewater as part of resource recovery and is part of our ongoing research in this area [49, 51].

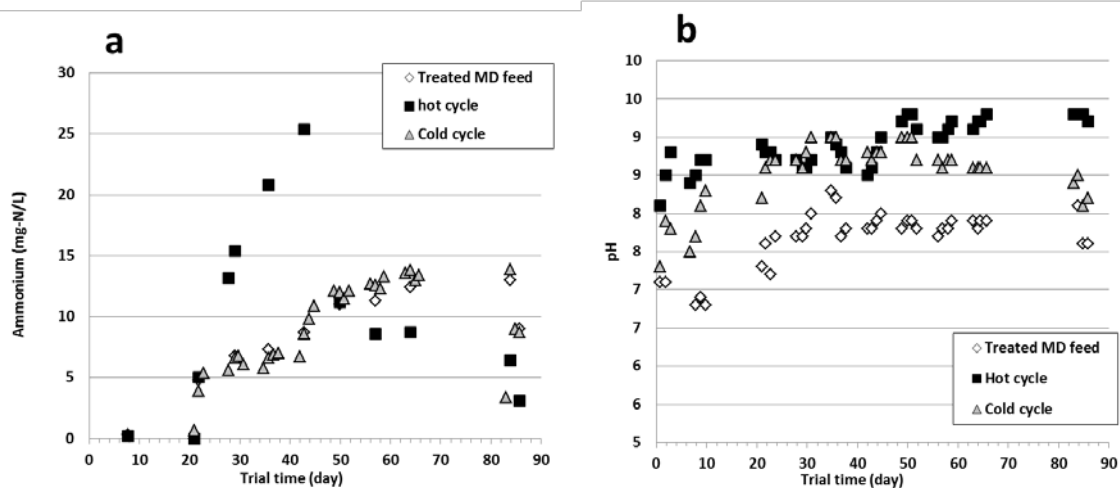

Figure 11: Ammonium concentrations (a) and pH (b) of the incoming ‘Treated MD feed’ and hot and cold cycles during the trial.

For ammonium to become sufficiently volatile, however, the solution pH generally needs to be increased to higher than the pH of the ‘Treated MD feed’ fed to the DCMD plant of 7.7 (Figure 1). Figure 11b shows the pH of the incoming ‘Treated MD feed’, hot cycle and cold cycle over the trial duration. While the pH of the incoming ‘Treated MD feed’ was stable during the trial at around 7.7 with standard deviation of 0.4 (Table 2), the pH of the hot cycle containing the concentrate was consistently higher, reaching 9.2 at times. This could be expected due to the concentrating effect of the MD system. At this pH, a higher proportion of volatile ammonia is present and can liberate as gaseous ammonia through the porous membrane. As this occurred, the ammonia redissolving into the cold cycle increased its pH as well. Therefore the water chemistry of the MD hot cycle was altered by the DCMD process

and favoured ammonium removal. The explanation of the useful mechanism for MD to permeate water as well as ammonia is subject of our further research.

Membrane fouling and energy assessment

The analysis of the membrane performance was undertaken by considering the mass transfer coefficient, C_m , which is shown in Figure 12. The value is expressed over the total normalised water permeated, which is derived from the accumulated volume of water permeated per unit membrane area expressed as m^3 per m^2 . The C_m started close to the original clean brine value of $131 \text{ L/m}^2/\text{h}/\text{bar}$, although the calculated values varied widely. While C_m principally removes dependency on temperature, it is still influenced by the large variations in temperature (Figure 7b) since it is an overall value and does not take into consideration temperature polarisation effects which can vary with temperature and are hard to measure as it requires membrane surface temperatures to calculate the real vapour pressure drop across the membrane. However, it is clear that as the trial progressed, the overall C_m value declined, which can be due slightly to rising concentration in the hot cycle to reduce vapour pressure (pure water values used for conversion of temperature to vapour pressure), but most likely to membrane fouling which adds to the resistance to water flux through the membrane for the given vapour pressure drop. This decline started to accelerate after about $2 \text{ m}^3/\text{m}^2$ of water had permeated (day 48) and prior to the cleaning shutdown, and ended at $30 \text{ L/m}^2/\text{h}/\text{bar}$ after $2.8 \text{ m}^3/\text{m}^2$ of water had been treated (day 65). The membrane underwent a four step cleaning routine, (results detailed in the next section) which restored C_m to around $90 \text{ L/m}^2/\text{h}/\text{bar}$, being 69% of the original value of $131 \text{ L/m}^2/\text{h}/\text{bar}$.

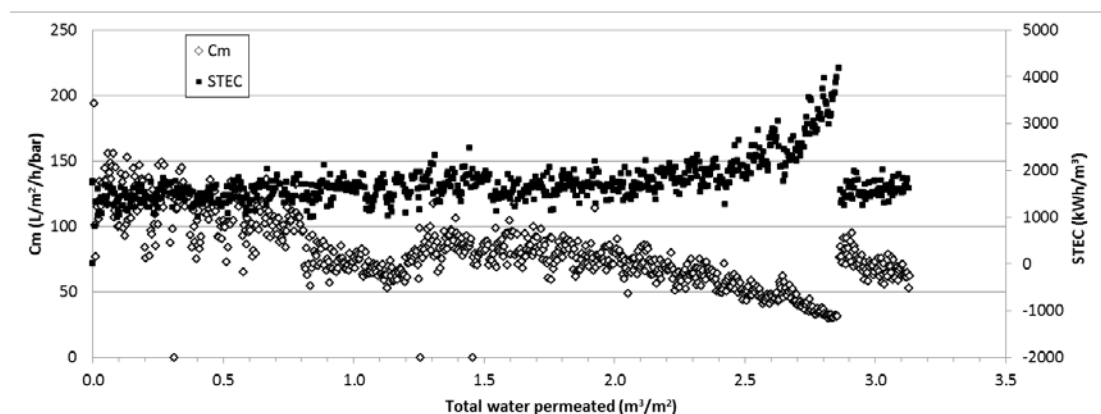

Figure 12: C_m and STEC calculated over the trial shown as a function of the total normalised water permeated through the membrane.

In terms of $STEC$, a clear loss of performance can be seen, where a sharp rise in $STEC$ started around the same time as the sharp decline in C_m at $2 \text{ m}^3/\text{m}^2$. Up until this point, $STEC$ was between $1,000$ and $1,900 \text{ kWh/m}^3$ (average $1,600 \text{ kWh/m}^3$), but rose sharply ending at $4,180$

kWh/m³ prior to the cleaning shutdown. A similar average *STEC* was found while operating a pilot trial at a power station, averaging at 1,500 kWh/m³, and rising sharply in consequence to a sudden fouling effect towards the end of the trial lasting 80 days [11]. The substantial rise in *STEC* leads to less water treated for the same thermal energy input and justifies the use of cleaning prior to this sudden *STEC* rise. The cleaning trials in this work demonstrated this to be the case, where the usual *STEC* values returned immediately after cleaning the membrane. The practical application of these *STEC* values to the site’s ability to treat its waste water will be considered further under the “Integration Assessment” section.

Membrane cleaning

The impact of cleaning on performance clearly led to a beneficial improvement to membrane flux and thermal energy use (*STEC*). The cleaning process itself is now considered more closely, with Table 4 showing the clean brine performance measured following each cleaning step outlined in Table 1.

Table 4: Results of clean brine testing after various steps during cleaning trials. Clean brine contained 5,000 mg/L Na₂SO₄, tests conducted at hot cycle temperature of 50°C and cold cycle temperature of 25°C.

Step	Flux (L/m ² /h)	Clean brine C_m (L/m ² /h/bar)	Cold cycle EC (µS/cm)	$C_m/C_{m,original}$ (%)
Original membrane	5.4	131	2.0	100
Fouled membrane	3.9	70	42	53
Post caustic clean #1	4.2	79	39	61
Post hypochlorite clean	5.0	79	31	61
Post DI water rinse	4.1	76	31	58
Post caustic clean #2	5.6	104	44	79

After fouling, clean brine C_m had reduced to 53% of the original value, which compares to the waste water C_m reduction to 69% observed in Figure 12, albeit at different conditions. After cleaning with caustic solution, a slight increase in flux and C_m occurred while a hypochlorite clean showed no further improvement. Caustic cleaning to remove organic fouling is expected to be effective, where previous work on caustic cleaning of polyvinylidene fluoride (PVDF) MD membranes fouled with humic acid and calcium solutions was very effective [41]. The inability of sodium hypochlorite to further restore flux

is surprising, as it is well known to clean both PVDF and ceramic membranes used in low pressure filtration [43, 44]. The reasons may relate to the very different membrane chemistries (hydrophobic PTFE vs hydrophilic PVDF) where the attachment of the fouling materials to the membrane work by different mechanisms [52, 53], or indeed the nature of textile processing materials and their resistance to chlorine degradation. DI water rinsing did not show any improvement, which may be expected for a membrane fouled with organic matter. Clean water rinsing has been confirmed to be effective at removing inorganic scale on MD membranes [38, 47], while only partially effective at removing humic acid [41]. Since caustic cleaning was found to be effective in the first attempt, a second caustic clean was found to further improve the flux and C_m . Flux was fully restored after the second caustic clean, but due to differences in the test temperatures, performance is better associated with C_m which showed 79% return to the original clean brine state. An important observation made during cleaning with caustic on both occasions was the formation of large quantities of foam in the hot cycle tank, being most significant in the first clean (approximately 0.5 m of stable foam rose above the tank surface). Optimisation of the caustic clean (e.g. concentration, temperature and time) to manage foaming and fully restore the membrane is needed. However, the timing of cleaning routines may need to be more frequent, as Figure 12 shows that fouling was quite severe prior to the cleaning event.

Integration assessment

Textile mill trial site waste water treatment requirement and thermal energy sources for MD application

MD is promoted as an energy saving water treatment technology, where the thermal energy can be drawn from waste or low cost sources. Textile plants use thermal energy in their operation, and this project considered the ability to integrate into the site and use available waste heat sources to drive an MD system. The MD treatment potential has to then be matched with the treatment requirement for the site.

The waste water produced at the textile plant where the trial was located is 1,000 kL/day. In terms of energy available for MD, the primary source of thermal energy at this textile mill was from 2×6 MW boilers, where one unit was operating at full capacity while the second was needed to raise the pressure of the steam at peak demand. For this assessment, a single unit (i.e. 6MW) has been considered as the upper limit of the thermal energy available on site. Some proportion of the 6 MW will be available somewhere as the waste heat supply to MD. After a closer assessment of the site, a potential source of waste heat that could drive an MD process was identified from an effluent collection tank with a volume of 60,000 L. After recovering higher grade heat from the hot water discharged by the equipment back to the processes, the combined effluent collected in this tank at 60°C then becomes a "waste" heat source. If the 1,000 kL/day flow is cooled to 40°C before disposal to the external effluent pit, it can provide 1MW of thermal energy to an MD system.

Water treatment potential by MD from site thermal energy

The volume of water that can be treated by MD for a given heat supply can be quickly determined from the *STEC* value. High thermal efficiency MD systems can achieve a *STEC* value of 175 kWh/m³ to 250 kWh/m³ depending on water recovery and membrane fouling where flux ranged from 2.2 to 1.4 L/m²/h [54]. If no heat recycling is used, the *STEC* is in the order of 1,600 kWh/m³ as determined from this trial using *DCMD* (Figure 12). The trade-off for the higher thermal energy use is a simpler, easier to maintain system. *DCMD* also operates at higher fluxes and can receive lower temperature waste heat forms. Clearly, the choice depends on the availability of waste heat. If waste heat is limiting, then high thermal efficiency design with low *STEC* is required as the energy cost becomes important, while if waste heat is abundant and low cost, then the ability to produce more water from the membrane (i.e. increased flux) at high *STEC* is a higher priority [55].

Table 5 shows the calculated MD treatment capacities using either the higher *STEC* values from this work (Figure 12) and from low *STEC* systems operated at higher concentrations [54]. The maximum heat available from the continuously operating boiler of 6 MW is compared to the identified waste heat source of 1 MW. If all the heat from the main boiler was directed through a low *STEC* MD system, 58% of the site's wastewater flow of 1,000 kL/day could be treated. This is not enough to make a substantial waste volume reduction from the site's effluent. In the case of the seawater cooled power station in our earlier trial, there was an abundant 500 MW of low grade (40°C) heat which could potentially produce 8,000 kL/day of high quality *DCMD* permeate where the *STEC* was 1,500 kWh/m³ [11]. However, in this instance, at a textile manufacturer, the heat supply is more constrained. Therefore, in order to achieve the goal of reduced waste volumes, other approaches will need to also be considered, such as saline waste water isolation and pre-concentration by reverse osmosis or nanofiltration. A closer investigation of the site found that saline waste water could be isolated to 40% of the current effluent flow rate (400 kL/day) which would have a salinity of 4,000 mg/L. If fed to RO operated at 90% recovery, the concentrate needing to be treated by MD reduces to 40 kL/day. The high *STEC* system could not treat this volume using the identified waste heat supply, but could if more waste heat sources were identified within the 6 MW boiler capacity. Meanwhile a low *STEC* system could treat this volume from the identified waste heat source as long as the 60°C temperature could be ensured as this is needed to reach the low *STEC* value of these systems. Alternatively a hybrid system could be used, where the low *STEC* system could be employed to concentrate to some fixed level, avoiding severe fouling and maintaining the low *STEC* value, followed by final concentration using a high *STEC* system which can utilise lower temperatures, operate at higher fluxes relative to available temperature, and may better avoid *STEC* rise from fouling as there is a more consistent temperature profile across the full length of the membrane (unlike low *STEC* systems).

Table 5 Treatment capacity of MD based on site assessment for maximum heat supply entering site from a single 6 MW boiler, and an identified point waste heat source of 1 MW. Both high and low *STEC* system designs considered.

MD system	<i>STEC</i> (kWh/m ³)	Treatment capacity (kL/day)	
		Maximum (6 MW)	Identified waste heat source (1 MW)
High flux, high <i>STEC</i>	1,600	90	15
Low <i>STEC</i> , low flux	250	580	96

Conclusions

Textile industry waste water treatment for volume reduction towards zero liquid discharge was considered in this work. Textile manufacture involves multiple fabric materials which are processed by multiple operations and varies from site to site. Some operations produce wastewaters which need to be treated, but these variabilities, along with the nature of textile wastewater, make it challenging for any water treatment technology. However, durable approaches to treat the combined effluent lead to simpler and more versatile operations. In this work, MD was demonstrated to concentrate a combined effluent coming from a textile mill. Direct treatment of untreated effluent discharged from the site led to immediate membrane wetting compromising treated water quality. The novel use of foam fractionation, however, appeared to avoid the wetting effect. Also, MD testing on effluent that was first treated by flocculation and anaerobic/aerobic digestions also eliminated the wetting issue. A site trial was conducted on this fully treated effluent coupled with foam fractionation. High concentration factors (reaching 43-fold demonstrated by sulphate concentration) were achieved after 3 months, and no membrane wetting was experienced. Membrane flux decline was observed but was restored to 79% of the original flux value by caustic cleaning. Ammonium was found in the permeate stream, which was transferred directly from incoming water fed to the DCMD pilot plant to the permeate. A waste heat integration assessment found that MD can be applied to the assessed textile plant, but only if strategies to isolate saline waste streams from the site and reverse osmosis or nanofiltration are also considered to first reduce brine volume.

Acknowledgements

The authors gratefully acknowledge the funding from Australian Textile Mills and the AusIndustry Strategic Capability Program in Textile Clothing and Footwear. The support from Sandip Ranjan of Australian Textile Mills is also gratefully acknowledged.

References

[1] Anon, Integrated Pollution Prevention and Control (IPPC): Reference Document on Best Available Techniques for the Textiles Industry, in, European Commission, Seville, Spain, 2003.

- [2] J. Volmajer Valh, A. Majcen Le Marechal, S. Vajnhandl, T. Jerič, E. Šimon, 4.20 - Water in the Textile Industry A2 - Wilderer, Peter, in: *Treatise on Water Science*, Elsevier, Oxford, 2011, pp. 685-706.
- [3] Philippe C. Vandevivere, Roberto Bianchi, W. Verstraete, Review: Treatment and reuse of wastewater from the textile wet-processing industry: Review of emerging technologies, *Journal of Chemical Technology and Biotechnology*, 72 (1998) 289–302.
- [4] A.K. Verma, R.R. Dash, P. Bhunia, A review on chemical coagulation/flocculation technologies for removal of colour from textile wastewaters, *Journal of Environmental Management*, 93 (2012) 154-168.
- [5] B.R. Babu, A.K. Parande, S. Raghu, T.P. Kumar, Cotton Textile Processing: Waste Generation and Effluent Treatment, *The Journal of Cotton Science*, 11 (2007) 141–153.
- [6] B. Van der Bruggen, B. Daems, D. Wilms, C. Vandecasteele, Mechanisms of retention and flux decline for the nanofiltration of dye baths from the textile industry, *Separation and Purification Technology*, 22–23 (2001) 519-528.
- [7] R.S. Dhodapkar, G.R. Pophali, T. Nandy, S. Devotta, Exploitation results of seven RO plants for recovery and reuse of treated effluents in textile industries, *Desalination*, 217 (2007) 291-300.
- [8] B. Van der Bruggen, L. Lejon, C. Vandecasteele, Reuse, Treatment, and Discharge of the Concentrate of Pressure-Driven Membrane Processes, *Environmental Science & Technology*, 37 (2003) 3733-3738.
- [9] I.S. Hussain, Case Study of a Zero Liquid Discharge Facility in Textile Dyeing Effluents at Tirupur, in: *One Day National Workshop on CETPs*, <http://www.igep.in/live/hrdpmp/hrdpmaster/igep/content/e48745/e49028/e51431/e51468/SajidHussain.pdf>, Hyderabad, India, 2012.
- [10] L. Camacho, L. Dumée, J. Zhang, J.-d. Li, M. Duke, J. Gomez, S. Gray, Advances in Membrane Distillation for Water Desalination and Purification Applications, *Water*, 5 (2013) 94-196.
- [11] N. Dow, S. Gray, J.-d. Li, J. Zhang, E. Ostarcevic, A. Liubinas, P. Atherton, G. Roeszler, A. Gibbs, M. Duke, Pilot trial of membrane distillation driven by low grade waste heat: Membrane fouling and energy assessment, *Desalination*, 391 (2016) 30-42.
- [12] U.K. Kesime, N. Milne, H. Aral, C.Y. Cheng, M. Duke, Economic analysis of desalination technologies in the context of carbon pricing, and opportunities for membrane distillation, *Desalination*, 323 (2013) 66-74.
- [13] S. Al-Obaidani, E. Curcio, F. Macedonio, G. Di Profio, H. Al-Hinai, E. Drioli, Potential of membrane distillation in seawater desalination: Thermal efficiency, sensitivity study and cost estimation, *Journal of Membrane Science*, 323 (2008) 85-98.
- [14] A. Hausmann, P. Sancio, T. Vasiljevic, U. Kulozik, M. Duke, Performance assessment of membrane distillation for skim milk and whey processing, *Journal of Dairy Science*, 97 (2014) 56-71.
- [15] A. El-Abbassi, A. Hafidi, M. Khayet, M.C. García-Payo, Integrated direct contact membrane distillation for olive mill wastewater treatment, *Desalination*, 323 (2013) 31-38.
- [16] M. Tomaszewska, Industrial wastewater treatment by means of membrane techniques, *Polish Journal of Chemical Technology*, 9 (2007) 138–142.
- [17] A. Alkhudhiri, N. Darwish, N. Hilal, Membrane distillation: A comprehensive review, *Desalination*, 287 (2012) 2-18.
- [18] S. Mozia, A.W. Morawski, Integration of Photocatalysis with Ultrafiltration or Membrane Distillation for Removal of Azo Dye Direct Green 99 from Water, *Journal of Advanced Oxidation Technologies*, 12 (2009) 111-121.
- [19] S. Mozia, A.W. Morawski, M. Toyoda, T. Tsumura, Integration of photocatalysis and membrane distillation for removal of mono- and poly-azo dyes from water, *Desalination*, 250 (2010) 666-672.
- [20] Y. Huo, Z. Xie, X. Wang, H. Li, M. Hoang, R.A. Caruso, Methyl orange removal by combined visible-light photocatalysis and membrane distillation, *Dyes and Pigments*, 98 (2013) 106-112.

- [21] S. Mozia, M. Tomaszewska, A.W. Morawski, Photocatalytic membrane reactor (PMR) coupling photocatalysis and membrane distillation—Effectiveness of removal of three azo dyes from water, *Catalysis Today*, 129 (2007) 3-8.
- [22] B. Van der Bruggen, E. Curcio, E. Drioli, Process intensification in the textile industry: the role of membrane technology, *Journal of Environmental Management*, 73 (2004) 267-274.
- [23] V. Calabrò, E. Drioli, F. Matera, Membrane distillation in the textile wastewater treatment, *Desalination*, 83 (1991) 209-224.
- [24] S. Mozia, A.W. Morawski, M. Toyoda, T. Tsumura, Effect of process parameters on photodegradation of Acid Yellow 36 in a hybrid photocatalysis–membrane distillation system, *Chemical Engineering Journal*, 150 (2009) 152-159.
- [25] F. Banat, S. Al-Asheh, M. Qtaishat, Treatment of waters colored with methylene blue dye by vacuum membrane distillation, *Desalination*, 174 (2005) 87-96.
- [26] Q. Ge, P. Wang, C. Wan, T.-S. Chung, Polyelectrolyte-Promoted Forward Osmosis–Membrane Distillation (FO–MD) Hybrid Process for Dye Wastewater Treatment, *Environmental Science & Technology*, 46 (2012) 6236-6243.
- [27] A. Criscuoli, J. Zhong, A. Figoli, M.C. Carnevale, R. Huang, E. Drioli, Treatment of dye solutions by vacuum membrane distillation, *Water Research*, 42 (2008) 5031-5037.
- [28] W. Xia, H. HaoSi, D. ZhongWei, L. LiYing, Study of membrane wetting in the process of membrane distillation of sodium dodecyl benzene sulfonate solution, *J Beijing Univ Chem Technol*, 39 (2012) 1-05.
- [29] J.B. Xu, D.A. Spittler, J.P. Bartley, R.A. Johnson, Alginate acid–silica hydrogel coatings for the protection of osmotic distillation membranes against wet-out by surface-active agents, *Journal of Membrane Science*, 260 (2005) 19-25.
- [30] J.B. Xu, S. Lange, J.P. Bartley, R.A. Johnson, Alginate-coated microporous PTFE membranes for use in the osmotic distillation of oily feeds, *Journal of Membrane Science*, 240 (2004) 81-89.
- [31] J.B. Xu, J.P. Bartley, R.A. Johnson, Application of Sodium Alginate-Carrageenan Coatings to PTFE Membranes for Protection Against Wet-Out by Surface-Active Agents, *Separation Science and Technology*, 40 (2005) 1067-1081.
- [32] S. Aabo, Method for Purifying Water by Membrane Distillation Comprising a Pre-Treatment, in, WIPO, 2008.
- [33] S. Goh, J. Zhang, Y. Liu, A.G. Fane, Fouling and wetting in membrane distillation (MD) and MD-bioreactor (MDBR) for wastewater reclamation, *Desalination*, 323 (2013) 39-47.
- [34] J. Merz, B. Burghoff, H. Zorn, G. Schembecker, Continuous foam fractionation: Performance as a function of operating variables, *Separation and Purification Technology*, 82 (2011) 10-18.
- [35] B.G. Bryson, K.T. Valsaraj, Solvent sublimation for waste minimization in a process water stream — a pilot-scale study, *Journal of Hazardous Materials*, 82 (2001) 65-75.
- [36] X. Hong Yang, Rui Tian, S. Juan Ma, H.L. Lv, Study on Membrane Fouling Experiment of Stacked AGMD Module in Low Temperature, *Advanced Materials Research*, 396-398 (2012) 458-462.
- [37] X. Yu, H. Yang, H. Lei, A. Shapiro, Experimental evaluation on concentrating cooling tower blowdown water by direct contact membrane distillation, *Desalination*, 323 (2013) 134-141.
- [38] L.D. Nghiem, T. Cath, A scaling mitigation approach during direct contact membrane distillation, *Separation and Purification Technology*, 80 (2011) 315-322.
- [39] T.-H. Khaing, J. Li, Y. Li, N. Wai, F.-s. Wong, Feasibility study on petrochemical wastewater treatment and reuse using a novel submerged membrane distillation bioreactor, *Separation and Purification Technology*, 74 (2010) 138-143.
- [40] E. Curcio, X. Ji, G. Di Profio, A.O. Sulaiman, E. Fontananova, E. Drioli, Membrane distillation operated at high seawater concentration factors: Role of the membrane on CaCO₃ scaling in presence of humic acid, *Journal of Membrane Science*, 346 (2010) 263-269.
- [41] S. Srisurichan, R. Jiratananon, A.G. Fane, Humic acid fouling in the membrane distillation process, *Desalination*, 174 (2005) 63-72.

- [42] M.S. Osman, J.J. Schoeman, L.M. Baratta, Desalination/concentration of reverse osmosis and electro dialysis brines with membrane distillation, *Desalination and Water Treatment*, 24 (2010) 293-301.
- [43] V. Puspitasari, A. Granville, P. Le-Clech, V. Chen, Cleaning and ageing effect of sodium hypochlorite on polyvinylidene fluoride (PVDF) membrane, *Separation and Purification Technology*, 72 (2010) 301-308.
- [44] N. Dow, J. Roehr, D. Murphy, L. Solomon, J. Mieog, J. Blackbeard, S. Gray, N. Milne, B. Zhu, A. Gooding, J. Currie, G. Roeszler, J. Clement, M. Duke, Fouling mechanisms and reduced chemical potential of ceramic membranes combined with ozone, *Water Practice & Technology*, 10 (2015) 806-813.
- [45] I. Vergili, Y. Kaya, U. Sen, Z.B. Gönder, C. Aydiner, Techno-economic analysis of textile dye bath wastewater treatment by integrated membrane processes under the zero liquid discharge approach, *Resources, Conservation and Recycling*, 58 (2012) 25-35.
- [46] J. Zhang, N. Dow, M. Duke, E. Ostarcevic, J.-D. Li, S. Gray, Identification of material and physical features of membrane distillation membranes for high performance desalination, *Journal of Membrane Science*, 349 (2010) 295-303.
- [47] P. Zhang, P. Knötig, S. Gray, M. Duke, Scale reduction and cleaning techniques during direct contact membrane distillation of seawater reverse osmosis brine, *Desalination*, 374 (2015) 20-30.
- [48] W.J. Koros, Y.H. Ma, T. Shimidzu, Terminology for membranes and membrane processes (IUPAC Recommendations 1996), *Journal of Membrane Science*, 120 (1996) 149-159.
- [49] X. Yang, T. Fraser, D. Myat, S. Smart, J. Zhang, J. Diniz da Costa, A. Liubinas, M. Duke, A Pervaporation Study of Ammonia Solutions Using Molecular Sieve Silica Membranes, *Membranes*, 4 (2014) 40-54.
- [50] H. Maruyama, H. Seki, A. Suzuki, N. Inoue, Batch foam separation of a soluble protein, *Water Research*, 41 (2007) 710-718.
- [51] L.D. Xing Yang, Martin Wolf, Frans Velterop, Henny J.M. Bouwmeester, Simon Smart, João C. Diniz da Costa, Audra Liubinas, Jun-De Li, Jianhua Zhang, Mikel Duke, Pervaporation of Ammonia Solution with γ -Alumina Supported Organosilica Membranes, *Separation and Purification Technology*, Accepted 18 May 2016 - in press (2016).
- [52] D.T. Myat, M.B. Stewart, M. Mergen, O. Zhao, J.D. Orbell, S. Gray, Experimental and computational investigations of the interactions between model organic compounds and subsequent membrane fouling, *Water Research*, 48 (2014) 108-118.
- [53] D.T. Myat, M. Mergen, O. Zhao, M.B. Stewart, J.D. Orbell, T. Merle, J.-P. Croué, S. Gray, Effect of IX dosing on polypropylene and PVDF membrane fouling control, *Water Research*, 47 (2013) 3827-3834.
- [54] H.C. Duong, A.R. Chivas, B. Nelemans, M. Duke, S. Gray, T.Y. Cath, L.D. Nghiem, Treatment of RO brine from CSG produced water by spiral-wound air gap membrane distillation — A pilot study, *Desalination*, 366 (2015) 121-129.
- [55] G. Guan, X. Yang, R. Wang, A.G. Fane, Evaluation of heat utilization in membrane distillation desalination system integrated with heat recovery, *Desalination*, 366 (2015) 80-93.