

Nickel-catalyzed Hydrosilylation of Alkenes and Transition-Metal-Free Intermolecular α -C-H Amination of Ethers

THÈSE N° 7129 (2016)

PRÉSENTÉE LE 28 JUILLET 2016

À LA FACULTÉ DES SCIENCES DE BASE

LABORATOIRE DE SYNTHÈSE ET DE CATALYSE INORGANIQUE

PROGRAMME DOCTORAL EN CHIMIE ET GÉNIE CHIMIQUE

ÉCOLE POLYTECHNIQUE FÉDÉRALE DE LAUSANNE

POUR L'OBTENTION DU GRADE DE DOCTEUR ÈS SCIENCES

PAR

Ivan BUSLOV

acceptée sur proposition du jury:

Prof. K. Severin, président du jury
Prof. X. Hu, directeur de thèse
Prof. E. P. Kündig, rapporteur
Prof. M. Driess, rapporteur
Prof. H.-A. Klok, rapporteur



ÉCOLE POLYTECHNIQUE
FÉDÉRALE DE LAUSANNE

Suisse
2016

Acknowledgements

First, I would like to thank my scientific advisor, Prof. Xile Hu, for giving me the opportunity to carry out my doctoral studies in his group. I am deeply grateful for his support, encouragement and guidance during my time as a Ph.D. student at EPFL. His optimistic energy and confidence in my research always inspired me and helped me to move forward.

I would like to thank my thesis jury: Prof. Kay Severin, Prof. Ernst Peter Kündig, Prof. Matthias Driess and Prof. Harm-Anton Klok for accepting to examine this manuscript.

Many thanks to the people working at EPFL: Annelise Carrupt, Gladys Pache and Benjamin Kronenberg - the team of BCH chemical store - for their excellent work; Dr. Pascal Miéville for his help with NMR machines and methods; Dr. Rosario Scopelliti and Dr. Euro Solari for performing the X-ray and elemental analyses; Dr. Laure Menin, Daniel Baumann and Francisco Sepulveda for the mass spectrometry analyses; Christina Zamanos-Epreman and Anne Lene Odegaard for their kind support and for the administrative work.

I would like to thank my apprentice, Sébastien Keller, for helping me with synthesis of many complexes and substrates for Chapter 3 and also for our conversations in French.

Many thanks to Dr. Gerald Bauer and Lucinda Batchelor for the proof reading of this manuscript and help with the SNSF application.

It was a big pleasure to work in such a nice atmosphere created by LSCI group members. I am thankful to Pablo M. Perez Garcia for taking care about me upon my arrival to the lab and for teaching me some important laboratory techniques. I want to express my gratitude to Dr. Fang Song for helping me with microscopy methods. I enjoyed sharing the lab with two awesome co-workers: Dr. Tao Xu and Dr. Chi Wai Cheung. I thank them for fruitful scientific discussions and pleasant working environment. I will never forget many enjoyable moments spent with Jan, Jésus, Thomas, Yeonji and Gerald in and outside the lab. Special thanks to Gerald for our unforgettable trips and sharing various activities.

Finally, I am very thankful to my family for the encouragements I received during these years. I give my deepest thanks to my wife for her love and support.

Abstract

Transition-metal-catalyzed hydrosilylation of olefins is one of the most important methods for the preparation of organosilicon compounds, which have broad applications in both synthetic and material chemistry. For decades, precious metals, principally platinum-based complexes, have been utilized as catalysts for olefin hydrosilylation. However, due to the high and volatile cost and low abundance of Pt, the development of active and selective catalysts based on Earth-abundant metals is highly desirable. In the first chapter, a short overview of state-of-the-art Pt catalysts and recent advances in development of Fe, Co and Ni-catalysts for olefin hydrosilylation is given. The applications, mechanisms and remaining challenges of transition-metal-catalyzed hydrosilylation are discussed.

In the chapter 2, chemoselective anti-Markovnikov hydrosilylation of functionalized alkenes using well-defined bis(amino)amide nickel pincer complexes is described. The catalysts exhibit both high turnover frequencies and turnover numbers. Alkenes containing amino, ester, amido, ketone, and formyl groups are selectively hydrosilylated with Ph_2SiH_2 . Chemoselective hydrosilylation of carbon-carbon double bond in the presence of formyl group using a base metal catalyst is reported for the first time. A modification of reaction conditions allows tandem isomerization-hydrosilylation reactions of internal alkenes to give terminal alkyl silanes.

Hydrosilylation of alkenes with tertiary silanes is more attractive from practical point of view. The screening of various nickel alkoxide complexes with reduced steric bulk led us to discovery of an efficient heterogeneous catalyst for alkene hydrosilylation with commercially relevant tertiary silanes (chapter 3). The catalyst exhibits high activity in anti-Markovnikov hydrosilylation of unactivated terminal alkenes and isomerizing hydrosilylation of internal alkenes. The catalyst can be applied to synthesize a single terminal alkyl silane from a mixture of internal and terminal alkene isomers. Furthermore, the same catalyst can be used to remotely functionalize an internal alkene derived from a fatty acid.

Chapter 4 describes a catalytic system composed of a nickel amido(bisoxazoline) complex and NaO^tBu for an unexpected synthetic transformation, leading to the synthesis of functionalized alkyl hydrosilanes from readily available alkenes and alkoxy silanes. This method provides a convenient and safe alternative to hydrosilylation using flammable and

potentially dangerous Me_2SiH_2 , MeSiH_3 and SiH_4 . The reaction mechanism was also described.

Efficient and atom-economical creation of C-N bond is one of the major tasks in synthetic organic chemistry. Direct C-H amination has emerged as an attractive method for the construction of new C-N bonds. In the chapter 5 a new transition-metal free method for the intermolecular amination of the α -C-H bonds of ethers is described. Using a hypervalent iodine reagent as oxidant the amination of cyclic and acyclic alkyl ethers with a wide range of amides, imides, and amines was achieved. The utility of this method was demonstrated in the synthesis of Tegafur and its analogues. This transition-metal-free method provides a rapid access to a large number of nitrogen-containing organic molecules that may serve as useful synthetic intermediates or biologically active agents.

Key words: hydrosilylation, olefins, silanes, nickel, pincer ligands, chemoselectivity, isomerization, nanoparticles, C-H amination, hypervalent iodine

Résumé

La réaction d'hydrosilylation d'oléfines catalysée par les métaux de transition est l'une des méthodes en laboratoire et industrielle la plus importante pour la préparation de composés organosiliciés. Ces composés trouvent de vastes champs d'application en chimie synthétique et en chimie des matériaux. Pendant des décennies, les métaux précieux, principalement des complexes à base de platine, ont été utilisés comme catalyseurs pour l'hydrosilylation d'oléfines. Toutefois, en raison du coût élevé et fluctuant, et de la faible abondance en Pt, le développement de catalyseurs actifs et sélectifs à base de métaux abondant sur Terre est hautement souhaitable. Dans le premier chapitre, un bref aperçu de l'état de l'art des catalyseurs à base de Pt et les progrès récents dans le développement de catalyseurs à base de Fe, Co et Ni pour l'hydrosilylation d'oléfines est donné. Les applications, les mécanismes et les défis restants de hydrosilylation catalysée par les métaux de transition sont également discutés.

Dans le chapitre 2, l'hydrosilylation chimiosélective anti-Markovnikov d'alcènes fonctionnalisés en utilisant des complexes pincer bis(amino)amide de nickel bien définis est décrite. Les catalyseurs montrent de hautes fréquences de rotation (TOF) et de hauts nombres de rotations (TON). Les alcènes contenant des groupes amino, ester, amido, cétone et formyle sont sélectivement hydrosilylés avec Ph_2SiH_2 . L'hydrosilylation chimiosélective d'une double liaison carbone-carbone en présence d'un groupe formyle et en utilisant un catalyseur à base de métal non précieux est décrite pour la première fois. Une modification des conditions de réaction permet la réaction d'alcènes internes en tandem hydrosilylation-isomérisation pour donner les produits terminaux.

L'hydrosilylation d'alcènes avec des silanes tertiaires ne contenant qu'une seule liaison Si-H est plus attrayante d'un point de vue pratique. La procédure de sélection de divers complexes d'alcoolate de nickel avec un encombrement stérique réduit nous a conduits à la découverte d'un catalyseur hétérogène efficace pour l'hydrosilylation d'alcène avec des silanes tertiaires commercialement utiles (chapitre 3). Le catalyseur montre une activité élevée pour l'hydrosilylation anti-Markovnikov des alcènes terminaux inactivés et l'isomérisation-hydrosilylation des alcènes internes. Le catalyseur peut être utilisé pour synthétiser un alkylsilane terminal à partir d'un mélange d'isomères d'alcènes internes et terminaux. En outre, le même catalyseur peut être utilisé pour fonctionnaliser à distance un alcène interne dérivé d'un acide gras.

Le chapitre 4 décrit l'emploi d'un complexe amido(bisoxazoline) de nickel et d'une quantité catalytique de NaO^tBu utilisés pour une transformation synthétique inhabituelle, ce qui conduit à la synthèse d'alkylhydrosilanes fonctionnalisés à partir d'alcènes et d'alcoxysilanes facilement disponibles. Cette méthode offre une alternative pratique et sans danger à l'hydrosilylation utilisant les composés inflammables et potentiellement dangereux Me₂SiH₂, MeSiH₃ et SiH₄. Le mécanisme réactionnel a été étudié.

La création efficace et économique en atome d'une liaison C-N est l'une des principales tâches de la chimie organique de synthèse. L'amination directe d'une liaison C-H a émergé comme une méthode importante pour la construction de nouvelles liaisons C-N. Dans le chapitre 5, une nouvelle méthode pour l'amination intermoléculaire des liaisons α-C-H d'éthers est décrite. La méthode se fait sans métal de transition. En utilisant un réactif d'iode hypervalent comme oxydant, l'amination des éthers d'alkyle cycliques et acycliques a été effectuée avec une large gamme d'amides, d'imides et d'amines. L'utilité de cette méthode a été démontrée dans la synthèse du Tégafur et de ses analogues. Ce procédé exempt de métal de transition fournit un accès rapide à un grand nombre de molécules organiques contenant un azote qui peuvent servir comme intermédiaires de synthèse utiles ou des agents biologiquement actifs.

Mots-clés: hydrosilylation, oléfines, silanes, nickel, ligands pincer, chimiosélectivité, isomérisation, nanoparticules, amination C-H, iode hypervalent

List of Symbols and Abbreviations

Å	angstrom
δ	chemical shift
°	degree
acac	acetylacetonate
APCI	atmospheric pressure chemical ionisation
APPI	atmospheric pressure photoionization
Ar	aryl
Ar ^F	3,5-difluoromethylphenyl
aq.	aqueous
atm	atmosphere
Bn	Benzyl
Boc	tert-butyloxycarbonyl
Bopa	bis(oxazolinyphenyl)amine
BOZ	bisoxazoline
br	broad
Bu	butyl
Bz	benzyl
calcd	calculated
cat.	catalyst
COD	1,5-cyclooctadiene
Coord.	coordination
Cp	cyclopentadienyl ligand
Cy	cyclohexyl
d	doublet
DCM	dichloromethane
dd	doublet of doublets
DFT	density functional theory
DHS	dehydrogenative silylation
DIB	(diacetoxy)benzene
DMA	N,N-dimethylacetamide
DMAP	4-Dimethylaminopyridine
DME	1,2-dimethoxyethane

DMF	N,N-dimethylformamide
DMSO	dimethyl sulfoxide
dppe	1,2-bis(diphenylphosphino)ethane
dt	doublet of triplets
<i>E</i> -	entgegen (olefin isomer)
EDX	Energy-dispersive X-ray spectroscopy
eq.	equation
equiv.	equivalent
ESI	electrospray ionization
Et	ethyl
Et ₂ O	diethylether
FG	functional group
FID	flame ionization detector
g	gram
GC	gas chromatography
GC-MS	gas chromatography coupled with mass detector
HAADF	high-angle annular dark-field imaging
HIV	human immunodeficiency virus
h	hour
HRMS	high resolution mass spectrometry
HS	hydrosilylation
Hz	hertz (s ⁻¹)
Ins.	insertion
ⁱ Pr	iso-propyl
<i>J</i>	coupling constant in NMR spectroscopy
K	Kelvin
KO ^t Bu	potassium tert-butoxide
KIE	kinetic isotopic effect
m	milli / multiplet
M	mega (10 ⁶) / molar
μ	micro
MD'M	1,1,1,3,3,5,5,5-heptamethyltrisiloxane
Me	methyl
MeCN	acetonitrile

mg	mili-gram
min.	minutes
mL	mili-liter
μ L	microliter
mmol	mili-mole
mol	mole
MS	mass spectrometry
NaOMe	sodium methoxide
NaO ^t Bu	sodium tert-butoxide
ⁿ Bu	normal-butyl
ⁿ Dec	normal-decyl
NHC	N-heterocyclic carbene ligand
ⁿ Hex	normal hexyl
nm	nanometer
NMP	N-Methylpyrrolidone
NMR	nuclear magnetic resonance
N ₂ N	bis(amino)amide
NRTI	nucleoside analog reverse-transcriptase inhibitor
ⁿ Oct	normal-octyl
ⁿ Octadecyl	normal-octadecyl
O. A.	oxidative addition
OAc	acetate
OTf	trifluoromethylsulfonate
PG	protecting group
PDI	pyridine diimine
Ph	phenyl
PMB	para-methoxybenzyl
PMDS	pentamethyldisiloxane
PPh ₃	triphenylphosphine
ppm	part per million
q	quartet
QTOF	quadrupole-time-of-flight
R. E.	reductive elimination
rt	room temperature

rxn	reaction
s	second / singlet
SET	single electron transfer
STEM	scanning transmission electron microscopy
t	triplet
TBAF	tetrabutylammonium fluoride
^t Bu	tert-butyl
TBS	tert-butyldimethylsilyl
td	triplet of doublets
TEM	transmission electron microscopy
TEMPO	(2,2,6,6-tetramethylpiperidin-1-yl)oxidanyl
THF	tetrahydrofuran
TMEDA	tetramethylethylenediamine
TMS	trimethylsilyl
TOF	turnover frequency
TON	turnover number
UV	ultraviolet
Z-	zusammen (olefin isomer)

Contents

Chapter 1	Introduction	1
1.1	General	2
1.2	Some Applications of Alkene Hydrosilylation Process	3
1.2.1	Silane Coupling Agents	3
1.2.2	Synthetic Applications of Organosilanes	6
1.2.3	Synthesis of Polymers and Materials	8
1.3	Platinum Catalysts.....	11
1.4	Iron Catalysts	15
1.5	Cobalt Catalysts	18
1.6	Nickel Catalysts	22
1.7	Catalysts Based on Other Metals for Hydrosilylation of Alkenes	27
1.8	Mechanism of Hydrosilylation.....	28
1.9	Asymmetric hydrosilylation of alkenes	33
1.10	Challenges of Alkene Hydrosilylation	37
1.11	References	39
Chapter 2	Chemoselective Alkene Hydrosilylation Catalyzed by Nickel Pincer Complexes	47
2.1	Introduction.....	48
2.2	Optimisation of the Reaction Conditions.....	50
2.3	Scope of Alkene Hydrosilylation Catalyzed by 2-2	51
2.3.1	Scope of Ni-catalyzed Hydrosilylation of Terminal and Cyclic Alkenes	52
2.3.2	Ni-catalyzed Hydrosilylation of Ketone- and Formyl-containing Alkenes..	54
2.4	Synthetic Utility of Synthesized Products	55
2.4.1	Nickel-catalyzed Tandem Isomerization - Hydrosilylation of Alkenes	55
2.5	Mechanistic Studies	57

2.6	Conclusions.....	60
2.7	Experimental.....	61
2.7.1	Chemicals and Reagents.....	61
2.7.2	Physical Methods.....	62
2.7.3	The Procedures for the Preparation of Starting Materials.....	63
2.7.4	General Procedures for Hydrosilylation Reactions.....	65
2.7.5	The Evaluation of the Activity of Complex 2-2	67
2.7.6	The Reactions Performed for Mechanism Studies.....	67
2.7.7	Detailed Descriptions of the Products.....	70
2.8	References.....	81
Chapter 3	An Easily-Accessed Nickel Nanoparticle Catalyst for Alkene Hydrosilylation with Tertiary Silanes.....	85
3.1	Introduction.....	86
3.2	Optimization of Reaction Conditions.....	87
3.3	Synthesis of Ni Precatalyst.....	89
3.4	Ni-catalyzed Hydrosilylation of 1-Decene with Various Silanes.....	90
3.5	Examination of Ni Catalyst Microstructure.....	91
3.6	Ni-catalyzed Hydrosilylation of Functionalized Alkenes with (MeO) ₃ SiH.....	92
3.7	Ni-catalyzed Isomerizing Hydrosilylation of Simple and Functionalized Internal Alkenes.....	94
3.7.1	Synthesis of Triethoxy(octyl)silane from Mixture of Isomeric Octenes.....	95
3.7.2	Conversion of Oleic Acid Derivative to a Terminal Alkyl Silane.....	96
3.8	Conclusions.....	97
3.9	Experimental.....	97
3.9.1	Chemicals and Reagents.....	97
3.9.2	Physical Methods.....	98
3.9.3	The Procedures for the Preparation of Ni Catalysts.....	99

3.9.4	General Procedures for Hydrosilylation Reactions	100
3.9.5	The Evaluation of the Activity of Ni(O ^t Bu) ₂ ·2KCl	101
3.9.6	Examination of Ni Catalyst Microstructure	101
3.9.7	Detailed Descriptions of the Products	103
3.10	References	111
Chapter 4	Alkoxy Hydrosilanes As Surrogates of Gaseous Silanes for Hydrosilylation of Alkenes.....	113
4.1	Introduction	114
4.2	Optimisation of Reaction Conditions	115
4.3	Ni-catalyzed Synthesis of Alkylhydrosilanes using Dimethylmethoxysilane	116
4.4	Synthesis of Alkylhydrosilanes using Me(EtO) ₂ SiH and (MeO) ₃ SiH	118
4.5	Synthesis of R ₁ R ₂ R ₃ -SiH	120
4.6	Mechanistic Studies	121
4.7	Conclusions	123
4.8	Experimental	124
4.8.1	Chemicals and Reagents	124
4.8.2	Physical Methods	124
4.8.3	The Procedures for the Preparation of Starting Materials	125
4.8.4	General Procedures for Hydrosilylation Reactions	126
4.8.5	NMR Experiments	127
4.8.6	Detailed descriptions of the products	139
4.8.7	Unreactive Substrates for Ni-catalyzed Hydrosilylation	148
4.9	References	149
Chapter 5	Transition-Metal-Free Intermolecular α-C-H Amination of Ethers ...	151
5.1	Introduction	152
5.2	Optimisation of the Reaction Conditions	153

5.3	Scope of Intermolecular α -C-H Amination of Ethers	154
5.3.1	Scope of Amination of THF with Sulfonamides	155
5.3.2	Scope of Amination of THF with Acetamides and Trifluoroacetamides ...	157
5.3.3	Amination with N-heterocyclic Amines	159
5.3.4	Amination of Other Alkyl Ethers	160
5.3.5	Amination of Alkyl Ethers with Protected Nucleobases	161
5.4	Proposed Reaction Mechanism	163
5.5	Conclusions	164
5.6	Experimental	165
5.6.1	Chemicals and Reagents	165
5.6.2	Physical Methods	166
5.6.3	The Procedures for the Preparation of Starting Materials	166
5.6.4	General Procedures for the Optimization of Conditions	168
5.6.5	General Procedures for the Intermolecular α -C-H Amination of Ethers....	168
5.6.6	Mechanistic Studies	170
5.6.7	Detailed descriptions of the products	172
5.7	References	190

Chapter 1

Introduction

1.1 General

The hydrosilylation reaction enables the addition of organic and inorganic silicon hydrides to multiple bonds such as carbon-carbon, carbon-oxygen, carbon-nitrogen, nitrogen-nitrogen and nitrogen-oxygen, and proceeds according to Scheme 1.1. Hydrosilylation of alkenes represents one of the most important reactions in the silicon chemistry.¹⁻⁷

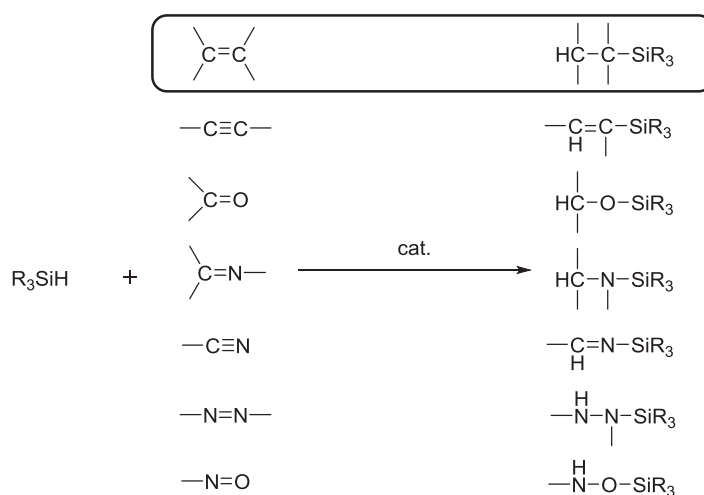

Scheme 1.1: Hydrosilylation reactions

The first hydrosilylation reaction was reported by Sommer in 1947 in which trichlorosilane and 1-octene reacted in the presence of benzoyl peroxide (Scheme 1.2).⁸

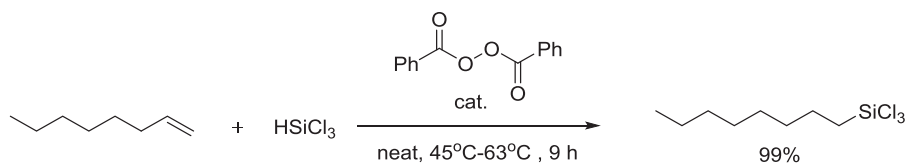

Scheme 1.2: Radical hydrosilylation of 1-octene catalyzed by benzoyl peroxide

Later, hexachloroplatinic acid $\text{H}_2\text{PtCl}_6 \cdot 6\text{H}_2\text{O}$ was revealed to be an effective homogeneous catalyst.⁹ Since then this type of reaction has emerged as one of the most fundamental methods for the synthesis of organosilicon compounds and gained noticeable industrial significance. Today platinum-based catalysts remain the catalysts of choice for industrial applications.^{7,10} However, high cost and limited availability of this noble metal motivate the development of alternative catalysts. The late 3d transition metals such as Fe, Co, and Ni are

inexpensive, Earth-abundant, and therefore they are promising candidates for non-precious metal-based hydrosilylation catalysts.

This chapter focuses on transition metal-catalyzed alkene hydrosilylation reactions (Scheme 1.3).

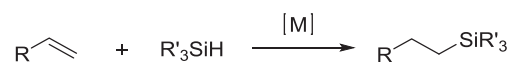

Scheme 1.3: Transition metal-catalyzed olefin hydrosilylation

First, the relevance of organosilanes produced by hydrosilylation to modern synthetic and material chemistry is described. Then the history and development of Pt-catalyzed olefin hydrosilylation is discussed. The main part of the chapter is an overview of recent progress in the field of alkene hydrosilylation catalyzed by late 3d metals (Fe, Co, and Ni). The catalysis by other precious metals, mechanisms of hydrosilylation and remaining challenges are briefly mentioned. Hydrosilylation of triple bonds, dienes, carbon-heteroatom bonds are beyond the scope and will therefore not be discussed.

1.2 Some Applications of Alkene Hydrosilylation Process

1.2.1 Silane Coupling Agents

Silane coupling agents are molecules which contain two classes of functionalities in their structures: (1) a hydrolyzable group on the silicon atom, typically alkoxy, acyloxy or halogen and (2) an organo functional group connected to the silyl group through a linker to bind with a substrate (Figure 1.1).¹¹⁻¹³ The number of hydrolyzable groups on Si is typically 3, however silane coupling agents containing less hydrolyzable groups can also be used.

Many of the coupling agents are synthesized by transition metal catalyzed hydrosilylation from hydrosilanes and functionalized olefins.¹¹

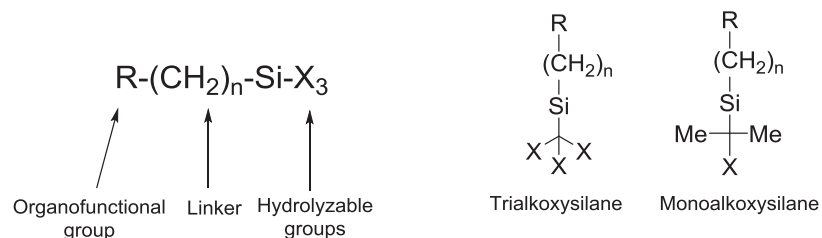
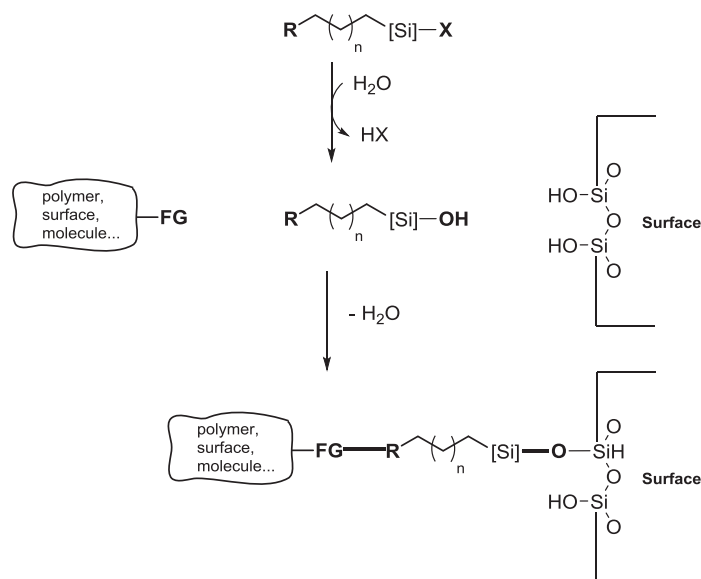

Fig 1.1: General formula of a silane coupling agent. Silane coupling agents with different number of hydrolyzable groups: trialkoxysilane and monoalkoxysilane

Silane coupling agents form a stable bond between organic (such as rubbers, thermoplastics or organic molecules) and inorganic materials (such as silicates, aluminates, borates, or even metals).^{14,15} They can be used as a powerful tool to reinforce typically weak interface between materials possessing different physical properties such as hydrophobic and hydrophilic materials. Originally silane coupling agents served to improve the adhesion of organic polymers to glass fibers,^{16,17} which were introduced into organic polymers in order to improve their mechanical properties. However, such materials were sensitive to water because the interface between hydrophobic organic and hydrophilic inorganic parts could be easily destroyed by polar water molecules. The use of organosilanes allowed to overcome this problem and greatly expanded the applications of these hybrid materials. This approach is widely used to integrate the bulk properties of different phases into a composite structure.

The general mechanism of adhesion by a silane coupling agent is depicted on Scheme 1.4.¹⁸ In the process of hydrolysis the reactive Si-OH groups are formed, which can further condense with other silanol groups on the surface of silicon oxide to form siloxane linkages. Stable condensation products can be formed with other oxides including aluminum, zirconium, tin, titanium, etc.¹¹



Scheme 1.4: Simplified mechanism of action of silane coupling agents

The organo functional group R is a nonhydrolyzable organic group. Because any silane that improves the adhesion of a polymer is often referred as a coupling agent regardless of whether or not a covalent bond is formed, the definition is rather ambiguous. In a more narrow definition only silanes that form covalent bonds through R to the organic substrate are called silane coupling agents.

A variety of functional groups can be used depending on particular organic substrate reactivity (Scheme 1.5). Coupling agents bearing unsaturated groups such as vinyl or methacryl^{19,20} are used to connect with organic polymers. These coupling agents bear reactive C=C which can participate in the chain growth of olefin-derived polymers.¹¹

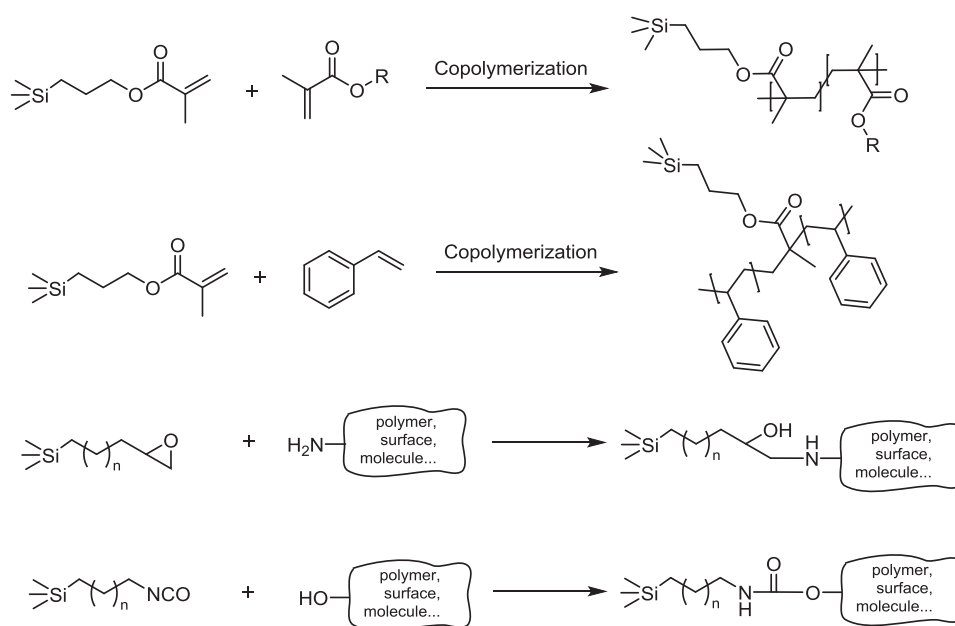

Scheme 1.5: Examples of reactivity of organofunctional groups in silane coupling agents

Many other functionalities such as amino, imino, mercapto, carbonyl, alkyl halide, isocyanate, epoxy groups²⁰⁻²² are widely used for covalent bonding (Scheme 1.5). Thus, it is highly desirable that a hydrosilylation catalyst tolerates these reactive groups. Despite the huge progress in the field of hydrosilylation, particularly in precious metal catalysis, serious challenges remain that limit the availability and increase the cost of desirable coupling agents.

1.2.2 Synthetic Applications of Organosilanes

Organosilanes are widely used in C–C bond formation reactions including cross-couplings (Hiyama coupling and Hiyama-Denmark coupling),²³ allylations (Sakurai allylation),²⁴ rearrangements,²⁵ and olefinations. For cross-couplings or allylation, only silanes with the Si atom attached to sp²-carbon or in allylic position are suitable partners.

The Tamao-Fleming oxidation allows the transformation of a C–Si bond into a C–O bond.²⁶⁻²⁸ Hydrogen peroxide or peroxyacids are usually used as the oxygen source.^{29,30} The

reaction is particularly useful for the preparation of enantiomerically enriched alcohols from enantiomerically enriched silyl ethers, which can be prepared by asymmetric hydrosilylation. The Tamao-Fleming oxidation proceeds with the retention of configuration at carbon atom (Scheme 1.6). The starting silyl ethers are stable under a variety of conditions, therefore they are valuable synthetic intermediates. The Tamao-Fleming oxidation has been used in the synthesis of many complex molecules including (+)-pramanicin³¹, (±)-lepadiformine,³² and fludelon³³. It is also a useful method for the synthesis of polyols.³⁴

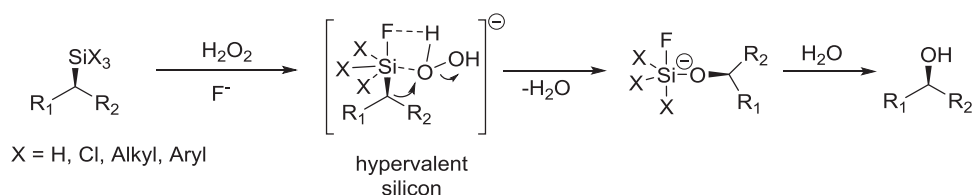

Scheme 1.6: The Tamao-Fleming oxidation

The Peterson olefination,³⁵ involving the addition of α -silyl carbanions to carbonyls followed by the elimination of silanols, is a powerful method for the regioselective synthesis of alkenes.³⁶⁻³⁸ β -Hydrosilanes, formed in the first step, are relatively stable and can be isolated. From these intermediates either *E*- or *Z*-isomers of corresponding olefins can be obtained. The *Z/E* selectivity is controlled by pH of the reaction (Scheme 1.7). Under basic conditions, *syn*-elimination occurs through a 4-membered ring intermediate giving *Z*-olefin. When acidic conditions are applied, *E*-olefin is formed by *E2*-elimination pathway. The Peterson olefination has been applied in the synthesis of many natural products, such as (+)-dactylolide³⁹, (+)-maritamol,⁴⁰ hydrazidomycins A and B,⁴¹ and hemibrevetoxin B⁴².

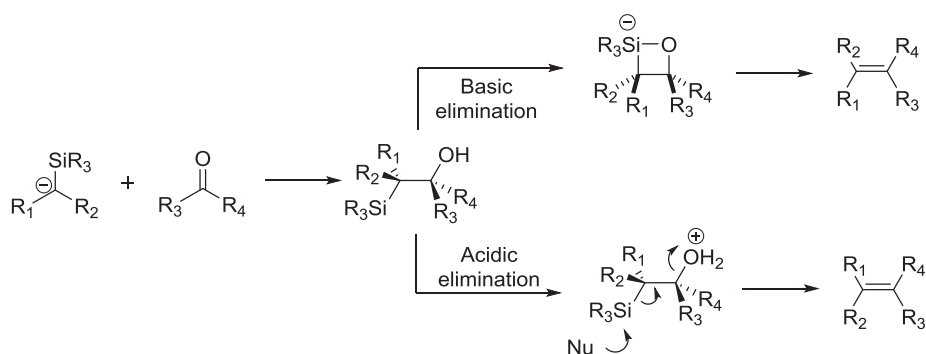

Scheme 1.7: The mechanism of Peterson olefination

However, the utility of organosilicon reagents in organic synthetic chemistry cannot compete, in terms of scale and significance, with the industrial production of silicon-based or

silicon-containing materials. Yet, both areas significantly benefitted from the developments of hydrosilylation methods.

1.2.3 Synthesis of Polymers and Materials

One of the most important applications of olefin hydrosilylation is the curing of silicon rubbers. During the curing process the crosslinking of polymer chains occurs: a Si-H group of one chain is inserted into vinyl group of another (Scheme 1.8).^{2,43}

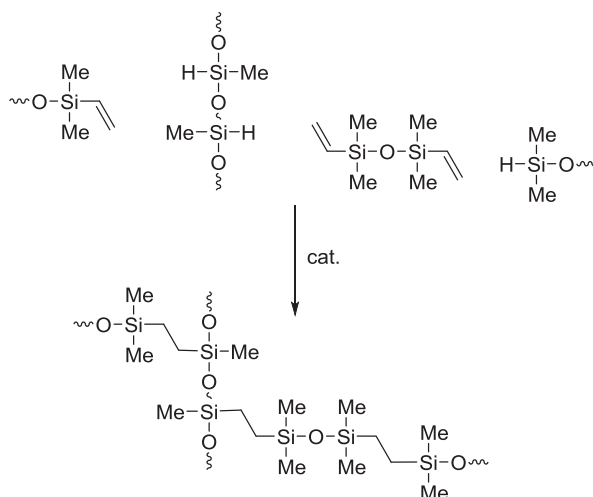

Scheme 1.8: Cross-linking between vinyl-containing polysiloxanes and hydride-functionalized silicone polymers

Another important and rapidly developing application of hydrosilylation is the synthesis of functional linear polymers and structured materials.^{5,44} An easy way to functionalize a silicone chain is to use the addition of hydrosilane to unsaturated carbon-carbon bonds (Scheme 1.9). For example, polysiloxanes were successfully modified with allyl-functionalized polyethylene oxide (PEO) or polypropylene oxide (PPO) blocks using Pt catalyst.⁴⁵ The resulting polyether-functionalized silicones have demonstrated a reduction of surface tension, the ability to form emulsions in aqueous systems, and foam improving properties.⁴⁶

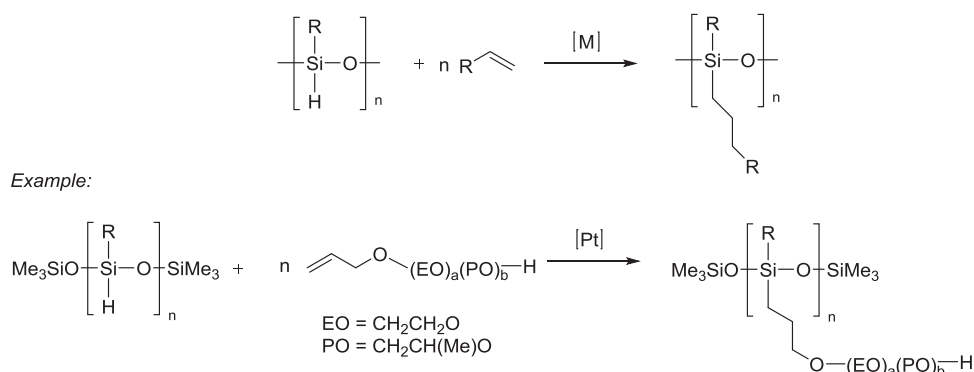

Scheme 1.9: Modification of polysiloxanes using hydrosilylation of alkenes. Addition of polyethylene oxide (PEO) and polypropylene oxide (PPO) block copolymer to a siloxane

Silane-modified polymers, prepared by hydrosilylation of polymers containing unsaturated bonds either in the main chain or in the backbone, are promising candidates for rubber materials, adhesives and drug delivery agents.⁴⁴ Silane-functionalized polybutadiene was synthesized using various silanes (Scheme 1.10). Pt nanoclusters were used as a catalyst.⁴⁷

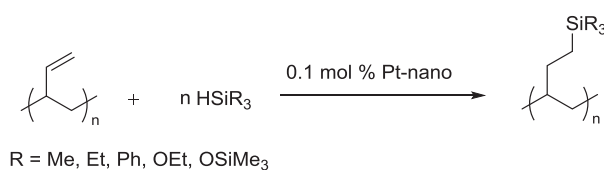

Scheme 1.10 Hydrosilylation of polybutadiene

Polycarbosilanes, polymers containing both organic and silicon parts in the main chain, can also be obtained *via* hydrosilylation. The intermolecular hydrosilylation polymerization of monomers containing both Si-H and C=C bonds serves as an efficient method for polycarbosiloxanes synthesis (Scheme 1.11).⁴⁸ An optically active isotactic poly(silethylensiloxane) was synthesized from an optically active monomer with Pt-based catalyst.⁴⁹

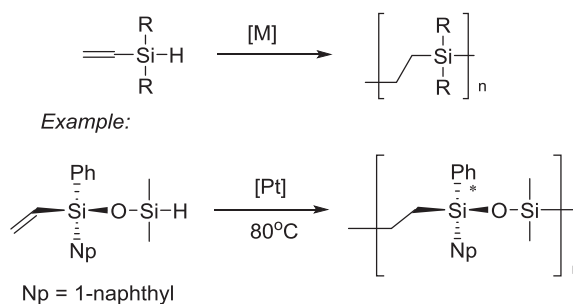

Scheme 1.11: The intermolecular hydrosilylation polymerization. Synthesis of optically active polycarbosiloxane

Polyaddition of dihydro siloxanes to α,ω -dienes is a powerful strategy for the synthesis of hybrid silicon materials (Scheme 1.12).^{50,51} The analysis of the end groups of polymers obtained from simple α,ω -dienes showed that the molecular weight was limited by the isomerization of terminal double bonds, which inhibited polymerization.⁵² Nevertheless, there is plethora of examples of successful application of this strategy for the synthesis of hybrid material.^{5,44} For instance, a very challenging monomer, diallyl bisphenol A containing two OH-groups and two allyl groups prone to isomerization was hydrosilylated with tetramethyldisiloxane using Pt catalysis (Scheme 1.12).⁵³

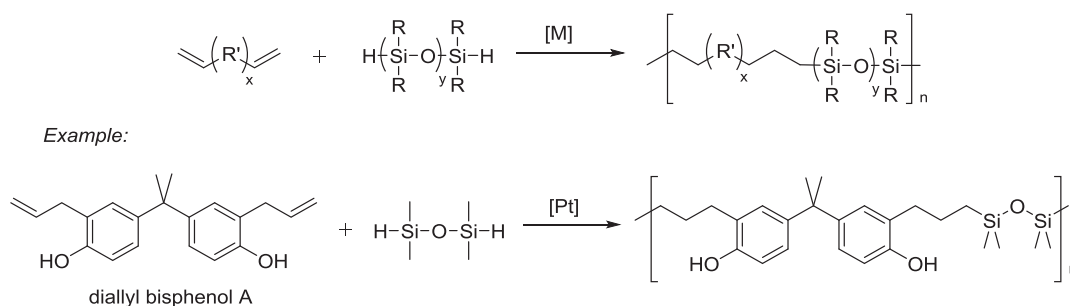

Scheme 1.12: Hydrosilylation polymerization of α,ω -dienes (diallyl bisphenol A)

Hydrosilylative polymerization of α,ω -dienes also can be used for the synthesis of crosslinked inorganic hybrid gels. 1,3,5,7-tetramethylcyclotetrasiloxane (TMCTS) and 1,5-hexadiene were reported to form this type of gel under Pt catalysis (Scheme 1.13).^{54,55}

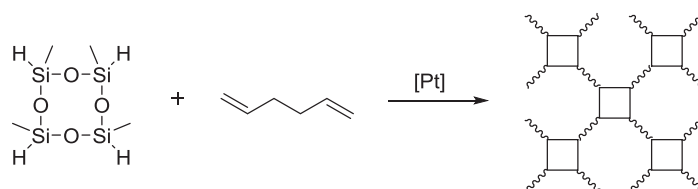

Scheme 1.13: Organic-inorganic hybrid gel formed from TMCTS and 1,5-hexadiene

In the contrast to abovementioned examples, the synthesis of polysilanes is not performed by hydrosilylation. However, hydrosilylation is widely used for the synthesis of monomers for polysilanes. Polysilanes can be obtained by metal-catalyzed dehydrogenative coupling (Scheme 1.14).^{56,57} These polymers, unlike polyolefins, are promising electronic materials, because they demonstrate fascinating electronic properties resulting from their σ -conjugated structures.^{58,59}

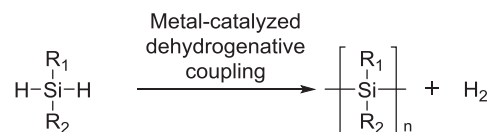

Scheme 1.14: Synthesis of polysilane by dehydrogenative polymerization

1.3 Platinum Catalysts

Although a large number of catalysts for hydrosilylation have been studied, platinum-based catalysts retain the dominant role in the industry due to their selectivity, high catalytic activity, and stability towards heat, oxygen and moisture. In 1957 John L. Speier discovered hexachloroplatinic acid ($\text{H}_2\text{PtCl}_6 \cdot 6\text{H}_2\text{O}$, **1-1**) as a very efficient catalyst for anti-Markovnikov alkene hydrosilylation (Scheme 1.15).⁹ The use of $\text{H}_2\text{PtCl}_6 \cdot 6\text{H}_2\text{O}$ was the first example of homogeneous transition metal-catalyzed hydrosilylation. In following decades, Pt catalysis has become the most effective method for the synthesis of alkyl- and vinylsilanes.¹⁻⁷ Only direct process is used in larger scale.⁶⁰

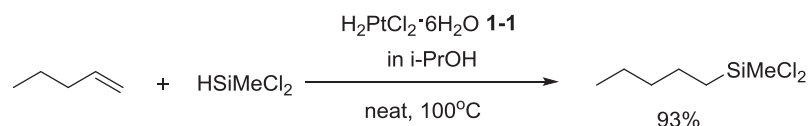

Scheme 1.15: Hydrosilylation of 1-pentene with dichloromethylsilane using Speier's catalyst

The hexachloroplatinic acid is usually dissolved in an organic solvent, and can be used in either the hydrate or the partially dehydrated form. A solution of $\text{H}_2\text{PtCl}_6 \cdot 6\text{H}_2\text{O}$ in isopropyl alcohol is referred to as "Speier's catalyst." A characteristic feature of this system is the induction period (when starting hexachloroplatinic acid is reduced to the active Pt(0) catalyst) which is followed by a fast exothermic hydrosilylation reaction. The temperature in the reaction vessel can increase significantly,⁶¹ however this usually does not lead to the deactivation of the catalyst.

Speier's catalyst allows the hydrosilylation of a variety of functionalized alkenes. Many functional groups can be tolerated, including amine, carbonyl, carboxylate, halide, alcohol to

name just a few. Catalyst loadings for the hydrosilylation using Speier's catalyst can be as low as 10^{-8} moles catalyst per mole of substrate. Despite the high price of Pt, this catalyst is used on industrial scale as a disposable catalyst because it demonstrates extremely high turnover number (TON) and turnover frequency (TOF).

Speier's catalyst, however, catalyzes some side reactions. For example, the reaction of allyl phenyl ether with silanes proceeds with isomerization and side reactions⁶² (Scheme 1.16). Allyl halides are not suitable substrates for Speier's system, because of competing hydrodehalogenation⁶³ (Scheme 1.16).

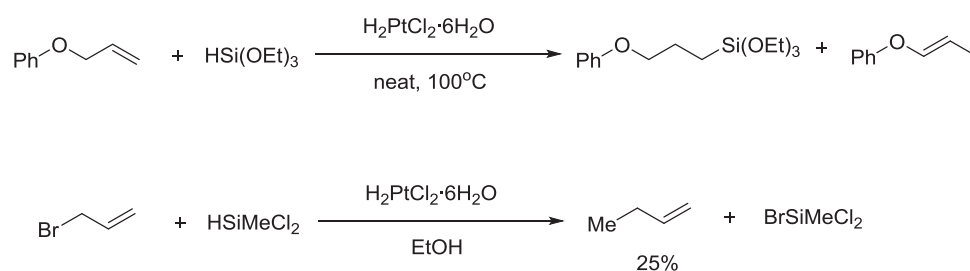

Scheme 1.16: Hydrosilylation of 2-pentene and allyl bromide using Speier's catalyst

The induction period and sudden exothermic reaction mentioned above produce serious safety issues when the process is applied in a large scale. Numerous studies were carried out in order to improve Speier's catalyst by the addition of co-catalysts and ligands.^{2,64}

One of the most industrially important platinum catalysts today, Karstedt's catalyst (**1-2**) (Figure 1.2), was reported in 1973.⁶⁵ Karstedt's catalyst is more soluble in organosilanes and shows higher activity in olefin hydrosilylation compared to Speier's catalyst.^{7,10} Furthermore, it does not require *in situ* reduction, however, induction periods are still observed. This induction period is explained by the process of ligand exchange.⁶⁶

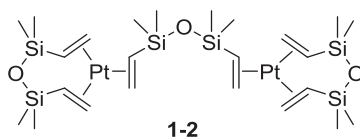

Figure 1.2: Karstedt's catalyst

However, Karstedt's catalyst can form Pt(0) colloids and platinum black due to decomposition, caused by dissociation of the weakly-bound vinylsiloxane ligands. This process reduces TON and increases the cost of hydrosilylation.^{7,10,66} To overcome this problem, several modifications improving the stability of original catalyst were proposed.

Phosphine ligands can protect against catalyst degradation and colloid formation, however these σ -donating ligands reduce the TOF.⁶⁷⁻⁶⁹ Recently, N-heterocyclic carbene (NHC) supported Pt(0) complexes (**1-3**, **1-4**, **1-5**) were reported as robust hydrosilylation catalysts (Figure 1.3).^{70,71}

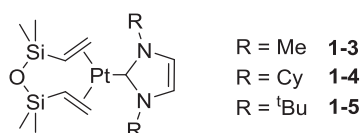
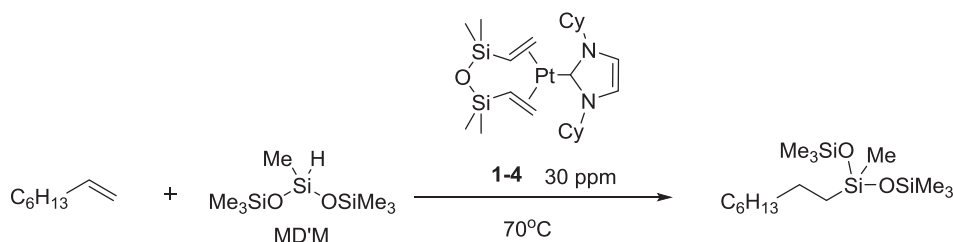

Figure 1.3: Pt(0) complexes supported by the NHC-ligands

Although these catalysts are less active than Karstedt's catalyst, the reaction between 1-octene and MD'M was fast and efficient even when catalyst loading was as low as of 30 ppm (Scheme 1.17). The reactivity and selectivity of these complexes depend on the size and electronic properties of N-substituents. When cyclohexyl was used (**1-4**), optimum selectivity was observed (less than 1% of side-products formed, compared to ~20% produced by Karstedt's catalyst in this reaction).



Scheme 1.17: Hydrosilylation of 1-octene with MD'M using Pt(0) complexes supported by N-heterocyclic carbene

Furthermore, many reactive functional groups including ketones, esters, silyl ethers, free and protected alcohols are tolerated by NHC-supported Pt(0) catalysts.

Based on studies, a plausible catalytic cycle was proposed (Scheme 1.18).⁷² Similarly to Karstedt's catalyst, the catalytic cycle was initiated by the dissociation of divinyltetramethyldisiloxane ligand.

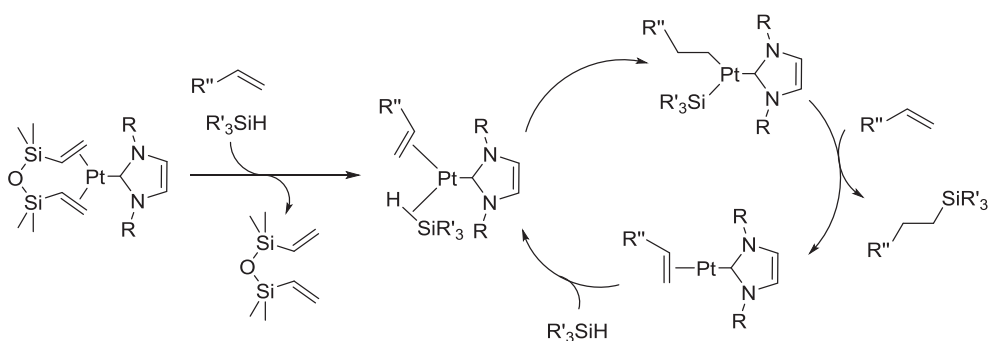

Scheme 1.18: Plausible catalytic cycle for Pt-NHC catalysts

Bidentate carbene Pt(0) complexes have also been applied for alkene hydrosilylation (Scheme 1.19).⁷³ These complexes were expected to exhibit higher stability under harsh reaction conditions. Indeed, the complexes were active in hydrosilylation of styrene with MD'M above 50°C (a mixture of Markovnikov and anti-Markovnikov products was obtained). At 140°C only 30 seconds was needed to complete the reaction (Scheme 1.19) using only 0.5% of bidentate NHC-supported Pt(0) catalyst **1-6**.

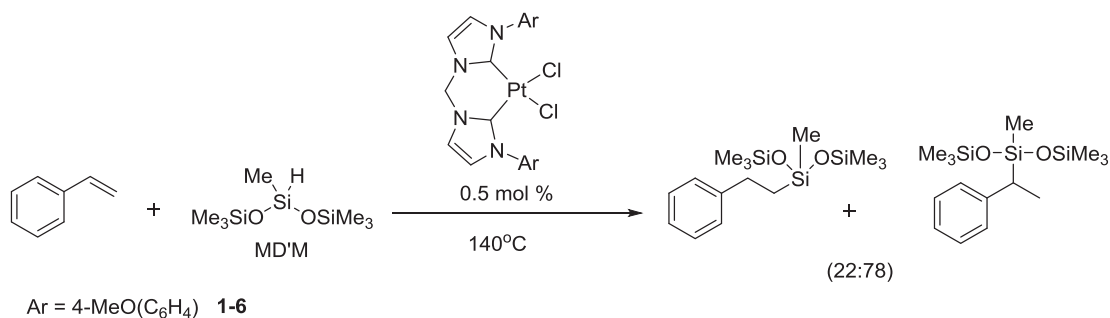

Scheme 1.19 Styrene hydrosilylation using bidentate NHC-supported Pt(0) complexes

The abovementioned industrially used Pt-based catalysts are usually not recovered from hydrosilylation products. Thus, a significant part of worldwide mined Pt is consumed by the silicon industry.⁷⁴ The price of platinum is high and depends on unpredictable world market (Figure 1.4). This motivates the development of alternative base-metal catalysts for hydrosilylation.



Figure 1.4: Platinum price trend from 2006 to 2016 (based on the Johnson Matthey monthly average prices)⁷⁵

1.4 Iron Catalysts

Iron pentacarbonyl was reported in 1962 by Nesmeyanov and co-workers as the first iron catalyst for hydrosilylation.⁷⁶ Following this discovery, several iron carbonyl systems were developed.⁷⁷⁻⁷⁹ These systems, however, require thermolysis or photolysis for activation and/or promote undesired processes such as dehydrogenative silylation. A breakthrough was made by Chirik and co-workers in 2004.⁸⁰ They used iron complexes with a redox-active bis(imino)pyridine (PDI) ligand for hydrosilylation reaction of terminal olefins with primary and secondary hydrosilanes. Complex $[\text{Fe}(\text{}^i\text{PrPDI})(\text{N}_2)_2]$ (**1-7**) ($\text{}^i\text{PrPDI} = 2,6\text{-}(2,6\text{-}^i\text{Pr}_2\text{C}_6\text{H}_3\text{N})\text{CMe}_2\text{C}_5\text{H}_3\text{N}$) (Scheme 1.20) was used for hydrosilylation with Ph_2SiH_2 and showed moderate activity in the reaction with tertiary such as $(\text{EtO})_3\text{SiH}$ and MD'M.

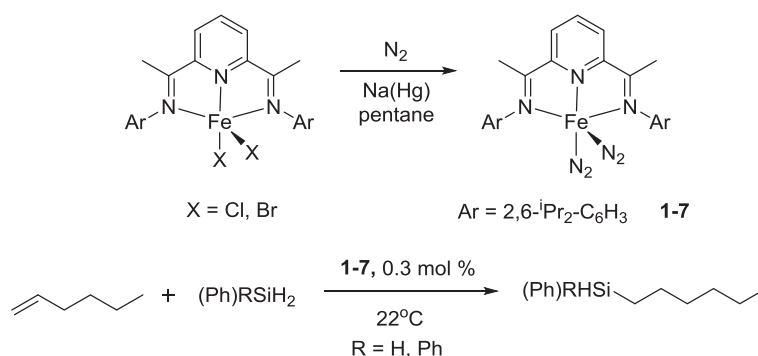
Scheme 1.20: Alkene hydrosilylation using $[\text{Fe}(i\text{PrPDI})(\text{N}_2)_2]$ (**1-7**)

Further study revealed that reducing the size of substituents in the aryl rings ($i\text{Pr} \rightarrow \text{Et}$, Me) leads to significant improvement of catalytic activity in hydrosilylation with tertiary silanes.⁸¹ These complexes ($[(^{\text{Et}}\text{PDI})\text{Fe}(\text{N}_2)]_2(\mu_2\text{-N}_2)$ (**1-8**) and $[(^{\text{Me}}\text{PDI})\text{Fe}(\text{N}_2)]_2(\mu_2\text{-N}_2)$ (**1-9**)) demonstrated activity comparable to that of $\text{Pt}(0)$ Karstedt's catalyst in the hydrosilylation of 1-octene and allyl polyethers.

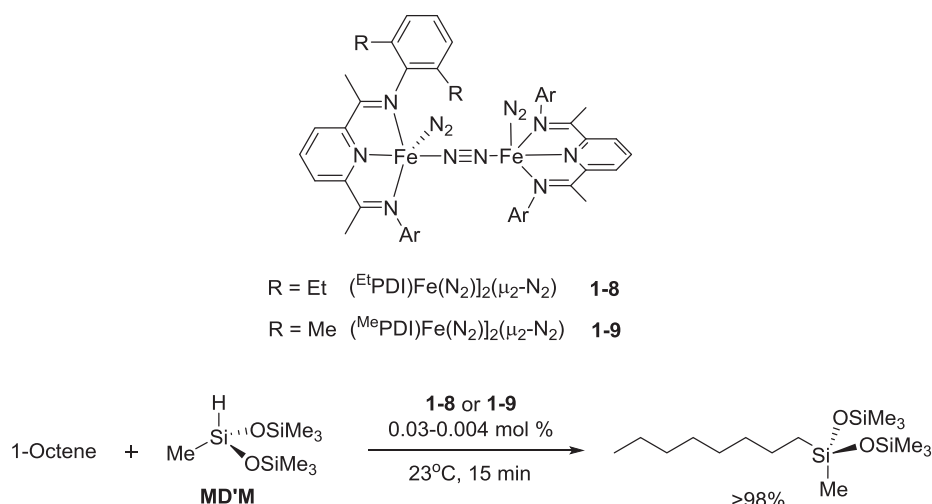
Scheme 1.21: Structures of $[(^{\text{Et}}\text{PDI})\text{Fe}(\text{N}_2)]_2(\mu_2\text{-N}_2)$ and $[(^{\text{Me}}\text{PDI})\text{Fe}(\text{N}_2)]_2(\mu_2\text{-N}_2)$. Hydrosilylation of 1-octene with MD'M

The same research group reported bis(imino)pyridine **1-10** – **1-12** and terpyridine $\text{Fe}(\text{II})$ dialkyl complexes⁸² **1-13** serve as alkene hydrosilylation catalysts, yet the activity was lower to those of PDI $\text{Fe}(0)$ systems **1-7** and **1-8** – **1-9**. It is noteworthy, that terpyridine complex **1-13**, unlike **1-8** – **1-9** and **1-10** – **1-12**, was compatible with vinylcyclohexene oxide - an important substrate for preparation of UV-release coating and silicone-modified organic polymers (Scheme 1.22).

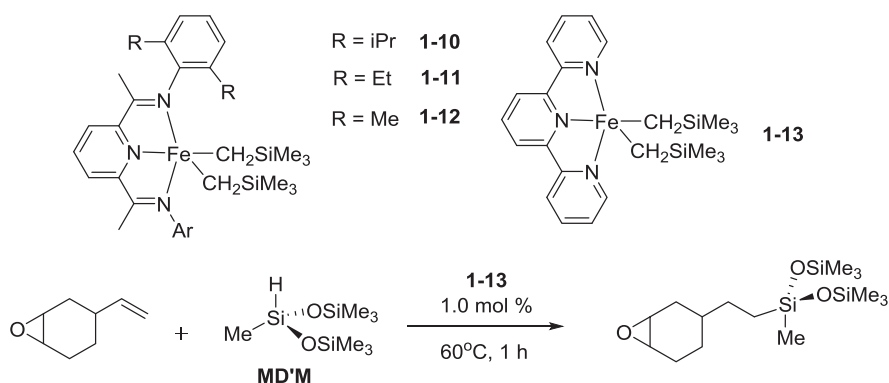

Scheme 1.22: Bis(imino)pyridine and terpyridine Fe(II) dialkyl complexes. Hydrosilylation of vinylcyclohexene oxide using **1-13**

Nakazawa and co-workers reported terpyridine Fe(II) dihalides **1-14** – **1-19** activated with NaBH₄ catalyzes alkene hydrosilylation with primary or secondary hydrosilanes at 0.05 – 0.1 mol% Fe loading (Scheme 1.23).⁸³

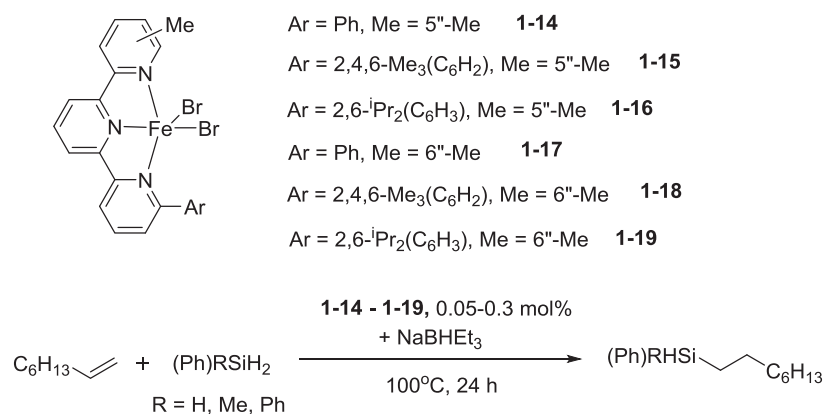

Scheme 1.23: Terpyridine Fe(II) dihalide precatalysts and 1-octene hydrosilylation

Thomas and co-workers reported the combination of bis(imino)pyridine (PDI) ligand, FeCl₂ and EtMgBr for alkene hydrosilylation. The active catalyst was formed *in situ*.⁸⁴ This system demonstrated good functional group compatibility: halides, amino-, ester-, keto-, imino-groups were tolerated. However, again primary and secondary silanes were used for hydrosilylation.

The modification of PDI system led to a discovery of Fe(II) phosphinite-iminopyridine (PNN) complexes, which selectively catalyze anti-Markovnikov alkene hydrosilylation in the presence of various functional groups, such as ester, amide, and keto-groups (Scheme 1.24).⁸⁵ Ketones are generally more reactive and readily undergo hydrosilylation. However, Fe(II)

complexes bearing electron-donating phosphinite-iminopyridine ligand (**1-20**) allow C=C hydrosilylation in 5-hexene-2-one.

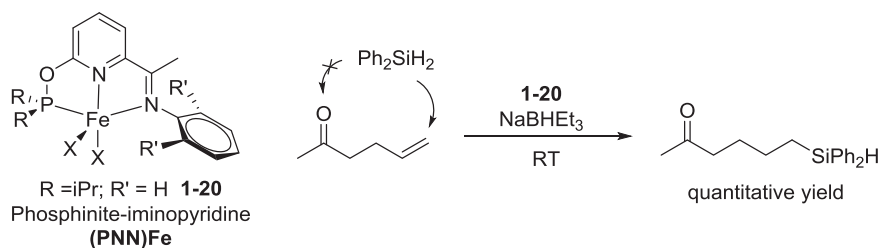

Scheme 1.24: Fe(II) phosphinite-iminopyridine (PNN) complexes and chemoselective hydrosilylation of 5-hexen-2-one

Very recently, a mixture of iron pivalate and an isocyanide ligand was reported to catalyze the hydrosilylation of alkenes with hydrosiloxanes with high efficiency ($\text{TON} > 10^3$) and high selectivity (Scheme 1.25).⁸⁶ This practical Fe catalyst showed excellent activity for hydrosilylation of styrene derivatives, but not simple alkenes.

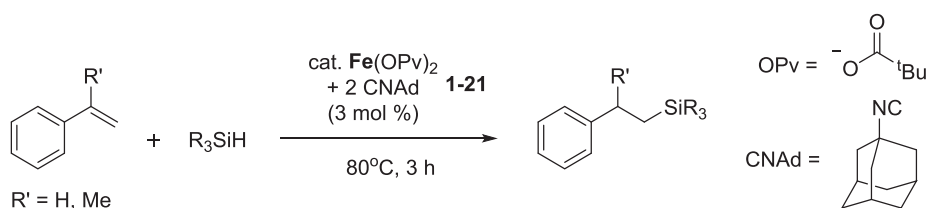

Scheme 1.25: Hydrosilylation of styrene or α -methylstyrene catalyzed by $\text{Fe}(\text{OPv})_2$ (**1-21**)

1.5 Cobalt Catalysts

Dicobalt octacarbonyl, $\text{Co}_2(\text{CO})_8$ (**1-22**) was reported by Chalk and Harrod in 1960's to catalyze the hydrosilylation of simple terminal alkenes with tertiary silanes. Anti-Markovnikov addition products were selectively produced (Scheme 1.26).^{87,88} The reaction has been conducted in solvent-free conditions, at ambient temperature with low catalyst loading (0.6–0.06 mol % of $\text{Co}_2(\text{CO})_8$). However, an excess amount of alkenes (3 equiv., relative to the hydrosilanes) had to be used because of Co-catalyzed isomerization of terminal alkenes to internal ones. The isomerization was faster than the hydrosilylation reaction.⁸⁷

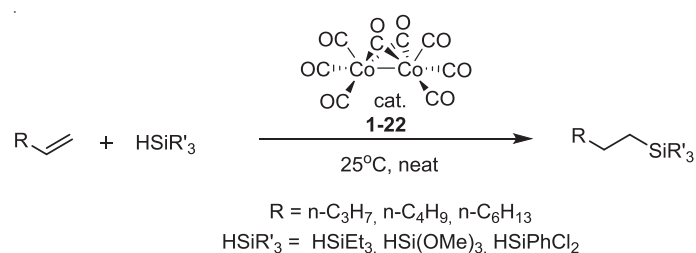
Scheme 1.26: $\text{Co}_2(\text{CO})_8$ -catalyzed alkene hydrosilylation

Kalinin and co-workers have investigated dicobalt octacarbonyl-catalyzed hydrosilylation of styrene, vinyltrimethylsilane, 1-vinyl-o-carborane, and allyl di(triethoxysilyl)amine with HSi(OEt)_3 .⁸⁹ These reactions selectively provided anti-Markovnikov addition products.

The hydrosilylation of alkenes bearing unsaturated functionalities was also reported using $\text{Co}_2(\text{CO})_8$. The reaction of α,β -unsaturated esters with various tertiary silanes gave a mixture of dehydrogenative silylation, hydrosilylation and reduction products (Scheme 1.27).⁹⁰

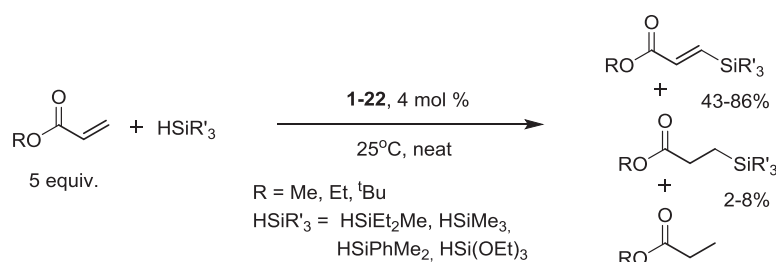
Scheme 1.27: $\text{Co}_2(\text{CO})_8$ -catalyzed reactions of α,β -unsaturated esters with hydrosilanes

The study revealed that the substituents on the $\text{C}=\text{C}$ bond and the molar ratio of esters to hydrosilanes influenced the product distribution. When the ratio of methyl acrylate/ HSiEt_2Me was set to 2.5, the β -silyl acrylate was obtained as the major product in a 94% yield.

Various ligands were used in Co-catalyzed hydrosilylation in order to outperform the activity and selectivity of dicobalt octacarbonyl. Haszeldine and co-workers reported that the phosphine cobalt hydride complexes, $\text{CoH(N}_2\text{)(PPh}_3\text{)}_3$ (**1-23**) and $\text{CoH}_3(\text{PPh}_3)_3$ (**1-24**) reacted reversibly with HSi(OEt)_3 to give cobalt(III) silyl complex $\text{CoH}_2(\text{Si(OEt)}_3)(\text{PPh}_3)_3$ (**1-25**). Complexes **1-23** – **1-25** catalyzed the hydrosilylation of 1-hexene with HSi(OEt)_3 at room temperature, however the rate of alkene isomerization only approximately two times lower than that of hydrosilylation.^{91,92}

Brookhart and Grant described pentamethylcyclopentadienyl cobalt(III) alkyl complex $[\text{Cp}^*\text{Co(P(OMe)}_3\text{)(CH}_2\text{CH}_3\text{)}][\text{BAR}^{\text{F}}_4]$ ($\text{Ar}^{\text{F}} = 3,5\text{-dinitrofluoromethylphenyl}$) (**1-26**) catalyzed

the hydrosilylation of 1-hexene with HSiEt_3 .⁹³ In the presence of 1 mol % of the cobalt (III) complex, the anti-Markovnikov addition product was obtained in high yield (Scheme 1.28).

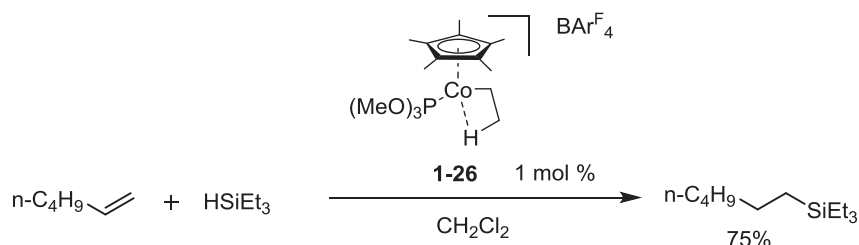

Scheme 1.28: $[\text{Cp}^*\text{Co}(\text{P}(\text{OMe})_3)(\text{CH}_2\text{CH}_3)][\text{BAr}^{\text{F}}_4]$ -catalyzed hydrosilylation of 1-hexene

The use of silyl-anchored NHC-Co(II) complexes (**1-27** – **1-29**) for the hydrosilylation of 1-octene with PhSiH_3 was reported by Deng and co-workers (Scheme 1.29).⁹⁴ Silyl-anchored NHC-Co(II) complexes catalyzed the reaction at room temperature to yield the secondary hydrosilane high anti-Markovnikov addition selectivity, forming only small amounts of alkene isomerization and hydrogenation products.

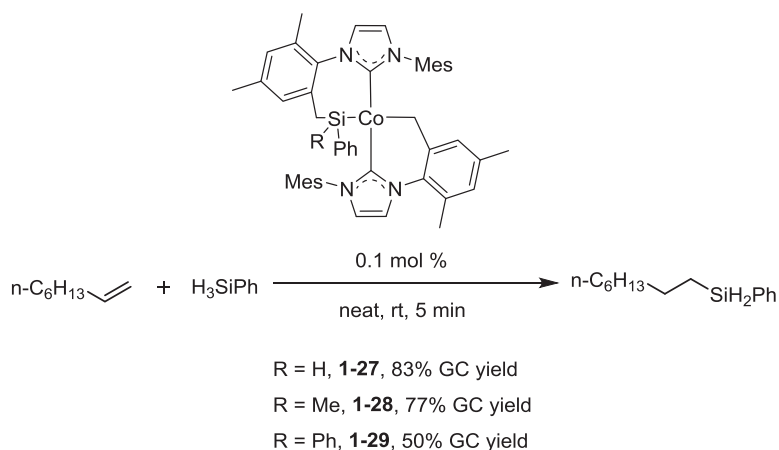

Scheme 1.29: Silyl-NHC-cobalt-catalyzed hydrosilylation of 1-octene

As mentioned above, bis(imino)pyridine (PDI) Fe(0) complexes developed by Chirik and co-workers exhibited activities comparable to those of traditional Pt catalysts.⁸¹ The same group discovered that cobalt complexes ($^{\text{Mes}}\text{PDI}$)CoCH₃ (**1-30**) and ($^{\text{Mes}}\text{PDI}$)Co(N₂) (**1-31**) served as active dehydrogenative silylation catalysts for the reaction of $\text{HSi}(\text{OSiMe}_3)_2\text{Me}$ (MD³M) with 1-octene (two equivalents).⁹⁵ In this reaction allylsilanes were formed in > 98% yield (5:2 *E/Z* mixture) together with 1 equivalent of n-octane. It is worth to note that internal alkenes such as trans-4-octene were also converted to corresponding allylsilanes and alkanes (Scheme 1.30).

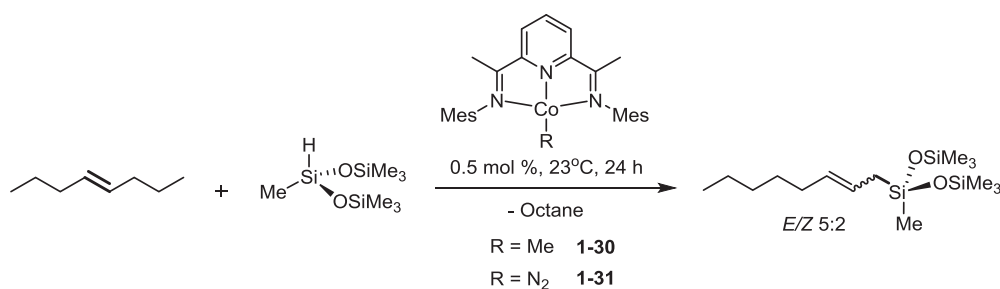
Scheme 1.30: (^{Mes}PDI)CoCH₃-catalyzed dehydrogenative silylation of 4-octene

Very recently, Holland and co-workers used cobalt(I) β-diketiminato complexes (such as **1-32**) alkene hydrosilylation. A variety of terminal alkenes were hydrosilylated with PhSiH₃ or (EtO)₃SiH.⁹⁶ The catalytic system is compatible with many functionalities: alkenes bearing silyl ether, chloro, tertiary amine, ester, and amide groups were employed. Furthermore, tandem isomerization-hydrosilylation strategy was used to form terminal alkyl silanes from internal alkenes. The combination of cobalt(I)-toluene complex and cobalt(I)-benzene complex as catalysts allowed the regioconvergent hydrosilylation of internal hexenes to yield 1-hexylsilane. However, only cis-isomers were converted to 1-hexylsilane with reasonable yields (Scheme 1.31).

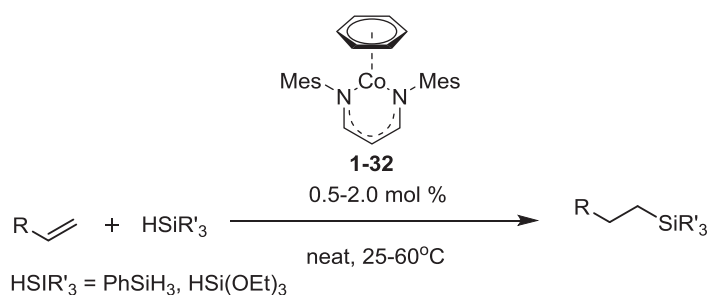

Scheme 1.31: Cobalt(I) β-diketiminato complex-catalyzed hydrosilylation of terminal alkenes

Finally, a mixture of cobalt pivalate Co(OPv)₂ (**1-33**) and an isocyanide ligand was reported to efficiently catalyze the hydrosilylation of alkenes with hydrosiloxanes.⁸⁶ This catalytic system was tolerant to ester and halogen groups in styrene or α-methylstyrene derivatives. Moreover, allylic ethers were the substrates that worked well with this system (Scheme 1.32). Chemical modification and cross-linking of silicones were also achieved using this catalyst.

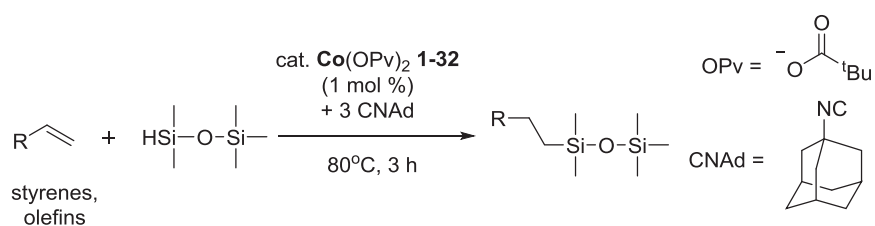

Scheme 1.32: Alkene hydrosilylation with hydrosiloxanes and tertiary silanes using Co(OPv)_2 and isocyanide ligand

1.6 Nickel Catalysts

Nickel salts and complexes are known to serve as hydrosilylation catalysts since 1950s. Pyridine supported nickel dichlorides,⁹⁷ nickel carbonyl⁹⁸ and iron pentacarbonyl-nickel chloride couple⁷⁶ were reported to catalyze alkene hydrosilylation. For olefin hydrosilylation with chlorosilanes, phosphine complexes of Ni(II) and Ni(0) were employed. However, the redistribution of chlorine and hydrogen on silicon atom led to the formation of several products.^{99,100} Marciniec and co-workers discovered in 1990's that Ni(acac)_2 (acac = acetylacetonato) (**1-34**) or Ni(COD)_2 ¹⁰¹⁻¹⁰³ (**1-35**) predominantly catalyze dehydrogenative silylation of vinylsubstituted silanes with triethoxysilane and triethylsilane. The dehydrogenative silylation occurs in the temperature range 80-120°C *via* three parallel pathways: direct dehydrogenation (DC), alkene hydrogenation (DS-1) and hydrogenative dimerization (DS-2). These reaction were also accompanied with side reactions (hydrosilylation of vinylsilanes (H) and substituent redistribution on the Si atom) (Scheme 1.33).

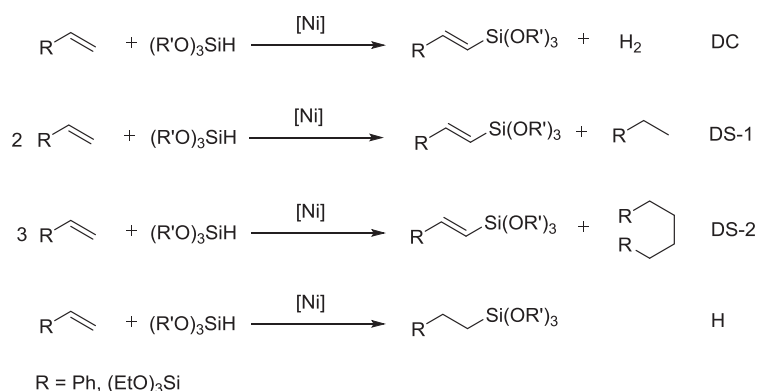

Scheme 1.33: Catalytic pathways of the dehydrogenative silylation catalyzed by nickel complexes

Phosphine coordinated Ni(II) and Ni(0) complexes also catalyze dehydrogenative silylation of styrene with tertiary silanes.¹⁰⁴ The reaction of styrene with trisubstituted silanes containing at least one alkoxy occurs in the temperature range of 20–120°C with moderate selectivity and activity. The requirement of rather harsh conditions and imperfect selectivity limit the applicability of abovementioned systems.

Another interesting example on Ni-based catalyst for hydrosilylation is nickel analogue of Karstedt's catalyst, $[\{\text{Ni}(\eta\text{-CH}_2=\text{CHSiMe}_2)_2\text{O}\}_2\{\mu\text{-}(\eta\text{-CH}_2=\text{CHSiMe}_2)_2\text{O}\}]$ (**1-36**) prepared by the same group.¹⁰⁵ Karstedt's catalyst is commonly used for hydrosilylation of vinylsilanes, including cross-linking of silicon polymers containing vinyl groups with polymethylhydrosiloxanes. However, complex **1-36** favourably catalyzes dehydrogenative silylation instead of hydrosilylation (Scheme 1.34).

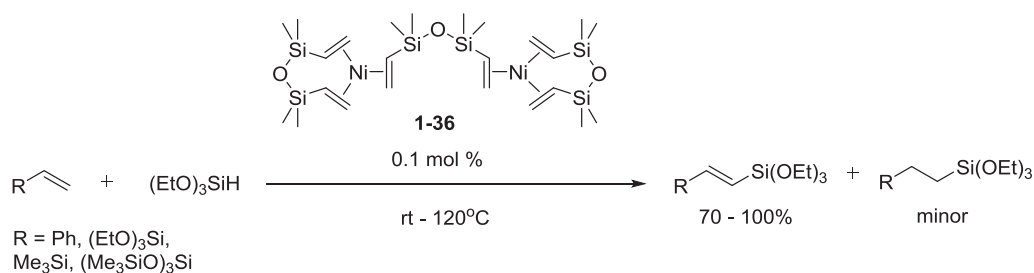

Scheme 1.34: Dehydrogenative silylation catalyzed by Ni analogue of Karstedt's catalyst

Recently, a number of nickel-based catalysts for regioselective hydrosilylation of alkenes have been reported. Of particular note are catalysts **1-37** – **1-39** where an indenyl ligand is used to anchor Ni. These complexes selectively catalyze Markovnikov hydrosilylation of styrene using NaBPh₄ as an initiator.¹⁰⁶ The addition of 1.5 equiv. of PhSiH₃ is essential due

to the dehydrogenative homocoupling of PhSiH_3 which also occurs under the reaction conditions.

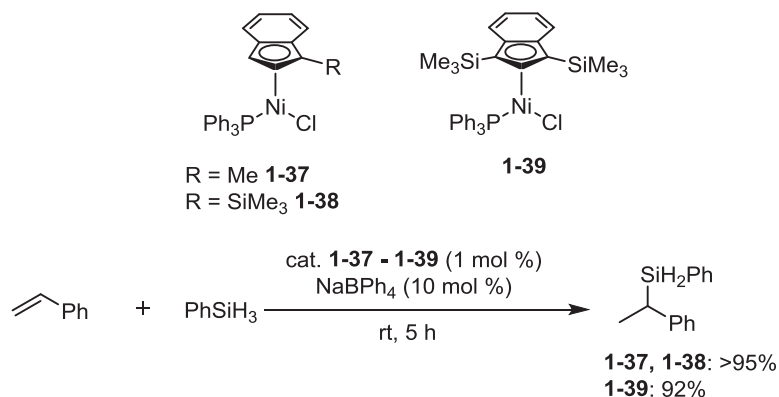

Scheme 1.35: The substituents on the R-Ind ligand do not effect significantly the activity of complexes

It was also possible to use Complex **1-39** for hydrosilylation without activating agent NaBPh_4 , while **1-37** and **1-38** required activation to obtain hydrosilylation product in a good yield. The proposed mechanism is shown in Scheme 1.36.

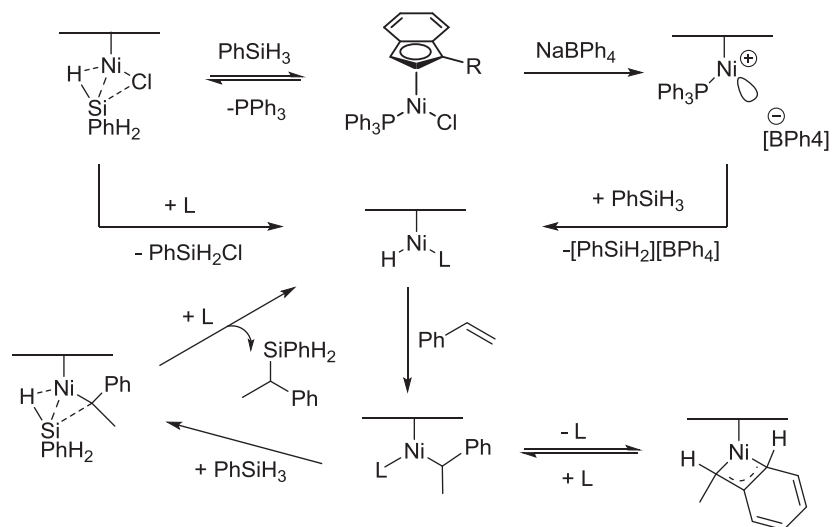

Scheme 1.36: Proposed mechanism for styrene hydrosilylation with complexes **1-37 – 1-39**

The intermediates $[\text{Ni}(\text{RInd})(\text{H})\text{L}]$ ($\text{L} = \text{PPh}_3$ or substrates) are proposed to be active species in both reactions with or without activation by NaBPh_4 . When NaBPh_4 was added, a cationic intermediate is generated, which then abstracts hydrogen from PhSiH_3 to form the active hydride species. In the absence of NaBPh_4 another way to generate active $[\text{Ni}(\text{RInd})(\text{H})\text{L}]$ was proposed. According to this pathway, phosphine-free $[\text{Ni}(\text{R-Ind})\text{Cl}]$ reacts with PhSiH_3 to give the active hydride species together with PhSiH_2Cl .

Cationic allyl nickel complexes $[\text{Ni}(\eta^3\text{-allyl})(\kappa^1P\text{-PR}_2\text{-CH}_2\text{=CH)CH}_2)_2][\text{BAR}'_4]$ ($\text{R} = \text{Ph}$ (**1-40**), $i\text{Pr}$ (**1-41**)) and $[\text{Ni}(\eta^3\text{-allyl})(\text{NHC})][\text{NHC} = 1\text{-}(2\text{-picolyl})\text{-}3\text{-}(\text{R})\text{-imidazol-}2\text{-ylidene}$ ($\text{R} = \text{Me}$ (**1-42**), $i\text{Pr}$ (**1-43**), $n\text{Bu}$ (**1-44**), Ph (**1-45**)), 1-(2-picolyl)-3- methylbenzoimidazol-2-ylidene (**1-46**), 1-(2-picolyl)-4,5-dichloro 3-methylimidazolylidene (**1-47**)] also selectively catalyze Markovnikov hydrosilylation of styrenes (Scheme 1.37).^{107,108} When reaction was monitored by ^1H NMR, signals in the metal-hydride region were observed, indicating that catalytic cycle involves Ni-hydride species.

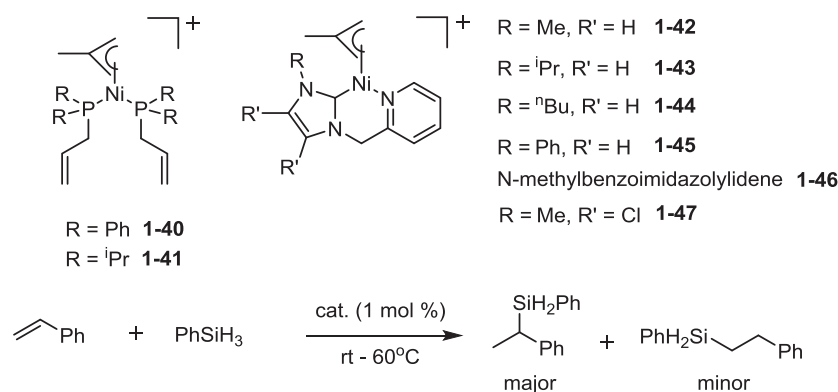

Scheme 1.37: Cationic allylic Ni-catalyzed Markovnikov hydrosilylation

A notable example of regioselective styrene hydrosilylation was demonstrated by Gevorgyan and co-workers.¹⁰⁹ In contrast to the examples mentioned above, phosphine coordinated Ni(II) system, $\text{NiBr}_2(\text{PPh}_3)_2$ (**1-48**), selectively produces anti-Markovnikov hydrosilylation products (Scheme 1.38). One-pot procedure converting starting styrenes to dihydrobenzosiloles has been developed. The reaction consists of nickel-catalyzed hydrosilylation of styrene with Ph_2SiH_2 , followed by the Ir-catalyzed dehydrogenative cyclization.

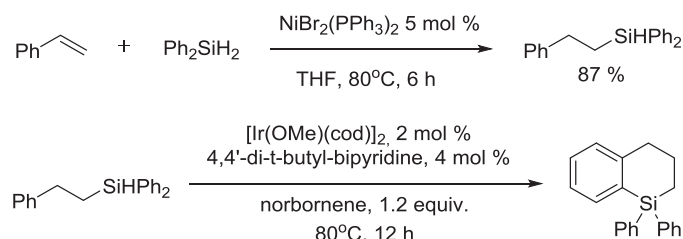

Scheme 1.38: Anti-Markovnikov hydrosilylation of styrenes with Ph_2SiH_2 using $\text{NiBr}_2(\text{PPh}_3)_2$ (**1-48**)

Tilley and co-workers described hydrosilylation of 1-octene with Ph_2SiH_2 using two-coordinate nickel bis(amido) complex $[\text{Ni}\{\text{N}(\text{SiMe}_3)(2,6\text{-}(i\text{Pr})_2\text{C}_6\text{H}_3)\}_2]$ (**1-49**) (Scheme

1.39).¹¹⁰ (ⁿOctyl)diphenylsilane was obtained in >95% yield with no observed isomerization of the olefin to internal isomers.

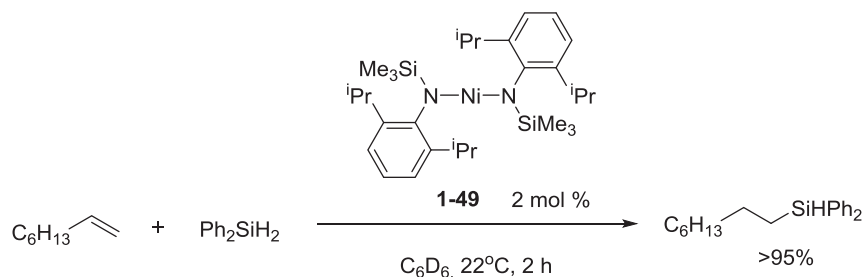

Scheme 1.39: 1-Octene hydrosilylation using bis(amido) complex containing two-coordinate nickel

Very recently, an example of anti-Markovnikov hydrosilylation of alkenes using (salicylaldiminato)Ni(II) complexes (**1-50**) was reported (Scheme 1.40).¹¹¹ Dihydrosilanes, such as Et₂SiH₂, (ⁿHex)₂SiH₂ or Ph₂SiH₂ were successfully employed, yet tertiary silanes did not react.

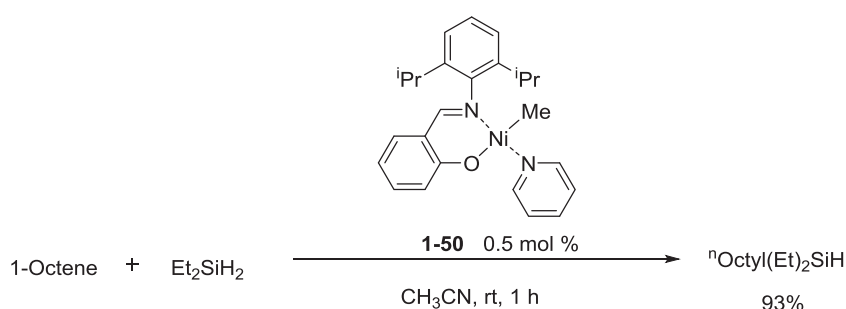

Scheme 1.40: Alkene hydrosilylation using salicylaldiminatoNi(II) catalyst

The authors also proposed the mechanism involved the activation of precatalyst with dihydrosilane, dissociation of the ligand and coordination of an alkene, followed by migratory insertion of C=C into Ni-Si bond and finally regeneration of (salicylaldiminato)(L)Ni-SiHR₂ species accompanied by the formation of the hydrosilylation product (Scheme 1.41).

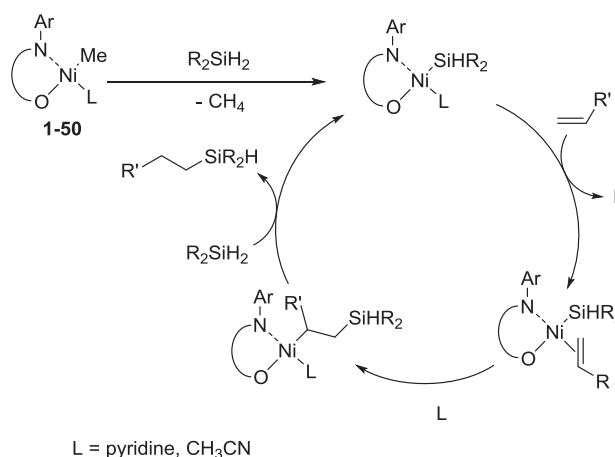

Scheme 1.41: Proposed catalytic cycle for alkene hydrosilylation using salicylaldiminato)Ni(II) catalysts

1.7 Catalysts Based on Other Metals for Hydrosilylation of Alkenes

Noble metals such as palladium,¹¹²⁻¹¹⁴ rhodium,¹¹⁵⁻¹¹⁹ ruthenium,¹²⁰⁻¹²² and iridium,^{123,124} electrophilic early transition metals,¹²⁵⁻¹³⁰ and lanthanides and actinides¹³¹⁻¹³⁴ all catalyze hydrosilylation of multiple bonds, including C=C, and show unique reactivity patterns. Group 1 and 2 metal complexes have also been reported to serve as hydrosilylation catalysts.¹³⁵⁻¹³⁷ Since alkali and alkaline earth metals are known to show similar reactivity to organolanthanides, the possible catalytic cycle could be analogous to that established for the hydrosilylation using lanthanides.

1.8 Mechanism of Hydrosilylation

Despite the rapid evolution of applications, the development of fundamental understanding of the catalytic hydrosilylation pathway has been difficult and slow, particularly for industrially relevant Pt catalysts. Typically, catalyst loadings are in the ppm range, and catalytic intermediates are extremely reactive and therefore difficult to isolate. Moreover, for many catalysts the turnover-limiting step is ligand dissociation, which limits the use of kinetic analysis. Nevertheless, continuous studies are addressed to the elucidation of transition metal-catalyzed hydrosilylation.⁶⁴

The initial model proposed by Chalk and Harrod¹³⁸ is still widely accepted for Pt catalysis. This mechanism consists of four elementary steps: (i) oxidative addition of the H-Si to low valent metal (**A**) to form silyl hydride complex (**B**); (ii) coordination of the olefin to give complex (**C**); (iii) migratory insertion of the olefin into the Pt-H bond to form alkyl silyl complex (**D**); (iv) reductive elimination to give hydrosilylation product and regeneration of the catalyst. Steps (i)-(iii) are reversible, and step (iv) is considered to be the irreversible rate-determining step. The formation of Pt⁰ particles is associated with catalyst deactivation (Scheme 1.42).

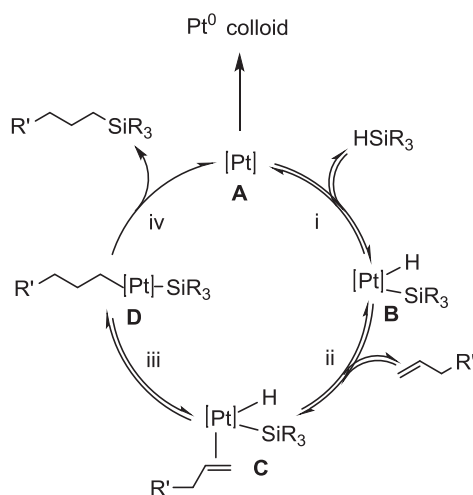

Scheme 1.42: Chalk-Harrod mechanism for Pt-catalyzed hydrosilylation

Several fundamental mechanistic works provided valuable insights in elemental steps of the Chalk-Harrod mechanism. For example, it was found that (1) the reaction proceeds homogeneously,⁶⁶ (2) the active species contains Pt-Si and Pt-C bonds,⁶⁶ (3) olefin insertion

into the Pt–Si bond is not facile.¹³⁹ These observations supported the Chalk–Harrod mechanism for Pt-catalyzed hydrosilylation.

In the majority of hydrosilylation reactions catalyzed by Speier’s and Karstedt’s catalysts, anti-Markovnikov addition products are selectively formed. The formation of anti-Markovnikov product can be explained by the Chalk-Harrod mechanism: the insertion of the olefin into the Pt–H bond generates terminal alkyl complex. In contrast, the insertion into Pt–Si bond would have given an intermediate in which Pt is attached to sterically more hindered carbon. Furthermore, the formation of anti-Markovnikov addition product suggests that metal hydride species react rapidly with C=C *via* migratory insertion and β -hydride elimination, forming the most stable terminal alkyl complex.

The isolation of the Chalk-Harrod mechanism intermediates is difficult, because they are highly reactive and short-living. In 2002 Roy and Taylor reported the first examples of platinum (II) complexes containing both olefin and silyl ligands.¹³⁹ These complexes exhibit no induction period in hydrosilylation and thus potentially can be reactive intermediates. Complex **1-51** remains unchanged in the catalysis and it was proposed to be the resting state of the catalysis. The study also revealed that complexes **1-51** and **1-52** did not undergo migratory insertion of olefins into Pt–Si bond. Therefore, the oxidation addition must be the first step of the catalytic cycle, implying that Pt(II)/Pt(IV) pair is involved.

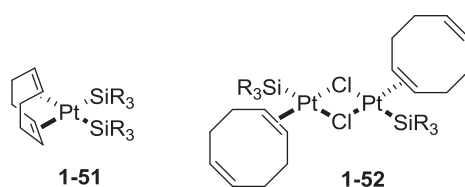

Figure 1.5: Structures of Pt complexes containing both silyl and olefin ligands

A number of theoretical studies of platinum-catalyzed hydrosilylation confirmed the validity of the proposed Chalk-Harrod mechanism and shed light on elemental steps (Scheme 1.42).¹⁴⁰⁻¹⁴⁵ Reductive elimination was claimed to be accelerated by a second equivalent of olefin, which is due to transition state stabilization. The reductive elimination was believed to be limiting,¹⁴⁶ however recent computational studies suggest that the highest energy barrier belongs to rotation of the alkyl-group preceding the reductive elimination.¹⁴⁷

Very recently, a detailed study of platinum-catalyzed hydrosilylation using Karstedt’s catalyst containing both mechanistic and kinetic investigations of the reaction pathway has

been reported.¹⁴⁸ A revised version of the Chalk-Harrod mechanism was proposed, which contains following important new features: (1) the rate determining step is assigned to the insertion of the olefin into the Pt-H bond, (2) a separate bypath is introduced for the isomerization of terminal olefins and (3) a correlation between the olefin coordination strength and the rate law governing the conversion of the olefin and structural features of the active species is established.

The hydrosilylation of alkenes catalyzed by transition metal complexes is often accompanied by side reactions such as isomerization, oligomerization, polymerization, reduction of alkenes, redistribution and dehydrogenation of silicon hydrides, as well as the dehydrogenative silylation (Scheme 1.43).

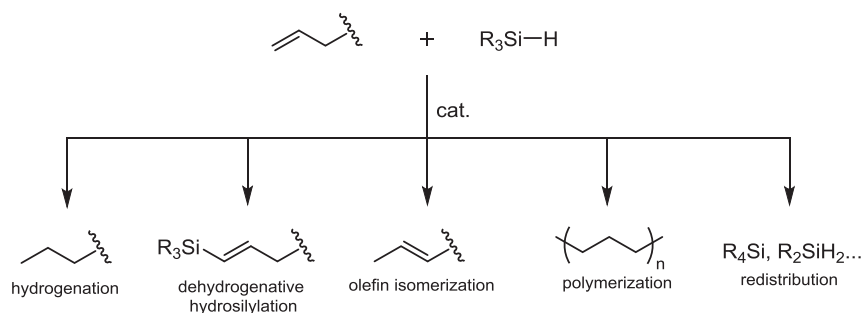

Scheme 1.43: Common side-products of transition metal-catalyzed hydrosilylation

The Chalk-Harrod catalytic cycle cannot explain the formation of all of these byproducts. On the other hand, complexes of Fe, Co, Ni, and Pd often favor dehydrogenative silylation reaction instead of hydrosilylation.² To explain the formation of dehydrogenative silylation products (vinylsilanes), the modified Chalk-Harrod mechanism was proposed by Wrighton and co-workers in 1977.¹⁴⁹ The authors proposed that migratory insertion of an alkene into M-Si bond is faster than the insertion in M-H bond (Scheme 1.44).

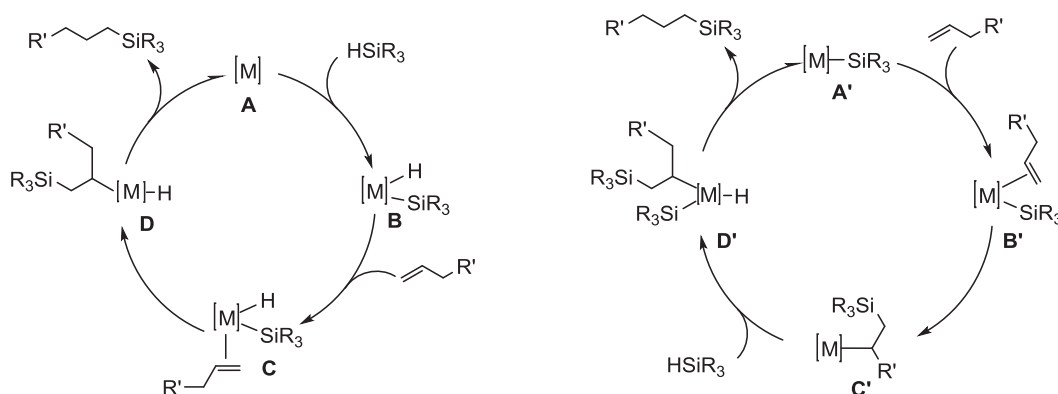

Scheme 1.44: Modified Chalk-Harrod mechanisms

Later Duckett and Perrutz suggested another mechanism for alkene hydrosilylation catalyzed by $(\eta^5\text{-cyclopentadienyl})\text{rhodium}$.¹¹⁹ They postulated that the metal hydride species is removed in the catalyst activation step and M-Si intermediate is formed. Next, the M-Si bond undergoes olefin migratory insertion followed by the oxidation addition of second molecule of silane. The last step is the reductive elimination and regeneration of M-Si species (Scheme 1.44).

Several studies of rhodium,^{115,116} iron,^{78,150} and cobalt-catalyzed^{93,151} hydrosilylation support the validity of the modified Chalk-Harrod mechanism and the mechanism proposed by Duckett and Perrutz.

The modified Chalk-Harrod mechanism explains the formation of dehydrogenative silylation side-products according to Scheme 1.45.

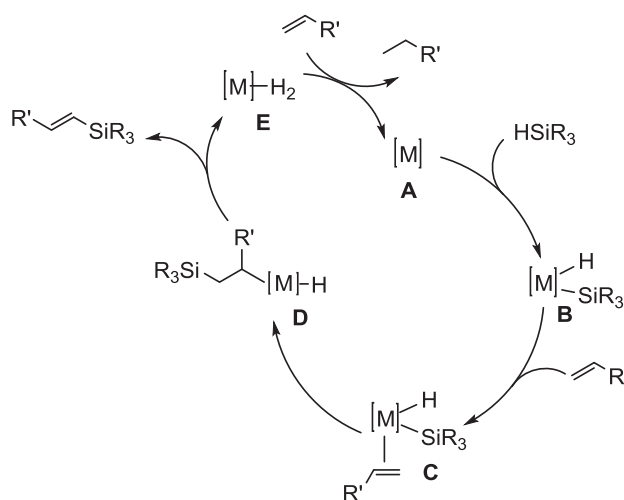

Scheme 1.45: The mechanism of dehydrogenative silylation

Early transition metals (Ti, Zr, Hf)¹²⁵⁻¹³⁰ as well as lanthanides and actinides¹³¹⁻¹³⁴ are also known to catalyze alkene hydrosilylation. For the hydrosilylation reactions catalyzed by complexes of metals in high oxidation state with d_0 electron configuration, since two-electron oxidative addition is not possible, two alternative kinds of mechanism are proposed: (i) olefin insertion into the M–H bond followed by Si–C bond formation *via* σ -bond metathesis of the resulting metal–alkyl with a hydrosilane, (ii) olefin migratory insertion into the M–Si bond with formation of Si–C bond, followed by σ -bond metathesis (Scheme 1.46).¹³⁴

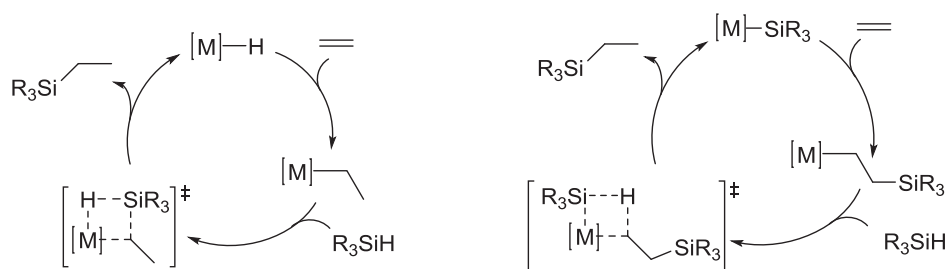

Scheme 1.46: Hydrosilylation mechanism catalyzed by d_0 metals *via* σ -bond metathesis

Glaser and Tilley reported a novel hydrosilylation reaction by using a cationic ruthenium silylene catalyst $[(\eta^5\text{-C}_5\text{Me}_5)(\text{P}^i\text{Pr}_3)(\text{H})_2\text{Ru}]\text{SiHPh}^+$ (**1-53**), which proceeds *via* a unique mechanism.^{121,122} This catalytic system demonstrates high anti-Markovnikov regioselectivity, yet it is effective only for primary hydrosilanes such as PhSiH_3 . The proposed novel mechanism (Glaser–Tilley mechanism) involves a cationic ruthenium silylene complex as a key species, which undergoes olefin insertion into a Si–H bond (Scheme 1.47). The oxidative addition of a Si–H bond, followed by 1,2-migration of a hydrogen atom from the silicon to ruthenium regenerates the silylene complex **1-53** and completes the catalytic cycle.

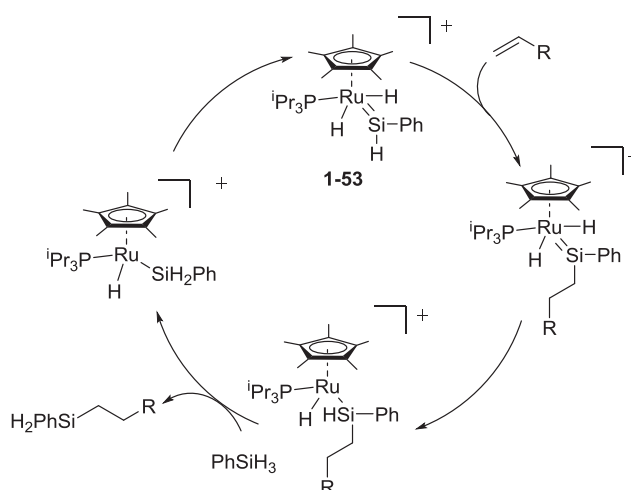

Scheme 1.47: Glaser–Tilley mechanism

To conclude, several catalytic cycles are proposed for the transition-metal-catalysed olefin hydrosilylation. While Pt complexes are shown to catalyze hydrosilylation by the Chalk-Harrod mechanism, the modified Chalk-Harrod mechanism explains the formation of side-products often observed in the reaction catalyzed by other late transition metals. The mechanism involving σ -bond metathesis is proposed for d_0 catalysts. The actual mechanism of alkene hydrosilylation depends on many factors including the configuration of metal center, ligand surrounding and silane type.

1.9 Asymmetric hydrosilylation of alkenes

A number of relatively facile methods for the removal of silyl-groups from organic compounds to give new derivatives are available and this motivates the development of asymmetric alkene hydrosilylation. Similarly to hydrogenation, hydrosilylation provides the opportunity to transform a sp^2 carbon to a sp^3 asymmetric center. Several reviews on this topic were already reported.^{5,152-154} The following short summary focuses on some recent advances in this area of silicon chemistry.

The asymmetric hydrosilylation of alkenes can be accomplished *via* either Markovnikov or anti-Markovnikov addition of Si-H depending on the particular olefin substituents present (Scheme 1.48).

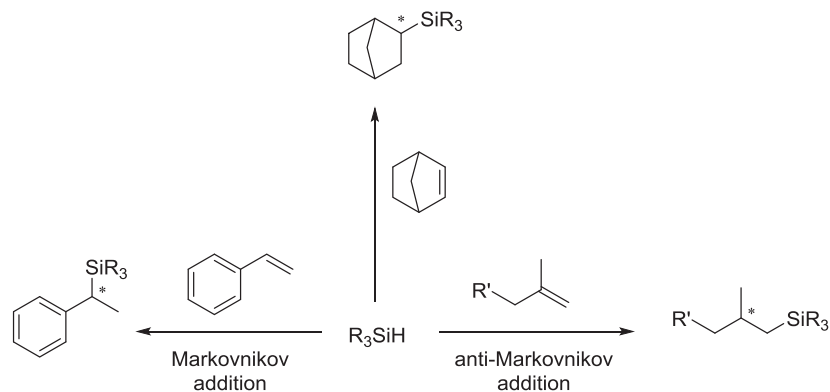

Scheme 1.48: Types of asymmetric alkene hydrosilylation

The most extensively studied asymmetric hydrosilylation so far is the palladium-catalyzed hydrosilylation of styrene derivatives with HSiCl_3 , due to the perfect regioselectivity of this reaction giving benzylic silanes. This regioselectivity is explained by the formation of stable-benzylpalladium intermediates (Scheme 1.49).¹⁵³

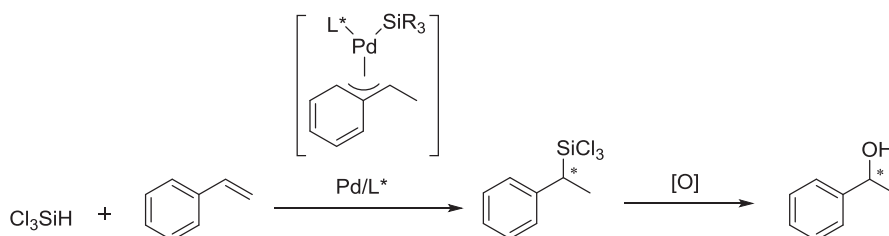

Scheme 1.49: Palladium-catalyzed asymmetric hydrosilylation of styrene

Palladium catalyst precursors combined with chelating diphosphine ligands, such as BINAP, do not exhibit catalytic activity in the hydrosilylation of alkenes. Hence, asymmetric synthesis has been achieved by the use of chiral monodentate phosphine ligands. In 1991 Hayashi and co-workers reported a new family of axially chiral monodentate phosphine ligands based on 2-di(phenyl)phosphine-1,1'-binaphthyls (abbreviated MOP's) (Scheme 1.50).¹⁵⁵ These ligands provided high regio- and enantioselectivity in the Pd-catalyzed asymmetric hydrosilylation of terminal¹⁵⁵ and cyclic olefins¹⁵⁶ with trichlorosilane. Highly regioselective Markovnikov-type hydrosilylation, unusual for the other transition metal-based catalysts, was achieved for linear 1-alkenes. The ligands used in these reactions (Scheme 1.50) gave very similar results, indicating that the X substituents did not significantly

influence the selectivity. However, the hydrosilylation of styrene derivatives did not lead to enantioselective transformation. In order to effectively perform enantioselective Pd-catalyzed hydrosilylation of styrenes, a different MOP derivative containing an H substituent at the 2'-position of the naphthyl moiety (H-MOP) has to be applied. Subsequent alcoholysis and oxidation enable the synthesis of alcohols with high regio and enantioselectivity (Scheme 1.50).

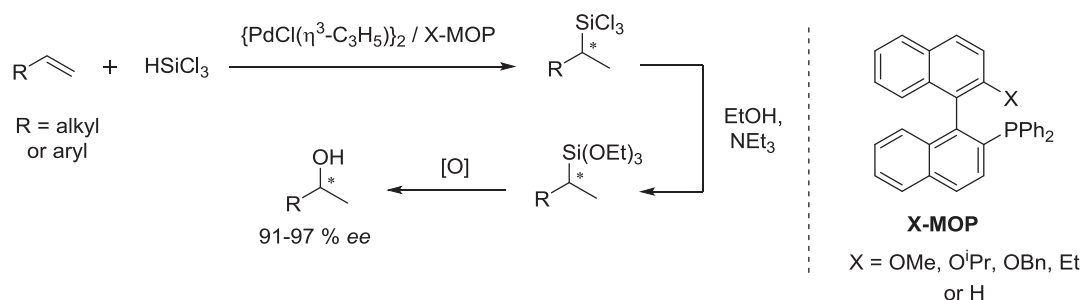

Scheme 1.50: The use of MOP ligands in Pd-catalyzed asymmetric hydrosilylation of alkenes

Ferrocene-anchored P,N-ligands were demonstrated to give excellent stereoselectivity in Pd-catalyzed hydrosilylation of norbornene (Scheme 1.51).¹⁵⁷ The introduction of electron-withdrawing substituents on the phosphine group lead to >99.5 % ee.

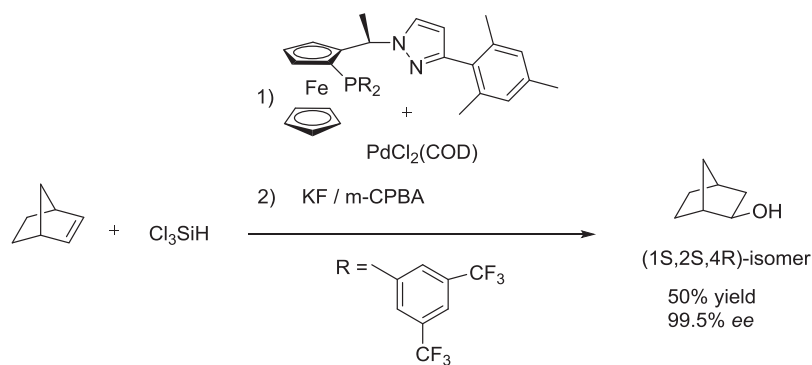

Scheme 1.51: Pd-catalyzed asymmetric hydrosilylation of norbornene

Johannsen and co-workers reported phosphoramidite-MOP Pd complexes demonstrated moderate to high enantioselectivity in hydrosilylation of various styrenes (Scheme 1.52).¹⁵⁸

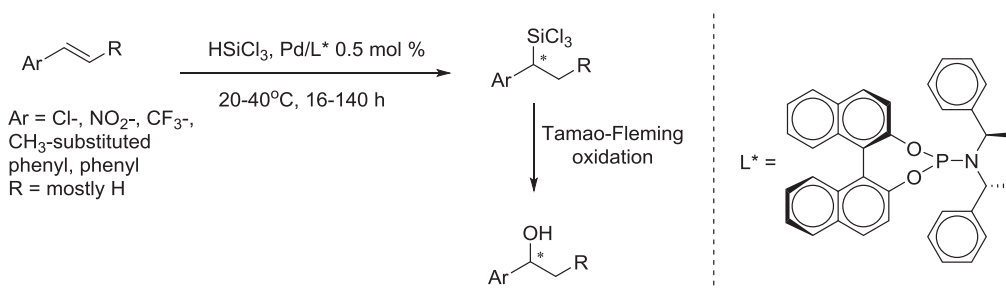

Scheme 1.52: Phosphoramidite ligands for Pd-catalyzed asymmetric hydrosilylation of styrenes

Besides Pd-based systems, Rh-based catalysts for asymmetric hydrosilylation of alkenes have been reported.¹⁵⁹ However, these reactions suffer from low regioselectivity, where a mixture of α - and β -adducts is formed. The asymmetric hydrosilylation with trialkoxysilanes using chiral bis(oxazolanyl)phenyl Rh complexes gives approximately a 1:1 ratio of regioisomers, yet high levels of ee can be achieved for selected examples.¹⁵⁹

Yttrium-based catalysts have been also successfully applied for asymmetric hydrosilylation of alkenes (Scheme 1.53).¹³⁴ For example, dimeric yttrium hydride **1-54** catalyzes hydrosilylation of norbornene with PhSiH₃ with 90% ee (Scheme 1.53).

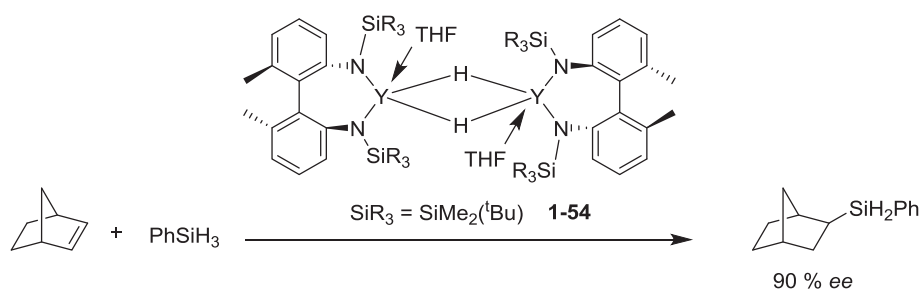
Scheme 1.53: Hydrosilylation catalysis by C₂-symmetric bis(silylamido) complexes of yttrium

Very recently, Lu and co-workers reported the first Fe-catalyzed asymmetric hydrosilylation of 1,1-disubstituted alkenes.¹⁶⁰ The highly regio- and enantioselective anti-Markovnikov hydrosilylation of 1,1-disubstituted aryl alkenes was developed using iminopyridine oxazoline complexes, such as **1-55** (Scheme 1.54). Subsequent derivatization of chiral organosilanes leads to chiral organosilanols, cyclic silanes, phenol derivatives and 3-substituted 2,3-dihydrobenzofurans.

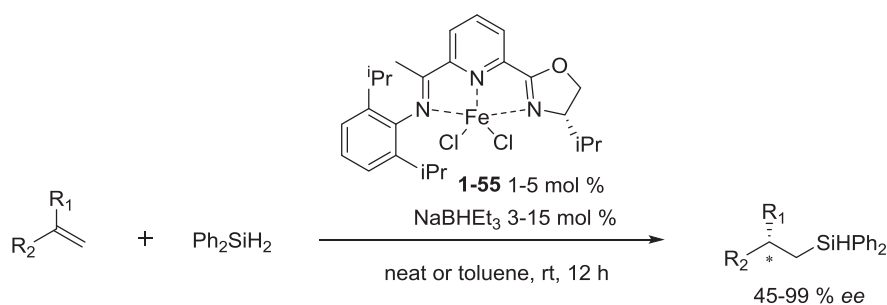

Scheme 1.54: Fe-catalyzed asymmetric hydrosilylation of 1,1-disubstituted alkenes

1.10 Challenges of Alkene Hydrosilylation

Precious metal catalysts are expensive and their reserves are constantly diminishing. Even when used in ppm quantities they increase the cost of organosilane production, because they are non-recyclable. On the other hand, continuous efforts have been devoted to the development of base-metal catalysts. However, reported catalytic systems often suffer from catalyst sensitivity towards water and oxygen, complexity and high cost of the ligand used, and undesired side-reactions. The synthesis of highly active, commercially viable non-precious metal catalysts would significantly contribute to the development of hydrosilylation methods.

The hydrosilylation of olefins containing some reactive functional groups is difficult to achieve using state-of-the-art Pt catalysts. Coordinating amines, allyl halides, allyl ethers and esters pose a serious challenge. The development of base-metal hydrosilylation catalysts tolerant to a wide scope of functional groups would provide distinct advantages, opening possibilities to synthesize new intermediates and polymers.

Reported non-precious metal catalytic system often operate well only when primary or secondary silanes (RSiH_3 or R_2SiH_2) are used. However, the use of tertiary silanes is more important, for example, for the synthesis of silane coupling agents and polymers. Furthermore, some simple silanes such as SiH_4 are not applied commonly for the organosilane synthesis due to their flammability and lack of methods allowing their safe use. The development of such methods would be beneficial.

Additionally, the ability of the catalyst to convert mixtures of alkenes into a single, terminal silane product with high selectivity would provide significant advantages. The isomerizing hydrosilylation of renewable feedstock materials such as derivatives of fatty acids would enrich the toolbox of remote functionalization.

1.11 References

- (1) Speier, J. L.; Stone, F. G. A.; Robert, W. In *Adv. Organomet. Chem.*; Academic Press: 1979; Vol. Volume 17, p 407-447.
- (2) Marciniak, B., Gulinski, J.; Urbaniak, W.; Kornetka, Z. W. *Comprehensive Handbook on Hydrosilylation*; Pergamon: Oxford, UK, 1992.
- (3) Ojima, I. In *The Chemistry of Organic Silicon Compounds*; Patai, S., Rappoport, Z., Ed.; Wiley Interscience: New York, 1989, p 1479.
- (4) Marciniak, B. *Silicon Chemistry* **2002**, *1*, 155-174.
- (5) Roy, A. K.; Robert West, A. F. H.; Mark, J. F. In *Adv. Organomet. Chem.*; Academic Press: 2007; Vol. Volume 55, p 1-59.
- (6) Marciniak, B. *Hydrosilylation: A Comprehensive Review on Recent Advances*; Springer Berlin, 2009.
- (7) Troegel, D.; Stohrer, J. *Coord. Chem. Rev.* **2011**, *255*, 1440-1459.
- (8) Sommer, L. H.; Pietrusza, E. W.; Whitmore, F. C. *J. Am. Chem. Soc.* **1947**, *69*, 188-188.
- (9) Speier, J. L.; Webster, J. A.; Barnes, G. H. *J. Am. Chem. Soc.* **1957**, *79*, 974-979.
- (10) Lewis, L. N., Stein, J.; Gao, Y.; Colborn, R. E.; Hutchins, G. *Platinum Met. Rev.* **1997**, *41*, 66-75.
- (11) Plueddemann, E. P. *Silane Coupling Agents*; Springer US, 1991.
- (12) Hill, R. M. *Silicone Surfactants*; Marcel Dekker: New York, 1999; Vol. 86.
- (13) Witucki, G. L. *J. Coat. Technol.* **1993**, *65*, 57-60.
- (14) Wagner, M. P. *Rubber Chem. Technol.* **1976**, *49*, 703-774.
- (15) Dreyfuss, P. *Macromolecules* **1978**, *11*, 1031-1036.
- (16) Erickson, P. W., ; Silver, I. U.S. Patent 2776910 1957.
- (17) Eilerman, G. E. U.S. Patent 3116192 A, 1963.
- (18) Osterholtz, F. D.; Pohl, E. R. *J. Adhes. Sci. Technol.* **1992**, *6*, 127-149.
- (19) Buening, R.; Hanisch, H.; Hass, H. J.; Roedder, K. M. Patent D.E. 2730008 A1, 1979.
- (20) Miller, A. C.; Berg, J. C. *J. Adhes. Sci. Technol.* **2002**, *16*, 1949-1956.
- (21) Plueddemann, E. P.; Fanger, G. *J. Am. Chem. Soc.* **1959**, *81*, 2632-2635.
- (22) Mittal, K. *Silanes and Other Coupling Agents*; VSP: Utrecht, 1992.
- (23) Denmark, S. E.; Regens, C. S. *Acc. Chem. Res.* **2008**, *41*, 1486-1499.
- (24) Fleming, I.; Dunoguès, J.; Smithers, R. In *Organic Reactions*; John Wiley & Sons, Inc.: 2004.
- (25) Brook, A. G. *Acc. Chem. Res.* **1974**, *7*, 77-84.

- (26) Tamao, K.; Ishida, N.; Tanaka, T.; Kumada, M. *Organometallics* **1983**, *2*, 1694-1696.
- (27) Tamao, K.; Ishida, N. *J. Organomet. Chem.* **1984**, *269*, c37-c39.
- (28) Fleming, I.; Henning, R.; Plaut, H. *J. Chem. Soc., Chem. Commun.* **1984**, 29-31.
- (29) Fleming, I.; Henning, R.; Parker, D. C.; Plaut, H. E.; Sanderson, P. E. J. *J. Chem. Soc., Perkin Trans. I* **1995**, 317-337.
- (30) Jones, G. R.; Landais, Y. *Tetrahedron* **1996**, *52*, 7599-7662.
- (31) Barrett, A. G. M.; Head, J.; Smith, M. L.; Stock, N. S.; White, A. J. P.; Williams, D. J. *J. Org. Chem.* **1999**, *64*, 6005-6018.
- (32) Sun, P.; Sun, C.; Weinreb, S. M. *J. Org. Chem.* **2002**, *67*, 4337-4345.
- (33) Harrison, T. J.; Rabbat, P. M. A.; Leighton, J. L. *Org. Lett.* **2012**, *14*, 4890-4893.
- (34) Tamao, K.; Nakajima, T.; Sumiya, R.; Arai, H.; Higuchi, N.; Ito, Y. *J. Am. Chem. Soc.* **1986**, *108*, 6090-6093.
- (35) Peterson, D. J. *J. Org. Chem.* **1968**, *33*, 780-784.
- (36) Chan, T.-H. *Acc. Chem. Res.* **1977**, *10*, 442-448.
- (37) Staden, L. F. v.; Gravestock, D.; Ager, D. J. *Chemical Society Reviews* **2002**, *31*, 195-200.
- (38) Ager, D. J. In *Organic Reactions*; John Wiley & Sons, Inc.: 2004.
- (39) Aubele, D. L.; Wan, S.; Floreancig, P. E. *Angew. Chem. Int. Ed.* **2005**, *44*, 3485-3488.
- (40) Toró, A. s.; Nowak, P.; Deslongchamps, P. *J. Am. Chem. Soc.* **2000**, *122*, 4526-4527.
- (41) Beveridge, R. E.; Batey, R. A. *Org. Lett.* **2013**, *15*, 3086-3089.
- (42) Zakarian, A.; Batch, A.; Holton, R. A. *J. Am. Chem. Soc.* **2003**, *125*, 7822-7824.
- (43) Noels, A. F., ; Hubert, A.J. In *Catalysis by Metal Complexes*; Mortreux, A., ; Petit, F., Ed.; Springer Netherlands: 1988.
- (44) Putzien, S.; Nuyken, O.; Kühn, F. E. *Prog. Polym. Sci.* **2010**, *35*, 687-713.
- (45) Huhn K.; Kaufmann, R. Patent DE 3431075, 1986.
- (46) Putzien, S. Dissertation, Technische Universität München, 2012.
- (47) Chauhan, B. P. S.; Balagam, B. *Macromolecules* **2006**, *39*, 2010-2012.
- (48) Curry, J. W. *J. Am. Chem. Soc.* **1956**, *78*, 1686-1689.
- (49) Li, Y.; Kawakami, Y. *Macromolecules* **1998**, *31*, 5592-5597.
- (50) Sommer, L. H.; Ansul, G. R. *J. Am. Chem. Soc.* **1955**, *77*, 2482-2485.
- (51) Guida-Pietrasanta, F.; Boutevin, B.; Nuyken, O. In *Inorganic Polymeric Nanocomposites and Membranes*; Springer Berlin Heidelberg: Berlin, Heidelberg, 2005, p 1-27.

-
- (52) Sargent, J. R.; Weber, W. P. *Macromolecules* **1999**, *32*, 2826-2829.
- (53) Mathias, L. J.; Lewis, C. M. *Macromolecules* **1993**, *26*, 4070-4071.
- (54) Naga, N.; Oda, E.; Toyota, A.; Horie, K.; Furukawa, H. *Macromol. Chem. Phys.* **2006**, *207*, 627-635.
- (55) Naga, N.; Kihara, Y.; Miyanaga, T.; Furukawa, H. *Macromolecules* **2009**, *42*, 3454-3462.
- (56) Tilley, T. D. *Acc. Chem. Res.* **1993**, *26*, 22-29.
- (57) Vera, B. P.; Mikhail, G. V.; Kopylova, L. I. *Russ. Chem. Rev.* **2000**, *69*, 137-151.
- (58) Feigl, A.; Bockholt, A.; Weis, J.; Rieger, B. In *Silicon Polymers*; Muzafarov, M. A., Ed.; Springer Berlin Heidelberg: Berlin, Heidelberg, p 1-31.
- (59) Priegert, A. M.; Rawe, B. W.; Serin, S. C.; Gates, D. P. *Chem. Soc. Rev.* **2016**, *45*, 922-953.
- (60) Rochow, E. G. *J. Am. Chem. Soc.* **1945**, *67*, 963-965.
- (61) Katoh, K.; Ito, S.; Wada, Y.; Higashi, E.; Suzuki, Y.; Kubota, K.; Nakano, K.; Wada, Y. *J. Chem. Thermodyn.* **2011**, *43*, 1229-1234.
- (62) Belyakova, Z. V.; Pomerantseva, M. G.; Efimova, L. A.; Chernyshev, E. A.; Storozhenko, P. A. *Russ. J. Gen. Chem.* **2010**, *80*, 728-733.
- (63) Saam, J. C.; Speier, J. L. *J. Am. Chem. Soc.* **1958**, *80*, 4104-4106.
- (64) Parker, S. E. Doctoral dissertation, Harvard university, 2014.
- (65) Karstedt, B. D. Patent DE 2307085 A1, 1973.
- (66) Stein, J.; Lewis, L. N.; Gao, Y.; Scott, R. A. *J. Am. Chem. Soc.* **1999**, *121*, 3693-3703.
- (67) Yamamoto, K.; Hayashi, T.; Kumada, M. *J. Am. Chem. Soc.* **1971**, *93*, 5301-5302.
- (68) Watanabe, H.; Asami, M.; Nagai, Y. *J. Organomet. Chem.* **1980**, *195*, 363-373.
- (69) Marciniak, B.; Guliński, J.; Urbaniak, W.; Nowicka, T.; Mirecki, J. *Appl. Organomet. Chem.* **1990**, *4*, 27-34.
- (70) Markó, I. E.; Stérin, S.; Buisine, O.; Mignani, G.; Branlard, P.; Tinant, B.; Declercq, J.-P. *Science* **2002**, *298*, 204-206.
- (71) Markó, I. E.; Stérin, S.; Buisine, O.; Berthon, G.; Michaud, G.; Tinant, B.; Declercq, J.-P. *Adv. Synth. Catal.* **2004**, *346*, 1429-1434.
- (72) Buisine, O.; Berthon-Gelloz, G.; Briere, J.-F.; Sterin, S.; Mignani, G.; Branlard, P.; Tinant, B.; Declercq, J.-P.; Marko, I. E. *Chem. Commun.* **2005**, 3856-3858.
- (73) Taige, M. A.; Ahrens, S.; Strassner, T. *J. Organomet. Chem.* **2011**, *696*, 2918-2927.
- (74) Holwell, A. J. *Platinum Met. Rev.* **2008**, *52*, 243-246.
- (75) <http://www.platinum.matthey.com/pgm-prices/>.
-

- (76) Nesmeyanov, A. N.; Freidlina, R. K.; Chukovskaya, E. C.; Petrova, R. G.; Belyavsky, A. B. *Tetrahedron* **1962**, *17*, 61-68.
- (77) A. Schroeder, M.; S. Wrighton, M. *J. Organomet. Chem.* **1977**, *128*, 345-358.
- (78) Randolph, C. L.; Wrighton, M. S. *J. Am. Chem. Soc.* **1986**, *108*, 3366-3374.
- (79) Sunada, Y.; Tsutsumi, H.; Shigeta, K.; Yoshida, R.; Hashimoto, T.; Nagashima, H. *Dalt. Trans.* **2013** *42*, 16687-16692.
- (80) Bart, S. C.; Lobkovsky, E.; Chirik, P. J. *J. Am. Chem. Soc.* **2004**, *126*, 13794-13807.
- (81) Tondreau, A. M.; Atienza, C. C. H.; Weller, K. J.; Nye, S. A.; Lewis, K. M.; Delis, J. G. P.; Chirik, P. J. *Science* **2012**, *335*, 567-570.
- (82) Tondreau, A. M.; Atienza, C. C. H.; Darmon, J. M.; Milsmann, C.; Hoyt, H. M.; Weller, K. J.; Nye, S. A.; Lewis, K. M.; Boyer, J.; Delis, J. G. P.; Lobkovsky, E.; Chirik, P. J. *Organometallics* **2012**, *31*, 4886-4893.
- (83) Kamata, K.; Suzuki, A.; Nakai, Y.; Nakazawa, H. *Organometallics* **2012**, *31*, 3825-3828.
- (84) Greenhalgh, M. D.; Frank, D. J.; Thomas, S. P. *Adv. Synth. Catal.* **2014**, *356*, 584-590.
- (85) Peng, D.; Zhang, Y.; Du, X.; Zhang, L.; Leng, X.; Walter, M. D.; Huang, Z. *J. Am. Chem. Soc.* **2013**, *135*, 19154-19166.
- (86) Noda, D.; Tahara, A.; Sunada, Y.; Nagashima, H. *J. Am. Chem. Soc.* **2016**, *138*, 2480-2483.
- (87) Chalk, A. J.; Harrod, J. F. *J. Am. Chem. Soc.* **1965**, *87*, 1133-1135.
- (88) Chalk, A. J.; Harrod, J. F. *J. Am. Chem. Soc.* **1967**, *89*, 1640-1647.
- (89) Magomedov, G. K. I.; Andrianov, K. A.; Shkolnik, O. V.; Izmailov, B. A.; Kalinin, V. N. *J. Organomet. Chem.* **1978**, *149*, 29-36.
- (90) Takeshita, K.; Seki, Y.; Kawamoto, K.; Murai, S.; Sonoda, N. *J. Org. Chem.* **1987**, *52*, 4864-4868.
- (91) Archer, N. J.; Haszeldine, R. N.; Parish, R. V. *J. Chem. Soc. D: Chem. Commun.* **1971**, 524-525.
- (92) Archer, N. J.; Haszeldine, R. N.; Parish, R. V. *J. Chem. Soc., Dalton Trans.* **1979**, 695-702.
- (93) Brookhart, M.; Grant, B. E. *J. Am. Chem. Soc.* **1993**, *115*, 2151-2156.
- (94) Mo, Z.; Liu, Y.; Deng, L. *Angew. Chem. Int. Ed.* **2013**, *52*, 10845-10849.
- (95) Atienza, C. C. H.; Diao, T.; Weller, K. J.; Nye, S. A.; Lewis, K. M.; Delis, J. G. P.; Boyer, J. L.; Roy, A. K.; Chirik, P. J. *J. Am. Chem. Soc.* **2014**, *136*, 12108-12118.
- (96) Chen, C.; Hecht, M. B.; Kavara, A.; Brennessel, W. W.; Mercado, B. Q.; Weix, D. J.; Holland, P. L. *J. Am. Chem. Soc.* **2015**, *137*, 13244-13247.
- (97) Nozakura, S.; Konotsune, S. *Bull. Chem. Soc. Jpn.* **1956**, *29*, 326-331.
- (98) Chukovskaya E. T.; Freidlina, R. K. *Izv. Akad. Nauk SSSR, Otd. Khim. Nauk* **1963**, 761.

-
- (99) Kiso, Y.; Kumada, M.; Maeda, K.; Sumitani, K.; Tamao, K. *J. Organomet. Chem.* **1973**, *50*, 311-318.
- (100) Kiso, Y.; Kumada, M.; Tamao, K.; Umeno, M. *J. Organomet. Chem.* **1973**, *50*, 297-310.
- (101) Marciniak, B.; Maciejewski, H.; Mirecki, J. *J. Organomet. Chem.* **1991**, *418*, 61-67.
- (102) Marciniak, B.; Maciejewski, H. *J. Organomet. Chem.* **1993**, *454*, 45-50.
- (103) Marciniak, B.; Maciejewski, H.; Rosenthal, U. *J. Organomet. Chem.* **1994**, *484*, 147-151.
- (104) Marciniak, B.; Maciejewski, H.; Kownacki, I. *J. Mol. Catal. A: Chem.* **1998**, *135*, 223-231.
- (105) Maciejewski, H.; Marciniak, B.; Kownacki, I. *J. Organomet. Chem.* **2000**, *597*, 175-181.
- (106) Chen, Y.; Sui-Seng, C.; Boucher, S.; Zargarian, D. *Organometallics* **2005**, *24*, 149-155.
- (107) Hyder, I.; Jimenez-Tenorio, M.; Puerta, M. C.; Valerga, P. *Dalt. Trans.* **2007**, 3000-3009.
- (108) , L.; Puerta, M. C.; Valerga, P. *Organometallics* **2012**, *31*, 2175-2183.
- (109) Kuznetsov, A.; Gevorgyan, V. *Org. Lett.* **2012**, *14*, 914-917.
- (110) Lipschutz, M. I.; Tilley, T. D. *Chem. Commun.* **2012**, *48*, 7146-7148.
- (111) Srinivas, V.; Nakajima, Y.; Ando, W.; Sato, K.; Shimada, S. *Catal. Sci. Technol.* **2015**, *5*, 2081-2084.
- (112) Guliński, J.; James, B. R. *J. Mol. Catal.* **1992**, *72*, 167-171.
- (113) Widenhoefer, R. A.; Vadehra, A. *Tetrahedron Lett.* **1999**, *40*, 8499-8502.
- (114) Motoda, D.; Shinokubo, H.; Oshima, K. *Synlett* **2002**, 1529.
- (115) Millan, A.; Towns, E.; Maitlis, P. M. *J. Chem. Soc., Chem. Commun* **1981**, 673-674.
- (116) Onopchenko, A.; Sabourin, E. T.; Beach, D. L. *J. Org. Chem.* **1984**, *49*, 3389-3392.
- (117) Ojima, I.; Clos, N.; Donovan, R. J.; Ingallina, P. *Organometallics* **1990**, *9*, 3127-3133.
- (118) Comte, V.; Le Gendre, P.; Richard, P.; Moïse, C. *Organometallics* **2005**, *24*, 1439-1444.
- (119) Duckett, S. B.; Perutz, R. N. *Organometallics* **1992**, *11*, 90-98.
- (120) Esteruelas, M. A.; Herrero, J.; Oro, L. A. *Organometallics* **1993**, *12*, 2377-2379.
- (121) Glaser, P. B.; Tilley, T. D. *J. Am. Chem. Soc.* **2003**, *125*, 13640-13641.
- (122) Brunner, H. *Angew. Chem. Int. Ed.* **2004**, *43*, 2749-2750.
- (123) Klei, S. R.; Tilley, T. D.; Bergman, R. G. *Organometallics* **2002**, *21*, 4648-4661.
- (124) Igarashi, M.; Matsumoto, T.; Kobayashi, T.; Sato, K.; Ando, W.; Shimada, S.; Hara, M.; Uchida, H. *J. Organomet. Chem.* **2014**, *752*, 141-146.
- (125) Harrod, J. F.; Yun, S. S. *Organometallics* **1987**, *6*, 1381-1387.
- (126) Kesti, M. R.; Abdulrahman, M.; Waymouth, R. M. *J. Organomet. Chem.* **1991**, *417*, C12-C15.
- (127) Corey, J. Y.; Zhu, X. H. *Organometallics* **1992**, *11*, 672-683.
-

- (128) Kesti, M. R.; Waymouth, R. M. *Organometallics* **1992**, *11*, 1095-1103.
- (129) Hao, L.; Harrod, J. F.; Lebuis, A.-M.; Mu, Y.; Shu, R.; Samuel, E.; Woo, H.-G. *Angew. Chem. Int. Ed.* **1998**, *37*, 3126-3129.
- (130) Jia, L.; Zhao, J.; Ding, E.; Brennessel, W. W. *J. Chem. Soc., Dalton Trans.* **2002**, 2608-2615.
- (131) Molander, G. A.; Romero, J. A. C. *Chem. Rev.* **2002**, *102*, 2161-2186.
- (132) Abinet, E.; Spaniol, T. P.; Okuda, J. *Chem. Asian J.* **2011**, *6*, 389-391.
- (133) Fu, P.-F.; Brard, L.; Li, Y.; Marks, T. J. *J. Am. Chem. Soc.* **1995**, *117*, 7157-7168.
- (134) Gountchev, T. I.; Tilley, T. D. *Organometallics* **1999**, *18*, 5661-5667.
- (135) Buch, F.; Brettar, J.; Harder, S. *Angew. Chem. Int. Ed.* **2006**, *45*, 2741-2745.
- (136) Harder, S. *Chem. Rev.* **2010**, *110*, 3852-3876.
- (137) Leich, V.; Spaniol, T. P.; Okuda, J. *Organometallics* **2016**, *35*, 1179-1182.
- (138) Chalk, A. J.; Harrod, J. F. *J. Am. Chem. Soc.* **1965**, *87*, 16-21.
- (139) Roy, A. K.; Taylor, R. B. *J. Am. Chem. Soc.* **2002**, *124*, 9510-9524.
- (140) Sakaki, S.; Ogawa, M.; Musashi, Y.; Arai, T. *J. Am. Chem. Soc.* **1994**, *116*, 7258-7265.
- (141) Ozawa, F.; Hikida, T.; Hayashi, T. *J. Am. Chem. Soc.* **1994**, *116*, 2844-2849.
- (142) Sakaki, S.; Mizoe, N.; Sugimoto, M. *Organometallics* **1998**, *17*, 2510-2523.
- (143) Sakaki, S.; Mizoe, N.; Musashi, Y.; Biswas, B.; Sugimoto, M. *J. Phys. Chem. A* **1998**, *102*, 8027-8036.
- (144) Sakaki, S.; Mizoe, N.; Musashi, Y.; Sugimoto, M. *J. Mol. Struct.: THEOCHEM* **1999**, *461-462*, 533-546.
- (145) Sakaki, S.; Mizoe, N.; Sugimoto, M.; Musashi, Y. *Coord. Chem. Rev.* **1999**, *190-192*, 933-960.
- (146) Tsipis, C. A.; Kefalidis, C. E. *J. Organomet. Chem.* **2007**, *692*, 5245-5255.
- (147) Tsipis, C. A.; Kefalidis, C. E. *Organometallics* **2006**, *25*, 1696-1706.
- (148) Meister, T. K.; Riener, K.; Gigler, P.; Stohrer, J. r.; Herrmann, W. A.; Kühn, F. E. *ACS Catal.* **2016**, *6*, 1274-1284.
- (149) Schroeder, M. A.; Wrighton, M. S. *J. Organomet. Chem.* **1977**, *128*, 345-358.
- (150) Mitchener, J. C.; Wrighton, M. S. *J. Am. Chem. Soc.* **1981**, *103*, 975-977.
- (151) Reichel, C. L.; Wrighton, M. S. *Inorg. Chem.* **1980**, *19*, 3858-3860.
- (152) Hayashi, T. *Acc. Chem. Res.* **2000**, *33*, 354-362.
- (153) H. Nishiyama, K. I.; Ojima, I., Ed.; Wiley-VCH: New York, **2000**, p 111.

- (154) T. Hayashi In *Comprehensive Asymmetric Catalysis*; E. N. Jacobsen, A. P., H. Yamamoto, Ed.; Springer: Berlin, **1999**.
- (155) Uozumi, Y.; Hayashi, T. *J. Am. Chem. Soc.* **1991**, *113*, 9887-9888.
- (156) Uozumi, Y.; Hayashi, T. *Tetrahedron Lett.* **1993**, *34*, 2335-2338.
- (157) Pioda, G.; Togni, A. *Tetrahedron: Asymmetry* **1998**, *9*, 3903-3910.
- (158) Jensen, J. F.; Svendsen, B. Y.; la Cour, T. V.; Pedersen, H. L.; Johannsen, M. *J. Am. Chem. Soc.* **2002**, *124*, 4558-4559.
- (159) Tsuchiya, Y.; Uchimura, H.; Kobayashi, K.; Nishiyama, H. *Synlett* **2004**, *2004*, 2099-2102.
- (160) Chen, J.; Cheng, B.; Cao, M.; Lu, Z. *Angew. Chem. Int. Ed.* **2015**, *54*, 4661-4664.

Chapter 2

Chemoselective Alkene Hydrosilylation Catalyzed by Nickel Pincer Complexes

Reprinted with permission from “Buslov, I.; Becouse, J.; Mazza, S.; Montandon-Clerc, M.; Hu, X. Chemoselective Alkene Hydrosilylation Catalyzed by Nickel Pincer Complexes *Angewandte Chemie International Edition*. doi: 10.1002/anie.201507829”. © 2015 WILEY-VCH Verlag GmbH & Co. KGaA, Weinheim

2.1 Introduction

Hydrosilylation of alkenes is widely used for the production of numerous consumer goods and fine chemicals.¹⁻⁵ Platinum catalysts, such as Speier's^{6,7} catalyst and Karstedt's⁸ complex, are most often used for this reaction due to their high activity and selectivity. However, the high cost and low abundance of platinum motivates the development of alternative catalysts based on more abundant and economical metals. A number of iron and nickel catalysts have shown good efficiency and activity for alkene hydrosilylation.^{1,9-14} In pioneer work, Chirik and co-workers reported that bis(imino)pyridine (PDI) iron(0) bis(dinitrogen) complexes catalyzed anti-Markovnikov hydrosilylation of terminal alkenes.¹⁵ Modification of the steric properties of the PDI ligands allows for the coupling of tertiary silanes.^{16,17} Related terpyridine and bis-(imino)pyridine iron(II) dialkyl complexes were also catalysts for the hydrosilylation of alkenes and alkynes.¹⁸ These iron complexes exhibit high activity with turnover frequencies (TOFs) of up to 100,000 h⁻¹, but they are not compatible with carbonyl groups, which compete favorably with alkenes for hydrosilylation. The limited stability of these complexes is another constrain. Several groups had then used stable Fe(II) complexes as pre-catalysts and NaBHET₃ or an organometallic reagent as activating reagent to generate active Fe catalysts for anti-Markovnikov alkene hydrosilylation.¹⁹⁻²¹ This modification improved the stability of the catalysts. Nevertheless, functional group compatibility remains to be improved. In a notable example, Huang and co-workers developed phosphinite-iminopyridine (PNN) Fe(II) complexes, where the more electron-rich character of PNN ligand relative to PDI was exploited to decrease the oxophilicity of the catalysts and improve their tolerance towards carbonyl groups. Indeed, in combination with NaBHET₃ as the activating agent, these complexes catalyzed anti-Markovnikov hydrosilylation of alkenes containing several important functional groups including ester, tertiary amide, and ketone.²⁰ Notwithstanding, internal alkenes and terminal alkenes containing secondary amide groups could not be hydrosilylated.

A number of nickel-based catalysts for regioselective hydrosilylation of alkenes have been reported recently. [Ni(R-Indenyl)(PPh₃)Cl] (R = Me, SiMe₃), activated by NaBPh₄, catalyzed hydrosilylation of styrene with PhSiH₃ to give the Markovnikov product.²² Cationic allyl nickel complexes also catalyzed Markovnikov hydrosilylation of styrenes with phenylsilane.^{23,24} On the other hand, (PPh₃)₂NiBr₂ catalyzed anti-Markovnikov

hydrosilylation of styrenes with Ph_2SiH_2 .²⁵ A two-coordinate nickel bis(amido) complex also catalyzed anti-Markovnikov hydrosilylation of 1-octene with Ph_2SiH_2 .²⁶ However, broad-scope and functional-group-compatible hydrosilylation of alkenes has not been demonstrated by a Ni-based catalytic system. In this chapter nickel (II) bis(amino)amide (N_2N) pincer complexes are reported to catalyze chemoselective anti-Markovnikov hydrosilylation of alkenes. The catalysis has high activity and broad scope. Not only ester, keto, and NH_2 groups, but also formyl and secondary amide groups, previously only tolerated in precious metal catalysis, is compatible with this Ni catalysis. The Ni catalysts also catalyze tandem isomerization and anti-Markovnikov hydrosilylation of internal alkenes.

It was demonstrated earlier that bis(amino)amide nickel chloride complex $[(^{\text{Me}}\text{N}_2\text{N})\text{Ni}-\text{Cl}]$ (**2-1**) was an excellent catalyst for cross-couplings of non-activated alkyl halides and direct C–H alkylation.²⁷⁻³² Reaction of **2-1** with NaOMe gave the methoxide complex $[(^{\text{Me}}\text{N}_2\text{N})\text{Ni}-\text{OMe}]$ (**2-2**), which reacted with Ph_2SiH_2 to yield the hydride complex $[(^{\text{Me}}\text{N}_2\text{N})\text{Ni}-\text{H}]$ (**2-3**) (Scheme 2.1).³³ Complex **2-3** reacted with acetone and ethylene and to give $[(^{\text{Me}}\text{N}_2\text{N})\text{Ni}-\text{O}^i\text{Pr}]$ (**2-4**) and $[(^{\text{Me}}\text{N}_2\text{N})\text{Ni}-\text{Et}]$ (**2-5**), respectively. The reaction with acetone was slow and took 12 h to complete. However, the reaction with ethylene was much faster and completed within minutes.

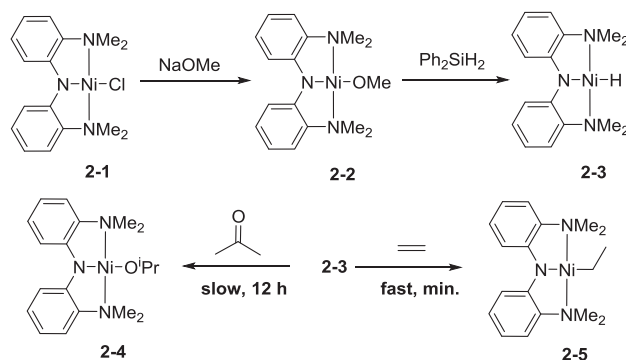

Scheme 2.1: Structure and transformations of N_2N nickel pincer complexes

Thus, supported by the $^{\text{Me}}\text{N}_2\text{N}$ pincer ligand, the Ni(II) hydride species, the proposed intermediate in many Ni-catalyzed hydrosilylation reactions, reacts preferentially with C=C double bond over a carbonyl group. This result suggests that the N_2N -Ni pincer complexes might be potential catalysts for chemoselective hydrosilylation of alkenes containing carbonyl groups.

2.2 Optimisation of the Reaction Conditions

In the presence of 1 equivalent of NaOⁱPr, 10 mol % of **2-1** catalyzed hydrosilylation of 1-octene with Ph₂SiH₂ at -70 °C to give octyldiphenylsilane in 93% yield. The NaOⁱPr base was used to convert **2-1** to [(^{Me}N₂N)Ni-OⁱPr], which presumably activated the silane to give the hydride complex **2-3**. To conduct the reactions under base-free conditions, which may provide better group tolerance, the alkoxide complexes [(^{Me}N₂N)Ni-OMe] (**2-2**) and [(^{Me}N₂N)Ni-OⁱPr] (**2-4**) were then tested as catalysts. Both complexes catalyze the hydrosilylation of 1-octene with Ph₂SiH₂ in high yields at room temperature.

The scope and tolerance of hydrosilylation were then explored using complex **2-2** as the catalyst (Table 2.1). For convenience of handling, the catalyst loading was 1 mol % in this lab-scale reactions (0.5 mmol). Secondary silanes worked best, while primary and tertiary silanes gave lower yields (Table 2.1).

Table 2.1: Silane scope and limitations of Ni-catalyzed hydrosilylation of alkenes^a

Reaction scheme: 1-octene (0.5 mmol) + Silane (1.2 equiv.) $\xrightarrow[\text{THF, rt, 12 h}]{\text{2-2, 1 mol \%}}$ Octylsilane (SiRR'₂)

Entry	Silane	Yield ^b (%)
1	PhSiH ₃	9
2	Ph ₂ SiH ₂	>95
3	(MeO) ₃ SiH	31
4	(EtO) ₃ SiH	8
5	Me(EtO) ₂ SiH	2
6	(Me ₃ SiO) ₂ MeSiH	0
7	Et ₃ SiH	0
8	Ph ₃ SiH	0

^aConditions : alkene (0.5 mmol), silane (1.2 equiv.), [Ni]OMe (1 mol %), THF (1 mL), 12 hours, rt. ^bThe reported yields are GCMS yields (dodecane was used as internal standard).

In entry 1 fast decomposition of the catalyst was observed, probably due to reaction of triphenylsilane with **2-3**. In entries 6-8 no hydrosilylation product was detected. Silanes (Me₃SiO)₂MeSiH and Et₃SiH do not react with **2-2** to give **2-3**, thus no hydrosilylation can occur. Ph₃SiH reacts slowly with **2-2**, however no octyltriphenylsilane was detected.

To estimate the activity, solvent-free reaction of 1-octene with Ph_2SiH_2 was performed at room temperature in a 10 mmol scale. Using 0.025 mol % of the catalyst [$^{13}\text{C}_6\text{N}_2\text{N}$]Ni-OMe, 98% conversion was reached in 2.5 - 3 minutes, giving an averaged TOF of about 83,000 h^{-1} . The catalyst loading for this reaction could be lowered to 0.01 mol %, giving a TON of about 10,000. (Table 2.2) This reactivity is among the highest for non-precious metals in alkene hydrosilylation reactions.

Table 2.2: Entries for the evaluation of activity of Ni precatalyst for the hydrosilylation of 1-octene with diphenylsilane

Entry	mol % = (mol complex / mol alkene) *100	ppm = mg complex / kg reaction mixture	time, sec	TOF (h^{-1})
1	0.025	270	180	80000
2	0.025	270	150	96000
3	0.025	270	180	80000
4	0.010	108	420	85700
5	0.010	108	480	75000

The formation of 15-25% of dioctyldiphenylsilane was observed by GCMS (neat reaction is highly exothermic, addition of the solvent prevents the formation of dialkyldiphenylsilanes). Blank experiment was performed: 2.02 g (10.98 mmol) of Ph_2SiH_2 and 1.12 g (10.00 mmol) of 1-octene were mixed in 20 mL vial with a screw cap, heated to 120°C and stirred for 10 min. No hydrosilylation product was observed in GC.



2.3 Scope of Alkene Hydrosilylation Catalyzed by **2-2**

With optimised conditions in hand we further discovered the scope and limitations of [$^{13}\text{C}_6\text{N}_2\text{N}$]Ni-OMe (**2-2**) in alkene hydrosilylation.

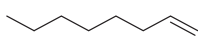
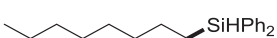
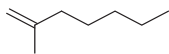
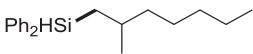
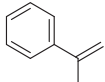
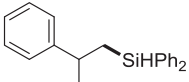

2.3.1 Scope of Ni-catalyzed Hydrosilylation of Terminal and Cyclic Alkenes

A large number of functionalized alkenes were hydrosilylated with anti-Markovnikov selectivity (Table 2.3). Not only terminal, but also cyclic alkenes (entries 4, 17, Table 2.3) were reactive. The reaction was faster for terminal alkene than for cyclic alkene, so a substrate containing both groups was selectively hydrosilylated at the terminal alkene moiety (entry 5, Table 2.3). Substitution at the internal position of the olefin was allowed (entries 2-3, Table 2.3). Excellent functional group tolerance was achieved. Epoxide (entry 6, Table 2.3), aryl bromide (entry 7, Table 2.3), alkyl bromide (entry 8, Table 2.3), ester (entries 9, 19, Table 2.3), and tertiary amine (entry 13, Table 2.3) were readily tolerated. Moreover, primary amine (entries 10-12, Table 2.3),³⁴ and NH-containing amides such as NH-COCF₃ (entries 14-15, Table 2.3), carbamate NH-Boc (entry 16, Table 2.3), and sulfonylamide NH-SO₂Me (entry 18, Table 2.3), which were challenging for previous Fe- and Ni-catalysts,²⁰ were compatible with the current method. Unfortunately, like for previous non-precious catalysts, alcohols, carboxylic acids, and allylhalides remained incompatible. Interestingly, no hydrosilylation was obtained for the reactions of Ph₂SiH₂ with terminal (1-octyne and phenylacetylene) and internal (2-octyne) alkynes.

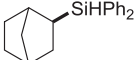
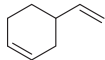
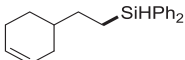
Table 2.3: Ni-catalyzed hydrosilylation of terminal and cyclic alkenes^a

Ph ₂ SiH ₂ + Alkene		$\xrightarrow[\text{THF, rt, 6 h}]{\mathbf{2-2} \text{ (1 mol \%)}}$	Alkyl-SiHPh ₂	
Entry	Alkene	Product	Yield ^b (%)	
1			93 ^c	
2			72	
3			90	
4			88 ^c	
5			80 ^d	

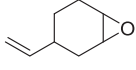
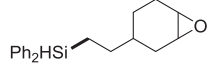
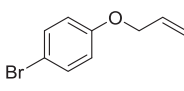
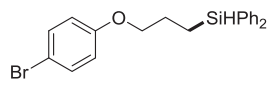
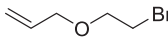
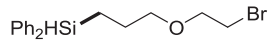
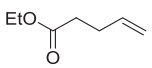
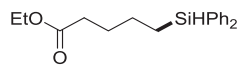
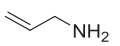
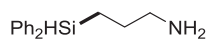
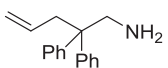
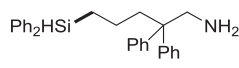
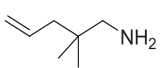
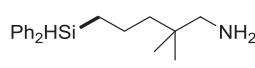
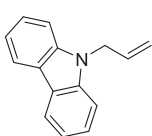
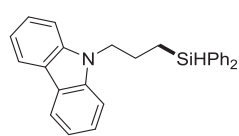
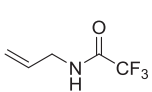
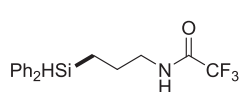
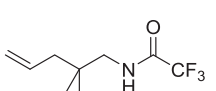
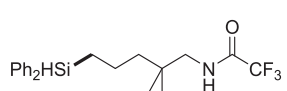
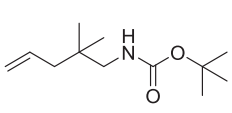
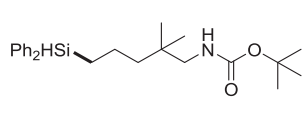
Chemoselective Alkene Hydrosilylation Catalyzed by Nickel Pincer Complexes

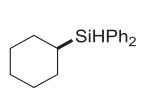
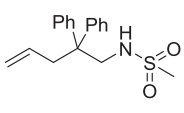
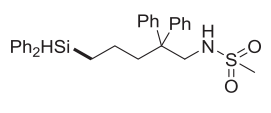
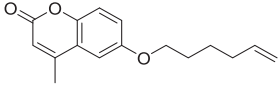
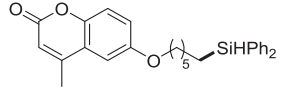
6			88
7			74
8			77
9			58
10			75 ^e
11			84
12			94
13			91
14			85
15			89
16			65
17			41 ^c
18			80
19			65

^a Conditions : alkene (0.5 mmol), Ph₂SiH₂ (1.2 equiv.), [(^{Me}N₂N)Ni-OMe] (1 mol %), THF (1 mL), 6 hours, rt. ^b Isolated yields are reported. ^c 5% of [(^{Me}N₂N)Ni-OMe] and 24 h. ^d Alkene (0.55 mmol), Ph₂SiH₂ (0.5 mmol). ^e 2 mmol scale, 8 % of 2-(diphenylsilyl)propanamine was also produced.

2.3.2 Ni-catalyzed Hydrosilylation of Ketone- and Formyl-containing Alkenes

Ni-catalyzed hydrosilylation of ketones and aldehydes is well established.³⁵⁻³⁷ Therefore, selective hydrosilylation of alkenes in the presence of ketones and aldehydes is challenging. Using the protocol in Table 2.1, 5-hexen-2-one was hydrosilylated with Ph_2SiH_2 giving 6-(diphenylsilyl)hexan-2-one in 53% yield and 9:1 selectivity for alkene versus ketone hydrosilylation. Changing the solvent from THF to DMA improved the selectivity to as high as 15:1. The yields for carbonyl-containing alkenes were further increased using a loading of 2 mol %. Thus, both aliphatic ketone and formyl groups were tolerated (entries 1-4, Table 2.4).

Table 2.4: Ni-catalyzed hydrosilylation of ketone- and formyl-containing alkenes^a

FG = ketone or aldehyde

Entry	Alkene	Product	Yield ^b (%)
1			74 ^c
2			75
3			71
4			94

^a Conditions for entries 1 and 2: alkene (0.55 mmol), Ph_2SiH_2 (0.5 mmol), $[(^{\text{Me}}\text{N}_2\text{N})\text{Ni}-\text{OMe}]$ (2 mol %), DMA (1 mL), 6 hours, rt; for entries 3 and 4: alkene (0.5 mmol), Ph_2SiH_2 (1.2 equiv.), $[(^{\text{Me}}\text{N}_2\text{N})\text{Ni}-\text{OMe}]$ (2 mol %), DMA (1 mL), 6 hours, rt. ^b Isolated yields are reported.

To the best of our knowledge it is the first example of selective hydrosilylation of formyl-containing alkenes by a base-metal catalyst (Table 2.4).

2.4 Synthetic Utility of Synthesized Products

To illustrate the synthetic utility of the hydrosilylation products, two alkylsilanes were oxidized using hydrogen peroxide. The corresponding alcohols were obtained in good yields (Scheme 2.2).

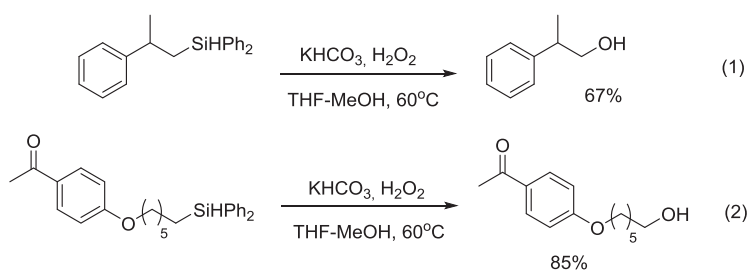



Scheme 2.2: Oxidation of alkylsilanes to alcohols

2.4.1 Nickel-catalyzed Tandem Isomerization - Hydrosilylation of Alkenes

When internal alkenes such as 2-pentene, 2-octene or 1-ethylcyclohexene were used as substrates, certain Pt- and Rh-based catalysts can catalyze tandem isomerization and hydrosilylation to give terminal alkylsilanes.^{6,38,39} Recently, analogous tandem isomerization-hydroboration of internal alkenes was developed.⁴⁰⁻⁴⁴ Related dehydrogenative silylation of internal olefins to yield allylsilanes was also reported.⁴⁵ However, there are few prior reports of base-metal catalyzed tandem isomerization-hydrosilylation reaction.¹⁵

It was found that in the presence of 10 mol % of **2-2**, 2-octene reacted with Ph_2SiH_2 to give octyldiphenylsilane in 77% yield (Table 2.5).

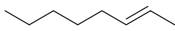
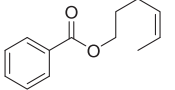
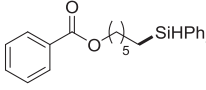
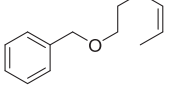
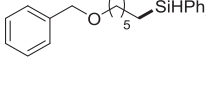
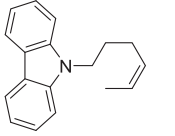
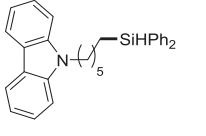
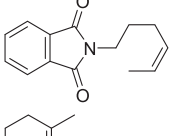
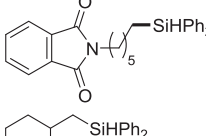
Table 2.5: Ni-catalyzed tandem isomerization-hydrosilylation of alkenes

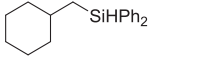
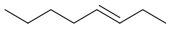
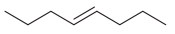
Entry	Method ^a	Substrate	Product	Yield ^b (%)
1	A		n-Octyl-SiHPh ₂	77 ^c
2	A			63 ^c
3	A			64 ^c
4	A			92
5	A			42 ^c
6	A			24 ^d
7	B		n-Octyl-SiHPh ₂	65
8	B		n-Octyl-SiHPh ₂	59

^a Method A: alkene (0.5 mmol), Ph₂SiH₂ (2.0 equiv.), [(^{Me}N₂N)Ni-OMe] (10 mol %), THF (3 mL), 24 hours, rt. Method B : alkene (0.5 mmol), Ph₂SiH₂ (2.0 equiv.), NaO^tBu (1.0 equiv.), [(^{Me}N₂N)Ni-Cl] (10 mol %), THF (3 mL), 24 hours, -70°C. ^b Isolated yields are reported. ^c 6-9 % of internal hydrosilylation product was also obtained. ^d 1-Methylcyclohexene was used as solvent, and GC-MS yield reported.

The reaction is proposed to occur via the isomerization of 2-octene to 1-octene followed by anti-Markovnikov hydrosilylation. The tandem isomerization and hydrosilylation also occurred to other 2-alkenes with various functional groups (entries 2-5, Table 2.5), with good selectivity for the formation of terminal alkylsilanes. For a cyclic substrate, 1-methylcyclohex-1-ene, the yield of isomerization-hydrosilylation was low (entry 6, Table 2.5). For similar reactions of 3- and 4-octenes, a modification of reaction conditions was beneficial. Thus, complex **2-1** was used as the precatalyst, 1 equiv of NaO^tBu was used as base, and the reactions were conducted at -70°C (Method B). Under these conditions, 3- and 4-octenes were isomerized and hydrosilylated to give linear octyldiphenylsilane in good yields (entries 7-8, Table 2.5). It is noted that these tandem reactions are slower than hydrosilylation reactions of terminal alkenes, suggesting that the slow step is the isomerization.

2.5 Mechanistic Studies

To give insights into the mechanism of this Ni-catalyzed hydrosilylation, several experiments were carried out. The hydrosilylation of 1-octene and 5-hexen-2-one with Ph_2SiH_2 had the same yields in the absence and presence of an excess (100 equiv) amount of Hg.²⁷ This result suggests that a homogeneous nickel species is the active catalyst. The reactivity of potential intermediates, $[(^{\text{Me}}\text{N}_2\text{N})\text{Ni-H}]$ (**2-3**) and $[(^{\text{Me}}\text{N}_2\text{N})\text{Ni-Octyl}]$ (**2-6**), was investigated (Scheme 2.3). As previously reported, complex **2-3** reacted rapidly with alkenes to give the corresponding Ni alkyl complexes. It also reacted with Ph_2SiH_2 , leading to decomposition over several hours to yield Ni particles and protonated ligand. This decomposition was not observed under catalytic conditions. Complex **2-6** was synthesized from **2-1** and octylmagnesium chloride following a known procedure.²⁸ No reaction was observed between $[(^{\text{Me}}\text{N}_2\text{N})\text{Ni-Octyl}]$ and Ph_2SiH_2 after 12 h in THF- d_8 . This results suggests that generation of $[(^{\text{Me}}\text{N}_2\text{N})\text{Ni-H}]$ and alkylsilane by reaction of $[(^{\text{Me}}\text{N}_2\text{N})\text{Ni-Octyl}]$ and Ph_2SiH_2 is not likely. On the other hand, addition of an equal amount of 1-decene to a 1:1 mixture of **2-6** and Ph_2SiH_2 triggered a rapid reaction and the formation of decyldiphenylsilane, the hydrosilylation product. Octyldiphenylsilane was not formed in an appreciable amount, indicating that the octyl group in **2-6** was not coupled to the silyl group.

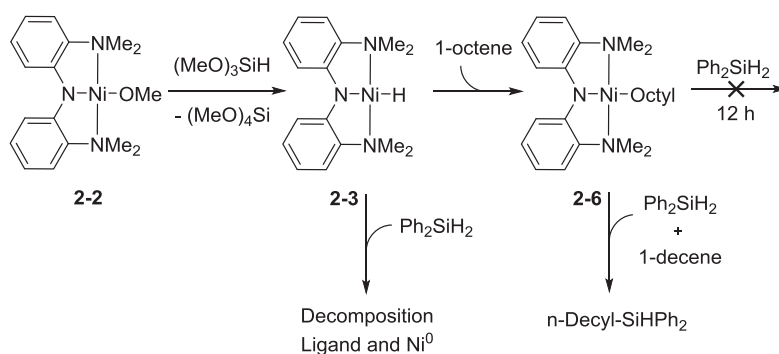

Scheme 2.3: The reactions performed for mechanism studies

The catalytic hydrosilylation of 1-octene with Ph_2SiH_2 using the protocol in Table 2.3 was monitored by ^1H NMR in THF- d_8 . In the beginning of the reaction a signal at - 23.09 ppm appeared, which corresponded to the hydride ligand in complex **2-3**. After 5 minutes a signal at - 0.50 ppm, corresponding to the CH_2 group bound to the Ni ion in complex **2-6** was observed. During the reaction the concentration of **2-6** grew and then reached a plateau, while

the amount of $[(\text{MeN}_2\text{N})\text{Ni-H}]$ constantly decreased. Thus, the Ni alkyl complex **2-6** was the resting state of the catalyst, while the Ni hydride complex **3** was the precursor to **2-6**. To further confirm this, **2-6** was used as the catalyst for the hydrosilylation of 1-octene with Ph_2SiH_2 . Octyldiphenylsilane was formed in a 95 % yield, confirming the catalytic efficiency of **2-6**. When this reaction was monitored by ^1H NMR, only **2-6** was observed as the Ni-containing species.

The information obtained from these experiments and DFT computations allow us to conclude that the catalytic cycle proceeding *via* hydride **2-3** and σ -bond metathesis^{46,47} (Scheme 2.4) is improbable.

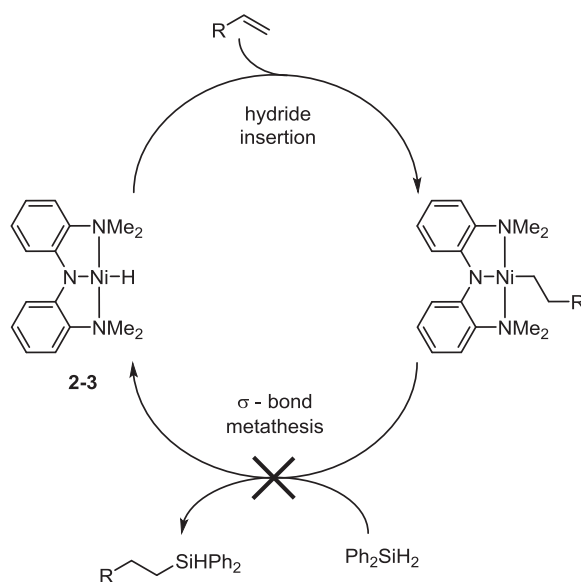

Scheme 2.4: Excluded σ -bond metathesis mechanism

The Chalk-Harrod mechanism,³⁹ widely accepted in Pt-catalyzed alkene hydrosilylation, was also considered and ruled out. According to calculations, oxidative addition of Ph_2SiH_2 to Ni (II) complex **2-6** to form 6-coordinate Ni (IV) intermediate does not occur (Scheme 2.5).

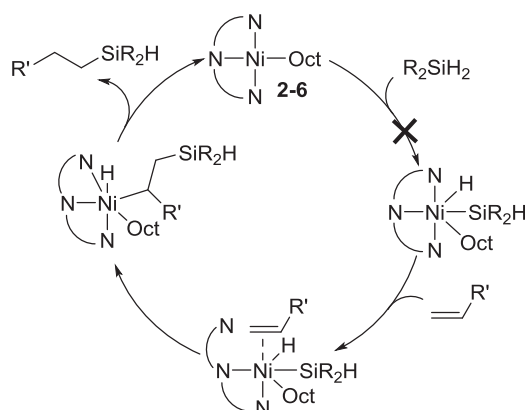

Scheme 2.5: The Chalk-Harrod mechanism for Ni-catalyzed hydrosilylation

We then analyzed another catalytic cycle consisting of (1) alkene coordination, (2) oxidative addition of Si-H, (3) silyl insertion and (4) C-H reductive elimination (Scheme 2.6).

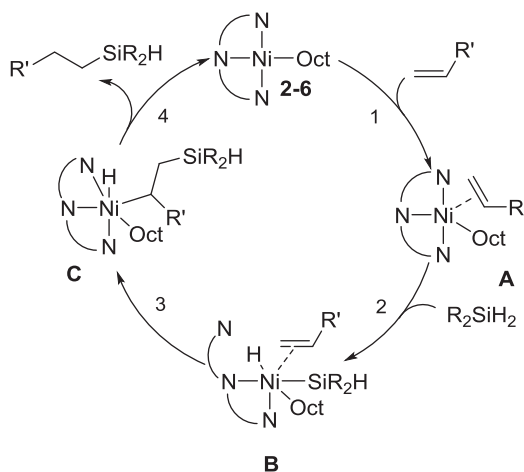
Scheme 2.6: Alternative mechanism starting with alkene coordination and followed by NMe₂ discoordination

The coordination of an alkene to the singlet Ni (II) complex **2-6** is uphill (ca. 15 kcal/mol). At the second step, oxidative addition of Ph₂SiH₂ and discoordination of the dimethylamino group occur (intermediate B). This process is associated with even higher increase of energy (> 25 kcal/mol) which suggests that this mechanism is energetically disfavored.

Finally, the participation of the ligand in elemental steps of catalytic cycle, similarly to reported bifunctional ligands,^{48,49} was also considered (Scheme 2.7). The coordination step is again uphill (ca. 15 kcal/mol). The next step, where Si-H bond is split by Ni and central amido N atom, is more viable than oxidative addition, however, still increasing energy on ~15

kcal/mol. The selectivity of the formation of hydrosilylation product from the intermediate **B** can be explained by higher stability of terminal Ni alkyl complex compared to secondary one.⁵⁰

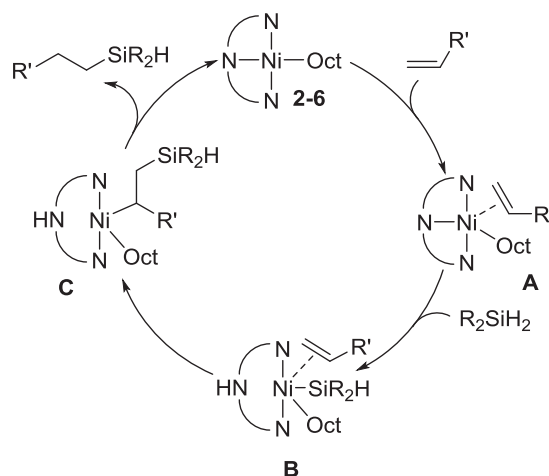

Scheme 2.7: Plausible catalytic cycle including ligand participation

Although this pathway occurs *via* high-energy intermediate species, it cannot be discounted. In order to provide further insights into Ni-catalyzed hydrosilylation mechanism additional density functional theory computations have to be undertaken.

2.6 Conclusions

In summary, we have developed an efficient protocol for Ni-catalyzed anti-Markovnikov hydrosilylation of functionalized alkenes. While several nickel bis(amino)amide pincer complexes are competent catalysts, the methoxide complex $[(^{\text{Me}}\text{N}_2\text{N})\text{Ni}-\text{OMe}]$ (**2-2**) is a highly active and selective catalyst under base-free condition. Ester-, amido-, sulfonylamido-, amino-, ketone- and even formyl-groups were tolerated. Furthermore, the nickel pincer complexes catalyze isomerization-hydrosilylation of internal functionalized alkenes.

2.7 Experimental

2.7.1 Chemicals and Reagents

All manipulations were carried out under an inert N₂(g) atmosphere using standard Schlenk or glovebox techniques. Solvents were purified using a two-column solid-state purification system (Innovative Technology, NJ, USA) and transferred to the glove box without exposure to air. Deuterated solvents were purchased from Cambridge Isotope Laboratories, Inc., and were degassed and stored over activated 3 Å molecular sieves. THF-d₈ was purchased from ARMAR AG, and was degassed and stored over activated 3 Å molecular sieves. Unless otherwise noted, all other reagents and starting materials were purchased from commercial sources and used without further purification. Liquid compounds were degassed by standard freeze-pump-thaw procedures prior to use. The following chemicals were prepared according to procedures in the literature:

complexes [(MeN₂N)Ni-Cl] (**2-1**), [(MeN₂N)Ni-Et] (**2-5**), [(MeN₂N)Ni-nOct] (**2-6**)⁵¹; [(MeN₂N)Ni-OMe] (**2-2**) and [(MeN₂N)Ni-iOPr] (**2-4**)⁵²; substrates 3-(2-bromoethoxy)prop-1-ene⁵³, (Z)-6-bromohex-2-ene⁵⁴, N-(2,2-diphenylpent-4-en-1-yl)-N-methanesulfonamide⁵⁵, N-allyl-2,2,2-trifluoroacetamide and N-(2,2-dimethylpent-4-en-1-yl)-2,2,2-trifluoroacetamide⁵⁶, 2,2-Dimethylpent-4-en-1-amine and 2,2-Diphenylpent-4-en-1-amine⁵⁷, N-Boc-2,2-Dimethylpent-4-en-1-amine⁵⁸, 4-(hex-5-en-1-yloxy)acetophenone⁵⁹, 1-(hex-5-en-1-yl)-1H-indole-3-carbaldehyde⁶⁰, 9-allyl-9H-carbazole⁶¹, (3-(allyloxy)prop-1-yn-1-yl)benzene⁶², (Z)-(6-benzyloxy)-2-hexene⁶³, (Z)-2-(hex-4-en-1-yl)isoindoline-1,3-dione⁶⁴.

2.7.2 Physical Methods

The ^1H and ^{13}C NMR spectra were recorded at 293 K or 373 K on Bruker Avance 400 spectrometers. ^1H NMR chemical shifts were referenced to residual solvent as determined relative to Me_4Si ($\delta = 0$ ppm). The $^{13}\text{C}\{^1\text{H}\}$ chemical shifts were reported in ppm relative to the carbon resonance of CDCl_3 (77.16 ppm), C_6D_6 (128.06). GC measurement was conducted on a Perkin-Elmer Clarus 400 GC with a FID detector. HRMS (ESI and APCI) measurements were conducted at the EPFL ISIC Mass Spectrometry Service with a Micro Mass QTOF. Elemental analyses were performed on a Carlo Erba EA 1110 CHN instrument at EPFL.

2.7.3 The Procedures for the Preparation of Starting Materials

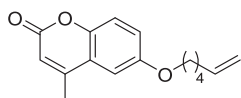

Preparation of 6-(hex-5-en-1-yloxy)-4-methyl-2H-chromen-2-one

A 100 mL round-bottom flask equipped with a Teflon-coated magnetic stirring bar was charged with 6-hydroxy-4-methylcoumarin (1.76 g, 10 mmol) and 20 mL of DMF. Sodium hydride (420 mg of 60 percent suspension in mineral oil, 10.5 mmol) was added and the reaction stirred at room temperature for 1 h. 6-bromo-1-hexene (1.80 g, 11.0 mmol) was added and the reaction allowed to stir for an additional 2 h at 60°C. Water was added and the mixture extracted with CH₂Cl₂. The organic layer was dried with anhydrous Na₂SO₄ and concentrated *in vacuo*. The crude product was purified by flash chromatography with silica gel using a mixture of hexane/EtOAc (10:1) as an eluent to afford the title compound as a pale-yellow oil (1.60 g, 6.2 mmol, 62%).

¹H NMR (400 MHz, CDCl₃) δ 7.48 (d, *J* = 8.8 Hz, 1H), 6.84 (dd, *J* = 8.8, 2.4 Hz, 1H), 6.79 (d, *J* = 2.4 Hz, 1H), 6.12 (d, *J* = 1.0 Hz, 1H), 5.90-5.78 (m, 1H), 5.07-4.87 (m, 2H), 4.02 (t, *J* = 6.4 Hz, 2H), 2.39 (d, *J* = 1.0 Hz, 3H), 2.17-2.11 (m, 2H), 1.87-1.80 (m, 2H), 1.59-1.55 (m, 2H).

¹³C NMR (101 MHz, CDCl₃) δ 162.3, 161.4, 155.4, 152.7, 138.4, 125.6, 115.0, 113.5, 112.7, 111.91, 101.4, 68.5, 33.5, 28.5, 25.3, 18.8.

GCMS: [M] = 176 detected which corresponds to C₁₆H₁₈O₃; the purity was further confirmed by GCMS.

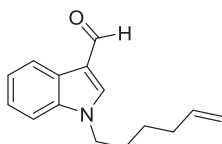

Preparation of 1-(hex-5-en-1-yl)-1H-indole-3-carbaldehyde

A 100 mL round-bottom flask equipped with a Teflon-coated magnetic stirring bar was charged with indole-3-carboxaldehyde (1 g, 6.89 mmol) and 20 mL of DMF. Sodium hydride (300 mg of 60 percent suspension in mineral oil, 7.5 mmol) was added and the reaction stirred at room temperature for 1 h. 6-bromo-1-hexene (1.14 g, 7 mmol) was added and the reaction allowed to stir for an additional 2 h at 60°C. Water was added and the mixture extracted with CH₂Cl₂. The organic layer was dried with anhydrous Na₂SO₄ and concentrated *in vacuo*. The crude product was purified by flash chromatography with silica gel using a mixture of hexane/EtOAc (10:1 to 5:1) as an eluent to afford the title compound as a pale-yellow oil (1.10 g, 4.82 mmol, 70%).

¹H NMR (400 MHz, CDCl₃) 10.0 (s, 1H), 8.32-8.31 (m, 1H), 7.70 (s, 1H), 7.38-7.26 (m, 3H), 5.80-5.70 (m, 1H), 5.02-4.95 (m, 2H), 4.17 (t, *J* = 7.1 Hz, 2H), 2.12-2.07 (m, 2H), 1.92-1.88 (m, 2H), 1.48-1.41 (m, 2H).

¹³C NMR (101 MHz, CDCl₃) δ 184.6, 138.3, 137.9, 137.3, 125.6, 124.0, 123.0, 122.25, 118.2, 115.5, 110.2, 47.3, 33.2, 29.2, 26.1.

HRMS (ESI): calculated for (C₁₅H₁₇NONa, M+Na), 250.1208; found 250.1214.

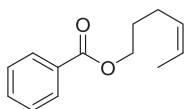

Preparation of (Z)-hex-4-en-1-yl benzoate

A 100 mL round-bottom flask equipped with a Teflon-coated magnetic stirring bar was charged with *cis*-4-hexen-1-ol (1.00 g, 10.0 mmol), triethylamine (1.21 g, 12.0 mmol) and 50 mL of CH₂Cl₂. Benzoyl chloride (1.55 g, 11.0 mmol) was added dropwise at 0° C. After stirring for 6 hours at room temperature 30 mL of water was added to the reaction solution. The organic phase was separated and aqueous layer was extracted two times with 50 mL of CH₂Cl₂. The resulting organic layer was concentrated after drying with anhydrous Na₂SO₄. The crude product was purified by flash chromatography with silica gel using a mixture of hexane/EtOAc (10:1) as an eluent to afford the title compound as a colorless oil (1.73 g, 8.5 mmol, 85%).

¹H NMR (400 MHz, CDCl₃) δ 8.05 (d, *J* = 7.4 Hz, 2H), 7.56 (t, *J* = 7.2 Hz, 1H), 7.44 (t, *J* = 7.6 Hz, 2H), 5.55-5.39 (m, 2H), 4.32 (t, *J* = 6.5 Hz, 2H), 2.25 (m, 2H), 1.87-1.81 (m, 2H), 1.61 (d, *J* = 6.5 Hz, 3H).

¹³C NMR (101 MHz, CDCl₃) δ 166.8, 133.0, 130.6, 129.7, 129.2, 128.5, 125.2, 64.6, 28.7, 23.4, 12.9.

HRMS (ESI): calculated for (C₁₃H₁₇O₂, M+H), 205.1229; found 205.1226.

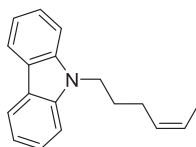

Preparation of (Z)-9-(hex-4-en-1-yl)-9H-carbazole

A 100 mL round-bottom flask equipped with a Teflon-coated magnetic stirring bar was charged with 9H-carbazole (1.67 g, 10.0 mmol) and 20 mL of DMF. Sodium hydride (420 mg of 60 percent suspension in mineral oil, 10.5 mmol) was added and the reaction stirred at room temperature for 1 h. (Z)-6-bromohex-2-ene (1.80 g, 11.0 mmol) was added and the reaction allowed to stir for an additional 2 h at 60° C. Water was added and the mixture extracted with CH₂Cl₂. The organic layer was dried with anhydrous Na₂SO₄ and concentrated *in vacuo*. The crude product was purified by flash chromatography with silica gel using a mixture of hexane/EtOAc (20:1) as an eluent to afford the title compound as a pale-yellow oil (1.37 g, 5.5 mmol, 55%).

¹H NMR (400 MHz, CDCl₃) δ 8.10-8.08 (m, 2H), 7.47-7.38 (m, 4H), 7.23-7.20 (m, 2H), 5.57-5.49 (m, 1H), 5.46-5.41 (m, 1H), 4.30 (t, *J* = 7.3 Hz, 2H), 2.16-2.11 (m, 2H), 1.97-1.90 (m, 2H), 1.58-1.55 (m, 3H).

¹³C NMR (101 MHz, CDCl₃) δ 140.5, 129.4, 125.7, 125.4, 123.0, 120.5, 118.9, 108.8, 42.6, 28.8, 24.5, 13.1.

HRMS (ESI): calculated for (C₁₈H₂₀N, M+H), 250.1596; found 250.1593.

2.7.4 General Procedures for Hydrosilylation Reactions

Preparation of the stock solution of [(MeN₂N)Ni-OMe] (2-2)

A stock solution of [(MeN₂N)Ni-OMe] (**2-2**) was prepared by dissolving 172 mg (0.5 mmol) of complex **2-2** in 10.0 mL of dry THF.

General procedure for the Ni-catalyzed hydrosilylation of functionalized alkenes (General Procedure I, Table 2.3)

In a nitrogen filled glovebox, an oven-dried 30 mL re-sealable screw-cap vial equipped with a Teflon coated magnetic stirring bar was charged with alkene (0.5 mmol), silane (0.6 mmol) and dry THF (1 mL). An aliquot of the stock solution of complex **2-2** (100 μ L, corresponding to 1 mol %) was added and the resulting mixture was stirred at room temperature for indicated time. After that, the vial was removed from the glovebox and the reaction mixture was concentrated under vacuum. The residue was purified by flash chromatography or distilled to afford the desired product.

The procedure for the Ni-catalyzed hydrosilylation of cyclic alkenes (General Procedure II, Table 2.3)

In a nitrogen filled glovebox, an oven-dried 30 mL re-sealable screw-cap vial equipped with a Teflon coated magnetic stirring bar was charged with cyclohexene or norbornene (0.5 mmol), diphenylsilane (0.6 mmol) and dry THF (1 mL). The complex **2-2** (8.6 mg, 0.025 mmol) was added and the resulting mixture was stirred at room temperature for 24 h. After that, the vial was removed from the glovebox and the reaction mixture was concentrated under vacuum. The residue was purified by flash chromatography to afford the desired product.

General procedure for the Ni-catalyzed hydrosilylation of ketone-functionalized alkenes (General Procedure III, Table 2.4)

In a nitrogen filled glovebox, an oven-dried 30 mL re-sealable screw-cap vial equipped with a Teflon coated magnetic stirring bar was charged with 5-hexen-2-one or 2-allylcyclohexanone (0.55 mmol), diphenylsilane (0.5 mmol) and dry DMA (1 mL). The complex **2-2** (3.4 mg, 0.01 mmol) was added and the resulting mixture was stirred at room temperature for indicated time. After that, the vial was removed from the glovebox and the reaction mixture was

concentrated under vacuum. The residue was purified by flash chromatography to afford the desired product.

General procedure for the Ni-catalyzed hydrosilylation of formyl-functionalized alkenes (General Procedure IV, Table 2.4)

In a nitrogen filled glovebox, an oven-dried 30 mL re-sealable screw-cap vial equipped with a Teflon coated magnetic stirring bar was charged with 10-undecenal or N-(hex-5-enyl)-indole-3-carbaldehyde (0.5 mmol), diphenylsilane (0.6 mmol) and dry DMA (1 mL). The complex **2-2** (3.4 mg, 0.01 mmol) was added and the resulting mixture was stirred at room temperature for indicated time. After that, the vial was removed from the glovebox and the reaction mixture was concentrated under vacuum. The residue was purified by flash chromatography to afford the desired product.

General procedures for tandem isomerization-hydrosilylation reactions

Method A

In a nitrogen filled glovebox, an oven-dried 30 mL re-sealable screw-cap vial equipped with a Teflon coated magnetic stirring bar was charged with alkene (0.5 mmol), silane (1.0 mmol) and dry THF (2 mL). Complex **2-2** (17 mg, 0.05 mmol) was added and the resulting mixture was stirred at room temperature for 24 hours. After that, the vial was removed from the glovebox and the reaction mixture was concentrated under vacuum. The residue was purified by flash chromatography to afford the desired product.

Method B

In a nitrogen filled glovebox, an oven-dried 30 mL re-sealable screw-cap vial equipped with a Teflon coated magnetic stirring bar was charged with trans-3-octene or trans-4-octene (56 mg, 0.5 mmol), NaO^tBu (1.0 mmol) and dry THF (2 mL). Complex **2-2** (17 mg, 0.05 mmol) was added and the resulting mixture was cooled down to -70°C. Diphenylsilane (184 mg, 1.0 mmol) was added slowly to cooled solution and the reaction mixture was stirred for 24 hours at -70°C. After that, the vial was removed from the glovebox and the reaction mixture was concentrated under vacuum. The residue was purified by flash chromatography to afford the desired product.

Remarks to Methods A and B: higher dilution improved reproducibility of the reaction and slightly increased the yields. At low temperature (-70°C) **2-3** is more stable in the presence of diphenylsilane, and we assume that by cooling we prolong the life time of **2-3**.

When Method A or B applied to the substrate containing terminal and internal double bonds, namely 4-vinyl-1-cyclohexene, complex mixture of products was obtained. However, products containing more than one silicon group in the molecule were not observed.

2.7.5 The Evaluation of the Activity of Complex **2-2**

In a nitrogen filled glovebox a stock solution of **2-2** in 1-octene was prepared by dissolving 6.9 mg (0.02 mmol) in 2.00 mL (12.77 mmol) of the olefin. A 20 mL vial with a screw cap was charged with with 1-octene and Ph_2SiH_2 followed by addition of the catalyst solution. The reaction was stirred for the desired amount of time and then quenched by exposing the reaction to air (aliquots were quenched by addition to CDCl_3). The product was analyzed by gas chromatography and NMR spectroscopy. Time indicated in the Table 2.2 corresponds to 98% conversion of starting 1-octene.

2.7.6 The Reactions Performed for Mechanism Studies

Synthesis of $[(^{\text{Me}}\text{N}_2\text{N})\text{Ni-H}]$ (**2-3**)

In a nitrogen filled glovebox to a purple solution of **2-2** (86 mg, 0.25 mmol) in 10 mL of Et_2O was added $(\text{MeO})_3\text{SiH}$ (30 mg, 0.25 mmol) at room temperature. The solution immediately turned orange and was stirred for 1 min before the solvent was removed under vacuum. The resulting orange powder was washed 2 times with small amount of pentane and dried to give **2-3** (71 mg, 0.23 mmol, 90% yield). The spectroscopic data were identical to those reported before.³³

Hg-test experiment

The reaction conditions were the same as in entry 1, Table 2.4, except that 100 equiv. Hg relative to Ni catalyst was added in the beginning of the reaction.

The reaction between complex 2-6, 1-decene and diphenylsilane

In a nitrogen filled glovebox to a red solution of **2-6** (21 mg, 0.05 mmol) in 0.5 mL of THF-d8 was added 1-decene (7 mg, 0.05 mmol) and diphenylsilane (9 mg, 0.05 mmol). Then solution was transferred to a NMR tube. ^1H NMR spectra were recorded after 5 min, 30 min, 60 min and 2 hours. The reaction was completed after 1 hour. The solution was subjected to GCMS analysis, which showed exclusive formation of decyldiphenylsilane and only trace amount of octyldiphenylsilane.

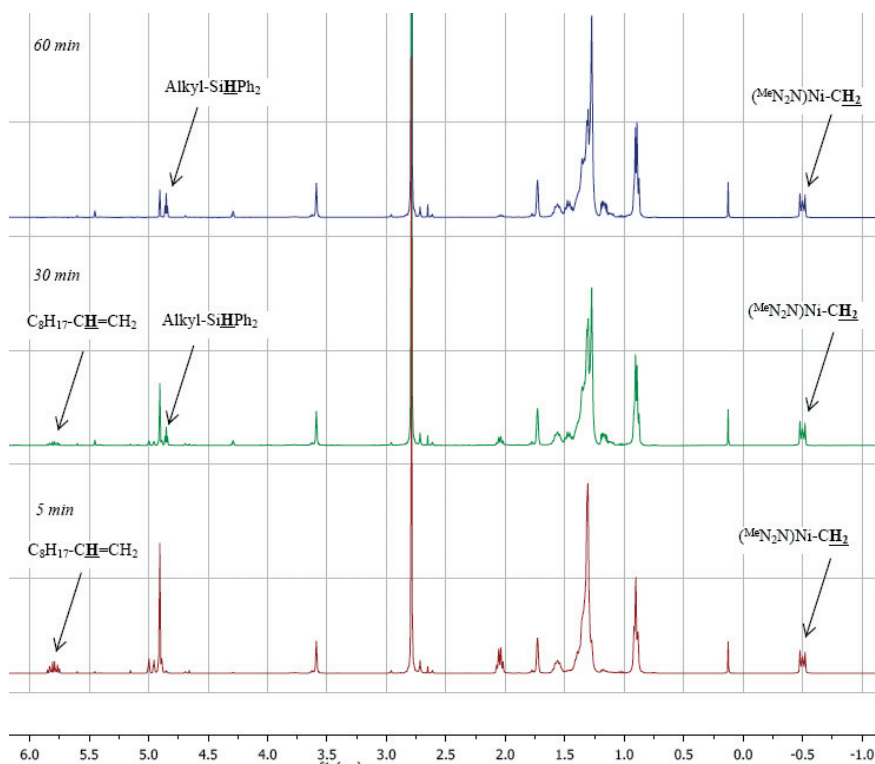

Figure 2.1 : The reaction between complex **2-6**, 1-decene and diphenylsilane

Observation of decomposition of 2-3 in the presence of diphenylsilane

In a nitrogen filled glovebox to a purple solution of **2-2** (17.2 mg, 0.05 mmol) in 0.6 mL of toluene-d8 Ph_2SiH_2 (9.2 mg, 0.05 mmol) was added at room temperature. The solution immediately turned dark orange and ^1H NMR spectrum was recorded. To the resulting orange solution new portion of Ph_2SiH_2 (18.4 mg, 0.10 mmol) was added. ^1H NMR spectra

were recorded after 5 minutes, 10 minutes, 30 minutes, 1 hour, 4 hours and 12 hours. The disappearance of a signal at - 22.92 ppm, which corresponded to the hydride in complex **2-3**, and the formation of protonated ligand was observed.

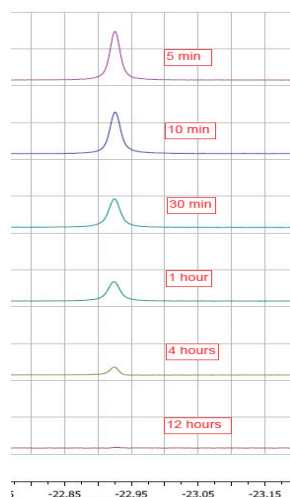

Figure 2.2 : The disappearance of hydride signal

Monitoring of Ni-catalyzed hydrosilylation by ^1H NMR

The catalytic hydrosilylation of 1-octene with Ph_2SiH_2 using the protocol in Scheme 2 was monitored by ^1H NMR in THF-d_8 : in a nitrogen filled glovebox to a purple solution of **2-2** (5 mg, 0.014 mmol) in 0.6 mL of THF-d_8 1-octene (16 mg, 0.14 mmol) and Ph_2SiH_2 (32 mg, 0.17 mmol) were added at room temperature. The solution immediately turned dark and ^1H NMR spectra were recorded after 5 minutes, 10 minutes, 30 minutes, and then every 30 minutes during 6 hours. In the beginning of the reaction a signal at - 23.09 ppm appeared, which corresponded to the hydride in complex **2-3**. After 5 minutes a signal at - 0.50 ppm, corresponding to the CH_2 group bound to the Ni in complex **2-6** was observed. During the reaction the concentration of **2-6** grew and then reached a plateau, while the amount of $[(^{\text{Me}}\text{N}_2\text{N})\text{Ni-H}]$ constantly decreased.

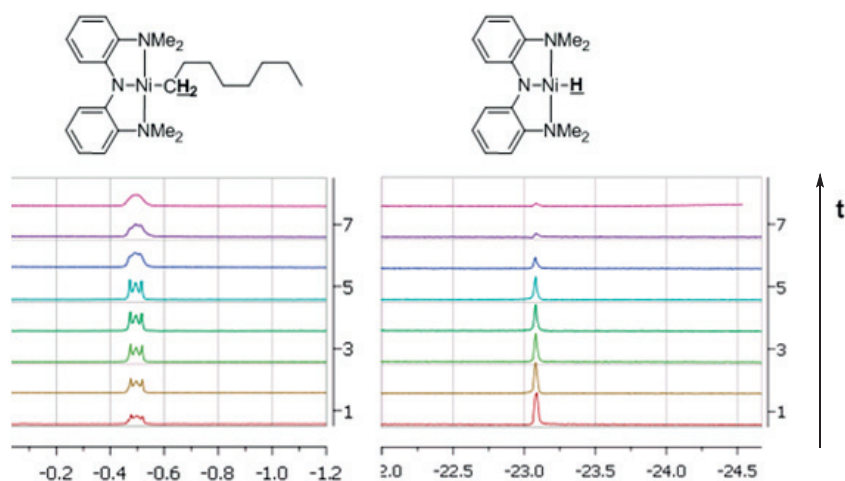
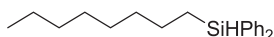

Figure 2.3: Monitoring of Ni-catalyzed hydrosilylation by ^1H NMR

2.7.7 Detailed Descriptions of the Products



Octyldiphenylsilane (entry 1, Table 2.3)

Following the general procedure I, the title compound was prepared using 1-octene (56 mg) and diphenylsilane (110 mg). The crude product was purified by flash chromatography using hexanes as an eluent to afford the title compound as colorless oil (138 mg, 0.47 mmol, 93 %).

^1H NMR (400 MHz, CDCl_3) δ 7.56-7.52 (m, 4H), 7.41- 7.33 (m, 6H), 4.84 (t, $J=3.7$ Hz, 1H), 1.47-1.42 (m, 2H), 1.37- 1.34 (m, 2H), 1.27- 1.23 (m, 8H), 1.16 – 1.11 (m, 2H), 0.86 (t, $J=6.8$ Hz, 3H).

^{13}C NMR (101 MHz, CDCl_3) δ 135.3, 134.9, 129.6, 128.1, 33.3, 32.0, 29.4, 29.3, 24.5, 22.8, 14.3, 12.3. The spectroscopic data corresponds to that previously reported.¹⁶

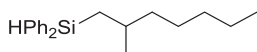

(2-Methylheptyl)diphenylsilane (entry 2, Table 2.3)

Following the general procedure I, the title compound was prepared using 2-methylhept-1-ene (56 mg) and diphenylsilane (110 mg). The crude product was purified by flash chromatography using hexanes as an eluent to afford the title compound as colorless oil (106 mg, 0.36 mmol, 72 %).

^1H NMR (400 MHz, CDCl_3) δ 7.64-7.61 (m, 4H), 7.45-7.38 (m, 6H), 5.00 (d, $J=2.8$ Hz, 1H), 1.80-1.71 (m, 1H), 1.36-1.23 (m, 9H), 1.14-1.07 (m, 1H), 1.01 (d, $J=6.6$ Hz, 3H), 0.92 (t, $J=6.9$ Hz, 3H).

^{13}C NMR (101 MHz, CDCl_3) δ 135.4, 135.3, 135.23, 135.19, 129.6, 129.5, 128.09, 128.07, 40.2, 32.2, 29.9, 26.8, 22.8, 22.8, 20.9, 14.3.

Elemental analysis: Anal. Calcd for $\text{C}_{20}\text{H}_{28}\text{Si}$: C, 81.01 ; H, 9.52. Found : C, 81.04 ; H, 9.48.

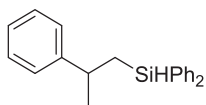

Diphenyl(2-phenylpropyl)silane (entry 3, Table 2.3)

Following the general procedure I, the title compound was prepared using α -methylstyrene (59 mg) and diphenylsilane (110 mg). The crude product was purified by flash chromatography using hexanes as an eluent to afford the title compound as colorless oil (136 mg, 0.45 mmol, 90%).

$^1\text{H NMR}$ (400 MHz, CDCl_3) δ 7.52-7.49 (m, 4H), 7.36-7.30 (m, 6H), 7.25-7.22 (m, 2H), 7.16-7.12 (m, 3H), 4.78 (t, $J = 3.9$ Hz, 1H), 2.99-2.92 (m, 1H), 1.61-1.48 (m, 2H), 1.30 (d, $J = 6.9$ Hz, 3H).

$^{13}\text{C NMR}$ (101 MHz, CDCl_3) δ 149.2, 135.3, 135.2, 134.8, 134.6, 129.7, 129.6, 128.5, 128.1, 126.7, 126.1, 36.4, 25.3, 22.8.

Elemental analysis: Anal. Calcd for $\text{C}_{21}\text{H}_{22}\text{Si}$: C, 83.38; H, 7.33 Found: C, 83.47; H, 7.27.

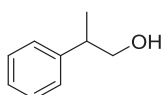

2-Phenylpropan-1-ol (equation 1, Scheme 2.2)

According to a modification of the procedure described by Tamao,⁶⁵ corresponding silane (100 mg, 33 mmol) was dissolved in tetrahydrofuran (1 mL) and methanol (1 mL). Potassium bicarbonate (50 mg, 0.5 mmol) and 30% aqueous hydrogen peroxide (12 equiv. per Si-C bond) were added and the reaction stirred at 60°C for 24 hours. Colorless, insoluble silicate products formed during the reaction. Aqueous sulfate buffer (10 mL) was added and the aqueous phase extracted with diethyl ether (3 x 20mL). The organic layer was dried with anhydrous Na_2SO_4 and concentrated *in vacuo*. The crude product was purified by flash chromatography with silica gel using a mixture of DCM/MeOH (50:1) as an eluent to afford the title compound as a colorless oil (30 mg, 0.22 mmol, 67%).

$^1\text{H NMR}$ (400 MHz, CDCl_3) 7.34-7.31 (m, 2H), 7.24-7.20 (m, 3H), 3.68 (d, $J = 6.7$ Hz, 2H), 2.98-2.91 (m, 1H), 1.50 (br, 1H), 1.27 (d, $J = 7.1$ Hz, 3H).

$^{13}\text{C NMR}$ (101 MHz, CDCl_3) δ 143.8, 128.7, 127.6, 126.8, 68.8, 42.6, 17.7.

The spectroscopic data corresponds to that of commercially available 2-phenylpropan-1-ol.

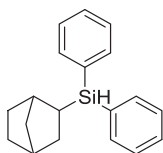

Bicyclo[2.2.1]heptan-2-ylidiphenylsilane (entry 4, Table 2.3)

Following the general procedure II, the title compound was prepared using norbornene (47 mg) and diphenylsilane (110 mg). The crude product was purified by flash chromatography using hexanes as an eluent to afford the title compound as colorless oil (122 mg, 0.44 mmol, 88%).

$^1\text{H NMR}$ (400 MHz, CDCl_3) δ 7.58-7.54 (m, 4H), 7.40-7.26 (m, 6H), 4.68 (d, $J = 5.2$ Hz, 1H), 2.33-2.15 (m, 2H), 1.60-1.47 (m, 4H), 1.35-1.23 (m, 4H), 1.13-1.11 (m, 1H).

$^{13}\text{C NMR}$ (101 MHz, CDCl_3) δ 135.6, 135.5, 135.2, 134.4, 129.5, 128.03, 128.0, 38.6, 37.7, 37.4, 34.0, 33.7, 29.3, 25.8.

Elemental analysis: Anal. Calcd for $\text{C}_{19}\text{H}_{22}\text{Si}$: C, 81.95; H, 7.96. Found: C, 81.96; H, 7.93.

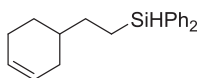

(2-(Cyclohex-3-en-1-yl)ethyl)diphenylsilane (entry 5, Table 2.3)

Following the general procedure I, the title compound was prepared using 4-vinylcyclohexene (60 mg, 0.55 mmol) and diphenylsilane (92 mg, 0.5 mmol). The crude product was purified by flash chromatography using hexanes as an eluent to afford the title compound as colorless oil (122 mg, 0.44 mmol, 88%).

$^1\text{H NMR}$ (400 MHz, CDCl_3) δ 7.56-7.54 (m, 4H), 7.39-7.34 (m, 6H), 5.64 (m, 2H), 4.84 (t, $J = 3.7$ Hz, 1H), 2.14-2.09 (m, 1H), 2.03-1.99 (m, 2H), 1.77-1.73 (m, 1H), 1.65-1.59 (m, 1H), 1.54-1.50 (m, 1H), 1.45-1.41 (m, 2H), 1.19-1.14 (m, 3H).

$^{13}\text{C NMR}$ (101 MHz, CDCl_3) δ 135.3, 134.7, 129.6, 128.1, 127.2, 126.7, 36.5, 31.7, 31.2, 28.6, 25.5, 9.4.

Elemental analysis: Anal. Calcd for $\text{C}_{20}\text{H}_{24}\text{Si}$: C, 82.13; H, 8.27. Found: C, 82.27; H, 8.21.

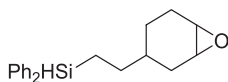

(2-(7-Oxabicyclo[4.1.0]heptan-3-yl)ethyl)diphenylsilane (mixture of cis- and trans-isomers) (entry 6, Table 2.3)

Following the general procedure I, the title compound was prepared using 3-vinyl-7-oxabicyclo[4.1.0]heptane (62 mg) and diphenylsilane (110 mg). The crude product was purified by flash chromatography using hexanes/EtOAc (20:1) as an eluent to afford the title compound as colorless oil (135 mg, 0.44 mmol, 88%).

$^1\text{H NMR}$ (400 MHz, CDCl_3) δ 7.54-7.52 (m, 4H), 7.40-7.33 (m, 6H), 4.83-4.81 (m, 1H), 3.15-3.09 (m, 2H), 2.21-1.93 (m, 2H), 1.83-1.65 (m, 1H), 1.55-0.83 (m, 9H).

$^{13}\text{C NMR}$ (101 MHz, CDCl_3) δ 135.2, 134.5, 129.7, 128.1, 53.4, 52.8, 52.1, 52.0, 35.4, 32.5, 31.6, 31.4, 30.9, 30.5, 26.8, 25.4, 24.1, 23.7, 9.4, 9.2.

Elemental analysis: Anal. Calcd for $\text{C}_{20}\text{H}_{24}\text{OSi}$: C, 77.87; H, 7.84; Found C, 77.93; H, 7.75.

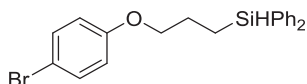

(3-(4-Bromophenoxy)propyl)diphenylsilane (entry 7, Table 2.3)

Following the general procedure I, the title compound was prepared using 1-(allyloxy)-4-bromobenzene (106 mg) and diphenylsilane (110 mg). The crude product was purified by flash chromatography using hexanes as an eluent to afford the title compound as pale yellow oil (146 mg, 0.37 mmol, 74%).

$^1\text{H NMR}$ (400 MHz, C_6D_6) δ 7.57-7.54 (m, 4H), 7.40-7.31 (m, 8H), 6.72-6.70 (m, 2H), 4.90 (t, $J = 3.7$ Hz, 1H), 3.89 (t, $J = 6.5$ Hz, 2H), 1.96-1.88 (m, 2H), 1.29-1.25 (m, 2H).

$^{13}\text{C NMR}$ (101 MHz, C_6D_6) δ 158.6, 135.5, 134.4, 132.5, 130.0, 128.4, 116.6, 113.0, 70.0, 24.5, 8.8.

HRMS (ESI): calculated for $(\text{C}_{21}\text{H}_{21}\text{BrOSiNa, M+Na})$, 397.0449; found 397.0442.

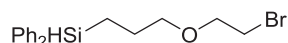
**(3-(2-Bromoethoxy)propyl)diphenylsilane (entry 8, Table 2.3)**

Following the general procedure I, the title compound was prepared using 3-(2-bromoethoxy)prop-1-ene (82 mg) and diphenylsilane (110 mg). The crude product was purified by flash chromatography using hexanes/EtOAc (20:1) as an eluent to afford the title compound as colorless oil (134 mg, 0.39 mmol, 77%).

$^1\text{H NMR}$ (400 MHz, CDCl_3) δ 7.57-7.54 (m, 4H), 7.40-7.32 (m, 6H), 4.87 (t, $J = 3.7$ Hz, 1H), 3.67 (t, $J = 6.2$ Hz, 2H), 3.47 (t, $J = 6.6$ Hz, 2H), 3.41 (t, $J = 6.2$ Hz, 2H), 1.77-1.70 (m, 2H), 1.21-1.16 (m, 2H).

$^{13}\text{C NMR}$ (101 MHz, CDCl_3) δ 135.3, 134.3, 129.7, 128.1, 73.4, 70.7, 30.6, 24.7, 8.5.

HRMS (APCI): calculated for ($\text{C}_{17}\text{H}_{22}\text{BrOSi}$, $\text{M}+\text{H}$), 349.0441; found 349.0436.

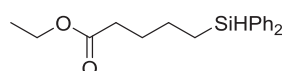
**Ethyl 5-(diphenylsilyl)pentanoate (entry 9, Table 2.3)**

Following the general procedure I, the title compound was prepared using ethyl pent-4-enoate (64 mg) and diphenylsilane (110 mg). The crude product was purified by flash chromatography using hexanes/EtOAc (10:1) as an eluent to afford the title compound as colorless oil (90 mg, 0.46 mmol, 58%).

$^1\text{H NMR}$ (400 MHz, CDCl_3) δ 7.55-7.49 (m, 4H), 7.38-7.23 (m, 6H), 4.85 (t, $J = 3.7$ Hz, 1H), 4.08 (q, $J = 7.1$ Hz, 2H), 2.27 (t, $J = 7.4$ Hz, 2H), 1.74-1.66 (m, 2H), 1.53-1.45 (m, 2H), 1.21 (t, $J = 7.1$ Hz, 3H), 1.18-1.13 (m, 2H).

$^{13}\text{C NMR}$ (101 MHz, CDCl_3) δ 173.8, 135.2, 134.4, 129.7, 128.1, 60.3, 34.1, 28.5, 24.2, 14.4, 12.1.

HRMS (ESI): calculated for ($\text{C}_{19}\text{H}_{25}\text{O}_2\text{Si}$, $\text{M}+\text{H}$), 335.1443 found 335.1451.

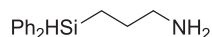
**3-(Diphenylsilyl)propan-1-amine (entry 10, Table 2.3)**

In a nitrogen filled glovebox, an oven-dried 30 mL re-sealable screw-cap vial equipped with a Teflon coated magnetic stirring bar was charged with allylamine (57 mg, 1 mmol), diphenylsilane (220 mg, 1.2 mmol) and dry THF (2 mL). An aliquot of the stock solution of complex **2** (200 μL , corresponding to 1 mol %) was added and the resulting mixture was stirred at room temperature for indicated time. After that, the vial was removed from the glovebox and the reaction mixture was concentrated under vacuum. The crude product was purified by vacuum distillation to afford the title compound as pale yellow oil (180 mg, 0.75 mmol, 75%). Contains traces of Nickamine ligand and 8% of 2-(diphenylsilyl)propan-1-amine.

$^1\text{H NMR}$ (400 MHz, CDCl_3) δ 7.58-7.54 (m, 4H), 7.40-7.31 (m, 6H), 4.87 (t, $J = 3.6$ Hz, 1H), 2.69 (t, $J = 7.0$ Hz, 2H), 1.61-1.53 (m, 2H), 1.26 (br, 2H), 1.16-1.11 (m, 2H).

$^{13}\text{C NMR}$ (101 MHz, CDCl_3) δ 135.2, 134.4, 129.7, 128.1, 45.1, 28.9, 9.5.

HRMS (ESI): calculated for ($\text{C}_{15}\text{H}_{20}\text{NSi}$, $\text{M}+\text{H}$), 242.1365; found 242.1362.

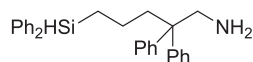
**5-(Diphenylsilyl)-2,2-diphenylpentan-1-amine (entry 11, Table 2.3)**

Following the general procedure I, the title compound was prepared using 2,2-diphenylpent-4-en-1-amine (119 mg) and diphenylsilane (110 mg). The crude product was purified by vacuum distillation to afford the title compound as pale yellow oil (177 mg, 0.42 mmol, 84%).

¹H NMR (400 MHz, CDCl₃) δ 7.46-7.44 (m, 4H), 7.38-7.29 (m, 6H), 7.25-7.14 (m, 6H), 7.07-7.05 (m, 4H), 4.79 (t, *J* = 4 Hz, 1H), 3.18 (s, 2H), 2.14-2.10 (m, 2H), 1.25-1.09 (m, 6H)

¹³C NMR (101 MHz, CDCl₃) δ 146.53, 135.19, 134.57, 129.62, 128.33, 128.11, 128.09, 126.04, 77.16, 52.13, 49.05, 39.95, 19.12, 12.85.

HRMS (ESI): calculated for (C₂₉H₃₂NSi, M+H), 422.2304; found 422.2304.

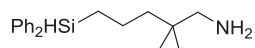

5-(Diphenylsilyl)-2,2-dimethylpentan-1-amine (entry 12, Table 2.3)

Following the general procedure I, the title compound was prepared using 2,2-dimethylpent-4-en-1-amine (57 mg) and diphenylsilane (110 mg). The crude product was purified by vacuum distillation to afford the title compound as pale yellow oil (140 mg, 0.47 mmol, 94%).

¹H NMR (400 MHz, CDCl₃) δ 7.57-7.53 (m, 4H), 7.40-7.32 (m, 6H), 4.86 (t, *J* = 3.7 Hz, 1H), 2.38-2.34 (m, 2H), 1.46-1.38 (m, 2H), 1.29-1.25 (m, 2H), 1.15-1.10 (m, 2H), 0.99-0.88 (br, 2H), 0.76 (s, 6H).

¹³C NMR (101 MHz, CDCl₃) δ 135.2, 134.7, 129.6, 128.1, 52.9, 43.3, 34.9, 24.8, 18.9, 13.1.

HRMS (ESI): calculated for (C₁₉H₂₈NSi, M+H), 298.1991; found 298.1996.

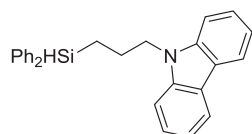

9-(3-(Diphenylsilyl)propyl)-9H-carbazole (entry 13, Table 2.3)

Following the general procedure I, the title compound was prepared using N-allyl-carbazole (104 mg) and diphenylsilane (110 mg). The crude product was purified by flash chromatography using hexanes/EtOAc (20:1) as an eluent to afford the title compound as pale yellow oil (178 mg, 0.46 mmol, 91%).

¹H NMR (400 MHz, CDCl₃) δ 8.05-8.02 (m, 2H), 7.42-7.34 (m, 6H), 7.23-7.06 (m, 10H), 4.93 (t, *J* = 3.6 Hz, 1H), 3.79 (t, *J* = 7.2 Hz, 2H), 1.81-1.73 (m, 2H), 0.95-0.90 (m, 2H).

¹³C NMR (101 MHz, CDCl₃) δ 140.5, 135.2, 133.8, 129.9, 128.2, 125.7, 123.0, 120.5, 118.9, 108.8, 45.6, 24.0, 9.7.

HRMS (ESI): calculated for (C₂₇H₂₅NSiK, M+K), 430.1393; found 430.1392.

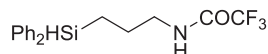

N-(3-(Diphenylsilyl)propyl)-2,2,2-trifluoroacetamide (entry 14, Table 2.3)

Following the general procedure I, the title compound was prepared using N-allyl-2,2,2-trifluoroacetamide (77 mg) and diphenylsilane (110 mg). The crude product was purified by gradient flash chromatography using hexanes/EtOAc (20:1 to 5:1) as an eluent to afford the title compound as colorless oil (143 mg, 0.43 mmol, 85%).

¹H NMR (400 MHz, CDCl₃) δ 7.55-7.53 (m, 4H), 7.41-7.35 (m, 6H), 6.27 (br, 1H), 4.88 (t, *J* = 3.7 Hz, 1H), 3.39-3.34 (m, 2H), 1.75-1.67 (m, 2H), 1.17-1.12 (m, 2H).

^{13}C NMR (101 MHz, CDCl_3) δ 157.3 (q, $J = 36$ Hz), 135.2, 133.6, 130.0, 128.3, 116.0 (q, $J = 289$ Hz), 42.58, 24.3, 9.6.

HRMS (ESI): calculated for ($\text{C}_{17}\text{H}_{18}\text{F}_3\text{NOSiNa}$, $\text{M}+\text{Na}$), 360.1007; found 360.1008.

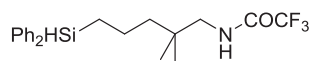

N-(5-(Diphenylsilyl)-2,2-dimethylpentyl)-2,2,2-trifluoroacetamide (entry 15, Table 2.3)

Following the general procedure I, the title compound was prepared using N-(2,2-dimethylpent-4-en-1-yl)-trifluoroacetamide (105 mg) and diphenylsilane (110 mg). The crude product was purified by gradient flash chromatography using hexanes/EtOAc (20:1 to 5:1) as an eluent to afford the title compound as colorless oil (175 mg, 0.45 mmol, 89%).

^1H NMR (400 MHz, CDCl_3) δ 7.55-7.53 (m, 4H), 7.40-7.32 (m, 6H), 6.26 (br, 1H), 4.86 (t, $J = 3.7$ Hz, 1H), 3.10 (d, $J = 6.4$ Hz, 2H), 1.48-1.41 (m, 2H), 1.31-1.27 (m, 2H), 1.15-1.10 (m, 2H), 0.82 (s, 6H).

^{13}C NMR (101 MHz, CDCl_3) δ 157.5 (q, $J = 37$ Hz), 135.2, 134.4, 129.7, 128.1, 116.1 (q, $J = 289$ Hz), 49.7, 43.5, 34.7, 24.7, 18.9, 12.9.

HRMS (ESI): calculated for ($\text{C}_{21}\text{H}_{26}\text{F}_3\text{NOSiNa}$, $\text{M}+\text{Na}$), 416.1633; found 416.1641.

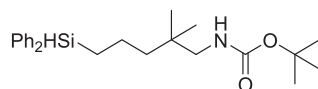

tert-Butyl (5-(diphenylsilyl)-2,2-dimethylpentyl)carbamate (entry 16, Table 2.3)

Following the general procedure I, the title compound was prepared using N-Boc-2,2-dimethylpent-4-en-1-amine (107 mg) and diphenylsilane (110 mg). The crude product was purified by gradient flash chromatography using hexanes/EtOAc (20:1 to 10:1) eluent to afford the title compound as colorless oil (128 mg, 0.32 mmol, 65%).

^1H NMR (400 MHz, CDCl_3) δ 7.55-7.53 (m, 4H), 7.37-7.32 (m, 6H), 4.86 (t, $J = 3.7$ Hz, 1H), 4.46 (br, 1H), 2.87 (d, $J = 6.4$ Hz, 2H), 1.47-1.41 (m, 11H), 1.28-1.24 (m, 2H), 1.13-1.09 (m, 2H), 0.77 (s, 6H).

^{13}C NMR (101 MHz, CDCl_3) δ 156.3, 135.2, 134.6, 129.6, 128.1, 79.0, 50.6, 43.6, 34.6, 28.5, 24.8, 18.8, 13.1.

HRMS (ESI): calculated for ($\text{C}_{24}\text{H}_{35}\text{NO}_2\text{SiNa}$, $\text{M}+\text{Na}$), 420.2335; found 420.2335.

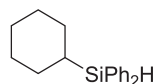

Cyclohexyldiphenylsilane (entry 17, Table 2.3)

Following the general procedure II, the title compound was prepared using cyclohexene (41 mg) and diphenylsilane (110 mg). The crude product was purified by flash chromatography using hexanes as an eluent to afford the title compound as colorless oil (71 mg, 0.21 mmol, 41%).

^1H NMR (400 MHz, CDCl_3) δ 7.58-7.53 (m, 4H), 7.40-7.25 (m, 6H), 4.67 (d, $J = 2.8$ Hz, 1H), 1.80-1.67 (m, 5H), 1.32-1.23 (m, 6H).

^{13}C NMR (101 MHz, CDCl_3) δ 135.7, 134.0, 129.6, 128.0, 28.5, 28.0, 26.9, 23.6.

Elemental analysis: Anal. Calcd for $\text{C}_{18}\text{H}_{22}\text{Si}$: C, 81.14; H, 8.32. Found: C, 81.17; H, 8.28.

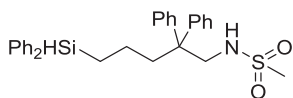

N-(5-(Diphenylsilyl)-2,2-diphenylpentyl)methanesulfonamide (entry 18, Table 2.3)

Following the general procedure I, the title compound was prepared using N-(2,2-diphenylpent-4-en-1-yl)methanesulfonamide (158 mg) and diphenylsilane (110 mg). The crude product was purified by gradient flash chromatography using hexanes/EtOAc (10:1 to 5:1) as an eluent to afford the title compound (**7r**) as colorless oil (200 mg, 0.40 mmol, 80%).

¹H NMR (400 MHz, CDCl₃) δ 7.45-7.43 (m, 4H), 7.34-7.17 (m, 12H), 7.07-7.05 (m, 4H), 4.78 (t, *J* = 3.6 Hz, 1H), 3.85 (t, *J* = 6.5 Hz, 1H), 3.69 (d, *J* = 6.5 Hz, 2H), 2.50 (s, 3H), 2.20-2.17 (m, 2H), 1.28-1.20 (m, 2H), 1.12-1.09 (m, 2H).

¹³C NMR (101 MHz, CDCl₃) δ 145.1, 135.1, 134.3, 129.6, 128.4, 128.0, 127.9, 126.7, 77.2, 50.2, 50.0, 40.0, 39.7, 19.0, 12.7.

HRMS (ESI): calculated for (C₃₀H₃₃NO₂SSiNa, M+Na), 522.1899; found 522.1892.

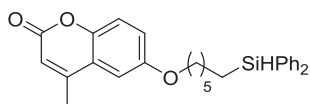

6-((6-(Diphenylsilyl)hexyl)oxy)-4-methyl-2H-chromen-2-one (entry 19, Table 2.3)

Following the general procedure I, the title compound was prepared using 6-(hex-5-en-1-yloxy)-4-methyl-2H-chromen-2-one (129 mg) and diphenylsilane (110 mg). The crude product was purified by flash chromatography using hexanes/EtOAc (20:1) as an eluent to afford the title compound (**7s**) as colorless oil (144 mg, 0.33 mmol, 65%).

¹H NMR (400 MHz, CDCl₃) δ 7.56-7.53 (m, 4H), 7.43 (d, *J* = 8.8 Hz, 1H), 7.38-7.32 (m, 6H), 6.81 (dd, *J* = 8.8, 2.4 Hz, 1H), 6.75 (d, *J* = 2.4 Hz, 1H), 6.09 (d, *J* = 1.0 Hz, 1H), 4.86 (t, *J* = 3.6 Hz, 1H), 3.94 (t, *J* = 6.5 Hz, 2H), 2.34 (d, *J* = 1.0 Hz, 3H), 1.76-1.73 (m, 2H), 1.51-1.36 (m, 6H), 1.18-1.13 (m, 2H).

¹³C NMR (101 MHz, CDCl₃) δ 162.2, 161.3, 155.3, 152.6, 135.1, 134.5, 129.6, 128.0, 125.5, 113.4, 112.6, 111.8, 101.3, 68.5, 32.8, 28.9, 25.6, 24.4, 18.7, 12.1.

HRMS (ESI): calculated for (C₂₈H₃₀O₃SiNa, M+Na), 465.1862; found 465.1868.

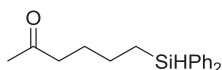

6-(Diphenylsilyl)hexan-2-one (entry 1, Table 2.4)

Following the general procedure III, the title compound was prepared using hex-5-en-2-one (54 mg) and diphenylsilane (92 mg). The crude product was purified by flash chromatography using hexanes/EtOAc (10:1) as an eluent to afford the title compound as colorless oil (104 mg, 0.37 mmol, 74%).

¹H NMR (400 MHz, CDCl₃) δ 7.55-7.52 (m, 4H), 7.37-7.32 (m, 6H), 4.85 (t, *J* = 3.7 Hz, 1H), 2.36 (t, *J* = 7.4 Hz, 2H), 2.06 (s, 3H), 1.67-1.60 (m, 2H), 1.49-1.41 (m, 2H), 1.17-1.12 (m, 2H).

¹³C NMR (101 MHz, CDCl₃) δ 209.0, 135.2, 134.4, 129.7, 128.1, 43.4, 29.9, 27.8, 24.2, 12.2.

The spectroscopic data corresponds to that reported.²⁰

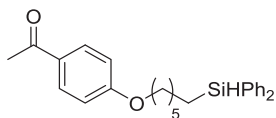

1-(4-((6-(Diphenylsilyl)hexyl)oxy)phenyl)ethan-1-one (entry 2, Table 2.4)

Following the general procedure III, the title compound was prepared using 4-(hex-5-en-1-yloxy)acetophenone (119 mg) and diphenylsilane (92 mg). The crude product was purified by flash chromatography using hexanes/EtOAc (10:1) as an eluent to afford the title compound as colorless oil (150 mg, 0.37 mmol, 75%).

$^1\text{H NMR}$ (400 MHz, CDCl_3) δ 7.91-7.87 (m, 2H), 7.56-7.53 (m, 4H), 7.37-7.31 (m, 6H), 6.89-6.86 (m, 2H), 4.86 (t, $J = 3.7$ Hz, 1H), 3.94 (t, $J = 6.5$ Hz, 2H), 2.51 (s, 3H), 1.75-1.70 (m, 2H), 1.51-1.41 (m, 6H), 1.18-1.13 (m, 2H).

$^{13}\text{C NMR}$ (101 MHz, CDCl_3) δ 196.8, 163.1, 135.2, 134.6, 130.6, 130.2, 129.6, 128.0, 114.2, 68.2, 32.8, 29.0, 26.4, 25.6, 24.4, 12.2.

HRMS (ESI): calculated for $(\text{C}_{26}\text{H}_{30}\text{O}_2\text{SiNa}, \text{M}+\text{Na})$, 425.1913 found 425.1913.

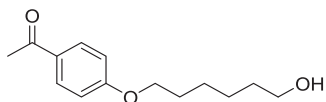

1-(4-((6-Hydroxyhexyl)oxy)phenyl)ethan-1-one (equation 2, Scheme 2.2)

According to a modification of the procedure described by Tamao,¹⁷ silane **9b** (101 mg, 0.25 mmol) was dissolved in tetrahydrofuran (1 mL) and methanol (1 mL). Potassium bicarbonate (25 mg, 0.25 mmol) and 30% aqueous hydrogen peroxide (9 equiv. per Si-C bond) were added and the reaction stirred at 60°C over night. Colorless, insoluble silicate products formed during the reaction. Aqueous sulfate buffer (10 mL) was added and the aqueous phase extracted with diethyl ether (3 x 20mL). The organic layer was dried with anhydrous Na_2SO_4 and concentrated *in vacuo*. The crude product was purified by flash chromatography with silica gel using a mixture of DCM/MeOH (20:1) as an eluent to afford the title compound as white solid (50 mg, 0.21 mmol, 85%).

$^1\text{H NMR}$ (400 MHz, CDCl_3) 7.92 (d, $J = 8.2$ Hz, 2H), 6.91 (d, $J = 8.2$ Hz, 2H), 4.02 (t, $J = 6.3$ Hz, 2H), 3.66 (t, $J = 6.3$ Hz, 2H), 2.55 (s, 3H), 1.84-1.79 (m, 2H), 1.65-1.55 (m, 2H), 1.51-1.42 (m, 4H).

$^{13}\text{C NMR}$ (101 MHz, CDCl_3) δ 197.0, 163.2, 130.7, 130.2, 114.2, 68.2, 62.9, 32.7, 29.2, 26.4, 25.9, 25.6.

HRMS (ESI): calculated for $(\text{C}_{24}\text{H}_{21}\text{O}_3, \text{M}+\text{H})$, 237.1491; found 237.1491.

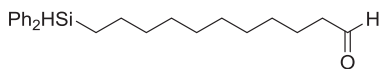

11-(Diphenylsilyl)undecanal (entry 3, Table 2.4)

Following the general procedure IV, the title compound was prepared using 10-undecenal (84 mg) and diphenylsilane (110 mg). The crude product was purified by flash chromatography using hexanes/EtOAc (10:1) as an eluent to afford the title compound as colorless oil (125 mg, 0.36 mmol, 71%).

$^1\text{H NMR}$ (400 MHz, CDCl_3) δ 9.75 (t, $J = 1.9$ Hz, 1H), 7.57-7.54 (m, 4H), 7.40-7.33 (m, 6H), 4.84 (t, $J = 3.7$ Hz, 1H), 2.40 (td, $J = 7.0$ Hz, 1.9 Hz, 2H), 1.61-1.54 (m, 2H), 1.47-1.43 (m, 2H), 1.36-1.23 (m, 12H), 1.15-1.10 (m, 2H).

^{13}C NMR (101 MHz, CDCl_3) δ 203.1, 135.3, 134.9, 129.6, 128.1, 44.1, 33.3, 29.6, 29.5, 29.5, 29.3, 24.5, 22.2, 12.3.

HRMS (ESI): calculated for ($\text{C}_{23}\text{H}_{23}\text{OSiNa}$, $\text{M}+\text{Na}$), 353.2301; found 353.2303.

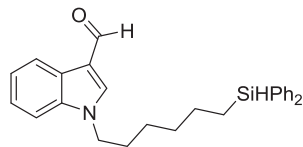

1-(6-(Diphenylsilyl)hexyl)-1H-indole-3-carbaldehyde (entry 4, Table 2.4)

Following the general procedure IV, the title compound was prepared using N-(hex-5-en-1-yl)-indole-3-carbaldehyde (114 mg) and diphenylsilane (110 mg). The crude product was purified by flash chromatography using hexanes/EtOAc (10:1) as an eluent to afford the title compound as colorless oil (193 mg, 0.47 mmol, 94%).

^1H NMR (400 MHz, CDCl_3) δ 9.95 (s, 1H), 8.31-8.28 (m, 1H), 7.58 (s, 1H), 7.54-7.51 (m, 4H), 7.35-7.26 (m, 9H), 4.83 (t, $J = 3.7$ Hz, 1H), 4.04 (t, $J = 7.2$ Hz, 2H), 1.81-1.74 (m, 2H), 1.46-1.34 (m, 4H), 1.29-1.26 (m, 2H), 1.13-1.08 (m, 2H).

^{13}C NMR (101 MHz, CDCl_3) δ 184.5, 138.4, 137.2, 135.1, 134.4, 129.6, 128.1, 125.5, 123.9, 122.9, 122.2, 118.0, 110.1, 47.2, 32.5, 29.6, 26.4, 24.3, 12.1.

HRMS (ESI): calculated for ($\text{C}_{27}\text{H}_{30}\text{NOSi}$, $\text{M}+\text{H}$), 412.2097; found 412.2093.

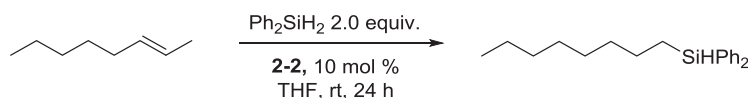

Octyldiphenylsilane obtained from of trans-2-octene (entry 1, Table 2.5)

Following the general Method A, the title compound was prepared using trans-2-octene (56 mg) and diphenylsilane (184 mg). The crude product was purified by flash chromatography using hexanes as an eluent to afford the title compound as colorless oil (114 mg, 0.39 mmol, 77 %). Spectroscopic data were identical to those reported for the same compound above.

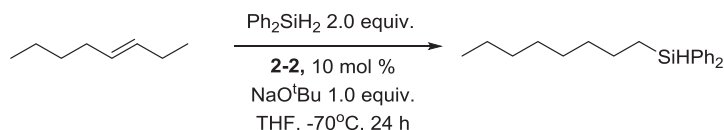

Octyldiphenylsilane obtained from of trans-3-octene (entry 7, Table 2.5)

Following the general Method B, the title compound was prepared using trans-3-octene (56 mg) and diphenylsilane (184 mg). The crude product was purified by flash chromatography using hexanes as an eluent to afford the title compound as colorless oil (96 mg, 0.33 mmol, 65 %). Spectroscopic data were identical to those reported for the same compound above.

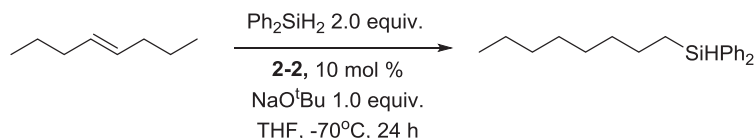

Octyldiphenylsilane obtained from of trans-4-octene (entry 8, Table 2.5)

Following the general Method B, the title compound was prepared using trans-4-octene (56 mg) and diphenylsilane (184 mg). The crude product was purified by flash chromatography using hexanes as an

eluent to afford the title compound as colorless oil (87 mg, 0.29 mmol, 59 %). Spectroscopic data were identical to those reported for the same compound above.

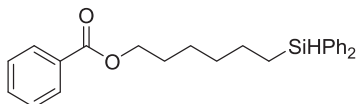

6-(Diphenylsilyl)hexyl benzoate (entry 2, Table 2.5)

Following the general Method A, the title compound was prepared using (Z)-hex-4-en-1-yl benzoate (102 mg) and diphenylsilane (184 mg). The crude product was purified by flash chromatography using hexanes/EtOAc (20:1) as an eluent to afford the title compound as colorless oil (122 mg, 0.32 mmol, 63%). Isolated product contains 9% of internal hydrosilylation by-product.

$^1\text{H NMR}$ (400 MHz, CDCl_3) δ 8.04-8.02 (m, 2H), 7.55-7.52 (m, 5H), 7.44-7.32 (m, 8H), 4.85 (t, $J = 3.7$ Hz, 1H), 4.28 (t, $J = 6.6$ Hz, 2H), 1.73-1.70 (m, 2H), 1.49-1.40 (m, 6H), 1.18-1.08 (m, 2H).

$^{13}\text{C NMR}$ (101 MHz, CDCl_3) δ 166.8, 135.3, 134.7, 132.9, 130.7, 129.7, 129.6, 128.5, 128.1, 65.2, 32.9, 28.8, 25.8, 24.5, 12.3.

HRMS (ESI): calculated for $(\text{C}_{25}\text{H}_{28}\text{O}_2\text{SiNa}, \text{M}+\text{Na})$, 411.1756; found 411.1752.

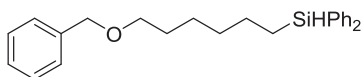

6-(Benzyloxy)hexyl diphenylsilane (entry 3, Table 2.5)

Following the general Method A, the title compound was prepared using (Z)-((hex-4-en-1-yloxy)methyl)benzene (95 mg) and diphenylsilane (184 mg). The crude product was purified by flash chromatography using hexanes as an eluent to afford the title compound as colorless oil (120 mg, 0.32 mmol, 64%). Isolated product contains 8% of internal hydrosilylation by-product.

$^1\text{H NMR}$ (400 MHz, CDCl_3) δ 7.56-7.53 (m, 4H), 7.39-7.24 (m, 11 H), 4.84 (t, $J = 3.7$ Hz, 1H), 4.48 (s, 2H), 3.43 (t, $J = 6.6$ Hz, 2H), 1.61-1.53 (m, 2H), 1.48-1.35 (m, 6H), 1.16-1.08 (m, 2H).

$^{13}\text{C NMR}$ (101 MHz, CDCl_3) δ 138.8, 135.3, 134.8, 129.6, 128.5, 128.1, 127.8, 127.6, 73.0, 70.6, 33.1, 29.8, 25.9, 24.5, 12.3.

HRMS (APCI): calculated for $(\text{C}_{25}\text{H}_{31}\text{OSi}, \text{M}+\text{H})$, 375.2144; found 375.2139.

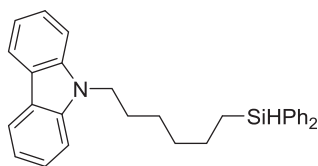

9-(6-(Diphenylsilyl)hexyl)-9H-carbazole (entry 4, Table 2.5)

Following the general Method A, the title compound was prepared using (Z)-9-(hex-4-en-1-yl)-9H-carbazole (125 mg) and diphenylsilane (184 mg). The crude product was purified by flash chromatography using hexanes/EtOAc (20:1) as an eluent to afford the title compound as pale yellow oil (199 mg, 0.48 mmol, 92%).

$^1\text{H NMR}$ (400 MHz, CDCl_3) δ 8.10-8.07 (m, 2H), 7.53-7.50 (m, 4H), 7.46-7.31 (m, 10H), 7.23-7.19 (m, 2H), 4.82 (t, $J = 3.7$ Hz, 1H), 4.24 (t, $J = 7.2$ Hz, 1H), 1.85-1.77 (m, 2H), 1.45-1.33 (m, 6H), 1.14-1.07 (m, 2H).

^{13}C NMR (101 MHz, CDCl_3) δ 140.5, 135.2, 134.7, 129.7, 128.1, 125.7, 123.0, 120.5, 118.8, 108.8, 43.1, 33.0, 29.90, 27.0, 24.4, 12.2.

HRMS (ESI): calculated for ($\text{C}_{30}\text{H}_{32}\text{NSi}$, M+H) calcd. 434.2304 found 434.2304

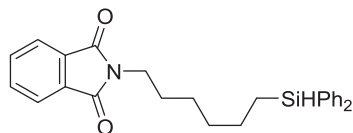

2-(6-(Diphenylsilyl)hexyl)isoindoline-1,3-dione (entry 5, Table 2.5)

Following the general procedure Method A, the title compound was prepared using (*Z*)-2-(hex-4-en-1-yl)isoindoline-1,3-dione (116 mg) and diphenylsilane (184 mg). The crude product was purified by flash chromatography using hexanes/EtOAc (10:1) as an eluent to afford the title compound as colorless oil (87 mg, 0.21 mmol, 42%). Isolated product contains 7% of internal hydrosilylation by-product.

^1H NMR (400 MHz, CDCl_3) δ 7.83-7.81 (m, 2H), 7.70-7.67 (m, 2H), 7.55-7.52 (m, 4H), 7.38-7.31 (m, 6H), 4.83 (t, $J = 3.7$ Hz, 1H), 3.64 (t, $J = 7.3$ Hz, 2H), 1.67-1.59 (m, 2H), 1.47-1.27 (m, 6H), 1.15-1.10 (m, 2H).

^{13}C NMR (101 MHz, CDCl_3) δ 168.6, 135.2, 134.7, 133.9, 132.3, 129.6, 128.1, 123.3, 38.2, 32.8, 28.6, 26.6, 24.4, 12.2.

HRMS (ESI): calculated for ($\text{C}_{26}\text{H}_{27}\text{NO}_2\text{SiNa}$, M+Na), 436.1709; found 436.1713.

2.8 References

- (1) Marciniac, B. *Hydrosilylation: A Comprehensive Review on Recent Advances*; Springer Berlin, 2009.
- (2) Lewis, L. N.; Stein, J.; Gao, Y.; Colborn, R. E.; Hutchins, G. *Platinum Met. Rev.* **1997**, 41, 66.
- (3) Hill, R. M. *Silicone Surfactants*; Marcel Dekker: New York, 1999; Vol. 86.
- (4) Tamao, K.; Ishida, N.; Tanaka, T.; Kumada, M. *Organometallics* **1983**, 2, 1694-1696.
- (5) Fleming, I.; Henning, R.; Plaut, H. J. *Chem. Soc., Chem. Commun.* **1984**, 29-31.
- (6) Speier, J. L.; Webster, J. A.; Barnes, G. H. *J. Am. Chem. Soc.* **1957**, 79, 974-979.
- (7) Speier, J. L.; Stone, F. G. A.; Robert, W. *In Adv. Organomet. Chem.*; Academic Press: 1979; Vol. Volume 17, p 407.
- (8) Hitchcock, P. B.; Lappert, M. F.; Warhurst, N. J. W. *Angew. Chem. Int. Ed.* **1991**, 30, 438-440.
- (9) Marciniac, B.; Gulinski, J.; Urbaniac, W.; Kornetka, Z. W. *Comprehensive Handbook on Hydrosilylation*; Pergamon: Oxford, UK, 1992.
- (10) Marciniac, B.; Gulinski, J. *J. Organomet. Chem.* **1993**, 446, 15-23.
- (11) Marciniac, B. *Coord. Chem. Rev.* **2005**, 249, 2374-2390.
- (12) Roy, A. K.; Robert West, A. F. H.; Mark, J. F. *In Adv. Organomet. Chem.*; Academic Press: 2007; Vol. Volume 55, p 1.
- (13) Troegel, D.; Stohrer, J. *Coord. Chem. Rev.* **2011**, 255, 1440-1459.
- (14) Nakajima, Y.; Shimada, S. *RSC Advances* **2015**, 5, 20603-20616.
- (15) Bart, S. C.; Lobkovsky, E.; Chirik, P. J. *J. Am. Chem. Soc.* **2004**, 126, 13794-13807.
- (16) Tondreau, A. M.; Atienza, C. C. H.; Weller, K. J.; Nye, S. A.; Lewis, K. M.; Delis, J. G. P.; Chirik, P. J. *Science* **2012**, 335, 567-570.
- (17) Hojilla Atienza, C. C.; Tondreau, A. M.; Weller, K. J.; Lewis, K. M.; Cruse, R. W.; Nye, S. A.; Boyer, J. L.; Delis, J. G. P.; Chirik, P. J. *ACS Catal.* **2012**, 2, 2169-2172.
- (18) Tondreau, A. M.; Atienza, C. C. H.; Darmon, J. M.; Milsman, C.; Hoyt, H. M.; Weller, K. J.; Nye, S. A.; Lewis, K. M.; Boyer, J.; Delis, J. G. P.; Lobkovsky, E.; Chirik, P. J. *Organometallics* **2012**, 31, 4886-4893.
- (19) Kamata, K.; Suzuki, A.; Nakai, Y.; Nakazawa, H. *Organometallics* **2012**, 31, 3825-3828.
- (20) Peng, D.; Zhang, Y.; Du, X.; Zhang, L.; Leng, X.; Walter, M. D.; Huang, Z. *J. Am. Chem. Soc.* **2013**, 135, 19154-19166.
- (21) Greenhalgh, M. D.; Frank, D. J.; Thomas, S. P. *Adv. Synth. Catal.* **2014**, 356, 584-590.

- (22) Chen, Y.; Sui-Seng, C.; Boucher, S.; Zargarian, D. *Organometallics* **2005**, *24*, 149-155.
- (23) Hyder, I.; Jimenez-Tenorio, M.; Puerta, M. C.; Valerga, P. *Dalton Trans.* **2007**, 3000-3009.
- (24) tez Junquera, L.; Puerta, M. C.; Valerga, P. *Organometallics* **2012**, *31*, 2175-2183.
- (25) Kuznetsov, A.; Gevorgyan, V. *Org. Lett.* **2012**, *14*, 914-917.
- (26) Lipschutz, M. I.; Tilley, T. D. *Chem. Commun.* **2012**, *48*, 7146-7148.
- (27) Vechorkin, O.; Hu, X. *Angew. Chem. Int. Ed.* **2009**, *48*, 2937-2940.
- (28) Vechorkin, O.; Proust, V.; Hu, X. *J. Am. Chem. Soc.* **2009**, *131*, 9756-9766.
- (29) Vechorkin, O.; Barmaz, D.; Proust, V.; Hu, X. *J. Am. Chem. Soc.* **2009**, *131*, 12078-12079.
- (30) Vechorkin, O.; Proust, V.; Hu, X. *Angew. Chem. Int. Ed.* **2010**, *49*, 3061-3064.
- (31) Hu, X. *Chem. Sci.* **2011**, *2*, 1867-1886.
- (32) Vechorkin, O.; Godinat, A.; Scopelliti, R.; Hu, X. *Angew. Chem. Int. Ed.* **2011**, *50*, 11777-11781.
- (33) Breitenfeld, J.; Scopelliti, R.; Hu, X. *Organometallics* **2012**, *31*, 2128-2136.
- (34) Sabourault, N.; Mignani, G.; Wagner, A.; Mioskowski, C. *Org. Lett.* **2002**, *4*, 2117-2119.
- (35) Chakraborty, S.; Guan, H. *Dalton Trans.* **2010**, *39*, 7427-7436.
- (36) Chakraborty, S.; Krause, J. A.; Guan, H. *Organometallics* **2009**, *28*, 582-586.
- (37) Tran, B. L.; Pink, M.; Mindiola, D. J. *Organometallics* **2009**, *28*, 2234-2243.
- (38) Benkeser, R. A.; Dunny, S.; Li, G. S.; Nerlekar, P. G.; Work, S. D. *J. Am. Chem. Soc.* **1968**, *90*, 1871-1875.
- (39) Chalk, A. J.; Harrod, J. F. *J. Am. Chem. Soc.* **1965**, *87*, 16-21.
- (40) Pereira, S.; Srebnik, M. *J. Am. Chem. Soc.* **1996**, *118*, 909-910.
- (41) Yamamoto, Y.; Fujikawa, R.; Umemoto, T.; Miyaura, N. *Tetrahedron* **2004**, *60*, 10695-10700.
- (42) Obligacion, J. V.; Chirik, P. J. *J. Am. Chem. Soc.* **2013**, *135*, 19107-19110.
- (43) Jia, X.; Zhang, L.; Qin, C.; Leng, X.; Huang, Z. *Chem. Commun.* **2014**, *50*, 11056-11059.
- (44) Palmer, W. N.; Diao, T.; Pappas, I.; Chirik, P. J. *ACS Catal.* **2015**, *5*, 622-626.
- (45) Atienza, C. C. H.; Diao, T.; Weller, K. J.; Nye, S. A.; Lewis, K. M.; Delis, J. G. P.; Boyer, J. L.; Roy, A. K.; Chirik, P. J. *J. Am. Chem. Soc.* **2014**, *136*, 12108-12118.
- (46) Gountchev, T. I.; Tilley, T. D. *Organometallics* **1999**, *18*, 5661-5667.
- (47) Barros, N.; Eisenstein, O.; Maron, L. *Dalton Transactions* **2010**, *39*, 10749-10756.
- (48) Morris, R. H. *Acc. Chem. Res.* **2015**, *48*, 1494-1502.
- (49) Chakraborty, S.; Bhattacharya, P.; Dai, H.; Guan, H. *Acc. Chem. Res.* **2015**, *48*, 1995-2003.

-
- (50) Breitenfeld, J.; Vechorkin, O.; Corminboeuf, C.; Scopelliti, R.; Hu, X. *Organometallics* **2010**, *29*, 3686-3689.
- (51) Csok, Z.; Vechorkin, O.; Harkins, S. B.; Scopelliti, R.; Hu, X. *J. Am. Chem. Soc.* **2008**, *130*, 8156-8157.
- (52) Vechorkin, O.; Csok, Z.; Scopelliti, R.; Hu, X. *Chem. Eur. J.* **2009**, *15*, 3889-3899.
- (53) Kinney, R. J.; Jones, W. D.; Bergman, R. G. *J. Am. Chem. Soc.* **1978**, *100*, 7902-7916.
- (54) Becker, D.; Nagler, M.; Sahali, Y.; Haddad, N. *J. Org. Chem.* **1991**, *56*, 4537-4543.
- (55) Zhang, G.; Cui, L.; Wang, Y.; Zhang, L. *J. Am. Chem. Soc.* **2010**, *132*, 1474-1475.
- (56) Barluenga, J.; Álvarez-Gutiérrez, J. M.; Ballesteros, A.; González, J. M. *Angew. Chem. Int. Ed.* **2007**, *46*, 1281-1283.
- (57) Tamaru, Y.; Hojo, M.; Higashimura, H.; Yoshida, Z. *J. Am. Chem. Soc.* **1988**, *110*, 3994-4002.
- (58) Michael, F. E.; Cochran, B. M. *J. Am. Chem. Soc.* **2006**, *128*, 4246-4247.
- (59) Shin, D.-M.; Song, D.-M.; Kim, Y. *Mol. Cryst. Liq. Cryst.* **2004**, *425*, 153-158.
- (60) Eberle, M. K.; Shapiro, M. J.; Stucki, R. *J. Org. Chem.* **1987**, *52*, 4661-4665.
- (61) Milen, M.; Grün, A.; Bálint, E.; Dancso, A.; Keglevich, G. *Synth. Commun.* **2010**, *40*, 2291-2301.
- (62) Morimoto, T.; Fuji, K.; Tsutsumi, K.; Kakiuchi, K. *J. Am. Chem. Soc.* **2002**, *124*, 3806-3807.
- (63) Nogawa, M.; Sugawara, S.; Iizuka, R.; Shimojo, M.; Ohta, H.; Hatanaka, M.; Matsumoto, K. *Tetrahedron* **2006**, *62*, 12071-12083.
- (64) Morino, Y.; Hidaka, I.; Oderaotshi, Y.; Komatsu, M.; Minakata, S. *Tetrahedron* **2006**, *62*, 12247-12275.
- (65) Tamao, K.; Ishida, N. *J. Organomet. Chem.* **1984**, *269*, c37-c39

Chapter 3

An Easily-Accessed Nickel Nanoparticle
Catalyst for Alkene Hydrosilylation with
Tertiary Silanes

3.1 Introduction

Hydrosilylation of alkenes is a main method to synthesize organosilicon compounds, which have broad applications in synthetic and material chemistry.¹⁻⁴ Platinum based catalysts such as Karstedt's⁵ and Speier's^{6,7} catalysts are the most widely used in the industry due to their stability, high activity, and broad scope. The high cost and low abundance of Pt have motivated the development of alternative catalysts based on Earth-abundant transition metals. While a number of systems based on Fe⁸⁻¹¹, Co^{12,13} and Ni¹⁴⁻¹⁷ complexes were shown to be efficient catalysts for hydrosilylation of alkenes, many of them are active only when using PhSiH₃ and Ph₂SiH₂ as hydrosilanes. The products of these reactions contain residual Si-H bonds, which leads to lower stability and utility of final products. Tertiary silanes are much more commercially relevant and are widely used to make silicones and silane coupling reagents. However, they are sterically demanding and less reactive. Chirik and co-workers showed that reducing the steric bulk of pyridine diimine (PDI) ligands enabled the first efficient iron-catalyzed alkene hydrosilylation using tertiary silanes.¹⁸ This strategy proved successful in the development of several other Fe- and Co-based catalysts that hydrosilylated alkenes using tertiary alkenes.^{10,19,20} Nevertheless, these catalysts employ designer ligands which can be expensive or difficult to make. Although Ni-based catalysts for alkene hydrosilylation are known,^{14-17,21-24} only system was shown to catalyze hydrosilylation of an unactivated alkene using a tertiary silane, and its scope was not reported.²⁵ Compared to the significant progress of base metal-catalyzed homogeneous alkene hydrosilylation, the development of their heterogeneous counterparts falls much behind. Heterogeneous catalysts are potentially less costly and more amenable to industrial applications. However, to our knowledge, there is no prior report of non-precious heterogeneous catalysts capable of alkene hydrosilylation using tertiary silanes.²⁶⁻²⁸ Reported here the heterogeneous nickel nanoparticles catalyze hydrosilylation of unactivated alkenes with tertiary silanes. The nanoparticles can be easily accessed from in-situ activation of a Ni(O^tBu)₂•2KCl precatalyst by the silane substrate. The precatalyst can be made in one-step from stable and readily available reagents. Not only terminal alkenes are hydrosilylated with high anti-Markovnikov selectivity, but also internal alkenes are hydrosilylated through a tandem isomerization-hydrosilylation process to give terminal alkyl silanes. The catalytic system can be applied to synthesize a single terminal alkyl silane from a mixture of internal and terminal alkene isomers, to remotely functionalize an internal alkene derived from a fatty acid.

3.2 Optimization of Reaction Conditions

We discovered previously nickel pincer complexes as active alkene hydrosilylation catalysts.²¹ However, they were not efficient when using tertiary silanes. To develop catalysts for alkene hydrosilylation using tertiary silanes, we screened a large number of nickel alkoxide complexes with reduced steric bulk for the reaction of 1-decene with trimethoxysilane (MeO)₃SiH. Certain nickel complexes appeared to lose the ligands and decompose into black residues during the reaction, nevertheless, the desired hydrosilylation product was formed using these complexes. We hypothesized that these complexes were converted into nickel nanoparticles upon reaction with silane, which was responsible for the hydrosilylation activity. We then searched for simpler precursors of the presumed nickel nanoparticles which contained no designer ligands. A number of nickel salts including Ni(OAc)₂ (Ac = acetate) (entry 2, Table 3.1), Ni(OTf)₂ (OTf = trifluoromethanesulfonate) (entry 3, Table 3.1), Ni(acac)₂ (acac = acetylacetonate) (entry 4, Table 3.1), Ni(OH)₂ (entry 5, Table 3.1), and Ni(OMe)₂ (entry 7, Table 3.1) were tested, but the best yield, obtained using Ni(acac)₂, was only 23%. A Ni(0) source, Ni(COD)₂, was also ineffective, giving a yield of 5% (entry 6, Table 3.1). The use of Ni(O^tBu)₂, however, led to much higher yields (entry 1, Table 3.1).

Table 3.1: Nickel precatalysts for 1-decene hydrosilylation with trimethoxysilane^a

Entry	Catalyst	Yield, (%) ^b
1	Ni(O ^t Bu) ₂ •2KCl	88
2	Ni(OAc) ₂	<2
3	Ni(OTf) ₂	<1
4	Ni(acac) ₂	23
5	Ni(OH) ₂	0
6	Ni(COD) ₂	5
7	Ni(OMe) ₂ •2KCl	12

^a Conditions : 1-decene (1 mmol), (MeO)₃SiH (1.2 mmol.), Ni cat. (1 mol %), THF (2 mL), 12 hours, rt.

^b Determined by GC-MS using dodecane as an internal standard.

Further several solvents including THF, DMA, 1,4-dioxane, toluene and acetonitrile were tested in this reaction. 1,4-Dioxane and THF were the best solvents (Table 3.2).

Table 3.2: The optimization of the solvent for Ni-catalysed 1-decene hydrosilylation with $(\text{MeO})_3\text{SiH}^a$

$$\text{C}_8\text{H}_{17}\text{CH}=\text{CH}_2 + (\text{MeO})_3\text{SiH} \xrightarrow[\text{Solvent, rt, 4 h}]{\text{Ni}(\text{O}^t\text{Bu})_2 \cdot 2\text{KCl 1 mol \%}} \text{C}_8\text{H}_{17}\text{CH}_2\text{CH}_2\text{Si}(\text{OMe})_3$$

1.0 mmol 1.2 mmol

Entry	Solvent	Yield, (%) ^b
1	THF	85
2	DMA	69
3	Dioxane	81
4	Toluene	11
5	MeCN	<5

^aConditions : 1-decene (1 mmol), silane (1.2 mmol.), Ni cat. (1 mol %), THF (2 mL), 4 hours, rt. ^b Determined by GC-MS using dodecane as an internal standard.

The effect of the ligand is illustrated in Table 3.3. Only addition of TMEDA did not influence significantly the reaction of 1-decene and $(\text{MeO})_3\text{SiH}$ (entry 2, Table 3.3). Addition of phosphines (entries 3-4, Table 3.3), tert-butyl isocyanide (entry 5, Table 3.3), NHC ligands (entries 6-7, Table 3.3) led to the crucial change in the reaction yield.

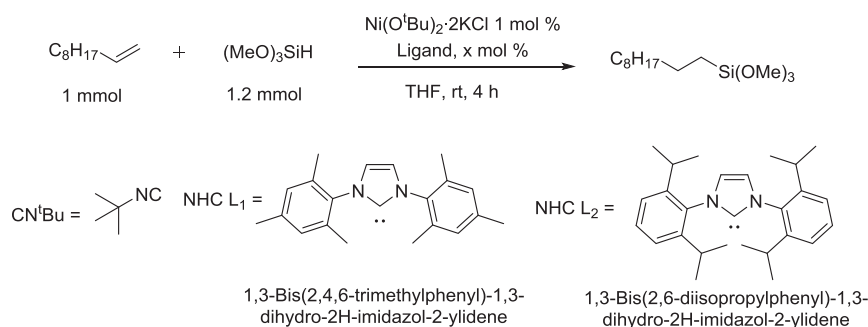
Table 3.3: The effect of ligands addition^a

Entry	Ligand, x mol %	Yield, (%) ^b
1	no ligand	88
2	TMEDA, 1	80
3	PPh ₃ , 2	0
4	dppe, 1	0
5	CN ^t Bu, 2	traces
6	NHC L ₁ , 2	12
7	NHC L ₂ , 2	9

^a Conditions: 1-decene (1 mmol), silane (1.2 mmol.), Ni cat. (1 mol %), THF (2 mL), 4 hours, rt. ^b Determined by GC-MS using dodecane as an internal standard.

3.3 Synthesis of Ni Precatalyst

While a method employing anhydrous NiCl₂ was reported for the synthesis of Ni(O^tBu)₂,²⁹ we chose to prepare it by reaction of a soluble nickel source, Ni(TMEDA)Cl₂ (TMEDA = tetramethylethylenediamine) with MO^tBu (M = Li, Na, K) in ^tBuOH or THF (Scheme 3.1, eq 1). The as-synthesized Ni(O^tBu)₂ is a blue insoluble solid. The sample prepared using KO^tBu was most active, giving a yield of 88% at a loading of 1 mol% for the anti-Markovnikov hydrosilylation of 1-decene with (MeO)₃SiH (Scheme 3.1, eq 2).

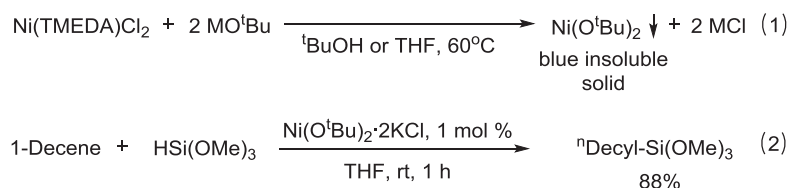

Scheme 3.1: Preparation of Ni catalyst and reaction of 1-decene with trimethoxysilane.

Elemental analysis of the precatalyst indicated that the sample has a composition of $\text{Ni(O}^t\text{Bu)}_2 \cdot 2\text{KCl}$ without additional organic ligands.

3.4 Ni-catalyzed Hydrosilylation of 1-Decene with Various Silanes

The $\text{Ni(O}^t\text{Bu)}_2 \cdot 2\text{KCl}$ precatalyst was tested for hydrosilylation of 1-decene with other tertiary silanes at room temperature (Table 3.4). $(\text{EtO})_3\text{SiH}$, $\text{Me}_2(\text{MeO})\text{SiH}$, and $\text{Me}(\text{EtO})_2\text{SiH}$ could be used, with yields of above 80% (entries 1-4, Table 3.4). For 1,1,3,3,3-pentamethyldisiloxane (PMDS) and 1,1,1,3,5,5,5-heptamethyltrisiloxane (MD³M), the yields were lower, possibly due to the slow activation of the precatalyst (entries 5-6, Table 3.4). However, better conversion and yields were obtained with these silanes if a small amount of $(\text{MeO})_3\text{SiH}$ was added to activate the precatalyst and if the temperature is increased to 60°C (entry 10, Table 3.4). Ph_2SiH_2 and Ph_3SiH were also successfully used (entries 8-9, Table 3.4).

Table 3.4: Ni-catalyzed hydrosilylation of 1-decene with various silanes^a

Entry	Silane	Yield, (%) ^b
1	(MeO) ₃ SiH	88 (86)
2	(EtO) ₃ SiH	91 (88)
3	Me ₂ (MeO)SiH	84 (83)
4	Me(EtO) ₂ SiH	81 (77)
5	PMDS	35
6	MD'M	14
7	Et ₃ SiH	6
8	Ph ₃ SiH	43 (44)
9	Ph ₂ SiH ₂	82 ^c
10	PMDS	55 (52) ^d

^a Conditions : 1-decene (1 mmol), silane (1.2 mmol.), Ni cat. (1 mol %), THF (2 mL), 4 hours, rt. ^b Determined by GC-MS using dodecane as an internal standard. Numbers in parentheses are isolated yields. ^c 12 % of dicycylodiphenylsilane was formed. ^d Alkene 5 mmol, PMDS 6 mmol, Ni cat. 1 mol %, neat, 60°C, 2 h. (MeO)₃SiH 2 mol % was added as an activator.

3.5 Examination of Ni Catalyst Microstructure

During the hydrosilylation reaction, when (MeO)₃SiH was added to the reaction mixture containing the insoluble Ni(O^tBu)₂•2KCl precatalyst, the latter solid immediately dissolved and a dark brown solution was formed. We suspected that the Ni(II) precatalyst was converted into colloidal nickel nanoparticles in this process, which is the active catalyst. When the reaction of 1-decene with (MeO)₃SiH was conducted in the presence of an excess of Hg (200 equiv. relative to Ni), the yield of decyltrimethoxysilane was only 20%. This significant drop of yield is consistent with heterogeneous nickel nanoparticles being the catalyst. To confirm the formation of nickel nanoparticles, the colloidal solution was subjected to transmission electron microscopy (TEM) measurements. Indeed, ultra-small nanocrystals were observed (Figure 3.1a). The bright field image (Figure 3.2) and corresponding high angle annular dark field (HAADF) image (Figure 3.1b) indicate that the

nickel nanocrystals are regular over a large area. The size distribution of the nanocrystals is fairly narrow (Fig 3.1c). The average size is about 3.5 nm. Lattice fringes were observed in high resolution TEM images (Figure 3.1d). The inter-planar distances of ~ 0.20 nm and ~ 0.18 nm correspond to the (111) and (020) planes of nickel metal (space group: Fm-3m, JCPDS No. 01-1258). This assignment was confirmed by the corresponding fast Fourier transformation (FFT) image (inset in Figure 3.1d). The elemental mapping analysis showed that the nanocrystals were mainly made of Ni (Figure 3.1e,f and Figure 3.3).

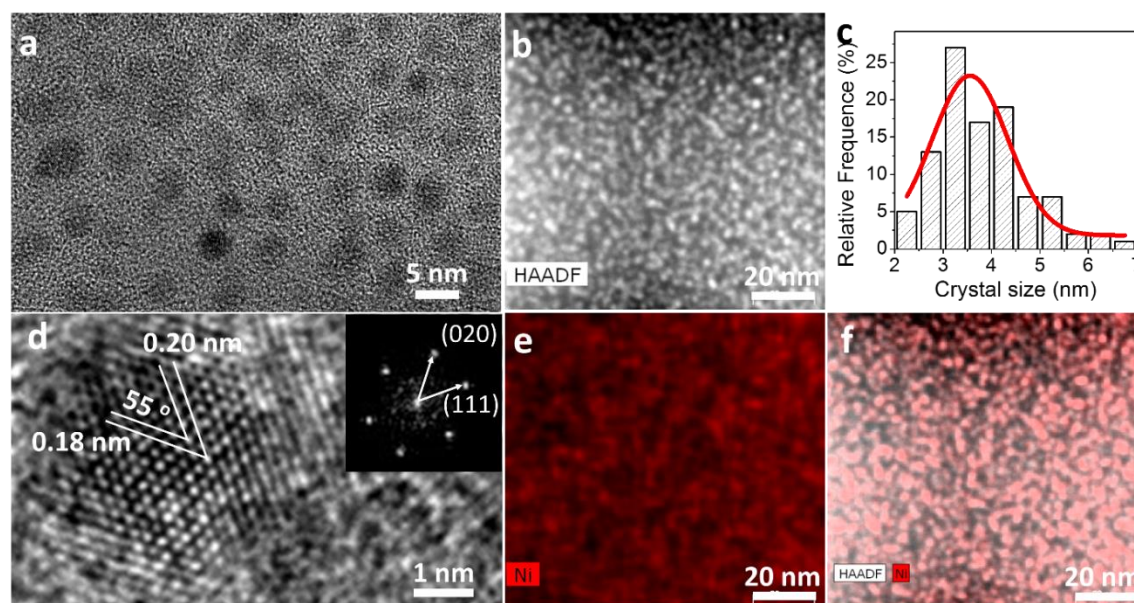



Figure 3.1: (a) TEM image of nickel nanocrystals. (b) HAADF image of nickel nanocrystals in large area. White dots in HAADF image are nickel nanocrystals. (c) The crystal size distribution. (d) High resolution TEM image of a nanocrystal. The inset shows the corresponding FFT image. (e) The elemental mapping image corresponding to (b) (based on nickel signal). (f) Combined HAADF and elemental mapping image based on nickel signal.

3.6 Ni-catalyzed Hydrosilylation of Functionalized Alkenes with $(\text{MeO})_3\text{SiH}$

The scope of alkene was then examined for this catalytic system using $(\text{MeO})_3\text{SiH}$. The reactions were performed with 1 mol % of Ni precatalyst in THF at room temperature. A

large number of unactivated terminal alkenes could be hydrosilylated (Table 3.5). When both internal and terminal C=C double bonds are present, hydrosilylation is selective for the terminal double bond (entry 4, Table 3.5). Importantly, functional groups such as epoxide (entry 6, Table 3.5), tert-butyldimethylsilyl-protected alcohol (entry 7, Table 3.5), acetal (entry 8, Table 3.5), amine (entry 10, Table 3.5), ester (entry 11, Table 3.5) and alkyl chloride (entry 12, Table 3.5) were tolerated. Allyl glycidyl ether is an important substrate because the alkoxy silanes derived from this alkene find broad application in coatings and as coupling agents for epoxy composites employed for electronic “chip” encapsulation.³⁰ However, hydrosilylation of allyl esters of this type using Pt catalysts are known to lead to side reactions.³¹ To our delight, the Ni system is efficient for hydrosilylation of allyl glycidyl ether, giving desired product in a 61% yield (entry 9, Table 3.5). More sensitive functional groups such as ketone, aldehyde, and amide are unfortunately not tolerated.

Table 3.5: Ni-catalyzed hydrosilylation of functionalized alkenes with (MeO)₃SiH^a

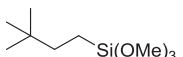
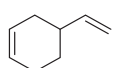
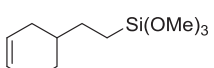
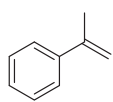
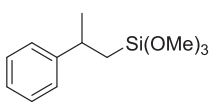
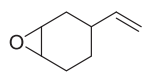
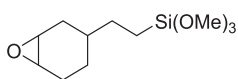
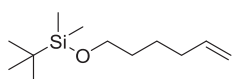
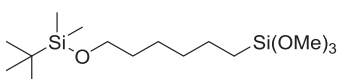
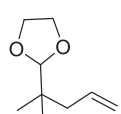
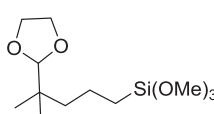
Entry	Alkene	Product	Yield (%) ^b
1	1-Octene	ⁿ Oct-Si(OMe) ₃	89
2	1-Octadecene	ⁿ C ₁₈ H ₃₇ -Si(OMe) ₃	84
3			78
4			63
5			55
6			74
7			92
8			95

9			61
10			90
11			67
12			58

^a Conditions : alkene (1.0 mmol), (MeO)₃SiH (1.2 mmol), Ni cat. (1 mol %), THF (2 mL), 4 hours, rt. ^b Isolated yields are reported. ^c (MeO)₃SiH (1.5 mmol).

3.7 Ni-catalyzed Isomerizing Hydrosilylation of Simple and Functionalized Internal Alkenes

Internal alkenes are generally unsuitable substrates for alkene hydrosilylation. Only very recently a couple of Ni- and Co-based catalytic systems were shown to convert internal alkenes to terminal silanes through a tandem isomerization-hydrosilylation process.^{20,21} In principle, this process can be used for the remote functionalization of alkenes, which has emerged as a desirable strategy in organic synthesis.³²⁻³⁶ However, using the two reported catalytic systems the tandem isomerization-hydrosilylation process remains sluggish. The scope is narrow and largely limited to simple 2-alkenes. The conversion is often incomplete. To our delight, the current system is very efficient for the tandem isomerization-hydrosilylation of various internal alkenes (Table 3.6). 2-, 3-, and 4-octenes were all selectively transformed to terminal trimethoxy(octyl)silane in high yields (entries 1-3, Table 3.6). Even 5-decene and 7-tetradecene were hydrosilylated in high yields and selectivity (entries 4-5, Table 3.6). It should be emphasized that for 7-tetradecene, the isomerization of alkene has to repeat five times before being hydrosilylated. Not only simple and linear internal alkenes, but also those containing functional groups such as ether and acetal (entries 6-7, Table 3.6), as well as an alkene with a secondary alkyl substituent (entry 8, Table 3.6) could be used. Both cis- and trans-alkenes were selectively converted in high yields.

Table 3.6: Ni-catalyzed tandem isomerization-hydrosilylation of internal alkenes with (MeO)₃SiH^a

$$\begin{array}{c}
 \text{R}_1\text{-CH=CH-R}_2 + (\text{MeO})_3\text{SiH} \xrightarrow[\text{THF, rt, 4-12 h}]{\text{Ni cat., 2-5 mol \%}} \text{R}_3\text{-CH}_2\text{-CH}_2\text{-Si(OMe)}_3 \\
 \begin{array}{ccc}
 1.0 \text{ mmol} & 1.2 \text{ mmol} &
 \end{array}
 \end{array}$$

Entry	Substrate	Product	Yield (%) ^b
1		n-Octyl-Si(OMe) ₃	95 ^c
2		n-Octyl-Si(OMe) ₃	97 ^c
3		n-Octyl-Si(OMe) ₃	89
4		n-Decyl-Si(OMe) ₃	83
5		n-Tetradecyl-Si(OMe) ₃	71
6			74 ^c
7			79
8			69

^a Conditions: alkene (0.5 mmol), silane (1.5equiv.), Ni cat. (5 mol %), THF (3 mL), 12 hours, rt. ^b Isolated yields are reported. ^c Ni cat. (2 mol %).

3.7.1 Synthesis of Triethoxy(octyl)silane from Mixture of Isomeric Octenes

The unprecedented activity and selectivity of this nickel nanoparticle catalyst in the isomerization-hydrosilylation tandem process prompted us to further exploit its potential applications. Triethoxy(octyl)silane is widely used coatings and is produced annually in a > 6000 ton scale.^{2-4,19} It might be economically advantageous to synthesize this silane from a

mixture of octenes. To explore this possibility, an equimolar mixture of 1-octene, 2-octene, 3-octene, and 4-octene was prepared and then subjected to the isomerization-hydrosilylation process using 0.5% of nickel catalyst and $(\text{EtO})_3\text{SiH}$ (Scheme 3.2). After 2 hours at 60°C , triethoxy(octyl)silane was obtained in a 81% yield with 96:4 HS:DHS selectivity (HS = hydrosilylation; DHS = dehydrogenative silylation). Thus, the current catalytic system is applicable for the synthesis of a single terminal alkyl silane from a mixture of different internal and terminal olefin isomers.

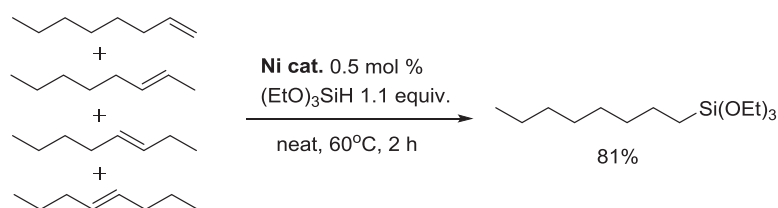

Scheme 3.2: Synthesis of triethoxy(octyl)silane from mixture of equimolar mixture of 1-, 2-, 3-, and 4-octenes

3.7.2 Conversion of Oleic Acid Derivative to a Terminal Alkyl Silane

Unsaturated fatty acids from plant oils are easily available and represent a unique class of chemical feedstock due to their characteristic long-chain methylene sequences.^{37,38} The generation of α,ω -difunctionalized compounds from plant oils while incorporating the entire length of fatty acids is attractive but challenging. We tested the current catalytic system for the isomerizing hydrosilylation of TBS-protected *cis*-9-octadecen-1-ol (oleyl alcohol; 85% purity). With 10 mol % of Ni precatalyst and using triethoxysilane at 0°C , the linear and saturated product, *O*-*tert*-butyldimethylsilyl 18-(triethoxysilyl)octadecan-1-ol, was obtained in a 45% yield (Scheme 3.3; the conversion was 80%). The reaction had good HS:DHS (>94:6) and terminal selectivity (>10:1). The isomerization propagated over 8 carbon-carbon bonds from the initial position of the double bond. It should be noted that the corresponding terminal olefin is not available from an equilibrium mixture of monounsaturated fatty acids. Thus, the current catalyst system is potentially useful for the utilization of renewable feedstock materials.

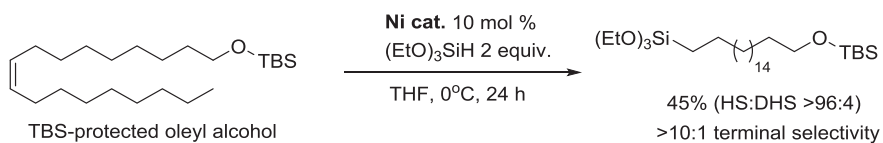

Scheme 3.3: Isomerizing hydrosilylation of oleic acid derivative

3.8 Conclusions

In summary, a new nickel nanoparticle catalyst has been developed for the hydrosilylation of unactivated alkenes with tertiary silanes. The catalyst can be easily prepared in-situ from a simple $\text{Ni}(\text{O}^t\text{Bu})_2 \cdot 2\text{KCl}$ precatalyst. The catalyst catalyzes anti-Markovnikov hydrosilylation of terminal alkenes and isomerizing hydrosilylation of internal alkenes. The catalyst can be applied to synthesize single terminal alkyl silanes from a mixture of alkene isomers, and convert fatty acid-derived internal alkenes into α,ω -difunctionalized compounds.

3.9 Experimental

3.9.1 Chemicals and Reagents

All manipulations were carried out under an inert $\text{N}_2(\text{g})$ atmosphere using standard Schlenk or glovebox techniques. Solvents were purified using a two-column solid-state purification system (Innovative Technology, NJ, USA) and transferred to the glove box without exposure to air. Deuterated solvents were purchased from ARMAR AG and were

degassed and stored over activated 3 Å molecular sieves. Unless otherwise noted, all other reagents and starting materials were purchased from commercial sources and used without further purification. Liquid compounds were degassed by standard freeze-pump-thaw procedures prior to use. The following chemicals were prepared according to procedures in the literature:

substrates tert-butyl(hex-5-enyloxy)dimethylsilane³⁹, 2,2-dimethyl-4-pentenal ethylene acetal⁴⁰; (E)-((but-2-en-1-yloxy)methyl)benzene⁴¹, (E)-pent-1-en-1-ylcyclohexane⁴², (Z)-2-(hex-3-en-1-yl)-1,3-dioxolane⁴³, (Z)-tert-butyl(dimethyl(octadec-9-en-1-yloxy)silane (analogously to tert-butyl(hex-5-enyloxy)dimethylsilane)³⁹.

3.9.2 Physical Methods

The ¹H and ¹³C NMR spectra were recorded at 293 K or 373 K on Bruker Avance 400 spectrometers. ¹H NMR chemical shifts were referenced to residual solvent as determined relative to Me₄Si (δ = 0 ppm). The ¹³C{¹H} chemical shifts were reported in ppm relative to the carbon resonance of CDCl₃ (77.16 ppm), C₆D₆ (128.06). GC measurement was conducted on a Perkin-Elmer Clarus 400 GC with a FID detector. GC-MS measurements were conducted on an Agilent Technologies 7890A GC system equipped with a 5975C MS detector. HRMS (ESI, APCI and APPI) measurements were conducted at the EPFL ISIC Mass Spectrometry Service with a Micro Mass QTOF. Elemental analyses were performed on a Carlo Erba EA 1110 CHN instrument at EPFL. Microstructure was examined by a FEI Tecnai Osiris transmission electron microscopy (TEM) equipped with high brightness XFEG gun. Energy-dispersive X-ray spectroscopy (EDX) mapping images was taken under a scanning TEM (STEM) modal. The nanocrystals size distribution was measured directly from the typical TEM images.

3.9.3 The Procedures for the Preparation of Ni Catalysts

Preparation of Ni(O^tBu)₂

In a nitrogen filled glovebox, an oven-dried 30 mL re-sealable screw-cap vial equipped with a Teflon coated magnetic stirring bar was charged with Ni(TMEDA)Cl₂ (1.228 g, 5.0 mmol), LiO^tBu (0.80 g, 10.0 mmol) and 15 mL of dry ^tBuOH. Resulting mixture was stirred for 48 hours at 60°C. After cooling down to room temperature, blue solid was filtered off (the solution must be colorless) and washed 3 times with small portions of THF and 1 time with pentane. After drying under reduced pressure, 0.85 g (4.9 mmol, 98%) of Ni(O^tBu)₂ was obtained.

Elemental analysis: Anal. Calcd for C₈H₁₈NiO₂: C, 46.89.14; H, 8.85. Found: C, 46.70; H, 8.90.

Preparation of Ni(O^tBu)₂•2KCl

In a nitrogen filled glovebox, an oven-dried 30 mL re-sealable screw-cap vial equipped with a Teflon coated magnetic stirring bar was charged with Ni(TMEDA)Cl₂ (1.228 g, 5.0 mmol), KO^tBu (1.122 g, 10.0 mmol) and 20 mL of dry THF. Resulting mixture was stirred for 24 hours at 60°C. After cooling down to room temperature, blue solid was filtered off (the solution must be colorless) and washed 3 times with small portions of THF. After drying under reduced pressure, 1.61 g (91%) of Ni(O^tBu)₂•2KCl was obtained.

Elemental analysis: Anal. Calcd for C₈H₁₈Cl₂K₂NiO₂: C, 27.14; H, 5.13. Found: C, 27.09; H, 5.10.

Note : Centrifugation can be used instead of filtration. Precatalyst is moisture sensitive and should be stored under N₂.

3.9.4 General Procedures for Hydrosilylation Reactions

General procedure for the Ni-catalyzed hydrosilylation of 1-decene with various silanes (General Procedure I, Table 3.4)

In a nitrogen filled glovebox, an oven-dried 30 mL re-sealable screw-cap vial equipped with a Teflon coated magnetic stirring bar was charged with Ni(O^tBu)₂•2KCl (3.5 mg, 0.01 mmol, corresponding to 1% of Ni) and 2 mL of dry THF. The suspension of precatalyst was stirred for 5 minutes. 1-Decene (140 mg, 1.0 mmol), silane (1.2 mmol) and dodecane (30 µL) were added. After 4 hours the solution was subjected to GCMS analysis. THF was removed under reduced pressure. Crude products were dissolved in hexane and filtered through a pad of silica.

General procedure for the Ni-catalyzed hydrosilylation of terminal alkenes with (MeO)₃SiH (General Procedure II, Table 3.5)

In a nitrogen filled glovebox, an oven-dried 30 mL re-sealable screw-cap vial equipped with a Teflon coated magnetic stirring bar was charged with Ni(O^tBu)₂•2KCl (3.5 mg, 0.01 mmol, corresponding to 1% of Ni) and 2 mL of dry THF. The suspension of precatalyst was stirred for 5 minutes. Alkene (1.0 mmol) and trimethoxysilane (146 mg, 1.2 mmol) were added at room temperature. After 4 hours THF was removed under reduced pressure. The residue was purified by flash chromatography to afford the desired product.

General procedure for the Ni-catalyzed isomerizing hydrosilylation of internal alkenes with (MeO)₃SiH (General Procedure III, Table 3.6)

In a nitrogen filled glovebox, an oven-dried 30 mL re-sealable screw-cap vial equipped with a Teflon coated magnetic stirring bar was charged with Ni(O^tBu)₂•2KCl (2 or 5% of Ni) and 3 mL of dry THF. The suspension of precatalyst was stirred for 5 minutes. Internal alkene (1.0 mmol) and trimethoxysilane (1.2 mmol) were added at room temperature. After 12 hours THF was removed under reduced pressure. The residue was purified by flash chromatography to afford the desired product.

3.9.5 The Evaluation of the Activity of $\text{Ni}(\text{O}^t\text{Bu})_2 \cdot 2\text{KCl}$

In a nitrogen filled glovebox a 30 mL vial with a screw cap was charged with 1-decene (1.4 g, 10 mmol) and 3.5 mg of Ni precatalyst (0.01 mmol, 0.1 mol %). The mixture was stirred for 5 minutes and $(\text{MeO})_3\text{SiH}$ (1.28 g, 10.5 mmol) was added (Caution: exothermic reaction!). The reaction was stirred at room temperature and aliquots for GCMS analysis were taken every 5 minutes (CDCl_3 was used as a solvent). After 30 min the GCMS yield of decyltrimethoxysilane was 85% (TON > 850; TOF = 1700 h^{-1}).

3.9.6 Examination of Ni Catalyst Microstructure

Preparation of the samples

In a nitrogen filled glovebox, an oven-dried 30 mL re-sealable screw-cap vial equipped with a Teflon coated magnetic stirring bar was charged with $\text{Ni}(\text{O}^t\text{Bu})_2 \cdot 2\text{KCl}$ (18 mg, 0.05 mmol) and 2 mL of dry THF. The suspension of precatalyst was stirred for 5 minutes. 1-Hexene (84 mg, 1.0 mmol) and trimethoxysilane (146 mg, 1.2 mmol) were added. After 10 minutes of stirring at room temperature, reaction mixture was filtered through a $0.22 \mu\text{m}$ PTFE membrane. The samples for TEM analysis were prepared by placing two drops of filtered solution on the TEM grid and drying in nitrogen-filled glovebox for 1 hour.

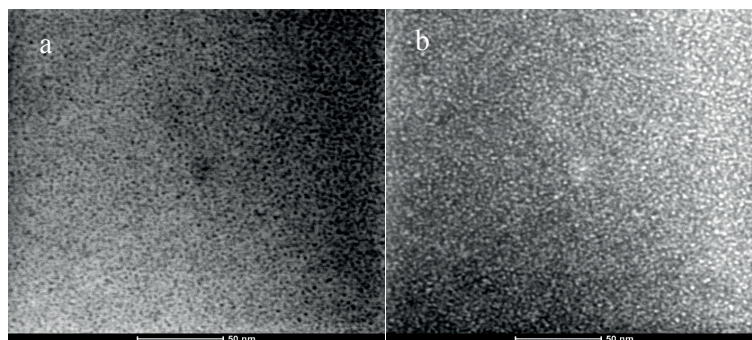

Figure 3.2: (a) Bright field TEM image and (b) the corresponding HAADF image of nickel nanocrystals in large area. The black dots in bright field TEM image and white dots in HAADF image are nickel nanocrystals.

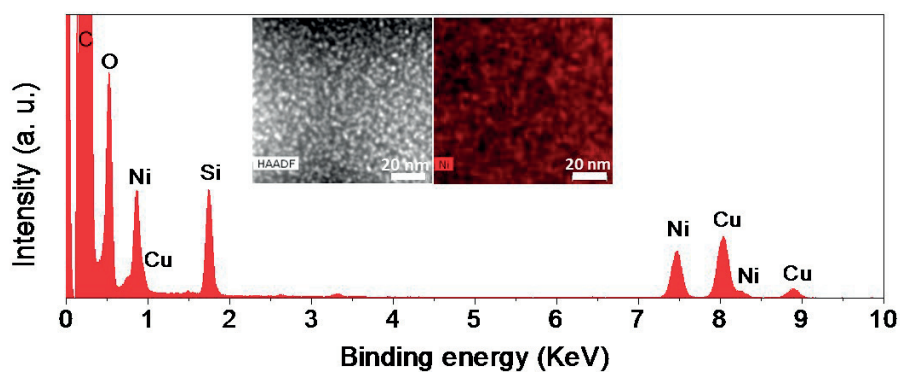

Figure 3.3: Elemental mapping analysis on nickel nanocrystals. The insets in the energy dispersive X-ray spectra show the HAADF image of the analyzed region and the corresponding elemental mapping image based on nickel signal. The Carbon (C) and Copper (Cu) signals are from sample support (the carbon-coated copper grid) for TEM observation. The Si and O are due to $(\text{MeO})_3\text{SiH}$ and $(\text{MeO})_3\text{SiO}^t\text{Bu}$.

3.9.7 Detailed Descriptions of the Products

¹²C-DecylSi(OMe)₃ (entry 1, Table 3.4)

Following the general procedure I the title compound was obtained as colorless oil (225 mg, 86%).

¹H NMR (400 MHz, CDCl₃) δ 3.58 (s, 9H), 1.43-1.21 (m, 16H), 0.88 (t, *J* = 6.7 Hz, 3H), 0.67-0.62 (m, 2H).

¹³C NMR (101 MHz, CDCl₃) δ 50.6, 33.3, 32.1, 29.8, 29.7, 29.5, 29.4, 22.8, 22.7, 14.3, 9.3.

HRMS (ESI): calculated for (C₁₃H₃₁O₃Si, M+H), 263.2043; found 263.2048.

The spectroscopic data is in agreement with previously reported.⁴⁴

¹²C-DecylSi(OEt)₃ (entry 2, Table 3.4)

Following the general procedure I the title compound was obtained as colorless oil (267 mg, 88%).

¹H NMR (400 MHz, CDCl₃) δ 3.81 (q, *J* = 7.0 Hz, 6H), 1.43-1.21 (m, 25H), 0.88 (t, *J* = 6.4 Hz, 3H), 0.65-0.61 (m, 2H).

¹³C NMR (101 MHz, CDCl₃) δ 58.4, 33.3, 32.1, 29.8, 29.7, 29.5, 29.4, 22.9, 22.8, 18.4, 14.2, 10.5.

The spectroscopic data is in agreement with previously reported.⁴⁵

¹²C-DecylSi(OMe)Me₂ (entry 3, Table 3.4)

Following the general procedure I the title compound was obtained as colorless oil (190 mg, 83%).

¹H NMR (400 MHz, CDCl₃) 3.42 (s, 3H), 1.37-1.22 (m, 16H), 0.88 (t, *J* = 6.2 Hz, 3H), 0.61-0.58 (m, 2H), 0.08 (s, 6H).

¹³C NMR (101 MHz, CDCl₃) δ, 50.4, 33.6, 32.1, 29.9, 29.8, 29.5, 23.3, 22.9, 16.1, 14.3, -2.5.

Elemental analysis: Anal. Calcd for C₁₃H₃₀OSi: C, 67.75; H, 13.12; found : C, 67.82 ; H, 12.99.

¹²C-DecylSi(OEt)₂Me (entry 4, Table 3.4)

Following the general procedure I the title compound was obtained as colorless oil (211 mg, 77 %).

¹H NMR (400 MHz, CDCl₃) δ 3.75 (q, *J* = 7.0 Hz, 4H), 1.38-1.19 (m, 22H), 0.88 (t, *J* = 7.0 Hz, 3H), 0.63-0.59 (m, 2H), 0.10 (s, 3H).

¹³C NMR (101 MHz, CDCl₃) δ 58.1, 33.5, 32.1, 29.8, 29.7, 29.5, 29.5, 23.0, 22.8, 18.5, 14.2, 14.0, -4.8.

Elemental analysis: Anal. Calcd for C₁₅H₃₄O₂Si: C, 65.63; H, 12.48; found : C, 65.73 ; H, 12.41.

¹²C-DecylSiPh₃ (entry 8, Table 3.4)

Following the general procedure I the title compound was obtained as a white solid (176 mg, 44%).

$^1\text{H NMR}$ (400 MHz, CDCl_3) δ 7.53-7.51 (m, 6H), 7.37-7.33 (m, 9H), 1.50-1.42 (m, 2H), 1.37-1.18 (m, 16H), 0.87 (t, $J = 6.7$ Hz, 3H).

$^{13}\text{C NMR}$ (101 MHz, CDCl_3) δ 135.8, 135.6, 129.4, 128.0, 34.0, 32.1, 29.8, 29.7, 29.5, 29.3, 24.1, 22.8, 14.3, 13.4.

Elemental analysis: Anal. Calcd for $\text{C}_{28}\text{H}_{36}\text{Si}$: C, 83.93; H, 9.06; found : C, 89.98 ; H, 8.99.

$^n\text{Decyl-Si(Me)}_2\text{-OSiMe}_3$ (entry 10, Table 3.4)

In a nitrogen filled glovebox, an oven-dried 30 mL re-sealable screw-cap vial equipped with a Teflon coated magnetic stirring bar was charged with $\text{Ni(O}^i\text{Bu)}_2 \cdot 2\text{KCl}$ (18 mg, 0.05 mmol) and 1-decene (700 mg, 5 mmol). The suspension of precatalyst was stirred for 5 minutes. PMDS (890 mg, 6 mmol) and $(\text{MeO})_3\text{SiH}$ (12 mg for activation of Ni catalyst) were added and mixture was stirred for 2 hours at 60°C . After filtration in hexane through a pad of silica the title compound was obtained as colorless oil (750 mg, 52%).

$^1\text{H NMR}$ (400 MHz, CDCl_3) δ 1.32-1.23 (m, 16H), 0.88 (t, $J = 7.0$ Hz, 3H), 0.52-0.48 (m, 2H), 0.06 (s, 9H), 0.03 (s, 6H).

$^{13}\text{C NMR}$ (101 MHz, CDCl_3) δ 33.6, 32.1, 29.9, 29.8, 29.6, 29.5, 23.5, 22.9, 18.6, 14.3, 2.14, 0.5.

HRMS (ESI): calculated for $(\text{C}_{15}\text{H}_{34}\text{O}_3\text{SiAg, M+Ag})$, 393.1199; found 393.1196.

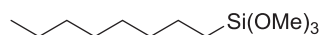

Trimethoxy(octyl)silane (entry 1, Table 3.5)

Following the general procedure II the title compound was obtained as colorless oil (208 mg, 89%).

$^1\text{H NMR}$ (400 MHz, CDCl_3) δ 3.57 (s, 9H), 1.45-1.37 (m, 2H), 1.34-1.26 (m, 10H), 0.88 (t, $J = 6.6$ Hz, 3H), 0.66-0.63 (m, 2H).

$^{13}\text{C NMR}$ (101 MHz, CDCl_3) δ 50.5, 33.3, 32.0, 29.4, 29.3, 22.8, 22.7, 14.2, 9.3.

Spectroscopic data is in agreement with published.⁴⁵

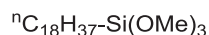

Trimethoxy(octadecyl)silane (entry 2, Table 3.5)

Following the general procedure II the title compound was obtained as colorless oil (315 mg, 84%).

$^1\text{H NMR}$ (400 MHz, CDCl_3) δ 3.57 (s, 9H), 1.45-1.20 (m, 32H), 0.88 (t, $J = 7.0$ Hz, 3H), 0.66-0.62 (m, 2H).

$^{13}\text{C NMR}$ (101 MHz, CDCl_3) δ 50.9, 33.6, 32.4, 30.2, 30.0, 29.9, 29.8, 23.2, 23.1, 14.6, 9.6.

HRMS (ESI): calculated for $(\text{C}_{21}\text{H}_{47}\text{O}_3\text{Si, M+H})$, 375.3294; found 375.3294.

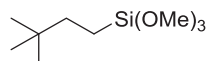

(3,3-Dimethylbutyl)trimethoxysilane (entry 3, Table 3.5)

Following the general procedure II the title compound was obtained as colorless oil (160 mg, 78%).

$^1\text{H NMR}$ (400 MHz, CDCl_3) δ 3.57 (s, 9H), 1.32-1.26 (m, 2H), 0.86 (s, 9H), 0.62-0.57 (m, 2H).

^{13}C NMR (101 MHz, CDCl_3) δ 50.6, 36.4, 31.0, 28.6, 3.6.

HRMS (ESI): calculated for ($\text{C}_9\text{H}_{22}\text{O}_3\text{SiNa}$, $\text{M}+\text{Na}$), 229.1236; found 229.1242.

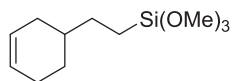

(2-(Cyclohex-3-en-1-yl)ethyl)trimethoxysilane (entry 4, Table 3.5)

Following the general procedure II the title compound was obtained as colorless oil (145 mg, 63%).

^1H NMR (400 MHz, CDCl_3) δ 5.64 (m, 2H), 3.56 (s, 9H), 2.13-2.02 (m, 3H), 1.76-1.71 (m, 1H), 1.64-1.58 (m, 1H), 1.50-1.33 (m, 3H), 1.21-1.12 (m, 1H), 0.68-0.64 (m, 2H).

^{13}C NMR (101 MHz, CDCl_3) δ 127.1, 126.6, 50.6, 36.3, 31.6, 29.3, 28.5, 25.4, 6.4.

HRMS (APCI): calculated for ($\text{C}_{11}\text{H}_{23}\text{O}_3\text{Si}$, $\text{M}+\text{H}$), 231.1416; found 231.1413.

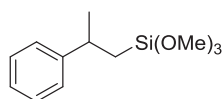

Trimethoxy(2-phenylpropyl)silane (entry 5, Table 3.5)

Following the general procedure II the title compound was obtained as colorless oil (133 mg, 55%).

^1H NMR (400 MHz, CDCl_3) δ 7.30-7.14 (m, 5H), 3.47 (s, 9H), 3.03-2.97 (m, 1H), 1.31 (d, $J = 6.9$ Hz, 3H), 1.10-0.98 (m, 2H).

^{13}C NMR (101 MHz, CDCl_3) δ 149.5, 128.4, 126.6, 126.0, 50.5, 34.9, 25.2, 19.5.

HRMS (ESI): calculated for ($\text{C}_{12}\text{H}_{20}\text{O}_3\text{SiNa}$, $\text{M}+\text{Na}$), 263.1079; found 263.1083.

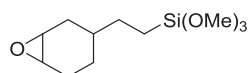

(2-(7-Oxabicyclo[4.1.0]heptan-3-yl)ethyl)trimethoxysilane (mixture of 2 diastereomers) (entry 6, Table 3.5)

Following the general procedure II using $(\text{MeO})_3\text{SiH}$ (183 mg, 1.5 mmol) the title compound was obtained as colorless oil (182 mg, 74%).

^1H NMR (400 MHz, CDCl_3) δ 3.58 (s, 9H), 3.20-3.13 (m, 2H), 2.22-2.14 (m, 1H), 2.11-1.97 (m, 1H), 1.87-1.67 (m, 1H), 1.55-1.06 (m, 5H), 0.94-0.84 (m, 1H), 0.64-0.59 (m, 2H).

^{13}C NMR (101 MHz, CDCl_3) δ 53.4, 52.9, 52.1, 52.0, 50.7, 35.4, 32.4, 31.5, 30.4, 29.5, 29.0, 26.9, 25.5, 24.0, 23.7, 6.4, 6.3.

HRMS (ESI): calculated for ($\text{C}_{11}\text{H}_{22}\text{O}_4\text{SiNa}$, $\text{M}+\text{Na}$), 269.1185; found 269.1188.

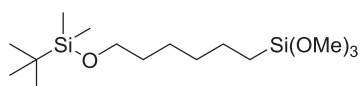

O-tert-butyldimethylsilyl 6-(trimethoxysilyl)hexan-1-ol (entry 7, Table 3.5)

Following the general procedure II the title compound was obtained as a colorless oil (310 mg, 95%).

¹H NMR (400 MHz, CDCl₃) δ 3.61-3.56 (m, 11H), 1.52-1.47 (m, 2H), 1.44-1.30 (m, 6H), 0.89 (s, 9H), 0.67-0.63 (m, 2H), 0.04 (s, 6H).

¹³C NMR (101 MHz, CDCl₃) δ 63.4, 50.6, 33.0, 32.9, 25.6, 22.7, 18.5, 9.2, -5.2.

HRMS (ESI): calculated for (C₁₅H₃₇O₄Si, M+H), 337.2230; found 337.2223.

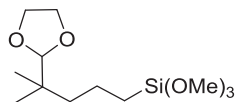

(4-(1,3-Dioxolan-2-yl)-4-methylpentyl)trimethoxysilane (entry 8, Table 3.5)

Following the general procedure II the title compound was obtained as a colorless oil (263 mg, 95%).

¹H NMR (400 MHz, CDCl₃) δ 4.53 (s, 1H), 3.94-3.82 (m, 4H), 3.57 (s, 9H), 1.43-1.32 (m, 4H), 0.88 (s, 6H), 0.64-0.60 (m, 2H).

¹³C NMR (101 MHz, CDCl₃) δ 110.1, 65.3, 50.6, 41.7, 37.3, 21.5, 16.9, 10.3.

HRMS (ESI): calculated for (C₁₂H₂₇O₅Si, M+H), 279.1628 found 279.1622.

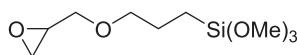

Trimethoxy(3-(oxiran-2-ylmethoxy)propyl)silane (entry 9, Table 3.5)

Following the general procedure II the title compound was obtained as a colorless oil (145 mg, 61%).

¹H NMR (400 MHz, CDCl₃) δ 3.71 (dd, *J* = 11.5, 3.0 Hz, 1H), 3.61-3.59 (m, 1H), 3.57 (s, 9H), 3.50-3.46 (m, 2H), 3.42-3.37 (m, 1H), 2.80-2.78 (m, 1H), 2.62-2.60 (m, 1H), 1.74-1.67 (m, 2H), 0.70-0.66 (m, 2H).

¹³C NMR (101 MHz, CDCl₃) δ 73.6, 71.5, 50.9, 50.6, 44.4, 22.9, 5.3.

HRMS (ESI): calculated for (C₁₉H₂₀O₅SiNa, M+Na), 259.0978 found 259.0984.

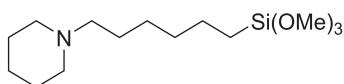

1-(6-(Trimethoxysilyl)hexyl)piperidine (entry 10, Table 3.5)

Following the general procedure II the title compound was obtained as a yellow oil (260 mg, 90%).

¹H NMR (400 MHz, CDCl₃) δ 3.57 (s, 9H), 2.40-2.31 (br, 4H), 2.28-2.24 (m, 2H), 1.61-1.55 (m, 4H), 1.50-1.28 (m, 10H), 0.66-0.62 (m, 2H).

¹³C NMR (101 MHz, CDCl₃) δ 59.8, 54.8, 50.5, 33.2, 27.5, 27.0, 26.1, 24.6, 22.6, 9.2.

HRMS (ESI): calculated for (C₁₄H₃₂NO₃Si, M+H), 290.2151; found 290.2150.

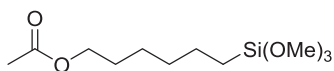

6-(Trimethoxysilyl)hexyl acetate (entry 11, Table 3.5)

Following the general procedure II the title compound was obtained as a colorless oil (176 mg, 67%).

¹H NMR (400 MHz, CDCl₃) δ 4.05 (t, *J* = 6.8 Hz, 2H), 3.57 (s, 9H), 2.04 (s, 3H), 1.65-1.60 (m, 2H), 1.45-1.34 (m, 6H), 0.67-0.61 (m, 2H).

¹³C NMR (101 MHz, CDCl₃) δ 171.3, 64.7, 50.6, 32.8, 28.6, 25.7, 22.6, 21.1, 9.2.

HRMS (ESI): calculated for (C₁₁H₂₄O₅SiNa, M+Na), 287.1291; found 287.1297.

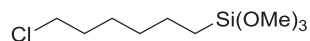

(6-Chlorohexyl)trimethoxysilane (entry 12, Table 3.5)

Following the general procedure II using (MeO)₃SiH (183 mg, 1.5 mmol) the title compound was obtained as a colorless oil (140 mg, 58%).

¹H NMR (400 MHz, CDCl₃) δ 3.57 (s, 9H), 3.53 (t, *J* = 6.7 Hz, 2H), 1.80-1.74 (m, 2H), 1.48-1.33 (m, 6H), 0.67-0.63 (m, 2H).

¹³C NMR (101 MHz, CDCl₃) δ 50.6, 45.2, 32.6, 32.4, 26.6, 22.6, 9.2.

HRMS (ESI): calculated for (C₉H₂₂ClO₃Si, M+H), 241.1027; found 241.1023.

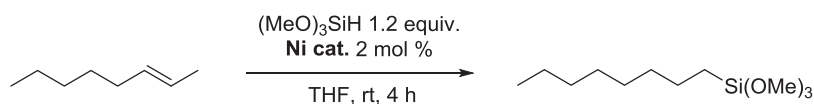

Trimethoxy(octyl)silane obtained from trans-2-octene (entry 1, Table 3.6)

Following the general procedure III, the title compound was prepared using trans-2-octene (112 mg), trimethoxysilane (146 mg) and Ni(O^tBu)₂•2KCl (7 mg). The crude product was filtered through a pad of silica to afford the title compound as colorless oil (223 mg, 95%).

Spectroscopic data were identical to those reported for the same compound above.

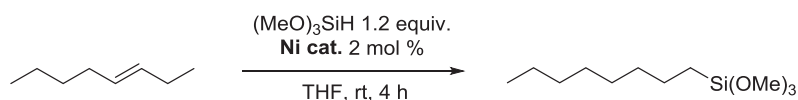

Trimethoxy(octyl)silane obtained from trans-3-octene (entry 2, Table 3.6)

Following the general procedure III, the title compound was prepared using trans-3-octene (112 mg), trimethoxysilane (146 mg) and Ni(O^tBu)₂•2KCl (7 mg). The crude product was filtered through a pad of silica to afford the title compound as colorless oil (226 mg, 97%).

Spectroscopic data were identical to those reported for the same compound above.

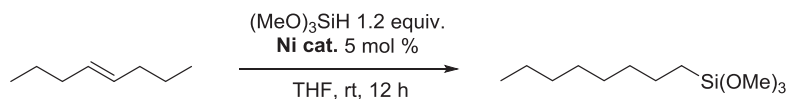

Trimethoxy(octyl)silane obtained from trans-4-octene (entry 3, Table 3.6)

Following the general procedure III, the title compound was prepared using trans-4-octene (112 mg), trimethoxysilane (146 mg) and Ni(O^tBu)₂•2KCl (18 mg). The crude product was filtered through a pad of silica to afford the title compound as colorless oil (207 mg, 89%).

Spectroscopic data were identical to those reported for the same compound above.

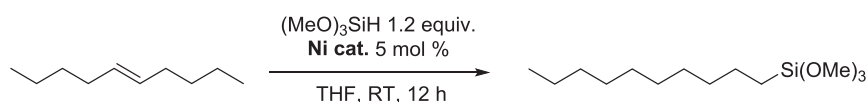

Decyltrimethoxysilane obtained from trans-5-decene (entry 4, Table 3.6)

Following the general procedure III, the title compound was prepared using trans-5-decene (140 mg), trimethoxysilane (146 mg) and $\text{Ni}(\text{O}^t\text{Bu})_2 \cdot 2\text{KCl}$ (18 mg). The crude product was filtered through a pad of silica to afford the title compound as colorless oil (218 mg, 83%).

Spectroscopic data were identical to those reported for the same compound above.

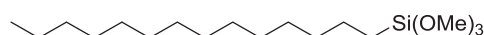

Trimethoxy(tetradecyl)silane (entry 5, Table 3.6)

Following the general procedure III, the title compound was prepared using trans-7-tetradecene (196 mg), trimethoxysilane (146 mg) and $\text{Ni}(\text{O}^t\text{Bu})_2 \cdot 2\text{KCl}$ (18 mg). The crude product was purified by flash column chromatography using hexane as an eluent to afford the title compound as colorless oil (225 mg, 71%).

Spectroscopic data were identical to those reported for the same compound above.

$^1\text{H NMR}$ (400 MHz, CDCl_3) δ 3.57 (s, 9H), 1.45-1.37 (m, 2H), 1.34-1.22 (m, 22H), 0.88 (t, $J = 6.7$ Hz, 3H), 0.67-0.63 (m, 2H).

$^{13}\text{C NMR}$ (101 MHz, CDCl_3) δ 50.6, 33.3, 32.1, 29.9, 29.8, 29.7, 29.5, 29.4, 22.8, 22.7, 14.3, 9.3.

HRMS (ESI): calculated for ($\text{C}_{17}\text{H}_{39}\text{O}_3\text{Si}$, $\text{M}+\text{H}$), 319.2668; found 319.2661.

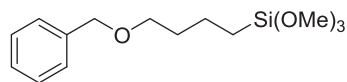

(4-(Benzyloxy)butyl)trimethoxysilane (entry 6, Table 3.6)

Following the general procedure III, the title compound was prepared using (E)-((but-2-en-1-yloxy)methyl)benzene (162 mg), trimethoxysilane (146 mg) and $\text{Ni}(\text{O}^t\text{Bu})_2 \cdot 2\text{KCl}$ (18 mg). The crude product was purified by flash column chromatography using hexane as an eluent to afford the title compound as colorless oil (210 mg, 74%).

$^1\text{H NMR}$ (400 MHz, CDCl_3) δ 7.35-7.23 (m, 5H), 4.49 (s, 2H), 3.56 (s, 9H), 3.47 (t, $J = 7.8$ Hz, 2H), 1.70-1.63 (m, 2H), 1.54-1.45 (m, 2H), 0.68-0.64 (m, 2H).

$^{13}\text{C NMR}$ (101 MHz, CDCl_3) δ 138.8, 128.5, 127.7, 127.6, 73.0, 70.1, 50.6, 33.1, 19.5, 9.1.

HRMS (ESI): calculated for ($\text{C}_{14}\text{H}_{24}\text{O}_4\text{SiNa}$, $\text{M}+\text{Na}$), 307.1342; found 307.1343.

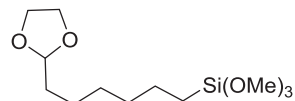

(6-(1,3-Dioxolan-2-yl)hexyl)trimethoxysilane (entry 7, Table 3.6)

Following the general procedure III, the title compound was prepared using (Z)-2-(hex-3-en-1-yl)-1,3-dioxolane (156 mg), trimethoxysilane (146 mg) and $\text{Ni}(\text{O}^t\text{Bu})_2 \cdot 2\text{KCl}$ (18 mg). The crude product was purified by flash column chromatography using mixture hexane/EtOAc (20:1) as an eluent to afford the title compound as colorless oil (220 mg, 79%).

¹H NMR (400 MHz, CDCl₃) δ 4.84 (t, *J* = 4.8 Hz, 1H), 3.96-3.94 (m, 2H), 3.86-3.84 (m, 2H), 3.56 (s, 9H), 1.67-1.62 (m, 2H), 1.43-1.31 (m, 8H), 0.66-0.62 (m, 2H).

¹³C NMR (101 MHz, CDCl₃) δ 104.7, 64.9, 50.5, 34.0, 33.1, 29.3, 24.0, 22.6, 9.2.

HRMS (ESI): calculated for (C₁₂H₂₆O₅SiNa, M+Na), 301.1447; found 301.1448.

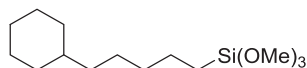

(5-Cyclohexylpentyl)trimethoxysilane (entry 8, Table 3.6)

Following the general procedure III, the title compound was prepared using (E)-pent-1-en-1-ylcyclohexane (152 mg), trimethoxysilane (146 mg) and Ni(O^tBu)₂•2KCl (18 mg). The crude product was purified by flash column chromatography using hexane as an eluent to afford the title compound as colorless oil (190 mg, 69%).

¹H NMR (400 MHz, CDCl₃) δ 3.57 (s, 9H), 1.72-1.62 (m, 2H), 1.43-1.11 (m, 12H), 0.90-0.81 (m, 2H), 0.66-0.62 (m, 2H).

¹³C NMR (101 MHz, CDCl₃) δ 50.6, 37.8, 37.5, 33.6 (2C), 26.9, 26.6 (2C), 22.8, 9.3.

HRMS (ESI): calculated for (C₁₄H₃₁O₃Si, M+H), 275.2043; found 275.2041.

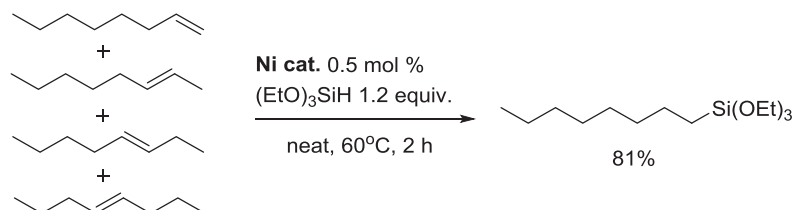

Triethoxy(octyl)silane (Scheme 3.2)

Mixture of octenes was prepared from 1-octene (112 mg, 1 mmol), 2-octene (112 mg, 1 mmol), 3-octene (112 mg, 1 mmol), and 4-octene (112 mg, 1 mmol). In a nitrogen filled glovebox, an oven-dried 30 mL re-sealable screw-cap vial equipped with a Teflon coated magnetic stirring bar was charged with Ni Ni(O^tBu)₂•2KCl (7 mg, 0.02 mmol, corresponding to 0.5 % of Ni) and mixture of octenes (448 mg). The suspension of precatalyst was stirred for 5 minutes. Triethoxysilane (787 mg, 4.8 mmol) was added and reaction mixture was allowed to stir for 2 hours at 60°C. Then THF was removed under reduced pressure. The residue was filtered through silica pad to afford the desired product (892 mg, 81%).

¹H NMR (400 MHz, CDCl₃) δ 3.82 (q, *J* = 7.0 Hz, 6H), 1.42-1.21 (m, 21H), 0.88 (t, *J* = 6.9 Hz, 3H), 0.65-0.61 (m, 2H).

¹³C NMR (101 MHz, CDCl₃) δ 58.4, 33.4, 32.1, 29.4, 22.9, 22.8, 18.5, 14.3, 10.5.

These spectroscopic data is in agreement with previously reported.¹⁰

HS:DHS ratio and terminal selectivity were determined by GC-MS analysis.

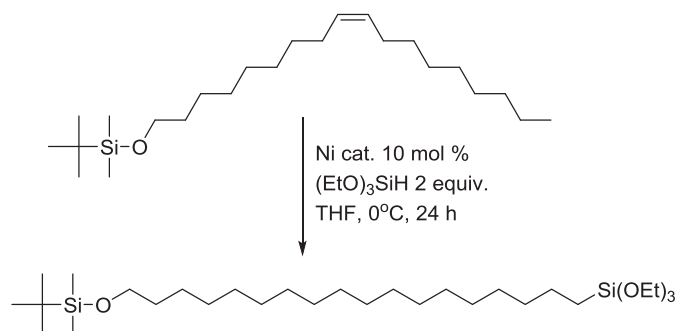

23,23-diethoxy-2,2,3,3-tetramethyl-4,24-dioxa-3,23-disilahexacosane (Scheme 3.3)

In a nitrogen filled glovebox, an oven-dried 30 mL re-sealable screw-cap vial equipped with a Teflon coated magnetic stirring bar was charged with Ni(O^tBu)₂•2KCl (18 mg, 0.05 mmol, corresponding to 10 % of Ni) and 2 mL of dry THF. The suspension of precatalyst was stirred for 5 minutes. TBS-protected oleyl alcohol (obtained from 85% pure oleyl alcohol, 369314 Aldrich) (192 mg, 0.5 mmol) and triethoxysilane (164 mg, 1.0 mmol) were added and reaction mixture was allowed to stir for 24 hours at 0°C. Then THF was removed under reduced pressure. The residue was purified by flash chromatography to afford the desired product as a colorless oil (123 mg, 45%). HS:DHS ratio and terminal selectivity were determined by GC-MS analysis.

¹H NMR (400 MHz, CDCl₃) δ 3.81 (q, *J* = 7.0 Hz, 6H), 3.60 (t, *J* = 6.6 Hz, 2H), 1.54-1.47 (m, 2H), 1.43-1.37 (m, 2H), 1.31-1.20 (m, 37H), 0.89 (s, 9H), 0.65-0.61 (m, 2H), 0.05 (s, 6H).

¹³C NMR (101 MHz, CDCl₃) δ 63.5, 58.4, 33.4, 33.1, 29.9, 29.81, 29.78, 29.7, 29.6, 29.4, 26.1, 26.0, 22.9, 18.5, 10.5, -5.1.

HRMS (ESI): calculated for (C₃₀H₆₇O₄Si₂, M+H), 547.4578; found 547.4587.

3.10 References

- (1) Ojima, I. In *The Chemistry of Organic Silicon Compounds*; Patai, S., Rappoport, Z., Ed.; Wiley Interscience: New York, 1989, p 1479.
- (2) Marciniak, B.; Gulinski, J.; Urbaniak, W.; Kornetka, Z. W. *Comprehensive Handbook on Hydrosilylation*; Pergamon: Oxford, UK, 1992.
- (3) Marciniak, B. *Hydrosilylation: A Comprehensive Review on Recent Advances*; Springer Berlin, 2009.
- (4) Putzien, S.; Nuyken, O.; Kühn, F. E. *Progr. Polym. Sci.* **2010**, *35*, 687-713.
- (5) Hitchcock, P. B.; Lappert, M. F.; Warhurst, N. J. W. *Angew. Chem. Int. Ed.* **1991**, *30*, 438-440.
- (6) Speier, J. L.; Webster, J. A.; Barnes, G. H. *J. Am. Chem. Soc.* **1957**, *79*, 974-979.
- (7) Speier, J. L.; Stone, F. G. A.; Robert, W. In *Advances in Organometallic Chemistry*; Academic Press: 1979; Vol. Volume 17, p 407-447.
- (8) Bart, S. C.; Lobkovsky, E.; Chirik, P. J. *J. Am. Chem. Soc.* **2004**, *126*, 13794-13807.
- (9) Kamata, K.; Suzuki, A.; Nakai, Y.; Nakazawa, H. *Organometallics* **2012**, *31*, 3825-3828.
- (10) Peng, D.; Zhang, Y.; Du, X.; Zhang, L.; Leng, X.; Walter, M. D.; Huang, Z. *J. Am. Chem. Soc.* **2013**, *135*, 19154-19166.
- (11) Chen, J.; Cheng, B.; Cao, M.; Lu, Z. *Angew. Chem. Int. Ed.* **2015**, *54*, 4661-4664.
- (12) Mo, Z.; Liu, Y.; Deng, L. *Angew. Chem. Int. Ed.* **2013**, *52*, 10845-10849.
- (13) Sun, J.; Deng, L. *ACS Catal* **2016**, *6*, 290-300.
- (14) Chen, Y.; Sui-Seng, C.; Boucher, S.; Zargarian, D. *Organometallics* **2005**, *24*, 149-155.
- (15) Hyder, I.; Jimenez-Tenorio, M.; Puerta, M. C.; Valerga, P. *Dalt. Trans.* **2007**, 3000-3009.
- (16) Lipschutz, M. I.; Tilley, T. D. *Chem. Commun.* **2012**, *48*, 7146-7148.
- (17) Srinivas, V.; Nakajima, Y.; Ando, W.; Sato, K.; Shimada, S. *Catal. Sci. Technol.* **2015**, *5*, 2081-2084.
- (18) Tondreau, A. M.; Atienza, C. C. H.; Weller, K. J.; Nye, S. A.; Lewis, K. M.; Delis, J. G. P.; Chirik, P. J. *Science* **2012**, *335*, 567-570.
- (19) Schuster, C. H.; Diao, T.; Pappas, I.; Chirik, P. J. *ACS Catal* **2016**, 2632-2636.
- (20) Chen, C.; Hecht, M. B.; Kavara, A.; Brennessel, W. W.; Mercado, B. Q.; Weix, D. J.; Holland, P. L. *J. Am. Chem. Soc.* **2015**, *137*, 13244-13247.
- (21) Buslov, I.; Becouse, J.; Mazza, S.; Montandon-Clerc, M.; Hu, X. *Angew. Chem. Int. Ed.* **2015**, *54*, 14523-14526.
- (22) Lappert, M. F.; Nile, T. A.; Takahashi, S. *J. Organomet. Chem.* **1974**, *72*, 425-439.

- (23) Marciniak, B.; Maciejewski, H.; Mirecki, J. *J. Organomet. Chem.* **1991**, *418*, 61-67.
- (24) Marciniak, B.; Maciejewski, H.; Kownacki, I. *J. Mol. Catal. A: Chem.* **1998**, *135*, 223-231.
- (25) Srinivas, V.; Nakajima, Y.; Ando, W.; Sato, K.; Shimada, S. *J. Organomet. Chem.* **2016**, *809*, 57-62.
- (26) Marciniak, B. *Coord. Chem. Rev.* **2005**, *249*, 2374-2390.
- (27) Roy, A. K.; Robert West, A. F. H.; Mark, J. F. In *Advances in Organometallic Chemistry*; Academic Press: 2007; Vol. Volume 55, p 1-59.
- (28) Nakajima, Y.; Shimada, S. *RSC Advances* **2015**, *5*, 20603-20616.
- (29) B. P. Baranwal, R. C. M. *Aust. J. Chem.* **1980**, *33*, 37-43.
- (30) Chernyshev, E. A.; Belyakova, Z. V.; Knyazeva, L. K.; Khromykh, N. N. *Russian Journal of General Chemistry* **2007**, *77*, 55-61.
- (31) Belyakova, Z. V.; Pomerantseva, M. G.; Efimova, L. A.; Chernyshev, E. A.; Storozhenko, P. A. *Russ. J. Gen. Chem.* **2010**, *80*, 728-733.
- (32) Vasseur, A.; Bruffaerts, J.; Marek, I. *Nat Chem* **2016**, *8*, 209-219.
- (33) Goldbach, V.; Roesle, P.; Mecking, S. *ACS Catal.* **2015**, *5*, 5951-5972.
- (34) Huber, T.; Firlbeck, D.; Riepl, H. M. *J. Organomet. Chem.* **2013**, *744*, 144-148.
- (35) Atienza, C. C. H.; Diao, T.; Weller, K. J.; Nye, S. A.; Lewis, K. M.; Delis, J. G. P.; Boyer, J. L.; Roy, A. K.; Chirik, P. J. *J. Am. Chem. Soc.* **2014**, *136*, 12108-12118.
- (36) Jia, X.; Huang, Z. *Nat Chem* **2015**, *8*, 157-161.
- (37) Chikkali, S.; Mecking, S. *Angew. Chem. Int. Ed.* **2012**, *51*, 5802-5808.
- (38) Biermann, U.; Bornscheuer, U.; Meier, M. A. R.; Metzger, J. O.; Schäfer, H. J. *Angew. Chem. Int. Ed.* **2011**, *50*, 3854-3871.
- (39) Schleicher, K. D.; Jamison, T. F. *Org. Lett.* **2007**, *9*, 875-878.
- (40) Paquette, L. A.; Leone-Bay, A. *J. Am. Chem. Soc.* **1983**, *105*, 7352-7358.
- (41) Lygo, B.; O'Connor, N.; Wilson, P. R. *Tetrahedron* **1988**, *44*, 6881-6888.
- (42) Jeganathan, S.; Tsukamoto, M.; Schlosser, M. *Synthesis* **1990**, *1990*, 109-111.
- (43) Jia, X.; Zhang, L.; Qin, C.; Leng, X.; Huang, Z. *Chem. Commun.*, *50*, 11056-11059.
- (44) B. Ameduri, B. Boutevin, J. I. J. E. Moreau, H. Moutaabbid, M. W. Chi Man, *J. Fluorine Chem.* **2000**, *104*, 185.
- (45) R. Hu, W. Hao, M. Cai, *Chin. J. Chem.* **2011**, *29*, 1629.
- (46) A. F. M. Brand, P. Lehnert, H. J. Metternich, J. Monkiewicz, J. Schram, *Z. Naturforsch., B: J. Chem. Sci.* **1999**, *54*, 155.

Chapter 4

Alkoxy Hydrosilanes As Surrogates of Gaseous Silanes for Hydrosilylation of Alkenes

Reprinted with permission from “Buslov, I.; Keller, S. C.; Hu, X. L. Alkoxy Hydrosilanes As Surrogates of Gaseous Silanes for Hydrosilylation of Alkenes. *Organic letters*. doi: 10.1021/acs.orglett.6b00792” © 2016 American Chemical Society

certain silanes by alkoxy hydrosilanes in hydrosilylation reactions, we decided to further explore it.

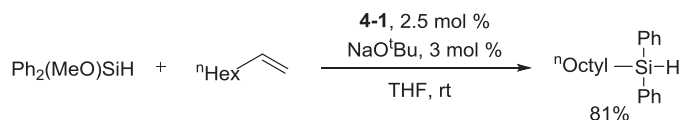

Scheme 4.2: The reaction of 1-octene with $\text{Ph}_2(\text{OMe})\text{SiH}$

4.2 Optimisation of Reaction Conditions

The reaction of 1-decene with $\text{Me}_2(\text{MeO})\text{SiH}$ was chosen as the test reaction for the optimization of conditions (Table 4.1; *Caution*: As shown later, a small amount of Me_2SiH_2 was formed as an intermediate in the beginning of the reaction, but it was quickly consumed during the reaction course. Me_2SiH_2 is a flammable gas, so safety precaution should be made when opening the reaction vessel at the end of the reaction. No accident was encountered in our studies). In tetrahydrofuran (THF) and at room temperature, $(\text{Decyl})(\text{Me})_2\text{SiH}$ was formed in a 91% yield using 2.5 mol% of **4-1** as catalyst and 5 mol% of NaO^tBu as base (entry 1, Table 4.1). $\text{Me}_2(\text{MeO})_2\text{Si}$ was the byproduct. If NaO^tBu was replaced by CsF, the yield was less than 1% (entry 2, Table 4.1). The yields were lower when THF was replaced by toluene or diethyl ether (entries 3-4, Table 4.1). When **4-1** was replaced by its phenyl analogue, $[\text{Ph}_2(\text{R,R})\text{-Bopa}]\text{NiCl}$ (**4-2**), the yield dropped to 59% (entry 5, Table 4.1). Two other Ni pincer complexes, **4-3** and **4-4**, were also tested as catalysts. However, the yields were below 50% (entries 6-7, Table 4.1). A soluble Ni(II) complex, $\text{NiCl}_2(\text{PPh}_3)_2$ was also tested as catalyst, but again the yield was modest (entry 8, Table 4.1). These results confirmed the superior catalytic activity of **4-1** in this reaction. When the loading of **4-1** was reduced to 1 mol%, the yield was nearly the same (87%; entry 9, Table 4.1). When 1 equivalent of NaO^tBu relative to **4-1** was added, no $(\text{Decyl})(\text{Me})_2\text{SiH}$ was formed (entry 10, Table 4.1).

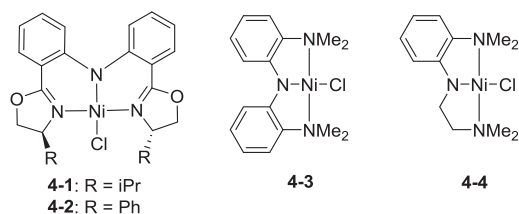
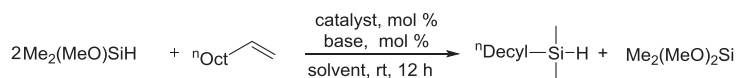
Table 4.1: Optimization of reaction conditions ^a

Entry	Complex, mol %	Base, mol %	Solvent	Yield, (%) ^b
1	4-1 , 2.5	NaO ^t Bu, 5	THF	91
2	4-1 , 2.5	CsF, 5	THF	<1
3	4-1 , 2.5	NaO ^t Bu, 5	toluene	45
4	4-1 , 2.5	NaO ^t Bu, 5	Et ₂ O	31
5	4-2 , 2.5	NaO ^t Bu, 5	THF	59
6	4-3 , 2.5	NaO ^t Bu, 5	THF	40
7	4-4 , 2.5	NaO ^t Bu, 5	THF	48
8	NiCl ₂ (PPh ₃) ₂ , 2.5	NaO ^t Bu, 7.5	THF	41
9	4-1 , 1	NaO ^t Bu, 2	THF	87
10	4-1 , 2.5	NaO ^t Bu, 2.5	THF	0

^a Conditions : 1-decene (0.5 mmol), dimethylmethoxysilane (1.2 mmol.), under N₂ in THF (4 mL), 12 hours, rt. ^b GC-MS yields are reported and n-dodecane was used as an internal standard. The yield is relative to 1-decene.

4.3 Ni-catalyzed Synthesis of Alkylhydrosilanes using Dimethylmethoxysilane

The optimized conditions were applied for the reactions of Me₂(MeO)SiH with various terminal alkenes (Table 4.2). 1-Decene and 1-octadecene were hydrosilylated with high yields (entries 1, 2, Table 4.2). 2-Methyl-2-heptene, which contained a methyl group at the β-position of the alkene, was also converted to the corresponding hydrosilane in a good yield (entry 3, Table 4.2). The reaction was selective to terminal C=C bond while leaving an internal C=C bond intact (entry 5, Table 4.2). Functional groups such as ether (entry 6, Table 4.2), epoxide (entry 7, Table 4.2), tert-butyl dimethylsilyl- (entry 8, Table 4.2) and

tetrahydropyran-protected alcohol (entry 9, Table 4.2), alkyl halide (entry 10, Table 4.2), amine (entry 11, Table 4.2) and acetal (entry 12, Table 4.2) were tolerated in the catalysis. Unfortunately alkenes bearing carbonyl, ester, amide and imide groups were not suitable reaction partners, likely due to the high reducing power of silanes in the presence of a base.¹³⁻¹⁶

Table 4.2: Ni-catalyzed synthesis of alkylhydrosilanes using dimethylmethoxysilane and alkenes^a

$$2 \text{ Me}_2(\text{MeO})\text{SiH} \quad + \quad \text{R}-\text{CH}=\text{CH}_2 \quad \xrightarrow[\text{THF, rt, 6 h}]{\text{4-1 2.5 mol \%}, \text{NaO}^t\text{Bu 5 mol \%}} \quad \text{R}-\text{CH}_2-\text{CH}_2-\text{Si}(\text{Me})_2\text{H} \quad + \quad \text{Me}_2(\text{MeO})_2\text{Si}$$

1.2 mmol 0.5 mmol

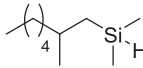
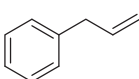
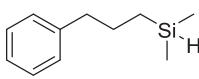
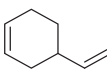
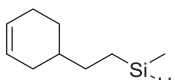
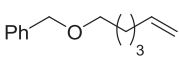
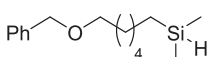
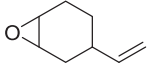
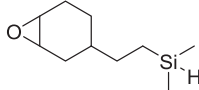
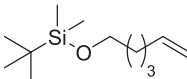
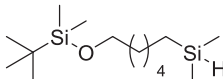
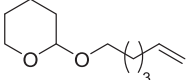
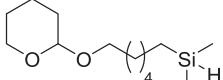
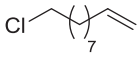
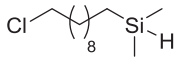
Entry	Alkene	Product	Yield ^b (%)
1	1-Decene	$\text{C}_{10}\text{H}_{21}-\text{Si}(\text{Me})_2\text{H}$	90
2	1-Octadecene	$\text{C}_{18}\text{H}_{37}-\text{Si}(\text{Me})_2\text{H}$	93
3			29 (70) ^c
4			81
5			85
6			92
7			93 ^d
8			83
9			89
10			72 ^e

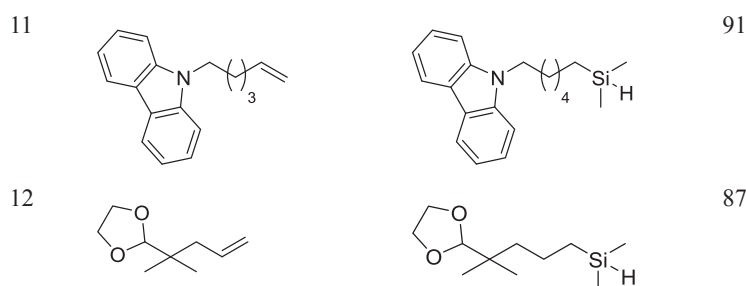

^a Conditions : alkene (0.5 mmol), dimethylmethoxysilane (1.2 mmol.), **4-1** (2.5 mol %), NaO^tBu (5 mol %), THF (3 mL), 6 hours, rt. ^b Isolated yields relative to alkene are reported. ^c GC-MS yields using n-dodecane as an internal standard are reported in parentheses. ^d Alkene (0.5 mmol), dimethylmethoxysilane (2.5 mmol.), 24 hours. ^e Alkene (0.5 mmol), dimethylmethoxysilane (2.0 mmol).

4.4 Synthesis of Alkylhydrosilanes using Me(EtO)₂SiH and (MeO)₃SiH

The reactions of alkenes with Me(EtO)₂SiH and (MeO)₃SiH were investigated. To our delight, the reactions gave various functionalized hydrosilanes in good yields (Tables 4.3 and 4.4). An increase of the loading of the catalyst to 5 mol % was necessary. For the reactions of alkenes with Me(EtO)₂SiH, (Alkyl)₂(Me)SiH were formed, in which the two alkyl groups came from the alkene.

Table 4.3: Ni-catalyzed synthesis of alkylhydrosilanes using methyldiethoxysilane and alkenes ^a

Entry	Alkene	Product	Yield ^b (%)
1	1-Octene	$(C_8H_{17})_2SiH$	75
2	1-Octadecene	$(C_{18}H_{37})_2SiH$	76
3		$(C_6H_{11})_2SiH$	73

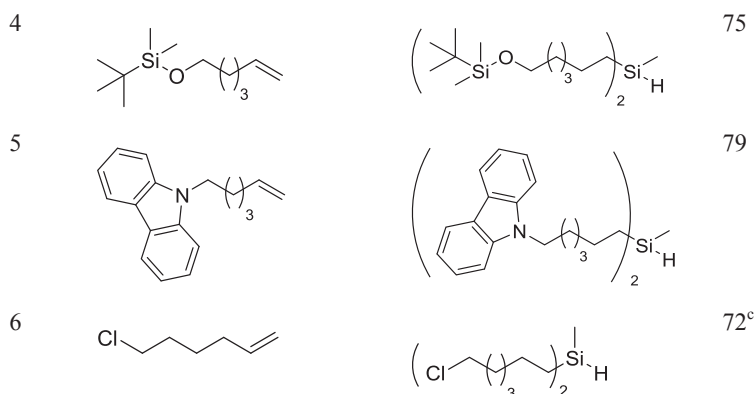

^a Typical conditions : alkene (1.2 mmol), methyldiethoxysilane (1.5 mmol), **4-1** (5 mol %), NaO^tBu (10 mol %), THF (4 mL), 24 hours, rt. ^b Isolated yields relative to intermediate silanes are reported. The theoretical yield is 0.5 mmol. ^c Alkene (1.35 mmol) was used.

Interestingly, for the reactions of alkenes with (MeO)₃SiH, (Alkyl)₂SiH₂ were obtained as the major product, and only less than 3% of (Alkyl)₃SiH was detected by GC-MS (Table 4.4). Even when the alkene was in large excess (6 equiv.) and the reaction time was increased to 36 hours, the yield of (Alkyl)₃SiH did not exceed 6%. The reaction of isolated dioctadecylsilane with 1.2 equivalent of 1-octadecene under the conditions of Table 4.2 was then monitored by ¹H NMR. (n-Octadecyl)₂SiH₂ was fully consumed in 1.5 hour, and (n-octadecyl)₃SiH was produced in a nearly quantitative yield. On the other hand, if 3 equivalents of (MeO)₄Si were added to the reaction mixture, the conversion of dioctadecylsilane was less than 40% in 6 hours. This result suggests that the (MeO)₄Si byproduct inhibits the hydrosilylation of alkenes with (alkyl)₂SiH₂, leading to selective formation of dialkylsilanes in the reaction of alkenes with (MeO)₃SiH.

Table 4.4: Ni-catalyzed synthesis of alkyl hydrosilanes using trimethoxysilane and alkenes ^a

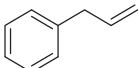
$4 \text{ (MeO)}_3\text{SiH} + 2 \text{ } \text{R-CH=CH}_2 \xrightarrow[\text{THF, rt, 24 h}]{\text{4-1 5 mol \%}, \text{NaO}^t\text{Bu 10 mol \%}} \left(\text{R-CH}_2\text{-CH}_2 \right)_2 \text{SiH}_2 + 3 \text{ (MeO)}_4\text{Si}$ <div style="display: flex; justify-content: space-around; width: 100%;"> 2 mmol 1.5 mmol </div>			
Entry	Alkene	Product	Yield ^b (%)
1	1-Octadecene	$\left(\text{C}_{18}\text{H}_{37} \right)_2 \text{SiH}_2$	81
2		$\left(\text{Ph-CH}_2\text{-CH}_2 \right)_2 \text{SiH}_2$	71 ^c

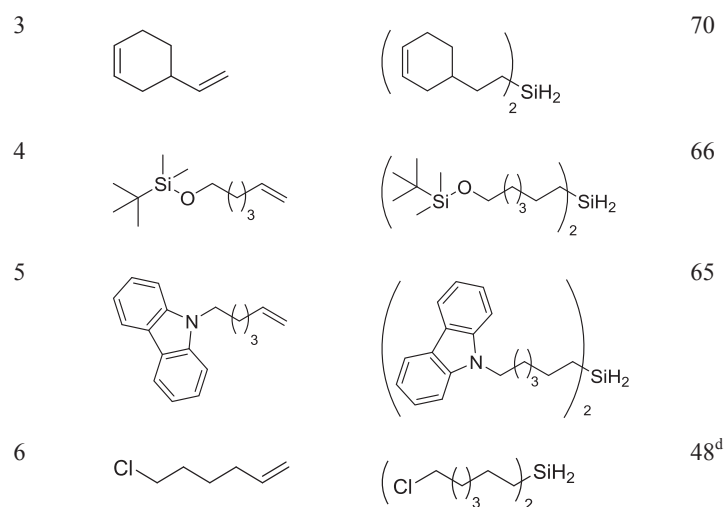

^a Typical conditions : alkene (1.5 mmol), trimethoxysilane (2 mmol), **4-1** (5 mol %), NaO^tBu (10 mol %), THF (4 mL), 24 hours, rt. ^b Isolated yields relative to intermediate silanes are reported. The theoretical yield is 0.5 mmol. ^c Alkene (1.8 mmol) was used. ^d Alkene (1.2 mmol) was used.

4.5 Synthesis of R₁R₂R₃-SiH

The above reactions could be applied for the synthesis of alkyl hydrosilanes containing different alkyl groups. For example (2-(cyclohex-3-en-1-yl)ethyl)(methyl)(octyl)silane was obtained in a 68% yield by step-wise addition of 1-octene and 4-vinylcyclohex-1-ene.

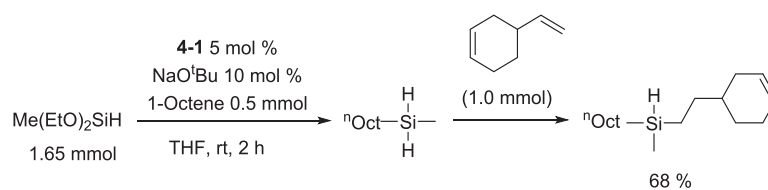

Scheme 4.3: Synthesis of (2-(cyclohex-3-en-1-yl)ethyl)(methyl)(octyl)silane

4.6 Mechanistic Studies

Several experiments were carried out to provide preliminary mechanistic insights in these reactions. The addition of a catalytic amount of NaO^tBu to $\text{Me}_2(\text{MeO})\text{SiH}$ led to a quick release of Me_2SiH_2 , detected by ^1H NMR. Likewise, the addition of a catalytic amount of NaO^tBu to $(\text{MeO})_3\text{SiH}$ led to the formation of SiH_4 , again detected by ^1H NMR. Thus, the alkoxy silanes were proposed to react first with a base to give hydrosilanes in a sequence shown in equations 1-2, Scheme 4.4. Nucleophilic attack of an alkoxide anion on $\text{Me}_2(\text{MeO})\text{SiH}$ gave the 5-coordinate species (A), which reacted with another molecule of $\text{Me}_2(\text{MeO})\text{SiH}$ to produce Me_2SiH_2 and $\text{Me}_2(\text{MeO})_2\text{Si}$, in a disproportionation manner. The base was also regenerated in this step. Similar base-catalyzed disproportionation reactions of alkoxy silanes were previously reported.¹⁷⁻¹⁹ The disproportionation of alkoxy silanes was followed by ^1H NMR. $\text{Me}_2(\text{MeO})\text{SiH}$ was converted to Me_2SiH_2 and $\text{Me}_2(\text{MeO})_2\text{Si}$ under 0.5 mol % of NaO^tBu in THF-d8 in 50 min. Analogous reaction of $\text{Me}(\text{EtO})_2\text{SiH}$ took 20 minutes to complete. The disproportionation of trialkoxy silane $(\text{MeO})_3\text{SiH}$ was even faster: in the presence of 0.1 mol % of NaO^tBu the conversion was completed after 5 minutes. Thus, the rate of disproportionation follows the order: $(\text{MeO})_3\text{SiH} > \text{Me}(\text{EtO})_2\text{SiH} > \text{Me}_2(\text{MeO})\text{SiH}$. It was noted that the nickel complex did not accelerate the rate of disproportionation (See Experimental section).

Complex **4-1** was found to be an efficient catalyst for the hydrosilylation of 1-octene by Ph_2SiH_2 and Et_2SiH_2 in the presence of 1 equivalent of NaO^tBu (relative to **4-1**), giving the respective hydrosilanes in good yields (equation 3, Scheme 4.4). Accordingly, we propose that the present reactions proceed first by base-catalyzed disproportionation of alkoxy silanes to give hydrosilanes, which upon catalysis by **4-1**, hydrosilylated alkenes to give the alkylhydrosilanes.

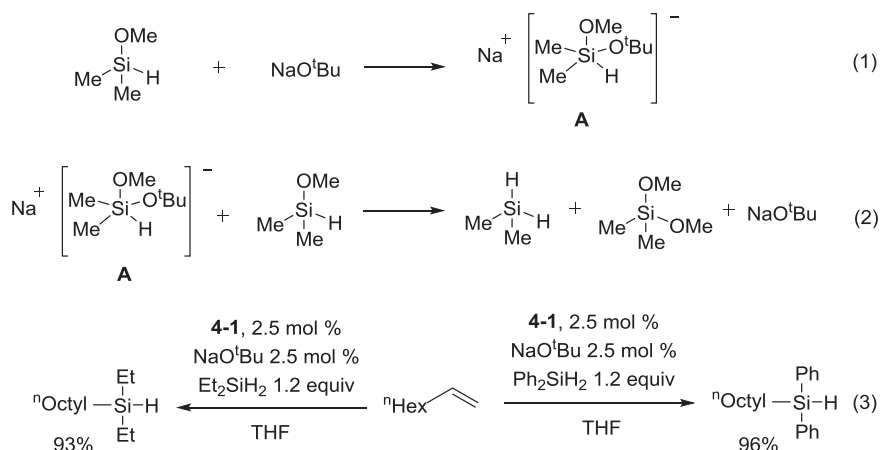

Scheme 4.4: Proposed mechanism

Because Me_2SiH_2 , MeSiH_3 and SiH_4 were proposed as intermediates in the hydrosilylation reactions reported here, it is important to compare the rate of their generation and that of hydrosilylation. For large scale applications, the rate of hydrosilylation should be faster than the rate of disproportionation in order to avoid the build-up of flammable intermediates, especially the pyrophoric SiH_4 . When an actual reaction of 1-decene with $\text{Me}_2(\text{MeO})\text{SiH}$ was monitored by ^1H NMR, a sub-stoichiometric amount of Me_2SiH_2 was detected in the beginning, but it disappeared after 15 minutes. This result suggests that the generation of Me_2SiH_2 is faster than hydrosilylation, but hydrosilylation is sufficiently fast so that the intermediate is quickly consumed. In the reaction of 1-decene with $\text{Me}(\text{EtO})_2\text{SiH}$, only $\text{Me}(\text{decyl})\text{SiH}_2$, but not MeSiH_3 , was detected as intermediate in the beginning of the reaction. This result suggests that hydrosilylation is faster than the generation of MeSiH_3 . And in an actual reaction of 1-decene with $(\text{MeO})_3\text{SiH}$, no SiH_4 was detected by ^1H NMR. The above results suggest that the reactions of alkenes with $\text{Me}(\text{EtO})_2\text{SiH}$ or $(\text{MeO})_3\text{SiH}$ described here are potentially suitable for large scale applications because there was no significant build-up of flammable MeSiH_3 or pyrophoric SiH_4 (*Caution:* Even though we used this method without any incident and there was no build-up of MeSiH_3 and SiH_4 in the reactions, precautions are required to run these reactions in large scales due to the flammable nature of these intermediates). Even the reactions of alkenes with $\text{Me}_2(\text{MeO})\text{SiH}$ might be suitable for large scale application given proper handling, because only a small amount of Me_2SiH_2 was formed as intermediate in the beginning of the reaction. Me_2SiH_2 has good solubility in organic solvents and is not pyrophoric.

The superior activity of **4-1** compared to other nickel complexes (Table 4.1), is tentatively attributed to the former's inability to catalyze isomerization of alkenes under basic conditions, as well as its low efficiency for the hydrosilylation with alkoxy silanes. It was found that under the reaction conditions of Table 4.1, various amounts of internal alkenes were formed using **4-2**, **4-3**, **4-4**, and $\text{NiCl}_2(\text{PPh}_3)_2$ as catalysts. Only minor amount of internal decenes were formed during the reaction (<5% by GCMS) when **4-1** was used as the catalyst. Moreover, less than 3% of conventional hydrosilylation product (Decyl)(Me)₂SiOMe was formed in the reaction of 1-decene with $\text{Me}_2(\text{MeO})\text{SiH}$ using **4-1** as precatalyst, while up to 19% of this compound was formed using other nickel catalysts in Table 4.1.

4.7 Conclusions

In summary, we have developed a novel catalytic method allowing the use of alkoxy hydrosilanes as surrogates of gaseous silanes in hydrosilylation reactions of alkenes. While serving as a convenient and safer alternative to methods using directly Me_2SiH_2 , MeSiH_3 and SiH_4 , the present approach actually facilitates the “formal” use of these underexplored reagents in chemical synthesis.

4.8 Experimental

4.8.1 Chemicals and Reagents

All manipulations were carried out under an inert N₂(g) atmosphere using standard Schlenk or glovebox techniques. Solvents were purified using a two-column solid-state purification system (Innovative Technology, NJ, USA) and transferred to the glove box without exposure to air. Deuterated solvents were purchased from Cambridge Isotope Laboratories, Inc., and were degassed and stored over activated 3 Å molecular sieves. THF-d₈ was purchased from ARMAR AG, and was degassed and stored over activated 3 Å molecular sieves. Unless otherwise noted, all other reagents and starting materials were purchased from commercial sources and used without further purification. Liquid compounds were degassed by standard freeze-pump-thaw procedures prior to use. The following chemicals were prepared according to procedures in the literature:

substrates 6-(benzyloxy)-hex-1-ene ²⁰, tert-butyl(hex-5-enyloxy)dimethylsilane ²¹, 6-(2-tetrahydropyranyl)oxy-1-hexene ²², 2,2-dimethyl-4-pentenal ethylene acetal ²³;

complexes **4-1** ²⁴ and **4-2** ²⁵, **4-3** ²⁶ and **4-4** ²⁷.

4.8.2 Physical Methods

The ¹H and ¹³C NMR spectra were recorded at 293 K or 373 K on Bruker Avance 400 spectrometers. ¹H NMR chemical shifts were referenced to residual solvent as determined relative to Me₄Si (δ = 0 ppm). The ¹³C{¹H} chemical shifts were reported in ppm relative to the carbon resonance of CDCl₃ (77.16 ppm), C₆D₆ (128.06). GC measurement was conducted on a Perkin-Elmer Clarus 400 GC with a FID detector. GC-MS measurements were

conducted on an Agilent Technologies 7890A GC system equipped with a 5975C MS detector. HRMS (ESI, APCI and APPI) measurements were conducted at the EPFL ISIC Mass Spectrometry Service with a Micro Mass QTOF. Elemental analyses were performed on a Carlo Erba EA 1110 CHN instrument at EPFL.

4.8.3 The Procedures for the Preparation of Starting Materials

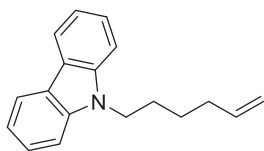

9-(hex-5-en-1-yl)-9H-carbazole

A 100 mL round-bottom flask equipped with a Teflon-coated magnetic stirring bar was charged with 9H-carbazole (1.0 g, 6.0 mmol) and 15 mL of DMF. Sodium hydride (240 mg of 60 percent suspension in mineral oil, 6.0 mmol) was added and the reaction stirred at room temperature for 1 h. 6-bromohex-1-ene (1.47 g, 9.0 mmol) was added and the reaction allowed to stir for an additional 2 h at 80°C. Water was added and the mixture extracted with CH₂Cl₂. The organic layer was dried with anhydrous Na₂SO₄ and concentrated *in vacuo*. The crude product was purified by flash chromatography with silica gel using a mixture of hexane/EtOAc (20:1) as an eluent to afford the title compound (**3k**) as a pale-yellow solid (1.34 g, 89 %).

¹H NMR (400 MHz, CDCl₃) δ 8.10-8.08 (m, 2H), 7.46-7.36 (m, 4H), 7.23-7.20 (m, 2H), 5.78-5.68 (m, 1H), 4.99-4.91 (m, 2H), 4.27 (t, *J* = 7.1 Hz, 2H), 2.08-2.04 (m, 2H), 1.87-1.82 (m, 2H), 1.50-1.43 (m, 2H).

¹³C NMR (101 MHz, CDCl₃) δ 140.5, 138.4, 125.7, 123.0, 120.5, 118.9, 115.1, 108.8, 43.0, 33.6, 28.5, 26.7.

HRMS (ESI): calculated for (C₁₈H₂₀N, [M+H]⁺), 250.1596; found 250.1595.

4.8.4 General Procedures for Hydrosilylation Reactions

Safety note: The reactions involve Me_2SiH_2 , MeSiH_3 and SiH_4 as intermediates which are flammable gases. Although during catalysis MeSiH_3 and SiH_4 was not observed, and Me_2SiH_2 was only present in the beginning of the reaction, cautions should be made. The reactions run in closed vessels may be subjected to increased pressures, although this was not encountered in our experiments. The reaction vessels should be purged with N_2 prior the contact with air.

Preparation of the stock solution of pre-catalyst

A stock solution of pre-catalyst was prepared by dissolving 120 mg (0.25 mmol) of complex $[\text{iPr}_2\text{(S,S)-BOZ}]\text{NiCl}$ (**4-1**) and 48 mg (0.5 mmol) of NaO^tBu in 20.0 mL of dry THF.

General procedure for the Ni-catalyzed hydrosilylation using dimethylmethoxysilane and alkenes

(General Procedure I, Table 4.2)

In a nitrogen filled glovebox, an oven-dried 30 mL re-sealable screw-cap vial equipped with a Teflon coated magnetic stirring bar was charged with alkene (0.5 mmol), dimethylmethoxysilane (1.2 mmol) and dry THF (2 mL). An aliquot of the stock solution of complex **4-1** and NaO^tBu (1.0 mL, corresponding to 2.5 mol % of Ni catalyst) was added and the resulting mixture was stirred at room temperature for indicated time. After that, the vial was opened in the glovebox, purged with N_2 , closed and removed from the glovebox. The reaction mixture was concentrated under vacuum. The residue was purified by flash chromatography to afford the desired product.

General procedure for the Ni-catalyzed synthesis of alkyl hydrosilanes using methyldiethoxysilane and alkenes.

(General Procedure II, Table 4.3)

In a nitrogen filled glovebox, an oven-dried 30 mL re-sealable screw-cap vial equipped with a Teflon coated magnetic stirring bar was charged with alkene (1.2 mmol), methyldiethoxysilane (1.5 mmol) and dry THF (2 mL). An aliquot of the stock solution of complex **4-1** and NaO^tBu (2.0 mL, corresponding to 5 mol % of Ni catalyst) was added and the resulting mixture was stirred at room temperature for indicated time. After that, the vial

was opened in the glovebox, purged with N₂, closed and removed from the glovebox. The reaction mixture was concentrated under vacuum. The residue was purified by flash chromatography to afford the desired product.

General procedure for the Ni-catalyzed synthesis of alkyl hydrosilanes using trimethoxysilane and alkenes.

(General Procedure III, Table 4.3)

In a nitrogen filled glovebox, an oven-dried 30 mL re-sealable screw-cap vial equipped with a Teflon coated magnetic stirring bar was charged with alkene (1.5 mmol), trimethoxysilane (2 mmol) and dry THF (2 mL). An aliquot of the stock solution of complex **4-1** and NaO^tBu (2.0 mL, corresponding to 5 mol % of Ni catalyst) was added and the resulting mixture was stirred at room temperature for indicated time. After that, the vial was opened in the glovebox, purged with N₂, closed and removed from the glovebox. The reaction mixture was concentrated under vacuum. The residue was purified by flash chromatography to afford the desired product.

4.8.5 NMR Experiments

4.8.5.1 Following the disproportionation of dimethylmethoxysilane

In a nitrogen filled glovebox, J. Young NMR tube was charged with NaO^tBu (2.0 mg, 21 μmol) and THF-d₈ (0.3 mL). To the solution dimethylmethoxysilane (23 mg, 0.25 mmol) in THF-d₈ (0.3 mL) was added. Outside the glovebox, the tube was shaken prior to introduction in to the NMR spectrometer. The ¹H spectrum was recorded after 3 min (Figure 4.1), all following spectra were identical.

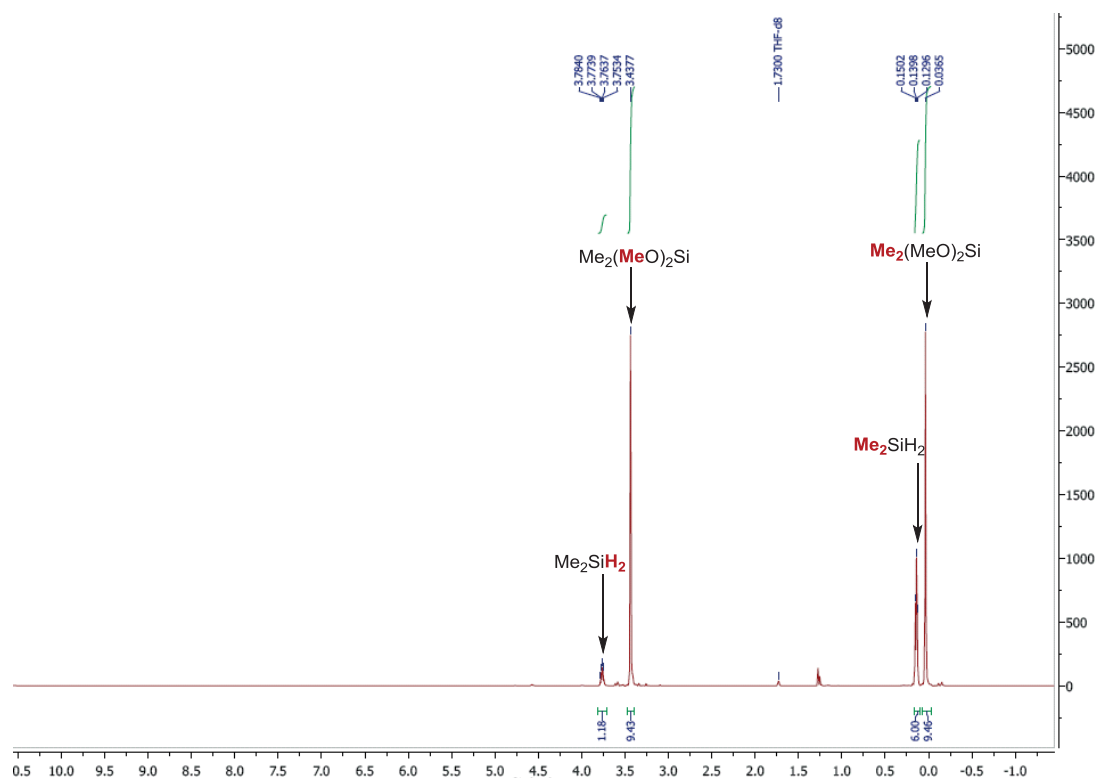
Figure 4.1: NaO^tBu-catalyzed disproportionation of dimethylmethoxysilane

4.8.5.2 Monitoring of the reaction of Table 4.1, entry 1.

In a nitrogen filled glovebox, an oven-dried vial was charged with 1-decene (42 mg, 0.3 mmol), dimethylmethoxysilane (45 mg, 0.5 mmol), mesitylene (9 mg, 0.075 mmol) and THF- d_8 (0.6 mL). The solution was placed in J. Young NMR tube and ^1H spectrum was recorded. Back in the glovebox a solution of complex **4-1** (3 mg, 6 μmol) and NaO^tBu (1.5 mg, 15 μmol) in 0.4 mL of THF- d_8 was added, the tube was closed and taken out. Outside the glovebox, the tube was shaken prior to introduction in to the NMR spectrometer. First measurement was made after 2 min from the moment when catalyst was added (Figure 4.2).

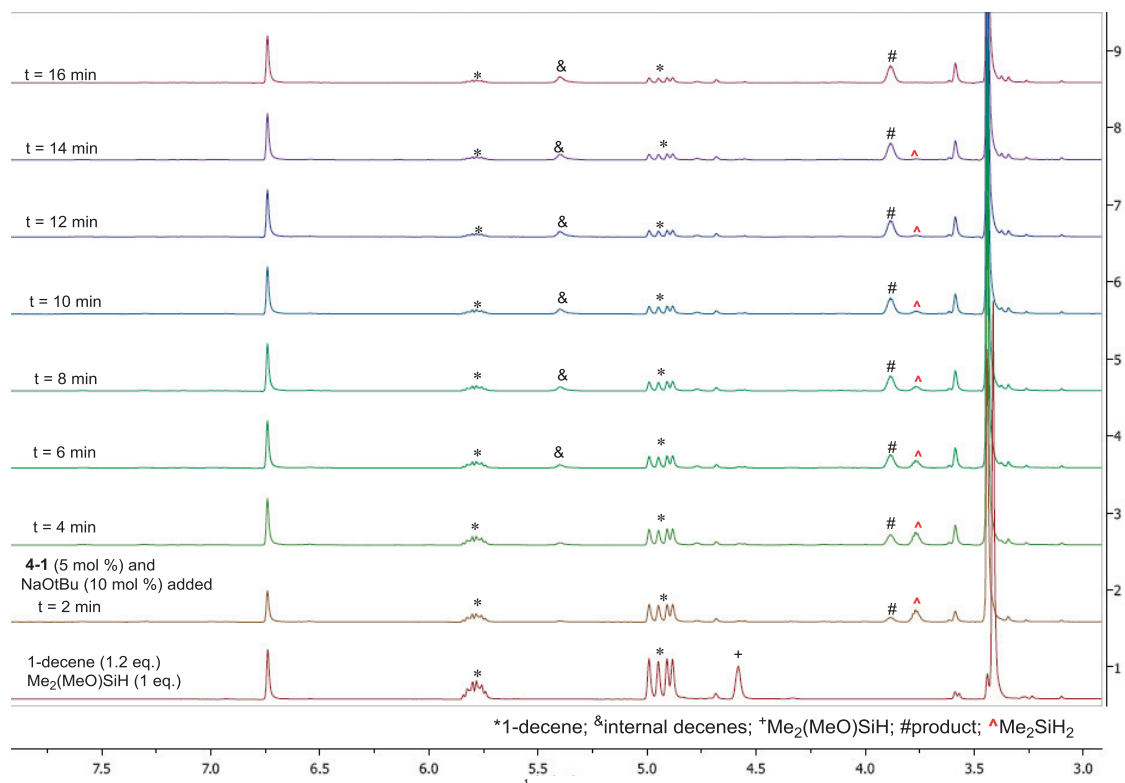
Figure 4.2: Stack ^1H NMR spectra (THF- d_8)

4.8.5.3 Following disproportionation of trimethoxysilane

In a nitrogen filled glovebox, J. Young NMR tube was charged with NaO^tBu (2.0 mg, 21 μmol) and THF- d_8 (0.3 mL). To the solution trimethoxysilane (31 mg, 0.25 mmol) in THF- d_8 (0.3 mL) was added. Outside the glovebox, the tube was shaken prior to introduction in to the NMR spectrometer. The spectrum was recorded after 3 min (Figure 4.3), all following spectra (5, 10, 15 min) were almost identical.

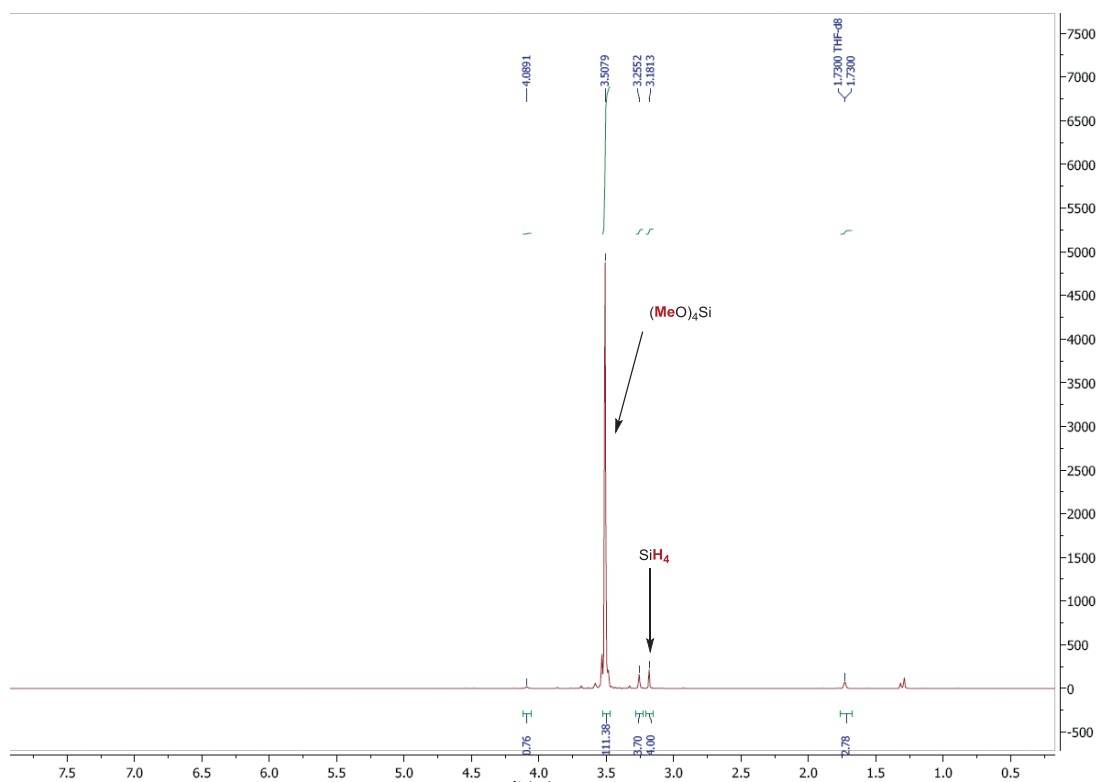
Figure 4.3: NaO^tBu catalyzed disproportionation of trimethoxysilane

In order to prove that the peak at 3.18 ppm corresponds to the protons of SiH_4 , a stream of SiH_4 obtained in a separated vessel by disproportionation of neat trimethoxysilane was bubbled through THF- d_8 in NMR tube (Figure 4.4).

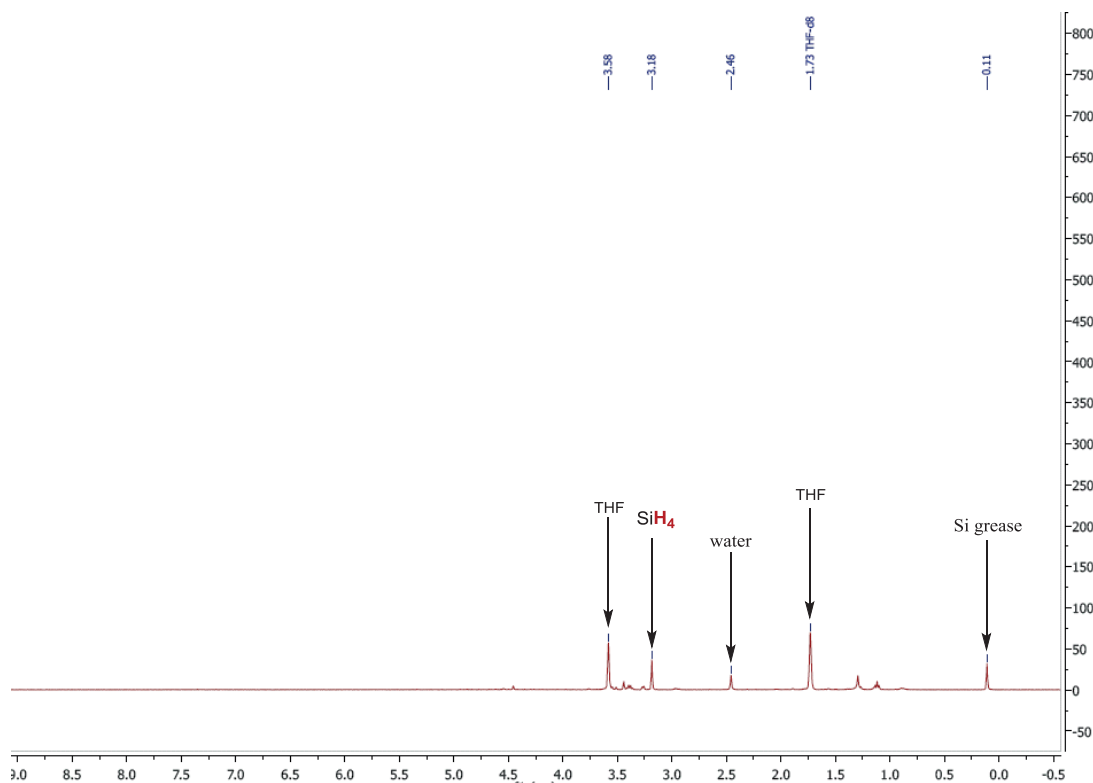
Figure 4.4: SiH_4 in THF-d_8 (3.18 ppm)

4.8.5.4 Monitoring of the reaction of 1-decene with trimethoxysilane

In a nitrogen filled glovebox, an oven-dried vial was charged with 1-decene (63 mg, 0.45 mmol), trimethoxysilane (61 mg, 0.5 mmol), mesitylene (10 mg, 0.083 mmol) and THF-d_8 (0.6 mL). The solution was placed in J. Young NMR tube and a solution of complex **4-1** (3 mg, 6 μmol) and NaOtBu (1.5 mg, 15 μmol) in 0.4 mL of THF-d_8 was added. The tube was immediately closed and taken out. Outside the glovebox, the tube was shaken prior to introduction in to the NMR spectrometer. First measurement was made after 4 min from the moment when catalyst was added. (Figure 4.5). No peak of SiH_4 was observed in the course of reaction.

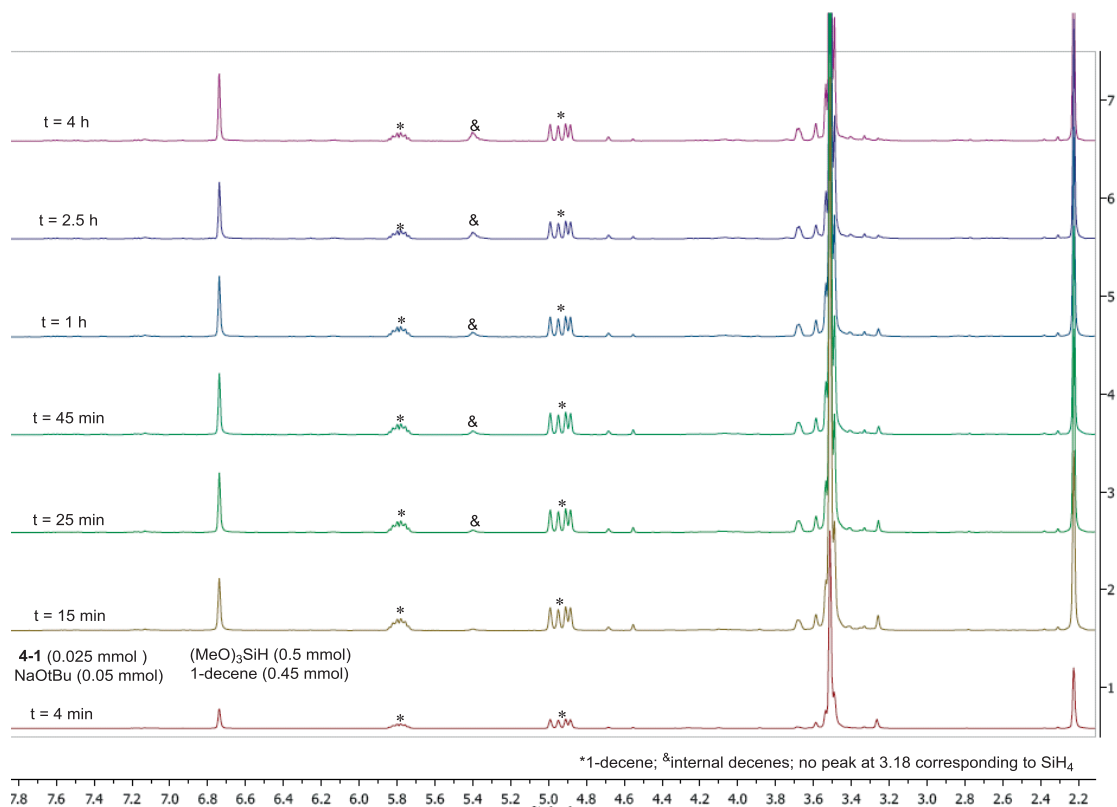

Figure 4.5: Stack ¹H NMR spectra of reaction 1-decene with trimethoxysilane (THF-d₈)

4.8.5.5 Monitoring of the reaction of 1-decene with methyldiethoxysilane

In a nitrogen filled glovebox, an oven-dried vial was charged with 1-decene (84 mg, 0.6 mmol), methyldiethoxysilane (100 mg, 0.75 mmol), mesitylene (10 mg, 0.083 mmol) and THF-d₈ (0.6 mL). The solution was placed in J. Young NMR tube and a solution of complex **4-1** (6 mg, 12 μmol) and NaO^tBu (2.5 mg, 26 μmol) in 0.4 mL of THF-d₈ was added. The tube was immediately closed and taken out. Outside the glovebox, the tube was shaken prior to introduction in to the NMR spectrometer. First measurement was made after 4 min from the moment when catalyst was added. (Figure 4.6). No peak of MeSiH₃ was observed in the course of reaction.

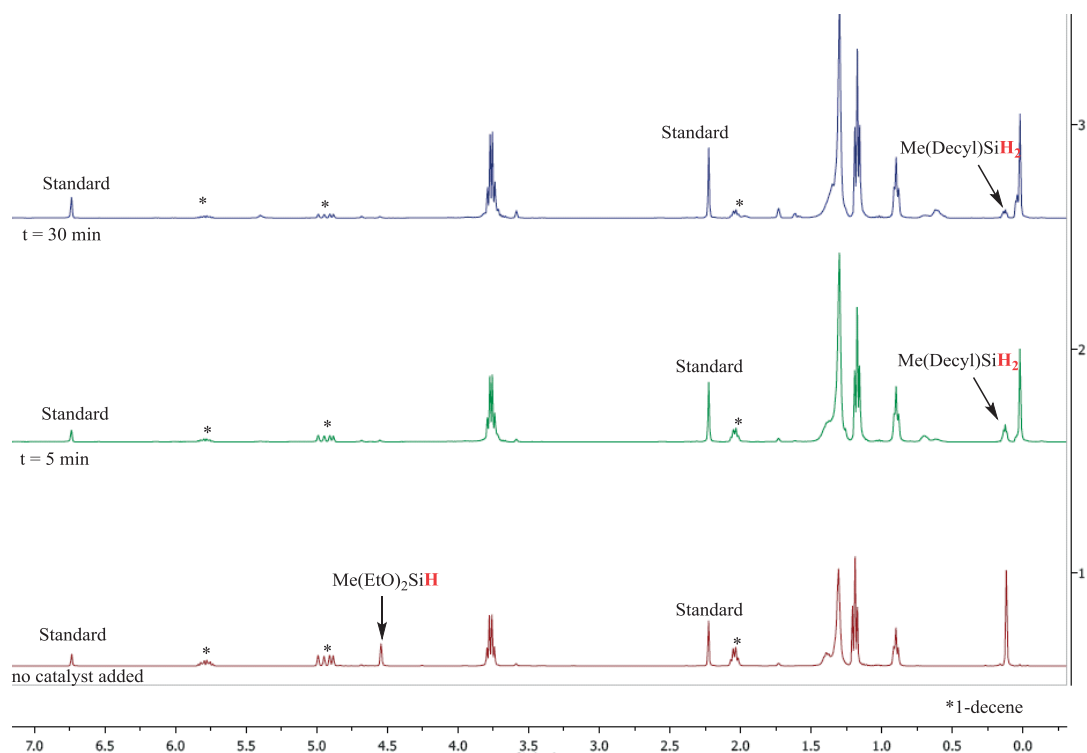

Figure 4.6: Stack ^1H NMR spectra of reaction 1-decene with methyl-diethoxy-silane (THF- d_8)

4.8.5.6 Monitoring of the disproportionation of dimethylmethoxysilane

Stock solution of NaO^tBu was prepared from 12 mg of NaO^tBu and 10.0 mL of THF- d_8 .

In a nitrogen filled glovebox, an oven-dried vial was charged with dimethylmethoxysilane (23 mg, 0.25 mmol), mesitylene (9 mg, 0.075 mmol) and THF- d_8 (0.5 mL). The solution was placed in J. Young NMR tube and an aliquot of stock solution of NaO^tBu (0.1 mL, 0.5%) in was added. The tube was closed and taken out. Outside the glovebox, the tube was shaken prior to introduction in to the NMR spectrometer. First measurement was made after 2 min from the moment when catalyst was added.

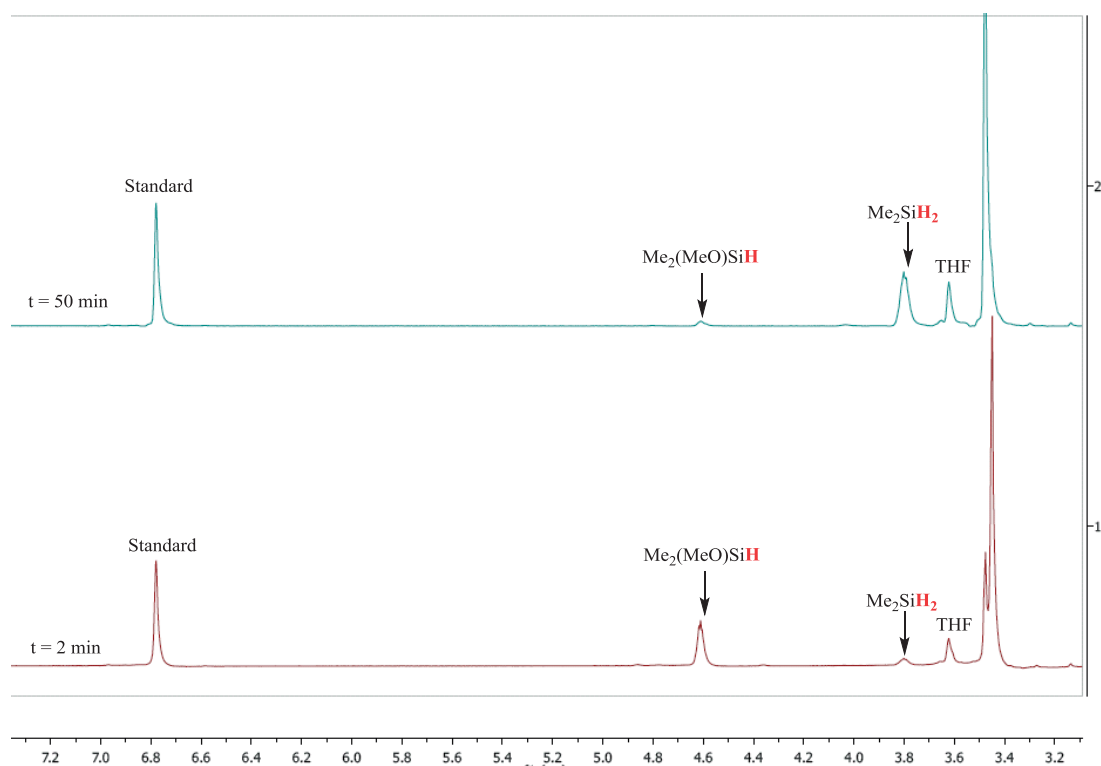

Figure 4.7: Selected ^1H NMR spectra of the disproportionation of dimethylmethoxysilane catalyzed by 0.5 mol % of NaO^tBu

4.8.5.7 Monitoring of the disproportionation of methyldiethoxysilane

In a nitrogen filled glovebox, an oven-dried vial was charged with methyldiethoxysilane (34 mg, 0.25 mmol), mesitylene (9 mg, 0.075 mmol) and THF-d_8 (0.5 mL). The solution was placed in J. Young NMR tube and an aliquot of stock solution of NaO^tBu (0.1 mL, 0.5%) in was added. The tube was closed and taken out. Outside the glovebox, the tube was shaken prior to introduction in to the NMR spectrometer. First measurement was made after 2 min from the moment when catalyst was added.

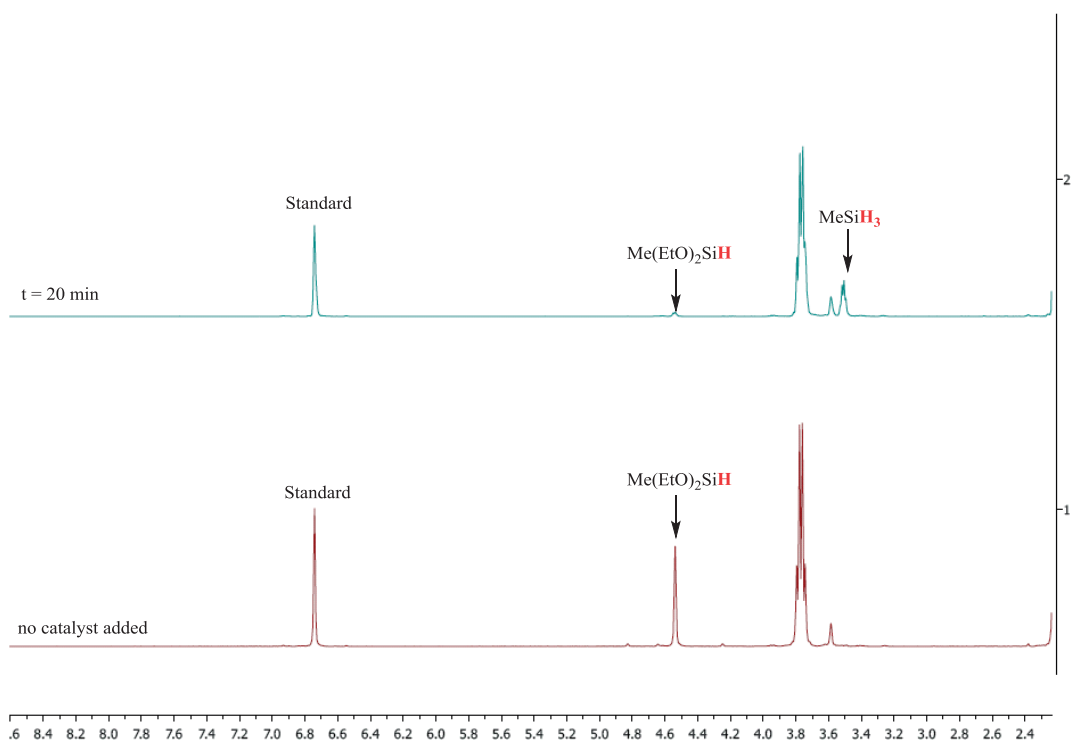

Figure 4.8: Selected ^1H NMR spectra of the disproportionation of methyldiethoxysilane catalyzed by 0.5 mol % of NaO^tBu

4.8.5.8 Monitoring of the disproportionation of trimethoxysilane

In a nitrogen filled glovebox, an oven-dried vial was charged with trimethoxysilane (31 mg, 0.25 mmol), mesitylene (9 mg, 0.075 mmol) and THF-d_8 (0.6 mL). The solution was placed in J. Young NMR tube and an aliquot of stock solution of NaO^tBu (0.02 mL, 0.1 mol %) in was added. The tube was closed and taken out. Outside the glovebox, the tube was shaken prior to introduction in to the NMR spectrometer. First measurement was made after 1 min from the moment when catalyst was added.

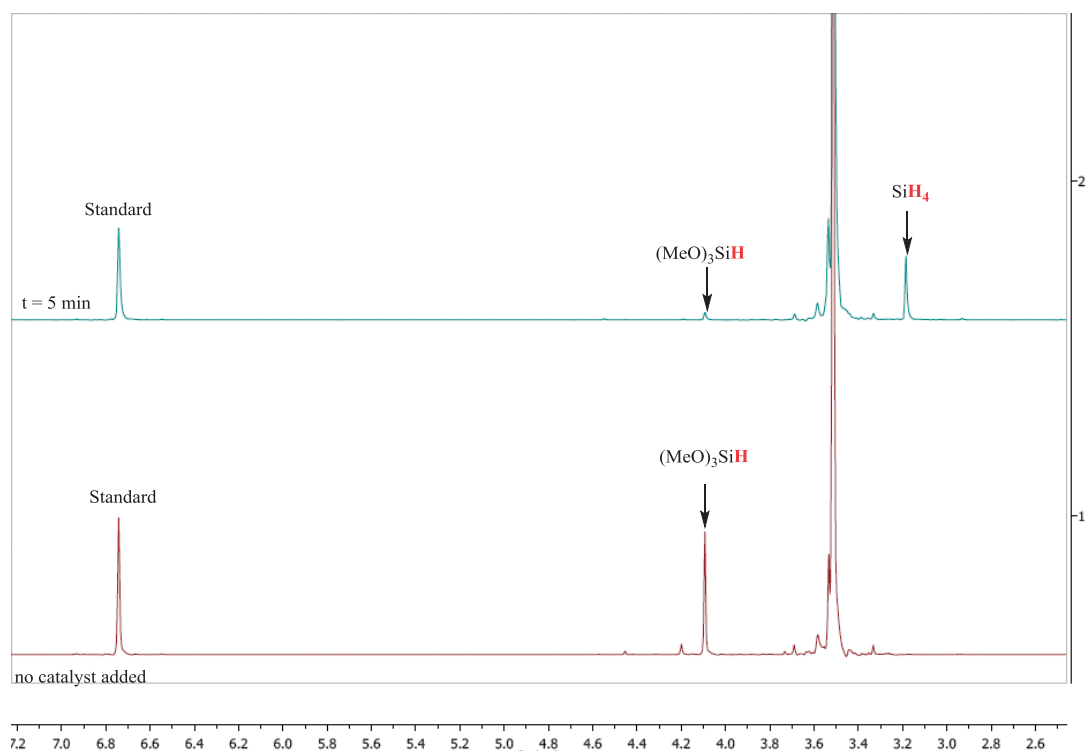

Figure 4.9: Selected ^1H NMR spectra of the disproportionation of trimethoxysilane catalyzed by 0.1 mol % of NaO^tBu

4.8.5.9 The comparison of the rates of disproportionation of dimethylmethoxysilane in the presence and absence of 4-1

Stock solution of **4-1** was prepared from 6 mg of **4-1** and 1.0 mL of THF- d_8

In a nitrogen filled glovebox, an oven-dried vial was charged with dimethylmethoxysilane (23 mg, 0.25 mmol), mesitylene (9 mg, 0.075 mmol) and THF- d_8 (0.3 mL). The solution was placed in J. Young NMR tube. Aliquots of the stock solutions of NaO^tBu (0.2 mL, 1.0 mol %) and **4-1** (0.1 mL, 0.5 mol %) were mixed in a separate vial, and after 10 minutes added to the NMR tube. The tube was closed and taken out. Outside the glovebox, the tube was shaken prior to introduction in to the NMR spectrometer. The rate of disproportionation was compared to that obtained in previous experiment where 0.5 mol % of NaO^tBu was the only catalyst.

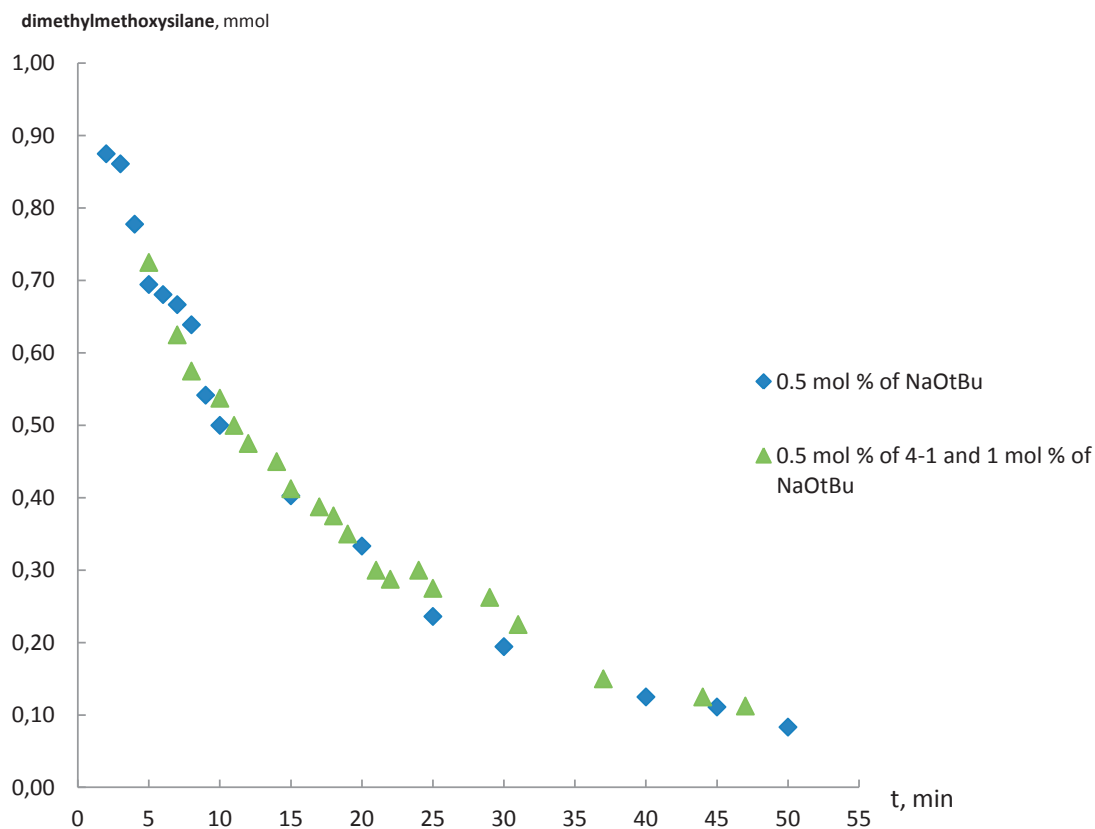

Figure 4.10: Reaction profiles of disproportionation of dimethylmethoxysilane catalyzed by 0.5 mol % of NaO^tBu and in the presence of Ni catalyst

4.8.5.10 Monitoring of the reaction of isolated dioctadecylsilane with 1-octadecene

In a nitrogen filled glovebox, an oven-dried vial was charged with 1-octadecene (37 mg, 0.15 mmol), dioctadecylsilane (67 mg, 0.125 mmol), mesitylene (10 mg, 0.083 mmol) and THF-d₈ (0.6 mL). The solution was placed in J. Young NMR tube and a solution of complex **4-1** (3 mg, 6 μmol) and NaO^tBu (1.5 mg, 15 μmol) in 0.4 mL of THF-d₈ was added. The tube was closed and taken out. Outside the glovebox, the tube was shaken prior to introduction in to the NMR spectrometer. First measurement was made after 2 min from the moment when catalyst was added. (Figure 4.11). Starting dioctadecylsilane was converted to trioctadecylsilane in 1 hour.

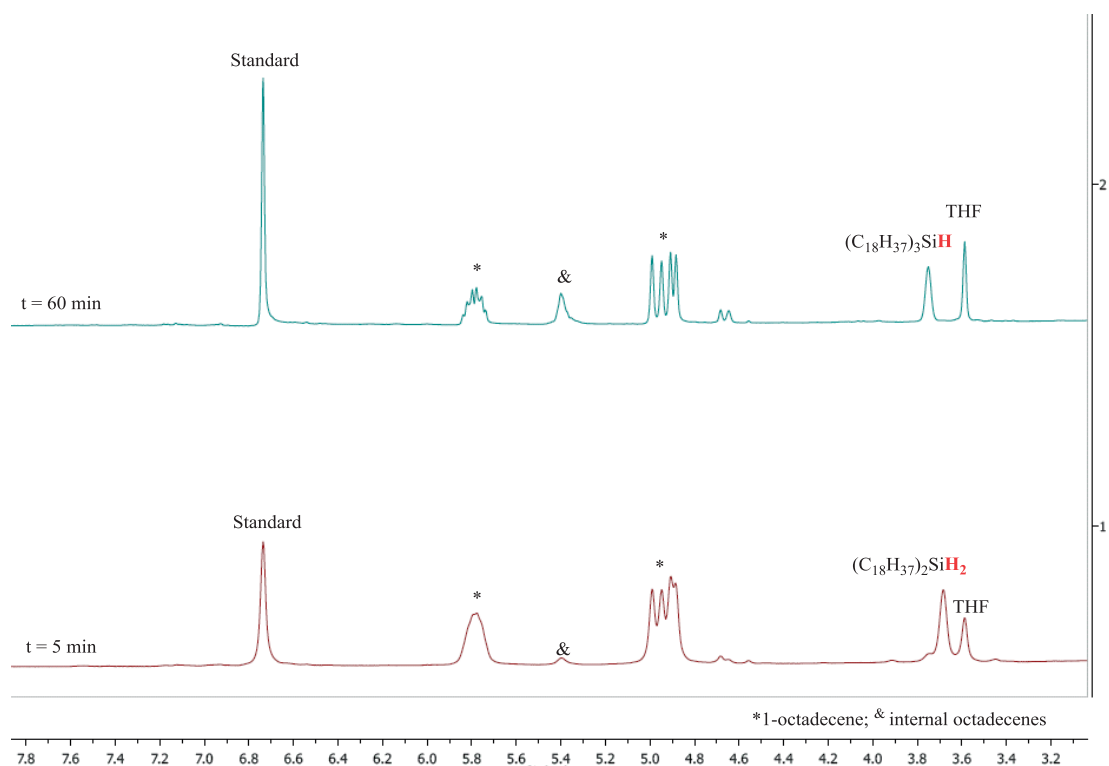

Figure 4.11: Selected ^1H NMR spectra of reaction di-octadecylsilane with 1-octadecene (THF- d_8)

4.8.5.11 Monitoring of the reaction of di-octadecylsilane with 1-octadecene in the presence of 3 equiv. of $(\text{MeO})_4\text{Si}$

In a nitrogen filled glovebox, an oven-dried vial was charged with 1-octadecene (37 mg, 0.15 mmol), di-octadecylsilane (67 mg, 0.125 mmol), mesitylene (10 mg, 0.083 mmol), $(\text{MeO})_4\text{Si}$ (57 mg, 0.375 mmol) and THF- d_8 (0.6 mL). The solution was placed in J. Young NMR tube and a solution of complex **4-1** (3 mg, 6 μmol) and NaOtBu (1.5 mg, 15 μmol) in 0.4 mL of THF- d_8 was added. The tube was closed and taken out. Outside the glovebox, the tube was shaken prior to introduction in to the NMR spectrometer. First measurement was made after 5 min from the moment when catalyst was added. Starting di-octadecylsilane did not disappear after 10 hours. The spectrum recorded after 6 hours shows <40% conversion (Figure 4.12).

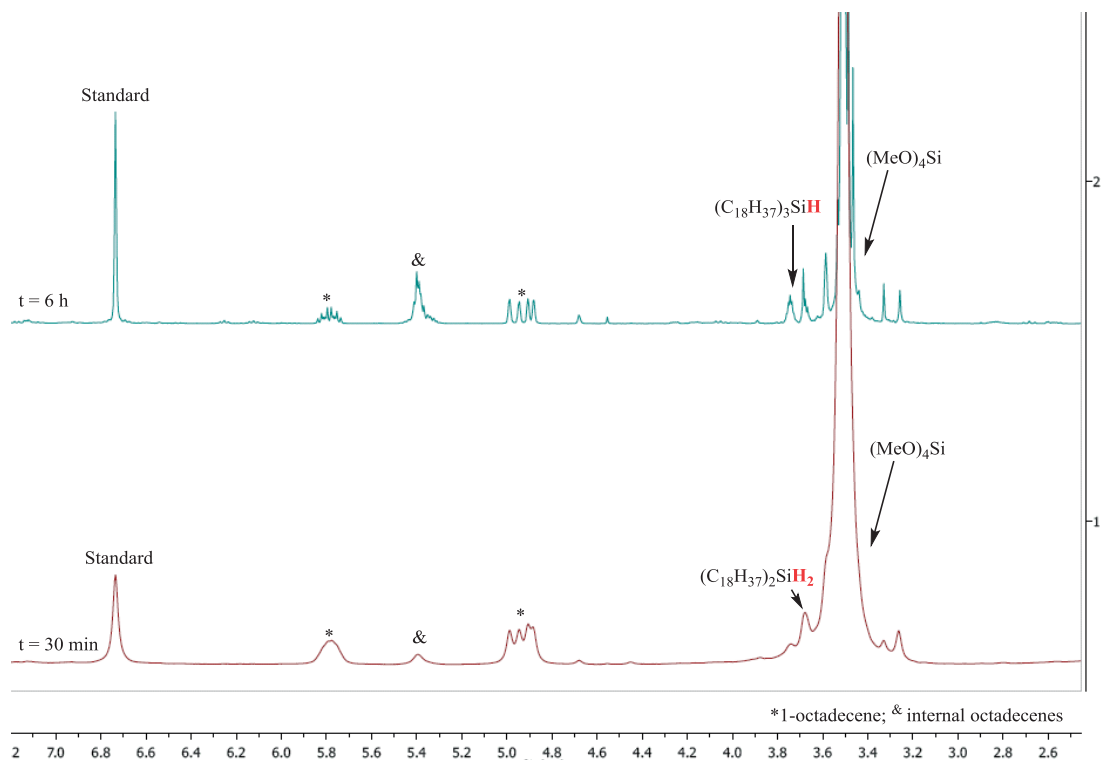
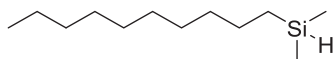

Figure 4.12. Selected ^1H NMR spectra of reaction dioctadecylsilane with 1-octadecene in the presence of 3 equiv. of $(\text{MeO})_4\text{Si}$ (THF-d_8)

4.8.6 Detailed descriptions of the products



Dimethyl(decyl)silane (entry 1, Table 4.2)

Following the general procedure I, the title compound was prepared using 1-decene (70 mg) and dimethylmethoxysilane (108 mg). The crude product was purified by flash chromatography using hexane as an eluent to afford the title compound as colorless oil (90 mg, 90%).

^1H NMR (400 MHz, CDCl_3) 3.86-3.81 (m, 1H), 1.36-1.26 (m, 16H), 0.88 (t, $J = 6.3$ Hz, 3H), 0.60-0.55 (m, 2H), 0.06 (d, $J = 3.6$ Hz, 6H).

^{13}C NMR (101 MHz, CDCl_3) δ 33.4, 32.1, 29.9, 29.8, 29.6, 29.5, 24.5, 22.9, 14.34, 14.28, -4.3.

Elemental analysis: Anal. Calcd for $\text{C}_{12}\text{H}_{28}\text{Si}$: C, 71.91; H, 14.08. Found: C, 71.52 ; H, 14.28.

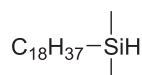
**Dimethyl(octadecyl)silane (entry 2, Table 4.2)**

Following the general procedure I, the title compound was prepared using 1-octadecene (126 mg) and dimethylmethoxysilane (108 mg). The crude product was purified by flash chromatography using hexane as an eluent to afford the title compound as colorless oil (145 mg, 93%).

¹H NMR (400 MHz, CDCl₃) δ 3.86-3.81 (m, 1H), 1.35-1.25 (m, 32H), 0.88 (t, *J* = 6.2 Hz, 3H), 0.60-0.55 (m, 2H), 0.06 (d, *J* = 3.6 Hz, 6H).

¹³C NMR (101 MHz, CDCl₃) δ 33.4, 32.2, 29.93, 29.89, 29.82, 29.61, 29.59, 24.58, 22.9, 14.4, 14.3, -4.3.

The spectroscopic data corresponds to that available on Sigma-Aldrich database (product **276138**)

Elemental analysis: Anal. Calcd for C₂₀H₄₄Si: C, 76.83; H, 14.19. Found : C, 76.46 ; H, 14.21.

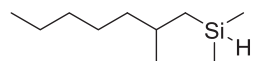
**Dimethyl(2-methylheptyl)silane (entry 3, Table 4.2)**

Following the general procedure I, the title compound was prepared using 2-methyl-2-heptene (56 mg) and dimethylmethoxysilane (108 mg). The crude product was purified by flash chromatography using hexane as an eluent to afford the title compound as colorless oil (25 mg, 29%).

¹H NMR (400 MHz, CDCl₃) δ 3.92-3.87 (m, 1H), 1.62-1.56 (m, 1H), 1.32-1.16 (m, 8H), 0.92-0.87 (m, 6H), 0.71-0.66 (m, 1H), 0.51-0.44 (m, 1H), 0.07 (d, *J* = 3.6 Hz, 6H).

¹³C NMR (101 MHz, CDCl₃) δ 40.3, 32.3, 30.0, 27.0, 23.0, 22.9, 22.7, 14.3, -3.6.

Elemental analysis: Anal. Calcd for C₁₀H₂₄Si: C, 69.67; H, 14.03. Found : C, 69.49 ; H, 14.14.

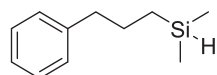
**Dimethyl(3-phenylpropyl)silane (entry 4, Table 4.2)**

Following the general procedure I, the title compound was prepared using allylbenzene (59 mg) and dimethylmethoxysilane (108 mg). The crude product was purified by flash chromatography using hexane as an eluent to afford the title compound as colorless oil (72 mg, 81%).

¹H NMR (400 MHz, CDCl₃) δ 7.34-7.30 (m, 2H), 7.22-7.20 (m, 3H), 3.94-3.90 (m, 1H), 2.68 (t, *J* = 7.8 Hz, 2H), 1.76-1.68 (m, 2H), 0.70-0.65 (m, 2H), 0.11 (d, *J* = 3.6 Hz, 6H).

¹³C NMR (101 MHz, CDCl₃) δ 142.7, 128.6, 128.4, 125.8, 39.6, 26.7, 14.1, -4.3.

HRMS (APPI): calculated for (C₁₁H₁₇Si, [M-H]⁺), 177.1100 found 177.1107.

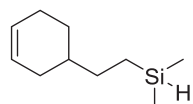
**(2-(Cyclohex-3-en-1-yl)ethyl)dimethylsilane (entry 5, Table 4.2)**

Following the general procedure I, the title compound was prepared using 4-vinylhexene (54 mg) and dimethylmethoxysilane (108 mg). The crude product was purified by flash chromatography using hexane as an eluent to afford the title compound as colorless oil (71 mg, 85%).

¹H NMR (400 MHz, CDCl₃) δ 5.69-5.63 (m, 2H), 3.87-3.83 (m, 1H), 2.15-2.03 (m, 3H), 1.78-1.75 (m, 1H), 1.65-1.59 (m, 1H), 1.50-1.42 (m, 1H), 1.33-1.26 (m, 2H), 1.24-1.16 (m, 1H), 0.63-0.58 (m, 2H), 0.07 (d, *J* = 3.6 Hz, 6H).

¹³C NMR (101 MHz, CDCl₃) δ 127.2, 126.8, 36.5, 31.8, 31.3, 28.7, 25.5, 11.3, -4.3.

HRMS (APPI): calculated for (C₁₀H₁₉Si, [M-H]⁺), 167.1251 found 167.1252.

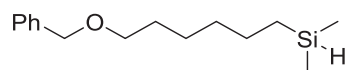

(6-(Benzyloxy)hexyl)dimethylsilane (entry 6, Table 4.2)

Following the general procedure I, the title compound was prepared using 6-(benzyloxy)hex-1-ene (95 mg) and dimethylmethoxysilane (108 mg). The crude product was purified by flash chromatography using hexane as an eluent to afford the title compound as colorless oil (115 mg, 92%).

¹H NMR (400 MHz, CDCl₃) δ 7.33-7.24 (m, 5H), 4.49 (s, 2H), 3.86-3.82 (m, 1H), 3.45 (t, *J* = 6.6 Hz, 2H), 1.65-1.57 (m, 2H), 1.38-1.30 (m, 6H), 0.60-0.54 (m, 2H), 0.05 (d, *J* = 3.6 Hz, 6H).

¹³C NMR (101 MHz, CDCl₃) δ 138.8, 128.4, 127.7, 127.6, 73.0, 70.6, 33.1, 29.8, 26.0, 24.4, 14.2, -4.3.

HRMS (ESI): calculated for (C₁₅H₂₇OSi, [M+H]⁺), 251.1831 found 251.1823.

115 mg, 92%

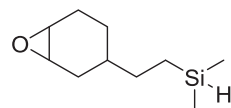

(2-(7-Oxabicyclo[4.1.0]heptan-3-yl)ethyl)dimethylsilane (mixture of isomers) (entry 7, Table 4.2)

Following the general procedure I, the title compound was prepared using 4-vinyl-1-cyclohexene 1,2-epoxide, (mixture of isomers) (62 mg, 0.5 mmol) and dimethylmethoxysilane (250 mg, 2.78 mmol). The crude product was purified by flash chromatography using hexane as an eluent to afford the title compound as colorless oil (86 mg, 93%).

¹H NMR (400 MHz, CDCl₃) δ 3.83-3.75 (m, 1H), 3.14-3.06 (m, 2H), 2.17-1.93 (m, 2H), 1.82-1.62 (m, 1H), 1.50-1.01 (m, 6H), 0.52-0.42 (m, 2H), 0.10-0.01 (m, 6H).

¹³C NMR (101 MHz, CDCl₃) δ 53.3, 52.8, 52.0, 51.9, 35.4, 32.3, 31.6, 31.4, 30.9, 30.5, 26.8, 25.4, 24.1, 23.7, 11.2, 11.0, -4.47.

HRMS (ESI): calculated for (C₁₀H₂₁OSi, [M+H]⁺), 185.1356 found 185.1358.

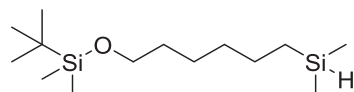

Tert-butyl((6-(dimethylsilyl)hexyl)oxy)dimethylsilane (entry 8, Table 4.2)

Following the general procedure I, the title compound was prepared using tert-butyl(hex-5-en-1-yloxy)dimethylsilane (107 mg) and dimethylmethoxysilane (108 mg). The crude product was purified by flash chromatography using hexane as an eluent to afford the title compound as colorless oil (114 mg, 83%).

¹H NMR (400 MHz, CDCl₃) δ 3.86-3.81 (m, 1H), 3.60 (t, *J* = 6.6 Hz, 2H), 1.54-1.47 (m, 2H), 1.37-1.28 (m, 6H), 0.89 (s, 9H), 0.60-0.55 (m, 2H), 0.10 (m, 12H).

^{13}C NMR (101 MHz, CDCl_3) δ 63.5, 33.1, 33.0, 26.2, 25.7, 24.5, 18.6, 14.3, -4.3, -5.1.

HRMS (APCI): calculated for ($\text{C}_{14}\text{H}_{34}\text{OSi}_2$, $[\text{M}+\text{H}]^+$), 275.2221 found 275.2212.

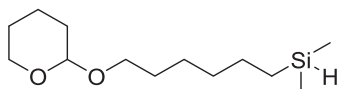

Dimethyl(6-((tetrahydro-2H-pyran-2-yl)oxy)hexyl)silane (entry 9, Table 4.2)

Following the general procedure I, the title compound was prepared using 6-(2-tetrahydropyranyl)oxy-1-hexene (92 mg) and dimethylmethoxysilane (108 mg). The crude product was purified by flash chromatography using hexane/EtOAc (20:1) as an eluent to afford the title compound (**4i**) as colorless oil (108 mg, 89%).

^1H NMR (400 MHz, CDCl_3) δ 4.58-4.56 (m, 1H), 3.89-3.82 (m, 2H), 3.76-3.70 (m, 1H), 3.52-3.46 (m, 1H), 3.41-3.35 (m, 1H), 1.86-1.81 (m, 1H), 1.75-1.69 (m, 1H), 1.64-1.50 (m, 6H), 1.39-1.35 (m, 6H), 0.60-0.54 (m, 2H), 0.02 (d, $J = 3.6$ Hz, 6H).

^{13}C NMR (101 MHz, CDCl_3) δ 98.9, 67.7, 62.3, 33.1, 30.9, 29.7, 26.0, 25.6, 24.4, 19.8, 14.2, -4.4.

HRMS (ESI): calculated for ($\text{C}_{13}\text{H}_{29}\text{O}_2\text{Si}$, $[\text{M}+\text{H}]^+$), 245.1937 found 245.1940.

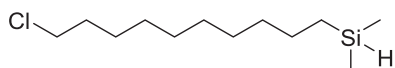

(10-Chlorodecyl)dimethylsilane (entry 10, Table 4.2)

Following the general procedure I, the title compound was prepared using 10-chlorohex-1-ene (87 mg) and dimethylmethoxysilane (180 mg). The crude product was purified by flash chromatography using hexane as an eluent to afford the title compound as yellowish oil (85mg, 72%).

^1H NMR (400 MHz, CDCl_3) δ 3.88-3.81 (m, 1H), 3.53 (t, $J = 6.6$ Hz, 2H), 1.80-1.73 (m, 2H), 1.45-1.38 (m, 2H), 1.31-1.23 (m, 12H), 0.60-0.54 (m, 2H), 0.05 (d, $J = 2.7$ Hz, 6H).

^{13}C NMR (101 MHz, CDCl_3) δ 45.3, 33.3, 32.8, 29.6, 29.6, 29.5, 29.0, 27.1, 24.5, 14.3, -4.3.

Elemental analysis: Anal. Calcd for $\text{C}_{12}\text{H}_{27}\text{ClSi}$: C, 61.36; H, 11.59. Found: C, 61.53 ; H, 11.48.

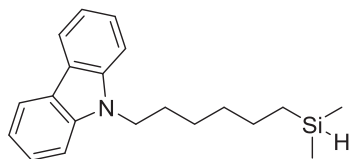

9-(6-(Dimethylsilyl)hexyl)-9H-carbazole (entry 11, Table 4.2)

Following the general procedure I, the title compound was prepared using 9-(hex-5-en-1-yl)-9H-carbazole (125 mg) and dimethylmethoxysilane (108 mg). The crude product was purified by flash chromatography using hexane/EtOAc (20:1) as an eluent to afford the title compound as colorless oil (140 mg, 91%).

^1H NMR (400 MHz, CDCl_3) δ 8.14 (d, $J = 7.8$ Hz, 2H), 7.50 (m, 2H), 7.44 (d, $J = 8.1$ Hz, 2H), 7.27 (m, 2H), 4.33 (t, $J = 7.2$ Hz, 2H), 3.87-3.85 (m, 1H), 1.93-1.89 (m, 2H), 1.42-1.33 (m, 6H), 0.60-0.58 (m, 2H), 0.08 (d, $J = 3.6$ Hz, 6H).

^{13}C NMR (101 MHz, CDCl_3) δ 140.6, 125.7, 123.0, 120.5, 118.8, 108.8, 43.2, 33.1, 29.0, 27.2, 24.4, 14.3, -4.3.

HRMS (ESI): calculated for ($\text{C}_{20}\text{H}_{28}\text{NSi}$, $[\text{M}+\text{H}]^+$), 310.1991 found 310.1996.

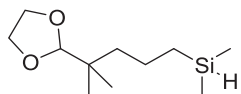
**(4-(1,3-Dioxolan-2-yl)-4-methylpentyl)dimethylsilane (entry 12, Table 4.2)**

Following the general procedure I, the title compound was prepared using 2,2-dimethyl-4-pentenal ethylene acetal (78 mg) and dimethylmethoxysilane (108 mg). The crude product was purified by flash chromatography using hexane/EtOAc (20:1) as an eluent to afford the title compound as colorless oil (94 mg, 87%).

$^1\text{H NMR}$ (400 MHz, CDCl_3) δ 4.51 (s, 1H), 3.92-3.81 (m, 5H), 1.36-1.30 (m, 4H), 0.86 (s, 6H), 0.58-0.50 (m, 2H), 0.04 (d, $J = 3.6$ Hz, 6H)

$^{13}\text{C NMR}$ (101 MHz, CDCl_3) δ 110.1, 65.3, 41.7, 37.4, 21.5, 18.5, 15.3, -4.2.

Elemental analysis: Anal. Calcd for $\text{C}_{11}\text{H}_{24}\text{O}_2\text{Si}$: C, 61.05; H, 11.18. Found: C, 61.36 ; H, 11.47.

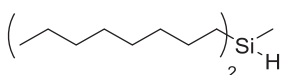
**Methyldioctylsilane (entry 1, Table 4.3)**

Following the general procedure II, the title compound was prepared using 1-octene (134 mg, 1.2 mmol) and methyldiethoxysilane (201 mg, 1.5 mmol). The crude product was purified by flash chromatography using hexane as an eluent to afford the title compound as colorless oil (101 mg, 75%).

$^1\text{H NMR}$ (400 MHz, CDCl_3) δ 3.78-3.71 (m, 1H), 1.39-1.21 (m, 24H), 0.88 (t, $J = 5.8$ Hz, 6H), 0.63-0.49 (m, 4H), 0.03 (d, $J = 3.0$ Hz, 3H).

$^{13}\text{C NMR}$ (101 MHz, CDCl_3) δ 33.5, 32.1, 29.5, 29.4, 24.7, 22.9, 14.3, 12.9, -6.1.

HRMS (APPI): calculated for $(\text{C}_{17}\text{H}_{37}\text{Si}, [\text{M}-\text{H}]^+)$, 269.2664 found 269.2679.

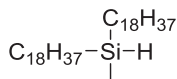
**Methyldioctadecylsilane (entry 2, Table 4.3)**

Following the general procedure II, the title compound was prepared using 1-octadecene (302 mg, 1.2 mmol) and methyldiethoxysilane (201 mg, 1.5 mmol). The crude product was purified by flash chromatography using hexane as an eluent to afford the title compound as white solid (210 mg, 76%).

$^1\text{H NMR}$ (400 MHz, CDCl_3) δ 3.79-3.73 (m, 1H), 1.42-1.15 (m, 64H), 0.88 (t, $J = 6.5$ Hz, 6H), 0.64-0.52 (m, 4H), 0.04 (d, $J = 3.0$ Hz, 3H).

$^{13}\text{C NMR}$ (101 MHz, CDCl_3) δ 33.5, 32.1, 29.9, 29.8, 29.6, 24.7, 22.9, 14.3, 13.0, -6.0.

Elemental analysis: Anal. Calcd for $\text{C}_{37}\text{H}_{78}\text{Si}$: C, 80.64; H, 14.27. Found: C, 80.71 ; H, 14.18.

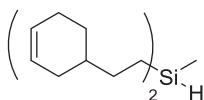
**Bis(2-(cyclohex-3-en-1-yl)ethyl)(methyl)silane (entry 3, Table 4.3)**

Following the general procedure II, the title compound was prepared using 4-vinylhexene (130 mg, 1.2 mmol) and methyldiethoxysilane (201 mg, 1.5 mmol). The crude product was purified by flash chromatography using hexane as an eluent to afford the title compound as colorless oil (96 mg, 73%).

¹H NMR (400 MHz, CDCl₃) δ 5.68-5.63 (m, 4H), 3.79-3.75 (m, 1H), 2.14-2.02 (m, 6H), 1.78-1.74 (m, 2H), 1.66-1.57 (m, 2H), 1.52-1.43 (m, 2H), 1.33-1.27 (m, 4H), 1.23-1.13 (m, 2H), 0.65-0.54 (m, 4H), 0.05 (d, *J* = 3.6 Hz, 3H).

¹³C NMR (101 MHz, CDCl₃) δ 127.2, 126.8, 36.5, 31.8, 31.4, 28.7, 25.5, 9.8, -6.2.

HRMS (ESI): calculated for (C₁₇H₃₀Si, [M⁺]), 262.2111 found 262.2112

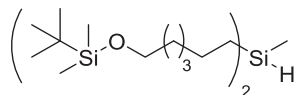

Bis(tert-butyl((6-(dimethylsilyl)hexyl)oxy)(methyl)silane (entry 4, Table 4.3)

Following the general procedure II, the title compound was prepared using tert-butyl(hex-5-en-1-yloxy)dimethylsilane (256 mg, 1.2 mmol) and methyl-diethoxysilane (201 mg, 1.5 mmol). The crude product was purified by flash chromatography using hexane/EtOAc (20:1) as an eluent to afford the title compound as yellowish oil (174 mg, 73%).

¹H NMR (400 MHz, CDCl₃) δ 3.76-3.74 (m, 1H), 3.60 (t, *J* = 6.5 Hz, 4H), 1.52-1.49 (m, 4H), 1.37-1.29 (m, 12H), 0.89 (s, 18H), 0.62-0.53 (m, 4H), 0.05-0.03 (m, 15H).

¹³C NMR (101 MHz, CDCl₃) δ 63.5, 33.2, 33.0, 26.2, 25.7, 24.6, 18.5, 12.9, -5.1, -6.1.

Elemental analysis: Anal. Calcd for C₂₅H₅₈O₂Si₃: C, 63.22; H, 12.31. Found: C, 63.21 ; H, 12.42.

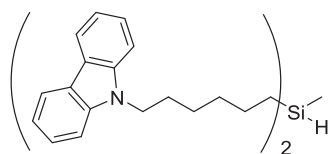

9,9'-((Methylsilanediy)bis(hexane-6,1-diyl))bis(9H-carbazole) (entry 5, Table 4.3)

Following the general procedure II, the title compound was prepared using 9-(hex-5-en-1-yl)-9H-carbazole (300 mg, 1.2 mmol) and methyl-diethoxysilane (201 mg, 1.5 mmol). The crude product was purified by flash chromatography using hexane/EtOAc (10:1) as an eluent to afford the title compound as colorless oil (214 mg, 79%).

¹H NMR (400 MHz, CDCl₃) δ 8.18 (d, *J* = 7.7 Hz, 4H), 7.53 (m, 4H), 7.46 (d, *J* = 8.2 Hz, 4H), 7.31 (m, 4H), 4.33 (t, *J* = 7.1 Hz, 4H), 3.84-3.78 (m, 1H), 1.94-1.90 (m, 4H), 1.43-1.33 (m, 12H), 0.62-0.58 (m, 4H), 0.08 (d, *J* = 3.2 Hz, 3H).

¹³C NMR (101 MHz, CDCl₃) δ 140.5, 125.7, 122.9, 120.5, 118.8, 108.8, 43.1, 33.1, 29.8, 27.1, 24.5, 12.8, -6.1.

HRMS (ESI): calculated for (C₃₇H₄₅N₂Si, [M+H]⁺), 545.3350 found 545.3347.

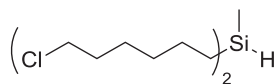

Bis(6-chlorohexyl)(methyl)silane (entry 6, Table 4.3)

Following the general procedure II, the title compound was prepared using 6-chlorohexene (160 mg, 1.35 mmol) and methyl-diethoxysilane (201 mg, 1.5 mmol). The crude product was purified by flash chromatography using hexane as an eluent to afford the title compound as colorless oil (120 mg, 85 %).

¹H NMR (400 MHz, CDCl₃) δ 3.77-3.72 (m, 1H), 3.53 (t, *J* = 6.7 Hz, 4H), 1.79-1.72 (m, 4H), 1.44-1.27 (m, 12H), 0.67-0.57 (m, 4H), 0.03 (d, *J* = 3.1 Hz, 3H).

$^{13}\text{C NMR}$ (101 MHz, CDCl_3) δ 45.3, 32.7, 32.6, 26.7, 24.5, 12.8, -6.1.

Elemental analysis: Anal. Calcd for $\text{C}_{13}\text{H}_{28}\text{Cl}_2\text{Si}$: C, 55.10; H, 9.96. Found: C, 55.26 ; H, 10.05.

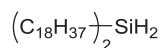

Diocadecylsilane (entry 1, Table 4.4)

Following the general procedure III, the title compound was prepared using 1-octadecene (378 mg, 1.5 mmol) and trimethoxysilane (244 mg, 2 mmol). The crude product was purified by flash chromatography using hexane as an eluent to afford the title compound as white solid (218 mg, 81%).

$^1\text{H NMR}$ (400 MHz, CDCl_3) δ 3.64-3.60 (m, 2H), 1.40-1.20 (m, 64H), 0.88 (t, $J = 5.8$ Hz, 6H), 0.71-0.63 (m, 4H).

$^{13}\text{C NMR}$ (101 MHz, CDCl_3) δ 33.1, 32.1, 29.86, 29.83, 29.7, 29.53, 29.49, 25.6, 22.9, 14.3, 9.3.

Elemental analysis: Anal. Calcd for $\text{C}_{36}\text{H}_{76}\text{Si}$: C, 80.51; H, 14.26; Found : C, 80.59 ; H, 14.16.

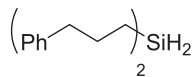

Bis(3-phenylpropyl)silane (entry 2, Table 4.4)

Following the general procedure III, the title compound was prepared using allylbenzene (212 mg, 1.8 mmol) and trimethoxysilane (244 mg, 2 mmol). The crude product was purified by flash chromatography using hexane as an eluent to afford the title compound as colorless oil (95 mg, 71%).

$^1\text{H NMR}$ (400 MHz, CDCl_3) δ 7.29-7.25 (m, 4H), 7.19-7.14 (m, 6H), 3.69-3.64 (m, 2H), 2.64 (t, $J = 6.2$ Hz, 4H), 1.74-1.66 (m, 4H), 0.73-0.69 (m, 4H).

$^{13}\text{C NMR}$ (101 MHz, CDCl_3) δ 142.4, 128.6, 128.4, 125.9, 39.2, 27.5, 9.0.

HRMS (APPI): calculated for ($\text{C}_{18}\text{H}_{23}\text{Si}$, $[\text{M}-\text{H}]^+$), 267.1569 found 267.1583.

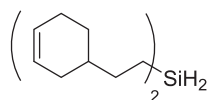

Bis(2-(cyclohex-3-en-1-yl)ethyl)silane (entry 3, Table 4.4)

Following the general procedure III, the title compound was prepared using 4-vinylcyclohexene (162 mg, 1.5 mmol) and trimethoxysilane (244 mg, 2 mmol). The crude product was purified by flash chromatography using hexane as an eluent to afford the title compound as colorless oil (87 mg, 70%).

$^1\text{H NMR}$ (400 MHz, CDCl_3) δ 5.68-5.61 (m, 4H), 3.69-3.61 (m, 2H), 2.13-1.97 (m, 6H), 1.78-1.75 (m, 2H), 1.66-1.59 (m, 2H), 1.55-1.44 (m, 2H), 1.36-1.28 (m, 4H), 1.21-1.11 (m, 2H), 0.71-0.62 (m, 4H).

$^{13}\text{C NMR}$ (101 MHz, CDCl_3) δ 127.2, 126.7, 36.3, 32.3, 31.7, 28.6, 25.4, 6.4.

HRMS (APPI): calculated for ($\text{C}_{16}\text{H}_{27}\text{Si}$, $[\text{M}-\text{H}]^+$), 247.1882 found 247.1891.

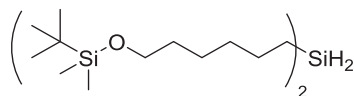

Bis(tert-butyl((6-(dimethylsilyl)hexyl)oxy)silane (entry 4, Table 4.4)

Following the general procedure III, the title compound was prepared using tert-butyl(hex-5-en-1-yloxy)dimethylsilane (321 mg, 1.5 mmol) and trimethoxysilane (244 mg, 2 mmol). The crude product was purified by flash chromatography using hexane/EtOAc (20:1 to 10:1) as an eluent to afford the title compound as colorless oil (152 mg, 66%).

$^1\text{H NMR}$ (400 MHz, CDCl_3) δ 3.63-3.56 (m, 6H), 1.53-1.47 (m, 4H), 1.41-1.30 (m, 12H), 0.89 (s, 18H), 0.70-0.61 (m, 4H), 0.05 (s, 12H).

$^{13}\text{C NMR}$ (101 MHz, CDCl_3) δ 63.5, 32.9, 32.8, 26.2, 25.6, 25.6, 18.5, 9.3, -5.1.

HRMS (ESI): calculated for $(\text{C}_{24}\text{H}_{57}\text{O}_2\text{Si}_3, [\text{M}+\text{H}]^+)$, 461.3666 found 461.3690.

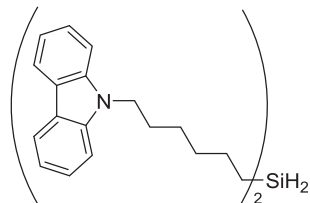

Bis(6-(9H-carbazol-9-yl)hexyl)silane (entry 5, Table 4.4)

Following the general procedure III, the title compound was prepared using 9-(hex-5-en-1-yl)-9H-carbazole (374 mg, 1.5 mmol) and trimethoxysilane (244 mg, 2 mmol). The crude product was purified by flash chromatography using hexane/EtOAc (20:1 to 10:1) as an eluent to afford the title compound as a yellowish viscous oil (172 mg, 65%).

$^1\text{H NMR}$ (400 MHz, CDCl_3) δ 8.17 (d, $J = 7.8$ Hz, 4H), 7.52 (m, 4H), 7.44 (d, $J = 8.1$ Hz, 4H), 7.30 (m, 4H), 4.32 (t, $J = 7.1$ Hz, 4H), 3.69-3.63 (m, 2H), 1.95-1.86 (m, 4H), 1.46-1.35 (m, 12H), 0.71-0.63 (m, 4H).

$^{13}\text{C NMR}$ (101 MHz, CDCl_3) δ 140.5, 125.7, 122.9, 120.5, 118.8, 108.8, 43.1, 32.7, 29.0, 27.0, 25.4, 9.2.

HRMS (ESI): calculated for $(\text{C}_{36}\text{H}_{43}\text{N}_2\text{Si}, [\text{M}+\text{H}]^+)$, 531.3190 found 531.3196.

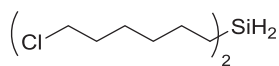

Bis(6-chlorohexyl)silane (entry 6, Table 4.4)

Following the general procedure III, the title compound was prepared using 6-chlorohexene (142 mg, 1.2 mmol) and trimethoxysilane (244 mg, 2 mmol). The crude product was purified by flash chromatography using hexane as an eluent to afford the title compound as a colorless oil (65 mg, 48%).

$^1\text{H NMR}$ (400 MHz, CDCl_3) δ 3.68-3.61 (m, 2H), 3.53 (t, $J = 6.6$ Hz, 4H), 1.80-1.73 (m, 4H), 1.45-1.30 (m, 12H), 0.72-0.64 (m, 4H).

$^{13}\text{C NMR}$ (101 MHz, CDCl_3) δ 45.2, 32.7, 32.2, 26.7, 25.4, 9.2.

HRMS (APPI): calculated for $(\text{C}_{12}\text{H}_{25}\text{Cl}_2\text{Si}, [\text{M}-\text{H}]^+)$, 267.1102 found 267.1097.

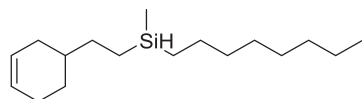

(2-(Cyclohex-3-en-1-yl)ethyl)(methyl)(octyl)silane (Scheme 4.3)

In a nitrogen filled glovebox, an oven-dried 30 mL re-sealable screw-cap vial equipped with a Teflon coated magnetic stirring bar was charged with methyl-diethoxysilane (1.65 mmol) and dry THF (2 mL).

An aliquot of the stock solution of complex **4-1** and NaOtBu (2.0 mL, corresponding to 5 mol % of Ni catalyst) was added. After that, 1-octene (56 mg, 0.5 mmol) in 1 mL of THF was added and the resulting mixture was stirred at room temperature for 2 hours. The vial was opened, 4-vinylcyclohex-1-ene (108 mg, 1.0 mmol) was added and mixture was stirred overnight. The reaction mixture was concentrated under vacuum. The residue was purified by chromatography using hexane as an eluent to afford title compound as colorless oil (90 mg, 68%).

¹H NMR (400 MHz, CDCl₃) δ 5.68-5.64 (m, 2H), 3.81-3.75 (m, 1H), 2.15-2.05 (m, 3H), 1.78-1.76 (m, 1H), 1.65-1.60 (m, 1H), 1.48-1.46 (m, 1H), 1.36-1.22 (m, 15H), 0.89 (t, *J* = 6.2 Hz, 3H), 0.68-0.54 (m, 4H), 0.05 (d, *J* = 3.6 Hz, 3H).

¹³C NMR (101 MHz, CDCl₃) δ 127.2, 126.8, 36.5, 33.5, 32.1, 31.8, 31.5, 29.5, 29.4, 28.7, 25.5, 24.7, 22.9, 14.3, 12.9, 9.9, -6.1.

Elemental analysis: Anal. Calcd for C₁₇H₃₄Si : C, 76.61; H, 12.86; Found : C, 76.43 ; H, 12.97.

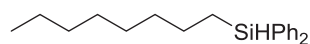

Octyldiphenylsilane (equation 3, Scheme 4.4)

Title compound was prepared using diphenylsilane (110 mg, 0.6 mmol) and 1-octene (56 mg) in 96 % yield. (142 mg)

¹H NMR (400 MHz, CDCl₃) δ 7.55-7.51 (m, 4H), 7.41- 7.33 (m, 6H), 4.84 (t, *J* = 3.7 Hz, 1H), 1.47-1.42 (m, 2H), 1.37- 1.34 (m, 2H), 1.27- 1.23 (m, 8H), 1.16 – 1.11 (m, 2H), 0.86 (t, *J* = 6.7 Hz, 3H).

¹³C NMR (101 MHz, CDCl₃) δ 135.2, 134.8, 129.5, 128.1, 33.3, 32.0, 29.4, 29.3, 24.5, 22.8, 14.3, 12.3. The spectroscopic data corresponds to that previously reported.²⁸

Et₂(nOct)SiH

Diethyloctylsilane (equation 3, Scheme 4.4)

Title compound was prepared using diethylsilane (53 mg, 0.6 mmol) and 1-octene (56 mg) in 93 % yield. (93 mg)

¹H NMR (400 MHz, CDCl₃) δ 3.66-3.56 (m, 1H), 1.31-1.26 (m, 12H), 0.97 (t, *J* = 7.7 Hz, 6H), 0.88 (t, *J* = 5.0 Hz, 3H), 0.59-0.57 (m, 6H).

¹³C NMR (101 MHz, CDCl₃) δ 33.6, 32.1, 29.5, 29.4, 24.8, 23.0, 14.3, 10.8, 8.4, 3.0.

The spectroscopic data corresponds to that previously reported.²⁹

4.8.7 Unreactive Substrates for Ni-catalyzed Hydrosilylation

Listed below are the substrates which didn't provide or provided only trace amount of desired hydrosilylation products using conditions of Table 4.2.

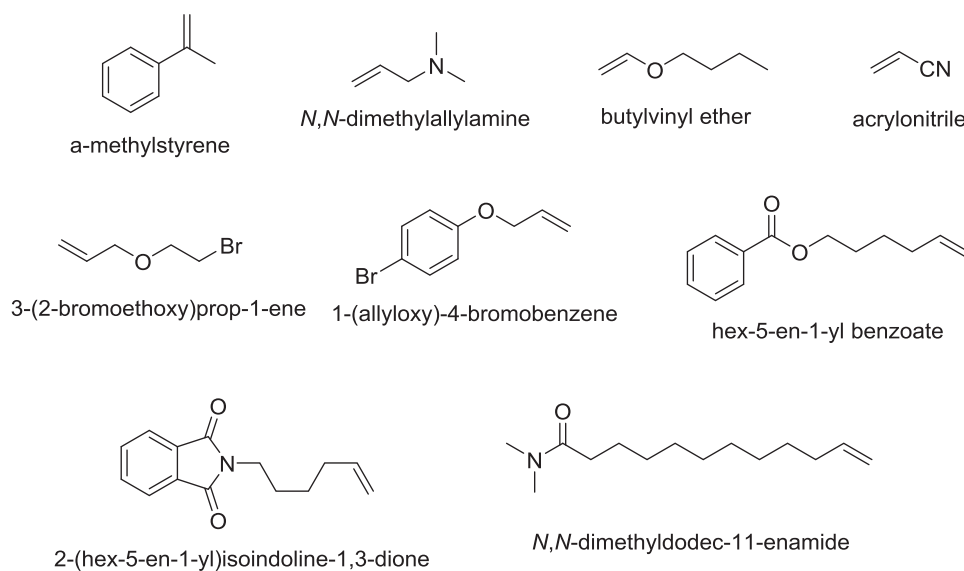

Figure 4.13: Unreactive hydrosilylation substrates

4.9 References

- (1) Griffiths, S. T.; Wilson, R. R. *Combust. Flame* **1958**, *2*, 244-252.
- (2) Chen, J.-R.; Tsai, H.-Y.; Chen, S.-K.; Pan, H.-R.; Hu, S.-C.; Shen, C.-C.; Kuan, C.-M.; Lee, Y.-C.; Wu, C.-C. *Process Saf. Prog.* **2006**, *25*, 237-244.
- (3) Salimgareeva, I. M.; Kaverin, V. V.; Jurjev, V. P. *J. Organomet. Chem.* **1978**, *148*, 23-27.
- (4) Itoh, M.; Iwata, K.; Takeuchi, R.; Kobayashi, M. *J. Organomet. Chem.* **1991**, *420*, C5-C8.
- (5) Kobayashi, M.; Itoh, M. *Chem. Lett.* **1996**, *25*, 1013-1014.
- (6) Itoh, M.; Iwata, K.; Kobayashi, M. *J. Organomet. Chem.* **1999**, *574*, 241-245.
- (7) Marciniak, B. *Hydrosilylation: A Comprehensive Review on Recent Advances*; Springer Berlin, 2009.
- (8) Marciniak, B. *Coord. Chem. Rev.* **2005**, *249*, 2374-2390.
- (9) Putzien, S.; Nuyken, O.; Kühn, F. E. *Prog. Polym. Sci.* **2010**, *35*, 687-713.
- (10) Simonneau, A.; Oestreich, M. *Angew. Chem. Int. Ed.* **2013**, *52*, 11905-11907.
- (11) Simonneau, A.; Oestreich, M. *Nat. Chem.* **2015**, *7*, 816-822.
- (12) Buslov, I.; Becouse, J.; Mazza, S.; Montandon-Clerc, M.; Hu, X. *Angew. Chem. Int. Ed.* **2015**, *54*, 14523-14526.
- (13) Kira, M.; Sato, K.; Sakurai, H. *J. Org. Chem.* **1987**, *52*, 948-949.
- (14) Becker, B.; Corriu, R. J. P.; Guérin, C.; Henner, B.; Wang, Q. *J. Organomet. Chem.* **1989**, *368*, C25-C28.
- (15) Becker, B.; Corriu, R.; Guerin, C.; Henner, B.; Wang, Q. *J. Organomet. Chem.* **1989**, *359*, C33-C35.
- (16) Chuit, C.; Corriu, R. J. P.; Reye, C.; Young, J. C. *Chem. Rev.* **1993**, *93*, 1371-1448.
- (17) Friedel, C.; Ladenburg, A. *Ann. Chim. Phys.* **1871**, *23*, 430.
- (18) Bailey, D. L. Patent CA 538521, 1957.
- (19) Suzuki, E.; Nomoto, Y.; Ono, Y. *Catal. Lett.* **1997**, *43*, 155-157.
- (20) Florence, G. J.; Fraser, A. L.; Gould, E. R.; King, E. F. B.; Menzies, S. K.; Morris, J. C.; Tulloch, L. B.; Smith, T. K. *ChemMedChem* **2014**, *9*, 2548-2556.
- (21) Schleicher, K. D.; Jamison, T. F. *Org. Lett.* **2007**, *9*, 875-878.
- (22) Nishida, A.; Kawahara, N.; Nishida, M.; Yonemitsu, O. *Tetrahedron* **1996**, *52*, 9713-9734.
- (23) Paquette, L. A.; Leone-Bay, A. *J. Am. Chem. Soc.* **1983**, *105*, 7352-7358.

- (24) Kieltsch, I.; Dubinina, G. G.; Hamacher, C.; Kaiser, A.; Torres-Nieto, J.; Hutchison, J. M.; Klein, A.; Budnikova, Y.; Vicic, D. A. *Organometallics* **2010**, *29*, 1451-1456.
- (25) He, J.; Liu, Z.; Du, G.; Fu, Y.; Zhang, S.; Li, X. *Organometallics* **2014**, *33*, 6103-6112.
- (26) Csok, Z.; Vechorkin, O.; Harkins, S. B.; Scopelliti, R.; Hu, X. *J. Am. Chem. Soc.* **2008**, *130*, 8156-8157.
- (27) Pérez García, P. M.; Ren, P.; Scopelliti, R.; Hu, X. *ACS Catal.* **2015**, *5*, 1164-1171.
- (28) Kamata, K.; Suzuki, A.; Nakai, Y.; Nakazawa, H. *Organometallics* **2012**, *31*, 3825-3828.
- (29) Srinivas, V.; Nakajima, Y.; Ando, W.; Sato, K.; Shimada, S. *Catal. Sci. Technol.* **2015**, *5*, 2081-2084.

Chapter 5

Transition-Metal-Free Intermolecular α -C-H Amination of Ethers

Reprinted with permission from “Buslov, I.; Hu, X. L. Transition-Metal-Free Intermolecular α -C-H Amination of Ethers at Room Temperature. *Advanced Synthesis & Catalysis* doi: 10.1002/adsc.201400646” Copyright © 2014 WILEY-VCH Verlag GmbH & Co. KGaA, Weinheim.

5.1 Introduction

Nitrogen is ubiquitous in pharmaceuticals, natural products and materials. The preparation of nitrogen-containing molecules is therefore a major task in synthetic chemistry. In recent years, direct C-H amination has emerged as an attractive method for the construction of new C-N bonds.¹⁻⁶ Compared with conventional amination methods, C-H amination avoids the pre-installation of transformable functional groups so that it is potentially more efficient and environmentally friendly. Transition metal catalysis plays a dominant role in this area, however, transition-metal-free C-H amination methods are desirable alternatives because they do not require expensive or toxic metal in the synthesis.⁷ Although a number of transition-metal-free intermolecular C-H amination reactions have been reported,⁷⁻¹⁶ the scope of these transformations is still narrow. For example, the nitrogen sources were limited to N-haloamines, phthalimides, sulfonamides and some specific nitrogen heterocycles. Moreover, amination mostly worked on activated aryl, benzylic, and allylic C-H bonds. Amination of other C(sp³)-H bonds is rarely reported.

Guo and co-workers developed metal-free direct alkylation of purines with tetrahydrofuran (THF) and ethers, but the reactions required illumination and heating at 70 °C and only purines were alkylated.¹⁷ Ochiai and co-workers reported metal-free α -C-H amination of ethers, but only the triflylamino group could be transferred.¹⁸ Herein, we report a mild and general method for the transition-metal-free direct C-H amination of ethers using a hypervalent iodine reagent¹⁹ as the sole oxidant at room temperature (Figure 5.1). The protocol has a wide substrate scope, especially on the nitrogen-containing reaction partners. The resulting aminated ethers can serve as valuable synthetic intermediates to α,ω -amino alcohols²⁰ and modified THF-containing natural products.^{21,22}

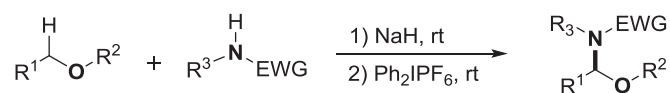

Figure 5.1: Intermolecular α -C-H amination of ethers

The introduction of an alkyl ether moiety on a biologically active amine molecule may enhance the latter compound's lipophilicity. Thus, the current amination method can be a useful tool in medicinal chemistry. Indeed, a number of aminated THF derivatives are anti-viral and anti-tumor agents (Figure 5.2).²³⁻²⁶

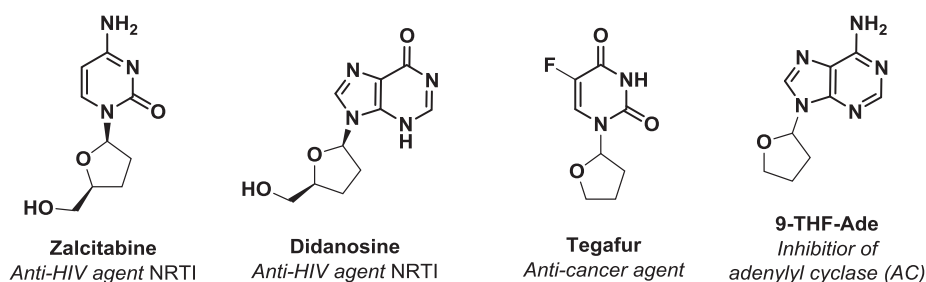

Figure 5.2: Selected examples of aminated THF derivatives that exhibit biological activity

Fuchigami et al. reported several examples of amination of THF with alkyl amines using electrochemical oxidation; however, the conversions and yields were low.²⁷ Feldman et al. reported a single example of amination of THF with cyclohexyltosylamide in a 45% yield using an alkynyliodonium triflate as oxidant.²⁸ Yu and co-workers reported tosylation of cyclic ethers using a Cu catalyst and $\text{PhI}(\text{OAc})_2$ as oxidant.²⁰ Compared with these precedents, our method is much more convenient, general, and synthetically useful.

5.2 Optimisation of the Reaction Conditions

The direct α -C-H amination of THF with N-benzylmethanesulfonamide was used as the test reaction (Table 5.1). This formal oxidative coupling²⁹ requires both an oxidant and a hydrogen acceptor. We found that amination product could be obtained by applying a one-pot, two-step reaction procedure. For example, deprotonation of N-benzylmethanesulfonamide by NaH followed by oxidation by (diacetoxyiodo)benzene (DIB), both in THF and at room temperature, gave N-benzyl-N-(tetrahydrofuran-2-yl)methanesulfonamide in a 43% yield (entry 1, Table 5.1). Other oxidants such as O_2 , $\text{K}_2\text{S}_2\text{O}_8$ and I_2 were ineffective (entries 2-5, Table 5.1). The yield could be improved to 85% and 87%, using Ph_2IOTf and Ph_2IPF_6 as the oxidant, respectively (entries 6-7, Table 5.1). NaH was the optimal base; replacement of NaH with Cs_2CO_3 , KOtBu , or NaOH led to diminished yields (entries 8-10, Table 5.1). THF was the best solvent; reactions carried out in dichloromethane, dichloroethane, ethyl acetate and toluene using 10 equiv. of THF as the reagent were inefficient (entries 11-14, Table 5.1). However, an encouraging yield of 66% was obtained when the amination reaction was carried

out in acetonitrile (MeCN) using 10 equiv. of THF at 40°C (entries 15-17, Table 5.1). Without the base, no product was formed (entry 18, Table 5.1).

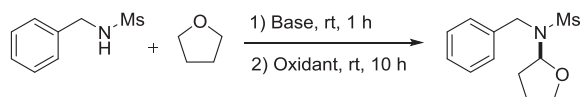
Table 5.1: Optimisation of the reaction conditions^a

Entry	Base	Oxidant	Solvent	Yield (%) ^b
1	NaH	DIB	THF	43
2	NaH	I ₂	THF	-
3	NaH	I ₂ /DIB	THF	36
4	NaH	K ₂ S ₂ O ₈	THF	-
5	NaH	O ₂	THF	-
6	NaH	Ph ₂ IOTf	THF	85
7	NaH	Ph ₂ IPF ₆	THF	87
8	KOtBu	Ph ₂ IPF ₆	THF	38
9	Cs ₂ CO ₃	Ph ₂ IPF ₆	THF	25
10	NaOH	Ph ₂ IPF ₆	THF	18
11	NaH	Ph ₂ IPF ₆	CH ₂ Cl ₂	5 ^c
12	NaH	Ph ₂ IPF ₆	ClC ₂ H ₄ Cl	<1 ^c
13	NaH	Ph ₂ IPF ₆	EtOAc	12 ^c
14	NaH	Ph ₂ IPF ₆	Toluene	4 ^c
15	NaH	Ph ₂ IPF ₆	MeCN	66 ^e
16	NaH	Ph ₂ IPF ₆	MeCN	40 ^e
17	NaH	Ph ₂ IPF ₆	MeCN	37 ^d
18	-	Ph ₂ IOTf	THF	-

^a Reaction conditions: under N₂, deprotonation of **2a** (0.25 mmol) with base (0.25 mmol) in THF (1 ml) at rt for 1 h, then addition of oxidant (0.3 mmol) and reaction at rt for 10 h. ^b Calibrated GC yield using n-dodecane as an internal standard. ^c THF (2.5 mmol) in 1 ml of solvent, rt, 12 h. ^d THF (1.25 mmol) in 1 ml of MeCN, 40°C, 6 h. ^e THF (2.5 mmol) in 1 ml of MeCN, 40°C, 6 h.

5.3 Scope of Intermolecular α-C-H Amination of Ethers



The developed method allows direct amination with a wide range of sulfonamides, amides, imides, and N-heterocycles with alkyl, aryl, allyl, and benzyl substituents. The utility of this method was demonstrated in the synthesis of Tegafur and its analogues.

5.3.1 Scope of Amination of THF with Sulfonamides

The optimized reaction protocol (entry 7, Table 5.1) was then applied for the amination of THF with a wide range of sulfonamides (Table 5.2). To our delight, aryl, benzyl, allyl, and alkyl-substituted mesyl amines all could be alkylated (entries 1-7, Table 5.2). Both primary and secondary alkyl mesyl amines were efficient reaction partners, giving high yields of amination products (entry 2 and entry 4, Table 5.2). Alkyl group containing a terminal double bond was tolerated without isomerization (entry 4, Table 5.2). A tert-butyl-substituted mesyl amine was coupled in a modest yield of 39% (entry 3, Table 5.2), probably due to the steric encumbrance of the tertiary alkyl group. A similar scope was found for the coupling of tosyl amines (entries 8-13, Table 5.2). Alkyl, benzyl, allyl-substituted tosyl amines could be used.

Table 5.2: Amination of THF with sulfonamides^a

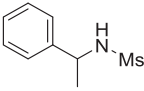
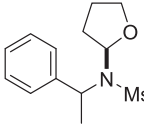
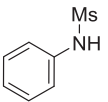
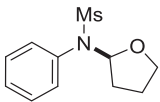
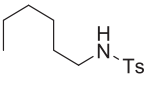
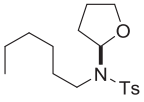
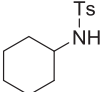
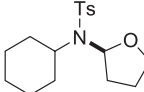
Entry	Sulfonamide	Product	Yield (%)
1			73
2			76
3			39
4			78
5			77

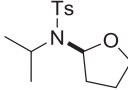
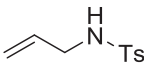
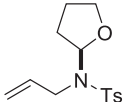
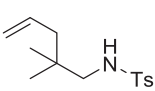
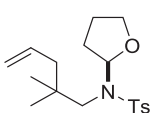
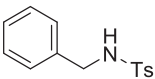
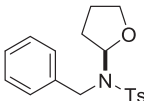
6			75 ^b
7			59
8			67
9			43
10			63
11			73
12			73
13			61

^a Reaction conditions: under N₂, deprotonation of a sulfonamide (0.5 mmol) with NaH (0.5 mmol) in 1 mL of THF at rt for 1 h, then addition of Ph₂IPF₆ (0.6 mmol) in 1 mL of THF and reaction at rt for 6 h, yields are of isolated products. ^b Yield of two diastereomers.

Nosyl amines, however, could not be alkylated, and the starting sulfonamides could be recovered at the end of the reactions. The unreactivity of nosyl amines suggests that the acidity of the amine N-H bond is not the only determining factor in this type of direct amination reaction.

5.3.2 Scope of Amination of THF with Acetamides and Trifluoroacetamides

The scope of the amine partner was then expanded to include acetamides and trifluoroacetamides. Gratifyingly, the reaction protocol was efficient for the direct amination of THF using these amides (Table 5.3). Increasing the amount of Ph_2IPF_6 to 1.5 equiv. was beneficial. Alkyl, allyl, benzyl and aryl-substituted amides could be alkylated in good yields (entries 1-8, Table 5.3). The functional group tolerance was demonstrated with aryl acetamides. Ester, nitrile, CF_3 , aryl-I, aryl-Br, and ether groups were all compatible (entries 9-14, Table 5.3). N-(6-methylpyridin-2-yl)acetamide was also successfully alkylated (entry 15, Table 5.3). Phenol group was not tolerated due to competitive O-arylation. Significantly, the bulky tert-butyl trifluoroacetamide was coupled in a good yield of 58% (entry 6, Table 5.3).

Table 5.3: Amination of THF with acetamides and trifluoroacetamides^a

Entry	Acetamide/ Trifluoroacetamide	Product	Yield (%)
1			54
2			82
3			71
4			95

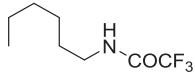
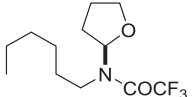
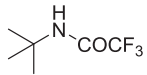
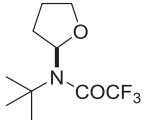
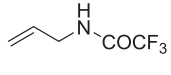
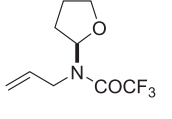
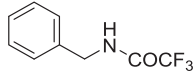
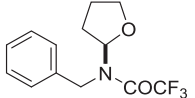
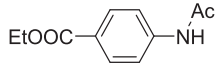
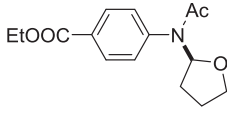
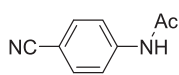
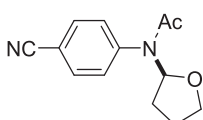
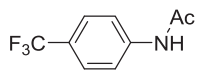
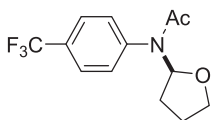
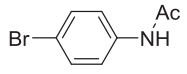
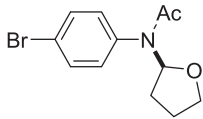
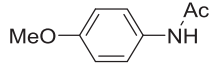
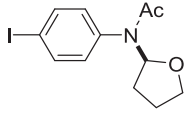
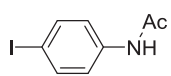
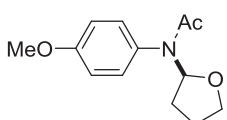
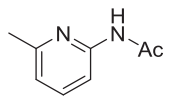
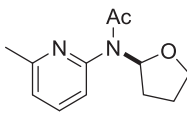
5			62
6			58
7			80
8			89
9			93
10			89
11			95
12			95
13			90
14			93
15			86

16

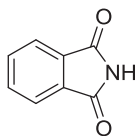
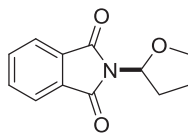
75^b

^a Reaction conditions: under N₂, deprotonation of an amide (0.5 mmol) with NaH (0.5 mmol) in 1 mL of THF at rt for 3 h, addition of Ph₂IPF₆ (0.75 mmol) in 1 mL of THF and reaction at rt for 6 h, the yields are of isolated products. ^b Ph₂IPF₆ (0.6 mmol) was added to potassium phthalimide (0.5 mmol) in 2 mL of THF and reaction at 40 °C for 12 h.

The reaction with N-benzyl-trifluoroacetamide was repeated in a 5 mmol scale leading to an 80% isolated yield of the desired N-benzyl-N-(tetrahydrofuran-2-yl) trifluoroacetamide. It is noted that aryl substituted amides were functionalized in very high yields, i.e., in the range of 90%. Finally, the commercially available potassium phthalimide could be alkylated in a 75% yield in a modified procedure (without the base) (entry 16, Table 5.3).

5.3.3 Amination with N-heterocyclic Amines

The α -C-H amination method could be applied on free secondary amines without a sulfonyl or acyl groups (Table 5.4). Imidazole, benzimidazole, indole, and carbazole could be alkylated in good to excellent yields (entries 1-4, Table 5.4). Aromatic amines worked better in these reactions.

Table 5.4: Amination of N-heterocyclic amines ^a

Entry	Amine	Product	Yield (%) ^b
1			52
2			85

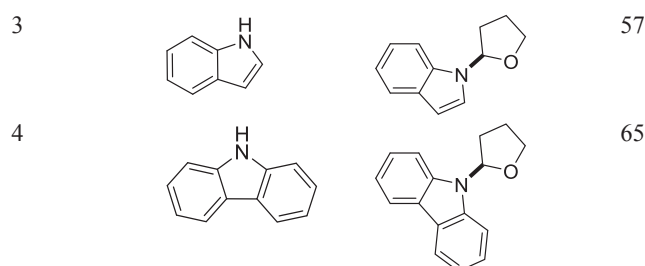

^a *Reaction conditions:* under N₂, deprotonation of an aromatic N-heterocycle (0.5 mmol) with NaH (0.5 mmol) in 1 mL of THF at rt for 1 h, then addition of Ph₂IPF₆ (0.75 mmol) in 1 mL of THF and reaction at rt for 6 h, the yields are of isolated products.

5.3.4 Amination of Other Alkyl Ethers

Alkyl ethers other than THF were then tested for the direct amination reactions (Table 5.5). 1,4-Dioxane could be aminated in good yields (entries 1, 2, Table 5.5). Tetrahydropyran was also aminated (entries 3, 4, Table 5.5). 2-Methyl THF presented an interesting test for chemoselectivity. An amination occurred with 4:1 selectivity favoring the sterically less encumbered C-H bond at the 4 position (entry 5, Table 5.5). No diastereoselectivity was observed.

Table 5.5: Amination of α -C-H bonds of various alkyl ethers^a

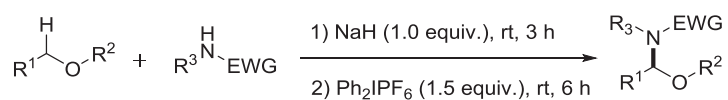

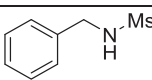
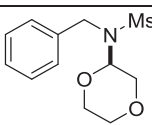
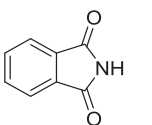
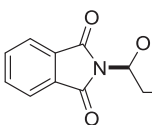
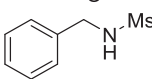
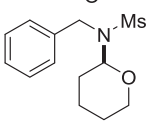
Entry	Substrate	Solvent	Product	Yield (%)
1		1,4-Dioxane		47
2		1,4-Dioxane		81 ^b
3		Tetrahydropyran		68

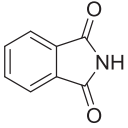
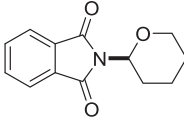
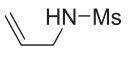
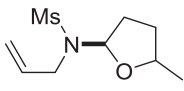
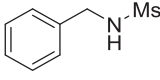
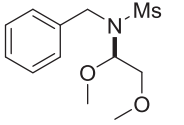
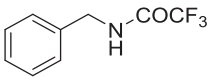
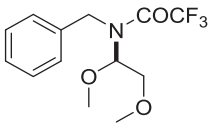
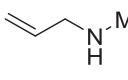
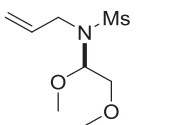
4		Tetrahydropyran		43
5		2-Me-THF		61 ^c
6		DME		50 ^d
7		DME		41 ^d
8		DME		56 ^d

^a Reaction conditions: under N₂, deprotonation of sulfonamide or amide (0.5 mmol) with NaH (0.5 mmol) in 2 mL of the corresponding ether at rt for 3 h, then addition of Ph₂IPF₆ (0.75 mmol) and reaction at rt for 6 h, the yields are of isolated products. ^b Ph₂IPF₆ (0.6 mmol) was added to potassium phthalimide (0.5 mmol) in 2 mL of dioxane, 10 h, 60 °C. ^c Combined yield of diastereomers. ^d Yield of major regioisomer.

The direct amination also worked on acyclic ethers such as dimethoxyethane (DME). The internal C-H bonds were preferentially aminated (entries 6-8, Table 5.5). Unfortunately diethyl ether and methyl tert-butyl ether could not be aminated in reasonable yields using this protocol, probably due to the low solubility of the other reagents in these solvents.

5.3.5 Amination of Alkyl Ethers with Protected Nucleobases

The new α -C-H amination protocol was applied for the synthesis of biologically active molecules including the anticancer prodrug Tegafur using nucleobases as the nitrogen sources. The reaction of para-methoxybenzoyl-protected thymine with THF was first tested (entry 1, Table 5.6). The corresponding nucleoside analogue was obtained in 85% yield. The PMB group on the thymine was difficult to remove.

Table 5.6: Amination of alkyl ethers with protected 5-methyluracil and 5-fluorouracil^a

Entry	Substrate	Solvent	Product	Yield (%)
1		THF		85
2		1,4-Dioxane		25
3		THF		81
4		DME		44
5		Tetrahydropyran		32

^a *Reaction conditions:* under N₂, deprotonation of protected uracil derivative (0.5 mmol) with NaH (0.5 mmol) in 2 mL of the corresponding ether at rt for 3 h, then addition of Ph₂IPF₆ (0.85 mmol) and reaction at rt for 6 h, the yields are of isolated products.

The more labile Boc group was used as the protecting group for the nucleobases. N3-Boc-5-fluorouracil was synthesized in two steps and was then reacted with different alkyl ethers. Reaction with THF provided alkylated product in a yield of 81% (entry 2, Table 5.6). The product was then converted quantitatively to N1-(tetrahydrofuran-2-yl)-5-fluorouracil, the Tegafur, by heating at 75°C in isopropanol. Alkylation with tetrahydropyran, dioxane, and DME also worked, albeit with lower yields (entries 3-5, Table 5.6). Therefore, this amination method might be useful for the rapid derivatization of biologically active compounds.

5.4 Proposed Reaction Mechanism

The mechanism of the direct C-H amination remains speculative. A radical process is consistent with some experimental observations. The amination is completely quenched in the presence of 10 mol% of TEMPO, a radical inhibitor. Lithiated alkyl amides failed to undergo amination, likely because alkyl aminyl radicals are too difficult to generate under the reaction conditions. Deuterium kinetic isotope effect (KIE) was measured in the reaction of acetanilide with THF and THF-d₈ at room temperature. A primary deuterium KIE of 4.6 was observed. This significant value of KIE suggests the rate determining step involves the breaking of α -C-H bond. Given previously proposed mechanism for the α -C-H amination of ethers^{20,27,28} and the specific reaction conditions described here, we considered several possible reaction pathways in Figure 5.3. The salt metathesis reaction between Ph₂IPF₆ and sodium amide gives an ionic complex of diphenyl iodonium and amide (A). Oxidation of the amide by the diphenyl iodonium oxidant via single electron transfer (SET) then yields an aminyl radical (B) and a diphenyl iodide radical (C) (eq 1, Figure 5.3). Radical C decomposes to give PhI and Ph radical (eq 2, Figure 5.3). It is known that aminyl radicals are poor hydrogen atom abstractors³⁰ so abstraction of hydrogen atom from THF by B is unlikely. Instead, the phenyl radical should react with THF to give the THF radical D (eq 3, Figure 5.3). Although combination of the two radicals, B and D, can lead to the formation of the amination product, due to the low concentration of both radical species, this pathway plays no major role here. Instead, two alternative pathways may be operating. In route I, D reacts with amidyl anion to form the corresponding anion-radical (E)³¹ which is easily oxidized by diphenyl iodonium cation to the amination product generating the diphenyl iodide radical (C) again and propagating the radical chain process (eq 4 and 5, Figure 5.3). In route II, the THF radical D is oxidized by diphenyl iodonium cation to give an oxonium ion (F) and radical C which also propagates the radical chain process (eq 6, Figure 5.3). Reaction of F with amide then gives the amination product (eq 7, Figure 5.3).

5.6 Experimental

5.6.1 Chemicals and Reagents

All manipulations were carried out under an inert $N_2(g)$ atmosphere using standard Schlenk or glovebox techniques. Solvents were purified using a two-column solid-state purification system (Innovative Technology, NJ, USA) and transferred to the glove box without exposure to air. Deuterated solvents were purchased from Cambridge Isotope Laboratories, Inc., and were degassed and stored over activated 3 Å molecular sieves. THF- d_8 was purchased from ARMAR AG, and was degassed and stored over activated 3 Å molecular sieves. Unless otherwise noted, all other reagents and starting materials were purchased from commercial sources and used without further purification. Liquid compounds were degassed by standard freeze-pump-thaw procedures prior to use. Tetrahydropyran and 2-methyltetrahydrofuran were distilled from stabilizers before use. Dry 1,2-dimethoxyethane was purchased from Aldrich and used without purification. Diphenyl iodonium hexafluorophosphate and triflate were purchased from ABCR and Aldrich correspondently. 2,2-Dimethylpent-4-en-1-amine was synthesized according to literature procedure.³² Other amines were purchased from commercial sources. Sulfonamides³³, amides and trifluoroacetyl amides³⁴ were prepared from corresponding amines by standard methods. 3-(4-methoxybenzyl)-5-methylpyrimidine-2,4(1H,3H)-dione³⁵ and di-tert-butyl 5-fluoro-2,4-dioxypyrimidine-1,3(2H,4H)-dicarboxylate³⁶ were prepared according to known procedures.

5.6.2 Physical Methods

The ^1H and ^{13}C NMR spectra were recorded at 293 K or 373 K on Bruker Avance 400 spectrometers. ^1H NMR chemical shifts were referenced to residual solvent as determined relative to Me_4Si ($\delta = 0$ ppm). The $^{13}\text{C}\{^1\text{H}\}$ chemical shifts were reported in ppm relative to the carbon resonance of CDCl_3 (77.16 ppm), DMSO-d_6 (39.52 ppm), CD_2Cl_2 (53.84 ppm) or CD_3CN (118.26 ppm). GC measurement was conducted on a Perkin-Elmer Clarus 400 GC with a FID detector. HRESI-MS measurements were conducted at the EPFL ISIC Mass Spectrometry Service with a Micro Mass QTOF Elemental analyses were performed on a Carlo Erba EA 1110 CHN instrument at EPFL.

5.6.3 The Procedures for the Preparation of Starting Materials

General procedure for the preparation of sulfonamides

To a stirred solution of primary amine (20 mmol) and pyridine (2.37 g, 30 mmol) in CH_2Cl_2 (50 mL) at 0°C a corresponding sulfonyl chloride (20 mmol) was slowly added. The reaction mixture was slowly warmed to room temperature and stirred for 12 hours, then the reaction was quenched with water (30 mL), extracted with CH_2Cl_2 (2x50 mL) and washed with water. The organic phase was dried over anhydrous Na_2SO_4 . The solvent was evaporated to afford the product. If needed, crude product was purified by silica gel flash chromatography using mixture of ethylacetate/hexane as an eluent.

General procedure for the preparation of N-acetamides

20 mmol of the corresponding amine was dissolved in 50 mL of CH_2Cl_2 followed by the addition of triethylamine (3.03 g, 30 mmol) and dropwise addition of acetyl chloride (1.72 g, 22 mmol) at 0°C . After stirring for 10 hours at room temperature 30 mL of water was added to the reaction solution. The organic phase was separated and aqueous layer was extracted two

times with 50 mL of chloroform, and the resulting organic layer was concentrated after drying with anhydrous Na_2SO_4 to obtain the product. If needed, crude product was purified by silica gel flash chromatography using mixture of ethylacetate/hexane as an eluent.

General procedure for the preparation of N-trifluoroacetamides

20 mmol of the corresponding amine and pyridine (2.37 g, 30 mmol) were dissolved in 50 mL of dry CH_2Cl_2 . Trifluoroacetic anhydride (22 mmol 4.62 g) in 20 mL of CH_2Cl_2 was added slowly at 0°C . The reaction was stirred overnight at room temperature, quenched with water, extracted twice with CH_2Cl_2 and washed with water. The organic layers were dried with Na_2SO_4 , and the solvent was evaporated. The residue was purified by silica gel flash chromatography using mixture of hexane/ethyl acetate as an eluent.

Tert-butyl 5-fluoro-2,6-dioxo-3,6-dihydropyrimidine-1(2H)-carboxylate

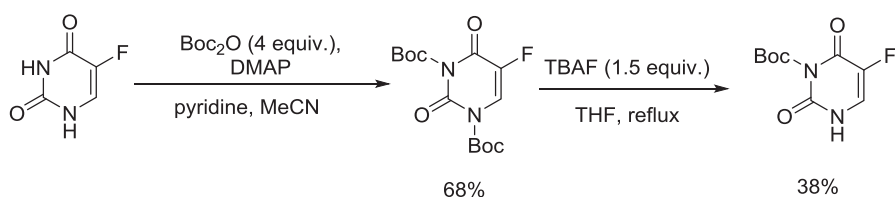

5-Fluorouracil (3.9 g, 30.0 mmol), di-tert-butyl dicarbonate (26.2 g, 120 mmol), pyridine (5 mL), DMAP (100 mg, 0.8 mmol) and MeCN (50 mL) were stirred together for 12 h at room temperature. The reaction mixture was concentrated in vacuo, and the residue was partitioned between CH_2Cl_2 (100 mL) and water (100 mL). The organic layer was separated, and the aqueous phase was extracted twice with CH_2Cl_2 (2×50 mL). The combined organic layers were dried over MgSO_4 and filtered, and the solvent was removed by evaporation in vacuo. The residue was purified by recrystallization from Hexane-EtOAc (10:1) to afford 6.70 g (68%) of di-tert-butyl 5-fluoro-2,4-dioxopyrimidine-1,3(2H,4H)-dicarboxylate.

Purified 5-fluoro-2,4-dioxopyrimidine-1,3(2H,4H)-dicarboxylate (330 mg, 1 mmol) was dissolved under argon in 2 mL of dry THF. A 1 M solution of Bu_4NF (1.5 mL, 1.5 mmol) in THF was then added and the reaction mixture was refluxed for 8 h. After cooling to room temperature, water (20 mL) was added. After extraction with AcOEt (2×20 mL), the organic layers were washed with brine (10 mL), dried with Na_2SO_4 , filtered and the solvent was removed under reduced pressure. The crude product was purified by gradient silica gel chromatography (hexane/EtOAc 10:1 to 1:1) to afford N3-Boc-5-fluorouracil as white powder 87 mg (38%).

5.6.4 General Procedures for the Optimization of Conditions

Entries 1-10, 18-20

Sodium hydride (60% dispersion in mineral oil, 10 mg, 0.25 mmol, entries 1-7) or corresponding base (0.25 mmol, entries 8-10) was added to a stirred solution of N-benzylmethanesulfonamide (46 mg, 0.25 mmol) in 1 mL of dry tetrahydrofuran at room temperature under nitrogen. After stirring for 1 hour an oxidant (0.3 mmol) was added slowly and the reaction mixture was left stirred for 10 hours. In entry 5 no oxidant was added; instead a balloon with O₂ was connected to reaction vessel. After the indicated time, the reaction mixture was analyzed by GCMS using 30 μ L of dodecane as an internal standard.

Entries 11-17

Sodium hydride (60% dispersion in mineral oil, 10 mg, 0.25 mmol) was added to a stirred solution of N-benzylmethanesulfonamide (46 mg, 0.25 mmol) and dry tetrahydrofuran (0.18 g, 2.5 mmol) in 1 mL of the corresponding solvent at room temperature under nitrogen. After stirring for 1 hour Ph₂IPF₆ (128 mg, 0.3 mmol) was added and the reaction mixture was left stirred for 10 hours.

5.6.5 General Procedures for the Intermolecular α -C-H Amination of Ethers

General procedure for the synthesis of N-(tetrahydrofuran-2-yl)sulfonamides (entries 1-13, Table 5.2)

To a suspension of sodium hydride (60% dispersion in mineral oil, 20 mg, 0.5 mmol) in 1 mL of dry THF a sulfonamide (0.5 mmol) in 1 mL of THF was added at room temperature under nitrogen. After stirring for 1 hour at room temperature Ph₂IPF₆ (256 mg, 0.6 mmol) was added and the reaction mixture was left stirred for 6 hours. The solvent was removed under reduced pressure and resulting solid was subjected to column chromatography (silica gel) to

afford the product. For the new compounds, their ^1H and ^{13}C data were reported together with high resolution mass spectrometric data or elemental analysis.

General procedure for the synthesis of N-(tetrahydrofuran-2-yl)amides (entries 1-15, Table 5.3)

To a suspension of sodium hydride (60% dispersion in mineral oil, 20 mg, 0.5 mmol) in 1 mL of dry THF an amide (0.5 mmol) in 1 mL of THF was added at room temperature under nitrogen. After stirring for 3 hours at room temperature Ph_2IPF_6 (319 mg, 0.75 mmol) in 1 mL of THF was added and the reaction mixture was left stirred for 6 hours. The solvent was removed under reduced pressure and resulting solid was subjected to the column chromatography (silica gel) to afford the product. For the new compounds, their ^1H and ^{13}C data were reported together with high resolution mass spectrometric data or elemental analysis.

General procedure for the synthesis of phthalimide derivatives (entry 16, Table 5.3; entries 2, 4, Table 5.5)

To a suspension of potassium phthalimide (92.5 mg, 0.5 mmol) in 2 mL of corresponding alkyl ether Ph_2IPF_6 (256 mg, 0.6 mmol) was added and reaction mixture stirred at 40°C or 60°C overnight under nitrogen. The solvent was removed under reduced pressure and resulting solid was subjected to the column chromatography (silica gel) to afford the product.

General procedure for the α -C-H bond amination with N-heterocyclic amines (entries 1-4, Table 5.4)

To a suspension of sodium hydride (60% dispersion in mineral oil, 20 mg, 0.5 mmol) in 1 mL of dry THF an amine (0.5 mmol) in 1 mL of THF was added at room temperature under nitrogen. After stirring for 1 hour at room temperature Ph_2IPF_6 (319 mg, 0.75 mmol) was added and the reaction mixture was left stirred for 6 hours. The solvent was removed under reduced pressure and resulting solid was subjected to column chromatography (silica gel) to afford the product. For the new compounds, their ^1H and ^{13}C data were reported together with high resolution mass spectrometric data or elemental analysis.

General procedure for the α -C-H bond amination of various alkyl ethers (entries 1-8, Table 5.5)

To a suspension of sodium hydride (60% dispersion in mineral oil, 20 mg, 0.5 mmol) in 3 mL of dry alkyl ether an amide or sulfonamide (0.5 mmol) was added at room temperature under nitrogen. After stirring for 3 hours at room temperature Ph_2IPF_6 (319 mg, 0.75 mmol) was added and the reaction mixture was left stirred for 6 hours. The solvent was removed under reduced pressure and resulting solid was subjected to the column chromatography (silica gel) to afford the product. For the new compounds, their ^1H and ^{13}C data were reported together with high resolution mass spectrometric data or elemental analysis.

General procedure for the synthesis of nucleoside analogues (entries 1-5, Table 5.6)

To a suspension of sodium hydride (60% dispersion in mineral oil, 20 mg, 0.5 mmol) in 1 mL of dry alkyl ether and N3-protected nucleobase (0.5 mmol) was added at room temperature under nitrogen. After stirring for 3 hours at room temperature Ph_2IPF_6 (362 mg, 0.85 mmol) in 2 mL of ether was added and the reaction mixture was left stirred for 6 hours. The solvent was removed under reduced pressure and resulting solid was subjected to the column chromatography (silica gel) to afford the product. For the new compounds, their ^1H and ^{13}C data were reported together with high resolution mass spectrometric data or elemental analysis.

5.6.6 Mechanistic Studies

Reaction in the presence of TEMPO

Sodium hydride (60% dispersion in mineral oil, 20 mg, 0.5 mmol) was added to a stirred solution of N-benzylmethanesulfonamide (93 mg, 0.5 mmol) in 1 mL of dry tetrahydrofuran at room temperature under nitrogen. After stirring for 1 hour TEMPO (7.8 mg, 0.05 mmol) and Ph_2IPF_6 (256 mg, 0.6 mmol) was added, and the reaction mixture was left stirred for 6 hours. After the indicated time the reaction mixture was analyzed by GCMS using 30 μL of dodecane as an internal standard. Desired product was not detected.

Comparison of rate constants of the reactions of acetanilide with THF and THF-d₈

Four stock solutions were prepared: 405 mg of acetanilide and 102 mg of dodecane in 6.0 mL of THF (Solution A); 1.50 g of Ph₂IPF₆ in 5.0 mL of THF (Solution B); 405 mg of acetanilide and 102 mg of dodecane in 6.0 mL of THF-d₈ (Solution C); 1.50 g of Ph₂IPF₆ in 5.0 mL of THF-d₈ (Solution D). To 1.0 mL of Solution A 20 mg of sodium hydride (60% dispersion in mineral oil) was added and the mixture was stirred for 30 minutes. Then 1.0 mL of Solution B was added at once at room temperature (23,5 °C). The aliquotes of the reaction mixture were quenched with ethanol and analyzed by GC (calibration was performed using dodecane as an internal standard). The procedure was repeated with Solutions C and D. The ratio between both reaction rate constants was determined to be 4.60.

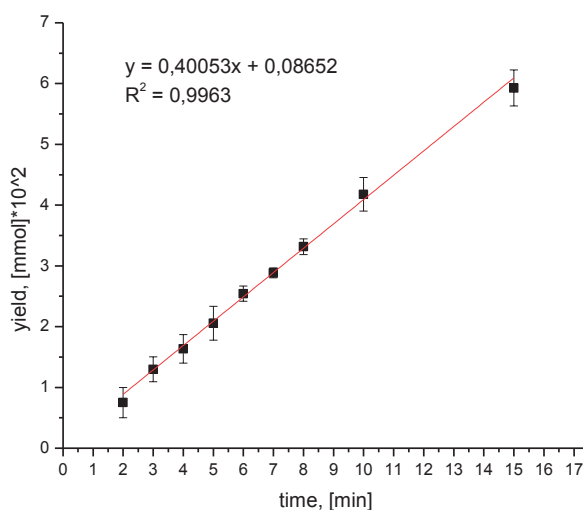
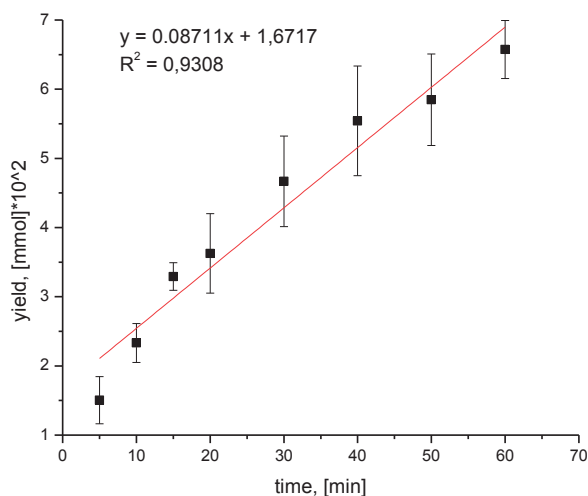
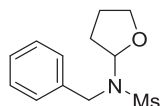

Figure 5.4: The rate of the reaction of acetanilide in THF

Figure 5.5: The rate of the reaction of acetanilide in THF-d₈

5.6.7 Detailed descriptions of the products



N-benzyl-N-(tetrahydrofuran-2-yl)methanesulfonamide (entry 1, Table 5.2)

Isolated by gradient elution from the column with hexane-EtOAc (9:1 to 4:1) in 73% yield as a colorless oil.

¹H NMR (400 MHz, CDCl₃): 7.42 (d, *J* = 7.5 Hz, 2H), 7.37-7.34 (m, 2H), 7.30-7.26 (m, 1H), 5.72 - 5.69 (m, 1H), 4.57 (d, *J* = 16.7 Hz, 1H), 4.27 (d, *J* = 16.7 Hz, 1H), 4.07-4.01 (m, 1H), 3.84-3.79 (m, 1H), 2.97 (s, 3H), 2.08-1.81 (m, 3H), 1.75-1.69 (m, 1H).

¹³C NMR (101 MHz, CDCl₃): 138.3, 128.7, 127.5, 127.1, 88.8, 68.4, 46.6, 39.6, 29.6, 24.8.

HRESI-MS: calculated for (C₁₂H₁₈NO₃S, M+H), 256.1007; found, 256.1000.

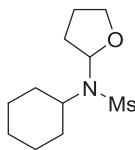
**N-cyclohexyl-N-(tetrahydrofuran-2-yl)methanesulfonamide (entry 2, Table 5.2)**

Isolated by gradient elution from the column with hexane-EtOAc (20:1 to 9:1) 76% yield as a colorless oil.

$^1\text{H NMR}$ (400 MHz, CDCl_3): 5.34 (m, 1H), 4.05-3.99 (m, 1H), 3.77-3.73 (m, 1H), 3.38-3.31 (m, 1H), 2.98 (s, 3H), 2.19-2.02 (m, 3H), 1.92-1.60 (m, 8H), 1.34-1.08 (m, 3H).

$^{13}\text{C NMR}$ (101 MHz, CDCl_3): 88.7, 68.1, 57.5, 43.4, 34.2, 31.4, 31.0, 26.6, 25.3.

HRESI-MS: calculated for $(\text{C}_{11}\text{H}_{21}\text{NO}_3\text{SNa}, \text{M}+\text{Na})$, 270.1140; found, 270.1143.

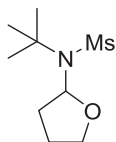
**N-(tert-butyl)-N-(tetrahydrofuran-2-yl)methanesulfonamide (entry 3, Table 5.2)**

Isolated by gradient elution from the column with hexane-EtOAc (19:1 to 9:1) in 39% yield as a white solid.

$^1\text{H NMR}$ (400 MHz, CD_2Cl_2): 5.33-5.29 (m, 1H), 4.08-4.03 (m, 1H), 3.74-3.69 (m, 1H), 2.99 (s, 3H), 2.51-2.44 (m, 1H), 2.12-1.99 (m, 2H), 1.88-1.79 (m, 1H), 1.43 (s, 9H).

$^{13}\text{C NMR}$ (101 MHz, CD_2Cl_2): 90.6, 68.5, 59.7, 45.7, 32.9, 30.8, 25.8.

HRESI-MS: calculated for $(\text{C}_9\text{H}_{19}\text{NO}_3\text{S}, \text{M}+\text{Na})$, 244.0983; found, 244.0984.

Elemental analysis: Anal. Calcd for $\text{C}_9\text{H}_{19}\text{NO}_3\text{S}$: C, 48.84; H, 8.65; N 6.33. Found: C, 48.88; H, 8.35; N 6.15.

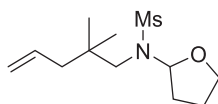
**N-(2,2-dimethylpent-4-en-1-yl)-N-(tetrahydrofuran-2-yl)methanesulfonamide (entry 4, Table 5.2)**

Isolated by gradient elution from the column with hexane-EtOAc (6:1 to 4:1) in 78 % yield as colorless oil.

$^1\text{H NMR}$ (400 MHz, CDCl_3): 5.88-5.78 (m, 1H), 5.32-5.03 (m, 3H), 4.11-4.06 (m, 1H), 3.81-3.76 (m, 1H), 3.24 (d, $J = 14.7$ Hz, 1H), 2.98 (s, 3H), 2.91 (d, $J = 14.7$ Hz, 1H), 2.54-2.45 (m, 1H), 2.22-2.10 (m, 2H), 2.03 (m, 2H), 1.89-1.82 (m, 1H), 0.95 (s, 3H), 0.94 (s, 3H).

$^{13}\text{C NMR}$ (101 MHz, CDCl_3): 134.8, 117.8, 94.7, 77.2, 68.6, 59.6, 45.4, 40.8, 35.5, 31.7, 25.737, 25.3, 25.1.

HRESI-MS: calculated for $(\text{C}_{12}\text{H}_{24}\text{NO}_3\text{S}, \text{M}+\text{H})$, 262.1477; found 262.1472.

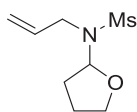

N-allyl-N-(tetrahydrofuran-2-yl)methanesulfonamide (entry 5, Table 5.2)

Eluated from the column with hexane-EtOAc (9:1) in 77% yield as a colorless oil.

¹H NMR (400 MHz, CDCl₃): 5.97-5.87 (m, 1H), 5.63-5.60 (m, 1H), 5.28 (dd, *J*=17.2, 1.4 Hz, 1H), 5.16 (dd, *J*= 10.2, 1.4 Hz, 1H), 3.99-3.93 (m, 1H), 3.82-3.78 (m, 3H), 2.93 (s, 3H), 2.13-2.05 (m, 1H), 1.98-1.85 (m, 3H).

¹³C NMR (101 MHz, CDCl₃): 135.5, 117.1, 88.7, 68.2, 45.4, 39.7, 29.4, 25.0.

HRESI-MS: calculated for (C₈H₁₅NO₃SNa, M+Na), 228.0670; found, 228.0668.

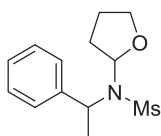

N-(1-phenylethyl)-N-(tetrahydrofuran-2-yl)methanesulfonamide (entry 6, Table 5.2)

Isolated by gradient elution from the column with hexane-EtOAc (20:1 to 9:1) in 75 % yield as white solid. Diastereomeric ratio is 2:3.

N-(1-phenylethyl)-N-(tetrahydrofuran-2-yl)methanesulfonamide (d.r- 2:3) major product

¹H NMR (400 MHz, CD₂Cl₂): 7.55 (d, *J* = 7.6 Hz, 2H), 7.38-7.27 (m, 3H), 5.48 (m, 1H), 4.89 (q, *J* = 7.24 Hz, 1H), 4.11-4.06 (m, 1H), 3.80-3.75 (m, 1H), 2.45 (s, 3H), 2.12-2.02 (m, 3H), 1.96-1.88 (m, 1H), 1.73 (d, *J* = 7.2 Hz, 3H).

¹³C NMR (101 MHz, CD₂Cl₂): 140.1, 129.00, 128.5, 128.00, 89.3, 67.9, 54.6, 42.4, 30.8, 25.5, 21.1.

HRESI-MS: calculated for (C₁₃H₁₉NO₃SNa, M+Na), 292.0983; found, 292.0981.

N-(1-phenylethyl)-N-(tetrahydrofuran-2-yl)methanesulfonamide (d.r- 2:3) minor product

Contains 15% of major isomer.

¹H NMR (400 MHz, CD₂Cl₂): 7.41-7.24 (m, 5H), 5.06-5.02 (m, 2H), 4.03-3.98 (m, 1H), 3.71-3.66 (m, 1H), 3.04 (s, 3H), 2.28-2.22 (m, 1H), 2.02-1.97 (m, 1H), 1.77-1.72 (m, 5H).

¹³C NMR (101 MHz, CD₂Cl₂): 142.2, 128.7, 127.5, 127.4, 89.3, 68.5, 55.6, 53.8, 43.8, 31.34, 25.5, 17.9.

Elemental analysis: Anal. Calcd for C₁₃H₁₉NO₃S: C, 57.97; H, 7.11; N 5.20. Found: C, 57.64; H, 7.20; N 4.88.

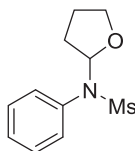

N-phenyl-N-(tetrahydrofuran-2-yl)methanesulfonamide (entry 7, Table 5.2)

Eluated from the column with CH₂Cl₂ in 59 % yield as a white solid.

¹H NMR (400 MHz, CDCl₃): 7.46-7.44 (m, 2H), 7.42-7.27 (m, 3H), 6.03-6.00 (dd, *J* = 7.1, 6.0 Hz, 1H), 3.92-3.87 (m, 1H), 3.78-3.72 (m, 1H), 3.07 (s, 3H), 2.13-2.04 (m, 1H), 1.77-1.59 (m, 2H), 1.46-1.36 (m, 1H).

^{13}C NMR (101 MHz, CDCl_3): 136.2, 131.4, 129.3, 129.1, 89.5, 68.4, 39.8, 29.7, 24.8.

HRESI-MS: calculated for ($\text{C}_{11}\text{H}_{16}\text{NO}_3\text{S}$, M+H), 242.0851; found, 242.0853.

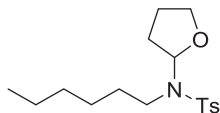

N-hexyl-4-methyl-N-(tetrahydrofuran-2-yl)benzenesulfonamide (entry 8, Table 5.2)

Eluted from the column with hexane-EtOAc (9:1) in 67% yield as a colorless oil.

^1H NMR (400 MHz, CDCl_3): 7.78 (d, $J = 8.3$ Hz, 2H), 7.28 (d, $J = 8.1$, 2H), 5.80-5.76 (m, 1H), 3.91-3.85 (m, 1H), 3.76-3.71 (m, 1H), 3.02-2.88 (m, 2H), 2.41 (s, 3H), 2.17-2.11 (m, 1H), 1.95-1.76 (m, 4H), 1.61-1.50 (m, 1H), 1.32-1.19 (m, 6H), 0.88 (t, $J = 6,7$ Hz, 3H).

^{13}C NMR (101 MHz, CDCl_3): 143.2, 137.2, 129.5, 127.8, 88.8, 68.1, 43.4, 31.5, 31.5, 30.3, 26.9, 25.0, 22.7, 21.6, 14.1.

HRESI-MS: calculated for ($\text{C}_{17}\text{H}_{27}\text{NO}_3\text{SNa}$, M+Na), 348.1609; found, 348.1610.

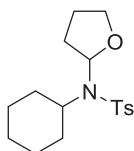

N-cyclohexyl-4-methyl-N-(tetrahydrofuran-2-yl)benzenesulfonamide (entry 9, Table 5.2)

Eluted from the column with hexane-EtOAc (9:1) in 43% yield as a colorless oil.

^1H NMR (400 MHz, CDCl_3): 7.81 (d, $J = 8.3$ Hz, 2H), 7.25 (d, $J = 8.6$ Hz, 2H), 5.44-5.30 (m, 1H), 4.11-4.06 (m, 1H), 3.80-3.76 (m, 1H), 3.30-3.26 (m, 1H), 2.40 (s, 3H), 2.35-2.29 (m, 1H), 2.15-2.07 (m, 2H), 1.95-1.43 (m, 8H), 1.26-0.99 (m, 3H).

^{13}C NMR (101 MHz, CDCl_3): 142.8, 140.0, 129.4, 127.4, 88.8, 68.1, 57.7, 33.8, 31.4, 26.7, 25.5, 25.4, 21.6.

HRESI-MS: calculated for ($\text{C}_{17}\text{H}_{26}\text{NO}_3\text{S}$, M+H), 324.1633; found, 324.1639.

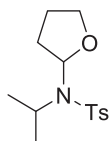

N-isopropyl-4-methyl-N-(tetrahydrofuran-2-yl)benzenesulfonamide (entry 10, Table 5.2)

Isolated by gradient elution from the column with hexane-EtOAc (9:1 to 4:1) in 63 % yield as a colorless oil.

^1H NMR (400 MHz, CDCl_3): 7.72 (d, $J = 8.3$ Hz, 2H), 7.17 (d, $J = 8.1$ Hz, 2H), 5.30 (t, $J = 7.0$ Hz, 1H), 4.02-3.96 (m, 1H), 3.72-3.63 (m, 2H), 2.31 (s, 3H), 2.28-2.22 (m, 1H), 2.08-2.01 (m, 2H), 1.85-1.77 (m, 1H), 1.19 (d, $J = 6.8$ Hz, 3H), 1.00 (d, $J = 6.8$ Hz, 3H).

^{13}C NMR (101 MHz, CDCl_3): 142.8, 139.7, 129.4, 127.5, 88.3, 68.0, 49.1, 31.3, 25.4, 23.4, 21.6, 21.0.

HRESI-MS: calculated for ($\text{C}_{14}\text{H}_{22}\text{NO}_3\text{S}$, M+H), 284.1320; found 284.1316.

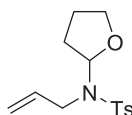

N-allyl-4-methyl-N-(tetrahydrofuran-2-yl)benzenesulfonamide (entry 11, Table 5.2)

Eluted from the column with hexane-EtOAc (3:1) in 73 % yield as a colorless oil.

¹H NMR (400 MHz, CDCl₃): 7.78 (d, *J* = 8.2 Hz, 2H), 7.28 (d, *J* = 8.2 Hz, 2H), 5.93-5.84 (m, 2H), 5.23 (dd, *J* = 17.2, 1.2 Hz, 1H), 5.10 (dd, *J* = 10.0, 1.2 Hz, 1H), 3.90-3.84 (m, 1H), 3.76-3.67 (m, 3H), 2.42 (s, 3H), 2.16-2.08 (m, 1H), 2.00-1.85 (m, 3H).

¹³C NMR (101 MHz, CDCl₃): 143.3, 137.1, 136.0, 129.5, 127.8, 116.4, 88.8, 68.3, 45.2, 30.0, 25.0, 21.6.

HRESI-MS: calculated for (C₁₄H₂₀NO₃S, M+H), 282.1164; found, 282.1166.

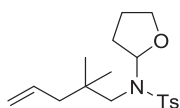

N-(2,2-dimethylpent-4-en-1-yl)-4-methyl-N-(tetrahydrofuran-2-yl)benzenesulfonamide (entry 12, Table 5.2)

Isolated by gradient elution from the column with hexane-EtOAc (9:1 to 6:1) in 62% yield as a colorless oil.

¹H NMR (400 MHz, CDCl₃): 7.77 (d, *J* = 8.2 Hz, 2H), 7.28 (d, *J* = 8.2 Hz, 2H), 5.89-5.78 (m, 1H), 5.27-5.24 (m, 1H), 5.08-5.02 (m, 2H), 4.00-3.95 (m, 1H), 3.71-3.67 (m, 1H), 3.27 (d, *J* = 15.2 Hz, 1H), 2.83 (d, *J* = 15.2 Hz, 1H), 2.42 (s, 3H), 2.36-2.27 (m, 1H), 2.14-2.06 (m, 1H), 1.90-1.81 (m, 1H), 0.99 (s, 6H).

¹³C NMR (101 MHz, CDCl₃): 143.1, 138.4, 135.1, 129.3, 127.90, 117.7, 93.1, 68.0, 57.7, 45.9, 35.2, 31.3, 26.2, 25.8, 25.0, 21.6.

HRESI-MS: calculated for (C₁₈H₂₇NO₃SNa, M+Na), 360.1609; found, 360.1611.

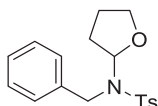

N-benzyl-4-methyl-N-(tetrahydrofuran-2-yl)benzenesulfonamide (entry 13, Table 5.2)

Isolated by gradient elution from the column with hexane-EtOAc (9:1 to 4:1) in 61% yield as a white solid.

¹H NMR (400 MHz, CDCl₃): 7.81 (d, *J* = 8.2 Hz, 2H), 7.43 (d, *J* = 7.5 Hz, 2H), 7.35-7.27 (m, 5 H), 5.95-5.92 (m, 1H), 4.44 (d, *J* = 17.0 Hz, 1H), 4.15 (d, *J* = 17.0 Hz, 1H), 3.91-3.86 (m, 1H), 3.78-3.73 (m, 1H), 2.44 (s, 3H), 2.03-1.97 (m, 1H), 1.95-1.64 (m, 3H).

¹³C NMR (101 MHz, CDCl₃): 143.4, 138.5, 136.9, 129.5, 128.5, 127.8, 127.2, 127.1, 88.9, 68.5, 46.0, 30.2, 24.8, 21.6.

HRESI-MS: calculated for (C₁₈H₂₂NO₃S, M+H), 332.1320; found, 332.1311.

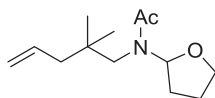
**N-(2,2-dimethylpent-4-en-1-yl)-N-(tetrahydrofuran-2-yl)acetamide (entry 1, Table 5.3)**

Eluted from the column with hexane-EtOAc (5:1) in 54 % yield as a pale yellow oil.

$^1\text{H NMR}$ (400 MHz, CD_2Cl_2): 5.91-5.80 (m, 1H), 5.35 (br, 1H), 5.03-4.99 (m, 2H), 3.98 (m, 1H), 3.74-3.69 (m, 1H), 3.38 (d, $J = 13.5$ Hz, 1H), 3.04 (d, $J = 13.5$ Hz, 1H), 2.13-1.92 (m, 9H), 0.87 (s, 6H)

$^{13}\text{C NMR}$ (101 MHz, CD_2Cl_2): 172.5, 136.1, 117.1, 90.7, 67.3, 52.7, 46.3, 36.0, 30.1, 26.0, 25.8, 25.4, 23.2.

HRESI-MS: calculated for ($\text{C}_{13}\text{H}_{24}\text{NO}_2$, M+H), 226.1807; found 226.1811.

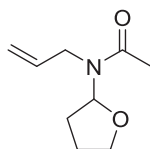
**N-allyl-N-(tetrahydrofuran-2-yl)acetamide (entry 2, Table 5.3)**

Isolated by gradient elution from the column with hexane-EtOAc (9:1 to 6:1) in 82% as a colorless oil.

$^1\text{H NMR}$ (400 MHz, DMSO-d_6 , 373K): 5.87-5.73 (m, 2H), 5.12 (dd, $J = 17.4, 1.4$ Hz, 1H), 5.07 (dd, $J = 10.4, 1.4$ Hz, 1H), 3.93-3.84 (m, 3H), 3.71-3.67 (m, 1H), 2.07-2.02 (m, 4H), 1.98-1.82 (m, 3H).

$^{13}\text{C NMR}$ (101 MHz, DMSO-d_6 , 373K): 170.2, 135.5, 114.3, 86.1, 66.4, 43.3, 28.3, 24.1, 21.0.

HRESI-MS: calculated for ($\text{C}_9\text{H}_{16}\text{NO}_2$, M+Na), 192.1001; found 192.1008.

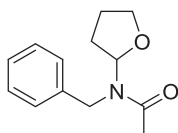
**N-benzyl-N-(tetrahydrofuran-2-yl)acetamide (entry 3, Table 5.3)**

Eluted from the column with hexane-EtOAc (4:1) in 71 % yield as an off-white solid.

$^1\text{H NMR}$ (400 MHz, DMSO-d_6 , 373K): 7.30-7.21 (m, 5H), 5.84 (m, 1H), 4.58 (d, $J = 16.7$ Hz, 1H), 4.40 (d, $J = 16.7$ Hz, 1H), 3.90-3.85 (m, 1H), 3.72-3.67 (m, 1H), 2.08-2.01 (m, 4H), 1.91-1.73 (m, 3H).

$^{13}\text{C NMR}$ (101 MHz, DMSO-d_6 , 373K): 170.1, 138.9, 127.4, 126.7, 125.8, 86.6, 66.4, 44.4, 28.5, 24.1, 21.2.

HRESI-MS: calculated for ($\text{C}_{13}\text{H}_{18}\text{NO}_2$, M+H), 220.1338; found 220.1341.

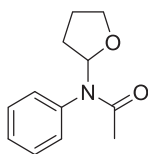
**N-phenyl-N-(tetrahydrofuran-2-yl)acetamide (entry 4, Table 5.3)**

Isolated by gradient elution from the column with hexane-EtOAc (4:1 to 2:1) in 95 % yield as a white solid

¹H NMR (400 MHz, CD₂Cl₂): 7.43-7.20 (m, 5H), 6.45 (br, 1H), 3.63-3.60 (m, 2H), 2.03-1.98 (m, 1H), 1.72-1.62 (m, 5H), 1.25-1.22 (m, 1H).

¹³C NMR (101 MHz, CD₂Cl₂): 171.1, 139.5, 131.0, 129.5, 128.6, 84.4, 68.4, 29.5, 25.3, 23.6.

HRESI-MS: calculated for (C₁₂H₁₆NO₂, M+H), 206.1181; found 206.1177.

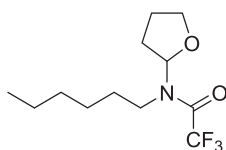
**2,2,2-Trifluoro-N-hexyl-N-(tetrahydrofuran-2-yl)acetamide (entry 5, Table 5.3)**

Isolated by gradient elution from the column with hexane-EtOAc (20:1 to 10:1) in 62% yield as a colorless oil.

¹H NMR (400 MHz, DMSO-d₆, 373K): 5.63-5.60 (m, 1H), 4.05-3.99 (m, 1H), 3.82-3.77 (m, 1H), 3.41-3.34 (m, 1H), 3.26-3.19 (m, 1H), 2.25-2.20 (m, 1H), 2.03-1.92 (m, 3H), 1.68-1.52 (m, 2H), 1.35-1.29 (m, 6H), 0.89 (t, *J* = 6.5 Hz, 3H).

¹³C NMR (101 MHz, DMSO-d₆, 373K): 155.1 (q, *J* = 35 Hz), 115.7 (q, *J* = 289 Hz), 87.0, 67.7, 42.3, 30.0, 29.2, 27.5, 25.4, 24.0, 21.1, 12.7.

HRESI-MS: calculated for (C₁₂H₂₀F₃NO₂Na, M+Na), 290.1344; found, 290.1348.

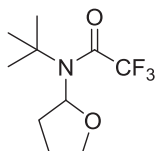
**N-(tert-butyl)-2,2,2-trifluoro-N-(tetrahydrofuran-2-yl)acetamide (entry 6, Table 5.3)**

Eluted from the column with hexane-EtOAc (5:1) in 58% yield as a colorless oil.

¹H NMR (400 MHz, CD₂Cl₂): 5.40 (m, 1H), 4.06-4.01 (m, 1H), 3.71-3.65 (m, 1H), 2.20-2.08 (m, 3H), 1.99-1.93 (m, 1H), 1.49 (s, 9H)

¹³C NMR (101 MHz, CD₂Cl₂): 159.1 (q, *J* = 37 Hz), 117.0 (q, *J* = 290 Hz), 88.9, 67.0, 60.2, 31.1, 28.8, 24.7.

HRESI-MS: calculated for (C₁₀H₁₆F₃NO₂Na, M+Na), 262.1031; found, 262.1035.

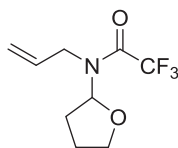
**N-allyl-2,2,2-trifluoro-N-(tetrahydrofuran-2-yl)acetamide (entry 7, Table 5.3)**

Eluated from the column with hexane-EtOAc (9:1) in 80 % yield as a yellowish oil.

$^1\text{H NMR}$ (400 MHz, DMSO- d_6 , 373K): 5.90-5.81 (m, 1H), 5.70-5.67 (m, 1H), 5.22-5.13 (m, 2H), 4.05-3.99 (m, 3H), 3.82-3.77 (m, 1H), 2.26-2.18 (m, 1H), 2.08-1.90 (m, 3H)

$^{13}\text{C NMR}$ (101 MHz, DMSO- d_6 , 373K): 155.3 (q, $J = 35$ Hz), 133.3, 115.7, 115.6 (q, $J = 290$ Hz), 86.8, 67.7, 43.9, 29.0, 23.9.

HRESI-MS: calculated for ($\text{C}_9\text{H}_{12}\text{F}_3\text{NO}_2\text{Na}$, M+Na), 246.0718; found, 246.0720.

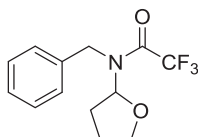
**N-benzyl-2,2,2-trifluoro-N-(tetrahydrofuran-2-yl)acetamide (entry 8, Table 5.3)**

Isolated by gradient elution from the column with hexane-EtOAc (3:1 to 2:1) in 89 % yield as slightly yellowish oil.

$^1\text{H NMR}$ (400 MHz, CD_2Cl_2): 7.25-7.15 (m, 5H), 5.70 (m, 1H), 4.54 (d, $J = 15.7$ Hz, 1H), 4.38 (d, $J = 15.8$ Hz, 1H), 3.97-3.91 (m, 1H), 3.77-3.72 (m, 1H), 2.11-2.03 (m, 1H), 1.91-1.72 (m, 3H).

$^{13}\text{C NMR}$ (101 MHz, CD_2Cl_2): 157.2 (q, $J = 36$ Hz), 137.5, 128.9, 127.6, 127.1, 117.0 (q, $J = 289$ Hz), 87.9, 69.2, 45.9, 30.5, 25.7.

HRESI-MS: calculated for ($\text{C}_{13}\text{H}_{14}\text{F}_3\text{NO}_2\text{Na}$, M+Na), 296.0874; found, 296.0873.

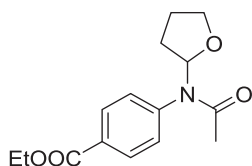
**Ethyl 4-(N-(tetrahydrofuran-2-yl)acetamido)benzoate (entry 9, Table 5.3)**

Eluated from the column with hexane-EtOAc (3:1) in 93 % yield as a colorless oil.

$^1\text{H NMR}$ (400 MHz, CD_2Cl_2): 8.07 (d, $J = 8.5$ Hz, 2H), 7.38-7.27 (br, 2H), 6.48-6.36 (br, 1H), 4.37 (q, $J = 7.1$ Hz, 2H), 3.65-3.61 (m, 2H), 2.08-2.00 (m, 1H), 1.78-1.58 (br+m, 5H), 1.38 (t, $J = 7.1$ Hz, 3H), 1.30-1.23 (m, 1H).

$^{13}\text{C NMR}$ (101 MHz, CD_2Cl_2) δ 170.7, 166.1, 143.7, 131.0, 130.7, 118.8, 85.1, 68.5, 61.6, 29.7, 25.3, 23.63, 14.5.

HRESI-MS: calculated for ($\text{C}_{15}\text{H}_{19}\text{NO}_4\text{Na}$, M+Na), 300.1212; found 300.1206.

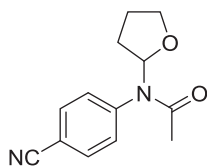
**N-(4-cyanophenyl)-N-(tetrahydrofuran-2-yl)acetamide (entry 10, Table 5.3)**

Isolated by gradient elution from the column with hexane-EtOAc (4:1 to 3:2) in 89 % yield as a colorless oil.

¹H NMR (400 MHz, CD₃CN): 7.79 (d, *J* = 7.4 Hz, 2H), 7.43 (d, *J* = 7.6 Hz, 2H), 6.27 (br, 1H), 3.61 (m, 2H), 2.08-1.99 (m, 1H), 1.76-1.54 (m, 5H), 1.27-1.18 (m, 1H).

¹³C NMR (101 MHz, CD₃CN): 171.5, 144.26, 134.1, 132.5, 119.1, 112.7, 85.9, 68.7, 29.9, 25.4, 23.5.

HRESI-MS: calculated for (C₁₃H₁₄N₂O₂ Na, M+Na), 253.0953; found 253.0956.

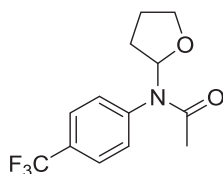
**N-(tetrahydrofuran-2-yl)-N-(4-(trifluoromethyl)phenyl)acetamide (entry 11, Table 5.3)**

Eluted from the column with hexane-EtOAc (7:3) in 95 % yield as a colorless oil.

¹H NMR (400 MHz, CD₂Cl₂): 7.69 (d, *J* = 8.1 Hz, 2H), 7.48-7.35 (br, 2H), 6.51-6.32 (br, 1H), 3.68-3.63 (m, 2H), 2.10-2.00 (m, 1H), 1.87-1.55 (m, 5H), 1.33-1.23 (m, 1H).

¹³C NMR (101 MHz, CD₂Cl₂): 170.7, 143.0, 131.6, 130.6 (q, *J* = 32 Hz), 126.7, 124.4 (q, *J* = 273 Hz), 84.9, 68.4, 29.6, 25.3, 23.6.

HRESI-MS: calculated for (C₁₃H₁₄F₃NO₂ Na, M+Na), 296.0874; found 296.0865.

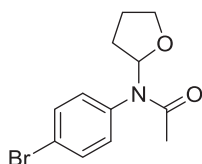
**N-(4-bromophenyl)-N-(tetrahydrofuran-2-yl)acetamide (entry 12, Table 5.3)**

Isolated by gradient elution from the column with hexane-EtOAc (4:1 to 2:1) in 95 % yield as a white solid

¹H NMR (400 MHz, CD₂Cl₂): 7.55 (d, *J* = 8.2 Hz, 2H), 7.30-6.99 (br, 2H), 6.42 (br, 1H), 3.66-3.60 (m, 2H), 2.07-1.98 (m, 1H), 1.82-1.57 (m, 5H), 1.34-1.24 (m, 1H).

¹³C NMR (101 MHz, CD₂Cl₂): 170.8, 138.6, 132.7, 122.6, 84.4, 68.4, 29.6, 25.3, 23.7.

HRESI-MS: calculated for (C₁₂H₁₄BrNO₂ Na, M+Na), 306.0106; found 306.0117.

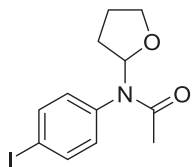
**N-(4-iodophenyl)-N-(tetrahydrofuran-2-yl)acetamide (entry 13, Table 5.3)**

Isolated by gradient elution from the column with hexane-EtOAc (4:1 to 2:1) in 90 % yield as a white solid

$^1\text{H NMR}$ (400 MHz, CD_3CN): 7.78 (d, $J = 8.2$ Hz, 2H), 7.07-7.03 (br, 2H), 6.42-6.32 (br, 1H), 3.60-3.54 (m, 2H), 2.03-1.94 (m, 1H), 1.77-1.56 (m, 1H), 1.26-1.20 (m, 1H).

$^{13}\text{C NMR}$ (101 MHz, CD_3CN): 171.0, 140.0, 139.3, 133.8, 94.3, 84.8, 68.7, 29.9, 25.5, 23.6.

HRESI-MS: calculated for ($\text{C}_{12}\text{H}_{15}\text{INO}_2$, M+H), 332.0148; found 332.0164.

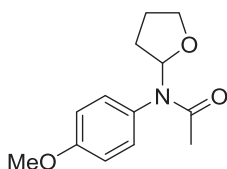
**N-(4-methoxyphenyl)-N-(tetrahydrofuran-2-yl)acetamide (entry 14, Table 5.3)**

Eluted from the column with hexane-EtOAc (4:1) in 93 % yield as a beige solid.

$^1\text{H NMR}$ (400 MHz, CD_2Cl_2): 7.26 (br, 1H), 7.05 (br, 1H), 6.91 (d, $J = 8.24$ Hz, 2H), 6.38 (m, 1H), 3.82 (s, 3H), 3.67-3.63 (m, 2H), 2.05-1.95 (m, 1H), 1.76-1.63 (m, 5H), 1.31-1.24 (m, 1H)

$^{13}\text{C NMR}$ (101 MHz, CD_2Cl_2): 172.5, 159.8, 131.9, 122.0, 114.6, 84.6, 68.5, 55.8, 29.4, 25.3, 23.6.

HRESI-MS: calculated for ($\text{C}_{13}\text{H}_{18}\text{NO}_3$, M+H), 236.1287; found 236.1278.

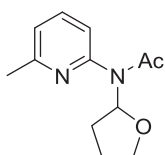
**N-(6-methylpyridin-2-yl)-N-(tetrahydrofuran-2-yl)acetamide (entry 15, Table 5.3)**

Isolated by gradient elution from the column with hexane-EtOAc (10:1 to 2:1) in 86 % yield as a colorless oil.

$^1\text{H NMR}$ (400 MHz, CD_2Cl_2): 7.69 (t, $J = 7.7$ Hz, 1H), 7.20 (d, $J = 7.6$ Hz, 1H), 7.11 (d, $J = 7.7$ Hz, 1H), 6.31-6.28 (m, 1H), 3.74-3.65 (m, 2H), 2.53 (s, 3H), 2.08-2.00 (m, 1H), 1.80-1.66 (m, 5H), 1.37-1.25 (m, 1H).

$^{13}\text{C NMR}$ (101 MHz, CD_2Cl_2): 171.9, 159.4, 152.3, 139.0, 123.4, 122.1, 85.7, 68.6, 29.3, 25.1, 24.3, 23.5.

HRESI-MS: calculated for ($\text{C}_{12}\text{H}_{17}\text{N}_2\text{O}_2$, M+H), 221.1290; found 221.1292.

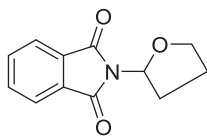

2-(Tetrahydrofuran-2-yl)isoindoline-1,3-dione (entry 16, Table 5.3)

Isolated by gradient elution from the column with hexane-EtOAc (9:1 to 6:1) in 75% yield as a white solid.

¹H NMR (400 MHz, CDCl₃): 7.86 (m, 2H), 7.73 (m, 2H), 6.06-6.03 (m, 1H), 4.23-4.16 (m, 1H), 3.96-3.93 (m, 1H), 2.57-2.50 (m, 1H), 2.42-2.24 (m, 2H), 2.04-1.98 (m, 1H).

¹³C NMR (101 MHz, CDCl₃): 168.0, 134.3, 132.0, 123.5, 81.0, 67.0, 29.3, 26.2.

HRESI-MS: calculated for (C₁₂H₁₂NO₄, M+H), 218.0817; found, 218.0812

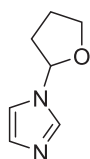

1-(Tetrahydrofuran-2-yl)-1H-imidazole (entry 1, Table 5.4)

Isolated by flash column chromatography (methanol/ dichloromethane = 1:10) in 52% as colorless oil. ¹H and ¹³C NMR spectra of the compound correspond to that published before.³⁷

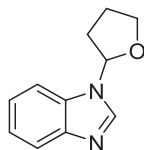

1-(Tetrahydrofuran-2-yl)-1H-benzo[d]imidazole (entry 2, Table 5.4)

Isolated by flash column chromatography (methanol/ dichloromethane = 1:10) in 85% yield as colorless oil. ¹H and ¹³C NMR spectra of the product correspond to that published before.³⁷

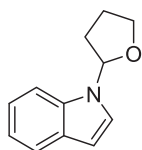

N-[Tetrahydrofuran-2-yl]-1H-indole (entry 3, Table 5.4)

Isolated by gradient elution from the column with hexane-EtOAc (20:1 to 9:1) in 57% yield as a colorless liquid.

¹H NMR (400 MHz, CD₂Cl₂): 7.59 (d, *J* = 7.7 Hz, 1H), 7.46 (d, *J* = 8.2 Hz, 1H), 7.25 – 7.18 (m, 2H), 7.12 (dd, *J* = 7.6, 7.6 Hz, 1H), 6.51 (d, *J* = 3.0 Hz, 1H), 6.22 (dd, *J* = 5.7, 4.2 Hz, 1H), 4.13-4.07 (m, 1H), 4.00-3.94 (m, 1H), 2.47-2.37 (m, 2H), 2.23-2.08 (m, H-2H).

¹³C NMR (101 MHz, CD₂Cl₂): 136.1, 129.5, 124.5, 122.0, 121.1, 120.2, 110.4, 102.4, 86.2, 68.7, 31.9, 25.2.

GCMS: [M] = 187 detected which corresponds to C₁₂H₁₃NO; the purity was further confirmed by GCMS.

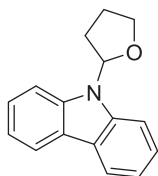
**9-(Tetrahydrofuran-2-yl)-9H-carbazole (entry 4, Table 5.4)**

Isolated by gradient elution from the column with hexane-EtOAc (15:1 to 9:1) in 65% yield as a white solid

$^1\text{H NMR}$ (400 MHz, CDCl_3): 8.10 (d, $J = 8.48$ Hz, 2H), 7.54-7.39 (m, 4H), 7.29-7.24 (m, 2H), 6.52-6.49 (m, 1H), 4.44-4.39 (m, 1H), 4.10-4.06 (m, 1H), 2.56-2.47 (m, 1H), 2.42-2.20 (m, 3H).

$^{13}\text{C NMR}$ (101 MHz, CDCl_3): 139.1, 125.8, 123.9, 120.4, 119.7, 110.5, 86.6, 68.2, 29.5, 25.8.

HRESI-MS: calculated for ($\text{C}_{16}\text{H}_{16}\text{NO}$, $\text{M}+\text{H}$), 238.1232; found, 238.1241

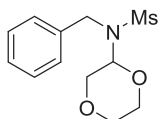
**N-benzyl-N-(1,4-dioxan-2-yl)methanesulfonamide (entry 1, Table 5.5)**

Isolated by gradient elution from the column with hexane-EtOAc (6:1 to 4:1) in 47 % yield as a beige solid.

$^1\text{H NMR}$ (400 MHz, CD_2Cl_2): 7.39-7.24 (m, 5H), 5.20-5.17 (m, 1H), 4.54 (d, $J = 16.6$ Hz, 1H), 4.43 (d, $J = 16.6$ Hz, 1H), 3.87-3.83 (m, 2H), 3.61-3.58 (m, 1H), 3.48-3.40 (m, 2H), 3.26-3.21 (m, 1H), 2.97 (s, 3H).

$^{13}\text{C NMR}$ (101 MHz, CD_2Cl_2): 138.6, 128.9, 127.8, 127.6, 83.4, 69.3, 67.3, 66.0, 47.8, 40.3.

HRESI-MS: calculated for ($\text{C}_{12}\text{H}_{17}\text{NO}_4\text{SNa}$, $\text{M}+\text{Na}$), 294.0776; found 294.0779.

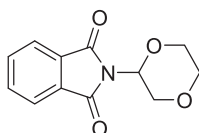
**2-(1,4-Dioxan-2-yl)isoindoline-1,3-dione (entry 2, Table 5.5)**

Isolated by gradient elution from the column with hexane-EtOAc (9:1 to 4:1) in 85% yield as a white solid.

$^1\text{H NMR}$ (400 MHz, CDCl_3): 7.87 (m, 2H), 7.76 (m, 2H), 5.56-5.53 (m, 1H), 4.61-4.56 (m, 1H), 3.98-3.95 (m, 2H), 3.78-3.76 (m, 3H).

$^{13}\text{C NMR}$ (101 MHz, CDCl_3): 167.2, 134.6, 131.7, 123.8, 76.3, 67.7, 66.5, 65.8.

HRESI-MS: calculated for ($\text{C}_{12}\text{H}_{12}\text{NO}_4$, $\text{M}+\text{H}$), 234.0766; found, 234.0768.

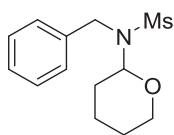

N-benzyl-N-(tetrahydro-2H-pyran-2-yl)methanesulfonamide (entry 3, Table 5.5)

Isolated by gradient elution from the column with hexane-EtOAc (9:1 to 6:1) in 68 % yield as a white solid.

¹H NMR (400 MHz, CD₂Cl₂): 7.39-7.24 (m, 5H), 5.03-5.01 (m, 1H), 4.53-4.40 (m, 2H), 4.01-3.98 (m, 1H), 3.59-3.53 (m, 1H), 2.93 (s, 3H), 1.79-1.76 (m, 1H), 1.56-1.36 (m, 5H)

¹³C NMR (101 MHz, CD₂Cl₂): 139.4, 128.7, 127.4, 127.4, 86.8, 68.4, 47.1, 40.0, 31.4, 25.4, 23.9.

HRESI-MS: calculated for (C₁₃H₁₉NO₃SNa, M+Na), 292.0983; found 292.0977.

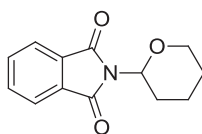

2-(Tetrahydro-2H-pyran-2-yl)isoindoline-1,3-dione (entry 4, Table 5.5)

Isolated by gradient elution from the column with hexane-EtOAc (9:1 to 6:1) in 43 % yield as a white solid.

¹H NMR (400 MHz, CD₂Cl₂): 7.85 (m, 2 H), 7.74 (m, 2H), 5.30-5.26 (m, 1H), 4.06-4.03 (m, 1H), 3.65-3.59 (m, 1H), 2.76-2.66 (m, 1H), 2.02-1.98 (m, 1H), 1.71-1.52 (m, 4H).

¹³C NMR (101 MHz, CD₂Cl₂): 167.7, 134.6, 132.2, 123.7, 79.6, 69.2, 28.2, 25.4, 24.0.

HRESI-MS: calculated for (C₁₃H₁₄NO₃, M+H), 232.0974; found 232.0963.

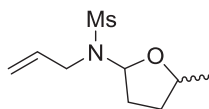

N-allyl-N-(5-methyltetrahydrofuran-2-yl)methanesulfonamide (entry 5, Table 5.5)

Isolated by gradient elution from the column with hexane-EtOAc (20:1 to 10:1) in 61 % yield as a colorless oil. The ratio of two diastereomers is 2:3.

¹H NMR (400 MHz, CD₂Cl₂): 6.00-5.89 (m, 1H_{overlap}), [5.68-5.65 (m, 0.6H_{major}), 5.57-5.54 (m, 0.4H_{minor})], 5.30 (m, 1H_{overlap}), 5.16 (m, 1H_{overlap}), [4.26-4.20 (m, 0.6H_{major}), 3.97-3.92 (m, 0.4H_{minor})], 3.85-3.73 (m, 2H_{overlap}) 2.90 (s, 3H_{overlap}), 2.16-1.92 (m, 3H_{overlap}), 1.53-1.41 (m, 1H_{overlap}), [1.26 (d, *J* = 6.0 Hz, 1.2H_{minor}), 1.18 (d, *J* = 6.0 Hz, 1.8H_{major}).]

¹³C NMR (101 MHz, CD₂Cl₂): 136.3, 136.1, 116.8, 116.7, 88.8, 88.6, 76.7, 75.1, 45.8, 45.7, 39.9, 39.8, 33.2, 32.0, 30.9, 29.8, 21.7, 21.00

HRESI-MS: calculated for (C₉H₁₇NO₃SNa, M+Na), 242.0827; found 242.0818.

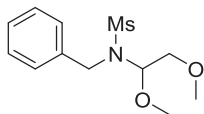
**N-benzyl-N-(1,2-dimethoxyethyl)methanesulfonamide (entry 6, Table 5.5)**

Isolated by gradient elution from the column with hexane-EtOAc (9:1 to 4:1) in 50 % yield as a colorless oil

$^1\text{H NMR}$ (400 MHz, CD_2Cl_2): 7.43-7.28 (m, 5H), 5.11-5.08 (m, 1H), 4.43 (d, $J = 15.8$ Hz, 1H), 4.29 (d, $J = 15.8$ Hz, 1H), 3.47 (m, 2H), 3.32 (s, 3H), 3.25 (s, 3H), 2.77 (s, 3H).

$^{13}\text{C NMR}$ (101 MHz, CD_2Cl_2): 138.1, 129.0, 128.7, 127.8, 87.8, 71.8, 59.0, 55.9, 46.0, 41.9.

HRESI-MS: calculated for $(\text{C}_{12}\text{H}_{19}\text{NO}_4\text{SNa}, \text{M}+\text{Na})$, 296.0933; found 296.0942.

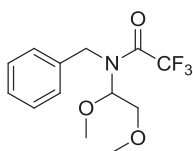
**N-benzyl-N-(1,2-dimethoxyethyl)-2,2,2-trifluoroacetamide (entry 7, Table 5.5)**

Isolated by gradient elution from the column with hexane-EtOAc (10:1 to 5:1) in 41 % yield as a colorless oil.

$^1\text{H NMR}$ (400 MHz, CD_2Cl_2): 7.32-7.26 (m, 5H), 5.16 (m, 1H), 4.68 (d, $J = 15.3$ Hz, 1H), 4.53 (d, $J = 15.3$ Hz, 1H), 3.47-3.40 (m, 1H), 3.34-3.28 (m, 4H), 3.17 (s, 3H).

$^{13}\text{C NMR}$ (101 MHz, CD_2Cl_2): 156.7 (q, $J = 33$ Hz), 137.3, 128.7, 128.2, 119.7 (q, $J = 289$ Hz), 87.3, 72.1, 59.1, 56.2, 44.7.

HRESI-MS: calculated for $(\text{C}_{13}\text{H}_{16}\text{F}_3\text{NO}_3\text{Na}, \text{M}+\text{Na})$, 314.0980; found 314.0975.

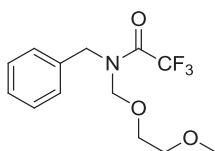
**N-benzyl-2,2,2-trifluoro-N-((2-methoxyethoxy)methyl)acetamide, (entry 7, Table 5.5)**

Isolated by gradient elution from the column with hexane-EtOAc (10:1 to 5:1) in 20 % yield as a colorless oil.

$^1\text{H NMR}$ (400 MHz, CD_2Cl_2): 7.39-7.23 (m, 5H), 4.81 (d, $J = 14.9$ Hz, 2H), 4.70 (s, 2H), 3.62-3.50 (m, 2H), 3.48 (m, 2H), 3.33 (s, 3H)

$^{13}\text{C NMR}$ (101 MHz, CD_2Cl_2): 157.3 (q, $J = 34$ Hz), 135.9, 129.1, 128.8, 128.3, 116.8 (q, $J = 287$ Hz), 77.0, 72.0, 68.0, 59.1, 48.5.

HRESI-MS: calculated for $(\text{C}_{13}\text{H}_{16}\text{F}_3\text{NO}_3\text{Na}, \text{M}+\text{Na})$, 314.0980; found 314.0974.

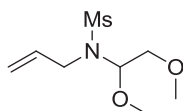

N-allyl-N-(1,2-dimethoxyethyl)methanesulfonamide (entry 8, Table 5.5)

Eluted from the column with hexane-EtOAc (7:3) in 56 % yield as a colorless oil

¹H NMR (400 MHz, CD₂Cl₂): 5.90-5.81 (m, 1H), 5.28 (dd, *J* = 17.2 Hz, 1.5 Hz, 1H), 5.17 (dd, *J* = 10.2 Hz, 1.3 Hz, 1H), 5.03 (m, 1H), 3.83 (d, *J* = 6.28 Hz, 2H), 3.49-3.39 (m, 2H), 3.34 (s, 3H), 3.30 (s, 3H), 2.91 (s, 3H).

¹³C NMR (101 MHz, CD₂Cl₂): 135.5, 118.1, 87.3, 71.8, 59.0, 55.5, 44.4, 42.5.

HRESI-MS: calculated for (C₈H₁₇NO₄SNa, M+Na), 246.0776; found 246.0780.

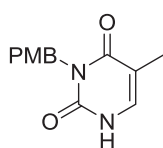

3-(4-Methoxybenzyl)-5-methylpyrimidine-2,4(1H,3H)-dione

¹H NMR (400 MHz, CDCl₃): 9.59 (br, 1H), 7.43 (d, *J* = 8.3 Hz, 2H), 6.99 (d, *J* = 5.2 Hz, 1H), 6.83 (d, *J* = 8.3 Hz, 2H), 5.05 (s, 2H), 3.77 (s, 3H), 1.92 (s, 3H).

¹³C NMR (101 MHz, CDCl₃): 164.1, 159.2, 153.1, 134.3, 130.7, 129.1, 113.8, 110.5, 55.4, 43.5, 13.2.

HRESI-MS: calculated for (C₁₃H₁₅N₂O₃, M+H), 247.1083; found 247.1088.

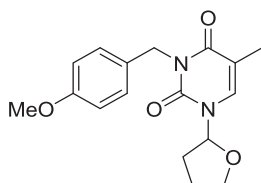

3-(4-Methoxybenzyl)-5-methyl-1-(tetrahydrofuran-2-yl)pyrimidine-2,4(1H,3H)-dione (entry 1, Table 5.6)

Isolated by gradient elution from the column with hexane-EtOAc (10:1 to 4:1) in 85 % yield as white solid.

¹H NMR (101 MHz, CD₂Cl₂): 7.36 (d, *J* = 8.5 Hz, 2H), 7.11 (s, 1H), 6.81 (d, *J* = 8.5 Hz, 2H), 6.01 (dd, *J* = 6.1, 2.9 Hz, 1H), 5.04-4.96 (m, 2H), 4.20-4.15 (m, 1H), 3.95-3.90 (m, 1H), 3.75 (s, 3H), 2.39-2.29 (m, 1H), 2.03-1.90 (m, 6H).

¹³C NMR (101 MHz, CD₂Cl₂): 163.8, 159.4, 151.2, 133.6, 130.6, 129.9, 113.8, 109.7, 87.7, 70.3, 55.6, 43.9, 33.0, 24.5, 13.5.

HRESI-MS: calculated for (C₁₇H₂₁N₂O₄, M+H), 317.1501; found 317.1509.

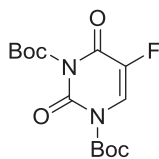
**Di-tert-butyl 5-fluoro-2,4-dioxypyrimidine-1,3(2H,4H)-dicarboxylate**

Recrystallized from hexane-EtOAc (10:1) in 68 % yield

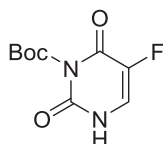
 $^1\text{H NMR}$ (400 MHz, CDCl_3): 7.97 (d, $J = 6.44$ Hz, 1H), 1.60 (s, 18H) $^{13}\text{C NMR}$ (101 MHz, CDCl_3): 154.5 (d, $J = 28.8$ Hz), 147.5, 146.1, 144.2, 139.9 (d, $J = 243.4$ Hz), 123.4 (d, $J = 37.0$ Hz), 88.4, 88.2, 27.9, 27.5.**HRESI-MS**: calculated for ($\text{C}_{14}\text{H}_{19}\text{FN}_2\text{O}_6\text{Na}$, $\text{M}+\text{Na}$), 353.1125; found 353.1130.**tert-Butyl 5-fluoro-2,6-dioxo-3,6-dihydropyrimidine-1(2H)-carboxylate**

Isolated by flash chromatography on silica gel (eluent - hexane-EtOAc 3:2) in 40% yield

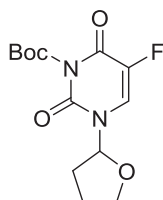
 $^1\text{H NMR}$ (400 MHz, DMSO-d_6): 11.53 (s, 1H), 7.98 (d, $J = 6.04$ Hz, 1H), 1.51 (s, 9H). $^{13}\text{C NMR}$ (101 MHz, DMSO-d_6): 155.1 (d, $J = 28.0$ Hz), 147.5, 147.1, 139.1 (d, $J = 229.3$ Hz), 127.4 (d, $J = 38.0$ Hz), 86.6, 27.0.**HRESI-MS**: calculated for ($\text{C}_9\text{H}_{11}\text{FN}_2\text{O}_4\text{Na}$, $\text{M}+\text{Na}$), 253.0601; found 253.0611.**tert-Butyl-5-fluoro-2,6-dioxo-3-(tetrahydrofuran-2-yl)-3,6-dihydropyrimidine-1(2H)-carboxylate (entry 2, Table 5.6)**

Isolated by gradient elution from the column with hexane-EtOAc (10:1 to 5:2) in 81 % yield as a white solid.

 $^1\text{H NMR}$ (400 MHz, CDCl_3): 7.42 (d, $J = 6.12$ Hz, 1H), 5.97-5.95 (m, 1H), 4.27-4.22 (m, 1H), 4.04-3.98 (m, 1H), 2.47-2.37 (m, 1H), 2.18-2.05 (m, 2H), 1.97-1.90 (m, 1H), 1.62 (s, 9H) $^{13}\text{C NMR}$ (101 MHz, CDCl_3): 154.8 (d, $J = 28.0$ Hz), 146.8, 146.7, 139.9 (d, $J = 238.0$ Hz), 123.2 (d, $J = 34.2$ Hz), 88.2, 87.8, 70.6, 33.1, 27.5, 23.8.**HRESI-MS**: calculated for ($\text{C}_{13}\text{H}_{17}\text{FN}_2\text{O}_5\text{Na}$, $\text{M}+\text{Na}$), 323.1019; found 323.1012.

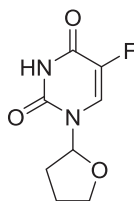

5-Fluoro-1-(tetrahydrofuran-2-yl)pyrimidine-2,4(1H,3H)-dione (Tegafur)

N3-Boc-N1-tetrahydrofuranyl-5-fluorouracil (60 mg, 0.2 mmol) was heated to 75°C in 2 mL of isopropanol for 4h. The evaporation of the solvent under reduced pressure gave 5-fluoro-1-(tetrahydro-2-furyl)-2,4(1H,3H)-pyrimidinedione in quantitative yield (40 mg).

¹H NMR (400 MHz, DMSO-d₆): 11.77 (br, 1H), 7.87 (d, *J* = 6.96 Hz, 1H), 5.90-5.88 (m, 1H), 4.24-4.19 (m, 1H), 3.81-3.75 (m, 1H), 2.25-2.17 (m, 1H), 2.03-1.87 (m, 3H)

¹³C NMR (101 MHz, DMSO-d₆): 157.2 (d, *J* = 26.3 Hz), 148.9, 139.9 (d, *J* = 231.0 Hz), 125.0 (d, *J* = 34.0 Hz), 86.3, 69.3, 31.5, 23.7.

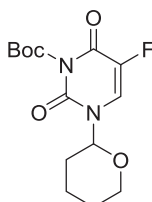

tert-Butyl 5-fluoro-2,6-dioxo-3-(tetrahydro-2H-pyran-2-yl)-3,6-dihydropyrimidine-1(2H)-carboxylate (entry 3, Table 5.6)

¹H NMR (400 MHz, CDCl₃): 7.50 (d, *J* = 6.1 Hz, 1H), 5.55-5.51 (m, 1H), 4.16-4.12 (m, 1H), 3.69-3.62 (m, 1H), 2.02-1.94 (m, 2H), 1.63-1.57 (m, 2H), 1.61 (s, 9H), 1.51-1.41 (m, 2H).

¹³C NMR (101 MHz, CDCl₃): 154.6 (d, *J* = 28 Hz), 146.9, 146.7, 140.2 (d, *J* = 239 Hz), 123.8 (d, *J* = 34 Hz), 87.8, 83.1, 69.4, 31.2, 27.6, 24.9, 22.6.

HRESI-MS: calculated for (C₁₃H₁₇FN₂O₆Na, M+Na), 337.1176; found 337.1171.

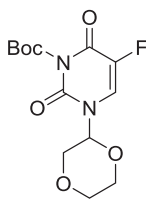

tert-Butyl 3-(1,4-dioxan-2-yl)-5-fluoro-2,6-dioxo-3,6-dihydropyrimidine-1(2H)-carboxylate (entry 4, Table 5.6)

¹H NMR (400 MHz, CDCl₃): 7.64 (d, *J* = 6.0 Hz, 1H), 5.72-5.70 (m, 1H), 4.03-3.99 (m, 2H), 3.95-3.90 (m, 1H), 3.81-3.77 (m, 1H), 3.70-3.63 (m, 1H), 3.43-3.38 (m, 1H), 1.60 (s, 9H).

¹³C NMR (101 MHz, CDCl₃): 154.4 (d, *J* = 28 Hz), 146.9, 146.4, 140.1 (d, *J* = 238 Hz), 123.9 (d, *J* = 35 Hz), 88.1, 78.9, 68.2, 66.8, 65.8, 27.5.

HRESI-MS: calculated for (C₁₃H₁₇FN₂O₆Na, M+Na), 339.0968; found 339.0978.

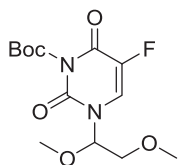

tert-Butyl 3-(1,2-dimethoxyethyl)-5-fluoro-2,6-dioxo-3,6-dihydropyrimidine-1(2H)-carboxylate (entry 5, Table 5.6)

Isolated by gradient elution from the column with hexane/EtOAc as eluent (10:1) in 44 % yield as a colorless oil.

$^1\text{H NMR}$ (400 MHz, CDCl_3): 7.47 (d, $J = 5.8$ Hz, 1H), 5.69-5.67 (m, 1H), 3.60-3.58 (m, 2H), 3.42 (s, 3H), 3.40 (s, 3H), 1.62 (s, 9H).

$^{13}\text{C NMR}$ (101 MHz, CDCl_3): 154.7 (d, $J = 27$ Hz), 147.9, 146.7, 140.3 (d, $J = 240$ Hz), 123.7 (d, $J = 33.5$ Hz), 88.0, 85.4, 72.4, 59.9, 57.6, 27.6.

HRESI-MS: calculated for ($\text{C}_{13}\text{H}_{19}\text{FN}_2\text{O}_6\text{Na}$, $\text{M}+\text{Na}$), 341.1125; found 341.1120.

5.7 References

- (1) Davies, H. M. L.; Manning, J. R. *Nature* **2008**, *451*, 417-424.
- (2) Díaz-Requejo, M.; Pérez, P. *Chem. Rev.* **2008**, *108*, 3379-3394.
- (3) Collet, F.; Dodd, R.; Dauban, P. *Chem. Commun.* **2009**, 5061-5074.
- (4) Zalatan, D.; Du Bois, J. *Top. Curr. Chem.* **2010**, *292*, 347-378.
- (5) Du Bois, J. *Org. Process Res. Dev.* **2011**, *15*, 758-762.
- (6) Gephart, R. T.; Warren, T. H. *Organometallics* **2012**, *31*, 7728-7752.
- (7) Samanta, R.; Matcha, K.; Antonchick, A. P. *Eur. J. Org. Chem.* **2013**, *2013*, 5769-5804.
- (8) Fan, R.; Li, W.; Pu, D.; Zhang, L. *Org. Lett.* **2009**, *11*, 1425-1428.
- (9) Kim, H.; Kim, J.; Cho, S.; Chang, S. *J. Am. Chem. Soc.* **2011**, *133*, 16382-16385.
- (10) Yan, Y.; Zhang, Y.; Feng, C.; Zha, Z.; Wang, Z. *Angew. Chem. Int. Ed.* **2012**, *51*, 8077-8081.
- (11) Youhei, T.; Junpei, H.; Kazuki, Y.; Satoshi, M. *Chem. Lett.* **2012**, *41*, 1672-1674.
- (12) Souto, J.; Zian, D.; Muñoz, K. *J. Am. Chem. Soc.* **2012**, *134*, 7242-7245.
- (13) Xue, Q.; Xie, J.; Li, H.; Cheng, Y.; Zhu, C. *Chem. Commun.* **2013**, *49*, 3700-3702.
- (14) Antonchick, A. P.; Samanta, R.; Kulikov, K.; Lategahn, J. *Angew. Chem. Int. Ed.* **2011**, *50*, 8605-8608.
- (15) Samanta, R.; Bauer, J.; Strohmann, C.; Antonchick, A. *Org. Lett.* **2012**, *14*, 5518-5521.
- (16) Ochiai, M.; Miyamoto, K.; Kaneaki, T.; Hayashi, S.; Nakanishi, W. *Science* **2011**, *332*, 448-451.
- (17) Guo, H.-M.; Xia, C.; Niu, H.-Y.; Zhang, X.-T.; Kong, S.-N.; Wang, D.-C.; Qu, G.-R. *Adv. Synth. Catal.* **2011**, *353*, 53-56.
- (18) Ochiai, M.; Yamane, S.; Hoque, M.; Saito, M.; Miyamoto, K. *Chem. Commun.* **2012**, *48*, 5280-5282.
- (19) Zhdankin, V. V.; Stang, P. J. *Chem. Rev.* **2008**, *108*, 5299-5358.
- (20) He, L.; Yu, J.; Zhang, J.; Yu, X.-Q. *Org. Lett.* **2007**, *9*, 2277-2280.
- (21) Lorente, A.; Lamariano-Marketegi, J.; Albericio, F.; Alvarez, M. *Chem. Rev.* **2013**, *113*, 4567-4610.
- (22) Liu, D.; Liu, C.; Li, H.; Lei, A. W. *Angew. Chem. Int. Ed.* **2013**, *52*, 4453-4456.
- (23) Haslam, R. J.; Davidson, M. M. L.; Desjardins, J. V. *Biochem. J.* **1978**, *176*, 83-95.
- (24) Rich, T. A.; Shepard, R. C.; Mosley, S. T. *J. Clin. Oncol.* **2004**, *22*, 2214-2232.
- (25) Martin, J. C.; Hitchcock, M. J. M.; De Clercq, E.; Prusoff, W. H. *Antiviral Res.* **2010**, *85*, 34-38.
- (26) De Clercq, E. *Rev. Med. Virol.* **2009**, *19*, 287-299.

- (27) Fuchigami, T.; Sato, T.; Nonaka, T. *J. Org. Chem.* **1986**, *51*, 366-369.
- (28) Feldman, K. S.; Bruendl, M. M.; Schildknecht, K.; Bohnstedt, A. C. *J. Org. Chem.* **1996**, *61*, 5440-5452.
- (29) Liu, C.; Zhang, H.; Shi, W.; Lei, A. W. *Chem. Rev.* **2011**, *111*, 1780-1824.
- (30) Newcomb, M. In *Encyclopedia of Radicals in Chemistry, Biology and Materials*; John Wiley & Sons, Ltd.: 2012, p 1-18.
- (31) Rossi, R. A.; Pierini, A. B.; Penenory, A. B. *Chem. Rev.* **2003**, *103*, 71-167.
- (32) Tamaru, Y.; Hojo, M.; Higashimura, H.; Yoshida, Z. *J. Am. Chem. Soc.* **1988**, *110*, 3994-4002.
- (33) Zhang, G.; Cui, L.; Wang, Y.; Zhang, L. *J. Am. Chem. Soc.*, *132*, 1474-1475.
- (34) Barluenga, J.; Álvarez-Gutiérrez, J. M.; Ballesteros, A.; González, J. M. *Angew. Chem. Int. Ed.* **2007**, *46*, 1281-1283.
- (35) Jaime-Figueroa, S.; Zamilpa, A.; Guzmán, A.; Morgans, D. J. *Synth. Comm.* **2001**, *31*, 3739-3746.
- (36) Jacobsen, M. F.; Knudsen, M. M.; Gothelf, K. V. *J. Org. Chem.* **2006**, *71*, 9183-9190.
- (37) Pan, S.; Liu, J.; Li, H.; Wang, Z.; Guo, X.; Li, Z. *Org. Lett.* **2010**, *12*, 1932-1935.

Buslov Ivan – Curriculum Vitae

Date of birth: 23.06.1989

Address: École Polytechnique Fédérale de Lausanne
Institute of Chemical Sciences and Engineering
Laboratory of Inorganic Synthesis and Catalysis
EPFL-SB-ISIC, BCH 3207
Av. F.-A. Forel 2
CH 1015 Lausanne, Switzerland
Telephone: +41 21 69 39881
E-mail: ivan.buslov@epfl.ch

Areas of interest: Synthetic methodology, organometallic chemistry, catalysis

Education:

07. 2012 - current PhD student in the Laboratory of Inorganic Synthesis and Catalysis, École Polytechnique Fédérale de Lausanne. Prof. Xile Hu

Base metal catalysis for organic synthesis, nickel catalyzed hydrosilylation of olefins, C-H amination

Responsible for the maintenance of lab equipment (GC, GC-MS, MS, HPLC, LC)

Teaching of undergraduate students and apprentices

09. 2006 - 06. 2011 MSc in Chemistry, Lomonosov Moscow State University, Chemistry Department

Diploma thesis "Design and Synthesis of New Types of Bis(imino)pyridyl Complexes as Catalysts for Ethylene Polymerization" supervisor: D.Sc. P.V. Ivchenko

Additional working experience:

03. – 10.2011 Engineer, International MSS Company; Moscow, Russia - Guangzhou, China

Quality inspection of metal alloys, supervision of production of carboxymethylcellulose and related substances

Awards and Honors:

- 2015 Prize for the best oral presentation (runner-up) SCS-Fall Meeting Lausanne, Switzerland
- 2011 Prize winner in MSU Chemistry Department Project Contest; Graduated with Honors
- 2006 Prize winner of All-Russian Chemistry Olympiad; Honor of the program of supporting talented young people

Publications

I. Buslov, S. C. Keller, X. Hu, *Organic Letters* **2016**, *18*, 1928

“Alkoxy hydrosilanes as surrogates of gaseous silanes for hydrosilylation of alkenes”

I. Buslov, J. Becouse, S. Mazza, M. Montandon-Clerc, X. Hu, *Angewandte Chemie, International Edition* **2015**, *54*, 14523

“Chemoselective Alkene Hydrosilylation Catalyzed by Nickel Pincer Complexes”

I. Buslov, X. Hu, *Advanced Synthesis & Catalysis*, **2014**, *356*, 3325

“Transition Metal-Free Intermolecular α -C-H Amination of Ethers at Room Temperature”

P. Ivchenko, I. Nifant'ev, I. Buslov, *Tetrahedron Letters*, **2013**, *54*, 217

“A Convenient Approach for the Synthesis of 2,6-diformyl- and 2,6-diacetylpyridines”

Conferences

SCS-Fall Meeting 2015, Lausanne, Switzerland (Oral Contribution)

Swiss Summer School “Rxn Design & Synthesis” 2015, Villars-sur-Ollon, Switzerland (Poster Contribution)

Swiss Summer School “Synthesis and Catalysis” 2013, Villars-sur-Ollon, Switzerland (Poster Contribution)

14th International IUPAC Conference on High Temperature Materials Chemistry, 2012, Beijing, China, (Poster Contribution)

Languages: Russian – native, English – fluent, French – professional working proficiency

