

Why don't avalanche-dynamics models of higher complexity necessarily lead to better predictions?

Christophe Ancey

École Polytechnique Fédérale de Lausanne.
Lausanne, Switzerland

ABSTRACT: The avalanche-dynamics approach has a long history in avalanche prediction. In the absence of computers, scientists and engineers focused on idealized models in which avalanches were seen as rigid sliding blocks. Although the resulting governing equation was very simple, the use of empirical rules made the model outcomes quite realistic, the errors being counterbalanced by common sense and experience of practitioners. To improve the earliest models, scientists explored two complementary paths. The first was to provide a more physical framework for avalanches. In the 1960s, Bruno Salm suggested that flowing snow can be regarded as a continuum, an idea which has encountered great success, but which, at that time, faced considerable computational difficulties. A second path was the development of analytical and numerical models to solve the governing equations of continuum models. In the 1970s, French and Soviet scientists played a key role in the development of the Saint-Venant models for flowing avalanches. Since the 1990s, these models have been made available worldwide.

Paradoxically, the substantial increase in model complexity can lead us to lose sight of the empirical nature of the assumptions used to build the models. Human expertise should still be of paramount importance when evaluating the relevance of numerical outputs. In 2004, Salm sounded an alarm, stating that excessive confidence was placed in the accuracy of model outputs. The problem of predictability and accuracy of models used for environmental purposes has attracted growing attention in recent years, but the debate seems an endless story as it is extremely difficult to determine the source of errors and remove them.

In this talk, I will present the conclusions of experimental campaigns conducted in the laboratory to study avalanches of fluid. In this setting, an avalanche of fluid results from the sudden release of a fixed volume of fluid down a sloping bed. Both fluid properties and flow geometry are imposed. Using high-resolution flow-visualization techniques, we are also able to monitor the internal evolution of the avalanche from release to runout. The experimental data can then be compared with models of varying complexity.

For Newtonian fluids (i.e., fluids whose rheological behavior is linear), we have found that the model accuracy increases with its degree of complexity. Surprisingly, for viscoplastic fluids (non-linear rheology), simple models perform much better than sophisticated models (such as the Saint-Venant equations). Our conclusions do not differ from the lessons learnt in other fields, such as atmospheric sciences, in which small nonlinearities in the governing equations are known to produce large errors, which accumulate to give false predictions.

There is no feasible reason why governing equations such as the Saint-Venant equations, which are unable to provide accurate predictions in well-controlled experiments should miraculously outperform other methods when applied to complex natural phenomena such as snow avalanches. Such models are certainly valuable in avalanche expertise as they provide a precise conceptual framework that link physical processes to universal principles such as conservation of mass and momentum. But, in agreement with Salm's warning, our experiments show that the returns from using sophisticated models may be minimal or diminishing unless we take notice of the errors and biases introduced by these models.

KEYWORDS: avalanche-dynamics model, Saint-Venant equation, prediction and uncertainty, maps

1 INTRODUCTION

Natural flows such as torrential floods, debris flows, and snow avalanches are a major threat to human activities in the Alps. Today, most safe terrains are settled and to host new populations and equipment, local authorities have to urbanize areas, which are exposed to

natural hazards to a varying degree. At the same time, the Alps start to experience the effects of global warming, which are more pronounced and spectacular than in the rest of continental Europe.

Scientific expertise is of paramount importance to face these new challenges. The last century saw the emergence of: (i) qualitative descriptions of how natural flows occur in Alpine settings, (ii) statistical tools, (iii) simple fluid-mechanics models that make it possible to com-

Corresponding author address: Christophe Ancey, EPFL/ENAC/IIC/LHE station 18 CH-1015 Lausanne
email: Christophe.ancey@epfl.ch

pute the salient flow features. The earliest avalanche-dynamics model date back to the 1920s, with the sliding block model developed by Mougín. The Voellmy-based sliding block model has formed a simple, but consistent framework that has been extensively used by scientists and engineers for several decades (Salm, 2004). Current models are usually based on depth-averaged (Saint-Venant) equations of mass and momentum conservation equations. As regards snow avalanches, we can trace the Saint-Venant approach to the 1960s with the work done by Salm (1966) and Soviet researchers (Bozhinskiy and Losev, 1998), but it was not until the late 1980s that special numerical methods made it possible to solve the governing equations (Brugnot and Pochat, 1981; Vila, 1986). With the advent of personal computers and improvement of numerical, academic avalanche-dynamics codes have been increasingly used in France and Italy for solving engineering problems (Ancey, 1994; Barbolini et al., 2000). As these codes have opened new directions for more realistic predictions, commercial avalanche-dynamics codes such as RAMMS and ELBA+ have been made available in the 2000s (Rudolf-Miklau and Sauermoser, 2011) and encounter considerable success even though their use must be framed and the range of applicability is limited (Jamieson et al., 2008).

Yet, our physical understanding and thereby the predictive power of models remain quite poor. The reasons are various. In part, even when vigorously debated, most theories are speculative and for lack of experimental and field data, little consensus has been reached, especially for some hot topics such as the rheology of snow. This explains why the gain in accuracy for land management and engineering applications appears much more limited than believed, as pointed out by the Swiss avalanche expert Bruno Salm (2004): “*An increase of complexity of models does not necessarily mean an increase of accuracy or a better hazard mitigation strategy.*” Indeed, a number of problems (such as model calibration and values of input parameters) that already existed in the earliest generation of models have not been fixed and persist, often hidden by the level of complexity of current models, but sometimes exacerbated by the growing differences between variants of the same original model. In many models, the rheological parameters could not be measured and were thus adjusted on field data. There is clear evidence that these parameters are more conceptual than physical in that they do not represent a physical process, but amalgamate many different physical processes (Meunier et al., 2004). There is still a vivid debate about the rheological law to be used in the depth-

averaged equations. For instance, a number of models use a Coulomb or a Voellmy empirical law to model bed resistance and internal energy dissipation, which amounts to positing that the rheological behavior can be described using a simple, single-valued expression of the bottom shear stress as a function of the depth-averaged velocity and flow depth (Ancey, 2012a).

Over the last 20 years, I have been a particular witness of the development of avalanche-dynamics models. Following Daniel Stokes' classification (Dudley, 2013), I am a member of Pasteur's quadrant, i.e. by doing consulting (avalanches) and working in basic science (flows out of equilibrium), I have one foot in applications and the other in pure sciences. As science and engineering go increasingly specialized, working in both of these fields leads to an uncomfortable position, which attracts neither people nor recognition. However, this is the right place to bring into the consciousness of the general public the added-value as well as the obvious but often neglected limitations of the fluid-mechanics approach. The fact that models are limited to some degree is not really new, and recent conferences are rife with critical assessments of their merits and shortcomings (Jamieson et al., 2008; Gauer et al., 2010). Since the very beginning of practice-oriented models, the practitioners have been warned against computational delusion. As hammered by avalanche expert such as André Roch (1980) and André Burkard (1992), avalanches are not suitable for exact calculations. Unfortunately, there is some ground for concern as in recent years a new generation of practitioners has arrived on the market. For lack of experience, they find security in models that seem absolute to them and that protect them from all contradiction. They are infatuated with science-looking techniques, and pathologically underestimate, or forget, that all model simplifies reality. This is a general trend that concerns all natural hazards, e.g. floods (Goutx and Narcy, 2013). A recent report issued by the French central administration recommends the systematic use of numerical models to increase accuracy and objectivity of avalanche maps (Le Gallou and Guignard, 2011), illustrating that at the highest level of national authorities, model outcomes are taken at face values, whereas they should be seen as parts and parcels of a wider process of risk analysis, in which historical evidence and hands-on knowledge are essential.

To cut to the heart of the matter, I will tackle the difficult issue of uncertainties and accuracy in numerical modelling of avalanches in the laboratory, an environment in which we have the priceless luxury to control and measure almost all parameters ranging from the rheological

properties to slope inclination. Modern visualization techniques allow us to track the front of the avalanche and probe the velocities within the leading edge and body without disturbing the flow. In this paper, I have picked up some of our recent results to illustrate why numerical models may fail to provide the right solution (Ancey et al., 2009a, b; Ancey et al. 2012b; 2013a, b; Andreini et al., 2012).

2 EXPERIMENTAL FACILITY

Experiments were conducted in a PMMA-bottomed flume with aluminium sidewalls. Figure 1 shows a sketch of the facility. The flume was 3.5 m long and 10 cm wide. It could be inclined from 0° to 35° . The upper part of flume was equipped with a sluice gate mounted on a pneumatic jack and was used as a reservoir.

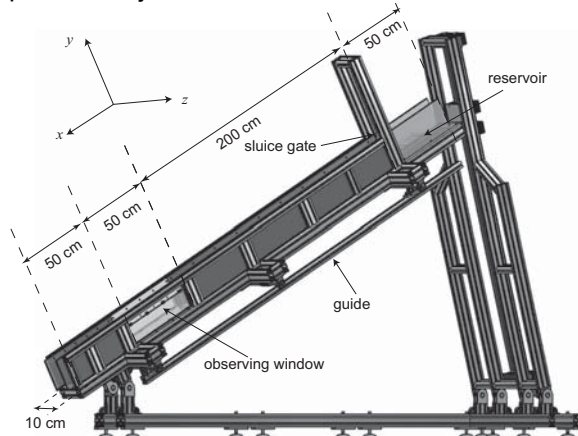

Figure 1. Flume used for the experiments. We defined a two-dimensional Cartesian coordinate system in which the x -axis points down the flume, the y -axis is in the direction of the upward pointing normal, and the z -axis is the cross-stream direction.

We took the following measurements: (i) the velocity profile throughout the experiment at $x = 255$ cm in a vertical plane Oxy passing through the centerline of the flume ($z = 5$ cm) and normal to the flume bottom, (ii) the position of the front as a function of time, and (iii) the flow depth evolution at $x = 255$ cm. To that end, we used a dual head, diode pumped, Q-switched Nd:YLF Laser (Litron LDY 303). The laser emitted a 527-nm beam (green) exciting fluorescent particles. Velocities were measured using high-speed cameras and particle image velocimetry (PIV) techniques. For PIV measurements, we used a Basler A504k camera (working in the 200–1000 Hz range), mounted with a Nikkor 105 mm macro lens and an orange filter. The images were then processed using classic PIV techniques. Velocity fields were computed using the open source software, MatPIV. The front position was monitored using two Basler A403kc cameras.

3 MATERIALS

Different fluids were used a substitute of snow in the laboratory: high-viscosity Newtonian liquids, viscoplastic gels, and neutrally buoyant particle suspensions. I do not claim that these industrial products mimicked snow in some way or that our experiments were in full or partial similarity with real snow avalanches, but the only way to make progress in our understanding of avalanches is by simplifying the picture of the real system to the point of absurdity.

As Newtonian fluids, we used 98.5% glycerol solutions (density $\rho = 1260$ kg m $^{-3}$, dynamic viscosity $\mu = 1.11$ Pa s at a temperature of 20°C).

As viscoplastic fluids, we used Carbopol ultrez 10 at a mass concentration of 0.15%. Given the low concentration in Carbopol, the density was that of water: $\rho = 1000$ kg m $^{-3}$. The pH was adjusted to 7.70 ± 0.5 by adding a sodium hydroxide solution. We measured the rheological properties using a parallel plate geometry (with serrated plates, diameter 60 mm and gap 2 mm) mounted on a Bohlin CVOR rheometer. Serrated surfaces were needed to avoid/limit wall slip. A Herschel-Bulkley model was fitted on the data. On average, we had: yield stress $\sigma_c = 33$ Pa, shear-thinning index $n = 0.33$, and consistency index $\kappa = 26$ Pa s n . The relative uncertainty on these parameters ranged from 6% to 15%. Additional tests showed that Carbopol ultrez 10 was negligibly viscoelastic and thixotropic.

All of our fluids were seeded with polyamide particles for particle imaging velocimetry. The particles were marked with rhodamine by leaving them in a concentrated rhodamine solution. For particle suspensions, please refer to our recent papers (Ancey et al., 2013a, b; Andreini 2013).

4 MODELS

We investigated the dam-break problem for Newtonian and viscoplastic fluids: a fixed volume of a fluid was released and flowed down an inclined flume (see Fig. 1). Using Particle Image Velocimetry techniques, we measured the velocity profiles far from the sidewalls, the front position as a function of time, and the flow depth evolution at a given place. The experimental data were compared to three models of increasing complexity: the kinematic wave model, an advection diffusion model (lubrication theory), and the one-layer Saint-Venant equations.

3.1 Kinematic wave model

The kinematic wave approximation is a common approach to describing slightly nonuniform flow for which the depth-averaged velocity

adapts instantaneously to any change in the flow depth. Surprisingly, the approximation is sufficiently robust to provide fairly good results for strong time-dependent flows such as dam-break waves for turbulent water flows and laminar Newtonian flows (Hunt, 1994; Ancey, 2009b). For this reason, it has been used to model dam-break waves for Bingham and Herschel-Bulkley fluids (Huang and García, 1998). In the framework of the kinematic wave approximation, the flow is assumed to be locally uniform. The variations in the depth-averaged velocity are then dictated by the flow depth alone: $\bar{u} = \bar{u}(h)$. The bulk mass balance

$$\frac{\partial h}{\partial t} + \frac{\partial h\bar{u}}{\partial x} = 0 \quad (1)$$

provides the governing equation for h . The depth averaged velocity is

$$\bar{u} = \frac{nA}{(n+1)(2n+1)} \frac{h^{(1+n)+nh_c}}{h} Y_0^{1+1/n} \quad (2)$$

with the parameters

$$A = \left(\frac{\rho g \sin \theta}{\kappa} \right)^{1/n}, h_c = \frac{\sigma_c}{\rho g \sin \theta}, Y_0 = h - h_c. \quad (3)$$

For Newtonian fluids, $n = 1, h_c = 0, Y_0 = 0, \kappa = \mu$. The nonlinear advection equation (1) can be solved easily using the method of characteristics. For the Newtonian case, linearity makes it possible to find an explicit solution, but for Herschel-Bulkley fluids, the final solution is implicit.

A shortcoming of the kinematic wave approximation lies in the front behavior. The key assumption that underpins the derivation of the governing equation (1) is that for the bulk of the flow, the depth varies uniformly and slowly so that inertia and pressure gradient terms can be neglected in the momentum balance equation (the gravitational forces are then counterbalanced by the shear-stress gradient). This assumption should break down in the tip region. Indeed the flow depth drops to zero at the front and therefore, the pressure gradient can no longer be neglected in the momentum balance equation. It can be shown that a boundary layer correction at the front can fix this issue, but at the cost of more complicated calculations (Ancey et al., 2009a, b). As this correction goes beyond the scope of the present paper, I will not use it.

Figure 2 and 3 show the evolution of the front position $x_f(t)$ and the time variations in the flow depth cm for Carbopol and inclination $\theta = 25^\circ$. Both experimental and theoretical results have been reported. There was excellent agreement between theory and experiment for this slope. The main difference concerned the shape of the $h(x, t)$ curves: since theory predicted that the front was a shock wave while the body was a rarefaction wave, there was a sudden increase of the flow depth followed by a slow decrease. Experimentally, the passage of the front was smoother; in particular, there was

no kink point at the front (this slight shortcoming can be remedied by using the boundary layer correction mentioned above). Another difference was the front behavior at short times ($t < 1$ s), but since the assumptions underpinning the kinematic wave approximation (shallow flow close to a steady uniform flow) were violated, this shortcoming could be anticipated.

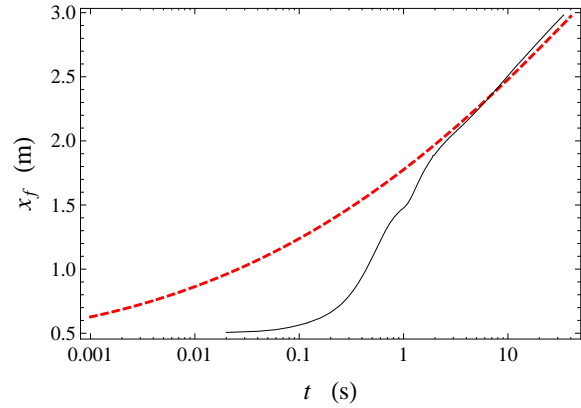

Figure 2. Front position as a function of time for a 6-liter volume of Carbopol, flume inclination $\theta = 25^\circ$. Comparison between analytical solution to (1) (dashed line) and experiments (solid line).

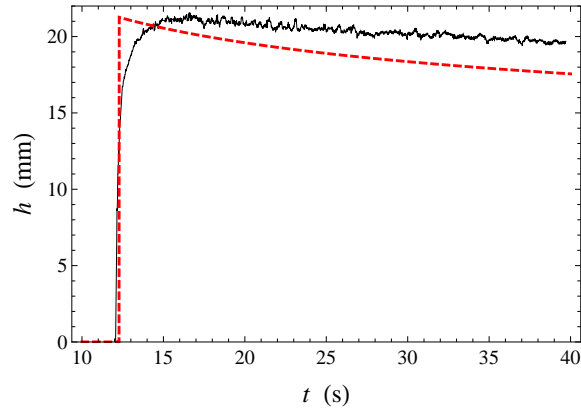

Figure 3. Flow depth profile for a 6-liter volume of Carbopol, flume inclination $\theta = 25^\circ$. Comparison between analytical solution to (1) (dashed line) and experiments (solid line).

For Newtonian fluids, comparison between theory and experiment is even better. I refer the reader to our papers for further information.

3.2 Advection diffusion model

One can elaborate on the kinematic wave model by considering that in elongating flows, the depth averaged velocity should depend on the free-surface gradient. The following governing equation is obtained for h

$$\frac{\partial h}{\partial t} + \frac{\partial}{\partial x} \left[F(h) Y_0^{1+1/n} \right] = 0, \quad (4)$$

with the following functions and parameters

$$F(h) = nK \left(\tan \theta - \frac{\partial h}{\partial x} \right) \frac{h(1+n)+nh_c}{(2n+1)(n+1)}, \quad (5)$$

$$K = \left(\frac{\rho g \cos \theta}{\kappa} \right)^{1/n}, \quad (6)$$

$$Y_0 = \max \left(0, h - h_c \left| 1 - \cos \theta \frac{\partial h}{\partial x} \right|^{-1} \right). \quad (7)$$

As far as I am aware, this equation was first obtained by Liu and Mei (1990) for Bingham fluids, then used and/or extended to Herschel-Bulkley fluids and three-dimensional problems. When the dependence on the free-surface gradient is taken into account, a diffusive term appears in the governing equation, which is likely to play a key role in regions with a marked curvature of the free surface (e.g., the head).

There is no analytical method available to solve, even approximately, this parabolic partial differential equation. There are a few solvers available, which are well-suited to computing numerical solutions to parabolic-elliptic equations in one space variable. We used the Matlab built-in routine called *pdepe*.

Figures 4 and 5 show the front position over time and the evolution in the flow depth for Carbopol at an inclination of 25° . Surprisingly, this model, which was more sophisticated than the kinematic wave model seen above, provided less satisfactory results. In particular the difference between the theoretical and experimental front position was increased. Note that the long-term trend was preserved, which shows that the deviation mainly resulted from the short-time behavior of the numerical solution. In short, the model overestimated initial acceleration. Figure 6 shows the measured profiles and theoretical velocity profiles for a flume inclination of 25° . Each subplot corresponds to a different time, but rather than providing the time at which the velocity measurements were taken, I gave the position of the front relative the point of measurement. The flow was from left to right. As detailed below, there was clearly a difference between the velocity field within the head ($|\Delta x| < 3$ cm) and the velocity field within the body ($|\Delta x| > 3$ cm). When the front was far away from the point of measurement at $x = 255$ cm, i.e. when the distance to the front was large $\Delta x < -73.2$ mm, there was good agreement between the theoretical velocity profile (for nonuniform flow conditions) and the experimental data. In contrast, close to the front ($\Delta x > -32.8$ mm), this agreement became poorer and poorer: the theoretical velocities were significantly higher than those observed. The discrepancy near the contact line was expected since the theoretical profile was derived for flow conditions slightly departed from the steady uniform regime; within

the tip region, the assumption of slightly nonuniform should break down because of the curvature of the surface. Another interesting feature was the existence of a pseudo-plug far from the front whereas the leading edge was entirely sheared across the depth. From a quantitative viewpoint, however, the discrepancy between theoretical and experimental velocity profiles may indicate that the flow conditions within the head could not be described within the framework of lubrication theory and/or the rheological behavior could not be fully captured by the Herschel-Bulkley equation.

In contrast, Fig. 7 reveals that lubrication theory performs with Newtonian liquids. This shows that the discrepancy between theory and experiments results mainly from the nonlinearities in the constitutive equation.

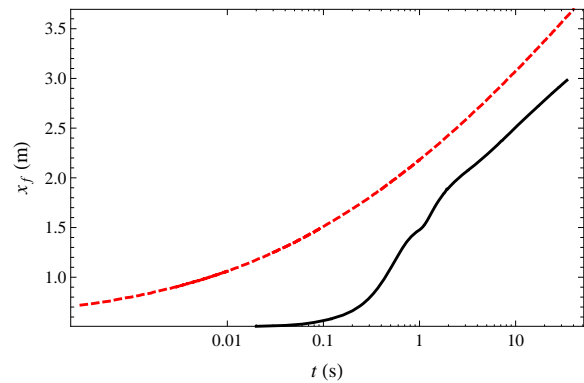

Figure 4. Front position as a function of time for a 6-liter volume of Carbopol, flume inclination $\theta = 25^\circ$. Comparison between analytical solution to (4) (dashed line) and experiments (solid line).

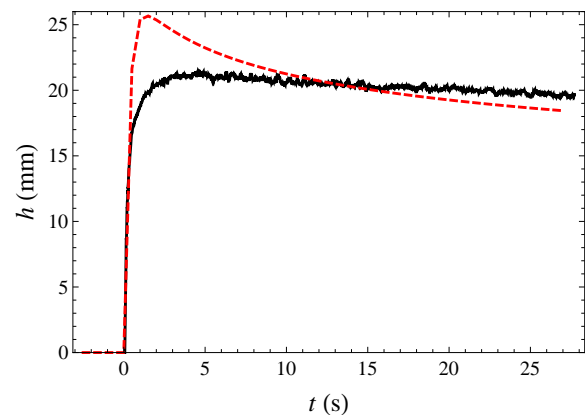

Figure 5. Flow depth profile for a 6-liter volume of Carbopol, flume inclination $\theta = 25^\circ$. Comparison between analytical solution (dashed line) and experiments (solid line).

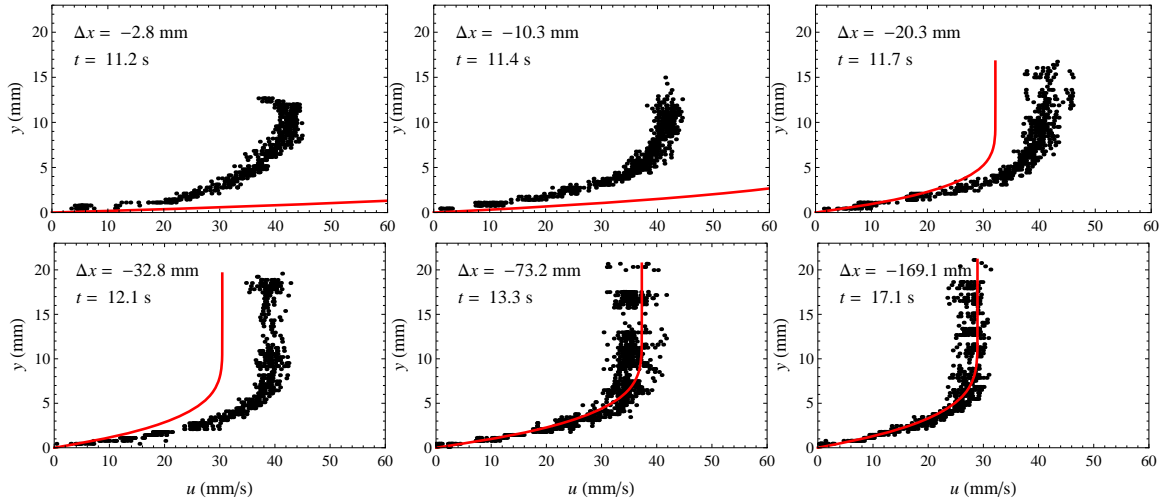

Figure 6. Velocity profiles for Carbopol at $\theta = 25^\circ$ and an initial volume of 6 liters. Dots: experimental values; (red) curves: theoretical. I also report the distance Δx between the front position and the point of measurement $x_0 = 255$ cm together with the time at which the data were recorded ($\Delta x < 0$ because the front is on the right of the point of measurement) together with the time at which the profile was measured.

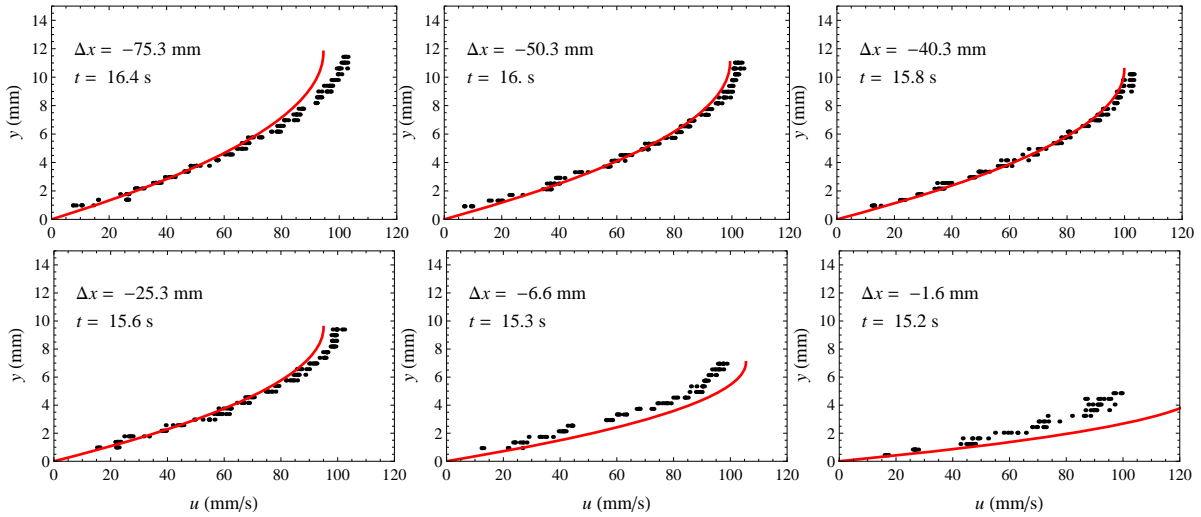

Figure 7. Velocity profiles for (Newtonian) glycerol solutions. Dots: experimental values; (red) curves: theoretical profiles. We also report the distance Δx between the front position and the point of measurement $x_0 = 255$ cm together with the time at which the data were recorded.

3.3 Depth-averaged model

The next step in our analysis of model performance is to consider that the depth-averaged velocity is not related to the flow depth through closed-form relations, but must be computed by solving the momentum balance equation. To that end, I will use the conservative form of the Saint-Venant equations

$$\frac{\partial h}{\partial t} + \frac{\partial h\bar{u}}{\partial x} = 0 \quad (8)$$

$$\frac{\partial h\bar{u}}{\partial t} + \frac{\partial h\bar{u}^2}{\partial x} + gh \cos \theta = gh \sin \theta - \frac{\tau_b}{\rho} \quad (9)$$

where τ_b is the bottom shear stress. Equations (8) and (9) are hyperbolic partial differential equations that call for special numerical methods. A high-resolution wave-propagation algorithm developed by LeVeque (2002) was used. This algorithm is a Godunov-type scheme that

employs the solution to local Riemann problems. It is part of an open-source library called CLAWPACK. More specifically, I used an approximate Riemann solver developed by David George (2008), which provides a well-balanced scheme that preserves balanced steady states, properly captures shock waves and fronts over dry surfaces, and maintains depth non-negativity. The source term in the momentum balance equation includes two contributions: the gravitational acceleration forces (also referred to as the topography source term) and a dissipation term. The augmented Riemann solver incorporates topography into the momentum flux on the left-hand side of (9). The remaining source term is then the dissipative contribution τ_b/ρ . I used a fractional-step approach, with a backwards Euler scheme, to deal with this source term. Comparison with similarity solutions to the viscous dam break problem also

shows that this model performs well with Newtonian fluids and available analytical solutions

As previously, I have plotted the front position and depth evolution (see Figs. 8 and 9). A striking feature is the lack of concordance with experimental data. For both slopes, the numerical model overestimated the front position and contrary to the advection diffusion model, the theoretical $x_f(t)$ curve was not parallel to the experimental curve at long times, which means that the model failed to find the pseudo-equilibrium regime reached by the flow. Strikingly, the kinematic wave model, which can be seen as a simplification of the Saint-Venant equations when the assumption of near-equilibrium flow is made, was able to provide the correct trend for $x_f(t)$ at any time. The one-layer Saint-Venant model was also unable to provide accurate predictions for the depth evolution (even though the order of magnitude was correct).

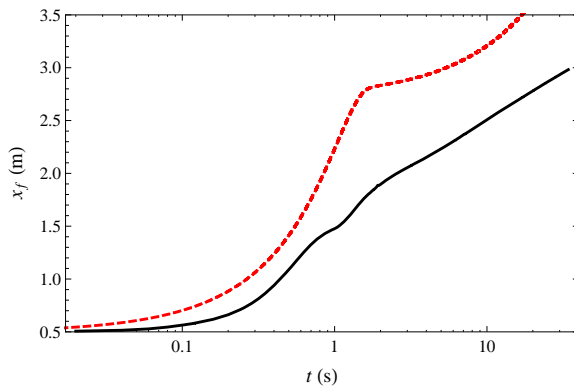

Figure 8. Front position as a function of time for a 6-liter volume of Carbopol, flume inclination $\theta = 25^\circ$. Comparison between analytical solution to (8-9) (dashed line) and experiments (solid line).

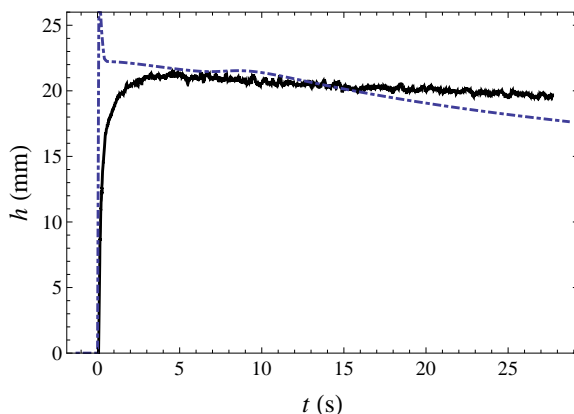

Figure 9. Flow depth profile for a 6-liter volume of Carbopol, flume inclination $\theta = 25^\circ$. Comparison between analytical solution to (8-9) (dashed line) and experiments (solid line).

4 CONCLUDING REMARKS

Strikingly, the best agreement with data was obtained with the simplest model: the kinematic wave model, which consists of a nonlinear advection equation. This model performed well for predicting the front position at steep slopes, but as it was slightly less efficient for predicting the depth evolution in the tip region (the front was indeed merely a shock wave). At longer times, the model gave satisfactory predictions of depth evolution. In an earlier paper (Ancey et al., 2009b) in which experimental data obtained with more concentrated Carbopol gels and a wider flume (30 cm instead of 10 cm) were presented, we came to similar conclusions about the good performance of the kinematic wave model.

In contrast, the results provided by the Saint-Venant equations were in poor concordance with experimental data. This was quite astonishing since, firstly, the kinematic wave model results from a simplification of the Saint-Venant equations and, secondly, this model is of greater complexity and generality. Taking a closer look at the front position curves reveals that the Saint-Venant equations significantly overestimated velocities at short times ($t < 2$ s), i.e. just after the slumping phase. This overestimation might not seem so surprising since, for nonlinear rheologies, the Saint-Venant equations are known to run into difficulty for the following reasons: (i) the assumption of a small aspect ratio (thin flow) breaks down at short times, (ii) when a mass collapses, part of the momentum is directed downwards whereas in the derivation of the Saint-Venant equations, it is assumed that the momentum flux is predominantly in the streamwise direction, (iii) for the initial stages of the flow, the assumption of simple shear flow is not realistic and thus (iv) simplified expressions of bottom shear stress are unlikely to be of sufficient generality for computing energy dissipation in strongly nonuniform flows. Although these limitations provide explanation of the model failure at the shortest times, they do not explain why (i) the results provided by the Saint-Venant equations were much poorer than those yielded by the other models and (ii) why the model predictions were in good agreement with experimental data for Newtonian fluids. Note also that taking sidewall friction into account did not change the model performance, but because of the limitations of the available empirical relations for computing sidewall drag, it was difficult to be conclusive on this.

To us, the failure of the Saint-Venant equations in the present context comes from the oversimplified expression used for computing the bottom shear stress, rather than from flaws in the numerical methods (although these could be optimized to cope with specificities intro-

duced by viscoplastic materials such as yielding deposition). Testing the performance of more complete governing equations is another path to explore. This series of experiments has shown that even under well-controlled experimental conditions, numerical solutions to the Saint-Venant equations failed to predict the experimental observations for nonlinear rheologies. A possible explanation is the ripple-through effect of errors: noise is amplified rather than dissipated by nonlinearities, leading to accumulating computational errors.

Numerical models are double-edge. It takes a real jolt to make see that everything is not ok. From the vantage point of this work, one can set that at best, they are a rough approximations; at worst, one can say that they are simply wrong when the rheological behaviour is nonlinear.

5 REFERENCES

- Ancey, C., 1994, Modélisation des avalanches denses, approches théorique et numérique, *La Houille Blanche*, 5-6, 25-39.
- Ancey, C., 2012a, Gravity Flow on Steep Slope, in *Buoyancy Driven Flows*, edited by E. Chassignet, C. Cenedese, and J. Verron, Cambridge University Press, New York.
- Ancey, C., and S. Cochard, 2009a, The dam-break problem for Herschel-Bulkley fluids down steep flumes, *Journal of Non-Newtonian Fluid Mechanics*, 158, 18-35.
- Ancey, C., N. Andreini, and Epely-Chauvin, 2012b, Viscoplastic dam break waves: review of simple computational approaches and comparison with experiments, *Advances in Water Resources*, 48, 79–91, 2012.
- Ancey, C., N. Andreini, and Epely-Chauvin, 2013a, The dam-break problem for concentrated suspensions of neutrally buoyant particles, *Journal of Fluid Mechanics*, 724, 95-122.
- Ancey, C., N. Andreini, and Epely-Chauvin, 2013b, Granular suspensions I. Macro-viscous behavior, *Physics of Fluids*, 25, 033301.
- Ancey, C., S. Cochard, and N. Andreini, 2009b, The dam-break problem for viscous fluids in the high-capillary-number limit, *Journal of Fluid Mechanics*, 624, 1-22.
- Andreini, N., Epely-Chauvin, and C. Ancey, 2012c, Internal dynamics of Newtonian and viscoplastic fluid avalanches down a sloping bed, *Physics of Fluids*, 24, 053101.
- Barbolini, M., U. Gruber, C.J. Keylock, M. Naaim, and F. Savi, 2000, Application of statistical and hydraulic-continuum dense-snow avalanche models to five European sites, *Cold Regions Science and Technology*, 31, 133-149.
- Bozhinskiy, N., and K.S. Losev, 1998, The fundamentals of Avalanche Science, EISFL, Davos.
- Brugnot, G., and R. Pochat, 1981, Numerical simulation study of avalanches, *Journal of Glaciology*, 27, 77-88.
- Burkard, A., 1992, Erfahrung mit der Lawinenzoning in der Schweiz, in *Internationales Symposium Interpraevent*, pp. 386-407, Interpraevent, Bern.
- Dudley, J.M., 2013, Defending basic research, *Nature Photonics*, 7, 338-339.
- Gauer, P., K. Kronholm, K. Lied, K. Kristensen, and S. Bakkehøi, 2010, Can we learn more from the data underlying the statistical α - β model with respect the dynamical behavior of avalanches, *Cold Regions Science and Technology*, 62, 42-54.
- George, D.L., 2008, Augmented Riemann solvers for the shallow water equations over variable topography with steady states and inundation, *Journal of Computational Physics*, 227, 3089-3113.
- Goutx, D., and J.-B. Narcy, 2013, La place des modèles numériques dans la prise de conscience locale des risques d'inondations: simulations ou stimulations ?, *La Houille Blanche* (1), 27-33.
- Huang, X., and M.H. García, 1998, A Herschel-Bulkley model for mud flow down a slope, *Journal of Fluid Mechanics*, 374, 305-333.
- Hunt, B., 1994, Newtonian fluid mechanics treatment of debris flows and avalanches, *Journal of Hydraulic Engineering*, 120, 1350-1363.
- Jamieson, B., S. Margreth, and A. Jones, 2008, Application and limitations of dynamic models for snow avalanche hazard mapping, in *Proceedings of the ISSW*, pp. 730-739, Whistler.
- Le Gallou, J.-Y., and P. Guignard, 2011, Modalités de prise en compte des avalanches exceptionnelles pour améliorer la prévention des risques et renforcer la sécurité des personnes, *Inspection générale de l'administration*, Paris.
- LeVeque, R.J., 2002, *Finite Volume Methods for Hyperbolic Problems*, Cambridge University Press, Cambridge.
- Liu, K.F., and C.C. Mei, 1990, Slow spreading of a sheet of Bingham fluid on an inclined plane, *Journal of Fluid Mechanics*, 207, 505-529.
- Meunier, M., C. Ancey, and J.-M. Taillandier, 2004, Fitting avalanche-dynamics models with documented events from the Col du Lautaret site (France) using the conceptual approach, *Cold Regions Science and Technology*, 39, 55-66.
- Roch, A., 1980, *Neve e Valanghe*, Club Alpino Italiano, Torino.
- Rudolf-Miklau, F., and S. Sauermoser, 2011, *Handbuch Technischer Lawinenschutz*, Ernst & Sohn, Berlin.
- Salm, B., 2004, A short and personal history of snow avalanche dynamics, *Cold Regions Science and Technology*, 39, 83-92.
- Salm, B., 1966, Contribution to avalanche dynamics, in *Scientific Aspects of Snow and Ice Avalanche*, pp. 199-214, IAHS Press, Wallingford.
- Vila, J.P., 1986, Sur la théorie et l'approximation numérique des problèmes hyperboliques non-linéaires, application aux équations de Saint-Venant et à la modélisation des avalanches denses, Ph.D. thesis thesis, Paris VI.