

Transworld Research Network  
37/661 (2), Fort P.O., Trivandrum-695 023, Kerala, India



Nanostructured Materials for Biomedical Applications, 2009:  
ISBN: 978-81-7895-397-7 Editor: M. C. Tan

5

## Superparamagnetic nanoparticles for biomedical applications

**Margarethe Hofmann-Antenbrink<sup>1</sup>, Brigitte von Rechenberg<sup>2</sup> and Heinrich Hofmann<sup>3</sup>**

<sup>1</sup>MatSearch Pully, Chemin Jean Pavillard, 14, CH-1009 Pully; <sup>2</sup>Musculoskeletal Research Unit, Equine Hospital, Vetsuisse Faculty Zurich, University of Zurich, Winterthurerstr. 260, 8057 Zurich, Switzerland; <sup>3</sup>Laboratory of Powder Technology, Institute of Materials, Swiss Federal Institute of Technology, EPFL, 1015 Lausanne, Switzerland

### 1. Introduction

Nanoparticles may provide advanced biomedical research tools based on polymeric or inorganic formulations or a combination of both. They have the potential to be used in many different biological and medical applications as in diagnostic tests assays for early detection of diseases, to serve as tools for noninvasive imaging and drug development, and to be used as targeted drug delivery systems to minimize secondary systemic negative effects.

---

Correspondence/Reprint request: Dr. Brigitte von Rechenberg, Musculoskeletal Research Unit, Equine Hospital Vetsuisse Faculty Zurich, University of Zurich, Winterthurerstr. 260, 8057 Zurich, Switzerland  
E-mail: [bvonrechenberg@vetclinics.uzh.ch](mailto:bvonrechenberg@vetclinics.uzh.ch)

Nanoparticles used in biomedical applications include liposomes, polymeric micelles, block ionomer complexes, dendrimers, inorganic and polymeric nanoparticles, nanorods and quantum dots. All have been tested pre-clinically or clinically for targeted drug and gene delivery and as agents to enhance diagnostic imaging output like in MRI [1,2,3]. Properties present only on the nanoscale level, like the increased intensity of fluorescent light emission of semiconductor crystals (quantum dots) or switchable magnetic properties of superparamagnetic nanoparticles (SPIONs), make these materials unique and useful for applications in the biomedical field of medical imaging and cell tracking. Other nanoparticles like water-soluble synthetic polymers (dendrimers) were tested in pre-clinical models for the delivery of drugs, genes, and as imaging agents showing a rich versatility for tailoring their binding properties to several requirements, among them facilitation of cellular uptake of drugs (e.g. cancer drugs) [4,5,6].

SPIONs belong to the class of inorganic based particles having an iron oxide core coated by either inorganic materials (silica, gold) and organic materials (phospholipids, fatty acids, polysaccharides, peptides or other surfactants and polymers) [7,8,9]. In contrast to other nanoparticles, their magnetic properties, based on their inducible magnetization, allow them to be directed to a defined location or heated in the presence of an externally applied AC magnetic field. This characteristics makes them attractive for many applications, ranging from various separation techniques and contrast enhancing agents for MRI to drug delivery systems, magnetic hyperthermia (local heat source in the case of tumor therapy), and magnetically assisted transfection of cells [10,11,12,13]. Research with SPIONs has already demonstrated that these particles have the potential become an important tool for enhancing magnetic resonance contrast. SPIONs coated with organic molecules showing an overall median diameter of less than 50 - 160 nm are available on the market or in final clinical trials as MRI contrast agents for detecting liver tumors or to differentiate metastatic from inflammatory lymph nodes. SPION functionalized with targeting peptides exhibit an additional potential for providing important information for a number of diseases for example due to the increased expression of cellular markers. Furthermore, they could due to specific adsorption possibly helping physicians to identify dangerous arteriosclerotic plaques by MRI [14,15]. The ongoing research is directed towards monitoring events on the physiological and molecular level, so that inflammatory diseases or tumors can be detected via the accumulation of SPIONs or markers expressed on the cell surface [16].

Already marketable products, so-called beads, are micron sized polymer particles loaded with SPIONs. Such beads can be functionalized with molecules that allow a specific adsorption of proteins or other biomolecules

and subsequent separation in a magnetic field gradient for diagnostic purposes. More interesting applications, like imaging of single cells or tumors, delivery of drugs or genes, local heating and separation of peptides, signalling molecules or organelles from a single living cell or from a living (human) body are still subject of intensive research, whereby the following issues are not yet fully understood:

- The mechanisms utilized by cells to take up multifunctional SPIONs in human cells in culture: are there membrane molecules involved?
- Specific adsorption of SPIONs to targeted subcellular components after uptake
- Transport of drugs, plasmids or other substances to specific cells followed by controlled release
- Separation of SPIONs from the cells after cell-uptake and specific adsorption to subcellular components or to biomolecules like proteins without interfering with cell function
- Prevention of uncontrolled agglomeration of modified SPION's in physiological liquids
- Short and long-term impact on cell functions by loading cells of different phenotypes with such nanoparticles

This book chapter gives a short overview of the research results achieved in the last years as well as the research activities in progress, especially in regard to SPIONs developed at our laboratory. For completeness and thorough understanding of our approach, the information about the physical background of superparamagnetism, the behavior of the particle in a static (permanent) homogeneous, as well as inhomogeneous magnetic field, and the heating in alternating magnetic fields is important in this context. The synthesis of these nanoparticles, the choice and fabrication of their coating and functionalization indispensable and responsible for the properties and biological behavior of the nanoparticles will be discussed and, last but not least, the variety of applications in which the authors are performing their research will be reviewed.

## **2. Superparamagnetic particles**

### **2.1. Superparamagnetism**

Magnetic materials encompass a wide variety of materials and are classified in terms of their magnetic properties and their uses. They are classified by their susceptibility to magnetic fields into diamagnetic materials with weak repulsion from an external magnetic field (negative susceptibility),

paramagnetic materials showing small and positive susceptibility, and ferromagnetic materials which exhibit a large and positive susceptibility to magnetic fields and are known as magnets in the daily life (“horseshoe magnets”). In the first two categories the magnetic properties do not persist if the external magnetic field is removed, while for ferromagnetic materials, which exhibit strong attraction to magnetic fields, these properties are stable even after removal of the external field.

If a sufficiently large magnetic field is applied, the spins within the material align with the field. The maximum value of magnetization achieved in this state is called the saturation magnetization,  $M_S$ . As the magnitude of the field decreases, spins cease to be aligned with the field and the total magnetization decreases. In ferromagnets, a residual magnetic moment remains at zero field. The value of the magnetization at zero field is called the remanent magnetization,  $M_R$ . The magnitude of the field that must be applied in the negative direction to bring the magnetization of the sample back to zero is called the coercive field. Changes in magnetization of a material occur via activation over an energy barrier. If the number of atoms per particles is decreasing, the interaction energy (exchange energy) could reach values as low as the thermal energy  $k_B T$  at room temperature. This leads to a spontaneous random orientation of the magnetic spin inside the particles, or in other words, the remanence magnetisation as well as the coercivity will be zero. This means no hysteresis and therefore paramagnetic behaviour. Such a behaviour could be observed at sizes  $< 20$  nm for iron oxide  $\gamma$  Fe<sub>2</sub>O<sub>3</sub>; Maghemite) or at 3 nm for pure iron. The saturation magnetisation reaches values of 90% of the bulk ferromagnetic material. This lower value is explained by the magnetically inactive first atomic layer at the surface of the particles. This layer, also existing in bulk material, has a non-negligible volume in small particles. The superparamagnetic behaviour is characterised by a typical relaxation time  $\tau$ ; the time which the systems need to achieve zero magnetisation after an external magnetic field is switched off:

$$\tau = \tau_0 \cdot \exp(KV/k_B T) \quad (1)$$

where  $\tau_0$  is the characteristic time ( $10^{-9}$  s),  $K$  is the anisotropy energy ( $20'000$  J/m<sup>3</sup> for iron oxide) and  $V$  the volume of the particle:  $k_B$  is the Boltzmann constant,  $T$  is the temperature.

Another effect which occurs only in such small sized crystallites is the presence of energy absorption in superparamagnetic particles due to Néel relaxation. If the magnetic domains, fixed within the particles, are directed to an alternating external magnetic field, the magnetic dipole moments of the

nanosized crystals have to be reoriented very quickly depending on the frequency and magnetic strength of the applied magnetic field, the size of the particles as well as the environmental temperature. The loss power of the particles is used to heat the surrounding environment, e.g. a tissue.

## 2.2. Physical properties of SPION

In this chapter, the behaviour of the particles in static (permanent) homogeneous as well as inhomogeneous magnetic fields and the heating in alternate magnetic field will be presented. Also, the colloidal properties of nanoparticles will be shortly discussed.

In a permanent magnetic field, the particles will be magnetized up to saturation magnetization. Each particle is a single domain magnet which influences the local magnetic field. This leads to a magnetic dipole-dipole interaction between the particles in such a manner that the particles are aligned following the field lines of the permanent external magnet. Perpendicular to the aligned magnetized particles a repulsive force exists. Because the attractive force depends on the number of particles in the chain, normally not more than 50 to 100 particles built-up a chain in the liquid (Fig. 1).

In a permanent magnetic field which shows a field gradient in  $z$  direction, a force  $F_m$  is acting on the magnetized particles:



**Figure 1.** Magnetic beads ( $1 \mu\text{m}$ ) in a permanent magnetic field with a low field gradient.

$$F_m(z) = \frac{4\pi}{3} r_m^3 \nabla (\vec{M}(z) \vec{B}(z)) \quad (2)$$

where  $r_m$  is the radius of the magnetic part of the particle,  $M$  the magnetization of the particle and  $B$  the magnetic flux. This magnetic force leads to an acceleration of the particles in the direction of increasing field strengths. In a liquid, the movement is hindered by a viscous drag (Stokes Force,  $F_s$ ), expressed by the following equation:

$$F_s = 6\pi\eta r_h v \quad (3)$$

where  $\eta$  is the viscosity of the liquid,  $r_h$  is the hydrodynamic radius of the particle and  $v$  is the velocity of the particles. It is important to note that the hydrodynamic radius of the particles could be much larger than the magnetic diameter of the particles, this is especially the case if the particles are coated with polymers and proteins (typical values:  $r_m = 5\text{ nm}$ ,  $r_h > 20\text{ nm}$ ). In the steady state,  $F_m = F_s$ , the velocity of the particles can be calculated easily. A typical velocity in a gel type environment is  $2\ \mu\text{m}/\text{min}$ .

In an alternating magnetic field at low frequencies (1 – 100 Hz), the particles can follow the changing forces and a rotational or oscillating movement is initiated. More interestingly are frequencies between 100 kHz and several MHz. For these frequencies, the magnetic dipole is changing, inducing a change in the local magnetic field. Because the magnetic dipole can not follow the external magnetic field changes without a time lag (see relaxation time equation 1) the complex part of the susceptibility is increasing and not negligible. This complex part leads to a loss of magnetic energy and heats up the particles and environment. Two types of relaxation exist in the field of nanoparticles: Brownian relaxation where the particles rotate, or the Néel relaxation. In the latter case the particles are fixed and the direction of magnetization inside the particles is changing. For particles smaller than 20 nm, only the Néel relaxation is of importance. Fig. 2 shows the loss power as calculated using equation 4.

$$P = \frac{(mH\omega\tau)^2}{[2\tau k_B T V (1 + \omega^2 \tau^2)]}, \quad \text{with } \omega = 2\pi f. \quad (4)$$

The maximum loss of power could be reached with small particles and high frequency.

Besides the magnetic properties, the colloidal properties are of high importance, especially if the particles are intended for an application in

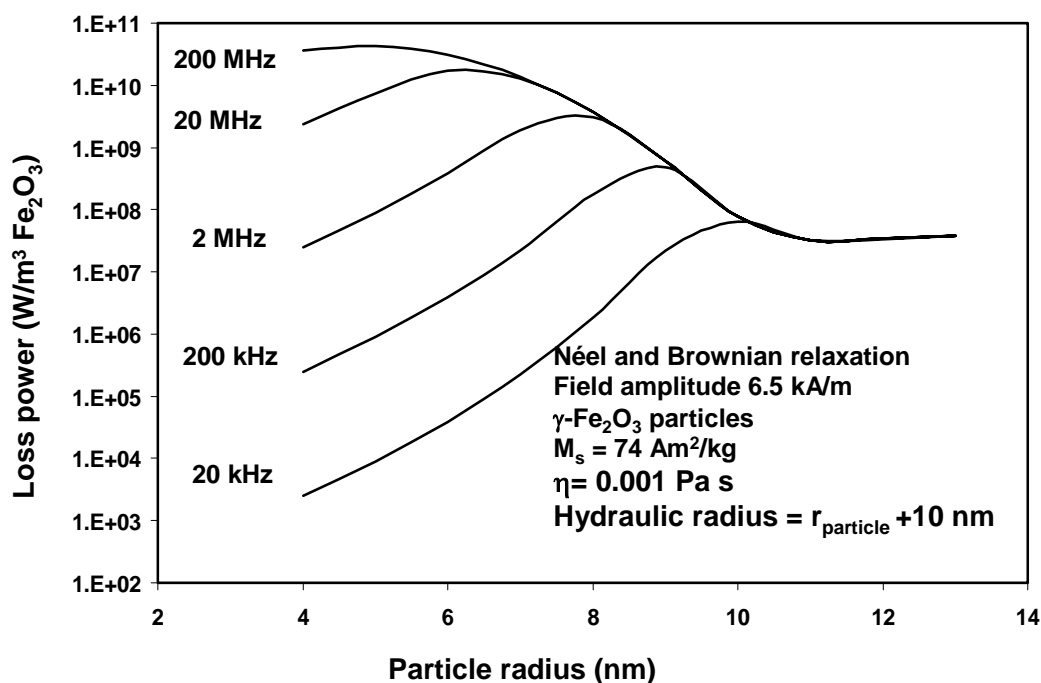

**Figure 2.** Loss of power as function of particle size and frequency of the applied alternate magnetic field.

physiological fluids. The attractive van der Waals force is always present and of a constant value, whereas the repulsive forces, like electrostatic or steric forces, depends strongly on the ionic strengths, pH-value and the type and conformation of the adsorbed polymers and biological molecules. According to preliminary data of our laboratory, we can say that in cell media and similar liquids with high ionic strength the double layer will be very small and therefore steric stabilisation is most important. Because no proven theory exists for the detailed modeling of the behavior of complex coated particles in physiological liquids, we have undertaken first phenomenological investigation of the behavior of such particles measuring the agglomeration rate in different cell media with serum or without serum.

### 2.2.1. Properties of nanoparticles in different biological solutions

The stability of nanoparticles is not only dependent on the coating itself but how it relates to the biological environment. Particles can agglomerate through contact with proteins and by this may provoke changes regarding cell internalisation or attachment and cytotoxicity. Turbidity measurement and photon correlation spectroscopy (PCS) have been used to examine the agglomeration of Polyvinyl alcohol coated nanoparticles (PVA-SPION) Vinyl alcohol/vinyl amine copolymer coated particles (A-PVA-SPION), and

those coated with polyethylenimine (PEI-SPION). While uncoated SPIONs agglomerate immediately in PBS and biological fluids, the investigated polymer coated SPIONs were absolutely stable in water and in PBS for months and over a pH range of 3–11 without showing any signs of agglomeration. However, using such particles in cell media such as RPMI and DMEM, both in presence and absence of 10% fetal calf serum (FCS), changes the behaviour of the particles and lead to different agglomeration behaviour when the particles are exposed to such media for more than 30 minutes. The A-PVA-SPIONs with a mean diameter of 40 nm (as all other SPIONs used in this investigation) showed in DMEM supplemented with FCS their initial size up to nine days (maximum time observed). A-PVA-SPIONs. used in DMEM only showed a stable particle size during the first hour but increased their diameters up to 110 nm after 2 h. PEI-SPION beads agglomerated immediately in the presence of fetal calf serum whereas they remained stable in all media without FCS and no change in the turbidity and bead size could be observed within 2 h [17]. The agglomeration behavior of nanoparticles in simulated body fluids as well as the knowledge on cell viability (cytotoxicity) for different cells determines the use of these particles for *in-vivo* application.

## 2.3. Materials and synthesis

### 2.3.1. Synthesis of coated SPION

Synthesis and coating of nanoparticles becomes a determining step in the further use of nanoparticles *in-vivo* and *in-vitro*. The potential toxicity of such material is not only related to their nanosize nature but especially to their surface properties, which is the determining factor for cellular uptake and cytotoxicity, whereas the type of particle does not seem to play such an important role [see <sup>17</sup>Fink *et al.*].

The colloidal stability and behaviour of nanoparticles in suspensions can be tailored and is related to the pH, additives in the solution as in cell media or body fluids, their viscosity and any other fluidic properties. Long range, attractive van der Waals forces are ubiquitous between such nanoparticles and must be balanced by Coulombic, steric, or other repulsive interactions to engineer the desired degree of colloidal stability. Beside a long term stability demanded for nanoparticle suspensions for use in biomedical applications, guarantees for a high quality in the particle production like small particle size distribution and constant coating properties are required. In a second step, the nanoparticles have to be tailored to render their performance in a specific biological environment, i.e. either to attach or to enter cells in case of drug targeting, gene transfection or for long time persistence within the blood



stream for MRI applications (blood-pool contrast agent). An overview on some current polymer coating materials is shown in the article of A.K. Gupta and M. Gupta, 2005 [see Ref 11], as well as other references dealing with different other polymer coatings among which are polysaccharides (dextran, starch and chitosan) [18,23], polyvinyl alcohol [19,20], poly(L-lysine) (PLL) [see Ref 3], starch derivatives with phosphate groups to bound mitoxantrone as chemotherapeutikum [21], and inorganic coatings like silica, or gold. All these coatings serve for further derivatization of the particles by ligands, such as peptide sequences conjugated to the nanoparticle surface to facilitate receptor-mediated endocytosis or phagocytosis, or proteins and antibodies to bind to biological receptors [25].

The commonly used multi-step liquid phase synthesis of SPIONs is time consuming and laborious because each additional reaction on the particle surface is followed by a purification step such as magnetic sedimentation, size exclusion chromatography, or dialysis. In addition, repeated magnetic sedimentation of the SPIONs may cause irreversible agglomeration of the nanoparticles. Although ultrasonication is often applied to dissociate the bead agglomerations, it may cause damage to the bound bio-active molecules, resulting in an overall decrease of their biological activity. The use of size exclusion chromatography in repeatedly multi-step modification results in dilution of the particles upon each purification step and in a loss of particle on the column.

In order to bypass the need for repeated purification and to assure continuous working processes, we immobilized SPIONs as a stationary solid phase in a column by a high gradient permanent magnetic field. For functionalization of the immobilized particles during solid phase synthesis, the chemical reagent is conducted over the SPIONs as solid support. Although solid phase synthesis on polymer support is widely described, to our knowledge the solid phase multi-step biofunctionalization of SPIONs in a magnetic fixed bed reactor has never been shown.

In this magnetic fixed bed reactor the immobilization of the magnetic particles is based on the attractive force exerted by a magnetic field gradient (Fig. 3.) We have developed a fixed bed reactor with a quadruple arrangement of magnets for the (bio)-modification of SPIONs. The immobilisation of SPIONs onto the fixed bed reactor and the subsequent functionalization of SPIONs are shown by different examples. We demonstrated that surface derivatization on SPIONs was made directly within this setup (Fig. 4).

Our data indicated that the efficiencies, product qualities, the low agglomeration, and recovery rates of the functionalized nanoparticles produced by solid phase synthesis were superior to those obtained by synthesis

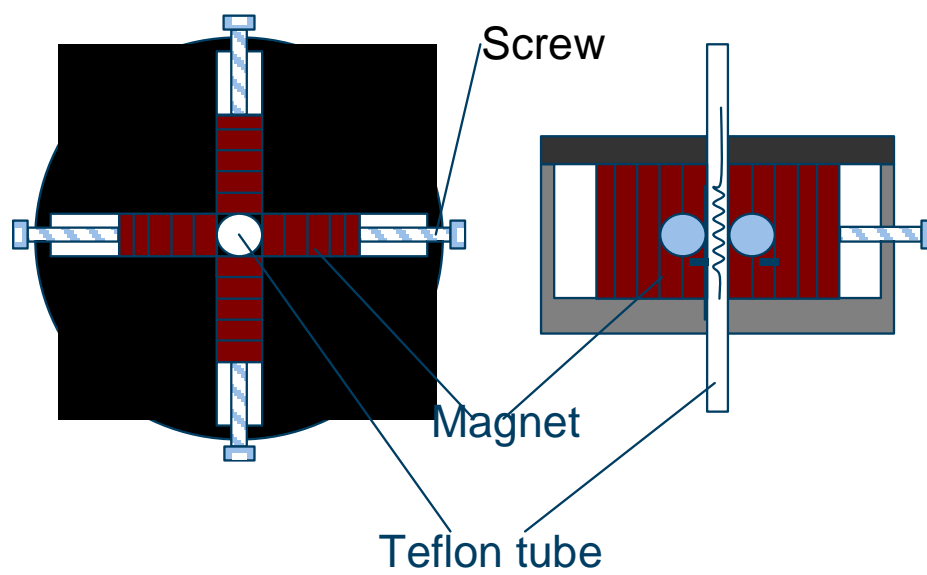

**Figure 3.** Layout of the reactor for coating SPIONs.

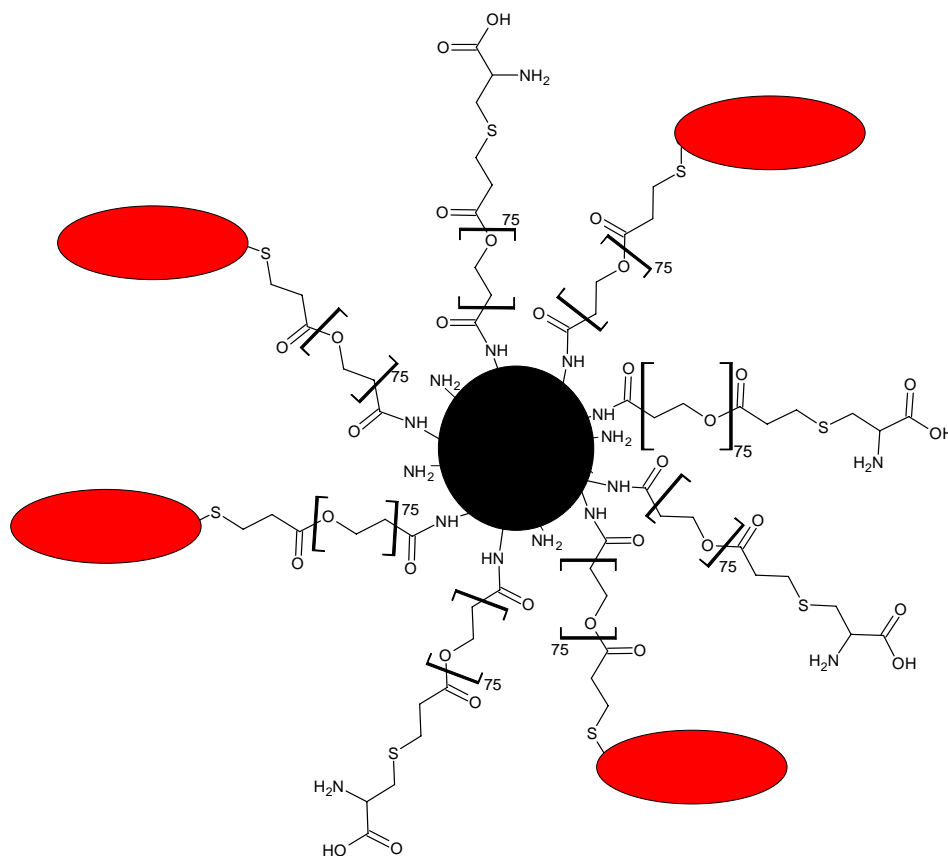

**Figure 4.** Structure of a typical SPION particle coated with a polymer, functional groups, linkers, fluorophores and peptides.

in the normal liquid phase. Such equipment allows for a semi automated coating of SPION including in-situ synthesis of peptides.

### 3. Applications in the biomedical field

The transdisciplinarity of basic and translational research carried out in nanotechnology during the last decades lead to a broad field of novel applications for nanoparticles; those for iron oxide particles with various coatings has been practiced for nearly 40 years in *in-vitro* diagnostics [26]. However novel biomedical fields of *in-vivo* applications further challenge nanoparticle development because of their double role: they are small enough to be transported within the blood stream or lymphatic system, but they may be attached to cells or even enter a cell and be transported by cells. If combined with drugs or genes, these particles may change the viability of or the transcription processes in cells which render them interesting for the pharmaceutical industry and for cell biology. But it raises the question about secondary effects of these particles on their passage through the human body. Nanoparticles have to be highly specific, efficient, and should be rapidly internalized by the target cells, which is limited by several factors [27] [see also Ref 21]: “(i) nanoparticle aggregation (nanoparticles have a large surface/volume ratio and tend to agglomerate); (ii) the short half-life of the particles in blood circulation (when nanoparticles agglomerate, or adsorb plasma proteins, they are quickly eliminated from the bloodstream by macrophages of the mononuclear phagocyte system before they can reach the target cells); (iii) the low efficiency of the intracellular uptake of nanoparticles; and (iv) nonspecific targeting.” The coating and functionalization of such particles described in the last section is therefore decisive for their specific application and their biocompatibility in the human body.

#### 3.1. Imaging

For many years, supermagnetic nanoparticles have been used in diagnostics as contrast agent in magnetic resonance imaging (MRI) and magnetic resonance angiography (MRA) [28,29,30]. To fulfill the requirements of improved enhancement, the substances used must be magnetically active. Negative enhancers - like most of the diamagnetic materials - have only a negligible effect on the MR signals. Instead, paramagnetic materials, like different compounds containing iron or lanthanide or ions like (gadolinium, manganese, dysprosium,) show positive enhancement by due to their unpaired electrons resulting in a positive susceptibility. They shorten the longitudinal relaxation time  $T_1$ , while e.g.

dysprosium predominantly shortens the transverse relaxation time  $T_2$ . The large magnetic moment of SPIONs at sizes of 5 to 10 nm creates large magnetic field heterogeneity through which water molecules diffuse by inducing dephasing of the proton magnetic moments that forms the data for MR images [31]. These SPIONs are mostly used because of their negative enhancement effect on the  $T_2$  relaxation time. The transport of most of the contrast agents is by intravenous administration, which determines the size of the nanoparticles. For successful delivery, the particles have to pass through the vascular capillary wall. While e.g. Gd ion – polymer complexes are of small size ( $\leq 10$  nm), the size of the coated SPIONs can be up to 100 nm and the delivery of these nanoparticles to the targeted tissue is more problematic. Depending on their size, charge and the configuration of the coating these particles are metabolized by the reticuloendothelial system (RES) consisting of monocytes and macrophages. These cells accumulate in lymph nodes and the spleen as well as in the liver (Kupfer cells) and are favored for the uptake of SPIONs and influence the delivery time and the diffusion to certain tissues. Smaller particles generally circulate longer and are taken up by cells of the lymphatic system and bone marrow while particles  $> 50$  nm are taken up by liver cells [32]. If particles are not entirely captured by the liver and spleen, they are widely evaluated as potential marker of inflammation for the diagnosis of inflammatory and degenerative disorders associated with high macrophage phagocytic activity like for plaque imaging or brain ischemia [33], [see Ref 14]. SPIONs are used in tumor detection, as the tumor lesions exclude the uptake of particles (tissue in MRI remains bright) while the macrophages in the normal liver tissue will take up the particles and darken the image of the tissue [34]. Other applications in MRI are the use of such particles to track stem cells transplanted into organs such as brain or to demonstrate macrophage activity within atherosclerotic plaque [35].

### **3.1.1. Imaging of atherosclerosis**

Research on the use of SPIONs for the detection of atherosclerotic plaques by MRI has been undertaken by the Powder Technology Laboratory, Swiss Federal Institute of Technology (EPFL), Lausanne, Switzerland in collaboration with the Department of Cardiology and Angiology, University of Freiburg, Freiburg, Germany. Monocytes, as precursor cells of macrophages, promote atherosclerosis by secreting mediators and are in highly active state of phagocytosis and secretion of cytokines and chemokines. Before the rupture of atherosclerotic lesions, they show an accumulation of macrophages. The phagocytosis of SPIONs by macrophages may therefore act as a potential marker of inflammation for plaque imaging. For

this study, MAC-1 expressing chinese hamster ovary (CHO) cells, expressing MAC-1 either in a native, low affinity state (wildtype, WT) or a high affinity state (GFFKR-deleted cells, DEL) were used to simulate the type of activated macrophages found in atherosclerotic plaques. CHO-cells not expressing MAC-1 were used as controls (NCHO). These cells were grown for 24 h at 38°C in a cell incubator, washed and then either incubated with or without CD11b-blocking monoclonal antibody 2LPM 19c and finally amino PVA-SPIONs were added to the cells and incubated for another 24 hours. Cell growth and viability was not influenced by the incubation with SPIONs (details of the study are shown in ref. 14). Those cell lines expressing the MAC-1-receptor showed higher signal values compared to natural CHO cells, and the activated receptor in the DEL cell lines raises the signal extinction in a significant manner. It can also be shown that MAC-1 expressing cells incubated with CD11b-antibody constantly show lower signal extinction than those without CD11b-antibody. The studies identified the integrin MAC-1 (CD 11b/CD18) as a mediator for the superparamagnetic iron oxide nanoparticles to endocytose into monocytes/macrophages and showed that MAC-1 is also a central mediator of inflammation. Dextran-coated particles, which are mostly used as contrast agents, are commonly attached to cells but not taken up by them, while SPIONs coated with amino-functionalized polyvinyl alcohols interact with different cells [see also Ref 19] [36] and therefore underline a receptor based uptake of SPIONs by cells, which could be further supported through these experiments.

### **3.2. Drug delivery and gene transfection**

The research on targeted drug delivery and gene transfection is motivated by the clinical need for a selective targeting of drugs and improved precise control of drug delivery kinetics, especially for drugs with low bioavailability, therapeutic indices, solubility and circulating half-time. Nanoparticles are very promising in this respect, particularly those with a hydrophilic surface because they can escape the uptake macrophages and reticuloendothelial systems (RES) in tissue and the lymphatic and blood system. The particles can also be functionalized by a biological molecule to be recognized as signal for targeted cells. This can be accomplished by using the unique properties of superparamagnetic iron oxide particles only available in their nano-scale structures. The polymeric coating component in overall development provides versatile chemical functionalization to optimize both drug delivery dosage regimens for local drug therapy and the ligands for targeting modes as well.

### **3.2.1. Drug delivery**

The use of magnetic particles in the treatment of cancer is less focused on the delivery of drugs and more on their use as a new therapeutic concept in which tumor cells are damaged by applying local heat through an external magnetic field. This application called hyperthermia will be discussed in chapter 3.5.1. Other aspects of cancer treatment is the early detection of metastasis of tumor cells, which involves nearly half of all cancers, and the occurrence of toxic side effects on systemically given anti-cancer chemotherapeutics. Using targeted drug delivery vehicles like nanoparticles, this shortcoming may be overcome as the drug will be carried directly to the tumor site which limits the exposure time to healthy tissue and organs and may also protect these drugs from early biodegradation. A further requirement for safe use of such targeted drug delivery is to target drugs to specific body sites and control the release of drugs for prolonged periods of time. The review on anticancer agents based on nanoparticles by Zamboni [37] gives a nice overview of agents which are used today or which are in further development. Most of them are based either on liposomes, so called nanosomes, dendrimers and nanospheres as subclass of nanoparticles. All these materials and formulations are chosen to provide a selective delivery of conventional and new genetic drugs [38], to preferably accumulate in tumor tissues and show a better solubility combined with a defined release protocol, as well as to have the potential to overcome resistance associated with the regular anticancer agent. Several nanobased drugs are already approved, others using new genetic based drugs like plasmid DNA-containing therapeutic genes, antisense oligonucleotides, and small, interfering RNA [siRNA] are still under development [39]. Magnetic nanoparticles, which can also be bound to drugs, have an additional value as they can be trapped at the target site by an external magnetic field. The hope that injecting magnetic nanoparticles combined with the targeting molecules, such as proteins or antibodies, and to direct them to any cell, tissue or tumor in the body is unrealistic today as the magnetic force is not high enough to guide the particles through the blood system. However, if used with cell specific molecules like other nanoparticle based formulations, these magnetic particles have the additional function to be visualized by MRI in the targeted tissue. This function helps not only for early detection but also in view of personalized medicine.

### **Drug delivery in joint diseases**

Magnetic drug targeting using superparamagnetic iron oxide particles (SPION) as carrier systems is attractive for the application in those parts of the body accessible with targeting magnetic fields showing locally high field

gradients. Therefore, SPIONs have been developed for therapy of joint diseases in human and animals. Conventional systemic and/or intraarticular therapies are normally associated with negative side effects of the drugs, such as nephrotoxicity, hepatic and gastric problems, especially in cases where prolonged therapy is necessary. But problems also arise with short term applications, such as the inability to maintain effective drug concentrations within the joint due to increased production of synovial fluid, its more rapid filtration through the joint membrane and elution into the vascular system. Therefore the aim is to increase the residence time of SPION through the application of high magnetic field gradients in the joint area by applying extracorporal magnets. Additionally protracted drug release could be achieved using functionalization with conjugated drug formulations. This combination could be the preferred method of choice for therapeutic application in chronic and acute joint affections (eg. synovitis, intraarticular trauma, rheumatoid arthritis, etc.). The goal of our consecutive studies in sheep was a “proof of principle” that intraarticular application of functionalized SPION is possible, safe and that the use of extracorporal magnets enhances their effect *in situ*.

Tissue involved in joint disease mainly consists of synovial membrane, capsular tissue, hyaline cartilage and subchondral bone, where synoviocytes, chondrocytes and osteoblasts play a major role. These cells originate from the mesoderm in embryogenesis and, depending on the environment, will differentiate into their final cell lineage. Chronic inflammation may lead to de-differentiation (e.g. fibrous tissue) which is normally associated with loss of function, which is detrimental to the overall functionality of the joint. Hyaline cartilage degenerates into fibrocartilage and bone resorption and additionally osteophyte formation changes the bone structures of joints. Furthermore, excessive fibrosis of the fibrous capsule and within the joints occurs, incapacitating normal joint function through limitation of flexion and extension. Therefore, it was important to clarify biocompatibility issues of SPION before they could be applied in living animals. Furthermore, if animal experiments were to be conducted, a reliable detection system had to be developed to track the particles within the joint itself as well as systemically. This was also important to study their distribution and elimination from the body system concerning safety issues.

In preliminary experiments with ovine synoviocytes, chondrocytes and osteoblasts, it was shown in routine cell cultures that plain polyvinyl alcohol coated SPION obtained by classical co-precipitation in water (Mowiol®, MW 12,000, Clariant) at a concentration of 5 mg/ml were well tolerated by synoviocytes, chondrocytes and osteoblasts and no up-regulation of inflammatory mediators occurred. Cellular uptake of SPION could be well

detected with special iron stains using Prussian Blue (Fe<sup>3+</sup>) and Turnbulls (Fe<sup>2+</sup>). SPION up-take over time was enhanced over time if magnets were placed under the cell culture vials for 12 hours (magnetic flux density 220mT at cell level, magnetization of particles 35Am<sup>2</sup>/kg). Cell viability at this concentration was 98% in all cell types and cell morphology was normal if plain PVA coated SPIONs were used. The main cellular up-take of SPION took place between 12 and 48 hours, when the cytoplasm was full with slightly aggregated SPION while still maintaining normal cell morphology. Detection of SPION using the special stains was reliable if compared to controls incubated without particles. While up-take was similar in synoviocytes, chondrocytes and osteoblasts, sensitivity was highest in synoviocytes when different concentrations of amino-vinyl amine copolymer PVA coated particles were used.

In a next step, functionalization of the PVA-vinyl coated SPION with fluorescence dyes was successfully performed and cellular up-take in synoviocytes repeated. The fluorescence dyes Cy3.5 and PVA-Texas Red were used *in vitro*. Synoviocytes, as the most sensitive cell types, were again chosen for proof of principle to deliver functionalized particles to the cytoplasm. With these experiments, it was demonstrated that functionalized particles were also taken up by synoviocytes and that external magnets enhanced delivery (NdFeB-permanent magnet, remanence field 1.3T, magnetic field at cell area 100 mT, field gradient 7T/m). Cy3.5 proved superior to Texas-Red for confocal microscopy, where cells were counterstained with Hoechst 33342 showed that nuclei were tightly surrounded by functionalized particles within the cytoplasm, but no SPION penetrated the nuclear membrane. Uptake was seen as early as 3 hours after incubation and, as with plain PVA-coated SPION, at 24 hours most of the cytoplasm was filled with fluorescent particles (Fig. 5). Flow cytometry confirmed macroscopical findings, that the majority of cells (ca. 82%) were positive for fluorescent signals.

With these results, *in vivo* experiments with intraarticular application of plain and with Cy3.5 functionalized particles were conducted. PVA-coated and amino-PVA Cy3.5-SPION at a concentration of 5 mg Fe/ml were injected into carpometaphalangeal (1.0 ml) and stifle joints (2.0 ml) of sheep under anesthesia. Tests were performed with and without extracorporeal magnets (NdFeB-permanent magnets, 1.3T) to test their influence *in vivo* (Fig. 6). The magnets were placed in pockets of specially designed bandages that were additionally sutured to the skin at the lateral (stifle) or dorsal (carpometaphalangeal) aspect of the joints. Similar to the *in vitro* experiments, uptake of SPION was followed over time and sheep were sacrificed at 3, 24, 72



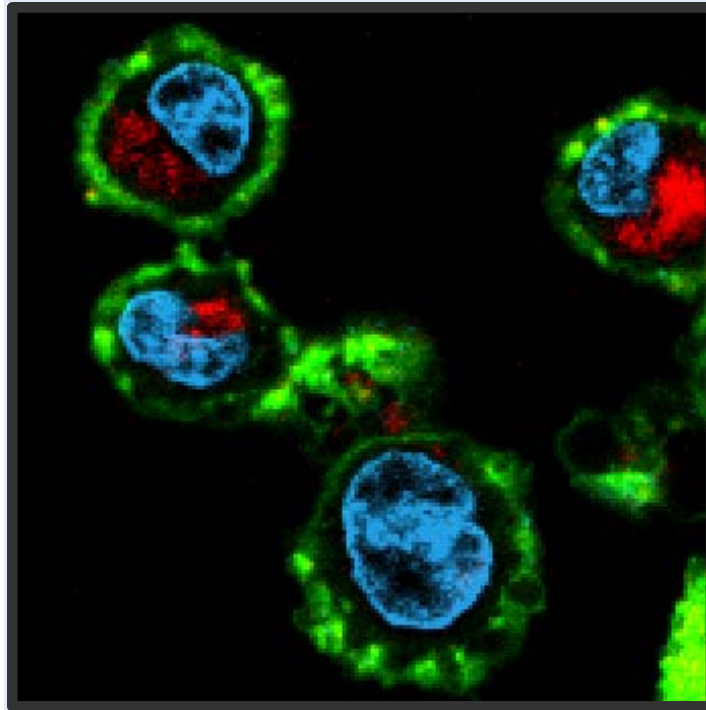
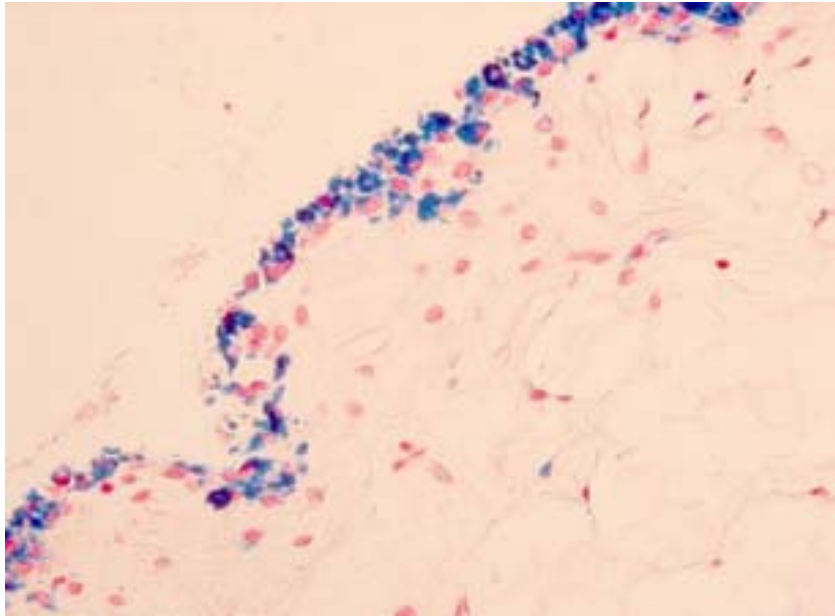

**Figure 5.** SPIONs labeled with Cy3.5 taken up by cells (microglia) can be visualized by confocal microscope (Photo: McGill University, Montreal, Canada).

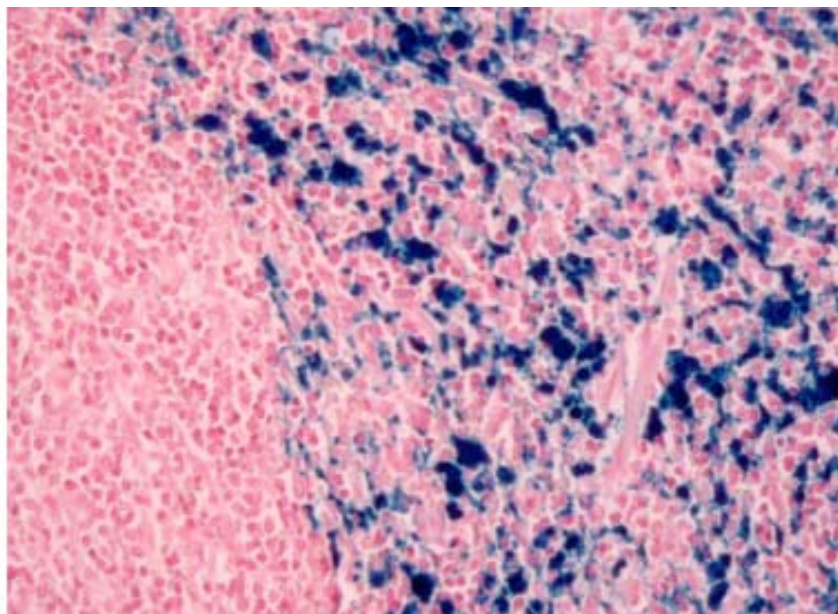

**Figure 6.** In vivo setup: Particles were injected in the joint of the sheep and were maintained at injection site by permanent magnets (blue pouches).

and 120 hours after injection (Fig. 7 and Fig. 8). Results demonstrated good biocompatibility of both plain and amino-PVA Cy3.5 SPION, although the latter showed a mild inflammatory reaction within the synovial membrane, which subsided in all instances at 120 hours. The hyaline cartilage surface appeared normal at all time periods. Macroscopical inspection revealed a



**Figure 7.** SPION (Blue) attached and up-taken by synovial cells.



**Figure 8.** SPION in the spleen after 3 h of injection of the particles into the joint.

more local concentration of SPION in the tissue if extracorporeal magnets were applied. Histologically, cellular uptake of SPION was demonstrated for the synovial membrane and joint capsule, but not for chondrocytes of hyaline cartilage or subchondral bone. SPION uptake in the intima was increased with magnets in place, whereas in the subintimal fibrous tissue (joint capsule) concentrations were decreased. Inflammatory responses were minimal, peaking at 24 h and were only related to the functionalized particles, where the fluorescent dye Cy3.5 was thought to be responsible. Furthermore, if magnets were applied, the inflammatory signs were less and more localized. Fluorescence within the tissue was more wide spread without extracorporeal magnets, but more localized if magnets were present. It was highest at 72 and 120 hours, when most particles had been internalized within the cytoplasm. Generally, functionalized particle uptake was less and peaked at a later time point compared to plain PVA-coated particles, which was attributed to stereometrical hindrance of larger particles and thus, slower uptake.

The distribution and elimination of SPION were also followed on a systemic level. For this, tissues of the sheep used for the intraarticular experiments were harvested from the neighboring inguinal, respectively axillary lymph nodes, from the liver, spleen, gall bladder, lungs, kidneys and urinary bladder. Samples were prepared for routine paraffin histology and stained with hematoxylin eosin (HE) to assess normal histomorphology, and Prussian blue as well as Turnbells to detect SPION within the tissue. SPION could be easily detected in histology sections of the lymph nodes, liver, spleen and kidneys, but not in the lungs, gall or urinary bladder. No histopathological changes were visible in all organ systems.

The detection of SPION was also followed over time (3, 24, 72 and 120 hours) and an interesting distribution pattern was detected. While it was well known that SPION were eliminated through the reticuloendothelial system, it was never described that SPION were first excreted within the primary urine through the glomerular filtration system of the kidneys and then reabsorbed in the proximal tubuli, after which they were transported to the liver and the spleen. In the liver, SPION were found clearly accumulated in the liver trias and in the Kupffer cells, whereas in the spleen mainly they were found in the red, but not in the white splenic pulp. Hemosiderin was also stained blue in the liver and the spleen. Nevertheless, the difference in staining intensity was clear between experimental animals and controls.

In conclusion of our experiments, PVA coated and amino-PVA Cy3.5 SPION were proven suitable as drug carriers for intraarticular use and seem attractive for modern treatment modalities in joint disease. Future investigations will focus on functionalization of SPION with chondroprotective or –modulating drugs.

### 3.2.2. Gene transfection

A large number of disorders can be explained or understood with of more detailed genetic information, which can then be used either for early detection of such diseases or even for their treatment. For more than twenty years, methods for targeted delivery of genes have been attempted either by viral or non-viral carriers. However the use of viral vectors has its limitations and several cases with severe side effects were observed [39]. Three adverse events occurred in a human gene transfer study involving “engraftment of an autologous bone marrow derived, CD34<sup>+</sup> hematopoietic stem cell enriched, cell population transduced with a Moloney murine leukemia retrovirus derived replication incompetent vector encoding the common gamma chain ( $\gamma_c$ ) transmembrane protein subunit shared by receptors for Interleukins 2, 4, 7, 9, 15 and 21. Three children in this study developed T-cell acute lymphoblastic leukemia (T-ALL) almost 3 years after their gene therapy treatment.” The US FDA has not yet approved any human gene therapy product for clinical application [40].

Even though viral vectors are the only ones successfully expressing genes *in vivo*, such problems mentioned in this former study, which are also not based on a single event, show the limitations of the viral gene transfer. Furthermore, viral vectors are immunogenic and may result in the production of neutralizing antibodies by the host and other inflammatory responses [see Ref 40]. Therefore, the development has been strongly focused on nonviral tools like nanoparticles complemented with DNA, plasmids or interfering RNA (RNAi). Most of the nanoparticles are positively charged to penetrate the cell membrane or need a cell surface membrane receptor that then brings the vector inside the cell [41]. Despite many years of research, the poor transfection rate in comparison to viral transfection limits the application of non-viral gene therapies *in vivo*. Yi-Yan Yang et al. [see Ref 40], show that various natural and synthetic materials can be used and have been further developed as non-viral gene vectors, e.g. cationic liposomes, cationic polymer and different inorganic nanoparticles like silica based nanoparticles, carbon nanotubes or metal nanorods. The authors show that cationic polymer nanoparticles are the most attractive because they can be synthesized and functionalized depending on the requirements for the different mechanism of internalization.

#### Non-viral gene transfer by SPION

After positive results using SPION as carrier system for drug delivery into the joint, an attempt was made to use the same nanoparticles as non-viral vectors for delivery of DNA or DNA fragments to the joint. For this experiment, coating and functionalization had to be adapted. As proof of

principle, transfection coding for green fluorescent protein (pEGFP-C2 plasmid) was performed *in vitro* using a pulsed magnetic field (0 to 30 mT, 1 Hz) for enhancing transfection efficiency in several cell lines. In contrast to our previous experiments, SPION were coated with polyethylenimines (PEI) that were shown reliable for condensing DNA and RNA into stable complexes by means of electrostatic interactions and protecting the nucleic acids from degradation by cellular polymerases within the tissues. PEI polyplexes allows uptake through endocytosis into endosomes that, after swelling, burst and release the nucleotide complexes into the cytoplasm, whereby the DNA translocates into the nucleus.

SPION were prepared by alkaline co-precipitation of ferric and ferrous chlorides in aqueous solution as earlier reported [42]. The pEFG-C2 plasmid was introduced into *Escherichia coli*, where DNA was purified using Maxiprep plasmid kits (Quiagen). PCR products from pEFG-C2 plasmid were amplified using primers designed to include the 5'human cytomegalovirus (CMV) immediate early promoter and a 3'SV40 early mRNA polyadenylation signal (forward primer; 5'CCG TAT TAC CGC CAT GCA T-3'; reverse primer: 5'GCC GAT TTC GGC CTA TTG GT-3').

Primary ovine synovial cells were collected from sheep that were sacrificed at the University's own slaughter facility, isolated and proliferated in 2-3 cell passages. HeLa (human cervix carcinoma cells) 293T and Cos7 (fibroblasts) were commercially available cell lines serving as controls. After routine cell seeding and proliferation including cell passages, cells were transfected with PEI coated SPION functionalized with DNA (5 $\mu$ g DNA/well) resp. PCR products (5 $\mu$ g/well). PEI (20% w/w, diluted 1:1000 in PBS, 10 $\mu$ m DNA/well) alone, lipofectamine (Invitrogen, 2.5 $\mu$ g DNA/well) or calcium phosphate transfection (10 $\mu$ g DNA/well) served as controls. Cell cultures were placed on a static NdFeB permanent magnet for 20 minutes (magnetic flux density 250mT, magnetic field gradient 10T/m in the cell area), and part of the groups were additionally exposed to a pulsed magnetic field (Dynamic Magnetic Field Generator, MatSearch, Switzerland; stationary wave of sinus type, max. amplitude 27mT, field gradient 10mT) 5 minutes before or after placing the vials on the magnetic field. Transfection was verified with a fluorescence microscope after trypsination with flow cytometry.

Transfection was possible with PEI-coated SPION in all cell types including ovine synoviocytes (ca. 73.%), but was higher when static magnets were applied (7-10 fold increase). When a pulsed magnetic field was created, a gradual temperature increase was recorded (37-42.5°) on the surface of the generator. Nevertheless, this did not impair cell viability rather, if applied 5 minutes before the static magnet, it increased transfection rates by up to 8-

fold in synoviocytes using PEI-SPION. Increase of transfection in controls was considerably less with lipofectamine and calcium phosphate (1.6-1.8 fold) compared to controls not exposed to magnets. Transfection cells including synoviocytes was also possible using PEI-SPION functionalized with eGFP PCR-products (1.6 kilobase pairs) with static magnets alone. As with plasmids, transfection rates could be still increased when a pulse magnetic field was applied beforehand. Further studies confirmed that pulsed magnetic field enhances transfection with eGFP plasmids in synoviocytes, chondrocytes and osteoblasts in sheep also if other magnetic carriers were used.

After successful transfections of synoviocytes *in vitro* using PEI-coated and eGFP functionalized SPION, animal experiments in sheep were conducted similar to our earlier experiments. PEI coated SPION complexed to plasmids encoding for GFP or dsRED and PEI coated particles were prepared according to Petri-Fink et al [43].

Again functionalized SPION (using 2 DNA concentrations) were injected into stifle and carpometaphalangeal joints with the animal under general anesthesia. Injection was performed with a static magnet (NdFeB) in place for 20 minutes followed by 5 minutes with a pulsed magnetic field. The static magnet was then kept in place for 12 hours using the specially designed magnet bandages before being removed for good. Animals were followed for 24, 72 and 120 hours after particle application. Samples of synovial membranes were harvested and processed for routine and fluorescence histology as described and special stains (Prussian blue, Turnbolls) were used for particle detection within the tissue. In addition, immunohistologic methods on cryosections were applied using antibodies against GFP.

In contrast to our earlier studies *in vitro*, transfection was not achieved at either time period. No fluorescence could be detected neither with GFP nor dsRED. Mild inflammatory reactions seen between 72 and 120 hours indicated diffuse plasmacytic and lymphocytic infiltration of tissue. Inflammatory changes were more pronounced when higher DNA concentrations were used. Furthermore, iron particles were infrequently observed in synovial membranes by special iron stains independent of time periods and despite application of magnets or pulsed magnetic field. Immunohistochemistry of the adjacent inguinal lymph nodes yielded few positive cells for GFP proteins indicating that transfection had occurred, although at a very low level and not as expected in the synovial membrane (unpublished data) but within lymph nodes. Further laboratory tests conducted at the EPFL demonstrated that PEI-coated SPION complexed to plasmids encoded for GFP aggregated immediately if added to fresh synovial



fluid. It was attributed to the positive electric charges of the DNA plasmids and the highly negative charge of the hyaluronic acid of the synovial fluid. This could not be overcome, even if samples were diluted *in vitro* or rigorous joint lavage was performed before the particles were injected into the joint. However, this aggregation explained also the stronger inflammatory response and influx of macrophages in the stifle and carpometaphalangeal joint of the experimental animals.

In the framework of the development of new non-viral gene vectors, novel DNA fragments (PCR products) were synthesized containing only the GFP gene and the 5'human cytomegalovirus (CMV) immediate early promoter and a 3'SV40 early mRNA polyadenylation signal (Institute of Veterinary Biochemistry and Molecular Biology, University of Zürich). When DNA/PEI-SPIONs and DNA/PVA-SPIONs complexes were added to cells that were subsequently exposed to permanent and pulsating magnetic fields, PEI-SPIONs proved to be very efficient gene vectors, more than the conventional non-viral vectors. We could show for the first time that the transfection of PCR products containing only the gene of interest, is also enhanced by combined use of magnets and SPIONs. (Vetsuisse, "Superparamagnetic iron oxide (SPION) nanoparticles for plasmid and protein delivery *in vitro* and *in vivo*: a feasibility study").

The derivatization of the particles with nucleus targeting peptides allows additionally the specific adsorption of the particles at the surface of the nucleus (Fig. 9) or as also shown at other targeted organelles.

Our results show that

- The SPION DDS has the *potential for dual function targeted imaging-delivery nanosystems* and can be locally targeted to specific sites guided by externally applied magnetic fields.
- The SPION remain inactive until application of an external magnetic field, triggering local release of drug from the nanoparticles using a thermosensitive polymer. Injected nanoparticles coated with drugs can be retained at the injected site by external applied magnetic fields where drug is released slowly by diffusion through the polymer layer. Additionally active drug delivery by promoting the cytosolic delivery of particle-drug-nanosystem into the cell where enzymatic action or general hydrolysis can release it.
- The SPION-DDS enables therapeutic and diagnostic effects and thus allows for treatment follow-up by magnetic resonance imaging
- The system can be tailored for *in vivo* cell targeting, cell internalization, and nuclear uptake.

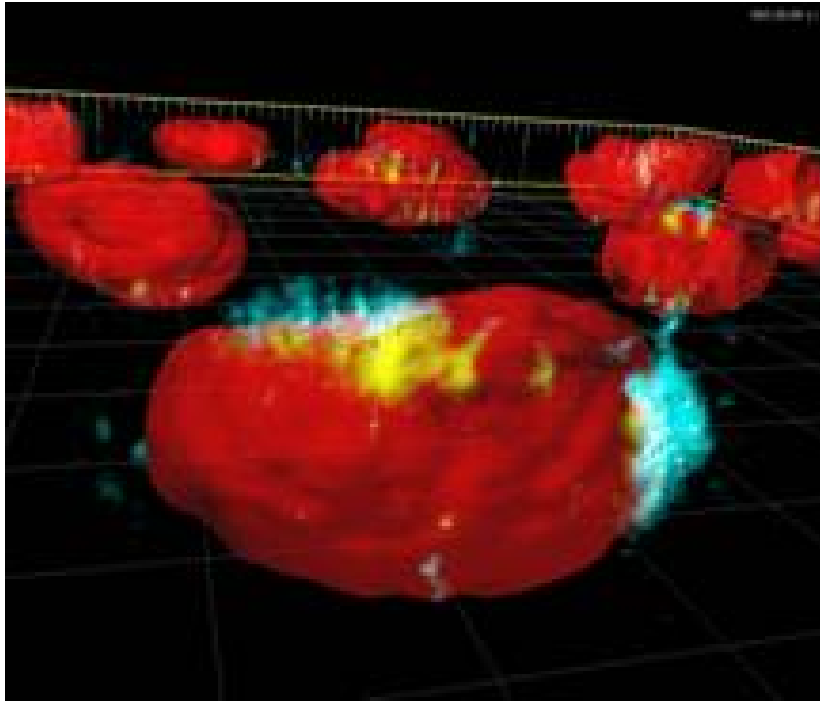

**Figure 9.** SPION Particles derivatized with nucleus targeting peptides at the surface of nucleus. (Photo Confocal microscope, A. Finka).

### 3.3. Effect of Néel relaxation

Magnetic nanoparticles coupled with biological substances have gained attention in a variety of biomedical applications, mostly based on their strong magnetic moment [44]. These particles can induce heat, if a certain concentration in an organ is exposed to a magnetic field. This is called selective ferromagnetic induced hyperthermia or magnetic fluid hyperthermia (MFH). It becomes important in cancer therapy as an additional therapy and will therefore significantly help to avoid or to minimize side effects of chemical or nucleic therapies. In this therapy, cells of a certain type will be heated up to about 43°C, at which temperature they will die. The surrounding tissue is not involved and therefore this method is much more protective than other cancer therapies in which large areas of cells or tissue will be destroyed. Nevertheless, problems were also associated with this type of therapy. Often the magnetic fields were not strong enough and the magnetic particles were too large to give enough heat per unit of particle in the body. Some people died of toxicosis because of the high quantity of iron into the body. Much empirical work was done in order to manifest a therapeutic effect on several types of tumors, and recently clinical tests are carried out by Magforce [45] for the treatment of brain and prostate cancer.



For the hyperthermia treatment, magnetite cationic liposomes [46] or dextran magnetite complex [47] and thermosensitive magnetoliposomes [48] are used. Until now, it was necessary to modify the surface of the core-shell particle for medical applications in order to target them to the specific organ.

### 3.3.1. Hyperthermia

Another approach has been made by the authors, in close cooperation with the Laboratoire de Pharmacie Galénique, Section de Pharmacie, Université de Genève, to overcome problems with the specific cell targeting of single particles for certain cancer treatments. Percutaneous injection of polymethyl-methacrylate (PMMA) into osteolytic lesions [49], has shown tumor cell damage by exothermic effects of the PMMA polymerization. The stabilizing effect of PMMA may be helpful in pain relief and the thermic reaction has an additional tumoricid effect. After applying a temperature raise of 20 °C vertebroplasty tumor necrosis could be observed extending well beyond the site of PMMA implantation (B,C). Such short term hyperthermia effect due to the PMMA polymerization could be even further improved through additional heating due to the interaction of superparamagnetic nanoparticles with an external AC magnetic field. Moreover, this effect can be easily controlled for long-term and adapted to the needs of cancer therapy. Therefore, the authors and in collaboration with researchers at Geneva have developed a new concept for hyperthermic treatment using SPION as heat source. For this development, free particles are encapsulated in bone cement or another polymer, so that this material will be classified by National Health Organisations as a medical device and not as a drug as mentioned in other publications. During polymerization, the hardening cement will provide the first part of energy for the heating of the tumor. In a second step, the superparamagnetic particles will be heated applying an external alternating magnetic field. For particles smaller than 20 nm, superparamagnetic behavior can be observed. Energy input using superparamagnetic particles and a field of 77 kHz and 6.5 kA/m (acceptable by the patient) is high enough to increase the temperature of the cement 7 °C of maximal 1 cm distance from the implant and after a short treatment of 30 to 60 min. The efficiency of the magnetic field, the increase of temperature in the tissue during the MFH therapy, is strongly dependent on the size and shape as well as the effect of biocompatible coatings of the superparamagnetic particles. The most effective particles are monodisperse, showing a diameter of 9 – 12 nm and are elongated in the direction of the easiest magnetization. The biocompatibility is guaranteed by its coating with silica which leads finally to so called micobeads, a composite of silica with a high (30 vol%) iron oxide. Preliminary

result show that *in vitro*, alternating magnetic fields induced a high temperature increase to over 60°C. Taking potential clinical applications into account, an optimal frequency of 141 kHz and a magnetic field strength between 6 and 12 mT were chosen. Mixtures of above mentioned nanoparticles embedded in silica were incorporated at the highest (still injectable) concentration in several embolization formulations. For *in vivo* tests, Swiss nude mice were grafted subcutaneously with human colocal carcinoma Co112. The formed tumor was injected with 0.25 ml of a mixture of poly(ethylene-co-vinyl alcohol) in dimethyl sulfoxide containing 40% nanoparticles embedded in silica. The implant was injected and hyperthermia was performed for 20 minutes the following day, checking continuously peripheral, implanted tumoral and superficial cutaneous temperature by fluoroptic probes. First experiments showed intratumoral equilibrium temperatures of 40.4, 43.0 and 44.5°C with a variability of the measured temperatures smaller than  $\pm 10\%$  at 9, 10 and 10.5 mT, respectively (N = 4 mice per group). Mice were euthanized after two days for standard histology. This short-term protocol addresses mainly hyperthermia cytotoxic effects. Reported intratumoral temperatures correlated with histological results. Clearly, heat induced necrosis occurred when steady-state temperature exceeded 42.5°C (Fig. 10). Together with an industrial investor, the inventor of the system has founded a company for further exploitation of these results.

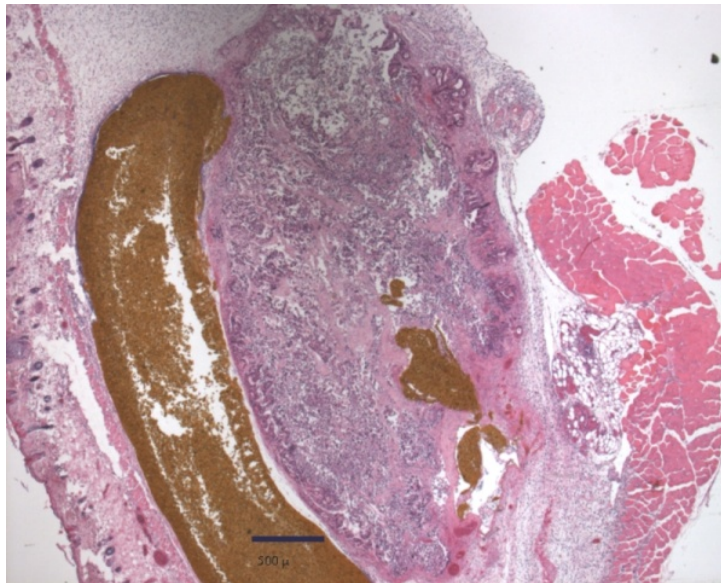

**Figure 10.** Histology of a treated tumor showing slight inflammatory necrosis close to the brownish implant. The skin on the left of the implant displays stigmas of heat exposition.

### **3.3.2. Tissue soldering**

Simplification and optimization of vascular bypass procedures is the main goal of all new anastomosis techniques, such as laser, biochemical or electromagnetic welding and soldering. In close cooperation with the Inselspital Bern, (Dr. M. Reinert) experiments with an alternating magnetic field on superparamagnetic iron oxide nanoparticles (SPIONs), figuring as energy transmitters, were performed. SPIONs were tested for their electromagnetic heating capability in an albumin solder solution alone and thereafter used as energy transmitters for soldering the adventitial layer of rabbit aortic tissue slices. Temperature profiles and rupture forces of the fused vascular tissue were measured and histological analyses were performed. The experiments clearly revealed the feasibility of tissue fusion by applying electromagnetic fields. The force of rupture was between 2600 and 3700 mN. Therefore, electromagnetic tissue soldering is a promising technique for vascular tissue fusion. Both particularly robust rupture forces and histological assessment profiles were achieved using SPIONs as energy transmitters. A patent was applied for and a publication is in preparation.

## **4. Intercellular tracking of biomarkers**

### **4.1. Particle library/separation**

The developments of the authors also includes techniques and devices for using SPIONs for use in targeting and magnetic extraction of cellular compounds and their chemical, optical, and physical analysis including proteomics. This use of functional nanoparticles enables identification of their specific interaction partners in a physiological environment, such as the entire intact cell. Proteomic analysis of diseases, where the immobilized interaction partner reacts with the target in physiological conditions, is possible as well as synthesis of peptide and molecule libraries for the determination of interaction partners. In contrast to all other techniques, interaction partners can be identified in physiological conditions in the cell.

We demonstrated that functionalized nanoparticles smaller than 100 nm carrying simultaneously specific organelle addressing peptides, a cyclic RGD peptide and a fluorescent dye are able to localize specifically at the target site (publication in preparation, patent applied). Nucleus and mitochondria were studied and in situ affinity chromatography was performed. In order to study particle-organelle interactions, we separated the cell lysate on a magnetic separator after the particle incubation with live cells and lysis of the cells. This cell separator has a strong magnetic field gradient of several hundred T/m. After protein electrophoresis, the analysis by mass spectroscopy revealed mitochondrial and nuclear proteins in magnetically enriched fractions.

To investigate how functionalized SPIONs interact with cell organelles, we covalently bound maleimide-PEG-NHS to amine groups of aminopropylsilica surface of the particle core generating PEG-SPIONs leaving maleimide group of the PEG for coupling of the fluorophores and peptides via thiol group. In order to assess the efficiency of mitochondrial targeting, three types of particles were functionalized by coumarin, c[RGDfK-(Ac-SH)] peptide and/or N-terminal 21 residues peptide from mitochondrial 3-oxoacyl-Coenzyme A thiolase (MTP) giving rise to the MTP-SPION, MTP-cRGD-SPION and cRGD-SPION, respectively. The evaluation of nuclear targeting employed two types of nanoparticles: the NTP-SPION were functionalized by FITC and PKKKRKV-GC peptide representing SV40 large T-antigen nuclear localization signal peptide (NTP) and the NTP-cRGD-SPION contained conjugated cRGD peptide in addition. After final synthesis step, functionalized particles showed size distribution in the range 70-100 nm.

The cells were lysed after incubation with the nanoparticles and mass spectrometric analysis of the proteins associated to magnetically sedimented complexes was performed. The detected proteins on the surface of MTP-cRGD-SPION can be subdivided into several classes: *i*), proteins associated directly in the transport of the nanoparticles to their target site (heat shock proteins); *ii*), proteins associated to the transport of the particles to the mitochondrial outer membrane; *iii*) proteins which are associated to the membrane of the mitochondria (e.g. *ATP synthase*); *iv*) proteins associated to the processing of the arriving signal in the mitochondria (e.g. *hsp 60*); *v*) proteins suggested being associated to the mitochondria, but proof was not fully given. Proteins belonging to the second part of glycolysis (*GAPDH*, enolase, Pyruvate kinase) were identified proteins. With this investigation, we successfully detected a tool for the investigation of the up-take mechanism, and also for screening of peptides and drugs.

## References

1. Gilmore JL, Yi X, Quan L, Kabanov AV. "Novel Nanomaterials for Clinical Neuroscience.", *J Neuroimmune Pharmacol.* 2008 Jan 22.
2. Deerinck TJ "The application of fluorescent quantum dots to confocal, multiphoton, and electron microscopic imaging." *Toxicol Pathol.*, 2008;36(1):112-6.
3. Son SJ, Bai X, Lee SB. "Inorganic hollow nanoparticles and nanotubes in nanomedicine Part 1. Drug/gene delivery applications", *Drug Discov Today.* 2007 Aug;12(15-16):650-6.

4. Duncan R, Spreafico F. "Polymer conjugates. Pharmacokinetic considerations for design and development.", *Clin Pharmacokinet.* 1994 Oct;27(4):290-306.
5. Boyd BJ. "Past and future evolution in colloidal drug delivery systems", *Expert Opin Drug Deliv.* 2008 Jan;5(1):69-85.
6. Duncan R. "Designing polymer conjugates as lysosomotropic nanomedicines", *Biochem Soc Trans.* 2007 Feb;35(Pt 1):56-60.
7. A.K. Gupta, A.S.G. Curtis, "Lactoferrin and ceruloplasmin derivatized superparamagnetic iron oxide nanoparticles for targeting cell surface receptors", *Biomaterials.* 2004 Jul;25(15):3029-40.
8. Babic M, et al. "Poly(L-lysine)-Modified Iron Oxide Nanoparticles for Stem Cell Labeling.", *Bioconjug Chem.* 2008 Mar 19;19(3):740-750. Epub 2008 Feb 21.
9. L.E. Euliss, S.G. Grancharov, S. O'Brien, et al., *Nano Lett.* 3/11, (2003) 1489.
10. D. Horák, "Magnetic microparticulate carriers with immobilized selective ligands in DNA diagnostics", *Polymer*, Volume 46, Issue 4, 7 February 2005, Pages 1245-1255.
11. A.K. Gupta, M. Gupta, "Synthesis and surface engineering of iron oxide nanoparticles for biomedical applications", *Biomaterials.* 2005 Jun;26(18):3995-4021.
12. A. Jordan et al. "Presentation of a new magnetic field therapy system for the treatment of human solid tumors with magnetic fluid hyperthermia", *Journal of Magnetism and Magnetic Materials* Volume 225, Issues 1-2, 2001, Pages 118-126.
13. Tobias Neuberger et al., "Superparamagnetic nanoparticles for biomedical applications: Possibilities and limitations of a new drug delivery system", *Journal of Magnetism and Magnetic Materials*, Volume 293, Issue 1, May 2005, Pages 483-496.
14. C. von Zur Muhlen et al. "Superparamagnetic iron oxide binding and uptake as imaged by magnetic resonance is mediated by the integrin receptor Mac-1 (CD11b/CD18): implications on imaging of atherosclerotic plaques", *Atherosclerosis.* 2007 Jul;193(1):102-11.
15. B.R. Smith et al., "Localization to atherosclerotic plaque and biodistribution of biochemically derivatized superparamagnetic iron oxide nanoparticles (SPIONs) contrast particles for magnetic resonance imaging (MRI). *Biomed Microdevices.* 2007 Oct;9(5):719-27.
16. D.L. Thorek et al., "Superparamagnetic iron oxide nanoparticle probes for molecular imaging.", *Ann Biomed Eng.* 2006 Jan;34(1):23-38.
17. A. Petri-Fink et al., "Effect of cell media on polymer coated superparamagnetic iron oxide nanoparticles (SPIONs): Colloidal stability, cytotoxicity, and cellular uptake studies", *European Journal of Pharmaceutics and Biopharmaceutics* 68 (2008) 129-137.
18. C. Grüttner et al in: U. Häfeli, W. Schütt, J. Teller, M. Zborowski (Eds), *Scientific and clinical applications of magnetic carriers*, Plenum Press, New York 1997, p. 53ff.

19. A. Petri-Fink *et al.*, “Development of functionalized superparamagnetic iron oxide nanoparticles for interaction with human cancer cells”, *Biomaterials* Volume 26, Issue 15, May 2005, Pages 2685-2694.
20. M. Chastellain *et al.* *Journal of Colloidal and Interface Science* 278 (2004) 353-360.
21. C. Alexiou *et al.*, “Targeting cancer cells: magnetic nanoparticles as drug carriers”, *Eur Biophys J.* 2006 May;35(5):446-50.
22. I. J. Bruce *et al.*, “Synthesis, characterisation and application of silica-magnetite nanocomposites”, *Journal of Magnetism and Magnetic Materials* Volume 284, December 2004, Pages 145-160.
23. M. Mikhaylova *et al.*, “Superparamagnetism of magnetite nanoparticles: dependence on surface modification”, *Langmuir.* 2004 Mar 16;20(6):2472-7.
24. M. Levin *et al.*, “Tat peptide derivatized magnetic nanoparticles allow in vivo tracking and recovery of progenitor cells”, *Nature Biotechnology* Vol 18, April 2000, 410-414.
25. A.K. Gupta, “Recent advances on surface engineering of magnetic iron oxide nanoparticles and their biomedical applications.”, *Nanomed.* 2007 Feb;2(1):23-3
26. Pankhurst, Q. A., Connolly, J., Jones, S. K., and Dobson, J. “Applications of magnetic nanoparticles in biomedicine.” *J. Phys. D: Appl. Phys.* 36, 2003, R167–R181.
27. B. Stella *et al.*, “Design of folic acid-conjugated nanoparticles for drug targeting”. *J. Pharm. Sci.* 89, 2000, 1452–1464.
28. M. Di Marco “Physicochemical characterization of ultrasmall superparamagnetic iron oxide particles (USPIO) for biomedical application as MRI contrast agents.” *Int J Nanomedicine.* 2007;2(4):609-22.
29. C. Corot *et al.*, “Recent advances in iron oxide nanocrystal technology for medical imaging.” *Adv Drug Deliv Rev.* 2006 Dec 1;58(14):1471-504.
30. Y.R. Kim *et al.*, “Detection of early antiangiogenic effects in human colon adenocarcinoma xenografts: in vivo changes of tumor blood volume in response to experimental VEGFR tyrosine kinase inhibitor.” *Cancer Res.* 2005 Oct 15;65(20):9253-60.
31. Y. Okuhata, “Delivery of diagnostic agents for magnetic resonance imaging”, *Advanced Drug Delivery reviews* 37 (1999) 121-137.
32. K.B. Saebo, “Degradation, metabolism and relaxation properties of iron oxide particles for magnetic resonance imaging”, *Dissertation at the University of Uppsala* 2004.
33. C. Corot *et al.*, “Recent advances in iron oxide nanocrystal technology for medical imaging”, *Advanced Drug Delivery Reviews* 58 (2006) 1471–1504.
34. L. LaConte *et al.*, “Magnetic nanoparticle probes”, *NanoToday* May 2005, 32 - 38
35. J. M. Hill *et al.*, “Serial cardiac magnetic resonance imaging of injected mesenchymal stem cells”, <http://circ.ahajournals.org/cgi/content/full/108/8/1009>.
36. B. Steitz *et al.*, “Characterization of PEI-coated superparamagnetic iron oxide nanoparticles for transfection: Size distribution, colloidal properties and DNA interaction” *Journal of Magnetism and Magnetic Materials* 311 (2007) 300–305.

37. W.C. Zamboni, "Concept and clinical evaluation of carrier-mediated anticancer agents.", *Oncologist*. 2008 Mar;13(3):248-60.
38. D.B. Fenske et al., "Liposomal nanomedicines: an emerging field." *Toxicol Pathol*. 2008;36(1):21-9.
39. Conclusions and Recommendations of the NIH Recombinant DNA Advisory Committee Gene Transfer Safety Symposium: Current Perspectives on Gene Transfer for X-SCID March 15, 2005.
40. Yi-Yan Yang et al., "Frontiers in Research Review: Cutting-Edge Molecular Approaches to Therapeutics Polymeric Core-Shell Nanoparticles for Therapeutics" *Clinical and Experimental Pharmacology and Physiology* (2006) **33**, 557–562.
41. P.B. Davis and M.J. Cooper "Vectors for airway gene delivery", *AAPS J*. 2007 Jan 19;9(1):E11-7
42. M. Chastellain, A. Petri , H. Hofmann "Particle size investigations of a multistep synthesis of PVA coated superparamagnetic nanoparticles" *Journal of Colloid and Interface Science*, vol 278; 353–360 (2004).
43. Petri-Fink, Alke; Hofmann, Heinrich Superparamagnetic iron oxide nanoparticles (SPIONs): from synthesis to in vivo studies - A summary of the synthesis, characterization, in vitro and in vivo investigations of SPIONs with particular focus on surface and colloidal properties, In: *IEEE Transactions on Nanobioscience*, vol. 6, num. 4, 2007, p. 289-953.
44. R. Kötiz et al "Determination of the binding reaction between avidin and biotin by relaxation measurements of magnetic nanoparticles" *J. of Magnetism and Magnetic Materials* 194, 1999, 62-68.
45. <http://www.magforce.de/>
46. M. Yanase et al. "Intracellular hyperthermia for cancer using magnetite cationic liposomes: ex vivo study" *Jpn J. Cancer Res*. 1997, 88(7), 630 – 32.
47. M. Mitsumori et al. "Targeted hyperthermia using dextran magnetite complex: a new treatment modality for liver tumors" *Hepatogastroenterology* 1996, 43(12) 1431-37.
48. E. Viroonchatapan et al "Preparation and characterisation of dextran magnetite-incorporated thermosensitive liposomes : an on-line flow system for quantifying magnetic responsiveness" *Pharm. Res*. 1995, 12(8), 1176 – 83.
49. This technology developed and applied at the University Hospital of Geneva is mainly applied in the spine (vertebroplasty) to provide long-term pain relief and stabilization in patients with neoplastic bone destruction. Application of the same technique in other bones (osteoplasty) is under investigation.