

Comparison of Taguchi Method and Robust Design Optimization (RDO)

- by application of a functional adaptive simulation model for the robust product-optimization of an adjuster unit -

Stefan Kemmler^{1*} & Alexander Fuchs² & Tobias Leopold² & Bernd Bertsche¹

¹ Institute of Machine Components (IMA), University of Stuttgart

² Knorr-Bremse Systeme für Nutzfahrzeuge GmbH

Abstract

Current research and development have been trending towards approaches based on simulation and virtual testing. Industrial development processes for complex products employ optimization methods to ensure results are close to reality, simultaneously minimizing required resources. The results of virtual testing are optimized in accordance with requirements using optimization techniques. Robust Design Optimization (RDO) is one established approach to optimization. RDO is based on the identification of an optimal parameter set which includes a small variance of the target value as a constraint.

Under most circumstances, this approach does not involve separate optimization of the target value and target variance. However, the basic strategy of the optimization approach developed by Taguchi is to first optimize the parameter sets for the target value and then optimize and minimize the target variance.

According to an application example, the benefit of Taguchi's approach (TM) is that it facilitates the identification of an optimal parameter set of nominal values for technical feasibility and possible manufacturing. If an optimal parameter set is determined, the variance can be minimized under consideration of process parameters.

This paper examines and discusses the differences between and shared characteristics of the robust optimization methods TM and RDO, and discusses their shortcomings. In order to provide a better illustration, this paper explains and applies both methods using an adjuster unit of a commercial vehicle braking system. A simulation model is developed including an appropriate workflow by applying **optiSLang**-modules.

Keywords: Robust Design, SMAR²T, Robust Design Optimization, Reliability-based Design Optimization, Taguchi Method, Adjuster Unit

*Contact: Dipl.-Ing. Stefan Kemmler, Institute of Machine Components (IMA), University of Stuttgart, Pfaffenwaldring 9, D-70569 Stuttgart, E-Mail: kemmler@ima.uni-stuttgart.de

1 Introduction

Faced with rapid product development and increasing customer requirements, it is not always possible to achieve required product quality. When a product does not meet quality standards, this can have major consequences, such as a loss of company image and/or uncontrollable declines in sales. There are many examples of consumer product recalls, which spread immediately through various media channels.

The demand for robust and reliable products is increasing to ensure these requirements are met. Products must be as insensitive as possible against both external (e.g. environmental conditions) and internal noise factors (e.g. component deviations). One approach to designing such products is the Robust Design Method (RDM), whose aim is to create products insensitive to uncontrollable variations (noise factors). Reliability engineering methods are deployed in order to provide the desired product functionality throughout the required service life. The multidomain method SMAR²T (Kemmler and Bertsche (2014a), Kemmler and Bertsche (2014b), Kemmler et al. (2014), Kemmler et al. (2015)) is used to design such robust and reliable products.

Virtual product development is an additional supportive indicator, specifically in simulation technology during the product development process (PDP). Virtual product development can predict the behaviour of products or their functions early on in the PDP, taking into account a large number of varying factors and resulting in saved resources. Simulation tools are being used more and more frequently in industry; one of these is the finite element method (FEM). Based on the simulation results provided by this method, developers can increase and optimize the robustness of products using the RD methods Robust Design Optimization (RDO) or the Taguchi Method (TM).

One simulation-based approach both in RDO and TM is the creation of Meta models, which are created from multiple design points as a result of the FEM using mathematical regression models describing the relationship between input and output characteristics. These regression models can allow developers to describe robustness and corresponding optimal parameter settings simultaneously. However, a production-oriented design must be determined and validated using specific and real experiments. This paper presents the fundamental characteristics of both RD methods, then applies them to a concrete example of an adjusting unit for commercial vehicle braking systems. Finally, as a result, it derives a universal workflow.

2 Differences and similarities between Robust Design Optimization and the Taguchi Method

According to Park et al. (2006) there are three basic methods of Robust Design: the Axiomatic Design (AD) (Suh (2001)), the Taguchi Method (TM) (Taguchi, G. et al. (2005)) and the new discipline of Robust Design Optimization (RDO). In general AD describes the complexity of a system and its relation between Customer Requirements (CR), Functional Requirements (FR), Design Parameters (DP) and Process Variables (PV). Furthermore, AD is used in the early concept phase after SMAR²T. Therefore, this paper will only examine and discuss the differences and similarities between TM and RDO.

2.1 Taguchi Method

Japanese electrical engineer Genichi Taguchi has developed an attractive tool for industry. The Taguchi Method optimizes the product development process to ensure that robust products of high quality can be developed at a low cost. The method aims to minimize variation of the quality characteristics of products.

2.1.1 Approach

Like RDO, the control and noise factors are first defined for the product to be optimized, which requires a profound understanding of the system. Instead of a quasi-continuous parameter space (RDO), TM uses a coarsely graded (typically a 2- or 3-step) parameter space for the optimization.

In contrast to RDO, where the robust optimum design is calculated using optimization algorithms, TM seeks to optimize the effects of the control factors on the mean value and on the robust degree of the objective function value in consideration of the noise factors by means of statistical design of experiments (DOE). The factor levels of the control factors are selected so that the variation of the objective function value decreases first, and then the mean value is adapted to the target size. Finally, a validation must be carried out.

2.1.2 Statistical Design of Experiments

The TM is a very efficient optimization tool that uses orthogonal arrays. These are highly mixed experimental designs in which a maximum amount of main effects are tested with a minimum number of experiments. For n parameters to be examined on two factor levels, only $n + 1$ experiments are required to evaluate the main effects ([Mori \(1990\)](#)). One negative aspect we should mention, however, is that the correlations cannot be separated from the main effects at a resolution of three. However, these can be approximately evaluated using correlation tables. Before applying TM, it is recommended to consider the correlations of the system, for example, by considering the cause-effect relations of the components within the system. [Table 1](#) shows an example of an orthogonal field. The factor levels are not identified in accordance with classical experimental designs using + and −, but with numbers 1 and 2. As mentioned before, the main effects of 7 parameters can be evaluated on two factor levels with only 8 experiments. Each orthogonal field is uniquely defined by a code ([Taguchi, G. et al. \(2005\)](#)). [Table 2](#) allows selection of the appropriate orthogonal array depending on the number of parameters (factors) and their stages. The number of lines corresponds to the number of tests to be performed.

2.1.3 Inner and outer arrays

Taguchi uses two experimental designs for its experimental procedure, called inner and outer arrays. All control factors are placed in the inner array, while all noise factors are considered in the outer array. [Figure 1](#) shows the applied Taguchi experimental setup. Each factor level combination of control factors from the inner array is tested against various combinations of the noise factors in the outer array, which can be referred to as “quasi-repetition“. Using this method, the behaviour of each factor level combination of

Table 1: Design of an orthogonal array

test-no.	Parameter							Orthogonal array $L_8(2^7)$
	1	2	3	4	5	6	7	
1	1	1	1	1	1	1	1	
2	1	1	1	2	2	2	2	
3	1	2	2	1	1	2	2	
4	1	2	2	2	2	1	1	
5	2	1	2	1	2	1	2	
6	2	1	2	2	1	2	1	
7	2	2	1	1	2	2	1	
8	2	2	1	2	1	1	2	

Code: $L_n(m^k)$

- n : number of lines,
- m : number of parameter levels,
- k : number of parameters.

Table 2: Orthogonal test arrays according to Gundlach (2004)

	Orthogonal array	Number of lines	Max. number of parameters	Max. number of columns for the respective levels			
				2-lv.	3-lv.	4-lv.	5-lv.
2-level arrays	L_4	4	3	3	-	-	-
	L_8	8	7	7	-	-	-
	L_{12}	12	11	11	-	-	-
	L_{16}	16	15	15	-	-	-
	L_{32}	32	31	31	-	-	-
3-level arrays	L_9	9	4	-	4	-	-
	L_{27}	27	13	-	13	-	-
	L_{81}	81	40	-	40	-	-
Multilevel arrays	L_{16}	16	5	-	-	5	-
	L_{25}	25	6	-	-	-	6
	L_{64}	64	21	-	-	21	-
Mixed 2- and 3-level arrays	L_{18}	18	8	1	7	-	-
	L_{32}	32	10	1	-	9	-
	L_{36}	36	23	11	12	-	-
	L_{36}	36	16	3	13	-	-
	L_{50}	50	12	1	-	-	11
	L_{54}	54	26	1	25	-	-

control factors can be tested under the influence of noise factors. It should be noted that a variation of the control factors due to repeated measures, such as adjustment errors, is mixed in with the noise factors. This means that the corresponding uncertainty can be regarded as an inner noise factor and that the system is designed to be robust against these noise factors.

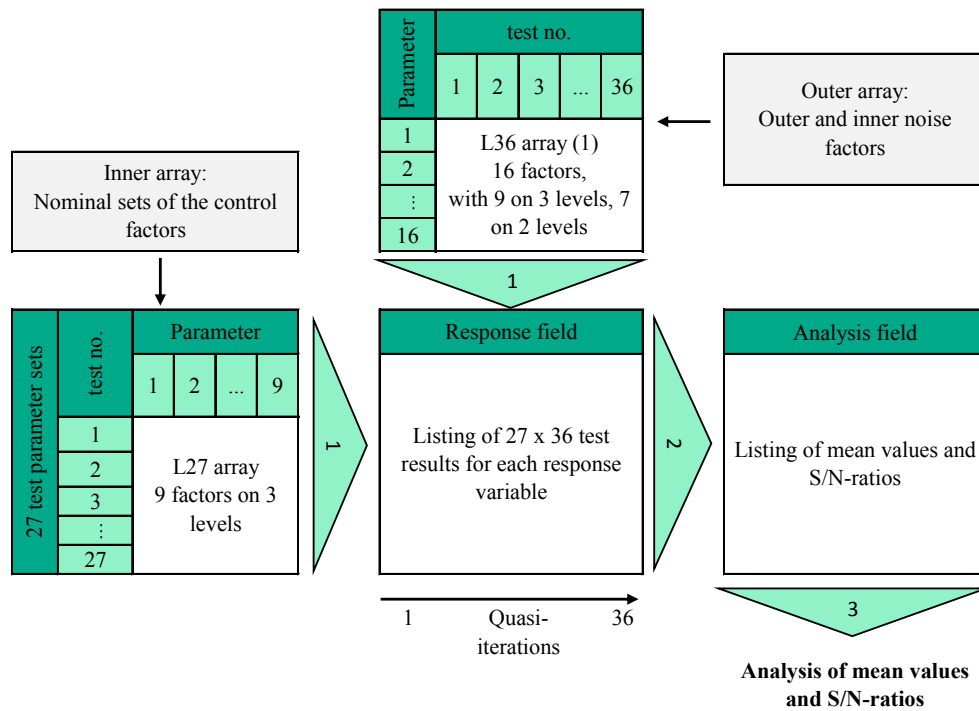

Figure 1: Classic Taguchi Design of Experiment

In this example, four quasi-repetitions are performed for each of the eight factor level combinations. This provides a total of 32 (8×4) experiments, whose results are entered in the response array. Each line in the response array has four results, from which the mean value and the signal-to-noise ratio (S/N ratio) - variation- are calculated. These may then be registered in the analysis array. Since the variation in the target value is usually relatively low, the variation in the S/N ratio is widened from a logarithmic transformation (Kleppmann (2013)), see Table 3.

Taguchi has provided corresponding approaches to calculating the S/N ratio for different target settings and target functions, see Table 3. The goal is to achieve the highest S/N ratio for each type of problem. Target value problems Type I and Type II are the most commonly used in the industry because they reflect the variation. The less the objective function value varies, the higher the S/N ratio, and the more robust the product will be. Therefore, the S/N ratio can be defined as a robust value.

Table 3: Adjusted S/N ratio following [Taguchi, G. et al. \(2005\)](#)

Problem type	Ideal target function value	S/N ratio
Minimization Problem	0	$-10 \log_{10} \left(\frac{1}{n} \sum_{i=1}^n y_i^2 \right)$
Target Value Problem Type I	$\neq 0$, finite	$10 \log_{10} \left(\frac{\mu^2}{s^2} \right)$
Target Value Problem Type II	finite	$-10 \log_{10} (s^2)$
Maximization Problem	∞	$-10 \log_{10} \left(\frac{1}{n} \sum_{i=1}^n \frac{1}{y_i^2} \right)$

y_i = target function value; μ = mean value; s = standard deviation

2.2 Robust Design Optimization

In modern development processes, designing for robustness is optimized at an early product development stage. RDO meets this challenge by using simulation tools. This method employs the following steps:

1. Sensitivity analysis,
2. Optimization,
3. Robustness analysis.

2.2.1 Sensitivity analysis

Before a product can be optimized, a profound understanding of both system and product are required, as well as an adequate knowledge of product characteristics. Therefore, the major factors of product characteristics must be analysed. The results of the analysis allow a determination of which parameters have what effect on the product and its environment, or what correlations they have with each other. This is generally understood as a sensitivity analysis. The product can be optimized using knowledge from the sensitivity analysis.

2.2.2 Optimization processes

From a mathematical standpoint, optimization is the search for a minimum or maximum for the target function corresponding to a product characteristic. Various methods and algorithms have been developed for optimization. The appropriate method should be selected depending on the problem. The most important selection criteria for optimization are ([Gamweger et al. \(2009\)](#)):

- Number of parameters to be optimized,
- Parameter (continuous, discrete or binary),
- Number of target functions,

- Possible noise of the objective function,
- The need for global optimum-determination.

Optimization methods are, in principle, divided into deterministic and stochastic strategies. Examples of the most important methods for are listed in Table 4. Deterministic strategies are mathematically and technically easier to use and control. A deterministic optimization method is normally best for an optimization problem with up to 20 parameters in combination with a single objective function problem.. Tasks with more than 100 parameters are processed best using stochastic methods. If several objective functions are to be considered at the same time, a stochastic process must be used [Gamweger et al. \(2009\)](#). The deterministic ARSM method is applied for the application example presented in this paper, and is briefly described below.

Table 4: Deterministic and stochastic optimization processes ([Kleppmann \(2013\)](#))

Deterministic	Stochastic
Gradient Process, Direction Search Process, Compass-Search-Process, Adaptive Response Surface Method.	Genetical Algorithms, Evolutionary Algorithms, Pareto-Optimization.

2.2.3 Adaptive Response Surface Method (ARSM)

The ARSM is a highly flexible deterministic optimization method. The principle of this method is to locally reproduce the objective function, generally by a linear or quadratic approximation. The local optimum can be determined very quickly on this analytically described approximation surface ([Kleppmann \(2013\)](#)). First, the mesh points are calculated for the approximation in a sub-region of the parameter space. The number and location of mesh points depends on the order of the approximation and the number of parameters. This procedure corresponds to the statistical design of experiments (DOE) in the classic product development process. Next, the approximation is spanned at the mesh points and the local optimum is determined. This serves as the new centre point for the next approximation surface, see Figure 2. Here, the approximation surface will be moved (panning) and / or resized (zooming). This step is repeated until the difference of the results is below the predetermined convergence criterion in two consecutive iteration steps. This optimum is determined for the approximation. Therefore, the actual optimum has to be recalculated with the same parameter combination using the original objective function. The approximation quality depends on the difference between the approximated and actual function values ([Gamweger et al. \(2009\)](#)).

2.2.4 Robustness analysis

After the optimal performance parameter setting has been found, the effect of inevitably varying noise factors must be determined. The goal is that desired product characteristics

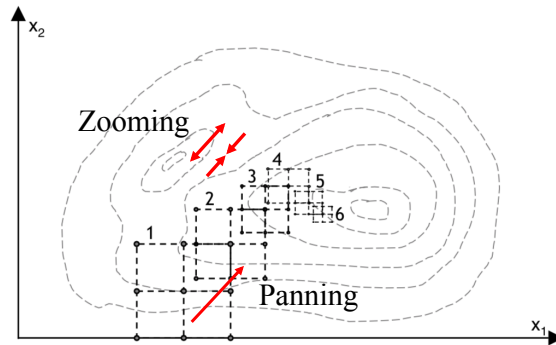

Figure 2: Graphic representation of the ARSM process ([Gamweger et al. \(2009\)](#))

will vary within the predetermined limits. The variation behaviour of the noise factors must be estimated by the noise factors' corresponding probability distributions, such as normal, lognormal, direct, exponential, or Weibull distributions. The quality of the input parameters has a significant effect on the quality of the robustness analysis. The predetermined distribution function is implemented via discretization with the adjusted number of samples using the Monte Carlo (MC) or Latin Hypercube Sampling (LHS) method. LHS is used to perform a more efficiently structured generation of samples. The clusters of input parameters (distribution) are decomposed at random by optimizing the distance between design points into intervals with equal probability and with respect to probability density. Using LHS, the minimum number of samples n^2 (MC) is reduced to $2n$, where n is the number of input and output parameters ([Gamweger et al. \(2009\)](#)). The various implementations of the input parameters are now put into multiple design points corresponding to the adjusted number of samples. These design points are composed to the nominal design and calculated. The calculated objective function values are then analysed statistically. Finally, the distribution of the objective function values and the relationship between input and output parameters can be determined.

2.2.5 Robustness Optimization

The robustness optimization is still a very young discipline in RDO. Compared to conventional RDO, wherein the robustness analysis is performed after optimization as a validation criterion, in this discipline the robustness analysis is integrated into the optimization process. This means that robustness is evaluated for each optimization iteration, which can significantly increase the computing time. Furthermore, robustness can also be considered as a target for optimization.

2.3 Evaluation of both RD methods

In summary, Table 6 lists a general overview outlining the approaches of the two methods. The basic differences between them are given in Table 5.

In comparison to RDO, TM aims to increase robustness, while the optimization process takes place predominantly using orthogonal arrays instead of optimization algorithms. Here, the parameters are clearly separated by arrays. After the sensitivity analysis, RDO

considers all or only the significant control and noise factors depending on simulation strategy and capacity. The significant parameters, which may be both noise and control factors, are preferred. This is because too many parameters can affect the approximation quality of the Meta model and the optimization algorithm, and more noise can occur. In TM, it is easier to take into account all parameters by using a larger orthogonal array for the DOE. However, in this case the tolerance limits must be chosen wisely by [Meng et al. \(2010\)](#), since their significance would otherwise be ignored.

Table 5: The procedure of RDO and TM in comparison

RDO	TM
1. System and parameter examination	
2. Design of the simulation model (in TM not necessary)	
3. Implementation of the sensitivity analysis and determination of the MOP	
4. Determination of the distribution function	4. Determination of the parameter test levels
5. Selection of the optimization process	5. DOE (orthogonal arrays)
6. Optimization with the target value and the constraints	6. Reduction of the variation
	7. Adaption of the mean value

Table 6: Fundamental differences of RDO and TM

RDO	TM
- only sensitive design parameters are considered	- obvious separation of the parameter through arrays
- target value and constraints are preset	- no direct preset of constraints
- simultaneous optimization of μ and σ	- separated optimization of μ and σ
- optimum not usually technically feasible	- parameter dimensioning on production engineering points of view

Both methods have the common goal of defining a robust design. However, the two methods use different approaches and optimization procedures to achieve this goal, see [Table 5](#). The effects of the design parameters are examined through various implementation methods (sampling or DOE) of the distribution function. TM is mainly limited to identifying the main effects, while RDO can also consider correlations. In RDO, the optimization is realised using different algorithms, and in TM by reducing variation with subsequent average adjustment. The adjustment levels of the parameters must be set using TM for this purpose. In this regard, and due to complex simulations or real experiments, the use of TM is recommended.

3 Service Brake

Today in Europe, commercial vehicles are almost always equipped with pneumatically operated disc brakes (Breuer and Bill (2012)). The common form uses a structure with a floating brake calliper, which provides a double-sided braking force effect with unilateral operation. The pneumatic disc brake described here is designed with two punches to tension and with a floating calliper.

3.1 Function

When the driver actuates the service brake, the lever (1), Figure 3, is operated by the connecting rod of the pneumatic cylinder (not shown in the figure) and the rotational movement of the lever by means of an eccentric bearing. Thus, a translational displacement of the traverse is achieved. The traverse, also referred to as a bridge, includes the absorption of the threaded spindle and the synchronization unit between them. The transmission is constant due to the construction of the lever, amplifying the braking force. Plungers secured to the threaded spindles transfer the translational movement of the inner brake pad (2). When the brake is actuated, the distance between the inner brake pad and the brake disc (3), called the clearance, has to be overcome, so that when the two components come into contact, the braking force can be initiated to decelerate the vehicle. The floating calliper inside the brake carrier (4) also initiates the braking force through the outer coating.

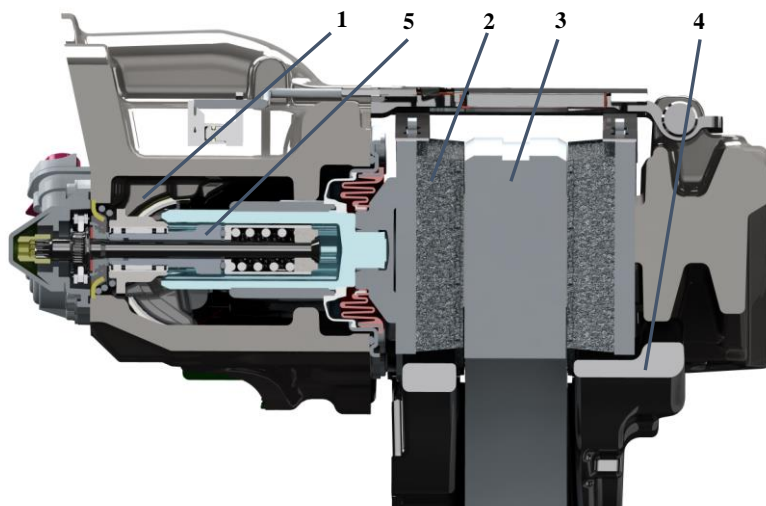

Figure 3: Air Disc Brake

3.2 Adjusting Unit

An wear adjustment system (5) is installed to compensate for the wear on the brake pads and the brake disc during operation. The operation of this mechanical system is identical regardless of brake type (Breuer and Bill (2012)). The actuation of the adjusting unit is

affected by actuation of the service brake. The clearance to be overcome in the idle stroke of the brake clearance is determined by the geometric parameters of the brake and set by the structural design of the adjuster.



Figure 4: Adjusting Unit

When the service brake is actuated, the rotational movement of the lever is transferred to the adjuster via a gear (5.1), activating the adjustment process. The constructive clearance must first be overcome. Then the actual adjustment process starts. For an existing operating clearance that deviates from the adjusted constructive clearance, the clearance is gradually reduced at any level of brake application until the deviation has been compensated for. The particular adjusting operation at the initiation of braking is performed until the fit between the pads and the brake disc leads to a disproportionately great increase in force, activating the overload protection of the adjusting unit. When this occurs, the adjuster is decoupled from the power flow and the adjustment process is completed. The introduced rotational movement during the resetting of the brake is decoupled using a free wheel, where a compliance of the set clearance is ensured.

Constant clearance set using various functional parameters. After the examination of [Kemmler et al. \(2014\)](#), see chapter 4, the intrinsic free plays of the adjusting unit have been identified as highly significant parameters in terms of objective function, a constant and nominal clearance. The internal system free plays of the adjuster unit are described briefly below.

3.3 Constructive clearance

The constructive clearance describes the structural clearance which adjusts itself during operation. It is determined by the interlocking of the lever wheel and the adjust gear wheel which significantly influences the operational clearance of the disc brake.

3.4 Output clearance

The output clearance is formed between the shaft drive (5.2) and threaded pipe (not shown). The rotational motion is transferred to the threaded pipe through the form-fitting connection, and the clearance is adjusted when abrasion occurs through the translational movement of the spindle. Depending on the size of the clearance of the form-fitting connection, it is possible to adjust the clearance with respective accuracy to the structurally defined value.

4 Application of SIM-SMAR²T and display of the results

The assembly adjusting unit was modelled and analysed according to the simulation strategy presented in Kemmler et al. (2014) for system analysis using parametric studies after TM. Meta models (MOP) of the operating torques of the respective operation modes have been created for this purpose. A Taguchi experimental design was constructed in optiSLang to keep the software interface interference as low as possible during the virtual experiments for reasons of time and cost efficiency. Combining different optiSLang module blocks and the internal MOP solver facilitates the creation of an efficient approach with regards to time for experimental designs with more than 30 parameters to be examined. An overview of the model is shown in Figure 5. Here, the system of the adjusting unit is modelled with MOPs of the individual operating modes (Kemmler et al. (2014)).

The output graphs of the monitoring modules in Figure 5 show the two operating torques of the operation modes adjustment and overload protection using the currently evaluated parameter settings.

Figure 6 shows the overall model of a Taguchi experimental design, which includes the overall model of the adjusting unit (Figure 5), extended using additional optiSLang elements. This addition allows the generation of Taguchi experimental designs with a combination of the respective parameters of inner and outer arrays. Creating a Taguchi experimental design in optiSLang will be described in the next section.

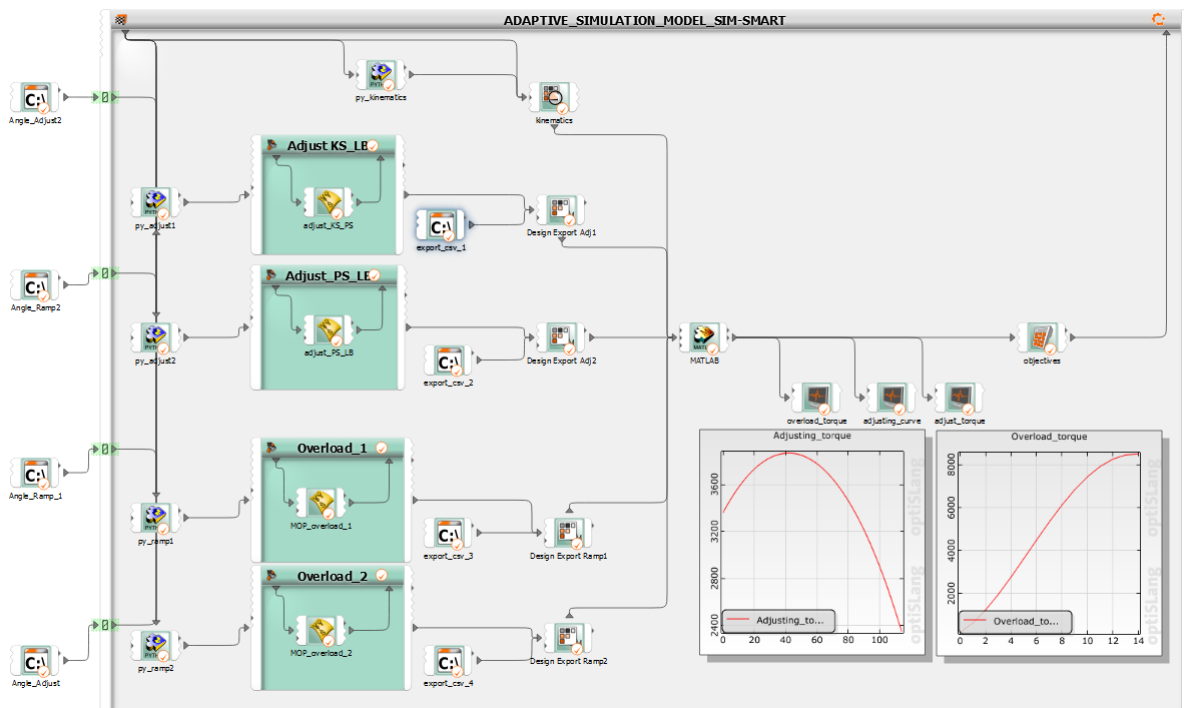

Figure 5: Total model adjuster unit

4.1 Creating a Taguchi Design of Experiment in **optiSLang**

To perform a variety of virtual experiments in a cost-effective manner, it is beneficial to keep software interface interference low, since running programs in batch mode can lead to increased time exposure. According to the simulation strategy described in [Kemmler et al. \(2014\)](#), the use of an outer MOP Solver by the company DYNARDO GmbH, which can be accessed and controlled from the MATLAB environment is assumed. Integrating MOPs with high level of detail causes the software interface to take a considerable amount of time to pass through automated loop functions. A procedure was developed to minimize the software interface and the resulting time.

The model of Taguchi experimental presented in this paper was designed considering the aforementioned goals of creating a time-effective simulation with a small number of software interfaces. A special feature of the model described is the fact that instead of individual discrete response values, a torque curve containing a defined angle size is the output. The schematic structure is explained in detail below with reference to [Figure 6](#). Different **optiSLang** elements must be connected to one another in a work-around to construct a Taguchi experimental design in **optiSLang**. The feature of the proposed model is the parameter definition in the main level and a targeted remittance of global and intrinsic parameters to the respective MOPs, which are modeled in sub-levels. The addressed main level is a sensitivity-environment (“Taguchi Testing“). All examined system parameters are declared in this main level. Care must be taken to maintain consistent parameter names in the main and sub-levels. The outer array of the noise factors, see [chapter 2](#), is input in the main level as StartDesigns for the sensitivity environment, using bin-file import. DYNARDO provides an Excel Add-on to create the bin files from a CSV spreadsheet. The noise factors are already registered in this three-stage classification. Dummy values are stored in the StartDesign for the control factors, which will be replaced automatically when the workflow is executed with the respective values. The parameters of the outer array are classified as parameter type “Optimization“, the internal parameters are classified as the parameter type “Stochastic“.

The actual StartDesigns are created through an automated, script-controlled combination of inner and outer parameters with a Python2 integration module, then transferred to a robustness environment (SIM SMAR²T). The inner parameters are connected as a csv-import with a Path Element to the input channel of the Python2 module for this purpose. The StartDesigns of the main level are linked to the respective angle values of the angle curve through the Python2 module within the robustness environment, thereby creating a number of sub-designs for each main design. The number of angle values to be examined depends on the level of detail, and can be adjusted. Each sub-design includes the parameters from the main level extended by the variable parameter angle. These sub-designs are then sent to the respective MOPs and evaluated. A torque curve over the defined angle of rotation is the response size as a result obtained with this procedure for each main design.

Using downstream data mining, modules are applied to export and cache the torque curve of the current design by outsourcing in an Excel spreadsheet. Afterwards the torque curves are re-imported and sent as an input to a Matlab module.

Caching is necessary to prevent a mixing of the response curves for the individual runs

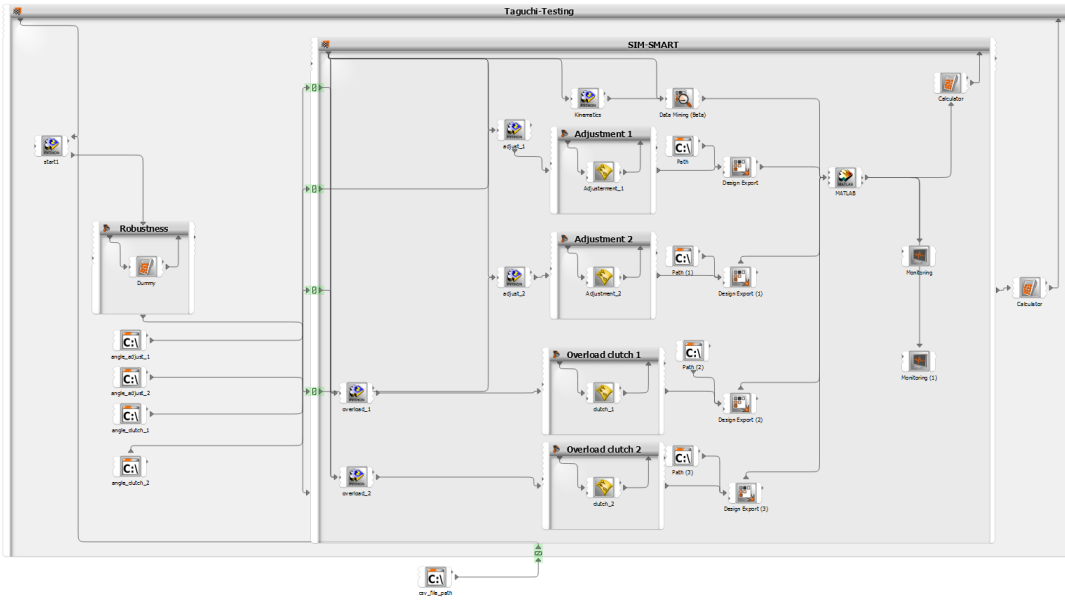

Figure 6: Taguchi Design of Experiment in optiSLang

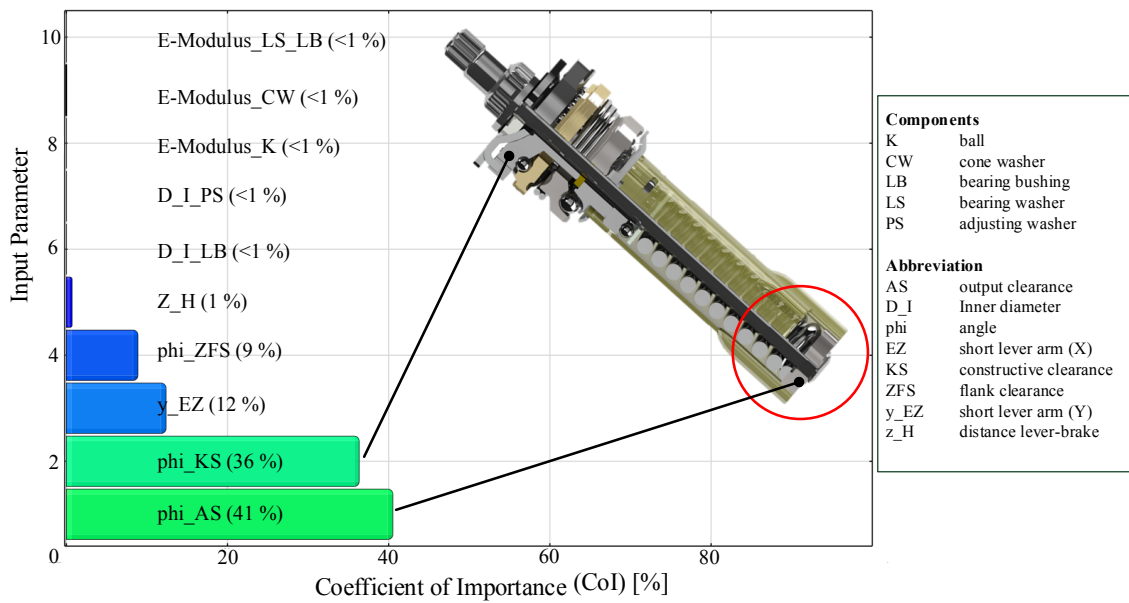

Figure 7: Results of the simulation after SIM-SMART²T

within the main designs. Target values for the current main designs are determined with the generated torque curve using an M-script code implemented in the Matlab module, then sent to the main level (“Taguchi testing”). The software interface to Matlab is necessary due to the use of symbolic variables.

Through a detailed sensitivity analysis of the simulation results, the intrinsic clearances of the adjusting unit were determined as highly significant in the objective function “constant clearance“, see Figure 7.

An optimization of the parameter output clearance will follow in the next section based on these results. Optimization using RDO is applied, and a parameter optimization according to the procedure of TM is performed.

5 Parameter optimization after RDO and TM in **optiSLang**

This chapter describes parameter optimization according to RDO and to the TM based on the example of output clearance (AS). Finally, the optimization results from both methods are compared and discussed.

5.1 Parameter optimization after RDO

After the definition of the parameter space and the limits of variation, the sensitivity analysis conducted in the next step. For an optimal and sufficient approximation quality of the MOP, it is advisable to simulate 100 design points in the parameter space. However, this procedure can require a large amount of effort, depending on the simulation model. For this purpose, the developer should apply an appropriate simulation strategy in advance in order to achieve a good compromise between cost, resources and target accuracy [Kemmler et al. \(2014\)](#).

5.1.1 Sensitivity analysis

The sensitivity analysis in optiSLang is used to create the MOP, whose quality has a decisive influence on the optimization result. After the sensitivity analysis is performed, the significances of all parameters and their possible correlations can be identified. The non-significant parameters can be neglected for increased optimization efficiency in the subsequent process.

The results of the sensitivity analysis and the MOP with a quadratic regression without coupling terms is shown in Figure 8. Accordingly, the depth and the radius of the interlocking of the sleeve (D_H_VZ_I, R_H_VZ) are most significant for the AS. However, they have large variation limits, which can easily enhance their significances. According to [Most and Will \(2011\)](#), the approximation quality of the Meta model is reduced when the number of parameters increases. The number of parameters also affects the optimization method in the subsequent process. For this reason, only the 8 most significant parameters are considered when creating the Meta model.

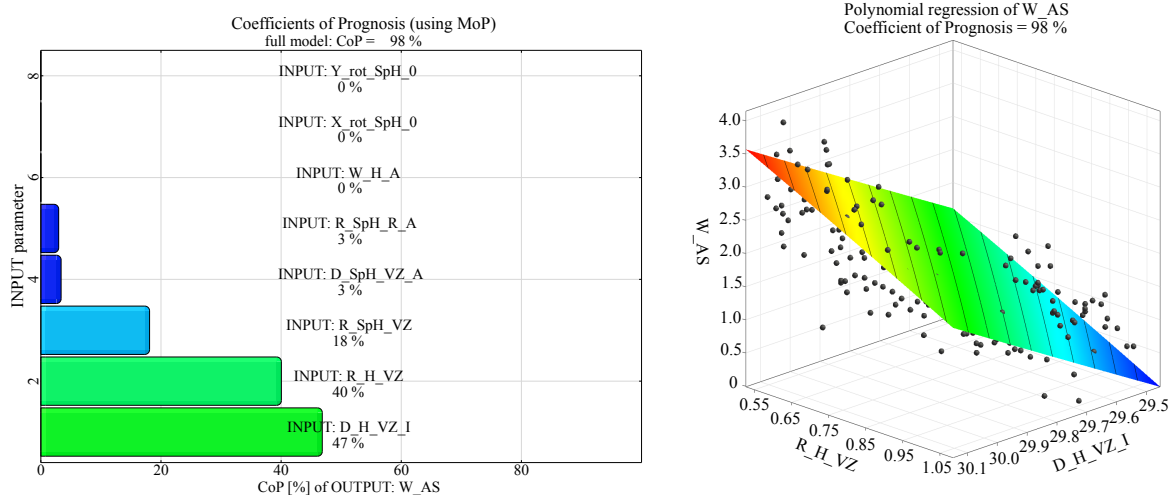

Figure 8: Significance of the parameter of the output clearance (left) and the MOP with quadratic regression with non-coupled terms (right)

5.1.2 Identification of interactions

According to Most and Will (2011) correlations are particularly important when the sum of the individual Coefficient of Prognosis (CoP) values of parameters is larger than the total CoP of the Meta model; that means:

$$\sum CoP(X_i) > CoP_{Meta} \quad . \quad (1)$$

For the AS, the results are $\sum CoP(X_i) = 111 \%$, and the $CoP_{Meta} = 98 \%$; accordingly, there are small correlations. However, the sensitivity analysis detects the parameters between which correlations exist. Contradicting the MOP has no coupling terms for the AS, which mathematically indicates that no correlations exist between the parameters in the MOP. To explain the contradiction, another examination of parameters has to be carried out using the significant parameters. A new variable A_VZ is defined as follows to explain the correlation:

$$A_VZ = \frac{D_H_VZ_I - D_SpH_VZ_A}{2} \quad . \quad (2)$$

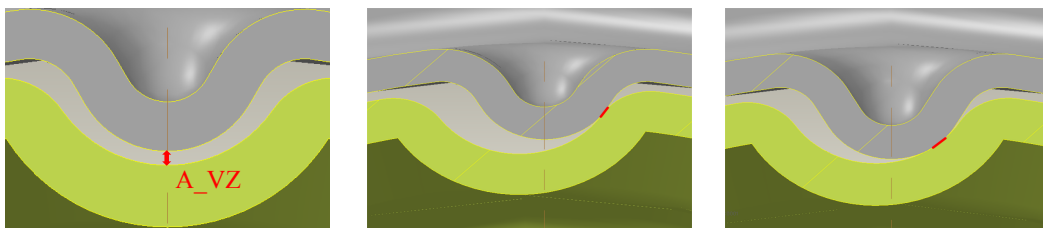

Figure 9: Radial distance of the interlock (left) and the contact surface with different radial distances (middle and right)

A_VZ here corresponds to the radial distance of the interlock. A correlation between the axial distance A_VZ and the tangential distance of the interlock exists, which is in turn dependent on the parameters R_H_VZ and R_SpH_VZ. Figure 9 shows the effect of gradually decreasing A_VZ, which means that the contact surface shifts downwards to the flank centre. In this case, the change in the radius of the interlock would have the contrary effect on the clearance.

In conclusion, the correlation in the Meta model can be neglected based on these facts. One reason for this is that the correlation exists only in a very small sub-region of the parameter space. In this case, it is probably necessary to create a Meta model with higher model accuracy for the entire parameter space, if the correlation is not considered. Another possible reason for this is that the correlation cannot be modeled with a simple mathematical model. Furthermore A_VZ is an indirect input parameter, which can lead to the correlation being neglected. In addition, the correlation is covered by main effects in such a high dimensional problem.

5.1.3 Handling with interactions

The robustness analysis is only recognized if a correlation exists. Further studies are needed to identify the correlation exactly. The mathematical function of the MOP can only be displayed in **optiSLang** if the Meta model has been created using a linear or quadratic regression. These correlations are detected by coupling terms of corresponding parameters. The monomial $x_1 x_2$ for example, points to the correlation between the parameters x_1 and x_2 . The functions can not be displayed with other regression methods, due to the high level of complexity. If the correlations on the mathematical function can not be precisely identified, the system and / or the result before the optimization has to be analyzed more deeply, especially the apparently erroneous results.

To increase the approximation quality of the Meta model, the correlation can be ignored if the designs can not be applied in this sub-region, in which the detected correlation can occur. Using the example of AS, this subsection is excluded from the entire parameter space. In many cases, this method can be applied in industrial settings, because a correlation is selectively removed for the majority of products.

If a good prediction in the sub region under the influence of correlations is required for other products, other measures have to be applied. Possible measures include:

- Local Meta models are created separately for the sub regions under the influence of the correlation. Then these Meta models are integrated into the global MOP.
- Several local Meta models are integrated into an overall MOP (nested) in the entire parameter space. This reduces difficulty by creating a local model, but the selection of the box areas must be carefully considered. This method can be compared with the MLS, however, it is more elaborate and may reflect a very complex reality.

Therefore, in applying both methods we must consider that, on the one hand, the integration must be easy to implement and automate and that, on the other hand, the potential inaccuracies must be corrected in the limit or overlapping areas of the boxes with a special method.

5.1.4 Defintion of the target

In this application example the required objective function value of the AS is:

$$\Phi_{AS} = 0.7^\circ \pm 0.2^\circ \quad . \quad (3)$$

The AS refers to the middle of the flanks. In a high-dimensional problem, it could be an infinite number of solutions without further restrictions (other objective functions or constraints). Therefore, in comparison to classic product optimization - i.e., sequential optimization procedures with subsequent robustness evaluation - the robustness is integrated here as a second optimization target into the optimization process by performing a robust optimization. The variation of the AS should be as small as possible in order to develop an appropriately robust product. Therefore the clearance Φ_{AS} and variation σ acting as a robustness coefficient are defined as objective functions.

5.1.5 Robustness Optimization

In this case, the robustness coefficient will be kept as small as possible, as will the variation. There are also other common definitions for the robustness coefficient, such as the S/N ratio (signal-noise factors ratio) in TM, which correlates well with the standard deviation σ . The various robustness coefficients can be easily converted to one another. According to the results of the sensitivity analysis, the geometry parameters have a decisive influence on the AS. In reality, the manufacturing tolerances of the geometry parameters must be considered as noise factors. All tolerances must be translated into actually occurring variations. The geometry parameters are described by these, i.e., by normal distributions. In this application example, the manufacturing processes have a process capability index C_{pK} of 1.33, which corresponds with state of the art technology. The tolerance of the geometric parameters of the standard deviation σ can be converted using this information, in this case by dividing by four. The process capability index C_{pK} is described by the mean value μ , the standard deviation σ , and the upper (USL) or lower (LSL) specification limit as follows (Roenpage and Lunau (2007)):

$$C_{pK} = \frac{\min(\mu - USL; LSL - \mu)}{3\sigma} \quad . \quad (4)$$

Table 7 gives an overview of all geometry parameters with their tolerances and standard deviations σ . In this application example, the coefficient of variation CV is the ratio of standard deviation σ and mean value μ (Dynardo (2010)):

$$CV = \frac{\sigma}{\mu} \cdot 100 \% \quad . \quad (5)$$

A normal distribution is uniquely defined with the specific mean value μ and standard deviation σ . Then the distributions are realized over a discretization by ALHS and the robust optimization performed by ARSM. The multi objective function problem can be simplified into a single objective function problem with the set target of $\Phi_{AS} = 0.7^\circ \pm 0.2^\circ$, because the target size of AS is defined as a boundary condition within the optimization. Accordingly, the robustness value σ is the only objective function. It should be considered that the constraint at `optiSLang` can only be defined in terms of comparison signs.

Table 7: Overview of the definition of parameters of the AS

No.	Parameter	Unit	μ	Tol.	σ	CV (%)
1	D_H_VZ_I	[mm]	29.950	± 0.150	0.03750	0.13
2	R_H_VZ	[mm]	0.725	± 0.075	0.01875	2.59
3	R_H_R_I	[mm]	0.800	± 0.150	0.03750	4.69
4	S_H	[mm]	0.800	± 0.050	0.01250	1.56
5	W_H_A	[°]	60.000	± 0.050	0.01250	0.02
6	D_SpH_VZ_A	[mm]	29.500	± 0.120	0.03000	0.10
7	R_SpH_VZ	[mm]	2.050	± 0.050	0.01250	0.61
8	S_SpH	[mm]	1.000	± 0.050	0.01250	1.25
9	R_SpH_R_A	[mm]	1.200	± 0.145	0.03600	3.00

5.1.6 Reduction of noise

Different designs were found as possible solutions after optimization with ARSM, see figure 10. After checking the settings, no significant correlations between the design and the ARSM settings were found. The different results can occur randomly while optimizing. After further investigations, it is confirmed that the randomness of the noise is generated in the robustness analysis. This means that a similar design can result in different standard deviations in the robustness analysis at the same time. For example, a normal distribution of a design parameter via ALHS is realized. Realizations can easily differ each time by chance. Table 8 shows the noise of the parameter Phi_AS. The more samples are scanned, the less noise is observed in the result.

Table 8: Mean value of 30 repetitions of the robustness analysis in AS

Samples	Unit	50	100	150	200
μ	[°]	0.07645	0.07730	0.07725	0.07675
σ	[°]	0.002030	0.001646	0.001440	0.000990
σ/μ	[%]	2.66	2.13	1.87	1.29

With such low noise, the robustness analysis can be used in the conventional RDO as a verification criterion after optimization without problems. However, we must observe that if an integration in the optimization process is conducted by itself as an objective function value, the noise interferes with the convergence history of the optimization algorithm. The algorithm of ARSM is searching for the global optimum. If there are several, very close local optima in the value of the objective function, a local optimum can be found.

In **optiSLang** it would be very costly to integrate an averaging of the results into the optimization process. An additional Meta-Meta model is created for the AS to reduce the noise of the robustness analysis. This principle is comparable to an averaging. The noisy result is smoothed through a regression of the calculated different standard deviations. In order to obtain a sufficiently effective smoothing of the noisy results, 1000 samples

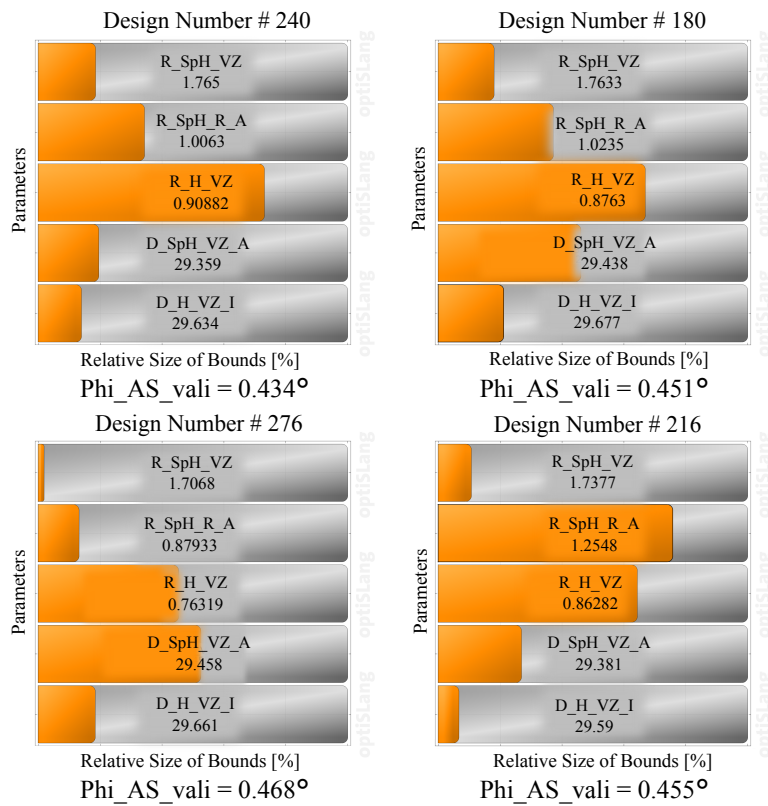

Figure 10: Optimized designs with different ARSM settings, Meta model with 8 parameters, $W_{H_A} = 60^\circ$, set value 0.45 %

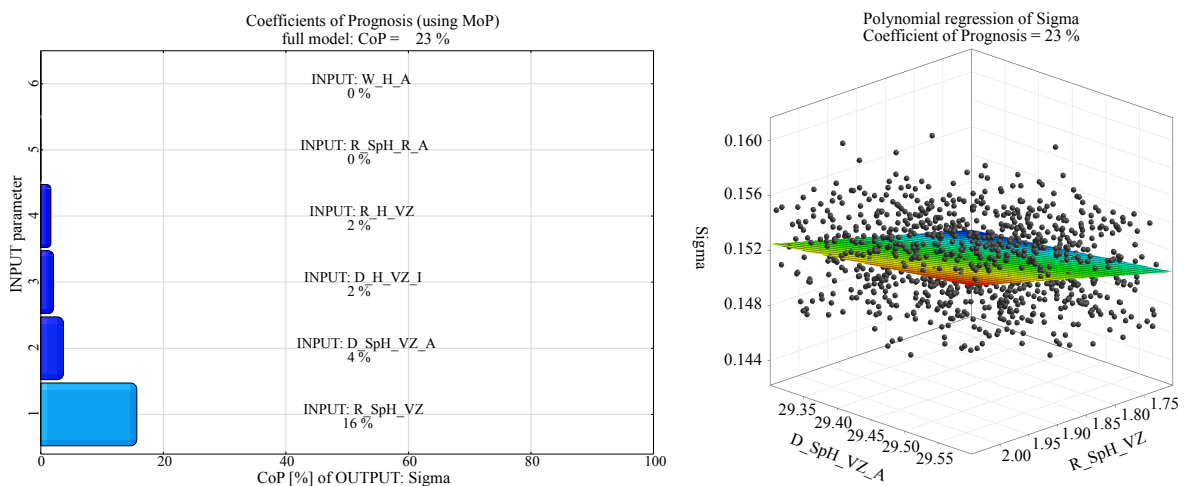

Figure 11: The significance of the parameter (left) and the Meta-Meta model of the output clearance (right)

are tested by the ALHS method to construct the Meta-Meta model. According to the CoP -value of 23 %, the approximation quality of the Meta-Meta model is not sufficient. However, a lower CoP is acceptable or even expected, because the CoP is ensued by a variance-based statistical method. The CoP indicates the percentage of the variance of the system response covered by the regression. The variance with noise is not completely accounted for by regression. Figure 11 directly demonstrates the significance of each design parameter for the robustness (variation). According to it, the parameter R_SpH_VZ has the most impact on the AS.

The convergence curve during the optimization process is an important indicator for the efficiency and accuracy of the results. With consideration of the noise, the objective function value σ converges insufficiently and slowly - up to 30 iterations - to the local optimum, while without consideration of the noise it converges quickly to the global optimum (up to 10 iterations), see Figure 12.

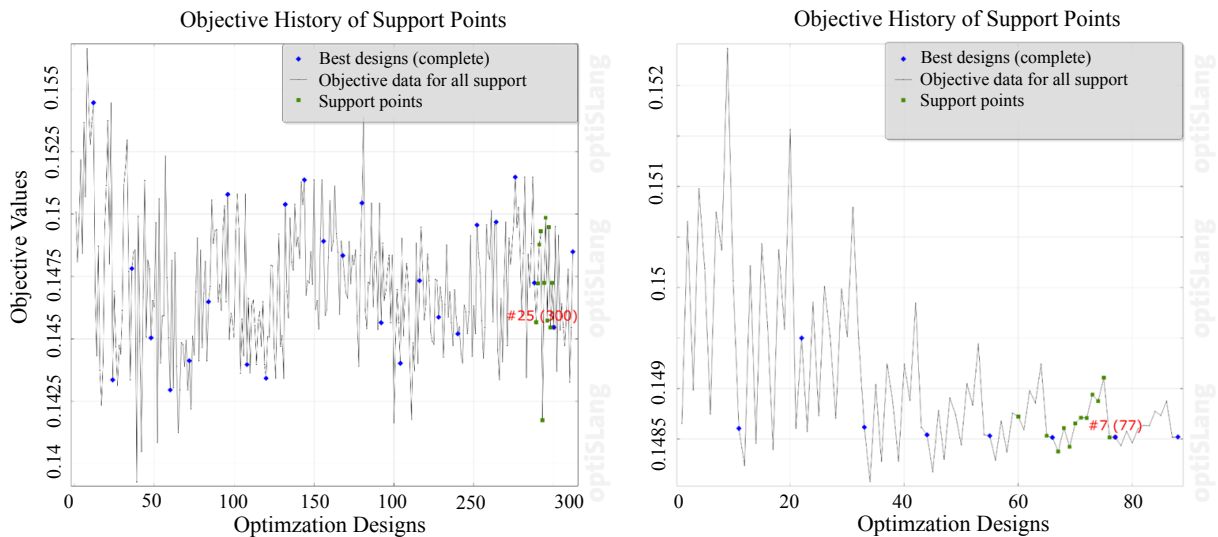

Figure 12: Comparison

The design determined by the Meta-Meta model is finally validated by 30 repetitive robustness analyses using the Meta model. The mean value of the 30 standard deviations corresponds very well with the results from the Meta-Meta model. The results from RDO are listed in comparison to the results of TM in Section 5.3.

5.2 Parameter optimization according to TM

The parameter space for the sensitivity analysis and for the Meta model must first be defined. Compared to RDO, TM after SMAR²T Kemmler et al. (2015) considers both the significant and the insignificant parameters for the sensitivity analysis and as well for creating the Meta model, which means that the full parameter space is examined in AS. The MOP is a quadratic regression without coupling terms involving no correlation, see Figure 13. The CoP of the Meta model of 98 % is quite satisfying, but the sum of

the individual CoP is 120 %. The correlation due to small A_VZ must be eliminated, according to RDO.

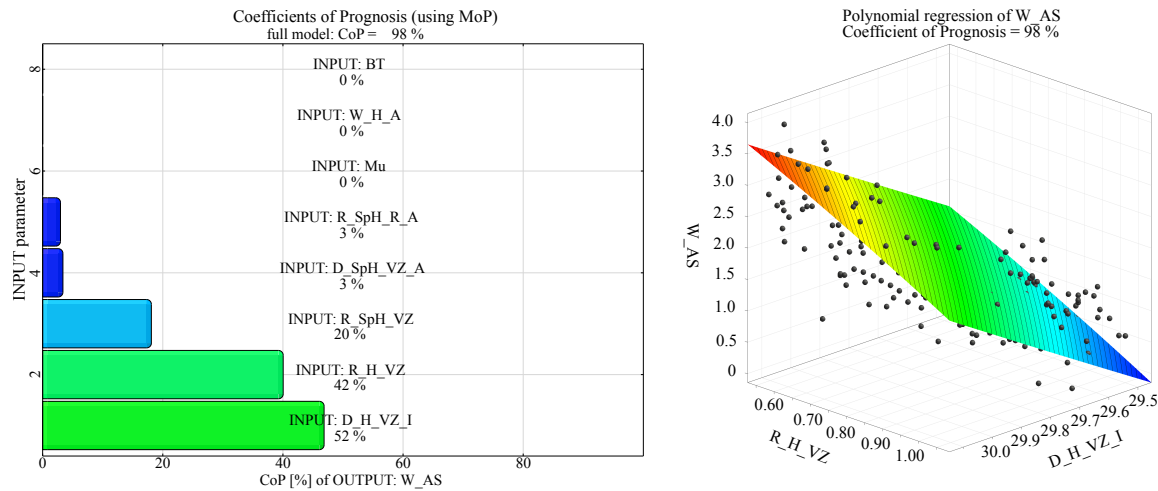

Figure 13: Significance of all parameters (left) and the MOP: quadratic regression with uncoupled terms (right)

5.2.1 Design of Experiment

As mentioned in Chapter 2, with the Taguchi method an experimental design is created in order to recognize the effects of the parameters on the objective function. A distinction is made between inner and outer arrays.

Inner array

Table 9 shows an overview of all control factors on three factor levels. The lower (LSL) and upper limits (USL) of the control factors are each limited to 10 % of the entire area inwards to avoid inaccuracy of the Meta model at the border area. That provides the possible application of a tolerance analysis, see Figure 14. An orthogonal array L_{27} is used for nine control factors on three levels (27 experimental settings), see Figure 16.

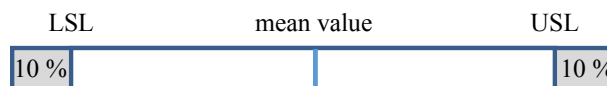

Figure 14: Restriction of the limits of variation

Outer array

Normally, in TM the outer array considers only the outer noise factors that are not connected to the control factors, such as the variation in operating temperature, material characteristics, and load. The classic Taguchi arrays can be used if

Table 9: Control factors (geometric parameter) on three setting levels for the inner array

No.	Parameter	Unit	UG	μ	OG
1	D_H_VZ_I	[mm]	29.5500	29.8200	30.0900
2	R_H_VZ	[mm]	0.5775	0.8138	1.0500
3	R_H_R_I	[mm]	0.6400	0.8000	0.9600
4	S_H	[mm]	0.6400	0.8000	0.9600
5	W_H_A	[°]	44.0000	60.0000	76.0000
6	D_SpH_VZ_A	[mm]	29.3300	29.4500	29.7500
7	R_SpH_VZ	[mm]	1.7350	1.8750	2.0150
8	S_SpH	[mm]	0.8400	1.0000	1.1600
9	R_SpH_R_A	[mm]	0.8000	1.1000	1.4000

- the control factors do not vary in practice,
- the variation of control factors can not be controlled or is very difficult to estimate,
- there is a linear correlation (first order) between the control factors and the target value.

In other cases, depending on the optimization strategy and capacity, only the significant or even all control factors are considered as noise factors in the outer array.

As is apparent from the sensitivity analysis, the control factors (geometric parameters) and their variation from manufacturing tolerances have a decisive influence on the AS. In addition, the Meta model is determined from a quadratic regression. In this regard, these variations must be considered as internal noise factors.

One fundamental difference between TM and RDO is described by the distribution of the variation. In RDO, the normal distributions of the input parameters are displayed on samples, causing the objective function value to be distributed in a realistic manner. In contrast, the normal distributions of the parameters in TM are converted to an approximately equal distribution (D’Errico and Zaino (1988)). Therefore, the parameters are either tested on three stages, the upper specification limit (USL), the mean value μ , and the lower specification limit (LSL), or in two stages (USL, LSL) in order to represent the variation in the system. The transformation can be carried out with the following notation:

$$\mu \pm \sigma\sqrt{3} \quad . \quad (6)$$

With two stages to be tested, the mean value is neglected. A very good estimation of the variation of this transformation is achieved after D’Errico and Zaino (1988).

For each setting stage of the parameters, the variation of the inner noise factors is converted on three stages. Figure 15 shows the variation of the parameter R_SpH_VZ, where the standard deviation is $\sigma = 0.0125$. With the notation 6, USL and LSL are set to $\pm\sigma \cdot \sqrt{3}$ or ± 0.022 .

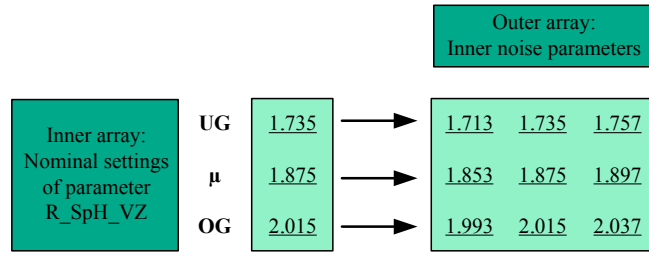

Figure 15: Implementation of the inner noise factors on the example of R_SpH_VZ

The 9 inner noise factors are tested on three levels, while the 7 outer noise factors are tested on two stages. According to Figure 16, an orthogonal array L_{36} with 36 tests is needed for the outer array. A new outer field is created in each test setting of the control factors, in which the inner noise factors are adjusted to the nominal values of the controlled factors. A total of $27 \cdot 36 = 972$ tests are performed by the MOP for the subsequent mean value and S/N analysis.

5.3 Evaluation of results from the optimization methods

In applying TM, the same Meta model is used as in the RDO, and contains all control and noise factors. After testing $27 \cdot 36 = 972$ samples, the effects of the control factors on the mean value and the S/N ratio of AS are determined see Figure 17. Here, the S/N ratio is calculated by “The nominal best type II“. The higher the S/N ratio, the more robust the product is.

In TM, the variation of the objective function value is initially reduced by setting the adjustment levels for all control factors. This maximizes the S/N ratios. However, with strict implementation, the mean value shifts. Thus the mean value must be adapted to the target value. Here, the adjustment levels of the control factors R_H_VZ, D_SpH_VZ_A and R_SpH_VZ are not changed. The subsequent adjustment of the mean value is carried out by varying the parameters D_H_VZ_I and R_SpH_R_A.

Similar trends in the main effects of AS are detected using DOE (TM) and Meta-Meta model (RDO), especially by the significant parameters D_H_VZ_I, R_H_VZ, D_SpH_VZ_A and R_SpH_VZ, see Figure 17. Table 10 presents a comparison of the best designs from RDO and TM. For most design parameters, particularly for the significant parameters, there is only a minimal deviation. The deviations cannot be avoided because when applying TM, the control factors are only graded in a very rough manner. The deviations of the parameters S_SpH and R_SpH_R_A are relatively large. The reason is that their parameter levels are set with a small priority for low significances to minimize the deviation of the mean value.

The robustness analysis by ALHS for the two best designs provides an equal standard deviation of 0.092° , when all noise factors are considered. However, the S/N ratios of DOE and ALHS do not correspond correctly. With the application of the Taguchi Method, the optimized S/N ratio by using DOE is about 18.25 (standard deviation of 0.122°), compared to the S/N ratio of 20.7 using ALHS (standard deviation of 0.092°). This deviation is caused by the different methods of implementing the distribution function.

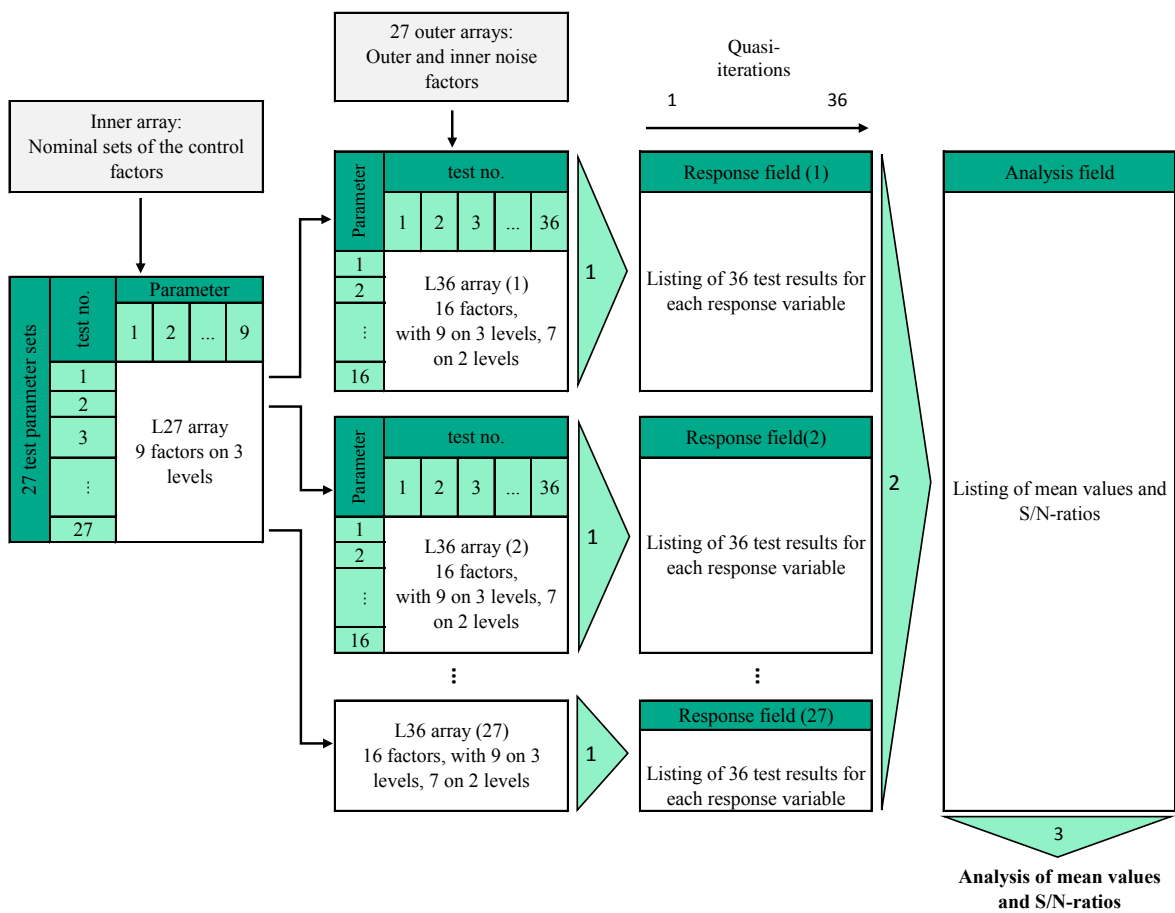

Figure 16: Design of experiment of the TM, outer array with inner noise factors

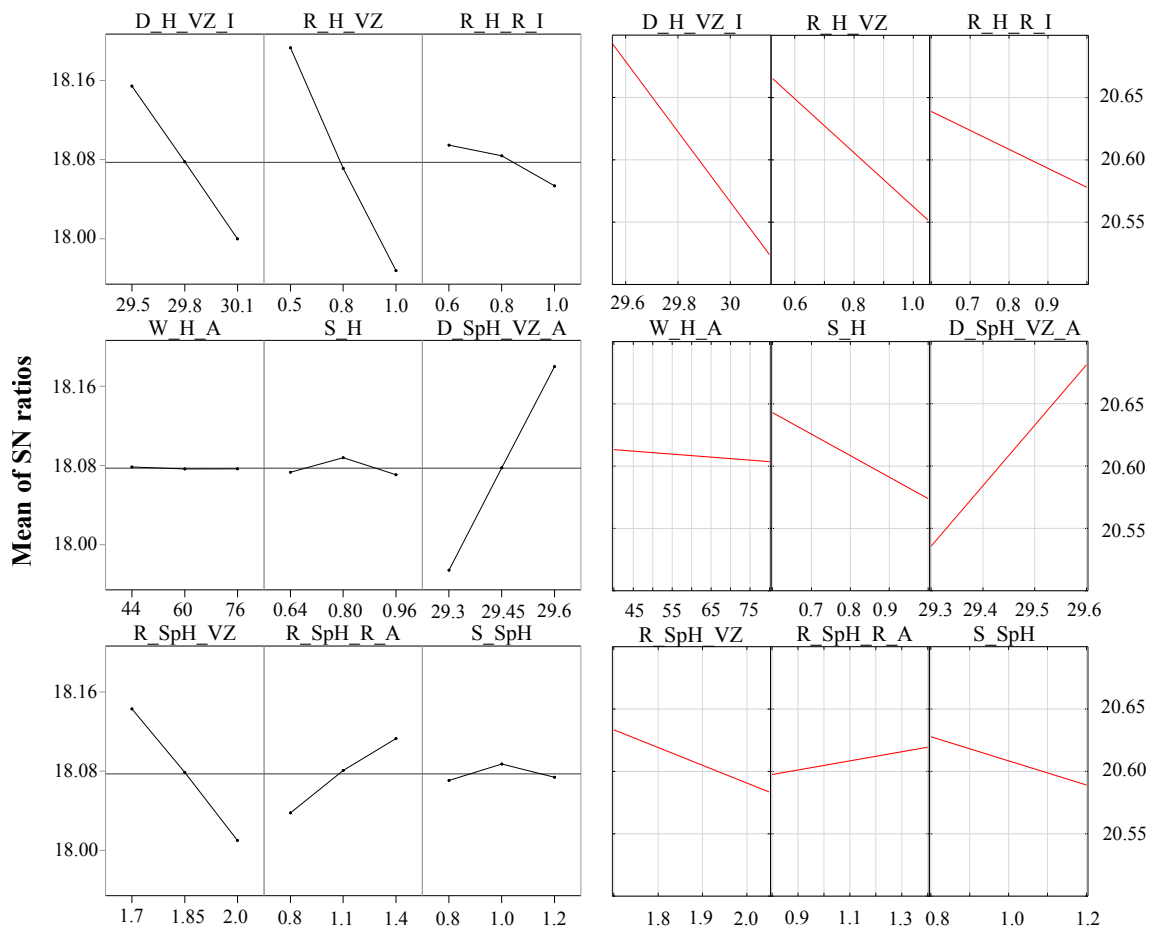

Figure 17: Results of TM (on the left - Minitab) and RDO (on the right - [optiSLang](#)), influence of the noise factors on S/N ratio, with selected setting levels

Table 10: Comparison of the best designs by RDO and TM

No.	Parameter	Unit	Best Design RDO	Best Design TM	Deviation [%]
1	D_H_VZ_I	[mm]	29.80	29.82	0.07
2	R_H_VZ	[mm]	0.60	0.58	3.45
3	R_H_R_I	[mm]	0.63	0.64	1.59
4	S_H	[mm]	0.77	0.80	3.75
5	W_H_A	[°]	54	60	11.11
6	D_SpH_VZ_A	[mm]	29.60	29.57	0.10
7	R_SpH_VZ	[mm]	1.700	1.735	2.35
8	S_SpH	[mm]	0.8	1.0	20.00
9	R_SpH_R_A	[mm]	1.1	0.8	37.5.
	Phi_AS	[°]	0.82	0.79	3.66
	Sigma_all_ALHS	[°]	0.091	0.092 (DoE: 0.122)	1.09

*the parameters in bold are significant

*Sigma.all: with all noise factors

Table 11: Fundamental differences of RDO and TM

TM	RDO
+ relatively simple method	+ mean value and nominal value are optimized separately
+ lower number of tests	+ high automization
+ flexible with few parameters and uncoupled CF and NF	+ definition of constraints possible
+ very robust method, suitable for early PDF or validation phase	+ fast adaption of the target value
+ Meta modeling not mandatory	+ fast adaption of new tolerances (but difficult with noise)
	+ multiobjective optimization possible
	+ optimization of up to 100 parameters
	+ no additional expense when extending parameters
- manual consideration of constraints	- no consideration of non-significant parameters
- no definiton of the random target value	

The best design with this present setting level combination is validated by MOP. The calculated nominal output clearance is 0.79° . This imprecision can not be avoided because of the coarsely graded control factors. In summary, the two methods provide very similar results.

Compared to RDO, TM considers the four most significant parameters. A smaller outer array (L_9) instead of L_{36} is used, and a similar design with high accuracy is achieved, when compared to RDO. In summary, both methods are compared in Table 11 with regards to their flexibility of application.

6 Instruction RDO and Taguchi

Based on the results presented, we have derived a recommendation for action for applying the two methods and visualized it using a flow chart, see Figure 18.

7 Discussion and summary

Many similarities can be found between the two optimization methods, as we have seen in the present investigation. If the same Meta model is used, similar results are achieved using TM and RDO, and robustness can be optimized. The TM is in general a universally applicable method that is mainly used in the statistical design of experiments (DOE). Due to the low number of tests it requires, this method can be used to carry out real experiments as well as simulations. This means that a Meta model is not mandatory. Possible noise in the results is prevented by converting parameter distribution functions into equal distribution with coarsely graded control factors.

However, TM is only limited to relatively simple optimization problems with a low number of parameters due to its manual optimization procedure. If boundary conditions need to be considered when optimizing, the optimization is more complicated and more expensive. In addition, an optimization aiming towards a coarse gradation of the control factors is not very easy to achieve. Furthermore, the calculated standard deviation (S/N ratio) should only be used to compare different parameter combinations. The actual value must be validated by ALHS because of the inaccurate implementation process of the test variations or robustness analysis.

In comparison with RDO, TM aims primarily to increase system robustness. However, the optimization process is performed manually using orthogonal arrays instead of with the help of optimization algorithms. The parameters are clearly separated by arrays here, but no multi-objective optimization can be realized.

According to the sensitivity analysis, depending on simulation strategy and capacity, either all or only the significant control and disturbance variables are considered. The significant parameters are preferred in RDO, which may be both noise factors and control factors. Examination of too many parameters causes noise to affect the approximation quality of the MOP and the optimization algorithm. In TM, it is less expensive to take all parameters into account by using a larger orthogonal array for the DOE. However, in this case the tolerance limits must be chosen wisely, otherwise the significances are covered. When optimizing manually, non-significant parameters can be optimized with

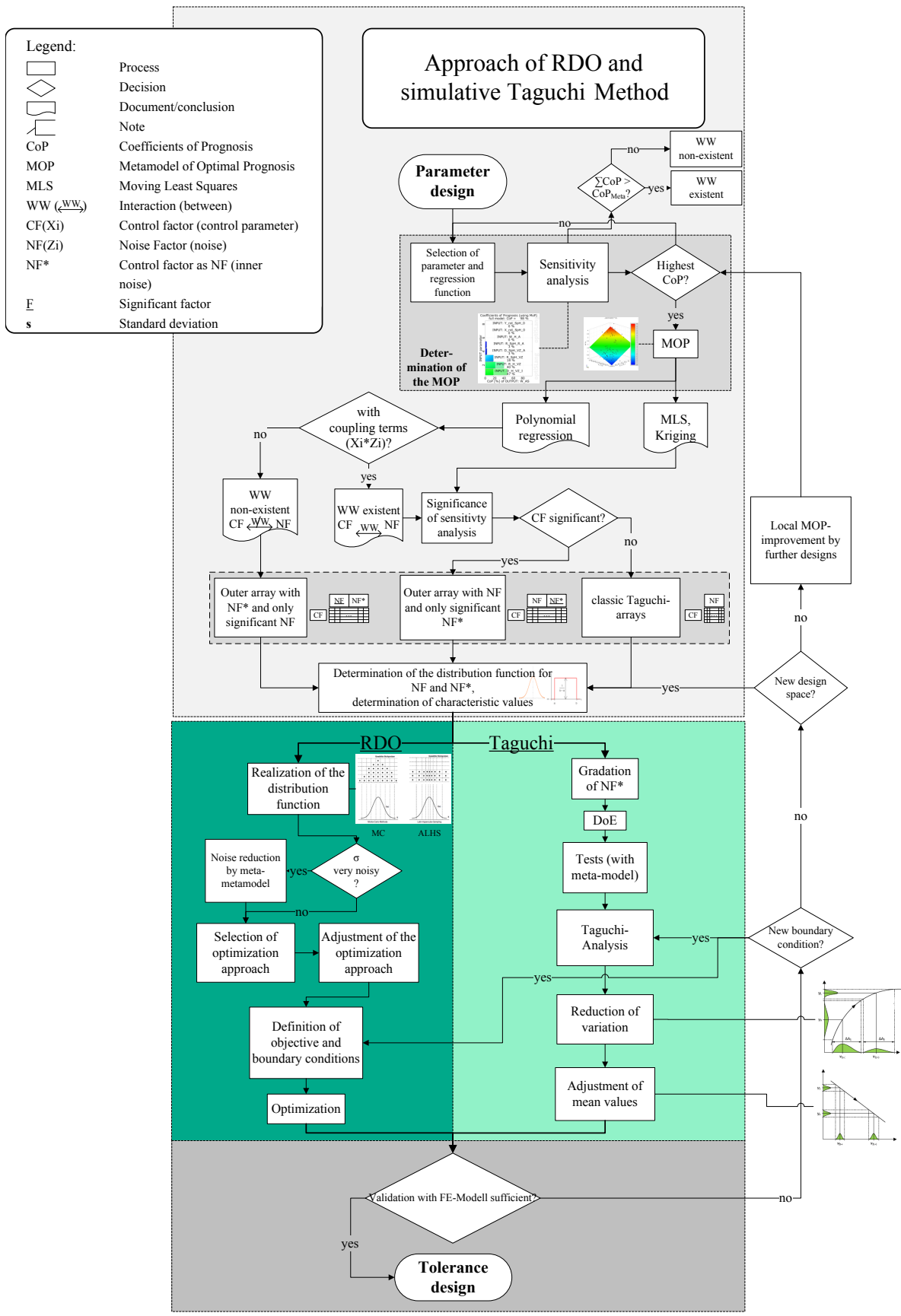

Figure 18: Flow chart pre-processing, RDO and Taguchi - optimization

low priorities at the end.

A specific procedure is presented in the form of a flow chart in Chapter 6 as a summary of this paper, see Figure 18.

In further investigations, the integration possibility of the variation should be examined with coarse gradation instead of classic sampling in RDO. This would prevent incidental noise. Subsequently, optimization with the actual variation of the best designs should be checked using the robustness analysis with classical sampling. This addition allows the advantages of both methods to be combined.

Acknowledge

The authors would like to thank Zeyi Wang (B.Sc.) for his intensive cooperation, his constructive comments, and his suggestions.

References

- BREUER, B. ; BILL, K. H.: *Bremshandbuch - Grundlagen, Komponenten, Systeme, Fahr-dynamik*. 4. Edition. Berlin : Springer Vieweg Verlag, 2012
- D'ERRICO, J. ; ZAINO, N.: *Statistical Tolerancing using a Modification of Taguchi's Method*. American Society for Quality, 1988
- DYNARDO: *OptiSLang - The optimizing structural language*. Weimar : dynardo - Dynamic Software and Engineering GmbH, 2010
- GAMWEGER, J. ; JÖBST, O. ; STROHRMANN, M.: *Design for Six Sigma - Kundenorientierte Produkte und Prozesse fehlerfrei entwickeln*. München : Carl Hanser Verlag, 2009
- GUNDLACH, C.: *Entwicklung eines ganzheitlichen Vorgehensmodells zur problemorientierten Anwendung der statistischen Versuchsplanung*. Kassel : Kassel university press GmbH, 2004
- KEMMLER, S. ; BERTSCHE, B.: Gestaltung robuster und zuverlässiger Produkte nach der SMART-Methode. In: *Proceedings of the 25th Symposium on Design for X*. Bamberg, October 2014, p. 169–180
- KEMMLER, S. ; BERTSCHE, B.: Systematic Method for Axiomatic Robustness-Testing (SMART). In: *Proceedings of the International Symposium on Robust Design*. Copenhagen, August 2014, p. 101–112
- KEMMLER, S. ; DAZER, M. ; LEOPOLD, T. ; BERTSCHE, B.: Method for the development of a functional adaptive simulation model for designing robust products. In: *11th Weimar Optimization and Stochastic Days*. Weimar, November 2014

- KEMMLER, S. ; FUCHS, A. ; LEOPOLD, T. ; BERTSCHE, B.: Systematisches Toleranz Design unter Berücksichtigung von Funktions- und Kostenaspekten nach der robusten Zuverlässigkeitsmethode SMAR²T. In: *Proceedings of the 26th Symposium on Design for X*. München, October 2015, p. 209–220
- KLEPPMANN, W.: *Versuchplanung: Produkte und Prozesse optimieren*. Carl Hanser Verlag, 2013
- MENG, J. ; ZHANG, C. ; WANG, B. ; ECKERLE, W.: Integrated robust parameter design and tolerance design. In: *Int. J. Industrial and Systems Engineering* Vol. 5 (2010), No. No.2, p. 159 – 189
- MORI, T.: *The New Experimental Design: Taguchi's Approach to Quality Engineering*. Dearborn, MI : ASI Press, 1990
- MOST, T. ; WILL, J.: Sensitivity analysis using the Metamodel of Optimal Prognosis. In: *Weimar Optimization and Stochastic Days 2011*. Weimar, November 2011
- PARK, G.-J. ; LEE, T.-H. ; LEE, K. H. ; HWANG, K.-H.: *Robust Design: An Overview*. AIAA Journal, Vol. 44, p. 181-191, 2006
- ROENPAGE, O. ; LUNAU, S.: *Six Sigma + Lean Toolset: Verbesserungprojekte erfolgreich durchführen*. 2. Edition. Berlin : Springer Vieweg Verlag, 2007
- SUH, N. P.: *Axiomatic Design - Advances and Applications*. New York : Oxford University Press, 2001
- TAGUCHI, G. ET AL.: *Taguchi's Quality Engineering Handbook*. New Jersey : John Wiley & Sons, Inc., 2005