

# **Remote Laboratory for Digital Holographic Metrology**

Marc Wilke, Guohai Situ, Igor Aleksenko, Margarita Riedel,  
Giancarlo Pedrini, Sabina Jeschke and Wolfgang Osten

Institut für Technische Optik  
Universität Stuttgart, Germany

# Motivation

---



- Scientists wish to collaborate on research
- Raw data is already often recorded and analyzed using computers
- Conditions of the measurement process need to be recorded to interpret the raw data (traditionally in a lab book)
- Publication of raw data desirable

# Motivation

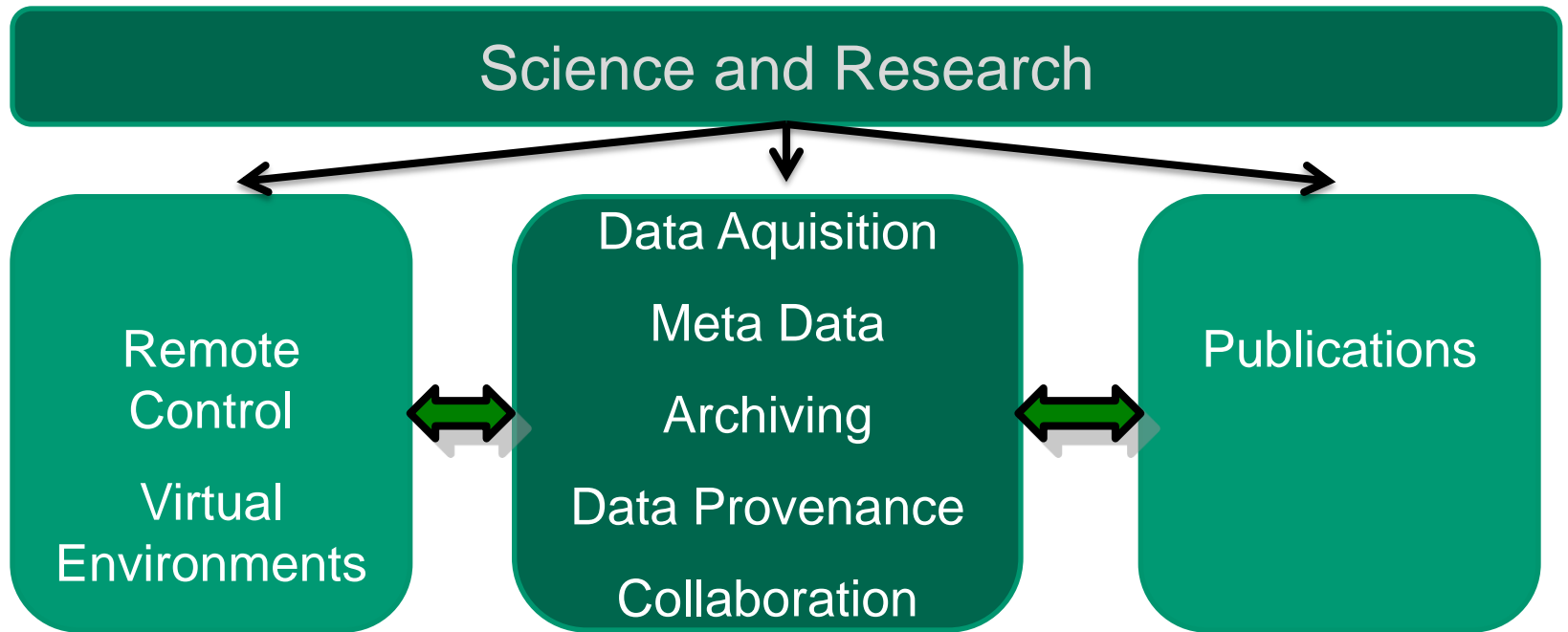

# Motivation

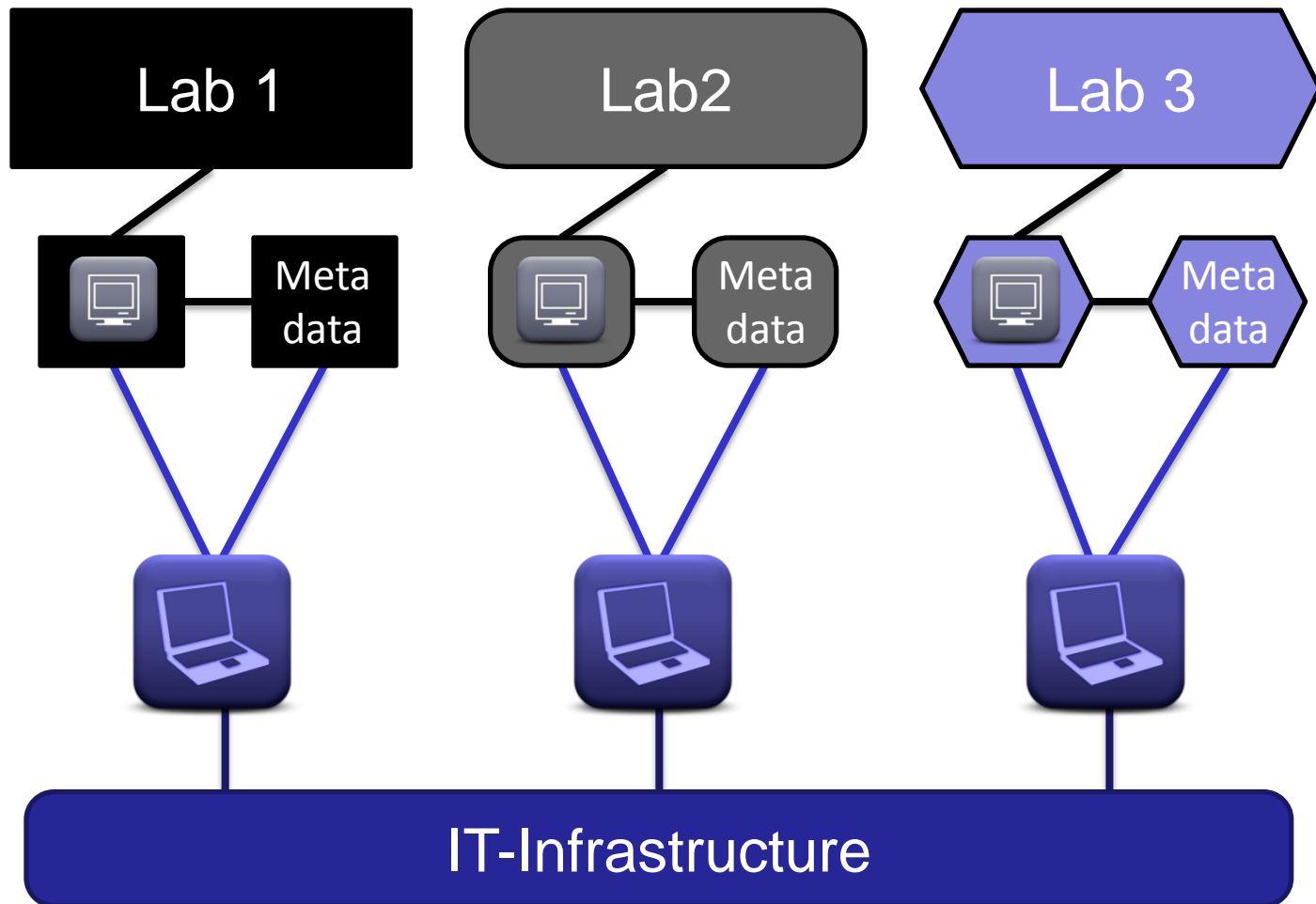

# Aim of BW-eLabs

---



- Design an Infrastructure for automatic recording, storage and access to research data
- Secure, single sign-on access to labs without loss of local control
- Support of publication process, including publication of raw data
- Support for integration of specific labs

# BW-eLabs Architecture

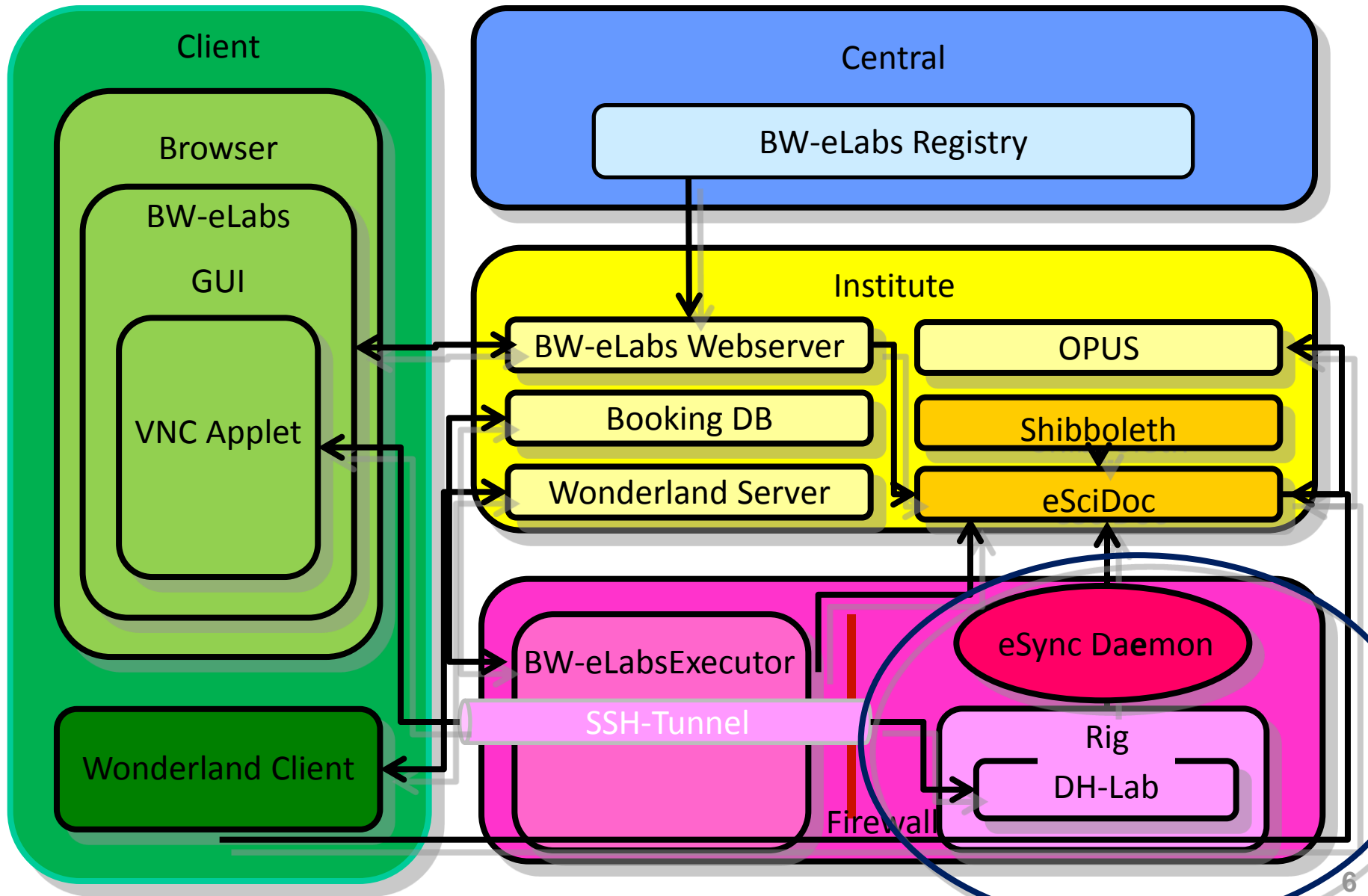

# Dataflow in BW-eLabs

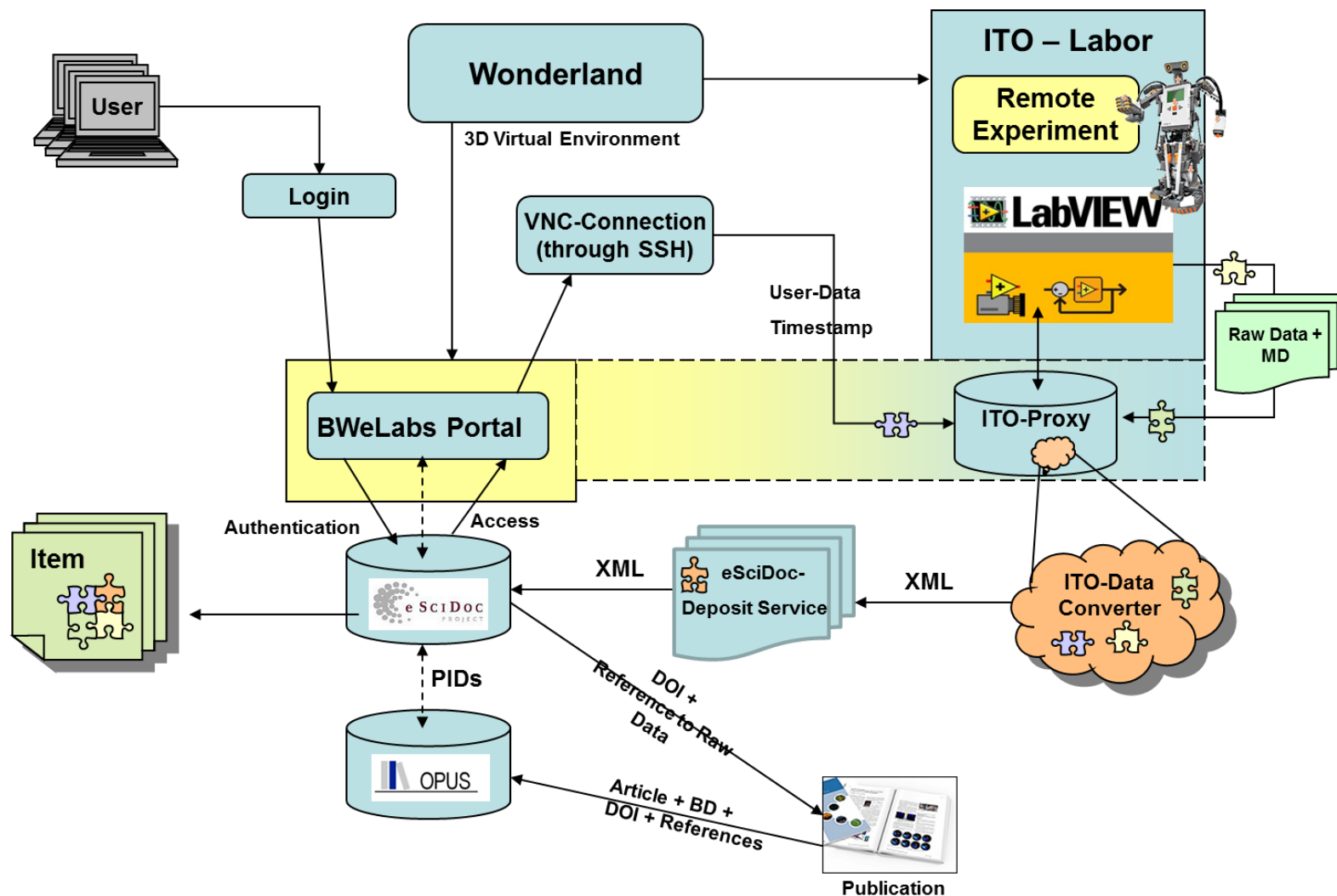

# DH Lab - Setup

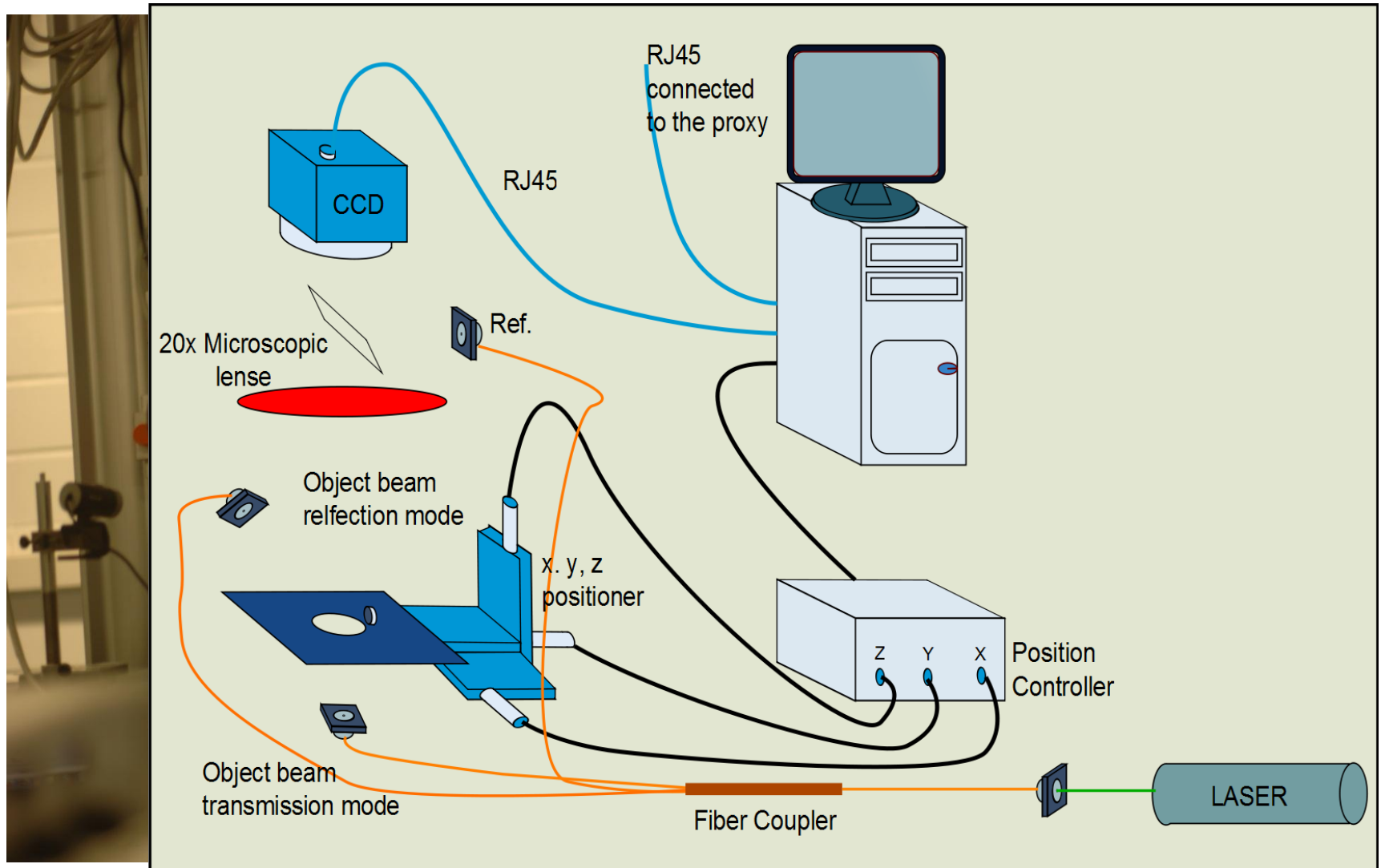



# DH Lab - GUI



RemoteRecoHoloCorrBETA\_a1.vi

Datei Bearbeiten Ansicht Projekt Ausführen Werkzeuge Fenster Hilfe

Intensity Phase Distribution Unwrapped Phase Phase Difference Unwrapped Phase Difference

3D options

alpha 45.00

beta 45.00

border 50

background 1

plane 120

Size reduction 1

Unwrapped Surface

900,000 0.5X 8-bit image1 (0,0)

Direction of View (NW) South West

Image Size Resolution 600

Scale of the 100

Interpolation Type Zero Order

WEBCAM

Camera 2

WebCams ON

RUN STOP

HOLOGRAM

RECONSTRUCTION

Detailed Information

ROI Activate

Reconstruction begin X

1000 1250 1500

750 1750 2000

500 0 250

Reconstruction begin Y

750 1000 1250

500 1500

250 0 1750 2000

EN 9:19 AM 5/18/2011

Topological  
Reconstruction

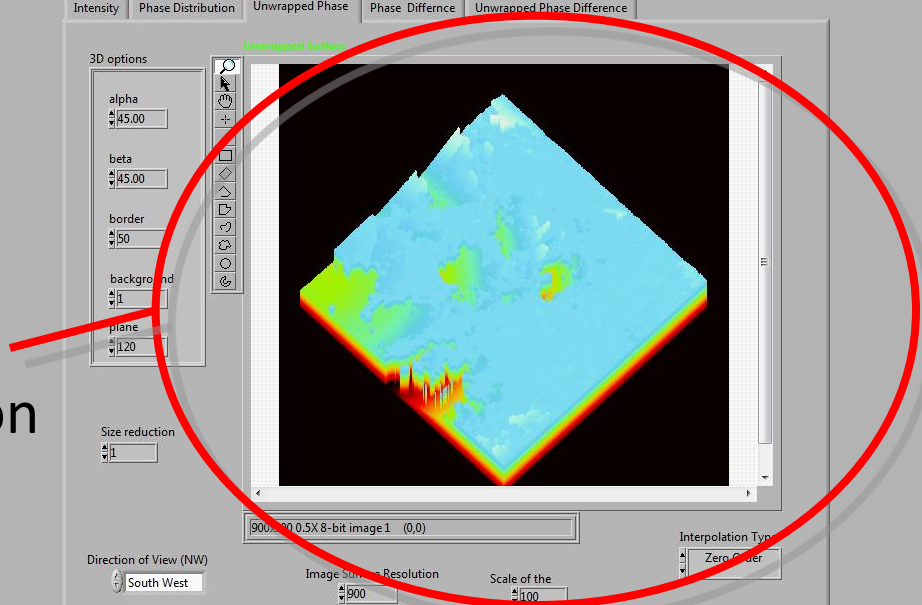

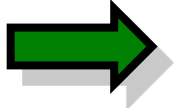
- Hologram stores all optical information of an object  Well suited for remote collaboration
- Complete state of the system can be saved and restored automatically (including geometry and position, reconstruction, description of experiment, description of Holograms)
- Searchable Meta Data generated and stored automatically in eSciDoc database

# Results and Future Work

---



- BW-eLabs implements an infrastructure for handling research data
- DH Lab implemented as a demonstrator
- Low level integration of additional labs already feasible through generic interfaces (VNC, eSync Daemon, eSciDoc Deposit Service)
- Future Work: 3D Interface in Wonderland, publication of raw data

# Acknowledgement

---



- Funded by the Ministerium für Wissenschaft, Forschung und Kunst, Baden-Württemberg under the „BW-eLabs“ Project
- Projectpartners:
  - Universität Stuttgart (RUS, IITS, ITO, Bibliothek)
  - FIZ Karlsruhe (Fachinformationszentrum)
  - Freiburger Materialforschungszentrum (FMF) und RZ der Universität Freiburg
  - Hochschule der Medien

*Thank You for Your Attention*