

Monoclonal and Recombinant Antibodies to Potyviral Proteins and Their Application

Monoklonale und Recombinante Antikörper gegen potyvirale
Proteine und ihre Verwendung

Von der Fakultät Geo- und Biowissenschaften der Universität Stuttgart
zur Erlangung der Würde eines Doktors der
Naturwissenschaften (Dr. rer. nat.) genehmigte Abhandlung

Vorgelegt von Fangbing Liu
aus Jiangxi, China

Hauptberichter:	Prof. Dr. Holger Jeske
Mitberichter:	Dr. habil. Jörg Schubert
	PD Dr. Thomas Frischmuth

Tag der mündlichen Prüfung: 15. Dezember 1999

Biologisches Institut der Universität Stuttgart

1999

Contents

Deutsche Zusammenfassung (Summary in German)	I
List of abbreviations	XI
1 General introduction and scope of the work	1
1.1 Generation of antibodies in the immune response	1
1.2 Antibody structure and function	3
1.3 Molecular and genetic basis of antibody structure	4
1.4 Monoclonal and recombinant antibodies	6
1.4.1 Monoclonal antibodies	6
1.4.2 Recombinant antibodies	7
1.4.2.1 Single chain variable fragment (scFv) antibody	8
1.4.2.2 Fab fragments	10
1.4.2.3 CDR ring peptides, potential of smallest synthesized antibodies	10
1.5 Phage display and antibody evolution <i>in vitro</i>	11
1.5.1 Phage display mimics B cells for secreting antibodies, an <i>in vitro</i> evolution	11
1.5.2 Mammalian antibody repertoires and antibody gene libraries	13
1.5.2.1 Mammalian antibody repertoires	13
1.5.2.2 Antibody gene libraries	14
1.5.3 Limitation of antibody phage display	15
1.6 Application of recombinant antibodies	16
1.6.1 Intracellular expression of scFvs (intrabodies) for gene therapy	16
1.6.2 Application of scFvs in diagnostics	16
1.6.3 Potential of scFvs in plant pathology and plant molecular biology	17
1.6.4 Antibodies expressed in plants – an example of the tomorrow's factory making bio-agents for all purpose applications	19
1.7 Genome organization and functions of potyvirus	20
1.7.1 Genome organization of potyviruses	20
1.7.2 Functions of potyviral RNA encoded proteins	21
1.7.2.1 P1 serine proteinase	21
1.7.2.2 HC-Pro protein	22
1.7.2.3 P3 protein, 6K ₁ and 6K ₂	22
1.7.2.4 CI protein	23
1.7.2.5 VPg	23

1.7.2.6	N1a protease	24
1.7.2.7	N1b replicase	25
1.7.2.8	Coat protein	26
1.8	Serology of potyviral structural protein and nonstructural proteins	27
1.9	Pathogen-derived resistance and antibody-mediated resistance	27
1.10	Scope of the work	29
2	Results	30
2.1	Sequence alignments and peptide syntheses	30
2.2	Expression of the R1-R2-R3 fusion protein in <i>E. coli</i> .	30
2.3	Expression of the recombinant N1b protein in <i>E. coli</i>	32
2.4	Production of antisera to the recombinant N1b of PVY	34
2.5	Generation and characterization of MAbs against different regions of N1b	34
2.6	Generation and characterization of MAbs against synthetic peptides of CP	36
2.7	Generation and characterization of MAbs to recombinant N1b and CP of PVY	36
2.8	Detection of the native N1b protein in potyvirus-infected plants	38
2.8.1	ELISA	38
2.8.2	Western blotting	38
2.9	Detection of the coat protein in potyvirus-infected plants	40
2.9.1	ELISA	40
2.9.2	Western blot analysis	40
2.10	Comparison of detection of the viral N1b and CP in PVY-infected plants	41
2.11	Temporal expression of potyviral N1b and CP in plants	42
2.12	Construction of recombinant single chain fragment (scFv) antibody	45
2.12.1	Cloning of immunoglobulin variable region genes	45
2.12.2	Synthesis of scFv by fusion PCR or from V _L and V _H combinatorial libraries	47
2.13	Size of Fv or scFv libraries	48
2.14	Biopanning for selection of functional scFv from the libraries	48
2.15	Sequences of scFv-clones	50
2.16	Expression of scFv antibodies in <i>E. coli</i>	53
2.16.1	Total protein analysis of scFv expression	53
2.16.2	Optimization of expression of scFv and extraction	54
2.17	IMAC purification and <i>in vitro</i> refolding of scFv	56
2.18	Expression of scFv-alkaline phosphatase fusion protein in <i>E. coli</i>	58
2.19	Comparison of different antibodies for detection of virus-infection	58

3	Discussion	60
3.1	Prediction of antigenicity of peptides derived from NIB	60
3.2	Antibody isotypes may be antigen-dependent in immune response	62
3.3	Overexpression of NIB of PVY in <i>E. coli</i>	63
3.4	Sensitivity of detection of NIB in different NIB preparations and assays	64
3.5	Viral and host plant RdRps	65
3.6	Phage display for selection of functional scFv	67
3.7	Expression of scFv in <i>E. coli</i>	68
3.8	Activity of scFv-AP fusion protein	70
3.9	Potentials of MAb or scFv in disease resistance engineering	71
4	Materials and methods	74
4.1	Materials	74
4.1.1	Experimental animals	74
4.1.2	Plant viruses and their host species for propagation	74
4.1.3	<i>Escherichia coli</i> strains	74
4.1.4	Plasmids	75
4.1.5	Myeloma cells	75
4.1.6	Primers and oligonucleotides	75
4.1.7	Enzymes	77
4.1.8	Antibodies and conjugates	77
4.1.9	DNA and protein markers	78
4.1.10	Other reagents and kits	78
4.1.11	Buffers and media	78
4.1.11.1	Buffers for electrophoresis, ELISA and Western blot	78
4.1.11.2	Growth media for bacteria/phages	79
4.1.11.3	Mammalian cell culture media	80
4.1.12	Special laboratory equipment and materials	81
4.2	Methods	82
4.2.1	Peptide identification and synthesis	82
4.2.2	Construction and overexpression of R1-R2-R3 fusion protein	82
4.2.3	Molecular cloning of PVY NIB gene and construction of expression plasmid	83
4.2.4	Purification of NIB protein by immobilized metal-ion affinity chromatography	83
4.2.5	Purification of potato virus Y	84
4.2.6	Production of antisera	85

4.2.7	Development and production of monoclonal antibodies	85
4.2.7.1	Mice immunization	85
4.2.7.2	Cell fusion and selection of hybridoma cell lines	86
4.2.7.3	Storage and recovery of hybridoma cells in liquid nitrogen	87
4.2.8	Enzyme-linked immunosorbent assay (ELISA)	87
4.2.8.1	PTA-ELISA	87
4.2.8.2	DAS-ELISA	88
4.2.8.3	TAS-ELISA	88
4.2.9	Antigen specificity assays	88
4.2.10	SDS-PAGE and Western blotting	88
4.2.11	Detection of RdRp and CP in potyvirus-infected plants	89
4.2.12	Time course study of expression of RdRp and CP of potyviruses	90
4.2.13	Molecular cloning and expression of single chain antibodies in <i>E. coli</i>	90
4.2.13.1	mRNA purification, cDNA synthesis and PCR amplification of V genes	90
4.2.13.2	Construction of scFv expression plasmids	90
4.2.14	Antibody phage display and cycles of selection	91
4.2.15	Phage-ELISA	92
4.2.16	DNA sequencing and sequence analysis software	92
4.2.17	Site-directed mutagenesis	93
4.2.18	Expression of soluble scFv in <i>E. coli</i> and optimization of conditions	93
4.2.18.1	PCR identification of colonies containing scFv inserts	93
4.2.18.2	Analysis of total protein of <i>E. coli</i> with Coomassie brilliant blue staining and Western blotting	93
4.2.18.3	Analysis of binding properties of scFv in ELISA	94
4.2.19	Purification and refolding of scFvs	94
4.2.19.1	Preparation of bacterial culture	94
4.2.19.2	Isolation of soluble secreted scFv from periplasma	95
4.2.19.3	Purification of scFv from inclusion bodies	95
4.2.19.4	<i>In vitro</i> refolding of scFvs derived from inclusion bodies	96
4.2.20	Construction of scFv-AP expression plasmid vector	96
4.2.21	Development of detection systems based on MAb and scFv	97
5	Summary	98
6	Reference	99
7	Appendix	128

Zusammenfassung

Die durch Pflanzenviren hervorgerufenen Ertragsausfälle sind beträchtlich. Es wird geschätzt, dass die jährlichen Verluste bis zu 15 Milliarden USD betragen. Unter den 34 verschiedenen Familien der Pflanzenviren nehmen die *Potyviridae* eine besondere Stellung ein, da sie mit 198 definierten und möglichen Vertretern, also etwa einem Drittel aller bekannten Pflanzenviren, die zahlenmäßig größte Familie ist (Ward und Shukla, 1991; Brunt, 1992). Die *Potyviridae* werden in die Genera *Potyvirus*, *Bymovirus*, *Ipomovirus*, *Rymovirus* und nicht definierte Potyviren unterteilt. Von diesen ist der Genus *Potyvirus* mit gegenwärtig 128 Arten (117 definierte und 11 mögliche) derjenige mit den meisten Arten. Potyviren werden in der Regel durch Vektoren, also Aphiden, Milben oder bodenbürtige Pilze, übertragen. Ihr sicherer Nachweis ist eine essentielle Voraussetzung für die Resistenzzüchtung, die Virusfreimachung sowie Bekämpfung der Viren. Für verschiedene Potyviren sind Resistenzgene bekannt, für andere wird nach ihnen gesucht. Allerdings kann der Prozeß ihrer Einkreuzung in Sorten sehr langwierig sein. Oftmals werden dadurch auch unerwünschte Eigenschaften, bis hin zur Anfälligkeit für andere Viren, mit übertragen. Daher gewinnen gentechnische Verfahren zur Verbesserung der Resistenz zunehmend an Bedeutung. Da die Akzeptanz bisher üblicher Verfahren über die pathogenvermittelte Resistenz (pathogen derived resistance) noch nicht gegeben ist, sind alternative Ansätze gefragt. Das Anliegen der vorliegenden Arbeit war es, die Grundlagen für einen solchen Ansatz zu schaffen. Dafür sollten die neuesten Entwicklungen auf dem Gebiet der Antiköperteknik genutzt werden. Es war in den letzten Jahren gelungen, die Gene für die variablen Regionen von Antikörpern zu klonieren und in Form aktiver, verkleinerter Moleküle neu zu kombinieren. Diese sogenannten "single chain variable fragment antibodies" (scFv) haben ihr Potential in der Diagnose inzwischen demonstriert. Sie fanden, wenn auch vorerst noch vereinzelt, bereits Einzug in die pflanzliche Virologie und zwar zum einen als Diagnosemittel aber auch zur Verbesserung der Resistenz. Dafür wurden die entsprechenden Gene für scFv in Pflanzen zur Expression gebracht. Bisher wurden dafür nur scFv eingesetzt, die mit viralen Hüllproteinen (CP) reagierten. Wir wollten dieses Verfahren nutzen, um mit Hilfe entsprechender scFv ein für die Vermehrung von Viren essentielles Enzym, die RNA-abhängige RNA-Polymerase (RdRp) zu blockieren. Dieses Enzym entspricht bei Potyviren dem NIb. Man kann erwarten, dass ihre Blockierung bereits die frühesten Stadien der Virusvermehrung unterbrechen würde. Um das Prinzip universell gestalten zu können, wurden bei der Herstellung der scFv Zielsequenzen ausgewählt, die für die RdRp aller Potyviren charakteristisch sind. Von diesen vermuten wir, dass sie für die Aktivität des Enzyms essentiell sind.

Gleichzeitig sollte der diagnostische Werte der gegen das Nib und Hüllprotein (CP) gewonnenen monoklonalen Antikörper (MAb) - letztere dienten für Vergleichszwecke - sowie daraus entwickelten scFv eingeschätzt werden.

Prinzipiell gibt es drei Möglichkeiten, scFv herzustellen:

- über fertige Banken,
- über die mRNA induzierter Milzzellen oder
- über MAb.

Wir wählten den letzten Weg, da uns Banken nicht zur Verfügung standen.

1 Identifizierung konservierter Regionen von Nib und CP

Alle zum Zeitpunkt der Analyse in der EMBL-Datenbank verfügbaren Sequenzdaten für das Nib von Potyviren wurden mit Hilfe eines Computerprogramms (DNASIS, Hitachi) genutzt, um die entsprechenden Aminosäuresequenzen abzuleiten und zu vergleichen. Damit die ausgewählten, stark konservierten Regionen eine ausreichend hohe Antigenität aufweisen, sollten sie länger als 20 Aminosäuren sein. Es konnten drei größere Bereiche identifiziert werden:

Region 1 (R1): ANKTRRTFTAAPLDTLLGGKVCVDDENNQFY,

Region 2 (R2): LPEGWVYCDADGSQFDSSLTPYLINAVL und

Region 3 (R3): NLYTEIVYTPILTPDGTIVKKFKGNNSGQPSTVVDNTLMV.

Die Motive FTAAP (R1), DGSQFD (R2) und GNNSGQPS (R3) waren dabei perfekt konserviert, während bei den anderen Aminosäuren in Abhängigkeit vom Virus in einigen Fällen eine oder zwei Aminosäuren verschieden sein konnten. Die unterstrichenen Teile der Sequenzen wiesen dabei die höchste Immunogenität auf. Entsprechende Peptide, z. T. gekoppelt mit Rinderserumalbumin als immunologisch inertem Träger und Verstärker der Immunantwort, wurden synthetisiert.

Für das CP von Potyviren konnten zwei stark konservierte Regionen nachgewiesen werden:

MVWCIENGTSPD und ENTERHTA, die im Kern- bzw. C-terminalen Bereich des Proteins lokalisiert sind. Diese wurden als "multiple antigen peptide" (MAP) synthetisiert. Dazu wurden vier Moleküle über Lysin miteinander gekoppelt. Wir erwarteten so eine Verbesserung der Immunogenität.

2 Überexpression eines R1-R2-R3-Fusionsproteins und des potato virus Y-NiB in *Escherichia coli*

Um die Reaktivität der gegen die Peptide gewonnenen MAb testen zu können, war es erforderlich, geeignete rekombinante Proteine herzustellen.

Als erstes wurden DNA-Fragmente synthetisiert, die für die Regionen eins bis drei kodierten, und nacheinander in das Plasmid pGEM3 kloniert. Das resultierende Insert R1-R2-R3 wurde in pET30a kloniert und das Protein in *E. coli* überexprimiert.

Für die Klonierung des nativen NiB wurde von Gesamt-RNA ausgegangen, die aus PVY^N-infizierten *Nicotiana tabacum*-Pflanzen isoliert worden war. Mit Hilfe spezifischer Primer gelang die Amplifikation des NiB-Gens durch RT-PCR. Es wurde anschließend in pCR-SCRIPT SK (+) kloniert und sequenziert. Für die Expression wurde das Insert in pET30a/*E. coli* BL21 (DE3) pLysS retransformiert und exprimiert. Die meisten der Klone erwiesen sich als instabil, da das NiB offensichtlich toxisch für *E. coli* ist. Von einem stabilen Klon gelang die Expression des NiB.



Abb. 1: Expression des rekombinanten NiB in *E. coli* BL21 (DE3) pLysS und Darstellung seines Reinheitsgrades nach Affinitätschromatographie.

a: Coomassie Brilliant Blau-gefärbtes SDS-Polyacrylamidgel von Gesamtproteinen. Bahn 1: mit IPTG induzierte Zellen, Bahn 2: nicht induzierte Zellen, Bahn 3: IPTG-induzierte Zellen mit pET30a ohne Insert, Bahn 4: nicht induzierte Zellen mit pET30a ohne Insert, Bahn 5: Zellen ohne Plasmid, Bahn M: vorgefärbter Proteinmarker.

b: Coomassie Brilliant Blau-gefärbtes SDS-Polyacrylamidgel mit über IMAC gereinigtem rekombinanten NiB. Bahn 1: Durchfluß von Ni²⁺-Säule; Bahn 2: Gesamtextrakt aus *E. coli*; Bahn 3-6: Eluate, Fraktionen 1, 2, 7 und 8; Bahn 7-8: Mischung der Fraktionen 1-4 bzw. 5-8, über PEG konzentriert; Bahn M: vorgefärbter Proteinmarker.

Beide rekombinanten Proteine wurden über Affinitätschromatographie an immobilisierten Metallionen (immobilized metal-ion affinity chromatography, IMAC; hier Ni²⁺ als Gegenion) gereinigt und für die Testung eingesetzt. Der Nachweis der Expression des

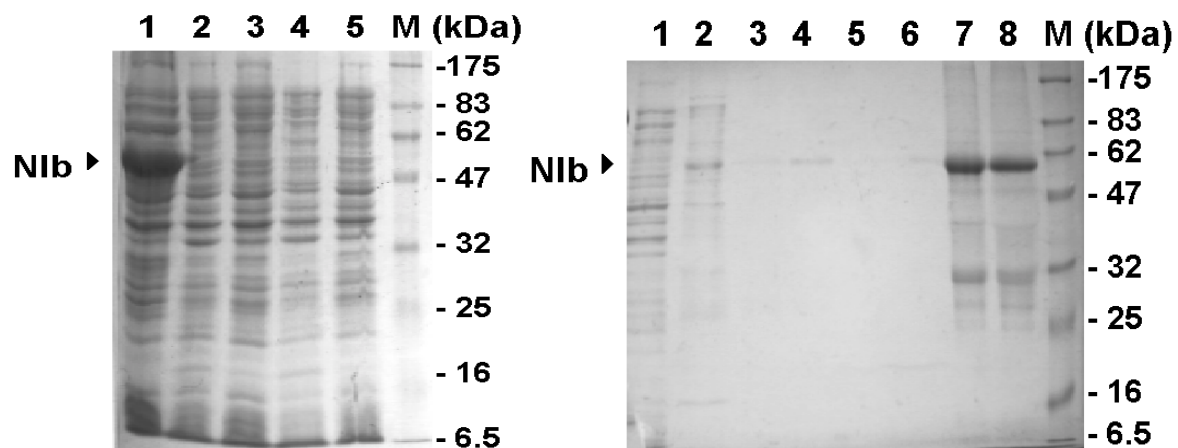
NIb und die Überprüfung seiner Reinheit nach Chromatographie sind in Abbildung 1 dargestellt.

3 Gewinnung von MAb gegen synthetische Peptide

Als Fusionspartner wurden die Myelomzelllinien SP2/0-Ag 14 bzw. X 63-Ag 8.653 verwendet.

Tabelle 1: Zusammenfassung der Eigenschaften der gegen das NIb gewonnenen MAb.

Zellkultur-überstand	Spezifisch für Peptid	A _{405nm} -Werte im PTA-ELISA										
		Synthetische Peptide			Recombinantes Protein		Blattextrakte aus infizierten Pflanzen					
		R1	R2	R3	RP1-3	NIb	PVY	gesund	PVA	PPV	PVV	TuMV
1G5	R1	1.16	0.11	0.09	0.03	0.03	0.03	0.07	nt*	nt	nt	nt
2C3	R1	1.66	0.12	0.10	0.03	0.03	0.26	0.30	nt	nt	nt	nt
2G10	R1	1.33	0.10	0.08	0.33	0.33	1.92	1.32	1.89	1.88	1.88	1.79
3C6	R1	1.13	0.12	0.11	0.82	0.32	0.45	0.07	0.47	0.38	0.33	0.27
3G4	R1	1.24	0.11	0.10	0.75	0.66	0.25	0.07	0.26	0.23	0.25	0.23
1B7	R2	0.16	1.69	0.19	1.08	0.68	0.25	0.08	0.34	0.22	0.24	0.26
1C8	R2	0.14	1.94	0.15	1.55	0.55	0.37	0.15	0.45	0.37	0.37	0.33
1G12	R2	0.12	1.80	0.11	0.85	0.78	0.30	0.07	0.39	0.30	0.33	0.31
1B9	R2	0.22	1.41	0.21	0.06	0.02	0.20	0.14	nt	nt	nt	nt
3B4	R3	0.16	0.11	0.32	0.05	0.02	0.04	0.05	nt	nt	nt	nt
3E11	R3	0.11	0.10	0.31	0.04	0.01	0.04	0.05	nt	nt	nt	nt

*nt = nicht getestet; RP1-3 = rekombinantes Protein R1-R2-R3; Die synthetischen Peptide, das rekombinante R1-R2-R3 und NIb wurden in einer Konzentration von 2 µg/ml verwendet. Der Isotyp aller MAb war IgM.

Aus den verschiedenen Fusionsexperimenten resultierten 11 Hybridomzelllinien, die MAb gegen die konservierten Regionen des NIb sekretierten. Ihre Reaktivität mit den korrespondierenden Antigenen verschiedenen Ursprungs wurde bestimmt. Die Ergebnisse sind in Tabelle 1 dargestellt. Vier der MAb, 1G12, 3G4, 1B7 und 3C6, die gegen die Peptide R1 bzw. R2 gewonnen worden waren, reagierten sowohl im Western blot als auch ELISA spezifisch mit den NIb verschiedener Potyviren.

Unter den gegen die CP-spezifischen MAP-Peptide hergestellten Hybridomazelllinien konnten vier identifiziert werden, die spezifische MAb sekretierten. Diese reagierten jedoch im PTA-ELISA unspezifisch mit Presssaft aus gesunden Pflanzen. Wurde für das Beschichten ein polyklonales Antiserum gegen das PVY eingesetzt, so ließ sich der MAb 5B3 auch für den Nachweis des PVY mittels DAS- bzw. TAS einsetzen, da kaum noch Reaktionen mit gesundem Material auftraten.

Die Ergebnisse demonstrierten, dass es prinzipiell möglich ist, Peptide für die Gewinnung von MAb einzusetzen, die mit spezifischen Regionen eines Proteins reagieren sollen.

4 Gewinnung von MAb gegen das rekombinante NIb und das CP des PVY

Im Ergebnis der Versuche wurden verschiedene MAb gegen das rekombinante NIb sowie das CP des PVY gewonnen. Ihre Eigenschaften sind in Tabelle 2 dargestellt. Es konnte gezeigt werden, dass sie für den Nachweis einer PVY-Infektion geeignet sind. Der gegen das PVY CP gerichtete MAb 1D6 wies alle zehn im PTA- und TAS-ELISA getesteten Isolate des PVY nach. Dabei ergaben die Isolate C, To1 und oGA im Western blot schwächere Signale (Abb. 2). Er weist weder im PTA-/TAS-ELISA noch Western blot Kreuzreaktionen mit anderen Potyviren auf, wie den getesteten potato virus A und V, watermelon virus 2, plum pox, lettuce mosaic, maize dwarf mosaic, turnip mosaic, ryegrass mosaic, barley yellow mosaic und barley mild mosaic virus.



Abb. 2: Western blot-Analyse der CP verschiedener PVY-Isolate auf *N. glutinosa*.

Bahn 1: Isolat A91; Bahn 2: Isolat M3; Bahn 3: Isolat NTN; Bahn 4: Isolat CH 605; Bahn 5: Isolat oGA; Bahn 6: Isolat To1; Bahn 7: Tomaten; Bahn 8: Isolat C; Bahn M: vorgefärbter Proteinmarker. Proben extrahiert mit 50 mM Tris-HCl-Puffer, pH 6.8.

Tabelle 2: Charakteristika und Reaktivität mono- und polyklonaler Antikörper gegen NIB und CP des PVY

Zellkultur-Überstand/Seren	Specificität für antigen	Isotyp		A_{405nm} Values in PTA-ELISA / TAS-ELISA		
		Schwere Kette	Leichte Kette	Überexprimiertes NIB (2µg/ml)	Extrakte aus PVY-infizierten Blättern (1:50)	Extrakte aus nicht infizierten Blättern (1:50)
1C8	NIB	µ	κ	1.25 [†] / 0.35 [‡]	0.73 / 0.27	0.65 / 0.19
1D8	NIB	µ	κ	1.14 / 0.32	0.67 / 0.15	0.58 / 0.11
2F5	NIB	µ	κ	1.39 / 0.42	0.92 / 0.33	0.13 / 0.18
2F10	NIB	µ	κ	1.32 / 0.39	1.05 / 0.32	0.16 / 0.18
2E11	NIB	µ	κ	1.63 / 0.48	1.12 / 0.43	0.11 / 0.15
3B10	NIB	µ	λ	1.20 / 0.37	0.96 / 0.16	0.03 / 0.09
1D6	CP	γ	κ	0.03 / 0.04	1.35 / 1.56	0.03 / 0.05
Serum M	NIB			1.35 / nt	1.27 / nt	0.53 / nt
Serum R1	NIB			2.18 / nt	0.66 / nt	0.17 / nt
Serum R2	NIB			2.32 / nt	0.73 / nt	0.22 / nt

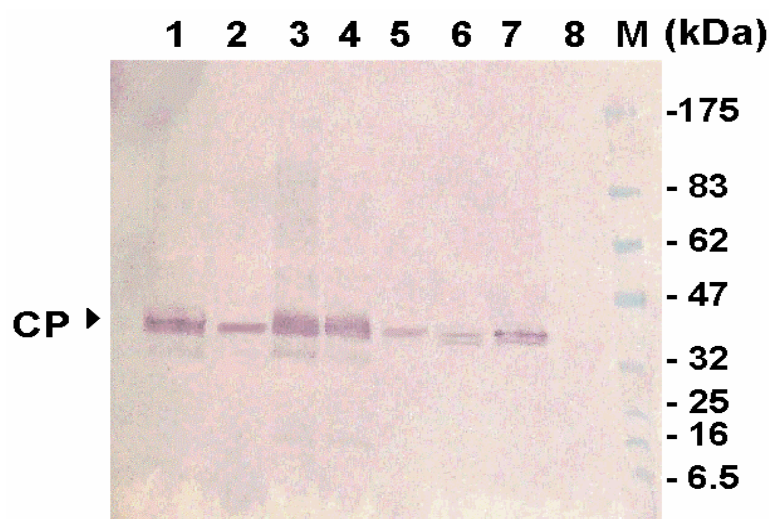
Serum M = Antiserum von für die Gewinnung von Milzzellen immunisierter Maus, vor Gebrauch 1:500 verdünnt; Seren R1 and R2 = Kaninchenantisera, vor Gebrauch 1:1000 verdünnt; nt = nicht getestet. Die A_{405nm} -Werte wurden nach 1 h Substratinkubation bei Raumtemperatur gemessen. [†] A_{405nm} -Werte für den PTA-ELISA, [‡] A_{405nm} -Werte für den TAS-ELISA. Systemisch infizierte Blätter wurden 14 dpi getestet.

5 Dynamik der Expression des NIB und des CP

Der zeitliche Verlauf des Auftretens des CP und des NIB wurde an PVY^N-infizierten *N. glutinosa* und *N. occidentalis* untersucht. Beide Proteine ließen sich in systemisch infizierten Blättern 5 dpi sowohl durch Western blot als auch ELISA nachweisen. Im Falle des Isolates 1427 konnte das NIB bereits eine Tag vor dem CP nachgewiesen werden. Beim Isolat oGA ließen sich CP und NIB erst 7 dpi nachweisen. Ähnliche Ergebnisse sind für das TEV beschrieben worden. Die Daten lassen den Schluß zu, dass sich verschiedene Isolate verschieden schnell in den Wirten vermehren und ausbreiten. Es konnte weiterhin beobachtet werden, dass in den älteren Blättern geringere Mengen der RdRp als in den jüngeren angereichert wurden. Das spricht für eine aktivere Vermehrung des Virus in den jüngeren, systemisch infizierten Blättern. Gleichzeitig waren die Absorptionswerte im ELISA für PVY-

infizierte *N. glutinosa*-Pflanzen höher als für *N. occidentalis* (Abbildung 3). Das traf sowohl für das CP als auch die RdRp zu.



Abb. 3: Zeitlicher Verlauf des Auftretens von NIb und CP in verschiedenen Wirten und Blättern. pi: 1. Blatt, lokal infiziert; si: 2. Blatt, systemisch infiziert; g: *N. glutinosa*; o: *N. occidentalis*; CP, NIb: Testung auf CP oder NIb. Die Pflanzen wurden mit dem Stamm PVY CH 605 inokuliert. Die Werte für die gesunde Kontrolle betragen für das NIb = 0.12 ± 0.15 , für das CP = 0.01 ± 0.05 . Probenanzahl (N) = 10. Für den Nachweis des NIb wurde der Kulturüberstand des MAb 2E11 (1:1 verdünnt) genutzt, für das CP der gereinigte MAb 1D6 (1mg/ml, 1:1000 verdünnt). Die A_{405nm} -Werte wurden nach 1 h Substratinkubation bei Raumtemperatur gemessen.

6 Klonierung und Überexpression der scFv-Gene in *E. coli*

ScFv-Antikörper bestehen aus den variablen Fragmenten (Fv) der leichten und schweren Kette eines Antikörpermoleküls und sind über einen Peptidspacer miteinander verbunden. Dieser ist in der Regel 15 Aminosäuren groß und ermöglicht eine korrekte Faltung des Moleküls, so dass es sich mit dem Antigen verbinden kann. Für die Klonierung der Fv konnten wir von publizierten Sequenzen für die angrenzenden Bereiche ausgehen und entsprechende Primer synthetisieren. Ausgangspunkt für die Klonierung war mRNA, die aus den entsprechenden MAb produzierenden Hybridomazellen gewonnen wurden. Die cDNA wurde mit Hilfe von Zufallsprimern generiert. Ausgehend von dieser cDNA erfolgte dann die separate PCR-Amplifikation der Fv der schweren und leichten Kette. Dafür wurden Primerpaare eingesetzt, die an Bereiche der konstanten 3'- oder 5'-Regionen binden, die an die

Fv angrenzen. Es waren degenerierte Primer zu wählen, da diese konstanten Regionen gewisse Variationen in der Nukleinsäuresequenz aufweisen. Der 5'-Primer für die schweren Kette enthält außerdem die Sequenz für ein Leader-Peptid. Die über PCR erhaltenen Fragmente wurden kloniert und sequenziert. Anschließend erfolgte zwecks Überexpression in *E. coli* eine Reklonierung in weitere Plasmide/Phagemide (pSEX81, pOPE101, pCANTAB 5E). Auf diese Weise konnten sowohl an der Phagenoberfläche exponierte als auch lösliche scFv gewonnen werden. Diese banden an die entsprechenden Antigene. Dabei zeigten beide rekombinante Antikörpertypen ein ungefähr gleiches Bindungsverhalten. Allerdings war ihre Affinität geringer als die der nativen MAb. Die Ergebnisse dieser Versuche sind in Tabelle 3 zusammengefaßt.

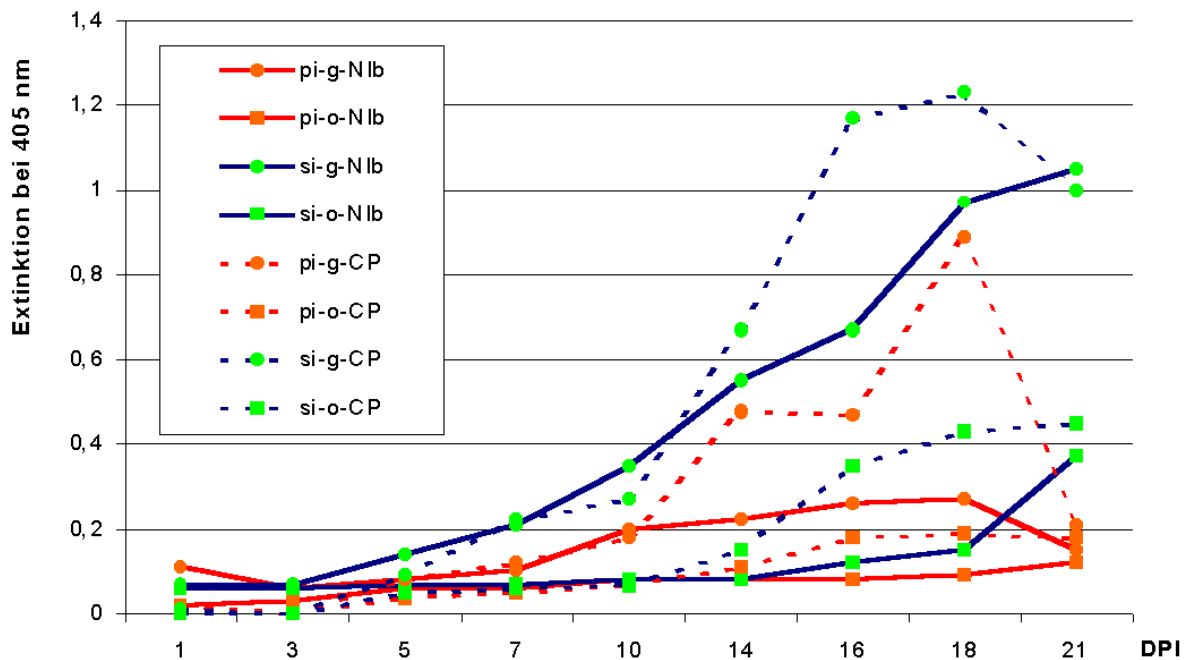
Der für das PVY-CP spezifische scFv F1 erreichte bei Expression in *E. coli* einen Anteil von 17% am Gesamtprotein (Abbildung 4). Das spricht für eine sehr hohen Expressionsrate. Allerdings mutierte die rekombinante DNA dieses Klons sehr stark, so dass vor der Induktion stets auf eine starke Repression zu achten war.

Die hier gewonnenen scFv-Antikörpergene werden die Grundlage für den Gentransfer in verschiedene Pflanzen bilden. In diesem Zusammenhang müssen sie wahrscheinlich mit verschiedenen Signalpeptiden oder Retentionssignalen versehen werden. Das kann erforderlich sein, um sie in definierte Zellkompartimente einzuschleusen, als auch, um sie zu stabilisieren.

Tabelle 3: Vergleich der Nachweisempfindlichkeit für das PVY-CP im PTA-ELISA bei Verwendung von nativen MAb und scFv

MAb/ ScFv	PTA-ELISA		Competition-ELISA	
	Ag—ScFv —AP	Ag—MAb—AP	Ag—ScFv —AP	Ag—MAb—AP
1D6	0.52	1.15	0.12	0.55
2E11	0.35	0.83	0.07	0.41
7C5*	0.04	0.05	nt	nt
1B7	0.23	0.68	0.06	0.32
1G12	0.26	0.78	0.07	0.33
3G4	0.25	0.66	0.06	0.32

*Der MAb 7C5 weist im PTA-ELISA und Western blot das CP des PVY nicht nach, reagiert jedoch mit ihm im TAS-ELISA, wenn für das Beschichten der Platten ein polyklonales Antiserum verwendet wird. Die A_{405nm} -Werte für 1B7, 1G12, und 3G4 wurden für das rekombinante N1b als Antigen erhalten, die Werte für 1D6 und 2E11 mit Saft aus PVY-infizierten *N. glutinosa*-Pflanzen. Die Messung erfolgte nach 1 h Inkubation bei Raumtemperatur.



Abb. 4: Optimierung der Expression von scFv in *E. coli*.

a: Gesamtproteinextrakte, analysiert auf einem 12%igen Gel, gefärbt mit Coomassie Brilliant Blau.

Bahn 1: nicht induzierte Zellen mit Konstrukt pOPE-scFv-myc/His-tag (Klon F1); Bahn 2: induzierte Zellen mit Plasmid pOPE ohne scFv-DNA; Bahn 3: induzierte Zellen mit Konstrukt pOPE-scFv-myc/His-tag (Klon F1); Bahn 4: Proteinmarker; Bahn 5: nicht induzierte Zellen mit Plasmid pOPE-scFv (K3); Bahn 6: induzierte Zellen mit Plasmid pOPE ohne scFv DNA; Bahn 7: induzierte Zellen mit Konstrukt pOPE-scFv-myc/His-tag-(Klon K3); Bahn M: Proteinmarker.

b: Gesamtproteinextrakte, analysiert auf einem 12%igen Acrylamid-Gel, geblottet auf PVDF-Membran und untersucht mit MAb 9E10 (spezifisch für c-myc-tag).

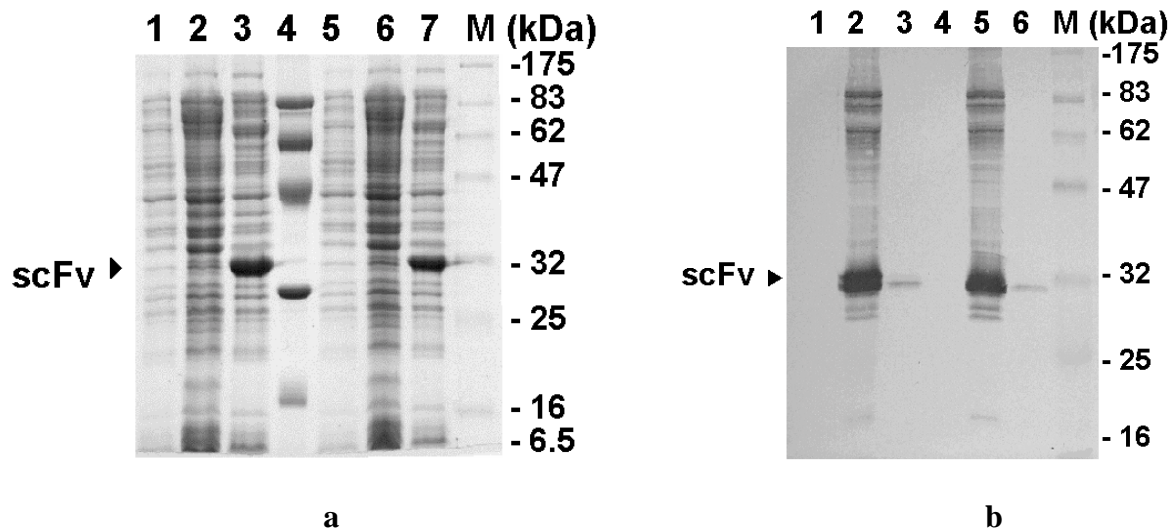
Bahn 1: induzierte Zellen mit Plasmid pOPE ohne scFv-DNA; Bahn 2: induzierte Zellen mit Konstrukt pOPE-scFv-myc/His-tag (Klon F1); Bahn 3: nicht induzierte Zellen mit Konstrukt pOPE-scFv-myc/His-tag (Klon F1); Bahn 4: induzierte Zellen mit Plasmid pOPE ohne scFv-DNA; Bahn 5: induzierte Zellen mit Konstrukt pOPE-scFv-myc/His-tag (Klon K3); Bahn 6: nicht induzierte Zellen mit Konstrukt pOPE-scFv-myc/His-tag (Klon K3); Bahn M: Proteinmarker.

7 Expression von mit bakterieller alkalischer Phosphatase fusionierten scFv in *E. coli*

Für immunologische Tests kommt eine Reihe von Enzymen zum Einsatz, darunter insbesondere alkalische Phosphatase (AP), Meerrettich-Peroxidase und β -Galaktosidase. Allerdings sind die Kosten für die Koppelung der Antiseren mit den detektierenden Enzyme hoch. Außerdem kann sich dadurch die Reaktivität der Antikörper verändern und es gibt Unterschiede zwischen den einzelnen Chargen. Auch hier bieten gentechnische Methoden interessante Ansätze, die Antikörper zu standardisieren und ihre Herstellung zu verbilligen. Dazu werden scFv-Gene mit den Genen für die entsprechenden Nachweisenzym fusioniert. In der Arbeit wurden die Möglichkeiten zur Fusion des vom PVY-CP-spezifischen MAb 1D6 abgeleiteten scFv (F1) mit bakterieller AP untersucht. Dazu wurde das entsprechende scFv-Gen in das Plasmid pOPE51-AP im Leserahmen zur bakteriellen AP kloniert. Das

Fusionsprotein wurde in *E. coli* überexprimiert (Abbildung 4). Die ungereinigte perioplasmatische Fraktion aus *E. coli* wurde direkt für den Nachweis des PVY im ELISA



Abb. 4: Western blot zum Nachweis der Überexpression eines scFv-AP-Fusionsproteins in *E. coli*. Bahn 1: induzierte Zellen mit scFv-AP-Konstrukt; Bahn 2: nicht induzierte Zellen mit scFv-AP-Konstrukt; Bahn 3: Zellen mit entsprechendem scFv-Konstrukt (ohne AP) als Kontrolle; Bahn M: Proteinmarker.

eingesetzt. Es zeigte sich jedoch, dass die katalytische Aktivität dieses Enzyms wesentlich geringer als die der AP aus Kälberdarm war. Das könnte darauf beruhen, dass die aktive Form der bakteriellen AP ein Homodimer ist. Wahrscheinlich behindert die Fusion mit dem scFv die Bildung dieser Homodimere. Inzwischen sind Gene für eine verbesserte Formen der bakteriellen AP zugänglich, die eine höhere Aktivität erwarten lassen. Die damit herstellbaren Konjugate könnten durchaus eine Alternative zu herkömmlichen Reagenzien darstellen.

List of Abbreviations

aa	amino acid(s)
ADEPT	antibody-directed enzyme prodrug therapy
Ag	antigen
AP	alkaline phosphatase
Amp	ampicillin
B cell	bone-marrow-derived lymphocyte
BACK-primer	PCR primer complementary to the 5'-end of a DNA template
Bis	<i>N,N</i> -methylenebisacrylamide
bp	base pairs
BSA	bovine serum albumin
CDR	complementary determining region
DMF	dimethylformamide
DMEM	Dulbecco's modified Eagle's medium
DMSO	dimethyl sulfoxide
DNA	deoxyribonucleic acid
dpi	day post inoculation
DTT	dithiothreitol
<i>E. coli</i>	<i>Escherichia coli</i>
ECL	enhanced chemiluminescence
EDTA	ethylenediamine tetra-acetic acid
ELISA	enzyme-linked immunosorbent assay
ER	endoplasmic reticulum
FCS	fetal cattle serum
FOR-primer	PCR primer complementary to the 3'-end of a DNA template
HAT	hypoxanthine, aminopterin, thymidine
HEPES	<i>N</i> -2-hydroxyethylpiperazine- <i>N'</i> -2 ethane sulfonic acid
HPRT	hypoxanthine guanosine phosphoribosyl transferase
HPLC	high performance (pressure) liquid chromatography
HT	hypoxanthine, thymidine
Ig	immunoglobulin
IPTG	isopropyl- β -D-thiogalactoside
IMAC	immobilised metal-ion affinity chromatography
KDEL	ER retention signal (aa sequence of the peptide)
LMW	low molecule weight
MAb	monoclonal antibody
MAP	multi-antigenicity peptide
2ME	2-mercaptoethanol
MHC	major histocompatibility complex
NTP	nucleotide triphosphate
OD	optical density
ori	origin of replication
PAGE	polyacrylamide gel electrophoresis
PBS	phosphate-buffered saline
PCR	polymerase chain reaction
PEG	polyethylene glycol
PMSF	phenylmethylsulfonyl fluoride
p-NPP	p-nitrophenyl phosphate
poly A	polyadenylation signal

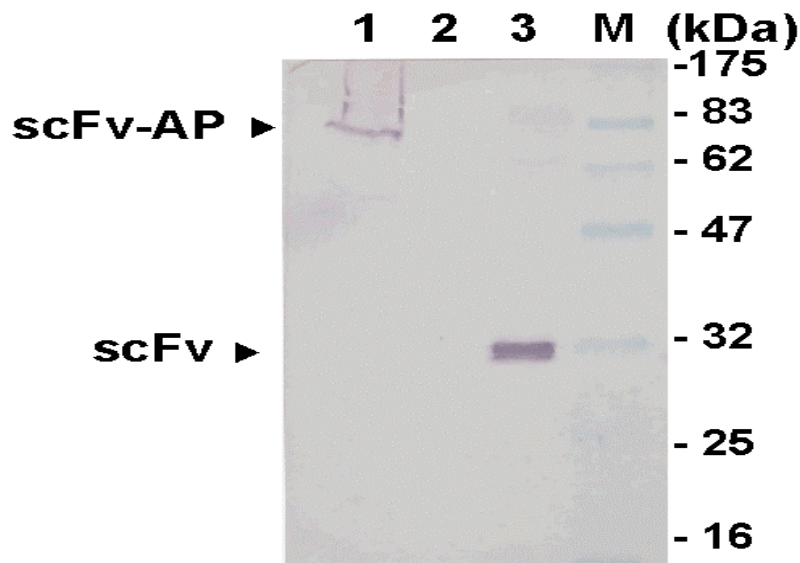
PVDF	polyvinylidene fluoride
RAG1/2	recombination active genes
RNA	ribonucleic acid
scFv	single chain variable fragment or single chain antibody
SDS	sodium dodecyl sulfate
TBS	tris-buffered saline
TCA	trichloroacetic acid
TCR	T cell receptor
TEMED	N,N,N',N'-tetramethylene-ethylenediamine
tet	tetracycline
T cell	thymus-derived lymphocyte
Tris	tris (hydroxymethyl) aminoethane
VDJ	variable, diversity, joining gene segments
X-gal	5-bromo-4-chloro-3-indolyl- β -D-galactoside

Acronym**Virus name**

ACMV	artichoke mottled crinkle virus
AMV	alfalfa mosaic virus
BaMMV	barley mild mosaic virus
BaYMV	barley yellow mosaic virus
BCMY	bean common mosaic virus
BMV	brome mosaic virus
BYMV	bean yellow mosaic virus
BrSMV	brome streak mosaic virus
CIYVV	clover yellow vein virus
CMV	cucumber mosaic virus
EMCV	encephalomyocarditis virus
JGMV	Johnson grass mosaic virus
LMV	lettuce mosaic virus
MDMV	maize dwarf mosaic virus
PepMoV	pepper mottle virus
PRSV	papaya ringspot virus
PSbMV	pea seed-borne mosaic virus
PStV	peanut stripe virus
PPV	plum pox virus
PVA	potato A virus
PVV	potato V virus
PVY	potato Y virus
RCNMV	red clover necrotic mosaic virus
RNMV	rice necrosis mosaic virus
RgMV	ryegrass mosaic virus
SMV	soybean mosaic virus
TEV	tobacco etch virus
TVMV	tobacco vein mottling virus
TYMV	turnip yellow mosaic virus
TuMV	turnip mosaic virus
ZYMV	zucchini yellow mosaic virus
WMV	watermelon mosaic virus

1 General introduction and scope of the work

Plant viruses are estimated to cause economic losses worldwide of about 15 billion USD per annum. The development of effective control strategies is mainly dependent on the availability of reliable methods of their identification and detection.

Of the 34 different plant virus families *Potyviridae* is by far the largest and consists of *Potyvirus*, *Bymovirus*, *Ipomovirus*, *Rymovirus* genera and unassigned *potyviruses*. This family contains 198 definitive and possible members, accounting for more than one third of all viruses known to infect plant species around the world (Ward and Shukla, 1991; Shukla et al., 1994; Brunt et al., 1997). The genus *Potyvirus* is the largest of the four genera and has the current 128 species (117 definite and 11 tentative species). Potyviruses cause significant diseases in agricultural, pasture, horticultural and ornamental crops. These viruses are usually transmitted from plant to plant by vectors, e.g. aphids, mites, and fungi. Successful detection and control of potyvirus infections are still challenges.

Serological methods play the most important role in detection and identification of viruses. MAbs have been widely applied for this purpose. So far a number of MAbs have been developed successfully for the detection and identification of potyviruses. Recently, recombinant antibodies, e.g. single chain variable fragment (scFv) antibodies, the second generation of MAbs have been developed and proved to have the potential both in immunomodulations and in virus disease diagnoses. ScFv antibodies can be produced in bacteria and plants. High level expression of scFv (Owen et al., 1992; Firek et al., 1993; Fiedler and Conrad, 1995; Longstaff et al., 1998) as well as whole size antibodies (Hiatt et al., 1989; De Neve et al., 1993; Voss et al., 1995) in plants, reduces the costs of antibody production and circumvents the use of animals. Furthermore, recently it has been evidenced that expression of scFv in transgenic plants can protect plants against virus attack (Tavladoraki et al., 1993; Fecker et al., 1997; Zimmermann et al., 1998).

1.1 Generation of antibodies in the immune response

The antibody is designed by nature to defend species of mammal against variable foreign intruders, e.g. viruses, bacteria, and parasites. By combining a set of variant gene cassettes with unique mutation mechanisms, a variety of more than a billion different sequences encoding for antibodies can be achieved in the mammalian immune system. The genetic material for this huge "library" of different antibodies is stored in the B-cell pool of the lymphatic tissue, which is the source to generate versatility of antibodies *in vivo*. In

mammalian species, circulating blood cells have their common origin in a small cluster of cells that move from the primitive yolk sac to the fetal liver, and finally to the bone marrow, where they take up permanent residence. These cells are the hematopoietic stem cells, the undifferentiated cells from which all the other specialized cells in blood develop. Of them B cells concern with the synthesis of antibodies, and T cells help this process.

After immunization there is usually a progressive increase in the affinity of the antibodies produced against the immunizing antigen. The high-affinity human/mouse antibodies to an immunized antigen are naturally selected by the human/mouse's immune system in a process of affinity maturation. This phenomenon is unique to antibodies (it does not occur in T cell receptors) and is due to the accumulation of point mutations specifically in both heavy- and light-chain variable region coding sequences (Walter et al., 1995). These mutations occur long after the coding regions have been assembled, when B cells are stimulated by antigen and helper T cells to generate memory cells in the activated center (so-called germinal center) of a lymphoid follicle in the secondary lymphoid organs. The point mutations occur at a rate of about one mutation per variable region coding sequence and per cell generation, which is about a million times greater than the spontaneous mutation rate in other genes (Alberts et al., 1994). Only a small minority of these point mutations will result in antigen receptors that have an increased affinity for the antigen. The few B cells expressing these high-affinity receptors will be able to survive and proliferate, while the other B cells will undergo apoptosis (programmed cell death) when the B cells are preferentially stimulated by antigen. As predicted by the clonal selection theory proposed and developed by Nobel Prize winners, Jerne and Burnet (Burne, 1957, 1959, 1968), B cells within this selected clone begin their antibody-synthesizing lives by making IgM molecules and inserting them into the plasma membrane as receptor for antigen. Before they have interacted with antigen, many B cells switch to make both IgM and IgD molecules as membrane-bound antigen receptors. Upon stimulation by antigen, some of these cells are activated to secrete IgM antibodies, which dominate the primary antibody response referred to as primary class of antibody (Alt et al., 1987). Other antigen-stimulated cells switch to make IgG, IgE, or IgA antibodies (Milstein et al., 1984); memory cells express one of these three classes of molecules on the surface, while activated B cells secrete them. The IgG, IgE, and IgA molecules dominate the secondary antibody response, so collectively they are referred to as secondary classes of antibodies.

Functional antibody genes do not exist as such in the germline DNA but are somatically created during maturation of pre-B-cells into mature B cells (Tonegawa, 1983; Chen and Alt,

1993; Shin et al., 1993; Walter et al., 1995). During B cell maturation, antibody genes are physically assembled by the translocation and joining of several gene segments to complete the coding sequences for one heavy chain gene and one light chain gene. While a single B-cell is committed to make only one set of VDJ genes and one type of light chains, so that a single B-cell produces an immunoglobulin of only one antigenic specificity (e.g. MAb). During the life time of this cell it can switch to make a different class of antibody, such as IgG, IgA or IgE, while retaining the same antigenic specificity (Esser and Radbruch, 1990; Harriman et al., 1993; Snapper and Mond, 1993). Different B cells are likely to make different antibodies since the individual antibody gene elements can be somatically rearranged in a number of different ways, resulting in highly diversified antibody coding sequences (Ravetch et al., 1981; Rolink and Melchers, 1991; Chen and Alt, 1993). The mammalian immune system has evolved unique genetic mechanisms that enable it to generate an almost unlimited number of different light and heavy chains in a remarkably economical way.

1.2 Antibody structure and function

The basic structural unit of an antibody molecule consists of four polypeptide chains, two identical light (L) chains (each containing about 220 aa) and two identical heavy (H) chains (each usually containing about 440 aa). The four chains are held together by a combination of noncovalent and covalent (disulfide) bonds (Fig. 1.1). The whole molecule is composed of two identical halves, each with the same antigen-binding site, and both light and heavy chains usually are together to form the antigen-binding surface. The heavy and light chains can be divided into a variable domain and a constant domain, respectively. The variable region of light chains, the N-terminal portion of approximately 108 residues, is actually encoded by two separate gene segments: a variable light chain (V_L) segment coding for the amino-terminal 95 residues and a small joining segment (J_L) coding for about 13 residues (96-108) at the C-terminal end of the variable region. The variable region (domain) of a heavy chain (V_H) consists of three gene segments (e.g. V, D, J). Thus apart from V and J segments, V_H genes also use a D (diversity) segment. The D and J segments code for amino acid sequences in the third hypervariable region (i.e. CDR3) of the heavy chain. The constant domain aa sequences, which determine biological properties of antibodies, are relatively conserved among immunoglobulins of a specific class, e.g. IgM, IgG, IgE, IgA, while the variable domains of an antibody are highly heterogeneous. The variable domain endows the antibody's binding specificity and affinity. It can be further subdivided into different regions, the framework

regions and the complementary determining regions (CDRs). CDRs are divided into CDR1, CDR2, and CDR3. The framework regions form a scaffold structure referred to as a β -pleated sheet from which the CDRs loop out. The aa sequences of the CDRs have been shown to be “hypervariable” and are largely responsible for interacting with the targeted antigen (Davies and Riechmann, 1996). To engineer a small recombinant antibody with the unique specificity and affinity of the parent antibody one must be cautious not to disrupt the tertiary structure and orientation of the CDRs residues.

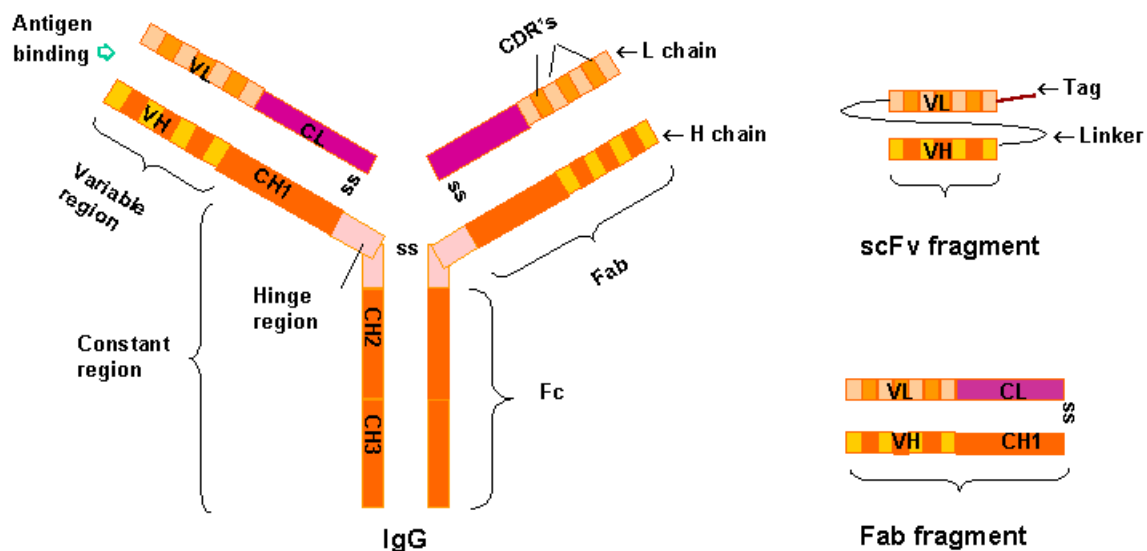

Fig. 1.1: Schematic drawing of an IgG antibody molecule (immunoglobulin) and small antibody fragments. VL = variable region of light (L) chain; VH = variable region of heavy (H) chain; VL + VH = variable region; CL + CH1 + CH2 + CH3 = constant regions; (CH2 + CH3)₂ = Fc; VL + CL = L-chain; VH + CH1 + CH2 + CH3 = H-chain; VH + CH1 + L chain = Fab; VH + linker + VL + Tag = scFv; SS = disulfide bond.

1.3 Molecular and genetic basis of antibody structure

The human genome is thought to contain fewer than 10^5 genes, but antibody molecules with different specificities are approximately 10^{6-8} in a given individual. Therefore, antibody diversity raises a special genetic question: how can a human being/an animal make more antibodies than there are genes in its genome?

Antibody gene rearrangements during lymphocyte differentiation, discovered by Susumu Tonegawa (the Nobelist), provide a simple solution to the above paradox or puzzle. Briefly, somatic recombination and mutation contribute greatly to an increase in the diversity of antibodies (Tonegawa, 1983; Wagner and Neuberger, 1996). Antibody genes can move and rearrange themselves within the genome of a differentiating cell (for loci of H-chain and L-chain of immunoglobulin genes on chromosomes see references, Cook et al., 1994; Ermert et

al., 1995; Tomlinson et al., 1995; Frippiat et al., 1997). A variable (V) gene located in one position in the DNA of an inherited chromosome (the germline), can move to another position on the chromosome during lymphocyte differentiation. This genetic recombination is promoted by proteins encoded by two closely linked genes, RAG1 and RAG2, which work together as a transposase, an enzyme that snips pieces of DNA out of one location in a chromosome and transposes these pieces elsewhere (Agrawal et al., 1998). This process of rearrangement during differentiation brings together an appropriate set of genes for the variable and constant regions. The variable domains are created by the combinatorial rearrangement of a relatively small number of gene segments, variable (V_H), diversity (D) and joining (J_H) segments for the V_H domain, and variable (V_L) and joining (J_L) segments for the V_L domain (Cook and Tomlinson, 1995; Kirschbaum et al., 1996). Together with deletion and insertion of nucleotides at the segment junction and association of different heavy chains and light chains, this generates a diverse primary repertoire of antibodies with huge number of antigen binding specificities. In other words, random recombination of V, (D), J gene segments and C genes in which an antibody can be coded by a DNA molecule considerably reduces the amount of genetic information required to encode different antibody molecules. V(D)J recombination, an unique mechanism mediated by RAG1 and RAG2, is employed to create an immunoglobulin chain. Two consensus sequences were identified, one is a palindromic heptamer sequence which always proximal to the linked coding sequence, and the other is an AT-rich nonamer sequence that always distal to the linked coding sequence. These heptamer and nonamer consensus sequences are always separated from one another by a nonconserved spacer sequence of either 12 bp or 23 bp (Kuby, 1997). Together, the heptamer, nonamer, and spacer sequences define the recombination signal sequences (RSS). These specific DNA sequences are recognized, cut and rejoined by DNA transposases or enzyme complexes (Agrawal and Schatz, 1997; Agrawal et al., 1998). At the beginning of an immunoglobulin gene rearrangement, the transposase creates double-stranded DNA breaks at the exon/RSS boundaries, effectively excising the intervening double-stranded DNA between the two exons (Shockett and Schatz, 1999). The exposed DNA ends of joining sequences are then ligated, creating a "coding joint" that corresponds to a contiguous reading frame running through the joined exons. Careful examination of the coding joint sequences in mature B cells has revealed the interesting fact that different coding joints can be created from the same two exons. In other words, a certain degree of "junctional flexibility" enters into the process of antibody gene rearrangements, producing multiple coding sequences at the V_L - J_L , V_H - D_H , and D_H - J_H exon/exon boundaries. Antibody gene rearrangements proceed through a temporal

cascade of order steps until the rearranged H and L chain genes encode a complete antibody molecule (Shin et al., 1993; Kuby 1997).

1.4 Monoclonal and recombinant antibodies

1.4.1 Monoclonal antibodies

Monoclonal antibodies, characterized by extraordinary specificity and binding affinity, were widely used as a unique analytical reagent (Laurino et al., 1999). Because of these two attributes, the antibodies become a 'dream' analytical reagent that is difficult to surpass. Since the elucidation of the cellular basis of immunology engendering the development of monoclonal antibodies (hybridoma technology, Fig. 1.2) in the 1970s by Niels K. Jerne, Georges J. Köhler, and Cesar Milstein, Nobel Prize winners all, numerous MAbs with specificity to cellular, bacterial, and viral proteins have been developed and resulted in a great impact on medicine and biology (Köhler and Milstein, 1975; Waldman 1991; Chien and Silverstein, 1993). Application of MAb in biomedical research has substantially contributed to our understanding of the structural and physiologic components of intra- and extra-cellular protein interactions (Jin et al., 1992; Mylvaganam et al., 1998). A novel spinoff of monoclonal antibody technology has been the creation of catalytic antibodies or abzymes generated by immunizing mice with enzyme transition state analogs (Pollack et al., 1986; Tramontano et al., 1986; Barbas et al., 1997). Abzymes represent a whole new approach to the study of enzyme mechanisms and to the creation of useful biological catalysts (Hsieh-Wilson, et al., 1996; Ma et al., 1998). Recently the development of MAb-based therapeutic reagents was made progress and well promised (Berkower, 1996; Farah et al., 1998; Panousis and Pietersz, 1999).

MAb, secreted by a single B-cell, has mono-specificity. It usually reacts with a single antigen determinant. Polyclonal antiserum recognizes a number of different determinants. Therefore, the application of MAbs avoids some problems arisen from polyclonal antisera which cross-react with non-immunized antigens. Although production of MAbs involves a great deal of work and requires the use of live animals, the advantages of high specificity and binding ability of MAb make it a valuable tool for identification and isolation of viruses.

Small antibody fragments were first produced in the late 1950s when Porter isolated Fab (fragment antigen binding) and Fc (fragment crystallizable) fragments from proteolytically cleaved rabbit gamma globulins (IgG). This work provided the first evidence that a MAb

molecule comprises Fab and Fc fragments (Fig. 1.1). Recent advances in understanding of immunoglobulin structure through three-dimensional studies, using nuclear magnetic resonance and X-ray crystallography and increased computer-assisted molecular modelling capabilities, combined with the applications of recombinant approaches and novel selection methods have led to the evolution of a new class of antibody-like molecules or recombinant antibodies.

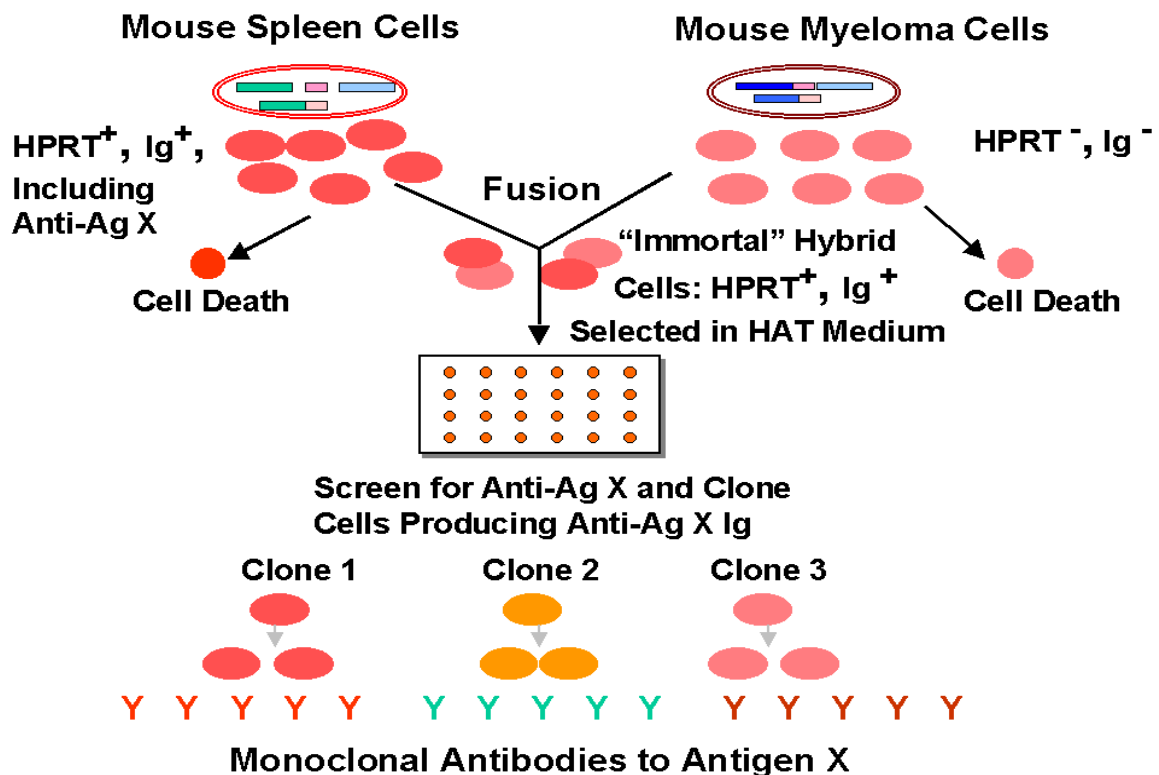

Fig. 1.2: A schematic representation of the production of monoclonal antibodies. $HPRT^+$: cells make HPRT, can grow in a culture medium containing hypoxanthine, aminopterin and thymidine (HAT medium). Ig^+ : cells can secrete immunoglobulins. Anti-Ag X: the antigen used for immunization. Mouse spleen cells are $HPRT^+$ and Ig^+ , thus they can survive in HAT medium and can secrete Ig (antibodies) into culture medium, but they will die in the culture medium after a few days. Mouse myeloma cells, defective in both HPRT production and Ig secretion, can grow in the culture medium unlimitedly. However, they do not survive in HAT medium because: (1) aminopterin blocks the cell's main biosynthetic pathway for guanosine; (2) the inability of mouse myeloma cells to make enzyme HPRT prevents them from using the alternative salvage pathway to make nucleic acids. Only the myeloma cells that obtain $HPRT^+$ Ig^+ from the fusion partner mouse spleen cells can grow in HAT medium. In other words, mouse spleen cells secreting specific Ig can unlimitedly grow in the culture medium after fusion with mouse myeloma cells, that is 'immortal' hybrid, or hybridoma technology.

1.4.2 Recombinant antibodies

Recombinant antibody is generally termed for either the form of the antigen binding Fab or Fv fragments of an antibody produced from a heterologous source. Enlightening of molecular

structure of immunoglobulins and sequence data made it possible to develop immunoglobulin-specific oligonucleotide primers and to use them in conjunction with polymerase chain reaction (PCR) techniques to clone antibody fragments for generating recombinant antibodies. The general strategy taken is to isolate the mRNA from mouse splenocytes or monoclonal antibody-producing hybridoma cells and to reverse transcribe the immunoglobulin encoding mRNA with a single primer, which binds either the heavy or light chain antibody gene near the beginning of the constant domain. Reverse transcription of the mRNA results in the production of immunoglobulin variable region cDNA. The cDNA is then amplified by PCR with the original 3' constant region primers and the 5' leader signal primers, binding upstream from the variable region. The immunoglobulin heavy or light chain cDNA amplified by PCR can be cloned into plasmid or phagemid vectors. Once the immunoglobulin genes are cloned, they can be rapidly sequenced and are accessible to recombinant techniques. Thereafter, the diversity of V_H and V_L chains can be created by DNA shuffling (Stemmer, 1994a, b).

1.4.2.1 Single chain variable fragment (scFv) antibody

ScFv is a man-made product resulting from the development of the current biotechnology and antibody engineering. The two antigen binding variable regions of the heavy and light chain (V_H and V_L , e.g. Fv fragments) are artificially connected by a linker aa peptide (Fig. 1.1), designated as single-chain variable fragment or single chain antibody (Bird et al., 1988; Orlandi et al., 1989; Clackson et al., 1991). This resulting scFv facilitates the equal expression of both Fv fragments in heterologous microorganisms, mammalian cells and plants.

The antigen binding site is made up of the variable domains of light and heavy chains of a monoclonal antibody. The smallest portion containing an antigen binding site is the variable fragments (Fv) of an antibody. Several investigations have shown that the Fv fragment has indeed the full intrinsic antigen binding affinity of one binding site of the whole antibody. The relative affinity of V_H and V_L fragments for each other depends on the particular sequence of the antibody. Low affinity may result in dissociation of the Fv fragment into its components. To stabilize the association of the recombinant Fv fragments, they were joined with a short peptide linker and expressed as a single polypeptide chain. A variety of linker peptides, generally of length 12-25 aa, were tested and did not disturb the proper folding of the V_H and V_L domains (Bird et al., 1988; Huston et al., 1988). The most frequently used linker today for scFv antibodies is $(Gly_4Ser)_3$, a single 15 aa peptide (e.g. 12 glycines and 3 serines) that

bridges the ~4.5 nm (theoretical distance 5.4 nm, Hudson, 1995) gap between the C terminus of one domain and the N terminus of the other and has a flexible structure with enhanced mobility (Huston, et al., 1988; Freund et al., 1993). This construction facilitates chain pairing and minimizes refoldings and aggregations encountered when the two chains are expressed individually. An NMR comparison of the unlinked Fv fragment of the antibody McPC603 with the corresponding scFv containing a linker (Gly₃Ser)₄ (V_H-linker-V_L constructs) has shown no perturbation of the folding of the variable domains by the linker (Freund et al., 1993).

ScFv antibodies have the following advantages:

- (1) overcome the problem of dissociation of V_H and V_L often encountered with Fv fragments,
- (2) provide immunologically active molecules of conveniently small size,
- (3) can be produced on large scale by fermentation with high purity and at low cost,
- (4) can be easily genetically manipulated and the MAb, used to obtain scFv, are immortalized by this way (some hybridoma cells are unable to generate stable antibodies).

Different forms of scFv exist:

- (1) soluble scFv antibody: the molecule is produced as a single polypeptide, this is the most popular form of scFv antibody, as it shares all advantages of the MAb.
- (2) recombinant phage display scFv antibody: the scFv genes are fused to gene3 protein (g3p) of the phage. This leads to the expression of scFv on the surface of the phage. An advantage of this form scFv is that the supernatant of the phage-infected bacterial culture can be directly used in ELISA (Navarro-Teulon et al., 1995). This is useful for screening specific scFv to target antigens from a scFv library through 3-4 rounds of selection. However, this kind of scFv may exhibit some cross-reactions (Bird et al., 1988).
- (3) dimeric forms of scFv or miniantibody: such molecules preserve the bivalency of native antibody molecules, which is a very effective means of increasing the functional affinity (avidity) to the surface of polymeric antigens (Pack et al., 1993; Kipriyanov et al., 1994; Dübel et al., 1995). ScFv fragments can be linked by a small modular dimerization domain in the form of one or two amphipathic helices (Pack and Plückthun, 1992). These miniantibodies assemble in dimeric form in *E. coli* and the avidity of the best of them is indistinguishable from a native antibody (Plückthun and Pack, 1997).
- (4) fusions of scFv with diagnostic enzymes: a common fusion is that with alkaline phosphatase. This enables the production of the antibody conjugate in bacteria, which could decrease the costs of the ELISA reagents (Suzuki et al., 1997).

(5) bi-specific scFv (diabody): bi-specific antibodies have been used to redirect T lymphocytes against defined antigens (Ags) on tumor cells. This approach relies on binding of one arm of the bi-specific antibody to a tumor-associated Ag, while the other arm, by recognizing the CD3 molecule on T cells, triggers their cytotoxic activity. Cross-linkage of the TCR-associated CD3 molecule by antibodies immobilized to solid surfaces or cell membranes or tissues has been found to be a particularly strong activation signal and occlusion of the neovasculature by antibody-direct targeting of tissue factors may result in tumor infarction and collapse (Mack et al., 1997).

The small scFv fragments are considered promising for medical and biological applications because of superior tissue penetration, absence of side reactions involving the constant domains, as well as easy engineering of fusion proteins, such as scFv-coupled toxins, the creation of multivalent or bispecific proteins or ADEPT (Hudson et al., 1993; Syrigos and Epenetos, 1999).

1.4.2.2 Fab fragments

Construction of Fab fragments is similar to that of scFv. The difference is that both variable and constant regions of light chain and heavy chain are still remained (Fig. 1.1). Therefore, a molecule of recombinant Fab fragments has the complete antigen binding site and scaffold structure of a natural antibody, which may result in a relative higher avidity than that of the same scFv in some cases. The thermodynamic stability of the corresponding Fab fragments is also somewhat higher than that of scFv (Shimba et al., 1995). Although Fab fragments have these advantages, Fab fragments are usually produced in *E. coli* at lower functional yields and do not have the same advantages of small size, especially in multivalent formats (Jung and Plückthun, 1997). Furthermore, Fab fragments libraries tend to be less stable after selection (Hoogenboom et al., 1998). Nevertheless, a number of Fab fragments have been developed and used in immunotherapy and diagnostics so far (Rodrigues et al., 1992; Marasco, 1995; Choi et al., 1998).

1.4.2.3 CDR ring peptides, potential of smallest synthesized antibodies

The sequence data have shown that the areas of highest natural diversity of antibody repertoire is in the loop most central to the antigen combining site, the CDR3 of the heavy chain, while the five other CDRs have limited variations (Kabat et al., 1991; Wilson and

Stanfield, 1993). Evidence from both biochemical and structural studies of antibody-antigen interactions suggests that CDR participation in antigen binding is unequal and that some CDRs (particularly CDR3) make a dominant contribution to the binding energy of an antibody (Chothia et al., 1989; Kabat and Wu, 1991). This suggests that an isolated CDR may be sufficient to bind an antigen and retains bio-activity similar to that of its parental antibody. Synthetic CDR ring peptides could be used as a novel type of medical agents for diseases treatment (Saragovi et al., 1991; Williams et al., 1991).

1.5 Phage display and antibody evolution *in vitro*

1.5.1 Phage display mimics B cells for secreting antibodies, an *in vitro* antibody evolution

The use of currently developed techniques for *in vitro* selection of molecular interactions under evolutionary pressure, such as phage display (Smith, 1985; Winter et al., 1994; Dunn, 1996), ribosome display (Mattheakis et al., 1994; Hanes and Plückthun, 1997), yeast surface display (Boder and Wittrup, 1997) and bacterial display (Daugherty et al., 1998) has provided a new perspective in the protein/antibody engineering. These selection approaches share a common requirement: physically connect genotype (DNA sequence, e.g. antibody gene) and phenotype (protein sequence, antibody) for selection and concurrently induce diversification between selection rounds (Duenas and Borrebaeck, 1994; Phizicky and Fields, 1995).

Phage display has been most popularly used in today's antibody engineering (Cortese et al., 1996; Hoogenboom et al., 1998). Like the natural evolution of antibodies, antibody phage display alternates between creation of diversity, mutation, and selection and thus speeds up conditions of antibody evolution *in vitro* (Fig. 1.3).

Phage display relies on fusing the protein of interest to the minor coat protein of the phage, the gene3 protein (g3p). This protein consists of three domains of 68 (N1), 131 (N2) and 150 (CT) aa, connected by glycine-rich linkers of 18 (G1) and 39 (G2) aa, respectively. The first N-terminal domain, N1, is thought to be involved in penetration of the bacterial membrane, while the second N-terminal domain, N2, may be responsible for binding of the bacterial F-pilus (reviewed in Spada et al., 1997). Recently, the structure of the N1-N2 domain complex has been solved at very high resolution (Lubkowski et al., 1998). In phage display, a ligand (e.g. an antigen) is immobilized and a collection of binding proteins (e.g. antibodies) are displayed on the phage, that is, provided as fusion to the g3p (Winter et al., 1994). The essential trick is that the genetic information of the displayed protein is contained

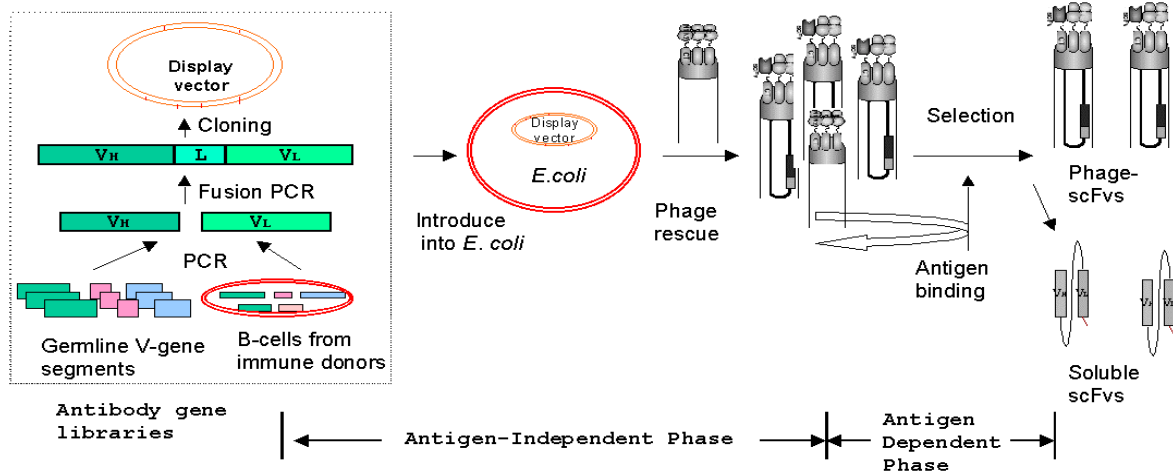
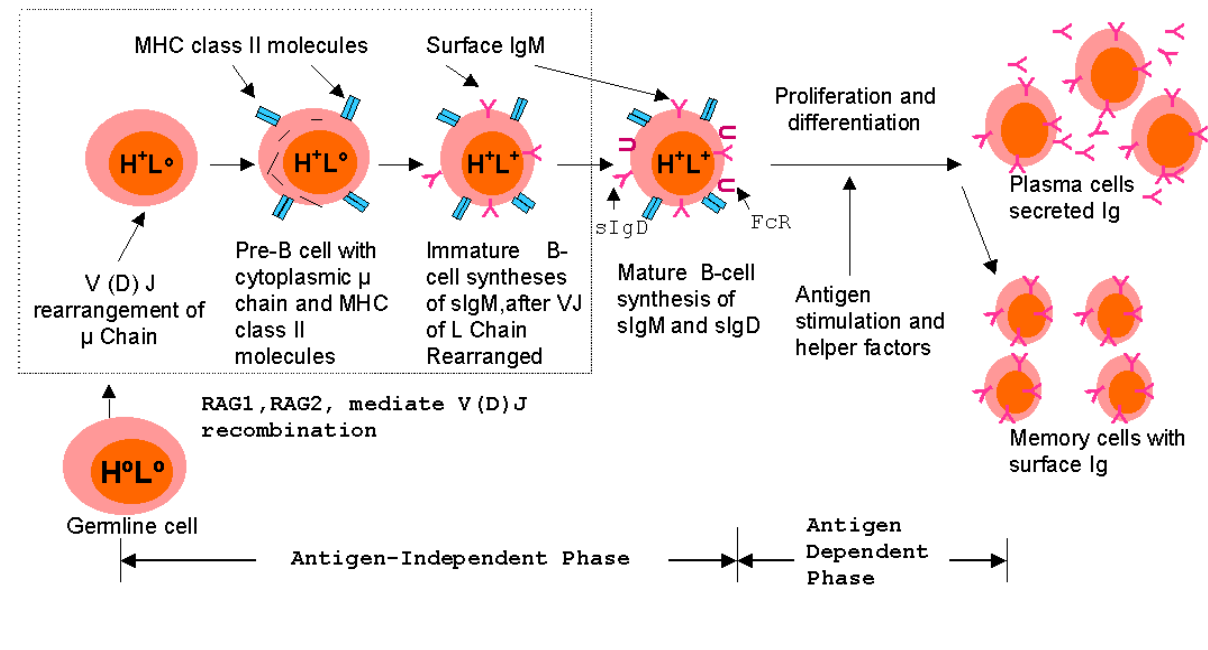

Fig. 1.3: Generation of antibodies in the immune system and by phage display technology. In the immune system, a germline cell differentiates into mature B cell through V(D)J recombination mediated by RAG1 and RAG2; the mature B cell proliferates and divides into plasma cells which secreting antibodies and memory cells (for more detail see section 1.1); similarly, by phage display technology, antibody gene libraries are generated from germline V-gene segments or B-cells via PCR; antibodies are displayed on the surface of phages through transformation into *E. coli* and phage rescue, specific phage-scFvs are selected by target antigen binding; subsequently, soluble scFvs can be obtained from different strains of *E. coli* after infection with phage-scFv or through subcloning. Note: Heavy chain (H) and light chain (L) are designated as $H^{\circ}L^{\circ}$ if in embryonic form and $H^{+}L^{+}$ if rearranged. FcR represents Fc receptors (CD16); sIgD: surface IgD, membrane bound form antibody; sIgM: surface IgM, membrane bound form.

within the phage DNA in the same phage particle and thus, physically connected to the expressed protein. Antibody phage display requires that a repertoire or library (see below) of immunoglobulin-encoding genes is cloned into the filamentous phage. The library is accomplished by amplifying variable region immunoglobulin fragments or germline V-genes. The PCR products are cloned into a filamentous phage to incorporate a heavy chain and a

light chain variable region cDNA copy connected by a linker and expressed on the surface of the filamentous phages (phagebodies). The phages without binding ability will be removed by washing. The remaining phages are used to infect *E. coli* for their amplification. The selection procedure, the so-called panning, can be repeated with increasing stringency to select clones with the highest affinity (Winter and Milstein, 1991; Mersmann et al., 1998). The cDNA of these clones can also be randomly or selectively mutated to create a second antibody heavy and light chain combinatorial cDNA library (Marks et al., 1992; Schier et al., 1996).

A modified version of phage display technology is the selectively infective phages (SIP) technique (Duenas and Borrebaeck; 1994; Krebber et al., 1995; Spada and Plückthun, 1997). The advantage of this method is that only those phages that combine with a ligand (e.g. antigen) are capable of infecting *E. coli*.

Phage display was initially used to select antibody fragments for simple antigens such as hen egg lysozyme from human peripheral blood lymphocytes (Ward et al., 1989), but soon display repertoires of human antibody fragments that recognize tumor cell antigens, viruses, cellular substrates, abzymes and others were generated (Baca et al., 1997). Because selection pressure is applied entirely *in vitro*, this technique has the potential to overcome difficulties encountered in the *in vivo* generation of antibodies that are specific for antigens which do not normally elicit strong humoral responses such as self-antigens or toxins. These *in vitro*-derived antibody fragments can be used as polyclonal and monoclonal reagents in ELISA, western blots, epitope mapping, and immunocytochemistry. An advantage of this technique is that immunochemical reagents can be obtained without the use of experiment animals. Genetic fusion and recombinant expression has led to the development of numerous novel heterologous fusion proteins for research, diagnosis and therapy (Reiter and Pastan, 1996; Colcher et al., 1998).

1.5.2 Mammalian antibody repertoires and antibody gene libraries

1.5.2.1 Mammalian antibody repertoires

It is estimated that even in the absence of antigen stimulation a human makes up to 10^{15} different antibody molecules - its pre-immune repertoire or primary antibody repertoire (Chothia et al., 1992; Alberts et al., 1994; Cook and Tomlinson, 1995). The number of antibody molecules in a given individual ranges from 10^6 to 10^8 in a typical immune response (Benjamini and Leskowitz, 1991; Williams et al., 1996). The diversity of antibodies is

generated from a result of multiple V-genes combination and association, as well as junctional flexibility and insertional diversity (Flanagan and Rabbitts, 1982; Kuby 1997). The primary antibody repertoire contains a large array of IgM antibodies that recognize a variety of antigens. The antigen binding sites of many antibodies can cross-react with a variety of related but different antigenic determinants, and the naive antibody repertoire is apparently large enough to ensure that there will be an antigen-binding site to fit almost any potential antigenic determinant albeit with low affinity (Flanagan et al., 1984; Sitnikova and Su, 1998). This huge repertoire is stored in the B cells of mammals.

1.5.2.2 Antibody gene libraries

One of the most successful applications of phage display has been the selection of monoclonal antibodies from large phage antibody libraries such as immune, naive and synthetic gene libraries.

(1) Antibody gene libraries from immunized animals or immune donors

So far the construction of immune libraries from a variety of species has been reported, including mouse (Chester et al., 1994), human (Barbas et al., 1993), chicken (Davies et al., 1995), rabbit (Lang et al., 1996) and camel (Arbabi Ghahroudi et al., 1997). This kind of libraries may be directly created by PCR amplification of the IgG genes of spleen B cells of mammalian immunized with antigen or from immune donors (Chiang et al., 1989). Many antibodies may be obtained from the material of a single immunized donor, and synthesized antibodies can be rapidly multiplied and further manipulated. Active immunization is, however, not always possible due to ethical constraints, neither always effective due to tolerance mechanisms towards or toxicity of the antigen involved. In many cases, antibodies selected from this kind of libraries usually have a lower affinity than that from hybridomas, but there are some exceptions (Chester et al., 1994; Schier et al., 1996). Ideally, universal, antigen-unbiased libraries would be available, from which very high affinity antibodies to any chosen antigen may be directly selected, independent of the immune history.

(2) Antibody gene libraries from non-immunized animals or donors

The naive antibody repertoire contains a large array of IgM antibodies that recognize a variety of antigens as mentioned above. This naive repertoire of rearranged genes can be cloned by PCR amplification of the V-genes from the IgM mRNA of B cells of unimmunized human donors, from peripheral blood lymphocytes (Marks et al., 1991; Huang et al., 1996), spleen, bone marrow or tonsil B cells (Vaughan et al., 1996) or from similar animal sources (Gram et

al., 1992). Antibody gene libraries could also be made from the possible more naive pool of IgD mRNA. The affinity of antibodies selected from a naive library is proportional to the size of the library, ranging from $K_a 10^{6-7} M^{-1}$ for a small library with 3×10^7 clones (Marks et al., 1991; Griffiths et al., 1993), to $K_a 10^{8-10} M^{-1}$ for a very large repertoire with 10^{10} clones made by brute force cloning (Vaughan et al., 1996), which is in line with theoretical considerations.

(3) Synthetic gene libraries

This type of antibody repertoire is constructed artificially, by *in vitro* assembly of V-gene segments and D/J segments. V-genes may be assembled by introducing a predetermined level of randomization of CDR regions into germline V-gene segments (Hoogenboom and Winter, 1992) or rearranged V-genes (Barbas et al., 1992). A set of 49 human V_H -segments was assembled via PCR with a short CDR3 loop (encoding five or eight aa) and a J-region, and cloned for display as a scFv with a human lambda light chain. Subsequently, the CDR3-regions were enlarged to supply more length diversity in this loop (Nissim et al., 1994). From this repertoire, many antibodies to haptens and one to a protein antigen were selected, but their affinities were in the macromolar affinity level (Hoogenboom and Winter, 1992). To date, nanomolar affinity antibodies were actually isolated from a largest synthetic library (Hoogenboom et al., 1998). In theory, the most complex antibody libraries could be constructed by antibody gene synthesis using random oligonucleotides for all the hypervariable regions (Little et al., 1995). However, completely random sequences for all hypervariable regions can not be used, since at least one stop codon would appear in every antibody statistically.

1.5.3 Limitation of antibody phage display

There are also physical limits to the enrichment in the *in vitro* selection procedure of phage display, which limits the size of accessible genetic diversity. It was never reported that a single selection round was higher than 10^5 clones per round. A typical phage titre is 10^6 clones eluted in the first, critical round of selection. Therefore, the total genetic diversity created by the selection procedure of phage display would be at most 10^{11} clones.

To date this limitation can be overcome by ribosome display (Mattheakis et al., 1994; Hanes and Plückthun, 1997). Ribosome or polysome display is a very recent development of display approaches, in which a pool of protein molecules is entirely *in vitro* translated, displayed, and selected on ribosomes, which circumvents the use of any cells or phages and overcomes a limited library size. Ribosome display has shown its power in the field of protein

engineering as well as protein structure, stability, and function studies (Hanes et al., 1998; Merk et al., 1999).

Finally, it should be mentioned that modern DNA recombinant technology makes it possible in future to construct a huge antibody repertoire at low cost. However, to date making monoclonal antibodies by hybridoma technology to some extent is still hard to be overpassed by other technologies because selection of scFv from hybridoma is a most straightforward way, which does not need to construct a large library, it is generally easier to be performed in most popular laboratories and without any license limitation, compared with the use of commercially available antibody libraries.

1.6 Application of recombinant antibodies

1.6.1 Intracellular expression of scFvs (intrabodies) for gene therapy

The intracellularly expressed single-chain antibodies, so called “intrabodies” represent a new class of neutralizing molecules with a potential use in gene therapy (Rondon and Marasco, 1997; zu Putlitz et al., 1999). The intrabodies contain an immunoglobulin heavy-chain leader sequence that targets it to the ER. Intrabodies may be especially well suited to target viral and cellular proteins trafficking through the secretory system (Marasco, 1995). A good example is that the cells expressing scFv105, engineered from human monoclonal antibody F105 which competes with CD4 for binding to gp120 of HIV-1 virus, leads to inhibition of envelope transport and the release of less-infectious and non-infectious virions. Collectively, it has been demonstrated that anti-HIV-1 intrabodies can be directed to multiple HIV-1 target proteins that are present in different sub-cellular compartments in the cell including the ER (Marasco et al., 1993; Chen et al., 1994a), secretory pathway (Chen et al., 1994b), cytoplasm (Duan et al., 1994; Duan and Pomerantz, 1994; Mhashilkar et al., 1995) and nucleus (Mhashilkar et al., 1995). Therefore, the different anti-HIV-1 intrabodies, used either alone or in combination with other intrabodies or other genetic based strategies, may be useful for the gene therapy of HIV-1 infection and AIDS (Melnick et al., 1994).

1.6.2 Application of scFvs in diagnostics

Application of 1C3 scFv-gp41 antibody to replace the current use of monoclonal antibodies and Fab fragments in HIV-1 rapid diagnostic test has firstly demonstrated the effectiveness of

scFv reagents in the whole blood agglutination assays (Lilley et al., 1994). So far, there are numbers of scFv reagents widely used in clinical diagnostics. ScFv reagents were firstly introduced in plant virus diagnosis in 1997 (Harper et al., 1997; Kerschbaumer et al., 1997). DNA encoding the scFv was sub-cloned into pDAP2 such that a scFv-alkaline phosphatase fusion protein was produced by transformed bacteria following induction by isopropyl-beta-D-thiogalactopyranoside (IPTG). The fusion protein was obtained at concentrations of 10 mg/l of *Escherichia coli* culture medium and these fusion protein preparations were used directly in ELISA to detect PLRV in sap extracts from infected plants. Two types of this scFv, i.e. ScFv32-AP (scFv fusion with alkaline phosphatase), scFv CL3D3 (fusion with light chain constant region, this fusion protein has related high binding ability, compared with non-fusion of the same scFv molecule when coated in ELISA plates) were generated subsequently (Harper et al., 1997; Kerschbaumer et al., 1997). They have been routinely used in PLRV diagnosis in different European laboratories (Legorburu et al., 1998). Recently, a scFv specific to PVY^O strain was selected from the human synthetic V_H+V_L scFv library produced by MRC, UK and used in ELISA for viral diagnosis. Its detection limit was equal to that of monoclonal antibodies (Boonham and Barker, 1998). The advantage of recombinant scFv reagents is that they can be produced cheaply on large scale and in a high purity.

1.6.3 Potential of scFvs in plant pathology and plant molecular biology

All species of plants do not have an immune system to make antibodies for withstanding an attack by invading pathogens or offending agents. However, today's genetic engineering and transgenic plant technology can transfer antibody genes into plants and then plants can produce functional antibodies or antibody fragments (i.e. 'plantibodies') against the target agents. In 1993 Tavladoraki and co-workers firstly verified the effects of an AMCV-specific scFv[F8] antibody transgene on virus infection. In these experiments the virus particles were challenged on both protoplasts and whole plants which produced specific scFv in cytoplasm. Protoplasts carrying the scFv[F8] construct accumulated smaller amounts of viral CP and showed a lower frequency of infection with AMCV, compared with untransformed control, while protoplasts infected with a heterologous virus, CMV, the infection occurred at the same level in both transgenic and control lines. Primary transgenic plants developed symptoms from 5 to 14 days later than did any of the control plants after inoculation of AMCV, and the progeny (R₁) also showed lower virus accumulation. These results demonstrated that transgenic plants expressing specific scFv could obtain resistance against attack of AMCV

(Tavladoraki et al., 1993). This pioneer work brought in a new concept of pathogen resistance research, presenting the first example of antibody-mediated plant resistance. Since then, scFv against other viruses, such as BNYVV (Fecker et al., 1996), TMV (Zimmermann et al., 1998), TSWV (Franconi et al., 1999), scFv against a cutinase produced by the fungus *Botrytis cinerea* (Schouten et al., 1996) and scFv against mollicutes (phytoplasmas and spiroplasmas), e.g. corn stunt spiroplasma (Chen and Chen, 1998), stolbur phytoplasma (Le Gall et al., 1998) were subsequently tested in transgenic plants. In these experiments, for example, one transgenic tobacco line containing anti-stolbur phytoplasma scFv construct was selected for challenge inoculation with the stolbur phytoplasma. When grafted on a stolbur phytoplasma-infected tobacco rootstock, the transgenic tobacco shoots grew free of symptoms and flowered after 2 months, while normal tobacco shoots showed severe stolbur symptoms during the same period and eventually died.

So far, transgenic plants expressing scFv against bacterial proteins have not been reported. Anti-virus scFv transgenic plants documented are all directed to the coat protein of viruses and the resulting resistance of the host plants has yet to reach the level such that the host can completely withstand the virus attack. It seems important in overall protection that targeting expression of scFv into the different compartments within plant. Although the precise mechanism(s) of the scFv antibody-mediated protection is unclear, the strategy of 'introducing engineered antibody into plants' will provide insights into molecular interactions between virus and the constitutive scFv, leading to elucidation of the *in vivo* relationships of the structure and function.

On the other hand, engineered antibodies specific to host cell regulation factors, e.g. transcription factors, cellular enzymes, metabolites, phytohormones, should provide an effective means to study physiological processes of plants. Owen and co-workers (1992) has demonstrated that expression of anti-phytochrome scFv antibodies in transgenic tobacco led to aberrant control of germination by light. Homozygous seeds showed only 60% germination in response to continuous red light irradiation compared with 90% in the wild type. Another example is the use of anti-ABA scFv antibodies, which bind to the phytohormone abscisic acid. Expression of this scFv resulted in a wilted phenotype of transgenic tobacco (Artsaenko et al., 1994, 1995).

ScFvs are the smallest immunologically active molecules endowed with the highest binding capacity to a potential target. They can be directed to any compartment of plant cell and even the apoplastic space (Firek et al., 1993). To date several signal peptide sequences have been used for secretory expression of scFv such as PelB-leader (pectate lyase B), PHA-

leader (phytohaemagglutinin) (Fecker et al., 1996), legumine B4-leader (Fiedler and Conrad, 1995), original murine signal peptide (Voss et al., 1995), a plant amylase signal peptide (Düring et al., 1990), yeast derived signal peptide (Hein et al., 1991). ScFv molecules are the most versatile antibody derivatives for regulation of gene expression in different tissues or cellular compartments of transgenic plants.

1.6.4 Antibodies expressed in plants – an example of the tomorrow’s factory making bio-agents for all purpose applications

Since the first reports of *Agrobacterium*-mediated tobacco transformation experiments in 1983 (Zambryski et al., 1983), a number of gene transfer techniques have been reported subsequently. For instance, particle bombardment (Bruce et al., 1989; Klein et al., 1992), electroporation (Rhodes et al., 1988), microinjection (Cairns et al., 1978; Klein and Fitzpatrick-McElligott., 1993) and PEG-mediated transformation of protoplasts (Ye et al., 1990; Mathur and Koncz, 1998). The rapid development of gene transfer techniques and tissue culture techniques makes the expression of recombinant proteins in plants to be a standard approach in molecular biology (Guerineau, 1995; Jones, 1995). To direct the expression of antibodies in the targeted organs, tissue-specific promoters should be chosen. The first report that plants can express whole size recombinant antibodies dated to 1989 when Hiatt and co-workers demonstrated that the functional recombinant antibodies could be assembled in their progenitor plants by sexually crossing of two plants, one transformed with heavy and the other with light chain of antibody (Hiatt et al., 1989). The source of the above immunoglobulin mRNA was a hybridoma line expressing a catalytic IgG1 antibody (6D4) which binding low molecular weight phosphonate ester (P3) and catalyses hydrolysis of certain carboxylic esters. Expression of small size antibody, e.g. scFv, can be obtained directly from the primary transformants. Plant storage organs such as seeds and tubers are suited for production of scFvs in plant, and even leaves can provide a suitable source (Artsaenko et al., 1998; Conrad et al., 1998). Targeting of recombinant antibodies has been shown to be very important not only for interaction with the corresponding antigen, if present in plant, but also for stabilization and correct folding of the recombinant antibodies. It is possible to express the desired scFv in different cell compartments including the cytoplasm, the ER, chloroplasts and the intercellular space. Signal sequences like the ER retention signal peptide (KDEL) can also result in stabilization of scFv in cytosol (Schouten et al., 1997). This peptide is nowadays widely used for scFv stabilization. Heterologous expression of

recombinant antibodies can reach expression levels up to 6.8% of total soluble protein for scFv-ABA or 4.0% for scFv-ox (Conrad et al., 1998), for a whole size antibody (6D4) 1.3% of the total soluble protein (Hiatt et al., 1989). These levels are high enough that a field of tobacco plants could produce 50-60 kg of recombinant protein per hectare. The transgenic proteins within the harvested plants are stable at least for a few days at room temperature (Fiedler et al., 1997). Additionally, recombinant antibodies (e.g. scFvs) are well suited for the construction of bifunctional molecules, such as fusions to the staphylococcal protein A or to enzymes (Gandecha et al., 1994). This would facilitate purification of plant-produced scFvs and improve their usefulness for analytical purposes in plant cell biology and pharmacology. Transgenic plants offer a number of advantages for production of recombinant proteins/antibodies (Hiatt, 1990). Plants are easy to grow and their cultivation does not require specialized equipment or chemicals in contrast to bacteria or animal cells. Plants have no immune system, therefore, only one antibody-species is expressed as a glycosylated protein and the absence of animal viruses or bacterial endotoxins and even oncogenes should provide maximum safety for human beings.

1.7 Genome organization and functions of potyvirus

1.7.1 Genome organization of potyviruses

Potyviruses are flexuous filamentous particles which contain a single positive stranded RNA of about 10,000 bases, possessing a covalently linked 5'-terminal viral protein (VPg) and a 3'-terminal poly (A) tail (reviewed in Riechmann et al., 1992). The genomic organization of potyviruses is illustrated schematically in Figure 1.4. As found for picornaviruses and comoviruses, the potyvirus genome contains a single open reading frame and is translated as a large polyprotein precursor (ranging between 340 and 368 kDa, depending on the potyvirus) which is subsequently cleaved by virus-encoded proteolytic enzymes to yield protein products of different size (Dougherty and Carrington, 1988). The order of these products from the N terminus to the C terminus of the polyprotein is: first protein (P1, protease), the helper component /protease (HC-Pro) protein, third protein (P3), a 6K peptide (6K₁), the cylindrical inclusion (CI) protein (movement protein with RNA helicase activity), a second 6K peptide (6K₂), the nuclear inclusion *a* protein (NIa, consisting of a VPg and a protease), the nuclear inclusion *b* protein (NIb, the RNA dependent RNA polymerase) and the coat protein (CP). Only two of these, VPg and CP are detectable in virus particles.

An obvious characteristic of potyviruses is the presence of a long untranslated region (UTR) at the 5' end of the genome. Its length ranges between 144 (TEV) and 205 (TVMV) nucleotides. The 5'-UTR is rich in adenine residues and has only a few guanine residues. Alignment of these regions of PPV, TEV, TVMV and PVY revealed some nucleotide blocks conserved in the four viruses (Turpen, 1989). The conservation of these sequences in the four potyvirus RNAs suggests that they could play an important role in the viral encapsidation or replication (Riechmann et al., 1992).

The 3'-UTR of different potyviruses have been described as heterogeneous in size, sequence and predicted secondary structure (Turpen, 1989; Quemada et al., 1990). A common feature of all of them is the presence of AU rich segments and the fact that each sequence can fold into stable secondary structures (Turpen et al., 1989). The poly (A) tails of the RNA have been found to be very heterogeneous in length.

Potyviruses lack a cap structure at the 5' end of the genomic RNA but share a genome-linked protein (VPg) and may perform a so-called cap-independent leaky scanning mechanism of translation (Fütterer and Hohn, 1996; Simon-Buela et al., 1997).

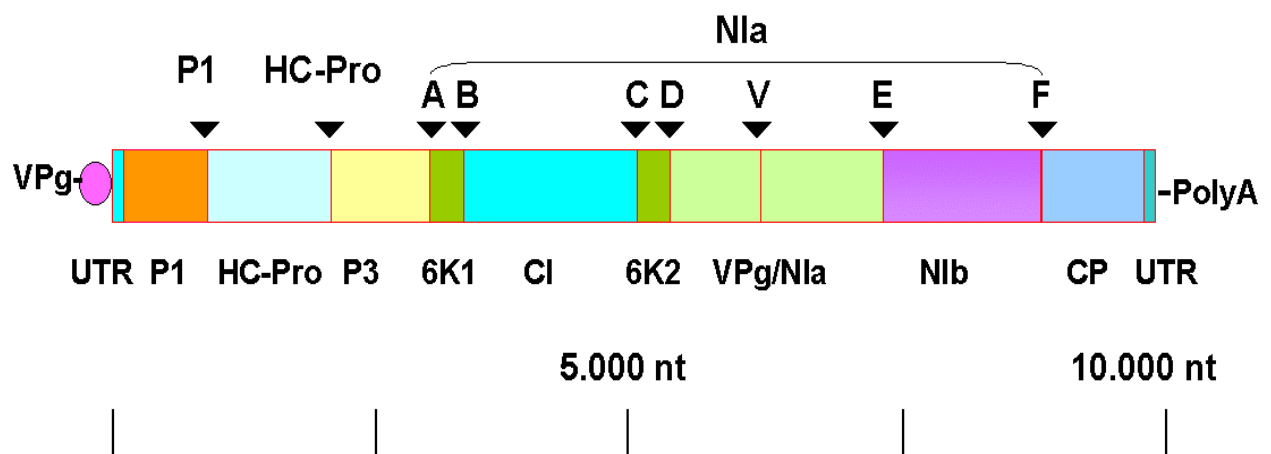

Fig. 1.4: Genomic organization of potyvirus RNA (not to a scale). The cleavage sites of the different proteases are indicated by arrows. There is no information about the sequential order of these events of polyprotein processing.

1.7.2 Functions of potyviral RNA encoded proteins

1.7.2.1 P1 serine proteinase

The P1 protein is a serine-type proteinase which catalyses autoproteolytic cleavage at a Tyr-Ser or Phe-Ser dipeptide between itself and the helper component-proteinase, HC-Pro (Verchot et al., 1991, 1992; Yang et al., 1998). The C-terminal 147 aa residues of the P1 protein constitute the complete functional proteinase; the N-terminal 157 aa residues are

dispensable for proteinase activity (Verchot et al., 1992). In addition to its proteolytic activity, the P1 protein has been shown to exhibit nonspecific RNA-binding activity (Brantley and Hunt, 1993; Soumounou and Laliberte, 1994). The RNA-binding properties of P1 are similar to those described for known movement proteins of plant viruses (Citovsky et al., 1991, 1992; Schoumacher et al., 1992; Osman et al., 1992, 1993) and it has been suggested that P1 could also be involved in cell-to-cell transport of virus in plants (Atabekov and Taliansky, 1990; Dougherty and Semler, 1993). However, it has been demonstrated by mutational and complementation analysis for another potyvirus, TEV, that the P1 protein plays little role in virus movement (Verchot and Carrington, 1995a, b). Deletion of the entire P1 coding sequence had only minor effects on cell-to-cell and long distance transport but considerably reduced genome amplification of TEV mutants, suggesting that the function of P1 is related to virus replication. The role of the N-terminal part of P1 in the life-cycle of potyvirus remained unclear.

1.7.2. 2 HC-Pro protein

Potyviral helper component-proteinase (HC-Pro) is a multifunctional protein involved in aphid transmission, long-distance movement, polyprotein processing, genome amplification and symptom expression (Cronin et al., 1995; Kasschau and Carrington, 1995; Blanc et al., 1998). The active form of HC-Pro is a homodimer (Guo et al., 1999). The N-terminal region is required for efficient genome amplification and aphid transmission. The C-terminal domain is a cysteine-type proteinase that autocatalytically cleaves between itself and the P3 protein. The central region is required for long-distance movement in plants (Wang et al., 1998). It was found that PVX/potyvirus synergistic disease is caused by interaction of potyviral HC-Pro and PVX and the central domain regions of HC-Pro are essential for mediating the synergistic disease when infected with PVX (Shi et al., 1997).

1.7.2.3 P3 protein, 6K₁ and 6K₂

The whole size of P3 protein function(s) still remain unclear. Immunogold labeling with the antiserum against the nonstructural P3 protein of TEV showed labels associated with nucleolus, nucleus, or nuclear inclusion. P3 protein presented in the nucleolus and nucleus may indicate that it is involved in early stages of viral replication (Langenberg and Zhang, 1997). The two small proteins 6K₁ and 6K₂ are co-existing with NIa and NIb in nuclear

inclusion, suggesting that they may play a role in RNA replication or function as NIa (Restrepo-Hartwig and Carrington, 1994).

1.7.2.4 CI protein

The CI protein contains a nucleotide binding motif typical of RNA helicases of the superfamily SF2 of RNA viruses (Lains et al., 1990). This motif consists of seven conserved sequences of VGSGKST from N to C terminus. The function of CI protein was first deduced from by aa sequence comparisons with several proteins of virus and cellular origins, like eIF-4A, suggesting that these motifs containing viral proteins possess nucleotide binding and helicase activity (Gorbalenya et al., 1988). Experimental data evidenced that the helicase activity of CI protein plays a role in virus RNA replication inside the infected cell. A systematic ultrastructural study across the edge of an advancing infection in PSbMV-infected pea cotyledons showed the cylindrical inclusion (CI) protein to exist in transient functional states, and the presence of the CI was linked with an apparent transient reduction in callose in the vicinity of the plasmodesmata in aiding virions to adjacent cell (Roberts et al., 1998). Recently, CI protein was analysed genetically using alanine-scanning mutagenesis. Thirty-one mutations were introduced into the CI protein coding region of modified TEV genomes expressing either beta-glucuronidase or green fluorescent protein reporters. The subsequent results provided genetic evidence for a direct role of CI protein in potyvirus intercellular movement, and for distinct roles of the CI protein in genome replication and cell-to-cell movement (Carrington et al., 1998).

1.7.2.5 VPg

The 5' ends of potyvirus RNA are not capped with 5'-5' triphosphate methylated nucleotides as most eukaryotic mRNAs. Like in several other viruses, the genome-linked protein, VPg, is attached to the 5' end of its genome. It may serve as the primer for viral RNA synthesis (Shahabuddin et al., 1988), may also be involved in cleavage of the replicative form of RNA (Tobin et al., 1989). In addition, the VPg is the moiety responsible for the stimulation of polymerase activity (Fellers et al., 1998b). A naturally occurring variation of several aa in the VPg of TVMV enabled the virus to overcome *va* gene resistance in tobacco (Nicolas et al., 1997), suggesting that changes in configuration of VPg may affect the interaction between VPg and appropriate host components regarding systemic virus movement. Recently, the

mechanism of *Pisum sativum* pathotype-specific resistance to PSbMV was investigated and the coding region determinant of PSbMV virulence was defined (Keller et al., 1998). Homozygous recessive *sbm-1* peas are unable to support replication of PSbMV pathotype 1 (P-1), whereas biochemically and serologically related pathotype 4 (P-4) is fully infectious in the *sbm-1/sbm-1* genotype. The lack of viral coat protein or RNA in P-1 transfected *sbm-1/sbm-1* protoplasts suggests that *sbm-1* resistance is occurring at the cellular level and that inhibition of cell-to-cell virus movement is not the operating form of resistance. As experiments to challenge P-1-resistant peas with infectious full-length P-1/P-4 recombinant clones of PSbMV revealed 21-kDa, VPg of the P4 pathotype determines its virulence, i.e. it is capable of overcoming *sbm-1* resistance. Clones containing the P-1 VPg coding region were noninfectious to *sbm-1/sbm-1* peas. VPg is thought to be involved in potyvirus replication and its identification as the PSbMV determinant of infectivity in *sbm-1/sbm-1* peas is consistent with disruption of an early P-1 replication event.

1.7.2.6 NIa protease

NIa, together with NIb, forms nuclear inclusion bodies in the cells of most potyvirus-infected plants. NIa consists of two proteins, the N-terminal VPg and a C-terminal trypsin-like serine protease. VPg is cleaved from the C-terminal 27K proteinase domain at a suboptimal cleavage site. The protease cleaves most of the proteins from the precursor protein, such as, the CI-NIa and NIa-NIb junctions and catalyses the production of CI, NIb and CP by cleaving the P3-CI, and NIb-CP junctions (Carrington and Dougherty, 1988) (see Fig. 1.4). Additional cleavages, to release VPg and 6K₁ and 6K₂ products also occur (Garcia et al., 1992). The protease recognition site is VXXHQ/A(S). An aa alignment of potyvirus NIa with other virus and cellular trypsin-like serine proteinase suggested a catalytic triad of histidine, aspartate and cysteine (Bazan and Fletterick, 1988) with the histidine residue in the substrate binding pocket characteristic of a Glu-X substrate specificity. Site-directed mutagenesis studies confirmed the importance of these residues for activity (Carrington et al., 1989). The RNA-binding activities of NIa protease domain (NIaPro) and full-length NIa protein were similar. Based on its RNA-binding activity and other known functions, NIaPro or a NIaPro-containing polyprotein is proposed to serve one or more direct roles during TEV RNA synthesis (Daros and Carrington, 1997). Recently the role of NIa both in protein cleavage and in cell to cell movement was evidenced by NIa gene transfer into plants (Maiti et al., 1993; Fellers et al., 1998a). C-terminal part of NIa of turnip mosaic potyvirus plays roles in the *cis*-cleavage

between NIa and NIb. The processing rate of the NIa-NIb junction sequence was decreased significantly by either V240D or Q243A mutation of NIa protease. The mutation of W212S, G213S, or I217D abolishing the cleavage at the NIb-CP or 6K₁-cylindrical inclusion protein junction sequence decreased the processing rate to half the level of that of the wild type (Kim et al., 1998).

1.7.2.7 NIb replicase

The NIb is the RNA-dependent RNA polymerase (RdRp) of the virus. It is responsible for replication of virus plus and minus RNA molecules (Deiman et al., 1997). There are a few direct experimental documents of potyviral NIb. One of the causes is mainly due to difficulties to purify and isolate this protein from the infected cells and due to the lack of a sensitive serological detection system. The most prominent sequence feature of the NIb is a glycine-aspartate-aspartate (GDD) motif characteristic for almost all RNA viruses of bacteria, animals, and plants (Koonin, 1991). By comparison of sequences of the RdRp of positive-stranded RNA viruses and evolutionary analysis of its recombination events it is possible to assign all the viruses into classes, orders, families and genera (Bruenn, 1991; Koonin, 1991; Koonin and Dolja, 1993). Recently experimental evidence for NIb protein possessing an RdRp activity has been obtained (Hong and Hunt, 1996). It was also found that the NIb protein interacts with both the NIa protein and the CP in yeast cells. The NIb protein interacts with the VPg domain of the NIa protein and this interaction requires a functional RNA attachment site. This interaction may be important for the initiation of viral RNA synthesis in infected cells. The polymerase activity of the NIb protein can be stimulated by VPg and NIa proteins. The CP interacts with the NIb in a manner that is sensitive to changes in the highly conserved GDD motif. The role of this interaction for the enzymatic activity of NIb protein or the function of CP is unclear, but may involve regulation of viral RNA synthesis in infected cells (Hong et al., 1995; Fellers et al., 1998a, b). Besides the functions of RNA-dependent RNA polymerase, the NIb protein of TEV possesses other functions, including nuclear translocation activities (Li and Carrington, 1993). NIb contains two independent nuclear localization signals (NLS I and NLS II). NLS I was mapped to a sequence within aa residues 1 to 17, and NLS II was identified between residues 292 and 316. Clustered point mutations resulting in substitutions of basic residues within the NLSs were shown to disrupt nuclear translocation activity. These mutations also abolished TEV RNA amplification when introduced into the viral genome. The amplification defects caused by each NLS mutation

were complemented *in trans* within transgenic cells expressing functional NIb. These data suggest that the NLSs overlap with essential regions necessary for NIb trans-active function(s). The fact that NIb functions *in trans* implies that it must interact with one or more other components of the genome replication apparatus. Clustered point mutations affecting the conserved GDD motif or NLS II within the central region of NIb, but not mutations affecting NLS I near the N terminus, reduced or eliminated the interaction. The C-terminal proteinase (Pro) domain of NIa, but not the N-terminal VPg domain, interacted with NIb. The effects of NIb mutations within NLS I, NLS II, and the GDD motif on the interaction between the Pro-domain and NIb were identical to the effects of these mutations on the interaction between full-length NIa and NIb (Li et al., 1997). NIb is directed to replication complexes through an interaction with the Pro-domain of NIa.

RdRp is required for viral genome replication. RdRp, probably together with other components of both virus and cellular sources, forms a replicase-complex to fulfil this process of viral genome replication. The important role of RdRp in the early events of virus replication and the sensitivity of this enzyme to the inhibitors were considered as the key parameters for designing a specific molecule e.g. scFv to inhibit the enzymatic activity of RdRp. In other words, blocking or inhibition of RdRp activity could provide a more effective way to interrupt virus replication at the early stages.

1.7.2.8 Coat protein

CP is the major gene product in virions and accounts for 90-95% of the mass of most virus particles. The structure and function of CP are extensively characterised, and a large number of CP sequences of potyviruses have been obtained (Puurand et al., 1994; Schukla et al., 1994; Aleman-Verdaguer et al., 1997; Sakai et al., 1997). The highly conserved central and C-terminal regions of CP are involved in encapsidating viral RNA. Evidence was found that assembly of a potyvirus begins near the 5' terminus of the viral RNA (Wu and Shaw, 1998). The highly variable N-terminal region displayed on the virus surface is involved in virus-specific functions or host/vector-virus interactions. Sequence data as well as site directed mutagenesis experiments confirmed that the conserved DAG motif located at the N terminus of CP, together with HC-Pro, is responsible for aphid transmission (Atreya et al., 1990) and long distance movement (Rojas et al., 1997), CP, together with CI, is also responsible for cell to cell or long distance movement of viruses (Carrington et al., 1998).

1.8 Serology of potyviral structural protein and nonstructural proteins

Serology of potyvirus CPs has made a great contribution in the understanding of viral biological properties, and widely used in the virus identification and isolation. A large number of MAbs have been generated and a series of reliable and sensitive serological methods have been established (Shukla et al., 1994). The standard of currently used virus classification is at most based on the serology of coat protein, biological properties and sequence data (Jordan and Hammond, 1991; Shukla et al., 1994; Jayaram et al., 1998). Since there are certain amounts of nonstructural components in the virus-infected plants, serology of nonstructural proteins including RdRp can serve as an additional criterion for the identification and classification of potyviruses. However, to date there are few experimental data about serology of potyviral non-structural proteins. Due to the fact that non-structural proteins do not exist in the virus particles and most of them exist in the virus-infected cells at low concentrations, these properties make it difficult to produce specific antibodies against them. Despite all efforts, RdRp have been successfully purified only for a limited number of plant viruses (Bates et al., 1995). Consequently, only a few monoclonal antibodies (MAb) to viral non-structural proteins have been produced (Slade et al., 1989; Liu et al., 1999 a, b). The use of a recombinant protein or synthetic peptides is a strategy to overcome this limitation. Antibodies to synthetic peptides that correspond to linear segments of a protein can react with the homologous sequence in the native folded protein provided it is exposed on the surface and exhibits a structure or conformation similar to the immunizing peptide (Craig et al., 1998). Broadly cross-reactive antibody probes were successfully generated using synthetic peptides corresponding to the conserved coat protein regions of potyviruses (Joisson et al., 1992 a, b). The advantage of the synthetic peptides approach is that the immune response can be directed to a region of special interest.

1.9 Pathogen-derived resistance and antibody-mediated resistance

In 1986 Powell-Abel and co-workers first demonstrated that transgenic plants expressing a virus coat protein gene could result in resistance to the virus infection. It was the first experimental proof of the concept of pathogen-derived resistance (PDR). To date this principle has been used to confer resistance against many viruses in a broad range of plant species (Wilson, 1993; Prins and Goldbach, 1996; Wintermantel et al., 1997). In the case of potyviruses either CP gene (Beachy et al., 1990) or genes for nonstructural protein such as P1

or P3 (Pehu et al., 1995; Moreno et al., 1998), HC-Pro, CI, NIa/VPg, NIB genes (Audy et al., 1994; Guo et al., 1997, 1998; Jones et al., 1998) has been transferred into plants, leading to different levels of resistance. However, despite of more than a decade's efforts, no clear correlation could be made between expression levels of the transgenes and observed virus resistance levels (Bendahmane et al., 1997). Several reports mentioned high resistance levels using genes incapable of producing protein, but in these cases, even plants accumulating high amounts of transgene RNA were not most resistant (Hammond and Dienelt, 1997). Different models have been proposed to elucidate the mechanism of resistance, such as, the RNA-mediated resistance mechanism, co-suppression phenomenon and post-transcriptional gene silencing (Smith et al., 1994; Baulcombe, 1996; Wassenegger and Pélissier, 1998).

PDR approach has successfully applied to generate resistance in a broad range of plant species. However, the problems that may arise from PDR are

- (i) **Synergism;**
- (ii) **Genetic recombination and complementation;**
- (iii) **Transcapsidation;**

Transcapsidation is the encapsidation of one virus with CP of another virus, which has been demonstrated to occur when two or more viruses infect the same plants (Rochow, 1970; Otsuki et al., 1978; Edwards et al., 1990). Since CP influences the transmission properties of viruses, a risk arises when the genome of a virus infecting a transgenic plant is encapsidated with CP produced by the transgene. The encapsidated virions might acquire the transmission characteristics of the transgene virus, which could give the virus temporary access to new plant species from which it previously had been excluded (de Zoeten, 1991). **Complementation** is the process by which a functional gene of one virus corrects for defectiveness in the same function of another co-infecting virus (Rochow 1977; Osbourn et al., 1990). **Genetic recombination** is the exchange of RNA between viral RNAs (Bujarski and Kaesberg, 1986; Candresse, 1996). Recombination events of this kind in plants transformed with viral genes could extend the potential for generation of new viruses with altered biological properties (Greene and Allison, 1994). **Synergism**, in this context, is the interaction between an infecting virus and the product of a transgene that results in more severe symptoms in transgenic plants than in the parental cultivar (Shi et al., 1997; Thomas et al., 1998). However, the antibody- or plantibody-mediated resistance has the advantages of specific recognition of viruses by constitutive antibodies and safety to the environment. By use of antibodies reacting with conserved domains of several viruses the transgenic plants

would subsequently obtain the broad spectrum resistance. The antibody-mediated resistance has given a great promise in plant resistance research (see section 1.6.3).

1.10 Scope of the work

The main objective of this thesis research was to engineer single chain variable fragment antibodies (scFvs) to highly conserved aa motifs of the RNA-dependent RNA polymerase (RdRp) of potyviruses and to characterize these scFvs, which could be applied to develop a new strategy for creating plant resistance towards these potyviruses.

To accomplish this goal the following MAbs and corresponding scFvs have been produced:

- I. Monoclonal antibodies against the CP of potyviruses as a control. Two synthetic peptides covering most conserved regions of the potyviral CP and the CP of PVY were used in mouse immunization for generation of MAbs.
- II. MAbs against NIB of potyviruses:
 - a) generation of MAbs against synthetic peptides. Based on the results of different computer program analyses, three highly conserved regions of RdRp (i.e. R1, R2, R3) were predicted with moderate antigenicity, respectively. Synthetic peptides corresponding to these regions were used in mouse immunizations for generation of MAbs.
 - b) Generation of MAbs against a recombinant NIB molecule. The sequence encoding for PVY NIB was cloned and overexpressed in *E. coli*. The recombinant protein was purified by IMAC and used in mouse immunizations for production of MAbs
- III. ScFvs were synthesized from the MAbs (hybridomas). Both NIB-specific and CP-specific scFv genes were cloned and overexpressed in *E. coli*. The phage displaying scFv and soluble scFv were capable of binding the target antigens.

The generated antibodies have been characterized for their reactivity with the corresponding native proteins of potyviruses. At the same time their diagnostic values have been tested.

2 Results

2.1 Sequence alignments and peptide syntheses

The most antigenic parts of the three highly conserved regions of potyviral N1b were determined. Their antigenicity estimated by computer analysis (Hopp and Woods, 1981) was only moderate (Fig. 2.1). The R3 was predicted with the highest index among them.

Peptides representing conserved regions of the potyviral CP sequence were synthesized as a multi-antigenic peptide (MAP) with the following structures:

S 319: (ENTERHTA)₄-K₂-K-A-OH.

S 193: (MVWCIEN)₄-K₂-K-A-OH.

Although MVWCIENGTSPPD is the complete original conserved region, an attempt to synthesize this sequence failed, since synthesis of N to G residues met difficulties.

2.2 Expression of the R1-R2-R3 fusion protein in *E. coli*.

The map of the expression cassette for a fusion R1-R2-R3 protein is shown in Figure 2.2a. The recombinant R1-R2-R3 protein was expressed in *E. coli* as a soluble protein. The expression levels of the recombinant protein were definitely lower than it was obtained in the same system for expressing viral CP. No distinct band could be observed on the Coomassie brilliant blue stained gels in SDS-PAGE analysis of the total proteins comparing IPTG-induced cells and non-induced cells. Applying an anti-His tag antibody for Western blotting a clear band was detected with extracts of IPTG-induced cells expressing fusion R1-R2-R3 peptide, only a faint band was observed in the case of non-induced cells (Fig. 2.3). After immobilized metal-ion affinity chromatography (IMAC) purification, this antigenic peptide was used to screen MAb against the three conserved region peptides.

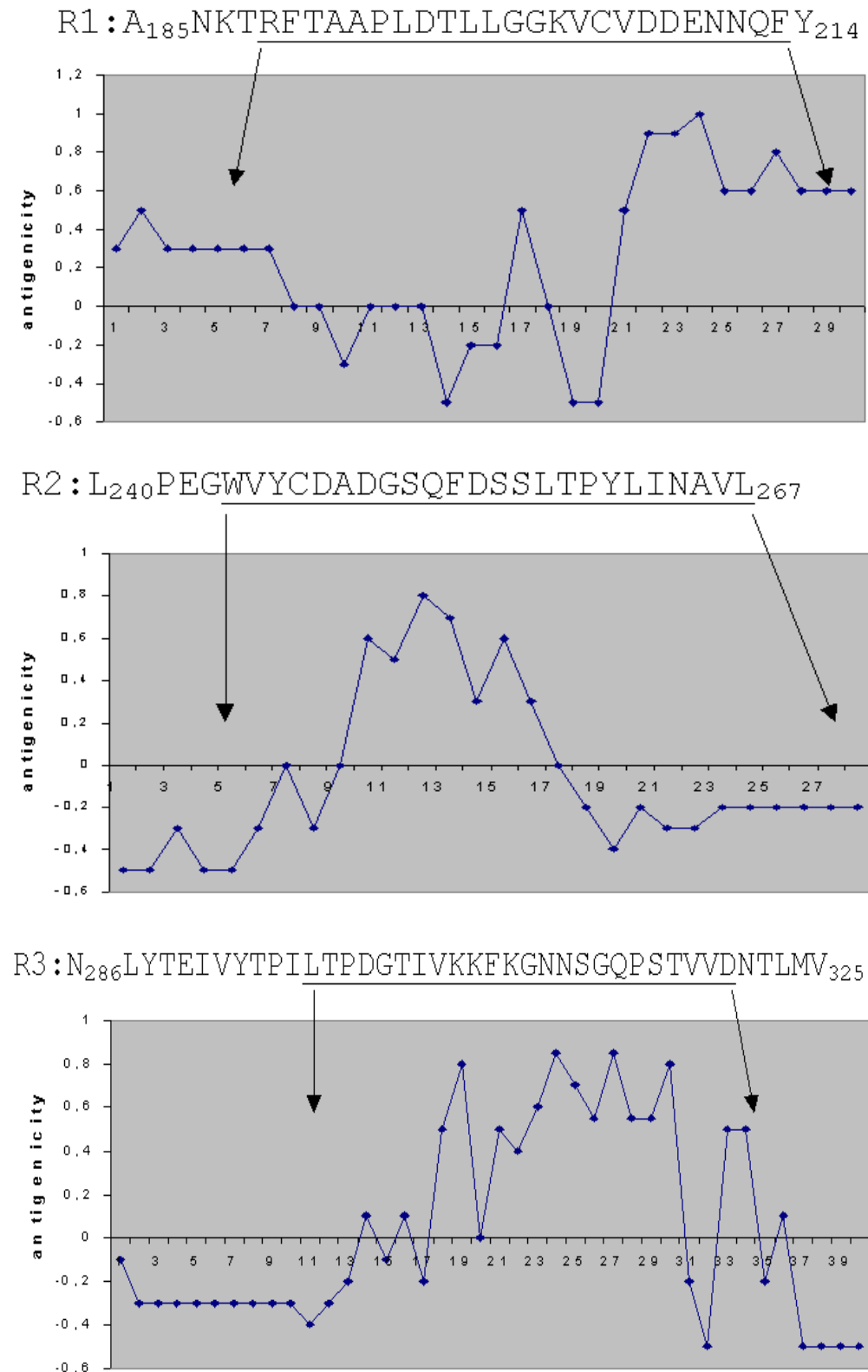

Fig. 2.1: Conserved regions of N1b protein of potyviruses. The positions of aa correspond to N1b of PVY. The sequences underlined represent the most antigenic parts, which were chosen for peptide synthesis. Diagrams below the sequences show the antigenicity profile of the corresponding regions according to Hopp and Woods (1981).

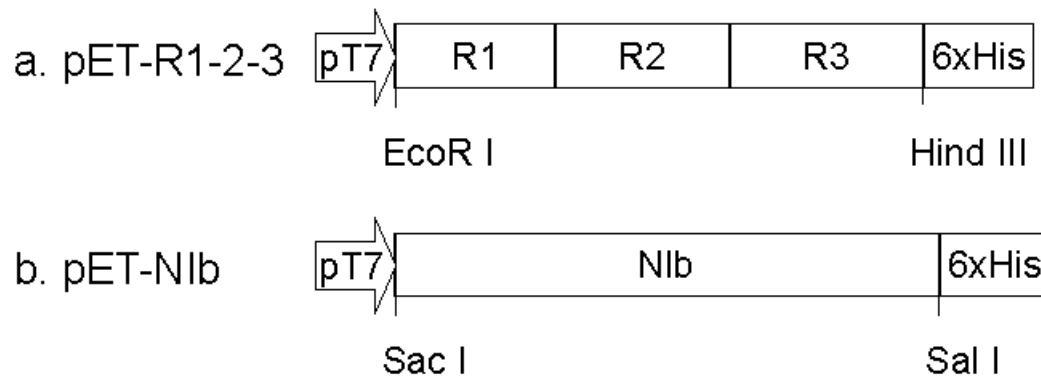

Fig.2.2: Maps of recombinant protein expression cassette.

a: The expression cassette of recombinant R1-2-3 protein;

b: The expression cassette of recombinant NIb protein;

pT7 = T7 promoter; R1, R2, R3 = oligonucleotides encoding for R1 peptide, R2 peptide and R3 peptide, respectively; 6× His = His-tag, NIb = gene encoding truncated NIb protein. Expression vector pET30a, which harboring the constructs, is not shown.

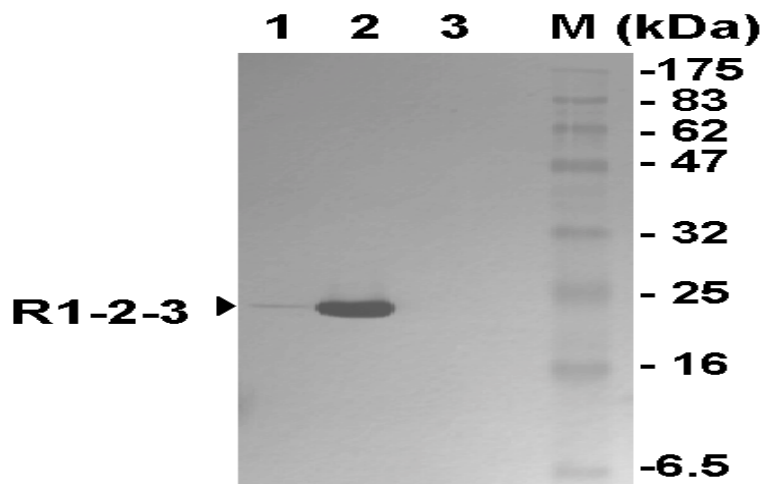

Fig. 2.3: Detection of recombinant R1-2-3 protein in a Western blot.

Lane 1: non-induced cells containing plasmid with insert; lane 2: IPTG-induced cells containing plasmid with insert; lane 3: cells containing plasmid without insert; lane M: prestained protein marker. Signal was revealed by ECL assay using anti-penta-His tag MAbs as a primary antibody.

2.3 Expression of the recombinant NIb protein in *E. coli*

PVY-NIb gene was obtained by RT-PCR (see section 4.2.3), cDNA was cloned into pGEM-T. Two independent clones were chosen from transformants and sequenced. The sequences of these two clones were identical (EMBL accession number Y16879). Comparisons between the sequence of PVY-NIb and the complete nucleotide sequence (EMBL accession number A08176) revealed that 360 nt were missing at their extreme 3'-ends. In addition, there existed a deletion of 6 nt at the 5'- terminal NIb and a frame shift leading to an altered 16 aa sequence

between positions 86-103. Since the clones contained sequences necessary to express all three regions of interest, no new cloning experiments were conducted.

The map of expression cassette for PVY-NIb is shown in Figure 2.2b. The NIb protein was expressed as an inclusion body in the bacteria after fractional analysis. The dynamics of recombinant NIb expression in *E. coli* showed that the highest amount of expressed NIb appeared 3 h after induction with 1 mM IPTG revealed by ECL assay, suggesting that long time induction resulted in degradation of the fusion protein (Fig. 2.4). The recombinant protein could also be detected by an anti-penta-His monoclonal antibody. A band of 60 kDa appeared, confirming that NIb was really fused to the His-tag.

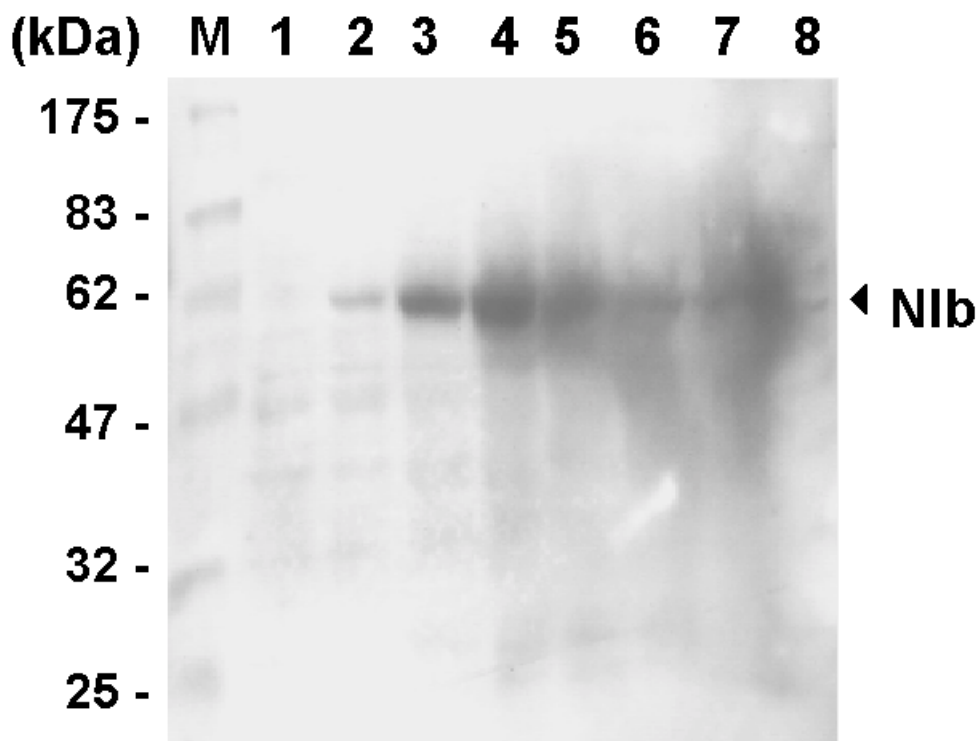

Fig. 2.4: Time course of the truncated NIb expression in *E. coli* BL21 (DE3) pLysS. Cells were induced with 1 mM IPTG at 28°C. Signal was revealed in Western blot by ECL assay (Perkin Elmer) using HisProbe-HRP conjugate (1:5000 dilution in TBST). Lane M: prestained protein marker; lane 1: non-induced cells; lanes 2 – 8: 1 h, 2 h, 3 h, 4 h, 6 h, 8 h and 20 h after induction, respectively.

The recombinant truncated NIb protein was successfully expressed *in vitro* and subsequently purified by IMAC (Fig. 2.5). The purified protein was used for mice immunization and generation of MAb against NIb.

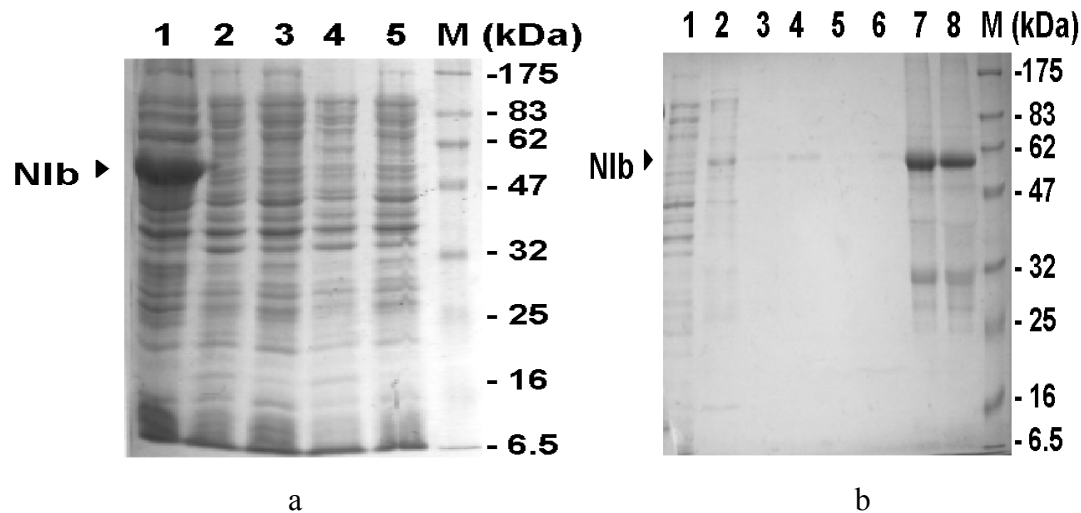

Fig. 2.5: Expression of recombinant truncated N1b in *E. coli* BL21(DE3) pLysS. Proteins were analyzed by SDS-PAGE, 12% PA gels were stained with Coomassie brilliant blue.

a: analysis of total protein of *E. coli*. Lane 1: IPTG-induced cells containing pET30a-N1b; lane 2: non-induced cells containing pET30a-N1b; lane 3: IPTG-induced cells containing pET30a; lane 4: non-induced cells containing pET30a; lane 5: cells without plasmid; lane M: prestained protein marker.

b: analysis of IMAC-purified recombinant N1b. Lane 1: urea-solubilized bacterial crude extract pellet flowed through Ni^{2+} -resin column; lane 2: urea-solubilized bacterial crude extract pellet; lanes 3 – 6: eluates of fraction 1, 2, 7, 8, from Ni^{2+} -resin column; lanes 7, 8: mixture of fractions 1 to 4 and 5 to 8, respectively, concentrated by PEG treatment; lane M: prestained protein marker.

2.4 Production of antisera to the recombinant N1b of PVY

Polyclonal antisera produced in response to this recombinant protein reacted specifically with both the recombinant protein and the viral N1b in PVY-infected plants, as shown in Table 2.3. The first bleeds cross-reacted with healthy plant leaf extracts, the second and the third bleeds were antigen-specific in PTA-ELISA. The antisera could be diluted up to 1:2000 for the assay.

2.5 Generation and characterization of MAbs against different regions of N1b

One fusion experiment with BSA-conjugated peptide corresponding to R1 was performed, but all hybrid clones reacted strongly with BSA. Thus, in subsequent experiments only splenocytes from mice immunized with the purified peptides were used for hybridization. In addition, three further fusion experiments with peptide corresponding to R1 were performed. Supernatant fluids of 17 cell cultures reacted to R1 in PTA-ELISA. Six hybrid cell lines were selected for cloning and further propagation.

Table 2.1 Summarized characteristics of hybrid lines established after screening.

Cell culture supernatants	Specific to peptide	A _{405nm} values in PTA-ELISA										
		Synthetic peptides			Recombinant proteins		Leaf extracts of infected plants					
		R1	R2	R3	RP1-3	Nlb	PVY	Healthy	PVA	PPV	PVV	TuMV
1G5	R1	1.16	0.11	0.09	0.03	0.03	0.03	0.07	nt*	nt	nt	nt
2C3	R1	1.66	0.12	0.10	0.03	0.03	0.26	0.30	nt	nt	nt	nt
2G10	R1	1.33	0.10	0.08	0.33	0.33	1.92	1.32	1.89	1.88	1.88	1.79
3C6	R1	1.13	0.12	0.11	0.82	0.32	0.45	0.07	0.47	0.38	0.33	0.27
3G4	R1	1.24	0.11	0.10	0.75	0.66	0.25	0.07	0.26	0.23	0.25	0.23
1B7	R2	0.16	1.69	0.19	1.08	0.68	0.25	0.08	0.34	0.22	0.24	0.26
1C8	R2	0.14	1.94	0.15	1.55	0.55	0.37	0.15	0.45	0.37	0.37	0.33
1G12	R2	0.12	1.80	0.11	0.85	0.78	0.30	0.07	0.39	0.30	0.33	0.31
1B9	R2	0.22	1.41	0.21	0.06	0.02	0.20	0.14	nt	nt	nt	nt
3B4	R3	0.16	0.11	0.32	0.05	0.02	0.04	0.05	nt	nt	nt	nt
3E11	R3	0.11	0.10	0.31	0.04	0.01	0.04	0.05	nt	nt	nt	nt

*nt = not tested; RP1-3 = recombinant protein R1-R2-R3; synthetic peptides, RP1-3 and Nlb were used at a concentration of 2 µg/ml. Isotype of all MAb was IgM.

One fusion experiment was performed with peptide corresponding to R2. Supernatant fluids of 15 cell cultures reacted to R2 in PTA-ELISA. Five hybrid cell lines were selected for cloning and further propagation.

Two fusion experiments were performed with peptide corresponding to R3. Supernatant fluids of 5 cell cultures reacted to R3 in PTA-ELISA. Two hybrid cell lines were selected for cloning and further propagation.

To screen MAbs reactivity by Western blotting, 11 MAbs, positive in PTA-ELISA, were chosen. Four MAbs, 1B7, 1G12, 3C6 and 3G4, showed positive reactions with the expressed single peptide R1-R2-R3. The others did not show any cross-reaction or a background activity. MAbs generated to R3, namely, 3B4, 3E11, only weakly reacted with overexpressed R1-R2-R3 protein after prolonged incubation with the substrate.

The complete recombinant Nlb protein was detected by the same 4 MAbs, i.e. 3G4, 3C6 (to R1), 1G12 and 1B7 (to R2). Fig. 2.6. provides an example for the recombinant Nlb detection. Similarly, MAbs 3B4, 3E11 very weakly reacted with the recombinant Nlb protein.

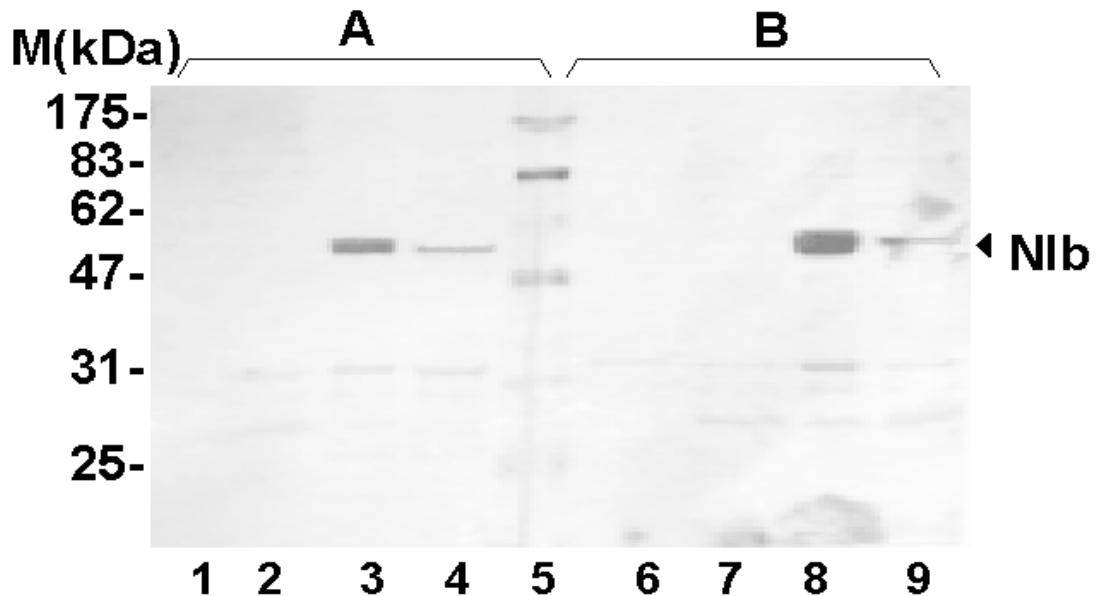

Fig. 2.6: Detection of the recombinant PVY-NIb by Western blotting. Lanes 1, 6: cells containing plasmid without insert; lanes 2, 7: crude extracts from non-induced cells; lanes 3, 8: crude extracts from induced cells; lanes 4, 9: 100 ng of purified NIb; lane 5: prestained protein marker. A: probed with MAb 1G12; B: probed with MAb 3G4.

2.6 Generation and characterization of MAbs to synthetic peptides of CP

Two fusion experiments were performed with peptides S193W4 and S319. In total, 4 hybridoma cell lines were obtained. The properties of MAbs are given in the Table 2.2. It was shown that these MAbs cross-reacted with healthy plant sap. The MAbs were unsuitable for PTA-ELISA.

2.7 Generation and characterization of MAbs to recombinant NIb and CP of PVY

Fusion experiments were carried out for both the recombinant NIb protein and the purified CP of PVY. Seven hybridoma cell lines were further propagated. Their characteristics are shown in the Table 2.3. The OD values obtained in PTA-ELISA were higher than those in TAS-ELISA in the case of detection of NIb. Of these MAbs 2E11 and 3B10 were specific to NIb. The results of PTA-/TAS-ELISA indicated that only MAb 1D6 was specific for PVY-CP. This MAb and the NIb-specific MAb 2E11 and 3B10 were employed for subsequent virus detection experiments.

Table 2.2 Characterization of monoclonal antibodies obtained against CP-derived synthetic peptides in PTA-ELISA

Cell culture supernatant	Isotype	A _{405nm} values in PTA-ELISA								
		Synthetic peptides		Leaf extracts of infected plants						
		S193	S319	PVY	PVA	TuMV	RgMV	PPV	PVV	Healthy
1G9	IgM, κ	1.58	0.12	1.25	1.28	1.02	1.09	1.12	1.19	0.55
5B3	IgM, κ	1.91	0.86	1.42	1.24	1.29	1.15	1.26	1.28	1.12
5F5	IgM, κ	1.63	0.06	1.32	1.35	1.09	1.23	1.20	1.20	0.33
1B5	nd*	0.10	1.15	0.87	0.89	0.91	0.85	0.90	0.90	0.32

*not determined; A_{405nm} values were measured after 1 h substrate incubation at room temperature.

Table 2.3 Characteristics and reactivity of monoclonal and polyclonal antibodies to NIB and CP of PVY in ELISA

Cell culture supernatant/sera	Specific to antigen	Isotype		A _{405nm} Values in PTA-ELISA / TAS-ELISA		
		Heavy chain	Light chain	Overexpressed NIB (2μg/ml)	PVY infected leaf extracts (1:50)	Healthy leaf extracts (1:50)
1C8	NIB	μ	κ	1.25 [†] / 0.35 [‡]	0.73 / 0.27	0.65 / 0.19
1D8	NIB	μ	κ	1.14 / 0.32	0.67 / 0.15	0.58 / 0.11
2F5	NIB	μ	κ	1.39 / 0.42	0.92 / 0.33	0.13 / 0.18
2F10	NIB	μ	κ	1.32 / 0.39	1.05 / 0.32	0.16 / 0.18
2E11	NIB	μ	κ	1.63 / 0.48	1.12 / 0.43	0.11 / 0.15
3B10	NIB	μ	λ	1.20 / 0.37	0.96 / 0.16	0.03 / 0.09
1D6	CP	γ	κ	0.03 / 0.04	1.35 / 1.56	0.03 / 0.05
Serum M	NIB			1.35 / nt	1.27 / nt	0.53 / nt
Serum R1	NIB			2.18 / nt	0.66 / nt	0.17 / nt
Serum R2	NIB			2.32 / nt	0.73 / nt	0.22 / nt

Serum M = mouse antiserum from immunized mouse for preparing splenocytes 1:500 diluted before use; Serum R1 and R2 = rabbit 1 and 2 antisera, 1:1000 diluted before use; nt = not tested. A_{405nm} values were measured after 1 h substrate incubation at room temperature. [†] A_{405nm} values in PTA-ELISA, [‡] A_{405nm} values in TAS-ELISA. Systemically infected leaves were extracted 14 dpi.

2.8 Detection of the native NIB protein in potyvirus-infected plants

2.8.1 ELISA

Six MABs raised to R1 or R2 were used to detect NIB of different potyviruses in PTA-ELISA (Table 2.1). All gave low $A_{405\text{nm}}$ values with the heterologous virus, indicating that they can not be applied for routine diagnosis.

As the PTA-ELISA was more sensitive than TAS-ELISA for NIB detection (see Table 2.3), the specificity and cross-reactivity of each of the MABs against the recombinant NIB of PVY was assessed in PTA-ELISA with different isolates of PVY and other potyviruses. The results are shown in Table 2.4. MAb 2F5 cross-reacted with PVA, PPV and RgMV. MAb 2E11 and 3B10 showed a high specificity. MAb 2E11 revealed the highest titer of all MABs, up to 100-fold dilution of the cell culture supernatant possible. Consequently, this specific antibody was used for detecting PVY infections.

Table 2.4 Reactivity of MABs with PVY isolates and other potyviruses in PTA-ELISA

Cell culture supernatant	$A_{405\text{nm}}$ values in PTA-ELISA									
	PVY CH	PVY NT	PVA Da	PVA LI	PPV Jena	TuMV	RgMV Bul	RgMV Czech	Buffer	Healthy
1C8	0.18	0.23	0.06	0.04	0.09	0.03	0.08	0.11	0.01	0.11
1D8	0.18	0.25	0.10	0.07	0.11	0.05	0.10	0.12	0.02	0.13
2F5	0.44	0.58	0.28	0.11	0.30	0.06	0.31	0.31	0.02	0.15
2F10	0.29	0.41	0.12	0.09	0.12	0.12	0.14	0.11	0.02	0.18
2E11	0.78	1.14	0.06	0.03	0.10	0.03	0.06	0.01	0.03	0.10
3B10	0.35	0.38	0.05	0.04	0.07	0.03	0.07	0.05	0.03	0.04
1D6	2.19	1.22	0.01	0.01	0.01	0.01	0.01	0.04	0.01	0.02

PVY CH = PVY CH 605, PVA Da = PVA Datura, PVA LI = PVA Lichte Industrie, RgMV Bul = RgMV Bulgarian. Virus infected plants were freshly sampled. Plates were coated with 1:50 diluted sap in coating buffer, 100 μl per well at 4°C overnight. Cell culture supernatants were 1:1 diluted before use; 1D6 = purified IgG, specific to PVY CP and 1:1000 diluted before use. $A_{405\text{nm}}$ values were measured after 1 h substrate incubation at room temperature.

2.8.2 Western blotting

The four MABs, 3G4, 3C6 (R1), 1B7, 1G12 (R2), were able to detect a polypeptide with the expected molecular mass of the NIB protein (~65 kDa) in potyvirus-infected plants. MAB

1G12 and 3G4 were specific for NIBs of potyviruses since a single band was observed on the blot (Fig. 2.7 a, c). MAb 1B7 and 3C6 had a similar reactivity, but cross-reacted with a 55 kDa protein (Fig. 2.7 b, d). In some cases, immunoblot assays revealed a large (~100 kDa) band as well as a small (~30 kDa) band (data not shown). This small band probably results from the degradation of NIB, since a similar band sometimes was found in a preparation of the recombinant NIB. The large band may be a complex of the unprocessed N1a-NIB or NIB-CP.

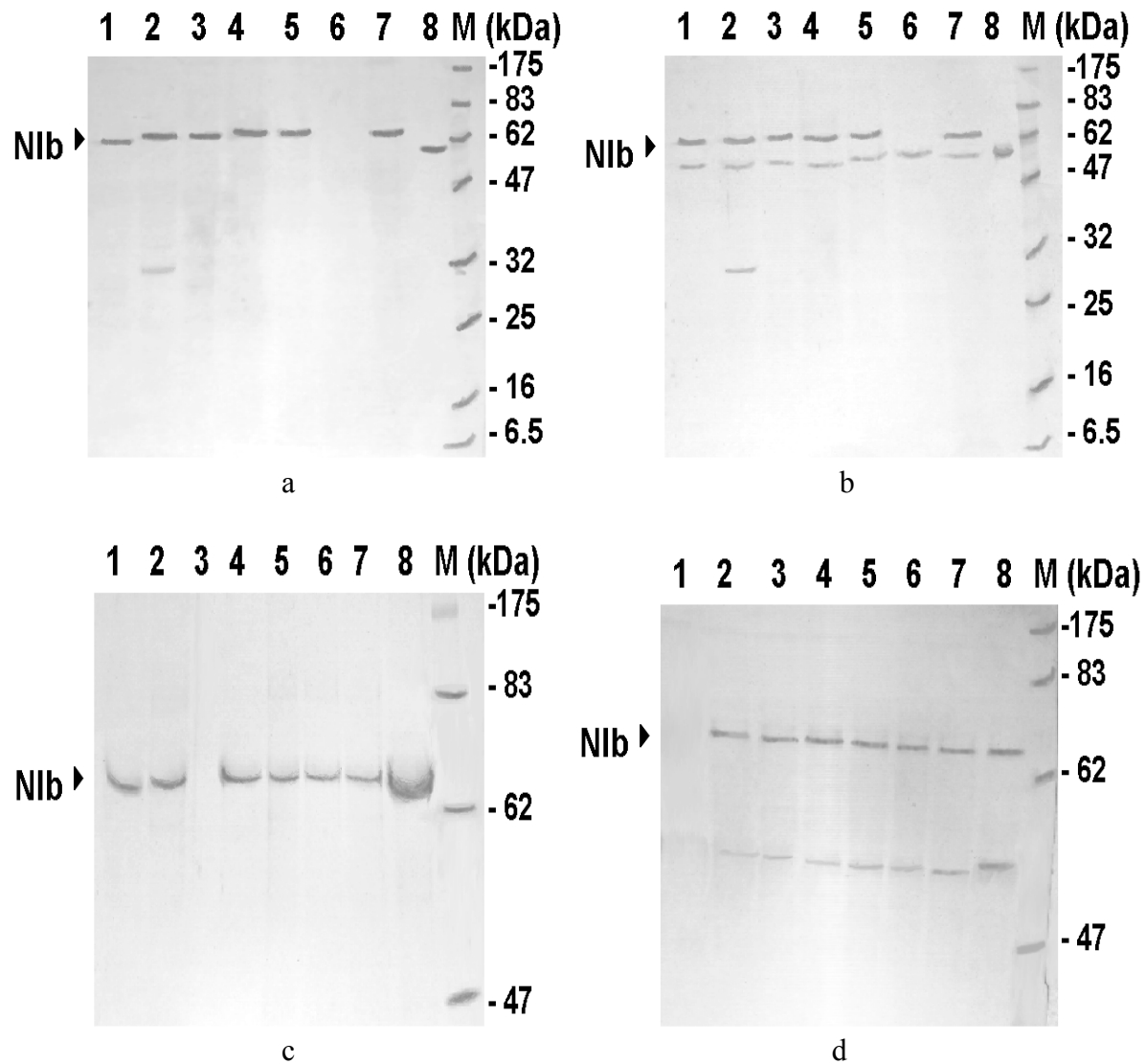

Fig. 2.7: Detection of native NIB proteins in potyvirus-infected plants by Western blot.

a: probed with MAb 3G4; **b:** probed with MAb 1B7. For both: lane 1: PVY D884; lane 2: TuMV; lane 3: PVA; lane 4: PPV; lane 5: PVV; lane 6: healthy control; lane 7: PVY CH 605; lane 8: purified recombinant NIB; lane M: protein marker.

c: probed with MAb 1G12. Lane 1: PVY-D884; lane 2: PVY CH 605; lane 3: healthy control; lane 4: TuMV; lane 5: PVA; lane 6: PPV; lane 7: PVV; lane 8: PVY-NTN; lane M: protein marker.

d: probed with MAb 3C6. Lane 1: healthy control; lane 2: PVY-D884; lane 3: PVY-CH605; lane 4: TuMV; lane 5: PVA; lane 6: PPV; lane 7: PVV; lane 8: PVY-NTN; lane M: protein marker.

2.9 Detection of the coat protein in potyvirus-infected plants

2.9.1 ELISA

MABs generated from synthetic peptides covering conserved regions of potyviral CP cross-reacted with extracts of healthy plants in PTA-ELISA. Therefore, these MABs are not suitable for routine detection of potyvirus infection. Interestingly, one of them, MAb 5B3, cross-reacted with the extract from healthy *N. clevelandii* plants in PTA-ELISA, but showed a specific reaction with CP of PVY in TAS-ELISA, where polyclonal rabbit antisera against PVY were used for coating the plate. MAb 1D6 reacted with all ten isolates of PVY tested in PTA- and TAS-ELISA, it did not cross-react with other potyviruses, such as, PVA, PPV, PVV, LMV, WMV, MDMV, TuMV, RgMV, BaYMV and BaMMV.

2.9.2 Western blot analysis

Of MABs to CP, only 1D6 could detect CP in Western blot. One or two specific bands could be seen on the blot corresponding to a size of approximately 39 and 33 kDa (Fig. 2.8a). In contrast, one or two more bands (Fig. 2.8b) were observed on the blot when extraction buffer containing 9 M urea was used in sample preparations. The bands of the different size suggested that there exists a dimer form of CP or unprocessed polyprotein containing CP. An approximately 20 kDa protein may be a degradation product of the CP. MAb 1D6 showed a high sensitivity and specificity to all ten isolates of PVY tested, of these isolates, C, and oGA usually gave a weaker signal. MAb 1D6 could not detect other potyviruses tested by Western blotting, such as, PVA (B11), PPV (Jena), PVV, LMV, WMV, MDMV, TuMV, RgMV, BaYMV and BaMMV. This was consistent with the results of PTA/TAS-ELISA. The results suggested that MAb 1D6 might recognize a linear epitope on the CP of PVY. This property makes it a valuable reagent in routine detection and identification of PVY infection by a variety of immunoassays.

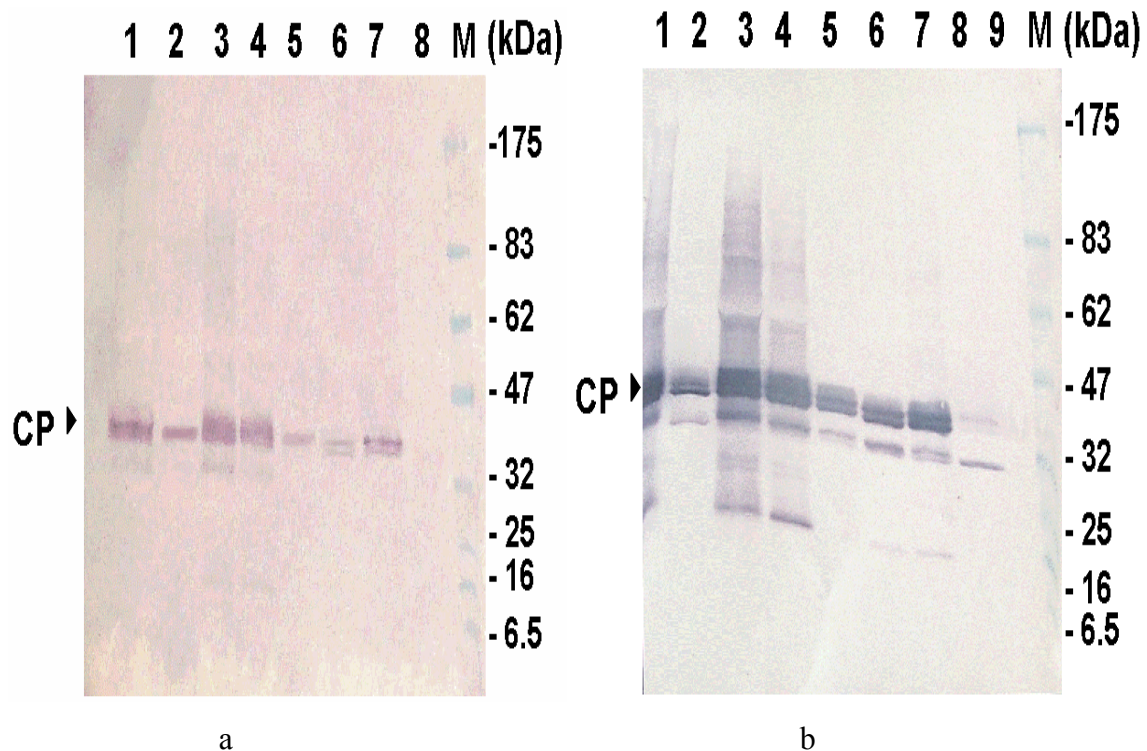

Fig. 2.8: Western blot analysis of CPs of different PVY isolates in *N. glutinosa* plants. **a:** extracts of infected leaves with 50 mM Tris-HCl buffer. Lane 1: A91; lane 2: M3; lane 3: NTN; lane 4: CH 605; lane 5: oGA; lane 6: To1; lane 7: Tomato; lane 8: C; M: prestained protein marker. **b:** extracts of infected leaves treated with extraction buffer containing 9 M urea. Lane 1: D884; lane 2: M3; lane 3: NTN; lane 4: CH 605; lane 5: oGA; lane 6: M3; lane 7: 1427; lane 8: C; lane 9: healthy *N. glutinosa* plants; M: prestained protein marker. 5-20% gradient gels containing 0.1% SDS was prepared for SDS-PAGE.

2.10 Comparison of detection of the viral Nib and CP in PVY-infected plants

Leaf extracts from both PVY-infected and healthy plants were tested in PTA-ELISA using the two MABs 2E11 and 3B10 specific to Nib and MAb 1D6 specific to CP of PVY. The results are shown in Fig. 2.9. All ten isolates of PVY were detected by MABs 2E11, 3B10 and 1D6. In any case, MAb 2E11 had higher $A_{405\text{nm}}$ values than MAb 3B10. Among PVY isolates only oGA and NTN had high $A_{405\text{nm}}$ values for Nib as well as CP. On the other hand, isolates 1427, To1 and C, showed higher $A_{405\text{nm}}$ values for NIBs than that for CPs, while the other isolates had very high values for the CP and relatively low ones for the NIB.

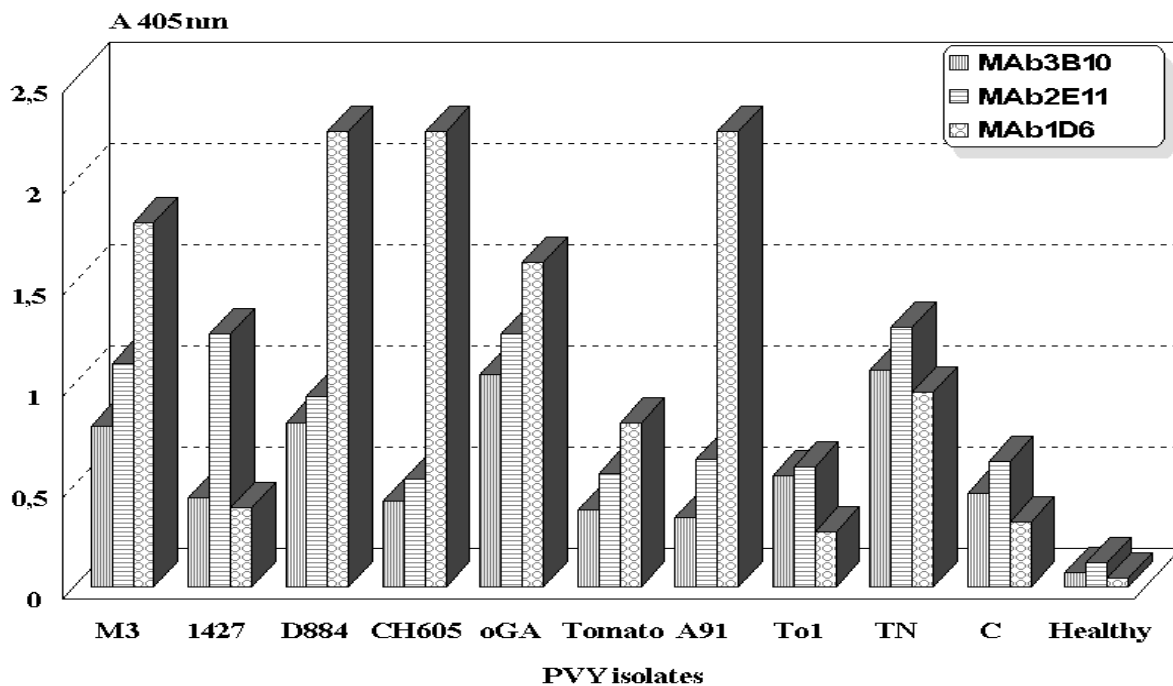

Fig. 2.9: Comparison of detection of the viral NIB and CP in leaves of *N. glutinosa* systemically infected with different isolates of PVY. Extracts were prepared freshly from the infected plants 12 dpi for PTA-ELISA. MAb 3B10 and 2E11 are specific to NIB, 1D6 specific to PVY CP. A_{405nm} values were measured after 1 h substrate incubation at room temperature.

2.11 Temporal expression of potyviral NIB and CP in plants

Time course studies on synthesis of NIB and CP in PVY-infected plants revealed that NIB can be first detected by PTA-ELISA in systemically infected leaves approximately 5 dpi and remains detectable up to 28 dpi. It was found that synthesis and accumulation of the viral NIB and CP in PVY-infected plants were shown to exhibit a similar pattern (Fig. 2.10a). This is in agreement with the results obtained from the Western blot (Fig. 2.10b)

During the time course study, it was observed that the locally infected leaves could accumulate less amounts of viral RdRp than that the young systemic leaves (Table 2.5). Under the same conditions the absorbance values for PVY-infected *N. glutinosa* plants were higher than those for *N. occidentalis* plants. This could be visualized with both CP and NIB specific MAb.

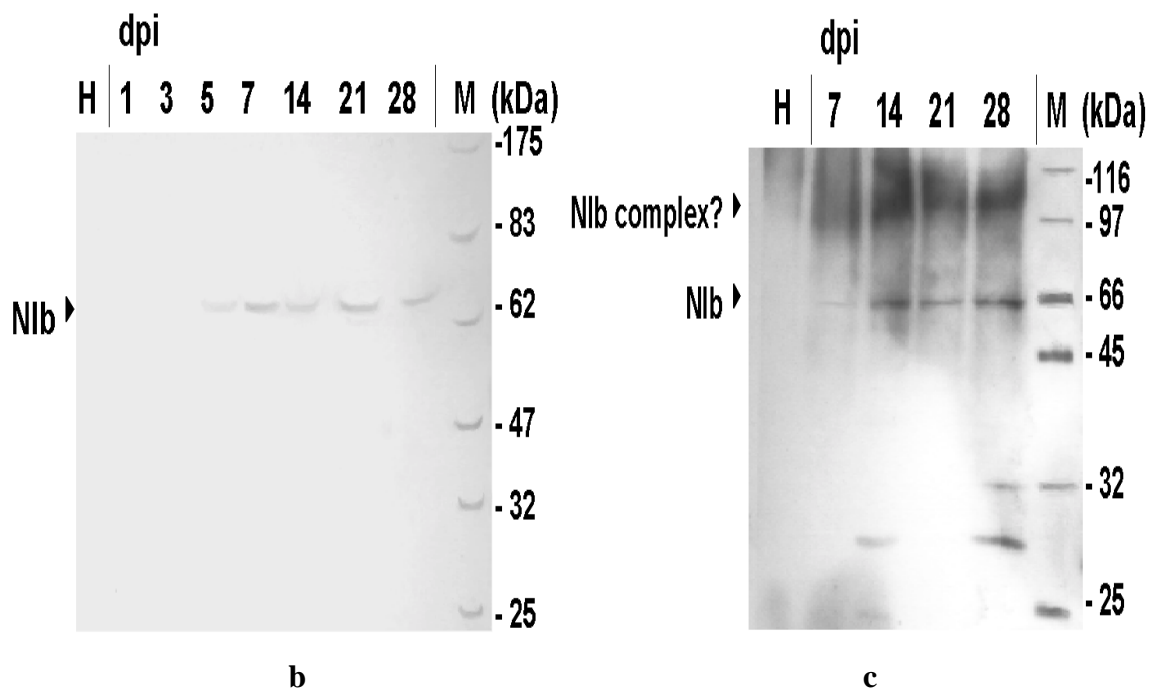
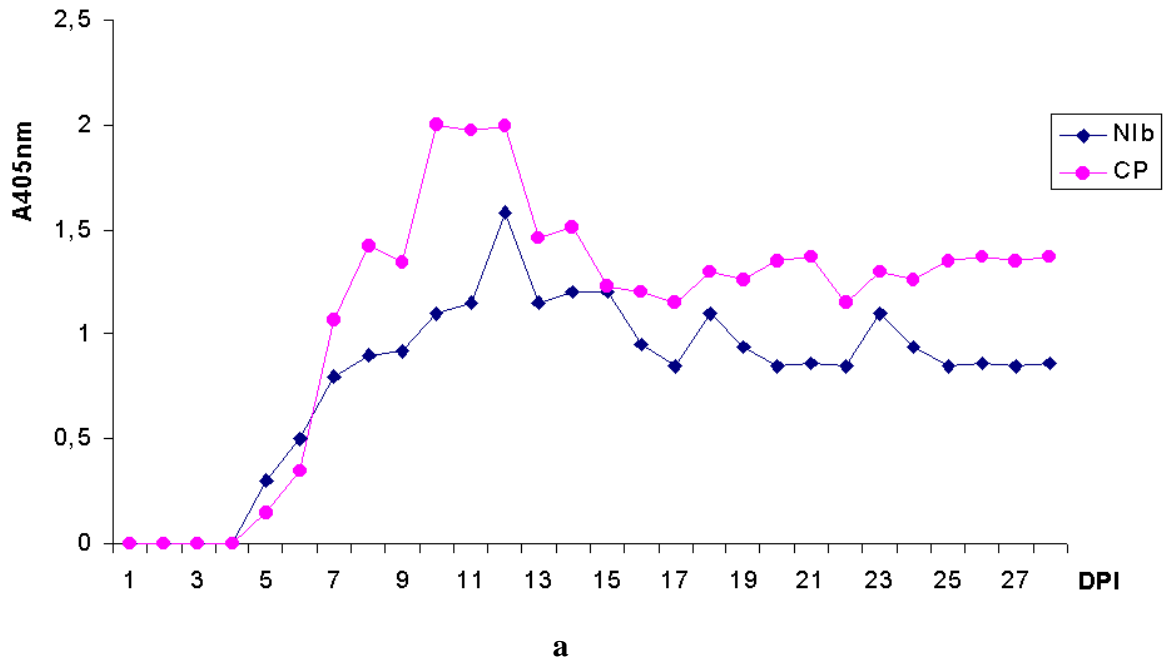

Fig. 2.10: Time course studies on expression of the CP and Nib of PVY and Nib of PVA.

a: synthesis and accumulation of CP and Nib of PVY in systemically infected leaves of *N. glutinosa*. Leaves were freshly sampled (1g fresh leaves was extracted in 0.5 ml of extraction buffer) for PTA-ELISA. A_{405nm} values were measured after 2 h substrate incubation at room temperature.

b: time course of Nib synthesis in systemically PVY-infected leaves of *N. glutinosa* revealed by Western blot. Lane H: healthy; lane M: protein marker. Probed with MAb 3G4, detected by ECL.

c: time course study on Nib synthesis in systemically PVA-infected leaves of *N. clevelandii*. Lane H: healthy; lane M: protein marker. Probed with MAb 1G12, detected by ECL.

Table 2.5 Temporal synthesis of RdRp and CP in different leaves and host plants

Leaves\ plant	dpi	A _{405nm} Values in PTA-ELISA			
		RdRp		CP	
		<i>N. glutinosa</i>	<i>N. occidentalis</i>	<i>N. glutinosa</i>	<i>N. occidentalis</i>
l. leaves	1	0.11±0.03	0.02±0.01	0.02±0.01	0.02±0.01
sy. leaves	1	0.07±0.02	0.06±0.02	0.01±0.01	0.00±0.00
l. leaves	3	0.06±0.01	0.03±0.01	0.00±0.00	0.00±0.00
sy. leaves	3	0.07±0.02	0.06±0.02	0.00±0.01	0.00±0.01
l. leaves	5	0.08±0.02	0.06±0.03	0.08±0.04	0.04±0.02
sy. leaves	5	0.14±0.04	0.07±0.03	0.09±0.05	0.05±0.02
l. leaves	7	0.10±0.03	0.06±0.04	0.12±0.05	0.05±0.03
sy. leaves	7	0.21±0.06	0.07±0.04	0.22±0.05	0.06±0.04
l. leaves	10	0.20±0.06	0.08±0.06	0.18±0.07	0.07±0.05
sy. leaves	10	0.35±0.10	0.08±0.08	0.27±0.12	0.07±0.06
l. leaves	14	0.22±0.11	0.08±0.05	0.48±0.17	0.11±0.10
sy. leaves	14	0.55±0.20	0.08±0.10	0.67±0.21	0.15±0.12
l. leaves	16	0.26 ±0.21	0.08 ± 0.05	0.47 ±0.13	0.18 ±0.13
sy. leaves	16	0.67 ±0.25	0.12 ±0.06	1.17 ±0.28	0.35 ±0.18
so. leaves	16	0.29 ±0.12	0.07 ±0.05	0.31 ±0.19	0.29 ±0.15
l. leaves	18	0.27±0.22	0.09±0.08	0.89±0.31	0.19±0.21
sy. leaves	18	0.97±0.29	0.15±0.11	1.23±0.25	0.43±0.24
so. leaves	18	0.33±0.21	0.10±0.09	0.91±0.22	0.21±0.22
l. leaves	21	0.15±0.21	0.12±0.13	0.21±0.19	0.18±0.21
sy. leaves	21	1.05±0.22	0.37±0.26	1.00±0.31	0.45±0.26
so. leaves	21	0.25±0.24	0.28±0.24	0.89±0.32	0.19±0.21

l. leaves = locally infected leaves; sy. leaves = systemically infected young leaves; so. leaves = systemically infected old leaves; plants were inoculated with PVY CH 605. Healthy control for NIB = 0.12±0.15, for CP = 0.01±0.05. A_{405nm} value = $\bar{x} \pm 2S$ (\bar{x} stands for means, S for standard deviation), sample numbers (N) =10. Culture supernatant of MAb 2E11 (1:1 dilution) was used to detect NIB, purified MAb 1D6 (1 mg/ml, 1:1000 dilution) was used for CP detection. A_{405nm} was measured after 1 h substrate incubation at room temperature.

2.12 Construction of recombinant single chain fragment (scFv) antibody

The procedures of molecular cloning and construction of scFv are represented in the schema of Figure 2.11.

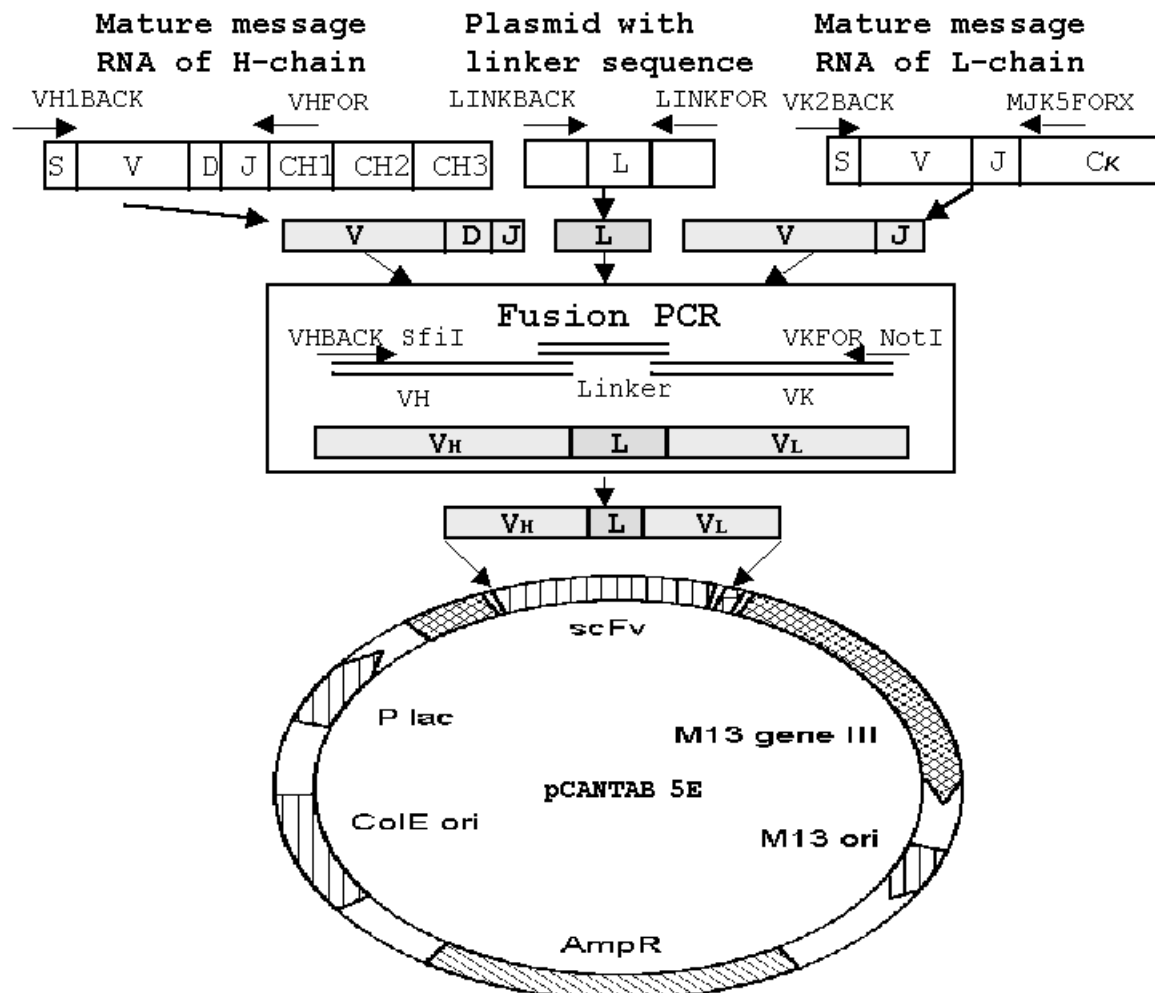

Fig. 2.11: Synthesis of scFv and construction of scFv gene library. S = signal peptide sequence (e.g. leader sequence); V = variable region; D = D (diversity) region; J = J (joining) region; CH1, CH2, CH3 = C (constant) region of H (heavy) chain; C κ = C region of L (light) chain (κ).

2.12.1 Cloning of immunoglobulin variable region genes

cDNAs were synthesized from individual mRNAs isolated from the respective hybridoma cell lines 1B7, 1G12, 3G4, 2E11, 1D6, and 7C5. (MAb 7C5, from Dr. F. Rabenstein, BAZ, Aschersleben, is specific to native PVY, cannot react with denatured PVY, unpublished data). Heavy and light chain Fv genes were cloned by PCR as described in Materials and Methods. The results are shown in Fig. 2.12. In some cases, the amount of the V_L DNA (e.g. 1B7) was

not sufficient for the following experiments. For this reason PCR reaction conditions were optimized to amplify the V_L DNA by making use of different enzymes and different concentrations of DMSO or $MgCl_2$. Addition of DMSO to PCR mixtures containing Pfu DNA polymerase resulted in the production of a single specific band of the expected size (Fig. 2.13).

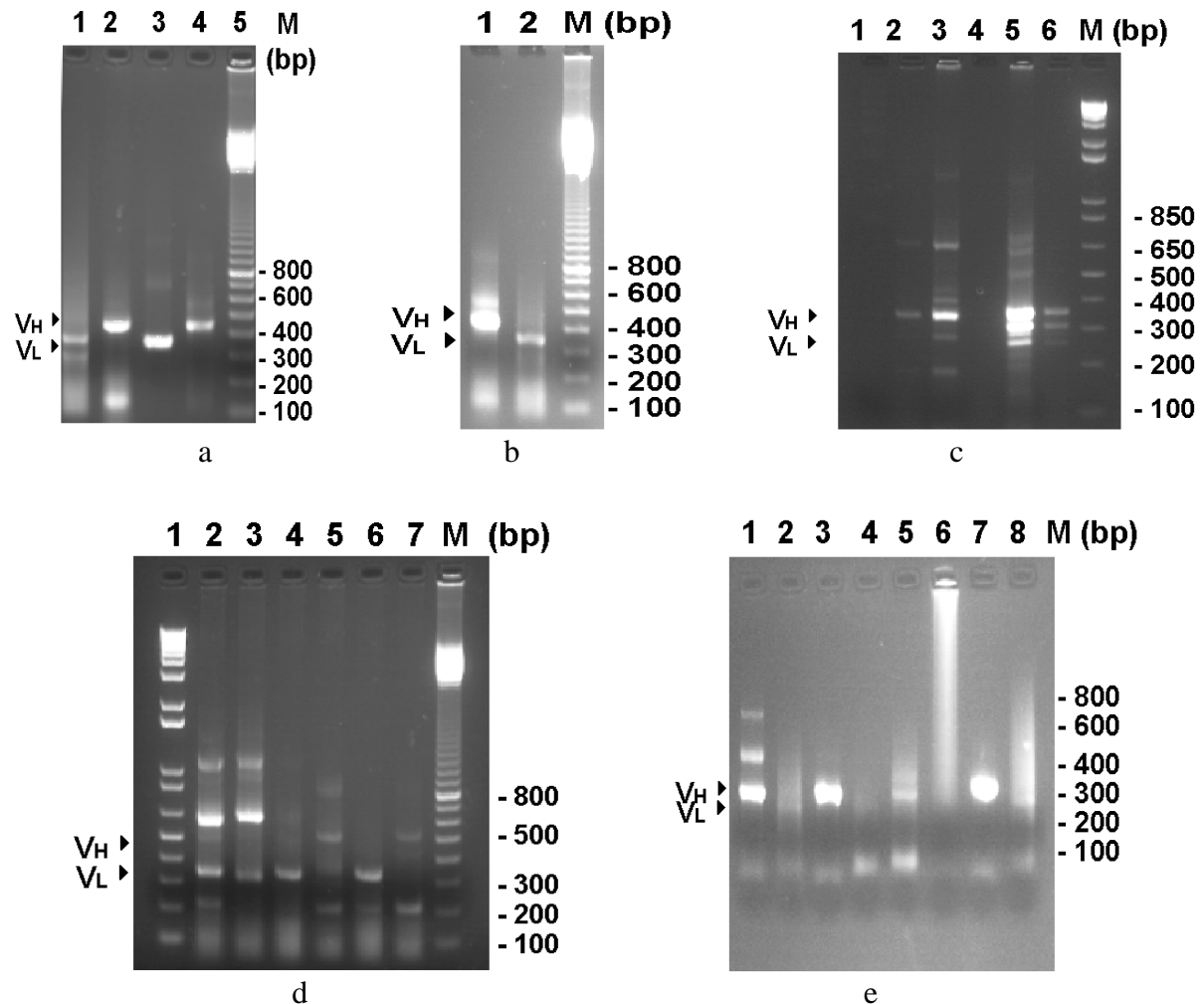

Fig. 2.12: Amplification of Fv genes from hybridoma cells by PCR.

a: lane 1: 1D6 V_L , ~350 bp; lane 2: 1D6 V_H , ~400 bp; lane 3: 7C5 V_L , ~350 bp; lane 4: 7C5 V_H , ~400 bp; lane 5: marker, 100 bp ladder, double intense band corresponds to the size of 800 bp. (5 μ l of 50 μ l PCR product was applied onto gel).

b: lane 1: 2E11 V_H , ~400 bp; lane 2: 2E11 V_L , ~350 bp; lane 3: marker, 100 bp ladder, double intense band corresponds to the size of 800 bp. (5 μ l of 50 μ l PCR product was applied onto gel).

c: lane 1: lacking template cDNA control; lanes 2-3: 3G4 V_H ~350-400 bp; lane 4: lacking template cDNA control; lanes 5-6: 3G4 V_L , ~300-350 bp; lane 7: marker, 100 bp ladder, double intense band corresponds to the size of 800 bp. (lanes 2, 5: 5 μ l, and lanes 3, 6: 15 μ l of 20 μ l PCR product were applied onto gel).

d: lane 1: marker, 1kb plus ladder; lane 2: 1G12 V_H , ~350 bp; lane 3: 1G12 V_L , ~330 bp; lanes 4, 6: 1B7 V_H , ~350 bp; lanes 5, 7: 1B7 V_L , ~330 bp; lane 8: marker, 100 bp ladder, double intense band corresponds to the size of 800 bp. (10 μ l PCR product was applied onto gel).

e: reamplification of 1B7 Fv genes by PCR and optimization of annealing temperature. Template DNA was gel-purified (see Fig. 2.12d); lanes 1, 3, 5, 7: 1B7 V_H , PCR reactions were carried out at annealing temperatures of 45°C, 55°C, 65°C and 58°C, respectively, lanes 2, 4, 6, 8: 1B7 V_L , PCR reactions were carried out at annealing temperatures of 45°C, 55°C, 65°C and 58°C, respectively.

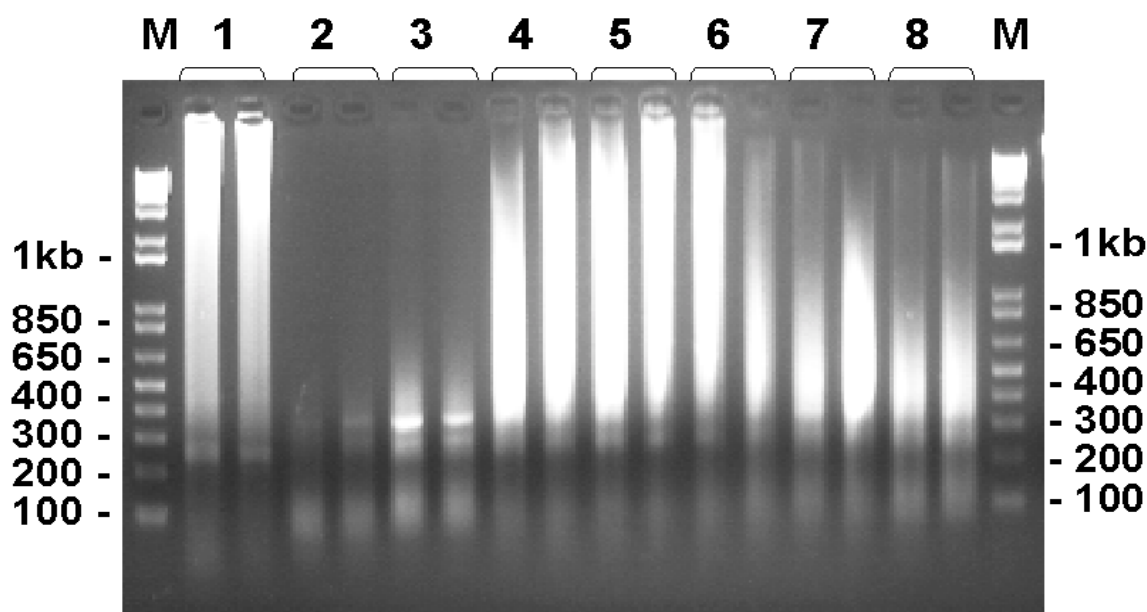

Fig. 2.13: Optimization of PCR amplification of 1B7 V_L by use of different enzymes and reaction conditions.

Lane M: 1 kb plus ladder; lane 1: Biotools taq polymerase; lane 2: Taq extender PCR additive; lane 3: Pfu DNA polymerase; lane 4: AmpliTaq polymerase; lane 5: Expand high fidelity taq polymerase; lanes 6, 7, 8: different concentrations of $MgCl_2$ (0.5 mM, 3mM, 5mM, respectively), were used in a PCR reaction with expand high fidelity taq polymerase. In each lane, the left well was subjected with 10 μ l of 20 μ l PCR product containing 5% DMSO in PCR reaction, the right well subjected with 10 μ l of 20 μ l PCR product containing 10% DMSO.

2.12.2 Synthesis of scFv by fusion PCR or from V_L and V_H combinatorial libraries

The above amplified V_H and V_L genes were linked together with a DNA fragment encoding a flexible peptide $(Gly_4Ser)_3$ via fusion PCR to synthesize scFv genes. The assembled scFvs, namely, scFv 1D6, scFv 2E11 (Fig. 2.14) and scFv 7C5 with a size of ~740 bp, were purified from agarose gels. ScFv 7C5 was cloned into phagemid vector pCANTAB 5E through restriction enzyme sites Sfi I and Not I, and scFv 1D6, 2E11, 1B7, 1G12, and 3G4 were cloned into pSEX 81 by Nco I and Not I sites.

For comparison of synthesis of scFv, the respective V_L and V_H genes of 1B7, 3G4, 2E11, were cloned into pSEX 81 separately, resulting in a configuration of V_H -linker- V_L -c-myc-tag-His-tag.

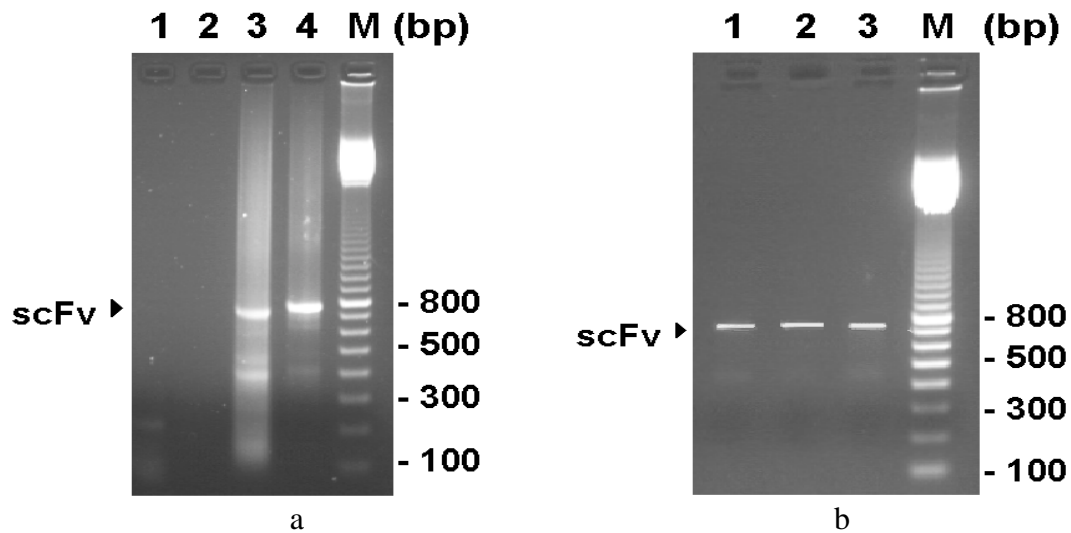

Fig. 2.14: Assembly of Fv genes into scFv by fusion PCR.

a: lane 1: PCR reaction mixture without V_H DNA; lane 2: master mixture without temple DNA; lane 3: scFv 1D6; lane 4: scFv 2E11; lane 5: marker, 100 bp ladder, double intense band corresponds to the size of 800 bp.

b: lane 1: scFv 1B7; lane 2: scFv 1G12; lane 3: scFv 3G4; lane 4: marker, 100 bp ladder, double intense band corresponds to the size of 800 bp.

2.13 Size of Fv or scFv libraries

The light chain Fv was ligated into plasmid pSEX 81 and transformed into supercompetent XL-blue 2 cells. The sizes of the light chain sublibraries for MAb 1B7, 3G4, 2E11 were approximately 5×10^5 , 8×10^5 , and 2×10^6 , respectively. The sizes of heavy chain sublibraries cloned into the corresponding light chain sublibraries in XL-blue 2 were 6×10^5 , 1×10^6 , and 2.3×10^6 , respectively. The library size of scFv for 7C5, 1D6, 2E11 was 5.6×10^5 , 6.4×10^5 , and 6.8×10^5 in TG1 cells, respectively. The library size of scFv for 1B7, 1G12, 3G4, was 6.1×10^5 , 6.4×10^5 , and 6.7×10^5 in XL-blue 2 cells. The individual library was kept at -80°C , or directly used for screening functional scFv.

2.14 Biopanning for selection of functional scFv from the libraries

After two rounds of selection on either PVY or NIB-coated tubes or tubes coated with leaf sap of PVY-infected plants, from each of 1D6, 2E11 and 7C5 libraries, 120 single colonies secreting phage scFv antibodies were tested for binding target antigens in phage ELISA. Some of them gave absorbance values similar to those of the negative control wells coated with healthy plant sap or BSA, but a proportion gave values two or three times greater than

background. Representative $A_{405\text{nm}}$ values of 20 single colonies derived from each of the phage scFv are given in Fig. 2.15. The phage scFv gave $A_{405\text{nm}}$ values ranging from 0.08 to 0.74 after 1 h substrate incubation at room temperature. The highest $A_{405\text{nm}}$ values were given by an anti-CP-scFv. This was expected as the parent MAb also gave high values. To check the presence of inserts in the phagmid, PCR and restriction enzyme analysis were performed. Some of the clones that gave $A_{405\text{nm}}$ values below 0.2 did not contain an insert. The positive clones containing pCANTAB-scFv constructs (see Fig. 2.18a) were used to infect HB2151 cells for expressing a soluble scFv. For soluble expression of scFv genes from the pSEX-scFv constructs, they were subcloned into pOPE101, the resulting pOPE-scFv constructs (see Fig. 2.18b) were expressed in TG1 or HB2151 cells.

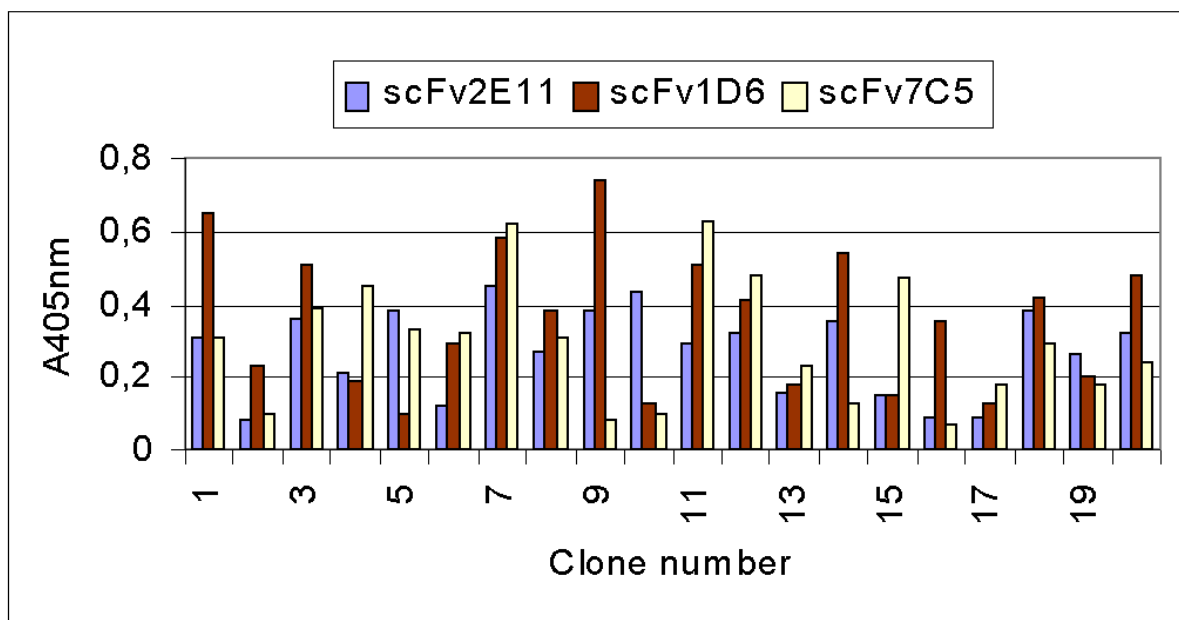

Fig. 2.15: Absorbance values ($A_{405\text{nm}}$) obtained in ELISA of phage-scFv from 20 single colonies tested after two rounds of selection from the phage display libraries, either 2E11, or 1D6 or 7C5. Wells of microtiter plates were coated with $5 \mu\text{g/ml}$ of purified recombinant NIB or virus or sap of PVY infected plants (1:50 dilution in PBS). $A_{405\text{nm}}$ was measured after 1 h of substrate incubation at room temperature. The values of the negative controls, BSA were 0.08, buffer, 0.05.

The selection of scFv to potyvirus Nib was done following essentially the same procedures. The purified recombinant Nib and an extract of potyvirus-infected plant were used as antigen for panning. The representative values of 20 single colonies obtained in phage-ELISA are shown in Fig. 2.16. The phage scFv gave $A_{405\text{nm}}$ values ranging from 0.07 to 0.39 after 1 h substrate incubation at room temperature.

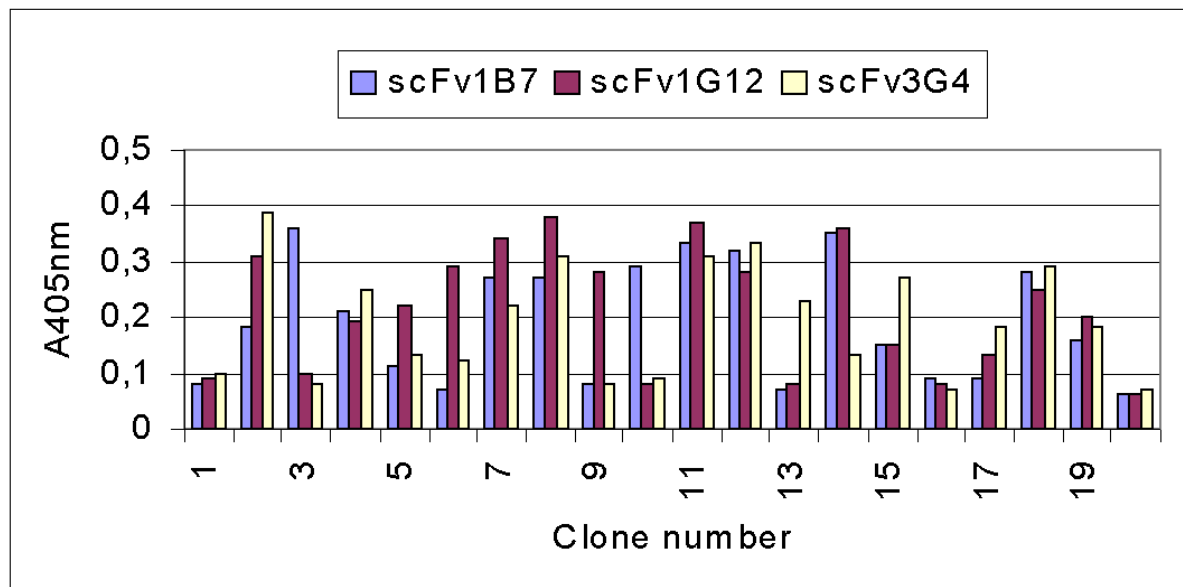

Fig. 2.16: Absorbance values (A_{405nm}) obtained in ELISA of phage-scFv from 20 single colonies tested after three rounds of selection from the phage display libraries of either 1B7 or 1G12 or 3G4. Wells of microtiter plates were coated with 10 $\mu\text{g/ml}$ of the purified recombinant N1b in coating buffer. A_{405nm} was measured after 1 h of incubation with substrate at room temperature. The values of the negative controls, BSA, were 0.08, buffer, 0.05.

2.15 Sequences of scFv-clones

For sequencing of the scFv 1D6, three clones with high binding ability in phage-ELISA after three rounds of panning, five randomly selected from libraries after one time panning, were investigated. Of them, five clones displayed identical sequences except for one or two point mutations, and one clone (f1) was mutated back by site-directed mutagenesis. According to alignments of the sequences, sequence of clone K1, which shares identical sequences with other four clones, was considered as the parent sequence from hybridoma cells, and designated as 1D6F1. In addition, another three clones also share high homology with nucleotide sequence of the parent in part; one had the same variable heavy chain sequence but with an aberrant rearrangement of variable light chain; the second one had four nucleic acid differences in V_H and misses seven aa in V_L , consequently, resulting in a reading frame shift; the third had a frame shift in both heavy chain and the light chain resulting in an unrelated aa sequence. The DNA sequence and deduced aa sequence of the scFv 1D6F1 are shown in Fig. 2.17a.

The nucleotide sequences of five clones from scFv 7C5 were determined. Similar to scFv 1D6, three clones have one to three point mutations, two have the identical sequence. The sequence of scFv 7C5 is shown in Fig. 2.17b.

```

1                                     A                                     60
ATGGCCAAGGTCCAACCTGCAGGAGTCTGGAGGAGGTTGGGTGCAACTTGGAGGATCCATG
M A K V Q L Q E S G G/E G W V Q L G G S M

61                                     120
AAATTCTCCTGTGTTGCCTCTGGATTCACTTTTCAGTAACTACTGGATGAGCTGGGTCCGC
K F S C V A S G F T F S N Y W M S W V R

121                                     180
CAGTCTCCAGAGAAGGGGCTTGAGTGGGTTGCTGAAATTAGATTGAAATCTAATAATTAT
Q S P E K G L E W V A E I R L K S N N Y

181                                     240
GCAACACATTATGCGGAGTCTGTGAAAGGGAGGTTACCATCTCAAGAGATGATTCCAAA
A T H Y A E S V K G R F T I S R D D S K

241                                     300
AGTAGTGTCTCCCTACAAATGAACAACCTTAAGAGTTGAAGACACTGGCATTATTACTGT
S S V S L Q M N N L R V E D T G I Y Y C

301                                     361
ACGGTGGACCTTGACTACTGGGGCCAAGGCACCACGGTCACCGTCTCCTCAGGTGGAGGC
T V D L D Y W G Q G T T V T V S S G G G

361                                     C 420
GGTTCAGGCGGAGGTGGCTCTGGCGGTGGCGGATCGGACATCGAGCTCACTCAGTCCCA
G S G G G G S G G G G S D I E L T Q S P

421                                     480
TCAATCATGTCTGCATCTCCAGGGGAGAGGGTACCATGACCTGCAGTGCCAGCTCAAGT
S I M S A S P G E R V T M T C S A S S S

481                                     540
ATACGTTACATATATTGGTACCAACAGAAGCCTGGATCCTCCCCAGACTCCTGATTTAT
I R Y I Y W Y Q Q K P G S S P R L L I Y

541                                     600
GACACATCCAACGTGGCTCCTGGAGTCCCTTTTCGCTTCAGTGGCAGTGGGTCTGGGACC
D T S N V A P G V P F R F S G S G S G T

601                                     660
TCTTATTCTCTCACAATCAACCGAATGGAGGCTGAGGATGCTGCCACTTATTACTGCCAG
S Y S L T I N R M E A E D A A T Y Y C Q

661                                     720
GAGTGGAGTGGTTATCCGTACACGTTCCGGAGAGGGGACCAAGCTGGAAATCAAACGGGCG
E W S G Y P Y T F G E G T K L E I K R A

721 726
GCCGCG
A A

```

Fig. 2.17a: Nucleotide and deduced aa sequences of scFv 1D6F1. Three separate clones shared identity on nucleotide sequence level except for one base difference between them (G-A, T-C, bold underlined letters indicated in the sequences). One base exchange resulted in a different aa sequence (K3 G-E, bold letter in the sequence). This aa mutation does not affect the scFv binding ability.

```
1 60
ATGGCCCAGGTGCAGCTGGTGGAGTCAGGGGGAGGTTTATGTCAGCCTGGAGGGTCCCTG
M A Q V Q L V E S G G G L V Q P G G S L

61 120
AAACTCTCCTGTGCAGCCTCTGGATTCACTTTTCAGTAGCCATACTATGTCTTGGGTTTCGC
K L S C A A S G F T F S S H T M S W V R

121 180
CAGACTCCAGAGAAGAGGCTGGAGTGGGTTCGCATATATTAGTAATGGTGGTGGTATCACC
Q T P E K R L E W V A Y I S N G G G I T

181 240
TCCTATTTCAGACACTGTAGAGGGCCGATTACCATCTCCAGAGACAATGCCAAGAACACC
S Y S D T V E G R F T I S R D N A K N T

241 300
CTGTACCTGCAAATGAGCAGTCTGAAGTCTGAGGACACGGCCATGTATTATTGTTCAAGA
L Y L Q M S S L K S E D T A M Y Y C S R

301 360
CATGGGGGTCATTATTACGGCCCGGGTACTTTGACTACTGGGGCCAAGGGACCACGGTT
H G G H Y Y G P G Y F D Y W G Q G T T V

361 420
ACCGTCTCCTCAGGTGGAGGCGGTTTCAGGCGGAGGTGGCTCTGGCGGTGGCGGATCGGAC
T V S S G G G S G G G S G G G S D

421 480
ATCGAGCTCACTCAGTCTCCATCTTATCTTGCTGCATCTCCTGGAGAAACCATTACTATT
I E L T Q S P S Y L A A S P G E T I T I

481 540
AATTGCAGGGCAAGTAAAACCATTAGCAAATTTTTAGCCTGGTATCAAGAGAAACCTGGG
N C R A S K T I S K F L A W Y Q E K P G

541 600
AAAATAAATAAGCTTCTTATCTACTCTGGATCCACTTTGCAATCTGGAACCTCCATCAAGG
K T N K L L I Y S G S T L Q S G T P S R

601 660
TTCAGTGGCAGTGGATCTGGTACAGATTTCACTCTCACCATCAGTAGCCTGGAGCCTGAA
F S G S G S G T D F T L T I S S L E P E

661 720
GATTTTGCAACTGTATTATGTCAACAACATAATGAATACCCGTACACGTTCCGGAGGGGGG
D F A T V L C Q Q H N E Y P Y T F G G G

721 747
ACCAAGCTGGAGCTGAAACGGGCGGCC
T K L E L K R A A
```

Fig. 2. 17 b: Nucleotide and deduced aa sequence of scFv 7C5 antibody.

2.16 Expression of scFv antibodies in *E. coli*

2.16.1 Total protein analysis of scFv expression

The scFv genes from pSEX 81, were re-cloned into pOPE101 between the leader sequence *pelB* of *Erwinia carotovora* and a detection tag as shown in Fig. 2.18b. The lac-promoter allows induction of expression of scFv by IPTG, whereas the N-terminal *pelB*-leader directs the product to the periplasmic space to allow easy harvest of concentrated fusion protein. In addition, the sequence encoding an 11 aa product of the *c-myc* oncogene, which is specifically detected by MAb 9E10, together with a sequence encoding for six histidine residues, fused to the C-terminus of scFv, facilitates detection by anti-c-myc antibody and purification via IMAC in a convenient way.

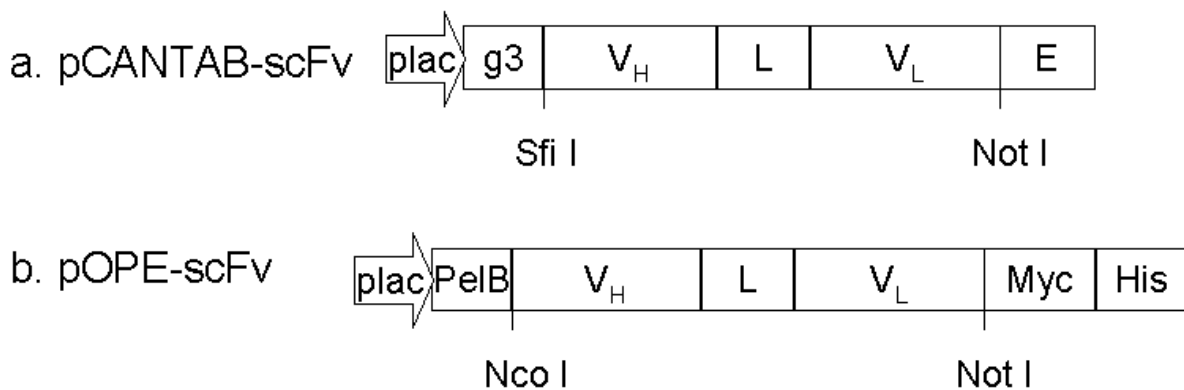

Fig. 2.18: The arrangement of genes in the various vectors used for expression of scFv antibodies in *E. coli*.

plac = lac promoter—for IPTG-induced expression of scFv; g3 = gene 3 of filamentous phage M13; PelB = signal peptide of pectate lyase B of *Erwinia carotovora*; V_H = variable region of heavy chain; L = linker, e.g. (GGGS)₃; V_L = variable region of light chain; E = E-tag; Myc = c-myc-tag; His = His-tag. The vectors pCANTAB 5E and pOPE 101, which harbouring the constructs, are not shown.

The expression of the scFv from pOPE-scFv after induction with 1 mM IPTG is demonstrated in Fig. 2.19a. A protein of about 31 kDa (calculated size is 28.4 kDa) can be seen on the stained gels. No band of the same size is observed in the controls. Specific expression of soluble scFv was further confirmed by Western blot analysis (Fig. 2.19b). The scFv proteins produced in *E. coli* were detected by MAb 9E10, which is specific for the c-myc-tag peptide, fused to the C terminus of the scFv. A protein of approximately 31 kDa, corresponding to the band visible on the gel, was detected on Western blot, too. No protein expression was detected in the control cells. A weak band of the same size appeared also without IPTG induction.

Levels of expression of soluble scFv against potyvirus NIB were very low, no distinct band was seen on actual gels. However, the recombinant protein could be visualized by applying an enhanced chemiluminescence detection system (Fig. 2.19c).

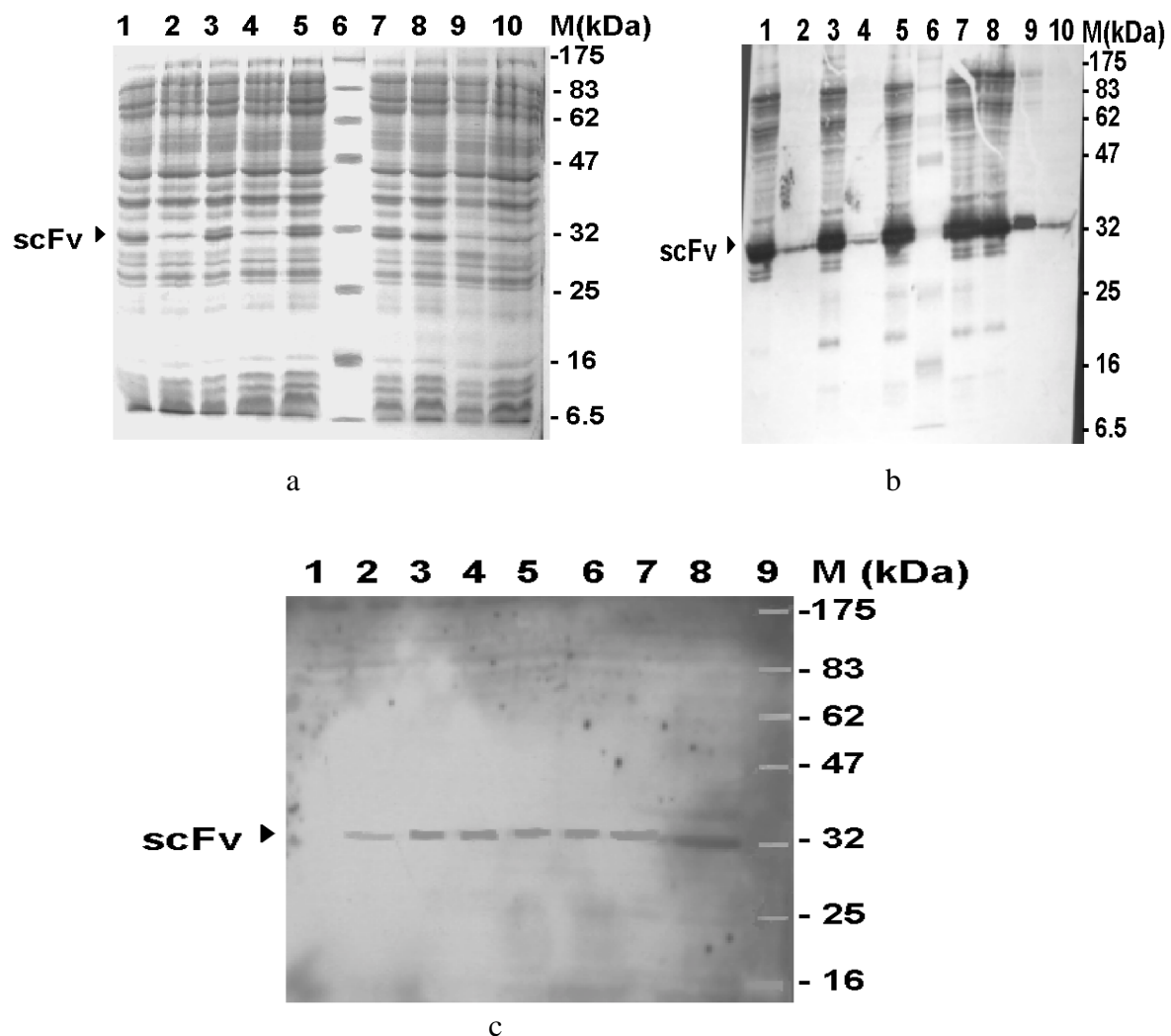

Fig. 2.19: Analysis of total proteins from different *E. coli* clones containing pOPE-scFv.

a: SDS-PAGE, 12% gel was stained with Coomassie brilliant blue; **b:** Western blot with c-myc-specific MAb 9E10. Induction of protein synthesis was achieved by addition of IPTG (1 mM). Cells were grown 5 h at 30°C with vigorous shaking. Non-induced cells were collected before addition of IPTG. For both, lanes 1, 3 and 5: induced cells of clones K1, K3, and K9 of scFv 1D6, respectively; lanes 2, 4: non-induced cells of clones K3 and K9; lane 6: protein marker; lanes 7, 8, 9: induced cells of clones K5, K7, K10 of scFv 2E11, respectively; lane 10: non-induced cells of clone K5.

c: detection of expression of scFv derived from synthetic peptides by ECL assay. Lane 1: non-induced cells; lanes 3: 4: scFv 1B7; lanes 5, 6, scFv 1G12; lanes 7, 8: scFv 3G4; lane 9: protein marker.

2.16.2 Optimization of expression of scFv and extraction

The optimal expression of scFv was observed when the cells were incubated for 5 h at 26°C after the addition of IPTG (0.4 mM). For example, scFv 1D6 F1, reached up to 17% of total

soluble protein (Fig. 2.20a); the specificity was revealed by Western blotting (Fig. 2.20b). scFv 2E11 reached up to 8% of total soluble protein at the same conditions (Fig. 2.21).

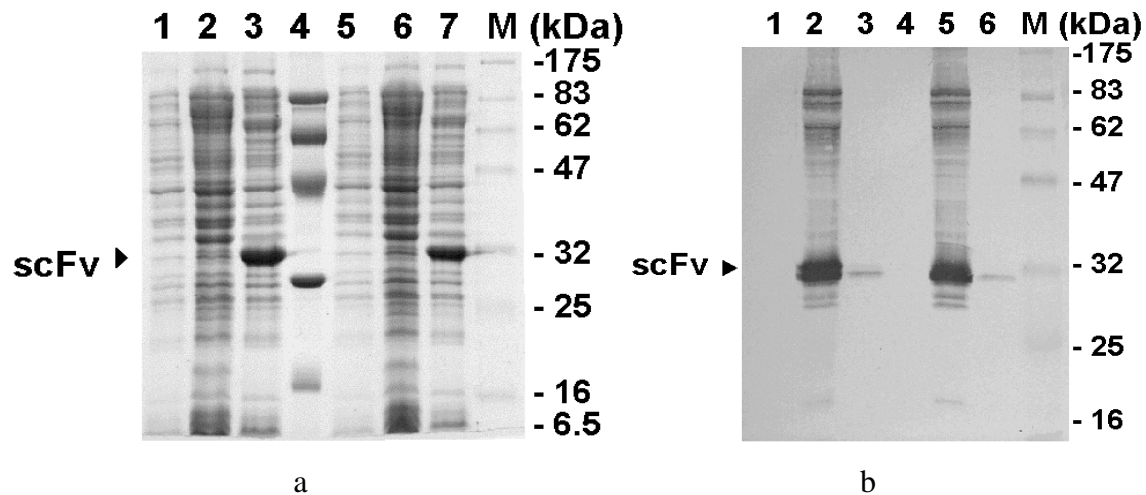

Fig. 2.20: Optimization of expression of scFv in *E. coli*.

a: total protein extracts of cells were analyzed in SDS-PAGE on 12% gel stained with Coomassie brilliant blue. Lane 1: non-induced cells containing pOPE-scFv-myc/His-tag construct (clone K1 = 1D6F1); lane 2: induced cells containing pOPE plasmid lacking scFv DNA; lane 3: induced cells containing pOPE-scFv-myc/His-tag construct (clone K1); lane 4: LMW protein marker; lane 5: non-induced cells containing pOPE-scFv plasmid (K3); lane 6: induced cells containing pOPE plasmid lacking scFv DNA; lane 7: induced cells containing pOPE-scFv-myc/His-tag (K3); lane M: protein marker.

b: total protein of cells were analyzed by Western blotting with MAb 9E10. Lane 1: induced cells containing pOPE plasmid lacking scFv DNA; lane 2: induced cells containing pOPE-scFv-myc/His-tag construct (K1); lane 3: non-induced cells containing pOPE-scFv-myc/His-tag construct (K1); lane 4: induced cells containing pOPE plasmid lacking scFv DNA; lane 5: induced cells containing pOPE-scFv-myc/His-tag construct (K3); lane 6: non-induced cells containing pOPE-scFv-myc/His-tag construct (K3); lane M: protein marker.

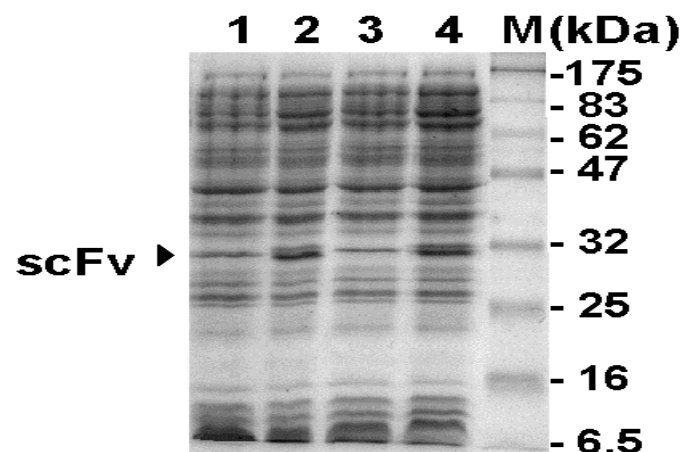

Fig. 2.21: Analysis of total protein extracts of *E. coli* cells containing pOPE-scFv2E11 by SDS-PAGE. Gel stained with Coomassie brilliant blue.

Lane 1: scFv 2E11 (clone K5), non-induced cells containing pOPE-scFv; lane 2: scFv 2E11 (K5), induced cells; lane 3: non-induced scFv 2E11 (K7); lane 4: scFv 2E11 (K7), induced cells; lane M: protein marker.

The amount of scFvs secreted into the cultural medium was quite low, even ten times concentrated, only a faint band was visible on Western blot revealed by anti-myc-antibody. In order to know the characteristics of scFv expression in *E. coli*, fractional analysis of their expression in *E. coli* was performed. It was found that scFv can exist in periplasmic space, or as inclusion bodies accumulated in periplasma or in cytoplasm as shown in Fig. 2.22. The dominant amount was found in the cytoplasmic extract.

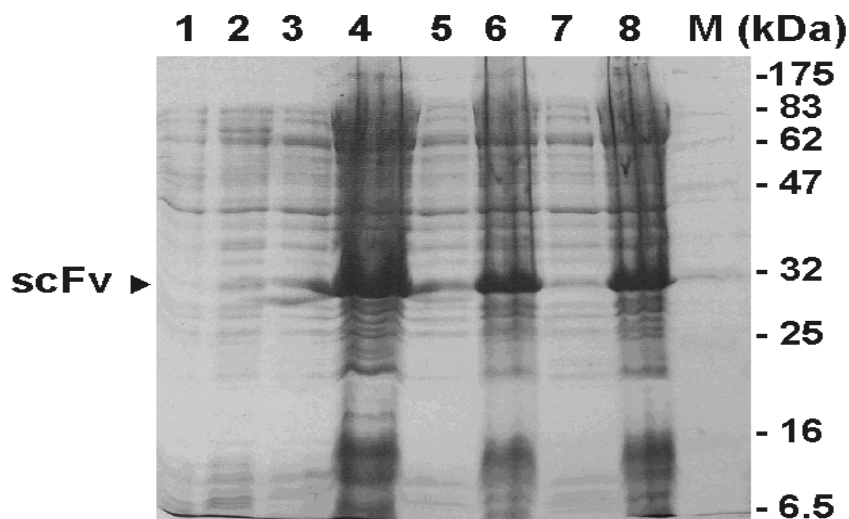

Fig. 2.22: SDS-PAGE analysis of fractional expression of scFv in *E. coli* TG1. 12% gel was stained with Coomassie brilliant blue.

Lane 1: non-induced cells (1D6F1); lane 2: osmotic shock fraction (1D6 K3); lane 3: periplasmic extract (1D6 F1); lane 4: cytoplasmic extract (1D6F1); lane 5: periplasmic extract (2E11 K7); lane 6: cytoplasmic extract (2E11 K7); lane 7: periplasmic extract (1D6 K3); lane 8: inclusion bodies (1D6F1); lane M: protein marker.

2.17 IMAC purification and *in vitro* refolding of scFv

To obtain high quality scFv preparations from *E. coli* and to compare their activity in relation to the locations in host cells, IMAC was used to purify scFv from periplasmic fractions, cytoplasmic extracts, and inclusion bodies (Fig. 2.23a). Three proteins of size, 68 kDa, 31 kDa and 28 kDa, respectively, are observed in the cytoplasmic fraction with a similar intensity in the gel. The 68 kDa protein, which is one of the most dominant products after IMAC purification, is assumed to represent a dimeric scFv, the 31 kDa protein is the monomeric scFv and the 28 kDa protein may be a cleaved scFv or degraded scFv product. Monomeric scFv is dominant in the periplasmic fraction (Fig. 2.23b, c). Taken into account of the concentrations of scFv in different cell fractions, it was notable that active scFv molecules tested in PTA-ELISA are mainly present in the periplasmic fraction, less active scFv

molecules are from cytoplasmic fraction and inclusions, although the concentration of scFv in cytoplasm or as inclusions is high than that of scFv in periplasma.

After refolding of isolated scFv *in vitro*, about 20% of scFv molecules recovered their binding activity, compared with the values in ELISA and concentrations, using known amount of purified periplasmic scFv as a standard. The concentrations of purified scFvs were measured and calculated from their OD₂₈₀. The yields of scFvs for clones 2E11 and 1D6 expressed in *E. coli* were approximately 1.3 mg/l and 3.0 mg/l (in periplasmic fraction), 7.0 mg/l and 15.0 mg/l (in cytoplasmic fraction), 3.2 mg/l and 5.0 mg/l (as inclusions), respectively.

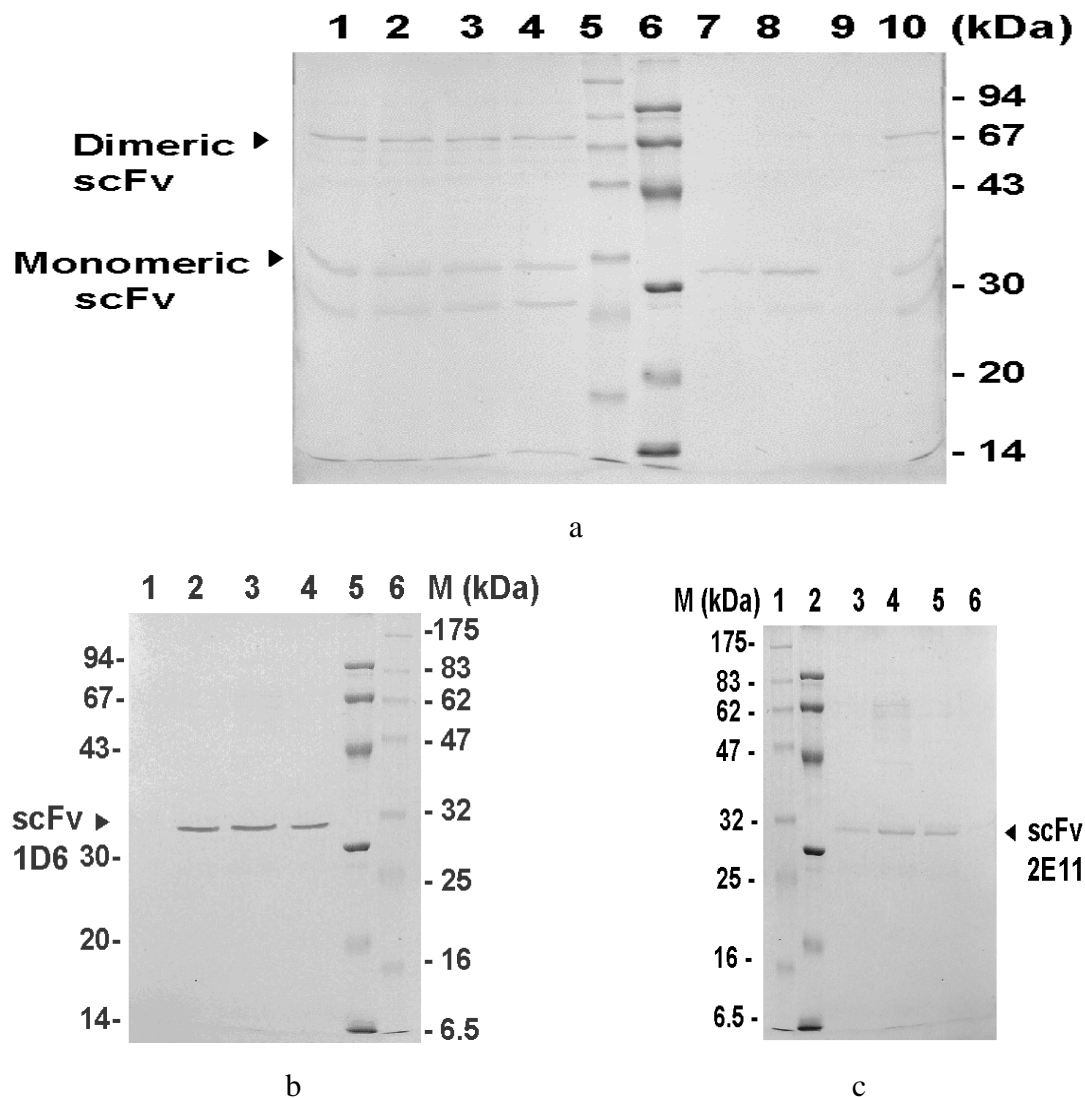

Fig. 2.23: SDS-PAGE analysis of scFv after purification from *E. coli* by IMAC, 12 % gels were stained by Coomassie brilliant blue.

a: lanes 1-4: eluates from cytoplasmic extract of scFv 1D6; lane 5: protein marker; lane 6: protein marker; lanes 7-9: eluates from periplasmic extract; lane 10: eluate from inclusion bodies.

b: lanes 1-4: purified scFv 1D6 from periplasm and concentrated by Centriplus Concentrator; lanes 5, 6: protein markers.

c: lanes 1, 2: protein markers; lane 3-6: purified scFv 2E11 from periplasm and concentrated by Centriplus Concentrator.

2.18 Expression of scFv-alkaline phosphatase fusion protein in *E. coli*

For the purpose of rapid diagnosis of PVY, the sequence encoding for scFv 1D6 was subcloned into a pOPE51-AP as a fusion with alkaline phosphatase. The expression plasmid was subsequently transferred into *E. coli*. After expression the fusion protein was detected by an anti-c-myc antibody on Western blot (Fig. 2.24). The level of expression was lower than in the case of the non-fused scFv 1D6. The fusion protein could not be effectively separated from other bacterial proteins in SDS-PAGE, and no distinct band could be observed in polyacrylamide gels. The $A_{405\text{nm}}$ values in PTA-ELISA for scFv-AP fusion protein in the same amount of cell periplasmic fraction were three times lower than those of the non-fused scFv. This leads to the suggestion that the alkaline phosphatase affected the tertiary structure of the scFv, resulting in a lower binding ability. The bacterial alkaline phosphatase activity was very low ($A_{405\text{nm}} \leq 0.1$) when 20 μl of the crude periplasmic fraction of scFv-AP fusion protein was incubated with 100 μl of p-NPP substrate solution, suggesting that active homodimer molecules of alkaline phosphatase were not sufficient for enzymatic activities.

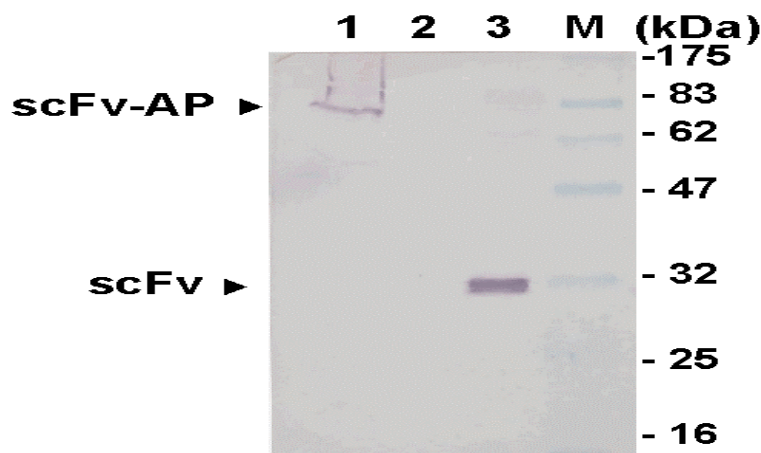

Fig. 2.24: Overexpression of scFv-AP in *E. coli* as detected by Western blotting. Anti-c-myc-antibody as secondary antibody and anti-mouse-Ig-AP conjugate as tertiary antibody.

Lane 1: induced cells containing scFv-AP construct; lane 2: noninduced cells containing scFv-AP construct; lane 3: cells containing scFv construct as a control; lane M: protein marker.

2.19 Comparison of the different antibodies for the detection of virus infection

A series of serological tests revealed that the scFv containing periplasmic space fraction of *E. coli* could be used for PTA-ELISA. The inclusions of scFv could recover the binding ability after purification and *in vitro* refolding.

Sap of PVY-infected plants or purified recombinant Nib was used for coating plates. ScFvs were obtained from periplasmic extracts. Detection was performed via the c-myc-tag

(see section 4.2.18.3). The results of Fig. 2.25 indicated that the phage scFv and the overexpressed soluble scFv did not reach the expected values obtained with the parent MAbs in ELISA.

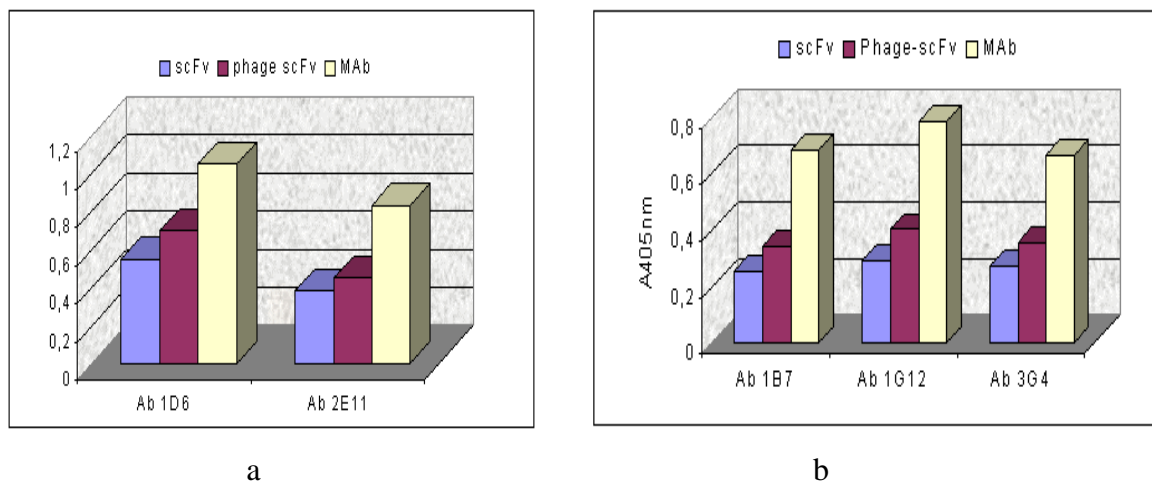

Fig. 2.25: Comparison of different antibodies in PTA-ELISA in the detection of target antigens.

a: sap of PVY-infected *N. glutinosa* plants was 1:10 diluted in coating buffer, 100 μl /well.

b: the purified recombinant NIB (10 $\mu\text{g}/\text{ml}$) in coating buffer, 100 μl /well.

ScFvs were obtained from periplasmic extracts and 1:2 diluted with PBST; Phage-scFvs were used at 1:2 dilution; MAbs were cell cultural supernatants, 1:2 diluted with PBST.

$A_{405\text{nm}}$ values were measured after 1 h substrate incubation at room temperature.

In competition ELISAs, both soluble scFv and phage displayed scFv partially (20%) inhibited the binding ability of the parent MAbs. In contrast, MAbs greatly inhibited binding ability of the scFv up to 80%. Therefore, most probably they recognized identical epitopes. The results of ELISA are summarized in Table 2.6.

Table 2.6 Comparison of MAb and scFv in PTA / Competition-ELISA

MAb/ ScFv	PTA-ELISA		Competition-ELISA	
	Ag—ScFv—AP	Ag—MAb—AP	Ag—ScFv—AP	Ag—MAb—AP
1D6	0.52	1.15	0.12	0.55
2E11	0.35	0.83	0.07	0.41
7C5*	0.04	0.05	nt	nt
1B7	0.23	0.68	0.06	0.32
1G12	0.26	0.78	0.07	0.33
3G4	0.25	0.66	0.06	0.32

*MAb 7C5 does not recognize CP of PVY in PTA-ELISA and Western blot, but in TAS-ELISA if plates were coated with polyclonal antibodies. $A_{405\text{nm}}$ values of 1B7, 1G12, and 3G4 were obtained from the recombinant NIB as antigen. $A_{405\text{nm}}$ values of 1D6 and 2E11 were from sap of PVY-infected *N. glutinosa* plants. $A_{405\text{nm}}$ values were measured after 1 h substrate incubation at room temperature.

3 Discussion

The main goal of the experiments was to develop scFv to highly conserved regions of potyviral Nib. Such specific antibodies are expected to be a valuable tool of plant virus resistance manipulation. Blocking the enzymatic activity of the RdRp with specific scFv would abort the process of virus replication. The question was which residues of Nib are essential for enzymatic activity and could serve as a target for the generation of antibodies. To date, no direct data are available on such residues except for the GDD domain (Koonin, 1991). Antisera raised to the peptides containing GDD motif, a hallmark of RdRp, have demonstrated the ability to inhibit the activity of this enzyme *in vitro*. The importance of the “core” RdRp motifs IV, V, and VI (Koonin and Dolja, 1993) for the polymerase activity has been proven by site-directed mutagenesis of EMCV polymerase (Sankar and Porter, 1992). Although their actual function is not known, it is thought that these motifs may be involved in the binding of the NTP substrate (Koonin, 1991). The assumption is that these highly conserved regions should be essential for the functions of these enzymes (Chou and Fasman, 1979). Therefore, these conserved regions potentially could serve as targets to direct the synthesis of antibodies. Three synthetic peptides, corresponding to three highly conserved regions of potyviral RdRp, i.e. R1 peptide contains the “core” RdRp motif, the motif II, R2 peptide includes the motif IV, and R3 peptide is included in the motif V, were used as antigens. For comparison, synthetic peptides covering most conserved regions of potyviral CP were employed by following the essential steps applied to peptides of interest.

Currently, there are two principal approaches used to obtain scFv: (i) cloning scFv genes from hybridoma cells secreting MAb or B-lymphocytes from immunized donors; (ii) selection from synthetic scFv libraries. In this work the first approach was chosen to generate scFv as an access to commercially available libraries was not possible at that time and there were also some limitations for their further application.

3.1 Prediction of antigenicity of peptides derived from Nib

In order to obtain antibodies able to cross-react with the majority of potyviruses, MAbs should be directed to defined sequences of the Nib. Two possibilities exist to accomplish this purpose. The first approach is to produce a number of different MAbs and to identify which of them binds to the regions of interest by appropriate methods. This way is time consuming and in the case of low immunogenicity of the region the chance to obtain a specific antibody

would be rather low. The second approach - the use of peptides which take advantage of immune system to produce antibodies against them, was chosen for this purpose. Synthetic peptides are widely used in generation of antibodies against target antigens. Epitopes recognized by antibodies are divided into discontinuous and continuous epitopes (i.e. linear epitopes). A linear stretch of 5 to 8 residues is believed to constitute a continuous epitope (Van Regenmortel, 1992). In some publications smaller epitopes comprising three or four aa were reported (Torrance, 1992; 1994; El Kasmi et al., 1998). β -turns frequently exist in proteins as elbows jutting out from the main body. The aa residues most frequent occurring in β -turns are asparagine, aspartic acid, proline and glycine (Chou and Fasman, 1974, 1978). The high quality of the immune response is attributed to a particularly stable conformation of the antigenic aa sequence, which is most likely an alpha-helix, especially the amphipathic helices (Pfaff et al., 1982; Berzofsky and Berkower, 1993). β -turns or α -helices may have a greater potential to form highly antigenic epitopes (El Kasmi et al., 1998), but it needs great efforts to find out conditions for a peptide that forms these structures which correspond to the native protein. None of the methods nowadays could achieve a high level of correct prediction (Van Regenmortel, 1992)

Taken into account the above given facts, it was necessary to identify those segments of the N1b sequence that

- are highly conserved among all potyviruses
- consist of at least 5 highly conserved residues
- have strong antigenic residues.

All sequenced N1b genes of potyviruses available at that time were investigated and their antigenic properties were analyzed by the Hopp and Woods (1981) algorithm. It was possible to identify three regions, named R1, R2 and R3, which fulfill the above mentioned requirements. These regions consist of perfectly conserved motifs, namely, FTAAP (R1), DGSQFD (R2) and GNNSGQPS (R3), flanked by aa motifs which show little variations in one or two aa in the case of some viruses. However, the GDD motif was not located in a highly immunogenic region.

MAbs obtained have strong binding ability to regions R1 and R2, but only weak binding ability to R3 although several attempts to obtain MAb with high binding ability were undertaken. The phenomenon that MAb weakly reacted with R3 could not be explained by the length of the peptides used for immunization as it was comparable with that of other peptides used. One can speculate that the structures between the native protein and this corresponding peptide may be greatly different in this region. It is likely that the R3 forms a

secondary structure, which effectively evokes an immune response. The fact that MAbs to R3 reacted with peptide, but could not react with recombinant proteins in both ELISA and Western blot suggested that this immunogenic structure may be different from the native protein or not linear. Although the peptides are very short, they can show a certain secondary folding (Toiron et al., 1996). A comparison of the probability of different structural forms for all three peptides is shown in the Appendix. R3 is different from the other two regions in that it shows a higher probability to form sheets, instead of coils which are preferably formed by the aa residues of the other two peptides. Probably, the sheet structures predicted have a low potential to mimic native protein in immune response.

3.2 Antibody isotypes may be antigen-dependent in immune response

A phenomenon was the isotype of MAb formed. Of twenty MAbs obtained from a series of different experiments on fusion and selection of hybridomas, all belonged to isotype IgM, when synthetic peptides or the recombinant N1b were used as antigens. Different schedules of immunizations had been applied, in most cases, three time injections after two-weeks intervals and one boost injection three days before removing spleens for fusions. The longest schedule lasted seven months with four injections in an interval of 3 months, 2 months, 1 month, and a final boost before fusion. Nevertheless, in all cases only IgM MAbs were obtained. In contrast, when purified virus was employed in the same schedule of immunization, the MAb obtained was of isotype IgG1 (κ), specific to PVY CP. Probably, the immunogenicity of the conserved synthetic peptides or the recombinant N1b (due to the insolubility of the latter), is not sufficient to evoke T-cells or helper factors and stimulate B-cells for further production of the late classes of immunoglobulins. The result suggested that isotype switch of antibodies *in vivo* may mainly depend on property of antigens, and be independent of immunization schedules. The above results are in agreement with the observations of Goldbaum et al. (1999). In these experiments the affinity and association rate constants of 23 mouse anti-lysozyme MAbs obtained after short and prolonged immunizations were measured by plasmon resonance techniques. The affinities, measured using their Fab, ranged from affinity (K_a) = 1.1×10^7 to $1.4 \times 10^{10} \text{ M}^{-1}$. Antibody affinity maturation of the response does not correlate with the length and dose of immunogenic challenge although higher affinities may result from an accumulation of mutations.

The majority of antigens involved in immune responses are proteins, (i.e. T-dependent antigens) which require interactive with T cells in order to provoke a response, and only a few

antigens are capable of activating B cells to produce antibodies in the absence of T cells or helper factors from T cell. The latter was referred to as T-independent antigens, which share a number of common properties: (i) large polymeric molecules with multiple, repeating, antigenic determinants, for instance, polysaccharides; and (ii) mitogenic properties, i.e. at high concentrations they are able to activate B-cell clones to produce antibody, and such antigens are called polyclonal activators, like lipopolysaccharides, dextran and ficoll. The T-independent immune responses generate primarily IgM and do not give rise to memory. In other words, a second injection of a T-independent antigen leads to the same level of production of IgM as the first, without increased level or class switch of antibodies. It could not be excluded that the possibility of the peptides used belongs to T-independent antigens.

Indeed, to produce high affinity antibodies to a particular antigen, the B cell needs T cell help. T cell-dependent antigens evoke high affinity antibodies. B cells recognize antigen via their membrane-bound sIg molecule exposed on the cell surface. The protein is then processed and presented as small peptides on MHC class II molecules (Benjamini and Leskowitz, 1991; Levelt et al., 1999) to be recognized by T cell receptors. This recognition will recruit further help from antigen-specific T cells. The response to a T-dependent antigen then continues via a specific interaction of the B cell with antigen specific T cells in a cognate (MHC-Ag-TCR) interaction. T cells play a crucial role in guiding the immune response and the B cell activation via cell-cell interactions and soluble factors (e.g. interleukins). This communication is in close association with different accessory cells, such as members of the APC population, contributing to both cell-bound and soluble co-stimulatory molecules. In view of the above facts, the peptides were conjugated with BSA to increase their antigenicity. Unfortunately, antisera of mice strongly reacted with BSA, and only weakly reacted with synthetic peptides. Probably, the much higher antigenicity of BSA buried that of the peptides.

3.3 Overexpression of NIB of PVY in *E. coli*

Previous work with polyclonal antisera against the recombinant NIB of PPV (kindly gift of Prof. Dr. Maiss, Uni. Hannover) demonstrated that the A_{405nm} value for NIB in infected plants was extremely low in ELISA assays. Consequently, an extract of infected plant leaves would not be suitable for screening reactivity and specificity of different MAbs generated from the synthetic peptides. To overcome this problem, all three conserved regions of potyviral NIB and a sequence encoding for NIB of PVY were overexpressed in *E. coli* as recombinant proteins to screen reactivity of MAbs. It was rather difficult to obtain stable clones expressing

the recombinant proteins although several expression systems have been used. However, it was necessary to test the reactivity of the MAb to a larger protein as the secondary structure of the protein could prevent interaction as shown for MAb to R3. An attempt to express PVY NIB failed when NIB was cloned into pThio-His vector. If plasmids contain highly toxic genes, mutants that retain the plasmid but have lost the ability to express the target gene, for instance, due to a mutation, can result from the overgrowth of the non-induced cells expressing the protein. This usually occurs in the phase of uninduced growth of bacteria if the suppression is not strong enough. The tightly controlled pET and *E. coli* strain BL21 (DE3) LysS, a strong restrictive strain, was chosen to express the recombinant NIB protein. It was observed that approximately 1% of clones stably expressed the target protein, the others were shown to be unstable. The reason why most of the clones containing the target gene tend to be unstable is not clear. It is likely that the expressed target protein causes toxic effects on the host cells by interacting with specific host protein(s). This phenomenon was also observed in expression of scFv in *E. coli* TG1 strain. Recently, a similar problem was reported for the construction of a full length cDNA of PVY (Jakab et al., 1997). The complete cDNA had to be maintained in the form of two subclones and the whole cDNA sequence of PVY was reconstructed via ligation before infection. A plasmid containing both fragments was unstable and consequently resulted in low yields of plasmid DNA. The problem was mainly due to the expression of the CI gene from upstream prokaryotic promoter-like elements within the PVY genome.

The toxicity of NIB was evidenced during the process of its expression in *E. coli* after induction with IPTG, as the host cells grow very slowly and rapidly died at higher IPTG concentrations. In addition, NIB could not be isolated from the overnight cultures, suggesting that the NIB protein was degraded by the host proteases released during cell death.

3.4 Sensitivity of detection of NIB in different NIB preparations and assays

Potyviral NIB is one of the non-structural proteins, and functions as an RNA dependent RNA polymerase. It is a kind of membrane-associated protein, being favored to form inclusion bodies in nucleus or nucleolus in the majority of potyvirus-infected plant cells. NIB was always detectable in the experiments, but the signal or signal-noise ratio was not satisfactory with currently used methods of both ELISA and Western blotting. It was suspected that one of problems might originate from the sample preparation. Therefore, three different approaches were employed in the potyviral NIB preparation from virus-infected *N. glutinosa* and *N. tabacum* plants. The results of Western blot analysis were improved by the use of urea in

extracts, which leads to three times higher signal for NIB than with the first method described in Materials and Methods. This approach was also suitable to CP preparations. The detection signal of NIB increased after phenol extraction, however, the background also increased. This indicates that the low solubility of NIB leading to a poor yield after extraction may be one of the causes for insufficient signals in the detection of NIB in potyviral infected plants.

In the same potyvirus-infected plants the $A_{405\text{nm}}$ values obtained from CP detection were usually higher than those of NIB detection. The low values might result from:

- 1) NIB is incompletely bound to the surface of the ELISA-plates due to its insolubility.
- 2) linear epitopes of the viral NIB recognized by the antibody were not fully exposed and thus not accessible to the antibody.
- 3) Affinity of MAbs raised to peptides may not be sufficient for PTA-ELISA.

According to Riedel et al. (1998), *in situ* immuno-labeling of potyviral non-structural proteins was more specific and sensitive than ELISA. NIBs of potyviruses were clearly localized in the nucleus or cytoplasm of plant cells by polyclonal antiserum specific to NIB of PPV, however, the $A_{405\text{nm}}$ values obtained from DAS-ELISA were very low, less than 0.1 after 20 h substrate incubation, suggesting that the concentration of NIB or soluble NIB in plant cells was low.

3.5 Viral and host plant RdRps

Both MAb 1G12 and 3G4 recognized the potyviral RdRp specifically in Western blots, whereas MAb 1B7 and 3C6, against R 1 or R2, cross-reacted with a ~55 kDa host protein in addition. This host protein might be a subunit of the putative plant host RNA-directed RNA polymerase (RdRp) which could possess common conserved regions with the viral RdRp (Schiebel et al., 1993a, b). Recently it was proposed that plant RdRps are involved in plant defense mechanisms (Jorgensen et al., 1998; Wassenegger and Pélissier, 1998). However, our MAbs did not react with a cDNA-derived tomato RdRp expressed in *E. coli* (kindly provided by Dr. Wassenegger, for reference see Schiebel et al., 1998), suggesting that RdRp from tomato and PVY may not share the both common regions.

In some cases, a protein of approximately 100 kDa was also detected, which might represent the uncleaved NIa-NIB protein complex. Similar products of 94 -110 kD were observed previously in the nuclear inclusions of potyviruses (Martin et al., 1990). For PPV the terminal aa of a 110 kD product were sequenced showing that it is indeed an unprocessed NIa-NIB polypeptide (Martin et al., 1990). An uncleaved protease-polymerase precursor has

been found for cowpea mosaic virus, comovirus. It appears at an early stage of virus replication. The uncleaved protease-polymerase precursor is thought to be involved in RNA replication (Martin et al., 1990). The same result was obtained for PVA where it appeared even before the NIb band became visible. For poliovirus a ribonucleoprotein complex, composed of a cellular protein and two poliovirus proteins (3C^{pro} and 3D^{pol}, functionally equivalent to potyviral NIa and NIb) forms around the 5' end of RNA, which is required for positive-strand RNA synthesis but not for negative-strand RNA synthesis (Andino et al., 1990).

Difficulties in purification of active potyvirus RdRp often limit the investigation of its functions in virus life cycle. Despite all efforts, only few RdRps have been successfully purified from a limited number of bacterial, animal, and plant viruses (Bates et al., 1995). The RdRps of positive stranded RNA viruses are divided into three supergroups (Hodgman, 1989; Ishihama and Barbier, 1994; Koonin, 1991). The RdRp of potyviruses belongs to supergroup I. From this group no RdRp has been purified so far. The best characterised RdRp is that of bacteriophage Q β (supergroup II), which was purified to homogeneity. It consists of one virus-encoded polypeptide and three host polypeptides (Blumenthal and Carmichael, 1979). RdRps of some plant viruses belonging to supergroup II, turnip crinkle virus (Song and Simon, 1994) and red clover necrotic mosaic dianthovirus (Bates et al., 1995) as well as supergroup III, brome mosaic virus (Quadt and Jaspars, 1990), cucumber mosaic virus (Hayes and Buck, 1990) and alfalfa mosaic virus (Quadt et al., 1993), were successfully purified in active conformation. MAbs raised against a purified CMV replicase complex, recombinant CMV 1a or 2a proteins (analogous to potyviral NIa and NIb, respectively), inhibited the RdRp activity of the purified replicase complex (Hayes et al., 1994).

In systemically infected leaves of *N. glutinosa* the RdRp of PVY was first detected at 5 dpi by both ELISA and Western blotting. This result is consistent with observations of Baunoch et al. (1991) and Hajimorad et al. (1996) for tobacco etch potyvirus and peanut stripe potyvirus, respectively. Three isolates of PVY, e.g. CH 605, 1427, oGA, showed similar accumulation patterns for both NIb and CP, but their respective A_{405nm} values differed in PTA-ELISA with the order from high to low: CH605, 1427, oGA. In addition, of the two host plants tested, the *N. glutinosa* always showed higher values than *N. occidentalis*, suggesting that *N. glutinosa* is a better host for PVY replication than *N. occidentalis* (refer to Table 2.5)

3.6 Phage display for selection of functional scFv

Phage display technologies facilitate the selection of functional scFvs from libraries. Phage displayed scFv can be directly used in ELISA. However, high frequency mutations occur in variable region genes (V-genes) cloned from hybridoma cells. It was speculated that these somatic mutated genes of antibodies have toxic effects on *E. coli*. This speculation was supported by others (Winter et al., 1994). In addition, the mutation rate can be enhanced as a result of leaky expression in *E. coli* (see Fig. 2.19b, 20b). For this reason tightly repressed promoters have to be used and culture medium should contain 2% glucose to repress the lac promoter.

Although hybridomas secreting high affinity antibodies are good sources of mRNA for cloning of desired V genes, sequences of non-functional rearranged V genes of the hybridoma cDNA are often obtained by PCR (Larrick et al., 1989; Orlandi et al., 1989). Thus, it was notable that amplification of the V genes from hybridoma cells, e.g. 1D6, 7C5, 1B7, 1G12, 3G4, gave different PCR products, either V_H or V_L or both (see Fig. 2.12). One of these products may have been the amplified products from the fusion partner (Ostermeier and Michel, 1996). Often, the non-secreting cell line P3-X63-Ag8.653 or SP2/0-Ag14 is used for the establishment of hybridoma cell lines by the standard fusion techniques (Köhler and Milstein, 1975). In many cases these hybridoma cells not only transcribe the desired MAb DNA, but also bear high levels of non-functionally rearranged mRNAs. These mRNAs represent pseudogenes and can greatly exceed the level of normal antibody mRNA. Practically, a hybridoma cell line may contain several different cell populations as a result of recombination during extended culture after limiting dilution. Additionally, modifications could be generated in the PCR amplification of V genes because the use of degenerate primers and Taq DNA polymerase. Affinity selection or panning was therefore necessary for isolation of the V genes with the desired specificity. In our experiments, the functional scFvs to the target antigen were isolated through two rounds of selection and functional scFvs were highly enriched. It was shown that high-affinity scFv antibody could be isolated only after one round of affinity selection (Yuan et al., 1997). Sequential selections mainly appeared to enrich clones with a higher yield of scFv protein, not necessarily improving the affinity (Clackson et al., 1991; Yuan et al., 1997). Theoretically, an scFv will have a specificity and sensitivity similar to those of the parent immunoglobulin molecule. In our cases, scFvs exhibited a specificity to the target antigen similar to those of the parent MAbs, but they gave lower sensitivity than the parent MAbs. In general, differences of antibody properties in affinity and

specificity could result from sequence changes and conformation differences between scFv and MAb. Sequence changes may occur during the scFv construction procedures, including RT-PCR, fusion PCR, enzyme digestion and ligation. Even if the sequences of V_H and V_L in the scFv are the same as those of a given immunoglobulin molecule, their conformations may be also different because a scFv molecule has V_H and V_L artificially coupled by a flexible peptide linker (G₄S)₃, while a natural immunoglobulin molecule does not.

Affinity of these scFv antibodies to the target antigen can further be improved by chain shuffling or by mutation of the V_H and V_L of a scFv (Marks et al., 1993; Schier et al., 1996). It was demonstrated that restriction of mutagenesis to the CDRs located in the center of the antibody combining site can yield increase in affinity (Schier et al., 1996). For instance, mutation of the V_L and V_H CDR3 of C6.5 scFv yielded a scFv with a 1230-fold increased affinity (Schier et al., 1996), which was comparable to values previously reported either for *in vivo* or *in vitro* affinity maturation of antibodies. Picomolar affinity antibody was actually isolated from CDR3 libraries by DNA shuffling and affinity selection of phage display.

3.7 Expression of scFv in *E. coli*

Expression of recombinant antibodies in bacteria has become a standard method. However, success of expressing antibody fragments in *E. coli* depends on the properties of the antibody sequence and structure. Different antibody fragments have different expression levels. Some of them may simply give no expression. For instance, an antibody 4-4-20 had very high aggregation tendency, which yielded almost no soluble protein after periplasmic expression (Mallender, et al., 1996); another antibody 4D5 revealed favorable folding properties and high expression (Eigenbrot et al., 1993). However, some antibody fragments cannot be expressed in bacterial periplasm, even not as insoluble fractions (Tsumoto et al., 1995). ScFv 7C5 which failed to express as a soluble protein may have such a property.

In the current study optimal expression levels of scFv 1D6F1 reached up to 17% of total soluble protein and up to 8% for scFv 2E11. After purification by IMAC the yields of functional scFv dramatically decreased. Aggregation of the scFv resulting in low yield could not be prevented by the buffers used in the procedure of the purification. Although different *in vitro* refolding methods were attempted (Kipriyanov et al., 1995; Tsumoto, 1998), only 15-20% of the scFv molecules derived from inclusion bodies (insoluble scFv molecules) could be refolded correctly as shown by their binding ability to the target antigen, the rest of the scFv molecules fail to refold and did not bind the target antigen in PTA-ELISA.

The yields of total protein were satisfactory for most scFv-constructs in strains and vectors optimized for expression, but the yield of functional, soluble scFv was often poor because off-pathway aggregates were found during the *in vivo* folding process (Jung and Plückthun, 1997). The *in vivo* folding properties of scFv are mainly dependent on the sequence of a given antibody. Changes of a few aa can dramatically alter the aggregation behavior of an antibody (Knappik and Plückthun, 1995). Secretory expression of most scFv and Fab fragments by *E. coli* results in production of their aggregated forms in the periplasm (Field et al., 1990).

Western blots showed many bands of different size from the crude bacterial extracts when detected with an anti-c-myc-tag antibody. After purification of the expressed products by IMAC, three bands of approximately 68, 31, 28 kDa in the cytoplasmic fraction, and one band of 31 kDa in periplasmic space still remained. Probably, the 68 kDa protein represents a dimeric form of the scFv, the 31 kDa protein the monomer scFv. The small band may be a product of degradation. The phenomenon of dimerization or even higher oligomerization of single-chain antibody Fv fragments has been reported previously (Essig et al., 1993; Griffiths et al., 1993; Whitlow et al., 1994; Kortt et al., 1994; Raag and Whitlow, 1995) and has been investigated in the context of the linker length (Alfthan et al., 1995; Turner et al., 1997). Using the same linker length, different antibodies were found to give different multimer distributions (Griffiths et al., 1993; Raag and Whitlow, 1995). The crystal structures of both a diabody and a triabody resulting from oligomerization have been determined. The V_H domain of one chain was paired with the V_L domain of the other chain and vice versa in the diabody (Perisic et al., 1994). The triabody had three Fv heads with the polypeptides arranged in a cyclic, head-to-tail fashion (Pei et al., 1997). The predominant monomer of scFv formed a dimer after freezing and thawing (Kortt et al., 1994). This phenomenon is called 'domain swapping' (Bennett et al., 1994, 1995). The factors influencing the monomer-dimer equilibrium were identified recently using the model antibody McPC603 (Arndt et al., 1998). In particular, (i) the expression methods have a profound effect on formation of dimeric single-chain Fv fragments; (ii) the presence of the antigen clearly influences the oligomerization state; (iii) ionic strength and pH influence the rate of the dimer to monomer conversion. The dimerization state mainly depends on the properties of scFv, some scFvs favor dimer format, others not.

An alternative approach to obtain recombinant antibody fragments from bacterial is to produce proteins as cytoplasmic inclusion bodies and then refold the proteins *in vitro* (Buchner and Rudolph, 1991). Expression of antibody fragments in the bacterial cytoplasm

can reach high levels (Martineau et al., 1998). Because of the strongly reducing environment of the cytoplasm (Gilbert, 1990), it must be assumed that disulfide bonds do not form under these conditions. In fact, this has been proven by one scFv fragment (Biocca et al., 1995). Nevertheless, in some cases antibodies are able to bind to their antigen intracellularly in the cytoplasm (Tavladoraki et al., 1991; Levin et al., 1997; Mhashilkar et al., 1997). However, it cannot be excluded that only a small fraction of these intrabodies will be folded correctly, and bind to the antigen. Better results may be achievable and a wider variety of antibodies may be functional when the scFvs are optimized to fold correctly in a disulfide-free format (Proba et al., 1998) or in a mutant *E. coli* (He et al., 1995). In general, up to date, to obtain the correctly folded molecules of scFv expressed in cytoplasm, refolding *in vitro* is necessary.

Recently it has been demonstrated that L-form cells of *Proteus mirabilis*, which lack a periplasmic compartment and cell wall, can be efficiently used in the production and secretion of heterologous proteins. Expression of scFv in *P. mirabilis* L VI and *E. coli* was directly compared. The results showed that stable protoplast-type-L-form cells overcome limitations associated with periplasmic expression of recombinant proteins, e.g. the toxic effect of heterologous protein on *E. coli* JM 109. Yields of expression of scFv in *P. mirabilis* L VI reached the range of 40 to 200 mg per liter of culture medium (corresponding to volume yields 33- to 160-fold higher than those with *E. coli* JM109), depending on sequence of the individual antibody (Rippmann et al., 1998). Advantages of this cell system are that correctly folded proteins are secreted directly into the surrounding growth medium and the proteins are very stable because of the absence of extracellular proteases.

3.8 Activity of scFv-AP fusion protein

To date a number of enzymes have been used in a variety of immunoassays, the most common enzymes being horseradish peroxidase (HRP), alkaline phosphatase (AP) and β -galactosidase. Chemical covalent coupling of entire immunoglobulins to enzymes or fluorochromes facilitates the production of the stable, specific and detectable immunoconjugates with wide range of applications (Kopetzki et al., 1994). However, the cost is high. In addition, the cross-linking reagents non-specifically react with the aa side chains of each individual protein of the conjugate and thus resulting products are heterogeneous mixtures, with various degrees of binding and enzyme activities.

The recombinant DNA technology facilitates the creation of well defined more effective molecules. In this work bacterial AP was fused to scFv 1D6 to generate colorimetric

conjugates. Besides the intention to use the scFv as resistance managing tools their diagnostic values should be evaluated. In DAS-ELISA the secondary antibody is usually conjugated with an enzyme, in most cases either AP or HRP. However, conjugation of antibody and enzyme is expensive. To fuse the scFv coding sequence with the enzyme gene and express scFv-AP fusion protein would decrease the cost. Until now several genes for bacterial AP are available which show different activities. The scFv can be fused either to the C- (Kohl et al., 1991) or N-terminus (Weiss and Orfanoudakis, 1994) of bacterial AP. In our experiments the scFv 1D6 was fused to the C-terminal of AP expressed in the plasmid pOPE51-AP. However, the results obtained in ELISA using this scFv-AP were not satisfactory. This seems to be mainly a problem of the low activity of bacterial AP expressed in *E. coli* as reported by others (Ducancel et al., 1993; Kopetzki et al., 1994; Weiss and Orfanoudakis, 1994). Probably a misfolding of the fusion protein leads to lower activity. The enzyme reaction catalyzed by the fusion protein was much slower than that using conventional enzyme catalysts in the immunoassay performed (Kopetzki et al., 1994). Indeed, the *E. coli* AP is a periplasmic protein, it is only active as a homodimer. Probably, the bifunctional scFv-AP fusion protein does not favor to form the homodimer and only a few molecules exist as the active dimers, therefore, decreased the enzymatic activity of *E. coli* AP. Furthermore, activity of bacterial AP is usually lower than that of human or animal AP. Recently, it was demonstrated that plasmids (pPAD2/S and pSKAP/S) containing a mutated *E. coli* PhoA/S gene (the conserved aspartate at position 101 of the AP sequence was changed to a serine) produced the AP with 35-fold increased activity (Mandecki et al., 1991; Kerschbaumer et al., 1997; Griep et al., 1999). The use of the new plasmids to express scFv-AP fusion protein might improve the sensitivity of detection assays.

3.9 Potential applications of MAb or scFv in disease resistance engineering

Bates et al. (1995) and Hayes et al. (1994) showed that polyclonal antibodies against synthetic peptides of conserved helicase and polymerase motifs in the 1a and 2a proteins of CMV and of the GDD motif in RNCMV were inhibitory to the enzymatic activities. The greatest inhibition was shown by antibodies to a peptide containing the GDD motif. These results demonstrated the importance of conserved sequence motifs for the enzymatic activity of viral RdRp. The RdRps of potyviruses contain the GDD motif and three large highly conserved regions. Therefore, MAbs obtained to those motifs or regions are good candidates for blocking the activity of RdRp significantly. Unfortunately, this assumption could not be tested

experimentally *in vitro* because trials to purify active RdRp from virus-infected plants were unsuccessful so far.

Several experiments have shown the potentials of scFv expression in plants for virus resistance. Compared to pathogen-derived resistance, this method bears no obvious ecological risks. One can reasonably assume that the expressed proteins are neither toxic nor allergenic to animals. So far all reported transgenic plants expressing anti-virus scFv were based on the expression of CP-specific scFv. Protection could be achieved for artichoke mottled crinkle tombusvirus (Tavladoraki et al., 1993), beet necrotic yellow vein furovirus (Fecker et al., 1996, 1997), tobacco mosaic tobamovirus (Voss et al., 1995; Zimmermann et al., 1998) and tospoviruses (Franconi et al., 1999). In general, the level of protection was not satisfactory as virions still multiplied in plants. One of the causes may be that the molar ratio of CP to scFv is unfavourable to block the process of RNA packaging during the stage of virions maturation. Tavladoraki et al. (1993) reported that protoplasts expressing anti-AMCV scFv accumulated less viral coat protein than the control protoplasts. Similar results were obtained with anti-TMV scFv24-mediated resistance by Zimmermann et al. (1998). They concluded that binding of scFv to the component of pathogen affects uncoating or assembly of virus. In natural infections, the onset of disease often begins with the virus invasion of one or a few cells, before progeny RNAs move symptomatically from cell to cell until the plant is systemically infected. Under these circumstances expressing apoplastic scFv is not an effective way to confer viral resistance. As virus replication takes place in the cytosol (Wilson, 1993), cytosolic scFvs can directly interfere with viral pathogenesis or replication. Therefore, cytosolic expression of scFvs is a more effective route to generate virus resistance (Tavladoraki et al., 1993; Zimmermann et al., 1998). During mechanical inoculation (Zimmermann et al., 1998), only a few virions penetrated into the cytosol whereas the amount of virions in the apoplast was significantly higher. However, a significantly higher level of resistance to TMV was generated by cytosolic expression of TMV-specific scFv24, although the scFv levels in cytosol were more than 700-fold lower than in the apoplast. This means that the “correct” localization of scFvs in the plant cell is a prerequisite for the effectiveness of protection against viral infection.

High level expression of scFv in the cytosol was difficult to obtain. Most of scFvs expressed in cytosol reached very low levels or remained undetectable (Owen et al., 1992; Fecker et al., 1996; Schouten et al., 1996). Only a few cytosolic scFvs reached levels of up to 0.2% of total proteins (Tavladoraki et al., 1993; Schouten et al., 1997). It is likely that the lack of proteins in the cytosol that promote the formation of disulphide bonds or chaperones

which facilitate the protein folding leads to the instability of scFvs. Recently it was reported that fusion of the ER-retention signal peptide (KDEL) to the C-terminal scFvs can improve the stability of scFvs in the cytosol (Schouten et al., 1997), and probably some of scFvs still remain in the ER (Bioca et al., 1995).

Based on the current success with cytosolic scFvs binding to the viral CP, production of scFvs binding to the conserved functional motifs of virus replicases could provide a more effective way to generate virus resistant plants. In addition, the effectiveness of the antibody-mediated resistance could be further enhanced by engineering bispecifics or diabodies for either the replicase or other functional domains of viral proteins.

4 Materials and Methods

4.1 Materials

4.1.1 Experimental animals

- (1) BALB/c mice were used for immunization and generation of monoclonal antibodies.
 (2) New Zealand rabbits were used for production of polyclonal antisera.

4.1.2 Plant viruses and their host species for propagation

All virus isolates used in the experiments listed in Table 4.1 are from the collection of viruses of the Institute of Epidemiology and Resistance, Aschersleben. Plants used for propagation of viruses were grown at 25°C in a green house. The virus infection was confirmed by symptoms or by DAS-ELISA.

Table 4.1 Virus isolates and their host plants for propagation

Plant virus	Isolate	Host plant
PPV	Jena (FRG), Jenzig (FRG)	<i>Nicotiana clevelandii</i>
PVA	Juliniere, Lichte Industrie and Rouge (The Netherlands)	<i>N. clevelandii</i>
PVV	Unknown	<i>N. clevelandii</i>
RgMV	Bulgaria and Czech Republic	<i>Lolium multiflorum</i>
TuMV	O/All (Hungary)	<i>Brassica chinensis</i>
PVY	A91 (FRG), C (Great Britain), CH605 (Switzerland), D884 (FRG), M3 (FRG), oGA (FRG), TN (Hungary), To1 (FRG), Tomato (FRG),1427 (FRG),	<i>N. clevelandii</i> , <i>N. glutinosa</i> , <i>N. occidentalis</i> , <i>N. tabacum</i> cv. <i>Xanthi</i> , <i>Solanum tuberosum</i>

4.1.3 *Escherichia coli* strains

BL21(DE3): F-ompT [lon] hsdS_B (r_B⁻m_B⁻) gal dcm (DE3)

BL21 (DE3) pLysS: F⁻ompT hsdS_B (r_B⁻m_B⁻) gal dcm (DE3) pLysS (cam^R)

HB 2151: Ara delta(lac-pro) thi/F' proA⁺B⁺ lacI^q Z deltaM15

JM101: F'traD36 lacI^q-delta(lacZ)M15 proA⁺B⁺/supE thi delta(lac-proAB)

JM109:	F' traD36 lacI ^q delta(lacZ)M15 proA ⁺ B ⁺ /e14 ⁻ (McrA ⁻) delta(lac-proAB) thi gyrA96 (Nal ^r) endA1 hsdR17(r _k ⁻ m _k ⁺) relA1 supE44 recA1
TG 1:	delta(lac-pro) supE thi hsd delta5/F' traD36 proA ⁺ B ⁺ lacI ^q Z deltaM15
TOP10:	F' mcrA delta(mrr ⁻ hsdRMS ⁻ mcrBC) phi80 lacZ deltaM15 deltalacX74 deo recA1 araD139 delta(ara ⁻ leu)7697 galU galK rpsL endA1 nupG
XL2-Blue	recA1 endA1 gyrA96 thi ⁻ 1 hsdR17 supE44 relA1 lac[F' proAB lacI ^q Z deltaM15 Tn10 (Tet ^r) Amy Cam ^r] ^a

Note: Some of them were obtained as competent cells from Stratagene, Promega and Novagen.

4.1.4 Plasmids

pALTER [®] -Ex1	Amp ^r and Tet ^r (Promega, Madison WI)
pBluescript SK ⁺	Amp ^r (Stratagene, Amsterdam Zuidoost)
pCANTAB 5E	Amp ^r (Amersham Pharmacia, Uppsala)
pCR-SCRIPT SK ⁺	Amp ^r (Stratagene, Amsterdam Zuidoost)
pET30a, b, c	Kan ^r (Novagen, Darmstadt)
pGEM3	Amp ^r (Promega, Madison WI)
pGEM5Zf ⁺	Amp ^r (Promega, Madison WI)
pGEM-T	Amp ^r (Promega, Madison WI)
pOPE101	Amp ^r (Dübel et al., 1992)
pOPE51-AP	Amp ^r (Dübel et al., 1992)
pSEX81	Amp ^r (Breitling et al., 1991)
pTHIO-His	Amp ^r (Invitrogene, Groningen)

4.1.5 Myeloma cells

Myeloma cells SP2/0-Ag 14 (Schulman et al., 1978)

Myeloma cells X63-Ag8.653 (Kearney et al., 1979)

4.1.6 Primers and oligonucleotides

Primers and oligonucleotides used in the molecular cloning and sequencing are listed in the following Tables. All oligonucleotides were synthesized at Biotex, purified by HPLC.

Table 4.2 cDNA synthesis primers

Name	Nucleotide sequence(5'—3')	Purpose
PVYNIbFOR	TCG ATC GCG ATG TAA TGG TGG AGC AAG C	NIb
MOCG12FOR	CTC AAT TTT CTT GTC CAC CTT GGT GC	IgG12(H)
MOCMFOR	TGG AAT GGG CAC ATG CAG ATC TCT	IgM(H)
MOCKFOR	CTC ATT CCT GTT GAA GCT CTT GAC AAT	Ig(C _K)

Table 4.3. PCR primers

Name	Nucleotide sequence (5'—3')	Purpose
PVYNIbBACK	CTG CCC GGG ATC CGC ATC TTT CTT G	NIb
PVYNIbFOR	TCG ATC GCG ATG TAA TGG TGG AGC AAG C	NIb
VH1BACK	AGG TSM ARC TGC AGS AGT CWG G	V _H
VH1FOR	TGA GGA GAC GGT GAC CGT GGT CCC TTG GCC CC	V _H
VK1BACK	GAC ATT CAG CTG ACC CAG TCT CCA	V _K
MJK1FORX	CCG TTT GAT TTC CAG CTT GGT GCC	V _K
MJK2FORX	CCG TTT TAT TTC CAG CTT GGT CCC	V _K
MJK4FORX	CCG TTT TAT TTC CAA CTT TGT CCC	V _K
MJK5FORX	CCG TTT CAG CTC CAG CTT GGT CCC	V _K
LINKBACK	ACG GTC ACC GTC TCC TCA GGT GGA GGC	linker
LINKFOR	AGT GAG CTC AAT GTC CGA TCC GCC ACC	linker
VH1BACK (SFI)	CAT GCC ATG ACT CGC GGC CCA GCC GGC CAT GGC CSA GGT SMA RCT GCA GSA GTC WGG	V _H V-region (Sfi I/Nco I site)
VK1FOR(NOT)	GAG TCA TTC TGC GGC CGC CCG TTT GAT TTC CAG CTT GGT GCC	V _K C-region (NotI site)
VK2FOR(NOT)	GAG TCA TTC TGC GGC CGC CCG TTT TAT TTC CAG CTT GGT CCC	V _K C-region (Not I site)
VK4FOR(NOT)	GAG TCA TTC TGC GGC CGC CCG TTT TAT TTC CAA CTT TGT CCC	V _K C-region (Not I site)
VK5FOR(NOT)	GAG TCA TTC TGC GGC CGC CCG TTT CAG CTC CAG CTT GGT CCC	V _K C-region (Not I site)
VHBI4FOR	GGA GAC GAG GGG GAA AAG CTT TGG GAA GGA CTG ACT CTC	V _H C-region (Hind III site)
VKBACK (Mlu)	GCA CGC GTA GAT ATC GAG TCT ACC ACG TCT CCA	V _K (Mlu I)
VHf1X1FOR	CCG GCC ATG GCC AAG GTC CAA CTG CAA CTG CAG GAG	V _H (Nco I)
VHf1X1BACK	CGG GGA TCC TGC GGC CGC CCG TTT GAT T	V _K (Bam/NotI)
VHf1BM	TGG GTT GCT GAA ATT AGA T	Back- mutation
SCFVFOR	TCA TTC TGC GGC CGC CCG T	amplify scFv
SCFVBACK	ATT GGC CCA GCC GGC CAT G	amplify scFv

Note: Degeneracy codes: K = G or T; M = A or C; S = C or G; R = A or G; W = A or T

Table 4.4 Sequencing and subcloning primers

Name	Nucleotide sequence (5'—3')	Purpose
Seq-S1	TTC AAC GTG AAA AAA TTA TTA TTC GC	V _H sequencing
Seq-S3	GCG GTT CAG GCG GAG GTG GCT CTG G	V _H sequencing
Seq-S4	CGC CAG CCA CCT CCG CCT GAA CC	V _K sequencing
Seq-S6	TAG TAA ATG AAT TTT CTG TAT GAG G	V _K sequencing
M13 universal	GTA AAA CGA CGG CCA GT	Sequencing
M13 reversal	AAC AGC TAT GAC CAT G	Sequencing
F1BgIIIBACK	GGA AGA TCT GCC ATG GCC AAG GTC CAA CTG	For fusion scFv with AP
F1BgIIIFOR	AGC AGA TCT CCG TTT GAT TTC CAG CTT GGT CC	For fusion scFv with AP

Table 4.5 Oligonucleotide sequence encoding for linker (G₄S)₃

Name	Nucleotide sequence (5'—3')	Purpose
Linker 1	ACG GTC ACC GTC TCC TCA <u>GGT GGA GGC GGT TCA</u> <u>GGC GGA GGT GGC TCT GGC GGT GGC GGA TCG GAC</u> ATC GAG CTC ACT	linker
Linker 2	AGT GAG CTC GAT GTC <u>CGA TCC GCC ACC GCC AGA</u> <u>GCC ACC TCC GCC TGA ACC GCC TCC ACC TGA GGA</u> GAC GGT GAC CGT	linker

Note: underlined sequences encoding for (GGGS)₃ linker.

4.1.7 Enzymes

AmpliTaq[®] polymerase (Perkin Elmer), Expand High Fidelity PCR System (Boehringer Mannheim), Expand Reverse Transcriptase (Boehringer Mannheim), Klenow enzyme (Boehringer Mannheim), Proteinase K (Serva), RNase A (Serva), restriction enzymes (from different suppliers, mainly New England Biolabs), shrimps alkaline phosphatase (Amersham Pharmacia), T4 DNA polymerase (Gibco BRL), T4 DNA ligase (Gibco BRL), T4 polynucleotide kinase (Gibco BRL).

4.1.8 Antibodies and conjugates

Anti-mouse IgG horseradish peroxidase conjugate (Amersham), anti-mouse IgG+IgM alkaline phosphatase conjugate (Dianova), anti-c-myc monoclonal antibody 9E10

(Calbiochem), anti-penta-His tag monoclonal antibody (Qiagen), rabbit anti-PVY-polyclonal antibody (F. Rabenstein, BAZ, ASL).

4.1.9 DNA and protein markers

1 kb plus DNA ladder (Gibco BRL), 100 bp DNA ladder (Gibco BRL), low molecular weight standard (Amersham Pharmacia), Prestained protein marker, broad range (New England Biolabs), Biotinylated SDS-PAGE molecular weight marker (14.4-200 kDa) (Perkin Elmer).

4.1.10 Other reagents and kits

ABTS (Sigma), ³³P-dATP (Hartmann Analytics), Altered sites[®] II *in vitro* Mutagenesis system (Promega), boric acid (Roth), DEPC (Sigma), p-NPP (Biomol), Freund's complete adjuvant (Sigma), Freund's incomplete adjuvant (Sigma), GFX columns (Amersham Pharmacia), hypoxanthine (Gibco BRL), aminopterin (Gibco-BRL), thymidine (Gibco BRL), IPTG, BCIP and NBT (Duchefa), PEG-1500 (Merck), PEG-6000 (Merck), PVP 25 (Serva), Western-light plus[™] chemiluminescent detection system and CSPD[®] alkaline phosphatase substrate (Perkin Elmer), mRNA purification kit (Amersham Pharmacia), DNA sequencing Sequenase[®] kit (USB), Cy5 AutoRead sequencing kit (Amersham Pharmacia), Quiagen plasmid purification kit (Quiagen), RNazol reagent (Gibco BRL), sucrose (Roth), Tris (Serva), X-gal (Duchefa).

Other chemicals were purchased from Roth, Serva or Sigma chemical companies.

4.1.11 Buffers and media

4.1.11.1 Buffers for electrophoresis, ELISA and Western blot

- ABTS substrate buffer: add 4.4 mg ABTS in 21 ml of 0.05M citric acid (pH 4.0), prior to use, add 36 µl of H₂O₂ to 21 ml of ABTS citric acid solution.
- Alkaline phosphatase substrate buffer for ELISA: 1 M diethanolamine, 1 mM MgCl₂ (pH 9.8).
- Alkaline phosphatase buffer for Western blot: 100 mM NaCl, 5 mM MgCl₂, 100 mM Tris-HCl (pH 9.5).
- Binding buffer: 20 mM Tris-HCl, 0.5 M NaCl, 5 mM imidazole, 6 M urea (pH 7.9).

- Blocking buffer: 1% skimmed dried milk in PBS.
- TAE buffer: 40 mM Tris-acetate, 1 mM EDTA (pH 8.0).
- Coating buffer: 0.05 M sodium carbonate buffer (pH 9.6).
- Elution buffer: 20 mM Tris-HCl, 0.5 M NaCl, 0.3 M imidazole, 6M urea, (pH 7.9).
- Extraction buffer for DAS-ELISA: 2% PVP 25 and 0.2% skimmed dried milk in PBS.
- Extraction buffer for solubilized protein: (9M urea, 4,5% SDS, 7.5% β -mercaptoethanol, 50 mM Tris-HCl, pH 6.8).
- Iodide Buffer: 10 mM Tris-HCl (pH 8.0), 1 mM EDTA, 4 M NaI.
- 2 \times Loading Buffer: 100 mM Tris-HCl (pH 6.8), 200 mM dithiothreitol, 4% SDS, 0.2% bromophenol blue, 20% glycerol.
- NBT/BCIP stock solution: add 0.35 g NBT in 10 ml of 70% DMF and 0.17 g BCIP in 10 ml of 100% DMF, store at -20°C . Before use, 100 μl NBT and 100 μl BCIP from stock were added into 10 ml of alkaline phosphatase buffer (pH 9.5) per blot (10 \times 10 cm).
- PBS: 10 mM $\text{Na}_3/\text{K}_3\text{PO}_4$, 150 mM NaCl (pH 7.4).
- PBST: PBS containing 0.05% (v/v) Tween-20.
- Protein electrophoresis buffer: 25 mM Tris, 192 mM Glycine, 0.1% SDS (pH 8.3).
- PEG/NaCl: 20%(w/v) PEG-6000, 2.5 M NaCl.
- TBS: 50 mM Tris-HCl, 150 mM NaCl (pH 7.5).
- TE buffer: 10 mM Tris-HCl (pH 8.0), 0.1 mM EDTA.
- TES buffer: 200 mM Tris-HCl (pH 8.0), 0.5 mM EDTA, 500 mM sucrose. Filter sterilize and store at 4°C . To prepare 1/5 \times TES, add 1 volume of 1 \times TES buffer to 4 volumes of distilled water.
- Transfer buffer: 39 mM glycine, 48 mM Tris-HCl, 0.037% SDS, 20% methanol (pH 8.3).
- Washing buffer: 20 mM Tris-HCl, 0.5 M NaCl, 20 mM imidazole, 6M urea (pH 7.9).

4.1.11.2 Growth media for bacteria/phages

All media were autoclaved at 121°C for 15 min, except for special description. Antibiotics were added to media after cooling down to room temperature, if needed.

- LB medium: 10 g/l Bacto-tryptone, 5 g/l Bacto-yeast extract, 5 g/l NaCl. For LB Plates: LB medium with 1.5% agar.
- 2 \times M9 salts: 12 g/l Na_2HPO_4 , 6 g/l KH_2PO_4 , 1 g/l NaCl, 2 g/l NH_4Cl .

- Minimal plates: per liter: 500 ml 2× M9 salts, 500 ml 3% agar. Autoclaved and cool to <70°C, added follows: 20 ml 20% glucose (filter-sterile), 2 ml 1 M MgSO₄, 0.1 ml 1 M CaCl₂, 1 ml thiamine (10 mg/ml, filter-sterile).
- SOBAG: to 20 g/l of Bacto-tryptone, 5 g/l of Bacto-yeast extract and 0.5 g/l NaCl, add distilled water to ~900 ml and autoclaved. After the medium has cooled to 50-60°C, add the follows: 10 ml of sterile 1 M MgCl₂, 55.6 ml of 2 M glucose (filter-sterile) and 5 ml of 20 mg/ml ampicillin (filter-sterile). For plates, add 15 g/l of Bacto-agar before autoclaving.
- Stock solutions: ampicillin (sodium salt): 100 mg/ml in deionized water, store at -20°C, use at 50-100 µg/ml; Kanamycin (sulfate): 30 mg/ml in deionized water, store at -20°C, use at 30 µg/ml; Chloramphenicol: 34 mg/ml in ethanol, store at -20°C, use at 34 µg/ml; 1M IPTG (isopropyl β-D-thiogalactopyranoside): add 2.38g IPTG in 10 ml deionized water, filter sterilize and store at -20°C; X-gal: make a stock solution by dissolving X-gal in DMF to a 20 mg/ml solution, store at -20°C.
- Top agarose: 10 % Bacto-tryptone, 0.5% Bacto-yeast extract, 0.5% NaCl, 1% MgCl₂·6 H₂O, 0.7% agarose. Dispensed into 3 ml aliquots. Store solid at 4°C, melt in microwave as needed.
- 2× TY medium: 17 g/l Bacto-tryptone, 10 g/l Bacto-yeast extract, 5 g/l NaCl.
- 2× TYAG medium: 2× TY medium, 2% glucose (filter sterile) and 100 µg/ml ampicillin. For TYAG plates add 1.5% Bacto-agar into TYAG medium. Pour plates quickly.
- 2× TYAK medium: 2× TY medium, 2% glucose and 50 µg/ml kanamycin. For TYAK plates add 1.5% Bacto-agar into TYAK medium.

4.1.11.3 Mammalian cell culture media

- Growth medium: Dulbecco's MEM supplemented with 10% FCS and 1× PSG.
- 100× HAT stock solution: 10 mM hypoxanthine, 40 µM aminopterin, 1.6 mM thymidine.
- HAT medium: Dulbecco's MEM supplemented with 20% FCS, 1× HAT and 1× PSG.
- 100× HT: 10 mM hypoxanthine, 1.6 mM thymidine.
- HT medium: Dulbecco's MEM supplemented with 20% FCS, 1× HT and 1× PSG.
- 100× PSG: 100 unit/ml penicillin, 100 mg/ml streptomycin, 3 mg/ml glutamine.

Above media were products of Gibco BRL (Gaithersburg MD), purchased from Life Technologies. Only Dulbecco's MEM medium was prepared in batches from Dulbecco's MEM powder by dissolving in double-distilled water, adjusting pH value with NaHCO₃

powders according to the manufacturer's instruction. Media were sterilized using Sartorius filter-sterile system (Sartorius, Göttingen).

4.1.12 Special laboratory equipment and materials

1. ALF Express sequencer (Amersham Pharmacia, Freiburg).
2. Alpha Imager 2000 (Biozym, Hess. Olderdorf).
3. Blotting paper GB 002 (Schleicher & Schuell, Darsel).
4. Centriprep-30 concentrators (Amicon, Beverly MA).
5. CO₂ incubator Bio-Center 2001 (Intra Biosciences, Fernwald).
6. Computer programs: DNAsis (Hitachi), Generunner (Hastings), ALFsequencer (Amersham Pharmacia), Micrografx picture publisher (Micrografx), Winscan (Heil).
7. CovaLink, PolySorp, and MaxiSorp microtiterplates, Immuno tubes, and Cryo tubes (Nalgene Nunc International, Wiesbaden-Biebrich).
8. Cybertech Photoscan (Wilfried Heil, Berlin), with white/UV transiluminator (UVP).
9. DC265 Camera (Kodak, Rochester NY).
10. Dialysis tube (Millipore, Bedford MA).
11. Dynatech MR5000 photometer (Dynatech Laboratories, Guernsey Channel Islands).
12. Gel dryer Model 583 (BioRad, Richmond CA).
13. Peltier Thermal Cycler PTC-200 (Biozym, Hess. Olderdorf).
14. PVDF membrane (Roth), Immobilon-P membrane (Millipore, Bedford MA).
15. Semidry electroblotter (BioRad, Richmond CA).
16. Sartorius filter-sterile system [stainless steel in-line filter holder SM 16275, pressure tank SM 17531 and cellulose nitrate filter, 0.2 µm] (Sartorius, Göttingen).
17. Syringe filters, 0.2 µm, 0.45 µm, and 0.8 µm (Nalgene Nunc International, Wiesbaden-Biebrich).
18. Ultrasonicator UP 200S (Dr. Hielscher, Stahnsdorf).
19. VacuCap® 90 filter unit, 0.2 µm (GelmanSciences, Ann Arbor MI).
20. X-ray film (Retina, Berlin).

4.2 Methods

4.2.1 Peptide identification and synthesis

Conserved regions of NIB were identified by comparison of all complete aa sequences of potyviruses published at that time in EMBL Nucleotide Sequence Database, namely, PVY, PVA, PPV, TEV, TuMV, ZYMV, TVMV, PepMoV, PSbMV, PStV, JGMV, BCMV, PRSV, SMV, BrSMV, with the help of computer program DNASIS. Three conserved regions, longer than 28 aa were identified as follows:

region1 (R1): ANKTRTFTAAPLDTLLGGKVCVDDENNQFY,

region2 (R2): LPEGWVYCDADGSQFDSSLTPYLINAVL and

region3 (R3): NLYTEIVYTPILTPDGTIVKKFKGNNSGQPSTVVDNTLMV,

They are at aa positions 185-214, 240-267, 286-325, for PVY NIB (EMBL sequence database, accession number A08776), respectively. The underlined parts represent aa which have a predominantly positive antigenic index, except for most of R2 (17/24 aa with negative index). The peptides of R1, R2, and R3 were synthesized and purified by HPLC to a purity of $\geq 95\%$ (Genosys, Pampisford), respectively. Additionally, to aliquots of the peptides a cysteine residue was added to the N terminus of each peptide by Genosys company to provide convenient coupling with bovine serum albumin (BSA) as a carrier. The conserved regions of the CP of potyviruses were also determined by the above methods. Two highly conserved regions were identified, one is MVWCIENGTSPP (equivalent to aa 2912-2923 in PVY) and the other is ENTERHTA (equivalent to aa 3040-3047 in PVY) within C terminus of CP. The two corresponding peptides were synthesized as a MAP with lysine as a linker molecule (BioTez, Berlin-Buch).

4.2.2 Construction and overexpression of R1-R2-R3 fusion protein

Oligonucleotides coding for R1, R2, and R3, synthesized with the corresponding restriction sites, were cloned step by step into pGEM 3 (Promega, Mannheim): R1: EcoR I/Xba I, R2: Xba I/Pst I, and R3: Nsi I/Pst I. The nucleic acid sequences were verified after each cloning by sequencing. After digestion with EcoRI/Hind III, the insert coding for the R1-2-3 single peptide was recloned into pET30a (Novagen, Darmstadt). The sequence of the insert was checked by sequencing. The map of the expression vector was shown in Figure 4.1a. The fusion protein R1-R2-R3 was overexpressed in *E. coli* BL21(DE3) pLysS.

4.2.3 Molecular cloning of PVY NIB gene and construction of overexpression plasmid

cDNA and double-stranded DNA of NIB were synthesized and amplified from total RNA according to standard methods (Sambrook et al., 1989). Total RNA was isolated from PVY^N-infected *N. tabacum* cv. Xanthi using an RNazol reagent (Gibco, BRL) according to the manufacturer's recommendations. The PVYNIBFOR and PVYNIBBACK primers were used for amplifications. The purified DNA was ligated into pCR-SCRIPT SK (+) (Stratagene, Amsterdam Zuidoost) and transformed into *E. coli* XL-2 blue. The NIB gene was subcloned in frame into the overexpression plasmid pET30a (Fig. 4.1b) and the host strain of *E. coli* BL21(DE3) or BL 21 (DE3) pLysS was used in the expression of the recombinant NIB protein.

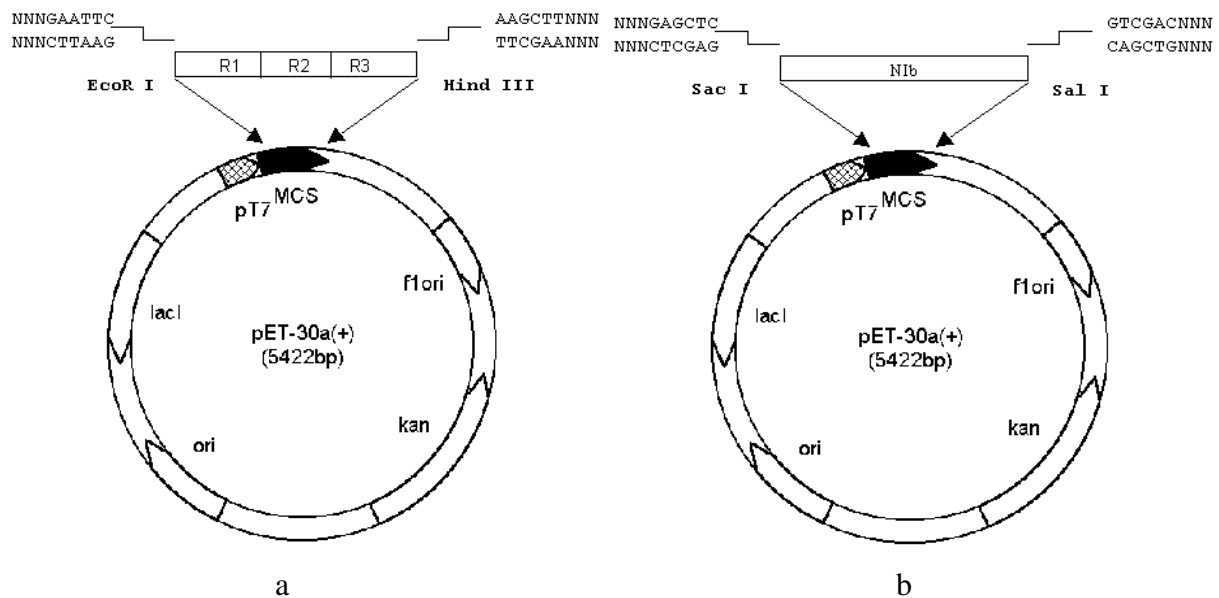

Fig. 4.1: Map of expression vector pET30a with R1-2-3 or NIB inserts, MCS = multiple cloning sites: the order from 5' to 3' end is Nco I, EcoR V, BamH I, EcoR I, Sac I, Sal I, Hind III, Not I, Eah I, Xho I, a 6 Histine-tag is followed by the Xho I sequence.

a: Sequence encoding for R1-2-3 peptide was cloned into pET30a through EcoRI and Hind III sites.

b: NIB was cloned into pET30a through Sac I and Sal I sites.

4.2.4 Purification of NIB protein by immobilized metal-ion affinity chromatography (IMAC)

Both recombinant proteins, NIB and R1-2-3, were fused in frame to the His-tag of the plasmid pET30a, thus enabling purification by IMAC (Hochuli et al., 1988). A chelating Sepharose column (Amersham Pharmacia, Uppsala) charged with Ni²⁺ was used for purification. The induced cells (grown for 3 h after IPTG induction as described above) were harvested by

centrifugation at $6.200\times$ g for 15 min, resuspended in binding buffer (40 ml buffer for 200 ml of bacterial culture) and disrupted by ultrasonification (Dr. Hilscher, Stahnsdorf). The suspension was centrifuged at $39.000\times$ g for 20 min at 4°C . The supernatant was discarded because the NIB was presented in the insoluble fraction. The pellet was washed twice with 20 ml binding buffer. The pellets were resuspended in binding buffer containing 6 M urea and incubated on ice for one hour. After centrifugation at $39.000\times$ g for 20 min, the supernatant was loaded onto the top of 3 chelating Sepharose columns (each 2 ml bed volume) pre-balanced with binding buffer containing 6M urea and passed through columns twice. After several washings with washing buffer, the bound fusion protein was eluted with 9 ml of elution buffer for each column. Fractions (each 1 ml) were collected and analyzed by PAGE. The fractions containing NIB were pooled together. For NIB refolding and solubilization, the collected fractions were first dialyzed against 50 mM Tris-HCl (pH 7.9) containing 1 M urea, followed by the same buffer containing 0.25 M urea (without stirring), and finally with stirring against dialysis buffer without urea. Dialysis was performed overnight at 4°C . Purified NIB protein was concentrated to an appropriate volume by PEG-15000 treatment.

Quantification of NIB was determined by Bradford method (Bradford, 1976) using BSA as a standard. This method quantitates the binding of Coomassie brilliant blue to an unknown protein and compares this binding to that of different amounts of the standard protein. Briefly, 1) add duplicate aliquots of 0.5 mg/ml BSA (5, 10, 15, and 20 μl) into microcentrifuge tubes, and bring the volume in each tube to 100 μl with 0.15 M NaCl. Prepare 2 blank tubes containing only 100 μl of 0.15 M NaCl. 2) add 1 ml Coomassie brilliant blue solution to each tube and vortex, and incubate 5 min at room temperature. 3) measure the $A_{595\text{nm}}$ using a 1-cm pathlength microcuvette (1 ml), and make a standard curve by plotting absorbance versus protein concentration. Measure the $A_{595\text{nm}}$ of the unknown and determine the protein concentration in the unknown from the BSA standard curve.

4.2.5 Purification of potato virus Y

Mechanically inoculated *N. tabacum* cv. Xanthi plants were grown for two weeks in a green house at 25°C . Virus was purified from fresh infected leaf tissue as described by Leiser and Richter (1978) with modifications. 95 g leaf tissue was homogenized in 450 ml of 50 mM potassium-citrate buffer (pH 7.0) containing 1 μM PMSF at room temperature. The homogenate was squeezed through cheesecloth and centrifuged for 15 min at $6.000\times$ g. Triton X-100 was added into the supernatant to a final concentration of 3% and stirred for 1 h at 4°C .

The supernatant was layered over a cushion of 20% (w/v) sucrose and centrifuged for 2 h at 45.000× g. The pellet was resuspended in 20 ml of potassium-citrate buffer (pH 7.0), incubated and stirred on ice for 1 h, then centrifuged for 10 min at 15.000× g. The supernatant was collected, and the sediments were resuspended in 20 ml of potassium-citrate buffer and this step was repeated once more. The collected supernatants were layered on an equal volume of cesium chloride (1 g/ml), and centrifuged in a vertical rotor for 14-16 h at 50.000× g. The virus bands were collected and sedimented by centrifugation for 2 h at 50.000× g. Virus particles were resuspended in 0.1 M Tris-HCl buffer (pH 7.0) for further use or kept at -20°C.

4.2.6 Production of antisera

Each of two rabbits was injected with approximately 0.2 mg of overexpressed purified N1b mixed with an equal volume of Freund's complete adjuvant. One week later the rabbits were immunized with the same amount of the purified N1b mixed with Freund's incomplete adjuvant. The third injection was done the same as the second injection. One week after the last boost injection the rabbits were bled and the titer of sera was evaluated. In total the rabbits were bled three times with a week's interval. Three months after the last bleeding the rabbits were immunized according to the above schedule again.

4.2.7 Development and production of monoclonal antibodies

4.2.7.1 Mice immunization

50 µg of the peptides R1, R2, R3, respectively, mixed with an equal volume of Freund's complete adjuvant was injected into the peritoneal cavity of 8 week old BALB/c mice. Two mice were used for each peptide. The second and third injections with incomplete Freund's adjuvant were given at 2-3 week intervals. Ten days after third injection the mice were bled and the antisera titers were evaluated. One mouse for each antigen with an antibody titer higher than 1:1000 was boosted with 100-150 µg of the antigen without adjuvant.

The synthetic peptides of S193W3 and S319 as well as the purified recombinant N1b and coat protein of PVY were used as an antigen, respectively, following the same immunization scheduled as above.

4.2.7.2 Cell fusion and selection of hybridoma cell lines

A vial of myeloma cells SP2/0-Ag14 or X63-Ag8.653 was recovered from liquid nitrogen and immediately put into 37°C water bath. After defrosting the cells were distributed into a 24 well plate or a 20 ml flask with Dulbecco's MEM supplement with 10% FCS and macrophages as feeder cells. The cell cultures were put into a CO₂ incubator at 37°C. For cell fusion, about eight 20 ml-flasks of myeloma cells were prepared. It is essential that they are in logarithmic growth phase and that the cell concentration on the day of fusion is not higher than 10⁶/ml.

The fusion was carried out 3 days after the boost. Mouse spleen cells were fused with one of the mouse myeloma cell lines using 45% PEG-1500 (Merck-Schuchardt, Hohenbrunn) as described by Köhler and Milstein (1975) with modifications. Briefly, the spleen was removed from a mouse under a sterile hood and disrupted into a single cell suspension in Dulbecco's MEM medium without FCS. The cells were spun down at 500× g for 7 min and resuspended in 40 ml of the above medium, the suspension was divided into two equal parts, and incubated at 37°C for 15 min. During this period, myeloma cells in logarithmic growth phase were collected from flasks in growth medium, washed with DMEM once, and pelleted. They were resuspended in 25 ml of DMEM, mixed with one part of the above spleen cells (another part can be frozen for a second fusion) in a 50 ml-tube and spun down as above. The supernatant was discarded, the cell pellets were loosed by gently topping the tube. 1 ml 45% PEG-1500 solution was added into them within 20 sec drops by drops, at the same time shaking the tube and again for another 10 sec. The cells were incubated at 37°C for 90 sec, 1 ml of DMEM with 20% FCS was added over 30 sec, and the suspension was shaken gently for 30 sec. Subsequently, 10 ml of DMEM was added over 45 sec and a rest of 40 ml rapidly. The fused cells were spun down at 500× g for 7 min, and gently resuspended in 50 ml of HAT medium. The fused cells were distributed into three to five 96-well tissue culture plates with peritoneal macrophages as feeder cells and placed in a CO₂ incubator at 37°C.

10-15 days after fusion, hybridomas producing antigen-specific antibodies were screened by PTA-ELISA (see section 4.2.8.1). The screening tests were performed four times during cell growth in HAT selection medium. Positive clones were subcloned twice by the limiting dilution method. Isotyping of monoclonal antibody was done on culture supernatants using a mouse monoclonal antibodies isotyping kit (Boehringer Mannheim).

The hybridoma selection for three synthetic peptides to NIB and two to CP conserved regions of potyviruses, and for the recombinant NIB and CP of PVY was done following essentially the same procedure. Only the target antigens used for selection were different.

4.2.7.3 Storage and recovery of hybridoma cells in liquid nitrogen

After resuspension in a mixture of 90% (v/v) FCS and 10% DMSO, cells were pipetted into vials ($\sim 10^{6-7}$ cells per vial). Vials were placed immediately into a cooling chamber in an ultra-deep freezer and cooled down at a rate of approximately 1°C per minute. After the cells reached a temperature of below -60°C , they were transferred directly into the liquid nitrogen or remained in the freezer. Regardless of how the cells were frozen, it is essential to test-thaw a vial to make sure that the cells can be recovered. The vials of frozen cells should be thawed rapidly in a 37°C water bath, and then immediately recovered by centrifugation. Several 10-fold diluted cells were distributed into wells containing growth medium (RPMI-1640 or DMEM with 10-15% FCS) with microphages, and cultured in a CO_2 incubator at 37°C .

4.2.8 Enzyme-linked immunosorbent assay (ELISA)

4.2.8.1 PTA-ELISA

The plate-trapped antigen (PTA)-ELISA was performed as described by Mowat (1985) with modifications. Microtiter plate wells (Polysorp, Nunc) were first coated with the target antigen, as a general rule at a concentration of $2\ \mu\text{g/ml}$, $100\ \mu\text{l}$ per well. For virus-infected leaf sap, 10-fold or 50-fold dilution in coating buffer, $100\ \mu\text{l}$ per well, was used. The plates were incubated overnight at 4°C . After blocking with 1% non fat dry milk in PBS for 1 h at 37°C and 3 washes with PBST, the cell culture supernatants (containing antibodies, in some cases to be diluted in PBST), $100\ \mu\text{l}$ per well, were added and incubated for 2 h at 37°C . After 4 washes with PBST, alkaline phosphatase conjugated to rabbit anti-mouse IgG + IgM (2000-fold dilution) was added, $100\ \mu\text{l}$ per well, and the plates were incubated for 1 h at 37°C . After 5 washes, alkaline phosphatase substrate solution ($1\ \text{mg/ml}$ p-NPP, pH 9.8) was added ($200\ \mu\text{l}$ per well), and the plates were incubated in the dark at room temperature. The $A_{405\text{nm}}$ values were measured in a Dynatech MR5000 photometer.

4.2.8.2 DAS-ELISA

The double antibody sandwich (DAS)-ELISA was performed as described by Clark and Adams (1977) with modifications. Microtiter plates (Maxisorp, Nunc) were first incubated (3-4 h, 37°C) with polyclonal rabbit antibodies (100-fold dilution with coating buffer). Subsequently, they were incubated at 4°C 12-16 h with virus-infected plants sap or healthy plant sap 10-fold diluted in extraction buffer (2% PVP 25, 0.2% skimmed dried milk in PBS). All subsequent steps (addition of culture supernatants, rabbit anti-mouse conjugate and substrate) were as described above.

4.2.8.3 TAS-ELISA

The triple antibody sandwich (TAS)-ELISA was performed as described by Al Medaille et al. (1984) with modifications. The microtitre plates (Maxisorp, Nunc) were first incubated (12-14 h, at 4°C or 4 h at 37°C) with polyclonal rabbit antibodies (1000-fold diluted in PBS, 100 µl per well) produced against target antigens before blocking with 1% skimmed dried milk in PBS, and subsequently incubated (2 h, 37°C) with target antigens or virus-infected plant leaf extracts diluted 10-fold in PBS. All subsequent steps (culture supernatants, anti-mouse conjugate and substrate) were as described above for PTA-ELISA.

4.2.9 Antigen specificity assays

The antigen specificity of the MAbs was tested in both PTA-ELISA and TAS-ELISA as described above. The specificity assay was also performed in Western blot, the procedure is described in the following section.

4.2.10 SDS-PAGE and Western blotting

After denaturation by boiling at 100°C for 3-5 min in loading buffer, proteins obtained from virus-infected plants or overexpressed recombinant proteins were separated on a 12% denatured polyacrylamide (PA) gel according to the method of Laemmli (1970). Proteins were transferred from the gel by electroblotting onto PVDF membrane at 13 V for 2 hours with transfer buffer using a semi-dry transfer apparatus (Towbin et al., 1979). Membranes

were blocked with 0.2% I-block (Tropix), and probed with the MAbs. Positive signals were detected by NBT/BCIP (Sambrook et al., 1989) or by ECL (Gillespie and Hudspeth, 1991).

4.2.11 Detection of RdRp and CP in potyvirus-infected plants

Method 1: Leaf tissues (1 g) of potyvirus-infected plants as tested in PTA-ELISA or healthy control plants were ground to a fine powder in liquid nitrogen and total proteins were extracted in 2 ml of the buffer containing 50 mM Tris-HCl pH 7.0; 1% SDS; 1 mM Pefablock (Roth, freshly added). The extracts were centrifuged at 10.000× g for 10 min. The supernatant was mixed with protein loading buffer, boiled for 3-5 min. Proteins from equivalent amounts of leaf tissue extracts or overexpressed NIb were loaded onto a 12% PA gel containing 0.1% SDS and subjected to electrophoresis (Laemmli, 1970). Proteins blotted onto PVDF membranes were detected by MAbs specific to RdRp or CP of PVY. The signals were revealed by the enhanced chemiluminescence system or chromogenic detection (NBT/BCIP).

Method 2: Total protein extraction was performed as described by Baunoch et al. (1991) in which high concentration of urea (9 M) was employed to extract plant proteins. One gram of leaf tissue from potyvirus-infected plants or healthy plants was ground to a fine powder in liquid nitrogen and extracted with 4 ml of extracting buffer (9 M urea, 4.5% SDS, 7.5% β-mercaptoethanol, 50 mM Tris-HCl, pH 6.8). The extracts were boiled for 10 min and then centrifuged at 10.000× g for 10 min. Equivalent amounts of 15 µl supernatant were directly loaded and electrophoresed as above.

Method 3: Protein extraction was carried out as described by Van Etten et al. (1979), which takes advantage of solubilization of proteins by phenol. Plant tissues were homogenized with 1.5 volumes (w/v) extraction buffer (80 mM Tris-HCl, 1 mM dithiothreitol [DTT], 10 mM EDTA, 2% SDS, 50 mg/ml PMSF, pH 6.8). After homogenization 1.5 volume of 80% phenol containing 100 mM ammonium acetate and 10 mM DTT were added to the homogenate. The extract was clarified by centrifugation at 3000× g for 5 min. The phenol layer was sucked off and extracted three times with equal volumes of buffer (80 mM Tris-HCl, 1 mM DTT, 10 mM EDTA, 100 mM ammonium acetate, pH 6.8). Protein was precipitated from the phenol phase by addition of 5 volumes of methanol containing 100 mM ammonium acetate at -20°C for 2 h. Proteins were collected by centrifugation at 5000× g for 10 min at 4°C, and washed 3 times with methanol-ammonium acetate buffer and finally one time with acetone. They were dissolved in loading buffer, boiled for 3-5 min and 15 µl of each sample were subjected to electrophoresis.

4.2.12 Time course study of expression of RdRp and CP of potyviruses

In each case ten young *N. glutinosa* and *N. occidentalis* plants (at the five leaves stage) were inoculated with PVY isolates CH605, 1427, oGA and five young *N. cleverlandii* plants were inoculated with PVA isolate Juliniere. The same inoculation was repeated with new plants daily for a week. From total seven inoculations locally and systemically infected leaves were sampled for a PTA-ELISA twice weekly until 4 weeks after the inoculation of the first set plants. The virus infection was confirmed by DAS-ELISA for coat protein.

4.2.13 Molecular cloning and expression of single chain antibodies in *E. coli*

4.2.13.1 mRNA purification, cDNA synthesis and PCR amplification of V genes

Standard methods of molecular cloning procedures were performed according to Sambrook et al. (1989). mRNA was purified from approximately 10^6 hybridoma cells using mRNA purification kit (Amersham Pharmacia, Uppsala). cDNA was synthesized from ~5 µg of mRNA. V_H and V_L were amplified separately by PCR, 1 U Taq polymerase was used (Note: other polymerases with proofreading activity can also be used. Taq polymerases may more effectively amplify all V genes of antibodies by degenerated primers; the automatically introduced mutations resulting from Taq polymerase synthesis errors during PCR procedure do not have harmful effects, because proteins/antibodies can also affinity-mature during cycles of the selection or panning). All primers are listed in Tables 4.2 and 4.3. The cycles were: 95°C/2min; 30 cycles: 94°C-30 s, 56°C-30 s, 72°C-45 s/ +2 s per cycles; 72°C-5 min; 4°C overnight. The PCR products were analyzed on 2% agarose gel. V_H and $V_{L(K)}$ DNA fragments were purified from bands of about 400 bp by using a Qiagen gel extraction kit.

4.2.13.2 Construction of scFv expression plasmids

The V_H and $V_{L(K)}$ DNA fragments were subsequently joined with a DNA linker fragment which codes for the peptide (Gly₄Ser)₃ by a fusion PCR in a 50 µl volume PCR reaction containing dNTP, each 1 mM, 2.5 mM MgCl₂, 20 ng linker (Table 4.5), V_H and V_L DNA each 50 ng, 1.5 U Taq polymerase (5 U/µl). The cycles were: 95°C 2 min; 7 cycles: 94°C-1.5 min, 72°C-2.5 min. Then 1 µl of VHBACK(SFI) (50 pm/µl) and 2 µl of VKFOR (NOT) mixed

primers (25 pm/μl) were added. The reaction was immediately continued with 25 cycles: 94°C 1 min, 58°C 1 min, 72°C 2 min; extension at 72°C for 2 min. Once assembled, the constructed scFv DNA fragments containing Sfi I and Not I restriction sites at the 5' end of V_H and the 3' end of V_L, respectively, were gel-purified. If the amount of scFv DNA was not sufficient, it was further PCR amplified with SCFVFOR/SCFVBACK primers using a Taq-polymerase with proofreading activity (e.g. Expand high fidelity taq polymerase system, Roche, Mannheim). Alternatively the method to synthesize scFv was performed as described by Breitling and Dübel (1997).

The scFv DNA was digested with Nco I or Sfi I and Not I. Purified V_H-Linker-V_L constructs were ligated into phagemid vectors (for pCANTAB5E through Sfi I and Not I sites, for pSEX81 through Nco I /Not I sites) in a 10 μl ligation reaction with 1.5 U of T4 DNA ligase for 14-16 h at 16°C. The resulting constructs, designated as pCANTAB-scFv or pSEX-scFv, were transformed into Epicurian Coli[®] XL2-Blue ultracompetent cells.

4.2.14 Antibody phage display and cycles of selection

Colonies were washed off from the transformation plates with 100 ml of 2× TY medium containing 2% glucose and 100 μg/ml ampicillin and bacterial density was adjusted to OD₆₀₀ ≤ 0.3. The suspension was shaken at 37°C until the culture density reached 0.6. The culture was divided into two aliquots of 50 ml, one for freeze stock, the other was rescued by adding helper phage M13KO7 (10¹⁰ pfu), and grown for 1 h at 37°C. After centrifugation at 1.500× g for 15 min at 28°C, the pellet was resuspended in 100 ml of 2× TYAK medium containing 100 μg/ml ampicillin and 50 μg/ml kanamycin, and incubated for 8 h at 37°C. The culture was centrifuged at 2.500× g for 15 min. The phage antibody was precipitated from 100 ml of supernatant by adding 20 ml of 20% PEG-6000/2.5 M NaCl keeping for 30 min at 4°C, and pelleting by centrifugation at 10.000× g for 10 min at 4°C. The pellets were suspended in 15 ml of 2× TY medium and diluted with an equal amount of PBS containing 10% skimmed dry milk, 0.2% Tween 20 and 0.01% Thimerosal. After centrifugation at 3.000× g for 10 min, the pellet was discarded. The supernatant was transferred to Immuno tubes, which had been pre-coated overnight at 4°C with target antigens (e.g. purified Nib, sap of PVY-infected leaves 1:10 diluted in PBS) and incubated for 3 h at room temperature. The tubes were washed 20 times with PBS and another 20 times with PBST. Log-phase TG1 cells grown in LB medium were added into the tubes and incubated for 2 h at 37°C. The culture was poured onto SOB plates containing 2% glucose and 100 μg/ml ampicillin and incubated overnight at 30°C.

Bacteria grown were rescued and the steps described above were repeated for total two-three rounds of selection.

For ELISA tests, the PEG/NaCl-precipitated antibody phages were resuspended in 1/10 of original volume PBS containing 2% skimmed dried milk.

4.2.15 Phage-ELISA

Phage-ELISA was performed as PTA-ELISA with some modifications. 96 well-microtiter plates were coated overnight at 4°C with extracts from PVY-infected *N. tabacum cv. Xanthi* leaves (1:10 dilution with PBS) or purified Nib. The wells were blocked with 300 µl of 2% skimmed dried milk in PBS. After 3 washes with PBST, preparations of phages displaying scFv antibodies (e.g., diluted with 2% skimmed dried milk in PBST) were added into the wells (100 µl each) and incubated for 2 h at room temperature with gently shaking. After 4 washes with PBST, 100 µl of 1:5000 diluted HRP anti-M13 antibody conjugate (Amersham Pharmacia, Uppsala) was added per well and incubated for 1 hour at room temperature. After 5 washes with PBST, 100 µl of ABTS substrate were added per well. A_{405nm} values were measured after 1 h substrate incubation at room temperature.

4.2.16 DNA sequencing and sequence analysis software

The target scFv genes were subcloned into pGEM-5Zf vector via Nco I and Not I sites, and transformed into competent cells of bacterial strain JM109.

Selection for transformants was on LB/ampicillin/IPTG/X-Gal plates. Individual white colonies were transferred into 20 ml of LB medium containing 100 µg/ml ampicillin, shaken 200 rpm/min overnight at 37°C. Plasmids with inserted DNA were prepared for sequencing using a Quiagen plasmid purification kit.

The nucleotide sequence of scFv 7C5 was obtained manually by use of the USB sequencing kit with primers Seq-S1, S3, S4, S6 (Table 4.4). Other sequences were determined on an automatic sequencer (ALFexpress) using the Cy5 AutoRead sequencing kit following the kit protocol. Cy5 amidite-labelled pUC/M13 forward sequencing and reverse sequencing primers were used in sequencing PCR reaction.

4.2.17 Site-directed mutagenesis

One sequenced clone (f1) with a nucleotide mutation at nt position 154 was mutated back *in vitro* by site-directed mutagenesis. The insert was amplified with the primers of VHF1X1FOR and VHF1X1BACK and cloned into pALTER-Ex 1 Vector (Promega, Madison WI). Primer VHF1BM was designed as a mutagenic oligonucleotide. All procedures of site-directed mutagenesis were performed according to the manual. The sequences of the *in vitro* mutations were checked by the automatic sequencer. The back-mutated insert was re-cloned into expression plasmid pOPE101 through Nco I and Not I sites.

4.2.18 Expression of soluble scFv in *E. coli* and optimization of conditions

4.2.18.1 PCR identification of colonies containing scFv inserts

The target scFv genes from pSEX-scFv plasmid were subcloned via Nco I and Not I sites into pOPE101 to yield pOPE-scFv constructs and the constructs were transformed into TG1 or HB2151 cells. Positive clones of phage displaying scFv antibodies from pCANTAB-scFv plasmid were used to re-infect *E. coli* HB2151 strain. PCR was used to screen and identify the colonies with inserts. For this purpose specific primers were used.

4.2.18.2 Analysis of *E. coli* proteins with Coomassie brilliant blue staining and Western blotting

A single colony was inoculated into 5 ml of LBGA and incubated overnight at 30°C with agitation. 0.2 ml of this culture were inoculated into 20 ml of LBA without glucose and maintained at 30°C until an $OD_{600} \geq 0.8$ was reached. 1 ml of the cell culture was collected as a non-induced control before adding IPTG to a final concentration of 0.4 mM. Subsequently, after 2 h, 4 h, 6 h, 8 h or overnight (14-16 h) induction, 1 ml of the culture was collected for protein analysis in SDS-PAGE, either by Coomassie brilliant blue staining or by Western blotting.

The procedure for Western blotting was partly described in section 4.2.10. Here, after blocking PVDF or Immobilon-P membranes with 1% skimmed dried milk, the membranes were probed with MAb 9E10, and developed with AP conjugated-anti-mouse IgG/IgM antibody and p-NPP as the substrate.

The gels after Coomassie brilliant blue staining were covered with cellophane membrane pre-wetted for 30 min, fixed in a Novey gel dryer and dried at room temperature for 3-4 days. An alternative is that the gel was covered with cellophane membrane pre-wetted for 30 min, vacuum dried at 60°C for 2 h in a gel dryer (BioRad, Richmond CA).

The percentage and quantification of target proteins were determined by scanning Coomassie brilliant blue stained gels with Alpha Imager 2000 or by Bradford method (Bradford, 1976) using BSA as a standard.

4.2.18.3 Analysis of binding properties of scFv in ELISA

To analyze the binding ability of scFvs, the culture supernatant or periplasmic extract (osmotic shock fraction) from selected clones was used as primary antibodies in standard PTA-ELISA. MAb 9E10 was used as secondary antibody, alkaline phosphatase conjugated anti-mouse IgG/IgM antibody as tertiary antibody, p-NPP as substrate.

To prepare the osmotic shock or periplasmic fraction from *E. coli*, procedures according to Skerra and Plückthun (1988) were performed with slight modifications. For each clone, 250 µl of an overnight culture grown at 30°C were inoculated into 25 ml of 2× TYAG medium. The culture was incubated at 30°C with vigorous shaking until an OD₆₀₀ = 0.6 was reached. The cells were spun down by centrifugation at 1500× g at 28°C for 15 min, and resuspended in 25 ml of fresh 2× TY pre-warmed to 30°C. After adding ampicillin and IPTG to a final concentration of 100 µg/ml and 0.4 mM, respectively, the incubation was continued for another 4 h. The cell were spun down as above, the culture supernatant was collected for ELISA. The pellet was resuspended in 0.5 ml of ice-cold 1× TES and then 0.75 ml of ice-cold 1/5× TES was added (this induced a mild osmotic shock). The slurry was vortexed and incubated on ice for 1 h. The content was transferred to a microtube and centrifuged at 13.000× g for 10 min. The supernatant (soluble periplasmic proteins) was carefully collected for ELISA.

4.2.19 Purification and refolding of scFvs

4.2.19.1 Preparation of bacterial culture

2 ml of an overnight culture grown in LBGA at 30°C were used to inoculate 200 ml fresh LBA. The culture was incubated at 30°C with vigorous shaking until an OD₆₀₀ = 0.8 was

reached and cooled down to room temperature. IPTG was added to a final concentration of 0.4 mM. The culture was incubated at room temperature for 4-5 h with shaking.

4.2.19.2 Isolation of soluble secreted scFv from periplasma

The following procedures were performed as described by Kipriyanov (1994). Bacterial cultures were centrifuged for 15 min at 6.200× g. The pellets were resuspended in 5% of initial volume of ice-cold 50 mM TE buffer with 20% sucrose and incubated on ice for 1 h with occasional stirring. The cell suspension was centrifuged at 30.000× g for 45 min at 4°C, the supernatant (soluble periplasmic proteins) was carefully collected and dialyzed against 30 mM Tris-HCl, 0.2 mM Pefabloc, 1 M NaCl (pH 7.4) at 4°C.

For IMAC, a column was filled with chelating Sepharose (Amersham Pharmacia, Uppsala) using 2 ml of resin per 1 l of cell culture, and washed with 5 bed volumes of distilled water. The Sepharose column was charged with Ni²⁺ by passing 0.7 bed volumes of 0.1 M NiCl₂ through it. The excess of ions was washed away with 3 bed volumes of distilled water. Then the column was equilibrated with 3 volumes of starting buffer (30 mM Tris-HCl, 1 M NaCl, pH 7.0). The soluble periplasmic proteins were passed 2-3 times over the column. The column was washed with 10 bed volumes of starting buffer, followed by 20 bed volumes of starting buffer containing 50 mM imidazole (all steps at 4°C). The bound scFv was eluted with 3 column volumes of starting buffer containing 250 mM imidazole and dialyzed against PBS with 0.2 mM Pefabloc at 4°C for two days, with changes of dialyzing buffer.

4.2.19.3 Purification of scFv from inclusion bodies

The bacterial culture (section 4.2.19.1) was centrifuged for 15 min at 6.200× g at 4°C. The pellet was resuspended in 1/30 of initial volume of ice-cold 50 mM TE buffer, 100 mM NaCl (pH 7.0). Bacterial cells were lysed by repeated freezing/thawing, followed by sonication on ice. The lysate was centrifuged at 30.000× g for 30 min at 4°C. The supernatant was collected and referred to as cytoplasmic extract (procedures of its purification were performed essentially as above periplasmic proteins). The pellets were resuspended in the same volume of 50 mM Tris-HCl, 100 mM NaCl (pH 7.0) and centrifuged again at 30.000× g for 30 min at 4°C. The pellet (inclusion bodies) was resuspended in 1/40 of the original volume in 6 M guanidine hydrochloride (GuHCl), 0.1 M Tris-HCl (pH 7.0). The solubilization was carried out by continuous shaking overnight at 4°C. The solution was cleared by centrifugation at

30.000× g for 1 h at 4°C. For IMAC, the solubilized inclusion bodies were loaded onto a chelating Sepharose column charged with Ni²⁺ and equilibrated with binding buffer containing 6 M GuHCl, 0.1M Tris-HCl, 1 M NaCl (pH 7.0). 5 ml of chelating Sepharose per 1 l of cell culture were used. After application of the solubilized inclusion bodies, the column was washed with 10 bed volumes of binding buffer and followed by 20 volumes of 6 M urea, 50 mM Tris-HCl (pH 7.0). The bound scFv was eluted with 4 column volumes of 6 M urea, 50 mM Tris-HCl, 250 mM imidazole (pH 7.0).

Quantification of proteins was determined by Bradford method (Bradford, 1976) using BSA as a standard. The concentrations of purified scFv were calculated from the OD₂₈₀ value, using the extinction coefficient $\epsilon^{1 \text{ mg/ml}} = 1.4837$ at 280 nm calculated according to the Edelhoch method (Pace et al., 1995).

4.2.19.4 *In vitro* refolding of scFvs derived from inclusion bodies

For refolding of scFv, the above eluted scFv was dialyzed against 1 l of TEA buffer (100 mM Tris-HCl, 2 mM EDTA, 400 mM L-arginine-HCl, pH 7.0) overnight at 4°C without stirring. To achieve gradual removal of the denaturing agent (urea), half amount of dialysis solution was changed with fresh TEA buffer. Then dialysis was continued with stirring, followed by several changes of dialysis solution. An alternative to optimize renaturation conditions was employed in a step-wise dialysis system according to procedures of Tsumoto et al. (1998).

4.2.20 Construction of scFv-AP expression plasmid vector

To obtain a fusion of scFv with AP, a Bgl II restriction enzyme site was introduced at both ends of scFv by PCR using the F1BglIIBACK/FOR primers. The amplified scFv DNA was digested with Bgl II (compatible with BamH I site, since scFv 1D6 contains two sites for BamH I). Gel-purified scFv was cloned into pOPE51-AP at its BamH I site to construct pOPE-scFv-AP, which was expressed in *E. coli* TG1 strain. The correct orientation of the insert was verified by restriction enzyme digestion analysis with BamH I. The expressed scFv-AP was detected by the anti-c-myc-tag antibody 9E10 and purified by IMAC.

4.2.21 Development of detection systems based on MAb and scFv or scFv fusion proteins

The purified soluble scFv antibodies with myc-tag or E-tag as well as scFv-AP fusion protein were used for the following ELISA protocols:

- (1) PTA-ELISA: microtiter plates were coated with virus-infected plant sap. After blocking with 1% skimmed dried milk and washing with PBST, 100 μ l of scFvs specific for NIB or CP was added and incubated for 2 h. Anti-c-myc antibody was used as the secondary antibody, AP conjugated anti-mouse IgG+IgM antibody as detection antibody and p-NPP as the substrate.
- (2) competition ELISA: based on PTA-ELISA, microtiter plates were coated with the virus-infected plant sap (1:10 and 1:50 dilution, 100 μ l/well) at 4°C for 14-16 h. After 3 washes with PBST, the plates were first incubated for 2 h with mixture of scFv and MAb, one of them with a serial dilution up to 50% maximum OD values. After 4 washes, the following procedures were performed: (i) AP conjugated anti-mouse IgG+IgM antibody was added in one plate for detection MAb and p-NPP used as the substrate or (ii) mouse anti-c-myc antibody was added into the other plate for detection of the scFv-myc-tag, then AP conjugated anti-mouse IgG+IgM antibody. p-NPP was used as the substrate.

5 Summary

The objective of this work was to engineer single chain variable fragment antibodies (scFvs) to highly conserved aa motifs of the RNA-dependent RNA polymerase of potyviruses (RdRp). The expression of scFv genes in plants holds great promise to create novel resistant crops against potyviral infections. One advantage of this approach is the universal applicability of such scFv to enhance resistance to several distinct potyviruses. Another advantage is that scFv-derived transgenic plants are environmentally safe. In addition, scFvs generated might find wide application in diagnosis of potyviral diseases.

The following results were obtained:

1. Four monoclonal antibodies (MAbs) obtained from synthetic peptides covering two of the three highly conserved regions of the nuclear inclusion b protein (NIb) of potyviruses reacted with the NIb of several potyviruses in both Western blot and ELISA.
2. The sequence encoding for the NIb of potato Y virus (PVY) as well as for a synthetic protein, consisting of a fusion of all three highly conserved NIb regions, was overexpressed in and purified from *Escherichia coli* near to homogeneity by immobilized metal-ion affinity chromatography. The fusion proteins were used to test the reactivity of MAbs. The overexpressed NIb was used as an antigen for MAb production.
3. MAbs to the recombinant NIb as well as to the coat protein (CP) of PVY were obtained. It was demonstrated that they can be used to detect PVY infection. Especially, the NIb-specific MAb 2E11 is a valuable tool to identify virus infection as it could be detect the virus infection even in the absence of the coat protein.
4. Dynamics of the expression of CP and NIb in PVY-infected *Nicotiana glutinosa* and *N. occidentalis* plants was systematically investigated. Both proteins could be detected in systemically infected leaves from the fifth day post infection on by ELISA and Western blotting.
5. ScFv antibodies were generated against CP and NIb from hybridoma cells secreting MAbs. Expression of scFv 1D6F1, specific for the PVY CP, reached a maximum of 17% of total soluble proteins in *E. coli*.
6. Both phage-displayed and soluble scFv showed a similar binding affinity to the target antigens. The detection sensitivity using scFv was lower than that of the parental MAb.
7. ScFv-alkaline phosphatase (AP) fusion proteins only showed low sensitivity, probably, due to the low enzymatic activity of the bacterial AP.

6 References

1. Agrawal A and Schatz DG (1997) RAG1 and RAG2 form a stable postcleavage synaptic complex with DNA containing signal ends in V(D)J recombination. *Cell* 89:43-53.
2. Agrawal A, Eastman QM and Schatz DG (1998) Transposition mediated by RAG1 and RAG2 and its implications for the evolution of the immune system. *Nature* 394:744-751.
3. Al Medaille Z, Altschuh D, Briand JP and Van Regenmortel MHV (1984) Comparative sensitivity of different ELISA procedures for detecting monoclonal antibodies. *J Immunol Methods* 68:35-43.
4. Alberts B, Bray D, Lewis J, Raff M, Roberts K and Watson JD (1994) *Molecular biology of the cell*, (3rd edn). Garland publishing Inc, New York.
5. Aleman-Verdaguer ME, Goudou-Urbino C, Dubern J, Beachy RN and Fauquet C (1997) Analysis of the sequence diversity of the P1, HC, P3, NIb and CP genomic regions of several yam mosaic potyvirus isolates: implications for the intraspecies molecular diversity of potyviruses. *J Gen Virol* 78:1253-1264.
6. Alfthan K, Takkinen K, Sizmann D, Soderlund H and Teeri TT (1995) Properties of a single-chain antibody containing different linker peptides. *Protein Eng* 8:725-731.
7. Alt FW, Blackwell TK and Vancopoulos GD (1987) Development of the primary antibody repertoire. *Science* 238:1079-1087.
8. Andino R, Rieckhof GE and Baltimore D (1990) A functional ribonucleoprotein complex forms around the 5' end of poliovirus RNA. *Cell* 63:369-380.
9. Arbabi Ghahroudi M, Desmyter A, Wyns L, Hamers R and Muyldermans S (1997) Selection and identification of single domain antibody fragments from camel heavy-chain antibodies. *FEBS Lett* 414:521-526.
10. Arndt KM, Muller KM and Plückthun A (1998) Factors influencing the dimer to monomer transition of an antibody single-chain Fv fragment. *Biochemistry* 37:12918-2926.
11. Artsaenko O, Weiler E W, Müntz K and Conrad U (1994) Construction and functional characterisation of a single chain Fv antibody binding to the plant hormone abscisic acid. *J Plant Physiol* 144:427-429.
12. Artsaenko O, Peisker M, zur Nieden U, Fiedler U, Weiler EW, Müntz K and Conrad U (1995) Expression of a single-chain Fv antibody against abscisic acid creates a wilted phenotype in transgenic tobacco. *Plant J* 8:745-750.
13. Artsaenko O, Kettig B, Fiedler U, Conrad U and Duering K (1998): Potato tubers as a biofactory for recombinant antibodies. *Molecular Breeding* 4: 313-319.

14. Atabekov JG and Taliansky ME (1990) Expression of a plant virus-coded transport function by different viral genomes. *Advances in Virus Res* 38:201-248.
15. Atreya CD, Raccach B, and Pirone TP (1990) A point mutation in the coat protein abolishes aphid transmissibility of a potyvirus. *Virology* 178:161-165.
16. Audy P, Palukaitis P, Stack SA and Zaitlin M (1994) Replicase-mediated resistance to potato virus Y in transgenic tobacco plants. *MPMI* 7: 15-22.
17. Baca M, Scanlan TS, Stephenson R C and Wells JA (1997) Phage display of a catalytic antibody to optimize affinity for transition-state analog binding. *Proc Natl Acad Sci USA* 94:10063-10068.
18. Barbas CF III, Bain JD, Hoekstra DM and Lerner RA (1992) Semisynthetic combinatorial antibody libraries: a chemical solution to the diversity problem. *Proc Natl Acad Sci USA* 89:4457-4461.
19. Barbas CF III, Rosenblum JS and Lerner RA (1993) Direct selection of antibodies that coordinate metals from semisynthetic combinatorial libraries. *Proc Natl Acad Sci USA* 90:6385-6389.
20. Barbas CF III, Heine A, Zhong G, Hoffmann T, Gramatikova S, Björnstedt R, List B, Anderson J, Stura EA, Wilson IA and Lerner RA (1997) Immune versus natural selection: antibody aldolases with enzymic rates but broader scope. *Science* 278:2085-2092.
21. Bates HJ, Farjah M, Osman TAM and Buck KW (1995) Isolation and characterization of an RNA-dependent RNA polymerase from *Nicotiana clelandii* plants infected with red clover necrotic mosaic dianthovirus. *J Gen Virol* 76:1483-1491.
22. Baulcombe DC (1996) Mechanism of pathogen-derived resistance to viruses in transgenic plants. *The plant Cell* 8:1833-1844.
23. Baunoch DA, Das P, Browing ME and Hari V (1991) A temporal study of the expression of the capsid, cytoplasmic inclusion and nuclear inclusion proteins of tobacco etch potyvirus in infected plants. *J Gen Virol* 72:487-492.
24. Bazan JF and Fletterick RJ (1988) Viral cysteine proteases are homologous to the trypsin-like family of serine proteases: structural and functional implications. *Proc Natl Acad Sci USA* 85:7872-7876.
25. Beachy RN, Loesch-Fries S and Tumer NE (1990) Coat protein-mediated resistance against virus infection. *Ann Rev Phytopathol* 28:451-474.

26. Bendahmane M, Fitchen JH, Zhang G and Beachy RN (1997) Studies of coat protein-mediated resistance to tobacco mosaic tobamovirus: correlation between assembly of mutant coat proteins and resistance. *J Virol* 71:7942-7950.
27. Benjamini E and Leskowitz S (1991) *Immunology: a short course*, (2nd edn). Wiley-Liss, Inc., New York.
28. Bennett MJ, Choe S and Eisenberg D (1994) Refined structure of dimeric diphtheria toxin at 2.0 Å resolution. *Protein Sci* 3:1444-1463.
29. Bennett MJ, Schlunegger MP and Eisenberg D (1995) 3D domain swapping: a mechanism for oligomer assembly. *Protein Sci* 4:2455-2468.
30. Berek C and Milstein C (1988) The dynamic nature of the antibody repertoire. *Immunol Rev* 105:5-26.
31. Berkower I (1996) The promise and pitfalls of monoclonal antibody therapeutics. *Curr Opin Biotechnol* 7:622-628.
32. Berzofsky JA and Berkower IJ (1993) Immunogenicity and antigen structure. In: W. E. Paul (ed), *Fundamental Immunology*, (3rd edn). pp 235-282. Raven Press, New York,
33. Biocca S, Ruberti F, Tafani M, Pierandrei-Amaldi P and Cattaneo A (1995) Redox state of single chain Fv fragments targeted to the endoplasmic reticulum, cytosol and mitochondria. *Biotechnology (N Y)* 13:1110-1115.
34. Bird RE, Hardman KD, Jacobson JW, Johnson S, Kaufman BM, Lee SM, Lee T, Pope SH, Riordan GS and Whitlow M (1988) Single chain antigen-binding proteins. *Science* 242:423-426.
35. Blanc S, Ammar ED, Sandra Garcia-Lampasona, Dolja VV, Cesar Llave, Baker J and Pirone TP (1998) Mutations in the potyvirus helper component protein: effects on interactions with virions and aphid stylets. *J Gen Virol* 79: 3119–3122.
36. Blumenthal T and Carmichael GG (1979) RNA replication: function and structure of Q beta-replicase. *Annu Rev Biochem* 48:525-548.
37. Boder ET and Wittrup K D (1997) Yeast surface display for screening combinatorial polypeptide libraries. *Nature Biotechnol* 15:553-557.
38. Boonham N and Barker I (1998) Strain specific recombinant antibodies to potato virus Y potyvirus. *J Virol Methods* 74:193-199.
39. Bradford MM (1976) A rapid and sensitive method for the quantitation of microgram quantities of protein utilizing the principle of protein-dye binding. *Anal Biochem* 72:248-254.

40. Brantley JD and Hunt AG (1993) The N-terminal protein of the polyprotein encoded by potyvirus tobacco vein mottling virus is an RNA-binding protein. *J Gen Virol* 74:1157-1162.
41. Breitling F, Dübel S, Seehaus T, Klewinghaus I and Little M (1991) A surface expression vector for antibody screening. *Gene* 104:147-153.
42. Breitling F and Dübel S (1997) Cloning and expression of single chain fragments from mouse and rat hybridomas. In: J. M. Walker (ed), *Molecular biology-based methods in clinical diagnosis*. Humanna Press Inc, Totowa, New York.
43. Bruce WB, Christensen AH, Klein T, Fromm M and Quail PH (1989) Photoregulation of a phytochrome gene promoter from oat transferred into rice by particle bombardment. *Proc Natl Acad Sci USA* 86:9692-9696.
44. Bruenn JA (1991) Relationships among the positive strand and double-strand RNA viruses as viewed through their RNA-dependent RNA polymerases. *Nucleic acids Res* 19:217-226.
45. Brunt AA, Crabtree K, Dallwitz MJ, Gibbs AJ, Watson L and Zurcher EJ (eds) (1996 onwards). *Plant Viruses Online: Descriptions and Lists from the VIDE Database*. Version: 9th April 1997. URL <http://biology.anu.edu.au/Groups/MES/vide/>
46. Buchner J and Rudolph R (1991) Routes to active proteins from transformed microorganisms. *Curr Opin Biotechnol* 2:532-538.
47. Bujarski JJ and Kaesberg P (1986) Genetic recombination between RNA components of a multipartite plant virus. *Nature* 321:528-531.
48. Burnet FM (1957) A modification of Jerne's theory of antibody production using the concept of clonal selection. *Austral J Sci* 20:67-69.
49. Burnet FM (1959) *The clonal selection theory of acquired immunity*. Cambridge University Press, Cambridge.
50. Burnet FM (1968) *Changing patterns: an atypical autobiography*. William Heinemann, London.
51. Cairns E, Gschwender HH, Primke M, Yamakawa M, Traub P and Schweiger HG (1978) Translation of animal virus RNA in the cytoplasm of a plant cell. *Proc Natl Acad Sci USA* 75:5557-5559.
52. Candresse T (1996) The use of pathogen derived resistance and other strategies to obtain transgenic plants resistant to viruses. *Acta Hort* 424:369-374.

53. Carrington JC, Freed DD and Sanders TC (1989) Autocatalytic processing of the potyvirus helper component proteinase in *Escherichia coli* and *in vitro*. *J Virol* 63:4459-4463.
54. Carrington JC and Dougherty WG (1988) A viral cleavage site cassette: identification of amino acid sequences required for tobacco etch virus polyprotein processing. *Proc Natl Acad Sci USA* 85:3391-3395.
55. Carrington JC, Cary SM, Parks TD and Dougherty WG (1989) A second proteinase encoded by a plant potyvirus genome. *EMBO J* 8:365-370.
56. Carrington JC, Jensen PE and Schaad MC (1998) Genetic evidence for an essential role for potyvirus CI protein in cell-to-cell movement. *Plant J* 14:393-400.
57. Chen J and Alt FW (1993) Gene rearrangement and B-cell development. *Curr Opin Immunol* 5:194-200.
58. Chen YD and Chen TA (1998) Expression of engineered antibodies in plants: a possible tool for spiroplasma and phytoplasma disease control. *Phytopathology* 88:1367-1371.
59. Chen SY, Khouri Y, Bagley J and Marasco WA (1994a) Combined intra- and extracellular immunization against human immunodeficiency virus type 1 infection with a human anti-gp120 antibody. *Proc Natl Acad Sci USA* 91:5932-5936.
60. Chen SY, Bagley J and Marasco WA (1994b) Intracellular antibodies as a new class of therapeutic molecules for gene therapy. *Hum Gene Ther* 5:595-601.
61. Chester KA, Begent RH, Robson L, Keep P, Pedley RB, Boden JA, Boxer G, Green A, Winter G and Cochet O (1994) Phage libraries for generation of clinically useful antibodies. *Lancet* 343:455-456.
62. Chiang YL, Sheng-Dong R, Brow MA and Larrick JW (1989) Direct cDNA cloning of the rearranged immunoglobulin variable region. *Biotechniques* 7:360-366.
63. Chien S and Silverstein SC (1993) Economic impact of applications of monoclonal antibodies to medicine and biology. *FASEB J* 7:1426-1430.
64. Choi ICH, Park SG, Chung JH, Kim IJ and Hong HJ (1998) Generation of human Fab monoclonal antibodies against preS1 of hepatitis B virus using repertoire cloning. *Hybridoma* 17:335-340.
65. Chothia C, Lesk AM, Gherardi E, Tomlinson IM, Walter G, Marks JD, Llewelyn MB and Winter G (1992) Structural repertoire of the human V_H segments. *J Mol Biol* 227:799-817.
66. Chou PY and Fasman GD (1974) Conformational parameters for amino acids in helical, beta-sheet, and random coil regions calculated from proteins. *Biochemistry* 13:211-222.

67. Chou PY and Fasman GD (1978) Prediction of the secondary structure of proteins from their amino acid sequence. *Adv Enzymol Relat Areas Mol Biol* 47:145-148.
68. Chou PY and Fasman GD (1979) Conservation of chain reversal regions in proteins. *Biophys J* 26:385-399.
69. Citovsky V, Knorr D and Zambryski P (1991) Gene 1, a potential cell-to-cell movement locus of cauliflower mosaic virus, encoded an RNA-binding protein. *Proc Natl Acad Sci USA* 88:3476-3480.
70. Citovsky V, Wong ME, Shaw AL, Venkataram P and Zambryski P (1992) Visualization and characterization of tobacco mosaic virus movement protein binding to single-stranded nucleic acids. *Plant Cell* 4: 397-341.
71. Clackson T, Hoogenboom HR, Griffiths AD and Winter G (1991) Making antibody fragments using phage display libraries. *Nature* 352:624-628.
72. Clark MF and Adams AN (1977) Characteristics of the micro plate method of enzyme-linked immunosorbent assay for the detection of plant viruses. *J Gen Virol* 34:475-483.
73. Colcher D, Pavlinkova G, Beresford G, Booth BJ, Choudhury A and Batra SK (1998) Pharmacokinetics and biodistribution of genetically-engineered antibodies. *Q J Nucl Med* 42:225-241.
74. Conrad U, Fiedler U, Artsaenko O and Phillips J (1998) High level and stable accumulation of single-chain Fv antibodies in plant storage organs. *J Plant Physiol* 152:708-711.
75. Cook GP, Tomlinson IM, Walter G, Riethman H, Carter NP, Buluwela L, Winter G and Rabbitts TH (1994) A map of the human immunoglobulin V_H locus completed by analysis of the telomeric region of chromosome 14q. *Nat Genet* 7:162-168.
76. Cook GP and Tomlinson IM (1995) The human immunoglobulin V_H repertoire. *Immunol Today* 16:237-242.
77. Cortese R, Monaci P, Luzzago A, Santini C, Bartoli F, Cortese I, Fortugno P, Galfre G, Nicosia A and Felici F (1996) Selection of biologically active peptides by phage display of random peptide libraries. *Curr Opin Biotechnol* 7:616-621.
78. Craig L, Sanschagrin PC, Rozek A, Lackie S, Kuhn LA and Scott JK (1998) The role of structure in antibody cross-reactivity between peptides and folded proteins. *J Mol Biol* 281:183-201.
79. Cronin S, Verchot J, Haldeman-Cahill R, Schaad MC and Carrington JC (1995) Long-distance movement factor: a transport function of the potyvirus helper component proteinase. *The Plant Cell* 7:549-559.

80. Daros JA and Carrington JC (1997) RNA binding activity of Nla proteinase of tobacco etch potyvirus. *Virology* 237:327-336.
81. Daugherty PS, Chen G, Olsen MJ, Iverson BL and Georgiou G (1998) Antibody affinity maturation using bacterial surface display. *Protein Eng* 11:825-832.
82. Davies J and Riechmann L (1996) Affinity improvement of single antibody V_H domains: residues in all three hypervariable regions affect antigen binding. *Immunotechnology* 1996 2:169-179.
83. Davies EL, Smith JS, Birkett CR, Manser JM, Anderson-Dear DV and Young JR (1995) Selection of specific phage-display antibodies using libraries derived from chicken immunoglobulin genes. *J Immunol Methods* 186:125-135.
84. De Neve M, De Loose M, Jacobs A, Van Houdt H, Kaluza B, Weidle U, Van Montagu M and Depicker A (1993) Assembly of an antibody and its derived antibody fragment in *Nicotiana and Arabidopsis*. *Transgenic Res* 2:227-237.
85. De Zoeten GA (1991) Risk assessment: Do we let history repeat itself? *Phytopathology* 81:585-586.
86. Deiman BA, Seron K, Jaspars EM and Pleij CW (1997) Efficient transcription of the tRNA-like structure of turnip yellow mosaic virus by a template-dependent and specific viral RNA polymerase obtained by a new procedure. *J Virol Methods* 64:181-195.
87. Dougherty WG and Carrington JC (1988) Expression and function of potyviral gene products. *Ann Rev Phytopathol* 26:123-143.
88. Dougherty WT and Semler BL (1993) Expression of virus-encoded proteinase: functional and structural similarities with cellular enzymes. *Microbiological Reviews* 57:781-822.
89. Duan L and Pomerantz RJ (1994) Elimination of endogenous aberrant kappa chain transcripts from sp2/0-derived hybridoma cells by specific ribozyme cleavage: utility in genetic therapy of HIV-1 infections. *Nucleic Acids Res* 22:5433-5438.
90. Duan L, Zhang H, Oakes JW, Bagasra O and Pomerantz RJ (1994) Molecular and virological effects of intracellular anti-Rev single-chain variable fragments on the expression of various human immunodeficiency virus-1 strains. *Hum Gene Ther* 5:1315-1324.
91. Dübel S, Breitling F, Klewinghaus I and Little M (1992) Regulated secretion and purification of recombinant antibodies in *E. coli*. *Cell Biophys* 21:69-79.

92. Dübel S, Breitling F, Kontermann R, Schmidt T, Skerra A and Little M (1995) Bifunctional and multimeric complexes of streptavidin fused to single-chain antibodies (scFv). *J Immunol Meth* 178:201-209.
93. Ducancel F, Gillet D, Carrier A, Lajeunesse E, Menez A and Boulain JC (1993) Recombinant colorimetric antibodies: construction and characterization of a bifunctional F(ab)₂/alkaline phosphatase conjugate produced in *Escherichia coli*. *Biotechnology (N Y)* 11:601-605.
94. Duenas M and Borrebaeck CA (1994) Clonal selection and amplification of phage displayed antibodies by linking antigen recognition and phage replication. *Bio/Technol.* 12:999-1002.
95. Düring K, Hippe S, Kreuzaler F and Schell J (1990) Synthesis and self-assembly of a functional monoclonal antibody in transgenic *Nicotiana tabacum*. *Plant Mol Biol* 15:281-293.
96. Dunn IS (1996) Phage display of proteins. *Curr Opin Biotechnol* 7:547-553.
97. Edwards JW, Walker EL and Coruzzi GM (1990) Cell-specific expression in transgenic plants reveals nonoverlapping roles for chloroplast and cytosolic glutamine synthetase. *Proc Natl Acad Sci USA* 87: 3459-3463.
98. Eigenbrot C, Randal M, Presta L, Carter P and Kossiakoff AA (1993) X-ray structures of the antigen-binding domains from three variants of humanized anti-p185HER2 antibody 4D5 and comparison with molecular modeling. *J Mol Biol* 229:969-995.
99. El Kasmi KC, Theisen D, Brons NH and Muller CP (1998) The molecular basis of virus crossreactivity and neutralisation after immunisation with optimised chimeric peptides mimicking a putative helical epitope of the measles virus hemagglutinin protein. *Mol Immunol* 35:905-918.
100. Ermert K, Mitlohner H, Schempp W and Zachau HG (1995) The immunoglobulin kappa locus of primates. *Genomics* 25:623-629.
101. Esser C and Radbruch A (1990) Immunoglobulin class switching: molecular and cellular analysis. *Annu Rev Immunol* 8:717-735.
102. Essig NZ, Wood JF, Howard AJ, Raag R and Whitlow M (1993) Crystallization of single-chain Fv proteins. *J Mol Biol* 234:897-901.
103. Farah RA, Clinchy B, Herrera L and Vitetta ES (1998) The development of monoclonal antibodies for the therapy of cancer. *Crit Rev Eukaryot Gene Expr* 8:321-356.
104. Fecker LF, Kaufmann A, Commandeur U, Commandeur J, Koenig R and Burgermeister W (1996) Expression of single-chain antibody fragments (scFv) specific for beet necrotic

- yellow vein virus coat protein or 25 kDa protein in *Escherichia coli* and *Nicotiana benthamiana*. *Plant Mol Biol* 32:979-986.
105. Fecker LF, Koenig R and Obermeier C (1997) *Nicotiana benthamiana* plants expressing beet necrotic yellow vein virus (BNYVV) coat protein-specific scFv are partially protected against the establishment of the virus in the early stages of infection and its pathogenic effects in the late stages of infection. *Arch Virol* 142:1857-1863.
106. Fellers JP, Collins GB, and Hunt AG (1998a) The NIa-proteinase of different plant potyviruses provides specific resistance to viral infection. *Crop Sci.* 38:1309-1319.
107. Fellers J, Wan J, Hong Y, Collins GB and Hunt AG (1998b) *In vitro* interactions between a potyvirus-encoded, genome-linked protein and RNA-dependent RNA polymerase. *J Gen Virol* 79:2043-2049.
108. Field H, Yarranton GT and Rees AR (1990) Expression of mouse immunoglobulin light and heavy chain variable regions in *Escherichia coli* and reconstitution of antigen-binding activity. *Protein Eng* 3:641-647.
109. Fiedler U and Conrad U (1995) High-level production and long-term storage of engineered antibodies in transgenic tobacco seeds. *Biotechnology (N Y)* 13:1090-1093.
110. Fiedler U, Phillips J, Artsaenko O and Conrad U (1997) Optimization of scFv antibody production in transgenic plants. *Immunotechnology* 3:205-216.
111. Firek S, Draper J, Owen MRL, Ganfecha A, Cockburn B and Whitlam GC (1993) Secretion of a functional single-chain Fv protein in transgenic tobacco plants and cell suspension cultures. *Plant Mol Biol* 23:861-870.
112. Flanagan JG and Rabbitts TH (1982) Arrangement of human immunoglobulin heavy chain constant region genes implies evolutionary duplication of a segment containing gamma, epsilon and alpha genes. *Nature* 300:709-713.
113. Flanagan JG, Lefranc MP and Rabbitts TH (1984) Mechanisms of divergence and convergence of the human immunoglobulin alpha 1 and alpha 2 constant region gene sequences. *Cell* 36:681-688.
114. Franconi R, Roggero P, Pirazzi P, Arias FJ, Desiderio A, Bitti O, Pashkoulov D, Mattei B, Bracci L, Masenga V, Milne RG and Benvenuto E (1999) Functional expression in bacteria and plants of an scFv antibody fragment against tospoviruses. *Immunotechnology* 4:189-201
115. Freund C, Ross A, Guth B, Plückthun A and Holak TA (1993) Characterization of the linker peptide of the single-chain Fv fragment of an antibody by NMR spectroscopy. *FEBS Lett* 320:97-100.

116. Fripiat JP, Dard P, Marsh S, Winter G and Lefranc MP (1997) Immunoglobulin lambda light chain orphans on human chromosome 8q11.2. *Eur J Immunol* 27:1260-1265.
117. Fütterer J and Hohn T (1996) Translation in plants—rules and exceptions. *Plant Mol Biol* 32:159-189.
118. Gandecha A, Owen MR, Cockburn W and Whitlam GC (1994) Antigen detection using recombinant, bifunctional single-chain Fv fusion proteins synthesised in *Escherichia coli*. *Protein Expr Purif* 5:385-390.
119. Garcia JA, Martin MT, Cervera MT and Riechmann JL (1992) Proteolytic processing of the plum pox potyvirus polyprotein by the NIa protease at a novel cleavage site. *Virology* 188:697-703.
120. Gilbert HF (1990) Molecular and cellular aspects of thiol-disulfide exchange. *Adv Enzymol Relat Areas Mol Biol* 63:69-172.
121. Gillespie PG and Hudspeth AJ (1991) Chemiluminescence detection of proteins from single cells. *Proc Natl Acad Sci USA* 88:2563-2567.
122. Goldbaum FA, Cauerhff A, Velikovskiy CA, Llera AS, Riottot MM and Poljak RJ (1999) Lack of significant differences in association rates and affinities of antibodies from short-term and long-term responses to hen egg lysozyme. *J Immunol* 162:6040-6045.
123. Gorbalenya AE, Koonin EV, Donchenko AP and Blinov VM (1988) A novel superfamily of nucleoside triphosphate-binding motif containing proteins which are probably involved in duplex unwinding in DNA and RNA replication and recombination. *FEBS Lett* 235:16-24.
124. Gram H, Marconi LA, Barbas CF III, Collet TA, Lerner RA and Kang AS (1992) *In vitro* selection and affinity maturation of antibodies from a naive combinatorial immunoglobulin library. *Proc Natl Acad Sci USA* 89:3576-3580.
125. Greene AE and Allison RF (1994) Recombination between viral RNA and transgenic plant transcripts. *Science* 263:1423-1425.
126. Griep RA, van Twisk C, Kerschbaumer RJ, Harper K, Torrance L, Himmler G, van der Wolf JM and Schots A (1999) pSKAP/S: An expression vector for the production of single-chain Fv alkaline phosphatase fusion proteins. *Protein Expr Purif* 16:63-69.
127. Griffiths AD, Malmqvist M, Marks JD, Bye JM, Embleton MJ, McCafferty J, Baier M, Holliger KP, Gorick BD, Hughes-Jones NC, Hoogenboom HR and Winter G (1993) Human anti-self antibodies with high specificity from phage display libraries. *EMBO J* 12:725-734.

-
128. Guerineau F (1995) Tools for expressing foreign genes in plants. In: H. Jones (ed), Plant gene transfer and expression protocols. In a series of Methods in Molecular Biology, Vol. 49. Humana Press Inc. New Jersey.
 129. Guo D, Merits A and Saarma M (1999) Self-association and mapping of interaction domains of helper component-proteinase of potato A potyvirus. *J Gen Virol* 80:1127-1131.
 130. Guo HS and Garcia JA (1997) Delayed resistance to plum pox potyvirus mediated by a mutated RNA replicase gene: involvement of a gene-silencing mechanism. *MPMI* 10: 160-170.
 131. Guo HS, Cervera MT and Garcia JA (1998) Plum pox potyvirus resistance associated to transgene silencing that can be stabilized after different number of plant generations. *Gene* 206:263-272.
 132. Hajimorad MR, Ding XS, Flasinski S, Mahajan S, Graff E, Haldeman-Cahill R, Carrington and Cassidy BG (1996) NIa and NIb of peanut stripe potyvirus are present in the nucleus of infected cells, but do not form inclusion. *Virology* 224:368-379.
 133. Hammond J and Dienelt MM (1997) Encapsidation of potyviral RNA in various forms of transgene coat protein is not correlated with resistance in transgenic plants. *MPMI* 10:1023-1027.
 134. Hanes J and Plückthun A (1997) *In vitro* selection and evolution of functional proteins using ribosome display. *Proc Natl Acad Sci USA* 94:4937-4942.
 135. Hanes J, Jermutus L, Weber-Bornhauser S, Bosshard HR and Plückthun A (1998) Ribosome display efficiently selects and evolves high-affinity antibodies *in vitro* from immune libraries. *Proc Natl Acad Sci USA* 95:14130-14135.
 136. Harper K, Kerschbaumer RJ, Ziegler A, Macintosh SM, Cowan GH, Himmler G, Mayo MA and Torrance L (1997) A scFv-alkaline phosphatase fusion protein which detects potato leafroll luteovirus in plant extracts by ELISA. *J Virol Methods* 63:237-242.
 137. Harriman WH, Völk H, Defranoux N and Wabl M (1993) Immunoglobulin class switch recombinations. *Annu Rev Immunol* 11:361-384.
 138. Hayes RJ and Buck KW (1990) Complete replication of a eukaryotic virus RNA *in vitro* by a purified RNA-dependent RNA polymerase. *Cell* 63:363-368.
 139. Hayes RJ, Pereira VCA, McQuillin A and Buck KW (1994) Location of functional regions of the cucumber mosaic virus RNA replicase using monoclonal and polyclonal antibodies. *J Gen Virol* 75:3177-3184.

-
140. He M, Hamon M, Liu H, Kang A and Taussig MJ (1995) Functional expression of a single chain anti-progesterone antibody fragment in the cytoplasm of a mutant *Escherichia coli*. *Nucleic Acids Res* 19:4009-4010.
 141. Hein MB, Tang Y, McLeod DA, Janda KD and Hiatt A (1991) Evaluation of immunoglobulins from plant cells. *Biotechnol Prog* 7:455-461.
 142. Hiatt A, Cafferkey R and Bowdish K (1989) Production of antibodies in transgenic plants. *Nature* 342:76-78.
 143. Hiatt A (1990) Antibodies produced in plants. *Nature* 344:469-470.
 144. Hodgman TC (1998) A new superfamily of replicase proteins. *Nature* 333:22-23.
 145. Hong Y, Levay K, Murphy JF, Klein PG, Shaw JG and Hunt AG (1995) A potyvirus polymerase interacts with the viral coat protein and VPg in yeast cells. *Virology* 241:159-166.
 146. Hong Y and Hunt AG (1996) RNA polymerase activity catalyzed by a potyvirus-encoded RNA-dependent RNA polymerase. *Virology* 226:146-151.
 147. Hoogenboom HR and Winter G (1992) By-passing immunisation. Human antibodies from synthetic repertoires of germline V_H gene segments rearranged *in vitro*. *J Mol Biol* 227:381-388.
 148. Hoogenboom HR, de Brine AP, Hufton SE, Hoet RM, Arends J and Roovers RC (1998) Antibody phage display technology and its applications. *Immunotechnology* 4:1-20.
 149. Hopp TP and Woods KR (1981) Prediction of protein antigenic determinants from amino acid sequences. *Proc Natl Acad Sci USA* 78:3824-3828.
 150. Hsieh-Wilson LC, Schultz PG and Stevens RC (1996) Insights into antibody catalysis: structure of an oxygenation catalyst at 1.9-angstrom resolution. *Proc Natl Acad Sci USA*, 93:5363-5367.
 151. Huang SC, Jiang R, Glas AM and Milner EC (1996) Non-stochastic utilization of Ig V region genes in unselected human peripheral B cells. *Mol Immunol* 33:553-560.
 152. Huston JS, Levinson D, Mudgett-Hunter M, Tai MS, Novotny J, Margolies MN, Ridge RJ, Brucoleri RE, Haber E, Crea R and Opperman H (1988) Protein engineering of antibody binding sites: recovery of specific activity in an anti-digoxin single-chain Fv analogue produced in *Escherichia coli*. *Proc. Natl. Acad. Sci USA* 85:5879-5883.
 153. Huston JS, McCartney J, Tai M S, Mottola-Hartshorn C, Jin D, Warren F, Keck P and Oppermann H (1993) Medical applications of single-chain antibodies. *Intern Rev Immunol* 10:195-217.

154. Hudson P (1995) Structure and application of single-chain Fvs as diagnostic and therapeutic agents. In: H. Zola (ed), Monoclonal antibodies the second generation. BIOS Scientific Publishers Limited, Oxford, UK.
155. Ishihama A and Barbier P (1994) Molecular anatomy of viral-directed RNA polymerase (Brief Review). Arch Virol 134:235-258.
156. Jakab G, Droz E, Brigneti G, Baulcombe D and Malnoë P (1997) Infectious *in vivo* and *in vitro* transcripts from a full-length cDNA clone of PVY-N605, a Swiss necrotic isolate of potato virus Y. J Gen Virol 78:3141–3145.
157. Jayaram C, Van Deusen RA, Eggenberger AL, Schwabacher AW and Hill JH (1998) Characterization of a monoclonal antibody recognizing a DAG-containing epitope conserved in aphid transmissible potyviruses: evidence that the DAG motif is in a defined conformation. Virus Res 58:1-11.
158. Jin L, Fendly BM and Wells JA (1992) High resolution functional analysis of antibody-antigen interactions. J Mol Biol 226: 851-865.
159. Joisson C, Dubs MC and Van Regenmortel MHV (1992a) Detection of potyviruses with antisera raised against synthetic peptides. Research in Virology 143:167-178.
160. Joisson C, Dubs MC and Van Regenmortel MHV (1992b) Cross-reaction of potential of monoclonal antibodies raised against proteolysed tobacco etch virus. Research in Virology 143:155-166.
161. Jones AL, Johansen IE, Bean SJ, Bach I and Maule AJ (1998) Specificity of resistance to pea seed-borne mosaic potyvirus in transgenic peas expressing the viral replicase (NIb) gene. J Gen Virol 79:3129-3137.
162. Jones H (1995) Plant gene transfer and expression protocols. In: J. M. Walker (ed), Methods in molecular biology, Vol. 49. Humana Press Inc. New Jersey.
163. Jordan R and Hammond J (1991) Comparison and differentiation of potyvirus isolates and identification of strain-, virus-, subgroup-specific and potyvirus group-common epitopes using monoclonal antibodies. J Gen Virol 72:25-36.
164. Jorgensen RA, Atkinson RG, Forster RLS and Lucas WJ (1998) An RNA-based information superhighway in plants. Science 279:1486-1487.
165. Jung S and Plückthun A (1997) Improving *in vivo* folding and stability of a single-chain Fv antibody fragment by loop grafting. Prot Eng 10: 959-966.
166. Kabat EA and Wu TT (1991) Identical V region amino acid sequences and segments of sequences in antibodies of different specificities. J Immunol 147:1709-1719.

167. Kabat EA, Wu TT, Reid-Miller M, Perry HM and Gottesman KS (1991) Sequences of proteins of immunological interest, (5th edn). National Institutes of Health, Bethesda, Maryland.
168. Kasschau KD and Carrington JC (1995) Requirement for HC-Pro processing during genome amplification of tobacco etch potyvirus. *Virology* 209:268-273.
169. Kearney JF, Radbruch A, Liesegang B and Rajewsky K (1979) A new mouse myeloma cell line that has lost immunoglobulin expression but permits the construction of antibody-secreting hybridoma cell lines. *J Immunol* 123:1548-1550.
170. Keller KE, Johansen IE, Martin RR and Hampton RO (1998) Potyvirus genome-linked protein (VPg) determines pea seed-borne mosaic virus pathotype-specific virulence in *Pisum sativum*. *MPMI* 11:124-130.
171. Kerschbaumer RJ, Hirschl S, Kaufmann A, Ibl M, Koenig R and Himmler G (1997) Single-chain Fv fusion proteins suitable as coating and detecting reagents in a double antibody sandwich enzyme-linked immunosorbent assay. *Analytical Biochem* 249:219-227.
172. Kim DY, Han JS, Lew J, Kim SS, Kang BH, Hwang DC, Jang DS, Kim W, Song BD and Choi KY (1998) Effects of mutations in the C-terminal region of NIa protease on *cis*-cleavage between NIa and NIb. *Virology* 241:94-100.
173. King RD and Sternberg MJ (1996) Identification and application of the concepts important for accurate and reliable protein secondary structure prediction. *Protein Sci* 5:2298-2310.
174. Kipriyanov SM, Duebel S, Breitling F, Kontermann RE and Little M (1994) Recombinant single-chain Fv fragments carrying C-terminal cysteine residues: production of bivalent and biotinylated miniantibodies. *Mol Immunol* 31:1047-1058.
175. Kipriyanov SM, Duebel S, Breitling F, Kontermann RE, Heymann S and Little M (1995) Bacterial expression and refolding of single-chain Fv fragments with C-terminal cysteines. *Cell Biophys* 26:187-204.
176. Kirschbaum T, Jaenichen R and Zachau HG (1996) The mouse immunoglobulin kappa locus contains about 140 variable gene segments. *Eur J Immunol* 26:1613-1620.
177. Klein TM, Arentzen R, Lewis PA and Fitzpatrick-McElligott S (1992) Transformation of microbes, plants and animals by particle bombardment. *Biotechnology (N Y)* 10:286-291.
178. Klein TM and Fitzpatrick-McElligott S (1993) Particle bombardment: a universal approach for gene transfer to cells and tissues. *Curr Opin Biotechnol* 4:583-590.

-
179. Knappik A and Plückthun A (1995) Engineered turns of a recombinant antibody improve its *in vivo* folding. *Protein Eng* 8:81-89.
 180. Kohl J, Ruker F, Himmler G, Razazzi E and Katinger H (1991) Cloning and expression of an HIV-1 specific single-chain Fv region fused to *Escherichia coli* alkaline phosphatase. *Ann N Y Acad Sci* 646:106-114.
 181. Köhler G and Milstein C (1975) Continuous cultures of fused cells secreting antibody of predefined specificity. *Nature* 256:495-497.
 182. Koonin EV (1991) The phylogeny of RNA-dependent RNA polymerases of positive-strand RNA viruses. *J Gen Virol* 72:2197-2206.
 183. Koonin EV and Dolja VV (1993) Evolution and taxonomy of positive-strand RNA viruses: implications of comparative analysis of amino acid sequences. *Crit Rev Biochem Mol Biol* 28:375-430.
 184. Kopetzki E, Lehnert K and Buckel P (1994) Enzymes in diagnostics: achievements and possibilities of recombinant DNA technology. *Clin Chem* 40:688-704.
 185. Kortt AA, Malby RL, Caldwell JB, Gruen LC, Ivancic N, Lawrence MC, Howlett GJ, Webster RG, Hudson PJ and Colman PM (1994) Recombinant anti-sialidase single-chain variable fragment antibody: Characterization, formation of dimer and higher-molecular-mass multimers and the solution of the crystal structure of the single-chain variable fragment/sialidase complex. *Eur J Biochem* 221:151-157.
 186. Krebber C, Spada S, Desplancq D and Plückthun A (1995) Coselection of cognate antibody-antigen pairs by selectively-infective phages. *FEBS Lett* 377:227-231.
 187. Kuby J (1997) Organization and expression of immunoglobulin genes, In: J. Kuby (ed), *Immunology*, (3 edn). W. H. Freeman & Company, New York.
 188. Laemmli UK (1970) Cleavage of structural proteins during the assembly of the head of bacteriophage T4. *Nature* 227:680-685.
 189. Lain S, Riechmann JL and Garcia JA (1990) RNA helicase: a novel activity associated with a protein encoded by a positive strand RNA virus. *Nucleic Acids Res* 18:7003-7006.
 190. Lang IM, Barbas CF III and Schleef RR (1996) Recombinant rabbit Fab with binding activity to type-1 plasminogen activator inhibitor derived from a phage-display library against human alpha-granules. *Gene* 172:295-298.
 191. Langenberg WG and Zhang L (1997) Immunocytology shows the presence of tobacco etch virus P3 protein in nuclear inclusions. *J Struct Biol* 118:243-247.

-
192. Larrick JW, Danielsson L, Brenner CA, Abrahamson M, Fry KE and Borrebaeck CA (1989) Rapid cloning of rearranged immunoglobulin genes from human hybridoma cells using mixed primers and the polymerase chain reaction. *Biochem Biophys Res Commun* 160:1250-1256.
193. Laurino JP, Shi Q and Ge J (1999) Monoclonal antibodies, antigens and molecular diagnostics: a practical overview. *Ann Clin Lab Sci* 29:158-166.
194. Lautner-Rieske A, Thiebe R and Zachau HG (1995) Searching for non-V kappa transcripts from the human immunoglobulin kappa locus. *Gene* 159:199-202.
195. Le Gall F, Bove JM and Garnier M (1998) Engineering of a single-chain variable-fragment (scFv) antibody specific for the stolbur phytoplasma (Mollicute) and its expression in *Escherichia coli* and tobacco plants. *Applied and Environmental Microbiology* 64:4566-4572.
196. Legorburu FJ, van den Bovenkamp GW, Browing I, Darling M, de Haan EG, Parper K, Pereira LG, Serra C, Toth R and Torrance L (1998) Routine detection of PLRV by recombinant antibodies: prospects for inter-laboratory standarization. The 10th EAPR Virology section meeting, Abstract, p 71-72.
197. Leiser RM and Richter J (1978) Reinigung und einige Eigenschaften des Kartoffel-Y-Virus. *Arch Phytopath PflSchutz* 14:337-350.
198. Levelt CN, de Jong YP, Mizoguchi E, O'Farrelly C, Bhan AK, Tonegawa S, Terhorst C and Simpson SJ (1999) High- and low-affinity single-peptide/MHC ligands have distinct effects on the development of mucosal CD8alphaalpha and CD8alphabeta T lymphocytes. *Proc Natl Acad Sci USA* 96:5628-5633.
199. Levin R, Mhashilkar AM, Dorfman T, Bukovsky A, Zani C, Bagley J, Hinkula J, Niedrig M, Albert J, Wahren B, Gottlinger HG and Marasco WA (1997) Inhibition of early and late events of the HIV-1 replication cycle by cytoplasmic Fab intrabodies against the matrix protein, p17. *Mol Med* 3:96-110.
200. Li XH and Carrington JC (1993) Nuclear transport of tobacco etch potyviral RNA-dependent RNA polymerase is highly sensitive to sequence alterations. *Virology* 193:951-958.
201. Li XH, Valdez P, Olvera RE and Carrington JC (1997) Functions of the tobacco etch virus RNA polymerase (NIb): subcellular transport and protein-protein interaction with VPg/proteinase(NIa). *J Virol* 71:1589-1607.

-
202. Lilley GG, Dolezal O, Hillyard CJ, Bernard C and Hudson PJ (1994) Recombinant single-chain antibody peptide conjugates expressed in *Escherichia coli* for the rapid diagnosis of HIV. *J Immunol Methods* 171:211-226.
 203. Little M, Breitling F, Dübel S, Fuchs P and Braunagel M (1995) Human antibody libraries in *Escherichia coli*. *J Biotechnol* 41:187-195.
 204. Liu F, Schubert J and Ambrosova S (1999a) Monoclonal antibodies against RNA-dependent RNA polymerase of potato Y potyvirus and their use in the detection of virus infection. *Zeitschrift für Pflanzenkrankheiten und Pflanzenschutz*. 106:181-187.
 205. Liu F, Sukhacheva L, Erokhina T and Schubert J (1999b) Detection of potyviral nuclear inclusion b protein by monoclonal antibodies raised to synthetic peptides. *Eur J Plant Pathol* 105:389-395.
 206. Longstaff M, Newell CA, Boonstra B, Strachan G, Learmonth D, Harris WJ, Porter AJ and Hamilton WD (1998) Expression and characterisation of single-chain antibody fragments produced in transgenic plants against the organic herbicides atrazine and paraquat. *Biochim Biophys Acta* 1381:147-160.
 207. Lubkowski J, Hennecke F, Pluckthun A and Wlodawer A (1998) The structural basis of phage display elucidated by the crystal structure of the N-terminal domains of g3p. *Nat Struct Biol* 5:140-147.
 208. Ma L, Hsieh-Wilson LC and Schultz PG (1998) Antibody catalysis of peptidyl-prolyl cis-trans isomerization in the folding of RNase T1. *Proc Natl Acad Sci USA* 95:7251-7256.
 209. Mack M, Gruber R, Schmidt S, Riethmuller G and Kufer P (1997) Biologic properties of a bispecific single-chain antibody directed against 17-1A (EpCAM) and CD3: tumor cell-dependent T cell stimulation and cytotoxic activity. *J Immunol* 158:3965-3970.
 210. Maiti IB, Murphy JF, Shaw JG and Hunt AG (1993) Plants that express a potyvirus proteinase gene are resistant to virus infection. *Proc Natl Acad Sci USA* 90:6110-6114.
 211. Malcolm S, Barton P, Murphy C, Ferguson-Smith MA, Bentley DL and Rabbitts TH (1982) Localization of human immunoglobulin kappa light chain variable region genes to the short arm of chromosome 2 by *in situ* hybridization. *Proc Natl Acad Sci USA* 79:4957-4961.
 212. Mallender WD, Carrero J and Voss EW JR (1996) Comparative properties of the single chain antibody and Fv derivatives of mAb 4-4-20: Relationship between interdomain interactions and the high affinity for fluorescein ligand. *J Biol Chem* 271:5338-5346.

-
213. Mandecki W, Shallcross MA, Sowadski J and Tomazic-Allen S (1991) Mutagenesis of conserved residues within the active site of *Escherichia coli* alkaline phosphatase yields enzymes with increased kcat. *Protein Eng* 4:801-804.
214. Marasco WA, Haseltine WA and Chen SY (1993) Design, intracellular expression, and activity of a human anti-human immunodeficiency virus type 1 gp120 single-chain antibody. *Proc Natl Acad Sci USA* 90:7889-7893.
215. Marasco WA (1995) Intracellular antibodies (introbodies) as research reagents and therapeutic molecules for gene therapy. *Immunotechnology* 1:1-19.
216. Marks JD, Hoogenboom HR, Bonnert TP, McCafferty J, Griffiths AD and Winter G (1991) By-passing immunization. Human antibodies from V-gene libraries displayed on phage. *J Mol Biol* 222:581-597.
217. Marks JD, Griffiths AD, Malmqvist M, Clackson TP, Bye JM and Winter G (1992) By-passing immunization: building high affinity human antibodies by chain shuffling. *Biotechnology (N Y)* 10:779-783.
218. Martin MT, Lopez Otin C, Lain S and Garcia JA (1990) Determination of polyprotein processing sites by amino terminal sequencing of nonstructural proteins encoded by plum pox potyvirus. *Virus Res* 15:97-106.
219. Martineau P, Jones P and Winter G (1998) Expression of an antibody fragment at high levels in the bacterial cytoplasm. *J Mol Biol* 280:117-127.
220. Mathur J and Koncz C (1998) PEG-mediated protoplast transformation with naked DNA. *Methods Mol Biol* 82:267-276.
221. Mattheakis LC, Bhatt R R and Dower W J (1994) An *in vitro* polysome display system for identifying ligands from very large peptide libraries. *Proc Natl Acad Sci USA* 91:9022-9026.
222. Melnick J, Dul JL and Argon Y (1994) Sequential interaction of the chaperones BiP and GRP94 with immunoglobulin chains in the endoplasmic reticulum. *Nature* 370:373-375.
223. Merk H, Stiege W, Tsumoto K, Kumagai I and Erdmann VA (1999) Cell-free expression of two single-chain monoclonal antibodies against lysozyme: Effect of domain arrangement on the expression. *J Biochem* 125:328-333.
224. Mersmann M, Schmidt A, Tesar M, Schoneberg A, Welschof M, Kipriyanov S, Terness P, Little M, Pfizenmaier K and Moosmayer D (1998) Monitoring of scFv selected by phage display using detection of scFv-pIII fusion proteins in a microtiter scale assay. *J Immunol Methods* 220:51-58.

-
225. Mhashilkar AM, Bagley J, Chen SY, Szilvay AM, Helland DG and Marasco WA (1995) Inhibition of HIV-1 Tat-mediated LTR transactivation and HIV-1 infection by anti-Tat single chain intrabodies. *EMBO J* 14:1542-1551.
226. Mhashilkar AM, Biswas DK, LaVecchio J, Pardee AB and Marasco WA (1997) Inhibition of human immunodeficiency virus type 1 replication *in vitro* by a novel combination of anti-Tat single-chain intrabodies and NF-kappa B antagonists. *J Virol* 71:6486-6494.
227. Milstein CP, Deverson EV and Rabbitts TH (1984) The sequence of the human immunoglobulin mu-delta intron reveals possible vestigial switch segments. *Nucleic Acids Res* 12:6523-6535.
228. Moreno M, Bernal J J, Jiménez I and Rodríguez-Cerezo E (1998) Resistance in plants transformed with the P1 or P3 gene of tobacco vein mottling potyvirus. *J Gen Virol* 79:2819-2827.
229. Mowat WP (1985) Simplified enzyme immunoassay for plant virus detection and identification. Report of the Scottish Crop Research Institute for 1984, pp 188.
230. Mylvaganam SE, Paterson Y and Getzoff ED (1998) Structural basis for the binding of an anti-cytochrome c antibody to its antigen: crystal structures of FabE8-cytochrome c complex to 1.8 Å resolution and FabE8 to 2.26 Å resolution. *J Mol Biol* 281:301-322.
231. Navarro-Teulon I, Peraldi-Roux S, Bernardi T, Marin M, Piechaczyk M, Shire D, Pau B and Biard-Piechaczyk M (1995) Expression in *Escherichia coli* of soluble and M13 phage-displayed forms of a single-chain antibody fragment specific for digoxin: assessment in a novel drug immunoassay. *Immunotechnology* 1:41-52.
232. Nicolas O, Dunnington SW, Gotow LF, Pirone TP and Hellmann GM (1997) Variations in the VPg protein allow a potyvirus to overcome va gene resistance in tobacco. *Virology* 237: 452-459.
233. Nissim A, Hoogenboom HR, Tomlinson IM, Flynn G, Midgley C, Lane D and Winter G (1994) Antibody fragments from a 'single pot' phage display library as immunochemical reagents. *EMBO J* 13:692-698.
234. Orlandi R, Güssow DH, Jones PT and Winter G (1989) Cloning immunoglobulin variable domains for expression by the polymerase chain reaction. *Proc Natl Acad Sci USA* 86:3833-3837.
235. Osbourn JK, Sarkar S and Wilson TMA (1990) Complementation of coat protein-defective TMV mutants in transgenic tobacco plants expressing TMV coat proteins. *Virology* 179:921-925.

-
236. Osman TAM, Hayes RG and Buck KW (1992) Cooperative binding of the red clover necrotic mosaic virus movement protein to single-stranded nucleic acids. *J Gen Virol* 73:223-227.
237. Osman TAM, Thömmes P and Buck KW (1993) Localization of a single-stranded RNA-binding domain in the movement protein of red clover necrotic mosaic dianthovirus. *J Gen Virol* 74: 2453-2457.
238. Ostermeier C and Michel H (1996) Improved cloning of antibody variable regions from hybridomas by an antisense-directed RNase H digestion of the P3-X63-Ag8.653 derived pseudogene mRNA. *Nucleic Acids Res* 24:1979-1980.
239. Otsuki Y and Takebe I (1978) Production of mixedly coated particles in tobacco mesophyll protoplasts double infected by strains of tobacco mosaic virus. *Virology* 84:162-171.
240. Owen M, Gandecha A, Cockburn B and Whitelam G (1992) Synthesis of a functional anti-phytochrome single-chain Fv protein in transgenic tobacco. *Bio/technology* 10:790-794.
241. Pace CN, Vajdos F, Fee L, Grimsley G and Gray T (1995) How to measure and predict the molar absorption coefficient of a protein. *Protein Sci* 4:2411-2423.
242. Pack P and Plückthun A (1992) Miniantibodies: use of amphipathic helices to produce functional flexibly linked dimeric Fv fragments with high avidity in *Escherichia coli*. *Biochemistry* 31:1279-1584.
243. Pack P, Kujau M, Schroeckh V, Knüpfer U, Wenderoth R, Riesenberg D and Plückthun A (1993) Improved bivalent miniantibodies, with identical avidity as whole antibodies, produced by high cell density fermentation of *Escherichia coli*. *Bio/Technology* 11:1271-1277.
244. Panousis C and Pietersz GA (1999) Monoclonal antibody-directed cytotoxic therapy: potential in malignant diseases of aging. *Drugs Aging* 15:1-13.
245. Pehu TM, Maki-Valkama TK, Valkonen KT, Koivu KT, Lehto KM and Pehu EP (1995) Potato plants transformed with a potato virus Y P1 gene sequence are resistant to PVY^O. *American Potato J* 72:523-532.
246. Pei XY, Holliger P, Murzin AG and Williams RL (1997) The 2.0 Å resolution crystal structure of a trimeric antibody fragment with noncognate V_H-V_L domain pairs shows a rearrangement of V_H CDR3. *Proc Natl Acad Sci USA* 94:9637-9642.
247. Perisic O, Webb PA, Holliger P, Winter G and Williams RL (1994) Crystal structure of a diabody, a bivalent antibody fragment. *Structure* 2:1217-1226.

-
248. Pfaff E, Mussgay M, Böhm HO, Schultz GE and Schaller H (1982) Antibodies against a preselected peptide recognize and neutralize foot and mouth disease virus. *EMBO J* 1:869-874.
249. Phizicky EM and Fields S (1995) Protein-protein interactions: methods for detection and analysis. *Microbiol Rev* 59:94-123.
250. Plückthun A and Pack P (1997) New protein engineering approaches to multivalent and bispecific antibody fragments. *Immunotechnology* 3:83-106.
251. Pollack SJ, Jacobs JW, and Schultz PG (1986) Selective chemical catalysis by an antibody. *Science* 234:1570-1573.
252. Powell-Able P, Nelson RS, De B, Hoffman N, Rogers SG, Fraley RT and Beachy RN (1986) Delay of disease development in transgenic plants that express the tobacco mosaic virus coat protein gene. *Science* 232:738-743.
253. Prins M and Goldbach R (1996) RNA-mediated virus resistance in transgenic plants. *Arch Virol* 141:2259-2276.
254. Proba K, Worn A, Honegger A and Plückthun A (1998) Antibody scFv fragments without disulfide bonds made by molecular evolution. *J Mol Biol* 275:245-253.
255. Puurand U, Makinen K, Paulin L and Saarma M (1994) The nucleotide sequence of potato virus A genomic RNA and its sequence similarities with other potyviruses. *J Gen Virol* 75:457-461.
256. Quadt R and Jaspars EM (1990) Purification and characterization of brome mosaic virus RNA-dependent RNA polymerase. *Virology* 178:189-194.
257. Quadt R, Kao CC, Browning KS, Hershberger RP and Ahlquist P (1993) Characterization of a host protein associated with brome mosaic virus RNA-dependent RNA polymerase. *Proc Natl Acad Sci USA* 90:1498-1502.
258. Quemada H, Sieu LC, Siemieniak DR, Gonsalves D and Slightom JL (1990) Watermelon mosaic virus II and zucchini yellow mosaic virus: cloning of 3'-terminal regions, nucleotide sequences, and phylogenetic comparisons. *J Gen Virol* 71:1451-1460.
259. Raag R and Whitlow M (1995) Single-chain Fvs. *FASEB J* 9:73-80.
260. Ravetch JV, Siebenlist U, Korsmeyer S, Waldmann T and Leder P (1981) Structure of the human immunoglobulin mu locus: characterization of embryonic and rearranged J and D genes. *Cell* 27:583-591.

-
261. Reiter Y and Pastan I (1996) Antibody engineering of recombinant Fv immunotoxins for improved targeting of cancer: disulfide-stabilized Fv immunotoxins. *Clin Cancer Res* 2:245-252.
262. Restrepo-Hartwig MA and Carrington JC (1994) The tobacco etch potyvirus 6-kilodalton protein is membrane-associated and involved in viral replication. *J Virol* 68:2388-2397.
263. Rhodes CA, Pierce DA, Mettler IJ, Mascarenhas D and Detmer JJ (1988) Genetically transformed maize plants from protoplasts. *Science* 240:204-207.
264. Riechmann JL, Lain S and Garcia JA (1992) Highlights and prospects of potyvirus molecular biology. *J Gen Virol* 73:1-16.
265. Riedel D, Lesemann DE and Maiss E (1998) Ultrastructural localization of nonstructural and coat proteins of 19 potyviruses using antisera to bacterially expressed proteins of plum pox potyvirus. *Arch Virol* 143:2133-2158.
266. Rippmann JF, Klein M, Hoischen C, Brocks B, Rettig WJ, Gumpert J, Pfizenmaier K, Mattes R and Moosmayer D (1998) Procaryotic expression of single-chain variable-fragment (scFv) antibodies: secretion in L-form cells of *Proteus mirabilis* leads to active product and overcomes the limitations of periplasmic expression in *Escherichia coli*. *Appl Environ Microbiol* 64:4862-4869.
267. Roberts IM, Wang D, Findlay K and Maule AJ (1998) Ultrastructural and temporal observations of the potyvirus cylindrical inclusions (CIs) show that the CI protein acts transiently in aiding virus movement. *Virology* 245:173-181.
268. Rochow WF (1970) Barley yellow dwarf virus: phenotypic mixing and vector specificity. *Science* 167:875-878.
269. Rochow WF (1977) Dependent virus transmission from mixed infections. In: K. F. Harris and K. Maramorosch (eds), *Aphids as Virus Vectors*. Vol 24, pp 253-277. Academic Press, New York.
270. Rodrigues ML, Shalaby MR, Werther W, Presta L and Carter P (1992) Engineering a humanized bispecific (Fab')₂ fragment for improved binding to T cells. *Int J Cancer Suppl* 7:45-51.
271. Rojas MR, Zerbini FM, Allison RF, Gilbertson RL and Lucas WJ (1997) Capsid protein and helper component proteinase function as potyvirus cell-to-cell movement proteins. *Virology* 237:283-295.
272. Rolink A and Melchers F (1991) Molecular and cellular origins of B lymphocyte diversity. *Cell* 66:1081-1094.

-
273. Rondon IJ and Marasco WA (1997) Intracellular antibodies (intrabodies) for gene therapy of infectious diseases. *Annu Rev Microbiol* 51:257-283.
274. Sakai J, Mori M, Morishita T, Tanaka M, Hanada K, Usugi T and Nishiguchi M (1997) Complete nucleotide sequence and genome organization of sweet potato feathery mottle virus (S strain) genomic RNA: the large coding region of the P1 gene. *Arch Virol* 142:1553-1562.
275. Sambrook J, Fritsch EF and Maniatis T (1989) *Molecular cloning: a laboratory manual* (2nd edn). Cold Spring Harbor Laboratory Press.
276. Sankar S and Porter AG (1992) Point mutations which drastically affect the polymerization activity of encephalomyocarditis virus RNA-dependent RNA polymerase correspond to the active site of *Escherichia coli* DNA polymerase I. *J Biol Chem* 267:10168-10176.
277. Saragovi U, Fitzpatrick D and Raktabuhr A (1991) Design and synthesis of a mimetic of an antibody complementarity determining region. *Science* 253:792-795.
278. Schiebel W, Haas B, Marinkovic S, Klanner A and Sanger HL (1993a) RNA-directed RNA polymerase from tomato leaves. I. Purification and physical properties. *J Biol Chem* 263:11851-11857.
279. Schiebel W, Haas B, Marinkovic S, Klanner A and Sanger HL (1993b) RNA-directed RNA polymerase from tomato leaves. II. Catalytic *in vitro* properties. *J Biol Chem* 263:11858-11867.
280. Schiebel W, Pelissier T, Riedel L, Thalmeir S, Schiebel R, Kempe D, Lottspeich F, Sanger HL and Wassenegger M (1998) Isolation of an RNA-directed RNA polymerase-specific cDNA clone from tomato. *The Plant Cell* 10:2087-2102.
281. Schier R, McCall A, Adams GP, Marshall KW, Merritt H, Yim M, Crawford RS, Weiner LM, Marks C and Marks JD (1996) Isolation of picomolar affinity anti-c-erbB-2 single-chain Fv by molecular evolution of the complementarity determining regions in the center of the antibody binding site. *J Mol Biol* 263:551-567.
282. Schoumacher F, Erny C, Berna A, Godefroy-Colburn T and Stussi-Garaud C (1992) Nucleic acid binding properties of the alfalfa mosaic virus movement protein produced in yeast. *Virology* 188:896-899.
283. Schouten A, Roosien J, van Engelen FA, de Jong GA, Borst-Vremsen AW, Zilverentant JF, Bosch D, Stiekema WJ, Gommers FJ, Schots A and Bakker J (1996) The C-terminal KDEL sequence increases the expression level of a single-chain antibody designed to be

- targeted to both the cytosol and the secretory pathway in transgenic tobacco. *Plant Mol Biol* 30:781-793.
284. Schouten A, Roosien J, de Boer JM, Wilmink A, Rosso MN, Bosch D, Stiekema WJ, Gommers FJ, Bakker J and Schots A (1997) Improving scFv antibody expression levels in the plant cytosol. *FEBS Lett* 415:235-241.
285. Schulman M, Wilde CD and Köhler G (1978) A better cell line for making hybridomas secreting specific antibodies. *Nature* 276:269-270.
286. Shahabuddin M, Shaw JG and Rhoads RE (1988) Mapping of the tobacco vein mottling virus VPg cistron. *Virology* 163:635-637.
287. Shi XM, Miller H, Verchot J, Carrington JC and Vance VB (1997) Mutations in the region encoding the central domain of helper component-proteinase (HC-Pro) eliminate potato virus X/potyvirial synergism. *Virology* 231:35-42.
288. Shimba N, Torigoe H, Takahashi H, Masuda K, Shimada I, Arata Y and Sarai A (1995) Comparative thermodynamic analyses of the Fv, Fab* and Fab fragments of anti-dansyl mouse monoclonal antibody. *FEBS Lett* 360:247-250.
289. Shin EK, Matsuda F, Fujikura J, Akamizu T, Sugawa H, Mori T and Honjo T (1993) Cloning of a human immunoglobulin gene fragment containing both V_H-D and D-J_H rearrangements: implication for V_H-D as an intermediate to V_H-D-J_H formation. *Eur J Immunol* 23:2365-2367.
290. Shockett PE and Schatz DG (1999) DNA hairpin opening mediated by the RAG1 and RAG2 proteins. *Mol Cell Biol* 19:4159-4166.
291. Shukla DD, Ward CW and Brunt AA (1994) *The potyviridae*. CAB International, Wellingford.
292. Simon-Buela L, Guo HS and Garcia JA (1997) Cap-independent leaky scanning as the mechanism of translation initiation of a plant viral genomic RNA. *J Gen Virol* 78:2691-2699.
293. Sitnikova T and Su C (1998) Coevolution of immunoglobulin heavy- and light-chain variable-region gene families. *Mol Biol Evol* 15:617-625.
294. Skerra A and Pluckthun A (1988) Assembly of a functional immunoglobulin Fv fragment in *Escherichia coli*. *Science* 240:1038-1041.
295. Slade DE, Johnston RE and Dougherty WG (1989) Generation and characterization of monoclonal antibodies reactive with the 49-kDa proteinase of tobacco etch virus. *Virology* 173:499-508.

-
296. Smith GP (1985) Filamentous fusion phage: novel expression vectors that display cloned antigens on the virion surface. *Science* 228:1315-1317.
 297. Smith HA, Swaney SL, Parks TD, Wernsman EA and Dougherty WG (1994) Transgenic plant virus resistance mediated by untranslatable sense RNAs: Expression, regulation, and fate of nonessential RNAs. *Plant Cell* 6:1441-1453.
 298. Snapper CM and Mond JJ (1993) Towards a comprehensive view of immunoglobulin class switching. *Immunol Today* 14:15-17.
 299. Song C and Simon AE (1994) RNA-dependent RNA polymerase from plants infected with turnip crinkle virus can transcribe (+)- and (-)-strands of virus-associated RNAs. *Proc Natl Acad Sci USA* 91:8792-8796.
 300. Soumounou Y and Laliberte JF (1994) Nucleic acid binding properties of the P1 protein of turnip mosaic potyvirus produced in *Escherichia coli*. *J Gen Virol* 75:2567-2573.
 301. Spada S and Plückthun A (1997) Selectively infective phage (SIP) technology: a novel method for the *in vivo* selection of interacting protein-ligand pairs. *Nature Med* 6:694-696.
 302. Spada S, Krebber C and Plückthun A (1997) Selectively infective phages. *Biol Chem* 378:445-456.
 303. Stemmer WP (1994a) Rapid evolution of a protein *in vitro* by DNA shuffling. *Nature* 370:389-391.
 304. Stemmer WP (1994b) DNA shuffling by random fragmentation and reassembly: *in vitro* recombination for molecular evolution. *Proc Natl Acad Sci USA* 91:10747-10751.
 305. Suzuki C, Ueda H, Suzuki E and Nagamune T (1997) Construction, bacterial expression, and characterization of hapten-specific single-chain Fv and alkaline phosphatase fusion protein. *J Biochem (Tokyo)* 122:322-329.
 306. Syrigos KN and Epenetos AA (1999) Antibody directed enzyme prodrug therapy (ADEPT): a review of the experimental and clinical considerations. *Anticancer Res* 19:605-613.
 307. Tainer JA, Getzoff ED, Alexander H, Houghten RA, Olson AJ, Lerner RA and Hendrickson WA (1984) The reactivity of antipeptide antibodies is a function of the atomic mobility of sites in a protein. *Nature* 312:127-134.
 308. Tavladoraki P, Benvenuto E, Trinca S, Martinis DD, Cattaneo A and Galeffi P (1993) Transgenic plants expressing a functional single-chain Fv antibody are specifically protected from virus attack. *Nature* 366:469-472.

309. Thomas PE, Hassan S, Kaniewski WK, Lawson EC and Zaleaski JC (1998) A search for evidence of virus/transgene interactions in potatoes transformed with the potato leafroll virus replicase and coat protein genes. *Molecular Breeding* 4:407-417.
310. Tobin GJ, Young DC and Flanagan JB (1989) Self-catalyzed linkage of poliovirus terminal protein VPg to poliovirus RNA. *Cell* 59:511-519.
311. Toiron C, Lopez JA, Rivas G, Andreu D, Melero JA and Bruix M (1996) Conformational studies of a short linear peptide corresponding to a major conserved neutralizing epitope of human respiratory syncytial virus fusion glycoprotein. *Biopolymers* 39:537-548.
312. Tomlinson IM, Cook GP, Walter G, Carter NP, Riethman H, Buluwela L, Rabbitts TH and Winter G (1995) A complete map of the human immunoglobulin V_H locus. *Ann N Y Acad Sci* 764:43-46.
313. Tonegawa S (1983) Somatic generation of antibody diversity. *Nature* 302:575-581.
314. Torrance L (1992) Analysis of epitopes on potato leafroll virus capsid protein. *Virology* 191:485-489.
315. Towbin H, Staehelin T and Gordon J (1979) Electrophoretic transfer of proteins from polyacrylamide gels to nitrocellulose sheets: Procedure and some applications. *Proc Natl Acad Sci USA* 76:4350-4354.
316. Tramontano A, Janda KD and Lerner RA (1986) Catalytic antibodies. *Science* 234:1566-1570.
317. Tsumoto K, Ogasahara K, Ueda Y, Watanabe K, Yutani K and Kumagai I (1995) Role of Tyr residues in the contact region of anti-lysozyme monoclonal antibody HyHEL10 for antigen binding. *J Biol Chem* 270:18551-18557.
318. Tsumoto K, Nishimiya Y, Kasai N, Ueda H, Nagamune T, Ogasahara K, Yutani K, Tokuhisa K, Matsushima M and Kumagai I (1997) Novel selection method for engineered antibodies using the mechanism of Fv fragment stabilization in the presence of antigen. *Protein Eng* 10:1311-1318.
319. Tsumoto K, Shinoki K, Kondo H, Uchikawa M, Juji T and Kumagai I (1998) Highly efficient recovery of functional single-chain Fv fragments from inclusion bodies overexpressed in *Escherichia coli* by controlled introduction of oxidizing reagent – application to a human single-chain Fv fragment. *J Immunol Methods* 219:119-129.
320. Turner DJ, Ritter MA and George AJ (1997) Importance of the linker in expression of single-chain Fv antibody fragments: optimisation of peptide sequence using phage display technology. *J Immunol Methods* 205:43-54.

321. Turpen T (1989) Molecular cloning of a potato virus Y genome: nucleotide sequence homology in non-coding regions of potyviruses. *J Gen Virol* 70:1951-1960.
322. Van Etten JL, Freer SN and McCune BK (1979) Presence of a major (storage?) protein in dormant spores of the fungus *Botryodiplodia theobromae*. *J Bacteriol* 138:650-652.
323. Van Regenmortel MHV (1992) Molecular dissection of protein antigens. In: M. H. V. Van Regenmortel (ed), *Structure of antigens*. CRC Press, London.
324. Vaughan TJ, Williams AJ, Pritchard K, Osbourn JK, Pope AR, Earnshaw JC, McCafferty J, Hodits RA, Wilton J and Johnson KS (1996) Human antibodies with sub-nanomolar affinities isolated from a large non-immunized phage display library. *Nat Biotechnol* 14:309-314.
325. Verchot J, Koonin EV and Carrington JC (1991) The 35-kDa protein from N-terminus of the potyvirus polyprotein functions as a third virus-encoded proteinase. *Virology* 185:527-535.
326. Verchot J, Herndon KL and Carrington JC (1992) Mutational analysis of the tobacco etch potyviral 35-kDa proteinase: identification of essential residues and requirements for autoproteolysis. *Virology* 190:298-306.
327. Verchot J and Carrington JC (1995a) Debilitation of plant potyvirus infectivity by P1 proteinase-inactivating mutations and restoration by second-site modifications. *J Gen Virol* 69:1582-1590.
328. Verchot J and Carrington JC (1995b) Evidence that the potyvirus P1 proteinase functions *in trans* as an accessory factor for genome amplification. *J Gen Virol* 69:3668-3674.
329. Voss A, Niersbach M, Hain R, Hirsch HJ, Liao YC, Kreuzaler F and Fischer R (1995) Reduced virus infection in *N. tabacum* secreting a TMV-specific full size antibody. *Molecular Breeding* 1:39-50.
330. Wagner SD and Neuberger MS (1996) Somatic hypermutation of immunoglobulin genes. *Annu Rev Immunol* 14:441-457.
331. Waldman TA (1991) Monoclonal antibodies in diagnosis and therapy. *Science* 252:1657-1662.
332. Walter G, Tomlinson IM, Dear PH, Sonnhammer EL, Cook GP and Winter G (1995) Comparison of the human germline and rearranged V_H repertoire reveals complementarity between germline variability and somatic mutation. *Ann N Y Acad Sci* 764:180-182.

333. Wang RY, Powell G, Hardie J and Pirone TP (1998) Role of the helper component in vector-specific transmission of potyviruses. *J Gen Virol* 79:1519-1524.
334. Ward CW and Shukla DD (1991) Taxonomy of potyviruses: current problems and some solutions (review article). *Intervirology* 32:269-296.
335. Ward ES, Güssow D, Griffiths AD, Jones PT and Winter G (1989) Binding activities of a repertoire of single immunoglobulin variable domains secreted from *Escherichia coli*. *Nature* 341:544-546.
336. Wassenegger M and Pélissier T (1998) A model for RNA-mediated gene silencing in higher plants. *Plant Mol Biol* 37:349-362.
337. Weiss E and Orfanoudakis G (1994) Application of an alkaline phosphatase fusion protein system suitable for efficient screening and production of Fab-enzyme conjugates in *Escherichia coli*. *J Biotechnol* 33:43-53.
338. Whitlow M, Filpula D, Rollence ML, Feng SL and Wood JF (1994) Multivalent Fvs: characterization of single-chain Fv oligomers and preparation of a bispecific Fv. *Protein Eng* 7:1017-1026.
339. Williams WV, Kieber-Emmons T, VonFeldt J, Greene MI and Weiner DB (1991) Design of bioactive peptides based on antibody hypervariable region structures: Development of conformationally constrained and dimeric peptides with enhanced affinity. *J Bio Chem* 266:5182-5190.
340. Williams SC, Fripiat JP, Tomlinson IM, Ignatovich O, Lefranc MP and Winter G (1996) Sequence and evolution of the human germline V lambda repertoire. *J Mol Biol* 264:220-232.
341. Wilson IA and Stanfield RL (1993) Antibody-antigen interactions. *Curr Opin Struct Biol* 3:113-118.
342. Wilson TM (1993) Strategies to protect crop plants against viruses: pathogen-derived resistance blossoms. *Proc Natl Acad Sci USA* 90:3134-3141.
343. Winter G and Milstein C (1991) Man-made antibodies. *Nature* 349:293-299.
344. Winter G, Griffiths AD, Hawkins RE and Hoogenboom HR (1994) Making antibodies by phage display technology. *Annu Rev Immunol* 12:433-455.
345. Wintermantel WM, Banerjee N, Oliver JC, Paolillo DJ and Zaitlin M (1997) Cucumber mosaic virus is restricted from entering minor veins in transgenic tobacco exhibiting replicase-mediated resistance. *Virology* 231:248-257.
346. Wu X and Shaw JG (1998) Evidence that assembly of a potyvirus begins near the 5' terminus of the viral RNA. *J Gen Virol* 79:1525-1529.

-
347. Yang LJ, Hidaka M, Masaki H and Uozumi T (1998) Detection of potato virus Y P1 protein in infected cells and analysis of its cleavage site. *Biosci Biotechnol Biochem* 62:380-382.
 348. Ye GN, Daniell H and Sanford JC (1990) Optimization of delivery of foreign DNA into higher-plant chloroplasts. *Plant Mol Biol* 15:809-819.
 349. Yuan Q, Clarke JR, Zhou HR, Linz JE, Pestka JJ and Hart LP (1997) Molecular cloning, expression, and characterization of a functional single-chain Fv antibody to the mycotoxin zearalenone. *Appl Environ Microbiol* 63:263-269.
 350. Zambryski P, Joos H, Genetello C, Van Montagu M and Schell J (1983) Ti-plasmid vector for introduction of DNA into plant cells without altering their normal regeneration capacity. *EMBO J* 2:2143-2150.
 351. Zimmermann S, Schillberg S, Liao Y-C and Fischer R (1998) Intracellular expression of TMV-specific single chain Fv fragments leads to improved virus resistance in *Nicotiana tabacum*. *Molecular Breeding* 4:369-379.
 352. zu Putlitz J, Skerra A and Wands JR (1999) Intracellular expression of a cloned antibody fragment interferes with hepatitis B virus surface antigen secretion. *Biochem Biophys Res Commun* 255:785-791.

7 Appendix

A. Structure of R1

Pos	aa	STR	HELIX	STRAND	COIL
1	R	Coil	0.09	0.03	0.88
2	T	Coil	0.09	0.22	0.69
3	F	Coil	0.19	0.27	0.54
4	T	Coil	0.28	0.33	0.40
5	A	Coil	0.10	0.40	0.50
6	A	Coil	0.10	0.17	0.73
7	P	Coil	0.24	0.18	0.58
8	L	Coil	0.32	0.13	0.55
9	D	Coil	0.39	0.15	0.46
10	T	Coil	0.30	0.30	0.40
11	L	Coil	0.13	0.43	0.44
12	L	Coil	0.13	0.43	0.44
13	G	Coil	0.09	0.16	0.75
14	G	Coil	0.06	0.21	0.73
15	K	Strand	0.05	0.61	0.34
16	V	Strand	0.02	0.83	0.15
17	C	Strand	0.02	0.83	0.15
18	V	Strand	0.03	0.66	0.31
19	D	Coil	0.12	0.26	0.62
20	D	Coil	0.19	0.14	0.67
21	E	Coil	0.09	0.02	0.89
22	N	Coil	0.09	0.02	0.89
23	N	Coil	0.09	0.02	0.89
24	Q	Coil	0.11	0.07	0.82
25	F	Coil	0.07	0.04	0.89

*Prediction accuracy= 66.16%

B. Structure of R2

Pos	aa	STR	HELIX	STRAND	COIL
1	W	Strand	0.05	0.61	0.34
2	V	Strand	0.02	0.83	0.15
3	Y	Strand	0.02	0.83	0.15
4	C	Strand	0.05	0.61	0.34
5	D	Coil	0.05	0.24	0.71
6	A	Coil	0.06	0.09	0.85
7	D	Coil	0.09	0.09	0.83
8	G	Coil	0.09	0.09	0.83
9	S	Coil	0.06	0.09	0.85
10	Q	Coil	0.09	0.16	0.75
11	F	Coil	0.12	0.26	0.62
12	D	Coil	0.14	0.19	0.67
13	S	Coil	0.14	0.19	0.67
14	S	Coil	0.09	0.22	0.69
15	L	Coil	0.09	0.22	0.69
16	T	Coil	0.09	0.09	0.83
17	P	Coil	0.39	0.15	0.46
18	Y	Coil	0.40	0.10	0.50
19	L	Coil	0.40	0.10	0.50
20	I	Strand	0.32	0.52	0.16
21	N	Strand	0.29	0.49	0.22
22	A	Coil	0.28	0.33	0.40
23	V	Coil	0.14	0.19	0.67
24	L	Coil	0.19	0.13	0.68

*Prediction accuracy= 64.17%

C. Structure of R3

Pos	aa	STR	HELIX	STRAND	COIL
1	L	Coil	0.03	0.10	0.87
2	T	Coil	0.03	0.10	0.87
3	P	Coil	0.03	0.10	0.87
4	D	Coil	0.06	0.09	0.85
5	G	Coil	0.03	0.10	0.87
6	T	Strand	0.06	0.48	0.47
7	I	Strand	0.03	0.89	0.09
8	V	Strand	0.05	0.87	0.09
9	K	Strand	0.05	0.93	0.01
10	K	Strand	0.05	0.87	0.09
11	F	Strand	0.01	0.89	0.10
12	K	Strand	0.03	0.66	0.31
13	G	Coil	0.07	0.37	0.57
14	N	Coil	0.03	0.10	0.87
15	N	Coil	0.03	0.10	0.87
16	S	Coil	0.03	0.10	0.87
17	G	Coil	0.03	0.10	0.87
18	Q	Coil	0.03	0.10	0.87
19	P	Coil	0.03	0.10	0.87
20	S	Strand	0.06	0.48	0.47
21	T	Strand	0.03	0.66	0.31
22	V	Strand	0.02	0.83	0.15
23	V	Strand	0.03	0.66	0.31
24	D	Coil	0.07	0.37	0.57

*Prediction accuracy= 80.45%

Probability of secondary structure of synthetic peptides used in immunization.
According to King and Sternberg (1996)

Declaration

I hereby declare that all the work represented in this manuscript is done by myself, except for the assistance acknowledged.

Aschersleben, July 1999.

Signature

Acknowledgments

I am indebted to Dr. J. Schubert for giving me the opportunity to work in his laboratory, for his supervision, constant support and encouragement during this work, and valuable suggestions for preparing the manuscript.

I am grateful to Prof. Dr. H. Jeske for his supervision and constructive suggestions for preparing the manuscript.

I am grateful to Dr. T. Kühne for his support and guidance during the years I spent at BAZ, Aschersleben, and for critical reading of the manuscript.

I would also like to express my gratitude to Dr. S. Dübel for providing the bacterial vectors pSEX81, pOPE101 and pOPE51-AP, valuable suggestions; Dr. F. Rabenstein for MAb 7C5, enthusiastic discussions; Drs. E. Suhkacheva, T. Erokhina and S. Ambrosova for their participation in cell fusion for R2, R3 peptides, and CP of PVY, suggestions regarding fusion experiments and Mr. X. Liu for critical reading of the manuscript.

I want to acknowledge the Ministry of Culture, Sachsen-Anhalt for funding my research projects and BAZ for many supports during this work.

Especially I want to thank Mrs M. Nielitz and H. Mühlheim for the assistance in this work; Mrs K. Erdmann and M. Wesemann for preparation and multiplication of viruses.

Thanks also go to all the people at BAZ, Aschersleben for their friendship and collaboration, scientific discussions, for chat, for coffee and delicious cakes at numerous birthday parties and during a number of excursions: Weimar, Erfurt, Spreewald, Bonn..... All these have made my stay here enjoyable, productive and it will be hard for me to say good-bye.

And last, but not least, I want to thank my wife, Jinping, for her constant love, support and encouragement; and my daughter and son, Jasmin and Jachen, for their patience and for the great fun they bring into my family life. My family members' enthusiastic participation and engagement in culturing cells that do not want to grow and cells that do grow weekends make doing science a more enjoyable experience.

Curriculum Vitae

Name: Fangbing Liu
Birthday: 7th February 1963
Family Status: Married, two children
Nationality: Chinese
Healthy: Excellent

Education

- M. Sc. Biochemistry and Molecular Virology. 1985.9—1988.7. Institute of Biochemistry, Department of Basic Sciences, Zhejiang University. Thesis: “Studies on Biological Properties and Molecular Characteristics of Gold Cat (*Felis temmincki*) Parvovirus”. Advisors: Yuexian Wang, Professor of Biochemistry, and Bingyao He, Professor of Virology.
- B. Sc. Biology 1980.9—1985.7 College of Animal Science and Technology, Jiangxi Agricultural University.

Experience

- 1995.12—present Ph.D. Candidate, BAZ, Institute for Resistance Research and Pathogen Diagnostics, Aschersleben. Research group leader: Dr. rer. nat. habil. Jörg Schubert. Research project was involved in 1) Development of monoclonal antibodies against RNA-dependent RNA polymerase (RdRp) of potyviruses using synthetic peptides and recombinant nuclear inclusion b protein (NIb); 2) Antibody engineering and phage display.
- 1988.7—1995.12 Graduate M. Sc./Assistant Researcher. Institute of Virology, Zhejiang Academy of Medical Sciences. Working on the molecular and biological characteristics of live attenuated hepatitis A virus (HAV) vaccine using sensitive immunoassays, *in situ* hybridization, and immuno-capture polymerase chain reaction (IC-PCR). My projects also include establishing the microcarrier cell-culture system for large scale preparation of HAV vaccine.
- 1986.9—1988.1 Laboratory of Virology, Shanghai Institute of Biochemistry, Chinese Academy of Sciences, working on part of M. Sc. thesis’ project.
Research Supervisor: Dr. ZuXun Gong.