

# Energy Efficiency Considerations for LED-based Lighting of Multipurpose Outdoor Environments.

Ahmed Farahat, Anna Florea, *Student member, IEEE*, Jose Luis Martinez Lastra (✉), *Member, IEEE*,  
Christian Brañas, *Member, IEEE*, Francisco Javier Azcondo Sánchez, *Member, IEEE*,

(An earlier version of preliminary contributions and results were presented in Fifteenth IEEE Workshop on Control and Modeling for Power Electronics (June 22–25, 2014 in Santander, Spain) under the title "Energy efficient outdoor lighting: An implementation".)

**Abstract**—Nowadays street lighting accounts for 53% of outdoor lighting use and the market is continuously increasing. In the context of rising energy prices and growing environmental awareness, energy efficiency is becoming one of the most important criteria for street lighting systems design. LED-based lights have become the primary option for replacing conventional light bulbs, being digitally controllable, small, highly efficient, and cheap to manufacture. Advanced control strategies adapted to ambient conditions are needed to combine low energy consumption and high quality light ambience according to changing specifications.

This paper describes an outdoor lighting solution aimed at energy efficient performance in the context of multipurpose outdoor environments, where control is crucial in achieving efficiency improvements. The work addresses efficiency at the component level, by optimizing the performance of LED drivers, and at system level, defining the control strategy and associated hardware infrastructure. The approach designed was tested in a real environment. The performance of the lighting installation was assessed using the web-based monitoring application, providing real-time consumption information and aggregated historical data.

**Index Terms**—LED lighting, resonant converter, web services, energy efficiency, smart lighting.

## I. INTRODUCTION

Outdoor lighting is an important functional and decorative component of built environments. Street lighting helps to ensure the safety of people in traffic and to prevent crimes. It even enables the efficient use of street space through informal self-regulation of the crowd [1].

Nowadays street lighting accounts for 53% of outdoor lighting use worldwide (115,54 TWh yearly) [2]. Furthermore, the outdoor lighting market continues to grow (Compound Annual Growth Rate of the outdoor lighting market is estimated to be 42% in period 2011-2020 [3]). In a context of rising energy prices and growing environmental awareness, the aforementioned trends call for improvements in street lighting efficiency.

A. Farahat, A. Florea and J. L. Martinez Lastra are with Tampere University of Technology, Tampere, Finland

C. Brañas and F. J. Azcondo Sánchez are with University of Cantabria, Santander, Spain

✉ Prof. Dr. J. L. Martinez Lastra, Tampere University of Technology, FAST Laboratory, P.O. Box 600, FIN-33101 Tampere, Finland, Phone: +358 40 779 4748, E-mail: jose.lastra@tut.fi

The two common approaches to efficiency and environmental friendliness in street lighting entail replacing light bulbs with more efficient ones and implementing advanced control scenarios considering multiple aspects of the designated areas.

As far as retrofitting is concerned, LED-based luminaires are being more widely adopted for better luminous efficacy and the option for digital control. Local governments have already recognized the cost reduction potential of outdoor lighting systems [4]: according to the PLUS project report [5], upgrading of the old conventional lights to LED in the German city of Leipzig achieved 74% energy savings.

Controllable lights enable interactive lighting, which helps optimize energy saving schemes [4]. In these cases technological solutions are often accompanied with campaigns targeting environmental awareness, which has been proven to facilitate the acceptance of reduced lighting levels [1].

As LED becomes state of the art technology in street lighting, it is very important to take full advantage of the technology and avoid losing the cost saving potential through excessive use of lighting. Control scenarios adapted to the environmental conditions are seen as the main solution to this problem. These scenarios leverage LED dimming capabilities and require a precise response to control commands. Therefore, factors allowing efficiency improvement beyond the LED performance characteristics are: LED luminaire driver performance, control scenarios, and control and communication infrastructure.

This paper presents a description of an outdoor lighting solution aiming at an energy efficient performance in the context of multipurpose outdoor environments. Special attention is paid to power management of the light source and dimming command execution as well as high-level adaptive control intended to provide lighting according to the environmental conditions and activities detected in the area.

The rest of the paper is organized as follows: Section II provides an overview of the notion of efficiency encountered in the context of the energy efficient performance of technical systems, discusses efficiency considerations in the context of outdoor lighting, focusing on power management and high level control, and considers related technological enablers; Section III describes the outdoor lighting system implemented; performance assessment results are provided in Section IV.

Finally, Section V offers conclusions summarizing the main contributions and suggesting directions for future work.

## II. BACKGROUND

### A. Energy Efficiency

Definitions of the energy efficiency concept found in the literature address both the qualitative aspects of system performance and their quantitative expression. The US Department of Energy provides two reference definitions used in defining energy policy and planning: *energy efficiency* and *energy intensity*. According to this definition, energy efficiency improves when the given level of service is provided with reduced amounts of energy inputs or services are enhanced for a given amount of energy input. In this context, efficiency is juxtaposed to energy intensity, which drops along with amount of energy required per product output. Efficient performance does not necessarily imply reduced energy consumption. A more formalized definition, allowing quantitative analysis of energy efficiency, is proposed in [6], where it is considered as a measurement of the performance of a device or system and defined as the ratio of output to input energies.

Modern outdoor lighting systems are complex systems built of numerous components (including light sources, power ballasts and drivers, control and communication infrastructure), for which more specific efficiency metrics have been defined. As far as luminaires are concerned, the two parameters helping to understand the performance of the lighting installations are luminaire efficacy and luminous efficiency. Luminaire efficacy expresses how good a light source is at producing visible light. Lighting efficiency is concerned with energy savings of lighting installations. It is defined as luminous flux per unit of electrical power input [7]. Studies show that LED-based luminaires outperform other types of lamps on both criteria [8].

Following these definitions of efficiency, one may perceive different ways to improve performance. The next subsection provides an overview of the research related to energy efficiency in lighting applications and their impact on system performance.

### B. Related work

Modern outdoor lighting systems offer a variety of opportunities for energy efficiency improvement. This can be addressed on different scales, from the scope of system components to cross-sectorial visions. On a macro scale the possibility of integrating lighting installations with the grid is considered as a means to improve the quality of power supply [9]. From the light source life cycle perspective, manufacturers endeavor to extend the useful lifetime of light sources ([10] proposes an approach to diode qualification testing allowing the testing time to be reduced from 6000 to 1200 hours). The research presented in this paper focuses on smaller scales, specifically the component level (by optimizing the performance of individual devices) and system level (specifically the control strategy and associated infrastructure).

Given LED as the lighting technology, most of the efficiency solutions revolve around the controllability of the LEDs. The

most straightforward way to reduce energy consumption is to reduce the time a lamp spends in states with high power consumption [11], which can be achieved by partial dimming or turning off the lights when not needed. Individually controlled lights have been estimated to achieve energy savings of as much as 50% [9].

However, deciding on dimming patterns is not a trivial task compared to simply switching the lights off. Perception of light strengths and associated comfort becomes a constraint for reducing the light intensity [2]. Needs for particular lighting conditions are decisively influenced by the type of activities people engage in and their age [8]. Moreover, eye sensitivity varies throughout the day, necessitating adjusting the light color temperature accordingly [7]. Given that human eyes are more responsive to green light at night and that less light intensity is required for this part of the spectrum, green street lighting has been deployed in the Dutch city of Eindhoven [5].

Poor consideration of user-related factors leads to increased discomfort and compromises safety. In indoor lighting such negligence often results in disabling of automatic control by the users [9]. However, this is rarely possible with outdoor installations, especially in public areas, and therefore multiple criteria must be taken into account in order to correctly assess the context of the environment. It has been shown in [12] that multi-modal control achieves more energy savings than do control strategies considering different individual variables. Adaptive control has high saving potential even with conventional light sources [11].

Capturing the context defining a lighting scene is often done with the help of a variety of sensors (e.g. temperature, light, presence, etc.). Wireless sensor networks have become the state-of-the-art solution for this task, offering flexibility in the control design [11]. On the other hand, this approach may add extra costs to the system as a whole in terms of equipment, installation, and maintenance. In this case, numerical methods and simulations have been proposed as a way of reducing the number of sensors [9] and allowing non-intrusive disaggregation of the collected data [13].

While adaptive control enables provision of an enhanced lighting experience and also energy savings, actuation components allow the actual execution of the designed control scenarios. In this context, it is important how fast the lamp can respond to the command and the capability of the luminaire to reduce the losses. LED lamps are actuated by drivers, which, in addition to their primary purpose, may help mitigate the performance drop associated with component overheating and quality of the power supply [14].

The following section discusses in more detail technologies allowing practical implementation of the efficiency considerations presented.

### C. Enabling technologies

Lighting systems offer numerous possibilities for performance improvements associated with control and component optimization. These systems, composed of WSNs, dimmers, meters, etc., are often referred to in the literature as smart lighting systems. They are considered to be the next generation standard for lighting systems [15].

Karlicek identifies two phases in smart lighting development [16]: *the first wave* and *the second wave*. *The first wave* stands for the replacement of standard bulbs with the new technology, where LEDs are used as the main light source. The main research effort in this direction is related to design and studying new technologies for improved performance of the LEDs (efficiency, cost reduction, prolonged lifetime) and related chip design. *The second wave* of development is concerned with lighting control. It seeks solutions allowing faster response and the design of control communications. The second wave aims at providing bases for the development of adaptive lighting solutions, characterized by superior performance efficiency and the ability to satisfy user comfort needs.

1) *LED lamps and drivers*: Being small, highly efficient, digitally controllable and cheap to manufacture [4] LEDs are the main enablers for smart lighting systems. Solid-state light sources are expected to become state-of-the-art lighting technology by 2020 [3]. However, it is important to realize that silicon components reach internal efficiency limits and further improvements are expected to come from external constituents and associated processes [17].

White LEDs have surpassed Sodium Vapor Lamps in luminous efficacy. Different manufacturers present figures clearly above 100 lm/W for their LEDs products with a sharply growing short-term road maps reaching up to 300 lm / W, as Cree<sup>TM</sup> recently announced in [18]. High power, i.e. over 100 W, LED matrix for street lighting require more challenging drivers than in indoor applications to meet tight specifications and obtain high quality regulation capabilities under a more irregular electrical and thermal environment. The LED drivers basically include a power factor correction, PFC, stage and a current-controlled converter. The two merged stages form a single converter for limited utility voltage and power range and regulation requirements as presented in [19], [20], while extended regulation capabilities, elimination of electrolytic capacitors and larger power rate with similar or higher efficiency is achieved with two stages solutions [21] at the expense of higher complexity and cost.

Resonant converters have been largely applied to drive discharge lamps due to their capacity of striking arcs and stabilize the lamp current. Resonant LCC and LLC converters also find application in high power LED drivers. Lossless switching transients result in highly efficient power conversion at high switching frequency. Sinusoidal waveforms simplify the magnetic component design. Inherent current-mode operation leads to simplifications of the controller design. Lossless passive solutions are implemented in the ac side to accurately balance the current sharing among the LED strings [22]. Current regulation in resonant converters is commonly implemented by the modulation of the switching frequency, which may reduce the efficiency and require complex EMI filters. For those reasons regulation at constant switching frequency, is more convenient.

2) *Lighting control* : In contrast to basic lighting architecture [23] composed of user initiated devices, hardware interface, and power controller actuating the power source, smart lighting leverages context recognition and scene rendering infrastructure [3] for elaborating the control signal supplied to

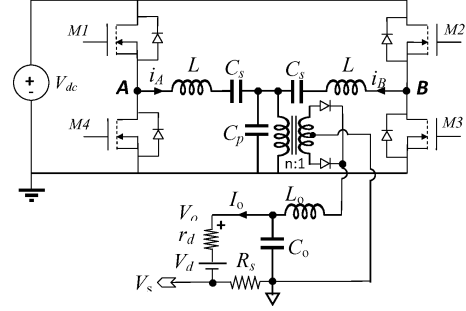

Fig. 1: Dual-phase  $LC_sC_p$  resonant converter.

the driver. This infrastructure is built of sensors, controllers, and associated software for data processing, storage and management [24].

In these systems, the user becomes a part of the context and the system captures this with the help of the sensors. This functionality became possible with advances in WSN and IoT [3], [11]. These pervasive technologies make it possible to consider parameters such as: presence, activities, traffic, and weather conditions for control command elaboration.

Design of control commands can be handled either in centralized or distributed manner. For example, Leipzig has centralized control with info on all light sources combined with traffic lights [5]. On the other hand, there are distributed control solutions, many of them using agent-based technology [11], [24].

Control protocols for lighting applications define the set of commands and the granularity of the instructions. Digital Addressable Lighting Interface (DALI) is being more widely adopted for the option to control individual luminaires as well as groups. This feature enables efficient communication and extends the range of potential lighting scenes. It is an open protocol developed as an extension to IEC60929, for architectural and commercial lights. The DALI network allows bus and star topologies [25]. In addition the DALI protocol supports two-way communication, allowing monitoring by querying lamps, status, and current.

### III. IMPLEMENTATION

#### A. Proposed Driver

The LED driver is in the bottom layer of a smart-lighting system, thus the reliability of the whole system depends on it. The proposed driver consists of a PFC stage, which supplies controlled dc voltage,  $V_{dc}$  to the second stage, a dual-phase resonant converter shown in Fig. 1.

The lamp is an LED array, which is represented in Fig. 1 by the equivalent diode model with parameters  $r_d$  and  $V_d$ . The two-stage architecture of the driver is preferred for reliability reasons. Each stage is designed to carry out the PFC and current source functions respectively, avoiding any extra current or voltage stresses in switches and therefore optimizing the efficiency [21]. The overall efficiency is in the 85-90% range.

The dual-phase  $LC_sC_p$  resonant converter comprises all the desired performance to interact with multiple and flexible

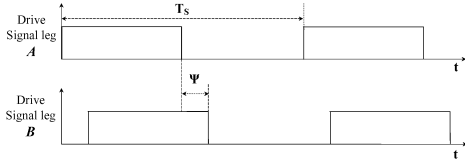

Fig. 2: Drive signals of the transistor legs A and B. The angle  $\Psi$  enables, at constant switching frequency, the amplitude modulation of the output current at constant switching frequency.

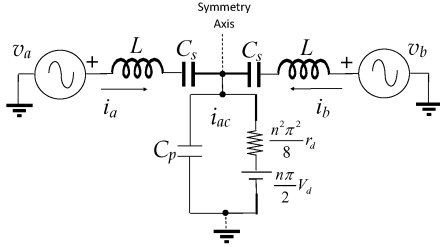

Fig. 3: Steady-state fundamental approximation of the resonant inverter stage for steady-state analysis purposes.

control commands. A high efficiency is obtained as a result of the soft-switch and the current sharing between the two branches. The current regulation is achieved, at constant switching frequency by controlling the phase-shift,  $\Psi$ , between the drive signals applied to branches A and B of the converter as represented in Fig. 2.

Considering a well-designed output filter that removes the high frequency ripple of the rectified output current, the load section is modeled by the average state variables at low frequency [26]. Using the first harmonic of a square waveform, the relationship between the AC and DC side currents is given by,

$$I_o = \frac{n\pi}{4} \cdot \hat{I}_{ac} \quad (1)$$

On the other hand, the voltage across the LED lamp,  $V_o$ , is obtained as the mean value of the full wave rectified voltage.

$$V_o = \frac{2}{n\pi} \cdot \hat{V}_{ac} = r_d \cdot I_o + V_d \quad (2)$$

From (1) and (2), the lamp is modeled in the AC side by,

$$\hat{V}_{ac} = \frac{n^2\pi^2}{8} r_d \cdot \hat{I}_{ac} + \frac{n\pi}{2} \cdot V_d \quad (3)$$

Once the load is transferred to the AC side, the fundamental approximation [26] is applied for the circuit analysis purposes. The mid-point voltages  $v_a$  and  $v_b$  in Fig. 3 are represented by complex phasors,

$$V_{A,B} = \frac{2V_{dc}}{\pi} \cdot e^{\pm j(\Psi/2)}, \quad (4)$$

where  $\Psi$  is the phase displacement between  $v_a$  and  $v_b$ .

For nominal conditions, the impedance seen from the AC side,  $R_{ac}$ , considering the rectifier operating in continuous conduction mode [26], is

TABLE I: Parameters of the  $LC_sC_p$  inverter

Parallel Resonant Frequency	Parallel Characteristic Impedance	Parallel Quality Factor
$\omega_p = \frac{1}{\sqrt{LC_p/2}}$	$Z_p = \omega_p L = \frac{2}{\omega_p C_p}$	$Q_p = \frac{2R_{ac}}{Z_p}$

$$R_{ac} = \frac{\pi^2}{8} n^2 R_o, \quad (5)$$

where  $R_o$  is the DC equivalent load of the LED array,  $R_o = V_o/I_o = r_d + V_d/I_o$ . The parallel parameters of the  $LC_sC_p$  inverter are summarized in Table I.

Since LEDs are current-driven devices, current source behavior of the driver circuit is highly desirable. For the  $LC_sC_p$  resonant inverter, the current source behavior is achieved by setting up the switching frequency at  $\omega = \Omega_o$ .

$$\Omega_o = \omega_p \sqrt{1 + C_p/2C_s}, \quad (6)$$

The frequency  $\Omega_o$  is the resonant frequency at the open circuit condition so; this frequency is high enough to assure the operation in ZVS mode for a range of load variations wider than its LLC counterpart [26], [27]. The amplitude of the output current in the ~~converter~~ AC side of the converter, at  $\omega = \Omega_o$  is calculated with,

$$\hat{I}_{ac} = \frac{4V_{dc}\sqrt{1 + C_p/2C_s}}{\pi Z_p} \cos(\Psi/2), \quad (7)$$

From (7) it can be observed that  $\hat{I}_{ac}$  can be adjusted, at constant switching frequency, by the phase displacement angle,  $\Psi$ , being the control parameter. Since the LED array is connected on the DC side, upon substitution of (7) into (1), the DC output current is obtained as a function of the inverter parameters:

$$I_o = \frac{nV_{dc}\sqrt{1 + C_p/2C_s}}{Z_p} \cos(\Psi/2). \quad (8)$$

From (8), the output current is maximum for  $\Psi_o=0^\circ$ . The nominal current,  $I_o$ , is set by the controller at  $\Psi = \Psi_o$ . In contrast, the output current is totally cancelled out for  $\Psi_o=180^\circ$ . This feature is used for implementing the PWM control of the output current as it is explained in Subsection III-C.

In order to verify the ZVS mode of all switches, each transistor leg has to see an inductive load defined by a positive power factor angle. The power factor angles,  $\phi_{A,B}$ , in transistors legs A and B are obtained by computing the power balance of the converter. The complex powers,  $S_{A,B}$ , corresponding to generators  $\nu_A$  and  $\nu_B$  are calculated according to:

$$\begin{aligned} S_{A,B} &= P + jQ \\ &= \frac{4V_{dc}^2\sqrt{1 + \frac{C_p}{2C_s}}}{\pi^2 Z_p} \cdot \left\{ Q_p \sqrt{1 + \frac{C_p}{2C_s}} \cdot \cos^2\left(\frac{\Psi}{2}\right) \right. \\ &\quad \left. + j \left[ 1 \pm Q_p \sqrt{1 + \frac{C_p}{2C_s}} \cdot \sin\left(\frac{\Psi}{2}\right) \cos\left(\frac{\Psi}{2}\right) \right] \right\} \quad (9) \end{aligned}$$

The power factor angle for each inverter leg is calculated from (9) applying

$$\phi_{A,B} = \arctan\left(\frac{Q_{A,B}}{P_{A,B}}\right) \quad (10)$$

### B. Converter Design

The nominal lamp current is  $I_o=1.75A$  and the nominal lamp power is  $P_o=120W$  thus, the equivalent DC load is  $R_o=39.2\Omega$ . In order to provide full control capability, the converter is designed so that the control action fixes  $\Psi$  around  $\Psi_o=45^\circ$  to supply  $I_o$ . The input DC voltage is  $V_{dc}=400V$ , supplied by a PFC stage. The transformer turns ratio is chosen to be  $n=2$ , which implies that  $R_{ac}=193\Omega$ . The capacitor ratio is  $C_p/C_s=0.1$ . Upon substitution the design data into (8), the characteristic impedance is obtained,  $Z_p=433\Omega$ . The switching frequency is set at  $\Omega_o=2\pi(100kHz)$ . The parallel resonant frequency is determined from (6),  $\omega_p=2\pi(97.6kHz)$ . Finally, the reactive components are obtained,  $L=705\mu H$ ,  $C_p=7.5nF$  and  $C_s=75nF$ . The output filter components are  $L_o=1mH$  and  $C_o=3.3\mu F$ . The use of electrolytic capacitors is avoided in order to increase the circuit reliability. The experimental prototype and lamp is shown in Fig. 4. The experimental waveform of the lamp current at nominal condition is shown in Fig. 5, which is in good agreement with the theoretical value of  $I_o=1.75A$  given by (8).

The ZVS mode of the converter is verified by using (9). Each inverter section handles half of the total active power,  $P_A=P_B=60W$ . The reactive powers are  $Q_A=101VA$  and  $Q_B=51VA$  respectively. The power factor angles,  $\phi_{A,B}$ , are obtained from (10) and both are positive:  $\phi_A=59.4^\circ$  and  $\phi_B=40.8^\circ$ , which are high enough for assuring the ZVS mode taking into account the dead-time of the transistors drive signals [28]. The experimental waveforms of current  $i_{DS}$  and voltage  $v_{DS}$  in low side switches M4 and M3 are shown in Fig. 6, where theoretical and experimental values of  $\phi_A$  and  $\phi_B$  are in good agreement, verifying the ZVS mode in both transistor legs. The experimental efficiency of the prototype was 89%. This value of efficiency was obtained for the lowest value of the utility line and operating the lamp at its rated power.

### C. Dimming Control

In order to implement dimming control, the pulse-width current modulation, PWM, is preferred over current amplitude modulation for preserving the color rendering of the LED lamp at different light levels. In resonant converters a PWM modulation should deal with the dynamic oscillations in the resonant tank during the transients [29]. The proposed high performance LED driver regulates at constant switching frequency the LED current amplitude,  $i_{led}$ , at the optimum level,  $i_{led}=I_o$ . It also makes  $i_{led}$  to switch between the regulated amplitude,  $I_o$ , and  $i_{led}=0$  A to perform PWM dimming at a frequency,  $f_{PWM}=500$  Hz, high enough to make the conscious and non-conscious flickering imperceptible, setting the duty cycle according to a dimming command. The off-time of the PWM output current is obtained by imposing  $\Psi = 180^\circ$  as

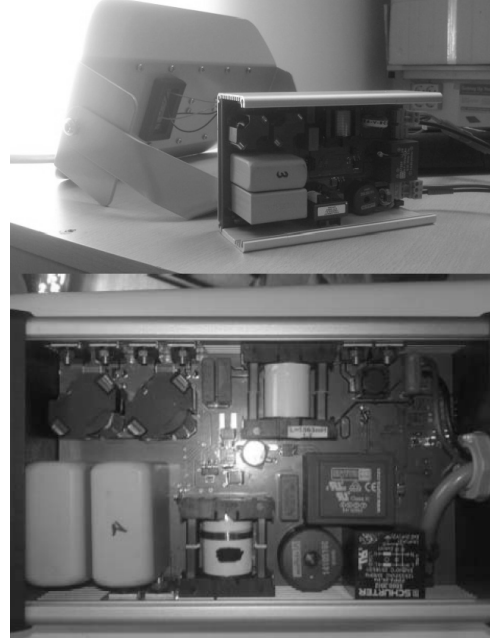

Fig. 4: Experimental prototype of the driver and lamp

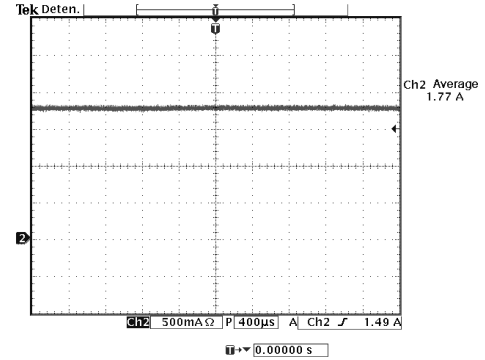

Fig. 5: Experimental lamp current a full power operation

can be seen in Fig. 7. On the other hand, during the on-time the value  $\Psi$  is adjusted by the control loop to achieve  $i_{led} = I_o$ . The phase-shift technique keeps some circulating energy in the resonant tank, which avoids transient oscillations and minimizes the audible noise caused by magnetostriction.

The dynamic response during the zero to  $I_o$  transition and vice versa limits the PWM frequency. The dynamic performance is described by the control to output current transfer function, obtained from the small-signal model shown in Fig. 8.

The detailed small-signal analysis of the converter is given in [30]. The bode diagram of the control to output current transfer function is shown in Fig. 9(a). It can be seen that flat gain is present up to 10 kHz. The frequency limitation is imposed by the dominant pole defined by the output filter ( $r_o = r_d + R_s$  and  $C_o$ ). The first order nature of the converter makes the controller design easy achieving a good phase margin  $\varphi_m = 80^\circ$  at a crossover frequency of  $\omega_c = 2\pi(10kHz)$  by using a Type II or integral-single-lead controller. The open loop response is shown in Fig. 9(b).

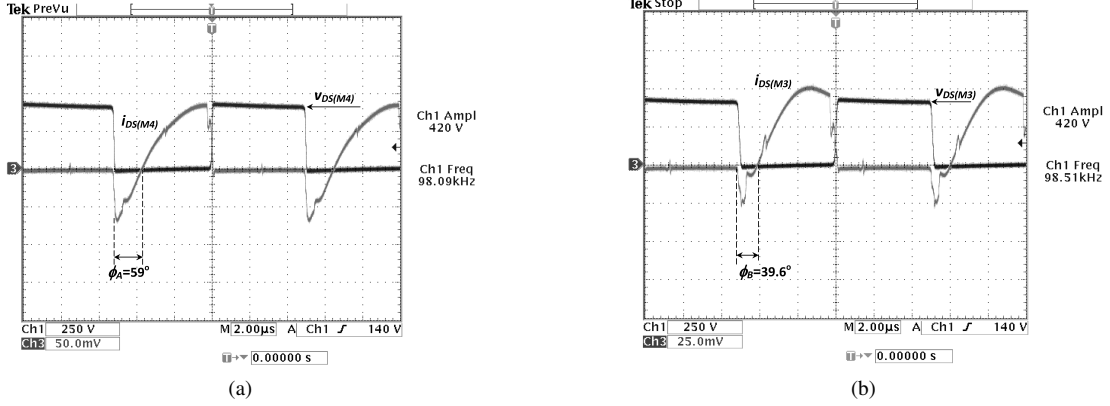

Fig. 6: The experimental waveforms of  $i_{DS}$  current (scale 100mV/A) and  $v_{DS}$  voltage in the low side switches: (a) M4 and (b) M3.

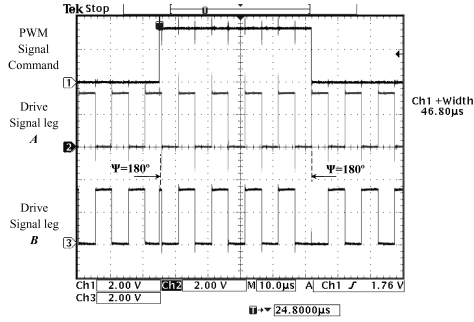

Fig. 7: Experimental waveforms of the implementation of the PWM dimming control.

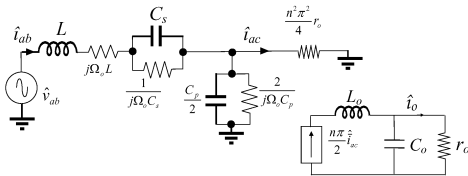

Fig. 8: Small-signal model of the converter to study its dynamic response.

Making the most of the fast dynamic of the converter, during the on-time,  $\Psi$  is adjusted by the control loop, setting up the nominal LED current  $i_{led}=I_o=1.75A$ , as shown in Fig. 10 (a). The control loop is fast enough to set the nominal LED current operation even at values of duty cycle as low as  $D=8\%$ , as it is shown in Fig. 10 (b), where the LED current switches from zero to the nominal value in  $100\mu s$ .

New specifications, which may arise to create different ambiances for special occasions, related to historical buildings or artistic outdoor scenes, can be fulfilled with the proposed LED driver using complex modulation patterns leveraging its fast dynamic response.

#### D. Control System

The control system was developed in order to create an adaptable energy efficient lighting environment in the backyard of an industrial laboratory. A set of LED lamp fixtures was installed in such a way as to ensure full coverage of the yard. The aim of the control is to deliver the minimum sufficient amount of luminance required by the user without disturbing visibility. Students, employees, and technicians use the yard, each performing a different kind of activity (i.e., entering the building or passing by, parking, loading and unloading trucks). The system identifies the current surrounding conditions using sensors and external services. A set of profiles was assigned to the different combinations of conditions.

Each profile defines the ambient lighting level, weather conditions and task to be accomplished. Lighting levels are assigned to each profile according to the American National Standards Institute (ANSI) standard [31] and the lighting distribution map. The lighting levels can be defined individually for each lamp, which gives more flexibility in designing the lighting scenes. The lighting scenes are designed in order to focus the light on the areas being used according to the task, thereby maximizing the light efficiency. The lights are dimmed to minimum safety level when no task is being performed in order to reduce energy consumption. Due to the simplicity of the algorithm, it is easy to add more variables for consideration depending on the application requirements and factors affecting visibility.

The architecture of the system consists of three layers: (1) device layer, (2) data layer, and (3) application layer (Figure 11). The top level is the application layer. It is responsible for system configuration, data storage, and calculation of the efficiency KPIs (Key Performance Indicators). The data layer contains controllers and energy analyzers. The data is gathered in the concentrator to be forwarded to different client applications in the upper layer. The bottom layer is the device layer containing sensors and drivers, which perform the physical control over the lamps.

In order to achieve homogeneity in the communication and interoperability of devices in the data layer, all data

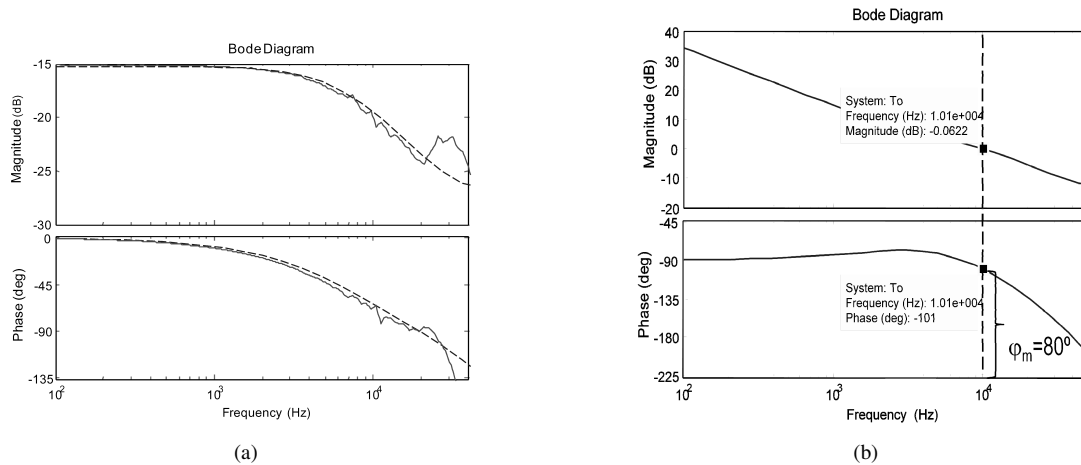

Fig. 9: (a). Control to output current transfer function: dashed line is the theoretical response and the solid line is the experimental result (b) Phase margin given by an integral controller at 10 kHz.

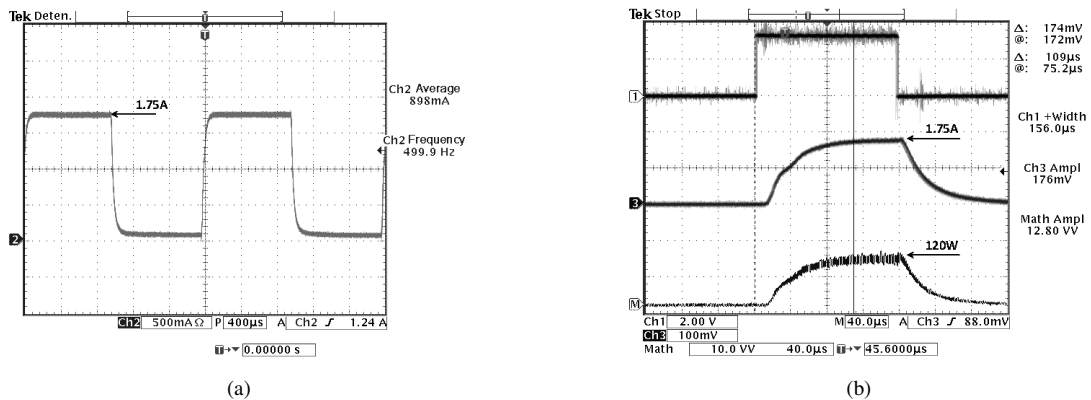

Fig. 10: Experimental waveforms showing the PWM control of the output current for two values of duty cycle  $D$ . (a)  $D=50\%$ . (b)  $D=8\%$ , the narrow pulse allows us to verify the fast dynamic response of the converter.

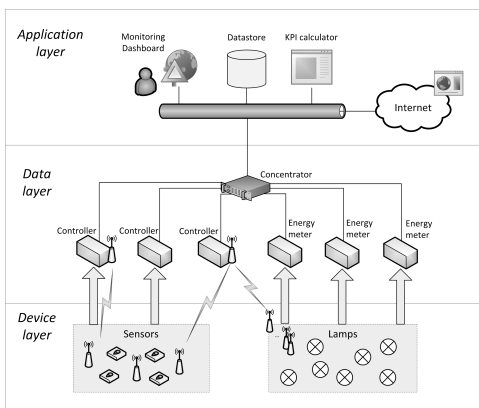

Fig. 11: Implemented lighting system architecture.

transfer between controllers, meters, and the application layer is accomplished using Simple Object Access Protocol (SOAP) message web services. These services are described in a Web Service Description Language (WSDL) file, which enables

other system components to discover and access them. Concentrator subscribes to the events provided by the services in order to obtain the data.

The control commands from the controller to the driver are executed in Digital Addressable Lighting Interface (DALI) protocol. This provides a logarithmic dimming scale for human eye sensitivity, built-in stored scene in the ballast, control over fading and dimming time [32], and synchronization of the clock [25]. As a result of grouping and homogeneity of communications, the implementation can easily be scaled up.

#### IV. RESULTS

A web application was developed and hosted on a dedicated server intended for monitoring and analyzing purposes. The server hosting the application is low energy consumption to keep the implementation at a low energy impact. The application provides different views depending on the user's role and interest in data representation. Technicians are provided with detailed real-time data, but managers obtain aggregated KPIs for long interval metrics. The application has simple



Fig. 12: Monitoring application dashboard.

and intuitive interface making it easily interpretable and easily mastered at any level of experience.

The home screen of the web application in Fig. 12 shows the essential data for the regular user. The user can navigate to different tabs on the top of the application to show real-time plots and historic reports or KPIs from the database. The upper section shows the weather data of the current location. On the left side there is a plan view of the backyard, where users can interact and hover over the lamps showing detailed energy data. In the middle of the screen, a tabbed chart displays the energy consumption on a daily, weekly, monthly, or yearly basis. The gauges on the right hand side show real-time power consumption for each lamp. The profile box displays the current conditions and the profile name of the surroundings. Total energy consumption and estimated cost are shown in the bottom right corner of the dashboard.

In order to assess the smart lighting performance, a benchmark should be set up to compare the energy readings. At the time the tests were conducted there were no earlier accounts or energy readings for purposes of comparison. An absolute scheduled system was used as a benchmark. The scheduled system was designed to work with 90% of full power from sunset till midnight, providing a reasonable amount of lighting needed during busy hours. It is assumed that the backyard is used less after midnight, so the lamps dim to 30% until they turn off completely at sunrise.

The testing period for the smart lighting was between November 15 and December 10, 2013. It is important to take into consideration the daylight length and weather conditions as in the northern countries the variations is vast, which affects directly the energy consumption and indirectly heat dissipation. During the testing period the average amount of daylight was six hours out of 24 and the sky was clear.

Testing of the smart lighting implementation took place starting from November 29, 2013. Daily energy consumption was stored and plotted in Fig. 13, where the vertical and horizontal axes represent the energy consumed in watts hour and days respectively. From the plot it is easy to see that initial consumption was around 12 kWh. The lighting levels were refined and the waiting time of the sensors was reduced to 10 s, consequently starting December 3 the energy consumption was reduced significantly to 8.4 kWh. A problem in the KPI calculation was noticed on December 4 and 5, thus for these days records are ignored. The measurements were made during the darkest period of the year at the latitude of  $61^{\circ}30'$  N. However, the amount of energy savings with respect to baseline will depend on the amount of hours of sunshine, and

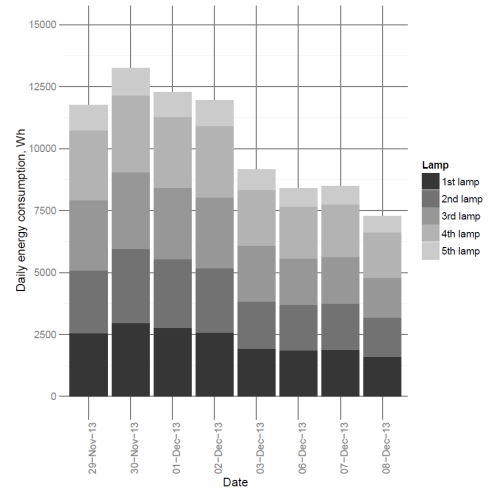

Fig. 13: Energy consumption by lamp

TABLE II: Scheduled and adaptive comparison

KPI	Scheduled	Controlled	Efficiency (%)
Energy (kWh)	12.655	8.4	33.62
Average Power (W)	104.845	84.678	12.24
LPD ( $W/m^2$ )	0.68	0.553	12.24
$C'O_2$ Equivalent (kg)	8.929	5.921	33.62
Cost (EUR)	1.012	0.672	33.62

will vary according to the season of the year and geographic location.

Table II shows a comparison between smart lighting and scheduled consumption. It is clear that consumption was reduced by 33.62%. The energy efficiency is calculated following the definition provided below, where  $E$  stands for energy. The smart lighting showed satisfactory performance regarding user experience and light distribution according to task being performed. This results in greater efficiency in the productivity of the working place. In future work more experiments should be conducted under different conditions to measure the performance.

$$\eta_{\%} = \frac{E_{Scheduled} - E_{Controlled}}{E_{Scheduled}} \times 100 \quad (11)$$

## V. CONCLUSION

Energy efficient performance of outdoor lighting systems has become a compulsory requirement. Adaptive distributed control is a crucial part of solutions aimed at energy efficiency. In this paper high-level adaptive control techniques are considered in connection with the process of dimming command execution. IoT technologies applied in the field of outdoor lighting help capture the state of the environment and communicate the control commands to the actuators clearly and transparently. Fast and precise execution of the dimming command with minimum energy losses makes distributed adaptive control approaches applicable in practice.

While the proposed approach demonstrably reduced energy consumption, future work should concentrate on enhancing



user comfort, extending supported use-cases, and optimizing the communication infrastructure.

#### ACKNOWLEDGMENT

This work was supported in part by the Spanish Government with the National Project TEC2014-52316-R: Estimation and Optimal Control for Energy Conversion with Digital Devices, ECOTREDD. The work was also partially funded by ARROWHEAD EU project (ARTEMIS JU, ARTEMIS12, GA no. 332987) and the Finnish Funding Agency for Technology and Innovation (TEKES).

#### REFERENCES

- [1] C. Boomsma and L. Steg, "The effect of information and values on acceptability of reduced street lighting," *Journal of Environmental Psychology*, vol. 39, pp. 22–31, Sep. 2014. [Online]. Available: <http://linkinghub.elsevier.com/retrieve/pii/S0272494413000844>
- [2] M. Johansson, E. Pedersen, P. Maleetipwan-Mattsson, L. Kuhn, and T. Laike, "Perceived outdoor lighting quality (POLQ): A lighting assessment tool," *Journal of Environmental Psychology*, vol. 39, pp. 14–21, Sep. 2014. [Online]. Available: <http://linkinghub.elsevier.com/retrieve/pii/S0272494413000923>
- [3] M. Jurvansuu, "ProductivityLeap with IoT," p. 99, 2013.
- [4] D. Aliakseyeu, H. van Essen, A. Lucero, J. Mason, B. Meerbeek, E. den Ouden, and A. Wiethoff, "Interactive city lighting," *CHI '13 Extended Abstracts on Human Factors in Computing Systems - CHI EA '13*, p. 3191, 2013. [Online]. Available: <http://dl.acm.org/citation.cfm?doid=2468356.2479644>
- [5] P. PLUS, "PLUS Review," LUCI, Tech. Rep., 2012. [Online]. Available: [http://www.luciasociation.org/images/stories/PDF/plus\\_review.pdf](http://www.luciasociation.org/images/stories/PDF/plus_review.pdf)
- [6] M. Burgos-Payan, F. Correa-Moreno, and J. Riquelme-Santos, "Improving the energy efficiency of street lighting. A case in the South of Spain," in *9th International Conference on the European Energy Market (EEM)*, May 2012, pp. 1–8.
- [7] E. F. Schubert and J. K. Kim, "Solid-state light sources getting smart," *Science (New York, N.Y.)*, vol. 308, no. 5726, pp. 1274–8, May 2005. [Online]. Available: <http://www.ncbi.nlm.nih.gov/pubmed/15919985>
- [8] Banner, "Light Up the Visual Factory Lighting Solutions for Lean Manufacturing," 2012. [Online]. Available: <http://www.hpisales.com/BannerVisualFactory.pdf>
- [9] C. Basu, J. Caubel, K. Kim, E. Cheng, A. Dhinakaran, A. Agogino, and R. Martin, "Sensor-based predictive modeling for smart lighting in grid-integrated buildings," *IEEE Sensors Journal*, pp. 1–1, 2014. [Online]. Available: <http://ieeexplore.ieee.org/lpdocs/epic03/wrapper.htm?arnumber=6883131>
- [10] Moon-Hwan Chang; Chaochao Chen ; Das, D. ; Pecht, M., "Anomaly Detection of Light-Emitting Diodes Using the Similarity-Based Metric Test," *IEEE Trans. on Industrial Informatics*, vol. 10, no. 3, pp. 1852 – 1863, 2014.
- [11] S. Escolar, J. Carretero, M.-C. Marinescu, and S. Chessa, "Estimating Energy Savings in Smart Street Lighting by Using an Adaptive Control System," *International Journal of Distributed Sensor Networks*, vol. 2014, pp. 1–17, 2014. [Online]. Available: <http://www.hindawi.com/journals/ijdsn/2014/971587/>
- [12] A. A. Williams, B. A. Atkinson, K. Garbesi, F. M. Rubinstein, and E. Page, "A meta-analysis of energy savings from lighting controls in commercial buildings," p. 25, September 2011.
- [13] P. Ducange, F. Marcelloni, and M. Antonelli, "A Novel Approach Based on Finite-State Machines with Fuzzy Transitions for Nonintrusive Home Appliance Monitoring," *IEEE Trans. on Industrial Informatics*, vol. 10, no. 2, pp. 1185–1197, May 2014. [Online]. Available: <http://ieeexplore.ieee.org/lpdocs/epic03/wrapper.htm?arnumber=6732883>
- [14] C. Branas, F.J. Azcondo, and J.M. Alonso, "Solid-State Lighting: A System Review," *IEEE Industrial Electronics Magazine*, vol. 7, no. 4, pp. 6–14. [Online]. Available: <http://ieeexplore.ieee.org/stamp/stamp.jsp?tp=&arnumber=6681992&isnumber=6681963>
- [15] M. Miki, T. Hiroyasu, and K. Imazato, "Proposal for an intelligent lighting system, and verification of control method effectiveness," in *2004 IEEE Conference on Cybernetics and Intelligent Systems*, vol. 1, Dec. 2004, pp. 520–525.
- [16] R. Karlicek, "Smart lighting - more than illumination," in *Communications and Photonics Conference (ACP), 2012 Asia*, 2012, pp. 1–2.
- [17] J. D. V. Wyk, L. Fellow, and F. C. Lee, "On a Future for Power Electronics," *IEEE Journal of Emerging and Selected Topics in Power Electronics*, vol. 1, no. 2, pp. 59–72, 2013.
- [18] Cree, "Cree news and events." [Online]. Available: <http://www.cree.com/News-and-Events/Cree-News/Press-Releases/2014/March/300LPW-LED-barrier>
- [19] C.-A. Cheng, C.-H. Chang, T.-Y. Chung, and F.-L. Yang, "Design and Implementation of a Single-Stage Driver for Supplying an LED Street-Lighting Module With Power Factor Corrections," *IEEE Trans. on Power Electronics*, vol. 30, no. 2, pp. 956–966, 2015.
- [20] C.-A. Cheng, H.-L. Cheng, and T.-Y. Chung, "A Novel Single-Stage High-Power-Factor LED Street-Lighting Driver With Coupled Inductors," *IEEE Trans. on Industry Applications*, vol. 50, no. 5, pp. 3037–3045, 2014.
- [21] M. Arias, D. G. Lamar, F. F. Linera, D. Balocco, A. A. Diallo, and J. Sebastian, "Design of a Soft-Switching Asymmetrical Half-Bridge Converter as Second Stage of an LED Driver for Street Lighting Application," *IEEE Trans. on Power Electronics*, vol. 27, no. 3, pp. 1608–1621, 2012.
- [22] R. Zhang and H.-H. Chung, "Daisy-chain transformer structure for current-balancing multiple LED strings," in *2013 IEEE Energy Conversion Congress and Exposition (ECCE)*, 2013, pp. 3118–3125.
- [23] IES, "Lighting Control Protocols," New York, 2011.
- [24] R. Klimek and G. Rogus, "Systems for the Outdoor Smart Lighting." Springer International Publishing Switzerland, 2014, pp. 257–268.
- [25] R. S. Simpson, *Lighting control: Technology and Applications*. Oxford: Focal Press, 2003.
- [26] R. Steigerwald, "A comparison of half-bridge resonant converter topologies," *IEEE Trans. on Power Electronics*, vol. 7, no. 2, pp. 89–98, Jan 1992.
- [27] B. Lu, W. Liu, Y. Liang, F. Lee, and J. Van Wyk, "Optimal design methodology for llc resonant converter," in *Twenty-First Annual IEEE Applied Power Electronics Conference and Exposition (APEC '06)*, March 2006, pp. –.
- [28] V. Lopez, A. Navarro-Crespin, R. Schnell, C. Branas, F. Azcondo, and R. Zane, "Current phase surveillance in resonant converters for electric discharge applications to assure operation in zero-voltage-switching mode," *IEEE Trans. on Power Electronics*, vol. 27, no. 6, pp. 2925–2935, June 2012.
- [29] W. Feng, F. C. Lee, and P. Mattavelli, "Optimal Trajectory Control of LLC Resonant Converters for LED PWM Dimming," *IEEE Trans. on Power Electronics*, vol. 29, no. 2, pp. 979–987, 2014.
- [30] Y. Yin, R. Zane, J. Glaser, and R. Erickson, "Small-signal analysis of frequency-controlled electronic ballasts," *IEEE Trans. on Circuits and Systems I: Fundamental Theory and Applications*, vol. 50, no. 8, pp. 1103–1110, Aug 2003.
- [31] J. Anshel, *Visual Ergonomics*, J. Anshel, Ed. Boca Raton: CRC Press, Taylor & Francis Group, 2005.
- [32] DALI-AG, "Digital Addressable Lighting Interface Activity Group (DALI AG)," 2011. [Online]. Available: [http://www.dali-ag.org/c/manual\\_gb.pdf](http://www.dali-ag.org/c/manual_gb.pdf)