

# SYSTEMS FOR SUSTAINABLE ENERGY SUPPLY FOR SMALL VILLAGES

Master in European Construction Engineering  
2012-2013

## Group Project 1



# SYSTEMS FOR SUSTAINABLE ENERGY SUPPLY FOR SMALL VILLAGES

Master in European Construction Engineering  
2012-2013

## Group Project 1



### **Authors:**

María Alberdi Pagola  
Laura Álvarez Antón  
Lulu Andersen  
Louis Kofi Awugya  
Valerio De Vivo  
Guillem Ferrer Ramells  
Giancarlo Gullotto  
Marta Hervías Gallardo  
Ali Kemal  
Claudie Louet  
Javier Manjón Herrero  
Victor Marcos Mesón  
Antoine Marie  
Marta Orejas Yáñez  
Mónica Oveysi Rivas  
Ismael Ruiz de Temiño Alonso  
Xavier Sintès Permanyer  
Keisha Tyrell  
Alberto Urbina Velasco  
Francisco Villegas Ruiz

# TABLE OF CONTENTS

<b>INTRODUCTION .....</b>	<b>6</b>
AIM AND STRUCTURE OF THE REPORT .....	7
OVERVIEW OF THE WORLD'S ENERGY CONSUMPTION .....	7
ENERGY CRISIS BRIEF REVIEW .....	8
EU 2020 TARGETS, PROTOCOLS AND GLOBAL WARMING .....	9
RENEWABLE/SUSTAINABLE ENERGY .....	10
GROWTH OF RENEWABLE ENERGY .....	10
WHY RENEWABLE ENERGY .....	11
<b>ENERGIES .....</b>	<b>13</b>
<b>SOLAR ENERGY .....</b>	<b>14</b>
INTRODUCTION .....	14
<b>THERMAL SYSTEMS .....</b>	<b>15</b>
LOW THERMAL SYSTEMS .....	15
DOMESTIC HOT WATER .....	15
HEATING .....	18
OTHER APPLICATIONS .....	18
CURRENT STATUS .....	20
FACTORS .....	20
SWOT .....	22
MEDIUM/HIGH THERMAL SYSTEMS .....	22
THERMOELECTRIC ENERGY .....	22
INDUSTRIAL PROCESSES .....	24
CURRENT STATUS .....	24
FACTORS .....	24
SWOT .....	25
<b>PHOTOVOLTAIC SYSTEMS .....</b>	<b>26</b>
HOME SUPPLY .....	27
HARVESTING SOLAR ENERGY .....	28
PHOTOVOLTAIC PLANTS .....	28
ELECTRICITY FOR BUILDINGS/COMMUNITIES .....	28
CURRENT STATUS .....	28
FACTORS .....	29
EXTERNAL INPUTS .....	29
ENVIRONMENTAL IMPACTS .....	29
ECONOMICAL ASPECTS .....	29
SOCIAL FACTORS .....	30
SWOT .....	30
<b>HYBRID SYSTEMS .....</b>	<b>31</b>
SOLAR THERMAL-PHOTOVOLTAIC PANELS .....	31
WIND-PHOTOVOLTAIC SYSTEMS .....	31
OTHER HYBRID SYSTEMS .....	32
<b>INTEGRATED SYSTEMS .....</b>	<b>33</b>
<b>FUTURE OF SOLAR ENERGY AND ON GOING RESEARCH .....</b>	<b>34</b>
<b>CONCLUSION .....</b>	<b>35</b>
<b>WIND ENERGY .....</b>	<b>36</b>
INTRODUCTION .....	36
DESCRIPTION .....	36
TECHNOLOGY .....	36
APPLICATIONS .....	40
CURRENT STATUS .....	46

WIND POWER CAPACITY.....	46
WIND ENERGY INSTALLATIONS.....	46
WIND ENERGY INVESTING.....	47
WIND FARMS.....	47
WIND ENERGY FUTURE.....	47
FACTORS.....	48
EXTERNAL INPUTS.....	48
ENVIRONMENTAL IMPACT.....	52
ECONOMIC ASPECT.....	54
SOCIAL ACCEPTANCE.....	55
EMPLOYMENT.....	57
POLICY.....	57
LEGISLATION.....	58
SWOT ANALYSIS / CONCLUSION.....	59
<b>WATER.....</b>	<b>60</b>
<b>HYDROPOWER.....</b>	<b>61</b>
INTRODUCTION.....	61
CLASSIFICATION, FOLLOWING DIFFERENT CRITERIA.....	61
DESCRIPTION.....	63
BASIC CONCEPTS AND TECHNOLOGY.....	63
CURRENT STATUS.....	67
FACTORS.....	68
EXTERNAL INPUTS.....	68
ENVIRONMENTAL IMPACTS.....	69
ECONOMIC ASPECTS.....	72
SOCIAL FACTORS.....	74
<b>CONCLUSION.....</b>	<b>76</b>
SWOT.....	77
<b>MARINE ENERGY.....</b>	<b>78</b>
INTRODUCTION.....	78
DESCRIPTION.....	79
TECHNOLOGY.....	79
CURRENT STATUS.....	86
FACTORS.....	88
EXTERNAL INPUTS.....	88
ENVIRONMENTAL FACTORS.....	89
ECONOMICAL FACTORS.....	90
SOCIAL FACTORS.....	91
<b>CONCLUSION.....</b>	<b>93</b>
SWOT.....	93
SUITABILITY FOR BUILDINGS.....	93
SUITABILITY FOR SMALL VILLAGES.....	93
<b>BIOENERGY.....</b>	<b>94</b>
INTRODUCTION.....	94
<b>SOLID BIOMASS.....</b>	<b>95</b>
INTRODUCTION.....	95
DESCRIPTION.....	95
TYPOLOGIES.....	95
CURRENT STATUS.....	102
FACTORS.....	102
EXTERNAL INPUTS.....	102
ENVIRONMENTAL IMPACT.....	103
ECONOMIC ASPECTS.....	103
SOCIAL FACTORS.....	103
SWOT.....	104
<b>LIQUID BIOFUELS.....</b>	<b>105</b>
INTRODUCTION.....	105
DESCRIPTION.....	105
TYPOLOGIES.....	105

CURRENT STATUS .....	108
FACTORS .....	109
EXTERNAL INPUTS .....	109
ENVIRONMENTAL IMPACT .....	109
ECONOMIC ASPECTS.....	110
SOCIAL FACTORS .....	110
SWOT.....	111
<b>BIOGAS .....</b>	<b>112</b>
INTRODUCTION .....	112
DESCRIPTION .....	112
CURRENT STATUS.....	113
FACTORS .....	114
EXTERNAL INPUTS .....	114
ENVIROMENTAL IMPACT.....	115
ECONOMIC ASPECTS.....	115
SOCIAL FACTORS .....	116
SWOT.....	117
SUITABILITY FOR SMALL COMUNITIES .....	117
<b>GEOHERMAL ENERGY .....</b>	<b>118</b>
INTRODUCTION .....	118
<b>SHALLOW GEOHERMAL.....</b>	<b>119</b>
INTRODUCTION .....	119
THE DEFINITION FOR SHALLOW GEOHERMAL ENERGY .....	119
THE OPTIONS OF HARNESSING RENEWABLE GEOHERMAL ENERGY.....	120
TECHNOLOGIES OF SHALLOW GEOHERMAL .....	121
HORIZONTAL LOOPS .....	122
VERTICAL LOOPS.....	123
THE CURRENT TECHNOLOGICAL STATUS.....	125
FACTORS .....	125
EXTERNAL INPUT .....	125
ENVIRONMENTAL IMPACT .....	127
ECONOMICAL ASPECT .....	128
SWOT.....	129
<b>DEEP GEOHERMAL .....</b>	<b>131</b>
INTRODUCTION .....	131
THE EARTH'S STRUCTURE.....	131
TECHNOLOGIES OF DEEP GEOHERMAL .....	132
DIRECT USE GEOHERMAL ENERGY .....	132
GEOHERMAL POWER PLANT.....	133
CURRENT STATUS.....	134
FACTORS .....	136
ENVIRONMENTAL IMPACT .....	136
ECONOMICAL ASPECT.....	139
SWOT.....	139
<b>CONCLUSION .....</b>	<b>140</b>
<b>SYSTEMS.....</b>	<b>141</b>
<b>HEAT PUMP.....</b>	<b>142</b>
KEY WORD.....	142
INTRODUCTION .....	142
CREATION .....	142
EVOLUTION .....	142
DESCRIPTION .....	143
TECHNOLOGY .....	143
CURRENT STATUS.....	150
FACTORS .....	153
EXTERNAL INPUTS .....	153
INSTALLATION .....	155

ENVIRONMENTAL IMPACT.....	156
ECONOMICAL ASPECT.....	157
FUTURE TRENDS.....	160
REORGANIZED SECTORS .....	160
POTENTIAL MARKET.....	161
TARGETS RESULTS.....	161
<b>CONCLUSION.....</b>	<b>162</b>
SWOT .....	162
<b>COGENERATION .....</b>	<b>163</b>
ABREBBIATIONS AND DEFINITIONS .....	163
ABBREVIATIONS.....	163
DEFINITIONS.....	163
INTRODUCTION .....	164
DESCRIPTION .....	164
TECHNOLOGY.....	164
TYPES OF CHP SYSTEMS .....	166
REAL APPLICATIONS .....	169
CURRENT STATUS .....	170
EFFICIENCY TERMS .....	170
EUROPEAN FRAMEWORK .....	170
UNITED STATES NUMBERS .....	171
FACTORS .....	172
EXTERNAL INPUTS.....	172
ENVIRONMENTAL IMPACT.....	172
ECONOMICAL ASPECT.....	174
SOCIAL FACTOR.....	174
<b>CONCLUSION.....</b>	<b>175</b>
SWOT .....	175
SUITABILITY FOR BUILDINGS & SMALL VILLAGE.....	176
<b>HYDROGEN.....</b>	<b>177</b>
INTRODUCTION .....	177
PRODUCTION .....	178
PRODUCTION PROCESSES .....	179
CHEMICAL SYNTHESIS .....	179
PHOTOLYTIC PROCESSES.....	182
IMPLEMENTATION OF SOURCES .....	183
FOSSIL FUELS .....	183
NUCLEAR ENERGY .....	183
RENEWABLE ENERGIES .....	184
STORAGE.....	185
COMPRESSED HYDROGEN .....	185
LIQUID HYDROGEN .....	185
METAL HYDRIDES .....	185
TRANSPORT & DISTRIBUTION. ....	187
FUEL CELLS.....	188
EXTERNAL INPUTS .....	189
ENVIRONMENTAL IMPACTS .....	190
ECONOMIC ASPECTS .....	190
SOCIAL FACTORS. ....	190
<b>CONCLUSION.....</b>	<b>192</b>
SWOT .....	192
<b>EFFICIENT ENERGY MANAGEMENT .....</b>	<b>193</b>
<b>ENERGY STORAGE SYSTEMS .....</b>	<b>194</b>
INTRODUCTION.....	194
DEFINITION OF THE THERMAL INERTIA.....	194

DIFFERENT TYPES OF HEAT .....	194
MAIN STORAGE SYSTEMS AND TECHNIQUES .....	197
STORAGE VOLUMES .....	197
STORAGE TIME .....	198
CONCLUSION .....	200
BUILDINGS APPLICATIONS .....	201
SEASONAL STORAGE APPLICATION .....	201
OTHER APPLICATION IN DEVELOPMENT .....	202
CHEMICAL STORAGE .....	203
HEAT DISTRIBUTION NETWORK .....	203
IMPACTS .....	204
ENERGETIC IMPACTS .....	204
ENVIRONMENTAL IMPACTS .....	204
COSTS AND EFFICIENCY COMPARISON .....	204
<b>PASSIVE BUILDING DESIGN .....</b>	<b>206</b>
INTRODUCTION .....	206
DESCRIPTION .....	206
CURRENT STATUS: ENERGY AND REGULATORY CONTEXT IN THE EUROPEAN UNION .....	206
FACTORS .....	208
DESIGN .....	209
PASSIVE CONSTRUCTION .....	211
ENVIRONMENTAL IMPACT .....	227
ECONOMICAL ASPECT .....	227
SOCIAL FACTORS .....	228
<b>CONCLUSION .....</b>	<b>229</b>
SWOT .....	230
<b>INSULATING MATERIALS .....</b>	<b>231</b>
INTRODUCTION .....	231
<b>TRADITIONAL INSULATING MATERIALS .....</b>	<b>232</b>
MINERAL WOOL .....	232
STONE WOOL .....	232
GLASS WOOL .....	234
MINERAL FOAM .....	234
<b>SYNTHETIC INSULATING MATERIALS .....</b>	<b>235</b>
POLYURETHANE (PUR) .....	235
POLYSTYRENE (PS) .....	236
EXPANDED POLYSTYRENE (EPS) .....	236
EXTREUDED POLYSTYRENE FOAMS (XPS) .....	237
<b>INSULATING MATERIALS FROM VEGETAL .....</b>	<b>238</b>
CORK .....	238
WOOD WOOL .....	239
CELLULOSE WADDING .....	239
HEMP WOOL .....	240
FLAX WOOL .....	241
<b>Insulating materials from animals .....</b>	<b>242</b>
SHEEP WOOL .....	242
<b>Advanced thermal insulation .....</b>	<b>243</b>
VACUUM INSULATION PANELS (VIP) .....	243
GAS-FILLED PANELS .....	244
AEROGELS .....	244
<b>Thermal insulation in development .....</b>	<b>246</b>
VACUUM INSULATION MATERIALS (VIM) .....	246
GAS INSULATION MATERIALS (GIM) .....	246
NANO-INSULATION MATERIALS (NIM) .....	246
DYNAMIC INSULATION MATERIALS (DIM) .....	247
<b>CONCLUSION .....</b>	<b>248</b>

<b>SMART GRIDS.....</b>	<b>251</b>
ABBREVIATIONS AND ACRONYMS .....	251
INTRODUCTION .....	251
<i>HISTORICAL DEVELOPMENT OF THE ELECTRICITY GRID .....</i>	<i>252</i>
CURRENT STATUS .....	253
ENERGY DEMAND .....	254
INELASTIC ENERGY DEMAND .....	254
ELASTIC ENERGY DEMAND .....	255
ENERGY BALANCE.....	255
DEMAND-RESPONSE.....	255
FORECASTING ELECTRICITY PRICE AND LOAD.....	256
DEMAND-SIDE MANAGEMENT.....	256
GAME THEORY FOR DEMAND-SIDE MANAGEMENT .....	256
ENERGY CONSUMPTION .....	257
SMART HOME AND DRM OPTIMIZATION .....	257
SENSORS.....	258
ADVANCED METERING INFRASTRUCTURE .....	258
SMART METER .....	258
PHASE MEASUREMENT UNITS .....	258
COMMUNICATION TECHNOLOGIES IN THE SMART GRID .....	259
MICROGRID .....	260
MICROGRID GAME THEORETIC MODEL .....	260
EUROPEAN FRAMEWORK .....	261
GUIDELINES AND STANDARDS.....	261
FUTURE TRENDS.....	262
<b>CONCLUSION .....</b>	<b>263</b>
SMALL VILLAGES .....	264
SWOT .....	264
<b>COMBINATION OF ENERGIES .....</b>	<b>265</b>
<b>COMBINATION OF ENERGIES .....</b>	<b>266</b>
WIND - WATER ENERGY .....	266
SOLAR – WIND ENERGY .....	267
SOLAR – HYDROGEN ENERGY.....	267
SOLAR – GEOTHERMAL ENERGY .....	267
<b>CONCLUSIONS.....</b>	<b>268</b>
CONCLUSIONS.....	269
GENERAL OVERVIEW OF THE POTENTIAL OF ENERGY .....	269
USES OF THIS ENERGIES CONCERNING TO HOUSES .....	270
COMPARISON AND SELECTION .....	271
CONFERENCES AND CONGRESSES.....	275
TRENDS, EVOLUTION AND PERSPECTIVE.....	277
<b>LIST OF FIGURES.....</b>	<b>279</b>
<b>REFERENCES.....</b>	<b>283</b>



# INTRODUCTION



# Aim and Structure of the Report

The main aim of this report is to identify the different sustainable sources and systems of energy and their technological principle which are under substantial development replacing the conventional or traditional sources of energy. It is also the objective of this study to identify the advantages and disadvantages of each system of energy in their actual application now and in the future. In addition, the report discusses the different Energy Systems and Efficient Energy Management systems, which are currently in use. Moreover, the report addresses the environmental, social and economic aspects sustainable energy in the context of buildings and small villages.

The report is organized in the following three main blocks:

**Block 1 Introduction:** - This section introduces the general overview of the world's energy consumption, the major energy crisis occurred in history and renewable/sustainable energy attached with its importance to the Building sector in relation to climate change.

**Block 2 Sustainable/Renewable Energy:** - This is the main body of the report in which the different sources and forms of sustainable energies will be dealt in-depth. The block introduces the principles, types and applications of Sustainable Energy, Sustainable Energy Systems and Efficient Energy Management System. In particular the topics to be treated in this part of the report are Solar Energy, Wind Energy, Water/Marine Energy, Bio-energy, Geothermal, Heat Pumps, Cogeneration, Hydrogen, Energy Storage, Passive Building Design, Insulation Materials, and Smart Grids. Moreover, the current status of each of these energy forms and systems and their applicability to small villages is also discussed.

**Block 3 Conclusion:** - This block provides a summarized reflection of what has been studied in this report. It particularly gives emphasis to the application of renewable and sustainable energy technologies to buildings and small villages.

## Overview of the World's Energy Consumption

The total Energy which has been utilized by all human civilization is referred to as World Energy Consumption. It comprises of all the energy from every source available applied to human activities across every sector and country in the world.

In recent years, global demand for energy has increased remarkably due to the industrial development and population growth of many nations in the world. The abrupt population and economic growth of the world has caused the Supply of energy to be far more less than the actual demand.

One of the major energy sources which has served for many generations is Oil and it has brought significant economic changes to the contemporary world. It covered more than 33% of world's Energy Demand. The contribution of coal in fulfilling the energy demand of the world is also immense. Only in 2009, it accounts for 27% of the overall world energy demand. As it is well known, these energy sources are not only being depleted from time to time but also their environmental impact is getting worse and worse to a level where it's irreversible unless we seek for better alternatives. Out of the

global energy mix currently, Fossil fuel accounts the most. In the year 2011, it has been subsidies by 523billion USD.

The data from the year 1990 to 2008 gathered by International Environment Agency in 2012 showed that the energy consumption of a single person has increased by 10% during these years. Simultaneously, the population has grown by 27%. Accordingly, the energy consumption and utilization of the different corner of the world has extremely increased. (IEA, 2012)

The following table shows the developing and developed portion of the world along with the corresponding energy consumption increase for the period between 1990 and 2008.

No.	REGION	ENERGY CONSUMPTION GROWTH
1	Middle East	170%,
2	China	146%
3	India	91%
4	Africa	70%
5	Latin America	66%
6	USA	20%
7	EU-27 Block	7%
8	Overall World	39%

Table 1.1 Regional Energy Consumption Growth Years 1990-2008 (IEA, 2012)

Energy consumption in the world has so far shown an increasing trend along with the growing population and development of Nations worldwide. The economic and financial crisis in 2009 however caused the energy sector to shown a setback with 1.1%. This has led to the reduction of the GDP of the world by 0.6%. (Global Energy review, 2011)

In spite of all these consumption, the world still needs more energy to be fed. The energy sources which have been exhaustively used up for over generations have brought disaster to the planet which led to the distortion of the climate and the environment. Continuing to use the same trend as before to satisfy the demand of the world's ever increasing energy requirement will without doubt dictate our survival.

## Energy Crisis Brief Review

All crises which have occurred so far one way or another are interrelated. Either it is energy crisis, developmental crisis or environmental crisis, all could mean the same. (UN Environmental Report, 1987). Even though the crisis is labeled as energy, developmental or environmental the root cause of these entire crisis converges to the same direction.

In 1970 energy crisis has occurred in Germany, United States, Canada, etc which are known for their advancement in industry and technology. The main cause of this crisis was the embargo by OPEC Oil producers. The embargo emanated from the claim that the westerns are supporting Israel during the Yom Kippur war. At this point in time, we can realize that just the oligopoly nature of these limited sources of energy which is found in only some portion of the world has enabled the producers to use it as a weapon to demand their interest by creating crisis. The gulf war has also brought about price shock in 1990.

The glob has passed through potentially devastating global energy crisis and environmental changes so far. This is due to not only a decline in the availability of cheap Energy but also its negative impact on the environment which calls for a decreasing dependency on non renewable and unsustainable energy sources such as fossil fuel.

The Buildings sector is one of the major areas where high improvement in energy efficiency and optimization is required to combat the difficulty faced in relation to environmental changes and global warming. This sector is said to cover up to 30 to 40% of the total energy consumption. The sector can play a key role in reducing the threat of environmental damage and climate changes.

In conclusion, it can evidently be seen from the above discussions that the world energy consumption is increasing, whereas the source of energy used to satisfy this need, on one hand are being depleted and manipulated because the source is finite and is found in some region, whereas on the other hand it is damaging the environment through pollution and CO<sub>2</sub> emissions. This indicates that the world needs to enter to an era where supply of clean and sustained energy is guaranteed for the present and the years to come. Hence, it is crucial and compulsory to look for a new, clean and sustainable approach to address the growing energy consumption of the world.

## **EU 2020 targets, Protocols and Global warming**

Under the Kyoto Protocol, the EU-15 countries have committed to a common emission reduction target of 8% to be achieved over 5 year commitment period from 2008 to 2012. Recent estimates of the EEA shows that in 2009 EU-15's have managed to reduce their emission by 6.9% compared to 2008. However, subsequent to the recovery from the recent economic crisis, the European Commission speculates that over the full commitment period (i.e. 2008 to 2012), EU-15 aggregated emission will stay well below its Kyoto target with the current policies in place. (EEA Report No 7/2010)

The EU-27 on the other hand has committed to reduce its GHG emission by at least 20% in the year 2020. It has also an ambition to increase the commitment to 30% if major emitting countries agree to the achievement of similar target. Based on the latest emission data, in 2009 the EU-27's emission was approximately 17.3% below the 1990 level. This indicates the bloc is very close to achieve its target by 2020. (EEA Report No 7/2010)

If major emitting countries adhere and strive to achieve these targets the challenge that our planet has confronted in relation to global warming will be solved over time provided that other sustainable developments are in place. Since 1979, land temperatures have increased about twice as fast as ocean temperatures (0.25 °C per

decade against 0.13 °C per decade). The initial cause of these temperature changes is the emission of GHG.

When we investigate the building sector and its contribution to environmental impacts, we realize that, it is under the operation phase of the building that most of the energy is used compared to construction of the same. Researches done in the area shows that less than 20% of energy is used during construction of building as oppose to the 80% of the total energy consumption used during its operation phase such as when heating, cooling, lighting, cooking, ventilation and so on.

Hence, optimization of the use of energy and use of sustainable/renewable energy sources will hugely contribute to the effort made for reducing GHG emission and thereby reducing global warming and environmental changes as well.

## **Renewable/Sustainable Energy**

It's obvious that we need energy to make use of all other natural resources. Simply, life cannot continue without energy and hence it is vital to all of us. Energy is also a resource which will endanger our wellbeing if we are not curious about its sources and implication to the environment.

Renewable Energy is described as the energy that can be obtained from natural recourses such as the sun, water, wind, geothermal, waves, tides etc. The word "renewable" signifies the fact that these energies are naturally replenished at a constant rate following the natural cycle.

It is obvious that the energy sources which are in use today are not sustainable and suitable to the environment. Whereas in contrary to the above, renewable energy sources are not only eco-friendly but also can replenish constantly insuring sustainable supply.

Now a days renewable energy sources are replacing the conventional fuel in many areas of the world energy sector such as electricity generation, hot water and/or space heating, etc.

## **Growth of Renewable Energy**

The initial circumstance which has initiated exploration and investigation of renewable energy sources is the depletion of the conventional ones. Following these, experiments for using solar energy and solar engines have been carried out up until the occurrence of the First World War. Environmentalists also have contributed to the development of renewable sources in 1970s by introducing the first wind turbines.

The figure below depicts the growth of Renewable energy to the global energy mix since 2004. Most of these renewable sources show an increasing trend which is hopefully the way forward. Renewable energies are all derived from the ultimate source of energy which the sun or the heat found deep within the earth. These energy sources constantly replenish themselves following a cyclic and natural path.

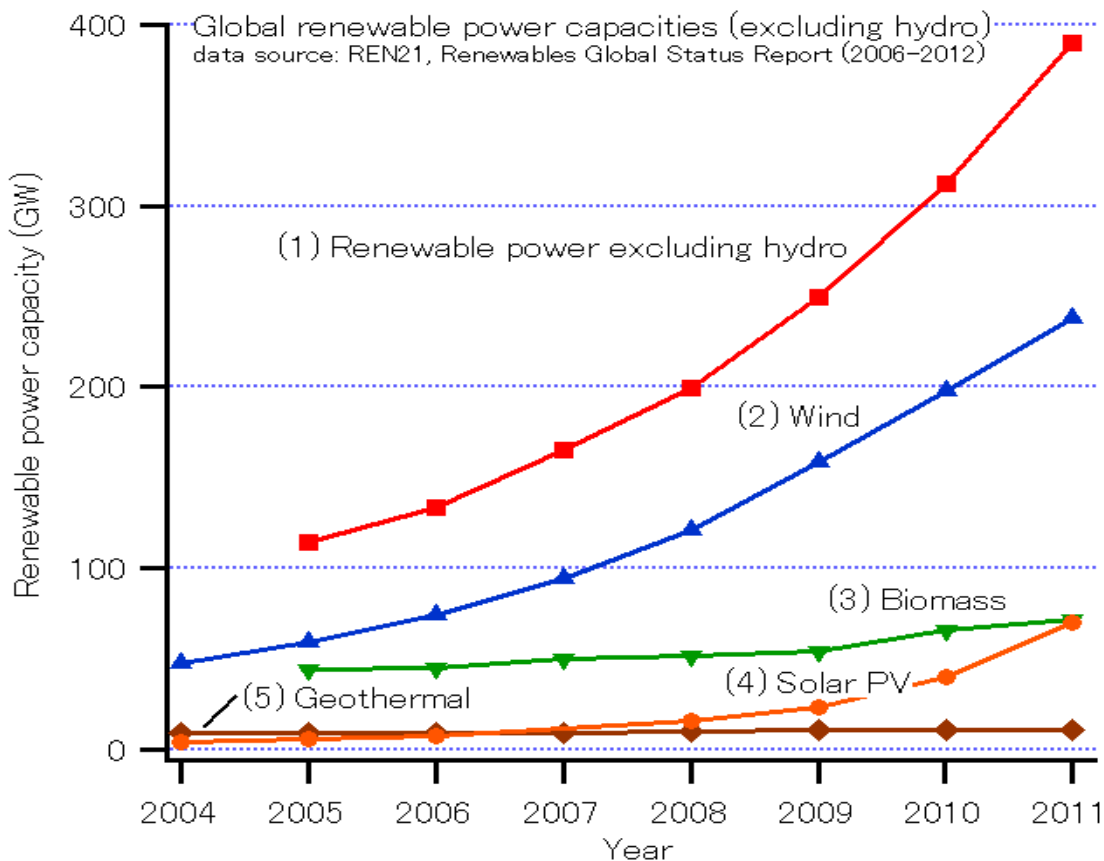

Fig 1.1 Global renewable power capacity (REN21, Renewables Global status Report, 2006-2012)

Data and literatures show that renewable energy sources have begun the way to replace the conventional energy source. If the support and commitment from the government bodies continues to be positive renewable energy sector will highly flourish in short period of time. To back up the above argument with some figurative data, currently, renewable energy sources constitute about 16% of the world energy consumption. Furthermore, 19% of global electricity generation comes from renewable energy sources.

## Why Renewable Energy

Basically, among the main reasons for emitting more Green House Gases (GHG) to the atmosphere such as CO<sub>2</sub> are burning fossil-fuels (oil, coal and natural gas) and deforestation. Once CO<sub>2</sub> is released to the atmosphere it can stay in the atmosphere for up to 200 years heating up our planet. Furthermore, the source of energy is limited and is confined in certain portion of the world which invites competition and conflict of interests.

To insure sustainable economic and social development, the utilization and use of energy shall be optimized to an extent of less impact on the environment and the continuity of supply has to be guaranteed. One of the major environmental impacts is the emission of GHG. Even though, the energy source used largely has brought dynamic economic development, its environmental implication which is the result of combustion

of fossil fuels has accounted for 56.6% of all GHG emission. Hence, it's crucial that the world need to cease its dependency from these energy sources and resemble more on the flourishing renewable alternative.

The wakeup call for the century's prime challenge: Environmental change and Global warming which has faced humanity, has been heard in every corner of the planet. People in power have begun to work for the betterment of the environment and budgets are being allocated for the developments of renewable and sustainable energies as they assume a huge contribution to tackle the problem.

# ENERGIES

Solar  
Wind  
Water  
Bioenergy  
Geothermal

---



# SOLAR ENERGY

## INTRODUCTION

The sun, origin of life and source of every way of energy that humans have been using since the dawn of history, can cover the needs that we have if we learn how to get profit from the light that continually is irradiated on the planet. It has been shining in the sky for about 5.000 years, and it has been estimated that it is not even in the middle of its life cycle.

During this year, the sun will radiate on earth **4.000** times the amount of energy consumed all over the world. It would be irrational not trying to exploit this free, clean and endless energy source that definitely can free us from dependence on oil or other unsafe alternatives, polluting or simply exhaustible.

Nevertheless, it must be taken into account that there are some problems that we must face and overcome. Apart from the general energetic policy difficulties, we must be aware that this power does not represent a constant supply of energy; moreover it suffers from sudden fluctuations. Thus, for instance, in winter the amount of energy received is lower, precisely when the need is higher.

It is essential to go on with the development and refinement of the collecting, accumulating and distributing technology of solar energy, in order to achieve the conditions that will definitely turn it into a competitive technology on a global scale (Progensa, 2007).

## LOW THERMAL SYSTEMS

### DOMESTIC HOT WATER

The production of Domestic Hot Water (**DHW**) is perhaps the practical application of solar energy that suits the best to the characteristics of this kind of energy, because, firstly, the temperature levels that are necessary to achieve (usually between 40 and 50°C) match with the optimum temperature for a good efficacy of the solar collector, and moreover, DHW is a need that must be satisfied during twelve months per year. Consequently, the investment in the solar system should pay off itself more quickly than in the case of seasonal applications, as can be heating in winter or summer pool heating.

Apart from systems with very peculiar characteristics, either experimental or very limited applications to produce hot water, the truth is that today almost all systems are a combination of plane surface collectors or vacuum tubes, with an accumulator integrated in the same set, or separately from those.

#### General Description

The whole system could be defined by pointing out the different parts integrating it and their functions:

-Collecting and storing function. It depends not only on the collectors, but also on different components that represent the whole collecting and storing subsystem. Among these components we will find primary and secondary water circuits, heat exchangers systems, water tanks, pumps, thermal sensors, controllers and expansion tank.

-Supporting function. It is necessary almost in every case, and it is really important that its design does not cause problems to the solar thermal performance. A gas or electrical boiler may carry out this function, for example.

-Utilization function. It represents the final goal of the whole system and thus, must guarantee the requirements of the system not only quantitatively but also qualitatively. This is the distribution subsystem.

#### Basic principles for the solar thermal energy optimum exploitation:

-First principle: *Collect as much energy as possible*. This does not only depend on the collecting surface and correct inclination, the regulation of this energy collection is a key factor to transform solar energy into useful energy. To achieve this we must design a system of thermal sensors and a control system that will regulate the water circulation in the primary circuit.

-Second principle: *Solar energy must be preferably consumed*. It is obvious that solar energy is free, and the supporting energy (electricity, gas, etc.) is not. The point, that the

storage system must give preference to the usage of solar energy rather than the supporting energy.

-Third principle: *Assure the optimum complementation between solar energy and conventional energy.* To make it simple: the solar energy will heat water from the very beginning, until it cannot raise its temperature more; to achieve the temperature needed, conventional energy will be used.

-Fourth principle: *Do not mix solar energy with conventional energy.* It must be avoided to mix heated water by the solar collectors with the one heated by the supporting energy.

Respecting these principles will result in excellent outputs of the solar thermal system.

### Different Systems

*Direct system:* It is disappearing because of the many inconvenients (corrosion, freezing, pressure) that it has. Its technology is based on a primary circuit open to the storage water tank.

*Thermosiphon:* It is a compact system, where the circulation of water works by gravity, as cold water is heavier than hot water.

*Forced circulation:* in this system, an electric water pump takes care of the water circulation in the primary circuit.

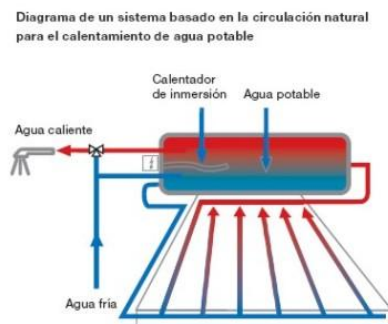

FigureE.1.1 Thermosiphon system (Erenovable, 2010)

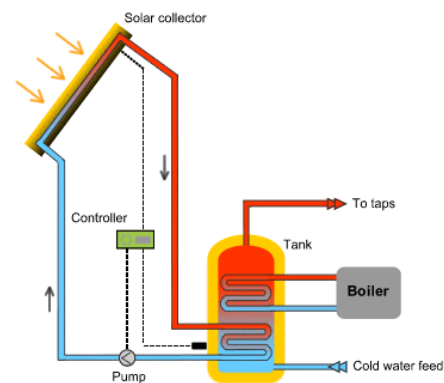

FigureE.1.2 Forced system (Solarsom, 2010)

*Which system should we choose?*

Thermosiphon systems have a notorious economical and thermal advantage for single-family homes. Pump systems offer more advantages economically and technically for bigger buildings. Anyway, each case should be deeply studied to come to a determined conclusion.

## Components

The main components of these systems have been already enumerated in the general description; anyway, it is important to go slightly deeper in the analysis of the different types of collectors.

### Types of collectors

We will find two main types of collectors used to generate Domestic Hot Water, the *flat plate collectors* and *evacuated tube collectors*.

#### Flat plate collectors



Figure E.1.3 Flat plate collector (Sun Tyne Solar,2012)

#### Evacuated-tube collectors

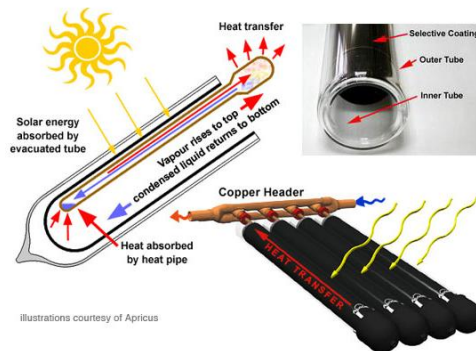

Figure E.1.4 Evacuated-tube collectors (Apricus, 2012)

*Flat plate collectors:* The main components are the ones appearing on the picture on the right, absorber, flow tubes, transparent cover, insulation and solid frame. The key factor for their success is the greenhouse effect that is produced between the absorbing surface and the transparent cover.

*Evacuated-tube collectors:* They also work with an absorber surface, but in this case, it is situated inside vacuum tubes. Inside

each one of these tubes the heat transfer liquid goes through a process of vaporization and condensation at really low temperatures. The result is a really good final output of heat produced and stored in water to be consumed.

Making a comparison between these two kinds of collectors, none of them wins over the other, as it always happens, it depends. In general though, if we have a determined absorber area, and taking into consideration a wide range of temperatures and heating needs, evacuated-tube collectors maintain a better efficiency compared to flat plate collectors. On the other hand, given a constantly sunny environment, flat plate collectors are more efficient regarding DHW needs (greenspec, 2012).

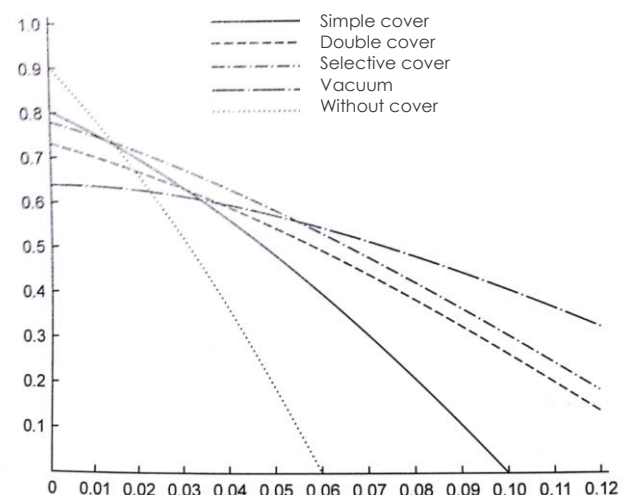

Figure E.1.5 Comparison of different covers (Progensa, 2007)

## HEATING

The possibility of giving an answer to the need of heating spaces inside buildings using solar energy is really attractive, and the combination of several factors is vital to achieve this goal. Referring to solar thermal systems, there are several options to design a heating system for a house, although as it will be explained in the following lines, not all of them are really appropriate.

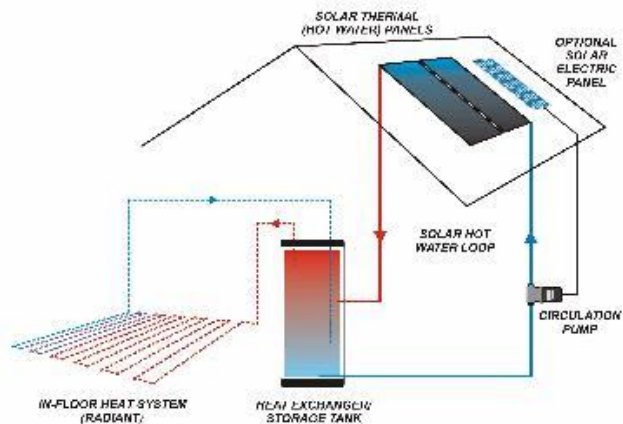

Figure E.1.6 Solar thermal system for radiant floor. (Aladdin Solar, 2008)

One of the most common ways to heat spaces is using radiators. These systems, normally attached to a gas/oil boiler, work with temperatures of around 70-90°C; obviously, this temperature can be easily achieved by those kinds of boilers, but when thinking about solar energy, things are different. It is true that these temperatures could be achieved by putting flat plate collectors in series, but it must be taken into account that the real outputs in winter are so low that the area needed would be extremely large.

Anyway, there is a really interesting solution to this problem, radiant floors. For this type of heating, solar thermal systems fit perfectly as energy suppliers, as its working temperature is around 30-40°C, which is an ideal range of working temperature for our flat plate collectors.

Nevertheless, there is a possibility to reach high temperatures over 70°C with an acceptable output, without having to use a huge amount of flat plate collectors installed in series, it consists of using evacuated-tube collectors. Their higher efficiency compared to flat plate collectors makes them perfect for this purpose.

It must be considered that the technical bases of these heating systems are basically the same as the ones considered for DHW (Starr, R., 2009; Aladdinsolar, 2008; Progenesa, 2007)

## OTHER APLICATIONS

### Air conditioning

Air conditioning using solar thermal energy is being developed nowadays, and although it is still quite expensive, the conception of this technology makes think that it will evolve in a near future to an economically affordable status. There are various physical principles to obtain a cooling system with heat, within them, the followings are some of the technologies already available in the market to produce chill water, which could be used to cool buildings during summer:

- Single effect absorption
- Double-effect absorption

- Adsorption
- Steam jet cycle

(European solar thermal Technology platform, 2009)

### **Swimming Pool Heating**

Another application of solar thermal energy is swimming pool water heating. In this case, once again we will find a solar thermal system, with the same conception mentioned before, but with some differences. The main distinction refers to the type of collector. In this case, we do not need high temperatures; indeed, we should not go over 30 °C, which is the ideal temperature for the water in a pool. Taking this into account, the collectors will be made of plastic materials (as ph levels of water may create conflicts with copper, aluminium, etc) specifically made for this purpose. These collectors will not have cover, or special components that would enhance the heat gain, or prevent heat loose (actually in 30°C levels, the loss of heat is much lower than in higher temperatures).

A key factor in the design of these systems is the volume of flow that goes through the collectors. This volume should be over 300 l/h per square meter of collector in small pools and could be lower for big installations (although it will be always over 150 l/h and m<sup>2</sup>). The reason for this, once again is the need of maintaining water under 30°C, as higher temperatures would result unpleasant.

Moreover, there is an important step that could be considered compulsory in some cases in order to assure the optimum state of the water from the pool, the thermic pool blanket. This special cover protects against evaporation during the nights, which is the main reason for energy loss in pools (U.S. Department of Energy, 2012; Progensa, 2007)

### **Greenhouses**

Apart from a convenient passive design, there are some cold areas where greenhouses may need additional heating supply. In those cases, a solar thermal system based on radiant floors may fit perfectly the needs of those constructions.

### **Drying systems**

Drying processes used in agriculture, such as grain or tobacco, or even in many different industries, consume a huge amount of energy due to the fact that they need a great flow of hot air during a long period of time.

In this spot, solar energy has another promising future thanks to the variety of plastic materials that can be used to fabricate pipes that would act as air collectors, able to raise its temperature 10 to 15 °C over ambient temperature. Installing a fan inside the pipe would be enough to complete the system (Progensa, 2007).

### **Water desalination**

A solar distiller is a simple and efficient system that allows you to reproduce more rapidly natural cycles of evaporation and condensation of water, which will result in obtaining pure water.

This process removes salt, eliminates waste of fungi, bacteria, viruses and other contaminants, obtaining water suitable for human consumption.

The principles of solar distillation can be applied at different levels, from small domestic distillers to get a few litres of water a day, to large facilities which will provide several cubic meters per day.

Currently there are large installations of this type that have been developed in various parts of the world with water shortages but with access to the sea as Israel, Canary Islands (Spain) and in various arid Mediterranean islands among others (FundaciónEnergizar, 2012).

## CURRENT STATUS

In the worldwide solar thermal market, the clear leader in square metres installed is China, followed by Turkey who has 14 times less square metres installed. The solar thermal energy installed in China is enough to supply domestic hot water to over 112 million homes (around 168 m<sup>2</sup>). One of the key factors is the low cost of these systems. The Chinese government goal is to meet 300 million square metres installed for the year 2020. Concerning Europe, where high cost of energy is a constant, the use of solar thermal systems in roofs is spreading widely. In Austria for instance, 15% of homes use this technology to heat water. In this line, the absolute leader in Europe is Germany with a 33%, whereas Spain, after a promising growth between 2004 and 2008, got stuck in a 9%. On the other hand, considering the percentage of Installed capacity/inhabitants, Cyprus would be the first one all over the world, with 0,89 m<sup>2</sup>/person, followed by Israel with 0,56 m<sup>2</sup>/person, country where more than 90% of homes have installed solar thermal systems on their roofs (energía solar España, 2012)

## FACTORS

### External inputs

Obviously the need of solar radiation is determinant when talking about this technology, but for domestic applications, such as Domestic Hot Water, heating, etc. it must be taken into account that the temperature needed is holdin a range between 40-60°C approximately, that means that a high level of solar radiation is not compulsory, although there is a minimum. It would be hard to establish this minimum, as it will depend on each particular case and installation.

Apart from this, there are other external conditions that may vary the efficiency and design of the solar thermal installation, such as average temperature of running water, average temperature of the area and possible shades on the panels (other buildings, vegetation, etc.)

### Environmental Impact

Regarding renewable energies, there are always benefits concerning environmental impact. Solar energy does not release any CO<sub>2</sub> emissions during its production, and moreover prevents this release acting as a substitute of common fossil energy production. The only environmental consideration that could be made is the emissions produced during its fabrication and transport, and those in relation with materials used. In this point, obtaining the plastic materials used to fabricate the panels (polyurethanes, insulating materials, etc) may be the critical phase in the fabrication process, although in the long run, are compensated with the free emissions energy produced. Anyhow, in

general, the production and materials used are considered of low environmental impact.

Another consideration that could be made is the low land occupation that these systems need, as they are conceived for domestic use and consequently installed normally in home roofs.

### Economical Aspect

This is one of the strong points of this technology. As average (in Spain), the cost of a solar thermal system to produce Domestic Hot Water is in a range between 1.500-3.000 €, and the amortization time rounds about 5-6 years. These numbers may act as a guide, and obviously each installation will have different amortization periods, depending on the area, scale of the installation, etc.

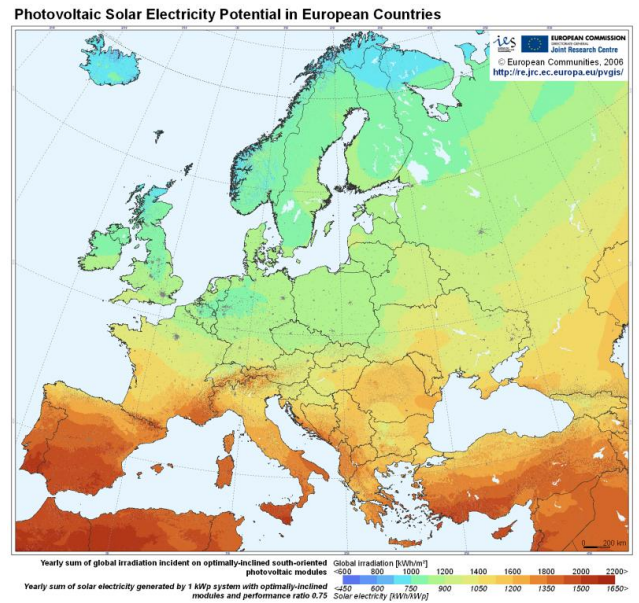

Figure E.1.7 Solar radiation in Europe (Solarfeedintariff, 2012)

Anyway, it is a good way to get a general overview of the high economical profitability of this system.

### Social Factor

The great acceptance of green energies among society is a truth nowadays. To this, we must add the economic advantages described before. Both factors assure the future of this technology, with the indispensable help of governments.

Although this, there is still a small rejection to the aesthetic impact of this panels in roofs. For this reason, there are a lot of innovative solutions integrating solar technology in new materials and construction process, to include these systems as a component of final designs.



# SWOT

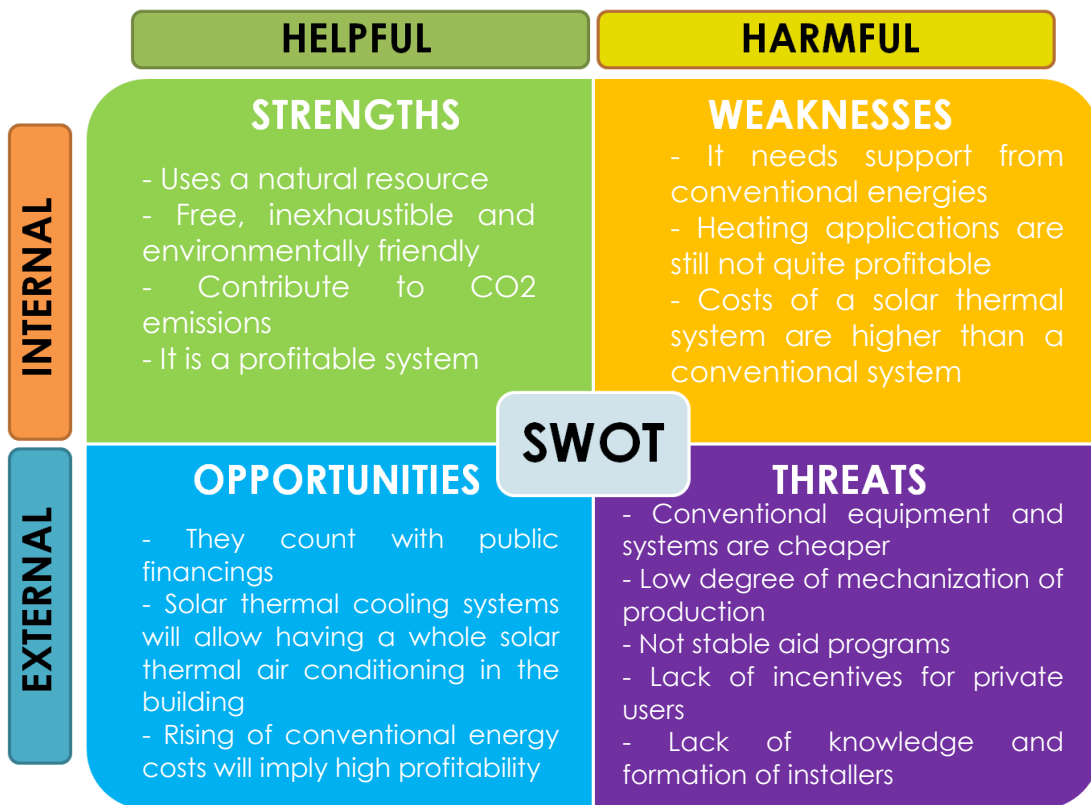

## MEDIUM/HIGH THERMAL SYSTEMS

### THERMOELECTRIC ENERGY

Solar thermoelectric energy is a technology that uses the sun's heat to generate electricity. This process is carried out in so-called solar thermal power plants that began to be built in Europe and Japan in the early 80s. This system shares all the advantages of other solar systems described before: free, green and inexhaustible energy source.

#### Principles

The working scheme of a solar thermoelectric plant is similar to a power station, but instead of coal or gas, it uses solar energy. The irradiation from the sun is concentrated by mirrors into a receiver that reaches temperatures up to 1000°C. This energy is used to heat a fluid and generate steam, which moves a turbine and produces electricity. While the first plants could only operate during the hours of sunlight, nowadays is possible to continue the electricity production at night thanks to the energy storage systems used in this plants.

## Types of Power Plants

Currently, there are three types of solar thermoelectric plants. In general, the process of producing energy is similar; the only difference is the way of concentrating the sun energy.

### Central Tower.

A plant of this type is formed by a heliostat field or large directional mirrors, which reflect and concentrate sunlight in a boiler located on the top of a high tower located in the centre of the field.

In the boiler, the heat input from the solar radiation is absorbed by a heat transfer fluid (melted salt, water or other). This fluid is led to a steam generator; where the heat is transferred to a second fluid, generally water, which is thereby converted into steam. From this point the plant operation is analogous to that of a conventional power station. Therefore, the steam is conducted to a turbine where its energy is converted into rotational mechanical energy that allows the generator to produce electricity. The fluid is subsequently liquefied in a condenser to repeat the cycle. The energy produced, is transformed to a transport voltage and poured to the distribution grid.

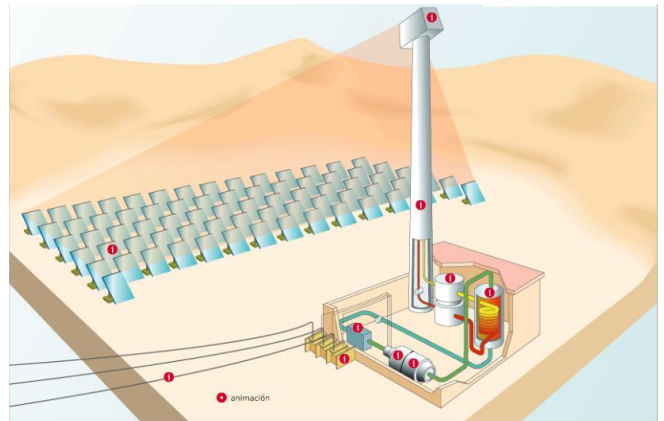

Figure E.1. 8 Central tower plant. (Unesa, 2012)

### Parabolic Dish Plant

This kind of solar thermoelectric power plant uses a parabolic dish mirror to reflect and concentrate sunlight on a Stirling engine placed at the centre of the parabola, that is the reason why it is also called Stirling Engine Plant. The accumulated energy increases the temperature of the air, which turns on the Stirling engine (which works thanks to the compression and expansion of a gas inside, produced by changes in its temperature) and moves a turbine to generate electricity.

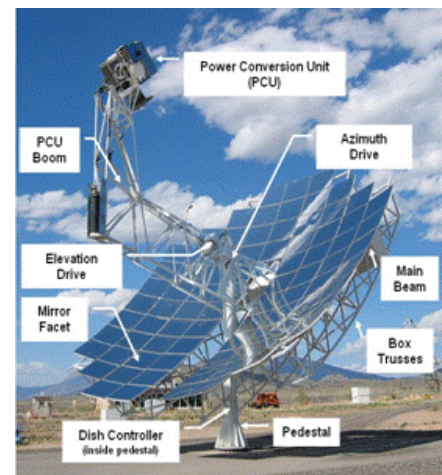

Figure E.1.9 Parabolic dish solar power plant. (Unesa, 2008)

### Parabolic Cylinder Collectors Plant

Another technique to obtain electricity from solar thermal energy is using parabolic cylinder collectors. Their working scheme is similar to one explained in the parabolic dish plant; it consists of parabolic cylinders that concentrate sunlight and channel it to the focus of the parabola, where there is installed a continuous tube. Inside this tube, a special kind of oil will raise its temperature thanks to the concentrated heat; this energy will be used, as in the first example, to produce steam that will finally move a turbine and obtain electricity.

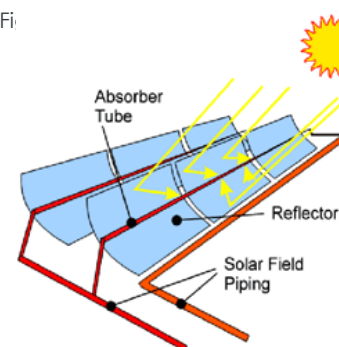

Figure E.1.10 Parabolic cylinder collectors (Solarpaces, 2009)

(Wang, Y., 2008; solarweb, 2011; UNESA, 2012)

## INDUSTRIAL PROCESSES

There are some industrial processes that need high temperatures that can get profit from the solar thermal energy. For example, in the first example of central tower plants, there is a special area inside the tower that is conceived as a solar oven. Its uses are focused on testing materials for industry, for example the ceramic shell of a space shuttle or surface treatments to steel (Ministerio de Economía y competitividad, 2012).

## CURRENT STATUS

In this area, where a constant and high level of solar radiation is crucial, inside Europe we find Spain as the leader of electricity production with this technology. In 2011, 21 solar thermal plants were already producing 852,4 MW, and 40 new plants are being developed right now. Perspectives for the year 2014 say that Spain will turn into the world first producer of this green energy (PROTERMOSOLAR, 2012).

## FACTORS

### External Inputs

In this case, a constant and high radiation of solar energy is a mandatory factor. That is the main reason why the main places where we find these solar plants are south Europe, North Africa or in the Southeast of the United States.

### Environmental Impact

Land occupation is one of the first thoughts regarding environmental impact. Anyway, normally, the places with higher solar radiation are located in desert areas, and taking into account that there are no CO<sub>2</sub> emissions, the final impact is lowered to that created during construction process and materials used.

### Economical Aspect

In growth tendency, these plants require high inversions, and still long periods to pay off; but considering the amount of energy able to produce and the reduction of emissions, their development is assured.

The LCOE parameter for this technology is: 0,2174€/kWh

### Social Factor

This technology represents an important step forward in producing electricity in big scale processes without fossil fuels.

As a green energy, and located in deserted areas, the level of acceptance of this type of energy production is really high, although as described before, the economic inversion is important, and thus a strong support from the society and governments to achieve a proper development is essential.

# SWOT

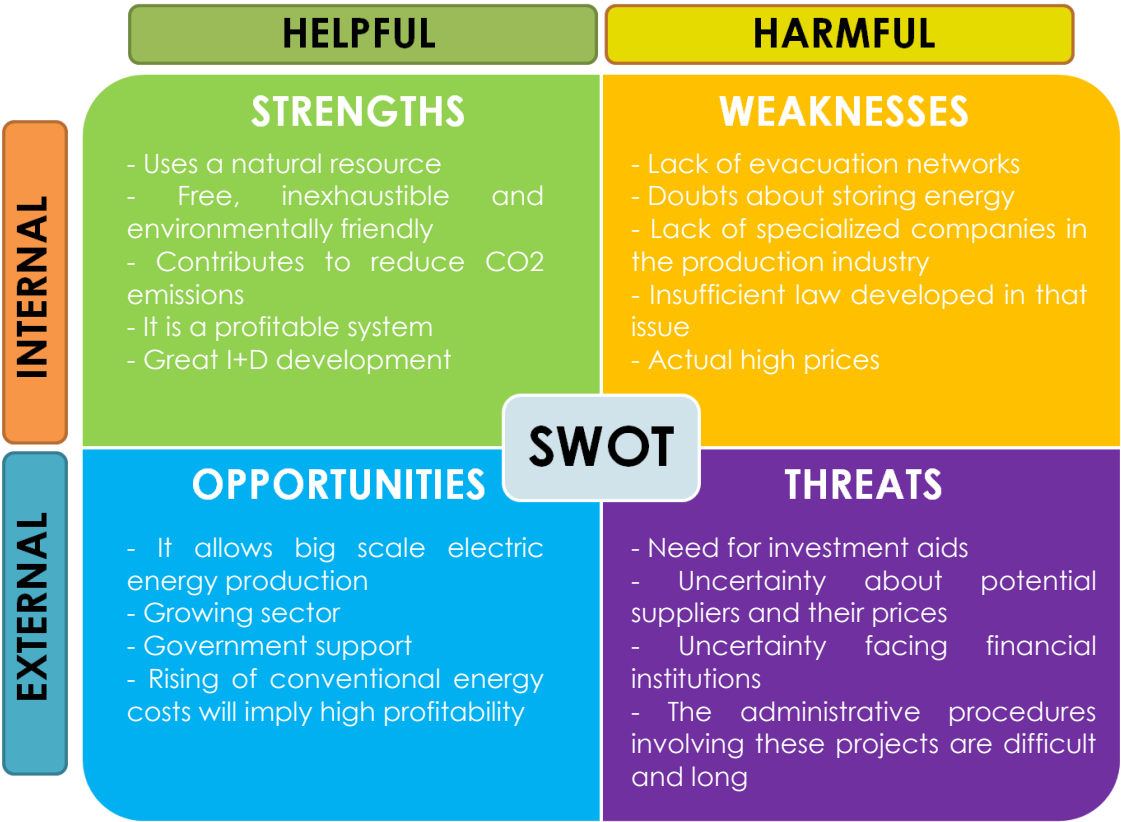

**SWOT**

# PHOTOVOLTAIC SYSTEMS

A photovoltaic system is a set of devices, which is conceived to capture solar energy and transform it into electricity for consumption.

This system is compound by one or more photovoltaic panels in charge of transforming sunlight into electrical energy thanks to the physical interaction of photons present in sunlight and electrons present in the materials of these panels. The output of this process is direct current (DC). As described in the following points, the layout of the installation will determine its final power and voltage.

There are three basic schemes in a photovoltaic system depending on their use:

- Day use, without energy storage need.
- Night use, which requires energy storage.
- Continuous use, which also requires energy storage.

## Generation

Photovoltaic panels are responsible for electricity generation. Their number will depend on several factors, the main ones are:

- The average solar irradiation of the area.
- Kind and range of electric needs.
- Maximum output power needed.

## Accumulation

The storage system is based on a special type of battery called solar battery. There are different batteries regarding its voltage, generally within a range between 4V to 24V and deep discharge range.

One of the main problems affecting the batteries in these systems is overcharge. This situation happens when the battery is 100% charged, but there is still more energy trying to get into it. The result is an elevation of the voltage of the battery, which will turn into its failure in the future. Consequently, it is compulsory the use of *regulators* in almost every installation. Its function is to control the electricity flow entering in the battery, so that when it is full, it stops the electricity flow in order to preserve the battery life.

## Transformation

The energy supplied can be used directly (previously regulated); anyhow it must be noticed that this electricity is presented as direct current (+ / - 24V), fact that could get into trouble with the few appliances and devices available in the common market ready for this electricity. For this reason it requires a component (Inverter), which

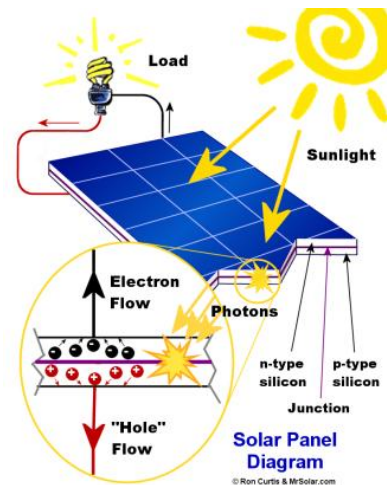

Figure E.1.11 Photovoltaic effect (Val, 2012)

transforms this electricity at 110-200 V (AC) making the photovoltaic installation totally compatible with the normal use of electricity nowadays.

### Losses and Design

When a type of energy (sunlight) is converted into another type (electricity) transformation cannot be accomplished without energy loss. Losses occur at all stages of the photovoltaic system, so the design should estimate system losses to keep the balance between generation and consumption.

### Special Considerations over Photovoltaic Panels

Talking about the outputs of the photovoltaic panels, nowadays, the more extended panels are those of second generation, with a level of efficiency between 14-22%. In the design step, we must consider the effect of temperature on the efficiency of the panels, taking into account that the optimum working temperature of the panels is 25°C (in its surface), and each °C over this temperature will result in a decrease of 0,5% of efficiency of the panel.

Another consideration regarding its design is the possibility to set the panels either in parallel or in series. In the first case we will raise the output power and in the second the Voltage (Energía Solar Fotovoltaica, 2012; Wikipedia, 2012; Progensa, 2007)

## HOME SUPPLY

As it can be imagine, one of the main applications of photovoltaic systems is home supply. In the beginning of its existence, it answered the needs of houses that were off the grid, becoming a safe-pack for rural houses, and areas with undeveloped infrastructure. The functionality of the system in those situations was dependent on the existence of a battery pack. The price for the batteries, and for the whole system (regarding all the components needed to assure a good performance) supposed a barrier for the photovoltaic industry to the urban areas, specially regarding home supply.

The solution for this problem was called “feed in tariff”. This system enables small “production plants” (home installations, for example) generating electricity to “sell” it to the grid. Meanwhile, they consume electricity as usual, and at the end of the month, a balance is made in order to see if the owner has to pay, or receive money depending on the amount of energy produced.

With this proposal and other similar to this, like net metering, where you can get profit from “putting” the electricity that you do not need in the grid, and not being dependent on a group of expensive batteries, there has been a revolution on the photovoltaic market that is spreading all over the world (Solar feed in tariff, 2012; Wikipedia, 2012; Sunshine, 2012)

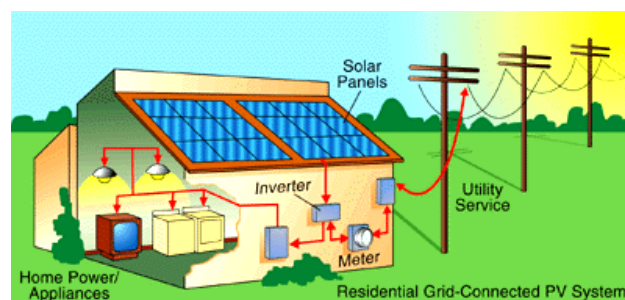

Figure E.1.12 PV installation connected to the grid (Houston solar tour, 2011)

# HARVESTING SOLAR ENERGY

## Photovoltaic Plants

These types of plants are design to produce and sell electricity in a huge amount. They need great areas and thus, they are normally installed out of cities, in rural areas.

A technique used to improve the solar collecting capacity of these plants (that is also applied in thermal plants seen before) is installing moving parts in the accommodation of the panels in order to track the sun during its movement. This way, we can obtain a better efficiency, as it is known that the more perpendicular the beam of light reflects on the panel surface, the more energy it will be able to receive and generate. There are different kinds of tracking systems, among them we can find from the most simple (moving the panel around one axis manually in order to reorientate the panels once or twice a year depending on the season) to the most sophisticated ones (automatized tracking systems with 3 axis movement) (Progensa, 2007).

## Electricity for buildings/communities

After seeing the smaller installations and the bigger ones, it can be figured out the large scope of this technology, which can produce electricity for a single home family, or for a whole city. A wide range of intermediate installations can be found almost anywhere, from university buildings to hotels, malls, etc.

## CURRENT STATUS

Photovoltaic energy was initially used for space applications or for electrification in remote locations. But in the last decade of the twentieth century, however, it has become an increasingly developing technology, with an annual production increase of 20% on average, and from 1997 of over 30% per year.

Last year, installed photovoltaic cells generated an electric peak power of 7.4 gig watts, of which 5.8 belong to Europe, according to a study made by the Institute for Energy, of the Common Research Centre (European Commission).

In 2009 in the EU, were installed more than three-quarters of new photovoltaic systems, that made a total (new equipment over existing) photovoltaic power generation of 16 gig watts, near 70% of the world total (22 gig watts).

Each gig watt of generation capacity of electricity of PV can supply about 250,000 European households during a year.

The highest growing sector is Germany (with a PV capacity of 9.8 gig watts), world leader country in installed capacity, followed by Spain with 3.5. They are followed by Italy with a capacity of 1.2, Japan, United States, Czech Republic and Belgium.

In 2009, the EU increased its total power capacity up to 27.5 gig watts, of which 21% came from the photovoltaic industry: its growth (5.8 gig watts) was higher than the one of 2008 (5.1 gig watts) (Lecue, A. 2011).

## FACTORS

### External inputs

The most important inputs for the collection of photovoltaic energy are the position, the orientation, geographic latitude, and the shading of the photovoltaic panel. It is necessary to realise a study about the orientation of the PV panels depending on the position of the sun, to ensure the highest working capacity possible (Instalaciónenergía solar, 2012).

### Environmental Impacts

Photovoltaic energy is seen as an environmental friendly energy, without noise or chemical pollution and ideal for urban environments.

However, during the manufacturing process fossil fuel emissions are produced. It is estimated that each kWh produced has caused 15 to 70 grams of CO<sub>2</sub> in the manufacturing process.

The manufacture of steel, copper and aluminium used as raw material for collectors, generates environmental problems because of emissions, for example, of powders and fluorinated compounds and produces not only large contamination, but also a large energy demand, especially in the case of aluminium.

Another impacts to take into account will be visual impact, the use of land or the impact inflicted on the wildlife of the environment.

### Economical Aspects

Photovoltaic systems require a significant initial capital investment, but have low maintenance expenses.

To analyse the economic aspects of photovoltaic systems it is necessary to take into account the following considerations:

Each installation has to be seen in its particular context, assessing local conditions, for example, legislation, solar radiation, space, etc.. The life of a photovoltaic generator is approximately 25 years. There are cases where the connection to the electrical grid is difficult (mountain huts, isolated houses, etc.).

Cost estimations:

Integrated systems → 6000 euros/kWp

Isolated systems → 10000 euros/kWp



In some cases, the initial investment is amortized only by the fact that the cost to electrify the area exceeds the cost of installing a solar photovoltaic system.

In many cases, a PV system has a cost per kWh produced significantly higher than the cost of kWh purchased from the grid. Therefore, the profitability of the installation of a PV system depends heavily on aid and incentives by the government (IBERDROLA, 2012; Insemur, 2012)

LCOE parameter: 0,2881€/kWh

## Social Factors

Photovoltaic energy systems produce beneficial outcomes to the society, social environmental awareness is a trending topic nowadays and the education is oriented in moulding the society of the future as concerned about sustainability as possible.

The only negative point to take into account of this kind of systems maybe that they can produce a negative visual impact in some cases. Technology is advancing at very fast speed, and also is design and architectural improvements regarding these kinds of systems.

## SWOT

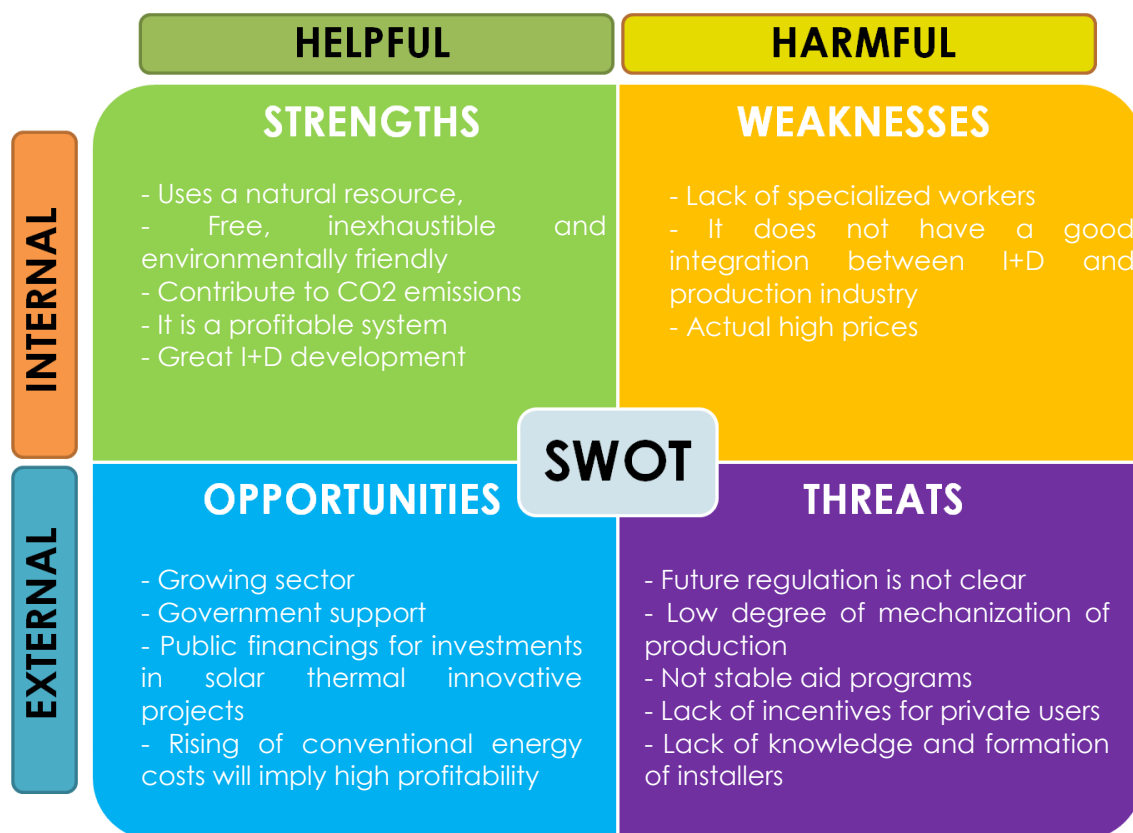

Regarding renewable energies, the combination of different production techniques is an essential issue in most of cases. Solar energy is not a constant supply, and the solution (batteries) is too expensive and not really green so far. The same problem is suffered by wind energy for instance.

In this point, combining different solutions may overcome the supply hitches, and make of our system a 100% reliable one in almost any environmental condition.

Apart from this, in some cases the combination of different technologies results in an improved solution. An example of this situation is the hybrid system obtained from combining solar thermal with photovoltaic panels.

## Solar thermal-photovoltaic panels

Remembering one of the points mentioned before in the considerations of the photovoltaic panels, the temperature of its surface is a key factor regarding functionality. It was shown, how each degree over 25°C means a 0,5% reduction of efficiency in the panel. With this situation, and considering that, on average, the temperature of the panel surface is about 20°C over the ambient temperature, we have that for a normal environment of 25°C, the loss of efficiency would be 10% on the one indicated by the manufacturer.

A perfect combination to reduce this side effect, and at the same time get profit from the excess of heat is to fabricate hybrid solar thermal-photovoltaic panels. This panel is basically a photovoltaic panel mixed with a solar thermal panel, with a heat transfer liquid acting as a cooler for the photovoltaic cells, and as a heat supply in a water storage tank, for example.

## Wind-Photovoltaic systems

Hybrid systems optimize the best conditions of wind and sun, complementing each other. In bad weather condition days, cold and cloudy, it is really hard to get profit from sunlight, while wind turbines are ideal for this occasions, as wind is a common "guest" in these days. On the other hand, calm sunny days are the worst friends for wind turbines, whereas they represent the perfect conditions for solar panels.

The general output of these systems in almost every European country, for example, is quite good considering a whole year. During winter, the wind will supply the majority of the electricity and the same will happen with the solar panels during summer.

The hybrid wind-solar systems have the advantage of being more reliable, since both complement each other and guarantees that in almost every moment one of them will produce energy (Putop, 2009).

## Other hybrid systems

There are many combinations of energies using solar panels, either for DHW, Heating, electricity, etc. This large amount of combinations makes us realise the possibilities of solar energy using it either as main source or as supporting source.

In this line, two interesting applications of solar energy combined with other technologies are being developed and used right now, and for sure, will represent a wide field of work in a near future. These are Hydrogen production, and geothermal technology. The basis for these combines technologies, are a key factor for the development of the renewable energy, storage (either as hydrogen, or in the ground, using geothermal systems).

# INTEGRATED SYSTEMS

## Construction

### -Photovoltaic transparent glass

Apart from producing electricity, it allows sunlight to come through it and at the same time preserves the interior from UVA and infrared radiation. There are some levels of transparency (10%, 20% and 30%) and colours available.



Figure E.1.13 Photovoltaic skylight (Onyx Solar, 2012)

### -Ceramic photovoltaic floor

It is a really new product, composed of a ceramic material with photovoltaic glass on its surface. The final product is completely transitable.



Figure E.1.14 Ceramic photovoltaic floor (Onyx Solar, 2012)

### -Photovoltaic ventilated façade

Apart from the technical advantages in thermal and acoustic insulation, this ventilated façade also produces free and green electricity for the building (Onyx Solar, 2012)



Figure E.1.15 Photovoltaic ventilated façade (Onyx Solar, 2012)

### -Active curtain wall and hybrid solar panels in active house.

The active curtain wall is used to act as insulation at the same time that uses the hot water heated in the wall to heat both domestic hot water and the swimming pool water. This water dissipates 70% of heat from infrared radiation.

The water inside the hybrid collectors also acts as a cooler for the photovoltaic cells (Gecohomeproject, 2011).

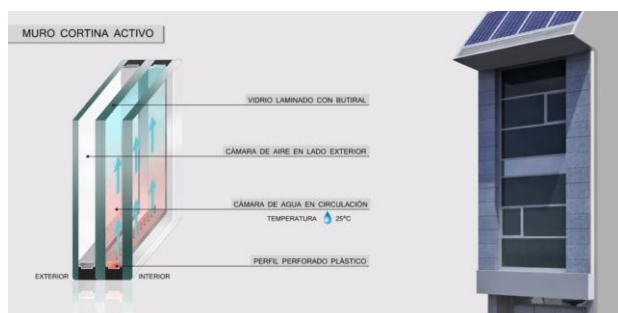

Figure E.1.17 Active curtain wall and hybrid system(II) (Gecohomeproject, 2011)



Figure E.1.16 Active curtain wall and hybrid system (Gecohomeproject, 2011)

The level of development in Europe reflects both the growth potential and the strength of solar PV. The European Union (EU) has also set the goal of meeting 20% of energy demand by using renewable energy sources by 2020. Regarding the photovoltaic market, the European Photovoltaic Industry Association (EPIA), has conducted a study, "SET for 2020", which shows that with a basic improvement of some laws, solar PV could rise up to 12% of the electricity demand in the EU in 2020.

Anyhow, there are some countries that show that this growth can be possible and even greater. In Denmark, they have already reached the solar energy goals established for 2020. That means that they already supply a 20% of the energy demand with renewable sources. That boost has been produced, in part, thanks to the implementation of the "net metering", a system to store the excess of energy produced in any installation to the grid.

This example represent the importance of developing active policies regarding the installation of renewable energies in every home, which in fact is the key factor of the future of this technology (Renewable Energy Corporation, 2012; Sunshine, 2012)

## Desertec

An interesting and really promising project regarding electricity production in big scale is being developed right now. Its purpose is not only to provide electricity to Middle East, North Africa and Europe but also to solve problems regarding potable water and global warming. The project is called "DESERTEC", and it represents a window to the future mass production of green energy (Desertec, 2012).



FigureE.1.18Desertec project (Ecologíaverde, 2007)

# CONCLUSION

In our case of study, low thermal applications represent an attractive investment for small villages, thanks to the high performance of these systems and, its relative low cost of installation. Referring to photovoltaic systems, if we talk about individual installations, it is a good option for countries where "feed in tariff"(in the best cases), or "netmetering" are available. Larger installations will rely on the investment that we want to do and also, on the conditions (say solar radiation) of the area, which will determine its feasibility.

In general terms, although there are still some hitches around this technology, it has been largely proved that this green energy is a reliable and feasible source that human kind can use to develop a sustainable future. We must not forget that solar energy, as said in the introduction, is the origin of everything, even of other forms of energy and an endless, free and green resource. All these advantages, together with the need of stopping CO<sub>2</sub> emissions, create a unique direction for a sustainable development, in which solar energy will be our companion.

# WIND ENERGY

## INTRODUCTION

Wind energy refers to those technologies and applications which convert the kinetic energy of the wind into electric or mechanical energy.

The use of wind power to produce mechanical energy dates around the Middle Ages and in 1900 appears the first machine equipped with an electrical generator. From the 30s and even early 50s machines became popular small-sized (up to 3kW) in rural areas, where there was still no electrification network system to cover large areas. But the technological problems and the low prices of the fuel made it difficult, if not impossible, for wind energy to compete.

The energy crisis of the 70s, which caused a sharp rise in oil prices and its derivatives, promoted the search of alternatives to satisfy the energetic needs of some countries really dependents on oil products. So those countries started thinking about saving and storing energy and also on not conventional energies, appearing energy wind as an economic solution. This encourages new technologies with reliable and powerful equipment.

Nowadays wind energy is mostly used to obtain electrical supply. It's a really powerful energy and its improvement means a vast advance for sustainable development.

Following data will help to realize how important and extent wind energy is becoming:

- On 2010 and 2011 9,648 MW and 9,616 MW respectively of wind power capacity was installed in the EU
- On 2011 21.4% of the power capacity installations was wind power (71.3% was renewable power installations)
- Since 2000 28.2% of new capacity installed was wind power concerning a total of 47.8% for renewable energies
- Wind power increased an annual average market of 15.6%

Moreover, wind power has not stopped its growth. As an inexhaustible source lots of expectations are put on it.

## DESCRIPTION

The following information includes wind energy needs to run, its applications and present and future development. The goal is to obtain a global framework that can serve as a guide for future researches.

## TECHNOLOGY

This section embraces the most important wind energy technologies and for each one the necessary equipment.

## WIND TURBINES

Device used to convert kinetic wind energy into electricity. Wind turbines consist of the following elements (EWEA; WWEA, 2006):

- Foundation: Its aim is to fix the wind generator into the soil. There are different types of foundations depending on the stability of this ground:
  - Shallow: This type is the most used. The footing for the Wind Turbine consists of a large reinforced concrete plate under the soil.
  - Pile: commonly used for weak subsoil. The foundation plate is fixed into the subsoil thanks to the piles

Offshore Wind Turbine foundations depend on the seabed:

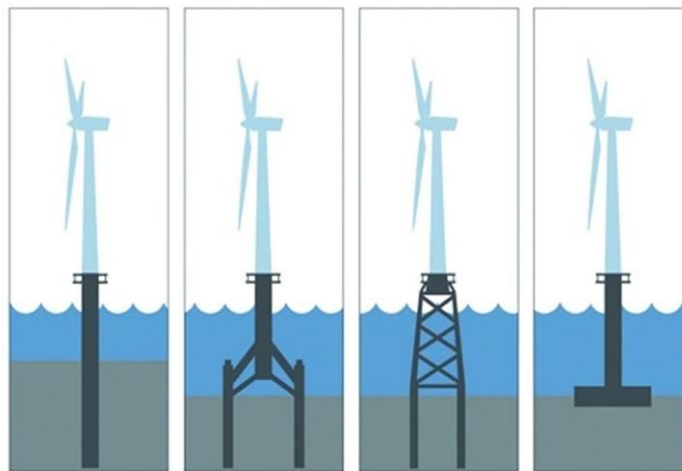

Figure E.2.1. Different types of offshore foundations, from left to right: monopile, tripod, jacket and gravity base. Source: <http://www.theengineer.co.uk>

- Monopile: the foundation is fixed into the sea floor around 10 to 20 metres deep. It is composed by a single pile with a diameter of approximately 4 metres.
- Tripod: Three piles are fixed around 10 to 20 metres deep in the sea floor. It also has a steel frame to distribute the loads along the tripod.
- Jacket: the structure is fixed deep in the sea floor. It looks like an electricity pylon that supports the loads.
- Gravity Base: Placed on the sea floor and made of concrete, has enough strength and stability to no longer need fixing.



- Tower: Its mission is to support the loads of the structure situated at the top and stabilize the whole structure against wind static loads. There are different types of towers: steel and concrete towers, pre-cast concrete towers, steel lattice towers, hybrid towers etc.
- Blades: Here is where energy creation starts. The wind speed creates an impulse that moves and spins the rotor blades (just like an aircraft wing). It is common to have three blades made of synthetics reinforced with fiberglass and carbon fibers.
- Nacelle: It is a frame which houses the machinery. Inside the nacelle we can find:
  - Low-speed shaft: the spin of the blades makes this shaft moved around 30-60 rotates per minute.
  - Gearbox: The gears in this box connect both shafts.
  - High-speed shaft: This shaft moves around 1000-1800 times per minute. This shaft is connected to the generator activating it to produce electric power.
  - Generator: leads this power to a transformer that converts it into the right voltage for the larger electricity grid.

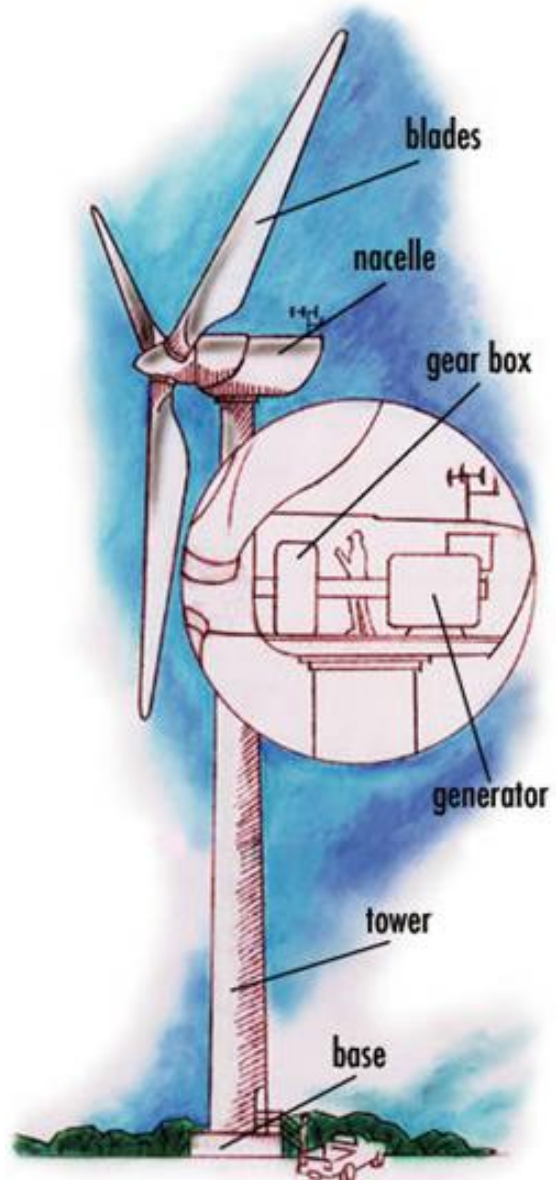

Figure E.2.2. Wind turbine elements.  
Source: Rowe, J., April 2002.

## WINDMILL

Device used to pump water, converting kinetic energy of the wind into mechanical energy. They started to be used thousands of years ago and its design has not changed. Their conservation and maintenance is minor. They are commonly used for small amounts of water and low pumping heights. Windmills consist of the following elements:

- Tower: made of galvanized steel and around 4 to 12 metres high.
- Blades: made of galvanized steel and around 1.8 to 5 metres long.
- Pump: is directly driven by the rotor.
- Regulating Reservoir: for covering consumption peaks and periods of wind calm.

## NOVEL DEVICES

### THE ZERO-BLADE TECHNOLOGY

The wind energy without blades. This device creates energy with a sail that follows a non-rotation spin and forth motion. This movement permits obtaining mechanical energy and then it allows its conversion into a hydraulic pressure that could be stored. Also electrical energy could be obtained with a hydraulic motor and a generator.



Figure E.2.3. Zero blade wind turbine Source: Shapon energy.

### WIND STALK

The wind energy through stalks instead of blades. This device generates electricity thanks to piezoelectric ceramic discs with electrodes between them located inside each pole. The wind speed moves the discs and compresses them, generating a current through the electrodes.



Figure E.2.4. Wind stalks. Source: Markham, D., April 2012.

### WIND LENS

The wind energy, whose blades are joined with a circle around. Its efficiency can be three times better than conventional wind turbines based on the same principles.

### WIND SPIRE

The wind energy with vertical axis. Already used in farms in United States for covering peak season and without creating environmental noise impact.



Figure E.2.5. Wind lens. Source: Markham, D., April 2012.



Figure E.2.6. Wind spire. Source: Markham, D., April 2012.

## APPLICATIONS

Wind Turbines and related applications can be classified in many ways and according to different parameters.

### DEPENDING ON THE SIZE

The first classification of wind turbines is based on their size, and the factor of this difference is mainly the energy output of the device. When many several wind turbines are gathered in the same plant it is common to talk about win farms.

- Wind farms are called like that because of the grid-like placement of the turbines in a field, which make it looks like an orchard. The ideal fields for farms are usually flat and wide opened, with a constant wind speed, which makes it possible to set them off-shore; nonetheless, the large number of turbines can compensate wind speed intermittency.
- Large wind turbines have a power output greater than 1000 kW; this happens mainly because increasing the size of the rotor, the output increases; furthermore, a bigger rotor implies high-resistant and lighter materials, with a general higher technology involved. This is possible because large wind turbines market is developing.
- Medium wind turbines have a power output varying from 100 to 1000 kW, which makes it suitable for applications in villages in remote areas and islands.
- Wind energy devices with a 1 to 100 kw output are called "small turbines"; there are two main kinds of small turbines; on-grid and off-grid. The firsts are generators connected to an electric grid, sometimes managed by a public entity, responsible of controlling devices; off-grid turbines are controlling voltage and frequency, and they can be interesting in developing countries or isolated areas, where is difficult to have a public network. This technology is currently still under development.

### DEPENDING ON THE ROTATION AXIS

#### VERTICAL

The oldest design concerning to wind energy appear while talking about rotors with a vertical axis of rotation. For example, "Savinous rotor" is used on railroad ventilators and sometimes for small and simple wind pumps but for supplying electricity is not useful. Another example is "Darrieus" or "H-Rotor" which is an advance of the previous using straight blades instead of wavy.

Although vertical rotors have some advantages as simple and cheap design, lower installation costs and a big area to be developed yet they have a clear and powerful disadvantage because they cannot compete with horizontal axis systems

#### HORIZONTAL

It's the most developed system because of its blade pitch control for the rotor speed and the output power, aerodynamically high optimised for the rotor blades and the

leading design of the propeller. All these advantages are the reason of why horizontal axis rotors are commonly used for wind energy.

## ON/OFF SHORE

A further classification for wind power is between onshore and offshore turbines. Offshore wind power refers to the construction of turbines in bodies of water, to take profit of the high speed of offshore wind.

There are many differences between onshore and offshore wind power; the wind potential for onshore is about 2000 full load hours, while for the offshore is twice that amount; normally, offshore wind turbines are bigger, in terms of blade length (can be around 100m), output of power of the device (3-7 MW against 1-3 MW of onshore) and of a farm (50 – 1000 MW against 10-50 MW of the onshore). Furthermore, offshore wind power can produce the annual consumption of a household in 40 minutes, while it takes 200 minutes to a normal onshore plant to do the same. In addition, offshore wind has a much larger availability of sites for installation (E.ON, 2011).

The great dimension of offshore wind power makes it a good potential energy source, but this kind of supply is exposed to many challenges, like waves, wind and climatic conditions, strongly influencing the result. These considerations imply a new kind of approach, which should be adopted in designing wind offshore turbines, considering the difference with onshore in terms of maintenance and operations and general logistics (E.ON, 2011).

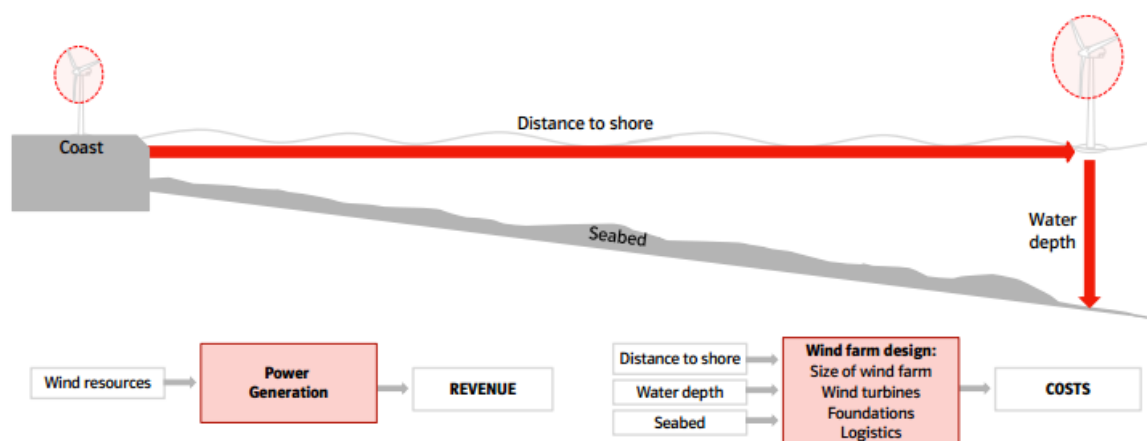

Figure E.2.7. Distance from land in offshore wind turbines; source: E.ON, 2011.

The main factors influencing an offshore wind power project are the seabed's features, the depth of the water and the distance from land. This last parameter strongly influences the difficulty in Operations & Maintenance (O&M) concepts, as well as the accessibility of the turbine itself.

The distance of turbine causes greater maintenance costs, so far plants need a higher energy production to return investments, which implies a need of larger and more expensive turbines.

Concerning foundations, the principal factor involved is the consistency and features of the seabed. Normally, the most diffuse type of foundation is the monopole, used in 2010 in the 67% of cases, while gravity foundations only achieved a 30%.

It is important to say that this sector is currently still under development, and needs strong R&D efforts to reach a good cost-efficiency for industrial scale production. In this moment, innovative concepts as floating foundations are being developed.

The energy scenario in Europe is witnessing a significant growth of Offshore wind power, with a rate of 30% per year; many European countries have implemented this

technology in large scale so far. Indeed, Europe is leader worldwide in Off-Shore wind energy; the first plants were installed back in 1991, and nowadays (June 2010) with a capacity of almost 2400 MW.

Thirty-nine Off-Shore wind farms are installed in Belgium, Denmark, Finland, Germany, Ireland, the Netherlands, Norway, Sweden, and United Kingdom

The depth of those installations varies from 0.8 to 220 m, using all kinds of foundations. The range of shore distance goes from 0.03 to 43 kilometers.

On positive point of Off-Shore wind applications is that European Union is strongly fostering its use to achieve sustainability and environmental goals; in the next years, a relevant developing of this technology is forecast, thanks also to individual nations' regulations.

In September of 2009, more than 100 GW of OS wind are being developed and proposed in this continent.

The EWEA (European Wind Energy Association) set targets of 40 GW to be achieved by 2020 and 150 GW by 2030 (Rock & Parsons, 2010).

Another strong opportunity of Off-Shore concerns its costs; nowadays, as shown in Figure E.2.8, the cost of Off-Shore wind is 6.2 €/kWh, but is forecast to reduce to 3 €/kWh before 2020; On-Shore wind is currently costing 2.5 €/kWh, and it will reduce its cost to 2 €/kWh (Blanch, et al.). It is therefore clear that to achieve EU goals by 2020, Off-Shore wind power will be a key factor .

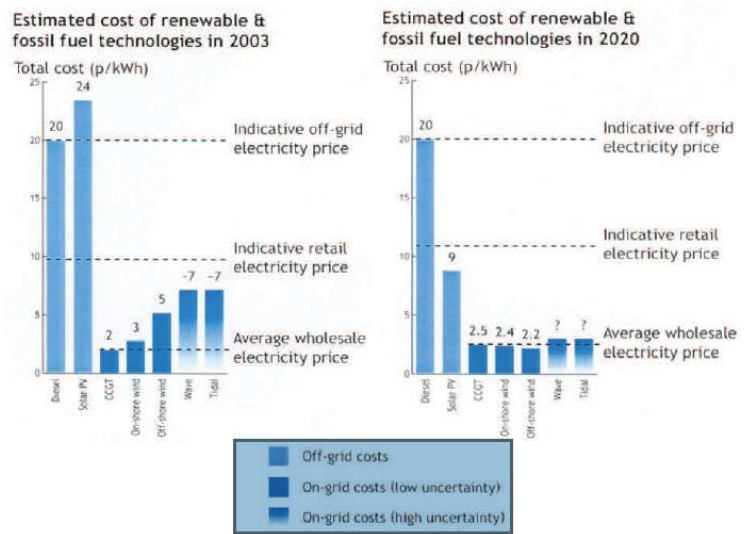

Figure E.2.8. Forecast costs in wind power; source: Blanch, et al., 2005.



Figure E.2.9. Diffusion in Europe of offshore wind plants; source: EWEA, 2007.

## **BUILDING INTEGRATED WIND TURBINES**

One of the most relevant wind energy applications is about its integration in the built environment.

Building integrated (or mounted) wind turbines (BIWT) is a term addressing to all wind energy devices that can be placed in a building, on a building or close to it, in the urban environment or outside of it.

Integrating devices that take profit of wind energy is not a new concept; history has witnessed the presence and development of many application of this, from wind powered saw mills to wind-driven water pumps, which were a significant feature in the built environment. From the architectural point of view, it is possible to say that wind integration has been an important feature. Nonetheless, these applications were usually placed out of the urban environment, and did not implemented augmentation concepts, and the only way to improve the output was raising the height.

The most important concept of BIWT is the augmentation, as these kind of devices can work close to the buildings. As it will be explained in the following paragraphs, wind regime in the urban environment is particular, and the presence of buildings strongly influences the output. BIWT can take profit of the amplification of the local flow caused by the shape of the building itself, or its height, making it a profitable application (Blanch, et al.).

Building integrated turbine can be either designed at the same time as the building, or being used for energetic retrofitting; in case they are connected to the envelope, the installation is more difficult, and have to take into account the increasing loads, vibrations and noise.

Mounting a wind turbine on a building gives the possibility to increase its height, which, as we will see in the following pages, gives a relevant contribution to the increase of power output.

As we already stated, the influence of buildings of the wind flow is remarkable; usually, small and micro turbines are installed away from buildings, to avoid possible reductions of the flow. The American Wind Energy Association (AWEA) proposed a distance of 20 times the height of the building; increasing this distance, the power loss in cases also increases, and better and more expensive cables will be needed, increasing as well the general costs and embodied energy of the application; that way, only higher building implementation could be profitable (Blanch, et al.).

Furthermore, AWEA estimates that before 2020, small wind applications will contribute 3% of US' total electricity demand (Blanch, et al.).

Buildings can increase wind speed locally, but in the design phase it is necessary to focus on the distribution of this speed, avoiding unwanted peaks in pedestrian areas and streets (Blanch, et al.).

Anyway, those theoretical analyses are often too severe, and many examples of successfully installed BIWT can be found.

### **EXAMPLES OF BIWT**

Some relevant and innovative examples of BIWT are described in the following paragraphs.

#### **AEOLIAN MODELS** (Blanch, et al.)

The company Altechnica designed a large range of BIWT; most of them take profit of the building to augment the power output. In the *Aeolian Roof™*, a device called planar concentrator is set on the top of a slope roof, in order to create a slot with a low

pressure and high velocity zone; here it is possible to install small diameter wind turbines (with horizontal or vertical axis as well) with a high power efficiency.

Another device designed by the same company allows taking profit of this low-pressure area to ventilate the interior of the building with a valve system. An excellent opportunity of this technology is also the possibility to integrate it with a solar panel.

Researches showed that wind speed can be augmented through curved eaves, but also that normal pitch roofs can augment the flow, offering an excellent retrofit opportunity.

### **PROVEN** (Blanch, et al.)

Proven is a well-developed small turbine company, currently researching and producing BIWT (projects in Ealing and Manchester are being executed). This manufacturer is studying Vertical Axis Wind Turbines (VAWT) for indoor ventilation, but the main field of research and application is the design of high-safety downwind turbines (Figure E.2.10) in an output range from 0.6 to 15 kW.

This turbines are currently on market, and suitable for standard and routine applications on flat rooftops, focusing in particular on Health and Safety (HS) aspects.

Many advantages are related to these HS turbines by this company:

- a flexible blade system featuring fail-safe speed control
- dissipation of mechanical forces in turbulent wind regimes as often found on building roofs
- they need less maintenance, thanks to the absence of the gear box
- low life cycle costs through longevity given by low rpm airfoil and generator design
- very low tip speed ratio of around 5, which gives excellent noise performance
- implementation of intelligent optimizing energy balancing control

### **THE ROBERSTON AND LEAMAN ROOF TURBINE** (Blanch, et al.)

This particular device is one of the most innovative turbines in terms of integration design. It works using the roof as an exhaust: the air enters the eaves end exits from the apex;

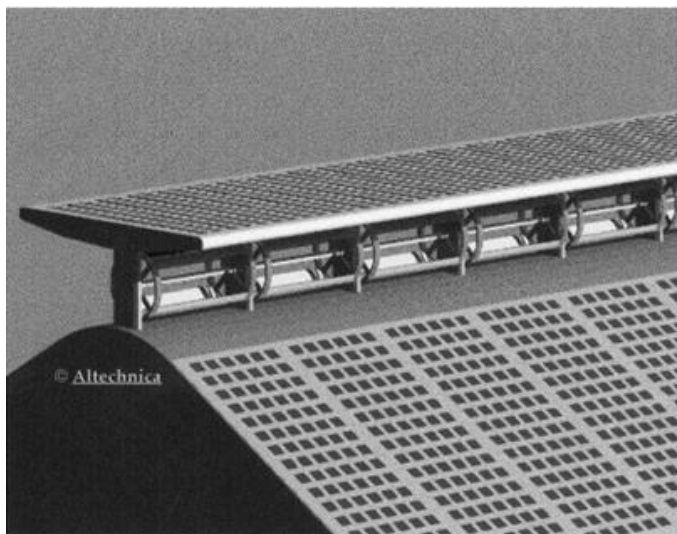

Figure E.2.10. Aeolian™ roof turbine; source: Blanch, et al., 2005.



Figure E.2.11. Proven HS turbines; source: Blanch, et al., 2005.

that way, it is possible to completely hide the turbine inside the building, which could make this application particularly architecture-integrated.

A research by Atkins R&D (1980) stated that such a device “has the potential to provide more power than a conventional horizontal axis wind turbine of equal diameter sited level with the apex of the roof”. Of course, researchers advised that the efficiency of the device would be strongly influenced by the quality of sealing, and for that, further tests in wind tunnels should be recommended.

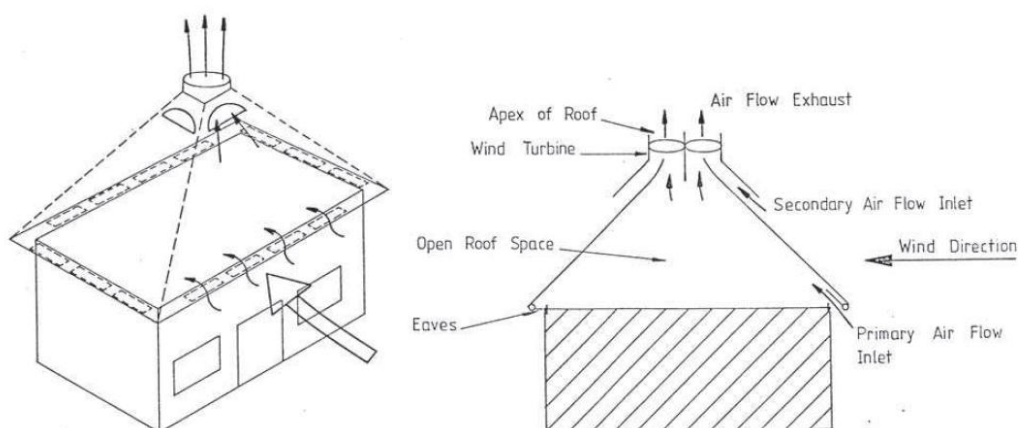

Figure E.2.12. Robertson and Leaman Roof Turbine; source: Blanch, et al., 2005.

### **NGUP WINDWALL** (Blanch, et al.)

A Dutch company called NGUp recently designed a turbine called WindWall (1.2m diameter and 9m long), and implemented it on the roof of an office building in The Hague, in the Netherlands. This device is a VAWT with modular helicoid blades, which was studied to be installed in a single or in multiple rows.

### **WEB CONCENTRATOR** (Blanch, et al.)

The WEB Concentrator (Figure E.2.12) is one of the most relevant concepts in BIWT; it was developed using Computational Fluid Dynamics (CFD), and a prototype has already been built, giving unexpected excellent performances. It enhances the effectiveness of wind power by raising the height, and working like a wind concentrator too, in order to improve the input wind speed thanks to aerodynamic concepts.

### **POTENTIAL DISADVANTAGES OF BIWTS**

The implementation of BIWT has some critical issues connected to it; first, the wind flow in urban environment is not completely clear. The influence of other buildings in an area could imply the reduction of wind exposure of the designed building and could increase its turbulence, as it would happen with tree growth (Blanch, et al.).

Assessing wind speeds in urban areas is not easy and because of the buildings interference, there will be a more turbulent regime, which would cause a more complex and



Figure E.2.13. WEB concentrator; source: Blanch, et al., 2005.



severe loading situation; this is the reason why BIWTs should be inherently safer than ordinary small wind devices (Blanch, et al.).

It is easy to understand how the risk of hazard is remarkable in case of BIWT; furthermore, it is enhanced by the presence of people in the near area (Blanch, et al.).

## CURRENT STATUS

### WIND POWER CAPACITY

In Europe during 2011, 9616 MW of wind power capacity were installed. From those, 8750 MW were destined to onshore and the rest, 866 MW, to offshore. It must be said that offshore annual market on 2011 was less stable than onshore one (EWEA., 2012).

The following table explains clearly where and how much wind energy capacity installations were developed on 2011 (EWEA., 2012).

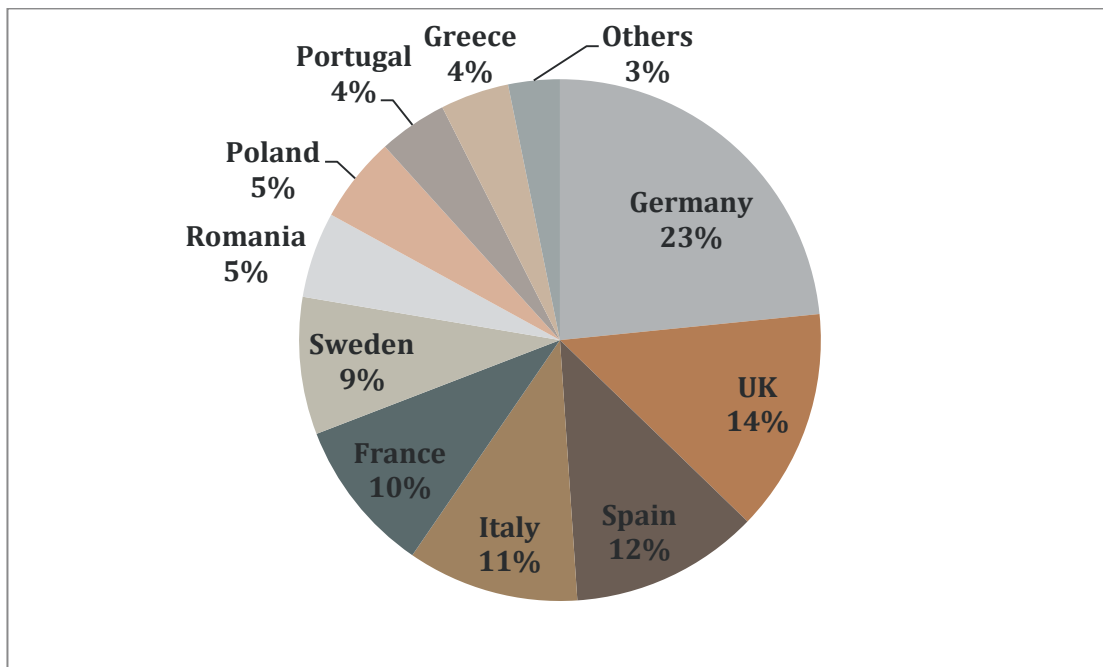

Figure E.2.14. Wind power capacity installed in Europe countries during 2011. Source: EWEA, 2012.

### WIND ENERGY INSTALLATIONS

While comparing wind energy with the rest of energies must be highlight that it's the third biggest one, 21.4% of new installations in 2011, after solar PV, 46.7% and gas, 21.6%. It cannot be compared with other energies while talking about installations (EWEA., 2012).

Germany Spain and Denmark are leaders on this sector. The following bar chart reflects the annual wind power installations in EU in GW from 2005 to 2011 and it's combined with the annual wind power installations in the leader countries (EWEA., 2012).

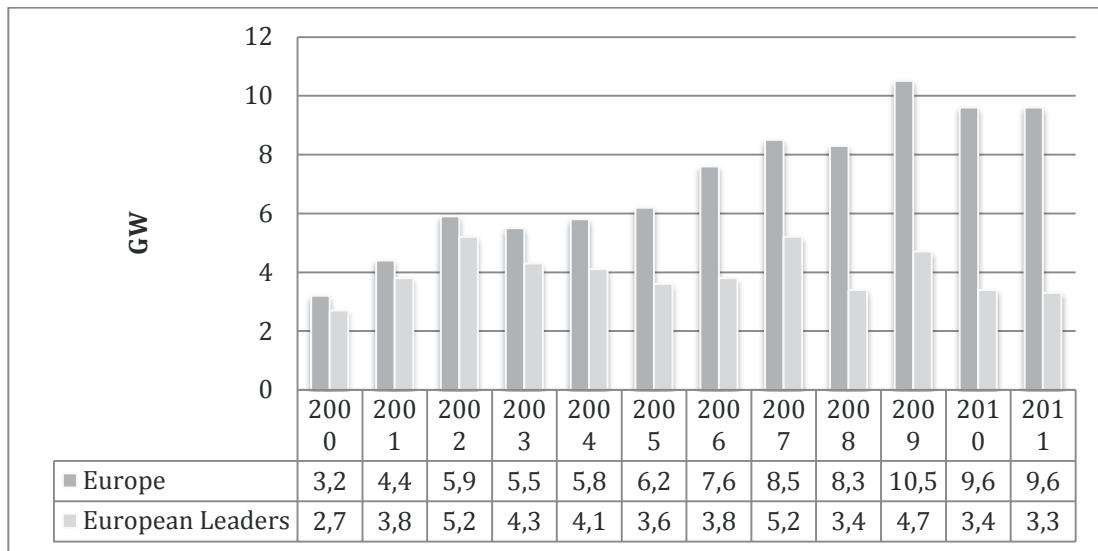

Figure E.2.15. Wind power installation in GW in EU comparing with European Leaders countries.  
Source: EWEA, 2012.

This wind energy capacity installed aforementioned will create in a normal wind year 204 TWh of electricity. This represents 6.3% of EU needs. Denmark and Spain covered 26% and 15.9% respectively the electricity consumption necessary with wind energy, followed by Portugal 15.6%; Ireland 12%; and Germany 10.6% (EWEA., 2012).

## WIND ENERGY INVESTING

The EU invested on 2011 €12.6 billion. There is a vast difference on this point between onshore and offshore, for the first one €10.2 billion were attracted and for the second one €2.4 billion (EWEA., 2012).

## WIND FARMS

Nowadays there are lots of wind farms around Europe. The biggest and so, the ones that obtain more capacity, are:

- Whitelee Wind Farm; 322 MW (United Kingdom)
- Thorntonbank Wind Farm; 300 MW (Belgium)
- Alto Minho Wind Farm; 240 MW (Portugal)
- Maranchon Wind Farm; 208 MW (Spain)

## WIND ENERGY FUTURE

The following table shows in a clear and visual way the future trend for wind energy but since 2010 in order to compare it with the actual wind power generation (Capros, P. Mantzos, L. Tasios, N. De Vita, A. Kouvaritakis, N., 4 August., 2010):

(TWh)	2010	2015	2020	2025	2030
Onshore	14	81	177	224	287
Offshore	147	243	348	381	407

As you can observe the EU wants to give a great and huge impulse to wind energy offshore without leaving behind onshore.

## FACTORS

### EXTERNAL INPUTS

A wide range of factors influences the power output of a conventional wind turbine; most of them relates to the site. The most important and influencing ones are the wind speed, elevation, air density, wind intermittency (daily, seasonal and annual variations) and influence of obstacles.

#### AIR DENSITY

Heavier air increases the rotation speed of the rotor; air density changes with elevation, temperature and pressure (Figure E.2.15). The air at high altitudes is low-pressure and light and the efficiency of wind turbines will be inferior. Near the sea, the air is dense and heavy, and the efficiency of turbines is higher. This is one of the reasons of the success of Off-Shore wind turbines (Rashford, et al.).

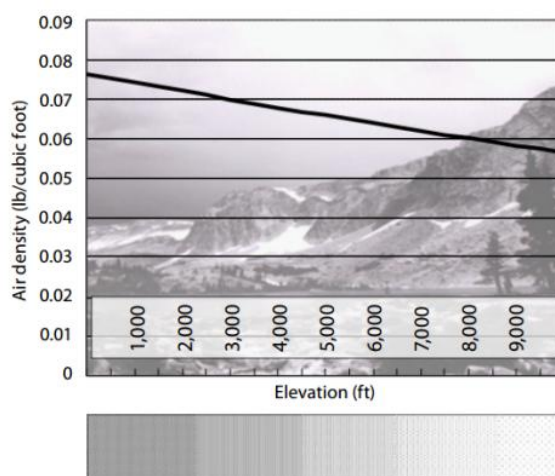

Figure E.2.16. Effects of elevation on air density; source: Rashford, et al., 2010.

#### WIND SPEED

The power output of turbines is strongly related to wind speed. Wind devices can generate energy in a determined wind speed range, from 4 m/s to 30 m/s. Over this speed, turbines automatically stop in order to avoid structural damages. The European Wind Atlas expresses average wind speeds at 50m height, dividing Europe in 5 speed classes. Of course, local wind speeds are affected by parameters related to the local site features.

In the figure E.2.16 is shown the wind speed at 50m of Europe in 1989. The European countries with the highest wind resources are UK, Denmark, Ireland and France (Blanch, et al.).

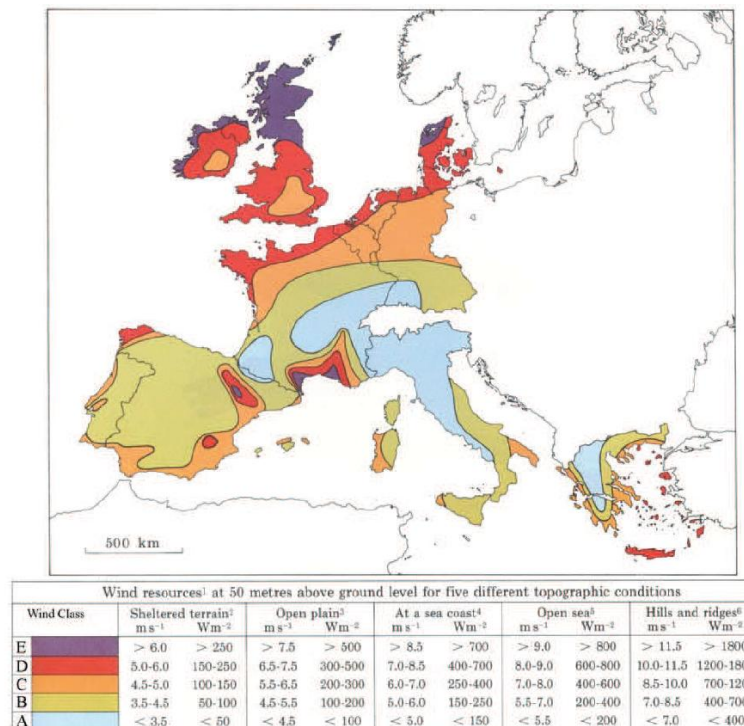

Figure E.2.17. Europe wind speeds at 50 m height. Source: wind atlas, 1989.

## SEASONAL AND ANNUAL VARIATIONS

The power output of a wind turbine is affected by several variations during hours, days or seasons (while annual variations are not important in the same way); nonetheless, we have to remember that wind energy is inexhaustible. For that reason, wind power should be forecast and scheduled, but predictability is a complex issue. Hourly wind output variations of less than 10% occur with 80% of possibility, while there is a 40% chance of changing more than 10% in five hours. For grid-connected devices, concerning the stability of the grid itself, it is necessary to maintain a constant power output.

The intermittency of this resource can increase remarkably the costs for regulation, energy demand management, storage, and cable connection. At low penetration

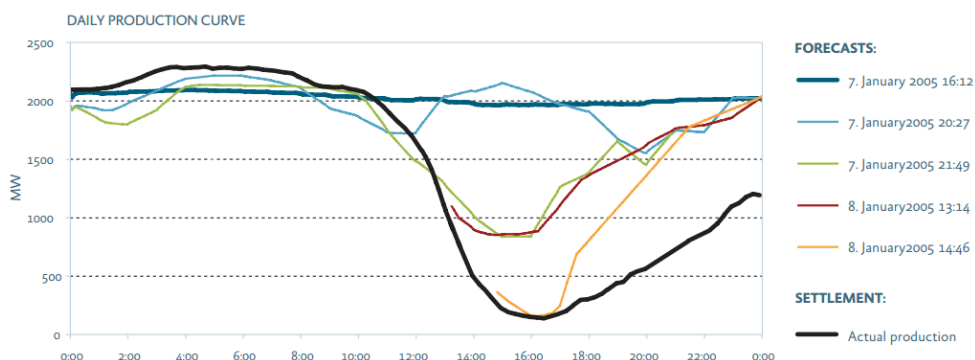

Figure E.2.18. Wind daily variations forecasting; source: Danish Energy Authority, 2005.

levels, load fluctuations may imply the presence of a reserve capacity to balance the intermittency, or may need the supply of other energies during wind scarcity periods (Blanch, et al.).

### COMPLEMENTARITY TO SOLAR POWER

Annual and daily variations of wind energy are not only a complex issue, as they make possible a very efficient coupling with solar energy, either thermal or photovoltaic. Of course, wind turbines can create power after sunset and in cloudy days, which are usually windier, while the solar power output is lower. Furthermore, wind has an excellent energy demand match, compared to sun, because the output peak corresponds to the energy demand peak, as in winter more energy for heating and electricity is needed, but more wind power is produced as well (Blanch, et al.).

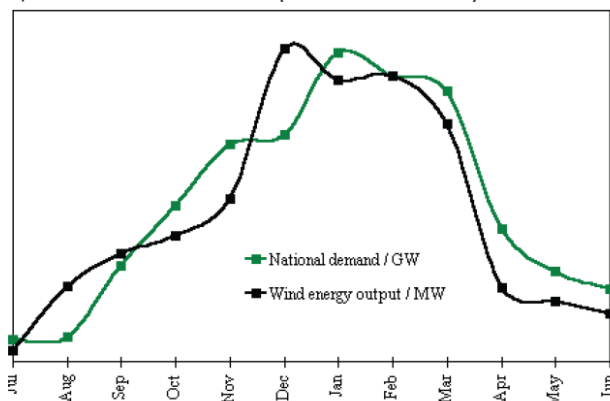

Figure E.2.19. Wind energy output – energy demand; source: Econnect Ltd, UK, using data

### ELEVATION

One of the most important factors in wind turbines power output is the elevation. Wind speed is higher at higher elevation, and lower near the soil. It is possible to say that wind speed doubles when the device's height increases five times, e.g. from 5m to 25m. This is the main reason why wind turbines are usually located on tall buildings or hilltops. It is important to consider that an increasing height implies a decreasing air density, which influences power output. Considering these factors, energy production at 1000m (keeping constant the other variables), is 10% lower than at sea level. At 2000m height is

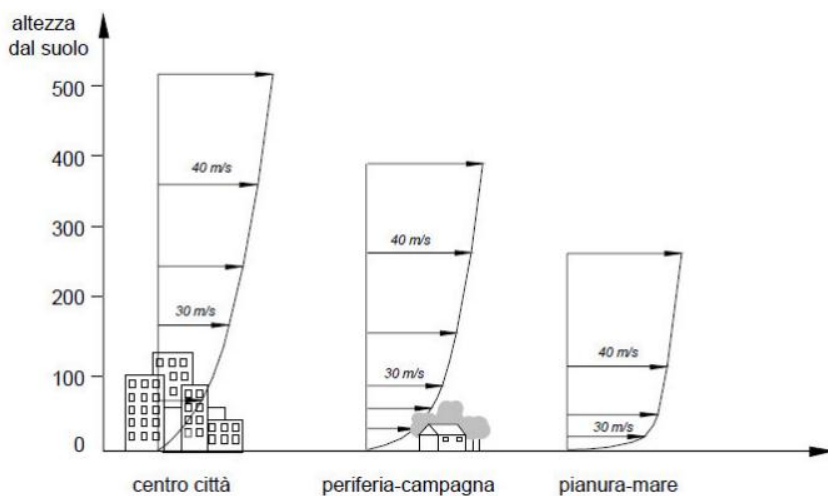

Figure E.2.20. Effect of elevation and terrain roughness on wind speed profile: source: D'Armetta. 2005.

20% lower; these considerations are essential in a feasibility study of wind turbines, especially from the economic point of view (Blanch, et al.).

### EFFECT OF BUILDINGS ON THE WIND RESOURCE

Even if it is hard to understand the wind distribution in the urban environment, it is possible to define some patterns, varying with height and terrain.

In the figure E.2.20 are shown three different wind curves in a rural area, a suburban one and a city area.

The variation of the terrain causes a different friction and, therefore, a different boundary layer development, which implies different roughness classes. In the rural area, the wind interacting with the building has a speed between 5m/s (at 50m) and 5.5 m/s (at 100m); in the suburban area, speed is lower (4.1 and 4.8 m/s), while in the city is the lowest (only 3 and 3.9 m/s). There is a greater reduction in speed at lower elevations, because the flow goes over built areas; this will be an extremely significant reduction, as energy power output of wind turbines is related to the cube of the speed.

Of course, the velocity profile of wind changes when the flows enters an area with a different terrain roughness. In the figure E.2.20 shows the possible changes in the velocity profile as the flow goes from a free area to a new roughness area, indicating the flow over a built area. In this model, wind speed is zero at a "d" height (3/4 the average height of buildings of the area); the reduction of the velocity depends on the buildings encountered and the horizontal distance achieved.

Therefore, the main factors influencing wind speed in an urban environment are relative orientation and heights of buildings involved, orientation and height of surrounding buildings and distance from urban area's boundary. It is proved that building taller than nearby buildings are less affected by wind speed reductions (Blanch, et al.).

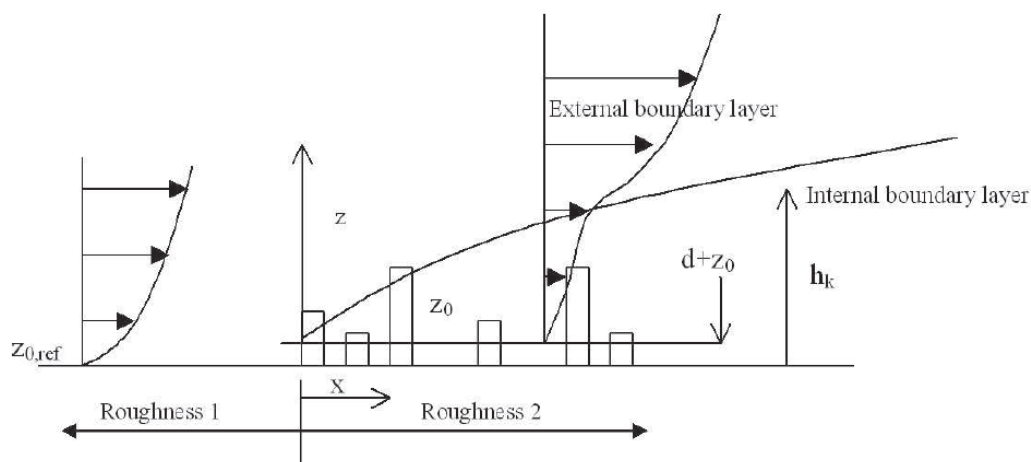

Figure E.2.21. Buildings interference on wind speed profile; source: Blanch, et al., 2005

## EXAMPLES

	ONSHORE				OFFSHORE	
<b>WIND SPEED</b>	4 m/s	4 m/s	25 m/s	25 m/s	4 m/s	25 m/s
<b>ALTITUDE</b>	0 m	1200 m	0 m	1200 m	0 m	0 m
<b>TURBINE CAPACITY*</b>	425 kW	7061 kW	8084 kW	7061 kW	425 kW	8084 kW
<b>ELECTRICITY PRODUCED*</b>	932 MWh	15463 MWh	17703 MWh	15463 MWh	1304 MWh	24785 MWh
<b>HOMES SUPPLIED*</b>	238	208	4524	3952	333	6334
<b>CO2 AVOIDED*</b>	533 t	466 t	10126 t	8845 t	746 t	14177 t
<b>ELEC. CARS FUELED*</b>	466	407	8852	7731	652	12392
<b>*: Per year.</b>						

## ENVIRONMENTAL IMPACT

Environmental impact is the effect caused by humans on the environment during an activity or project. Wind energy has an environmental impact of low importance because the requirements of materials and area are quite short. However, using steel or plastic materials generate environmental problems during their fabrication. Before talking about the few negative effects we will have to highlight the positives ones (EWEA):

- Wind energy, as renewable energy, is inexhaustible and clean.
- Wind energy doesn't emit greenhouse gases. This helps to the fight against the climate change.
- Wind turbines are nearly recyclable and the use of water is short.
- Wind energy doesn't create wastes; this means no need of dumps.
- Wind energy doesn't need vast earthmovings, transport of sediments, alteration of watercourses, contamination by particles or accumulation of radioactive waste.
- Wind energy doesn't emit air pollutants and micro-particles which can cause acid rain and cancer and respiratory diseases respectively.
- Wind energy, after hydropower, creates the lowest emissions of CO<sub>2</sub>\* and uses the lowest energy to construct the devices.

(\*) talking about CO<sub>2</sub> must be highlight that each time a wind turbine produces kWh avoids creating a kWh by a not green energy as coal, gas or oil. This supposes approximately 696 gCO<sub>2</sub>/kWh.

Wind energy also has some negative points:

## NOISE

It is usually one of the most important impacts (reference3: Wagner, Bareis and Guidati, 1996). At the beginning wind turbines were really noisy what caused complaints of those living around. Nowadays the technological development reduces the noise and controls the nuisance created (Burton, T. Sharpe, D. Jenkins, N & Bossanyi, E. 2001). There are two main sources that create the noise on wind turbines:

- Aerodynamic noise: created when the wind goes through the rotor. It's an unavoidable noise.
- Mechanical noise: created because of a poor design. It can be avoid with a better design, insulating materials or soundproofing.

## **ELECTROMAGNETIC INTERFERENCE**

Nowadays there are lots of signals of modern systems of communication and sometimes wind turbines interfere with them. In particular wind energy competes with radio systems for obtaining the better positions on hilltops and open areas. Wind turbines affect mostly to: VHF radio systems (30-300 MHz), UHF television broadcast (300 MHz-3 GHz) and microwave links (1-3 GHz). They also interference with defence and civilian radar used for air traffic control. (ETSU, 1995; Burton, T. Sharpe, D. Jenkins, N & Bossanyi, E. 2001).

## **VISUAL IMPACT**

It's a polemic and difficult to assess topic. From the authorities to the nature organisations, a new wind application supposes a vast visual impact on the landscape (Hau, E., 2006).

The real problem appears while talking about development; this means the visual effect caused by wind farms (Hau, E., 2006).

The Swedish "national board of energy (NE)", summarize the visual impact effect with three factors (Engstrom, S. & Pershagen, B., 1980):

- Psychological factors: what does the observer associate with the wind turbine?
- The type of landscape: Is the wind turbine settlement in an open area or closer to trees and/or buildings?
- The size of the wind turbine: if turbine's height is less than 50 metres could be masked if not they will dominate the landscape over long distance.

The conclusion of the research was that everyone will accept a wind farm if this is farther than 8 to 10 rotor diameter (Burton, T. Sharpe, D. Jenkins, N & Bossanyi, E. 2001; Hau, E., 2006).

## **SHADOW FLICKER**

Normally the shadow of a wind turbine does not differ from tree's or building's shadows. But when the rotor blades spin this shadow could be annoying for humans. It is a constant blinking that cuts the sun 3 times per rotation producing an effect called "stroboscopic" or "disco". Moreover, we have to take into account the speed these blades spin (Hau, E., 2006).

If many wind turbines, like a wind farm, produce this effect at the same time annoyance to people inside buildings can be created. A frequency between 2.5-20 Hz can cause it



and there are few cases of anomalous EEG (electroencephalogram) reaction (Verkuijlen, E. & Westra, C.A., 1984). So it must be limited to a determinate value without overcoming it (Hau, E., 2006).

## **LAND USE**

Current wind turbines only need the area that tower and foundation occupied because all the equipment needed for operation and grid connection is inside the tower base. Sometimes is said that around the turbines there must be a safety area in case of accidents, but this is not applied to other technologies as airports, railways, road etc. Wind energy is the renewable energy that needs less area. Moreover, if you compare it with power plant and all its annexes (fuel storage and others) the land used is the same. (Sengupta, D.L. Senior, T.B.A. & Ferris, J.E., 1983; Hau, E., 2006).

## **WILDLIFE IMPACT**

Sometimes wind farms are settled in areas with a really important ecological aspect that must be protected. Moreover, the wind farm impact and its reduction must be measure. English Nature (1994) state that all wind energy projects must consider the impact to wildlife habitats during the construction and operation of the wind farm on a directly and/or long-term way. So, the ecological assessment must include: botanic map and identification, existing birds and non-avian fauna, hydrological conditions, importance of the ecology, how the wind farm will impact and attenuation measures, even where you cannot build (Burton, T. Sharpe, D. Jenkins, N & Bossanyi, E. 2001).

## **BIRDS CASE**

There is another problem according to wildlife at the areas where wind turbines are arranged. On one hand, local birds get used to wind turbines; birds identify them as an obstacle and fly around them. On the other hand, not local birds, like migratory birds, can be damage with wind turbines. This case is important but we will have to take into account that migratory bird rarely fly at altitudes of less than 200 m (Hau, E., 2006).

## **ECONOMIC ASPECT**

Wind energy has many economic benefits which includes reduced exposure to fuel price volatility and no societal cost of pollution.

The elements that determine the basic costs of wind energy are;

- Upfront investment costs, which is approximately 75% of total cost. This includes the cost of the turbines, foundation, electrical installations and grid-connection.
- Wind turbine installation cost
- Capital Cost or discount rate
- Operation and maintenance (O&M) costs, such as insurance, maintenance, repair, spare parts and administration.
- Project development and planning costs

- Lifetime of the Turbine
- Electricity production and energy losses

The initial investment for a wind energy system:

- Suitable for a small community
  - Onshore 1400 to 1600 €/kW
  - Offshore 3000 to 3450 €/kW
- Private users
  - Building integrated turbines 1200 to 2200 €/kW

Fuel prices do not affect wind generation costs. A wind turbine is *capital-intensive* compared to conventional fossil fuel power generating plants. Approximately 40-70% of costs are related to fuel and operations and maintenance (O&M).

In 2011, the global investment in wind power was reduced by 12% to USD 84 billion. This is due lower turbine prices, uncertainty with regards to European policy and a reduction in China's wind installations.

Wind power is becoming more competitive. Production cost per kWh has declined by over 80% within the last 20 years. The trend is expected to continue and may result in a competitive technology in 7-10 years according to the DWIA.

The majority of the traditional power production facilities are depreciated and paid by the consumers. Wind Power is only able to enter the market with governmental support. The costs of the health and environmental impact are not calculated in the price of energy. If priced, wind power might be more competitive.

Wind power installation is encouraged in some countries by a payment system which includes an environmental bonus added to the market price. In Denmark, investors in wind power receive an environmental premium of 0.10 DDK/kWh (approx. 0.013 EUR/kWh) with the Nordic power exchange, Nord Pool market price.

Arrived to this point LCOE parameter can give us an overall view of the cost of generating energy concerning to electricity.  $LCOE = \text{Total Life Cycle Cost} / \text{Total Lifetime Energy Production}$ . The Levelised Cost of Energy (LCOE) of a typical new wind farm ranges from:

- Onshore 0.061 – 0.107 €/kWh
- Offshore 0.107 – 0.145 €/kWh

Offshore Wind generally costs 50% more than onshore Wind technology. This is primarily due to higher foundation costs, Transformer stations and sea transmission cables.

## SOCIAL ACCEPTANCE

Social Acceptance is one potential barrier to the development of Wind Energy. It was a neglected factor because preliminary surveys indicated large support for the technology, however these surveys were limited in nature and needed to consider other factors. These factors could include; location of the turbines, visual and environmental impact and short-term costs versus long term benefits when compared with existing non-renewable power sources.

Socio-political acceptance is the widest and most general level of acceptance. It considers public acceptance of technologies and policies.

Community acceptance refers to acceptance by local stakeholders, such as residents and the local authorities, of the wind projects and their proposed location.

Market acceptance refers to the adoption of the wind technology by the market. The focus is on both the consumers and investors. Large monopoly companies create a link between market acceptance and socio-political acceptance, as these companies are usually influential in the development of energy policies.

The result of a survey administered by the DWIA, in 2009 on the Danish Population, indicates that the majority of the population supports the expansion of the Wind Energy Power generation. More specifically;

91% think that Denmark should expand Wind Power usage, while 85% support local area expansions taking place. The latter statistic, suggests that although the "Yes, but not in my backyard" opinion may exist; it represents the minority of the Danish population. 62% believe that over 50% of electricity production should be produced from Wind Power.

In support of the latter statistics, the responses to one of the 2009 survey questions, "What do you believe are the main challenges for more wind turbines in your municipality?" is displayed below.

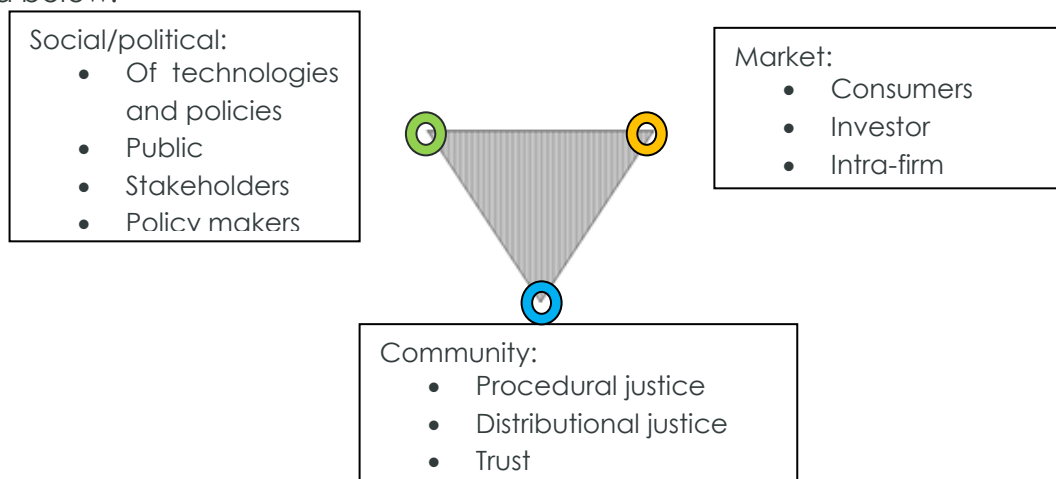

Figure E.2.22. The triangle of social acceptance. Source: IEA, 2007.

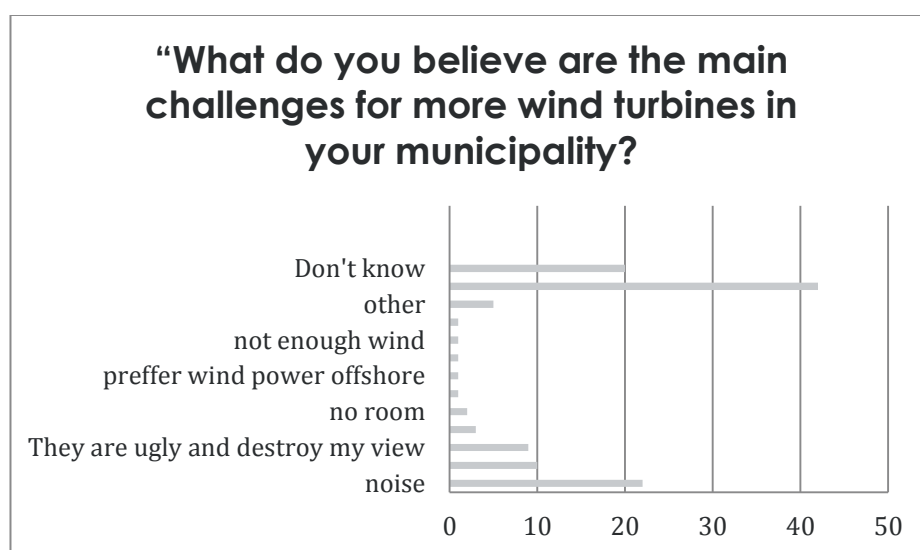

Figure E.2.23. What do you believe are the main challenges for more wind turbines in your municipality?. Source: IEA, 2007.

## EMPLOYMENT

The wind Industry employed approximately 30,000 people globally according to a 1995 DWIA study. It accounts for both direct and indirect employment.

Wind Industry employment is estimated at 670,000 in 2011, according to the Renewable Energy Policy Network for the 21<sup>st</sup> Century (Ren21) (2012). Future employment numbers is expected to be impacted by the Recession & Tax Policies.

Denmark, Germany and Spain account for approximately 77% of direct employment within the Wind Industry. The European Wind Energy Association (2009) states that 15.1 EU jobs are created for each new MW installed. Also, 0.4 jobs are created per MW of total installed capacity in existing installations.

## POLICY

A major challenge for Wind Energy is reduced competitiveness with traditional fossil fuel dependent energies. This is primarily due to the high initial investment costs. In light of the long term potential benefits of using the wind energy and other renewable energy sources, Governments and other International bodies develop Policies to support the development and expansion of the energy systems. Policies help to overcome some of the following obstacles to the development of Wind Energy;

- Existing Infrastructure, dominance of existing industry and the current regulation of energy systems
- Market overlook of the cost impact on health and the environment
- Limited access to knowledge based on Wind Energy and limited suitability qualified on human resource capacity
- Public perception and societal values

The Danish Parliament, in March 2012, formalized an energy agreement which states that 50 % of electricity consumption will be generated by Wind Energy.

Wind Energy development is supported by a host of Renewable Energy Policies and Legislation. Some policies are specific for each country, while others are international agreements. The policies include the following;

### TYPE: REGULATIONS

- feed-in-tariffs
- quotas
- priority grid access
- building mandates

### TYPE: FISCAL INCENTIVES

- tax policies
- direct government payments such as rebates and grants

- public finance mechanisms such as loans and guarantees

#### TYPE: POLICIES TO REDUCE GREEN HOUSE GAS EMISSIONS

- carbon pricing mechanisms

Some countries reduced their fiscal support policies in 2011 and early 2012. China ended subsidies for domestic wind turbine manufacturers and India suspended accelerated depreciation of wind farms.

Some governments implemented measures to encourage research, development and deployment in Wind Energy. 2011 support programmes include;

- Scotland budgeted USD 54 million (GBP 35 million) for production of full-scale prototypes of next generation offshore wind turbines;
- An EU specific budget line item was wind energy R&D;
- The United States offered grants and loans of at least USD 196 million for specific renewable energies which includes offshore wind projects.

In 2011, Spain had almost met its Policy target to install 22GW of Wind Power.

## LEGISLATION

Renewable Energy Directives support entry into the EU Wind Energy market  
The 2001 Directive covers;

- Compensation for environmental impact and supply security,
- Administrative support for new developments, etc.
- Origin of product is published
- The methods of avoiding or reducing Technical Adaptation costs are regulated

The 2009 Directive;

- Made 2020 Renewable Energy Targets Legally binding

The European heads of states enacted an environment and energy package, in 2008. It states that 20 % of European energy consumption by 2020 must come from renewable energy.

Denmark aims to increase the share of wind in total generation to 50% by 2020.

There are many active Wind Associations across the globe that are actively involved in lobbying for Policy and Legislative review in the Wind Energy Sector. These include;

- Danish Wind Industry Association (DWIA)
- The European Wind Energy Association (EWEA)

"Ontario (Canada) amended legislation to exempt most renewable energy installations from property tax." (REN21, 2012).

"The Production Tax Credit, the main support scheme for U.S. wind power, is due to expire at the end of 2012, and few investors are confident that Congress will agree to extend the legislation into 2013 and beyond." (REN21, 2012).

# SWOT ANALYSIS / CONCLUSION

Concerning to integration of wind energy into buildings or small villages we have to highlight some advantages:

- Small rural villages have free land for the settlement of a wind farm
- Isolated buildings in a small village have great opportunities to include wind turbines into their structure for supplying electricity with better results than in an urban area.

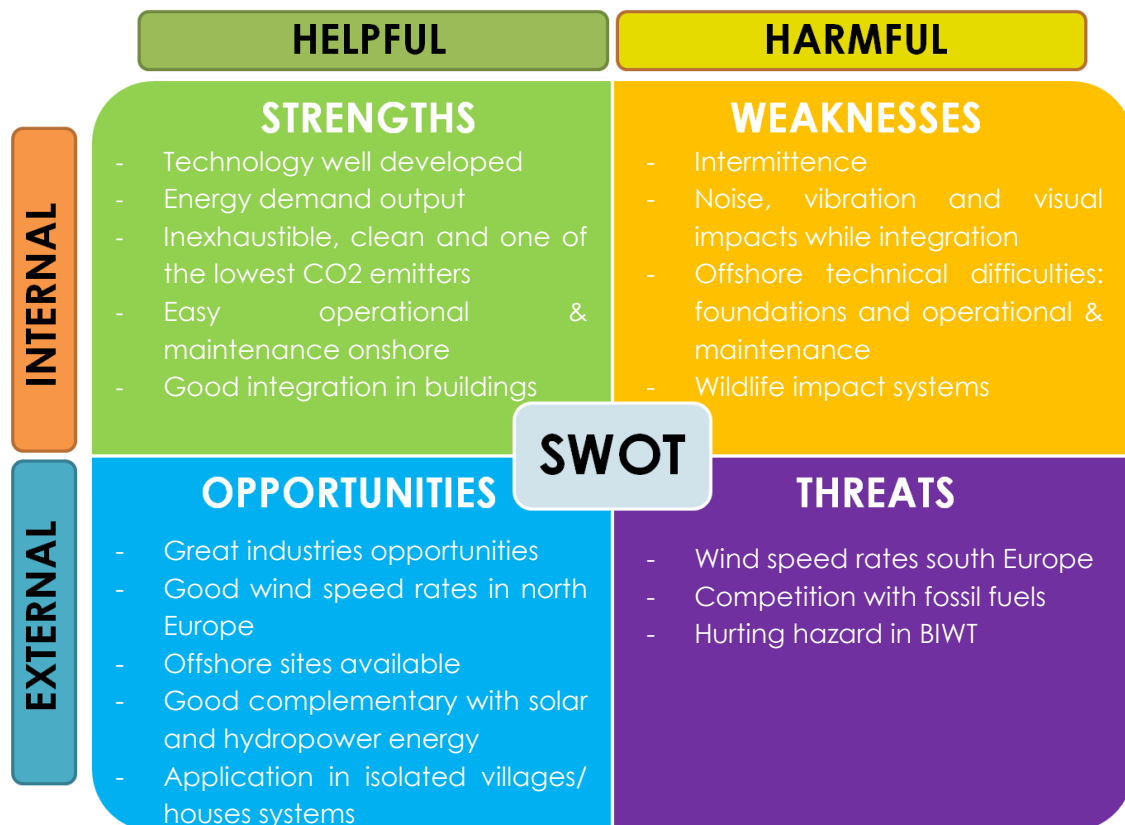

# WATER

Three quarter parts of the world's surface are water, either salt or freshwater. Water cycle puts at our disposal 1.386.000.000 km<sup>3</sup>. We are able to take advantage of a big part of this almost inexhaustible resource by means of different technologies. Indeed, water is life, and our survival is directly linked to it in many aspects, not only in the energetic one. In this part of the report we will deal separately with hydropower and marine energies since they use the water as their fuel, but they exploit it by different ways.

## INTRODUCTION

According to EU Directive 2001/77/EC, any hydraulic energy, independently of its size it is a renewable energy thanks to the natural hydrological cycle (HayaComunicación, 2008). This report wants to be a practical and understandable introduction to the hydropower energy and that is why we are not studying the developing of this issue in depth, but the main concepts are being explained in the next pages.

In 1880, it was built in Northumberland (Great Britain) the first installation which can take advantage of the strength of the water falling from a height to activate a turbine that at the same time made an alternator turn, producing electricity. But hydropower had been used for centuries, even 2000 years ago (HayaComunicación, 2008).

Nowadays, we use hydropower to get electricity. Although when it comes to water projects, more aims apart from energy supply should be considered. This is known as the Multi-Purpose development: water supply, flood control and protection, drought management, irrigation, navigation and hydropower (Chin, D.A., 2006; International Energy Agency IEA, 2012)

So there are many demands on the world's water resources. Hydropower development must be balanced with social and environmental responsibility, industry requirements, making an integrated resource management. Besides, regarding energy-water nexus, there are many sustainable development consequences (International Energy Agency IEA, 2012).

- Rapid population growth
- Enhancement of regional development
- Combination of energy and water security

## CLASSIFICATION, FOLLOWING DIFFERENT CRITERIA

Hydropower plants (HPP) are very diverse and their election and design are very close to the local conditions. There are at least three different criteria to divide this type of water projects:

### HPP SIZE/CAPACITY INSTALLED

- Conventional or Large Scale (Storage HPP):  $IC > 20\text{MW}$
- Small-scale (SHPP):  $1 < IC < 20\text{MW}$
- Mini:  $100\text{KW} < IC < 1\text{MW}$
- Micro:  $IC < 100\text{KW}$
- Pico:  $IC < 5\text{KW}$

This classification could change depending on the sources (D.A., 2006; HayaComunicación, 2008). There is no worldwide consensus in size categories so the limits could change in a few MW. Just to make an idea of the size of this type of projects, Three Gorges Dam (China) has 22500MW of electrical energy installed.



## PLANT TYPES BY HYDRAULIC HEAD

Head refers to the difference between the upstream and the downstream water levels. According to the IEA (International Energy Agency IEA, 2012):

- High Head: above 300 m
- Medium Head: between 30 and 300 m
- Low Head: less than 30 m

## PLANT TYPES BY FUNCTIONAL CATEGORIES

There are three principal functional categories, but we can find lots of different configurations that will be described later (Anagnostopoulos, J.S. & Papantonis, D.E., 2007; Lowe, P., 2012).

- Storage or Reservoir HPP: the energy is provided by the water stored in a dam so that it is reduced the dependence on the variability of inflows. These kind of projects re usually linked to large scale exploitations.
- Run-of-river (RoR): this kind of plant takes advantage of the flow of the river. They may include short-term storage or "pondage", so they are best located on rivers with a consistent and steady flow. Most of the SHPP are RoR which is much different in design, appearance and impact from conventional large. All diverted water returns to the stream below the plant.
- Reversible plants or Pumped Storage Plants (PSP): in this kind of plants water is pumped from a lower storage into an upper storage when electricity supply exceeds demand or can be generated at low cost. Water comes down when there is a peak demand or electricity becomes expensive. They can use the water stored from more than one reservoir HPPs.

Taking into account that the aim of this report is to give a general vision of the sustainable energies and to get familiar with the different kinds, we have considered that the best option was giving a general overview of the sector since the theoretical basis is the same for all size projects. Precisely, the main difference lies in the capacity installed (Nautiyal& Kumar, 2010).

Nevertheless, we cannot believe that a SHPP is a little large scale power station. Specific equipment is necessary to meet fundamental requirements regarding simplicity, energy output and reliability. In addition, another thing we cannot forget is that SHPP as they produce less power than big ones needs to decrease cost in order to improve their performance. This is why specific equipment is required, more optimized (Bueno, 2010; European Small Hydropower Association ESHA, 2008).

Later on, we will talk about Hydropower Plants (HPP) mixing both classifications, the functional one and the size one.

# DESCRIPTION

## BASIC CONCEPTS AND TECHNOLOGY

The energy for the hydropower exploitations could be achieved in two ways: by potential energy and by kinetic energy, being the most popular and effective the first one (Aquaret, 2012).

### POTENTIAL ENERGY

A hydropower station gets the energy from water. We can take advantage of this energy before it is dissipated when it goes from one status with a higher energy level to one with inferior level. This can be achieved with the cote difference between two points, usually in a river. These points would be upstream and downstream of a power station. This level difference is obtained by just natural falls or by artificial dams, weirs or deviation (Bueno, 2010).

Apart from this, we have to bear in mind the load drops that occur in the pipes and in the different elements of the installation (valves, section changes, elbows, turbines, alternator...).

From the energy between two points we can consider that we can take advantage of the 85-90% for hydroelectric use, being the rest load drops. So, the final head that is used to get energy, is smaller than the real one (Bueno, 2010).

The aim of this renewable energy is the conversion of water potential energy into electric energy. But, how? Two steps are required for that (Bueno, 2010):

- Hydraulic energy conversion into mechanical energy using **turbines**.
- Mechanical energy conversion into electric energy by an **alternator**.

### KINETIC ENERGY

In this case, kinetic energy devices (hydrokinetic turbines or in-stream flow turbines) generate electricity from the free-flowing water rather than from hydraulic head created by weirs or control structures. The kinetic energy is not as developed as the potential energy. For this aim hydrokinetic turbines are being developed in the last years due to the recent research activity and investment in technology to capture tidal energy (Aquaret, 2012; International Energy Agency IEA, 2012).

## PARTS OF A HYDROELECTRIC PROJECT AND COMMON ELEMENTS

Almost all the power stations follow the same scheme, although some modifications may happen. Anyway, the main parts are (Bueno, 2010):

1. **Water Intake.** Here we have two possibilities:
  - In weirs for diversion plants for RoR.
  - The aim is to channel the water and maintain its level.
  - In reservoir dams.

The aim of the reservoir in this case is the creation of the head and the flow control. We must take into account that the water level can change due to

many factors. There are lots of types of dams and each permits many different configurations for hydropower exploitation: concrete dams (arch dams, gravity dams), embankment dams (rock-fill dams, concrete-face rock-fill dams, earth-fill dams, asphalt-concrete core), steel dams, timber dams.

2. **Conduction** to the forebay tank. The conduction could be:
  - In free-surface flow: in a channel (open or tunnel).
  - In pressure: high pressure gallery and penstock.
  - Mixed: channels and penstocks
  - Other elements: surge tanks and the problems derived from the use of penstocks, such as the water hammer effect.
3. **Powerhouse**. The power house can be placed underground, or it can be an external plant. They have the same elements but with different distribution.
  - Hydromechanical equipment. Turbines and alternators (in some cases reversible groups for PSP) are the most important ones. But also take part of this equipment: flow regulators, flow and speed control systems, valves, cofferdams, floodgates...
  - Discharge channel
  - Auxiliaries elements (cranes, fire systems...)
4. **Transformation centre** and exit to electric grid.
5. **Long distance power lines**. Transport grid in high voltage.

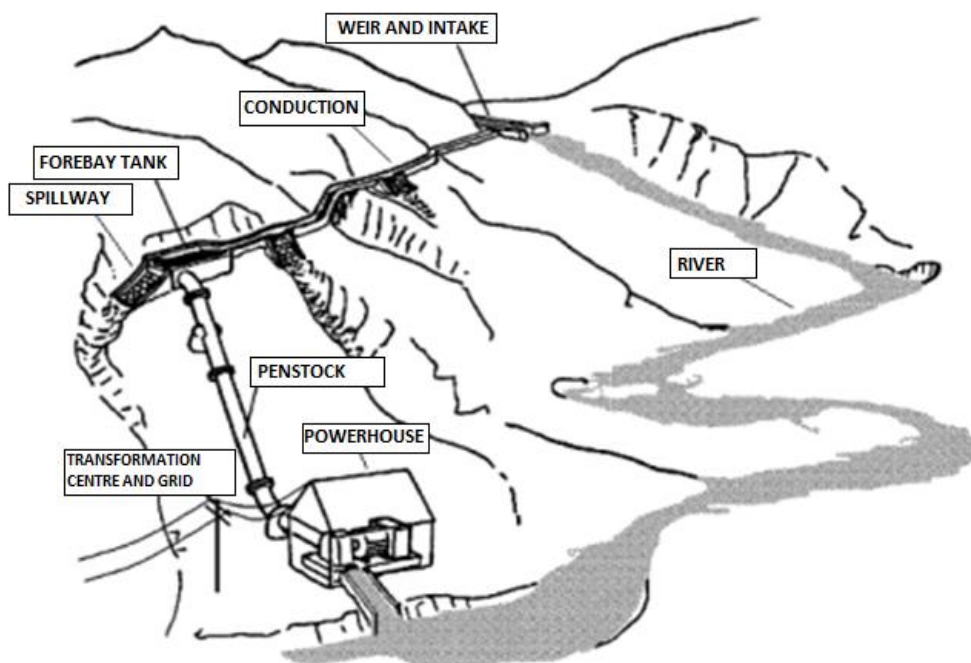

Figure E.3.1 :Oliver Paish, 2002. Small hydro site layout.  
(Small hydro power: Technology and Current Status).

Now, in the table provided, we will see more configurations although all follow the same basis.





Different Plants Configurations		
Storage or Reservoir HPP	Run-of-river (RoR)	
<p>Waterfall in pressure (1)</p> 	<p>Natural waterfall (2)</p> 	<p>Pumps as Turbines (3)</p> 
<p>Exploitation in the base of the dam (4)</p> 	<p>Weir type plant (5)</p> 	<p>Cascading system (6)</p> 
<p>Exploitation in a subterranean plant (7)</p> 	<p>Kinetic Energy Devices (8)</p> 	<p>Pumped Storage Plants (PSP) (9)</p> 

Figure E.3.2 : Table with different plant configurations. Most popular configurations. (1) Waterfall in pressure. Available at: [http://www.cd3wd.com/cd3wd\\_40/EMGroups/MicroHydro/Hydro%20Power.htm](http://www.cd3wd.com/cd3wd_40/EMGroups/MicroHydro/Hydro%20Power.htm). (2) Iguazú Waterfalls. Available at: <http://www.disfrutabuenosaires.com/cataratas-iguazu>. (3) Pumps as Turbines. Available at: <http://homepage.ntlworld.com/regina.dengler/main%20content/full/cases/case1/case1.htm>. (4) Powerhouse in the base. Available at: <http://powercentralselena.blogspot.com.es/2011/05/hydroelectric-plants.html>. (5) Weir Plant Available at: <http://puntosgps.com/wp/lu-monforte-de-lemos-azud-de-ribasaltas/>. (6) International Energy Agency IEA, 2012. Cascading System. Technology Roadmap. (7) Subterranean HP. Available at: [http://www.cd3wd.com/cd3wd\\_40/EMGroups/MicroHydro/Hydro%20Power.htm](http://www.cd3wd.com/cd3wd_40/EMGroups/MicroHydro/Hydro%20Power.htm). (8) Kinetic energy. Available at: [www.aquaret.com](http://www.aquaret.com). (9) International Energy Agency IEA, 2012. Pumped Storage System. Technology Roadmap.

At this point, we consider that is good to obtain some knowledge about the devices that are used to get the electricity: turbines.

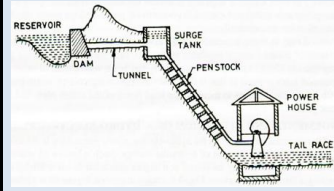
## TURBINES

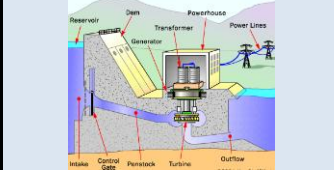
The turbine is a hydraulic engine with efficient performance, safe and easily controllable (Bueno, 2010). As we have explained before, the aim of this renewable energy is the conversion of water potential energy into electric energy using turbines and alternators. The turbine, with the strength of the water gets rotation in the rotor using propellers or blades. This rotation is transmitted by an axis and by means of the electromagnetism, generates Alternating Current (AC).

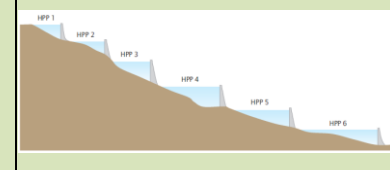
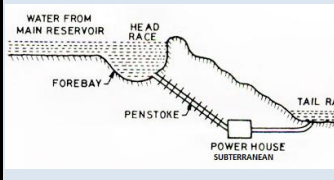
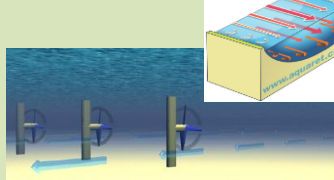
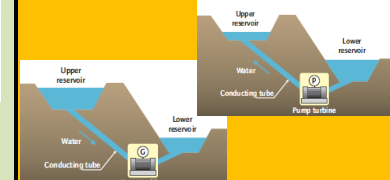
Turbines can change the load received and stop in a fast way as well as they are able to start working quickly. Turbines use a wide range of differences in height and in flows and this has led to the development of many diverse types of turbines, although the all of them have, generally, three principal elements: Distributor, Runner or rotor assembly and Diffuser suction shaft (Bueno, 2010).

Besides, turbines can be classified in two main groups (Paish, 2002):

- **Impulse turbines:** the runner works in atmospheric pressure. There are 3 main types of impulse turbine in use: the Pelton (A), the Turgo, and the Crossflow (also known as Banki turbine).
- **Reaction turbines:** the rotor of the reaction turbine is fully immersed in water and is enclosed in a pressure casing. The two main types of reaction turbine are the Propeller (with Kaplan (C) variant) and Francis (B) turbines.

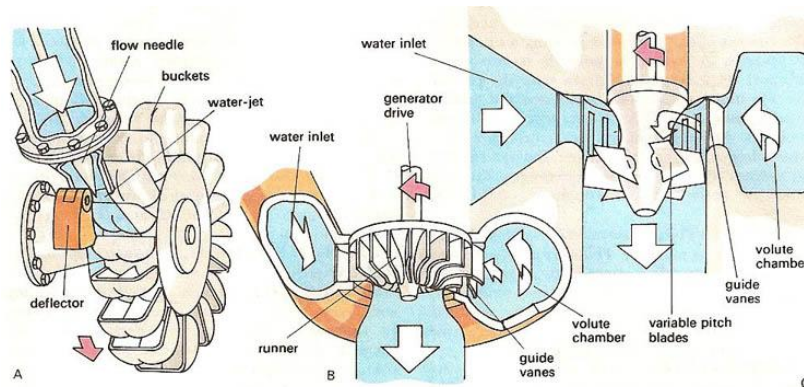

Figure E.3.3 :The Encyclopedia of Alternative Energy and Sustainable Living. The three main types of water turbine: (A) the Pelton turbine (or wheel); (B) the Francis turbine; (C) the Kaplan turbine. [Electronic Print]. Available at: [http://www.daviddarling.info/encyclopedia/W/AE\\_water\\_turbine.html](http://www.daviddarling.info/encyclopedia/W/AE_water_turbine.html) [Accessed 20 October 2012]

The choice of the best turbine for a particular hydro plant depends on two parameters: the head and flow or discharge available. The next table gives general criteria for a good first approach to the selection:

Impulse and Reaction turbines			
Turbine type	Head classification		
	High (>50 m)	Medium (10-50 m)	Low (<10m)
Impulse	Pelton	Crossflow	Crossflow
	Turgo	Turgo	
	Multi-jet Pelton	Multi-jet Pelton	
Reaction		Francis	Francis
			Propeller
			Kaplan

Figure E.3.4: Oliver Paish, 2002. Table with ranges and best options for each case. (Small hydro power: Technology and Current Status).

### ALTERNATIVE FOR MICRO-HYDROPOWER PLANTS: PUMPS AS TURBINES

Another way to obtain good performance, most of all in micro-hydropower schemes is the use of a pump as a turbine. This is one of the best alternatives to supply the demands in remote rural areas. Why? Because the use of centrifugal pumps in reverse mode is one of the easiest way to reduce economical costs. Pumps are mass produced are easy to operate and more feasible to find an expert in pumps than an expert in turbines. There are several methods for the optimum selection of this kind of pumps, but no one is

appropriate for all the places and speed ranges so each case needs to be studied separately (Nautiyal& Kumar, 2010).

### **MINI/MICRO/PICO HPP**

They use the natural flow of water, so they are RoR. These HPP can provide power to an isolated home or small village, or to the grid. And they complement photovoltaic solar energy systems because in many areas, water flow, and thus available hydro power, is higher in the winter when solar energy is at a minimum (HayaComunicación, 2008).

When the flow and the head are suitable enough to use directly the energy produced, we can install small equipment composed of turbine-alternator compact groups, easy to place and that require small infrastructure (HayaComunicación, 2008).

In addition, there are lots of devices for this kind of exploitation, but one of the most interesting is the PowerPal, an innovative microturbine that produces AC directly in 220 V (HayaComunicación, 2008).

As an ending for this part it is important to remind two important characteristics of this kind of renewable energy. Hydroelectric plants allow (International Energy Agency IEA, 2012):

- Controlling the frequency in the grid.
- Store energy by water reservoirs and pumped storage plants.

### **CURRENT STATUS**

Hydropower is the largest single renewable energy source today, providing **16,3%** of world's electricity (about 3 500 TWh in 2010), at competitive prices. More than nuclear power (12.8%), much more than wind, solar, geothermal and other sources combined (3.6%), but much less than fossil fuel plants (67.2%)(International Energy Agency IEA, 2012; Paish, 2002). The Technology Roadmap of the International Energy Agency (IEA) forecasts that for 2050 these levels should be doubled because still has a large potential for future development.

It is clear that the hydropower resource is very wide, with many parts of the world being fortunate enough to have large water potentials. The major hydropower producer in Europe is Norway with 122 TWh of capacity installed. Concerning SHPP in Europe there are 11MW capacity installed (International Energy Agency IEA, 2012; European Small Hydropower Association ESHA, 2008).

### **VISION FOR HP DEPLOYMENT FOR EACH PLANT TYPE**

#### **- Storage Plants:**

The tendency is that the installation is SHPP. This does not mean the large scale exploitation ends. In general, dams are considered safe, and there are many possibilities to increase the capacity, efficiency and environmental performance of old plants. In fact, the multi-purpose development and the integration of HP into existing dams is a feasible development that is becoming more and more spread. The environmental impact is null in the projects that consists of the implementation of the hydropower used in existing buildings or the increase in the capacity installed in old power stations. In fact, In 2009, the World Bank highlighted the importance of multi-purpose infrastructure as a driver for future hydropower development (International Energy Agency IEA, 2012).

- **Small HPP and RoR (micro, mini, pico):**

There are many opportunities to build new plants, especially in emerging and developing economies. For these cases, and with electricity supply purposes, SHPP is the best option. Small-scale hydropower is one of the most cost-effective energy technologies to be considered for rural electrification programmes in less-developed countries. And it is considered very important for the HP development in Europe.

In 2006 there were nearly 23000 SHPPs and for 2010 the potential of hydropower capacity was 23480 MW and the energy produced 84327 GWh taking into account EU 27, Candidate Countries, Norway, Switzerland and other associated countries.

The difference between Large Hydro and Small Hydro is still vast in proportion of Renewable energy sources: 55% to 9% in 2006.

For micro-hydropower the alternative is still the Pump as Turbine (International Energy Agency IEA, 2012).

- **Pumped Storage Plants:**

For this type the European Union is the leader with 45 GW from the 140 GW worldwide installed turbine capacity. PSPs, previously used for night pumping and diurnal generation, are now used for frequent pumping and generation during either day or night, as a result of the expansion of variable renewables (PV and wind). This provokes a need for flexibility that just hydropower could provide. An innovation in this type is the marine pumped storage system (International Energy Agency IEA, 2012).

However, we have to take into account that the development is not going to be the same in all around the world, neither in Europe. Each country has its particularities and those factors limit the deployment of the HP.

## **R&D PRIORITIES AND INNOVATION**

Equipment manufacturers are researching for higher efficiency, reliability and longevity through computational fluid dynamics design, advanced manufacturing processes and new materials. R&D is also directed into Information Technology (IT) Systems: automation, remote control and diagnostics and hydrokinetic turbine's development. Also, new devices for Micro-hydropower in RoR are appearing (International Energy Agency IEA, 2012).

## **FACTORS**

There are many things we must take into account when it comes to execute a project of these characteristics: external inputs, environmental impacts, economic aspects and social factors. These factors affect in the selection of the place, plant capacity and size, configuration system, dam type, uses, etc. For the achievement of a compromising solution in each case, detailed assessments would need to be undertaken.

### **EXTERNAL INPUTS**

Hydropower is not considered variable in the same sense as wind power or solar PV. This is in part due to the **control over the resource** through its storage capabilities and the

greater predictability (over wind power) of its generation (even for run-of-river plants). Anyway, those energies are complementary (International Energy Agency IEA, 2012).

One of the most important aspects is the **geography** of the country and its variations (topography and geology), because this directly affects in the obtaining of elevation and potential difference for an optimum possession of the head (Fritz, 1984).

Hydropower is, besides, **variable** over longer time scales, as it depends on water runoff related to precipitation and melt rates and droughts. As it is shown, this type of energy is very sensitive to climatic variations, seasonal and annual water patterns (climatic suitability). This affects to the kinetic energy in rivers and in the water flow. These factors are related also related to risks, requiring design changes and dam safety improvements (Chin, 2006).

So, it is clear that one of the most important parts when it comes to the project design is the **hydrologic** study of the area.

Apart from this, another vital aspect is the **sediment load** due to floods. Sediments could affect turbines and storage volume (Fritz, 1984).

Regarding reservoir storage, this is also is affected by the use of the catchment. Hydro projects exploitation has more than one **use**, indeed, they are multi-purpose. We can refer to them as non-power constraints: irrigation, environmental regulation, recreation, flood control and human consumption. Of course, this reduces the ability of hydropower to integrate variable renewables. But we cannot forget the determination of the demand, which is what principally determines the need for a power generation project (International Energy Agency IEA, 2012)

Limitations on flow variability may affect fluctuations in tailwater (downstream) levels. This is a crucial aspect in some places under **jurisdiction** (International Energy Agency IEA, 2010).

Predictions for **climate change** impact are uncertain. Different studies with different modeling show a wide range of results, but all have in common one point: at high latitudes and in part of the tropics an increase in precipitation is forecasted whereas in some subtropical and lower mid-latitude regions, precipitations are predicted to go down. In any case, the affection in hydropower generation potential will be small, but impacts on an individual project can be considerable and exhaustive assessment and studies would be needed (International Energy Agency IEA, 2012).

Hydropower is considered as part of the strategies to adapt to climate change, most of all in order to its ability to provide **flexibility** by storage for al purposes (International Energy Agency IEA, 2012).

## ENVIRONMENTAL IMPACTS

The tendency is leading to the development of SHPP and some environmental NGO also support that idea, basing their arguments on the big environmental and social impacts that large scale exploitations have (Fritz, 1984; European Small Hydropower Association ESHA, 2008). On the other hand, some HP Organizations and Agencies defend that the cumulative impacts of many smaller-scale plants might be equivalent to one single larger plant generating the same power output (International Energy Agency IEA, 2012). Being aware of the importance that nowadays large scale projects have in our society and that they are an undeniable reality, we cannot ignore their environmental impacts. The main environmental impacts are going to be explained now.

The electricity production in plants does not generate affections to the environment. But when the attention is paid just to impacts that the **construction** of regulation projects, necessary for hydropower use have upon the environment, a bad image of this water use has been created. So the fault of that **negative perception** is the civil work required for the infrastructure (Fritz, 1984).



New environmental goals required the adoption of integral points of view that take into account all the environmental problems, along with economic and social ones. The **environmental costs** of the hydropower are linked to the reservoir need for the production. Those costs are locals, quantifiable and variable depending on the location and the corrective measures that have been adopted. Therefore, as long as these impacts are bear in mind since the designs phase of the project, it can be decreased or avoided if an appropriated study of alternatives and of corrective measures were done (International Energy Agency IEA, 2012).

In order to implement hydropower projects in a sustainable way, the International Energy Agency (IEA) has updated its **Recommendations for Hydropower** considering this energy as a renewable and sustainable resource, as a system integrator and also deals with the multi-purpose nature. In addition, the Environment and the International Hydropower Association has developed a Draft Hydropower Sustainability Assessment Protocol which aims to be an assessment tool in four different phases in a project's life cycle: early stage and design, preparation, implementation and operation of individual hydropower projects. It helps in the developing of strategies to address weaknesses (International Energy Agency IEA, 2012).

The aim of the deployment of sustainable hydropower is to avoid the annual **emission** of 1 billion tones CO<sub>2</sub> by 2050. Further, reservoir and pumped-storage hydropower make easier the implementation and management of wind and solar PV electricity. This leads to a reduction in CO<sub>2</sub> emission. For instance, SHPP production reduces GHG such as CO<sub>2</sub> by 29000000 tons annually and sulfide dioxide by 108000 tons annually (International Energy Agency IEA, 2012).

Green House Gas (GHG) emissions occur during the construction phase, while operating and maintaining and dismantling of a hydropower project. For the calculation of these emissions the point of view of the LCA has been taken. From this analysis is concluded that after measuring all the variables, hydropower is one of the energy sources with less emission per generated kWh (HayaComunicación, 2000). Data from 2000 says:

	GHG (Kt CO <sub>2</sub> /TWh)	SO <sub>2</sub> (t SO <sub>2</sub> /TWh)	NO <sub>x</sub> (t Nox/TWh)	Particles
<b>Storage HP</b>	2 to 48	5 to 60	3 to 42	5
<b>Run-of-River</b>	1 to 18	1 to 25	1 to 68	1 to 5

Figure E.3.5: International Agency of Energy, 2000. Table with emissions generated per TWh. (Hydropower and the Environment: Present Context and Guidelines for Future Action, IEA Technical Report, IEA Hydropower Agreement).

Possible emissions from reservoir hydropower are being taken into account. This kind of exploitations affect flooded areas. During construction, another big affection is the diversion of the river (International Energy Agency IEA, 2012).

The question of the size of the projects obviously changes the importance or affection of these impacts. For instance, in LFA SHPP has the highest ranking of all electricity production technologies (International Energy Agency IEA, 2012).

Apart from this, the environmental **footprint** of **PSP** is expected to be small. The water is reused, limiting extraction from external resources to the minimum. The way to gain ecological value is that they use existing dams favoring opportunities and funding, as well as reducing social and ecological impacts. PSP require small land areas as they are designed to supply hours or days demands, although civil work is required (International Energy Agency IEA, 2012).

Regarding water **use** and water **quality** impacts we must say that the fuel of hydropower is water, but the process does not consume it. However, additional evaporation may occur from the water stored upstream, which it is denominated as water consumption of

hydropower. Anyway, evaporation can take place even without hydropower exploitation (International Energy Agency IEA, 2012).

The impact of hydropower plants on water quality depends on the place, the type of plant, how it operates, the stream impoundments and the water quality before it reaches the plant (International Energy Agency IEA, 2012).

**RoR** plants are often used to improve dissolved oxygen levels and retain floating debris for disposal. In places where silting or sedimentation accumulation entering the reservoir from upstream sources is significant, managing the water quality in the reservoir may be very challenging (International Energy Agency IEA, 2012).

**Dissolved oxygen** (DO) levels are an important aspect of reservoir water quality. Large, deep reservoirs may have reduced DO levels in downstream waters. This could produce damage to aquatic habitat. This can be avoided by multi-level water intakes in reservoirs, and by new turbine designs. In addition, water temperature can change and reservoir sedimentation and debris can reduce the storage capacity and damage the installations as well as various impacts downstream (Fritz, 1984).

As a consequence of the previous aspects, there are many impacts on migratory species and **biodiversity**. Wildlife and ecology are affected, along with fisheries industry. Many old plants did not take into account the migration capability. The downstream flow regime could be modified too, affecting to the sediment carrying capacity and erosion. But this kind of projects do not only affect in the aquatic wildlife, but also in humans, mammals, birds and invertebrates (International Energy Agency IEA, 2012; Fritz, 1984).

**Implementing** hydropower projects in areas with low or no anthropogenic activity could affect strongly in the environment due to the need for large settlements for workers and their families with supporting infrastructure, during construction and operation phase (International Energy Agency IEA, 2012).

Following with **land use**, although it depends on the size of the project, all the exploitations entail some land occupation. Of course, large-scale projects have the biggest impact but SHPP are not free from this impact. As we have seen before, SHPP gathers lots of configurations (International Energy Agency IEA, 2012).

Other factors worthy to take into account are the **noise** pollution during operation and the **visual impact**.

With regard to decommission or **dismantling** of the plants, it is an aspect that cannot be forgotten. Dams and HPP are tools and at some point they will stop serving their purpose. Not always hydropower benefits overcome costs associated to environmental impacts or security issues. When this happens, it is time to start thinking in the dismantling of the infrastructure. The main problem with this kind of projects, generally with the biggest ones, is that they have been designed from 100 to 120 years life span but they have not been thought to be decommissioned. That is why we need to be aware of the entire life-cycle of these projects during the planning phase. In this aspect, the most conflictive projects are the storage HPP. Dams and plants removal needs to take into account lots of impacts and consequences in: sediment removal, wildlife due to stream and area restoration, region (energy supply and other uses), population and economic affections, Waste Management, disposal for future generations (International Water Power & Dam Construction, 2012).

As a conclusion, we cannot deny the impacts of this energy source, but new technology and improved operating methods show that it is possible to reduce the local environmental impact. The application of ISO 14000 environmental management standards could be a great help to achieve this aim.

## ECONOMIC ASPECTS

The main expenditures in hydropower projects include the **construction costs**: costs of civil engineering works (in new HPP construction can be up to 70% of the total cost), type of project, electromechanical equipment (follow world market prices and their own manufacturing market), access roads and difficulty of accesses, transmission lines, and the costs related to management. In this part are also include: planning costs, labour costs, raw materials costs, feasibility assessment, permits, environmental impact analysis, mitigation of impacts, repopulation and water quality maintenance, etc. (International Renewable Energy Agency IRENA, 2012).

In this kind of projects costs are very characteristic of each case, but in most cases (International Renewable Energy Agency IRENA, 2012):

- Small projects, low head and RoR: high ratio of electromechanical equipment to civil work. EUR 1041/KW to EUR 6406,7/KW
- Large reservoir projects: civil engineering works dominate the costs. EUR 840/KW to EUR 6126,4/KW
- Refurbishment and upgrade projects: EUR 400,4/KW to EUR 800,8/KW
- PSP: EUR 400,4/KW to EUR 4601,7/KW. The average price in Europe is estimated EUR 961/KW

**Operational and maintenance costs** without taking into account refurbishment, are moved between EUR 1,6/MWh to EUR 4/MWh, although the difference can move up to EUR 16/MWh and twice much for small HPP (International Renewable Energy Agency IRENA, 2012).

The **capacity factors** of HPP also vary depending on the design and the aims. So, following the flowing pattern, HPP can have their function in the electric grid that can change depending on the situation. I.e. yearly production depends on the site. This is why the range of prices is so wide (Bueno, 2010):

**RoR** plants capacity factors depend on the variability of the resource. Generally, they are flowing, i.e. without weir or storage system. Their main purpose is to supply the base demand.

They can also obtain daily or weekly regulation: with a small reservoir capacity. They allow saving some flow in off-peak hours and weekends to turbine it on peak hours (Bueno, 2010).

**Reservoir HPP** can be used to supply base load and peak demand. On the one hand, for base-load plants, the reservoir serves the resource variability. On the other hand, big storage capacity allows the independence of the flow for turbines and the flowing one. They are equipped to face peak demands, hours when the electricity is more valuable. These types of plants have an average Capacity Factor of 50% (individual ranges between 23 to 95%). Peaking ones have lower capacity factors than average but they are designed with higher capacity and with larger electrical equipment to increase performance, but also the electricity price. Large HPP is the most cost-effective storage technology available to support electric demand. These are cheaper than PSP (Bueno, 2010; International Renewable Energy Agency IRENA, 2012).

**Pumped Storage Plants PSP**: they consume pumped energy in off-peak hours and they turbine it in the maximum points of the demand curve. These kinds of power stations have a very low energetic performance but a very high economic performance because they are able to produce a controlled energy that is unique with strategic value. However, competitive markets do not reflect the contribution of PSP to the optimization of the whole generation system maybe because the need is considered by a future scenario, even recognizing the need for electricity storage. Nowadays PSP have to pay many fees, but its flexibility and security in the supply will give this energy the

market value it deserves (Bueno, 2010; International Renewable Energy Agency IRENA, 2012).

**Conditioned:** the turbine's work depend on no energetic reasons. They have more constraints (Bueno, 2010).

One practical way to compare the costs of Hydropower across HPP and other energy sources is the calculation of the **Levelised Cost of Electricity** (LCOE). It is very useful concerning comparison of the costs of generation from different sources. Relating to this case, variations in LCOE may be +/-20% (International Renewable Energy Agency IRENA, 2012):

- Large HPP: is competitive with other electricity producers with a LCOE ranging between EUR 20/MWh (low production cost, high capacity factor projects) to EUR 53,6/MWh. For high cost and low capacity factor projects as PSP, LCOE can rise to EUR 103,6/MWh.
- Small HPP: LCOE moves in the same ranges, but sometimes reaches EUR 181,8/MWh.
- Micro HPP and Pico HPP can have even EUR 216,2/MWh. Large difference between countries happen.

The **financing** of HPP used to be public. But now, due to the liberalization of the energy industry with private financing, this funding is in danger. From energy agencies the public-private partnership (PPP) is encouraged (International Renewable Energy Agency IRENA, 2012).

Like most renewable energy technologies hydropower has high **initial investments** and long **construction periods** but very low operating costs. Returns of investment may vary a lot. This affects in the risk evaluation of the investment. Depending on the nature of the project, the main risks potentially affecting hydro plant financing may include: construction risk, hydrologic risk, off-taker risk, regulatory risk and Life-cycle risk (International Energy Agency IEA, 2012).

As it has been mentioned before, from 70% to 80% of the total project costs are from construction and technical **lifetime** around 30 to 40 years for electro-mechanical equipment and more than 80 years for civil works. Long periods characterize the HPP investments so it is typically difficult to obtain money from private commercial lenders. Besides, most of the generation cost is associated with the depreciation of fixed possessions, the generation cost decreases if the projected plant's lifetime is extended. What is more, many hydropower plants built 50 to 100 years ago are fully amortized and still operate efficiently today (International Energy Agency IEA, 2012).

Concerning **cost reduction**, here we have some improvements or steps that could be taken for cost decrease and support to financing, advised by IEA Roadmap (International Energy Agency IEA, 2012):

- Improvements in turbines
- Hydrokinetic turbines
- Improvements in Civil Works
- Asset management of HPP
- Modernization. Refurbishment, repowering and rehabilitation of existing hydropower plants.
- Redevelopment
- Adding HP to existing water resource projects
- Innovation in PSP

Finally, when the lifetime of a HPP or a dam reaches its end, decommission and **removal costs** need to be considered. These costs are affected by the following factors (International Water Power & Dam Construction, 2012):

- Timing
- Installed capacity
- Dam height/size
- Reservoir area
- Region
- Waste management

Indeed, when it comes to the size of these projects, dismantling costs are very high, rounding, in big dam cases hundreds of million euros. According to some sources, nowadays, the cost of dismantling a hydro electric power plant, including the removal of pen stocks and return of foot print area to uncontaminated situation is about 20 million per installed MW (International Water Power & Dam Construction, 2012).

Finally, when it comes to designing and sizing a HPP of any type is a very critical aspect the **optimization** of those two aspects because of the cost effectiveness of the investment. Different numerical methods are used for that aim, depending on the case. But in all the methods we have to deal with the study of the site conditions, together with economic and other additional goals (optimization of the water condition's potential for a better performance, combination of different size turbines in different configurations-in parallel or in series), to conclude in the most advantageous alternative for the plant. Additionally, financial and fiscal parameters may be introduced (Paish, 2002).

In most cases, the optimal sizing in terms of economic benefits of the investment does not coincide with the one that maximizes exploitation of the hydraulic potential. This is a complex issue, though a balanced and compromised solution regarding economy, performance and environmental impact and social impacts should be taken (Paish, 2002).

## SOCIAL FACTORS

**Public acceptance** is vital in any HP project since the perception determines the financing and the regulatory context (permits, approvals, licenses, etc.) (International Energy Agency IEA, 2012). In fact, there must be mentioned that very cruel movements have been developed around some dam sites. Some cases have been very conflictive and the consequences, hard.

Anyway, numerous benefits for communities have been justified the last decades of the 20th century, which have been characterized by the opposition to large scale dam developments. This has led into a repositioning of the industry, addressing the efforts to communicate sustainability aspects (proper social and environmental assessment) and multi-purpose benefits that the sector has taken successfully with multi-stakeholder groups (International Energy Agency IEA, 2012).

Another issue worth bearing in mind is the possibility to apply the **Social Engineering** as a tool to implement a HPP in places with objections from the community. Social Engineering is the combination of technical and economic aspects with a wide range of social features. It could be used to overcome resistance to a project (International Energy Agency IEA, 2012).

Regarding SHPP, it constitutes a cost effective technology for rural regions in developing countries and it can mean an important boost to the economic and social development since it could interfere in employment and food production (irrigation and

water supply) following the multi-purpose policies. Actually, these actuations have nothing to do with big dams which are too expensive for undeveloped regions (Paish, 2002).

## **POLICY FRAMEWORK**

HPP exploitation is a business for governmental regulations and administrative procedures, so they are variable from one country to another. This is why EU Member States (MS) must fulfill the RES-E Directive in force which can be considered a kind of barrier for the free development of the energy. Besides, there are more barriers that limit HPP developers: grid, financial, environmental and social nature (International Energy Agency IEA, 2012).

The 2001 RES-E Directive is considered a support system for HPP. It gives Member States the possibility to choose from different support mechanisms for the promotion of renewable energy sources that produce electricity. There are two main tools: Feed-in tariffs and Green Certificates (International Energy Agency IEA, 2012).

Another support mechanism could be the introduction of a price on CO<sub>2</sub> emissions. This will make a difference with fossil-fuelled alternatives (International Energy Agency IEA, 2012).

Following the goal of hydropower development, legislation can help, regarding, for instance, reconsideration of grid fees for PSP in pumping mode. Legislation has the strength to make easier the implementation of renewable energies, not only making the application compulsory, but also facilitating renewable energy financing (International Energy Agency IEA, 2012).

Nowadays, the EU Directives in force affecting HPP are International Renewable Energy Agency IRENA, 2012:

- Directive 2001/77/EC: fosters the renewable energy sources for the electricity generation.
- Directive 2000/60/EC: administrates inland surface water.
- Proposed Directive: EU Energy and Climate Change Package 2020: it promotes the use of renewable energy sources and it gives certain targets to achieve.

Politic actions have much to say when it comes to promote the hydro energy power's sustainability, social and economic development, etc. In the Technology Roadmap for Hydropower published by IEA some proposals and milestones that constitute a strategic plan in hands of politicians and governments, are given to achieve the aim of the expansion of this source of energy (International Energy Agency IEA, 2012).

At this point we need to remind the objective of this renewable energy: enabled the environmental integration for:

- Replacement of fossil electricity generation
- Reduction of risk of river flooding

# CONCLUSION

Concerning integration of hydropower energy into buildings or small villages we have to say:

- For **rural areas** there are two suitable possibilities:
  - o **Pumps as Turbines** is one of the best alternatives to supply electricity demands in remote rural areas as micro HPP.
  - o **Small Hydropower** is also a good option for rural electrification in less-developed countries since it is one of the most cost-effective energy technologies.
    - Initial investment – 1041 €/KW to 6406,7 €/KW
    - O&M costs – 0,016 €/kWh to 0,032 €/kWh.
    - Electricity LCOE – 0,020 €/kWh (low production cost, high capacity factor projects) to 0,0536 €/kWh. Average: 0.037 €/kWh. Sometimes even 0,1818/kWh.
- Integration in **isolated buildings** is not feasible. The need of a river or storage project determines this energy so a **micro** and **pico** installation per each house in a small village does not make sense because it is not cost effective.
  - Initial investment – 1041 €/KW to 6406,7 €/KW
  - O&M costs – 0,016 €/kWh to 0,032 €/kWh.
  - Electricity LCOE – can reach 0,2162 €/kWh. Large difference between countries.

# SWOT

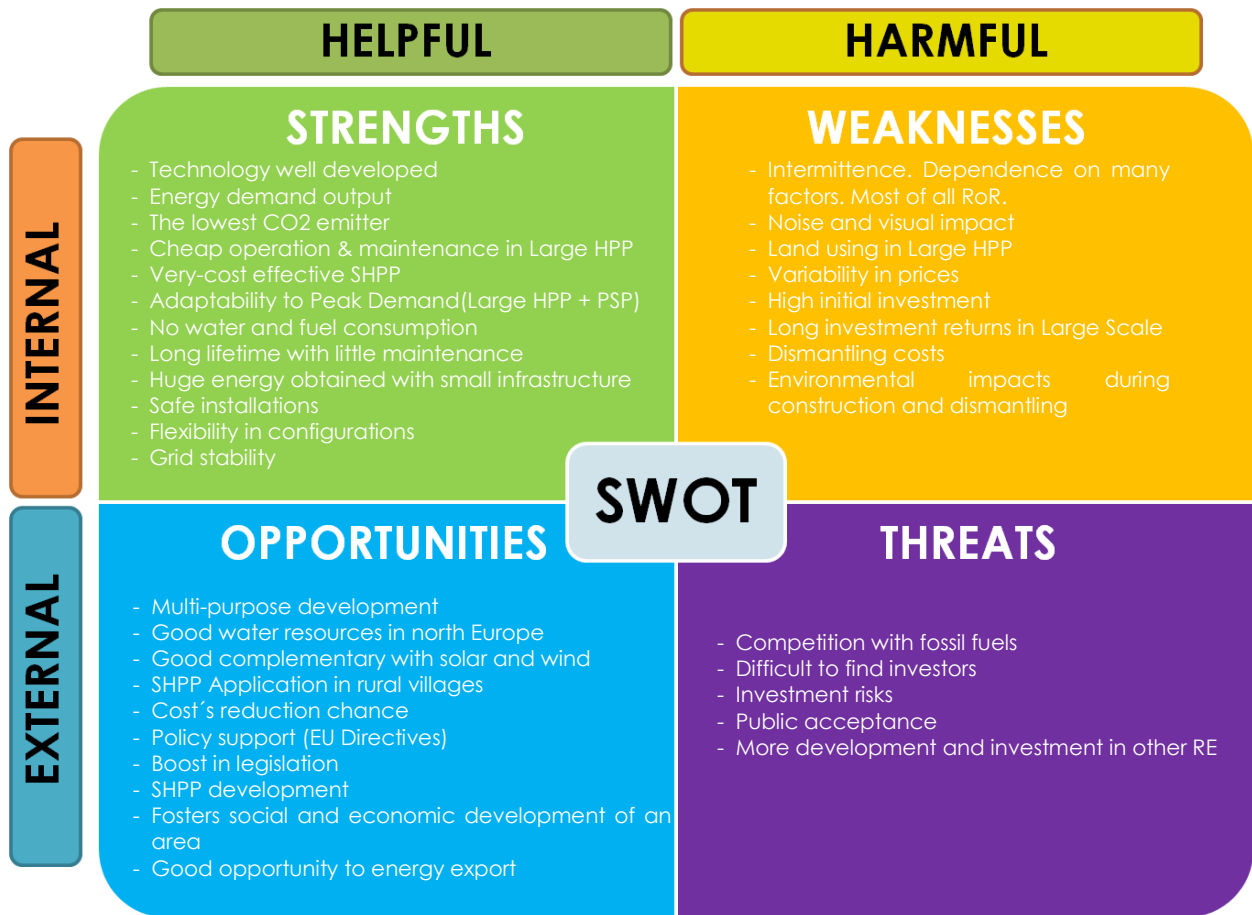



## INTRODUCTION

With the huge dimensions of its waters (an approximated area of 361 million km<sup>2</sup> and a volume of 1.370 million km<sup>3</sup>), oceans are one of the most powerful sources of energy known to date (Miguélez, 2009). Although the potential of marine power is huge, it still remains on the list of the less exploited renewable energies, fact that could change in the coming decades.

As part of the Solar System, The Earth and therefore the oceanic waters are constantly receiving the energy of the Sun not only as heat by means of radiation, but also by the effects of the gravitational attraction that both the Sun and the Moon exert on them.

The harness of renewable and clean energy from the sea can be achieved in the following ways:

- Tidal Power: Tidal Impoundment and Tidal Streams
- Wave Power
- Ocean Thermal Energy
- Osmotic Power

Ocean Thermal Energy Conversion (OTEC) technology is probably the most advanced one among the above mentioned and vast amounts of energy can be achieved by using it. However, as these systems to be efficient a minimum temperature difference of about 20°C is needed between surface and deep waters, only tropical waters at specific latitudes are suitable. Europe is totally out of those areas and does not have the required external inputs to get profit from this technology.

In respect to Osmotic Power, i.e., the technology taking advantage of the salinity gradient between river and sea waters is at the very beginning of the investigation phase and it is limited to very few studies, laboratory models, prototypes and experimental installations.

In consequence, so as to set a priority in relation to our needs, only the energies related to the motion of sea and oceanic waters are going to be developed on the following pages: tidal power, including both impoundment and streams, and the power of waves.

# DESCRIPTION

## TECHNOLOGY

### TIDAL POWER

Tides are cyclic variations in the level of sea and oceans created by the gravitational effect of the Moon and the Sun, combined to the rotation of the Earth. Even though the attraction of the first one is more significant due to mass and distance factors (the sun is way larger than the moon, but at the same time it is way farther from the Earth than the moon), both account on the final scale of the created tides.

The interaction between Solar and Lunar tides results in the creation of spring tides in those moments when the Sun and the Moon are aligned (new moon and full moon), and neap tides (first and third quarters) when their position creates an angle of 90°. That makes tides something as predictable as the lunar calendar, having certain energy peaks along the year.

Certain patterns based on a wide range of temporary cycles are strictly followed by tides:

- A **daily** 12-hour cycle due to the rotation of Planet Earth within Moon's gravitational field: high and low tides
- A **monthly** 14-day cycle: spring and neap tides
- An **annual** 6-month cycle: remarkable spring tides during March and September (equinoxes)
- **Other** more complex gravitational interactions that take place each 19 and 1600 years, for example.

Apart from the mentioned phenomenon of vertical variations, the periodical changes in the sea level originated by the displacement of water bodies create streams. Thus, there are two different ways to take advantage of tidal power:

- Using **potential energy** by means of impoundment of water
- Using **kinetic energy** generated by the horizontal streams

### TIDAL IMPOUNDMENT

Tidal impoundment is achieved by constructing barrages in strategic locations such as estuaries harnessing the potential energy generated by the rise and fall of sea levels to produce clean electricity at the end. As tides are based on complex astronomical processes they are totally predictable, just the opposite to the wind phenomenon, which is based on random atmospheric processes.

This basic concept was historically used for grain grinding in tide mills with similar applications to those of the river mills. But it was not until the XX Century when tides were seriously studied as a potential source for the electrical industry.

The concept is similar to that described in the hydropower chapter: potential energy is transformed in kinetic energy and is used to run turbines so as to create electricity. The creation of a plant is needed which will be similar to dams with low head-difference requirements. The main difference is that an inflow and outflow is naturally created by

the effect of tides. Therefore, the technology related to tidal impoundment involves large scale systems due to the fact that they require constructing quite large plants to generate electricity, instead of installing offshore or near shore devices.

Usually there are two different kinds of lock gates: the main lock gate and the turbine lock gate. Combining their opening and closing the flow is controlled and adapted to the needs. 3 different ways are possible depending on how the flows are utilized to run the turbines:

- Using the **outflow** (Ebb):  
This is the most common operating way of tidal plants. The production of electricity lasts up to 40% of each tidal cycle. Simply explained, the same process is followed for each daily tide-cycle:
  1. Both the main and turbine lock gates are opened as the sea level rises.
  2. Once high tide is reached lock gates are closed to maintain the level in the interior of the dam.
  3. When the water level is low enough outside the turbine lock gates are opened to start generating electricity as the water falls down.
  
- Using the **inflow** (Flood):  
The output is lower and the environmental impact higher. Basic process:
  1. Both the main and turbine lock gates are closed as the sea level rises.
  2. Once high tide is reached the water is accumulated in the exterior of the dam.
  3. When the height difference between the interior and the exterior is enough the turbine lock gates are opened and the water flows to the interior, generating electricity.
  
- Using both the **outflow and inflow** → **Bidirectional System** (Ebb + Flood):  
This system combines the previous two systems, generating electricity during the whole cycle. Even though the bidirectional system is possible, it is only used in extraordinary occasions, such as spring tides, because the performance is not considered to be significantly improved. In addition, it entails a higher cost due to the need of using **bidirectional turbines**, which are more expensive than the conventional ones.

Depending on the features of the mentioned constructions there are also 3 different methods or technologies for harnessing tidal power by impoundment:

### **TIDAL BARRAGES**

This system involves the construction of a dam across an estuary, i.e., totally obstructing it from one bank to the other. This is the most common and utilized way for tidal impoundment known to date.

### **TIDAL BUNDED LAGOONS**

This system consists of a barrage constructed against one of the banks of an estuary. Unlike the conventional tidal barrages, the banded lagoons do not completely obstruct the estuary.

## TIDAL OFFSHORE LAGOONS

As the previous system, the modern concept of offshore lagoons avoids obstructing an estuary, but this time by means of impoundment walls within an offshore area. Therefore, they are independent of the shoreline because none of the banks of the estuary is in contact with the walls.



Figure E.3.6: From left to the right: Tidal barrage, tidal bunded lagoon & tidal offshore lagoon. (Aqua-RET Consortium, 2012)

Even though the concepts of tidal lagoons were revealed few years ago, there is no real application of these systems to date. Double impoundments systems, i.e, tidal lagoons including more than one reservoir, could help enhance the productivity of electricity adjusting it to the demand, providing energy during those moments when the system is out of the tidal cycle.

## TIDAL STREAMS

Tidal streams are part of the phenomenon of tides and their embodied kinetic energy harness is the topic to be treated on this point. They consist in horizontal flows that can vary depending on the layout of the seabed and other geographical features. They are more significant in narrow passages like channels and straits due to the higher speed these flows can reach, phenomenon also known as "funneling effect". The concept of tidal streams conversion presents many similarities with the harnessing of the kinetic energy of wind.

Concepts of tidal impoundment were present far long before, whilst it took longer for the concepts of tidal streams to arise. This emergence is related to the development of wind energy during the last decades, which helped realizing that similar principles taken from it could be introduced in this new technology. A serious approach with the aim of producing electricity to these systems was not made until the late XX Century, in the 1990s.

While large scale systems are used for the harnessing of tidal impoundment, smaller devices are generally required to take profit of tidal streams. These devices can be set up either individually or in group, creating tidal farms or tidal fences. This last option seems to be the most appealing one, because this is when significant energy amounts could be generated. The concept of tidal fences has also been aim of study, where the creation of a barrage including stream turbines all along its length is needed, but it has not been deployed.

Depending on the concept used by these devices, clean energy can be generated by using 3 different technologies (Aqua-RET Consortium, 2012):

## TIDAL CURRENT TURBINES

Marine current turbines can be either horizontal or vertical axis turbines. It is essential for horizontal ones to take into account the direction of the streams, while this factor is not decisive for vertical axis turbines because the flow is mainly horizontal. Horizontal axis turbines are the most commonly used, though. The most common tidal turbine types are normal bladed turbines (Marine Current Turbines Ltd., 2012) and open-centre turbines (OpenHydro Group Ltd., 2012). They are very similar to wind turbines, especially to those installed offshore in spite of the existing shape-based and operational differences:

- Smaller in size (around half the diameter):  $\varnothing = 15\text{-}30\text{ m}$
- Less current speeds are required 2-5 m/s (five times less)
- Density of water is much greater  $1025\text{ kg/m}^3$  (about 800 times more dense)

A very significant datum is that marine turbines can produce as much energy as wind turbines with a third of their size.

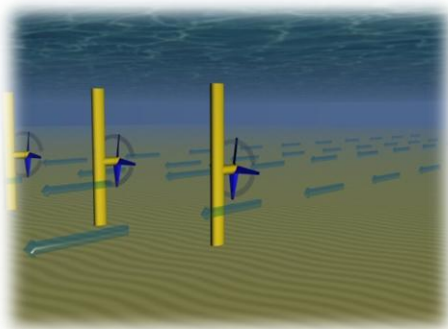

Figure E.3.7: Horizontal Axis Turbines  
(Aqua-RET Consortium, 2012)

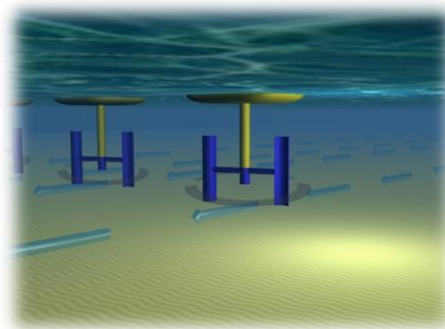

Figure E.3.8: Vertical Axis Turbines  
(Aqua-RET Consortium, 2012)

## RECIPROCATING HYDROFOILS

The operating principle of these devices is the creation of an oscillating motion which linked to a complex hydraulic system is able to produce electricity. These devices usually have one or more hydrofoils attached to an oscillating arm, which is supported by a structure lying on the seabed. Therefore, the hydrofoils take care of facing the flow with their big area, whilst the articulated arm creates the oscillation.

## VENTURI EFFECT DEVICES

This last harnessing principle among tidal streams consists of an artificial duct built around a turbine so as to create a space with a considerably greater flow-speed. Apart from that they are able to redirect the flow direction, up to a  $40^\circ$  offset, having always a perpendicular facing towards turbines for a better efficiency. They are totally suitable for deep waters as they use to simply rest on the seabed. Furthermore, for devices with a relatively big diameter, shallow waters would not be as suitable as deep waters.

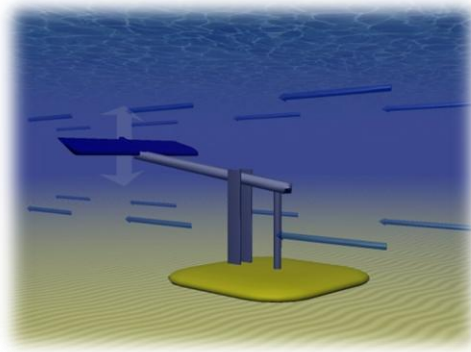

Figure E.3.9: Reciprocating hydrofoil  
(Aqua-RET Consortium, 2012)

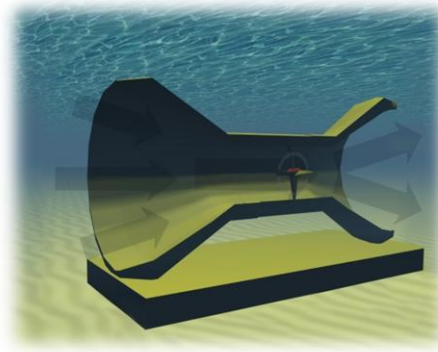

Figure E.3.10: Venturi effect device  
(Aqua-RET Consortium, 2012)

These systems can be secured to the seabed in different ways depending on its state and the depth at which they are situated. They are very similar to those for wind offshore systems:

- **Monopile systems:** they consist of one pile covering all the water depth, from the seabed to the surface. They are not suitable for very deep waters.
- **Gravity systems:** these systems are deployed on straight on the seabed and are more suitable for deeper waters.
- **Anchors:** they are also suitable for higher depths.

## WAVE POWER

Waves are created by the effect of wind moving on the oceans. Compared to the tides and streams phenomena, waves offer more diverse options to harness their embodied kinetic energy and these is reflected in the higher amount of different devices that have been proposed during the past and recent years. Though, they are not as predictable as them, because they do not follow precise cycles as tides.

Depending on the location of these systems, onshore, near shore and offshore devices and installations can be distinguished. The direction of these devices in respect to the wave direction is important: parallel or perpendicular to the wave front, in order to take profit of the motion or the terminating effect (by impact, when they break down) of waves, respectively. The power generated by these devices is generally transmitted ashore via underwater power cables. The nearer to the shore the easier the system is, and the less expensive it results.

Another classification criterion is their relative position to the sea: they can be either floating, supported or submerged systems, or a combination of them.

There are many different principles (Aqua-RET Consortium, 2012) of wave power obtaining and the following are worth mentioned:

### OSCILLATING WATER COLUMN (OWC)

They mainly involve large scale structures built up in the shoreline with an entrance below the water surface. A water column is created so that when waves break down (terminating effect) the water enters the hollow structure and compresses the air contained above it, creating an upward air-flow. With the aid of bidirectional air turbines both the upward and downward air-flow is harnessed to produce electricity. There are

three plants to be mentioned in Europe: PICO (Portugal), Mutriku (Spain) and LIMPET (Scotland). The one in Mutriku is the most recent one, consisting of 16 Wells 18,5 kW turbines installed along a breakwater, with an installed capacity of 300 kW (Ente Vasco de la Energía, 2011).

### ATTENUATORS

These devices take advantage of the up-and-down motion of waves to create clean electricity. This is achieved by means of several floating cylinders tied to each other and positioned perpendicular to the wave front. These cylinders are flexible in both vertical and horizontal direction. The most significant one is the "Pelamis" (Pelamis Wave Power Ltd., 2012) wave converter device.

### POINT ABSORBERS

Point absorbers are relatively small devices which can be installed independently to the direction of the incident wave. The most common solutions are based on buoys. They are suitable for the idea of wave power farms. The "PowerBuoy" (OPT, 2012) point absorber is the one of the most developed one.

### OSCILLATING WAVE SURGE CONVERTERS (OWSC)

They consist of an oscillating arm in the form of an inverted pendulum with a considerable area, which placed on the seabed take profit of the movement of the sea-surface. This oscillation movement is converted into clean electricity. The "Oyster" (Aquamarine Power, 2012) near shore device is a good example.

### OVERTOPPING DEVICES

The concept of overtopping devices is similar to that of hydro power plants, but with an offshore small-scale application. A reservoir is created in order to get water accumulation by the action of waves going over it. This accumulation of water is equal to potential energy that is harnessed using low-head turbines located in the lower part of the device. A good example is the prototype "Wave Dragon" (Wave Dragon, 2005), which is being tested since many years in Denmark, west of Jutland.

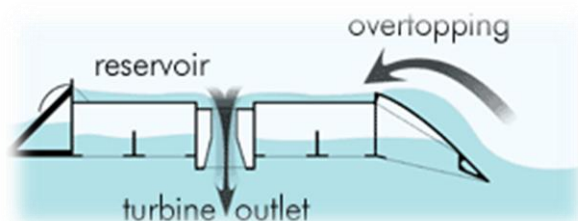

Figure E.3.11: Overtopping devices basic concept. (Wave Dragon, 2005)

### ARCHIMEDES EFFECT DEVICES

Typically installed on the seabed they harness the pressure differential created by the motion of the waves above them. The level rises and falls as waves pass by, moving the top part of these devices up and down. This oscillating motion produces electricity by means of a lineal generator. The "Archimedes Wave Swing" (AWS Ocean Energy Ltd., 2012) is the best example.

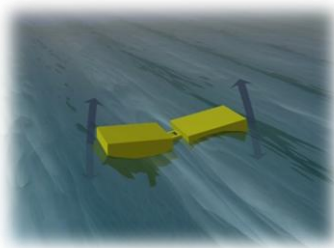

Figure E.3.12: Attenuators

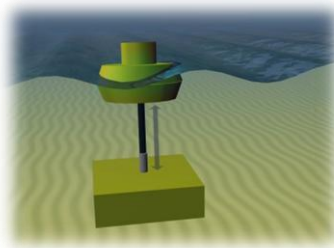

Figure E.3.13: Point Absorbers

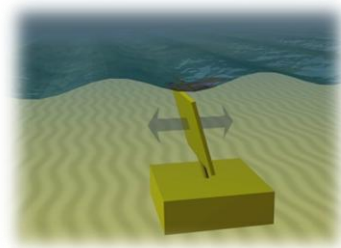

Figure E.3.14: OWSC

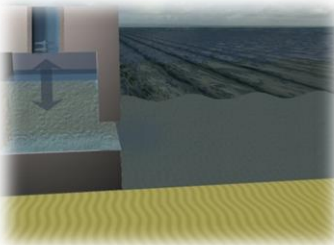

Figure E.3.15: OWC

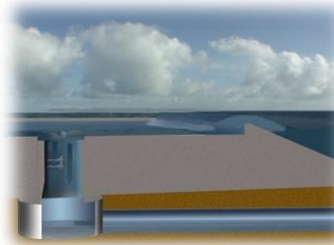

Figure E.3.16: Overtopping Devices

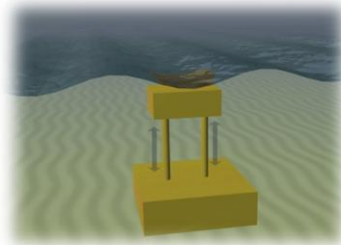

Figure E.3.17: Archimedes Effect Devices

Source of figures: (Aqua-RET Consortium, 2012)

There is a wide range of devices for harnessing tidal streams and waves. The most of them are prototypes, but there are also manufactured solutions being the ones shown in the Table 1 some of the most worth mentioned.

TIDAL STREAM DEVICES		
TYPE	DESCRIPTION	PICTURE
<b>Seagen</b> Marine Turbines Ltd. Current	<b>Type:</b> Horizontal Axis Turbine <b>Place:</b> Strangford Narrows (Northern Ireland) <b>Capacity:</b> 1,2 MW <b>Dimensions:</b> Total height 40 m, 16 m diameter turbines.  (Connected to the grid since 2008 with a production of 6,000 MWh/year It is able to supply 1000 average dwellings)	
<b>OpenHydro</b> OpenHydro Group Ltd.	<b>Type:</b> Open-centre turbine <b>Capacity:</b> 2 MW <b>Dimensions:</b> 22 m high with a weight of 850 T.  (This is the model of the 4 turbines to be installed off the coast of Paimpol-Bréhat in Brittany, France)	







<p><b>Clean Current</b> Clean Current Power Systems</p>	<p><b>Type:</b> Venturi effect device <b>Capacity:</b> 65-500 kW <b>Dimensions:</b> 3,5-10 m diameter</p> <p>(There are 4 different models provided by Clean Current Power Systems and they range within the mentioned capacities and dimensions)</p>	
<b>WAVE POWER DEVICES</b>		
<p><b>Pelamis</b> Pelamis Wave Power Ltd.</p>	<p><b>Type:</b> Attenuator <b>Capacity:</b> 750 kW <b>Dimensions:</b> Up to 180 m long and 4 m diameter</p> <p>(A three machine farm was installed in Portugal [2008] with a capacity of 2.25 MW)</p>	
<p><b>PowerBuoy</b> OPT, Ocean Power Technologies</p>	<p><b>Type:</b> Point Absorber <b>Capacity:</b> 150 kW (PB150) <b>Dimensions:</b> 45 m high (9 m above the surface) and a weight of 150 T.</p> <p>(The company is developing a new 500 kW model, PB500)</p>	
<p><b>Wave Dragon</b> Wave Dragon</p>	<p><b>Type:</b> Overtopping Device <b>Place:</b> Nissum Bredning Fjord (Denmark) <b>Capacity:</b> 4-7 MW <b>Dimensions:</b> 300x170x17 m</p> <p>(It has been built for a 36 kW/m wave climate)</p>	

Figure E.3.18: – Tidal Streams & Wave Power devices

Source of figures:

- (1) (Marine Current Turbines Ltd., 2012)
- (2) (OpenHydro Group Ltd., 2012)
- (3) (Clean Current Power Systems Inc., 2012)
- (4) (Pelamis Wave Power Ltd., 2012)
- (5) (OPT, 2012)
- (6) (Wave Dragon, 2005)

## CURRENT STATUS

Marine energy is at the bottom of the list of renewable energies, both in terms of energy production and installed capacity. Compared to other renewable energies the global installed capacity is irrelevant: 527 MW to 2011. Nevertheless, the total installed capacity has been doubled in 2011 and this could happen year after year during the coming decade (REN21, 2012).

In regard to the countries with the highest potential for an implementation of these technologies, the United Kingdom has one of the largest marine energy resources in the world, as it is estimated in over 10 GW. This number represents around 50% of the possible tidal energy capacity in Europe. Globally speaking the tidal stream energy capacity is considered that could be around 120 GW (Marine Current Turbines Ltd., 2012). These are theoretical values that could be reached in a relatively distant future, since in view of

the figures of currently installed capacity it is obvious that we are far from achieving them.

## **TIDAL IMPOUNDMENT**

There are important differences between the development statuses of the previously mentioned technologies for marine energy harnessing. Tidal impoundment technology is the most developed one among the 3 of them. It is been long since it was introduced in the market: 1960s.

Among the different systems mentioned within tidal impoundment only tidal barrages have been erected so far. No tidal lagoons have been built yet, although serious proposals do already exist for the Severn Estuary Project in the United Kingdom, in order to avoid the construction of a barrage, which would have a greater environmental impact.

Even in a much smaller number than conventional dams, there are some existing tidal plants in the globe with different capacities, being *Annapolis* in Canada (1984 – Capacity: 20 MW), *La Rance* in France (1966 – Capacity: 240 MW) and *Sihwa Lake* in South Korea (2011 – Capacity: 254 MW) the best examples. Another one is under construction in South Korea, which is expected to have a generating capacity of over 1300 MW. Many others are at proposal stage, among which the one in the Severn Estuary (Wales, United Kingdom) is one of the most significant.

Even so, the most developed European country in terms of tidal impoundment energy harnessing is France, basically thanks to the Tidal Power Plant of *La Rance* located in the estuary between Dinard and Sain-Malo. According to data from the International Energy Agency (IEA) 497 GWh were provided to the French electricity grid during the year 2009. It is stated that since it was built it contributes with an average of 544 GWh/year, discounting the 64,5 GWh/year required for pumping. This is an idea of what these systems can provide, being *La Rance* the only real example existing in Europe.

## **TIDAL STREAMS & WAVE POWER**

A total of 6,8 MW of tidal stream and wave power are installed within the UK (REN21, 2012), the European country with the highest potential. That is at the same time the total installed capacity of these technologies globally speaking.

Even though they have suffered a slow implementation process taking long periods of time, tidal stream and wave power systems are just emerging technologies. Indeed, they are currently experiencing an important turn because it is now when they are starting to be deployed. A good indicator of this fact is that more and more projects to be realized by 2015 are coming to light worldwide.

Within these technologies vertical axis turbines, venture effect devices, wave attenuators and point absorbers are some of the devices (shown previously in Table 1) that are starting to be introduced in the market by companies such as “Marine Current Turbines Ltd.”, “OpenHydro Group Ltd.”, “Hammerfest Strom UK Ltd.” (in collaboration with Andritz Hydro and Iberdrola), “Clean Current Power Systems” or “Pelamis Wave Power Ltd.”.

Many areas in different European countries are proposed as interesting possible spots for the harnessing of tidal stream and wave power: United Kingdom, France, Portugal, Ireland, Spain. A significant project to be mentioned is the Tidal Power array of Paimpol-Bréhat being installed off the French coast. It will consist of a farm with an installed capacity of 8 MW using several OpenHydro tidal turbines (HydroWorld, 2012).

## FACTORS

### EXTERNAL INPUTS

These are some of the external inputs needed for the application of these systems:

#### TIDAL IMPOUNDMENT

- The most important one is an **area with a high tidal range**. A tidal range of **at least 5 m** is needed to make these systems viable.
- An **estuary** is needed to create a tidal barrage.
- **Shallow waters**, especially for the **tidal lagoons**. As these systems use low head-difference turbines, no excessively deep waters are required (less than 10 m).

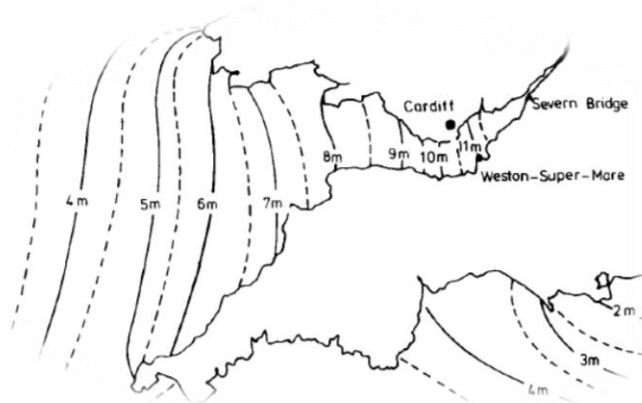

Figure E.3.19: Tidal Range in the Severn Estuary (United Kingdom): up to 12 m. (Hammons, 1993)

#### TIDAL STREAMS

- **Current speed:** The real minimum velocity to make these systems viable is 1 m/s, but the desired range of speeds is comprised between 2-5 m/s. Current or flow speed is related to the tidal range of an area, the speed tends to be higher with higher tidal ranges. The higher flow speed the more efficient the devices within the aforementioned range.
- **Direction of the streams**, especially for vertical axis turbines. For horizontal axis turbines it is not an important requirement as they are placed horizontally, in the same direction of the flow. Venturi Effect devices solve this problem by redirecting the flow.
- A **narrow passage** in which the tidal stream speed is probable to be higher. In relation with the bathymetry of the seabed.

- **Water depth.** The depth of the seabed is important because some systems need a minimum water depth to be installed, while others have maximum depth restrictions.

## WAVE ENERGY

- **Wave power** of the area (KW/m). Values ranging from 20 to 70 kW/m are considered good for implementing these systems.
- **Direction of the waves**
- **Height of the waves**

## ENVIRONMENTAL FACTORS

### TIDAL IMPOUNDMENT

The environmental interactions during the whole life of these systems can be either negative or positive.

<b>NEGATIVE POINTS</b>	<b>Obstruction of the estuary (*)</b> . Barrages are erected all the way across it.
	<b>Impact to the sea bed.</b> During surveying, site preparation and construction phases.
	<b>Marine wildlife impact.</b> In relation with the previous impact, during the surveying, site preparation, construction, operation and maintenance of these systems, marine plants and animals can be affected. (**)
	<b>Changes in the water flow</b> of the surroundings and <b>alteration of tidal patterns</b> , especially during operation. Loss of intertidal zones as a consequence.
	<b>Noise pollution.</b> Especially during construction and operating phases. Not only would the animals be affected, but the human beings too.
	<b>Visual impact.</b> Manmade new constructions are introduced within natural ecosystems.
	<b>Pollution of water.</b> Debris generated in the construction phase. Risk of <b>accidental events</b> . Chemical or oil/fuel spills could occur.
<b>POSITIVE POINTS</b>	<b>Clean electricity generation.</b> After the completion of the installation and while operating, it helps reduce hazardous emissions to the environment.

(\*) Lagoons are less responsible for this impact. They are actually solutions proposed to reduce the environmental impact of barrages.

(\*\*) These systems can provide protection to some sub-marine species such as shells that find a proper settlement on the foundations. So, this fact could in a way be considered as a positive interaction too.

### TIDAL STREAMS & WAVE DEVICES

The environmental interactions mainly depend on the amount of devices installed in a given area: the more devices the higher the environmental impact. The way they are installed also has an effect, in particular due to the density of devices placed within an area.

As we have seen different systems, the way they are fixed to the seabed is another relevant factor in regards to environmental impact. The monopile system is the less respectful one with the environment.

<b>NEGATIVE POINTS</b>	<b>Impact to the sea bed.</b> Especially during site preparation and construction phases. The surveying phase does not require much work.
	<b>Marine wildlife impact.</b> In relation with the previous impact, during the site preparation, transportation, construction, operation and maintenance of these systems, marine plants and animals can be affected. (*)
	<b>Noise pollution.</b> Especially during construction and operating phases. Not very significant.
	<b>Reduction in tidal current and wave action.</b>
<b>POSITIVE POINTS</b>	<b>Clean electricity generation.</b> After the completion of the installation and while operating, it helps reduce hazardous emissions to the environment.
	<b>No visual impact.</b> They are hidden below the ocean surface. This visual impact varies depending on whether they are located offshore or near-shore, but in general, due to their small scale, it is considered as a positive point

(\*) These systems can provide protection to some sub-marine species such as shells that find a proper settlement on the foundations. So, this fact could in a way be considered as a positive interaction too.

The environmental negative interactions of tidal stream and wave devices are way less important than the ones produced by tidal impoundment systems. This is the main reason why these systems are likely to be developed in a not too distant future.

## ECONOMICAL FACTORS

The fact that tidal impoundment involves large scale projects makes them have a high construction cost, and therefore the initial investment is important. Obviously everything depends on the characteristics of the project, such as width and depth of the estuary where it is to be implemented or the total potential installed (e.g., amount of turbines and their performance). Since few projects have been developed to date, they are the only source of information as far as the cost is concerned.

The construction cost for the Tidal Power Plant of *La Rance* in France was 95 million € in 1967, quite a high sum for those times, because it currently would mean about 580 million € (The Green Age, 2012). The payback period for this plant has been 20 years. The construction cost of the most recent plant in South Korea, *Sihwa Lake*, was around 280 million € (PEMSEA, 2012). As previously mentioned, there are no real executed projects involving tidal lagoon schemes and therefore no relative data can be provided about their cost. When it comes to large scale projects, decommissioning cost has to be considered, because one day the life of the plant may come to an end with it consequent dismantling.

In order to compare the costs of the 3 different technologies we are going to look at an indicator of a study from 2008 (International Energy Agency [IEA], 2008), in which the investment and the production of electricity costs are calculated, comparing the present and the expected implementation. As among marine energy technologies tidal impoundment is the most developed one, the cost concerning power generation is not as high as for the others. Although, it does not have a relevant development potential and predictions show that cost will not vary much in the coming decades. The investment cost for tidal impoundment harnessing was 2000-4000 USD/kW in the year

2005, whereas the cost of production of electricity was 0,06-0,10 USD/kWh. By the year 2030 the cost should be lower: 0,05-0,08 USD/kWh and 1700-3500 USD/kW.

The investment cost for tidal stream power was 7000-10000 USD/kW in the year 2005, whereas the cost of production of electricity was 0,15-0,20 USD/kWh. Due to the development potential of this energy technology, both the production and investment costs are predicted to fall by 2030: 0,08-0,10 USD/kWh and 5000-8000 USD/kW.

The cost of the investment is still very high for wave source energy, 6000-15000 USD/kW in the year 2005. In terms of electricity production costs, it also has the highest among the 3 sources of energy we are analyzing: 0,20-0,30 USD/kWh (2005). As it is considered that this technologies will experience an important development by 2030, both the production and investment costs should be much lower: 0,045-0,09 USD/kWh and 2500-5000 USD/kW.

Another point concerning costs is that near-shore locations involve a far lower investment per MW of generating capacity. Even though the offshore resources are higher, the conditions are more extreme and the access to them is significantly more difficult.

## SOCIAL FACTORS

The social acceptance of marine energy is quite different for some of these technologies in respect to the others. This is due to different factors:

Tidal impoundment technology involves such a long constructing period that decisions have to follow a long acceptance period that may take years or even decades. The main reason why people very often refuse using them is the environmental impact they suppose into the natural areas.

Another fact to be taken into account when considering applying these technologies is the possible affectation to other trades such as fisheries and shipping industries. Totally closing an estuary, apart from having an important environmental impact, would affect those industries operating through them, becoming as a result in important enemies of tidal power plants.

The creation of new jobs in the area where these kinds of projects are constructed is important, due to their large scale. As a figure, it is estimated that the Severn Estuary project would create around "20,000 jobs in construction and another 30,000 in activity around the barrage". This is an example of the positive impact these large scale projects could have in the society.

Due to the huge amount of power hidden in the oceans and the implementation opportunity that it entails, marine energy development is one of the investigation priorities of the energy sector since some decades. The tendency is to try to replace large scale systems with high environmental impact, and the future is focused in tidal streams and wave potential. A good indicator is the fact that the European Commission has invested more than 55 million € on ocean energy so far from the 1980s, especially during the last decade (European Commission, 2012).

In order to accelerate the development of marine energy, a clear policy framework is needed to address the requirements of a commercial Ocean Energy Industry. As a starting point, the European Ocean Energy Association has recently drawn a Roadmap for Marine Energy. They want it to experience a similar growth to that the wind energy has experienced during the last decades. For that some targets (Fig. E.3.20) have been set to be fulfilled by 2020 and 2050.

Installed Capacity / GW	Direct Jobs <sup>1</sup>	Total Jobs (Direct & Indirect) <sup>2</sup>	CO <sub>2</sub> avoided Mt/year <sup>3</sup>	Investment €m. <sup>4</sup>
3.6 (in 2020)	26,000	40,000	2.61	8,544
188 (in 2050)	314,213	471,320	136.3	451,104

Figure E.3.20: Estimated benefits of developing a world leading European Ocean Energy Industry (European Ocean Energy Association, 2010)

# CONCLUSION

## SWOT

All the technologies are included in the same SWOT analysis so as at the end we have a clear idea in mind of which of them has more opportunities in a future.

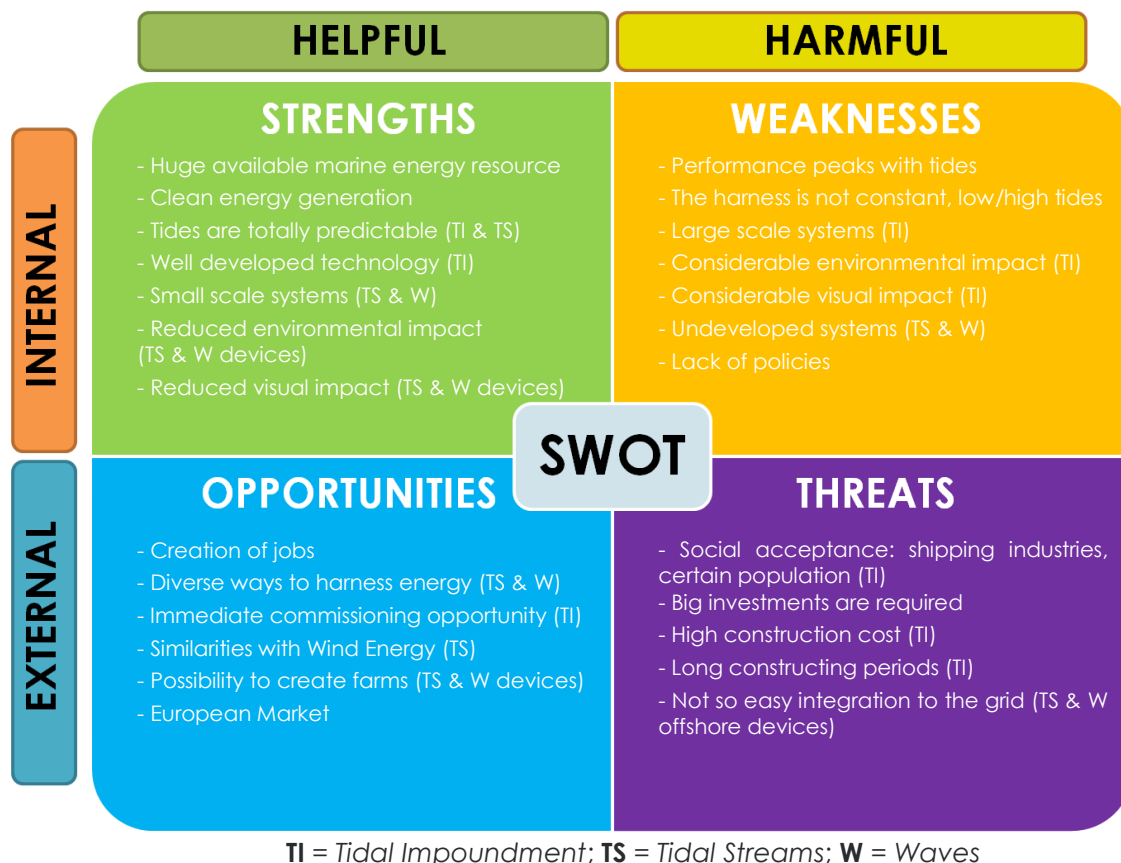

Therefore, we can predict that the future trend to let marine energy grow will be the deployment of tidal stream and wave energy devices.

## SUITABILITY FOR BUILDINGS

None of these systems seem to be suitable at all for their direct integration in buildings.

## SUITABILITY FOR SMALL VILLAGES

Near-shore devices could provide clean energy for a reduced amount of houses. The rest of the solutions would not be justified and therefore would not be suitable for their application in small villages. The "SeaGen" tidal turbine prototype is a good example because it is estimated that it is able to supply 1000 average dwellings. Offshore devices would be justified if they are built in farms to send great amounts of energy to the main grid, but not for a small scale application.



# BIOENERGY

## INTRODUCTION

Before explaining the concept of bioenergy and its different systems, there are two definitions that should be clarified.

Biomass *“is any organic, i.e. decomposing, matter derived from plants or animals available on a renewable basis. Biomass includes wood and agricultural crops, herbaceous and woody energy crops, municipal organic wastes as well as manure.”* (International Energy Agency)

Bioenergy *“is energy derived from the conversion of biomass where biomass may be used directly as fuel, or processed into liquids and gases.”* (International Energy Agency)

For this report, a classification depending on the state of the different resultant fuels produced nowadays has been set:

- Solid Biomass
- Liquid Biofuels
- Biogases

As a summary, the current status of this energy can be accounted as a 10% of world total primary energy supply. Most of this energy is consumed in developing countries, but there is a tendency of increasing use on Europe and other developed regions.

## INTRODUCTION

On the term solid biofuels is included each solid material proceeding from natural resources that is commonly burned to produce heat or electricity. These fuels can be divided in three main groups: forestry fuels, agriculture fuels, and industrially processed fuels. In this classification several typologies can be found.

## DESCRIPTION

### TYOLOGIES

#### FIREWOOD

##### DEFINITION

Firewood is commonly used in rural areas, but nowadays there is an incipient development in urban areas. The process is basically a combustion reaction of the wood pieces into a heater or stove into a rich oxygen environment. In this reaction Carbon, Hydrogen and sulphur are oxidized in an exothermic reaction. The SCP of firewood ranges between 1400-2100Kwh/T depending on the tree species, humidity and quality of the wood.

Several polluting substances are emitted in this reaction, such as SO<sub>2</sub>, CO, CO<sub>2</sub>, and CH<sub>4</sub>, which contributes to the greenhouse effect.

##### PRODUCTION METHODS

This kind of product is usually derived from forestry wastes like branches, tree crowns etc. It has in its origin a humidity level between 20-40%; to use it for heating is necessary to lower this humidity up to 25%, so it is necessary to dry it during storage periods of 6 months. There can also be used timber from industrial wastes (carpentry, construction etc.), but this waste timber has to be free of chemical treatments and contamination. The prices at 2006 were estimated at 28€/m<sup>3</sup> when is supplied in large amounts at close areas from the production, and of around 50€/m<sup>3</sup> for supply to privates in smaller amounts.

##### USES

The main use of this fuel is heating in private small residential applications (88%): usually in traditional heating systems with performances between 10-15%, small heaters and stoves with performance levels of 40-60%, and modern heaters and boilers with performances over 70%. These small installations reach powers ranging from 5-50Kw, and requires initial investments of 300-800€/Kw.

Forestry, carpentry and agricultural industries use this source of energy also for heating and energy production for its processes (10%); it is also used in collective and public heating services (2%). Usually for this purposes are used big installations which in some cases combine heating and electricity production (cogeneration), with overall

performances of around 80-95%. These big heating systems can supply powers between 1-5Mw, with initial investments of 400-700€/Kw.

The main producers of these systems in Europe are: Heizomat, Reka, Energie Systeme, Weiss and Hargassner. The main producers in Europe of these systems are Brisach, Palazetti, Calimax, Drove, Okofen, Pagnod, Piroux, Rika and Wanders.

## **FOREST CHIPS**

### **DEFINITION**

Forest chips are mainly a sub-product of forestry industry; the composition is basically the same as firewood, so the chemical reactions are the same. It's only difference with firewood is the smaller size, which eases the storage and usage. The medium size of the chips is below 10cm and has an initial humidity around 20-50%, which is reduced up to 20-30% during a 2-3 months drying. The SPC of forest chips is around 2200-3400Kw/T.

### **PRODUCTION METHODS**

This product comes mainly from wastes generated during forestry exploitation (tree harvesting, maintenance...) by the trituration of small branches, bark and leaves; before the cutting of the tree, the release of the bark and the collection and stack of the log, all the wastes are piled and trituated. Before this process are carried out to a warehouse to dry. The price of this kind of chips is about 33-47€/T without considering transport and storage.

Also some carpentry wastes can be reduced to chips and used as fuel, in this case the drying is not usually needed, since the wood was already dried. This kind of chips are usually of a better quality than forest chips and its price rises up to 75€/T without considering storage and transport.

The cutting and production machinery for forest chips production is supplied mainly in Europe by these companies: Austsoft, Claas, John Deere and Salix Maskiner Bender.

### **USES**

The main use of this product is heating for industrial processes, and usually the production company is the one which utilizes them (e.g. Sawmills uses heaters fed by the wood chips they collect during the tree harvesting process, so they save energy and money by reducing energy consumption). The systems supplied with these fuels are similar to the firewood ones, with slight variations in the feeding system, which consists usually in an automatic chute system. The main producers of these systems in Europe are: Heizomat, Reka, Energie Systeme, Weiss and Hargassner.

The private use of this kind of fuel is much more limited due to the fact that is not a product designed for small installations, a chute system and the storage facility requires a high initial investment and the use of heavy machinery to load the chips (front loader), therefore is not an interesting investment for particulars or small systems. Nowadays the use of pellets has completely unseated this fuel from small systems due to its simpler manipulation, the easier distribution and the lower initial investment needed.

## **PELLETS**

### **DEFINITION**

Pellets are small cylinders (from 5-10mm of diameter, and lengths between 10-30mm) made of compacted sawdust. Its composition is similar to the previous fuels studied, as

it's composed by wood dust. The medium humidity of this fuel ranges from 7-12%, has a volumetric mass of 650-700Kg/m<sup>3</sup> and a SCP of 4400-5000KWh/T. In other words a cubic metre of pellets is equivalent to 300-330l of light fuel.

## **PRODUCTION METHODS**

This fuel is produced by compacting wood sawdust using high pressures. Sawdust is collected from carpentry and forestry industries, usually not so far from the production site (up to 100-200km). Sawdust is firstly dried, reducing the humidity from 55% to 10%; then, this dust is compacted and extruded through a rotating perforated matrix where the small pellets are formed. During this compaction process temperature raises up to 90°C, melting the lignin, which will act as a binder when cooled.

This product proceeds usually from big factories, but nowadays several small pelleting systems are installed in individual or small installations, to provide service for small productions usually focused in self-use.

The prices ranges nowadays from 180-250€/t for big bags (500-1000kg), and 250-300€/t for small bags (15-20kg). This number represents approximately a cost of 40-60€/MWh, ranging from big to small bags.

## **USES**

The main use of this fuel is for private heating systems, which vary from individual to collective heating installations. In individual installations is mainly composed by a manual loading heater, which has an integrated reservoir which has to be filled daily, this reservoir feeds automatically the fireplace. These individual systems have a performance around 90%, depending on the heating installation (radiators, floor heating...). The heating power given by this solution ranges from 16-1000Kw, depending of the kind of solution adopted (individual or collective installation), what gives the designer and the users a great number of possible solutions. The price of this system varies from 280-500€/KW, depending on the loading system (manual loading or automatic loading), and the number of users (collective systems are cheaper).

For industrial purposes, this fuel is used for heating and hot water systems. Due to the higher cost of the fuel compared to wood chips and other biofuels, this kind of solution is usually applied for small industries and stores. The total power of the installation varies from 100-1500KW depending on the needs. The final price of the installation is about 200-400€/KW, depending on the total power required (small systems are more expensive per KW).

The main producers for these systems in Europe are: Cliber, Hertz, Calimax, Palazetti, Okofen, Wanders, Rika, Piroux, Pagnod and Dovre.

## **BRIQUETTES**

### **DEFINITION**

Solid biofuel briquettes are products made of compacted wood by-products (forestry, carpentry...), straw or coal compacted. These elements have usually a cylindrical shape, in some cases with a series of longitudinal hollows to increase the burning surface, and they have a diameter of 75-100mm with a length of 200-500mm. The rest of properties are similar to the pellets due to the similarities in the production system, an average humidity of 10%, and a SCP of 4000-5000Kw/t.

## **PRODUCTION METHODS**

The production system of briquettes consist in the extrusion of the by-product mixture (wood, straw...) under high pressure and temperatures of 150-350°C, as in the pellet production system this process dries the mixture and makes it compact and cohesive. As for the production plants, this fuel is usually fabricated in specialized pelleting centres but nowadays, there are in the market several small-systems which can be handled by private users.

The price in Europe ranges from 170-200€/t for big orders and 250-350€/t for small packs of 5-10Kg. It is very important to take into account the transport costs for this fuel, being interesting to use close suppliers (less than 50Km).

## **USES**

The main use for this system is heating and hot water production in small systems, usually with decorative stoves, hearths or 1-3 users' boilers. The main reason for the use in small power installations (5-40KW), is that the loading system is usually manual, and automatic loading systems makes this fuel not competitive with firewood or pellets. Nowadays, there are some interesting gasification boilers with powers between 20-40KW, which have performances around 85-90%, and require initial investments around 300-700€/KW. The main brands in Europe for this system are: Atmos, Brisach, Palazetti, Calimax, Drove, Okofen, Pagnod, Piroux, Rika and Wanders.

## **TREE BARK**

### **DEFINITION**

Tree bark is basically a forestry waste, produced in the tree harvesting process. Its composition is different depending on the kind of wood, actually tree bark contains several toxic compounds in some species, so there is a risk of contamination during its storage.

This fuel has a SCP ranging from 5.1-6.4KWh/Kg dried, in its natural state the humidity is around 40-60%, it has a density ranging from 250-500Kg/m<sup>3</sup> depending on the species.

### **PRODUCTION METHODS**

As this fuel is a by-product of logging, its production starts with the cutting and cleaning of the tree, once the log has been piled up the bark is heaped and loaded on a truck. This load is dried and stored inside a warehouse to protect it from weather. Once dried it is triturated and can be packed or used. The prices nowadays are near 40-50€/t, considering local or close distribution.

### **USES**

The main use for this fuel is feeding heating and hot water systems, due to the particularities of the tree bark it requires complex and big installations, so most of these systems are set in industries or district heating services. Due to its low density and high heating power, tree bark produces much heat but during a small period of time, so is usually combined with other solid biomass as harvested grain, wood chips and firewood. A multi-fuel boiler is needed to burn efficiently a mixture of biomass, these installations have an initial investment of 300-800€/KW and handle powers between 200-5000KW with

average performances of 70-80%. Some producers in Europe for these systems are: DCM, Sugimat, Levenger and Gilles.

## **SHAVINGS AND SAWDUST**

### **DEFINITION**

Shavings and sawdust are two by-products originated in carpentry industry, when produced they are vacuumed and stored into silos where there will be stored or distributed. These by-products have an initial humidity of 50-70%, but can easily be dried to 15% due to its small granulometry. They have SCP of 4400KWh/t for a humidity of 15-20%, and a SCP of 1600-2800KWh/t for humidity around 40-60%.

### **PRODUCTION METHODS**

Due to its by-product nature, there is not much interest on explaining its production method, but it's strongly related to carpentry and forestry industries, as an example: A sawmill's sawdust production is between a 10-12% of the mass of the incoming timber. The price of sawdust for these products in 2007 were of 16.50€/t for hard wood, and 23.4€/t for soft wood, shavings cost about 24€/t, (all this prices are on the production site and without taxes included)

### **USES**

The principal uses of this fuel are briquettes and pellets production for heating systems and the direct combustion of it in specific heaters. The combustion of sawdust and shavings for heating and hot water production is mainly used by the same manufacturers who produce them, usually to feed their processes and heat the building if necessary.

It is not usual to implement this kind of fuel in building applications, due to the high initial investment and maintenance costs and attention required. Nowadays pellet systems have a higher performance and a lower initial cost, so the implementation of the system is not economically interesting.

This heating systems can work with powers ranging from 30-500KW for small heaters, and heating powers from 500-2000KW for bigger industrial installations. The prices range from 250-400€/KW, depending on the automatization level of the system. The main producers in Europe for this system are: Metalcover, Novaenergia, Wood-Mizer, Hurst, Hamech, GreenTec, and IBC.

## **CHARCOAL**

### **DEFINITION**

Wood charcoal is the product resulting of the combustion of wood in low oxygen atmospheres; the amount of carbon in this product is between 50-95%. It is a fuel which absorbs water easily, so it has to be stored in dry areas to keep an optimum humidity of 10-15%. It has a SCP of 8330KWh/t, with an average density ranging from 0.20-0.30t/m<sup>3</sup>.

### **PRODUCTION METHODS**

The production procedure consists basically in a low temperature pyrolysis (350-400°C) with a low heating speed. In these conditions a ton of wood can produce 430Kg of

charcoal; the energetic performance of the method is around 75%. The main methods for this process are the following:

Traditional methods, such as soil charcoal kiln or brick stoves, which are still used in rural areas and countries in development. These systems are not interesting for commercial applications in Europe.

Modern methods such as portable metal stoves have a more interesting performance. With these systems the carbonization process can be developed in 2-3days, with energetic performances of 50-70%.

The price for this fuel, considering the boilers adapted format, is around 680-730€/t, (considering local distribution); it is usually distributed in sacs of 20Kg.

## **USES**

The use of charcoal as a fuel is mainly developed by private single users, usually in small installations. These systems consist in heating and hot water production installations with small powers (15-50KW), with performances around 80-87% for charcoal gasification boilers (this gasification models reach higher performances by controlling the pressure and quantity of oxygen inside the boiler). The prices for this kind of installation are around 90-130€/KW, depending on the complexity of the system and the automation level.

Bigger installations for this fuel can be set for industrial purposes or collective heating, but due to the high cost of the fuel in relation to its SCP, and its lower performance compared to wood it is not recommended. We have to take in mind that the use of charcoal just gives us the benefit of having a smaller and more workable solid fuel, but in terms of energy performance it loses efficiency compared to wood or other solid fuels.

The main producers in Europe for these boilers are: Atmos, Roca, Vaillant, Palazetti, Drac, Greencalor, Cliber, and Hertz.

## **STRAWS**

### **DEFINITION**

Straws as a fuel consist basically in the use of agriculture by-products to be burnt in specific heating systems. These by-products are mainly:

- Cereal wastes (wheat, barley, rye...) with an average humidity of 15%, and a SCP of 3472-3722KWh/t.
- Rapeseed, with an average humidity of 72%, and a SCP of 4583KWh/t.
- Sunflower, with a humidity of 40%, and a SCP of 4833KWh/t.
- Beet leaves, with a humidity of 75% and a SCP of 4055KWh/t.
- Vine shoots, with a humidity of 40% and a SCP of 5083KWh/t.

### **PRODUCTION METHODS**

As these fuels are by-products of agriculture processes, their production method consists basically in the piling up of the wastes, usually the packing of them before the transportation, and the posterior drying and storing of them. The production rates of these by-products are the following:

- Cereal wastes, 1.20-1.35t/t of grain, with an estimation of 2.5-5t/Ha per year.
- Rapeseed, 1.26t/t of seeds, with an estimation of 3.8t/Ha per year.
- Sunflower, 2t/t of seeds, with an estimation of 3-4t/Ha per year.
- Beet leaves, 0.4t/t of beets, with an estimation of 34-40t/Ha per year.

- Vine shoots, 0.83t/t of grapes, with an estimation of 3-4t/Ha per year.

Considering these numbers, and taking into account that in the cereal cases by-products are still used for Cattle with prices around 50-60€/t. We could set that the price of these by-products cannot be considered as a market price and should be set directly with the producers; considering transport, production and storage costs, the prices could range from 7-40€/t, depending on proximity and the kind of by-product.

## **USES**

The main use of these fuels is the heating and hot water production in industrial processes or district heating systems; nowadays, there are some of these systems working with mixtures of cereal wastes, rapeseed and sunflower by-products. The need of big installations is due to the complexity of the systems required and the need of heavy machinery to load these fuels. The average initial investment is about 150-250€/KW, and the installation has to be done by developing a project which usually would be in the order of millions of Euros, with powers of 2000-8000KW.

The use of these fuels in small private systems is mainly limited to the use of vine shoots, as this fuel is similar to a wood chips or a firewood system, there is just the need to change slightly the burner specifications and adapt the loading system with a crusher on the chute system. The overall performance is around 80-85% and the system can supply powers between 5-100KW, with initial investments of 250-600€/KW, depending on the automat grade and complexity of the system.

The main producers in Europe for these systems are: Brisach, Palazetti, Piroux, Calimax, Sugimat, Levenger, DCM, Gilles and Wanders.

## **HARVESTED GRAIN**

### **DEFINITION**

Harvested grain as a fuel consists in the use of wheat and mainly corn grain as a fuel, as the state and granulometry of these products make easier the production and handling. Wheat grain has a density of 0.78t/m<sup>3</sup> with a humidity of 15%, and a SCP of 4200KWh/t. Corn grain has a density of 0.72t/m<sup>3</sup> with a humidity of 15% and a SCP of 4400KWh/t.

### **PRODUCTION METHODS**

The production method of these fuels starts at the end of the harvesting and storing of the grain, the grain is dried to a humidity of around 15% (usually by indoor storage), the grain sometimes is just stored outside and dried before burning in a preheat chamber.

The prices for Wheat and Corn are 120€/t and 100€/t respectively, which gives a final cost of 2.9€/100KWh and 2.3€/100KWh, which is almost the half of the cost of a hydrocarbon based fuel.

## **USES**

The main use for these fuels is usually the burning of a mixture of them, usually combined with wood chips and other solid biofuels, in big installations. These installations are in much cases oriented to heating and hot water production for district heating systems, and in a lesser extent the feeding of industrial processes. The price for these big systems is similar to the straws or wood chips systems, ranging from 300-700€/KW, with average performances of 80% for heating powers between 1000-5000KW.



The use of harvested grains for small systems can be easily implemented by adapting a forest-chips boiler with a solid-multifuel burner. As the granulometry of both fuels is similar the loading and storing systems are similar and the prices are almost the same (300-800€/KW) with powers ranging from 5-50KW.

The main producers in Europe for these systems are: Brisach, Palazetti, Piroux, Calimax, Sugimat, Levenger, DCM, Gilles and Wanders.

## CURRENT STATUS

Up to the end of the year 2009, it has been valued that solid biomass fuels and crops met 4% of the European Union energy needs (69 million toe, "tonnes of oil equivalent"), the outlook for 2010 has been to increase the use of these fuels by to meet a 8.7% (150 million of toe). The estimated investment in Europe in these fuels is around 9 billion Euros per year; the main areas where these efforts are focused are the use of biomass for heating and electricity production from biomass.

To guarantee a sufficient biomass supply, the Common Agricultural Policy has been modified in 2006 introducing a special "aid for energy crops". Also some statistics have shown that up to a 35% of annual forest growing resources are still unused, and the European Energy Commission has set an action plan to exploit wood in electricity production and cogeneration processes.

Focusing on the building industry, there is actually an increasing proliferation on the use of pellet heating system in individual and collective building applications, due to the price difference between this fuel an traditional petrol-based fuels (30€/Mwh against 75€/MWh) or natural gas (50€/KWh). This situation resulted in an increase of 7% on European Union pellet demand which is expected to rise up to a 9% on 1011.

The solid biofuels usage forecast for the next 10 years indicates a growth to at least 105million tons by 2020, which compared with the actual consumption of 11million tons, would represent a market expansion of a 955% in this period. It could be concluded from this data that, there is an important market gap with an interesting future overview for the use of solid biofuels, especially in building and district heating systems.

## FACTORS

### EXTERNAL INPUTS

Taking into account the two kinds of raw materials used (forestry and agricultural):

- For wood-based fuels, the existence of nearby (50Km radius) forests and carpentry industries to provide with materials.
- For agricultural fuels, the presence of important (cereal, corn, sunflower...) in the nearby area (50Km radius) to provide raw materials.

Considering the height of the consumer installations (small and big installations):

- In case of district-heating installations it is required the collaboration with councils and associations to implement the system.
- In all cases is necessary to set on an enterprise or entity to store, transform and distribute the fuels among the users.

- The fuel suppliers should be in the nearby area of the users, meeting these maximum distances (transport costs are important).
  - o For small users should be no further than 15Km
  - o For big users the maximum distance is around 50Km

## ENVIRONMENTAL IMPACT

There has to be considered the following:

- Biomass use in burning applications is considered in European legislation 0.0 CO<sub>2</sub> emissions energy, because it is compensated by the CO<sub>2</sub> absorbed during the growing of future plants, (considered the replanting).
- The real CO<sub>2</sub> emissions of these solid fuels are around 0.33-0.37Kg/KWh.
- The use of industrial by-products helps waste reduction.
- Transport is an important factor to take into account and has to be minimized.

## ECONOMIC ASPECTS

Considering the height of the consumer installations (small and big installations):

- For big installations, we have fuel prices of 14-17€/MWh for unprocessed biomass (tree bark, shavings, chips, straw...), with initial investments of 200-400€/KW. For processed biomass (pellets, briquettes) fuels ranges from 25-35€/MWh, and initial investments are around 400-800€/KW.
- For small installations prices rises to 20-24€/MWh for unprocessed biomass, with initial investments of 300-800€/KW. For processed biomass fuels ranges from 35-45€/MW, with initial investments of 280-500€/KW

## SOCIAL FACTORS

There has to be considered the following:

- Nowadays, there is a great effort from the European Union and its members to promote this kind of energy and has good acceptance levels among the population due to its low price and "0 CO<sub>2</sub> emissions."
- There is a large amount of normative, even European regulations and national, regional and local legislation, most part of them are designed to encourage and grant investments in this field.
  - o EU Directive 2001/77/CE – Promotion of electric energy production by biomass.
  - o EU Directive 2001/80/CE – 0.0 CO<sub>2</sub> emissions consideration for solid biomass.
  - o European Technical Committees: TC 335 – Solid Biofuels and TC 343 – Solid Recovered Biofuels
  - o European Directive 2003/96/CE – Taxes reduction for biomass

# SWOT

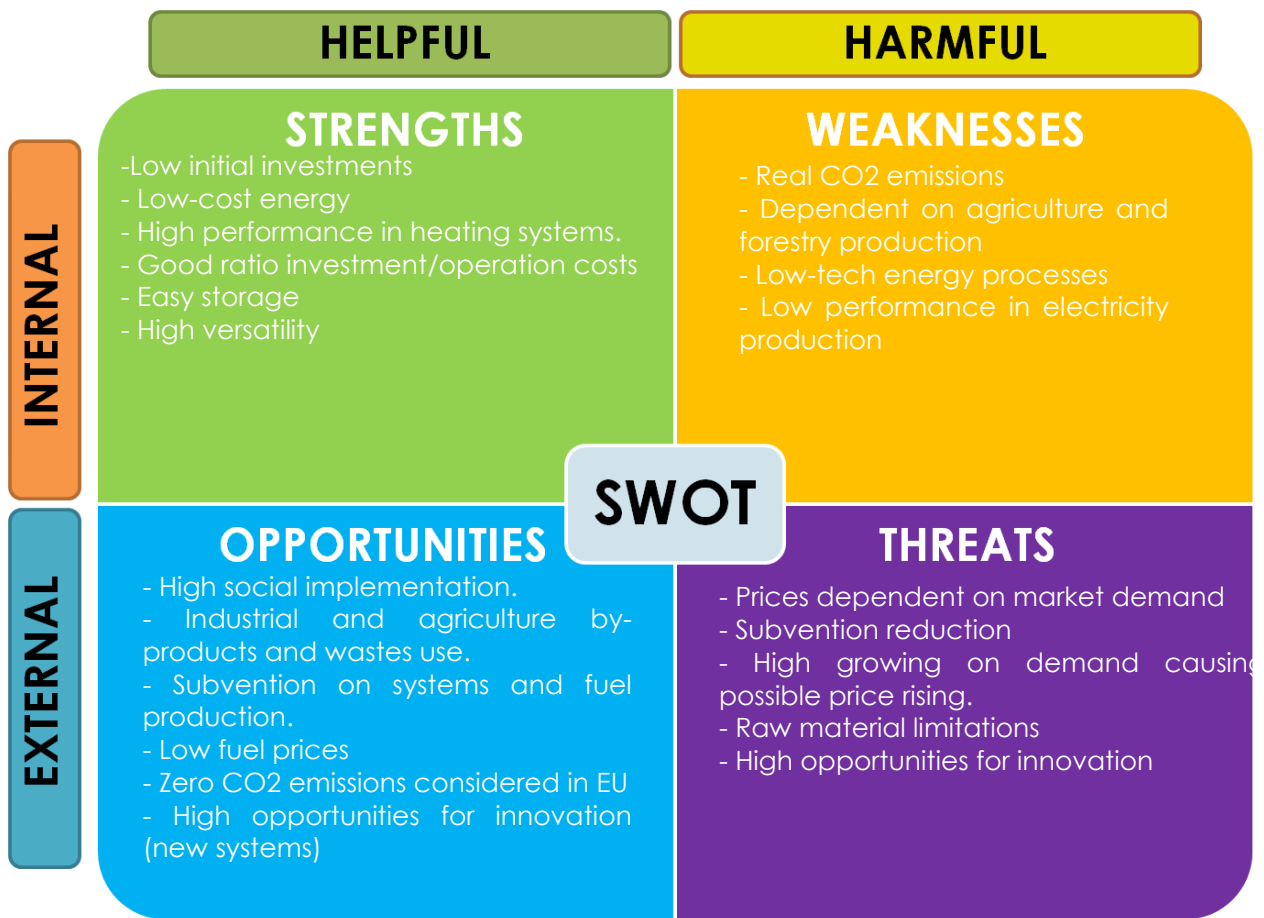

## INTRODUCTION

Under the term liquid biofuels there can be included every liquid fuel, proceeding from the transformation of organic matter. On this kind of fuel, two main products can be identified: Bioalcohols (bioethanol, and biomethanol), and Biodiesel. These two fuels are used in a combustion reaction for heat production and car-fuels (the most important application).

## DESCRIPTION

### TYPOLOGIES

#### BIOALCOHOLS, BIOETHANOL

##### DEFINITION

Organic-source alcohols can be divided into two main groups: ethanol and methanol. The actual development methods of methanol, and the suitability of ethanol for use as a biofuel makes this last one the best option to substitute traditional liquid fuels.

Methanol is an alcohol produced by the alcoholic fermentation of sugars, usually coming from vegetal complex-hydrates (starch, cellulose, saccharose). This process is very similar to the production method for spirits and alcoholic drinks.

Ethanol physicochemical properties are similar as gasoline properties, so, it can be easily combined and mixed with it in proportions from 5-20%.

This inflammable liquid has a density of  $789\text{Kg/m}^3$ , with an ebullition point at  $78^\circ\text{C}$ , and a SCP of  $8256\text{KWh/T}$ .

##### PRODUCTION METHODS

The production method of bioethanol starts with the obtaining of sugars contained into vegetal matter. The gathering of these sugars requires additional processes for some products; taking into account these processes we can set three families of products for the production of bioethanol:

- Starch rich products, (Corn, wheat, barley, potato). To obtain sugars from these products there are two different processes.

The wet milling process is carried out for the treatment of corn; this method consists on a first step of boiling and grinding, a second step of drying and the immersed into water, and a third step where the starch is separated from the mixture by a centrifugation process.

The dry milling process is carried out for the rest of products; the process starts with the grinding of the material, then the mixture is hydrolysed using enzymes or an acid solution, obtaining the starch which can be directly fermented.

- Cellulose and Hemicellulose rich products, (biomass, wood...); as cellulose cannot be fermented directly it has to be transformed into simple-sugars. The method used is a Hydrolysis process; this process can be developed by using a mixture of water and sulphuric acid or by an enzymatic hydrolysis process, this last method is the easier one and the most used in industrial processes. The result in both methods is a solution of simple sugars which can be fermented.
- Simple sugar rich products, (beet, sugarcane), in the case of these products just a grinding and filtering process is needed to separate the sugars, the result product of this grinding can be fermented.

The second step of the process is the fermentation of the previous step resulting sugars, it is used a similar yeast than used in the spirits industry.

The efficiency levels of this process (input energy/produced energy) are: 86% for beet, 59% for potato, 25% for corn, and 66% for sugarcane. The average production cost in Europe for bioethanol is 0.4-0.7€/l.

## USES

The main use for bioethanol is the mix with gasoline for car fuels, in proportions of 5-15% in Europe (E05 – E15), the use of these mixes reduces the performance for non-adapted motors by a 2% and increases consumption by a 4%, with a tune-up of the motor rising the compression-ratio the performance increases by a 9% and the consumption is reduced by a 7%.

For the use of ethanol as a unique fuel, there are adapted vehicles (Flexible Fuel Vehicles) which can work with mixes of 85% (E85) and also with common gasoline. Saab has an ethanol model (Saab 95 turbo) which reaches higher performances than gasoline cars.

There is an application of bioethanol in the production of ethyl-tertiary butyl ether, which is mixed with gasoline up to a 15% (ETBE15), and represents nowadays the main use of bioethanol in Europe.

Bioethanol is also being mixed with diesel fuel in mixes of up to 15% (E-Diesel), improving the performance of the vehicles with this technology.

The use of bioethanol in heating installations is limited to small fireplaces and stoves, as ethanol combustion does not generate toxic gases (CO<sub>2</sub> + H<sub>2</sub>O) there is no need of extraction system. There is no use for heating installations due to its low performance levels and high energy costs (0.190-0.310€/KWh against 0.068€/Kwh for gasoil).

## BIODIESEL

### DEFINITION

Biodiesel is a liquid biofuel produced by using vegetal oils, animal fats and used oils. Also, as a result of the bio-oil production a valuable material is obtained from the rests of the seeds used.

The main vegetal raw materials for biodiesel production by means of mechanical or chemical processes are rapeseeds, sunflower seeds and soya seeds.

The calorific power of the Rapessed oil is 10912,10 kWh/T (PCS), with a density of 921 kg/m<sup>3</sup>. The calorific power of the sunflower oil is 10305,5 kWh/T, with a density of 925 kg/m<sup>3</sup>. And the calorific power of the soya oil is 10944,4 kWh/T with a density of 920 kg/m<sup>3</sup>. In terms of biodiesel production, it ranges from 1400 l/ha to 954 l/ha for rapessed, from 767 l/ha to 682 l/ha in the case of the sunflower, and from 922 l/ha to 3000 l/ha for soya ranges.

By means of using used oils, these oils can be recycled and reused, avoiding its spill, and entailing a cheap raw material. The calorific power of this oil is 10305,5 kWh/T

If Animals' fats are used, its fabrication process is a bit more complicated, but the obtained product quality is as good as in the other processes. Moreover, the raw material is cheaper due to the use of the stockbreeder industry wastes, originating a benefit to this industry. Concerning the calorific power, the value is around 11.666,6 kWh/T.

The biodiesel obtained by using these raw materials has an average calorific power of 10416,6 kWh/T that can vary depending on the raw material used; and a density of 860-900 kg/m<sup>3</sup>.

Moreover, biodiesel can be blend with diesel, but biodiesel term is used to refer to the pure fuel, without blending. The most common nomenclature to denote biodiesel blends is "Bxx", where "xx" express the percentage per volume of the biodiesel in the blend. For example pure biodiesel is represented by B100 (it means that a 100% of biodiesel is in the blend).

## **PRODUCTION METHODS**

The biodiesel production could be split into two phases.

The first one is the bio-oil production. It is obtained from the feedstocks (the unrefined oil) and can be used directly as a combustible, but it must undertake deep transformation so it is not a very common practice. That is why usually this bio-oil is refined and prepared for the next step of the biodiesel production. The cost of an average oil extraction process could range from 50€/t to 60 €/t, and the refine process from 30 €/t to 48€/t. Moreover, some benefits are obtained by selling the valuable product, a "pie" used for animals feeding made by the rests of the seed; these "pies" can be sold at a price of 0,25 €/kg.

The second phase is the biodiesel production by the transformation of the feedstock oils by means of a process called transesterification. It consists on combining the oil with an alcohol, usually methanol, in order to separate the glycerin from the feedstoks and substitute it by the alcohol. By using a catalyst, and thanks to the heat, the reaction is accelerated and as a result biodiesel and a valuable product (glycerol) are obtained. This chemical process doesn't demand a complex chemical process, neither large equipments. If the glycerin is refined for pharmacologic used, income benefits are achieved, being part of the economic benefits of the whole process.

On an economical approach, it could be said that for an average biodiesel plant with a minimum production of 7800 t/year, the initial investment is approximately 2.000.000 €. Roughly speaking, the market prices of the biodiesel are about 0,80 €/l if it is bought directly at the plant, or between 1,319 €/l to 1,420 €/l at the gas station for vehicles uses. Whereas for heating purposes the prices of the biogas are 1- 1,5 % cheaper than the diesel ones.

As far as storage is concerned, it could be used approximately the same as for petroleum diesel. It should be stored in a clean, dry, dark environment. Materials such as cooper, zinc, tin, and lead should be avoided.

Nowadays, new ways of producing biodiesel are being developed; another way of liquid biomass fuel production that nowadays is being developed is the catalytic Fischer-Tropsch process. It is based on the biomass conversion to liquids (BTL). The used raw matters are wood and a wide range of biomass. First of all, these feedstocks are used to feed the gasifier; this chemical conversion process consists in three phases, pyrolysis, partial oxidation and hydrogenation, obtaining a gas as a product. When this gas is purified the syngas is obtained, consisting mainly in H<sub>2</sub> and CO. Then the syngas is introduced in the Fischer-Tropsch reactor. After an upgrading and distillation process the final diesel is obtained.

## USES

Biodiesel is mainly used as a fuel in vehicles. It can be used unblended (B100) or blended with diesel (B5 – B30) which is the most common use. In the past biodiesel couldn't be used in conventional motors because they dissolved the tire used in some elements. But nowadays thanks to the development on motors design these materials have been replaced for new ones that aren't damaged by the biodiesel.

It also can be used for heating and water heating purposes, feeding individual or collective boilers. The use of this fuel just requires a common gasoil boiler with small modifications into the burner settings.

## CURRENT STATUS

As far as biodiesel is concerned, the production has grown significantly over the past ten years, slowing this cadence in the last ones. The growth from 2008 to 2009 was of 17%. The worldwide production of biodiesel in 2009 was of 18000 MI, being Europe the first biodiesel producer with 10187 MI (55-60% of the world production) followed by the United States (2060 MI), Brazil (1535 MI) and Argentina (1340 MI).

Within Europe, Germany is the major biodiesel producer with nearly the 28% of the European production, despite that this production has decreased in the last years. Germany is followed by France, Spain and Italy.

This growth reduction of biodiesel production in Europe can be explained by the unfair trade practices undertaken in the current biodiesel market. Mainly since 2007 US has been exporting biodiesel B99 reaching prices even lower than the raw material themselves. Also a big exportation from Argentina has emerged, due to the Differential Export Taxes.

In spite of this low production reduction, Europe is still being the first biodiesel producer. Its current biodiesel production capacity is around 25 billion liters, thanks among other reasons, to the investments planned before 2007.

Concerning to bioethanol production, it is one of the most produced biofuel, with a production of 74 billion liters in 2009. The United States is the first bioethanol producer (40 billion liters), followed by Brazil (25 billion liters) and Europe (3.7 billion liters). Asia has emerged in the bioethanol market and it would experience high growths in the following years.

European bioethanol production grew a 60% in 2008 and a 31% from 2008 to 2009. France is the bigger European bioethanol producer, with a production in 2009 of 1,250 MI. Followed by Germany which is also increasing its production (750 MI) and Spain (465 MI). Moreover, a great increase of the bioethanol consumption has taken place. In 2009, 4,3 billion liters were consumed, being Germany the bigger consumer.

In the European framework, biodiesel is the main biofuel produced, reaching a 75% of the biofuels' production.

However, nowadays the biofuels obtained mainly from food crops (the ones called first-generation biofuels) have not enough competitive production infrastructures for a complete substitution of the actual fossil fuels. This is increasing the interest on developing the non-food biomass fuels, known as second-generation biofuels that are produced by using ligno-cellulosic feedstock. Several investigation are being undertaken in order to commercialize these fuels in the future.

# FACTORS

## EXTERNAL INPUTS

- For biodiesel production, there has to be considered the availability of raw materials to transform such as:
  - o Agriculture products: Sunflower oil (performance of 682-767l of oil per Ha), rapeseed oil (oil production of 954-1400l/Ha), or soya (oil production of 922-1500l/Ha)
  - o Animal fats (stockbreeder industry), as a use of some by-products.
  - o Used oils (food industry), as a recycling process for its by-products.
- For bioethanol production, the presence of nearby crops, agriculture industries or forestry industries could entail a raw material source:
  - o Sugar rich products: Sugarcane (production 5600-7000 l/Ha) this product is not used in Europe due to the climatic conditions needed to its growing, and Beet (production 6500-7000 l/Ha) this kind of crop is commonly used in Europe for ethanol production due to its high performance.
  - o Star rich products: Corn (production 3500l/Ha), Wheat (3000l/Ha), Barley (2000l/Ha), Potato (5000-6000l/Ha)
  - o Cellulose and hemicellulose rich products: Conifers (190-290l/t), and Deciduous woods (160-220l/t)

## ENVIRONMENTAL IMPACT

- Both biofuels can be considered as renewable energy sources, as they are produced by agriculture crops or industrial wastes.
- In some cases biodiesel can be produced by industrial wastes such as animal fats and used oils, it is an optimum method to reuse these by-products.
- Both biofuels are considered 0.00 CO<sub>2</sub> emission fuels, at the CO<sub>2</sub> emissions are compensated by the CO<sub>2</sub> absorption of the crops or the gases not emitted during wastes processing.
- Both biofuels are 98% biodegradable, so accidental leaks have lower repercussions on the environment.
- Intensive use of biofuel crops can end up on deforestation and soil contamination by fertilizers and pesticides. This situation is common in developing countries; European regulation controls these possible issues.
- Even if these biofuels are considered 0.00 CO<sub>2</sub> emissions fuels, the use of this fuels represents the emission of big amounts of CO<sub>2</sub> specifically 150-190kg/MWh. Some important scientifics, like **Hartmut Michel (chemistry Nobel prize)** have developed some researches showing the real impact of the use of these fuels.



## ECONOMIC ASPECTS

- For biodiesel production in Europe:
  - o The production costs are about 0.80€/l
  - o The average market price is 1,319 €/l to 1,420 €/l
  - o The initial investment for a production plant is around 256€/t per year, with initial investments usually about 2.000.000-4.000.000€.
- For bioethanol production in Europe:
  - o The production costs are 0.40-0.70€/l.
  - o The market price is around 0.190-0.310€/KWh
  - o The initial investment for a production plant is around 650€/t per year, with initial investments of 60-100 millions of euros.

## SOCIAL FACTORS

There are some European regulations and initiative concerning to the biofuels. Some of these regulations are:

- Directive 2003/30/CE of the European parliament related to the use of biofuels or other renewable fuel for vehicles. Its aim is to promote the replace petrol and diesel with renewable fuels.
- Directive 2009/28/EC of the European parliament: Renewable energy directive, promoting the use of renewable sources for energy production. Each Member State should achieve a 10% of renewable energy production by 2020. Its goal is to guarantee the exclusive use of biofuels without negative impact on biodiversity and land use.
- SET-Plan: it sets an energy technology policy for Europe. Regards the development and effectiveness of the low carbon technologies. One of the initiatives developed in the framework of the this plan is the "European Industrial Bioenergy Initiative",
- Energy 2020: A strategy for competitive sustainable and secure energy: it defines the next ten years energy priorities and determines actions that have to be taken.
- Strategy for a Sustainable European Bioeconomy: its aim is to to drive the transition from a fossil-based economy to a sustainable bioeconomy in Europe
- Regarding the public acceptance of biofuels, the results of some surveys shown that they are well accepted in Europe. Biofuels are seen as a substitute of fossil fuels, and its use on vehicles is being support by some European polices. Despite there are some concerns about the motors adaptation and the competition with food.

# SWOT

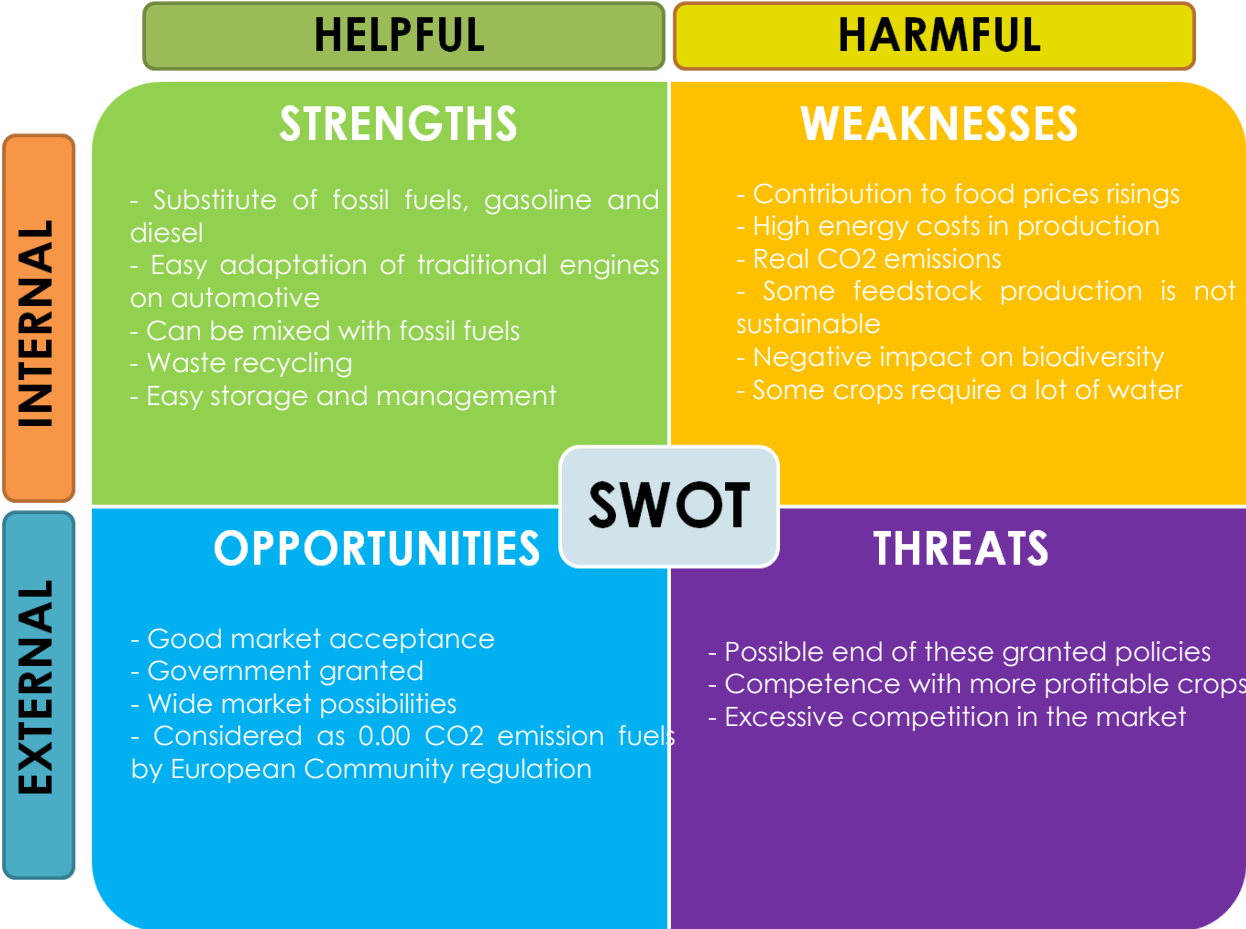

**SWOT**

## INTRODUCTION

By the term biogas fuels, there are considered the fuels resulting on the transformation of organic matter, usually on bacterial decomposition processes. The main fuel which is going to be studied is Biogas (Methane), commonly produced by biological decomposition processes. The main uses for this fuel are heat production and electricity production.

## DESCRIPTION

### DEFINITION

It is a combustible gas, produced as a result of the decomposition of the organic matter in an anaerobic process. During this process, bacteria consume the carbon and nitrogen producing a gas. Depending on the type of technology used and the nature of the organic composite involved in this process its composition is:

- Methane (CH<sub>4</sub>) that ranges from 55% to 65 %
- Carbon dioxide (CO<sub>2</sub>) that ranges from 35% and 45%
- In a lower amount: Nitrogen, Hydrogen (0-1%), Oxygen (0-1%) and Hydrogen Sulfur and other gases.

The Superior Calorific Power is between 5,5 –7,5 kWh/Nm<sup>3</sup> , being the methane proportion the main factor contributing to its SCP, which is approximately the half of Natural Gas SCP. It can be used just unblended or mixed with others gases, for energetic supply in motors, turbines or boilers or others systems for gas combustion. As higher the amount of methane is, better the biogas is, and more similar uses to the natural gas could be achieved.

### PRODUCTION METHODS

The process of the anaerobic digestion could be carried out with almost every organic waste, but it is better to count with the presence of liquid effluents with a high pollution power.

The organic wastes are introduced in a biodigester, which is a hermetic and impermeable reactor where the anaerobic process takes place. This reaction is developed if the wastes are liquid (that is why sometimes an amount of water is added), contains fermentable matter and its composition and concentration is more or less stable.

These organic wastes act as nutrients of the microorganism that are in charge of the digestion; the different phases of the process are carried out by different species of bacteria, which are not the aim of this study.

As a result of the fermentation a mix of gases with a high content of methane, and remainders with a high content of nutrients and organic material that could be used as fertilizer, are produced.

There are some factors that must be controlled during the anaerobic process:

- Temperature: It is usually done with a mesophilic temperature (around 35 °C) because the behavior of the bacteria that take part in the process is better. As well sometimes this process is done with a thermophilic temperature ( 50 – 55 °C) or with psychrophilic temperature (20 °C)
- pH : The optimal range of pH is 7.0 to 7.2 , because some of the bacteria involved are sensitive to the variation of it.
- The presence of some elements: a high concentration of heavy metals, phenols, ammonia, aromatics etc, affects negatively the reaction.

The speed of the biogas production is limited by the celerity of the slowest phase of the procedure, that is why this treatment takes around two or three weeks.

Between 300 and 400 liters of biogas can be produced per day for each kilogram of matter used, lasting this process around 50 days.

The pre-treatment of the organic matter used could improve the efficiency of the biodigestion quickening it. This previous step consists in the reduction of the size of the particles, improving the solubility, and reaching an increment of the biodegradability. Some of these pre-treatments are: maceration, crushing, ultrasound, heat treatment (pasteurization), high pressure, combination of high pressures and temperatures and biological treatment.

## USES

The main application of the biogas is its energetic exploitation. The main use of this fuel is heating and hot water production for industrial and building applications; or as well the generation of electricity is possible by means of electrical generators, the efficiency of this process could be improved by using a cogeneration procedure. The average electrical production per m<sup>3</sup> of a biogas with a percentage of methane of 60%, is around 2,07 kWh, whereas the average heat production is about 2,67 kWh.

It can be used for:

- Heating and hot water production in boilers.
- Generation of electricity by using electric generator or turbines.
- Use in fuel cells (previous treatment)
- Use it as automotive fuel (previous treatment)
- As base component for other products such as liquefied natural gas.

When district heating is concern, the biogas boilers are quite similar to the Gas Natural ones, being their prices more or less the same. Some of the biogas boilers producers are Emission, Beralmar, Kromschroeder.

The biogas can be stored as a compressed gas achieving a volume 200 lower, or liquefied with a volume 600 times lower than the original one. At any rate, maintaining the energetic potential.

## CURRENT STATUS

Nowadays biogas is undergoing the biggest growth ever, due to recent policies about renewable energy commitments and restrictions on the treatment of organic waste that the European Union members have developed.

The biogas is ending up with the thought of just waste cleanup activities and starting to be considered seriously as a way of energy production.

Nowadays, Biogas is mainly used for electric energy production. In 2009, 25,2TWh were produced using biogas; comparing it with the 2008 production, it has underwent a rise of 17,9%. The 53,4% of the biogas electricity is produced in methanisation plants, whereas the production of biogas electricity in landfills is around 37,2%, and a lower amount is produced in water treatment plants (9,4%). As a general overview, in the European Union in 2009, the equivalent of 8,3 millions of tonnes of petrol have been replaced by biogas.

Also the number of co-generation plants is being increased. These plants are able to produce electricity and heat. Being part of this heat used for the methanisation process and the rest for supplying heat to houses or industries.

Besides, an increased of the agricultural biogas methanisation plants is being observed. The production of these plants is bigger than the landfill plants and the wastewater treatment plants.

What is more, nowadays some European countries, such as Germany and Netherland, are developing a "fuel-grade biogas", which is a biogas with a high content of methane, having similar properties to the natural gas. These countries aim is reduce their dependence of natural gas. However this is hard to set up because big infrastructure investments are required.

These days, the European Union is financing a project called SEBE (Sustainable and innovative European Biogas Environment) in order to investigate the most suitable technologies and policies for the European biogas production. The budget of this project is 2.6 M€.

## FACTORS

### EXTERNAL INPUTS

The main raw materials for the biogas production are:

- Ranching and farms wastes: As they are really pollutant and abundant they are one of the most used elements for the biogas production, despite they aren't very suitable for it due to its high content of nitrogen and the liquid nature.
- Agricultural wastes: They are suitable for the biogas generation, but varying depending on the composition. However their availability depends on the season.
- Animal and food wastes: They are suitable for the biogas generation and also abundant.
- Waste water treating plant: A certain amount of biogas is generated during the biological process that takes place in a purifying plant, and by treating the mud of the plant.
- Organic fraction of solid urban wastes: Using them for biogas production (previously treated), also their reduction is achieved.
- Landfill gas: The biogas is produced because of the anaerobic decomposition of the wastes in the dump in different phases (it can be considered as a passive methanisation). Some dumps have pipe and chimney systems to collect the biogas.

Some factors must be taken into account to decide the suitability of the resources to produce the biogas: the volume of waste available, the contaminant potential, the biogas potential production, the methane content of the biogas generated, the by-products that would be generated during the reaction, if a pre-treatment is needed or not, etc.

## ENVIRONMENTAL IMPACT

Biogas production is one of the cleanest and least toxic gas production processes, its combustion releases a lower quantity of greenhouse gases compared to other fuels.

- It is considered a clean energy because it is based on the production of energy by a fermentation process of organic matter. It brings the possibility to recycle these wastes and use the treated effluents as nutrients for the ground. As a result of this process an odorless gas and a high nutrient fertilizer are generated.
- It is a way of reducing the environmental pollution that the wastes used for its production, could generate if they were not treated.
- It avoids the soil contamination by farming wastes (high nitrate contents), thanks to the waste management conducted to produce biogas.
- It involves a reduction of the emission of greenhouse gases such as CO<sub>2</sub>, CH<sub>4</sub> and NO into the environment. It enables that a higher rate of the emission of methane to be controlled, and also it avoids the emission of CO<sub>2</sub> that would have been produced if fossil resources were used.
- It reduces the carbon footprint of wastes generating a positive balance of the carbon footprint of the process, (reduction of free methane in the atmosphere).
- During the combustion of biogas, CO<sub>2</sub> is emitted (189, 11 g CO<sub>2</sub>/KWh).
- Possible gas leakages in the biogas production plant could generate important harms in its surrounding.

As a conclusion it could be said that it is more positive for the environment undertaking this process than not doing it.

## ECONOMIC ASPECTS

Concerning to the economic factors of the biogas

- Focusing on biogas production plants, high economical investments are required, being the financing one of the key elements for the viability of the project. Moreover, for most of these projects, supplementary government subsidies were given, representing more or less a 30% of the investment costs of the project.
- For an average biogas plant of 500 kW, an estimated investment of 1.950.000€ would be needed; and it would be amortized in 10 or 12 years.
- Focusing on housing heating biogas installations, the rough cost for an individual house ranges from 120 to 160 €/kW. Besides the cost of a big installation for more than one house ranges from 110 to 130 €/kW.
- The average price of the biogas in Europe is 4 €/Nm<sup>3</sup>.

## SOCIAL FACTORS

- Biogas sometimes generates lots of complaints, due to the lack of information between citizenship, policy makers and stakeholders that influences the acceptance of the biogas technology. It could be wrongly thought that the plant is going to cause bad smells and a negative impact on their quality of life.
- On the other hand, nowadays more and more communities are expressing their interest on installing biogas plants, because of the benefits that the community could perceive.
- Some European surveys show that the biogas is within the sustainable energy more known in Europe.
- Fits with some European Union Policies, such as:
  - o Renewable Energy Directive (2009/28/CE), which aim is to achieve a 20% renewable energy of the final energy consumption by 2020.
  - o European regulation (Directive 1999/31/CE on the landfill of waste), related to the organic waste management. And reduction of the amount of biodegradable waste (Directive 2008/98/EC on waste)

# SWOT

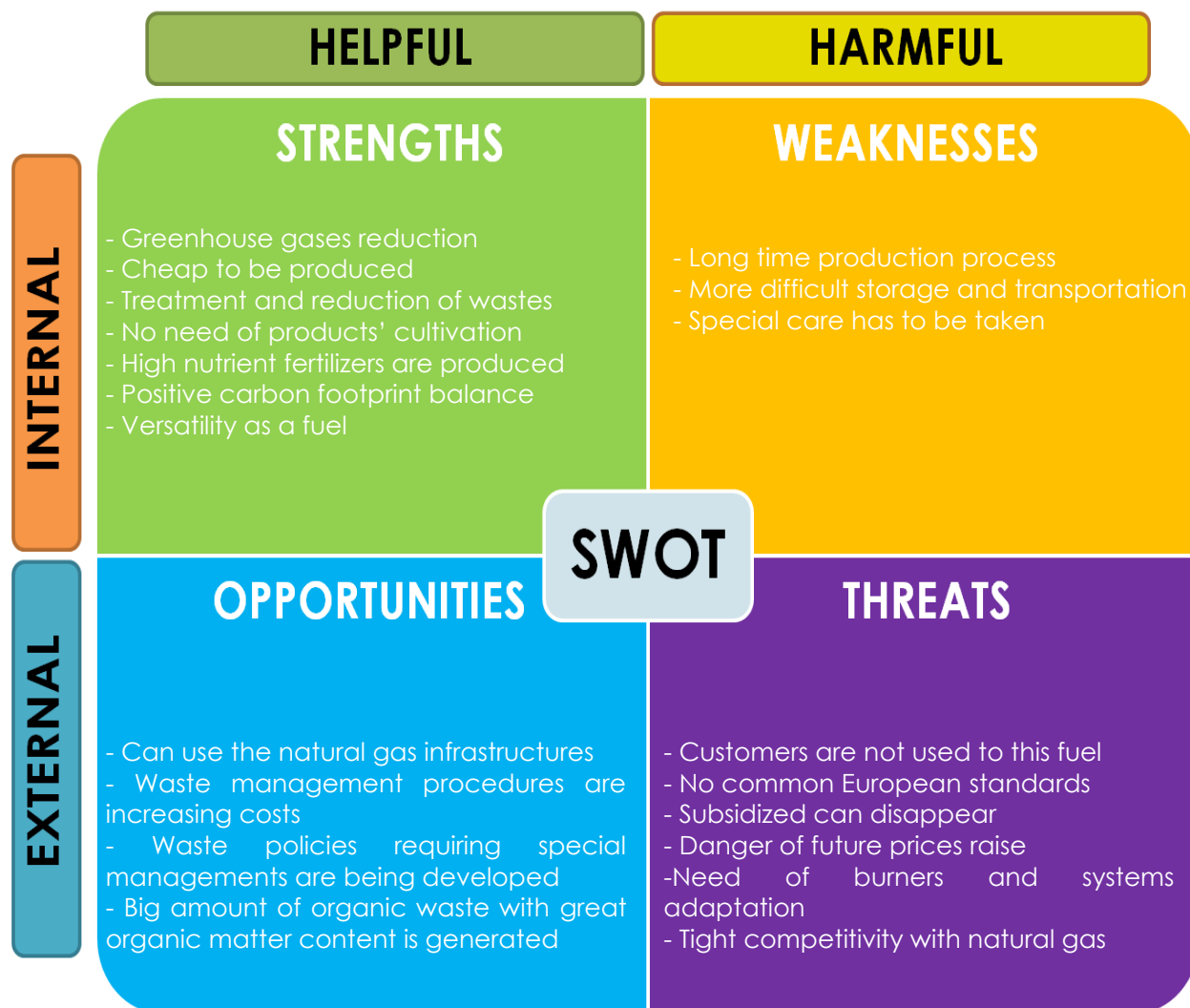

## SUITABILITY FOR SMALL COMMUNITIES

- Solid biomass
  - Small heating systems for private users. (Pellets and firewood)
  - District heating systems with: Straws, Woodchips, Harvested grain, Savings and sawdust. Possibility of cogeneration systems.
- Liquid biofuels
  - Vehicles fuels substitution for: Bioethanol and Biodiesel.
  - Private investments needed for production.
- Biogas
  - District heating interesting option. Possibility of District heating + Electricity production (cogeneration)
  - Production not interesting. Needs high investments.



# GEOHERMAL ENERGY

## INTRODUCTION

Geothermal energy is the energy contained as heat in the inside of our planet. The source of this heat is associated with the interior structure of the earth and the physical processes. A definition given by the European Geothermal Energy Council (EGEC) is that the surface of the solid earth only functions as a boundary for geothermal.

In the following report we have identified and classified the characteristics of the two types of geothermal energy resource: shallow geothermal and deep geothermal. The report we will provide you with more information about the currently technologies, future opportunities and environmental impact of geothermal energy. Thus it will clarify and gives the reader an international perspective on the European applicability of geothermal energy.

# SHALLOW GEOTHERMAL

## INTRODUCTION

### The definition for shallow geothermal energy

The distinction between deep and shallow geothermal energy is not fixed. In several countries, the general governmental definition of shallow geothermal resource is defined as depths of up to 400 m.

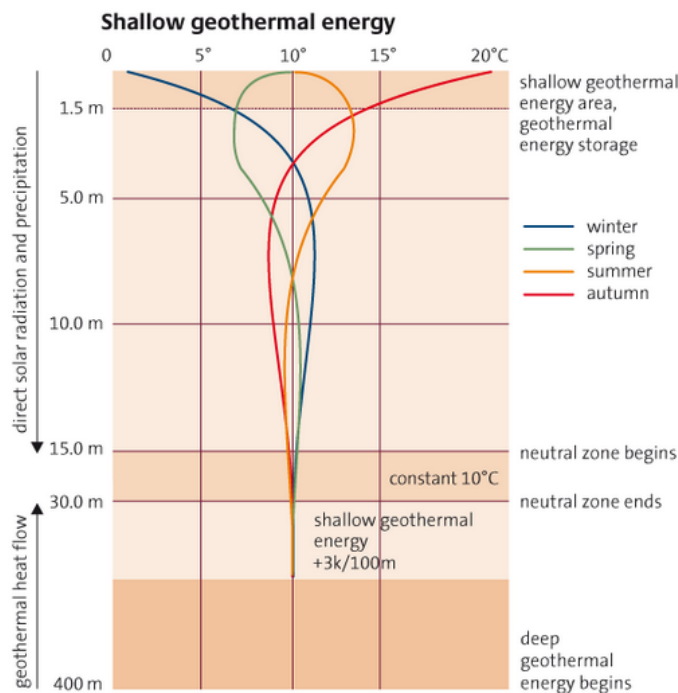

Fig E.5.1: Natural near-surface temperature development at various depths. [www.solarpraxis.de](http://www.solarpraxis.de)

Our Earth conserves much more heat than water and air, below the ground there are huge geothermal resources which have great availability. Because the ground source heat is not dependent on the weather conditions it is the most stable renewable energy resource (Chao Luo, et al., 2012) for cooling and heating buildings.

As (Fig E.5.1) shows, the temperature in the Earth's top layers, are subject to periodic changeability influenced by the solar radiation. Further down at depths of about 15 meter and down to a maximum of 40 meter, the temperature distribution of ground source heat is depending on the geological conditions. At these levels, the soil temperature prevails just above the yearly average temperature on the Earth's surface. From this depth continuously, the temperature rises at a geothermal inclination of approx. 3 °C per 100 meter of depth, until a depth of 400 meter where the temperature has reached 20 - 25 °C. All in all, the ground source heat is not only determined by the geological conditions, it also depends on the quality of the ground and rock.

## The options of harnessing renewable geothermal energy

As Iglesias and Torres (2009) mentioned in an article in *Geotermia* (2009), “Such massive amounts of recoverable energy and the associated temperatures are potentially important for the economic development of nearby localities and the nation.”

In many countries geothermal energy has been applied for different purposes, according to the different temperature range. Low-temperature geothermal energy has normally been used for sustainable buildings heating and cooling system, storing and extracting heat. The mid-low temperature geothermal resource, which is between 60°C-180°C, has generally been utilized for geothermal power plants which support public electricity demand. (Iglesias & Torres, 2009)

To harness geothermal energy, there are several systems to be used, such as boreholes, energy piles, geothermal heat probes, geothermal heat collectors, and other ground-contact concrete units. To use the constant low temperatures of the underground there are two options. The first one is the ground source heat pumps (GSHP) (Fig.2) that usually are operated directly together with different types of shallow geothermal systems, in which it has a very important contribution role.

The function of the heat pump in these systems, is to increase the temperature of heat gained from shallow depth, to a usable level for supplying buildings with heat or hot water. In reverse if the soil is not providing enough cooling the other function of the heat pump is to supply the building with the required cooling capacity. (For more information about heat pumps, see chapter 2.1)

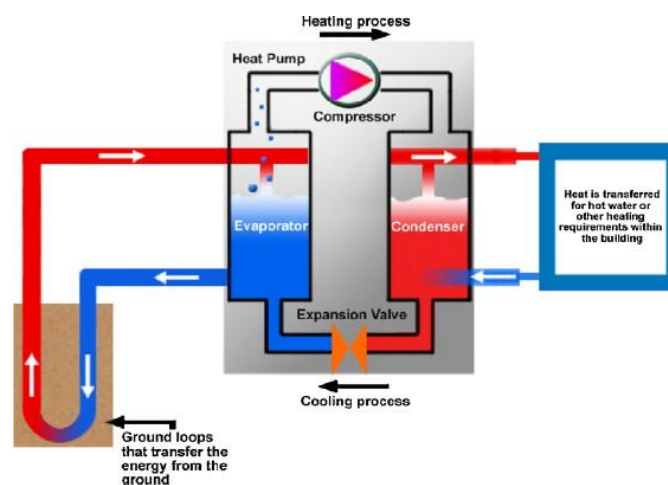

Fig E.5.2 : Heat pump concept. [www.sciencedirect.com](http://www.sciencedirect.com)

Another option that also utilizes shallow geothermal energy, is underground thermal energy storage systems (UTES) (Fig E.5.3). They may or may not include a heat pump. They function as heat sinks or heat sources for heating and cooling supply in buildings, and the system is based on using the constant low temperature, either in the soil underground or in the aquifers (Eugster & Sanner, 2007). These systems are usually also combined with other sustainable energy technologies such as photovoltaic (PV) systems (For more information about solar thermal energy storage, see chapter 3.1).

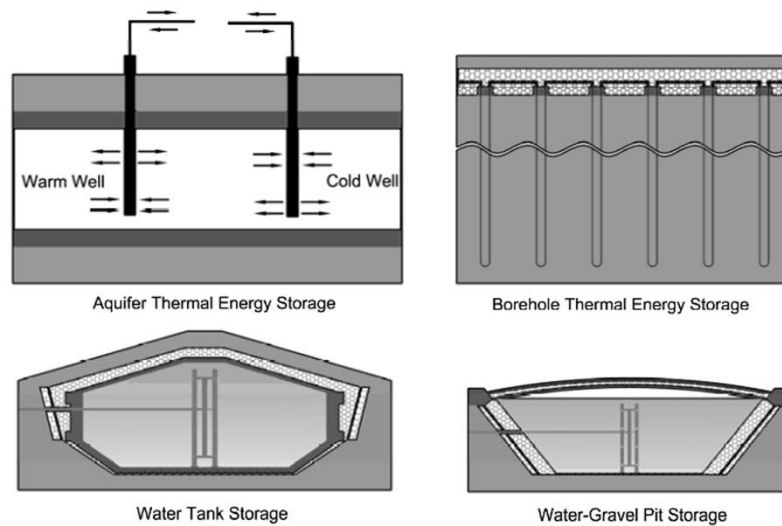

Fig E.5.3: Underground thermal energy storage concepts (Palov & Olesen, 2011)

## TECHNOLOGIES OF SHALLOW GEOTHERMAL

Shallow geothermal systems are typically linked to a GSHP for achieving sufficiently high temperatures, and uses ground water and underground soil as heat sink and heat source. GSHP systems are the most commonly used shallow geothermal systems in Europe (Eugster & Sanner, 2007). According to the GEOTRAINET information, GSHP systems can be classified generally as open or closed systems, and a third category for those not truly belonging to one or the other. “Systems that are using water from the ground and are having a heat exchanger above ground are called “open” systems. Systems using a heat exchanger inside the ground are called “closed” systems” (Corry & Jones, 2011).

Groundwater wells are the main technical part of open circuit systems, in most case two wells are required and directly connected to the ground water bearing layer as (fig E.5.4) shows a borehole pump up the water from the production well to the heat pump or other infiltration structure, and then returns the used water into the underground via the injection well.

The solid ground heat systems normally use the close circuit heat pipe system, which can be installed both vertically and horizontally.

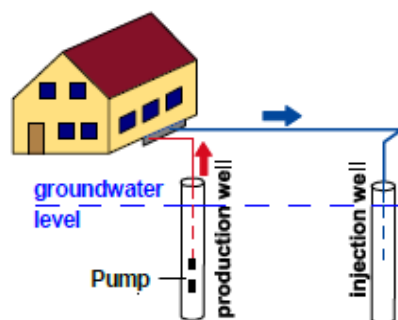

Fig E.5.4: Diagram of common ground-coupling methods for groundwater wells (EGEC, 2009)

The heat pipe system uses vertical or horizontal pipe loops, with the structural differences between them shown in (Fig E.5.5). Vertical loops are operated with borehole heat exchangers (BHE), and horizontal loops are comprised compact systems with trenches and spirals. A different kind of loop that belongs to the third GSHP category, as I mentioned before, is called “geostructures”. They are connected to a water-saturated underground by embedment in the foundation of the walls and/or piles.



Fig E.5.5: Diagram of common ground-coupling methods (from left), horizontal and vertical loops (EGEC, 2009)

The closed GSHP systems usually have three circuits: heat source circuit, heat pump circuit and heating circuit (Fig E.5.6), and they can in general all be used for both cooling and heating. There are some limitations for the directly expansion of GSHP with a horizontal collector system or Borehole GSHP system, in that these two systems can only be used for heating. However, in the last few years, heat piles combined with vertical BHE systems have been recommended for seasonal or short-term underground storage (Eugster & Sanner, 2007).

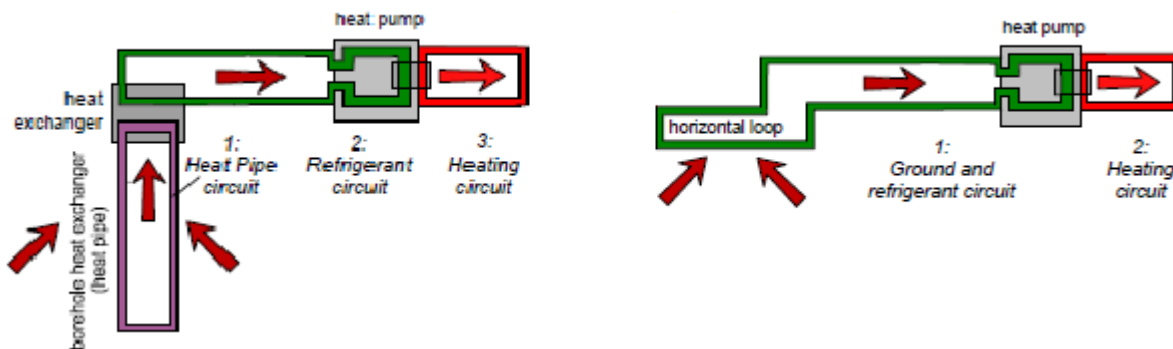

Fig E.5.6: Scheme of the ground loop circuits from the left: heat pipe circuit vertical loop, direct expansion circuit horizontal loop (Eugster & Sanner, 2007).

## Horizontal loops

### Ground heat exchangers

In Central Europe horizontal ground heat exchangers (Fig.E.5.7), are installed at a depth of between 1.0m and 1.5m (Eugster & Sanner, 2007). The pipes are typically made of Polyethylene (PE100) and have a size of up to 25 mm. The separate pipes are laid in a relatively dense pattern, linked either in series or in parallel.

For the horizontal ground heat collectors where the pipes are laid, the entire top soil layer is usually removed, and distributed back over the pipes after installation. In Northern Europe and North America where land area is cheaper, a wide pipe pattern with trenches is preferred. Trenching machines facilitate the installation of pipes and the backfilling.

The main heat recharge for all horizontal loops is supplied by the solar radiation to the ground surface. It is important not to cover the surface above the ground heat exchangers, or to operate it as heat storage.

Ground heat collectors with GSHP systems have been developed to save surface area, but the technology is suited best for larger installations, where the underground has a large volume of heat and cold compared to the number of buildings supplied, (Eugster & Sanner, 2007) and where the natural temperature recharge of the ground is not dynamic (Sanner, 2009).

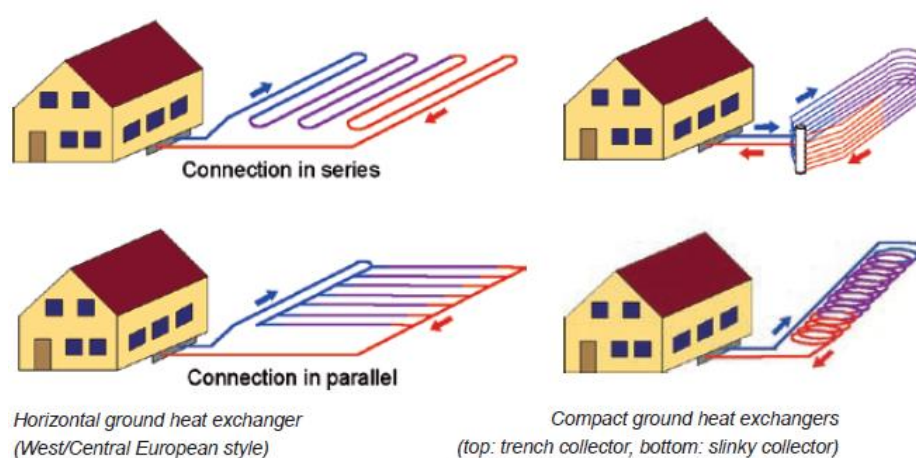

Fig E.5.7: Basic scheme of horizontal heat exchangers (EGEC, 2009).

## Vertical loops

### Borehole heat exchangers

Borehole heat exchangers (BHE) have a characteristic depth between 10m and 250m which can vary from country to country (Eugster & Sanner, 2007). There are two basic concepts of BHE systems, one with U-pipes and another with concentric pipes. In central Europe BHE are usually made with two U-shaped pipes of polyethylene such as PE100, or PE-X that is used for high temperature applications. The single pipes have diameters of between 40, 32 and 25mm (Fig.8). In Scandinavian countries the single-U pipes are used as standard.

The complete BHE system is normally made by a manufacturer, and is installed into the borehole by a drilling contractor. Directly after the BHE have been inserted into the borehole, the annulus is filled carefully and tightly through an injection tube from the bottom to the top. The purpose of filling is to create a good and compressed contact to the underground, and at same time to avoid any water effect and/or movement along the borehole (Eugster & Sanner, 2007).

The heat source for borehole heat exchangers is solar thermal in the upper ground, and geothermal heat flux in the lower ground), with some additional effect from flowing underground water or percolating water. The effect of groundwater in most cases is not very big, and the heat conductivity of the underground is the main parameter.

BHE technology can be used in all kind of buildings such as, small residential houses, large commercial and public buildings (schools, offices, hotels, shopping, etc).

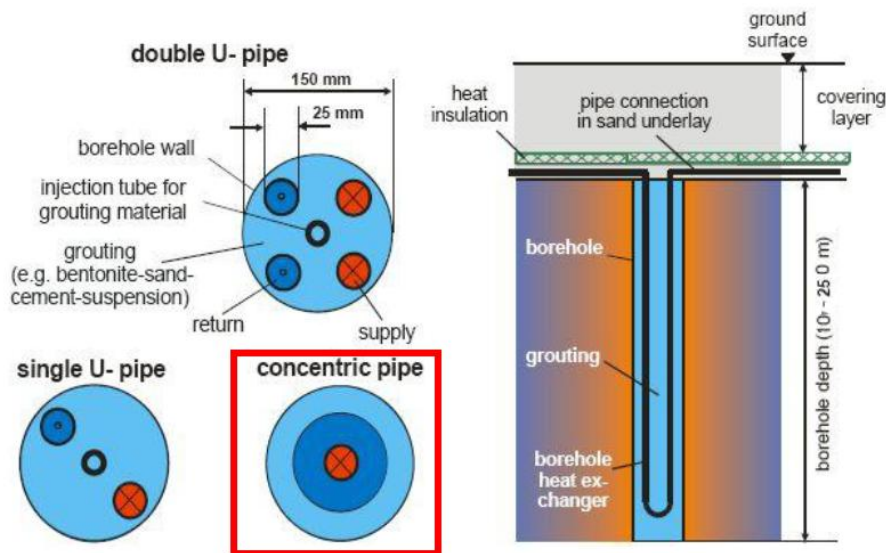

Fig E.5.8: Basic scheme of a borehole heat exchanger installation.  
VIA College University

### Energy piles

Energy pile technology is a special case of a vertical closed system, it includes deep concrete piles, diaphragm walls or other underground concrete components. Foundation piles have typically diameters from 40 cm up to 1 m, and they are outfitted with heat exchanger tubes that can be prefabricated or cast on site (Fig.E.5.9).

The geothermal heating or cooling energy source for energy piles is the flowing ground water. The system absorbs ground heat to warm up the cold water in the concrete piles, where after the hot water passes through a GSHP to heat the building. This system can under normal conditions also be used for temperate cooling in the summer.

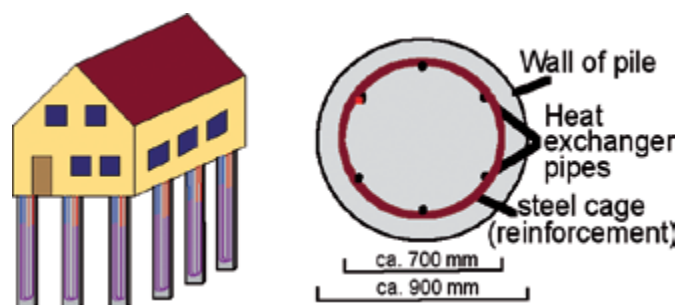

Fig E.5.9: Basic scheme of energy pile installation (EGEC, 2009)

## The current technological status

Horizontal ground heat exchangers are widely used in central Europe, mainly in Austria and Southern Germany, where they are using the trench collector for the cooling/heating applications.

The vertical GSHP technologies are mainly used as heating systems in middle and northern European countries because the higher heating demands. However in those countries there have also been used GSHP technology for free cooling and active cooling systems, but only in larger commercial installations. Of course, in southern European countries the cooling ability of GHSP technology is more important than heating (Eugster & Sanner, 2007)

In general over the last few years, the EU market has shown a strong and increased interest in the GSHP technology, as e.g. in Switzerland, 80% of the new-built small houses are equipped with a heat pump because of the market (Corry & Jones, 2011). In Germany there has been seen an increase in new GSHP units of around 20% in average per year over 5 years, and more than 100% in 2006 according to (Fig.E.5.10). These central European countries have a long history of using the GSHP, and they have now been followed by France, Luxembourg, Belgium, Ireland, Finland, Netherlands, the United Kingdom and the Eastern Europe countries. As of 2010 the GSHP technology has actually spread to all the EU countries (Eugster & Sanner, 2007).

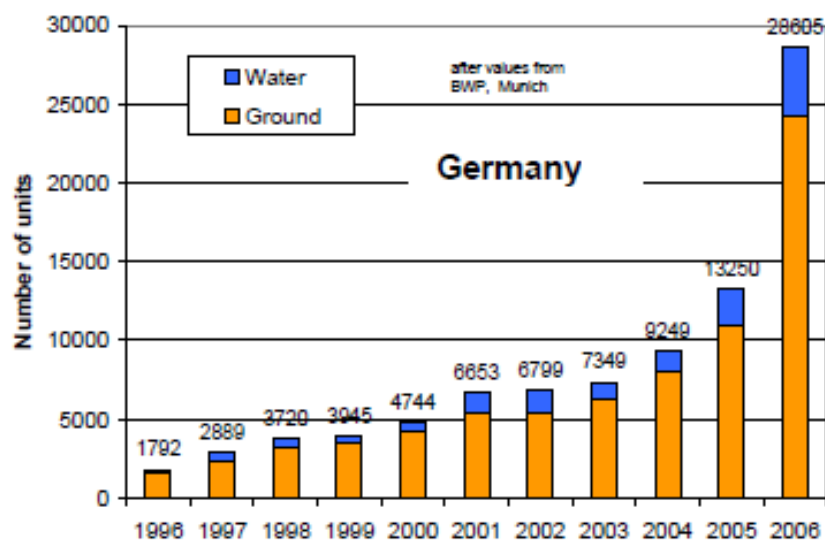

Fig E.5.10: Annual number of new ground source heat pump units in Germany since 1996 (Eugster & Sanner, 2007)

## FACTORS

### External input

Shallow geothermal technologies' external input can be represented as local or site specific circumstances, which are not only related to the geology and the climate. It is also connected to the legislation and sector of applications.



## Geological external inputs

Usually GSHP technologies are feasible in all type of geology, but the difficulty can be to find a suitable installation method on the site, for each special geological condition. Therefore the geological external inputs varies according to what type of system that are to be installed, it summarizes up to the following.

Closed loop systems are used in all types of geology. Still, thermal properties and drilling technologies may here be external input factors.

Open systems (based connected with ground water) normally requires one or more aquifers. Nevertheless, aquifer geometry, hydraulic properties and water chemistry will be other external input factors.

## Climatically external inputs

Climatically external inputs have a very important role in the application of geothermal technologies. One of the main reasons is that the ambient temperature of the ground, is reflected by the average temperature in the air. The type of climate such as Mediterranean, tropical, arid, maritime, or continental, will all be external input factors for the usage of a geothermal system (Fig.E.5.11).

Climate type	Weather conditions	GSHP systems	
		GSHP	UTES
Tropical	Hot, no seasons	Not feasible	Not feasible
Arid	Hot, cool nights	Not feasible	Storage of cold night - day
Mediterranean	Warm Summer Mild Winter	Occasionally feasible	Seasonal storage heat and cold
Marine	Warm Summer Chilly Winter	Feasible	Seasonal storage heat and cold
Continental	Warm Summer Cold Winter	Very feasible	Seasonal storage heat and cold

Fig E.5.11: Table of prime feasibility for GSHP systems in different climates(Corry & Jones, 2011)

## Economical external inputs

In the commercial market, investors expect that the geothermal systems should be cost-effective. However in some cases where a very ecological profile is desired, the system might not be able to sustain itself economically, and will then be dependent on favorable funding. For the commercial point of view the factors below, are main economical inputs for geothermal technologies.

- The total cost of operation and maintenance should be less than the competitive systems.

- The cost of extra investment for the geothermal systems has to be paid back by the value of energy saving and maintenance cost within the technical life time of the systems.
- The reasonable payback time usually is 10-15 years, but it can be different between the varying countries and sectors (Corry & Jones, 2011).

### **Legislation factors**

Legislation external inputs are associated to the laws, codes, standards and norms. Such rules are more common in those countries that already frequently use shallow geothermal systems, where as in other countries, there may be very few regulations. This situation creates a protective factor in itself, as the authorities do not know how to respond to certificate applications. Consequently, these technologies can sometimes cause big problems and never get the chance to develop. For that reason as a limiting factor, to create functional laws and standards in different countries, the legislators have to be more responsive, informed and possibly trained on how GSHP systems work and what they represent.

### **Environmental impact**

Geothermal energy is an environmental friendly energy source, especially when compared to fossil fuel or other conservative energy sources. GSHP technologies have a big contribution to CO<sub>2</sub> emission reduction and energy savings, all of them are big advantages for the environment (EGEC, 2009).

However any holes and installations into the ground may carry a potential environmental risk, mainly concerning the underground water. Because ground water is a premier resource of our drinking water, its protection is necessary.

The geothermal field is below the ground, and contains heated fluids and solids. The geological, chemical and physical characteristics of the ground resource can be very different from each other. When we exploit our geothermal resources for green energy production, the local environment can be adversely affected. As I mentioned before in chapter technologies of shallow geothermal, the GSHP systems have different extents a potential for ground and groundwater pollution. The main negative environmental impact related to GSHP system can be characterized as follows:

- Leakage of antifreeze or refrigerant
- Connecting aquifers to surface or connection of different aquifers
- Drilling into artesian aquifers
- Heat effects
- Negative effects due to anhydrite and swelling clays
- Pollution from the polluted drilling sites by unclean rigs.

Name	Percentage	Freezing point
Monoethylenglycol	25 %	-14 °C
Monoethylenglycol	33 %	-21 °C
Monopropylenglycol	25 %	-10 °C
Monopropylenglycol	33 %	-17 °C
Ethanol	25 %	-15 °C
<b>Salt (brines):</b>		
Potassium carbonate	25 %	-13 °C
Potassium carbonate	33 %	-20 °C
Calcium chloride	20 %	-18 °C

Fig E.5.12: Table of some suitable antifreeze agents; water antifreeze mixtures with the amount of antifreeze in percentage (Corry & Jones, 2011).

In Northern and central Europe, antifreeze (Fig.E.5.12) or refrigerants are often added in heat carrier fluids, for the closed systems to achieve a lower freezing temperature. In those cold areas winter temperatures are normally below 0°C, and it is impossible to use pure water for operating. Therefore too tight and badly designed loops, can cause environmental problems in cases where the heat carrier fluid leaks from the tubes and pose a threat to the groundwater (Corry & Jones, 2011).

In 2009 in south-western Germany, a small city was damaged by ground movements due to anhydrite that had come in contact with groundwater after geothermal drilling. Anhydrite (CaSO<sub>4</sub>) is slowly changed into gypsum (CaSO<sub>4</sub> \* 10 H<sub>2</sub>O), which is accompanied by a considerable growth in size of the mineral (EGEC, 2009).

The damages to the city were caused by the anhydrite rich rocks that grew under the presence of groundwater. These kind of damages starts very slowly, but if it has started, it is impossible to stop again.

Groundwater and underground protection together with sustainability, are determined by a clean installation and operation of the GSHP system, which requires high knowledge on the work force (planners, drillers or installer) and among the authorities. To give guarantees and to be responsible for the environment requires education, training and certifications (EGEC, 2009).

## Economical aspect

For geothermal heat pump systems, the cost is site dependent, but not as much as for deep geothermal systems. It is further possible to drill for a BHE in almost every location, with the cost not varying too much between the different sites.

The cost of a GSHP is depending on the geological underground. As e.g. granite is easier and quicker to drill with air and a downhole hammer, whereas clays and sands are slow to work with conventional rotary rig with mud and temporary casing. The availability of underground resources, such as groundwater determines the choice of an open or a closed system, and thermal properties will decide the necessary length of the BHE.

The operational cost is mainly influenced by electricity and fuel prices, and by the efficiency of the GSHP system. Systems that are used for both heating and cooling can be more efficient than only heating systems. The GSHP installation is used all year round, and the price of cold and heat from these systems falls into the same level of conventional alternatives, which is containing the payback of investment cost (EGEC, 2009).

For large profitable installations that are used for heating and cooling supply, geothermal heat pumps or geothermal energy storage can effect in reductions of operational cost, and a short amortization period. In many cases the geothermal system can further reduce the room usage for heating and cooling equipment in the building (e.g. by replacing cooling towers), and as a result free up valuable area for more cost-effective use.

## SWOT



Geothermal energy is a very stable renewable energy source, especially compared to other nature energy sources such as wind, water and solar. This is due to the fact that the ground source energy is not varying by the seasonal weather or climate conditions, and it also has a great availability.

In many countries around Europe, shallow geothermal energy has already been used efficiently for heating and cooling applications in a variety of sectors, from private resident houses to small industry buildings. It is a great and successful substitute for conventional (conservative) energy resources.

GSHP systems are the most commonly used shallow geothermal technology in Europe, and have a big contribution to CO<sub>2</sub> emission reduction and energy savings, all of them are big advantages for the environment.

The disadvantages of geothermal technologies have proved in the harnessing process, because any installation and construction holes drilling into the ground may carry a potential environmental risk. As I mentioned in chapter technologies of shallow geothermal, the GSHP systems have different extents to a potential for underground and groundwater pollution.

Out of consideration for the groundwater and ground protection together with sustainability, it is important to control the design of the installations and secure a clean operation of the GSHP systems. To do that, it requires a highly educated work force (planners, drillers, installers or controllers) and authorities, to give guarantees and to be able to show responsibility for the environment (EGEC, 2009).

GSHP technologies have a wide application in simple cases of heating and cooling of residential houses in many countries. For the future, more great opportunities for use of these technologies can be seen mainly in the large commercial sector such as offices, factories, department stores, hospitals, within Europe where sustainable heating and cooling supplies are required.

## INTRODUCTION

### The Earth's structure

Deep geothermal energy is a naturally occurring energy produced from the heat within the earth surface at a depth of 4000 miles (6400 kilometers). Here is a very hot core. Scientists estimate to reach a temperature of around 4200°Celsius (Alan w, 2010).

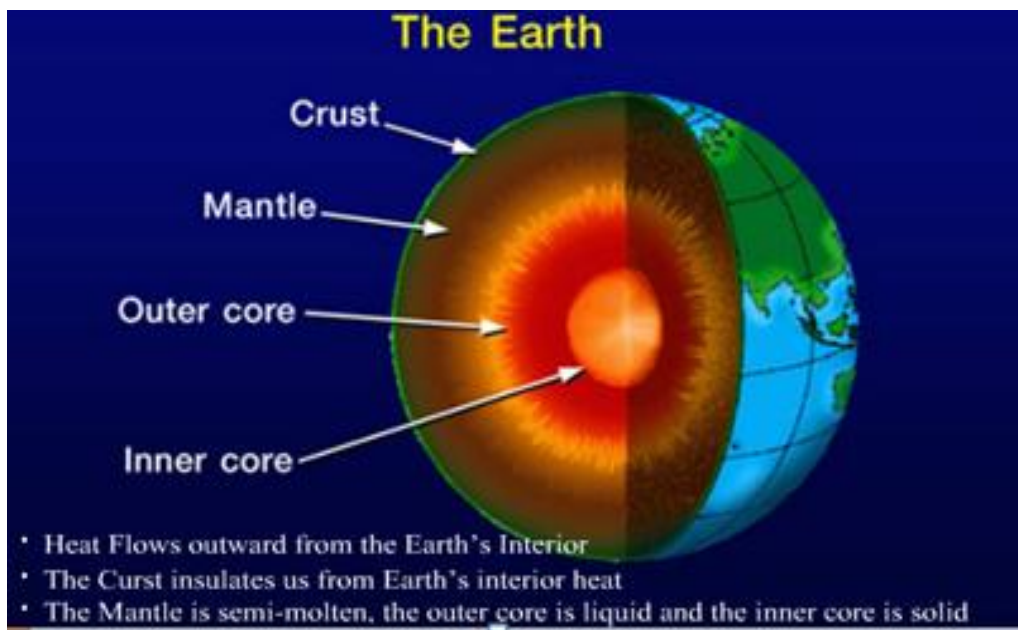

Fig E.5.13 : Inside the earth, layer (Alan w, 2010)

The heat that emanates from the core is great and sufficient enough to melt rocks into a hot fluid referred to as magma. The melted rock produce the outer core (fig 13), Geothermal Energy comes from this extremely hot core.

The heat created by magma increases through the earth's mantle, the mantle is the form layer that surrounds the core. Geothermal energy powers volcanoes, geysers, and also natural hot springs. Erupting volcanoes are perhaps the most famous geothermal events. When a volcano erupts magma from the underground shoots through the earth's crust and flows onto the surface as lava.

Over the time much research into geothermal energy has resulted in it being used in a positive manner, e.g. for heating homes and generating electricity.

Energy demand is rather on the increasing side, with the demand for it mostly for the purpose of heating homes and hot water production, especially during winter, however

also for fuelling cars, and for electricity generation to power all electrical gadgets right from the industry to personal computers.

Also with increasing standard of living and economic activities in countries over the world, there has been a tremendous demand for energy. Meeting these increasing energy demands therefore require exploring various sources of energy. Fossil fuels have over the years accounted for about 85% of primary energy generation (Bhargava, 2006).

The use of fossil fuels, a non-renewable energy source has come under much scrutiny in the recent years. Concerns that have been raised from the use of fossil fuels include, security of supply, non-renewable energy and been it has been identified as the major cause of climate changes.

It is in this respect that much attention has been focused on the use of renewable energy sources. Among them is geothermal energy, a renewable energy source that comes from deep under the ground, where the temperature is high, reaching over four thousand degrees.

## TECHNOLOGIES OF DEEP GEOTHERMAL

The use of geothermal energy can be classified into two. All take benefit of the heat beneath earth's surface either near to the surface or deep underneath.

Power plants systems generate electricity by use hot water and steam from deep underground to generate electricity.

Direct use systems, get their benefit from the high ground temperature at great depths by means of hot water that is at or close the ground surface.

### Direct use geothermal Energy

In some of the residences, hot water naturally derived up toward or near earth's surface. Naturally heated hot water which comes from the surface is termed to be a hot spring. Naturally heated underground tanks are also referred to as geothermal reservoirs; people have used this kind of hot water for many centuries. In locations that require hot spring or geothermal tank, people consumed simple methods towards the benefit by the heat.

In the direct use of geothermal energy, hot water runs as of a source (such as bore whole) into the house heating system. The temperature of the water can ranges from about (20°C -15 °C).

The heating system uses what is called a heat exchanger which is advice which can transfer the heat from single to another, such as from water to air. One example of a heat exchanger is the radiator.

The radiator releases the heat. Pipes at that point transfer the water back into the underground, from then water is heated once again and used again to produce extra energy.

## Geothermal Power Plant

Geothermal energy is moreover used to produce electricity .Hydrothermal system, which use a hot water or vapor from underground to concealed, energy as of earth's heat into electricity.

The dry steam power plants flash steam power plants and binary cycle power plants are the three main types of hydrothermal system .These three systems harness their power source through hydrothermal fluid which is water or steam that is naturally heated with earths. (fig.E.5.14) showing all the three major types of geothermal power plants, steam, hot water or vapor is used to drive a turbine.

### The dry –steam power plants

Takes steam inside earth then use it to drive a turbine.  
 Geothermal reservoirs within the Earth are filled with steam. Before a well is drilled

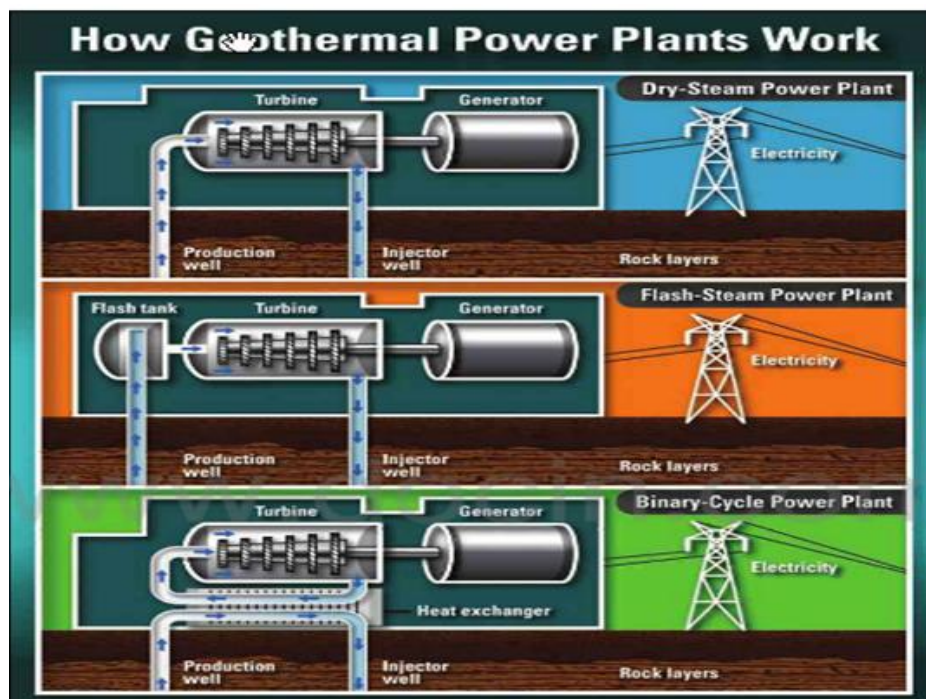

Fig E.5.14: Geothermal power plants generator produced the electricity(Alan w, 2010)

to reach the steam. The steam rise through the well. As it rises, it spins the rotors of the turbine. The turbine is connected to a generator. Electricity produce by the generator can carried by wires to where ever people need it. The dry-steam power plants were the first kind of geothermal power plant.



## The Flash –steam power plants

In the direct use of geothermal energy, hot water runs as of a source (such as bore hole) into the house heating system. The temperature of the water can ranges from about (20°C -15 °C).

The heating system uses what is called a heat exchanger which is advice which can transfer the heat from single to another, such as from water to air. One example of a heat exchanger is the radiator.

The radiator releases the heat. Pipes at that point transfer the water back into the underground, from then water is heated once again and used again to produce extra energy. Heat comes to the well surface. The surface is sprayed into the tank. The reservoir is considered to be much lower than the geothermal fluid pressure. When the hot water hit the tank, it vaporizes (turns-steam), a flash of energy. Energy flash turns a turbine, which is connected to an electric generator rotor.

Some flash steam power plant use more than one tank. If there is still hot water in the first tank, it can be flashed again in the second tank, through the heat energy. When the steam cools, it changes back into water. Water may be forced back into the land to be reused. Flash steam plant is the most common type of geothermal plants in use today.

## The binary-cycle power plants

Binary-Cycle Plants usually Organic Rankine Cycle (ORC) units are usually set up to draw out heat from the low and medium temperature geothermal fluids (typically 70-1700C), hydrothermal and EGS-type plants. Binary plants are convoluted than condensing ones because geothermal fluids are channeled via a heat exchanger which heats other working fluid. Working fluids like pentane or isobutene with low boiling point evaporates and drives a turbine. It is then cooled off using air and it condenses back to water. Binary plants are often built as a modular unit linked several MW in capacity. There is also a combination of hybrid power units which consist of two or more of the above basic types. For example, using a binary with a flash stream plant to ameliorate the versatility and also to increase the general thermal efficiency. This improves the load capacity of the lowest – cycle power plants and resources to effectively cover a wide temperature range.

## CURRENT STATUS

In some parts of Europe, geothermal power plant already makes an important contribution to the environment and sustainable energy, the use of steam and hot water tank using existing technology.

This is done mainly in Italy, Iceland and the azores including other volcanic islands in Europe. In Iceland, geothermal energy lays a foundation on which the supply of completely renewable energy is built. In South-East Europe, Turkey and the Caucasus in the vast unexploited reservoirs also contribute to a sustainable energy supply. In Austria there are two power plants using binary technology, one at Blumau(0.2MW,which started in 2001) and other at Altheim(1MW,which started in 2002 it uses river water to cool the condenser).In Germany ,technology is used to generate geothermal binary cycle power.

Ever since November 2003, at Neustadt- Glewe a ca, 0.2 MWe (megawatt electrical )pilot plant using this process and additional twenty megawatts (4 or 5 plants) have been used, is currently in the design and building phase, mainly in southern Bavaria. The most developed project is that of Unterhaching.

This little town is situated in the southwest of Munich, has 122 ° C hot water depth at a 3446 meters depth flow rate of 150 l/s. The considered system is made up of 41 MWt combined heat and power (CHP) plant that might be able to develop an electrical volume of 3.5 to 4 MWe (Eurobserv'ER, 2005).

Geothermal power plant electricity production has move higher since 1999, in Iceland significantly, with the setting up of new plants at Svartsengi, Krafla and Nesjavellir with current value of 202 MW. Additional 30 MW single flash unit at Nesjavellir is at an advanced stage of construction (Ragnarsson, et al 2005).

Italy celebrate it first geothermal power plant installation centenary in the year (Larderello 1904) hosts two major high-temperature geothermal deposits in Europe (810.5 MWe out of 1059.9 MWe).

Italy geothermal plants are concentrated around the three locations: Larderello (563 MWe), Travele-Radicondoli (160 MWe) and Monte Amiata (88 MWe). Italy mounted 10 new power plants in the last five years with a total volume size of 264 MW in Italy (EurObserv'ER 2005, and Buonasorte al, 2007).

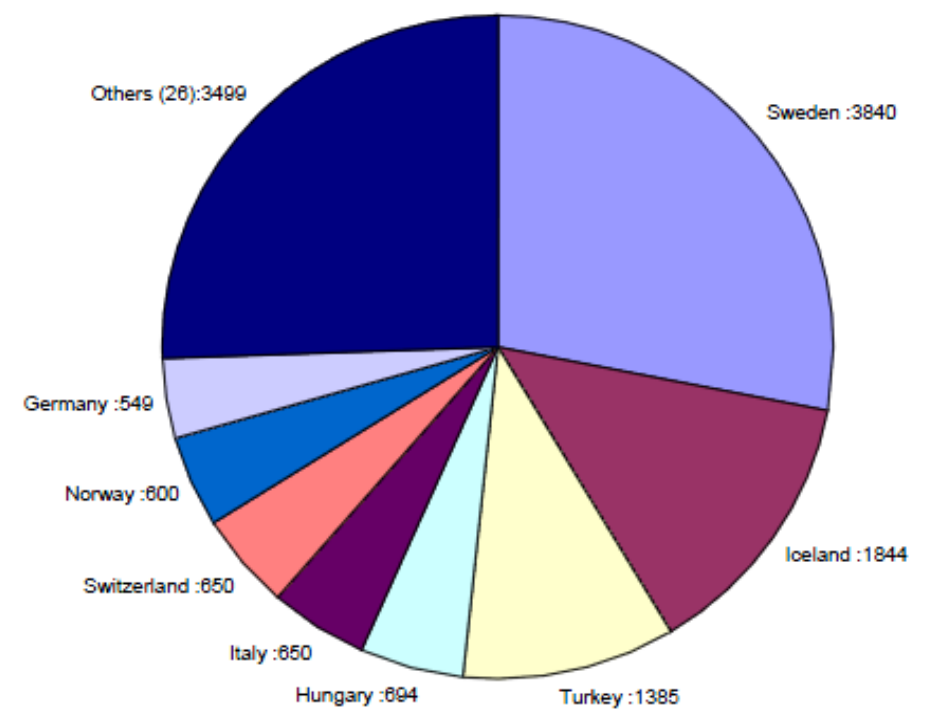

Fig E.5.15: Geothermal direct use capacity distribution in Europe (MWt).

# FACTORS

## Environmental Impact

Potential environmental effects of conventional hydrothermal energy power are widely known to the public. Several reports and articles have referenced the various potential impacts of dry steam, geothermal flash steam and binary power conversion systems. The general deduction from all the studies shows that emissions and other impacts from geothermal plants are much lower than that from generating electricity (Armstead et al., 1987)

There are a lot of prospective environmental impacts of geothermal power development which includes gaseous emissions, solid emissions, water pollution, noise pollution, land use, land subsidence, induced seismicity, water use and induced landslides. In spite of this long list, recent geothermal energy technologies generally have a reduced impact on the environment than the conventional fossil fuels and nuclear power plants.

For example, the power plants situated above the geothermal resource by eliminating the need for (a) Mine physical source of energy (fuel) in the classical sense and in the procedure disrupt the earth's surface.(b)Processing the fuel and the use of additional energy for transporting the fuels over long distances. Moreover, the conversion equipment used in geothermal energy is relatively compact, making the general footprint of the entire system small. Particulate matter or nitrogen oxides are not released into the atmosphere with geothermal energy and radioactive waste materials need not be disposed.

The next section presents some estimated overview of summarized environmental issues from various power plants and geothermal power plant systems.

### Gaseous emissions

Gases are emitted as a result of the release of noncondensable gases (NCGs) that are carried in the source stream to the power plant. The emissions remain controlled through the scheme design process. The naturally occurring NCGs in the production fluid of steam and flash plants must be removed to obviate the buildup of pressure in the condenser and the loss of power from the steam turbine.

The whole flow of NCGs can be treated chemically to remove H<sub>2</sub>S (hydrogen sulfide) or can be recompressed and pumped back into the ground with the spent liquid stream from the plant. These solutions require strength, which tends to increase the parasitic load and reducing plant output and efficiency.

This problem is avoided by binary plants because they only recover heat from the source fluid using a secondary working fluid stream. The source of geofluid or subsurface fluid streams are re-injected without discharging any of the non-condensable.

Plant type	CO <sub>2</sub> kg/MWh	SO <sub>2</sub> kg/MWh	NO <sub>x</sub> kg/MWh	Particulates kg/MWh
Coal-fired	994	4.71	1.955	1.012
Oil-fired	758	5.44	1.814	N.A.
Gas-fired	550	0.0998	1.343	0.0635
Hydrothermal – flash-steam, liquid dominated	27.2	0.1588	0	0
Hydrothermal – The Geysers dry steam field	40.3	0.000098	0.000458	negligible
Hydrothermal – closed-loop binary	0	0	0	negligible
EPA average, all U.S. plants	631.6	2.734	1.343	N.A.

Fig E.5.16: Gaseous emissions from various power plants by (kagel et al., 2005)  
N.A: means not available

## Water Pollution

Liquid streaming from the drilling, stimulation and production may comprise of a number of dissolved minerals particularly in high temperature reservoir (>230°C). The amount of solute is directly proportional to the temperature (thus it increases significantly with temperature). Majority of these dissolved mineral (eg. boron and arsenic) could have intoxicated the ground water and harm local plants. Liquid streams can affect the environment via surface runoff or via cracks in well casing. Surface runoff is controlled by maneuvering fluids to impenetrable holding ponds and injection of all waste streams deep underground.

To prevent from leaking into the shallow freshwater aquifers and casings are designed with multiple redundant arrays to provide a barrier between the adjacent formations and the inside of the well. However, it is essential to observe and supervise the wells during drilling and subsequent operations, so that any leakages detected via casing failures can be addressed with immediate effect.

## Noise Pollution

The deafening sound from geothermal setups is regular of numerous industrial activities (DiPippo, 1991). The loudest noise levels are typically produced in the course of well drilling, stimulation and trying stages. Noise level in the range of about 80-115 weighted decibel occur in the plant fenced boundaries. In the course of a normal operation of a geothermal power plant, ranges from 71-83 decibel at a distance of 900m (DiPippo, 2005).

The level of noise from the source drops with distance, so that if the plant is placed in large geothermal reservoir areas, noise limits should not be unwelcomed. The noise level can further be minimized by the introduction of dumpers or other soundproofing means at an extra cost. For comparison, choked urban areas tend to have noise level of about 70-80 decibels and the noise level near a large highway around 90 decibels.

## The Land Use

Land fingerprints for hydrothermal power plants differ considerably in location, since their good option for waste stream discharge and geothermal reservoir fluids are mostly site-specific.

Normally, the power plant is built near or on the geothermal reservoir since long lines degrades the temperature and pressure on the geo-fluid. Although these items may conceal large areas of about 5- 10km<sup>2</sup> or more, well pads themselves only cover up to 2% of the zone.

Gathering pipelines are usually mounted on stanchions, in order to use the remaining plot for cultivation and pasture (see Fig E.5.18). Imprint power, cooling tower and ancillary buildings and substations is comparatively modest. Holding ponds for temporal discharges (during drilling and stimulation) may be significant, but they stand for only a small part of the total well field. (Fig E.5.17).



Fig E.5.17: Typical pipeline at Miravalles geothermal power plant, Costa (photo by R. DiPippo).

Technology	Land use m <sup>2</sup> /MW	Land use m <sup>2</sup> /GWh
110 MW geothermal flash plant (excluding wells)	1,260	160
20 MW geothermal binary plant (excluding wells)	1,415	170
49 MW geothermal FC-RC plant <sup>(1)</sup> (excluding wells)	2,290	290
56 MW geothermal flash plant (including wells, <sup>(2)</sup> pipes, etc.)	7,460	900
2,258 MW coal plant (including strip mining)	40,000	5,700
670 MW nuclear plant (plant site only)	10,000	1,200
47 MW (avg) solar thermal plant (Mojave Desert, CA)	28,000	3,200
10 MW (avg) solar PV plant <sup>(3)</sup> (Southwestern US)	66,000	7,500

Fig E.5.18: Comparison of land requirements for typical power generation options, using data from (DiPippo., 1991b)

## Economical Aspect

According to the feasibility studies made from Coalgate University College in New York, 2009 in terms of cost of installing geothermal power plants. Setting up geothermal heating and cooling systems is associated with a lot of cost. This includes mining, construction materials and the cost of installing pipes and other necessary mechanical units and a heat pump. Based on the data obtained from Hamilton College, each well cost about \$5313 to dig and mechanical system (labor, piping, glycol etc.) costs are around \$29,875 per well. A structure requires about one well for every 1,300 square feet of a building space. The cost of the heat pump alone is about \$2500 per ton of capacity on average. In the climate of the village of Hamilton, the climate, about one ton of geothermal heating or cooling capacity required about 500 square feet building.

## SWOT



# CONCLUSION

The following are the strength, weakness, opportunity and threat for geothermal energy: Geothermal energy power plants generate a stable and predictable base load power. Carefully monitoring and controlled geothermal sources can supply energy and provide power for decades.

Since the ancient days people have been using this source of energy to swim, materials and food preparation .Today it is also used for heating homes and office as well as compatible with agriculture land use. Geothermal plants pollute the environment but not as much as the traditional fossil fuel power plants. This type of technology is not widely used due to lack of equipment, personnel and facilities. The setting up of a geothermal energy site is very expensive because it requires the installation of a power plant, time investment and hiring a qualified trained personnel to be in charge.

Geothermal sites can run out of steam over time due to too much water drop injected to cool the rock or drop in temperature and this can cause major damage to individuals or investors. By developing new technology to improve the permeability of the rock .This can be done by supplementing the water with hot water deficient rocks. Scientist predicts that by the year 2020, artificial reservoir can generate 5%-10% electricity power to the whole world. Physical plumes seen rising from the geothermal power plant emissions is the water vapor, containing low emission because geothermal energy does not produce smoke.

Research has proven that geothermal energy has less effect on the environment that other energy sources like fossil fuels. Last but not least geothermal energy is reliable and it provides base load power which stands out among most other renewable options existing.

# SYSTEMS

Heat Pumps  
Cogeneration (CHP)  
Hydrogen

---



# HEAT PUMP

## KEY WORD

- ASHP: Air Source Heat Pump
- Btu/h: British thermal unit per hour
- COP: coefficient of performance
- EER: energy efficiency ration
- GSCP: Ground source heat pump
- SPF: seasonal performance factor

## INTRODUCTION

### CREATION

The Heat Pump was invented in 1855 - 1857 by Peter von Rittinger, but his achievement would not have been possible without other important previous advances in the field. In 1748 William Cullen demonstrated artificial refrigeration. In 1834 Jacob Perkins designed a practical refrigerator with diethyl ether. In 1852 Lord Kelvin, a British engineer, described the theory of the heat pump. He foresaw the use of heats pump in the cooling oh buildings. In 1855 – 1857 Peter von Rittinger developed and built the first heat pump. In 1940 Robert C. Webber developed and built the first ground heat pump.

### EVOLUTION

Since the firsts heat pumps, a lot of improvements have been implemented, triggering a rising in the efficiency and, therefore, in the COP. Some of these improvements in the last decades are:

- Thermostatic expansion valves can get more precise control of the refrigerant flow to the indoor coil.
- Variable speed blowers. These are more efficient and are able to compensate some of the adverse effects of restricted ducts.
- Improved design of the coil.
- Improved design of the electric motor and two speed compressor.
- Copper tubing grooved inside to increase area.

# DESCRIPTION

## TECHNOLOGY

### OPERATION PRINCIPLE

It is known that heat flows from hot areas to cold areas and that is the reason why there is a need to constantly heat buildings spaces. The idea is to drive heating from outside heat sources (ground, water, air...) or from heating human waste into buildings, with the smallest amount of energy required as possible. There are many different systems with their own efficiency, advantages and disadvantages. Moreover, heat pumps can have many others applications than heating, especially in industry. The Heat Pump is the device that can create a revolution in construction and in a few years in industry.

### EFFICIENCY (COP)

It is better to talk of Coefficient Of Performance (COP) instead of heat pump efficiency. It is the ratio of heat delivered in system distribution and electricity required to make the system work. This coefficient permits the determination of which kind of heat pump will be the best for our needs: industrial, domestic, hot or cold area:

Pump type and source	Typical use	COP variation with output temperature					
		35 °C	45 °C	55 °C	65 °C	75 °C	85 °C
Air source heat pump (-20 °C)		2,2	2,0	-	-	-	-
Air source heat pump (0°C)	Low output temperature	3,8	2,8	2,2	2,0	-	-
Ground source heat pump water at 0 °C		5,0	3,7	2,9	2,4	-	-
Ground source heat pump ground at 10 °C	Low output temperature	7,2	5,0	3,7	2,9	2,4	-
Theoretical Carnot cycle limit, source -20 °C		5,6	4,9	4,4	4,0	3,7	3,4
Theoretical Carnot cycle limit, source 0 °C		8,8	7,1	6,0	5,2	4,6	4,2
Theoretical Carnot cycle limit, source 10 °C		12,3	9,1	7,3	6,1	5,4	4,8

Figure S.1.1: Table to compare efficiency of different heat pumps in relation to output temperature.

Typical heat pumps, in good conditions, can provide for instance 300 kWh of heat which can be used, with only 100 kWh of electrical energy, and 200 kWh heat from environment or human waste. It should be noted that the COP decrease when the difference of temperature between the heat source and the heat sink increase. This is the reason why heat pumps are better performing in warm areas. Ground source heat is preferred instead of an air source, because the ground has relatively the same warm temperature during the whole year, and that is not the case of air which can vary between -20°C to 35°C in some areas. To consider this parameter, there exists the Seasonal Performance Factor (SPF) which is the ratio of the heat delivered and the energy required over the season in order to compare the heating and cooling demands. Moreover, instead of COP, when it is a question of cooling, it is common to use the Energy Efficiency Ratio (EER), not expressed in W but in Btu/h. (1Btu/h=0,293W)

Users have to be aware that several factors reduce efficiency of heat pump:

- The difference between heat source and heat sink
- The size of the heat pump as a function of the demand
- The control system
- The energy consumption for auxiliary system (fans, hybrid system need more heating...)
- The heat exchanger must be the largest possible
- The type of heat pump: air may condense inside the system and may freeze, so energy needed to defrost it, or to move air into the system which requires more energy than liquid.

## REFRIGERANT

The fluid which transfers the heat in the heat pump is the refrigerant. The refrigerant is a volatile fluid sealed in to a closed circuit and must not degrade in the life of the device. Different refrigerants are available. Chlorofluorocarbons, such as R-12 was often used until the 1990s, but now it is not allowed because it causes damage to the ozone layer if release into the atmosphere. R-134a has been adopted widely but heat pumps that use this refrigerant are not as efficient as those that used R-12. Ammonia (R717) is used on a large scale. Propane and butane can be used as well. Recently, the carbon dioxide (R-744) has increased and R-22 is still widely used. However HFC R-410A does not damage the ozone layer and is being used also. Nowadays, most refrigerators use isobutene, which does not damage the ozone layer. The use of Dimethyl ether is also increasing.

## TYPES OF HEAT PUMPS

### ACCORDING TO THE OPERATION MODE

#### COMPRESSION

Most of the heat pumps work in compression, because of its high efficiency. Its need of electric energy or fuel is the disadvantage of this heat pump, even if heat from fuel can be used on the condenser. How does it work?

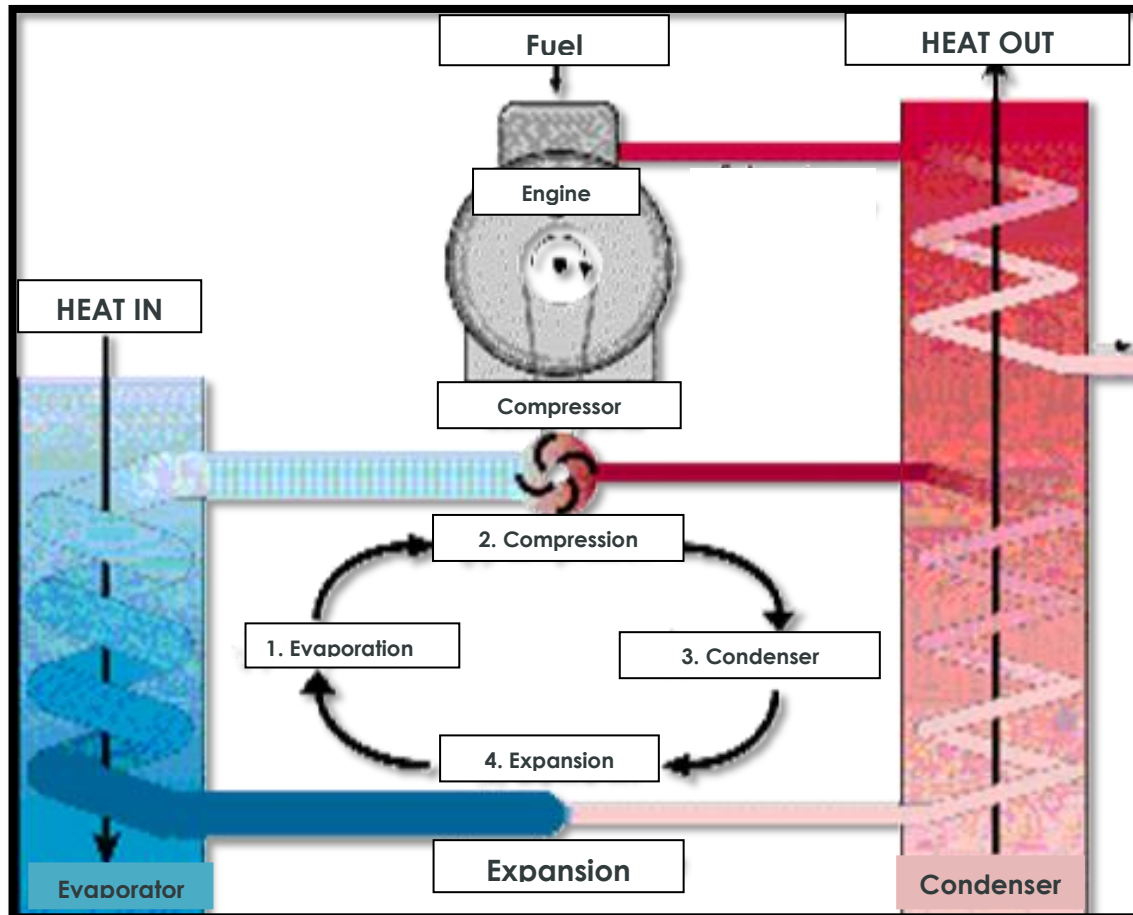

Figure S.1.2: Closed cycle, engine-driven vapour compression heat pump. (IEA Heat Pump Center, 2010)

A compression heat pump is composed of four components and an engine to provide energy (electric motor or combustion engine) to make the compressor work. Those four main components, which are the evaporator connected with the heat source, the compressor, the condenser, connect with the heat sink with the second exchanger, and the expansion valve, are linked in a closed circuit where a refrigerant is circulated.

Firstly in the evaporator, heat from the heat source is transferred to the refrigerant which has a lower temperature, because heat naturally flows from higher to lower temperatures. Then, the heated refrigerant evaporates into the compressor. There, high pressure is applied to the hot vapor, which increases refrigerant temperature in order to inject it into the condenser where it transfers heat to the heat sink with the help of an exchanger and the natural flow of heat. Then, the condensate hot vapor is driven into the expansion valve to decrease the pressure and therefore decrease the temperature. Finally, it returns in the evaporator at its natural temperature, in order to make another cycle.

## ABSORPTION

The advantage of an absorption heat pump is that it does not need electricity, but only natural gas, because it works with an internal combustion engine. In addition to areas where electricity is expensive, this kind of heat pump is particularly useful in cool areas, because it needs lower operating temperature from outside sources. How does it work?

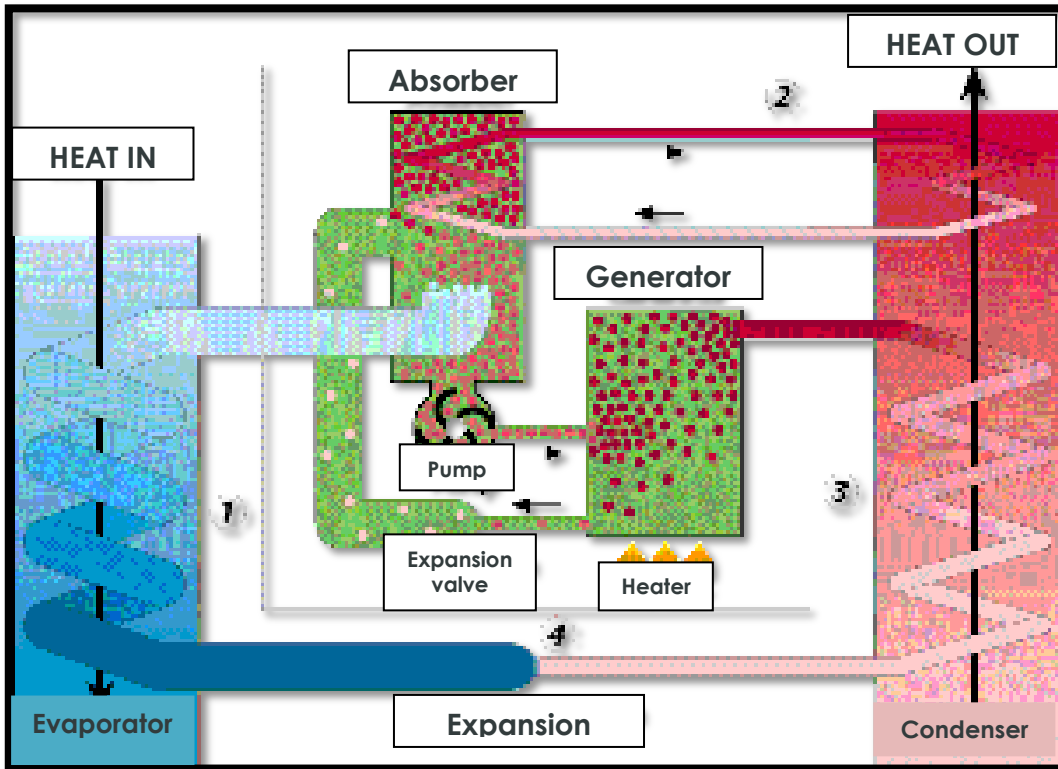

Figure S.1.3: Absorption heat pump (IEA Heat Pump Center, 2010)

Its way of working is similar with the electrical compression heat pump with its main components: the evaporator, the condenser and the expansion valve. The new element is the electrical compressor which is replaced by a natural compressor made with mainly an absorber and a generator heated with the natural gas. Like in the previous one, the refrigerant called the working fluid is in liquid state in the evaporator. Being in contact with the heat source makes it into a vapor. This vapor goes up naturally into the absorber where the vapor from the working fluid will be absorbed into the absorbent. Nowadays, two different couples of working fluid / absorbent are used: Water/Lithium bromide or Ammonia / Water (It should be noted that water can be used for the working fluid or for the absorbent!)

This absorption produces heat that is used to heat the heat sink, and this is the reason why the temperature of the heat source can be lower than with an electrical compression heat pump. Once the vapor is absorbed into the absorbent, a little pump mechanically drives the liquid into the generator. There, it will be heated by the natural gas (at the end, this waste heat will also serve to heat the sink) in order to separate absorbent and the working fluid drive naturally them into respectively the absorber to be reused and the condenser to heat the heat sink.

## ACCORDING TO THE SOURCE/SINK STATE

### AIR-AIR

This is a very popular type of heat pump, and the cheapest. In fact, an air conditioner is an air to air heat pump which cool the inside air. The air to air heat pump transfers the heat from the outside air to the inside air. This air contains some heat, so the device can take some heat to cool or heat the interior of the building. The main components of an air-air heat pump are:

- An outdoor exchanger coil, which extracts heat from the outside air
- An indoor exchanger, which transfers the heat to the inside air

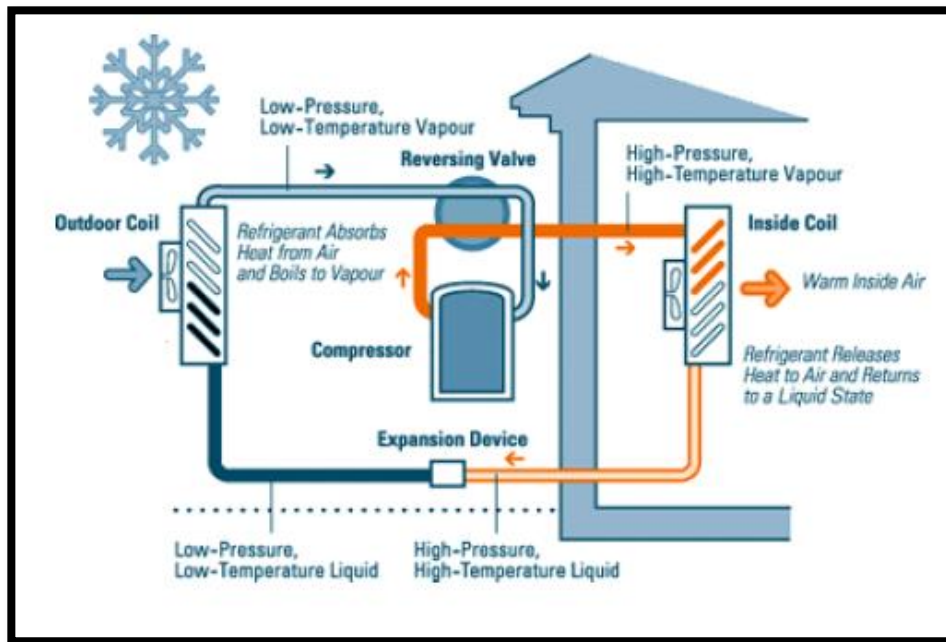

Figure S.1.4: Air- Air heat pump. (Poulsen, C., 2012)

## AIR-WATER

In this type of heat pump, the outside air is still the heat source, but the heat is transferred into a heating circuit, a floor heating (the most efficient), or even into a water tank to be used in the shower and hot water taps of the building. Air to water heat pump usage is growing in Europe because it is very easy to install and to integrate in to an existing water system.

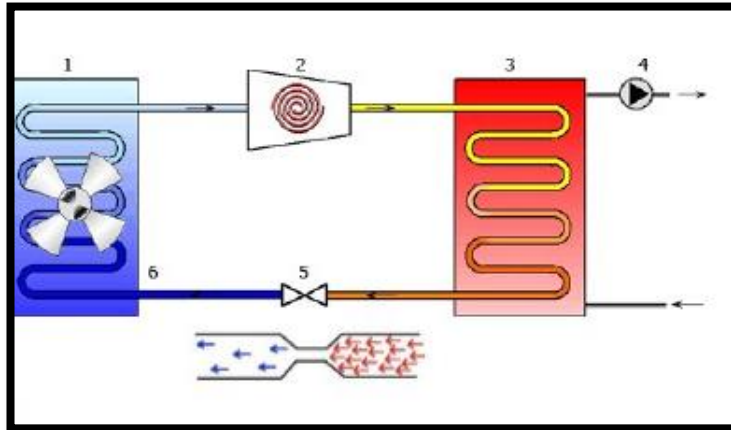

Figure S.1.5: Air- Water heat pump. (Poulsen, C., 2012)

## WATER-WATER

In this case, both the source and the sink are water. The process is similar, but there are differences in the exchangers. Usually the water source is in the ground (ground- source systems), but can be different: river, waste water...

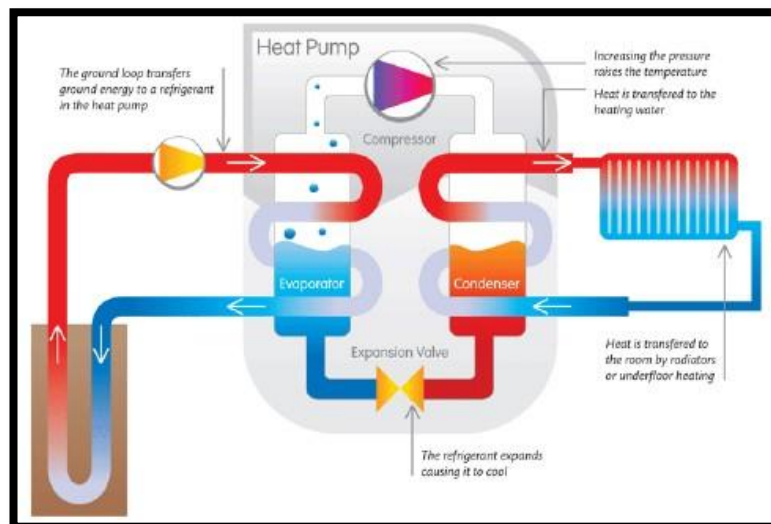

Figure S.1.6: Water- water heat pump. (Poulsen, C., 2012)

## ACCORDING TO THE SIZE

### STANDARD HEAT PUMPS

In houses, usually, there is a possibility of choosing to implement the heat pump outside or in the boiler room, so any type of heat pump can be chosen as needed based on the function of the device to which the heat pump is linked. Actually, the supply temperature range needed will depend on the application:

Application		Supply temperature range (°C)
Air distribution	Air heating	30 - 50
	Floor heating; low temperature (modern)	30 - 45
Hydronic systems	Radiators	45 - 55
	High temperature (conventional) radiators	60 - 90
	District heating - hot water	70 - 100
	Under floor heating	30 - 35
District heating	District heating - hot water/stream	100 - 180
	Cooled air	10 - 15
Space cooling	Chilled water	5 - 15
	District cooling	5 - 8

Figure S.1.7: Table of supply temperature range in function of different applications of heat pumps (IEA Heat Pump Center, 2010)

### LARGE SCALE HEAT PUMPS

In industry or in commercial environments, most of the time, the heat pump has to be outside of the building because of the lack of space. So in order to avoid a supplementary boiler, it is easy to choose an absorption heat pump which does not need high temperature from the heat source to work. But the choice of the heat pump still depends on the difference between the heat source and the heat sink.

It is common for commercial and institutional buildings to prefer heat pump with water in order to be able to cool and heat different places at the same time by dividing a loop into little loops for each rooms. In that case, the source is cold but is reinforced by a boiler in the case of heating. To cool room driving cool water into the building can reduce or even eliminate the air conditioning.

It may be noticed that using heap pumps for industry has a COP more efficient than heat pumps for residential buildings. That can be explained because conditions for operating in industry remain stable in comparison to house conditions. Moreover, industry needs lower temperatures so the difference between the heat source and sink are smaller.



Heating need	Temperature [°C]	Purpose
Hot Water	50 - 95	Production process
Cleaning	30 - 40	General cleaning
Meat	< 60	Production cleaning
Fish	< 40	Production cleaning
Dairy	< 100	Process
Heating	> 40	Continuous

Figure S.1.8: Table of temperature required in function of several industrial applications. (Poulsen, C., 2012)

## CURRENT STATUS

### SITUATION

Despite the increasing use of heat pumps, fossil fuels still dominate the market of heating houses, and air to air heat pump have a big implementation in the market of cooling buildings. In some European countries like Germany, Switzerland, Austria, Sweden, Denmark, Norway, and France and in USA as well, a large number of geothermal heat pumps are currently working.

Most of the market development takes place in Central and Northern Europe. In these countries air conditioning is rarely required, so heat pumps mainly operate in the heating mode. With the inclusion of more applications and the proliferation in to the South of Europe, the use for both heating and cooling will be more important.

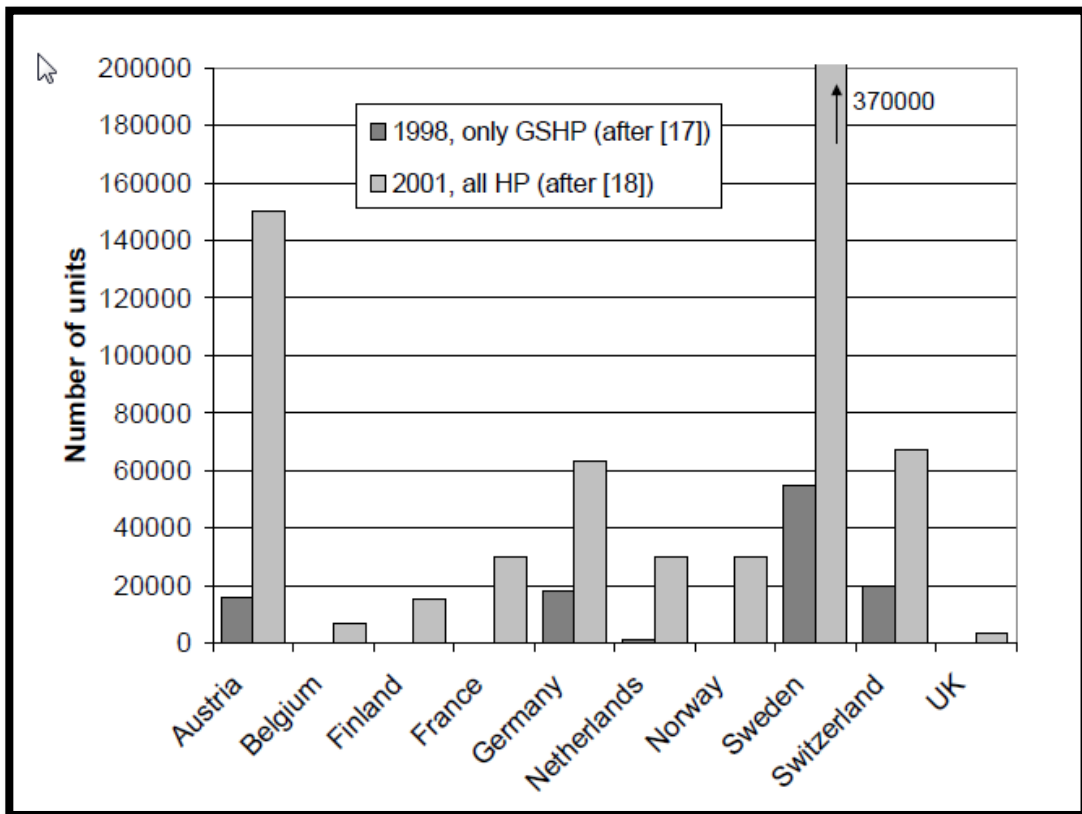

Figure S.1.9: Number of installed heat pump units in some European countries (Sanner, B. et al., 2003)

As for the Ground source Heat pumps, the popularity is still modest in Europe, with the exception of Sweden and Switzerland. Further market growth can be expected.

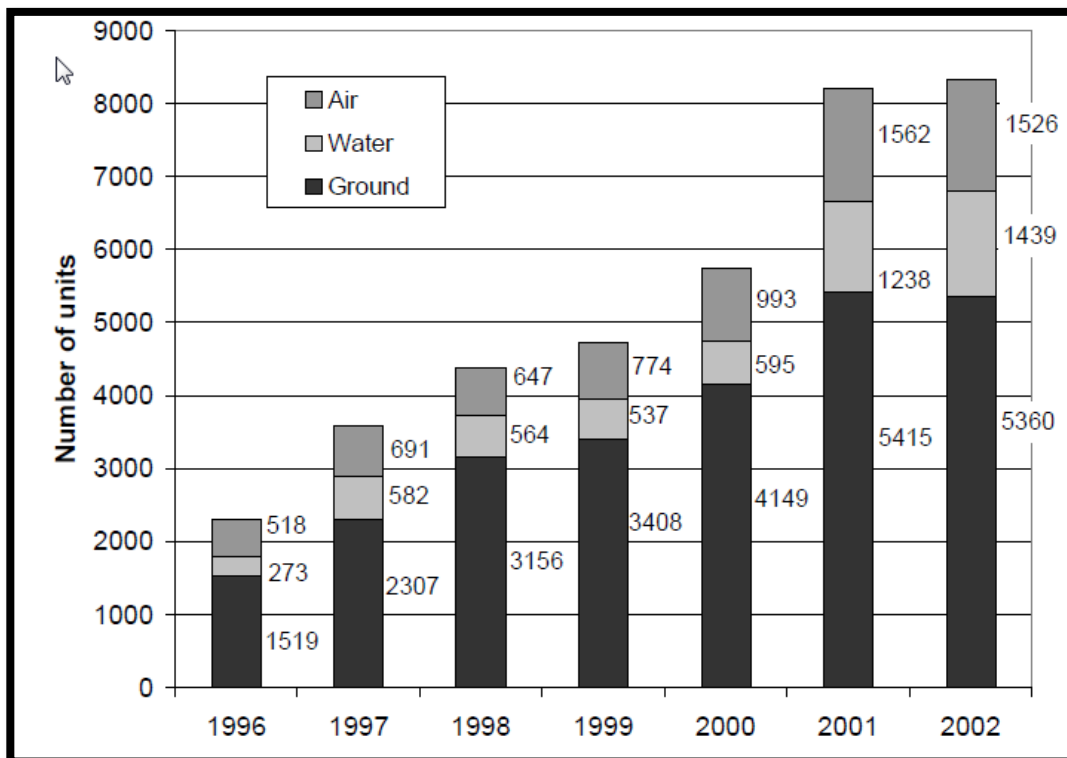

Figure S.1.10: Annual heat pump sales in Germany (Sanner, B. et al., 2003)

## EXTRA APPLICATIONS

The main utilization of heat pump is heating room spaces, and also cooling for some of them. Moreover, the heat pump can be used to heat domestic water for cleaning, taking a shower or even for hot tub or swimming pool. This can be very interesting because we need to heat the swimming pool during the summer when we need to cool the house. In that case, one can be the source, while the other is the sink!

As seen previously, in industry, the heating requirements can be varied. In addition to the heating system, heat pumps can be useful during the process of production especially for dairies, to clean spaces with hot water (breweries, beverage industry, etc.) and products (fruits and vegetables, etc.) or to dry ham or fishes.

## COUNTRIES CONCERNED

Heat pump systems are well developed in the world, and according to the area, some kind of heat pumps are more common than others.

For example, Japan and United States give priority to air distribution, while Europe Canada and north east of United States favour water. That can be explained by the fact that in the latter countries, the temperature often goes under zero degrees Celsius during the summer, so using air like a heat source could have bad effects with condensation which can freeze in the system.

Even if it is well known that the heat pump has been a proven technology for many years in the north of Europe (Sweden, Norway, Finland, and Denmark), it is interesting to focus on Europe to evaluate, where the heat pump could be developed, where it is developed and also where it is trendy.

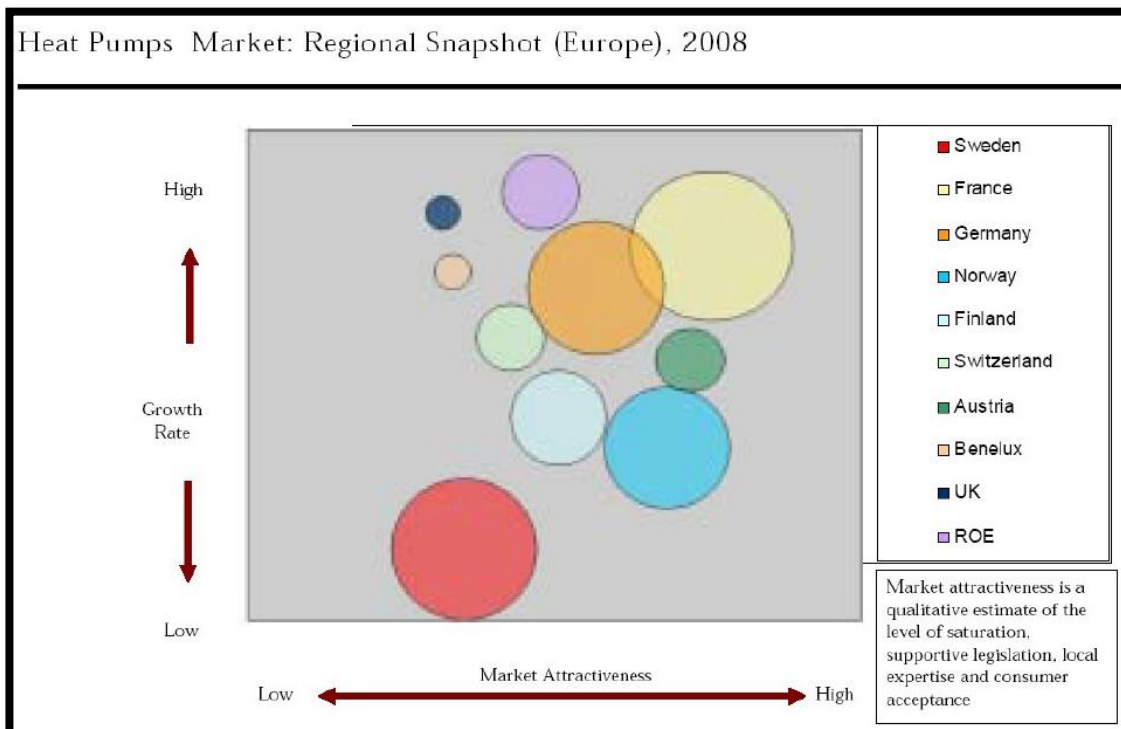

Figure S.1.11: Heat pump market in Europe (Poulsen, C., 2012)

# FACTORS

## EXTERNAL INPUTS

### HEAT SOURCES / SINKS

#### NATURAL

##### **Air**

Air source heat pumps (ASHP) extract the heat from the outside air, and can deliver it either to the inside air or to an interior water system. They work by the same principles of an air conditioner, but air conditioners are optimized for cooling instead of heating. ASHP have historically been the most widely used type of heat pump, because they are the simplest and the cheapest, but when the exterior temperature fall below around 5° the heat pump starts being less efficient. An air source heat pump will never be as efficient as a well-designed ground source heat pump. The COP in a mild weather may be around 3-4 but it decreases with lower temperatures. The main advantage of them is their lower initial investment.

##### **Ground source (solar)**

A ground source heat pump extracts heat from the ground. The ground temperature is rather steady, warmer than the air in winter and cooler in summer. As we have seen before, the smaller the difference between the source temperature and the sink temperature the higher the efficiency. For this reason ground source heat pumps are more efficient than air source heat pumps, despite the fact that ground source heat pumps have more initial costs. This energy source is even more interesting in the coldest regions, where an air source heat pump would have a very bad COP in winter, and in fact, is in these regions where it is more popular.

The most common way to extract the heat is with pipes in the ground. The pipes are usually putted in horizontal trenches at depth about 2 meters. Vertical boreholes are an alternative if there is not enough space to put them horizontally, but it is a more expensive solution.

Ground source heat pumps typically have more or less steady COPs of 3.5-4. However, the ground temperature can fall if a heat pump is extracting a lot of heat year by year, making the COP worse. To solve this problem, solar collectors can be used to replace the extracted heat, as we will see later.

Ground source heat pumps are commonly confused with geothermal energy. Actually, geothermal energy can be found at depths of about 500 meters or in specific places like Iceland, where volcanic activity comes close to the earth surface. The heat extracted by a ground source heat pump is caused by the sun.

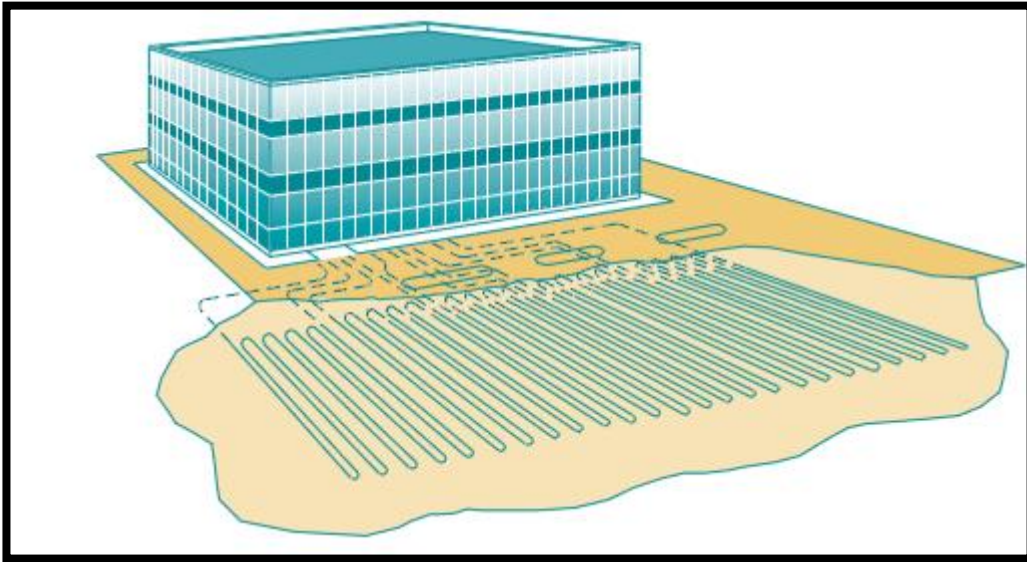

Figure S.1.12: Ground source heat pump (CANMET Energy Technology Centre, 2002.)

### **Solar**

The use of solar energy in heat pumps is related to ground source heat pumps. In a solar assisted ground source heat pump, the solar thermal collecting mechanism replaces the heat that the heat pump extracts from the ground. This is important because the ground temperature can fall year by year and therefore, if the source temperature decreases, the COP get worse, and the costs rises. Besides, there is the possibility of using these solar systems to store summer solar energy for use in winter, improving substantially the efficiency of the ground source heat pump. Some types if storage systems are by tanks, by boreholes, aquifers... This combination of energies and technologies (ground source and solar collectors, heat pumps and storage systems) is still not widely developed and some researches are focused on this issue.

### **Water**

Water source heat pumps commonly refer to the types of heat pumps that extract heat from a water source like a body of water or a stream, even from a recirculation system (typically in an industrial setting).

### **WASTE HEAT**

Free and in great quantity in our society, the use of human wasted heat is developing to improve efficiency of heat pump and reduce energy requirements. Actually, inside boilers are less efficient than centralized production of heat with interrelated system from various wasted heat.

We have many examples of countries which already have used human wasted heat. For instance, heat from incineration, or from sewage.

## ELECTRICITY

As we have seen before, some heat pumps do not need electricity to work. Nevertheless, compression heat pumps work with electricity which can be provided from hydropower or renewable energy in order to reduce carbon gas emission compared to coal, oil or gas electrical sources. It is noticed that heat pumps optimize electrical sources more than resistance heaters, because with one quantity of electricity, heat pumps can produce three times more heat energy in order to drive it into the sink.

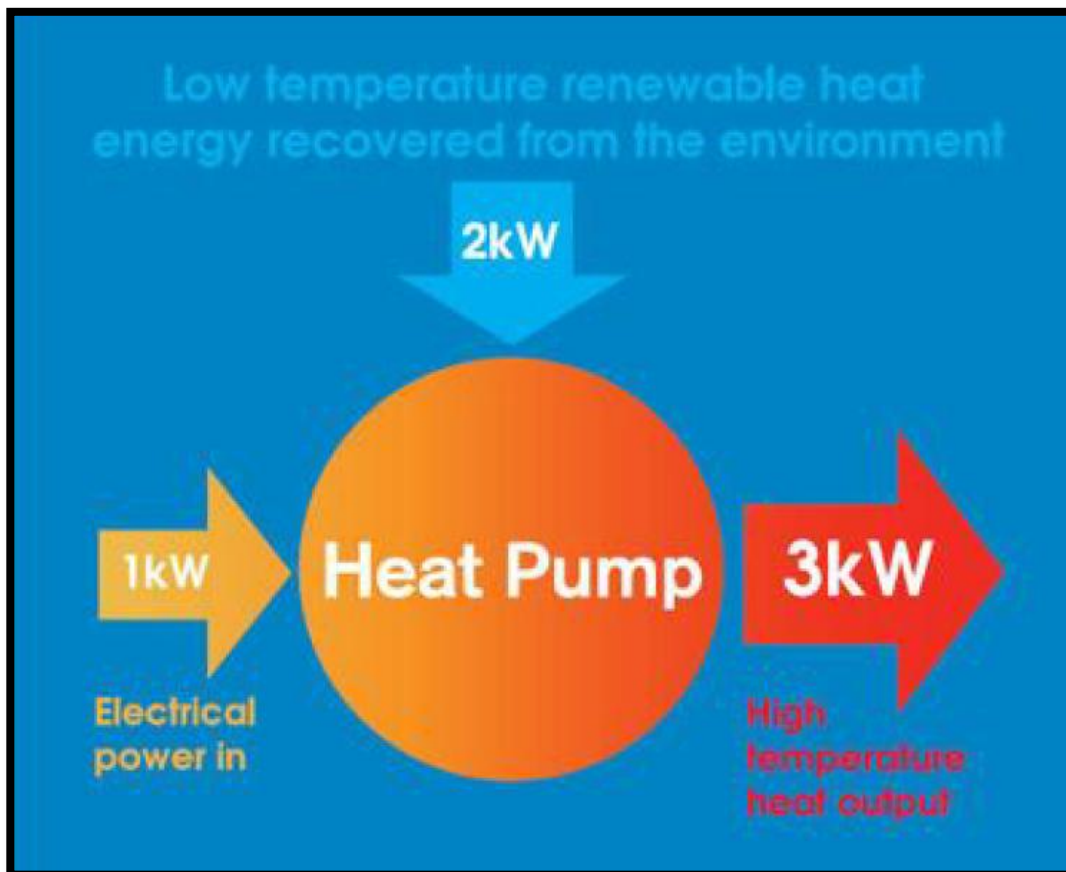

Figure S.1.13: Electrical energy required for heat pump with a COP of 3. (Poulsen, C., 2012)

## INSTALLATION

Heat pumps are a reliable system for many years, if users install them well at the beginning and provide to them a good maintenance during its years of work. The installation must be led by experts or qualified technicians who could advice users for supplementary equipment.

For instance, to prevent condensation which can freeze during the winter, insulating pipes which can contain cold liquid can be very important in some areas. Also in evaporator, still to prevent the condensation, it is good to drain it regularly with basin or adapted pipe.

Moreover, to get operating conditions more stable in order to extend heat pump life span, linking the heat pump with an inertial tank is a good solution.

Finally, it is advisable in cold areas, to add boilers for electric heat pump when the system is outside or with a cold source, whereas absorption heat pump can work with -20°C air.

## ENVIRONMENTAL IMPACT

### CO<sub>2</sub> EMISSIONS

How much can use of heat pumps reduce gas emission?

We always talk about carbon gas emissions, but many gases are responsible for the environment global warming: the sulphur dioxide (SO<sub>2</sub>), the nitrogen oxides (NO<sub>x</sub>) and the well-known carbon dioxide (CO<sub>2</sub>). The use of heat pumps rather than common boilers can reduce all emissions. Actually, this system requires much less primary energy. For example, gas boilers produce 40% more CO<sub>2</sub> than air source heat pump.

22 billion metric tons was the emission of carbon gas fifteen years ago. One third was produced by building heating and one third was emitted because of industrial activities. It was calculated that if only 30% of the residential and commercial building heating is provided by heat pump, one billion metric ton will not be emitted, which is a reduction of half of the carbon emissions. In industry only 0,2 billion metric tons could be eliminated but it represents in total 6% of the total emissions.

To have an idea, if all the boilers are replaced by heat pumps, 35 to 50% of fuel will be saved and an equal quantity of CO<sub>2</sub> emission reduced.

### THERMAL IMPACT

There is not much information about if the temperature's descent triggered by a ground source heat pump or an air source heat pump can affect organisms and plants that surround the device. However, it has to be considered, especially the large scale heat pumps, because it can produce thermal contamination in aquifers and ground water near the heat pump sink, affecting to the organisms.

### REFRIGERANT

As it has been mentioned before, some refrigerants are very aggressive with the ozone layer. One of them is HCFC-22 (R-22), the most common refrigerant for heat pumps. But its production and use is being prohibited. It will be shown a Schedule for its phasing out:

- 2004: reduction of 35% below 1989 levels
- 2010: reduction of 65%
- 2015: reduction of 90%
- 2020: HCFCs phased out (0,5% allowed until 2030 for existing equipment)

A lot of heat pumps are still being marketed with R-22 as refrigerant. Despite being available other refrigerants, they are still less efficient. Research and developments are underway to achieve substitutes of R-22.

### ANTIFREEZE

In colder climates antifreeze solutions are necessary to avoid freezing during the heating operation. A lot of these products are toxic, corrosive and flammable. Some good solutions are Ethanol, which is efficient, have a low toxicity and is biodegradable; and Propylene glycol which is also not aggressive with the environment, but it is less efficient.

## ECONOMICAL ASPECT

### MICRO ECONOMICAL

It is very difficult to estimate the costs and savings of a heat pump system because as they depend on a large number of factors, they vary a lot. The main factors that affect both the investments and the energy savings are:

- Size of the buildings
- Energy needs
- Climate (for air source heat pumps mainly)
- Insulation of the house
- Heating current system (radiators, air ventilation, floor heating)
- Ground characteristics (for the ground source heat pumps only)
- Exterior factors (Fuel costs, fundings)
- Control and use of the system

However it will be shown some typical average values as a guide, without taking into account possible government subventions.

### INVESTMENT

**Air source heat pump:** This system is the cheapest. A typical system for a familiar house costs around 6 000 to 10 000 euros.

**Ground source heat pump:** A typical system for a familiar house would cost around 9 000 to 17 000 euros.

### SAVINGS

#### **Air source heat pump:**

Existing system	Units	Air source heat pump performing at COP 2.2	Air source heat pump performing at COP 3
Gas	euros/year	125	160
Electric	euros/year	475	760
Oil	euros/year	100	390
Solid	euros/year	125	410

Figure S.1.14: Energy savings in an air source heat pump. (Energy saving trust, 2012)

#### **Ground source heat pump:**

The table has been calculated with COPs of 2.5 and 3. However in a well-designed ground source heat pump it can be achieved higher values.



Existing system	Units	Ground source heat pump performing at COP 2.5	Air source heat pump performing at COP 3
Gas	euros/year	0	165
Electric	euros/year	600	765
Oil	euros/year	225	385
Solid	euros/year	250	490

Figure S.1.15: Energy savings in ground source heat pumps. (Energy saving trust, 2012)

## PAYBACK TIME

### Air source heat pump

Existing system	Air source heat pump performing at COP 2.2	Air source heat pump performing at COP 3
Gas	60	45
Electric	16	10
Oil	75	20
Solid	60	18

Figure S.1.16: Payback time in air source heat pumps. (Energy saving trust, 2012)

### Ground source heat pump

Existing system	Ground source heat pump performing at COP 2.5	Air source heat pump performing at COP 3
Gas	-	75
Electric	21	17
Oil	58	34
Solid	52	26

Figure S.1.17: Payback time in ground source heat pumps. (Energy saving trust, 2012)

## ECONOMICAL CONCLUSIONS

If the existing system is gas, the payback time is very high due to the competitive gas prices. If the existing system is electrical we can achieve easily low payback times. In other systems the payback time depends a lot on the efficiency of the system. It has to be mentioned that the values of ground source heat pumps has been calculated with medium efficiencies: a well design ground source heat pump can improve these values. Besides, the values have been calculated for an average European house. The higher needs of energy of the northern European countries because of their lower temperatures make the heat pump systems even more feasible. Some European countries have funding schemes to install these systems.

## MACRO ECONOMICAL

### STATE SUBVENTIONS FROM THE DIFFERENT COUNTRIES

Governments begin to be aware of their role in environment protection. By introducing tax breaks and grants they can make people invest so increase the market of sustainable supply in construction.

In some countries, residential or industrial users can receive grant in order to invest in heat pumps, equipment and materials required. Grants can depend on heat pump power, type of organization (industrial, commercial, public, community or households).

The grant can usually account for 40-50% of the total investment (Austria, Czech Republic, Slovenia, and Luxembourg) but the record is with 70% of eligible costs in Hungary.

Moreover users can be exempted of taxes on energy saving measures, CO<sub>2</sub> emissions and energy taxes. Also, in some countries, they can deduct a part of their total investment of materials and equipment from their annual taxes (from 11% to 55% in Italy for building renovation).

Nevertheless, many countries have a maximum budget for grants and taxes exemption per organization: usually from 700€ to 3500€ for households (in Greece, Ireland, Sweden) but can be a limit of 200 000€ in Slovenia or even 850 000€ in Cyprus.

Many European countries do not help organizations which want to improve their production system or heating system with heat pump to reduce their energy consumption and gas emissions: Estonia, Spain, Bulgaria, Slovakia, Romania, Poland, Malta, and Lithuania. Most of these countries are either in hot areas, or not very developed.

Even if most of the time, the whole investment is not covered, the subventions and taxes exemptions can be very helpful initially before saving money on long term with less energy required.

### ENERGY SAVINGS

The real advantage of the heat pump is that use free and renewable energy from outside: ground, air, water heated by the sun.

It reduces fuel or electrical bills because can provide the same amount of energy with three times less primary energy. Some heat pumps in industry can even provide the same quantity of heat with only 3 or 4% of electricity, but this high performance has not been developed for households yet.

To compare heat pump or other boilers on energy saving, the SPF can be used, because it takes into account primary energy required during the whole year, CO<sub>2</sub>, and the efficiency.

The best way to save energy is to combine the heat pump with other sustainable devices in the same building in order to have a passive or even a positive house which does not need any external energy to make inhabitants comfortable during all seasons.

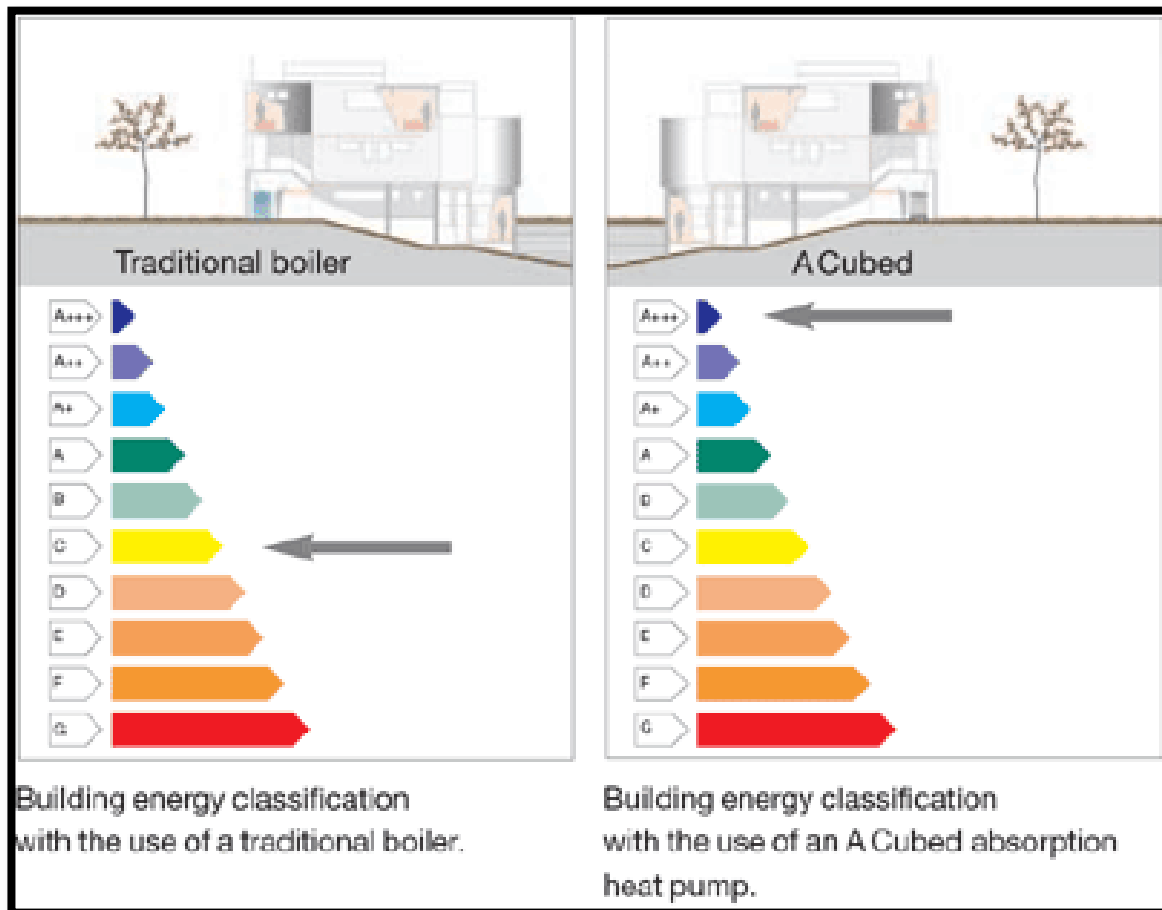

Figure S.1.18: Energy required by a traditional boiler and an absorption heat pump (IEA Heat Pump Center, 2010)

## FUTURE TRENDS

### REORGANIZED SECTORS

In order to develop heat pump in new sectors, a new way of thinking is needed to combine cold areas with hot areas. That is why, it is common to see ice rink next to swimming pool, because with the help of a heat pump, the cold or the heat of one of those areas can be the sources for heating or cooling the other one. To make it clear, take the heat from ice rink to give it to swimming pool in order to heat the water has a double effect: cooling the ice rink and heating the swimming pool.

This example can be developed in many sectors. For instance, in supermarkets, it will be ingenious to put fridge and freezer next to bakery, in order to combine that heat and cold sources. This way of thinking can help to save a lot of energy and money; we just have to think about it during the implementation of commerce or industry.

## POTENTIAL MARKET

### BUILDING SECTOR

The heat pump potential market is as wide as the heating systems market, with some specific features. In rural areas, where natural gas pipelines are not available, heat pumps seem to be more attractive. Most of the market growth is related to new constructions with low-temperature heating systems, but the main potential market is in existing building stock with high-temperature heating systems. Unfortunately, the high temperature of operation is a technical obstacle to large-scale use of individual heat pumps.

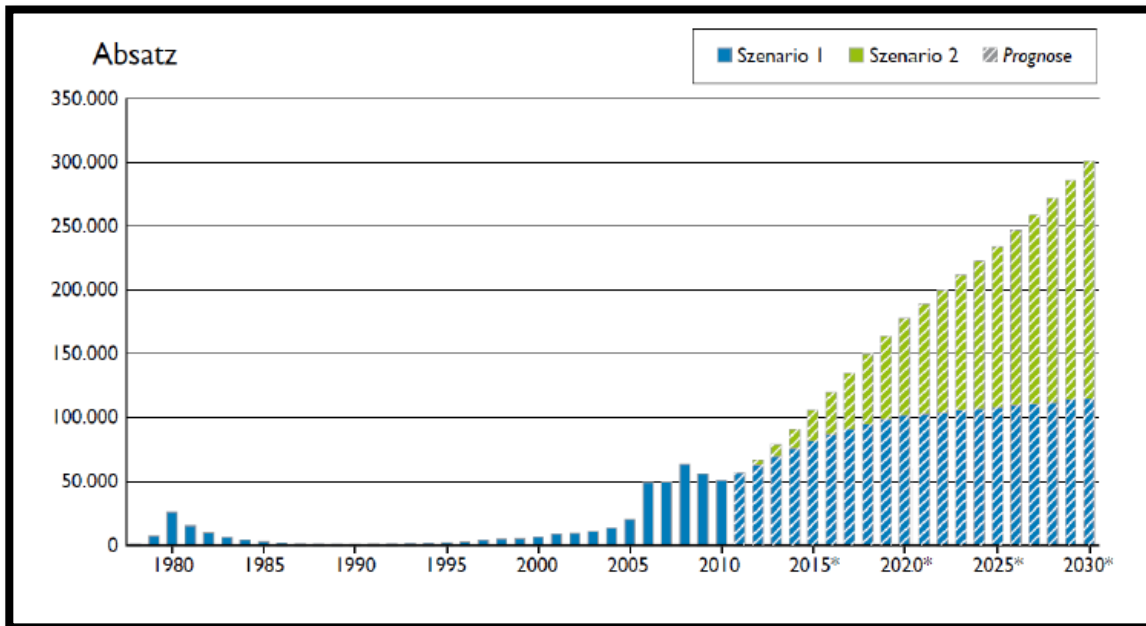

Figure S.1.19: Electrical energy required for heat pump with a COP of 3. (Poulsen, C., 2012)

### INDUSTRIAL SECTOR

The industrial heat pump is being developed as well, with more than 20% increase every year. More than 50 countries are promoting these systems. Besides, it is expected to have a higher penetration by 2020.

## TARGETS RESULTS

Government assistance and realization by the society that the environment has to be protected will improve the heat pump development in Europe, as well in industry as in commercial and residential buildings. Europe wants to implement by 2020, a strategy "for smart, sustainable and inclusive growth" focusing on environment targets: reducing by 20% (from rates in 1990) CO<sub>2</sub> emissions, and increase by 20% energy efficiency improvements and renewable energy sources in total energy supply.

# CONCLUSION

To conclude, heat pump has many advantages. The improvement of efficiency of heating/cooling systems triggers a direct reduction of gas emissions, and the possibility of save money in many different applications. The economic feasibility is not so obvious and depends on many factors, mainly on the climate (hard temperatures worse the efficiency), on the existing heating system and on the heat pump design. State subvention and tax exemption can make a big difference for potential users.

## SWOT

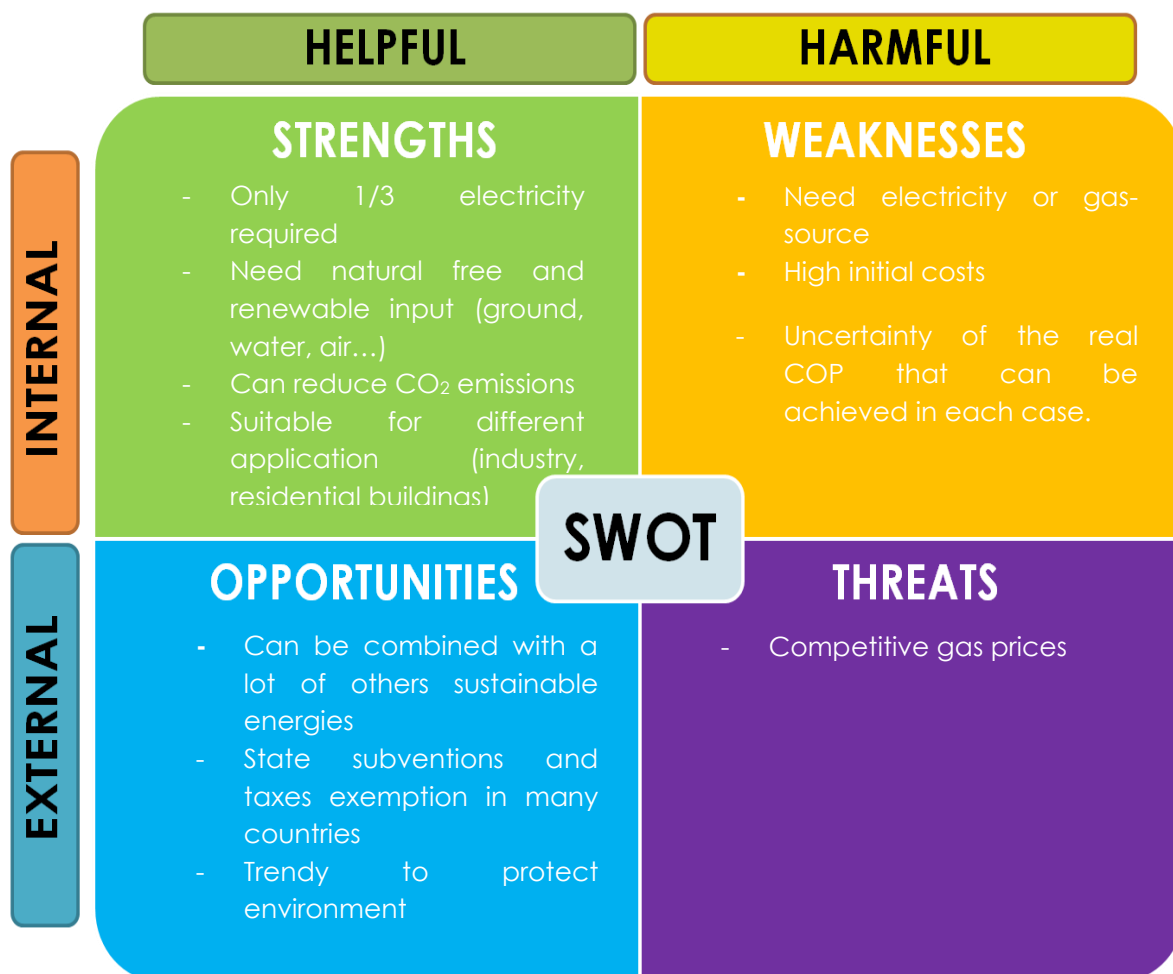

# COGENERATION

## ABBREVIATIONS AND DEFINITIONS

### ABBREVIATIONS

- CHP = Combined Heat and Power (Cogeneration)
- CCHP= combined cooling, heat and power
- HR = heat recovery
- HRSG heat recovery steam generator
- CHPDH = Combined Heat and Power District Heating
- CCGT =Combined Cycle Gas Turbine
- DER = Distributed Energy Resource
- PV = Photovoltaic

### DEFINITIONS

- **HRSG heat recovery steam generator:** is an energy recovery heat exchanger that turns heat energy from a hot gas stream into a useful steam for heat needed processes such as cogeneration and for driving a steam turbine (combined cycle).
- **Absorption chiller:** is an absorption refrigerator whose source is heat for providing the needed energy to drive the cooling system. When electricity source is unfeasible and no noise from compressors is desired, it is popular alternative to regular compressor refrigerators.
- **Rankine cycle:** is a cycle that converts heat into work. The heat is supplied externally to a closed loop, which usually uses water.
- **Combined Cycle Gas Turbine (CCGT):** assembly of heat engines working in tandem
- **Stirling engine** is a heat engine operating by close cyclic regenerative compression and expansion of air or other gas, a permanently working fluid, at different temperature levels such that there is a theoretical "net" conversion of heat energy to mechanical work or with high efficiency. Regenerative meaning the use of a heat exchanger to maintain the cycle, and this is the difference of stirling from other closed cycle hot air engines. (def1)

# INTRODUCTION

We could think that **cogeneration is** “energy recycling” as it is usually thought as a complement to increase energy efficiency in electricity production plants in order not to waste the “waste heat” when producing electricity. But when cogeneration was invented it was thought as a way of producing two energy demands simultaneously, electricity and heating, from one process.

Plants or systems are referred as “energy” plants, not electrical, because we take into account the improving of the overall energy efficiency: electricity and heat.

**Historically** this system was mostly implemented in industries, large offices or apartment buildings and hotels when the earliest power generation plants were built before the utility electricity provided by central stations became available bursting the electricity market.

Even though, cogeneration systems have been used for many years and they are still commonly used in large industrial processes. However, due to the climatic change and the will to reduce the pollution and energy footprint, but overall because it is energy efficient, economically feasible and a way to the energy production sustainability, it is a growing system nowadays.

## DESCRIPTION

### TECHNOLOGY

Cogeneration means “energy recycling” because it takes advantage of what usually is a waste in the electricity production process. *It is an electricity conventional production process:* when fuelling a thermal engine, heat energy turns into mechanical energy. Then mechanical energy is turned into electrical energy by using a **transformer**.

Following the second law of thermodynamics and Carnot's theorem, thermal engines lose mostly half of its energy as leftover heat. Therefore the idea of cogeneration is to use this “excess” of heat, which normally would be a waste, for heating purposes or creating more electricity. CHP systems reach an efficiency of up to 80% (Oak Ridge National Laboratory, 1 December 2008).

**Stated technical definitions by international institutions:**

**European Union:** “Cogeneration shall mean the simultaneous generation in one process of thermal energy and electrical and/or mechanical energy” (European Parliament, 2004).

**MIT:** “Cogeneration is the simultaneous generation of two or more types of energy from a single fuel source” (Massachusetts Institute of Technology, n.d.).

The following example shows graphically the energy process IDEA:

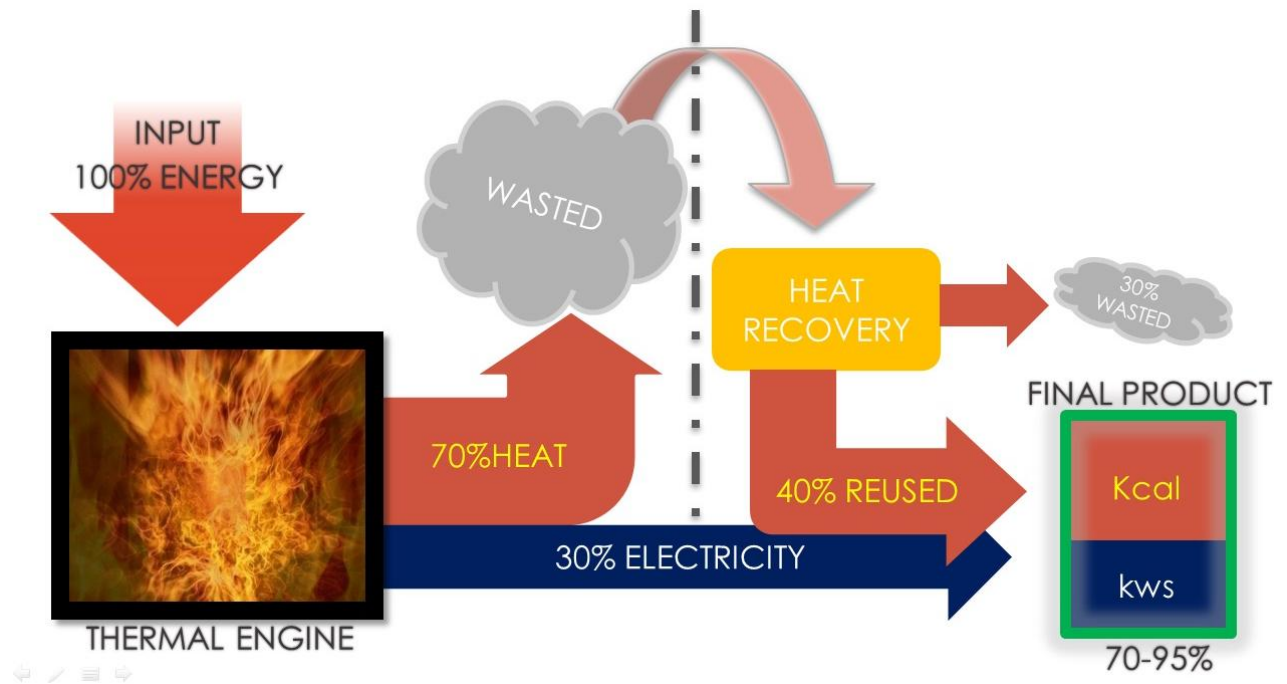

Figure S.2.1 Conventional vs CHP Schematic explanation

Percentages are theoretical and approximate. Different manufacturers show different efficiencies and this is also directly connected to the input energy and type of thermal engine. The dotted line splits the process from the conventional systems without HR from CHP systems.

**INPUT:** several options can be the input energy, from Gas to biodiesel and Nuclear.

**CHP SYSTEM:** Depending on the input energy the thermal engine will be decided and also depending on the thermal engine the input will be decided. Unlike traditional power stations where exhaust gases are directly evacuated by the chimney, the gases produced by cogeneration are first cooled before being evacuated by the chimney, releasing their energy into a heat recovery system, usually a hot water/steam circuit. The most common heat recover is the Heat Recovery Steam Generator (HRSG).  
See input fuel and the common thermal systems for CHP CHART

**THERMAL LOADS:** what for traditional electricity plants would be a loss, in this case a gaining up to 40% of the traditional energy loss. The thermal engines release heat and exhaust hot gases. Then we use a HR to recover this released heat to produce a useable steam. Thermal loads can be used to warm water (ranging from 80 to 130°C) providing a heating system or for using a steam turbine and producing more electricity or even for feeding and absorption chiller for cooling purposes (trigeneration).

**ELECTRICITY:** around 30% Kws load: it is a reality the low efficiency of the simple and conventional production.

**WASTE HEAT:** even though we greatly increase the energy efficiency, nowadays we still have around 30% of energy loss. To sum up, the CHP process would be:



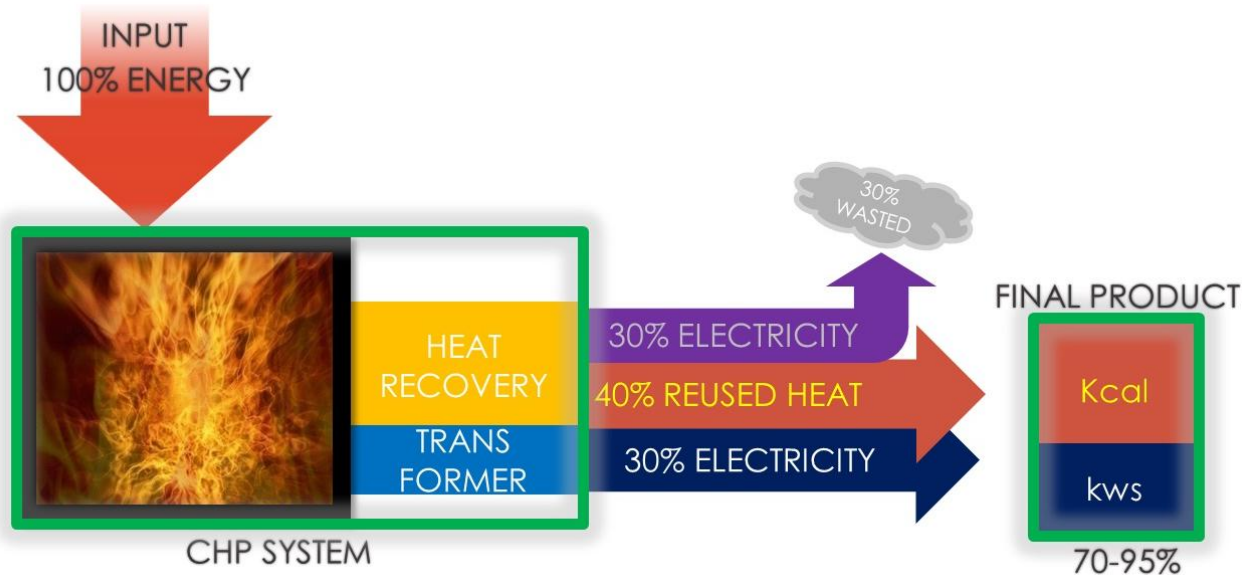

Figure S.2.2 CHP Schematic functioning

## TYPES OF CHP SYSTEMS

The production and size of a CHP system can range from the demand of 5kw for a single family home to several hundred MWs for a large building complex or industry. Depending on which customer is directed to, we can find CHP in different types of technology.

### MAIN PURPOSE

We can divide cogeneration into two main groups depending on the main purpose of the plant:

- **TOPPING CYCLE PLANTS:** the primary production is the electricity and then heat surplus is used.
- **BOTTOMING CYCLE PLANTS:** the aim is to produce high temperature heat for industrial processes and then by using a waste heat recovery system a power plant is feed.

### USE OF HEAT

We can divide cogeneration into two main groups in relation to the use of heat:

- **COMBINED HEAT AND POWER:** ELECTRICITY + HEAT. It uses the heat surplus for heating purposes.
- **CHP WITH SECONDARY PURPOSES MORE THAN JUST HEATING:**
  - CCGT: ELECTRICITY. It uses the heat surplus for generating more electricity.
  - Trigeneration (CCHP): ELECTRICITY + HEAT + COOLING. It uses heat also for an absorption chiller for cooling purposes.

## POWER STATIONS

All CHP systems can be created for heat purposes or secondary purposes. However, for secondary purposes, the turbines are the common system due to its simplicity and functioning.

The most general classification of CHP plants is in relation with the input fuel and the common thermal engine systems:

<b>TURBINE</b>	Gas	Combined cycle gas turbine with heat recovery
		Gas turbine with heat recovery
	Steam	Steam backpressure turbine (non-condensing)
		Steam condensing extraction turbine
<b>ENGINE</b>	Gas	
	Steam	
	Biofuel	
	Stirling	
<b>FUEL CELLS</b>	Molten-carbonate fuel cells	
	Solid oxide fuel cells	
<b>NUCLEAR POWER PLANTS</b>		

Figure S.2.3 Types of engines/fuel

## SIZE

In relation with the size and application of the cogeneration system there are:

- **LARGE SCALE >500KW:** CHP such as CHPDH or CHP Electricity Plants
- **DISTRIBUTED ENERGY RESOURCE (DER):** also called distributed generation, on-site generation, decentralized energy, etc., generates electricity from many small energy sources. It mainly uses micro turbines, combustion engines, stirling engines, closed cycle steam engines and fuel cells. According to the energy supplied we find 2 types of DER:
  - **5KW < MINI CHP <500KW:** for buildings and medium sized business. It is the most CHP critical installation in terms of efficiency and cost effectiveness (payback) feasibility. If the utilization factor (% of hours of operation/year) is less than 40%, then it is considered to be unviable. To be viable there must be a continued electrical and heat demand. Checking a big manufacturer such as "Alfagy" we can see the average efficiency of two middle systems, one of NG and another of BioG, with 100%, 75% and 50% working loads (Alfagy, n.d.):

LOADS	Electricity			Heat			Overall		
	100%	75%	50%	100%	75%	50%	100%	75%	50%
<b>Natural Gas</b>	39,3	37,7	35,1	47,7	49,3	51,5	87	87	86,6
<b>BioGas</b>	41,2	39,5	36,5	35,1	37,3	40,7	76,3	76,8	77,2

Figure S.2.4. Minic CHP average loads/ inputs (Alfagy, n.d.)

- **MICRO CHP <5KW:** for houses / small business. It creates electricity in addition to heating and if there is a surplus and the grid allows it, it can be sold back. Some manufacturers are already offering microchip stations with energetic efficiency of 95% or 100% based on calorific value of natural gas. In this type of stations the sound attenuation is a key factor, which also seems that manufacturers are very concerned about(2G, n.d.).

Moreover, studies show that the use of Mini CHP + PV (photovoltaic) as a hybrid system can enable an additional deployment of a factor of 5 (Pearce, 2009)

Theoretical studies also proposed to use a CHP thermal energy production for fuelling an absorption chiller and then cooling of PV-CHP system, creating trigen+PV systems which would save even more energy (Pearce, 2011).

Another cogeneration system may be the use of exhaust gases from the kitchen and bathrooms to heat the dwellings or be used as a heat exchange for the new incoming outside air for air ventilation during the winter.

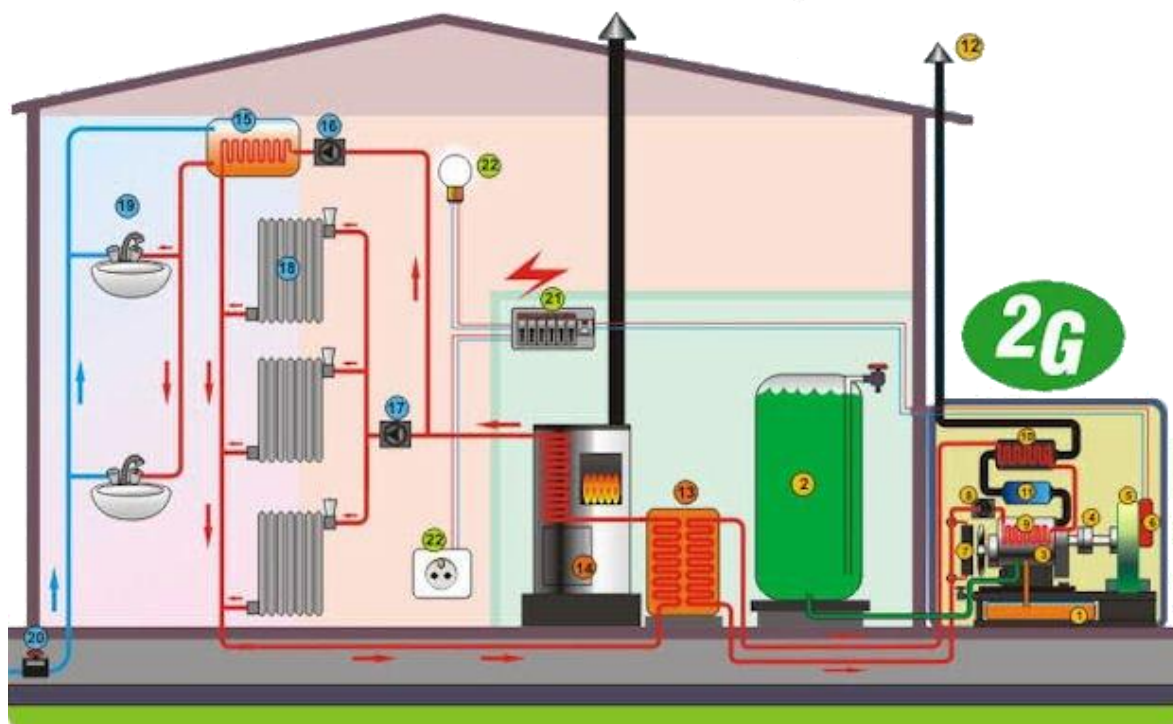

- |                            |                             |                               |                                  |
|----------------------------|-----------------------------|-------------------------------|----------------------------------|
| 1. Engine Skid             | 7. HE Cooling               | 13. Heat Exchanger            | 19. Bathroom Shower              |
| 2. Gas Storage or Pipeline | 8. Water Pump               | 14. Boiler                    | 20. Cold Water Supply / Utility  |
| 3. Gas Engine              | 9. Engine Heat Recovery     | 15. Hot Water Tank            | 21. Circuit Breaker Panel        |
| 4. Flywheel                | 10. Exhaust Gas Heat Recov. | 16. Circulation Pump          | 22. Electricity / Lights / Power |
| 5. Generator               | 11. Catalytic Converter     | 17. Circulation Pump          | Red Line: Hot water Circulation  |
| 6. Electrical Terminal     | 12. Exhaust                 | 18. Heating Radiator Elements | Blue Line: Cold Water            |

Figure S.2.5 Micro CHP house system (2G, n.d.)

## REAL APPLICATIONS

The main real applications of cogeneration District heating are:

### E: IMPROVING ELECTRICITY PRODUCTION PLANTS EFFICIENCY

CHP systems with CCGT that uses the heat surplus to generate more electricity and increasing the whole system efficiency by turning heat into mechanical energy through a HRSG. The combination of two or more thermodynamic cycles improves the overall efficiency.

### E + DISTRICT HEATING

Also called "Teleheating", is the idea of providing heating for a certain group of buildings. To meet the heating demands of a district heating, if not possible by itself, cogeneration is usually set up in parallel with a heat-only boiler station. The efficiency of conventional thermal power station ranges from 20 to 35%, while a modern plant with high temperatures plus syngas an hydrogen fuelling it will reach up to 60% or more; if cogeneration is used; efficiencies of 80% will be reached (U.S. DOE, n.d.).

Heat is usually distributed by water or, less commonly, by steam, through a two lines (feed and return) insulated pipes network, usually underground but sometimes over ground.

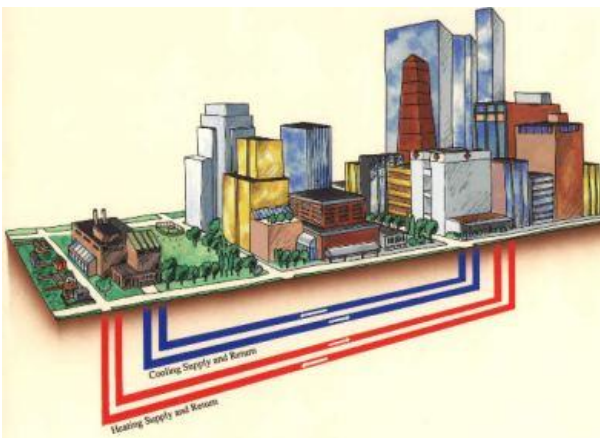

Figure S.2.6 City DH (R&S Biomass, n.d.)

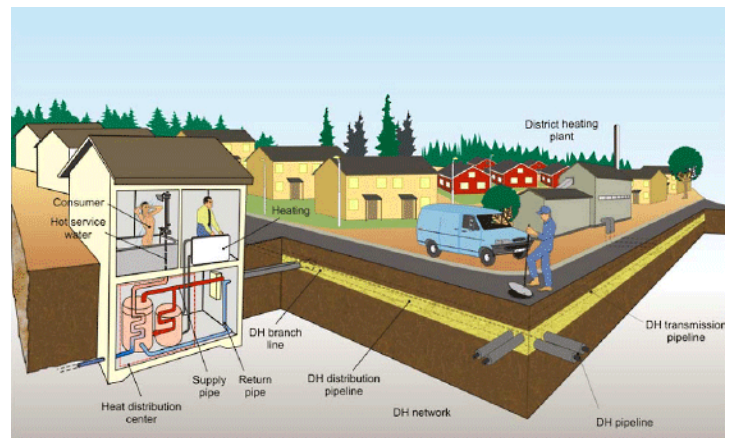

Figure S.2.7 Village DH (Living Energy, n.d.)

Despite few exceptions, the water or steam from the heating system is not mixed with the dwellings' water. According to Norway reports, the distributing loss is about 10% (Norwegian Water Resources and Energy Directorate, n.d.).

The size of the DH system can range from small towns of 20 dwellings to big cities such Stockholm, varying the diameters of the network pipes in each case.

**Pros&Cos:** thanks to the cogeneration, district heating energy efficiency is higher than individual systems.

It is not a short term return of investment and it needs a high- capital initial investment. It is a technology that might be more focussed to state utilities, for the community, lowering investments in individual households and reducing the heating charge. It is also more profitable to install these kinds of systems in high-density areas or to block of flats rather than detached houses, as the installation cost rises comparatively.

## **E+HEATING + COOLING: ABSORPTION CHILLER, TRIGENERATION**

Waste heat can be used as a source for an absorption chiller in order to provide cooling such as air-conditioning in buildings. Exceed heat can come from a water heater or a gas turbine, generating this way electricity, hot water and air-conditioning.

## **E+HEATING + COOLING: DISTRICT COOLING**

Taking advantage from mixing district heating with an absorption chiller we can also create a district cooling. By using resources that other way would be wasted, district cooling systems reach efficiencies that are between 5 and 10 times higher than traditional electricity-driven equipment(Euroheat, n.d.).

Even without CHP, district cooling could work out using natural cooling from deep sea, lakes and rivers.

## **E + WATER DESALINATION PLANTS:**

This application is interesting for the driest countries with sea and actually is also used for large ships or submarines.

# **CURRENT STATUS**

The United Nations has been trying to push the countries through its several environmental and climatic change Protocols.

The International Energy Agency (IEA) did a modelling of cogeneration expansion for the G8 countries in 2008. According to it, the diffusion of cogeneration in France, Germany, Italy and the UK alone would successfully double the current primary fuel savings by 2030(IEA, n.d.).

## **EFFICIENCY TERMS**

Conventional power plants (1 cycle or without CHP) have an energy efficiency around 35-40%, while with cogeneration their efficiency raises up to around 70% (Oak Ridge National Laboratory, 1 December 2008)or even more if trigeneration is applied. Some manufacturers reached energetic efficiencies up to 70%-90%, while water heating temperature may be delivered at a temperature ranging from 90 -130°C. Natural Gas is the current most utilized primary source (Alfagy, n.d.; RED, n.d.; EP, 2004).

## **EUROPEAN FRAMEWORK**

For the promotion of CHP, the European Union set a legislative act, the **Directive on the promotion of cogeneration based on a useful heat demand in the internal energy market 2004 and amending Directive 92/62/EEC**. That can be adopted by means of a variety of legislative procedures. The main point of the CHP Directive is to improve energy efficiency, environmental protection, security of supply, renewable energy sources and evaluation of costs.

In short terms it is expected to consolidate existing cogeneration plants and set new plants. In medium to long term the Directive is expected to create a framework for

highly efficient CHP production in order to reduce emissions of CO<sub>2</sub> and other substances and contribute to sustainable development (European Parliament, 2004).

The EU also launched a project called ECOHEATCOOL carried out by the Euroheat&Power organization with the Intelligent Energy Europe program support, from 2005 to 2006, assessing the heating & cooling markets as well as looking for further options and assessing policy makers.

The project concluded that it is feasible to use a wide range of renewable energy fuel inputs for CHP or also from waste incineration and industrial processes (Euroheat, n.d.).

As a whole, the EU is producing 11% of its electric power using cogeneration. Three of the world's most intensive cogeneration countries are European: Denmark, the Netherlands and Finland. Then they are followed by Germany that currently states that 50% of the electricity demand in the whole country could be provided by cogeneration. Apart from that, east countries such as Poland and Czech Republic also have a wide percentage of cogeneration-produced electricity, either DH. It is clearly observed that the most developed countries are the ones with higher CHP generation as well as the ones that have more necessity of that kind of heating due to its climate (European Association for the Promotion of Cogeneration, n.d.).

## UNITED STATES NUMBERS

The average U.S. power plant is no more than 33% efficient and use three units of fuel to produce one unit of electricity. The rest is wasted energy, mainly heat that's vented into the atmosphere. Most of the plants can't use this heat because they are located far away from consumers, and heat cannot travel far before turning cold.

This is what is called "Central" generation, the prevalent way of producing power in the U.S.

On the other hand, cogeneration provides what the U.S. Environmental Protection Agency (EPA) calls "an efficient, clean, and reliable approach to generating electricity and heat energy from a single fuel source." The main point is that CHP plants produce energy on site, near the costumers at industrial facilities and other large institutions, enabling these plants to turn their waste heat into clean electricity and or useful steam, which can be used for heating nearby buildings or assisting industrial processes, magnifying widely energy efficiency.

Studies indicate that 40% of total U.S. electricity needs could come from waste energy recycling and CHP (RED, n.d.).

The US Department of Energy (DOE) has established the goal of having the 20% of CHP of the US generation capacity by the year 2030. Initially, the DOE worked together with the Oak Ridge National Laboratory (ORNL) to implement the first Regional Clean Energy Application Center (CEAC) in 2001 and due to its good results, the DOE set 7 more. Its mission is to develop the required technology application knowledge and educational infrastructure necessary to lead "clean energy" (**Combined Heat and Power, Waste Heat Recovery and District Energy**) technologies as viable energy options and reduce any perceived risks associated with their implementation (U.S. DOE, n.d.). Then CHP plants increased and about 8% of all US energy came from cogeneration (World Alliance for Decentralized Energy, 2006).

Recycled Energy Development stated in 2008: "We think we could make about 19 to 20 % of U.S. electricity with heat that is currently thrown away by industry" (National Public Radio, n.d.).

Nowadays, Manhattan is the biggest steam district in US with 7 CHP plants that supplies 100,000 buildings.

# FACTORS

## EXTERNAL INPUTS

The inputs are the type of fuel or source needed to make the system work. There are many types of inputs depending of the type of plant designed, as follows:

- Natural Gas
- Bio Gas
- Vegetable Oil
- Biodiesel
- Fuel cells
- Molten-carbonate fuel cells
- Solid oxide fuel cells
- Nuclear Power
- Biomass (Boilers)

Usually Gases are used for turbine engines, but also for internal combustion engines as well as the biodiesels. Fuel cells are a case apart, being the input and the system itself closely related.

Biomass CHP systems are always preceded by a boiler system to transform the biomass. Despite what is generally thought, nuclear power is one of the most energy efficient systems and it is also good for cogeneration. The problem comes with the radioactive waste storage and a big social factor as nobody wants to have a Nuclear Plant in its city or nearby.

## ENVIRONMENTAL IMPACT

CHP is one of the most cost-efficient methods to reduce carbon emissions of heating in cold climates and in any plant. The key of CHP to reduce the greenhouse gas emissions is that by magnifying the efficiency of power systems, less input resources will be needed to produce the same amount of energy, as well as using cleaner sources, and consequently emitting lower levels of greenhouse gases and pollutants reducing its environmental impact. It also reduces contamination because of the advance in filters (chemically active).

If we take the efficiency percentage of improving, then we can say that the footprint will be reduced around 50%. Or what is the same, to meet the same production of energy compared to conventional plants, CHP systems require around 60% less primary source.

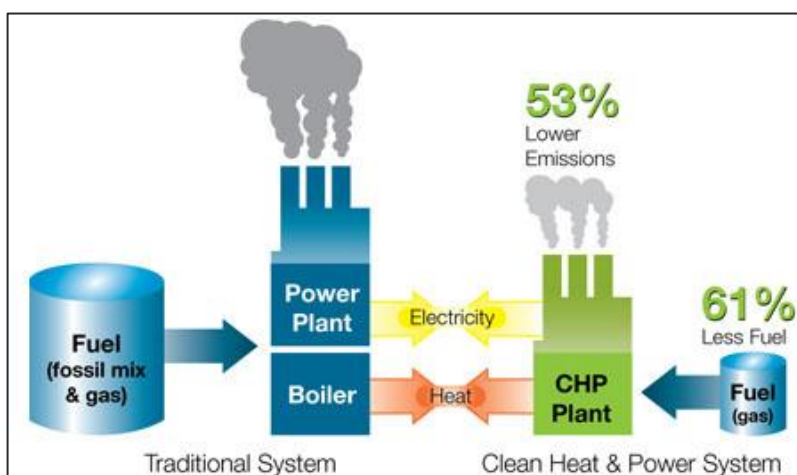

Figure S.2.9. Conventioneer CHP Comparison (Ameresco Intelligent Systems, n.d.)

The grade of renewability of CHP systems depends on the primary source used, from a fossil fuel such as natural gas, to renewable biofuels. The efficiency variations of CHP depend on the type of engines used and on the primary source. As CHP is usually

complementary to other energy production plants, they depend on them in what environmental impact is referred and therefore depend on the input fuel to create electricity.

The next table shows the different numbers according to each **primary sources:**

**CO2 Footprints for Heat Supply to buildings** piped heat serving radiators and electric heating from different sources. Central and distributed supplies for different fuel sources. Tax signal when displacing CO2 valued at £80 per tonne. (ROC)

Note: For biofuels, the table separates out CO2 emitted when bio fuel is burnt from CO2 removed when the bio fuel is grow. These signals allow optimal growth and use of biomass to neutralise or displace CO2.

Heat supply options gross (higher) CV basis	kg/CO <sub>2</sub> /kWh per unit of Energy	Distribution losses		kg/CO <sub>2</sub> /kWh Energy delivered	Tax signal pence per kWh
		Energy Average loss %	CO <sub>2</sub> Average loss kg		
Electricity from Coal 36% & CHP	0.837	10	0.084	0.920	7.360
Biogas as a fuel 40% efficient conversion from Biomass (Lund University Maria Berglund Pal Borjesson)	0.850	2	0.017	0.867	6.936
Electricity from Gas 48% & CHP	0.397	10	0.040	0.437	3.496
Biomass (Wood) as a fuel	0.340	NA	NA	0.340	2.720
Air source Heat Pump COP 2.5	0.335	0	0.000	0.335	2.678
Electricity from coal	0.301	NA	NA	0.301	2.408
Coal as fuel	NA	NA	NA	0.255	2.040
Old Gas Boiler	NA	NA	NA	0.222	1.776
New Condensing Gas Boiler	0.212	NA	NA	0.212	1.696
Heat Micro CHP 1kWel 6% (el) 86% overall efficiency	0.191	2	0.004	0.195	1.560
Gas as fuel	0.167	0	0.000	0.167	1.339
Heat Pump good heat source COP 5 electricity from coal	0.103	10	0.010	0.113	0.904
Piped Heat from 500 kWel CHP 34.7 % (el) 86% overall efficiency Gas	0.066	20	0.013	0.079	0.632
Piped Heat from large biomass CHP co fired with coal.	0.066	20	0.013	0.079	0.632
Piped Urban Hot Water Heating from Coal fired CHP COP 12.7	0.033	20	0.007	0.040	0.320
Piped Urban Hot Water heating from Gas fired CCGT CHP COP 12	0.010	10	0.001	0.011	0.088
Electricity from Nuclear	0.010	10	0.001	0.007	0.056
Electricity by Wire from Renewables Wind/Solar Coal fired plant displaced	0.001	20	0.000	0.001	0.010
Piped Urban Hot Water heating from Nuclear fired CHP COP 10					

Figure S.2.10 Systems + Primary sources efficiency(Orchad, s.f.)



## ECONOMICAL ASPECT

Energy efficiency and cost efficiency are proportionally connected. The main reason why CHP is not so widespread is because today's liberalized markets are more focused on short-term payback, leaving long-term commitments such as district heating as unattractive options. Utilities will only take the right strategic and technological decisions until when they will be pushed by the society and the climatic change.

As stated in EUROHEAT&POWER org: *“Energy infrastructure planning must be driven by the objective of climate protection. Furthermore, to ensure an adequate return on investment in the district heating infrastructure, legislation must provide for fair allocation of the economic value of the benefits to all parties including to the investor and operator. These benefits- including avoiding energy imports, price stability and environmental savings - are indeed huge for the local community and the national economy as a whole”.*

The feasibility of Cogeneration is directly depending on a base load. The smaller it is the CHP system, the more consistent the base load has to be. The utilization factor, % of hours of operation/year, must be over 40% for a system to be viable. As said before, Mini CHP for medium sized buildings happen to be the most critical installations in terms of efficiency and cost effectiveness (payback).

Furthermore, it is rarely found a precise match between heat and electrical demand. A plant can be run as a heat supplier mainly or as an electrical power plant, which is less advantageous in terms of utilization factor and global efficiency. But when heat has to be transported over long distances it requires heavily insulated pipes, expensive and inefficient; whereas electricity is transmitted along a comparatively simple wire, much longer distances and less energy loss. So a heat supplier plant has to be on site or nearby to be feasible, which is good for a decentralized energy and close to the customer system. Trigeneration also plays an important role as it increases the overall efficiency.

## SOCIAL FACTOR

If we think about CHP as a district heating, a heat supplier plant has to be on site or nearby to be feasible, which is good for a decentralized and close to the customer energy system. This would deeply affect the current energy distribution system and the global infrastructure and urban layout.

It is a growing system nowadays, and it is changing the centralized energy structure system, mostly in the coldest countries due to its characteristics, but appropriate in any place since heat can be turned into electricity or cooling for a higher total efficiency. Due to its characteristics, it is spread mainly in the coldest countries, but is appropriate in any place, since heat can be turned into electricity or cooling for a higher total efficiency.

The centralized or decentralized power system is a big issue to debate. Distributed energy is closely related with the smart grid system, which is still being developed and also discussed.

# CONCLUSION

## SWOT

Despite having lump together the two numbers efficiency (electrical and heat) into a single total efficiency, the fact is that electrical energy is generally more valuable than heat. Heat pump is the fierce competence of CHP due that it produces Heat or Cooling as well but with much higher efficiencies and a Coefficient of Performance nowadays ranging from 3 to 7. The point is that heat pumps needs electricity and cogeneration creates it.

The future may lay on the research and development of hydrogen and syngas turbines and also in the engines with organic Rankine cycle (the type of engine with higher efficiency) and heat pumps than use cogeneration to be supplied.

To analyse, conclude and sum up the main points of Cogeneration, a SWOT has been done:

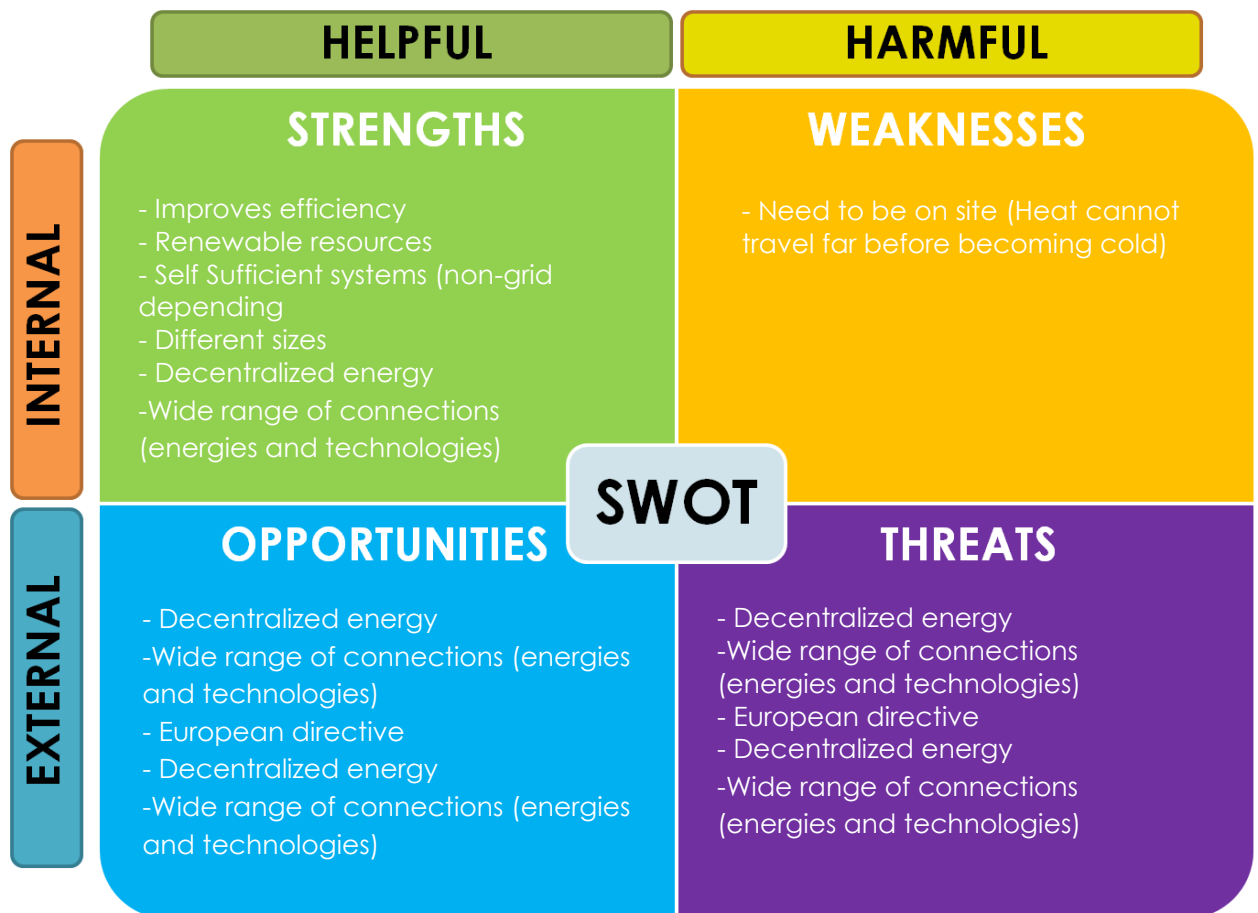

## SUITABILITY FOR BUILDINGS & SMALL VILLAGE

Cogeneration was created when utility electricity was not yet a feasible reality, mainly because it was expensive. Nowadays it's growing again in order to increase the power plants efficiency (big power production sites) but has also begun to be used as a DER. As said before, the creation of a small CHP system for a village should need a careful study of the utilisation factor in order to know its feasibility or if it is rather better than other systems, both in economic and eco-sustainable terms. It is already a reality that can be used and no doubt, it will be.

# HYDROGEN

## INTRODUCTION

Hydrogen is small and simple. Compound of one proton and one electron it is the most common atomic form in the universe from the Big Bang to present. It accounts 90% of the atoms in the universe, two-thirds of the atoms in water, and a pretty good amount of the atoms in living organisms and fossil fuels.

Highly electronegative, they are impatient waiting to bond, releasing a large amount of energy when they do. On Earth, unattached hydrogen is quite uncommon. It must be liberated by breaking chemical bonds, which requires energy.

Hydrogen is not an energy resource owing to it is not isolated in nature. Such as electricity hydrogen is a carrier of energy. It is necessary to produce it from other raw materials such as water, biomass, and fossil fuels. To convert these materials into hydrogen is necessary to follow some transformations which consumed some primary energy. Besides the need to obtain the hydrogen is hard to store, transport, liquefy and also handle safely. In other words these disadvantages indicate that using hydrogen to achieve an energy economy will be far from simple.

As a result, it appears that all are inconvenient so why the United States and the European Union strongly support hydrogen as a renewable source to produce energy? Here there are some powerful reasons:

- Energy efficient reasons  
The chemical energy of hydrogen can be converted directly into energy, without passing through the thermal actuation of a power cycle. This direct conversion is performed in the fuel cells, capable of converting the chemical energy into electrical energy using electro-chemical resources.
- Energy dependence reasons  
Nowadays there is a strong dependence of fossil fuels which are in finite quantities.  
Even though hydrogen is not an energy source, it facilitates the transportation and storage of them and can be produced from renewable sources and therefore may play an important role in the reduction of energy dependence.
- Environmental reasons.  
The hydrogen combustion only releases water vapor. That means that the production of electricity using hydrogen is free of pollutant emissions.

Nowadays the development has to be suitable with the respect for the environment. On one hand the society demands the best use of existing resources increasing the efficiency and on the other hand the use of clean energy products.

The main attraction of hydrogen is that in a long term provides the possibility of a closed and clean energy cycle scenario. Below hydrogen as energy will be developed.

# PRODUCTION

Since hydrogen is not isolated in nature it must be obtained from other raw material conducting certain transformation processes.

The figure represents the sources of hydrogen produced at the present. The bar diagram represents that almost half of all the hydrogen produced is obtained from natural gas. What is more 96% of hydrogen requires fossil fuels to be produced and 95% of this production is for industries consumption.

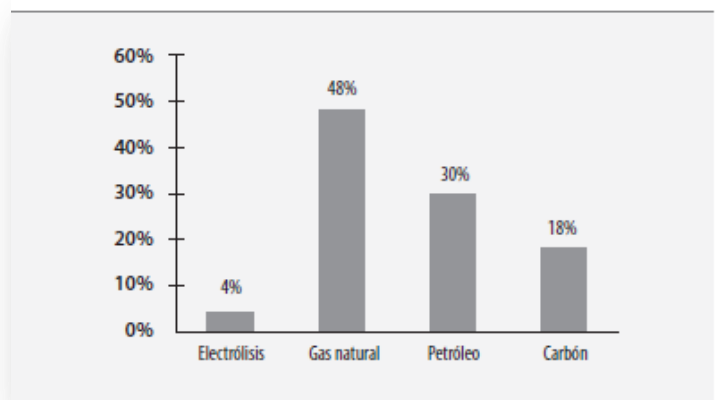

'Figure S.3.1. 'Hydrogen production at the present' (Linares and Moratilla, 2007, p.30.)'

Fortunately the methods to produce hydrogen are varied, some of them admitting more than one scheme: centralized or massive schemes and decentralized. The figure below shows the main ways of obtaining hydrogen, adapted Turner (2004). The graph shows that if you categorize the methods attending to the sources, several of them share the same process. Thus, electrolysis can be carried out from nuclear energy or wind power, with the same physical process. Something similar happens to thermolysis processes, which can be activated from nuclear or high temperature solar energy (not shown in the figure). Gasification is another example of process that can be applied to coal (fossil fuel) or biomass (renewable).

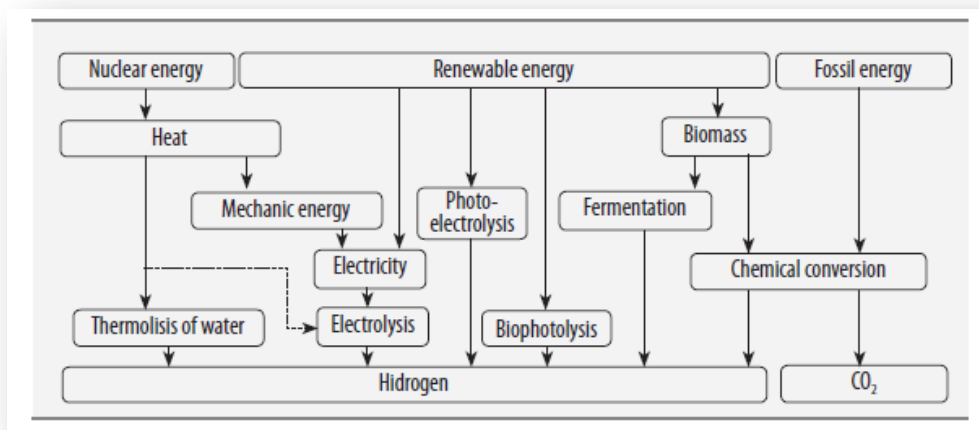

'Figure S.3.2. 'Hydrogen production processes' (Linares and Moratilla, 2007, p.31.)'

Consequently in order to not repeat contents the hydrogen production would be separated in two big groups. First of all it's going to be explained the production processes followed by the implementation of sources. The former is focus on the processes which produce hydrogen whereas the latter calls attention to the sources in which the production of hydrogen is normally based on.

## PRODUCTION PROCESSES

### CHEMICAL SYNTHESIS

The production process called chemical synthesis is quite extensive, that is to say chemical synthesis can be applied to fossil fuels (coal and oil) as long as renewable sources (biomass). The main processes are steam reforming, pyrolysis and gasification.

#### STEAM REFORMING

This kind of process is the most common today for obtaining hydrogen. From a thermodynamic point of view can be divided into endotherms and exotherms. The former requires the input of heat from an external source, such as the 'steam methane reformer' (SMR), the later releases heat in the reaction, being the case of 'partial oxidation' (POX). In the same way the 'auto-thermal reforming' is a combination of the two processes, resulting in a zero net heat balance

#### SMR. 'Steam Methane Reformer'

This process can be applied to a great variety of hydrocarbons such as natural gas, LPGs or liquids hydrocarbon and alcohols. The most widely used is natural gas due to its availability and ease of operation.

The reaction that is verified in the first reforming stage is corresponding to the equation (i1). The equation takes place at temperatures around 900 ° C in circulating tubes over which flow methane and water vapor through catalyst beds of nickel base.

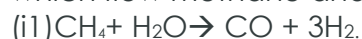

When the first reaction is finished the gas is directed to the 'CO- shift' unit wherein the exothermic reaction (i2) takes place on copper catalysts.



As a result of equations i1 and i2 the produced gas must be passed through a condensation process called purification in which the gas is stripped of the water vapor. The gas that arrives to this process is a gas rich in H<sub>2</sub> with CO<sub>2</sub>, remaining water, CO and CH<sub>4</sub>. This stream of gas is purified in a separating membrane system called 'Pressure Swing Adsorption' (PSA) obtaining hydrogen with a purity of 99,99 %.

The performance of the reforming process of natural gas with water vapor is approximately around 80% (measured regarding to the produced hydrogen lower calorific point and the consumed natural gas)

### **POX. 'Partial Oxidation'**

The Partial Oxidation consists of an incomplete oxidation of a hydrocarbon (for example natural gas) where only carbon is oxidized leaving free the hydrogen according to the reaction i3.

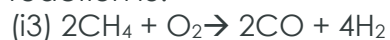

The reaction takes place at temperatures around 800°C. The CO formed can be removed oxidizing it to form CO<sub>2</sub> or displacing it with water according to the reaction i4 to get more hydrogen and CO<sub>2</sub> again.



Just because the reaction is exothermic and it's easily activated POX is considered as an interesting process to get hydrogen for transport applications. It could be used by vehicles powered by natural gas.

The process efficiency is around 70% in large industrial productions.

### **ATR 'Auto- Thermal Reforming'**

This is a method that combines the SMR and the POX, so the heat released by the latter is used by the former, resulting in a zero net balance.

The CO produced is displaced with water to produce more hydrogen and CO<sub>2</sub>. The efficiency of the process is similar to the partial oxidation method. (Approximately 70%)

ATR is a well-studied process applied to industry. Only recently this technology has been transferred to small equipment.

## **PYROLYSIS**

Pyrolysis is the decomposition of a solid fuel (coal or biomass) by means of heat (normally reaching temperatures around 450 ° C for biomass and 1200 ° C for coal) in a free-oxygen atmosphere.

The final products of this process depend on: the nature of the fuel used the temperature and the pressure of the operation and the duration of the process. The products that can be obtained are:

- Gases composed of H<sub>2</sub>, CO, CO<sub>2</sub> and hydrocarbons (methane)
- Hydrocarbon liquids.
- Carbon residues (coke)

From the point of view of the hydrogen production it's interesting to monitor the reaction in order to produce a synthesis gas compound of CO and H<sub>2</sub> which can subsequently be conditioned by the 'CO-shift' reaction (i2).

The application of pyrolysis in solid urban wastes to produce liquid hydrocarbon is also interesting. This hydrocarbon can be reformed to produce hydrogen.

## **GASIFICATION**

The gasification process consists in combustion with oxygen flow in which is obtained some different proportions CO, CO<sub>2</sub>, H<sub>2</sub> and CH<sub>4</sub>, depending on the composition of the raw materials and the conditions of the process. Gasification can be applied to biomass and coal.

If the reaction takes place with air a 'poor gas' is obtained. In the case of coming from coal or coke would be necessary to condition the gas by the 'CO-shift' reaction.

Nevertheless, if the reaction takes place with oxygen and water vapor, a synthesis gas (H<sub>2</sub> and CO) is obtained. It can be used to produce hydrogen as well as to get liquid fuels such as methanol and gasoline.

Therefore, from the point of view of the hydrogen production, it's important to stand out the gasification processes which take place with water vapor and pure oxygen, either from coal or biomass.

With reference to gasification processes it is agreed that the gasification of coal can be a massive process for producing hydrogen with CO<sub>2</sub> capture. Coal gasification can be integrated properly in a combined cycle (GICC) with CO<sub>2</sub> capture giving place to a new form of cogeneration: the simultaneous production of electricity and hydrogen. (Linares & Moratilla, 2007)

## **THERMOLYSIS OR THERMAL DESCOMPOSITION**

Thermolysis processes involve the hydrogen extraction breaking the chemical bounds of the water or hydrocarbon molecule by the application of heat.

The consideration of these processes as chemical methods or thermolytic depends on the heat source used. Thus we speak of chemical processes within the meaning of the previous section, when the process heat is extracted from the raw material itself through combustion. In contrast it is called thermolysis processes when the heat comes from an external source, such as high temperature solar energy or nuclear energy.

## **ELECTROLYSIS**

Electrolysis is the rupture of the water molecule by action of an electric current. When it happens in environment conditions (25 ° C and 1 atm) is an interesting process, as shows the energy balance performed on the following equation (i5).



This equation requires a power demand that reduces as much as the temperature increases. What is more, the highest reduction of power demand takes place when water vapor instead of liquid water. Consequently there are two different ways to perform the electrolysis:

- Low temperature electrolysis.

The power consumption is very high, in the range of the energy contained in the produced hydrogen. Another alternative may be the integration of this system with renewables energies (mainly wind) getting focus into a way to store surplus wind potential.

- High temperature electrolysis.

Even though the electricity consumption remains high, this process begins to be acceptable. For this operation it is necessary to have water vapor and a high temperature heat source, which can be concentrated solar energy or nuclear energy of advanced reactor.



## FERMENTATION

Fermentation techniques are mainly used to produce hydrogen from biomass. There are two fermentation techniques:

- Alcoholic fermentation.  
Plants store the captured solar energy in the form of simple carbohydrates (sugars) or complex carbohydrates (starch or cellulose), from which ethanol can be obtained by fermentation.
- Anaerobic fermentation.  
Also known as anaerobic digestion is a microbial fermentation absent of oxygen which produces a mixture of gases (mainly CH<sub>4</sub> and CO<sub>2</sub>) known as biogas. This biogas contains an amount of CH<sub>4</sub> which ranges between 50% and 79%. The remainder is mainly CO<sub>2</sub>.  
This biogas can be treated with any of the steam reforming processes (SMR, POX or ATR) which have been explained in the chemical synthesis section.

## PHOTOLYTIC PROCESSES

Photolytic processes use sunlight to produce water hydrolysis. Two methods are currently known: the photobiological and photoelectrochemical processes. In both cases they are currently under investigation.

### PHOTOBIOLOGICAL PROCESSES

This technology will produce hydrogen from water, electricity, enzymes and biomass, although would be a reality in a long-term.

### PHOTOELECTROCHEMICAL PROCESSES.

This process aims to achieve the electrolysis of water using sunlight through semiconductor specialized in the dissociating of water. They achieve efficiencies of 30% higher than the electrolysis with photovoltaic cells. In other words, photoelectrochemical processes would be an attractive procedure to get hydrogen.

# IMPLEMENTATION OF SOURCES

After analyzing the different hydrogen production processes, in this part of the report the attention is focused on the sources in which the production of hydrogen is normally based on.

A first consideration, from a practical point of view is the difference between centralized versus decentralized production. Both have advantages and disadvantages that must be taken into account in order to choose the most appropriate methodology in each case.

For instance in the centralized production the CO<sub>2</sub> capture resulted cheaper when fossil fuels are used as a source. Nevertheless, in the decentralized production transport and infrastructure costs are eliminated.

## FOSSIL FUELS

### NATURAL GAS

The hydrocarbons have great advantages as raw materials in order to obtain hydrogen.

- The transport systems of raw materials are safe and efficient. The gas and oil pipelines systems are secure and reliable as well as they have low energy consumption.
- Today, natural gas is the first raw material for hydrogen production, thus it is a mature technology.

On the other hand some of the disadvantages are:

- This source requires CO<sub>2</sub> capture in order to achieve a sustainable hydrogen production. This is only economically feasible in large installations.
- Use natural gas as an energy source in small decentralized production needs the adaptation.

### COAL

The coal gasification integrated in a combined cycle with CO<sub>2</sub> capture is displayed to be the most interesting alternative within fossil fuels for several reasons.

Coal is the most abundant fossil fuel. (Reserves are for around 200 years)

- The geographical distribution of coal is quite varied
- The costs of hydrogen production are very low, although it requires high investments
- Hydrogen and electricity are produced simultaneously being possible to change the type of production depends on the current market.

For all these reasons as much USA as Europe, with the project called 'HYPOGEN', strongly support this type of source at the present.

## NUCLEAR ENERGY

In order to achieve a cost effective application of nuclear energy for hydrogen production, the hydrogen has to be produced by nuclear processes which require high temperature. For example, high temperature electrolysis.

In the same way as coal, the hydrogen production by nuclear energy can be performed simultaneously with the electricity.

## RENEWABLE ENERGIES

Renewable energies are greatly attractive for hydrogen production. Nowadays different levels of development are found due to their wide diversity.

According to the predictions established by the project called HyNET nowadays the low temperature electrolysis is possible use by photovoltaic and wind energy and the biomass gasification using solar means. As of 2015 it is expected that the decarbonization of fossil fuels would be done by solar energy and photochemical processes.

### SOLAR

At present the largest application of solar energy is the high temperature which it use in a massive scale.

Today it is technically possible the application of photovoltaic panels to produce low-temperature electrolysis. However the high cost of this system suggest to relegate it to isolated applications where another hydrogen supply couldn't be possible.

In a long term and focusing on decentralized systems, photoelectrochemical processes expect to reduce costs as well as photobiological processes.

### BIOMASS

The processes for producing hydrogen from biomass can be of two types: thermochemical processes such as pyrolysis and gasification or biological processes like alcoholic fermentation or anaerobic digestion.

Hydrogen production from biomass competes with biofuels productions that are easier to introduce into the market.

Thermochemical processes have efficiency between 42 and 72% with a production cost of 100 euros / MWh.

### WIND POWER

The hydrogen production from wind power passes through low temperature electrolysis and can be considered an available technology today.

Despite the mature of wind technology and low-temperature electrolysis systems, it cannot be thought as a massive hydrogen production from wind power, since the calorific power of hydrogen is 3 kWh/Nm<sup>3</sup>.

Assuming an efficiency of 50% a low temperature fuel cell would have a global efficiency of the system equal to:

$$\left(3,5 \frac{\text{kWh supplied to the electrolyzer}}{\text{Nm}^3 \text{H}_2}\right) \left(\frac{1 \text{ Nm}^3 \text{ H}_2}{3 \text{ kWh}}\right) \left(\frac{100 \text{ kWh consumed H}_2}{50 \text{ kWh produced by the cell}}\right) = \left(\frac{2,33 \text{ kWh supplied}}{1 \text{ kWh produced}}\right)$$

That means that is recovered about 43% of the electric power generated by wind power. Even though this result clearly is not appropriate for the massive production of hydrogen, it is also doubtful as pumped storage technique of wind farms.

In other words, it is under examination the store of energy produced in off-peak hours as hydrogen in order to sell the electricity generated by the fuel cell later.

Electrolyzers and batteries technologies should reduce costs to achieve more competitive investment in hydrogen systems.

## STORAGE

Hydrogen has physical characteristics that make it difficult to store in large quantities without taking up a significant amount of space.

Hydrogen has very high energy content by weight (about three times more than gasoline) but it has very low energy content by volume (liquid hydrogen is about four times less than gasoline).

From the point of view of hydrogen stored per weight unit, the best store system are compressed and liquid hydrogen.

## COMPRESSED HYDROGEN

The hydrogen storage as a compressed gas is the easiest storage system, although the energy densities achieved are lower. Actually, high densities are only achieved if the hydrogen is compressed using high pressure.

The current working pressures are 200 bar, reaching 700 bar in the most advanced equipment. Nowadays the compressed hydrogen storage is a mature technology, but in the recent years great efforts have been done to develop the 700 bar equipment.

Therefore, the energy consumption of this process is determined by the hydrogen's need to be compressed.

## LIQUID HYDROGEN

The cryogenic hydrogen technology is not as widespread as is the compressed hydrogen. It is a complex technology that seems to be reserved for industrial use because of the complications associated with the generalized used by citizens. The main area of application is large-scale storage, including in particular the transoceanic transport in boat.

Liquefied hydrogen is denser than gaseous hydrogen and thus it contains more energy in a given volume. Similar sized liquid hydrogen tanks can store more hydrogen than compressed gas tanks, but it takes energy to liquefy hydrogen.

The saturation temperature of hydrogen at 1 atm is approximately around 20K (-253°C). This is the highest temperature at which the hydrogen exists as liquid at ambient pressure.

As a result this temperature must be maintained in order to store the hydrogen in that state. So to tell the truth, store hydrogen as a liquid presents two main problems: achieve and maintain this temperature.

## METAL HYDRIDES

The hydrogen storage into metal hydrides is done through chemical means, establishing a process of "charging" (hydrogen adsorption by hydrides) and a "discharge" (releasing). In the adsorption process is necessary to reduce the temperature and remove heat from the hydride. Thereby the charging process in the hydride is encouraged. By contrast, in the discharge process is necessary to heat the hydride and operate it at an elevated temperature to assist the discharging of the hydrogen.

There are two kinds of hydrides: the high temperature hydrides in which the discharge process takes place at temperatures between 150 and 300°C and the low temperature hydrides in which the discharge process occurs at temperature between 20 and 90°C. In terms of pressure, the adsorption takes place between 30 and 55 bar and the discharge between 0.7 and 10 bar. It is estimated that the energy consumed by this type of storage is around 13% of the hydrogen lower heating value, thus this system is comparable to the compressed hydrogen storage at 700 bar.

The table below shows the main types of hydrides which may be used for storing hydrogen.

- The element 'A' is generally a rare earth element or an alkali metal and tends to form a stable hydride.

- The element 'B' is usually a transition metal and tends to form only stable hydrides.

<u>Compuesto intermetálico</u>	<u>Hidruros</u>
$AB_5$	$LaNi_5H_6$
$AB_2$	$ZrV_2H_{5.5}$
$AB_3$	$CeNi_3H_4$
$A_2B_7$	$Y_2Ni_7H_3$
$A_6B_{23}$	$Ho_6Fe_{23}H_{12}$
$AB$	$TiFeH_2$
$A_2B$	$Mg_2NiH_4$

'Figure S.3.3. 'Main families of metal hydrides for hydrogen storage'  
(Linares and Moratilla, 2007, p.78)'

Summing up: Hydrogen can be stored in different forms according to the U.S. Department of Energy (2011).

- In tanks such as compressed gas or cryogenic liquid.

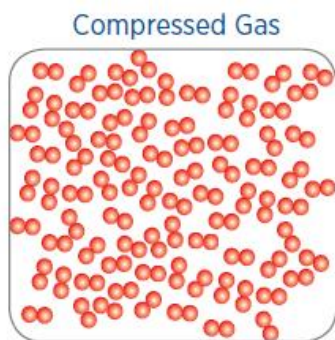

Figure S.3.4. 'Compressed hydrogen gas'

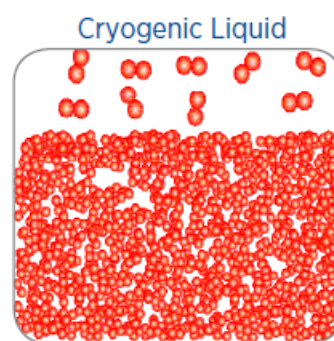

Figure S.3.5. 'Cryogenic hydrogen liquid'

- And in materials.

Hydrogen can be stored on the surface of solids (by adsorption) or within solids

- Material 'A'. Hydrogen attaches to the surface of the material either as hydrogen molecules  $H_2$  or hydrogen atoms  $H$  by adsorption.
- Material 'B'. Hydrogen molecules dissociate into hydrogen atoms that are incorporated into the solid framework. This method could be used in order

to store large quantities of hydrogen in small volumes at low pressure at environmental temperatures.

- Finally the hydrogen can be strongly bound within molecular structures as chemical compounds (materials 'C' and 'D').

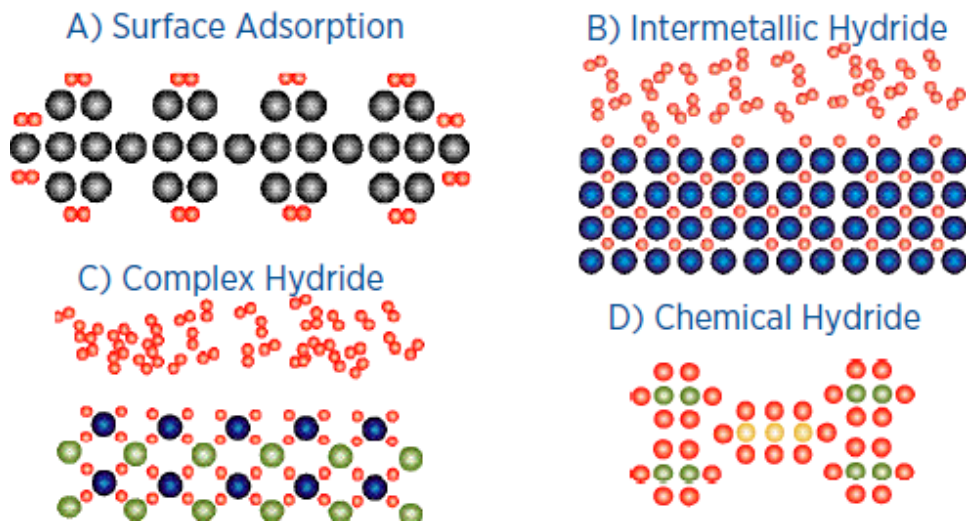

Figure S.3.6. 'Metal hydrides devices'

Source of figures S.3.4 ; S.3.5 and S.3.6. U.S. Department of Energy, 2011. Fuel cell technologies program. (EERE Information Center)

## TRANSPORT & DISTRIBUTION.

When the hydrogen had already been storage the kind of distribution service that would be use is determined according to consumption and consumer needs.

Nowadays the industry is the main user of hydrogen. Consequently the hydrogen transport could be:

- By roads in pressurized bottles.
- By rail or ship in cryogenic tanks or pressurized bottles cooled around a temperature not exceeding the boiling point of nitrogen.

Just as soon as the widespread use of hydrogen as a energy source became real, the massive hydrogen transportation channelled could be shifted to other small ways to transport it.

Currently (and for some 50 years) there are about 1,500 km of 'hidrogenoductos' in the U.S., Germany and France.

The conventional natural gas pipelines support a mixture of hydrogen into natural gas ranging from 5% to 30%. What is more, the construction of pipelines for hydrogen transport is not a big drawback neither technical nor economic.

The European Union put into practice different ways to distribute the hydrogen attending to the applications. All the information was collected by the European project called 'HyWAYS'.

# FUEL CELLS.

Fuel cells are electrochemical devices which directly converts chemical energy into electrical energy.

There are many types fuel cells such as:

- PEM cells(H<sup>+</sup> ion, T: 30-100°C)
- Alkaline cells (OH<sup>-</sup> ion cell, T: 50-100°C)
- Methanol cells (H<sup>+</sup> ion, T: 20-90)
- Phosphoric acid cells (H<sup>+</sup> ion, T: 90°C)
- Ground carbonate cells (CO<sub>3</sub><sup>2-</sup> ion)
- Solid Oxide cells (O<sub>2</sub><sup>-</sup> T: 500-1000)

For being a typical example, henceforth it is explained how the proton exchange membrane fuel cell works (PEMFC).

## Reactions:

Proton exchange membrane fuel cells, also known as polymer electrolyte membrane (PMR) fuel cells (PEMFC), are a type of fuel cell used for transport application as well as for stationary and portable fuel cell applications. They work at low temperature (about 90°C) using pure hydrogen as fuel and oxygen to oxidize the fuel.

A proton exchange membrane fuel cell transforms the chemical energy liberated during the electrochemical reaction of hydrogen and oxygen into electrical energy, in contrast to the direct combustion of hydrogen and oxygen gases which produce thermal energy.

A stream of hydrogen is delivered to the anode side of the membrane electrode assembly (MEA). At the anode side it is catalytically split into protons and electrons

This oxidation reaction or Hydrogen Oxidation Reaction (HOR) is represented by the equation (i1).

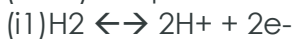

The electrons travel along an external load circuit to the cathode side of the MEA, thus creating the current output of the fuel cell. Meanwhile, a stream of oxygen is delivered to the cathode side of the MEA. At the cathode side oxygen molecules react with the protons permeating through the polymer electrolyte membrane and the electrons arriving through the external circuit to form water molecules. This oxygen reduction reaction (ORR) is represented by the equation (i2).

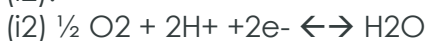

The following figure illustrates schematically the behavior of a PEMFC cell.

It can be seen that the reactions occur constantly. The electrons produced in the anode pass through the electric circuit towards the cathode, whereas the H<sup>+</sup> ions pass through the electrolyte.

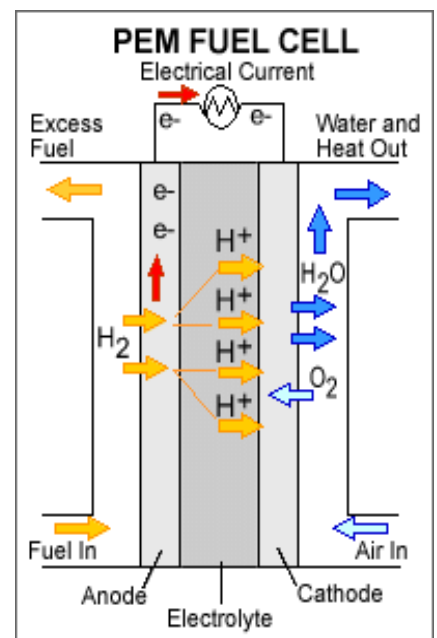

Figure S.3.7. 'PEM fuel cell'  
[http://en.wikipedia.org/wiki/File:Solid\\_oxide\\_fuel\\_cell.svg](http://en.wikipedia.org/wiki/File:Solid_oxide_fuel_cell.svg)

### **Fuel cells application.**

The final use of hydrogen energy as fuel cells includes stationary, transport and portable equipment applications.

Phosphoric acid cells are operating in many places around the world, providing heat and energy for buildings and industrial applications. These cells also include the generation of hydrogen from natural gas.

In the transport sector, fuel cells are being used and tested successfully in private vehicles

Currently vehicle manufacturers like Hyundai, Ford and Toyota are developing hydrogen vehicles for personal use.

### **Advantages vs. disadvantages.**

#### **Advantages:**

- High efficiency. Fuel cells convert directly the chemical energy into electricity in a more efficient way than any other power system.
- Fast response.
- No emissions. It produces no pollution or consumes natural resources.
- Security. In most of the cases hydrogen is more secure than fossil fuels. In case of leakage it could be quickly dissipated into the atmosphere.
- Modularity. Fuel cells can be constructed in any size. This modularity allows the user to increase the power of the system according to the growth rates of energy demand.
- Quiet. In normal operation, the fuel cell is nearly completely silent.

#### **Disadvantages:**

- High cost.

As a result, even the fuel cells cost is not already cheap enough, it is known that one of the most attractive ways to obtain electrical energy from hydrogen is using fuel cells.

## **EXTERNAL INPUTS**

In the late twentieth century, after several energy crises, the world began to realize that the twenty-first century would be the "century of energy." The humanity would have to deal with some challenges such as the development of hydrogen as a clean energy. Some of the triggers are:

- Exhaustion of fossil fuels. The oil reserves have a life expectancy of 40 years, while the natural gas and coal have 60 and 200 years respectively.
- Some producer countries of fossil fuel adopted customs duties.
- Increasing levels of contamination. Particularly in cities the massive use of the car creates strong pollution problems.
- Climate change. Since the discovery of the greenhouse climate some measures and international agreements (Kyoto) have been taken in order to control and reduce greenhouse emissions and CO<sub>2</sub> emissions.



## ENVIRONMENTAL IMPACTS

A compatible development with the nature requires the best use of existing resources which will increase efficiency and what is more the use of clean energy products.

The main attraction of hydrogen consists on the possibility of establish a close energy cycle inherently clean.

This involves taking water from nature, separated into its components (hydrogen and oxygen) using electricity which come from renewable sources, storing the hydrogen, transporting it, distributing it and finally use it following conventional thermal processes (internal combustion engines or turbines), or innovative electrochemical processes (fuel cell).

Consequently if all these steps are followed we would return to nature the same amount of water which it had previously been taken.

To tell the truth, thermal processes would emit some nitrogen oxides, although in a proportion far below those emitted with fossil fuels. Nevertheless electrochemical processes as fuel cells would not emit polluting gases.

## ECONOMIC ASPECTS

When evaluating costs, fossil fuels are generally used as the reference. The energy content of these fuels is not a product of human effort and so has no cost assigned to it. Only the extraction, refining, transportation and production costs are considered.

On the other hand, the energy content of a unit of hydrogen fuel must be manufactured, and so has a significant cost, on top of all the costs of refining, transportation, and distribution.

The barrier to lowering the price of high purity hydrogen is a cost of more than 35 kWh of electricity used to generate each kilogram of hydrogen gas.

Demonstrated advances in electrolyzer and fuel cell technology are claimed to have made significant in-roads into addressing the cost of electrolyzing water to make hydrogen.

## SOCIAL FACTORS.

Briefly, hydrogen has been accepted as a future energy for all the society owing to all the aspects presented before. Hydrogen is seen as the clean energy that will allow us to free ourselves from the tyranny of fossil fuels.

As a result, so much European Union as the U.S.A has given an important support for all the research about hydrogen and fuel cell development.

In spite of the beauty and the charm of the 'hydrogen economy', some unwilling scientists manifest their doubts around the hydrogen as an economy and feasible future way of energy.

The hydrogen economy depends on two main things: fuel cells and hydrogen obtaining. The batteries are very efficient devices which reach extremely high efficiencies. However, this high efficiency can be overshadowed by the fact that hydrogen is not only an energy source but is an energy carrier, as can be gasoline or electricity. Therefore, the efficiency of the battery is to be clarified by the efficiency of the hydrogen production process.

Since hydrogen is an energy carrier its comparison to electricity comes naturally. It cannot be forgotten that just for being an energy carrier, hydrogen allows the application of nuclear energy, coal and wind to transport, storing surplus of renewable energies and use hydrogen as an energy source for electric vehicles.

# CONCLUSION

It must be remembered that hydrogen could not be the energy of the future could be only a future energy carrier.

Hydrogen cannot be the whole solution to the currently energy problem. If hydrogen is produced from renewable energy such as coal with CO<sub>2</sub> capture or nuclear energy, hydrogen can be a good solution in order to resolve the energy problem. As a matter of fact it would not be true that the economy would be based on hydrogen. The economy must be based on primary sources as renewable energies, coal or nuclear energy.

The energetic model should be based on a basket that combines different sources where each energy must be used in an efficient way.

In conclusion nobody should talk about the "hydrogen economy" without taking into consideration a correct framework. In other words it would be like speak about the 'electricity

## SWOT

In the SWOT analysis below is evaluated the general Strengths, Weaknesses, Opportunities and Threats of the hydrogen as a sustainable energy.

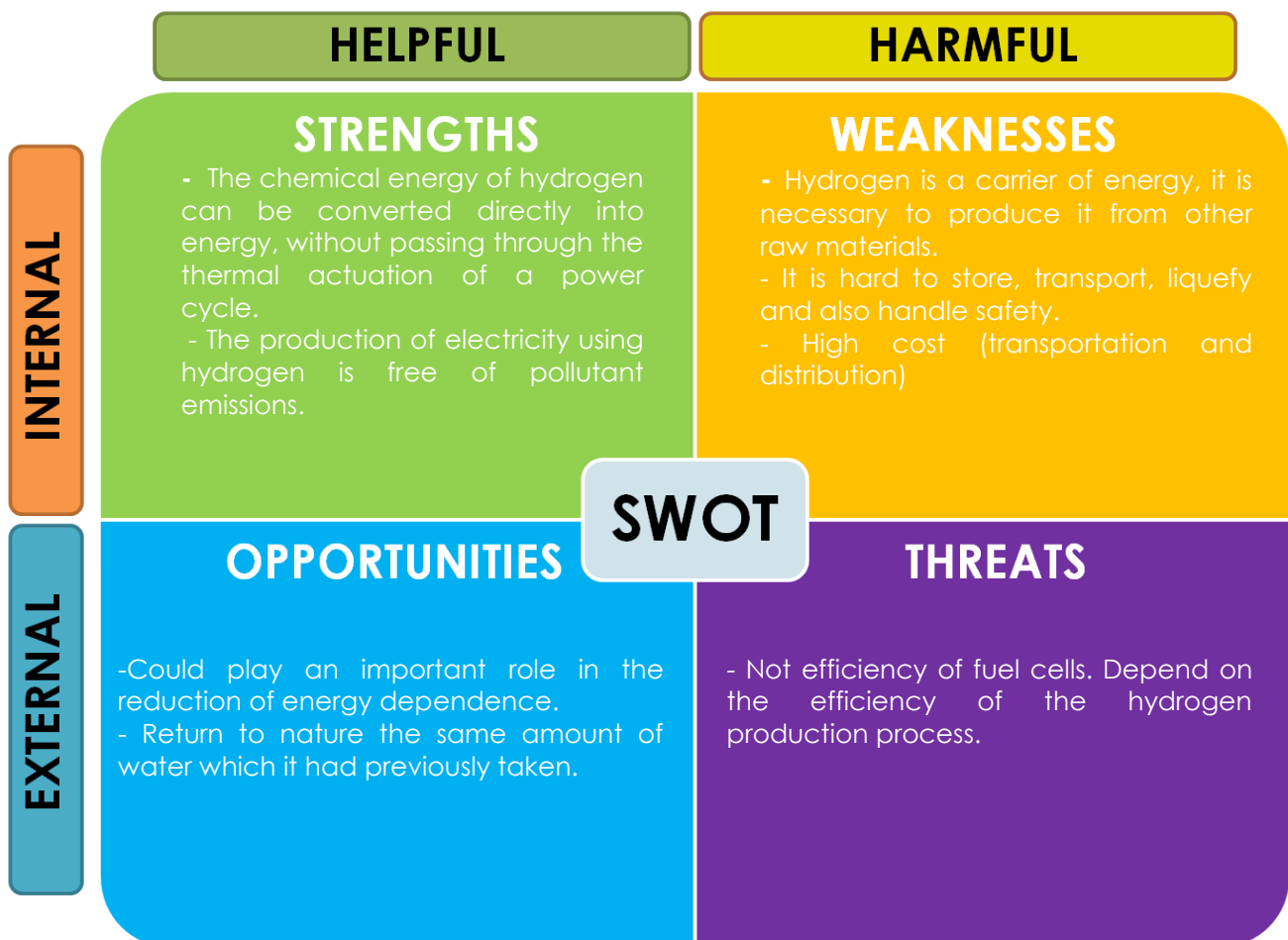

# EFFICIENT ENERGY MANAGEMENT

Energy Storage  
Passive Building Design  
Insulating Materials  
Smart Grids

---

# ENERGY STORAGE SYSTEMS

## INTRODUCTION

Thermal energy storage (TES) has been one important research field during the last years. The development of TES materials and technology try to deal with two main objectives: the energy efficiency and energy savings. Those points have been first studied in 1983 by Abhat (1983, pp.313-332). First of all, the different thermal energy systems are link to some basics notions which will be developed in the next paragraphs.

### Definition of the thermal inertia

The thermal inertia of a system/element can be defined as his resistance to temperature changes. As a contrary, the thermal conductivity is the property of transmit and literally conduce heat. In the building field, those properties are used to regulate the internal temperature with two phenomena: the thermal absorption (Capacity of the constructive element to prevent against temperature peaks) and thermal delay (Time to transmit heat from outside to inside). Those two notions are linked to the inertia. Higher is the inertia value, more important are those two phenomena. In a building context, they take part in the natural thermal control which is one of the bases of bioclimatic and passive houses.

### Different types of heat

#### Sensible heat

The sensible heat is the most common way to store and transmit energy and is used in many of our actual houses and devices. Here the body or the system can absorb or release energy changing his own temperature.

The energy stored mainly depends on the volume and the temperature of the material. This kind of storage is efficient for important volume and high temperature. According to that, the main problems are link to thermal losses and insulation which both impact the system's performance.

Material with high density can be used (water, concrete, ground, etc.)

#### Examples:

Water tanks, wall inertia, concrete slab for direct solar energy storage.

## Latent heat

### *Definition of latent heat*

The latent heat is the energy which can be absorbed or released by a body or a system when it changes his state with constant temperature and pressure. Most of the time, the energy is absorbed as heat and this absorption occur without any raise of the temperature. This latent heat can occur in three different cases:

- Change state from solid to liquid
- Change state from liquid to gas
- Change state from solid to gas

The main aim of using this latent energy is to optimize the compactness (reduce the volume of a heat storage element) and energetic density (raise the quantity of energy which can be store in a same volume) (Lane 1983, 1986). This type of heat is directly linked to the use of PCMs.

### *Definition of PCMs*

Basically, PCMs are materials able to absorb and release energy during a phase change. Felix Regin, et al. (2008, pp.2438-2458) define it as a storage material with an important TES density, which is able to absorb and release a lot of energy changing his phase (constant  $T^\circ$  and pressure).

One of the most important characteristic of PCMs is their Phase Change Temperature (PCT), sometimes also call melting point. The use of a PCM in a system is directly link to this temperature. The phenomenon occurring around this temperature is the following one: Around their PCT, PCMs inertia is more important and they are able to store the energy without changing their own temperature but just phase changing (Zalba, et al., 2003).

The latent heat and more specifically PCMs are mainly used in order to raise the Stability of inside temperature and so, the comfort.

The following diagram shows that around his melting point (27°C), the PCM studied continue to absorb energy without changing his own temperature. The storage capacity of the PCM around its melting point rises and becomes higher than water and concrete ones. The use of PCMs is directly link to their melting temperature.

*Figure EEM.1.1. Comparison of energy storage capacity of three different materials  
(NB: the PCM studied is Calcium Chloride Hexahydrate ( $\text{CaCl}_2+6\text{H}_2$ ))*

## Characteristic and applications

**Advantages:** Rise of thermal stability, storage capacity and Inertia

**Problems:** Costs of PCMs for implementation, still in development, only useful around some temperatures

**Materials:** Water, Paraffin, Salt

### Examples of applications:

Rise of building envelop inertia

Water tank with PCMs

Rise of concrete slab inertia

## Chemical heat

This type of heat is based on an exothermic reaction of two liquid or solid. It can be used if the reaction is reversible and without losses. The chemical heat is the basis of classic batteries where the two chemical elements exchange an ion.

**Advantages:** Large energy storage in a small volume at a certain temperature

**Problems:** reversibility, toxicity of components, double storage volume, Chemical components and materials costs, High temperature non well-adapted to residential buildings.

### Examples:

60-150°C: NaOH,

150-200°C: Mg(SO<sub>4</sub>)7H<sub>2</sub>O

High temperature: ZnO

## Sorption heat

Sorption is a physical and chemical process where one substance gets linked to another. This type of heat is not really developed for building applications but some researches are actually going on for cooling air systems for example.

Two types of sorption heat are existing:

- Adsorption: The gas get link to a solid surface (Zeolithes, Silicagels)
- Absorption: Chemical reaction due to a melt between a fluid and an absorbent (hydrated salt, ammoniac, LiCl, BrLi)

The different systems used for this type of heat can be organized in two groups:

- Closed systems, where fluid transfer is directly spread in the environment with his entropy (mainly used with Water)
- Open systems where only entropy is spread in the environment

This type of heat will not be detailed more in this report. Its building applications in term of energy storage are actually not developed enough.

# MAIN STORAGE SYSTEMS AND TECHNIQUES

## Storage volumes

Link to those notions, different systems and techniques have been developed in order to improve the energy management. To be efficient, the energy created should be stored and kept, but where?

The first answer to this question is quite obvious and the system we are talking about has always been used (consciously or not): The building itself!

### Building envelop

The volume we want to heat, a house, a building, is the first thermal storage system. We are talking here about everything link to insulation, envelop inertia and thermal bridges (Materials used for the building envelop will be developed in another part).

We can consider two different approach, the house and his envelop is the storage system or the buildings element are used and improved for energy storage. Those "storage" systems permit mainly to keep heat and fresh in the building and to exploit natural conditions (solar radiations, external temperatures, etc.).

With a good conception, less energy is needed to maintain a comfortable inside environment and energy savings are realized both exploiting external natural conditions and limiting thermal losses.

The necessity of other energy storage system is based on a simple statement: all the energy produced cannot be stored in the building or in his envelop, moreover the thermal losses are not optimum and do not guarantee a high efficiency.

### Storage units

For most of actual installations, the energy produced is stored in individual or common tank containing water or other thermal conductor fluids. Those determined volumes are able to store the energy for a short duration at important temperature (50-100°C) but some other implementation and application are also developed for longer storage and bigger volume.

One Important point is the insulation of these storage units. In order to be as efficient as possible the volume must be completely insulated and do not permit any losses. Even if this point is already handled for individual water tank, some difficulties are nowadays link to large storage for seasonal storage. For those the use of a concrete with high sealing properties seems to be one solutions but the technology is constantly improved in order to optimize the efficiency of that kind of storage.

### Natural Storage volumes

The third main solution to store energy is to use existing volume, soil, sub-soil water, sub-soil cavity, etc. Mainly used for large implementation, those natural storage volumes offer, without complex construction work. Here we use directly the properties of the ground and water (density, thermal conductivity, etc.) to store energy. The systems linked to that kind of storage, mainly long term storage, are developed in the next paragraphs.



## Storage time

The second main point link to a storage system is the storage time, or more exactly, for how long is the system designed to keep this energy? The storage time is directly link to the technology available (techniques/ materials) but also to the uses. In this part, we are going to separate Short and medium storage from seasonal and long term storage.

### Short and medium term storage

Short and medium storage are mainly related with building envelop and storage units, which are used to temporally store energy. Those systems permit **to balance the difference between energy production and energy need**.

Some common applications of short and medium storage systems:

- Buildings' envelop inertia (temperature between 18-26°C) passive heating based on sensible heat (*Really used but not always calculated*).
- Inertia improvements (temperature between 18-24°C) for comfort (*not well developed*).
- Water tanks (10-100°C) most common storage system (good both for individual and collective buildings)
- Water tanks integrating PCMs (10-70°C) in development

### Long term storage

#### Introduction

Long term storage, or also called seasonal storage, are nowadays the heart of many researches and developing projects. The aim is of those storage systems is to permit to store energy (electricity, heat, etc.) for a long period in order to be able to distribute it when it will be needed. Once again this kind of systems is made on a simple statement: **Production of energy and energy needs do not always occur in the same time**. How could we collect heat from summer conditions to use it during winter? The first part of the question is already answered and we know nowadays how to collect that kind of energy, the main challenge is to keep this energy somewhere and somehow.

#### History

It's in 1973, after the petrol crisis that countries like USA, Switzerland and France, started thinking about energy savings and more precisely, energy storage. They started to think about sub-soil water for large energy storage. In the 80's, northern countries such as Sweden also started to think about long term storage using natural volumes, soils in particular.

Nowadays, in Europe, most of researches and projects are lead by centre and northern European countries, such as Belgium, Netherlands, Denmark, Sweden, Switzerland, Austria, etc. Since 1995 Deutschland, is also one of the principal country developing projects and researches about long term storage systems.

During the last years some researches have been realized about electricity storage and large chemical battery for seasonal storage. In the USA, batteries with magnesium and antimony have been developed in order to store large quantities of renewable energy.

## Long term energy storage principles

### Long term heat storage

Basically there are three different principles used for long term energy storage linked to the storage element (mainly soil or Water):

**Convection:** This physical phenomenon is used for energy storage in water.

**Diffusion:** This physical phenomenon is used for energy storage in the ground.

**Mixed:** This principle used both convection and diffusion phenomena with particular applications as shown on the following figure.

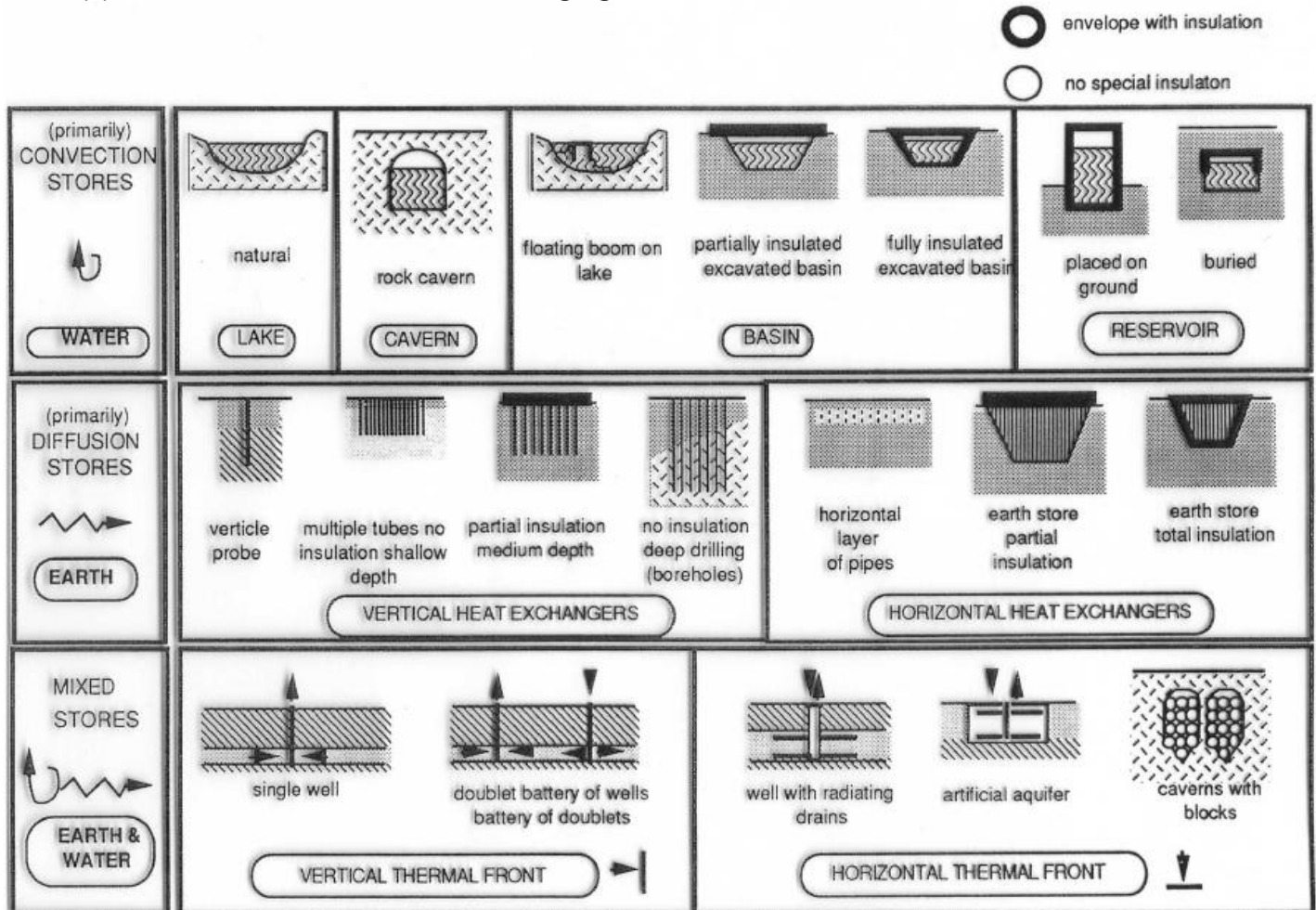

Figure EEM.1.2. Main different principles of seasonal storage with low costs and important volumes (Hadorn, 1988)

### Long term electricity storage

For the storage of electricity we know for a long time how to realize batteries for our devices. The point is that for the energy sector, this technology is not implementable for a large scale. During the last years, some researches have been carried out in order to find an answer to the energy storage problem. Some searchers adopted a philosophy, which can be resumed with Donald Sadoway words: 'We need to think about the problem differently. We need to think big. We need to think cheap.'

They try to find out a way to store large quantities of energy in cheap batteries, able to store renewable energy for a long period.

Using chemical reactions, this system constitutes another approach of energy storage, none focused directly on the heat but on the electricity.

# Conclusion

## Definition of good storage systems

A good storage system must take into account the following points in order to be as **efficient** as possible, **easily implementable** and **affordable**:

- Maximum heat storage capacity
- Low thermal losses
- Good thermal exchange coefficient
- Low fire and toxicity risks
- Reversibility and long life cycle (for PCMs)
- Costs
- Compatibility with available and cheap tanks

## Specific losses are linked to the volume (bigger are the volumes and smaller are the specific losses)

Systems performances depend on the storage duration, storage capacity and use temperature.

In most cases the efficiency of a short term storage system is about 80% (around 20% of thermal losses per day).

Seasonal storage systems have an efficiency which varied between 30 and 70% depending of its size and life cycles. It can be more, such as in Sweden, where a 95% efficient ground storage system of 3500m<sup>3</sup> have been realized.

# BUILDINGS APPLICATIONS

## Seasonal storage application

### Water storage integrated in the sub-soil

One of the main difficulties in the current application is the integration of a volume in the subsoil to store water. The solution which is the most efficient seems to use a high sealing capacity concrete like the one used in the following example.

Project CSHPSS in Munich (storage volume integrated in the subsoil)

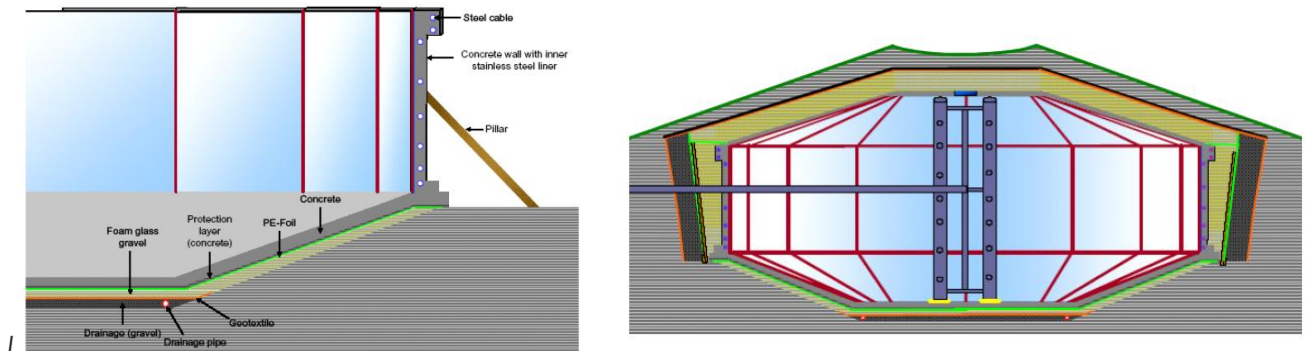

Figure EEM.1.3. Cross section view of CSHPSS in Munich

### Water storage integrated in the building

Another application for the water storage could be the integration of the storage volume directly in the building. This kind of system has been developed in Switzerland for the project Jenni. The 205m<sup>3</sup> water tank situated in the middle of the building works with more than 275m<sup>2</sup> of solar panels. The efficiency of this huge storage system is based on the statement established previously: "bigger are the volumes and smaller are the specific losses".

### Geothermal storage

The geothermal energy will be developed more precisely in another part of this report but from an energy storage point of view, ground permit to store and take energy with less efficiency than water (link to the soil density compared to water) but with low costs. Another advantage is the possibility to store Heat and also fresh, as it has been developed in Switzerland and Deutschland. For this kind of application the system workability has been proved but some problems are link to the recharge by the network.

## Sub-soil water storage

Store energy directly in sub-soil water provides one main specificity: It also permits to realize fresh storage. This technology is mainly used in Netherlands and Belgium but also in Deutschland.

Examples:

In Berlin (Reichstag), the rehabilitation of the parliament integrated heat and fresh subsoil water storage.

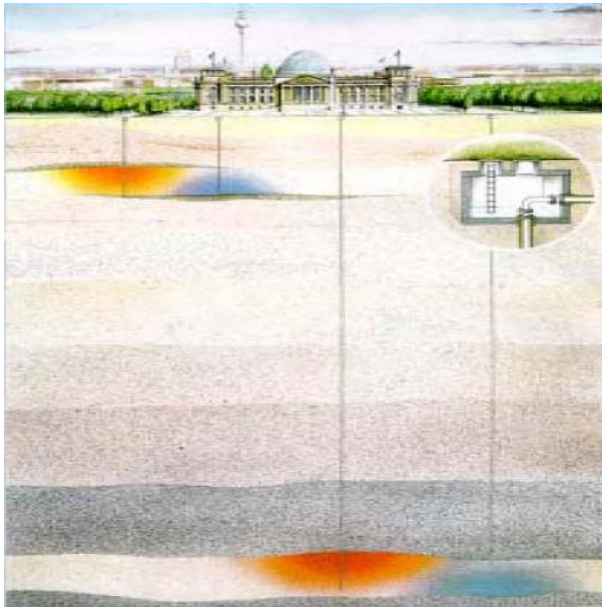

### Cold Storage ( $\approx 50\text{m}$ depth)

- Storage Efficiency  $>90\%$
- Input  $T^{\circ}\text{C}$  (summer/winter):  $15\text{-}28^{\circ}\text{C}$  /  $5^{\circ}\text{C}$
- Output  $T^{\circ}\text{C}$  (summer/winter):  $6\text{-}10^{\circ}\text{C}$  /  $22^{\circ}\text{C}$
- Injected energy  $>4200$  MWh/a
- Extracted energy  $>3900$  MWh/a

Figure EEM.1.4. Reichstag heat and fresh storage

## Other application in development

The main developments in the building sector for short term storage are link to the improvement of individual and collectives water tanks. One way of improvement concerns the insulation of those water tanks and the limitation of thermal losses. The integration of PCMs for solar energy storage (water tank), could also constitute an interesting improvement in terms of efficiency.

Concerning the building envelop, some improvement are currently in development to raise the inertia of walls, slabs, ceilings, etc. using better materials or integrating new components in concrete (PCMs) for example.

## Chemical storage

One amazing improvement in the domain of energy storage concerns the electric storage with large-scale batteries. As the other energy storage systems, this solution is a **response to the intermittency of solar, water and wind energies**.

Donald Sadoway, professor in the MIT, developed with his student a liquid metal battery able to store large quantities of energy with a low cost process and working at elevating Temperature. The company LMBC developed that kind of batteries made of magnesium, salt and antimony, with small then large storage capacities as it is shown on the following figures.

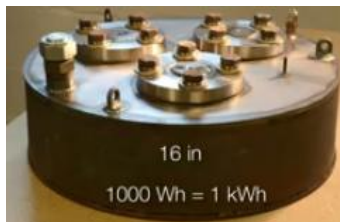

Figure EEM.1.5.



Figure EEM.1.6.

Figure EEM.1.5: Battery of 16 inches in diameter with a capacity of 1 kWh

Figure EEM.1.6: Giant battery of 40 foot with a capacity of 2 MWh (daily electrical needs of 200 households)

This storage system still in development could be one of the future solutions to support the development of renewable energy, with the following advantages: Grid level storage, silent, emissions-free, remotely controlled.

## Heat distribution network

Link to those technologies, the distribution network should also be ready to support this new way to manage energy. In Denmark (Copenhagen) and Finland (Helsinki) some huge network are already implemented. In Marstal (Denmark) it's this network which is directly heating and maintain to a constant temperature in order to store solar energy.

# IMPACTS

## Energetic impacts

Short time storage is really important for an efficient energy management. Without a water tank, a solar installation would give only 1/100 of what it can provide. Moreover the design of the envelop permit easily to reduce the energy consumption. Long time storage permits to raise the efficiency of large energy production, raising its efficiency.

## Environmental impacts

Seasonal storage in sub-soil water, can impact the water quality. A previous analysis and study must be realized. A soil storage system can also impact the environment if it's not well controlled and managed. The perturbation caused by the implementation of that kind of system must be studied and simulated. If an over-exploitation would occur, heat pumps would be damaged after 10 or 15 years.

All those kind of storage systems permit to reduce carbon footprint helping the implementation and the optimization of solar and other green energies.

## Costs and efficiency comparison

Here can be find some estimation of the costs of different types of installations (short and long term):

**Collective water tank** (100 to 1000L)  
Estimation of investment costs: 400-1000 €/m<sup>3</sup>  
Efficiency: 70-90 %

**Concrete water storage for seasonal storage** (100 to 1000 m<sup>3</sup>)  
Estimation of investment costs: 180-600 €/m<sup>3</sup>  
Efficiency: 50-75 %  
(Values depending on the excavation, the insulation and the sealing)

**Sub-soil metallic water tank for short time storage** (20 000m<sup>3</sup>)  
Estimation of investment costs: 60-200 €/m<sup>3</sup>  
Efficiency: 70-80 % (depending of the depth of the tank)

**Ground storage with vertical probes** (between 100 and 1 000 probes of maximum 100m depth)  
Estimation of investment costs: 30-80 €/m<sup>3</sup> (the cost mainly depend of the depth more than the volume excavated)  
Efficiency: 40-60 %

**Sub-soil water for fresh energy storage** (5 to 20°C)

Estimation of investment costs: 5-10 €/m<sup>3</sup> (non significant, values can vary a lot depending of the aquifer)

Efficiency: 90-100 %

**Sub-soil water for heat storage** (30 to 70°C)

Estimation of investment costs: 5-40 €/m<sup>3</sup> (non significant, values can vary a lot depending water-processing)

Efficiency: 30-70 %

This small comparison permits to give a better idea of the costs and the efficiency of some applications. The use of sub-soil water volumes for fresh energy storage shows an important interest in terms of efficiency and costs. Countries such as Belgium and Netherlands already realized the opportunities offer by that kind of system if it is implemented taking into account environmental conditions.

For heat storage, performances are mainly linked to our ability to insulate the volume but also to the storage time. For long term storage systems, costs vary with the geological context, but the efficiency is directly link to the size of the volume.



# PASSIVE BUILDING DESIGN

## INTRODUCTION

The passive house concept is the foundation of bioclimatic architecture; the buildings try to take profit from the resources of the environment, through appropriate design of the space projected, to obtain an indoor environment as optimal as possible, with minimal use of energy. The ultimate goal is achieved an energy efficient, comfortable and affordable building at the same time.

## DESCRIPTION

To achieve this kind of design it must be consider the orientation, the openings in the outside walls, the interior design of the rooms, as well as the qualities of the environment where the building will be constructed, such as weather, wind, rain, latitude and longitude, vegetation, slope of the solar radiation and others. By that way a custom design will be achieved for the specific project to develop.

This concept was introduced in the book "Passive Solar Energy Book" by Edward Mazria in 1979, and later became a Standard concept of passive buildings in 1988, by the professors Bo Adamson and Wolfgang Feist. They established the definition for the Passive House Standard as: *"It's a design method in order to achieve a building that has so low necessity of energy that doesn't need any heating or cooling mechanical system"* (PassivhausInstitut, 2012).

## CURRENT STATUS: energy and regulatory context in the European Union

Nowadays, in Europe we are facing three major challenges that will mark the development of future generations of Europeans: the economic crisis, insecurity of energy supply and climate change, caused basically by increased greenhouse gas concentrations in the atmosphere.

In this context, it seems to be necessary the implementation of actions to improve energy efficiency of our processes and activities and the widespread use of renewable energy. Indeed, the European Commission has set some objectives for the coming years in order to reduce dependence on foreign energy in Europe - nowadays around the 55% of total energy we consume is imported, but in cases such as natural gas and oil this percentage increases up to 60% and 80% respectively - and to reduce the concentration of CO<sub>2</sub> in the atmosphere (Market Observatory for Energy, June 2011).

Nowadays, our economic model is based on the consumption of fossil fuels. From the economic point of view, it is obvious that an economic recovery based on oil as the main source of energy in Europe is not possible. It is clear the need for a profound restructuring of our economic activities, based on efficiency and increased productivity.

The European long-term strategic is based on energy efficiency. The whole "saving and energy efficiency" has been identified not just as the best strategy with the greatest impact when it comes to tackling climate change, but also as the one with best affordable cost -less than \$ US20 / CO2 tonne year- (IPCC, 2007), specifically in the field of building construction.

The 20-20-20 EU policy, which addresses climate change, establishes three key objectives in the energy context of EU by 2020: a 20% reduction in CO2 emissions, a minimum of a 20% reduction in the primary energy consumption through energy efficiency, and the supply of at least 20% of the consumed energy from renewable sources.

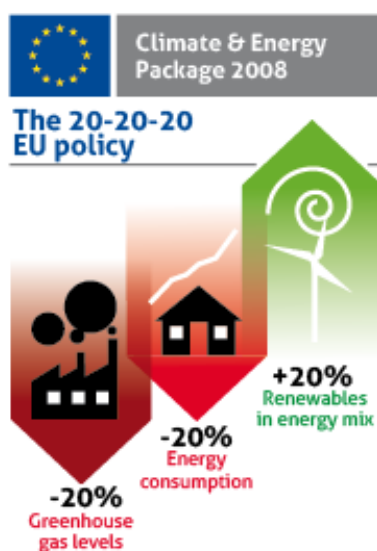

Figure EEM.2.1: The 20-20-20 EU policy (Stephen, N., 2011)

The Europe's goal of reducing its annual consumption of primary energy by 20% by 2020, includes consequently to reduce their CO2 emissions by 780 million tonnes, and save about 100,000 million per year in fuel costs (Energy Agency Corner, 2012). And the buildings are responsible for 40% of final energy consumption in the EU, representing a key element in achieving this objective.

In the building sector, the European Commission adopted the "Energy Performance of Buildings Directive" (Directive 2002/91/EC, EPBD) including a common methodology for calculating the energy performance of buildings, minimum requirements for energy efficiency in new buildings and rehabilitations, as well as systems energy certification of buildings.

One of the most important changes of the EPBD is the emergence of the concept of 'nearly zero-energy buildings'. According to the EPBD, Member States shall ensure that all buildings are constructed or rehabilitated in Europe are 'nearly zero-energy buildings' from 2018 for public buildings, and from 2020 to the other buildings. EPBD defines 'nearly

zero-energy buildings' as "a building that has a very high energy performance, determined in accordance with Annex I. The nearly zero or very low amount of energy required should to a very significant level be covered by energy from renewable source."

However, since the goal of reducing energy consumption seems that would not been reached, the European Commission is currently developing a new directive on energy efficiency.

In brief, most of the strategies and policies that attempt to regulate energy consumption in buildings, as well as CO2 emissions resulting from the construction activity and the use of buildings, derive from the 20-20-20 targets for 2020, the EPBD and, in the near future, the new directive on energy efficiency.

## FACTORS

Nowadays, for achieving an adequate level of comfort in buildings, we usually rely in conventional cooling/heating systems; to a lesser extent in passive systems and solutions; and we hardly lend weight to the influence of architectural form. (Figure EEM.2.2)

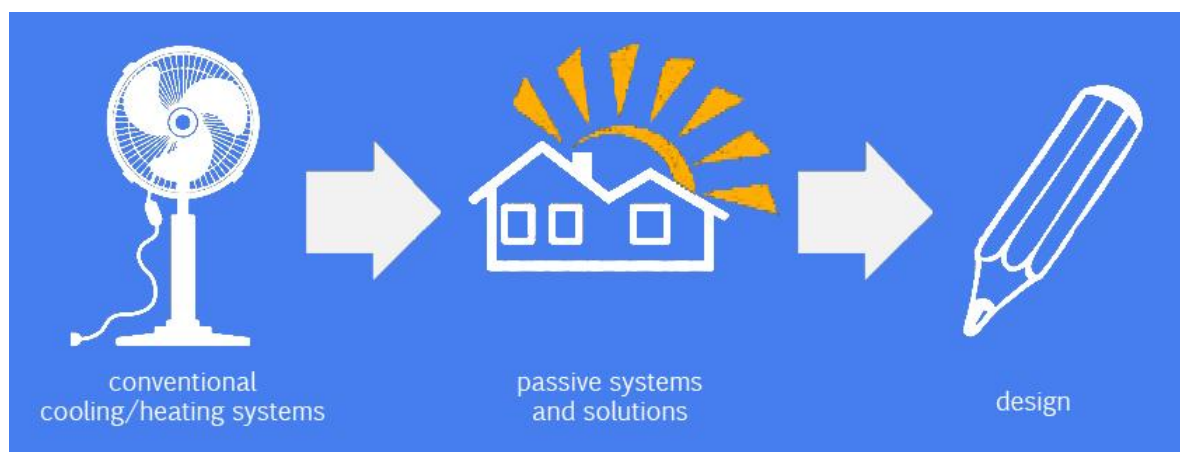

Figure EEM.2.2: Actual way of achieving comfort in buildings

The energy efficiency in the building industry demands changing the order of these strategies and proposing a reversed scheme, in which most of comfort is achieved thanks to the shape, the proportions, and the materials, and to a lesser extent, to passive systems that take advantage of climatic ambient conditions. And, finally, to the high-efficiency active systems powered by renewable energy. (Figure EEM.2.3)

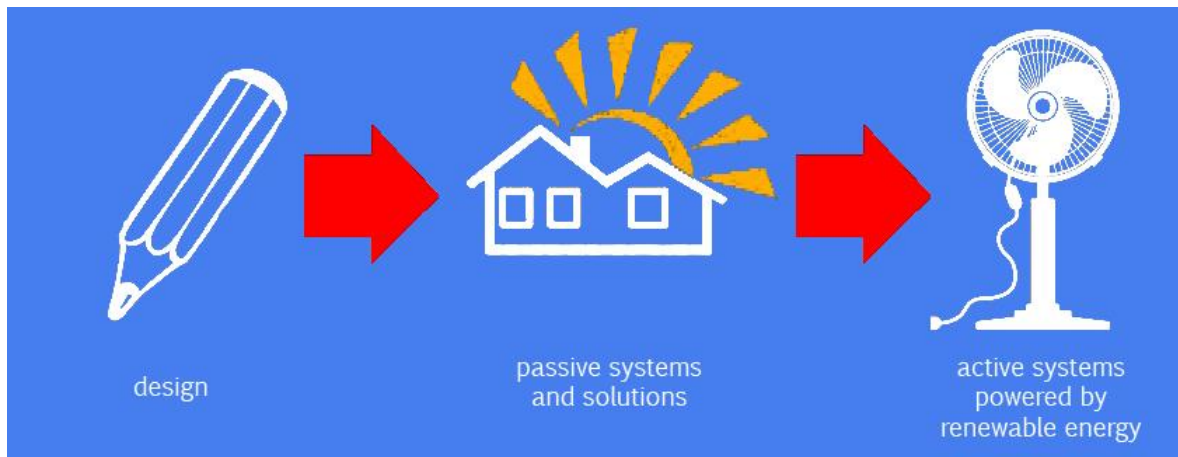

Figure EEM.2.3: Desired way of achieving comfort in buildings

## Design

A comprehensive climate study, with analysis of all the hygrothermal variables that affect the project is always the first step, so that from the first moment, data are available on what can be, a priori, the variables from the ones we must take shelter, and which ones have the potential for energy use.

From the analysis of this data and other conditions, must come the first idea of how to adapt program, form and place. This first phase will bring ideas that, through understanding climate and simply with a sensitive response to it, will result in projects with low energy demand.

## Location

The location is central to the behaviour of a building, as it determines the climatic characteristics influencing it, affecting the demand for heating, cooling or lighting. Moreover, a proper selection of the site as well as intelligent design can use local conditions to improve comfort.

Such weather conditions can be divided into macroclimatic and microclimatic:

Macroclimatic conditions depend on the area of the planet where the building is located, i.e., depend on the latitude, longitude and the specified region. The most important are:

1. Air temperature: average, maximum and minimum throughout the day during the winter and summer.
2. The relative humidity.
3. The incident solar radiation (direct and diffuse).

Microclimatic conditions are the ones that are determined by the geography of the place, altering macroclimatic conditions (Boumaraf, H., 2011). The most important are:

1. Topography. The orography can determine the solar access and the direction of the prevailing winds.  
For instance, sun-facing slopes (the ones with south facing in the northern hemisphere) allow the exposure of the building to solar radiation, during winter when the solar altitude is low. Another sample would be the one of the low areas,

like valleys surrounded by mountains. They can suffer from poor ventilation, trap gas emissions or, conversely, may become fresh air reservoirs.

2. Water bodies: the closeness of a site to large water bodies (i.e. the sea) reduces the sharp variations in temperature and increases the humidity. Generally, the effect that a water mass might have on the local weather conditions of a place diminishes not just with distance from the water body, but also with elevation.
3. Vegetation. Due to low friction with the ground, arid areas usually experience high wind speeds. Also, the exposed soil absorbs and emits radiation, heating rapidly during the day, and cooling quickly at night. In contrast, besides shade and wind protection, the areas covered by vegetation suffer minor differences in temperature and humidity. Therefore, the vegetation can play an important role in the modification of the local weather conditions.

## Function

The end use of a building conditions logically the energy demand. For instance, an office building will have very different necessities in quality and quantity of energy than a home, a hotel or a hospital. Demand also varies differently throughout the day.

## Shape and proportion

The building has a huge impact on energy demand. It is crucial to find solutions in order to ensure a minimum energy demand covered by active systems and take advantage from the most of solar radiation and natural lighting.

For this reason, it is necessary to study the shape and proportion on the following aspects of the building design:

- The contact area between the building and the outside. It is directly affected for solar radiation and exposure to the winds, indicating the energy loss or the energy gain towards the outside. The more contact surface there is, the more heat exchange will be. This situation is in principle favourable for warm weathers, but unfavourable in case of continental climate.
- The resistance against the wind. The larger the building is, the greater the wind resistance is. A greater wind resistance is good in summer as it increases ventilation, but bad in the winter because it favours infiltration. The designer must play with the shape of the building to get good ventilation in summer and a winter minimum infiltration.
- The position of the holes in the facade and their size, which will allow greater solar gain and reduce energy demand.
- The building orientation. It determines the solar energy through glass surfaces. In general, it is interesting that housing in continental climates captures more energy as it helps reduce winter fuel consumption. During the summer it is necessary to limit this radiation by means of shading elements, or other techniques to avoid overheating. In office buildings it is necessary to find the compromise between natural lighting and cooling, as if the light enters, the heat enters as well.

The general characteristics of the main orientations are(Lascano, M.E., 2012):

- a. Northern exposure. It only receives a few hours of solar radiation in summer and none in winter. It corresponds to the coldest part of the house.
- b. Southern exposure. In winter, the south facade receives directly many hours throughout the day, while in summer radiation reaches more vertical,

and most of it gets the roof.

- c. Eastern and western exposure. The facades facing east and west receive 2.5 times more radiation in summer than in winter while the facades of direction southeast and southwest receive a similar amount of radiation throughout the year. The east and west are very troubled during the summer, especially the west orientation, because from noon it gets a lot of radiation, very difficult to control because of its perpendicular incident on the glass surface. In this orientation glazed voids must be protected from the sun during the summer. Horizontal protections (like overhangs) are ineffective, therefore it is preferable vertical protections, such as lamas, trees or similar.

## Passive construction

In this point techniques, heating and cooling systems, ventilation systems, water management, passive insulation and PHPP systems, will be developed in relation with design and implementation in buildings.

### Techniques

#### *Passive solar design*

Passive solar design is one of the most important strategies for the replacement of conventional fossil fuels and reduction of environmental pollution in the field of construction. Solar energy can be a great contribution to the heating requirements of a building. Depending on the local weather and prevailing need for heating or cooling, there are a wide range passive techniques.

These systems can be used for heating, cooling and lighting. Their main function is to reduce the power supply. This is achieved through design where the building and its solar system are closely linked, architects play an essential role in its development(Hartweg, L., 2010).

Principles:

- Solar gains, in which solar energy is collected and converted into heat.
- Heat storage, the heat collected during the day is stored within the building to be used in the future.
- Distribution of heat, the heat gathered / stored is distributed to rooms or areas that require thermal conditioning.
- Preservation of heat, the heat is retained in the building as longer a possible.

Strategies:

- Reduce energy losses

A passive solar home should be well insulated and sealed, preventing leaks. Reducing losses and gains of heat through the thermal enclosure, the remaining thermal loads can be effectively managed through passive solar techniques. Strategies that contribute to the reduction of demand for heating and cooling include high performance framings, the use of high levels of insulation and reducing losses through thermal bridges.

- Solar orientation of the building

It was explained in the building orientation point.

- Selection and location of the windows

Heat with Passive solar energy is simple; just allow the sun to enter the house through the windows. The problem is to adequately dimensions southern front windows to maximize the daylight energy entry reducing nocturne energy losses that use to increase in glazed openings in the winter, and minimizing by shading in summer avoiding overheating.

- Increasing the area of glass will increase the heat losses. Glass surfaces can be further included if it is built an internal thermal mass able to hoard the incident overheating.
- Use of passive solar energy

In cold climates, solar heating strategy consists in orienting the majority of the openings in the façade to the south. An approximate starting ratio would be a 7% of glass amount of the total surface built in living areas of the building. This strategy has no additional cost beyond the project planning effort. Larger glass receiving surfaces can be installed as long as it will be provided with a thermal mass capable of storing the exceeding energy and then releasing it overnight.

- Sun protection

Solar altitude is greater in summer than in winter. Well calibrated eaves or awnings are an effective option to optimize the gain of heat. They allow protection against overheating in the summer but let the sun enter in winter. Landscaping with deciduous vegetation helps to shade in summer the windows oriented to the south, east and west, preventing heat gains during the summer.

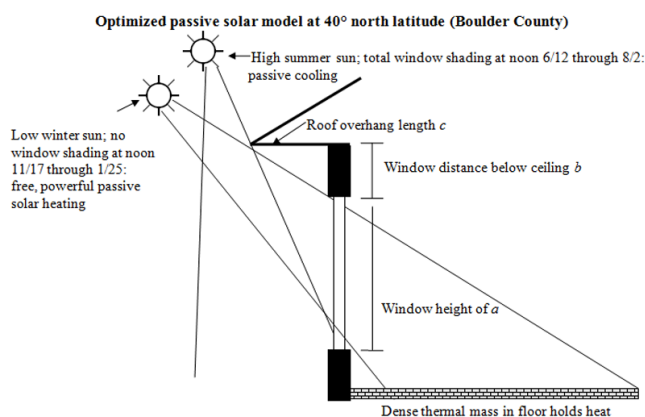

Figure EEM.2.4: Optimized passive solar model (Marsh, M., 2005)

- Heat storage

This point will be developed in the point of Storage of Energy from Summer to Winter.

- Lighting. Systems that facilitate the use of natural lighting

Conventional Systems of natural illumination include well sized and well positioned windows, automatic lighting control systems that reduce the use artificial lighting.

Special Solar Lighting Systems such as "light shelves". These systems increase the penetration of sunlight and enhance the uniformity of distribution of the light, but do not increase the available amount of light.

Natural lighting walls with transparent insulation between the leaves of the windows. They are different than conventional windows regarding the eye contact, the natural lighting distribution in the room and aesthetic quality.

Granulate silica gel is one of the transparent insulating materials used in natural lighting walls(Sustainable sources, 2012).

## Passive heating systems

### Direct Gains

Thermal direct gain passive systems are designed to capture solar energy and reduce heat losses inside the housing. It is the simplest approach to passive solar energy. It is produced by large glazed openings facing the sun (south in the northern hemisphere and north in the southern hemisphere) and open directly into the living spaces in which the mass amount of materials that can be used as thermal storage systems should be large enough. Sufficient thermal insulation is essential to preserve these gains. The elimination of thermal bridges is a priority, as they represent the heat escapes.

The main factors affecting the effectiveness of the direct gain systems in buildings are:

- Location of glazed areas in the building
- Glazing dimensioning
- Choice of glazing type
- "Thermal Quality" of the whole construction.
- Heat Storage: quantity and location of the thermal mass in the building.
- Topological relationship between solar gain spaces and the ones without it.

In direct gain systems is not possible to increase the glazed area beyond a certain limit without causing overheating on clear days, even in winter. This characteristic sets a limit of the solar energy that can be collected and stored during sunny days using solar windows.

In Direct Gain, architectural details (thermal bridges, situation insulation, carpentry, shading) are essential in determining the energy efficiency and interior comfort conditions of a passive building.

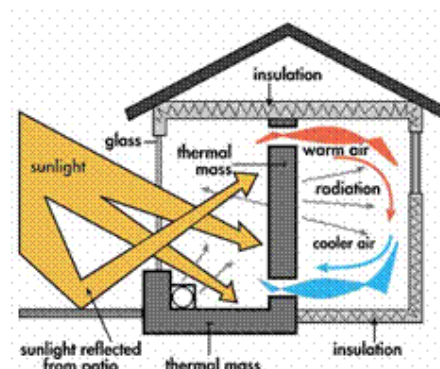

Figure EEM.2.5: Direct solar gains scheme (Currie, R., et al., 2002)



If rooms without sun access exist, air circulation between spaces with direct solar radiation and spaces without solar radiation is vital for the success of the direct gain systems. In some circumstances it may be necessary to create air flows through mechanical ventilation.

**Indirect gains**

The systems of indirect heat gain include elements of high thermal mass.

In some specific elements, for example in the Trombe wall, storage is done in a wall exposed to the sun, of considerable mass thermal, whose outer surface is glazed to reduce heat losses. It can deploy some insulating protection during the night to prevent heat loss. It may include top and bottom ventilation racks to allow convective heat transfer to the space occupied, while the mass wall rests on heat conduction.

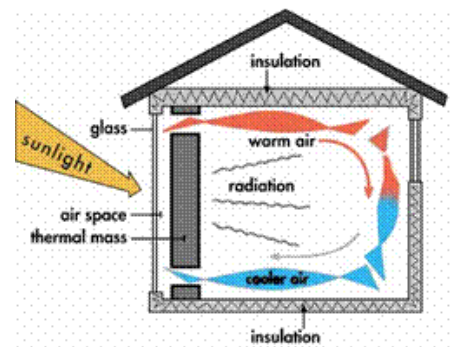

Figure EEM.2.6: Indirect solar gains scheme (Currie, R., et al., 2002)

One advantage over direct gain systems is that glare and deterioration problems of the materials made by ultraviolet rays are eliminated.

- Trombe wall

A Trombe wall or Trombe-Michel, is a wall facing the sun, in the south in the northern hemisphere and north in the southern hemisphere. It is constructed from materials with a high thermal mass to store energy on them, combined with an air space and a glass sheet.

Is a passive system to collect solar energy collection indirectly, which can be used for the internal heating of the housing by means of heat transfer, either by conduction, convection and / or radiation. This is an indirect system because the absorption of energy is performed through an element situated between a glass and the interior of the housing, and it is a passive system because it doesn't use mechanical means to work.

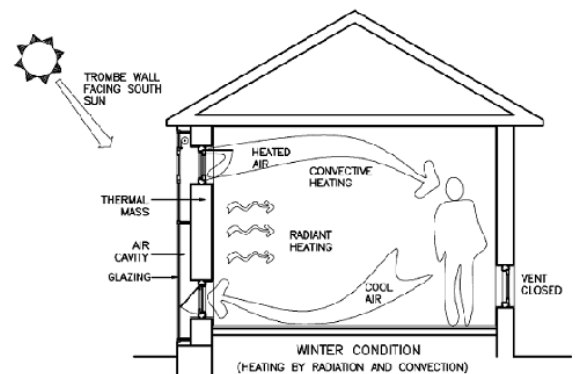

Figure EEM.2.7: Trombe wall (Nayak, J., Prajapati, J., 2006)

**Isolated gains**

Isolated gain systems (e.g. attached greenhouse) gather up the solar radiation in an area that can be closed or open selectively, connecting with the rest of the house at times when there are solar gains, and isolating from the house when there are energy losses (overnight). In summer conditions the greenhouse must be operable to avoid undesirable uptake of heat.

- Greenhouse

Attached greenhouses in a building have traditionally been used as passive solar collectors in vernacular architecture.

They consist basically in a glazing space permeable to solar radiation, which allows sun radiation to impact on a thermal mass (wall, floor or ceiling). Later, when returning the energy absorbed, the glass trap it, not letting it go. All this results in a gradual warming of the air in the greenhouse, which can be used to heat by natural convection a living adjacent space besides of being accumulated in the thermal mass of the building elements for later use at night.

The green house can be part of a whole building or is situated attached to habitable areas of a building, but which can be isolated completely from these.

The greenhouse can be built as part of a new building or as an addition to an existing home in a rehabilitation work.

Ideally, the glass gallery, situated in front of the sunny façade of the building, has a heavy wall separating it from inside part of the building (Sitiosolar, 2012; U.S. Department of Energy, 2012; (World Environmental Library, 2000).

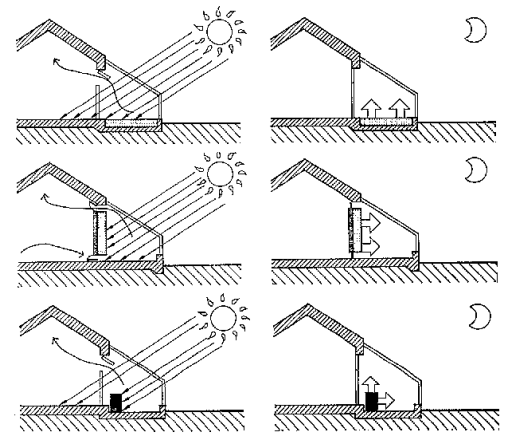

Figure EEM.2.8: Greenhouse example of isolated solar gains (World Environmental Library, 2000)

### **Thermal mass**

Thermal mass is a passive strategy for both heating and cooling systems.

The use of thermal mass is a strategy of passive heating in winter that supplements the solar collection strategy, but also is a strategy to avoid overheating in summer, so it is always advisable to consider building elements with thermal mass.

As heating strategy, once sunlight is captured inside the building, the heat generated needs to be kept inside. This heat is stored within the material and will be released to the atmosphere when required.

Materials with higher thermal mass and inertia are stone materials, either concrete, brick masonry, adobe and stone. This is a property of materials that depends on the specific heat and thermal conductivity and is related to the amount of heat that a material can retain and the speed at which it cedes or absorbs it from the environment. This property is used to make the temperature inside buildings more stable, particularly when there is a significant temperature variation outside.

The heat accumulation property of the materials allows the attenuation of temperature changes inside and the thermal gap between the outside and the inside temperature (Building Green, 2008).

Material	Density (Kg/m <sup>3</sup> )	Specific heat (kJ/kg.K)	Thermal mass (kJ/m <sup>3</sup> .K)
Water	1000	4,186	4186
Concrete	2240	0,920	2060
Brick	1700	0,920	1360
Stone	2000	0,900	1800
Adobe	1550	0,837	1300
Compacted soil	2000	0,837	1673

(California Energy Commission, 2012)

### **Passive cooling systems**

The meaning of the term "passive cooling" is applied to those processes of heat dissipation that occur naturally, i.e., without the mediation of mechanical components or additional power supplies. The definition encompasses situations where the relationship of spaces with accumulators and sinks (air, sky, earth and water) through natural ways of heat transfer, leads to an appreciable cooling effect in the inside. However, before take steps to dissipate unwanted heat, it is prudent to first consider how this heat accumulation can be minimized. In this context, natural cooling can be considered in a broader sense than the strict definition suggested above, to include preventing cooling control load measures and also the possibility of mechanical heat transfer (hybrid system) to enhance natural processes of passive cooling.

Fixed or adjustable shading devices, or shading by vegetation and polished terminations can be used to reduce the amount of solar radiation that reaches the building. It is also convenient and pleasant exposing the house to environmental sinks, such as the shadow cast by the trees.

Usually only one combination of these cooling techniques is used.

### **Passive cooling strategies**

External heat gains due to solar radiation can be minimized by isolation, reduction of the window size, thermal inertia in the building envelope, reflective materials and compact construction layout.

An alternative solution is the use of the called "smart windows", i.e., chromogenic layered windows. Such layers are sensitive to the intensity of light, temperature or small electrical currents and give the surface of the crystal controllable optical properties.

### **Smart windows**

These kinds of windows are part of a building conservation strategy.

They allow control of the light intensity capable of penetrating inside a closed space: buildings, cars, airplanes, etc.

The most used is a three-layer structure. A change in the colour of the glass occurs due to a chemical reaction (from pale yellow to blue) and increases its reflectivity, so the intensity of light passing through the window decreases.

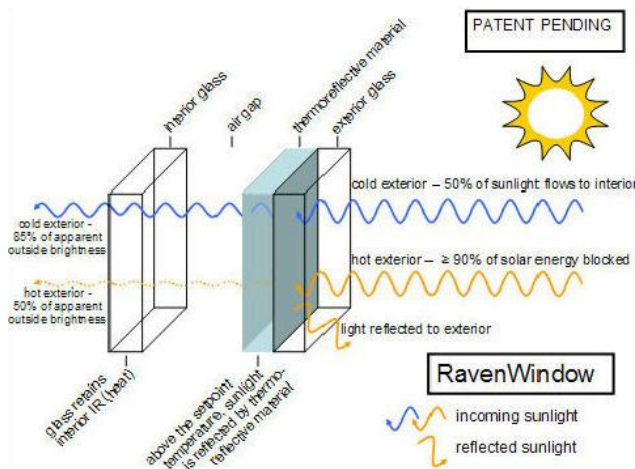

Figure EEM.2.9: 3D view of smart window layers, and their operation (The Modern Green, 2010)

When outdoor temperatures drop it becomes transparent and when they raise it reflects the sun light away from the building.

The intensity can be controlled manually or automatically by connecting to a software that defines the intensity level required. When evening light is not sufficient to maintain adequate lighting (being the polymer in the reduced state) it automatically connects the electric light and controls the intensity until the exact right level of intensity is reached (Ravenbrick, 2009).

## Ventilation systems

### Natural ventilation

Natural ventilation is the ventilation in which air exchange occurs exclusively by the wind action or by the existence of a temperature gradient between the point of entry and exit. It consist in favouring the conditions (by pressure differences and / or temperature ones) in order to produce air currents so that the indoor air is renewed by the outside air, cooler, oxygenated and decontaminated.

Features:

The driving forces of the air movement in all cases regarding natural ventilation are attributed to pressure differences created by the different openings in the building structure. These pressure differences are caused by the combined effect of two mechanisms: wind and temperature difference.

The ventilation covers hygiene and welfare needs. Regarding building ventilation there are two possible strategies to take into account: replacement of the air, to renew the unclean air, and its motion to reduce the feeling of heat in an overheated environment. In general, the more correct ventilation is the one which uses both techniques, while maintaining low air movement to achieve comfort functional limits.

Natural ventilation can be used as bioclimatic strategy for eliminating overheating and reduction of the sensation of heat during periods of overheating.

To use the natural ventilation as a strategy is important to note that the hot air has a lower specific weight than cold air and warm air masses are concentrated in the upper parts of the rooms, being sometimes sufficient ventilation of the upper parts by manual means, or moving away these air masses with higher ceilings than usual.

Natural ventilation techniques are classified into (Neila, 2004):

### **Pure natural ventilation**

Occurs when pressure differences exist between the inside and outside the room.

- Direct: it consists in the renewal of the air through open windows during a period of time (Figure EEM.2.10).
- Cross ventilation: it occurs by opening windows in opposite facades that are facing the exterior part of the building (Figure EEM.2.11). Ideally, they should be oriented to the prevailing wind, according to its characteristics. The effect is also achieved if the façades are receiving solar radiation in a non-simultaneously way, so that there is a thermal difference between the surface temperature and in air close to it.

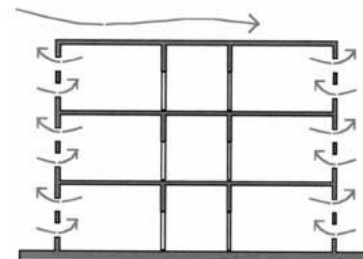

Figure EEM.2.10: Direct ventilation scheme (The American Institute of Architects, 2009)

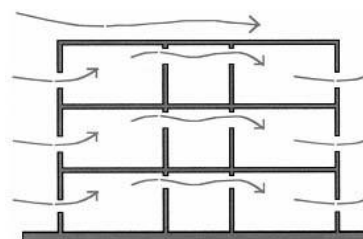

Figure EEM.2.11: Cross ventilation scheme (The American Institute of Architects, 2009)

### Forced natural ventilation

It's a backing system for natural ventilation in order to be more effective.

- Façade overheating: the heaters systems for the winter, such as Trombe-walls and greenhouses, can serve as air heaters in summer, increasing his speed, forcing by natural means the ventilation.

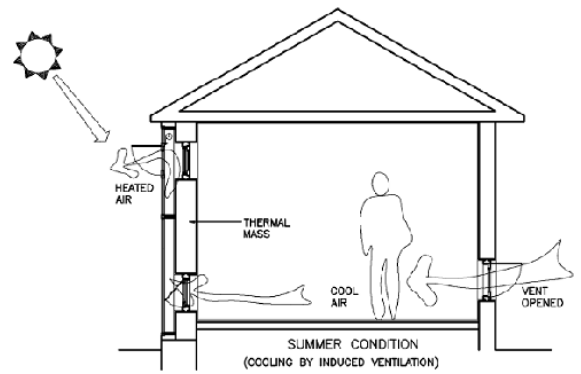

Figure EEM.2.12: Trombe wall ventilation system scheme (Nayak, J., Prajapati, J., 2006)

- Solar chimney: the airflow is generated from thermal gradients caused by solar radiation when the air is being restrained in an enclosure (called solar chimney) in what is known as a chimney effect. This effect consists on; when the hot air(of lower density) tend to rise and go outside, it forces the creation of an airflow of fresh air from the outside entering in the building to replaced the old one, thereby the inside air is going replaced by the outside air with a lower temperature (Oliveira, A., 2000; Vail, J., 2005)

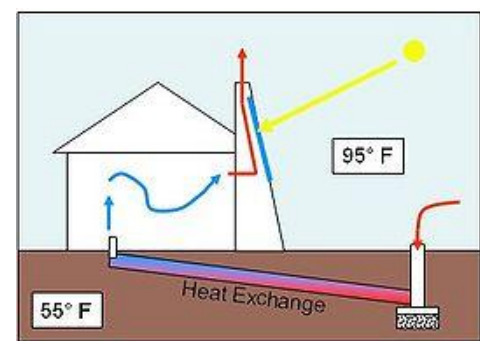

Figure EEM.2.13: Solar chimney ventilation system scheme (Vail, J., 2005)

### Induced ventilation

It works forcing air into a room through an opening sufficiently large, properly oriented and with enough height.

- Chimney or wind tower is also used to achieve a good ventilation inside small or medium scale buildings, but in this case the effect of the wind is taken as an advantage. It consists in some protrusions above the roofs oriented in the opposite direction of the wind for capturing and conducting the fresh air into the building. Used mostly in warm areas with abundant fresh winds in a predominant direction(Natural Institute of Building Sciences, 2010).

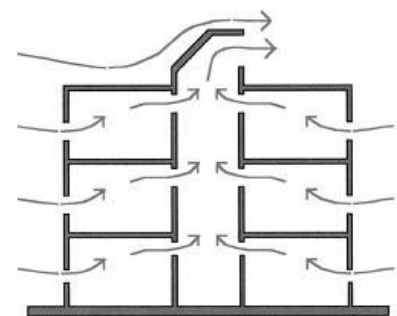

Figure EEM.2.14: Chimney or wind tower ventilation system scheme The American Institute of Architects, 2009)

## Evaporative cooling systems

The strategy of exploiting the potential of cooling that has evaporated water has been used in countries with warm, dry weather for centuries. In general, you can achieve a reduction in temperature from 10 ° C to 12 ° C when the air is relatively dry, with a less effective when the air is more humid (Ford, Schiano-Phan and Francis, 2010).

There are several strategies to achieve the evaporative cooling system, where one of them is the down flow evaporative cooling, which take advantage of the effect of gravity on the relatively cold air, to create a descendent flow.

The cold air source can be either "passive" (through evaporation of water) or "active". This system generates a flow of cold air through the evaporation of water inside of an air flow. This can be generated in several ways:

- Spraying drops of water in the air flow
- Spraying water mist into the air flow
- Wet porous surfaces in the air flow (e.g. porous ceramic)

The exterior hot air enters to a tower where it is exposed to water, and as the water evaporates inside the tower, the temperature of the air decreases and its moisture content increases. Dense and moist air goes down the tower and goes out through openings in the base thereof. This downward movement generates a negative pressure (suction) at the top of the tower and a positive pressure in the base. Cooler air enters the enclosures that require cooling (Akihan, 2012; Arizona Solar Center, 2012; Ben-Gurion University, 2000)

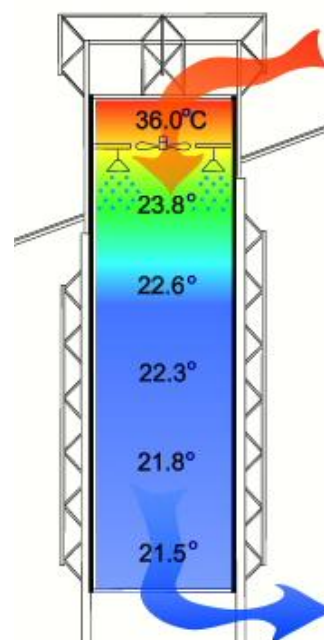

Figure EEM.2.15: Evaporative cooling system scheme (Ben-Gurion University, 2000)

## Mechanical Ventilation with Heat Recovery (MVHR)

A low-energy building will decrease the infiltration of unwanted cold air and the escape of heated air through an airtight construction. Nevertheless, a supply of air is still necessary, so there is a need for controlled ventilation.

This is the cause because airtight buildings require a Mechanical ventilation system in order to control airflow, guaranteeing in this way the inhabitants comfort.

Mechanical ventilation is a fundamental concept for buildings with very low energy consumption like the passive house. Its advantage lies in the ability to recover much of the energy that comes out when we renew the used air with good fresh air with hygienic characteristics. MVHR (Mechanical Ventilation with Heat Recovery) uses the energy from waste heat (for instance the one from cooking or showers) to pre-heat the incoming air in the Mechanical Ventilation system by means of a heat recovery exchanger.

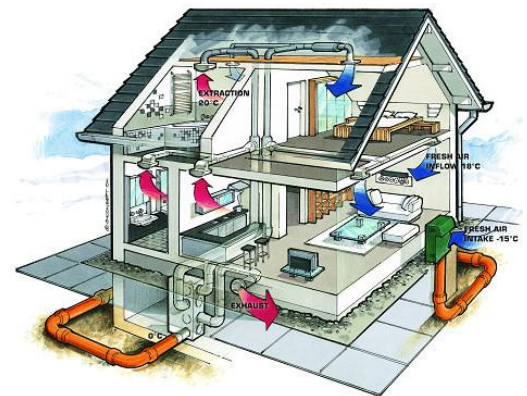

Figure EEM.2.16: 3D view of a mechanical ventilation system (Paulventilation, 2010)

The heat recovery exchanger allows renewing the air inside a room by preserving and recovering the energy used to heat the air. The heat recovery system works by combining two centrifugal fans with low noise level, where one of them performs the extraction of stale air inside the room to the street, and the other pulls in fresh air from outside to inside the premises. The two circuits cross without mixing, and the heat from the outgoing air is transferred to the fresh outdoor air, heating it. In this way we recover a high percentage of the energy used to heat or cool the air inside the room. Without the use of this exchanger, this energy would be lost completely.

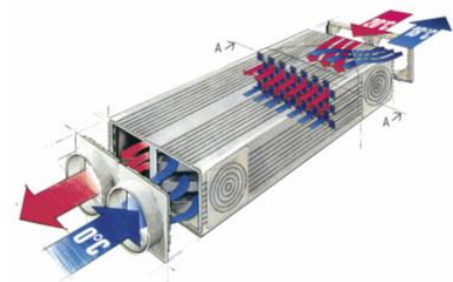

Figure EEM.2.17: 3D view of a heat recovery exchanger (Paulventilation, 2010)

In mild climates, it is possible to build a passive house building without heat recovery systems. In this case, if there is no a ventilation system, sealing is not as important. By contrast, very tight buildings without ventilation systems are at risk of having poor air quality and excess moisture.

MVHR will offer extra benefit in passive houses, as they are supposed to have a low heat requirement. Nevertheless, MVHR doesn't make sense in buildings where there is no airtight.



## Passive water management

### Rainwater Collection

In many areas water is becoming an increasingly appreciated resource. The shortage of it and the expensive treatments for purification or transport to the consumer are increasing the price every year. If we add the increasing demand of water, makes it necessary to consider alternative systems to solve this problem.

Replace not drinking water by rainwater is a sustainable measure that will help to save resources.

Up to 50% of the water used in homes can be replaced by rainwater. It can be used for those applications that do not require potable water, for example the WC tank, washing machine, general cleaning or for irrigating the garden.

Rainwater is pure water that does not contain calcium or chemicals, which benefit the pipes maintenance, avoid calcium in the washing machine and garden irrigation is made with excellent natural water. Besides the environmental benefit, the considerable economic savings is another good reason to take advantage of rainwater collection.

The system is really simple; rainwater is collected by a wire of draining pipes and stored in cisterns until there is a need for its use.

The drainage of the water can be made by the same cistern that has a filter to clean the water inside or by a system of draining pipes combined with draining soil structures in the garden (Agrilife, 2012).

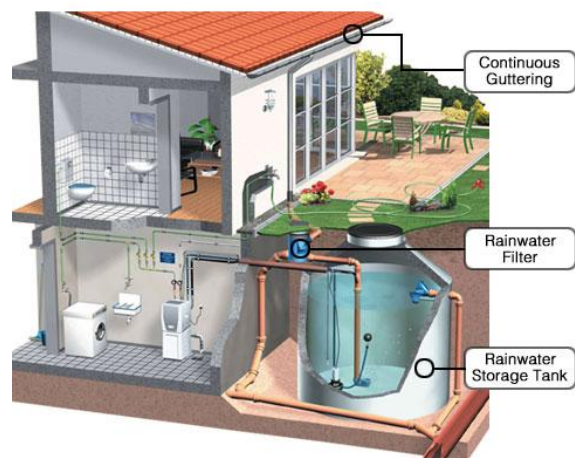

Figure EEM.2.18: 3D view of a rainwater collection system (Jones, A., 2009)

### Passive insulation

When the goal is to reduce the demand for heating in buildings, the strategy is to capture the largest amount of solar energy, store and distribute it in the building, and then keep it for the time that there is no solar gain. In other words, the architect must design a building that allows solar radiation to penetrate inside, and on the other hand the thermal envelope must ensure, through the façade insulation, sealing windows, and the airtightness in carpentries, that energy losses through the envelope to be the lowest possible.

## Green roof

Green roof may have different degrees of complexity, depending on the construction system applied and the use given to the roof.

Green roof can be simple or intensive. The simple one is generically called green roof, while the intensive one includes garden terraces.

### Building systems

Simple green roof is the one used as non accessible roof. The vegetal layer is not too thick, thereby providing little weight to the structure. Its application is recommended in areas with dry climates, and using native vegetation. Usually they are composed of wildflowers and grass. Higher plants than those mentioned can not be placed on the simple green roof.

It doesn't require irrigation, and maintenance costs are very low.

More complex systems are those that allow you to add a bigger type of vegetation and even a small tree. Those are called garden terraces.

Obviously in these cases the depth of the support layer is greater than that described above. They require an irrigation and fertilization system, so that the system has a higher maintenance cost. For the foregoing reasons, it also becomes an element to take into account when calculating the structure as it provides considerable weight that cannot be ignored.

### Construction parts

It's composed as every a roof structural system by, a vapour barrier and a thermal insulator. From there the layers of the green roof are developed.

It has to be considered that a green roof will receive water through two means: irrigation (if there is any) and rain. So there have to be installed a waterproof membrane that protects the structural layer. There should also be a layer that protects against the roots. Above it is placed the waterproofing and the draining layer.

Completing the process the growth layer is placed above formed by soil and fertilizer and finally the vegetation (SafeguardEuropeLimited, 2006).

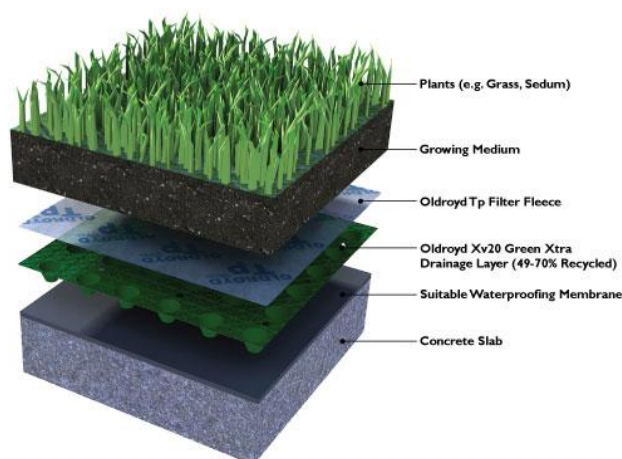

Figure EEM.2.19: 3D view of the component layers of a green roof system (Safeguard Europe Limited, 2006)

## Ventilated façade

It's a façade with a camera that allows air circulation. Usually is performed with a coating attached to a metallic substructure. This is fixed in the inside part of the outside walls. Between them there is an air chamber partially filled with thermal insulation. The ventilation is caused by upper and below openings or through the joints of the envelope.

This system can transform the entire appearance of buildings (new or existing) with a simple operation of assembling exterior plates, without disturbing the interior use (Austral Bricks, 2008).

Regarding control of the transfer of energy, the basic input is to provide the building with a first "shield" against the weather changes and an extra insulation layer.

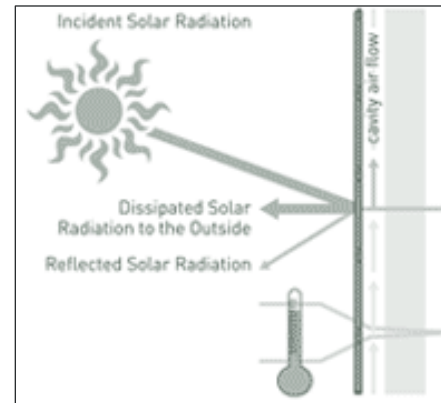

Figure EEM.2.20: Ventiladed façade system scheme (Austral Bricks, 2008)

## Superinsulation

Although there is no definition of it yet, superinsulation is an approach to passive design that decreases both heat loss and heat gain by means of higher levels of insulation and airtightness if compared with normal buildings.

If we want to use the way of superinsulation, the following are possible solutions:

- Thick insulation under the floor, on the walls and into the roof.
- Meticulous isolation of joints between roof and walls, foundation and walls, etc.
- Watertight construction especially around doors and windows.
- Create a heat recovery system to provide fresh air.
- Avoiding large windows.
- Installing a vapour barrier to prevent condensation and a possible apparition of mildew.

## Eliminating the thermal bridges

Transmission of energy happens not only in general elements such as walls and ceilings, but also occurs in the corners, joints, etc. These points are likely to become a thermal bridge if the insulation is not continuous. Thermal bridges undermine the effectiveness of the rest of the insulation and could increase the risk of must formation.

Following a few simple rules, we can eliminate the effects of thermal bridges:

- Do not interrupt the insulation layer
- The insulation layer must unite and fill the joints of the construction elements of the building.
- If it is inevitable to avoid interrupting the thermal insulation layer, we should use a material with the highest possible thermal resistance.

- Thermal bridges can also be minimized by if the windows are installed on the insulation layer, covering part of the frame with insulation. However, due to the change of thickness of the insulating layer, it is normal to have a thermal bridge in the joint between the window and the wall.

### **Airtightness**

Air flows from the inside through cracks and holes have a high risk of causing condensation on the construction, also causing users a feeling of low comfort.

In turn, these infiltrations of cold air also increase the temperature difference between different floors. Because in most climates a passive building requires a mechanical support for the continuous supply of outside air (as we explained in the point regarding the MVHR), an excellent airtightness of the building envelope is required

Unwanted air draughts and cold air pockets decrease the effectiveness of the insulation. But also, air infiltrations contain water vapour that could lead into moisture on walls and ceilings. The only way in order to prevent these possible damages is that one airtight layer covers the entire building.

Moreover, airtightness involves a better acoustic protection.

The airtightness can be checked by means of the Blower-door-Test (pressurization test). It consists of a fan placed in a window or outer door creating a pressure difference of 50 Pa.

### **Carpentries**

The carpentry is the weakest element of the building envelope. It has a dual role: to reduce heat flow and allow maximum solar gain, especially in winter. Carpentries have to have a very high quality to ensure a high degree of comfort.

According to the European Council Directive 2002/91/EC, the union joints of exterior carpentry must have the same properties of tightness to air and water, and of thermal and acoustic insulation as adjacent building elements. These union joints must offer a good permeability to water vapour (Sustainable Energy Authority of Ireland, 2012).

For this reason the sections of the different carpentries must be carefully studied, with double (or even triple) airtightness joints, low emissivity double or triple glazing, and gases in the cavities in order to improve heat transfer coefficients.

Besides the great effort to improve the energy efficiency of the carpentries, we should also make an effort to improve the placement of carpentry, implementing a third barrier by means of airtightness joints, which would be added to the more common thermal insulation and waterproof barrier.

## **PHPP software**

Any new building anywhere in the world, even the non-residential ones, could be designed in order to reach the Passive House Standard.

Based on simulations from hundreds of low-energy buildings, the PHPP or the "Passive House Planning Package" is a calculating software which determines the optimum levels of insulation, glazing and so on, making it ideal for the building design stage, when there are many things to decide regarding the size and quality of the various components of the building (Feist, W. et al., 2004/2007).

With the aim of defining the final energy requirements of the building, this tool also takes into account both solar heat gains and occupants heat gains.

The PHPP software treats the building and the mechanical equipment as one global system, containing useful tools for reliable design of passive buildings buildings. In this way, we find dimensioning tools for the windows, for the displacement ventilation by means of the heat recover, for the mechanical systems and finally, for comfort during the summer.

The major advantage of using this tool when designing low-energy buildings is that variables such as size, thickness or type, can be tweaked in order to find the optimum levels of insulation and glazing.

## **Active measures**

After establishing strategies for energy demand reduction (achieved with passive measures), it is necessary to select specific bioclimatic solutions to be incorporated naturally into the design of building. This is called active systems, and their objective is to minimize the energy consumption of the building.

The next step should be to seek maximum efficiency through active measures of ventilation and air conditioning systems.

Finally, after having designed a building with little demand for energy to operate, and having provided the most efficient active systems for every situation, we should be carefully analysing local resources and demands in order to capture the maximum energy from renewable sources, minimizing the use of fossil fuels with maximum efficiency criteria.

This Group Project will develop those equipment and active systems that are particularly relevant because of their high efficiency and / or use of renewable energy sources.

## ENVIRONMENTAL IMPACT

The adaptation of a building design to a passive energetic approach does not necessarily have to increment its environmental impact. As one of the first measures to take into account when building a passive building, obtaining materials from its local source is important to reduce this impact.

Raw materials have to be extracted and this always will imply an environmental impact. When extracting inorganic materials from the earth the shape of the soil is changed, when harvesting wooden materials the ecosystem around it changes completely, etc.

What is important to have in mind is not to add to that impact the one that will come from transporting the materials from a distant place, which will imply high CO<sub>2</sub> emissions. Also the situation of the building will always change environment where there was nothing before. Urban planning has to evaluate settlements due to the growth of the cities in order not to destroy high value environment or to attempt to find the less harmful way of combination of humans and nature.

To conclude, the human beings are also an environmental impact to take into account. The best way to deal with all the problems involving human settlements is to considerate them from the regenerative design point of view. Humans and nature have to reach an understanding in which any of them will be damaged but both will obtain positive values from this bond.

## ECONOMICAL ASPECT

Regarding construction costs, a home of this nature can be, in general, 14% more expensive than a conventional home. But the wide variety of possible elements implies that prices can vary considerably. Besides, generalization and optimization of these systems will reduce costs. For example, in the ecological Vauban district in Freiburg (Germany), buildings constructed with German passive house standards (Passivhaus) have reached the same costs as conventional houses.

The main advantages are according the Passiv Institute, this houses consume a 90 per cent less of energy in comparison with an already built house, and a 75 per cent less than a new built house, taking as a reference European standards.

The passive house optimises all the heat available, not only the one from solar radiation but also the corporal heat of its inhabitants and the one generated by house appliances. This heat is kept inside the house by high performance insulation in walls, floors, ceilings and carpentries. Insulation can be also achieved by several passive techniques that will have to be part of the designing part of the building.

Through ventilation measures these buildings can achieve more than acceptable cooling systems that can substitute our current mechanical cooling systems, of course always depending on the climate zone where they are situated; some of them will need a back up system when the passive system wont reach the consequent requirements.

All these systems can be completed with smart windows that will manage the exact illumination needed inside the house or rain water collection that will manage the water consumption in the house using a renewable source as the rain.

With all these measures the house achieve consuming less energy or none at all.

If the infiltrations control is achieved, the energetic consume of a well built passive house can be up to 10 or 15 euros each month, according the PassivInstitut. The impact of this cost in the family budget it's so low that the finances aren't affected by the fossil fuel oscillating prices, making them autonomous and profitable.

In addition to reducing energy costs, passive houses have other advantages. Thanks to its design and ventilation systems, air is cleaner inside. Also, the temperature of all rooms is homogeneous and there are no sudden changes. Moreover, by not using radiators, walls are free and the organisation of the space is considerably better(Altertech, 2011;PassivhausInstitut, 2012).

## **SOCIAL FACTORS**

The construction has been a faithful representative of society over time. In this second decade of the century the way it express and materialize is given by, among others, energy efficiency and its impact on the environment.

Not long ago the "sustainable construction" was usual, but was not recognized as such by that looked like something logical and normal. Local materials and local procedures were used; there was no great energy consumption (both in production and in use), and so on. Today, the society has returned to reclaim sustainable projects because we are concerned, above all, by the high environmental impact of construction, the high price of housing and its high maintenance costs. And the passive measures can be applied in any kind of social environment, independent of its cultural background.

The only need is that the professionals who are going to develop these measures to have specific knowledge about this kind of design and its techniques.

# CONCLUSION

A passive building is an energetic concept; it doesn't imply any specific construction style or any specific material in order to achieve it.

It's a very adaptable concept; it allows many construction solutions depending on the weather and the architectonic culture where is going to be applied.

Energy savings is the most important part of this building. Energy expenses can be reduced up to only 15 kWh/m<sup>2</sup>, that is the energy used for the mechanical ventilation (FAEN, 2008).

It has been almost 20 years since the finishing of the first Passive house building in Darmstadt, near Frankfurt. This first project had conventional heating system, which was eliminated in subsequent projects. And most important: energy consumption is so low in theory as in real buildings built, and the first building still continues to operate according to the original estimation criteria.

Since that first Passive house construction thousands of buildings have been built following these criteria and not only in Germany. There are examples in almost all European countries, in the U.S., and in Japan.

What has been proven over the last twenty years is that it is a very reliable system that complies with the provisions of minimum consumption, while providing much greater comfort than conventional constructions (Plataforma Edificación Passivhaus, 2012; Blomsterberg, A., 2011)

As passive building systems are easy to implement in any kind of construction the suitability of these systems for a small village is optimal. Its implementation will be completed with the use of active systems, such as the ones showed in that report. With that complement a house will be energetically auto sufficient, and this implementation will be easier to realise in a small village because with less budget they will achieve the final goal in a short time.



# SWOT

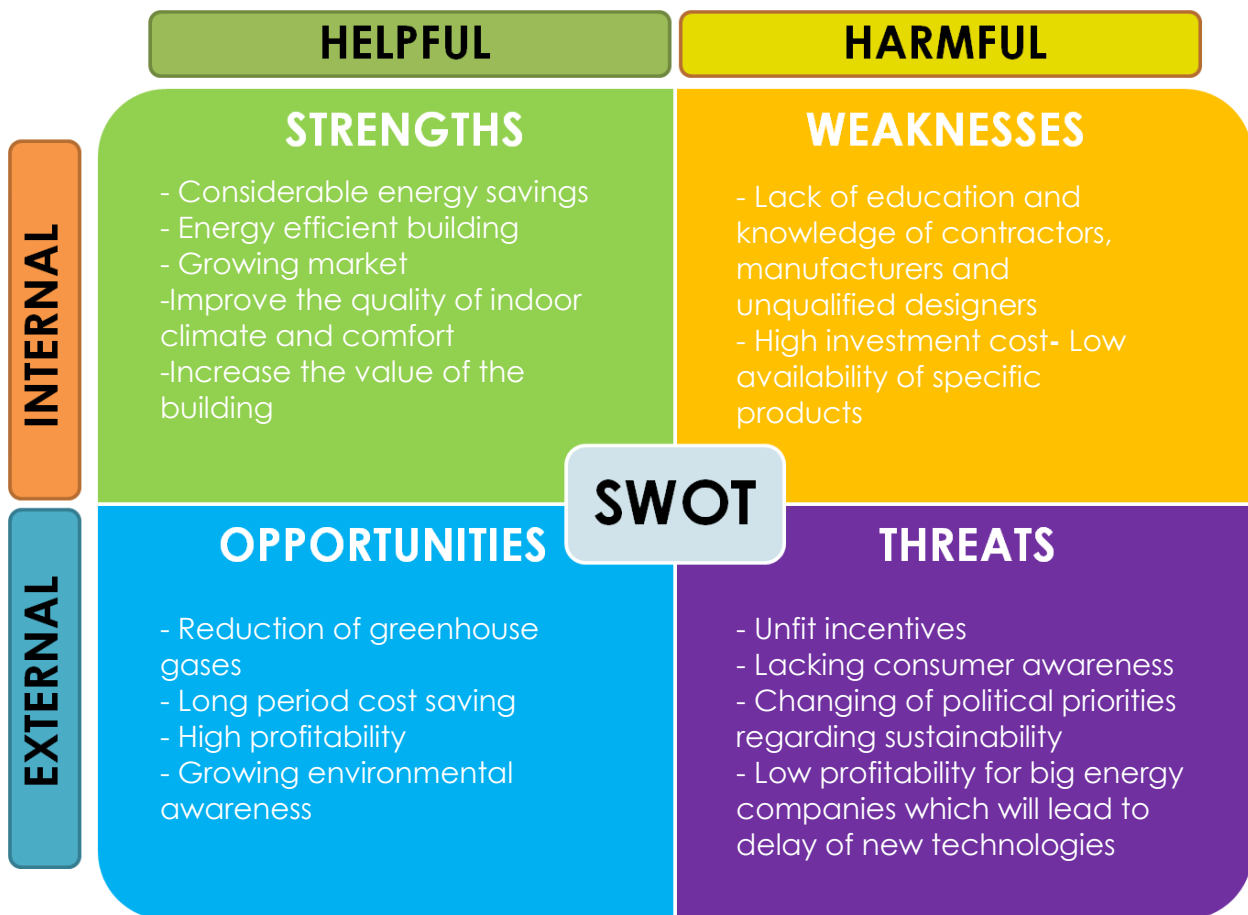

# INSULATING MATERIALS

## INTRODUCTION

The greener energy is obviously the one that is not wasted, for this reason a good thermal insulation can reduce the consumption of energy for heating of buildings saving valuable raw materials and to avoid the emission of substances such as carbon dioxide (CO<sub>2</sub>), very harmful to the climate. The directives related to energy savings provide for the use of insulation high performance, in the design phase is therefore necessary to carry out a proper choice of insulating materials able to target the best choice in each case.

In the paragraph about the thermal insulation materials, we want to consider the production, application, features, the appearance about ecological and health aspect without taking part in one or another product. Each material with thermal and acoustic insulation properties have their own particular application in different fields. In the construction of a building, the choice of each insulation material depends on the final destination, the type of construction and also on the preferences of customers and designers. It's required to understand the characteristics and properties of insulating materials widely used, to know the specified insulating properties, the ability to water vapor diffusion and the aspects related to the resistance. It's not simple balancing all features in a unique compilation, because the environmental impacts present too different and therefore difficult to compare. The manufacturers are the best source of information because the completeness of information is one the criteria distinguishing the reliability of the product.

## MINERAL WOOL

Mineral fibers or mineral wool are filament produced by natural or synthetic minerals. The term "mineral fibers" appertain generally to synthetic materials comprehend the fiberglass, ceramic fibers and rock stones. Industrial applications of mineral wool include thermal insulation (both as structural insulation and pipe insulation), soundproof panel, and also is used like base to the germination of the plants.

Other production techniques using spinning molten rock at high speeds to achieve a compound of thin filaments, that present a diameter from 6 to 10 micrometers containing a binder and an oil to reduce the dust produced during the machining process. Subsequently, the fibrous product is pressed for rolls and panels, this contributes to their excellent thermal insulation and sound absorption.

Fire resistance: the compound is not immune to the effects of a warm fire, but the fire resistance of rock wool is required when it is necessary as a passive fire protection, injected as protection spray, or in cavity wall and as fireproof packing materials.

Advantage: For the sustainable aspect the stone wool insulation product saves more than 100 times the energy invested in its manufacture, transport and disposal. Abundant availability of the raw material, it can also be reused or recycled.

Disadvantage: workers need protection when handling a fiber product, as it can irritate the eyes, skin and respiratory tract. Some types of mineral wool are considered a possible carcinogen if there is a prolonged exposure.

## STONE WOOL

Natural material product with volcanic and basaltic rock, break up to a similar size, compound of coke fused in a furnace at a temperature of 1500 °C. The fused rocks are directed in a complex machine that present rotating wheels where it is worked into wool. From the spinning machine is added in the wool small quantities of resin and oil to binder the fibers together and make them also waterproof. The wool is shaped in blankets and subsequently cured and compressed. Then it's cut into different



Figure EEM.3.1: Insulation materials for constructions (Energetic House, 2010)



Figure EEM.3.2: Stone Wool Insulation (2012)

sizes and kinds which can be combined to create a sandwich panel for different applications.

Thermal Conductivity ( $\lambda$  [W/mK]) : 0,040

Fire Resistivity : 700-850°C

Volumic Mass  $\rho$  [kg/m<sup>3</sup>] : 30

Price: 150,00 €/m<sup>3</sup>

External wall panel 10 cm > 70,00 €/m<sup>2</sup>

Roof panel 10 cm > 23,00 €/m<sup>2</sup>

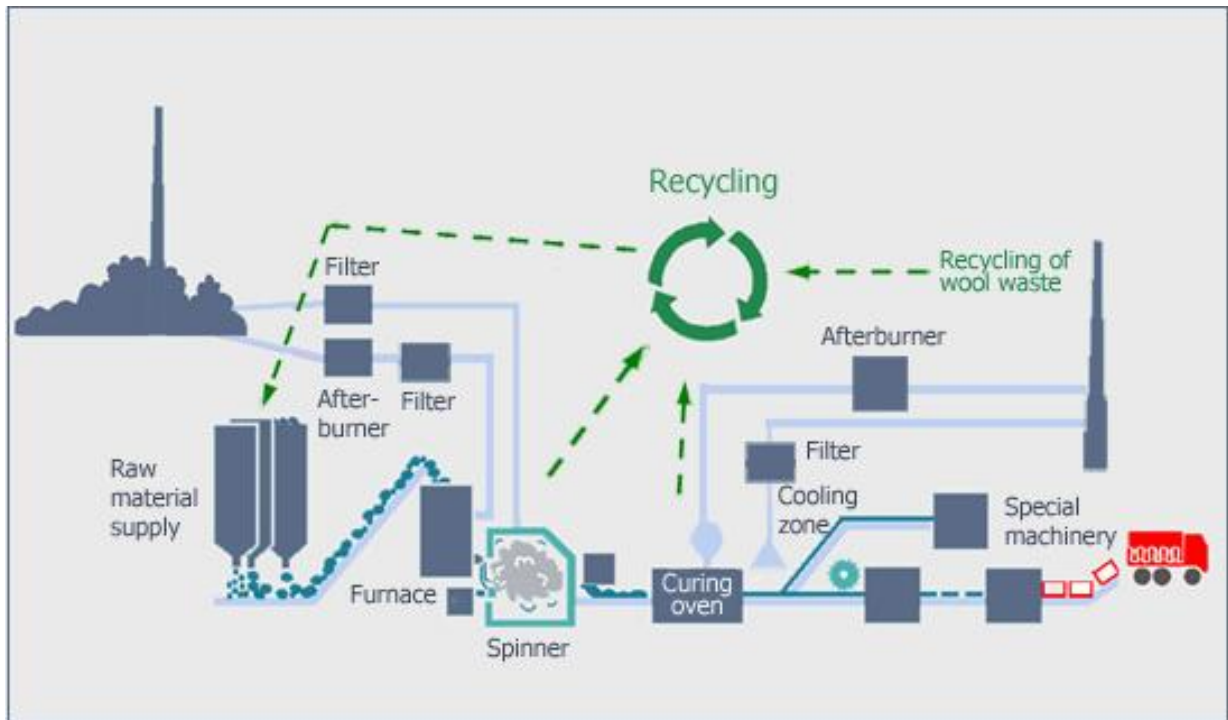

Figure EEM. 3.3: Production Process (Rockwool, 2012)

## GLASS WOOL

The glass wool is obtained by melting a compound of glass and sand, which is subsequently worked into filaments arranged into a texture similar to wool and cut to make rolls or panels. The glass wool is not suitable in the roofs that present an inverse structure (where the insulating panel is located above that of waterproofing panel) because it is not waterproof but is perfect for the insulation of all other element of the building also because present good acoustic features. The panels present the ability to accommodate in the surfaces that need to be isolated. In addition, the fiberglass is used to protect the discontinuities (lines, edges, protrusions) ensuring the hold in terms of thermal and acoustic insulation.

Sustainability:

Reuse the recycled glass to produced glass fibers



Figure EEM.3.4: Glass Wool  
(Energetic House 2012)

Thermal Conductivity ( $\lambda$  [W/mK]) : 0,040

Fire Resistivity : 230 - 250°C

Volumic Mass  $\rho$  [kg/m<sup>3</sup>] : 30

Price: 140,00 €/m<sup>3</sup>

External wall panel 10 cm > 65,00 €/m<sup>2</sup>

Roof panel 14 cm > 40,00 €/m<sup>2</sup>

## MINERAL FOAM

The mineral foam consists entirely of mineral components, such as lime or expanded calcium silicate. The panels in mineral foam present hydrophobic properties but we need to pay attention when laying them because the material if is exposed for a long time directly to the weather tends to absorb water. It's necessary also during assembly wear a dust mask. The mineral foam panels are environmentally friendly and completely reusable.



Figure EEM. 3.5: Mineral Foam  
(Energetic House,2010)

Thermal Conductivity ( $\lambda$  [W/mK]) : 0,045

Fire Resistivity : 700-850°C

Volumic Mass  $\rho$  [kg/m<sup>3</sup>] : 115

Price: 250,00 €/m<sup>3</sup>

External wall panel 10 cm > 95,00 €/m<sup>2</sup>

# SYNTHETIC INSULATING MATERIALS

Insulation materials synthesis, petroleum-based

## POLYURETHANE (PUR)

The polyurethane foam (PUR) is a derivative of petroleum and natural gas usually used for specific goal, for examples the continuous insulation for the supporting beams, the floor insulation as subflooring, the isolation of pipes and water heaters.

The Polyurethane indicates a wide family of polymers in which the polymer chain is composed of urethane.

Thermal Conductivity ( $\lambda$  [W/mK]) : 0,030

Volumic Mass  $\rho$  [kg/m<sup>3</sup>] : 35

Price: 195,00 €/m<sup>3</sup>

External wall panel 7 cm > 20,00 €/m<sup>2</sup>

Wall floor 10 cm > 30,00 €/m<sup>2</sup>



Figure EEM. 3.6: Polyurethane section (Energy Consulting, 2012)

Disadvantage: Health problems in case of a fire. During a fire release hydrogen cyanide (HCN) and isocyanates, which is very poisonous.

Panels Flexible coatings : The panels in rigid polyurethane foam are produced with different shims and with different types of cover, organic like paper and inorganic (aluminum, mineral fibers) .The main uses of polyurethane panels with flexible coatings are to produce pipelines and to insulated walls floors and roofs

The panels in rigid polyurethane foam used to produce for sandwich panels. The main uses of rigid polyurethane foam with hard cover are: straight and curved sandwich panels for roofing, sandwich panels for walls, cold storage, insulated doors.

The block in rigid polyurethane foam can be produced like molds, mixed in concrete block, after than can be cut in sheets of various thicknesses to create complex shapes. The particular technology used in the process allows to realize density foams that present particular features for the industrial applications.

The main uses of blocks and slabs of polyurethane are, refrigeration industry, modeling industry and obviously thermal and acoustic insulation.

## POLYSTYRENE (PS)

Polystyrene (PS) is obtained from benzene and ethylene, in turn, derived from oil and methane. The more propellant used for the expansion of the polystyrene is the liquid CO<sub>2</sub>. Polystyrene a plastic material widely present to realize consumer product.

Products made from foamed polystyrene are in all objects, for example packing materials.

It is produced in slim thickness, rolls of polyethylene foam are used primarily for the impact sound insulation subfloor.



Figure EEM. 3.7: Polystyrene (Energetic House, 2010)

Thermal Conductivity ( $\lambda$  [W/mK]) : 0,040

Volumic Mass  $\rho$  [kg/m<sup>3</sup>] : 17

Price: 190,00 €/m<sup>3</sup>

Roof Panel > 114,00 €/m<sup>2</sup>

Wall floor > 32,00 €/m<sup>2</sup>

Foams: Polystyrene foams are good thermal insulators used often used as insulation materials for the constructions .

Blanket panel: Its used for producing consumer product because is a economical plastic. Polystyrene is a important component in the biomedical field. The products for the medial fied are made by injection molding, and often sterilized post-molding.

Disadvantages: the material present a slow biodegradation and is considered like a waste for the environment.

## EXPANDED POLYSTYRENE (EPS)

The synthesized expanded polystyrene (EPS) is composed of benzene and ethylene, which are petroleum based and natural gas and is composed of granules of polystyrene expanded. Rigid and tough, closed-cell foam. Widely used like panels for building insulation and packing material. Sheets are commonly packaged as rigid panels. The rigidity of the panel in expanded polystyrene (EPS) along with a lightweight plaster can go into resonance and reduce noise reduction.



Figure EEM. 3.8: EPS, (Insulation Centre, 2012)

Thermal Conductivity ( $\lambda$  [W/mK]) : 0,033 / 0,044

Volumic Mass  $\rho$  [kg/m<sup>3</sup>] : 17

Price: 110,00 €/m<sup>3</sup>

roof > 22,00 €/m<sup>2</sup>

external wall > 39,00 €/m<sup>2</sup>

## EXTRUDED POLYSTYRENE FOAMS (XPS)

The extruded polystyrene foam (XPS) has a very low water absorption and is therefore used for the application in a humid environment, such as walls and floors of the basement floors. It presents closed cells, improved higher stiffness and reduced thermal conductivity. Extruded polystyrene material is also used in crafts and architectural models.

Thermal Conductivity ( $\lambda$  [W/mK]) :0.030 / 0.040

Volumic Mass  $\rho$  28–45 kg/m<sup>3</sup>

Price: 190,00 €/m<sup>3</sup>

Roof > 114,00 €/m<sup>2</sup>

External wall > 36,00 €/m<sup>2</sup>

Floor > 32,00 €/m<sup>2</sup>



Figure EEM. 3.9: XPS (Building 2000, 2012)



## CORK

The cork is a plant tissue that covers stem and the roots of woody plants. The most widely used commercially is produced by the cork is composed by a hydrophobic substance impermeable and fire resistance.



Figure EEM. 3.10: Cork Panel (Archi Expo,2012)

The cork insulation is presented in granules (used as the background, mixed with cement) or in panels (12 cm-layer). The bulk granular cork insulation is used in cavity walls, roofs, and floors. The panels of cork insulation will still be applied in the perimeter walls and partitions, in flat roofs and ground water, in ceilings, attics, floors and subfloors. It is resistant to insects and fungi has excellent thermal characteristics but is not suitable for the subflooring. The cork insulating material is a fairly expensive, for this reason we prefer the use of wood fiber.

Sustainability: easy to recycled, The bark has the cellular structure consisting of myriads of tiny, 14-sided cells, each imprisoning a microscopic volume of air. The cork presents million of these minute cells separated by an impermeable resinous membrane. Is a natural soft material because present air cavity inside the cells. This is the reason of the light cork structure buoyant and resistant to the penetration of moisture. Cork panels burn slowly when subjected to a flame but it does not produce toxic gases. Granules of cork can also be mixed into concrete to improve a lower thermal conductivity, lower density and good energy absorption. High Resistance to fatigue

Expanded Cork (panel form)

Thermal Conductivity ( $\lambda$  [W/mK]) :0,040

Volumic Mass  $\rho$  kg/m<sup>3</sup>: 100

Granulate Cork (Bulk Form)

Thermal Conductivity ( $\lambda$  [W/mK]) :0,040

Volumic Mass  $\rho$  kg/m<sup>3</sup>: 120

Price: 340,00 €/m<sup>3</sup>

roof 10 cm > 47,00 €/m<sup>2</sup>

external wall 10 cm > 119,00 €/m<sup>2</sup>

## WOOD WOOL

The wood fiber is made using sawmill residues, crushed and broken down into wood fibers which are then compacted to make the panels moisture resistant are used some hydrophobic substances, and of the adhesives to make the material stable. It is common use for packaging or for various construction products like slabs for decking, rood slabs or insulating panels, or combined with cement to produce a mixed boards. The panels in wood fiber have good characteristics of thermal and acoustic insulation and a good capacity for heat accumulation, which in the summer results in a good level of delay in the way of heat from outside to inside. The wood fiber panels are used for the insulation of cavity structures in wood and masonry, coats, linings, flat and pitched roofs and floors.

Sustainability: environmentally friendly material. The cellulose component (typically around 80% of the total) contains over 90% post-consumer recycled material, Sequesters CO<sup>2</sup> during tree growth.

Thermal Conductivity ( $\lambda$  [W/mK]) :0,040

Volumic Mass  $\rho$  kg/m<sup>3</sup>: 80

Price: 175,00 €/m<sup>3</sup>

Roof panel 10 cm > 30,00 €/m<sup>2</sup>

Floor panel 4 cm > 22,00 €/m<sup>2</sup>



Figure EEM. 3.11. Wood wool (Isotermo,2012)

## CELLULOSE WADDING

The cellulose fiber is derived from recycled newspaper ordinarily handle with a brew substances as aboric acid to endue a good fire resistance and get result inoffensive the fungi. The paper is shredded and mixed with boron salts in order to make the material flame retardant and pesticide: by this procedure are produced flakes that can be pressed into granules.

As a insulation present a low-thermal-conductivity, the cellulose is used in wall and roof cavities to separate thermally and acoustically. The cellulose fiber can also be used in panels, mixed with a 15% of polyester fiber which contributes to stiffen the material. The cellulose fiber in flakes is used in the recovery work, to isolate the cover, or to insulate the walls in empty box, by blowing the material in the cavity of air. The cellulose fiber is also used to isolate the newly built houses with wooden frame. The laying of the cellulose fiber is extremely easy and is inexpensive, also the cellulose fiber does not contain harmful substances.



Figure EEM.3.12: Cellulose panel (Archi Expo, 2012)

Cellulose insulation is produced utilizing recycled paper and is now a preferable material for building insulation because it is considered ecofriendly. Cellulose insulation is available as a dry state or used with a spray device to use for timber frames. Thanks to its characteristics of diffusion it is particularly suitable both for interior walls and for external ones. It allows you, while insulating thermo acoustically, to perspire the walls. Being a bulk material to be used for blowing can be injected into cavities of multi-layer walls, a characteristic that makes it ideal in the insulation of walls in existing buildings as part of interventions of restoration. The dry cellulose was used to insulate old homes pushing inside the cavity the cellulose and replenish all the wall using different holes.

The cellulose can be applied also like a spray method used in the new construction adding water mixed to the cellulose and additive as a chlorine. Thermal and acoustic insulation are used to insulate pipes and wiring fixed in the wall, leaving few air pockets. Noise reduction is achieved with cellulose that can be completely grout the cavities to avoid the sound diffusion.

**Sustainability:** Cellulose insulation is growing in popularity, because it can be composed with a high percentage of recycled paper fiber adding just a small quantity of fire retardant and additive.

Thermal Conductivity ( $\lambda$  [W/mK]) :0,040

Volumic Mass  $\rho$  kg/m<sup>3</sup>: 400

Price: 170,00 €/m<sup>3</sup>

Roof panel 10 cm > 30,00 €/m<sup>2</sup>

Insufflation > 100,00 €/ml

## HEMP WOOL

The insulating panels are produced by treating the fiber hemp with boron salts to improve the fire resistance and also an appropriate treatment to avoid mould proliferation. They have excellent thermal and acoustic properties, are breathable and hygroscopic, don't contain toxic substances, risk to health during processing, either during the useful life of the material. The panels and rolls of fiber hemp are used in the realization of cavity walls, roofs of (inserted between the rafters or beams above), of coverings (with load-bearing strips, if the panel is low density, or without battens if the panel has high density and walkable), suspended ceilings, or underlay for reducing impact noise.

Hemp insulation is used in breathing wall construction, ventilated roofs and floors.

The high density and high flexural are important properties for ease of installation, particularly in timber frame walls and between rafters. The high density combined with the sound damping properties of natural fibres results in good acoustic performance.

Thermal Conductivity ( $\lambda$  [W/mK]) :0,040

Volumic Mass  $\rho$  kg/m<sup>3</sup>: 30 / 40

Price: 170,00 €/m<sup>3</sup>

Roof panel 10 cm > 30,00 €/m<sup>2</sup>

wall panel 10 cm > 25,00 €/m<sup>2</sup>



Figure EEM. 3.13: Hemp wool (Energetic House, 2012)

## FLAX WOOL

The insulation products in flax fibers are made from organically grown plants, working with non-polluting and low energy demand. For the production of insulating panels, the fibers are treated with boron salts and in some cases with the addition of a support made of polyester fiber. The linen fiber is a material with outstanding thermal and acoustic insulation, is highly breathable and hygroscopic, and does not contain substances harmful to health. The soft panels are used to isolate thermally and acoustically hollow wooden construction, for internal coats, coats for external air supply for ventilated roofs, for partition, for slabs. The rigid panels in linen fiber are used for sound insulation of floors floating. The fibers of the flax are admixture with natural starch and processed with borax to improve the endurance against bugs and against the fire.



Figure EEM. 3.14: Flax wool (Infobuild, 2012)

**Sustainable:** Low embodied energy is natural, non-toxic and bio-degradable material. Suited to a breathable construction insulation, present good sound insulation. Transpiring owing to its fibers composition benefiting the building, the flax fibers is robust, and can absorb up to 12% of its own weight in water, and its strength increases by 20% when wet. It also dries in few time, and is an anti-static material.

Thermal Conductivity ( $\lambda$  [W/mK]) :0,040

Volumic Mass  $\rho$  kg/m<sup>3</sup>: 30

Price: 200,00 €/m<sup>3</sup>

Roof panel 10 cm > 30,00 €/m<sup>2</sup>

wall panel 10 cm > 25,00 €/m<sup>2</sup>

## SHEEP WOOL

The slabs and rolls are produced using wool mixed a polyester binder to improve the fireproof and the resistance against insects. The sheep wool is useful as insulation between rafters, joists and timber in timber 'breathing' wall construction. Sheep's wool present optimal hygroscopic features that avail of the different temperature to moderate the season's conditions. Sheep Wool Insulation present a various kinds of products to suit a variety of applications. The thickness and density of the insulation depending on its intended application: thermal insulation applications in buildings, acoustic underlay applications, packaging products and membranes to minimize the air leakage into the building elements. Wool fibers are hygroscopic and will have a moisture weight content of up to 35%, dependent on the relative humidity of the surroundings. Assimilating the humidity, the wool way out the heat, increasing the temperature in the near environment. Obviously liberating this moisture in a hot seasons, the wool produce a cooling effect.



Figure EEM. 3.15: Sheep wool  
(Sheep wool Insulation, 2012)

**Risk and Safety:** Is a reliable material, it's possible to use and work with them without requiring no protective equipment to cover the skin. Wool does not support combustion because present inside a few quantity of humidity and will switch off itself when the fire flame is removed. The wool is a much safer material than artificial products because does not release poisonous.

**Sustainable:** Is a natural fiber, renewable and sustainable because source of raw material and present a low carbon footprint. At the end of its useful life, it can be reused or recycled into other wool products or buried where it will eventually biodegrade.

Thermal Conductivity ( $\lambda$  [W/mK]) :0,040

Volumic Mass  $\rho$  kg/m<sup>3</sup>: 288

Price: 100,00 €/m<sup>3</sup>

Roof panel 7 cm > 15,00 €/m<sup>2</sup>

wall panel 7 cm > 10,00 €/m<sup>2</sup>

## VACUUM INSULATION PANELS (VIP)

The vacuum insulation present a panels composed by porous acid silicon covered with a plastic film metallized that consent to preserve the vacuum. It is a product that is born insulating low refrigerating industry to minimize the thicknesses .

The thermal conductivity of these panels is about one tenth that of conventional insulating materials because 2 cm of V.I.P. panel have the same insulation properties of a polystyrene panel of 20 cm of thickness.

Advantage insulation material are not easy to realize compared the polyurethane types or mineral wools, and accurate quality control in the process of realizing the membranes is important if a panel is to preserve its vacuum for a long time.

The Vip panels can't be cut but is produced in required format and it require a admits of dimensional tolerances minimum  $1 \pm 1$  mm) in order to avoid losses in the connections panels causing an increase of thermal conductivity.

The vacuum insulation panels are made to order and you have to take special care in installation to avoid destroying the protective film and avoid undermining the vacuum, since it will increase the thermal conductivity. It's preferable to the application in sandwich panels with outer layer made of various materials including slabs of polystyrene or plastic for the thermo-acoustic insulation. In this way you can ensure a more robust and limit damage during transport and construction, avoiding accidental perforations. Can be applied directly to the existing external wall surface. No protective equipment required to install. Does not produce any dust o fibers.

**Disadvantages:** No renewable, no bio-degradable ,depend by fossil material. It' s expensive and reducing insulating capacity slowly over time. If vacuum seal is broken, panel is useless.

Thermal Conductivity ( $\lambda$  [W/mK]) :0,004

Volumic Mass  $\rho$  kg/m<sup>3</sup>: 1

Price: 5.550,00 €/m<sup>3</sup>

Panel 1 cm > 100,00 €/m<sup>2</sup>



Figure EEM. 3.16: VIP panel (Panasonic ideas for life, 2012)

## GAS-FILLED PANELS

The insulating panel known as (GFP) . GFP is constituted essentially by hermetic bags that can assume a variety of shapes and sizes . Gas as the argon for an effective level of thermal resistance, using a microscopic cellular structure containing inside a gas at low conductance such as argon (Ar), krypton (Kr) or xenon (Xe).

Thermal Conductivity ( $\lambda$  [W/mK]) :0,004

Volumic Mass  $\rho$  kg/m<sup>3</sup>: 1



Figure EEM. 3.16: Gas-filled panel (Builder, 2012)

## AEROGELS

Aerogels are produced by the extraction of liquid from a gel component through supercritical drying, and replaced by air. It is known for being one of the less dense and lighter materials worldwide because 99.8% of its volume consists of air-filled spaces.

Then the most remarkable value is a thermal conductivity of 13 mW/mK for commercial products, the lowest thermal conductivity of any known solid. These features would improve the building insulation making huge savings of energy up to 50% of heat loss and therefore energy supplying for heating. Not only this, it also provides the creation of new architectural solutions.

Aerogels are good thermal insulators since they nullify the three methods of heat transfer: radiation, convection and conduction. In general, the gases are very poor heat conductors and the silica aerogel is particularly good in this point. This is one of the most important features of the material since it becomes several times more insulating than the best thermal fiberglass currently in the insulation materials market.

In addition to its low thermal conductivity, aerogels shows a wide range of characteristics that make of it an interesting material for the construction industry:

- Optical properties
- Acoustic properties
- Catalytic properties

**Advantage:** Processed by natural materials, present a optimum insulating value for relatively little thickness. Very good thermal, electrical and sound insulator is available in sheets or panel is Impermeable and fire proof, can be applied directly to the existing external walls surface.

**Disadvantage:** No renewable, no bio-degradable, Protective equipment required to install (mask), New product, little known of possible problems.



Figure EEM. 3.17: Aerogel sheet (Midwest Ecodesign, 2010)

However, silica aerogels have very poor mechanical properties. Although they have a very strong structure - supporting up to 4,000 times its own weight -, pressing an aerogel piece with some firmness causes a depression permanently.

Another disadvantage of the aerogel is the vulnerability to the liquid water. Whereas the adsorption of water vapour by the silica does not spoil aerogels, the contact with liquid water can harm them quickly. So, the waterproof protection is required if the aerogels are used in any building component.

Thermal Conductivity ( $\lambda$  [W/mK]) : 0,03

Volumic Mass  $\rho$  kg/m<sup>3</sup>: 1

Panel : 45 €/m<sup>2</sup>



## VACUUM INSULATION MATERIALS(VIM)

Material of new conception made a closed-cell structure under vacuum with a total thermal conductivity of less than  $4 \text{ mW} / (\text{mK})$ . The panel is easily used on site and can be cut and adapted on site without the ruin of low thermal conductivity. Pierce the VIM with a nail or similar would only result in a thermal bridge local, without loss of low thermal conductivity.

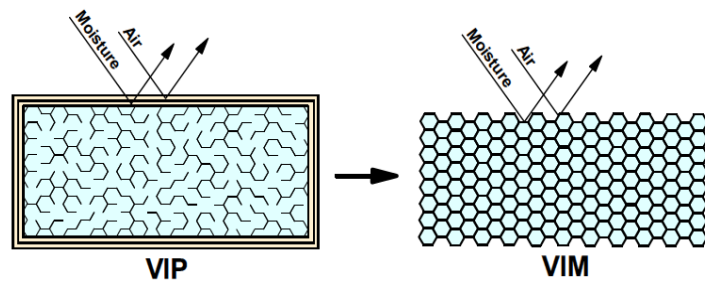

Figure EEM. 3.18. Vacuum insulation panels for building applications: A review and beyond (Baetens, et al. 2010)

## GAS INSULATION MATERIALS (GIM)

The Gas Insulation Material (GIM) is a material develop by the panel VIM but present inside a gas at low conductance. It is a new technology in develop to improve thermal insulation using different gas combined with a polymeric film to create a device with exceptional thermal insulation properties. The structure inside present a homogeneous micro cells with gas as argon (Ar) or krypton (Kr) or xenon (Xe) with an overall thermal conductivity of less than  $4 \text{ mW}/(\text{mK})$  in the pristine condition.

## NANO-INSULATION MATERIALS (NIM)

Development from VIP panel, the NIM is the nano insulation materials, where the pore size into the material is reduce and arrive to  $40 \text{ nm}$  or below for air. The NIM that present a small nano structure with an total thermal conductivity of less than  $4 \text{ mW}/(\text{mK})$  in the normal condition.

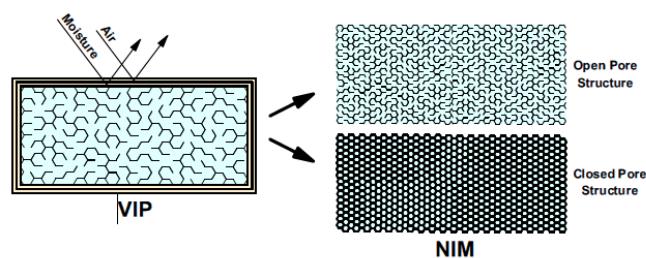

Figure EEM. 3.19: Traditional, state-of-the-art and future thermal building insulation materials and solutions – Properties, requirements and possibilities (B. Petter Jelle, 2011)

## DYNAMIC INSULATION MATERIALS(DIM)

Product of new conception developing that has a dynamic capacity of insulation (DIM) the thermal conductivity can be manipulated to suit your requirements. This may be done by controlling the thermal conductivity through the use of gas in different concentrations inside of the pores or through the thermal conductivity latex solid state. The models studied using two different methods:

- Thermal conductivity Phonon
- atom lattice vibrations
- Thermal conductivity for free electrons

This in order to study possible changes to the thermal conductivity from very low to very high making a DIM with dynamic properties. The thermal insulation of adjustment ability of DIM to give these materials a lot of potential. However, first of all it must be proved that those fades robust and practices can be produced.

# CONCLUSION

The analysis of the different insulating materials has had as the goal to make a description between products. This comparison can be obtained examining performance levels of thermal insulation. The materials for thermal insulation are produced in different types depending on the area to be insulated and there are presents on the market with different variables. There are varied kinds: fibrous mineral insulating panels, synthetic panels natural insulation materials and advanced insulation materials. Choose the type of insulation for a building is an important aspect during the design since the thermal insulation is one of the factors that affected more on energy saving. Excluding the use of advanced insulation materials for the isolation of the common housing, however, is not the same use an insulating synthetic material, such as EPS (expanded polystyrene) and XPS (extruded polystyrene), compared for example to a insulating wood fiber.

Indeed a synthetic insulating panel, generally presents an insulating capacity greater than that of wood fiber, with the advantage of being able to use smaller thicknesses to achieve the same thermal transmittance values on the wall, but it is a material derived from petroleum, not sustainable and harmful if it is burning. Therefore it is not easy to draw up a comparative table between the different materials, presenting different physical and mechanical properties, as well as for their ability to be sustainable materials. But the use, in particular, of insulating materials from natural sources, greatly reduces the negative consequences on the environment and on humans limiting, also, the use of non-renewable raw materials. The natural insulation materials allow, moreover, to obtain a high level of environmental comfort inside buildings thanks to their properties of thermal and acoustic insulation and breathability.

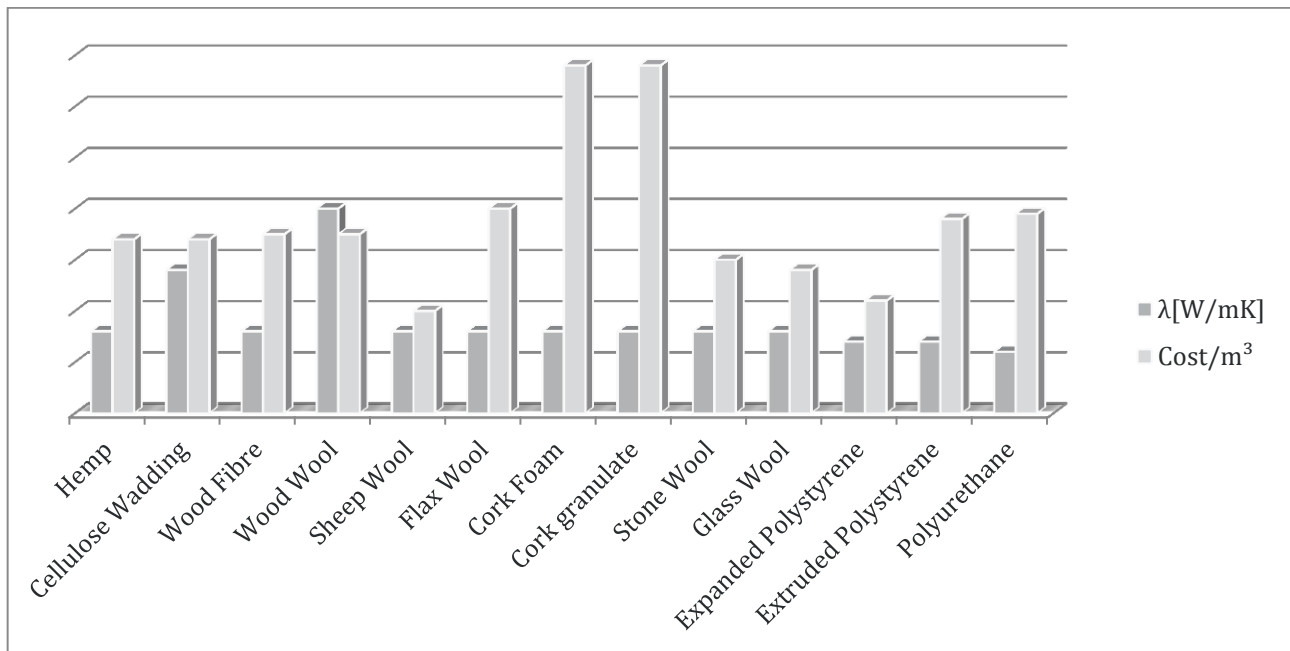

Figure EEM. 3.20: Comparison between Insulation properties and cost

## ADVANTAGES

### ✓ MINERAL WOOL

- Excellent thermal insulation and sound absorption.

### ✓ STONE WOOL

- Abundant availability of the raw material and it is recyclable.
- For the sustainable aspect, this material saves more than 100 times the energy invested in its manufacture, transport and disposal.

### ✓ GLASS WALL

- It can be obtained due to recycled glass
- Useful for the building insulation (less roof and walls)

### ✓ POLYSTYRENE

- Good thermal insulators used often as insulation materials for the constructions.

### ✓ CORK

- Resistance to insect and has excellent thermal characteristics.

### ✓ WOOD WOOL

- Good thermal and acoustic insulation and a good capacity for heat accumulation.

### ✓ CELLULOSE WADDING

- Insulation material with low-thermal conductivity
- The layer of the cellulose fibres is extremely easy and is inexpensive.
- Use in building insulation, because is considered eco-friendly.

### ✓ HEMP WOOL

- The high density combined with the sound damping properties of natural fibres results in good acoustic performance.

### ✓ FLAX WOOL

- Is a material with outstanding thermal and acoustic insulation, is highly breathable and hygroscopic, and doesn't contain substances harmful to health.

### ✓ VACUUM INSULATION PANELS (VIP)

- Can be applied directly to the existing external wall surface. No protective equipment required to install. Does not produce dust or fibres.

### ✓ AEROGELS

- Are good thermal insulators
- It is an interesting material for the construction industry caused by optical properties, acoustic properties and catalytic properties.
- Impermeable and fire proof can be applied directly to the existing external walls surface.

## DISADVANTAGES

- × **STONE WOOL**
  - It can irritate the eyes, skin and respiratory track
  - Some types are considered carcinogen.
- × **GLASS WOOL**
  - It is not waterproof and as a consequence it is not suitable for walls and roof inverse structure.
- × **POLYURETHANE (PUR)**
  - Health problems in case of a fire.
- × **POLYSTYRENE (PS)**
  - Slow biodegradation and is considered like a waste for the environment.
- × **CORK**
  - It is not suitable for the subflooring and is fairly expensive.
- × **VACUUM INSULATION PANELS (VIP)**
  - No renewable, no bio-degradable, depend by fossil materials.
  - Expensive and the insulating capacity reduces over time.
- × **AEROGELS**
  - No renovable, no bio-degradable.
  - Protective equipment required to install mask.
  - Very poor mechanical properties
  - Vulnerability to the liquid water.

### Natural Insulation Material

Material	type	application	$\lambda$ [W/mK]	$\rho$ [kg/m <sup>3</sup> ]	$\mu$
Hemp	Mat	Wall	0,040	22	2
Cellulose Wadding	Bulk	Wall	0,070	400	2
Wood Fibre	Mat	Wall	0,040	80	100
Wood Wool	Panel	Wall	0,100	400	4
Sheep Wool	Mat	Wall	0,040	28	2
Flax Wool	Mat	Wall	0,040	30	1
Cork Foam	Panel	Floor, Wall, Ceiling	0,040	100	10
Cork granulato	Bulk	Wall	0,040	120	9
Stone wool	Mat	Wall	0,040	30	1
Glass wool	Mat	Wall	0,040	30	1
Expanded Polystyrene	Panel	Floor, Wall, Ceiling	0,035	25	50
Extruded Polystyrene	Panel	Floor, Wall, Ceiling	0,035	25	80
Polyurethane	Panel	Floor, Wall, Ceiling	0,035	35	80

# SMART GRIDS

## ABBREVIATIONS AND ACRONYMS

AC	Air Conditioning
AMI	Advanced Metering Infrastructure
DA	Day-Ahead
DS	Demand Side
DSM	Demand Side Management
DR	Demand Response
EC	European Commission
EEGI	European Electricity Grid Initiative
EMS	Energy Management System
ETP	European Technology Platform
EU	European Union
Km	Kilometer
MW	Mega Watt
PHEV	Plug-in Hybrid Electric Vehicle
PLC	Power Line Communication
PMU	Phase Measurement Units
PP	Peak Prices
RTP	Real Time Price
R&D	Research and Development
RD&D	Research Development and Deployment
SA	Smart appliances
SGTF	Smart Grid Task Force
SRA	Strategic Research Agenda
TOU	Time Of Use
US	United States of America

## INTRODUCTION

According to Albuyeh and Ipakchi (2009) the Smart Grid would empower the accomplishment of environmental targets, giving a big importance on demand response, and promoting the deployment of plug-in hybrid electric vehicles (PHEVs) as well as spread energy generation and storage capacities.

Though Smart Grid is not yet a reality, one is able to enunciate how the design should be, Fig. EEM.4.1. Apart from the traditional power network, the Smart Grid will have the following components:

- Renewable energy generation: the rising will to find new and/or better ways to obtain energy from renewable sources in order to reduce the CO<sub>2</sub> emissions has brought green energies to become fundamental for our future. Nonetheless, these green sources have a high variability and this will be a big challenge to the utilities when the penetration rises (Vittal, 2010).
- Energy storage: instead of generating power for the peaks another option is to

have some storages that could supply electricity to the grid when it is needed. According to Markel and Simpson, (2006) PHEVs batteries can be seen as provisional storages.

- Demand side management: Although traditional energy system generates extremely adaptable supply to an extremely uncontrolled demand, with green energies this changes completely, so a new balancing system is needed.
- Smart appliances: devices such as dish washer, heaters, air conditioners, etc. that can have elastic energy demand and delay tolerant. That means that the important is the finishing time, more than the starting time.
- Communications layer: network that enables information flow across the grid system. A combination of technologies will be needed to cover all the necessities of the Smart Grid.

In order to reduce line transmission losses from electricity delivery, the power should be generated as near as possible from the consuming point.

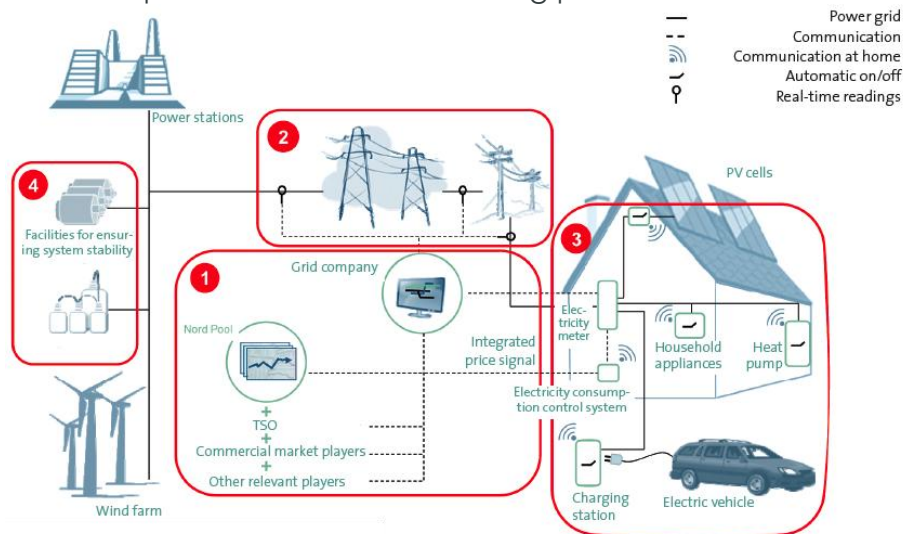

Figure EEM.4.1: Smart Grid break down(Energinet, 2012).

## Historical development of the electricity grid

The result of Nikola Tesla's research published in 1888 was the base for the traditional power grid. This network was a centralized and unidirectional system of power generation, transmission, distribution and demand control.

During the 20th century power grids grew exponentially and were interconnected to achieve more reliability. Power networks were very large, with coal, gas and oil power stations located near to the fossil fuel reserves or close to roads, rails or ports but as far as possible from the cities because of their pollution. By the second half of the century, in the developed countries, only a few rural areas were still outside the grid.

Collecting the data of electricity consumption was difficult and the processing capability unable to generate per-user based billing. Fixed-tariff was the most common way to bill the users. In this period first dual-tariff with cheaper power at night than day were introduced, because at night the demand was lower. Dual tariffs abled to use cheaper electric power on maintenance tasks that at the same time helped to smooth the daily demand.

By 1980s the electricity supply on peak times was not able to keep up with the demand causing poor power quality and sometimes power cuts, brownouts and blackouts.

Gradually, consumers demanded better reliability because communication, heating, industry, lighting, etc. depended on electricity.

Demand patterns were recognized at the end of the 20<sup>th</sup> century. Air-conditioned and domestic heating produced daily peaks in demand and extra power generators (normally, gas turbines due to faster start-up time) were needed for short periods to meet the demand. This produced high cost to power companies, which at the same time increased tariffs.

The turn of the century has brought new advances in electronic and communication, so the peak power prices are no longer averaged out for all the consumers equally. At the same time renewable energies have been a step forward in the way electricity is produced. Wind power and solar power are the dominant forms, but they are very variable, so complex control systems are needed to adapt this variable energy sources into the demand-response power grid.

The fear over terrorist attack has also led to design more robust power grids and less dependent on isolated power stations that are potential targets.

Early in the 1980s the firsts automatic meter readers were incorporated to monitor the consumption from large customers. In the 1990s they evolved into smart meters, which could set nonstop communication with the electricity company being this way able to monitor in real time. At the same time they could be used as a gateway to demand response devices.

This devices checked changes in the electric supply frequency becoming primary systems of demand side management.

The first large scale project that used smart meters (27 million) started in the year 2000 as Italy's ENEL Telegestore Project.

It was not until 2005 when Amin and Wollenberg (2005) popularized the term Smart in his article "Toward a Smart Grid".

Nowadays the most accepted definition is the one of the European Technology Platform for Smart Grids. "Electricity networks that can intelligently integrate the behavior and actions of all users connected to it – generators, consumers and those that do both – in order to efficiently deliver sustainable, economic and secure electricity supplies."

## CURRENT STATUS

Within the European Union 56 billion Euros will be invested by 2020 on Smart Grid research. Among all the Euro countries, the fifteen with more projects being developed on Smart Grid are Denmark 22%, Germany 11,1%, Spain 8,7% and UK 6,8%.

The Telegstore project cited on the introductions finished in the year 2006 and Enel deployed 32 million smart meters in Italy, from which encouraging results can be extracted; the "minutes of interruption per year" were reduced from 128 to 49 in the 2001-2009 period. Telegstore is the most important project done by now. Following the steps of the Smart Grid, a new project called "StAMI" was launched in 2010. On it a web interface has been developed to collect RT data from the smart meters. This will just collect the data for the utilities to predict the demand with more accuracy, but no DR method is being tested.

The graph below (Fig. EEM.4.2) shows that right now Smart Grids are just a theoretic aspect with great potential but still far from being applied. As can be seen on the graph below, the red color representing the amount of projects being deployed is really small, while the R&D and demonstration projects are much bigger.



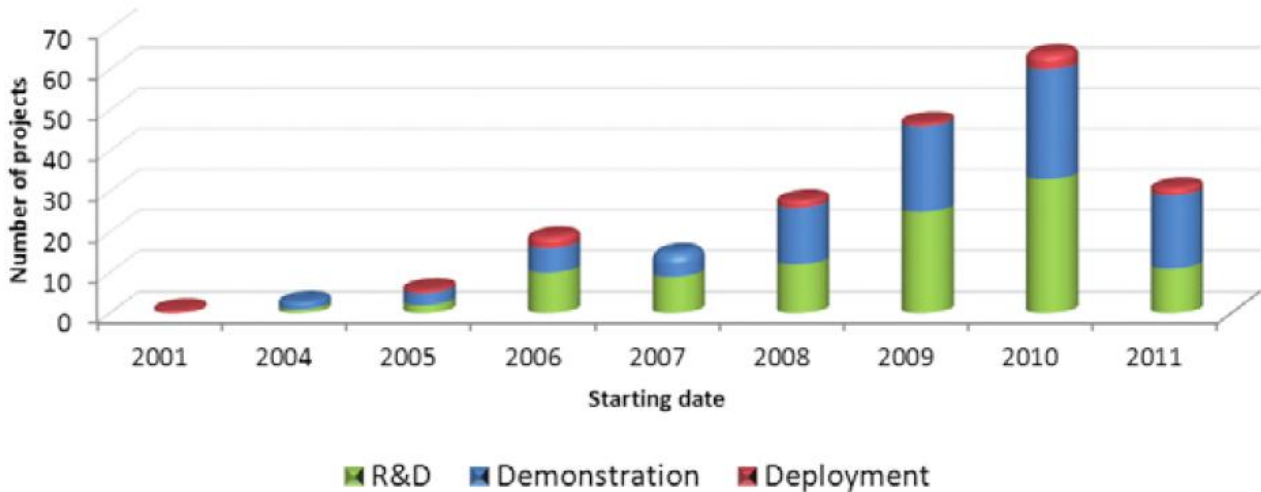

Figure EEM.4.2: Number of projects involving Smart Grid in Europe (Fulli, et al., 2011).

## ENERGY DEMAND

### INELASTIC ENERGY DEMAND

Inelastic demand means that the power requests have to be met exactly at the same time when they are required. In residential buildings some examples are TV, computers, lighting, etc.

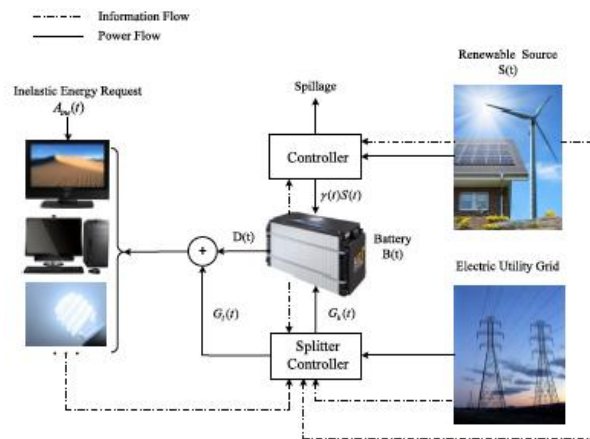

Figure EEM.4.3: EMS for inelastic energy demand (Fang, et al., 2012).

Figure EEM.4.3 illustrates information flow and power flow. The splitter controller is a switcher that automatically decides if the battery needs to be recharged or energy has to be supplied directly to the demand points. To do that the splitter monitors the state of charge of the battery and according to preset parameters decides which option is the right one. Another controller monitors the renewable energy generation and the battery state of charge and it is used to regulate the share of renewable energy the battery needs (Fang, et al., 2012).

## ELASTIC ENERGY DEMAND

On the contrary to the section above, other appliances do not need the electricity in a precise moment. That means that they can be controlled to regulate the process duration and the total quantity of energy used. In other words, the customers establish fixed deadlines, and whenever their requirements are met by the time they have fixed, they will be satisfied. Examples are heater, cloth washer, air conditioner and PHEVs. The applicable graph is the same that shown in Fig. 1 but with elastic request appliances.

According to this section (energy and money saving could be achieved) in the following way: when the renewable sources generate more electricity than it is needed, the battery should storage the surplus for later use when renewable energy would not be enough. Another way is charging the battery and discharging it according to the electricity market prices; discharging it when the price is high and charging it when the price is low.

## ENERGY BALANCE

### DEMAND-RESPONSE

Utility companies and clients are needed to work together to reduce peak load and improving the operation at off-peak hours. This normally implicates complex and RT optimization at all levels. Power market and electrical operators have to deal with the unpredictable and variable large-scale renewable energy sources in their forecast and decisions. In a power grid, electricity production and consumption must be balanced at all times. Hence, generation capacity corresponds to total peak demand with certain margin for errors and allowances for contingencies.

The mechanism used to balance this situation is the Demand-Response system that balances consumers' electricity consumption in response to supply conditions. There are mainly two DR methods: incentive-based (Oren, 2011) and time-based (Ghatikar, et al., 2010). In the first one, clients join voluntarily in rewarding programs and consent the power company to control some of their appliances. For example ACs to decrease loads during emergencies or peaks. The second one is based on the pricing of dynamic electricity to control power consumption. They can be simple systems such as time-of-use (TOU), where the prices are set according to the time electricity has been used, to others such as Peak-pricing (PP), where the price rises only during peak times, or Real-Time-pricing (RTP) where the higher the demand is, the higher the prices get.

In the Smart Grid RTP is mainly spread. RTP enables consumers modifying their electricity load manually or using an Energy Management System (EMS). Basically, customers can plug the most consuming appliances at off-peak periods depending on their "sensitivity to price" (Chan, et al., 2012). In this way DR stimulates the demand when the supply is abundant and the demand is scarce in order to maintain the network stability.

In order to support DR programs Advanced Metering Infrastructure (AMI) are being deployed to trade minutely pricing and other data.

## FORECASTING ELECTRICITY PRICE AND LOAD

DR relies on the forecast accuracy of renewable energies load done by the utilities and the price forecasting done by customers. Nowadays “load/demand forecasting is a settle field” (Chan, et al., 2012) but with RTP this forecast has to be done in an interval that could be as small as two minutes. Because DR interacts with demand and price of electricity, and the high electricity production from renewable sources varies from one second to another, this requires tools able to feed reliable intervals instead of just estimation to take into account the uncertainties. Weron (2006) Hou, et al., (2012) suggest that the behavior of electricity prices depend on:

- Season
- Price-dependent peaks and instabilities
- Connection between price and load

Because electricity price/load is time varying, the batch processing of the algorithms used in the forecast mission are vital to adapt to trend's variation.

Huisman and Mahieu (2003) say that day-ahead (DA) hourly prices should not be considered as linear, because they are not produced serially in DA market. Consequently, it is necessary to slice spot prices into segments of one day long curves, seeing time as a succession of curves.

## DEMAND-SIDE MANAGEMENT

Demand-Side Management (DSM) is a set of measures and policies that help to regulate the electricity demand reducing the consumption while keeping steady the comfort level. DSM is indispensable for the Smart Grids. With it the utilities can monitor and regulate the energy consumption according to the consumers' will. DSM at residential dwellings aims to reduce consumption providing energy-efficient appliances and promoting energy-aware consumption. DSM can also be used to offer incentives to consumers to decrease their consumption when the energy grid is heavily loaded and vice versa. To do so utilities can offer lower fees during night hours.

DSM interacts between power companies, microgrids, consumers, and this connection can only be made with efficient DSM techniques. “Game theory provides abundant tools that can be used for developing pricing and incentive mechanisms, scheduling of appliances, and enabling efficient interconnection of heterogeneous nodes” (Başar, et al., 2012).

## GAME THEORY FOR DEMAND-SIDE MANAGEMENT

Many reports (Alvarado, et al., 1999; Gellings, 2009; Chen, et al., 2010; Giupponi, et al., 2010; and Chen, et al., 2011) demonstrate that game theory has been widely used for DSM; and DR models for Smart Grids. In Chen, et al., (2010) a research on a two-market study for balancing the supply and the demand is made. A demand response process with time-varying pricing model was analyzed by Li, et al., (2011). A noncooperative game with dynamic pricing was studied by Giupponi, et al., (2010).

Traditional DSM schemes are based on the interaction between the utility company and consumers. These schemes use the direct load control to regulate the appliances inside the home of each consumer, with preceding agreement. Therefore the base of smart pricing is to feed the users with monetary incentives and then they will voluntarily change their consumption and balance the grid. But instead of focusing on each

individual consumer. Mohsenian-Rad, et al., (2010) conclude that it is better to set a DSM, that using communication technologies, enables users to modify their power usage when they think this will be beneficial. So instead of counting each consumer as an individual user, a microgrid system should be set.

Game theory can be split into two categories: noncooperative game theory and cooperative game theory. The first one is used to evaluate the tactical decision-making processes of a quantity of players with contradictory interests over the result of a decision process. This can be for instance a decision-making process that allows customers optimizing their energy consumption. Being noncooperative does not mean that the cooperation is forbidden; it means that the players should self-enforce any cooperation.

Noncooperative game theory can be divided into two main categories: static and dynamic games. In static games the time and information do not alter the player's choices, in other words, players take their actions only once.

On the other hand, in the dynamic games the players can act more than once, they have certain information about each other's choices, and time has a main role in the decision-making.

Cooperative game theory is the opposite of the later and players can communicate between them and interact in the decision-making process and then choose with whom they want to cooperate with and under which conditions. Cooperative game theory can be branched into two parts: Nash bargaining for situations where the players have to agree under which conditions they want to cooperate, and coalitional game theory, which is for cooperative groups or coalitions.

"Apart from infrastructure and communications, game theory can be used for securing power grid state estimation against data injection attacks" (Kosut, et al., 2010)

"Noncooperative games can perform distributed demand-side management and real time monitoring or deploy and control microgrids"

Traditional game-theoretic designs assume that players are rational; so all tries to optimize its individual benefit, therefore act with some concept of balance play. On the Smart Grid, as the system nodes interact and learn their tactics, one or more might diverge from the intended move and take non-rational decisions. This may be caused by "failure or delay in learning". Taking mistaken decisions can lead to a non-balanced system. The robustness in the model and algorithm design for Smart Grid game-theoretic models is the key point. Some solutions against errors for this difficulty have been found (Fudenberg & Levine, 1998; Young 2005; Nisan, et al., 2007; and Debbah, et al., 2011). The most important one is to design learning algorithms where players can "experiment" and choose none rational tactics. These bad decisions are turned into a chance to increase the efficiency for other players and then the algorithms will learn why they were wrong or were can they improve.

## ENERGY CONSUMPTION

### SMART HOME AND DRM OPTIMIZATION

At home all the electric appliances or the now emerging smart appliances are interconnected and controlled by EMS. The process is simple; the utilities gather information about consumers from the smart meters, such as electricity consumption, and establish the prices using, for instance, Real Time Price DR. Knowing the electricity

price, the customers can shift their demand manually or automatically with the help of EMS to the off-peak hours in order to reduce their bill.

Using SA the overall electricity bill for the consumers can be reduced, and the peak demand for the utilities can be cut down.

Minimizing the electricity bill and at the same time maximizing the users' satisfaction and comfort is the main goal of DR. To do so a constant monitoring of the electricity price and an active management of the load of appliances is needed.

In order to perform DR optimization and carry out proper control with the forecasted electricity prices and predicted energy consumption, proper models for the appliances are required. Examples can be found in Bargiotas and Birdwell (1988) and Guay and Sane (2008).

As demonstrated by Samadi, et al., (2010), Li, et al., (2011) an alternative cost model is the utility maximization function, which measures how satisfied the users are with the appliances. The reports show that the relation is normally inversely proportional to the volume of energy consumed by the electrical goods, so the energy cost can be reduced without causing major inconvenience to the users.

## **SENSORS**

### **ADVANCED METERING INFRASTRUCTURE**

Advanced Metering Infrastructure (AMI) is a combination of technologies that enable a two-way communication between consumers and utilities. This systems measure, collect and analyze the energy usage. It includes software, hardware, communications, consumer energy displays and controllers. The communication between the metering devices and business systems permits the gathering and distribution of information to customers, suppliers, utility companies and service providers. AMI allows these businesses joining in demand response services and also consumers modifying their normal consumption patterns. The most important AMI is the Smart Meter.

### **SMART METER**

An electric device located on the consumer side that measures the electricity consumption (it can also measure natural gas or water consumption) in intervals. It also sends the data in real-time or almost real-time to the utility company for monitoring and billing purposes. It enables a two-way communication between the consumer and the utility.

Some concerns regarding health, security, privacy and cost are the main problems for the smart meter integration.

### **PHASE MEASUREMENT UNITS**

High speed sensors called Phase Measurement Units (PMUs) (Phadke, 1993) have to be adapted at both transmission and distribution levels. This is made in order to permit RT measurements of voltage and currents at transmission lines and distribution stations, monitoring the power quality and, if necessary, responding automatically to any problem

detected. To detect a problem, PMUs measure the phase (representation of the waveform of AC) and detect if there is any variation of the ideal shape. When this happens it means that a perturbation is detected, so there is a problem on the network.

With this the detection, the isolation and the recovery of faults will be faster, and will enable better control for system balancing, optimization and recovery (self healing) (Abur, et al., 2011).

When congestion affects the power grid its yield and reliability gets affected as well. In Gharavi and Hu (2011) reports, multigate mesh grid architecture is studied and uses a time-based multipath to enable the transmission path and gateways be flexible and use the less congested path. By doing this some non-congested ways could end up being congested, so a new "backpressure-based scheduling scheme" (Gharavi & Hu, 2011) is needed to level the traffic among multiple paths.

## COMMUNICATION TECHNOLOGIES IN THE SMART GRID

All the components in a Smart Grid must be able to send and receive information. As shown by Pavlidou, et al., (2011) the smart meters for instance require communication with control centers to send meter readings and receive market prices or other data. Other researches (Denholm, et al., 2009 and EPRI 2011) show that a load signal from the utility company to PHEVs is expected to be a key component for DR.

Basic communication cases in the Smart Grid are:

- Multi-interval meter reading: the utility company configures the meter to report the meter data 4-6 times a day. A report includes data from various meter intervals. For example one interval every 30 minutes.
- On-demand meter reading: the company can require real time data from the smart meter and this should report the meter reading in less than 5 seconds.
- Firmware/program update: the utility company updates new firmware images to the meter because of improvements on the version or bug fixes.
- Distribution automation (centralized control): the company sends guidelines to the distribution devices to modify their configurations or to regulate its actions.

Power line communication (PLC) and wireless communication are the main candidates, but both have their advantages and drawbacks and their own application scope. PLC and high-data PLC are mainly studied for smart metering communication between the utility company and the consumer. As PLC has low deployment cost many articles suggest that it can be the principal communication technology (Gali, et al., 2010; Gali et al., 2011; and NIST, 2011). With them the utility company owns the communication channel, so the latency and security can be easily monitored. As shown by Galli, et al., (2011) PLC can be used from high voltage lines to smart meters. On the other hand, recent studies (Cypher, et al., 2010 and Gungor et al., 2010) have stated that wireless should be the main communication technique in the Smart Grid. According to Niyato, et al., (2011) what is almost sure is that wireless communication will have the main role for home energy management systems. In practice, the Smart Grid will have a mix of both (Schneiderman, 2010).

A main concern regarding communication technologies is the security and privacy (Honary, et al., (2011)). The communication aim is to be part of the Smart Grid system. Combining both elements increases the complexity of the grid design and analysis, encouraging the implementation of powerful tools with demonstrated efficiency in wire line and wireless communications, such as game theory (Başar, et al., 2011).

## MICROGRID

Is a networked group of generation, storage and consumption of electricity placed at the distribution network side, but normally connected to the general “macro” grid, that can supply power to small geographical zones. Being connected with the general grid allows the Microgrid to function also autonomously in “island mode” (Hatziaargyriou, et al., 2007 and Kaplan & Sissine 2009).

Energy production and loads are normally at low voltage and the grid can be controlled as if it was only one entity. Having distributed microgrids is a way to help the Smart Grid to isolate the microgrid from the main grid in case of any anomaly occurs and by doing so provide highly reliable electric power.

The microgrids size should be 30-50 km radius and the power stations to serve the microgrid between 5-10 MW. That make them perfect to cover small towns or neighborhoods in the big cities but they should be connected to the main grid anyway.

Micgrogrids improve reliability and power quality because permit higher penetration of renewable energies and faster insolation, and because it is more branched; the monitoring of the grid becomes simplifier. For instance when heat generation is needed, the use of cogeneration or trigeneration can faster deliver electricity and heat to the consumers.

### MICROGRID GAME THEORETIC MODEL

In order to smooth the demand on the main grid, microgrids should service small geographical areas or consumers' groups. The problem may be that some microgrid has not enough energy production at some moment, either by the unpredictable energy generation sources or because the unpredictable consumers' demand. That means that the microgrid will need extra energy supply. In the past, the power grid was the one that provided this extra energy, but in the future, the Smart Grid is planned to enclose a high number of microgrids so whenever one microgrid have a power need while others have an excess it might be better for both microgrids, the main grid and their consumers to exchange energy among them instead of demanding/sending it from/to the main grid. Doing so the benefit is twofold because the near the grids are, the less power is wasted within the distribution lines, and local energy exchange reduces the dependence on the main grid and increases the independence of the microgrid.

Some microgrids might want to create a cooperative group instead of trading electricity only with the substation. In a partnership the microgrids can exchange electricity locally among themselves and at the same time with the main grid. This will reduce the waste power because as seen before closer the grids are, less energy is wasted; and local trade may help to prevent the substation's power losses.

Figure EEM.4.4 represents the microgrid network cooperation. This can be executed either automatic, using software or via an external company. The player's objective is to trade with the energy to optimize its benefit. Techniques developed in Samadi, et al., (2010), Gali, et al., (2011) and Li, et al., (2011) the equilibrium price can be determined.

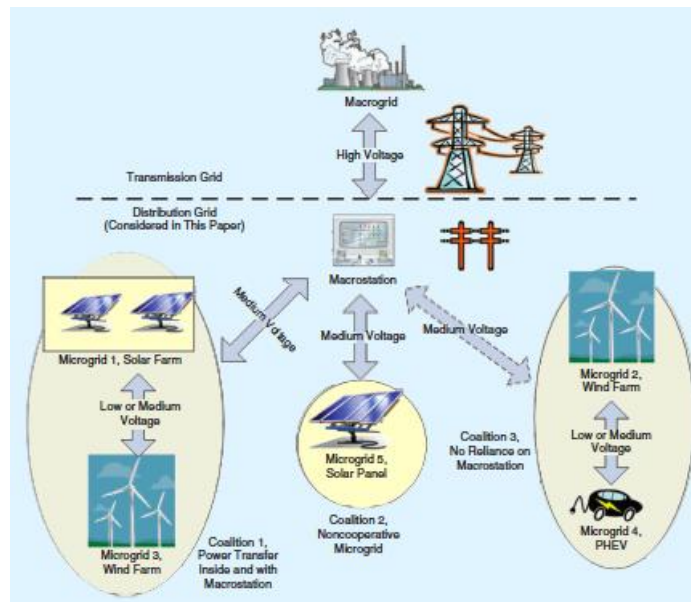

Figure EEM.4.4: microgrid network cooperation scheme (Başar, et al., 2012. Page 92).

## EUROPEAN FRAMEWORK

### GUIDELINES AND STANDARDS

In 2007 the European Technology Platform (ETP) for the Electricity Networks of the Future published its Strategic Research Agenda (SRA) on Smart Grids. This document identified research areas in the short and medium term in Europe. Thenceforth the report has become the key contribution to the European Electricity Grid Initiative (EEGI), placing the RD&D requirements to achieve the EU's objectives for 2020. The goal of the Smart Grids SRA 2035 is to establish the long-term research and the activities, needed to bring intelligent power grids further and that help to reduce EU's CO<sub>2</sub> emissions an 80% by 2050.

RD&D will have to consider the growth of renewable energy sources that is estimated to provide 34% of the total energy consumed by 2020.

IEEE 2030 was published in September 2011 under the title: "Guide for Smart Grid Interoperability of Energy Technology and Information Technology Operation with the Electric Power System (EPS), and End-Use Applications and Loads". The document, sets the standards for Smart Grid interoperability, and the specific assess criteria. It also provides the guidelines for defining and understanding the Smart Grid interoperability of electricity grid, as well as the combination of energy, information and communications technology and its need to reach an unified process for electric generation, delivery, and end-use benefits to enable two-way communication and power flow between the utility companies and the consumers.

The European Commission (EC) created in late 2009 the Smart Grids Task Force (SGTF). The SGTF has agreed on the strategy and the regulatory guidelines for the deployment of Smart Grids. The SGTF has established the bases (Dimeas, et al., 2008) for standardization, consumer data privacy and security. The SGTF results have allowed the EC to implement a Communication on Smart Grids (COM, 2011), issue a Mandate for Smart Grids standards to the European Standardization Organization and generate an Inventory of Smart Grid projects in the EU. As they know this is just the beginning, the EC



has updated the Mission and the Framework Program for the SGTf and has agreed to prolong its activities for two more years.

However, all this standardization efforts arrive few years late and when in the market is possible to find different types of smart meters and sensors that use different protocols and connection patterns. Furthermore, not having the same standardization is a problem for future interconnections, because it might happen that the money already invested end up being useless and then new standard devices will have to be purchased.

## FUTURE TRENDS

The main future trends to develop in future and long term are:

The coordination of Smart Grids initiatives to share their experiment's results, this will include a save of time and money.

The EU-US Energy Council has the mission to adapt the EPRI (American regulation) to the European context and to perform a cost-benefit analysis. In the same direction the standards will have to catch the deployment because until now, the Smart Grid deployments were faster than standards. For instance, AMI could be found while there was not any standard available yet. Standards catching up deployments are expected for the near future as well as the unification of them, avoiding with this too many parallel standards.

The security will continue being the major Smart Grid concern:

It has always been a concern for the industry, even more when in July 2010 a worm called "Stuxnet" (Harley, et al., 2010) was discovered into the supervisory control and data acquisition (SCADA) system. Cyber security measures, regulations and standards need to be evolving. Nowadays the most important standard is the one from the National Institute of Standards and Technology (NIST) "Guidelines for Smart Grid Cyber Security."

The reliability has to be improved; a lot of research is still needed to prevent data collapse and smart meters blackout like the "Bakersfield effect" in 2010.

Regarding the AMI and the Smart Meter a lot of programs are taking place in Europe with a total of 100 million smart meters (Gohn & Wheelock, 2010). An U.K. program aims to improve the communications infrastructure. On the same line, but on larger-scale, in China plans to install over 700million smart meters across the country by 2020 are being considered.

The Demand Response business transformation will be accelerated due to the implementation of new EMS systems. Multinational companies like Siemens or Johnson Controls are developing electro-mechanical optimization controllers for buildings, focusing more on energy management than the traditional ones.

Data management will be the next obstacle for the Smart Grid. The fear to a "data tsunami" (Acharya, 2012) when the utility companies, used to monthly meter readings, will move to every 15 minutes or less readings. This huge amount of data will have to be narrowed down to useful information, and this will be the important point to be developed in the future.

# CONCLUSION

As explained in this report, the Smart Grid system represents a revolutionary way of seeing our electricity consumption. The main differences between the actual grid and the Smart Grid are summarized on the Figure EEM.4.5.

SMART GRID	EXISTING GRID
Digital	Electro-mechanical
Two way communication	One way communication
Distributed generation	Centralized generation
Network	Hierarchical
Sensors throughout	Few sensors
Self monitoring	Blind
Self healing	Manual restoration
Adaptive and islanding	Failures and blackouts
Remote checking	Manual checking
Pervasive control	Limited control
Many customers choices	Few customer choices
Consumption metering on the second	Monthly metering consumption

Figure EEM 4.5: differences between existing grid and Smart Grid

In a future with less or no dependence from fossil fuels, and more from renewable sources, the Smart Grid will become the key point. It will allow regulating the consumption at home thanks to the EMS, which will decide when to turn on or off the smart appliances according to the electricity price. At the same time EMS will have control over the PHEV car and will decide whether charge it or discharge it according to the electricity price. With these procedures EMS will contribute to reduce the homes consumption and doing so, the bill.

On larger scale, the Smart Grid will allow the utility company to reduce the peak demand thanks to the real time communication established with the consumers.

Having the distribution centers nearer to the consuming points will also reduce the distribution losses and its union with the consumers will allow the creation of microgrids. The microgrid will work as an independent grid but connected to the main one. Having this configuration will allow the microgrids trade electricity among them, first with the closest one and then further.

The implementation of the Smart Grid will enable a real competence market and not the oligopoly that we have in Spain, where the electricity price is constant for the consumers. Having "prosumers" and smart meters will create a real time market which will be self-balanced (matching demand and response all day long) thanks to game theoretic systems.

Regardless to the latter, right now the Smart Grids are still being under development, and a large-scale test is still needed to assure that all the characteristics will work smoothly together. Also the consumers' security is one of the biggest concerns for the public and until these fears disappear, it will be very difficult to implement.

## SMALL VILLAGES

The Smart Grid deployment for small villages can be faster and independent to the main grid, because create a microgrid system onwards the distribution grid is easier than create one in the whole grid. With this system and the implementation of renewable energy systems, the village can be self-sufficient, energetically speaking. But if this is not accomplish the main grid can supply electricity during low productivity periods or emergency situations in the microgrid.

Using game theoretic systems will enable the consumers to reduce their demand and, at the same time balance the microgrid supply. If the electricity produced is not consumed, the microgrid can trade its energy with the main grid.

To make this happen the power grid will have to be adapted as well as the consumers' meters. Therefore an initial investment will be needed, but with the expected savings the utility company and the consumers will have a fast payback.

## SWOT

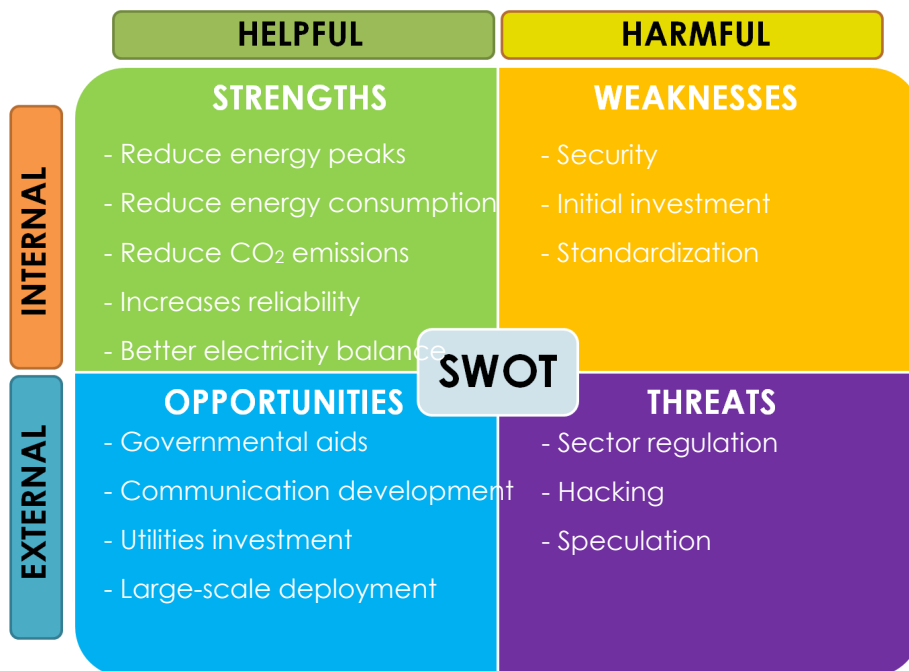

# COMBINATION OF ENERGIES



# COMBINATION OF ENERGIES

In the different analysis made of all the renewable energies are found many references regarding the possible combinations between them.

It is a fact produced in part by the discontinuity in the energy supply, say sun or wind for example, as it is known that, although with great advantages, these technologies are still evolving.

	WIND	WATER	GEO THERM	HYDROGEN	BIOENERGY	SOLAR THERMAL	SOLAR ELECTRIC
WIND							
WATER	<b>X</b>						
GEO THERM							
HYDROGEN							
BIOENERGY							
SOLAR THERMAL			<b>X</b>				
SOLAR ELECTRIC	<b>X</b>			<b>X</b>			

In this evolution, the combination mentioned before is a key factor that will finally boost them to become, in the future, our 100% energy sources.

## WIND - WATER ENERGY

Wind and water energies could be complementary since the wind energy that cannot be used to supply the demand it is used to pump water from a lower level to a higher one. This is made so as to store water energy and use it at the moment that is required to supply peak demands. This may be the case of pumped storage plants PSP.

Nowadays, following the same idea, some companies are developing the "Energy Islands". In places that there is no a natural level difference between the water storage and the powerhouse, the solution thought is to create an artificial PSP in the sea. This project consists of a ring shape dyke that encircles a huge area about 10 km long and 6 km wide. This dyke separates two water levels. The level in the interior would be from 32 to 40 m less than in the exterior. So, the energy would be generate using the potential energy of the water when passes through the turbines to the inner side. On the contrary, water would be pumped out to the outer side when electricity is cheap. This inexpensive energy could be achieved thanks to the wind turbines that would be installed on the dykes, reducing the cost of offshore wind but with their load factors because of the location in the sea. The estimated storage potential is supposed to be 1500 MW by 12 hours, or 18GWh (International Energy Agency IEA, 2012).

## **SOLAR – WIND ENERGY**

This combination represents a great solution for the typical discontinuities in energy supply that both systems suffer in different situations. Normally, as explained in the wind report (Seasonal and annual variations), cloudy days are windy whereas sunny are not. This environmental scenario is perfect for the combination of both systems, constituting a perfect complemented energy supply.

Furthermore, often wind energy devices can “host” solar cells, as in the Altechnica's Solar Planar Concentrator shown in the wind report (BIWT). In this case, the shape of the solar panel enhances the aerodynamic benefit, increasing the input wind speed. Currently, several devices integrating solar cells and wind turbines are in the market; is it possible to think that, thanks to the adaptability to the energy intermittence explained before, those devices could suit particularly off-grid houses and isolated villages, assuring an energetic independence.

## **SOLAR – HYDROGEN ENERGY**

Although we get perfect combinations of energy, having a constant supply is not the perfect deal sometimes. Of course it would be ideal, but the perfect situation would be being able to store this energy. In this line, new researches that are being carried out right now by the University of Ceará in Brazil, are implementing a new technology to the well-known energy combination sun-wind, which is hydrogen.

This hybrid system will allow not only to generate free energy more constantly, but also to be able to store it in a green way, using hydrogen, and reuse it when necessary. (Renovablesverdes, 2011).

## **SOLAR – GEOTHERMAL ENERGY**

Apart from the problems regarding non-continuous energy supply, the combination among different renewable technologies and systems is also produced in order to get profit from the various features of each one of them. As a clear example, when talking about energy storage in long term (from summer to winter) a really interesting system gets profit from geothermal and solar technology. This installation captures the energy from the sun, as seen in “Solar Energy”, and stores it into the ground, as heat, thanks to the geothermal principles. Obviously, several considerations have to be made in these cases, as not all the soils are indicated for this solution. Normally, clay soils with no flux of water are indicated (in general terms) for this kind of applications.

# CONCLUSIONS



# CONCLUSIONS

To conclude we will like to summarize all data this report goes through. The following scheme is going to be followed in the conclusion:

- General overview of the potential of energy.
- Uses of this energies concerning to houses.
- Comparison of energies and systems according to different parameter to supply a small village: Initial investment, LCOE and Heat cost.
- Conferences and congress that try to improve the actual situation.
- Trends, evolution and perspective.

## GENERAL OVERVIEW OF THE POTENTIAL OF ENERGY

First of all, it would be clarified, with the following table, the availability and consumption of energy in the world. As the chart reflects non-renewable energies have a minimal use comparing with renewable energy.

WORLD ENERGY AVAILABLE AND CONSUMPTION					
ENERGY	AVAILABLE (TWh)	CONSUMPTION (GWh/year)		CONS. (TWh/year)	USE ‰
<b>RENEWABLE (TW available per year)</b>					
Solar	350.000.000	Solar Photovoltaic	20.155	20,155	<b>0,000058‰</b>
		Solar Thermal	872		
Wind	200.000	273.153		273,153	<b>1,37‰</b>
Hydroelectric	300.000	3.328.627		3.328,627	<b>11,10‰</b>
Tidal / Wave	5.000	530		0,530	<b>0,11‰</b>
Biomass	50.000	Solid biofuels	267.636	267,636	<b>5,35‰</b>
		Biogases	41.788		
		Liquid biofuels	6.985		
Geothermal	10.000	70.167		70,167	<b>7,02‰</b>
<b>TOTAL</b>	<b>350.565.000</b>			<b>3.960</b>	<b>0,01‰</b>
<b>NON RENEWABLE (TW available)</b>					
Coal	6.000.000	9.483.455		9.483	<b>1,58‰</b>
Batural Gas	1.500.000	6.017.706		6.018	<b>4,01‰</b>
Oil	1.800.000	1.249.704		1.250	<b>0,69‰</b>
Nuclear	1.500.000	2.702.793		2.703	<b>1,80‰</b>
<b>TOTAL</b>	<b>10.800.000</b>			<b>19.454</b>	<b>1,80‰</b>

Figure C.1. World energy available and consumption

While comparing the energy consumption in Europe with the world consumption just before mentioned we obtain the table below. It shows how in proportion to the whole World, Europe uses renewable and non-renewable energies in the same percentage, 16%. This positions Europe in a good place in agreement to use of renewable energies.



EUROPE ENERGY CONSUMPTION					
ENERGY	WORLD CONS. (TWh)	E.U. CONSUMPTION (GWh/year)	E.U. CONS. (TWh/year)	EU PROP %	
<b>RENEWABLE (TW available per year)</b>					
Solar	20,155	Solar Photovoltaic	14.058	14,058	<b>70%</b>
		Solar Thermal	52		
Wind	273,153	132.666		132,666	<b>49%</b>
Hydroelectric	3.328,627	359.106		359,106	<b>11%</b>
Tidal / Wave	0,530	497		0,497	<b>94%</b>
Biomass	267,636	Solid biofuels	127.669	127,669	<b>48%</b>
		Biogases	27.132		
		Liquid biofuels	6.858		
Geothermal	70,167	6.208		6,208	<b>9%</b>
<b>TOTAL</b>	<b>3.960</b>			<b>640</b>	<b>16%</b>
<b>NON RENEWABLE (TW available)</b>					
Coal	9.483	1.058.076		1.058	<b>11%</b>
Batural Gas	6.018	1.010.429		1.010	<b>17%</b>
Oil	1.250	144.821		145	<b>12%</b>
Nuclear	2.703	895.844		896	<b>33%</b>
<b>TOTAL</b>	<b>19.454</b>			<b>3.109</b>	<b>16%</b>

Figure C.2. Europe energy consumption

## USES OF THIS ENERGIES CONCERNING TO HOUSES

What are the services that need to be supplied in a house? The following list explains them:

- HVAC: Heating, Ventilation and Air-conditioning.
- Electricity, for lighting and force and induction equipment.
- Water supply and sanitation.

This means that energy is needed to guarantee these facilities, but not every type of energy is suitable for supplying each service. The list below shows the suitable supply that energies can offer:

- Wind energy for electricity.
- Solar energy:
  - Solar thermal energy for HSW and heating.
  - Photovoltaic Solar Energy for electricity.
- Geothermal Energy/ Heat pump for HSW and heating.
- Biomass for HSW and heating.
- Hydropower for electricity.
- Marine energy for electricity.

## COMPARISON AND SELECTION

First of all, it will be studied in tables the initial investments required to implement the energy systems, devices and energy storage management systems in a small village, taking into account the conclusion in each of the topics developed in the report.

Initial Investment costs for suitable energy systems in small villages							
Energy Technology	Solar Energy		Wind Energy			Hydropower	
	Low Thermal (Domestic Hot Water)	Photovoltaic	Wind farms		Building integrated turbines	SHPP	Micro HPP
			Onshore	Offshore			
Private users €/KW	800 to 1000	6000			1200 to 2200		
Community €/KW		10000	1400 to 1600	3000 to 3450		1040 to 6400	1040 to 6400

Initial Investment costs for suitable energy systems in small villages								
Energy Technology	Marine Energy		Bioenergy				Geothermal	
	Near-Shore	Offshore	Solid Biomass (heating system)	Liquid biofuels		Biogas (heating system + Cogeneration)	Shallow Geothermal	Deep Geothermal
				Bioethanol	Biodiesel			
Private users			280 to 500				1000 to 1500	
Community	No Data	5390 to 7700	150 to 350	650 €/ton	260 €/ton	200 to 400	900 to 1200	2200 to 2800

Figure C.3. Initial investment for energy systems

In the next figure the provided data can be observed in a bar chart. It is shown that while almost all the energy systems have applicability in communities the application by private users is more expensive and sometimes not feasible. Although regarding building integrated wind turbines it seems a good private investment. The problem with this can be the feasibility, due to the devices required. That is why solar photovoltaic is more popular even with the high cost, due to the facility in the deployment process. With regard to offshore marine it looks a huge investment, since it is the lowest developed technology, but with a great future potential indeed.

*Figure C.4. Initial investment for energy systems*

*Figure C.5. Initial investment for systems*

*Figure C.6. Initial investment for energy storage & management*

Secondly, there is attached the energy costs for heating:

Costs for Heating for suitable energy systems in small villages					
Technology	Solar Energy	Bioenergy		Geothermal	
	Low Thermal (Domestic Hot Water)	Solid Biomass (heating system)	Biogas (heating system + Cogeneration)	Shallow Geothermal	Deep Geothermal (Cogeneration)
€/MWh for private users	77	50 to 60		10 to 15	
€/MWh for community		10 to 20	13 to 15	5 to 10	27 to 45

Figure C.7. Costs for Heating

And finally, the LCOE parameter to measure the electricity cost is provided:

LCOE Parameter for suitable energy systems in small villages						
Technology	Solar Energy	Wind Energy			Hydropower	
	Photovoltaic	Wind farm		Building integrated turbines	SHPP	Micro HPP
		Onshore	Offshore			
Average €/kWh	0,2881	0,084*	0,126*	No Data	0,037*	0,2162

\* It requires a construction of a plant.

LCOE Parameter for suitable energy systems in small villages					
Technology	Marine Energy		Bioenergy		Geothermal
	Near-Shore	Offshore	Solid Biomass (Cogeneration system)	Biogas (Cogeneration system)	Deep Geothermal
Average €/kWh	No Data	0,1348*	0,05*	0,05*	0,036

\* It requires a construction of a plant.

Figure C.8. LCOE for electricity production

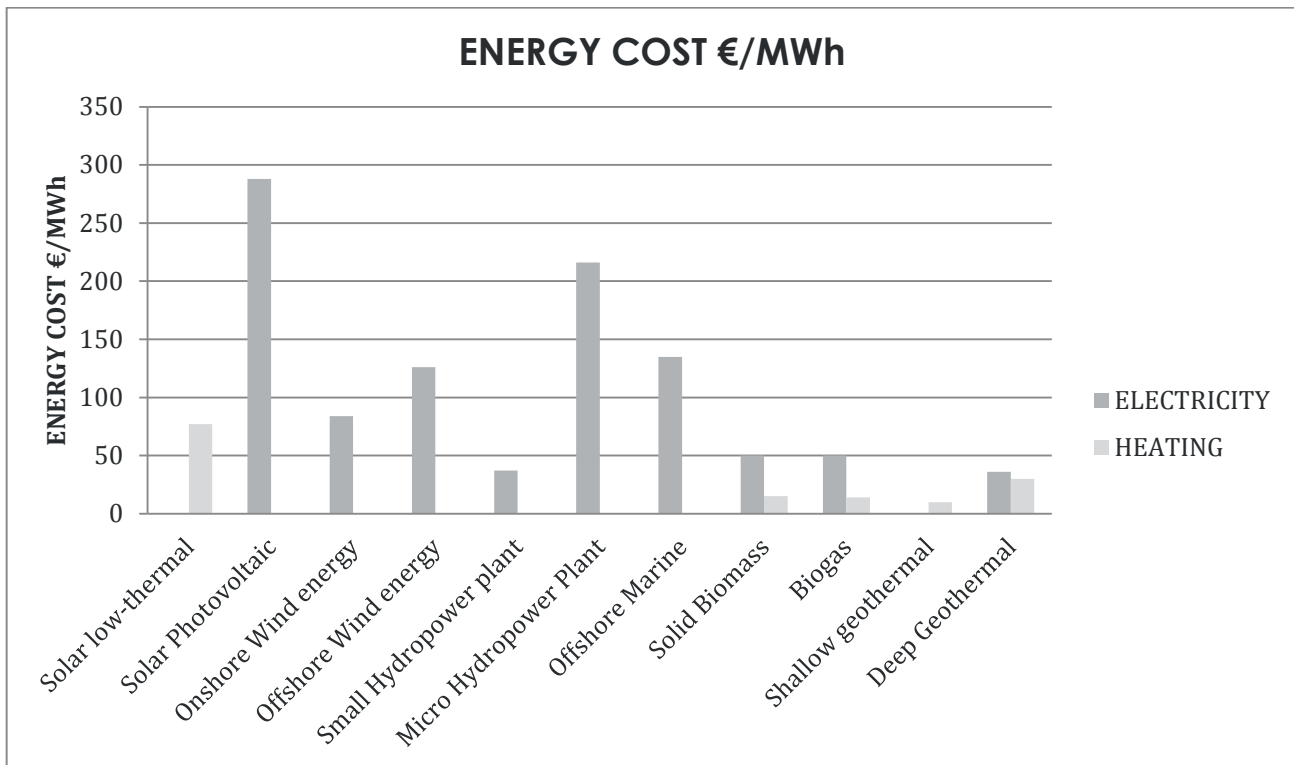

Figure C.9. Energy cost in €/MWh for electricity and heating

Once analysed these previous data charts, and understanding the particularities of each solution, there can be set an initial discarding process, which would provide the list the not feasible technologies on a small village, for heating and/or electricity production.

The red colour "X" represents the discarded systems; the green "O" represents the options considered as feasible.

	ELECTRICITY	HEATING
Solar low-thermal	X	O
Solar Photovoltaic	O	X
Onshore Wind energy	X	X
Offshore Wind energy	X	X
Building integrated turbines	O	X
Small Hydropower plant	O	X
Micro Hydropower Plant	X	X
Offshore Marine	X	X
Solid Biomass	O	O
Biodiesel	X	O
Bioetanol	X	X
Biogas	O	O
Shallow geothermal	X	O
Deep Geothermal	X	X
Hydrogen	O	X
Smart Grids	O	X
Thermal Storage	X	O

Figure C.10. Solution discarding chart

\* Passive construction and insulation have been extracted from the list, as the implementation of these “solutions” is considered compulsory, (high benefits with minimum investments).

\* Technologies such as heat pumps and cogeneration systems have been also extracted, due to its condition of support technologies for the energy production and storage systems.

The ranking proposed now, has been structured depending on the initial investments required for each energy technology, and the energy costs obtained by these investments. The adoption of an energetic solution has to be considered as an investment, which will give a return to the community by energy savings and emissions reductions.

ELECTRICITY		HEATING	
#1	Small Hydropower	#1	Shallow Geothermal
#2	B.I. Wind Turbines	#2	*Solid Biomass
#3	Solar Photovoltaic	#3	*Biogas
#4	*Biogas	#4	Solar Low-thermal
#5	*Solid Biomass	#5	Biodiesel
#1	Smart Grids	#1	Thermal Storage
#2	Hydrogen		

Figure C.11. Solution ranking

\* In the case of the choice of a biogas combustion plant or a solid biomass plant, the combination of electricity production and heating by implementing a cogeneration system can reduce the initial investment compared with the choice of two different solutions. In this specific case, a cogeneration bioenergy plant would reach a high rank.

Nevertheless, there has to be taken into account the need of diversification and combination of energies to guarantee an independent and stable energy supply. This kind of choice can just be made when applying to a specific project, by the studying of all the external factors influencing.

So, at this point, we are able to contemplate possible solutions to apply in a small village. Indeed is not easy dealing with all this topics since they depend on many external factors and each location, economic situation and environmental affections constitute constraints for their deployment. It is impossible trying to get the best approach when we are talking in general. Each real case should be studied in depth and try to achieve the most sustainable solution, combining the most suitable systems studied in this report and bearing in mind environmental, social and economic features. In fact, the aim of the report was getting familiar with the renewable energies and the energy management systems. Now we should be able to face a real case and give the most efficient solution.

## CONFERENCES AND CONGRESSES

Finally we would like to highlight that there exist several organisations and conferences that are focused on various aspects of the environment, climate change and renewable energies, which is a sign of the Global concern and commitment to the environment and sustainability issues, acknowledging the need to utilize renewable

energy as a major source of energy. They achieve their objectives with a variety of approaches which includes but is not limited to; the drafting of Policies, the organisation and dissemination of Scientific Research, creation of information portals, the hosting of conferences, the provision of relevant education and the facilitation of financial mechanisms.

The list below shows some of the major associations and organisations in the Renewable Energy Issue:

- Renewable Energy and Efficiency Partnership (REEEP)
- International Energy Agency (IEA)
- International Renewable Energy Agency (IRENA)
- Intergovernmental Panel on Climate Change (IPCC)
- Renewable Energy Policy Network for the 21st Century (REN21)

Some of the significant conferences and congresses with worldwide impact are:

- The European Union Climate and Energy Package. The European Parliament of the 27 member states of the European Union (EU) ratified the binding legislation of the Climate and Energy Package in December 2008. It aims to achieve "20-20-20" targets which consists of three main objectives for 2020 as outlined below;
  - The reduction in EU greenhouse gas emissions by 20% from 1990 levels;
  - Raising by 20%, EU energy consumption from renewable resources;
  - An improvement in the EU's energy efficiency by 20%.
- The United Nations Framework Convention on Climate Change (UNFCCC or FCCC) is a global accord related to environmental issues. It was discussed and initiated during the 1992 United Nations Conference on Environment and Development (UNCED). The main aim and purpose of the treaty is to bring the level of atmospheric greenhouse gas emissions to a point that would avert dangerous degradation of the environment by human activity, with specific focus on the climate. The conference is focused on four aspects of climate change; Adaptation, Finance, Mitigation and Technology (United Nations Framework Convention on Climate Change, 2012). Renewable Energies play a crucial role in the achievement of the objectives.

The 2012 United Nations Climate Change Conference is currently taking place, during the writing of this report, from November 26 – December 7, 2012, in Doha, Qatar. The conference seeks to address issues which include the following:

- Consideration of extending the Kyoto Protocol which will expire at the close of 2012,
- The creation of a Post-Kyoto Protocol by 2015 which will be enforced by 2020, according to the 2011 Durban Platform,
- The current standing of the \$30 Billion USD financial pledges "Fast Start" engendered in the 2009 COP15 Copenhagen consensus,
- The Green Climate Fund progress as it relates to development and funding in the amount of \$100 billion USD per year.

(Wikipedia, 2012)

- The Kyoto Protocol is a global accord related to the United Nations Framework Convention on Climate Change. The Kyoto Protocol was created and agreed on

in Kyoto, Japan, in December 1997, then enforced in February 2005. A significant aspect of the Kyoto Protocol is that it sets legally binding targets for 37 developed countries and the European Union to reduce greenhouse gas (GHG) emissions by 5% in comparison 1990 emission levels. The protocol is enforced from 2008 to 2012. (United Nations Framework Convention on Climate Change, 2012)

Countries are required to achieve the targets principally through nationally implemented processes. The Kyoto Protocol also offers countries supplementary methods of achieving the targets with three market-based systems; Emissions trading, Clean development mechanism (CDM) and Joint implementation (JI). The systems promote and encourage green investment and assist the countries in achieving their emission targets with an economical approach. (United Nations Framework Convention on Climate Change, 2012)

- The United Nations Conference on Sustainable Development (also referred to as Rio+20 or Earth Summit 2012) was convened in June 2012. It was a meeting of world leaders from 193 countries, specifically UN member states. Non-Governmental organisations and Private Sector entities were also in representation at the conference. The achievements of the conference included; the recognition of the delicate environmental situation on the planet, Confirmation and endorsement of Rio 1992 principles and past action plans and established commitments to acquire funding for the Sustainable Energy Policies, that place importance and focus on access to clean energy.
- A significant historical milestone in the development of the Renewable Energy issue is the Brundtland Report, 1987. It addressed the untapped potential of Renewable Energy and the current Brundtland Commission speaks to and focuses on using Renewable Energy as a means of achieving some amount of environmental protection.

## TRENDS, EVOLUTION AND PERSPECTIVE

To clarify the future trends of renewable energies in Europe the chart below shows them since 2005 until 2030, some conclusion can be obtained:

- Very low developed energies in the past like marine, solar and geothermal are starting to be developed right now and they will continue growing in the future in a very steady way.
- Average developed energies like Biomass or wind onshore are having since now on a huge impulse
- Offshore wind energy which is not exploited at all right now, is going to have a vast impulse
- High developed energies like hydropower will have a steady and gentle growth



## Evolution of gross power generation TWh

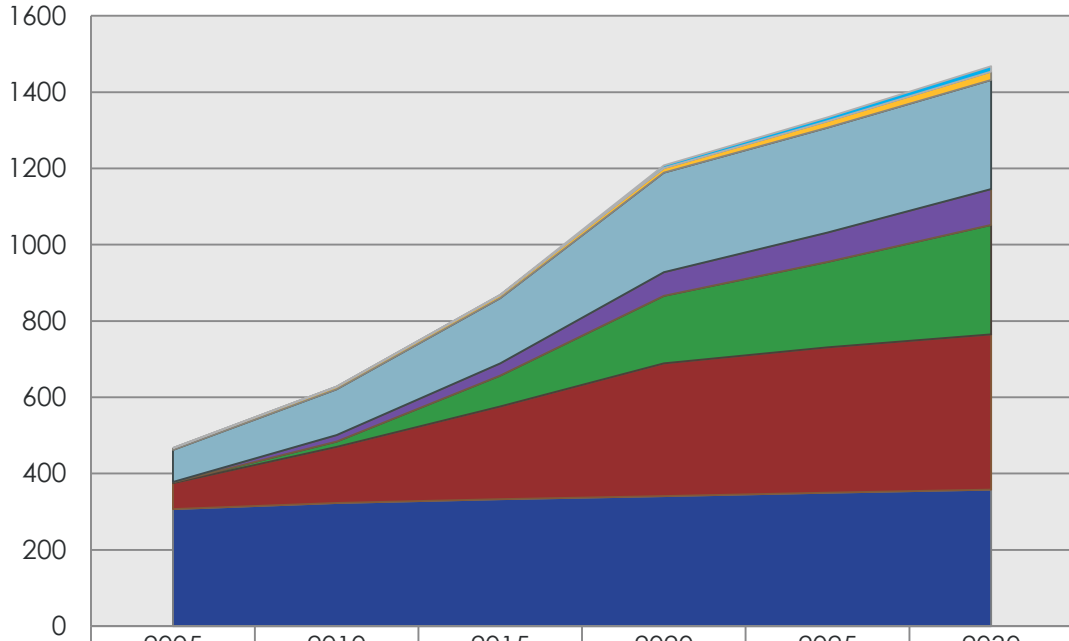

	2005	2010	2015	2020	2025	2030
■ Tidal etc.	0	0	1	7	10	14
■ Geothermal	5	7	8	12	17	22
■ Biomass/waste	84	120	171	261	275	286
■ Solar	1	17	32	62	77	94
■ Wind offshore	2	14	81	177	224	287
■ Wind onshore	68	147	243	348	381	407
■ Hydro	307	323	333	341	350	358

Figure C.12. Evolution of gross power generation in TWh. Source: European Commission, 2010.

Looking at the future and in relation to the global energetic problems we are going through, the development of renewable energies will mark a vast part of the industry in general. This, far from being a problem, must be taken as an opportunity to show the contribution to sustainable living of construction sector. The tendency is not about generating energy, but also maximizing energy saving in order to achieve energy efficient buildings and infrastructures. This challenge can be apply in all the fields that construction involves and dealing with new and sustainable materials and new technologies will be a must in short term and we must start as soon as possible.

The implication of everybody is required. And as it has been said in the introduction it is not about how we have received the world, but how we borrow it to the future generations in order to provide them a high quality life. The future perspective must be maintained and that is why long lifetime products are required. Do not forget: "We do not inherit the earth from our ancestors, we borrow it from our children."

# LIST OF FIGURES

Figure I. 1. Global renewable power capacity (REN21, Renewables Global status Report, 2006-2012)

Figure E.1.1 Thermosiphon system (Erenovable, 2010)  
Figure E.1.2 Forced system (Solarsom, 2010)  
Figure E.1.3 Flat plate collector (Sun Tyne Solar, 2012)  
Figure E.1.4 Evacuated-tube collectors (Apricus, 2012)  
Figure E.1.5 Comparison of different covers (Progenssa, 2007)  
Figure E.1.6 Solar thermal system for radiant floor. (Aladdin Solar, 2008)  
Figure E.1.7 Solar radiation in Europe (Solarfeedintariff, 2012)  
Figure E.1.8 Central tower plant. (Unesa, 2012)  
Figure E.1.9 Parabolic Dish Plant (Npu, 2008)  
Figure E.1.10 Parabolic cylinder collectors (Solarpaces, 2009)  
Figure E.1.11 Photovoltaic effect (Val, 2012)  
Figure E.1.12 PV installation connected to the grid (Houston solar tour, 2011)  
Figure E.1.13 Photovoltaic skylight (Onyx Solar, 2012)  
Figure E.1.14 Ceramic photovoltaic floor (Onyx Solar, 2012)  
Figure E.1.15 Photovoltaic ventilated façade (Onyx Solar, 2012)  
Figure E.1.16 Active curtain wall and hybrid system (Gecohomeproject, 2011)  
Figure E.1.17 Active curtain wall and hybrid system(II) (Gecohomeproject, 2011)  
Figure E.1.18 Desertec project (Ecología verde, 2007)

Figure E.2.1. Different types of offshore foundations, from left to right: monopile, tripod, jacket and gravity base. Source: <http://www.theengineer.co.uk>  
Figure E.2.2. Wind turbine elements. Source: Rowe, J., April 2002.  
Figure E.2.3. Zero blade wind turbine Source: Shapon energy.  
Figure E.2.4. Wind stalks. Source: Markham, D., April 2012.  
Figure E.2.5. Wind lens. Source: Markham, D., April 2012.  
Figure E.2.5. Wind lens. Source: Markham, D., April 2012.  
Figure E.2.6. Wind spire. Source: Markham, D., April 2012.  
Figure E.2.7. Distance from land in offshore wind turbines; source: E.ON, 2011.  
Figure E.2.8. Forecast costs in wind power; source: Blanch, et al., 2005.  
Figure E.2.9. Diffusion in Europe of offshore wind plants; source: EWEA, 2007.  
Figure E.2.10. Aeolian™ roof turbine; source: Blanch, et al., 2005.  
Figure E.2.11. Proven HS turbines; source: Blanch, et al., 2005.  
Figure E.2.12. Robertson and Leaman Roof Turbine; source: Blanch, et al., 2005.  
Figure E.2.13. WEB concentrator; source: Blanch, et al., 2005.  
Figure E.2.14. Wind power capacity installed in Europe countries during 2011. Source: EWEA, 2012.  
Figure E.2.15. Wind power installation in GW in EU comparing with European Leaders countries. Source: EWEA, 2012.  
Figure E.2.16. Effects of elevation on air density; source: Rashford, et al., 2010.  
Figure E.2.17. Europe wind speeds at 50 m height. Source: wind atlas, 1989.  
Figure E.2.18. Wind daily variations forecasting; source: Danish Energy Authority, 2005.  
Figure E.2.19. Wind energy output – energy demand; source: Econnect Ltd, UK, using data from the National Grid Company and wind farms, 2005.  
Figure E.2.20. Effect of elevation and terrain roughness on wind speed profile; source: D'Armetta, 2005.  
Figure E.2.21. Buildings interference on wind speed profile; source: Blanch, et al., 2005  
Figure E.2.22. The triangle of social acceptance. Source: IEA, 2007.  
Figure E.2.23. What do you believe are the main challenges for more wind turbines in your municipality?. Source: IEA, 2007.

Figure E.3.1: Small hydro site layout.  
Figure E.3.2: Table with different plant configurations. Most popular configurations.  
Figure E.3.3: The three main types of water turbine: (A) the Pelton turbine (or wheel); (B) the Francis turbine; (C) the Kaplan turbine.  
Figure E.3.4: Table with ranges and best options for each case  
Figure E.3.5: Table with emissions generated per TWh.  
Figure E.3.6: From left to the right: Tidal barrage, tidal bunded lagoon & tidal offshore lagoon.

Figure E.3.7: Horizontal Axis Turbines  
 Figure E.3.8: Vertical Axis Turbines  
 Figure E.3.9: Reciprocating hydrofoil  
 Figure E.3.10: Venturi effect device  
 Figure E.3.11: Overtopping devices basic concept.  
 Figure E.3.12: Attenuators  
 Figure E.3.13: Point Absorbers  
 Figure E.3.14: OWSC (Oscillating Water  
 Figure E.3.15: OWC (Oscillating Water Column)  
 Figure E.3.16: Overtopping Devices  
 Figure E.3.17: Archimedes Effect Devices  
 Figure E.3.18: – Tidal Streams & Wave Power devices  
 Figure E.3.19: Tidal Range in the Severn Estuary (United Kingdom): up to 12 m  
 Figure E.3.20: Estimated benefits of developing a world leading European Ocean Energy Industry

Figure E.5.1 Natural near-surface temperature development at various depths  
 Figure E.5.2 Heat pump concept  
 Figure E.5.3 Underground thermal energy storage concepts  
 Figure E.5.4 Diagram of common ground-coupling methods for groundwater wells  
 Figure E.5.5 Diagram of common ground-coupling methods (from left), horizontal and vertical loops  
 Figure E.5.6 Scheme of the ground loop circuits from the left: heat pipe vertical loop, direct expansion circuit  
 horizontal loop  
 Figure E.5.7 Basic scheme of horizontal heat exchangers  
 Figure E.5.8 Basic scheme of a borehole heat exchanger installation  
 Figure E.5.9 Basic scheme of energy pile installation  
 Figure E.5.10 Annual number of new ground source heat pump units in Germany since 1996  
 Figure E.5.11 Table of prime feasibility for GSHP systems in different climates  
 Figure E.5.12 Table of some suitable antifreeze agents; water antifreeze mixtures with the amount of  
 antifreeze in percentage  
 Figure E.5.13 Inside the earth, layer  
 Figure E.5.14 Geothermal power plants generator produced the electricity  
 Figure E.5.15 Geothermal direct use capacity distribution in Europe  
 Figure E.5.16 Gaseous emissions from various power plants  
 Figure E.5.17 Typical pipeline at Miravalles geothermal power plant  
 Figure E.5.18 Comparison of land requirements for typical power options

Figure S.1.1: Table to compare efficiency of different heat pumps in relation to output temperature  
 Figure S.1.2: Closed cycle, engine-driven vapour compression heat pump  
 Figure S.1.3: Absorption heat pump  
 Figure S.1.4: Air- Air heat pump  
 Figure S.1.5: Air- Water heat pump  
 Figure S.1.6: Water- water heat pump  
 Figure S.1.7: Table of supply temperature range in function of different applications of heat pumps  
 Figure S.1.8: Table of temperature required in function of several industrial applications.  
 Figure S.1.9: Number of installed heat pump units in some European countries  
 Figure S.1.10: Annual heat pump sales in Germany  
 Figure S.1.11: Heat pump market in Europe  
 Figure S.1.12: Ground source heat pump  
 Figure S.1.13: Electrical energy required for heat pump with a COP of 3.  
 Figure S.1.14: Energy savings in an air source heat pumps  
 Figure S.1.15: Energy savings in ground source heat pumps  
 Figure S.1.16: Payback time in air source heat pumps  
 Figure S.1.17: Payback time in ground source heat pumps  
 Figure S.1.18: Energy required by a traditional boiler and an absorption heat pump  
 Figure S.1.19: Electrical energy required for heat pump with a COP of 3.

Figure S.2.1 Conventional vs CHP Schematic explanation  
 Figure S.2.2 CHP Schematic functioning  
 Figure S.2.3 Types of engines/fuel  
 Figure S.2.4 Minic CHP average loads/ inputs (Alfagy, n.d.)  
 Figure S.2.5 Micro CHP house system (2G, n.d.)  
 Figure S.2.6 City DH (R&S Biomass, n.d.)  
 Figure S.2.7 Village DH (Living Energy, n.d.)  
 Figure S.2.8 Conventional vs CHP Comparison (Ameresco Intelligent Systems, n.d.)

Figure S.2.9 Systems + Primary sources efficiency (Orchad, s.f.)

Figure S.3.1: 'Hydrogen production at the present'.

Figure S.3.2: 'Hydrogen production processes'.

Figure S.3.3: 'Main families of metal hydrides for hydrogen storage'.

Figure S.3.4: 'Compressed hydrogen gas'.

Figure S.3.5: 'Cryogenic hydrogen liquid'.

Figure S.3.6: 'Metal hydrides devices'.

Figure S.3.7: 'PEM fuel cell'

Figure EEM.1.1. Comparison of energy storage capacity of 3 different materials

Figure EEM.1.2. Main different principles of seasonal storage with low costs and important volumes (Hadorn, 1988)

Figure EEM.1.3. Cross section view of CSHPSS in Munich

Figure EEM.1.4. Reichstag heat and fresh storage

Figure EEM.1.5: Battery of 16 inches in diameter with a capacity of 1kWh

Figure EEM.1.6: Giant battery of 40 foot with a capacity of 2MWh (daily electrical needs of 200 households)

Figure EEM.2.1: The 20-20-20 EU policy (Stephen, N., 2011)

Figure EEM.2.2: Actual way of achieving comfort in buildings

Figure EEM.2.3: Desired way of achieving comfort in buildings

Figure EEM.2.4: Optimized passive solar model (Marsh, M., 2005)

Figure EEM.2.5: Direct solar gains scheme (Currie, R., et al., 2002)

Figure EEM.2.6: Indirect solar gains scheme (Currie, R., et al., 2002)

Figure EEM.2.7: Trombe wall (Nayak, J., Prajapati, J., 2006)

Figure EEM.2.8: Greenhouse example of isolated solar gains (World Environmental Library, 2000)

Figure EEM.2.9: 3D view of smart window layers, and their operation (The Modern Green, 2010)

Figure EEM.2.10: Direct ventilation scheme (The American Institute of Architects, 2009)

Figure EEM.2.11: Cross ventilation scheme (The American Institute of Architects, 2009)

Figure EEM.2.12: Trombe wall ventilation system scheme (Nayak, J., Prajapati, J., 2006)

Figure EEM.2.13: Solar chimney ventilation system scheme (Vail, J., 2005)

Figure EEM.2.14: Chimney or wind tower ventilation system scheme The American Institute of Architects, 2009)

Figure EEM.2.15: Evaporative cooling system scheme (Ben-Gurion University, 2000)

Figure EEM.2.16: 3D view of a mechanical ventilation system (Paulventilation, 2010)

Figure EEM.2.17: 3D view of a heat recovery exchanger (Paulventilation, 2010)

Figure EEM.2.18: 3D view of a rainwater collection system (Jones, A., 2009)

Figure EEM.2.19: 3D view of the component layers of a green roof system (Safeguard Europe Limited, 2006)

Figure EEM.2.20: Ventilated façade system scheme (Austral Bricks, 2008)

Figure EEM.3.1: Insulation materials for constructions (Energetic House, 2010)

Figure EEM.3.2: Stone Wool Insulation (2012)

Figure EEM. 3.3: Production Process (Rockwool, 2012)

Figure EEM.3.4: Glass Wool (2012)

Figure EEM. 3.5: Mineral Foam (Energetic House,2010)

Figure EEM. 3.6: Polyurethane section (Energy Consulting, 2012)

Figure EEM. 3.7: Polystyrene (Energetic House, 2010)

Figure EEM. 3.8: EPS, (Insulation Centre, 2012)

Figure EEM. 3.9: XPS (Building 2000, 2012)

Figure EEM. 3.10: Cork Panel (Archi Expo,2012)

Figure EEM. 3.11. Wood wool (Isothermo,2012)

Figure EEM.3.12: Cellulose panel (Archi Expo, 2012)

Figure EEM. 3.13: Hemp wool (Energetic House, 2012)

Figure EEM. 3.14: Flax wool (Infobuild, 2012)

Figure EEM. 3.15: Sheep wool (Sheep wool Insulation, 2012)

Figure EEM. 3.16: VIP panel (Panasonic ideas for life, 2012)

Figure EEM. 3.17: Aerogel sheet (Midwest Ecodesign, 2010)

Figure EEM. 3.18. Vacuum insulation panels for building applications: A review and beyond (Baetens, et al. 2010)

Figure EEM. 3.19: Traditional, state-of-the-art and future thermal building insulation materials and solutions – Properties, requirements and possibilities (B. Petter Jelle, 2011)

Figure EEM. 3.20: Comparison between Insulation properties and cost

Figure EEM.4.1: Smart Grid break down.

Figure EEM.4.2: Number of projects involving Smart Grid in Europe.  
Figure EEM.4.3: EMS for inelastic energy demand.  
Figure EEM.4.4: microgrid network cooperation scheme.  
Figure EEM 4.5: differences between existing grid and Smart Grid.

Figure C.1. World energy available and consumption  
Figure C.2. Europe energy consumption  
Figure C.3. Initial investment for energy systems  
Figure C.4. Initial investment for energy systems  
Figure C.5. Initial investment for systems  
Figure C.6. Initial investment for energy storage & management  
Figure C.7. Costs for Heating  
Figure C.8. LCOE for electricity production  
Figure C.9. Energy cost in €/MWh for electricity and heating  
Figure C.10. Solution discarding chart  
Figure C.11. Solution ranking  
Figure C.12. Evolution of gross power generation in TWh. Source: European Commission, 2010.

# REFERENCES

2G, n.d. *2G Energy*. [Online] Available at: <http://www.2g-cenergy.com/MicroCHP.html>[Accessed November 10 2012].

Abadia, J., 2006. *Energia y sostenibilidad. La energia y el medio ambiente en la Union Europea*. Madrid, s.n.

Abur, A., Gomez-Exposito, A., Jaen, A. V., and Gomex-Quiles, C. "A multilevel state estimation paradigm for smart grids," *Proc. IEEE*, vol. 99, no. 6, pp. 952–976, June 2011.

Agencia Andaluza de la Energía, 2011. *Estudio Básico del Biogas*. Available at: [http://www.agenciaandaluzadelaenergia.es/sites/default/files/estudio\\_basico\\_del\\_biogas\\_0.pdf](http://www.agenciaandaluzadelaenergia.es/sites/default/files/estudio_basico_del_biogas_0.pdf)

Agrilife, 2012. *Rainwater Harvesting*. [Online] Available at: <http://rainwaterharvesting.tamu.edu>

Akihan, 2012. *Evaporative Cooling System Design*. [Online] Available at: <http://akihan.hubpages.com/hub/evaporative-cooling-system-design>

Aladdin solar, 2008. *Solar Air Heating System (In-Floor Radiant)*. [Electronic print] Available at: <http://www.aladdinsolar.com/hotwatersystems.html>

Aladdin solar, 2008. *Solar Hot Water ( Solar Thermal\* ) Systems*. [Online] Available at: <http://www.aladdinsolar.com/hotwatersystems.html>

Alakangas, E., 2009. *Classification of biomass origin in European solid biofuel standard*. Eurobionet III, Volumen 2009, pp. 1-18.

Alan, Wachtel, 2010. *science and curriculum consultant*

Alasti, E., 2011. *Social Acceptance of Bioenergy in Europe*. Master of Science in Environmental Management and Policy : Lund, Sweden.

Albuyeh, F., and Ipakchi, A. "Grid of the Future," *IEEE Power and Energy Magazine*, vol. 7, no. 2, pp. 52-62, Mar./Apr. 2009.

Alfagy, n.d. *Alfagy*. [Online] Available at: <http://www.alfagy.com/what-is-chp/135-what-is-chp.html>[Accessed 5 November 2012].

Alfagy, n.d. *Alfagy*. [Online] Available at: <http://www.alfagy.com/products-chp,-boilers-other.html>[Accessed 5 November 2012].

Altertech, 2011. *Passivehaus*. [Online] Available at: [http://www.altertech.es/web/passivhaus\\_altertechnica.html](http://www.altertech.es/web/passivhaus_altertechnica.html)

Alvarado, F., Fahrioglu, M., and Fern, M., "Designing cost effective demand management contracts using game theory," in *Proc. IEEE Power Energy Society Winter Meeting*, New York, Jan. 1999, pp. 427–432.

- Ameresco Intelligent Systems, n.d. *EPSWAY*. [Online] Available at: <http://www.epsway.com/products-solutions/eps-clean-generation-solutions/> [Accessed 13 November 2012].
- Amorin Insulation, *Cork for construction sustainable solution, 2012*. [Online] Available at: <http://www.archiexpo.com/prod/amorim-isolamentos-sa/insulation-panels-in-expanded-cork-89328-863798.html>
- Apricus, 2012. *Heatpipe*. [Electronic print] Available at: <http://www.greenspec.co.uk/solar-collectors.php>
- Aquamarine Power, 2012. *Aquamarine Power*. [Online] Available at: <http://www.aquamarinepower.com/> [Accessed 2 November 2012].
- Aqua-RET Consortium, 2012. *Aquaret*. [Online] Available at: <http://aquaret.com/> [Accessed 27 October 2012].
- Archi Expo, *Isonat cellulose panel, 2012* [Online] Available at: <http://www.archiexpo.it/prod/wwwisonatcom/pannelli-isolanti-flessibili-in-fibre-di-cellulosa-59629-351551.html>
- Arizona Solar Center, 2012. *Passive Solar Heating & Cooling Manual*. [Online] Available at: <http://www.azsolarcenter.org/tech-science/solar-for-consumers/passive-solar-energy/passive-solar-design-manual-consumer/passive-solar-design-manual-cooling.html>
- Armistead, H., 1987. *Heat mining: a new source of energy*. E. & F.N. Spon, London
- Atmos, 2012. [www.atmos.cz](http://www.atmos.cz). [On-line] Available at: [www.atmos.cz](http://www.atmos.cz) [Accessed: 17 October 2012].
- Austral Bricks, 2008. *Sustainability, Terracotta façade system*. [Online] Available at: <http://www.terracade.com.au/sustainability>
- Available at: <http://www.renovablesverdes.com/brasil-y-un-novedoso-sistema-hibrido-solar-eolico/>
- AWS Ocean Energy Ltd., 2012. *AWS Ocean Energy*. [Online] Available at: <http://www.awsocean.com/PageProducer.aspx> [Accessed 2 November 2012].
- Barbier, Enrico. 2002. *Geothermal energy technology and current status: an overview review article*. *Renewable and Sustainable Energy Reviews*, 6:3-65.
- Bargiotas, D., and Birdwell, J. D. "Residential air conditioner dynamic model for direct load control," *IEEE Trans. Power Delivery*, vol. 3, no. 4, pp. 2119–2126, 1988.
- Başar, T., and Olsder, G. J. *Dynamic Noncooperative Game Theory* (SIAM Series in Classics in Applied Mathematics). SIAM: Philadelphia, PA, Jan. 1999.
- Başar, T., Han, Z., Niyato, D., Saad, W., and Hjørungnes, A. *Game Theory in Wireless and Communication Networks: Theory, Models and Applications*. Cambridge, U.K.: Cambridge Univ. Press, Oct. 2011.
- Başar, T., Saad, W., Zhu, H., Poor, H., *Game-Theoretic Methods for the Smart Grid*. *IEEE SIGNAL PROCESSING MAGAZINE*. September 2012. Pp 86-106.
- Baskaran, S. Davis, B. Long, J. Steiner, M., 2009, *Building-Integrated small wind energy*, EDSGN 100H, Pennsylvania State University

- Ben-Gurion University, 2000, Innovations in passive heating and cooling. [Online] Available at: <http://www.bgu.ac.il/CDAUP/energy.html>
- Bertani, R. 2010. Geothermal power generation in the world - 2005–2010.
- Biocalora, 2012. Biocalora. [On-line] Available at: <http://www.biocalora.com/> [Accessed: 30 October 2012].
- BirdLife International. Biobombustibles . El combustible del future?. Available at: <http://www.seo.org/wp-content/uploads/2012/04/Biocombustibles.pdf>
- Blanch, M. Dutton, A. Halliday, A., 2005. The feasibility of Building-Mounted/Integrated Wind Turbines (BUWTs): Achieving their potential for carbon emission reductions
- Blomsterberg, A., 2011. Barriers to implementation of very low energy residential buildings and how to overcome them, Intelligent Energy Europe, NorthPass, 2011
- Borlase, P., 2012. *SMART GRIDS Infrastructure, Technology and Solutions*. CRC Press.
- Boumaraf, H., 2011. Microclimate Conditions and Space use Variations, *European Journal of Scientific Research*, 63 (2), pp.286-295.
- BP Energy outlook 2030, January 2011
- Brisach, 2012. Brisach. [On-line] Available at: <http://www.brisach.com> [Accessed: 16 October 2012].
- Building Green, 2008. Environmental Building News. [Online] Available at: <http://www.buildinggreen.com/auth/article.cfm/1998/4/1/Thermal-Mass-and-R-value-Making-Sense-of-a-Confusing-Issue/>
- Burton, T. Sharpe, D. Jenkins, N & Bossanyi, E. 2001. Wind energy handbook. United Kingdom: John Wiley & Sons, LTD.
- California Energy Commission CEC., 2003. California Gross System Power for 2003.
- California Energy Commission, 2006. Geothermal or Ground Source Heat Pumps.
- California Energy Commission, 2012. Consumer Energy Center, [Online] Available at: <http://www.consumerenergycenter.org/index.html>
- Calimax, 2012. Calimax. [On-line] Available at: <http://www.calimax.com/> [Accessed: 15 October 2012].
- Canada's Fossil Energy future, the way forward on carbon capture and storage, January 9, 2008 <http://www.unep.org/Documents.Multilingual/Default.asp?DocumentID=502&ArticleID=5545&I=en>
- CANMET Energy Technology Centre, 2002. *Commercial earth energy systems: a buyer's guide*. Available at: <http://publications.gc.ca/collections/Collection/M92-251-2002E.pdf> [Access in 19/11/12]
- Capros, P. Dr. Mantzos, L. Tasios, N. De Vita, A. & Kouvaritakis, N. 4 August 2010. EU energy trends to 2030. EUROPEAN COMMISSION, directorate-General for energy in collaboratin with Climate Action DG and Mobility and Transport DG
- Capros, P. Mantzos, L. Tasios, N. De Vita, A. Kouvaritakis, N., 4 August., 2010. EU energy trends to 2030- Update 2009. European Comission, Directorate-General for energy. Luxembourg: Publications office of the European Union, 2010.



Carazo, A., 2006. Cifras basicas de la relacion Madera-fijacion de carbono-CO2 atmosferico. *Divulgacion*, 2006(84), pp. 48-52.

Chan, S. C., Tsui, K. M., Wu, H. C., Hou, Y., Wu, Y., and Wu, F. F. Load/Price forecasting and managing demand response for Smart grids – Methodologies and challenges. *IEEE SIGNAL PROCESSING MAGAZINE* (68). SEPTEMBER 2012. Pp68-85

Chao Luo, Lichang Huang, Yulie Gong, Weibin Ma. 2012. Thermodynamic comparison of different types of geothermal power plant systems and case studies in China.

Chen, L., Li, N., and Low, S. H. "Optimal demand response based on utility maximization in power networks," in Proc. IEEE Power and Energy Society General Meeting, July 2011, pp. 1–8.

Chen, L., Li, N., Low, S. H., and Doyle, J. C. "Two market models for demand response in power networks," in Proc. Int. Conf. Smart Grid Communications, Gaithersburg, MD, Oct. 2010, pp. 397–402.

Claverton Energy Research Group, 2012. *Claverton Energy*. [Online] Available at: (footprint) <http://www.claverton-energy.com/carbon-footprints-of-various-sources-of-heat-chpdh-comes-out-lowest.html>[Accessed 1 November 2012].

Clean Current Power Systems Inc., 2012. *Clean Current. Renewable Energy Systems*. [Online] Available at: <http://www.cleancurrent.com/>[Accessed 2 November 2012].

COM(2011)202 on 12 April 2011, Smart Grids: from innovation to deployment, available at: <http://eur-lex.europa.eu/LexUriServ/LexUriServ.do?uri=CELEX:52011DC0202:EN:HTML:NOT>

Coontz, R. Hanson, B., 2004. Toward a Hydrogen Economy, *Science*, 305 (5686), pp.957-967

Coordinación de Energías Renovables, Dirección Nacional de Promoción, Subsecretaria de Energía Eléctrica., 2008. Energías renovables 2008 - Energía Eólica. Argentina: Secretaria de Energía.

Corry, Maureen, Mc, Jones, Gareth, Ll. 2011. *Geotrained Training Manual For Designers Of Shallow Geothermal Systems*. ISBN No. 978-2-9601071-0-4

Cowan, L., and Sennebogen, E., 2012. *Howstuffworks* "How Heat Pumps Work" Available at: <http://home.howstuffworks.com/home-improvement/heating-and-cooling/heat-pump.htm>[Access in 19/11/12]

Creus Solé, A. 2008. *Aerogeneradores (Wind turbines)*. Spain: Cano Pina, S.L. – CeysaEditions.

Currie, R., Elrick, B., Ioannidi, M., Nicolson, C., 2002. *Renewables in Scotland*. [Online] Available at: [http://www.esru.strath.ac.uk/EandE/Web\\_sites/01-02/RE\\_info/passive\\_solar.htm](http://www.esru.strath.ac.uk/EandE/Web_sites/01-02/RE_info/passive_solar.htm)

Cypher, D., Souryal, M., Gentile, C., Griffith, D., and Golmie, N. "A methodology to evaluate wireless technologies for the Smart Grid," in Proc. Int. Conf. Smart Grid Communications, Gaithersburg, MD, Oct. 2010.

D'Armetta, N., 2005. *Il minieolico: tecnologia ed applicazioni*, Università degli studi di Palermo

Damien, A., 2010. *La biomasa. Fundamentos, tecnologías y aplicaciones*. Primera ed. Madrid: AMV Ediciones.

Danish Energy Authority, 2005. *Offshore wind power – Danish experiences and solutions*

- Danish Wind Industry Association, 2009. Market and Prices [online]. Available at: [http://www.windpower.org/en/policy/market\\_and\\_prices.html](http://www.windpower.org/en/policy/market_and_prices.html) [Accessed: November 11, 2012]
- Danish Wind Industry Association, 2009. Survey on attitudes towards wind power (Selected responses) [online]. Available at: [http://www.windpower.org/download/1069/Megafon\\_survey\\_aug2009\\_results.pdf](http://www.windpower.org/download/1069/Megafon_survey_aug2009_results.pdf) [Accessed: November 5, 2012]
- Danish Wind Industry Association, n.d. Planning [online]. Available at: <http://www.windpower.org/en/policy/planning.html> [Accessed: November 11, 2012]
- Danish Wind Industry Association, n.d. Policy [online]. Available at: <http://www.windpower.org/en/policy.html> [Accessed: November 5, 2012]
- Dcm, 2008. Biomasa calderas de policombustible. s.l.:Solar Home.
- Debbah, M., Rose, L., Lasaulce, S., and Perlaza, S. M., "Learning equilibria with partial information in decentralized wireless networks," *IEEE Commun. Mag.*, vol. 49, no. 8, pp. 136–142, Aug. 2011.
- Denholm, P., Markel, T., and Kuss, M., "Communication and control of electric vehicles supporting renewables," in *Proc. IEEE Vehicle Power and Propulsion Systems Conf.*, Dearborn, MI, Sept. 2009, pp. 27–34.
- Desertec, 2012. *Desertec project*. [Online] Available at: <http://www.desertec.org/>
- Developing Geothermal Energy at Low Temps, 2010. Available at: <http://www.renewableenergyworld.com/rea/news/article/2010/09/low-temperature-geothermal-energy-expanding-market-opportunities>
- Dimeas, A., Katiraei, F., Iravani, R., and Hatzargyriou, N. "Microgrids Management," *IEEE Power and Energy Magazine*, vol. 6, no. 3, pp. 54-65, May/June 2008.
- DiPippo, R. 2005. *Geothermal Power Plants: Principles, Applications and Case Studies*, Elsevier, Oxford
- DiPippo, R., 1991b. *Geothermal Energy: Electricity Generation and Environmental Impact*, *Energy Policy*, 19, pp. 798–807
- DOE, 1995. *Energy Information Administration. Renewable Energy Consumption*. Florence 18–31 May 1995, *International Geothermal Association*, vol. 4, pp. 2825–2836
- DOE. *Energy Information Administration. Renewable Energy Trends*.
- E.ON Climate and renewables, *Wind Energy Factbook*, 2011. Available on the website [http://www.eon.com/content/dam/eoncom/en/downloads/e/EON\\_Offshore\\_Wind\\_Factbook\\_en\\_December\\_2011.pdf](http://www.eon.com/content/dam/eoncom/en/downloads/e/EON_Offshore_Wind_Factbook_en_December_2011.pdf)
- EBA- European Biogas Association. 2011. *Biogas Simply the best*. Renewable Energy House. Belgium. Available at: [http://www.european-biogas.eu/images/stories/biogas-brochure-2011-1\\_small.pdf](http://www.european-biogas.eu/images/stories/biogas-brochure-2011-1_small.pdf)
- Eco Green Innovations, 2011. Available at <http://www.harrogateheatpumps.co.uk/how-do-heat-pumps-works.asp> [Accessed in 19/11/12]
- Ecología Verde, 2007. *Saharaforest1*. [Electronic print] Available at: <http://www.ecologiaverde.com/proyecto-desertec-energia-solar-en-el-sahara/>

Edilizia 2000, Synthetic Insulation products, 2012 [Online] Available at: [http://www.edilia2000.it/Pannello-URSA-XPS-WALL-C-Plus\\_6-9-8995,269.html](http://www.edilia2000.it/Pannello-URSA-XPS-WALL-C-Plus_6-9-8995,269.html)

EEA Report No 7/2010, tracking Progress towards Kyoto and 2020 targets in Europe

EGEC. 2009. Brochure Ground source Heat pumps

Electric Power Research Institute (EPRI). (2011, June). PAP11—Electric vehicle load management. EPRI Res. Program Use Case [Online]. Available: <http://smartgrid.epri.com>.

Energía solar España, 2012. *Situación actual del Mercado mundial de la energía solar térmica*. [Online] Available at: <http://www.energiasolaresp.com/2012/01/situacion-actual-del-mercado-mundial-de.html>

Energía solar fotovoltaica, 2012. *Sistema fotovoltaico*. [Online] Available at: [http://www.energia-solar-fotovoltaica.info/5\\_Tecnologia\\_Solar\\_Fotovoltaica/15\\_Sistema\\_Fotovoltaico.html](http://www.energia-solar-fotovoltaica.info/5_Tecnologia_Solar_Fotovoltaica/15_Sistema_Fotovoltaico.html)

Energía solar, 2012. *Energía solar fotovoltaica*. [Online] Available at: <http://www.instalacionenergiasolar.com/fotovoltaica.html>

Energy [r]evolution, A SUSTAINABLE WORLD ENERGY OUTLOOK, January 2007

Energy Agency Corner, 2012: *Key Information related to energy efficiency* [Online] (Updated 12 November 2012) Available at: <http://www.managenergy.net/ee.html> [Accessed 15 November 2012]

Energy and climate Change, Friends of Earth, reprinted August 2008

Energy and Climate Change, World Energy Council 2007

Energy Consulting, *Synthetic Insulation Materials, 2012* [Online] Available at: <http://www.consulente-energia.com/sa-polistirolo-espanso-estruso-eps-xps-poliuretano-espanso-resine-fenoliche-espanso-polinilcloruro-pvc-espanso-costo-prezzi-per-isolamento-termico-a-cappotto-edifici.html>

Energy for a sustainable future, Summary Report, United Nations, April 28, 2010

Energy savings trust, 2012. Available at <http://www.energysavingtrust.org.uk/> [Accessed in 19/11/12]

Engstrom, S. & Pershagen, B., 1980. Aesthetic Factors and Visual Effect of Large-Scale WEC's. National Swedish Board for Energy Source Development, NE.

Ente Vasco de la Energía, EVE, 2011. *EVE, Ente Vasco de la Energía*. [Online] Available at: <http://eve.es/web/Energias-Renovables/Energia-marina.aspx> [Accessed 22 October 2012].

Erenovable, 2010. Fototermosifón. [electronic print] Available at: <http://erenovableseficients.blogspot.com.es/2010/08/tipus-de-sistemas-denergia-solar.html>

ETSU, 1995. Wind farm radar study. ETSU Report W/32/00228/49/REP. Harwell, UK: ETSU.

Eugster, Walter, J., Sanner, Burkhard. 2007. Technological Status of Shallow Geothermal Energy in Europe

Euroserv'er. 2010. Biogas Barometer. Systèmes solaires. Le journal des énergies renouvelables. Available at: <http://www.euroserv-er.org/pdf/baro200b.pdf>

Euroheat, n.d. *Euroheat*. [Online] Available at: [http://www.euroheat.org/District-heating---cooling-4.aspx#What\\_is\\_district\\_cooling](http://www.euroheat.org/District-heating---cooling-4.aspx#What_is_district_cooling)[Accessed November 10 2012].

Euroheat, n.d. *Euroheat*. [Online] Available at: [http://www.euroheat.org/District-heating---cooling-4.aspx#If\\_District\\_Heating\\_is\\_so\\_smart\\_\\_why\\_isn\\_t\\_it\\_more\\_widespread\\_](http://www.euroheat.org/District-heating---cooling-4.aspx#If_District_Heating_is_so_smart__why_isn_t_it_more_widespread_)[Accessed 11 November 2012].

Euroheat, n.d. *Euroheat*. [Online] Available at: <http://www.euroheat.org/ecoheatcool>[Accessed 11 November 2012].

europa.eu, 2012. Europa Summaries of EU legislation. [On-line] Available at: [europa.eu/legislation\\_summaries/energy/renewable\\_energy/l27014\\_en.htm](http://europa.eu/legislation_summaries/energy/renewable_energy/l27014_en.htm)[Accessed: 20 October 2012].

European Assosiation for the Promotion of Cogeneration, n.d. *Cogeneurope*. [Online] Available at: [http://www.cogeneurope.eu/cogen-europe-position-paper-on-proposals-regarding-third-phase-of-the-ets\\_425.html](http://www.cogeneurope.eu/cogen-europe-position-paper-on-proposals-regarding-third-phase-of-the-ets_425.html)[Accessed 15 November 2012].

European Biofuels Technology Platform. Available at: <http://www.biofuelstp.eu/biodiesel.html>

European comission, 2012. European comission of energy, renewable energy. [On-line] Available at: [ec.europa.eu/energy/renewables/index\\_en.htm](http://ec.europa.eu/energy/renewables/index_en.htm)[Accessed: 20 October 2012].

European Commission Community Research, World Energy, Technology and Climate Policy Outlook, WETO 2030

European Commission, 2012. *European Commission Research & Innovation*. [Online] Available at: [http://ec.europa.eu/research/energy/eu/research/ocean/support/index\\_en.htm](http://ec.europa.eu/research/energy/eu/research/ocean/support/index_en.htm)[Accessed 2 November 2012].

European Ocean Energy Association, 2010. *European Ocean Energy Roadmap 2010-2050*. [Online] Belgium: European Ocean Energy Association. Available at: <http://www.eu-oea.com/wp-content/uploads/2012/02/EUOEA-Roadmap.pdf>[Accessed 5 November 2012].

European Parliament, 2004. Directive 2004/8/EC and amending directive 92/42/EEC. *Promotion of cogeneration based on a useful heat demand in the integral energy market*, p. 7.

European Solar Thermal Technology Platform, 2012. *European Technology Platform on Renewable Heating and Cooling*. [Online] Available at: [http://esttp.org/cms/front\\_content.php](http://esttp.org/cms/front_content.php)

European Technology Platform for Electricity Networks of the Future, 2012. *Frequent Asked Questions*. [Online] Available at: <http://www.smartgrids.eu/node/56#12> [10-10-2012].

European Wind Energy Assotiation, 2007. Delivering offshore wind power in Europe - policy recommendations for large-scale deployment of offshore wind power in Europe by 2020

Fanelli, D., 2001. Hidden resources – power from geothermal energy. *Renewable Energy World*, July–August, pp. 211–217

Fang, Y., Guo, Y., and Pan, M., Optimal power management of residential customers in the Smart Grid, *IEEE TRANSACTIONS ON PARALLEL AND DISTRIBUTED SYSTEMS*, Vol 23, NO 9, September 2012. Pgs 1593-1606

Feist, W. ed., 2004/2007. *Passive House Planning Package 2004, Specifications for Quality Approved Passive Houses*, Darmstadt: Passivhaus Institute.

Fernandez Gonzalez, J. & al., [., 2009. Biomasa: estado actual y perspectiva. Primera ed. Madrid: Asociacion Nacional de Ingenieros del ICAI.

Financing Renewable Energy in the European energy market (Ecofys, 2012)

Fridleifsson, 1994. Freestone DH Geothermal energy research and Development. *Geothermics* 23:175–214.

Fudenberg, D., and Levine, D., *The Theory of Learning in Games*. Cambridge, MA: MIT Press, 1998.

Fulli, G., Gangale, F., Giordano, V. 2011. Smart Grid projects in Europe: lessons learned and current developments. *JRC Reference Reports*, EUR 24856. Pag: 24

fundacion de la Energia de la Comundiad de Madrid, 2006. Biocarburantes. *Energias renovables*, Volumen 2006, pp. 1-20.

FundaciónEnergizar, 2012. *Destilador Solar*. [Online]Available at: [http://www.energizar.org.ar/energizar\\_desarrollo\\_tecnologico\\_destilador\\_solar\\_que\\_es.html](http://www.energizar.org.ar/energizar_desarrollo_tecnologico_destilador_solar_que_es.html)

Galli, S., Scaglione, A., and Wang, Z. "For the grid and through the grid: The role of power line communications in the Smart Grid," *Proc. IEEE*, vol. 99, no. 6, pp. 998–1027, June 2011.

Galli, S., Scaglione, A., and Wang, Z. "Power line communications and the Smart Grid," in *Proc. Int. Conf. Smart Grid Communications*, Gaithersburg, MD, Oct. 2010, pp. 303–308.

García, F., 2006. Generación de electricidad e hidrógeno a partir de la gasificación de carbón y secuestro de CO<sub>2</sub>. 8 de marzo 2006. Club Español de la Energía.

Gecohomeproject, 2011. *Prototype*. [Online]Available at: <http://www.gecohomeproject.com/en/>

Gecohomeproject, 2011. Video 3d ViviendaPasiva HD. [ScreenShots]Available at: <http://www.youtube.com/watch?v=fP0g14ai2xc>

Gellings, C. W. *The Smart Grid: Enabling Energy Efficiency and Demand Response*. London, U.K.: CRC Press, Aug. 2009.

Ghatikar, G., Mathieu, J. L., Piette, M. A., and Liliccote, S., (2010, Dec. 1–3). Open automated demand response technologies for dynamic pricing and Smart Grid. presented at Grid-Interop Conference 2010, Chicago, IL. [Online]. Available at: <http://drc.lbl.gov/sites/drc.lbl.gov/files/lbnl-4028e.pdf>

Gilles, 2012. Gillesw biomass heating. [On-line] Available at: [www.gillesenergie.es](http://www.gillesenergie.es)[Accessed: 19 October 2012].

Giupponi, L., Ibars, C., and Navarro, M., "Distributed demand management in Smart Grid with a congestion game," in *Proc. Int. Conf. Smart Grid Communications*, Gaithersburg, MD, Oct. 2010, pp. 495–500.

Global Energy Review in 2011, Enerdata Publication

Global Trend in Renewable Energy Investment 2012, Frankfurt School UNEP Collaborating Center for Climate and Sustainable Energy Finance.

Global Trend in Renewable Energy Investment 2012, United Nations Environment Program

- Gohn, B., and Wheelock, C., 2010. Smart Grid: Ten Trends to Watch in 2011 and Beyond. Pike Research. 4Q. 2010.
- Grant, M., Geothermal reservoir modelling. *Geothermics* 1983;12:251–63.
- Greenspec, 2012. *Solar hot water collectors*. [Online] Available at: <http://www.greenspec.co.uk/solar-collectors.php>
- Gsänger, S. &Rehmet, F., 2006. World Wind Energy Association (WWEA). [Internet] Available at: <http://www.wwindea.org/home/index.php> [Accessed 13 November 2012]
- Guay, M., and Sane, H., "Minimax dynamic optimization over a finite-time horizon for building demand control," in Proc. 2008 American Control Conf., Seattle, WA, June 11–13, 2008, pp. 1469–1474.
- Guentert, D., Rutz, D. & Janssen, R. 2011. Assessment of Public Perception on Biofuels in Germany. WIP Renewable Energies.
- Gungor, V., Lu, B. and Hancke, G. "Opportunities and challenges of wireless sensor networks in Smart Grid," *IEEE Trans. Ind. Electron.*, vol. 57, pp. 3557–3564, Oct. 2010.
- Hammons, T.J., 1993. Tidal Power. *Proceedings of the IEEE*, 8(3), p. 421.
- Hargassner, 2012. Hargassner Iberica. [On-line] Available at: <http://www.hargassner-iberica.com/> [Accessed: 2 October 2012].
- Harley, D., Matrosov, A., Rodionov, E., and Malcho, J., Stuxnet Under the Microscope. ESET. [online] [go.eset.com/us/resources/white-papers/Stuxnet\\_Under\\_the\\_Microscope.pdf](http://go.eset.com/us/resources/white-papers/Stuxnet_Under_the_Microscope.pdf).
- Hartweg, L., 2010. Passive Solar Energy. [Online] Available at: <http://www.passivesolarenergy.info/#S1>
- Hatziaargyriou, N., Sano, H., Iravani, R., and Marnay, C. "Microgrids: An overview of ongoing research development and demonstration projects," *IEEE Power Energy Mag.*, vol. 27, pp. 78–94, Aug. 2007.
- Hau, E., 2006. Wind turbines: Fundamentals, technologies, applications & economics. Berlin, Germany: Springer-Verlag.
- Heizomat, 2012. Heizomat. [On-line] Available at: <http://www.eng.heizomat.de/> [Accessed: 29 October 2012].
- High Level Group, 2003. *Hydrogen Energy and Fuel cells: A Vision of Our Future*. EUR 297 19 EN
- Homeenergy, networkfortheconstruction and energetic design, 2012. *Insulating materials for construction*. [Online] Available at: <http://www.casaenergetica.it/info/tecnologia/materiali.html>
- Honary, B., Pavlidou, N., Vinck, A., and Yazdani, J., "Smart meters for power grid: Challenges, issues, advantages and status," *Renewable Sustainable Energy Rev.*, vol. 15, no. 6, pp. 2736–2742, Aug. 2011.
- Hou, Y., Liu, C. C., and Salazar, H. "Electricity prices as stochastic processes," in *Advances in Electric Power and Energy* (Power Engineering Series of IEEE Press/Wiley books), M. El Hawary, Ed., 2012.
- Houston Solar Tour, 2011. Solar electric power picture. [Electronic print] Available at: <http://www.houstonsolartour.com/info-center/solar-electric-power-faqs/>
- <http://ecoalfabeta.blogosfere.it/2008/11/ecco-il-minieolico-italiano.html>

<http://en.wikipedia.org/wiki/EnergyCrisis>

<http://en.wikipedia.org/wiki/Worldenergyconsumption>

<http://www.100ambiente.it/index.php?/archives/188-Minieolico,-microeolico-e-grandi-impianti.-Vantaggi-e-svantaggi..html>

[http://www.cajaespana.es/Images/JUAN%20BISQUERT\\_tem25-23175.pdf](http://www.cajaespana.es/Images/JUAN%20BISQUERT_tem25-23175.pdf)

<http://www.nosinteresa.com/>

Huisman, R and Mahieu, R. "Regime jumps in electricity prices," *Energy Economics*, vol. 25, no. 5, pp. 425–434, 2003.

Hvac, 2012. Hvac for beginners. [On-line] Available at: [www.hvac-for-beginners.com](http://www.hvac-for-beginners.com) [Accessed: 27 October 2012].

HydroWorld, 2012. *HydroWorld*. [Online] Available at: <http://www.hydroworld.com/articles/print/volume-19/issue-5/departments/new-hydro.html> [Accessed 3 November 2012].

Hyways, 2008. *European Hydrogen Energy Roadmap- Assumptions and final results*. [Online] (Updated 25 Feb 2008) Available at: [www.hyways.de](http://www.hyways.de)

I.S. Department of Energy, 2012. *Passive Solar Home Design*. [Online] Available at: <http://energy.gov/energysaver/articles/passive-solar-home-design>

Iberdrola, 2012. *Energía solar fotovoltaica*. [Online] Available at: <https://www.iberdrola.es/webibd/corporativa/iberdrola?IDPAG=ESWEBCLIHOGAHOEQUFOT>

ICAX, 2012. Available at [http://www.icax.co.uk/Heat\\_Pumps.html](http://www.icax.co.uk/Heat_Pumps.html) [Accessed in 19/11/12]

IDAE, 1996. *Energía de la biomasa*. Especial ed. Madrid: Cinco Dias.

IEA Heat Pump Center, 2010. *How heat pumps achieve energy savings and CO<sub>2</sub> emissions reduction*. Available at <http://www.heatpumpcentre.org/en/aboutheatpumps/howheatpumpsachieveenergysavings/Sidor/default.aspx> [Accessed in 19/11/12]

IEA, 2012. *International Energy Agency*. [Online] Available at: <http://www.iea.org/> [Accessed 25 October 2012].

IEA, n.d. *International Energy Agency*. [Online] Available at: <http://www.iea.org/> [Accessed 15 November 2012].

Ifeu. 2005. *Biodiesel initiatives in Germany*. Heidelberg. Germany. Available at: [http://www.bioenergy.org.nz/documents/liquidbiofuels/PREMI\\_A\\_Germany\\_biodiesel.pdf](http://www.bioenergy.org.nz/documents/liquidbiofuels/PREMI_A_Germany_biodiesel.pdf)

Iglesias, Eduardo, R., Torres, J. Rodolfo. 2009. *First assessment of low- to medium-temperature geothermal reserves in 20 Mexican states*

Insemur, 2012. *Aspectos económicos de las instalaciones fotovoltaicas*. [Online] Available at: <http://www.insemur.com/economicos%20fotovoltaica.htm>

Intergovernmental Panel on Climate Change, 2011. Renewable Energy Sources And Climate Change Mitigation, Summary For Policymakers And Technical Summary, Special Report Of The Intergovernmental Panel On Climate Change [online]. Available at: <http://www.ipcc.ch/> [Accessed: November 7, 2012]

International Energy Agency [IEA], 2008. *Energy Technology Perspectives 2008. Scenarios & Strategies to 2050*, Tokyo: OECD. International Energy Agency (IEA).

International Energy Agency IEA, 2012. *Technology Roadmap. Hydropower*, annual report. Paris Cedex 15, France. International Energy Agency IEA.

International Energy Agency, 2007. Biomass for Power Generation and CHP\*. Available at: <http://www.iea.org/publications/freepublications/publication/name,3738,en.html>

International Energy Agency, 2007. Good practice guidelines. Bioenergy Project Development & Biomass Supply. Available at: <http://www.iea.org/publications/freepublications/publication/name,3732,en.html>

International Energy Agency, 2007. Good practice guidelines. Sustainable production of second-generation biofuels. Potential and perspectives in major economies and developing countries. Available at: [http://www.iea.org/publications/freepublications/publication/second\\_generation\\_biofuels.pdf](http://www.iea.org/publications/freepublications/publication/second_generation_biofuels.pdf)

International Energy Agency, 2009. IEA's Report on 1st- to 2nd- Generation Biofuel Technologies. Available at: <http://www.renewableenergyworld.com/rea/news/article/2009/03/ieas-report-on-1st-to-2nd-generation-biofuel-technologies>

International Energy Agency, Executive Summary, World Energy Outlook 2010

IPCC, 2007. *Cambioclimático 2007: Informe de síntesis. Contribución de los Grupos de trabajo I, II y III al Cuarto Informe de evaluación del Grupo Intergubernamental de Expertos sobre el Cambio Climático* [Pachauri, R.K. Reisinger, A.]. IPCC, Geneva, Switzerland, 104 pages.

Isotermo Firm, 2012. *Insulation material*. [Online] Available at: [http://www.trovavetrine.it/isotermo-genova/sezione.php?sz=1634\\_TERMOACUSTICA](http://www.trovavetrine.it/isotermo-genova/sezione.php?sz=1634_TERMOACUSTICA)

J. M. Pearce, 2011. Dispatch Strategy and Model for Hybrid Photovoltaic and Trigenation Power Systems. *Applied Energy*, 88(9), p. 3270–3276.

Jelle, B.P., 2010. Traditional, state-of-the-art and future thermal building insulation materials and solutions – Properties, requirements and possibilities. *Journal of Building Physics* (2010)

Jelle, B.P., Gustavsen, A., Baetens, R., 2010. The path to the high performance thermal building insulation materials and solutions of tomorrow. *Journal of Building Physics* (2010)

Jelle, B.P., Gustavsen, A., Grynning, S., Wegger, E., Baetens, R., (2010). Nanotechnology and possibilities for the thermal building insulation materials of tomorrow. *Journal of Building Physics* (2010)

Jones, A., 2009. Custom design rainwater collection system. [Online] Available at: <http://www.allthingsrainwater.com>

Kaarsberg, T., 2010. *Ground Source Heat Pump Subprogram Overview*, "Geothermal Technologies Program Peer Review" Available at: [http://www1.eere.energy.gov/geothermal/pdfs/peer\\_review\\_2010/overview\\_gshp.pdf](http://www1.eere.energy.gov/geothermal/pdfs/peer_review_2010/overview_gshp.pdf) [Accessed in 19/11/12]



Kagel, A., D. Bates, K. Gawell. 2005. *A Guide to Geothermal Energy and the Environment*, Geothermal Energy Association, Washington, D.C

Kaltschmitt, M. & Weber, M., 2006. Markets for solid biofuels within the EU-15. *Biomass & Bioenergy*, 2006(30), pp. 897-907.

Kaplan, S. M., Sissine, F., (ed.) *Smart Grid: modernizing electric power transmission and distribution...* The Capitol Net Inc, 2009, ISBN 1-58733-162-4, page 217.

Khan and Holz, Evolution of future energy demands till 2030 in different world regions: an assessment made for the two iiasa scenarios. International Institute for Applied Systems Analysis, Laxenburg, Austria, RR-82-14, April 1982

Lamers, P., Junginger, M., Hamelinck, C. & Faaij, A., 2012. Developments in international solid biofuel trade - An analysis of volumes, policies and market factors. *renewable and Sustainable Energy Reviews*, 2012(16), pp. 3176-3199.

Lascano, M.E., 2012. *Passive Systems* [Online] Available at: <http://www.bibliocad.com/blog/tag/natural?lang=en> [Accessed 12 November 2012].

Lecue, A., 2011. *Situación actual de la energía solar fotovoltaica en el mundo según el Plan de Energías Renovables PER 2011-2020*. [Online] Available at: <http://www.suelosolar.es/newsolares/newsol.asp?id=6209>

Levenger, 2012. Levenger energías renovables. [On-line] Available at: [www.levenger.es](http://www.levenger.es) [Accessed: 14 October 2012].

Levine, M., et al., 2007. *The IPCC 4<sup>th</sup> Working Group report*. "Residential and commercial buildings". Available at: <http://www.ipcc.ch/pdf/assessment-report/ar4/wg3/ar4-wg3-chapter6.pdf> [Accessed in 19/11/12]

Liang, N., and Tian, C., 2006. *Renewable Energy Resources and a Greener Future*. Vol. VIII-12-5. "State of the Art of Air-source Heat pump for Cold Regions". Available at: <http://repository.tamu.edu/bitstream/handle/1969.1/5474/ESL-IC-06-11-312.pdf> [Accessed in 19/11/12]

Linares, J.J. Moratilla, B.Y., 2007. *El hidrógeno y la energía*. Madrid: Universidad Pontificia Comillas & Asociación Nacional de Ingenieros del ICAI.

Marcos Martin, F., 1994. Pélets y briquetas. *Aiitm*, 1994(171), pp. 54-62.

Marine Current Turbines Ltd., 2012. *Marine Current Turbines*. [Online] Available at: <http://www.marineturbines.com/> [Accessed 2 November 2012].

Markel, T., and Simpson, S. "Plug-in Hybrid Electric Vehicle Energy Storage System Design," Proc. Advanced Automotive Battery. Conf., 2006.

Market Observatory for Energy, 2011. *Key figures* [Online] (Updated June 2011) Available at: [http://ec.europa.eu/energy/observatory/countries/doc/key\\_figures.pdf](http://ec.europa.eu/energy/observatory/countries/doc/key_figures.pdf) [Accessed 30 October 2012]

Marsh, M., 2005, MarshAssociatesDesign. [Online] Available at: <http://www.marshassociates.net/amazing.html>

Massachusetts Institute of Technology, n.d. *MIT*. [Online] Available at: <http://cogen.mit.edu/> [Accessed 1 November 2012].

Massoud S. A., and Wollenberg, B. F., 2005. Toward a Smart Grid, *IEEE P&E Magazine*3(5) pp34–41.

Mendoza, M., 2004. Hidrogeno: la energía del futuro. [Online] Available at: [www.minpetel.com/proyectos/hidrogeno/HidrogenoEnergiaFuturo.pdf](http://www.minpetel.com/proyectos/hidrogeno/HidrogenoEnergiaFuturo.pdf)

Miguélez, F., 2009. *La energía que viene del mar*. 1 ed. La Coruña: Netbiblo.

Ministerio de Economía y Competitividad, 2012. *Instalaciones de torre con receptor central*. [Online] Available at: <http://www.psa.es/webesp/instalaciones/receptor.php>

National Institute for Standards and Technology (NIST). (2011, Nov.). Harmonize power line carrier standards for appliance communications in the home. NIST Priority Action Plan (PAP-15) [Online]. Available: <http://collaborate.nist.gov/twiki-sggrid/bin/view/SmartGrid/PAP15PLCForLowBitRates>.

National Public Radio, n.d. *NPR*. [Online] Available at: <http://www.npr.org/templates/story/story.php?storyId=90714692>[Accessed 15 November 2012].

Natural Institute of Building Sciences, 2010. Natural ventilation. [Online] Available at: <http://www.wbdg.org/resources/naturalventilation.php>

Nayak, J., Prajapati, J., 2006. *Handbook on Energy Conscious Buildings*, Indian Institute of Technology, Bombay and Solar Energy Centre, Ministry of Non-conventional Energy Sources, Government of India

Neila, F., 2004. *Arquitectura bioclimática en el entorno sostenible*. Munilla-Leria, Madrid, 2004

Nisan, N., Roughgarden, T., Tardos, E., and Vazirani, V. V., *Algorithmic Game Theory*. Cambridge, U.K.: Cambridge Univ. Press, 2007.

Norwegian Water Resources and Energy Directorate, n.d. *Energy in Norway*, s.l.: s.n.

Nova Energia, 2012. Nova Energia. [On-line] Available at: [www.novaenergia.org](http://www.novaenergia.org)[Accessed: 28 October 2012].

Npu, 2008. *Solar Stirling Engine*. [Electronic print] Available at: <http://www.npu.edu/seminars/index.php?entry=entry081126-200257>

Oak Ridge National Laboratory, 1 December 2008. *Combined Heat and Power - Effective Energy Solutions for a Sustainable Future*, s.l.: s.n.

OES, 2008-2011. *Ocean Energy Systems*. [Online] Available at: <http://www.ocean-energy-systems.org/>[Accessed 28 October 2012].

Ökofen, 2012. Ökofen. [On-line] Available at: <http://www.okofen.es/>[Accessed: 23 October 2012].

Oliveira, A., 2000. Solar chimneys: Simulation and experiment. *Energy and Buildings*, 2000, (32), pp. 71-79

Onyx Solar, 2012. Fachada Ventilada fotovoltaica. [Electronic print] Available at: <http://www.onyxsolar.com/es/fachada-ventilada-fotovoltaica.html>

Onyx Solar, 2012. Lucernario fotovoltaico. [Electronic print] Available at: <http://www.onyxsolar.com/es/lucernario-fotovoltaico.html>

Onyx Solar, 2012. *Soluciones Constructivas*. [Online] Available at: <http://www.onyxsolar.com/es/index.html>

Onyx Solar, 2012. Suelo Fotovoltaico transitable. [Electronic print] Available at: <http://www.onyxsolar.com/es/suelo-fotovoltaico-transitable.html>

Opdal, A., 2006. Production of synthetic biodiesel via Fischer-Tropsch synthesis. Faculty of Engineering Science and Technology. Norway.

OpenHydro Group Ltd., 2012. *Openhydro Tidal Technology*. [Online] Available at: <http://www.openhydro.com/home.html>[Accessed 2 November 2012].

OPT, 2012. *Ocean Power Technologies*. [Online] Available at: <http://www.oceanpowertechnologies.com/>[Accessed 2 November 2012].

Orchad, W., n.d. *Claverton Energy*. [Online] Available at: (@William Orchard) <http://www.claverton-energy.com/wp-content/uploads/2009/02/footprinttaxheatforbuildings1.jpg> [Accessed 13 November 2012].

Oren, S. S., "Demand response: A historical perspective and business models for load control aggregation," presented at the Power System Engineering Research Center Public Webinar, Feb. 1, 2011.

Palazzetti, 2012. Palazzetti. [On-line] Available at: [www.palazzetti.it](http://www.palazzetti.it)[Accessed: 23 October 2012].

Partyka, Eric, 2010. Solar PV Market: Understanding the Fundamentals. In: US Department of Energy, Solar Energy Technologies Program, GovEnergy2010. Dallas, Texas, USA, August 15-18, 2010. [online]: US Department of Energy

Passivhaus Institute, 2012. About passive house. [Online] Available at: [http://www.passiv.de/en/02\\_informations/01\\_what\\_is\\_a\\_passive\\_house/01\\_what\\_is\\_a\\_passive\\_house.htm](http://www.passiv.de/en/02_informations/01_what_is_a_passive_house/01_what_is_a_passive_house.htm)

Paulventilation, 2010, Ventilation Heat Recovery. [Online] Available at: <http://www.paulventilation.co.uk/>

Pavlov, G.K., Olesen, B.W. Seasonal solar thermal energy storage through ground heat exchangers- Review of systems and applications

Pearce, J. M., 2009. Expanding Photovoltaic Penetration with Residential Distributed Generation. *Energy*, 34(11), p. 1947–1954.

Pelamis Wave Power Ltd., 2012. *Pelamis Wave Power*. [Online] Available at: <http://www.pelamiswave.com/>[Accessed 2 November 2012].

PEMSEA, 2012. *Partnerships in Environmental Management for the Seas of East Asia*. [Online] Available at: [http://pemsea.org/eascongress/international-conference/presentation\\_t4-1\\_kim.pdf](http://pemsea.org/eascongress/international-conference/presentation_t4-1_kim.pdf)[Accessed 25 October 2012].

Phadke, A. G. "Synchronized phasor measurements in power systems," IEEE Comput. Appl. Power, vol. 6, no. 2, pp. 10–15, Apr. 1993.

Piroux, 2012. Piroux. [On-line] Available at: <http://www.piroux.com/> [Accessed: 10 October 2012].

PlataformaEdificaciónPassivhaus, 2012. Documentación. [Online] Available at: <http://www.plataforma-pep.org/index.php?page=12>

Poulsen, C., 2012. *Sustainable energy*, "Alternative and renewable energy solutions for buildings Heat Pump intro".

Progensa, 2007. *Instalaciones de Energía solar; Tomo III Sistemas de aprovechamiento térmico I*. 7<sup>th</sup> ed. Spain: Censolar.

Progensa, 2007. *Instalaciones de Energía solar; Tomo IV Sistmas de aprovechamiento térmico II*. 7<sup>th</sup> ed. Spain. Censolar.

Progensa, 2007. *Instalaciones de Energía solar; Tomo V Sistemas de conversion eléctrica*. 7<sup>th</sup> ed. Spain: Censolar.

Protermosolar, 2012. *La energía termosolar*. [Online] Available at: <http://www.protermosolar.com>

Putop, 2009. *Sistemashíbridos: solar-eólico*. [Online] Available at: <http://www.zytechaerodyne.com/sp/product.asp?sortid=240&pid=1&id=487>

Rashford, B. Macsalka, N. Geiger M., 2010. The effect of altitude on small wind turbine power production, University of Wyoming

Ravenbrick, 2009. Smart windows. [Online] Available at: <http://www.ravenbrick.com/default.asp>

RED, n.d. *Recycled Energy Development*. [Online] Available at: [http://www.recycled-energy.com/main/combined\\_heat\\_power.html](http://www.recycled-energy.com/main/combined_heat_power.html) [Accessed 11 November 2012].

RED, n.d. *Recycled Energy Development*. [Online] Available at: [http://www.recycled-energy.com/main/combined\\_heat\\_power.html](http://www.recycled-energy.com/main/combined_heat_power.html) [Accessed 11 November 2012].

Reka, 2012. Reka. [On-line] Available at: <http://www.reka.com/> [Accessed: 7 October 2012].

REN21, Renewable Energy Policy Network for the 21<sup>st</sup> Century, 2012. *Renewables 2012 Global Status Report*. [Online] Available at: [http://www.ren21.net/Portals/97/documents/GSR/GSR2012\\_low%20res\\_FINAL.pdf](http://www.ren21.net/Portals/97/documents/GSR/GSR2012_low%20res_FINAL.pdf) [Accessed 5 November 2012].

Renewable Energy Corporation, 2012. *El futuro de la energía solar*. [Online] Available at: [http://www.recgroup.com/es/Tecnologia/El\\_futuro\\_de\\_la\\_energia\\_solar/](http://www.recgroup.com/es/Tecnologia/El_futuro_de_la_energia_solar/)

Renewable Energy Sources, Antonia V. Herzog, Timothy E. Lipman, Daniel M. Kammen, Energy and Resources Group, Renewable and Appropriate Energy Laboratory (RAEL), University of California, Berkeley, USA

Renewable Energy technologies, Long Term Research in the 6<sup>th</sup> framework program, 2002 | 2006, European Commission Community Research

Renewable UK, 2012. *Renewable UK, The voice of wind & marine energy*. [Online] Available at: <http://www.renewableuk.com/> [Accessed 25 October 2012].

Renovables verdes, 2011. Brasil y un novedoso sistema hibrido solar-eólico. [Online].

Rika, 2012. Rika. [On-line] Available at: <http://www.rika.at> [Accessed: 03 November 2012].

Robert Horbaty, ENCO Energie –Consulting AG, 2007. Proposal for a New Task: Social Acceptance of Wind Energy Projects "Winning Hearts and Minds". [online]. Available at: [http://www.ieawind.org/iea\\_wind\\_pdf/New\\_Task\\_Social\\_Acceptance\\_29\\_10\\_07.pdf](http://www.ieawind.org/iea_wind_pdf/New_Task_Social_Acceptance_29_10_07.pdf) [Accessed: November 9, 2012]

Rock, M. Parson, L., 2010. Offshore wind energy - Fact sheet, Environmental and Energy Study Institute, Washington. Available on the website [http://www.eesi.org/files/offshore\\_wind\\_101310.pdf](http://www.eesi.org/files/offshore_wind_101310.pdf)

Rockwool, *Production process, 2012* [Online] Available at:  
<http://www.rockwool.it/lanadiroccia/processo+produttivo>

Rodriguez Flores, E., 2009. Biomasa. Pellets y briquetas. La Energia, Volumen 2009, pp. 19-24.

SafeguardEuropeLimited, 2006. Flat greenroofs. [Online]Available at:  
[http://www.safeguardeurope.com/applications/green\\_roofs\\_flat.php](http://www.safeguardeurope.com/applications/green_roofs_flat.php)

Samadi, P., Mohsenian-Rad, A., Schober, R., Wong, V. W. S., and Jatskevich, J. "Optimal real-time pricing algorithm based on utility maximization for Smart Grid," in Proc. IEEE Int. Conf. Smart Grid Communications, 2010, pp. 415–420

Sanner, B. et al,2003. *Current status of ground source heat pump and underground thermal energy storage in Europe*. Available at: <http://www.sciencedirect.com/science/article/pii/S0375650503000609> [Accessed in 19/11/12]

Saphon Energy, *Redefining wind.*, 2012. The zero-blade technology. [Internet] Available at:  
<http://www.saphonenergy.com/index.php> [Accessed 13 November 2012]

Schneiderman, R., "Smart Grid represents a potentially huge market for the electricity industry," IEEE Signal Processing Mag., vol. 27, no. 5, pp. 8–15, Sept. 2010.

Seadi, T. et al., 2008. Biogas Handbook. Teodorita Al Seadi. Esbjerg: University of Southern Denmark.

SEAI, 2012. Sustainable Energy Authority of Ireland. [On-line] Available at: [www.seai.ie](http://www.seai.ie)[Accessed: 13 October 2012].

Sengupta, D.L. Senior, T.B.A. & Ferris, J.E., 1983. Television interference measurement near the MOD-2 array at Codnoe Hills, Washington: SERI/STR-211-2086.

Sitiosolar, 2012. *Arquitecturabioclimática*. [Online]Available at:  
<http://www.sitiosolar.com/La%20arquitectura%20bioclimatica.htm>

Solar feed in tariff, 2012. *Denmark*. [Online]Available at: <http://www.solarfeedintariff.net/>

Solar feed in tariff, 2012. *Europemap*. [Electronic print]Available at: <http://www.solarfeedintariff.net/>

Solarpaces, 2009. *Cilindro-parabólico*. [Electronic print]Available at:  
<http://www.solarweb.net/termosolar.php>

Solarsom, 2010. *Agua Caliente Sanitaria*. [Electronic print]Available at: <http://www.solarsom.es/solar-termica/agua-caliente-sanitaria.html>

Solarweb, 2011. *Energía solar termoeléctrica*. [Online]Available at: <http://www.solarweb.net/termosolar.php>

SPD Biogas. Available at: <http://www.spdbiogas.com/normativa-vigente>

Starr, R.J., 2009. *Radiantec solar heating: An idea whose time has come*. [Online]Available at:  
<http://www.radiantsolar.com/index.php>

Statistical Review of World Energy, June 2012, <http://www.bp.com/statisticalreview>

Stephen, N., 2011 Roundtable on Sustainable Biofuels (RSB) paves road into EU [electronic print] Available at: <http://www.greenprospectsasia.com/content/roundtable-sustainable-biofuels-rsb-paves-road-eu> [Accessed 30 October 2012]

Stone Wool Insulation, 2012 [Online] Available at: <http://gcsephysics101t.wikispaces.com/Stone+Wool+Insulation>

Sugimat, 2012. Sugimat. [On-line] Available at: [www.sugimat.com](http://www.sugimat.com) [Accessed: 16 October 2012].

Sun Tyne Solar, 2012. Flat Plate Collector. [Electronic print] Available at: <http://www.suntynesolar.co.uk/story/solar-thermal-how-it-works>

Sunshine, 2012. *Dinamarca logra sus objetivos de energía 8 años antes de lo previsto*. [Online] Available at: <http://www.ison21.es/2012/10/11/dinamarca-logra-sus-objetivos-de-energia-solar-8-anos-antes-de-lo-previsto/>

Sustainable Energy Authority of Ireland, 2012. *Passive Solar / Low Energy Buildings* [Online] Available at: [http://www.seai.ie/Renewables/Solar\\_Energy/Solar\\_Heat/Passive\\_Solar\\_Low\\_Energy\\_Buildings/](http://www.seai.ie/Renewables/Solar_Energy/Solar_Heat/Passive_Solar_Low_Energy_Buildings/) [Accessed 4 November 2012].

Sustainable sources, 2012. *Passive solar design*. [Online] Available at: <http://passivesolar.sustainable-sources.com>

Taylor, D., 2008. *Renewable energy for Uttlesford – Wind energy*, Altechnica

Tedel, 2012. *Impacto ambiental de la energía solar y eólica*. [Online] Available at: [http://tedel.org/nuestroambiente/index.php?option=com\\_content&task=view&id=25&Itemid](http://tedel.org/nuestroambiente/index.php?option=com_content&task=view&id=25&Itemid)

The American Institute of Architects, 2009. *Natural Ventilation*. [Online] Available at: <http://wiki.aia.org/wiki%20pages/natural%20ventilation.aspx>

The Energy Crisis, P. E. HODGSON, Corpus Christi College, Oxford, Spring 2008, Page 140

The European Marine Energy Centre Ltd., 2012. *EMEC Orkney, A global centre of excellence in marine energy testing and research*. [Online] Available at: <http://www.emec.org.uk/> [Accessed 2 November 2012].

The European Wind Energy Association (EWEA), 2005-2012. *Legal Framework for Wind Energy* [online]. Available at: <http://www.ewea.org/policy-issues/legal-framework/> [Accessed: November 7, 2012]

The European Wind Energy Association (EWEA), 2009. *The Economics of Wind Energy* [online]. Available at: [http://www.ewea.org/fileadmin/ewea\\_documents/documents/00\\_POLICY\\_document/Economics\\_of\\_Wind\\_Energy\\_March\\_2009\\_.pdf](http://www.ewea.org/fileadmin/ewea_documents/documents/00_POLICY_document/Economics_of_Wind_Energy_March_2009_.pdf) [Accessed: November 9, 2012]

The European Wind Energy Association (EWEA)., 2005. Brussels, Belgium. [Internet] Available at: <http://www.ewea.org/> [Accessed 13 November 2012]

The European Wind Energy Association (EWEA)., February 2012. *Wind in power 2011 European statistics*. [Internet] Available at: <http://www.ewea.org/> [Accessed 13 November 2012]

The Future of the oil and gas Industry: Past Approches new challenges, Harry J. Longwell, Page 100 to 104

The Green Age, 2012. *The Green Age*. [Online] Available at: <http://www.thegreenage.co.uk/greencommercial/tidal-energy/rance-tidal-power>[Accessed 6 November 2012].

The Modern Green, 2010. Smart windows save energy. [Online] Available at: <http://themoderngreen.com/2010/06/smart-windows-save-energy/>

The Open University, 1999. *Waves, tides and shallow-water processes*. 2 ed. Burlington, MA, USA: Butterworth-Heinemann.

The Way forward on Global Warming, Environment California Research & Policy Center, Summer 2011

Tidal Electric Inc., 2012. *Tidal Electric*. [Online] Available at: <http://www.tidalelectric.com/> [Accessed 28 October 2012].

Troen, I. and Peterson, E. L., 1989. European Wind Atlas, Risoe National Laboratory, Roskilde, Denmark.

Tuck, G. y otros, 2006. The potential distribution of bioenergy crops in Europe under present and future climate. *Biomass & Bioenergy*, 2006(30), pp. 183-197.

Turner, J.A.,2004. Sustainable Hydrogen Production, *Science*, 305 (5686), pp.972-974

U.S. Department of Energy, 2000. Passive solar design. Increase energy efficiency and comfort in homes by incorporating passive solar design features, Technology fact sheet. *Office of building technology, state and community programs energy efficiency and renewable energy*. U.S. department of energy. EEUU, 2000

U.S. Department of Energy, 2011. *Fuel cell technologies program*. (EERE Information Center) (Published January 2011) Available at: <http://www.eere.energy.gov/informationcenter>.

U.S. Department of Energy, 2012. *Solar Swimming Pool Heaters*. [Online] Available at: <http://energy.gov/energysaver/articles/solar-swimming-pool-heaters>

U.S. DOE, n.d. *Department of Energy*. [Online] Available at: [http://fossil.energy.gov/programs/powersystems/turbines/turbines\\_howitworks.html](http://fossil.energy.gov/programs/powersystems/turbines/turbines_howitworks.html)[Accessed 1 November 2012].

U.S. DOE, n.d. *Gulfcoastcleanenergy*. [Online] Available at: <http://www.gulfcoastcleanenergy.org/WhatIsCHP/StateInformation/OtherStates/tabid/1349/Default.aspx> [Accessed 13 November 2012].

UN, Report of the World commission on Environment and Development, Our Common Future, 1987

Unesa, 2012. *Central solar térmica*. [Online] Available at: <http://www.unesa.es/sector-electrico/funcionamiento-de-las-centrales-electricas/1350-central-solartermica>

Unesa, 2012. *Solartermica2*. [Electronic print] Available at: <http://www.unesa.es/sector-electrico/funcionamiento-de-las-centrales-electricas/1350-central-solartermica>

United Nations, 2009. *The Biofuels Market: Current Situation and Alternative Scenarios*. Geneva and New York.

Vail, J., 2005. *A Theory of Power*, iUniverse, Lincoln

Val, 2012. Comofuncionanpanelessolares. [Electronic print] Available at:  
<http://www.hormigasolar.com/paneles-solares-%C2%BFcomo-funcionan/>

Van Thuijl, E., Roos, C. J. & Beurskens, L. W. M., 2003. An overview of biofuel technologies, markets and policies in europe. ECN, 2003(8), pp. 1-64.

Verkuijlen, E. & Westra, C.A., 1984. Shadow hindrance by wind turbines, Proceedings of the European Wind Energy Conference, pp. 356-361.

Vittal, V. "The Impact of Renewable Resources on the Performance and Reliability of the Electricity Grid," US Nat'l Academy of Eng., <http://www.nae.edu/Publications/Bridge/TheElectricityGrid/18587.aspx>, 2010.

Wachtel, A., 2010. Science and curriculum consultant

Wagner, Bareis and Guidati, 1996. Wind turbine noise. Berlin, Germany: Springer-Verlag.

Walker, G., 1980. Stirling Engines. Clarendon Pres, p. 1.

Wanders, 2012. Wanders. [On-line] Available at: <http://www.wanders.com> [Accessed: 6 October 2012].

Wang, Y., 2008. *Parabolic Dish*. [Online] Available at:  
<https://www.mtholyoke.edu/~wang30y/csp/ParabolicDish.html>

Wave Dragon, 2005. *Wave Dragon...for a better future*. [Online] Available at:  
<http://www.wavedragon.net/> [Accessed 2 November 2012].

Weiss, 2012. Weiss GmbH. [On-line] Available at: <http://www.weiss-kessel.de> [Accessed: 03 October 2012].

Wells, J. Electricity Markets—Consumers Could Benefit From Demand Programs, But Challenges Remain. Washington, DC: Government Accountability Office, 2004.

Weron, R. Modeling and Forecasting Electricity Loads and Prices: A Statistical Approach. West Sussex, England: Wiley, 2006.

Wikipedia, 2012. *Energía solar fotovoltaica*. [Online] Available at:  
[http://es.wikipedia.org/wiki/Energ%C3%ADa\\_solar\\_fotovoltaica](http://es.wikipedia.org/wiki/Energ%C3%ADa_solar_fotovoltaica)

Wikipedia, 2012. *Feed in tariff*. [Online] Available at: [http://en.wikipedia.org/wiki/Feed-in\\_tariff#Spain](http://en.wikipedia.org/wiki/Feed-in_tariff#Spain)

Wikipedia, 2012. *Glass wool*. [Online] Available at: [http://it.wikipedia.org/wiki/Lana\\_di\\_vetro](http://it.wikipedia.org/wiki/Lana_di_vetro)

Wikipedia, 2012. *Thermic Insulation in building*. [Online] Available at:  
[http://it.wikipedia.org/wiki/Isolante\\_termico\\_in\\_edilizia](http://it.wikipedia.org/wiki/Isolante_termico_in_edilizia)

World Alliance for Decentralized Energy, 2006. *World Survey of Decentralized Energy*, s.l.: s.n.

World Business Council for Sustainable Development (WBCSD), Publication for World Water Forum in Istanbul, Turkey (March 2009)

WORLD ENERGY OUTLOOK 2012 FACTSHEET



World Environmental Library, 2000. Design for temperate and upland zones. [Online] Available at:  
[http://www.greenstone.org/greenstone3/nzdl;jsessionid=959D1742C82B5ECD8D3D68881A68A6C1?\\_a=d&d=H  
ASH7fb3fd71d302d3efdf64e.4.6&c=envl&sib=1&dt=&ec=&et=&p.a=b&p.s=ClassifierBrowse&p.sa=](http://www.greenstone.org/greenstone3/nzdl;jsessionid=959D1742C82B5ECD8D3D68881A68A6C1?_a=d&d=H ASH7fb3fd71d302d3efdf64e.4.6&c=envl&sib=1&dt=&ec=&et=&p.a=b&p.s=ClassifierBrowse&p.sa=)

Young, H. P., Strategic Learning and Its Limits. London, U.K.: Oxford Univ. Press, 2005.

Zoellner, J., Rau, I. & Schweizer-Ries, P. 2010. Public Acceptance of Biogas Plants. Magdeburg University, Germany.



Master in European Construction Engineering  
2012-2013

