

## The finitely based varieties of graph algebras

KIRBY A. BAKER\*, GEORGE F. MCNULTY\*\* and HEINRICH WERNER

*Dedicated to the memory of András P. Huhn*

### 1. Introduction

SHALLON [17] proposed a method of making graphs into algebras (algebraic systems) for which even a small finite graph can have a rich theory of equations with unusual properties.

Specifically, for any graph  $G$  (possibly with loops at the vertices but without multiple edges), add one new element  $\infty$  to obtain the set  $G^\# = G \cup \{\infty\}$ , and define a binary operation  $*$  on  $G^\#$  by  $x*y = x$  if  $x$  and  $y$  are joined by an edge; and  $x*y = \infty$  otherwise. The *Shallon graph algebra* is the pair  $\mathbf{G}^\# = \langle G^\#; * \rangle$ . Such algebras have been investigated in [9], [12], [14], [15], [16] and [17].

An *equational basis* for an algebra is a list of equations, true in the algebra, of which all equations true in the algebra are logical consequences. LYNDON [7] discovered the surprising fact that a finite algebra may have no finite equational basis. His example had seven elements and one binary operation. MURSKIĬ [10] later found a three-element example. Such algebras are said to be *nonfinitely based*.

SHALLON [17] showed that for the looped graph  $L_3$  of Figure 1,  $\mathbf{L}_3^\#$  is nonfinitely based. She also noted that Murskiĭ's example is  $\mathbf{M}^\#$ , and gave additional examples.

In a further development, PERKINS [13] and MURSKIĬ [11] discovered that some algebras, including Murskiĭ's example, are nonfinitely based in a contagious way: If the algebra in question is a subalgebra or homomorphic image of another finite algebra, then that algebra too is nonfinitely based. More generally, an algebra  $A$  is said to be *inherently nonfinitely based* [13] if  $A$  is contained in some locally finite

---

Received June 20, 1986, and in revised form November 14, 1986.

\* Supported in part by NSF Grant # MCS 81-02519.

\*\* Supported in part by NSF Grant # ISP-11451, a Fulbright-Hays Grant from the Philippine-American Educational Foundation, and a Fellowship from the Alexander von Humboldt Stiftung.

variety but in no finitely based locally finite variety. (A variety is said to be locally finite if its finitely generated members are finite.) In [1], the authors showed that in fact all four graphs of Figure 1 have inherently nonfinitely based graph algebras.

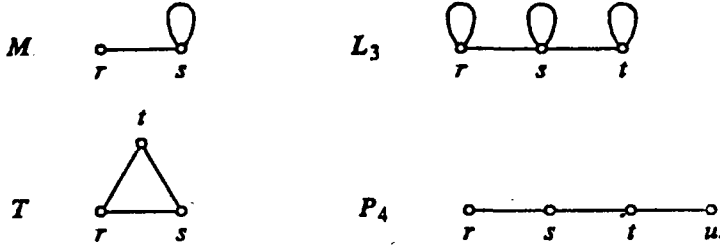

Figure 1

It follows that any graph with one of these four as an induced subgraph also has an inherently nonfinitely based graph algebra.

We obtain the following facts.

1.1. Theorem. *A graph  $G$  has a finitely based graph algebra if and only if  $G$  has no [induced] subgraph isomorphic to one of the four graphs of Figure 1.*

1.2. Corollary. *If a graph algebra is not finitely based, then it is inherently nonfinitely based.*

Indeed, in Section 2 it is shown that the graph algebras of graphs not containing one of the four graphs of Figure 1 are members of a specific variety (Proposition 2.4), and in Section 3 it is shown that all graph algebras in that variety are finitely based (Theorem 3.1). These facts, together with the result quoted from [1], constitute a proof of Theorem 1.1 and Corollary 1.2.

Further, we show that for the specific variety just mentioned, all subvarieties are finitely based. For each of these we give explicit defining equations. The lattice of subvarieties is discussed in Sections 4, 5.

Graph algebras are natural candidates for applying the methods of [1]. They are locally finite and have absorbing elements. Further, it is not hard to show that the variety generated by a class of graph algebras must be locally finite and generated by a single graph algebra. Some interesting algebraic features, such as simplicity and subdirect irreducibility, can be easily discerned by inspection of the graph.

It simplifies the arguments below to consider *augmented graph algebras*. For a graph  $G$ , the corresponding augmented graph algebra, here denoted by  $G^*$ , is obtained from  $G^\#$  by declaring the absorbing element  $\infty$  to be a nullary operation (distinguished constant). We actually prove Theorem 1.1 for the case of augmented graph algebras and then in Section 5 explain the modifications necessary for the unaugmented case.

We denote by  $\langle G \rangle$  the variety generated by the augmented graph algebra  $G^*$ . For each  $k=1, 2, \dots$ ,  $L_k$  and  $P_k$  will denote  $k$ -vertex graphs in the form of a path, with and without loops, respectively, as in the diagrams of  $P_4$  and  $L_3$  in Figure 1. In particular,  $L_1$  is the graph with a single looped vertex and  $P_1$  is the graph with a single unlooped vertex. For graphs  $G$  and  $H$ ,  $G+H$  will denote the disjoint union of  $G$  and  $H$ , with no edges between the two.

In most respects we follow the terminology and notation of [1] and [2]. Additional valuable references are [3] and [8]. We use the notation  $G$  both for a graph and for its vertex set. By a subgraph we always mean an induced subgraph.

The authors are grateful to the referee for detailed suggestions.

## 2. A characterization of graphs with excluded subgraphs

By a *complete* graph we mean a graph in which every two vertices are joined by an edge and in which there is a loop at each vertex. A graph  $G$  is said to be *bipartite-complete* if  $G$  decomposes into two disjoint subsets,  $G=G_0+G_1$ , and there is an edge between every member of  $G_0$  and every member of  $G_1$  but no other edges; in particular, there are no loops.

2.1. Proposition. *For a graph  $G$ , the following conditions are equivalent:*

- (a)  *$G$  has no subgraph isomorphic to  $M$ ,  $T$ ,  $P_4$ , or  $L_3$ ;*
- (b) *each connected component of  $G$  is complete or bipartite-complete.*

Proof. Trivially, (b) $\Rightarrow$ (a). For (a) $\Rightarrow$ (b): Let  $G$  be a connected graph that does not contain  $M$ ,  $T$ ,  $P_4$ , or  $L_3$  as a subgraph. Since  $M$  is not a subgraph of  $G$ ,  $G$  has either no loops at all or a loop at every vertex.

*Case 1:* All vertices of  $G$  have loops. Since  $L_3$  is not a subgraph of  $G$ , any two vertices are connected by an edge and hence  $G$  is complete.

*Case 2:* No vertex of  $G$  has a loop. Since  $T$  and  $P_4$  are not subgraphs of  $G$ , each path of three edges must have an extra edge between its beginning and end vertices, as portrayed in Figure 2.

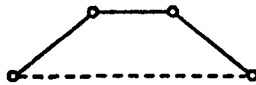

Figure 2

Thus every vertex has an edge to any other vertex at an odd distance, but no edge to any vertex at an even distance. Therefore  $G$  is bipartite-complete.

We shall now need more information about the class of graphs  $G$  whose augmented graph algebras  $G^*$  belong to a given variety  $\mathbf{V}$ . A *groupoid with absorbing*

*element* is an algebra with one binary operation and a nullary operation  $\infty$  that is absorbing for the binary operation.

2.2. Lemma. *Let  $\mathbf{V}$  be a variety of groupoids with absorbing element  $\infty$ . The class of graphs  $G$  with  $G^* \in \mathbf{V}$  is closed under formation of*

- (i) *subgraphs;*
- (ii) *strong homomorphic images;*
- (iii) *Cartesian products;*
- (iv) *disjoint (i.e., disconnected) unions.*

(For a converse see PÖSCHEL and WESSEL [14] and KISS [4]; for related results on digraph algebras see PÖSCHEL [14], [15].)

*Proof.* For (i): If  $H$  is a subgraph of  $G$  then clearly  $H^*$  is a subalgebra of  $G^*$ .

For (ii): Let  $f: G \rightarrow H$  be a strong homomorphism of  $G$  onto  $H$ . In other words,  $f(x)$  is adjacent to  $f(y)$  if and only if  $x$  is adjacent to  $y$ . Extend  $f$  to  $G^*$  by setting  $f(\infty) = \infty$ . Then  $f$  becomes a homomorphism of  $G^*$  onto  $H^*$ .

For (iii): The subset  $B = \{x \in \prod_{i \in I} G_i^* \mid x(i) = \infty \text{ for some } i\}$  defines a congruence  $\Theta = \text{id} \cup (B \times B)$  on  $\prod_{i \in I} G_i^*$ , and  $(\prod_{i \in I} G_i^*)^* \cong (\prod_{i \in I} G_i^*) / \Theta$ .

For (iv): The subset  $C = \{x \in \prod_{i \in I} G_i^* \mid x(i) \neq \infty \text{ for at most one } i\}$  defines a subalgebra of  $\prod_{i \in I} G_i^*$  isomorphic to  $(\sum_{i \in I} G_i)^*$ .

This lemma enables the construction of many augmented graph algebras in a variety  $\mathbf{V}$  containing  $G^*$  for some graph  $G$ .

2.3. Proposition. *Suppose  $\mathbf{V}$  is a variety containing  $G^*$  for some graph  $G$ .*

(a) *If  $G$  contains a connected component that is complete and has at least two vertices, then  $\mathbf{V}$  contains all graphs whose connected components are complete.*

(b) *If  $G$  contains a connected component that is bipartite-complete and has at least three vertices, then  $\mathbf{V}$  contains all graphs whose connected components are bipartite-complete.*

*Proof.* By 2.2-(iv), it suffices to prove that  $\mathbf{V}$  contains all complete graphs in case (a) and all bipartite-complete graphs in case (b).

For (a): By (i)  $\mathbf{V}$  contains  $L_2^*$ . Every complete graph is a subgraph of some power of  $L_2$  and so yields an augmented graph algebra in  $\mathbf{V}$ .

For (b): If  $G$  contains a connected component that is bipartite-complete and has at least three vertices, then by (i)  $\mathbf{V}$  contains  $P_3^*$ .  $P_3 \times P_3$  has the two components  $X$  and  $Q$  of Figure 3, and every bipartite-complete graph is a subgraph of some power of  $Q$ ; hence 2.2-(iii) and 2.2-(i) apply to show that  $\mathbf{V}$  contains every bipartite-complete graph.

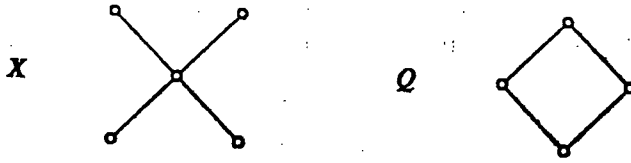

Figure 3

In contrast to Proposition 2.3, these graphs  $G$  have the property that every power of  $G$  has only copies of  $G$  itself as connected components:  $L_1$ ,  $P_1$ , and  $P_2$ .

**2.4. Proposition.** *All augmented graph algebras that are not inherently non-finitely based belong to the variety  $\langle P_2 + L_2 \rangle$ .*

(The converse is true and forms part of Theorem 3.2.)

*Proof.* The variety  $V = \langle P_2 + L_2 \rangle$  contains  $L_2^*$  and therefore contains all complete graphs by Proposition 2.3. By 2.2-(i) and 2.2-(iii),  $V$  contains  $(P_2 \times L_2)^*$ . But  $P_2 \times L_2 \cong Q$ , a bipartite-complete graph of more than two elements, so that  $V$  contains all bipartite-complete graphs by Proposition 2.3. Now, any augmented graph algebra that is not inherently nonfinitely based has components of only these two kinds, by Lemma 2.1; and so is in  $V$  by 2.2-(iv).

### 3. Equations and the finitely based varieties

Since we want to give finite equational bases for the varieties in question, we must examine the evaluations of (groupoid) terms in augmented graph algebras.

Because graph varieties have an absorbing element  $\infty$ , their equations have a particular form:

**3.1. Lemma.** *Let  $V$  be a variety with absorbing element  $\infty$  and  $\sigma = \tau$  an equation true in  $V$ . Then either  $\sigma = \tau$  is a regular equation (i.e., in  $\sigma$  and  $\tau$  the same variables occur) or else the equations  $\sigma = \infty$  and  $\tau = \infty$  also hold in  $V$ .*

*Proof.* Assume some variable  $x$  occurs in  $\sigma$  but not in  $\tau$ . Replace  $x$  by  $\infty$  and leave all other variables unchanged. Then  $\sigma$  evaluates to  $\infty$  and hence  $\tau = \infty$  holds in  $V$ . Since  $\sigma = \tau$  also holds in  $V$ ,  $\sigma = \infty$  follows.

A term  $\tau$  takes the value of its leftmost variable or  $\infty$ , depending on whether or not for each subterm  $\sigma_2 \cdot \sigma_3$  of  $\tau$  the values of the leftmost variables of  $\sigma_2$  and  $\sigma_3$  are connected by an edge in the underlying graph or not.

Here are some simple examples of equations true in every augmented graph algebra; see Figure 4 for illustrations of substitutions that give values other than  $\infty$ :

- (0)  $x\infty = \infty = \infty x$ ,  
 (1)  $xy = (xy)y$ ,  
 (2)  $x(yz) = (xy)(yz)$ ,  
 (3)  $(xy)z = (xz)y$ ,  
 (4)  $xy = x(yx)$ ,  
 (5)  $x((yz)u) = (x(yz))(yu)$ .

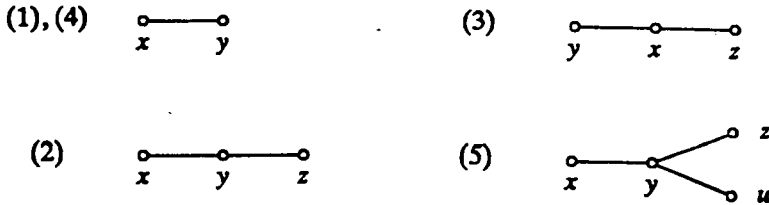

Figure 4

If all vertices of a graph are looped (as in a complete graph) its augmented graph algebra satisfies the *idempotent law*

(id)  $xx = x$ .

However, if no vertex has a loop (as in a bipartite-complete graph) its augmented graph algebra satisfies the *nilpotent law*

(np)  $xx = yy$ .

These two laws are contradictory, in the sense that they together imply  $x=y$ , the equation of the trivial variety.

Additional equations true in  $P_2^*$  and  $L_2^*$  are these; illustrations giving values other than  $\infty$  are shown in Figure 5.

- (6)  $x(yzu) = (x(yz))(uz)$ ,  
 (7)  $(x(yz))(uv) = (x(yv))(uz)$ ,  
 (8)  $x(xy) = x(yy)$ ,  
 (9)  $(xx)(yz) = (x(yy))(zz)$ .

(The proofs are omitted. The solid edges in the graph diagrams are edges that must exist in order that the terms have values given by their leftmost variables.)

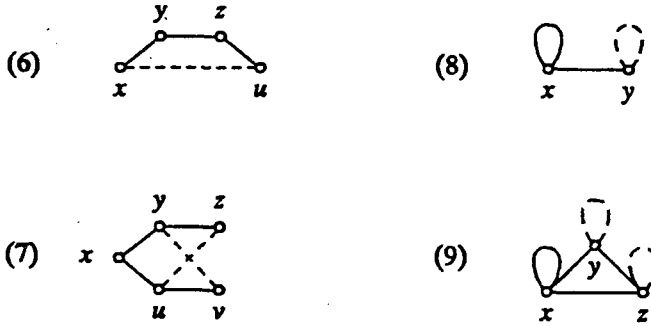

Figure 5

Another useful consequence of these equations is that

$$(10) \quad x(yy) \stackrel{(1)}{=} x(yy)(yy) \stackrel{(9)}{=} (xx)(yy) \stackrel{(4)}{=} (x(xx))(yy).$$

The difficulty with varieties generated by graph algebras, augmented or not, is that most algebras in such varieties are *not* graph algebras. For example, the product of graph algebras is typically not a graph algebra. Thus in order to find an equational base for the variety generated by a graph algebra it is not sufficient to consider graph algebras alone (augmented or not). Our strategy will be as follows:

Step 1: Give a finite generator  $G^*$  of the variety.

Step 2: Give a description of (possibly) all augmented graph algebras in the variety.

Step 3: Give a finite set of equations true in  $G^*$  (the hoped-for equational base).

Step 4: Use the equations of Step 3 to find a normal form for all groupoid terms.

Step 5: Determine all equations between normal forms not derivable from the equations of Step 3 and show that they fail in  $G^*$ .

Note that if  $G$  has two connected components  $G_0$  and  $G_1$ ,  $G = G_0 + G_1$ , then an equation holds in  $G^*$  if and only if it holds both in  $G_0$  and in  $G_1$ .

3.2. Theorem: Let  $\mathbf{V}$  be the variety  $\langle P_2 + L_2 \rangle$ .

(a)  $G^* \in \mathbf{V}$  if and only if all connected components of  $G$  are complete or bipartite-complete.

(b) The equations (0)—(9) form an equational base for  $\mathbf{V}$ .

(c) By using the equations (1)—(9), every term in which  $\infty$  does not occur can be transformed into one of the normal forms

- (i)  $x$  (one variable),
- (ii)  $x_1(x_1x_1)(x_2x_2) \dots (x_nx_n)$ ,  $n \geq 1$ ,
- (iii)  $x_1(y_1x_1)(y_2x_2) \dots (y_nx_n)$ ,  $n \geq 1$ ,  $\{x_1, \dots, x_n\} \cap \{y_1, \dots, y_n\} = \emptyset$ ,

where  $u_1 u_2 \dots u_n = (\dots (u_1 u_2) u_3 \dots) u_n$  (association from the left). In type (iii) the variables  $x_1, \dots, x_n$  will be referred to as bottom variables and  $y_1, \dots, y_n$  will be referred to as top variables.

(d) A regular equation  $\tau = \sigma$  is derivable from (0)–(9) if and only if both sides have the same normal form, the same leftmost variable, and the same top and bottom variables (in the case of type (iii)) or both sides have an occurrence of  $\infty$ .

(e) An equation not derivable from (0)–(9) fails in  $(P_2 + L_2)^*$ .

*Proof.* The “if” direction of (a) is clear by previous reasoning and the “only if” direction follows from the rest of the theorem, since by Proposition 2.1 every other graph is inherently nonfinitely based and hence cannot be a member of the locally finite and finitely based variety  $\mathbf{V}$ .

The condition (b) follows from (c)–(e) and the fact that (0)–(9) hold in  $(P_2 + L_2)^*$ .

For (c): First we show that the terms of the form  $x(u_1 v_1) \dots (u_n v_n)$  ( $n \geq 0$ ) are closed under multiplication (in the presence of (0)–(10)): Write  $\rho = x(u_1 v_1) \dots (u_n v_n)$  and  $\sigma = y(r_1 s_1) \dots (r_m s_m)$ . By using (3) repeatedly we have  $\rho\sigma = x[y(r_1 s_1) \dots (r_m s_m)](u_1 v_1) \dots (u_n v_n)$ . If  $m=0$ , we use (4) to replace  $xy$  by  $x(yx)$ , and we are done. If  $m > 0$  then

$$\begin{aligned} x[y(r_1 s_1) \dots (r_m s_m)] &\stackrel{(6)}{=} x[y(r_1 s_1) \dots (r_{m-1} s_{m-1}) r_m] (s_m r_m) \stackrel{(8)}{=} \\ &\stackrel{(8)}{=} x[y r_m (r_1 s_1) \dots (r_{m-1} s_{m-1})] (s_m r_m) = \dots = x[y r_1 \dots r_m] (s_1 r_1) \dots (s_m r_m). \end{aligned}$$

By an induction on  $m$  using (5), (3) and (1), we obtain that  $x[y r_1 \dots r_m] = x(y r_1) \dots (y r_m)$  for  $m \geq 1$ . Thus  $\rho\sigma$  is reduced to the desired form.

Since terms equivalent to terms of the desired form include the variables and are closed under multiplication, we conclude that any term  $\tau$  without  $\infty$  can be written in the form  $x(u_1 v_1) \dots (u_n v_n)$ , where  $x, u_1, v_1, \dots, u_n, v_n$  are the variables occurring in  $\tau$ .

By equation (7) we can freely interchange the  $v_1, \dots, v_n$  and then by (3) and (7) together we also can interchange the  $u_1, \dots, u_n$  among each other. If some  $u_i = v_j$  we can use (3) and (7) to obtain  $u_i = v_i$  and then thence

$$x(u_1 u_1)(u_2 v_2) \dots (u_n v_n) = x(u_1 u_1)(u_2 u_2)(v_2 v_2) \dots (u_n u_n)(v_n v_n),$$

as follows:  $x(u_1 u_1)(u_2 u_2)(v_2 v_2) \stackrel{(9)}{=} ([x(u_1 u_1)][x(u_1 u_1)])(u_2 v_2)$ , and the computation of multiplicative closure given above shows that

$$[x(u_1 u_1)][x(u_1 u_1)] = x(xu_1)(u_1 u_1) \stackrel{(8)}{=} x(u_1 u_1)(u_1 u_1) \stackrel{(10)}{=} x(u_1 u_1).$$

Moreover, by (10),  $x(u_1 u_1) = x(xx)(u_1 u_1)$ , and therefore we may assume  $x = u_1$ . By (1) we may also assume that all the variables are distinct. If some  $u_i = x$ ,



we can use (8) to obtain  $u_i=v_i$  for some  $i$ . Hence in these cases we arrive at normal form (ii).

Now we may assume  $\{u_1, \dots, u_n\} \cap \{v_1, \dots, v_n\} = \emptyset$  and  $x \notin \{u_1, \dots, u_n\}$ . By (2) and (4),  $x(u_1 v_1) = (x u_1)(u_1 v_1) = x(u_1 x)(u_1 v_1)$ , so we may assume  $x \in \{v_1, \dots, v_n\}$ , say  $x = v_1$ . Thus in this case  $\tau$  reduces to normal form (iii). It is not always possible to remove all duplications of variables; however, if there are duplications both among the top variables and among the bottom variables we can remove them using (3), (7) and (1). Furthermore, the following reasoning shows that duplications among the  $u_1, \dots, u_n$  can be arranged so that only  $u_1$  is duplicated, and similarly for  $v_1, \dots, v_n$ :

$$\begin{aligned} x(u_1 v_1)(u_1 v_2)(u_3 v_3) &\stackrel{(1)}{=} x(u_1 v_1)(u_1 v_2)(u_3 v_3) \stackrel{(7)}{=} \\ &\stackrel{(7)}{=} x(u_1 v_3)(u_1 v_3)(u_3 v_1)(u_3 v_2) \stackrel{(1)}{=} x(u_1 v_3)(u_3 v_1)(u_3 v_2) \stackrel{(7)}{=} x(u_1 v_1)(u_3 v_2)(u_3 v_3). \end{aligned}$$

This reasoning already provides a proof for the “if” direction of (d), while the “only if” direction follows from (e).

For (e): By Lemma 3.1 we need consider only equations  $\sigma = \infty$  and regular equations  $\sigma = \tau$  in which  $\infty$  does not occur.

*Case 1:* Let  $\sigma = x$  be a regular equation with  $\sigma$  of type (ii) or (iii). Then  $\sigma = x(x x) = x x$  by (1) and (4) and hence the equation  $\sigma = x$  is equivalent to the idempotent law  $x = x x$ , which holds in  $L_2^*$  but fails in  $P_i^*$  ( $i = 1, 2, 3$ ).

*Case 2:* Let  $\sigma = \tau$  be a regular equation with  $\sigma$  and  $\tau$  of type (ii). If  $\sigma = \tau$  is not derivable from (0)–(9) then  $\sigma$  and  $\tau$  must have different leading variables  $x$  and  $y$ . Replacing all other variables by  $x$  we derive the equation  $x(x x)(y y) = y(y y)(x x)$ , which is equivalent to  $x(y y) = y(x x)$ , by (10). The equation  $x(y y) = y(x x)$  clearly implies every regular equation  $\sigma = \tau$  in which both  $\sigma$  and  $\tau$  are of type (ii).  $x(y y) = y(x x)$  is true in  $P_i^*$  ( $i = 1, 2, 3$ ) and in  $L_1^*$  but not in  $L_2^*$ .

*Case 3:* Let  $\sigma = \tau$  be a regular equation with  $\sigma$  of type (iii) and  $\tau$  of type (ii). Substitute  $x$  for each bottom variable and  $y$  for each top variable of  $\sigma$ . Then  $\sigma = x(y x) = x y$  and  $\tau = x(x x)(y y) = x(y y)$  or  $\tau = y(x x)(y y) = y(x x)$  (see Case 2), and hence we can derive  $x y = x(y y)$  or  $x y = y(x x)$ . From  $x y = x(y y)$  we can derive the associative law:

$$\begin{aligned} x(y z) &\stackrel{(2)}{=} (x y)(y z) = x(y y)(y z) \stackrel{(10)}{=} x(y y)(y y)(z z) = x(y y)(z z) = (x y)(z z) \stackrel{(3)}{=} \\ &\stackrel{(3)}{=} (x(z z)) y = (x z) y \stackrel{(3)}{=} (x y) z \end{aligned}$$

and conversely the associative law implies  $x y \stackrel{(1)}{=} (x y) y = x(y y)$ .  $x y = x(y y)$  holds in  $P_1^*$  and in  $L_2^*$  but not in  $P_2^*$  and  $L_3^*$ . On the other hand, from  $x y = y(x x)$  we can derive the commutative law:

$$x y = y(x x) \stackrel{(1)}{=} (y(x x))(x x) \stackrel{(8)}{=} (y(y x))(x x) \stackrel{(6)}{=} y(y(x x)) = y(x y) \stackrel{(4)}{=} y x.$$

Then  $x y = y x = x(y y)$ , as before.

*Case 4:* Let  $\sigma = \tau$  be a regular equation with  $\sigma, \tau$  of type (iii). If  $\sigma$  and  $\tau$  have different top and bottom variables the same substitution as in Case 3 will lead to an equation  $xy = x(yy) \dots$  or  $xy = y(xx) \dots$  and we are in Case 3. Since  $\sigma = \tau$  is not derivable from (0)–(9) and since we assume that top and bottom variables coincide, the leading variables must be different, say  $x$  and  $z$ . Substitute  $y$  for all top variables and  $x$  for all bottom variables different from  $z$  and obtain from  $\sigma = \tau$  the equation

$$x(yz) \stackrel{(2)}{=} (xy)(yz) = x(yx)(yz) = z(yx)(yz) \stackrel{(2)}{=} z(yx)$$

which in turn obviously implies  $\sigma = \tau$ .  $x(yz) = z(yx)$  fails in  $P_3^*$  and  $L_2^*$  but holds in  $P_2^*$  and  $L_1^*$ .

*Case 5:* Let  $\sigma = \infty$  be an equation such that  $\infty$  does not occur in  $\sigma$ . By substituting  $x$  for all variables in  $\sigma$  we obtain the equation  $xx = \infty$  or even  $x = \infty$ . These equations fail to hold in  $L_2^*$ . If  $\sigma$  has a normal form of type (iii), by substituting  $x$  for all the bottom variables and  $y$  for all the top variables, we can obtain  $xy \stackrel{(4)}{=} x(yx) \stackrel{(2)}{=} \sigma = \infty$ . Note that  $x = \infty \Rightarrow xy = \infty \Rightarrow xx = \infty$ , and moreover that  $x = \infty \Leftrightarrow x = y$ ,  $xy = \infty \Leftrightarrow xy = zz$ , and  $xx = \infty \Leftrightarrow xx = yy$ .

This completes the proof of (e) and the whole theorem.

The preceding proof was a bit more elaborate than actually needed because we want next to classify the subvarieties of  $\mathbf{V}$  and therefore need a classification of all possible equations, as given in the proof.

#### 4. The lattice of finitely based subvarieties

4.1. Theorem. *The lattice of all subvarieties of  $\mathbf{V} = \langle P_2 + L_2 \rangle$  is as given in Figure 6.*

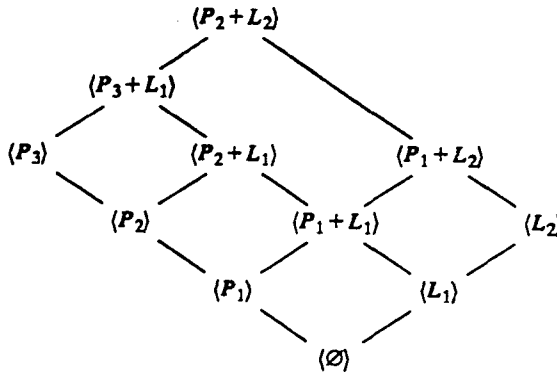

Figure 6

These varieties have the following equational bases:

- $\langle P_2 + L_2 \rangle$ : (0)—(9);  
 $\langle P_3 + L_1 \rangle$ : (0)—(9),  $x(yy) = y(xx)$ ;  
 $\langle P_3 \rangle$ : (0)—(9),  $xx = yy$ ;  
 $\langle P_2 \rangle$ : (0)—(9),  $xx = yy$ ,  $x(yz) = z(yx)$ ;  
 $\langle P_1 \rangle$ : (0),  $xy = uz$ ;  
 $\langle \emptyset \rangle$ :  $x = y$ ;  
 $\langle P_2 + L_1 \rangle$ : (0)—(9),  $x(yz) = z(yx)$ ;  
 $\langle P_1 + L_2 \rangle$ : (0)—(9),  $x(yz) = (xy)z$ ;  
 $\langle P_1 + L_1 \rangle$ : (0),  $x(yz) = (xy)z$ ,  $xy = yx$ ,  $xy = x(yy)$ ;  
 $\langle L_2 \rangle$ : (0),  $x(yz) = (xy)z$ ,  $xx = x$ ,  $x(yz) = x(zy)$ ;  
 $\langle L_1 \rangle$ : (0),  $x(yz) = (xy)z$ ,  $xx = x$ ,  $xy = yx$ .

**Proof.** From the proof of Theorem 3.1 we can deduce the following classification of equations not derivable from (0)—(9).

(a) Each equation  $\sigma = \infty$  not derivable from (0)—(9) is equivalent to one of  $x=y$ ,  $xy=zz$ , or  $xx=yy$ .

(b) Each regular equation  $x=\tau$  is equivalent to  $xx=x$ .

(c) Each regular equation  $\sigma=\tau$  with both sides of type (ii) is equivalent to  $x(yy)=y(xx)$ .

(d) Each regular equation  $\sigma=\tau$  with both sides of type (iii) with the same top and bottom variables is equivalent to  $x(yz)=z(yx)$ .

(e) Each of the remaining regular equations  $\sigma=\tau$  implies  $xy=x(yy)$  or even  $xy=y(xx)$ . The first of these implies every regular equation  $\sigma=\tau$  with the same leading variable, because  $xy=x(yy) \Leftrightarrow x(yz)=(xy)z$ . The second of these implies every regular equation  $\sigma=\tau$ , because  $xy=y(xx) \Leftrightarrow (x(yz)=(xy)z \ \& \ xy=yx)$ .

This reasoning shows that every equation not derivable from (0)—(9) is equivalent in the presence of (0)—(9) to one of the equations  $x=\infty$ ,  $xy=\infty$ ,  $xx=\infty$ ,  $xx=x$ ,  $x(yy)=y(xx)$ ,  $xy=x(yy)$ ,  $xy=y(xx)$ ,  $x(yz)=z(yx)$ . Moreover, between these we have the implications necessary to yield the diagram claimed by the theorem, when it is further observed that

$$\begin{aligned}
 &xx = \infty \text{ and } xy = x(yy) \text{ imply } xy = \infty, \\
 &xx = \infty \text{ and } xx = x \text{ imply } x = \infty, \text{ and} \\
 &x(yy) = y(xx) \text{ and } xx = x \text{ imply } xy = yx.
 \end{aligned}$$

**4.2. Corollary.** For any graph  $G$  either  $G^*$  is inherently nonfinitely based or else  $G^*$  is finitely based and generates one of the eleven varieties in Theorem 4.1.

5. Graph algebras versus augmented graph algebras

The situation for augmented graph algebras is now clear. To obtain similar results for graph algebras only a little more work is needed. By removing (0) from all the bases given in Theorem 4.1 and taking  $[G]$  to mean the variety generated by  $G^\#$ , analogously to  $\langle G \rangle$  for  $G^*$ , the arguments given above yield eleven finitely based subvarieties of  $[P_2 + L_2]$ .

However, the analysis of the nonregular equations not derivable from (1)—(9) must now be done without the help of 3.1 and (0). It turns out that there are only three additional nonregular equations:  $x=xy$ ,  $xx=xy$ , and  $xx=x(yy)$ . In the presence of (0) and in all graph algebras  $x=xy$  is equivalent to  $x=y$  and  $xx=xy$  is equivalent to  $xy=zz$ . In the presence of (0) and (4) and in all graph algebras  $xx=x(yy)$  is equivalent to  $xx=yy$ . However, (1)—(9) are not sufficient to establish any of these equivalences. There are, in fact, three additional subvarieties of  $[P_2 + L_2]$ :

- $U_0$ , based on  $x = xy$ ,
- $U_1$ , based on  $xx = xy$ ,
- $U_2$ , based on (1)—(9) and  $xx = x(yy)$ .

These new varieties are not generated by graph algebras. In the case of graph algebras we obtain the lattice of Figure 7.

We deduce an analogue of Corollary 4.2 for graph algebras:

5.1. Corollary. *Let  $G$  be any graph. If  $G$  has an induced subgraph isomorphic to one of  $M, T, P_4$ , or  $L_3$ , then  $[G]$  is inherently nonfinitely based. Otherwise,  $[G]$  is one of the eleven finitely based varieties generated by graph algebras and appears in Figure 7.*

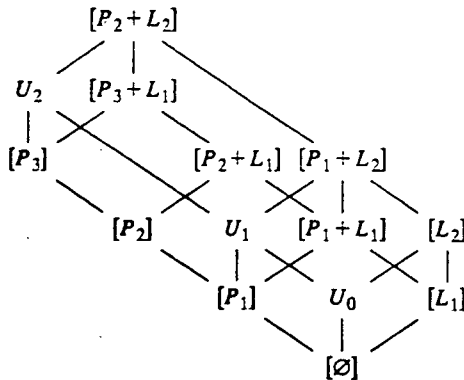

Figure 7

## References

- [1] K. A. BAKER, G. McNULTY and H. WERNER, Shift-automorphism methods for inherently nonfinitely based varieties of algebras, preprint.
- [2] S. BURRIS and H. P. SANKAPPANAVAR, *A Course in Universal Algebra*, Graduate Texts in Mathematics, v. 78, Springer-Verlag (New York, 1981).
- [3] G. GRÄTZER, *Universal Algebra*, 2nd ed., Springer-Verlag (New York, 1979).
- [4] J. JEŽEK, Nonfinitely based three-element idempotent groupoids, *Algebra Universalis*, **20** (1985), 292—301.
- [5] B. JÓNSSON, *Topics in Universal Algebra*, Lecture Notes in Mathematics, vol. 250, Springer-Verlag (New York, 1972).
- [6] E. KISS, A note on varieties of graph algebras, in: *Proceedings of the Charleston Conference on Universal Algebra and Lattice Theory* (S. Comer, ed.), Lecture Notes in Mathematics, vol. 1149, Springer-Verlag (New York, 1985); pp. 163—166.
- [7] R. LYNDON, Identities in finite algebras, *Proc. Amer. Math. Soc.*, **5** (1954), 8—9.
- [8] G. McNULTY, How to construct finite algebras which are not finitely based, in: *Proceedings of the Charleston Conference on Universal Algebra and Lattice Theory* (S. Comer, ed.), Lecture Notes in Mathematics, vol. 1149, Springer-Verlag (New York, 1985); pp. 167—174.
- [9] G. McNULTY and C. SHALLON, Inherently nonfinitely based finite algebras, in: *Universal Algebra and Lattice Theory* (R. Freese and O. Garcia, eds.), Lecture Notes in Mathematics, vol. 1004, Springer-Verlag (New York, 1983); pp. 206—231.
- [10] V. L. MURSKIĬ, The existence in three-valued logic of a closed class with finite basis not having a finite complete set of identities, *Dokl. Akad. Nauk. SSSR*, **163** (1965), 815—818; English Translation: *Soviet Math. Dokl.*, **6** (1965), 1020—1024.
- [11] V. L. MURSKIĬ, On the number of  $k$ -element algebras with one binary operation without a finite basis of identities, *Problemy Kibernet.*, **35** (1979), 5—27.
- [12] S. OATES-WILLIAMS, Graphs and universal algebras, in: *Combinatorial Mathematics VIII* (K. MacAvaney, ed.), Lecture Notes in Mathematics, vol. 884, Springer-Verlag (New York, 1981); pp. 351—354.
- [13] P. PERKINS, Basis questions for general algebras, *Algebra Universalis*, **19** (1984), 16—23.
- [14] R. PÖSCHEL, Graph varieties, preprint.
- [15] R. PÖSCHEL, Graph algebras and graph varieties, preprint.
- [16] R. PÖSCHEL and W. WESSEL, Classes of graphs which can be defined by equations in their graph algebras, preprint.
- [17] C. SHALLON, *Nonfinitely Based Finite Algebras Derived from Lattices*, Ph. D. dissertation, UCLA, 1979.

(K. A. B.)  
 DEPARTMENT OF MATHEMATICS  
 UNIVERSITY OF CALIFORNIA  
 LOS ANGELES, CA 90024, USA

(G. F. M.)  
 DEPARTMENT OF MATHEMATICS  
 UNIVERSITY OF SOUTH CAROLINA  
 COLUMBIA, SC 29208, USA

(H. W.)  
 FB 17 MATHEMATIK  
 GESAMTHOCHSCHULE  
 3500 KASSEL, BRD