

Mini course

On the Syntax & Semantics of Aspect



Dr María J. Arche
University of Greenwich

University of Southampton, 19th January 2018

Plan

1. What is Aspect?
2. The analysis of Aspect: a syntactic referential approach
3. Some of the recent revisions of the theory
4. Questions and conversation

As for the approach

❖ The **rationale** and **mechanics** of the system

- How the system works
 - Components
 - How they operate - based on independent principles of the grammar
- How it has looked like so far and how it is being revised now
 - Coping with nuances & Principled
- So you can see how you can exploit it for your purposes
 - And enrich it and modify it

Aspect --Viewpoint Aspect

- Part of language
- Linguistic category that gives us *temporal information*
- Not the only one.
- Temporal information is crucial for adequate communication
 - When we speak, we describe **situations**

- We need to know *when* they happen before we speak, as we speak, after we speak.
 - Time is segmentable in intervals.
 - We **order** them
 - Vantage point of reference: Speech Time
- We need to know whether they are finished or still ongoing or about to occur



TENSE



ASPECT

Viewpoint Aspect

- | | |
|---------------------------------|-----------------------|
| 1) John kissed Mary. | <i>Finished</i> |
| 2) John was kissing Mary. | <i>Ongoing</i> |
| 3) John was about to kiss Mary. | <i>About to start</i> |

- All situations before the Utterance Time “past”.
- Each situation *in a different moment of its internal life*.
- The status of the internal life of the situation is what is captured by
 - “Viewpoint Aspect”
 - “Grammatical Aspect”
 - “Outer Aspect”

Viewpoint Aspect

- Semantic piece, semantic category –
it has an impact on **interpretation**.
- Syntactically represented because it is sensitive to structure.

Viewpoint Aspect -- Formalization

- Steer clear of metaphorical descriptions:
 - Open/closed intervals. Comrie 1976
 - Intervals viewed from the outside, the inside, through a lens. Smith 1991
- How can the semantic content of Aspect be defined in formal terms? What does Aspect have inside? What is it? What is its nature?

Viewpoint Aspect -- Formalization

- 4) When Tim opened the door, John was kissing Mary.
- 5) When Tim opened the door, John kissed Mary.

Tim opening the door x
John kissing Mary /

- Are *ordered* in a different manner depending on their Aspect:

4') -----///x///-----
5') -----x-/----

Therefore: Aspect also contributes to *temporal ordering* → it is a ordering predicate

The System – Main properties

- If it contributes to ordering in time, it cannot be so different from Tense
 - Intuitively appealing to say they have the same primitives; accounted for in a similar manner.
 - Klein 1994; Hale 1986; Stowell 1993; Demirdache & Uribe-Etxebarria 2000.
 - What do Tense and Aspect order? Intervals of time.
 - What is the nature of these intervals? Pronominal
- Tense and Aspect subject to the principles that regulate reference

The referential approach to Tense & Aspect

- Partee 1973
- Enç 1987
- Stowell 1993, ss.

- Klein 1994 and ss
- Demirdache & Uribe-Etxebarria 2000 and ss

The referential approach to Tense & Aspect

- History; overcoming flaws of logic
- Sentential operator designating the time at which the truth is to be evaluated
 - Tense logic (Prior 1957; Montague 1973)
 - Incorrect interpretations
 - Partee 1973

6) I didn't turn off the stove. NEG>PAST; PAST>NEG

6') There is no time in the past in which I turned off the stove

6'') There is at least one time in the past at which I didn't turn off the stove

The referential approach to Tense & Aspect

- Intended interpretation: particular time in the past.
- Tense can denote the particular time of an event or situation.
- Tenses can refer to a salient time; they can co-refer, they can be anaphoric.
- **Tenses are analogous to pronouns.**
- Temporal relations can be defined using the same tools as those for pronouns.

The referential approach to Tense & Aspect

- Analogy between temporal and nominal categories
- Proving/probing into the types of relations that temporal categories enter in, the relations that they establish, we can learn the kind of elements tense and aspect are.
- Analytical tool to investigate different languages:
 - E.g., whether they have tenses

The referential approach to Tense & Aspect

- Tenses refer to times.
- Tense *orders*; interpretation relative to a given interval.
- Stowell captures both intuitions

S
T
O
W
E
L
L

9
3

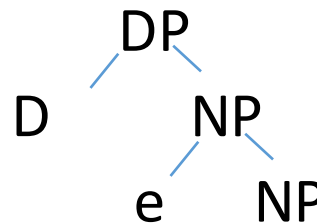
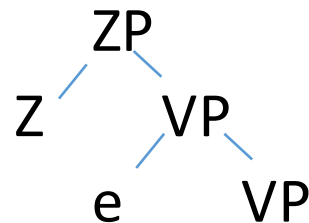
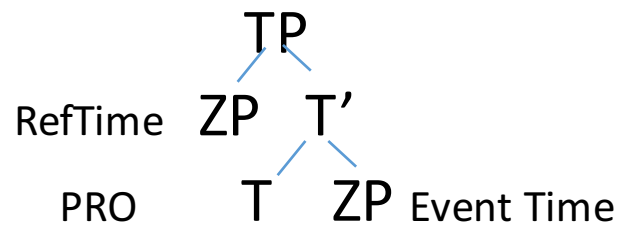

- **ZP *Zeit* Phrase 'time'**
- Tense: orders; like prepositions (before, after)
- ZPs are the intervals analogous to pronouns

The referential approach to Tense & Aspect

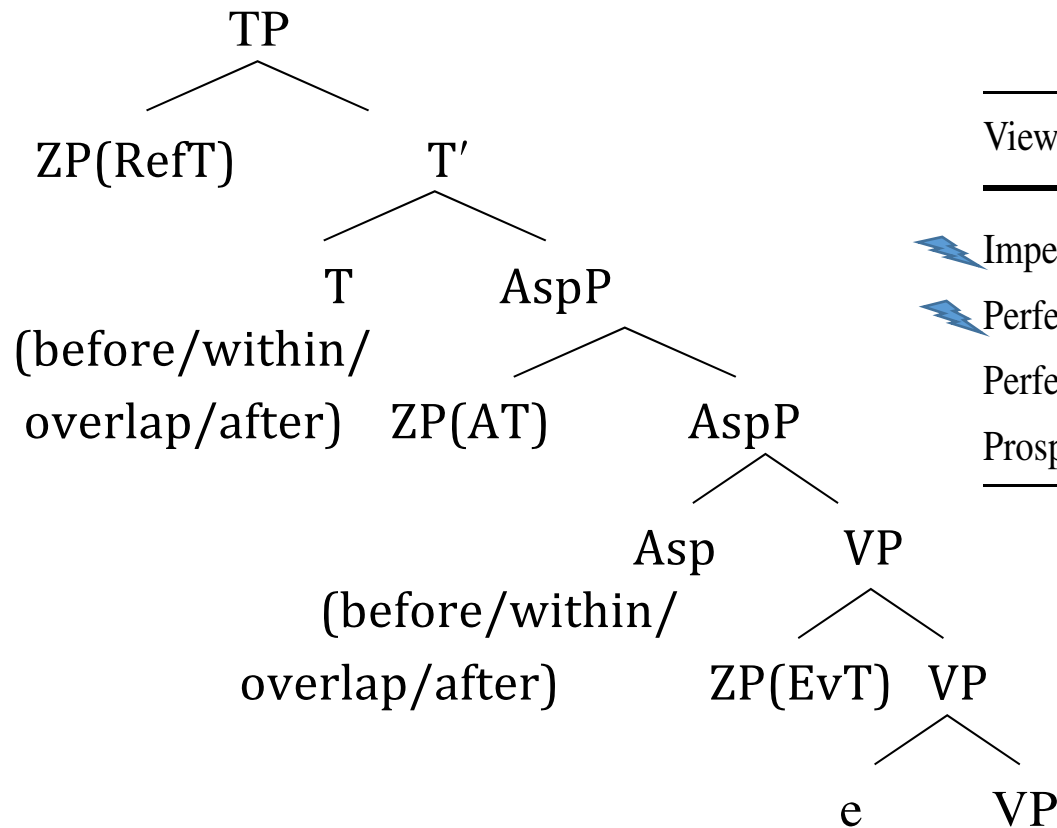

Viewpoints

Predicate

⚡ Imperfective

AT (WITH)IN EvT

⚡ Perfective

AT (Total) OVERLAP EvT

Perfect

AT AFTER EvT

Prospective

AT BEFORE EvT

The referential approach to Tense & Aspect

7) Juan washed the car.

-----wash the car-----Utterance Time

8) Maria said that Juan washed the car.

-----wash ----say---- Utterance Time

- The reference of the RefT (the time wrt we order) is affected by syntactic conditions.
- Bound/controlled by the closest c-commanding interval.
- Tree:

Complement clauses

Maria said that John washed the car

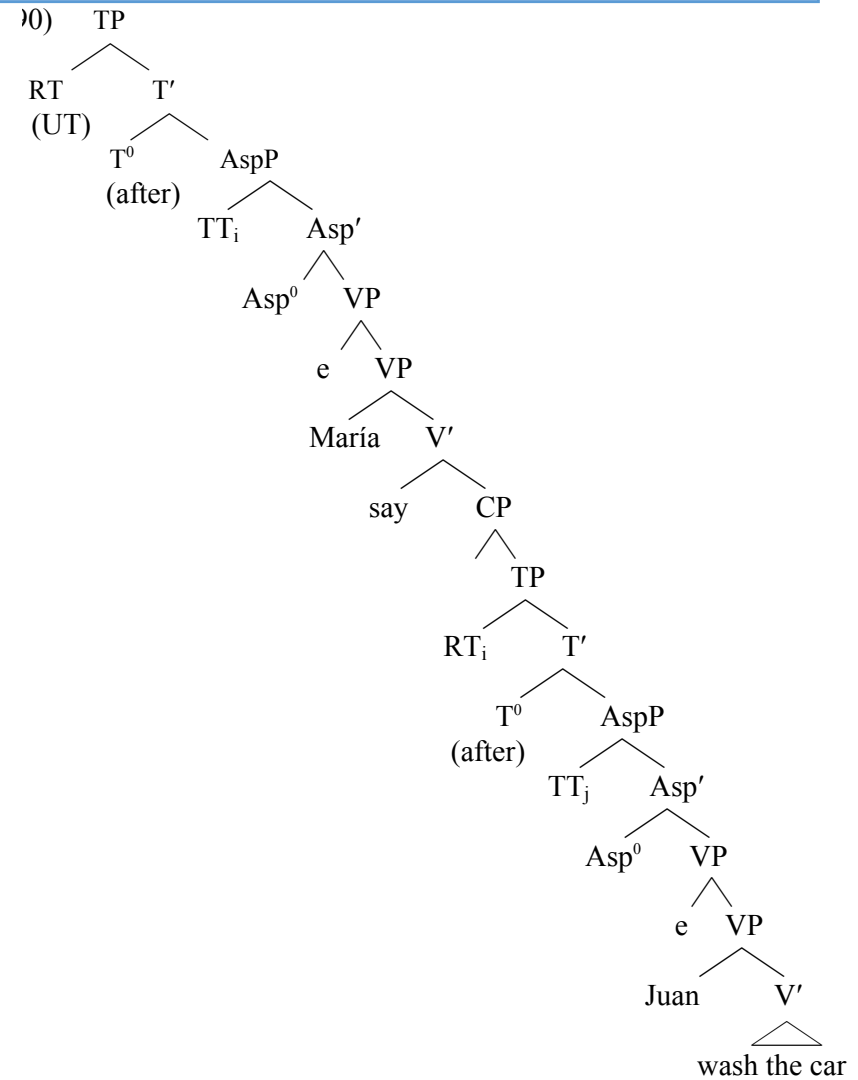

The referential approach to Tense & Aspect

9) John looked for a girl who danced at the party.

9') look for > a(ny) girl *de dicto* narrow scope

9'') a girl > look for *de re* wide scope

- Ladusaw 1977
- Abusch 1988
- Stowell 1993

• Narrow scope -----dance----look for

• Wide scope a. -----dance----look for

b. -----look for----dance

c. -----look for----UTT

-----dance----UTT

Past meaning future?

Relative Clauses Independent reading

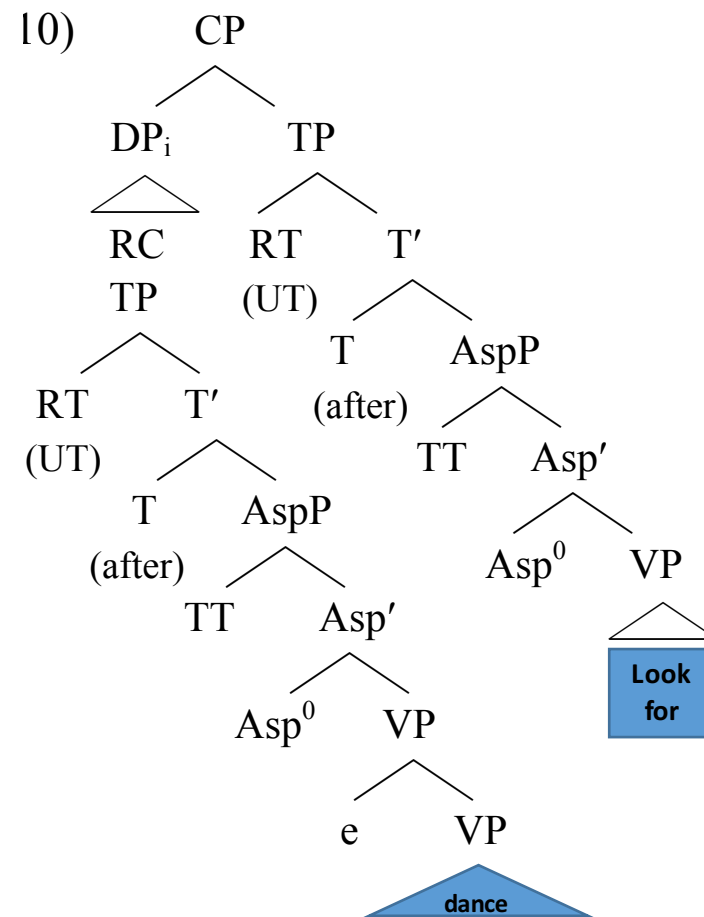

Topic Times and Event Times

- Is the whole ZP event Time ordered with respect to another interval?
- Or, rather, the time the speaker makes an assertion to?

11) When Tim opened the door, John was kissing Mary.

- The whole *John kissing Mary* – left in the dark
- How much of the time of the kissing is asserted?
- The bit that overlaps with *Tim opening the door*.
- Klein 1994 -- Topic Time / Assertion Time AT
- Topic Time > as a ZP

Really?

The referential approach to Tense & Aspect

(11') When Tim opened the door, John was kissing Mary. *It was 11 hours 2 seconds in the morning.*

It = when Tim opened the door = 11 hours 2 seconds in the morning.

It = TT; "it" picks out the TT.

We know John was kissing Mary for the time that overlaps with 11 hours 2 seconds in the morning.

The contribution of Aspect to Temporal Ordering

- If Aspect exists a predicate that takes intervals as its arguments, we should be able to see its contribution to temporal ordering.

Two classical puzzles

Arche 2010

12 John said that Bill was depressed.

(1.1.) Bill's depression locates at a time prior to Bill's saying

(1.2.) Bill's depression overlaps with John's saying

13 John said that Bill is depressed.

Bill's depression is understood as overlapping with the time of John's saying AND with the utterance time.

Questions throughout the years

- How can a past interval be understood as located in two different points in time?
 - Traditional answer: overlapping interpretation corresponds to a semantics where there is 'no past', but present.
- If present tense refers to the present moment, the utterance time per excellence, how come can a present tense form be understood as overlapping with a past interval?

In common

- The cases in (12) and (13) have the same underlying question in common: how can these forms refer to intervals that seem not to be the ones they should be referring to?
- Can past mean something other than 'past'?
- Can present mean 'past'?
- Why only under certain circumstances?

Non uniformity of Tense

Sequence of Tense Account (Stowell 1993)

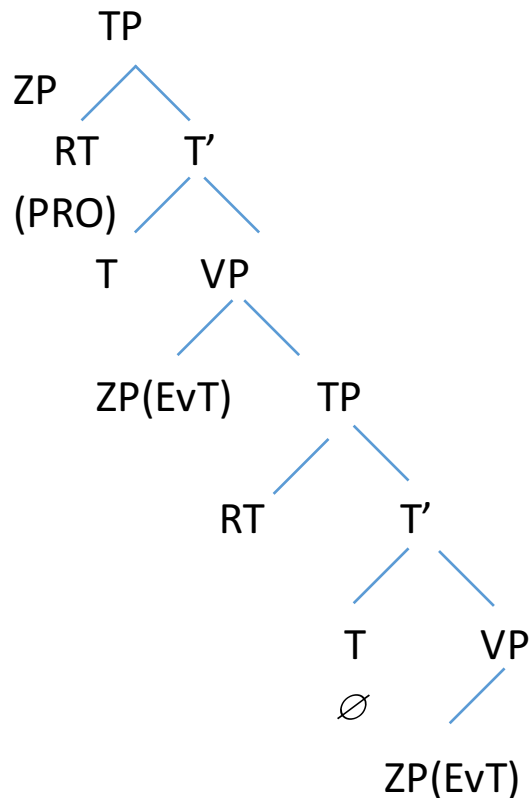

- Morphological Past works as a Polarity Item.
- Semantic PAST is in T
- In SOT cases, **there is no semantic PAST in Tense**
- Morphological past is a Polarity Item from the Past in the main clause.
- **PAST DOES NOT MEAN 'PAST'**

Some Facts related to Aspect

- SIMultaneous reading emerges **ONLY** with **IMPERFECT aspect**.
 - Also mentioned by Stowell 1993, Boogaart 1999, Gennari 2003, Arche 2006, a.o.
- Romance languages with a contrast imperfect/perfective show that the reading disappears when the perfective form is used, regardless of the inner aspect characterization of the predicate.

Examples in imperfective

(14) Juan dijo que Marta estaba enferma

Juan say-pf-3ps that Marta be-**impf**-ill

‘Juan said Marta was ill’



Past Shifted
SIM

(15) Juan dijo que Marta estaba construyendo una casa

Juan said that Marta be-**impf**-3ps building a house

‘Juan said that Marta was building a house’

Examples in perfective

(16) Juan dijo que Marta estuvo enferma
Juan say-pf-3ps that Marta be-pf.3ps ill
'Juan said Marta was ill'

Past Shifted
SIM

(17) Juan dijo que Marta estuvo construyendo una casa
Juan said that Marta be-pf-3ps building a house
'J said that Marta was building a house'

The idea in short

- Within a syntactic approach to Aspect, I propose that the content of the Aspect head (imperfect) suffices to derive both Past Shifted and SIMultaneous.
- Past Shifted reading and Simultaneous readings are not a case of ambiguity but vagueness.

- Main TT binds subordinate RT
- Subordinate TT is located in the past with respect to the main event (Past Shifted) and within the Event Time.
- Due to the semantics of the imperfect, the assertion only concerns the beginning of the event (which is before the main EvT).
- This is compatible with two situations: the event finishing before the main event and the event not being finished, and therefore, containing the main TT (i.e. the saying time).

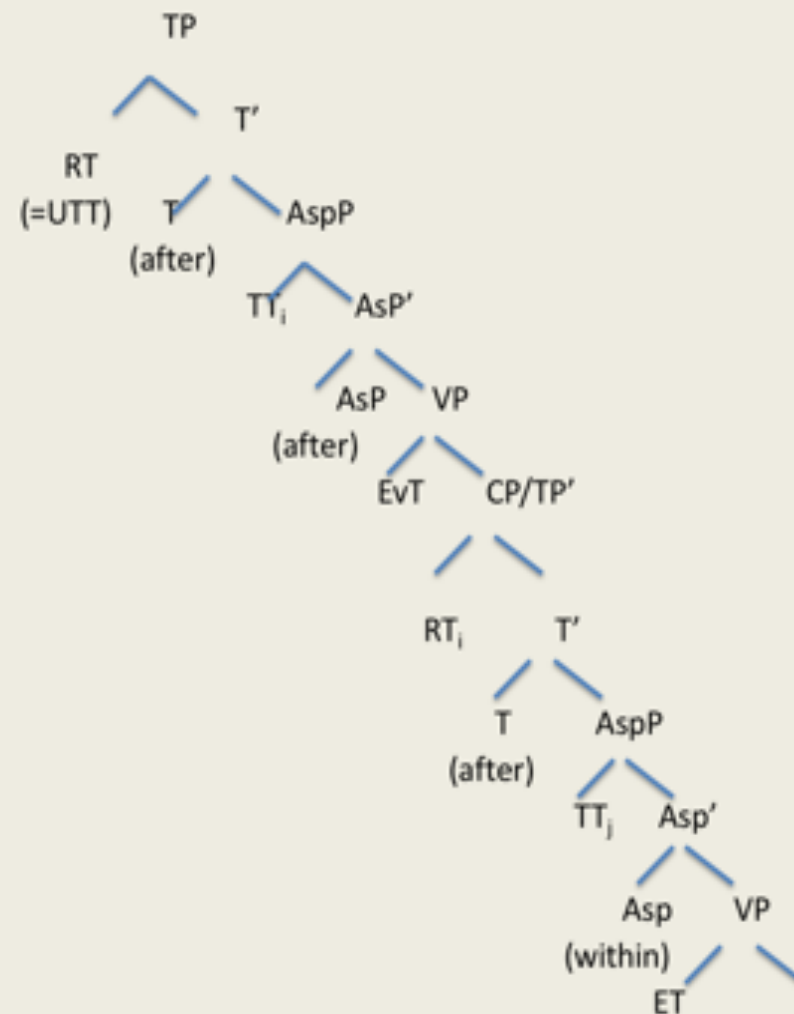

(18) Juan said last week that Marta was depressed last month, but she got well quickly.

depressed
-----|
-----say-----UT

PastShifted

(19) Juan said last week that Marta was depressed. It all started last month and she continues feeling that way.

depressed

-----say-----UTT-----

SIM

Temporal proposal based on Aspect

- **Past always means past**
- We make use of temporal predicate 'within' (imperfect)
- The SIM reading is an effect of the semantics of the imperfect: the **end** of the event is **not asserted**.
- Since the semantics of the imperfect locates an interval **within** another interval, the previous initiation of that latter interval is entailed.
- SOT is not a case of ambiguity (2 LFs) but vagueness.

Afterthoughts on the system

- Revisions and changes
- To capture finer-grained nuances
- To capture cross-linguistic differences (massive)
- Maintaining the system principled

Revision about the imperfect

Readings of the imperfect

(20) Pedro arreglaba la valla
Pedro fix-impf.3ps the fence

Possible interpretations:

(21)

- a. Pedro was fixing the fence (when I saw him).
- b. Pedro fixed the fence every time he arrived at his summer house
- c. Pedro was in charge of fixing the fence (he may have never had to actually fix it)

Progressive

Habitual

Attitudinal

Some revisions (I): quantifiers over occasions

Arche 2006

In Domínguez, Arche & Myles 2017

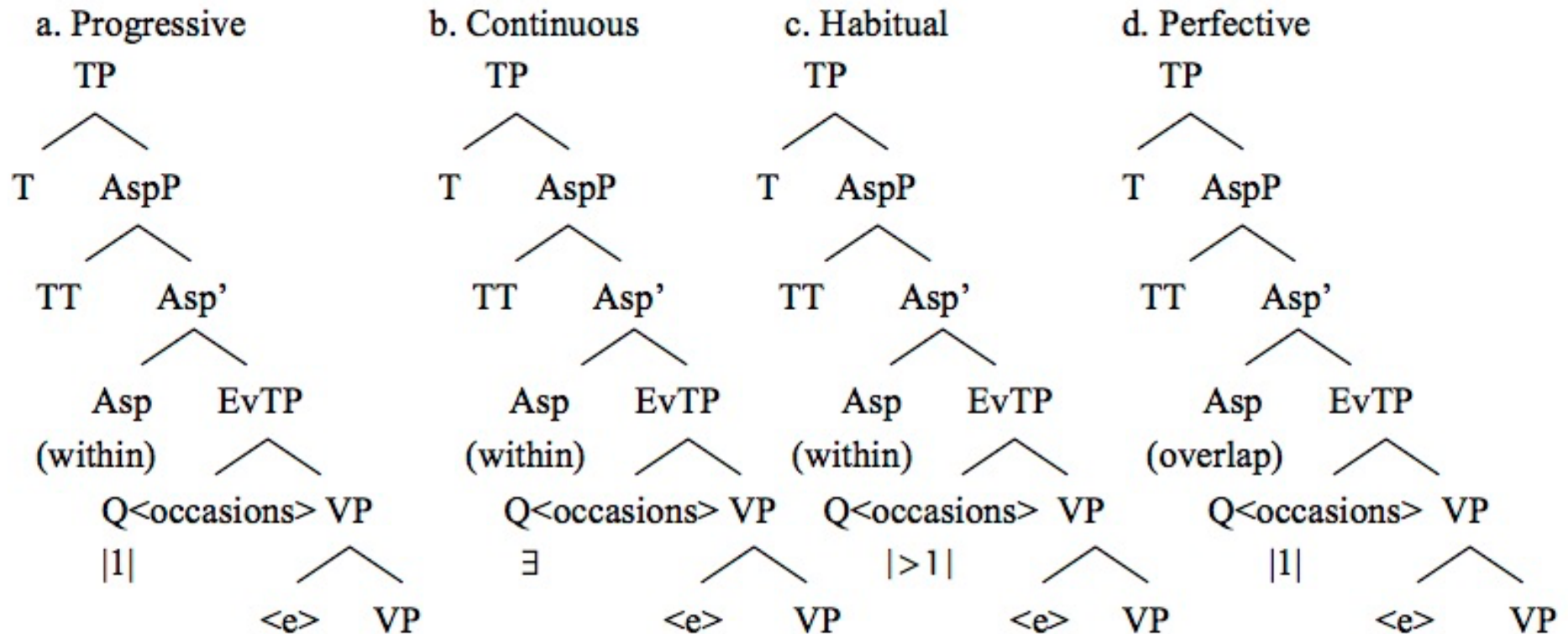

Attitudinal eventive
Stative

Some revisions (II)

- Demirdache & Uribe-Etxebarria 2014
- Abandon Aspect as an ordering predicate for impf and pfve:
 - Obtained by anaphora relation between TT and EvT.
 - Imperfect is explained as binding; EvT bound by lambda operator creating a predicate that holds at TT.
 - Perfective is explained as coreference: TT and EvT corefer.

Issues with anaphora only

- Stowell 2014 points out issues with such a view:
- Role of Aspect head dubious. Not necessary anymore???
- Coreferential and bound pronouns are always definite, but indefinite temporal reference is possible

(22) Bill found a diamond.

- Difficult to capture all the readings of the imperfective

Revision on the progressive

Some revisions (III): the progressive

Arche 2014

- “Progressive” may not be sufficient:

- Imperfective progressive

(23) Pedro arreglaba la valla

Pedro fix-impf.3ps the fence

(24) Pedro estaba arreglando la valla

Pedro was-impf.3ps fixing the fence

Some revisions (II): the progressive

Arche 2014a, b; c, d

- Perfective progressive

(25) Pedro arregló la valla.

Pedro fix-pfve.3ps the fence

(26) Pedro estuvo arreglando la valla.

Pedro was-pfve.3ps fixing the fence

(27) Pedro arregló la valla durante un par de horas.

Pedro fix-pfve.3ps the fence for a couple of hours

(28) Pedro estuvo arreglando la valla durante un par de horas.

Pedro was-pfve.3ps fixing the fence for a couple of hours

=

Syntactic capture of the forms & meanings

29

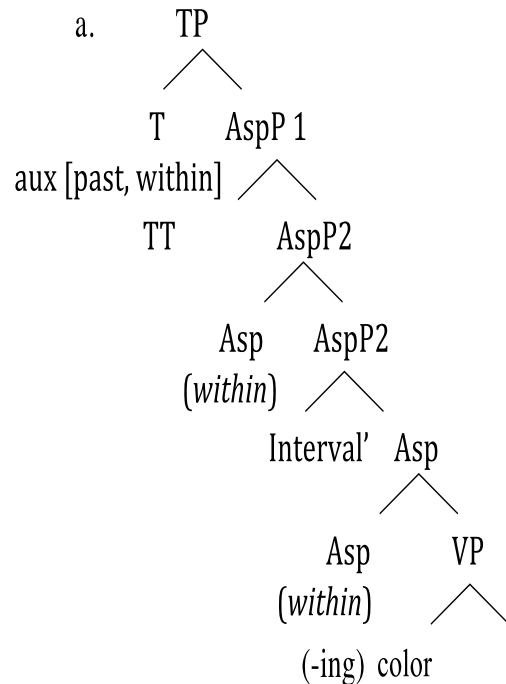

b.

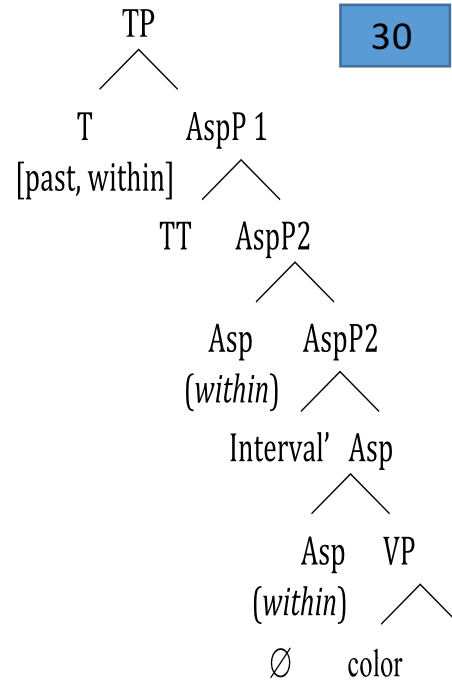

30

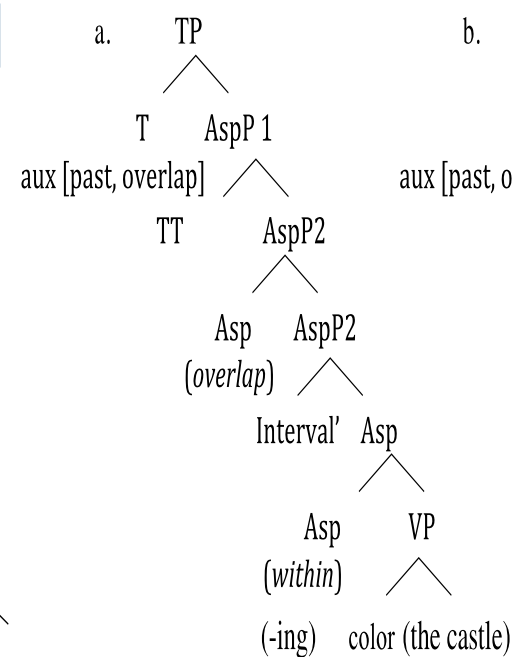

b.

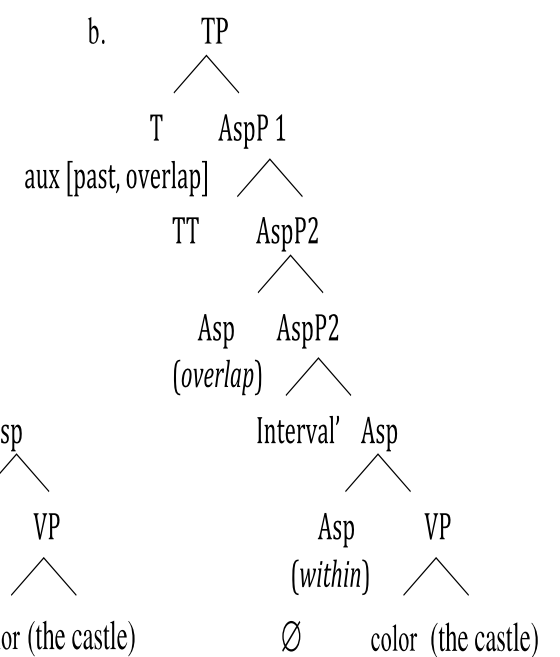

Some revisions (III)

Arche in progress

- How many TTs?
- Surely not more than one. Post-syntactic morphology
- Unclear status/identity of the intermediate intervals
- More importantly:
- **Imperfective progressive: event not finished; TT interval included**
- **Perfective progressive: event not finished; TT interval included**
- Is “predicate ordering” enough?
- **Is EvT really never visible?**

Revision on the perfective

The perfective

- In all of the sentences it is understood that the period of time during which the event took place is over.
- **With telic predicates**, it is also typically understood that the **relevant point** needed for the situation to be substantiated has been reached.
- That is to say, perfective accomplishments typically yield the interpretation of ‘culminated’.
- **BUT**

Study case

(31) Pedro **coloreó** **el castillo**, pero **no terminó**.

Pedro colour-pfve.3ps the castle, but not finished

'Pedro coloured the castle but he did not finish to'

Points for exploration

1. Quality of the eventuality: true accomplishments?
2. Semantics of the perfective
3. Syntax-semantics of the temporal modifiers that seem to foster non-culmination in these cases

“For x time”

4. The **compatibility** of the overt clause declaring the lack of culmination explicitly **“not finish to”** (vs. not completely).

1. Quality of the eventuality

True accomplishment? *yes*

1.1. Culmination is possible

(32) Pedro coloreó el castillo durante un rato y lo terminó.

P. coloured.pfve the castle for a while and it finished

‘Pedro coloured the castle for a while and he finished it’

(33) Pedro nadó durante un rato (# y terminó).

Pedro swim-pfve.3ps for a while and finished.

‘Pedro swam for a while and finished’

Vagueness wrt culmination

- The sentence

Pedro coloreó el castillo durante un rato.

Pedro colored.pfv the castle for a while

is **vague with respect to culmination**. It is compatible with both scenarios: one where there is no culmination and another one where there is (Arche 2014a).

- in a similar way in which we speak about vagueness in temporal ordering in the so-called Independent temporal construal observed in relative clauses (Stowell 1993; see Arche 2001 for Spanish).

2. The meaning of the perfective

- In all these cases, the perfective can be paraphrased with what can be called “perfective progressive”:

(34) Pedro **coloreó** el castillo, pero **no terminó**.

Pedro colour-pfve.3ps the castle, but not finished
‘Pedro coloured the castle but he did not finish to’

(35) Pedro **estuvo coloreando** el castillo, pero no terminó.

Pedro was.pfve coloring the castle, but not finished.

N.B. Note that this form **IS NOT** equivalent in any sense to an imperfective progressive.

The meaning of the temporal modifier

- **For-time** adverbials sharply contrast with *in-time* adverbials:

(36) Pedro coloreó el castillo **durante tres horas**.
Pedro coloured.pfv the castle for three hours

- **It is still true** if Pedro was engaged for five hours in colouring the castle.
- **can** be continued by “**not finish to**”

The meaning of the temporal modifier

- *For-time* adverbials sharply contrast with ***in-time*** adverbials:

(37) Pedro coloreó el castillo **en tres horas**.

Pedro coloured.pfve the castle in three hours

- **cannot be true** if it took Pedro five hours to colour the castle.
- **cannot** be continued by “**not finish to**”

(38) *Pedro coloreó el castillo **en tres horas**,

Pedro coloured.pfve the castle in three hours,

pero no terminó.

but not finished

The meaning of the temporal modifier

En tres horas

in three hours → interval of the whole actual event

Durante tres horas

for three hours → interval of the assertion

- Demirdache & Uribe-Etxebarria 2004: temporal adverbials can be modifiers of the Assertion Time or the Event Time.

The syntax of *interval size* modifiers

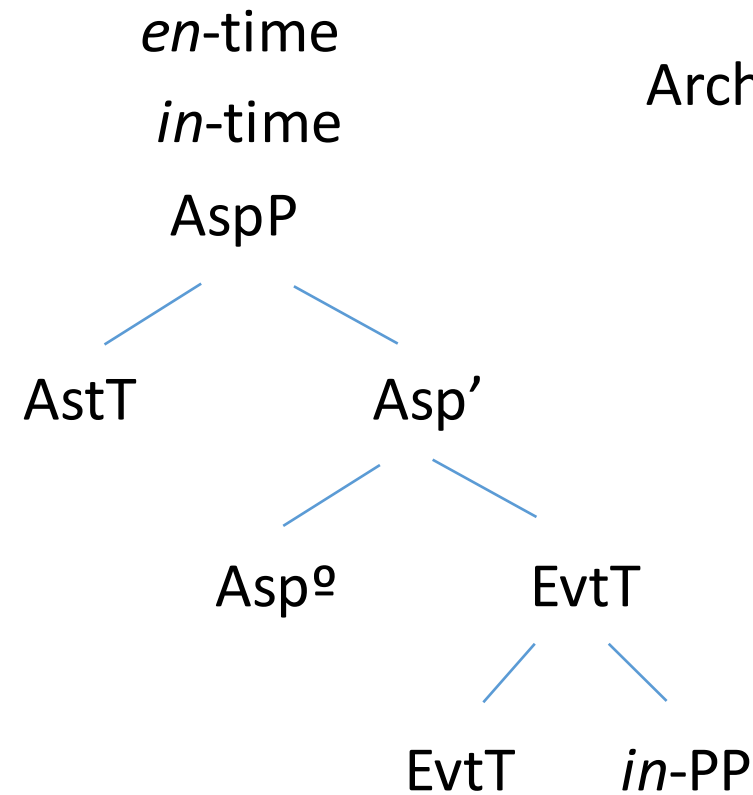
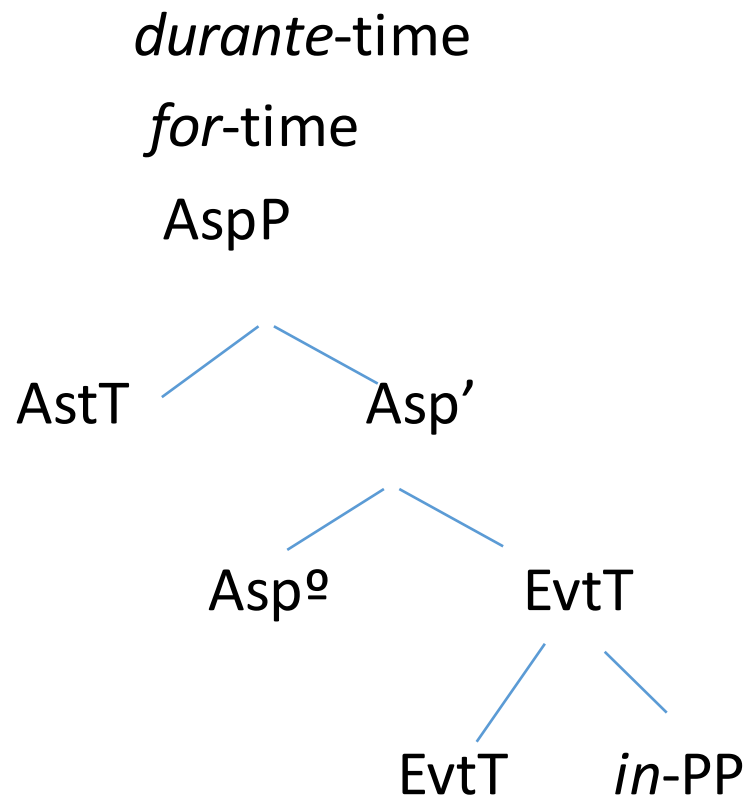

Arche 2017

Semantics of interval size modifiers

- Both *for*-time & *in*-time give the **size** of an interval
 - Hence both are compatible **only with perfective** (in Spanish)
- ❖ *For*-time: measures the Assertion Time, hence the interval can give us only **PART** of the Event Time.
- ❖ *In*-time: measures the Event Time (→ bounds the **whole event**— and that is why it is not okay with activities or states.)
- ❖ **If the Event Time can be modified, it is visible for the derivation.**

Summary of the system

- Primitives
 - temporal ordering predicates
 - intervals: pronominal-like entities
- Independently motivated principles related to reference

Some references

- Abusch, D. 1988. Sequence of Tense, Intensionality and Scope. *Proceedings of the West Coast Conference in Formal Linguistics 7*: 1-14.
- Arche, M.J. In progress. Rethinking Aspect Types. Ms
- Arche, M.J. 2017. The semantics of viewpoint aspect in non-culminating accomplishments. Presented at TELIC Workshop, University of Stuttgart, 12th January.
- Arche, M.J. 2014a. The construction of viewpoint aspect: the imperfective revisited. *Natural Language and Linguistic Theory* 32: 791-831.
- Arche, M.J. 2014b. About the primitives of aspect across languages. *Natural Language and Linguistic Theory* 32: 711-733.
- Arche, M.J. 2014c. Viewpoint aspect and agent control in Spanish non culminating accomplishments. Talk delivered at *Chronos XI*, Pisa June 2014.
- Arche, M.J. 2010. Aspect matters in temporal interpretation. Workshop on Tense & Aspect in Generative Grammar, Lisbon, 1st July.

Some references

- Arche, M.J. 2006. *Individuals in Time: Tense, aspect and the individual/stage distinction*. Amsterdam: John Benjamins.
- Arche, M.J. 2001. A note on distributivity and the independent temporal construal. *Working Papers in Linguistics of the Institute Ortega y Gasset*. Madrid.
- Demirdache, H. and M. Uribe-Etxebarria. 2014. Aspect and temporal anaphora. *NLLT* 32: 855-895.
- Demirdache, H. and M. Uribe-Etxebarria. 2004. The syntax of .me adverbs. In *The Syntax of Time*, J. Guéron and J. Lecarme (eds.), 143–179. Cambridge, MA: MIT Press.
- Demirdache, H. and M. Uribe-Etxebarria. 2000. The primitives of temporal relations. In *Step by Step: Essays on Minimalist Syntax in Honor of Howard Lasnik*, R. Martin, D. Michaels, and J. Uriagereka (eds.), 157–186. Cambridge, MA: MIT Press.

Some references

- Enç, M. 1987. Anchoring conditions for tense. *Linguistic Inquiry* 18:633–657.
- Hale, K. 1986. Notes on World View and Semantic Categories: Some Warlpiri Examples, in P. Muysken and H. van Riemsdijk (eds.), *Features and Projections*, Foris, Dordrecht, 233-254.
- Klein, Wolfgang. 1994. *Time in language*. London: Routledge.
- Partee, B. 1973. Some Structural Analogies between Tenses and Pronouns in English. *Journal of Philosophy* 70: 601-609.
- Stowell, T. 2014. Capturing simultaneity: a commentary on the paper by Hamida Demirdache and Myriam Uribe-Etxebarria. *NLLT* 32: 897-915.
- Stowell, T. 2007. The syntactic expression of tense. *Lingua* 117: 437-463.
- Stowell, T. 1993. *Syntax of tense*. Ms., University of California, Los Angeles.