

AN EVALUATION OF  
RECIRCULATING ARTIFICIAL STREAM DESIGNS  
FOR ACUTE TOXICITY TESTING  
USING TWO SOUTH AFRICAN EPHEMEROPTERA SPECIES  
EXPOSED TO SODIUM SULPHATE

A thesis submitted in fulfilment of the  
requirements for the degree of

MASTER OF SCIENCE

of

RHODES UNIVERSITY

by

MARKUS BINDER

April 1999

---

# *Abstract*

---

Three artificial stream designs, termed Large Artificial Stream Units (LASUs), Raceways, and Channels, at two major scales (1700 L, 12.5 L and 20 L recirculated volume) were developed at the Institute for Water Research, Rhodes University, Grahamstown, in order to explore the possibilities of using indigenous rheophilic macroinvertebrates in routine toxicity tests. This study compared these systems, using 96h-EC50 values from sodium sulphate toxicity tests as the experimental response. Two local Ephemeroptera (Leptophlebiidae: *Adenophlebia auriculata* Eaton, and Baetidae: *Afroptilum sudafricanum* Lestage) were evaluated for their suitability in routine toxicity tests; and the possible effects of elevated salinity levels in South African rivers on the test species were assessed.

Two sets of experiments with each mayfly species were conducted, following an unreplicated regression design. Dechlorinated tap water was used as the water source. Experiments in the Channels were repeated to determine experimental variability. Results were compared statistically by testing for overlap of 95% confidence limits (95%CLs) of EC50 values.

The differences between *A. auriculata* EC50 values in the different systems were statistically significant (no overlap of 95%CLs), but they were not more variable than has been considered normal for biological systems (Coefficient of variation 20.1%; ratio of greatest EC50 / smallest EC50 1.63). The differences were not related to the scale or the average current velocity characteristic of each stream design (average current velocity LASUs - Raceways - Channels 0.090 - 0.083 - 0.038 m/s). The Channels proved to be most efficient with regard to practical performance as they are portable and easily transportable, user-friendly, reliable, splash-free, cost effective to construct, and can easily be adapted to specific requirements. These systems are therefore recommended for regular use.

The suitability of the two mayfly species for routine toxicity testing was evaluated. *A. auriculata* EC50 values showed a significant negative correlation with the corresponding average body-size (range 1476 - 1610  $\mu\text{m}$ , mean 1555  $\mu\text{m}$ ). The different average body-sizes probably reflected the abundance of a certain size range present in the Palmiet River at the time of collection. Both species reacted similarly to  $\text{Na}_2\text{SO}_4$  (similar slopes of the toxicity curves), identifying this salt as a slow acting toxicant. *A. sudafricanum* populations were more sensitive to  $\text{Na}_2\text{SO}_4$  (EC50 3.404 g/L) than *A. auriculata* (EC50 8.090 g/L), probably because of its smaller body-size (mean 709  $\mu\text{m}$ ) and a lack of extremely tolerant individuals. In comparison to other freshwater macroinvertebrates, including the standard toxicity test organism *Daphnia* spp., both mayfly species seemed to be moderately tolerant of  $\text{Na}_2\text{SO}_4$ ; therefore there was no particular advantage to using these indigenous taxa rather than *Daphnia* spp.

An assessment of the effects of elevated salinity/TDS levels on the test taxa yielded preliminary insights. A NaCl-EC50 for *A. sudafricanum* could be extrapolated and suggested a higher sensitivity to  $\text{Na}_2\text{SO}_4$  than to NaCl. When  $\text{Na}_2\text{SO}_4$  EC50 values of both species were compared to selected TDS levels of South African rivers, *A. auriculata* would mostly not be affected, but *A. sudafricanum* might occasionally suffer from sub-lethal effects, depending on the sulphate proportion of the TDS. The South African guideline for TDS seemed to protect both species sufficiently.

### **Declaration**

This thesis is the result of my own independent research. However, the advice and suggestions offered by my supervisors have been included. Neither the whole, nor any other part of the thesis has been, is being, nor will be the subject for a higher degree from any other university.

## Contents

Abstract.....	ii
Contents.....	v
List of Tables.....	ix
List of Figures.....	xii
Glossary.....	xv
List of Acronyms.....	xvii
Acknowledgements.....	xxi

<i>Chapter 1: Aquatic toxicology and its application in South Africa.....</i>	<i>1</i>
1.1. Introduction.....	1
1.2. Historic development of aquatic toxicology and definitions.....	2
1.3. Experimental methods in aquatic toxicology.....	5
1.3.1. Single-species toxicity tests.....	7
1.3.2. Multispecies toxicity tests.....	8
1.3.3. Experimental techniques.....	9
1.3.4. Selection of test species.....	10
1.3.5. The concentration-response relationship.....	10
1.4. Water quality management and aquatic toxicology in South Africa.....	14
1.4.1. Historical perspective: water quality management.....	14
1.4.2. Water legislation.....	15
1.4.3. Determination of the ecological Reserve.....	17
1.4.4. The application of aquatic toxicology in South Africa.....	19
1.4.5. Research in aquatic toxicology at the Institute for Water Research.....	20
1.5. Scope, aims and objectives of this study.....	21
1.6. Summary of thesis structure.....	22
<i>Chapter 2: Contextual review.....</i>	<i>24</i>
2.1. Introduction.....	24
2.2. Research using artificial streams.....	24
2.2.1. General artificial stream issues.....	25
2.2.2. Artificial stream designs.....	26
2.2.3. Artificial streams at the Institute for Water Research.....	29

2.3. The test taxa.....	36
2.3.1. <i>Adenophlebia auriculata</i> (Eaton).....	36
2.3.2. <i>Afroptilum sudafricanum</i> (Lestage).....	37
2.3.3. Suitability of the test species selected for this study .....	38
2.3.4. The sampling site at the Palmiet River .....	41
2.4. Salinization of South African inland waters.....	42
2.4.1. TDS, salinity and salinization.....	43
2.4.2. Sources of salinity.....	44
2.4.3. Regions and rivers of elevated salinities in South Africa.....	45
2.4.4. Effects on aquatic ecosystems .....	45
 <i>Chapter 3: Experimental methods</i> .....	 48
3.1. General experimental design .....	48
3.1.1. Test sequence.....	48
3.1.2. Data requirements for a regression design.....	50
3.1.3. Assessing the difference between EC50 values.....	51
3.2. The test procedure .....	53
3.2.1. Experimental medium.....	53
3.2.2. The toxicant sodium sulphate and experimental concentrations .....	54
3.2.3. Sampling and sorting of experimental organisms.....	56
3.2.4. Acclimation.....	57
3.2.5. Range-finding tests .....	58
3.2.6. Acute toxicity tests .....	58
3.3. Methods for calculating EC50 values.....	63
3.3.1. Probit analysis.....	64
3.3.2. The Trimmed Spearman-Kärber analysis .....	66
3.4. Analyses after EC50 determination.....	68
3.4.1. Time-toxicity curves.....	68
3.4.2. Headwidth measurements of test organisms.....	69
 <i>Chapter 4: Results</i> .....	 70
4.1. Introduction .....	70
4.1.1. Transformation of data.....	71
4.2. <i>Adenophlebia auriculata</i> .....	72
4.2.1. Results of Experiment 1 in the LASUs.....	73
4.2.2. Results of Experiment 2 in the Raceways .....	77
4.2.3. Results of Experiment 3 in the Channels.....	81
4.2.4. Results of Experiment 4 in the Channels.....	85

---

4.2.5. Results of Experiment 5 in the Channels.....	89
4.2.6. Comparison of headwidth-means between experiments.....	93
4.3. <i>Afroptilum sudafricanum</i> .....	93
4.3.1. Results of Experiment 6 in the LASUs.....	95
4.3.2. Results of Experiment 7 in the Channels.....	99
4.3.3. Results of Experiment 8 in the Channels.....	103
4.3.4. Comparison of headwidth-means between experiments.....	106
4.3.5. Identification of species.....	107
4.4. Comparison of EC50 values.....	107
4.4.1. Comparison of the two distribution models.....	107
4.4.2. Comparison of Probit and Trimmed Spearman-Kärber EC50 values.....	108
4.4.3. Statistical significance of differences between EC50 values.....	110
4.5. Investigation of factors discriminating EC50 values.....	112
4.5.1. Factors related to artificial stream design.....	112
4.5.2. Water quality constituents.....	113
4.5.3. Factors related to the experimental organism.....	117
<i>Chapter 5: Discussion</i> .....	121
5.1. Introduction.....	121
5.2. Evaluation of artificial stream designs.....	122
5.2.1. Variability of tolerance data.....	122
5.2.2. Differences between artificial stream systems.....	124
5.2.3. Effects of water quality constituents.....	126
5.2.4. Evaluation of the practical performance of each system.....	130
5.2.5. Artificial stream designs: General conclusion.....	134
5.3. Evaluation of test species and their responses.....	135
5.3.1. Effects of body-size and season on EC50 values.....	135
5.3.2. Differences between species.....	137
5.3.3. Test species: General conclusion.....	139
5.4. Evaluation of the response of the two test taxa to elevated salinities.....	140
5.4.1. The test taxa in comparison to other freshwater macroinvertebrates.....	140
5.4.2. Extrapolation of test results to the field.....	144
5.4.3. Comparison of EC50 data to guideline criteria.....	147
5.4.4. Elevated salinities: General conclusion.....	148
5.5. The two taxa for routine toxicity testing.....	149
5.5.1. The two taxa for routine toxicity testing: General conclusion.....	150

---

5.6. General criticism, recommendations, and research suggestions .....	151
5.6.1. General criticism.....	151
5.6.2. Comments and recommendations.....	151
5.6.3. Research suggestions .....	152
<i>Chapter 6: Concluding summary</i> .....	153
<i>Appendices</i> .....	156
Appendix A: Current velocity and water depth measurements in the artificial stream systems .....	156
Appendix B: Water chemistry equations and water quality profiles.....	160
Appendix C: Example of a spreadsheet for data collection.....	163
Appendix D: Experimental results of Probit analyses, and an example of the data output of the Trimmed Spearman-Kärber analysis software .....	164
Appendix E: Example of an Excel Table .....	173
Appendix F: Regression analysis of mean headwidth <i>versus</i> EC50 and slope of experiments with <i>A. auriculata</i> .....	174
<i>References</i> .....	175

## List of Tables

(Table captions have been abbreviated)

1.1.	A structured summary of selected terms used in aquatic toxicity testing.....	6
2.1.	Design parameters of artificial stream systems used in ecotoxicological studies between 1964 and 1986. ....	27
2.2.	Summary of technical specifications and stream characteristics of the LASU systems.....	32
2.3.	Summary of technical specifications and stream characteristics of the Raceway systems .....	34
2.4.	Summary of technical specifications and stream characteristics of the Channel systems. ....	35
3.1.	Summary of the experiments carried out, and the general test design.....	50
3.2.	Chlorine content of tap water and a LASU.....	54
3.3.	Product specification of sodium sulphate used in this study as provided by Protea Industrial Chemicals, Wadeville, South Africa. ....	54
3.4.	Summary of important characteristics of all experiments, including test concentrations. ....	56
3.5.	Water quality constituents determined by IWQS .....	63
4.1.	Experiment 1: Summarized results of statistical analyses using both the Probit and the Trimmed Spearman-Kärber (TSK) method to calculate 96h-EC50 values. ....	75
4.2.	Experiment 1: Comparison of selected water constituents of the Palmiet River at the time of nymph collection, and the range of those water constituents in LASUs during acclimation. ....	76
4.3.	Experiment 1: Range of selected water constituents during the test periods of LASU sub-tests. Values are pooled for all sub-tests. ....	76
4.4.	Experiment 2: Summarized results of statistical analyses using both the Probit and the Trimmed Spearman-Kärber (TSK) method to calculate 96h-EC50 values. ....	79
4.5.	Experiment 2: Comparison of selected water constituents of the Palmiet River at the time of nymph collection, and the range of those water constituents in Raceways during acclimation and the test period. ....	80
4.6.	Experiment 3: Summarized results of statistical analyses using both the Probit and the Trimmed Spearman-Kärber (TSK) method to calculate 96h-EC50 values. ....	83

---

4.7.	Experiment 3: Comparison of selected water constituents of the Palmiet River at the time of nymph collection, and the range of those water constituents in Channels during acclimation and the test period.....	84
4.8.	Experiment 4: Summarized results of statistical analyses using both the Probit and the Trimmed Spearman-Kärber (TSK) method to calculate 96h-EC50 values.....	87
4.9.	Experiment 4: Comparison of selected water constituents of the Palmiet River at the time of nymph collection, and the range of those water constituents in Channels during acclimation and the test period.....	88
4.10.	Experiment 5: Summarized results of statistical analyses using both the Probit and the Trimmed Spearman-Kärber (TSK) method to calculate 96h-EC50 values.....	91
4.11.	Experiment 5: Comparison of selected water constituents of the Palmiet River at the time of nymph collection, and the range of those water constituents in Channels during acclimation and the test period.....	92
4.12.	Experiment 6: Summarized results of statistical analyses using both the Probit and the Trimmed Spearman-Kärber (TSK) method to calculate 96h-EC50 values.....	97
4.13.	Experiment 6: Comparison of selected water constituents of the Palmiet River at the time of nymph collection, and the range of those water constituents in LASUs during acclimation.....	98
4.14.	Experiment 6: Range of water constituents during the test periods of LASU sub-tests. Values are pooled for all sub-tests.....	98
4.15.	Experiment 7: Summarized results of statistical analyses using both the Probit and the Trimmed Spearman-Kärber (TSK) method to calculate 96h-EC50 values.....	101
4.16.	Experiment 7: Comparison of selected water constituents of the Palmiet River at the time of nymph collection, and the range of those water constituents in Channels during acclimation and the test period.....	102
4.17.	Experiment 8: Summarized results of statistical analyses using both the Probit and the Trimmed Spearman-Kärber (TSK) method to calculate 96h-EC50 values.....	105
4.18.	Experiment 8: Comparison of selected water constituents of the Palmiet River at the time of nymph collection, and the range of those water constituents in Channels during acclimation and the test period.....	106
4.19.	Summary of species other than <i>A. sudaffricanum</i> found in all experiments. ....	107

---

4.20.	Comparison of the fit of the two different distribution models (NFD-Log and NFD-Lin) used in the Probit-calculations for EC50s of experiments with <i>A. auriculata</i> .	108
4.21.	Sodium sulphate EC50 values of experiments with <i>A. auriculata</i> , calculated with the Probit analysis (NFD-Log model).	110
4.22.	Sodium sulphate EC50 values of experiments with <i>A. sudafricanum</i> , calculated with the Probit analysis (NFD-Lin model).	111
4.23.	Geometric means of EC1, EC5, EC50 and EC99 values after 96 h exposure and their 95% confidence limits, for <i>A. auriculata</i> and <i>A. sudafricanum</i> .	111
4.24.	Geometric mean EC50 values at 24, 48 and 72 h for Experiments 1–5 and 6–8, calculated using the 8% Trimmed Spearman-Kärber analysis.	111
4.25.	Ranges of nutrients, major ions and silica for experiments with <i>A. auriculata</i> during the test period.	114
4.26.	Ranges of nutrients, major ions and silica for experiments with <i>A. sudafricanum</i> during the test period.	114
4.27.	A comparison of the pH-conditions between Palmiet River water during collection of test organisms, and the experimental water to which they were transferred.	115
4.28.	Summary of headwidth (HW) ranges, means and related parameters for all experiments.	117
5.1.	The variation of EC50 values encountered for each species, expressed as the ratio of the greatest and the smallest EC50 (maximum ratio), and the coefficient of variation.	123
5.2.	Guideline values for selected water quality constituents.	126
5.3.	Toxic effects of sodium sulphate on various aquatic freshwater species, in comparison with mean EC50 values of the test taxa.	141
5.4.	Sodium chloride tolerances of some freshwater macroinvertebrates in comparison with preliminary and extrapolated data for <i>A. auriculata</i> and <i>A. sudafricanum</i> .	143
5.5.	The salinity levels of some South African rivers.	146

## List of Figures

(Figure captions have been abbreviated)

1.1.	Levels of biological organization..	2
1.2.	A graphical display of the many scientific disciplines integrated in the science of aquatic toxicology.....	4
1.3.	The frequency distribution of tolerance concentrations, on linear (a) and logarithmic (b) scale .....	11
1.4.	The typically sigmoid shaped cumulative concentration-response curve, on linear (a) and logarithmic (b) scale.....	12
1.5.	The legal division of water in the National Water Act (No. 36 of 1998). .....	16
2.1.	The artificial streams of McIntire <i>et al.</i> (1964) served as a prototype for many later designs. ....	28
2.2.	Small-scale flow-through artificial streams used by Lowell <i>et al.</i> (1995a, b).....	28
2.3.	Behavioural test chambers and experimental channel by Gerhardt <i>et al.</i> (1994).....	29
2.4.	An elevation of one of three Large Artificial Stream Units (LASUs).....	31
2.5.	Test chamber used in LASU experiments. ....	31
2.6.	Diagram of a Raceway system.....	33
2.7.	Diagram of a Channel system.....	35
2.8.	Distribution of <i>A. auriculata</i> in South Africa.....	37
2.9.	Frequency distribution of headwidths of <i>A. auriculata</i> sampled 3 March 1997 in the Palmiet River ( $n = 812$ ). .....	37
2.10.	Distribution of <i>A. sudafricanum</i> in southern Africa. ....	38
2.11.	Distribution of <i>A. sudafricanum</i> in different biotopes.....	38
2.12.	The sampling site at the Palmiet River. ....	42
3.1.	The normal sigmoid curve of Figure 1.4.b. before and after transformation of percentage responses to probits.....	65
3.2.	Data adjustments of the 10% Trimmed Spearman-Kärber method for a hypothetical data set.....	67
4.1.	Range finding experiment with <i>Adenophlebia auriculata</i> (Experiment RF-AA): Cumulative effect of sodium sulphate on <i>A. auriculata</i> versus exposure time, in the Raceway range-finding test.....	72
4.2.	Experiment 1: Cumulative effect of sodium sulphate on <i>A. auriculata</i> versus exposure time, in the LASUs.....	74
4.3.	Experiment 1: Time-toxicity curve of sodium sulphate for <i>A. auriculata</i> in the LASUs. ....	74

---

4.4.	Experiment 1: Concentration-response curve for <i>A. auriculata</i> in the LASUs after 96 h. ....	75
4.5.	Experiment 2: Cumulative effect of sodium sulphate on <i>A. auriculata</i> versus exposure time, in the Raceways.....	78
4.6.	Experiment 2: Time-toxicity curve of sodium sulphate for <i>A. auriculata</i> in the Raceways. ....	78
4.7.	Experiment 2: Concentration-response curve for <i>A. auriculata</i> in the Raceways after 96 h. ....	79
4.8.	Experiment 3: Cumulative effect of sodium sulphate on <i>A. auriculata</i> versus exposure time, in the Channels. ....	82
4.9.	Experiment 3: Time-toxicity curve of sodium sulphate for <i>A. auriculata</i> in the Channels.....	82
4.10.	Experiment 3: Concentration-response curve for <i>A. auriculata</i> in the Channels after 96 h. ....	83
4.11.	Experiment 4: Cumulative effect of sodium sulphate on <i>A. auriculata</i> versus exposure time, in the Channels. ....	86
4.12.	Experiment 4: Time-toxicity curve of sodium sulphate for <i>A. auriculata</i> in the Channels.....	86
4.13.	Experiment 4: Concentration-response curve for <i>A. auriculata</i> in the Channels after 96 h. ....	87
4.14.	Experiment 5: Cumulative effect of sodium sulphate on <i>A. auriculata</i> versus exposure time, in the Channels. ....	90
4.15.	Experiment 5: Time-toxicity curve of sodium sulphate for <i>A. auriculata</i> in the Channels.....	90
4.16.	Experiment 5: Concentration-response curve for <i>A. auriculata</i> in the Channels after 96 h. ....	91
4.17.	Range finding experiment with <i>Afroptilum sudafricanum</i> (Experiment RF-AS): Cumulative effect of sodium sulphate on <i>A. sudafricanum</i> versus exposure time, in the Raceway range-finding test. ....	94
4.18.	Experiment 6: Cumulative effect of sodium sulphate on <i>A. sudafricanum</i> versus exposure time, in the LASUs.....	96
4.19.	Experiment 6: Time-toxicity curve of sodium sulphate for <i>A. sudafricanum</i> in the LASUs. ....	96
4.20.	Experiment 6: Concentration-response curve for <i>A. sudafricanum</i> in the LASUs after 96 h. ....	97
4.21.	Experiment 7: Cumulative effect of sodium sulphate on <i>A. sudafricanum</i> versus exposure time, in the Channels.....	100

---

4.22.	Experiment 7: Time-toxicity curve of sodium sulphate for <i>A. sudafricanum</i> in the Channels. ....	100
4.23.	Experiment 7: Concentration-response curve for <i>A. sudafricanum</i> in the Channels after 96 h. ....	101
4.24.	Experiment 8: Cumulative effect of sodium sulphate on <i>A. sudafricanum</i> versus exposure time, in the Channels. ....	104
4.25.	Experiment 8: Time-toxicity curve of sodium sulphate for <i>A. sudafricanum</i> in the Channels. ....	104
4.26.	Experiment 8: Concentration-response curve for <i>A. sudafricanum</i> in the Channels after 96 h. ....	105
4.27.	Sodium sulphate EC50 values of <i>A. auriculata</i> experiments, sorted in increasing order. ....	109
4.28.	Sodium sulphate EC50 values of <i>A. sudafricanum</i> experiments, sorted in increasing order. ....	109
4.29.	Sodium sulphate EC50 values of experiments with <i>A. auriculata</i> plotted against system volume (a) and average current velocity (b). ....	113
4.30.	pH measurements versus sodium sulphate concentrations of final Raceway and Channel experiments. ....	116
4.31.	An illustration of the time-dependent pH fluctuations in selected sodium sulphate concentrations of Experiment 4. ....	116
4.32.	Correlation of sodium sulphate 96h-EC50 values of <i>A. auriculata</i> experiments (1–5) with corresponding headwidth-means. ....	118
4.33.	Mean headwidths of experiments with <i>A. auriculata</i> (a) and <i>A. sudafricanum</i> (b), grouped according to the season in which test organisms were collected and tests conducted. ....	118
4.34.	Sodium sulphate EC50s of experiments with <i>A. auriculata</i> (a) and <i>A. sudafricanum</i> (b), grouped according to the season in which test organisms were collected and tests conducted. ....	119
4.35.	Concentration-response curves of all experiments in a graph with arithmetic concentration scale and response proportions in per cent. ....	119
4.36.	Correlation of slope values of <i>A. auriculata</i> experiments (1–5) with corresponding headwidth-means. ....	120
5.1.	Comparison of the two tolerance distribution models used in this study, and its implications. ....	138

## Glossary

The definitions have been compiled from various sources: Curtis 1983; Lincoln *et al.* 1983; Hurlbert 1984; Dickson *et al.* 1985; Giesy and Allred 1985; Moriarty 1988; Lamberti and Steinman 1993; Rand *et al.* 1995; Slabbert *et al.* 1998a.

**Acute.** Lasting for a short time. In acute aquatic toxicity tests the duration is generally 4 days.

**Anthropogenic.** Produced by mankind.

**Aquatic toxicology.** The study of the effects of manufactured chemicals and other anthropogenic and natural materials and activities (collectively termed toxic agents or substances) on aquatic organisms at various levels of organization, from subcellular through individual organisms to communities and ecosystems.

**Artificial stream.** A constructed channel having a controlled flow of water, which is used to study some physical, chemical, or biological property of natural streams.

**Bioavailability.** The portion of the total quantity or concentration of a chemical in the environment or a portion of it that is potentially available for biological action, such as uptake by an aquatic organism.

**Chronic.** Lasting for an extended time period. In chronic aquatic toxicity tests the duration is generally several weeks to months.

**Ecology.** The study of the interactions between organisms with their physical environment and with each other.

**Ecotoxicology.** The branch of toxicology that studies the toxic effects of natural or artificial substances on living organisms (e.g. fish, birds, plants), whether animal or vegetable, terrestrial or aquatic, that constitute the biosphere.

**Environmental water.** Encompassing all natural fresh waters of the environment such as water from rivers, dams, and groundwater.

**Eurihaline.** A characteristic of an aquatic animals which can tolerate a wide variation of salt concentrations of their ambient water.

**Flow-through.** An experimental technique in aquatic toxicity tests where the test medium passes through the test system once only.

**Hyperosmotic.** A characteristic of an aquatic animal whose body fluid solutes are higher concentrated than the ambient water.

**Hypo-osmotic (also hyposmotic).** Characteristic of an aquatic animal whose body fluid solutes are lower concentrated than the ambient water.

**Iso-osmotic (also isosmotic).** An aquatic animal with body fluids having the same osmotic pressure as the ambient water.

- 
- Limnocorral.** Artificial enclosures placed in the pelagic region of ponds, lakes, or marine environments. General size 1000–10 000 L.
- Littoral.** Pertaining to a shoreline.
- Littoral enclosure.** Artificial enclosures created with plastic dividers to isolate the littoral region of ponds. General size 1000 to 50 000 L.
- Macrocosm.** An experimental system in aquatic toxicology with a volume >10 000 L, using multiple species.
- Mesocosm.** An experimental system in aquatic toxicology with a volume of 10–10 000 L, using multiple species.
- Microcosm.** An experimental system in aquatic toxicology with a volume <10 L, using multiple species.
- Most sensitive species.** The species in an ecosystem which is - compared to other species in this ecosystem - most sensitive to a particular toxicant.
- Multispecies test.** Any test which has a level of biological organization higher than that of a single-species.
- Osmoconformer.** An aquatic animal which adjusts the osmotic pressure of its body fluids to that of the ambient water when the salinity of the water changes. It thus stays iso-osmotic.
- Osmoregulator.** An aquatic animal which attempts to maintain the same osmotic pressure of its body fluids although the salinity of the ambient water changes.
- Partial exposure.** An experimental technique in aquatic toxicology where the test organisms are (repeatedly) exposed to the toxicant for a certain period of time which is shorter than the entire test period.
- Pelagic.** Pertaining to the water column of the sea or lake. Used of organisms' inhabiting the open waters of an ocean or lake.
- Pseudoreplication.** the use of inferential statistics to test for treatment effects with data from experiments where either treatments are not replicated (though samples may be), or replicates are not statistically independent.
- Pulse.** An experimental technique in aquatic toxicology where the test organisms are exposed to the toxicant for very short period of time compared to the entire test period.
- Recirculating.** A technique in aquatic toxicity tests where the experimental medium in the the test system is recirculated for the entire test period.
- Renewal.** A technique in aquatic toxicity tests where the experimental medium in the test system is replaced several times during the test period.
- Single-species test.** A test where only one species is used as test organisms.

**Standard laboratory (test) organism.** An organism which has been bred and reared in the laboratory for the purpose of being used in toxicity tests.

**Static.** Not moving. An experimental technique in aquatic toxicology where the experimental medium is not moving; thus the test organisms are not exposed to a flow.

**Stenohaline.** Aquatic animals with a limited tolerance to salt concentration variation.

**Toxicology.** The study of poisonous substances and their effects on individual organisms.

## List of Acronyms

95%CL	95 per cent confidence limits
AEV	Acute effect value
CEV	Chronic effect value
DAAD	Deutscher Akademischer Austauschdienst
EC	Electrical conductivity; Units in mS/m (Millisiemens per meter)
EC50	Effective concentration at which 50 per cent of the test organisms experienced an adverse effect
IWQS	Institute for Water Quality Studies
IWR	Institute for Water Research
LASU	Large Artificial Stream Unit
LC50	Lethal concentration at which 50 per cent of the test organisms experienced a lethal effect
LOAEC	Lowest observed adverse effect concentration
LOEC	Lowest observed effect concentration
MATC	Maximum allowable tolerance concentration
NFD-Log	Normal frequency distribution on a logarithmic concentration scale
NFD-Lin	Normal frequency distribution on a linear (arithmetic) concentration scale
NOAEC	No observed adverse effect concentration
NOEC	No observed effect concentration
PVC	Polyvinylchloride
RWQO	Receiving water quality objectives
SAWQG-AQ	South African Water Quality Guidelines for Aquatic Ecosystems
TDS	Total dissolved solids
TSK	Trimmed Spearman-Kärber (analysis)
TWQR	Target water quality range
US EPA	United States Environmental Protection Agency

Dedication

To my mother  
who was always on my side

and to Nicole Margaret Ghislaine Motteux  
whom I owe more than I can express in words

*Bitte*

Wir werden eingetaucht  
und mit dem Wasser der Sintflut gewaschen,  
wir werden durchnäßt  
bis auf die Herzhaut.

Der Wunsch nach der Landschaft  
diesseits der Tränengrenze  
taugt nicht,  
der Wunsch, den Blütenfrühling zu halten,  
der Wunsch, verschont zu bleiben,  
taugt nicht.

Es taugt die Bitte,  
daß bei Sonnenaufgang die Taube  
den Zweig vom Ölbaum bringe.  
Daß die Frucht so bunt wie die Blüte sei,  
daß noch die Blätter der Rosen am Boden  
eine leuchtende Krone bilden.

Und daß wir aus der Flut,  
daß wir aus der Löwengrube und dem feurigen Ofen  
immer versehrter und immer heiler  
stets von neuem  
zu uns selbst  
entlassen werden.

Hilde Domin

*Request*

We will be submerged  
and washed by the waters of Noah's flood,  
we will be soaked through  
to the skin of our heart.

It is of no use to wish  
for a land that lies  
beyond the border of tears,  
no use to wish  
for the spring to remain,  
to wish to be spared.

What is of use is to request  
that the dove will bring at dawn  
the twig from the olive tree.  
To request that the fruit  
will be as colourful as the blossom,  
that the petals of the rose  
which have fallen to the ground  
will yet form a bright crown.

And that we will be set free  
from the flood,  
out of the lions den and the fiery furnace  
every time more healed and cleansed  
and be released  
again and again  
to ourselves.

Hilde Domin  
(My translation; from Domin 1987)

*Written in the rain*

He who could be like the bee  
which can feel  
the sun through the clouds  
which finds its way to the blossom  
and never loses its way,  
his fields would lie spread  
in everlasting golden shine,  
short though his life,  
rare would be  
his tears.

Hilde Domin  
(My translation; from Domin 1987)

*Im Regen geschrieben*

Wer wie die Biene wäre,  
die die Sonne  
auch durch den Wolkenhimmel fühlt,  
die den Weg zur Blüte findet  
und nie die Richtung verliert,  
dem lägen die Felder in ewigem Glanz,  
wie kurz er auch lebte,  
er würde selten  
weinen.

Hilde Domin

---

## Acknowledgements

My first and sincerest thanks go to my supervisors Dr Patricia-Ann Scherman (previously Goetsch) and Dr Carolyn Palmer. I wish to thank Patsy for her constant commitment, support and advice throughout the thesis. I particularly appreciated her patient and thorough proof-reading, especially towards the end when time was not readily available to her. To Tally I am very grateful for her encouragement and sound advice during my write-up where she helped me to see the path through the thicket of all those arguments.

The staff of the Institute for Water Research, especially those of the Ecology section, made me feel at home from the first moment I arrived. I very much enjoyed the special and friendly working environment which is such a fundamental characteristic of this institution. I will miss all those tea-parties for sure!

Without Kekere Soxujwa, Mbambezili Simani and Nkosinathi Mtwana it would have been impossible to collect all these mayflies in time. Thanks for all your help during the sampling trips, your helping hands in the lab during experiments, and for the measurements later on. Special thanks also to Kek for identifying the baetid mayfly species.

Like many other zoologists, I owe Professor Sarah Radloff a great deal for guiding me through the statistical mysteries, and for checking the statistical software I used. Her patience, commitment and ever-open door is almost unrivalled!

Terry Butterworth was of great practical assistance in the early stages of the project. Thank you for your practical advice in professional and private matters, and for always being available.

Many other people contributed to this thesis with expert advice, exciting and stimulating discussions, and guidance through difficult times, particularly Martin Villet on statistics and organisation, Peter Wade on water chemistry, Sebastian Jooste on ecotoxicological theory, and Paddy Kuun on general philosophy of life and everything. Special thanks to Helen Barber-James for the data on Ephemeroptera.

Thanks also to Andrew Cook and Andreas Katzerke for undertaking the last editorial checks; all remaining errors are, however, my responsibility.

Finally, my warmest feelings go to my friends for their support and patience, particularly Nicky, Dave, Sarah, Barbara, Sven, Paddy, Lil, Dez, Undine, and Bala. What can I say? You were there when I needed you. I apologize for having allowed the work to take over at times (shoo, what an understatement), but from now on, no thesis talk anymore. Big promise! Angie and Derek, you were great digsmates and friends, and you allowed me to enjoy our place to the fullest. And very special thanks to Ully, Jan, Uli, Anke and Bjela for not forgetting me despite 10 000 km and my sporadic replies!

I am grateful for financial support from the Water Research Commission who allowed me to use resources from the second phase of the artificial stream project; the Deutscher Akademische Austauschdienst (DAAD) [*German Academic Exchange Service*] for covering living expenses and tuition; and my dear mother, who so generously supported me during the last phase when all other sources had run out.

---

# *Chapter 1*

## *Aquatic toxicology and its application in South Africa*

---

### **1.1. Introduction**

South Africa's water resources are limited and, in global terms, scarce. In a worst case scenario, where the highest estimated population growth rate and water demand is assumed, all surface and subsurface water in the country will be fully committed by 2015 (Davies and Day 1998). The protection and conservation of this water is therefore one of the main policies of the Department of Water Affairs and Forestry (DWAF 1997a).

In 1989 the Department of Water Affairs adopted the Receiving Water Quality Objectives (RWQO) approach which recognized the need for managing surface and groundwater resources instead of focusing on the effluents discharged into them (Van der Merwe and Grobler 1990). The change in government in 1994 led to a review of the existing water legislation and resulted in a new National Water Act (No. 36 of 1998). Within this act, the importance of maintaining aquatic ecosystems in a healthy state where they would not lose their assimilative capabilities was formulated as a legal right.

To implement this policy, data of the tolerance of local aquatic species to a certain water quality were needed, but it was recognized that these data were scarce (DWAF 1996a). In response to those research needs which had already arisen with the RWQO approach, the Artificial Stream project was initiated in 1991 at the Institute for Water Research (IWR). This project had the general aim of employing the experimental methods of aquatic toxicology to explore the possibilities of conducting experiments using test organisms indigenous to South African rivers. Two artificial stream designs at two scales and with different properties were constructed and used in toxicological experiments. At the end of the first phase of this project it became clear that the influence of scale and associated advantages and limitations had to be investigated to be able to define the future role of the two stream designs in routine toxicity tests.

The present study commenced within the second phase of the Artificial Stream project and aimed to compare the two stream designs. A third artificial stream system from a parallel

study was incorporated into the comparison. Acute toxicity tests with single species were chosen as the experimental method, as it is a common test type for governmental regulatory purposes. Indigenous organisms were used in the study so that the suitability of these organisms for standard test protocols could be tested. Sodium sulphate was used as the toxicant, as the results would contribute to understanding the effects of elevated salinity. The salinization of South African inland waters has been recognized as a major threat to the supply of fresh water (Stander 1987).

In this chapter, the historic development of aquatic toxicology is described with particular emphasis on its conflicting position between scientific rigour and the required compromise when it is used for regulatory purposes (Section 1.2.). Experimental methods of aquatic toxicology are briefly reviewed (Section 1.3.), and the position of aquatic toxicology in South Africa and its application in water quality management is outlined (Section 1.4.). The aim and objectives of this study are then given (Section 1.5.). A summary of the structure of the thesis is added (Section 1.6.).

## 1.2. Historic development of aquatic toxicology and definitions

The science of aquatic toxicology is historically rooted in classical toxicology and environmental chemistry. Toxicology arose as a formal scientific discipline in the early 1800s in response to the development of organic chemistry (Buikema *et al.* 1982) and has been defined as "the study of poisonous substances and their effects on individual organisms" (Moriarty 1988). This definition also encompasses lower levels of biological organization (Figure 1.1.). In the 1920s, mammals were a prime test species when systematic studies on the effects of toxicants in laboratory animals were initiated. This formed the scientific discipline of mammalian toxicology. In the 1950s and 1960s,

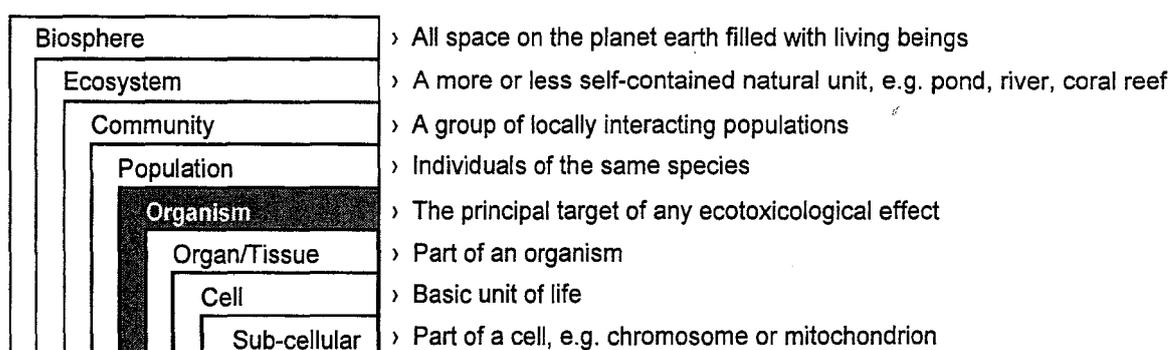


Figure 1.1. Levels of biological organization. Only the most distinct levels are displayed (various sources).

activities in the field of toxicology were renewed and enhanced and the range of test organisms extended. These increased efforts were motivated by incidents such as the death of about 3500 people in the mid-1950s in Minamata, Japan, because of mercury poisoning caused by the bioaccumulation of mercury in fish which originated from a factory effluent (Davies and Day 1998), or the disappearance of terrestrial and aquatic wildlife from extensive pesticide applications in agriculture (Moriarty 1988). In order to develop measures which protect not only man but also other biotic species, aquatic organisms were included in toxicological experiments.

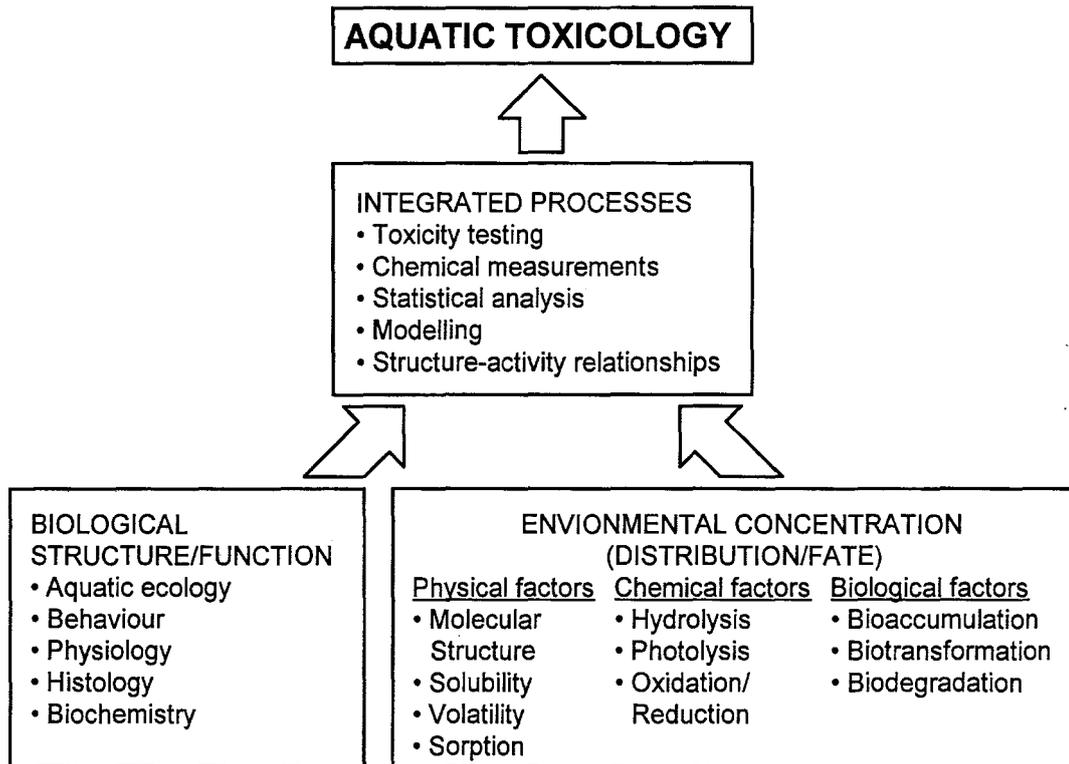
In 1969, Truhaut (1977) proposed the term *ecotoxicology*<sup>1</sup> for the branch of toxicology which operates within an ecological context. Ecology is "the study of the interactions between organisms with their physical environment and with each other" (Curtis 1983) and therefore deals with the levels of biological organization from the individual up to the biosphere (Figure 1.1.). Ecotoxicology aims at the protection of "populations and communities of many diverse species from exposure to toxic substances and materials at concentrations which are, or may be, associated with adverse effects" (Rand *et al.* 1995). As aquatic toxicology deals with the aquatic part of the environment, it has been defined by Rand *et al.* (1995) as "[...] the study of the effects of manufactured chemicals and other anthropogenic and natural materials and activities (collectively termed toxic agents or substances) on aquatic organisms at various levels of organization, from subcellular through individual organisms to communities and ecosystems". Although Rand *et al.* (1995) have extended the meaning of the term "aquatic toxicology" to all levels of biological complexity, in this thesis the terms "toxicology", "ecology", "aquatic toxicology" and "ecotoxicology" will be used as defined above and in the glossary.

Aquatic toxicology is a multidisciplinary science which borrows freely from several other basic sciences. The main compartments of this field are shown in Figure 1.2.

Funding agencies and regulatory bodies such as the United States Environmental Protection Agency (US EPA) played an important role in directing research activities in aquatic toxicology and ecotoxicology because of their requirement for a toxicological database on toxicity to aid legislative decision-making. This led to a division of the field into groups of different research interests. Pascoe and Edwards (1989) identified three groups: (1) those who study the toxicity of substances in a wider research context with the purpose of increasing scientific knowledge, (2) those who need to determine the

---

<sup>1</sup> *Ecotoxicology* is derived from the Greek words *toxon* (bow) and *toxema* (arrow), merged to form *toxicon* (poison of an arrow). "Eco" stems from *oikos* which means house.



**Figure 1.2.** A graphical display of the many scientific disciplines integrated in the science of aquatic toxicology (redrawn from Rand *et al.* 1995)

environmental hazard of substances which might enter the water course (e.g. through LC50 values) for regulatory purposes, and (3) those who monitor effluents or contaminated water in order to detect toxic discharges. Newman (1996) described three different goals of ecotoxicology which seem to coincide with the groups mentioned above. The *scientific goal* of ecotoxicology is "the organization of knowledge about fate and effects of toxicants in ecosystems based on explanatory principles". The *technological goal* aims at the "development and effective application of tools and procedures to acquire a better understanding of toxicant fate and effects in ecosystems". These two goals seem to reflect the research goals of the first group. Workers from groups (2) and (3) seem to follow what Newman describes as the *practical goal* of ecotoxicology where available knowledge, tools, and procedures are applied to specific problems. It is the technological and the practical goals which, in his opinion, have received too much attention in the ecotoxicological sciences throughout the past 30 years.

The emphasis on technological and practical aims originated from the experimental practices of mammalian toxicology. Aquatic toxicity tests in the 1950s and 1960s were conducted in a similar fashion, using aquatic species like fish or the water flea instead of the laboratory rat (Moriarty 1988). This approach is known as the single-species test approach and became a basic philosophy for environmental legislation in the US and other

western countries. Although the approach is simplistic, useful information has been accumulated upon which most regulatory limits were based. However, around the 1980s criticism arose that this approach ignores the fact that a pollutant does not only affect single organisms, but also higher levels of the biological hierarchy (Figure 1.1.) (Cairns 1975, 1986; Levin *et al.* 1989; Cairns *et al.* 1992). Researchers suggested that predictions of environmental hazard of contaminants based on single-species tests have no sound scientific basis, and stressed the importance of incorporating ecological aspects into aquatic toxicology and ecotoxicology (Cairns 1983, 1985; Kimball and Levin 1985). It was proven that multispecies tests at varying degrees of complexity have the capacity to reveal mechanisms which could not have been predicted by single-species tests alone. Multispecies tests also proved to be valuable in the field-verification of established limits (e.g. Schindler *et al.* 1985; La Point *et al.* 1989; Belanger *et al.* 1994; Newman and Jago 1996).

Although much evidence for the usefulness of multispecies toxicity tests has been collected, Pratt and Cairns noted in 1996 that routine US governmental toxicity testing for environmental risk assessments was still based on the single-species test approach. Despite ongoing criticism of the shortcomings of this approach, no multispecies test has been required to register a new chemical in the US (Pratt and Cairns 1996); this reflects international trends (Berghahn, personal communication). Schindler (1996) deemed it unrealistic to expect complex ecosystem-level testing ever becoming part of routine ecotoxicological procedures. He listed the "vast number of environmental stresses that must be monitored, the high cost and long duration of ecosystem-scale tests, and the problem of assessing synergisms, antagonisms, and other interactive effects" as prohibitive reasons.

Single-species tests, therefore, seem to remain the major regulatory tool upon which governmental decision-making and management is based. The study presented here therefore conducts single-species toxicity tests.

### **1.3. Experimental methods in aquatic toxicology**

Until the mid-1940s it was believed that non-biological methods such as chemical monitoring were superior for estimating hazard to the environment (Cairns and Pratt 1989). However, these physical and chemical methods cannot measure toxicity, and are therefore incapable of predicting potential hazards to humans and other organisms. In 1945 Hart *et al.* (1945, cited in Cairns and Mount 1990) introduced the first aquatic single-species

toxicity test using fish as an experimental organism, to test the potential toxicity of industrial wastes and other chemicals. Since then a multitude of toxicity test types have evolved. They differ in the test species used, the type of environment that is modelled, levels of biological complexity, scale, duration, and other factors, depending on the research focus. Table 1.1. outlines the most important terms used in connection with these tests. Some of these terms will be discussed briefly in the following sections.

**Table 1.1.** A structured summary of selected terms used in aquatic toxicity testing. Definitions of terms appear in the glossary and are discussed in the text. NOEC No observed effect concentration; NOAEC No observed adverse effect concentration; LOEC Lowest observed effect concentration; NOAEC Lowest observed adverse effect concentration; MATC Maximum acceptable toxicant concentration.

<b>Experimental parameters, related to the level of biological complexity</b>				
<i>Level of biol. complexity</i>	<i>Test type</i>	<i>Duration</i>	<i>End points</i>	<i>Expression of test results</i>
Individual and population	Single-species test	• Acute (ca. 24–120 h)	Lethal or adverse effect (quantal)	LC50/EC50 conc.-response relationship
		• Chronic (ca. >7 d) = Partial and full life cycle or life stage • Early life stage	Lethal and sub-lethal, e.g. biochemical, physiological, histological, behavioural	NOEC/NOAEC LOEC/LOAEC MATC, threshold values
Community and ecosystem	Multispecies test	<i>Size</i> • Microcosm • Mesocosm • Macrocosm • Ecosystem manipulation	As for acute and chronic tests, and those typical of ecosystems, e.g. predator-prey interactions, productivity, nutrient spiralling or chlorophyll content	
<b>Experimental techniques, depending on research focus and facilities</b>				
<i>Type of environment</i>	<i>Manipulated system</i>	<i>Location of experiment</i>	<i>Renewal of test solution</i>	<i>Dosage of chemical</i>
Lentic:	Aquarium, pond, limnocorral, littoral enclosure, lake	Indoor / Laboratory Outdoor / Field / <i>in situ</i>	Static Renewal	Pulse Partial exposure
Lotic:	Artificial stream, river		Flow-through	Chronic
Marine:	Enclosure		Recirculating	

Toxicity testing in laboratories usually follows a stepwise tiered approach, with rapid, simple tests in the early tiers (e.g. short-term single-species tests), and then progressing to more complex and sophisticated long-term experiments (multispecies tests)(Rand *et al.* 1995). In South Africa such an approach has not yet been formulated explicitly, but is in development (Jooste, personal communication).

### 1.3.1. Single-species toxicity tests

Single-species toxicity tests use individuals of one species from any trophic level, are generally conducted in the laboratory, and the environmental realism is therefore low. Species include bacteria, algae, higher plants, protozoa, coelenterata, platyhelminthes/turbellaria, rotifera, annelida, crustacea, insecta, mollusca, and fish (Pascoe and Edwards 1989). Generally, single-species tests provide practical means of identifying the toxicity of a chemical, of ranking chemicals and species for relative toxicity, of evaluating the effects of water quality on chemical toxicity, and of determining whether treatment methods effectively reduce toxicity (Loewengart and Maki 1985; La Point *et al.* 1989). Single-species tests may be divided into categories, depending on the test duration in relation to the life time of the test organism.

#### *Acute toxicity tests*

Acute toxicity tests are short in comparison to the life span of the organism under study and typically last between 24 and 96 h. Microbiological tests can be much shorter (e.g. 30 minutes)(DIN 1991). The observed end point is usually mortality, expressed as the lethal concentration at which 50% of the test population die, hence LC50 (Rand *et al.* 1995). The test is usually designed to determine a concentration-response relationship (Section 1.3.5.). In comparison to other toxicity tests, acute tests are short, simple to conduct, and the results are easy to interpret, thus suitable for legislative purposes. Acute tests are therefore used to screen the toxicity of pure compounds, chemical mixtures and effluents, as well as to establish initial results for untested species or chemicals in a stepwise tier approach (Parrish 1985; Rand *et al.* 1995). Although the ecological relevance of LC50 values is low, their meaning may be enhanced when the test is continued until a threshold toxicity is reached – the incipient LC50. At this concentration, 50% of the test population can be expected to survive indefinitely (Rand and Petrocelli 1985). In the present study, acute toxicity tests were used as the experimental tool to compare different artificial stream designs, and to record responses to sodium sulphate.

#### *Chronic toxicity tests*

Chronic toxicity tests last for extended periods of time depending on the species tested. They may cover a large proportion of an animal's life span, or the full life-cycle (McKim 1985), in which case they are often referred to as full life-cycle tests. For invertebrates a duration of 3–4 weeks is common (Petrocelli 1985) and can cover several life cycles (e.g. *Daphnia*). Full life-cycle tests with fish species require a minimum of 6–12 months exposure (*ibid.*). Chronic tests with bacteria covering 3–4 generations are, however, much shorter (e.g. 7 h)(DIN 1995). The observed end points may be lethal or sub-lethal. Sub-

lethal effects include changes in biochemistry, physiology, histology, behaviour, or growth and reproduction (Rand and Petrocelli 1985; Pascoe and Edwards 1989; van Vuren *et al.* 1994). Results are usually expressed as no-observed-effect concentrations (NOEC), and lowest-observed-effect concentrations (LOEC). These values provide information on pollutant influences at environmentally realistic concentrations, and are useful when concentration limits must be established with a low risk of environmental damage (Loewengart and Maki 1985; La Point *et al.* 1989).

Partial and early life stage tests are categorized as chronic toxicity tests. Although many aquatic toxicologists consider full life cycle tests to be the most sensitive for evaluating environmental risks of a chemical, they are very labour intensive and can be of long duration, especially when fish are used (McKim 1985). As regulatory bodies such as the US EPA constantly evaluate the toxicity of large numbers of new chemicals, partial life cycle tests were proposed to reduce the time required per test. The rationale is that certain developmental stages of fish have consistently been found to be more sensitive than others; thus focusing on these stages allows extrapolation to chronic effects (*ibid.*). The duration of early life-stage tests is much shorter, usually between 30 and 120 days. Although the most common end points are growth and mortality, other end points can be applied. Results are expressed as NOECs and LOECs (La Point *et al.* 1989).

#### *In situ* single-species tests

Single-species tests can also be conducted in the field with the test species held in containers submerged in the receiving water body. For instance, Oikari *et al.* (1985) investigated the response of rainbow trout which were caged in the receiving lake, at different distances from the out-fall, to bleached kraft pulp mill effluent. This approach overcomes several shortcomings associated with conventional laboratory experiments and field studies. It enables the researcher to interpret directly cause-effect relationships with a high degree of ecological realism. Also, the changes in effluent structure, e.g. because of volatile components or changes in chemical speciation during transport, are avoided (La Point *et al.* 1989).

### 1.3.2. Multispecies toxicity tests

Up till now, multispecies toxicity tests have mainly been used for research purposes. They can be defined as "any test which has a level of organization higher than that of a single-species" (Dickson *et al.* 1985). They can be carried out in the laboratory or in the field, and

provide information on aspects of ecosystems, especially at the community level, which cannot be addressed by single-species tests. These aspects encompass:

- predator-prey interactions between different species
- competitive interactions between individuals of one population
- community compensation (e.g. processes of adaptation, or selection of resistant individuals) which lowers toxicity threshold values determined from single-species tests
- rate of detritus processing and energy flow (nutrient spiralling)
- determination of species diversity
- identification of keystone species
- formulating and testing ecological and ecotoxicological hypotheses

(Cairns 1985; Kooijman 1985; Loewengart and Maki 1985; Mount 1985; La Point *et al.* 1989)

The range of scale in multispecies tests is very broad and can reach from laboratory test systems containing only several litres of water to the manipulation of whole ecosystems. They have been classified by Giesy and Allred (1985) on the basis of scale, i.e. microcosms, mesocosms and macrocosms, with water volumes of <10 L, 10–1000 L, and >1000 L respectively. These categories were, however, arbitrarily chosen and are used at random by other authors. Generally, with increasing scale, complexity of the design and number of trophic layers, the environmental realism of the studies increases, making results more ecologically relevant. Unfortunately, as biological complexity increases, so does parameter variability which means a reduction in the replicability of the experiment (Giesy and Allred 1985; La Point *et al.* 1989; Belanger 1992; Swift *et al.* 1993).

### 1.3.3. Experimental techniques

Different experimental techniques have been developed to accommodate specific research concerns.

Test species are most commonly exposed to constant concentrations of the toxicant throughout the entire test period (Kosinski 1989). Other dosing techniques may better simulate a pollution event since it is known that pollutants may occur in fluctuating concentrations or as a single episodic event (Pascoe and Edwards 1989). To model the latter situation, the toxicant may be applied in one pulse, or in several pulses of different lengths (e.g. Cooper and Stout 1985). In this study, test species were continuously exposed to the toxicant.

There are several methods of renewing the test solution during a toxicity test. In a static test system (i.e. a lentic environment) the test solution is not replaced during the test period, but may be stirred or aerated to maintain a certain water quality (Pascoe and Edwards 1989). For lotic environments in artificial stream systems, the test medium may be recirculated. When the desired water quality cannot be maintained over time, a part of the total volume can be replaced (partial renewal practice), usually every 24 h. For volatile toxicants (e.g. chlorine) or those which might precipitate during the test period (e.g. heavy metals), a flow-through design overcomes these problems (Williams 1996). Water only passes through the test system once, and the toxicant is added at the inflow. In two of the artificial stream designs used in this study (the Large Artificial Stream Units (LASUs), and the Channels), a recirculating design was employed, while water was partially renewed in the Raceways to avoid potential nutrient-accumulation (Goetsch and Palmer 1997).

#### **1.3.4. Selection of test species**

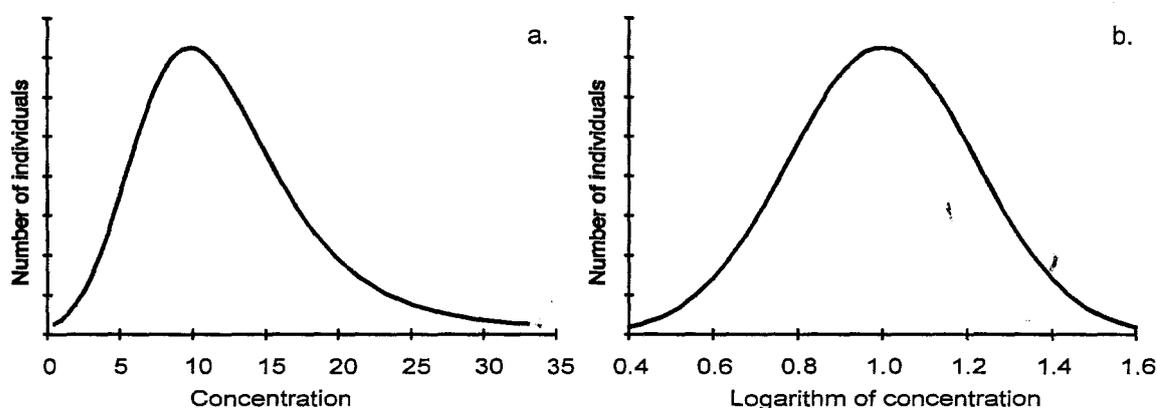
Experiments in aquatic toxicology historically used fish as the test taxon. It was an animal of economic interest, an important part of aquatic ecosystems, easy to culture in the laboratory, and sensitive to pollutants (Pascoe and Edwards 1989). As toxicological data accumulated, it became apparent that other aquatic animals, such as insects, may be as sensitive as fish, or even more sensitive (Mayer and Eilersieck 1988). At present, species of all major trophic levels are used in toxicity tests (e.g. DWAF 1996a). To assess their suitability, a number of criteria have been proposed (e.g. Rand and Petrocelli 1985; APHA 1992; Buikema and Voshell 1993). These criteria are presented in Section 2.3.3., together with an evaluation of the species selected for this study. Selecting test species is strongly influenced by research objectives, as no universal species can be used for all purposes (Rand and Petrocelli 1985).

#### **1.3.5. The concentration-response relationship**

The concentration-response relationship is a fundamental principle of aquatic toxicology. In aquatic toxicity tests the experimental organisms are exposed to a concentration of the test chemical in the water, and the effects exhibited can be expressed in quantal or continuous terms. A quantal response can take on only two states: a defined effect was either observed or not, hence expressions such as all-or-none, or binary response (Stephan 1977), with mortality being a typical example. For continuous responses the extent of the

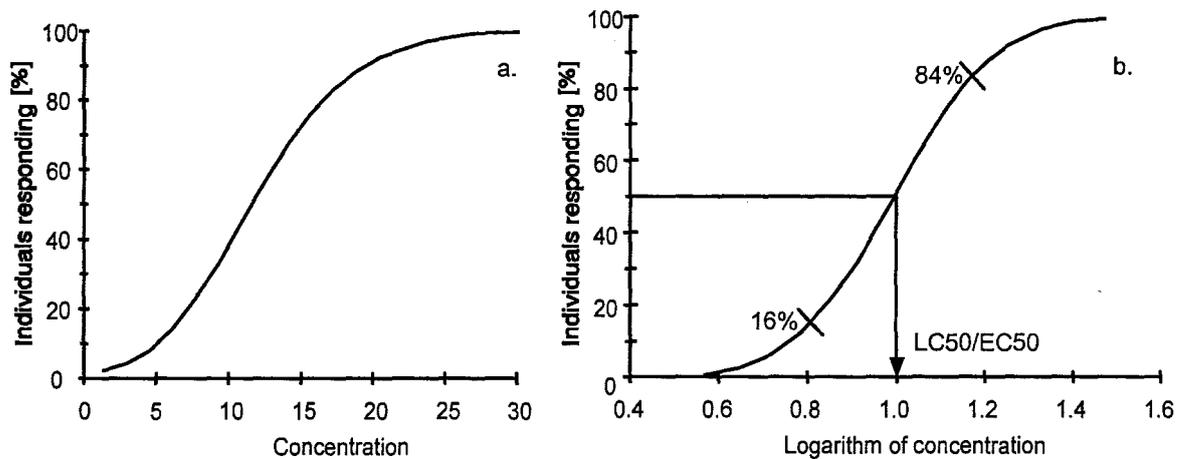
response needs to be determined for each animal. Examples include some measure of growth, or behaviour.

The concentration-response relationship is based on several important assumptions. Although a group of organisms of the same species might be considered to be homogeneous, the individuals of this group will exhibit significant differences. These differences can be attributed to internal physiological conditions and natural biological variability. When such a group is exposed to a concentration of a chemical, not all individuals will react in the same way. Their response might range from very intense (e.g. death) in some, to minimal in others. The threshold concentration at which an individual organism shows a quantal effect is usually termed *tolerance value* (Finney 1971). The *frequency distribution of tolerance concentrations* of a population is the count of only those animals of the population who share the same tolerance value, over a range of concentrations. Plotted on a graph, it has been found that for many chemicals the curve will be shaped as displayed in Figure 1.3.a. This curve is skewed to the right because a few individual organisms show extremely high tolerance values. When the concentrations are logarithmically transformed, the tolerance distribution approximates the bell-shaped gaussian or normal form (Figure 1.3.b.).



**Figure 1.3.** a. The frequency distribution of tolerance concentrations for a population as found for many chemicals. b. Frequency distribution of the same population after log-transforming the concentrations. Redrawn from Finney (1971).

In practice it is not possible to count only individuals with the same tolerance value. When a concentration is applied in a toxicological test, all animals with this tolerance value *and lower* will respond. Thus the resulting curve is cumulative, describing the *concentration-response relationship* between the chemical and the test population. The response- or toxicity-curve of a population with the tolerance distribution of Figure 1.3.a. has an asymmetric sigmoid shape (Figure 1.4.a.). After log-transforming of concentrations, the sigmoid curve becomes symmetric (Figure 1.4.b.).



**Figure 1.4.** a. The typically sigmoid shaped cumulative concentration-response curve. b. After log-transforming the concentrations, the curve is transformed into a normal form. Between 16 and 84% the curve is considered to be linear. At 50% response the LC50/EC50 can be read off the graph. Both graphs taken from Finney (1971).

The sigmoid concentration-response curve approaches 0% response at lower concentrations, and 100% at higher concentrations, but theoretically never reaches these values. Between 16% and 84% (Figure 1.4.b.) the curve is considered to be linear (Rand and Petrocelli 1985). This is the span of one standard deviation of the mean of the underlying normal tolerance distribution of the test population (Figure 1.3.b.). In applying the concentration-response concept, the following assumptions are accepted (*ibid.*):

- There is a causal relationship between the concentration of the chemical and the response of the organism. However, the concentration-response relationship is only a "reasonable presumption" because the chemical might change in the water through time, the animal might actually experience a different concentration in the water, or the response might be due to factors other than the chemical.
- The response is a function of the concentration of the chemical, and one generally expects a greater response with increasing concentrations.
- There is a threshold concentration for each toxicant below which no response occurs.

#### *Median lethal concentration (LC50), or effective concentration (EC50)*

To be able to compare the effects of different chemicals on a test organism, or the tolerances of different species to one chemical, a relative measure of toxicity is needed. In acute toxicity tests this is usually the median lethal concentration (LC50). It estimates the concentration at which 50% of the test population experienced death within a defined period of time (e.g. 24 or 96 h). With some aquatic insects the point of death is difficult to determine. In these cases, other end points, such as immobility, can be chosen, but have to be described in quantal terms (APHA 1992). They are expressed as the effective

concentration (EC50), and the type of effect (e.g. loss of swimming capability or decreased photoluminescence) must be provided. In this study the term EC50 is used, since immobility was the recognized end point; however, it would be reasonable to consider this the equivalent to LC50.

The 50% level is the point where test results show the least variability. It is therefore the most precise estimate, compared to other response levels such as EC1 or EC99. The EC50 can be graphically interpolated by reading the concentration in the graph of Figure 1.4.b. at the level of 50% response of the test organism. Methods of calculating the EC50 will be described in Section 3.3.

#### *Confidence limits*

The EC50 is not a precise value but an estimation because it has been obtained from a sample of the aquatic species under investigation and not the entire population (Gelber *et al.* 1985). It is therefore necessary to determine how probable it is for the true value to lie between certain limits. This probability is usually expressed through 95% confidence limits (95%CLs). "The [95% confidence] limits indicate the area or range within which the concentration-response line would be expected to fall in replicate tests in 19 of 20 samples taken at random from the same test population under the same conditions" (Rand *et al.* 1995). This statistic describes the distribution of the susceptibilities of the individual test organisms at a specified level of response (e.g. 50%), but does not contain any information on the actual precision of the test (Stephan 1977).

#### *Slope*

When parametric methods are applied to calculate an EC50 value (e.g. Probit analysis, Section 3.3.1.), the slope of the toxicity curve can be determined. The slope provides useful information on the range of sensitivities of the organisms selected for the test to the chemical (Rand and Petrocelli 1985). Different chemicals can yield the same EC50 value, but the slopes might be significantly different. A steep slope means that with a small increase in concentration the effect on the population will be great. It can be interpreted as a rapid absorption of the chemical with an immediate effect on the organisms. A flat slope indicates that a great change in the concentration will only have a small effect on the population. In this case, possible causes may be slow absorption, fast detoxification or excretion, or delayed toxification (*ibid.*).

### *Time-toxicity curve*

Another useful measure in an acute toxicity test is the determination of the time at which acute toxicity has ceased. EC50 values for different intermediate exposure times are calculated and plotted on a log-log scale with the concentration on the abscissa (x-axis), and the time on the ordinate (y-axis). A curve is fitted through the points by eye, and where it becomes asymptotic to the time axis, cessation of acute toxicity has been reached. An EC50 on this straight part of the curve is termed "threshold" or "incipient" EC50 (APHA 1992). It means that at this concentration 50% of the test population can survive for an indefinite time, or that this is the lethal level for 50% of a population in long-term toxicity tests (Rand and Petrocelli 1985). A threshold EC50 is generally more meaningful in comparison with other EC50 values.

## **1.4. Water quality management and aquatic toxicology in South Africa**

Since the beginning of the 1990s, major changes in the water legislation of South Africa have contributed to the initiation of the Artificial Stream project at the Institute for Water Research (IWR), Rhodes University (Palmer *et al.* 1996; Palmer and Scherman in press). The study presented here is part of the Artificial Stream project, and was therefore directly influenced by these changes. In the following sections, water management and legislation, and the application of aquatic toxicological methods in South Africa will be outlined.

### **1.4.1. Historical perspective: water quality management**

In the 1950s South Africa's economic base changed from agricultural dominance to industry and mining. The new demands on effluent regulation were met by the release of the Water Act in 1956. It was based on the Uniform Effluent Standards approach, with the aim of minimizing pollution from point-sources by the application of General and Special Standards to all effluents equally. In 1991, the Department of Water Affairs and Forestry (DWAF) adopted a new policy by introducing the Receiving Water Quality Objectives (RWQO) approach (Van der Merwe and Grobler 1990). It brought a shift in management policy away from "end-of-pipe" regulations towards the recognition of site-specific objectives for the receiving water body (DWAF 1991). The natural environment was recognized as a water user as important as industry, mining, agriculture, domestic use and recreation. In 1993 water quality guidelines were published for all five users other than the natural environment (DWAF 1993). During the development of these guidelines it was

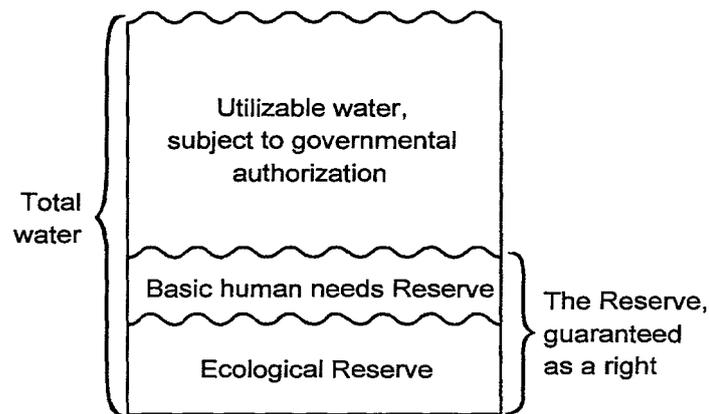
recognized that aquatic ecosystems should not be regarded as a "user" of water in competition with other users, "but as the base from which the [water] resource is derived" (DWAF 1994). Consequently, guidelines for aquatic ecosystems were published (DWAF 1996a), which adopted a specific set of values to ensure ecosystem protection.

With the democratically elected government in 1994, the Minister of Water Affairs and Forestry set new directives for water legislation (DWAF 1994). As proper accessibility and distribution of water were previously limited to a minority of the country, he called for a review of the existing water law and encouraged the general public to participate in the review process (DWAF 1995). This process lasted four years (DWAF 1996b, c, 1997b) and resulted in the new National Water Act (No. 36 of 1998). The overall goals of the National Water Act are captured by the official slogan of DWAF "Some, For All, For Ever". *Some* water as it is a limited resource; *for all* citizens on an equitable basis; *for ever* – implying now and in the future, in a sustainable manner (DWAF 1997b).

#### 1.4.2. Water legislation

The new National Water Act brought fundamental changes to the rights to use water, and to the status of protection of the aquatic environment. The first priority of the new National Water Act is to ensure that all people have access to sufficient water. The second priority is to provide the aquatic environment reliably with water sufficient in quantity and quality to maintain its functioning sustainably. This water is termed the ecological Reserve, and together with the water for basic human needs, is referred to as the Reserve (Figure 1.5.). All citizens have a right to the Reserve; all other water is subject to governmental authorization (DWAF 1997b).

The functioning of aquatic ecosystems has been recognized as being vital to human well-being because they provide certain "silent services". These services include the dilution, removal and purification of wastes; commercial and subsistence supply of food and plants; retention, supply, transport and storage of water (including flood water); recreation and ecotourism; and the conservation of biodiversity through the maintenance of habitats (DWAF 1997b; Palmer in press). In making use of these services it is assumed that ecosystems have the important characteristics of assimilative capacity and resilience (Pratt and Cairns 1996). Thus, even though water may have been abstracted, and aquatic ecosystems might have been burdened with some pollutants, they continue to function, but probably at a different level of biotic integrity (Palmer in press). However, once the burden has become too heavy, they will start to deteriorate and lose their ability to sustain



**Figure 1.5.** The legal division of water in the National Water Act (No. 36 of 1998). Modified from DWAF (1996b).

utilization in the long term. It is the task of the new National Water Act to prevent use beyond this level.

Two sets of measures have been developed to protect effectively the ecological Reserve from deterioration. *Resource-directed measures* involve the classification of water bodies and the determination of the ecological Reserve in terms of water quantity and quality. For quality aspects, the South African Water Quality Guidelines for Aquatic Ecosystems (DWAF 1996a), provide a published set of quantified resource directives (see below). When a water body is classified and the ecological Reserve has been set, management goals are assigned to ensure a desired level of protection. *Source-directed controls* for water quality include all actions which may be used to prevent or minimize wastewater discharges which might impact on the aquatic environment. A wide range of policy instruments can be used for implementation which include impact assessments, standards for waste discharges, economic incentives, licenses to abstract or discharge water, or the registration of sources of impact (DWAF 1996c, 1997b). Toxicity tests will probably be included as source-directed controls (Scherman, personal communication).

A balanced application of both measures is recommended as the best protection for aquatic ecosystems (DWAF 1996c). Using only source-directed control strategies might result in over- or under-protection of the environment because the environment is variable. Over-protection might result in unnecessary financial strain for polluters, while under-protection might lead to damage of especially sensitive ecosystems. Alternatively, relying only on resource-directed measures might result in data-gathering for site-specific limits, which renders this approach impractical on the basis of time and financial constraints (*ibid.*).

### 1.4.3. Determination of the ecological Reserve

The implementation of the new National Water Act will lead to an increased number of water use licenses which will have to be issued in the near future (DWAF 1999a). The issuing of a license requires that the ecological Reserve of the water body of concern be determined. As some methodologies for an ecological Reserve determination are still under development, a phased implementation of the new National Water Act is planned. A transitional phase of three to five years with special transitional tools will accommodate pilot testing, refinement of existing tools, and the development of the full suite of tools needed to implement the Act. To aid the efficient issuing of water use licenses during this period, the ecological Reserve of an aquatic ecosystem will be determined – depending on the level of urgency – using three different methodologies with varying degrees of precision (*ibid.*):

- the Planning Estimate (for the water quantity Reserve only); a first prototype exists.
- the Preliminary Ecological Reserve Methodology (PERM); a first prototype exists. For detailed information see DWAF (1999a).
- the Comprehensive Ecological Reserve Methodology (CERM); most aspects of this tool are still in development.

The most rapid tool is the Planning Estimate. As it is a desktop method, an assessment can be completed within hours. However, it accounts only for the water quantity of a river, and therefore no license can be issued based on this estimate. The PERM is estimated to take about 2 months per ecological Reserve determination (DWAF 1999a), and licenses may be issued based on this method. The CERM is expected to take 8–12 months (*ibid.*), will deliver the most reliable results and will form the core of a comprehensive catchment management strategy.

#### *Aquatic ecosystem assessment tools*

A number of aquatic ecosystem assessment tools exist which form important components of the ecological Reserve determination process. These include the determination of the Instream Flow Requirements of a river using the Building Block Methodology (King and Louw in press), the indices developed for the River Health Programme (Hohls 1996) such as the aerial habitat integrity survey (Kleynhans 1996) and the South African Scoring System for invertebrate assessment (Chutter 1994, 1998), and the South African Water Quality Guidelines for Aquatic Ecosystems (DWAF 1996a). The guidelines are outlined below because of their relevance to toxicity data.

In the process of adapting the RWQO approach as a national policy, the South African Water Quality Guidelines for Aquatic Ecosystems were introduced in 1996 as an assessment of the tolerances of instream biota (*ibid.*). They follow the rationale of protecting "the most sensitive species within each trophic level" (*ibid.*). The guidelines contain values for a selected range of constituents expressed as Target Water Quality Ranges (TWQR), Chronic Effect Values (CEV), and Acute Effect Values (AEV). The TWQR is not a water quality criterion but rather a management objective. When the instream concentration or level of a constituent can be kept within this range, no adverse effect on the aquatic environment is expected on a long-term basis. It is the policy of the DWAF to strive for maintaining constituents within the TWQR as part of its protective approach to water quality management. The CEV "is defined as that concentration or level of a constituent at which there is expected to be a significant probability of measurable chronic effects to up to 5 % of the species in the aquatic community" (*ibid.*). If constituents are allowed to persist at this level in the aquatic ecosystem for longer periods, death of individuals and the eventual disappearance of sensitive species from the ecosystem can be expected. The AEV is defined as "that concentration or level of a constituent at which there is expected to be a significant probability of measurable acute effects to up to 5 % of the species in the aquatic community" (*ibid.*). Constituents existing at this level even for short times might result in quick disappearances of sensitive species and considerable negative consequences for the aquatic ecosystem.

The AEV and CEV values are derived mostly from international acute and chronic toxicity data on single-species from different trophic levels. These species include representatives of a cold and a warm water fish, a planktonic and a benthic crustacean, an insect, and a family other than Arthropoda or Chordata (e.g. Rotifera, Annelida, Mollusca). Values are calculated following a procedure described by Roux *et al.* (1996). Where the data for calculating guideline values did not meet the specified database requirements, safety factors were applied to compensate for the uncertainties associated with missing data. These factors can range from 1 (no compensation necessary) to 100 (acute values) or 1000 (chronic values) (DWAF 1996a). Where safety factors were applied, the guideline values were ranked "tentative" and may be reviewed as more data become available. During a workshop in the Kruger National Park in 1989 it became evident that almost no toxicological data existed for South African freshwater species (Moore 1990; Moore *et al.* 1991). Because of this paucity of data, most of the calculated guideline values had to be based on results from international databases and species not indigenous to South Africa.

#### 1.4.4. The application of aquatic toxicology in South Africa

The application of aquatic toxicology in South African water quality management is relatively new. Although toxicity tests have been used in South Africa since the early 1980s (Slabbert *et al.* 1998a), they have not yet been required for regulatory purposes. Recently, a range of tests using different standard laboratory test organisms have been evaluated for their suitability for testing drinking and environmental water (encompassing all natural fresh waters of the environment such as water from rivers, dams, and groundwater), and whole effluents (Slabbert *et al.* 1998a, b). The tests examined used guppies, water fleas, protozoa, algae, enzymes, mammalian cells and bacteria as toxicity indicators. For the testing of drinking and environmental waters, all tests except the luciferase enzyme test proved to be valuable in the monitoring of water quality (Slabbert *et al.* 1998b). For whole effluent toxicity testing, the use of the fish and water flea lethality tests, and algal growth inhibition test, were recommended, based on test sensitivity, while the mutagenicity and teratogenicity test should be added when the water downstream of an effluent discharge is used for drinking water purposes (Slabbert *et al.* 1998a). Indigenous macroinvertebrates were not evaluated as toxicity test organisms by Slabbert *et al.* (1998a, b).

However, whether these standard laboratory organisms are protective of the aquatic fauna of South African rivers has not yet been established. The use of indigenous organisms in toxicity tests is therefore important for two reasons.

Firstly, there is a general need for toxicity data of any aquatic organism indigenous to South Africa which became apparent during the development of the South African Water Quality Guidelines for Aquatic Ecosystems. Because of the lack of local data, tolerances of standard test species and other international data had to be used to calculate national water quality criteria (Roux *et al.* 1996; Palmer in press), and it is not known how these data compare to the responses of local species, or the actual level of protection needed. The national water quality criteria which have been derived may therefore either be over- or underprotective: overprotective because uncertainties and lack of data had to be accounted for by applying high safety-factors; underprotective because the high sensitivity of local species to a particular chemical may not yet have been discovered. The generation of data using indigenous organisms increases both the environmental realism and reliability of derived data. The use of local organisms could be particularly useful in setting site-specific guidelines.

Secondly, there is a need for the development of standardized test protocols for indigenous organisms. A protocol for the use of indigenous macroinvertebrates is currently under

development by Scherman and Palmer (DWAF 1999b). This information is necessary as the South African Water Quality Guidelines for Aquatic Ecosystems require site-specific data with local species, should there be no criteria available for a water quality constituent (DWAF 1996a).

The recognition of these research needs led to the initiation of a number of projects at the IWR.

#### 1.4.5. Research in aquatic toxicology at the Institute for Water Research

The first phase of the Artificial Stream project started in 1992 (Palmer *et al.* 1996). Funded by the Water Research Commission (WRC), it aimed to develop methods for toxicity testing using indigenous macroinvertebrates, and to provide data for the development and refinement of environmental water quality guidelines (*ibid.*). South African bioassessment studies sample and consider predominantly riffle-dwelling organisms. To be able to interpret these data with results obtained by toxicity tests, the test animals targeted were rheophilic; thus the provision of a flowing-water environment was imperative (*ibid.*). During the project, two artificial stream systems at different scales (the Large Artificial Stream Systems (LASUs), and the small-scale portable Raceways) were constructed (Palmer *et al.* 1994), calibrated for physical, chemical and biological parameters (Palmer and Goetsch 1997), and initial experiments were conducted in the field using the Raceways and salinity as the first water quality variable under investigation (Goetsch and Palmer 1997). It was, however, realized that without a reliable supply of test organisms, toxicity testing on a regular basis would be impossible. Therefore a second project was initiated. The two-phased Standard Laboratory Organism project aimed at the identification of indigenous freshwater macroinvertebrates as suitable test organisms, and subsequent laboratory-based fertilization and rearing methods (Haigh and Davies-Coleman 1997, in press). The leptophlebiid mayfly *A. auriculata* was identified as a potential indicator and standard test organism.

The second phase of the Artificial Stream Project, also funded by the WRC, commenced in July 1995 (Palmer and Scherman in press). A third small-scale artificial stream system was developed (the Channels) specifically to investigate macroinvertebrate responses to chlorine and chlorinated sewage effluents (Williams 1996). This system showed some practical advantages and was therefore also used in the ongoing field-based research on salinity tolerances, together with the Raceways (Scherman *et al.* in press a; Scherman *et al.* in press b). The Channels were later also used to investigate the effects of two metal-ions

(copper and zinc) on indigenous macroinvertebrates (Everitt *et al.* in press; Gerhardt and Palmer 1998). The present study is part of the second phase of the Artificial Stream Project, and its aims and objectives will be outlined below.

## 1.5. Scope, aims and objectives of this study

### *Motivation*

This study was initiated for the following reasons:

- In the final report of Phase One of the Artificial Stream project (Palmer *et al.* 1996), it was proposed to "undertake [...] acute tolerance testing" and to "evaluate the effects of scale, and define the roles" of the Raceways and the Large Artificial Stream Units in future toxicological research. This recommendation was extended to the third artificial stream design, the Channels, which was originally developed and successfully used by Williams (1996).
- Method development and testing is necessary for acute toxicity testing when indigenous macroinvertebrates are to be included in license requirements. This study therefore used acute toxicity tests with indigenous organisms as the experimental tool.
- In using sodium sulphate as a reference toxicant together with two local mayfly species, this study also aimed to contribute to the national toxicity database, and the understanding of effects of salinization on South African organisms. Sodium sulphate was chosen as the toxicant since many South African rivers (e.g. the Vaal river) have high sulphate levels, resulting from mining and industrial water use.

### *Scope*

The scope of this study therefore encompasses the comparison of three different artificial stream designs using acute toxicity testing as the test method, and two local species as test organisms. The responses of the test taxa to sodium sulphate will be evaluated in the context of the salinization problem in South Africa. However, the toxicity of the *sulphate ion* will *not* be evaluated, as this approach requires chemical speciation modelling using specialized software and expertise, and is outside the scope of this study.

The aim of this study was therefore formulated as follows.

### *Aim*

To evaluate the performance of a variety of artificial stream designs by comparing the salinity tolerances of selected mayfly nymphs, and secondarily to evaluate the response of the test taxa to elevated salinities.

The aim was achieved by meeting the following objectives:

- 1) To conduct short-term experiments in three different artificial stream systems at two main scales using *A. auriculata* and *A. sudafricanum* as test taxa, and sodium sulphate ( $\text{Na}_2\text{SO}_4$ ) as the reference toxicant; and to use the test results, and the practical performance of the artificial stream systems, to define their future application in acute toxicity tests.
- 2) To compare and evaluate the responses of the two mayfly species in order to assess their suitability for routine toxicity testing.
- 3) To assess the effect of increased salinity levels on the test taxa.

Originally it was intended to use both test taxa *A. auriculata* and *A. sudafricanum* equally, and to compare their responses. This proved impossible because of two main constraints. 1) The limited number of independent LASUs required sequential experimentation, and there was insufficient time to complete experiments with two taxa. 2) *A. sudafricanum* nymphs of an appropriate size were only available in spring, summer and early autumn. As a result, limited comparisons were possible; therefore the discussion of the effect of experimental scale was based mainly on data from *A. auriculata*.

## **1.6. Summary of thesis structure**

### **Chapter 1: Aquatic toxicology and its application in South Africa**

This chapter has provided the context for the present study. It outlines the potential role of aquatic toxicology in decision-making, presents experimental methods and describes the progress in incorporating these methods in South African water legislation. It highlights the lack of toxicity data for indigenous species, the need for standard test protocols, and the requirement for testing the proposed methods.

### **Chapter 2: Contextual review**

The contexts of the three main aspects of this study are reviewed in this chapter. These are 1) the use of artificial streams in aquatic toxicology, with a focus on single-species tests; 2) the use of local species as test organisms, with particular reference to the two test species,

*A. auriculata* and *A. sudafricanum*; and 3) the salinization problem of South African water courses.

### **Chapter 3: Experimental methods**

In this chapter the experimental methods applied are described. These include statistical design, the general test procedure for acute toxicity testing, the methods used for calculating EC50 values, and the analyses conducted after the tests, e.g. measuring the body-sizes of the test organisms.

### **Chapter 4: Results**

This chapter presents the results of the two sets of acute toxicity experiments conducted using each species. The differences between EC50 values are examined in the light of artificial stream related factors, and factors related to the test organisms.

### **Chapter 5: Discussion**

The results are discussed from four main perspectives. Firstly, the different artificial stream designs are evaluated considering aspects such as the EC50 values as system-related responses, the "natural" variability of EC50 values derived under standardized test conditions, and the practical performance of the systems. The test taxa are then discussed; the discussion refers for example to the influence of their body-size on EC50s. Thirdly, the responses of both species are discussed in the light of the salinity problems in South Africa. Finally, both taxa are evaluated in respect of their use as standard laboratory organisms.

### **Chapter 6: Concluding summary**

In this concluding chapter, the main outcomes of the discussion are summarized.

---

# Chapter 2

## Contextual review

---

### 2.1. Introduction

The aims and objectives of this study span three main areas:

- the use of artificial streams
- the use of indigenous taxa as test organisms
- the salinization of South African water bodies

The aim of this chapter is to provide the research context for each of these areas, and to indicate the links between them.

### 2.2. Research using artificial streams

An artificial stream can be defined as a "constructed channel having a controlled flow of water, which is used to study some physical, chemical, or biological property of natural streams" (Lamberti and Steinman 1993a). An artificial stream is therefore an experimental tool to investigate unique properties of a flowing water environment which cannot be simulated by a lentic system. This tool has been used in both ecology and aquatic toxicology.

Artificial streams were used first in the late 1950s. They consisted of wooden troughs which were applied in fish bioassays or the study of periphyton communities (McIntire *et al.* 1964; McIntire 1993). Early ecotoxicological studies in larger systems were conducted by Wuhrmann *et al.* (1967), who investigated self-purification of an artificial stream exposed to a model effluent. Subsequently the use of artificial streams increased as their many advantages became known. These advantages have been documented in four major reviews (Warren and Davis 1971; Shriner and Gregory 1984; Kosinski 1989; Lamberti and Steinman 1993b).

### 2.2.1. General artificial stream issues

A number of issues must be carefully considered when artificial streams are constructed. The issues raised here are all relevant to this study.

**SCALE:** the scale of the systems and the biological complexity will be determined by the research objectives. Small systems are not capable of supporting a high number of trophic levels; thus size and biological complexity influence the resulting environmental realism and the potential for extrapolating results to the field (Cairns 1985; La Point *et al.* 1989).

**NUMBER OF UNITS AND STATISTICAL DESIGN:** the number of stream units that can be installed is often limited by financial constraints. This influences the statistical design of the study and replication within treatments. Hurlbert (1984) and Kosinski (1989) found that many studies suffer from pseudoreplication<sup>2</sup> in an ANOVA design. Kosinski (1989) therefore proposed to resort to a concentration-response approach with a minimum of four increasing concentrations. Although Guckert (1993) acknowledged that this is "a compromise experimental design" where "treatment replication [...] is sacrificed for information generated by being able to test a wider array of chemical concentrations", Stephan and Rogers (1985) and Liber *et al.* (1992) advocated the use of this approach.

**WATER SOURCE:** different water sources such as dechlorinated tap water, spring water, well water, local river water and water from a reservoir have been used in artificial stream studies (Shriner and Gregory 1984; Swift *et al.* 1993). Guckert (1993) deemed untreated local river water as the most realistic of all these sources.

**HYDRAULIC CONDITIONS:** the hydraulic regime riverine organisms experience has an important influence on their ecology, physiology and behaviour (Statzner *et al.* 1988; Bothwell 1993; Gelwick and Matthews 1993). Depending on research objectives, it may be necessary to give an accurate description of flow characteristics (Craig 1993). The Large Artificial Stream Units (LASUs) used in this study (Section 2.2.3.) offer extensive control over hydraulic conditions.

**LIGHTING:** the lighting of an indoor artificial stream laboratory can be done using artificial light or a translucent roof. Light intensity, photoperiod and emitted wave spectrum should be reported as they may enhance the growth of specific algal species (Berghahn, personal

---

<sup>2</sup> Pseudoreplication is defined as "the use of inferential statistics to test for treatment effects with data from experiments where either treatments are not replicated (though samples may be), or replicates are not statistically independent" (Hurlbert 1984).

communication). The OSRAM® Biolux light tubes installed in the artificial stream laboratory in Grahamstown emit a wave-spectrum similar to daylight.

WASTEWATER: the disposal of wastewater is problematic, especially for flow-through stream designs where large quantities of wastewater are produced (Crossland *et al.* 1991; Guckert 1993). In these instances, the stream laboratory should be built close to a wastewater treatment plant. A recirculating stream design reduces the problem by producing less wastewater.

Animal recruitment and sampling frequency are also important issues to consider in an artificial stream study. As these issues are only relevant to multispecies studies, they are not further considered here.

### **2.2.2. Artificial stream designs**

During 40 years of artificial stream research, a wide variety of stream designs has been developed. These designs can be classified into three general types, based on the exchange of water in the system (McIntire 1993). Totally closed systems recirculate the water without exchange. In partially closed systems, the main water body is recirculated, and some water is exchanged continuously. In open, flow-through systems, the water passes through once. Artificial streams can be located indoors, either in a laboratory with artificial lighting or in a greenhouse, or outdoors. Some of these outdoor systems are located stream-side and draw water and organisms directly from the natural watercourse (Lamberti and Steinman 1993a).

Shriner and Gregory (1984), Kosinski (1989) and Guckert (1993) reviewed the use of artificial streams in studies of aquatic toxicology. Kosinski (1989) provided a detailed overview of studies conducted between 1964 and 1986, and Guckert (1993) interpreted these data. The results of their analyses are summarized in Table 2.1.

**Table 2.1.** Design parameters of artificial stream systems used in ecotoxicological studies between 1964 and 1986 (Kosinski 1989; Guckert 1993).  $n = 58$ .

Papers per decade (1964-1986)	4 in the 1960s 16 in the 1970s 38 in the 1980s
	<u>Median (range)</u>
Channels per experiment	4 (1-32)
Treatments per experiment	3 (1-12)
Channel length [m]	7 (1-1000)
Current speed [m/s]	0.1 (0-0.74)
Colonization time [days]	50 (7-1095)
Length of exposure	12 wk (hours-2 years)
Habitat	50% Riffle and pool 50% single habitat
Physical design	56% Flow-through 20% Completely recirculating 19% Partially recirculating
Location/lighting	59% Outdoor 26% Indoor with artificial lighting 14% Indoor greenhouse
Exposure	84% Continuous
Biological components	58% analysed macroinvertebrates 54% analysed periphyton 23% analysed fish
Biological complexity	78% multispecies tests 22% single-species tests

### *Single species studies*

Of the studies analysed by Kosinski (1989), 22% were carried out using single species (Table 2.1.). Kosinski (1989) found that the artificial stream designs most commonly used in these studies are based on a design proposed by McIntire *et al.* (1964, 1968), who used their streams to investigate periphyton growth dynamics (Figure 2.1.). Other workers used designs which were similar in functional structure to McIntire *et al.*'s (1964, 1968) streams, but with a more elliptical channel shape resembling a raceway track. These systems were usually smaller (e.g. Crowther and Hynes 1977; Peters *et al.* 1985; Belanger *et al.* 1986, 1990; Goetsch and Palmer 1997). Both designs – the straight channels and the raceway design – can be used to study a broad range of species, when modified appropriately, from macroinvertebrates to fish. The systems used by Lowell *et al.* (1995a, b)(Figure 2.2.) and Gerhardt *et al.* (1994)(Figure 2.3.) may serve as examples for artificial stream designs which are more specialized according to specific research objectives.

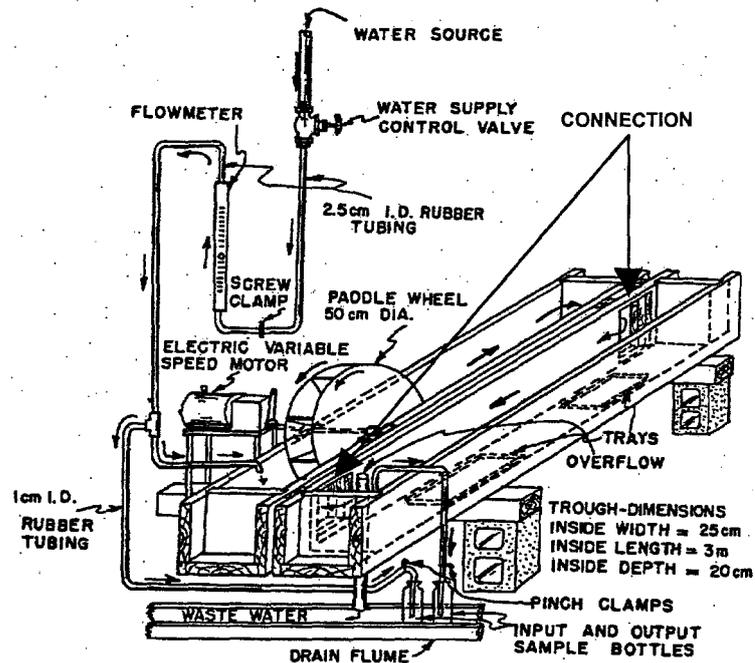


Figure 2.1. The artificial streams of McIntire *et al.* (1964) served as a prototype for many later designs.

Lowell *et al.* (1995a, b) tested the responses of mayflies at different current velocities and pulp mill effluent using small circular streams, 88 mm in diameter (Figure 2.2.). In this flow-through design, the current velocity could be regulated by water jets driven by pumps

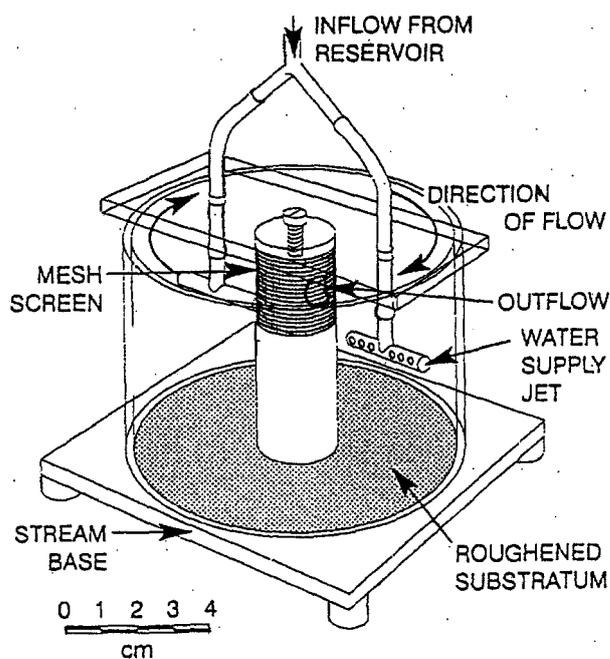
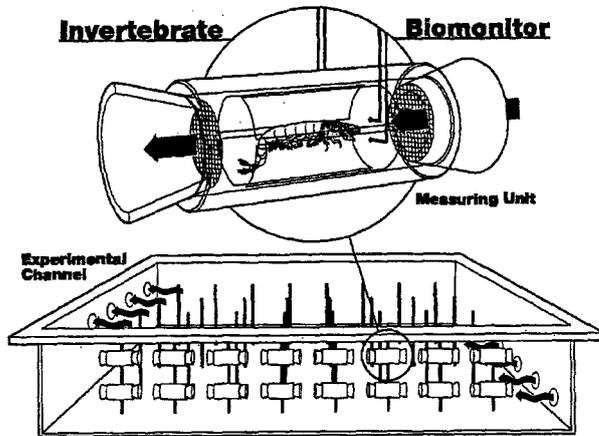


Figure 2.2. Small-scale flow-through artificial streams used by Lowell *et al.* (1995a, b).

which were drawing water from a general supply reservoir. Ten baetid mayflies could be held for over two weeks in each system. Because of its small and relatively simple design, a large number of streams could be constructed. In the pulp mill study of Lowell *et al.* (1995b), 42 streams were used for an experimental layout based on a  $2 \times 3$  factorial design with seven replicates.

Gerhardt *et al.* (1994) developed special test chambers for macroinvertebrates to measure behavioural responses. The macroinvertebrates were held in experimental channels as



**Figure 2.3.** Behavioural test chambers and experimental channel by Gerhardt *et al.* (1994).

shown in Figure 2.3. Within the test chambers, an electrical field was created with electrodes. The impedance of the field changed with the movement of the animal (e.g. through locomotion, feeding or ventilation) which was measured, converted into electrical signals and processed by a computer. With this technique, Gerhardt (1995) was able to demonstrate that ventilation of *Gammarus pulex* (a freshwater crustacean) increased from a level defined as normal after only one hour of exposure to Pb concentrations as low as  $10\mu\text{g/L}$ .

### *Multispecies studies*

The majority of the papers (78%) reviewed by Kosinski (1989) used multiple species to model trophic relationships and ecosystem responses (Table 2.1.). Kosinski (1989) described a design similar to that used by Crossland *et al.* (1991) as most common for artificial streams of up to 10 m channel length. Streams in a raceway design have also been used successfully in multispecies studies (Clements *et al.* 1988; Kiffney and Clements 1994; Kiffney 1996). Larger systems with a channel length between 50 and 518 m have been described by Swift *et al.* (1993), who focused on artificial streams in the United States. They listed ten outdoor and five indoor facilities as currently being in operation.

### **2.2.3. Artificial streams at the Institute for Water Research**

Three different artificial stream designs at two scales have been developed at the Institute for Water Research (IWR), Rhodes University. These are the large-scale Large Artificial Stream Units (LASUs), and the two small-scale Raceways and Channels. In all stream designs, the water is recirculated, but the Channels can also be used as flow-through systems (Williams 1996; Gerhardt and Palmer 1998).

### *Large Artificial Stream Units*

The LASUs are based on a design by Horne and Bennison (1986, 1987a, b). They are built as a "trough-cum-waterfall" design (*sensu* Vogel 1981, cited in Craig 1993), where water runs through a channel and falls into a sump. Three independent LASUs have been built in the artificial stream laboratory in Grahamstown. Each LASU contains three channels which replicate hydraulic conditions. The three channels can, however, not be used to replicate test organism responses as they are pseudoreplicates. They share the same water source and are therefore not statistically independent (Hurlbert 1984).

During the design phase of the LASUs, great effort was undertaken to allow an extensive control over hydraulic variables. In order to create flow conditions suitable for a broad range of aquatic species, stream design provides for current velocities from 30 to more than 1 m/s (for example the blackfly *Simulium chutteri* requires current velocities in excess of 1 m/s). With a water depth in the channels ranging from 30 to 60 mm, the pumps, total water volume and pipe sizes of a LASU had to be selected carefully. As the Grahamstown municipal electricity supply suffers periodic power cuts, a backup power supply is available. A float switch is installed in the sump which automatically switches the pumps off below a certain water level. This prevents pump damage should there be a leakage in the system.

An elevation of a LASU is shown in Figure 2.4. The water is pumped at a constant rate of 20 L/s up the delivery pipe through a non-return and a control valve into the head tank. The non-return valve prevents back-flow of the water which would damage the pump. From the head tank the water flows through the feed pipe via a second control valve into the inlet tank. Turbulence in the inlet tank is greatly reduced by using a perforated diffuser pipe at the end of the feed pipe. From the channels the water falls into the sump from where it is returned through the suction pipe to the head tank. The flow rate in the channels can be controlled by control valve 2 (Figure 2.4.). At less than 20 L/s delivery to the channels the excess water overtops an internal weir in the head tank and is returned through the overflow pipe directly into the sump. The gradient of the channels can be varied from -1% to 4% with the adjustable channel support. A wide range of hydraulic conditions can be achieved by varying slope and discharge. A cooling coil in the sump allows cooling of the water to compensate for the heat introduced by the pumps. A summary of technical specifications is given in Table 2.2. For a more detailed account of the LASU design see Palmer *et al.* (1994, 1996).

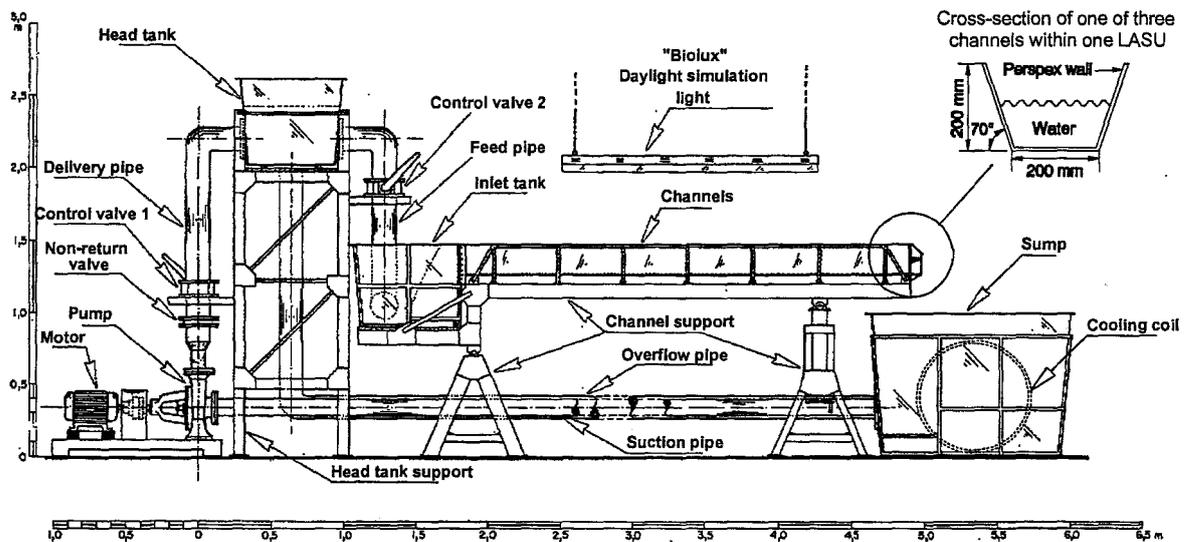


Figure 2.4. An elevation of one of three Large Artificial Stream Units (LASUs). Modified from Palmer *et al.* (1994).

When Palmer *et al.* (1996) used baetid nymphs in the LASU, they noted that most of the nymphs were quickly washed into the sumps after introduction. This prompted them to construct 1 m long perspex frames covered in 500  $\mu\text{m}$  mesh to form "baskets" which fitted snugly into the channels to contain test organisms. They have been used successfully in experiments (Corbett 1996). However, it was necessary to seek another solution to retain test organisms in this study, for two reasons: (1) the basket changed the hydrodynamic environment as water entered the inside of the basket not only from upstream but – because

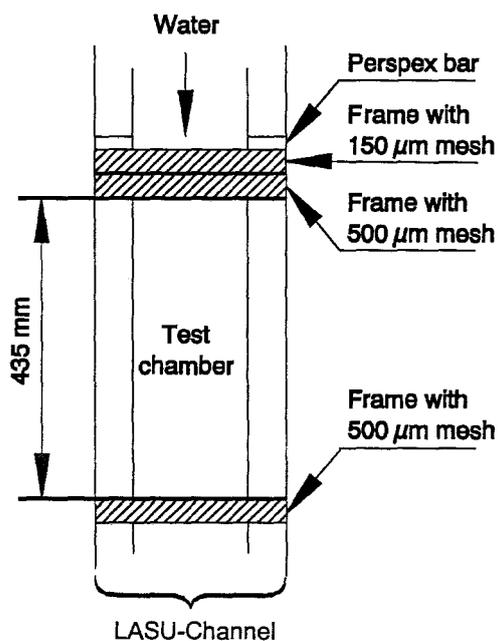


Figure 2.5. Test chamber used in LASU experiments (plan view).

of the construction – also through the bottom of the basket; (2) Corbett (personal communication) noted that the upstream mesh of the baskets became blocked by debris. This might have changed the water depth and current velocity within the baskets throughout his experiments. To avoid and amend these adverse characteristics, new test chambers were created by covering trapezoidal perspex frames with mesh of different pore-sizes and glueing them with silicone into the channels within the upper third of the length of the channel (Figure 2.5.). The use of silicone glue allowed easy removal of the frames after experiments. The downstream frame was covered with 500  $\mu\text{m}$  mesh. Two upstream frames were installed in a channel. The first frame was covered with

150  $\mu\text{m}$  mesh and fitted in loosely. With perspex bars glued onto either side for support, the frame could be slid in and out for cleaning purposes. The second frame was covered with 500  $\mu\text{m}$  mesh. Test chambers were set up in the left and the right channel of each LASU to provide space for two different test populations. The middle channel was therefore not used.

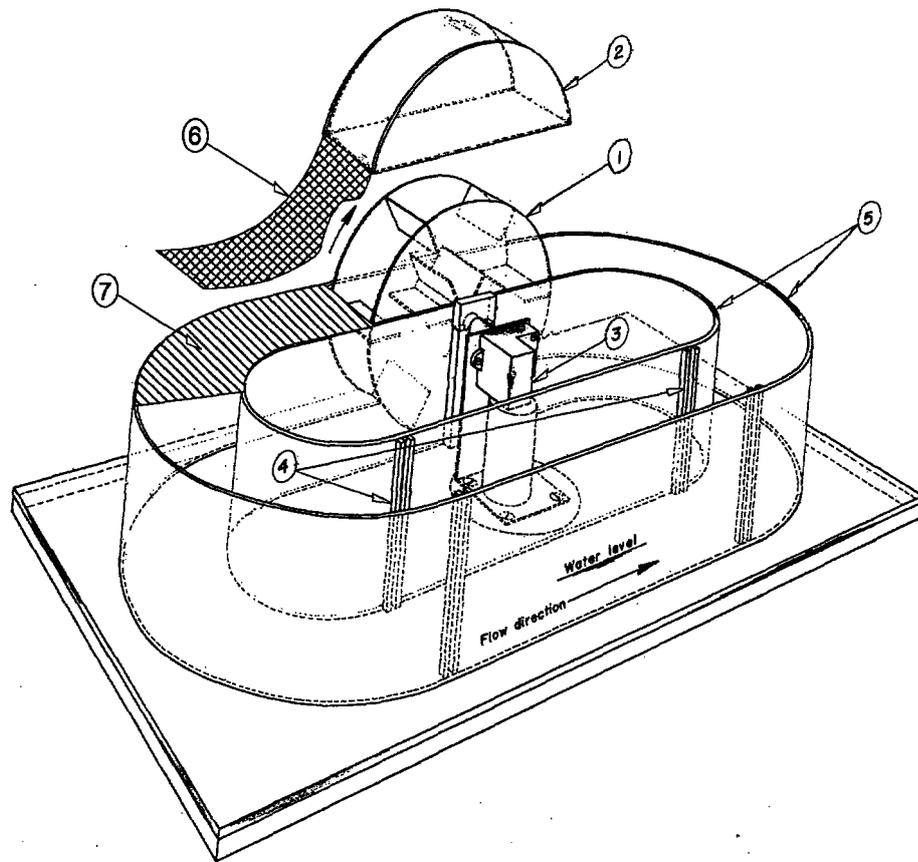
The resulting current velocities within the test chambers were measured at different slope and discharge combinations and were set to a gradient of -1% and a discharge of <5L/s for final experiments. A negative gradient was chosen to create higher water levels at a low discharge. The final settings resulted in an average current velocity of 0.090 m/s (range 0.068–0.111 m/s) at an average water depth of 50 mm (Appendix A). This current velocity range coincides with the range of velocities recorded for *A. auriculata* and *A. sudafricanum* (Hunt 1997; collection records of the Albany Museum, Grahamstown; Section 2.3.). A detailed account of current velocity measurements in the LASUs is given in Appendix A.

**Table 2.2.** Summary of technical specifications and stream characteristics of the LASU systems (Palmer *et al.* 1996).

Dimensions	Channel length	3 200 mm
	Total width of three channels	1 200 mm
Hydraulic parameters	Total volume	ca. 1700 L
	Bottom area of test chamber	435 mm $\times$ 200 mm (87 000 mm <sup>2</sup> )
	Maximum flow rate	25 L/s
	Channel gradient	-1° to 4°
Materials	Max. current velocity (Palmer <i>et al.</i> 1996), measured at 1 600 mm length of channel	1.23 m/s (3% slope, 25 L/s discharge)
	Slope and discharge set for experiments	-1% slope, <5 L/s discharge
	Average current velocity during exp. (range)	0.090 m/s (0.068–0.111 m/s)
	Average water depth during exp. (range)	50 mm (45–57 mm)
Materials	Tankage	Fibreglass
	Channels	6 mm Perspex
	Pumps	AZG 100-200/180 CI/CI/MS; Cast iron, nickel plated
	Cooling coil	Stainless steel
	Support structure	Timber, mild steel painted with corrosion resistant paint
	Materials in contact with water	Perspex, fibreglass, polyvinylchloride, silicone, stainless steel

### Raceways

The oval shape of one of the two portable small-scale artificial stream systems is reminiscent of a raceway (or "race track" *sensu* Nowell and Jumars 1987, cited in Craig 1993). They have accordingly been termed Raceways. The design is based on a system used by Ciborowsky (1983), and has also been used by other workers (Peters *et al.* 1985;



**Figure 2.6.** Diagram of a Raceway system. (1) paddle wheel; (2) paddle wheel cover; (3) Bosch windscreen-wiper motor; (4) tracks for frames with mesh; (5) perspex walls; (6) mesh-apron; (7) plastic sheet. Modified from Palmer *et al.* (1994).

Belanger *et al.* 1990; Kiffney and Clements 1996). Because of the size of the artificial stream laboratory, only nine independent systems could be used simultaneously. Figure 2.6. shows a Raceway. The paddle wheel has six blades and is driven by a Bosch windscreen-wiper motor. The motor can be run at two speeds (45 and 60 r/min). The average current velocity in the test chamber with the lower speed of the motor was found to be 0.083 m/s (range 0.036–0.114 m/s) at a water depth of about 51 mm. A detailed account of the measurements is given in Appendix A. The test organisms were kept in the straight section opposite to the paddle wheel. To prevent their escape into the rest of the system, frames covered with 500  $\mu\text{m}$  mesh were slid into tracks (4) to create test chambers, and spaces filled with silicone glue. Problems of pulsed flow through the blades and excessive splashing (also noted by Craig (1993) for this type of propulsion) were approached in the following way. A long mesh-apron (1.2 mm mesh width) (6) was glued to the paddle wheel cover (2) which came to lie on the water surface and thus suppressed waves and splashing. Additionally, the section behind the paddle wheel was covered with a plastic sheet (7). With these measures, the pulse of the flow was greatly reduced, but not completely suppressed. Leaking and splashing nevertheless remained a problem. Technical

specifications of the Raceways are summarized in Table 2.3. A detailed account of current velocity measurements is provided in Appendix A.

**Table 2.3.** Summary of technical specifications and stream characteristics of the Raceway systems (Palmer *et al.* 1996).

Dimensions	Channel length (outer circumference)	2 600 mm
	Working volume	12.5 L
	Bottom area of test chamber	495 mm × 125 mm (61900 mm <sup>2</sup> )
Hydraulic parameters	Average current velocity during exp. (range)	0.083 m/s (0.036–0.114 m/s)
	Water depth at 12.5 L volume	51 mm
Materials	Channel walls, base, paddle wheel	5 mm perspex
	Motor	Bosch CHP 12V 9 390 292 085
	Materials in contact with water	Perspex, silicone

### *Channels*

The Channels are based on a design by Williams (1996) who initially used these systems in a recirculating design, but later modified it to a flow-through design. For this study, the water was recirculated using a submersible pump.

Figure 2.7. displays a Channel. The water enters the top of the channel through a 15 mm plastic tube. To reduce the kinetic energy of the water and excessive splashing, the end of the tube was modified as seen in the inset of Figure 2.7. A large stone placed next to the inflow confined the splashing to a short channel section, and a splash cover prevented spillage. From the top section, the water runs down the channel (1 m length) and falls into a bucket. A mesh at the end of the channel (500 µm) prevents the escape of test organisms. A transition pipe mounted into the bucket-lid prevents splashing from water falling into the bucket. This together with the splash-cover at the inflow eliminated splashing so that water loss was confined to evaporation in the open channel section. The water was pumped back to the upper end of the channel by a pump submerged in the bucket.

Seven Channels were set up and left to run for two days. Current velocities and water depths were measured in each stream before and after cleaning the mesh. The average current velocity was found to be 0.038 m/s (range 0.024–0.054 m/s) at an average water depth of 40 mm (range 38–47 mm). A detailed account of the measurements is given in Appendix A. Table 2.4. summarizes technical specifications.

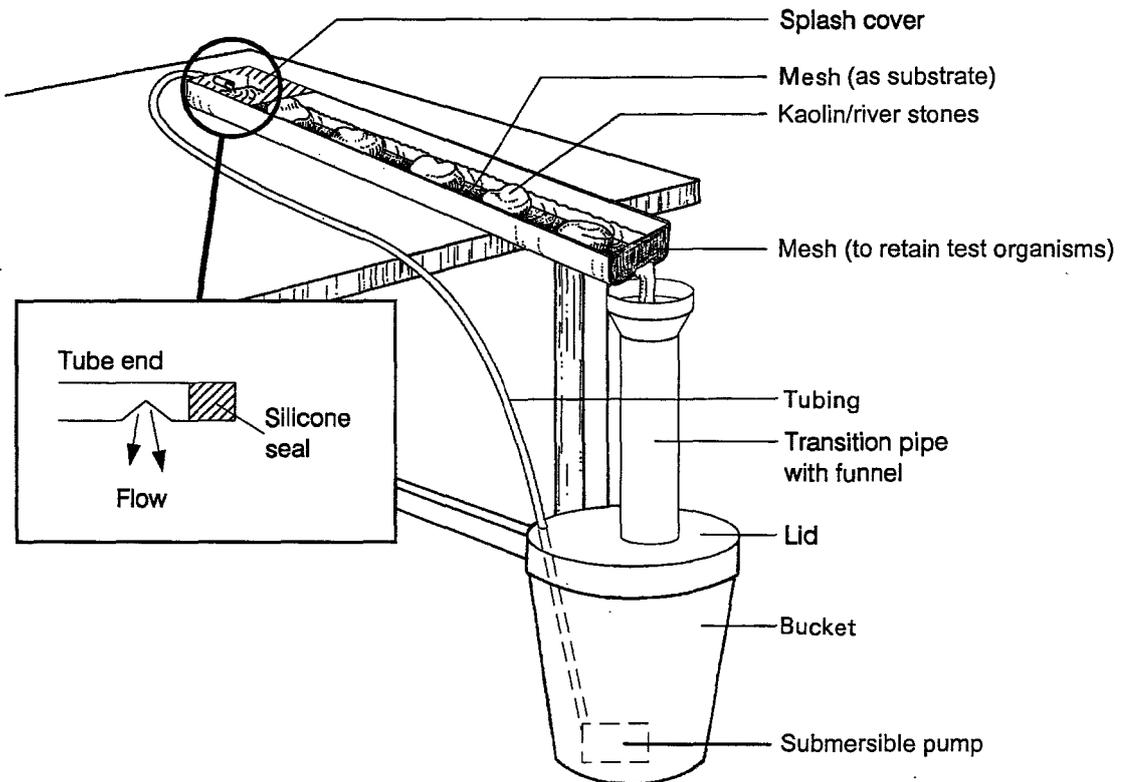


Figure 2.7. Diagram of a Channel system. Modified from Scherman and Palmer (in press).

Table 2.4. Summary of technical specifications and stream characteristics of the Channel systems.

Dimensions	Channel length	1 000 mm
	Working volume	20 L
	Bottom area of test chamber (depending on where the bottom is considered to end as it is curved)	1 000 mm × 100 mm (100 000 mm <sup>2</sup> )
Hydraulic parameters	Average current velocity during exp. (range)	0.038 m/s (0.024–0.054 m/s)
	Average water depth (range)	40 mm (38–47 mm)
Materials	Pump	RENA® water pump Type C40 (water head max. 1.5 m, 9 L/min)
	Channels	PVC
	Bucket	Plastic
	Materials in contact with water	PVC, plastic, silicone

## 2.3. The test taxa

Many authors and governmental environmental protection agencies have recommended the use of aquatic insects in toxicity tests (APHA 1992; Rosenberg and Resh 1993). This is probably due to the sensitivity of some aquatic insects as compared to other aquatic organisms (Mayer and Ellersieck 1988), and their importance in the aquatic food web (Allan 1995). Among aquatic insects, Ephemeroptera (mayflies) have been found to be especially sensitive (Williams *et al.* 1984; Pontasch and Cairns 1991), particularly some members of the baetid mayfly family (Mayer and Ellersieck 1986, cited in Buikema and Voshell 1993). In the United States, four mayfly species have been recommended as test taxa (APHA 1992), and for the derivation of South African aquatic ecosystem water quality criteria, data on acute toxicity are required for at least eight different families of aquatic organisms, which also include mayflies (DWAF 1996a).

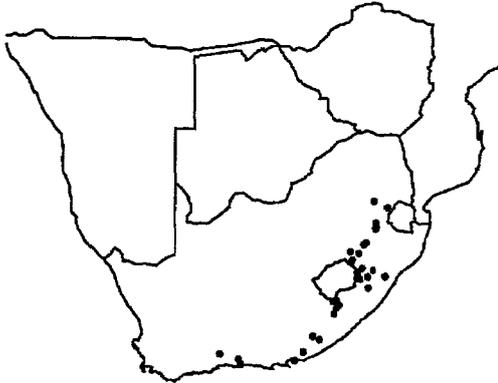
Two mayfly species were selected as test organisms for this study: *Adenophlebia auriculata* (Eaton) and *Afroptilum sudafricanum* (Lestage). Each species is briefly discussed below.

### 2.3.1. *Adenophlebia auriculata* (Eaton)

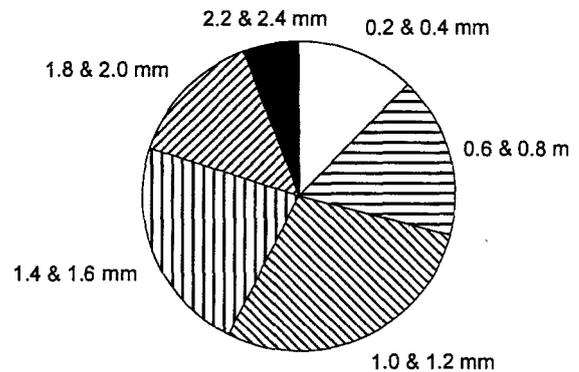
The mayfly *Adenophlebia auriculata* belongs to the leptophlebiid family (McCafferty 1991). This species was identified as a potential water quality indicator species and test organism for toxicological experiments after investigations of its life history, and development of culturing and rearing techniques (Haigh and Davies-Coleman 1997, in press).

*A. auriculata* is a multivoltine species with an annual or semi-annual life cycle, and has repeated emergences throughout the year, except from mid-winter to early spring. The length of the life cycle has been estimated to be "a few weeks short of 52" (Haigh and Davies-Coleman in press). *A. auriculata* has been classified into the functional feeding group of an opportunistic collector/brusher (Palmer 1991; Palmer *et al.* 1993). Nymphs for this study were collected from the Palmiet River (Section 2.3.4.) where *A. auriculata* is an indigenous and abundant species. The species distribution is shown in Figure 2.8. and is confined to South African territory (Barber-James, personal communication).

Hunt (1997) investigated the distribution of the species between different biotopes. He concluded that the optimal conditions for *A. auriculata* of the size-range 1.5–2.5 mm are



**Figure 2.8.** Distribution of *A. auriculata* in South Africa, based on collection records of the Albany Museum, Grahamstown (Everitt 1996).



**Figure 2.9.** Frequency distribution of headwidths of *A. auriculata* sampled 3 March 1997 in the Palmiet River ( $n = 812$ ). Each slice represents the percentage of the total as a sum of two size classes. Adapted from Haigh and Davies-Coleman (in press).

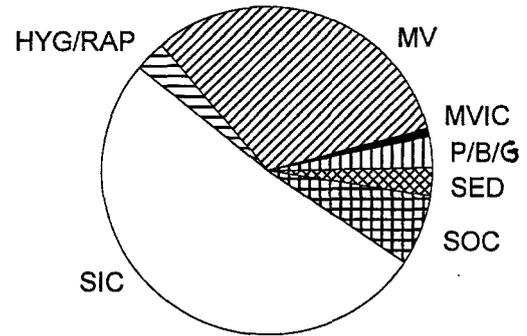
slow current (up to ca. 0.10 m/s), large substrate size and vegetation, and large quantities of detritus. The population structure of *A. auriculata* in the Palmiet River (Figure 2.9.) shows that medium-sized nymphs (0.9–1.7 mm) comprise about 50% of the total population. This "standing stock" exists throughout the year, except for brief periods (Haigh and Davies-Coleman in press).

### 2.3.2. *Afroptilum sudafricanum* (Lestage)

The mayfly *Afroptilum sudafricanum* belongs to the baetid family (McCafferty 1991). Nothing specific is known of the life history and life cycle of this species apart from the little that Barnard (1932) noted in his description of the species. The species distribution is afrotropical (Barber-James, personal communication) and has been recorded throughout southern Africa (Figure 2.10.). This broad distribution suggests that *A. sudafricanum* is an opportunistic species and tolerant in respect of habitat and associated parameters. This is further supported by the range of biotopes where the species has been found (Figure 2.11.). In the Palmiet River, *A. sudafricanum* nymphs of an appropriate size for toxicity tests were abundant for  $\frac{3}{4}$  of the year (spring-autumn; Haigh, personal communication).



**Figure 2.10.** Distribution of *A. sudafricanum* in southern Africa, based on collection records of the Albany Museum, Grahamstown.



**Figure 2.11.** Distribution of *A. sudafricanum* in different biotopes, based on collection records of the Albany Museum, Grahamstown. The full circle designates 100%. MV Marginal vegetation; MVIC Marginal vegetation in current; P/B/G Pool/Benthos/Gravel; SED Sediment; SOC Stones out of current; SIC Stones in current; HYG/RAP Hygropetric<sup>3</sup>/Rapid.  $n = 103$ .

### 2.3.3. Suitability of the test species selected for this study

The main reasons for selecting the two test taxa were the following:

- Both species were fairly abundant at the Palmiet River collection site.
- *A. auriculata* was identified by the Standard Laboratory Organisms Project (Haigh and Davies-Coleman 1997, in press) as a potential test organism, has successfully been kept in the laboratory and has previously been used in acute toxicity tests (Everitt 1996).
- *A. sudafricanum* has successfully been used in acute toxicity experiments (Corbett 1996).
- As leptophlebiid mayflies have been shown to be relatively tolerant (Gerhardt 1992, 1994), including *A. auriculata* (Everitt 1996), *A. sudafricanum* was chosen as an additional test species because of the documented sensitivity of some Baetidae (Mayer and Ellersieck 1986, cited in Buikema and Voshell 1993).
- Using two different species increased data on responses to different artificial stream designs, and to salinity.

A number of authors have proposed criteria which should be considered when selecting a test species (Buikema and Benfield 1979; Rand and Petrocelli 1985; Pascoe and Edwards 1989; APHA 1992; Buikema and Voshell 1993). These criteria are listed and used to discuss the selected taxa.

<sup>3</sup> Hygropetric - Living in the thin film of water flowing over rock surfaces (*sensu* Lincoln *et al.* 1983).

- 1) The species selected should be sensitive towards toxicant stress and have a wide variation in responses to different toxicants. The sensitivity between different species can vary by a factor of more than 6600 for a single toxicant (Williams *et al.* 1984).

Aquatic insects have shown a broad range of sensitivities to various chemicals, stretching about seven orders of magnitude (Mayer and Ellersieck 1988). Mayflies are generally considered to be sensitive (Williams *et al.* 1984; Pontasch and Cairns 1991); this is particularly true of some baetid families (Mayer and Ellersieck 1986, cited in Buikema and Voshell 1993). Although *A. auriculata* was shown to be tolerant to zinc (Everitt 1996), its salinity tolerance had not previously been tested. As a baetid mayfly, *A. sudafricanum* could be more sensitive than species from other families.

- 2) The species should be indigenous to the water body under protection, or representative of a (recreationally, commercially, ecologically) important group within this water body.

Both mayfly species are indigenous to the Palmiet River. Often, mayflies fulfil key functions in the food web. As secondary producers, they feed on detritus and periphyton, but are preyed upon by larger insects, fish and other organisms of higher trophic levels. Mayflies can also represent a greater biomass in a stream than fish (Buikema *et al.* 1982).

- 3) The collected species should be in good physical condition and disease-free.

All mayflies were collected in the Palmiet River, a stream of good water quality (Section 2.3.4., Appendix B). Organisms collected for toxicity tests were checked visually and appeared to be in good physical condition.

- 4) The species should survive laboratory conditions well and should be amenable to rearing and culturing.

Both species showed good survival during previous investigations (Corbett 1996; Haigh and Davies-Coleman 1997, in press). Rearing and mass-breeding techniques of *A. auriculata* were investigated (Haigh and Davies-Coleman in press) but proved unsuccessful. No attempts to rear and breed *A. sudafricanum* in captivity could be located in the literature.

- 5) The species should be widely available and abundant at the source of collection, in a suitable size-range.

Both mayfly species were found in relative abundance at the sampling site. The availability of *A. auriculata* in the Palmiet River (Section 2.3.1. and Figure 2.9.) generally met the demands of the toxicity tests. However, collection trips did not always yield sufficient numbers in the desired size-range, and a broader range had to be used. The effects of an extended size-range on test results are discussed in Section 5.3.1. Over-sampling of indigenous populations did not take place, but may present a problem in the future.

*A. sudafricanum* nymphs of a suitable size-range were only available for  $\frac{3}{4}$  of the year, restricting experiments to this time period (during which nymphs were more abundant and easier to collect than *A. auriculata*). Collection records of both species documented a wide distribution within southern Africa (Figures 2.10. and 2.11.). This is advantageous as they could be collected from a wide range of water bodies for subsequent experiments.

- 6) Data on life history, physiology, genetics, and behaviour should be known to assist in interpreting results.

Not much is known about the life histories of either species. The investigations of Haigh and Davies-Coleman (1997, in press) have only yielded some preliminary information on *A. auriculata*. Besides general knowledge concerning the baetid family, very little is known of *A. sudafricanum* specifically. However, this situation appears representative for most African Ephemeroptera (Barber-James, personal communication).

- 7) The taxonomy of the species should be reliable and easy to conduct for the non-professional.

*A. auriculata* is relatively large and has significant taxonomic features. It was easy to identify as it was the only leptophlebiid mayfly in the Palmiet River. No identifications were therefore necessary after the completion of the experiments. Some difficulties existed, however, with the smaller *A. sudafricanum* nymphs. Species belonging to baetid mayfly families can often only be determined by examining the mouth-parts, which is impossible to do with the live organism. Thus, when baetid mayflies are collected from the natural environment, the requirement of a single-species population for toxicity tests may be difficult to meet as several species may be present, e.g. as experienced by Palmer *et al.* (1996). In the Palmiet River, more than five baetid species have been recorded (Barber-

James, personal communication), making identification after experiments imperative. However, baetid nymphs collected by Corbett (personal communication) and for trial experiments were all *A. sudafricanum*, with very few exceptions. It could therefore be assumed that collected populations will mainly consist of this species. Nymphs of *A. sudafricanum* were nevertheless identified after all experiments were completed.

8) The species should exhibit an end point which can easily be identified and measured.

For both species mortality was difficult to determine as death did not occur immediately. This phenomenon is well-known and common in many invertebrates (Rand and Petrocelli 1985; APHA 1992). A different quantal end point was used in this study and termed "immobilization" (Section 3.2.6.).

#### 2.3.4. The sampling site at the Palmiet River

The Palmiet River is a perennial subtropical mountain stream with clear water and a turbulent flow. It arises about 70 km from the Eastern Cape coast as a tributary of the Kariega River which drains into the Indian Ocean. It is unimpounded upstream of the study site and not affected by point source pollution. A survey of the macroinvertebrate fauna carried out in 1993 indicated a pristine system with good water quality according to the SASS2 water quality index (Davison 1993; De Moor, personal communication)<sup>4</sup>.

The sampling site (33°22'15"S 26°28'30"E) was about 12.5 km south west of Grahamstown at an altitude of 526 m and about 0.8 km upstream from the confluence with the Berg River. It was easily accessible from the national road (N2) which crossed the river just above the confluence (Figure 2.12.). Mayflies were sampled over a stretch of about 0.5 km consisting of two riffles, two runs and a pool (Haigh and Davies-Coleman 1997).

Everitt (1996) analysed the water quality of the river in March 1996 for physico-chemical constituents, including major ions, nutrients and metals. The river water is soft<sup>5</sup> with a low electrical conductivity (EC) and low total dissolved solids (TDS) content, at circumneutral pH, and has a low buffering capacity<sup>6</sup>. A metal analysis did not show ions of any significant<sup>7</sup> concentration. A water quality profile taken in April 1997 (Appendix B)

---

<sup>4</sup> Specimens are lodged with the Albany Museum, Grahamstown, General Catalogue No. 985ff.

<sup>5</sup> "soft" means <75 mg/L total hardness expressed as CaCO<sub>3</sub> (EPA 1976, cited in Sprague 1985).

<sup>6</sup> "low" means < 24 mg/L total alkalinity expressed as CaCO<sub>3</sub> (Chapman 1992).

<sup>7</sup> "significant" means metal ion concentrations close to detection limit.

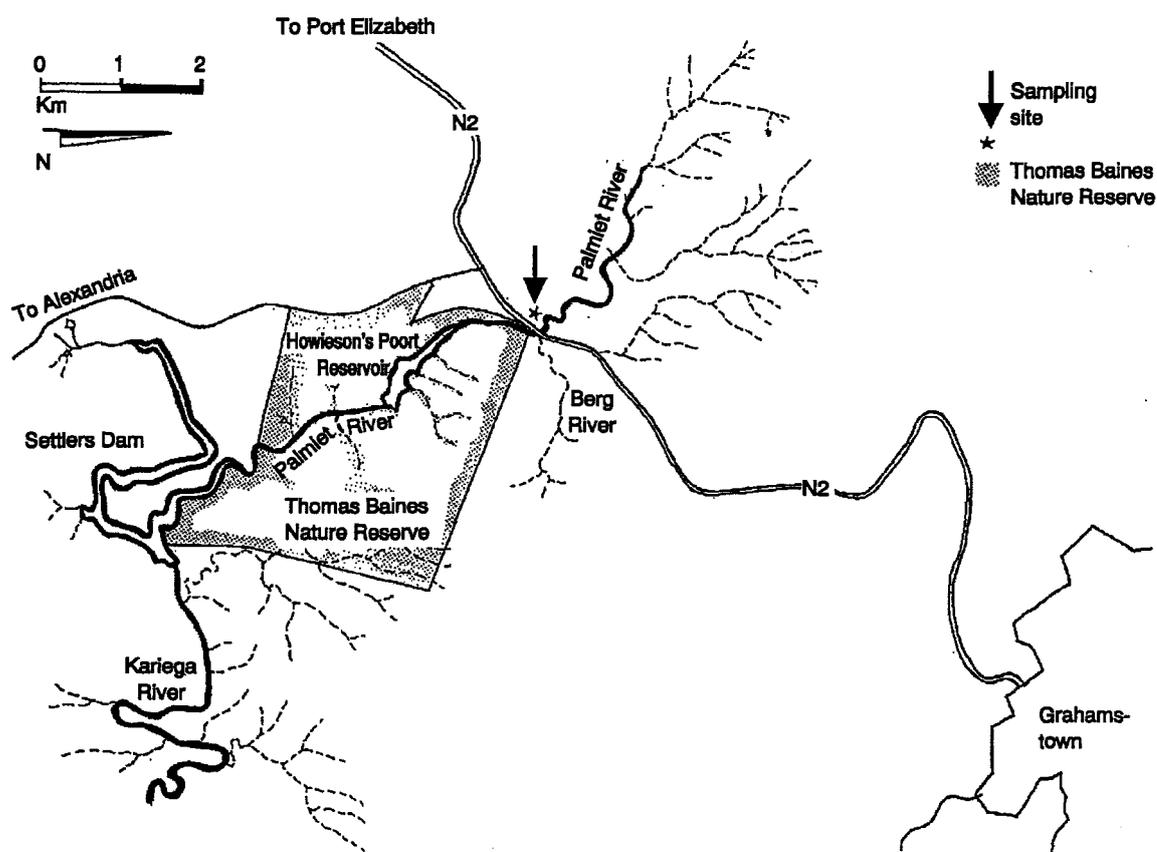


Figure 2.12. The sampling site at the Palmet River (modified from Everitt 1996).

supported her findings in most respects. However, Al concentrations around 1 mg/L were found which were not present in Everitt's 1996 sample. Their potential effect on the physiological conditions of the test species is not known.

## 2.4. Salinization of South African inland waters

The experiments of this study were carried out using sodium sulphate as the reference toxicant. This salt was also used to model salinity, as many South African rivers have developed elevated salinity levels which now threaten the availability of good quality water. The understanding of the toxic effects of salinity on riverine biota is therefore important.

Salinization has been defined as the "increase in the inorganic salt content of water along a water course as it flows towards the sea, or at a given point in a water course or body over time" (Du Plessis and Van Veelen 1991). During this process, mainly the sodium, chloride and sulphate ions increase in concentration (Davies and Day 1998). The negative effects on

various water users such as industry, the domestic sector and agriculture depend on the overall concentration of these ions, but have already been shown to be tremendous, requiring cost-intensive treatments for salt removal (DWA 1986; Stander 1987; Du Plessis and Van Veelen 1991; DWAF 1996d). Aquatic ecosystems are also likely to suffer (DWAF 1996a). The Department of Water Affairs and Forestry therefore recognized salinization as South Africa's "single biggest pollution problem" (Stander 1987).

#### 2.4.1. TDS, salinity and salinization

The salinity of water is usually described as the total amount of substances dissolved in it, and expressed as total dissolved solids (TDS)<sup>8</sup>. It can be estimated by measuring the electrical conductivity (EC<sup>9</sup>) of the water and multiplying the EC by a factor of 6.5 which is commonly used for South African inland waters (DWAF 1996a). The equation is

$$\text{TDS [mg/L]} = \text{EC [mS/m at 25°C}^{10}] \times 6.5 \quad \text{Equation 2.1.}$$

The ion composition of the TDS varies between different freshwater ecosystems and depends mainly on the underlying geological formation and weathering-behaviour of the soil, evaporation, and precipitation within the catchment. Major ions found in freshwaters are the cations sodium (Na<sup>+</sup>), potassium (K<sup>+</sup>), calcium (Ca<sup>2+</sup>) and magnesium (Mg<sup>2+</sup>), and the anions chloride (Cl<sup>-</sup>), sulphate (SO<sub>4</sub><sup>2-</sup>), bicarbonate (HCO<sub>3</sub><sup>-</sup>) and carbonate (CO<sub>3</sub><sup>2-</sup>) (Dallas and Day 1993). An arbitrary level of 3 g/L TDS is commonly accepted to distinguish between fresh and saline waters (Williams 1987).

<sup>8</sup> DWAF (1996c) distinguishes between TDSalts (Total dissolved Salts) and TDSolids (Total Dissolved Solids). TDSalts comprise all substances which carry an electrical charge (ions). TDSolids comprise those, plus uncharged substances such as organics. When the electrical conductivity is measured, the TDSalts is determined. However, since most substances dissolved in water carry an electrical charge, the TDSalts is a good estimate of the TDSolids (*ibid.*).

<sup>9</sup> The acronym EC is also used to abbreviate "effective concentration". In this thesis, EC as an abbreviation for "effective concentration" is always be used with the percentage effective concentration (e.g. EC50) to avoid confusion.

<sup>10</sup> The EC is temperature dependent and therefore has to be measured at a standard temperature, usually 25°C. Measurements at other temperatures should either be converted, or the temperature should be given with the EC value.

### 2.4.2. Sources of salinity

Salinity has natural and anthropogenic sources. Natural salinity may derive from water evaporation of internally draining water courses, wind-borne sea spray, saline groundwater, sea-salt stored in rocks, or rocks with high concentrations of mineral ions which are easily weathered (Davies and Day 1998). Globally, TDS concentrations in surface waters can range from 0.007 g/L as measured in some tributaries of the Amazon River, through 35 g/L in sea water, to ca. 330 g/L (close to sodium chloride saturation) in some saline lakes (Dallas and Day 1993). Most rivers usually have salinity levels below 0.1 g/L, although rivers in arid climates such as in South Africa may naturally be saltier. For example, in the Sak River, Karoo, South Africa, a salinity of 84 g/L has been recorded (*ibid.*).

Human activities have increased salt levels of continental waters worldwide ("secondary salinization"; Hart *et al.* 1990), particularly in dry regions. Agricultural and industrial activities are the main contributors. The main agricultural practice guilty is irrigation. Because of partial evaporation of the applied water and the leaching of soil salts, the excess water returning to natural water courses (irrigation return flow) has higher salt concentrations than its origin. But these salts can also be stored in the soil because of evaporation and are only flushed out during the next rainfall. This can cause sharp salinity peaks in nearby rivers (Williams 1987; Hart *et al.* 1990, 1991; Davies and Day 1998). Excessive irrigation may also raise already saline groundwater tables, and lead to tremendous soil salinization, as observed in Australia (Williams 1987; Allison *et al.* 1990; Hart *et al.* 1991). Other practices contributing to salinity are dryland farming (Williams 1987; Flügel 1991), and deep ploughing when done on soil of marine origin (Græff 1994).

A more obvious source of salinity is the direct discharge of saline effluents into natural waters. Saline effluents are produced by a broad range of industries, the more important ones being textile, leather/tanning, paper, and zinc. Saline effluents particularly high in sulphate concentrations are discharged by power stations, zinc plants, and pulp and paper, fertilizer, and textile industries (Trusler *et al.* 1991; Kleynhans 1992; Anon 1993; Dallas and Day 1993; Shin *et al.* 1996).

The mining industry is another major contributor of salt and sulphate to some South African rivers. This is mainly due to the formation of acid mine drainage as a result of the oxidation of pyrite, a sulphide mineral contained in many ores. When pyrite is in contact with air, water and chemolithotrophic bacteria, it is oxidized, and sulphate and sulphuric acid are produced. This reaction takes place when rainwater percolates through mine deposits. Enriched with these reaction products, it enters local groundwater systems where

it causes high sulphate levels and low pH in nearby rivers (Jones *et al.* 1989; Dallas and Day 1993).

Other sources contributing to, or exacerbating the salinization problem are large surface areas of dams which facilitate water evaporation, repeated abstraction of water which is returned to the same water body as effluent with increased salinity, cascading use and re-use of irrigation water, and aerial input of substances from combustion process residues (Dallas and Day 1993; Davies and Day 1998).

### **2.4.3. Regions and rivers of elevated salinities in South Africa**

Since the 1950s the rise of salinity levels in South African rivers has become a general concern (DWA 1986). This is best documented by the development of the Vaal River as the main water provider for the highly industrialized and populated Pretoria-Witwatersrand-Vereeniging (PWV) region. The river receives all effluents from the region, and many mine deposits are located in its catchment. This resulted in salinity levels in 1986–1989 ranging between 0.108 and 1.032 g/L TDS, with an average of 0.512 g/L. Because of acid mine drainage, the mean ionic composition of this TDS contained 41% sulphate, which is among the highest levels reported for a river worldwide (Roos and Pieterse 1995). Other South African rivers such as the Buffalo, Mkuzi, Pongola, Wasbank, Mfolozi and Tugela rivers in KwaZulu-Natal, also exhibit elevated salinities derived from mining activities (Davies and Day 1998). Problems with salinity arising from agricultural practices have been reported for the lower Vaal River, the lower Modder and Riet Rivers in the Vaal catchment, the Great Berg and Breede rivers in the south-western Cape, the Olifants River in Mpumalanga, the Sundays and Fish River in the Eastern Cape, and the Pongola River in KwaZulu-Natal (Flügel 1991; Greeff 1994; Herold 1994; Aihoon *et al.* 1997; Davies and Day 1998). The consequences for the riverine biota are, however, difficult to assess.

### **2.4.4. Effects on aquatic ecosystems**

Limited information is available about the effects of elevated TDS concentrations on aquatic ecosystems. Hart *et al.* (1990, 1991) attested a general lack of data concerning the responses of many freshwater and salt-sensitive species, and a lack of studies on the long term and sub-lethal effects of exposure to salts. In their reviews they concentrated on Australia as data from this continent was most abundant. A topic-related search on three

major databases<sup>11</sup> showed that since 1991 the international literature on salinization of freshwater ecosystems has not increased substantially. Most of the information given below therefore draws on the reviews of Hart *et al.* (1990, 1991). Because of climatic and resultant ecological similarities between Australia and South Africa, this data was deemed applicable.

#### *Biotic responses to salinity*

As aquatic animals are usually in intimate contact with water, osmosis takes place. Depending on their habitat (fresh, brackish or salt water), they have adapted different strategies to maintain an appropriate level of body fluid concentration which supports normal body function against osmotic forces. Freshwater organisms are *hyper-osmotic*; their body fluid contains more solutes than the exterior, and their cell membranes therefore gain water through osmosis and lose ions through diffusion. To maintain their ionic balance, the animals usually counteract this with the excretion of dilute urine and the active uptake of ions, and are termed *osmoregulators*. On the contrary, marine organisms are often *hypo-osmotic* as their body fluid contains fewer solutes than their environment. They control the resulting loss of water by the excretion of only small amounts of concentrated urine and the exclusion of salts during fluid-uptake. Animals with *iso-osmotic* body fluids maintain an osmotic pressure similar to their environment and are therefore *osmoconformers*. The capability of dealing with different external osmotic gradients determines the salinity tolerance of an animal. *Euryhaline* organisms are good regulators and can cope with a broad range of salinities. *Stenohaline* organisms are poor regulators and are confined to a tight concentration regime (Schmidt-Nielsen 1979;<sup>3</sup> Hart *et al.* 1991).

The most important single organ which enables freshwater insects to deal with low-salinity water is the cuticle. It prevents or retards the diffusion of water and salts between the blood and the external medium. The direct toxic action of changing salinity levels in most freshwater invertebrates is a breakdown of their osmoregulatory capability. Since they are mostly hyper-osmotic regulators, the active uptake of ions is a vital mechanism to keep their body fluid solute concentrations (salinity 1.0–15.0 g/L) above that of the water they live in (salinity usually 0.1–0.5 g/L). As the external salinity increases, excessive amounts of ions are taken up with a simultaneously reduced water uptake and loss of ions through diffusion. This leads to an over-concentration of solutes, which results in dysfunction of the body cells and thus mortality (Hart *et al.* 1991). Freshwater invertebrates with higher blood ionic concentration are able to adapt to higher salinities than those with lower concentrations. Hart *et al.* (1991) state a general lethal limit of 9.0 g/L for most

---

<sup>11</sup> Water Resources worldwide, Fish and Fisheries worldwide, Aquatic Biology.

freshwater invertebrates, although significant adverse effects on physiology, biochemistry and behaviour could be expected at much lower salt concentrations.

Most freshwater insects, including mayflies, have been found to be very sensitive to salinity. They are generally not found at levels >1.0 g/L TDS. The exception are Dipterans as many species of this family are capable of hypo-osmotic regulation and therefore have been found to tolerate salinity levels up to 70 g/L. Crustaceans are more salt-tolerant, and although some are found only in very pure waters, they may show considerable salt-tolerance in the laboratory (e.g. Tyson 1993). Freshwater fish seem to be most tolerant and may cope with salinity concentrations up to 10 g/L (Hart *et al.* 1990, 1991).

The results of some studies investigating responses to increased salinities at the community level, are still controversial and reflect the general lack of data in this field (*ibid.*). Where some workers documented evidence for severe changes in riverine community structure and function (Short *et al.* 1991; Bäche *et al.* 1994) and a shift to crustacean-dominated communities (Bunn and Davies 1992), others found no significant changes and supposed that the fauna might be more resilient than anticipated (Williams *et al.* 1991; Metzeling 1993).

Hart *et al.* (1990, 1991) suggested that macroinvertebrates and plants are the most salt-sensitive components in lowland river communities, and proposed a general threshold level of 1.0 g/L above which adverse biological effects can be expected. These may be due to direct toxic action of a salt ion, or may indirectly influence the productive success of a species or its food supply. The authors also noted that a pulsed release of saline wastewater with a steep incline and the gentle decline of salinity levels in the river have greater detrimental effects on the riverine biota than continuous releases.

---

# *Chapter 3*

## *Experimental methods*

---

The general aim of this project was to evaluate three artificial stream designs, by conducting acute (96 h) toxicity tests and assessing whether the resultant toxicity values were significantly different between the systems. Two species of Ephemeroptera from the Palmiet River, Eastern Cape, were employed as test organisms (Leptophlebiidae *Adenophlebia auriculata*; and Baetidae *Afroptilum sudafricanum*), and sodium sulphate was chosen as a reference toxicant. This chapter will describe the general test layout (Section 3.1.), and the experimental methods applied (Sections 3.2. and 3.4.), give a brief overview of how to calculate acute toxicity values (Section 3.3.), and describe analyses conducted after the completion of the experiments (Section 3.4.).

### **3.1. General experimental design**

The selected method of statistical analysis of the data usually guides the layout of an experiment. Acute toxicity tests are generally based on a regression design, where groups of test organisms are exposed to a number of progressively increasing concentrations of a toxicant (Gelber *et al.* 1985). At least one untreated control has to monitor the natural responses of the test organisms to the test conditions (Parrish 1985). The result of such experiments is a toxicity curve which describes the concentration-response relationship between the toxicant and the test organism (Section 1.3.5.). The curve is used to determine the median lethal concentration (LC50) for a selected exposure time. Where mortality is difficult to determine, the median effective concentration (EC50) may be computed (APHA 1992). This was the end point used in this study.

#### **3.1.1. Test sequence**

In order to compare EC50 values from different artificial stream designs, it would have been ideal to conduct all experiments at the same time, with an equal number of concentrations within each experiment. This would have reduced confounding variables to a minimum. However, this approach was not feasible for several reasons: 1) space constraints in the artificial stream laboratory made it impossible to install all three systems

simultaneously; 2) the number of test organisms required would have exceeded the capacity of the sampling site to supply them; 3) the design of the Large Artificial Stream Units (LASUs) and the available number of independent experimental units (Section 2.2.3.) imposed several limitations on the experimental design: a) because of a shared sump and water source, the three channels within one LASU could not be used to replicate population responses within one concentration without problems of pseudoreplication (Section 2.2.3., LASU); b) with three independent experimental units available, only two different concentrations could be run in parallel, as the third unit had to be used as a control.

Experiments were therefore run sequentially. For the LASUs, several sub-tests were planned until the data were sufficient to describe the concentration-response relationship, a strategy which has been followed by other workers (e.g. Van Noordwijk and Van Noordwijk 1988, or Krewski and Franklin 1991, both cited in Hoekstra 1993). However, the tolerance of test populations may change over time as a result of a changing environment. For standard laboratory organisms this may be less problematic, as their environment is controlled, and their genetic background is more homogeneous. Responses of organisms collected in the field may be more variable, as they are exposed to selective stress and a larger fluctuation of environmental variables. It therefore was also necessary to repeat experiments in the same system (Channels) at different times to be able to assess whether different EC50 values were due to changing tolerances of the test population or other factors related to sequential testing.

The length of time required to complete a LASU experiment consisting of several sequential sub-tests, made the repetition of experiments impractical. Only one experiment was therefore conducted in these systems with each test species. During the course of the experimental work it also became obvious that the Raceways were impractical to use, and that the Channels adequately represented the small-scale systems. Raceways were therefore not used to test *A. sudafricanum*, the second test species. Experiments were thus repeated only in the Channel systems, twice with *A. auriculata*, and once with *A. sudafricanum*. A repetition of experiments in a regression design was recommended by Stephan (1977) and Hoekstra (1993) in preference to the replication of test concentrations within one experiment. All experiments conducted are summarized in Table 3.1.

Table 3.1. Summary of the experiments carried out, and the general test design.

	LASU		Raceways		Channels	
Experimental units available	3		9		15	
Sub-tests needed	yes		no		no	
Concentrations and controls applied per (sub-)test	2 conc.; 1 contr.		8 conc.; 1 contr.		10–14 conc.; 1–2 contr.	
Species	<i>A. auri-culata</i>	<i>A. sud-africanum</i>	<i>A. auri-culata</i>	<i>A. sud-africanum</i>	<i>A. auri-culata</i>	<i>A. sud-africanum</i>
Number of sub-tests employed for final result	4	3	–	–	–	–
Total number of experiments conducted	1	1	1	–	3	2

### 3.1.2. Data requirements for a regression design

The opinions of aquatic toxicologists and biostatisticians differ on the minimum number of different concentrations required to describe a precise concentrations-response relationship. The issue of experimental replication is another much debated concern.

Stephan (1977), working on routine toxicity and effluent testing with fish, argued against the need for any partial response when determining EC50 values. He stated that a test with only 0 and 100% response and an unaffected control also contains useful information and recommended replicating tests in time to obtain information on the precision of an acute mortality test.

Kosinski (1989) and Guckert (1993) demonstrated that at least four increasing concentrations are needed when test concentrations are not replicated. However, their argument is aimed at artificial stream macrocosm studies where replication of treatments is costly and labour-intensive. Both authors recommended the replication of treatments wherever possible.

APHA (1992) recommended at least duplicate test treatments with a minimum of five test concentrations plus a control. No justification is given for this number, and it is also not stated if these five concentrations have to yield five responses (e.g. 0 and 100% response, and three partial responses) which can be used in a statistical analysis. No indication is given if a test with less usable responses is invalid.

Radloff (personal communication) stated that a limit of six concentrations for determining a regression line is commonly accepted in statistical science. Unfortunately, no references could be found in standard statistical text books to support this statement (e.g. Sokal and Rohlf 1981; Zar 1984).

Gerhardt (personal communication) advocated the opinion that a number of 6–7 concentrations is sufficient to describe a concentration-response relationship when the responses evenly cover the range from 0–100% response, and suggested that an unreplicated regression design is adequate for aquatic toxicity testing.

Based on this information and the practicalities associated with the test procedure, it was decided to plan for a minimum of six concentrations including 0 and 100% response. This should result in at least four partial responses which should be evenly distributed over the response range. Four partial responses also allow for the use of Probit analysis to calculate EC50 values. Employing this parametric procedure is preferable because the analysis yields more information on the concentration-response relationship than a non-parametric method (Hoekstra 1991a; Section 3.3.1.). Where possible, more concentrations were planned to increase test precision (Buikema *et al.* 1982; APHA 1992).

### 3.1.3. Assessing the difference between EC50 values

The EC50 values from duplicate tests can preliminarily be compared by examining their 95% confidence limits (95%CLs). They are generally considered to be statistically significantly different when the 95%CLs do not overlap (APHA 1992). APHA (1992) proposed the following procedure to compare EC50s, even under conditions of overlapping 95%CLs.

Calculate the factor  $f_{1-2}$  from EC50<sub>1</sub> and EC50<sub>2</sub> with

$$f_{1-2} = \text{antilog} \sqrt{(\log f_1)^2 + (\log f_2)^2} \quad \text{Equation 3.1.}$$

where

- $f_1$  factor 1, to be calculated as the ratio of (upper 95%CL of EC50<sub>1</sub>)/(EC50<sub>1</sub>)
- $f_2$  factor 2, to be calculated as the ratio of (upper 95%CL of EC50<sub>2</sub>)/(EC50<sub>2</sub>)

If the ratio

$$\frac{\text{greater EC50}}{\text{smaller EC50}} > f_{1-2} \quad \text{Equation 3.2.}$$

then the difference between EC50<sub>1</sub> and EC50<sub>2</sub> is statistically significant.

If EC50s are significantly different according to Equations 3.1. and 3.2., APHA (1992) recommended to test whether populations used in experiments differed in length, weight, age or sex as these parameters may influence the sensitivity of the test organisms.

In this study, the statistical significance of differences between EC50 values from different experiments in different stream systems was determined by following APHAs (1992) recommendations described above. Because of the sequential test strategy, two issues demand clarification. Firstly, when EC50s are compared, APHA (1992) refers to EC50 values of "duplicate tests". It could not be established how strictly this term had to be interpreted, but it is probably reasonable to include similar tests repeated at different times (Radloff, personal communication). Secondly, it is important to realise that the width of 95%CLs changes with the data used in regression calculations. This can in turn influence the decision whether EC50s are statistically significantly different, should two EC50 values from experiments with different data be compared. This is likely to happen in regression design experiments. Although changes of the width of 95%CLs are of minor importance, if differences between EC50s are clearly recognisable (Radloff, personal communication), decisions within the threshold-area may be difficult to make. In these instances, Kirk's statement (1968, cited in Giesy and Allred 1985) should be remembered: "Hypothesis testing procedures should be viewed as tools that aid an experimenter in interpreting the outcome of research. Such procedures should not be permitted to replace the judicial use of logic by an alert analytical experimenter".

The biological significance of 95%CLs has also been criticized. Stephan (1977) noted that "confidence limits calculated from one test give no indication of the reproducibility or repeatability of the acute mortality test", and Hoekstra (1993) remarked that "confidence intervals give an optimistic view of the true uncertainty". The variability of EC50 values of this study due to sequential testing was therefore quantified and compared with variability reported in the literature. Two methods are commonly used to quantify toxicity test variability. Following the one approach, the ratio of the greatest and the smallest EC50 observed in a test series can be calculated (e.g. Buikema 1983; Sprague 1985), and the factors obtained from different series can be compared. In the other approach, the

coefficient of variation (CV) of a series of EC50s is calculated, and these values are compared (e.g. Cooney 1995). Both methods were used in this study and allowed the comparison of test variability regardless of the concentration range within which experiments were conducted.

## 3.2. The test procedure

### 3.2.1. Experimental medium

Dechlorinated tap water was used in all experiments as the experimental medium. It is a common alternative to river water when river water is not readily available (Rand and Petrocelli 1985; APHA 1992). It was not feasible to use water from the Palmiet River because of difficulties associated with transporting river water to the laboratory, and rain water was not an option owing to the dry Grahamstown climate.

The use of dechlorinated tap water has several limitations: there is often a change of major ion proportions and the concentration of dissolved and particulate organic matter relative to the natural environment of the test organisms; the water quality may change over the course of the year; tap water may contain high levels of metal ions; and dechlorination may be incomplete, resulting in toxic levels of residual chlorine (Cooney 1995; Rand *et al.* 1995). However, practical limitations dictated the choice of experimental medium, and test organisms survived the acclimation and test period without showing any signs of stress. Since this study did not focus specifically on the Palmiet River as a receiving water body, the use of tap water was acceptable.

Artificial stream systems were prepared, filled with tap water, and water recirculation started 24 h before collecting the test organisms. The water was therefore thoroughly aerated, which is a common method of removing chlorine (APHA 1992). Chlorine concentrations were measured with a Lovibond 3/40E comparator disc at different times after experimental systems had been filled. Tap water was once analysed by the analytical laboratories of the Leather Industries Research Institute (LIRI) at Rhodes University. Results are summarized in Table 3.2.

**Table 3.2.** Chlorine content of tap water and a LASU. LIRI Leather Industries Research Institute at Rhodes University. Units in [mg/L].

	Free chlorine	Combined chlorine	Total residual chlorine	Method
Tap water, analysed at LIRI	–	–	<0.1	Iodometric (Anon 1958)
Tap water from a LASU, after filling	<0.02	0.06 ± 0.02	0.08 ± 0.02	Lovibond 3/40E
LASU water after 24 h recirculation	–	–	0.04 ± 0.02	Lovibond 3/40E

### 3.2.2. The toxicant sodium sulphate and experimental concentrations

Industrial grade anhydrous sodium sulphate was used as large quantities were required for the LASUs, and the price of analytical grade sodium sulphate was prohibitive. The salt was

obtained from Protea Industrial Chemicals, Wadeville, South Africa.

**Table 3.3.** Product specification of sodium sulphate used in this study as provided by Protea Industrial Chemicals, Wadeville, South Africa

Na <sub>2</sub> SO <sub>4</sub>	98% min
Chlorides	1.5% as NaCl
Ca	0.5%
Mg	0.5%
Fe	50 ppm
Ni	45 ppm
pH	7 to 9.5

Product specifications are listed in Table 3.3. No specific care was required while handling the salt as sodium sulphate is considered to be non-toxic and non-irritating to the skin and mucous membranes of humans. It also does not show bioaccumulation or food chain contamination potential (Anon 1985).

The sodium sulphate was weighed out on a Denver Instrument Company Electronic Balance, Model DE-400D. The concentrations were prepared by dissolving the required amount of salt for each Channel and Raceway unit in 2.5 L tap water. For the LASUs, the required amounts of salt were weighed on a balance from Adam Equipment, Model HCW 22, which had a greater capacity (22 kg). The salt was poured directly into the sumps as it was found that the turbulence was sufficient to dissolve even large quantities of salt quickly.

Based on sulphate ion measurements in water samples taken at the beginning and the end of the test period (Section 3.2.6.), the actual concentration of sodium sulphate was calculated using the following equation:

$$c_{\text{Na}_2\text{SO}_4} = \frac{c_{\text{SO}_4 \text{ treatment}} - c_{\text{SO}_4 \text{ control}}}{96.062} \times 142.043 \quad \text{Equation 3.3.}$$

where:

$c_{\text{Na}_2\text{SO}_4}$	concentration of sodium sulphate [g/L]
$c_{\text{SO}_4 \text{ treatment}}$	concentration of sulphate measured in one treatment of the test [g/L]
$c_{\text{SO}_4 \text{ control}}$	concentration of sulphate measured in the control for this test [g/L]
96.062	atomic mass units for sulphate
142.043	atomic mass units for sodium sulphate

In this equation, the background levels of sulphate in the tap water have been taken into account. Where more than one control for an experiment was used (mainly in the LASU experiments), the mean of the background levels was calculated. For data analysis, the mean of both  $\text{Na}_2\text{SO}_4$  measurements per unit (beginning and end of experiment) was determined and used in EC50 calculations. APHA (1992) recommended that the measured (actual) toxicant concentrations during chronic experiments should not fluctuate by more than  $\pm 15\%$ <sup>12</sup> from the nominal concentration; no recommended ranges could be found for acute toxicity tests.

In general, the concentration range selected for final experiments depended, on range-finding test results. For the final determination of EC50 values, the spacing of test concentrations does not have to follow a particular pattern, but a geometrically spaced concentration series results in an even distribution of concentrations when concentrations are log-transformed for statistical analysis (*ibid.*). For this study, selected test concentrations were initially based on the results of the range-finding test, and then successively on conducted experiments. Linear spacing intervals were predominantly applied. Where possible, concentrations were focused around the expected EC50 value to obtain a more precise estimate (Finney 1971; APHA 1992). Table 3.4. shows the selected concentrations for all experiments.

<sup>12</sup> The change in sodium sulphate concentration during the four day test period was calculated as the absolute deviation of sodium sulphate concentration of day four from the concentration measured at day one (which was assumed to be 100%), in percent.

**Table 3.4.** Summary of important characteristics of all experiments, including test concentrations. RF-AA Range-finding test with *A. auriculata*; RF-AS Range-finding test with *A. sudafricanum*.

Experiment	Test species	Stream design	Test period	Experimental sodium sulphate concentrations [g/L]	No. of conc. + control(s)
RF-AA	<i>A. auriculata</i>	Raceway	28.10.–01.11.96	3.04; 5.68; 12.11; 18.19; 23.41	5 + 2
1	<i>A. auriculata</i>	LASU	28.10.96–23.04.97	4.92; 5.67; 6.50; 7.80; 8.51; 9.86; 11.54; 15.01	8 + 4
2	<i>A. auriculata</i>	Raceway	19–23.04.97	4.89; 6.06; 6.91; 7.89; 9.79; 10.68; 11.80; 12.84	8 + 1
3	<i>A. auriculata</i>	Channel	28.04–02.05.97	5.37; 6.74; 7.43; 8.27; 8.73; 8.96; 9.50; 9.84; 10.77; 10.91; 11.60; 11.98; 13.26; 15.02	14 + 1
4	<i>A. auriculata</i>	Channel	01–05.09.97	4.82; 6.04; 6.96; 8.10; 9.03; 10.11; 11.43; 12.54; 13.35; 14.33	10 + 1
5	<i>A. auriculata</i>	Channel	08–12.12.97	4.12; 5.13; 6.10; 6.99; 8.21; 8.97; 10.23; 11.16; 11.92; 13.53; 13.97	11 + 1
RF-AS	<i>A. sudafricanum</i>	Raceway	10.10.–14.10.96	0.37; 0.77; 3.10; 5.95	4 + 1
6	<i>A. sudafricanum</i>	LASU	06.10.–05.11.97	0.51; 2.04; 2.34; 2.73; 3.60; 5.46	6 + 3
7	<i>A. sudafricanum</i>	Channel	27.09.–01.10.97	0.99; 1.89; 2.66; 3.29; 4.33; 5.12; 5.63; 6.48; 7.51; 8.47; 9.35	11 + 1
8	<i>A. sudafricanum</i>	Channel	28.04.–02.05.98	0.06; 1.00; 2.12; 2.43; 2.88; 3.29; 3.74; 4.08; 4.92; 5.91; 7.48	11 + 1

### 3.2.3. Sampling and sorting of experimental organisms

All test organisms were collected from the same stretch of the Palmiet River outside Grahamstown (Section 2.3.4.). The leptophlebiid mayfly *A. auriculata* was mostly found under stones in slow-flowing or still water at the river banks. Stones were picked up and held over a 5 L bucket containing some river water. The gentle splashing of water over the stone washed most of the nymphs into the bucket. The baetid mayfly *A. sudafricanum* occurred mostly in fast-flowing currents on the upper surfaces of stones, but could also be found in slower flowing stony pools. This species, like the baetid mayfly *Baetis harrisoni* (Williams 1996), was more sensitive to mechanical stress than *A. auriculata*, so careful handling was essential. The use of a squeeze bottle to wash the nymphs off the stones with a water jet was necessary, as *A. sudafricanum* tended to cling to stone surfaces. Organisms were transferred to a 25 L cooler box filled with aerated river water. For *A. sudafricanum*, a large and heavy stone served as a substrate, while some pieces of rubber foam were preferable for *A. auriculata*.

In the laboratory, the animals were immediately sorted, and placed in artificial stream systems. Organisms were picked from sorting trays using a piece of mesh and a paint brush which reduced mechanical stress to a minimum. They were then randomly distributed

between different experimental units. Organisms were transferred into the streams in batches of three to ensure an equal distribution of body-sizes into the systems (APHA 1992).

Only undamaged nymphs were selected, and those with dark wingbuds (indicating the last instar, close to emergence) were excluded. Organisms of as similar a size as possible were used. For fish it is recommended that individuals should be in a range where the largest is not more than 50% longer than the shortest (Coler and Rockwood 1989; APHA 1992). This size-range could often not be achieved because of a low abundance of the species at the sampling site, and smaller animals had to be used to obtain the required numbers of organisms per unit. Smaller nymphs were, however, equally distributed between the systems. No detailed size limits for macroinvertebrates could be found in the literature.

Where possible, about 30 nymphs were allotted to each test unit. For fish, APHA (1992) advised the use of at least 20 organisms per unit, but recommended higher numbers for macroinvertebrates. Jensen (1972) found that an increase in the number of test organisms from 10 to 20 per unit decreases the relative standard error of an EC50 by 29%. An increase from 20 to 30 organisms decreases the standard error for another 13%, and increasing the number from 30 to 40 decreases the error only for another 8%. If emergence caused the total number of organisms in a unit to drop below 20, the results were discarded.

#### 3.2.4. Acclimation

After nymphs had been placed into the artificial streams, they were left in the systems for 2½ days to acclimate to laboratory conditions (Parrish 1985; APHA 1992). This resulted in a total acclimation time of  $63 \pm 3$  h. Reported acclimation times for invertebrates range from no acclimation (Arthur *et al.* 1987) to several weeks (Lowell *et al.* 1995a).

Test organisms should not experience changes in temperature greater than 3 °C in any 24 h period (APHA 1992), although Parrish (1985) considered 5 °C to be acceptable. During transport from the river to the laboratory, temperatures were kept within a 4 °C range. During the 48 h before and throughout the experiment, the temperature change was kept to  $\pm 2$  °C (APHA 1992).

Organisms were observed daily for adverse effect, moults and emergence. Where responses during acclimation exceeded 10%, test units were excluded from the experiment (*ibid.*). Exuviae were collected daily as they can be confused with dead nymphs, and it was also

occasionally observed that they served as a food source, which was not desirable (Section 3.2.6.). Emergence was recorded based on skins which were found above the water level or floating on the water surface<sup>13</sup>, or emerged adults found on the rim of a test unit. These records were not reliable, but might account for nymphs missing at the termination of the experiment.

Temperature, pH and conductivity were monitored daily. Dissolved oxygen was not measured, as values near saturation had been recorded in previous experiments for all systems and reported to be constant (Everitt 1996; Palmer *et al.* 1996; Palmer and Goetsch 1997). The nymphs were not fed during acclimation (Parrish 1985).

### 3.2.5. Range-finding tests

Preliminary or range-finding tests are required for chemicals of unknown toxicity (APHA 1992). As tolerances of *A. auriculata* and *A. sudafricanum* to sodium sulphate had not been determined previously, range-finding tests were carried out using the Raceway systems. For an untested chemical or a new test species, range-finding-concentrations usually cover several orders of magnitude. For this study, it was not necessary to cover a broad concentration range, as results for some South African Ephemeroptera tested against sodium sulphate and sodium chloride were already available (Corbett 1996; Goetsch and Palmer 1997). The test procedure for range-finding tests is similar to the procedure for the final experiments.

### 3.2.6. Acute toxicity tests

Acute toxicity of sodium sulphate was tested for four days, or 96 h, the commonly recommended test duration for fish and macroinvertebrates (Parrish 1985; APHA 1992). Before any experiment was initiated, tap water was added to a pre-determined volume mark to compensate for spillage and evaporation during acclimation. No further water was filled in the LASU. The prepared salt solutions were then added and the time recorded as the start of the experiment.

---

<sup>13</sup> Exuviae left behind after emergence were found to have different physical features compared to those of earlier (submerged) larval stages: water did not adhere to them which made them float on the water surface.

During the 96 h test period, tap water was added daily to the Raceways to compensate for spillage and evaporation. It was added every second day to the Channels as they lost less water. In selected tests, the added volume of water was recorded to determine the average loss of water during the test period. In previous experiments with the Raceways (Goetsch and Palmer 1997), it was found that nutrients accumulated during the test period. To keep nutrient levels within acceptable limits, 20% of the total volume (2.5 L) of the experimental medium was replaced daily with freshly prepared salt solution. This practice was continued for this study.

### *Feeding*

The mayflies were not fed during the course of the experiment to reduce the variability due to nutritional and metabolic condition (Parrish 1985) and nutritional stress (Peters *et al.* 1985). APHA (1992) suggested feeding only for periods greater than 96 h, which is usually the non-feeding limit for macroinvertebrates (Buikema and Voshell 1993). For example, Hickey and Vickers (1992) found increased control mortality (30%) after six days when the mayflies *Deleatidium* spp. were not fed. Although not actively fed, detritus from within the artificial stream systems (especially from the LASUs which could not be cleaned properly, Section 5.2.4.) was available throughout the test period, particularly at the outgoing mesh of the test chambers.

### *Biological data and observation*

Responses of the nymphs were recorded every 12 h; Appendix C shows a spreadsheet used for data collection. From previous tests it was known that sodium sulphate is a slow-acting toxicant (Goetsch and Palmer 1997); therefore observations at shorter intervals (e.g. 1.5, 3 and 6 h after the experiments were initiated) were not necessary.

The most common end point in acute toxicity testing is mortality (Rand and Petrocelli 1985; APHA 1992). In this study, mortality end points for the mayfly species were sometimes difficult to determine. Immobilization was therefore used as the response, and the EC50 rather than the LC50 recorded as an end point (APHA 1992). For this study, a specimen was counted as affected when it did not actively return to the substrate and cling to it once it had been removed with a glass pipette and put back gently in an area of low current. Only organisms which were not already completely immobile, and those not showing major movements of their appendages when stimulated with a water-jet and observed by eye, were tested using this procedure. This chosen effect appeared to be very close to a mortality end point, but it was felt that in cases of doubt the described method was preferable.

Exuviae were removed twice daily, and emergences recorded (Section 3.2.4.). In rare cases where a nymph died during emergence, it was excluded from the test when it was found above the water surface, and scored as being affected when it was found below.

#### *Responses in the control units*

Tests with a control response greater than 10% were considered unacceptable and repeated or discarded (Parrish 1985; APHA 1992). Buikema *et al.* (1982) acknowledged that the choice of this level is arbitrary, but demonstrated some statistical support based on experience with *Daphnia*.

A formula proposed by Abbott (1925) allows for a correction if organisms in the control are affected. Stephan (1977) called such corrections a "meaningless exercise", as, in his opinion, the formula does not produce results which are more accurate. When test animals die, for example of stress, their sensitivity towards the toxicant will have changed and invalid results are produced. APHA (1992) advised the use of the formula with appropriate caution. Hoekstra (1993) and Finney (1971) both recommended its use. The equation was therefore used in the data analysis where control responses were in the range >0–10%. Abbotts formula is described as follows (APHA 1992):

$$P = \frac{P^* - C}{1 - C} \quad \text{Equation 3.4.}$$

where:

- $P$  Corrected responding proportion
- $P^*$  Observed responding proportion
- $C$  Proportion responding in the control

#### *Water and air temperature*

The nominal temperature of the water during the tests was selected to be 19 °C (APHA 1992). Water temperature was measured daily during the experiment. A minimum-maximum thermometer was used for measuring the air temperature in the laboratory. It was found that the water temperature followed the air temperature with a difference of about 0–2 °C, depending on the stream design. Thus the water temperature could be monitored and controlled through the air temperature which, once adjusted, proved to be constant within ±1 °C (Palmer *et al.* 1996). The thermal input of the aquarium pumps in the Channels was constant and evenly distributed. The temperature difference between

units due to uneven air circulation from the air conditioners was considered to be acceptable within a range of  $\pm 2$  °C (APHA 1992).

#### *Current velocity and substrate*

The nominal current velocity in the LASUs was chosen to be 0.10 m/s, which is a compromise setting for the two test species. *A. auriculata* was mainly found in slow currents around 0.10 m/s (Hunt 1997), while *A. sudafricanum* can be found in fast currents as well as in slower flowing water (Section 2.3.2. and Figure 2.11.). Occasional current velocity measurements at different sites in the Palmet River supported these findings.

In the Channels and the Raceways the current velocities could not be changed because of a constant motor speed and pumping rate respectively. The paddle wheels of the Raceways produced a mean current velocity of 0.094 m/s in the test chambers, whereas the submersible pumps of the Channels delivered a mean current velocity of 0.039 m/s. A more detailed account of flow measurements in the artificial streams is provided in Appendix A.

In all systems, plastic mesh with a mesh size of 1 mm was placed on the bottom of the test chambers as a substrate. For *A. auriculata*, several kaolinite ( $\text{Al}_2\text{Si}_2\text{O}_5(\text{OH})_4$ ) stones were placed on the mesh as refuge. For *A. sudafricanum*, river stones from the Palmet River which were acid-washed before use, served as an additional substrate.

#### *Photoperiod and light intensity*

A standard photoperiod of 12 h light:12 h dark was chosen for all experiments. Light was provided by OSRAM® Biolux tubes which provided a full spectrum of wavelengths similar to sunlight. Measurements with a Lutron LX-101 Digital Lux Meter at the water level of all systems showed a range of light intensities between 564 and 670 lux. This range correlated with light intensities found at shady banks of the Palmet River. No references could be found in the literature as to the range of light intensities suitable for macroinvertebrates.

#### *pH*

The pH was measured daily (APHA 1992) using a Beckman  $\Phi^{\text{TM}}10$  pH Meter and a HANNA Instruments HI 9023 microcomputer pH/°C Meter respectively, both equipped with a combination pH electrode. Over the period of two years (1994–1995) the pH in the Palmet River ranged from 5.8 to 8.0 (Haigh and Davies-Coleman 1997). A pH range of 7.0 to 8.2 in test systems, as suggested by APHA (1992), therefore seemed to be appropriate.

### *Electrical conductivity*

Electrical conductivity (EC) was measured daily in each unit, during both acclimation and the test period (APHA 1992). A conductivity meter 160 from AMEL Instruments with probe s.r.l. 193 for high salinity solutions, and an instrument from SwissLab with a glass probe, were used for this purpose. As the EC is influenced by the water temperature, this was also recorded.

Increasing salt concentrations in a test should produce a concurrent rise of EC measurements. The EC-readings were therefore used to monitor salt concentrations after the initiation of toxicity tests, and their fluctuation throughout the test period. It was found that the Raceways lost considerable amounts of water because of evaporation and splashing. Evaporative losses could be compensated for by adding water, but water lost through splashing also removed salt and thus could not be replaced by simply adding more tapwater. The daily exchange of 2.5 L experimental medium in these systems introduced a further factor of uncertainty. An attempt was therefore made in some of the first experiments to control salt concentrations using EC readings, but with limited success. However, the results confirmed that the fluctuations did not exceed the APHA-limit of  $\pm 15\%$  (APHA 1992).

### *Chemical water profile*

Water samples were taken at the beginning and the end of each test period. At the beginning the samples were taken one hour after the concentrated toxicant solution had been added, to ensure an even concentration gradient. When a concentration produced 100% response during a period  $< 96$  h, the unit was stopped and the water sample immediately taken for analysis. In addition, samples of tap water and Palmiet River water were taken at random intervals. The water from the controls was analysed for chlorine to determine whether dechlorination had been successful (Section 3.2.1.).

Samples were preserved using mercuric chloride ampoules and sent to the Institute for Water Quality Studies (IWQS), Pretoria, for analysis (Table 3.5.). Methods for analysis are described in DWAF Analytical Methods Manual (1992).

**Table 3.5.** Water quality constituents determined by the Institute for Water Quality Studies (IWQS), Pretoria.

<u>Phys.-chem. variab.</u>	<u>Cations</u>	<u>Anions</u>	<u>Nutrients</u>
pH	Sodium Na <sup>+</sup>	Fluoride F <sup>-</sup>	Ammonium NH <sub>4</sub> <sup>+</sup>
EC at 25 °C	Potassium K <sup>+</sup>	Chloride Cl <sup>-</sup>	Nitrite NO <sub>2</sub> <sup>-</sup>
Total Dissolved Solids (TDS)	Magnesium Mg <sup>2+</sup>	Sulphate SO <sub>4</sub> <sup>2-</sup>	Nitrate and nitrite NO <sub>3</sub> <sup>-</sup> + NO <sub>2</sub> <sup>-</sup>
Total alkalinity as calcium carbonate (TAL as CaCO <sub>3</sub> )	Calcium Ca <sup>2+</sup>		Phosphate PO <sub>4</sub> <sup>3-</sup>
Dissolved Organic Carbon (DOC)		<u>Element</u> Silica Si	

### *Wastewater disposal*

With each sub-test of the LASUs a total volume of about 5000–6000 L of salt-contaminated water was produced. In some instances the salt concentrations were too high to be released directly on to the ground (Port Elizabeth Municipality, personal communication). After checking for adverse effects and by arrangement with the Grahamstown Sewage Works, experimental wastewater was drained into the Grahamstown sewage system.

## **3.3. Methods for calculating EC50 values**

The calculation of EC50 values and 95% confidence limits (95%CLs) has been discussed at length in the literature (e.g. Armitage and Allen 1950; Stephan 1977; Gelber *et al.* 1985; Hoekstra 1991a). Methods proposed can broadly be classified into parametric and non-parametric methods. Parametric methods assume a certain shape of the frequency distribution of tolerances (Section 1.3.5.) and use a curve-fitting technique to estimate the EC50. Typical examples are the Probit method (Bliss 1934), and the logit method which relies on similar model assumptions (Gelber *et al.* 1985). Non-parametric methods use interpolation to calculate an EC50. The Trimmed Spearman-Kärber (TSK) method (based on developments by Spearman and Kärber (Hoekstra 1991a), improved by Hamilton *et al.* (1977)), the moving average method, the moving average angle method, and the kernel methods, all fall into this category (Stephan 1977; Gelber *et al.* 1985; Hoekstra 1991a).

Parametric methods generally have the advantage that they describe the concentration-response curve more precisely and therefore provide information such as the slope and effective concentration values from 1 to 99% response of the test population. Non-parametric methods are more robust and calculate only an EC50, sometimes with 95%CLs. There is no universal method suitable for all situations. In fact, it is often not possible to

select the method before toxicity data have been generated. As the data have to meet model-assumptions and minimum criteria, the previously chosen method might not be applicable. Hoekstra (1991a), however, recommended the use of a parametric method where  $\geq 3$  partial responses are available, and non-parametric methods where there are less, or where the concentration-response curve is only poorly covered. On the other hand, Stephan (1977) and Gelber *et al.* (1985) compared methods by applying the same data and found that differences in results were small compared to the normal biological and test variability. They therefore concluded that methods are equivalent and left the choice of the method up to the experimenter.

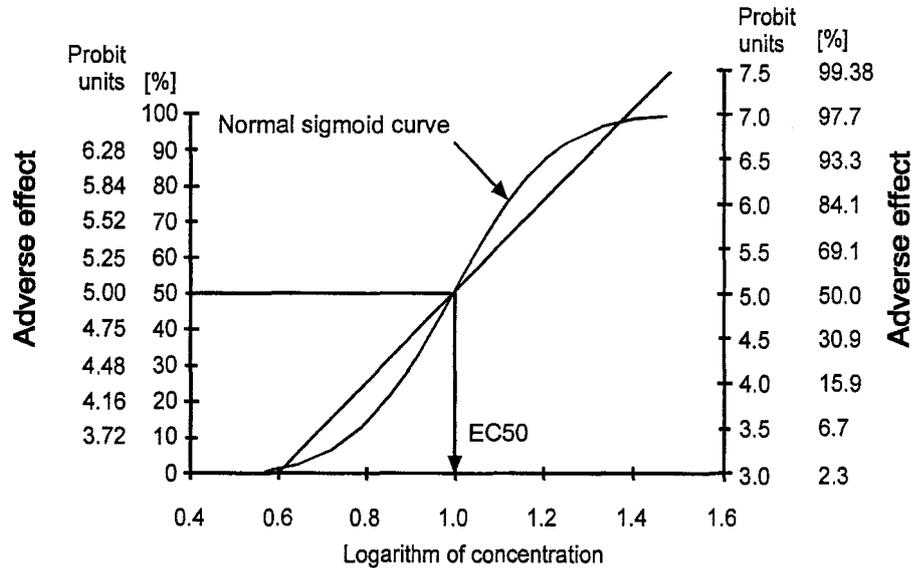
This study was designed to accommodate the requirements of the parametric Probit analysis, so as to yield a maximum amount of information. The non-parametric TSK method was used where parametric model assumptions were not met, and for comparative purposes. Two different computer programs from the United States Environmental Protection Agency (US EPA) were available to carry out EC50 calculations. The program for the Probit calculations (Version 1.4) followed the method described by Finney (1971). The other program (Anon 1986) used the TSK estimation based on calculations described by Hamilton *et al.* (1977).

In some experiments, more than one concentration yielded 0 or 100% response at a specified time. Where several 0% responses occurred, only the highest concentration producing 0% response was included in the analysis. For several 100% responses, only the lowest concentration producing 100% response was included. Hamilton *et al.* (1977) recommend this data exclusion for the TSK estimator. In this study the exclusion procedure has also been applied for the Probit analysis to make results more comparable.

### 3.3.1. Probit analysis

When Probit analysis is used to calculate an EC50 value, one assumes that the *frequency distribution of tolerance concentrations* is normal for log-transformed concentrations (Section 1.3.5.). Other transformations producing a normal frequency distribution are known (e.g. logit) and have been described (Finney 1971). Based on the normal distribution, the percentage response can be converted to deviations from the mean, or normal equivalent deviations (Gaddum 1933, cited in Finney 1971). The normal equivalent deviations can take on negative values which is inconvenient when the calculations are carried out manually. Therefore Bliss (1934) proposed the addition of 5 to the normal

equivalent deviations and termed his new value "probits" (probability units). Using probits transforms the normal sigmoid curve into a straight line (Figure 3.1.).



**Figure 3.1.** The normal sigmoid curve of Figure 1.4.b. before and after transformation of percentage responses to probits. The left ordinate has a linear percentage scale and applies to the normal sigmoid curve. The right ordinate has a linear probit scale and applies to the straight line. Modified from Finney (1971).

The straight line in Figure 3.1. can be calculated using the following equation (Finney 1971):

$$Y = 5 + \frac{1}{\sigma}(x - \mu) \quad \text{Equation 3.5.}$$

where:

- $Y$  Probability of response at a certain concentration [probits]
- $\sigma$  Sigma ( $\hat{=}$  reciprocal of the slope) [x/probits]
- $\mu$  Mu ( $\hat{=}$  log EC50)
- $x$  Logarithm of concentration

The best fit of the curve through the data can be achieved by using the maximum likelihood estimation procedure. This procedure is iterative where initial values for  $\sigma$  and  $\mu$  are estimated and then recalculated until their numerical values become sufficiently stable. To test whether the straight line represents the data adequately, a  $\chi^2$  (chi-square) test can be performed (Finney 1971). The statistical significance of the  $\chi^2$ -heterogeneity can be obtained from a  $\chi^2$ -distribution table. The degrees of freedom needed to obtain probabilities are  $n - 2$  where  $n$  equals the number of concentrations tested.

The Probit method bears advantages and limitations. The advantages include the following:

- Information on the toxicity curve is plentiful as the method is parametric.
- The data set does not have to include 0 or 100% response.
- The method can calculate an EC50 with only up to 49% response, though this result may be questionable.
- Equal spacing between log-concentrations and symmetrical distribution of the concentrations around the expected EC50 value is desirable, but not necessary.
- Similar numbers of test organisms in each treatment are not required.

(Stephan 1977; Gelber *et al.* 1985; Hoekstra 1991a)

Limitations have been pointed out by Hamilton *et al.* (1977) and Stephan (1977):

- The method is invalid if the model assumption of normality of the tolerance distribution is not met and the true dose-response curve is asymmetric. This becomes apparent when the maximum likelihood estimation procedure does not converge, or the deviation of data from the curve is systematic.
- The method requires at least two partial kills for the maximum likelihood estimation procedure to be effective. This is problematic for many data sets. APHA (1992) quotes a US EPA study from 1983 where only 7% of 60 performed effluent toxicity tests met the data requirements for Probit. The limitation can be circumvented by adjusting the data, e.g. a 0% response result to 5%, but this is not desirable.
- The maximum likelihood estimation procedure can converge to different values for the same test, depending on the initial assumptions used to start the procedure.

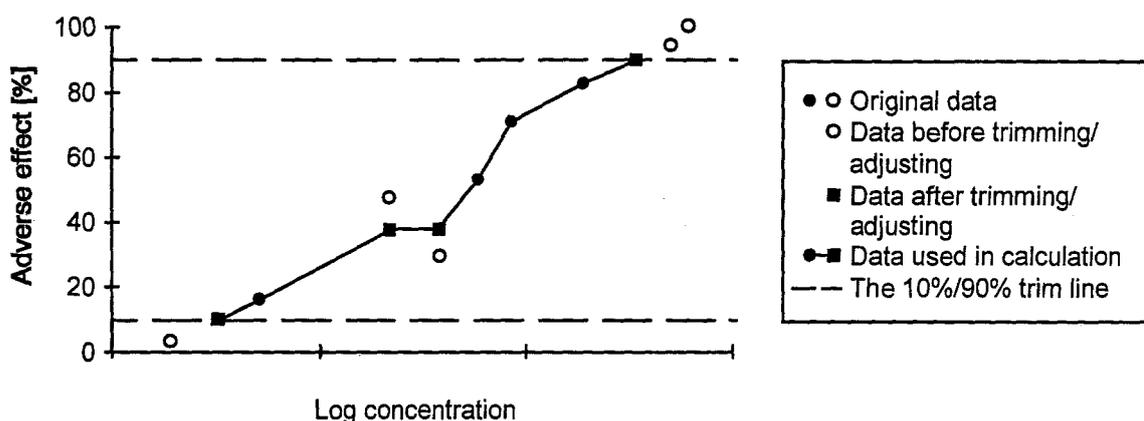
The Probit analysis program from US EPA, Version 1.4, was used for data analysis. No detailed manual was available, but Prof. S.E. Radloff, Head of the Statistics Department, Rhodes University, Grahamstown, tested the software and confirmed that it follows Finney's (1971) procedure. A full account of the results produced by the software is provided in Appendix D.

### 3.3.2. The Trimmed Spearman-Kärber analysis

The calculations for the Trimmed Spearman-Kärber (TSK) analysis have been described by Hamilton *et al.* (1977) and are a modification of the conventional Spearman-Kärber method. The method is non-parametric and requires only the symmetry of the tolerance distribution data – the shape of the distribution curve is irrelevant. EC50 values are calculated by interpolation. The major improvement over the conventional Spearman-Kärber method is the trimming procedure which eliminates the necessity for toxicity data

to cover 0 and 100% response. When the toxicity curve is trimmed, the experimenter chooses a constant  $\alpha$  where  $0 \leq \alpha \leq 50$ . This is the percentage that symmetrically trims (cuts) the curve at both tails. When  $\alpha$  is chosen to be 0, the method works like the conventional Spearman-Kärber method.

Another requirement for the data is monotonicity which means that the response proportions constantly increase with increasing concentration. When this order is violated, the TSK method adjusts or "smoothes" the data. The neighbouring decreasing response proportion is averaged with the previous response proportion to define a new estimate (the ■ symbols in Figure 3.2.). The adjustment does not affect the estimate of the EC50 value itself, but it does affect its variance (Hoekstra 1991a). Trimming and the creation of a monotonic increasing order of concentrations are displayed in Figure 3.2. for hypothetical data.



**Figure 3.2.** Data adjustments of the 10% Trimmed Spearman-Kärber method for a hypothetical data set. The original data are displayed by circles (empty and full). Empty circles represent data which were adjusted during the statistical procedure. They were either trimmed off (circles below and above the dashed line) and replaced by modified data (full squares on dashed lines), or modified to achieve monotonicity (full squares at about 40% response replace adjacent empty circles). The connected solid circles and squares represent the data used in the final EC50 calculation.

The trimmed method assumes that the tolerance distribution within the enclosed range (10–90% for the data of Figure 3.2.) is symmetric. The 95%CLs are derived as  $\mu \pm 2$  standard errors with  $\mu$  as the median of the tolerance distribution.

The TSK method has the following advantages:

- The method is fail-safe as long as  $\alpha$  (within the range of  $0 \leq \alpha \leq 50$ ) is at least as great as the lowest or highest observed response when 0 or 100% response are not present (Hamilton *et al.* 1977).

- Only one partial response is required for the calculation (Hoekstra 1993). However, the software used (see below) does calculate an EC50 with only 0 and 100% response. Hamilton *et al.* (1977) did not mention any limitations in this respect.

Limitations have been pointed out by Stephan (1977) and Hoekstra (1991a):

- In cases where the data are not symmetrically distributed around  $\mu$ , the method has a bias independent of the number of data. However, Irwin (1937, cited by Finney 1971) found this bias to be negligible.
- Only EC50 values and 95%CLs are produced. No other information on the toxicity curve is given.

A modified version of the TSK analysis program from US EPA, Version 1.0, was used for data analysis. It carries out the TSK calculations described by Hamilton *et al.* (1977). In 1990 Hoekstra (1991b) added Abbotts correction to the algorithm. For this study, P. Wade of Environmentek, Council for Scientific and Industrial Research (CSIR), Pretoria, South Africa, extended the number of observations which could be entered from 10 to 99. An example of data output is presented in Appendix D.

## 3.4. Analyses after EC50 determination

### 3.4.1. Time-toxicity curves

Most toxicity tests contain information about responses prior to the final selected exposure time. With these data, EC50 values for a shorter exposure period can be calculated to construct a time-toxicity curve. This curve contains information on the mode of action of the toxicant (Rand and Petrocelli 1985; APHA 1992). EC50 values for all experiments were therefore calculated for 12, 24, 36, 48, 60, 72, 84 and 96 h where possible. The TSK analysis (Section 3.3.2.) was used for two reasons. The method is more robust than the Probit analysis, and the software offers multiple entry of similar data sets which can easily be modified. The EC50 values were plotted on a log-log scale with the EC50 of the toxicant on the abscissa (x-axis) and the exposure time on the ordinate (y-axis) (*ibid.*). Where the curve asymptotically approached the time-axis, the EC50s on the most parallel part have been termed "threshold" or "incipient" EC50 (*ibid.*). At these concentrations 50% of the test organisms can survive for an indefinite time (Rand and Petrocelli 1985). Other shapes of the curve such as a straight line or irregular curves have been described (Sprague 1969).

### 3.4.2. Headwidth measurements of test organisms

When differences in EC50 values were found to be significant, APHA (1992) recommended a determination of whether the test populations differ in length, weight, age, or sex, as these factors have an influence on the sensitivity of the test organism (Sprague 1985; Rand *et al.* 1995). The analysis of experimental results revealed statistically significant differences between EC50 values as will be seen in Chapter 4. It therefore became necessary to test the populations.

It was decided to measure the headwidths of test organisms for both species. For *A. auriculata*, Haigh and Davies-Coleman (in press) found that the headwidths show a closer correlation to the instar than body-length. This argument might also be valid for *A. sudafricanum* as it is a species of the same order. Additionally, the body of both species stiffened in a curved position after the animal was preserved in alcohol, making body-length measurements inaccurate. Other workers also preferred headwidth over body-length measurements (Corkum and Pointing 1979; Ciborowski 1983; Diamond *et al.* 1992; Kiffney and Clements 1996).

The headwidths of *A. auriculata* were determined under a microscope with six-fold enlargement. The conversion factor from microscopic units to millimeters was 1.539. For *A. sudafricanum*, a 50-fold enlargement was used, and microscopic units were converted to millimeters with a factor of 0.198. All analyses were carried out using raw data (microscopic units), and only the final results were converted to millimeters.

As a first step, headwidth-measurements of organisms for one artificial stream unit were grouped, and differences between units within one experiment tested. During a second analysis, headwidth-measurements of one experiment were pooled, and differences between experiments were tested. The headwidth-distributions in test units and experiments were first analysed for normality and homogeneity of variances to determine whether the data was suitable for a parametric analysis of variance (ANOVA). The Statgraphics package Version 7.0 was used. For all statistical tests, the chosen level of significance was 0.05. Normality was analysed using the Kolmogorov-Smirnov test for goodness-of-fit. The homogeneity of variances were examined using Bartlett's test. Where parametric assumptions were not violated, a one-way ANOVA was performed to determine whether the differences in headwidth-means were statistically significant. Where differences were significant, Tukey's multiple comparison test was employed to identify groups of similar values. When data did not satisfy parametric requirements (Zar 1984), the non-parametric Kruskal-Wallis test corrected for ties was used.

---

# Chapter 4

## Results

---

### 4.1. Introduction

The results of the experiments are presented in four sections. The tolerances of *Adenophlebia auriculata* (Section 4.2.) and *Afroptilum sudafricanum* (Section 4.3.) are reported first, followed by a comparison of EC50 values obtained from different statistical procedures (Section 4.4.) and an investigation of factors discriminating EC50 values (Section 4.5.). All EC50 values were calculated using parametric and non-parametric methods, and all results are presented following a standard protocol.

#### *Probit analysis (Parametric method)*

The Probit analysis results for 96 h concentration-response data are tabulated and presented graphically. The graphs can be used to evaluate whether the experimental data deviate from the calculated curve in a random or a systematic manner. They also allow an assessment of the fluctuation of the sodium sulphate concentration in each test unit during the test period through the display of *horizontal bars*, which unlike conventional error bars, simply display the sodium sulphate concentration measurements within one experimental unit taken at the beginning and the end of the test period. On each graph, the filled circles in the middle of the horizontal bars show the mean of these two measurements. A detailed account of the results for each Probit analysis is provided in Appendix D.

#### *Trimmed Spearman-Kärber analysis (Non-parametric method)*

The Trimmed Spearman-Kärber (TSK) analysis was used to calculate EC50 values for the time-toxicity curves (Section 3.4.1.). Additionally, results of the 96h-EC50 values are presented in the same tables as Probit results for comparison<sup>14</sup>. For the 96h-EC50 values, the percentage trim ( $\alpha$ ) was standardized. A trim of 8% was selected as this allowed the inclusion of a maximum number of observations (*sensu* Hamilton *et al.* 1977).

---

<sup>14</sup> TSK results are presented with two decimal places as provided by the software (Appendix D). In the literature, three decimal places are used more commonly to present toxicity data from salts (e.g. Dowden and Bennett 1965; VCI 1992).

#### 4.1.1. Transformation of data

For many toxicity tests it has been found that the frequency distribution of tolerance concentrations of a test population is normal for *log-transformed* toxicant concentrations (Finney 1971; see also Section 1.3.5.). The acronym NFD-Log<sup>15</sup> will be used to refer to this distribution model. Because of its frequent occurrence in toxicology, this model was incorporated in the Probit analysis program (Section 3.3.1.) which thus log-transforms concentrations automatically before internal calculations are continued. However, other distributions are known, and a better fit of the concentration-response curve may be obtained when the tolerance distribution is assumed to be normal for *untransformed* toxicant concentrations. This model will be referred to as NFD-Lin<sup>16</sup>. As the Probit software was not programmed to allow for changes of the assumed distribution model, the data entry was adapted to force the program to assume a NFD-Lin. To carry out EC50 calculations with the NFD-Lin model, the *anti-logarithms* of concentrations were entered. Because of the internal automatic log-transformation, the entered anti-logs were transformed backwards, and hence untransformed concentrations were used in further calculations of the Probit program<sup>17</sup>.

For experiments with *A. auriculata*, all Probit 96h-EC50 values were calculated using both the NFD-Log and the NFD-Lin models. It was found that the NFD-Log model generally gave the better results (Section 4.4.1.). All graphs for Probit results therefore depict data based on this model. Results of both models are displayed in the tables below the graphs to allow for comparison.

When the NFD-Log model was used for experiments with *A. sudafricanum*,<sup>1</sup> the curve-fitting process was invalid (Experiment 6), or 95% confidence limits (95%CLs) could not be calculated (Experiment 7). This indicated that the NFD-Log model was not appropriate. As the shape of the concentration-response curve in a preliminary graph with untransformed data appeared to be symmetrical (see Appendix E for an example), the NFD-Lin model might have been more appropriate. Calculations were therefore repeated using this model, and resulted in a smooth fit of the curves through all data, showing very

---

<sup>15</sup> NFD-Log as for "normal frequency distribution on a logarithmic concentration scale".

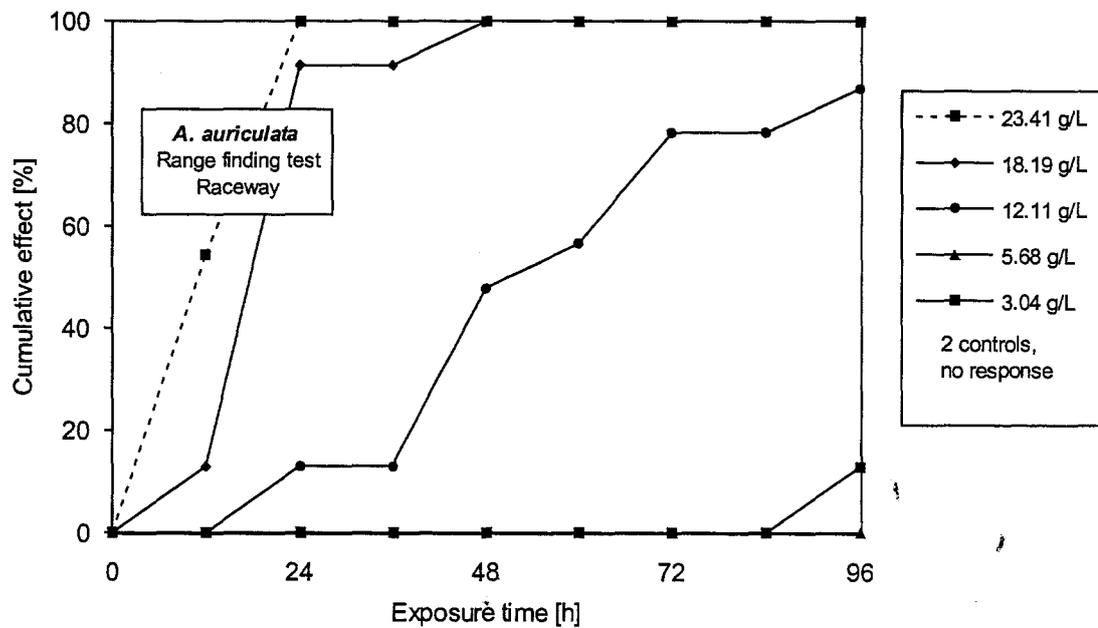
<sup>16</sup> NFD-Lin as for "normal frequency distribution on a linear concentration scale".

<sup>17</sup> However, entering the anti-log concentrations had the consequence that the result-output also provided the anti-logs of the desired values (e.g. EC values). Also, e.g. the slope of such calculations is not directly comparable with a slope stemming from the NFD-Log model (compare with Appendix A.). To obtain "normal" EC values, the results provided had therefore to be transformed backwards, using the log-operation.

low  $\chi^2$ -values. All graphs depicting Probit results for *A. sudafricanum* experiments were therefore based on the NFD-Lin model.

## 4.2. *Adenophlebia auriculata*

In preliminary range-finding experiments, *A. auriculata* and *A. sudafricanum* were tested simultaneously, but in separate LASU channels. Up to a concentration of 5.67 g/L no response occurred after 96 h; a later range-finding test showed that a response range of 0 and 100% could be expected between 4 and 15 g/L (Figure 4.1.). Final experiments were therefore carried out within this concentration range.

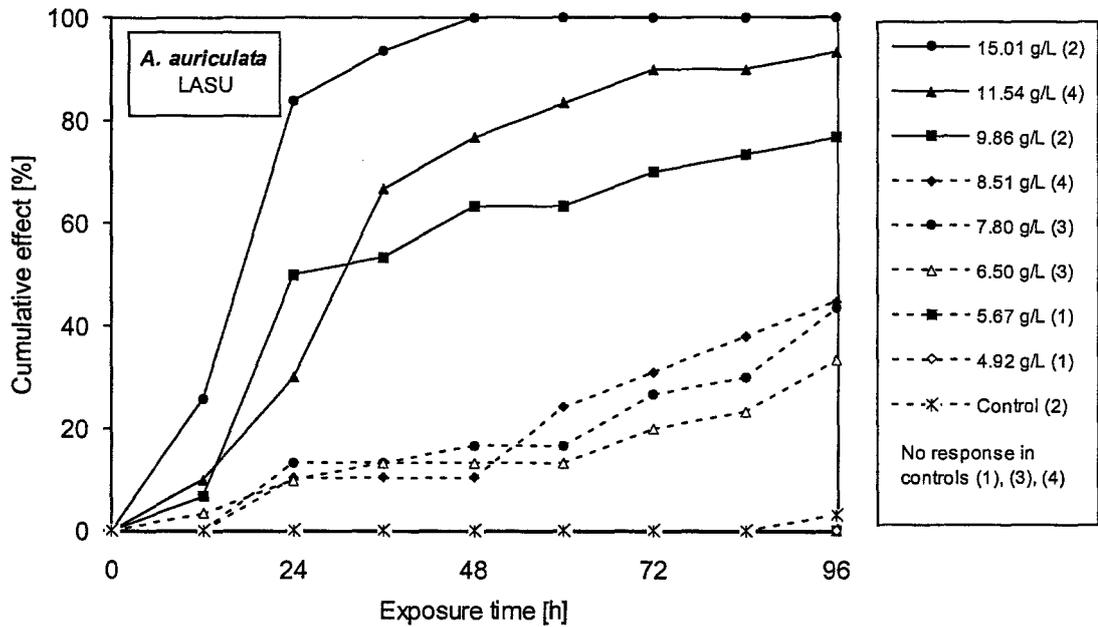


**Figure 4.1.** Range finding experiment with *Adenophlebia auriculata* (Experiment RF-AA): Cumulative effect of sodium sulphate on *A. auriculata* versus exposure time, in the Raceway range-finding test. Five concentrations (3.04–23.41 g/L) and two controls were used.

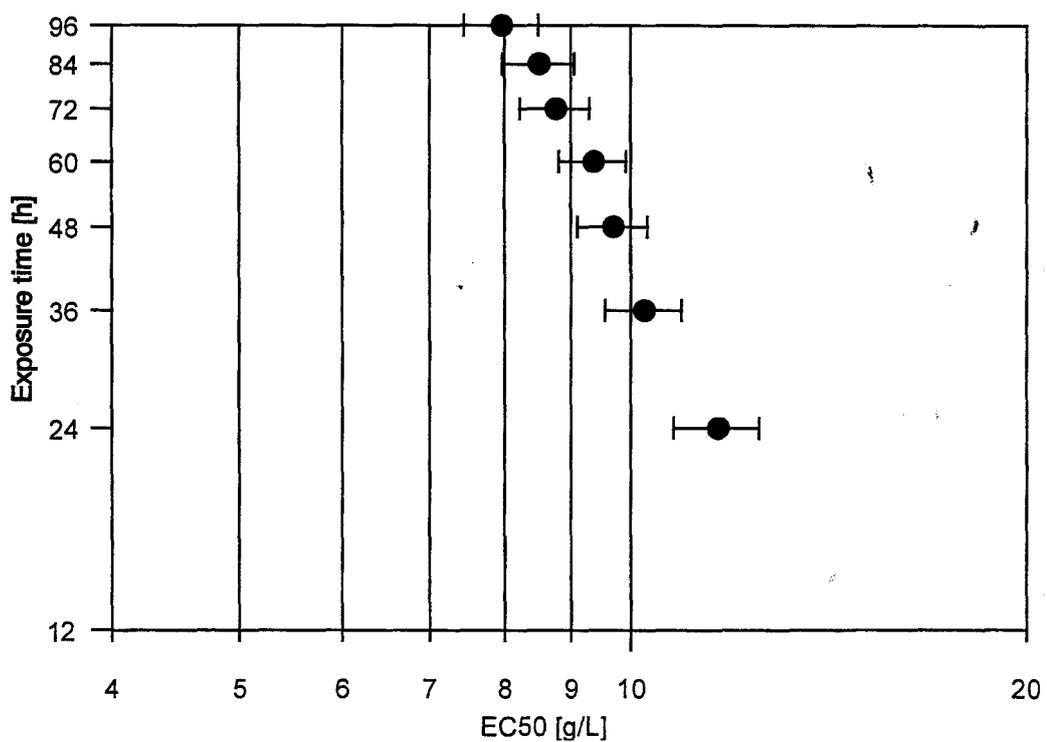
#### 4.2.1. Results of Experiment 1 in the LASUs

Based on the concentration range determined in the range-finding test (Figure 4.1.), four final sub-tests were conducted for Experiment 1 at eight concentrations between 4.92 and 15.01 g/L (Figure 4.2.). The 0% response datum at 5.67 g/L (Sub-test 1) could not be used for the EC50 calculations because of increased emergence during the test. This caused the nymph population to drop below 20 individuals which was considered to be unacceptable (Jensen 1972).

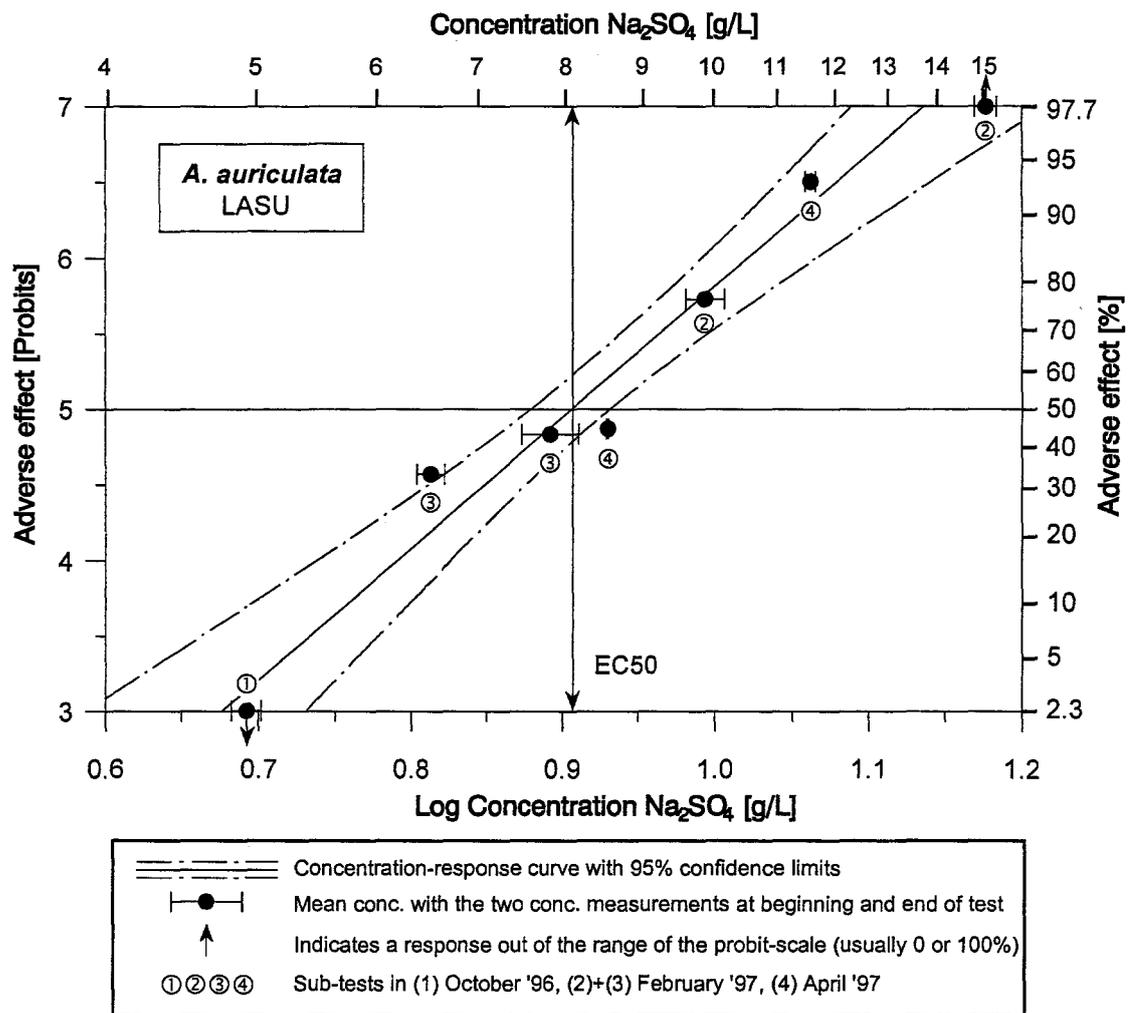
Figure 4.2. displays the cumulative effect of sodium sulphate concentrations during the course of the experiment (0–96 h). In Figure 4.3. the time-toxicity curve of sodium sulphate is shown. Figure 4.4. depicts the concentration-response relationship after 96 h, calculated with Probit analysis using the NFD-Log model (Section 4.1.1.). Table 4.1. summarizes results of the Probit and TSK 96h-EC50 analyses. In Tables 4.2. and 4.3., some water quality constituents of the Palmet River at the time of nymph collection, and of the artificial streams during acclimation and the test period are presented.



**Figure 4.2.** Experiment 1: Cumulative effect of sodium sulphate on *A. auriculata* versus exposure time, in the LASUs. The salt concentrations used are given in the legend. The numbers behind the concentrations indicate the date at which the sub-tests were conducted: (1) 28.10.–01.11.96; (2) 09–13.02.97; (3) 22–26.02.97; (4) 19–23.04.97. Response in the control of sub-test 2: 3.23%. No response occurred in the controls of other sub-tests.



**Figure 4.3.** Experiment 1: Time-toxicity curve of sodium sulphate for *A. auriculata* in the LASUs. EC50s for various exposure times were calculated with the Trimmed Spearman-Kärber analysis where possible. EC50s are displayed along with their 95% confidence limits.



**Figure 4.4.** Experiment 1: Concentration-response curve for *A. auriculata* in the LASUs after 96 h. The curve was calculated using Probit analysis with the NFD-Log model. The implications of this model are explained in Section 4.1.1.

**Table 4.1.** Experiment 1: Summarized results of statistical analyses using both the Probit and the Trimmed Spearman-Kärber (TSK) method to calculate 96h-EC50 values. For the Probit analysis, results for two model distributions (NFD-Log and NFD-Lin) were calculated. The implications of these models are explained in Section 4.1.1. The  $\chi^2$  (chi-square) statistic quantifies the deviation of data from the model distribution (smaller value = small deviations). Probabilities  $P > 0.05$  indicate statistically insignificant deviations of the model distribution at the 5% level. Detailed results of the Probit analysis can be found in Appendix D.

	Lower 95%CL [g/L]	EC50 [g/L]	Upper 95%CL [g/L]	Slope	Statistics $P$	Statistics $\chi^2$
Probit analysis: NFD-Log model	7.583	<b>8.073</b>	8.550	8.66	>0.25	6.15
Probit analysis: NFD-Lin model	7.761	<b>8.264</b>	8.758	0.45	>0.25	5.23
TSK analysis with a trim of 8%	7.45	<b>7.96</b>	8.50	-	-	-

**Table 4.2.** Experiment 1: Comparison of selected water constituents of the Palmet River at the time of nymph collection, and the range of those water constituents in LASUs during acclimation. For the EC of LASUs, only the highest reading is shown.

	Sub-test 1		Sub-test 2		Sub-test 3		Sub-test 4	
	Palmet	LASU water	Palmet	LASU water	Palmet	LASU water	Palmet	LASU water
Date	25.10.96	26–28.10.96	06.02.97	06–09.02.97	19.02.97	19–22.02.97	16.04.97	16–19.04.97
Temp.[°C]	20	17.5–20.0	-	18.8–19.5	23	20.1–20.8	18.5	17.0–19.0
pH	-	7.8 <sup>a</sup>	-	7.5–7.6	-	7.6	6.9	7.4–7.5
EC [mS/m@°C]	-	44.1–42.3 <sup>b</sup>	-	24.7@18.8	-	33.7@19.2	13.8@20.7	29.5@19.4

Comments: <sup>a</sup> From tap water sample 10.10.96; <sup>b</sup> No temperature recorded.

**Table 4.3.** Experiment 1: Range of selected water constituents during the test periods of LASU sub-tests. Values are pooled for all sub-tests. No ECs are displayed for the test periods as the EC is strongly correlated with sodium sulphate concentrations.

	Sub-tests 1–4	
	Range of all measurements	Mean
Temperature [°C]	17.0–21.0	18.72
pH	7.5–8.1	7.76
Change in Na <sub>2</sub> SO <sub>4</sub> conc. [%]	Range: 0.3–9.1	Geometric mean: 2.83

#### *Headwidth measurements*

The headwidths of all nymphs in this experiment ranged between 923 and 2308  $\mu\text{m}$ . All headwidth distributions in the stream units were found to be normal. A one-way ANOVA indicated significant differences between headwidth-means of stream units ( $P = 0.009$ ), and the Tukey test revealed that the population in the control of Sub-test 3 was significantly smaller compared to the other sub-tests. Bartlett's test indicated heterogeneity ( $P = 0.008$ ) in the variances of the test populations. An underlying assumption of ANOVA was therefore violated, and the non-parametric Kruskal-Wallis test was used instead. The significantly different control was now excluded from the test samples as this control exhibited 0% response and thus did not have an influence on the EC50. The result of the Kruskal-Wallis test did not show significant differences ( $P = 0.411$ ).

#### 4.2.2. Results of Experiment 2 in the Raceways

Experiment 2 was carried out using eight concentrations ranging between 4.89 and 12.84 g/L (Figure 4.5.). No response in the control was observed.

Figure 4.5. displays the cumulative effect of sodium sulphate concentrations during the course of the experiment (0–96 h). In Figure 4.6. the time-toxicity curve of sodium sulphate is shown. Figure 4.7. depicts the concentration-response relationship after 96 h, calculated with Probit analysis using the NFD-Log model (Section 4.1.1.). Table 4.4. summarizes results of the Probit and TSK 96h-EC50 analyses. In Table 4.5., some water quality constituents of the Palmet River at the time of nymph collection, and of the artificial streams during acclimation and the test period are presented.

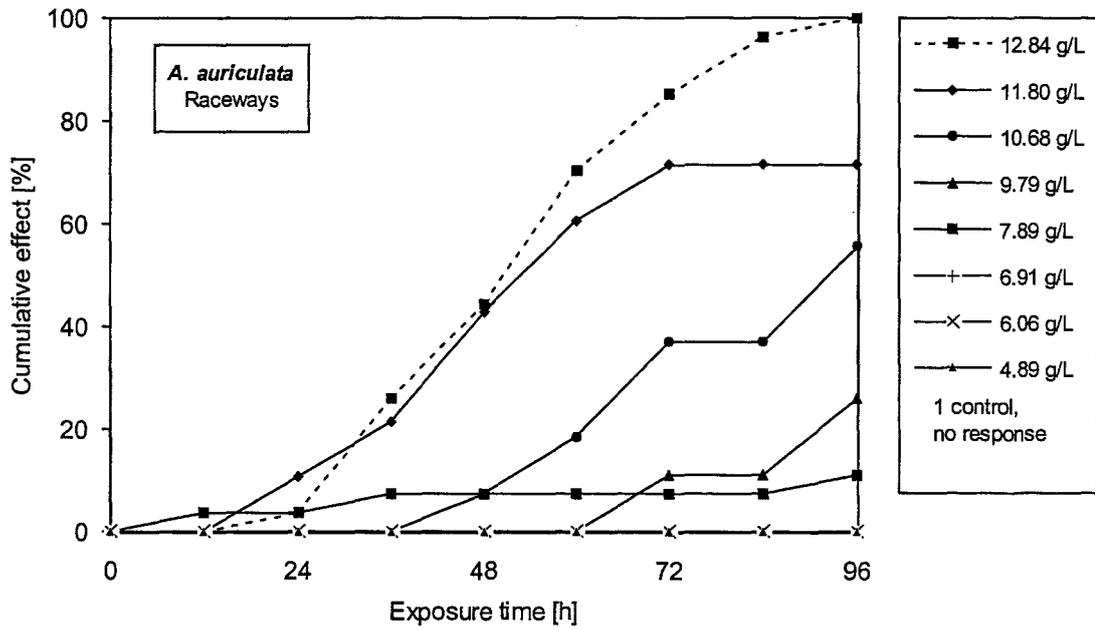


Figure 4.5. Experiment 2: Cumulative effect of sodium sulphate on *A. auriculata* versus exposure time, in the Raceways. Test period 19–23 April 1997. The salt concentrations used are given in the legend. No response occurred in the control.

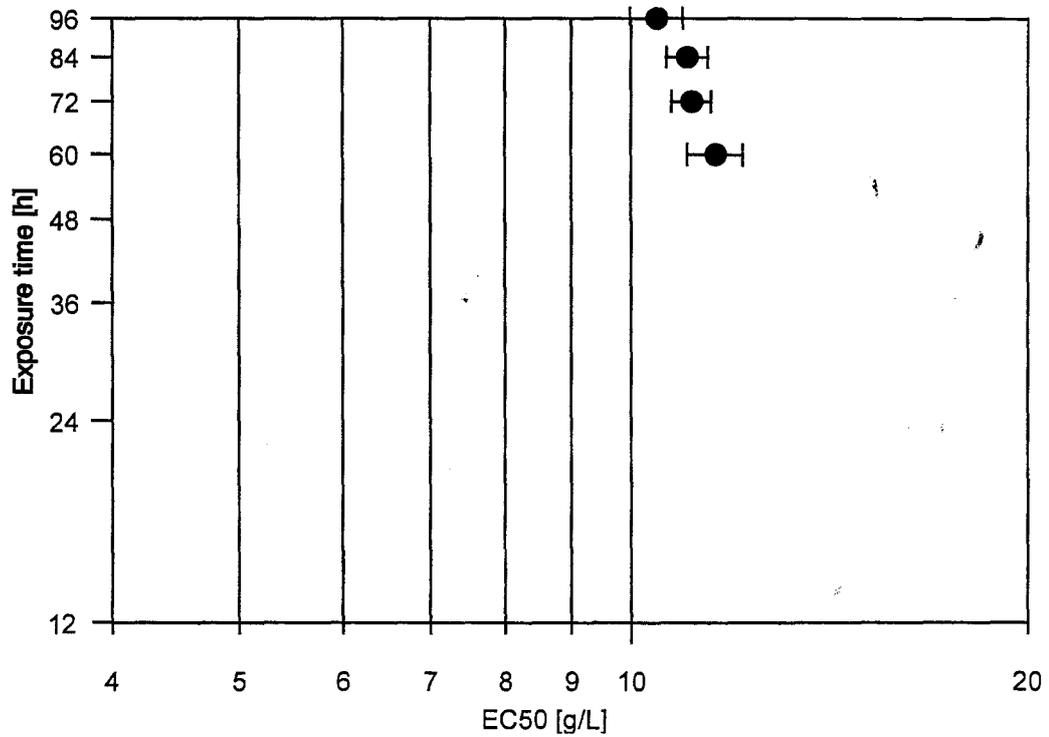
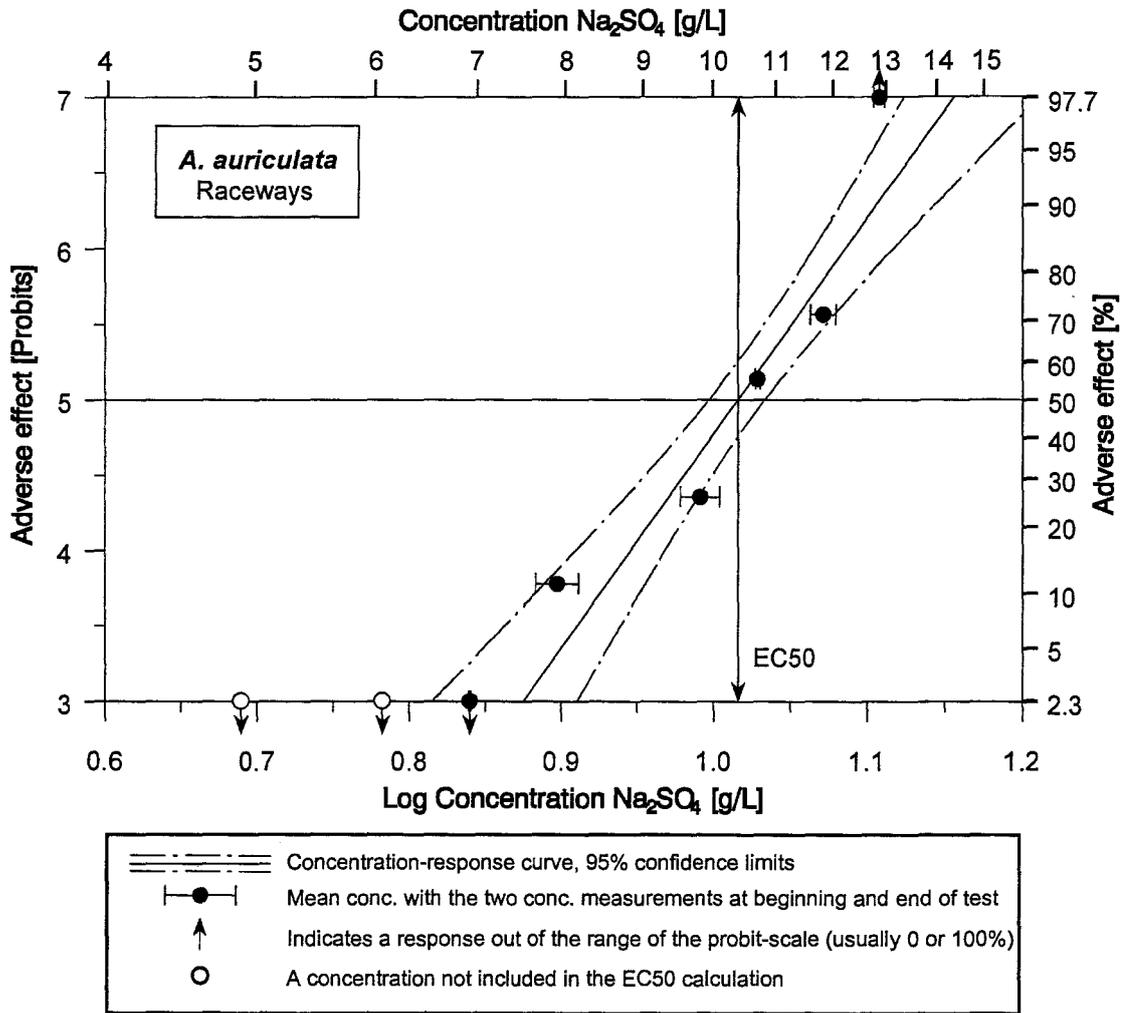


Figure 4.6. Experiment 2: Time-toxicity curve of sodium sulphate for *A. auriculata* in the Raceways. EC50s for various exposure times were calculated with the Trimmed Spearman-Kärber analysis where possible. EC50s are displayed along with their 95% confidence limits.



**Figure 4.7.** Experiment 2: Concentration-response curve for *A. auriculata* in the Raceways after 96 h. The curve was calculated using Probit analysis with the NFD-Log model. The implications of this model are explained in Section 4.1.1.

**Table 4.4.** Experiment 2: Summarized results of statistical analyses using both the Probit and the Trimmed Spearman-Kärber (TSK) method to calculate 96h-EC50 values. For the Probit analysis, results for two model distributions (NFD-Log and NFD-Lin) were calculated. The implications of these models are explained in Section 4.1.1. The  $\chi^2$  (chi-square) statistic quantifies the deviation of data from the model distribution (small value = small deviations). Probabilities  $P > 0.05$  indicate statistically insignificant deviations of the model distribution at the 5% level. Detailed results of the Probit analysis can be found in Appendix D.

	Lower 95%CL [g/L]	EC50 [g/L]	Upper 95%CL [g/L]	Slope	Statistics <i>P</i>	$\chi^2$
Probit analysis: NFD-Log model	9.940	<b>10.379</b>	10.807	14.18	>0.10	7.71
Probit analysis: NFD-Lin model	10.087	<b>10.497</b>	10.898	0.63	>0.10	6.17
TSK analysis with a trim of 8%	10.00	<b>10.47</b>	10.96	-	-	-

**Table 4.5.** Experiment 2: Comparison of selected water constituents of the Palmiet River at the time of nymph collection, and the range of those water constituents in Raceways during acclimation and the test period. For the EC of the Raceway water, only the highest reading is shown. No ECs are displayed for the test period as the EC is strongly correlated with sodium sulphate concentrations.

Experiment 2:	Collection and initiation 16.04.1997		Test period 19–23.04.1997	
	Palmiet River	Range in Raceways	Range in Raceways	Mean
Temperature [°C]	18.5	18.3–18.8	17.7–19.3	18.31
pH	6.9	7.5–7.6	7.6–7.9	7.74
EC [mS/m @ °C]	16.3 @ 25.0	32.2 @ 19.8	-	-
Change in Na <sub>2</sub> SO <sub>4</sub> concentration during test period [%]			Range: 0.3–6.2	Geometric mean: 1.98

#### *Headwidth measurements*

The headwidths of all nymphs in this experiment ranged between 923 and 2308  $\mu\text{m}$ . All headwidth distributions in the stream units were found to be normal. A one-way ANOVA did not indicate significant differences between headwidth-means ( $P = 0.736$ ), and Bartlett's test confirmed that variances were homogeneous ( $P = 0.604$ ).

### 4.2.3. Results of Experiment 3 in the Channels

In Experiment 3 the greater available number of experimental Channel units was used to increase the number of concentrations. This was achieved by applying smaller increments between concentrations steps and is considered to increase test precision (Buikema *et al.* 1982; APHA 1992). The concentrations ranged from 5.37 to 15.02 g/L (Figure 4.8.). No response was recorded in the controls. The partial responses of the experiment exhibited scatter around the theoretical response curve, with significant  $\chi^2$ -heterogeneity of  $P < 0.001$  (Figure 4.10.). When the NFD-Lin model was used,  $\chi^2$  decreased and the 95%CLs became narrower. However, the heterogeneity of data remained significant ( $P < 0.05$ ). The reason for this heterogeneity is not known. The headwidth analysis for this experiment showed that the test organisms did not differ significantly in their average headwidths between the Channel units, thus excluding this factor as a possible influence. Finney (1971) proposed two reasons for significant heterogeneity: either the test organisms do not respond independently, or the linear Probit function does not sufficiently describe the concentration-response relationship. An examination of Figure 4.10. on the latter possibility did not show a systematic departure of data from the Probit line. It was consequently assumed – according to Finney's first suggestion – that test individuals did not react independently. The consequences of this are a reduced precision of the line, but its position should be free from bias (*ibid.*). The Probit model was therefore still considered to represent the data adequately. This was further supported by the result of the non-parametric TSK analysis (Table 4.6.). A comparison of the EC50 values of both methods showed that they differed by only 0.03 g/L.

Figure 4.8. displays the cumulative effect of sodium sulphate concentrations during the course of the experiment (0–96 h). In Figure 4.9. the time-toxicity curve of sodium sulphate is shown. Figure 4.10. depicts the concentration-response relationship after 96 h, calculated with Probit analysis using the NFD-Log model (Section 4.1.1.). Table 4.6. summarizes results of the Probit and TSK 96h-EC50 analyses. In Table 4.7., some water quality constituents of the Palmiet River at the time of nymph collection, and of the artificial streams during acclimation and the test period are presented.

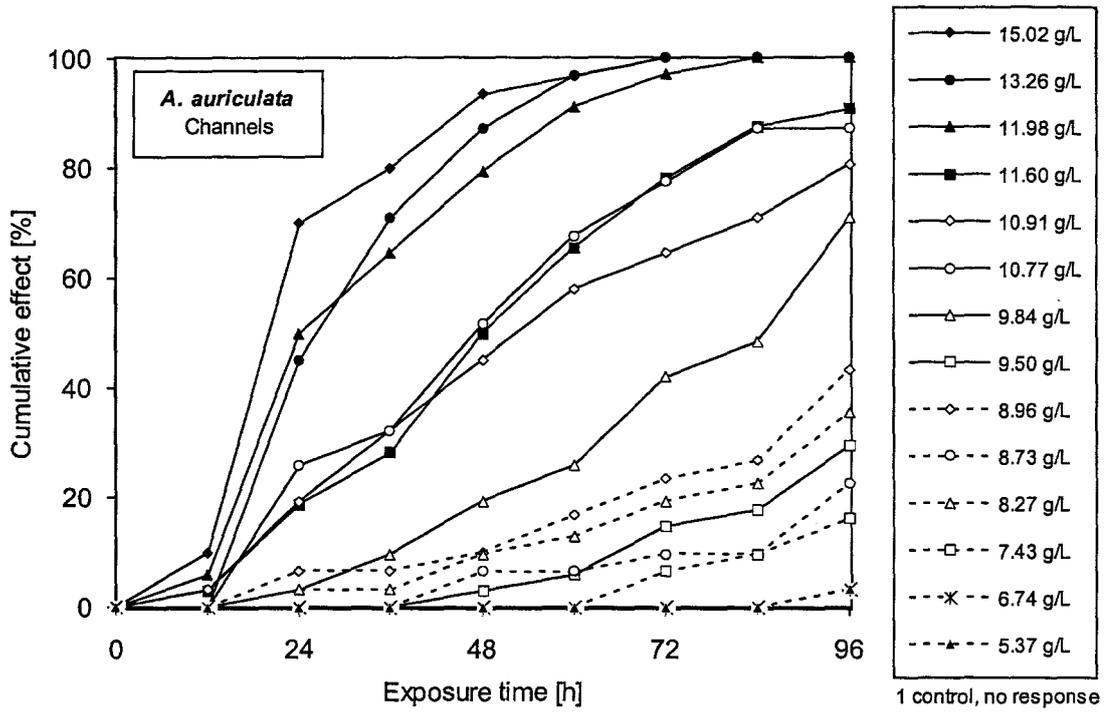


Figure 4.8. . Experiment 3: Cumulative effect of sodium sulphate on *A. auriculata* versus exposure time, in the Channels. Test period 28 April – 02 May 1997. The salt concentrations used are given in the legend. No response occurred in the control.

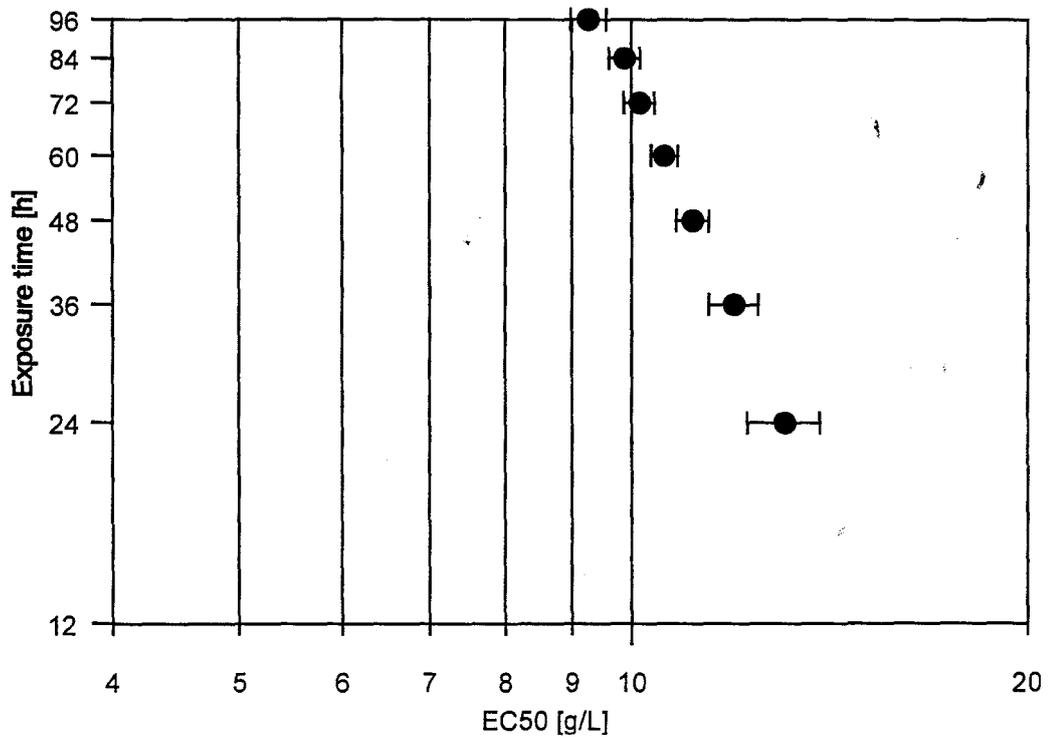
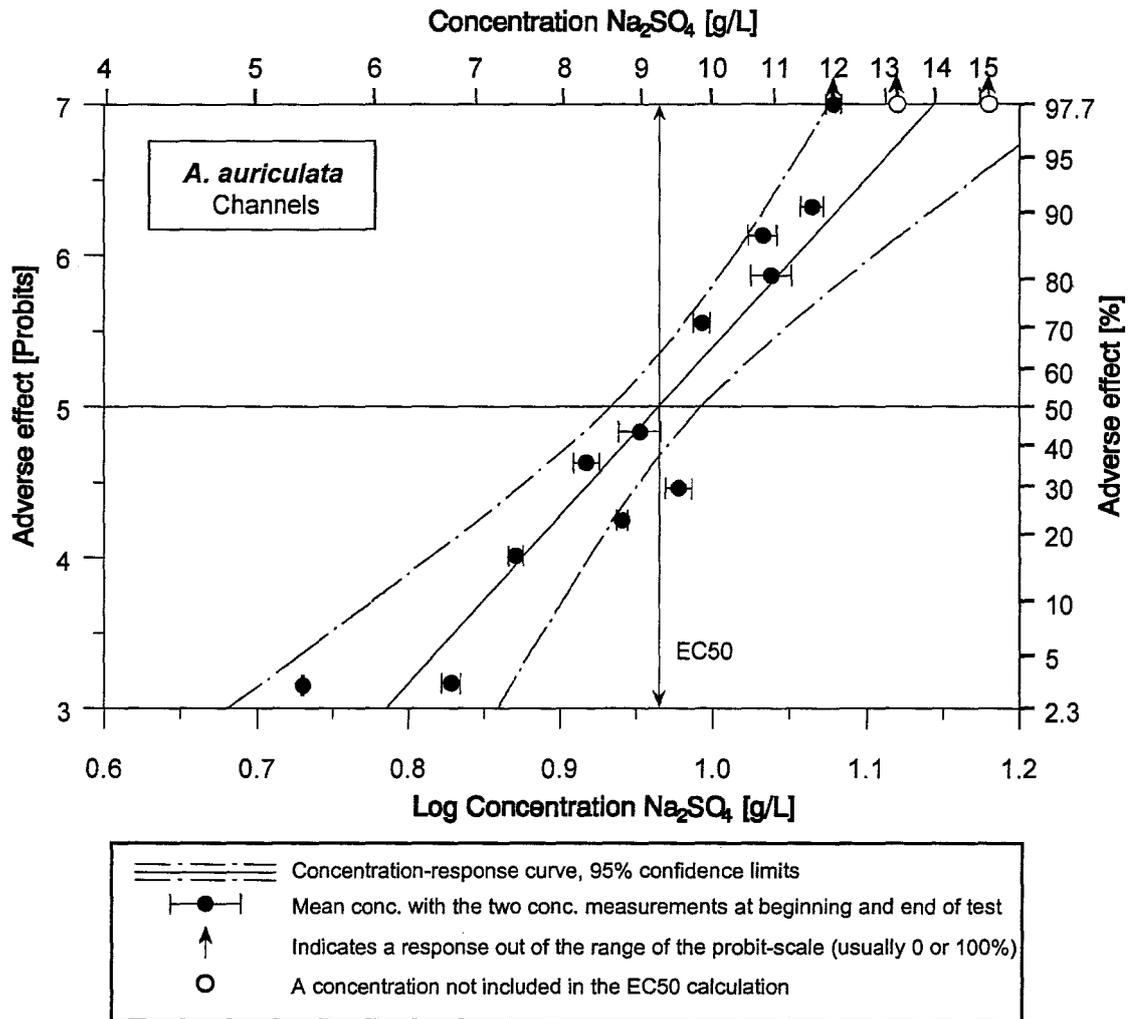


Figure 4.9. Experiment 3: Time-toxicity curve of sodium sulphate for *A. auriculata* in the Channels. EC50s for various exposure times were calculated with the Trimmed Spearman-Kärber analysis where possible. EC50s are displayed along with their 95% confidence limits.



**Figure 4.10.** Experiment 3: Concentration-response curve for *A. auriculata* in the Channels after 96 h. The curve was calculated using Probit analysis with the NFD-Log model. The implications of this model are explained in Section 4.1.1.

**Table 4.6.** Experiment 3: Summarized results of statistical analyses using both the Probit and the Trimmed Spearman-Kärber (TSK) method to calculate 96h-EC50 values. For the Probit analysis, results for two model distributions (NFD-Log and NFD-Lin) were calculated. The implications of these models are explained in Section 4.1.1. The  $\chi^2$  (chi-square) statistic quantifies the deviation of data from the model distribution (small value = small deviations). Probabilities  $P > 0.05$  indicate statistically insignificant deviations of the model distribution at the 5% level. Detailed results of the Probit analysis can be found in Appendix D.

	Lower 95%CL [g/L]	EC50 [g/L]	Upper 95%CL [g/L]	Slope	Statistics <i>P</i>	Statistics $\chi^2$
Probit analysis: NFD-Log model	8.589	9.233	9.840	12.46	<0.001	36.65
Probit analysis: NFD-Lin model	8.927	9.349	9.757	0.61	<0.05	19.35
TSK analysis with a trim of 8%	8.98	9.26	9.55	-	-	-

**Table 4.7.** Experiment 3: Comparison of selected water constituents of the Palmiet River at the time of nymph collection, and the range of those water constituents in Channels during acclimation and the test period. For the EC of the Channel water, only the highest reading is shown. No ECs are displayed for the test period as the EC is strongly correlated with sodium sulphate concentrations.

Experiment 3:	Collection and initiation 25.04.1997		Test period 28.04.–02.05.1997	
	Palmiet River	Range in Channels	Range in Channels	Mean
Temperature [°C]	16.1	19.9 <sup>a</sup> ; 18.3 <sup>b</sup>	17.4–18.7	18.12
pH	7.6	7.5–7.6	7.7–8.7	7.78
EC [mS/m @ °C]	13.3 @ 18.6	27.0 @ 17.6	-	-
Change in Na <sub>2</sub> SO <sub>4</sub> concentration during test period [%]			Range: 0.4–6.6	Geometric mean: 2.57

Comments: <sup>a</sup> 4 h after inserting nymphs; <sup>b</sup> 19 h after inserting nymphs.

#### *Headwidth measurements*

The headwidths of all the nymphs in this experiment ranged between 769 and 2308  $\mu\text{m}$ . All headwidth distributions in the stream units were found to be normal except for the control in this test ( $P = 0.035$ ). For the one-way ANOVA this control was excluded as it had 0% response and thus did not influence the toxicity value. The result did not indicate significant differences between headwidth-means ( $P = 0.088$ ), and Bartlett's test confirmed that variances were homogeneous ( $P = 0.123$ ).

#### 4.2.4. Results of Experiment 4 in the Channels

In Experiment 4 a broader increment (1 g/L) was used in an attempt to avoid the non-monotonicity seen in Experiment 3 (Figure 4.10.). With ten experimental units, a range from 4.82 to 14.33 g/L was covered (Figure 4.11.). No control response was observed. Because of conflicting results of some water analyses from the laboratories of the Institute for Water Quality Studies (IWQS) and measurements conducted in the artificial stream laboratory, in four test treatments only the SO<sub>4</sub>-ion measurements at the end of the experiment were considered.

Figure 4.11. displays the cumulative effect of sodium sulphate concentrations during the course of the experiment (0–96 h). In Figure 4.12. the time-toxicity curve of sodium sulphate is shown. Figure 4.13. depicts the concentration-response relationship after 96 h, calculated with Probit analysis using the NFD-Log model (Section 4.1.1.). Table 4.8. summarizes results of the Probit and TSK 96h-EC50 analyses. In Table 4.9., some water quality constituents of the Palmiet River at the time of nymph collection, and of the artificial streams during acclimation and the test period are presented.

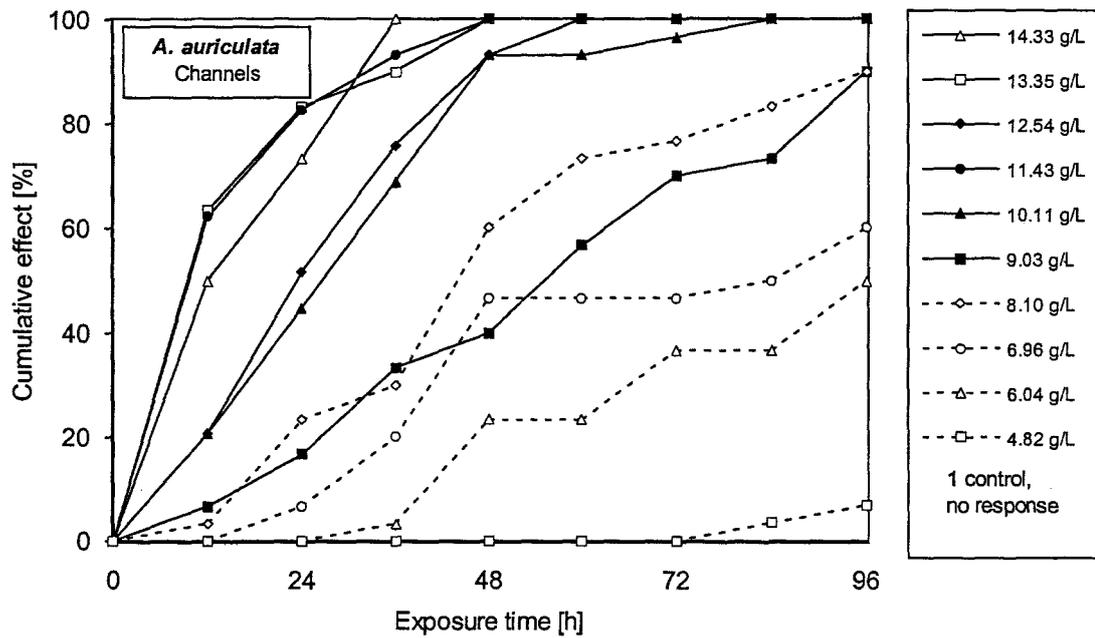


Figure 4.11. Experiment 4: Cumulative effect of sodium sulphate on *A. auriculata* versus exposure time, in the Channels. Test period 01–05 September 1997. The salt concentrations used are given in the legend. No response occurred in the control.

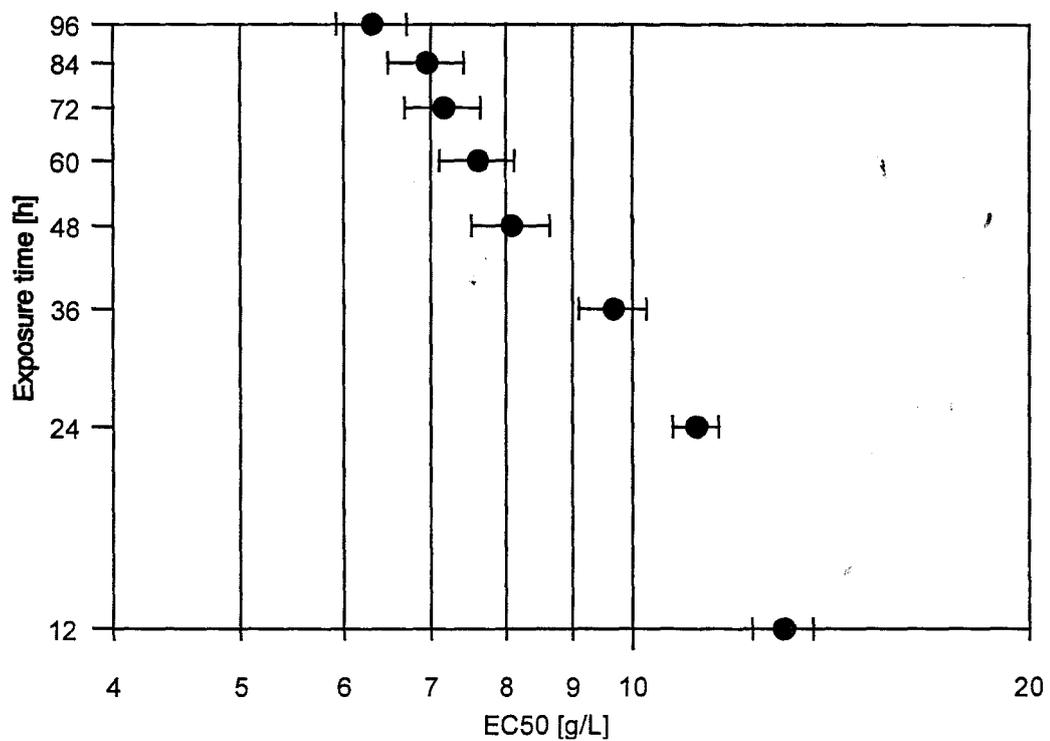
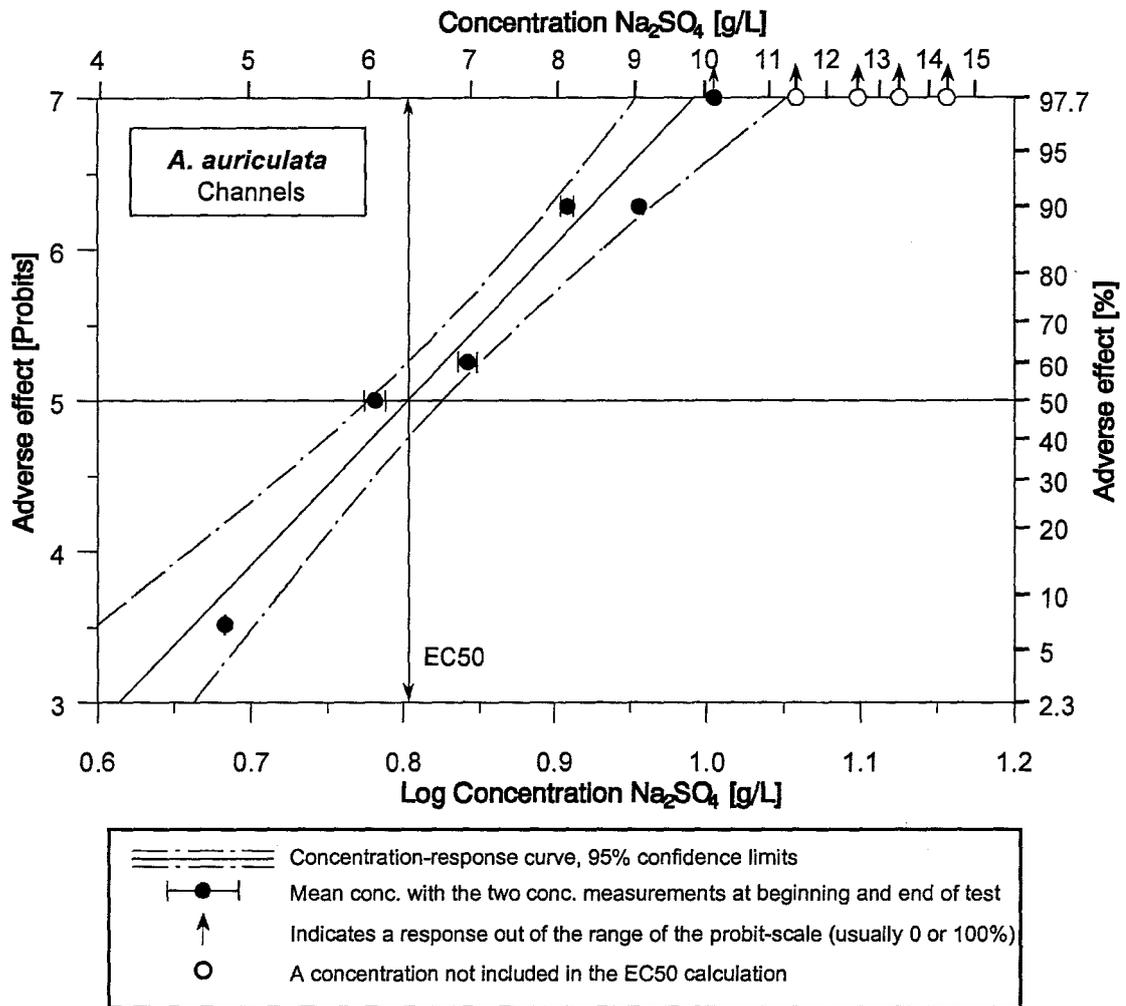


Figure 4.12. Experiment 4: Time-toxicity curve of sodium sulphate for *A. auriculata* in the Channels. EC50s for various exposure times were calculated with the Trimmed Spearman-Kärber analysis where possible. EC50s are displayed along with their 95% confidence limits.



**Figure 4.13.** Experiment 4: Concentration-response curve for *A. auriculata* in the Channels after 96 h. The curve was calculated using Probit analysis with the NFD-Log model. The implications of this model are explained in Section 4.1.1.

**Table 4.8.** Experiment 4: Summarized results of statistical analyses using both the Probit and the Trimmed Spearman-Kärber (TSK) method to calculate 96h-EC50 values. For the Probit analysis, results for two model distributions (NFD-Log and NFD-Lin) were calculated. The implications of these models are explained in Section 4.1.1. The  $\chi^2$  (chi-square) statistic quantifies the deviation of data from the model distribution (small value = small deviations). Probabilities  $P > 0.05$  indicate statistically insignificant deviations of the model distribution at the 5% level. Detailed results of the Probit analysis can be found in Appendix D.

	Lower 95%CL [g/L]	EC50 [g/L]	Upper 95%CL [g/L]	Slope	Statistics $P$	$\chi^2$
Probit analysis: NFD-Log model	5.988	<b>6.363</b>	6.700	10.57	>0.25	3.95
Probit analysis: NFD-Lin model	6.071	<b>6.478</b>	6.834	0.66	>0.10	5.51
TSK analysis with a trim of 8%	5.95	<b>6.29</b>	6.65	-	-	-

**Table 4.9.** Experiment 4: Comparison of selected water constituents of the Palmiet River at the time of nymph collection, and the range of those water constituents in Channels during acclimation and the test period. For the EC of the Channel water, only the highest reading is shown. No ECs are displayed for the test period as the EC is strongly correlated with sodium sulphate concentrations.

Experiment 4:	Collection and initiation 29.08.1997		Test period 01-05.09.1997	
	Palmiet River	Range in Channels	Range in Channels	Mean
Temperature [°C]	15.5	18.0-19.0	18.1-20.4	19.07
pH	7.2	7.2-7.4 <sup>a</sup>	7.1-8.7	7.60
EC [mS/m @ °C]	16.1 @ 20.3	25.2 @ 19.5 <sup>a</sup>	-	-
Change in Na <sub>2</sub> SO <sub>4</sub> concentration during test period [%]			Range: 0.1-5.6	Geometric mean: 1.55

Comments: <sup>a</sup> Measured 31.08.97

#### *Headwidth measurements*

The headwidths of all the nymphs in this experiment ranged between 615 and 2462  $\mu\text{m}$ . All headwidth distributions in the stream units were found to be normal. A one-way ANOVA did not indicate significant differences between headwidth-means ( $P = 0.979$ ), and Bartlett's test confirmed that variances were homogeneous ( $P = 0.598$ ).

#### 4.2.5. Results of Experiment 5 in the Channels

Eleven experimental units were used in Experiment 5 (Figure 4.14.). The concentrations covered a range from 4.12 to 13.97 g/L, with concentration intervals similar to Experiment 4. In the control, one organism, or 3.33% responded. The EC50 value was corrected for this response. Despite non-monotonicity between 8.12 and 8.97 g/L, the  $\chi^2$ -value of the curve was not significant ( $P > 0.05$ ).

Figure 4.14. displays the cumulative effect of sodium sulphate concentrations during the course of the experiment (0–96 h). In Figure 4.15. the time-toxicity curve of sodium sulphate is shown. Figure 4.16. depicts the concentration-response relationship after 96 h, calculated with Probit analysis using the NFD-Log model (Section 4.1.1.). Table 4.10. summarizes results of the Probit and TSK 96h-EC50 analyses. In Table 4.11., some water quality constituents of the Palmiet River at the time of nymph collection, and of the artificial streams during acclimation and the test period are presented.

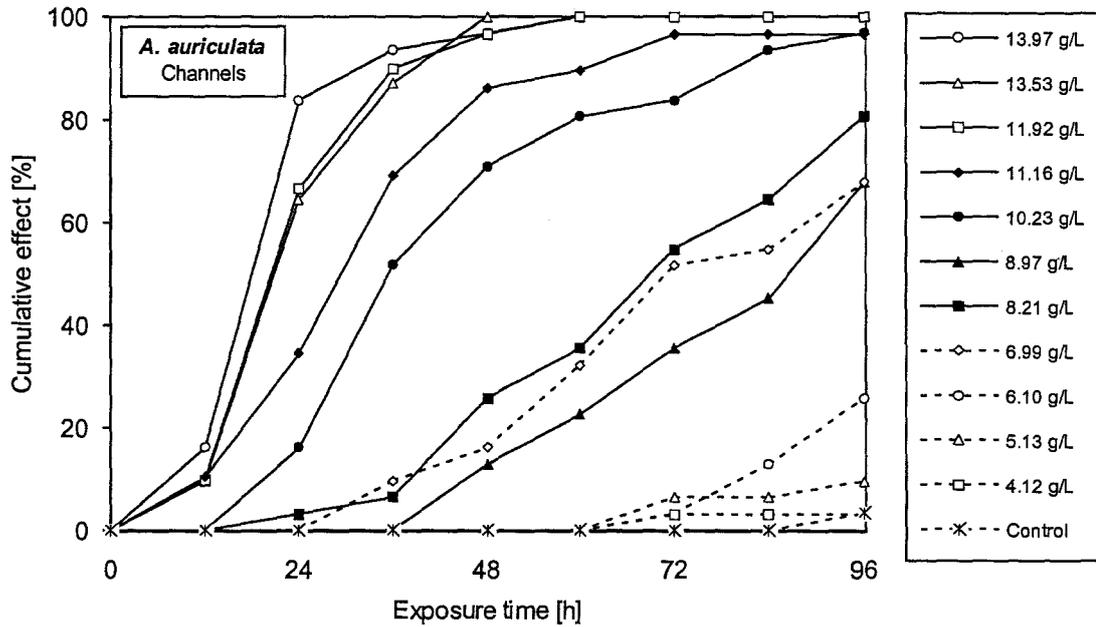


Figure 4.14. Experiment 5: Cumulative effect of sodium sulphate on *A. auriculata* versus exposure time, in the Channels. Test period 08–12 December 1997. The salt concentrations used are given in the legend. Response in the control after 96 h: 3.33%.

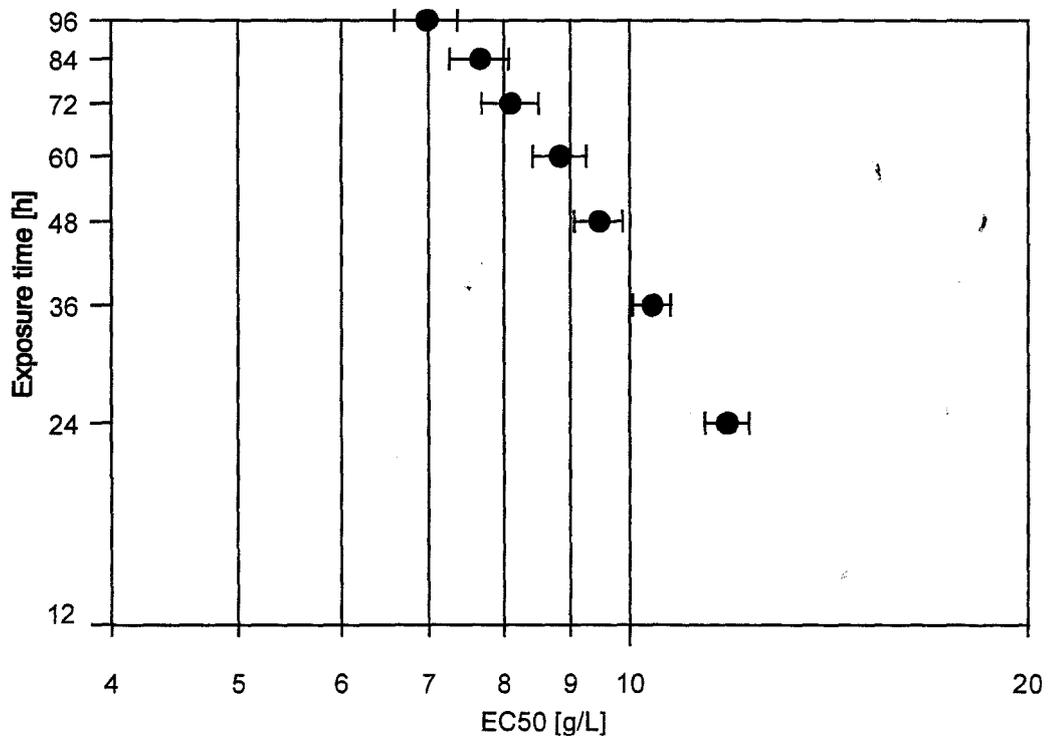


Figure 4.15. Experiment 5: Time-toxicity curve of sodium sulphate for *A. auriculata* in the Channels. EC50s for various exposure times were calculated with the Trimmed Spearman-Kärber analysis where possible. EC50s are displayed along with their 95% confidence limits.

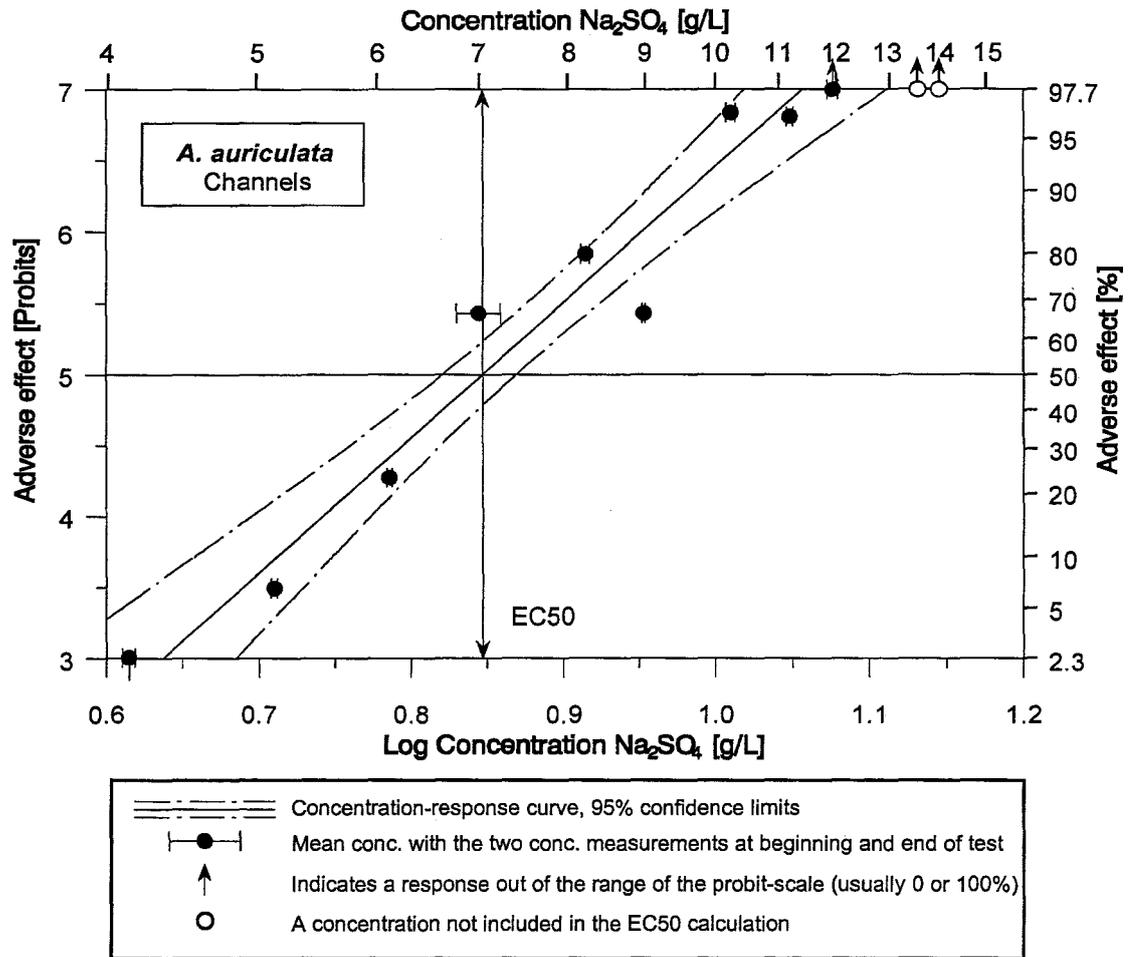


Figure 4.16. Experiment 5: Concentration-response curve for *A. auriculata* in the Channels after 96 h. The curve was calculated using Probit analysis with the NFD-Log model. The implications of this model are explained in Section 4.1.1. Displayed data are corrected for 3.33% response in the control.

Table 4.10. Experiment 5: Summarized results of statistical analyses using both the Probit and the Trimmed Spearman-Kärber (TSK) method to calculate 96h-EC50 values. For the Probit analysis, results for two model distributions (NFD-Log and NFD-Lin) were calculated. The implications of these models are explained in Section 4.1.1. The  $\chi^2$  (chi-square) statistic quantifies the deviation of data from the model distribution (small value = small deviations). Probabilities  $P > 0.05$  indicate statistically insignificant deviations of the model distribution at the 5% level. Detailed results of the Probit analysis can be found in Appendix D.

	Lower 95%CL [g/L]	EC50 [g/L]	Upper 95%CL [g/L]	Slope	Statistics <i>P</i>	$\chi^2$
Probit analysis: NFD-Log model	6.625	7.031	7.402	9.52	>0.05	12.76
Probit analysis: NFD-Lin model	6.432	7.231	7.935	0.55	<0.05	15.43
TSK analysis with a trim of 8%	6.61	6.98	7.38	-	-	-

**Table 4.11.** Experiment 5: Comparison of selected water constituents of the Palmiet River at the time of nymph collection, and the range of those water constituents in Channels during acclimation and the test period. For the EC of the Channel water, only the highest reading is shown. No ECs are displayed for the test period as the EC is strongly correlated with sodium sulphate concentrations.

Experiment 5:	Collection and initiation 05.12.97		Test period 08-12.12.1997	
	Palmiet River	Range in Channels	Range in Channels	Mean
Temperature [°C]	21.5	19.6-20.2	16.3-19.2	18.60
pH	6.8	7.4-7.5	7.4-8.5	7.75
EC [mS/m @ °C]	15.0 @ 18.0	25.0 @ 18.3 <sup>a</sup>	-	-
Change in Na <sub>2</sub> SO <sub>4</sub> concentration during test period [%]			Range: 0.3-6.4	Geometric mean: 1.31

Comments: <sup>a</sup> Measured 06.12.97

#### *Headwidth measurements*

The headwidths of all the nymphs in this experiment ranged between 1077 and 2308  $\mu\text{m}$ . All headwidth distributions in the stream units were found to be normal. A one-way ANOVA did not indicate significant differences between headwidth-means ( $P = 0.641$ ), and Bartlett's test confirmed that variances were homogeneous ( $P = 0.100$ ).

#### 4.2.6. Comparison of headwidth-means between experiments

The pooled headwidths of the nymphs in each experiment ranged between 615 and 2462  $\mu\text{m}$  with a mean of 1596  $\mu\text{m}$  in Experiment 1, 1476  $\mu\text{m}$  in Experiment 2, 1497  $\mu\text{m}$  in Experiment 3, 1594  $\mu\text{m}$  in Experiment 4, and 1610  $\mu\text{m}$  in Experiment 5 (Table 4.28.).

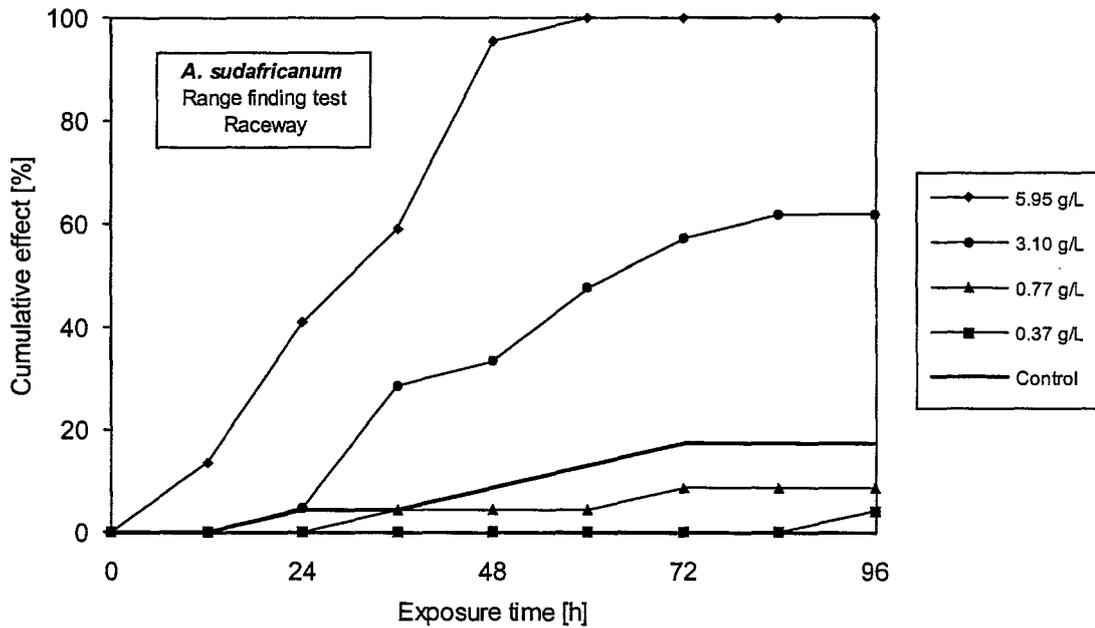
The headwidth distributions of all five experiments were not normal ( $P < 0.001$ ) and could not be normalized using one of the common transformations (Zar 1984). The variances were significantly heterogenous ( $P = 0$ ) according to Bartlett's test. Therefore an ANOVA could not be employed and the non-parametric Kruskal-Wallis test corrected for ties was used instead. The result of this test indicated significant differences between the five experiments ( $P = 7.19 \times 10^{-11}$ ).

### 4.3. *Afroptilum sudafricanum*

*A. sudafricanum* had not previously been used in a test with sodium sulphate as toxicant. The first step was therefore to establish the concentration range which produced 0 and 100% responses. However, response data of some other South African Ephemeroptera for some salts were already available. Goetsch and Palmer (1997) found a mortality of between 50 and 60% for *Tricorythus nr. tinctus*<sup>18</sup> (Ephemeroptera, Tricorythidae) at 0.66 g/L sodium sulphate, and a LC50 for sodium chloride ranging between 2.2 and 4.5 g/L. Corbett (1996) found mortalities for *A. sudafricanum* ranging between 10 and 22% when exposed to 6.95 g/L sodium chloride at current velocities comparable to the present test conditions. These findings indicated that sodium sulphate is probably more toxic than sodium chloride, and that the EC50 for *A. sudafricanum* for sodium sulphate can be expected to be below 6.95 g/L. Therefore a range-finding experiment was carried out in the Raceways using concentrations of 0.37, 0.77, 3.10 and 5.95 g/L sodium sulphate. The result of the test confirmed this expectation and is presented in Figure 4.17.

---

<sup>18</sup> Helen Barber-James (personal communication) determined the species to be near *Tricorythus tinctus*. The confirmation is still in process.



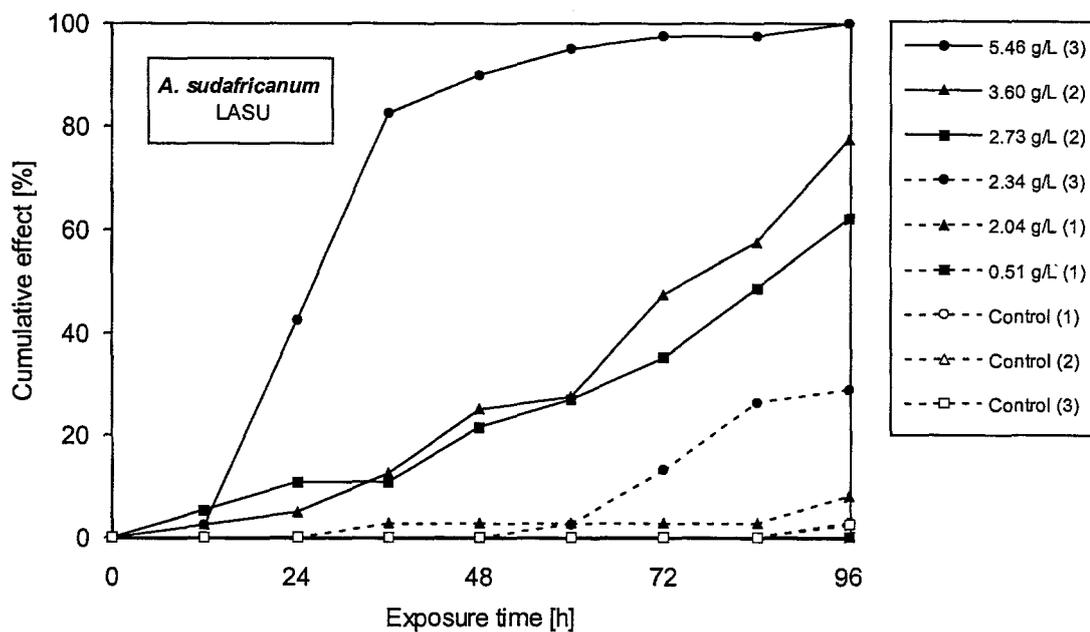
**Figure 4.17.** Range finding experiment with *Afroptilum sudafricanum* (Experiment RF-AS): Cumulative effect of sodium sulphate on *A. sudafricanum* versus exposure time, in the Raceway range-finding test. Four concentrations (0.37–5.95 g/L) and one control were used.

The result of the range-finding test was confounded by the high response in the control (17.4%) which was unacceptable. However, it indicated that 100% response could probably be expected around 6.0 g/L. High control mortalities have been reported for baetid mayflies (Williams 1996; Palmer *et al.* 1996; Goetsch and Palmer 1997). Two sub-tests were conducted in the LASUs at 3.28/4.37 and 4.92/5.67 g/L to produce final data for the LASU response curve, but both sub-tests showed control responses of 23.8% and 11.5% respectively. These high levels were not acceptable, and the results were not used as final data. Williams (1996) found the baetid mayfly *Baetis harrisoni* very sensitive to handling, and control mortalities were largely influenced by collection stress. Although all operations were carried out with appropriate care, mechanical stress during collection for subsequent experiments was further reduced by changing the sampling technique (Section 3.2.).

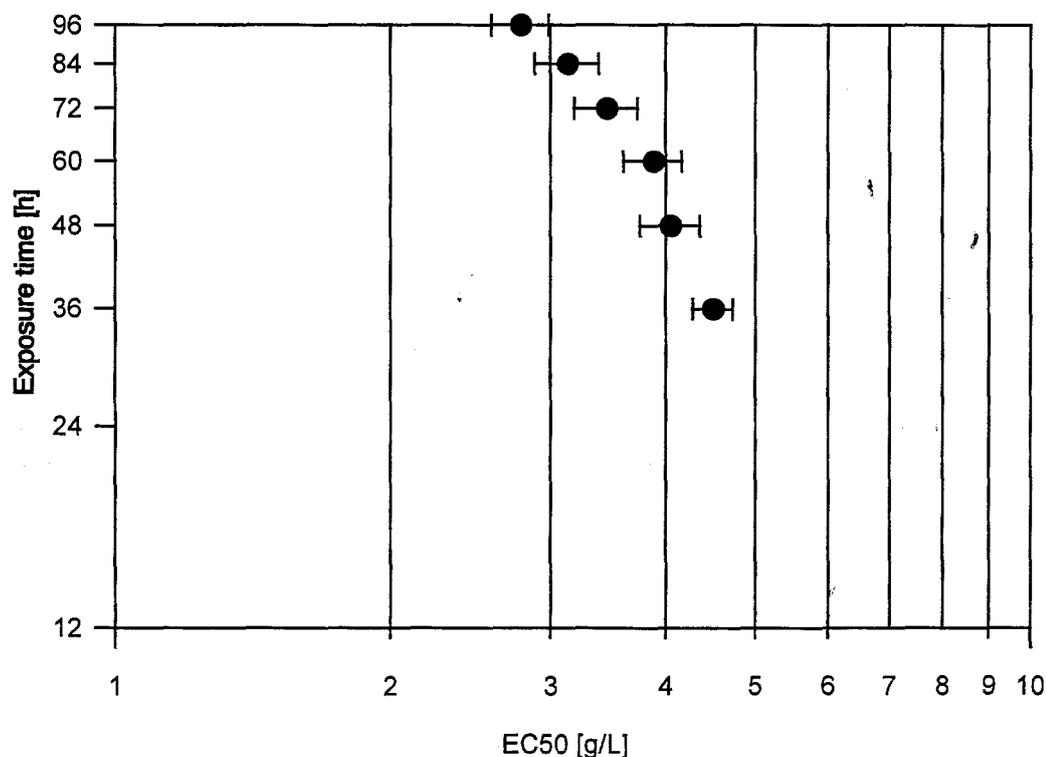
### 4.3.1. Results of Experiment 6 in the LASUs

Three sub-tests were carried out for Experiment 6 with concentrations ranging between 0.51 and 5.64 g/L (Figure 4.18.). In all three sub-tests one test organism responded in the control. This resulted in an average response of 2.69% for which the EC50 was corrected.

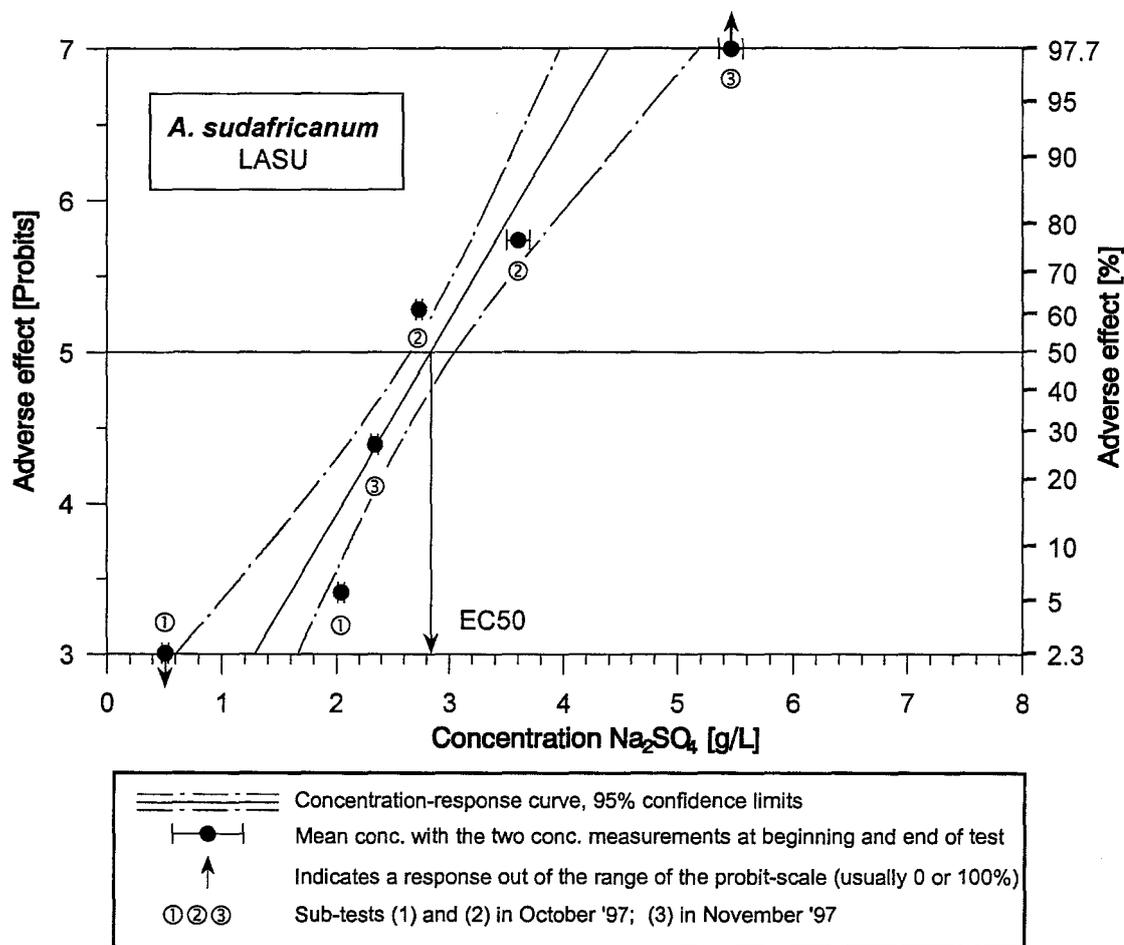
Figure 4.18. displays the cumulative effect of sodium sulphate concentrations during the course of the experiment (0–96 h). In Figure 4.19. the time-toxicity curve of sodium sulphate is shown. Figure 4.20. depicts the concentration-response relationship after 96 h, calculated with Probit analysis using the NFD-Log model (Section 4.1.1.). Table 4.12. summarizes results of the Probit and TSK 96h-EC50 analyses. In Tables 4.13. and 4.14., some water quality constituents of the Palmiet River at the time of nymph collection, and of the artificial streams during acclimation and the test period are presented.



**Figure 4.18.** Experiment 6: Cumulative effect of sodium sulphate on *A. sudafricanum* versus exposure time, in the LASUs. The salt concentrations used are given in the legend. The numbers behind the concentrations indicate the date at which the sub-tests were conducted: (1) 06–10.10.97; (2) 23–27.10.97; (3) 01–05.11.97. Average response in the controls after 96 h: 2.69%.



**Figure 4.19.** Experiment 6: Time-toxicity curve of sodium sulphate for *A. sudafricanum* in the LASUs. EC50s for various exposure times were calculated with the Trimmed Spearman-Kärber analysis where possible. EC50s are displayed along with their 95% confidence limits.



**Figure 4.20.** Experiment 6: Concentration-response curve for *A. sudafricanum* in the LASUs after 96 h. The curve was calculated using Probit analysis with the NFD-Lin model. The implications of this model are explained in Section 4.1.1. Displayed data are corrected for 2.69% average response in the control.

**Table 4.12.** Experiment 6: Summarized results of statistical analyses using both the Probit and the Trimmed Spearman-Kärber (TSK) method to calculate 96h-EC50 values. For the Probit analysis, the NFD-Lin model was used. The implications of this model are explained in Section 4.1.1. The  $\chi^2$  (chi-square) statistic quantifies the deviation of data from the model distribution (small value = small deviations). Probabilities  $P > 0.05$  indicate statistically insignificant deviations of the model distribution at the 5% level. Detailed results of the Probit analysis can be found in Appendix D.

	Lower 95%CL [g/L]	EC50 [g/L]	Upper 95%CL [g/L]	Slope	Statistics <i>P</i>	$\chi^2$
Probit analysis: NFD-Lin model	2.663	2.844	3.052	1.34	>0.05	8.58
TSK analysis with a trim of 8%	2.59	2.78	2.99	-	-	-

**Table 4.13.** Experiment 6: Comparison of selected water constituents of the Palmiet River at the time of nymph collection, and the range of those water constituents in LASUs during acclimation. For the EC of LASUs, only the highest reading is shown.

	Sub-test 1		Sub-test 2		Sub-test 3	
	Palmiet	LASU water	Palmiet	LASU water	Palmiet	LASU water
Date (1997)	03.10.	03–06.10.	20.10.	20–23.10.	29.10.	29.10.– 01.11.
Temp. [°C]	20.0	18.0–19.6	21.5	19.8–20.0	17.8–20.4	19.4–19.6
pH	6.92 <sup>a</sup>	7.2–7.3	-	7.3–7.4	6.6	7.2–7.3
EC [mS/m@°C]	-	26.2 @ 19.5	-	25.4 @ 20.0	15.7 @ 20.4	25.7 @ 19.6

Comments: <sup>a</sup> Measured 21.09.97

**Table 4.14.** Experiment 6: Range of water constituents during the test periods of LASU sub-tests. Values are pooled for all sub-tests.

	Sub-tests 1–3	
	Range of all measurements	Mean of LASU means
Temperature [°C]	18.2–19.9	18.91
pH	7.1–7.7	7.36
Change in Na <sub>2</sub> SO <sub>4</sub> conc. [%]	Range: 2.0–9.7	Geometric mean: 3.75

#### *Headwidth measurements*

The headwidths of all nymphs in the LASU experiment ranged between 495 and 950  $\mu\text{m}$ . All headwidth distributions in the stream units were found to be normal. A one-way ANOVA did not indicate significant differences between headwidth-means ( $P = 0.159$ ). Bartlett's test indicated heterogeneity in the variances of the test populations ( $P = 0.049$ ), but as the sample sizes were nearly equal, ANOVA was considered to be robust enough to deal with this heterogeneity (Zar 1984).

### 4.3.2. Results of Experiment 7 in the Channels

Eleven concentrations were used in Experiment 7, ranging between 0.99 and 9.35 g/L (Figure 4.21.). The response in the control was 0%.

Figure 4.21. displays the cumulative effect of sodium sulphate concentrations during the course of the experiment (0–96 h). In Figure 4.22. the time-toxicity curve of sodium sulphate is shown. Figure 4.23. depicts the concentration-response relationship after 96 h, calculated with Probit analysis using the NFD-Log model (Section 4.1.1.). Table 4.15. summarizes results of the Probit and TSK 96h-EC50 analyses. In Table 4.16., some water quality constituents of the Palmiet River at the time of nymph collection, and of the artificial streams during acclimation and the test period are presented.

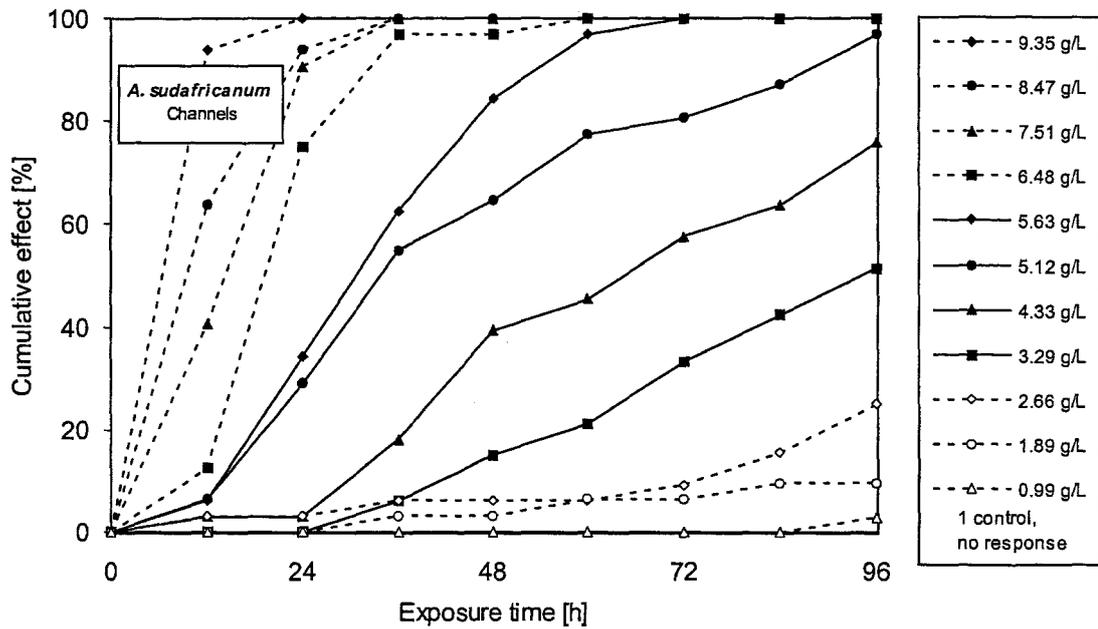


Figure 4.21. Experiment 7: Cumulative effect of sodium sulphate on *A. sudafricanum* versus exposure time, in the Channels. Test period 27 September – 01 October 1997. The salt concentrations used are given in the legend. No response occurred in the control.

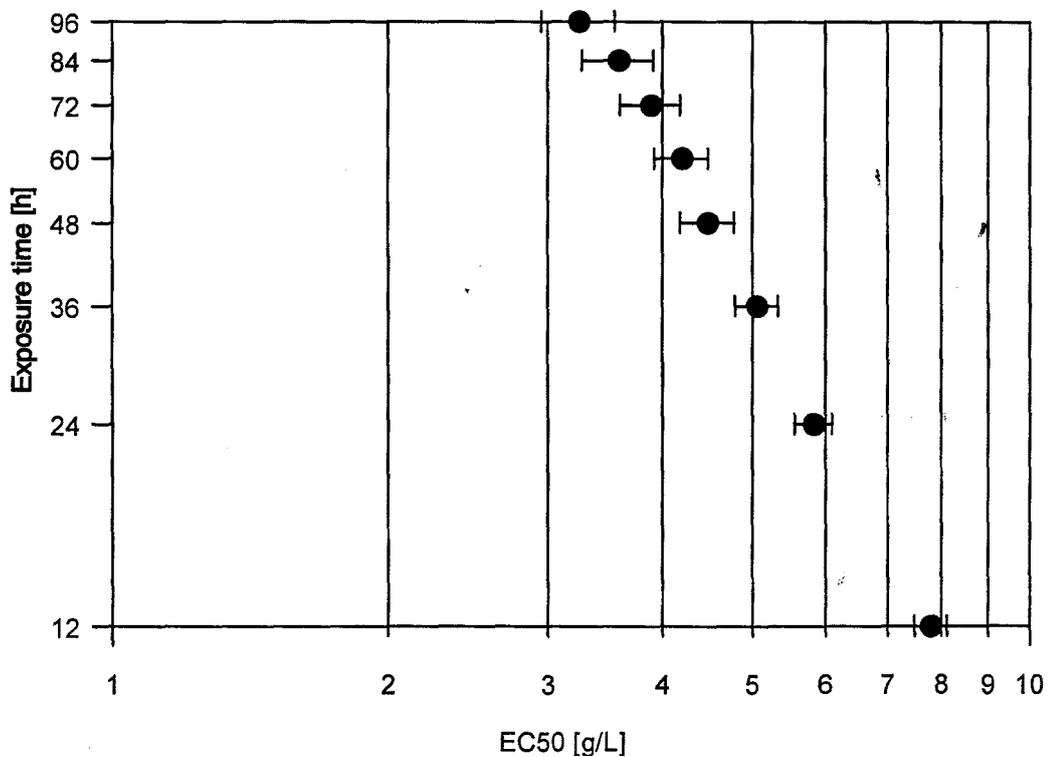


Figure 4.22. Experiment 7: Time-toxicity curve of sodium sulphate for *A. sudafricanum* in the Channels. EC50s for various exposure times were calculated with the Trimmed Spearman-Kärber analysis where possible. EC50s are displayed along with their 95% confidence limits.

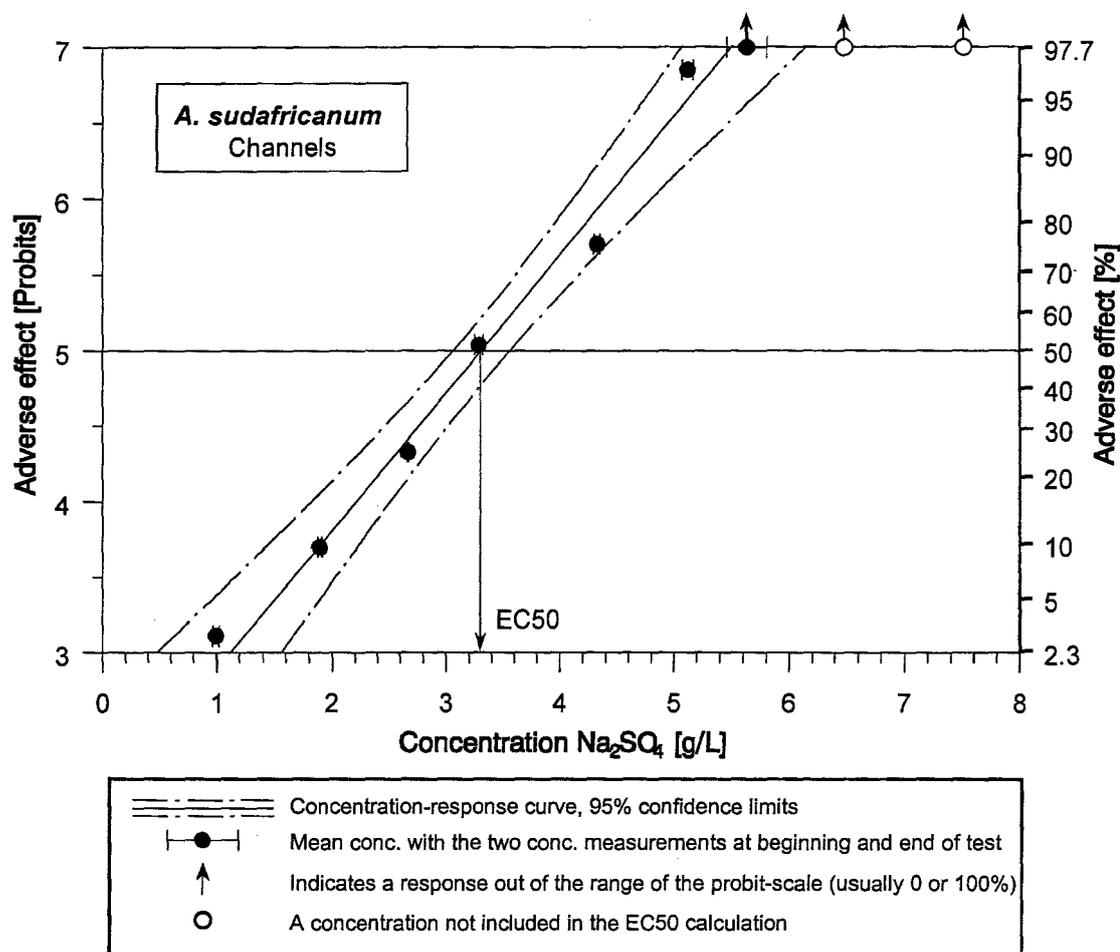


Figure 4.23. Experiment 7: Concentration-response curve for *A. sudafricanum* in the Channels after 96 h. The curve was calculated using Probit analysis with the NFD-Lin model. The implications of this model are explained in Section 4.1.1.

Table 4.15. Experiment 7: Summarized results of statistical analyses using both the Probit and the Trimmed Spearman-Kärber (TSK) method to calculate 96h-EC50 values. For the Probit analysis, the NFD-Lin model was used. The implications of this model are explained in Section 4.1.1. The  $\chi^2$  (chi-square) statistic quantifies the deviation of data from the model distribution (small value = small deviations). Probabilities  $P > 0.05$  indicate statistically insignificant deviations of the model distribution at the 5% level. Detailed results of the Probit analysis can be found in Appendix D.

	Lower 95%CL [g/L]	EC50 [g/L]	Upper 95%CL [g/L]	Slope	Statistics $P$	$\chi^2$
Probit analysis: NFD-Lin model	3.071	3.319	3.566	0.91	>0.75	2.21
TSK analysis with a trim of 8%	2.97	3.25	3.56	-	-	-

**Table 4.16.** Experiment 7: Comparison of selected water constituents of the Palmiet River at the time of nymph collection, and the range of those water constituents in Channels during acclimation and the test period. For the EC of the Channel water, only the highest reading is shown. No ECs are displayed for the test period as the EC is strongly correlated with sodium sulphate concentrations.

Experiment 7:	Collection and initiation 24.09.1997		Test period 27.09.–01.10.1997	
	Palmiet River	Range in Channels	Range in Channels	Mean
Temperature [°C]	17.7	17.7–18.6	17.8–19.4	18.59
pH	6.6	6.7–6.8	6.9–7.7	7.29
EC [mS/m @ °C]	14.8 @ 17.7	24.9 @ 17.9	-	-
Change in Na <sub>2</sub> SO <sub>4</sub> concentration during test period [%]			Range: 0.6–8.1	Geometric mean: 2.10

#### *Headwidth measurements*

The headwidths of all nymphs in Experiment 7 ranged between 396 and 1089  $\mu\text{m}$ . All headwidth distributions in the stream units were found to be normal. A one-way ANOVA did not indicate significant differences between headwidth-means ( $P = 0.077$ ), and Bartlett's test confirmed that variances were homogeneous ( $P = 0.074$ ).

### 4.3.3. Results of Experiment 8 in the Channels

In Experiment 8 twelve concentrations ranging from 0.06 to 7.48 g/L were selected. They were more densely distributed around the expected EC50 value of 3 g/L. In some experimental units increased responses occurred during acclimation, and one unit had to be excluded from the test as the response exceeded 10% (the maximum allowed percentage response during acclimation; Section 3.2.4.). The control response during the test period was relatively high (8.7%), but still below the 10% limit. The partial responses were corrected for this control response. The partial response at 2.43 g/L was higher than the curve suggested, but  $\chi^2$ -heterogeneity remained insignificant ( $P > 0.90$ ). It is interesting to note that at this concentration the Ca, Mg and Cl ion concentrations measured at the end of the experiment (Table 4.26.) were significantly higher than in all other test units.

Figure 4.24. displays the cumulative effect of sodium sulphate concentrations during the course of the experiment (0–96 h). In Figure 4.25. the time-toxicity curve of sodium sulphate is shown. Figure 4.26. depicts the concentration-response relationship after 96 h, calculated with Probit analysis using the NFD-Log model (Section 4.1.1.). Table 4.17. summarizes results of the Probit and TSK 96h-EC50 analyses. In Table 4.18., some water quality constituents of the Palmiet River at the time of nymph collection, and of the artificial streams during acclimation and the test period are presented.

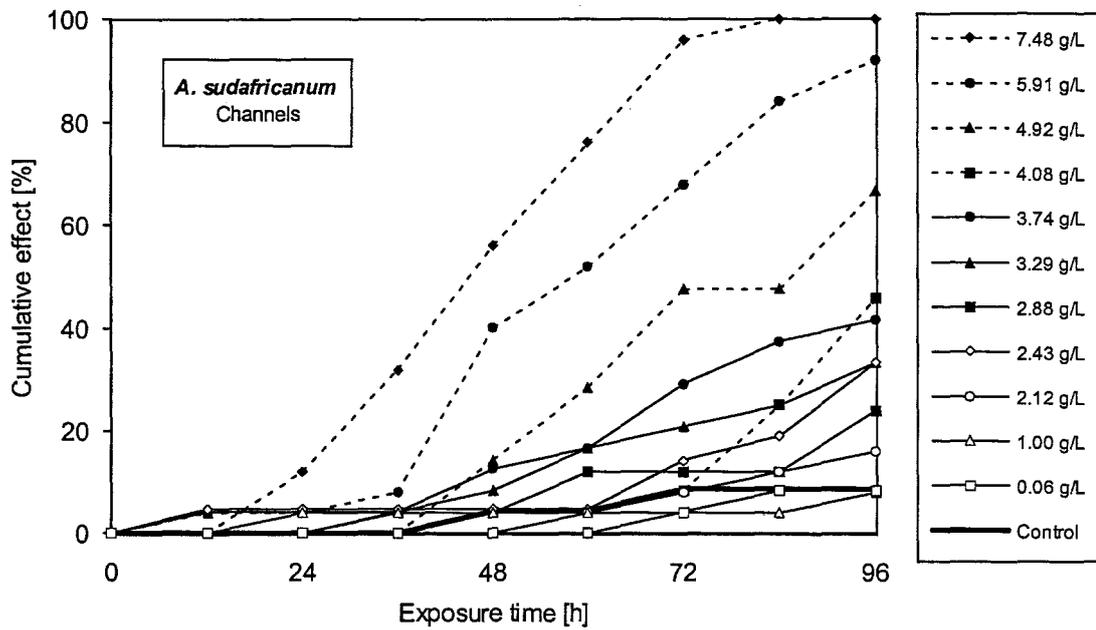


Figure 4.24. Experiment 8: Cumulative effect of sodium sulphate on *A. sudafricanum* versus exposure time, in the Channels. Test period 28 April – 02 May 1998. The salt concentrations used are given in the legend. Response in the control after 96 h: 8.70%.

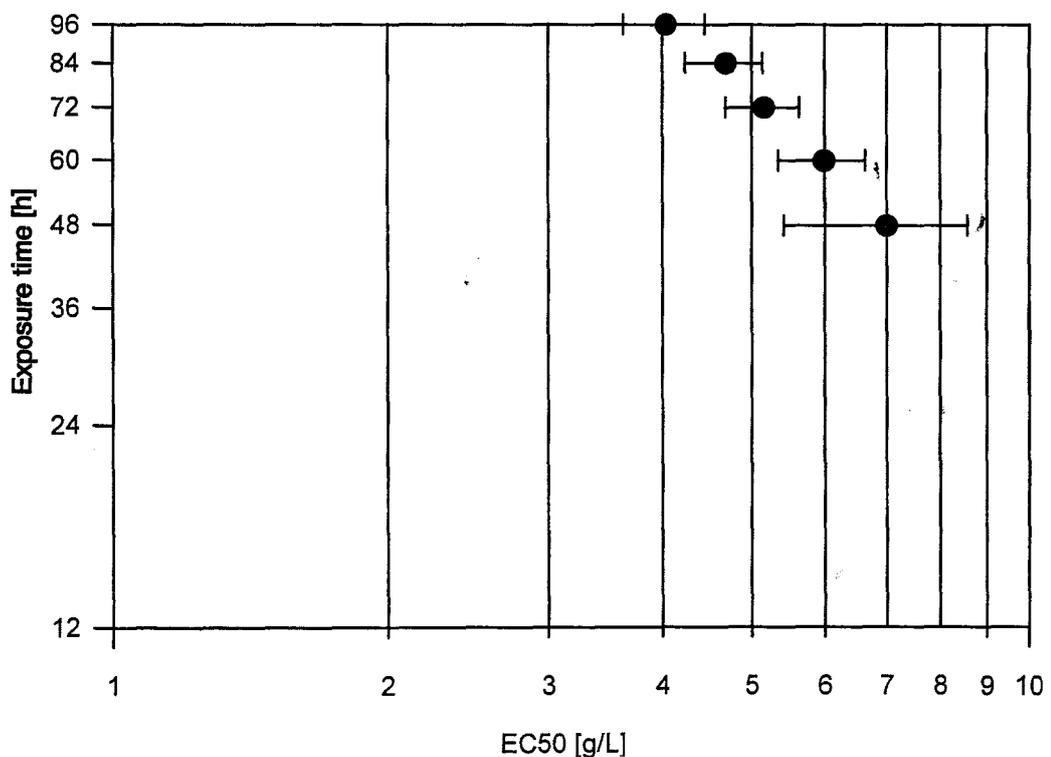


Figure 4.25. Experiment 8: Time-toxicity curve of sodium sulphate for *A. sudafricanum* in the Channels. EC50s for various exposure times were calculated with the Trimmed Spearman-Kärber analysis where possible. EC50s are displayed along with their 95% confidence limits.

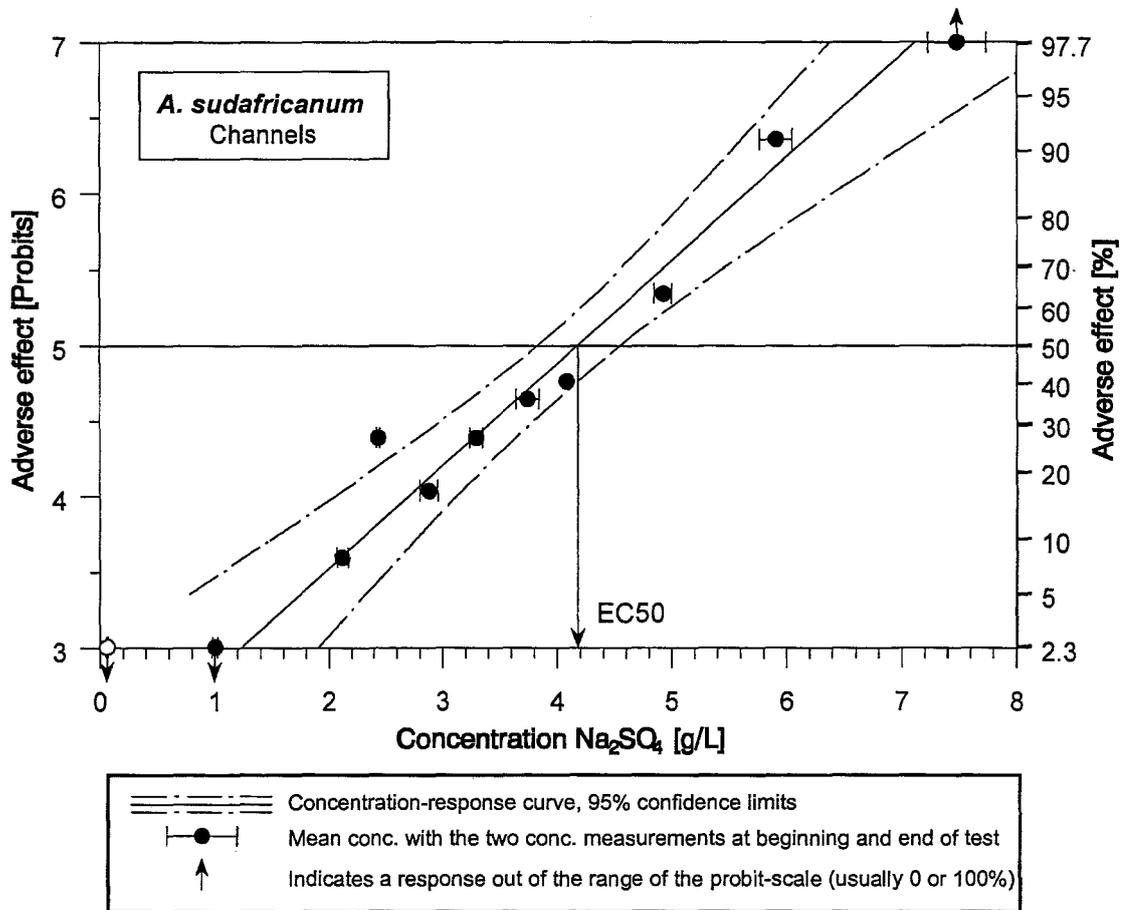


Figure 4.26. Experiment 8: Concentration-response curve for *A. sudafricanum* in the Channels after 96 h. The curve was calculated using Probit analysis with the NFD-Lin model. The implications of this model are explained in Section 4.1.1. Displayed data are corrected for 8.7% response in the control.

Table 4.17. Experiment 8: Summarized results of statistical analyses using both the Probit and the Trimmed Spearman-Kärber (TSK) method to calculate 96h-EC50 values. For the Probit analysis, the NFD-Lin model was used. The implications of this model are explained in Section 4.1.1. The  $\chi^2$  (chi-square) statistic quantifies the deviation of data from the model distribution (small value = small deviations). Probabilities  $P > 0.05$  indicate statistically insignificant deviations of the model distribution at the 5% level. Detailed results of the Probit analysis can be found in Appendix D.

	Lower 95%CL [g/L]	EC50 [g/L]	Upper 95%CL [g/L]	Slope	Statistics $P$	$\chi^2$
Probit analysis: NFD-Lin model	3.835	4.180	4.554	0.68	>0.90	4.00
TSK analysis with a trim of 8%	3.64	4.03	4.46	-	-	-

**Table 4.18.** Experiment 8: Comparison of selected water constituents of the Palmiet River at the time of nymph collection, and the range of those water constituents in Channels during acclimation and the test period. For the EC of the Channel water, only the highest reading is shown. No ECs are displayed for the test period as the EC is strongly correlated with sodium sulphate concentrations.

Experiment 8:	Collection and initiation 25.04.1998		Test period 28.04.–02.05.1998	
	Palmiet River	Range in Channels	Range in Channels	Mean
Temperature [°C]	18.5–20.6	20.9–21.4	18.0–19.3	18.66
pH	6.7	8.1–8.2	8.0–8.2	8.12
EC [mS/m @ °C]	16.3 @ 22.1	54.6 @ 21.4	-	-
Change in Na <sub>2</sub> SO <sub>4</sub> concentration during test period [%]			Range: 1.3–27.3	Geometric mean: 4.80

#### *Headwidth measurements*

The headwidths of all nymphs in Experiment 8 ranged between 594 and 931  $\mu\text{m}$ . All headwidth distributions in the stream units were found to be normal except for the unit of 0.05 g/L sodium sulphate ( $P = 0.026$ ). This violated the assumption of normality for an analysis of variance. However, the validity of results is affected only slightly by even considerable deviations from normality, especially as  $n$  increases (Zar 1984). An ANOVA was therefore still considered to be an appropriate procedure. The one-way ANOVA did not indicate significant differences between headwidth-means ( $P = 0.267$ ), and Bartlett's test confirmed that variances were homogeneous ( $P = 0.912$ ).

#### **4.3.4. Comparison of headwidth-means between experiments**

The pooled headwidths of the nymphs in each experiment ranged between 396 and 1089  $\mu\text{m}$  with a mean of 690  $\mu\text{m}$  in Experiment 6, 700  $\mu\text{m}$  in Experiment 8, and 743  $\mu\text{m}$  in Experiment 9 (Table 4.28.). All three distributions were not normal ( $P < 0.001$ ) and could not be normalized using one of the common transformations (Zar 1984). The variances were significantly heterogeneous ( $P = 1.67 \times 10^{-6}$ ) according to Bartlett's test. Therefore an ANOVA could not be employed and the non-parametric Kruskal-Wallis test corrected for ties had to be used. The result of this test indicated significant differences between the three experiments ( $P = 1.66 \times 10^{-15}$ ).

### 4.3.5. Identification of species

Many South African baetid mayfly populations consist of multiple species (Williams 1996; Palmer *et al.* 1996). As each taxon might exhibit a different sensitivity to the same toxicant, a test population consisting of only one species is of great importance (Section 2.3.3.). It was therefore necessary to identify baetid mayfly nymphs after the completion of toxicity experiments. The results of the determination of species are summarized in Table 4.19. It was found that the proportion of species other than *A. sudafricanum* was never problematic. However, they were excluded from EC50 calculations.

**Table 4.19.** Summary of species other than *A. sudafricanum* found in all experiments.

	Experiment 6	Experiment 7	Experiment 8
Total number of test organisms	341	452	307
<i>Baetis latus</i>	1	10	-
<i>Afroptilum excisum</i>	-	1	2
<i>Baetis harrisoni</i>	-	3	-
Sum of species other than <i>A. sudafricanum</i> [% of total]	0.3	3.1	0.7

## 4.4. Comparison of EC50 values

The experiments of this study yielded a set of EC50 values for each test taxon. These EC50s were calculated using two different statistical methods, the Probit and the TSK method. Additionally, two different distribution models were used in the Probit calculations (NFD-Log and NFD-Lin, Section 4.1.1.). The most appropriate statistical procedure was therefore selected systematically:

- The results of the two distribution models used in the Probit analysis were evaluated.
- The EC50s of the Probit and TSK calculations were compared.
- The differences between EC50 values of one set of EC50 values were examined statistically.

### 4.4.1. Comparison of the two distribution models

For experiments with *A. auriculata* (Experiments 1–5), results for two model distributions (NFD-Log and NFD-Lin) were calculated using the Probit method. The fit of each model is summarized in Table 4.20. The NFD-Log model was judged to provide a better fit, mainly

as the  $\chi^2$ -heterogeneity changed from insignificant to significant at the 5% level when using the NFD-Lin model for the data analysis of Experiment 5. For experiments with *A. sudafricanum* (Experiments 6–8), the NFD-Lin model was (except for Experiment 8) the only one which allowed Probit-EC50 calculations.

**Table 4.20.** Comparison of the fit of the two different distribution models (NFD-Log and NFD-Lin) used in the Probit-calculations for EC50s of experiments with *A. auriculata*.  $\chi^2$  chi-squared. *P* probability (significance level 5%).

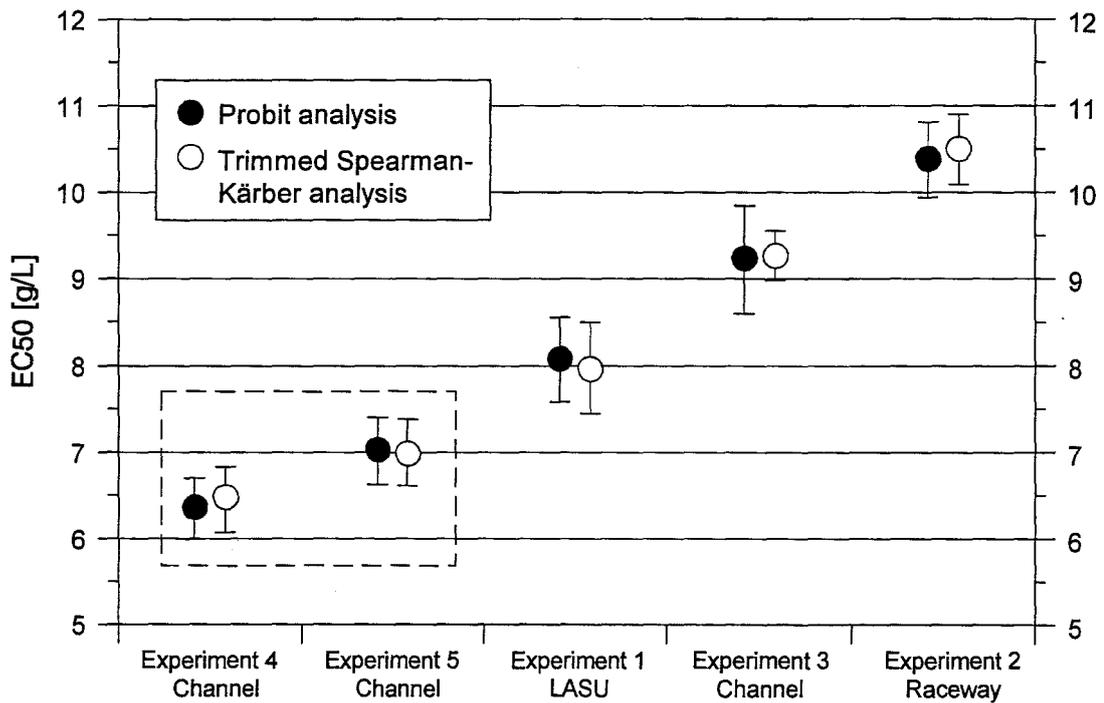
	Experiment 1	Experiment 2	Experiment 3	Experiment 4	Experiment 5
$\chi^2$ NFD-Log	6.15	7.71	36.65	3.95	12.76
$\chi^2$ NFD-Lin	5.23	6.17	19.35	5.51	15.43
<i>P</i> changed? <sup>a</sup>	No	No	Improved, but still <0.05	Worsened, but still >0.05	Worsened, from >0.05 to <0.05

Comment: <sup>a</sup> Did *P* change when the NFD-Log model is compared to the NFD-Lin model?

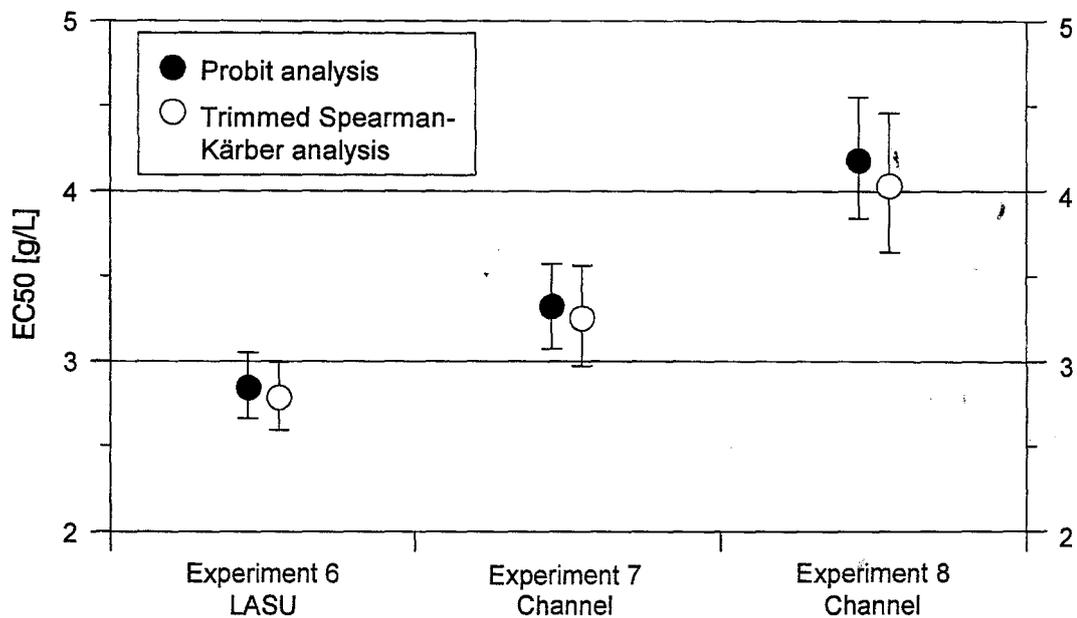
#### 4.4.2. Comparison of Probit and Trimmed Spearman-Kärber EC50 values

In order to determine whether the Probit and the TSK method (Section 3.3.) produced significantly different EC50 values, the EC50s of each method were compared graphically (Figures 4.27. and 4.28.).

For all experiments it can be seen that Probit and TSK analyses yielded almost identical EC50 values. The 95%CLs of two EC50s of one experiment (from Probit and TSK analyses) overlap in most experiments to a large extent, and they have a similar width. The only exception is Experiment 3 (Figure 4.27.) where the 95%CLs of the Probit-EC50 are broader as compared to the 95%CLs of the TSK-EC50. This is due to the higher degree of scatter of data which affected the Probit calculation, but not the TSK method (Section 4.2.3.). However, as explained in Section 4.2.3., the Probit-EC50 of Experiment 3 is still valid. In all subsequent analyses, EC50s and associated slope values from Probit analyses were used.



**Figure 4.27.** Sodium sulphate EC50 values of *A. auriculata* experiments, sorted in increasing order. Results of the Probit analysis (NFD-Log model) are compared to results from the Trimmed Spearman-Kärber analysis (8% trim). The error bars indicate 95% confidence limits. The dashed box indicates an overlap of Probit-95% confidence limits.



**Figure 4.28.** Sodium sulphate EC50 values of *A. sudafricanum* experiments, sorted in increasing order. Results of the Probit analysis (NFD-Lin model) are compared to results from the Trimmed Spearman-Kärber analysis (8% trim). The error bars indicate 95% confidence limits.

#### 4.4.3. Statistical significance of differences between EC50 values

To determine the statistical significance of differences between EC50 values, their 95%CLs were compared for overlap. This procedure has been described in Section 3.1.3. If they did overlap, EC50 values were again compared using Equations 3.1. and 3.2. (Section 3.1.3.).

##### *EC50 values of experiments with A. auriculata*

The EC50 values of experiments with *A. auriculata* are summarized in Table 4.21. It can be seen that only the 95%CLs of the EC50s of Experiments 4 and 5 overlap (Figure 4.27.), indicating similarity. When these EC50s were examined more carefully using Equations 3.1. and 3.2., they were found to be statistically significantly different. Hence, all EC50 values from experiments with *A. auriculata* are statistically significantly different.

**Table 4.21.** Sodium sulphate EC50 values of experiments with *A. auriculata*, calculated with the Probit analysis (NFD-Log model). EC50s are sorted in increasing order to facilitate comparisons of 95%CLs. *n* Number of concentrations used in Probit analyses. Units in [g/L] except for the slope.

	Experiment 4 Channels	Experiment 5 Channels	Experiment 1 LASUs	Experiment 3 Channels	Experiment 2 Raceways
Lower 95%CL	5.988	6.625	7.583	8.589	9.940
<b>EC50</b>	<b>6.363</b>	<b>7.031</b>	<b>8.073</b>	<b>9.233</b>	<b>10.379</b>
Upper 95%CL	6.700	7.402	8.550	9.840	10.807
Slope	10.57	9.52	8.66	12.46	14.18
<i>n</i>	7	6	12	6	9

##### *EC50 values of experiments with A. sudafricanum*

The EC50 values of experiments with *A. sudafricanum* are summarized in Table 4.22. It can be seen that the 95%CLs of all EC50 values do not overlap (Figure 4.28.). All EC50 values from experiments with *A. sudafricanum* were therefore statistically significantly different.

**Table 4.22.** Sodium sulphate EC50 values of experiments with *A. sudafricanum*, calculated with the Probit analysis (NFD-Lin model). EC50s are sorted in increasing order to facilitate comparisons of 95%CLs. *n* Number of concentrations used in the Probit analysis. Units in [g/L] except for the slope.

	Experiment 6 LASU	Experiment 7 Channel	Experiment 8 Channel
Lower 95%CL	2.663	3.071	3.835
<b>EC50</b>	<b>2.844</b>	<b>3.319</b>	<b>4.180</b>
Upper 95%CL	3.052	3.566	4.553
Slope	1.34	0.91	0.68
<i>n</i>	6	7	10

*EC values of both species at various exposure times*

Results of acute toxicity tests are most often presented in the form of EC50 values at a specified time, e.g. 96 h exposure. However, exposure times commonly stretch from 12 h to ca. 120 h, and some authors also present EC0/EC5 or EC100 values (VCI 1992). To facilitate comparisons using these expressions of the data, various EC values and EC50s at varying exposure times are presented for both test taxa (Tables 4.23. and 4.24.).

**Table 4.23.** Geometric means of EC1, EC5, EC50 and EC99 values after 96 h exposure and their 95% confidence limits, for *A. auriculata* and *A. sudafricanum*. The Probit analysis software did not calculate EC0 or EC100 values. EC1 and EC99 values were therefore chosen as closest substitutes. Units in [g/L].

Exposure time: 96 h		EC 1	EC 5	EC 50	EC 99
<i>A. auriculata</i> Experiments 1-5	Lower 95%CL	3.936	4.811	7.619	11.956
	EC value	<b>4.910</b>	<b>5.683</b>	<b>8.088</b>	<b>13.324</b>
	Upper 95%CL	5.563	6.259	8.527	16.125
<i>A. sudafricanum</i> Experiments 6-8	Lower 95%CL	0.097	0.912	3.154	5.331
	EC value	<b>0.840</b>	<b>1.608</b>	<b>3.404</b>	<b>5.924</b>
	Upper 95%CL	1.413	2.028	3.673	6.928

**Table 4.24.** Geometric mean EC50 values at 24, 48 and 72 h for Experiments 1-5 and 6-8, calculated using the 8% Trimmed Spearman-Kärber analysis. This analysis was preferred due to its robustness. For Experiment 2 at 24 and 48 h, and for Experiments 6 and 7 at 24 h, EC50 values were not computable and could therefore not be incorporated in the geometric mean. Units in [g/L].

	24 h	48 h	72 h
<i>A. auriculata</i> , Experiments 1-5	11.905	9.529	8.944
<i>A. sudafricanum</i> , Experiments 6-8	5.830	5.024	4.104

## 4.5. Investigation of factors discriminating EC50 values

In the previous section it was shown that all EC50 values of all experiments were statistically significantly different. This section attempts to identify causative factors. Important stream system parameters such as scale (volume) or current velocity are considered. However, other factors may also have played an important role in influencing EC50 values. The influence of the following factors were therefore considered:

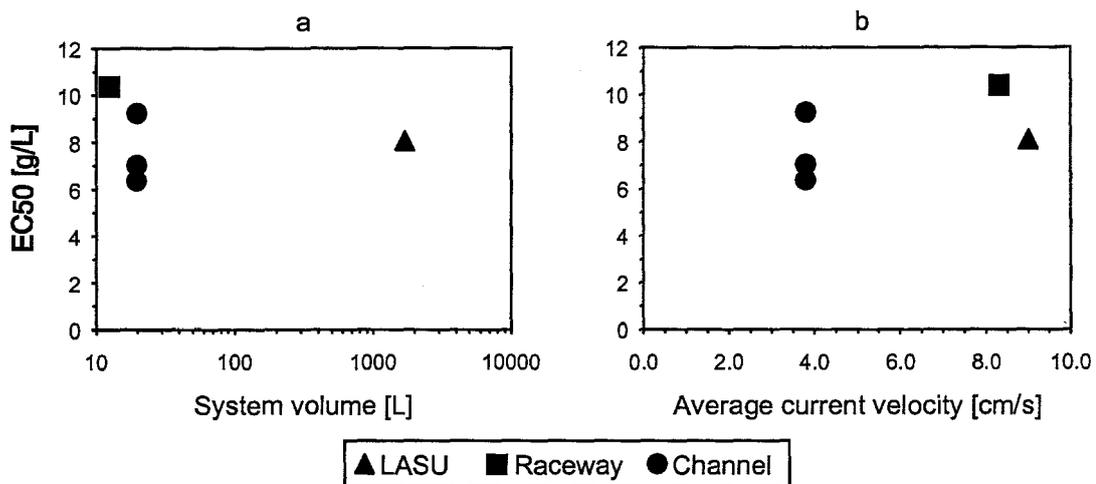
- factors associated with the artificial stream design
- factors associated with water quality constituents
- factors associated with the experimental organisms

### 4.5.1. Factors related to artificial stream design

The most important parameters distinguishing the different artificial stream designs used in this study were the recirculated volume of water and the average current velocity. The water volume constitutes the scale of the artificial stream systems and could have affected test responses through the dilution of metabolic by-products such as ammonia (Rand *et al.* 1995). The average current velocity of a system is also important, as flow is an important physical factor of aquatic environments (Statzner *et al.* 1988; Allan 1995).

It was originally planned to use the tolerance results of both species for a comparison of stream designs. However, since *A. sudafricanum* needed to be identified after experiments (Section 3.4.2.), and was less routinely available (insufficient abundance in the Palmiet River in the winter months, Section 2.3.2.), not enough data could be gathered for a full comparison. Only *A. auriculata* results were therefore used in the identification of design-related factors.

*A. auriculata* EC50 values (Experiments 1–5) were plotted against system volume (Figure 4.29.a.) and average current velocity (Figure 4.29.b.), but there was no pattern to indicate a causal link between either aspect of stream design and EC50 values.



**Figure 4.29.** Sodium sulphate EC50 values of experiments with *A. auriculata* plotted against system volume (a) and average current velocity (b). The nominal values for the system volume were 1700 L for the LASUs, 12.5 L for the Raceways, and 20 L for the Channels. The average current velocities for artificial stream designs were 0.090 m/s for the LASUs, 0.083 m/s for the Raceways, and 0.038 m/s for the Channels.

#### 4.5.2. Water quality constituents

Many water quality constituents have been proved to influence toxic responses (Sprague 1985; APHA 1992). Water samples were therefore taken during experiments and analysed by the analytical laboratories of IWQS for a number of parameters (Section 3.2.6.). The results are summarized in Tables 4.25. and 4.26. in the form of ranges. Total dissolved solids (TDS), total alkalinity (TAL), electrical conductivity (EC) and Na measurements were correlated with sodium sulphate concentrations. Although measured, no ranges are therefore given for these constituents. The pH changed after the initiation of experiments, depending on sodium sulphate concentrations. These pH changes are displayed in Figure 4.30. The Palmiet River water and the tap water were analysed once for metals. These results, along with a full water quality profile, are provided in Appendix B. All water quality constituents are compared to South African and international guideline values and are discussed in the following chapter (Section 5.2.3.).

**Table 4.25.** Ranges of nutrients, major ions and silica for experiments with *A. auriculata* during the test period. RF-AA Range finding test with *A. auriculata*. Units in [mg/L].

	Exp. RF-AA	Experiment 1	Experiment 2	Experiment 3	Experiment 4	Experiment 5
NH <sub>4</sub>	<0.04	<0.04	<0.04–0.08	<0.04–0.06	<0.04	<0.04
NO <sub>2</sub> + NO <sub>3</sub>	<0.04–0.10	<0.04–0.45	<0.04–0.50	0.34–0.59	<0.04–0.28	<0.04–0.08
PO <sub>4</sub>	0.014–0.033	0.005–0.025	0.005–0.014	0.005–0.045	0.009–0.038	0.005–0.017
K	2.7–8.7	1.1–10.2	1.5–14.9	1.3–9.5	0.6–7.7	0.8–3.0
Ca	19–57	1–34	14–63	10–32	12–28	2–11
Mg	14–33	1–30	5–19	5–16	4–21	4–5
F	0.1–0.2	0.1–0.2	0.1	0.1–0.2	0.1	0.1–0.2
Cl	105–183	47–212	51–206	46–300	39–135	19–52
Si	2.7–3.6	2.4–4.6	2.7–4.3	2.9–4.1	3.3–3.9	3.1–3.7
Fluctuation Na <sub>2</sub> SO <sub>4</sub> <sup>a</sup>	–	0.3–9.1%	0.3–6.2%	0.4–6.6%	0.1–5.6%	0.3–6.4%
TDS in control(s)	319–346	149–309	199–202	170–179	137–170	146–172

Comments: <sup>a</sup> Range of Na<sub>2</sub>SO<sub>4</sub> fluctuation in percentage.

**Table 4.26.** Ranges of nutrients, major ions and silica for experiments with *A. sudafricanum* during the test period. RF-AS Range finding test with *A. sudafricanum*. Units in [mg/L].

	Experiment RF-AS	Experiment 6	Experiment 7	Experiment 8
NH <sub>4</sub>	<0.04–1.44	<0.04	<0.04–0.05	<0.04–0.05
NO <sub>2</sub> + NO <sub>3</sub>	0.05–0.13	<0.04–0.28	0.12–0.29	<0.04–0.10
PO <sub>4</sub>	0.005–0.007	0.008–0.015	0.005–0.021	0.005–0.025
K	2.9–4.8	0.6–2.8	0.7–13.3	1.3–14.5; 41.0 <sup>a</sup>
Ca	20–26	9–16	10–33	14–30; 91 <sup>b</sup>
Mg	14–15	4–10	4–27	5–21; 107 <sup>b</sup>
F	0.1	0.1	0.1	0.1–0.2
Cl	83–140	36–47	33–129	74–130; 546 <sup>b</sup>
Si	2.8–3.2	3.4–4.0	2.4–3.5	2.0–5.2
Fluctuation Na <sub>2</sub> SO <sub>4</sub> <sup>c</sup>	–	2.0–9.7%	0.6–8.1%	1.3–6.5; 27.3% <sup>d</sup>
TDS in control(s)	339–359	129–156	138–153	309–334

Comments: <sup>a</sup> In the 3.29 g/L concentration at the beginning of the test; <sup>b</sup> In the 2.43 g/L concentration at the end of the test; <sup>c</sup> Range of Na<sub>2</sub>SO<sub>4</sub> fluctuation in percentage; <sup>d</sup> In the lowest concentration during the test period.

### Changes in pH

The test organisms experienced pH-changes during the transfer from the Palmet River to laboratory water, and during the initiation of an experiment. The magnitude was sometimes beyond generally accepted limits ( $\pm 0.2$  pH units from selected value: APHA (1992); fluctuation not  $> 0.5$  pH units from the range of background values: DWAF (1996a)) and therefore demanded special attention. In Table 4.27., the pH of the Palmet River at the time of nymph collection and the laboratory water directly after the transfer are compared.

In most experiments the pH changed by no more than 0.7 units, but in Experiment 8 it changed by 1.5 units. This higher change coincided with a mean response in Experiment 8 which was higher than in all other experiments.

**Table 4.27.** A comparison of the pH-conditions between Palmet River water during collection of test organisms, and the experimental water to which they were transferred. The response which occurred during acclimation is also listed. Parameters A and B must be read as follows: In A experimental units an average response (geometric mean) occurred of B%.

Experiment	pH Palmet River	pH range of experimental water	Response during acclimation	
			A: Affected units	B: Mean response
1; Sub-test 4 <sup>a</sup>	6.9	7.4–7.5	0 <sup>b</sup>	–
2	6.9	7.5–7.6	2 out of 9 (22%)	3.6%
3	7.6	7.5–7.6	0	–
4	7.2	7.2–7.4	0	–
5	6.8	7.4–7.5	0	–
6; Sub-test 1 <sup>a</sup>	6.9	7.2–7.3	4 out of 9 (44%) <sup>b</sup>	3.5%
6; Sub-test 3 <sup>a</sup>	6.6	7.2–7.3	–	–
7	6.6	6.7–6.8	5 out of 14 (36%)	3.3%
8	6.7	8.1–8.2	5 out of 13 (38%)	6.2% <sup>c</sup>

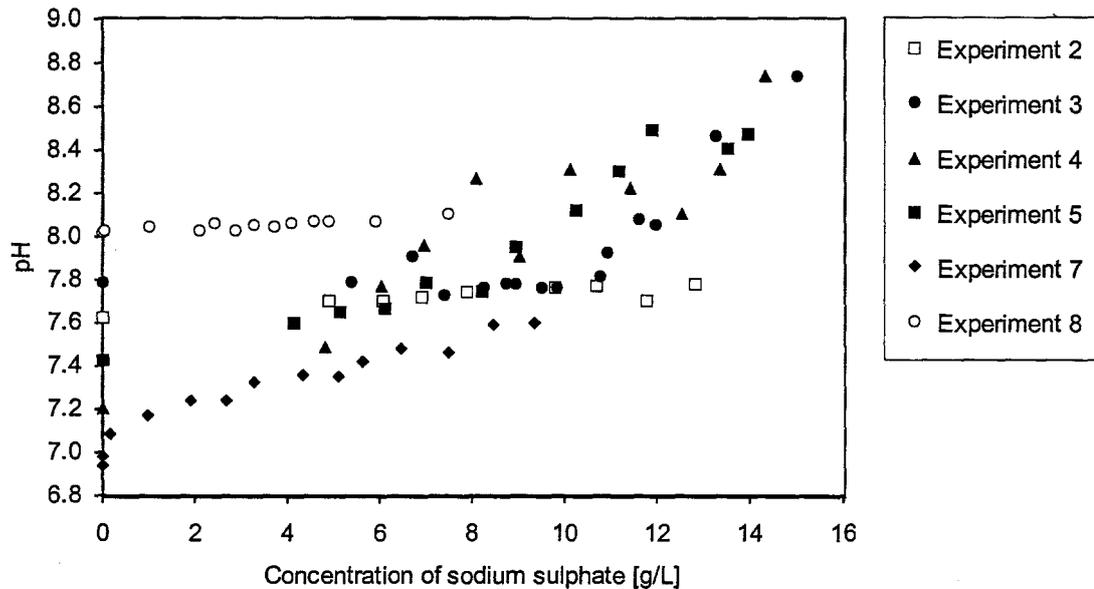
Comments: <sup>a</sup> During other sub-tests in the LASUs, the pH was not measured in the Palmet River; <sup>b</sup> Encompasses all sub-tests of this experiment; <sup>c</sup> One of the affected units showed 11.1% response during acclimation and was therefore excluded from the test.

During the initiation of all experiments, the pH changed after adding the sodium sulphate stock solutions (Section 3.2.2.). It increased with increasing sodium sulphate concentrations as shown in Figure 4.30. Experiments in the LASUs (1 and 6) were excluded from this observation as no pH measurements were taken directly after test initiation and could therefore not be directly compared to measurements of other experiments. The maximum increase recorded was 1.5 pH units in the highest concentration of Experiment 4, where the pH reached a value of 8.74. After peaks, the pH dropped in most experiments within the first 12 h of test initiation, below pH 7.9, and stabilized for the rest of the experiment. This pattern is illustrated by selected concentrations of Experiment 4 (Figure 4.31.). The pH in all controls, however, ranged between 6.9 and 7.8 throughout the test period. An exception was Experiment 8 (empty circles in Figure 4.30.), where the base-line pH of the tap water was already at 8.0, masking a possible pH increase on sodium sulphate addition.

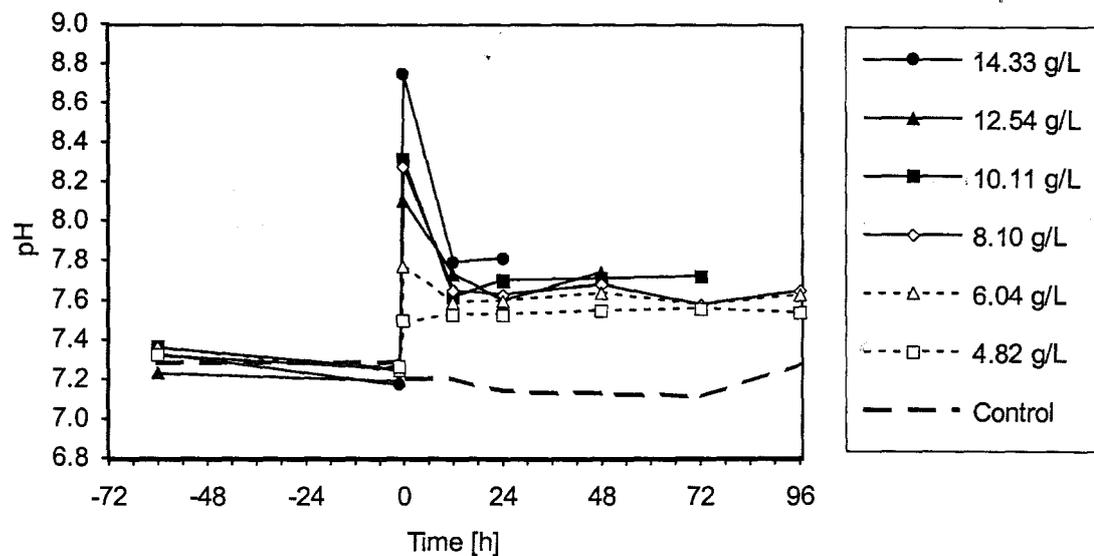
The increase of pH after test initiation is most probably due to contaminations of the industrial-grade sodium sulphate. Pure sodium sulphate does not change the pH when dissolved in water because of the strength of the corresponding base/acid (NaOH/H<sub>2</sub>SO<sub>4</sub>) and resulting complete dissociation of the ions. The pH-range of the salt used is 7.0–9.5 as

provided by the manufacturer (Table 3.3) which covers the range experienced in the experiments.

The solution of atmospheric  $\text{CO}_2$  may have contributed to the decrease of pH 12h after test initiation. In water the weak acid bicarbonate ( $\text{HCO}_3^-$ ) is formed which lowers the pH.



**Figure 4.30.** pH measurements *versus* sodium sulphate concentrations of final Raceway and Channel experiments. pH readings were taken immediately after adding the sodium sulphate stock solutions. LASU experiments (1 and 6) were excluded as no pH readings were taken directly after salt addition. Note: The pH at 0 g/L sodium sulphate reflects the baseline-pH of the experimental water.



**Figure 4.31.** An illustration of the time-dependent pH fluctuations in selected sodium sulphate concentrations (see legend) of Experiment 4. This pattern was typical for all experiments of this study.

### 4.5.3. Factors related to the experimental organism

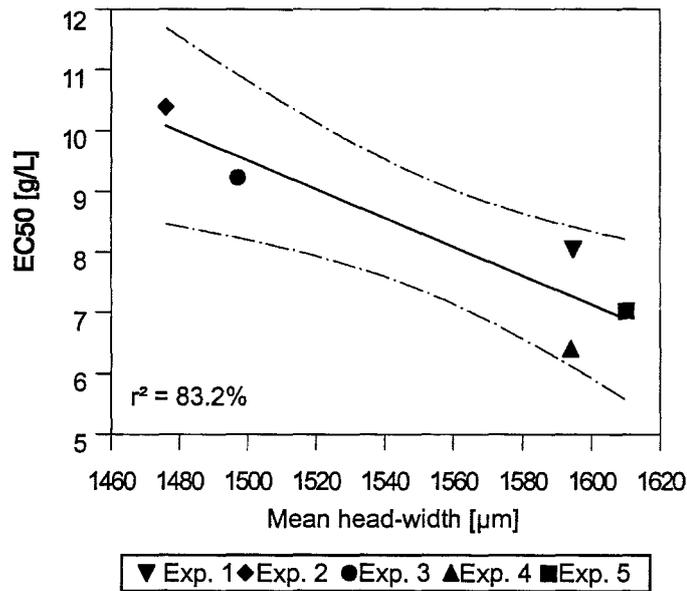
#### *Effects of body-size and season*

In Section 4.4.3. it was shown that all EC50 values were statistically significantly different. In this instance, APHA (1992) recommended that the experimental populations be tested for differences in body-size. The headwidths (as an indicator of size) of nymphs of both species were therefore measured. For each species there was no significant *within-experiment* variation in headwidth-means (Sections 4.2.1.–4.2.5. and 4.3.1.–4.3.3.). There were, however, significant differences in the mean headwidth of nymphs of the same species, *between* experiments conducted at different times of the year (Sections 4.2.6. and 4.3.4.; Table 4.28.).

**Table 4.28.** Summary of headwidth (HW) ranges, means and related parameters for all experiments. Experiments 1–5 were conducted with *A. auriculata*; Experiments 6–8 were conducted with *A. sudafricanum*. CV Coefficient of variation.

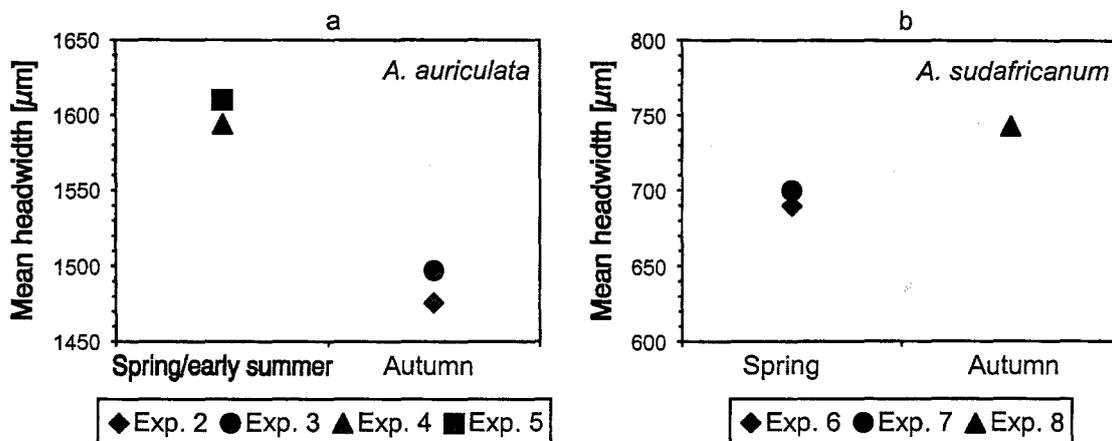
Experiment(s)	<i>n</i>	HW range [ $\mu\text{m}$ ]	HW mean [ $\mu\text{m}$ ]	CV [%]
1	312	923–2308	1596	17.9
2	243	923–2308	1476	21.1
3	469	769–2308	1497	21.0
4	325	615–2462	1594	26.2
5	369	1077–2308	1610	15.7
1–5	$\Sigma 1718$	615–2462	grand mean: 1555	20.8
6	335	495–950	691	10.6
7	446	396–1089	700	13.6
8	307	954–931	743	10.8
6–8	$\Sigma 1088$	396–1089	grand mean: 709	12.3

In experiments with *A. auriculata*, smaller mean headwidths were significantly correlated with higher EC50 values (Appendix F), and experiments with larger mean headwidths were significantly correlated with lower EC50 values (Figure 4.32.).

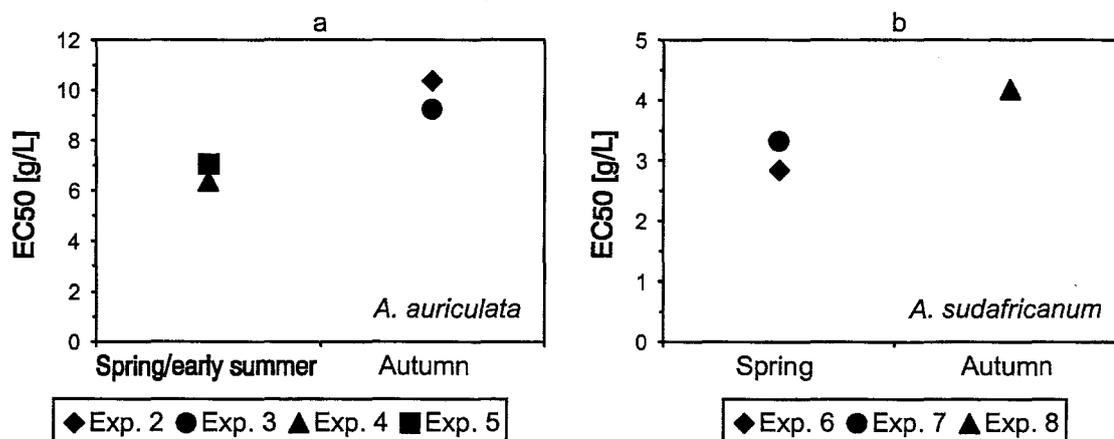


**Figure 4.32.** Correlation of sodium sulphate 96h-EC50 values of *A. auriculata* experiments (1–5) with corresponding headwidth-means. The dashed lines designate 95% confidence limits.

Although the possible effect of season was not identified as an objective of this study, seasonal sampling and consequent use of nymphs of different mean size required the consideration of seasonality (Figures 4.33. and 4.34.). *A. auriculata* nymphs collected in spring and early summer were larger than those collected in autumn (Figure 4.33.a.). Although *A. sudafricanum* data are few, they are also presented. *A. sudafricanum* nymphs collected in autumn were larger than those collected in spring (Figure 4.33.b.). For both species, EC50 values were higher in autumn experiments (Figure 4.34.).<sup>3</sup>



**Figure 4.33.** Mean headwidths of experiments with *A. auriculata* (a) and *A. sudafricanum* (b), grouped according to the season in which test organisms were collected and tests conducted. Dates for experiments: 2) 19–23.04.97; 3) 28.04.–02.05.97; 4) 01–05.09.97; 5) 08–12.12.97; 6) 06.10.–05.11.97; 7) 27.09.–01.10.97; 8) 28.04.–02.05.98.



Figures 4.34. Sodium sulphate EC50s of experiments with *A. auriculata* (a) and *A. sudafricanum* (b), grouped according to the season in which test organisms were collected and tests conducted. Dates for experiments see Figure 4.33.

#### Comparison of the slopes of the concentration-response curves

The slope of a concentration-response curve contains information about the physiological response of the test organisms to the test chemical (Rand *et al.* 1995). The slopes of both test taxa were therefore compared to reveal differences. This could not be done numerically because of the different tolerance distribution models of the two taxa (Section 4.1.1.). The concentration-response curves of all experiments were therefore constructed with the aid of the data provided by the Probit analysis (Appendix D), and plotted together in one graph so that slopes could be examined graphically (Figure 4.35.). All slopes appeared to be fairly similar.

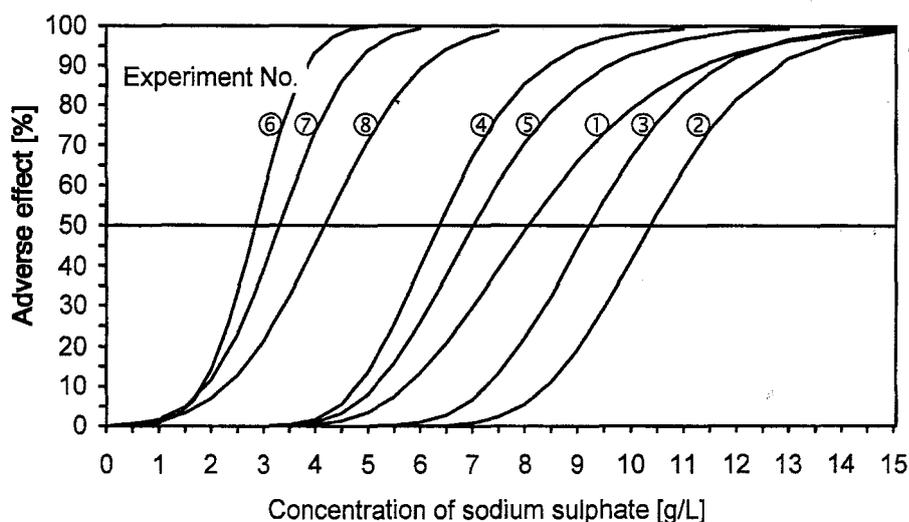


Figure 4.35. Concentration-response curves of all experiments in a graph with arithmetic concentration scale and response proportions in per cent.

Since the headwidth-means were significantly correlated with EC50 values (see previous section), it was interesting to see whether the slope of *A. auriculata* experiments were also correlated with EC50s. This correlation is displayed in Figure 4.36., was statistically tested (Appendix F) and was found to be significant. For reasons explained in Section 4.5.1., *A. sudafricanum* data were too few to allow a meaningful correlation.

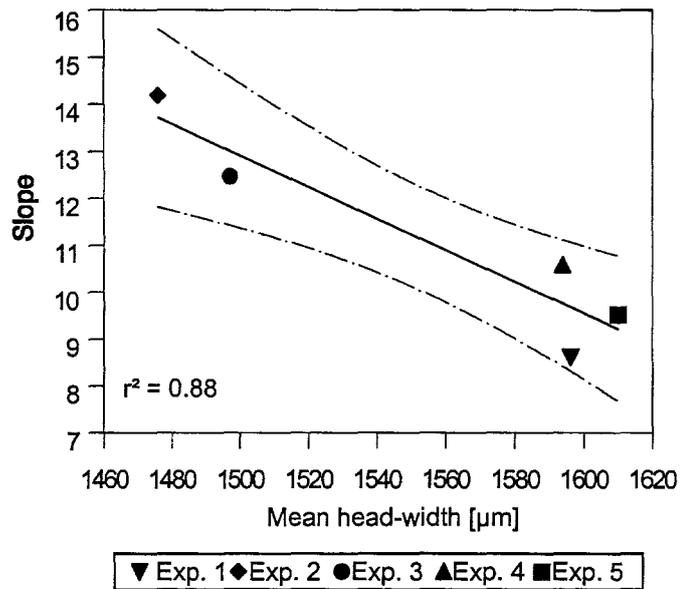


Figure 4.36. Correlation of slope values of *A. auriculata* experiments (1–5) with corresponding headwidth-means. The slopes were calculated with the Probit analysis from 96h-EC50 values. The dashed lines designate 95% confidence limits.

---

# Chapter 5

## Discussion

---

### 5.1. Introduction

Within the Artificial Stream project (Palmer *et al.* 1996; Palmer and Scherman in press), artificial streams were developed at two main scales: Large Artificial Stream Units (LASUs), recirculating 1700 L water, and Channels and Raceways, recirculating 12.5 and 20 L water respectively. The investment for building the hydraulically adjustable large systems was made on the basis of the importance of volume and the use of riffle-dwelling organisms in artificial stream research (Palmer *et al.* 1996). However, the advantages of smaller portable units were soon apparent. The main focus of this study was to evaluate the two scales of design, so as to provide guidelines about the appropriate application and use of these systems.

The streams were developed in order to conduct toxicity testing using rheophilic invertebrates specifically, and salinity was selected as the first water quality constituent to be investigated. The main aim of this study was therefore to evaluate the performance of the three artificial stream designs by comparing the salinity tolerances of selected mayfly nymphs (Section 1.5.). To achieve this aim, nymphs of the leptophlebiid mayfly *Adenophlebia auriculata*, and as a secondary species, nymphs of the baetid mayfly *Afroptilum sudafricanum*, were exposed for four days to a range of sodium sulphate concentrations. Experiments were conducted in the three different systems, and as a result, a set of EC50 values was obtained for each species. In order to meet the objectives of the main aim, sets of EC50 values per species were discussed from two perspectives:

- evaluation of different artificial stream designs (Section 5.2.)
- evaluation of test species and their responses (Sections 5.3. and 5.5.)

A secondary aim was to evaluate the response of the test taxa to elevated salinities. This is discussed in Section 5.4.

## 5.2. Evaluation of artificial stream designs

The artificial stream systems were compared and evaluated using 96h-EC50 values as a response, because EC50s are a common end point and criterion in aquatic toxicology (Rand *et al.* 1995). The set of EC50 values from experiments with the two taxa have been summarized in Tables 4.21. and 4.22., and are graphically displayed in Figures 4.27. and 4.28. From these tables and figures it is apparent that each test response was different. It therefore became necessary to establish whether these differences were statistically significant. EC50 values were subjected to assessment procedures described in Sections 3.1.3. and 4.4.3. It was shown that all EC50s were statistically significantly different. However, it must be noted that the criterion upon which this decision was based was not unequivocal. The main criterion is the comparison of the 95% confidence limits (95%CLs) for overlap (Section 3.1.3.) which is obviously influenced by the width of the 95%CLs. The 95%CLs, however, do change not only with the scatter of data, but also with the number of treatments ( $n$ ) incorporated in the statistical analysis. Since  $n$  changed between experiments (Tables 4.21. and 4.22.), and the differences between EC50 values were not great,  $n$  might have influenced the outcome of the assessment procedure. Kirk's statement (1968, cited in Giesy and Allred 1985) therefore becomes relevant: "Hypothesis testing procedures should be viewed as tools that aid an experimenter in interpreting the outcome of research. *Such procedures should not be permitted to replace the judicial use of logic by an alert analytical experimenter*" (italics were added). Hence it was decided that differences between EC50s were sufficiently different to warrant further investigation.

### 5.2.1. Variability of tolerance data

In principle, variability can be due to two effects: genetic differences of the test organisms, or experimental error. Both effects can occur separately or together. The distinction between these effects is important, because variability originating from genetic differences cannot be reduced except by using cloned organisms. Variability as a result of experimental error can be reduced, but is subject to practical limitations. Since test organisms of this study and of the literature cited therein were not cloned, the variability experienced may be due to both effects.

Before possible causes of differences between EC50 values will be investigated, it is useful to briefly review how variations in test results have been experienced by other researchers. The toxicity tests of this study were conducted using field-collected animals; therefore not much was known of their history or previous exposure to toxicants. This contributed to

some "natural" or unknown variability in terms of their sensitivity. However, toxicity tests with standard laboratory organisms and highly standardized test protocols also exhibit significant variability (Fogels and Sprague 1977; Canton and Adema 1978; Buikema 1983; Sprague 1985; Cooney 1995). In order to place the variability encountered in this study into an international perspective, both the ratio of the greatest and the smallest EC50 value (referred to here as the maximum ratio) of a set of experiments per species, and the coefficient of variation (CV) were calculated (Buikema 1983; Sprague 1985; Cooney 1995; Section 3.1.3.)(Table 5.1.).

**Table 5.1.** The variation of EC50 values encountered for each species, expressed as the ratio of the greatest and the smallest EC50 (maximum ratio), and the coefficient of variation.

	<i>A. auriculata</i> Experiments 1–5	<i>A. sudafricanum</i> Experiments 6–8
Geometric mean of EC50 values [g/L]	8.09	3.40
Coefficient of variation [%]	20.12	19.95
Maximum ratio	1.63	1.47

Some publications reviewed the intralaboratory variability of standardized toxicity tests with laboratory-reared organisms such as *Daphnia* or rainbow trout which were exposed to a single toxicant (Fogels and Sprague 1977; Canton and Adema 1978; Sprague 1985). The authors found that test results ranged from a maximum ratio of only about 1.3 (CV 6%; Sprague 1985) to as high as 5.5 (*ibid.*). Norberg-King from the United States Environmental Protection Agency (personal communication) considers, as did Canton and Adema (1978), that acute toxicity values differing by a factor of 2–3 are acceptable. Cooney (1995) reviewed intralaboratory CVs for short-term tests with effluents<sup>19</sup>, and found them ranging between 15.8 and 24.6%.

In comparison with the maximum ratios and CVs listed above, the values found in this study (Table 5.1.) seem to lie well within the acceptable limits. Considering that experiments were carried out using field-collected indigenous mayfly nymphs which display more variability than standard laboratory organisms (Scherman and Palmer in press), the variation is actually rather low<sup>20</sup>. This has important implications for the use of

<sup>19</sup> It should be noted that the variability of toxicity tests with effluents is considered to be greater compared to single substances because of the day-to-day variability of effluents and their often complex chemical composition.

<sup>20</sup> Cooney (1995) noted that variations in this range (ca. 20-30% CV) compare very well with variations frequently encountered in classical methods of analytical chemistry and thus concluded that standard toxicity test methods yield results as precise as chemical analyses.

indigenous organisms in toxicity tests for regulatory purposes, and will be discussed further in Section 5.5.

### 5.2.2. Differences between artificial stream systems

Even though the tolerances were all within a similar range, the statistically significant differences could have been associated with aspects of stream design or other experimental factors. As these features will influence the future application of the artificial stream systems, an effort was made to identify the reasons for these differences.

Following the main aim of this study, the possible influence of stream design on the response of test organisms was investigated first. The difference in scale was the most obvious feature of different designs. The average current velocity was identified as a second important physical variable distinguishing the systems (Section 4.5.1.).

For each test species, experiments were repeated in time in the Channel systems in order to assess the variability of test results without system-related confounding variables (Section 3.1.1., Table 3.1.). Tables 4.21. and 4.22., and Figures 4.27. and 4.28. show that there is no obvious system-related trend in EC50 values. This was further investigated by correlating system volume and current velocity with EC50 values (Figure 4.29.). Artificial stream designs were compared only on the basis of *A. auriculata* data (see Section 4.5.1. for details).

#### *Effects of scale*

In the literature, scale has often been used in connection with the level of biological complexity present in an artificial stream system (*sensu* Kosinski 1989; Swift *et al.* 1993; Graney *et al.* 1995). A "large artificial stream" would therefore not only be large in size, but would also contain a number of trophic layers. In this study, the scale of the different artificial stream designs refer to the physical features only, which are the volume of recirculated water, and the space available for the test taxa. However, as the space within the test chambers of each artificial stream design was of similar size (Section 2.2.3.), it was discarded as a contributing factor. Thus, water volume was considered as the only factor representing scale.

Most of the artificial stream studies in aquatic toxicology reviewed by Kosinski (1989; Table 2.1.) renewed the experimental water continuously (56% flow-through) or partially (19% partially recirculating). With these techniques, the build-up of by-products was avoided (Rand *et al.* 1995), and water volume was considered unimportant. Recirculating

systems were selected for this study, and a potential influence of water volume on experimental results was expected. However, when *A. auriculata*-EC50 values were plotted against the system volume of artificial streams (Figure 4.29.a.), there did not seem to be a correlation between these two variables. This therefore suggested that differences in EC50 values were not related to the recirculated volume of water<sup>21</sup>.

#### *Effects of current velocity*

The flow in lotic systems is a physical variable of great importance (Statzner *et al.* 1988; Allan 1995). As the average current velocities of artificial streams of this study were different (Section 2.2.3.), this parameter might have influenced test results. However, when EC50 values were plotted against the average current velocity of artificial stream systems (Figure 4.29.b.), no correlation was apparent. This lack of influence may be accounted for by a number of factors.

*A. auriculata* nymphs of the size used in this study (ca. 600–2400  $\mu\text{m}$ ) have predominantly been found at current velocities between ca. 0 and 0.20 m/s (Hunt 1997), which may express a natural tolerance of this species to current velocities in this range. The nymphs also usually hide underneath stones which protect them from the direct influence of currents (*ibid.*, Everitt 1996; and personal observation). The findings of other researchers are comparable for the current velocity range used in this study (ca. 0.03–0.11 m/s). Lowell *et al.* (1995a) found that the mayfly *Baetis tricaudatus* showed signs of stress at a current velocity of 0 m/s in 48 h toxicity tests with sodium chloride. This resulted in a lower EC50 (end point: immobilization) as compared to EC50 values at higher current velocities (0.06 and 0.12 m/s). The authors therefore suggested a threshold between 0 and 0.06 m/s above which no effect of current velocity could be detected. In another study, Corbett (1996) conducted experiments in the LASUs, exposing *A. sudafricanum* for 96 h to different sodium chloride concentrations (1.65 and 6.95 g/L) at different current velocities (0, 0.06 and 0.12 m/s). Mortalities were highest in the two NaCl concentrations at no flow conditions, with less pronounced differences between 0.06 and 0.12 m/s current velocity. In this study, the Channels had the lowest average current velocity (0.038 m/s). Since no current velocity related effects were detectable, this flow may be just above the limit above which the influence of current velocity was found to be negligible.

---

<sup>21</sup> As described in Section 3.2.6., 20% of the experimental water recirculated in the Raceways was replaced because of a nutrient build-up experienced by Goetsch and Palmer (1997). Nutrient build-up was not a problem in experiments of this study as will be discussed in the next section.

### Conclusion

There seems to be no evidence as provided by the data of this study that either scale or current velocity had an influence on the responses of *A. auriculata*. The decision as to which stream design to use for short-term toxicity tests with lotic single species (which require flow, but not a precisely defined flow) may therefore be based on practical considerations.

### 5.2.3. Effects of water quality constituents

Although there was no correlation between EC50 values and water volume, which covers most dilution issues, correlations with a range of individual chemical constituents were checked because of their documented potential influence on the response of test organisms to test materials (Sprague 1985; Cooney 1995). These can physical (e.g. temperature and pH) or chemical (nutrients, salts, metals), and many of them interact with each other, often exerting potential effects on biotic species only in specific combinations. The results of this study have been examined considering selected physical and chemical water quality constituents, on the basis of samples taken at the beginning and the end of each test period, and analysed by analytical laboratories of the Institute for Water Quality Studies (IWQS). The results of the analyses have been summarized in Tables 4.25. and 4.26., and are compared with generally accepted no-effect limits (Table 5.2.).

**Table 5.2.** Guideline values for selected water quality constituents. No guideline values could be found for K, Ca, Mg, Si. SAWQG-AQ South African Water Quality Guidelines for Aquatic Ecosystems (DWA 1996a); TWQR Target Water Quality Range; AEV Acute Effect Value. Units in [mg/L].

	SAWQG-AQ		APHA (1992)	Ranges of interna- tional guidelines <sup>a</sup>	Other/comments
	TWQR	AEV			
NH <sub>3</sub>	≤0.007	0.1	0.020	0.004-0.130	0.71-2.3 <sup>b</sup>
NO <sub>3</sub>	-	-	-	90	<0.1 <sup>c</sup>
NO <sub>2</sub>	-	-	-	0.009-5.0	0.06 & 0.24 <sup>d</sup> ; 1.8 <sup>e</sup> ; 60 <sup>f</sup>
PO <sub>4</sub>	≤15% <sup>g</sup>	-	-	-	0.025-0.250 eutrophic conditions <sup>h</sup>
SO <sub>4</sub>	-	-	-	150-250; 1400	-
TDS	≤15% <sup>g, i</sup>	-	-	1000-2000	-
pH	≤0.5 pH unit or ≤5% <sup>g</sup>	-	7.0-8.2; ±0.2 <sup>j</sup>	6.5-9.0	-

Comments: <sup>a</sup> Ranges were compiled from McKee and Wolf 1963; Kempster *et al.* 1980; USEPA 1986; Canadian Guidelines 1987; Chiaudani and Premazzi 1988; Gardiner and Zabel 1989; Hart *et al.* 1992; <sup>b</sup> Range of 96h-LC50 values for aquatic invertebrates (Dallas and Day 1993); <sup>c</sup> Normal for natural surface waters (Dallas and Day 1993); <sup>d</sup> 6-month no effect & 96h-LC50 of *Salmo gairdneri* (Dallas and Day 1993); <sup>e</sup> 35% growth reduction of *Macrobranchium rosenbergii* (freshwater prawn)(Dallas and Day 1993); <sup>f</sup> LC0 for *Daphnia magna* (Leaflet Spectroquant<sup>®</sup> Nitrite Test); <sup>g</sup> The allowed change of the present concentration in a local water body under unimpacted conditions at any time of the year (DWA 1996a); <sup>h</sup> DWA (1996a); <sup>i</sup> The amplitude and frequency of natural cycles in TDS concentrations should not be changed (DWA 1996a); <sup>j</sup> In long-term experiments

### *Fluctuation of toxicant concentrations*

The recommended limit for fluctuations of toxicant concentrations during chronic toxicity tests is  $\pm 15\%$  (APHA 1992; Section 3.2.6.). No limit could be found for short-term experiments. In most of the final experiments of this study, concentrations never fluctuated by more than 9.7%, except for Experiment 8 (27.3%, Table 4.18.). The extent of sodium sulphate fluctuations was therefore considered to be small. The large fluctuation in Experiment 8 occurred in the lowest test concentration. As the response in the control of this experiment was higher than the response in the lowest concentration, it was not incorporated in the EC50 calculation and therefore did not influence the test results.

### *Nutrients*

Nutrients are a natural component of freshwaters and include ammonia ( $\text{NH}_3$ ), nitrate ( $\text{NO}_3$ ), nitrite ( $\text{NO}_2$ ) and phosphate ( $\text{PO}_4$ ). Nitrate and phosphate are generally not considered to be toxic<sup>22</sup>, whereas ammonia and nitrite may be toxic, depending on the concentration and state of ionization (Dallas and Day 1993), which is mainly dependent on pH and water temperature (DWAF 1996a). The only critical ammonium concentrations above guideline values (Table 5.2.) occurred in the range-finding experiment for *A. sudafricanum* (Table 4.26.). A maximum value of 1.44 mg/L ammonium ( $\text{NH}_4$ ) was recorded which corresponds to 0.026 mg/L ammonia<sup>23</sup>. These  $\text{NH}_3$ -levels might have affected the test organisms. However, this value is within the range of international guidelines and just outside the APHA (1992) limit. Ammonia concentrations in final experiments were always below guideline values. The highest range of nitrate and nitrite was recorded in Experiment 3 (0.34–0.59 mg/L; Table 4.25.). Even if the maximum value was nitrite, no effect should be expected for macroinvertebrates (see comments, <sup>e</sup> and <sup>f</sup> in Table 5.2.). However, because of the well-oxygenated experimental water, and pH values  $\geq 7.0$  which resulted in the less toxic ionized form of nitrite, it was unlikely that nitrite was formed in significant proportions and therefore affected experiments (Chapman 1992).

### *Major ions*

Some or all of the major ions (Na, K, Ca, Mg,  $\text{HCO}_3$ ,  $\text{CO}_3$ , Cl, and  $\text{SO}_4$ ) may have influenced test results. However, to determine the concentration and bioavailability of ionic species in experimental treatments accurately, the water chemistry data should have been analysed by a chemical speciation program (e.g. MINTEQA2; Kerr 1995). This would have made it possible to determine the bioavailable ionic species by means of subsequent

---

<sup>22</sup> They are usually used as an indicator for the trophic state of a water body.

<sup>23</sup> The ammonia concentration has been calculated using the formula provided in Appendix B for the pH and temperature conditions recorded during this experiment.

tests of correlations between conductivity or TDS, single ionic species, and test response. As chemical speciation is highly specialized, it was beyond the scope of this study. Since test organisms responded (EC50) to concentrations an order of magnitude above the background concentrations of major ions (experimental water), it is unlikely that these ions influenced the test responses.

Other factors associated with major ions is buffering capacity, the availability of essential elements to the aquatic biota, and the toxicity of metals (Dallas and Day 1993). They were, however, also unlikely to have affected results. The change of buffering capacity is a secondary effect and of no direct importance to this study; the availability of essential elements affects only long-term parameters, such as growth (not considered by this study); and the modification of metal toxicity was negligible, as metals were present only at very low background levels (Appendix B).

#### *Temperature*

Temperatures mostly ranged between 17 and 21°C, which is within  $\pm 2^\circ\text{C}$  of the selected value (APHA 1992). On three occasions, the recommended maximum rate of  $3^\circ\text{C}$  temperature change in any 24 h (*ibid.*) was exceeded (maximum rate measured:  $3.9^\circ\text{C}$ ): twice during transfer of the test organisms from the Palmiet River to the laboratory (Experiments 3 and 4), and once during Experiment 5 before initiation of the test. Although these changes were beyond the proposed maximum rate, it seemed unlikely that they negatively influenced test results. Occasional measurements in the Palmiet River showed that the water temperature at the sampling site fluctuated within  $5^\circ\text{C}$  over time intervals from four to 17 hours. This suggested that aquatic species from the Palmiet River are tolerant of a wider temperature range than proposed by APHA (1992).

#### *pH*

APHA (1992) recommended a pH in the range of 7.0–8.2 for toxicity tests, but advised not to exceed a fluctuation of  $\pm 0.2$  pH units from the selected value during chronic experiments. Both limits were exceeded during this study.

The first change in pH that the test organisms experienced was during the transfer from the Palmiet River to the test systems (Table 4.27.). The pH always increased, a maximum 1.5 units (Experiment 8). This increase may have contributed to the increased responses during acclimation, and also in the control during the test period of Experiment 8<sup>24</sup>. However, the

---

<sup>24</sup> A second contributor to increased acclimation and control responses may have been the TDS level of the experimental water. It was more than 3 times higher than the TDS of the Palmiet River.

response rates during these two experimental phases were within the accepted limits (i.e. responses were below 10%). In the other experiments, the pH never increased more than 0.7 units, and as there were no significantly elevated responses during acclimation in comparison to experiments with smaller pH changes, it was assumed that a rate of 0.7 units lies within the tolerance of both test species.

The second change occurred when the concentrated sodium sulphate solution was added to the experimental units at the initiation of the tests. The pH rapidly increased again (Figure 4.31.), with the height of the peak dependent on the particular salt concentration (Figure 4.30.). To evaluate the influence on test responses, two different effects were identified: the *absolute increase* of pH, and the *relative change* of pH. The following section mainly refers to experiments with *A. auriculata*. Experiments with *A. sudafricanum* were not significantly affected by pH changes as the salt concentrations were much lower (maximum pH peaks 7.7)(Sprague 1985; APHA 1992).

The maximum pH value recorded in the highest concentrations of *A. auriculata* experiments was 8.74 (Experiment 4). This value was compared with the following data from the literature. APHA (1992) recommended a pH range of 7.0–8.2 for toxicity tests, whereas Sprague (1985) considered a range of 6.5–9.5 "harmless for invertebrates". Peters *et al.* (1985), however, found an acute (96 h) LC50 of pH 9.54 for the mayfly *Isonychia bicolor*. In the light of these data, the maximum pH of 8.72 encountered in this study may be close to, or within an area where, at least, sub-lethal effects could occur. The situation is, however, further complicated by the dependency of pH on salt concentration. The lower the concentration, the lower the maximum pH, and therefore its possible effect on test responses.

The greatest relative change of pH after test initiation was an increase of 1.57 units, from pH 7.14 to 8.74 in the highest concentration of Experiment 4. This is higher than the maximum range of pH units recommended by APHA (1992)(0.4 pH units) or DWAF (1996a)(0.5 pH units)(Table 5.2.). However, the relative changes in other test concentrations of Experiment 4 and other experiments were lower because of the correlation of pH and salt concentration. Figure 4.31. illustrates the general course of pH during a test period, and it can be seen that after a peak the pH usually stabilized after 12 h, to values mostly below 7.9. Although this suggested that mayflies could probably recover from potential adverse effects of pH-peaks, Peters *et al.* (1985) found that intermittent alkaline pH peaks above 1 h duration were as harmful to *I. bicolor* as 96 h continuous

exposure to alkaline pH. It is therefore likely that effects of pH-peaks (if any) lasted for the entire test period.

The effects of the pH peaks on test results caused by the addition of the sodium sulphate solution are problematic to assess because of the pH-salt concentration dependency. For *A. sudafricanum* experiments, the pH fluctuations encountered are probably negligible. For experiments with *A. auriculata*, additional effects, at least in the higher salt concentrations, might have occurred. However, only specific research on pH tolerances of the test species, especially in connection with sodium sulphate as the main toxicant, can resolve these uncertainties.

### *Conclusion*

Most water quality constituents measured were within the limits listed in Table 5.2. Some limits were exceeded, but this did either not occur in final experiments, or the test organisms seemed to be more tolerant to the fluctuation of a particular water quality constituent than proposed. The exception may be the pH peaks which occurred after test initiation. It cannot be ruled out that magnitude and duration of these peaks may have had a modifying effect on test responses, at least in the higher concentrations of experiments with *A. auriculata*. Should pH and salinity effects act additively, the EC50s obtained would be lower than without pH-related stress. However, these effects could not be quantified in the present experimental design.

#### **5.2.4. Evaluation of the practical performance of each system**

During the course of experiments, each system design exhibited both advantages and limitations. Since the evaluation of the practical performance of each artificial stream design was an objective of this study, the following practical points most relevant to acute toxicity testing were assessed for each stream design:

- number of available systems
- volume of water
- fluctuation of current velocity
- evaporation and splashing of water
- ease of use
- general reliability

### LASUs

**NUMBER:** Three independent units were not sufficient for a sound statistical basis for acute toxicological experiments (Section 3.1.1.). To determine an EC50 value with the LASUs, the experiment had to be split into several sub-experiments. This multiplied the time for obtaining results, introduced confounding variables and thus decreased the precision of test results.

**VOLUME:** In the acute toxicity tests of this study, the high volume of water (ca. 1700 L) did not appear to be of advantage over the smaller volumes of other designs, in terms of either test responses or water quality (Sections 5.2.2. and 5.2.3.). In practice, the large water quantities created large volumes of wastewater, which may become a logistical and financial obstacle if using hazardous toxicants as test material.

**CURRENT VELOCITY FLUCTUATION:** Current velocities were measured in some experiments (Appendix A), and fluctuations were found to be larger than expected by Palmer *et al.* (1996)<sup>25</sup>. The introduction of mesh in the channels to retain test organisms greatly reduced the hydraulic accuracy of the LASUs. Accuracy was reduced further by the regular clogging of the mesh with detritus. However, when the coefficients of variation (CV) of the overall current velocity means of the stream systems were compared, the CV was lowest for the LASUs (Appendix A), rendering them the most accurate.

**EVAPORATION AND SPLASH:** The open surfaces of the channels and the sump (Figure 2.4.) allowed water to evaporate. Increased splash was experienced in the sump and could only partially be confined by splash covers. However, salt concentrations fluctuated within the range encountered with other systems (Tables 4.25. and 4.26.).

**EASE OF USE:** Draining and cleaning of the LASUs was complicated and laborious. The greatest difficulties were experienced with the drains of the tankage. The drains were not installed at the deepest point, which left water at the bottom of the tank after draining. The installation of hose-siphons facilitated the removal of the left-over water, but sedimented dirt still had to be removed manually. Cleaning of all parts of the system was not possible as some pipes are not accessible. A considerable amount of detritus had accumulated in those parts, causing the fine mesh of the test chambers to clog up regularly. The support structure of the systems was coated with rust-proof paint, but the paint failed to prevent

---

<sup>25</sup> When Palmer *et al.* (1996) compared flow conditions among LASUs, the worst variation in current velocity was expected to be  $\pm 12\%$ . With an average current velocity of 0.090 m/s calculated for experiments of this study, this would result in a range of ca. 0.079–0.101 m/s. The range actually encountered was 0.068–0.111 m/s (Appendix B.).

rusting. Some parts have already suffered serious weakening. The physical space between the experimental streams in the laboratory was very limited and did not allow for much movement.

**RELIABILITY:** The pumps and the electric circuit which controls the re-start of the LASU pumps after a power-cut, proved to be reliable.

#### *Raceways*

**NUMBER:** The nine systems available in the artificial stream laboratory were sufficient for ecotoxicological experiments, although a larger number would have allowed for a more flexible distribution of experimental treatments. Because of space constraints in the laboratory, no more than nine systems could be accommodated at one time.

**VOLUME:** The small water volumes (ca. 12.5 L) did not negatively influence test results (Sections 5.2.2. and 5.2.3.).

**CURRENT VELOCITY FLUCTUATION:** Of all three designs, the current velocity fluctuated most in the Raceways. The mesh which confined the test chambers was regularly clogged with detritus which had the greatest impact on current velocity stability (Appendix A). Despite daily brushing of the mesh to dislodge the detritus, the current velocity dropped in one extreme case from 0.098 to 0.036 m/s in a six-day period.

**EVAPORATION AND SPLASH:** Evaporation and splash due to the paddle wheel – a common problem of this design (Craig 1993) – caused an average reduction of 33% of the total volume of test solution during the test period. In this study sodium sulphate solution was replenished daily. This design may however not be appropriate for volatile and degradable toxicants such as whole effluents.

**EASE OF USE:** The Raceways were built to be portable. In practice they turned out to be bulky, utilized a lot of space and leaked often after transport (also mentioned in Palmer *et al.* 1996). The edges of the perspex were sharp and could lead to minor injuries when not handled carefully. However, thorough cleaning of an experimental unit was possible and fairly easy.

**RELIABILITY:** The Bosch windscreen-wiper motors which propel the paddle wheels, were not constructed for long-term use, and thus failed several times during experiments. The

revolution speeds of the motors differed slightly and therefore contributed to differences in current velocities between experimental units.

### *Channels*

**NUMBER:** Fifteen systems were sufficient for acute toxicity tests. If greater numbers are required, new units can be constructed easily and cheaply.

**VOLUME:** The small water volumes (ca. 20 L) did not negatively influence test results (Sections 5.2.2. and 5.2.3.).

**CURRENT VELOCITY FLUCTUATION:** As in the Raceways, the mesh at the end of the channel gathered detritus and reduced the flow, which resulted in changes in current velocity (Appendix A).

**EVAPORATION AND SPLASH:** The original stream design of Williams (1996) was modified to reduce evaporation and splash. A transition pipe, splash cover and lid for the bucket (Figure 2.7.) were added to reduce the loss of experimental water. After the modification, water spillage was eliminated, so the water lost due to evaporation could be compensated by simply adding fresh water. The losses ranged between one and three litres during the test period.

**EASE OF USE:** The Channels were very user-friendly. The components were light, easy to clean and transport, and the replacement of damaged parts inexpensive.

**RELIABILITY:** No failures of the submersible pumps were recorded.

### *Conclusion*

The main advantages of the LASUs (large system volume, hydraulic accurate flow) did not prove to be of advantage in the acute toxicity tests of this study. In fact, because of other characteristics associated with the large scale (limited number of independent units and thus prolonged experiments, large volumes of waste water, laborious operation of the systems), the LASUs proved to be the least efficient. The Raceways provided just enough independent units for effective tests, were easier to handle than the LASUs, and the small volume (ameliorated by partial water replacement) did not demonstrate negative influence in the short-term tests. They were, however, very bulky for portable systems, unreliable because of motor failures, and, since evaporation and splashing could not be reduced by simple means, they were impractical to use. The Channels provided all the positive aspects

of a small-scale portable system, without the negative characteristics of the Raceways. They were light, cheap, user-friendly, reliable, splash-free, and offer opportunities for further improvement. The small volume could easily be extended by using a bigger water container, and the present low current velocity can be increased by using stronger pumps. From a practical perspective, the Channels are therefore recommended for future use in acute toxicity testing with lotic freshwater macroinvertebrates. The LASUs should only be used where a high control over flow conditions is required.

### 5.2.5. Artificial stream designs: General conclusion

The EC50 values for the two test taxa (*A. auriculata*: Experiments 1–5; *A. sudafricanum*: Experiments 6–8) were all statistically significantly different from each other, within each set of experiments per test species. However, these differences were low and well within the range of variability encountered internationally for standard laboratory organisms. Experiments with *A. auriculata* indicated that the differences were not related to the main stream design characteristics of scale and current velocity. Except for pH, no water quality constituent seemed to influence test responses of both test taxa. The influence of alkaline pH peaks at the initiation of toxicity tests might have lowered EC50 values (i.e. EC50s may have been higher had salinity been the only stressor), but this modification was probably small, most likely occurred only for experiments with *A. auriculata*, and was independent of artificial stream systems. Since EC50s did not appear to be influenced by any design-related parameters, decisions regarding the usefulness of stream design may be based on practical considerations. The evaluation of the practical performance of each stream design showed that the Channels were most useful and efficient. These systems are therefore recommended for future use of rheophilic macroinvertebrate taxa in short-term single species toxicity tests.

### 5.3. Evaluation of test species and their responses

No standardized test protocols exist to date in South Africa for the use of indigenous organisms in toxicity tests for regulatory purposes. The data from this study contribute to the first standard test protocol, currently in preparation by Scherman and Palmer (DWAF 1999b). Furthermore, the database of responses of any organisms indigenous to South Africa to any chemical is limited. In this study, indigenous organisms were chosen as test species in order to:

- contribute to method development regarding the use of site-specific macroinvertebrates for regulatory toxicity testing.
- contribute to the development of a protocol for these toxicity tests.
- protect riverine biota by gaining knowledge of the tolerances of indigenous rheophilic organisms. These organisms are considered to be more representative of the riverine biota than standard laboratory organisms which are usually kept under static conditions.
- contribute to the toxicity database for indigenous organisms.

The two selected test species met many of the criteria for "ideal" test organisms (Section 2.3.3.). In the following sections, the responses of the test taxa will – in accordance with the objectives of the study (Section 1.5.) – be discussed from two perspectives:

- effects of body-size and season on EC50 values
- comparison of test taxa

#### 5.3.1. Effects of body-size and season on EC50 values

The examination of differences between EC50 values showed that they were statistically significant, but differences were not related to artificial stream design (Sections 4.4.3. and 5.2.). Where statistically significant differences are detected, APHA (1992) recommended that the experimental populations be tested for significant differences in physiological parameters such as body-size. The influence of body-size on tolerance is well documented in the literature (Sprague 1985; APHA 1992; Diamond *et al.* 1992; Rand *et al.* 1995; Cooney 1995; Kiffney and Clements 1996). Therefore, the headwidths of all individuals (as an indicator for body-size) were measured and analysed (Section 3.4.2.).

For each species, there was no significant *within-experiment* variation in headwidth-means (Sections 4.2.1.–4.2.5. and 4.3.1.–4.3.3.), hence the technique employed to distribute organisms between stream units in such a way that size-ranges in the stream units were equal (Section 3.2.3.) was successful. The difference in mean headwidths *between*

experiments (e.g. the five headwidth-means of Experiments 1–5) were, however, statistically significant (Sections 4.2.6. and 4.3.4.). This indicated that body-size might have influenced test responses. EC50 values of experiments with *A. auriculata* were therefore correlated with mean headwidths to evaluate the relationship. Data of experiments with *A. sudafricanum* were too few for a meaningful correlation (Section 4.5.1.).

For experiments using *A. auriculata*, the graph shows a significant inverse correlation between EC50 and mean headwidth (Section 4.5.3., Figure 4.32.). An inverse correlation means higher sensitivity of large mayfly nymphs. This is contrary to the findings of many other researchers. Usually the small organisms of a particular species show increased sensitivity, often explained by the larger surface area/body volume ratios of smaller organisms because of faster toxicant-enrichment of body tissues up to harmful levels (Sprague 1985; Rand *et al.* 1995). No simple explanation can be offered for the finding of this study. It must be acknowledged that the average headwidth of nymphs used in an experiment is a rather crude parameter. Also, the largest mean headwidth differed from the smallest only by a factor of 1.09 (Table 4.28.). However, experiments were not specifically designed to explore headwidth-EC50 correlations. Haigh (personal communication) stated that in her experiments with *A. auriculata* she experienced atypical responses at headwidths >1600  $\mu\text{m}$ . A similar finding was reported by Fremling (1975) for large nymphs of the mayfly *Hexagenia rigida*. Everitt (1998) also observed that small *A. auriculata* nymphs survived longest in her experiments (Everitt 1996). Specific physiological investigations would have to be conducted to identify the causes of decreased sensitivity in large *A. auriculata* nymphs.

Experiments in the LASUs had to be split into sub-tests, which were run sequentially over a time period spanning different seasons (Section 3.1.1.). Acute toxicity tests were therefore repeated at different times of the year in one other system (Channels) using *A. auriculata*, so as to evaluate the influence of sequential testing on test results, without stream design characteristics as confounding variables. Although testing for seasonal influences was not initially identified as an objective of this study, seasonal sampling and consequent use of nymphs of different mean size required the consideration of seasonality (Section 4.5.3.; Figures 4.33. and 4.34.). *A. sudafricanum* data were included in this investigation for supportive purposes. The mean headwidth of *A. auriculata* nymphs collected in spring/early summer was larger than those collected in autumn (Figure 4.33.a.), whereas *A. sudafricanum* nymphs collected in spring were smaller than those collected in autumn (Figure 4.33.b.). Figure 4.34. shows that the EC50 values for both

species were higher in autumn experiments. These four figures therefore suggest that the headwidth-distribution of test populations is probably correlated with season. Because of the small data set, this is a preliminary finding which should be substantiated with further investigations.

The following explanation can be offered. The size-distribution of the population of *A. auriculata* nymphs at the Palmiet River collection site was found to fluctuate over time (Haigh and Davies-Coleman in press). This may also be the case for *A. sudafricanum*. Although nymphs for experiments were actively selected in respect of size (Section 3.2.3.), the aim to select nymphs "of as similar a size as possible" often had to be compromised because of the number of nymphs of a particular size available at the sampling site. It is therefore likely that the size-range present in the Palmiet River was reflected – to a certain extent – by the size-range of nymphs used in toxicity tests, which in turn affected EC50 values.

### *Conclusion*

The body-size, indicated by headwidth-means, most likely had an influence on test results of both species and reflected probably the abundance of nymphs of a certain size in the Palmiet River. Although the EC50–headwidth correlation for *A. auriculata* tests was statistically significant, the correlation was negative, which is in contrast to most findings documented in the literature. However, some researchers also noted atypical responses for the largest of the test organisms. No explanation can yet be offered as to possible causes.

### **5.3.2. Differences between species**

Two different species were used in this study as each test species had specific advantages, and were expected to differ in sensitivity (Section 2.3.3.). It was therefore an objective of this study to compare the two taxa. This was done by examining their mean EC50 values, parameters of the Probit analysis (slope and tolerance distribution), time-toxicity curves, and the general shape of cumulative effect *versus* time curves. Some of the curves also contain information on the toxic action of sodium sulphate.

#### *Mean EC50 values*

The mean EC50 values of both species are displayed in Table 5.1. It can be seen that *A. auriculata* is more tolerant to the toxicant sodium sulphate than *A. sudafricanum*, differing by a factor of 2.38. Hickey and Vickers (1992) pointed out that lower tolerances can generally be anticipated for smaller aquatic organisms because of the relationship between

organism size and response. Since the test species differ in body-size by a factor of 2.19 (the quotient of the grand mean headwidths, Table 4.28.), this factor is comparable to the factor between mean EC50s. Thus the different sensitivities between the test species may be explained by body-size differences.

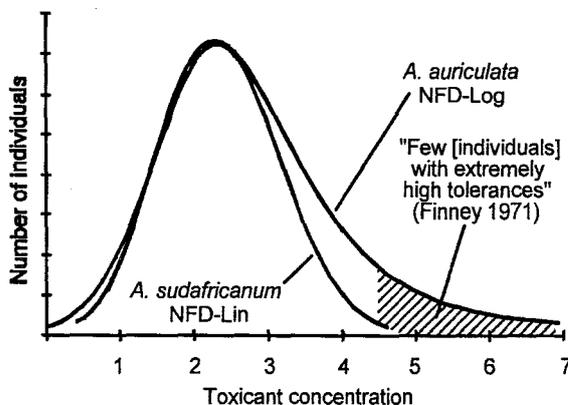
#### *Slopes of concentration-response curves*

The slope of a concentration-response curve contains information about the toxic action of the test chemical (Rand *et al.* 1995). When the slopes were compared graphically, they all seemed to be fairly similar (Figure 4.35.). This indicated that the toxic mechanism of sodium sulphate may be similar for both test species (*sensu* Rand and Petrocelli 1985).

Slopes of concentration-response curves were also correlated with headwidth-means of the test species (Table 4.28.) because the headwidth-means had a significant influence on test results (Section 5.3.1.). For experiments with *A. auriculata*, the graph shows a significant inverse correlation between slope values and mean headwidth (Figure 4.36.). Surprisingly, the same experiments as for the headwidth-EC50 relationship (Figure 4.32.) are grouped together. This may be a further indication of the link between body-size (as indicated by headwidth) and EC50 values. Small nymphs responding with a steep slope may be interpreted as responding faster to toxic effects than larger nymphs.

#### *Evaluation of tolerance distribution models*

EC50 calculations using Probit analysis revealed that the tolerance distributions of the two mayfly species were different (Section 4.1.1.). The significance of this finding is best explained graphically. Figure 5.1. shows the theoretical tolerance distributions for both models in a graph with linear concentration-scale. The distribution corresponding with the



**Figure 5.1.** Comparison of the two tolerance distribution models used in this study, and its implications.

NFD-Lin model is bell-shaped. The distribution corresponding to the NFD-Log model extends to the right. Finney (1971) assigns the striped area under the NFD-Log model curve to "a few [individuals] with extremely high tolerances". As *A. sudafricanum* tolerance distributions were best described using the NFD-Lin model, it appears that these populations lack extremely tolerant individuals. This suggests that *A. sudafricanum*

populations are less tolerant than *A. auriculata* populations. This difference in population-structure may be of significance when *A. auriculata* and *A. sudafricanum* would respond with the same EC50 value to a particular toxicant. With equal EC50s, but different tolerance distributions (NFD-Log for *A. auriculata*, NFD-Lin for *A. sudafricanum*), *A. sudafricanum* populations should still be more vulnerable. This hypothesis needs, however, to be verified with appropriate experiments.

#### *Time-toxicity curves*

Time-toxicity curves were linear for both species and did not show an asymptotic approach to the time-axis. Linear time-toxicity curves have been reported (Sprague 1969), but as toxicity tests were terminated after 96 h it is not known how the curve would have continued. The 96h-EC50 values for both species were therefore not threshold values and thus bear less ecological significance (Rand *et al.* 1995).

#### *Cumulative effect curves*

The general shape of cumulative effects over time curves were examined as they contain information on the toxic action of sodium sulphate. The general pattern of the curves for both species seemed to be fairly similar and ranged between a somewhat asymmetric sigmoid curve (similar to Figure 1.4.), often obvious at concentrations around the EC50 and higher, and a more linear increase of responses at the EC50 or lower concentrations. Most interestingly, in many experiments even at the highest concentrations not more than 20% of the test population responded within the first 12 h, and the highest response rates often occurred between 12 and 36 h. This delayed response may be interpreted as a resistance of the nymphs to the toxicant and thus may characterize slow acting toxicants such as sodium sulphate. The linear increase at lower concentrations supported the fact that the EC50 had not reached a threshold limit after 96 h.

### **5.3.3. Test species: General conclusion**

The examination of test results showed that *A. sudafricanum* is more sensitive to sodium sulphate than *A. auriculata*, which may be due to the differences in average body-size. The increased sensitivity of *A. sudafricanum* is further enhanced by the absence of extremely tolerant individuals, which is reflected by the shape of their tolerance distributions. However, both species seemed to react in a similar way to sodium sulphate as shown by similar slopes of the concentration-response curve and similar patterns of cumulative effect *versus* time graphs. These graphs, and their gentle slopes, identify sodium sulphate as a

slow acting toxicant. The significant correlations between headwidth and slope for *A. auriculata* emphasized the link between body-size and sensitivity.

## 5.4. Evaluation of the response of the two test taxa to elevated salinities

The increasing salinization of South African rivers is a serious threat to the domestic, industrial and agricultural sector of the country. Salinization has therefore been recognized as South Africa's single biggest pollution problem (Stander 1987). The effects on aquatic communities are, however, difficult to assess since research in this field has been rare. In selecting sodium sulphate as a salt to model salinity, the results of this study contribute to a better understanding of the responses of indigenous macroinvertebrates to salinization. This has formed a secondary aim of this study; results will be discussed by comparing test taxa responses with values from the literature, with salinity levels found in some South African rivers, and with national and international guideline criteria.

### 5.4.1. The test taxa in comparison to other freshwater macroinvertebrates

To be able to compare the sodium sulphate toxicity values for *A. auriculata* and *A. sudafricanum* with those of other freshwater macroinvertebrates, data were compiled from various sources and are presented in Table 5.3. From this table it can be seen that acute sodium sulphate toxicity values cover a range of about 3 orders of magnitude. Although the tolerances of both test species lie in the medium to upper part of this range, and the taxa therefore seem to be rather tolerant, they coincide well with values recorded for most of the other species. The majority of acute tolerance values lies within a range of about 0.5 to 10 g/L.

Salinity or TDS is a bulk variable comprising of many different ions. To determine the influence of the major ions (Na, K, Ca, Mg,  $\text{HCO}_3$ ,  $\text{CO}_3$ , F, Cl, and  $\text{SO}_4$ ; Dallas and Day 1993) on the response of aquatic organisms, their concentrations and bioavailability must be known. This is possible only when determining the ionic species formed by each element present in the water. When  $\text{Na}_2\text{SO}_4$  is dissolved in water, it forms the ionic species  $\text{Na}^+$  and  $\text{SO}_4^{2-}$ . However, the sulphate ion is known to interact with other ions such as metals, which may also be present in the sample, and forms chemical complexes (Ure and Davidson 1995). This complex formation reduces the overall sulphate ion concentration and adds the sulphate-metal complex to the sample. Since complex formation is an equilibrium reaction, not all sulphate ions react with all metal ions, and the concentration

of the newly formed species depends on factors such as temperature and pH (*ibid.*). For the multitude of ionic species present in a water sample, and the many possible ion-interactions, the calculation of an equilibrium between all ionic species and identification of influential ions is a complex task and requires specialized software such as the geochemical speciation program MINTQA2 (Kerr 1995). This type of determination was not within the scope of this thesis.

**Table 5.3.** Toxic effects of sodium sulphate on various aquatic freshwater species, in comparison with mean EC50 values of the test taxa. Values are sorted in decreasing order; in cases of conflict the 96 h toxicity estimator was prioritized. IT Immobilization threshold; MLC Minimum lethal concentration; NTP No time provided; RDW Reference dilution water; SM Stimulate movement; SRW Standard reference water; TT Toxicity threshold; ULW University lake water. Units in [g/L].

Species	Common name	Toxicity estimator	Duration of exposure			Other exposure time Conc. (time)	Comment	Ref.
			24 h	48 h	96 h			
-	Water beetle	SM	-	-	-	35.600 (NTP)	-	A
<i>Baetis harrisoni</i> <sup>a, b</sup>	Mayfly	LC50	-	-	-	13.49 (16.66 h)	20°C, pH 7.0	B
<i>Culex</i> sp. larvae <sup>b</sup>	Mosquito	LC50	11.430	13.350	-	-	RDW	C
<i>Choroerpes bugandensis</i> <sup>a, b</sup>	Mayfly	LC50	-	-	-	11.36 (16.66 h)	20°C, pH 7.0	B
<i>Fragilaria</i>	Diatom	no growth	-	-	-	10.000 (NTP)	-	A
<i>A. auriculata</i> <sup>a</sup>	Mayfly	EC50	11.905	9.529	8.090	8.944 (72 h)	-	
<i>Daphnia magna</i>	Water flea	EC50	-	-	-	7.105 (15 min)	-	D
<i>Polycelis nigra</i>	Flatworm	toxic	-	-	-	6.820 (NTP)	-	A
<i>Daphnia magna</i>	Water flea, young	EC50	6.800	6.100	-	-	SRW	C
<i>Daphnia pulex</i> <sup>b</sup>	Water flea	LC50	-	-	6.453	-	-	E
<i>Daphnia magna</i>	Water flea	IT	-	-	-	5.960 (0 h)	Lake Erie water	A
<i>Daphnia magna</i>	Water flea	TT	-	-	-	5.514 (NTP)	636 mg/L DO	A
<i>Daphnia magna</i>	Water flea	EC100	-	5.200	-	-	-	D
-	Microcrustacean	toxic	5.000	-	-	5.000 (6 d)	-	A
-	Water snails	toxic	-	-	-	5.000 (68 h)	-	A
<i>Daphnia magna</i> <sup>b</sup>	Water flea	EC50	-	-	4.547	-	SRW	C
<i>Lymnaea</i> sp. eggs <sup>b</sup>	Pond snail	LC50	5.401	5.400	3.553	-	ULW	C
<i>A. sudafricanum</i> <sup>a</sup>	Mayfly	EC50	5.830	5.024	3.404	4.104 (72 h)	-	
<i>Daphnia magna</i>	Water flea	TT	-	-	-	2.752 (NTP)	1.46 mg/L DO	A
<i>Hydra</i>	Polyp	toxic	-	-	-	1.000 (NTP)	-	A
<i>Amphipoda</i>	Crustacean	EC50	2.380	1.110	0.880	-	ULW	C
<i>Tricorythus nr. tinctus</i> <sup>a, b</sup>	Mayfly	LC50	-	-	0.838	-	Sabie River water	F
<i>Daphnia magna</i> <sup>b</sup>	Water flea	EC50	8.384	2.564	0.630	0.725 (72 h)	ULW	C
<i>Stenonema ares</i>	Caddis fly	LC50	-	-	-	0.320 (40 d)	soft water	A
<i>Artemia salina</i> , 2 week larvae	Brine shrimp	EC0	-	-	-	0.024 (100 h)	static water	D

References: A) Anon 1985; B) Noble 1970; C) Dowden and Bennett 1965; D) VCI 1992; E) Truter, personal communication; F) Scherman *et al.* in press b.

Comments: <sup>a</sup> Species indigenous to South Africa; <sup>b</sup> The sodium chloride toxicity value of this species is directly comparable to the sodium sulphate toxicity value of Table 5.4. in terms of test conditions.

In this study, the use of sodium sulphate to model salinization ignored the influence of individual ions and their interactions, therefore simplifying the chemical reality and rendering predictions less accurate. However, for this study this approach was acceptable as the investigation of the effects of salinity was only the secondary aim of the thesis, and using a single salt as toxicant greatly simplified the conducting of toxicity tests in the different artificial stream designs. Also, in the process of the salinization of rivers, three main ions normally increase in concentration: sodium, chloride, and sulphate (Davies and Day 1998). The influence of other ions was therefore considered to be small.

Although Scherman *et al.* (in press b) found sulphate ions to have an exacerbating effect on mortalities of mayfly nymphs exposed comparatively to sodium chloride and sodium sulphate, other studies have found NaCl to be more toxic than Na<sub>2</sub>SO<sub>4</sub> (Dowden and Bennett 1965; Truter, personal communication). The EC50s for both salts are similar enough to place the results of this study in the context of comparative studies of responses to either salt.

Sodium chloride is usually the main contributor to the salinization of fresh waters (Davies and Day 1998). As the sodium cation is common to both sodium chloride and sodium sulphate, a comparison of the toxicity of the two salts provides some indication of the toxicity of their anions and thus can assist in the assessment of the overall toxicity of TDS. Some acute sodium chloride tolerances for some freshwater macroinvertebrates have therefore been summarized in Table 5.4.

The knowledge of the tolerance to sodium chloride of the two test species would therefore greatly assist in evaluating their responses to salinity. No tests were conducted in this study using sodium chloride as toxicant, but Corbett (1996) conducted experiments with *A. sudafricanum* using sodium chloride. Although his data did not yield an EC50, an EC50 can be extrapolated using the Probit analysis results of this study and some reasonable assumptions. This extrapolation relies on the following facts. In Corbett's (1996) study, *A. sudafricanum* was exposed to a concentration of 6.95 g/L NaCl and responded on average with 18.3% mortality after 96 h. If it is assumed that Na<sub>2</sub>SO<sub>4</sub> and NaCl have similarly shaped concentration-response curves because they are similar salts and may therefore display similar toxic mechanisms, the Probit equation (Equation 3.5., Section 3.3.1.) can be used to extrapolate an EC50. The concentration-response data of Experiments 6 and 8 were selected as models because these curves represent the extremes in terms of slope (compare

with Figure 4.35.). Using a transformed version of Equation 3.5.<sup>26</sup>, a sodium chloride EC5 of 5.513–6.374 g/L, and an EC50 of 7.653–8.285 g/L for *A. sudafricanum* can be extrapolated. These values have been included in Table 5.4.

**Table 5.4.** Sodium chloride tolerances of some freshwater macroinvertebrates in comparison with preliminary and extrapolated data for *A. auriculata* and *A. sudafricanum*. BW Borehole water; DS Diluted seawater; GHT Grahamstown, South Africa; MTS Median time of survival; MW Municipal water; RDW Reference dilution water; RW River water; SRW Standard reference water; ULW University lake water. Units in [g/L].

Species	Common name	Toxicity estimator	Duration of exposure			Other exposure time Conc. (time)	Comment	Ref.
			24 h	48 h	96 h			
<i>Baetis harrisoni</i> <sup>a, b</sup>	Mayfly	LC50	-	-	-	13.44 (16.67 h)	NaCl in BW	A
<i>Choroterpes</i>	Mayfly	LC50	-	-	-	11.69 (16.67 h)	NaCl in BW	A
<i>bugandensis</i> <sup>a, b</sup>								
<i>Culex sp. larvae</i> <sup>b</sup>	Mosquito	LC50	10.500	10.200	-	-	NaCl in RDW	B
<i>A. auriculata</i> <sup>a</sup>	Mayfly	EC50	-	-	>8.088	-	Likely location of EC50 (see text)	-
<i>A. sudafricanum</i> <sup>a, b</sup>	Mayfly	EC50	-	-	7.653– 8.285	-	Likely range of EC50 (see text)	-
<i>Cloeon crassi</i> <sup>a</sup>	Mayfly	MTS	10.500	-	-	7.000 g/L (10.8 d)	DS	C
<i>Afroptilum excisum</i> <sup>a</sup>	Mayfly	MTS	≈10.500	-	-	7.000 g/L (40 h)	DS	C
<i>Baetis tricaudatus</i>	Mayfly	EC50	7.33	4.74	-	-	NaCl in RW	D
<i>Daphnia magna</i> <sup>b</sup>	Water flea	LC50	6.447	5.874	-	3.114 (100 h)	NaCl in SRW	B
<i>Choroterpes sp.</i> <sup>a</sup>	Mayfly	LC50	-	-	4.430	-	Sabie RW	E
<i>Lymnaea sp. eggs</i> <sup>b</sup>	Pond snail	LC50	3.412	3.388	-	-	NaCl in ULW	B
<i>Daphnia magna</i> <sup>b</sup>	Water flea	LC50	3.412	3.310	-	-	Static, NaCl in ULW	B
<i>Daphnia pulex</i> <sup>b</sup>	Water flea	LC50	-	-	3.010	-	3	F
<i>Daphnia pulex</i>	Water flea	LC50	3.090	2.420	-	-	Sabie RW	E
<i>Tricorythus nr tinctus</i> <sup>a, b</sup>	Mayfly	LC50	-	-	2.300	-	Sabie RW	E

References: A) Noble (1970); B) Dowden and Bennett (1965); C) Forbes and Allanson (1970); D) Lowell *et al.* (1995a); E) Palmer and Scherman in press; F) Truter (personal communication).

Comments: <sup>a</sup> Species indigenous to South Africa; <sup>b</sup> The sodium chloride toxicity value of this species is directly comparable to the sodium sulphate toxicity value of Table 5.3. in terms of test conditions.

As for *A. auriculata*, no data are available concerning its response to sodium chloride. A comparison of Tables 5.3. and 5.4. may, however, provide some hint on the most likely range where an NaCl-EC50 could be expected.

<sup>26</sup> When Equation 3.5. (Chapter 3.3.1.) is solved for  $\mu$ , this results in the equation  $\mu = x - [\sigma(Y - 5)]$ . For an explanation of equation variables see Chapter 3.3.1. In the following, an example is given for the calculation of an EC50 value of Experiment 6: when  $x = 6.95$  g/L (the NaCl concentration with 18.3% mortality as found by Corbett (1996)),  $\sigma = 0.777457$  (see Appendix A Experiment 6 "sigma"), and  $Y = 4.096$  (probit value which corresponds with 18.3% response), then  $\mu = 7.653$ .

In Tables 5.3. and 5.4., the responses of nine species can be compared directly (marked with <sup>b</sup> in both tables) as tests were conducted under similar conditions. Of these species, four exhibited higher sensitivity to Na<sub>2</sub>SO<sub>4</sub> than to NaCl, whereas for five species the opposite was the case. *Tricorythus nr. tinctus* responded most differently to the two salts (differing by factor 2.74), but six species responded in a fairly similar manner (factor <1.6). Generally, most species of both tables responded to the two salts within an order of magnitude (ca. 0.5–10 g/L). This is quite a narrow range considering that responses of one species to different toxicants may differ by a factor of 1800 (Williams *et al.* 1984), but even more so since the response of one species to a single toxicant in repeated short-term experiments has been found to differ by factors between 2 and 5.5 (Sprague 1985; Cooney 1995; see also Section 5.2.1.). Although the database for these findings is small, the following statements are reasonable:

- The toxicity of both salts is similar because similar numbers of species responded either to NaCl or Na<sub>2</sub>SO<sub>4</sub> more sensitive, and responses differed by no greater factor than 2.74 which falls within the variation of responses considered normal for a single species exposed repeatedly to the same toxicant.
- The toxic action of both salts may be similar because all species responded in a similar concentration range (ca. 0.5–10 g/L).
- Both salts seem to be equally useful in modelling salinity because of the rather narrow response range of all species to both salts.
- The NaCl-EC50 for *A. auriculata* is likely to be similar or greater than its Na<sub>2</sub>SO<sub>4</sub>-EC50 because the majority of the nine comparable species showed equal responses to both salts, while the two South African mayflies (*Tricorythus nr. tinctus* and *A. sudafricanum*), in tests with equal exposure times, were more sensitive to Na<sub>2</sub>SO<sub>4</sub> than to NaCl.

Dallas and Day (1993) stated that the proportional concentrations of the major anions in TDS is not of great biological significance. The general similarity of responses to the two salts as seen in Tables 5.3. and 5.4. supports this statement.

#### 5.4.2. Extrapolation of test results to the field

The toxicity values of this study have been obtained from short-term experiments. Although these results provided a first indication of the response of *A. auriculata* and *A. sudafricanum* to sodium sulphate, a direct extrapolation to field TDS levels which are safe for the two taxa is very difficult because of the enormous number of additional relevant environmental factors. At most, it may therefore be suggested whether a safe TDS level

might lie above or below the mean EC5 values of both species. For a field-extrapolation, the EC5 (the concentration at which five per cent of the test population is affected) is ecologically more sensible than the EC50 because it provides 95% protection for the population of concern (DWAF 1996a). The following factors are likely to cause EC5 values to be *lower* than no-effect TDS levels in the field:

- Factors associated with the test type, which are generally the high artificiality of the laboratory environment, the use of a single species which excludes interactions at higher biological organizational levels, and the short exposure to the toxicant (*sensu* Parrish 1985).
- The sudden addition of sodium sulphate at the initiation of the toxicity test, which resulted in a sharp increase in salinity. Compared to the situation in the field, this is a rather unusual scenario since salinities mostly rise gradually over extended periods. A gradual increase would probably have allowed the species to acclimate to new conditions, resulting in a higher sodium sulphate tolerance. For the same reason Hart *et al.* (1991, 1992) suggested that saline wastewater be released into a river gradually in preference to a quick release of large quantities.
- The alkaline pH peaks at test initiation were likely to have adversely affected toxic responses, especially in Experiments 1–5. Presuming that the effects of sodium sulphate and pH acted additively, EC5 values might have been higher without the influence of alkaline pH.

The following factor may have caused EC5 values to be *higher* than no-effect TDS levels in the field.

- The EC5/EC50 values of this study were time-dependent. After 96 h exposure, no threshold toxicity was found, thus a longer exposure might have resulted in lower EC5s/EC50s.

Since more factors in the extrapolation point towards less severe effects in the environment, "safe" TDS levels may be higher than the EC5 values calculated in this study. However, because of the high degree of uncertainty, and the use of a single salt as a model for TDS (a simplification whose effects are impossible to quantify without specific focused research), a comparison of EC5/EC50 values with environmental TDS or sulphate levels will only provide a very preliminary indication of the extent to which test taxa might be affected by salinity. The TDS-levels of some South African rivers have been listed (Table 5.5.), along with the sulphate ion concentration where provided. This table documents selected salinity levels of some rivers, but does not intend to give a comprehensive account of the present situation.

**Table 5.5.** The salinity levels of some South African rivers. Percentage of sulphate is given where TDS and SO<sub>4</sub> data could be directly related, i.e. TDS and SO<sub>4</sub> levels were measured at the same time. NC Natal coalfields.

River	Samples taken	TDS [g/L] mean (range)	Sulphate	Ref.
Buffalo River (E.C.)	Middle/lower reaches	ca. 0.4	-	A
Great Fish River	Jordaans Kraal	1.7 (1.2-2.3)	-	B
Klip River <sup>a</sup>	Witwatersrand area	(0.930-1.530)	0.405–1.660 g/L	C
Klipspruit River <sup>a</sup>	Witwatersrand area	(0.241–0.624)	0.475 g/L	C
Olifants River <sup>a</sup>	Loskop valley	1.050 <sup>b</sup>	-	D
Poesjesnels River	Breede River tributary	5.296	13% (0.678 g/L)	E
Pongolo River	M'Hlati	(0.1–1.2)	-	B
Riet River	Lower reaches	2.4	-	F
Sandspruit	Berg River tributary	(4.5–9.0)	-	G
Streams through NC <sup>a</sup>		2.5–3.0	ca. 2.0 g/L	C
Sundays River	Lower reaches	(0.8–14.9)	12–20%	H
Umzinyatshana <sup>a</sup>	Lower reaches (NC)	1.037	0.697	C
Vaal River <sup>a</sup>	Balkfontein	0.512 (0.108–1.032)	41% (0.209 g/L)	I
Wasbank <sup>a</sup>	NC	3.105	2.010	C

References: A) Maart 1996; B) Du Plessis and van Veelen 1991; C) Dallas and Day 1993; D) Aihoon *et al.* 1997; E) Greeff 1994; F) Herold 1994; G) Flügel 1991; H) Forbes and Allanson 1970; I) Roos and Pieterse 1995.

Comments: <sup>a</sup> Catchment of river incorporates significant mining activities; <sup>b</sup> Value described as "often reached upper limit".

Six rivers in Table 5.5. run through areas of mining activity (marked with <sup>a</sup>), and consequently the sulphate ion forms a significant part of the TDS. In these cases, the realism of sodium sulphate as a salinity model substance is enhanced.

EC values of this study are repeated below to ease comparison of test taxa tolerances with river salinities:

- *A. auriculata* and Na<sub>2</sub>SO<sub>4</sub>: EC5 5.683 g/L; EC50 8.088 g/L
- *A. auriculata* and NaCl: EC50 likely >8.088 g/L
- *A. sudafricanum* and Na<sub>2</sub>SO<sub>4</sub>: EC5 1.608 g/L; EC50 3.404 g/L
- *A. sudafricanum* and NaCl (extrapolated): EC5 5.513–6.374 g/L; EC50 7.653–8.285 g/L

The salinity in most rivers exceeded a level of 1 g/L by their mean or peak values, but very few exceeded 5 g/L. For *A. auriculata* these levels do not seem to be harmful since their Na<sub>2</sub>SO<sub>4</sub>-EC5 value is above 5 g/L, a "safe" TDS level is probably higher, and their NaCl tolerance is also likely to be higher. Effects on *A. sudafricanum* populations are more difficult to assess. The Na<sub>2</sub>SO<sub>4</sub>-EC5 value is exceeded by the TDS-levels of most rivers, but only few rivers showed higher mean or peak salinities than the extrapolated NaCl-EC5. The effect of TDS on *A. sudafricanum* populations therefore seems to depend more on its ion composition. TDS concentrations with higher sulphate proportions probably have a

more negative effect than NaCl-dominated TDS concentrations. However, these assessments bear a great deal of uncertainty since the influence of other ions on the overall effect is unknown (the calcium ion for example has been found to have an ameliorative influence; Scherman *et al.* in press b). For ecologically sound deductions, site-specific chronic tests should be conducted with a more realistic ionic composition of the TDS.

Despite the uncertainties associated with these extrapolations, the results are useful for two reasons. Firstly, the sodium sulphate EC50 values of both taxa may contribute to the development of a sodium sulphate guideline for the South African Water Quality Guidelines for Aquatic Ecosystems, where they may be incorporated in the calculation of a Final Acute Value (FAV) (DWAF 1996a; Roux *et al.* 1996). Secondly, an acute toxicity value may realistically predict short-term effects and be of use when predicting the effects of an accidental spill into a natural water course.

#### 5.4.3. Comparison of EC50 data to guideline criteria

The South African Water Quality Guidelines for Aquatic Ecosystems provide a guideline for TDS, but not for sulphate or sodium sulphate. Internationally, only sulphate guidelines have been reviewed (Kempster *et al.* 1980; Chiaudani and Premazzi 1988). These guidelines, and the TDS limit proposed by Hart *et al.* (1990, 1991) will be discussed.

The TDS guideline in the South African Water Quality Guidelines for Aquatic Ecosystems contains a Target Water Quality Range (TWQR), but no Acute Effect Values (AEVs) or Chronic Effect Values (CEVs). The TWQR is stated "in terms of case- and site-specific TDS concentrations" and therefore requires the determination of local conditions (i.e. TDS concentrations, variability, seasonal changes) before the guideline can be applied. The guideline states that the "TDS concentrations should not be changed by >15% from the normal cycle of the water body under unimpacted conditions at any time of the year; and the amplitude and frequency of natural cycles in TDS concentrations should not be changed" (DWAF 1996a). The Palmiet River has been used to evaluate the water quality criterion because it is the natural habitat of both test species, and sufficient TDS data were available (Haigh and Davies-Coleman 1997; measurements of this study). The TDS recorded during Haigh and Davies-Coleman's study (1994–1996, unpublished data), and the measurements taken throughout this thesis (Appendix B) covered a range of 0.039–0.141 g/L TDS. When this range is extended by the allowed 15%, the maximum TDS is 0.162 g/L. This TDS concentration is considerably below the EC5 of the more sensitive *A. sudafricanum*, which means that the TWQR will protect both test taxa. The limitations of

an extrapolation of toxicity values of this study to the field must, however, be borne in mind. Also, neither test taxon appears to be particularly sensitive to sodium sulphate, yet the guidelines aim to protect the most sensitive species. The protective nature of the TDS guideline should therefore be tested by more data, especially chronic toxicity studies.

The limit of 1 g/L TDS, proposed by Hart *et al.* (1990, 1991) for aquatic ecosystem protection, would well protect *A. auriculata*, and probably also *A. sudafricanum*. The  $\text{Na}_2\text{SO}_4$ -EC5 of *A. sudafricanum* (1.608 g/L) is, however, close to the 1 g/L limit. Here, too, a comparison with chronic toxicity data would yield a more realistic evaluation.

International guideline criteria for sulphate ranged between 0.150 and 1.400 g/L  $\text{SO}_4$  (0.22–2.07 g/L  $\text{Na}_2\text{SO}_4$ ) (Kempster *et al.* 1980; Chiaudani and Premazzi 1988; Table 5.2.). The lower limit advocated by the Netherlands (Chiaudani and Premazzi 1988) will protect both test species, but the upper limit would probably not be protective of *A. sudafricanum*, as it lies between the  $\text{Na}_2\text{SO}_4$ -EC5 and the EC50 of this species. The protective nature of the guidelines of the Netherlands should, however, be tested more realistically with results from long-term toxicity tests.

#### 5.4.4. Elevated salinities: General conclusion

In comparison to other freshwater macroinvertebrates, both test taxa showed moderate tolerance to sodium sulphate. Their mean 96h-EC50s (8.088 g/L for *A. auriculata* and 3.404 g/L for *A. sudafricanum*) fall in the range of 0.5–10 g/L, which is occupied by most other macroinvertebrates. Preliminary data from Corbett (1996) allowed an extrapolation to a sodium chloride EC50 for *A. sudafricanum* (7.653–8.285 g/L) which suggested that this species is more tolerant to NaCl than to  $\text{Na}_2\text{SO}_4$ . This trend was also found for another South African mayfly, but not for other macroinvertebrates. Of the species whose test results were directly comparable, most showed similar tolerances to the two salts. These data point towards a similarity of the toxicity and toxic mechanism of both salts, and suggest that the NaCl tolerance of *A. auriculata* is likely to be equal or greater than its  $\text{Na}_2\text{SO}_4$  tolerance. Both test taxa therefore appear to be moderately tolerant to both salts.

A direct extrapolation of test results to the field is very difficult because of the short duration of the test, the use of a single species, controlled laboratory conditions, and an unlikely exposure scenario (immediate exposure to the salt). Further uncertainties are the time-dependency of the EC50 values of this study, and the simplification of responses to TDS by using only one salt as a salinity model. However, most of these factors would

cause the EC5/EC50 to over-estimate adverse effects of salinity in the field. Using the EC5 as a "safe" TDS level, this level might be higher than the calculated EC5. *A. auriculata* would be less affected by some salinity levels found in South African rivers, whereas *A. sudafricanum* might suffer sub-lethal effects, more likely to appear when the sulphate ion proportion of the TDS increases.

The TWQR for TDS of the South African Water Quality Guidelines for Aquatic Ecosystems assures protection of both test taxa in the Palmiet River. The maximum allowable TDS concentration of 1 g/L proposed by Hart *et al.* (1990, 1991) would protect *A. auriculata* well, and probably also *A. sudafricanum*. A different scenario emerges for a comparison of international sulphate guidelines. *A. auriculata* would be protected in all cases, but *A. sudafricanum* populations might suffer sub-lethal effects. For a more comprehensive guideline evaluation, chronic toxicity data are necessary.

## 5.5. The two taxa for routine toxicity testing

The database for responses of macroinvertebrates indigenous to South Africa to chemical substances is limited. It would therefore be of great value to identify a local species which is sensitive and could be reared in the laboratory. *A. auriculata* was identified by the Standard Laboratory Organism project (Haigh and Davies-Coleman 1997, in press) as such a potential species as it was amenable to rearing in the laboratory. However, fertilization could not be repeated and breeding failed. It exhibited, however, only moderate sensitivity to some toxicants (Everitt 1996; Gerhardt and Palmer 1998). Therefore the baetid *A. sudafricanum* was selected as an alternative species for this study. Some members of the baetid mayfly family have shown increased sensitivity (Buikema and Voshell 1993), thus *A. sudafricanum* could be more sensitive.

One of the main arguments for the use of standard laboratory organisms in toxicity tests for regulatory purposes is the standard nature of their response characteristics. As they are bred and reared in the laboratory, their physiology and genetic background is known. However, even for these organisms variability of acute test results has been recorded, and toxicity values differing by a factor of 2–3 are considered to be normal (Cooney 1995). In this study it was shown that the variability of test results with indigenous organisms (maximum ratio 1.65 for *A. auriculata*, and 1.47 for *A. sudafricanum*; Table 5.1.) was well within the range internationally accepted (*ibid.*). This holds despite the fact that the desired range of body-sizes was compromised because of the level of availability in the field, which in turn resulted in significant differences of mean body-sizes between test populations. This may

serve as an indication that results obtained from field-collected animals can be more reliable than expected.

However, neither species seemed to be particularly sensitive. *A. auriculata* proved to be moderately to highly tolerant to the metals copper (Gerhardt and Palmer 1998) and zinc (Everitt 1996). In the present study, they were also fairly tolerant to sodium sulphate, and probably sodium chloride. Although *A. sudafricanum* was shown to be more sensitive to both salts, this may be due to the smaller body-size. When the salinity tolerances of other aquatic macroinvertebrates are compared, *A. sudafricanum* also appears to be quite tolerant.

The sensitivity of both species is too similar to make one preferable for regular use in toxicity tests (*sensu* Fogels and Sprague 1977). The mean EC50s of both species differed by a factor of only 2.38, which falls within the variability accepted as normal for standard laboratory organisms tested against single toxicants (e.g. range 2–3, Cooney 1995; also Section 5.2.1.).

However, since both species seemed to be rather tolerant, they do not fulfil the demands of a "most sensitive species", an approach adopted by the South African Water Quality Guidelines for Aquatic Ecosystems (DWA 1996a). Standard test organisms such as *Daphnia* spp. showed a similar or higher sensitivity to sodium sulphate and sodium chloride. Management decisions based on these results would therefore also be protective for *A. auriculata* and *A. sudafricanum*.

#### **5.5.1. The two taxa for routine toxicity testing: General conclusion**

The variability of test results from the two local species used in this study compares well with the results encountered for standard laboratory organisms. However, both species are moderately tolerant to sodium sulphate, and preliminary results indicated that the same is likely for sodium chloride. Since standard laboratory organisms such as *Daphnia* spp. showed a similar or higher sensitivity to both salts, they seem to be a suitable substitute for the tested taxa. For sodium sulphate tolerance testing, the use of the indigenous mayfly species *A. auriculata* and *A. sudafricanum* was of no particular advantage.

## 5.6. General criticism, recommendations, and research suggestions

The following list provides some criticisms and comments on various aspects of the study, and suggests further research.

### 5.6.1. General criticism

- **ALKALINE PH PEAKS:** The fluctuation in pH after the addition of sodium sulphate put additional stress on test taxa. This effect could easily have been eliminated by neutralising the concentrated salt solutions before test initiation, e.g. using sulphuric acid. All experiments could then have been run at a neutral pH.

### 5.6.2. Comments and recommendations

- **END POINT:** The literature clearly distinguishes between LC50 and EC50 values (Rand and Petrocelli 1985; APHA 1992), and since an "effect" occurs in an individual before it dies, EC50 values are in principle a more sensitive toxicity estimator than LC50s. However, of the literature reviewed in this study, none of the authors distinguished between LC50s and EC50s when acute toxicity values of various species were compared (e.g. Mayer and Ellersieck 1988; Buikema and Voshell 1993). When one looks at the techniques used to determine whether a test organism, especially an macroinvertebrate, is dead (e.g. gentle prodding (Hickey and Vickers 1992); hydraulic agitation using a plastic pipette (Hickey and Vickers 1994); ability to right themselves after being overturned (Lowell 1995a); cessation of gill movement (Palmer, personal communication)), then it becomes obvious that it is seldom known how to determine the occurrence of death, and thus a rather arbitrarily chosen criterion is often used. It therefore appears that LC50 and EC50 values are much less different in practice than the different terms imply.
- **ACCLIMATION:** Experiment 8 demonstrated the disadvantages of immediately transferring test organisms from the river to laboratory water, and also short acclimation periods, through increased responses during acclimation, and in the control during the test period. The only way to avoid these effects is a gradual acclimation of test organisms to laboratory water and an extended acclimation period (Rand and Petrocelli 1985). A careful monitoring of the water quality of both water sources (river

and tap water) prior to an experiment, may assist in an assessment of potential transfer effects.

- **TEMPERATURE CONTROL:** Although the laboratory water temperature could generally be kept within a range of  $\pm 2^{\circ}\text{C}$ , the use of the air conditioners in the artificial stream laboratory in order to control water temperatures was problematic. It was experienced that they were influenced to a certain degree by ambient temperatures. This remains a problem for future studies in this laboratory.

### 5.6.3. Research suggestions

- **BODY-SIZE EFFECTS:** This study demonstrated the effects of body-size on EC50 values. Worthwhile questions include: why the correlation between the average body-size of *A. auriculata* and EC50 values is negative; and what the maximum allowable size-range for macroinvertebrates is to be used in (acute) toxicity tests.
- **SALINITY INCREASE:** The salinity in rivers usually increases gradually. What is the EC50 of both test taxa when they are given a chance to acclimate to increased sodium sulphate levels over an extended period?
- **COMPROMISE ABUNDANCE OF FIELD-COLLECTED TEST ORGANISMS WITH STATISTICAL DESIGN:** Site-specific research will always rely upon the abundance of the selected test species. This often requires a compromise of the following test-design related factors: Total number of insects required; acceptable size-range of test organisms; minimum number of concentrations; minimum number of replicates; minimum number of animals per concentration. How can these factors be ranked in their importance to test precision, so as to combine the available number of test organisms with the most powerful test design?
- **TEST POPULATION CHARACTERISTICS:** *A. sudafricanum* populations exhibited a lack of extremely tolerant individuals. What are the environmental and perhaps ecological implications for *A. sudafricanum* populations specifically, and populations with this characteristic in general?

---

# Chapter 6

## Concluding summary

---

The aim and objectives of this study were met as follows:

- 1) To conduct short-term experiments in three different artificial stream systems at two main scales using *A. auriculata* and *A. sudafricanum* as test taxa, and sodium sulphate ( $\text{Na}_2\text{SO}_4$ ) as reference toxicant; and to use the test results, and the practical performance of the artificial stream systems, to define their future application in acute toxicity tests.

The comparison of the artificial stream designs was based only on data from *A. auriculata* as *A. sudafricanum* was not available throughout the year, and the species required identification after experiments to ensure a single-species test population. The comparison showed that the EC50 values obtained from the different systems were statistically significantly different, but did not differ more than is considered to be normal for biological systems. A closer observation demonstrated that the apparent differences were not related to the scale or the average current velocity inherent to each stream design. The decision as to which artificial stream system to use for regular toxicity testing, could therefore be based on practical considerations. Since the small-scale Channels proved to be most efficient throughout this study, these are the systems recommended for use in future short-term experiments with freshwater macroinvertebrates requiring a lotic environment. The large-scale Large Artificial Stream Units (LASUs) should be used where the accurate description of hydraulic variables is necessary.

- 2) To compare and evaluate the responses of the two mayfly species in order to assess their suitability for routine toxicity testing.

Four areas were examined in order to assess test taxa responses: The effects of body-size, the general reaction to the salt under investigation, their sensitivity in comparison to each other and other freshwater macroinvertebrates, and the variability of responses. It could be shown that EC50 values from the set of experiments with *A. auriculata* were significantly correlated with their average body-size, that is experiments with nymphs with a small average body-size produced higher EC50 values than experiments with nymphs having a larger mean body-size. The specific average body-size encountered in an experiment may have reflected the abundance of a certain body-size-range in the Palmiet River present at

the time of collection. The negative correlation between average body-size and EC50 values is in contrast to most other findings documented in the literature, but some researchers have reported abnormal responses of very large individuals. No explanation for this phenomenon can yet be offered. From a relative perspective, both species reacted similarly to sodium sulphate as indicated by similar slopes of the 96 h toxicity curves and cumulative effect *versus* time curves. These curves also identified sodium sulphate as a slow acting toxicant. In absolute terms, *A. sudafricanum* was more sensitive to sodium sulphate than *A. auriculata*. This is probably due to its smaller average body-size, but *A. sudafricanum* populations also exhibited – in contrast to *A. auriculata* populations – a lack of extremely tolerant individuals, which further increased their sensitivity. In comparison to other freshwater macroinvertebrates, including standard laboratory organisms such as *Daphnia* spp., both species seemed to be moderately tolerant to sodium sulphate, and indications are that this may also be the case for sodium chloride. The variability of test results for both field-collected indigenous mayfly species did not fall outside the range of variations experienced elsewhere using standard laboratory organisms. However, because of the moderate tolerance of both taxa towards salinity, their use in routine toxicity tests seems to be of no particular advantage in comparison to *Daphnia* spp.

### 3) To assess the effect of elevated salinity levels on the test taxa.

The mean sodium sulphate EC50 values of both test taxa were compared to those of other freshwater macroinvertebrates. Both EC50s fell well into the middle range of recorded short-term tolerance values, with *A. auriculata* towards the upper range. Preliminary data for *A. sudafricanum* from another study, allowed extrapolation to a sodium chloride EC50, which showed that this species is more tolerant to NaCl than to Na<sub>2</sub>SO<sub>4</sub>. A comparison of acute toxicity data for both salts of various test species (Tables 5.3. and 5.4.) showed that freshwater macroinvertebrates do not generally exhibit preferential sensitivity for one of the two salts. Whether NaCl or Na<sub>2</sub>SO<sub>4</sub> is more toxic therefore seems to be species-dependent. However, most toxicity values for either of the salts occurred within a range of ca. 0.5–15 g/L.

A direct extrapolation of the results of this study to TDS levels in the field is very difficult owing to the short test exposure, the use of single species, artificial laboratory conditions, an unlikely exposure scenario, the time-dependency of the EC50 values, and the simplification of the physico-chemical reality by using only a single salt. However, results suggest that a TDS level harmless to both taxa is probably higher than the acute EC50 values of this study. Since *A. sudafricanum* exhibited higher sensitivity to Na<sub>2</sub>SO<sub>4</sub> than to

NaCl (extrapolated data), a TDS with increased sulphate levels is probably more toxic for this species than a NaCl-dominated one. A preliminary comparison of EC5 values of both taxa with TDS levels documented for some South African rivers, showed that *A. auriculata* populations would mostly not be affected. However, *A. sudafricanum* populations may suffer from sub-lethal to lethal effects, depending on the proportion of the sulphate ions making up the TDS.

The Target Water Quality Range for TDS of the South African Water Quality Guidelines for Aquatic Ecosystems (DWAF 1996a) is stated in terms relative to the water body of concern; this means that the maximum allowed alteration from natural, seasonal, unimpacted TDS cycles in the water body must not exceed  $\pm 15\%$ . The guideline was therefore evaluated using the TDS range recorded for the Palmiet River, which is a natural habitat for both test species. If the TDS range were extended to its maximum allowable limit, it still would not have negative effects on either test species. The guideline therefore seems to be protective. Internationally proposed guideline values for TDS or sulphate (Kempster *et al.* 1980; Chiaudani and Premazzi 1988) were protective for *A. auriculata* in all cases, but some did not sufficiently protect *A. sudafricanum*.

The approach of this study has been successful and yielded results which have been used in the development of a protocol for the acute toxicity testing of single substances using riverine macroinvertebrates in artificial stream systems (DWAF 1999b).

---

# *Appendices*

---

## **Appendix A**

### **Current velocity and water depth measurements in artificial stream systems**

All current velocity measurements were carried out using a Scientific Instruments current velocity meter Model 1205 (Mini Meter with a 50 mm dia propeller), unless stated otherwise. The rating limit range for this instrument is 7.5 - 91.4 cm/s. Within this range, the following equation can be used to calculate velocities out of pulse counts.

$$U = \left( \left( \frac{n}{\Delta t} \times 0.977 \right) + 0.028 \right) \times 30.48 \text{ [cm]} \quad \text{Equation A.1.}$$

where:

- $U$  current velocity [cm/s]
- $n$  acoustic pulses of the instrument
- $\Delta t$  time interval [s]

Pulses were generally counted within a 90 s interval, and the measurements were taken 22 mm off the stream bottom (i.e. the lowest possible setting of the instrument to submerge the propeller completely) in the LASUs and the Raceways. As the instrument lost oil from its bearings during measurements this might have had an adverse effect on the test organisms. Both artificial stream systems were therefore drained and cleaned after measurements were taken, and refilled prior to final experiments.

A Marsh-McBirney current velocity meter Model 2000 Flo-Mate became available during the study. This instrument uses an electromagnetic sensor and has no lower limit for measuring velocities. It was therefore used to measure current velocities in the Channels, as measurements with the Scientific Instruments current velocity meter were constantly below the rating limit and thus unreliable. As the probe consists of a polyurethane body with some metal elements, the experimental medium was left unaltered. Velocities were measured for a 30 s period using the "fixed point averaging" method, where the measured velocities are averaged over a fixed period of time. A comparison of the Marsh-McBirney

current velocity meter with the Scientific Instruments current velocity meter in a LASU channel showed good agreement of measurements.

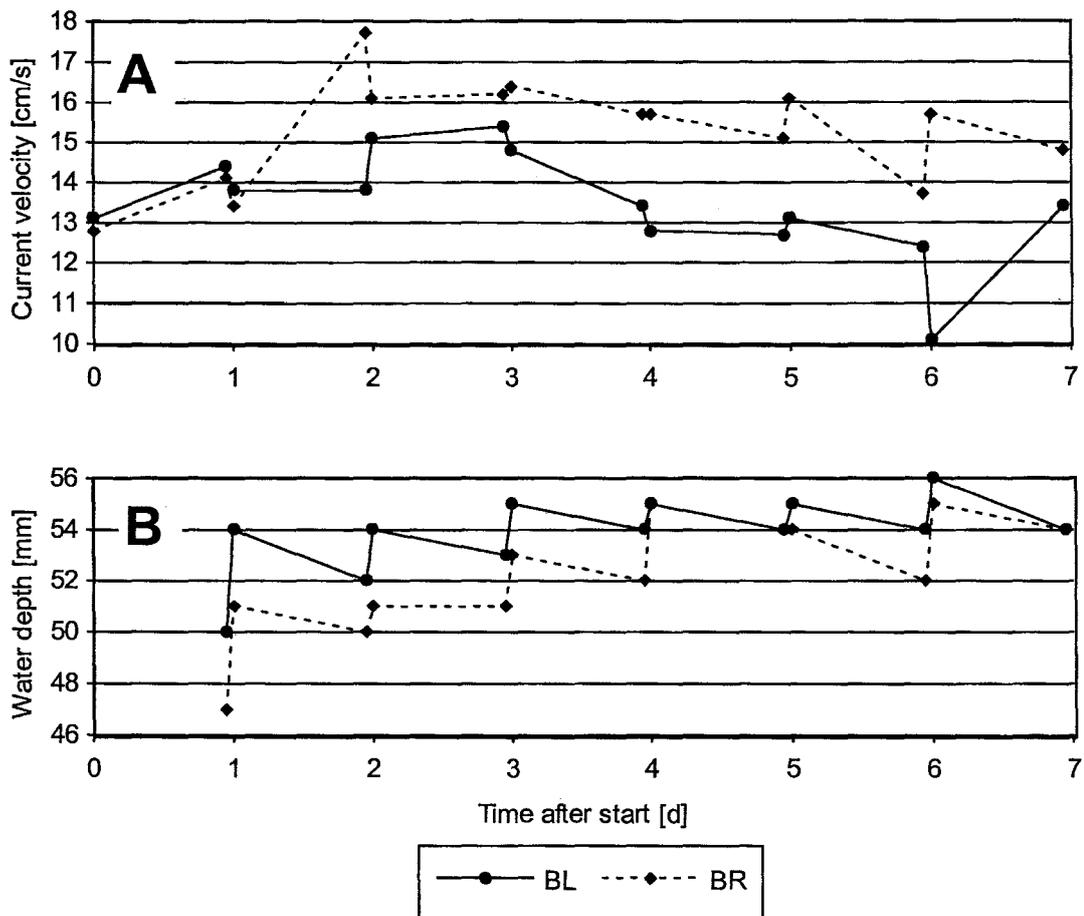
### LASUs

The mesh of the test chambers in the LASUs regularly clog up with detritus from within the systems, especially on the upstream side. To investigate current velocity fluctuations caused by blocking of the mesh and cleaning (this was done with a spray pistol for the movable frame and a toothbrush for the fixed frames), current velocities and water depths were measured over a period of seven days in the left and the right channel (viewing downstream) of LASU blue. The measurements were taken in the middle of the empty test chambers (no substrate). The discharge was 10 L/s and slope 0%. Current velocities were measured 22 mm above the stream bottom. Water depths were measured at the same spot with a ruler. As the hydraulic characteristics between different LASUs were found to be fairly constant during calibration (Palmer *et al.* 1996), similar current velocity fluctuations were expected for LASU yellow and red. Results are shown in Figure A.1. and Table A.1.

Current velocity measurements were taken during some experiments at the beginning and end of the six-day test period, in LASU-channels used for final testing. Final experiments were set up with a gradient of -1% and a discharge <5 L/s to achieve a higher water depth at this low discharge. The results are given in Table A.1.

**Table A.1.** Current velocity ( $U$ ) measurements in the three LASUs before and after the six-day test period of some experiments. Measurements were taken in the centre of the test chamber with no substrate. End-measurements were taken after the mesh was cleaned. CV Coefficient of variation.

	$U$ beginning	$U$ end	$U$ overall	Water depth overall
$n$	9	6	15	5
Range	8.5–11.1 cm/s	6.8–9.5 cm/s	6.8–11.1 cm/s	45–57 mm
Mean	9.5 cm/s	8.3 cm/s	9.0 cm/s	50 mm
CV	9.2 %	12.1 %	11.9 %	9.3 %



**Figure A.1.** Fluctuations in current velocity (A) and water depth (B) in LASU blue over a period of six days. BL = LASU blue, left channel; BR = LASU blue, right channel

### Raceways

The water volume was reduced during tests because of splashing and evaporation. To determine if the volume influences the current velocity, measurements were carried out in one Raceway at different water volumes. Measurements were taken at the middle of the test chamber, without substrate, 22 mm from the stream floor. Results are given in Table A.2.

**Table A.2.** Current velocity and water depth at different water volumes in a Raceway.

Water volume	Current velocity	Water depth
10.0 L	9.4 cm/s	41 mm
12.5 L	8.8 cm/s	51 mm
15.0 L	8.1 cm/s	59 mm

Current velocity measurements were carried out at the beginning and the end of two experiments. During this period the mesh was brushed daily with a tooth brush. The measurements at the end were taken after cleaning the mesh. In every instance the velocity was decreased at the end of the experiment, probably because of blocking of the mesh. Results are given in Table A.3.

**Table A.3.** Current velocity ( $U$ ) measurements in the Raceways before and after the six-day test period of two experiments. End-measurements were taken after the mesh was cleaned. CV Coefficient of variation.

	$U$ beginning	$U$ end	$U$ overall
$n$	12	12	24
Range [cm/s]	8.5–11.4	3.6–9.5	3.6–11.4
Mean [cm/s]	10.2	6.5	8.3
CV[%]	10.6	25.9	27.8

## Channels

Measurements of current velocities were carried out using a Marsh McBirney current velocity meter 19 mm from the channel floor. Seven Channels were set up, filled with water and allowed to run for two days. Current velocity measurements were then taken in the middle of the lower (downstream) third of each channel before and after cleaning the mesh. Water depth measurements were taken at the lower end of the channels, also before and after cleaning. Results are given in Table A.4.

**Table A.4.** Current velocity and water depth measurements in the Channels after a two-day period. Measurements were taken before and after the mesh was cleaned. CV Coefficient of variation.

	Before cleaning	After cleaning	Overall
$n$	7	7	14
Current Range [cm/s]	2.4–4.6	2.5–5.4	2.4–5.4
velocity Mean [cm/s]	3.8	3.9	3.8
CV[%]	21.6	28.3	24.4
Water Range [mm]	38–47	38–39	38–47
depth Mean [mm]	41	39	40
CV[%]	7.6	1.3	6.1

## Appendix B

### Water chemistry equations and water quality profiles

#### *Total hardness as CaCO<sub>3</sub>*

The total hardness of a water can be calculated with the following equation (APHA 1992):

$$\text{THd.} = 2.497 \times \text{Ca} + 4.118 \times \text{Mg} \quad \text{Equation B.1.}$$

where:

THd. Total hardness as CaCO<sub>3</sub> [mg/L]

Ca Calcium ion [mg/L]

Mg Magnesium ion [mg/L]

#### *Calculating ammonia (NH<sub>3</sub>) out of ammonium (NH<sub>4</sub><sup>+</sup>)*

The contribution of un-ionized ammonia (NH<sub>3</sub>) to total ammonia in water depends on pH and temperature and can be estimated with a table provided by DWAF (1996c). As the ionized ammonium ion (NH<sub>4</sub><sup>+</sup>) concentration was determined by IWQS, NH<sub>3</sub> was calculated using the following equation:

$$c_{\text{NH}_3} = \left( \frac{100 \times c_{\text{NH}_4}}{100 - p_{\text{NH}_3}} \right) - c_{\text{NH}_4} \quad \text{Equation B.2.}$$

where

$c_{\text{NH}_3}$  Concentration of un-ionized ammonia NH<sub>3</sub> [mg/L]

$c_{\text{NH}_4}$  Concentration of ionized ammonium NH<sub>4</sub><sup>+</sup> [mg/L]

$p_{\text{NH}_3}$  Contribution of NH<sub>3</sub> to total ammonia [%]

**Table B.1.** Water quality results for Palmiet River water (analysis by IWQS). Methods of analysis are described in DWAF (1992). Inorganic constituents were analysed several times ( $n=7$ ) between 05.12.1996 and 21.04.1998. Metal contents were analysed once (16.04.1997). TAL Total Alkalinity; EC Electrical Conductivity; TDS Total Dissolved Solids; THd. Total Hardness; DOC Dissolved Organic Carbon.

Constituent [mg/L]	Range encountered	16.04. 1997	Detect. limit	Metals [ $\mu\text{g/L}$ ] (16.04.1997)	Ion	Acid-Sol.	Detect. limit
pH <sup>a</sup>	6.6–7.0	6.9	2	Al	1180	678	20
NH <sub>4</sub> - N	0.04–0.05	0.05	0.04	As	<50	<50	50
NO <sub>3</sub> +NO <sub>2</sub> -N	0.04–0.08	0.08	0.04	B	<2	<2	2
NO <sub>2</sub> -N	0.04	<0.04	0.04	Ba	<2	<2	2
F	0.1	<0.1	0.1	Be	<1	<1	1
TAL as CaCO <sub>3</sub>	6–14	7	4	Cd	<1	<1	1
Na	20–38	20	2	Co	<5	<5	5
Mg	2–4	3	1	Cr	<3	<3	3
Si	3.7–4.1	3.9	0.4	Cu	<4	<4	4
PO <sub>4</sub> - P	0.006–0.027	0.017	0.005	Fe	572	485	3
SO <sub>4</sub>	11–52	19	4	Hg	<20	<20	20
Cl	30–39	30	25	Mn	<1	<1	1
K	0.4–0.7	0.4	0.3	Mo	<6	<6	6
Ca	2–3	2	1	Ni	<4	<4	4
EC at 25°C <sup>b</sup>	16.3–18.3	16.3	1	Pb	<20	<20	20
TDS	83–141	84	1	Sr	<1	<1	1
THd. as CaCO <sub>3</sub>	13.2–24.0	17.4	-	Ti	<1	19	1
DOC	2.0–2.4	-	0.2	V	<3	<3	3
				Zn	<3	<3	3
				Zr	<1	<1	1

Comments: <sup>a</sup> no unit; <sup>b</sup> mS/m.

**Table B.2.** Water quality analysis results for tap water of the artificial stream laboratory (analysis by IWQS). Methods of analysis are described in DWAF (1992). Inorganic constituents were analysed several times ( $n=5$ ) between 10.10.1996 and 21.04.1998. Metal contents were analysed once (10.10.1996). TAL Total Alkalinity; EC Electrical Conductivity; TDS Total Dissolved Solids; THd. Total Hardness; DOC Dissolved Organic Carbon.

Constituent [mg/L]	Range encountered	10.10. 1996	Detect. limit	Metals [ $\mu\text{g/L}$ ] (10.10.1996)	Ion	Acid-Sol.	Detect. limit
pH <sup>a</sup>	7.2-7.9	7.8	2	Al	<20	<20	20
NH <sub>4</sub> - N	0.04	<0.04	0.04	As	<50	<50	50
NO <sub>3</sub> +NO <sub>2</sub> -N	0.05-0.56	0.11	0.04	B	<2	<2	2
NO <sub>2</sub> -N	0.04	<0.04	0.04	Ba	30	42	2
F	0.1	<0.1	0.1	Be	<1	<1	1
TAL as CaCO <sub>3</sub>	16-50	50	4	Cd	<1	<1	1
Na	28-65	65	2	Co	<5	<5	5
Mg	4-13	13	1	Cr	<3	<3	3
Si	2.1-4.2	2.8	0.4	Cu	<4	<4	4
PO <sub>4</sub> - P	0.005-0.012	<0.005	0.005	Fe	<3	78	3
SO <sub>4</sub>	27-89	27	4	Hg	<20	<20	20
Cl	41-120	120	25	Mn	<1	<1	1
K	0.7-2.5	2.5	0.3	Mo	<6	<6	6
Ca	11-22	18	1	Ni	<4	<4	4
EC at 25°C <sup>b</sup>	25.4-57.7	57.7	1	Pb	<20	<20	20
TDS	155-308	308	1	Sr	169	140	1
THd. as CaCO <sub>3</sub>	44.0-98.5	98.5	-	Ti	<1	3	1
DOC	3.5-4.4	3.5	0.2	V	<3	<3	3
				Zn	<3	<3	3
				Zr	<1	<1	1

Comments: <sup>a</sup> no unit; <sup>b</sup> mS/m.

# Appendix C

## Example of a spreadsheet for data collection

Testorg.: **A. sudafricanum** Code: **L - C1** desired g/l Na2SO4  
 Num. anim.: **30** Channel actual  
 Comments: acclimation \*\*\*\*\* - \*\*\*\*\* 1997

96 hr Testperiod												
Day	0 before	0 toxicant added		1		2		3		4	Sum	
Date	27.09	27.09	6h	12h	28.09		29.09		30.09	01.10		
Time	am	am, 10	pm	pm	am	pm	am	pm	am	pm	am	alive
Dead												responding
Emerged												emerged
Exuviae												
Temp.[oC]												
pH												
DO [%O2]												
EC [mS/m]												
@ T [oC]												
vc [cm/s]												
[n/t]												
depth [mm]												
Comments:												

Collection and acclimation							
Day	Palmiet	Lab	A1	A2	A3	A4	A5
Date	24.4.		25.4.	26.4.			
Time	Collected	1-hour	pm	pm	am	pm	am
Dead							
Emerged							
Distribution							
Exuviae							
Temp.[oC]							
pH							
DO [%O2]							
EC [mS/m]							
@ T [oC]							

L - C1

## **Appendix D**

### **Experimental results of Probit analyses, and an example of data output of the Trimmed Spearman-Kärber analysis**

In the following sections the complete result-output of the probit analysis software from the United States Environmental Protection Agency (US EPA) Version 1.4 is presented for each experiment together with the different model assumptions. Abbreviations used: NFD-Log = Normal frequency distribution of responses for log-transformed concentrations; NFD-Lin = Normal frequency distribution of responses for untransformed (linear) concentrations. See Section 4.1.1. for more details.

The result of *Experiment 1: NFD-Log* was used to explain parameters of the the probit analysis result-output. The original graph provided by the software is also shown, but omitted for later results. Additionally, an example is provided of the output of the Spearman-Kärber analysis program, using the data of *Experiment 1: NFD-Log*.

Following the Probit analysis results, an example of data output of the Trimmed Spearman-Kärber analysis software is provided.

*Adenophlebia auriculata**Experiment 1: NFD-Log*

Conc.	Number Exposed	Number Resp.	(1) Observed Proportion Responding	(2) Adjusted Proportion Responding	(3) Predicted Proportion Responding
4.9200	22	0	0.0000	0.0000	0.0313
6.5000	30	10	0.3333	0.3333	0.2075
7.8000	30	13	0.4333	0.4333	0.4485
8.5100	29	13	0.4483	0.4483	0.5785
9.8600	30	23	0.7667	0.7667	0.7739
11.5400	30	28	0.9333	0.9333	0.9104
15.0100	31	31	1.0000	1.0000	0.9901

Chi - Square Heterogeneity = 6.152 (4)

Mu = 0.907053 (5)

Sigma = 0.115512 (6)

Parameter	Estimate	Std. Err.	95% Confidence Limits	
Intercept	-2.852449	1.039623	( -4.890111,	-0.814787) (7)
Slope	8.657098	1.119185	( 6.463495,	10.850700) (8)

Theoretical Spontaneous Response Rate = 0.0000 (9)

Estimated EC Values and Confidence Limits

Point	Conc.	Lower 95% Confidence	Upper Limits
EC 1.00	4.3485	3.4461	5.0140
EC 5.00	5.2125	4.3782	6.8135
EC10.00	5.7413	4.9688	8.2976
EC15.00	6.1283	5.4075	8.6521
EC50.00	8.0733	7.5829	8.5503
EC85.00	10.6358	9.9065	11.7967
EC90.00	11.3526	10.4770	12.8227
EC95.00	12.5043	11.3619	14.5362
EC99.00	14.9889	13.1869	18.4493

- (1) The observed response of the test organisms; in [%].
- (2) The observed response of the test organisms, adjusted for response in the control; in [%].
- (3) The theoretical response of test organisms, calculated with the probit equation which is given below; in [%].
- (4)  $\chi^2$  (chi-square) value of the regression line; quantifies the deviation of data from the regression line and takes on values – in case of good fit – around the number of  $(n - 2)$  degrees of freedom (Finney 1971). The statistical significance of this value can be obtained from a  $\chi^2$  table, using  $n - 2$  degrees of freedom ( $n =$  number of observations). The internal level of significance of the probit software is set at 5%. If  $P < 0.05$ , the software gives a warning to interpret results with "appropriate caution". The results of Experiment 3 are an example for this warning.
- (5)  $\mu$  (Mu), a parameter of the probit equation below; it is the logarithm of the EC50.
- (6)  $\sigma$  (Sigma), a parameter of the probit equation below; it is the reciprocal of the slope.
- (7) The intercept of the probit regression line; describes where the straight line crosses the y-axis.
- (8) The slope of the probit regression line ( $= 1/\sigma$ )
- (9) The response in the control; in [%]

The parameters  $\mu$  and  $\sigma$  appear in the probit equation which describes the concentration-response relationship (Finney 1971). This equation appears in the thesis as Equation 4.3.

$$Y = 5 + \frac{1}{\sigma}(x - \mu)$$

where

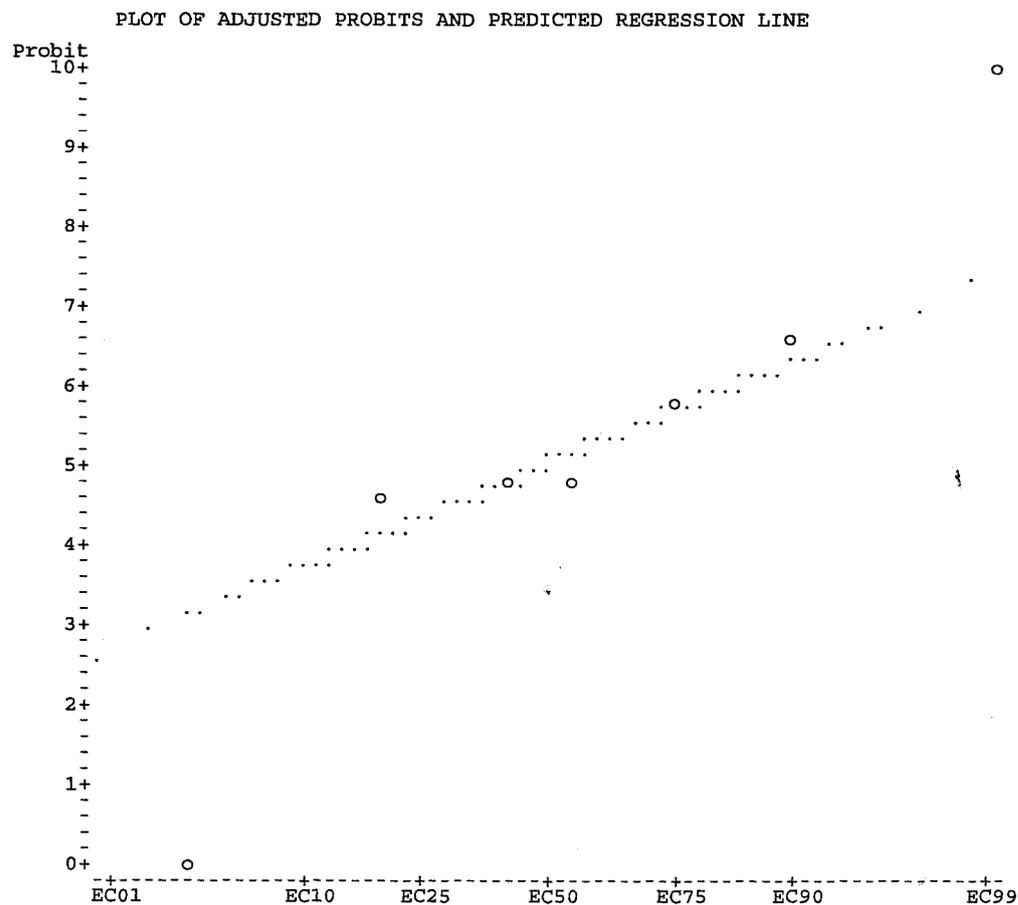
$Y$  Probability of response at a certain concentration [probit units]

$\sigma$  Sigma ( $\hat{=}$  reciprocal of the slope) [ $x$ /probit units]

$\mu$  Mu ( $\hat{=}$  log EC50)

$x$  Logarithm of concentration

The obtained probit values can be converted to percentage responses with a specific table such as e.g. provided by Finney (1971). The following graph is included in the result file of the probit analysis.



The concentration scale of this graph is expressed in EC units. This is a program-specific feature which allows the software to display the distribution of data without needing to adjust the concentration range of the x-axis. The scale therefore remains constant for all possible EC values.

**Experiment 1: NFD-Lin**

Conc.	Number Exposed	Number Resp.	Observed Proportion Responding	Adjusted Proportion Responding	Predicted Proportion Responding
83364.0000	22	0	0.0000	0.0000	0.0670
%3152891.0000	30	10	0.3333	0.3333	0.2144
%63733160.0000	30	13	0.4333	0.4333	0.4184
%325569280.0000	29	13	0.4483	0.4483	0.5444
% 7178.0367E+06	30	23	0.7667	0.7667	0.7624
% 3445.4159E+08	30	28	0.9333	0.9333	0.9289
% 1017.7844E+12	31	31	1.0000	1.0000	0.9988

Chi - Square Heterogeneity = 5.258

Mu = 8.263592  
Sigma = 2.230622

Parameter	Estimate	Std. Err.	95% Confidence Limits	
Intercept	1.295387	0.520478	{ 0.275249,	2.315524}
Slope	0.448305	0.061130	{ 0.328491,	0.568120}

Theoretical Spontaneous Response Rate = 0.0000

Estimated EC Values and Confidence Limits

Point	Conc.	Lower 95% Confidence Limits	Upper 95% Confidence Limits
EC 1.00	1187.1252	12.0290	18254.2891
EC 5.00	39304.4650	1332.2277	309557.7800
EC10.00	253996.1410	15991.8047	1435050.0000
EC15.00	894902.0600	84038.4450	4114611.8000
EC50.00	%183481280.0000	57610712.0000	572264700.0000
EC85.00	%37619147000.0000	%8530508800.0000	%368486380000.0000
EC90.00	%132543168000.0000	%24564257000.0000	%1928121020000.0000
EC95.00	%856527210000.0000	%114312823000.0000	%2305602000000.0000
EC99.00	% 2835882.2000E+07	% 1945255.5400E+06	% 254468440.0000E+07

When the probit analysis was run using the NFD-Lin model, concentrations were entered as their antilogs. This is reflected in the probit result file in the concentration column (Conc.), and also affects the probit equation parameters mu, sigma, intercept, slope, and EC values. To convert EC values "back to normal", the logs of the data need to be calculated.

**Experiment 2: NFD-Log**

Conc.	Number Exposed	Number Resp.	Observed Proportion Responding	Adjusted Proportion Responding	Predicted Proportion Responding
6.9100	28	0	0.0000	0.0000	0.0061
7.8900	27	3	0.1111	0.1111	0.0456
9.7900	27	7	0.2593	0.2593	0.3594
10.6800	27	15	0.5556	0.5556	0.5698
11.8000	28	20	0.7143	0.7143	0.7853
12.8400	27	27	1.0000	1.0000	0.9050

Chi - Square Heterogeneity = 7.705

Mu = 1.016169  
Sigma = 0.070502

Parameter	Estimate	Std. Err.	95% Confidence Limits	
Intercept	-9.413286	2.037105	{ -13.406012,	-5.420561}
Slope	14.183941	1.985779	{ 10.291813,	18.076069}

Theoretical Spontaneous Response Rate = 0.0000

Estimated EC Values and Confidence Limits

Point	Conc.	Lower 95% Confidence Limits	Upper 95% Confidence Limits
EC 1.00	7.1148	6.0830	7.8025
EC 5.00	7.9469	7.0670	8.5314
EC10.00	8.4297	7.6488	8.9549
EC15.00	8.7720	8.0636	9.2580
EC50.00	10.3793	9.9397	10.8070
EC85.00	12.2811	11.6974	13.2138
EC90.00	12.7798	12.1011	13.9214
EC95.00	13.5562	12.7093	15.0585
EC99.00	15.1418	13.9044	17.4847

**Experiment 2: NFD-Lin**

Conc.	Number Exposed	Number Resp.	Observed Proportion Responding	Adjusted Proportion Responding	Predicted Proportion Responding
%8193567.0000	28	0	0.0000	0.0000	0.0118
%78311288.0000	27	3	0.1111	0.1111	0.0500
% 6200.4516E+06	27	7	0.2593	0.2593	0.3281
% 4839.4318E+07	27	15	0.5556	0.5556	0.5474
% 6251.8290E+08	28	20	0.7143	0.7143	0.7943
% 6847.0702E+09	27	27	1.0000	1.0000	0.9304

Chi - Square Heterogeneity = 6.167

Mu = 10.496560  
Sigma = 1.581958

Parameter	Estimate	Std. Err.	95% Confidence Limits	
Intercept	-1.635171	0.892671	{ -3.384805,	0.114464}
Slope	0.632128	0.083734	{ 0.468010,	0.796246}

Theoretical Spontaneous Response Rate = 0.0000

Estimated EC Values and Confidence Limits

Point	Conc.	Lower Upper 95% Confidence Limits	
EC 1.00	6553185.5000	268992.9400	46017180.0000
EC 5.00	78414648.0000	7213732.5000	351734560.0000
EC10.00	%294525470.0000	40792956.0000	1062483900.0000
EC15.00	%719481090.0000	%129410624.0000	2274065200.0000
EC50.00	%31373292000.0000	%12211931100.0000	%79081882000.0000
EC85.00	%1368046.3000E+06	%448578360000.0000	%7064990000000.0000
EC90.00	%3341929.4000E+06	%964659510000.0000	%22307095000000.0000
EC95.00	%1255230.3000E+07	%2926880.2000E+06	%125586983.0000E+06
EC99.00	%1502000.3900E+08	%2246573.0000E+07	%335387610.0000E+07

Experiment 3: NFD-Log

Conc.	Number Exposed	Number Resp.	Observed Proportion Responding	Adjusted Proportion Responding	Predicted Proportion Responding
5.3700	31	1	0.0323	0.0323	0.0017
6.7400	30	1	0.0333	0.0333	0.0443
7.4300	31	5	0.1613	0.1613	0.1199
8.2700	31	11	0.3548	0.3548	0.2756
8.7300	31	7	0.2258	0.2258	0.3809
8.9600	30	13	0.4333	0.4333	0.4355
9.5000	34	10	0.2941	0.2941	0.5613
9.8400	31	22	0.7097	0.7097	0.6347
10.7700	31	27	0.8710	0.8710	0.7976
10.9100	31	25	0.8065	0.8065	0.8167
11.6000	32	29	0.9063	0.9063	0.8915
11.9800	34	34	1.0000	1.0000	0.9206

Chi - Square Heterogeneity = 36.649

\*\*\*\*\*  
\* WARNING \*  
\* Significant heterogeneity exists. The results reported \*  
\* for this data set may not be valid. The results should \*  
\* be interpreted with appropriate caution. \*  
\*\*\*\*\*

Mu = 0.965346  
Sigma = 0.080272

Parameter	Estimate	Std. Err.	95% Confidence Limits	
Intercept	-7.026000	2.241375	{ -12.019783,	-2.032218}
Slope	12.457707	2.294784	{ 7.344929,	17.570484}

Theoretical Spontaneous Response Rate = 0.0000

Estimated EC Values and Confidence Limits

Point	Conc.	Lower Upper 95% Confidence Limits	
EC 1.00	6.0063	4.3441	6.9173
EC 5.00	9.8125	5.3594	7.5905
EC10.00	9.2857	5.9871	7.9856
EC15.00	7.6235	6.4460	8.2713
EC50.00	9.2331	8.5892	9.8401
EC85.00	11.1825	10.3942	12.8900
EC90.00	11.7010	10.7776	13.8627
EC95.00	12.5137	11.3500	15.4714
EC99.00	14.1933	12.4652	19.0710

Experiment 3: NFD-Lin

Conc.	Number Exposed	Number Resp.	Observed Proportion Responding	Adjusted Proportion Responding	Predicted Proportion Responding
%235890.0000	31	1	0.0323	0.0323	0.0074
%5464023.0000	30	1	0.0333	0.0333	0.0549
%26885940.0000	31	5	0.1613	0.1613	0.1199
%186270128.0000	31	11	0.3548	0.3548	0.2544
%542553220.0000	31	7	0.2258	0.2258	0.3533
%913434180.0000	30	13	0.4333	0.4333	0.4060
%3175.8991E+06	34	10	0.2941	0.2941	0.5373
%6961.4182E+06	31	22	0.7097	0.7097	0.6188
%5936.2742E+07	31	27	0.8710	0.8710	0.8084
%8203.2624E+07	31	25	0.8065	0.8065	0.8310
%4009.0550E+08	32	29	0.9063	0.9063	0.9162
%9584.7075E+08	34	34	1.0000	1.0000	0.9465

Chi - Square Heterogeneity = 19.349

\*\*\*\*\*  
\* WARNING \*  
\* Significant heterogeneity exists. The results reported \*  
\* for this data set may not be valid. The results should \*  
\* be interpreted with appropriate caution. \*  
\*\*\*\*\*

Mu	=	9.349121		
Sigma	=	1.633151		
Parameter	Estimate	Std. Err.	95% Confidence Limits	
Intercept	-0.724592	0.737980	{ -2.368812,	0.919629}
Slope	0.612313	0.077357	{ 0.439963,	0.784664}

Theoretical Spontaneous Response Rate = 0.0000

Estimated EC Values and Confidence Limits

Point	Conc.	Lower 95% Confidence Limits	Upper 95% Confidence Limits
EC 1.00	354750.4100	9076.1152	2974137.2000
EC 5.00	4599939.5000	302720.5300	23301554.0000
EC10.00	18033306.0000	1924580.6200	71259424.0000
EC15.00	45344400.0000	6609201.0000	153758832.0000
EC50.00	%2234194900.0000	%845113660.0000	5708828200.0000
EC85.00	%110082556000.0000	%34483397000.0000	%664243860000.0000
EC90.00	%276800730000.0000	%74937237000.0000	%2264905500000.0000
EC95.00	%1085152.9500E+06	%230654394000.0000	%14306700700000.0000
EC99.00	%1407084.5500E+07	% 1817856.5700E+06	% 474357190.0000E+06

Experiment 4: NFD-Log

Conc.	Number Exposed	Number Resp.	Observed Proportion Responding	Adjusted Proportion Responding	Predicted Proportion Responding
4.8200	29	2	0.0690	0.0690	0.1012
6.0400	30	15	0.5000	0.5000	0.4054
6.9600	30	18	0.6000	0.6000	0.6596
8.1000	30	27	0.9000	0.9000	0.8660
9.0300	30	27	0.9000	0.9000	0.9459
10.1100	29	29	1.0000	1.0000	0.9832

Chi - Square Heterogeneity = 3.948

Mu	=	0.803680		
Sigma	=	0.094628		
Parameter	Estimate	Std. Err.	95% Confidence Limits	
Intercept	-3.493028	1.137790	{ -5.723098,	-1.262959}
Slope	10.567678	1.358085	{ 7.905830,	13.229525}

Theoretical Spontaneous Response Rate = 0.0000

Estimated EC Values and Confidence Limits

Point	Conc.	Lower 95% Confidence Limits	Upper 95% Confidence Limits
EC 1.00	3.8331	3.1309	4.3413
EC 5.00	4.4466	3.8073	4.9018
EC10.00	5.8129	4.9223	5.2341
EC15.00	5.0770	4.5252	5.4741
EC50.00	5.3633	5.9879	6.7004
EC85.00	7.9754	7.5306	8.6294
EC90.00	8.4131	7.8950	9.2258
EC95.00	9.1061	8.4493	10.2083
EC99.00	10.5636	9.5604	12.3878

Experiment 4: NFD-Lin

Conc.	Number Exposed	Number Resp.	Observed Proportion Responding	Adjusted Proportion Responding	Predicted Proportion Responding
66134.8520	29	2	0.0690	0.0690	0.1365
%1104795.3800	30	15	0.5000	0.5000	0.3869
%9074711.0000	30	18	0.6000	0.6000	0.6246
%126135320.0000	30	27	0.9000	0.9000	0.8586
% 1071.5193E+06	30	27	0.9000	0.9000	0.9543
% 1288.2496E+07	29	29	1.0000	1.0000	0.9919

Chi - Square Heterogeneity = 5.511

Mu	=	6.477572		
Sigma	=	1.511656		
Parameter	Estimate	Std. Err.	95% Confidence Limits	
Intercept	0.714917	0.612493	{ -0.485569,	1.915403}
Slope	0.661526	0.088000	{ 0.489046,	0.834006}

Theoretical Spontaneous Response Rate = 0.0000

Estimated EC Values and Confidence Limits

Point	Conc.	Lower 95% Confidence Limits	Upper 95% Confidence Limits
EC 1.00	914.1273	34.4419	6626.4141
EC 5.00	9796.0059	812.8423	45572.6520
EC10.00	34692.3400	4322.0688	129271.4610
EC15.00	81450.1800	13216.7520	263910.5900
EC50.00	3003118.2000	1177146.1200	6817989.0000
EC85.00	%110726952.0000	42736012.0000	432114780.0000
EC90.00	%259962848.0000	89752152.0000	1284500100.0000
EC95.00	%920653180.0000	%261304944.0000	6654498800.0000
EC99.00	%9865946100.0000	%1840935170.0000	%153310085000.0000

Experiment 5: NFD-Log

Conc.	Number Exposed	Number Resp.	Observed Proportion Responding	Adjusted Proportion Responding	Predicted Proportion Responding
4.1200	32	1	0.0313	- .0022	0.0136
5.1300	31	3	0.0968	0.0656	0.0963
6.1000	31	8	0.2581	0.2325	0.2786
6.9900	31	21	0.6774	0.6663	0.4905
8.2100	31	25	0.8065	0.7998	0.7394
8.9700	31	21	0.6774	0.6663	0.8431
10.2300	31	30	0.9677	0.9666	0.9395
11.1600	29	28	0.9655	0.9643	0.9720
11.9200	30	30	1.0000	1.0000	0.9855

Chi - Square Heterogeneity = 12.764

Mu = 0.846986  
 Sigma = 0.105025

Parameter	Estimate	Std. Err.	95% Confidence Limits
Intercept	-3.064634	0.945349	{ -4.917518, -1.211750}
Slope	9.521567	1.065830	{ 7.432541, 11.610594}

Theoretical Spontaneous Response Rate = 0.0333

Estimated EC Values and Confidence Limits

Point	Conc.	Lower 95% Confidence Limits	Upper
EC 1.00	4.0056	3.3150	4.5361
EC 5.00	4.7231	4.0825	5.2072
EC10.00	5.1569	4.5581	5.6093
EC15.00	5.4719	4.9074	5.9014
EC50.00	7.0305	6.6251	7.4015
EC85.00	9.0330	8.5329	9.7302
EC90.00	9.5849	8.9996	10.4497
EC95.00	10.4650	9.7173	11.6400
EC99.00	12.3397	11.1796	14.3032

Experiment 5: NFD-Lin

Conc.	Number Exposed	Number Resp.	Observed Proportion Responding	Adjusted Proportion Responding	Predicted Proportion Responding
13124.0000	32	1	0.0313	- .0021	0.0441
%134732.0000	31	3	0.0968	0.0657	0.1249
%1272466.0000	31	8	0.2581	0.2325	0.2687
%9697654.0000	31	21	0.6774	0.6663	0.4468
%160901792.0000	31	25	0.8065	0.7998	0.7035
%927537020.0000	31	21	0.6774	0.6663	0.8292
% 1707.3578E+07	31	30	0.9677	0.9666	0.9499
% 1460.8964E+08	29	28	0.9655	0.9643	0.9844
% 8293.4615E+08	30	30	1.0000	1.0000	0.9949

Chi - Square Heterogeneity = 15.434

\*\*\*\*\*  
 \* WARNING \*  
 \* Significant heterogeneity exists. The results reported \*  
 \* for this data set may not be valid. The results should \*  
 \* be interpreted with appropriate caution. \*  
 \*\*\*\*\*

Mu = 7.230735  
 Sigma = 1.826113

Parameter	Estimate	Std. Err.	95% Confidence Limits
Intercept	1.040367	0.685424	{ -0.580661, 2.661396}
Slope	0.547611	0.088847	{ 0.337488, 0.757734}

Theoretical Spontaneous Response Rate = 0.0333

Estimated EC Values and Confidence Limits

Point	Conc.	Lower 95% Confidence Limits	Upper
EC 1.00	960.8372	1.0861	23316.1426
EC 5.00	16864.0762	102.3110	205058.2340
EC10.00	77694.3520	1117.2676	675429.1900
EC15.00	217847.4220	5482.5928	1544868.1200
EC50.00	17011214.0000	2702881.8000	86046248.0000
EC85.00	%1328368770.0000	%231080272.0000	%27636285000.0000
EC90.00	%3724613100.0000	%548202750.0000	%130749440000.0000
EC95.00	%17159615500.0000	%1868101370.0000	%1380121710000.0000
EC99.00	%301176980000.0000	%16961734700.0000	% 125933852.0000E+06

***Afroptilum sudafricanum***

**Experiment 6: NFD-Lin**

Conc.	Number Exposed	Number Resp.	Observed Proportion Responding	Adjusted Proportion Responding	Predicted Proportion Responding
3.2400	37	0	0.0000	-0.0276	0.0013
109.6500	37	3	0.0811	0.0557	0.1505
218.7800	38	11	0.2895	0.2698	0.2584
537.0300	37	23	0.6216	0.6112	0.4416
3981.0701	40	31	0.7750	0.7688	0.8345
288403.16	40	40	1.0000	1.0000	0.9996

Chi - Square Heterogeneity = 8.581

Mu = 2.844126  
Sigma = 0.777457

Parameter	Estimate	Std. Err.	95% Confidence Limits
Intercept	1.341758	0.568153	{ 0.228179, 2.455338}
Slope	1.286245	0.204557	{ 0.885313, 1.687177}

Theoretical Spontaneous Response Rate = 0.0269

Estimated EC Values and Confidence Limits

Point	Conc.	Lower 95% Confidence Limits	Upper 95% Confidence Limits
EC 1.00	10.8524	1.7539	29.1871
EC 5.00	36.7524	10.0224	76.1665
EC10.00	70.4266	25.0818	128.5498
EC15.00	109.2368	46.1421	184.7687
EC50.00	698.4346	460.5868	1128.1200
EC85.00	4465.6230	2379.8235	13306.4600
EC90.00	6926.5132	3385.8694	24730.4941
EC95.00	13272.8555	5664.1128	62440.1020
EC99.00	44949.4380	14666.6299	359591.1900

**Experiment 7: NFD-Lin**

Conc.	Number Exposed	Number Resp.	Observed Proportion Responding	Adjusted Proportion Responding	Predicted Proportion Responding
9.7970	34	1	0.0294	0.0294	0.0169
78.3060	31	3	0.0968	0.0968	0.0968
461.5030	32	8	0.2500	0.2500	0.2752
1938.3400	33	17	0.5152	0.5152	0.4887
21228.9102	33	25	0.7576	0.7576	0.8212
130999.9920	31	30	0.9677	0.9677	0.9496
427666.7500	32	32	1.0000	1.0000	0.9826

Chi - Square Heterogeneity = 2.209

Mu = 3.318513  
Sigma = 1.096009

Parameter	Estimate	Std. Err.	95% Confidence Limits
Intercept	1.972186	0.343507	{ 1.298913, 2.645459}
Slope	0.912401	0.097596	{ 0.721113, 1.103688}

Theoretical Spontaneous Response Rate = 0.0000

Estimated EC Values and Confidence Limits

Point	Conc.	Lower 95% Confidence Limits	Upper 95% Confidence Limits
EC 1.00	5.8731	1.0929	18.3709
EC 5.00	32.7859	9.2221	79.4696
EC10.00	82.0101	28.3581	175.9258
EC15.00	152.2680	59.9581	303.6353
EC50.00	2082.1543	1176.3218	3680.6912
EC85.00	28471.9180	14322.9053	71891.6480
EC90.00	52863.7970	24731.2012	151935.4840
EC95.00	132232.6880	54772.0820	467001.9100
EC99.00	738176.5600	237034.2660	3938944.0000

**Experiment 8: NFD-Lin**

Conc.	Number Exposed	Number Resp.	Observed Proportion Responding	Adjusted Proportion Responding	Predicted Proportion Responding
10.0800	25	2	0.0800	-0.0077	0.0158
130.3800	25	4	0.1600	0.0800	0.0811
266.9800	21	7	0.3333	0.2698	0.1176
756.7500	25	6	0.2400	0.1676	0.1893
1946.6100	24	8	0.3333	0.2698	0.2733
5526.9702	24	10	0.4167	0.3611	0.3837
12094.2598	24	11	0.4583	0.4067	0.4738
83080.7810	21	14	0.6667	0.6349	0.6918
803576.3800	25	23	0.9200	0.9124	0.8786
29929746.000	25	25	1.0000	1.0000	0.9872

Chi - Square Heterogeneity = 3.985

Mu = 4.179521  
Sigma = 1.477046

Parameter	Estimate	Std. Err.	95% Confidence Limits	
Intercept	2.170351	0.406389	{ 1.373828,	2.966874 }
Slope	0.677027	0.097004	{ 0.486900,	0.867154 }

Theoretical Spontaneous Response Rate = 0.0870

Estimated EC Values and Confidence Limits

Point	Conc.	Lower 95% Confidence Limits	Upper 95% Confidence Limits
EC 1.00	5.5395	0.2551	33.1992
EC 5.00	56.2249	6.0436	214.6423
EC10.00	193.4369	31.9702	593.4375
EC15.00	445.3597	96.7875	1198.5601
EC50.00	15118.9307	6832.5415	35779.8440
EC85.00	513252.9400	168673.7340	3054338.5000
EC90.00	1181688.7500	336100.1900	9372462.0000
EC95.00	4065497.0000	918078.1200	50182080.0000
EC99.00	41264200.0000	5871109.0000	1202166530.0000

*Example of data output of the Trimmed Spearman--Kärber analysis program*

The data of Experiment 5: NFD-Log is used.

TRIMMED SPEARMAN-KARBER METHOD. MONTANA STATE UNIV  
ADAPTED FOR BACKGROUND MORTALITY. RIVM, THE NETHERLANDS  
VERSION NOVEMBER 1990

FOR REFERENCE, CITE:  
HAMILTON, M.A., R.C. RUSSO, AND R.V. THURSTON, 1977.  
TRIMMED SPEARMAN-KARBER METHOD FOR ESTIMATING MEDIAN  
LETHAL CONCENTRATIONS IN TOXICITY BIOASSAYS.  
ENVIRON. SCI. TECHNOL. 11(7): 714-719;  
CORRECTION 12(4):417 (1978).

DATE: 0812-121297  
CHEMICAL: Na2SO4

TEST NUMBER: Experiment 5  
SPECIES: A. Auriculata

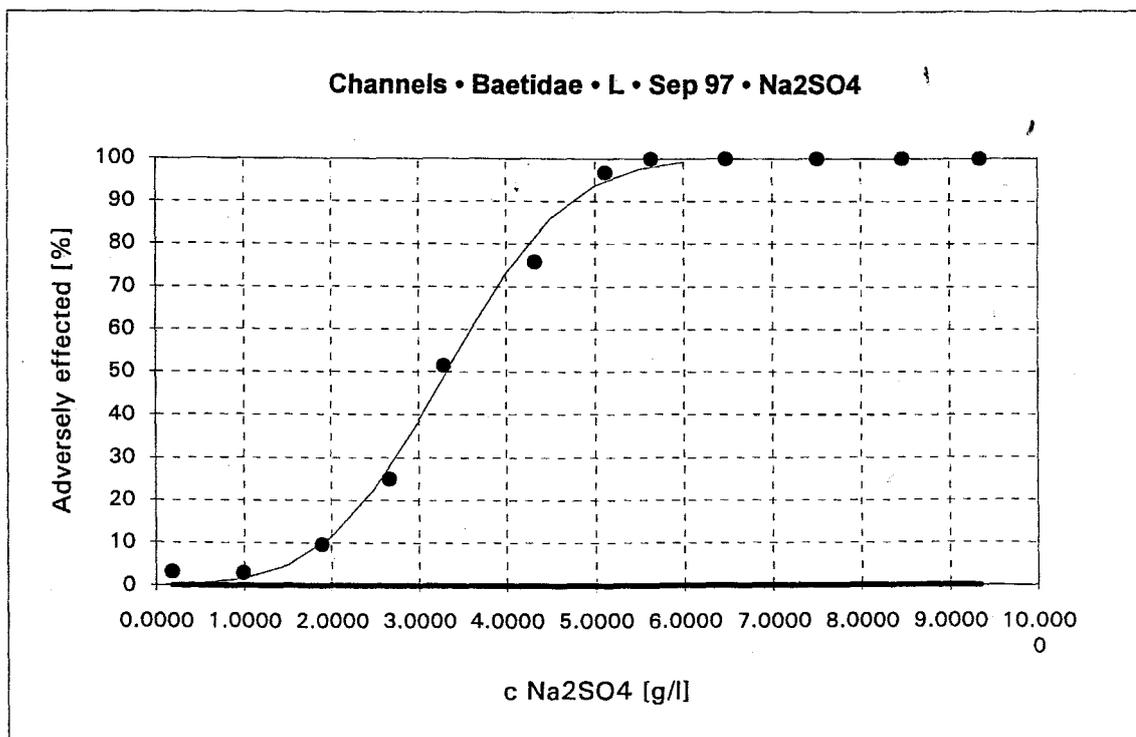
RAW DATA:										
CONCENTRATION(g/l )	4.12	5.13	6.10	6.99	8.21	8.97	10.23	11.16	11.92	
NUMBER EXPOSED:	32	31	31	31	31	31	31	29	30	
DURATION (hours )	EC50	LOWER 95% LIMIT	UPPER 95% LIMIT	PERCENT TRIM						
96	6.98	6.61	7.38	8.00						

# Appendix E

## Example of an Excel Table

System: Channels Result: Final  
 Species: *A. sudafricanum* Included setups: L  
 Toxicant: Sodium sulphate Date of exp.: 27.09. - 01.10.1997  
 Duration: 96 h

System	Concentrations c, based on IWQS-Results									Response calculations					System
	Sulphate Ion SO <sub>4</sub> <sup>-</sup>			Sodium Sulphate Na <sub>2</sub> SO <sub>4</sub>						Response [%]	* alive	+ responding	Σ	Σ ≥20?	
	day 0 [mg/l]	day end [mg/l]	mean [g/l]	day 0 [g/l]	day 4 [g/l]	or	mean [g/l]	nominal [g/l]	in graph [g/l]						
L-C2	missing	167	0.08		0.18		0.18	0.20	0.18	3.13	31	1	32	ok	L-C2
L-C10	724	695	0.71	1.02	0.96		0.99	1.00	0.99	2.94	33	1	34	ok	L-C10
L-C9	1303	1337	1.32	1.87	1.91		1.89	1.80	1.89	9.68	28	3	31	ok	L-C9
L-C4	1831	1851	1.84	2.66	2.67		2.66	2.60	2.66	25.00	24	8	32	ok	L-C4
L-C8	2283	2242	2.26	3.32	3.25		3.29	3.40	3.29	51.52	16	17	33	ok	L-C8
L-C11	2942	2989	2.97	4.30	4.36		4.33	4.20	4.33	75.76	8	25	33	ok	L-C11
L-C1	3529	3471	3.50	5.17	5.07		5.12	5.00	5.12	96.77	1	30	31	ok	L-C1
L-C13	3960	3735	3.85	5.80	5.46	3	5.63	5.80	5.63	100.00	0	32	32	ok	L-C13
L-C6	4585	4254	4.42	6.73	6.23	3	6.48	6.60	6.48	100.00	0	32	32	ok	L-C6
L-C12	5129	5106	5.12	7.53	7.49	3	7.51	7.40	7.51	100.00	0	32	32	ok	L-C12
L-C5	5746	5791	5.77	8.44	8.50	3	8.47	8.20	8.47	100.00	0	33	33	ok	L-C5
L-C3	6489	6231	6.36	9.54	9.15	3	9.35	9.00	9.35	100.00	0	32	32	ok	L-C3
L-C7	35	46	0.04	-	-		-	-	0.00	0.00	31	0	31	ok	L-C7
L-C14	missing	41	0.02	-	-		-	-	0.00	0.00	34	0	34	ok	L-C14
avg.	35.0	43.5													452



## Appendix F

### Regression analyses of mean headwidth *versus* EC50 and slope of experiments with *A. auriculata*

#### *A. auriculata*: HW *versus* EC50

Regression Analysis - Linear model:  $Y = a+bX$

Dependent variable: EC50 Independent variable: HW

Parameter	Estimate	Standard Error	T Value	Prob. Level
Intercept	44.8786	9.51786	4.71519	.01806
Slope	-0.0235846	6.11838E-3	-3.85471	.03084

#### Analysis of Variance

Source	Sum of Squares	Df	Mean Square	F-Ratio	Prob. Level
Model	8.805817	1	8.805817	14.85877	.03084
Residual	1.7779030	3	.5926343		
Total (Corr.)	10.583720	4			
Correlation Coefficient =	-0.912149			R-squared =	83.20 percent
Std. Error of Est. =	0.769827				

#### *A. auriculata*: HW *versus* Slope

Regression Analysis - Linear model:  $Y = a+bX$

Dependent variable: Slope Independent variable: HW

Parameter	Estimate	Standard Error	T Value	Prob. Level
Intercept	63.1089	10.8978	5.79097	.01024
Slope	-0.033469	7.00545E-3	-4.77756	.01743

#### Analysis of Variance

Source	Sum of Squares	Df	Mean Square	F-Ratio	Prob. Level
Model	17.733669	1	17.733669	22.82511	.01743
Residual	2.3308110	3	.7769370		
Total (Corr.)	20.064480	4			
Correlation Coefficient =	-0.940124			R-squared =	88.38 percent
Std. Error of Est. =	0.88144				

---

# References

---

- Abbott WS (1925) A method of computing the effectiveness of an insecticide. *J Econ Ent* 18:265-267
- Aihoon JK, Groenewald JA, Sartorius von Bach HJ (1997) Agricultural salinization in the Olifants River at Loskop Valley, Mpumalanga. *Agrekon* 36(3):268-282
- Allan JD (1995) *Stream ecology - Structure and function of running waters*. Chapman & Hall, London, UK, 388 pp
- Allison GB, Cook PG, Barnett SR, Walker GR, Jolly ID, Hughes MW (1990) Land clearance and river salinization in the Western Murray basin, Australia. *J Hydrol* 119:1-20.
- Anon (1958) Recommended methods for the analysis of trade effluents. Published for the Society for Analytical Chemistry by W. Heffer & Sons Ltd., Cambridge, UK, pp 86-87
- (1985) Sodium sulphate: Environmental and technical information for problem spills. Technical Services Branch, Environmental Protection Programs Directorate, Environmental Protection Service Ottawa, Ontario, Canada, 56 pp
- (1993) Water and waste-water management in the textile industry. WRC Project No. 145 TT 50/90. Box 824, Pretoria, South Africa
- APHA (1992) *Standard Methods for the examination of water and wastewater*. 18th edition. American Public Health Association, Washington, DC
- Armitage P, Allen I (1950) Methods of estimating the LD50 in quantal response data. *J Hyg* 48:298-322
- Arthur JW, West CW, Allen KN, Hedtke SF (1987) Seasonal toxicity of ammonia to fish and nine invertebrate species. *Bull Envir Contam Toxicol* 38:324-331
- Barnard KH (1932) South African May-flies (Ephemeroptera). *Trans R Soc S Afr* 20(3):201-259
- Bäthe J, Herbst V, Hofmann G, Matthes U, Thiel R (1994) Folgen der Reduktion der Salzbelastung in Werra und Weser für das Fließgewässer als Ökosystem. [*Changes in the aquatic ecosystems of the Werra River and the Weser River after a reduction of salinity concentration*]. *WSWTA* 84(10):528-536
- Belanger SE (1992) Use of experimental stream mesocosms to assess ecosystem risk: a case study with a cationic surfactant. In: Cairns JJr (ed) *Predicting ecosystem risk*. Princeton Scientific Publishing, Princeton, New Jersey, pp 263-287

- Belanger SE, Barnum JB, Woltering DM, Bowling JW, Ventullo RM, Schermerhorn SD, Lowe RL (1994) Chapter 28: Algal periphyton structure and function in response to consumer chemicals in experimental stream mesocosms. In: Graney RL, Kennedy JH, Rodgers JH (eds) Aquatic mesocosm studies in ecological risk assessment. Lewis Publishers, Boca Raton, Florida, pp 535-568
- Belanger SE, Farris JL, Cherry DS, Cairns J Jr (1986) Growth of Asiatic clams (*Corbicula* sp.) during and after long-term zinc exposure in field-located and laboratory artificial streams. Arch Environ Contam Toxicol 15(4):427-434
- , ———, ———, ——— (1990) Validation of *Corbicula fluminea* growth reductions induced by copper in artificial streams and river systems. Can J Fish Aquat Sci 47(5):904-914
- Bliss CI (1934) The method of probits. Sc 79:38-39
- Bothwell ML (1993) Artificial streams in the study of algal/nutrient dynamics. In: Lamberti GA, Steinman AD (eds) Research in artificial streams: Application, uses, and abuses. J N Am Benthol Soc 12(4):327-333
- Buikema AL Jr (1983) Variation in static acute toxicity tests with *Daphnia magna* exposed to refinery effluents and reference toxicants. J Oil Petrochem Pollut 1(3):189-198
- Buikema AL Jr, Benfield EF (1979) Use of macroinvertebrate life history information in toxicity tests. J Fish Res Board Can 36:321-328
- Buikema AL Jr, Niederlehner BR, Cairns J Jr (1982) Biological monitoring. Part IV: Toxicity testing. Water Res 16:239-262
- Buikema AL Jr, Voshell JR Jr (1993) Toxicity studies using freshwater benthic macroinvertebrates. In: Rosenberg DM, Resh VH (eds) Freshwater biomonitoring and benthic macroinvertebrates. Chapman & Hall, London, UK, pp 344-398
- Bunn SE, Davies PM (1992) Community structure of the macroinvertebrate fauna and water quality of a saline river system in South-Western Australia. Hydrobiol 248:143-160
- Cairns J Jr (1975) Critical species, including man, within the biosphere. Die Naturwissenschaften 62:193-199
- (1983) Are single species toxicity tests alone adequate for estimating environmental hazard? Hydrobiol 100: 47-57
- (1986) The myth of the most sensitive species. BioSci 36:670-672
- (ed) (1985) Multispecies toxicity testing. Pergamon Press, Elmsford, NY, 261 pp
- Cairns J Jr, McCormick PV, Belanger SE (1992) Ecotoxicological testing: Small is reliable. J Environ Pathol Toxicol Oncol 11(5,6):247-263
- Cairns J Jr, Mount DI (1990) Aquatic toxicology: Part 2 of a four-part series. Environ Sci Technol 24(2):154-161

- Cairns J Jr, Pratt JR (1989) The scientific basis of bioassays. *Hydrobiol* 188/189:5-20
- Canadian Guidelines (1987) Canadian water quality guidelines. Prepared by the task force on water quality guidelines of the Canadian Council of Resource and Environmental Ministers, Canada
- Canton JH, Adema DMM (1978) Reproducibility of short-term and reproduction toxicity experiments with *Daphnia magna* and comparison of the sensitivity of *Daphnia magna* with *Daphnia pulex* and *Daphnia cucullata* in short-term experiments. *Hydrobiol* 59(2):135-140
- Chapman D (ed) (1992) Water Quality Assessments - A guide to the use of biota, sediments and water in environmental monitoring. Chapman & Hall, London, UK, 585 pp
- Chiaudani G, Premazzi G (1988) Water quality criteria in environmental management. Report No. EUR 11 638 EN. Commission of the European Communities, Directorate general Science, Research and Development, Joint research Centre, Luxembourg, 78 pp
- Chutter FM (1994) The rapid biological assessment of stream and river water quality by means of the macroinvertebrate community of South Africa. In: Uys MC (ed) Classification of rivers and environmental health indicators. Proceedings of a joint South African - Australian workshop. WRC Report No. TT 63/94. Box 824, Pretoria, 0001, South Africa, pp 217-234
- (1998) Research on the rapid biological assessment of water quality impacts in stream and rivers. WRC Report No. 422/1/98. Box 824, Pretoria, 0001, South Africa
- Ciborowski JJH (1983) Influence of current velocity, density, and detritus on drift of two mayfly species (Ephemeroptera). *Can J Zool* 61:119-125
- Clements WH, Cherry DS, Cairns J Jr (1988) Structural alterations in aquatic insect communities exposed to copper in laboratory streams. *Environ Toxicol Chem* 7(9):715-722
- Coler RA, Rockwood JP (1989) Water pollution biology: A laboratory/field handbook. Technomic, Lancaster, PA, 107 pp
- Cooney JD (1995) Freshwater tests. In: Rand GM (ed) Fundamentals of aquatic toxicology - Effects, environmental fate, and risk assessment. 2nd edition, Taylor & Francis, Washington, pp 71-102
- Cooper WE, Stout RJ (1985) The Monticello experiment: A case study. In: Cairns J Jr (ed) Multispecies toxicity testing. Pergamon press, New York, pp 96-116

- Corbett CJ (1996) Toxicity testing with artificial streams: Effects of differences in current velocity. 3rd year Project, Department of Zoology and Entomology, Rhodes University
- Corkum LD, Pointing PJ (1979) Nymphal development of *Baetis vagans* McDunnough (Ephemeroptera: Baetidae) and drift habits of large larvae. *Can J Zool* 57:2348-2354
- Craig DA (1993) Hydrodynamic considerations on artificial stream research. In: Lamberti GA, Steinman AD (eds) *Research in artificial streams: Application, uses, and abuses*. *J N Am Benthol Soc* 12(4):313-384
- Crossland NO, Mitchell GC, Bennett D, Maxted J (1991) An outdoor artificial stream system designed for ecotoxicological studies. *Ecotoxicol Environ Saf* 22(2): 175-183
- Crowther RA, Hynes HBN (1977) The effect of road de-icing salt on the drift of stream benthos. *Environ Pollut* 14:113-126
- Curtis H (1983) *Biology*. Fourth edition, Worth Publishers, New York, 1159 pp
- Dallas HF, Day JA (1993) The effect of water quality variables on riverine ecosystems: A review. WRC Report No. TT61/93. Box 824, Pretoria, 0001, South Africa, 240 pp
- Davies BR, Day JA (1998) *Vanishing waters*. University of Cape Town Press, Cape Town, South Africa, 487 pp
- Davison B (1993) Spatial and temporal distribution of the nymphs of *Adenophlebia auriculata* (Eaton) (Ephemeroptera: Leptophlebiidae) in different habitats in the Berg River, Eastern Cape, South Africa. *Entomology III - Project*, Department of Zoology and Entomology, Rhodes University
- Diamond JM, Winchester EL, Mackler DG, Gruber D (1992) Use of the mayfly *Stenonema modestum* (Heptageniidae) in subacute toxicity assessments. *Environ Toxicol Chem* 11:415-425
- Dickson KL, Duke T, Loewengart G (1985) A synopsis: Workshop on multispecies toxicity tests. In: Cairns J Jr (ed) *Multispecies toxicity testing*. Pergamon press, New York, pp 249-253

- DIN* (1991) Deutsche Industrie Norm 38412 Teil 34. Deutsche Einheitsverfahren zur Wasser-, Abwasser- und Schlammuntersuchung. Testverfahren mit Wasserorganismen (Gruppe L). Bestimmung der Hemmwirkung von Abwasser auf die Lichtemission von *Photobacterium phosphoreum* - Leuchtbakterien-Abwassertest mit konservierten Bakterien (L 34) [*German Industrial Norm 38412 Part 34. Standardized methods for the analysis of water, effluent and sediment. Test methods using aquatic organisms (Group L). Determination of inhibitive effects of effluents on the light emission of Photobacterium phosphoreum - Effluent test using cultured luminescent bacteria (L 34)*]. Normenausschuß Wasserwesen (NAW) im Deutschen Institut für Normung e.V. Beuth Verlag, Berlin, Germany
- (1995) Deutsche Industrie Norm 38412 Teil 37 (Norm-Vorlage). Deutsche Einheitsverfahren zur Wasser-, Abwasser- und Schlammuntersuchung. Testverfahren mit Wasserorganismen (Gruppe L). Bestimmung der Hemmwirkung von Wasserinhaltsstoffen auf das Wachstum von *Photobacterium phosphoreum* - (Photobacterium phosphoreum- Zellvermehrungs-Hemmtest) (L 37) [*German Industrial Norm 38412 Part 37 (Draft document). Standardized methods for the analysis of water, effluent and sediment. Test methods using aquatic organisms (Group L). Determination of inhibitive effects of substances contained in water on the growth of Photobacterium phosphoreum - Growth-inhibition using Photobacterium phosphoreum (L 37)*]. Normenausschuß Wasserwesen (NAW) im Deutschen Institut für Normung e.V. Beuth Verlag, Berlin, Germany
- Domin H (1987) Gesammelte Gedichte [*Collected poems*] S.Fischer Verlag, Frankfurt, Germany, 416 pp
- Dowden BF, Bennett HJ (1965) Toxicity of selected chemicals to certain animals. *J Water Pollut Contr Fed* 37(9):1308-1316
- Du Plessis HM, Van Veelen M (1991) Water quality: salinization and eutrophication time series and trends in South Africa. *S Afr J Sci* 87:11-16
- DWA* (1986) Management of the water resources of the Republic of South Africa. Government Printer, Department of Water Affairs, Pretoria, South Africa
- DWAF* (1991) Water quality management policies and strategies in the RSA. Department of Water Affairs and Forestry, Pvt Bag X313, Pretoria, 0001, South Africa
- (1992) Analytical Methods Manual, TR 151. Department of Water Affairs and Forestry, Pvt Bag X313, Pretoria, 0001, South Africa
- (1993) South African Water Quality Guidelines. Volume 1: Domestic use. Volume 2: Recreational use. Volume 3: Industrial use. Volume 4: Agricultural use. 1st edition. Department of Water Affairs and Forestry, Pvt Bag X313, Pretoria, 0001, South Africa

- (1994) Water supply and sanitation policy - White paper. Department of Water Affairs and Forestry, Pvt Bag X313, Pretoria, 0001, South Africa
- (1995) You and your water rights. South African law review - A call for public response. Department of Water Affairs and Forestry, Pvt Bag X313, Pretoria, 0001, South Africa
- (1996a) South African Water Quality Guidelines. Volume 7: Aquatic ecosystems. 1st edition. Department of Water Affairs and Forestry, Pvt Bag X313, Pretoria, 0001, South Africa
- (1996b) Water law principles - Discussion document. Department of Water Affairs and Forestry, Pvt Bag X313, Pretoria, 0001, South Africa
- (1996c) Water law review - Water environmental quality policy. Draft version 1.5. Department of Water Affairs and Forestry, Pvt Bag X313, Pretoria, 0001, South Africa
- (1996d) South African Water Quality Guidelines. Volume 1: Domestic use. Volume 2: Recreational use. Volume 3: Industrial use. Volume 4: Agricultural use: Irrigation. Volume 5: Agricultural use: Livestock watering. Volume 6: Agricultural use: Aquaculture. 2nd edition. Department of Water Affairs and Forestry, Pvt Bag X313, Pretoria, 0001, South Africa
- (1997a) Overview of water resources availability and utilization in South Africa. Report P RSA/00/0197. Department of Water Affairs and Forestry, Pvt Bag X313, Pretoria, 0001, South Africa, 72pp
- (1997b) White paper on a national water policy for South Africa. Department of Water Affairs and Forestry, Pvt Bag X313, Pretoria, 0001, South Africa
- (1999a) Resource Directed Measures for Water Resource Protection. Report Number N/0000/00/\_/REH0299. Unofficial first draft 8 January 1999. Department of Water Affairs and Forestry, Pvt Bag X313, Pretoria, 0001, South Africa
- (1999b) A protocol for acute toxicity testing of single substances using selected riverine invertebrates in artificial stream systems. 1st Draft. Produced by Scherman P-A and Palmer CG, Institute for Water Research, Rhodes University, Grahamstown, South Africa
- Everitt V (1996) Zinc toxicity of a selected macroinvertebrate, *Adenophlebia auriculata*: Method development. Honours thesis, Institute for Water Research, Rhodes University
- Everitt V, Scherman P-A, Villett MH (in press) Zinc toxicity of a selected macroinvertebrate, *Adenophlebia auriculata* (Ephemeroptera, Leptophlebiidae): method development. South Afr J Aquat Sci

- Finney DJ (1971) Probit Analysis, 3rd ed. Cambridge University Press, Cambridge, UK, 333 pp
- Flügel WA (1991) River salination due to dryland agriculture in the Western Cape Province, Republic of South Africa. In: Sediment and stream water quality in a changing environment: Trends and explanation. Proceedings of the Vienna Symposium, August 1991, IAHS Publ. No. 203:191-200
- Fogels A, Sprague JB (1977) Comparative short-term tolerance of zebrafish, flagfish, and rainbow trout to five poisons including potential reference toxicants. *Water Res* 11:811-817
- Forbes AT, Allanson BR (1970) Ecology of the Sundays River Part II: Osmoregulation in some mayfly nymphs (Ephemeroptera: Baetidae). *Hydrobiol* 36(3-4):489-503
- Fremling CR (1975) Acute toxicity of the lampricide 3-trifluoro-methyl-4-nitrophenol (TFM) to nymphs of mayflies (*Hexagenia* sp.). *US Fish Wildl Serv Invest Fish Control* 58:1-8
- Gardiner J, Zabel T (1989) United Kingdom water quality standards arising from European Community directives - An update. Water Research Centre Report No. PRS 2287-M, 120 pp
- Gelber RD, Lavin PT, Mehta CR, Schoenfeld DA (1985) Statistical analysis. In: Rand GM, Petrocelli S (eds) *Fundamentals of Aquatic Toxicology - Methods and Applications*. Taylor & Francis, Washington, pp 110-123
- Gelwick FP, Matthews WJ (1993) Artificial streams for studies of fish ecology. In: Lamberti GA, Steinman AD (eds) *Research in artificial streams: Application, uses, and abuses*. *J N Am Benthol Soc* 12(4):343-347
- Gerhardt A (1992) Effects of subacute doses of iron (Fe) on *Leptophlebia marginata* (Insecta: Ephemeroptera). *Freshw Biol* 27(1):79-84
- (1994) Short term toxicity of iron (Fe) and lead (Pb) to the mayfly *Leptophlebia marginata* (L.) (Insecta) in relation to freshwater acidification. *Hydrobiol* 284(2):157-168
- (1995) Effects of metals on stream invertebrates. PhD Thesis, Department of Ecology, Lund University, Lund, Sweden
- Gerhardt A, Svensson E, Clostermann M, Fridlund B (1994) Monitoring of behavioural patterns of aquatic organisms with an impedance conversion technique. *Environ Int* 20(2):209-219
- Gerhardt A, Palmer CG (1998) Copper tolerances of *Adenophlebia auriculata* Eaton 1884 (Insecta: Ephemeroptera) and *Burnupia stenochrias* Cawston 1932 (Gastropoda: Ancyclidae) in indoor artificial streams. *Sci Tot Environ* 215: 217-229

- Giesy JP, Allred PM (1985) Replicability of aquatic multispecies test systems. In: Cairns J Jr (ed) Multispecies toxicity testing. Pergamon press, Elmsford, New York, pp 187-247
- Goetsch P-A, Palmer CG (1997) Salinity tolerances of selected macroinvertebrates of the Sabie River, Kruger National Park, South Africa. Arch Environ Contam Toxicol 32:32-41
- Graney RL, Giesy JP, Clark JR (1995) Field studies. In: Rand GM (ed) Fundamentals of aquatic toxicology - Effects, environmental fate, and risk assessment. 2nd edition, Taylor & Francis, Washington, pp 257-305
- Greeff GJ (1994) Ground-water contribution to stream salinity in a shale catchment, RSA. Ground Water 32(1):63-70.
- Guckert JB (1993) Artificial streams in ecotoxicology. In: Lamberti GA, Steinman AD (eds) Research in artificial streams: Application, uses, and abuses. J N Am Benthol Soc 12(4):313-384
- Haigh EH, Davies-Coleman HD (1997) Standard laboratory organisms for water quality studies programme. WRC Report No. 545/1/97. Box 824, Pretoria, 0001, South Africa
- , ——— (in press) The development of a production facility for standard laboratory test organisms for ecotoxicological research. WRC Report No. pending. Box 824, Pretoria, 0001, South Africa
- Hamilton MA, Russo RC, Thurston RV (1977) Trimmed Spearman-Kärber method for estimating median lethal concentrations in toxicity bioassays. Environ Sci Technol 11(7):714-719; Correction 12(4):417 (1978)
- Hart BT, Angehrn-Bettinazzi C, Campbell IC, Jones MJ (1992) Australian water quality guidelines. Australian and New Zealand Environment and Conservation Council
- Hart BT, Bailey P, Edwards R, Hortle K, James K, McMahon A, Meredith C, Swadling K (1990) Effects of salinity on river, stream and wetland ecosystems in Victoria Australia. Water Res 24 (9):1103-1117
- , ———, ———, ———, ———, ———, ——— (1991) A review of the salt sensitivity of the Australian freshwater biota. Hydrobiol 210:105-144
- Herold CE (1994) Water quality - Meeting the challenge in the face of a diminishing resource. Proceedings of 50 years of water engineering in South Africa, 14-15 July 1994. Water Engineering Division, South African Institution of Civil Engineers, pp 163-182
- Hickey CW, Vickers ML (1992) Comparison of the sensitivity to heavy metals and pentachlorophenol of the mayflies *Deleatidium* spp. and the cladoceran *Daphnia magna*. N Z J Mar Freshw Res 26(1):87-93

- , ——— (1994) Toxicity of ammonia to nine native New Zealand freshwater invertebrate species. *Arch Environ Contam Toxicol* 26(3):292-298
- Hoekstra JA (1991a) Estimation of the LC50: A review. *Environmetrics* 2:139-152
- (1991b) Approximate variances for tolerance-distribution free LD50-estimators supplemented with Abbott's correction. *Communications in Statistics* 20:715-723
- (1993) Statistics in ecotoxicology: Quantifying the biological effects of chemicals. PhD Thesis, Vrije Universiteit, Amsterdam, The Netherlands, pp 1-25
- Hohls DR (1996) National biomonitoring programme for riverine ecosystems: Framework document for the programme. NBP Report Series No. 1. Institute for Water Quality Studies, Department of Water Affairs and Forestry, Pretoria, South Africa, 39 pp
- Horne PA, Bennison GL (1986) Laboratory stream research: Concept, significance & application. Report WQ8. Rural Water Commission of Victoria, Australia
- , ——— (1987a) A laboratory stream design for biological research. *Water Res* 21(12):1577-1579
- , ——— (1987b) The development and application of a laboratory stream for biological research. Completion report. Water quality Assessment Section, Rural Water Commission, Armadale, Australia
- Hunt B (1997) Population size distribution of the nymphs of *Adenophlebia auriculata* in two Eastern Province rivers, and the application of the biotope concept to ecological studies. Honours thesis, Institute for Water Research, Rhodes University
- Hurlbert SH (1984) Pseudoreplication and the design of ecological field experiments. *Ecol Monogr* 54(2): 187-211
- Jensen AL (1972) Standard error of LC50 and sample size in fish bioassays. *Water Res* 6:85-89
- Jones GA, Brierley SE, Geldenhuis SJJ, Howard JR (1989) Research on the contribution of mine dumps to the mineral pollution load in the Vaal Barrage. WRC Report No. 136/1/89. Box 824, Pretoria, South Africa, 183 pp
- Kempster PL, Hattingh WHJ, van Vliet HR (1980) Summarized water quality criteria. Technical report TR 108. Department of Environmental Affairs, Pretoria, 0001, South Africa.
- Kerr CA (1995) Technology transfer of aquatic chemical speciation modelling. WRC Report No. 530/1/95. Box 824, Pretoria, 0001, South Africa
- Kiffney PM (1996) Main and interactive effects of invertebrate density, predation, and metals on a Rocky Mountain stream macroinvertebrate community. *Can J Fish Aquat Sci* 53:1595-1601

- Kiffney PM, Clements WH (1994) Effects of heavy metals on a macroinvertebrate assemblage from a Rocky Mountain stream in experimental microcosms. *J N Am Benthol Soc* 13(4):511-523
- , ——— (1996) Size dependent response of macroinvertebrates to metals in experimental streams. *Environ Toxicol Chem* 15(8):1352-1356
- Kimball KD, Levin SA (1985) Limitations of laboratory bioassays: The need for ecosystem-level testing. *BioSci* 35(3):165-171
- King J, Louw D (in press) Instream flow assessments for regulated rivers in South Africa using the Building Block Methodology. *J Aquat Ecosyst Health*
- Kleynhans CJ (1996) A qualitative procedure for the assessment of the habitat integrity status of the Luvuvhu River (Limpopo System), South Africa. *J Aquat Ecosyst Health* 5: 41-54
- Kleynhans CJ, Schulz GW, Engelbrecht JS, Rousseau FJ (1992) The impact of a paper mill effluent spill on the fish populations of the Elands and Crocodile Rivers (Incomati System, Transvaal). *Water SA* 18(20):73-80
- Kooijman SALM (1985) Toxicity testing at population level. In: Cairns J Jr (ed) *Multispecies toxicity testing*. Pergamon press, New York, pp 143-164
- Kosinski RJ (1989) Artificial streams in ecotoxicological research. In: Boudou A, Ribeyre F (eds) *Aquatic ecotoxicology: Fundamental concepts and methodologies*. CRC Press, Boca Raton, Florida, pp 297-316
- La Point TW, Fairchild JF, Little EE, Finger SE (1989) Laboratory and field techniques in ecotoxicological research: Strength and limitations. In: Boudou A, Ribeyre F (eds) *Aquatic ecotoxicology: Fundamental concepts and methodologies*. CRC Press, Boca Raton, Florida, pp 239-255
- Lamberti GA, Steinman AD (1993a) Introduction. In: Lamberti GA, Steinman AD (eds) *Research in artificial streams: Application, uses, and abuses*. *J N Am Benthol Soc* 12(4):313-317
- , ——— (eds) (1993b) *Research in artificial streams: Application, uses, and abuses*. *J N Am Benthol Soc* 12(4):313-384
- Leaflet Spectroquant® Nitrite test, Art. 1.14776.0001. Merck KGaA, Darmstadt, Germany
- Levin SA, Harwell MA, Kelly JR, Kimball KD (eds) (1989) *Ecotoxicology: Problems and approaches*. Springer-Verlag, New York, 547 pp
- Liber K, Kaushik NK, Solomon KR, Carey JH (1992) Experimental designs for aquatic mesocosm studies: a comparison of the "ANOVA" and "regression" design for assessing the impact of tetrachlorophenol on zooplankton populations in limnocorrals. *Environ Toxicol Chem* 11(1):61-77

- Lincoln RJ, Boxshall GA, Clark PF (1983) A dictionary of ecology, evolution and systematics. University Press, Cambridge, UK, 298 pp
- Loewengart G, Maki AW (1985) Multispecies toxicity tests in the safety assessment of chemicals: Necessity or curiosity. In: Cairns J Jr (ed) Multispecies toxicity testing. Pergamon press, New York, pp 1-12
- Lowell RB, Culp JM, Wrona FJ (1995a) Toxicity testing with artificial streams: Effects of differences in current velocity. *Environ Toxicol Chem* 14(7):1209-1217
- , ———, ——— (1995b) Stimulation of increased short-term growth and development of mayflies by pulp mill effluent. *Environ Toxicol Chem* 14(9):1529-1541
- Maart B (1996) The problem of salinity in South Africa: A literature review. In: Palmer *et al.* (1996) Development of a recirculating artificial stream system to investigate the use of macroinvertebrates as water quality indicators. WRC Report No. 475/1/96. Box 824, Pretoria, 0001, South Africa, pp 125-146
- Mayer FL Jr, Ellersieck MR (1988) Experiences with single-species tests for acute toxic effects on freshwater animals. *Ambio* 17(6):367-375
- McCafferty WP (1991) Towards a phylogenetic classification of the Ephemeroptera (Insecta): A commentary on systematics. *Ann Entomol Soc Am* 84(4):343-360.
- McIntire CD (1968) Structural characteristics of benthic algal communities in laboratory streams. *Ecology* 49(3):520-537
- (1993) Historical and other perspectives of laboratory stream research. In: Lamberti GA, Steinman AD (eds) *Research in artificial streams: Application, uses, and abuses*. *J N Am Benthol Soc* 12(4):313-384
- McIntire CD, Garrison RL, Phinney HK, Warren CE (1964) Primary production in laboratory streams. *Limnol Oceanogr* 9:92-102
- McKee JE, Wolf HW (1963) Water quality criteria. The resource agency of California, 2nd edition, State Water Quality Control Bd., Publ. 3A, 584 pp
- McKim JM (1985) Early life stage toxicity tests. In: *Fundamentals of aquatic toxicology - Methods and applications*. Taylor & Francis, Washington, pp 58-95
- Metzeling L (1993) Benthic macroinvertebrate community structure in streams of different salinities. *Aust J Mar Freshw Res* 44:335-351
- Moore CA (1990) Water quality requirements of the biota of the Kruger National Park rivers. Workshop on the Preliminary Water Quality Guidelines for the Kruger National Park Rivers, 23-24 October 1990. Kruger National Park Rivers Research Programme, 21 pp

- Moore CA, van Veelen M, Ashton PJ, Walmsley RD (1991) Preliminary water quality guidelines for the Kruger National Park. Kruger National Park Rivers Research Programme Report No. 1, ISBN No. 0-9583181-4-X, 91pp
- Moriarty F (1988) Ecotoxicology - The study of pollutants in ecosystems. 2nd edition. Academic Press, London, UK, 289 pp
- Mount DI (1985) Scientific problems in using multispecies tests for regulatory purposes. In: Cairns J Jr (ed) Multispecies toxicity testing. Pergamon press, New York, pp 13-18
- Newman MC (1996) Ecotoxicology as a science. In: Newman MC, Jagoe CH (eds) Ecotoxicology - A hierarchical treatment. CRC Lewis Publishers, Boca Raton, Florida, pp 1-9
- Newman MC, Jagoe CH (eds) (1996) Ecotoxicology - A hierarchical treatment. CRC Lewis Publishers, Boca Raton, Florida
- Noble RG (1970) Relation between tolerances and distribution of two species of Ephemeroptera. Limnological Project Reports Vol. 3 No. 3. National Institute for Water Research, Pretoria, South Africa, 491 pp
- Oikari A, Holbom B, Ånäs E, Miilunpalo M, Kruzynski G, Castrén M (1985) Ecotoxicological aspects of pulp and paper mill effluents discharged to an inland water system: Distribution in water, and toxicant residues and physiological effects in caged fish (*Salmo gairdneri*). *Aquat Toxicol* 6:219-239
- Palmer CG (1991) Benthic assemblage structure, and the feeding biology of sixteen macroinvertebrate taxa from the Buffalo River, Eastern Cape, South Africa. PhD Thesis, Faculty of Science, Rhodes University
- (in press) The application of ecological research in the development of a new water law in South Africa. *J N Am Benthol Soc*
- Palmer CG, Goetsch P-A (1997) The calibration of an artificial stream system used to investigate the tolerances of South African riverine invertebrates to selected water quality variables. *Arch Environ Contam Toxicol* 32:22-32
- Palmer CG, Goetsch P-A, O'Keeffe JH (1996) Development of a recirculating artificial stream system to investigate the use of macroinvertebrates as water quality indicators. WRC Report No. 475/1/96. Box 824, Pretoria, 0001, South Africa
- Palmer CG, O'Keeffe J, Palmer A (1993) Macroinvertebrate functional feeding groups in the middle and lower reaches of the Buffalo River, Eastern Cape, South Africa. II. Functional morphology and behaviour. *Freshw Biol* 29:455-462
- Palmer CG, Rowston WS, Jezewski WA, Skotnicky PI (1994) The design and research potential of an artificial stream system for the investigation of macroinvertebrate water quality tolerances. *Water SA* 20(3):247-258

- Palmer CG, Scherman P-A (in press) Application of an artificial stream system to investigate macroinvertebrate water quality tolerances. WRC Report No. pending. Box 824, Pretoria, 0001, South Africa
- Parrish PR (1985) Acute toxicity tests. In: Rand GM, Petrocelli S (eds) *Fundamentals of Aquatic Toxicology: Methods and Applications*. Taylor & Francis, Washington, pp 31-57
- Pascoe D, Edwards RW (1989) Single species toxicity tests. In: Boudou A, Ribeyre F (eds) *Aquatic ecotoxicology: Fundamental concepts and methodologies*. CRC Press, Boca Raton, Florida, pp 93-126
- Peters GT, Cherry DS, Cairns J Jr (1985) Responses of *Isonychia bicolor* to alkaline pH: An evaluation of survival, oxygen consumption, and chloride cell ultrastructure. *Can J Fish Aquat Sci* 42(6):1088-1095
- Petrocelli SR (1985) Chronic toxicity tests. In: *Fundamentals of aquatic toxicology - Methods and applications*. Taylor & Francis, Washington, pp 96-123
- Pontasch KW, Cairns J Jr (1991) Multispecies toxicity tests using indigenous organisms: Predicting the effects of complex effluents in streams. *Arch Environ Contam Toxicol* 20(1):103-112
- Pratt JR, Cairns J Jr (1996) Ecotoxicology and the redundancy problem: Understanding effects on community structure and function. In: Newman MC, Jagoe CH (eds) *Ecotoxicology - A hierarchical treatment*. CRC Lewis Publishers, Boca Raton, Florida, pp 347-370
- Rand GM, Petrocelli SR (1985) Introduction. In: Rand GM, Petrocelli SR (eds) *Fundamentals of aquatic toxicology - Methods and applications*. Taylor & Francis, Washington, pp 1-28
- Rand GM, Wells PG, McCarthy LS (1995) Introduction to aquatic toxicology. In: Rand GM (ed) *Fundamentals of aquatic toxicology - Effects, environmental fate, and risk assessment*. 2nd edition, Taylor & Francis, Washington, pp 3-67
- Roos JC, Pieterse AJH (1995) Salinity and dissolved substances in the Vaal River at Balkfontein, South Africa. *Hydrobiol* 306:41-51
- Rosenberg DM, Resh VH (eds) (1993) *Freshwater biomonitoring and benthic macroinvertebrates*. Chapman & Hall, London, Great Britain, 488 pp
- Roux DJ, Jooste SHJ, MacKay HM (1996) Substance-specific water quality criteria for the protection of South African freshwater ecosystems: methods for derivation and initial results for some inorganic toxic substances. *S Afr J Sci* 92:198-206
- Scherman P-A, Palmer CG (in press) The evaluation and application of two artificial stream designs and associated experimental designs in aquatic toxicology: a case study. *Australas J Ecotox*

- Scherman P-A, Wade PW, Palmer CG (in press a) Toxicological studies to examine the salinity response of an indigenous mayfly of the Sabie River, South Africa. Arch Environ Contam Toxicol
- Scherman P-A, Palmer CG, Wade PW (in press b) Responses of a riverine indigenous macroinvertebrate, *Tricorythus* sp., to selected sulphate salts. Water SA
- Schindler DW (1996) Ecosystems and ecotoxicology: A personal perspective. In: Newman MC, Jagoe CH (eds) Ecotoxicology - A hierarchical treatment. CRC Lewis Publishers, Boca Raton, Florida, pp 371-398
- Schindler DW, Mills KH, Malley DF, Findlay DL, Shearer JA, Davies IJ, Turner MA, Linsey GA, Cruikshank DR (1985) Long-term ecosystem stress: the effects of years of experimental acidification on a small lake. Science 228:1359-1401
- Schmidt-Nielsen K (1979) Animal physiology - Adaptation and environment. 2nd edition. Cambridge University Press, Cambridge, UK, 560 pp
- Shin HS, Oh SE, Bae BU (1996) Competition between SRB and MPB according to temperature change in the anaerobic treatment of tannery wastes containing high sulfate. Environ Technol 17:361-370
- Short TM, Black JA, Birge WJ (1991) Ecology of a saline stream: community responses to spatial gradients of environmental conditions. Hydrobiol 226:167-178.
- Shriner C, Gregory T (1984) Use of artificial streams for toxicological research. Crit Rev Toxicol 13(3):253-281
- Slabbert JL, Oosthuizen J, Venter EA, Hill E, Du Preez M, Pretorius PJ (1998a) Development of procedures to assess whole effluent toxicity. WRC Report No. 453/1/98. Box 824, Pretoria, 0001, South Africa
- \_\_\_\_\_, \_\_\_\_\_, \_\_\_\_\_, \_\_\_\_\_, \_\_\_\_\_, \_\_\_\_\_ (1998b) Development of guidelines for toxicity bioassaying of drinking and environmental waters in South Africa. WRC Report No. 358/1/98. Box 824, Pretoria, 0001, South Africa
- Sokal RR, Rohlf FJ (1981) Biometry. 2nd edition, W. H. Freeman and company, New York, 859 pp
- Sprague JB (1969) Measurement of pollutant toxicity to fish. I. Bioassay methods for acute toxicity. Water Res 3:793-821
- \_\_\_\_\_ (1985) Factors that modify toxicity. In: Rand GM, Petrocelli S (eds) Fundamentals of Aquatic Toxicology - Methods and Applications. Taylor & Francis, Washington, pp 124-163
- Stander JvR (1987) Fighting SA's salinity problem. SA Waterbull 13(5):10-13.
- Statzner B, Gore JA, Resh VH (1988) Hydraulic stream ecology: Observed patterns and potential applications. J N Am Benthol Soc 7(4):307-360

- Stephan CE (1977) Methods for calculating an LC50. In: Mayer FL, Hamelink JL (eds) Aquatic toxicology and Hazard Evaluation ASTM STP 634. American Society for Testing and Materials, Philadelphia, pp 65-84
- Stephan CE, Rogers JW (1985) Advantages of using regression analysis to calculate results of chronic toxicity tests. Aquatic Toxicology and Hazard Assessment: 8th symposium ASTM STP 891, Bahner RC, Hansen DJ (eds) American Society for Testing and Materials, Philadelphia, pp 328-338
- Swift MC, Troelstrup NHJr, Detenbeck NE, Foley JL (1993) Large artificial streams in toxicological and ecological research. In: Lamberti GA, Steinman AD (eds) Research in artificial streams: Application, uses, and abuses. J N Am Benthol Soc 12(4):313-384
- Truhaut R (1977) Ecotoxicology: Objectives, principles and perspectives. Ecotoxicol Environ Saf 1:151-173
- Trusler GE, Edwards RI, Buckley CA (1991) Sulphate, calcium and heavy metal removal from industrial effluents using barium carbonate. Water SA 17(2):167-172
- Tyson D (1993) Lethal and sublethal effects of elevated salinity on the mountain stream amphipod, *Paramelita nigroculus* (Barnard). Honours thesis, Department of Zoology, University of Cape Town, Rondebosch, Cape Town, 41 pp
- Ure AM, Davidson CM (eds) (1995) Chemical speciation in the environment. Chapman & Hall, London, UK, 408 pp
- US EPA (1986) Quality criteria for water - 1986. United States Environmental Protection Agency, Washington
- Van der Merwe W, Grobler DC (1990) Water quality management in the RSA: Preparing for the future. Water SA 16(1):49-53
- Van Vuren JHJ, Du Preez HH, Deacon AR (1994) Effect of pollutants on the physiology of fish in the Olifants River (Eastern Transvaal). WRC Report No. 350/1/94. Box 824, Pretoria, 0001, South Africa
- VCI (1992) Natriumsulfat - Grunddatensatz der Bayer AG vom 23.9.1992. In: Altstoffe: Daten zur Beurteilung der Wirkung auf Mensch und Umwelt - Datensätze. [*Sodium sulphate - Database of the Bayer AG, 23.9.1992. In: Chemical substances: Data to evaluate their impact on man and environment*] VCI (Verband der Chemischen Industrie), Frankfurt, Germany, Vol. 12, 23 pp
- Warren CE, Davis GE (1971) Laboratory stream research: Objectives, possibilities, and constraints. Annu Rev Ecol Syst 2:111-144

- Williams K, Green D, Pascoe D (1984) Toxicity testing with freshwater macroinvertebrates: Methods and application in environmental management. In: Pascoe D, Edwards RW (eds) Freshwater biological monitoring. Advances in Water Pollution Control. Pergamon, 167 pp
- Williams ML (1996) Macroinvertebrate community and species responses to chlorinated sewage effluent in the Umsunduze and Umbilo rivers, KwaZulu-Natal, South Africa. MSc thesis, Institute for Water Research, Rhodes University
- Williams WD (1987) Salinization of rivers and streams: An important environmental hazard. *Ambio* 16(4):180-185
- Williams WD, Taaffe RG, Boulton AJ (1991) Longitudinal distribution of macroinvertebrates in two rivers subject to salinization. *Hydrobiol* 210:151-160
- Wuhrmann K, Ruchti J, Eichenberger E (1967) Quantitative experiments on self-purification with pure organic compounds. *Adv Water Pollut Res* 1:229-251.
- Zar JH (1984) Biostatistical analysis. 2nd edition. Prentice Hall, Englewood Cliffs, New Jersey, 718 pp