

# Sustainable Machining Process - Myth or Reality

**Franci PUŠAVEC<sup>1)</sup>, Antun STOIC<sup>2)</sup> and Janez KOPAČ<sup>1)</sup>**

- 1) Fakulteta za strojništvo, Univerza v Ljubljani  
(Faculty of Mechanical Engineering,  
University of Ljubljana),  
Aškerčeva 6, 1000 Ljubljana  
**Slovenia**
- 2) Strojarski fakultet u Slavnoskom Brodu  
Sveučilišta J. J. Strossmayera u Osijeku  
(Mechanical Engineering Faculty, J. J.  
Strossmayer University of Osijek),  
Trg Ivane Brlić-Mažuranić 2,  
HR-35000 Slavonski Brod,  
**Republic of Croatia**

franc.pusavec@fs.uni-lj.si

## Keywords

*Costs*  
*Cryogenics*  
*Machining process*  
*Performances*  
*Sustainability*

## Ključne riječi

*Kriogenici*  
*Održivost*  
*Proces obrade*  
*Svojtva*  
*Troškovi*

**Received (primljeno):** 2009-09-01

**Accepted (prihvaćeno):** 2010-02-19

## 1. Introduction

The idea of sustainability presents the development in a way that meets the needs of the present without compromising the ability of future generations to meet their own needs (Gro Harlem Bruntland, 1987).

The global environmental problems caused by the consumption of natural resources and pollution resulting from technical products, have led to increasing political pressure and stronger EU regulations being applied to both, the producers and users of such products. The

Preliminary note

The industry is under increasing pressure of the financial crisis, global competition, stricter environmental legislation and supply-chain demand. To tackle these issues, a sustainable development trend has to be assured synergetically on all the levels/fields, including machining processes. This paper promotes sustainable production via an improvement of machining technologies through an alternative cryogenic machining process. Presented are comparative experimental results of cryogenic machining performances in accordance with conventional processes, through the analysis of: cutting forces, tool-wear, temperatures and costs. This work proves that the cryogenic machining technology has a high potential to cut costs and improve competitiveness by reducing resource consumption therefore, creating less waste, and has less of an environmental and social impact. The results of this work confirm that alternative sustainable cryogenic machining offers conditions for fulfilling the sustainability pillars: the economical, social and environmental one, over conventional machining processes

## Održivi proces obrade – mit ili stvarnost

Prethodno priopćenje

Industrija je pod sve većim pritiskom financijske krize, globalne konkurencije, strožih zakona o zaštiti okoliša, lanaca ponude i potražnje. Da rješavajući ova pitanja, održivi trend razvoja mora osigurati sinergiju na svim razinama / poljima, uključujući i obrade. Ovaj rad promovira održivu proizvodnju putem suvremene tehnologije u vidu alternativnog kriogenog procesa obrade. Prikazani su eksperimentalni rezultati komparativne kriogene obrade u odnosu na konvencionalne procese, kroz analizu: sila rezanja, trošenja alata, temperature i troškove. Ovaj rad dokazuje da kriogene tehnologije imaju visok potencijal za smanjenje troškova i poboljšanje konkurentnosti smanjenjem potrošnje resursa, dakle, omogućuje manje otpada, a ima manji ekološki i društveni utjecaj. Rezultati ovog rada potvrđuju da alternativna održiva kriogena obrada omogućava ispunjenje uvjeta za održivost: ekonomsku, socijalnu i ekološku, u odnosu na konvencionalnu obradu.

industries involved in production are additionally under economic pressure and are attempting to compensate for increasing costs and create added value for their products. The adoption of sustainable development in production offers the industry a cost effective route for an improved economic, environmental, and social performance (i.e. the three pillars of sustainability – Figure 1) [5, 7, 15, 17].

Sustainable development initiatives are established on a political level within the UN, the OECD, the EU, and national levels. These initiatives are well positioned

and promoted on the production macro level, but there is a severe lack of implementation practices on the shop floor dealing with machining technologies. With the implementation of sustainability principles on the machining technology level, industry has the potential to save money and improve their environmental and social performance even if their production stays in the same range, as shown in the machining evaluation included in this paper. In this way conducted evaluation of sustainability in cryogenic machining is more than a method for supporting the design of technology and an instrument for supporting decision-making. It is also a tool for supporting technology policy and for encouraging its adoption and application in industry.

The growing awareness of sustainability issues in machining, especially in the case of high-tech materials machining that identifies oil-based cooling/lubrication fluids (CLF) as a major non-sustainable element of the process, have led R&D on finding alternate cooling and/or lubrication mechanisms [12, 14]. Besides environmental and health issues, 15 – 20 % of the overall machining costs are related to CLFs [3]. With progressing R&D, there are new part materials coming into use, which are extremely difficult to machine (i.e. high-temperature alloys used in aerospace industry: nickel alloys, titanium alloys, Co-Cr alloys, etc.), due to their ability of maintaining properties even at high operational temperatures (jet engines, electron guns, etc.). Those materials have relatively small thermal conductivity, leading to extremely high temperatures in the cutting zone. In combination with high cutting speed, serious difficulties occur, which disable the use of conventional machining processes for their production [1-2, 4, 8-9, 16]. Therefore, alternative machining technologies, considering R&D on CLFs, are emerging as viable. The sustainable alternative to conventional flood cooling/lubrication focused in this work is “clean” cryogenic machining, offering improved performances of the process, system and final product via 6R implementation [6] (Figure 2).

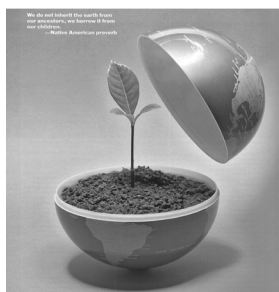

Figure 1. Three pillars of sustainability

Slika 1. Tri uvjeta održivosti

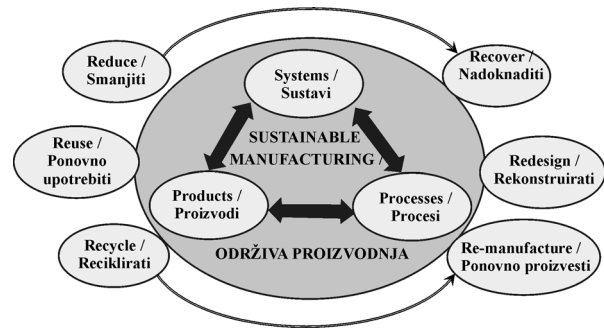

Figure 2. Elements of sustainable manufacturing

Slika 2. Elementi održive proizvodnje

## 2. Cryogenic machining

Cryogenic machining is an innovative method of cooling the cutting tool and/or part during the machining process. More specifically, it relates to delivering cryogenic CLF (instead of an oil-based CLF) to the local cutting region of the cutting tool, which is exposed to the highest temperature during the machining process, or to the part in order to change the material characteristics and improve machining performance.

The cryogenic coolant used in this work is nitrogen fluid, which is liquefied by cooling to  $-196\text{ }^{\circ}\text{C}$  (liquid nitrogen - LN). Nitrogen is a safe, non-combustible, and non-corrosive gas. In fact, 78 % of the air we breathe consists of nitrogen, and does therefore, not cause any health problems. It is a colorless, odorless, tasteless and inert fluid that quickly evaporates when delivered to the cutting zone and returns to the atmosphere, leaving no residue to contaminate the part, chips, machine tool, or operator. Thus, it eliminates disposal costs related to CLF usage. This represents a completely clean process in contrast to conventional oil-based CLFs. The setup of cryogenic machining with LN delivery is shown in Figure 3.

Potential benefits of cryogenic machining are [11-13]:

- sustainable machining (a cleaner, safer, and environmentally friendly method),
- increased heat sink performances (lower temperatures in the cutting zone),
- prolongation of cutting insert life,
- improved chip breakability,
- decreased possibility of burr formation on the machined part,
- decreased possibility of build up edge (BUE) formation,
- improved machined part surface quality/integrity with the absence of mechanical and chemical degradation of the machined surface,

- increased material removal rate (MRR) with no increase in tool-wear and with reduced cutting tool changeover cost, resulting in higher productivity,
- decreased production costs, etc.



**Figure 3.** Cryogenic machining set-up with cryogenic fluid (LN) delivery into the cutting zone

**Slika 3.** Postavka kriogene obrade s dobavom tekućeg dušika (TD) u zonu rezanja

In previous work of author [10], it has been shown that cryogenic cooling/lubrication condition has an influence on machining performance. This relates to decreased cutting forces in machining of high temperature nickel alloy (Inconel 718), and prolongation of tool-wear. The reasons were in detailed analysed in this work and are presented through analysed tool-wear, temperatures, and analyses of the influences of nitrogen delivery phase on cutting forces and chip formation.

### 3. Tool-life vs. temperature correlation

When the machining process optimal machining conditions are known [10], additional experiments were performed to define the tool-life for different CLF conditions: dry, MQL (minimum quantity lubrication), flood, cryogenic and combination of cryogenic and MQL machining. In all the cases, CLF is delivered on the cutting tool rake face, while machining nickel-based alloy (Inconel 718) with carbide inserts. The tool-life criterion is related to the upper limit on tool flank face wear,  $VB_{max} \leq 0.4$  mm. The tool-life results are presented in Figure 4. In comparing the results, it can be observed that the behavior of dry and MQL is relatively comparable, which means that even when using MQL instead of dry machining, the process does not sufficiently remove the heat generated in the cutting zone. If flood machining that is most frequently used in industrial applications is use, it is possible to almost double the tool-life in comparison to

dry machining (70 % increase). In alternative machining process, this work shows that tool-life can be additionally prolonged (60 %) by using cryogenic machining. This proves performance gain, while the remaining question is of economical nature and is going to be answered in one of the next sections.

The mechanisms that increase performances are mainly related to the effective cooling and minor lubrication effect. To support this conclusion, temperature measurements in the cutting zone are performed. For measurements, small size Ni-Cr thermocouple ( $d = 0.5$  mm) with short response time ( $\tau_r = 0.5$  s) is used. While it is practically impossible to measure temperature exactly at the cutting zone due to cutting tool-chip interaction, the system for temperature measurement in close proximity to the cutting zone is developed with the thermocouple mounted in the cutting insert itself, shown in Figure 5. The results of measured temperatures are shown in Figure 6.

Increased temperature in the cutting zone affects the hardness and strength of the cutting insert material and thus, accelerates tool-wear. From the measurements it can be observed that any CLF used instead dry machining conditions decreases temperature in the cutting zone. While temperatures in dry machining increase to  $350$  °C on  $0.5$  mm distance from the cutting zone (corresponding to approximately  $600$  °C in the actual cutting zone), the temperatures decrease to extreme values in the case of cryogenic machining (from  $-50$  °C to  $0$  °C). This proves that sufficient heat removal from the cutting zone, especially in the case of high-temp alloys machining, can drastically decelerate tool-wear and therefore, prolong cutting tool-life.

With the observation of tool-wear mechanisms, it is possible to be noticed that a classical abrasive wear mechanism on the flank face of the cutting tool mainly occurs. While on the rake face, the specific crater wear is generated. High temperature alloys maintain their mechanical performances even under high temperatures leading to high mechanical and thermal pressure on the cutting tool during the performed process. Additionally, those materials have poor thermal conductivity, which means that temperature generated in the cutting zone is hardly transferred from there. Therefore, most of the heat generated in the cutting zone is accumulated there, resulting in high cutting zone temperatures. Consequently, a deep crater wear occurs on the rake face in the close proximity to the cutting edge. With the crater progress, the cutting edge loses support ending up with a catastrophic fracture of the cutting tool.

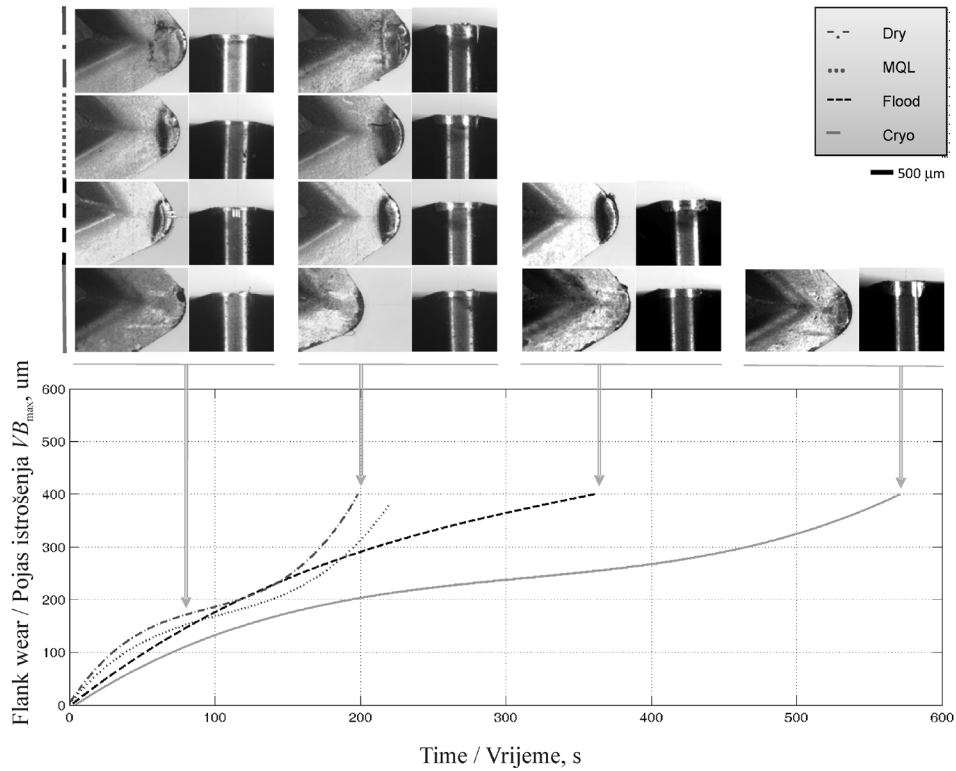

Figure 4. Cutting tool-life in machining of Inconel 718 under different CLF conditions

Slika 4. Vijek trajanja rezne oštrice pri obradi Inconela 718 u različitim uvjetima

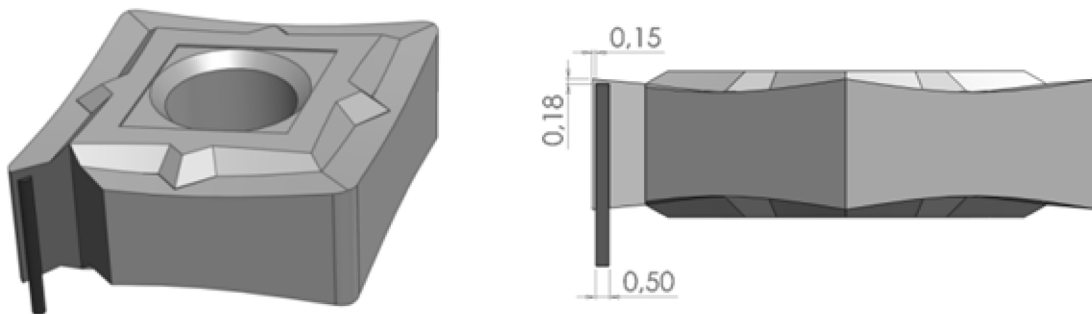

Figure 5. Temperature measurement setup in close proximity of cutting tool edge

Slika 5. Postavka za mjerenje temperature u blizini rezne oštrice

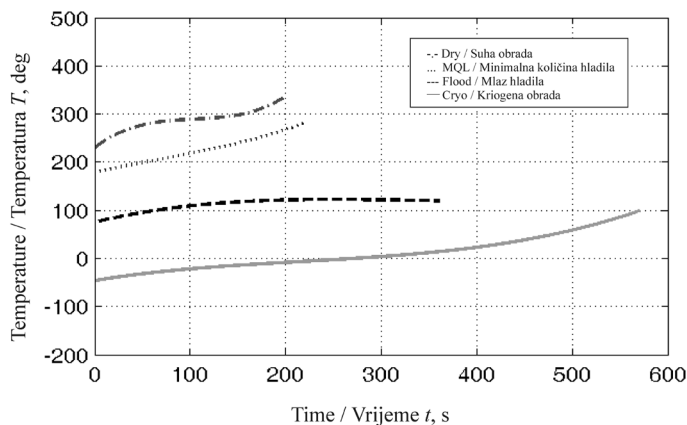

Figure 6. Comparison of cutting tool tip temperatures under different CLF conditions (measured at the distance 0.5 mm from the cutting zone)

Slika 6. Usporedba temperature reznih oštrica u različitim uvjetima (mjerena na udaljenosti 0,5 mm od zone rezanja)



#### 4. Performance investigation – surface roughness

Although, numerous studies have analyzed the effects of machining parameters, tooling geometry, etc. on machining performances, there is a gap in understanding effects of cooling/lubrication on the surface integrity. The later is especially related to the influence of cooling/lubrication on the machined surface roughness, that is evaluated in this section.

The effects of varying cooling/lubrication conditions on the machined surface roughness when machining Inconel 718 are presented in Figure 7. The machining parameters employed were  $f = 0.05$  mm/rev,  $v_c = 60$  m/min, and  $a_p = 0.63$  mm that were found as the closest parameters to the optimum condition from the set of performed experiments, while the details on the measurement procedure with deeper understanding of phenomena is presented in mentioned work [10].

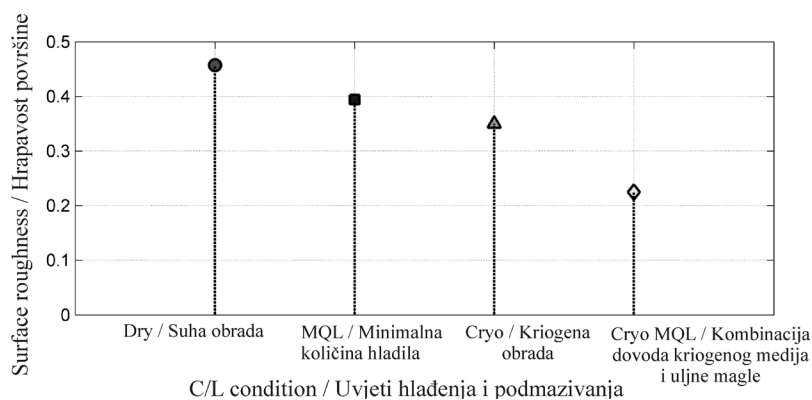

Figure 7. Machined surface roughness for different cooling/lubrication conditions

Slika 7. Hrapavost obrađene površine za različite uvjete hlađenja/podmazivanja

The machined surface roughness is measured for all four CLF delivery cases. The measurements were performed with a non-contact, three-dimensional, interferometry profiler ZYGO 3D - New View 5000. On each of machined surfaces, 5 measuring points were taken and averaged for the sake of statistical significance of the measurements. From the results, it can be seen that CLF is significantly influencing the machined surface finish, even when machined with the same parameters. While using MQL, better surface roughness are obtained, due to improved lubrication effect. A decrease in surface roughness, can be achieved by using cryogenic machining instead of conventional machining processes. In this way, the results prove that cryo+MQL CLF is providing some lubrication into the process, beside cooling mechanisms and improves it.

At this point, it has to be emphasized the big difference between different cooling/lubrication conditions. For this cutting forces in relation to different CLF are analysed and presented in next section.

#### 5. Performance investigation – cutting forces

In addition to using cryogenic machining in the machining of high-temperature alloys, there is an attempt to demonstrate that cryogenic machining is a potential alternative even in the machining of conventional or widely used materials, and thus the Ck45 workpiece material was chosen.

The reasons for improvements in cryogenic machining are expected to be related to decreased cutting forces and sufficient heat removal from the cutting zone. In order to prove this, additional experimental

observations were performed by changing the temperature and phase of the delivered nitrogen, comparing dry machining, machining with delivered gaseous phase cold nitrogen, and machining with liquid nitrogen delivery. The results are presented in Figure 8, in which a 0 – 20% decrease in cutting force can be observed, while the lowest forces are obtained in liquid phase cryogenic fluid delivery to the cutting zone. This confirms the assumption that liquid phase in comparison to gaseous phase, besides heat removal, also provides better lubrication to the primary and secondary zones of the machining process.

Additionally, the effect on the thermal conditions can be seen to be improved. The effect is recognized by the color of the formed chips that undergo the machining process. The chips from the previous experiments have been collected and are presented in Figure 9. The different cooling/lubrication conditions in machining process are highly recognizable from the color of the chip formed. The darker the color is, the higher the thermal loads are, affecting the machined workpiece surface and cutting tool performances. Even from this point of view, cryogenic machining with liquid nitrogen delivery to the cutting zone represents an alternative capable of sufficient heat removal from the process.

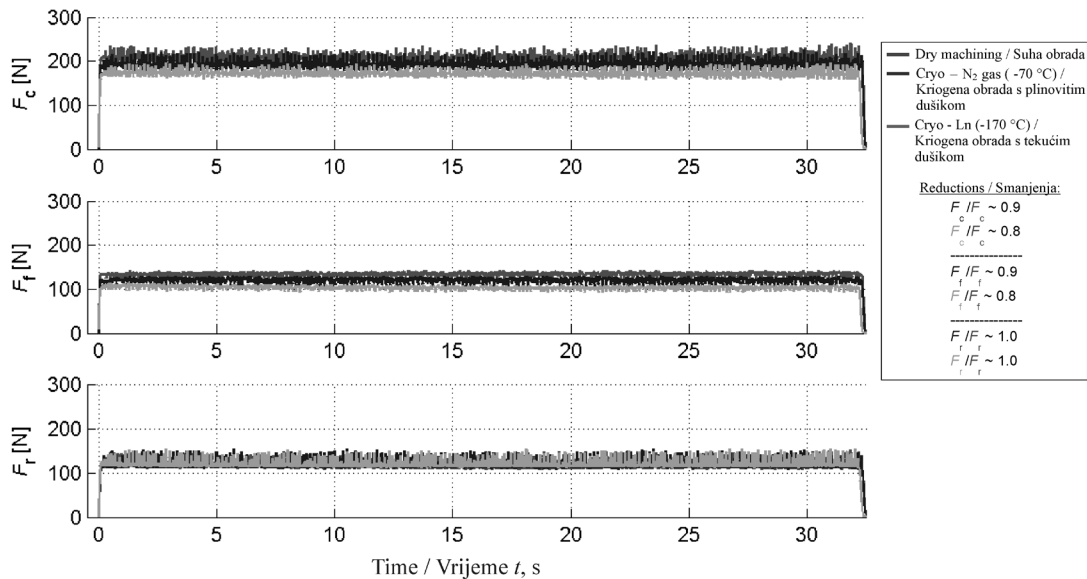

**Figure 8.** Cutting force components comparison between dry, gaseous cold nitrogen and liquid nitrogen cryogenic machining (parameters:  $f = 0.15$  mm/rev,  $v_c = 180$  m/min,  $a_p = 0.5$  mm,  $r_e = 0.4$  mm)

**Slika 8.** Usporedba komponenta sile rezanja u uvjetima suhe obrade, plinovitog dušika i tekućeg dušika (parametri:  $f = 0.15$  mm/rev,  $v_c = 180$  m/min,  $a_p = 0.5$  mm,  $r_e = 0.4$  mm)

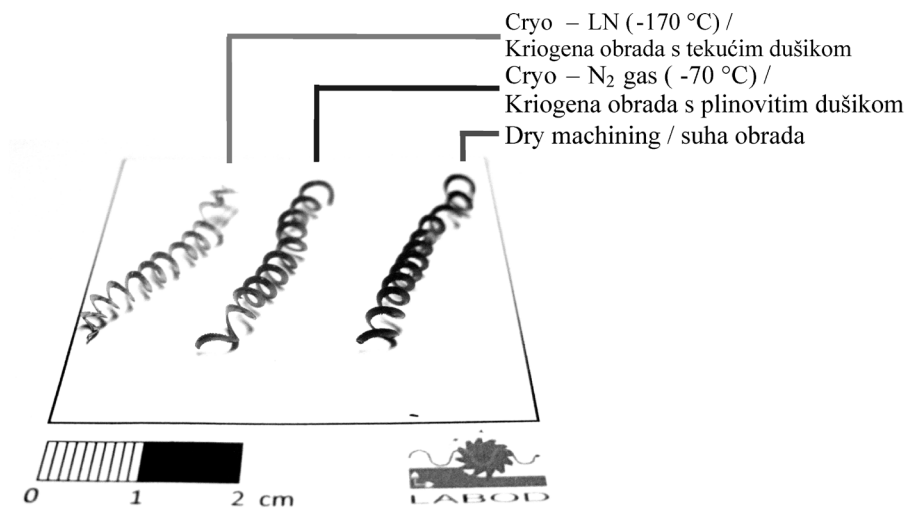

**Figure 9.** Chip comparison between dry, gaseous cold nitrogen, and liquid nitrogen cryogenic machining (parameters:  $f = 0.15$  mm/rev,  $v_c = 180$  m/min,  $a_p = 0.5$  mm,  $r_e = 0.4$  mm)

**Slika 9.** Usporedba odvojenih čestica u uvjetima suhe obrade, plinovitog dušika i tekućeg dušika (parametri:  $f = 0.15$  mm/rev,  $v_c = 180$  m/min,  $a_p = 0.5$  mm,  $r_e = 0.4$  mm)

Besides machining performances, economical evaluation of the machining process has been carried out to demonstrate that cryogenic machining offers a cost effective route to improve sustainability performance in comparison to conventional machining. To determine the applicability of cryogenic machining, costs have to be calculated and are presented in next section.

## 6. Overall cost analysis

In order to use alternative machining technology, it has to be economical. From this aspect an overall machining cost evaluation of cryogenic machining was performed in comparison to conventional flood machining. In cost evaluation all the costs are included, from the sources to the final product and recycling needs. This includes:

equipment costs, machining costs, electrical costs, costs related to CLF usage, costs for cleaning of the final part with corrosion protection, swarf/chip cleaning costs and preparation costs for their recycling/reusage. Besides health and environmental problems connected with CLF and cleaning emulsion (CE) usage in oil-based CLFs, the processes of cooling/lubrication and additional cleaning are time consuming and costly. The same applies to swarf disposal preparation process, where chips have to be separated from oil and shredded if needed. However, in Cryo machining, besides longer tool-life, complete elimination of oil-based CLF is achieved, resulting in elimination of part/swarf cleaning need and CLF recycling. Taking this into account the overall part production (longitudinal turning of bar with the diameter of 40mm and length 100mm) costs and their composition are calculated. The results are shown in Figure 10.

The production cost for different machining processes are represented with stacked bars. Each of the bars corresponds to the production costs of individual machining process (Conventional or Cryo), at the mean cutting speed, ( $v_c = 75$  m/min). The solid line shows the trend of production costs if cutting speed changes. To analyze the contribution of production cost segments, the bar plot is stacked. The height of each bar equals the sum of elements contributing to the overall production costs ( $C_m$  – machining costs,  $C_t$  – tooling costs,  $C_e$  – energy costs,  $C_{cp}$  – CLF costs,  $C_{cl,p}$  – cleaning costs).

From the presented results it is possible to assert that conventional machining is significantly more expensive than Cryo machining. This trend is even more dominant if employing high cutting speeds. From those plots it is really interesting that at lower cutting speed, conventional machining can be the cheapest. However, this production rate is not optimal. Therefore, a sustainable alternative machining process like Cryo machining should be used when high efficiency and high productivity are required. Regarding the contribution to the overall production cost, it can be seen that the machining cost and the cost due to cutting tool changing are the highest in conventional machining. The energy consumption cost is almost negligible in both cases, while the coolant costs are almost negligible in conventional, however not in Cryo since the price of LN is much higher. If conventional machining has low CLF cost, the costs of cleaning are higher, but negligible in the case of Cryo.

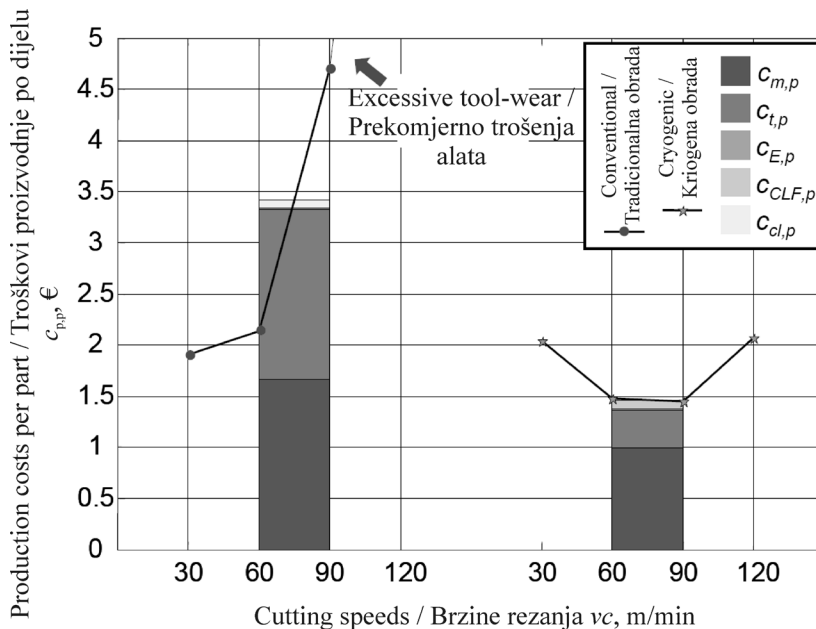

Figure 10. Production cost comparison for conventional, cryogenic and HPAJM  
Slika 10. Usporedba troškova obrade za konvencionalnu obradu, kriogenu i HPAJM

### 7. Conclusions

The presented work points out the reasons and the needs for practices in the field of sustainable development on all levels and fields, including the machining process, in order to assure the common goal of global sustainability. The focus is on novel machining technologies that are meeting environmental and social regulations while still being competitive. As an alternative to conventional machining processes, “clean” cryogenic machining is presented and analyzed in this work.

Challenges in production with regard to economy, society, and the environment in view of machining technology, are discussed in the first part of this paper. More specifically, the study covers the main pillars of sustainability, i.e. reduced energy consumption, prolongation of tool-life, improved final product functionalities through improved machined surface integrity, etc.

Besides machining performances, an overall process cost analysis is also performed, showing that costs can be drastically decreased if using cryogenic machining instead of a conventional one. This confirms that even though the initial cost and effort involved with cryogenic machining are higher, it can obviously offer significant sustainability benefits through shorter production cycles and the lower cost needed to machine a part as well as the enhanced productivity due to higher output.

Therefore, it is expected that the future of sustainable CLF will entail the use of LN with new delivery systems that reduce consumption rates (costs), environmental

burdens, and health risks, while simultaneously increasing machining process performance and profitability.

Cryogenic machining solution implemented in machining process is therefore one of the realistic alternatives that can rise the machining processes on a sustainable level.

## 8. Acknowledgements

This research was conducted within the E! 4550 – PRO-FACTORY SUSCRYMAC project, which was sponsored by the EUREKA initiative.

## REFERENCE

- [1] COURBON, C.; KRAMAR, D.; KRAJNIK, P.; PUSAVEC, F.; RECH, J.; KOPAC, J.: *Investigation of machining performance in high pressure jet assisted turning of inconel 718: An experimental study*, International Journal of Machine Tools and Manufacture, 49 (2009), 14; 1114-1125.
- [2] DUBZINSKI, D.; DEVILLEZ, A.; MOUFKI, A.; LARROUQUERE, D.; ZERROUKI, V.; VIGNEAU, J.: *A review of developments towards dry and high speed machining of inconel 718 alloy*, International Journal of Machine Tools and Manufacture, 44 (2004); 439-456.
- [3] Envirowise GG 446: *Sustainable manufacturing - A signposting guide for metal machining companies*, Project documentation, 2004.
- [4] EZUGWU, E.O.: *Key improvements in the machining of difficult-to-cut aerospace superalloys*, International Journal of Machine Tools and Manufacture, 45 (2005); 1353-1367.
- [5] JOVANE, F.; WESTKÄMPER, E.; WILLIAMS., D.: *The Manufuture Road*, Springer-Verlag, Berlin Heidelberg, 2009.
- [6] JAWAHIR, I. S.; DILLON, O. W.: *Sustainable manufacturing processes: New challenges for developing predictive models and optimization techniques*, Proceedings of First International Conference on Sustainable Manufacturing SM1. Montreal, Canada, 2007.
- [7] KOPAC, J.: *Odrežavanje – teoretične osnove in tehnološki napotki (in Slovene)*, University of Ljubljana, Ljubljana, 2008.
- [8] KRAMAR, D.; KOPAC, J.: *High performance manufacturing aspect of hard-to-machine materials*, Journal of Advances in Production Engineering & Management (APEM), 1-2 (2009); 3-14.
- [9] KRAMAR, D.; KRAJNIK, P.; KOPAC J.: *High pressure jet assisted turning of surface hardened piston rods*, Journal of Materials Processing Technology, 210 (2010), 2; 212-218.
- [10] PUSAVEC, F.; DESHPANDE, A.; M'SAOUBI, R.; KOPAC, J.; DILLON, O.W.; JAWAHIR, I.S.: *Modeling and optimization of machining of high temperature Nickel alloy for improved machining performance and enhanced sustainability*. Proceedings of the 11th CIRP Conference on Modeling of Machining Operations, Gaithersburg, USA, September 16-18, 2008.
- [11] PUSAVEC, F.; KOPAC, J.: *Achieving and implementation of sustainability principles in machining Processes*, Journal of Advances in Production Engineering & Management (APEM), 3 (2009), 3-4; 58-69.
- [12] PUSAVEC, F.; KRAJNIK, P.; KOPAC, J.: *Transition to sustainable production – part I: Application on Machining Technologies*, Journal of Cleaner Production, 18 (2010), 2; 174-184.
- [13] PUSAVEC, F.; KRAMAR, D.; KRAJNIK, P.; KOPAC, J.: *Transition to sustainable production – part II: Evaluation of sustainable machining technologies*, Journal of Cleaner Production, In press.
- [14] SKERLOS, S.J.; HAYES, K.F.; CLARENS, A.F.; ZHAO, F.: *Current advances in sustainable metalworking fluids research*, International Journal of Sustainable Manufacturing (IJSM), 1 (2008), 1/2; 180-202.
- [15] SUTHERLAND, J.W.; RIVIERA, J.L.; BROWN, K.L.; LAW, M.; HUTCHINS, M.J.; JENKINS, T.L.; HAAPALA, K.R.: *Challenges for the manufacturing enterprise to achieve sustainable development*, 41st CIRP Conference on Manufacturing Systems, Japan 2008.
- [16] WEINERT, K.; INASAKI, I.; SUTHERLAND, J.W.; WAKABAYASHI, T.: *Dry machining and minimum quantity lubrication*, *CIRP Annals - Manufacturing Technology*, 53(2004), 2; 511-537.
- [17] WESTKAMPER, E.: *Manufuture and sustainable manufacturing*, 41st CIRP Conference on Manufacturing Systems, Japan, 2008.