

Edgar Bruk, student
Entoni Marinčić, student
Mr. sc. Josip Orović / M. Sc.
 Sveučilište u Rijeci / University of Rijeka
 Pomorski fakultet u Rijeci /
 Faculty of Maritime Studies Rijeka
 Studentska 2
 51000 Rijeka / Croatia

**Pregledni članak/
 Review article**

UDK / UDC: 621.311.2
 621.18

Primljeno / Recived:
 10. travnja 2010. / 10th April 2010
 Odobreno / Accepted:
 18. svibnja 2010. / 18th May 2010

OPTIMIRANJE PARNOTURBINSKOG POSTROJENJA POMOĆU SIMULATORA BRODSKE STROJARNICE

THE OPTIMIZATION OF THE STEAM PLANT BY MEANS OF AN ENGINE ROOM SIMULATOR

SAŽETAK

U radu je prikazano optimiranje parnoturbinskog pogonskog postrojenja na brodu za prijevoz ukapljenog prirodnog plina. Izvršena je analiza pogonskih radnih parametara te su na simulatoru brodske strojarnice simulirane situacije koje utječu na iskoristivost postrojenja. Izvršene simulacije na simulatoru LNG broda omogućile su praćenje promjene radnih parametara pri pojavi neželjenih i neočekivanih stanja za koje postoji vjerojatnost pojavljivanja unutar funkcionalnog realnog sustava. Na taj način je moguće bolje dijagnosticirati greške unutar realnog sustava te odrediti optimalno ponašanje pojedinih elemenata sustava. Kod generatora pare analiziran je utjecaj pojave čađe na cijevima zagrijača vode i pregrijača pare na potrošnju goriva, te utjecaj izgaranja različitih goriva na emisiju NO_x. Kod parne turbine analiziran je utjecaj istrošenosti odzivnog ležaja turbine i istrošenosti lopatica niskotlačne turbine na snagu, aksijalni pomak i na pojavu vibracija turbine. Dobiveni rezultati pokazuju da primjena simulatora može poslužiti brodarskim kompanijama i pomorskim edukacijskim ustanovama za uvježbavanje pomoraca i studenata za rad u različitim okolnostima te za brzo i učinkovito reagiranje u kritičnim situacijama.

Ključne riječi: *optimiranje, parnoturbinsko postrojenje, simulacija, analiza kvarova*

SUMMARY

The optimization of the steam propulsion plant on LNG tankers is dealt with in this paper. The operational parameter analysis was performed and the situations influencing the plant efficiency were simulated on the engine room simulator. The performed simulations on the LNG simulator module enabled monitoring of the operational parameters change in undesirable and unexpected conditions for which there is a probability to occur within the operational system. In such a way an enhanced diagnostics of failures within a real system and the determination of the optimal performance of individual components are possible. The boiler analysis has concentrated not only on the influence of soot deposit on the economizer and superheater piping to the fuel consumption but also on the influence of burning different fuels to NO_x emission. Another analysis has been carried out in the main turbine in which the influence of worn out thrust bearing and low-pressure turbine blades to the turbine output, axial displacement and vibrations was analysed. The results have shown that the simulator can serve the shipping companies and maritime educational institutions to train the students and seafarers for working in various situations and to prepare them to respond to emergencies promptly and efficiently.

Key words: *optimization, steam plant, simulation, failure analysis*

1. UVOD

Optimiranje parnoturbinskog postrojenja u ovome radu je podijeljeno u dva dijela. Najprije se analizira utjecaj glavnih pogonskih parametara i gubitaka na iskoristivost parnoturbinskog postrojenja, a u drugom dijelu se simulira i analizira utjecaj neželjenih radnih stanja na rad glavnih generatora pare i glavne turbine.

Optimalno stanje sustava predstavlja ono stanje u kojem sustav, bez obzira na opterećenje, besprijekorno funkcionira uz najveću iskoristivost i uz minimalno održavanje. Analizom utjecajnih parametara i upotrebom simulatora brodskog parnoturbinskog postrojenja može se postići bolje upravljanje postrojenjem, bolje razumijevanje cjelokupnog procesa i utjecaja na iskoristivost pogona, a redovitim uvježbavanjem uspostavlja se i zadovoljavajuća razina sigurnosti te spremnost za eventualne stvarne situacije.

U radu su prikazane simulacije stanja parnoturbinskog postrojenja tankera za prijevoz ukapljenog prirodnog plina (LNG tanker) pomoću simulatora brodske strojarnice Transas ERS 4000 ver. 7. 3. na Pomorskom fakultetu u Rijeci. Simulator je vjerodostojni model realnih sustava i kao takav omogućuje izvršavanje raznih testiranja, provjera i sprječavanja neželjenih situacija unutar postrojenja. Upotrebom simulatora omogućeno je, podešavanjem raznih parametara, optimiranje rada cijelog postrojenja u različitim uvjetima opterećenja. Također se mogu simulirati greške i kvarovi na svakom pojedinom elementu sustava te pratiti njihov utjecaj na funkcionalnost i iskoristivost postrojenja. Na taj način se studentima pomaže u boljem razumijevanju rada pogonskih sustava kao i njihovih radnih parametara, a iskusnim pomorcima u brzom i pravovremenom reagiranju u specifičnim situacijama.

2. ANALIZA RADA PARNOTURBINSKOG POSTROJENJA

Na slici 1. prikazana je shema parnoturbinskog postrojenja preuzeta sa simulatora Transas ERS 4000 ver. 7. 3. Ovo postrojenje tipično je za brodove koji prevoze ukapljeni prirodni plin (LNG tankeri). Kod ove vrste brodova plin se prevozi u posebno izrađenim spremnicima

1. INTRODUCTION

The steam plant optimization is divided in two main parts in this paper. Firstly, the analysis of the main operational parameters and losses that affect the overall steam propulsion plant efficiency is dealt with. In the second part, the simulation of the impact of undesirable operational conditions in main boilers and the main turbine is analysed.

The system is considered to be optimal when operating perfectly, regardless the load, and achieves the highest efficiency at minimum maintenance. The engine operational parameters analysis combined with the usage of a marine steam plant simulator gives rise to a better plant control, a more thorough understanding of the overall process and a higher overall efficiency. The satisfactory safety level and response to the possible actual situations can be achieved by constant training.

The simulation of the various occurrences of a steam turbine plant on a liquefied natural gas tanker (LNG tanker) is shown in the paper. The simulations were taken on the marine engine room simulator Transas ERS 4000 ver. 7. 3. at the Faculty of Maritime Studies in Rijeka. The simulator represents a true model of the actual system allowing the execution of various tests, checks and the prevention of undesirable situations within the plant. The operational parameter adjustment and the optimization of the plant operation in various conditions are enabled by means of the simulator. Faults and failures on the individual system components and their influence on the plant operation and efficiency can also be simulated. In this way, the students are trained in a better understanding of the propulsion system operation and of the optimum operating parameters setting. Besides, experienced seafarers are prepared to respond promptly and efficiently in specific situations on board a ship.

2. ANALYSIS OF THE STEAM PLANT OPERATION

The steam plant scheme, taken out from the Transas ERS 4000 ver. 7.3. simulator, is shown in Figure 1. This plant is typical for the ships carrying liquefied natural gas (LNG tankers). On these types of ships, the gas is transported in specially designed tanks at the temperature

na temperaturi od oko $-160\text{ }^{\circ}\text{C}$. Usprkos današnjem trendu ukapljivanja isparenog dijela tereta i ugradnje raznih vrsta pogonskih postrojenja na ovim brodovima, parnoturbinsko postrojenje se još uvijek zadržalo na njima. Razlog tomu je velika pouzdanost i sigurno iskorištavanje isparenog dijela tereta koji se koristi kao pogonsko gorivo.

of approximately $-160\text{ }^{\circ}\text{C}$. Despite today's trend of the reliquefaction of vaporized cargo and the installation of various propulsion machinery types, the steam plant has still been retained on board such ships. The reason can be sought in its high reliability and in the safe use of vaporized cargo used as fuel.

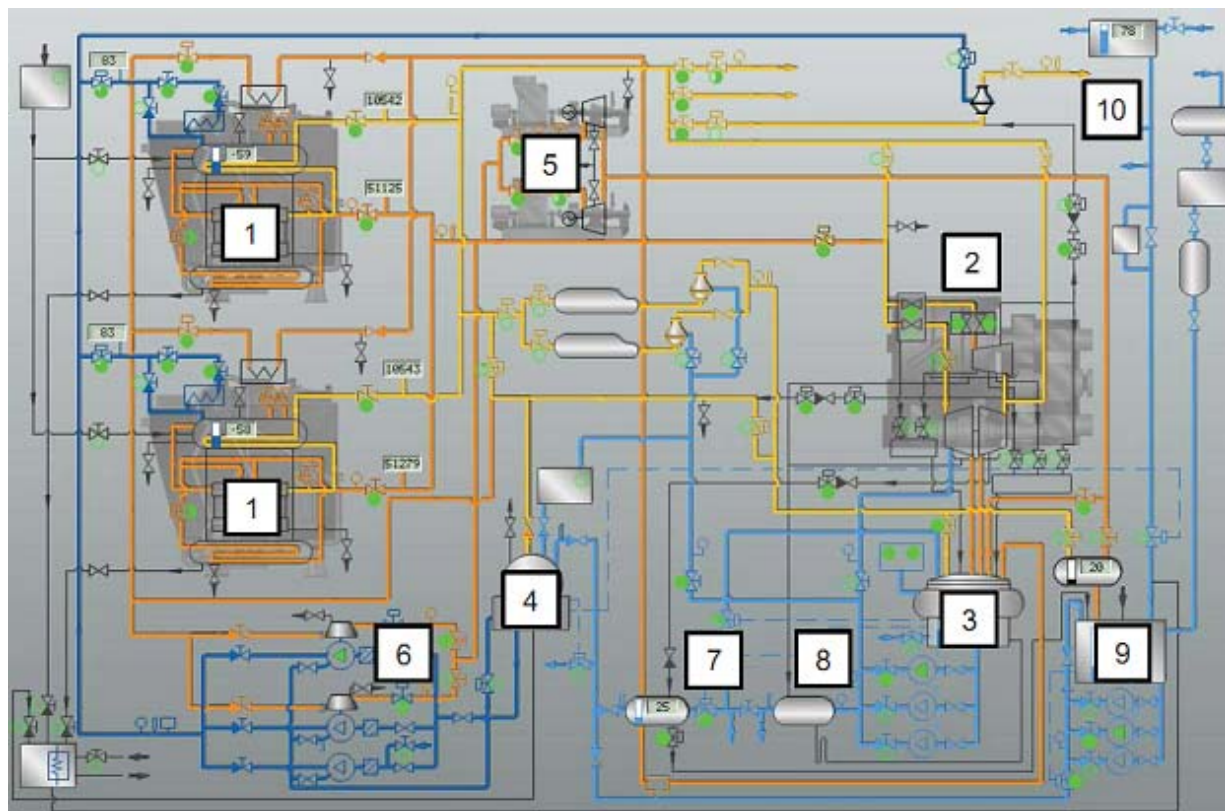

Slika 1. Shema parnoturbinskog postrojenja [1]

Figure 1. Steam plant scheme [1]

1 – Generatori pare, 2 – Pogonska turbina, 3 – Vakuumski kondenzator, 4 – Otplinjač, 5 – Turbogeneratori, 6 – Napojne pumpe, 7 – Niskotlačni zagrijač napojne vode, 8 – Kondenzator brtvene pare, 9 – Atmosferski drenažni tank, 10 – Visokotlačno oduzimanje pare

1 – Main boilers, 2 – Propulsion turbine, 3 – Vacuum condenser, 4 – Deaerator, 5 – Turbo generators, 6 – Feed pumps, 7 – Low-pressure feed water heater, 8 – Gland steam condenser, 9 – Atmospheric drain tank, 10 – High-pressure bleed

Prikazano postrojenje sastoji se od pogonske turbine tipa Kawasaki UA-400 koja pri parametrima pare od 57,4 bar i $515\text{ }^{\circ}\text{C}$ postiže snagu od 29 450 kW pri maksimalnom trajnom opterećenju. Dva generatora pare tipa Mitsubishi MB-4E mogu izgarati tekuće i plinovito gorivo. Kapacitet generatora pare je 63 500 kg/h pare pri maksimalnom trajnom opterećenju, a proizvode paru tlaka 61,5 bar i $515\text{ }^{\circ}\text{C}$. U sustavu su još dva turbogeneratora snage 3150 kW te turbo napojne pumpe. Podtlak u kondenzatoru je 0,963 bar.

The plant consists of the Kawasaki UA-400 propulsion turbine of 29 450 kW output power at steam inlet conditions of 57.4 bar and $515\text{ }^{\circ}\text{C}$ at M.C.R. There are also two Mitsubishi MB-4E boilers with dual fuel burners. The steam generating capacity of each boiler is 63 500 kg/h at M.C.R. at steam conditions of 61.5 bars and $515\text{ }^{\circ}\text{C}$. There are also two 3150 kW turbo generators and steam driven feed pumps in the system. The condenser vacuum is 0.963 bar.

Izgled ovog teoretskog kružnog procesa s regenerativnim zagrijavanjem napojne vode prikazan je na slici 2.

The theoretical closed cycle with regenerative feed water heating is shown in Figure 2.

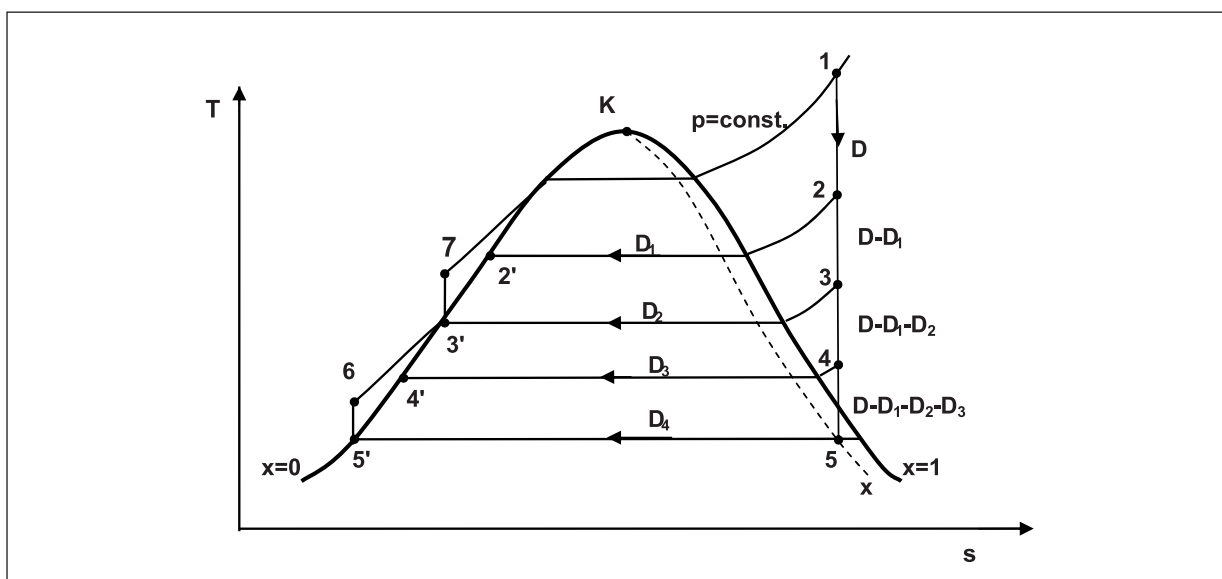

Slika 2. Proces s regenerativnim zagrijavanjem napojne vode [4]

Figure 2. Process with regenerative feed water heating [4]

Toplinu parnoturbinskom postrojenju dovodimo izgaranjem goriva u generatoru pare, a mehanički rad se dobiva na osovini turbine. Iskristivost cjelokupnog parnoturbinskog postrojenja, kao i svih toplinskih strojeva, predstavlja omjer između dobivenog rada i dovedene topline:

$$\eta = \frac{P}{Q_g}, \quad (1)$$

gdje je: P – snaga na propeleru, Q_g – ukupno gorivom dovedena toplinska snaga u ložište generatora pare.

Ako uzmemo u obzir sve gubitke (stupnjeve djelovanja) u parnoturbinskom postrojenju tada se ukupan stupanj djelovanja postrojenja može izračunati prema [3]:

$$\eta = \eta_t \cdot \eta_T \cdot \eta_m \cdot \eta_r \cdot \eta_{GP} \cdot \eta_c, \quad (2)$$

gdje je: η_t – termodinamički stupanj djelovanja kružnog toplinskog procesa, η_T – stupanj djelovanja turbine kao rezultat nepovratnih gubitaka u turbini, η_m – mehanički stupanj djelovanja turbine, η_r – mehanički stupanj djelovanja reduktora, η_{GP} – toplinski stupanj djelovanja generatora pare, η_c – stupanj djelovanja cjevovoda.

The heat in the steam plant is produced by means of the fuel combustion within the boiler and the mechanical work is gained on the turbine shaft. The overall plant efficiency represents the ratio between the gained work and the produced heat, as well as in all thermal engines:

$$\eta = \frac{P}{Q_g}, \quad (1)$$

where P is the power on the propeller and Q_g is the thermal power produced in the boiler furnace by means of fuel.

If all losses (efficiencies) within the steam plant are considered, then the overall efficiency can be calculated as follows [3]:

$$\eta = \eta_t \cdot \eta_T \cdot \eta_m \cdot \eta_r \cdot \eta_{GP} \cdot \eta_c, \quad (2)$$

where η_t is the thermodynamic closed cycle efficiency, η_T is the turbine efficiency as a result of irreversible losses in the turbine, η_m is the turbine mechanical efficiency, η_r is the gearbox mechanical efficiency, η_{GP} is the thermal boiler efficiency, η_c is the pipeline efficiency.

The specific fuel consumption d_g [kg/kWh] of a steam plant is gained from the heat balance:

Specifična potrošnja goriva d_g [kg/kWh] parnoturbinskog postrojenja dobiva se iz toplinske bilance:

$$P = Q_g \cdot \eta = D_g \cdot H_d \cdot \eta \quad [\text{kW}] \quad (3)$$

$$d_g = \frac{D_g}{P} = \frac{H_d \cdot \eta}{P} = \frac{3600}{H_d \cdot \eta} \quad [\text{kg/kWh}] \quad (4)$$

$$d_g = \frac{3600}{H_d \cdot \eta_t \cdot \eta_T \cdot \eta_m \cdot \eta_r \cdot \eta_{GP} \cdot \eta_c} \quad [\text{kg/kWh}] \quad (5)$$

gdje je: η – ukupni stupanj djelovanja parnoturbinskog postrojenja, D_g – masena potrošnja goriva u generatoru pare [kg/s], H_d – toplinska vrijednost goriva [kJ/kg].

Iz prikazanih jednadžbi vidljivo je da iskoristivost postrojenja, a time i specifična masena potrošnja goriva, ovisi o toplinskoj vrijednosti goriva te o stupnjevima djelovanja pojedinih elemenata postrojenja. Povećanjem stupnjeva djelovanja pojedinih elemenata postrojenja (pravilnim održavanjem i rukovanjem) povećava se iskoristivost postrojenja i smanjuje specifična potrošnja goriva.

Postoji nekoliko osnovnih načina povećanja iskoristivosti brodskih parnoturbinskih postrojenja, a time i smanjenja specifične potrošnje goriva. To se ostvaruje povećanjem ulazne temperature i tlaka pare u turbinu, sniženjem izlaznog tlaka pare iz turbine te regenerativnim zagrijavanjem napojne vode.

Na slici 3a i 3b prikazan je utjecaj povišenja temperature i tlaka pare na ulazu u turbinu u T-s dijagramu. Iz dijagrama se može vidjeti da rast srednje temperature dijela procesa na kojemu se dovodi toplina uzrokuje porast toplinske iskoristivosti cjelokupnog procesa. Povećanjem temperature ulazne pare također se smanjuje vlažnost pare u izlaznim stupnjevima turbine, a time i erozija. Povećanje tlaka ulazne pare u turbinu dovodi do povećanja vlažnosti izlazne pare iz turbine, odnosno do povećanja utjecaja erozije u zadnjim stupnjevima turbine. Da bi se to izbjeglo, potrebno je uz tlak povećavati i ulaznu temperaturu, što se može provesti do granice koju podnosi kvaliteta ugrađenog materijala.

Na slici 4 prikazan je u T-s dijagramu utjecaj sniženja tlaka u kondenzatoru. Vidi se da pad

$$P = Q_g \cdot \eta = D_g \cdot H_d \cdot \eta \quad [\text{kW}] \quad (3)$$

$$d_g = \frac{D_g}{P} = \frac{H_d \cdot \eta}{P} = \frac{3600}{H_d \cdot \eta} \quad [\text{kg/kWh}] \quad (4)$$

$$d_g = \frac{3600}{H_d \cdot \eta_t \cdot \eta_T \cdot \eta_m \cdot \eta_r \cdot \eta_{GP} \cdot \eta_c} \quad [\text{kg/kWh}] \quad (5)$$

where η is the overall steam plant efficiency, D_g is the mass fuel consumption in the boiler [kg/s], H_d is the calorific value [kJ/kg].

The above equations show that the plant efficiency, thus the specific mass consumption of fuel, depends on the calorific value and on the efficiency of individual plant elements. The plant efficiency is increased and the specific fuel consumption is reduced by increasing the efficiency of individual plant elements achieved with proper maintenance and operation.

There are several basic methods to increase the marine steam plant efficiency, thereby reducing the specific fuel consumption. This is accomplished by increasing the inlet steam temperature and the pressure of the turbine, by reducing the exhaust steam pressure from the turbine and by the regenerative feed water heating.

Figures 3a and 3b in T-s diagram show the influence of the increased steam temperature and pressure at the turbine inlet. The diagram shows that the overall thermal cycle efficiency is increased by increasing the average temperature of the process part where the heat is brought. Increasing the input steam temperature, the wetness of steam, and thus the erosion in the turbine last stages, is reduced. As the inlet steam pressure increases, the wetness of steam, and thus the erosion in the turbine last stages, is increased. In order to avoid erosion, it is necessary to increase both the inlet steam pressure and temperature. This can be made up to the limit corresponding to the material structural features.

The influence of the condenser pressure drop is shown in Figure 4. As it can be seen, the low exhaust steam pressure from the turbine i.e. the pressure drop in the condenser causes a lower temperature in the process part where the heat is rejected in the environment. There-

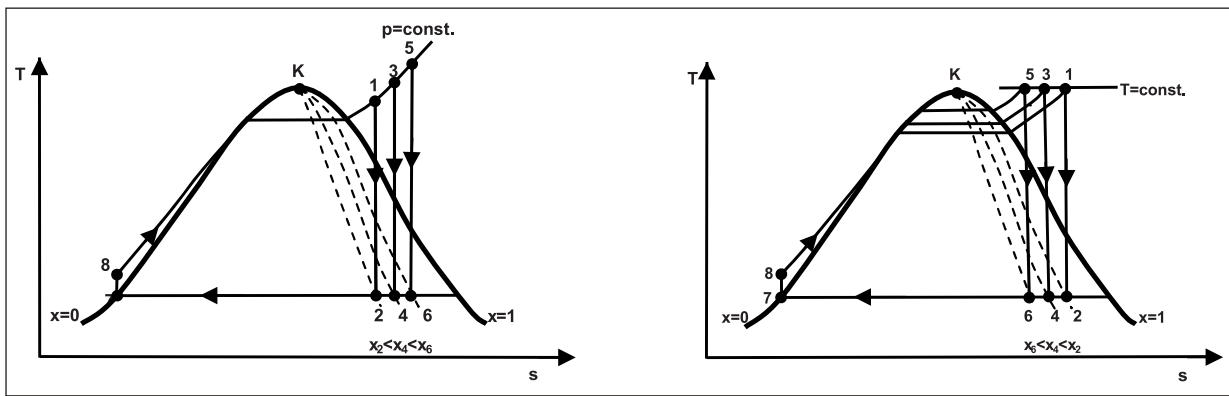

Slika 3. a) Utjecaj povišenja ulazne temperature pare u turbinu [4]; b) Utjecaj povišenja ulaznog tlaka pare u turbinu [4]

Figure 3. a) Influence of increased inlet steam temperature [4]; b) Influence of the increased inlet steam pressure [4]

tlaka izlazne pare iz turbine, odnosno pad tlaka u kondenzatoru, uzrokuje nižu temperaturu dijela procesa na kojemu se odvodi toplina (u okolinu), pa je stoga veća toplinska iskoristivost procesa. Na tlak izlazne pare iz turbine, odnosno na tlak u kondenzatoru, utječe veličina rashladnih površina kondenzatora, čistoća rashladnih površina kondenzatora, temperatura okoline, odnosno rashladne vode, opterećenje turbine, odnosno dotok pare u kondenzator.

Regenerativnim zagrijavanjem napojne vode povećava se srednja temperatura dijela procesa na kojemu se izvana dovodi toplina, čime se također povećava toplinska iskoristivost procesa. Smanjuje se količina pare koja ulazi u kondenzator, a time se smanjuje i toplina koja se nepovratno odvodi u okolinu putem rashladne vode. Dodatni efekti ugradnje regenerativnih zagrija-

fore, the thermal cycle efficiency is higher. The exhaust steam pressure from the turbine and the condenser pressure are affected by the size and cleanliness of the condenser cooling surfaces, ambient temperature i.e. cooling water temperature, turbine load and the steam flow to the condenser.

The regenerative feed water heating increases the average temperature of the process part where the heat is externally brought, whereby the thermal cycle efficiency is also increased. The amount of steam that enters the condenser and the heat which is irreversibly rejected into the environment by means of the cooling water are also reduced. The additional effects of the installation of the regenerative feed water heaters are that the steam flow through the first turbine stages is increased and the steam flow

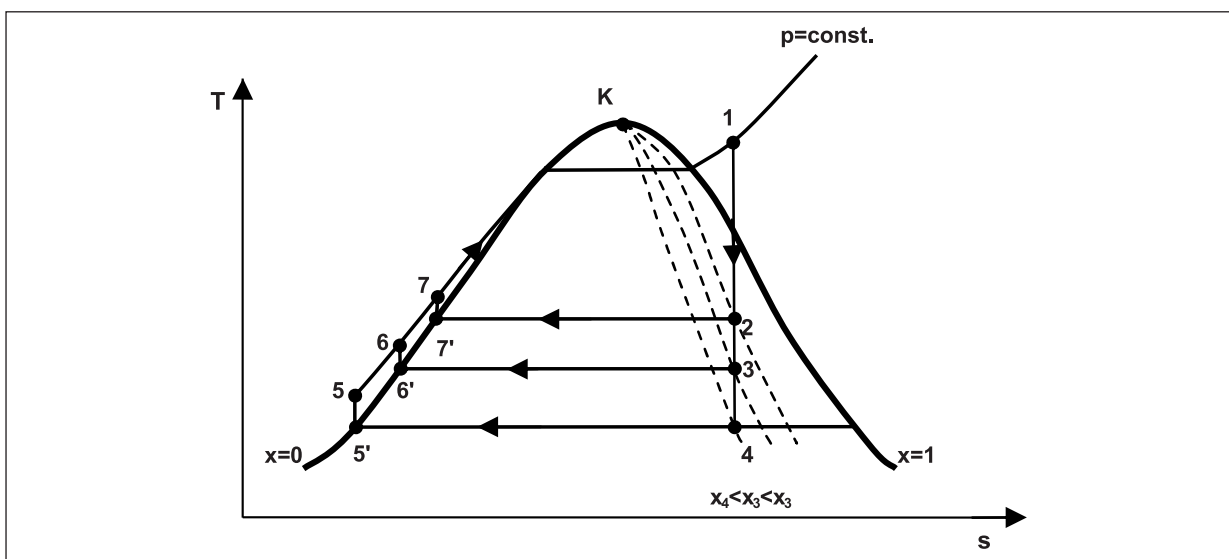

Slika 4. Utjecaj sniženja tlaka u kondenzatoru [4]

Figure 4. Influence of the condenser pressure drop [4]

ča vode su povećanje protoka pare kroz prve stupnjeve turbine i smanjenje kroz zadnje stupnjeve, čime se povećava iskoristivost turbine i smanjuju gubici vrtložnja u izlaznom dijelu turbine. Također se smanjuje protok pare u kondenzator, umanjuju njegove dimenzije i potrebna količina rashladne vode, ali se povećava složenost postrojenja u slučaju većeg broja zagrijača napojne vode [2].

Kako se vidi iz gore navedenih jednadžbi, pretvorba toplinske energije u mehanički rad u parnoturbinskom postrojenju događa se uz određene gubitke. To su gubici u generatorima pare, turbini, cjevovodima, gubici trenja te ostali gubici koji uzrokuju smanjenje ukupnog stupnja djelovanja ispod vrijednosti koje ostvaruju dizelmotorna ili kombinirana postrojenja.

Toplinski gubici koji nastaju pri radu generatora pare su gubitak zbog osjetne topline izlaznih dimnih plinova, gubitak zbog zračenja topline u okolinu i gubitak zbog kemijski nepotpunog izgaranja [2].

Dimni plinovi pri izlasku iz generatora pare imaju uvijek temperaturu veću od temperature okoline pa nastaje gubitak zbog neiskorištene osjetne topline. To je najveći gubitak koji nastaje u pogonu generatora pare, a ovisi o temperaturi izlaznih dimnih plinova i o pretičku zraka za izgaranje. Ovaj gubitak se može smanjiti iskorištavanjem topline dimnih plinova za zagrijavanje napojne vode i/ili zraka za izgaranje. Također treba paziti da pri korištenju goriva s većim sadržajem sumpora, temperatura dimnih plinova ne bude preniska jer dolazi do pojave tzv. niskotemperaturne korozije.

Gubitak zbog zračenja topline u okolinu nastaje zbog temperaturnih razlika između vanjskih površina generatora pare i okoline zbog čega se dio topline odvodi konvekcijom i zračenjem. Ovaj gubitak se smanjuje kvalitetnom izolacijom i konstrukcijskom izvedbom generatora pare koji se kod brodskih konstrukcija često izvode s dvostrukom stijenkom gdje se ta toplina iskorištava za dodatno zagrijavanje zraka za izgaranje.

Gubitak zbog kemijski nepotpunog izgaranja ovisi o sastavu goriva, efikasnosti miješanja zraka s gorivom te opterećenju ložišta. Ovaj gubitak se smanjuje pravilnim podešavanjem pretička zraka, viskoznosti goriva te pravilnim rukovanjem i održavanjem gorionika.

through the last stages is decreased. This increases the turbine efficiency and reduces the losses due to whirling in the turbine last stages. The steam flow into the condenser, its dimensions and the required amount of cooling water are also reduced, but the plant requires a greater number of feed water heaters [2].

As it can be seen from the above mentioned equations, the conversion of the thermal energy into the mechanical work in the steam plant occurs with some losses. Those are the losses in boilers, turbine, pipelines, friction losses and other losses which cause the reduction of the overall efficiency below the value achieved by the diesel or combined propulsion plants.

The thermal losses in the boiler operation are due to the unutilised heat from the exhaust gas, heat radiation and incomplete combustion.

The exhaust gas leaving the boiler has always a higher temperature than the ambient, so the loss due to the unused heat occurs. This is the largest loss occurring in the boiler, and it depends upon the exhaust gas temperature and the excess air. This loss can be reduced by using the exhaust gas heat for the feed water and / or combustion air heating. Furthermore, care must be taken when using fuel oil with high sulphur content in order to avoid the too low exhaust gas temperature and low-temperature corrosion.

The loss due to heat radiation into the environment is caused by temperature differences between the boiler external surface and the environment which causes the part of heat to transfer by convection and radiation. This loss is reduced by means of the quality insulation and marine boiler construction which are frequently built with double walls where heat is used for additional combustion air heating.

The loss due to incomplete combustion depends upon the fuel oil content, fuel and air mixing efficiency and the furnace load. This loss is reduced by the proper adjustment of the excess air, fuel viscosity and by the proper handling and maintenance of burners.

The loss due to soot appearance occurs mainly because of the irregular boiler handling and incomplete combustion. Poor fuel oil and air mixing and the low temperature of boiler heating surfaces enhances carbon deposition in the form of soot. These losses are reduced by proper handling of the boiler and associated equipment and by the regular soot blowing.

Gubitak zbog pojave čađe javlja se uglavnom kod nepravilnog rukovanja generatorom pare i nepravilnog izgaranja. Taloženju ugljika u obliku čađe pogoduje loše miješanje zraka i goriva te niska temperatura ogrjevnih površina generatora pare. Smanjenje ovih gubitaka postiže se pravilnim rukovanjem s generatorom pare i pripadajućim uređajima te redovitim ispuhivanjem čađe s cijevi.

Pri radu parne turbine nastaju unutarnji i vanjski gubici energije. Pod unutarnjim gubicima smatraju se gubici zbog trenja u sapnicama, privodnim kanalima i lopaticama, gubici zbog trenja i vrtloženja u okretnom dijelu turbine, gubici zbog propuštanja pare između stupnjeva turbine te gubici energije zbog izlazne brzine pare [3].

Pod vanjskim gubicima smatraju se mehanički gubici zbog trenja u ležajima te gubici zračenjem topline s cjevovoda i kućišta prema okolini. Većina gubitaka koji nastaju u radu turbine posljedica su konstrukcijske izvedbe, a samo pravilnim održavanjem mogu se ti gubici svesti na minimalnu razinu. Jedne od najvećih opasnosti po rotor turbine su pojava vibracija i aksijalnog pomaka. Vibracije rotora nastaju uslijed njegovog debalansa što je izravna posljedica nepravilnog rukovanja, prolaza kroz kritične brzine, istrošenja pojedinih dijelova, prevelikog toplinskog opterećenja ili iskrivljenja rotora zbog neujednačenog hlađenja.

3. SIMULACIJA UTJECAJA NEŽELJENIH STANJA NA ISKORISTIVOST POSTROJENJA

Simulator brodske strojarnice omogućuje prikaz raznih scenarija unutar realnog sustava, gdje se na "bezbolan" način mogu simulirati najčešći problemi u radu ili havarije postrojenja. To predstavlja prednost u odnosu na realne sustave gdje je to tehnički neizvedivo ili neisplativo izvesti. Na simulatoru se može simulirati veliki broj raznih stanja na svakoj pojedinoj komponenti sustava, te pratiti utjecaj na čitav sustav (potrošnja goriva, snaga turbine, emisija štetnih plinova, požar u strojarnici, kvarovi na automatici...). Dobiveni rezultati se mogu koristiti za edukaciju studenata i pomoraca za precizno i pravovremeno upravljanje postrojenjem u takvim situacijama.

The internal and external losses occur during the steam turbine operation. Frictional losses in nozzles, inlet passages and blades, the losses due to friction and whirling in the rotary turbine parts, the losses due to steam leakage through the turbine stages and the energy losses due to the exit velocity of the exhaust steam are considered as internal losses [3].

Mechanical losses due to bearing friction and the losses due to heat radiation from the pipeline into the environment are considered as external losses. The majority of losses which occur during the turbine operation are the consequence of the construction arrangement. Those losses can be minimized by proper maintenance. One of the main threats to the turbine rotor is the axial displacement and vibration. The rotor vibrations occur due to its imbalance which is a direct consequence of the inadequate operation, critical revolutions, wear of the turbine parts and the excessive thermal load or the rotor distortion due to uneven cooling.

3. SIMULATION OF THE IMPACT OF UNDESIRABLE OPERATIONAL CONDITIONS TO THE PLANT EFFICIENCY

A marine engine simulator allows the display of various scenarios within the real system, enabling the simulation of common faults or breakdowns without any consequences to the plant. This represents an advantage over the real systems where it is technically impracticable to carry them out. The simulator can simulate a large number of different conditions on each individual system component and monitor their impact to the whole system. In such way fuel consumption, turbine output, emissions, fire in engine room, failures in automation equipment and etc. can be observed. The results can be used for the education of both the students and the seafarers who should be prepared to respond to emergencies promptly and efficiently.

For the purpose of this paper, four states on the LNG tanker steam plant at full load were simulated: the influence of soot deposit on the economizer and of the superheater piping to fuel consumption, the influence of burning different fuels to NO_x emission, the influence of worn out thrust bearing and low-pressure tur-

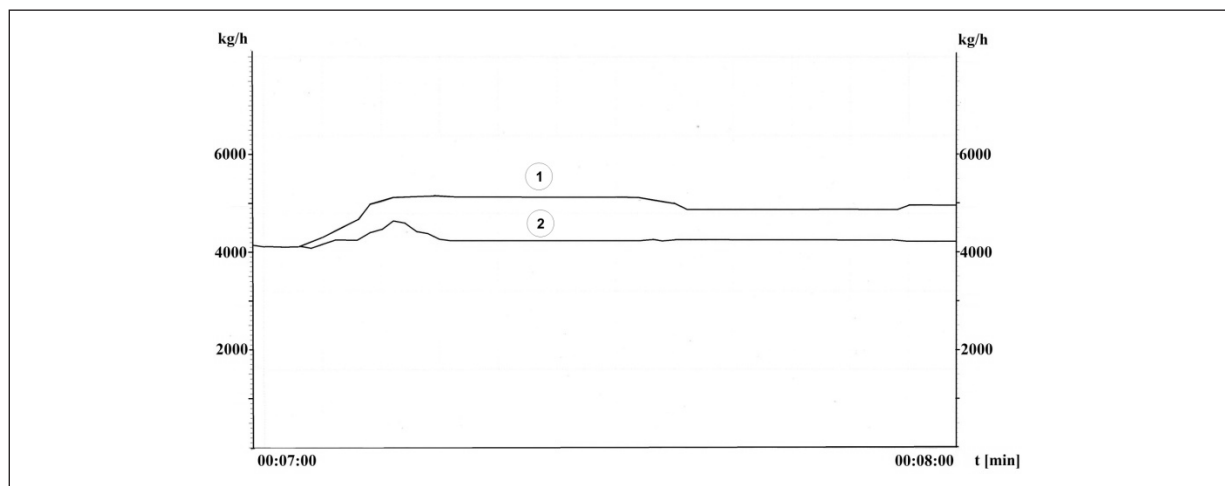

Slika 5. Utjecaj zaprljanja cijevi zagrijača vode i pregrijača pare čađom na potrošnju goriva kod onečišćenog (1) i čistog generatora pare (2) [3]

Figure 5. Influence of the soot deposit on the economizer and of the superheater piping to fuel consumption of dirty (1) and clean (2) boiler [3]

Za potrebe ovog rada simulirana su četiri stanja postrojenja LNG tankera u plovidbi pri punom opterećenju i to: utjecaj zaprljanja cijevi zagrijača vode i pregrijača pare čađom na potrošnju goriva; utjecaj izgaranja tekućeg ili plinovitog goriva na emisiju NO_x ; utjecaj istrošenosti odzivnog ležaja turbine i istrošenosti lopatica niskotlačne turbine na snagu turbine, aksijalni pomak i vibracije.

Na slici 5. prikazan je utjecaj zaprljanja cijevi zagrijača vode i pregrijača pare čađom na potrošnju goriva kod generatora pare u paralelnom radu. Iz slike je vidljiv porast (linija 1) potrošnje goriva kod generatora pare sa zaprljanim cijevima. Razlika u potrošnji prikazuje važnost pravilnog održavanja, pregleda, ali i pravovremenog dijagnosticiranja. Simulator nema mogućnost mjerenja ili promjene debljine sloja čađe već se razlike u potrošnji goriva određuju u edukacijske svrhe.

Na slici 6. prikazan je utjecaj izgaranja tekućeg i plinovitog goriva na emisiju NO_x . Jedan generator pare izgara teško gorivo (1), a drugi izgara ispareni dio tereta (2). Iz slike je vidljivo da je pogodnije izgarati metan koji je iz ekološkog aspekta prihvatljiviji jer pri izgaranju emitira manju koncentraciju dušikovih oksida (otprilike 35 mg/m^3). Usprkos tome, upotreba dijela tereta kao pogonskog goriva ovisi o režimu plovidbe, količini isparenog dijela tereta, ugovorenim uvjetima, cijeni plina i goriva na tržištu, ekološkim propisima itd.

turbine blades to the turbine output, axial displacement and vibrations.

The influence of soot deposit on the economizer and of the superheater piping to fuel consumption of boilers in parallel operation is shown in Figure 5. The increased fuel oil consumption (line 1) due to dirty boiler pipes is visible from the figure. The difference in the consumption shows the importance of proper maintenance, inspection and timely diagnosis. The simulator does not have the option of measuring or changing the thickness of soot deposits, so the differences in the fuel consumption are predetermined for educational purposes.

The influence of burning liquid and gaseous fuel to NO_x emission is shown in Figure 6. One boiler burns heavy fuel oil (1) and the other burns boil-off (2). It can be seen that it is more appropriate, from the ecological point of view, to burn methane because it emits less nitrogen oxide (approximately 35 mg/m^3). Nevertheless, the use of boil-off as a fuel depends upon the navigational conditions, the amount of boil-off, terms of contract, the cost of gas and oil on the market, the environmental regulations etc.

The influence of the worn out thrust bearing to the turbine output (1), the vibrations of the high pressure (2) and low pressure turbine (3) and the axial displacement of the high pressure (4) and low pressure turbine (5) is shown in Figure 7. The simulation below shows the reduction in the turbine output at constant steam consumption. On top of all, increased turbine

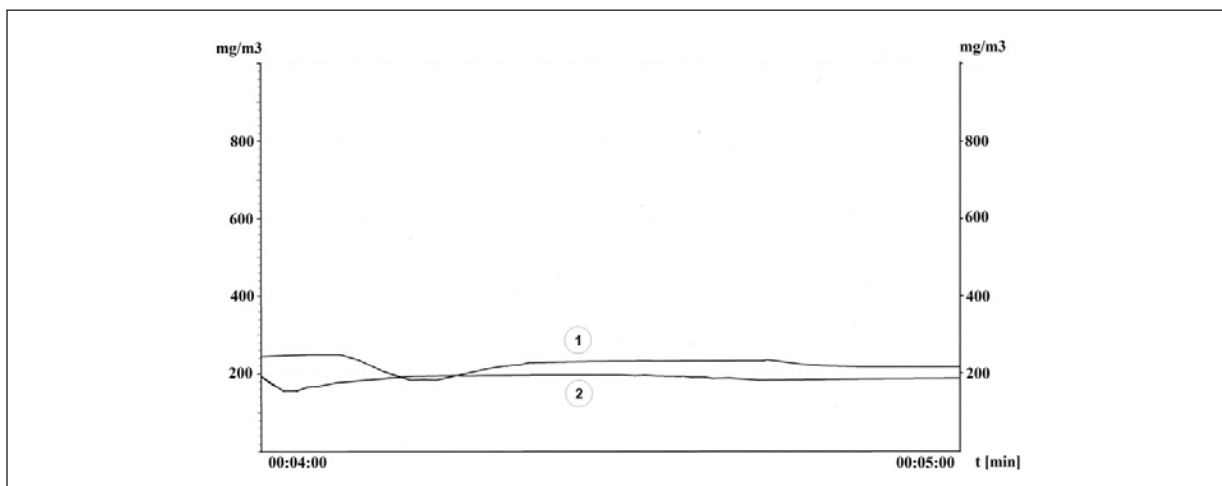

Slika 6. Emisije NO_x generatora pare koji izgara teško gorivo (1) i generatora pare koji izgara prirodni plin (2) [3]

Figure 6. NO_x emission of the boiler burning heavy fuel oil (1) and the boiler burning natural gas (2) [3]

Na slici 7. prikazan je utjecaj istrošenosti odzivnog ležaja na snagu turbine (1), na vibracije visokotlačne (2) i niskotlačne turbine (3), te na aksijalne pomake niskotlačne (4) i visokotlačne turbine (5). Prikazana simulacija pokazuje da uz konstantnu potrošnju pare, snaga turbine počinje padati, a dolazi i do vibracija i aksijalnih pomaka turbina koji mogu dovesti do njihovog zaustavljanja. Da bi snaga turbine ostala na konstantnoj razini potrebno je povećati proizvodnju pare, time i potrošnju goriva čime pada sveukupna iskoristivost postrojenja.

Na slici 8. prikazan je utjecaj istrošenosti lopatica niskotlačne turbine na snagu turbine i na pojavu vibracija niskotlačne turbine. Prikazana simulacija pokazuje da ako dođe do istrošenosti

vibrations and axial displacement are developed which could lead to the tripping out of the turbine. To maintain the turbine output at a constant level, it is necessary to increase the production of steam, thereby increasing the fuel consumption. Consequently, this will result in the reduction of the overall plant efficiency.

The influence of the worn out low-pressure turbine blades to the turbine output (1) and the low-pressure turbine vibrations (2) is shown in Figure 8. The simulation shows that there is a rapid reduction in the turbine output and a gradual increase in the low-pressure turbine vibrations in case of the worn out blades. In practice, this phenomenon does not occur so quickly as simulated, but through out a longer period

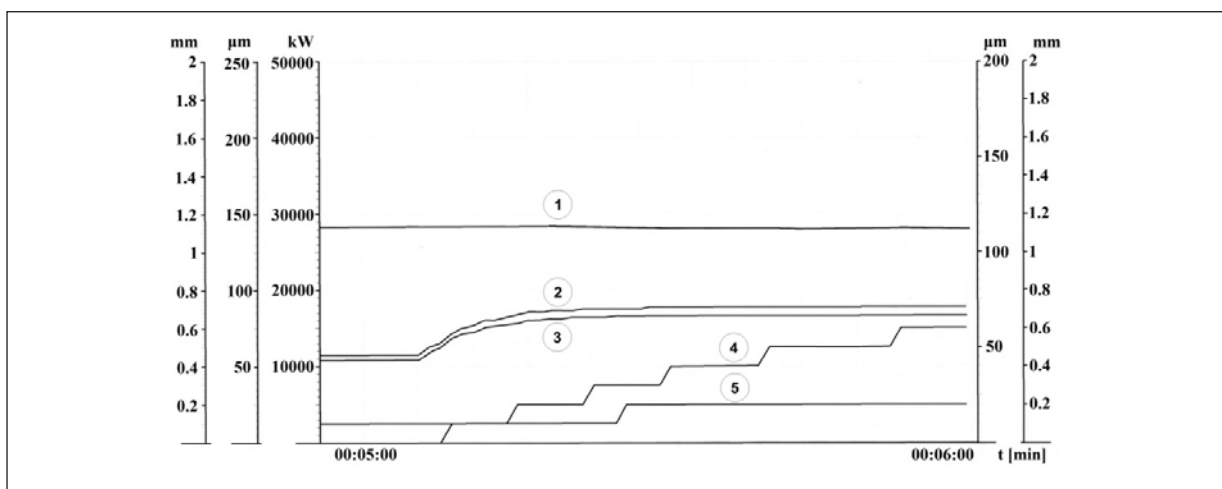

Slika 7. Utjecaj istrošenosti odzivnog ležaja parne turbine na snagu (1), vibracije visokotlačne (2) i niskotlačne turbine (3), te aksijalni pomak visokotlačne (4) i niskotlačne turbine (5) [3]

Figure 7. Influence of the worn out thrust bearing to the turbine output (1), the vibrations of the high pressure (2) and low pressure turbine (3) and the axial displacement of the high pressure (4) and low pressure turbine (5) [3]

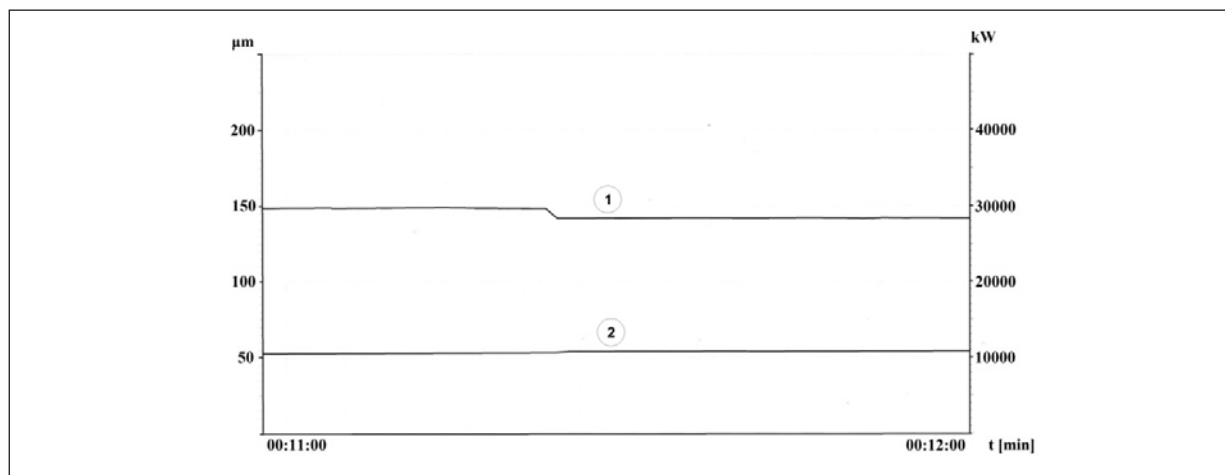

Slika 8. Utjecaj istrošenosti lopatica niskotlačne turbine na snagu turbine (1) i na pojavu vibracija niskotlačne turbine (2) [3]

Figure 8. Influence of the worn out low-pressure turbine blades to the turbine output (1) and the vibrations of low-pressure turbine (2) [3]

lopatica, snaga turbine (1) naglo pada, a postupno se povećavaju vibracije niskotlačne turbine (2). U praksi do ove pojave ne dolazi trenutno (kako je simulirano), nego kroz određeni vremenski period. Ako bi se turbina zadržala u ovakvom nepravilnom radu, moguće je da u određenom vremenskom razdoblju vibracije prouzrokuju prisilno zaustavljanje turbine. Pojava istrošenosti lopatica niskotlačne turbine najčešće je uzrokovana visokom koncentracijom vode u pari (vlažnost) što dovodi do njihove erozije. Mogući uzroci ove pojave su i dotrajalost lopatica odnosno nepravilno rukovanje. Izbjegavanje istrošenosti lopatica može se postići održavanjem kvalitete vode (redovita analiza) te pravilnim rukovanjem parnom turbinom.

4. ZAKLJUČAK

U radu je analizirano brodsko parnoturbinско postrojenje za koje su utvrđeni načini koji pridonose optimiranju takvog pogonskog sustava na brodovima za prijevoz ukapljenog prirodnog plina. Analizom karakteristika ove vrste postrojenja razmatrana je iskoristivost te načini poboljšanja ekonomičnosti rada u ovisnosti o pogonskim radnim parametrima.

Glavni utjecajni parametri na ukupnu iskoristivost postrojenja su tlak i temperatura svježeg pare te tlak, odnosno temperatura na kojoj se zbiva kondenzacija izlazne pare. Iskoristivost postrojenja bitno je ovisna i o izvedbi, odnosno o regenerativnom zagrijavanju napojne vode. Ukupni stupanj djelovanja parnoturbinскоg po-

of time. If the turbine operates in such an irregular way, it is possible that the vibrations could cause the turbine to trip after some time. The phenomenon of the low-pressure turbine blade wear is usually caused by the high concentration of water in the steam (wetness of steam), leading to the blade erosion. The other possible causes of this phenomenon are the worn out blades and improper operation. The turbine blade wear can be avoided by maintaining a high boiler water quality and the appropriate steam turbine operation.

4. CONCLUSION

The paper analyses the steam propulsion plant and the methods of optimizing such a propulsion system on board LNG tankers. The plant efficiency and the methods of improving the economic operation, depending on the operating parameters, were considered by the analysis of plant characteristics.

The main parameters that affect the overall plant efficiency are the pressure and the temperature of the inlet steam and the pressure or temperature at which the exhaust steam condensation occurs. The efficiency of the plant substantially depends on the design i.e. on the regenerative feed water heating. The overall efficiency of the steam plant also depends on the efficiency of its individual accessories.

The engine room simulator enables the analysis of various scenarios, errors, failures and adjustments of the working parameters aiming at

strojenja ovisi također o iskoristivosti njegovih pojedinih dijelova.

Simulator brodske strojarnice omogućuje analiziranje raznih scenarija, kvarova, greški te provjera i podešavanja parametara s ciljem optimiranja postrojenja i stručnog usavršavanja pomoraca. U radu su simulirana četiri scenarija te se analizirao njihov utjecaj na iskoristivost. Simuliran je utjecaj zaprljanja cijevi zagrijača vode i pregrijača pare čadom na potrošnju goriva, utjecaj izgaranja tekućeg i plinovitog goriva na emisiju NO_x te utjecaj istrošenosti odzivnog ležaja turbine i istrošenosti lopatica niskotlačne turbine na vibracije i snagu turbine.

Optimiranjem na simulatoru omogućuje se uspješnije upravljanje i održavanje postrojenja, tj. onih radnih parametara čijim se podešavanjem pogoduje najvećoj iskoristivosti i najmanjoj potrošnji goriva. Dobiveni rezultati pokazuju da primjena simulatora može poslužiti brodarskim kompanijama i pomorskim edukacijskim ustanovama za uvježbavanje pomoraca i studenata za rad u različitim specifičnim situacijama pri upravljanju parnoturbinskim postrojenjem.

the plant optimization and professional training. In this paper four scenarios were simulated and their influences on the plant efficiency were analysed. The influence of the soot deposit on the economizer and of the superheater pipes to the fuel consumption, the influence of burning different fuels to the NO_x emission and the influence of the worn out thrust bearing and of the low-pressure turbine blades to the turbine output, axial displacement and the vibrations were simulated.

The optimization, by using a simulator, enables a successful control and maintenance of the plant i.e. of those operating parameters whose adjustment results in the maximum plant efficiency and in the minimum fuel consumption. The results have shown that the simulator can serve the shipping companies and maritime educational institutions to train the students and the seafarers for working in various specific situations.

LITERATURA / REFERENCES

- [1] Simulator Transas ERS 4000 ver. 7. 3.
- [2] Prelec, Z., *Brodski generatori pare*, Zagreb, Školska knjiga, 1990.
- [3] Tireli, E, D. Martinović, *Brodske toplinske turbine*, Rijeka, Sveučilište u Rijeci, Pomorski fakultet, 2001.
- [4] Orović, J., *Priprema i optimiranje brodskih parnoturbinskih postrojenja*, magistarska radnja, Rijeka, J. Orović, 2006.
- [5] Udruga pomorskih strojara Split, *Ukorak s vremenom* br. 35, 36, 37 i 38.
- [6] Internet