

# **Propagation of EM Signal in Underground Mines**

**Prepared for**

**UNITED STATES DEPARTMENT OF THE INTERIOR  
BUREAU OF MINES**

**by**

**Collins Commercial Telecommunications Group  
Circuit Switching Systems Division  
Cedar Rapids, Iowa 52406**



**Rockwell International**

**FINAL REPORT**

*Contract No. H0366028*

*September 1977*

**DISCLAIMER NOTICE**

*The views and conclusions contained in this document are those of the authors and should not be interpreted as necessarily representing the official policies or recommendations of the Interior Department's Bureau of Mines or of the US Government.*

1. Report No.	2.	3. Recipient's Accession No.	
4. Title and Subtitle <b>Propagation of EM Signals In Underground Mines</b>		5. Report Date <b>22 August 1977</b>	6.
7. Author(s) <b>Terry S. Cory</b>		8. Performing Organization Report No.	
9. Performing Organization Name and Address <b>Rockwell International Commercial Telecommunications Group 1200 North Alma Road Richardson, Texas, 85080</b>		10. Project/Task/Work Unit No. <b>93-7890</b>	11. Contract or Grant No. <b>H0366028</b>
12. Sponsoring Organization Name and Address <b>Office of The Assistant Director of Mining Bureau of Mines Department of the Interior Washington, D.C. 20241</b>		13. Type of Report <b>Final Report</b>	
14.			
15. Supplementary Notes			
16. Abstract <p>This report is a comprehensive summary of the results of the propagation measurements program conducted for the US Bureau of Mines under Contract H0366028. Data was gathered in the MF frequency range from a cross sample of six mines representative of the industry having typical wireless requirements. From the raw data which was gathered, a logical method of data reduction is presented which culminates in a set of average attenuation characteristics for all mines visited. These characteristics define a typical MF wireless system when the communication range requirements are known. Direct through-the-earth propagation and the range enhancement mechanism due to coupling on and off conductors are evaluated and related to the planning of a typical wireless MF communications system.</p>			
17. Originator's Key Words <b>propagation characteristics; conductors; overburden and underburden conductivities; communication range; MF frequencies.</b>		18. Availability Statement	
19. U.S. Security Classif. of the Report <b>Unclassified</b>	20. U.S. Security Classif. of This Page <b>Unclassified</b>	21. No. of Pages <b>174</b>	22. Price

## FOREWORD

This report was prepared by Collins Commercial Telecommunications Group, Rockwell International, Cedar Rapids, Iowa under USBM Contract Number H0366028. The contract was initiated under the Coal Mine Health and Safety Program. It was administered under the technical direction of PM&SRC with Mr. Harry Dobroski acting as the Technical Project Officer. Mrs. Pearl A. Shapert was the contract administrator for the Bureau of Mines.

This report is a summary of the work recently completed as part of this contract during the period August 2, 1976 to September 30, 1977. This report was submitted by the authors on April 26, 1977.

## Table of Contents

	Page
Report Documentation Page .....	1
Foreword.....	3
1.0 Introduction.....	9
1.1 Program Background.....	9
1.2 Summary of Program Goals and Technical Objectives..	10
1.3 Program Overview.....	11
1.4 Report Contents .....	12
2.0 Executive Summary .....	12
2.1 Overview of Results.....	13
2.1.1 Results Summary.....	13
2.1.2 Correspondence of Results to Program Goals .....	14
2.1.3 Summary of Evaluation Criteria.....	14
2.2 Specific Observations and Conclusions .....	15
2.3 Recommendations.....	22
3.0 Technical Approach .....	22
3.1 Empirical Techniques .....	23
3.1.1 General Measurement System Redesign .....	23
3.1.2 Transmit Antenna and Antenna Coupler Design.....	26
3.1.3 Receive System Calibration .....	32
3.1.4 Deployment of Measurement Equipment.....	32
3.2 Data Reduction and Display Methods .....	32
4.0 Compended Results and Analysis.....	37
4.1 Reduction of Measured Field Strengths to Maximum Communication Range-Presentation of Reduced Data.....	37
4.2 Analysis and Development of System Application of Data.....	42
4.2.1 Quasi-Conductor-Free Maximum Communication Range Vs Frequency.....	42
4.2.2 Conductor Proximity Maximum Communication Range Vs Frequency.....	43
4.2.3 Range Variability Assessment.....	49
5.0 Individual Mine Tests Descriptions.....	51
5.1 Ireland Mine.....	51
5.2 Inland Steel Coal Mine No. 1 (Sesser).....	52
5.3 Consolidation Coal Mine No. 5 (Robinson Run).....	52
5.4 Eastern Associated Coal Mine Federal No. 1.....	53
5.5 Virginia Pocahontas No. 1 Mine .....	53
5.6 Peabody Coal Company Mine No. 10.....	54
6.0 Conclusions and Recommendations .....	55
6.1 State of Knowledge of Propagation Effects.....	55
6.2 Usability of Program Results .....	56
6.3 Potential MF Wireless Communication Applications ....	56

Table of Contents (Cont)

	Page
6.4 Recommendation for Further Measurements and Analysis.....	57
6.5 Typical System Performance Considerations.....	57
6.6 Effect of an Ideal Repeater in Conductor-Free Areas.....	58
6.7 Effect of an Ideal Repeater in Proximity to Conductors.....	59
Appendix A Mine Test Data .....	63
Appendix A1 Ireland Mine Test Data at Medium Frequency.....	67
Appendix A2 Sesser Mine Test Data at Medium Frequency and UHF.....	87
Appendix A3 Consolidation Coal Mine No. 95 (Robinson Run Portal).....	111
Appendix A4 Eastern Associated Coal Federal No. 1 Mine (Eddy Portal).....	125
Appendix A5 Island Creek Coal Co. Virginia Pocahontas No. 1 Mine.....	139
Appendix A6 Peabody Coal Co. Mine No. 10.....	149
Appendix B Errata and Added Calibration Information.....	163
Appendix C Magnetic Field Strength Sensitivity of an FM Receiver .....	167
References.....	173

List of Illustrations

Figure	Page
1 Maximum Communication Range Vs Operating Frequency in Conductor-Free Areas of Coal Mines - Geometric Average of All Data Sets .....	16
2 Maximum Communication Range Vs Operating Frequency in Proximity to Conductor's RX Antenna 2 Meters From Conductor(s), TX Located Remotely - Pittsburgh Seam .....	17
3 Maximum Communication Range Vs Operating Frequency in Proximity to Conductor's RX Antenna 2 Meters From Conductor TX Located Remotely - Pocahontas #3 Seam .....	18
4 Maximum Communication Range Vs Operating Frequency in Proximity to Conductor's RX Antenna 2 Meters From Conductor TX Located Remotely - Herrin #6 Seam .....	19
5 Maximum Communication Range Vs Operating Frequency, Both TX and RX Antennas Located 2 Meters From Conductor.....	21
6 Measurement Test Equipment Configurations .....	24
7 Schematic Diagram of Transmit Antenna Tuning Unit .....	27
8-a Input Resistance of Low Frequency Transmit Antenna .....	28
8-b Input Reactance of Low Frequency Transmit Antenna .....	29
8-c Input Resistance of Low Frequency Transmit Antenna .....	30
9 Input Impedance of High Frequency Transmit Antenna .....	31
10 Swept Spectrum of Transmit Antenna Current Showing Harmonics.....	33
11 Average Calibration Data for Singer NM-12 and NM-25 Field Strength Meters Using Singer 0.73 Meter Antennas .....	35
12 Comparison of High Frequency Vs Low Frequency Antennas .....	36
13 Maximum Communication Range Vs Operating Frequency in Conductor-Free Areas of Coal Mines - Pittsburgh Seam Data Sets.....	38
14 Maximum Communication Range Vs Operating Frequency in Conductor-Free Areas of Coal Mines - Herrin No. 6 Seam Data Sets.....	40

List of Illustrations (Cont)

Figure	Page
15 Maximum Communication Range Vs Operating Frequency in Conductor-Free Areas of Coal Mines - Pocahontas No. 3 Seam Data Sets.....	41
16 Required Field Strength Sensitivity Levels for Mine Wireless Radios Based on the Collins-Developed Mine Wireless Prototype Radios at 520 kHz.....	44
17 Estimated Noise Magnetic Field in Coal Mines Extrapolated Beyond 200 kHz From NBS Data .....	61



## 1.0 INTRODUCTION

This is the Final Report covering work performed by Collins Telecommunications Group, Rockwell International under Bureau of Mines Contract H0366028 entitled Propagation of EM Signals in Underground Mines.

The technical work was performed by Spectra Associates, Inc. personnel under Subcontract C-651333 with administrative direction provided by Collins Telecommunications Group, Mine Electronics Department, and with technical assistance provided by Collins Telecommunications Group personnel using Collins Telecommunications Group facilities. The technical work was directed by the Principal Investigator, Terry S. Cory, P. E. under Spectra Associates, Inc. Subcontract 002607.

The primary program work consisted of performing measurements of magnetic field strength in six underground coal mines coordinated with a concurrent theoretical study, performed by the Arthur D. Little Co. (ADL) by action of a Goal Setting Committee. The Goal Setting Committee members included personnel from the Bureau of Mines, ADL, Collins Telecommunications Group, Spectra Associates, Inc., and the Principal Investigator.

The test equipment was furnished by Collins Telecommunications Group and the Bureau of Mines, except for special antennas and antenna matching assemblies designed during this program. The magnetic field strength measurement sets from each mine were separately reported in each of six interim Summary Data Reports. The analysis and assessment of the measured data together with a summary of the specific work performed is the subject of this report.

The measurements were performed by a team consisting of Bureau of Mines personnel, a Collins Telecommunications Group furnished technician, and the Principal Investigator.

## 1.1 PROGRAM BACKGROUND

Bureau of Mines (Bu Mines) investigations during 1973-74 identified a possible need for face area communications forward of the section phone toward improving operating efficiency in some mines. The coverage area required for this communication could extend forward at least 750 feet from the section phone and, if the miner(s) was driving, say, 12 parallel entries (characteristic of mains and submains in some mines) on 90- to 100-foot centers, the required communication range could be as great as 1,300 feet.

In December of 1974 and January of 1975 as part of Phase 1 of a subsequent Bu Mines contract with Collins Telecommunications Group (H0346067) for development of prototype portable and base station mine wireless radio equipment, field strength measurements were made in Consolidation Coal Company's Rose Valley (1)\* and Ireland mines (2) by Spectra Associates, Inc. under Collins Telecommunications Group Subcontract C-615171. These measurements were made to determine maximum communication range and to select the operating frequency for the prototype radios.

Previous theoretical work performed in 1974 under Bu Mines Contract H0232056 to Collins Telecommunications Group by Spectra Associates, Inc. under Subcontract C-696447 using homogeneous earth theory (3) predicted maximum communication ranges of the order of 750 feet (depending on the electrical ground parameters) employing VMD orientation of both transmit and receive loop antennas. In August of 1974, Bu Mines personnel range tested mine

---

\*Numbers in parentheses refer to References at the end of this report.

wireless portable radios made by ECAM Ltd. of Braamfontein, South Africa, in the conductor-free 8-north escapeway area of the Ireland mine. They were able to communicate to a range of 1,200 feet which, at the time, was thought to be an anomaly. The late 1974/early 1975 testing under the Mine Wireless program not only confirmed the 1,200-foot range in Ireland, but also postulated the HMD orientation of both antennas to be optimum; meaning the possibility that transmission had occurred via a seam waveguide mode. The Rose Valley data was taken to be inconclusive as the transmission path was only one entry removed from a 7,200 V ac power cable. That the 1,200 feet achieved in Ireland almost matched the desired 1,300 feet was only coincidental.

ADL, using a 3-layer (5) wave equation formulation was able to "match" the measured Ireland data, but only by using a seam conductivity of the order of  $10^{-4}$  mho/meter (at that time considered unthinkable low) and an overburden/underburden conductivity approaching 1 mho/meter (which seemed very high). The Ireland mine measurements resulted in the selection of nominally 500 kHz for the Mine wireless operating frequency.

The validity of the Ireland data was suspect in terms of being representative of a number of mines. The concern over these results engendered this current measurement program. As initially conceived, this program was to investigate wireless radio propagation in both mf and uhf frequency ranges (low coal) and also in hard rock and metal mines. Subsequent planning limited the measurements to the mf region in medium-to-high coal.

This program came under contract effective in July 1976, and has continued through the time of this writing.

## 1.2 SUMMARY OF PROGRAM GOALS AND TECHNICAL OBJECTIVES

The major thrust of this program from the onset has been verification (or nullification) of the 1975 Ireland results as being representative of, at least, the Pittsburgh seam and to develop a more complete understanding of the radio propagation mechanism(s) involved.

As the program planning developed, the consensus of the Goal Setting Committee was to investigate and characterize the radio propagation in as many seams representing as many high-production coal areas as possible. As it occurred, these were the Pittsburgh seam in northern West Virginia, the Pocahontas #3 seam in southern West Virginia/Virginia pan-handle, and the Herrin #6 seam in central-to-southern Illinois.

Emphasis was placed, during the measurements, on obtaining field strength vs range and frequency in quasi-conductor-free areas in sufficient detail to enable ADL to fit the measured data with computed data using their model. This, then, permitted estimates of seam and overburden/underburden conductivity for each test area to be made.

As the particular sets of field strength measurements are summarized in the Summary Data Reports with the data from each of the mines given in the appendix to this report, it was decided not to simply resummairize this data in field strength form for this report. The data is compended in terms of maximum communication range vs frequency, thus leading back to results that can be used directly in the solution of communications problems. This same form for compending the measured field strength data was used with the Ireland Mine data (4) from the previous program which led to the selection of 500 kHz as the operating frequency.

The program structure was configured to permit redirection of both the goals and the particular data taking objectives in particular mines as the work progressed. The preliminary planning for the first two mines was determined at the program kick-off meeting in August by the Goal Setting Committee. During the first two mine visits, the character of the data taken

was discussed day-by-day either in face-to-face working sessions (when Bu Mines and ADL representatives were present) or verbally by telecon. After each set of mine measurements, the raw data and the preliminary reduced data were sent informally to both Bu Mines and ADL within a week, followed by an unedited draft of the Summary Data Report within two weeks.

The selection of, and revised technical objectives for, the second two mines were determined without a face-to-face Goal Setting Committee meeting by a series of telecons. A second Goal Setting Committee meeting was held in December to plan the remaining two sets of mine measurements. The format for forwarding preliminary data/data reduction and draft report material continued, intermixed with frequent telecons.

The measurements were performed at a rate of approximately one mine per month.

### 1.3 PROGRAM OVERVIEW

Measurements were performed in six mines in chronological order as follows:

- a. September 1976, Ireland Mine, Ohio Valley Division, Consolidation Coal Co, Moundsville, West Virginia- Pittsburgh Seam
  1. Field strength vs range and frequency in 8-north submain -- quasi-conductor-free and conductor dilute
  2. Field strength mapping of 8-north 3-right working section -- conductor-dense
- b. October 1976, Inland Steel Coal Mine #1 (Sesser), Sesser Illinois - Herrin #6 Seam
  1. Field strength vs range and frequency in 1-main east -- quasi-conductor-free
  2. Field strength mapping of 1-main east 5- and 6-left and 9-right working sections -- conductor dense
  3. Comparative testing of South African and our mine wireless prototype radios -- quasi-conductor-free
- c. November 1976, Consolidation Coal Mine #95 (Robinson Run), Mountaineer Division, Consolidation Coal Co., Shinnston, West Virginia - Pittsburgh Seam
  1. Field strength vs range and frequency in main-north 2-west -- quasi-conductor-free
  2. Field strength vs range and frequency in main-north 2-west -- conductor proximity
  3. Noise near conductors @ 1000 kHz in main-north 2-west
- d. November 1976, Federal #1 Mine, Eastern Associated Coal Co., Grantown, West Virginia, - Pittsburgh Seam
  1. Field strength vs range and frequency in 8-main north -- quasi-conductor-free
  2. Field strength vs range and frequency in 3-main left working section -- conductor-dense
- e. January 1977, Virginia Pocahontas #1 Mine (VP #1), Island Creek Coal Co., Grundy, Virginia - Pocahontas #3 Seam
  1. Field strength vs range and frequency in 3-south -- quasi-conductor-free
  2. Field strength vs range and frequency in 2-north #1 plow -- quasi-conductor-free
  3. Range testing Collins mine wireless prototype radios -- quasi-conductor free

- f. February 1977, Peabody Coal Mine #10, Peabody Coal Co., Pawnee, Illinois - Herrin #6 Seam
1. Field strength vs range and frequency in 1-south 1st west 2nd north working section -- quasi-conductor-free
  2. Field strength vs range and frequency in 1-south submain -- quasi-conductor-free
  3. Field strength and noise vs range in 5-1/2-east/1-south junction -- conductor dense

#### 1.4 REPORT CONTENTS

Section 2.0 presents an Executive Summary consisting of an overview of the results in terms of maximum communication range vs frequency plus specific observations and conclusions, and recommendations all based on the maximum communication range data.

Section 3.0 presents the technical approach to the program including a program description (expansions on paragraphs 1.1 and 1.2), a description of the measurement test equipment, a description of the measuring technique(s), and details of the data reduction process.

Section 4.0 presents the technical formulation of methods used in summarizing the report results in terms of maximum communication range and optimum frequency and in estimating maximum communication range and optimum frequency in the presence of conductors.

Section 5.0 presents a description of the tests conducted and a summary of results for each of the six mines visited.

Section 6.0 presents the program conclusions and recommendations, including several strawman system calculations to further illustrate the use of the data.

Appendix A presents complete summary data sets from the Summary Data Reports.

Appendix B presents a list of "tracks" including any errata and corrections to data previously published in the Summary Data Reports.

Appendix C presents Magnetic Field Strength Sensitivity of an FM Receiver.

#### 2.0 EXECUTIVE SUMMARY

Wireless radio transmission at medium frequency is feasible for both section and haulage communications in underground coal mines. The radio wave propagation occurs via either a coal seam waveguide mode or electromagnetic coupling into and out of mine wiring, or both. The capabilities of battery operated portable and base station radios being developed by the Bureau of Mines are compatible with this wireless transmission means. The results of this measurement program provide a starting point for design and implementation of radio systems for coal mines. Further refinement beyond these results will be necessary to design radio systems predictively and to formulate performance requirements for sophisticated applications employing multiple radios and repeaters in disciplined operation.

This report stresses mine wireless communications at medium frequency using the measured results rather than dealing only with the intricacies of the measured results themselves. To this end, performance measures have been derived in part directly from the measured data and in part from simple analyses verifiable from the data. These analyses embody some aspects of the Arthur D. Little Co. (ADL) radio propagation analysis method (6) which separately has served toward defining the basic propagation mechanisms and providing the theoretical data base for this work. The philosophy developed in this report is to define

typical performance characteristics, using these above measures based on reasonable estimates of noise (7), (8), and a simple conductor geometry defined in section 4.0 of this report. The performance characteristics defined are in the form of graphs of maximum communication range vs frequency.

## 2.1 OVERVIEW OF RESULTS

### 2.1.1 Results Summary

The communication range depends primarily on the particular seam electrical characteristics, the local radio noise, the proximity to mine wiring, and the operating frequency. Based on the typical performance characteristics presented in this report, maximum ranges will generally exceed 600 meters with radios located within one entries' distance from a conductor-carrying entry and 100 to 300 meters with radios located beyond 2-3 entries' distance from this conductor-carrying entry.

Of the three seams tested (Pittsburgh, Pocahontas No 3, and Herrin No 6) the greatest range was achieved in the Pittsburgh seam and the least range in the Herrin No 6 seam. If both radios are located in the same entry as conductors (or in any entries containing connected conductor strings), the particular seam characteristics become less important. The greatest range differences between seams occur when communicating in areas where at least one radio is well removed from conductors.

Mine wiring conductors extend the communication range well beyond that achievable in their absence. Ranges of several miles are obtainable for haulage service if both radio units are in entries containing connected conductors. Similarly, complete section radio coverage is obtained if one of the radios is close to any conductor leading toward the face. If one or both radios are two or more entries away from conductors (three entries in the case of the Pittsburgh seam), the communication range is not extended. Elevated suspended conductors are better for radio transmission than conductors lying on the floor or closely strapped to the roof.

An examination of the measured data reveals that the frequency range of 700 to 1000 kHz is optimum for achieving the optimum communication range in proximity to conductors; and is roughly independent of the type of coal seam involved.

This frequency range is higher than that obtained for transmission along conductors where both radios are closely coupled to the conductors. For this latter case, the communication range improved with decrease in frequency over the test frequencies considered which varied between nominally 100 and 5000 kHz. The optimum area coverage frequency range is largely independent of the characteristics of the particular seam and is governed largely by the coupling characteristics of radio waves to conductors and by radio noise.

Radio noise limits the communication range and influences the optimum frequency range for maximum area coverage. The greatest communication range occurs when the external noise is so low that the radios are set-noise limited. This noise condition occurs in remote areas of the mine or in sections and especially when the power is down. Based on the typical performance characteristics of this report, the optimum frequency range for maximum communication coverage is 200 to 500 kHz remote from conductors and 500 to 700 kHz near conductors. Noise floors in quiet areas of mines have never been measured at medium frequency.

The communication range is secondarily dependent on the mine topology, excluding conductors. The maximum communication range in areas remote from conductors is shorter when the transmission path is through a solid coal block than it is in a room and pillar area.

Transmission paths through coal pillars at discrete frequencies exhibit a standing wave in field strength with range due to the periodic path discontinuities presented by the coal pillars. This latter effect has limited practical significance and was only occasionally observed during the measurement program.

### 2.1.2 Correspondence of Results to Program Goals

Extended lateral through-the-earth transmission, compared to that expected using homogeneous earth theory, was first observed in testing in two mines in the Pittsburgh seam in 1975 (9). The limited test sample was insufficient upon which to base a technology. The results of this measurement program have confirmed the extended range phenomenon and have provided the basis for categorizing mine wireless radio propagation in six mines comprising 3 seams in medium-to-high coal. Concurrent analytical modeling by ADL has enabled the categorization of the electrical parameters of major importance in the waveguide transmission mode in conductor-free areas using this basis. Modeling to account for topological effects remains to be accomplished but is of secondary importance at the time of this writing in establishing wireless radio feasibility and in providing initial system design guidelines.

Of significance is the analytical marriage of measured field strength data in quasi-conductor-free areas with a conductor coupling and transmission model. A simple model for doing this is presented in section 4.0 of this report. This model has permitted reasonable computations to be made of combined through-the-coal and conductor-carried transmission effects on communication range and operating frequency.

We have fallen short of the original program goal of measuring the radio noise floor and radio noise values in operationally important areas of mines at frequencies above 200 kHz due to emphasis in obtaining high quality quasi-conductor free field strength data. Noise in particular areas of a mine can always be measured, however, and thus can easily be made a part of particular future system design analysis. Of perhaps more concern is the fact that much of the time the measurement receiving equipment was set-noise limited. Knowledge of the noise floor is necessary for effective design of base stations and repeaters using large antennas.

Overall, between the measured results of this program and the accompanying theoretical analysis of ADL, substantial progress has been made toward predictive modeling of mine wireless performance, although this modeling is not a specific goal of either this program or the companion ADL program. The model(s) is simple and imperfect in many respects as a purely predictive tool, but it has enabled characterizing the electrical properties of the coal seams (and nearby overburden/underburden) with accuracies commensurate with the measurement accuracy and the statistical size of the total measurement sample to date.

### 2.1.3 Summary of Evaluation Criteria

Criteria for evaluating communication performance have been based on characteristics and specifications for mine wireless portable radio performance put forth by the Bureau of Mines and which have evolved as a result of the mine wireless prototype radio development by Collins Telecommunications Group; and also on noise performance previously determined by the National Bureau of Standards (10) and as summarized by Collins Telecommunications Group/Spectra Associates (11). These characteristics and specifications were known to the author prior to performing the mine measurements. The measured results were gathered largely using test equipment with a dynamic range encompassing that of portable radio designs. Periodic tests were performed using actual mine wireless prototype radios and similar radios developed by ECAM, Ltd. in South Africa.

The criteria for performance evaluation based on the portable radio equipment include the following:

- a. NIA = 2.5, the transmit magnetic current moment of the radio using a loop antenna
- b. Receive sensitivity of  $0.02 \mu\text{A}/\text{meter}$  for 12-dB SINAD
- c. Receive noise bandwidth of 12 kHz.

The above are applicable to any operating frequency from nominally 100 to 5000 kHz.

The noise criteria used included the following:

- a. Radio set noise limit
- b. Median mine noise, based on the NBS work, and defined by Decker (12)  
 $H_N = 121.5 - 32.5 \log_{10} f \text{ (Hz)}$   
in dB greater than  $1 \mu\text{A}/\text{meter}/\text{Hz}$

## 2.2 SPECIFIC OBSERVATIONS AND CONCLUSIONS

The frequency dependence of the maximum communication range in conductor-free areas is summarized for the three seams and for both set-noise-limited and median-mine-noise environments in figure 1. These summary curves present the geometric mean of all applicable data sets and include the Ireland mine data obtained prior to this program (13).

Specific observations that may be drawn from figure 1 include the following:

- a. The increase in optimum frequency with increase in noise; from 400 kHz to 800 kHz in the Pittsburgh seam being typical
- b. The decrease in optimum frequency in progressing from the Pittsburgh seam results to the Pocahontas no. 3 seam results to the Herrin no. 6 seam results; from 800 to 500 kHz to 250 kHz assuming median-mine-noise being typical
- c. The progressive decrease in maximum communication range going from the Pittsburgh seam results to the Pocahontas no. 3 seam results to the Herrin no. 6 seam results; from 300 meters to 180 meters to 95 meters assuming median-mine-noise being typical.

The maximum range obtained using the mine wireless prototype radios in Sesser and VP no. 1 mines are representative of performance in the median-mine-noise case. Range tests performed with the South African radios in the Ireland mine resulted in roughly 400 meters which is between set-noise and median-mine-noise.

Considering the variation of optimum frequency with seam type and noise and the fairly broad optimum frequency peaking; the choice of 520 kHz for mine wireless prototype radios was wise if the radios were always expected to operate in quasi-conductor-free transmission situations. The Bu Mines desire to achieve a 1,300-foot range in a conductor-free area (assumed to be near the face) may be possible in many Pittsburgh seam mines as the face areas are generally the quietest.

The frequency dependence of the maximum communication range with radios located in varying proximity to conductors is typified for the three seams and median mine noise in figures 2, 3, and 4. These figures consider the situation where the receiver is located two meters away from an elevated conductor (or dilute grouping of conductors) having a surge impedance of 50 ohms in the presence of a rock conductivity as defined by ADL. The transmitter is assumed located 1, 2, or 3 entries away with the entries spaced on 30-meter centers.

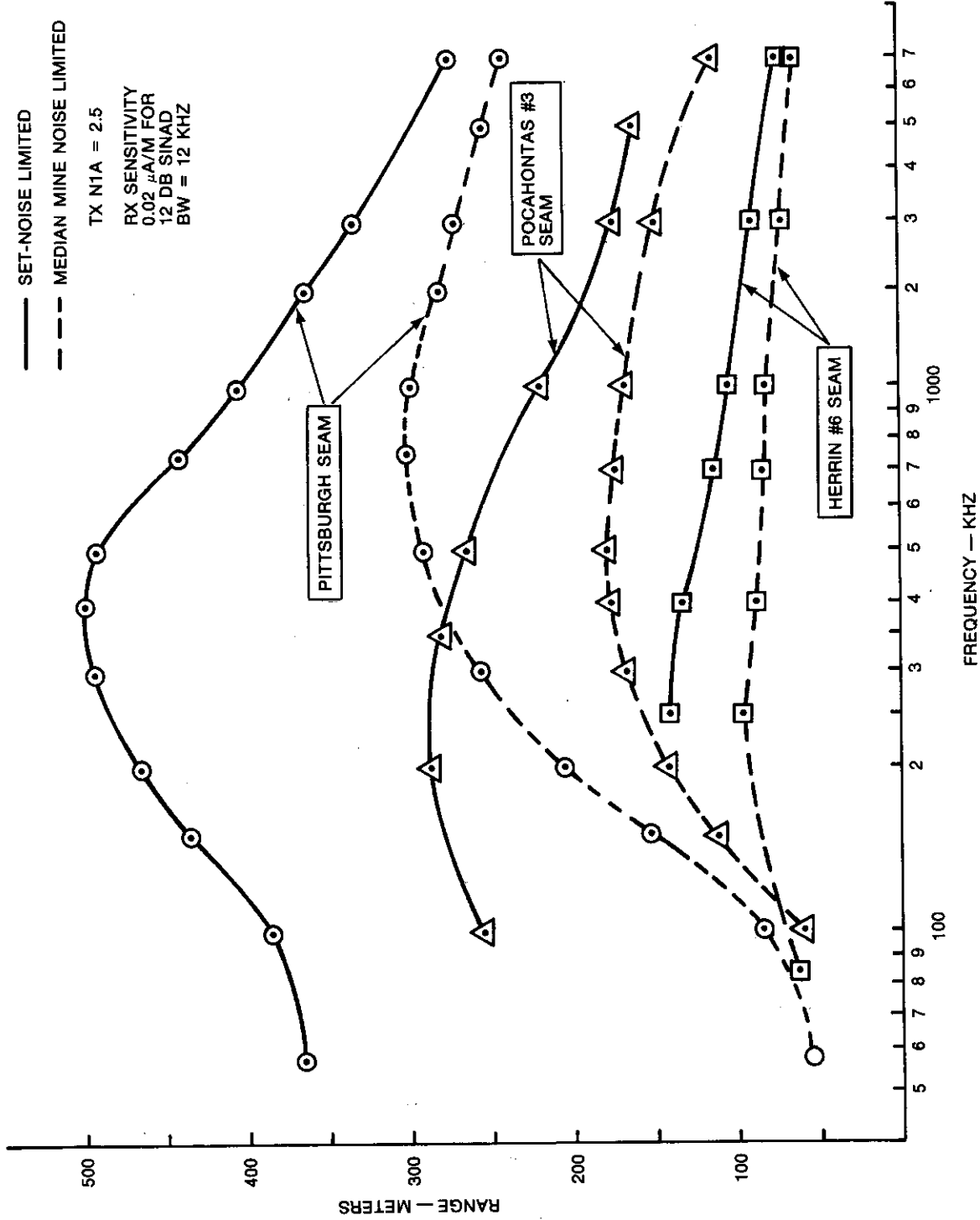

Figure 1. Maximum Communication Range Vs Operating Frequency In Conductor-Free Areas of Coal Mines - Geometric Average of All Data Sets.



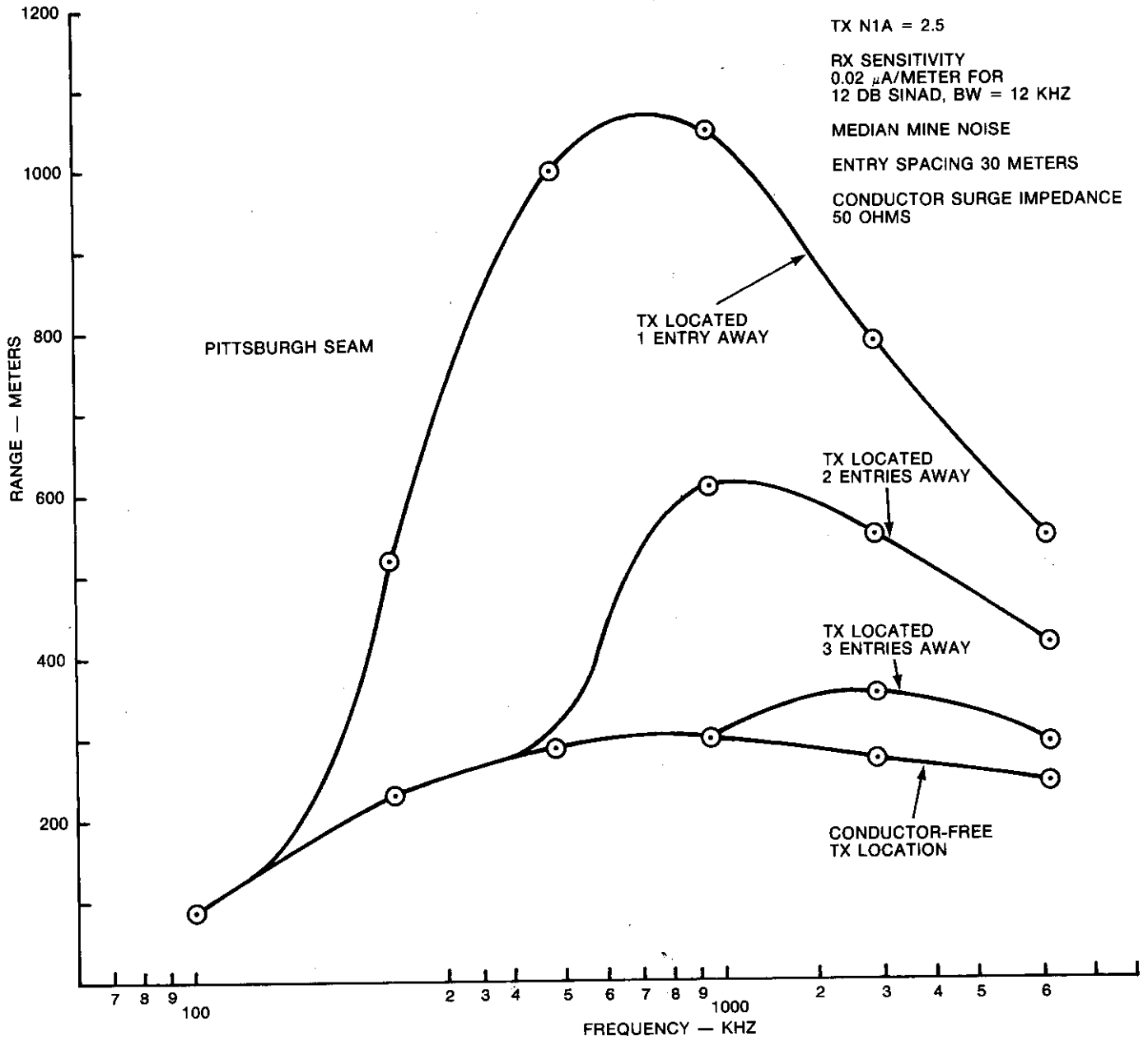

Figure 2. Maximum Communication Range Vs Operating Frequency in Proximity to Conductor's RX Antenna 2 Meters From Conductor(s), TX Located Remotely - Pittsburgh Seam.

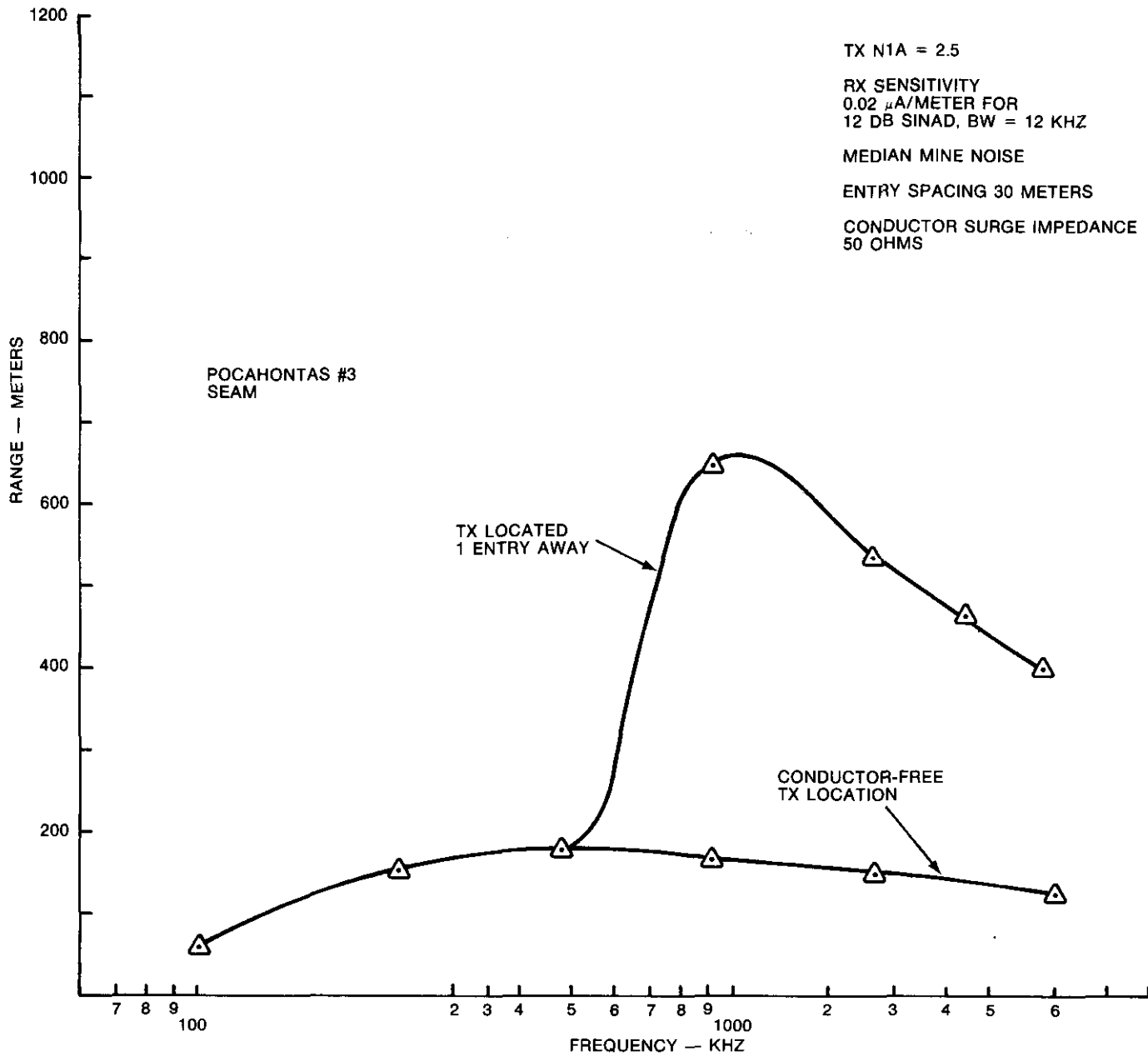

Figure 3. Maximum Communication Range Vs Operating Frequency in Proximity to Conductor's RX Antenna 2 Meters From Conductor TX Located Remotely - Pocahontas #3 Seam.

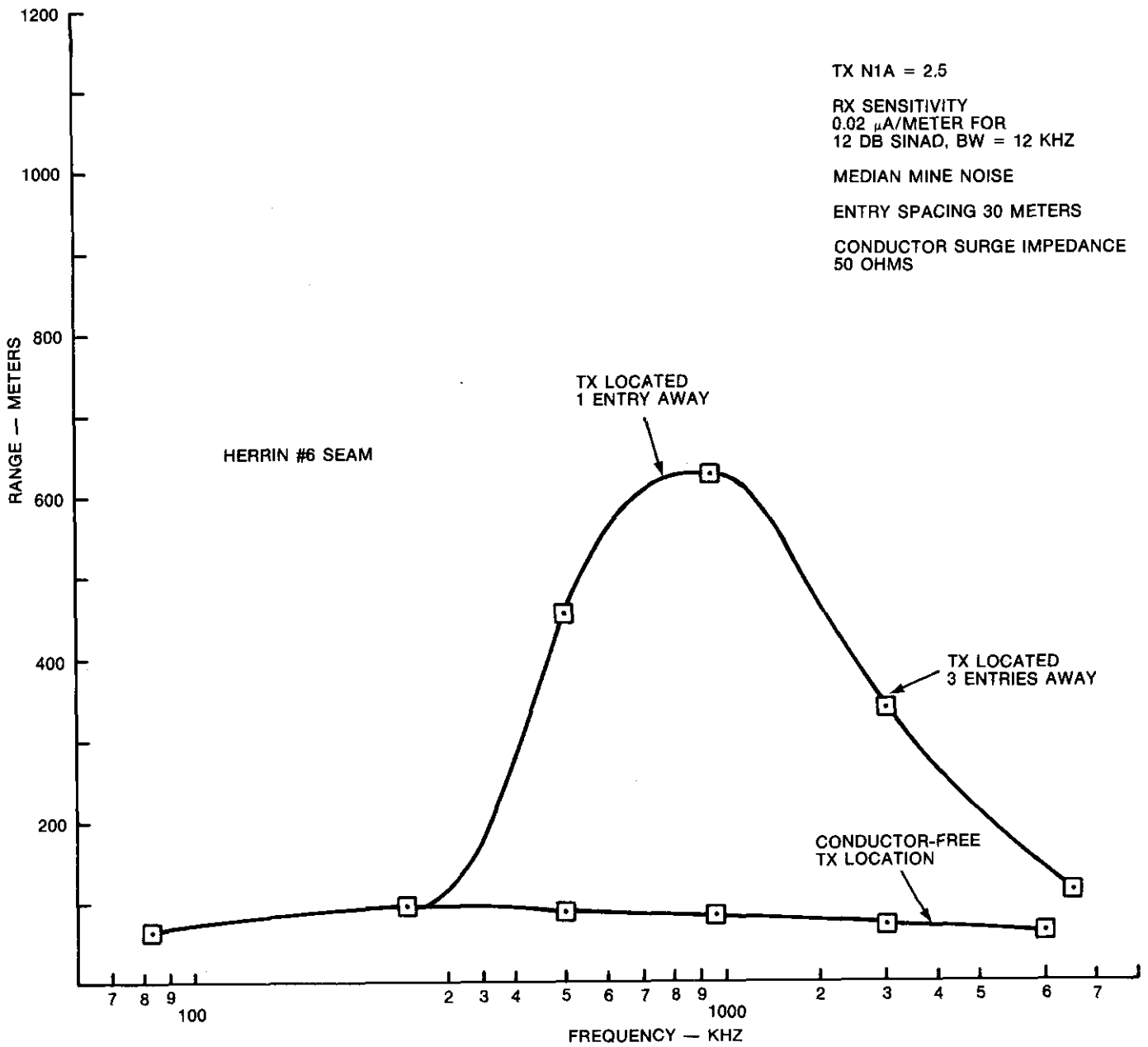

Figure 4. Maximum Communication Range Vs Operating Frequency in Proximity to Conductor's RX Antenna 2 Meters From Conductor TX Located Remotely - Herrin #6 Seam.

Specific observations that may be drawn from figures 2, 3, and 4 include the following:

- a. The increase in optimum frequency with increased distance away from conductors; from 700 to 1000 kHz to 2000 kHz are typical for the Pittsburgh seam, respectively, 1, 2, and 3 entries away.
- b. For seams other than Pittsburgh, the communication ranges for transmitter distances greater than one entry away from conductors are determined by direct through-the-earth transmission.
- c. The communication range and optimum frequency for a transmitter located two entries away in the Pittsburgh seam and one entry away for either the Pocahontas no. 3 or Herrin no. 6 seams are near constant at 600 meters and 1000 kHz.
- d. The decrease in communication range with distance of one of the radios from a conductor-carrying entry; from 1070 meters to 600 meters to 360 meters in the Pittsburgh seam are typical progressively 1, 2, and 3 entries away.

Considering most communication paths to be in proximity to conductors, 520 kHz (chosen on the basis of conductor-free data only) is too low a frequency to take full advantage of nearby conductors, particularly in the Herrin #6 seam. 1000 kHz seems to be the best overall choice of operating frequency based on figures 2, 3, and 4.

In areas with dense conductor groupings in several adjacent parallel entries (such as are found in typical four-parallel-entry section headings) the range achieved is governed by the superposition of the individual entry conductor grouping fields excited at the receiver. The excitation of the individual groupings from an arbitrarily located transmitter is not a simple problem, however. Mapping of field strength shows that the section coverage is adequate to ensure communications in both the Pittsburgh and Herrin no. 6 seams.

Of interest in the dense conductor grouping data is the case in the Ireland mine with a track entry sandwiched between a belt entry and a power cable/phone line entry. Of the three mapping frequencies 488, 954 and 4220 kHz, 954 kHz was the only frequency producing significant current in the track and trolley wire.

The frequency dependence of the maximum communication range with both radios in the conductor-carrying entry (or both in entries carrying conductors which are connected) for the three seams in median mine noise is illustrated in figure 5. These curves assume transmit and receive antennas located two meters away from and oriented coplanar with respect to elevated conductor(s) (or dilute conductor groupings) having 50-ohm surge impedance in the presence of rock conductivity as determined by ADL. Also assumed are no conductor branch points or unusual shunting impedances to ground.

Specific observations that may be drawn from figure 5 include the following:

- a. Within the frequency limits shown, the maximum communication range increases with decrease in frequency exhibiting the effect of lower line attenuation; showing a range of about 6 miles at 100 kHz and a range of 2 miles at 1000 kHz.
- b. The differences in communication range with seam type are relatively minor with the least difference occurring between the Pittsburgh and Herrin no. 6 data.

There will be an optimum frequency range for this type of transmission with the low frequency range reduction eventually occurring due to the increase in noise. Perhaps the optimum frequency range roughly agrees with the trolley phone frequency band, although no quantitative data is available to support the conclusion.

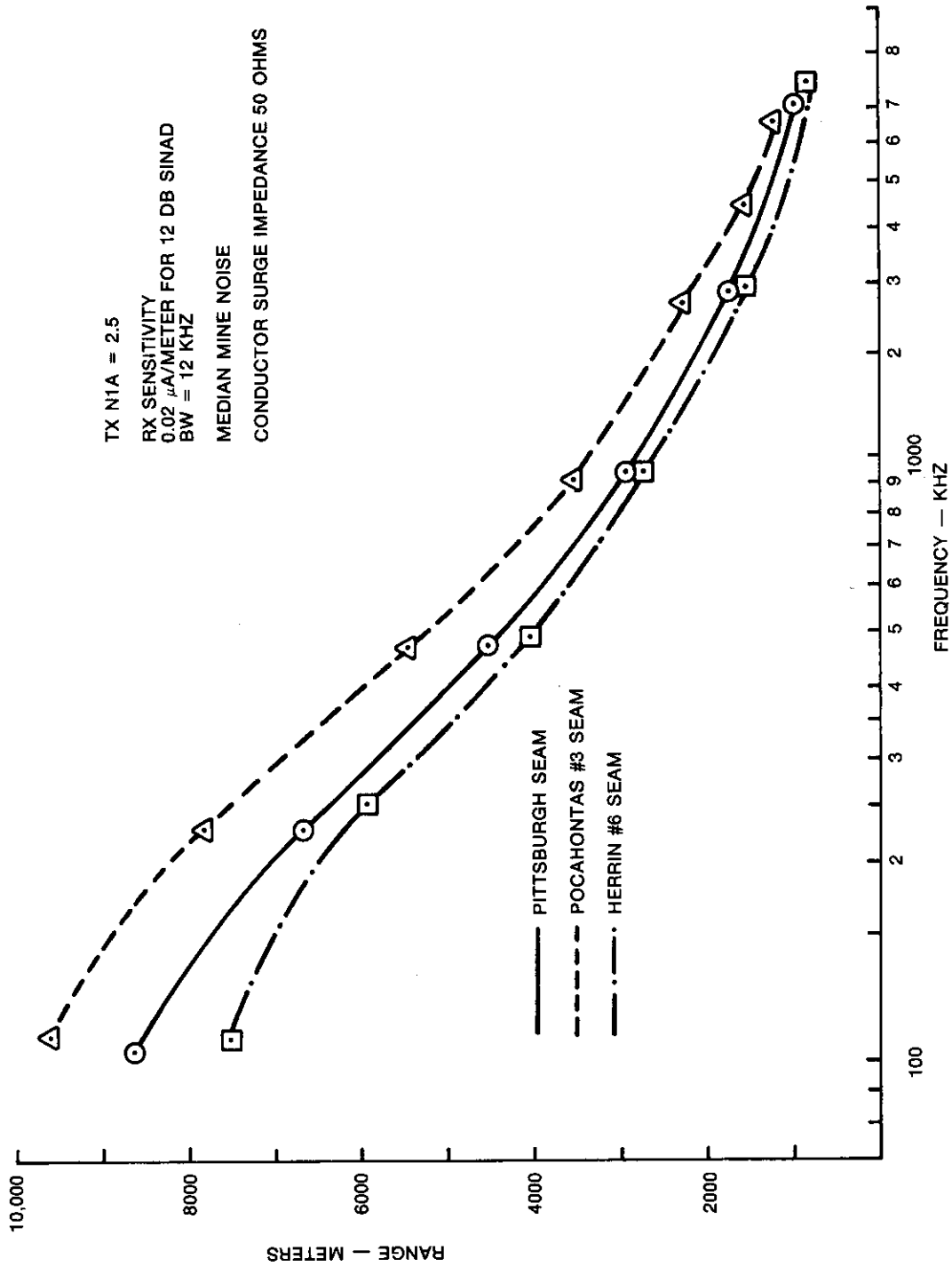

Figure 5. Maximum Communication Range Vs Operating Frequency, Both TX and RX Antennas Located 2 Meters From Conductors.

## 2.3 RECOMMENDATIONS

Recognizing the limited resources available for gathering additional related measured data, future measurement goals should be prioritized according to the degree to which the data base will be enhanced. Accordingly, a list of recommendations for further measurements and accompanying theoretical modeling includes, in priority:

- a. Performing measurements and modeling in additional high-productivity seam/region areas including low coal.
- b. Investigating conductor proximity modeling plus verification measurements including characterizing important conductor groupings and topological strings of conductors.
- c. Performing additional higher frequency mf noise measurements including characterizing noise sources and their coupling into mine power, control, and phone wiring.
- d. Investigating topological variations in mf propagation with emphasis on comparing solid coal block and room and pillar paths.
- e. Performing measurements and modeling at lower frequencies than 100 kHz including optimum frequency identification for long-range transmission conductors from closely coupled radios.
- f. Performing measurements to assess location variability in coal mines.

The results of this measurement program have also influenced the mine wireless equipment development activities. The following recommendations are included in this area:

- a. Change the operating frequency to about 1000 kHz.
- b. Reconfigure the portable units to make them smaller and more portable (including a flexible antenna); in doing so, the NIA could be reduced to the order of 0.7 to 1.0.
- c. For the portable radios, provide an optional "clip-on" shielded loop probe for coupling tightly into insulated conductors in coal mines.

Sufficient information is available to permit a simple computerized predictive model to be prepared including conductor proximity. This development would be particularly helpful in evaluation of transmission characteristics in the presence of conductors for future measurements. The analysis in this report provides a starting point for this effort, but the work needs to be put on a sound theoretical basis where variation of many parameters can be included.

As nearly all real transmission paths in coal mines involve conductor proximity, any predictive model must include these effects. ADL's model in quasi-conductor-free areas has served as a tool to define seam plus overburden/underburden electrical parameters. The author suggests using the ADL propagation model plus one or more simple models for conductor configurations and include the possibility of branches in conductor runs and the simultaneous excitation of conductors in more than one entry by electromagnetic coupling.

## 3.0 TECHNICAL APPROACH

Magnetic field strength measurements made during Phase 1 of the Mine Wireless program were limited in dynamic range. Also, the HP467A transmit amplifier driving the antenna was limited to approximately 1 MHz and tended to produce an unstable output for antenna currents of about 1 ampere. In addition, the antenna tuning circuitry used consisted only of a resonating capacitor rather than an L matching section.

The dynamic range was limited partly due to the transmit NIA achievable with the 31-turn 8-inch loop antenna due to higher antenna resistance (NIA of 0.7 was achieved for an antenna current of 1 ampere) and partly due to the sensitivity of the EMC-25. The noise figure of the

EMC-25 was determined to be about 18 dB and the single-turn receive antenna only had an area of 1/4 square meters.

As will be discussed in the next subsection, the selection of a wideband solid-state amplifier was instrumental in increasing transmit equipment operational stability and in increasing the usable measurement frequency range toward higher frequencies.

The selection of Singer NM-12 and NM-25 field strength meters and the use of a receive antenna of increased area  $(0.73 \text{ m})^2$  were instrumental in improving the receive system sensitivity.

The use of discrete L-section matching networks, while limiting the tuning to rather discrete ranges in frequency, resulted in improved transfer of amplifier power output into antenna current.

The assembly and implementation of the test equipment into a viable measuring system was a joint effort between Spectra Associates, Collins Telecommunications Group, and the Bureau of Mines. The signal generator used was provided from the Collins Telecommunications Group test equipment pool. The amplifier, battery packs, and the field strength meters were furnished GFE. For each mine visit, both the Bu Mines and Collins Telecommunications Group technicians on the measurement team brought along backup pieces of equipment, hand tools, repair equipment, power supplies for recharging batteries, and other items.

The technical approach to the performance of the measurements at a particular mine was one of evaluating the character of the data after each day of measurements and using this evaluation as a guide in determining the next day's measurement effort. This evaluation involved the nature of the test area (proximity to conductors), range achieved vs frequency, the uniformity of the test results, and other factors. The procedure for quick dissemination of data and preliminary summary results was that outlined in section 1.0.

### 3.1 EMPIRICAL TECHNIQUES

#### 3.1.1 General Measurement System Redesign

The main objective in designing the test equipment configuration was to obtain a transmit NIA and receive system sensitivity as high or higher than that of the mine wireless prototype portable radio at 520 kHz and further to sustain as high values of NIA and sensitivity as possible over the frequency range of nominally 100 to 5000 kHz. This was so the dynamic range of the test equipment would encompass that for the prototype radio at 520 kHz, plus encompassing the expected range of NIA and sensitivity with change in frequency. The size of the test antennas had to be constrained to values useful in a mine environment.

A block diagram illustrating the test equipment configuration is shown in figure 6.

The receive equipment consisted of Singer NM-12 (10 to 250 kHz) and NM-25 (150 kHz to 32 MHz) field strength meters. The available Singer receive antennas for these instruments were square shielded loops of the same size  $(0.73 \text{ m})^2$  but with separate low frequency and high frequency coarse "tuning heads" (vlf type 929380-2 and mf/hf type 92943-1). These antennas, consisting of 1 turn each, were judged to be of the largest practical size for use in the mine. The initial design question was whether or not the receive sensitivity of the field strength meters using these antennas would be adequate. The receive system sensitivity measurement of the NM-25 was made in the environmental screen rooms at Collins Telecommunications Group. In addition, the NM-25 noise figure was measured and found to be 1.9 dB. The NM-25 sensitivity values are shown in table 1. The sensitivity of the NM-12 wasn't

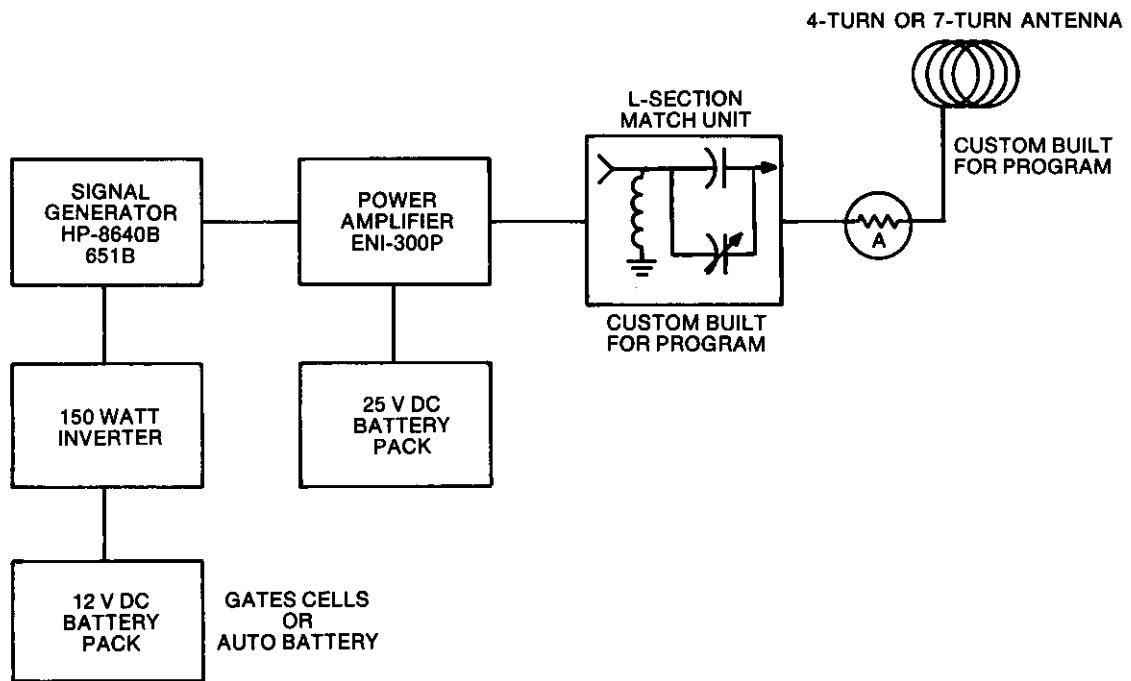

TRANSMITTING TEST SETUP

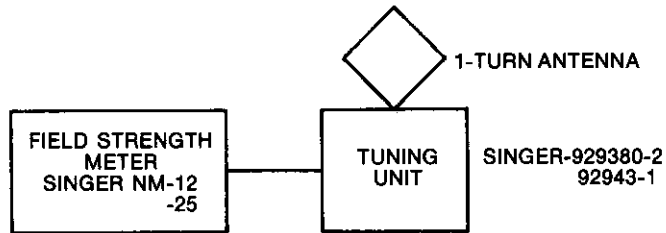

RECEIVING TEST SETUP

Figure 6. Measurement Test Equipment Configurations.



Table 1. NM-25 Sensitivity.

RX ANTENNA BAND SET NO.	FREQUENCY (kHz)	EASY AND QUICK MIN USEFUL SIG (dB > 1 $\mu$ A/m)	CAREFUL SET MIN USEFUL SIG (dB > 1 $\mu$ A/m)	MIN DET SIGNAL (dB > 1 $\mu$ A/m)	MIN DET SIG DENSITY (dB > 1 $\mu$ A/m $\sqrt$ Hz )
1	228	-30.5	-34.5	-40.5	-76.1
2/1	520	-36.5/-43.1	-40.5/-47.5	-46.5/-53.1	-82.1/-87.1
2	1086	-36.8	-40.8	-46.8	-82.4
3	2271	-42.6	-46.6	-52.6	-88.2
4	4750	-47.0	-51.0	-57.0	-92.6

measured due to the difficulty in making measurements at 50 and 100 kHz in the Collins Telecommunications Group environmental area.

These sensitivities were judged to be adequate as the value at 520 kHz exceeds that for the mine wireless radio (-34 dB/ above 1  $\mu$ A/meter for 12 dB SINAD). The sensitivities given in the table are given in terms of four numbers; "easy and quick" minimum useful level, minimum useful level if care was exercised in taking the reading (4 dB more sensitivity than "quick and easy"), the minimum detectable signal level (taken to be 10 dB below "quick and easy") and the minimum detectable signal density.

The transmit equipment consisted of either an HP-8640B or an HP-651B signal generator driving an ENI Model 300P broadband amplifier (150 kHz to 30 MHz, 3 watts, maximum output at 50 ohms) in turn driving either of two loop antenna and special matching circuitry designed as part of this program. The loop antennas were nominally 2 feet in diameter. One loop antenna was designed for frequencies below 1000 kHz and having 7 turns. The other loop antenna was designed for a frequency range of 1000 to 5000 kHz and having 4 turns. The nominal antenna current available from the amplifiers was 1 ampere. With this value of current, the achievable NIA's were respectively 2.04 at lower frequencies and 1.17 at higher frequencies. Actual values of antenna current achieved during measurements were 0.7 to 1.0 A at all frequencies except above 3000 kHz where the antenna current was typically 0.4 A.

The transmitting equipment was powered from two separate battery packs. The amplifier (requiring 0.9 A at 25 V dc) was driven from one of two available 5 A hour, 25 V dc Gates cell packs. The signal generator was powered from a 150-watt inverter, in turn driven by a 12 V dc Gates cell pack or from a 12-volt automobile storage battery. A single 2.5-A hour Gates cell is capable of powering the generator for one hour. A pack of 4 such cells in parallel was normally used.

Early in the program, the HP-8640B generator was used exclusively with the HP-651B provided as backup plus for use at 50 and 100 kHz. Due to bulk and increased power drain of the HP-8640, the HP-651B was used exclusively later in the program.

### 3.1.2 Transmit Antenna and Antenna Coupler Design

The antenna and matching circuitry design is shown schematically in figure 7. The main antenna design criterion was that of keeping the antenna resistance as low as possible with increase in frequency so that, when tuned, maximum current could be driven into the antenna. Additionally, the maximum reactance was designed to be less than about 700 to 800 ohms so that with 1.0 A of current flowing, the maximum voltage stress across capacitors could be kept less than 1000 volts. The impedance curves for the low frequency and high frequency antennas are given in figures 8-a, b, c and 9.

The antenna tuning circuitry was designed to tune the antennas at the following discrete frequency ranges (matching the antenna to 50 ohms resistive):

- 95 to 100 kHz
- 225 to 240 kHz
- 465 to 500 kHz
- 980 to 1100 kHz
- 1800 to 2300 kHz
- 3800 to 4600 kHz.

The particular frequency for optimum antenna current varied from mine to mine according to details of the antenna mounting and the length of the antenna tuning leads. In the last two

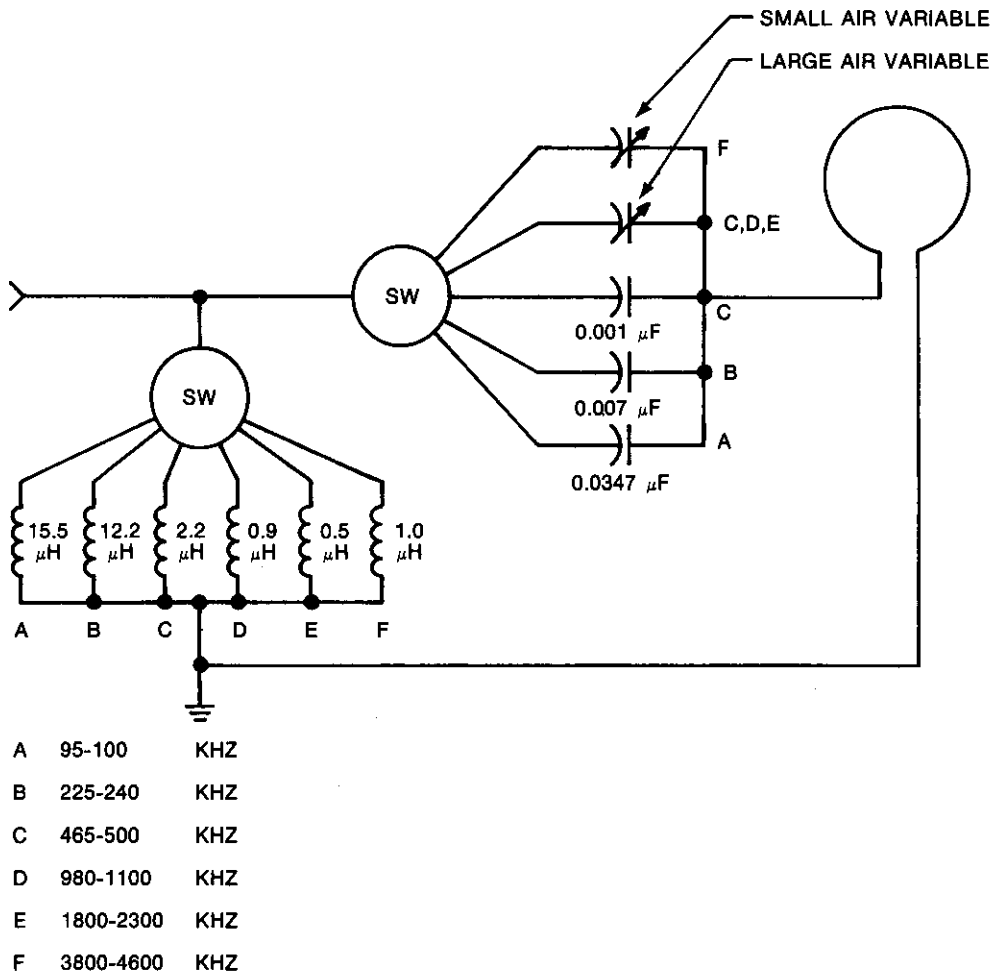

Figure 7. Schematic Diagram of Transmit Antenna Tuning Unit.

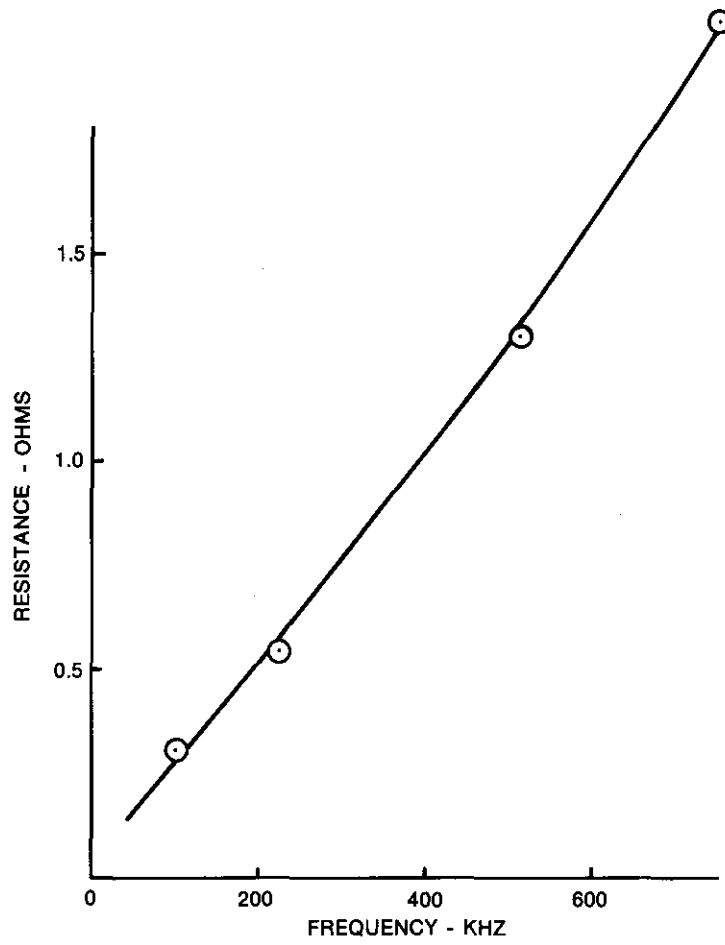

Figure 8-a. Input Resistance of Low Frequency Transmit Antenna.

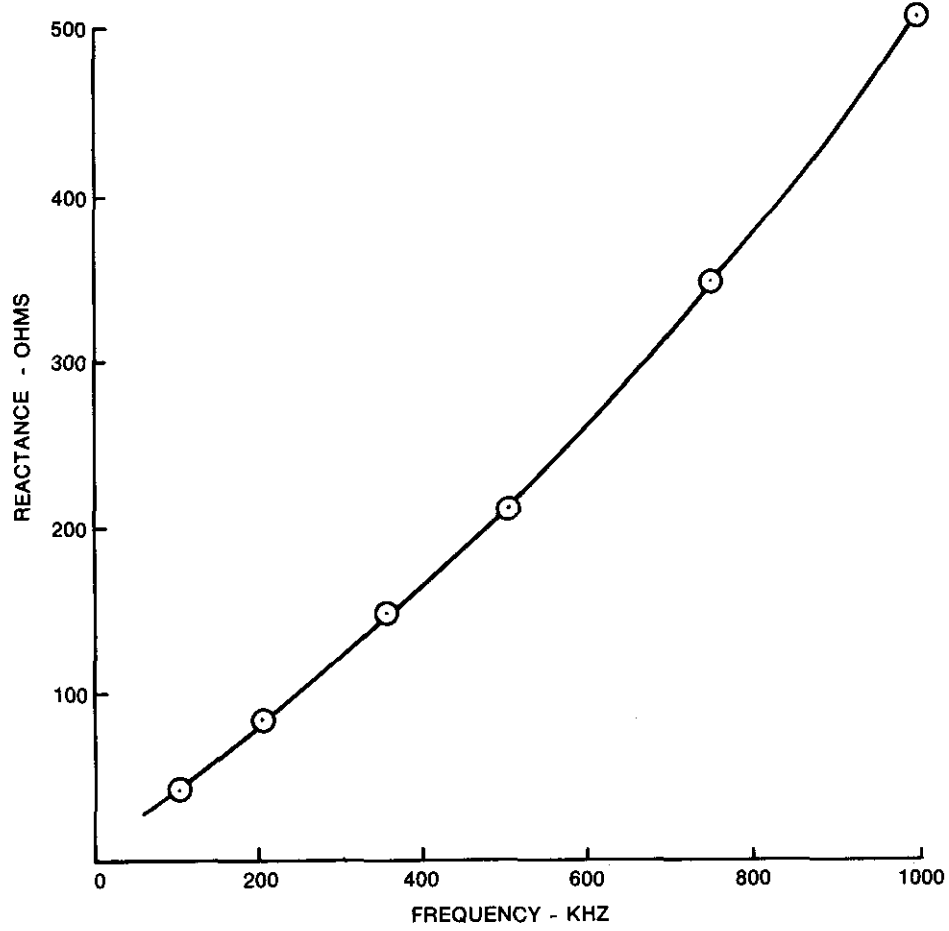

Figure 8-b. Input Reactance of Low Frequency Transmit Antenna.

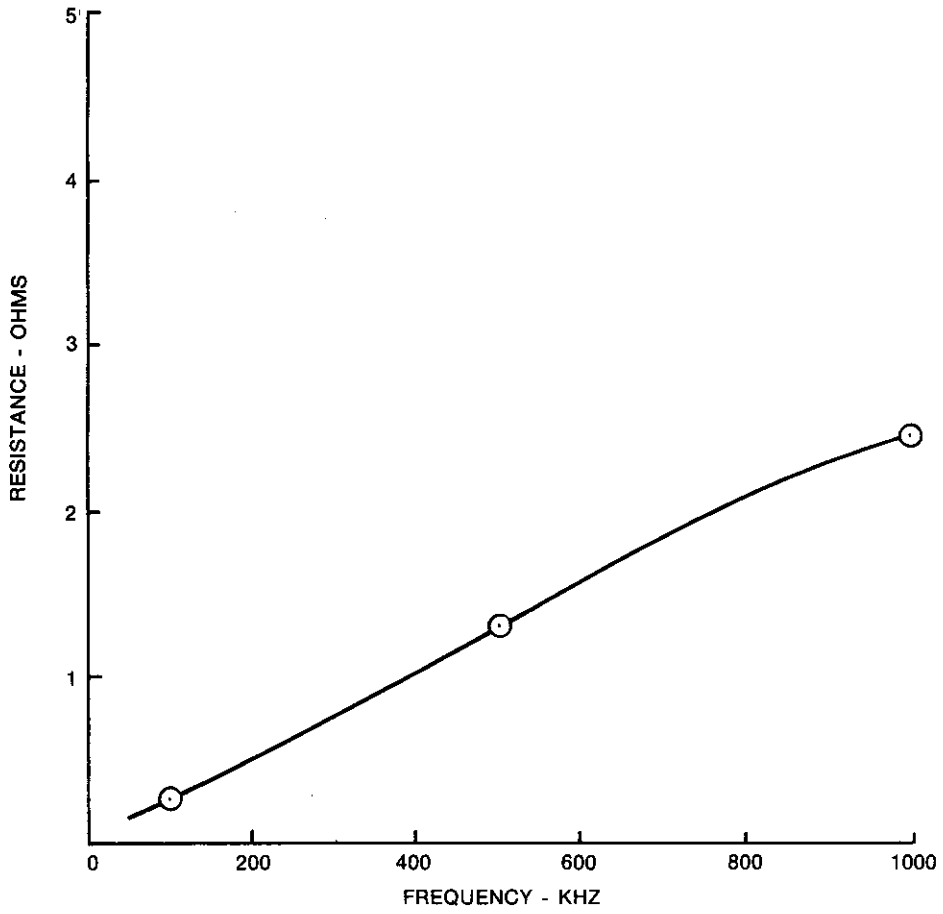

Figure 8-c. Input Resistance of Low Frequency Transmit Antenna.

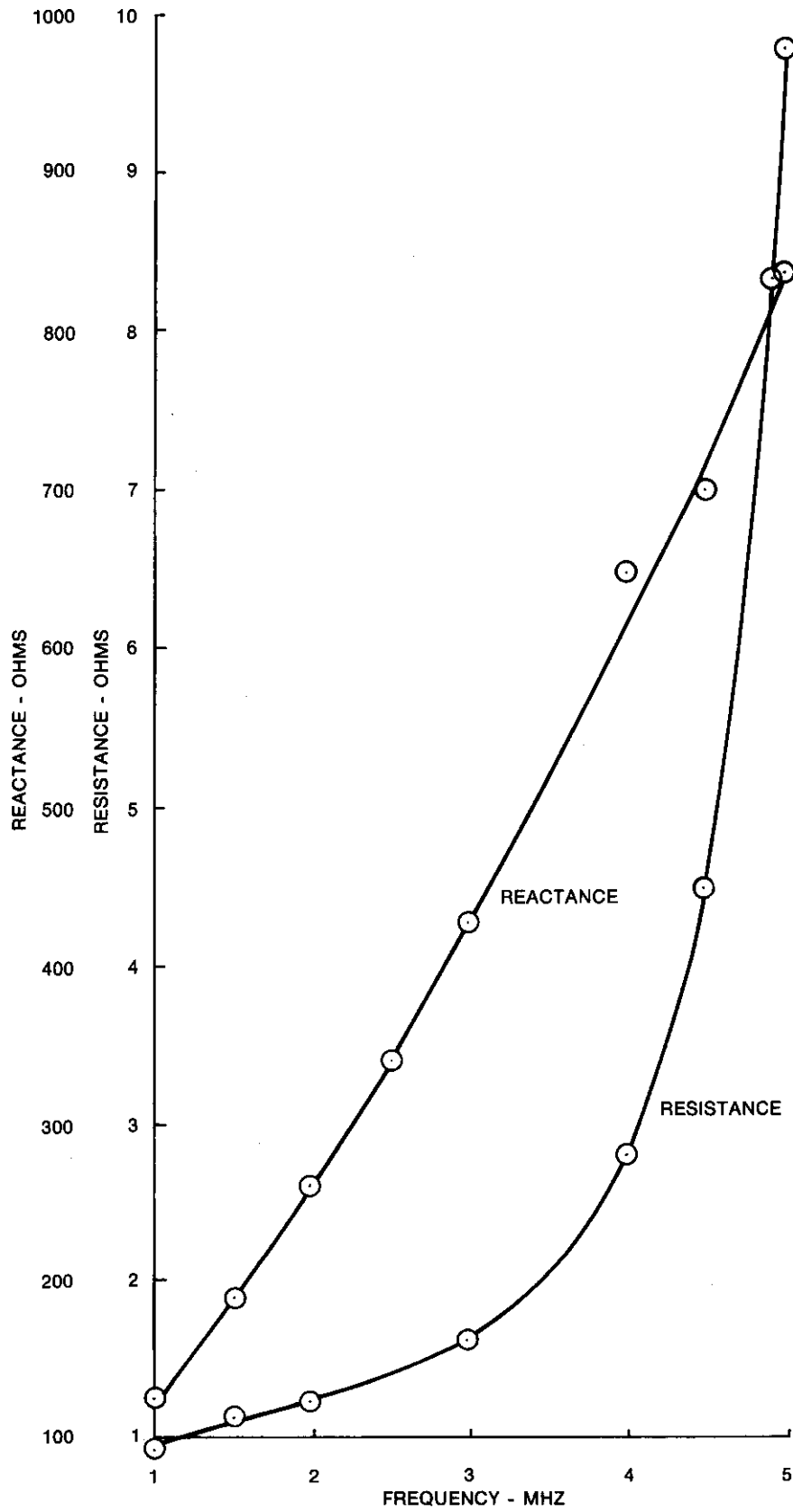

Figure 9. Input Impedance of High Frequency Transmit Antenna.

mines, antenna leads 6 to 7 feet in length were employed and the highest frequency to which the antenna would tune slipped to approximately 2900 to 3800 kHz.

An additional feature of antenna tuning is that of ensuring a "clean" transmit frequency spectrum; particularly at lower frequencies of nominally 50 and 100 kHz. (During the fifth mine visit, a tuning circuit was added to permit tuning to 50 kHz) where the 300P amplifier was operated below its design limit. The transmit spectra of the antenna current is shown in figure 10. In each case, the 2nd harmonic component is seen to be at least 20 dB below the fundamental.

### 3.1.3 Receive System Calibration

The receive system was calibrated for field strength in the Collins Telecommunications Group environmental area. This calibration was performed several times during the course of the program, serving to both expand the calibration baseline and also to pinpoint changes in the condition of the equipment due to the relatively hard use experienced during this program. The field strengths resulting in the analog meter reading on the instrument calibration mark with the attenuator in the -20 dB position were used (calibration marks were at +10 dB on the NM-25 and at +25 dB on the NM-12). The field strength calibration obtained was in terms of  $\mu\text{V}/\text{meter}$ . Table 2 gives the magnetic field and plane-wave-equivalent electric field strength values at frequencies actually used during the program. Figure 11 shows an average curve of all the calibration data (assuming the high frequency antenna tuner only is used) and is within 2 dB of all particular calibration readings taken. The calibration data in reality does not follow a perfectly continuous curve due to switching of the antenna tuners in roughly 3:1 bandwidth segments.

Figure 12 shows the measured comparison between the low frequency and high frequency tuners used with the 0.73-square-meter shielded loop antenna.

### 3.1.4 Deployment of Measurement Equipment

The transmitting power amplifier, tuner, rf ammeter and test leads were carried in a metal suitcase. Similarly, the signal generator(s) were (each) carried in another metal suitcase(s). The antennas were both carried in a heavy duty cardboard box just made to fit. The battery packs were carried into the mine separately. Each field strength meter and both antennas were transported in separate portable cases. The antennas were assembled on-site for use.

Typically, the transmit antenna was positioned in an entry/crosscut cross-section geometric center. The antenna was almost always suspended from a roof bolt by a piece of nylon cord. The transmitting equipment was deployed on the floor immediately beneath the antenna.

The transmitting equipment was set up on a particular frequency, tuned for maximum antenna current, and was left on continuously while the field strengths were being measured at locations on a particular measurement traverse.

## 3.2 DATA REDUCTION AND DISPLAY METHODS

During the measurements, particular measurement locations or stations were designated by counting crosscuts (or half crosscuts). These stations were located on a mine map and the actual ranges from the transmitter to the receiver in each case were determined from the map. Field strength readings were recorded in terms of the analog meter reading and the attenuator setting from the field strength meter. For each set of readings, the receive antenna band switch position, the frequency, and the transmit antenna current were recorded.



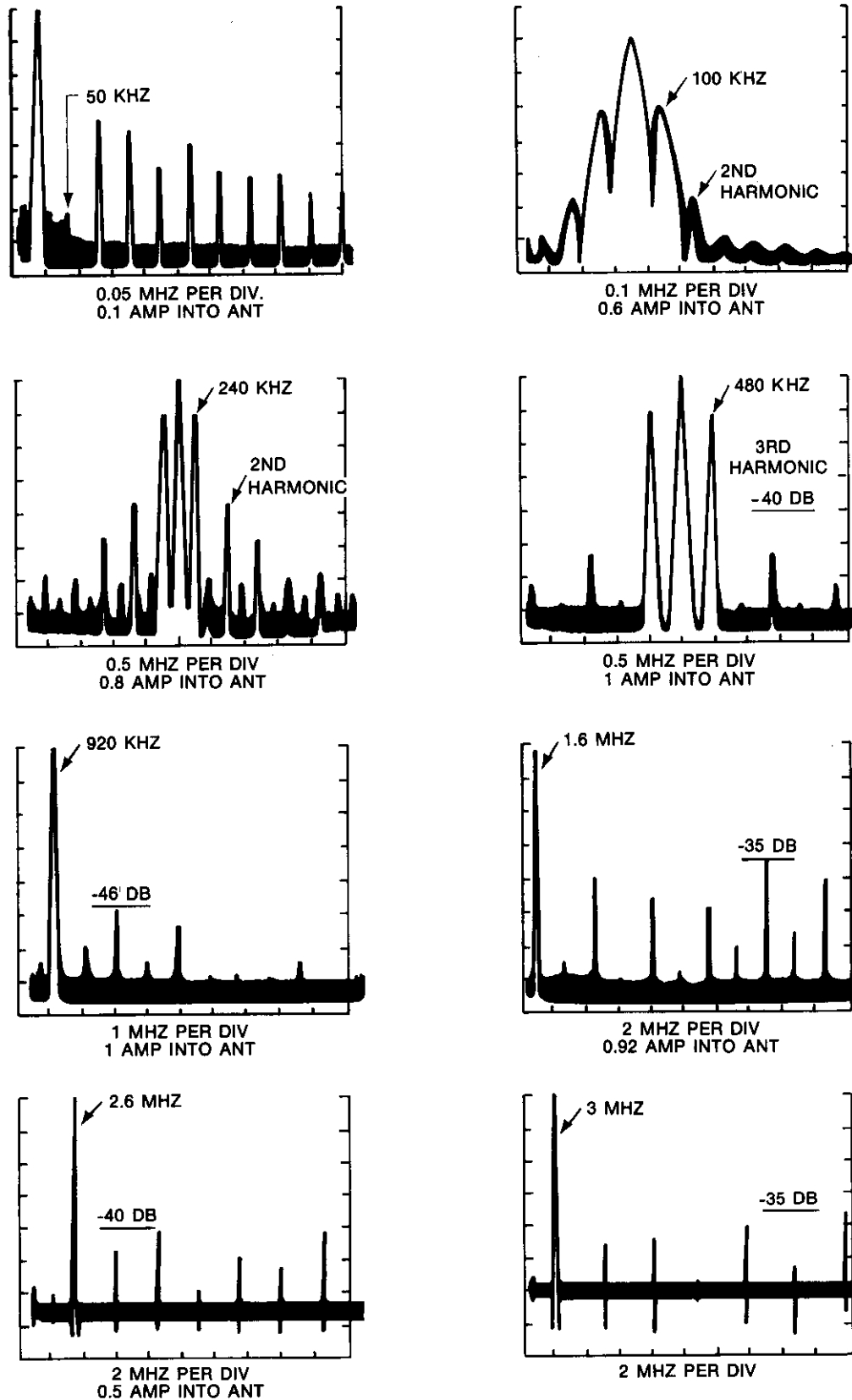

Figure 10. Swept Spectrum of Transmit Antenna Current Showing Harmonics.

Table 2. Field Strength Calibration Factors Used in Data Reduction.

RX ANTENNA BAND SET	FREQUENCY (kHz)	FIELD STRENGTH MICROVOLTS/METER
3 lf tuner	83	103
1 hf tuner	92 to 100	251.2
1 hf tuner	228 to 250	71
1 hf tuner	420	62
1 hf tuner	470 to 485	56
1 hf tuner	935	22
2 hf tuner	910 to 1047	34.9
3 hf tuner	940	46.5
3 hf tuner	1800 to 1840	20.5
3 hf tuner	1940 to 2030	16.6
3 hf tuner	2750	13.5
4 hf tuner	3100 to 3200	11.5
4 hf tuner	3400	10.5
4 hf tuner	3800	9.5
4 hf tuner	3960 to 4120	8.9
3 hf tuner	4750	5.6

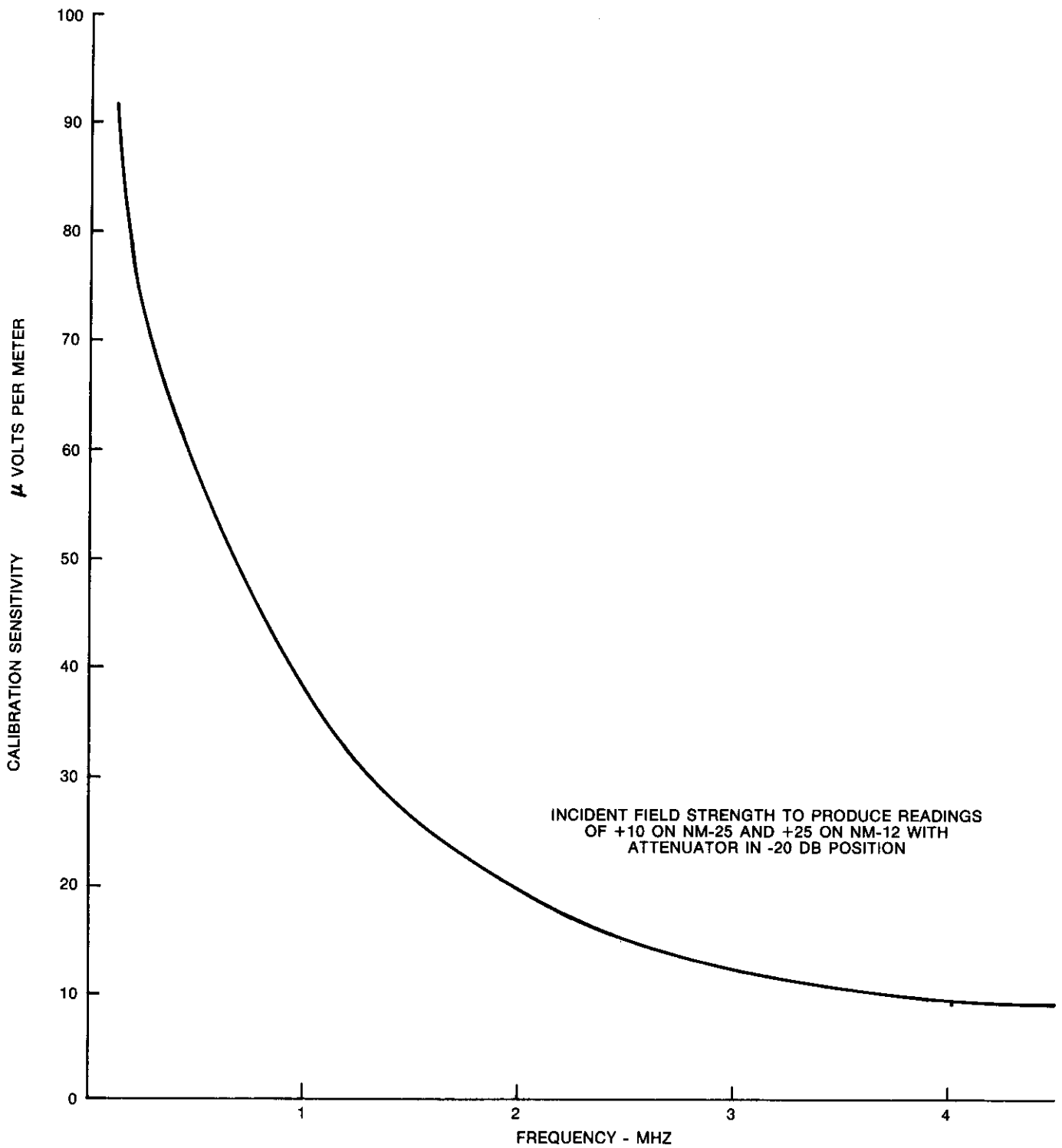

Figure 11. Average Calibration Data for Singer NM-12 and NM-25 Field Strength Meters Using Singer 0.73 Meter Antennas.

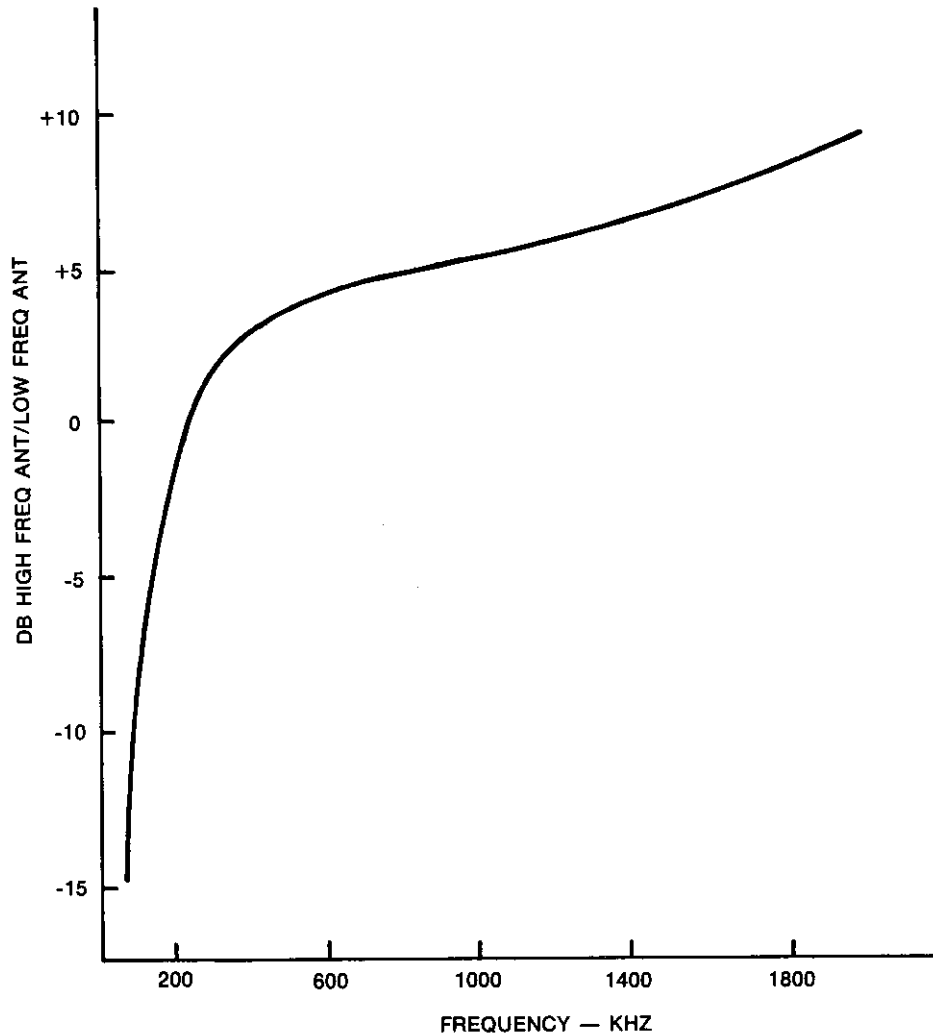

Figure 12. Comparison of High Frequency Vs Low Frequency Antennas.

In reducing the field strength data the field strength at each location in dB greater than  $1 \mu\text{A}/\text{meter}$  was found as the sum of the reading as determined in dB, minus the field strength meter calibration point in dB (exp: for NM-25 + 10 dB with -20 dB attenuation setting), the calibration factor in dB and the factor to convert the actual transmitted NIA to a common NIA of 2.5 in dB. In equation form, this is expressed as:

$$\begin{aligned} \text{Field strength} = & (\text{analog meter reading} - 10) + (\text{attenuator range setting} + 20) \\ & + \text{calibration field} + 20 \text{ Log}_{10} \frac{2.5}{\text{Tx current} \times (2.04 \text{ or } 1.17)} \\ & \text{in dB greater than } 1 \mu\text{A}/\text{meter}. \end{aligned}$$

The data display most commonly used during the program in the summary Data Reports consisted of field strength in dB greater than  $1 \mu\text{A}/\text{meter}$  vs range in meters plotted on linear

paper. As the attenuation in the conductor medium goes as dB per lineal distance (except for a (range)<sup>-1/2</sup> variation), the field strength curves then plot as straight lines.

Another display, used to present the field mapping data, was a contour map of field strength (in dB greater than 1  $\mu$ A/meter) with approximately 6-dB contour intervals. These contours were overlaid on an appropriate mine map section.

#### 4.0 COMPENDED RESULTS AND ANALYSIS

##### 4.1 REDUCTION OF MEASURED FIELD STRENGTHS TO MAXIMUM COMMUNICATION RANGE-PRESENTATION OF REDUCED DATA

Each of the quasi-conductor-free field strength data sets, consisting of magnetic field strength vs range for several frequencies between nominally 100 and 5000 kHz, were converted to a maximum communication range vs frequency curve. This was accomplished by identifying the range at which a minimum required field strength level was obtained for each of two noise criteria; set-noise-limited and median-mine-noise-limited as defined in paragraph 4.2.1 using the characteristics and specifications of the mine wireless prototype portable radios developed by Collins Telecommunications Group for the Bureau of Mines as a model. The detailed technique for compending the measured results in this manner is described in the next subsection. The technique was first employed during the previous measurement program (14) where it was found to be the most direct and useful way of summarizing a large amount of radio propagation data. Results in the form of maximum communication range vs frequency for an assumed 12-dB SINAD condition of the mine wireless portable receiver permit conclusions to be drawn directly from the results regarding the performance of radio systems.

The Pittsburgh seam maximum communication range vs frequency data are given in figure 13 for four data sets in three mines (Ireland mine data from current and previous programs (15), Federal no. 1 data (16), and Consolidation Coal Mine no. 95 (17)). There is an optimum operating frequency for achieving maximum range.

The optimum operating frequency for set-noise-limited operation is lower than that for operation in the presence of median-mine-noise. The optimum frequency for the set-noise-limited case varies from 300 kHz for Consolidation Coal Mine no. 95 to 400 kHz for the Ireland mine results from this program. The data for the previous Ireland mine testing is limited in the number of frequencies considered and there is no clear cut optimum in this case.

When limited by median-mine-noise, the optimum frequency for Federal no 1 and Consolidation Coal Mine no. 95 are clearly defined as being about 600 kHz for Consolidation Coal Mine no. 95 and 940 kHz for Federal no. 1. The Ireland mine data from the previous program follows the Federal no. 1 data closely and the optimum frequency is probably about 1000 kHz. For the Ireland mine data taken during this program, the optimum frequency is not clearly defined, but is probably about 2000 kHz.

The geometric mean summary curves of the four data sets of figure 13 shown in figure 1 place the set-noise-limited optimum frequency at 400 kHz and the median-mine-noise-limited optimum frequency at 800 kHz. These summary curves were obtained by arranging the form data sets according to the relative

$$\text{Range } (R_1 R_2 R_3 R_4)^{1/4}$$

Where  $R_1 R_2 R_3 R_4$  on the individual data set maximum ranges.

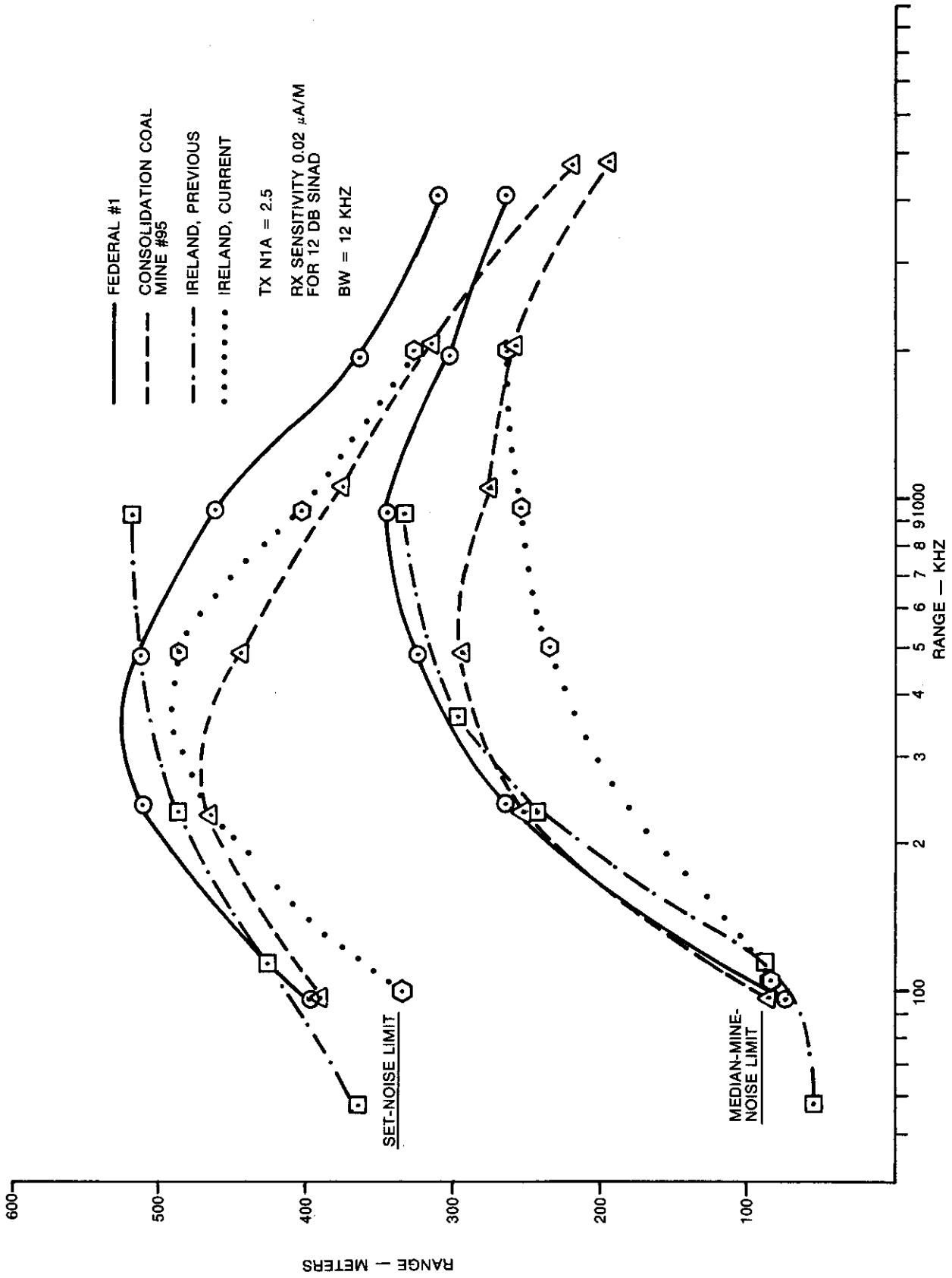

Figure 13. Maximum Communication Range Vs Operating Frequency in Conductor-Free Areas of Coal Mines - Pittsburgh Seam Data Sets.

An analysis of the range variability is presented in the next subsection. The geometric mean ranges for these data sets show roughly 500 meters for the set-noise-limit and 300 meters for the median-mine-noise-limit.

The Herrin no. 6 seam maximum communication range vs frequency data is given in figure 14 showing results from three data sets in two mines (Sesser mine, and sets in two areas of the Peabody no. 10 mine). For the set-noise-limited case, no optimum frequencies are clearly defined except along the coal block in the 1-south 1st west, 2nd north area of Peabody no. 10 where the optimum frequency is probably about 250 kHz. The optimum frequencies for Sesser and for the 1-south submain area of Peabody no. 10 will be below 100 kHz.

In the presence of median-mine-noise, the optimum frequencies are clearly defined except through the coal block in the 1-south 1st west 2nd north area of Peabody no. 10. The optimum frequencies vary from 240 kHz for the 1-south submain area of Peabody no. 10 to about 600 kHz for Sesser.

The geometric mean summary curves of the figure 13 data sets in figure 1 place no optimum frequencies on set-noise-limited data and a broad optimum frequency of about 250 kHz on the median-mine-noise-limited data.

The mine wireless portable prototype radio maximum communication range was tested in Sesser and was found to agree closely with the median-mine-noise-limited range at about 105 meters.

Figure 14 also shows a partial data set in the 1-south 1st west 2nd north area through a solid coal block. This set is not extensive enough to show the optimum frequencies in either the set-noise-limited or median-mine-noise-limited situations.

The Pocahontas no. 3 seam maximum communication range vs frequency data is given in figure 15 showing results from three data sets in the VP no. 1 mine. For the set-noise-limited case, optimum frequencies are clearly defined at about 240 kHz in the 3-south area (54-inch seam) and at about 480 kHz in the lower coal 2-north no. 1 Plow area (48-inch seam), both of which are at least one entry removed from a coal block or from conductors. The data set in the 3-south area along a coal block exhibited a slightly lower optimum frequency of about 200 kHz.

In the presence of median-mine-noise, the optimum frequencies were clearly defined and were somewhat higher than those for the open-entry cases. These frequencies were about 330 kHz in the 3-south area and 700 kHz in the 2-north no. 1 Plow area. Correspondingly, along the coal block in the 3-south area, the optimum frequency was about 400 kHz.

The figure 1 geometric mean summary curves of the data sets place the optimum frequency for the set-noise-limited case at about 230 kHz and the optimum frequency for the median-mine-noise-limited operation at about 500 kHz.

The mine wireless portable prototype radio maximum communication range was tested through a solid coal block in VP no. 1 with the maximum communication range experienced at 520 kHz of 140 meters being a little greater than that expected for median-mine-noise-limited operation.

Partial data sets were taken during the mine measurements showing the effect of proximity to conductors with the transmitter remotely located from the conductors. In addition, quasi-conductor-free data occasionally exhibited a decrease in attenuation slope at low field strength levels due to the presence of conductors. Sufficient measured data to show range vs frequency

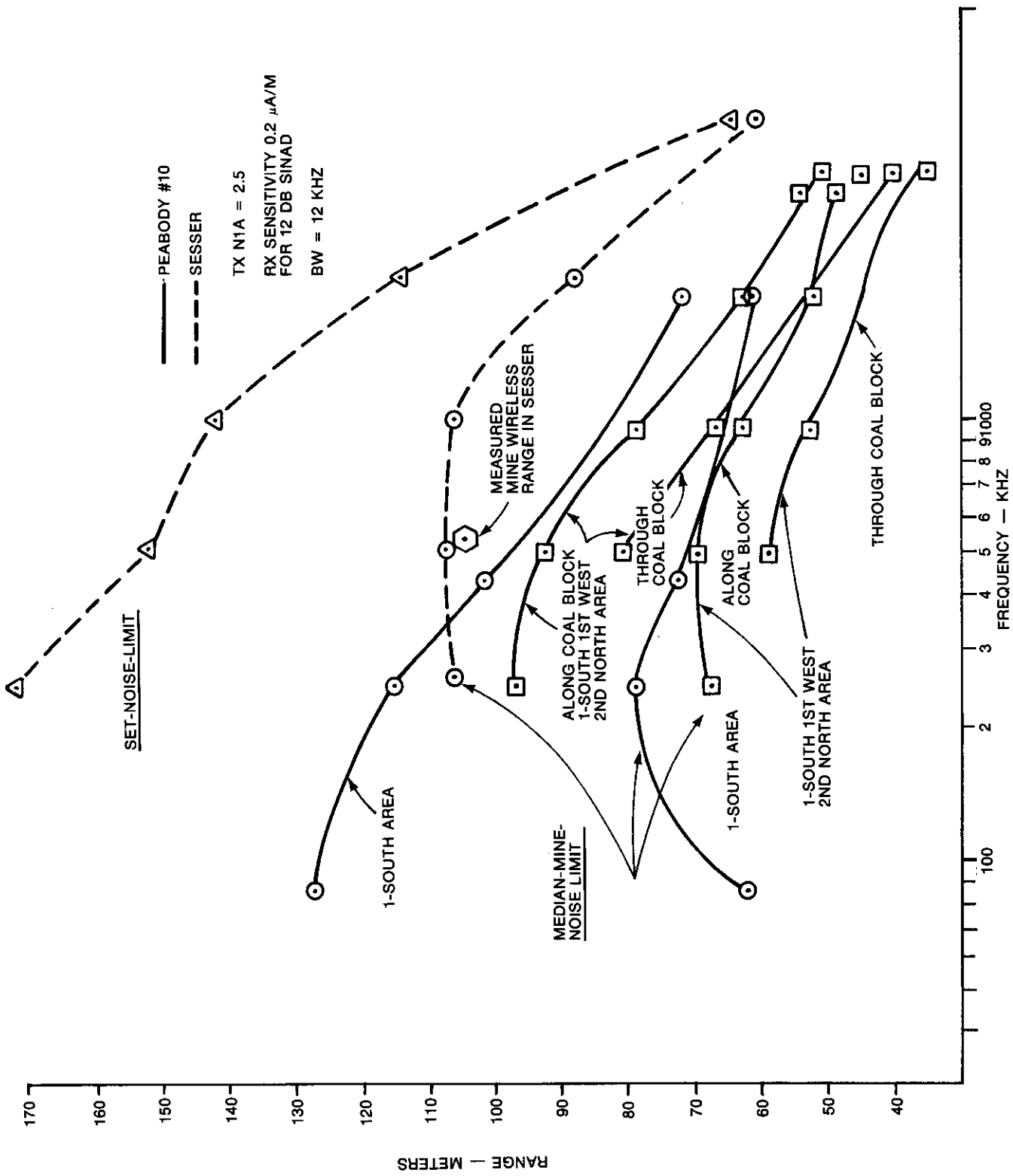

Figure 14. Maximum Communication Range Vs Operating Frequency in Conductor-Free Areas of Coal Mines - Herrin No. 6 Seam Data Sets.



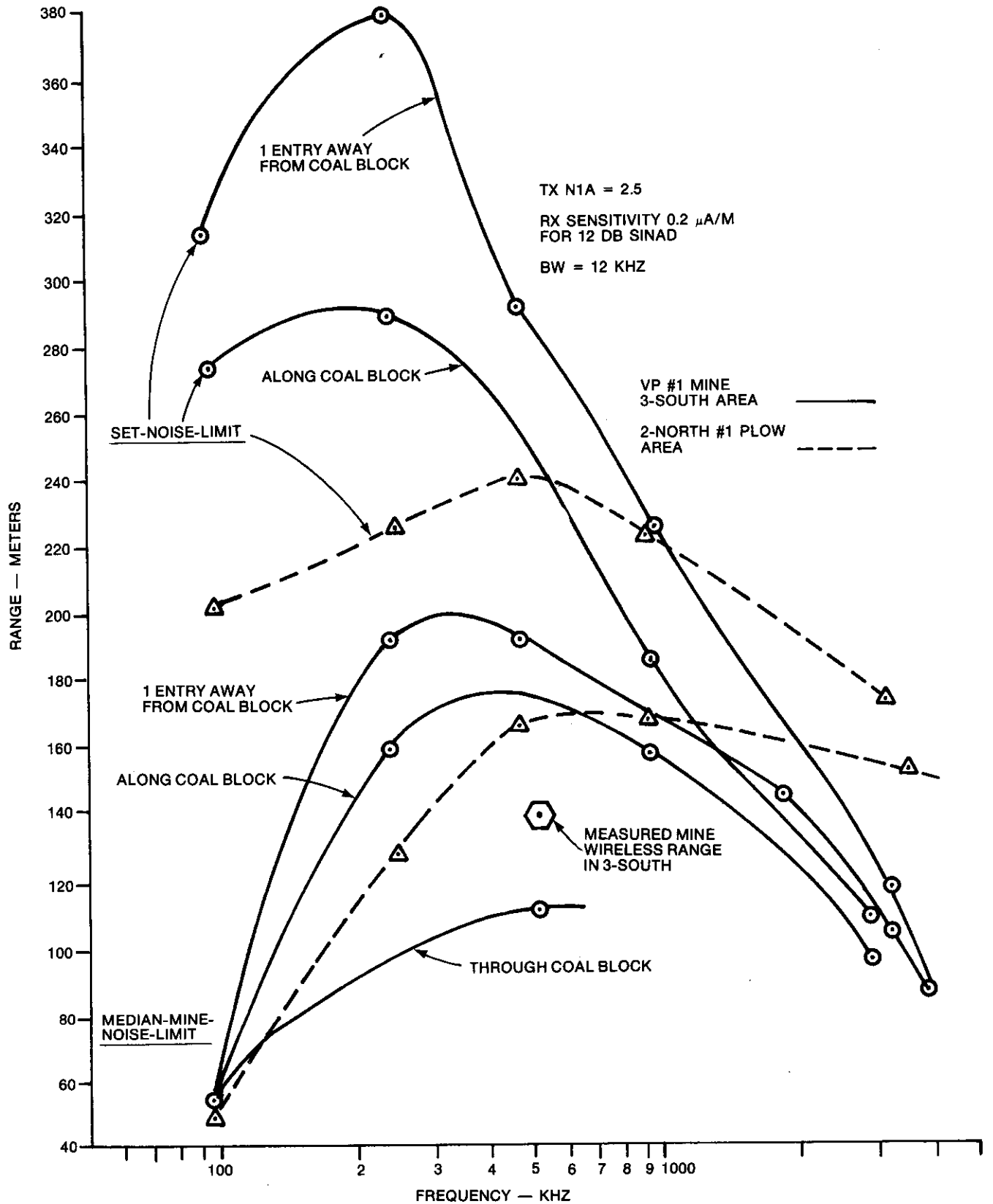

Figure 15. Maximum Communication Range Vs Operating Frequency In Conductor-Free Areas of Coal Mines - Pocahontas No. 3 Seam Data Sets.

effects was not taken due to the exhaustive testing required to obtain this data. Instead, the existing conductor proximity data has been used in this report to gain insight into possible modeling in the presence of conductors and, finally, as a check on the accuracy of an elementary model at discrete points.

Complete magnetic field strength mappings were taken in working sections in the Ireland and Sesser mines during the measurement program. This data speaks for itself in showing that a complete section can be covered with communications via mine wireless radios with dense groupings of conductors. There is little summarizing or data refinement which is practical to perform with regard to these mappings. Consideration of this type of data in this report is limited to the observations that can be drawn directly from these maps as shown in sections 2.0 and 5.0.

## 4.2 ANALYSIS AND DEVELOPMENT OF SYSTEM APPLICATION OF DATA

### 4.2.1 Quasi-Conductor-Free Maximum Communication Range Vs Frequency

This subsection develops the basis for obtaining the maximum communication range in quasi-conductor-free areas from the measured magnetic field strength data.

The set-noise performance limit at the mine wireless prototype operating frequency comes directly from the specification

$$\text{Sensitivity} = 0.02 \mu\text{A}/\text{meter for 12-dB SINAD}$$

This specification is taken to be the minimum incident field strength to obtain a usable received signal from the radio. At 520 kHz this corresponds to -34 dB greater than 1  $\mu\text{A}/\text{meter}$ . The complete sensitivity expression for the 12-dB SINAD condition is given by

$$H_{\text{SN}} = \frac{86.9}{120\pi} \sqrt{\frac{\Delta f}{f} \left(\frac{1}{Q}\right) \frac{1}{A^{3/2}}} \cdot 10^{N/20} \mu\text{A}/\text{meter}$$

where,  $\Delta f$  is the bandwidth of 12 kHz

Q is the antenna "Q" made as narrow as possible to be consistent with transmission; this Q is 44 for the prototype radio unit

A is the antenna area = 0.217 meter<sup>2</sup>

N is the noise figure of the receiver, = 2 dB for the mine wireless prototype

The above expression for sensitivity makes allowance for an input signal-to-noise ratio to produce 12-dB SINAD. The absolute accuracy of this expression is dependent on the loop conductors being given by the form

$$L = KA^{1/2} n^2$$

Where K is proportionately constant

Appendix C provides an alternate analysis method that affects somewhat improved results for purely FM systems.

For the mine wireless receiver,  $H_{SN}$  computes to be  $0.021 \mu\text{A}/\text{meter}$  which is very close to the specification.

The frequency dependence of  $H_{SN}$  is needed to perform evaluations with frequency. For this purpose, it is assumed that the  $Q$  varies directly with frequency so that  $H_{SN}$  varies directly with frequency.

For median mine noise,  $H_N$  (1-Hz bandwidth) the formula given in section 2.0 was

$$H_N = 121.5 - 32.5 \log_{10} f \text{ (Hz) in dB greater than } 1 \mu\text{A}/\text{meter} / \sqrt{\text{Hz}}$$

The 12-dB SINAD condition for the mine wireless prototype radio corresponds to a signal-to-noise ratio of 13.51 dB. At 520 kHz, computing  $H_N$  in a 12-kHz bandwidth and adding 13.51 dB, the sensitivity corresponding to that given for the set noise limit is -9.97 dB greater than  $1 \mu\text{A}/\text{meter}$ . The frequency dependence is derived from the  $H_N$  formula.

The above two field strength sensitivity conditions used in summarizing the magnetic field strength data are given in figure 16. The maximum communication range vs frequency data was developed by taking the level at a particular frequency from one of the two curves in this figure, finding this level on a particular measured field strength curve corresponding to this frequency, and recording the range at which this field strength level was developed. The measured field strength data sets for the mine measurements are given in appendix A to this report.

#### 4.2.2 Conductor Proximity Maximum Communication Range Vs Frequency

All conductor proximity range computations, except those where both radios were assumed to be very close to conductors, were determined as follows:

- a. Select fixed transmitter and receiver ranges away from the conductor.

For the cases developed in this report, the receiver range was 2 meters and the transmitter ranges were 30, 60, or 90 meters corresponding to 1, 2, or 3 entries away from the conductors.

- b. Select measured field strength curves to be used which are representative of the seams.

For the cases developed in this report, the Federal no. 1 mine data was used for the Pittsburgh seam, the Sesser mine data for the Herrin no. 6 seam, and the VP no. 1 data for the Pocahontas no. 3 seam.

- c. Compute the scatter gain, which is the ratio of the field strength at the receiver in the presence of the conductor to the field strength in absence of the conductor. Multiply the scatter gain by the field strength at the conductor determined from b at the range determined from a.
- d. Divide the result of c, which is the scattered field at the receiver, by the sensitivity field strength for median mine noise which gives the margin ratio to accommodate attenuation along the conductor.
- e. Compute the conductor attenuation per unit length. Divide the field strength margin ratio of d by the conductor attenuation per unit length to get range.

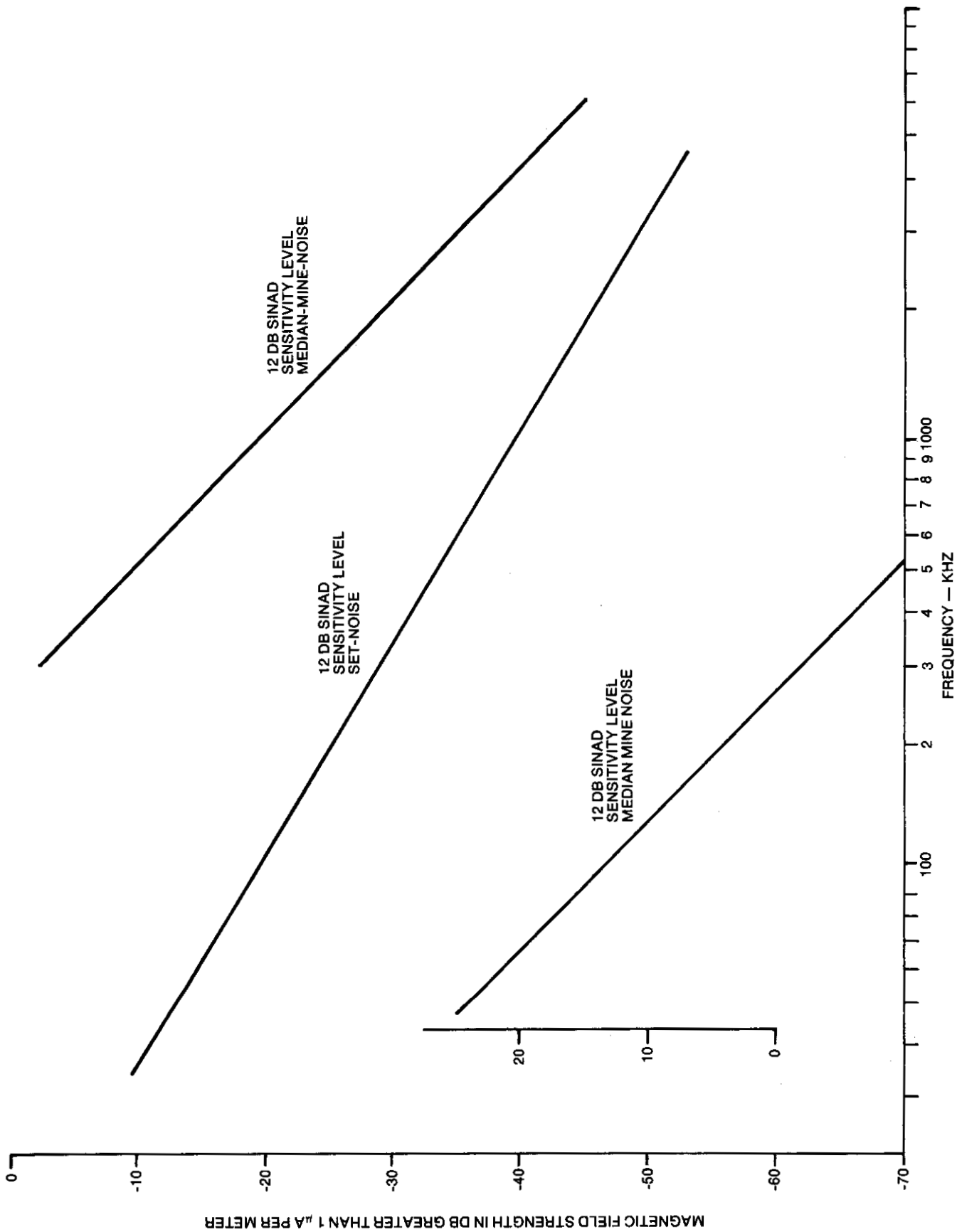

Figure 16. Required Field Strength Sensitivity Levels for Mine Wireless Radios Based on the Collins-Developed Mine Wireless Prototype Radios at 520 kHz.

These steps are illustrated in the following equation:

$$1 = \frac{H_T (G_S)}{H_N e^{-\alpha \rho R}}, \text{ in field form with } \alpha \rho \text{ in nepers/meter}$$

$$\text{or } 0 = 20 \log_{10} H_T + 20 \log_{10} G_S - 20 \log_{10} H_N - \alpha \rho R$$

where  $\alpha \rho$  is in dB/meter.

To illustrate the concept of scatter gain, this gain will be computed for free space, homogeneous earth, and in-mine situations.

The scattered field from an infinite sheathed conductor in a nonmagnetic conducting medium excited by a small transmitting loop is

$$H_S = \frac{30 (\alpha^2 + \beta^2)^{1/2} (IAN)}{4\pi Z_{OS} R_T R_R}, \text{ A/meter}$$

where

$\alpha, \beta$  are the attenuation and phase constants of the "transmission line" formed by the conductor and the medium

(IAN) is the transmit loop magnetic moment

$Z_{OS}$  is the "line" surge impedance

$R_T, R_R$  are respectively the transmit and receive ranges in meters.

The direct field in homogeneous earth is given by:

$$H_{HE} = \frac{(\alpha^2 + \beta^2) (IAN)}{4\pi R_T}, \text{ A/meter}$$

or, in free space for  $\alpha = 0$ ,

$$H_{FS} = \frac{\beta^2 (IAN)}{4\pi R_T}, \text{ where } \beta = 2\pi/\lambda.$$

For free space, the scatter gain ratio is given by:

$$G_S = \frac{H_S}{H_{FS}} = \frac{15\lambda}{\pi Z_{OS} R_R}$$

For homogeneous earth where, in a conducting medium,

$$|\alpha| = |\beta| = \frac{\sqrt{2}}{\delta}, \delta \text{ being the skin depth} = \frac{1}{\sqrt{\pi f \mu \sigma}} \text{ with } \sigma \text{ being the conductivity of the medium.}$$

the scatter gain is given by:

$$G_S = \frac{H_S}{H_{HE}} = \frac{\sqrt{2} \cdot 15\delta}{Z_{OS} R_R}$$

For the in-mine situation, we assume the direct field is given by expression used by ADL (18):

$$H_M = \frac{(\alpha^2 + \beta^2)^{3/4} \text{ (IAN)}}{\sqrt{8\pi} R_T (h + \delta_r)}$$

where h is the seam height in meters  
 $\delta_r$  is the skin depth of the rock  
 overburden/underburden

and the scatter gain is given by:

$$G_S = \frac{H_S}{H_M} = \frac{11.97}{Z_{OS} (h + \delta_r) \sqrt{R_T} R_R (\alpha^2 + \beta^2)^{1/4}}$$

From the equation for the complex propagation constant used by ADL (20), calculations of  $\alpha$  and  $\beta$  were made over a wide range of frequency, seam and overburden/underburden conductivities, and dielectric constant. Using values of conductivity and dielectric constant obtained by private communication with R. Lagace of ADL values of  $\alpha$  and  $\beta$  were selected from the values calculated as being representative of the three seams. These values are given in the paragraphs to follow where specific approximate formulas for scatter gain are derived.

For the Pittsburgh seam, assume  $\alpha = 0.02$ ,  $\beta = 0.03$  at 316 kHz so that  $(\alpha^2 + \beta^2)^{1/4} = 0.19$ ; also h = 2 meters.

From computations of  $\alpha$  and  $\beta$  for various frequencies,  $(\alpha^2 + \beta^2)^{1/4}$  is approximately proportional to  $\sqrt{f}$ . Then, as the skin depth is inversely proportional to  $\sqrt{f}$ , the Pittsburgh seam scatter gain is approximately frequency independent and given by:

$$G_S \approx \frac{9.53}{Z_{OS} \sqrt{R_T} R_R}$$

For the Herrin no. 6 seam, assume  $\alpha = 0.145$ ,  $\beta = 0.10$  at 1 MHz so that  $(\alpha^2 + \beta^2)^{1/4} = 0.420$ ; also,  $h = 3$  meters.

From computations of  $\alpha$  and  $\beta$  for various frequencies,  $(\alpha^2 + \beta^2)^{1/4}$  is approximately proportional to  $f^{1/4}$  and the Herrin no. 6 scatter gain is given approximately by:

$$G_S \approx \frac{7.0 f_{\text{MHz}}^{1/4}}{Z_{OS} \sqrt{R_T} R_R}$$

For the Pocahontas no. 3 seam, assume  $\alpha = 0.16$ ,  $\beta = 0.175$  at 1 MHz so that  $(\alpha^2 + \beta^2)^{1/4} = 0.488$ ; also,  $h = 1.5$  meters.

From computation of  $\alpha$  and  $\beta$  for various frequencies,  $(\alpha^2 + \beta^2)^{1/4}$  is approximately proportional to  $f^{0.425}$  and the Pocahontas no. 3 seam scatter gain is given approximately by:

$$G_S = \frac{3.76 f_{\text{MHz}}^{0.075}}{Z_{OS} \sqrt{R_T} R_R}$$

Verification of these formulations for scatter gain was obtained for the Pittsburgh and Pocahontas no 3 seams by comparison with measured data where signal "plateau" levels were observed in the measured field strength. These comparisons are given in table 3.

Table 3. Comparisons of Measured and Computed Scatter Gains.

MINE/SEAM	FREQUENCY (kHz)	CONDUCTOR TYPE	$Z_{OS}$	$R_T$	$R_R$	MEAS $G_S$	CALC $G_S$
Consol Mine No. 95 Pittsburgh	935	Water line	$50\Omega$	46M	1M	-28 dB	-31 dB
Federal No. 1 Pittsburgh	236	Water line buried	$10\Omega$	55M	1/2M	-13.5 dB	-11.8 dB
VP No. 1 Pocahontas No. 3	520	Water line	$50\Omega$	62.6	1M	-35 dB	-35.5 dB

The line attenuation is determined considering the lowest order TM mode on a transmission line formed by a conductor a distance away from a lossy conducting medium with a plane interface. For this case, the normalized attenuation constant is given by:

$$\frac{\alpha}{k} \approx \frac{\pi/8}{\left[ \ln \frac{2a}{a_i} \left( \ln \frac{2a}{a_i} - \ln \frac{2.517}{\delta_r} \right) \right]^{1/2}}$$

where,

a is the distance from the conductor center to the interface

$a_1$  is the conductor radius

the computations used in this report assumed a ratio of  $a/a_1 = 9$ .

For the Pittsburgh seam, assuming  $\sigma_r = 0.085$  mho/meter

$$\frac{a}{k} = 0.14652 \text{ at 1 MHz}$$

For the Herrin No. 6 seam, assuming  $\sigma_r = 0.22$  mho/meter

$$\frac{a}{k} = 0.16030 \text{ at 1 MHz}$$

For the Pocahontas No. 3 seam, assuming  $\sigma_r = 0.01$  mho/meter

$$\frac{a}{k} = 0.12518 \text{ at 1 MHz}$$

Taking  $k = 2\pi/\lambda$  and multiplying by 8.686 to change nepers to dB, these attenuation constants are easily expressible in dB/meter at any particular frequency of interest.

A check is afforded from field mapping data in the Ireland mine in the 8-north 3-right section at 4220 kHz in the Pittsburgh seam. The measured attenuation constant along the belt entry is 0.09612 dB/meter and the computed attenuation constant is 0.11248 dB/meter.

The coupled (scattered) field strength when both transmit and receive antennas are close to the conductor in the same entry (or in separate entries with conductors which are connected) is given by:

$$H_S = \frac{w\mu \text{ (IAN)}}{4 (2\pi)^2 Z_{OS} R_T R_R}, \text{ A/meter}$$

assuming no line attenuation when there are no conductor branch points or unusual shunting impedances and with antennas oriented for maximum coupling. For the computations performed in this report,

$$Z_{OS} = 50 \text{ ohms}$$

$$R_T, R_R = 2 \text{ meters}$$

and the field strength is:

$$H_S = 55.9 + f_{\text{MHz}} \text{ dB greater than } 1 \mu\text{A/meter}$$



In a manner similar to that used for the remote transmitter calculations, the maximum communication range is found by subtracting the sensitivity field in dB for median mine noise from  $H_S$  and then dividing the answer (which is the margin ratio for attenuation) by the attenuation constant in dB/meter, or:

$$R_{MAX} = \frac{H_S - H_N}{\alpha \rho}$$

where  $H_S$ ,  $H_N$ ,  $\alpha \rho$  are expressed in dB.

#### 4.2.3 Range Variability Assessment

The assessment of range variability will be constrained in this report to the variability values afforded by comparison of ranges derived from the field strength measurement sets obtained during this program plus the previously obtained Ireland data. The statistical sample of data in various mines and vs location in each mine is not large enough to allow estimation of the true location variability.

The assessment also considers on the quasi-conductor-free data as there is no real way to estimate the variability of the conductor proximity data.

The results of comparing the variability of data sets on a per-seam basis are shown in table 4. These results show variations between data taken in open entries, with topological range differences being considered separately. The comparison between four data sets in the Pittsburgh seam gives the least average variation, while the comparison between the two Herrin No. 6 seam data sets gives the greatest average variation. Considering maxima and minima with frequency, the Herrin No. 6 provides the least variation over frequency while the Pocahontas No. 3 seam gives the greatest variation.

Variations with topology are also important; the most significant of which are those encountered in comparing paths away from (open room and pillar areas), along (adjacent to), and through a solid block of coal. Data supporting these comparisons was taken in the Pocahontas No. 3 seam in the VP No. 1 mine and in the Herrin No. 6 seam in the Peabody No. 10 mine. The only Pittsburgh seam data of this kind was taken in the Ireland mine during the previous program with the field strengths between open-entry and through-coal-block paths being within 3 dB of one another on average and, thus, showing essentially a negligible range decrease in going through the coal block.

Considering the Peabody No. 10 data first, the main effect of transmission through the coal block compared with transmission in an open entry was an amplitude offset in the field strength (the attenuation slopes were nearly identical) vs range data with the offset varying from about 10 dB at 480 kHz to about 20 dB at 3400 kHz. This offset resulted in a range decrease in going through the coal block which varied between 19.7 percent at 480 kHz and 35.8 percent at 1800 kHz when set-noise-limited, and 17.8 percent at 480 kHz, and 35.5 percent at 1800 kHz when median-mine-noise-limited. Comparing the data along the coal block with the data one entry away from the coal block (assumed to be representative of the open entry case data), the range on paths along the coal block decreased with respect to the range away from the coal block. With frequency, this decrease varied between 18.6 percent at 240 kHz to 3.4 percent at 600 kHz to 14.3 percent at 1800 kHz when set-noise-limited, and 16.1 percent at 240 kHz to 1 percent at 600 kHz to 15.1 percent at 1800 kHz when median mine noise limited.

Table 4. Maximum Communication Range Variability From Mean Values Based on Measured Magnetic Field Strength Data Sets Converted to Maximum Communication Range.

PITTSBURGH SEAM - 4 DATA SETS		
FREQUENCY (kHz)	SET-NOISE-LIMITED RANGE VARIABILITY	MEDIAN-MINE-NOISE-LIMITED RANGE VARIABILITY
100	±11.1%	±14.9%
200	±5.5	±20.4
400	±6.8	±18.0
800	±13.5	±17.1
2000	±6.4	±7.8
4000	±13.6	±11.5
Average	±9.5%	±15.0%
HERRIN NO. 6 SEAM - 2 DATA SETS		
FREQUENCY (kHz)	SET-NOISE-LIMITED RANGE VARIABILITY	MEDIAN-MINE-NOISE-LIMITED RANGE VARIABILITY
250	±22.2%	±15.8%
500	±25.2	±22.8
1000	±31.9	±27.7
2000	±26.7	±20.1
Average	±26.5%	±21.6%
POCAHONTAS NO. 3 SEAM - 2 DATA SETS		
FREQUENCY (kHz)	SET-NOISE-LIMITED RANGE VARIABILITY	MEDIAN-MINE-NOISE-LIMITED RANGE VARIABILITY
100	±23.9%	±14.0%
200	±31.1	±38.9
400	±25.2	±10.9
800	±3.0	±1.8
2000	±9.8	±6.1
3000	±19.1	±18.7
Average	±18.7%	±15.1%

For the VP No. 1 mine data, there was only a single point "through the coal block" which represented the tests with the mine wireless prototype radios. For this case, at 520 kHz, there was a range reduction of 72 percent.

Comparing the data along the coal block with the data one entry away from the coal block, the range along the coal block was decreased (as in Peabody No. 10 mine). With frequency, this decrease varied between 31.2 percent at 240 kHz to 16.4 percent at 600 kHz to 21.6 percent at 1800 kHz when set-noise-limited, and 20.8 percent at 240 kHz to 8.9 percent at 600 kHz to 12.3 percent at 1800 kHz when median-mine-noise-limited.

The large decrease in going through the coal block in VP No. 1 could be due to the fact that the roof and seam conductivities were much closer together (possibly within an order of magnitude) whereas, these conductivities were at least two orders of magnitude or more apart in the other seams. This particular result should be confirmed with additional data.

## 5.0 INDIVIDUAL MINE TESTS DESCRIPTIONS

All test areas in the six underground mines at which testing was conducted were in medium-high coal with seam thickness varying between 54 and 108 inches except for the northern 43-inch-seam area in the VP No. 1 mine. Half the mines used belt haulage from the section to the surface excluding Ireland, Federal No. 1 and Consolidation Coal Mine No. 95. All mines employ tracked support vehicles except for Sesser. All mines were shaft-entry mines except for Consolidation Coal Mine No. 95. All mines used continuous mining (or long wall mining) exclusively except for Peabody No. 10 where conventional mining was still used in sections on the north side of the mine.

Summary characteristics and measurement results are presented for each of the mines in the subsections to follow.

### 5.1 IRELAND MINE

The Ireland mine is in high coal in the Pittsburgh seam located 500 to 1000 feet beneath the surface. The coal is soft bituminous; so soft that working sections cannot be "pillared" in retreat mining. A typical entry/crosscut crosssection was 16 feet wide and 6 to 7 feet high. The seam was approximately 5 feet thick covered (in sequence) with 6 to 18 inches of drawslate, 6 to 12 inches of additional coal, and additional drawslate.

The 8 north submain and 8 north 3 right working section test areas were very close to the conductor-free 8-north escapeway area in which the original mine wireless testing was accomplished. In the submain, the testing was always within one entry of a conductor (7200-V ac line on floor). In the section, which was mapped, each of the three fresh air entries contained conductors. The transmitter was closely coupled to the wiring near the section headpiece.

Mine maps and both the quasi-conductor-free/conductor-dilute and the mapping magnetic field strength data are given in appendix A1. Key results of the testing include the following:

- a. The maximum communication range in a quasi-conductor-free area continued to be in excess of 1,000 feet in the Pittsburgh seam. South African radios were used.
- b. A field strength level adequate for communication coverage of an entire 2,000-foot 4-parallel-entry working section panel was demonstrated for a portable transmitter located at the section headpiece.

## 5.2 INLAND STEEL COAL MINE NO. 1 (SESSER)

The Sesser mine is in high coal in the Herrin No. 6 seam located nominally 725 to 750 feet beneath the surface. The seam is thick, varying between 9 and 14 feet. The mining process leaves top coal with the result that entry/crosscut heights were 6-1/2 to 7-1/2 feet. Entry widths were normally 14 feet. The underburden is fire clay. The overburden contains no draw slate but supposedly shale in the dry area and sandstone in the wet area. "Domed-out" areas from roof falls to heights of 30 to 40 feet revealed limestone overburden which was laminated near the seam and homogeneous near the 30- to 50-foot level.

The 1-main east main and 1-main east left, 6-left and 9-right working section test areas were in the flat/dry area of the mine. In the main, the testing was conducted two entries away from conductors (which were located in the belt haulageway); and, due to the highest seam attenuation, the test environment was truly conductor free. In the sections, which were mapped, two of the three fresh air entries contained conductors (no track and trolley wires in the mine). The fixed transmitter for the mapping was located approximately in the middle of a 2,000-foot working section panel, closely coupled to the 7,200-V ac power cable.

Mine maps and both the quasi-conductor-free and free mapping magnetic field strength data is given in appendix A2.

Key results of the testing include the following:

- a. The maximum communication range in a quasi-conductor-free area was roughly 500 feet in the Herrin No. 6 Seam for Rockwell-Collins Mine-Wireless Prototype radios and 440 feet for the South African radios.
- b. A field strength level adequate for communication coverage of an entire 2,000-foot working section panel was demonstrated for a portable transmitter located close to the 7,200-V ac power cable in the approximate center of the panel.
- c. A field strength level adequate for communications coverage between adjacent working section panels and between adjoining panels separated by a 13-parallel-entry main line was demonstrated (for the transmit location of b above). Ranges of 3,800 feet between adjacent panels and 5000 feet between adjoining panels were achieved (and these were not maximum ranges).

## 5.3 CONSOLIDATION COAL MINE NO. 5 (ROBINSON RUN)

The Consolidation Coal Mine No. 95 is in medium high coal in the Pittsburgh seam. In the quasi-conductor-free test area, the seam was approximately 5 feet thick. With nominally 6 inches of top coal, the entry/crosscut heights in this area averaged 54 inches. In haulage entries, the underburden was "trenched-out" giving entry heights of approximately 6 feet. Entry widths averaged 14 feet. The overburden consisted of 10 to 15 feet of unconsolidated shale (no draw slate was observed) above which was grey sandstone of undetermined thickness.

The main north 2-west submain area used for both quasi-conductor-free and conductor proximity measurements consisted of 9 parallel entries. The quasi-conductor-free measurements were made three entries removed from conductors. The transmitter location remained unchanged for both sets of measurements. The conductor-proximity measurements were made largely in the main haulage entry (the entry with conductors closest to the transmitter).

Mine maps and both the quasi-conductor-free and conductor proximity data are given in appendix A3.

Key results of the testing include the following:

- a. A field strength level adequate for a maximum quasi-conductor-free communication range exceeding 1,000 feet in the Pittsburgh seam was demonstrated. The greatest usable test range was approximately 1,300 feet.
- b. The measured noise field strength levels along the main haulage conductors were as much as 27 dB greater near conductors than away from conductors with the noise levels near the trolley wire being the greatest (this compares with 30 dB predicted in comparing the median-mine-noise and trolley noise data).
- c. As range increases, the field strength at the receiver eventually is determined by reradiation from nearby conductors as evidenced by a very pronounced plateau in field strength with range.

#### 5.4 EASTERN ASSOCIATED COAL MINE FEDERAL NO 1

The Federal No. 1 mine is in high coal in the Pittsburgh seam. In the 8-main north and 3-left main areas used respectively for quasi-conductor-free and conductor proximity testing, the seam height was 7 to 7-1/2 feet with 11 to 14 inches of top coal so that the entry/crosscut heights averaged 6 to 6-1/2 feet. Entry widths averaged 13 feet. The overburden consisted of approximately 60 feet of unconsolidated shale and no draw slate. An occasional 16- to 18-inch "wild" seam approaching as close to the main seam as 2 feet existed.

The 8-main-north and 3-left-main area employed respectively 7-parallel-entry and 10-parallel-entry patterns. The quasi-conductor-free testing was performed 2 entries removed from a water line (partially buried) lying on the floor. The 3-left-main area, being mined as two adjacent and adjoining sections (10 and 22) contained conductors in nearly every entry. In the conductor-proximity measurements, the transmitter was located approximately 90 to 100 feet from the nearest conductor.

Mine maps and both the quasi-conductor-free and conductor proximity measurements are given in appendix A4.

Key results of the testing include the following:

- a. A field strength level adequate for a maximum quasi-conductor-free communication range of 1,300 feet was demonstrated. The greatest usable test range was approximately 1,200 feet.
- b. In an entry with conductors, fields strengths representative of conductor-free areas can be measured out to a range of several hundred meters if the transmitting antenna is located well away from conductors. At 236 to 238 kHz in this mine, this range was approximately 200 meters for an approximate 27-meter separation between the transmit loop and the nearest (7200-V ac cable) conductor.

#### 5.5 VIRGINIA POCAHONTAS NO. 1 MINE

The VP No. 1 mine is in low-medium coal in the Pocahontas No. 3 seam. This seam is at a depth ranging between 1,100 to 1,200 feet in the valleys to 1,850 to 2,400 feet under hill crests. Mines in this seam are quite gassy. The seam height extremes in this mine ranged between 38 inches in the north and 66 inches in the south. The 3-south and 2-north No. 1 plow test areas respectively had 54- and 48-inch seam heights.

No top coal is left. The entry/crosscut width averages 29 to 22 feet. The overburden and underburden close to the seam consists of grey shale with a few inches of draw slate immediately above the seam. In the overburden above the gray slate is hard gray sandstone.

The 3-south submain and 2-north No. 1 plow access to a nearby longwall section were both used for quasi-conductor-free tests and these areas were separated by about 2-1/3 miles. In the 3-south submain, field strength data was taken at two entries away from an air line lying on the floor; also, data was taken through a solid coal block. In the 2-north No. 1 plow area, the measured path was only one entry away nearest conductors, but the transmitter was located two entries away from the conductors.

Mine maps and the quasi-conductor-free measurements for both areas are given in appendix A5.

Key results of the testing include the following:

- a. The path attenuation through a solid coal block is greater than that along open entries.
- b. The maximum communication range through a solid coal block is 460 to 490 feet in the Pocahontas No. 3 seam. Collins Mine Wireless Prototype portable radios were used. The open entry maximum range is roughly 900 feet (as determined by comparison with field strength data).

#### 5.6 PEABODY COAL COMPANY MINE NO. 10

The Peabody Coal Co. Mine No. 10 is in high coal in the Herrin No. 6 seam. This averages 350 feet in depth in this part of Illinois. In the 1-south main test area, the seam height averaged 6-1/2 feet (no top coal) and the entry/crosscut width was 15 feet. In the 1-south 1st west 2nd north section, the seam height averaged 7 feet (no top coal) with the entry/crosscut width averaging 20 feet. The underburden close to the seam consisted of 1 to 2 feet at siltstone grading into claystone. The overburden consisted of gray shale near the seam (no draw slate) grading into hard limestone.

The 1-south 1st west 2nd north section area was truly conductor-free and permitted multiple direction conductor-free transmission paths from a fixed transmitter location including through a solid coal block. The 1-south submain test area was 1 and 2 entries removed from conductors with the transmit being 2-1/2 entries removed from test conductors.

Mine maps and both the quasi-conductor free data sets from both test areas are given in appendix A6.

Key results of the testing include the following:

- a. Field strengths adequate for maximum quasi-conductor free communication ranges of 330 feet for frequencies below 1000 kHz and 165 feet for frequencies above 1000 kHz were demonstrated.
- b. The range achievable through a solid coal block was less than that achievable in open entries. The attenuation rates were similar for these two cases but the coal block field strengths experienced an amplitude offset varying from 10 dB at 430 kHz to 20 dB at 3400 kHz.
- c. A "periodic loading" effect was observed at 240 kHz on a path through coal pillars appearing as a standing wave in field strength with range. The maximum variation from the open entry field strength curve observed was  $\pm 10$  dB.

## 6.0 CONCLUSIONS AND RECOMMENDATIONS

### 6.1 STATE OF KNOWLEDGE OF PROPAGATION EFFECTS

This measurement program has primarily provided magnetic field strength data toward characterizing mf radio wave propagation in conductor-free areas. This characterization has been made according to seam type in three important seams (corresponding to three important geographic production regions) and in two or more locations per seam/region (except for the Pocahontas seam in Virginia). The extent of this data has shown that a particular measurement set of field strength vs range and frequency was at least not atypical for the seam/region. Secondly, magnetic field strength data in proximity to conductors has been obtained toward demonstrating area coverage between portable radios in conductor-dense working section environments for seams giving the greatest (Pittsburgh) and the least (Herrin No. 6) communication ranges when away from conductors. Also, a few magnetic field strength data samples were gathered along conductor runs, developed in the process of checking to see how "conductor-free" particular measurement paths actually were.

The data base gathered during this program constitutes the first step toward designing wireless radio systems for coal mines. The data base enables an estimate of "mean" propagation characteristics per seam/region and the test area deviations from this mean to be put forth. The base is insufficient, however, for enabling a statistical propagation prediction analysis of communication performance to be made similar to those which can be made for hf, vhf, and uhf above-ground systems. In particular, these above-ground analyses predict the probability of communicating (service probability) based on known statistics of location variability, signal fading, and noise. The in-mine data base is not large enough to accurately access location variability, that is, local variations in field strength in terms of nonuniformity of seam thickness in inhomogeneities in overburden/underburden and in terms of topological variations due to the configuration of the mined areas.

A good body of noise data in mines has been gathered by NBS at lower frequencies (generally below 200 kHz). Above 200 kHz the best available estimate is an extrapolation of this lower frequency data. Also, the NBS data is not characterized according to its being carried by conductors, which becomes increasingly important at higher frequencies. The few times that mine wireless prototype portable radios were tested in mines during this program, the noise environment seemed to be characteristic of median-mine-noise. The majority of the time in conductor-free areas, however, the measuring equipment was set-noise-limited. We do not know what the noise floor(s) in quiet mine areas is (are). For tracked haulage communication situations, the noise needs to be characterized according to proximity to dc power sources and the ways in which these sources are tied into the trolley feeder system.

Insufficient data was available to permit defining the maximum range below about 100 kHz. However, data summarized in figure 14 shows that frequencies below 100 kHz are important in obtaining maximum communication range in quiet areas of the Herrin No. 6 seam. Also, for radios closely coupled to conductors, frequencies below 100 kHz are important for obtaining the maximum communication range. We cannot be sure that simple extrapolation to lower frequencies than were measured using the ADL 3-layer model will predict performance adequately when using the higher-frequency-determined conductivities. This is because the skin depth is greater at lower frequencies. A theory embracing more than 3 layers may be required.

The data base is lacking when the propagation paths are in proximity to conductors. Practical mine wireless communication paths will invariably involve conductor proximity and the current data is insufficient in extent to support a conductor proximity model of more sophistication than that used in this report. Of most practical importance is the case where one of the

radios is located remotely from conductors by one or more entries. The signal attenuation on the portion of the transmission path along the conductors will be very much a function of the conductor grouping configuration(s). The transmission performance will also be influenced by conductor branching and by shunting impedances along conductor strings.

The measured data has consisted of field strength amplitude only and has not considered phase. While phase knowledge may be of secondary importance in characterizing communication range/coverage (multipath null field areas have not shown up during the measurement program) it is of importance in the development of mathematical models for computing propagational performance. A simple technique for measuring phase in a mine environment has not yet emerged.

## 6.2 USABILITY OF PROGRAM RESULTS

While the program results provide only guidelines toward predictive modeling synthesis of communication system designs, the data base in its current form is sufficient for system design if a more direct approach is taken for a particular mine. The more direct approach involves measuring certain propagation characteristics in particular mines for which a system is designed. The results can readily be used to determine what is to be measured and where it should be measured during the survey phase of the system design for a particular time.

Knowing the conductor types and topology and the operational requirements for the system, estimates of maximum communication range can be made from the results in this report for a particular mine. This may require a reasonable assumption on current splitting at branch points, etc. These estimates will show locations in range where measurements of both signal and noise should be made. The calculations can then be modified using the measured results to extend the analysis to a larger operating area. Again, if not exposed by the first survey measurements, additional survey data can be obtained to positively identify the marginal signal areas and to assess the field strength location variability which occurs in these areas.

## 6.3 POTENTIAL MF WIRELESS COMMUNICATION APPLICATIONS

Originally conceived to serve communication needs in developing face areas forward of the section phones, MF wireless communication development activities and application concepts have been extended by the Bureau of Mines to include the following (some of which have evolved into separate programs):

- a. Haulage communications to and from a central dispatch point in trackless areas where trolley phone communications is not possible.
- b. Telemetry of data from methane sensors mounted on continuous miners to a remote monitoring location near the section power center; with the capability of shutting down the section power if necessary.
- c. Fire boss communications to serve safety and maintenance needs, particularly along extended belt haulage ways having limited pager phone capabilities.
- d. Telemetry of airflow data from remotely located air shafts to a central monitoring location to facilitate quick assessment of ventilation system failures.
- e. "Snapper" communications in tracked haulage applications for communicating between the locomotive operator and the man coupling strings of coal cars near the section head-piece tipple for example.

Additional applications in section communications emerged from discussion with Peabody Coal Mine No. 10 personnel. These involved communications to expedite logistics over the entire section and communications to permit the face boss to control section operations efficiently.



## 6.4 RECOMMENDATION FOR FURTHER MEASUREMENTS AND ANALYSIS

Typical areas for further measurements and analysis have been alluded to in paragraphs 6.1 and 6.2 which would lead toward a broader data base for system design applications. These have been data base expansions in seams/regions already visited. Additional areas for further measurements include low coal seams and possibly area coverage throughout longwall sections whose topologies depart significantly from room and pillar mining and which are characterized by large roof falls.

For current energy resource reasons, coal mine communications has been emphasized during this program. EM signal propagation in mine types other than coal remains virgin research territory.

Particular areas for further measurements and analysis, arranged in descending order of priority by the author, include the following:

- a. Performing measurements and modeling in additional high-productivity seam/region areas including low coal
- b. Investigating conductor proximity modeling plus verification measurements including characterizing important conductor groupings and topological strings of conductors
- c. Performing additional higher frequency mf noise measurements including characterizing noise sources and their coupling into mine power, control, and phone wiring.
- d. Investigating topological variations in mf propagation with emphasis on comparing solid coal block and room and pillar paths
- e. Performing measurements and modeling at lower frequencies than 100 kHz, including optimum frequency identification for long-range transmission conductors from closely coupled radios
- f. Performing measurements to assess location variability in coal mines
- g. Performing mf field strength vs range and frequency measurements in mine types other than coal
- h. Performing field mapping in conductor-dense section areas from a remotely located transmitter near the face.

## 6.5 TYPICAL SYSTEM PERFORMANCE CONSIDERATIONS

Consider the Pittsburgh seam as represented by the Federal No. 1 mine data for quasi-conductor-free propagation shown on page A4-3 in the appendix. Let us choose the 479-kHz curve to represent nominal 500-kHz operation. The attenuation slope as determined from this curve is approximately 0.143 dB/meter.

If the base station equipment were set-noise-limited, the increase in the base station sensitivity compared to that of the portable (from the equation given in section 4.0) is given by:

$$\begin{aligned} \text{sensitivity increase} &= 20 \log_{10} \left( \frac{\text{base station antenna area}}{\text{portable antenna area}} \right)^{3/4} \\ &= 20 \log_{10} \left( \frac{14.4}{0.217} \right)^{3/4} \\ &= 27.1 \text{ dB} \end{aligned}$$

Using the attenuations slope defined above for the Pittsburg seam at 500 kHz, the set-noise-limited sensitivity (if it could be realized) would give a range increase of

$$\text{range increase} = \frac{27.1 \text{ dB}}{0.143 \text{ dB/m}} = 190 \text{ meters.}$$

If the noise level is median-mine noise, both the portable and base stations receiving equipments will be external noise limited so that no advantage is achieved with increased base stations receive sensitivity.

The increased base station NIA over that of the portable is

$$20 \log_{10} \frac{\text{base station NIA} = 14}{\text{portable NIA} = 2.5} = 14.4 \text{ dB,}$$

which corresponds to a range extension over that of the portable of:

$$\text{range extension} = \frac{14.4 \text{ dB}}{0.143 \text{ dB/m}} = 105 \text{ meters}$$

in a conductor-free area. Or, in proximity to conductors with the base station transmitter and portable transmitter assumed located at the same distance away from the conductor so that the increased base station NIA corresponds purely to overcoming attenuation along the conductors;

using the equation for attenuation, constant in section 4.0; at 520 kHz

$$\frac{\alpha}{k} = 0.13706$$

$$k = 0.010889$$

$$\alpha = 0.001492 \text{ nepers/meter}$$

$$= 0.001492 (8.686) = 0.012963 \text{ dB/meter}$$

so that the range extension along the conductor is:

$$\text{range extension} = \frac{14.4 \text{ dB}}{0.012963 \text{ dB/m}}$$

$$= 1111 \text{ meters.}$$

## 6.6 EFFECT OF AN IDEAL REPEATER IN CONDUCTOR-FREE AREAS

Now, consider the base station to be an ideal repeater (not limited by transmit noise spectrum at the receive frequency or limited by receiver desensitization) extending range of portable-portable operation in a conductor-free environment. If the portables are both set-noise limited, the maximum communication range of 495 meters as determined from figure 1 for the Pittsburgh seam at 500 kHz is extended to:

495 meters: the range from a portable assumed to be transmitting to the repeater if the repeater receive sensitivity were the same as that of the portable.

- plus 190 meters: The range increase due to the increased base station/repeater sensitivity over that of the portable,
- plus 495 meters: The range from the repeater assumed to be transmitting to the other portable if the transmit NIA of the repeater were the same as that of the portable,
- plus 105 meters: The range increase due to the increase base station/repeater NIA over that of the portable,

which gives:

$$495 + 190 + 495 + 105 = 1285 \text{ meters.}$$

Similarly, if the portables are both medium-mine-noise-limited, the maximum communications range of 290 meters as determined from figure 1 for the Pittsburgh seam at 500 kHz is extended to:

- 290 meters: The range from a portable assumed to be transmitting to the repeater which is the same as that to another portable (both are external-noise-limited),
- plus 290 meters: The range from the repeater assumed to be transmitting to the other portable if the NIA of the repeater were the same as that of the portable,
- plus 105 meters: The range increase due to the increased base station of repeater NIA over that of the portable,

which gives:

$$290 + 290 + 105 = 685 \text{ meters.}$$

## 6.7 EFFECT OF AN IDEAL REPEATER IN PROXIMITY TO CONDUCTORS

Consider the base station to be configured as an ideal repeater to extend the portable-to-conductor range while achieving a desired maximum range along a conductor. As a baseline reference, consider the minimum range along the conductor to be 1020 meters, (the range determined from figure 2 in the Pittsburgh seam at 500 kHz in median-mine-noise) with the receiver located 2 meters from the conductor and the transmitter located 30 meters from the conductor for assumed portable-portable operation.

Consider the repeater to be located near the transmit end of the path at a range so as to permit the maximum range extension of the portable away from the conductor. The portable transmitter range of 30 meters is extended to:

- 30 meters: The original range without the aid of the repeater,
- plus 290 meters: The range from the portable transmitter to the repeater, assuming the same INA for portable and repeater noted in paragraph 6.6,
- plus 105 meters: The range increase due to the increased base station/repeater NIA over that of the portable noted in section 6.5.

which gives,

$30 + 290 + 105 = 425$  meters if the repeater is located  $30 + 105 = 135$  meters away from the conductor.

If the repeater were located at the original portable transmitter location 30 meters away from the conductor, the range extension would be

$$30 + 290 = 320 \text{ meters}$$

and the distance along the conductor could be increased to

1020 meters: The original desired maximum range along the conductor,

plus 1111 meters: The increased range along the conductor if the increased NIA of the base station/repeater over that of the portable were used to overcome conductor attenuation

which yields:  $1020 + 1111 = 2131$  meters.

If the repeater, located at 30 meters from the conductor, were haulageway-noise-limited instead of median mine-noise-limited, the maximum range of the portable away from the conductor would be reduced to:

320 meters: The range computed above,

minus 70 meters: The range reduction due to a 10-dB increase in noise above median-mine-noise as determined from figure 17 and computed from

$$\frac{10 \text{ dB}}{0.143 \text{ dB/inch}} = 70 \text{ dB}$$

which gives:

$$320 - 70 = 250 \text{ meters.}$$

Similarly, if the repeater (located at 30 meters from the conductor) were trolley-noise-limited, the maximum range of the portable away from the conductor would be further reduced to:

250 meters, the range computed above for the haulage-noise-limit

Minus 140 meters: The range reduction due to a 20 dB increase in noise above haulage-noise as determined from figure 17 and computed from

$$\frac{20 \text{ dB}}{0.143 \text{ dB/inch}} = 140 \text{ dB}$$

which gives

$$250 - 140 = 110 \text{ meters.}$$

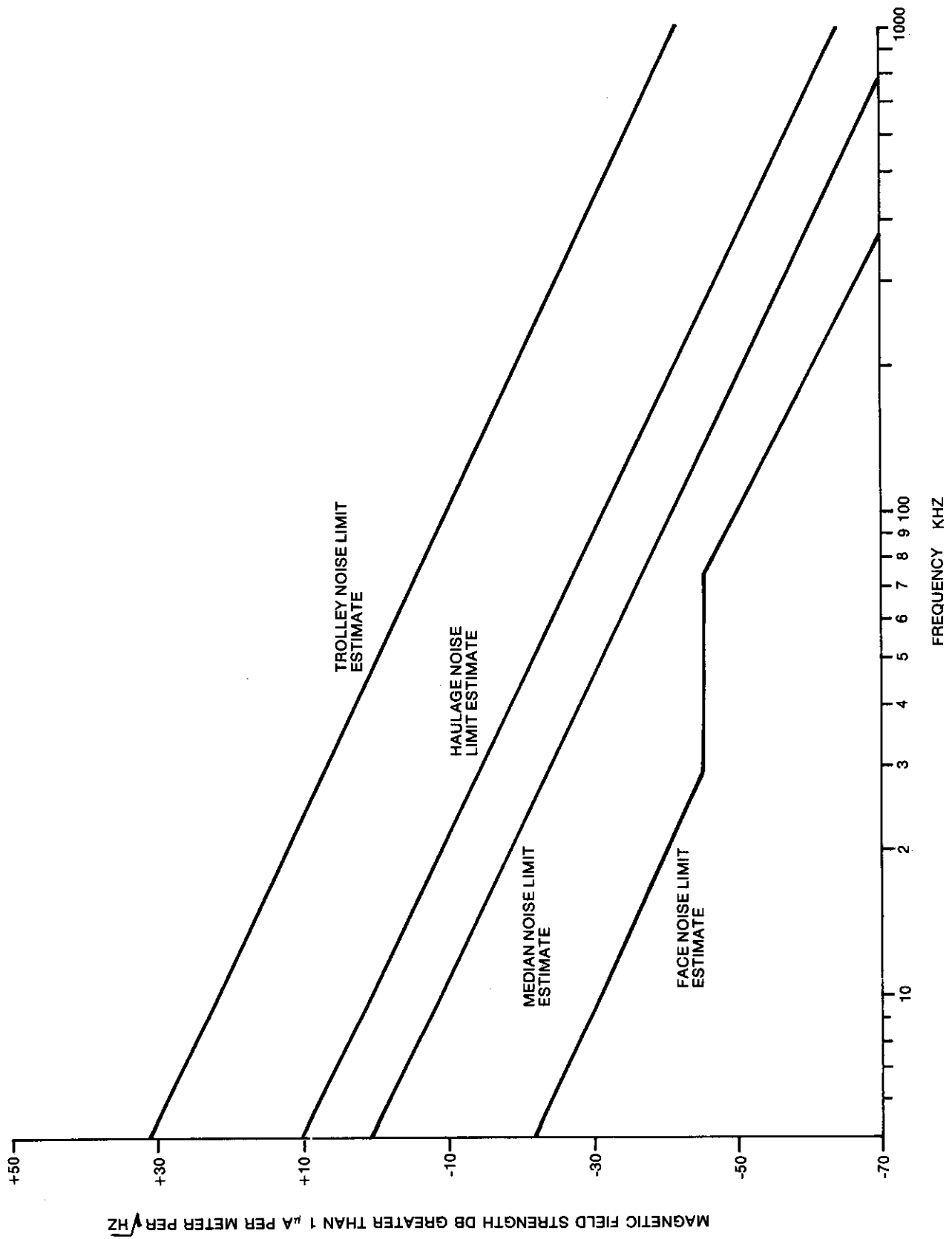

Figure 17. Estimated Noise Magnetic Field in Coal Mines Extrapolated Beyond 200 kHz From NBS Data.

APPENDIX A

A1 - A6

MINE TEST DATA

## APPENDIX A

This appendix gives the mine maps and summary reduced field strength plotted data sets from each of the six Summary Data Reports prepared during this program. For additional information regarding a particular mine, the reader is referred to the particular Summary Data Report for that mine.

The information in this appendix is organized as:

Appendix A1	Ireland Mine
A2	Inland Steel Coal Mine No. 1 (Sesser)
A3	Consolidation Coal Mine No. 95 (Robinson Run)
A4	Eastern Associated Coal Mine Federal No. 1
A5	Virginia Pocahontas No. 1 Mine
A6	Peabody Coal Company Mine No. 10

The particular references for the six Summary Data Reports are given as references (23) to (28).

APPENDIX A1

IRELAND MINE TEST DATA AT MEDIUM FREQUENCY



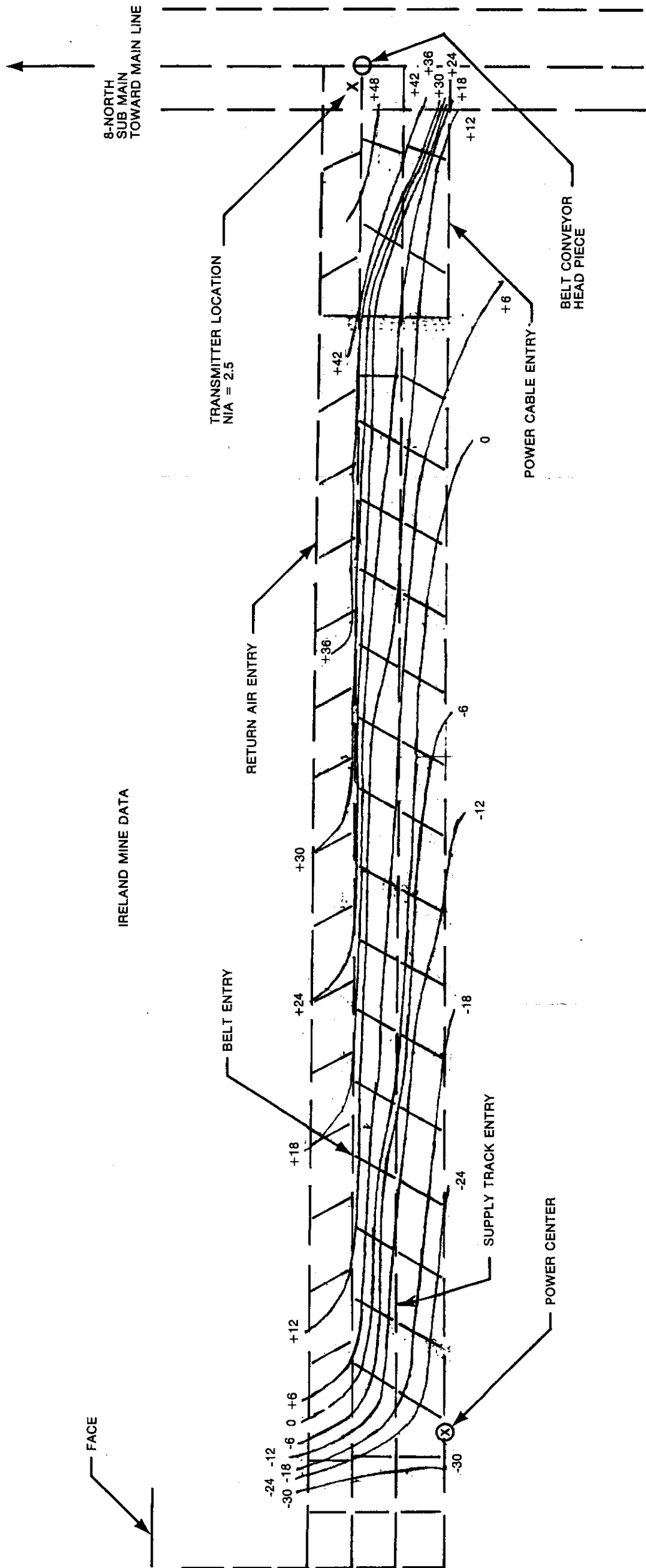

Figure A1-1. Magnetic Field Strength Coverage Map of 8-North 3-Right Working Section at 4220 kHz With Transmitter Located Adjacent to the Conveyor Headpiece and With the Transmit Loop Antenna Plane Oriented Parallel to the Entries -- The Field at Any Point is the Maximum Field in dB Greater Than 1  $\mu$ A Per Meter.

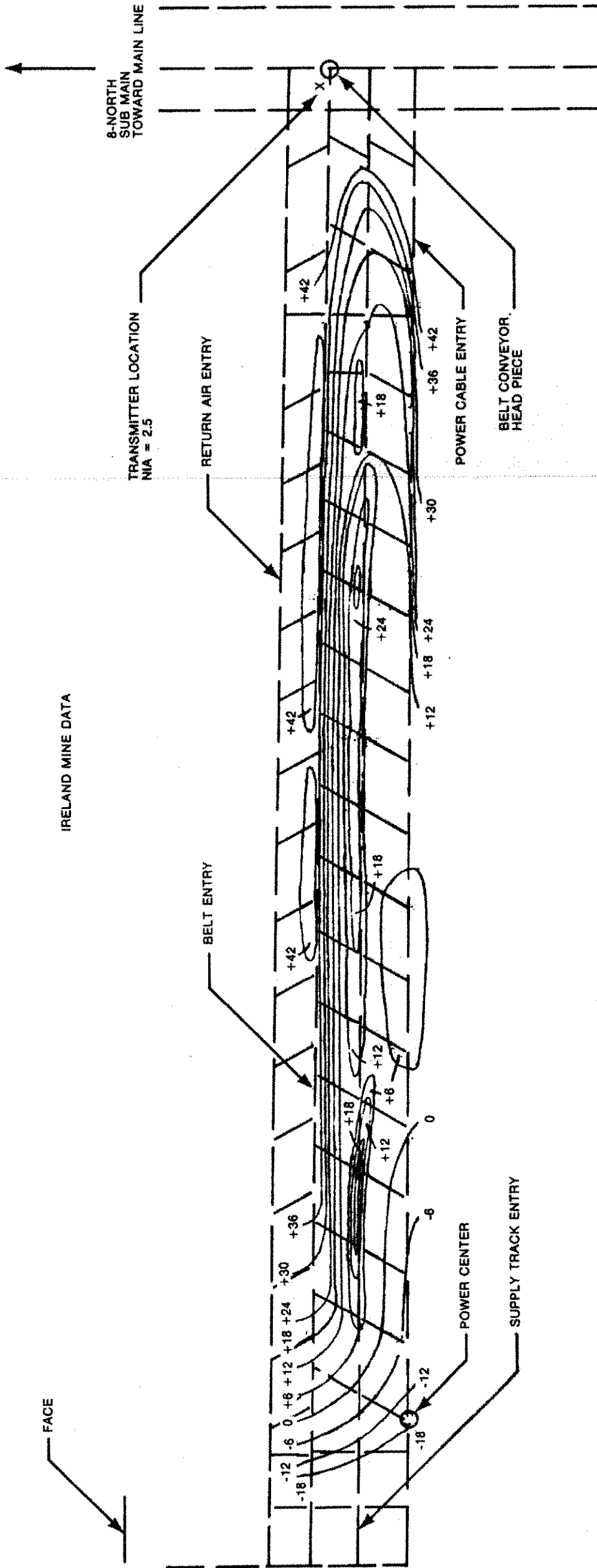

Figure A1-2. Magnetic Field Strength Coverage Map of 8-North 3-Right Working Section at 954 kHz With Transmitter Located Adjacent to the Conveyor Headpiece and With the Transmitter Antenna Loop Plane Oriented Parallel to the Entries -- The Field at Any Point is the Maximum Field in dB Greater Than 1  $\mu$ A Per Meter.

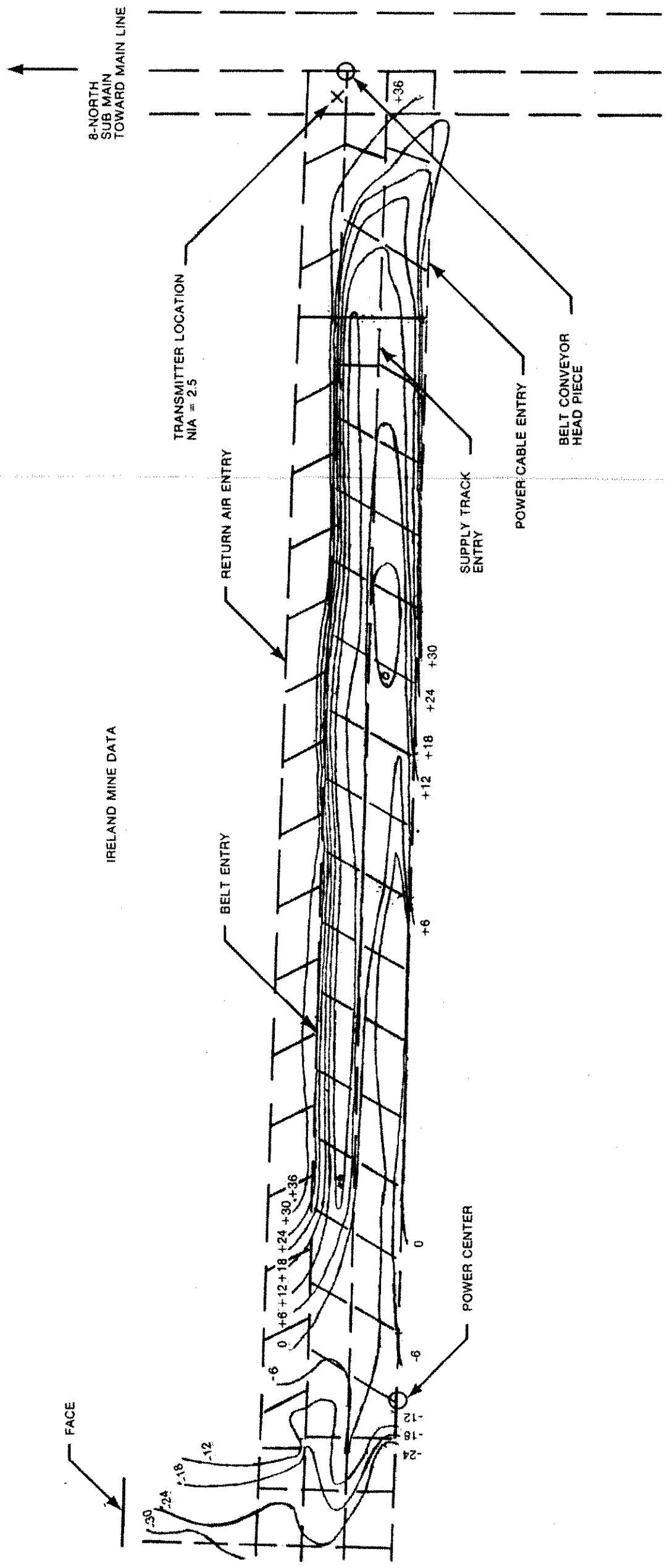
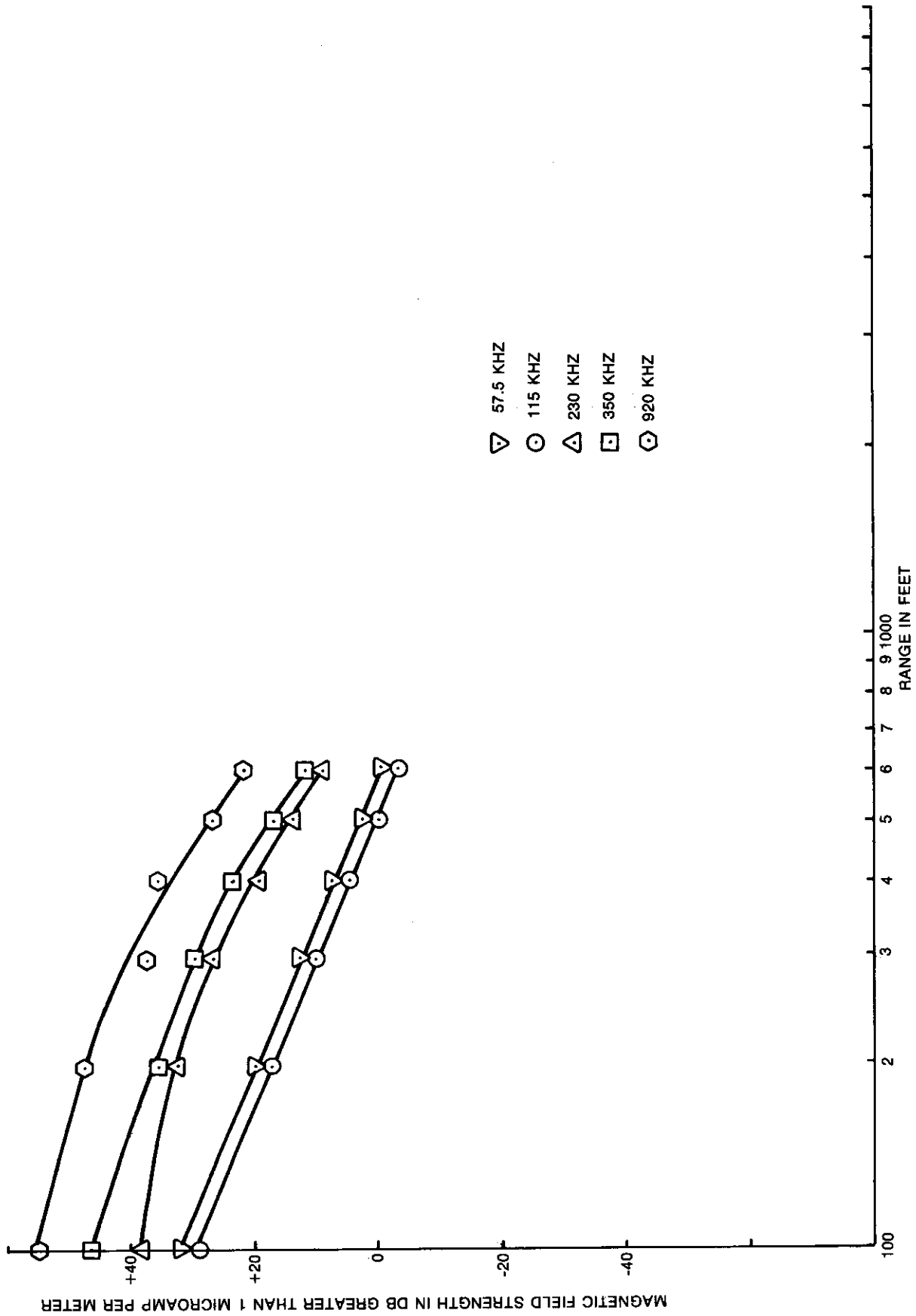

Figure A1-3. Magnetic Field Strength Coverage Map of 8-North 3-Right Working Section at 486 kHz With Transmitter Located Adjacent to the Conveyor Headpiece and With the Transmitter Antenna Loop Plane Oriented Parallel to the Entries -- The Field at Any Point is the Maximum Field in dB Greater Than  $1 \mu A$  Per Meter.



▽ 57.5 KHZ  
 ○ 115 KHZ  
 △ 230 KHZ  
 □ 350 KHZ  
 ◇ 920 KHZ

Figure A1-4. Field Strength Data From Previous Testing in Ireland Mine -- Conductor-Free 8-North Escapeway Normalized to a Transmit NIA = 2.5 (Performed Under Bu Mines Contract H0346067).

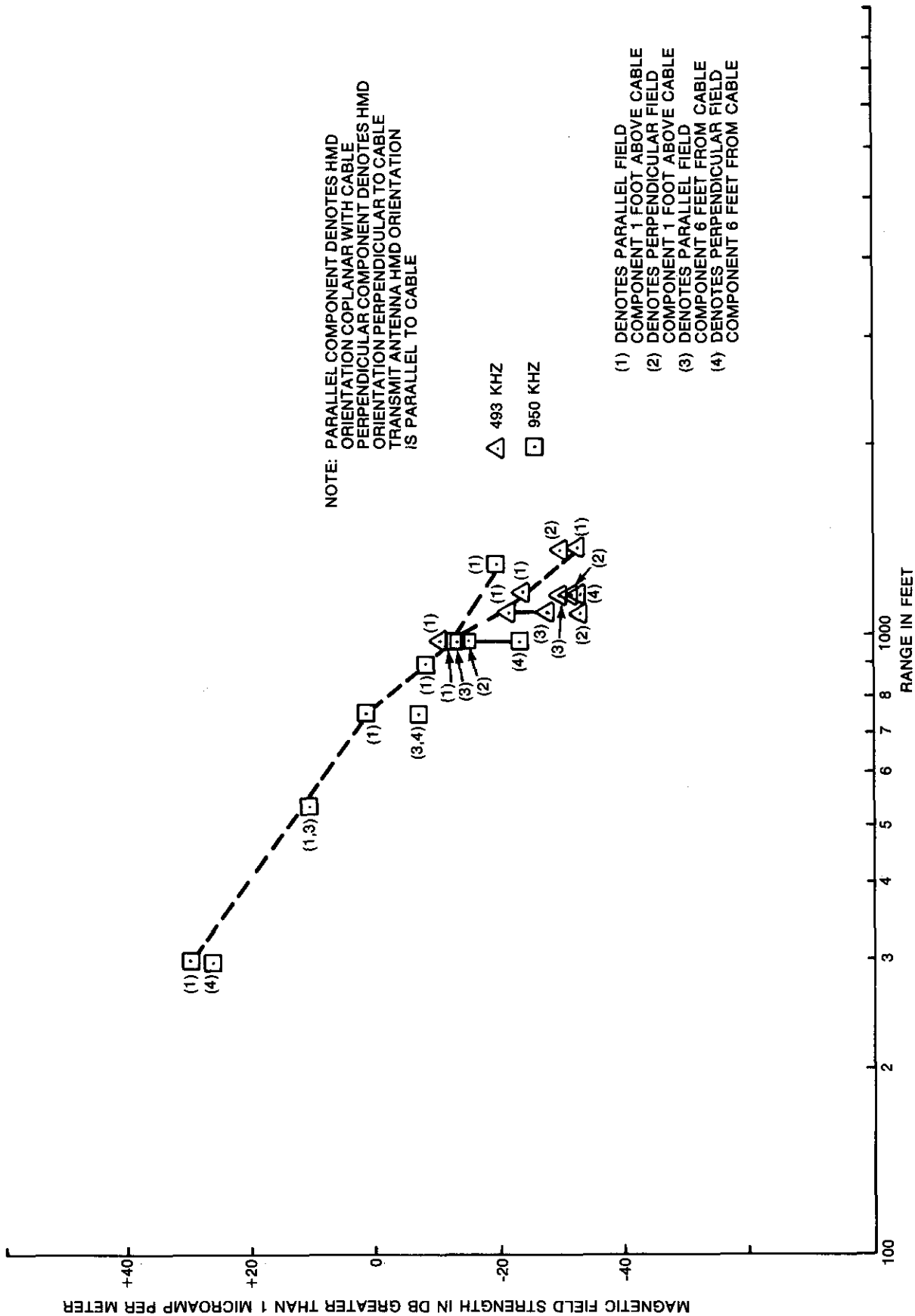

Figure A1-5. Field Strength Data Taken in the 8-North Submain Cable Entry Adjacent to the Farthest Left-Hand Fresh Air Entry With Transmitter Located at 31 + 85 Crosscut Proceeding South Toward Main Line -- Data Normalized to a Transmitter NIA = 2.5.

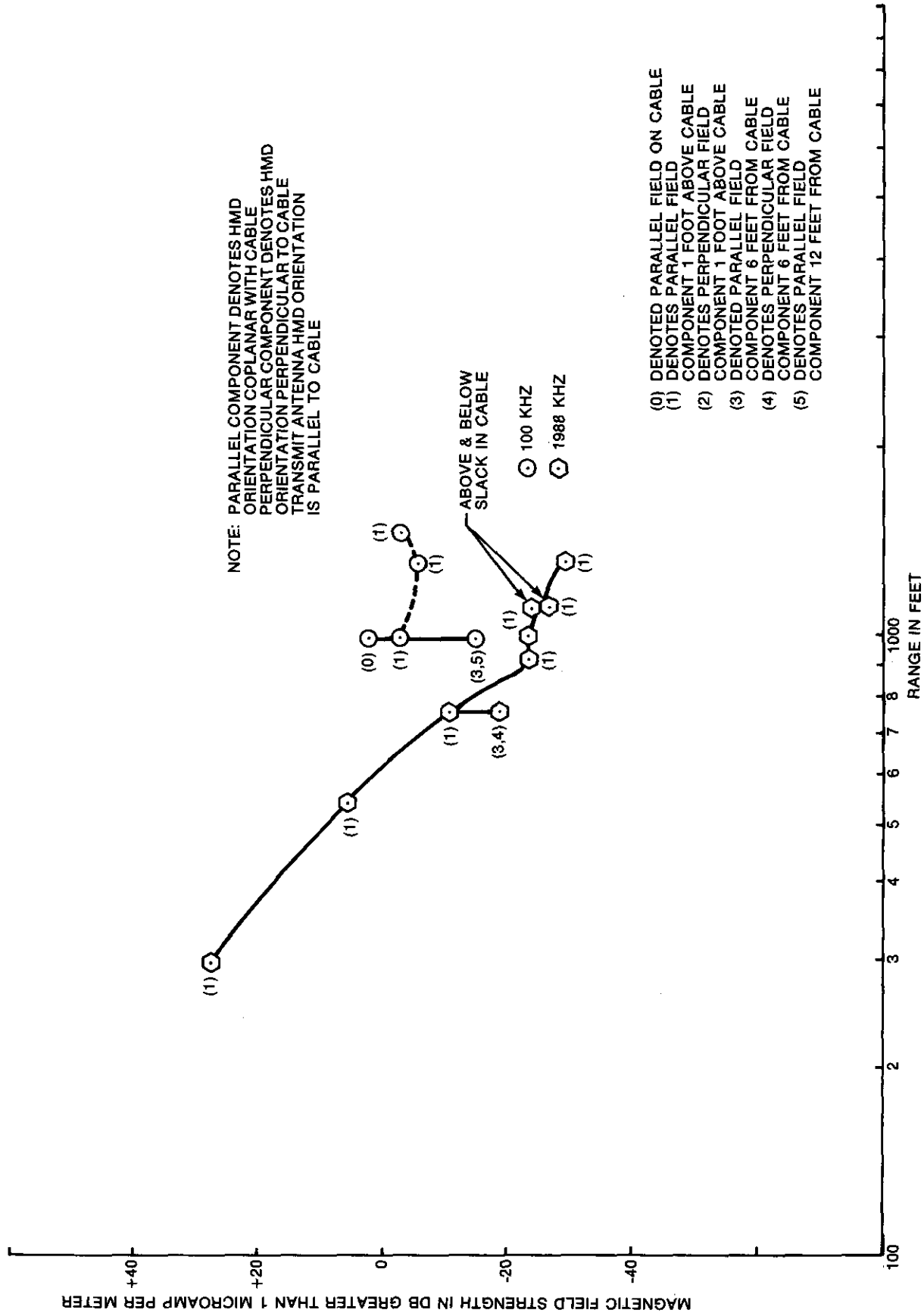

Figure A1-6. Field Strength Data Taken in the 8-North Submain Cable Entry Adjacent to the Farthest Left-Hand Fresh Air Entry With Transmitter Located at 31 + 85 Crosscut Proceeding South Toward Main Line -- Data Normalized to a Transmit NIA = 2.5.

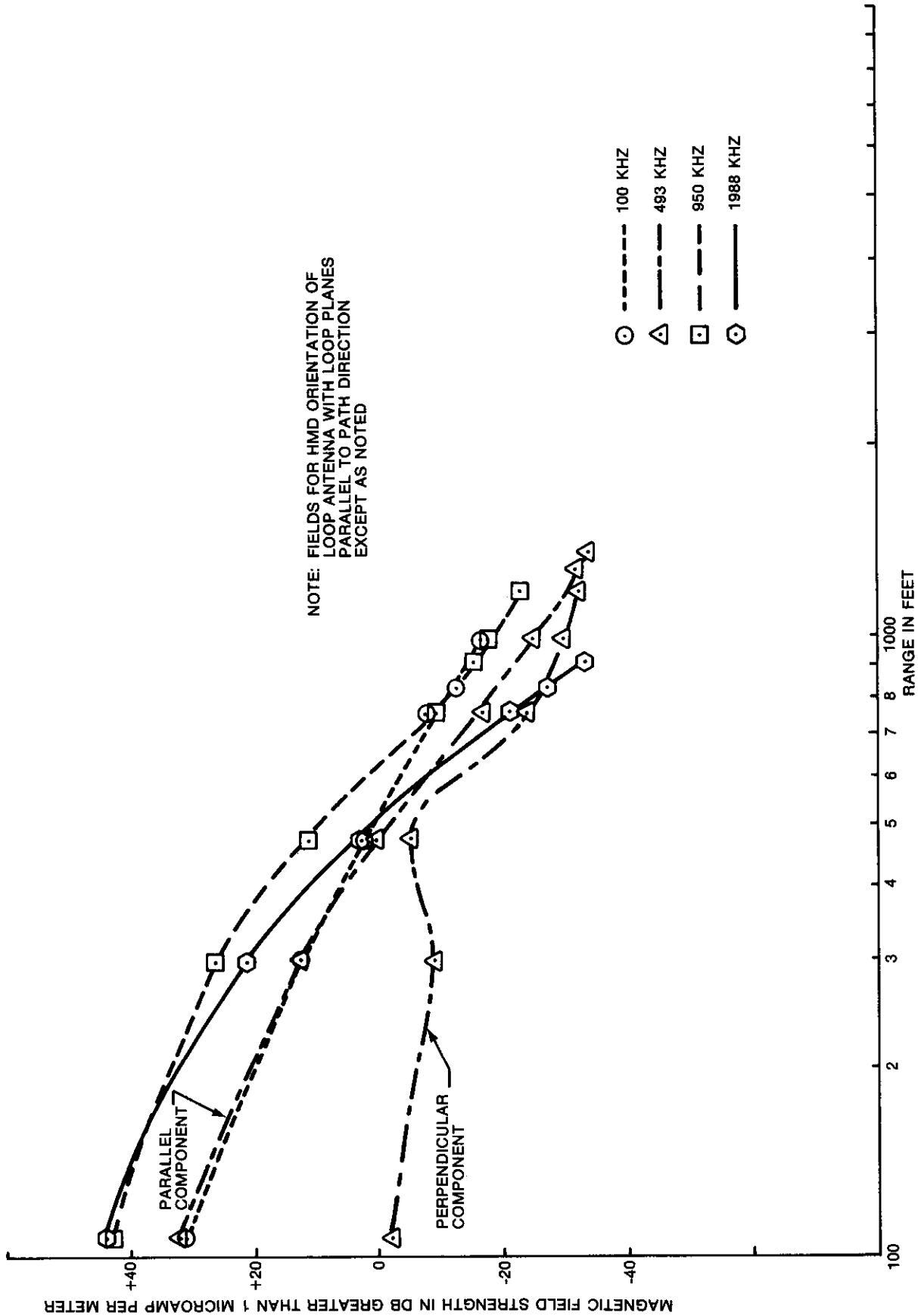

Figure A1-7. Field Strength Data Taken in 8-North Submain in Farthest Left-Hand Fresh Air Entry With Transmitter Located at 31 + 85 Crosscut Proceeding South Toward Main Line -- Data Normalized to a Transmit NIA = 2.5.

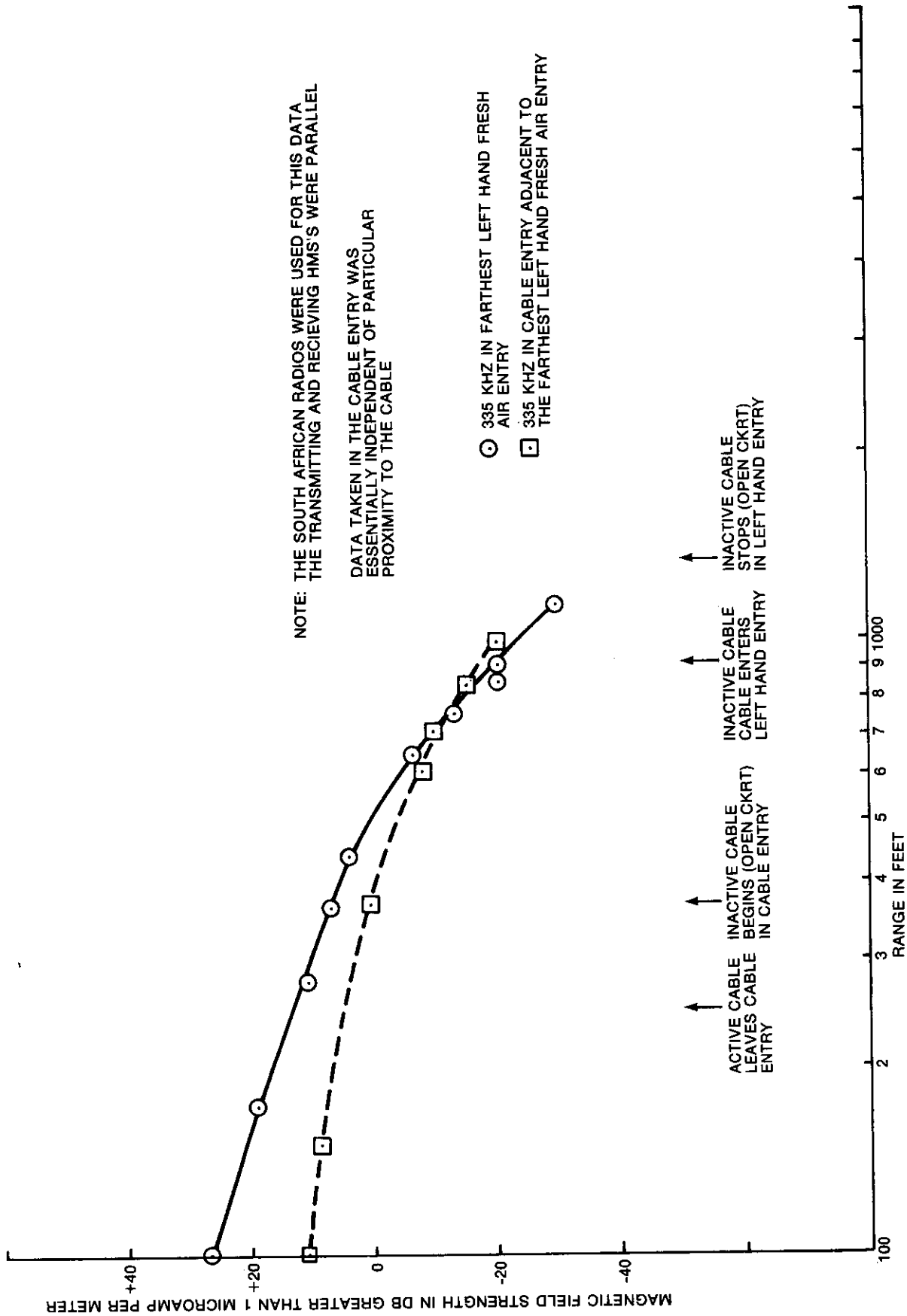

Figure A1-8. Field Strength Data Taken in the 8-North Submain With Transmitter Located at 24 + 40 Crosscut Proceeding North Toward Grave Creek -- Data Normalized to a Transmit NIA = 2.5.



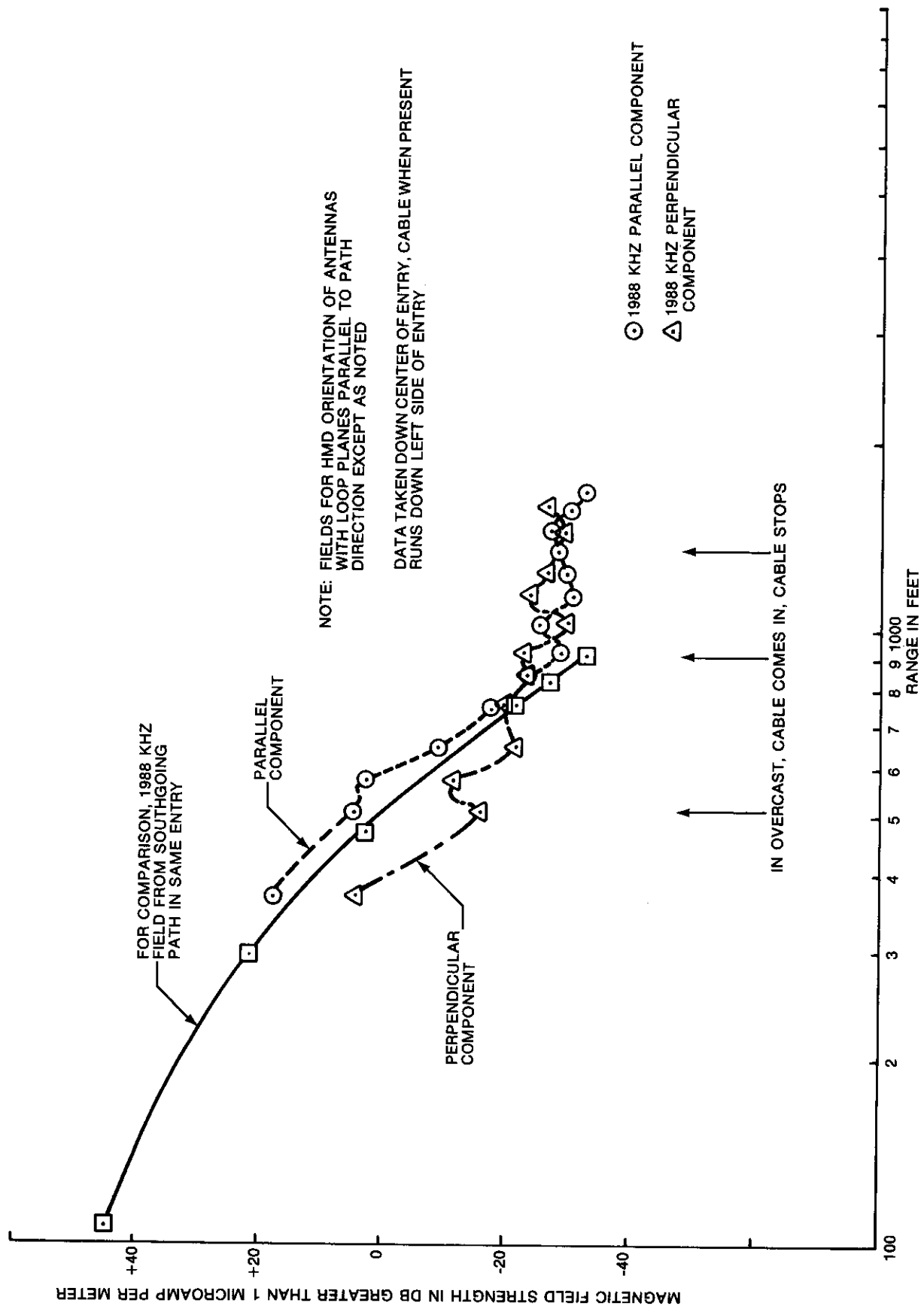

Figure A1-9. Field Strength Data Taken in the 8-North Submain in Farthest Left-Hand Fresh Air Entry With Transmitter Located at 24 + 40 Crosscut Proceeding North Toward Grave Creek -- Data Normalized to a Transmit NIA = 2.5.

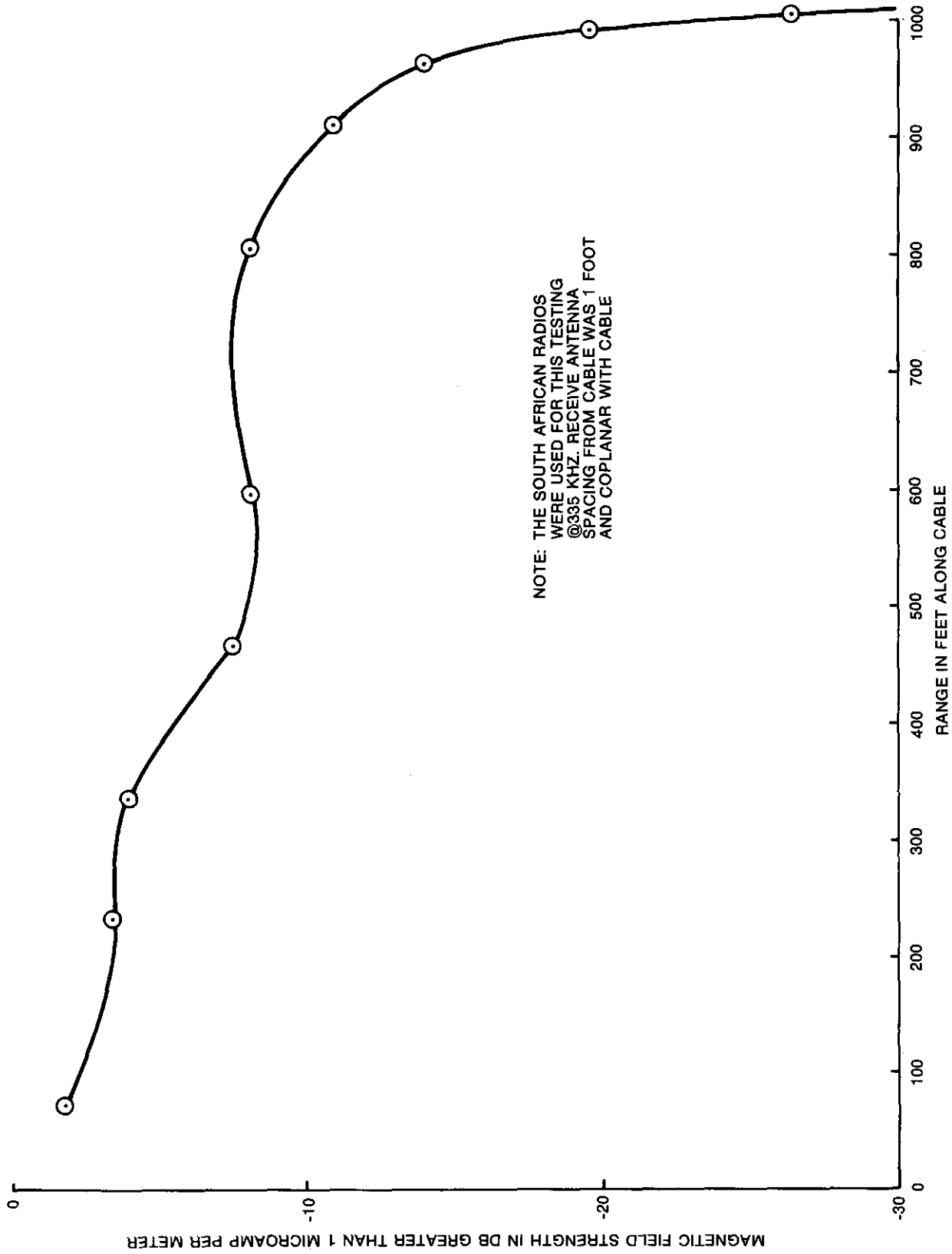

Figure A1-10. Field Strength Data Taken in the 8-North Submain With Transmitter Located at 24 + 40 Crosscut Proceeding North Toward Grave Creek --- Data Taken in Close Proximity to Inactive Cable With Distance Normalized to Cable End Closest to Transmitter - Data Normalized to NIA = 2.5.

IRELAND MINE DATA

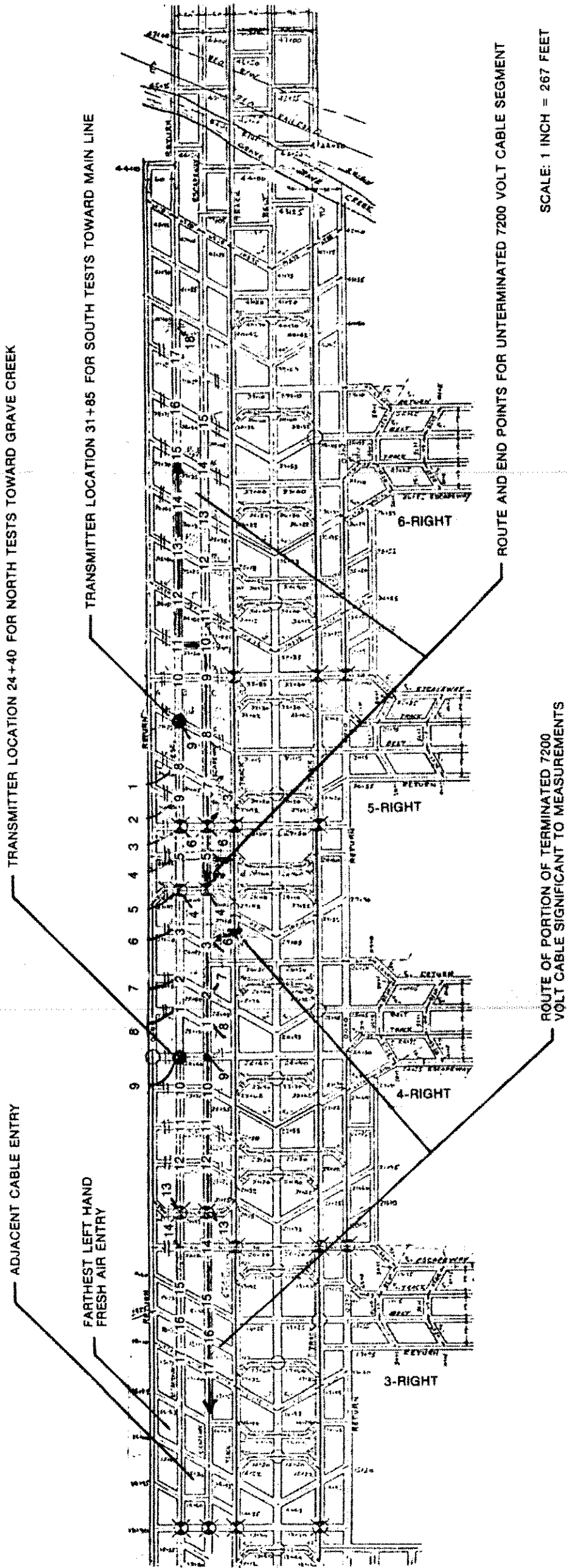
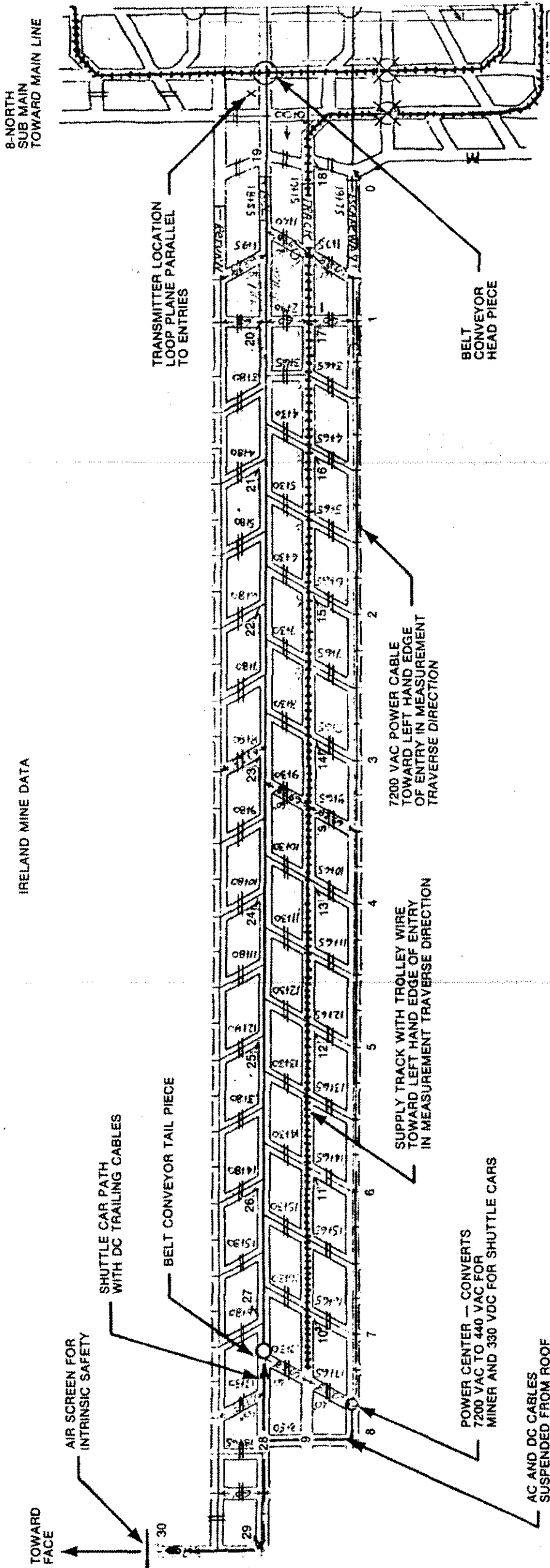

Figure A1-11. Topology of 8-North Submain Showing Measurement Traverse For Magnetic Field Strength Testing.



SCALE: 5/8 INCH = 100 FEET

Figure A1-12. Topology of 8-North 3-Right Working Section Showing Measurement Traverse For Magnetic Field Strength Mapping.

APPENDIX A2

SESSER MINE TEST DATA AT MEDIUM FREQUENCY AND UHF

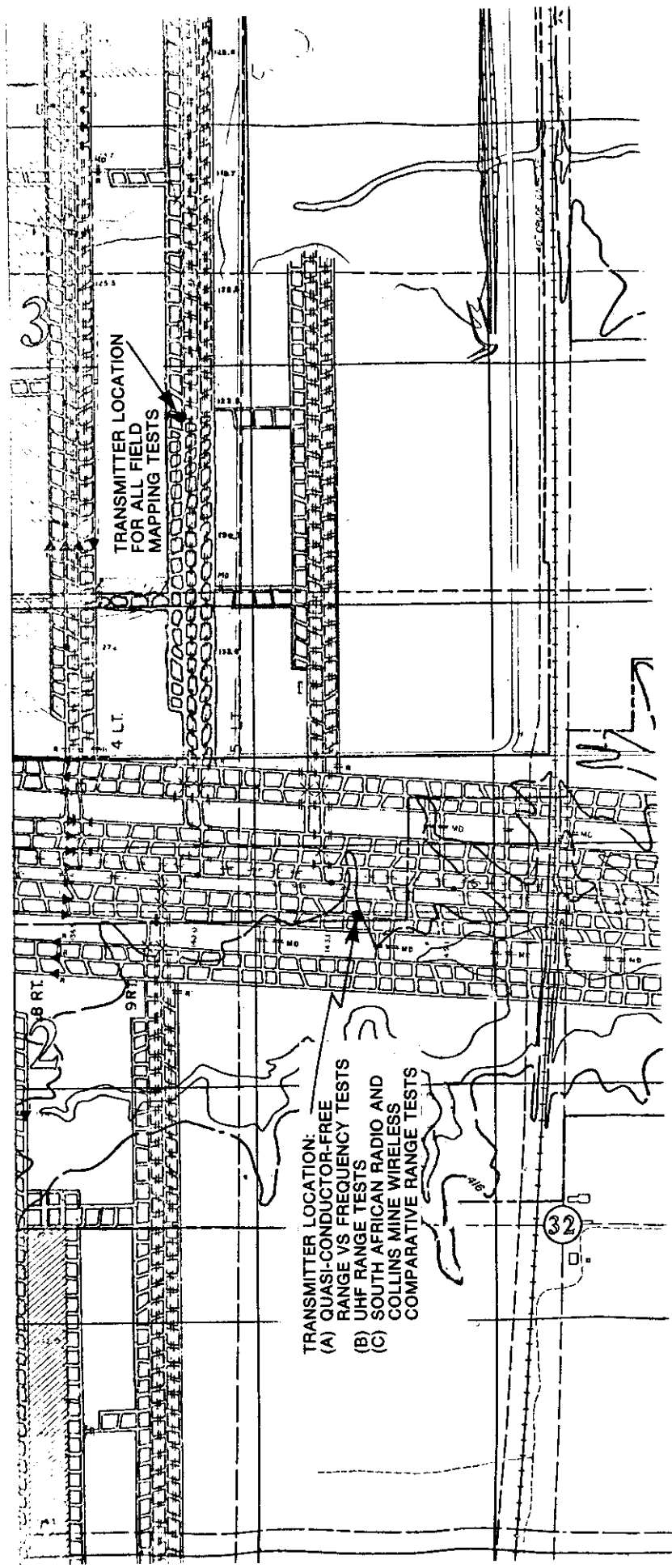

SCALE: 1 INCH = 655 FEET

TRANSMITTER LOCATION:  
 (A) QUASI-CONDUCTOR-FREE  
 RANGE VS FREQUENCY TESTS  
 (B) UHF RANGE TESTS  
 (C) SOUTH AFRICAN RADIO AND  
 COLLINS MINE WIRELESS  
 COMPARATIVE RANGE TESTS

TRANSMITTER LOCATION  
 FOR ALL FIELD  
 MAPPING TESTS

4 LT.

6 RT.

SRI

32

Figure A2-1. Overall Perspective of Area in Which EM Measurements Were Made Inland Steel Coal Mine No. 1 (Sesser) in Main East Section.

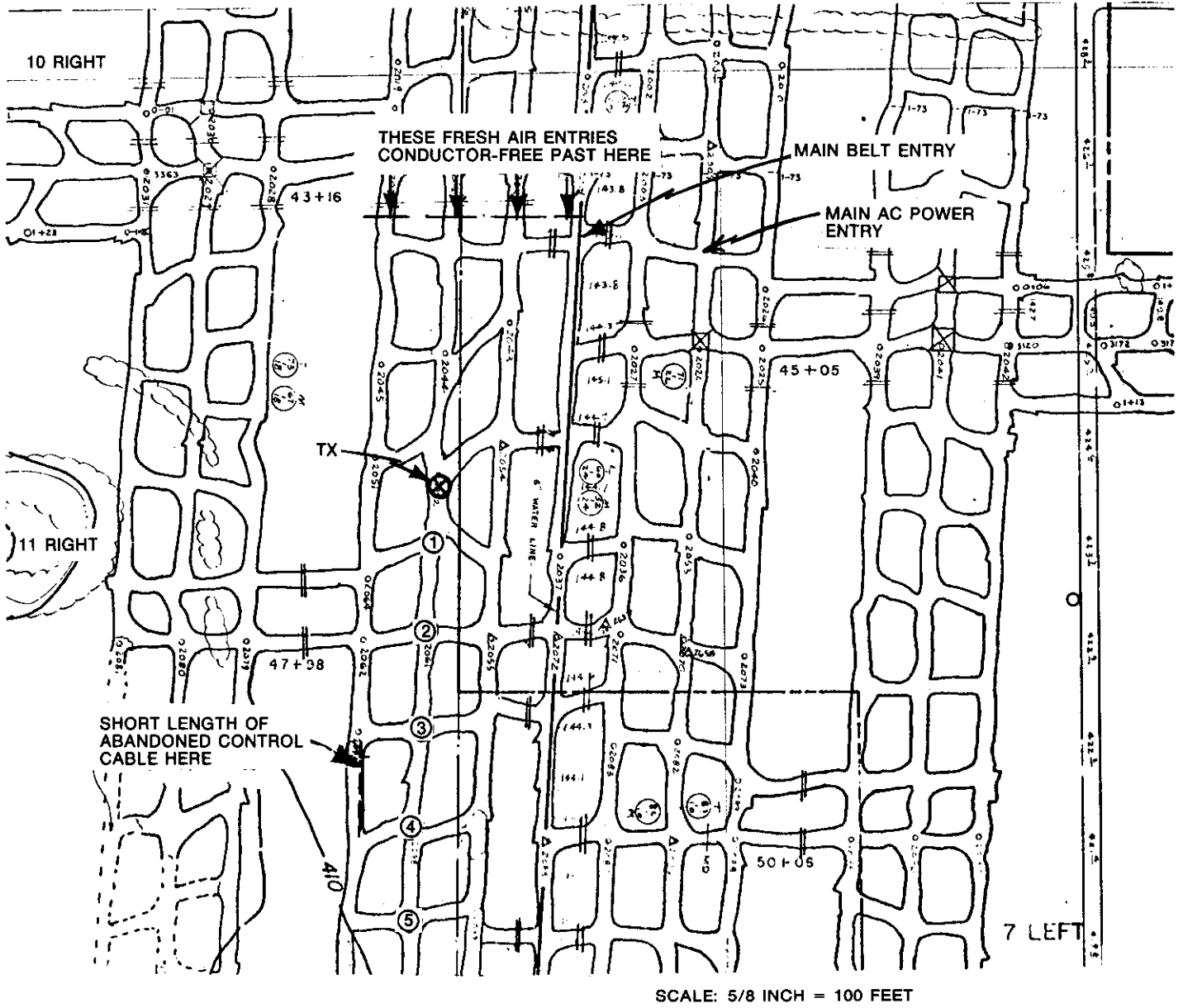

Figure A2-2. Location of Quasi-Conductor-Free Range Vs Frequency Tests.

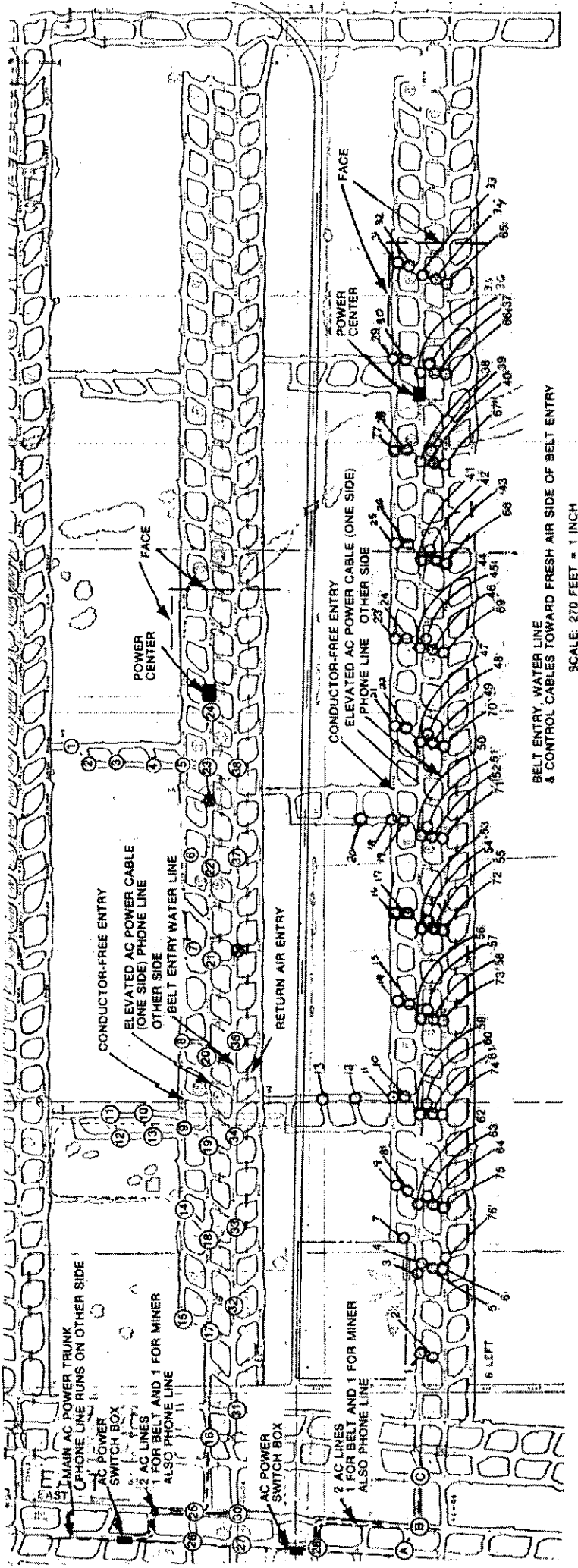

Figure A2-3. Topology of 1-Main East 5-Left and 6-Left Working Sections and Measurement Traverse Used in Obtaining the Magnetic Field Strength Mapping.



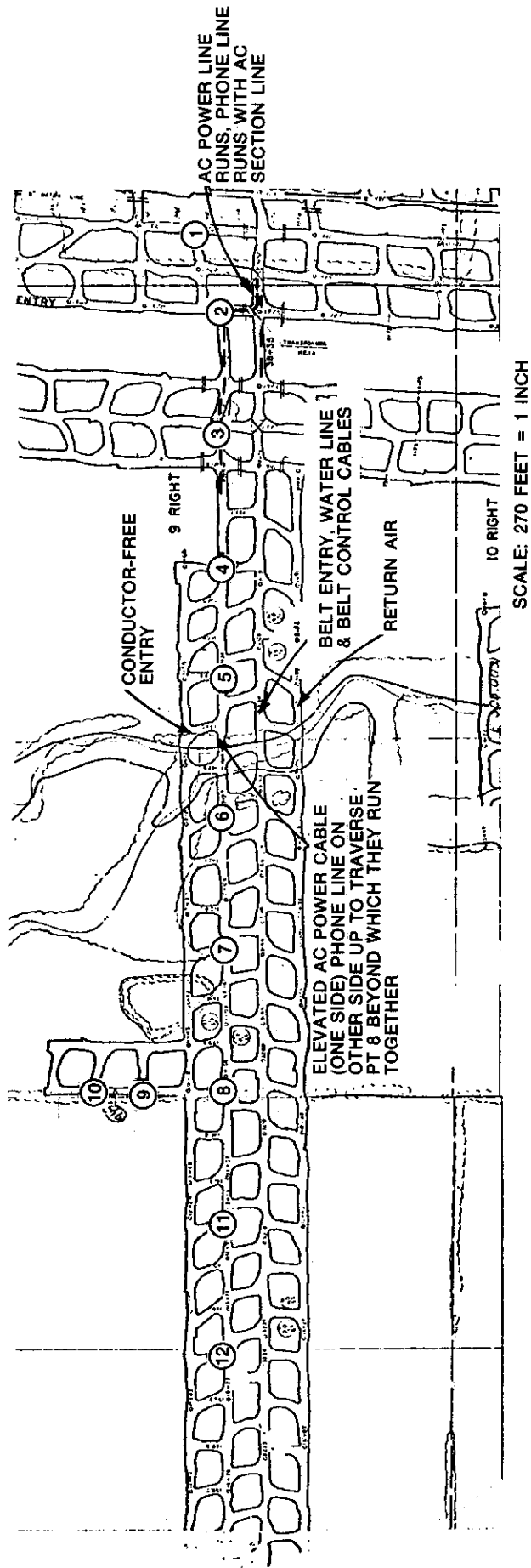

Figure A2-4. Topology of 1-Main East 9-Right Working Section and Measurement Traverse Used in Obtaining the Magnetic Field Strength Mapping.

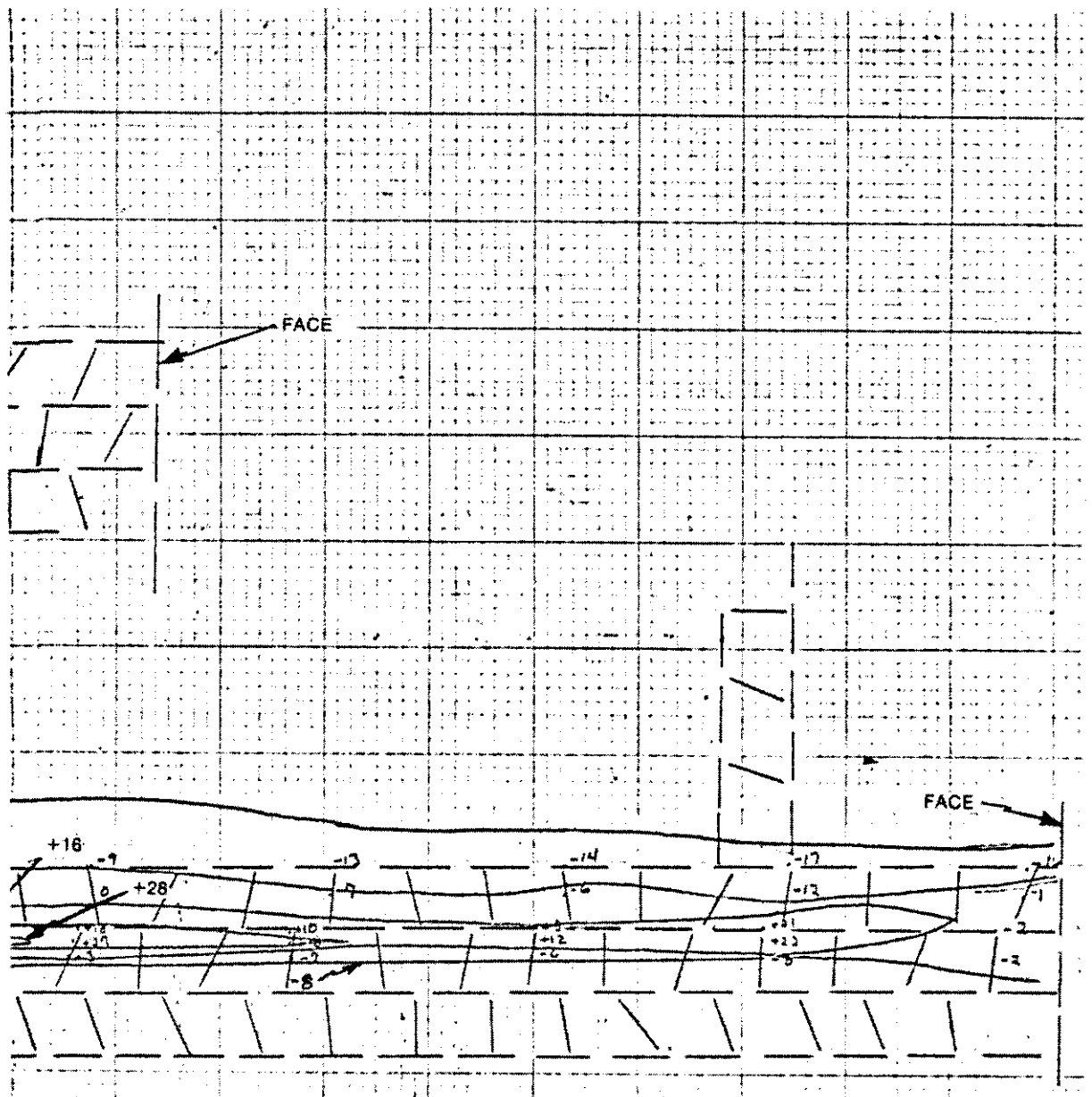
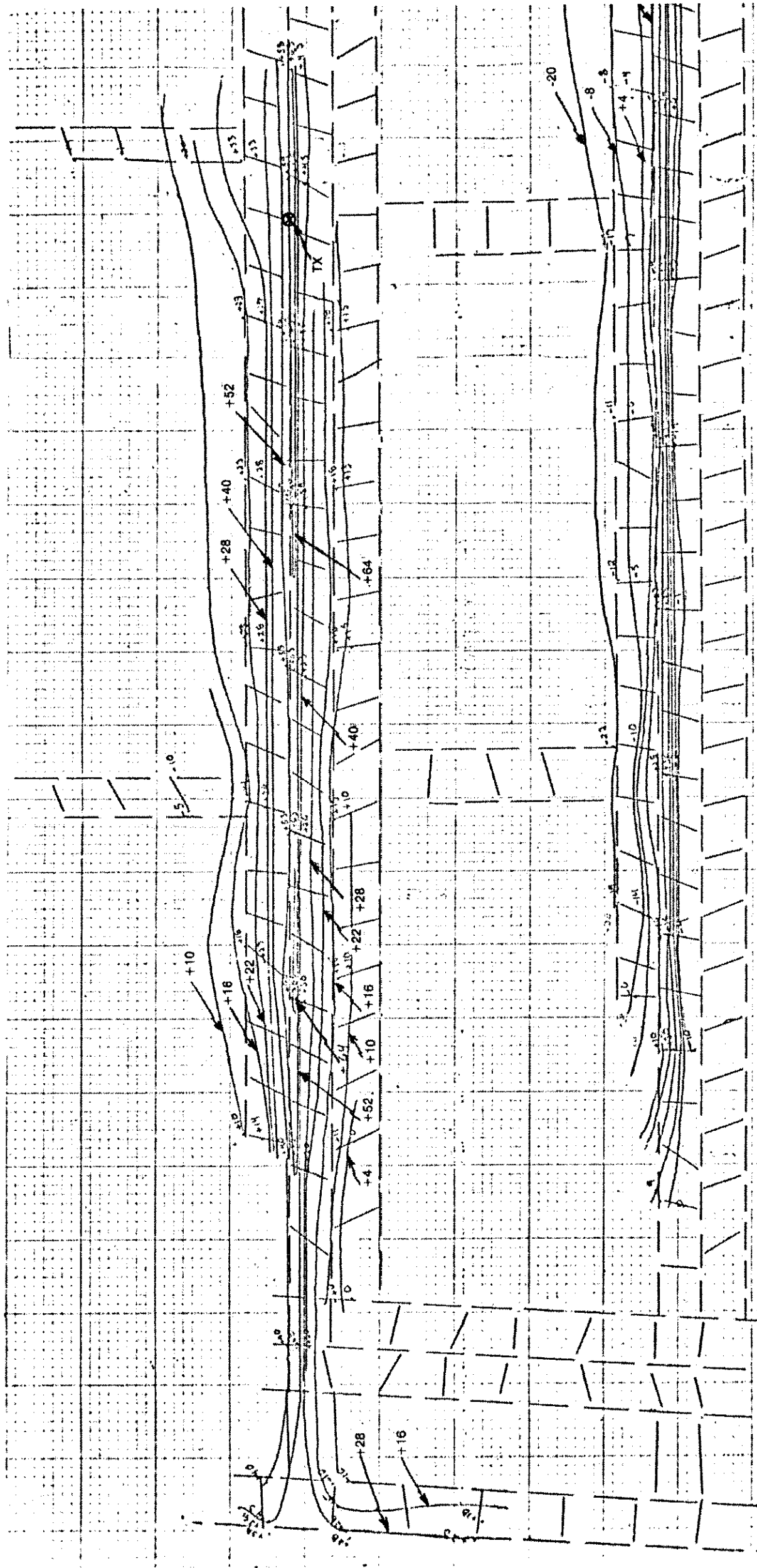

Figure A2-5. Magnetic Field Strength Coverage Map of 1-Main East 5-Left and 6-Left Working Sections at 952 kHz With Transmitter Located Adjacent to the AC Power Cable in 1-Main East 5-Left With the Transmit Loop Antenna Oriented Parallel to the Cable -- The Field at Any Point is the Maximum Field in dB Greater Than  $1 \mu\text{A}$  Per Meter Normalized to a Transmit NIA of 2.5.



THE CONTOUR INTERVAL IS 12 DB SUPPLEMENTED WITH 6 DB INTERVALS BETWEEN +4 AND +28 DB

SCALE: 1 INCH = 167 FEET  
 SESSER MINE DATA

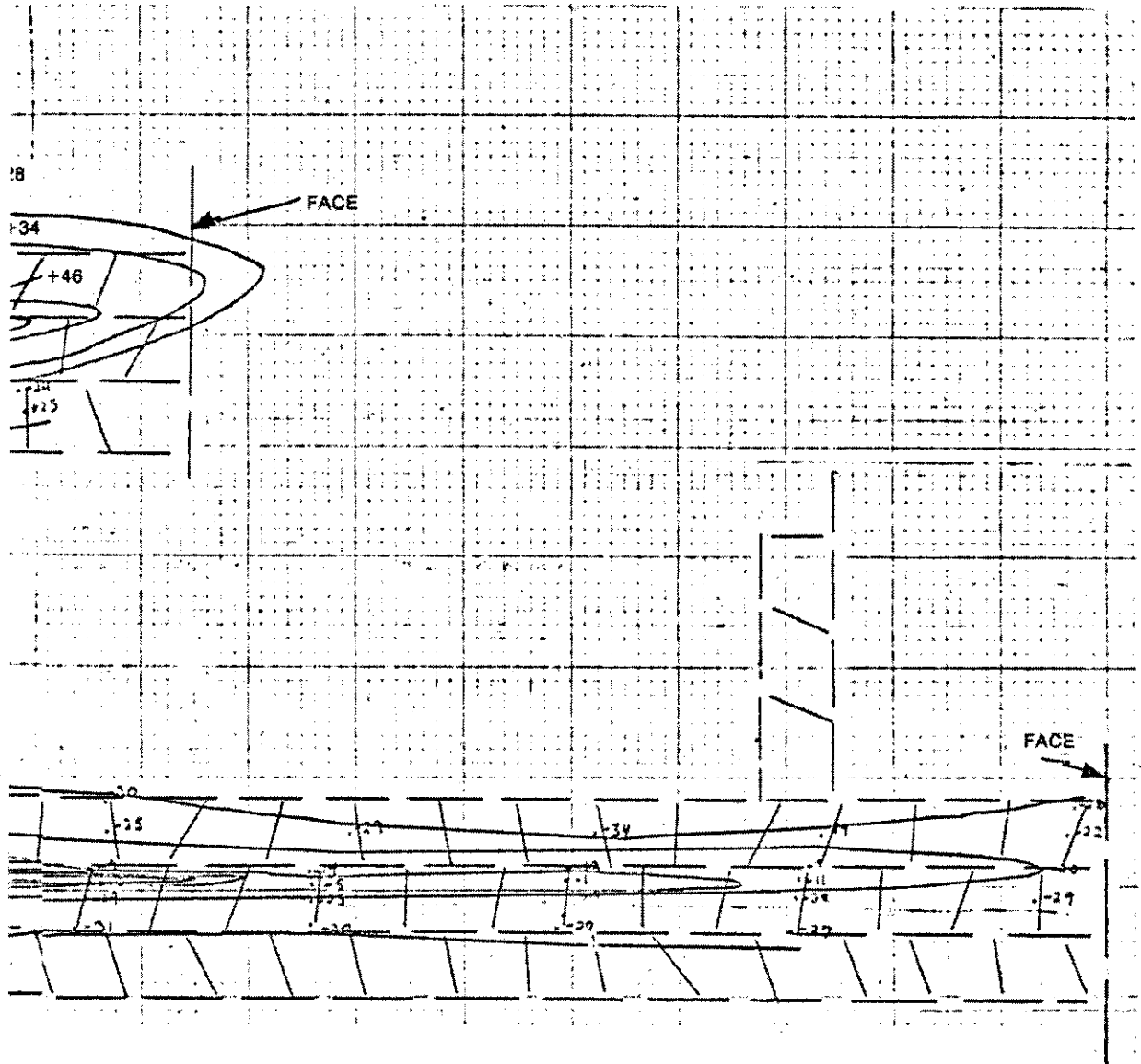
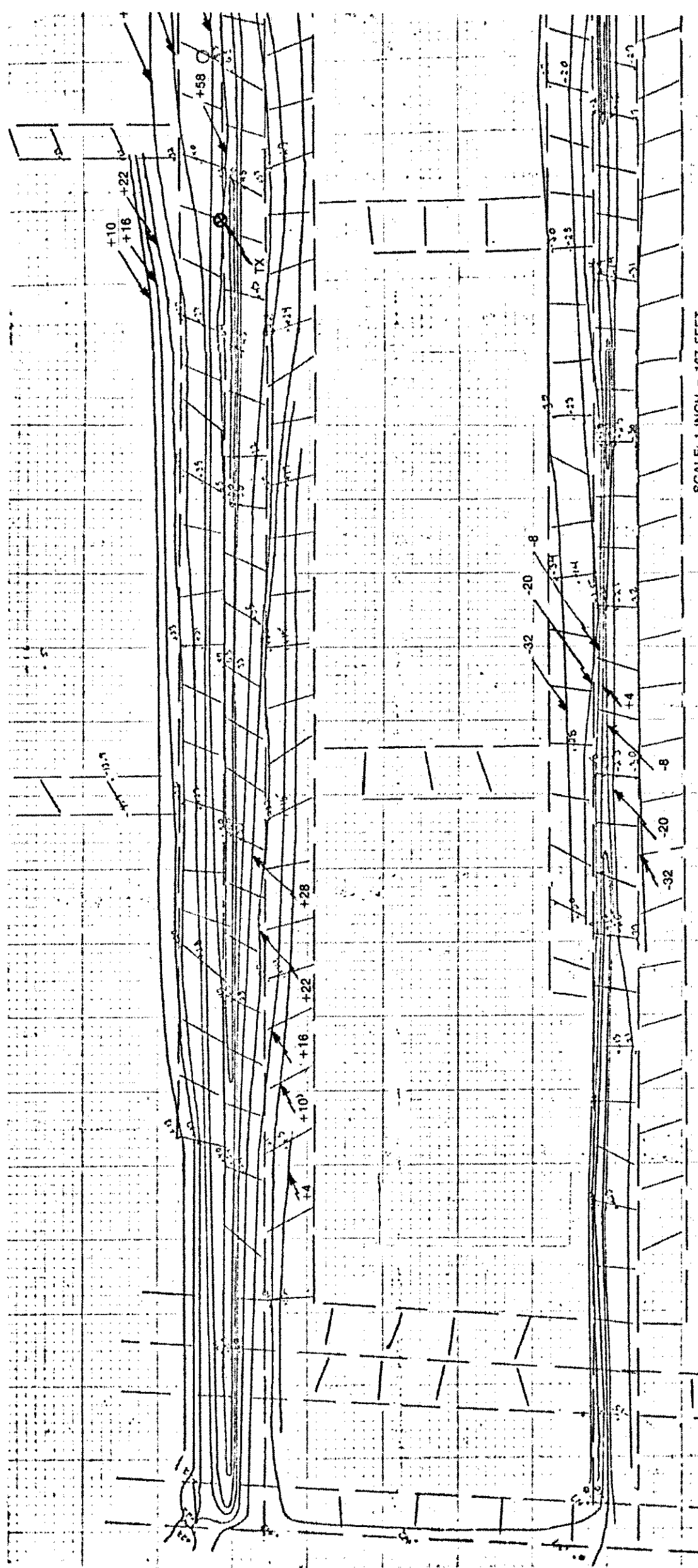

Figure A2-6. Magnetic Field Strength Coverage Map of 1-Main East 5-Left and 6-Left Working Sections at 1950 kHz With Transmitter located Adjacent to the AC Power Cable in 1-Main East 5-Left With the Transmit Loop Antenna Oriented Parallel to the Cable - The Field at Any Point is the Maximum Field in dB Greater Than  $1 \mu\text{A}$  Per Meter Normalized to a Transmit NIA of 2.5.



SCALE: 1 INCH = 167 FEET

SESSER MINE DATA

THE CONTOUR INTERVAL IS 12 DB SUPPLEMENTED WITH 6 DB INTERVALS BETWEEN +4 AND +28 DB

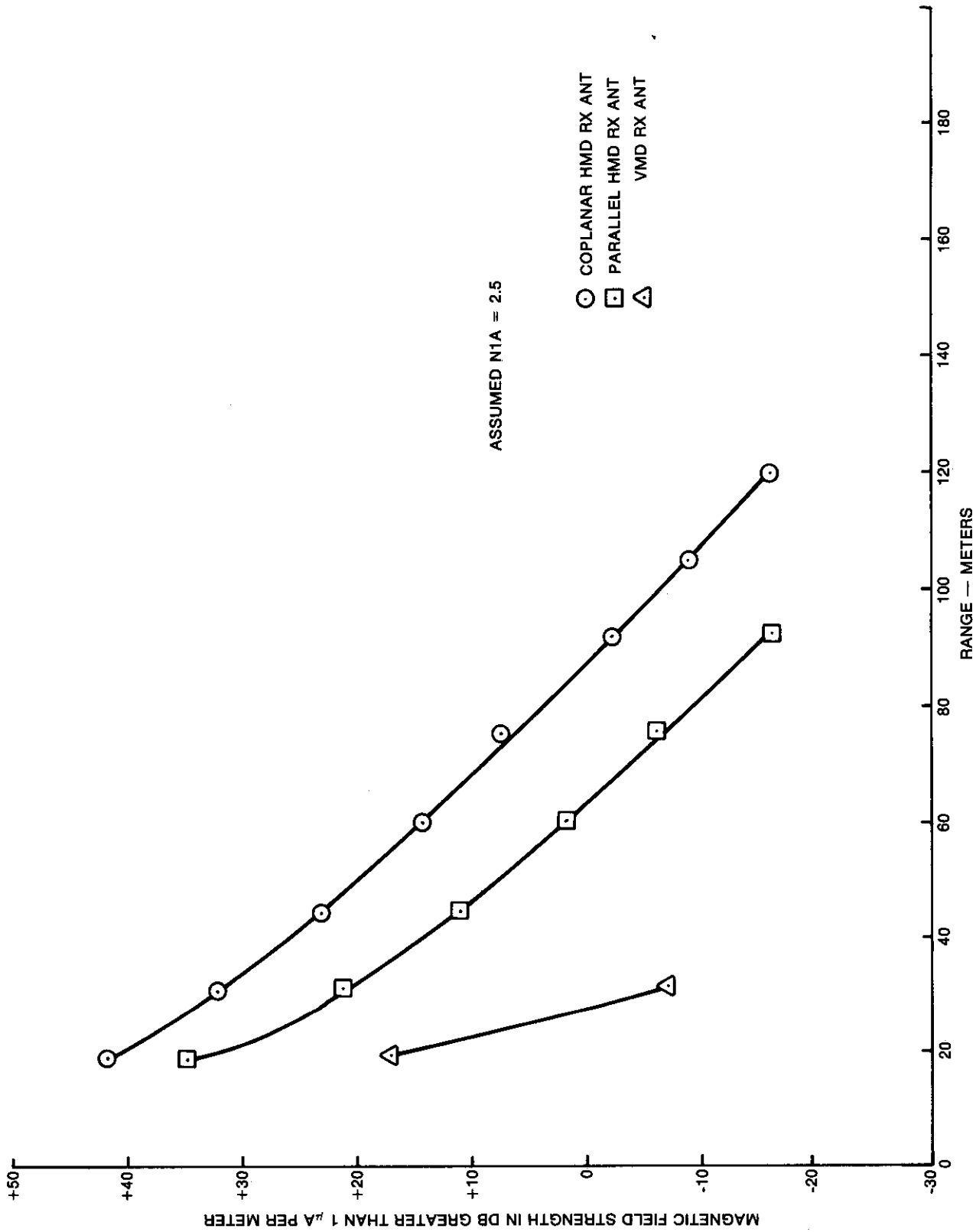

Figure A2-7. Magnetic Field Strength Vs Range in Quasi-Conductor-Free Area of 1-Main East for South African Radios With the Coplanar HMD Transmit Antenna Orientation.

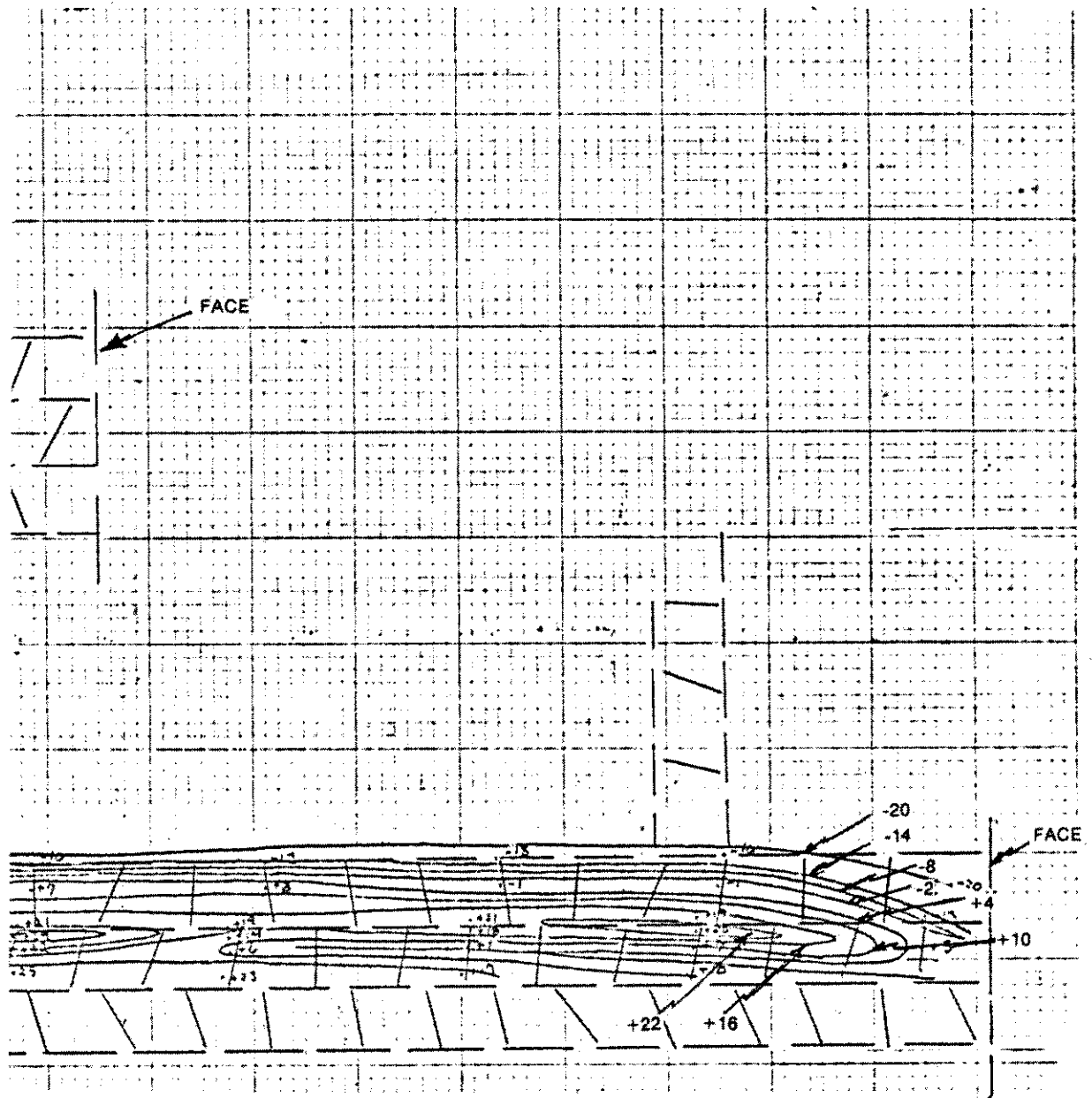
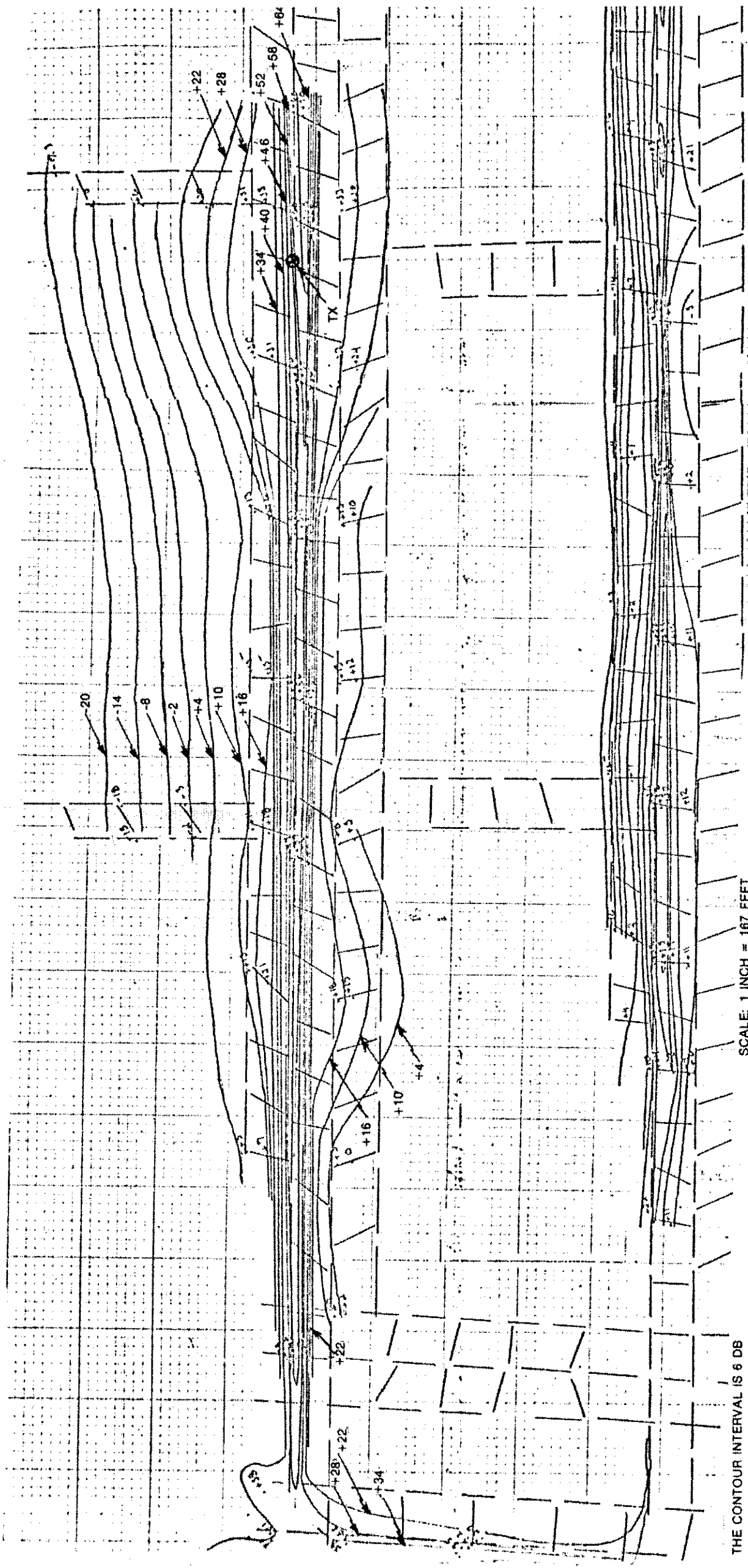

Figure A2-8. Magnetic Field Strength Coverage Map of 1-Main East 5-Left and 6-Left Working Sections at 265 kHz With Transmitter Located Adjacent to the AC Power Cable in 1-Main East 5-Left With the Transmit Loop Antenna Oriented Parallel to the Cable - The Field at Any Point is the Maximum Field in dB Greater Than  $1 \mu\text{A}$  Per Meter Normalized to a Transmit NIA of 2.5.



THE CONTOUR INTERVAL IS 6 DB

SCALE: 1 INCH = 167 FEET



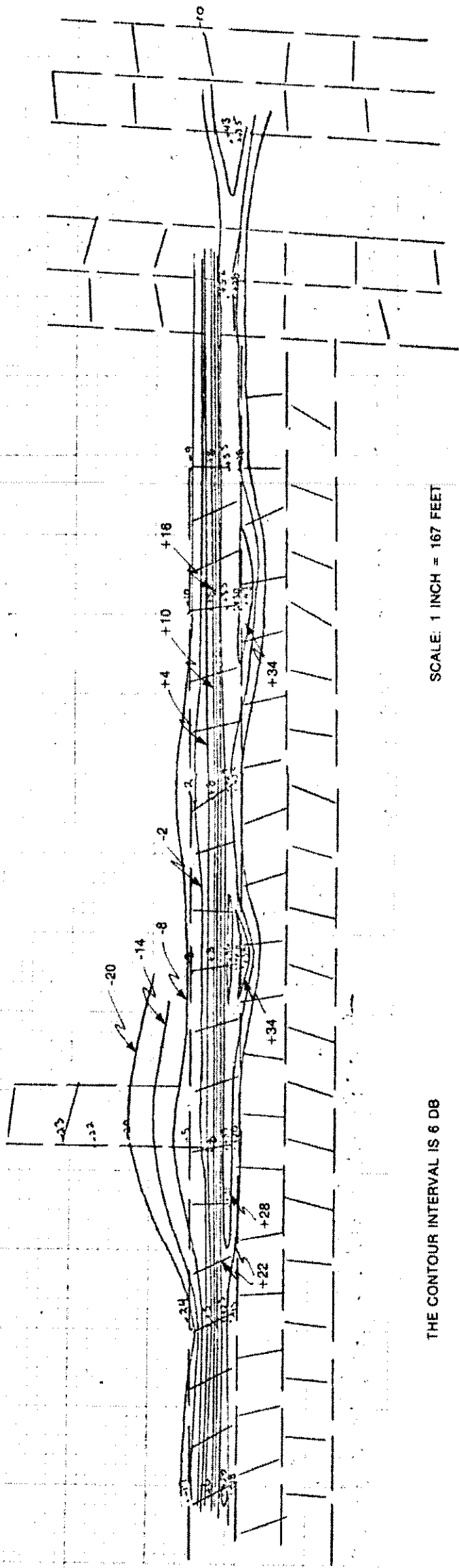

THE CONTOUR INTERVAL IS 6 DB

SCALE: 1 INCH = 167 FEET

Figure A2-9. Magnetic Field Strength Coverage Map of 1-Main East 9-Right Working Section at 265 kHz With Transmitter Located Adjacent to the AC Power Cable in 1-Main East 5-Left With the Transmit Loop Antenna Oriented Parallel to the Cable -- The Field at Any Point is the Maximum Field in dB Greater Than  $1 \mu\text{A}$  Per Meter Normalized to a Transmit NIA of 2.5.

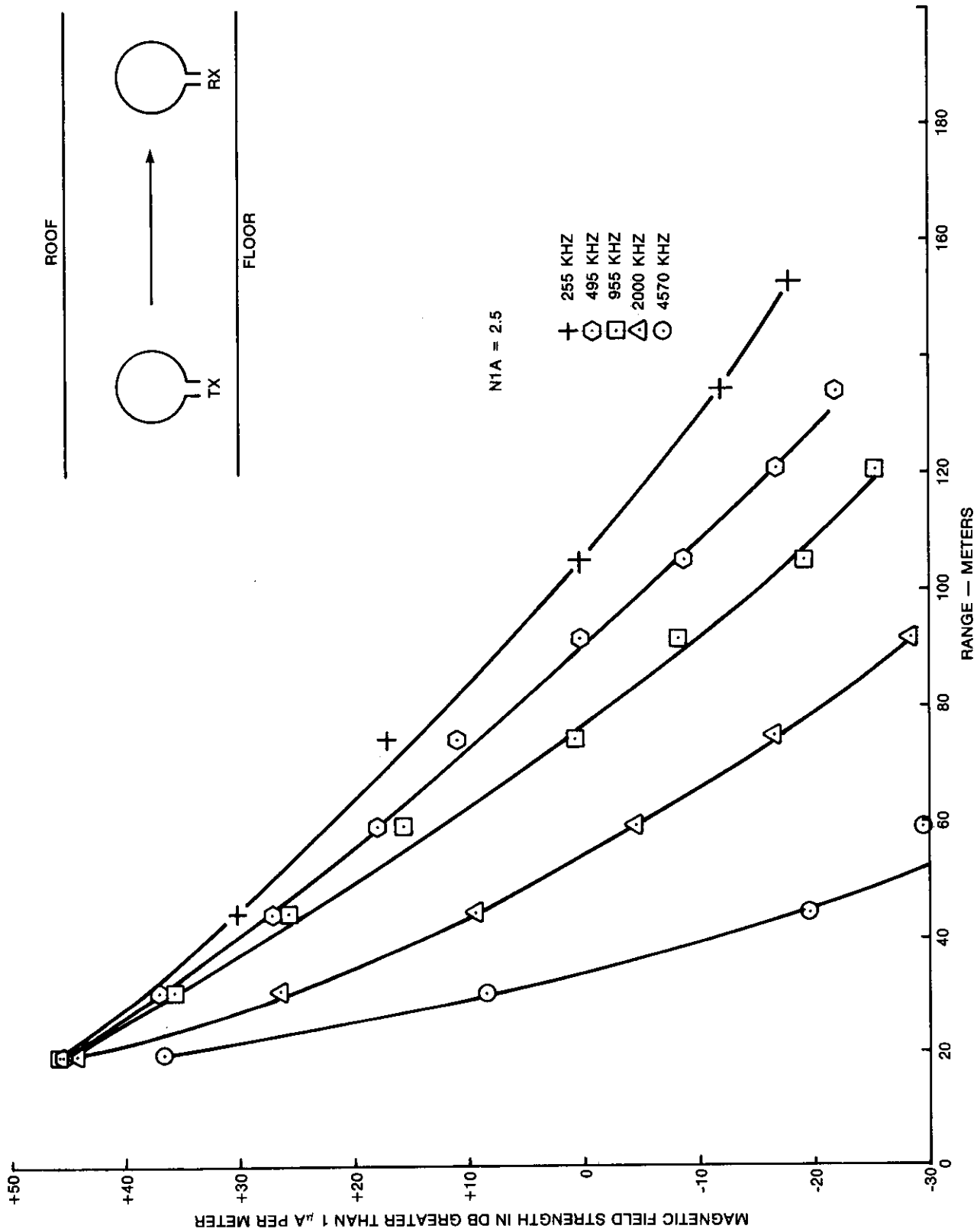

Figure 2-10. Magnetic Field Strength Vs Range in Quasi-Conductor-Free Area of 1 Main East for Coplanar HMD Orientation of Transmit and Receive Antennas.

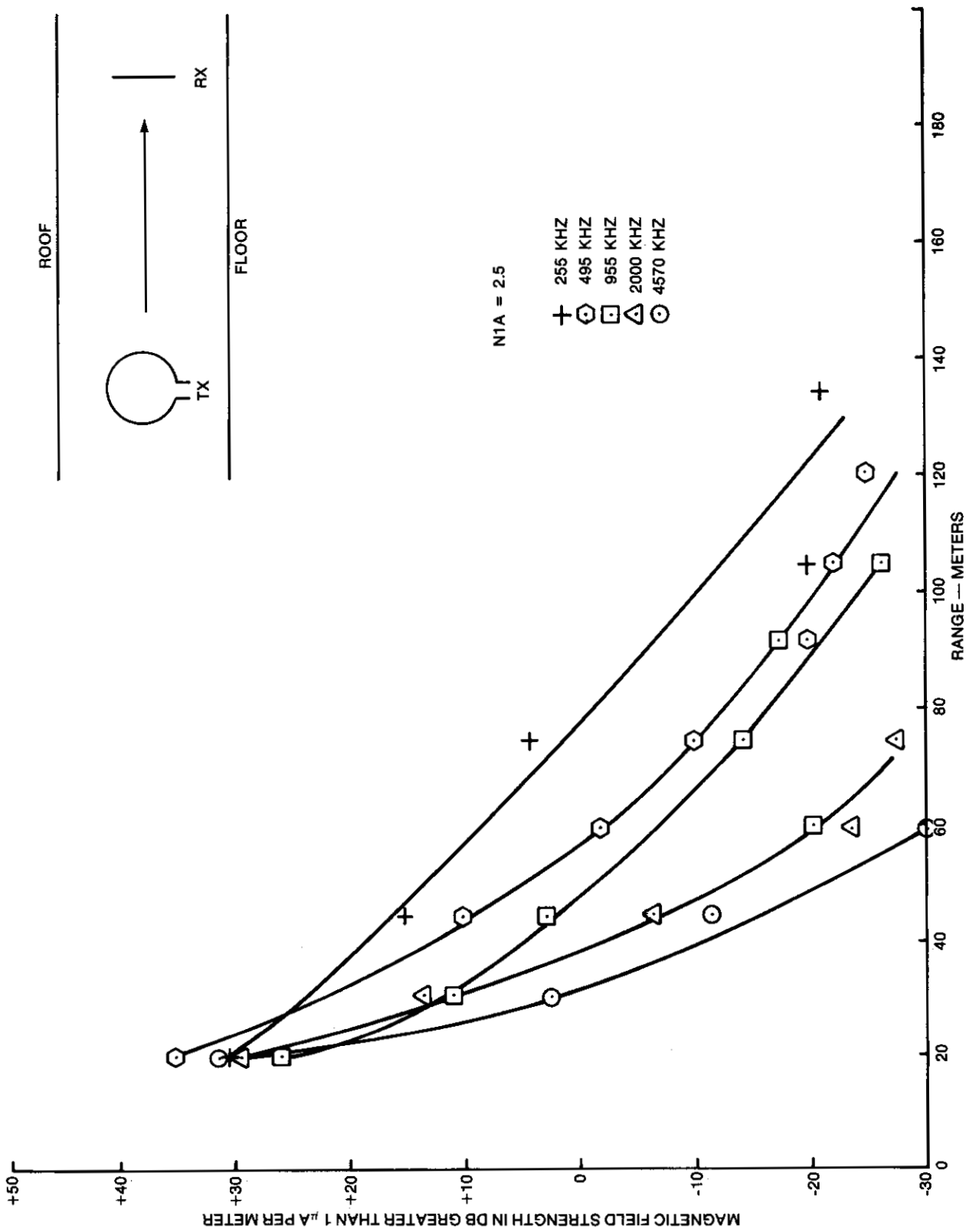

Figure A2-11. Magnetic Field Strength Vs Range in Quasi-Conductor-Free Area of 1 Main East for Coplanar HMD Transmit and Parallel HMD Receive Antenna Orientations.

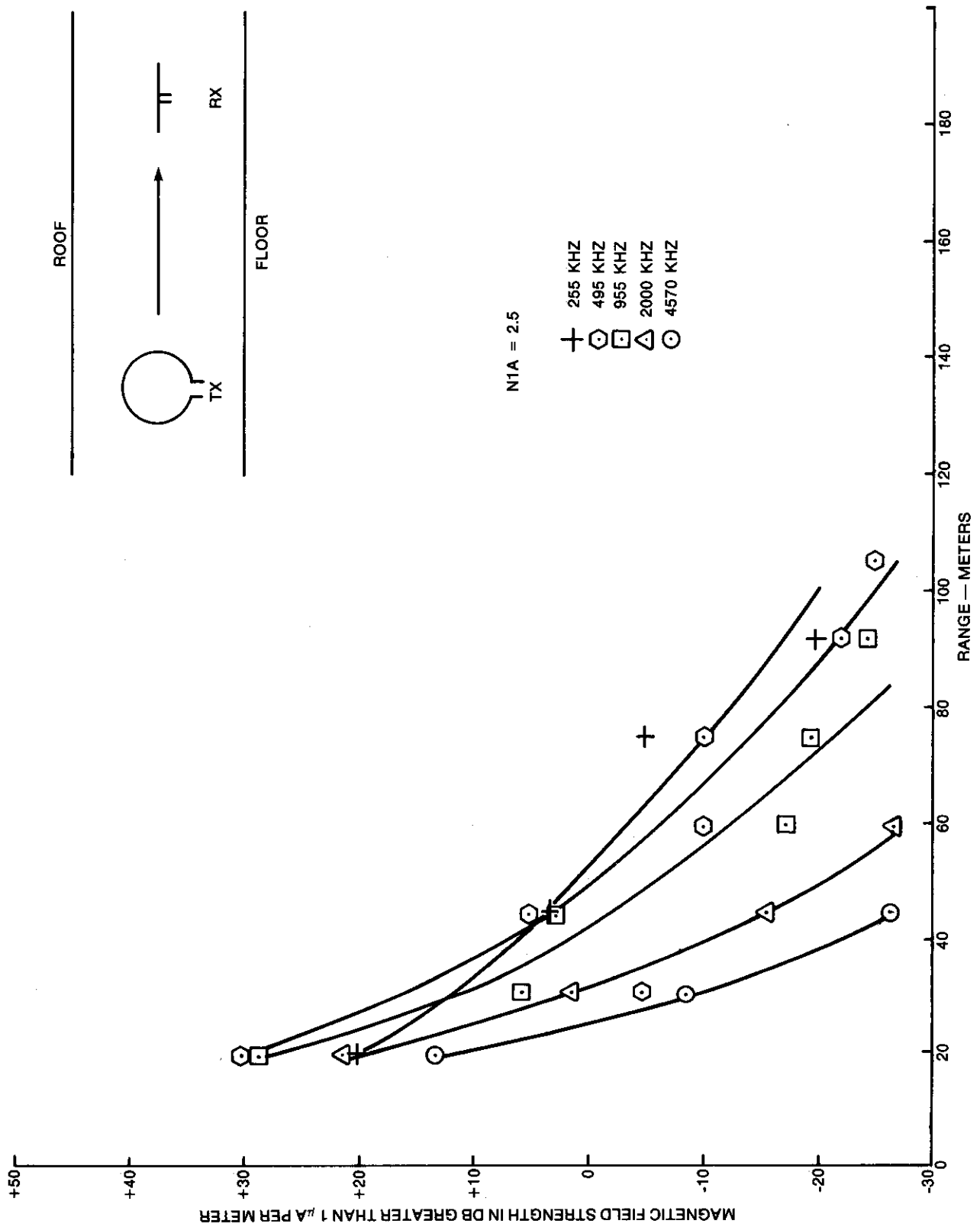

Figure A2-12. Magnetic Field Strength Vs Range in Quasi-Conductor-Free Area of 1-Main East For Coplanar HMD Transmit and VMD Receive Antenna Orientations.

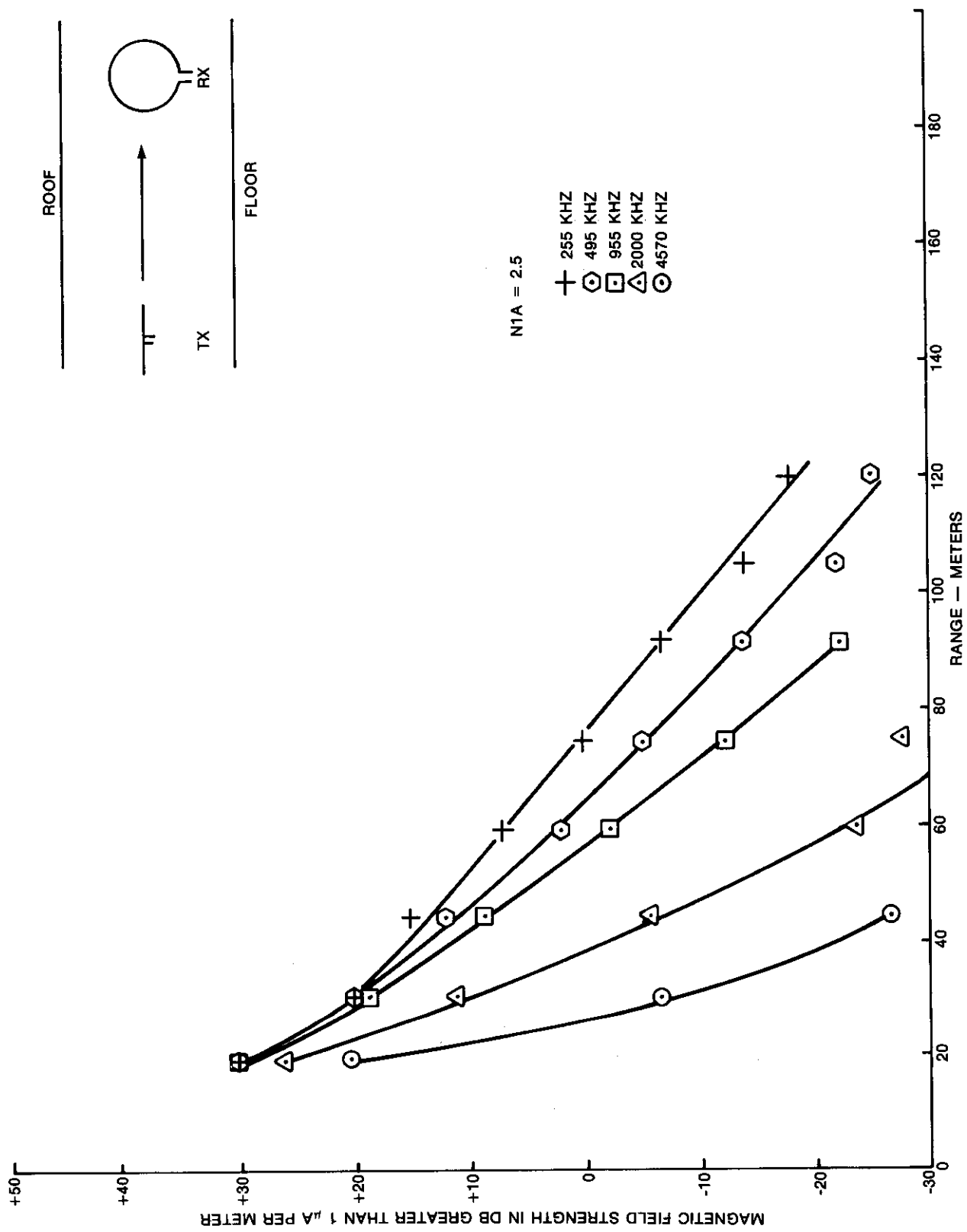

Figure A2-13. Magnetic Field Strength Vs Range in Quasi-Conductor-Free Area of 1-Main East for VMD Transmit and Coplanar Receive Antenna Orientations.

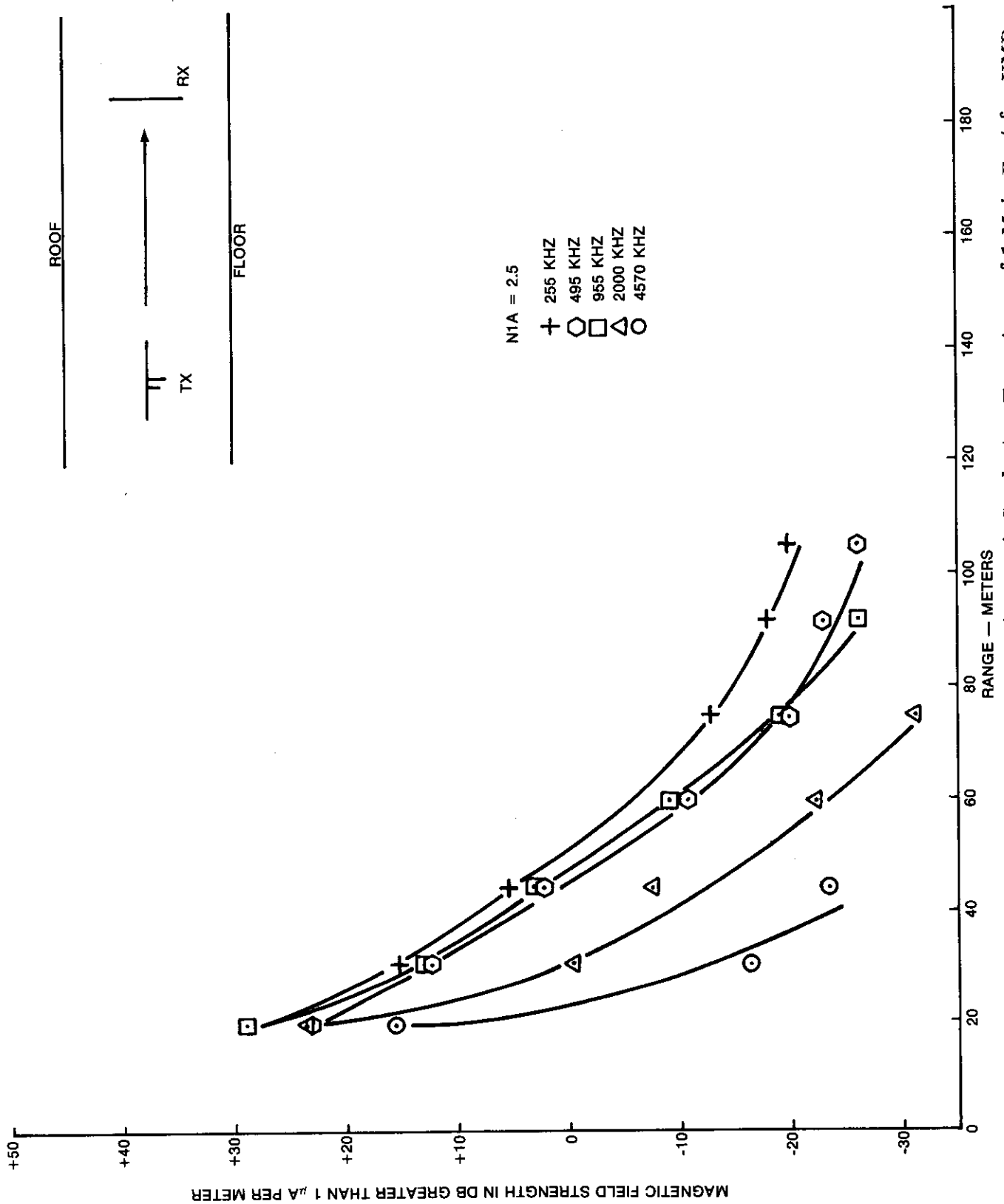

Figure A2-14. Magnetic Field Strength Vs Range in Quasi-Conductor-Free Area of 1 Main East for VMD Transmit and Parallel HMD Receive Antenna Orientations.

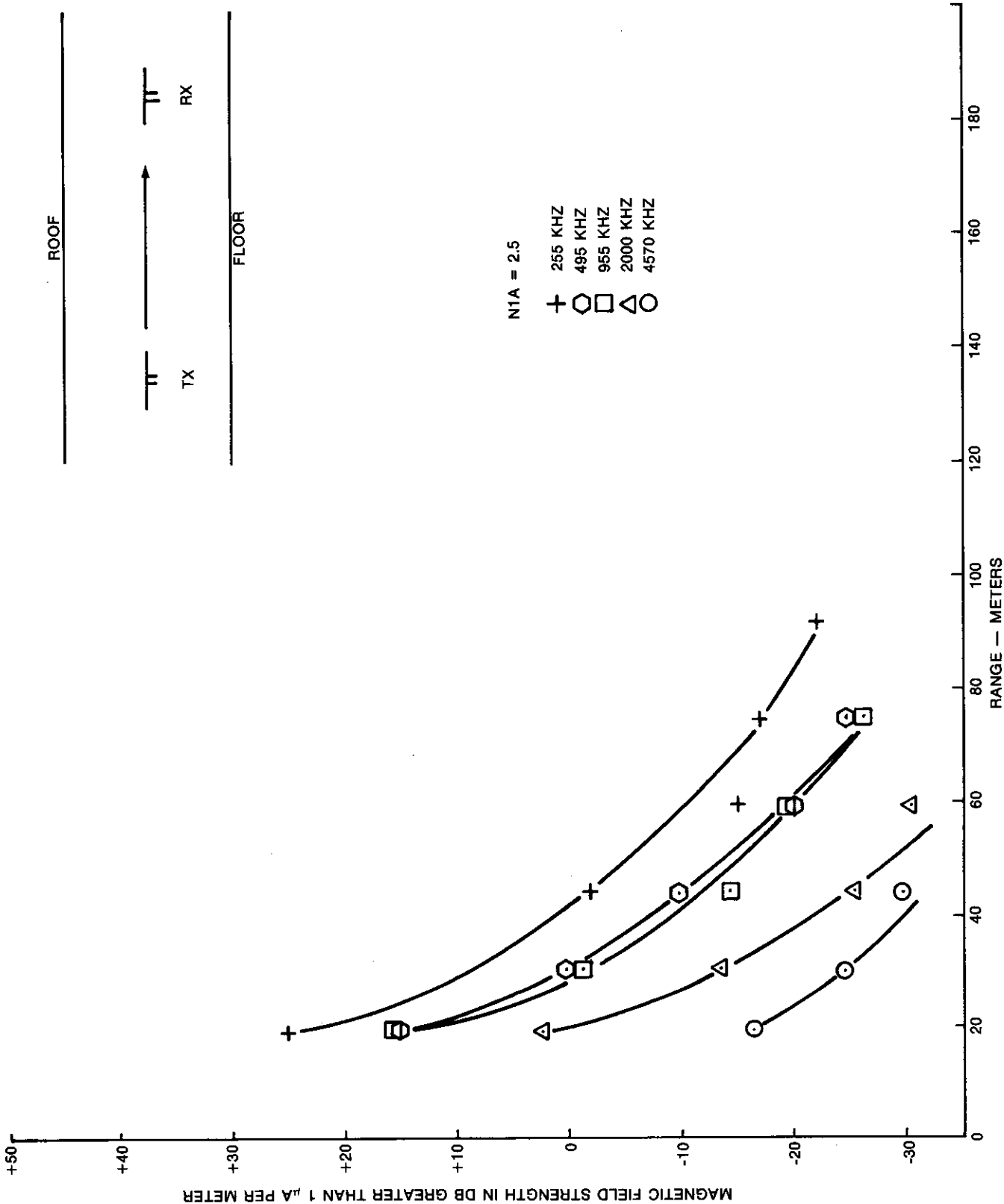

Figure A2-15. Magnetic Field Strength Vs Range in Quasi-Conductor-Free Area of 1 Main East for VMD Orientation of Transmit and Receive Antennas.

APPENDIX A3

CONSOLIDATION COAL MINE NO. 95 (ROBINSON RUN PORTAL)



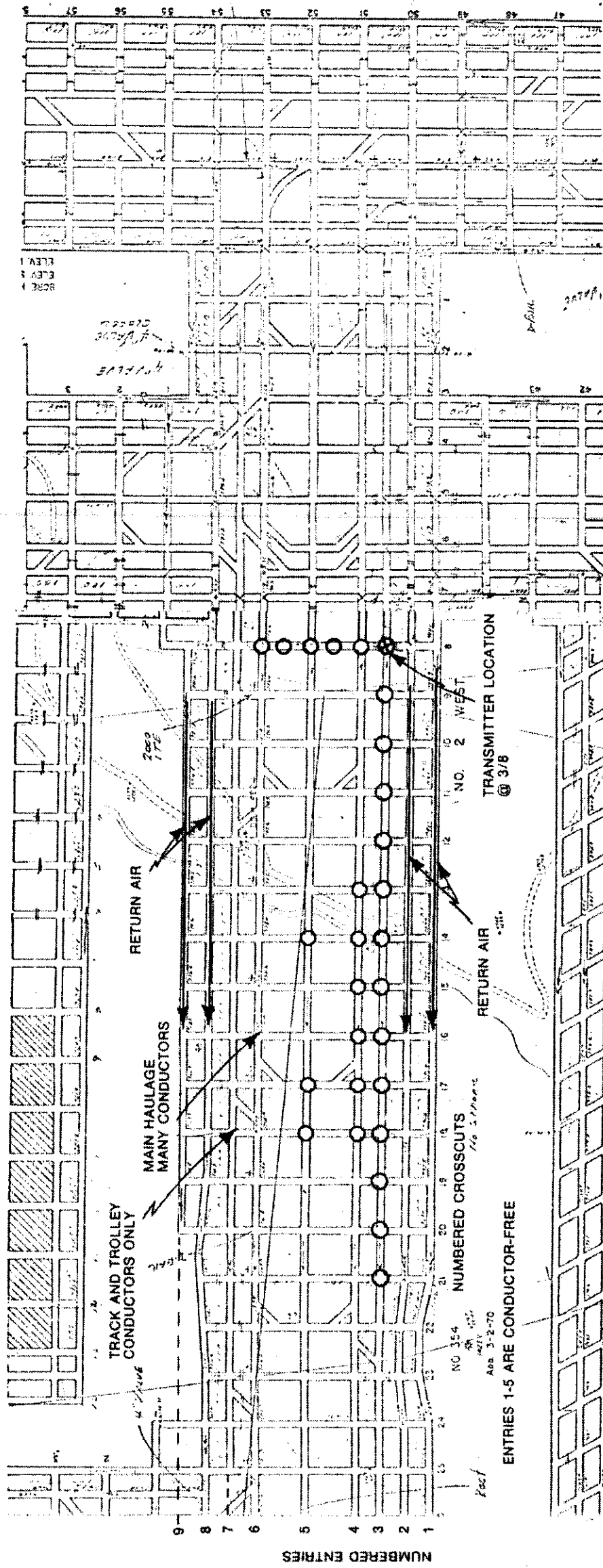

Figure A3-1. Topology of Main North 2 West Area of Consolidation Coal Mine No. 95 (Robinson Run) Showing Quasi-Conductor-Free Test Locations With Transmitter Located at 3/8.

SCALE: 267 FEET = 1 INCH  
 CROSSCUTS ON 100 FOOT CENTERS

ENTRIES 1-5 ARE CONDUCTOR-FREE

NO 354  
 AREA 3-2-70

TRANSMITTER LOCATION  
 @ 3/8

MAIN HAULAGE  
 MANY CONDUCTORS

RETURN AIR

TRACK AND TROLLEY  
 CONDUCTORS ONLY

MAIN NORTH

MAIN NORTH PARALLEL

NUMBERED ENTRIES

NUMBERED CROSSCUTS

SCORE  
 ELEV  
 ELEV

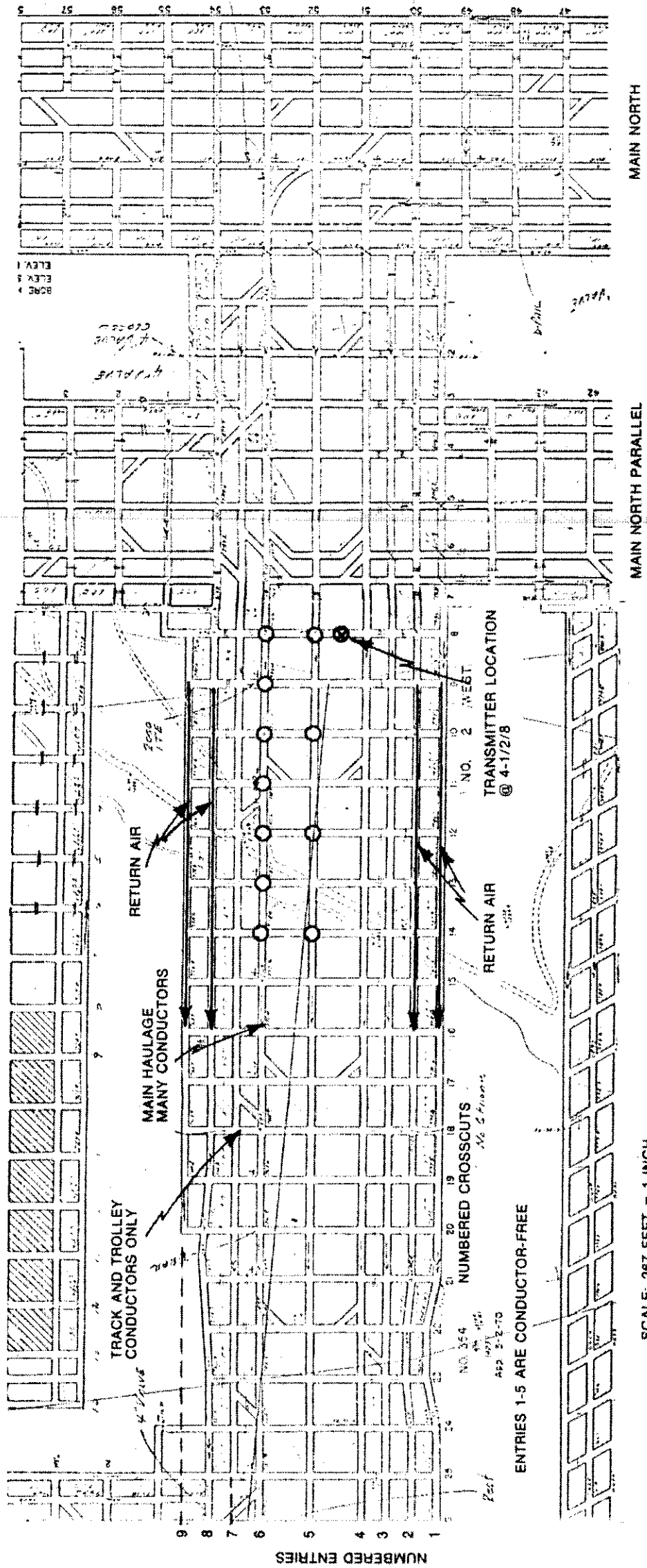

SCALE: 267 FEET = 1 INCH  
 CROSSCUTS ON 100 FOOT CENTERS

Figure A3-2. Topology of Main North 2 West Area of Consolidation Coal Mine No. 95 (Robinson Run) Showing Conductor-Proximity Test Locations With Transmitter Located at 4-1/2/8.

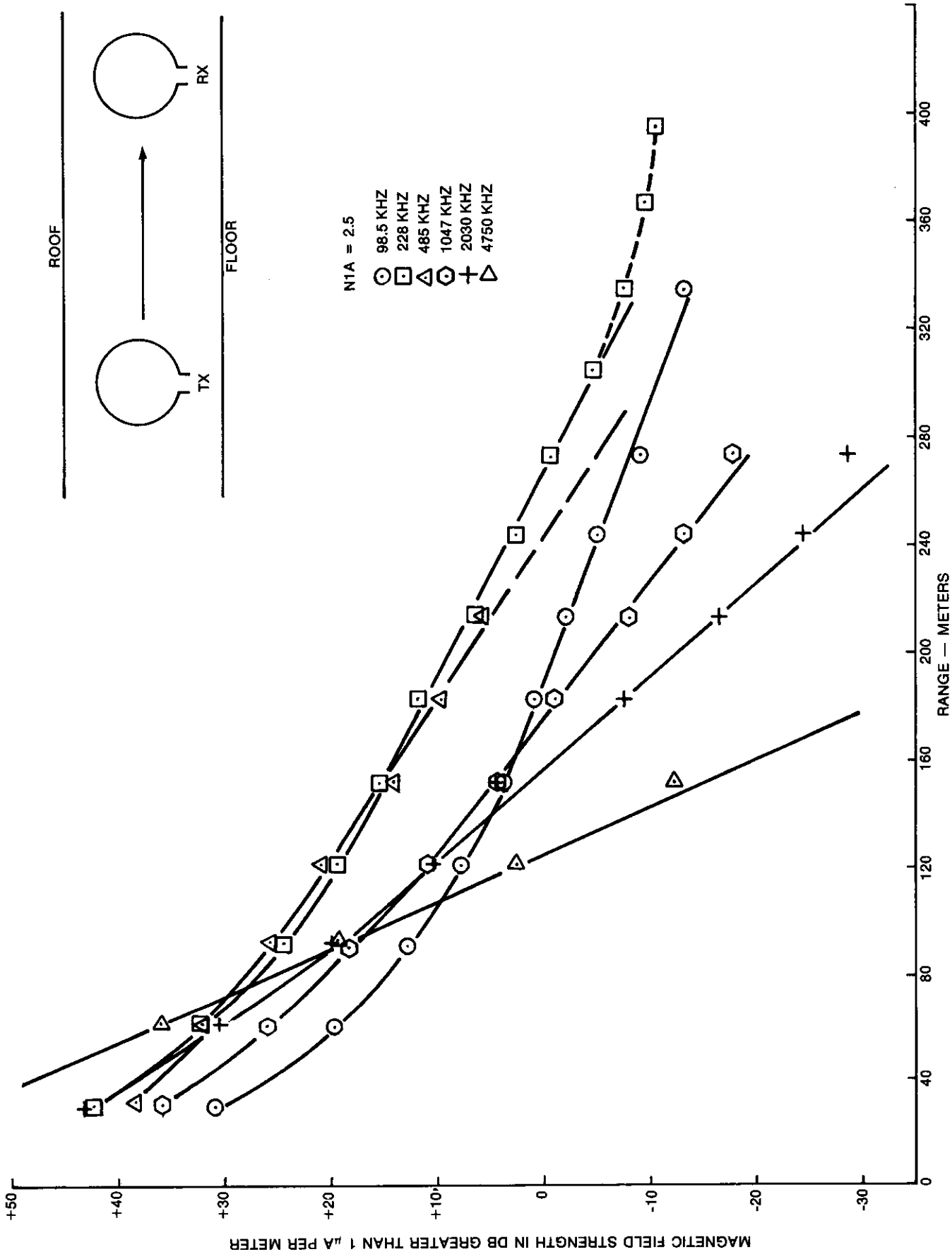

Figure A3-3. Magnetic Field Strength Vs Range in Quasi-Conductor-Free Main North 2 West Area of Consolidation Coal Mine No. 95 (Robinson Run) for Coplanar Orientation of Antennas.

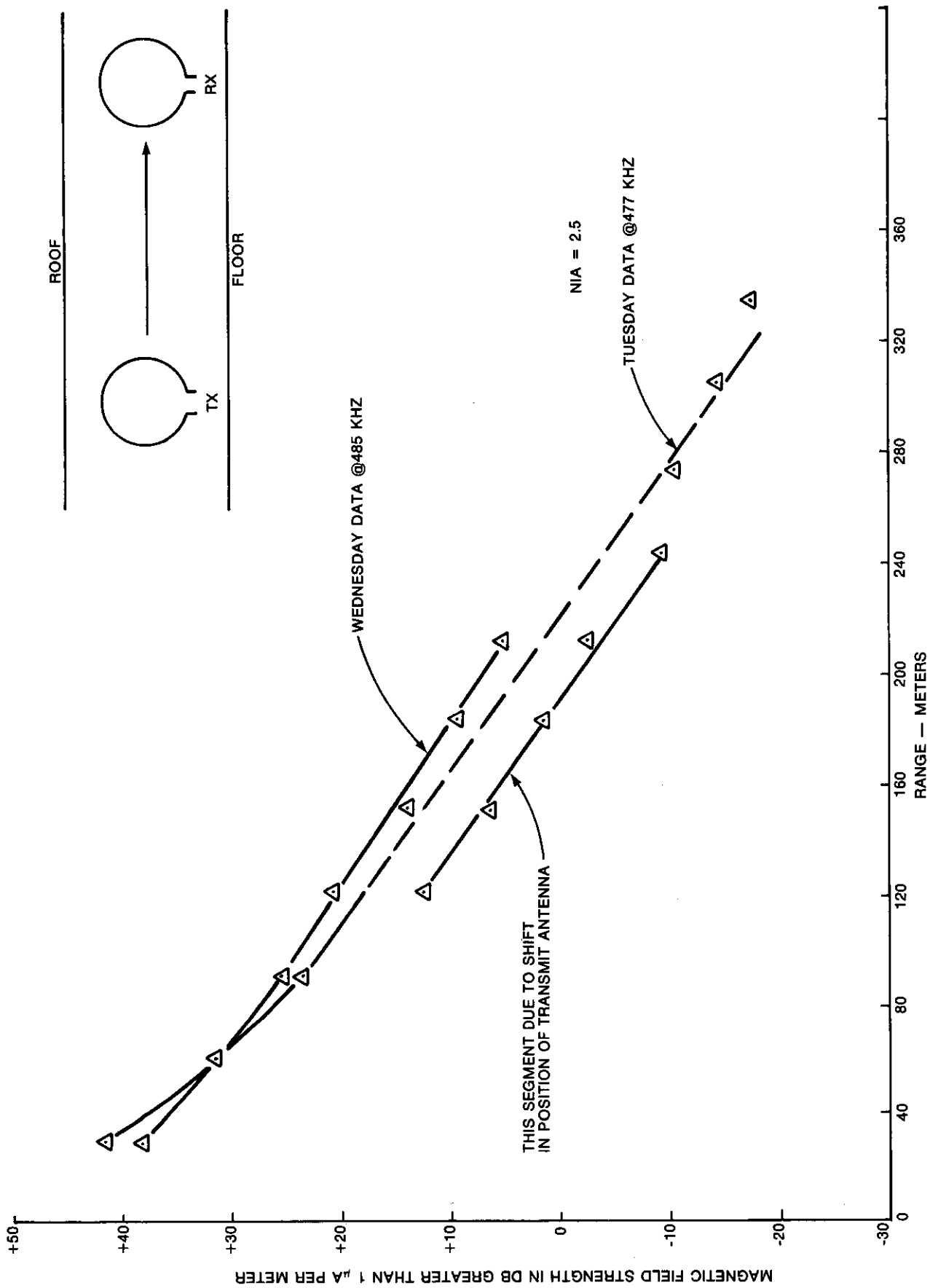

Figure A3-4. Magnetic Field Strength Vs Range in Quasi-Conductor-Free Main North 2 West Area of Consolidation Mine No. 95 (Robinson Run) for Coplanar Orientation of Antennas Comparing Nominal 485 kHz Data From Two Different Days.

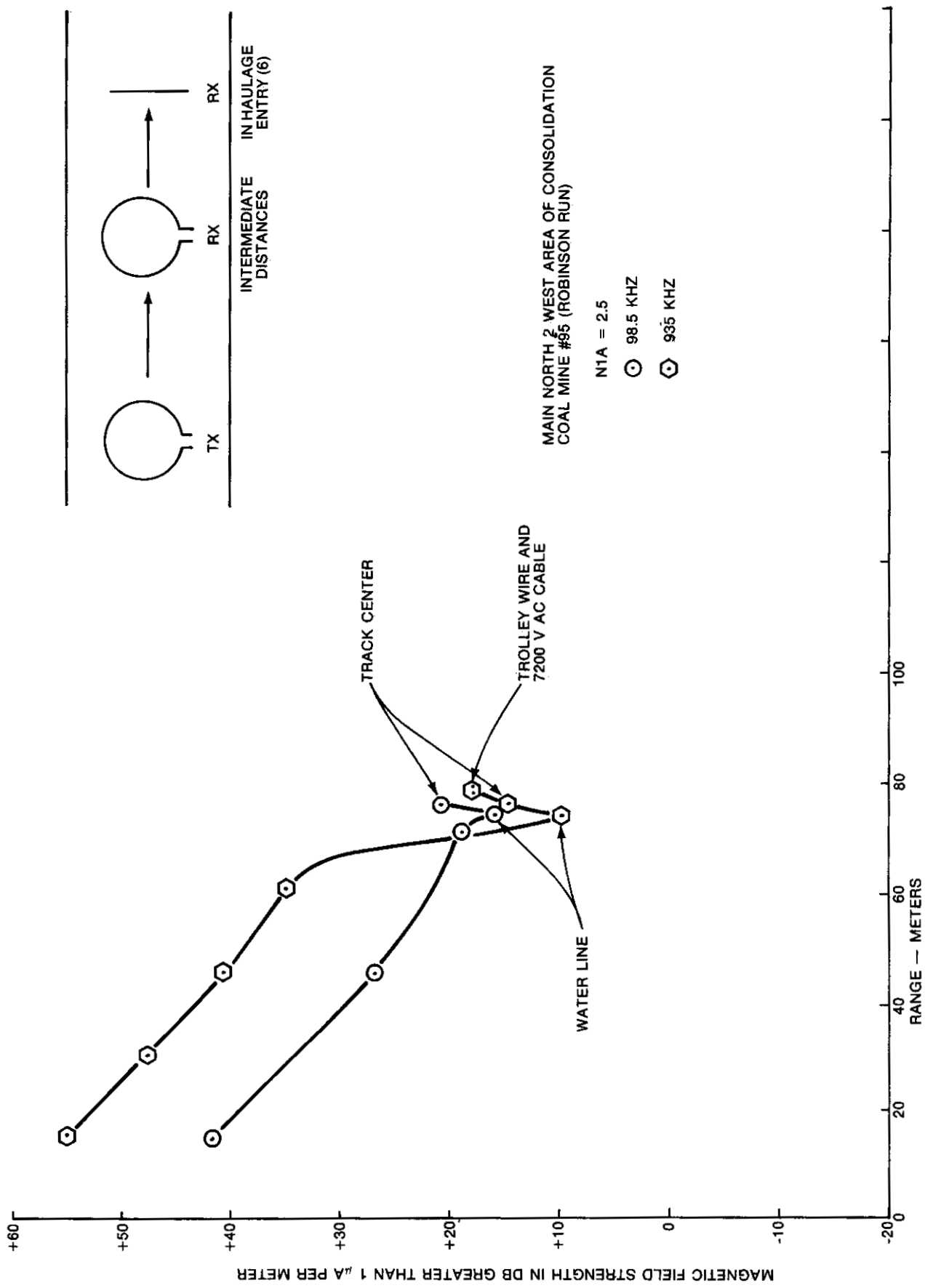

Figure A3-5. Magnetic Field Strength Vs Range on a Transverse Path to Conductors (Crosscut 8) With Transmit Loop Plane Oriented Parallel to the Path and With the Receive Loop Plane Oriented for Maximum Signal.

MAIN NORTH 2 WEST AREA OF CONSOLIDATION COAL MINE #86 (ROBINSON RUN)

NIA = 2.5

○ --- ENTRY 5  
 △ --- ENTRY 6

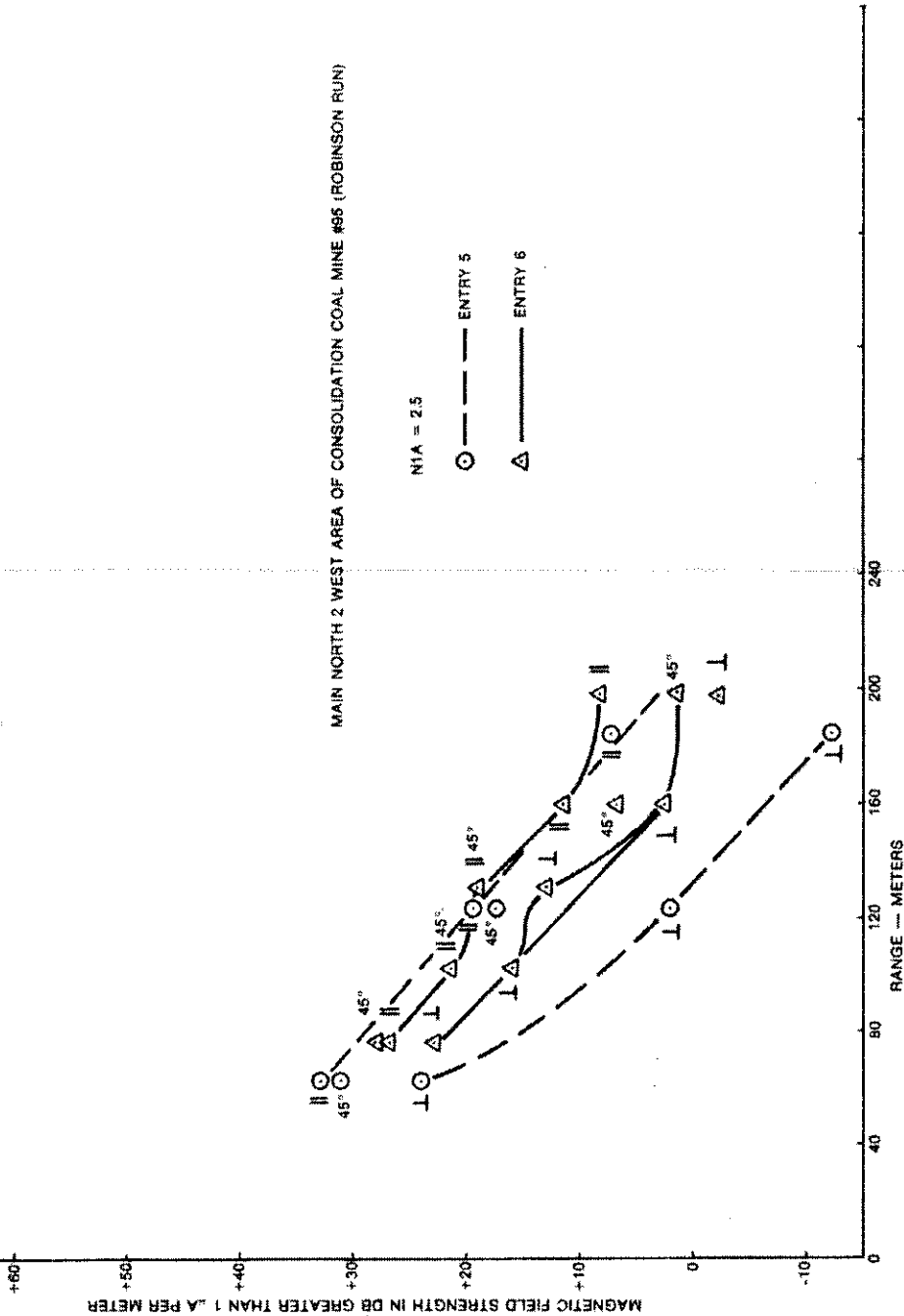

Figure A3-6. Magnetic Field Strength Vs Range at 935 kHz Taken on Two Paths Parallel to Conductors With Transmitter Located Nominally 46 Meters Away From Conductors in Entry 6 With Transmit Antenna Loop Plane Oriented Parallel to Conductors (Receive Antenna Orientations as Shown) NIA = 2.5.

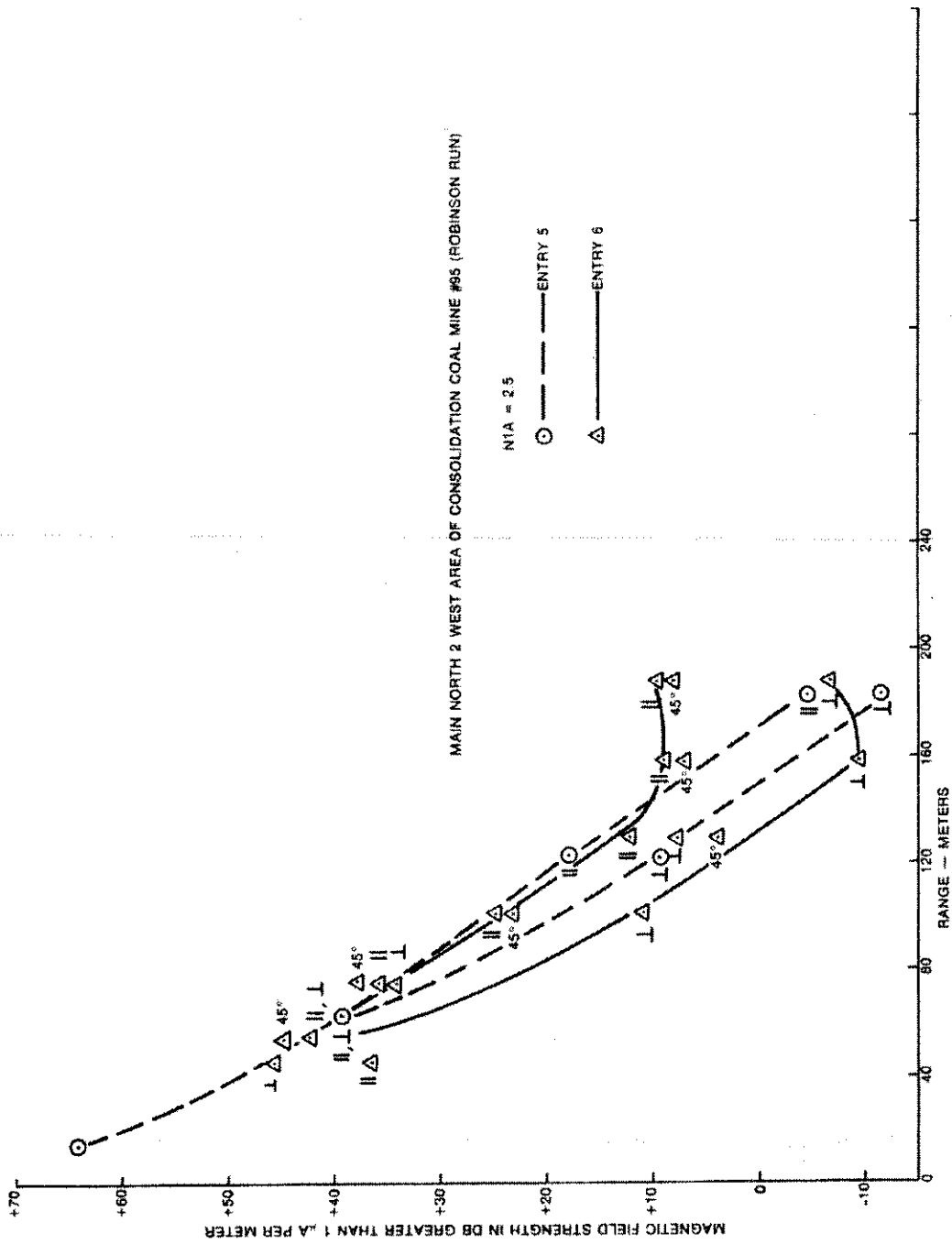

Figure A3-7. Magnetic Field Strength Vs Range at 3960 kHz Taken on Two Paths Parallel to Conductors With Transmitter Located Nominally 46 Meters Away From Conductors in Entry 6 With Transmit Antenna Loop Plane Oriented Parallel to Conductors (Receive Antenna Orientations as Shown) NIA = 2.5.

APPENDIX A4

EASTERN ASSOCIATED COAL FEDERAL NO. 1 MINE (EDDY PORTAL)





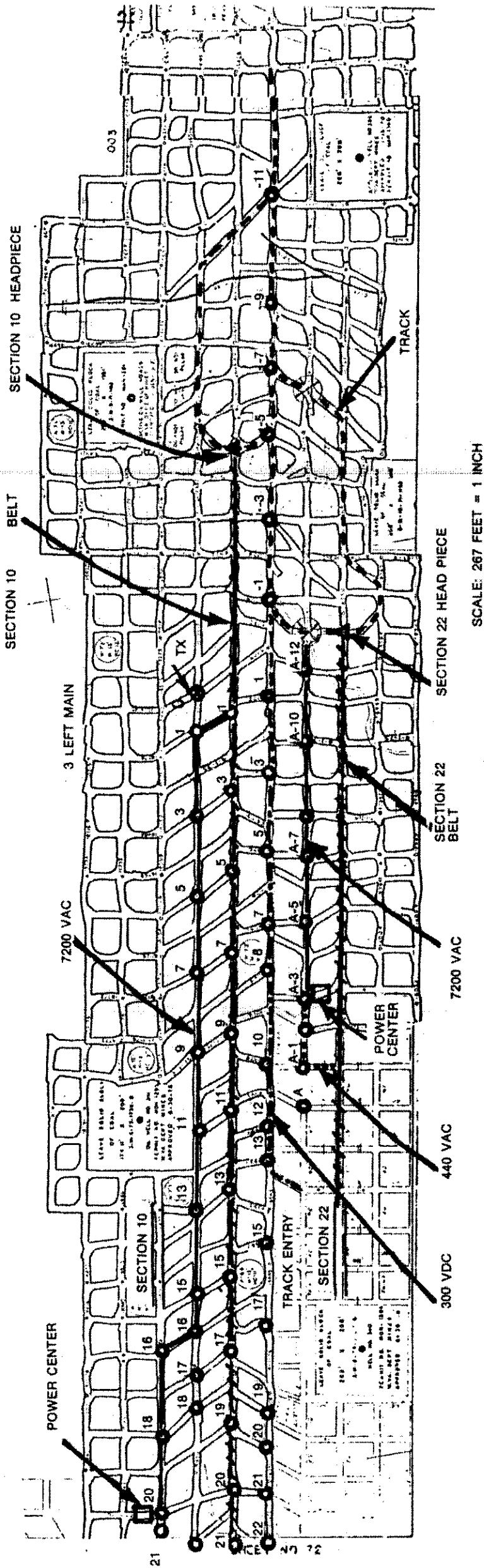

Figure A4-2. Topology of 3 Main Left Working Sections 10 and 22 in Eastern Associated Coal Federal No. 1 Mine (Eddy Portal) Showing Conductor-Proximity Test Locations With Transmitter Located at Station Zero in Section 10 Power Cable Entry.

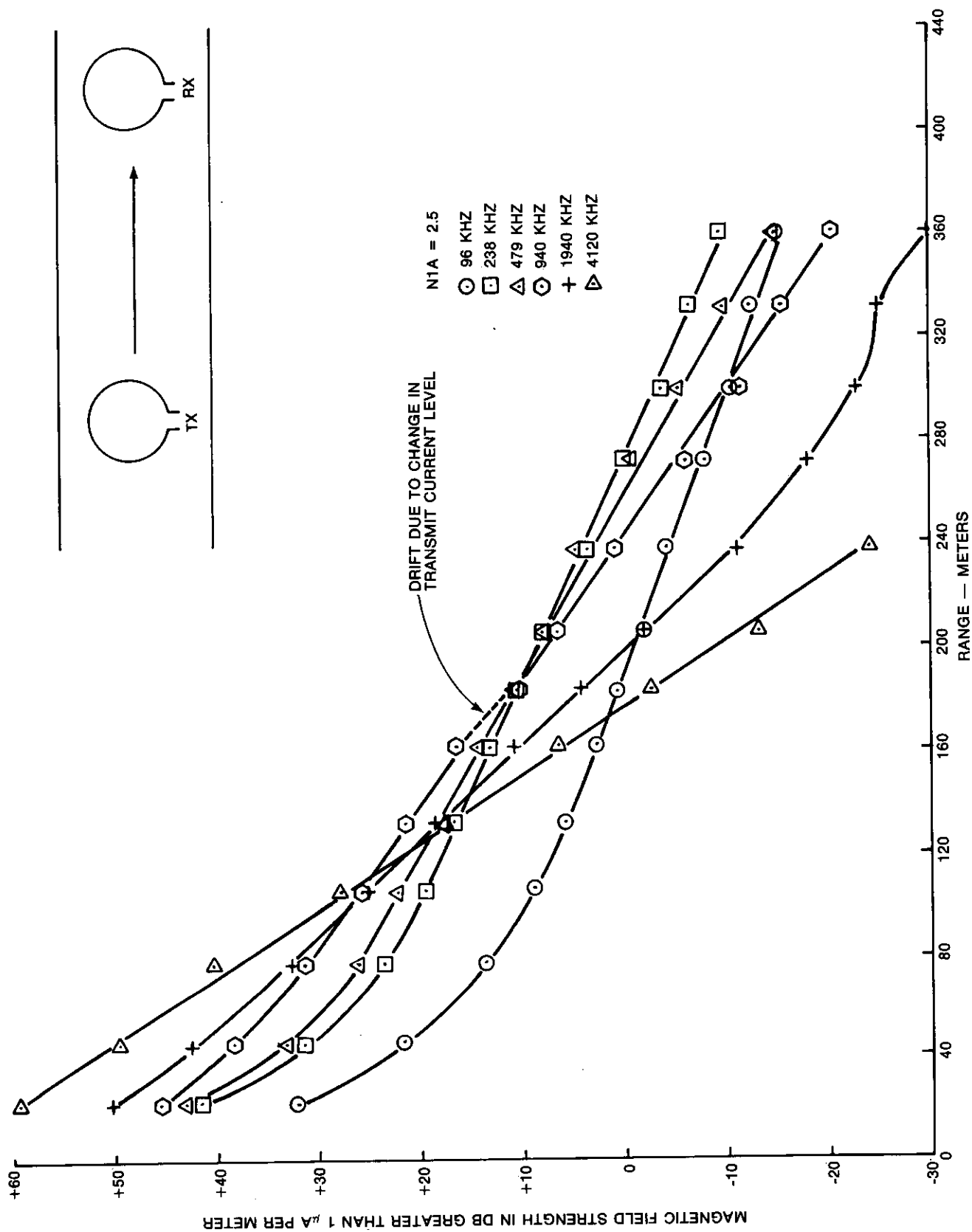

Figure A4-3. Magnetic Field Strength Vs Range in Quasi-Conductor-Free 8 Main North Area of Eastern Associated Coal Federal No. 1 Mine (Eddy Portal) for Coplanar Orientation of Antennas.

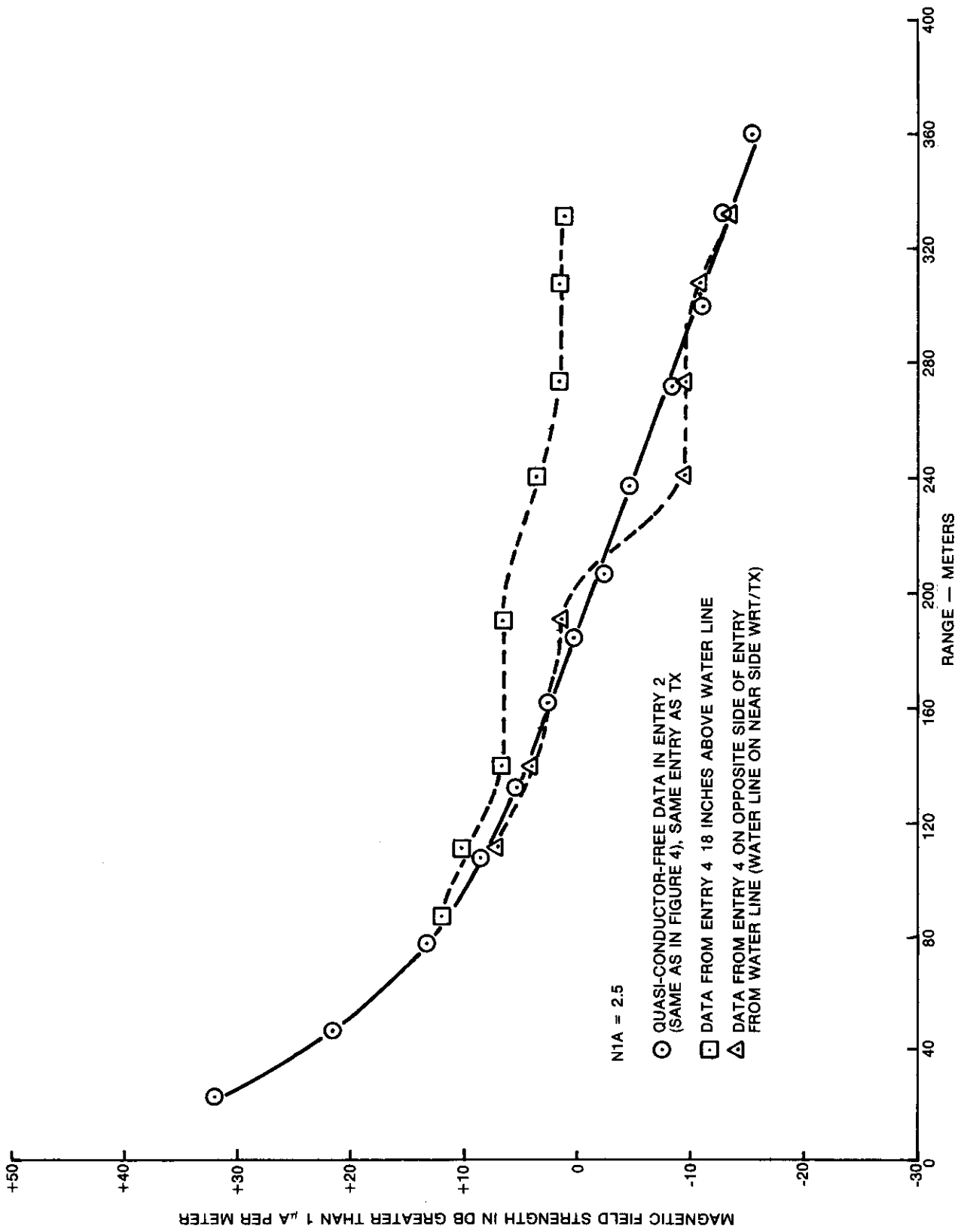

Figure A4-4. Magnetic Field Strength Vs Range in Quasi-Conductor-Free 8 Main North Area of Eastern Associated Coal Federal No. 1 Mine (Eddy Portal) Comparing Data Taken in Same Entry as Transmitter With Data Taken in Entry 4 Containing the Water Line Including Data Taken Directly Over the Water Line -96 kHz.

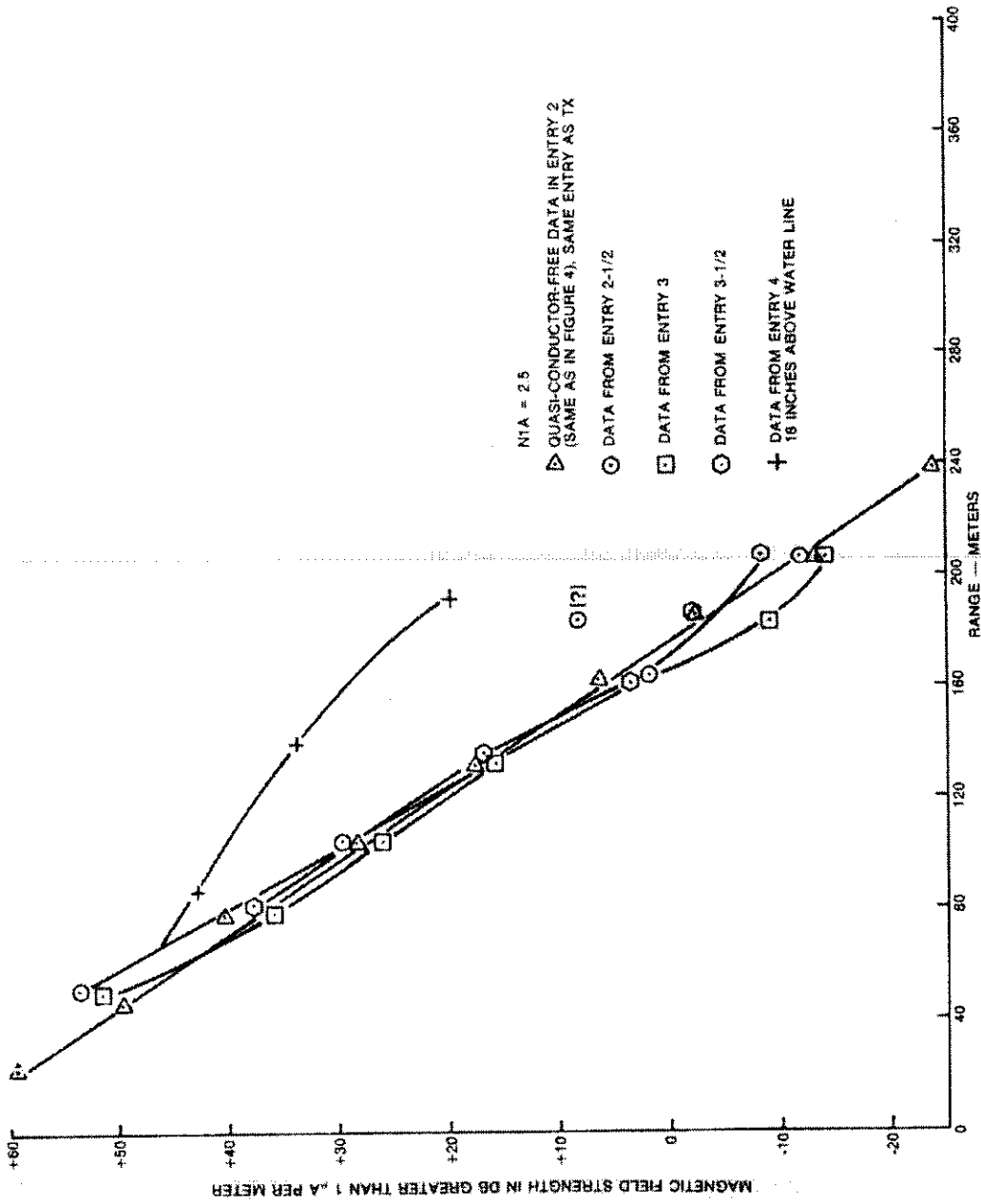

Figure A4-5. Magnetic Field Strength Vs Range in Quasi-Conductor-Free 8 Main North Area of Eastern Associated Coal Federal No. 1 Mine (Eddy Portal) Showing Effect of Data Taken in Different Entries and Paths Parallel to Entries at 4120 kHz Including Data Directly Over Water Line in Entry 4.

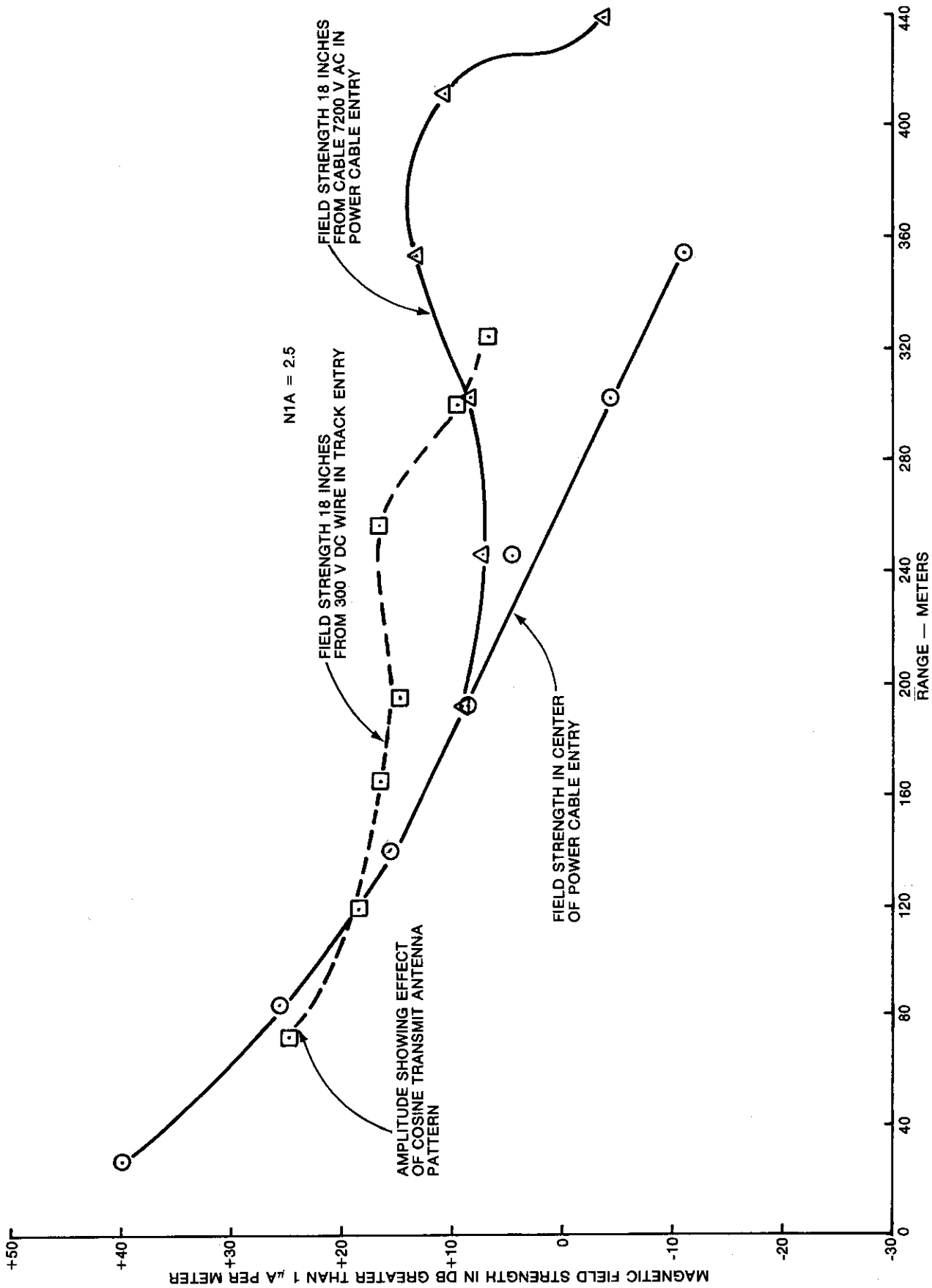

Figure A4-6. Magnetic Field Strength Vs Range in 3 Left Main Section 10 Area of Eastern Associated Coal Federal No. 1 Mine (Eddy Portal) in Power Cable and Track Entries for Transmit Antenna Located 27 Meters From 7200 V AC Cable and With Transmit Antenna Loop Plane Oriented HMD Parallel With Entries at 236 kHz.

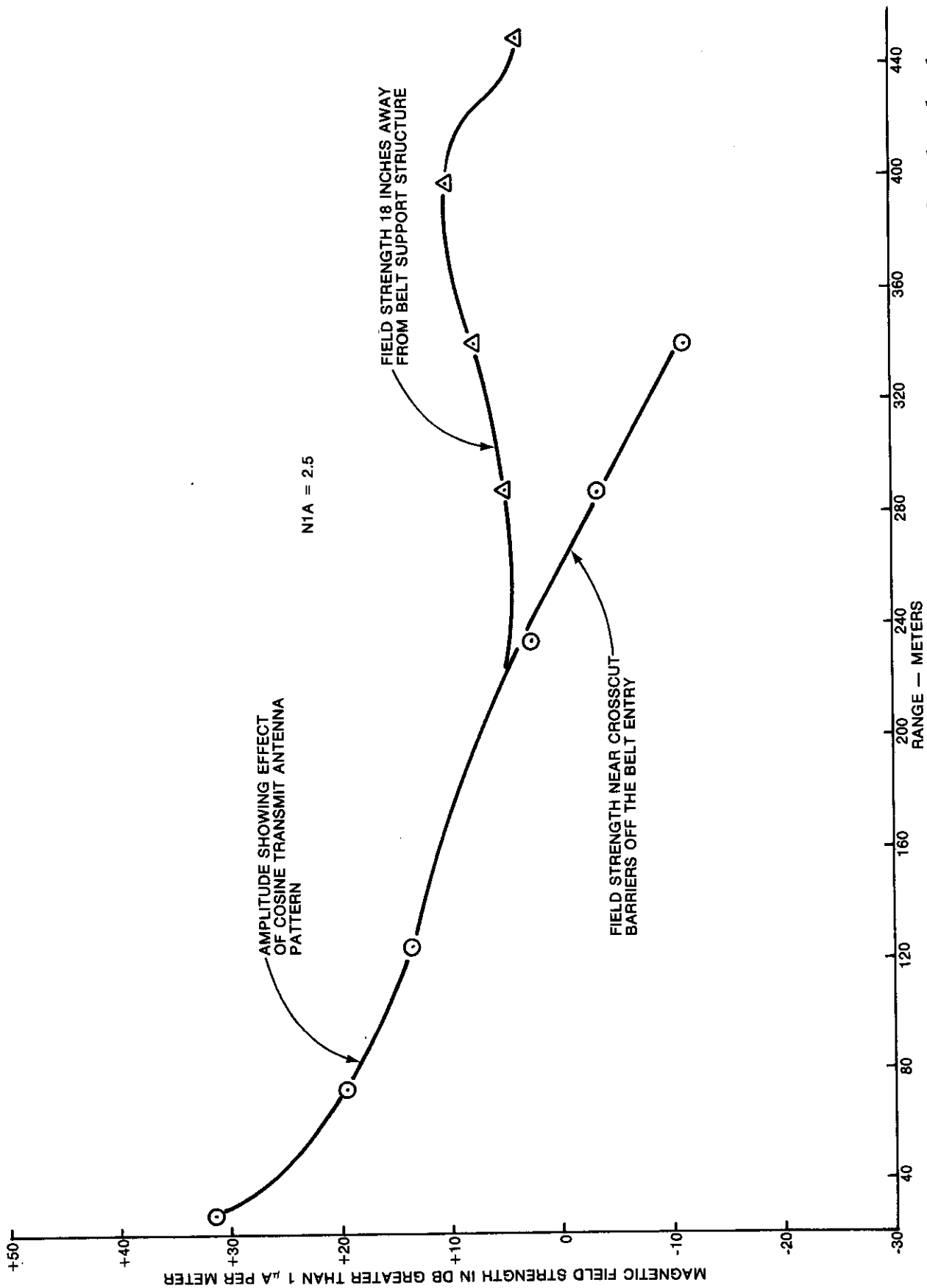

Figure A4-7. Magnetic Field Strength Vs Range in 3 Left Main Section 10 of Eastern Associated Coal Federal No. 1 Mine (Eddy Portal) in Belt Entry for Transmit Antenna Located 27 Meters From 7200 V AC Cable and With Transmit Antenna Loop Plane Oriented HMD Parallel With Entries at 236 kHz.

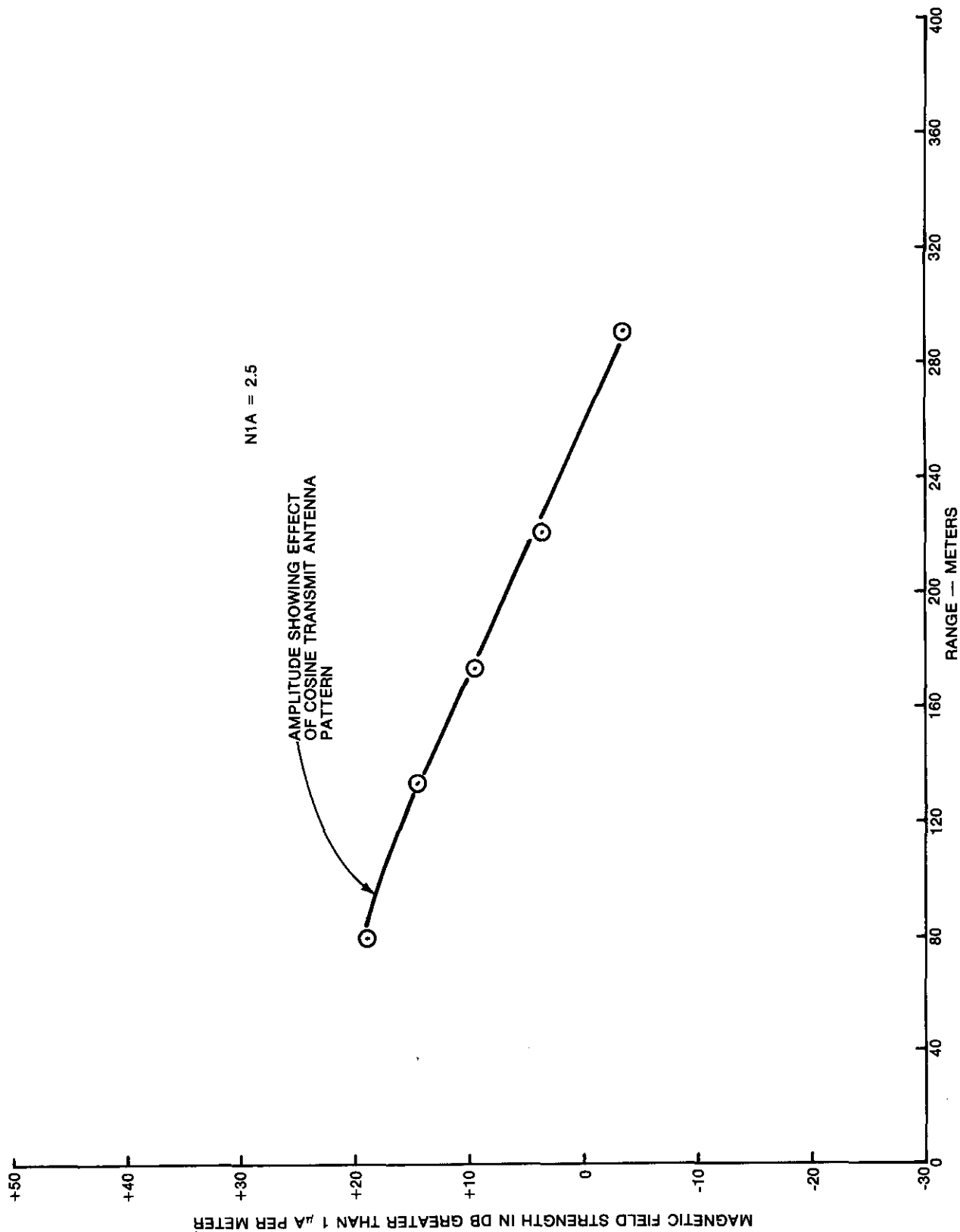

Figure A4-8. Magnetic Field Strength Vs Range in 3 Left Main Section 22 of Eastern Associated Coal Federal No. 1 Mine (Eddy Portal) in Power Cable Entry for Transmit Antenna Located 27 Meters From 7200 V AC Cable in Section 10 and With Transmit Antenna Loop Plane Oriented HMD Parallel With Entries at 236 kHz.



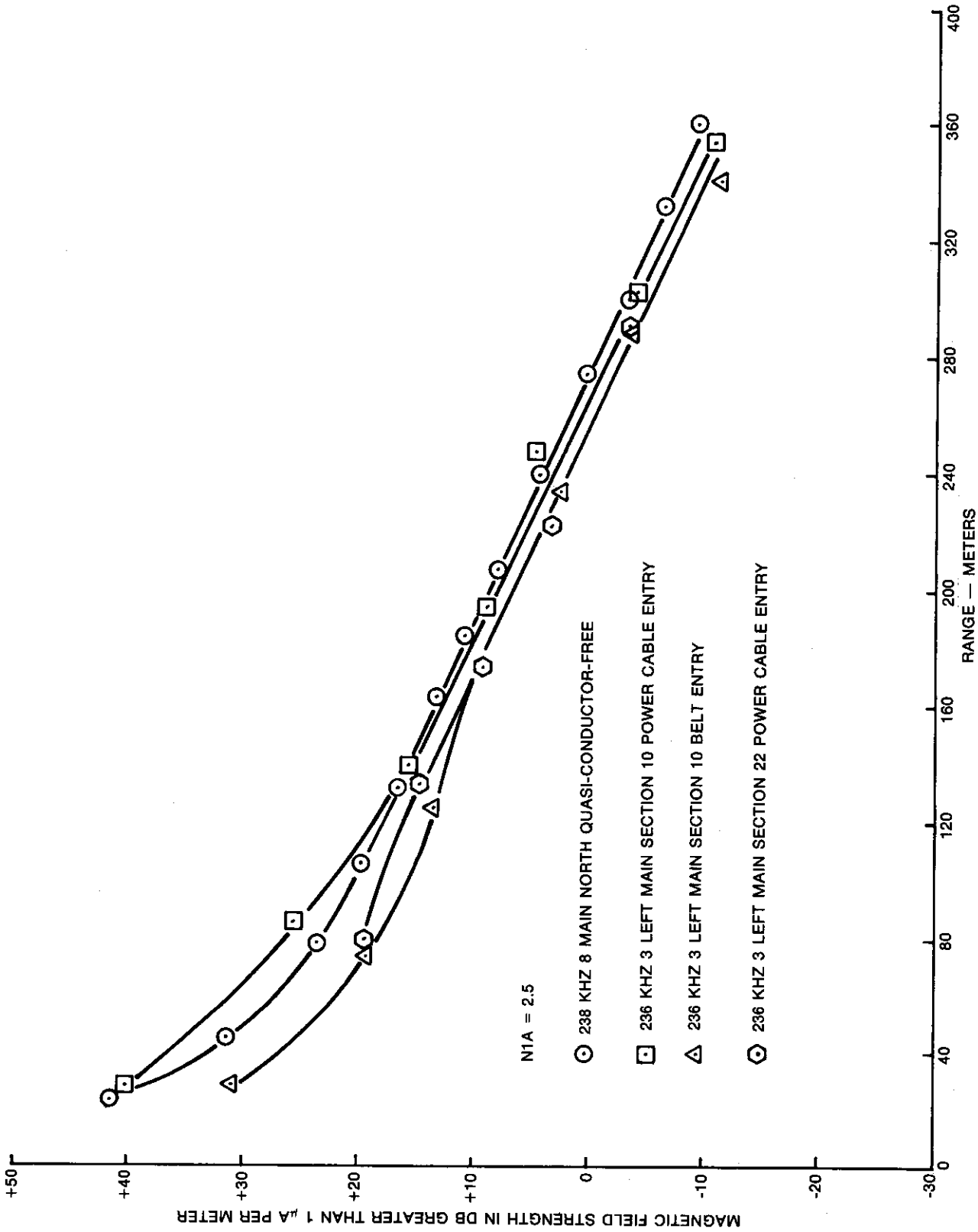

Figure A4-9. Comparison of 236 and 238 kHz Magnetic Field Strength Vs Range Data in Eastern Associated Coal Federal No. 1 Mine (Eddy Portal) in Both Quasi-Conductor-Free and Conductor-Proximity Environments: Quasi-Conductor-Free Curve Segments Only.

APPENDIX A5

ISLAND CREEK COAL CO. VIRGINIA POCAHONTAS NO. 1 MINE

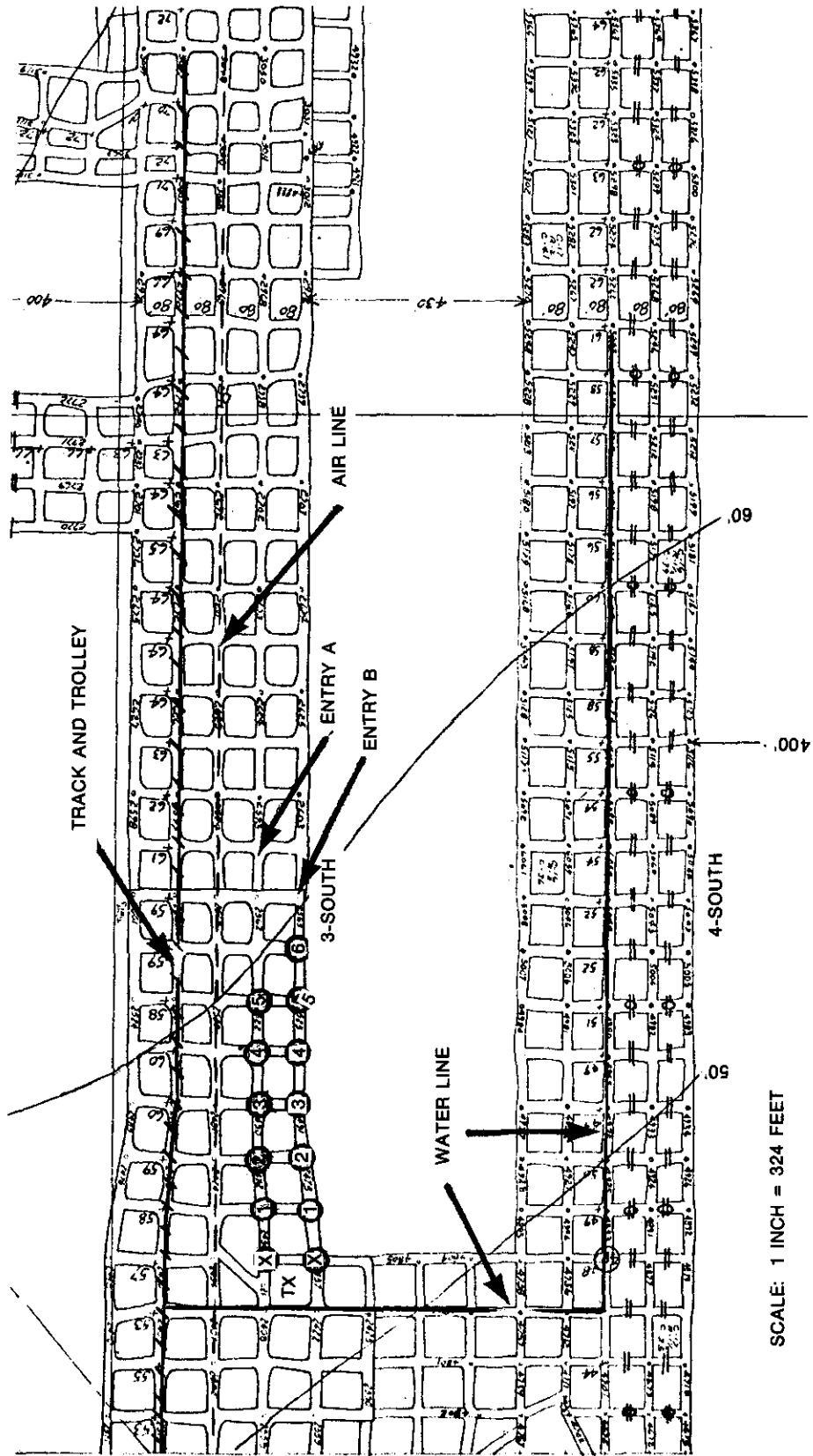

Figure A5-1. Topology of 3-South Area of Island Creek Coal Co. Virginia Pocahontas No. 1 Mine Showing Test Locations for Quasi-Conductor Free Measurements.

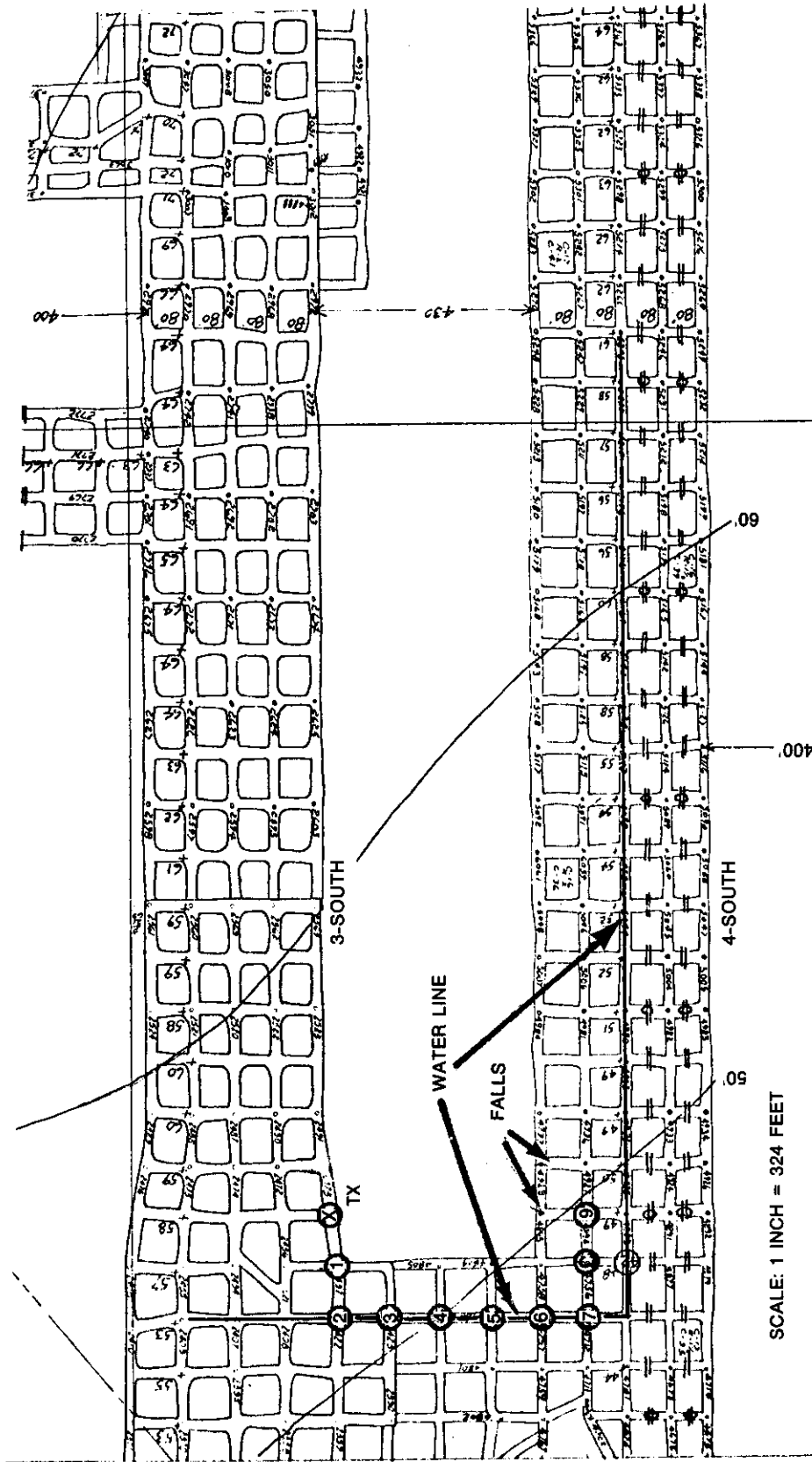

Figure A5-2. Topology of 3-South Area of Island Creek Coal Co. Virginia Pocahontas No. 1 Mine Showing Test Locations for Mine Wireless Radio Tests Through Solid Coal Block.

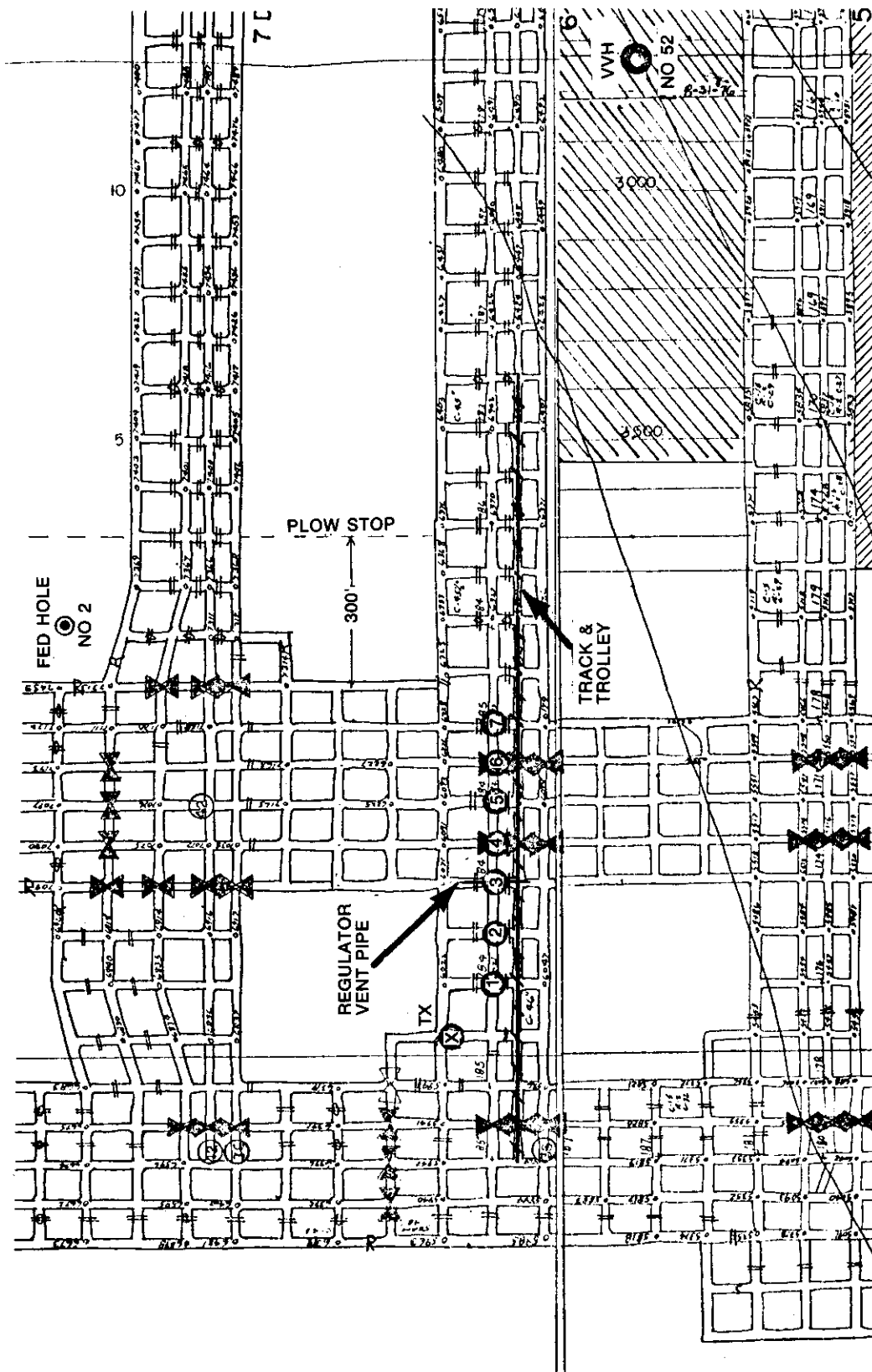

Figure A5-3. Topology of 2 North No. 1 Plow Area of Island Creek Coal Co. Virginia Pocahontas No. 1 Mine Showing Test Locations for Quasi-Conductor-Free Measurements.

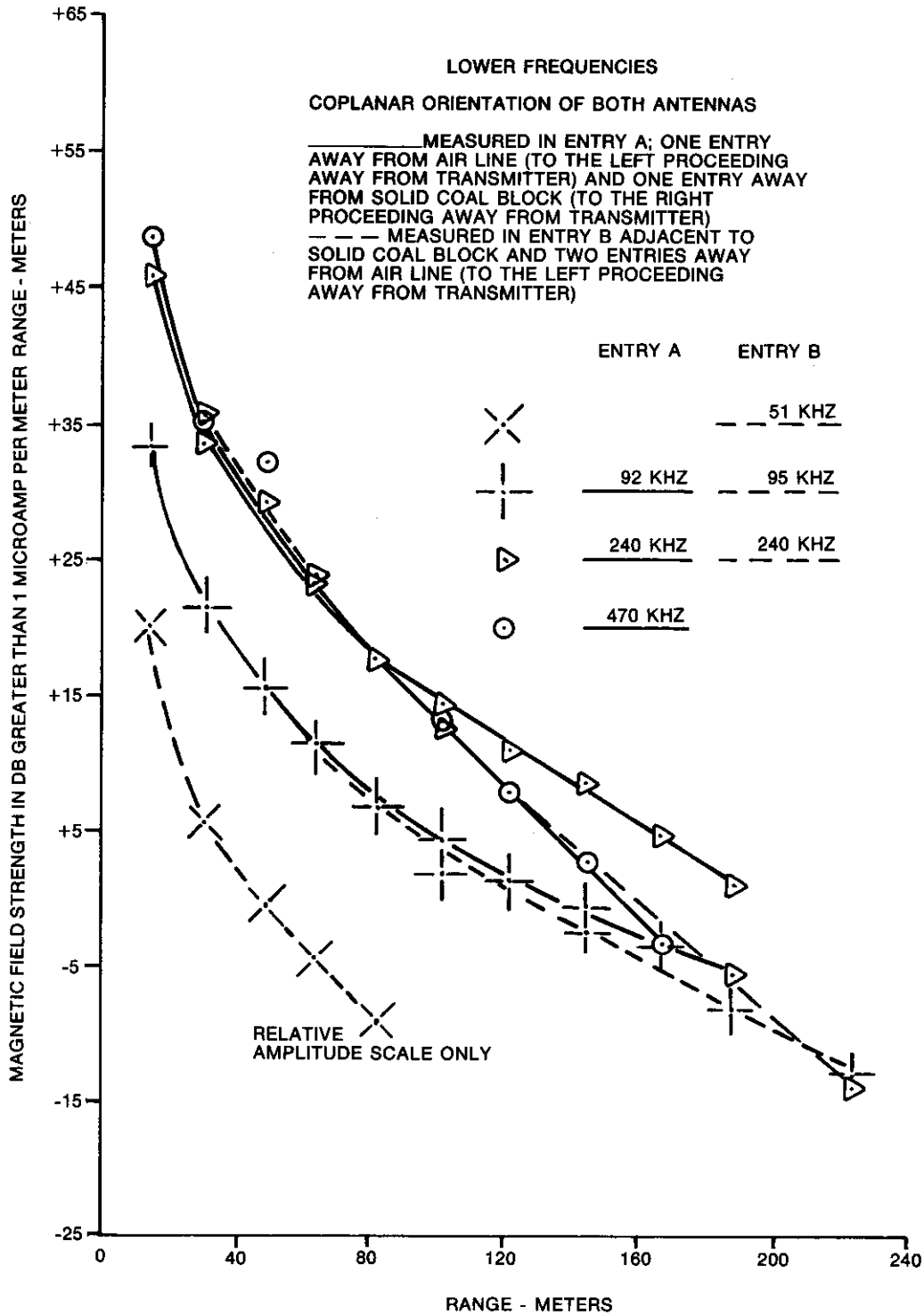

Figure A5-4. Magnetic Field Strength Vs Range in 3-South Area of Island Creek Coal Co. Virginia Pocahontas No. 1 Mine Comparing Two Paths Along Adjacent Entries (TX Located in Measurement Entry for Both Paths) NIA = 2.5.

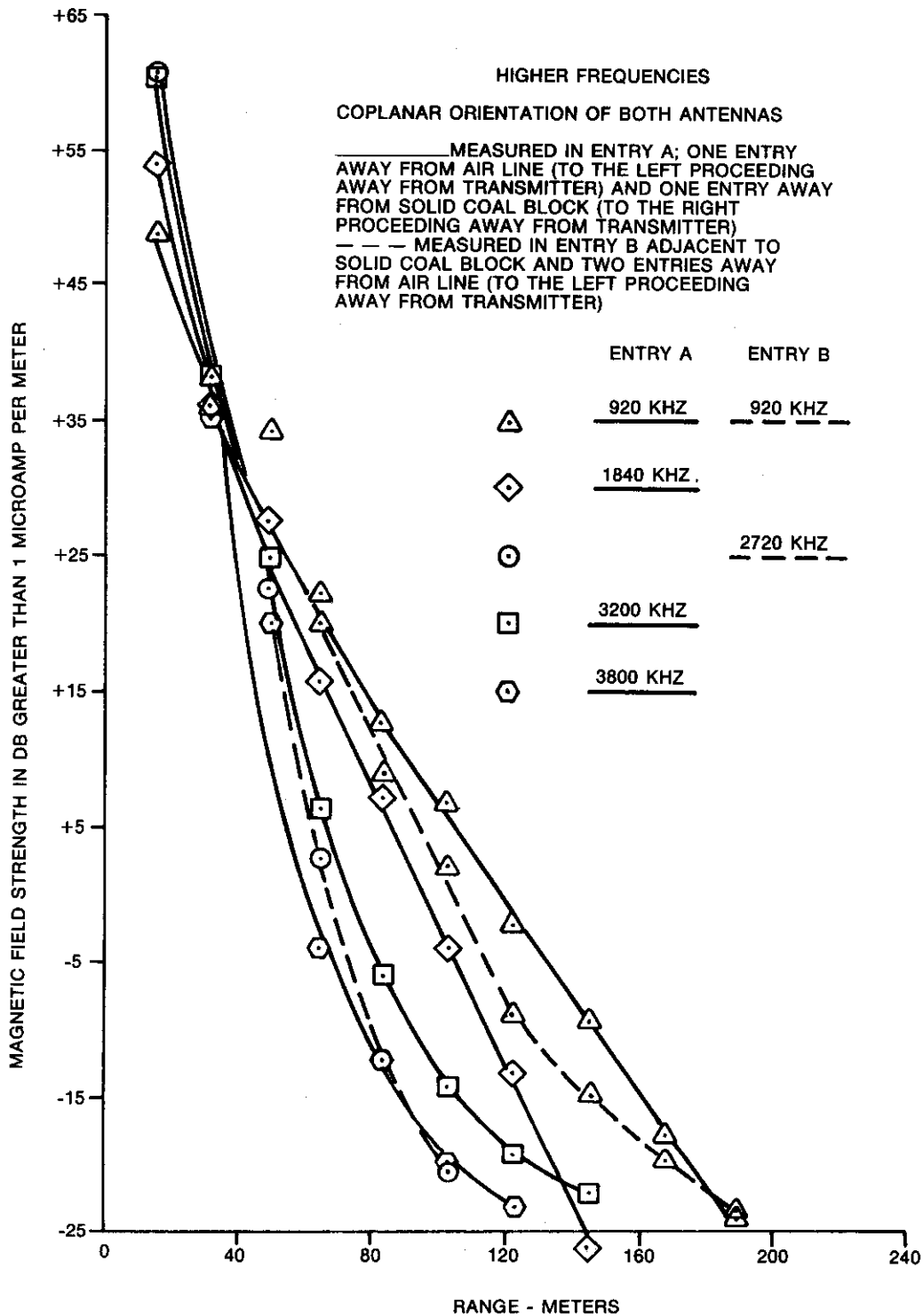

Figure A5-5. Magnetic Field Strength Vs Range in 3-South Area of Island Creek Coal Co. Virginia Pocahontas No. 1 Mine Comparing Two Paths Along Adjacent Entries (TX Located in Measurement Entry for Both Paths) NIA = 2.5.

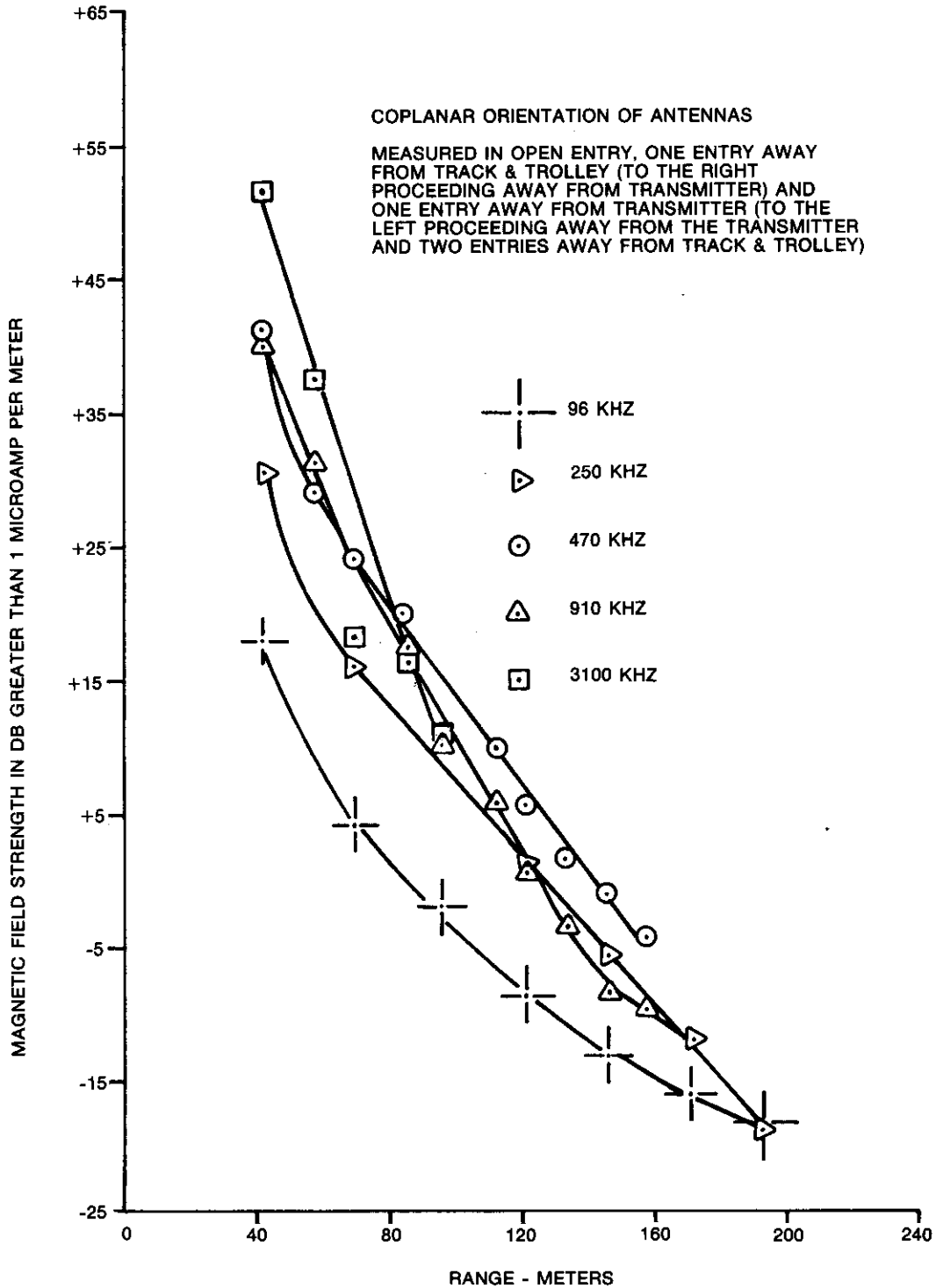

Figure A5-6. Magnetic Field Strength Vs Range in 2-North No. 1 Plow Area of Island Creek Coal Co. Virginia Pocahontas No. 1 Mine (TX Located 1 Entry Away From Measurement Entry) NIA = 2.5.



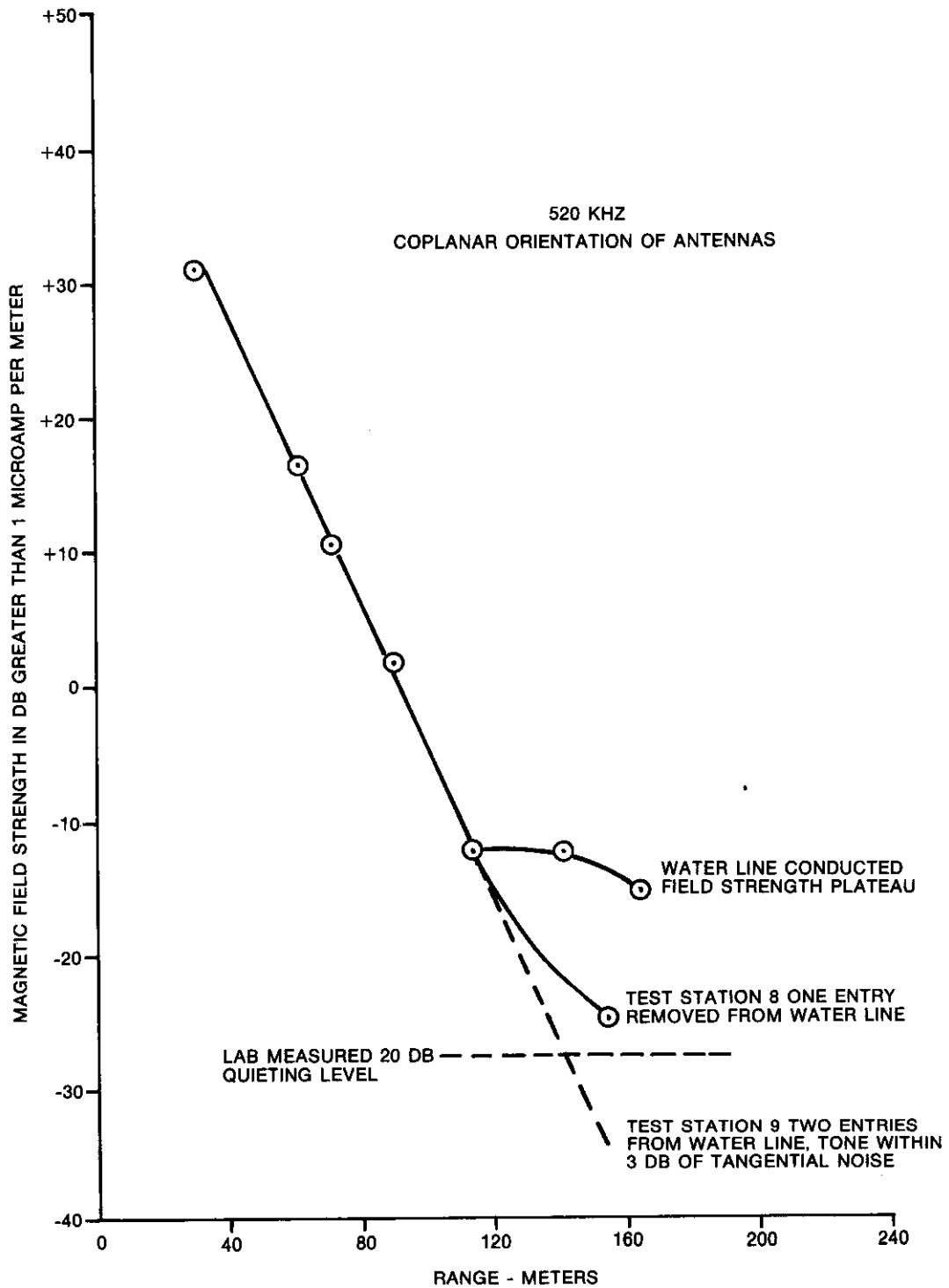

Figure A5-7. Magnetic Field Strength Vs Range in 3-South Area of Island Creek Coal Co. Virginia Pocahontas No. 1 Mine for Collins Mine - Wireless Radio on Path Around and Through Solid Coal Block NIA = 2.5.

APPENDIX A6

PEABODY COAL CO. MINE NO. 10

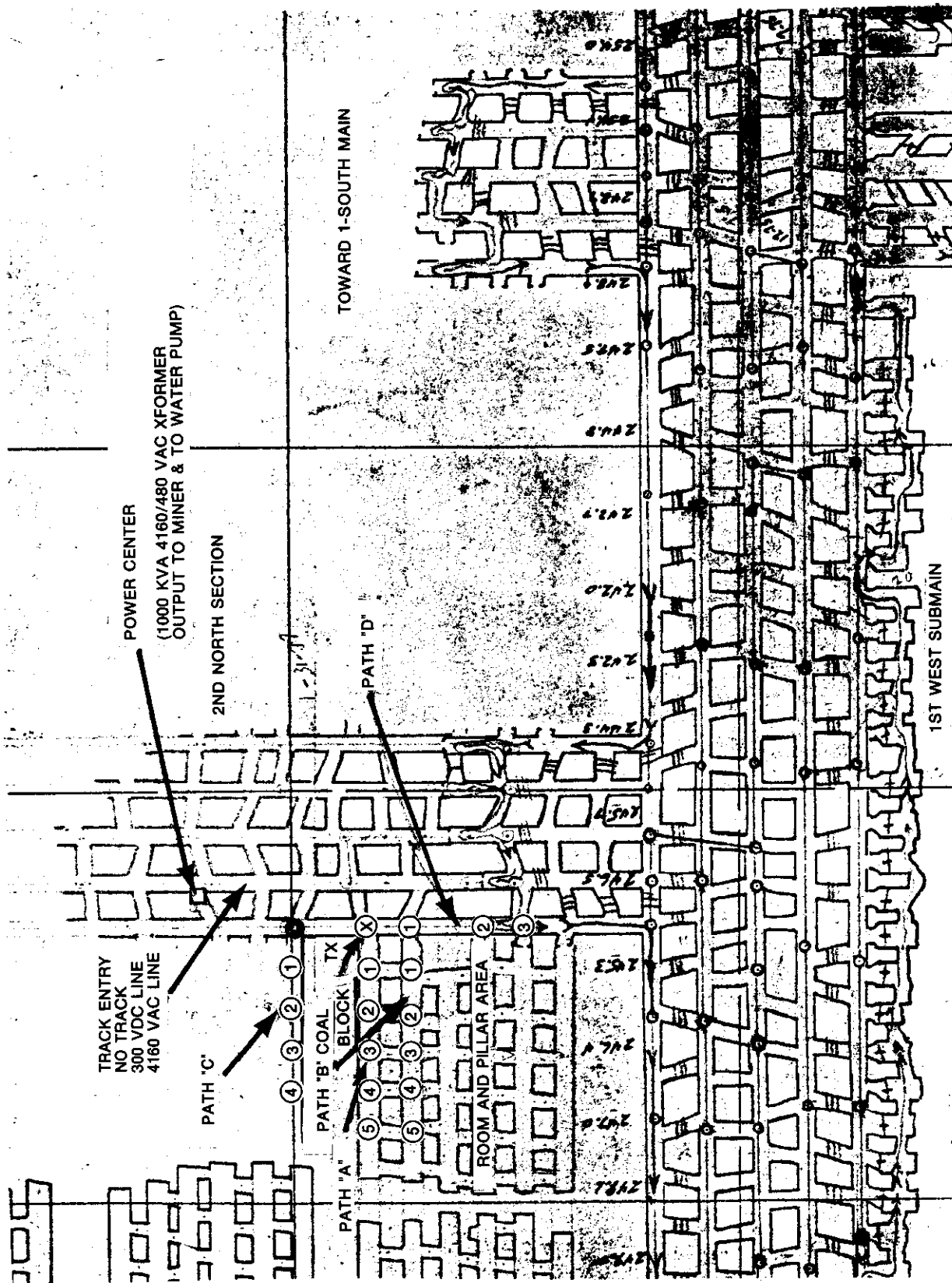

Figure A6-1. Topology of 1-South First West Area of Peabody Coal Co. Mine No. 10 Showing Test Locations For Quasi-Conductor-Free Measurements in Second North Section.

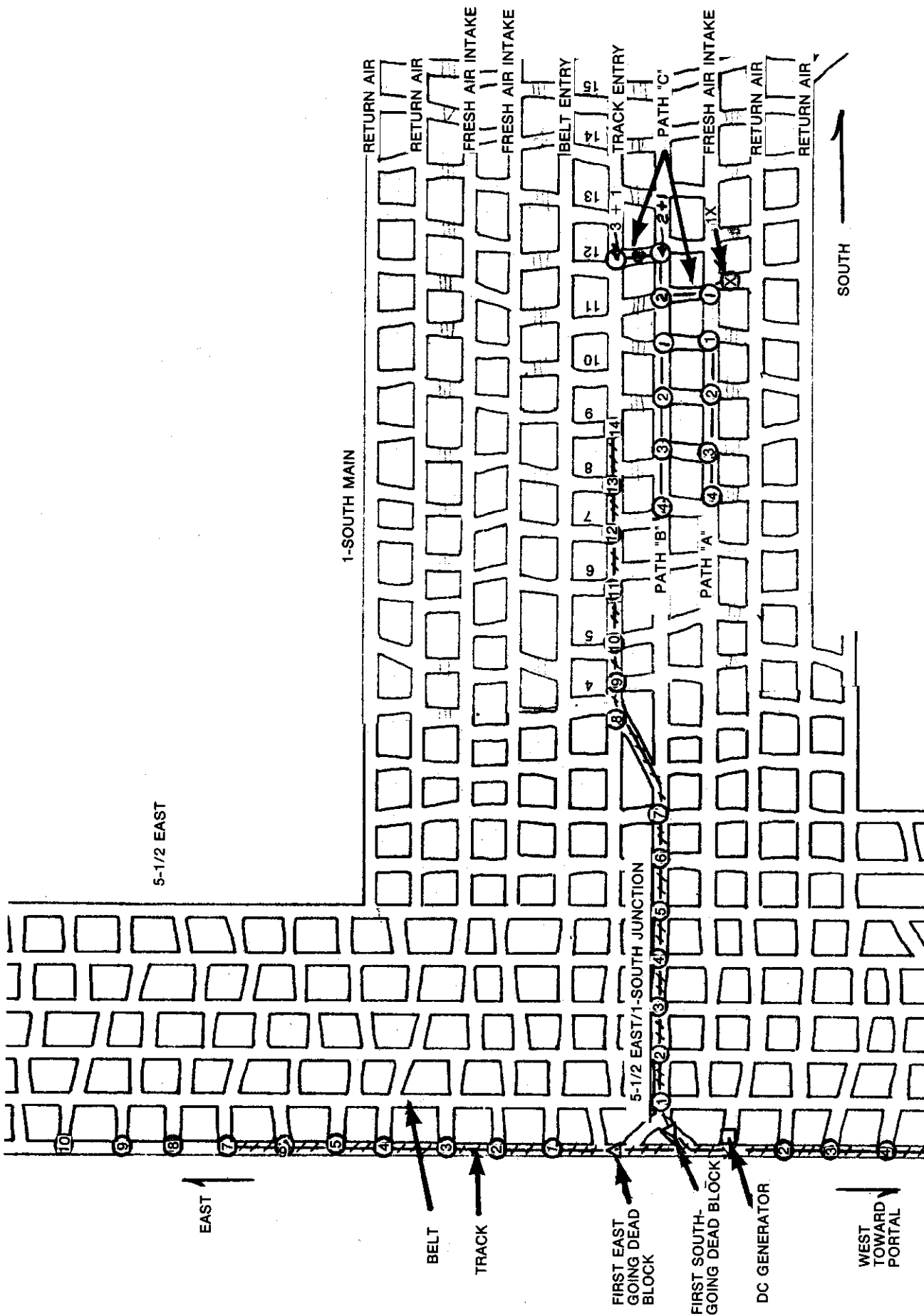

Figure A6-2. Topology of 5-1/2 East/1-South Junction and 1-South Main Areas of Peabody Coal Co. Mine No. 10 Showing Test Locations in Both Areas.

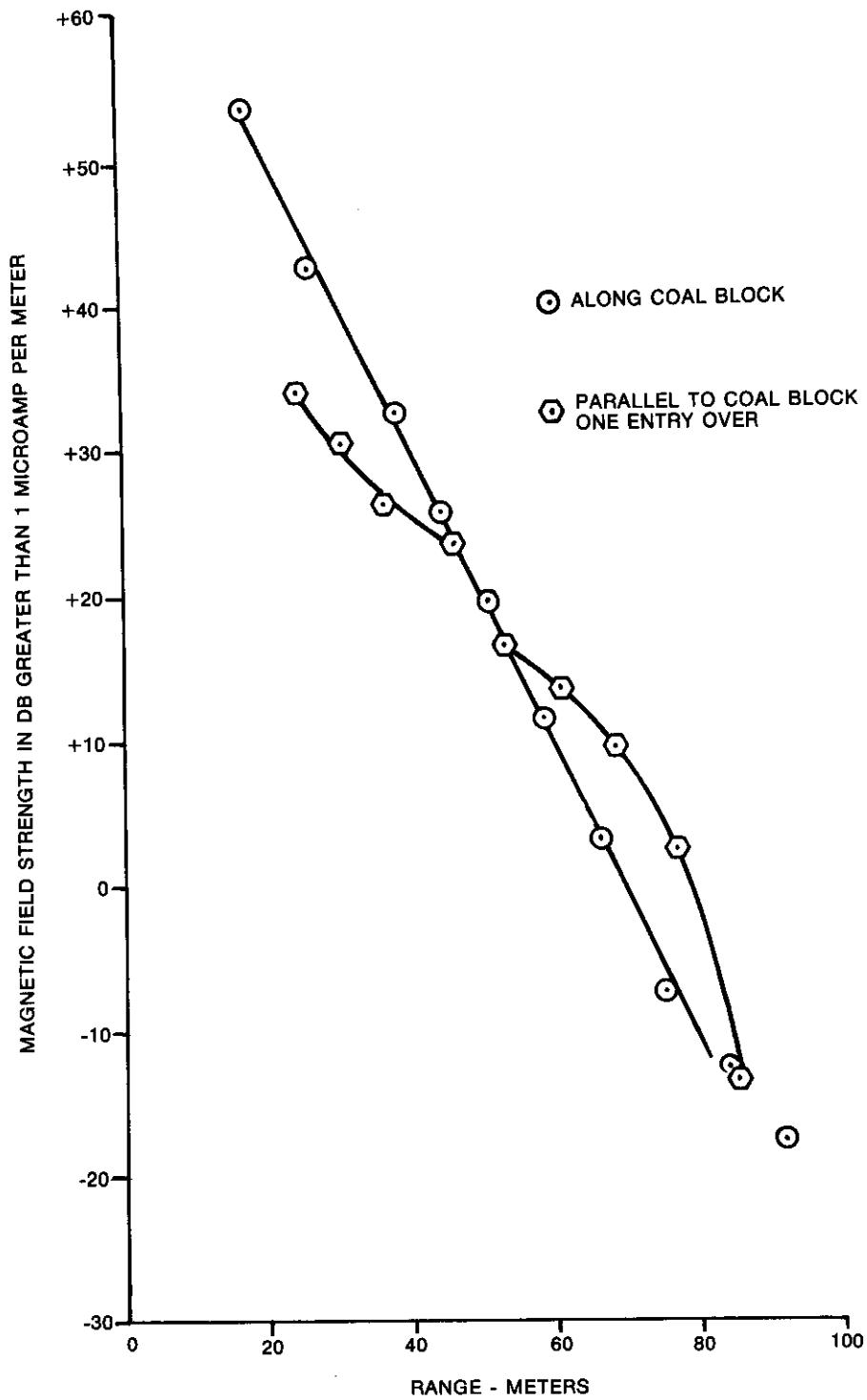

Figure A6-3. Magnetic Field Strength Vs Range in Room and Pillar Area of 1-Main South 1st West 2nd North Working Section of Peabody Coal Co. Mine No. 10 at 240 kHz for Coplanar Antenna Orientation and NIA = 2.5 Comparing Paths.

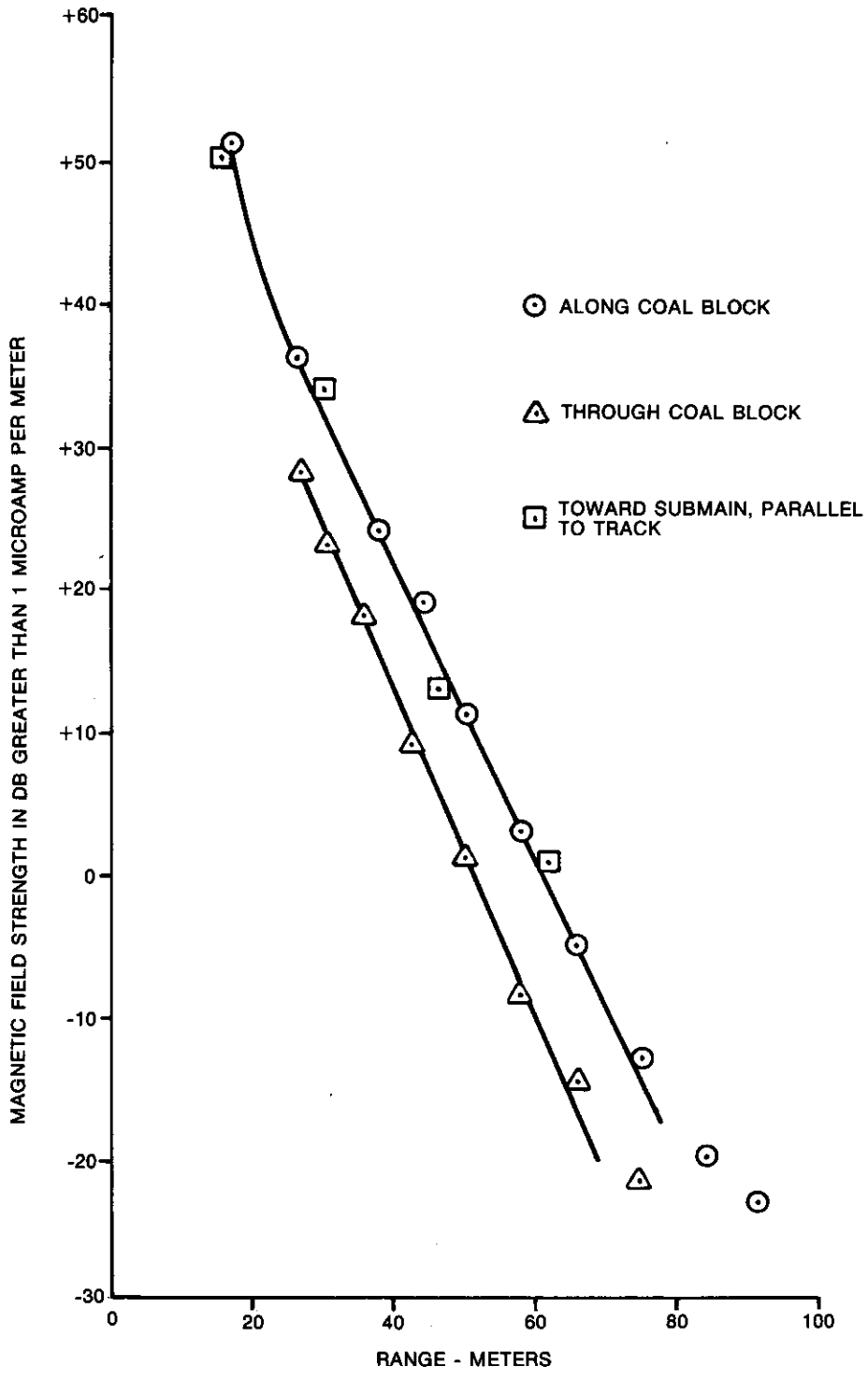

Figure A6-4. Magnetic Field Strength Vs Range in Room and Pillar Area of 1-Main South 1st West 2nd North Working Section of Peabody Coal Co. Mine No. 10 at 480 kHz for Coplanar Antenna Orientation and NIA = 2.5 Comparing Paths.

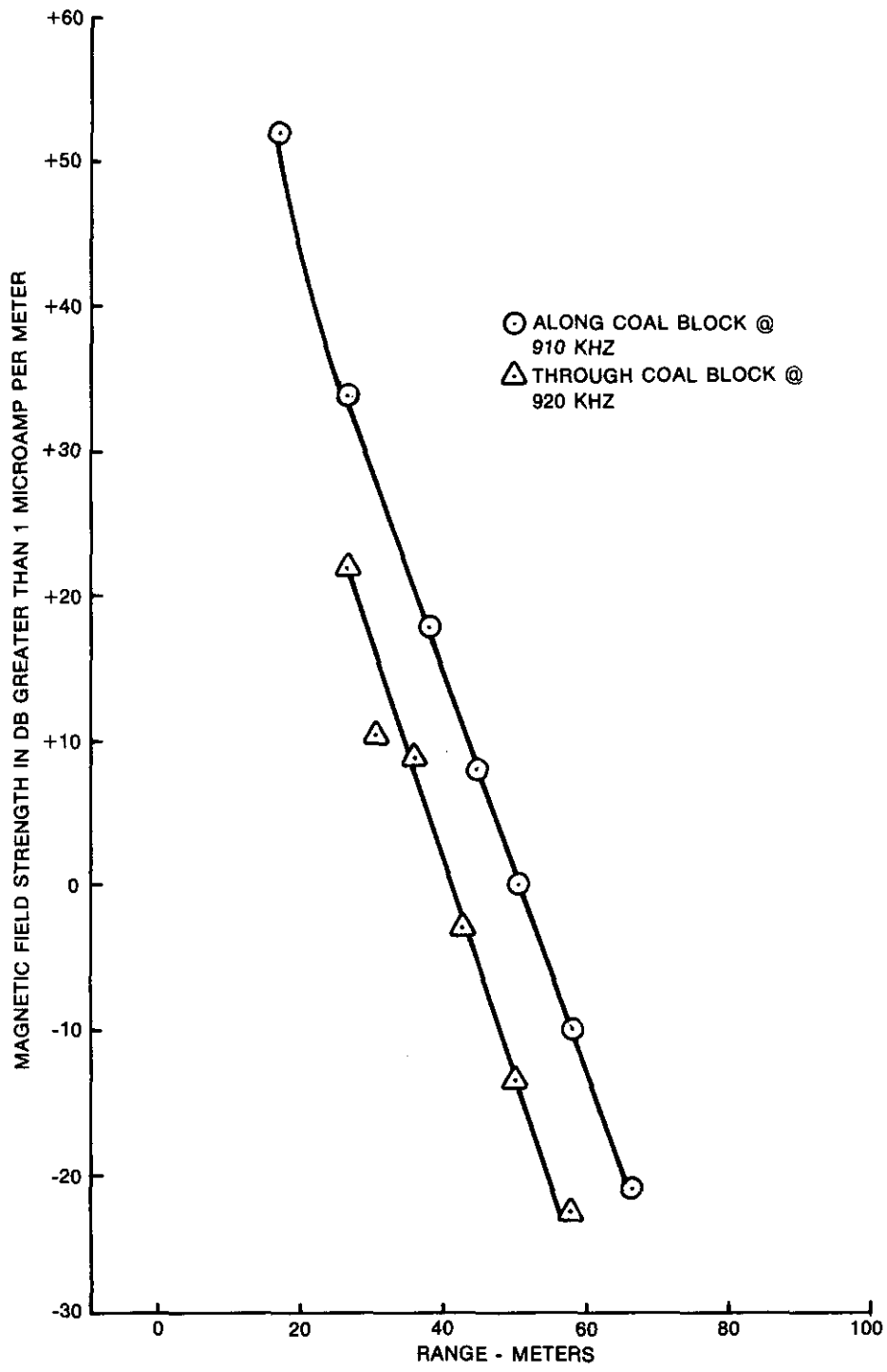

Figure A6-5. Magnetic Field Strength Vs Range in Room and Pillar Area of 1-Main South 1st West 2nd North Working Section of Peabody Coal Co. Mine No. 10 at 910 and 920 kHz for Coplanar Antenna Orientation and NIA = 2.5 Comparing Paths.

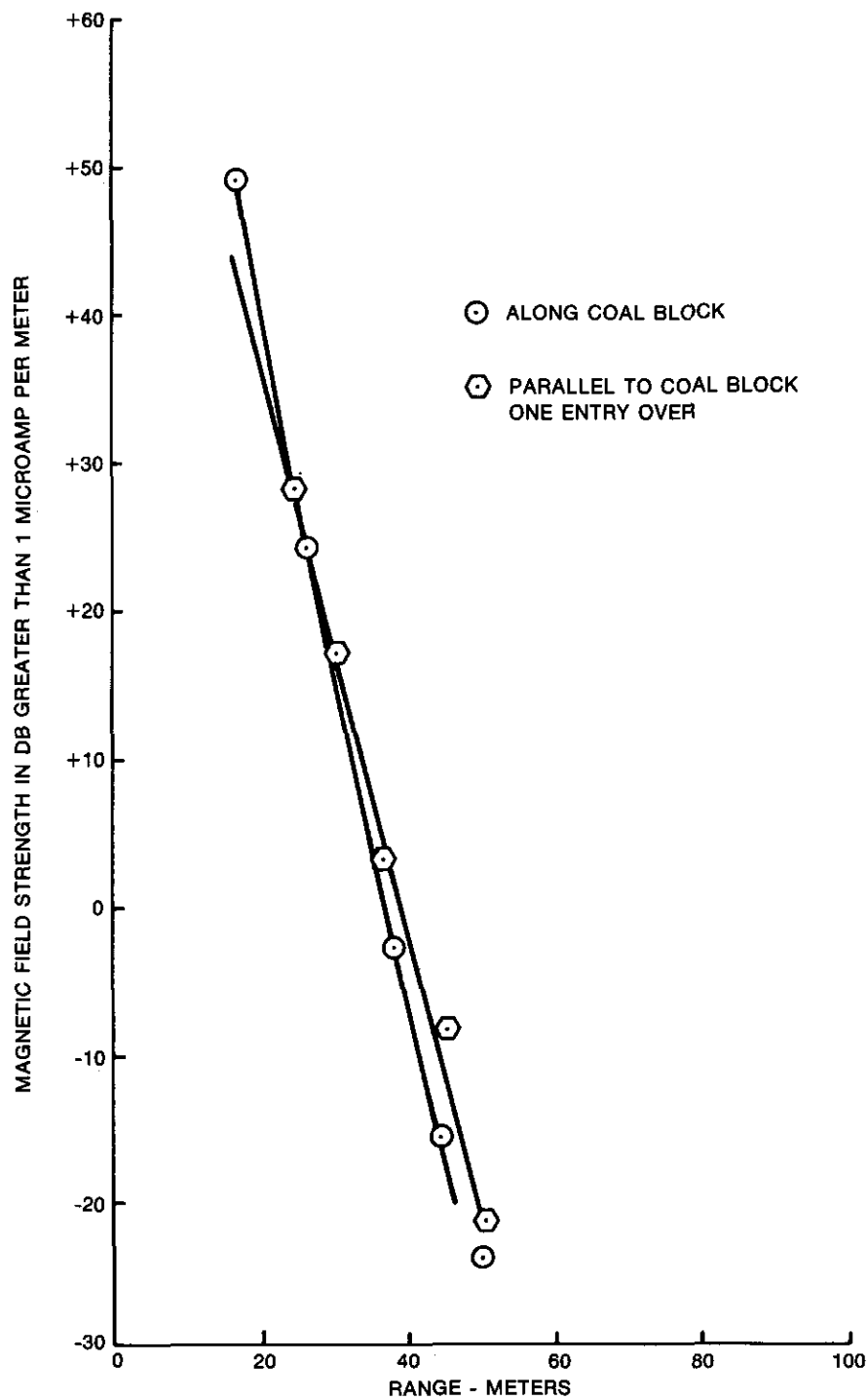

Figure A6-6. Magnetic Field Strength Vs Range in Room and Pillar Area of 1-Main South 1st West 2nd North Working Section of Peabody Coal Co. Mine No. 10 at 1800 kHz for Coplanar Antenna Orientation and NIA = 2.5 Comparing Paths.



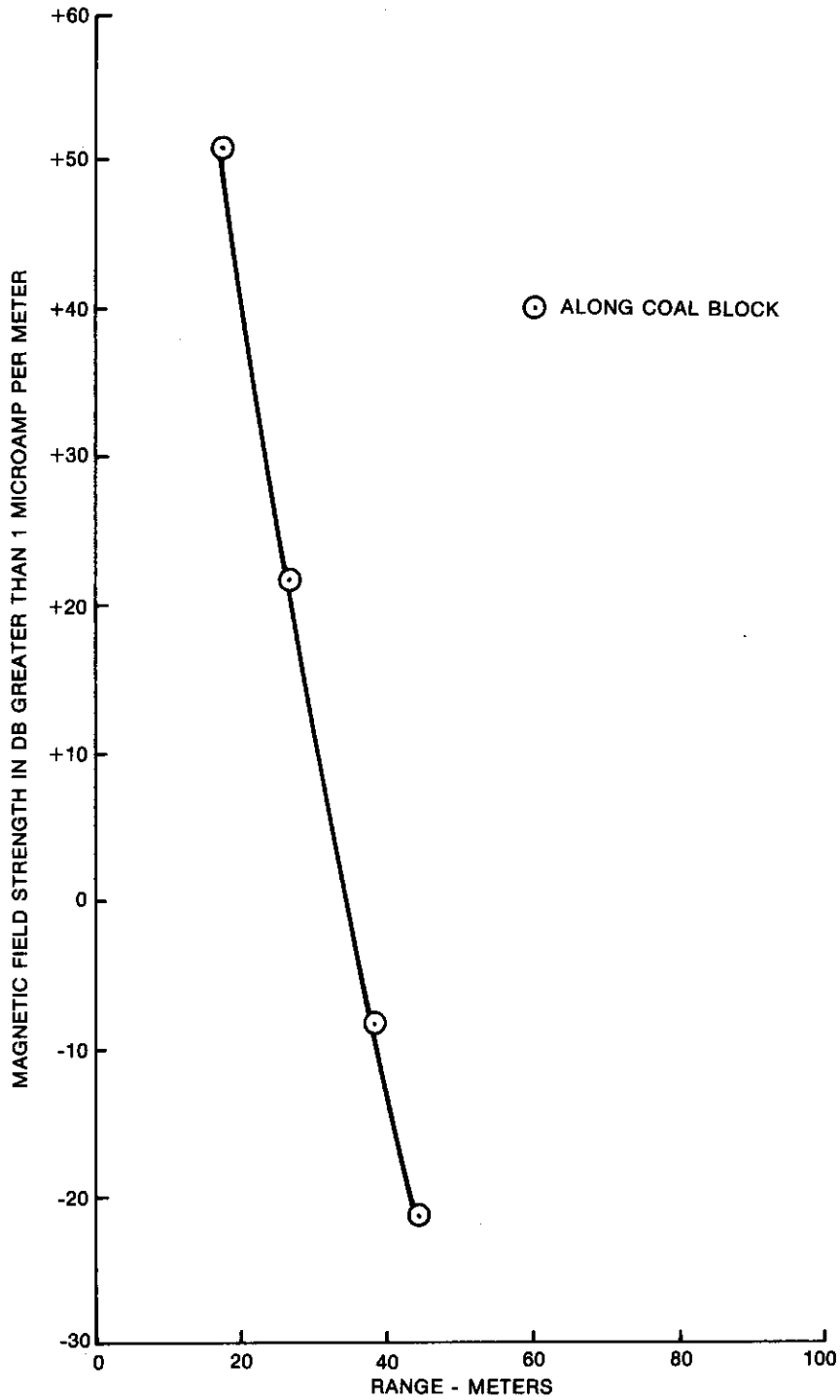

Figure A6-7. Magnetic Field Strength Vs Range in Room and Pillar Area of 1-Main South 1st West 2nd North Working Section of Peabody Coal Co. Mine No. 10 at 3100 kHz for Coplanar Antenna Orientation and NIA = 2.5 Comparing Paths.

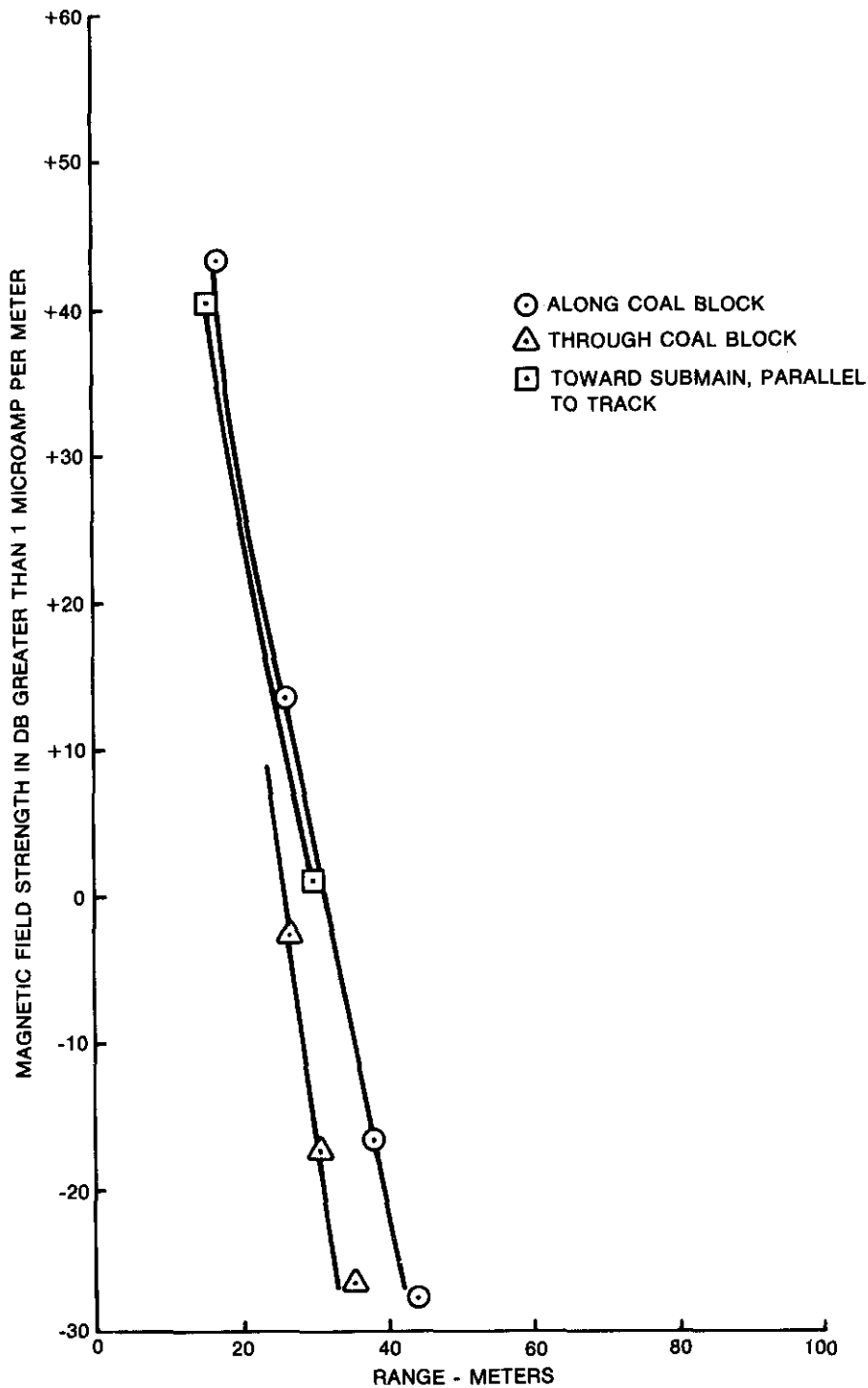

Figure A6-8. Magnetic Field Strength Vs Range in Room and Pillar Area of 1-Main South 1st West 2nd North Working Section of Peabody Coal Co. Mine No. 10 at 3400 kHz for Coplanar Antenna Orientation and NIA = 2.5 Comparing Paths.

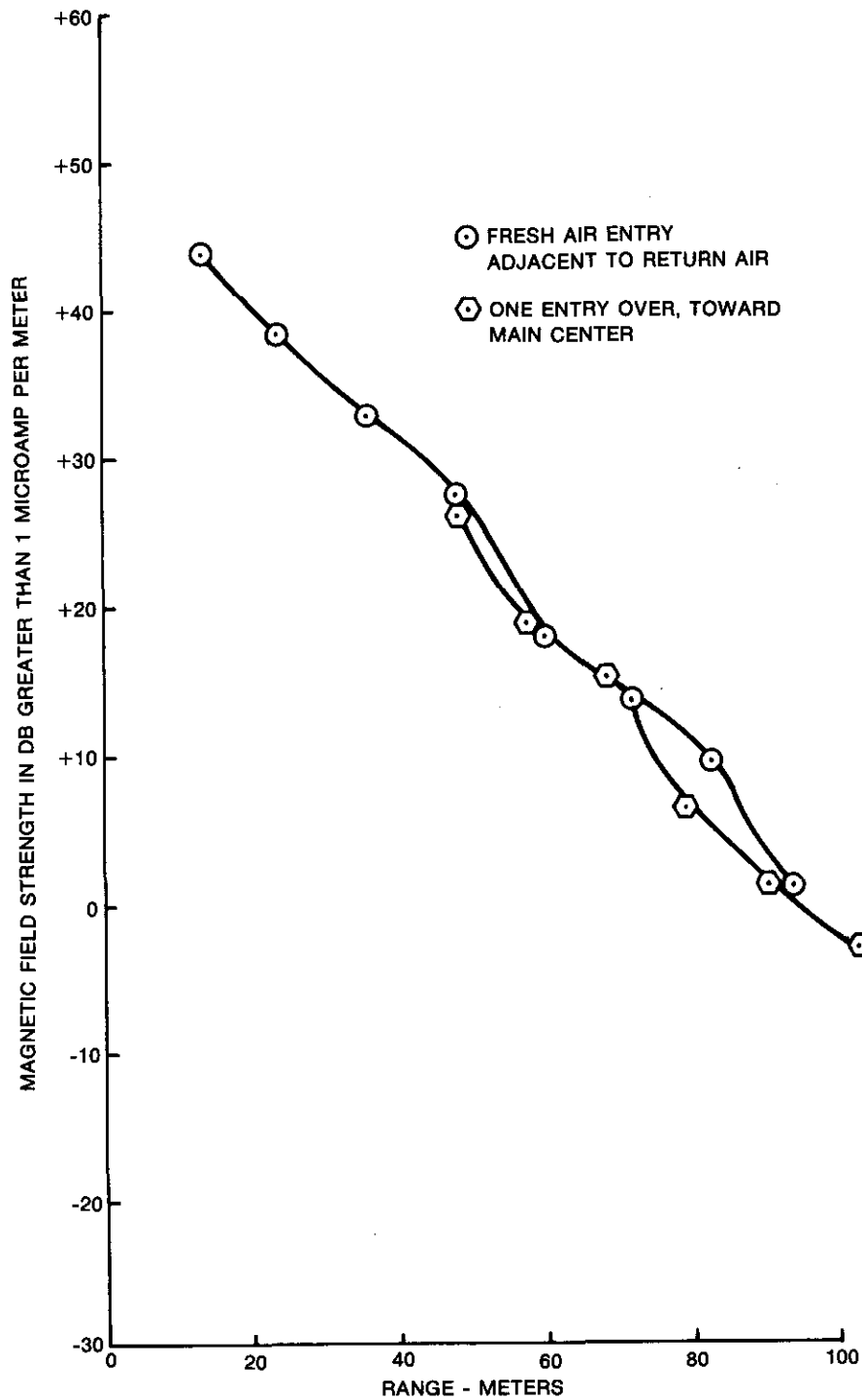

Figure A6-9. Magnetic Field Strength Vs Range in 1-South Conductor-Free Entries Near the 5-1/2-East/1-South Junction of Peabody Coal Co. Mine No. 10 at 83 kHz for Coplanar Antenna Orientation and NIA = 2.5 Comparing Paths.

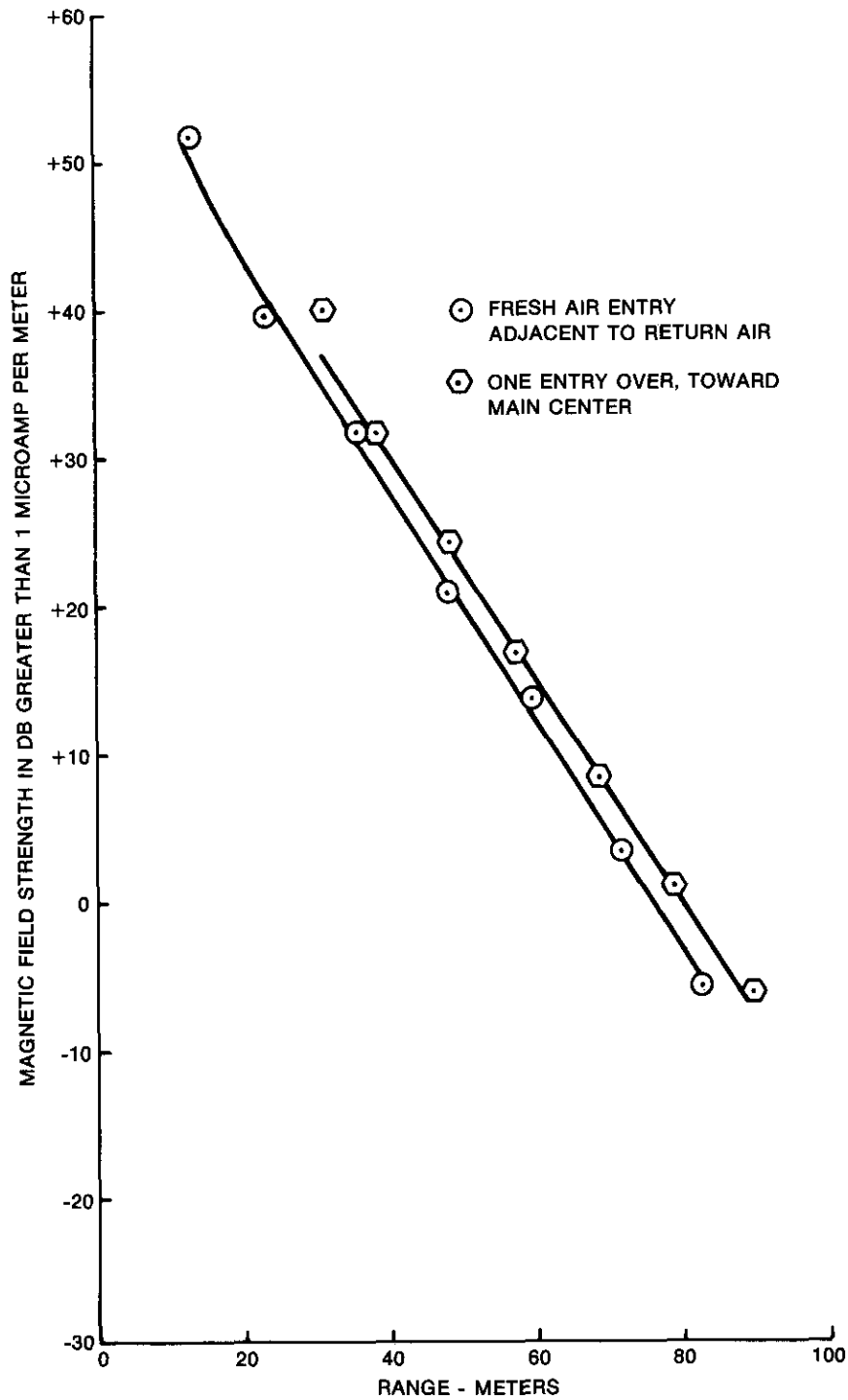

Figure A6-10. Magnetic Field Strength Vs Range in 1-South Conductor-Free Entries Near the 5-1/2-East/1-South Junction of Peabody Coal Co. Mine No. 10 at 245 kHz for Coplanar Antenna Orientation and NIA = 2.5 Comparing Paths.

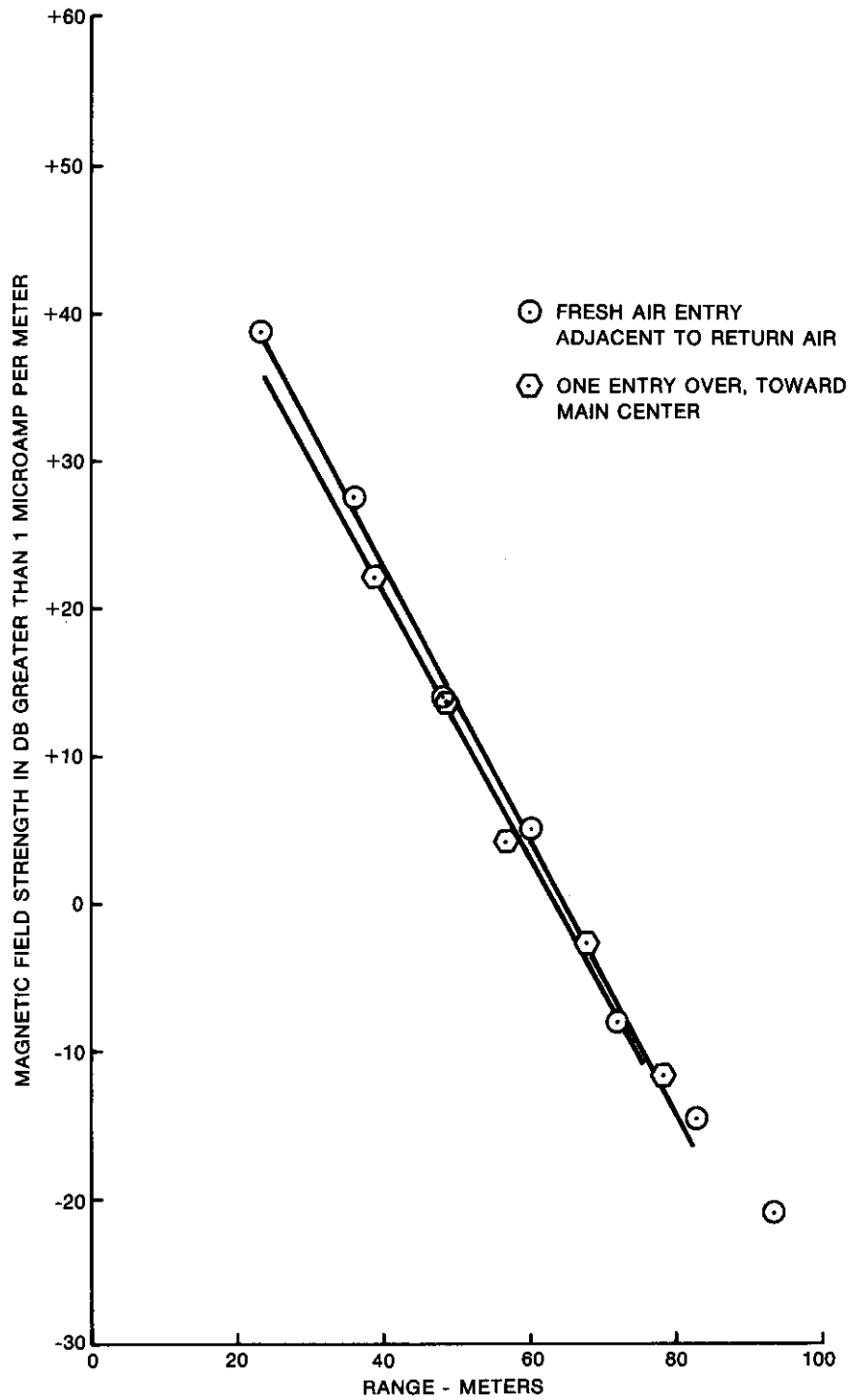

Figure A6-11. Magnetic Field Strength Vs Range in 1-South Conductor-Free Entries Near the 5-1/2-East/1-South Junction of Peabody Coal Co. Mine No. 10 at 420 kHz for Coplanar Antenna Orientation and NIA = 2.5 Comparing Paths.

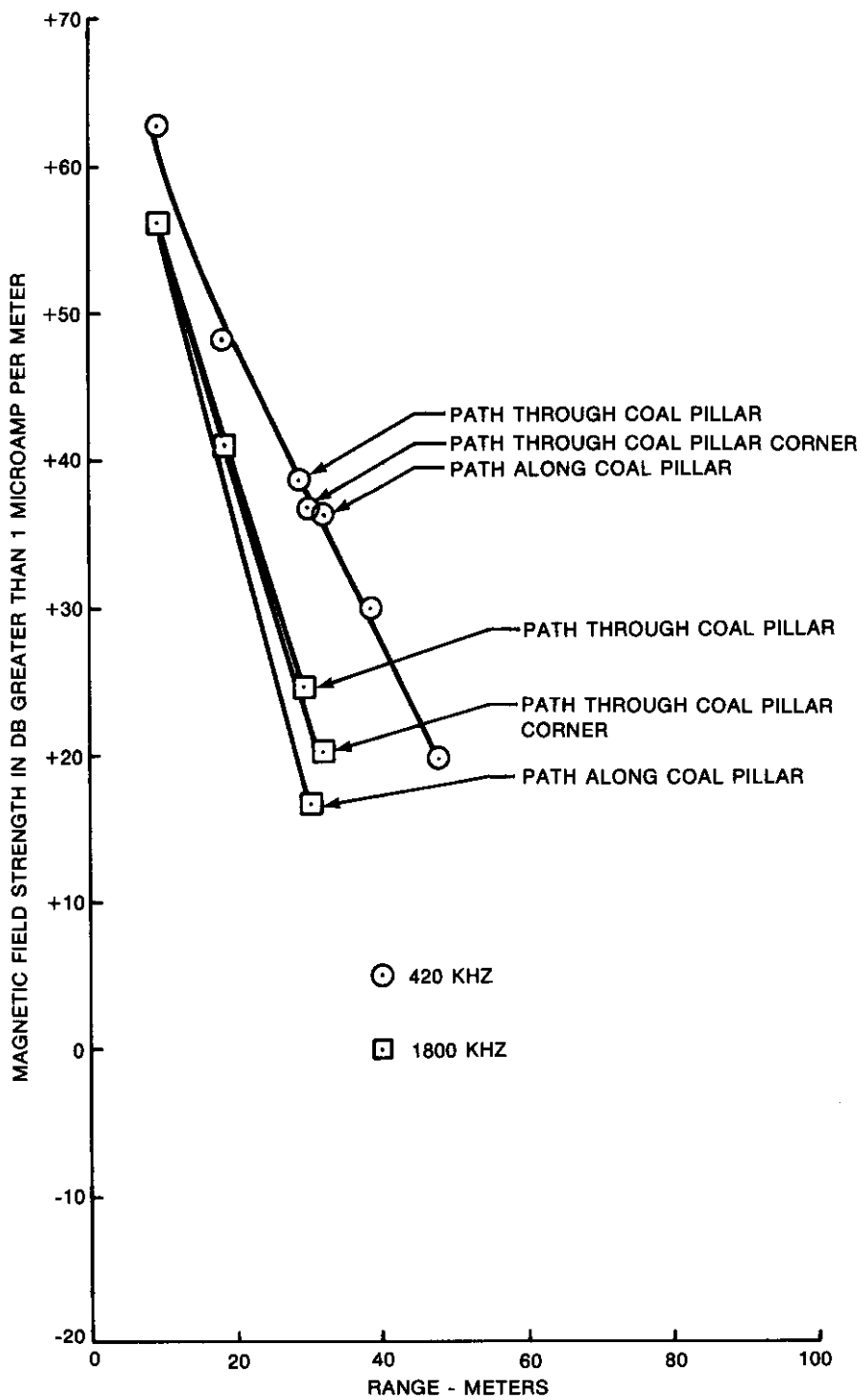

Figure A6-12. Magnetic Field Strength Vs Range in 1-South Conductor-Free Area Near the 5-1/2-East/1-South Junction of Peabody Coal Co. Mine No. 10 at 420 and 1800 kHz for Coplanar Antenna Orientation and NIA = 2.5 on Paths Generally Perpendicular to Entries From a Fixed Transmitter Location.

APPENDIX B

ERRATA AND ADDED CALIBRATION INFORMATION

## APPENDIX B

The NM-25 calibration data at nominally 500 and 1000 kHz used in reducing the Ireland Mine data was in error. The field strength at 500 kHz should be increased 8.2 dB and the field strength at 1000 kHz should be decreased by 1.1 dB. The correct calibration factors were used in reducing the data taken in the other five mines.

The frequency of 100 kHz was the most difficult at which calibration of the receive system was accomplished. This was due to the transition region at about 100 kHz which occurred between sets of equipment used to make the calibration measurements. The calibration level of 251.2  $\mu\text{V}$  was determined by extrapolating the antenna factor for the reference antenna used in the screen room as checked by plotting a smooth curve through successive calibration points above 100 kHz from 150 kHz up. The absolute accuracy of this calibration level is unknown but expected to be within  $\pm 3$  dB.

A calibration level was developed for 50 kHz, but was not used during the program due to equipment failures and lack of backup test equipment in this frequency. This calibration level was 230  $\mu\text{V}/\text{m}$  using the low frequency antenna tuner on band 3 or, correspondingly, 1293  $\mu\text{V}/\text{m}$  using the high-frequency antenna on band 1.

Early calibration data of the receive system was made over small frequency ranges about fixed frequencies. Later in the program, additional calibration information was gathered which enabled the average curve shown in figure 11 to be drawn. The earlier fixed frequency calibrations were used for all frequencies close to these points, however, in reducing the measured data for this program. The error incurred in this way of using the calibration data is estimated to be less than 1 dB at any particular frequency.



APPENDIX C

MAGNETIC FIELD STRENGTH SENSITIVITY OF AN FM RECEIVER

## APPENDIX C

As an alternative approach to the determination of the magnetic field strength sensitivity of an FM receiver, the following analysis is offered which is based on the measured loop resistance rather than loop Q.

$$\text{Let } \gamma = 4\pi\omega NA \times 10^{-7}$$

Where  $\omega = 2\pi f$

N = number of turns

A = loop area in meters<sup>2</sup>

The matched output voltage of a loop, transformed to an impedance Z is

$$E = \frac{\gamma H_s}{2} \sqrt{\frac{Z}{R_L}} \text{ volts} \quad (1)$$

where  $R_L$  is the loop resistance;

where  $H_s$  = magnetic field strength in A/m.

The 12-dB SINAD noise figure relationship for a 50-ohm FM receiver with a 12-kHz IF bandwidth, using EIA test procedures is (\*).

$$E_{12} = NF_s - 19.75 \text{ dB} > 1 \mu\text{V} \quad (2)$$

where  $NF_s$  can be considered to be the system noise figure in dB.

Now, if there is no external noise field  $H_n$ , the equivalent external noise figure = 1, and  $NF_s = 10 \log F_r$ , the receiver noise figure. In general, however, since the external noise power  $P_n$ , injected at the receiver input terminal is

$$P_n = \frac{\gamma^2 H_n^2}{4 R_L} \text{ watts/Hz} \quad (3)$$

The equivalent external noise figure  $F_x$ , can be derived from

$$P_n = (F_x - 1) k T_o$$

or

$$F_x = \frac{\gamma^2 H_n^2}{4 R_L k T_o} + 1 \quad (4)$$

---

\*"FM Noise Figure and 12 dB SINAD Sensitivity", R. P. Decker, Spectra Associates Internal Memo, 4-15-76

The system noise figure  $F_s$  is

$$F_s = F_x - 1 + F_r \text{ (ratios)}$$

or

$$NF_s = 10 \log \left[ \frac{\gamma^2 H_n^2}{4R_L k T_o} + F_r \right] \text{ dB} \quad (5)$$

Converting equation (2) to volts, and allowing for an input impedance  $Z$  other than 50 ohms (but requiring a match between loop and receiver), we have

$$\begin{aligned} E_{12} &= 10 \left[ NF_s - 19.75 + 10 \log \left( \frac{Z}{50} \right) - 120 \right] / 20 \\ &= \sqrt{Z \frac{\gamma^2 H_n^2}{4R_L k T_o} + F_r} \times 10^{-7.836985} \text{ volts} \end{aligned} \quad (6)$$

Combining equations (1) and (6), we have

$$H_s = 1.4555094 \frac{\sqrt{R_L \left( \frac{\gamma^2 H_n^2}{4R_L k T_o} + F_r \right)} \cdot 10^5}{2\pi\omega \text{ NA}} \mu\text{A/m}$$

or

$$H_s = 3686.8484 \frac{\sqrt{R_L \left( \frac{\gamma^2 H_n^2}{4R_L k T_o} + F_r \right)}}{\text{fnA}} \mu\text{A/m} \quad (8)$$

Using equation (8) and assuming

$$\frac{\gamma^2 H_n^2}{4R_L k T_o} \gg F_r \text{ (set noise limited sensitivity)}$$

For the Collins mine wireless radio:

$$f = 520 \text{ kHz}$$

$$R_L = 5.0 \text{ ohms}$$

$$F_r = 1.59 \text{ (2 dB)}$$

$$N = 7 \text{ turns}$$

$$A = 0.217 \text{ meter}^2$$

we find

$$H_s = 0.01313951 \mu\text{A/m}$$

It is interesting to note that the effective noise power of the above receiver is equal to the external noise power when the external noise field is -84.8 dB below  $1 \mu\text{A}/\text{meter}/\sqrt{\text{Hz}}$

The sensitivity of the base station receive system is

$$0.1313951 \times 7 \times \sqrt{\frac{5.6}{5}} \times \frac{.217}{14.4} = 0.00146684 \mu\text{A/m}$$

or 19 dB greater than the portable system.

The increase in base station communication range mentioned in sections 6-6 and 6-9, then become 133 meters in lieu of the 190 meters computed by the loop Q method.

## REFERENCES

- (1) Summary Data Report, "Rose Valley Mine Measurements", Mine Wireless Propagation Test Program, Spectra Associates, Inc., Bureau of Mines Contract H0346067, Phase 1, Collins Groups Subcontract C-65171, 7 January 1975.
- (2) Summary Data Report-2, "Ireland Mine Measurements", Mine Wireless Propagation Test Program, Spectra Associates, Inc., Bureau of Mines Contract H0346067, Phase 1, Collins Groups Subcontract C-65171, 12 March 1975.
- (3) Report, Research and Development Contract, Volume 3, Theoretical Data Base, Section 7.5, Theoretical Predictions for In-Mine Propagation, pp 7-16 through 7-36, Spectra Associates, Inc., (R. Decker principal contributor) Bureau of Mines Contract H0232056, Collins Groups Subcontract C-696447, 15 November 1974.
- (4) Op Cit Summary Data Report-2, "Ireland Mine Measurements," p 26.
- (5) R. Lagace and F. Emslie (Arthur D. Little Co.), "Theory of the Propagation of Low and Medium Frequency Radio Waves in a Coal Seam, Radio Science," Vol. 11 No. 4, pp 253-262, April 1976.
- (6) Loc Cit R. Lagace & F. Emslie.
- (7) W. Bensema, M. Kandu, I. W. Adams, "Electromagnetic Noise in Robena No. 4 Coal Mine," NBS Technical Note 654, April 1974.
- (8) Op Cit Report, Research and Development Contract, Vol 3, Theoretical Data Base, Section 6; "The Application of Recent NBS Noise Data to Mine Communications, p 6-30.
- (9) Ibid, Ref (2), Summary Data Report-2, "Ireland Mine Measurements."
- (10) Loc Cit W. Bensema, et al.
- (11) Ibid, Ref (8), Report, Research and Development Contract, Vol 3, Theoretical Data Base, p 6-30.
- (12) Ibid, Ref (8), Report, Research and Development Contract, Vol 3, Theoretical Data Base, p 6-30.
- (13) Ibid, Ref (2), Summary Data Report-2, "Ireland Mine Measurements."
- (14) Ibid, Ref (4), Summary Data Report-2, "Ireland Mine Measurements," p 26.
- (15) Ibid, Ref (2), Summary Data Report-2, "Ireland Mine Measurements."
- (16) Summary Data Report-4, Eastern Associated Coal Federal No. 1 Mine (Eddy Portal), "Propagation of EM Signals in Underground Mines," Spectra Associates, Inc., Bureau of Mines Contract H0366028, Collins Groups, Subcontract C-651333, p 3-5, December 1976.
- (17) Summary Data Report-3, Consolidation Coal Mine No. 95 (Robinson Run Portal), "Propagation of EM Signal in Underground Mines," Spectra Associates, Inc., Bureau of Mines, Contract H0366028, Collins Groups Subcontract C-651333, p 3-5, December 1976.
- (18) R. P. Decker, "FM Noise Figure and 12-dB SINAD Sensitivity," Spectra Associates, Inc. Internal Memorandum, April 15, 1976.
- (19) Loc Cit, R. Lagace and F. Emslie.
- (20) Loc Cit, R. Lagace and F. Emslie.
- (21) W. Weeks and R. Fenwick, Engineering Report, Submerged Antenna, Collins Groups, CER-T1477, pp 12-13, May 1962.
- (22) Ibid, Ref (8), Report, Research and Development Contract, Vol 3, Theoretical Data Base, p 6-30.

The following six reports were prepared under Bureau of Mines Contract H0366028, Collins Groups Subcontract C-651333, Spectra Associates Inc., Subcontract 002607 entitled "Propagation of EM Signals in Underground Mines."

- (23) T. Cory, Summary Data Report-1, "Ireland Mine Test Data at Medium Frequency," 1 October 1976.

- (24) T. Cory, Summary Data Report-2, "Sesser Mine Test Data at Medium Frequency and UHF," November 1976.
- (25) T. Cory, Summary Data Report-3, "Consolidation Coal Mine No. 95 (Robinson Run Portal), December 1976.
- (26) T. Cory, Summary Data Report-4, "Eastern Associated Coal Federal No. 1 Mine (Eddy Portal)," December 1976.
- (27) T. Cory, Summary Data Report-5, "Island Creek Coal Co. Virginia Pocahontas No. 1 Mine," February 1977.
- (28) T. Cory, Summary Data Report-6, "Peabody Coal Co. Mine No. 10," March 1977.