

Ivo SENJANOVIĆ  
Joško PARUNOV  
Smiljko RUDAN

# Remedy for Misalignment of Bilobe Tank Heads in Liquefied Petroleum Gas Carrier

Professional paper

The article describes the remedy for a misalignment of Y-joint in hemispherical and torispherical heads of the bilobe cargo tank on a Liquefied Petroleum Gas Carrier. The misalignment is the result of connecting relatively thin shells and production difficulties. The measured rather large shell eccentricity in the Y-joint causes bending moment, which cannot be withstood by shells designed as membrane, and therefore it has to be controlled. The remedy of misalignment is achieved by reinforcement of the Y-joint with inside and outside bars and knees. In this way stress concentration determined by the FEM analysis is reduced within the allowable stress given for secondary stress level.

**Keywords:** LPG carrier, bilobe tank, misalignment, reinforcement, strength analysis, FEM

## Ukrućenje nesavršenih čela dvodjelnih spremnika na brodu za prijevoz ukapljenog plina

Stručni rad

Opisuje se sanacija nesavršeno izgrađenog hemisferičnog i torisferičnog čela dvocilindarskog teretnog spremnika na jednom brodu za prijevoz ukapljenog plina. Geometrijska nepravilnost je rezultat spajanja relativno tankih segmenata ljuski i tehnoloških poteškoća. Izmjereni prilično veliki ekscentar ljuski čela na Y-spoju stvara spreg membranskih sila, koji tanke ljuske ne mogu preuzeti. Stoga je Y-spoj ukrućen s vanjske i unutarnje strane spremnika trakama i koljenima. Na taj način ukrućenje preuzima moment savijanja, dok je plašt čela izložen samo membranskim naprezanjima. Koncentracija naprezanja u Y-spoju provjerena je FEM analizom segmenata spremnika. Maksimalna naprezanja reducirana su ispod dopuštene granice za sekundarna naprezanja.

**Ključne riječi:** brod za ukapljeni plin, dvocilindarski spremnik, geometrijska nesavršenost, ukrućenje, analiza čvrstoće, MKE

### Author address:

Faculty of Mechanical Engineering  
and Naval Architecture, University of  
Zagreb, Zagreb, Croatia

E-mail: ivo.senjanovic@fsb.hr

**Received (Primljeno):** 2008-10-20

**Accepted (Prihvaćeno):** 2008-11-28

**Open for discussion (Otvoreno za raspravu):** 2010-09-30

## 1 Introduction

Increase in energy consumption results in the growth of gas sea-transport in liquefied state by means of special ships called Liquefied Gas Tankers. Two categories of these ships are distinguished, depending on the cargo type, i.e. Liquefied Natural Gas (LNG) and Liquefied Petroleum Gas (LPG) Carriers [1,2]. Both types have unique construction features and differ considerably from other classes of ships.

The liquid petroleum gases are transported in one of the following conditions:

- fully refrigerated at slightly above atmospheric pressure,
- refrigerated, semi-pressurised below ambient temperature and over atmospheric pressure,
- fully pressurised at ambient temperature.

In all cases the cargo liquid state is near the boiling temperature at the given pressure. The boil-off petroleum gases are reliquefied and returned to the cargo tank.

Since the transportation of gas is hazardous due to many reasons of potential danger (fire, toxicity, corrosivity, reactivity, low temperature and high pressure), it is regulated by the International Maritime Organisation (IMO) within IGC Code

[3]. This ISO document has been accepted by the International Association of Classification Societies (IACS) and included in the Classification Rules.

For liquefied gas transportation different cargo tanks are used: integral tanks, membrane tanks, semi-membrane tanks and independent tanks.

The independent cargo tanks are self-supported structures and they do not participate in the ship's strength. They are further subdivided into A, B and C types. The first two tank categories are usually constructed of plane surfaces (gravity tanks) and the design vapour pressure is to be less than 0.7 bar. Type C independent tanks are shell structures (also referred to as pressure vessels) meeting vessel criteria. They operate up to the design vapour pressure of 20 bar.

Fully refrigerated cargo tanks are free-standing prismatic type operating at temperatures down to -50 °C and limited pressure of 0.7 bar.

Refrigerated semi-pressurised tanks are usually of bilobe type. Their operation is limited by pressure of 7 bar and associated boil temperature depending on the kind of cargo.

Full-pressurised tanks are spherical, cylindrical or lobed supported by saddles. The maximum value of working pressure is 20 bar.

Pressurised cargo tanks are shell structures and their manufacturing is rather complex due to the curved surface and relatively thick walls. Therefore, they are made of high tensile steel and welded segments with varying success in geometrical perfection. Besides the residual stress due to welding, misalignment of segments also causes stress concentration and it must be controlled.

**2 Ship and tank characteristics**

A liquefied Petroleum Gas Carrier (LPG) having a total capacity of 6500 m<sup>3</sup> is considered, Figures 1 and 2 [4]. The ship particulars are listed in Table 1. The ship is designed and constructed in accordance with the Rules for Classification and Construction, Germanischer Lloyd [5].

The ship has two cargo tanks: the front one is of cylindrical form while the aft one is of bilobe type, Figure 3. Their dimensions are listed in Table 2. Geometry of Tank No. 2 is shown in Figure 3. The ship is assigned to transport a list of products rang-

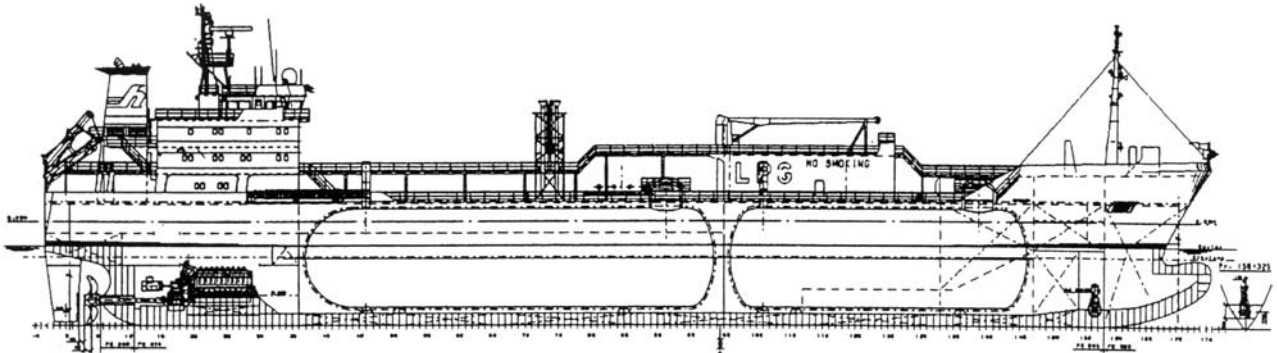

Figure 1 **General arrangement of 6500 m<sup>3</sup> LPG**  
 Slika 1 **Opći plan LPG broda kapaciteta 6500 m<sup>3</sup>**

Figure 2 **Cross-section of LPG**  
 Slika 2 **Poprečni presjek LPG broda**

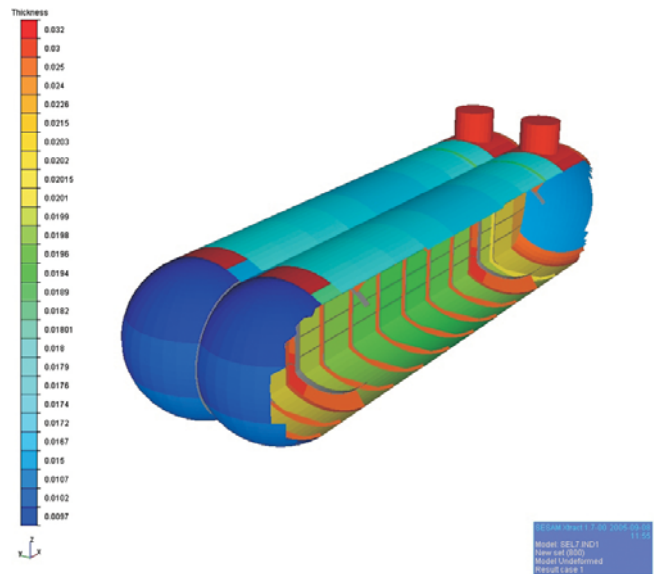
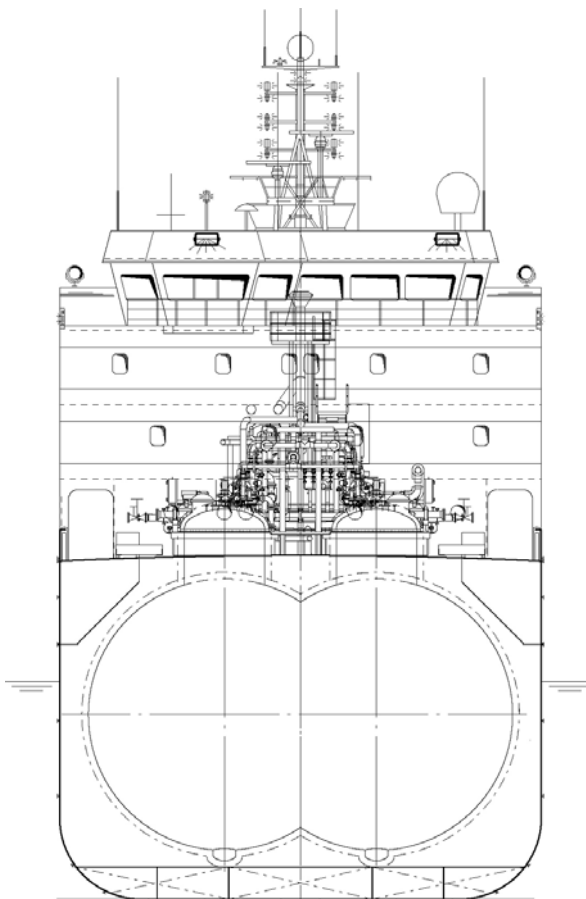

Figure 3 **Bilobe cargo tank (computer graphic)**  
 Slika 3 **Dvocilindarski teretni spremnik (računalna grafika)**

ing from ethylene to vinyl chloride monomer, for which the mass density is 0.56 and 0.97 t/m<sup>3</sup> respectively. The tanks are declared as C type and semi refrigerated. The working conditions for tank operation are related to the design pressure and temperature, and they are listed in Table 3.

The tanks are made of high tensile steel 12Ni19 containing not more than 5% nickel. The material mechanical properties and the allowable stresses according to GL Rules are given in Table 4. The secondary stress is the self-limiting stress concen-

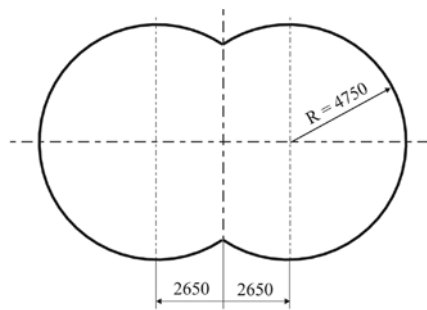
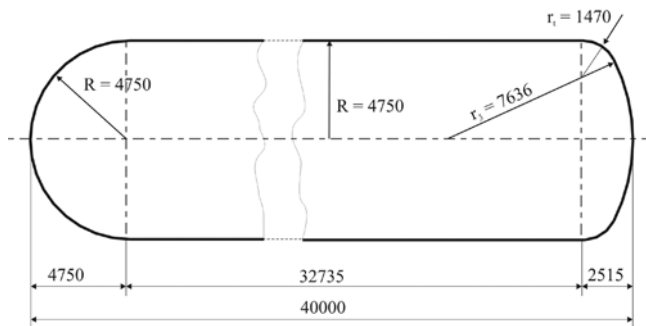

Figure 4 Geometry of bilobe tank  
Slika 4 Geometrija dvocilindarskog spremnika



tration, i.e. a local high stress which can be redistributed in the surrounding material.

Table 1 Particulars of LPG carrier, total capacity 6500 m<sup>3</sup>  
Tablica 1 Značajke LPG broda, ukupan kapacitet 6500 m<sup>3</sup>

Length overall	$L_{out} = 114.89$ m
Length between perpendiculars	$L_{pp} = 109.21$ m
Breadth moulded	$B = 16.80$ m
Depth to main deck, moulded	$H = 11.825$ m
Design draught	$T = 7.60$ m
Block coefficient	$C_b = 0.709$
Service speed	$v \approx 16$ kn

Table 2 Tank particulars  
Tablica 2 Značajke spremnika

Tank No. 1 - Cylindrical	
Volume	$V = 1960$ m <sup>3</sup>
Length	$l = 29.29$ m
Radius of cylinder	$R = 4.75$ m
Radius of head sphere	$r_s = 7.636$ m
Radius of head torus	$r_t = 1.47$ m
Tank No. 2 – Bilobe, Figure 4	
Volume	$V = 4485$ m <sup>3</sup>
Length	$l = 40.0$ m
Breadth	$b = 14.8$ m
Radius of cylinder and hemisphere head	$R = 4.75$ m
Radius of head sphere	$r_s = 7.636$ m
Radius of head torus	$r_t = 1.47$ m
Distance of cylinder centres	$2a = 5.3$ m

Table 3 Working conditions for the operation of the tanks  
Tablica 3 Radni uvjeti spremnika

Design vapour pressure, IMO*	4.5 bar
Design vapour pressure, USCG**	3.2 bar
External pressure	0.3 bar
Test pressure	6.75 bar
Working temperature	-104 deg C + 45 deg C

\*IMO = International Maritime Organisation;

\*\*USCG = US Coast Guard.

Table 4 Mechanical properties and allowable stresses of tank material  
Tablica 4 Mehanička svojstva i dopuštena naprezanja materijala spremnika

Young's modulus	$E = 2.06 \cdot 10^8$ kN/m <sup>2</sup>
Poisson's ratio	$\nu = 0.3$
Yield stress	$R_e = 390$ N/mm <sup>2</sup>
Tensile strength	$R_m = 540$ N/mm <sup>2</sup>
Allowable membrane stress	$\sigma_{adm} = 180$ N/mm <sup>2</sup>
Allowable total stress (membrane + bending stress)	$\sigma_{at} = 308$ N/mm <sup>2</sup>
Allowable secondary stress	$\sigma_{as} = 390$ N/mm <sup>2</sup>

### 3 Misalignment of Y-joint

Y-joint is a detail of the bilobe tank No. 2. Its misalignment is expressed by the shell eccentricity,  $e = A - B$ , at the longitudinal

Table 5 Misalignment of Y-joint in Tank No. 2  
Tablica 5 Geometrijska nesavršenost Y-spoja u spremniku No. 2

Section No.	A [mm]	B [mm]	$e = A - B$ [mm]	Section No.	A [mm]	B [mm]	$e = A - B$ [mm]
1	36	41	-5	91	43	85	-42
37	70	60	10	92	43	80	-37
38	217	206	11	93	47	93	-46
39	214	210	4	94	47	64	-17
40	200	196	4	95	42	47	-5
41	200	200	0	96	40	46	-6
42	251	250	1	97	37	50	-13
43	210	212	-2	98	40	46	-6
44	225	224	1	99	35	40	-5
45	210	196	14	100	35	42	-7
46	199	186	13	101	34	39	-5
47	195	200	-5	102	35	40	-5
48	195	182	13	103	40	39	1
48A	190	162	28	104	38	45	-7
49	195	157	38	105	41	39	2
49A	195	166	29	106	46	46	0
50	142	115	27	107	51	46	5
50A	107	85	22	108	50	57	7
51	70	67	3	109	45	54	-9
87	28	35	-7	110	60	62	-2
88	51	73	-22	111	56	60	-4
89	48	90	-42	112	51	68	-17
90	52	90	-38				

bulkhead. Values A and B are measured at 112 sections along the Y-joint as shown in Figure 5. In the cylindrical part of the tank the eccentricity  $e$  is small and can be tolerated. However, in the down part of the left hemispherical head and the fore tori-spherical head the eccentricity is very high, up to 46 and 38 mm respectively, Table 5. Therefore, these parts of the tank structure have to be reinforced and stress concentration checked by the FEM analysis.

Figure 5 Measuring points of misalignment in the Y-joint  
Slika 5 Mjerna mjesta geometrijske nepravilnosti Y-spoja

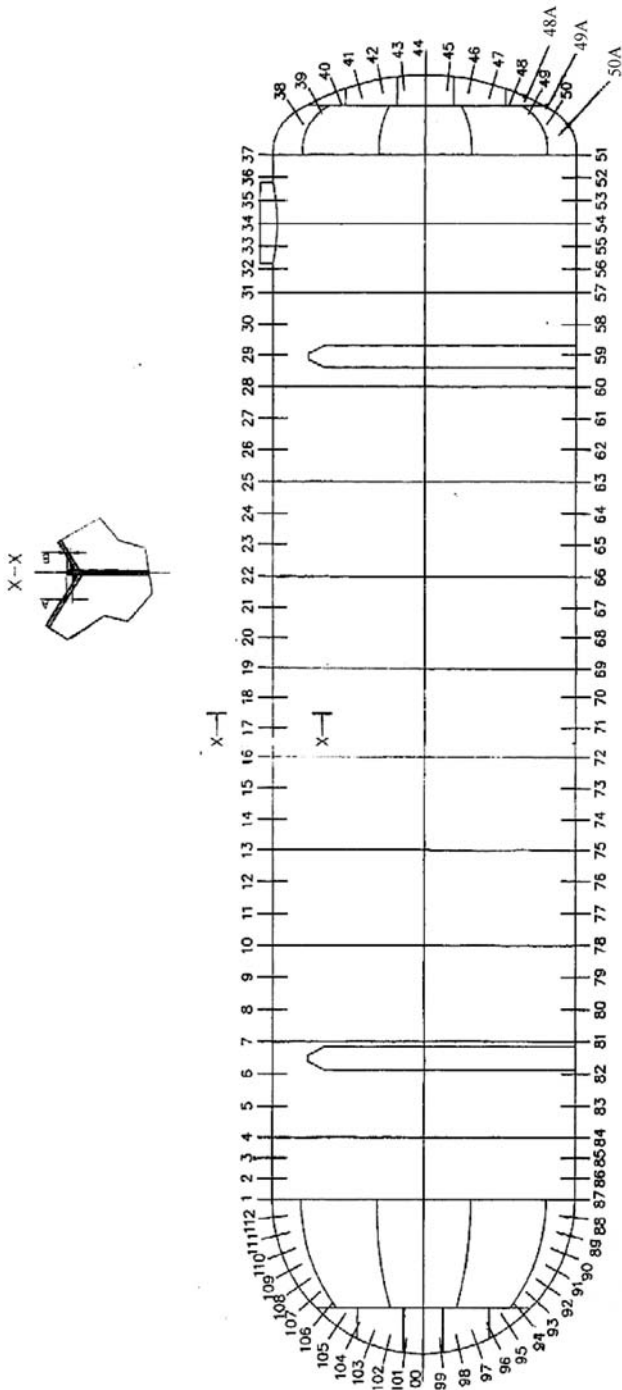

#### 4 Reinforcement of the aft and fore head

Eccentricity in the aft head is especially high in the span of the measuring sections Nos. 87 to 90, and 91 to 94, with average values  $e = 27.25$  and  $35.5$  mm respectively. Reinforcement of the aft head, based on experience [6...10], is shown in Figures 6 and 7. It consists of a set of the inside bars and outside knees lying in the tank cross-section planes. The reinforcement is divided into two blocks and the block closer to the cylinder is considered in the FEM analysis as a worse case.

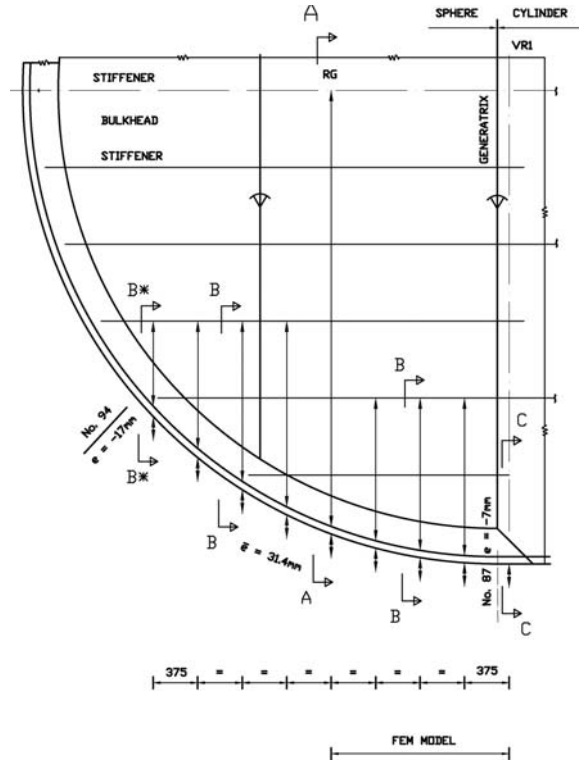
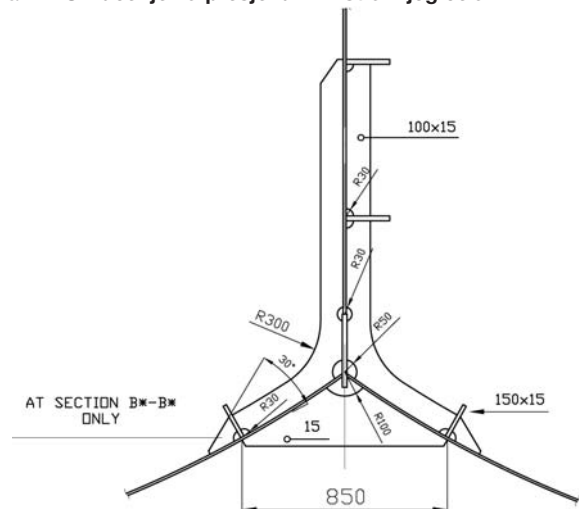

Figure 6 Arrangement of reinforcement in the aft hemisphere head

Slika 6 Raspored ukrućenja stražnjeg hemisferičnog čela

Figure 7 Reinforcement at section B-B of the aft head  
Slika 7 Ukrućenje na presjeku B-B stražnjeg čela



Eccentricity of the Y-joint in the fore head is large in the span of measured sections Nos. 48 and 50A, and yields  $\bar{e} = 26.2$  mm. The inserted reinforcement of the fore head is shown in Figures. 8, 9 and 10. It consists of the inside bars/brackets and outside knees.

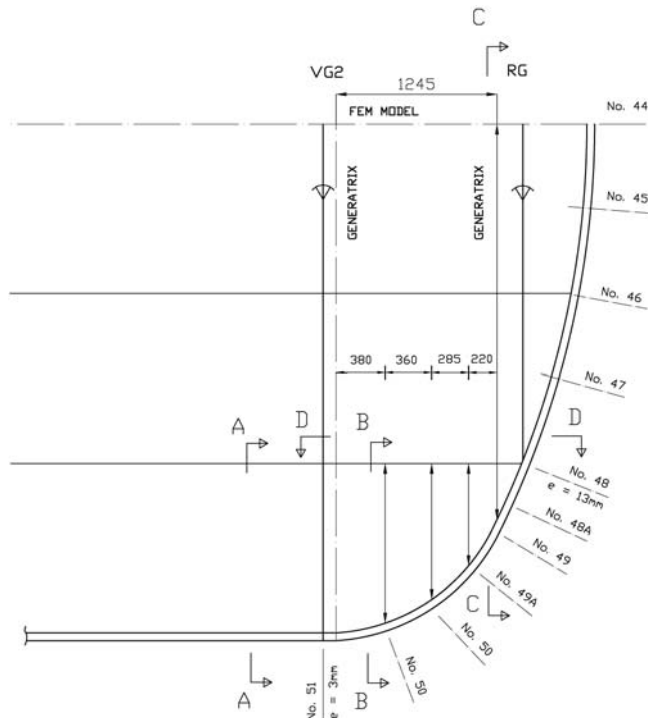

Figure 8 Arrangement of reinforcement in the fore torispherical head

Slika 8 Raspored ukrućenja prednjeg torisferičnog čela

Figure 9 Reinforcement at section B-B of the fore head

Slika 9 Ukrućenje na presjeku B-B prednjeg čela

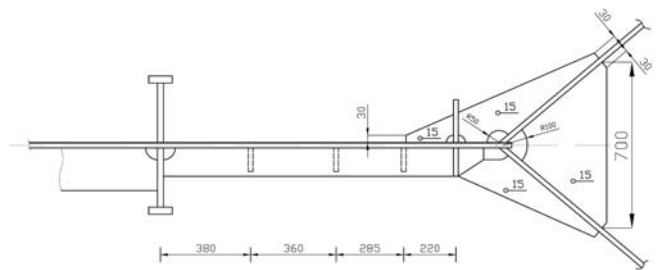
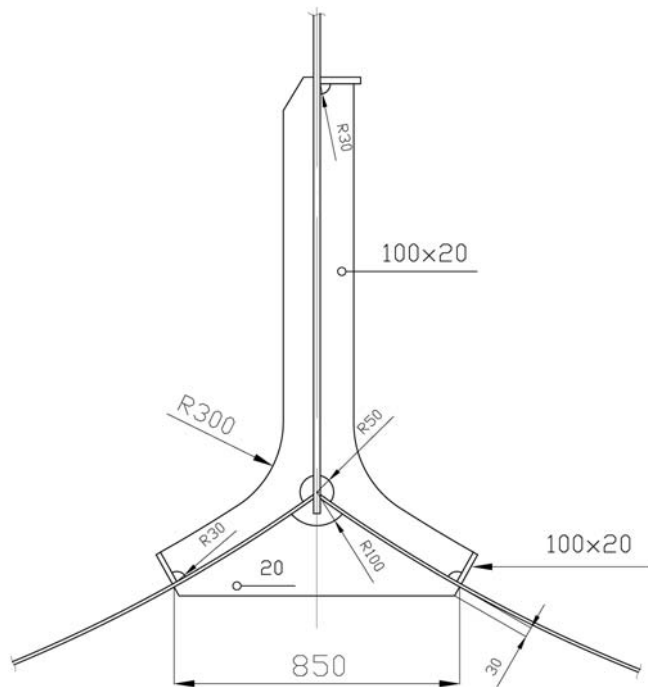

Figure 10 Reinforcement at section D-D of the fore head  
Slika 10 Ukrućenje na presjeku D-D prednjeg čela

### 5 Strength analysis of the aft head

The FEM model of the aft head reinforced segment, generated by package [11], is shown in Figure 11. The right-hand side coordinate system is used with the coordinate axes: x-longitudinal, y-transverse and z-vertical. Generatrix of the hemisphere and longitudinal bulkhead is a circle. In order to simplify the modelling this circle is rotated around the axial axis of the cylinders. In that way the parallelogram shell elements are generated. The mesh density is increased in the vicinity of the Y-joint where stress concentration is expected.

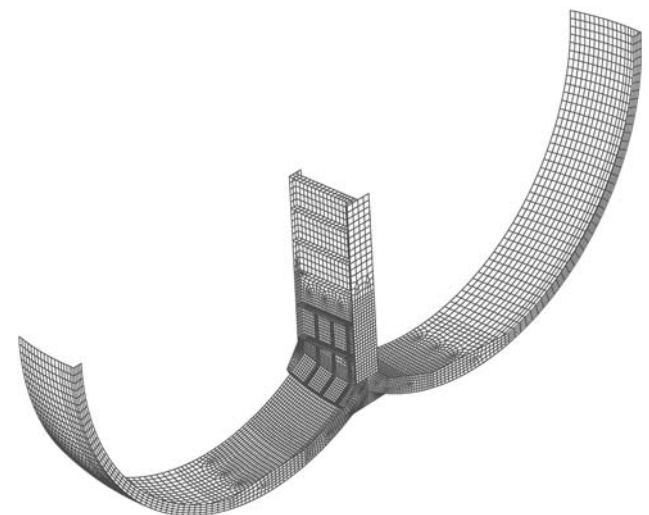
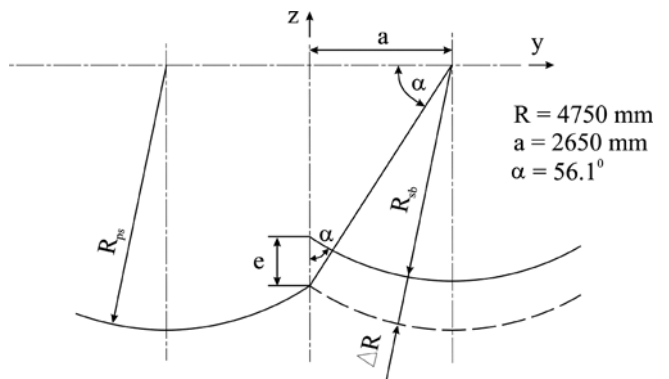

Figure 11 FEM model of the aft head segment

Slika 11 Model konačnih elemenata segmenta krmnog čela

Figure 12 Modelling of eccentricity of the Y-joint

Slika 12 Modeliranje ekscentričnosti Y-spoja



The eccentricity of Y-joint is modelled by specifying different radius of the portside and starboard hemisphere, Figure 12. Eccentricity  $e = 35$  mm is taken into account in the model. Thus, according to Figure 12

$$\Delta R = e \sin a = 35 \cdot 0.830 = 29 \text{ mm.}$$

The boundary conditions for the FEM model are the following:

- the model base, i.e. the bulkhead and hemisphere at  $z=0$ , is fixed in vertical direction as well as rotations:  $\Delta z = 0, \varphi_x = \varphi_z = 0$ ,
- the bulkhead at  $z = 0$  is also fixed in the transverse direction, i.e.  $\Delta y = 0$ ,
- the bulkhead and sphere are fixed at the cross-section  $x = 0$ , i.e.  $x = 0$ , i.e.  $\Delta x = 0, \varphi_y = \varphi_z = 0$ .

The structure is exposed to the total pressure which consists of the design vapour pressure  $p_0 = 5.41$  bar and liquid pressure  $p_{gd} = 1.8$  bar [4, 5]. Thus, the total pressure  $p = 0.721$  N/mm<sup>2</sup> is imposed to the FEM model.

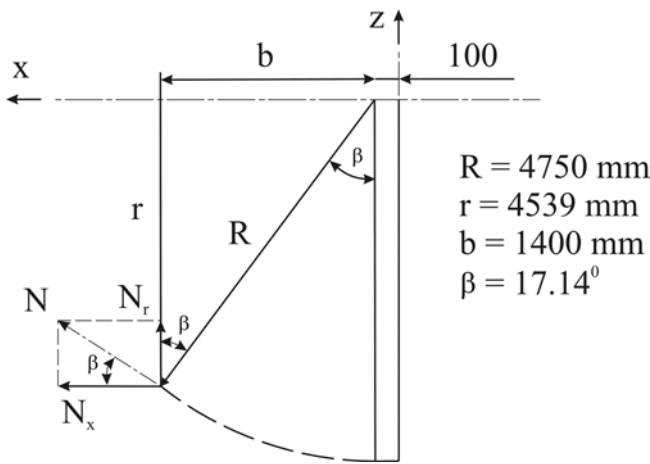

Figure 13 Boundary load of the spherical segment  
Slika 13 Rubno opterećenje sfernog segmenta

At the free cross-section,  $x = b$  in Figure 13, the membrane force acts:

$$N_x = \frac{pr}{2}, N_r = \frac{pb}{2}.$$

The longitudinal bulkhead is loaded by axial membrane force  $N_b$  as substitution of the assumed sphere axial force in that area. It has to equilibrate pressure force in the triangles, Figure 14.

$$F_a = pah$$

so that

$$N_b = \frac{F_b}{h} = pa.$$

Distribution of total (membrane + bending) von Mises stress is presented in Figure 15. Maximum value of stress concentration reads 222 N/mm<sup>2</sup>, which is below the allowable value of 390 N/mm<sup>2</sup> for the secondary stress.

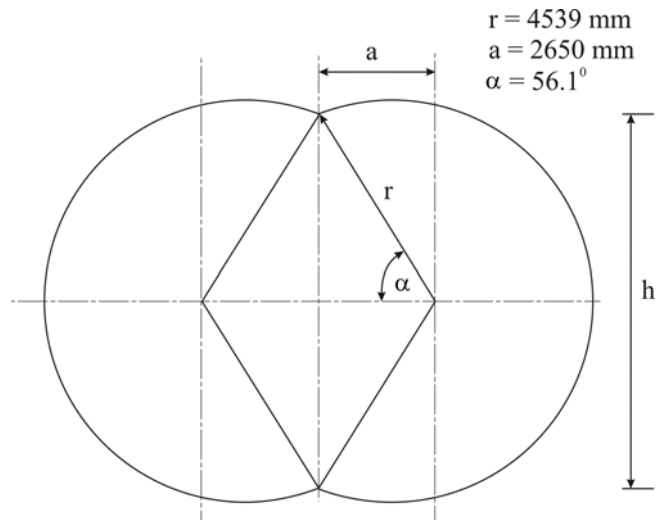

Figure 14 Boundary load of the longitudinal bulkhead  
Slika 14 Rubno opterećenje uzdužne pregrade

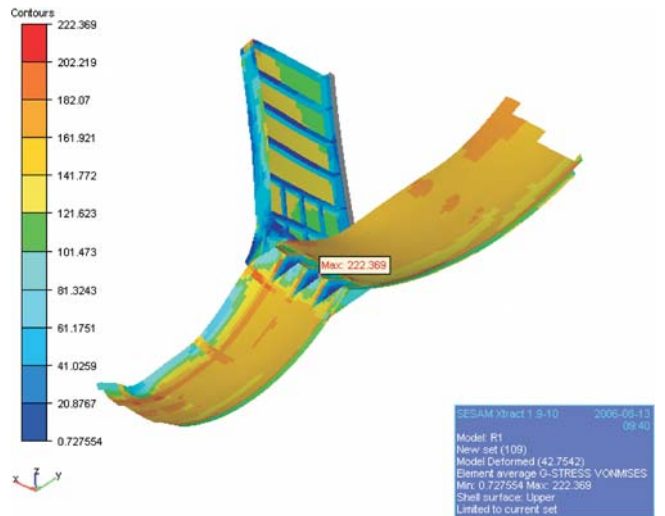

Figure 15 Total von Mises stress distribution in the aft head  
Slika 15 Raspodjela ukupnog von Misesovog naprezanja u stražnjem čelu

### 6 Strength analysis of the fore head

Down part of the toroidal shell is modelled where eccentricity is large, Figure 16. Generatrix of the torus and bulkhead is a curve which is not possible to generate by the available program facilities [11]. Therefore, the torus is approximated by a cone in the bulkhead area. The obtained generatrix is rotated around the cylinder longitudinal axis forming in such a way approximated torus surface.

The FEM model includes eccentricity  $e = 26$  mm of the Y-joint. That is achieved by difference of the torus cross-sectional radius in two bilobes (similar to the case of the aft head, Figure 12).

$$\Delta r_i = e \sin \alpha = 26 \cdot 0.85 = 22 \text{ mm}$$

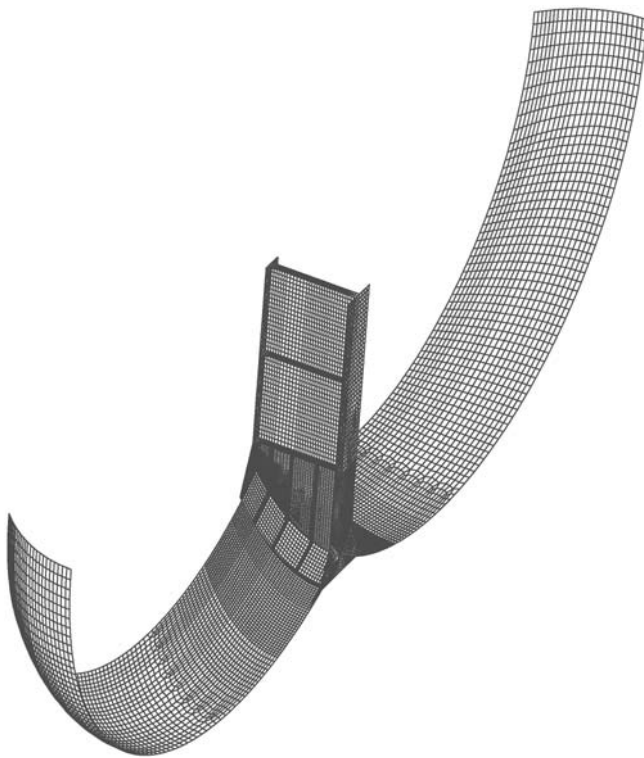

Figure 16 **FEM model of the fore head segment**  
Slika 16 **Model konačnih elemenata segmenta prednjeg čela**

The model base, i.e. the bulkhead and torus at  $z = 0$ , is fixed in vertical direction as well as the rotations:

$$\Delta z = 0, \varphi_x = \varphi_z = 0.$$

The bulkhead at  $z = 0$  is also fixed in transverse direction,  $\Delta_y = 0$ . At the cross-section  $x = 0$  the bulkhead and torus are fixed in longitudinal direction,  $\Delta_x = 0, \phi_y = \phi_z = 0$ .

The FEM model is fixed at  $x = 0$ , while the opposite side  $x = b$  is free and loaded with the membrane force:

$$N = \frac{pR_s}{2},$$

where  $R_s$  is radius of the sphere. According to Figure 17 the force components read:

$$N_x = \frac{pr}{2}$$

$$N_r = \frac{p(R_s - c)}{2}$$

The membrane force in the bulkhead, according to Figure 17, yields:

$$N_b = pa$$

The total stress distribution is shown in Figure 18. Maximum stress concentration value of 330 N/mm<sup>2</sup> is within the allowable value of 390 N/mm<sup>2</sup>.

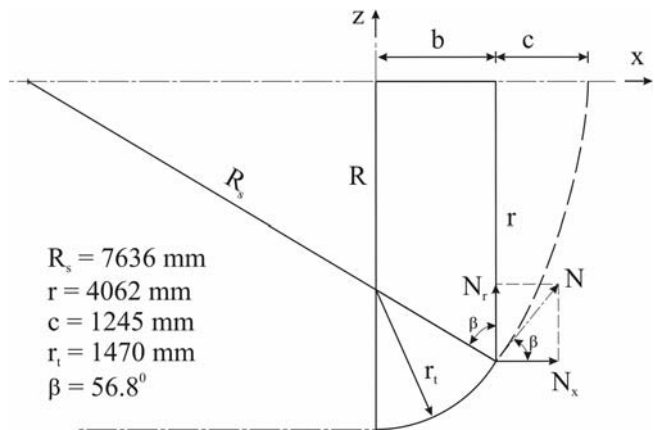

Figure 17 **Boundary load of the fore head segment**  
Slika 17 **Rubno opterećenje segmenta prednjeg čela**

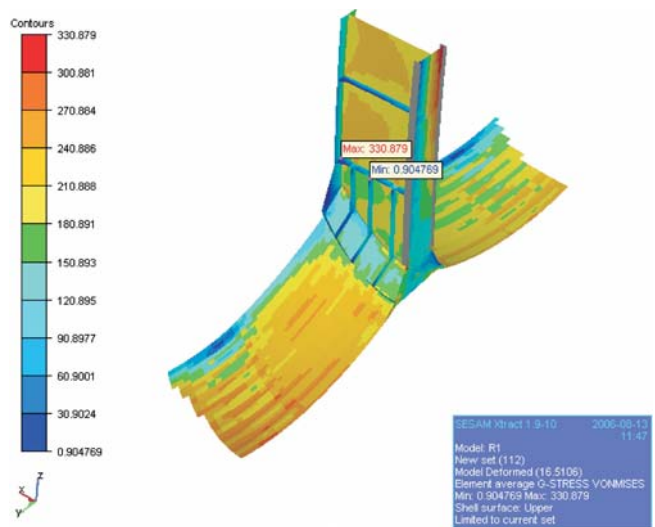

Figure 18 **Total von Mises stress distribution in the fore head**  
Slika 18 **Raspodjela ukupnog von Misesovog napreznja u prednjem čelu**

### 7 Conclusion

The bilobe tank heads are double curved shells and it is difficult to achieve an ideal Y-joint of the shells and longitudinal bulkhead. Eccentricity of the shell connection causes a large bending moment. As a result, very high stress concentration occurs in the Y-joint, since the tank shell is designed as a membrane structure.

In the considered case a remedy for the misalignment in the Y-joint of the bilobe tank heads is achieved by reinforcement consisting of inner bars and outer knees. In such a way high shell bending, which is kept in the neutral axis, is avoided.

Strength of the reinforced heads is checked by the finite element method as a very effective tool for the stress concentration analysis. Size of the FEM model is reduced to the reinforced head area. Tank segment between two cross-sections is modelled with a very fine mesh. One section is fixed and on the other shell membrane forces are imposed.

The performed FEM analysis of the reinforced tank heads shows that the level of the total stress is below the allowable secondary stress. Thus, the reinforcement is very effective and relatively simple for construction. It required only a small quantity of additional material. In this way safety of the tank structure is increased to the level of almost ideal constructions. Therefore, the required hydraulic test for checking of the tank structure can be performed with no doubt. The recommended tank reinforcement is general and can be used in similar situations.

## References

- [1] ...: "Safe Havens for Disabled Gas Carriers", Society of International Gas Tanker & Terminal Operators Ltd., Third Edition, 2003.
- [2] ...: "Resolution MSC.5 (48) International Code for the Construction and Equipment of Ships Carrying Liquefied Gases in Bulk", IMO, Edition 1993.
- [3] RUDAN, S.: "Safety of Cargo Tank Structure on LPG Carriers, Doctoral Thesis, University of Zagreb, 2006 (in Croatian).
- [4] ...: "Rules for Classification and Construction; Ship Technology -1 Seagoing Ships, 6 Liquefied Gas Tankers", Germanischer Lloyd, 2000.
- [5] SENJANOVIĆ, I., MRAVAK, Z., SLAPNIČAR, V., GOSPIĆ, I.: "Structure Design of Bilobe Cargo Tanks in Liquefied Gas Carriers", *Brodogradnja* 50(2002)3, p. 323-334.
- [6] SENJANOVIĆ, I., RUDAN, S., LJUŠTINA, A.M.: "Remedy for Misalignment of Bilobe Cargo Tank in Liquefied Petroleum Gas Carrier", *Journal of Ship Production*, 20(2004)3, p. 133-146.
- [7] SENJANOVIĆ, I., RUDAN, S., SLAPNIČAR, V.: "Design and Construction of Bilobe Cargo Tanks", *Proceedings of International Conference: Design, Construction and Operation of Natural Gas Carriers & Offshore Systems*, Busan, Korea, 2006, p. 91-110.
- [8] SENJANOVIĆ, I., RUDAN, S., TOMIĆ, M., VLADIMIR, N.: "Some Structural Aspects of LPG Cargo Tank Design and Construction", *International Conference: Design and Operation of LPG Ships*, RINA, London, 2008.
- [9] SENJANOVIĆ, I., RUDAN, S., LJUŠTINA, A.M.: "Remedy for Misalignment of Hemispherical Head of Bilobe Cargo Tank in Liquefied Petroleum Gas Carrier", *International Shipbuilding Progress*, (in press).
- [10] ...: "SESAM User's manual", Det Norske Veritas, Høvik, 2006.



# ncp

NAUČIČKI CENTAR PRGIN



[www.ncp.hr](http://www.ncp.hr)

**REMONT**  
održavanje jahti



**MARINA**

Lat. 43° 43.0' N  
Long. 015° 54.3' E



**CHARTER**  
i škola jedrenja



**NCP - Remontno brodogradilište Šibenik**  
Obala J. Šižgorića 1, CROATIA - Šibenik  
t. +385 22 312 971 / [sales@ncp.hr](mailto:sales@ncp.hr)

**NCP - Marina Mandalina**  
Obala J. Šižgorića 1, CROATIA - Šibenik  
t. +385 22 312 975 f. +385 22 312 976  
[marina@ncp.hr](mailto:marina@ncp.hr)

**NCP - Charter**  
Obala J. Šižgorića 1, CROATIA - Šibenik  
t. +385 22 312 999 f. +385 22 312 988  
[ncp@ncp.hr](mailto:ncp@ncp.hr)



# 3. MAJ

*Shipyard*

**3. MAJ Brodogradilište d.d.**  
Liburnijska 3, P.O.Box 197  
51000 RIJEKA, Croatia  
Sales Division  
Phone: **+385 (51) 61 13 80, 61 10 16**  
Fax: **+385 (51) 61 18 10**  
e-mail: [salesdpt@3maj.hr](mailto:salesdpt@3maj.hr)  
**[www.3maj.hr](http://www.3maj.hr)**

# HRVATSKA GOSPODARSKA KOMORA



## Sektor za industriju

### Zajednica proizvođača brodske opreme



### Članica Europskog vijeća proizvođača brodske opreme - EMEC

Zajednica proizvođača brodske opreme okuplja proizvođače uređaja i opreme te pružatelje usluga povezanih s brodogradnjom radi ostvarivanja njihovih interesa.

#### ZAJEDNICA SVOJIM ČLANOVIMA OMOGUĆUJE:

zajednički nastup pred državnim institucijama radi osiguranja što povoljnijih uvjeta poslovanja;  
jedinственu promociju kod domaćih i inozemnih brodograditelja, tiskanje promotivnih materijala i organiziranje izlaganja na sajmovima u inozemstvu u suradnji s Hrvatskom brodogradnjom - Jadranbrodom d.d.;  
mogućnost povezivanja s inozemnim partnerima radi izvoza ili kooperacije;  
usuglašavanje razvoja proizvodnih programa u suradnji s Hrvatskom brodogradnjom - Jadranbrodom d.d. odnosno hrvatskim brodogradilištima.

# CROATIAN CHAMBER OF ECONOMY



## Industry and technology department

### Affiliation of marine equipment manufacturers



### Member of the European Marine Equipment Council - EMEC

The Affiliation of Marine Equipment Manufacturers gathers the manufacturers of marine instruments and equipment, and service providers to the shipbuilding industry.

#### THE AFFILIATION ADDRESSES ITS MEMBERS NEEDS IN THE FOLLOWING WAYS:

joint approach to government institutions in order to ensure the most favourable business conditions;

joint promotion among both the domestic and foreign shipbuilding companies - publication of promotional materials and organizing the display of products at international fairs in cooperation with the Croatian Shipbuilding Corporation (Hrvatska brodogradnja - Jadranbrod d.d.);

establishment of links with foreign partners, with a focus on exports and cooperation;

coordination of the development of manufacturing programmes in cooperation

with the Croatian Shipbuilding Corporation, i.e. with Croatian shipyards.

HRVATSKA GOSPODARSKA KOMORA - SEKTOR ZA INDUSTRIJU  
CROATIAN CHAMBER OF ECONOMY - INDUSTRY AND TECHNOLOGY DEPARTMENT  
phone: +385 1 4606 705; fax: +385 1 4606 737; e-mail: industrija@hgk.hr;  
www.hgk.hr; www.biznet.hr

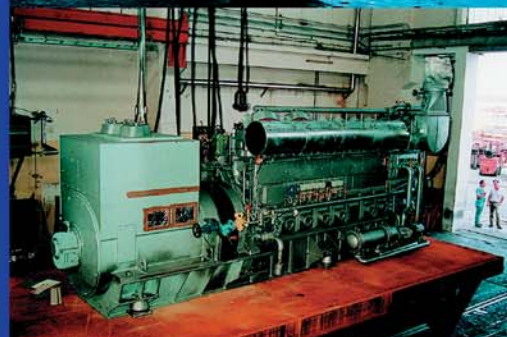
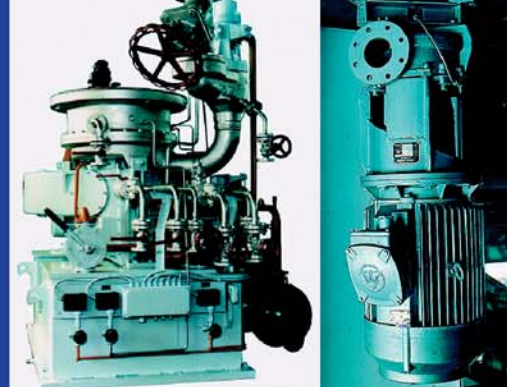

# KRALJEVICA SHIPYARD

SHIPBUILDING SINCE 1729

The **KRALJEVICA** Shipyard, shipbuilding and shiprepairing company, is the oldest shipyard on the eastern coast of the Adriatic Sea.

The continuity of shipbuilding in **KRALJEVICA** has been lasting uninterrupted since 1729, when the Shipyard has been established by the Austrian Emperor Karl VI.



The **KRALJEVICA** Shipyard ranks, in view of its capacities, among medium-sized shipyards (500 employees, area of 110,000 m<sup>2</sup>).

The **KRALJEVICA** Shipyard's activities are divided in three main groups: newbuildings (asphalt tankers, multipurpose vessels, container vessels, dry cargo vessels, paper carriers, RO-RO vessels, car ferries, offshore supply vessels, tugs, yachts, fishing vessels, small aluminum crafts, etc.), navy vessels (patrol vessels, corvettes, coast guard vessels, etc.), shiprepairing/retrofitting (merchant and navy vessels).

As from the end of Second World War, the Shipyard built more than 180 vessels of which 80 navy vessels and more than 100 merchant vessels on two open slipways of up to 10,000 tdw (125 x 21 m) and one sheltered slipway in hall (for vessels up to 60 x 11 m).

Shiprepairing and marine service-conversions for vessels up to 25,000 tdw in two floating docks of 450 tons and 6,500 tons lifting capacity (for vessels of maximum 155 x 21 m), and on shiprepairing quay of 575 meters in length.

The Shipyard have awarded for his quality two prestigious prizes:

- in Year 1989 for RO-RO/Container/paper carrier of 3,400 tdw as one of **the Most Outstanding Ship of the Year** (by US magazine "Maritime Reporter & Engineering News")
- in Year 2005 for Asphalt carrier of 9,200 tdw as one of **the Significant Ship of the Year** (by UK magazine "The Naval Architect")



## KRALJEVICA Shipyard

Obala Kralja Tomislava 8, P.O.Box 35,  
51262 Kraljevica, Croatia  
Sales Department  
Tel.: +385 (51) 416 278  
Fax: +385 (51) 416 405  
e-mail: bk-sales@brodskr.hr

[www.brodskr.hr](http://www.brodskr.hr)

# Tradition | Quality

# Inovation



## SHIPYARD TROGIR |



**BRODOTROGIR** d.d.  
**SHIPYARD TROGIR**  
TROGIR - CROATIA

### SHIPYARD TROGIR

Put brodograditelja 16  
21220 TROGIR - CROATIA

Phone:

+385 21 / 883 333 (Switchboard)  
+385 21 / 883 201 (Sales Department)

Fax:

+385 21 / 881 881 (Central)  
+385 21 / 883 417 (Sales Department)  
e-mail: sales@brodotrogir.hr



### SHIPREPAIR DIVISION

Put brodograditelja 16  
21220 TROGIR - CROATIA

Phone: +385 21 / 883 303

Fax: +385 21 / 883 406

E-mail: repairsales@brodotrogir.hr

[www.brodotrogir.hr](http://www.brodotrogir.hr)



FOR SIGNIFICANT CUSTOMERS

SIGNIFICANT SHIPS

Croatian shipyard with a long tradition and experience in designing and building various types of ships, always significant in their class.

**BRODOSPLIT Shipyard LTD.**

Put Supavla 21, 21000 SPLIT, Croatia, P.O.Box 517  
Phone. +385 (21) 382 617, 382 428, Fax. +385 (21) 382 648  
[www.brodosplit.hr](http://www.brodosplit.hr)



**BRODOSPLIT**

ISO 9001  
BUREAU VERITAS  
Certification





## ADRIA-MAR BRODOGRADNJA

je tvrtka specijalizirana za projektiranje, gradnju i remont ratnih brodova i brodova specijalne namjene, te njihove pripadajuće opreme.

NAŠ USPJEH se temelji na pouzdanoj suradnji sa klijentima i kooperantima.

## RASPOLAŽEMO

- visokoobrazovanim osobljem školovanim na CAD sustavima
- najnovijim referencama u ratnoj brodogradnji
- tehnologijom remonta sustava broskog naoružanja

## AKTUALNI PROJEKTI NOVOGRADNJE



## GENERALNI REMONTI



# ULJANIK



## Efficiency



[www.uljanik.hr](http://www.uljanik.hr)

## Versatility



**we know** HOW TO TURN  
*ideas*  
INTO PRACTICAL  
**realities**

## Practicability



Our cooperation and our technical skills with professional staff and stable management offer you an opportunity to build ships according to your own ideas and requests.

## Durability



### ULJANIK Shipyard

- Founded in 1856
- Educated personnel
- CAD/CAM system
- ISO 9001, ISO 14000
- Diesel engine MAN-B&W licence
- High quality of various types of ships

## Safety



AXIS-DESIGN



# ULJANIK

ULJANIK Brodogradilište d.d. Flacijusova 1, 52100 PULA, Croatia  
Tel. +385 (52) 374 000 - Switchboard; +385 (52) 374 450 - Sales Dept.  
Fax. +385 (52) 374 504 E-mail: [sales.dept@uljanik.hr](mailto:sales.dept@uljanik.hr)



grafička priprema ✓ tisak ✓ digitalni tisak ✓ dorada ✓

izrada svih vrsta: tiskanica ✓ plakata ✓ diploma ✓  
prospekata ✓ brošura ✓ knjiga ✓ monografija ✓ ... ✓



**SVEUČILIŠNA TISKARA** d.o.o.

Grafičko-izdavačko i trgovačko poduzeće  
10000 Zagreb, Trg m. Tita 14  
tel.: 385 /01 / 45 64 430, fax: 45 64 427  
e-mail: [sveucilisna-tiskara@zg.htnet.hr](mailto:sveucilisna-tiskara@zg.htnet.hr)