

Documenting & Using Cognitive Complexity Mitigation Strategies (CCMS) to Improve the Efficiency of Cross-Context User Transfers

by

Rahul Bhagat

A thesis

presented to the University of Waterloo

in fulfilment of the

thesis requirement for the degree of

Master of Applied Science

in

Systems Design Engineering

Waterloo, Ontario, Canada, 2011

©Rahul Bhagat 2011

AUTHOR'S DECLARATION

I hereby declare that I am the sole author of this thesis. This is a true copy of the thesis, including any required final revisions, as accepted by my examiners.

I understand that my thesis may be made electronically available to the public.

Abstract

Cognitive complexity mitigation strategies are methods and approaches utilized by users to reduce the apparent complexity of problems thus making them easier to solve. These strategies often effective because they mitigate the limitations of human working memory and attention resources. Such cognitive complexity mitigation strategies are used throughout the design, development and operational processes of complex systems. Thus, a better understanding of these strategies, and methods that leverage them, can help improve the efficiency of such processes.

Additionally, changes in the use of these strategies across various environments can identify cognitive differences in operating and developing across these contexts. This knowledge can help improve the effectiveness of cross-context user transfers by suggesting change management processes that incorporate the degree of cognitive difference across contexts.

In order to document cognitive complexity mitigation strategies and the change in their usage, two application domains are studied. Firstly, cognitive complexity mitigation strategies used by designers during the engineering design process are found through an ethnographic immersion with a participating engineering firm, followed by an analysis of the designer's logbooks and validation interviews with the designers. Results include identification of five strategies used by the designers to mitigate design complexity. These strategies include Blackbox Modeling, Whitebox Modeling, Decomposition, Visualization and Prioritized Lists. The five complexity mitigation strategies are probed further across a larger sample of engineering designers and the usage frequency of these strategies is assessed across commonly performed engineering design activities which include the Selection, Configuration and Parametric

activities. The results indicate the preferred use of certain strategies based on the engineering activity being performed. Such preferential usage of complexity mitigation strategies is also assessed with regards to Original and Redesign projects types. However, there is no indication of biased strategy usage across these two project characterizations. These results are an example of a usage-frequency based difference analysis; such analyses help identify the strategies that experience increased or reduced usage when transferring across activities.

In contrast to the first application domain, which captures changes in how often strategies are used across contexts, the second application domain is a method of assessing differences based on how a specific strategy is used differently across contexts. This alternative method is developed through a project that aims to optimize the transfer of air traffic controllers across different airspace sectors. The method uses a previously researched complexity mitigation strategy, known as a structure based abstraction, to develop a difference analysis tool called the Sector Abstraction Binder. This tool is used to perform cognitive difference analyses between air traffic control sectors by leveraging characteristic variations in how structure based abstractions are applied across different sectors. This Sector Abstraction Binder is applied to two high-level airspace sectors to demonstrate the utility of such a method.

Acknowledgements

First and foremost, I would like to thank my supervisor, Professor Jonathan Histon, for his guidance and support throughout my graduate research. Over the past two years, he has provided me with the freedom and opportunity to explore diverse projects both within and beyond the confines of academia. Consequently, I also appreciate his patience as I assembled this diversity into a coherent research contribution.

I would also like to acknowledge my readers, Professor Eihab Abdel-Rahman and Professor Arsen Hajian, for their assistance and tutelage through numerous aspects of this dissertation.

Much of this research has been performed through collaborative endeavours with numerous individuals and organizations. Firstly, I would like to recognize Arjae-Spectral Enterprises for facilitating my research by allowing me to become a part of their design team. Specifically, I would like to thank Professor Arsen Hajian and Brad Schmidt for providing me with the opportunity and members of the engineering design team, including Iman Shafieloo, Iman Khodadad, Len Ball and Lev Chifman. Secondly, I would like to recognize my collaboration with the Massachusetts Institute of Technology's International Center for Air Transportation and specifically thank Professor John Hangman and Emilio Filho.

Finally, and perhaps most importantly, I am indebted to the University of Waterloo Human Factors Group and my lab mates in the Humans in Complex Systems Lab. They helped foster a fantastic working environment and their friendships have been tremendously important.

For Mum and Dad. Thank You.

Table of Contents

Author's Declaration	ii
Abstract.....	iii
Acknowledgements.....	v
Dedication.....	vi
Table of Contents	vii
List of Figures.....	x
List of Tables.....	xi
List of Acronyms	xii
Chapter 1 Introduction.....	1
1.1 Improving Performance in the Engineering Design Process	1
1.2 Problem	2
1.3 Cognitive Difference Analyses	3
1.4 Research Objectives	4
1.5 Thesis Organization.....	5
Chapter 2 Background.....	6
2.1 Cognitive Complexity.....	6
2.2 Human Information Processing	8
2.3 CCMS in the Engineering Design Process.....	12
2.4 Chapter Summary	14

Chapter 3 Study I: Documenting CCMS Used During Engineering Design.....	15
3.1 Problem: Commercializing an Electromechanical Device.....	15
3.2 Method: Identifying & Validating CCMS.....	17
3.3 Results: CCMS Used During Engineering Design.....	22
3.4 Chapter Summary	38
Chapter 4 Study II: Improving the Efficiency of Cross-Activity Designer Transfer.....	40
4.1 Problem: Supporting Efficient Design Practices Using CCMS	40
4.2 Method: Assessing CCMS Preferences Across Design Activities.....	43
4.3 Results: Usage Frequency-Based Analysis of CCMS.....	47
4.4 A Cognitive Difference Analysis Based on the Usage Frequency of CCMS.....	58
4.5 A Tool to Improve the Design Process.....	60
4.6 Chapter Summary	62
Chapter 5 Study III: Improving the Efficiency of Cross-Sector Air Traffic Controller Transfer	64
5.1 Problem: Accelerated Air Traffic Controller Retirement Rates	65
5.2 Method: The Sector Abstraction Binder	68
5.3 Results: A Cognitive Difference Analysis of Two Airspace Sectors	72
5.4 A Cognitive Difference Analysis Based on Characteristic Variations in CCMS.....	78
5.5 Chapter Summary	79
Chapter 6 Conclusions & Future Work.....	81
6.1 Study I: Documenting CCMS	81
6.2 Study II: Efficient Transfer Through Differences in the Usage Frequencies of CCMS.....	83
6.3 Study III: Efficient Transfer Through Characteristic Differences in CCMS.....	85
6.4 Future Work	86

References	88
Appendix A Study I: Validation Interviews.....	92
Appendix B Study II: Retrospective Interviews	98
Appendix C Brewton HL - Geneva HL Sector Abstraction Binder	102

List of Figures

Figure 1: Relationships between the three classifications of complexity	8
Figure 2: Human Information Processing Model (Adapted from Wickens & Hollands, 2000)	9
Figure 3: Relationships between working & long term memory.....	11
Figure 4: Illustration of how an abstraction mitigates complexity.....	13
Figure 5: A block diagram depicting the MPG device	17
Figure 6: Sanitized snippet from MPG device designer's logbook showing.....	25
Figure 7: Schematic of MPG device including mass-spring-damper system.....	27
Figure 8: Snippet from a designer's logbook showing a commonly used MPG formula.....	28
Figure 9: Using a Decomposition CCMS on the MPG device.....	31
Figure 10; Logbook snippet showing the use of a Prioritized List CCMS.....	33
Figure 11: Logbook snippet showing the MPG competitive landscape	37
Figure 12: Logbook snippet showing a rectifier circuit.....	37
Figure 13: CCMS usage frequencies for Selection activity	49
Figure 14: CCMS usage frequencies for Configuration activity	52
Figure 15: CCMS usage frequencies for Parametric activity.....	54
Figure 16: Comparison of Original vs. Redesign Projects.....	55
Figure 17: Likelihood of experiencing a reduction in perceived complexity for each CCMS	57
Figure 18: Representation of an air traffic controller's cognitive processes.....	67
Figure 19: Bottom-up depiction of the Sector Abstraction Binder methodology.....	69
Figure 20: Identifying abstraction instances in Brewton and Geneva	73

List of Tables

Table 1: Matrix used for project characterization	44
Table 2: Definitions of CCMS-design activity pairings	46
Table 3: Selection activity specific definitions of the CCMS	49
Table 4: Configuration activity specific definitions of the CCMS	51
Table 5: Parametric activity specific definitions of the CCMS:.....	53
Table 6: CCMS usage preferences across engineering activities.....	59
Table 7: CCMS usage preferences across engineering activities including perceived complexity reduction data.....	61
Table 8: Commonly occurring structure based abstractions	68
Table 9: Examples of contextual and specification factors for each abstraction type	70
Table 10: Partial abstraction profile for Brewton outbound handoffs.....	71
Table 11: Information sources used to evaluate characteristic factors	74
Table 12: Sample comparison of two outbound Brewton handoffs	74
Table 13: Sample of Brewton outbound handoff profile.....	76
Table 14: Outbound handoff difference analysis between Brewton and Geneva.....	76
Table 15: Standard flow difference analysis between Brewton and Geneva.....	77

List of Acronyms

ATC – Air Traffic Controller

CCMS– Cognitive Complexity Mitigation Strategies

FAA – Federal Aviation Administration

MOA – Military Operations Area

MPG – Micro-Power Generation

NAS – National Airspace System

OJT– On-the-Job Training

SAB– Structure Abstraction Binder

SUA – Special Use Area

Chapter 1

Introduction

Today's socio-technical systems are larger, more interdisciplinary, and contain more intricate connections amongst their sub-systems than ever before. This growth emphasizes a need to understand how the designers and operators of these systems manage the complexity of their tasks. This thesis documents the cognitive complexity mitigation strategies (CCMS) used during the engineering design process and explores how the use of such strategies changes across different contexts. Understanding this change can help support the efficient transfer of human resources across different contexts because the problems that may arise from the transfer are better anticipated and planned for.

1.1 Improving Performance in the Engineering Design Process

Complex problem solving tasks, such as engineering design problems, stress the limitations of an engineering designer's working memory and can result in diminished task performance (Maynard & Hakel 1997). This working memory can be described as the "workbench" of consciousness and is where mental representations are evaluated, examined, transformed and compared. Its limitations include the quantity of information it can store and the duration it can store the information for (Wickens & Hollands 2000).

To manage the limitations of working memory, designers employ strategies that mitigate the complexity of the system they are working on. The identification and selection of the most appropriate strategy is important because it determines how effectively a designer can reduce working memory stress and thus increase complex problem solving task performance.

By identifying commonly used cognitive complexity mitigation strategies (CCMS) in the engineering design process, this thesis aims to increase the effectiveness of the engineering design process. Firstly, this can be accomplished by incorporating the findings of this research into design

processes that promote and support the use of CCMS. Second, differences in how these strategies vary across different projects can help support the efficient transfer of designers to different projects.

1.2 Problem

The complexity of a designer's task is well documented as an important variable in decision making performance research (Larichev & Moshkovich 1988; Locke et al. 1981). The strategies employed to execute and plan for tasks are either created or recalled from memory and the choice of strategy is dictated by the task's objective complexity (Bodenhausen & Lichtenstein 1987; Paquette & Kida 1988). Thus, decision making performance in the engineering design process can be improved if the problem solving strategies used by designers are documented, their effect on objective complexity is better understood, and the strategies are better supported in the designer's working environment. Furthermore, analyzing the differences in mitigation strategy usage across projects can help support the efficient transfer of designers to new projects.

1.2.1 Supporting the Use of CCMS

Supporting the use of cognitive complexity mitigation strategies (CCMS) can help a user more effectively manage the objective complexity of their task. This can lead to an increase in task performance. In order to achieve this performance increase, this thesis aims to identify some of the most common CCMS used during the engineering design process. The identification of these strategies allows them to be incorporated within training activities and facilitates the creation of work environments and protocols that are more conducive to their use. For example, the identification of a very commonly occurring complexity mitigation strategy suggests the formalization of the strategy within a design group's processes. This formalization would result in all designers having knowledge of the same strategy through a common training protocol. Such homogeneity in the complexity mitigation approaches used by the design team would allow for

more efficient communication of ideas. Furthermore, knowledge of commonly used CCMS provides a mechanism of vetting proposed workplace changes. Workplace changes that encourage the use of CCMS would be promoted while the changes that limit their used should be reconsidered.

1.2.2 Facilitating Efficient Designer Transfer

Beyond a designer's performance on an individual project, another opportunity to increase design process efficiency is by improving the effectiveness of transferring designers to different projects. Anticipating the degree to which a new project differs from the original is the key to determining the type and amount of retraining a designer may require.

The identification of CCMS provides an opportunity to document the change in these strategies when the context (or project) changes. Across different projects, a complexity mitigation strategy may experience a change in its usage frequency, or the way in which it is used. Identifying these changes can help inform a cognitive difference analysis which can be used to facilitate efficient contextual transfer of designers. For example, transferring a designer across projects that prefer the use of different CCMS can be more effectively supported if the designer is specifically trained on the CCMS requirements of the new project.

1.3 Cognitive Difference Analyses

Cognitive differences analyses attempt to capture the differences in mental representations and cognitive processes across different contexts. The analyses provide a tool that, when informed with cognitive complexity mitigation strategies (CCMS), can help identify differences that may be of concern when performing a cross-context designer transfer. Cognitive complexity analyses can utilize CCMS into two distinct methods.

The first method is based on the change in the usage frequencies of commonly used CCMS. This method characterizes projects by the preferred usage of certain CCMS over others. A cognitive difference analysis can then be performed by comparing the preferred CCMS across various

projects. This change in the preferential use of certain CCMS captures the cognitive similarities (and differences) across different types of projects. By highlighting strategies through which designers prefer to manage complexity in certain types of projects, assessments on the effectiveness of transferring a designer across projects can be made.

The second method of cognitive difference analysis that is explored is based on the change in characteristics of a single cognitive complexity mitigation strategy. This method characterizes an environment by establishing and evaluating numerous factors that define a specific complexity mitigation strategy. Multiple environments are then compared by analyzing the differences in the defining factors. This can provide insight on how a particular mitigation strategy changes across environments and if using it in a new environment will require significant relearning.

1.4 Research Objectives

The investigation of cognitive complexity mitigation strategies (CCMS) by this thesis addresses the following research questions:

1. What are the commonly used CCMS in the engineering design process?

Identifying commonly used complexity mitigation strategies involves documenting high level processes and methods that are repeatedly and consistently used by designers to model a system during the design process. This objective is pursued in Chapter 3 where the design of an electromechanical device is studied, the strategies used during its design are documented, and how these strategies mitigate complexity is analyzed.

2. How do CCMS vary with changes in context (i.e. projects or environments)?

Understanding the changes in CCMS across various projects and environments can be leveraged to perform cognitive difference analyses. The results of such analyses can be used to reduce, anticipate and plan for problems that may arise from transferring users to different contexts. This objective is explored in Chapter 4 and Chapter 5 where changes in CCMS usage

frequency and usage characteristics across different contexts are presented and implications from performing a cognitive difference analysis examined.

1.5 Thesis Organization

The remainder of the thesis is organised as follows:

Chapter 2: Background contains a review of complexity and how humans manage it based on the Human Information Processing Model (Wickens & Hollands 2000).

Chapter 3: Study I: Documenting CCMS Used During Engineering Design reviews the design of an electromechanical device and the complexity mitigation strategies used during its design.

Chapter 4: Study II: Improving the Efficiency of Cross-Activity Designer Transfer explores which of the strategies identified in the previous chapter are preferred by designers across specific engineering design activities.

Chapter 5: Study III: Improving the Efficiency of Cross-Sector Air Traffic Controller Transfer creates a framework for a cognitive difference analysis using the characteristic differences in structure based abstractions, a specific type of complexity mitigation strategy used by air traffic controllers.

Chapter 6: Conclusions & Future Work summarizes the findings of this thesis and proposes areas for further research.

Chapter 2

Background

This chapter provides background on complexity research. It provides a working definition of the term and describes the different types of complexity. This is followed by a discussion of the human information processing model with a focus on the limitations of working memory, long-term memory and mental models. Finally, previous work on cognitive complexity mitigation strategies is discussed in the context of accommodating cognitive complexity within the limitations of human information processing.

2.1 Cognitive Complexity

Complexity is formally defined as "hard to separate, analyze, or solve" (Mish 2008). However, this definition can vary across domains. To achieve a better understanding of generalized complexity, an analysis of the common characteristics contained in the definitions of complexity was performed by Histon & Hansman (2008). This revealed three consistent traits across the definitions.

The first common trait amongst the definitions was that they tended to capture aspects of "size", "count", and "number of" items within a system (Edmonds 1999). The second trait looked at the interconnections between the items and viewed a system or problem as "composed of interconnected parts" (Flexner 1980). The greater the intricacy of the interconnections and dependencies amongst the items within the system, the greater the potential for complexity. The final trait described the effect that problem representation has on complexity. For example, Histon & Hansman (2008) describe the complexity of "a pile of nails being very different depending on whether one is searching for something to hang a picture on, or trying to model the forces that help the pile maintain its shape".

The last two traits of complexity definition are reflected in Edmonds (1999) working definition of complexity:

That property of a language expression which makes it difficult to formulate its overall behaviour, even when given almost complete information about its atomic components and their inter-relations.

This working definition is a combination of both the physical manifestation of complexity within a system, through its parts and interconnections, and the mental manifestation of this system within its users and designers. As the focus of this thesis is on the complexity mitigation strategies used by designers, it is important to distinguish between the physical and mental, or objective and cognitive, manifestations of complexity.

2.1.1 Objective, Cognitive & Perceived Complexity

Figure 1 provides a breakdown of three manifestations of complexity: objective, cognitive, and perceived. The system in this model may, for example, be an object, protocol, method, or problem. The user or designer is an individual who is operating or designing the system. The interactions between these two entities are the actions which the user/designer performs on the system and the system's response to these actions which is perceived by the user/designer.

The objective complexity is an attribute of the system and does not change unless the system itself is altered. Objective complexity is a result of the number of components within the system, the number of interconnections and dependencies, and the intricacy of these interconnections.

Cognitive complexity is the manifestation of objective complexity within the individual's thought processes. The working mental model drives an individual's understanding of the system and is responsible for the process by which the objective complexity manifests itself. There are many factors that affect the working mental model from learned attributes such as knowledge and mental model choice to physical attributes such as fatigue and stress. Due to this, even for the same objective complexity, the resulting cognitive complexity will vary across individuals and

environments. This research is interested in documenting the most common mental models, or cognitive complexity mitigation strategies (CCMS), used during the engineering design process.

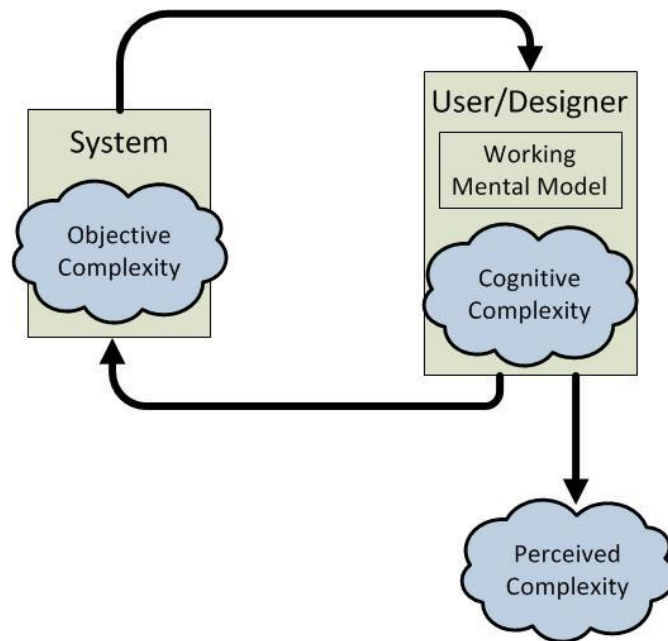

**Figure 1: Relationships between the three classifications of complexity
(adapted from Histon & Hansman, 2008)**

Perceived complexity is an individual's self-reported complexity which can be gauged by asking an individual to report how complex they find a problem to be. These self-reports are closely related to cognitive complexity and have been widely used in complexity research (Laudeman et al. 1998; Kopardekar et al. 2007). It is however important to note that such reports are not always able to identify the types of methods individuals use to deal with complexity. Thus, this research uses alternative means to identify the types of strategies used to reduce complexity during the engineering design process. Self reports on how effective those strategies are at reducing perceived complexity are then used to gauge their impact on cognitive complexity.

2.2 Human Information Processing

The focus of this thesis is on cognitive complexity and the methods used to mitigate it. The human information processing model can help describe the causes of cognitive complexity and how

mitigating it can lead to improved decision making and performance. Figure 2 provides the stages of human information processing as adapted from Wickens & Hollands (2000).

According to the model, information provided by the system/problem is sensed and processed by an individual's sensory organs. For example, when a driver hears the horn of an oncoming car they may sense that as an intense sound. This raw sensory data is then relayed to the brain where it is interpreted and given meaning to. At this stage the intense sound of the horn is assigned a meaning which may indicate a warning or alarm from the car straight ahead.

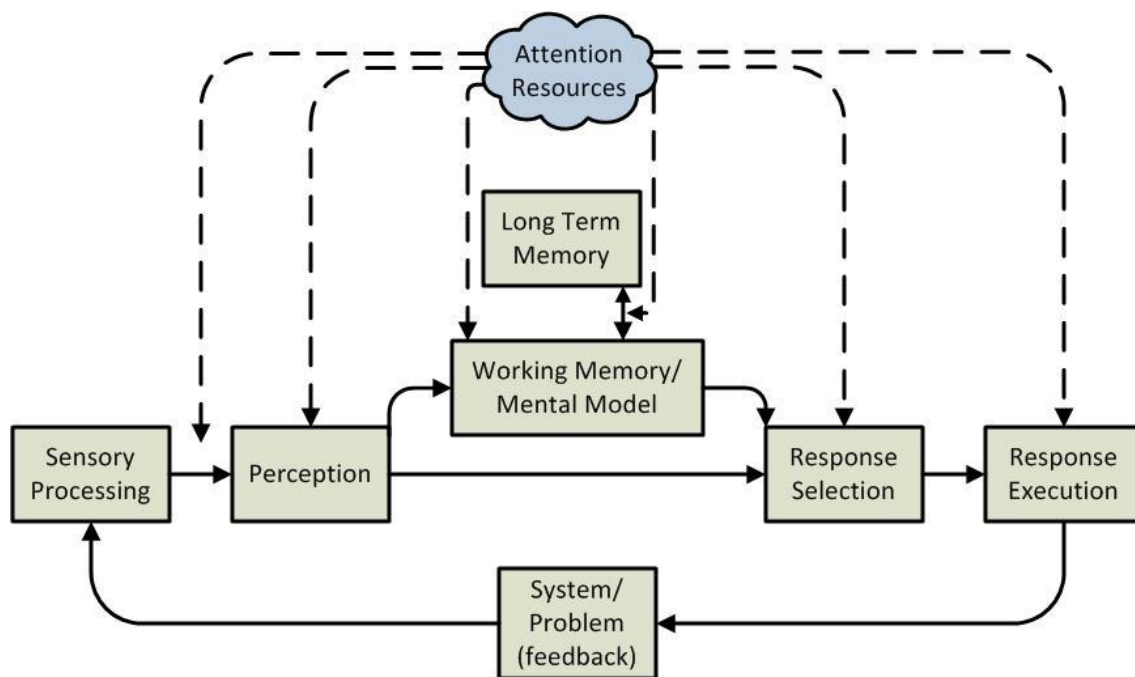

Figure 2: Human Information Processing Model (Adapted from Wickens & Hollands, 2000)

Depending on a variety of factors, including the expertise and complexity of the perceived information, the individual may go directly to the response selection stage where they choose the best action from possible alternatives or the individual may relay the perceived data into the working memory. At the working memory stage, cognitive operations such as rehearsal, reasoning, or image transformation are carried out (Baddeley 1992). The working memory stage is a vulnerable, temporary store of activated information that is resource limited (Norman & Bobrow

1975). This means that if attention resources are diverted from it, the performance of working memory can be disrupted. When certain types of perceived information is repeatedly rehearsed and/or especially complex, the individual may refer to their long term memory stores for past experiences and strategies to deal with certain types of perceived data. This is especially important in complex problems because an individual cannot process the entirety of a complex problem within working memory and must employ strategies to reduce the complexity such that it becomes more manageable. After gaining a better understanding of the perceived data through the working memory/mental model stage the individual proceeds to choose a course of action in the response selection stage. After a choice is made, the response execution stage involves the physical actions required to carry out the selected response. This response enters the system or problem and the changes in state are once again sensed by the individual and the cycle begins again.

Another important component of the human information processing model is attention resources. Research has shown that many mental operations require the selective application of limited attention resources (Kahneman 1973; Pashler 1998). Thus, diverting attention to specific stages of the information processing model would cause other areas to suffer a performance decrement since there is a limit to an individual's overall attention pool.

This research analyses the engineering design process in which individuals are faced with highly complex problem solving tasks. The drivers of performance in such complex tasks include working memory and attention resources. Thus, it is expected that the limitations of working memory impose themselves on complex problem solving tasks and there should be a performance decrement in situations where there is increased working memory load (Ward & Allport 1997). However, working memory load can be managed by strategies that reduce the complexity of, or simplify, the problem that is being solved. Thus the knowledge and appropriate use of these cognitive complexity mitigation strategies (CCMS) is a key driver of an individual's performance in complex problem solving tasks. If an individual knows how to effectively deal with complexity by

having learned the most effective CCMS for a given problem, they are able to most efficiently counteract the limitations of their working memory and attention resources.

2.2.1 Long Term Memory, Working Memory & Mental Models

The relationship between working memory, long term memory and mental models is shown in Figure 3. Information that is input into the model is encoded, first, into working memory; a temporary, attention demanding store that is used to retain new information. If this information is repeated and rehearsed then it may get encoded into long term memory. This process of encoding is the primary objective of training and learning. Depending on the nature of the problem, information from working or long term memory is retrieved and used to support the subsequent stages of human information processing.

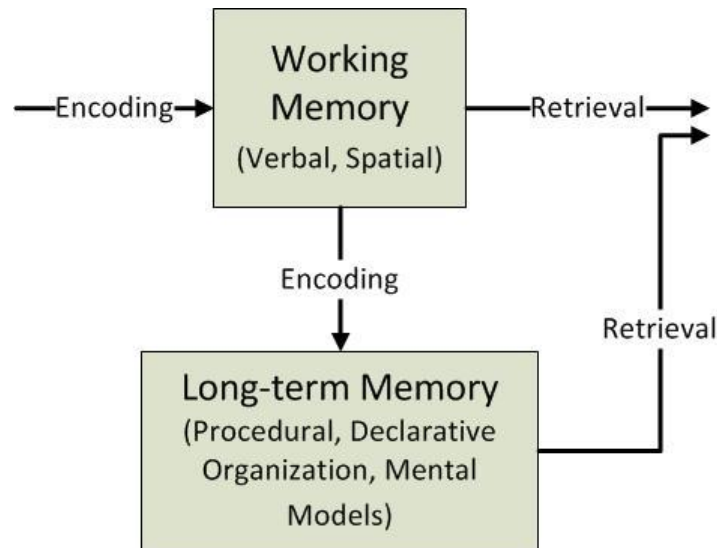

**Figure 3: Relationships between working & long term memory
(Adapted from Wickens & Hollands, 2000)**

The types of information stored within working and long term memory are of importance to this research. Working memory tends to hold verbal and spatial codes whereas long-term memory is more conducive to procedural, declarative and mental model coding. Mental models, for example, are structures that reflect an individual's understanding of the system. In particular, they allow the

user to mentally try out an action (Carroll & Olson 1987). These models then have to be generalized and abstracted such that they can be applied to a variety of different situations and problems. The CCMS that this thesis aims to document are very similar to the generalized mental models that are stored in long-term memory. Knowledge of their presence in long-term memory in an abstracted state suggests that the research methods used to uncover these strategies must analyze generalized approaches and structures to solving a problem. Furthermore, an analysis must look for the repeated use of these approaches across various engineering design activities.

2.3 CCMS in the Engineering Design Process

Abstractions, a type of cognitive complexity mitigation strategy (CCMS), provide a means of representing a system such that it is manageable under the constraints of human memory and processing. Rasmussen (1986) states that these abstractions are not simply derived by a "removal of details of information on physical material properties. More fundamentally, information is added on higher level principles governing the cofunction of the various functions or elements at the lower levels."

Reynolds et al. (2002) presented a notional representation of how an abstraction might aid human information processing by reducing subjective system complexity. As shown in Figure 4, an individual has a limited attention spotlight which is dictated by the limits of human cognition. Complex systems, before the use of any abstraction mechanisms, can overwhelm an individual's limited attention and working memory resources. However, abstracting portions of the system that are not of primary importance by, for example, consolidating all their functions into a single entity, can help alleviate the number of subsystems and interactions that need to be considered at any given time. This type of abstraction is one method of managing a system's subjective complexity.

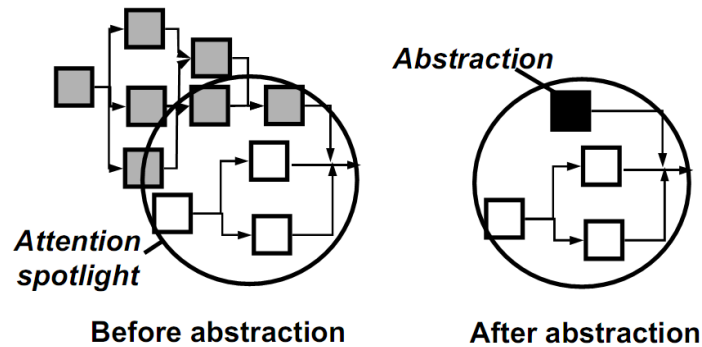

**Figure 4: Illustration of how an abstraction mitigates complexity
(from Reynolds et al. 2002)**

The use of abstractions as a complexity mitigation technique in the design process has been documented in many empirical studies including those by Ullman et al. (1988), Takeda et al. (1990) and Stauffer et al. (1987). The presence of abstractions as a recurring theme in studies led by Hoover et al. (1991) to investigate the effect of abstractions on the design process and the methods of generating useful abstractions. However, Hoover et al. also cites characterizing the use of abstractions as an area of future research.

Previous research also identifies the use of abstractions during the engineering design process due to the cognitive limitations of the designer coupled with the complex nature of the problems (Ullman et al. 1988; Goel & Pirololi 1989; Ullman 2002). Cognitive limitations restrict the complexity of the system that can be managed by a designer at any given time. Thus, the designer must employ complexity mitigation techniques and find methods of simplifying the system they are working on to produce effective designs.

This thesis documents CCMS, in addition to abstractions, and characterizes how these strategies are applied during the engineering design process. This operational understanding can be used to directly impact design processes and protocols. Furthermore, this research attempts to further the utility of CCMS by leveraging them as a basis for performing cognitive difference analyses.

2.4 Chapter Summary

This chapter presented the prevailing paradigm of complexity. It was explored in terms of the actual complexity present within a system (objective), its manifestation within an individual's thought processes (cognitive), and an individual's self-reported complexity (perceived). An individual's limited ability to manage complexity was also explored in the context of the human information processing model through the limitations of human working memory and attention resources. Thus the importance of documenting cognitive complexity management techniques for the purposes of increasing design process performance was established.

Finally, prior work in cognitive complexity mitigation strategies (CCMS) within the engineering design process revealed abstractions, which are stored in long term memory, as a method of managing task complexity. Chapter 3 is a documentation of other CCMS that were found to be used during the design of an electro-mechanical device.

Chapter 3

Study I: Documenting CCMS Used During Engineering Design

This chapter presents the cognitive complexity mitigation strategies (CCMS) used by designers during the development of a micro-power generation (MPG) electro-mechanical device. The strategies were documented through a working collaboration with the design team at an engineering firm whose goal was to commercialize a MPG device that had been developed in a controlled laboratory environment. The collaboration involved a three part study which included:

- An ethnographic component for the purposes of learning the design processes, protocols and designer working culture in a participatory manner to better support the findings of the next two parts of the study (Section 3.2.1).
- A retrospective analysis of designer logbooks to determine commonly recurring complexity mitigation strategies used to manage complex design problems (Section 3.2.2).
- Retrospective validation interviews with designers to confirm their use of the complexity mitigation strategies identified through the logbook analysis (Section 3.2.3).

The result of this study was the documentation of five CCMS that were used by the designers to improve their understanding of the MPG device, focus on individual components of interest, and simplify complex behaviours for further analysis. These strategies were identified based on evidence of their usage during the MPG project. Before describing the strategies and how they were identified, the chapter begins with a brief background on the MPG device itself.

3.1 Problem: Commercializing an Electromechanical Device

The engineering firm that was the focus of this study specializes in the commercialization of novel devices and instrumentation for the aerospace and defence, space science, and transportation industries. As one of its initiatives, the firm sought to commercialize an inductive, low-frequency, micro-power generation (MPG) device which was acquired from Dr. Eihab Abdel-Rahman at the

University of Waterloo (Soilman et al. 2010). At the time of this study, a handful of companies were attempting to establish a presence in a growing MPG market and the firm had the potential of becoming a significant competitor by aggressively pursuing the commercialization of its version of the technology.

Inductive MPG devices work on the principles of Faraday's Law; the relative motion between a magnet and a conductive material produces an electric current (Fitzpatrick 2008). To gain this relative motion, MPG devices are affixed to other devices, such as motors and pumps, which produce stray vibrations. The result is the harvesting of some of the wasted vibrational energy as more useful electrical current. The current state of MPG innovation allows sufficient energy harvesting to support low-power electronics. Typical applications are environments with low frequency, low amplitude vibrations that use batteries to power electronic systems. Generally, the operational life of these systems depends on the charge capacity of the battery. Using an MPG setup instead of the battery can greatly increase the operational life-span of such systems.

Figure 5 provides an overview of the MPG device through the use of a block diagram. A vibrational source provides the input energy for the device. The vibrations can be characterized through a number of parameters however the most important are acceleration, amplitude and frequency. These vibrations produce a relative motion between a winding of coils and an array of magnets within the mechanical subsystem. The efficiency of this relative motion is dictated by various components within the mechanical subsystem. The output of the mechanical subsystem, unconditioned power, is noisy alternating current which is not suitable for most uses. Thus, an electrical subsystem acts to condition the power. A consequence of introducing this electrical subsystem however is a feedback effect; the electrical subsystem affects the behaviour of the mechanical subsystem (Khodadad et al. 2011). This coupling of the two systems is one of the sources of complexity within the MPG device as the two subsystems are not independent of each

other. Finally, the electrical subsystem generates a conditioned power output that can be used to power devices or, for example, store charge in a battery for future use.

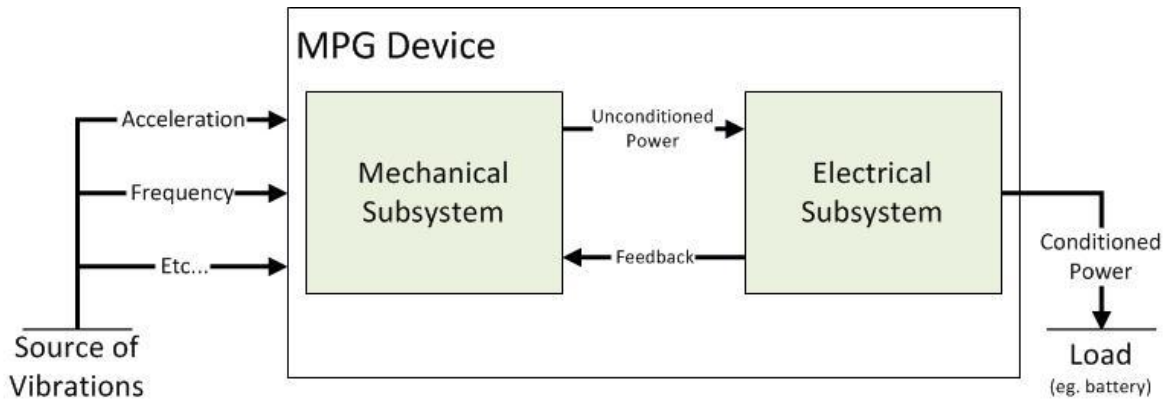

Figure 5: A block diagram depicting the MPG device

The engineering design problem presented to the design team was to commercialize the MPG device by meeting certain performance targets for the device. This involved tuning dozens of components within the mechanical and electrical subsystem, determining the characteristics of the optimal input vibrations, packaging the device into a complete solution without significant performance degradation, and understanding the interactions within and across the electrical and mechanical subsystems. Accomplishing these tasks on an aggressive development timeline made the MPG device project an ideal candidate for studying the strategies used by the designers to efficiently manage cognitive complexity.

3.2 Method: Identifying & Validating CCMS

This study used a three step methodology to identify and validate cognitive complexity mitigation strategies (CCMS) used during the design of the micro-power generation (MPG) device. An ethnographic approach was first used to gain expertise with the design practices at the engineering firm. This was followed by an analysis of each design team member's logbook for the purposes of tracing commonly used approaches for managing complexity. Finally, validation interviews were conducted with each design team member to confirm the findings from the

logbook analysis. Each of these methods is discussed in detail within the following sub-sections and the findings are discussed in Section 3.3.

3.2.1 Ethnographic Immersion

Ethnographic research is well established in the fields of anthropology and sociology. It aims to capture the knowledge and processes that guide the life of a cultural group. This is accomplished through qualitative research methods including participant observation, interviews and questionnaires. Researchers, including Ball & Ormerod (2000), have explored the validity of using ethnographic research methods in studying engineering design. They argue that "the complex, ongoing, and multi-faceted nature of commercial design projects" does not lend itself to experimental control and may be more conducive to ethnographic methods. Baird et al. (2000) for example, successfully used ethnographic studies to characterize the complexities of interdisciplinary design teams at Rolls-Royce Aerospace.

To gain a better understanding of the nature of MPG design team, their processes, protocols and habits, this study involved immersing a researcher into the daily routines of the design team. This immersion lasted for a period of eight months during which the researcher was assigned the position of "Design Engineer" and worked out of the same laboratory and office space as his design team colleagues. During this time, the researcher contributed to the development of the MPG device, took part in design meetings, tested device performance, and extensively interacted with other design team members. The researcher was also subject to the same protocols and processes as the rest of the team. For example, similar to the other designers, the researcher was required to maintain a record of all his work through the use of mandated logbooks.

The ethnographic immersion was very effective at understanding the working environment and culture of the MPG design team. The experiences and findings of the researcher were used to corroborate and better understand the results of the subsequent logbook analysis. Furthermore,

they provided a level of expertise and project specific knowledge that was essential in developing the validation interviews that were performed towards the end of the study.

The immersion however, did not provide systematic data on the problem solving approaches and complexity management strategies employed by individual designers. In order to gain an understanding of the CCMS employed by the MPG designers, the ways in which they cognitively internalized the system, processed it into smaller more manageable pieces, and simplified non-pertinent components had to be understood. Such thought processes are generally internal to the designer and are rarely expressed in a form that can be captured by the researcher in an ethnographic immersion. Thus, the immersion was complemented through the use of a research method specifically designed to understand internal thought processes.

3.2.2 Logbook Analysis

Protocol analysis is a qualitative, non-experimental, research method that elicits verbal reports from participants for the purposes of understanding their behaviour (Ericsson & Simon 1984). The "thinking-aloud" protocol for example, asks participants to voice their thoughts and emotions as they perform a task or solve a problem (Lewis 1982). The researcher transcribes the user's utterances as they are being voiced and analyses the transcriptions for patterns and behaviours. There are two strengths of the protocol analysis method. Firstly, data is being captured as the task is being performed which is more accurate than asking a participant to recall their thought process in a retrospective interview. Secondly, the method avoids the use of directed questions by the researcher. This avoids situations where a participant's actions are influenced by the researcher's questions.

A traditional protocol analysis could not be performed as a part of this study however; a variation on the methodology was employed through the analysis of each designer's logbook. The engineering firm mandated the use of logbooks to capture each MPG designer's contributions for the purposes of intellectual property management. As a result, the logbooks were extensively used

by the designers through a variety of design processes including design reviews, meetings, recordkeeping and the white-boarding of new ideas. The logbooks were also used by designers to record individual thought exercises performed outside of group environments. For example, when a designer redesigned a component, they were required to capture the redesign and record the methodology they used within their logbook. Although the purpose behind mandating the logbook was to have a record of intellectual property development, they also provided insight into the problem solving strategies used by each designer.

The validity of the data captured by the logbook analysis method was strengthened by its parallels to the well established protocol analysis research method. Similar to protocol analysis, the logbook analysis examined data that was captured while a design task was being performed and the use of a logbook had a limited influence on a designer's thought processes. Thus, reviewing the contents of the logbooks was an insightful glimpse into the problem solving approaches and complexity management strategies used by each designer.

Upon the completion of the MPG project, each designer's logbook was copied and separated into numerous design activities. Expertise developed through the ethnographic immersion made it possible to identify individual activities because certain features such as the recording methodology, dates, and formatting were distinct. For example, the documentation of a design review meeting had a more verbose, free-flowing structure which was distinct from the more formal recording structure of device testing results. These activities were then sorted based on various schemes including, chronology, sub-projects, and designer. The various sorting schemes were used to uncover repeating high-level methodologies that were used to organize information and conceptualize designs for the purposes of managing complexity. These potential CCMS were corroborated using the validation interviews which are described in the following section.

3.2.3 Validation Interviews

The purpose of these interviews was to validate the MPG design team's use of the CCMS gathered through the logbook analysis. It was hypothesized that these CCMS were consistently and repeatedly used across design iterations of the MPG device to help mitigate complexity. This hypothesis led to three interview objectives:

1. Determine if each strategy identified in the logbook analysis phase was used repeatedly during the MPG device development process.
2. Determine if the strategy aided in mitigating complexity and if so, gain insight on the mechanisms by which it did so.
3. Document specific examples of when each strategy was used during the MPG device development process.

Three designers each participated in a 90 minute one-on-one interview. During the interview, the researcher noted the designer's responses and audio-recorded the interactions for future reference. The validation interview (attached as Appendix A) consisted of three sections:

Section 1 - This section included background questions that established the designer's role on the MPG device design team. It also inquired about methods and processes the designer thought were consistently performed throughout MPG device development and the designer's own recollection of how they managed complexity. The purpose of these questions was to profile the designer as well as capture any complexity management methods that may not have been gathered through the logbook analysis.

Section 2 - This section individually presented each of the CCMS discovered through the logbook analysis. The designer was first provided with a description of the strategy, followed by a snippet from a logbook showcasing its use. This was used to assess the designer's familiarity with the strategy. The designer was then presented with another snippet of the same strategy and was asked to use the "thinking aloud" method while analyzing what the snippet inferred. This was done

to explore the thought processes used to decode the logbook snippet into information about the physical MPG system. These thought processes were revealing of how the strategy may be acting to mitigate complexity. Furthermore, to infer the effect on cognitive complexity, the designer was also asked if using the strategy reduced the perceived complexity of design problems. Finally, the designer was asked to provide numerous examples of using the strategy within both the MPG project, and other projects they had experiences with. These questions were presented to establish repeated use of the strategy and confirm that it was not MPG project specific.

Section 3 - This section concluded the interview by attempting to find connections across the different CCMS and the engineering design process. The use of some of the CCMS in a preferred sequence was explored. In addition, the failures and pitfalls of using complexity mitigation methods in general were discussed. Finally, the designer was asked to suggest improvements to the engineering firm's design processes.

The results of the interviews were consolidated and analyzed. The consistencies across the responses coupled with the findings of the logbook analysis and support from the ethnographic immersion revealed five CCMS that were used during the MPG design process.

3.3 Results: CCMS Used During Engineering Design

The micro-power generation (MPG) design team consisted of three designers and the researcher. The designers included a project manager, a mechanical, and an electrical specialist. The mechanical specialist was responsible for the mechanical components, assembly and mechanical optimization of the MPG device. The electrical specialist was tasked with designing and testing the electrical components that accompanied that mechanical assembly. The project manager ensured the progress of the project and communicated project requirements, successes and failures to the CEO of the company. Finally, the researcher was tasked with device testing and performance reporting. Although the responsibilities were distinct, the small size of the MPG design team, coupled with the aggressive deliverable timeline, resulted in overlapping and interdisciplinary

functions. It was not uncommon for the project manager to assist with device testing or for the other designers to be involved in communicating progress reports to the CEO. Such overlapping functions resulted in an extensive use of cognitive complexity mitigation strategies (CCMS). For example when testing an electrical subsystem, the mechanical designer, who had limited electrical expertise, would use a simplified model of the electrical subsystem that only focused on the variables being tested.

Since the goal of the design team was to commercialize a device that was developed in an academic environment, there was significant interaction with external collaborators. Subject matter experts, who first devised a working MPG device, were heavily consulted for their insights on improving device performance and achieving the commercialization objectives. Contractors, who were hired to manufacture device components, interacted with the designers to exchange component specifications and drawings. These interactions required further use of CCMS. Subject matter experts, for example, had a very intricate understanding of the mathematical models that governed the performance of the device. These models were sometimes simplified by decomposing them to capture an isolated behaviour of the MPG system that could be used to propose a design improvement.

Mandated practices in the design process involved the extensive use of individual logbooks and formal weekly design reviews. The formal design reviews were an opportunity to monitor progress and establish objectives for the upcoming week. They were also used to brainstorm, analyze, and receive feedback on potential design improvements. However, such activities were not solely performed at the weekly design reviews. Since the team was co-located in an open office space which was very proximal to the two laboratories which were extensively used for development and testing purposes, there was significant impromptu brainstorming and analysis as well. Impromptu activities heavily relied on CCMS because the resources and data that were present at the formal sessions were not necessarily available. For example, in the absence of data specifying the

dimensions of a component, for an impromptu assessment a designer may use an approximation based on the component's relationships to other known device dimensions.

The ethnographic immersion and logbook analysis studies provided specific examples of when and how designers mitigated complexity in the MPG device development project. By identifying common elements across these examples, a set of five approaches that reduced cognitive complexity were identified. These CCMS are Blackbox Modelling, Whitebox Modelling, Decomposition, Visualization and Prioritized Lists.

3.3.1 Blackbox Modelling

This CCMS involves describing a system in terms of input and output variables of interest while "blackboxing", or ignoring the internal constructs of the system itself. Complexity is mitigated because only the variables of interest, their values, and their co-dependencies are considered. This limits the amount of information a designer has to retain in their working memory. The Blackbox Modelling strategy does not explicitly showcase how a system works. Instead, it simply develops relationships between certain input and the output variables.

An instance of using Blackbox Modelling on the MPG device is shown in Figure 6. In this instance, the designer was concerned with four input variables (a, b, c & d) and two output variables ($f(a,..)$ & $g(a,..)$). This snippet shows an attempt to establish the relationships between the input and output variables and attempts to assess the change in system behaviour as one of the input variables (b) is changed in a controlled manner. There were several other variables that affected the behaviour of the MPG device; however the designer's attention resources and working memory were processing only the ones listed. Furthermore, the snippet does not support any explicit understanding of how or why the input variables affected the output. Such intricacies were disregarded for the purposes of complexity mitigation.

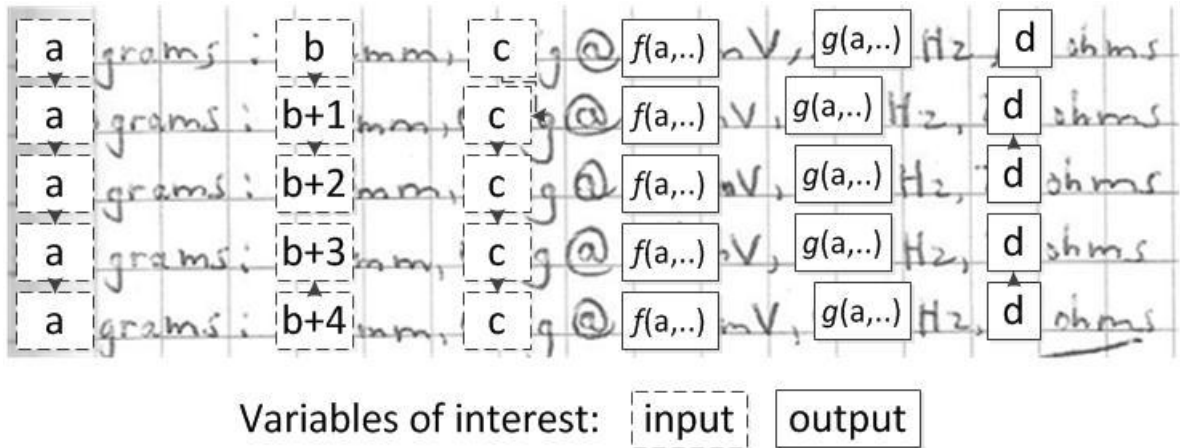

Figure 6: Snippet from MPG device designer's logbook showing Blackbox Modelling (sanitized for confidentiality)

The validation interviews revealed that all MPG designers were familiar with the Blackbox Modelling CCMS. As per one designer, it was "constantly being used across multiple [sub]projects" throughout the MPG device's development. The designers also indicated that they extensively used this CCMS across other engineering projects. This was because Blackbox Modelling was effective at reducing the perceived complexity of the system under study. All designers claimed a reduction in their self-reported complexity of the MPG system when using this CCMS. One designer claimed that "characterizing [the system] in a very small way", or by eliminating the facets that were not of interest was what helped mitigate complexity.

The designer's also reported two main disadvantages to the Blackbox Modelling CCMS. The first disadvantage was an over-emphasis on the variables of interest. Since the effectiveness of this CCMS relied on focusing on certain variables of interest, cases arose where designers attempted to inappropriately attribute system anomalies only to the variables of interest without considering other variables outside the Blackbox Model. Thus, choosing the appropriate variables of interest is very important. Furthermore, when faced with system anomalies that cannot be explained by the chosen variables, it is recommended that designers reassess their choice of variables of interest early on in the analysis process.

The second reported disadvantage of this CCMS was that it was resource intensive. In the case of the MPG device, the Blackbox Model was a physical construction of the device. In addition to the device, a test-bed was required that could provide controlled vibrations and a designer was required to run the tests. Changing input variables, to explore the relationships between the input and output variables of interest, either required changing the type of vibration provided by the test-bed or altering a component on the device itself. The manufacture and assembly of the devices that acted as the Blackbox Models, coupled with the investments in the test-bed, and designer time requirements to perform each test made this CCMS resource intensive. Accounting for these resources, it is recommended that Blackbox Modelling be used in the latter parts of the development process when the number of design improvements is more limited.

3.3.2 Whitebox Modelling

This CCMS attempts to explicitly define relationships between a system's input and output variables using mathematical models. These models can be derived by numerically analyzing results of Blackbox Modelling, or through the modelling of physical phenomena. Complexity is thought to be mitigated in two ways. Firstly, modelling the system based on physical phenomenon allows designers to draw upon experiential knowledge of other systems that adhere to similar phenomena. This experiential knowledge reduces the attention resources required to mentally process a system. For example, Figure 7 shows the schematic used to derive mathematical functions governing the MPG device. The core of this schematic, and the resulting functions, are very similar to a commonly used engineering model known as the mass-spring-damper system. Thus, when designers view this schematic and the resulting functions, they can draw parallels between the behaviour of the MPG device and other mass-spring-damper systems. The degree to which complexity can be mitigated by this particular Whitebox Model is dependent on the degree of expertise the designer has with mass-spring-damper systems.

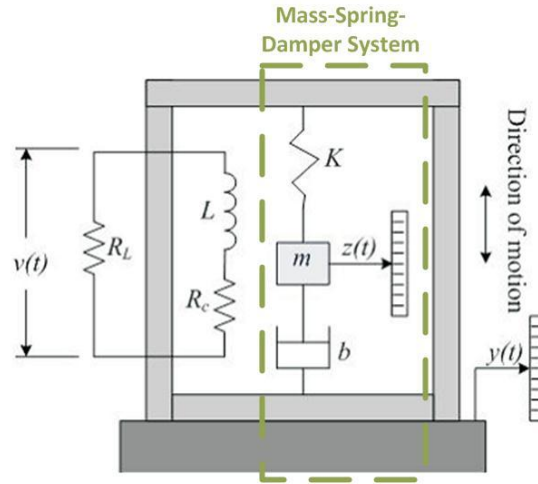

**Figure 7: Schematic of MPG device including mass-spring-damper system
(adapted from Soilman et al., 2010)**

The second means by which Whitebox Modelling mitigates complexity draws on the proficient use of mathematical formulae by the designers. The relationships amongst system variables can be described in tabular form by listing each value an input variable can assume and noting the corresponding values of output variables. A mathematical formula however, describes these relationships in a succinct manner such that it can be easily recalled from long term memory or retained in working memory. Furthermore, a designer's understanding of mathematical formulae allows them to decipher the characteristics of these relationships in a manner that minimizes cognitive complexity. This is illustrated in Figure 8 which is a snippet from a designer's logbook showing a commonly recurring formula in MPG device development. When designers were asked to report their interpretation of the formula and how they might utilize it to increase the value of variable P , the common response was to infer the correlation (positive or negative) and the mathematical power of each of the variables. One designer stated that they would, "increase m and A and decrease μ ". This insight was provided by the positioning of the variables as numerators or denominators. Additionally, designers commented that they would first consider variables that had greater mathematical power, such as A or μ , because their higher power would more effectively

influence P . In this instance, the Whitebox Model drew upon the designers' long term memory stores which contained a learned expertise in mathematics. This expertise in assessing positive versus negative correlations, and the mathematical power of variables was being leveraged by the designer to mitigate the complexity associated with the formula itself and the task of increasing the variable P .

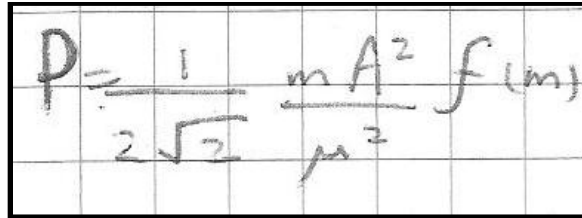

A photograph of a handwritten formula on a grid background. The formula is
$$P = \frac{1}{2\sqrt{2}} \frac{mA^2}{\mu^2} f(m)$$

Figure 8: Snippet from a designer's logbook showing a commonly used MPG formula

All designers confirmed their familiarity with the Whitebox Modelling CCMS during the validation interviews. The ethnographic immersion revealed that Whitebox Modelling was predominantly used to identify the most promising avenues for improving the MPG device's performance. The models were able to specify which of the MPG device's components provided the most performance improvement opportunities. This was an advantage of Whitebox Modeling as it allowed designers to abstract the MPG device into various representations such as energy flow processes which were better suited for identifying the device's bottlenecks.

The designers also indicated that they used the Whitebox Modelling CCMS in other projects as well. However, they mentioned that the nature of the project had a significant bearing on the utility the CCMS. For example, engineering projects that mostly involved system integration, i.e. they involved combining existing, well-developed subsystems into a complete solution, did not require a significant degree of Whitebox Modelling. This was because each subsystem would already have well documented specifications and operational requirements. Instead, the Whitebox Modelling CCMS was gauged to be more useful in developing novel devices which were built from "scratch".

The MPG device designers agreed that the Whitebox Modelling CCMS reduced their perceived complexity of the device. Although they stated that the systems of mathematical formulae that described the MPG system could become quite extensive and intricate, the designers mentioned that the only alternative to this was the explicit testing of every behaviour captured by the mathematical formulae. Thus, under the assumption that understanding certain behaviours of the MPG system was required, the designers found mathematical models of system behaviours less complex compared to extensive explicit testing. This was because of the designers' proficiency with mathematical relationships (as demonstrated through Figure 8) which allowed them to better manage the complexities of a particular behaviour.

Although Whitebox Modelling provides a significant degree of complexity mitigation, it relies on the scientific understanding of physical phenomena. There are limitations to how well certain phenomenon are understood thus, there are components of Whitebox Modelling that involve assumptions. Thus, a disadvantage of this CCMS is that it is not always a perfect description of the system being studied. The ethnographic immersion captured cases when the MPG design team would implement performance improvements suggested by the MPG device's Whitebox Model. However, upon testing, the team would find that the actual performance gains were not as significant as those suggested by the model. It was found that the Whitebox Modelling CCMS was effective at suggesting avenues for improvement but it was not as effective at determining the absolute gains that the improvement would provide.

The MPG design team also mentioned that the Whitebox Modelling CCMS does not have the same degree of capital and labour requirements as the Blackbox Modelling strategy. So, it can frequently be used for exploring design improvement opportunities. However, the results it provides may not be very definitive due to its inherent assumptions. Thus, a synergistic use of the two CCMS is recommended, where Whitebox Modelling is used early in the development cycle to

suggest a large array of design improvement opportunities and Blackbox Modelling is used in the latter parts of the cycle to more exhaustively test promising improvements.

3.3.3 Decomposition

This CCMS involves separating a system into simpler, more manageable subsystems. Since the subsystems involve fewer components and interactions, they can be processed more easily in a designer's working memory and require less attention resources. The Decomposition CCMS can be employed through the metrics that independently measure the performance of each subsystem or by dividing the physical system and focusing on the division of interest.

A traditional decomposition scheme that is used in the development of electro-mechanical devices is the division of electrical and mechanical subcomponents. Such a division mitigates complexity by allowing designers to focus on the subcomponents in which their expertise are most applicable. The development of the MPG device used such a Decomposition CCMS where the mechanical and electrical design specialists focused on the mechanical and electrical subsystem respectively. However, as demonstrated in Figure 5, the mechanical and electrical subsystems within the MPG device had coupling effects such that the performance of each subsystem was dependent on the other. Thus in some cases, a physical separation of the mechanical and electrical components was not feasible. In such cases, a customized metric named the Quality factor (Q-factor) was introduced as a type of Decomposition CCMS. The open-loop Q-factor characterized the performance of the mechanical components in a manner that was independent of the electrical subsystem. Therefore, it mitigated complexity by providing designers with a means of quantifying only the mechanical performance while disregarding the effects of the electrical subsystem.

A second method of employing the Decomposition CCMS was through the physical division of the entire MPG device. Considering the capacity limitations of working memory, a designer can sacrifice the details and intricacies of the device if they attempt to retain the entire MPG device within their temporary short term memory store. However, in the redesign of individual

components of the device, these details may be important. Thus to accommodate the details while addressing the limitations of their working memory, designers tactically divided the MPG device into smaller pieces. An example of this is shown in Figure 9. During this exercise, the designer was attempting to devise a new method of attaching the cantilever beam to the support. Based on the MPG device schematic, the region of interest was a small portion of the device itself. A snippet from the designer's logbook indicates that during the process of developing and evaluating alternative designs, the designer considered only the portion of the device where the connection occurred. This is apparent because the designer only drew that limited portion of the whole device within their logbook. Thus, using the Decomposition CCMS to focus on this region allowed the designer to consider details, such as the distribution of the screws that may be used to attach the beam to the support.

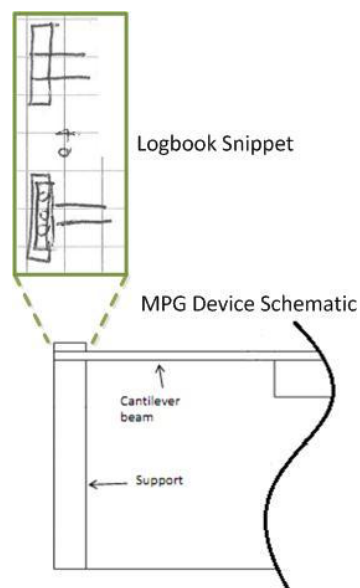

**Figure 9: Using a Decomposition CCMS on the MPG device
(partly adapted from Khodadad et al., 2011)**

During the validation interviews, all MPG designers confirmed their familiarity with the Decomposition CCMS. Initially, they viewed the CCMS primarily as a means of efficiently allocating designer labour, i.e. it was necessary to decompose the MPG device so that multiple designers could

contribute to its development. However, upon further questioning, the designers revealed that they used Decomposition as a part of their individual thought processes to limit scope and focus on the particular subsystem they were redesigning. In this context, the designers confirmed a reduction in perceived complexity that was attributed to the use of a Decomposition CCMS. The designers also cited using this CCMS across many phases of MPG device development and confirmed its use in other projects they had been involved in.

The Decomposition CCMS focused a designer's attention to a particular part or subsystem. However, this focus and disregard for the rest of the system was also found to be a source of error if managed improperly. The division of a device into smaller subsystems must be tactically performed. When a designer focuses on redesigning a particular component, the boundaries of their subsystem selection must be such that they minimize the cross-effects between the subsystem and all other components that are out of focus. This minimizes errors when reintroducing the redesigned component back into the system. To further mitigate these errors, designers should periodically revisit how the specific components they are developing interact and couple with the system as a whole.

3.3.4 Prioritized Lists

This CCMS involves identifying a system objective that is to be optimized and listing the components within the system using a prioritization scheme that is based on the influence each component has on the system objective. This strategy mitigates complexity because once the designer generates the list, they do not need to individually consider the interactions amongst the components and between each component and the system. Instead, the prioritization simplifies these numerous and complex interactions into an ordinal list which is more easily retained in working memory and requires fewer attention resources to process.

Figure 10 shows an example of a Prioritized List that was used during the development of the MPG device. The objective, noted at the top of the figure, was to optimize the power output. The

components of the MPG system were listed in order of their influence on power output. Mathematically, these components had complex interactions amongst themselves and their influence on the MPG device's power was nonlinear. Furthermore, the prioritization took into account factors such as the component costs, manufacturability, expert opinions, and a variety of other business considerations. Thus, the synthesis of this list incorporated understanding a variety of complex interactions. However, once it was generated, the designer had a simplified method of identifying which components provided the greatest added value in terms of power output.

Design decisions that required assessing the relative importance of various components within the MPG system occurred throughout the development process. The Prioritized List CCMS provided a simplified method of gauging relative importance that could be retained in a designer's working memory. That is, design decisions that required sacrificing one component for another were better supported because designers could easily recall the relative positions of the components within the list.

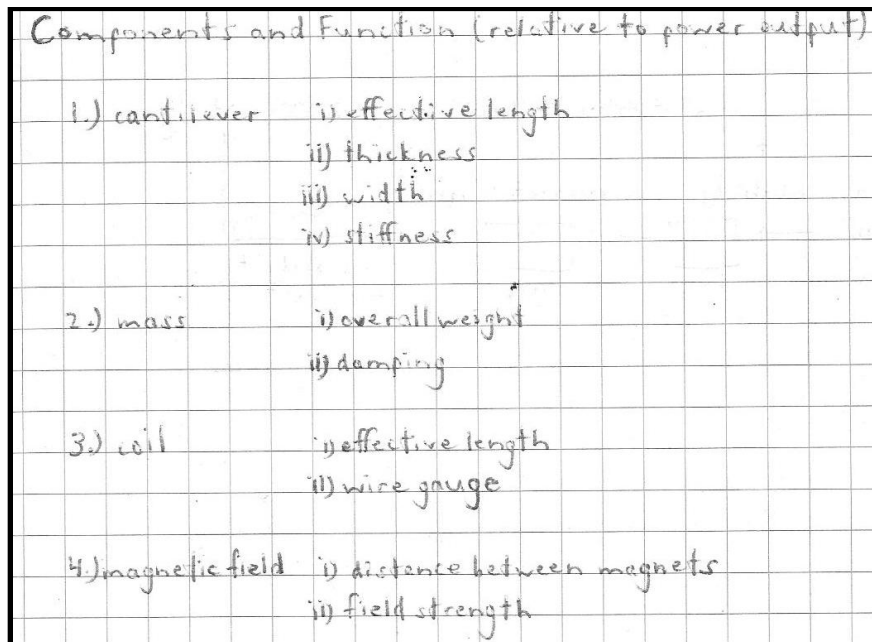

Components and Function (relative to power output)	
1.) cantilever	i) effective length ii) thickness iii) width iv) stiffness
2.) mass	i) overall weight ii) damping
3.) coil	i) effective length ii) wire gauge
4.) magnetic field	i) distance between magnets ii) field strength

Figure 10; Logbook snippet showing the use of a Prioritized List CCMS

The MPG design team was familiar with the Prioritized List CCMS during the validation interviews. They claimed it was used throughout the MPG device design process. The lists were collaboratively generated during weekly design reviews and then referred to or recalled from memory during day-to-day design activities. The generation of these lists occurred at weekly meetings because they provided the team with an opportunity to consolidate information from various sources, including other team members, and validate the ranking of the components. The design team claimed that the Prioritized List CCMS helped reduce perceived complexity by simplifying the interactions amongst the individual components thus aiding the decision making process and identifying the components that were the most fruitful for design revisions.

The ethnographic immersion and validation interviews revealed some disadvantages of using Prioritized Lists. Since this CCMS heavily relies on the correct prioritization of components with respect to an objective, mistakes in this ordinality can lead to poor design decision making. The first source of mistakes can occur during the list generation process. Since many different sources of information are being consolidated and generalized to synthesize a single list, it is important to validate the result. A method of validation could be to generate the list in a collaborative manner, similar to how the MPG design team generated these lists during design reviews. This collaboration helps reduce bias and increases the expertise that is being drawn on during the generation process.

Another source of mistakes in the ordinality can occur due to a stale list. One of the mechanisms by which complex non-linear interactions are reduced to a simple Prioritized List is by taking a snapshot of the system during the list generation activity. Technically, the ordinality of the components is only valid for an infinitesimal change in any component. Once a component is changed, its ordinal ranking can also change because the component's influence on the system is affected. If designers continue to use the original, stale list that does not account for the change, they may make poor design decisions. Though it is impractical to generate a new list after every

minor design revision, a focus should be placed on revising the list on a periodic basis, especially after significant design modifications.

Finally, the simplifications made during the generation process coupled with the potential for ranking changes within a list suggest that designers should be discouraged from relying on minor ranking differences between components. Instead, the Prioritized List CCMS should be used to guide decisions where high ranking components are being evaluated against components that are towards the lower end of the ranked list.

3.3.5 Visualization

This CCMS captures the use of various Visualization strategies to depict a system or its components. These depictions can be internal, such as imagining the trend line produced by a set of raw data, or external, such as sketching a system block diagram on a piece of paper. Although there are many instances of Visualization that occur for the purposes of communicating information, this research only documents these depictions in the context of reducing cognitive complexity during a designer's thought processes. Depending on the type of Visualization strategy used, cognitive complexity is reduced by either supplementing cognitive resource limitations through visual externalizations, or by reducing the amount of information that must be retained in working memory to support a working mental model.

The Visualization CCMS can help supplement the limitations of working memory by providing an opportunity to externalize portions of a working mental model. For example, a designer may use the CCMS by sketching a block diagram representation of a system that includes various components and interactions for the purposes of investigating high level system features. The amount of information stored within the sketch can be significantly more than the capacity of the designer's working memory. By focusing attention resources to various portions of the sketch, the designer can still execute their mental model of the system by systematically loading and unloading portions of the sketch into their working memory. This collaboration between the external

Visualization and the designer's working memory is acting to artificially increase the capacity limitations of their working memory. Using a Visualization such as a sketch also changes the use of attention resources. In the presence of an external Visualization, the designer increases the attention resources dedicated to perceiving external stimuli and decreases the attention resources used to recall components or interactions from long term memory.

The Visualization CCMS can also mitigate complexity by reducing the amount of information that needs to be retained in working memory for the purposes of supporting a mental model. Visualization strategies tend to exploit the use of trends and emergent features for the purposes of making generalizations of the underlying data. In many instances, these generalizations can be of sufficient resolution to support mental models. For example, MPG designers consistently graphed raw data for the purposes of uncovering trends between variables. These trends, which were high level patterns found within the explicit numerical data, were easier to retain in memory than the data itself. The general high level relationships captured by the trend were then used to support mental models of the system.

Figure 11 is a sanitized logbook snippet showing an example of the use of trends. It captures a designer's visual description of the competitive landscape of the MPG market. The Visualization captures the characteristic that most competitors are clustered within a certain output power range and that there are two outliers, who are explicitly named. This Visualization has mitigated complexity by capturing important aspects of the competitive landscape that can be easily retained in working memory. Competitor names and performance values have been removed from the main cluster and the relative performance and competitor names of the outliers have been maintained. Thus the designer is easily able to gauge the MPG device's competitiveness by mentally plotting its performance value relative to the main competitor grouping and the outliers.

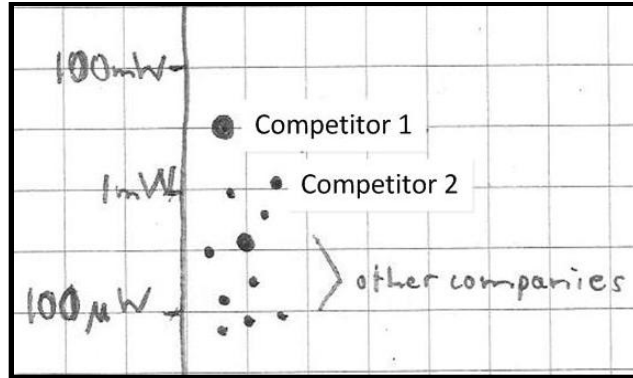

Figure 11: Logbook snippet showing the MPG competitive landscape

The use of trends and emergent features in Visualizations can leverage a designer's expertise and long term knowledge to reduce the attention resources required to support a mental model. This is extensively demonstrated in specialized domains where Visualizations are the primary design tool. For example a MPG designer that specialized in the electrical subsystem instantly identified the logbook snippet in Figure 12 as a voltage rectifier. Although the snippet contains four electrical components, the designer was easily able to recognize the configuration of these components from previous experience. Furthermore, the designer associated behavioural characteristics to this visual structural grouping without going through the process of combining the behaviours of each individual component. Characterizing the behaviour of the circuit in Figure 12 required less attention resources and presented less cognitive complexity to a designer that used emergent features found through the Visualization CCMS coupled with expertise from long term memory.

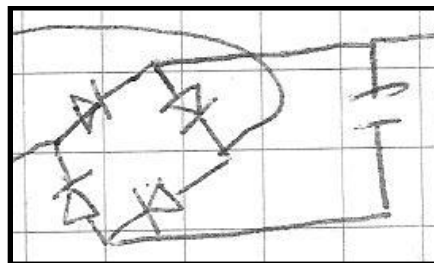

Figure 12: Logbook snippet showing a rectifier circuit

The validation interviews revealed that designers were very familiar with the Visualization CCMS. They extensively used it throughout MPG device development and many other projects they were involved in. The designers also indicated that the ability of Visualization to capture high level trends and emergent features helped reduce the perceived complexity of design problems.

The incorrect use of Visualizations due to the oversimplification of data was cited as one of the disadvantages of this CCMS. Oversimplified data might not contain the details or context required to effectively understand it. If this oversimplified Visualization is not validated, it may be incorrectly used and may support poor decision making. Thus, it is recommended that designers remain aware of the assumptions and simplifications made when using a Visualization CCMS. This is especially true in cases when a designer uses a Visualization strategy that they have not generated themselves.

3.4 Chapter Summary

This chapter presented a study of the cognitive complexity mitigation strategies (CCMS) that were used during the engineering design process. This study was conducted in collaboration with an engineering firm that was commercializing a laboratory developed micro-power generation (MPG) device. The MPG device was a complex system with closely coupled electrical and mechanical sub-systems. This made it ideal for the study of complexity mitigation strategies that the engineering design team used during the commercialization process.

Three complementary methods were used to investigate CCMS. The first was an ethnographic immersion where a researcher became part of the design team for a period of eight months to gain exposure to the firm's design processes and protocols. The second was a logbook analysis where the engineering design team's logbooks were analyzed for the repeated use of certain problem solving approaches. These approaches were used to identify potential CCMS. Finally, validation interviews were performed using consolidated findings from the first two methods for the purposes of verifying the use and complexity reduction capabilities of the identified CCMS. The

results of this study documented five CCMS that were used in the development of the MPG device. They were Blackbox Modelling, Whitebox Modelling, Decomposition, Prioritized Lists and Visualization. Validation interviews indicated that these CCMS were used by designers in various projects beyond MPG development. A follow-up study, presented in Chapter 4, assessed the use of these CCMS across a larger, more diverse sample of engineers and design projects.

Chapter 4

Study II: Improving the Efficiency of Cross-Activity Designer Transfer

A cognitive difference analysis is a systematic method of assessing the cognitive similarities and differences across two or more environments. This chapter presents a study in which the usage frequency of the five cognitive complexity mitigation strategies (CCMS) is assessed across various design activities that constitute the engineering design process. The differences in usage frequency are used to perform a cognitive difference analysis between design activities which can be used to support efficient design processes.

Furthermore, the likelihood of a reduction in perceived complexity through the use of the CCMS is also explored. This can reveal which of the five CCMS are most likely to reduce complexity. Such information can be used as a basis for justifying the use of a resource intensive CCMS when dealing with especially complex problems.

The usage frequencies and complexity reduction capabilities of the five CCMS are gathered through retrospective interviews with numerous design engineers, each of whom discussed up to three design projects they had been involved in. The data from these interviews revealed design activity specific preferences towards certain CCMS and also differences in the likelihood that each of the five CCMS reduced perceived complexity. These findings were combined into a matrix which was presented to the engineering firm from the previous study as a means of improving their design processes.

4.1 Problem: Supporting Efficient Design Practices Using CCMS

The engineering firm that was commercializing the micro-power generation (MPG) device wanted to assess the applicability of the CCMS to specific activities that constituted the engineering design process. This would allow them to apply the findings to projects beyond MPG device development. Furthermore, they wanted to assess how the usage frequency of CCMS changed

across these activities and how the complexity mitigation effects of the strategies could be leveraged to improve their internal design processes and protocols. This cognitive difference analysis of the change in CCMS usage across design activities would allow the engineering firm to:

1. Train new engineering hires and create a supportive environment for existing engineers. Explicit knowledge of the preferential use of specific CCMS for performing certain design activities can be included in the training that new engineering hires receive. The working environments of existing engineers can also be improved to better support certain CCMS when specific design activities are being performed.

2. Efficiently transfer existing designers and project managers across different types of engineering projects. Different types of engineering projects emphasize the use of different design activities and thus different CCMS. Knowledge of how CCMS change across projects can better prepare engineers and projects managers for the transition.

3. Provide strategic focus during complex engineering design activities. The cognitive difference analysis also identifies which CCMS are most likely to reduce perceived complexity of design problems. However, there are times when these CCMS are not undertaken due to resource constraints. The results of the cognitive difference analysis may be used to justify the use of a resource intensive strategy in exchange for the gain in complexity reduction.

4.1.1 Engineering Design Activities

In order to assess the applicability of the CCMS to projects other than MPG development, it is necessary to establish engineering design activities that are common to all engineering projects. By gathering data on how frequently each of the five CCMS are used in each of these engineering activities, it is possible to perform a cognitive difference analysis across the activities. A common breakdown of an engineering project into constituent design activities is proposed by Ullman (2002). He proposes a categorization of activities that is not discipline-specific and thus can be applicable to a variety of different projects. The proposed design activities are:

Selection: The process of choosing a component from a catalogue of alternatives. In the design of an electronic circuit for example, a need for a resistor would require the designer to choose one candidate from a variety of alternatives. Depending on the scope of the project, this selection can be very complex as the evaluation criteria can include performance, costs, reliability, availability etc.

Configuration: The process of assembling or packaging components into a complete system. Continuing the example from Selection, once the resistor and other components are selected the designer is required to lay them out on a circuit board. Depending on the number of components, there can be numerous layouts and the optimal choice can be dictated by a variety of factors such as heat dissipation, power conservation, cost, board form factor etc.

Parametric: The process of determining values for features that characterize the system. For example if there is a requirement for a certain number of hours of battery life, a parametric activity would involve determining the size of the battery given the power consumption of the circuit board.

In addition to the above design activities, two more categorizations of design projects are also suggested:

Original Design: Involves the creation of a novel system that, as far as the designer knows, does not exist. This categorization attempts to capture projects where the designer is not working from a template or improving an existing system.

Redesign: Involves projects where an existing system is being improved upon or repurposed to meet a new set of requirements. This categorization captures situations where the designer has references to prior work and the project requires modifications that do not influence the core principles of the original design.

Retrospective interviews were performed with numerous designers in which they were asked to identify their use of CCMS when performing the above design activities. The results of these interviews helped establish CCMS usage frequencies for each of the activities and the differences in usage were used to perform a cognitive difference analysis.

4.2 Method: Assessing CCMS Preferences Across Design Activities

Validation interviews from the previous study indicated minimal differences in CCMS usage frequencies. All three designers indicated using all five CCMS during the MPG project. However, this was most likely because the usage was identified across the entire project, and all the design activities that comprised it, as opposed to the individual design activities themselves. This study involved retrospective interviews that were designed to illicit responses from participating designers regarding their use of each of the five CCMS across each of the three design activities and two project categorizations.

Assessing CCMS usage frequencies with statistical significance required increasing the sample size and diversity of the designers interviewed. Sample size was increased by allowing each engineer to discuss up to three projects they had experiences with. This allowed the retrospective interviews to capture up to three samples per individual interviewed. Furthermore, this study openly recruited designers and engineers from a variety of backgrounds and experiences for the purposes of increasing diversity. The experiences involved various specialties in mechanical, electrical, systems and nanotechnology engineering. However, projects that involved significant programming and specialties in computer science or software engineering were not included. This was for the purposes of limiting the scope of this research and because extensive studies of CCMS such as abstractions in software design already exist (Jackson 2006; Martin 2000).

4.2.1 Retrospective Interviews

The retrospective interviews were performed in a quiet environment that was free from distractions and the researcher noted and audio-recorded the designer's responses. The complete version of the retrospective interview is available in Appendix B. Each interview was designed to take 60 minutes and included three sections.

Section 1 - This section captured background information regarding the designer including the type of work they currently perform, years of experience, domain of expertise, and a brief overview of up to three projects that they were willing to discuss for the remainder of the interview.

Section 2 - This section performed a characterization of each of three projects the designer was willing to discuss. The purpose of this characterization was to determine which design activities were performed during the projects and whether the designer considered the project an original or redesign project. Table 1 shows the matrix, with sample data, that was used to perform this characterization.

Table 1: Matrix used for project characterization

Design Activities	Project # 1	Project # 2	Project # 3
Selection	Y	Y	..
Configuration	Y	N	..
Parametric	N
Original	Y
Redesign	N

First, the designer was given a brief description of each of the three design activities and two project categorizations. The interviews required that for each activity and project pairing, the designer is asked to provide a "yes or no" answer based on if the activity was performed for that project. Following this, the designer was to be asked to provide "yes or no" responses to characterize each project as an original design, redesign, or both. In cases of "yes" responses, the designer was asked to provide an example which helped the researcher verify the response and provided qualitative data on the project itself. When conducting the interviews in this structured manner, it was found that designers were poor at recollecting the activities and specifics of the project they were discussing. In many cases, it was found that populating the characterization

matrix in an exploratory manner was more effective. This involved the researcher asking the designer generic questions regarding the tasks, goals and problems associated with each of the projects. As the designer described these generalized aspects of each project, they were more easily able to recall and identify the use of specific activities. The "yes/no" responses and examples from this section were then used in Section 3 of the retrospective interview.

Section 3 - The purpose of this section was to determine if any of the five CCMS were used across every project-activity pairing that the designer positively identified. For example, if a designer indicated using the selection activity during one of their projects, the purpose of this section was to determine if they had used any of the five CCMS to manage the complexity associated with performing that activity. In order to identify this activity-specific usage of CCMS, the five strategies documented in Chapter 3 were defined in terms of Ullman's (2002) description of the three commonly occurring engineering design activities. In other words, the definitions of how each CCMS would apply to each activity were devised. These definitions are provided in Table 2.

During the retrospective interviews, every designer was presented with the definitions (Table 2) and was asked to recall project-activity specific examples of using any of the five CCMS. These responses were required to be in a "yes/no" format. Similar to Section 2, it was found that an exploratory interviewing methodology was more effective at aiding the designer's recollections. Furthermore, each of the designers was also asked if their use of each of the CCMS helped mitigate complexity. This question was also used to illicit a "yes/no" response.

Table 2: Definitions of CCMS-design activity pairings

<p>Design Activity/CCMS</p>	<p>Selection <i>Mitigating the complexity associated with identifying an optimal component from possible alternatives by...</i></p>	<p>Configuration <i>Mitigating the complexity associated with determining an optimal system layout or package by...</i></p>	<p>Parametric <i>Mitigating the complexity associated with determining the value of a system feature by...</i></p>
<p>Blackbox Modeling</p>	<p>...physically testing each alternative within the system.</p>	<p>...physically assembling various configurations.</p>	<p>...evaluating it as a variable during physical Blackbox testing.</p>
<p>Whitebox Modeling</p>	<p>...evaluating a mathematical model that dictates component requirements.</p>	<p>...evaluating a mathematical model of various configuration characteristics.</p>	<p>...evaluating a mathematical model of the system feature.</p>
<p>Decomposition</p>	<p>...isolating the required behaviour of the component from the rest of the system.</p>	<p>...breaking down the system into sub-systems that can be configured.</p>	<p>...isolating the physical system or its model to capture only the feature of interest.</p>
<p>Prioritized Lists</p>	<p>...generating lists that rank the alternatives based on desirable characteristics.</p>	<p>...generating lists that rank configurations based on desirable characteristics.</p>	<p>...generating lists which rank the variables that most affect the system feature.</p>
<p>Visualization</p>	<p>...visualizing the effect of each alternative on the system.</p>	<p>...generating visualizations and sketches of the layouts.</p>	<p>...visualizing the trends and factors that affect the value.</p>

4.2.2 Data Analysis

The binary, "yes/no", responses from the retrospective interviews were used to evaluate the following:

- A preference for the use of each CCMS in original vs. redesign projects. For every CCMS, this involved calculating the percentage of original and redesign projects that used the strategy. The results of this analysis are presented in Section 4.3.1.
- The likelihood of a reduction in cognitive complexity when using each of the CCMS. For every CCMS, this involved calculating the percentage of designers that reported a reduction in perceived complexity. The results of this analysis are presented in Section 4.3.2.
- A statistically significant preference for the use of certain CCMS when performing each of the three common design activities. For every CCMS, this involved calculating the percentage of selection, configuration and parametric activities that used the strategy. The results of this analysis are presented in Section 4.3.3.

For each of the percentages above, a 95th percentile confidence interval was calculated for the purposes of evaluating statistical significance. This was performed using the Clopper-Pearson interval which is a common method for determining the confidence intervals of binomial data sets (Clopper & Pearson 1934).

4.3 Results: Usage Frequency-Based Analysis of CCMS

The retrospective interviews were conducted with 25 designers most of whom were able to discuss three projects from their past experiences. This produced a sample size of 71 design projects that spanned various engineering domains, time frames and team sizes. The experience levels of these designers also varied ranging from a few to several years of work within the relevant field. Each interview took approximately 50 minutes however this figure varied based on the number of projects the designers discussed and the amount of details they provided. The data

provided by the designers was used to calculate usage frequencies of the five CCMS based on original vs. redesign project characterizations and the three commonly performed engineering design activities. The interviews also provided data regarding the likelihood of a reduction in perceived complexity when using the CCMS. The differences across these usage frequencies facilitated a cognitive difference analysis which is presented in Section 4.4. This difference analysis combined with the likelihood of a reduction in perceived complexity is presented as a tool to aid the engineering design process in Section 4.5.

4.3.1 Selection Activity

This analysis explores the designers' CCMS preferences while performing the selection activity. Table 3 defines the activity and describes how each of the five CCMS can help manage activity associated complexity. For each project in the data set, the associated designer was asked to identify their use of the selection activity. In every instance the activity was identified, designers were also asked to identify which of the five CCMS, if any, were used to manage the complexity associated with performing the activity. The usage of each CCMS is evaluated by calculating the percentage of selection activity instances that incorporated the use of the strategy. The results, presented in Figure 13, indicate the following:

- All of the five CCMS were used during the selection activity. The least used strategy, Blackbox Modelling, was still identified across approximately half the projects.
- There was a statistical preference for Decomposition, Prioritized Lists and Whitebox Modeling. This was followed by a preference towards Visualization and Blackbox Modeling with no statistically significant preference between the two strategies.

Table 3: Selection activity specific definitions of the CCMS

Selection Activity: Mitigating the complexity associated with identifying an optimal component from possible alternatives by...				
<i>Visualization</i>	<i>Prioritized Lists</i>	<i>Decomposition</i>	<i>Whitebox Modeling</i>	<i>Blackbox Modeling</i>
...visualizing the effect of each alternative on the system.	...generating lists that rank alternatives based on desirable characteristics.	...isolating the required behaviour of the component from the rest of the system.	...evaluating a mathematical model that dictates component requirements.	...physically testing each alternative within the system.

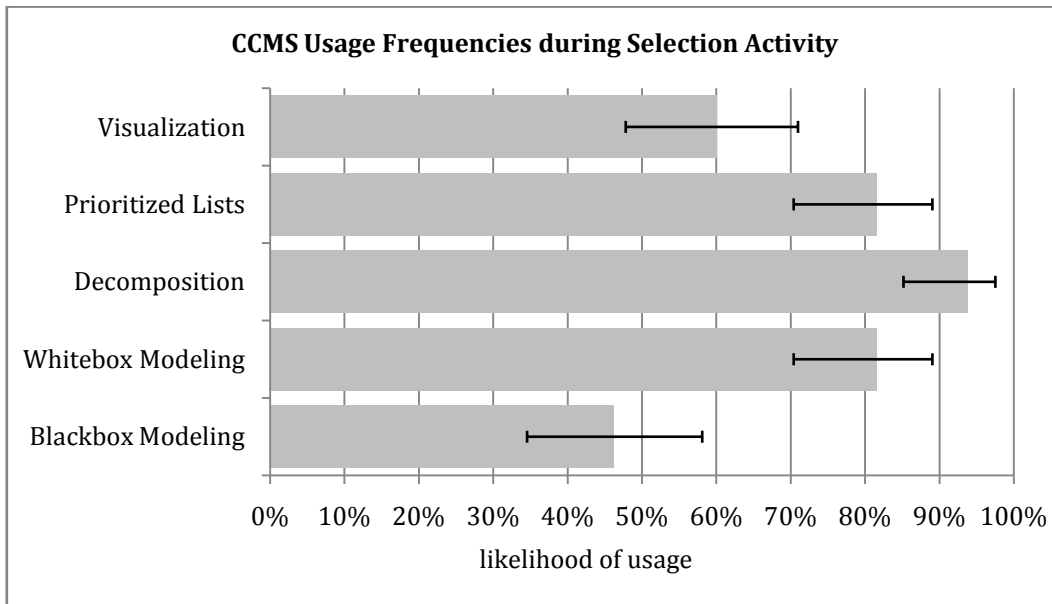

Figure 13: CCMS usage frequencies for Selection activity

Performing a selection activity, where the task is to choose an optimal component from a list of alternatives, is likely to involve use of five CCMS with a preference given to Decomposition, Prioritized Lists and Whitebox Modeling. Designer interviews and examples revealed that the Decomposition CCMS was very well suited towards the selection activity. When tasked with selecting a component, many designers cited methods of isolating or decomposing the behaviour of a component from the rest of the system. A successful decomposition allowed the designer to

allocate more attention and working memory resources to a specific component and its interactions with the system. This assisted in evaluating alternatives to the component which was a requirement of the selection activity.

Whitebox Modeling and Prioritized Lists were also frequently used during the selection activity because they helped reduce the number of component alternatives under consideration. Whitebox Modeling provided performance specifications and tolerances which helped eliminate alternatives while Prioritized Lists provided a means of filtering alternatives by ranking their performance in various categories and choosing ones that had consisted high rankings.

It was also found that Visualization and Blackbox Modeling, though used, were not preferred. In many projects, the component selection did not consider spatial constraints. The projects where spatial constraints were a factor saw the use of the Visualization CCMS especially when the component alternatives significantly varied in size and shape. Blackbox Modeling, though effective, was not used as often because many designers cited a lack of resources to physically implement component alternatives in an attempt to deduce the optimal choice. The exceptional cases involved instances where components could not be effectively isolated from the remainder of the system because the interactions were not well understood. Thus, deducing the optimal component selection required a "trial and error" Blackbox approach.

4.3.2 Configuration Activity

This analysis explores the designers' CCMS preferences while performing the configuration activity. Table 4 defines the activity and describes how each of the CCMS can help manage complexity associated with performing it. As with the analysis in the previous section, the designers were asked to identify which of the five CCMS, if any, were used during the configuration activity. The usage of each CCMS is evaluated by calculating the percentage of configuration activity instances that incorporated the use of the strategy. The results (Figure 14) indicate the following:

- All of the five CCMS were used during the configuration activity. The least used strategy, Whitebox Modelling, was still identified across approximately half the projects.
- There was a statistical preference for Visualization, Prioritized Lists and Decomposition in comparison to Whitebox Modeling. Blackbox Modeling was also often used but its usage was not statistically distinguishable from the remaining four activities.

Table 4: Configuration activity specific definitions of the CCMS

Configuration Activity: Mitigating the complexity associated with determining an optimal system layout or package by...				
<i>Visualization</i>	<i>Prioritized Lists</i>	<i>Decomposition</i>	<i>Whitebox Modeling</i>	<i>Blackbox Modeling</i>
...generating visualizations and sketches of the layouts.	...ranking configurations based on desirable characteristics.	...breaking the system into sub-systems that can be configured.	...evaluating mathematical models of configuration characteristics.	...physically assembling various configurations.

Performing a configuration activity, where the task involves optimizing the layout of subsystems and components, is likely to involve use of the five CCMS with a preference towards the Visualization, Prioritized Lists, Decomposition and possibly the Blackbox Modeling strategies. Designer interviews revealed that the Visualization CCMS was well suited for the configuration activity. This is because of the five CCMS, Visualization was best suited to mitigate the complexity of performing spatial tasks that are generally associated with the activity. The Decomposition strategy was also frequently used because the activity required the system to be broken down into constituent sub-systems when they were arranged in various configurations. Finally, it was found that Prioritized Lists were commonly used during the activity for the purposes of ranking various configurations against optimization goals and choosing the configurations that were consistently high ranking.

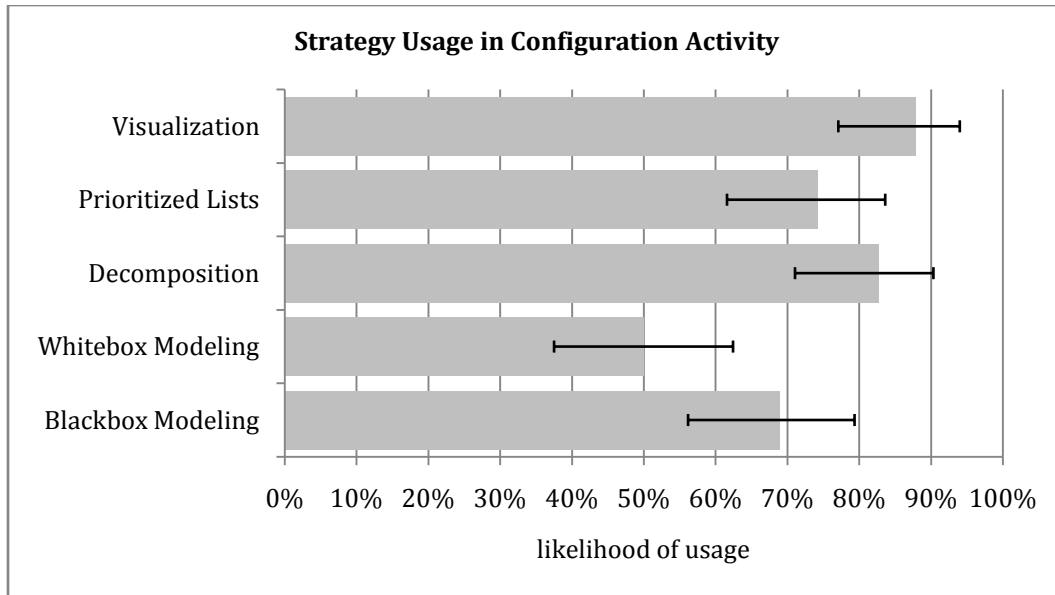

Figure 14: CCMS usage frequencies for Configuration activity

Blackbox Modeling was commonly used during the configurations activity as well. Although the physical assembly of a device is an expensive and resource intensive process, it was found the Blackbox Modeling of configurations was performed towards the end of the design process when there were fewer alternative configurations being considered. The reasoning behind the strategy's use was that it provided the most accurate validation of the design and its performance.

Whitebox Modeling during the configuration activity only occurred during specialized projects where the spatial organization of subsystems had to adhere to low tolerance constraints. An example of this was the configuration of the circuit board. The limited space on the circuit board required designers to maintain spreadsheets that captured the footprints of every component that was required. Sourcing an alternative component required the re-calculation of the footprints to ensure it would fit onto the circuit board.

4.3.3 Parametric Activity

This analysis explores the designers' CCMS preferences while performing the parametric activity. Table 5 defines the activity and describes how each of the five CCMS can help manage the

associated complexity. Similar to the previous analyses, the preferential usage of CCMS was evaluated by calculating the percentage of parametric activity instances that incorporated the use of each strategy. The results, presented in Figure 15, indicate the following:

- All of the five CCMS were used during the parametric activity.
 - The least used strategy, Prioritized Lists, was still identified across at least half the projects.
- There was no statistically significant preference towards any of the CCMS.

Table 5: Parametric activity specific definitions of the CCMS:

Parametric Activity: Mitigating the complexity associated with determining the value of a system feature by...				
<i>Visualization</i>	<i>Prioritized Lists</i>	<i>Decomposition</i>	<i>Whitebox Modeling</i>	<i>Blackbox Modeling</i>
...visualizing the trends and factors that affect the value.	...ranking the variables that most affect the system feature.	...isolating physical system/ its model to capture a feature of interest.	...evaluating a mathematical model of the system feature.	...evaluating it as a variable during physical Blackbox testing.

Performing a parametric activity, where the task is to determine the value of a system feature, is likely to involve use of the five CCMS without a preference towards any specific strategy. The CCMS that was best suited to determine the value of a system feature or parameter depended on a variety of factors such as the amount of resources available, whether it was the earlier or later phases of the design process, and if the tools to execute the strategy existed. For example if a mathematic model of system was available, designers used the Whitebox Modeling strategy to calculate the value of the feature. If however a higher degree of accuracy was required and the resources were available, Blackbox Modeling was used to experimentally determine the value. In both cases, it was advantageous to use Decomposition to efficiently divide the system into sub-systems that could be individually evaluated. This helped reduce the resources required to perform Blackbox Modeling as only the subsystem had to be physically assembled. It also helped improve

the accuracy of the Whitebox Model as the mathematical models of subsystems generally involved fewer assumptions.

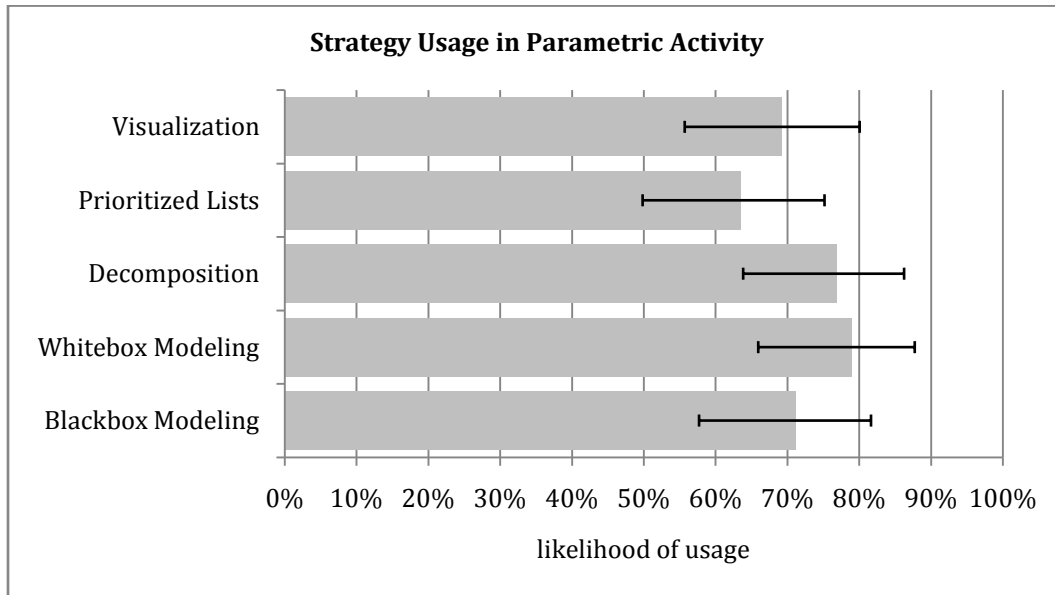

Figure 15: CCMS usage frequencies for Parametric activity

The Visualization and Prioritized List strategies were also used to support Blackbox and Whitebox Modeling. Visualization helped provide a means of observing trends and emergent characteristics of the system feature value. This helped evaluate the output of the Blackbox and Whitebox Models. At times, the visualized trends could also be used to interpolate or extrapolate values from a limited data set. Finally, Prioritized Lists ranked the variables and system components that most influenced the feature value. This ranking helped determine the variables of interest in during Blackbox and Whitebox Modeling and testing.

4.3.4 Original vs. Redesign Projects

This analysis explores the interviewed designers' preferential use of CCMS across original and redesign projects. This is determined by the percentage of projects across both characterizations that were identified for using any of the five CCMS. In most cases, each project used more than one CCMS to manage problem complexity. The findings, presented in Figure 16, indicate the following:

- There are no statistically significant differences in the usage frequencies of the CCMS across original and redesign projects.
- All of the five CCMS are used across both original and redesign project characterizations. Even the lesser used strategies, Whitebox and Blackbox modelling, are still identified in approximately half the projects.
- The five CCMS form two groups when sorted by usage frequency. The most frequently used strategies comprise the first group and include Visualization, Prioritized Lists and Decompositions. Each of these strategies is used in approximately three-quarters of the studied projects. The second group consists of Whitebox and Blackbox Modelling and each of these strategies is used in approximately half the studied projects.

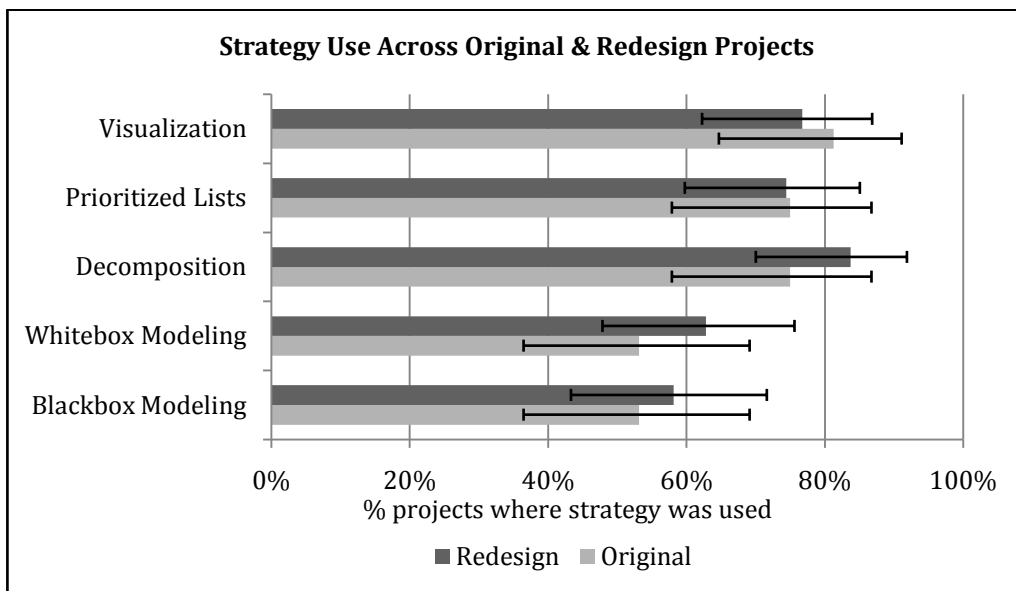

Figure 16: Comparison of Original vs. Redesign Projects

Based on these results an engineering design project, regardless of its characterization as original or redesign, is likely to use CCMS with a preference for Visualization, Prioritized Lists, and Decomposition. The extensive use of all CCMS was inferred during the validation interviews in Chapter 3. The three designers that were interviewed indicated using the CCMS in projects other than the development of the micro-power generation device. The ability of the strategies to mitigate

the limitations of working memory and attention resources coupled with their generalized frameworks make them applicable to a variety of situations. The preference towards Visualization, Prioritized Lists, and Decomposition may be because these strategies are not as resource and expertise intensive as Whitebox and Blackbox modelling. They do not require the monetary and development resources consumed by Blackbox modelling nor do they require the subject matter expertise that is usually leveraged for Whitebox modelling.

A cognitive difference analysis based on the usage frequencies of the five CCMS across original and redesign projects did not yield any statistically significant results at a 95% confidence level. Although the definitions of original and redesign projects are different, these differences do not seem to simply manifest themselves through usage frequencies alone. However it is possible that the CCMS, though used just as often, are characteristically different across original and redesign projects. For example, a Whitebox model may be much more intricate and resource intensive in an original design as opposed to a redesign because a redesign may simply use existing models. Such differences would not be captured through a cognitive difference analysis that is based on usage frequency alone. Instead, the analysis must be based on how a complexity mitigation strategy changes across two projects or environments. This method of capturing changes in characteristic differences is presented in Chapter 5.

4.3.5 Likelihood of Reduction in Cognitive Complexity

This section explores the likelihood of a reduction in cognitive complexity when using CCMS. During the interviews, designers were asked if they perceived a reduction in complexity when using each of the five CCMS. Their consolidated responses are presented in Figure 17 which shows the percentage of participants that claimed a reduction in perceived complexity.

Although such self-reported complexity measures have limitations, as discussed in Section 2.1.1, they are closely related to cognitive complexity. Thus, these findings can be used to infer the

effectiveness of each CCMS at reducing cognitive complexity across a population of diverse designers. Figure 17 provides the following observations:

- A majority of interviewed designers indicated a reduction in perceived complexity when using each of the CCMS except Whitebox Modelling. Thus, it can be inferred that the remaining four CCMS are likely to reduce a designer's cognitive complexity.
- Decomposition, Visualization, and Blackbox Modeling appear to be most effective at reducing cognitive complexity followed by Prioritized lists and finally Whitebox Modeling.

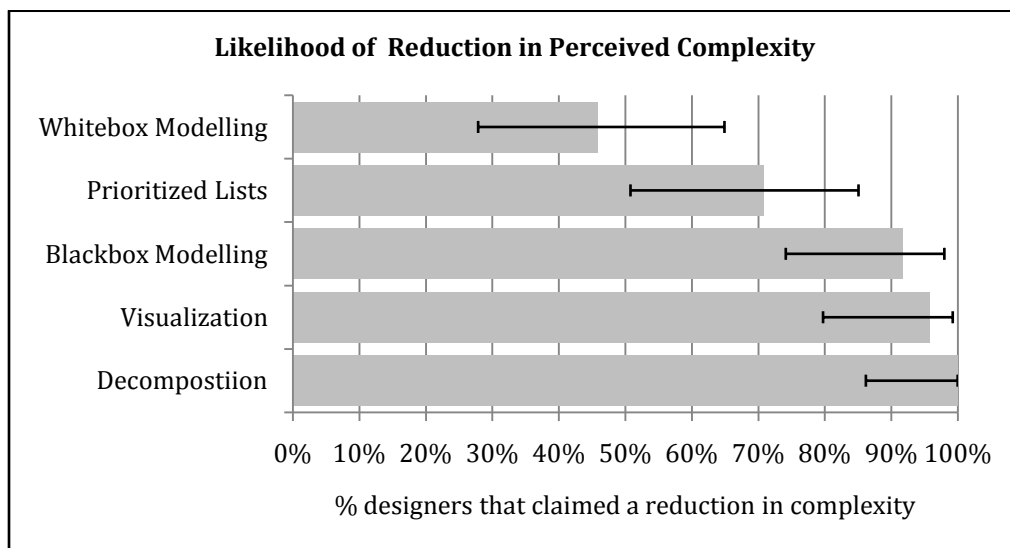

Figure 17: Likelihood of experiencing a reduction in perceived complexity for each CCMS

The interviews confirmed that Decomposition, Blackbox Modeling and Visualization mitigated the limitations of the designers' working memory and attention resources in order to manage complexity. The findings were consistent with the validation interviews performed with the micro-power generation (MPG) design team in Chapter 3. However, differences were observed in the complexity mitigation effectiveness of Prioritized Lists and Whitebox Modeling. While the MPG design team agreed that these strategies mitigated complexity, some of the designers interviewed for this study did not agree. They claimed that Prioritized Lists were used solely for organizational

purposes and were not able to identify any instances where they perceived a reduction in complexity from the use of such lists.

Approximately half the interviewed designers also indicated using Whitebox Modeling because it was necessary for effective design and not because it reduced cognitive complexity. In contrast, the remaining designers that claimed the mathematical formulations used by Whitebox Modeling facilitated a reduction in cognitive complexity by leveraging learned mathematical knowledge.

4.4 A Cognitive Difference Analysis Based on the Usage Frequency of CCMS

A cognitive difference analysis attempts to capture the similarities and differences in the cognitive processes across environments or activities. One method of performing such an analysis for the engineering design process would be through a comparison of CCMS usage frequencies, presented in Chapter 4.3, across the various engineering project breakdowns and activities. The differences in usage frequencies can infer changes in cognitive processes across these environments. This can highlight the challenges that might be faced by designers as they transfer from one activity to another or the need to support certain CCMS over others.

Table 6 is a summary of the five CCMS in terms of the three engineering activities. This table is sorted with respect to the usage frequency groupings that were presented in Section 4.3. A cognitive difference analysis can be conducted by performing pair wise comparisons between sets of activities.

Selection vs. Configuration: Between the Selection and Configuration activities, the major difference in usage preference occurs with Whitebox Modeling. This strategy is highly preferred for the Selection activity and least preferred for Configuration. There are also minor preference differences in the Blackbox Modeling and Visualization strategies while Decomposition and Prioritized Lists are equally highly preferred. Thus, in situations where designers or projects are shifting towards the Selection activity from Configuration, it is important that design processes become highly supportive of Whitebox Modeling while reducing the support for Visualization and

Blackbox Modeling if necessary. Consequently, if the shift occurs from the Selection activity towards Configuration, support for Whitebox Modeling can be reduced while increasing the support for Blackbox Modeling and Visualization.

Table 6: CCMS usage preferences across engineering activities

	Selection Activity Identifying an optimal component from possible alternatives by...	Configuration Activity Determining an optimal system layout or package by...	Parametric Activity Determining the value of a system feature by...
<i>Highly Preferred</i>			Blackbox Modeling ...evaluating it as a variable during physical Blackbox testing.
	Decomposition ...isolating the required behaviour of the component from the rest of the system.	Decomposition ...breaking down the system into sub-systems that can be configured.	Decomposition ...isolating the system or its model to capture only the feature of interest.
	Prioritized Lists ...generating lists that rank the alternatives based on desirable characteristics.	Prioritized Lists ...generating lists that rank configurations based on desirable characteristics.	Prioritized Lists ...generating lists which rank the variables that most affect the system feature.
		Visualization ...generating visualizations and sketches of the layouts.	Visualization ...visualizing the trends and factors that affect the value.
	Whitebox Modeling ...evaluating a mathematical model that dictates component requirements.		Whitebox Modeling ...evaluating a mathematical model of the system feature.
<i>Less Preferred</i>	Visualization ...visualizing the effect of each alternative on the system.	Blackbox Modeling ...physically assembling various configurations.	
<i>Least Preferred</i>	Blackbox Modeling ...physically testing each alternative within the system.	Whitebox Modeling ...evaluating a mathematical model of various config. characteristics.	

Selection vs. Parametric: The Parametric activity places an equal usage preference across all CCMS. Between the Selection and Parametric activities, the most prominent difference in usage preference occurs across Blackbox Modeling followed by a minor difference in Visualization. Thus, in situations where a shift occurs from the Selection to Parametric activity, an increase in support for the Blackbox Modeling strategy is most important seconded by processes that are more supportive of Visualization. Shifting from the Parametric to the Selection activities however, can allow for reduced support for Blackbox Modeling and Visualization.

Configuration vs. Parametric: Between the Configuration and Parametric activities, the most prominent difference in usage preference exists across Whitebox Modeling followed by a minor difference in Blackbox Modeling. Thus, a shift from Configuration to a Parametric activity is best supported by increasing the support for both Blackbox and Whitebox Modeling and a transition in the opposite direction can accommodate a reduction in support for these activities.

The Original and Redesign project categorizations provide another scheme for performing a cognitive difference analysis. However, as presented in Section 4.3.4, there are no significant differences in CCMS usage preferences across the two categorizations. However, the impact of cognitive differences can be further investigated in such cases by exploring differences in how a CCMS is used across two environments as opposed to assessing the likelihood of its usage. This alternative method of performing a cognitive difference analysis is presented in Chapter 5 through the development of a tool to capture the cognitive differences between air traffic control sectors.

4.5 A Tool to Improve the Design Process

Combining the cognitive difference analysis from the previous section with the likelihood of reduction in perceived complexity offered by each cognitive complexity mitigation strategy (CCMS), found in Section 4.3.5, produces Table 7. In addition to providing the differences in preferential use of CCMS across engineering design activities, this table also provides insight on the effectiveness of each CCMS at reducing cognitive complexity.

Table 7: CCMS usage preferences across engineering activities including perceived complexity reduction data

	Selection Activity Identifying an optimal component from possible alternatives by...	Configuration Activity Determining an optimal system layout or package by...	Parametric Activity Determining the value of a system feature by...			
<i>Most Preferred</i>			Blackbox Modeling ...evaluating it as a variable during physical Blackbox testing.			
	Decomposition ...isolating the required behaviour of the component from the rest of the system.	Decomposition ...breaking down the system into sub-systems that can be configured.	Decomposition ...isolating the physical system or its model to capture only the feature of interest.			
	Prioritized Lists ...generating lists that rank the alternatives based on desirable characteristics.	Prioritized Lists ...generating lists that rank configurations based on desirable characteristics.	Prioritized Lists ...generating lists which rank the variables that most affect the system feature.			
		Visualization ...generating visualizations and sketches of the layouts.	Visualization ...visualizing the trends and factors that affect the value.			
	Whitebox Modeling ...evaluating a mathematical model that dictates component requirements.		Whitebox Modeling ...evaluating a mathematical model of the system feature.			
<i>Less Preferred</i>	Visualization ...visualizing the effect of each alternative on the system.	Blackbox Modeling ...physically assembling various configurations.				
<i>Least Preferred</i>	Blackbox Modeling ...physically testing each alternative within the system.	Whitebox Modeling ...evaluating a mathematical model of various configuration characteristics.				
<table border="1" style="width: 100%; text-align: center;"> <tr> <td style="width: 33%;">High Complexity Reduction</td> <td style="width: 33%;">Less Complexity Reduction</td> <td style="width: 33%;">Least Complexity Reduction</td> </tr> </table>				High Complexity Reduction	Less Complexity Reduction	Least Complexity Reduction
High Complexity Reduction	Less Complexity Reduction	Least Complexity Reduction				

There is no trend between CCMS that provide a high degree of complexity reduction versus their preferential usage frequencies. For example, Whitebox Modeling, which provides the least amount of complexity reduction also has a high usage preference during the Selection and Parametric activities. Blackbox Modeling, which provides a high degree of complexity mitigation, is not a part of the most preferred grouping within the Selection or Configuration activities. This disparity between the preferential usage and complexity mitigation effectiveness of CCMS may be because designers do not consider the ability of a CCMS to mitigate complexity when choosing a strategy.

Additionally, many factors beyond complexity mitigation effectiveness affect the preferential usage of CCMS. These factors include costs, available resources, and expertise and business requirements amongst many others. For example the use of Blackbox Modeling during the Selection activity can significantly help reduce the complexity associated with choosing an optimal component from a range of alternatives. However, physically testing each alternative, as Blackbox Modeling suggests, can be a very expensive endeavour. Thus, the strategy is least preferred in comparison to other alternatives.

However, knowledge of the complexity data presented in Table 7 can justify the use of lesser preferred CCMS in situations where a high degree of complexity mitigation is required. These situations can involve design problems that are known to have high objective complexity or ones where the design team begins to face difficulties due to their lack of expertise or knowledge. Such complex situations may be overcome using CCMS that provide a high degree to complexity mitigation at the expense of other resources, such as cost.

4.6 Chapter Summary

The purpose of this chapter was to investigate efficient cross-activity transfer protocols. This was done by performing a cognitive difference analysis across the commonly occurring Selection, Configuration and Parametric engineering activities and across two engineering design

classifications; Original and Redesign. The use of the five cognitive complexity mitigation strategies (CCMS), documented in Chapter 3, was validated across these characterization and activities through retrospective interviews. These interviews were performed with 25 designers, each of whom discussed up to three projects for a total sample of 71 design projects.

The results of these interviews established that each of the five CCMS are indeed used in Original and Redesign projects. Furthermore, the strategies are also frequently used during the Selection, Configuration and Parametric design activities. The interviews also provided usage frequencies for each of the CCMS with respect to the three design activities. This data established the preferential usage of CCMS which was used to perform a usage frequency based cognitive difference analysis. The results this cognitive difference analysis were presented in Chapter 4.4 and, when supplemented with the effectiveness of each CCMS's ability to mitigate complexity, were created into a tool to aid the design process and justify CCMS selection. The cognitive difference analysis also revealed no differences in the preferential usage of CCMS across Original and Redesign projects. Chapter 5 develops an alternative difference analysis method that involves an in-depth exploration of how CCMS are applied across projects to supplement usage frequency comparisons.

Chapter 5

Study III: Improving the Efficiency of Cross-Sector Air Traffic

Controller Transfer

Chapter 4 presented a cognitive difference analysis across commonly occurring engineering design activities. This analysis was based on differences in the usage frequencies of cognitive complexity mitigation strategies (CCMS) when performing these activities. This chapter presents a second method of performing a cognitive difference analysis which is based on characteristic differences in one complexity mitigation strategy across various environments. Instead of analysing the differences in usage frequencies, this alternative method evaluates how a single complexity mitigation strategy changes as it is applied across various environments.

The alternative method presented in this chapter is illustrated through a study involving air traffic controllers (ATCs) and the Federal Aviation Administration (FAA). The goal of this study is to create a tool for performing a cognitive difference analysis across various air traffic control sectors - regions of responsibility for individual ATCs. The results of the analysis are to be used to assess the appropriateness of transferring ATCs to different sectors and the associated retraining that may be required.

The cognitive complexity mitigation strategy that is leveraged to perform this analysis is well documented by Histon & Hansman (2008) and is termed a "structure-based abstraction". Further details regarding the study and the use of structure based abstractions are presented in Section 5.1. By identifying the characteristic factors that affect how structure based abstractions are used, a tool termed the sector abstraction binder (SAB) is developed in Section 5.2. The SAB is then used to perform a cognitive differences analysis of two air traffic control sectors and the results are presented in Section 5.3.

5.1 Problem: Accelerated Air Traffic Controller Retirement Rates

Recent years have seen accelerated rates of retirement rate amongst United States air traffic controllers (FAA 2010a). In addition, controllers maintain proficiency on only a limited number of sectors. In combination with the retirement pressures, this is creating the possibility of localized and national shortages of air traffic controllers. This creates a need for greater staffing flexibility: an effective response is to transfer experienced controllers to provide coverage for sectors experiencing shortfalls. However, efficient transfer requires minimizing the amount of retraining an experienced controller needs.

A key factor affecting controller training is airspace structure. Airspace structure is defined as the physical and informational elements that organize and arrange the air traffic control environment (Histon & Hansman 2008). It plays an important role in developing air traffic controller mental models and strategies. However, airspace structure can vary considerably between sectors and across facilities necessitating site-specific training. Air traffic controller training includes a considerable amount of time devoted to on the job (OJT) training where controllers learn relevant airspace structures and internalize the mental models and strategies that help them safely control traffic. This training develops localized sector-specific knowledge that has to be learned when even experienced controllers transfer to a new sector.

One strategy for mitigating these training needs is the development of generic airspace with similar structure such that controllers only require training on the minimal differences between sectors (FAA 2010b). This approach requires assessing the applicability of a controller's sector-specific knowledge to other airspace sectors and identifying the cognitive differences amongst sectors. In order to provide a framework for conducting these assessments, previously identified knowledge of how controller's use structure to reduce complexity is used as a basis for determining the similarity of one or more airspace sectors. The sector abstraction binder provides a comprehensive tool for assessing generic airspace sector groupings for cognitive similarity.

5.1.1 Characterizing Airspace Sectors

The generic airspaces concept identifies opportunities to standardize airspace in an attempt to increase air traffic controller training efficiency. In the short to mid-term, the goal is to identify similarities across existing airspace sectors and produce sector groupings based on minimizing training differences within each group. In the longer term, the factors used to assess these similarities can be used as heuristics for sector redesign with the goal of reducing overall NAS-wide differences in training.

Previous attempts at characterizing airspace sectors have mostly looked at aggregate complexity measures based on a combination of air traffic and structural considerations. Christien et al. (2002) proposed a set of complexity factors, or a complexity index, which could then be evaluated and compared across airspace sectors. Goldman et al. (2006) similarly proposed a set of sector factors which were independent of specific air traffic situations. Yousefi et al. (2004) proposed metrics for measuring airspace density and transit time. These works show promise for characterizing airspace sectors and are used as a basis for deriving factors that characterize abstractions within the SAB. However, the factors presented in these works lack a strong association to structure based abstractions which are shown to greatly influence air traffic controller mental models (Histon & Hansman 2008).

5.1.2 Structure Based Abstractions

Figure 18 is a representation of an air traffic controller's cognitive processes (Histon & Hansman 2008). A key component of this representation is the working mental model which supports the generation and maintenance of situation awareness along with decision-making and implementation processes of the controller's task. The working mental model is a result of the specific air-traffic situation, or operational environment, that the controller is managing and the mental models and abstractions that the controller has retained within their long term memory.

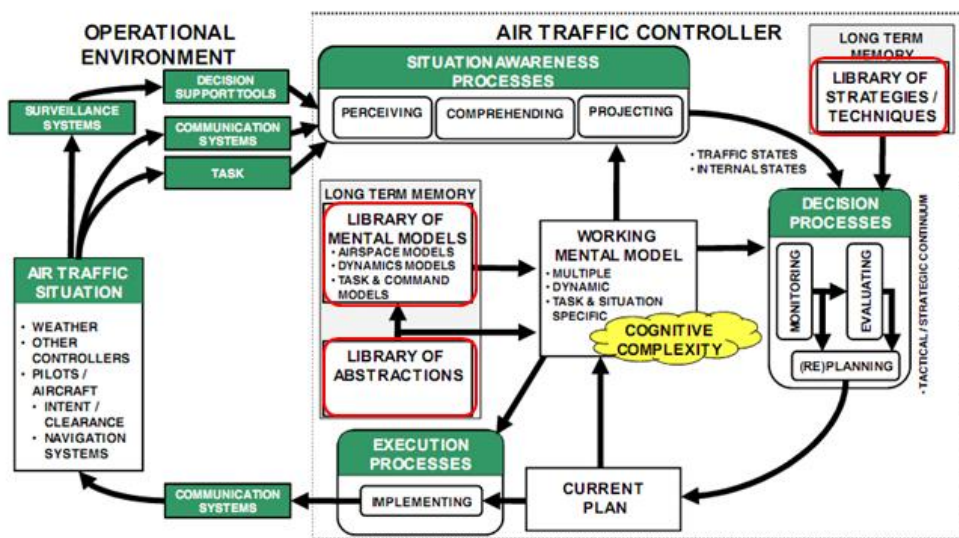

Figure 18: Representation of an air traffic controller's cognitive processes (Histon & Hansman, 2008)

Over the course of OJT, controllers build up their libraries of knowledge consisting of generalized abstractions and are thought to use sector-specific instantiations of those abstractions when they are being applied. For example, a controller may develop a generalized abstraction for a merge pattern that involves a consolidation of two or more aircraft flows which is applicable across many airspace sectors. However, a sector-specific instantiation of merge includes the geographic location, spacing, velocity and other requirements which may be unique across each airspace sector. If the controller is accustomed to utilizing a certain generalized abstraction then transfer to a sector that requires the same generalized abstraction can be accomplished with reduced training because only the sector specific instantiation details need to be relearned.

The working mental model is also influenced by the operational environment or context under which the abstraction is used. This incorporates the effects of other structure-based abstractions on the abstraction of interest. For example, a military operations area may project certain constraints on a merge abstraction if they are in close proximity. Learning the operational environment and context of a specific sector is also an important part of OJT.

The presence and context under which structure based abstractions are utilized across airspace sectors can be used as a method of clustering for the purposes of generic airspaces. The underlying hypothesis of this research is that controller transfers between airspace sectors should involve minimal training if the needed abstractions exist and are "similar". The challenge is to assess the similarity of these abstractions by determining the specification and context based factors that influence them, evaluating these factors and comparing them across sectors. This document presents the Sector Abstraction Binder (SAB) which is a bottom up method for identifying and evaluating the similarities in abstractions across airspace sectors.

5.2 Method: The Sector Abstraction Binder

The Sector Abstraction Binder (SAB) is a bottom up methodology for assessing cognitive similarities across airspace sectors by leveraging the importance of structure based abstractions. To limit scope, the analysis is limited to four commonly used abstractions with a focus on a high-altitude enroute airspace sectors. However, additional abstractions can be easily incorporated. The abstractions include merges, inbound and outbound handoffs and, standard flow segments. Table 8 provides a working definition for these abstractions and reasoning for inclusion into the SAB.

Table 8: Commonly occurring structure based abstractions

Abstraction	Definition	Reason for Selection
<i>Std. Flow Segment</i>	This abstraction is the presence of densely organized air traffic that is generally but not exclusively associated with jet routes.	Selected because of their very common occurrence and tendency to be the basis of abstractions like merges and handoffs.
<i>Merge</i>	This abstraction involves the consolidations of n flow segments to $n-1$ or fewer segments while resolving sequencing conflicts.	Selected because they are commonly found and involve traffic sequencing by air traffic controllers.
<i>In/Outbound Handoff</i>	In/Outbound handoffs are the process of giving away/receiving control of an aircraft. They are treated as distinct abstractions because of significant procedural differences.	Selected because they are very common and are an example of an air traffic situation where coordination with another controller is required.

5.2.1 A Bottom-Up Process

Figure 19 provides an overview of the bottom up nature of the SAB. First, each abstraction instance within a sector is evaluated. This involves the assessment of characteristic factors related to that abstraction type. The factors capture key properties of the abstraction determined from an assessment of how it fits into a controller’s mental model. There are two distinct types of factors: specifications and context. Specifications represent the core parameters required to describe an abstraction and distinguish it from another instance of the abstraction; for example, the frequency of an adjoining sector is a key specification of a handoff abstraction. Context captures the relationship between an instance of the abstraction and features in the airspace. For example, the same handoff abstraction may occur at a different distance from key confliction points in the sector, leading to different abstraction instances. Generally, specifications tend to be discrete bits of information while context tends to encapsulate the operational environment and behaviours of abstractions. Table 9 provides examples of both specification and context factors for each of the three abstractions. A complete listing can be found in the Brewton-Geneva Sector Abstraction Binder (Appendix C).

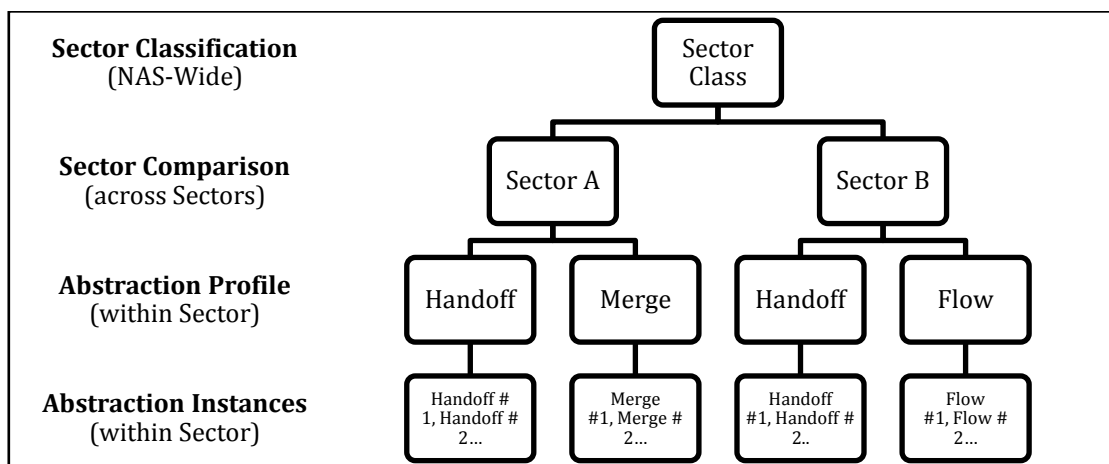

Figure 19: Bottom-up depiction of the Sector Abstraction Binder methodology

Table 9: Examples of contextual and specification factors for each abstraction type

		Charac. Factor	Definition	
<i>Handoffs (Inbound/Outbound)</i>	<i>Specs.</i>	Position/Location	- sector boundary location of handoff instance	
		# Interacting Sector(s)	- # sectors that feed/accept aircraft to/from instance	
		Adjacent Sector Freq.	- adjacent sector primary/backup radio frequencies	
			
	<i>Context</i>	Dist. to Internal Critical Points (nm)	- dist. from handoff to critical points within sector	- distance from handoff to critical points within receiving sector
		Handoff Angle (deg)	- angle between handoff flow and sector boundary	
.....				
<i>Merges</i>	<i>Specs</i>	Position/Location	- location of merge instance	
		Entry/Exit Headings	- headings of n entry flow segments and $n-1$ or less exit segments	
			
	<i>Context</i>	Dist. to Internal Critical Points (nm)	- distance from merge point to other critical points within sector	
		Nearby Elements	- list of nearby airspace elements not including MOA/SUA	
			
<i>Std. Flow Segments</i>	<i>Specs.</i>	Position/Location	- heading required to maintain flow segment track	
		Flight Levels	- flight levels available to aircraft that will use flow instance	
			
	<i>Con.</i>	Segment Length	- length of flow segment	
		Terminal Elements	- elements that establish the end point elements of flow segment	
			

Consolidating the results of these abstraction instances provides an *abstraction profile* which is a summary of the range of both specifications and context factors found for each abstraction type within a sector. The abstraction profiles represent the types of specification and contextual environments an abstraction operates under for a specific sector. This can be seen in Table 10 which illustrates a partial abstraction profile of outbound handoffs for the Brewton high level sector in Jacksonville Center. The complete profile can be viewed in Appendix C. Table 10 also shows a visualization of some of the contextual features. These profiles can be compared across different sectors to establish cognitive similarities. Such profiles can be used to create groupings of cognitively similar sectors or *sector classes*. Since the analysis begins from individual structural features within airspace sectors and progressively makes generalizations, this method leverages benefits of bottom up methodologies. It provides transparency into the causes of cross sector dissimilarities as any difference can be traced to a specific factors and their corresponding data

source. Furthermore, the approach allows the consolidation of various qualitative and quantitative data sources at an early stage ensuring a comprehensive analysis.

Table 10: Partial abstraction profile for Brewton outbound handoffs

Specifications		Visualization of Brewton-HL Out. Handoffs
Position/Location	Eastbound. Westbound.	
# Interacting Sector(s)	1-2	
Adj. Sector Freq.	128.07/307.2...	
...	...	
Context		
Dist. to Internal Critical Points (nm)	50-120	
Handoff Angle (deg)	30-90	
Nearby MOAs/SUAs	Up to 3	
...	...	

5.2.2 Applying the Sector Abstraction Binder

The following is a step-by-step breakdown of the SAB process and how it can be applied to perform a cognitive difference analysis of two or more airspace sectors:

1. Identify instances of merges, handoffs (inbound & outbound), and standard flow segments within sectors of interest.
2. Characterize each instance by evaluating it against each of the specification and context factors devised in the SAB.
3. Develop an abstraction profile for each of the four abstractions (inbound/outbound handoff, merge, standard flow segment) across each sector. This involves consolidating each instance analyzed in Step 2. The consolidation scheme can vary depending on the type of characterization factor.
4. Compare abstraction profiles across the two sectors to determine emergent differences in abstractions for the purposes of performing a cognitive difference analysis.

The SAB uses 19 factors to characterize inbound and outbound handoffs, 17 factors for merges and 15 factors for standard flow segments. Examples of these characterization factors are shown in Table 9 and a full list can be viewed in Appendix C.

5.3 Results: A Cognitive Difference Analysis of Two Airspace Sectors

The Sector Abstraction Binder (SAB) is a means of performing a cognitive differences analysis across air traffic control sectors. It is based on the characteristic differences across a single cognitive complexity mitigation strategy (CCMS) identified as structure based abstractions. This section implements the SAB methodology to two high level airspace sectors - Brewton HL and Geneva HL which operate above the state of Florida within the United States. These sectors were chosen due to the availability and access to their standard operating procedures, change notices and radar track information. The following sections execute the methodology presented in Chapter 5.2.2 using data that was consolidated by Emilio Filho at the Massachusetts Institute of Technology's International Center for Air Transportation. A detailed implementation of this sector abstraction binder can be found in Appendix C.

5.3.1 Step 1: Identifying Abstraction Instances

Figure 20 illustrates the number of abstraction instances found in Brewton HL and Geneva HL. Abstraction instances were identified using airspace sector density plots which were created by plotting two weeks' worth of available aircraft radar track data. This density plot illustrated commonly used aircraft trajectories that tended to coincide with jet routes. Every portion of these trajectories that maintained a common heading was defined as a standard flow segment. Figure 3 illustrates these segments.

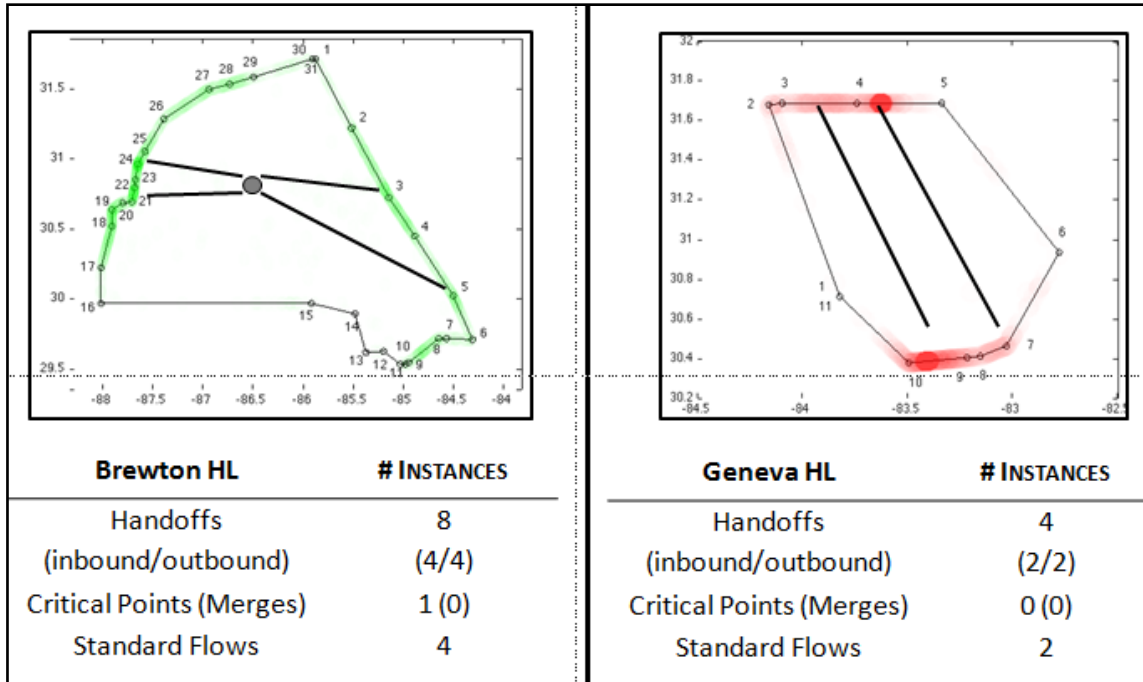

Figure 20: Identifying abstraction instances in Brewton and Geneva

A sector boundary penetration distribution provided a visual representation of the number of aircraft that crossed every finite increment of the sector boundary. This distribution tended to show increased aircraft penetration values where standard flow segments intersected the boundary. This penetration distribution is graphically illustrated in Figure 3 using a shading scheme overlaid on the sector boundary. The distribution also helped determine if the handoff was inbound, outbound or both.

Geneva HL did not have intersecting standard flow segments and although Brewton HL had an intersection point it was not considered to be a merge because (1) there was insufficient consolidation of N to $N-1$ flows and (2) the usage frequency of these flows did not facilitate significant conflict resolution between two or more aircraft to validate a merge.

5.3.2 Step 2: Evaluating Each Abstraction Instance

The SAB uses 19 characteristic factors for inbound and outbound handoffs, 17 factors for merges and 15 factors for standard flow segments. The complete list of factors can be found in

Appendix C. These characteristic factors were devised from literature reviews of existing complexity factors, qualitative analysis of standard operating procedures, change notices and reviews of first-hand descriptions of air traffic control procedures and processes (Majumdar & Ochieng 2002; Histon et al. 2002; Jacksonville-ARTCC 2011). Table 11 describes the information sources that are used to evaluate specification and context factors within the SAB. These sources provide both qualitative and quantitative data. This variety and the depth of the informational analysis is one of the strengths of the bottom-up SAB process.

Table 11: Information sources used to evaluate characteristic factors

Information Source	Used to Evaluate/Generate:
<i>ETMS Data</i>	- aircraft densities, abstraction usage frequencies, aircraft mixes, abstraction dimensions, density plots (to assess emergent groupings), boundary penetration distributions (to assess handoff coverage)
<i>Sector Binders</i>	- radio frequencies, sector names, establish high level purpose of sector
<i>Standard Operating Procedures (SOP), Change Notices</i>	- specific instructions/restrictions, heading and altitude changes, recommended destination specific routes and re-routes during MOA/SUA activation
<i>Cartographic Maps</i>	- spatial positioning of abstractions and sector features, distances between critical features, handoff angles

Each abstraction instance identified in the previous section is evaluated using the set of characteristic factors. These factors are devised such that they capture both specification and contextual characteristics of the abstraction instance providing insight into the cognitive make-up of the instance. Table 12 shows two outbound handoff abstractions in Brewton HL for the purposes of illustration. A full list of the instances and factor evaluation can be found in Appendix C.

Table 12: Sample comparison of two outbound Brewton handoffs

	Factor	OH2	OH4
Specifications	Position/Location	eastern boundary	western boundary
	Interacting Sector(s)	dual (PERRY HI & MICANOPY UHI)	single (MOB HI - 63)
	Neighbouring Sector	PERRY HI - 135.65/291.7	Mobile Hi - 63 125.77/322.4
	Primary/Backup Frequencies	MICANOPY UHI - 135.32/380.25	
	Unique Instructions	<i>Sector 11 BREWTON Change Notice - Section 2: (2) ...</i>	None
	Ceiling/Floor or Sector Wall	wall	wall
Context	Distance to Int. Crit. Points (nm)	120 (CP), <i>165</i> (IH4), <i>170</i> (IH3)	50 (CP), <i>100</i> (IH3), <i>125</i> (IH1), <i>165</i>
	Distance to Ext. Crit. Points (nm)	40 (PERRY, MICANOPY - HEVVN)	Not Available
	Handoff Angle	30	90
	Avg. Frequency (18 hour day)	10/day	19/day
	Overlap w/ Outbound Handoff	IH2 (30/day)	IH4 (19/day)
	Dominance	Inbound	Shared
	Boundary Coverage	medium (20 miles)	low (15 miles)
	Aircraft Mix	96% jet 4% turboprop	96% jet 4% turboprop
	Inter/Intra ARTCC Handoff	Intra	Inter (ZHU)
	Overlapping MOAs/SUAs	Florida "A" SUA...	None
	Nearby MOAs/SUAs	South: ACMI West	South: Eagle A SUA
	Suggested Alternates	<i>Sector 11 BREWTON Change Notice - Section 2: If ...</i>	None

5.3.3 Step 3: Creating Abstraction Profiles

The purpose of the abstraction profile is to consolidate the evaluation of each instance into a single characterization. This produces four profiles, one for inbound handoffs, another for outbound handoffs, one for merges and a final one of standard flow segments. The profile captures the types of abstraction variations a controller is accustomed to operating within the sector of interest. For Brewton HL and Geneva HL, a merge profile does not exist due to a lack of merge instances within these sectors. The profiles facilitate a cross-sector comparison such that overlaps in abstraction properties can be identified. Table 13 provides an example portion of Brewton HL outbound handoff profile. The remaining profiles can be found in Appendix C.

Table 13: Sample of Brewton outbound handoff profile

Outbound Handoff Profile		
Specs.	Position/Location	eastern and western facing boundaries
	Interacting Sector(s)	single and double
.....		
Context	Distance to Critical Point (nm)	50-120 (external: 40-50)
	Handoff Angle	30-90
	Avg. Frequency (18 hour day)	10/day - 35/day
.....		

5.3.4 Step 4: Cognitive Difference Analysis

The following sets of tables highlight the differences in abstraction profiles between Brewton HL and Geneva HL. Factors that do not show significant differences are excluded for the purposes of brevity. Table 14 illustrates the differences in outbound handoff profiles between the two sectors and Table 15 compares standard flow segments.

Table 14: Outbound handoff difference analysis between Brewton and Geneva

	Characteristic Factor	Brewton-HL	Geneva- HL
Specificatio	Position/Location	eastern and western facing boundaries	northern and southern facing boundaries
	Unique Instructions	Ranges from none specified to destination based flight level restriction	Ranges from none specified to destination based flight level restrictions, modified altitude..
Context	Dist. to Int. Critical Points	50-120 nm	80 nm
	Dist. to Ext. Critical Points	40-50 nm	60 - Unknown nm
	Handoff Angle	30-90	90
	Avg. Freq. (18 hour/day)	10/day - 35/day	18/day - 36/day
	Overlap w/ In. Handoff	All overlap	None overlap
	Dominance	Shared/Inbound/Outbound	Outbound
	Boundary Coverage	Low - High (15 - 35 miles)	Low (10-15 miles)
	Overlapping MOA/SUA	Up to 2	None
	Nearby MOA/SUA	Up to 3	Up to 1
Suggested Alternates	Ranges from none specified to up to 3 reroutes based on the activation of adj...	None	

Table 15: Standard flow difference analysis between Brewton and Geneva

	Characteristic Factor	Brewton-HL	Geneva-HL
<i>Spec.</i>	Heading	8 dominant	2 dominant
	Flight Levels	FL240 & Above w/ 7110.65 assignments	FL240 & Above w/ unique heading based assignment
<i>Context</i>	Segment Length (nm)	50 - 120	80
	Usage Frequency (18 hour day)	0.3 - 0.7 aircraft/hour	0.4 - 1.40
	Freq. of Non-Standard. Intersections (18 hour day)	1.40 - 3.50 aircraft/hour	0.80 - 1.60
	Directional Breakdown	Avg. 50/50 split	Unidirectional Flow
	Overlapping MOAs/SUAs	Up to 2	None
	Nearby MOAs/SUAs	Up to 3	1
	Suggested Alternates	Either none or 2 rerouting instructions.	None

From a comparison of the abstraction profiles, the following differences are apparent across Brewton HL and Geneva HL:

- Distances to critical points and standard flow segment lengths in Geneva HL are a constant 80nm compared to the variable 50-120nm found in Brewton HL (Table 14 & Table 15)
- Geneva HL's handoff angles are constant (90 degrees) whereas Brewton HL's angles are variable between 30 and 90 degrees depending on the specific handoff instance. (Table 14)
- Geneva HL does not have any overlapping handoffs i.e. boundary areas that serve as both inbound and outbound handoffs but the converse is not true for Brewton HL. (Table 14)
- Geneva HL tends to have a lower frequency of non-standard intersections (0.6-1.60 aircraft/hour) compared to Brewton HL (1.40 - 3.50 aircraft/hour). (Table 15)
- Brewton HL has bi-directional flow segments which mean that a flow segment has aircraft travelling in opposing directions at staggered flight levels. However, Geneva HL flow segments are unidirectional. (Table 15)
- Geneva HL has a single proximal MOA/SUA but Brewton HL has 2/3 MOAs which result in more instructions for MOA/SUA activation in Brewton HL (Table 14 & Table 15)

- Based on usage frequencies of handoffs and flow segments, Geneva HL tends to operate a greater volume of aircraft compared to Brewton HL (Table 14 & Table 15)

These observations suggest that Geneva HL tends to operate in a structured, high traffic environment. The airspace sector potentially manages higher traffic volume through a reduction in operational variability that can be attributed to minimal influence of MOA/SUAs, unidirectional flow, and spatially separated inbound and outbound handoffs. Brewton HL tends to operate in a more variable environment such that the abstraction characterizing factors vary from one instance to another.

Based on the profile comparisons between Brewton HL and Geneva HL it appears unlikely that the two sectors would be ideal candidates for cross-sector controller transfers with only minimal retraining. However without analyzing more airspace sectors, it is difficult to definitively state whether Geneva HL and Brewton HL are similar. The goal of generic airspace is to identify sectors that show promise of facilitating cross-sector transfer with minimal re-training. Minimal re-training is a relative measure that cannot be measured by the comparison of two airspace sectors but instead requires a larger sample - one that would ideally be NAS-wide.

5.4 A Cognitive Difference Analysis Based on Characteristic Variations in CCMS

The results demonstrate that the Sector Abstraction Binder (SAB) can be used to perform a cognitive difference analysis across two or more airspace sectors. Assessing the characteristic differences in structure based abstractions, a cognitive complexity mitigation strategy used by air traffic controllers, is a useful methodology because it provides a bottom up analysis of cognitive differences. This bottom-up progression allows differences in characteristic factors to be traced to the contributing abstraction instance thus providing significant transparency on the sources of the cognitive dissimilarities. When coupled with the variety of data sources the SAB incorporates, an analysis can pinpoint specific trends within a sector's standard operating procedures or radar track

data that contribute to cross-sector differences. This is important for generating strategies to mitigate differences in future sector redesign.

The comparison of Brewton-HL and Geneva-HL using the SAB process also revealed that this method of performing cognitive difference analyses is more resource and data intensive compared to the alternative presented in Chapter 4. This makes it infeasible to use this bottom-up cognitive differences method across a large number of comparisons. Instead it is recommended that a characteristic variations-based cognitive difference analysis method, such as the SAB, is complemented by a less resource intensive, usage frequency-based, difference analysis method which was presented in Chapter 4. Thus, a frequency based method can be initially used to explore a difference analysis problem and the most relevant or noteworthy results can be investigated in further detail using the characteristic-variations based methodology.

5.5 Chapter Summary

This chapter presented a second method of performing a cognitive difference analysis. This method used the characteristic variations in the application of a single cognitive complexity mitigation strategy (CCMS) across different contexts. This was in contrast to Chapter 4, which performed a cognitive difference analysis by analyzing variations in the usage frequencies of various CCMS. This alternative method was studied in conjunction with a project that explored methods of mitigating the effects of accelerated air traffic controller (ATC) retirement rates across the United States National Airspace System (NAS). One mitigation technique involved the identification of cognitively similar air traffic control sectors for the purposes of increasing the flexibility of the air traffic controller (ATC) workforce. To identify cognitively similar sectors, a tool that helped perform a cognitive difference analysis was required.

This chapter developed the Sector Abstraction Binder (SAB) tool to perform cognitive difference analyses of airspace sectors. It leveraged the characteristic variations in a commonly employed air traffic control CCMS known as structure based abstractions. The tool identified four

common air traffic control abstractions including merges, inbound/outbound handoffs and standard flows. It then characterized factors that affected the performance of each of these abstractions. These factors consisted of easily retained specification factors and more difficult context factors. The specifications attempted to capture discrete information regarding the abstractions whereas the contextual factors were affected by the relative position of each abstraction in relation to other airspace sector features.

The SAB tool was successfully used to perform a cognitive difference analysis between two airspace sectors in the United States; Brewton-HL and Geneva-HL. The results of this analysis indicated that Geneva-HL operates in a highly structured environment and consequently manages greater air traffic volume. In contrast, Brewton-HL experiences more operational variability and thus less traffic volume. Due to these differences, it was concluded transferring ATCs across the two airspace sectors would probably require more than a minimal amount of retraining. However, a larger sample of airspace sectors must be analyzed to verify the findings.

Finally, it was stated that the characteristic variations-based cognitive difference methodology presented in this chapter is very resource intensive and an effective solution would be to supplement this method with the usage frequency-based method presented in Chapter 4.

Chapter 6

Conclusions & Future Work

This thesis was an investigation of commonly used cognitive complexity mitigation strategies (CCMS) used during the engineering design process and the variations in these strategies as a result of a change in context. The resulting research questions that were proposed at the beginning of this thesis were:

1. What are the commonly used CCMS in the engineering design process?

This research question was investigated in Chapter 3 through a collaborative project with an engineering design firm. The findings that support this question are discussed in Section 6.1.

2. How do CCMS vary with changes in context (i.e. projects and environments)?

This research question was investigated in Chapters 4 and 5. Chapter 4 attempted to describe the variations in terms of the differences in usage frequencies of each of the CCMS. Alternatively, Chapter 5 attempted to describe the variations in terms of characteristic differences that were intrinsic to the strategy itself. These findings are further discussed in Section 6.2 and 6.3.

6.1 Study I: Documenting CCMS

This study presented cognitive complexity mitigation strategies (CCMS) that were used during the engineering design process. The study was conducted in collaboration with an engineering firm that was commercializing a laboratory developed micro-power generation (MPG) device. The MPG device was a complex system with closely coupled electrical and mechanical sub-systems. This made it ideal for the study of complexity mitigation strategies that the engineering design team used during the commercialization process.

Three complementary methods were used to investigate CCMS. The first was an ethnographic immersion where a researcher became part of the design team for a period of eight months to gain exposure to the firm's design processes and protocols. The second was a logbook analysis where

the engineering design team's logbooks were analyzed for the repeated use of certain problem solving approaches. These approaches were used to identify potential CCMS. Finally, validation interviews were performed using consolidated findings from the first two methods for the purposes of verifying the use and complexity reduction capabilities of the identified CCMS. The results of this study documented five CCMS that were used in the development of the MPG device. They were:

Blackbox Modelling: This CCMS involved describing a system in terms of its input and output variables of interest while "blackboxing", or ignoring the internal constructs of the system itself. Complexity was mitigated because only the variables of interest, their values, and their co-dependencies were considered. The Blackbox Modelling strategy did not explicitly showcase how a system worked. Instead, it simply developed relationships between certain input and the output variables.

Whitebox Modelling: This CCMS attempted to explicitly define relationships between a system's input and output variables using mathematical models. These models could be derived by numerically analyzing results of Blackbox Modelling, or through the modelling of physical phenomena.

Decomposition: This CCMS involved separating a system into simpler, more manageable subsystems. Decomposition could be employed through metrics that independently measure the performance of each subsystem or by dividing the physical system and focusing on the division of interest.

Prioritized Lists: This CCMS involved identifying a system objective that was to be optimized and listing the components within the system using a prioritization scheme that was based on the influence each component has on the system objective. The prioritization simplified these numerous and complex interactions into an ordinal list.

Visualization: This CCMS captured the use of various Visualization strategies to depict a system or its components. These depictions could have been internal, such as imagining the trend line produced by a set of raw data, or external, such as sketching a system block diagram on a piece of paper.

Validation interviews indicated that these CCMS were used by designers in various projects beyond MPG development. It was also indicated that designers perceived a reduction in cognitive complexity when employing these CCMS. This was likely due to the ability of these CCMS to supplement the limitations of the designer's working memory and attention resources. Thus, it was beneficial to support and promote the use of these strategies through appropriate design processes and protocols. This would help encourage more efficient and production design.

6.2 Study II: Efficient Transfer Through Differences in the Usage Frequencies of CCMS

The purpose of this study was to perform a cognitive difference analysis across commonly occurring engineering design activities for the purpose of investigating efficient cross-activity transfer protocols. Two types of engineering project characterizations are used, Original and Redesign, to complement the three engineering design activities; Selection, Configuration and Parametric. These characterizations and activities were defined as follows:

Selection: The process of choosing a component from a catalogue of alternatives. Depending on the scope of the project, this selection could have been very complex as the evaluation criteria could include performance, costs, reliability, availability etc.

Configuration: The process of assembling or packaging components into a complete system. Depending on the number of components, there could have been numerous layouts and the optimal choice could be dictated by a variety of factors such as heat dissipation, power conservation, cost, board form factor etc.

Parametric: The process of determining values for features that characterized the system. For example if there was a requirement for a certain number of hours of battery life, a parametric

activity would involve determining the size of the battery given the power consumption of the circuit board.

Original Design: Involved the creation of a novel system that, as far as the designer knew, did not exist. This categorization attempts to capture projects where the designer was not working from a template or improving an existing system.

Redesign: Involved projects where an existing system was being improved upon or repurposed to meet a new set of requirements. This categorization captured situations where the designer had references to prior work and the project required modifications that did not influence the core principles of the original design.

The use of the five cognitive complexity mitigation strategies (CCMS) was validated across these characterizations and activities through retrospective interviews. These interviews were performed with several designers, each of whom discussed up to three projects. The results of these interviews established that each of the five CCMS were used in Original and Redesign projects. However, a cognitive difference analysis also revealed no differences in the preferential usage of CCMS across these two project categorizations.

The CCMS strategies were also frequently used during the Selection, Configuration and Parametric design activities. The interviews also provided usage frequencies for each of the CCMS with respect to the three design activities. A cognitive difference analysis of these usage frequencies revealed the following:

Selection vs. Configuration: In situations where designers or projects were shifting towards the Selection activity from Configuration, it was important that design processes became highly supportive of Whitebox Modelling while reducing the support for Visualization and Blackbox Modelling if necessary. Consequently, if the shift occurred from the Selection activity towards Configuration, support for Whitebox Modelling could be reduced while increasing the support for Blackbox Modelling and Visualization.

Selection vs. Parametric: In situations where a shift occurred from the Selection to Parametric activity, an increase in support for the Blackbox Modelling strategy was most important seconded by processes that were more supportive of Visualization. Shifting from the Parametric to the Selection activities however, could have allowed for reduced support for Blackbox Modelling and Visualization.

Configuration vs. Parametric: Shifting from Configuration to a Parametric activity was best supported by increasing the support for both Blackbox and Whitebox Modelling while a transition in the opposite direction could accommodate a reduction in support for these activities.

Finally, the interviews also provided data on the likelihood of each CCMS to achieve a reduction in perceived complexity. This data coupled with the preferential usage of CCMS revealed no correlation indicating that usage of a CCMS is not necessarily governed by its ability to mitigate complexity. This information was incorporated into a tool which could help justify the use of a resource intensive CCMS for its improved ability to mitigate complexity when faced with a high complexity problem.

6.3 Study III: Efficient Transfer Through Characteristic Differences in CCMS

This purpose of this study was to investigate a method of accommodating efficient cross-sector air traffic controller transfers. This method used the characteristic variations in the cross-sector application of a specific cognitive complexity mitigation known as structure based abstractions. The assessment and evaluation of these variations developed using a tool called the Sector Abstraction Binder. The purpose of the tool was to perform a cognitive difference analyses across airspace sectors. It identified four common air traffic control abstractions including merges, inbound/outbound handoffs and standard flows and characterized factors that affected the performance of each of these abstractions. These factors consisted of easily retained specification factors and more difficult context factors. The specifications attempted to capture discrete

information regarding the abstractions whereas the contextual factors were affected by the relative position of each abstraction in relation to other airspace sector features.

Upon developing the tool, the study also involved demonstrating its use through a cognitive difference analysis between two airspace sectors in the United States; Brewton-HL and Geneva-HL. In general, it was found that Geneva-HL operated in a highly structured environment and consequently managed greater air traffic volume. In contrast, Brewton-HL experienced more operational variability and thus less traffic volume. Due to these differences, it was concluded that transferring air traffic controllers across these two sectors would require more than a minimal amount of retraining thus making it inefficient.

It was also found that the characteristic variations-based cognitive difference methodology presented in this study was very resource intensive and though the results it provided were highly transparent it would be infeasible to use this methodology across a large number of difference analyses. Thus, a resource effective solution would be to complement this method with the usage frequency-based method which can perform a preliminary difference analysis.

6.4 Future Work

There are three main areas of future work with regards to this research. Firstly, the cognitive complexity mitigation strategies (CCMS) that were documented through the ethnographic immersion and logbook analysis were based off of a single engineering design project. It is prudent to apply the CCMS documentation methodology provided in Study I to several other engineering design projects such that more complexity mitigation methods are found. Furthermore, a similar methodology can also be used to investigate CCMS beyond the engineering design domain.

Second, the retrospective interviews performed in Study II captured binary responses regarding the use of CCMS across engineering design activities. The nature of these binomial distributions requires large sample sizes to achieve modest reductions in confidence intervals. The

CCMS usage preferences proposed in Study II can be made more robust by interviewing additional designers and further increasing the number of design projects that constitute the data set.

Finally, the two difference analysis methodologies presented in Studies II and III can be further validated by studying them across various other cross-context user transfer scenarios. These studies should be focused on quantifying the gain made in transfer efficiency in conditions that involve the use of either, both or none of the two difference methodologies. This can help establish which of the two methodologies is more effective and under what conditions.

References

- Baddeley, A., 1992. Working memory G. H. Bower, ed. *Science*, 255(5044), pp.556-559. Available at: <http://www.sciencemag.org/content/255/5044/556.short>.
- Baird, F., Moore, C. & Jagodzinski, A., 2000. An ethnographic study of engineering design teams at Rolls-Royce Aerospace. *Design Studies*, 21(4), pp.333–355. Available at: <http://www.sciencedirect.com/science/article/pii/S0142694X00000065> [Accessed December 14, 2011].
- Ball, L.J. & Ormerod, T.C., 2000. Applying ethnography in the analysis and support of expertise in engineering design. *Design Studies*, 21(4), pp.403–421. Available at: <http://www.sciencedirect.com/science/article/pii/S0142694X00000090> [Accessed December 14, 2011].
- Bodenhausen, G.V. & Lichtenstein, M., 1987. Social stereotypes and information-processing strategies: the impact of task complexity. *Journal of Personality and Social Psychology*, 52(5), pp.871-880. Available at: <http://www.ncbi.nlm.nih.gov/pubmed/3585699>.
- Carroll, J.M. & Olson, J.R. eds., 1987. *Mental models in human-computer interaction: Research issues about what the user of software knows*, Washington, D.C.: National Academy Press.
- Christien, R. et al., 2002. Air traffic complexity indicators & ATC sectors classification. In *Proceedings The 21st Digital Avionics Systems Conference*. Ieee, pp. 2D3-1-2D3-7. Available at: <http://ieeexplore.ieee.org/lpdocs/epic03/wrapper.htm?arnumber=1067924>.
- Clopper, C. & Pearson, E.S., 1934. The use of confidence or fiducial limits illustrated in the case of the binomial. *Biometrika*, 26(4), pp.404–413. Available at: <http://www.jstor.org/stable/10.2307/2331986> [Accessed December 14, 2011].
- Edmonds, B., 1999. Syntactic Measures of Complexity. *Machine Learning*, p.245.
- Ericsson, K.A. & Simon, H.A., 1984. *Protocol Analysis*, MIT Press. Available at: <http://www.psy.fsu.edu/faculty/ericsson/ericsson.proto.thnk.html>.
- FAA, 2010a. A Plan for the Future: 10-Year Strategy for the Air Traffic Control Workforce. Available at: http://www.faa.gov/air_traffic/publications/controller_staffing/media/CWP_2010.pdf.
- FAA, 2010b. FAA's NextGen Appendix B: Implementation Plan. Available at: http://www.faa.gov/nextgen/media/appendix_b.pdf.
- Fitzpatrick, R.C.N.M.L.F.M.O.N.D., 2008. *Maxwell's equations and the principles of electromagnetism*, Infinity Science Press.

- Flexner, S.B. ed., 1980. *The Random House Dictionary*, New York: Random House.
- Goel, V. & Pirolli, P., 1989. Motivating the notion of generic design within information processing theory: the design problem space. *AI Magazine*, 10(1), pp.18-36.
- Goldman, S.M., Manning, C.A. & Pfeleiderer, E., 2006. *Static sector characteristics and operational errors*, FEDERAL AVIATION ADMINISTRATION OKLAHOMA CITY OK CIVIL AEROMEDICAL INST. Available at: <http://libraryonline.erau.edu/online-full-text/faa-aviation-medicine-reports/AM06-04.pdf>.
- Histon, J M et al., 2002. Introducing Structural Considerations into Complexity Metrics. *ATC Quarterly*, (December), pp.1-12. Available at: <http://dspace.mit.edu/handle/1721.1/37320>.
- Histon, Jonathan M. & Hansman, R. John, 2008. *Mitigating complexity in air traffic control: The role of Structure-Based abstractions*. Massachusetts Institute of Technology. Available at: <http://dspace.mit.edu/handle/1721.1/42006> [Accessed December 14, 2011].
- Hoover, S.P., Rinderle, J.R. & Finger, S., 1991. Models and abstractions in design. *Design Studies*, 12(4), pp.237–245. Available at: <http://www.sciencedirect.com/science/article/pii/0142694X9190039Y> [Accessed December 14, 2011].
- Jackson, D., 2006. *Software Abstractions*, MIT Press.
- Jacksonville-ARTCC, V., 2011. Jacksonville Air Route Traffic Center Forum. Available at: <http://www.zjxartcc.org/PNphpBB2.html>.
- Kahneman, D., 1973. *Attention and Effort* Daniel Kahneman, ed., Prentice-Hall. Available at: <http://www.jstor.org/stable/1421603?origin=crossref>.
- Khodadad, I. et al., 2011. Optimization of a Micro Power Unit. In *ASME 2011 International Design Engineering Technial Conferences & Computers and Information in Engineering Conference*. Washington.
- Kopardekar, P. et al., 2007. Airspace complexity measurement: An air traffic control simulation analysis. *7th USAEurope Air Traffic Management RD Seminar Barcelona Spain*, 16(1), pp.1-9. Available at: http://www.atmseminarus.org/seminarContent/seminar7/presentations/pr_052_AAPM.pdf.
- Larichev, O.I. & Moshkovich, H.M., 1988. Limits to decision-making ability in direct multiattribute alternative evaluation. *Organizational Behavior and Human Decision Processes*, 42(2), pp.217-233.

- Laudeman, I.V. et al., 1998. Dynamic Density: An Air Traffic Management Metric. *Ames Research Center*, (April). Available at:
<http://www.csa.com/partners/viewrecord.php?requester=gs&collection=TRD&recid=200111014552MT>.
- Lewis, C., 1982. Using the “thinking-aloud” method in cognitive interface design. *IBM Research Report*, Research R(IBM Research Report RC 9265), p.0. Available at:
<http://portal.acm.org/citation.cfm?id=92544>.
- Locke, E.A. et al., 1981. Goal Setting and Task Performance. *Psychological Bulletin*, 90(1), pp.125-152.
- Majumdar, A. & Ochieng, W., 2002. Factors Affecting Air Traffic Controller Workload: Multivariate Analysis Based on Simulation Modelling of Controller Workload. *Transportation Research Record*, 1788(1), pp.58-69. Available at:
<http://trb.metapress.com/openurl.asp?genre=article&id=doi:10.3141/1788-08>.
- Martin, R.C., 2000. Design principles and design patterns. *Object Mentor*, (c), pp.1-34. Available at:
http://www.cogs.susx.ac.uk/users/ctf20/dphil_2005/Photos/Principles_and_Patterns.pdf
 [Accessed December 14, 2011].
- Maynard, D.C. & Hakel, M.D., 1997. Effects of Objective and Subjective Task Complexity on Performance. *Human Performance*, 10(4), p.303. Available at:
<http://search.ebscohost.com/login.aspx?direct=true&db=bth&AN=7309076&site=ehost-live>.
- Mish, F.C. ed., 2008. *complex*, Merriam-Webster Online Dictionary. Available at:
<http://www.merriam-webster.com/dictionary/complex>.
- Norman, D. & Bobrow, D., 1975. On data-limited and resource-limited processing. *Cognitive Psychology*, 7, pp.44-60.
- Paquette, L. & Kida, T., 1988. The effect of decision strategy and task complexity on decision performance. *Organizational Behavior and Human Decision Processes*, 41(1), pp.128-142. Available at: <http://www.sciencedirect.com/science/article/B6WP2-4CYG27T-5D/2/555d997c3276d5bf4bcd563b3dbeb75a>.
- Pashler, H.E., 1998. *The psychology of attention* M. S. Gazzaniga & C. Blakemore, eds., MIT Press. Available at:
<http://scholar.google.com/scholar?hl=en&btnG=Search&q=intitle:The+psychology+of+attention#0>.
- Rasmussen, J., 1986. *Information processing and human-machine interaction* A. P. Sage, ed., Elsevier Science Publishers.

- Reynolds, T.G. et al., 2002. Structure, Intent & Conformance Monitoring in ATC. In *ATM 2002*. Capri, Italy.
- Soilman, M.S.M. et al., 2010. Output Power Optimization for Electromagnetic Vibration Energy. In *ASME 2010 International Design Engineering Technical Conferences & Computers and Information in Engineering Conference*. Montreal.
- Stauffer, Larry A, Ullman, David G & Dietterich, Thomas G, 1987. Protocol Analysis of Mechanical Engineering Design. In *ICED 87 Boston*. American Society of Mechanical Engineers, pp. 74-85.
- Takeda, H. et al., 1990. A Cognitive Approach to the Analysis of Design Processes. In *Design theory and methodology*. American Society of Mechanical Engineers, pp. 153-160.
- Ullman, D. G., Dietterich, T. G. & Stauffer, L. A., 1988. A model of the mechanical design process based on empirical data. *AI EDAM*, 2(01), pp.33-52.
- Ullman, David G, 2002. *The Mechanical Design Process*, McGraw-Hill. Available at: <http://www.amazon.com/Mechanical-Design-Process-Mcgraw-Hill-Engineering/dp/0072975741>.
- Ward, G. & Allport, A., 1997. Planning and Problem solving Using the Five disc Tower of London Task. *The Quarterly Journal of Experimental Psychology A*, 50(1), pp.49-78. Available at: <http://www.catchword.com/cgi-bin/cgi?body=linker&ini=xref&reqdoi=10.1080/027249897392224>.
- Wickens, C.D. & Hollands, J.G., 2000. *Engineering Psychology and Human Performance* Thrid Edit., New Jersey: Prentice-Hall Inc.
- Yousefi, A., Donohue, G.L. & Chen, C.H., 2004. Investigation of Airspace Metrics for Design and Evaluation of New ATM Concepts. In *NEXTOR - FAA - INFORMS joint conference on Air Traffic Management and Control*. Falls Church, Virginia.

Appendix A

Study I: Validation Interviews

Note: Images have been sanitized where appropriate for the purposes of confidentiality.

Mechanisms to Mitigate Complexity - MPG Design Case Study

Participant ID# _____

Background Questions

1. What was your role in the Micro Power Generator project at Arjae Ltd. between Sept 2010 and March 2011?
2. Who did you interact with?
3. On the provided piece of paper, chronologically order the MPG development process by identifying some of the major projects and undertakings associated with the development of the device.
4. What are some things you consistently performed throughout the design process and across all projects?
5. The development of the MPG was a complex process - there were many different subcomponents that interacted in a closely coupled manner. What are some of the methods you used to reduce complexity of the development process?

The remainder of the interview is broken in to 5 sections. Each section is one method/process that was commonly used during MPG development.

Blackbox Modelling

This technique involves exploring a system from an input - output standpoint. In all cases the input variables and the measured output variables are only a subset of all possible variables. Generally

the input variables are the ones that are manipulated and the output are the ones that are expected to change. An example of Blackbox Modelling occurs in the form:

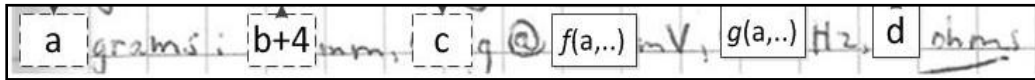

6. Does this method seem familiar to you? (Y/N)
7. A "thinking aloud" method is when a participant vocalizes their thoughts and reasoning. This gives the observing researcher insight into their cognitive processes. The following snippet is from the development documentation. What can you infer from it? Please use the thinking aloud method.

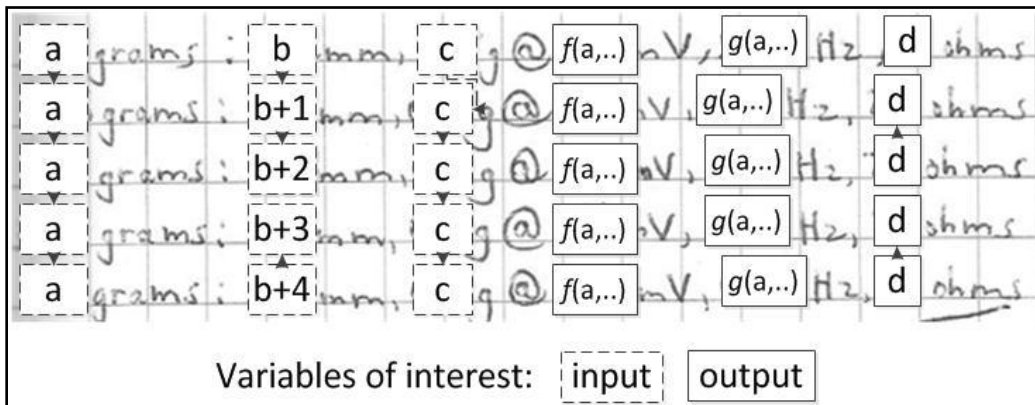

8. Does depicting the MPG in this manner help reduce complexity? If so, why?
9. How did you decide what input and output variables were recorded?
10. Are there any other techniques you used during the design process that you would classify as Blackbox Modelling?
11. Can you provide some situations when this type of modelling was especially useful? You may use the timeline to aid your memory and mark off points when you used Blackbox Modelling.
12. Were there any limitations that you encountered when using this type of modelling?
13. Have you used Blackbox Modelling on other projects that you've been involved with? If yes, when? If no, would you consider using it in the future?

Whitebox Modelling

This technique involves exploring a system through an inference on the relationships that relate input and output parameters. Unlike Blackbox Modelling, one has insight into how certain input parameters will affect output parameters. Thus, a prediction on the value or behaviour of the output can be made for a given change on the input. An example would be the following equation:

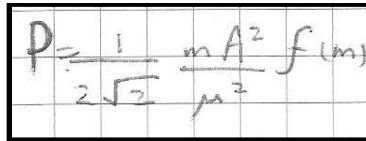
$$P = \frac{1}{2\sqrt{2}} \frac{mA^2}{\mu^2} f(m)$$

14. Does the above equation seem familiar to you? (Y/N)
15. If you were looking to maximize the variable P, what would you look to do? Please use the thinking aloud method.
16. Does depicting the MPG in this manner help reduce complexity? If so, why?
17. Are there any other techniques you used during the design process that you would classify as Whitebox Modelling?
18. Can you provide some examples of when this type of modelling (not just the above equation) was especially useful. You may use the timeline to aid your memory and mark off points when you used Whitebox Modelling.
19. Were there any limitations that you encountered when using Whitebox Modelling?
20. Have you used Whitebox Modelling on other projects that you've been involved with? If yes, when? If no, would you consider using it in the future?

Domain Separation

This technique involves breaking the device down into subsystems. One breakdown involves separating the MPG into the mechanical and electrical sub-systems. The Q-factor was deemed to be an important mechanical measure.

$$Q = \frac{Wm}{b(m)}$$

21. Does the above equation seem familiar to you? (Y/N)
22. What does the Q factor represent?
23. Does evaluating the MPG in this manner help reduce complexity? If so, why?
24. Are there any other techniques you used during the design process that you would classify as Domain Separation? Is there an electrical equivalent to the Q-factor? Are there other types of domains?
25. Can you provide some examples of when Domain Separation was especially useful? You may use the timeline to aid your memory and mark off points when you used Domain Separation.
26. Were there any limitations that you encountered when using the Q-factor or other Domain Separation techniques?
27. Have you used Domain Separation on other projects that you've been involved with? If yes, when? If no, would you consider using it in the future?

Prioritized Lists

This involves listing components of the MPG relative to a parameter for the purposes of identifying next important tasks and the most value-add area of improvements. The following is an example:

Components and Function (relative to power output)	
1.) cantilever	i) effective length ii) thickness iii) width iv) stiffness
2.) mass	i) overall weight ii) damping
3.) coil	i) effective length ii) wire gauge
4.) magnetic field	i) distance between magnets ii) field strength

28. Does the above seem familiar to you? (Y/N)
29. What can you infer from the above list? Please use the thinking aloud method.
30. Does prioritizing in this manner help reduce complexity? If so, why?
31. What criteria did you use to prioritize your lists? How did you decide on this criteria?
32. Are there any other techniques you used during the design process that you would classify as Prioritization?
33. Can you provide some examples of when Prioritization was especially useful? You may use the timeline to aid your memory and mark off points when you used Prioritization.
34. Were there any limitations that you encountered when using Prioritization techniques?
35. Have you used Prioritization on other projects that you've been involved with? If yes, when? If no, would you consider using it in the future?

Visualization

This method is the use of sketches to depict the MPG or its components in various forms. The following are examples:

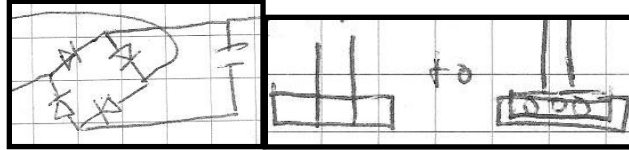

36. Did you use sketches during the MPG development process? (Y/N)
37. What can you infer from the above sketches? Please use the thinking aloud method.
38. Does sketching in this manner help reduce complexity? If so, why?
39. How did you decide what to include and exclude from your sketch?
40. Are there any other techniques you used during the design process that you would classify as Visualization that may not be a sketch?
41. Can you provide some examples of when Visualization was especially useful? You may use the timeline to aid your memory and mark off points when you used Visualization.
42. Were there any limitations that you encountered when using Visualization techniques?
43. Have you used Visualization on other projects that you've been involved with? If yes, when? If no, would you consider using it in the future?

Concluding Questions

44. Of the 5 methods discussed above, was there any sequencing or preferred order of use? That is, was one method used before the other?
45. The development of the MPG was a complex process - there were many different subcomponents that interacted in a closely coupled manner. What are some of the methods you used to reduce complexity of the development process?
46. Was there any time when using complexity reduction techniques led you astray? Describe.
47. Did working on the MPG project reveal any new complexity reduction techniques for design? If yes, what were they and were they different from what we've discussed.
48. What recommendations would you make to improve the development process in future projects?

Appendix B

Study II: Retrospective Interviews

Abstractions Used for Complexity Mitigation in Mechanical and Electrical Design

Participant ID# _____

Background Questions

1. What is your position/title?
2. Briefly describe your daily activities.
3. How long have you been designing electrical/hardware components?
4. Describe three projects you've been involved in.

Design Activities

The following are some common types of design activities. After reading through the descriptions, please fill out the table below by assigning each of your three projects to the appropriate design type (using Y/N). You can assign a project to more than one design type if necessary.

Selection: "Choosing one item (or maybe more) from a list of similar items"

Configuration: "Assembling selected components into complete product"

Parametric Design: "Finding values for the features that characterize object being studied"

Original Design: "Development of a process, assembly, or component that is not in existence"

Redesign: "Design based on prior, similar solutions"

Design Activities	Project # 1	Project # 2	Project # 3
Selection			
Configuration			
Parametric			
Original			
Redesign			
Reasoning:			

Blackbox Modelling

This technique involves exploring a system from an input - output standpoint. In all cases the input variables and the measured output variables are only a subset of all possible variables. Generally the input variables are the ones that are manipulated and the output are the ones that are expected to change.

5. Did you use Blackbox Modelling in any of your three projects (Y/N)? If yes, what design activities were they a part of?

Design Activities	Project # 1	Project # 2	Project # 3
Selection			
Configuration			
Parametric			
Original			
Redesign			
Reasoning:			

6. Can you provide some specific examples or situations when Blackbox modelling was especially useful (with regards to the projects you described above)?
7. Why did you use Blackbox Modelling? Did it mitigate complexity?

Whitebox Modelling

This technique involves exploring a system through an inference on the relationships that relate input and output parameters. Unlike Blackbox Modelling, one has insight into how certain input parameters will affect output parameters. Thus, a prediction on the value or behaviour of the output can be made for a given change on the input. An example would be an equation.

8. Did you use Whitebox Modelling in any of your three projects (Y/N)? If yes, what design activities were they a part of?

Design Activities	Project # 1	Project # 2	Project # 3
Selection			
Configuration			
Parametric			
Original			
Redesign			
Reasoning:			

9. Can you provide some specific examples or situations when Whitebox modelling was especially useful (with regards to the projects you described above)?

10. Why did you use Whitebox Modelling? Did it mitigate complexity?

Decomposition

This technique involves breaking the device down into subsystems. One breakdown involves separating an electromechanical device into mechanical and electrical sub-systems. The mechanical system can also be further decomposed.

11. Did you use Decomposition in any of your three projects (Y/N)? If yes, what design activities were they a part of?

Design Activities	Project # 1	Project # 2	Project # 3
Selection			
Configuration			
Parametric			
Original			
Redesign			
Reasoning:			

12. Can you provide some specific examples or situations when Decomposition was especially useful (with regards to the projects you described above)?

13. Why did you use Decomposition? Did it mitigate complexity?

Prioritized Lists

This involves listing components of a device relative to a criteria for the purposes of identifying next important tasks and the most value-add area of improvements.

14. Did you use Prioritized Lists in any of your three projects (Y/N)? If yes, what design activities were they a part of?

Design Activities	Project # 1	Project # 2	Project # 3
Selection			
Configuration			
Parametric			
Original			
Redesign			
Reasoning:			

15. Can you provide some specific examples or situations when Prioritized Lists were especially useful (with regards to the projects you described above)?

16. Why did you Prioritized Lists? Did it mitigate complexity?

Visualization

This method is the use of sketches to depict the system or its components in various forms.

17. Did you use Visualization in any of your three projects (Y/N)? If yes, what design activities were they a part of?

Design Activities	Project # 1	Project # 2	Project # 3
Selection			
Configuration			
Parametric			
Original			
Redesign			
Reasoning:			

18. Provide specific examples or situations when Visualization was especially useful.

19. Why did you use Visualization? Did it mitigate complexity?

Appendix C

Brewton HL - Geneva HL Sector Abstraction Binder

Sector Abstraction Binder - Brewton/Geneva

The Sector Abstraction Binder provides an analysis of the quantity and characteristics of merges, flow segments, inbound and outbound handoffs within a specific sector. The intent of this document is to facilitate a means of comparison between abstractions that occur across different sectors such that difference analysis may be performed.

Abstractions

The figure below is a representation of an air traffic controller's mental model based on "Mitigating Complexity in Air Traffic Control: The Role of Structure-Based Abstractions" [Histon and Hansman, 2008]. It incorporates Endsley's model of situation awareness and also includes a high-level decision making process identified by Pawlak et al.

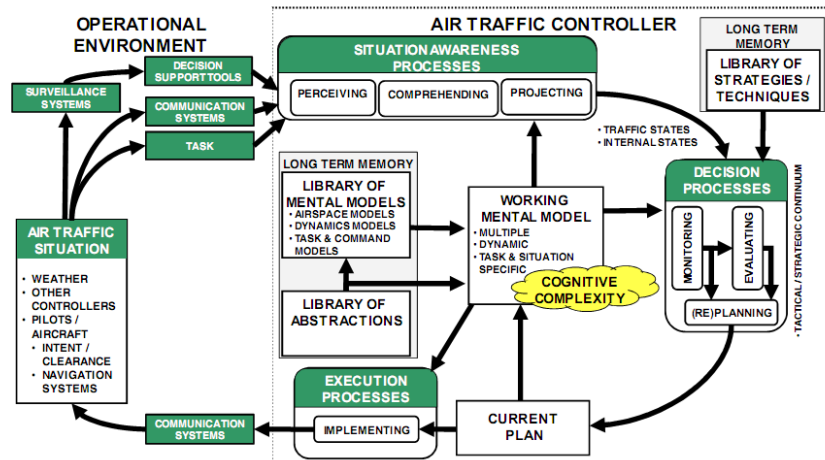

A key component of this figure is the working mental model. Its purpose is to maintain air traffic awareness and support decision-making and implementation processes of a controller's task. The working mental model is driven by (1) the available mental models and abstractions that the controller has knowledge of and (2) the specific air-traffic situation that the controller is managing.

In order to assess the similarities and knowledge transfer possibilities across different airspace sectors, one approach is to compare the working mental models of the controllers that operate each of these sectors.

(1) For the purposes of this research, the focal abstractions include merges, inbound/outbound handoffs and flow segment. These abstractions were chosen because they are commonly used and represent and present a variety of operational actions i.e. aircraft sequencing, controller coordination, conflict resolution etc..

(2) The specific air traffic situation is a result of the spatiality of sector elements, the distribution of air traffic and the operational conditions mandated through standard operating procedures and change notices. Qualitative research has suggested that the factors listed in the following section capture the air traffic situation for their respective abstractions.

Although the factors are abstraction dependent, there are two emerging properties amongst them: specifications and context

Specifications: These factors represent the defining dimensions for their associated abstraction. They are generally considered core parameters and encompass discrete bits of knowledge.

Context: These factors capture the environment under which an abstraction is employed. They illustrate the effect of sector features on the abstraction instance in question.

The purpose of the sector abstraction binder is to evaluate the specification and context based factors for an occurrence of each abstraction with the goal of characterizing the airspace situation within the sector and comparing it to another.

Abstraction Factors

The following charts define the specification and contextual factors for each abstraction along with the *metric* used to assess them. These factors are evaluated for each abstraction instance in latter parts of this abstraction binder.

Inbound/Outbound Handoffs

<i>Specifications</i>		
Position/Location	- sector boundary location of handoff instance	- <i>Reference to cartographic map</i>
Interacting Sector(s)	- sectors that are feeding (inbound)/accepting (outbound) aircraft to/from handoff instance	- <i># Sectors (Sector Identifiers)</i>
Adjacent Sector Primary/Backup Freq.	- adjacent sector radio frequencies	- <i>Sector Name (prim. & backup frequency)</i>
Unique Instructions	- instance specific instructions that are constant but deviate from 7110.65 - <i>Inbound:</i> Check change notices, binders of adjacent sectors - <i>Outbound:</i> Check change notices, binders of sector of interest	- <i>Source; Instruction</i>
Handoff Spacing Req.	- spacing requirements between two aircraft that will use handoff instance	- <i>distance (if altered from 7110.65)</i>
Velocity Req.	- velocity requirements of aircraft that will use handoff instance	- <i>velocity (if altered from 7110.65)</i>
Altitude Req.	- altitude requirements of aircraft that will use handoff instance	- <i>altitude (if altered from 7110.65)</i>
Sector Wall, Ceiling, Floor	- identifies if the handoff occurs across a sector floor, ceiling or wall	- <i>Wall/Ceiling /Floor/Mixed</i>
<i>Context</i>		
Distance to Critical Point	- <i>Inbound:</i> distance from handoff to critical points within sector by traversing flow - <i>Outbound:</i> distance from handoff to critical points within receiving sector (based on cartographic information)	- <i>Critical Point Identifier: Distance</i>
Handoff Angle	- angle between flow and sector boundary	- <i>degrees</i>
Daily Usage Frequency	- average usage frequency of handoff instance based on 24 hour day	- <i>#aircraft/hour</i>
Overlap w/ Outbound/Inbound Handoff	- degree to which inbound/outbound handoff instance overlaps with its outbound/inbound counterpart	- <i>Minimal/Partial /Complete</i>
Dominance	- in event of overlap, identifies if current instance encounters majority of aircraft	- <i>Yes/No</i>
Boundary Coverage	- the size of the boundary footprint for handoff instance	- <i>distance, Wide/ Medium/Narrow</i>
Aircraft Mix	- aircraft mix percentages across sector	- <i>% jet, % turboprop</i>
Inter/Intra ARTCC Handoff	- handoff to/from within (intra) center or from adjacent (inter) center	- <i>Inter/Intra (Sector Name, Center Name)</i>
Overlapping MOAs/SUAs	- list MOA/SUA that overlap the handoff instance	- <i>MOA/SUA name</i>
Nearby MOAs/SUAs	- list MOA/SUA that are nearby	- <i>MOA/SUA name</i>
Suggested Alternates	- documented alternate to instance due to MOA/SUA activation or inclement weather	- <i>Source: Instructions</i>

Merges

<i>Specifications</i>		
Position/Location	- location of merge instance	- <i>Reference to cartographic map</i>
Entry/Exit Headings	- headings of n entry flow segments and n-1 or less exist flow segments	- <i>Entry: headings, Exit headings</i>
Climbing/Descending	- captures if merge consistently occurs on aircraft ascent or descent and degree of altitude change (if observable)	- <i>Climb/Descent: Altitude Change</i>
# Incoming Flow Segments	- # of incoming flow segments (n)	- <i># incoming</i>
# Outbound Flow Segments	- # outbound flow segments (n-1 or less)	- <i># outbound</i>
Inbound/Outbound Angle	- minimum angle that is created between an inbound and an outbound flow segment	- <i>Angle, (Loose/Medium/Tight)</i>
# Flight Levels	- flight levels inbound traffic can arrive at and outbound traffic may be assigned to	- <i>Inbound Levels, Outbound Levels</i>
Required Spacing	- spacing requirements between two aircraft that will use merge instance	- <i>distance (if altered from 7110.65)</i>
Required Velocity	- velocity requirements of aircraft that will use merge instance	- <i>velocity (if altered from 7110.65)</i>
<i>Context</i>		
Distance to Critical Points	- distance from merge point to other critical points including handoffs within sector	- <i>Critical Point Identifier: Distance</i>
Daily Usage Frequency	- average usage frequency of merge instance based on 24 hour day	- <i>#aircraft per hour</i>
Nearby Airspace Elements	- list of nearby airspace elements not including MOA/SUA	- <i>Element Identifier, Type, Proximity</i>
Aircraft Mix	- aircraft mix percentages observed across entire sector	- <i>% jet, % turboprop</i>
Frequency of Non-Standard. Intersections	- # of aircraft that do not belong to emergent flow segments intersecting merge area based on 18 hour days	- <i># aircraft per hour</i>
Overlapping MOAs/SUAs	- list MOA/SUA that overlap the merge instance	- <i>MOA/SUA name</i>
Nearby MOAs/SUAs	- list MOA/SUA that do not overlap but are nearby	- <i>MOA/SUA name</i>
Suggested Alternates	- documented alternate to instance due to MOA/SUA activation or inclement weather	- <i>Source: Instructions</i>

Standard Flows

<i>Specifications</i>		
Radar Track	- the track of the flow segment through the airspace sector	- <i>Reference to cartographic map</i>
Heading	- heading required to maintain flow segment track	- <i>Heading</i>
Climbing/Descending	- captures if flow segment requires aircraft ascent or descent and degree of altitude change (if observable)	- <i>Climb/Descent: Altitude Change Amount</i>
Spacing Requirements	- spacing requirements between two aircraft that will use handoff instance	- <i>distance (if altered from 7110.65)</i>
Velocity Requirements	- velocity requirements of aircraft that will use handoff instance	- <i>velocity (if altered from 7110.65)</i>
Flight Levels	- altitude requirements and number of flight levels available to aircraft that will use handoff instance	- <i>min. altitude, max. altitude, # flight levels (if altered from 7110.65)</i>
<i>Context</i>		
Segment Length (nm)	- length of flow segment	- <i>distance</i>
Usage Frequency	- average hourly usage frequency of flow instance based on 18 hour day	- <i>#aircraft per hour</i>
Terminal Elements	- elements that establish the end point elements of flow segment	- <i>Handoff, Merge, Critical Point, Other/ Handoff, Merge, Critical Point, Other</i>
Frequency of Non-Standard. Intersections	- # of aircraft that do not belong to other emergent flow segments intersecting flow segment based on 18 hour days	- <i># aircraft per hour</i>
Aircraft Mix	- aircraft mix percentages observed across entire sector	- <i>% jet, % turboprop</i>
Directional Breakdown	- directional breakdown of flow	- <i>heading: # aircraft, heading + 180: #aircraft</i>
Overlapping MOAs/SUAs	- list MOA/SUA that overlap the merge instance	- <i>MOA/SUA name</i>
Nearby MOAs/SUAs	- list MOA/SUA that do not overlap but are nearby	- <i>MOA/SUA name</i>
Suggested Alternates	- documented alternate to instance due to MOA/SUA activation or inclement weather	- <i>Source: Instructions</i>

Other Factors

In addition to the above, the following factors were identified as having an effect on their respective abstractions. However, they are excluded in the analysis due to resource limitations.

Handoffs (Inbound/Outbound)

<i>Factor</i>	<i>Definition</i>
Observed Velocity	- the average aircraft velocity observed at the handoff instance
Observed Spacing	- the average spacing observed between two or more aircraft that are being handed off
Elapsed Time	- elapsed time between initiating and completing transfer of control
Weather	- frequency of weather effects on handoff instance

Merges

<i>Factor</i>	<i>Definition</i>
Observed Velocity	- the average observed aircraft velocity at the merge instance including velocity change during transition from inbound to outbound from merge instance
Observed Spacing	- the average observed spacing between two or more aircraft on the inbound and outbound legs of the merge instance
Frequency of Sequencing Conflicts	- occurrences of sequencing conflicts that require modification to aircraft track, velocity or altitude
Footprint	- the size and shape of the merge instance
Weather	- frequency of weather effects on merge instance

Flow Segments

<i>Factor</i>	<i>Definition</i>
Observed Velocity	- the average and peak velocity observed within flow segment
Observed Spacing	- the average spacing observed between two or more aircraft that are using the same flow segment
Frequency of Sequencing Conflicts	- occurrences of sequencing conflicts that require modification to aircraft track, velocity or altitude
Thickness of Flow	- width of flow segment such that peak flow is captured
Elapsed Time	- average time spent by an aircraft on the flow segment
Weather	- frequency of weather effects on flow segment

Abstraction Overview

Sector: Brewton ZJX-11
FL240 and ABOVE

ARTCC: Jacksonville

Data Sources:

- Oct 13, 2004 ZJX11 10-13-2004 050000 to 10-14-2004 050000.mat
- Section 2 - Sector 11 BREWTON Change Notice October 2, 2007
- Section 2 - Sector 17 PERRY Change Notice October 2, 2007
- Section 4 - Sector 34 SEMINOLE Change Notice October 2, 2007
- Sector 11 - BREWTON Sector Binder
- SkyVector Online Aeronautical Charts

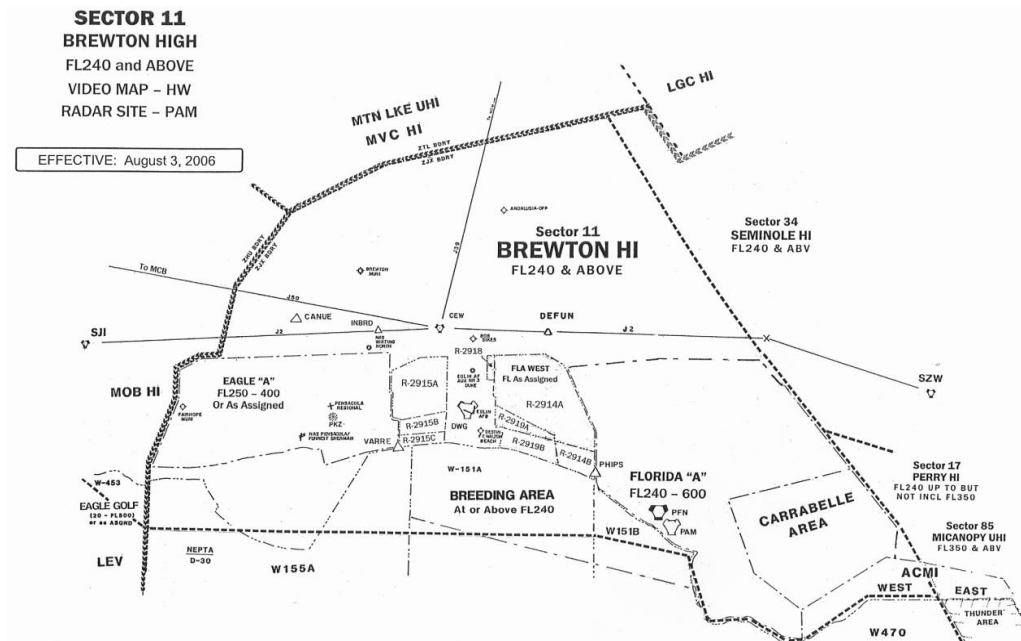

Description: This sector transitions traffic into PNS, VPS, and PAM complexes. The CEW VORTAC is the single NAVAID. This sector is responsible for AWAC flights in AW006 north of J2. Point outs shall be made to R34 each time the AWAC enters R34 airspace.

Figure 21: Density Map w/ Flow Arrows Beginning Oct 13, 2004. Threshold 15%-100%.

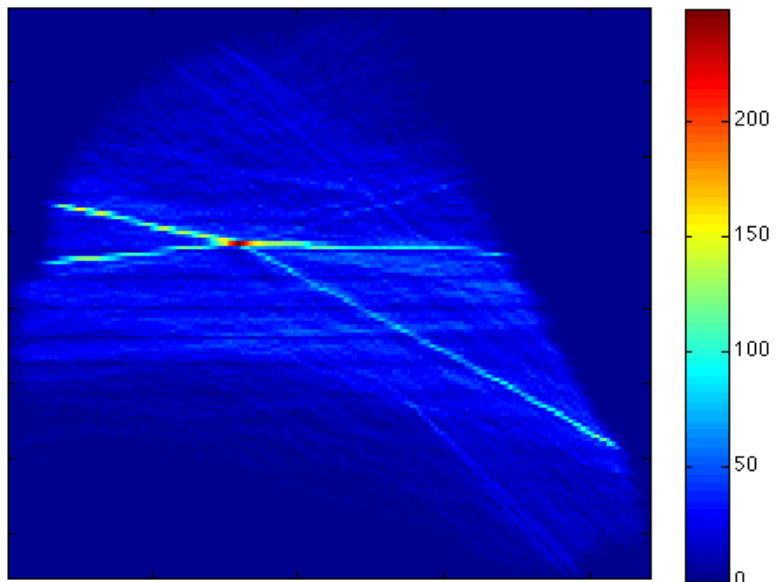

Inbound Handoffs

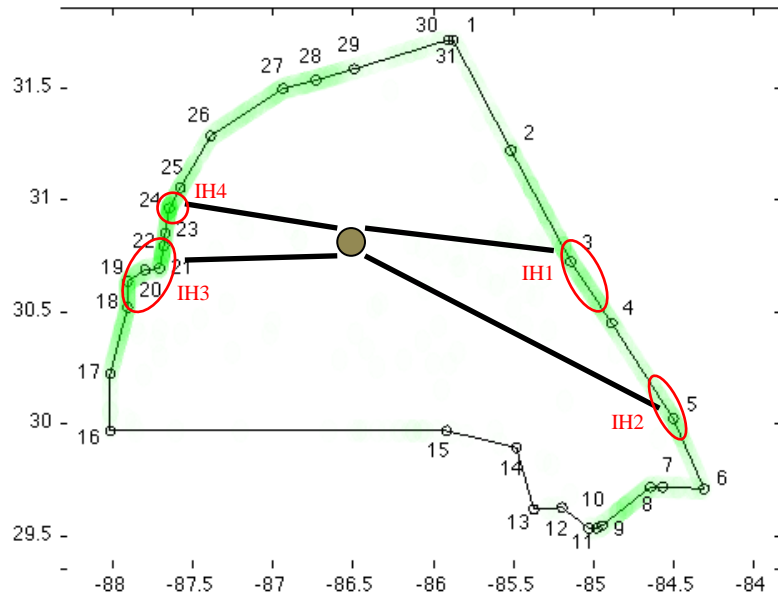

Figure 22: Inbound Handoffs

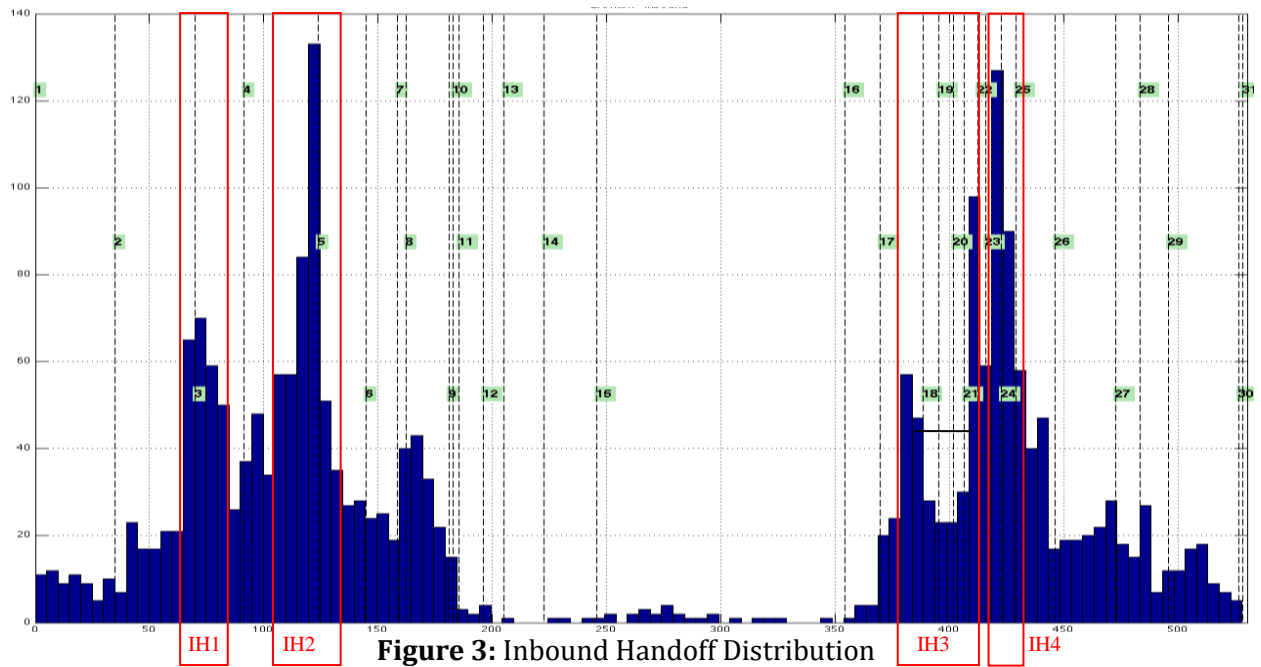

Figure 3: Inbound Handoff Distribution

	<i>IH1</i>	<i>IH2</i>	<i>IH3</i>	<i>IH4</i>
<i>Specifications</i>				
Position/Location	eastern boundary	eastern boundary	western boundary	western boundary
Interacting Sector(s)	single (SEMINOLE HI - 34)	dual (PERRY HI - 17, MICANOPY - 85)	single (MOB HI - 63)	single (MOB HI - 63)
Adjacent Sector Primary/Backup Freq.	Seminole Hi - 128.07/307.2	Perry Hi - 135.65/291.7 Micanopy UHI - 135.32/380.25	Mobile Hi - 63 125.77/322.4	Mobile Hi - 63 125.77/322.4
Unique Instructions	<i>Sector 34 SEMINOLE Change Notice -Section 4: (1) Traffic landing VPS terminal area is established on or north of J2 and cleared to cross 80NM east of CEW at FL240.</i>	None	Not Available	Not Available
Handoff Spacing Req.	7110.65			
Velocity Req.				
Altitude Req.				
Sector Wall, Ceiling, Floor	wall	wall	wall	wall
<i>Context</i>				
Distance to Critical Point (nm)	80 (CP), 125 (IH4), 130 (IH3), 195 (IH2)	120 (CP), 165 (IH4), 170 (IH3), 195 (IH1)	50 (CP), 100 (IH4), 130 (IH1), 170 (IH2)	50 (CP), 100 (IH3), 125 (IH1), 165 (IH2)
Handoff Angle	60	30	80	90
Avg. Frequency (18 hour day)	18/day	30/day	12/day	19/day
Overlap w/ Outbound/Inbound Handoff	OH1 (18/day)	OH2 (10/day)	OH3 (35/day)	OH4 (19/day)
Dominance	Shared	Inbound	Outbound	Shared
Boundary Coverage	medium (20 miles)	high (30 miles)	high (35 miles)	low (15 miles)
Aircraft Mix	96% jet 4% turboprop	96% jet 4% turboprop	96% jet 4% turboprop	96% jet 4% turboprop
Inter/Intra ARTCC Handoff	Intra	Intra	Inter (ZHU)	Inter (ZHU)
Overlapping MOAs/SUAs	None	Florida "A" SUA Carrabelle Area SUA	Eagle A SUA	None
Nearby MOAs/SUAs	South: Florida "A" SUA	South: ACMI West SUA Southeast: ACMI East SUA	None	South: Eagle A SUA
Suggested Alternates	<i>None</i>	<i>None</i>	Not Available/None	Not Available/None

Characteristic Inbound Handoff

Specifications	
Position/Location	eastern and western facing boundaries
Interacting Sector(s)	single and double
Adjacent Sector Primary/Backup Freq.	N/A
Unique Instructions	Ranges from none specified to destination based flight level restriction
Handoff Spacing Req.	7110.65
Velocity Req.	
Altitude Req.	
Sector Wall, Ceiling, Floor	Wall
Context	
Distance to Critical Point (nm)	50 - 120
Handoff Angle	30 - 90
Avg. Frequency (18 hour day)	12/day - 30/day
Overlap w/ Outbound/Inbound Handoff	All overlap
Dominance	Shared/Inbound/Outbound
Boundary Coverage	Low - High (15 - 35 miles)
Aircraft Mix	96% jet 4% turboprop
Inter/Intra ARTCC Handoff	Intra/Inter
Overlapping MOAs/SUAs	Up to 2
Nearby MOAs/SUAs	Up to 2
Suggested Alternates	None/Not Available

Outbound Handoffs

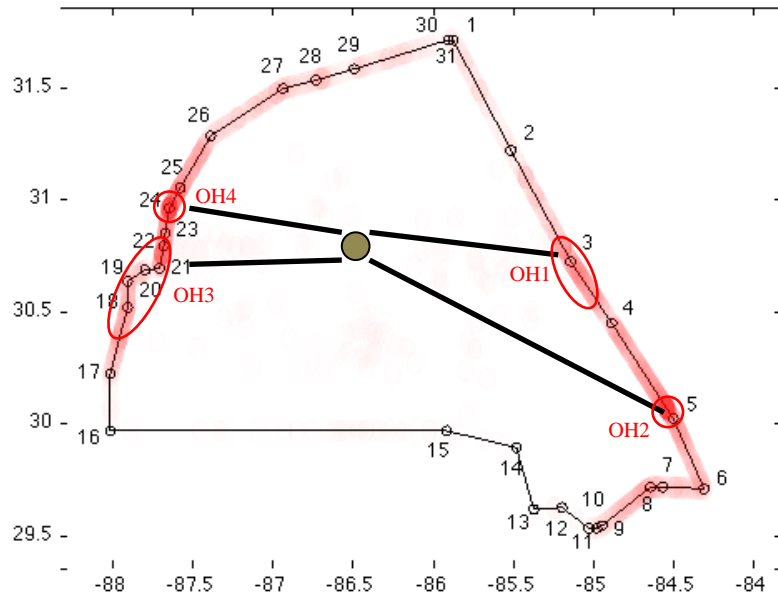

Figure 4: Outbound Handoffs

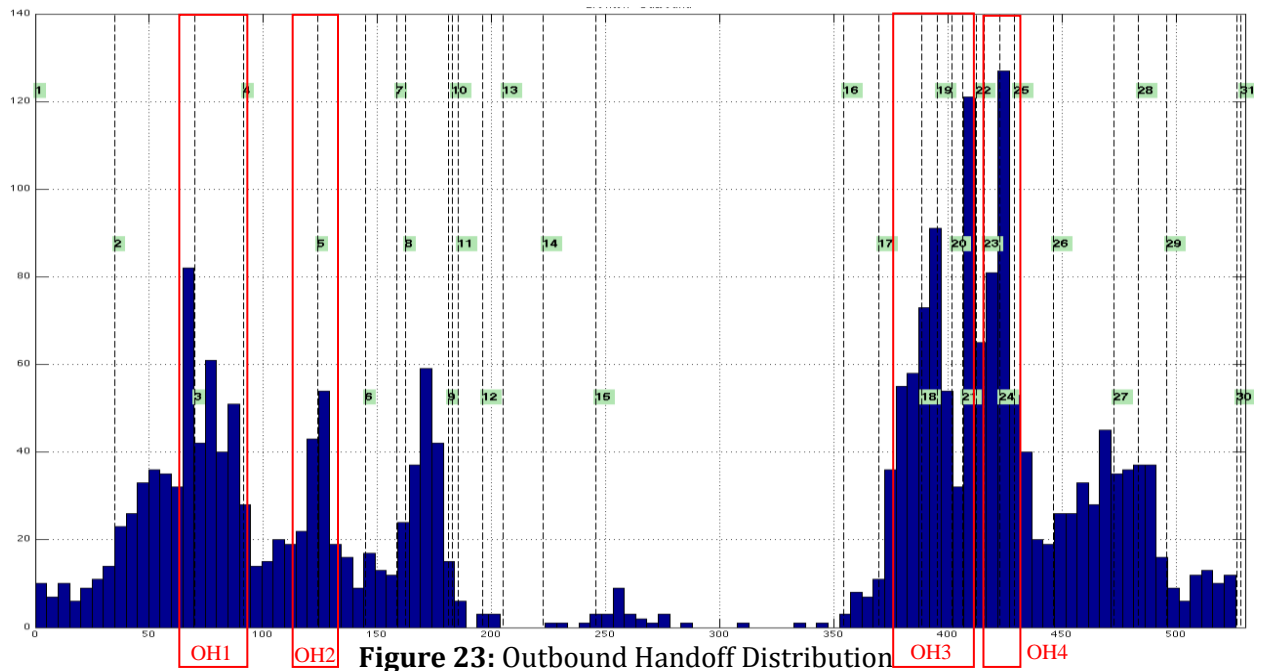

Figure 23: Outbound Handoff Distribution

	OH1	OH2	OH3	OH4
Specifications				
Position/Location	eastern boundary	eastern boundary	western boundary	western boundary
Interacting Sector(s)	single sector (SEMINOLE HI - 34)	dual (PERRY HI - 17 & MICANOPY UHI - 85)	single sector (MOB HI - 63)	single sector (MOB HI - 63)
Neighboring Sector Primary/Backup Frequencies	Seminole Hi - 128.07/307.2	PERRY HI - 135.65/291.7 MICANOPY UHI - 135.32/380.25	Mobile Hi - 63 125.77/322.4	Mobile Hi - 63 125.77/322.4
Unique Instructions	<i>Sector 11 BREWTON Change Notice -Section 2:</i> (1) The Brewton Sector shall issue a restriction to traffic above FL330, on J2 and south, landing JAX, VQQ, CRG, NIP, NRB, and 55J to cross 20 miles northwest of SZW at FL330 .	<i>Sector 11 BREWTON Change Notice - Section 2:</i> (2) Aircraft landing SFB shall enter the Perry Sector at or below FL290 .	None	None
Handoff Spacing Req.	7110.65			
Velocity Req.				
Altitude Req.				
Ceiling/Floor or Sector Wall	wall	wall	wall	wall
Context				
Distance to Internal Critical Points (nm)	80 (CP), 125 (IH4), 130 (IH3), 195 (IH2)	120 (CP), 165 (IH4), 170 (IH3), 195 (IH1)	50 (CP), 100 (IH4), 130 (IH1), 170 (IH2)	50 (CP), 100 (IH3), 125 (IH1), 165 (IH2)
Distance to External Critical Point (nm)	50 (SEMINOLE - SZW)	40 (PERRY, MICANOPY - HEVVN)	Not Available	Not Available
Handoff Angle	60	30	80	90
Avg. Frequency (18 hour day)	18/day	10/day	35/day	19/day
Overlap w/ Outbound Handoff	IH1 (18/day)	IH2 (30/day)	H3 (12/day)	IH4 (19/day)
Dominance	Shared	Inbound	Outbound	Shared
Boundary Coverage	high (30 miles)	medium (20 miles)	high (35 miles)	low (15 miles)
Aircraft Mix	96% jet 4% turboprop	96% jet 4% turboprop	96% jet 4% turboprop	96% jet 4% turboprop
Inter/Intra ARTCC Handoff	Intra	Intra	Inter (ZHU)	Inter (ZHU)
Overlapping MOAs/SUAs	None	Florida "A" SUA Carrabelle Area SUA	Eagle A SUA (vertices 18-21)	None

Nearby MOAs/SUAs	South: Florida "A" SUA	South: ACMI West South: W470 Southeast: ACMI East	South: Eagle A SUA (vertices 21-22)	South: Eagle A SUA
Suggested Alternates	None	<p><i>Sector 11 BREWTON</i> <i>Change Notice -Section 2:</i> (3) If the Micanopy Sector is open and W470 is hot, all TPA complex arrival aircraft, including SRQ shall be routed over SZW. Exception: Aircraft routed DEFUN.Q104.HEVVN may remain on course. If Micanopy sector is closed, TPA/SRQ complex arrival traffic may be cleared direct HEVNN.</p> <p>(5) If the Zephyr Sector is open and W470 is cold, aircraft filed via MINEE arrival maybe be cleared direct PIE and Nepta shall hand off to Mayo or Darbs at FL330 or below. If W470 is hot, MINEE arrival aircraft may be cleared direct HEVVN.</p> <p>(6) When the Carrabelle Area is active, aircraft routed via DEFUN.Q104/Q112.HEVVN may be rerouted DEFUN..CLRKK..HEVVN (F.P.R) to ensure SUA avoidance.</p>	None	None

Characteristic Outbound Handoff

Specifications	
Position/Location	eastern and western facing boundaries
Interacting Sector(s)	single and double
Neighboring Sector Primary/Backup Frequencies	N/A
Unique Instructions	Ranges from none specified to destination based flight level restriction
Handoff Spacing Req.	7110.65
Velocity Req.	
Altitude Req.	
Ceiling/Floor or Sector Wall	wall
Context	
Distance to Internal Critical Points (nm)	50-120
Distance to External Critical Point (nm)	40-50
Handoff Angle	30-90
Avg. Frequency (18 hour day)	10/day - 35/day
Overlap w/ Outbound Handoff	All overlap
Dominance	Shared/Inbound/Outbound
Boundary Coverage	Low - High (15 - 35 miles)
Aircraft Mix	96% jet 4% turboprop
Inter/Intra ARTCC Handoff	Intra/Inter
Overlapping MOAs/SUAs	Up to 2
Nearby MOAs/SUAs	Up to 3
Suggested Alternates	Ranges from none specified to up to 3 reroutes based on the activation of adjacent sectors/SUAs.

Merges

The following chart shows a breakdown of Brewton flows over the 14 day study period. It is used to assess the consolidation of flows and the existence of merge situations. The flows are labeled in the Flow Analysis sections of this document. Other flows comprise of aircraft that do not belong to any of the identified major flows but still contribute to merge traffic.

		Destination				
		<i>1</i>	<i>2</i>	<i>3</i>	<i>4</i>	<i>other</i>
Origin	<i>1</i>	0	0	20	13	6
	<i>2</i>	0	0	11	35	18
	<i>3</i>	20	3	0	0	32
	<i>4</i>	20	7	0	0	42
	<i>other</i>	15	11	29	61	0

The chart above identifies four flow consolidations that occur at the central critical point in Brewton. For example, flows 1, 2, and other consolidate into flow 4. This particular example represents 109 aircraft (13+35+61) that are redirected into flow 4 over a two week period. This represents an average rate of 0.43 redirections/hour assuming 18 hour days. Considering the average time spent by an aircraft in Brewton (20 minutes) it is unlikely that this consolidation leads to many sequencing conflicts. Since the presence of conflicting aircraft is a key component of the merge abstraction, it is concluded that this example does not represent a merge abstraction.

A similar argument is made for the remaining consolidations since their volumes are even lower than those of the previous example. Further evidence is required to establish these consolidations as merges. This can include a more elaborate temporal analysis. For example, the consolidation patterns could be examined at shorter intervals (20 minutes) in an attempt to deduce sequencing conflicts.

Flow Segments

The following identifies major Brewton flow segments.

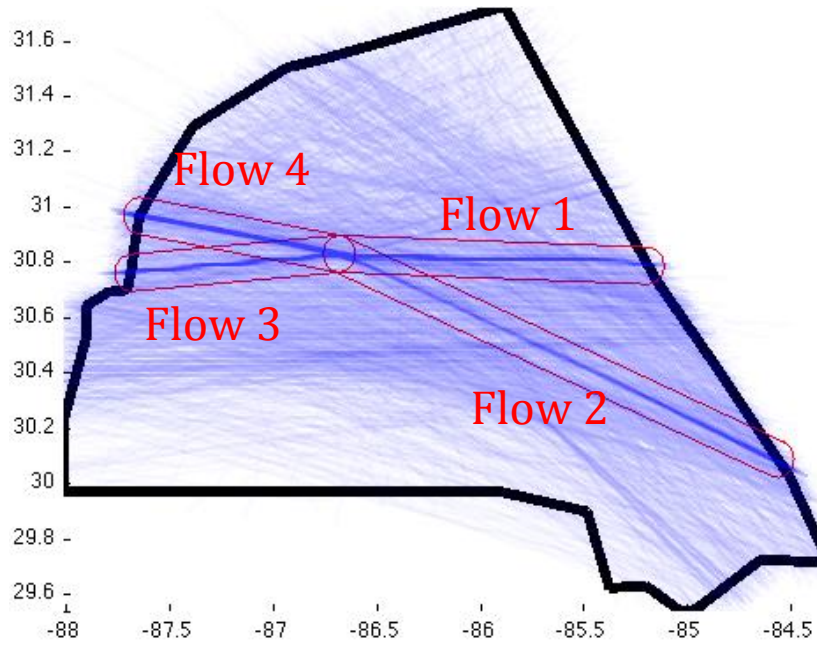

	F1	F2	F3	F4
Specifications				
Radar Track	Refer to previous figure.			
Heading	Inbound - 270 Outbound - 090	Inbound - 290 Outbound - 110	Inbound - 080 Outbound - 260	Inbound - 100 Outbound - 280
Climbing/Descending	No Data.	No Data.	No Data.	No Data.
Spacing Requirements	7110.65			
Velocity Requirements				
Flight Levels	FL240 & Above (using 7110.65 assignments)			
Context				
Segment Length (nm)	80	120	50	50
Usage Frequency	0.40 aircraft/hour	0.30 aircraft/hour	0.50 aircraft/hour	0.70 aircraft/hour
Non. Standard. Intersect.	2.90 aircraft/hour	3.50 aircraft/hour	1.70 aircraft/hour	1.40 aircraft/hour
Terminal Elements	Handoff/Critical Point	Handoff/Critical Point	Handoff/Critical Point	Handoff/Critical Point
Aircraft Mix	96% jet 4% turboprop	96% jet 4% turboprop	96% jet 4% turboprop	96% jet 4% turboprop
Directional Breakdown	Inbound - 40% (270) Outbound - 60% (090)	Inbound - 80% (290) Outbound - 20% (110)	Inbound - 50% (080) Outbound - 50% (260)	Inbound - 40% (100) Outbound - 60% (280)
Flight Level Breakdown	Refer to Flow 1 histogram.	Refer to Flow 2 histogram.	Refer to Flow 3 histogram.	Refer to Flow 4 histogram.
Overlapping MOAs/SUAs	None	Florida A SUA, Carrabelle SUA	None	None
Nearby MOAs/SUAs	South: Florida "A" SUA South: R-2914A MOA	South: ACMI West, South: ACMI East, South: W470	South: Eagle "A" SUA South: R-2915A MOA	None
Suggested Alternates	None	<i>Sector 11 BREWTON Change Notice -Section 2:</i> (3) If the Micanopy Sector is open and W470 is hot, all TPA complex arrival aircraft, including SRQ shall be routed over SZW. Exception: Aircraft routed DEFUN.Q104.HEVVN may remain on course. If Micanopy sector is closed, TPA/SRQ complex arrival traffic may be cleared direct HEVNN. (6) When the Carrabelle Area is active, aircraft routed via DEFUN.Q104/Q112.HEVVN may be rerouted DEFUN..CLRKK..HEVVN (F.P.R) to ensure SUA avoidance.	None	None

Flight Level Breakdown

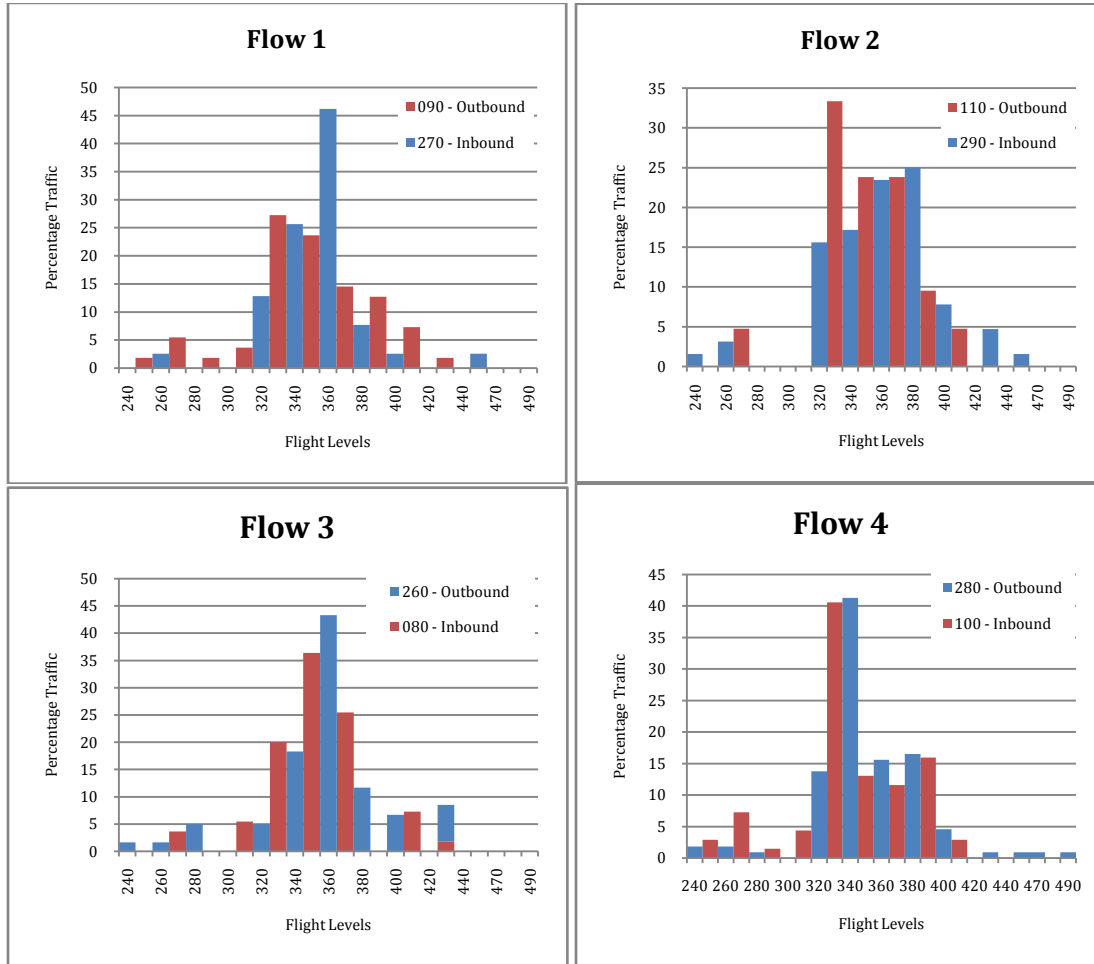

Characteristic Flow Segment

<i>Context</i>		<i>Specifications</i>	
Segment Length (nm)	50 - 120	Radar Track	N/A
Usage Frequency	0.3 - 0.7 aircraft/hour	Heading	8 dominant
Non. Standard. Inter.	1.40 - 3.50 aircraft/hour	Climbing/Descending	No Data
Terminal Elements	Handoff/Critical Point 96% jet 4% turboprop	Spacing Requirements	7110.65
Aircraft Mix		Velocity Requirements	
Directional Breakdown	Avg. 50/50 split	Flight Levels	FL240 & Above w/ 7110.65 assign.
Flight Level Breakdown	On average utilize FL320 to FL390 with minor instances of unique FL assignment		
Overlapping MOAs/SUAs	Up to 2		
Nearby MOAs/SUAs	Up to 3		
Suggested Alternates	Either none or 2 rerouting instructions.		

Abstraction Overview

Sector: Geneva ZJX-33
FL240 and ABOVE

ARTCC: Jacksonville

Data Sources:

- Oct 13, 2004 ZJX11 10-13-2004 050000 to 10-14-2004 050000.mat
- Change Notice October 2, 2007
- Sector Binder

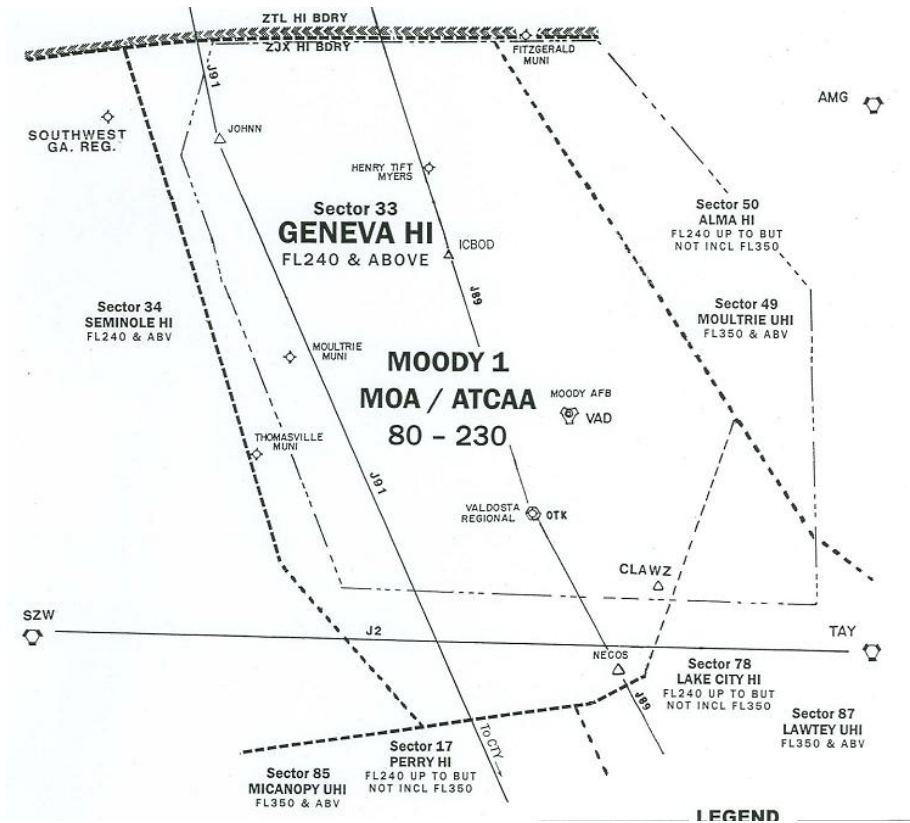

Description: The Geneva sector is responsible for working a high volume of en route traffic and transitioning traffic inbound to TPA, SRQ, and MCO.

Figure 24: Density Map w/ Flow Arrows Beginning Oct 13, 2004. Threshold 15%-100%.

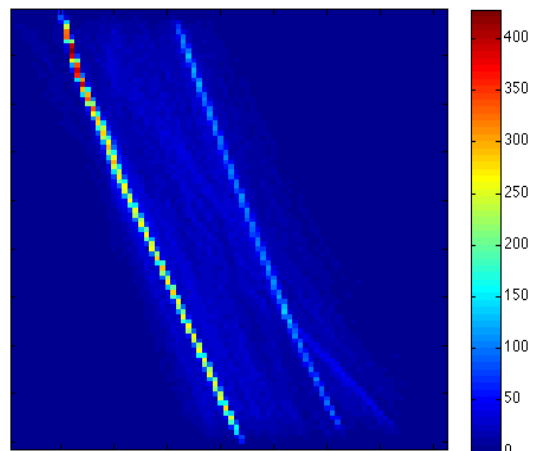

Inbound Handoffs

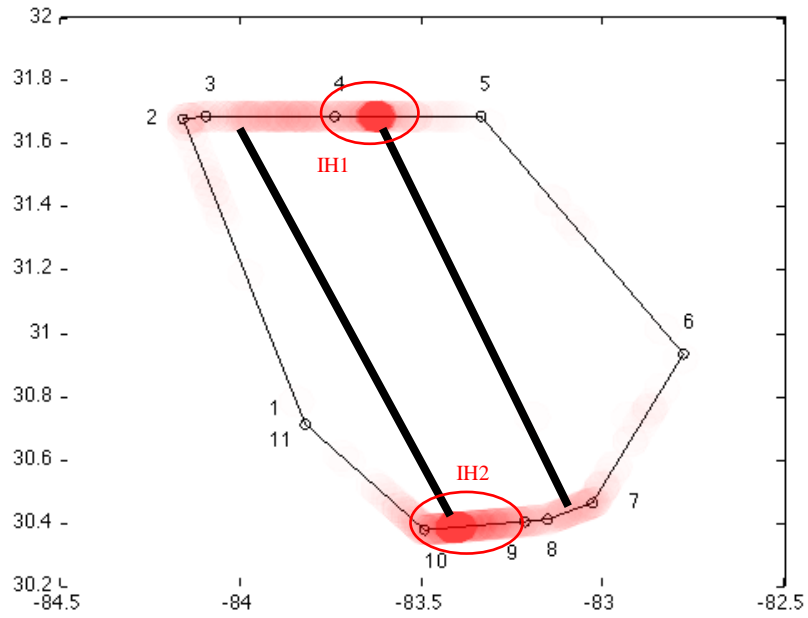

Figure 25: Inbound Handoffs

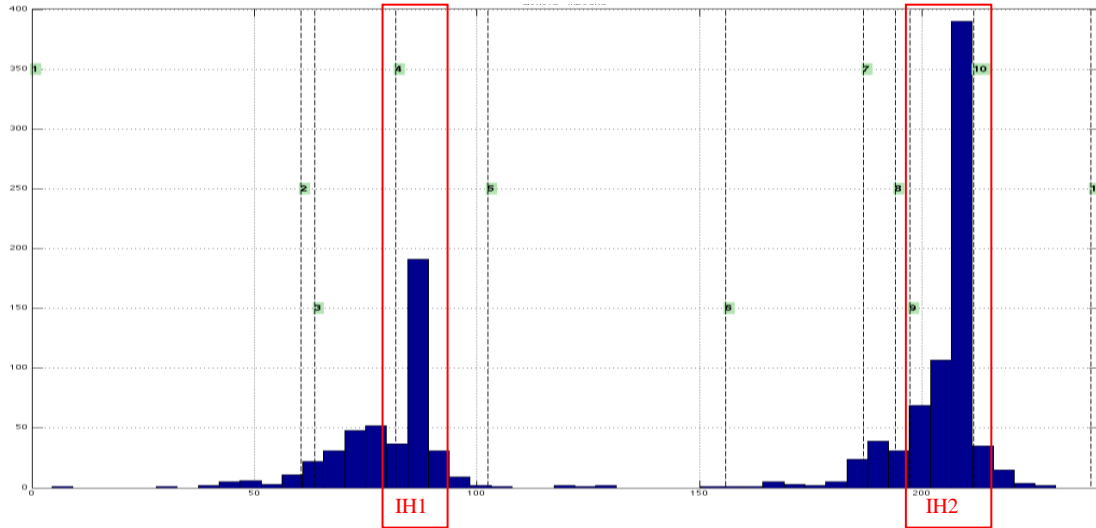

Figure 3: Inbound Handoff Distribution

	<i>IH1</i>	<i>IH2</i>
<i>Specifications</i>		
Position/Location	northern boundary	southern boundary
Interacting Sector(s)	single (MACON HI - 22)	dual (PERRY HI - 17 & MICANOPY UHI - 85)
Adjacent Sector Primary/Backup Freq.	Macon Hi - 119.375/371.95	Perry Hi-135.65/291.7 Micanopy UH - 128.625/380.25
Unique Instructions	Not Available	None
Handoff Spacing Req.	7110.65	
Velocity Req.		
Altitude Req.		
Sector Wall, Ceiling/Flr.	wall	wall
<i>Context</i>		
Dist. to Crit. Point (nm)	80 (OH1)	80 (OH2)
Handoff Angle	70	70
Avg. Frequency	20/day	40/day
Overlap w/ Out./In.	No Overlap	No Overlap
Dominance	Inbound	Inbound
Boundary Coverage	Low (15 miles)	Medium (20 miles)
Aircraft Mix	Not Available	Not Available
Inter/Intra Handoff	Inter	Intra
Overlapping MOAs/SUAs	None	None
Nearby MOAs/SUAs	Lower FL: Moody 1 MOA	None
Suggested Alternates	None/Not Available	None

Characteristic Inbound Handoff

<i>Specifications</i>	
Position/Location	northern and southern boundaries
Interacting Sector(s)	Single and double
Adjacent Sector Primary/Backup Freq.	N/A
Unique Instructions	None specified
Handoff Spacing Req.	7110.65
Velocity Req.	
Altitude Req.	
Sector Wall, Ceiling, Floor	Wall
<i>Context</i>	
Distance to Critical Point (nm)	80
Handoff Angle	70
Avg. Frequency (18 hour day)	25/day - 40/day
Overlap w/ Outbound/Inbound Handoff	None overlap
Dominance	Inbound
Boundary Coverage	Medium (20 - 25 miles)
Aircraft Mix	Not Available
Inter/Intra ARTCC Handoff	Intra/Inter
Overlapping MOAs/SUAs	None
Nearby MOAs/SUAs	Up to 1
Suggested Alternates	None/ Not Available

Outbound Handoffs

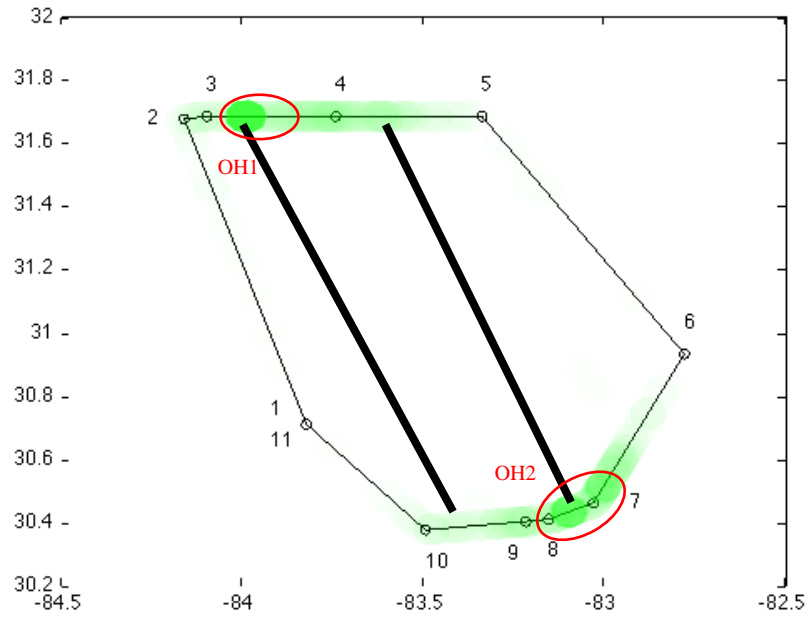

Figure 4: Outbound Handoffs

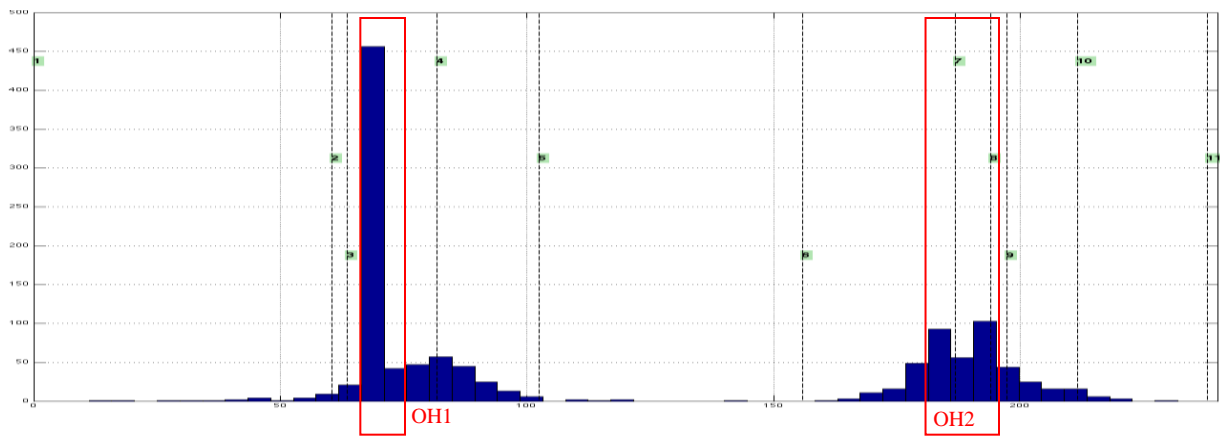

Figure 26: Outbound Handoff Distribution

	OH1	OH2
Specifications		
Position/Location	Northern boundary	Southern boundary
Interacting Sector(s)	Single, (MACON HI - 22)	dual (LAKE CITY HI - 78 & LAWTEY UHI - 87)
Neighboring Sector Primary/Backup Frequencies	Macon Hi - 119.375/371.95	Lake City Hi - 133.87/322.47 Lawtey UHI - 132.82/269.6
Unique Instructions	None	<p><i>Sector 33 Geneva Change Notice -Section 3: (2) The Geneva Sector shall provide mandatory in-trail spacing, regardless of altitude, for MCO Complex landing aircraft. MCO Complex landing traffic shall be established on the LEESE (STAR) at or prior to UGENE, to cross GEN/LKC boundary at or below FL270.</i></p> <p><i>(3) Arrivals to GNV shall be cleared via TAY..GNV.</i></p> <p><i>(4) Aircraft landing MCO Complex airports shall be released for turns and descent to the Lake City controller within the Geneva Sector south of the OTK VORTAC.</i></p> <p><i>(5) LAL landers shall be cleared direct TAY..GNV..DRCT and shall cross the LKE/GEN boundary at or below FL270.</i></p> <p><i>(6) Aircraft landing APF/MKY shall be routed via J89 FAGAN..PIE.ZEILR (STAR).</i></p> <p><i>(7) Aircraft landing RSW/FMY shall be routed via J89 to J75.KRNEL..PIE.JOSFF (STAR).</i></p> <p><i>(8) Aircraft landing PBI cleared through Lake City sector shall be cleared J89.HITTY.J91.INPIN.LLAKE STAR or GULLO STAR.</i></p> <p><i>(9) Aircraft landing BCT cleared through Lake City Sector shall be cleared J89.HITTR.J91.INPIN.LLAKE STAR or SHDAY STAR.</i></p> <p><i>(10) Aircraft operating between the Perry/Micanopy/Geneva/Mayo/Zephyr and Lake City/Lawtey Sectors shall be cleared northbound at EVEN altitudes and southbound at ODD altitudes.</i></p>
Handoff Spacing Req.	7110.65	
Velocity Req.		
Altitude Req.		
Ceiling/Floor or Sector Wall	wall	wall
Context		
Dist. to Int. Critical Pt. (nm)	80 (IH2)	80 (IH1)
Dist. to Ext. Critical Pt. (nm)	Not Available	60 (LAKE CITY - FAGAN)
Handoff Angle	90	90
Avg. Frequency (18 hour day)	36/day	18/day
Overlap w/ Outbound Handoff	No	No
Dominance	OH1	OH2
Boundary Coverage	low (10 miles)	low (15 miles)
Aircraft Mix	Not Available	Not Available
Inter/Intra ARTCC Handoff	Inter	Intra
Overlapping MOAs/SUAs	None	None
Nearby MOAs/SUAs	Lower FL: Moody 1 MOA	None
Suggested Alternates	None	None

Characteristic Outbound Handoff

Specifications	
Position/Location	northern and southern facing boundaries
Interacting Sector(s)	single and double
Neighboring Sector Primary/Backup Frequencies	N/A
Unique Instructions	Ranges from none specified to destination based flight level restrictions, modified altitude restrictions, release points for turns and descent, and destination based routing instructions.
Handoff Spacing Req.	7110.65
Velocity Req.	
Altitude Req.	
Ceiling/Floor or Sector Wall	wall
Context	
Distance to Internal Critical Points (nm)	80
Distance to External Critical Point (nm)	60 - XX
Handoff Angle	90
Avg. Frequency (18 hour day)	18/day - 36/day
Overlap w/ Outbound Handoff	None Overlap
Dominance	Outbound
Boundary Coverage	Low (10-15 miles)
Aircraft Mix	Not Available
Inter/Intra ARTCC Handoff	Inter/Intra
Overlapping MOAs/SUAs	None
Nearby MOAs/SUAs	Up to 1
Suggested Alternates	None

Merges

There are no observed merge abstractions in the Geneva sector.

Flow Segments

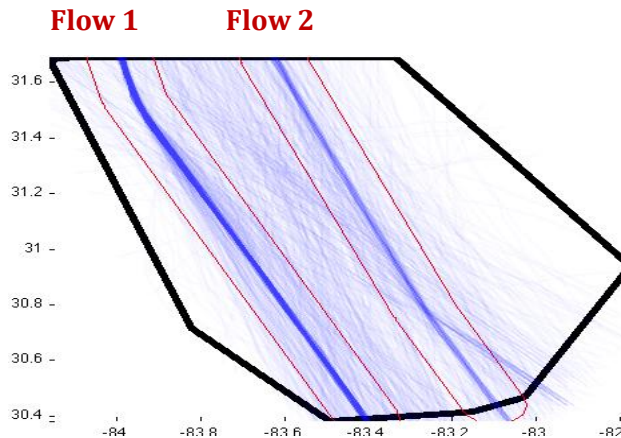

	<i>F1</i>	<i>F2</i>
<i>Specifications</i>		
Radar Track	Refer to previous figure.	
Heading	340 (dominant)	165 (dominant)
Climbing/Descending	No Data	No Data
Spacing Requirements	7110.65	
Velocity Requirements	7110.65	
Flight Levels	FL240 & Above (Sector 33 Geneva Change Notice -Section 3: (10) Aircraft operating between the Perry/Micanopy/Geneva/Mayo/Zephyr and Lake City/Lawtey Sectors shall be cleared northbound at EVEN altitudes and southbound at ODD altitudes.)	
<i>Context</i>		
Segment Length (nm)	80	80
Usage Frequency (18 hour day)	1.40 aircraft/hour	0.40 aircraft/hour
Freq. of Non. Standard. Intersections (18 hour day)	1.60 aircraft/hour	0.80 aircraft/hour
Terminal Elements	Handoff/Handoff	Handoff/Handoff
Aircraft Mix	Not Available	Not Available
Directional Breakdown	Effective Single Direction Route (340)	Effective Single Direction Route (165)
Flight Level Breakdown	Refer to Flow histogram.	Refer to Flow histogram.
Overlapping MOAs/SUAs	None	None
Nearby MOAs/SUAs	Lower FL: Moody 1	Lower FL: Moody 1
Suggested Alternates	None	None

Flow Breakdown

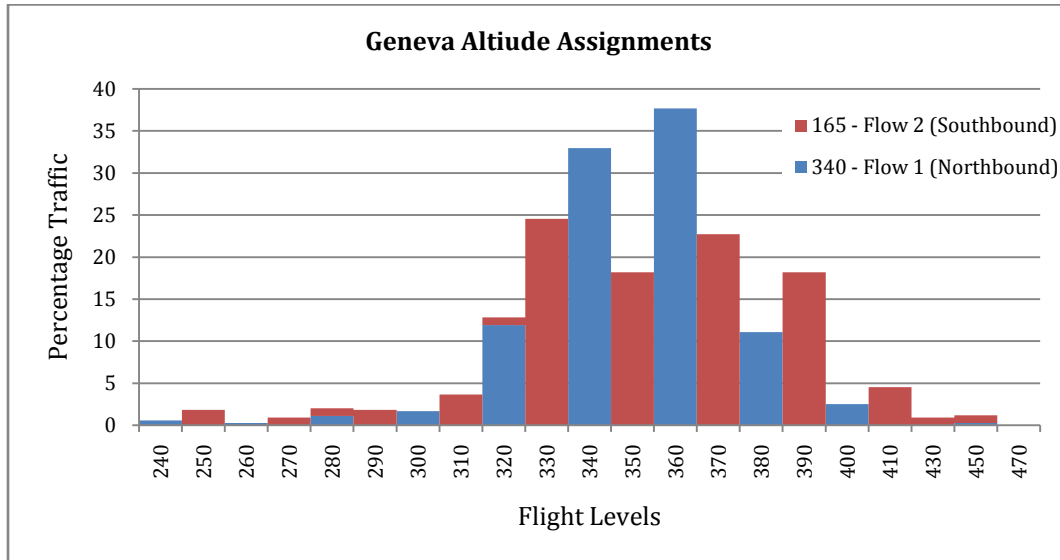

Characteristic Flow Segment

<i>Specifications</i>	
Radar Track	N/A
Heading	2 dominant
Climbing/Descending	No Data
Spacing Requirements	7110.65
Velocity Requirements	
Flight Levels	FL240 & Above w/ unique heading based assignment
<i>Context</i>	
Segment Length (nm)	80
Usage Frequency (18 hour day)	0.4 - 1.40
Freq. of Non. Standard. Intersections (18 hour day)	0.80 - 1.60
Terminal Elements	Handoff/Handoff
Aircraft Mix	Not Available
Directional Breakdown	Single Direction Only
Flight Level Breakdown	Mostly utilize FL320 to FL390 with minor instances of unique FL assignment
Overlapping MOAs/SUAs	None
Nearby MOAs/SUAs	1
Suggested Alternates	None

Cognitive Comparison

This section compares the characteristic abstractions found within the Brewton and Geneva airspace sectors. The following tables highlight key differences between the sectors which can be used to assess the transferability of controller knowledge across these two sectors.

Inbound Handoffs

Specifications	Brewton	Geneva
Position/Location	eastern and western facing	northern and southern
Interacting Sector(s)	single and double	single and double
Adj. Sector Freq.	N/A	N/A
Unique Instructions	None specified - destination based flight level restriction	None specified
Handoff, Velocity, Altitude, Spacing Req.	7110.65	7110.65
Sector Wall, Ceiling, Floor	wall	wall
Context		
Distance to Critical Point	50 - 120 nm	80 nm
Handoff Angle	30 - 90	70
Avg. Freq.(18 hour day)	12/day - 30/day	25/day - 40/day
Overlap w/ Out/In	All overlap	None overlap
Dominance	Shared/Inbound/Outbound	Inbound
Boundary Coverage	Low - High (15 - 35 miles)	Medium (20 - 25 miles)
Aircraft Mix	96% jet 4% turboprop	Not Available
Inter/Intra ARTCC Handoff	Intra/Inter	Intra/Inter
Overlapping MOAs/SUAs	Up to 2	None
Nearby MOAs/SUAs	Up to 2	Up to 1
Suggested Alternates	None/Not Available	None/ Not Available

- Geneva tends to operate in a less variable environment; its distance to critical point, inbound handoff angle are constant, the inbound/outbound handoffs do not overlap and the boundary coverage is constrained to between 20 and 25 miles
- Brewton tends to operate a lower inbound handoff frequency on a per handoff basis (however it has a total of 4 inbound handoffs compared to Geneva's 2)
- Some of Brewton's handoffs also operate in a MOA/SUA intensive environment which would procedurally only affect outbound handoffs but could play a role in redistribution of inbound handoff traffic

Outbound Handoffs

Specifications	Brewton	Geneva
Position/Location	eastern and western facing boundaries	northern and southern facing boundaries
Interacting Sector(s)	single and double	single and double
Neighboring Sector Primary/Backup Frequencies	N/A	N/A
Unique Instructions	Ranges from none specified to destination based flight level restriction	Ranges from none specified to destination based flight level restrictions, modified altitude restrictions, release points for turns and descent, and destination based routing instructions.
Handoff Spacing Req.	7110.65	7110.65
Velocity Req.		
Altitude Req.		
Ceiling/Floor or Sector Wall	wall	wall
Context		
Distance to Internal Critical Points (nm)	50-120	80
Distance to External Critical Point (nm)	40-50	60 - XX
Handoff Angle	30-90	90
Avg. Frequency (18 hour day)	10/day - 35/day	18/day - 36/day
Overlap w/ Outbound Handoff	All overlap	None overlap
Dominance	Shared/Inbound/Outbound	Outbound
Boundary Coverage	Low - High (15 - 35 miles)	Low (10-15 miles)
Aircraft Mix	96% jet 4% turboprop	Not Available
Inter/Intra ARTCC Handoff	Intra/Inter	Inter/Intra
Overlapping MOAs/SUAs	Up to 2	None
Nearby MOAs/SUAs	Up to 3	Up to 1
Suggested Alternates	Ranges from none specified to up to 3 reroutes based on the activation of adjacent sectors/SUAs.	None

Flow Segments

Specifications	Brewton	Geneva
Radar Track	N/A	N/A
Heading	8 dominant	2 dominant
Climbing/Descending	No Data	No Data
Spacing Requirements	7110.65	7110.65
Velocity Requirements		
Flight Levels	FL240 & Above w/ 7110.65 assignments	FL240 & Above w/ unique heading based assignment
Context		
Segment Length (nm)	50 - 120	80
Usage Frequency (18 hour day)	0.3 - 0.7 aircraft/hour	0.4 - 1.40
Freq. of Non. Standard. Intersections (18 hour day)	1.40 - 3.50 aircraft/hour	0.80 - 1.60
Terminal Elements	Handoff/Critical Point	Handoff/Handoff
Aircraft Mix	96% jet 4% turboprop	Not Available
Directional Breakdown	Avg. 50/50 split	Single Direction Only
Flight Level Breakdown	On average utilize FL320 to FL390 with minor instances of unique FL assignment	Mostly utilize FL320 to FL390 with minor instances of unique FL assignment
Overlapping MOAs/SUAs	Up to 2	None
Nearby MOAs/SUAs	Up to 3	1
Suggested Alternates	Either none or 2 rerouting instructions.	None