

SMANJENJE UDARNIH STRUJA UKLOPA TROFAZNOG ENERGETSKOG TRANSFORMATORA REDUCTION OF THE INRUSH CURRENTS OF THREE-PHASE POWER TRANSFORMERS

Goran Petrović – Tomislav Kilić – Ozren Bego, Split, Hrvatska

Udarne struje koje se javljaju prilikom uklopa energetskog transformatora mogu doseći vrlo velike iznose te uzrokovati mnogobrojne probleme u elektroenergetskom sustavu. Za istraživanje ove pojave razvijen je matematički model transformatora s uračunatim efektima zasićenja, histereze i zaostalog magnetskog toka, a opisan je i algoritam za određivanje povoljnog trenutka uklopa s ciljem smanjenja udarnih struja. Za metodu mjerenja zaostalog magnetskog toka, predložena je integracija napona sekundara pri prethodnom isklopu. Realizirana je laboratorijska maketa sustava za upravljanje uklop trofaznog transformatora na kojoj su mjerenjem potvrđeni rezultati simulacija.

Inrush currents that occur during the energization of a three-phase power transformer can reach very high values and cause many problems in a power system. A mathematical model of a transformer has been developed for the investigation of this problem, taking into account the effects of saturation, hysteresis and remanent magnetic flux. An algorithm has been described for the determination of the optimal instant of energization, with the goal of reducing inrush currents. As a method for measuring remanent magnetic flux, integration of the secondary voltage during the previous de-energization is proposed. A circuit model has been prepared of a system for the controlled energization of a three-phase transformer in which the simulation results are confirmed by measurement.

Ključne riječi: petlja histereze, remanentni magnetizam, struje uklopa, transformator

Key words: hysteresis loop, inrush current, remanent magnetism, transformer



1 UVOD

Neupravljeni uklop transformatora praćen je velikom nesimetrijom tokova u željeznoj jezgri. Kao posljedica takvih nesimetričnih tokova javljaju se velika izobličenja valnog oblika struje magnetiziranja, vrlo velike udarne struje uklopa, te vrlo velike istosmjerne komponente struje [1] i [2]. Problemi uzrokovani udarnim strujama uklopa mogu izazvati kvarove ili pogrešan rad osigurača, zaštitnih releja ili drugih vrsta zaštita u elektroenergetskom sustavu. Udarne struje uklopa mogu izazvati i mehanička oštećenja. Maksimalni iznos udarne struje uklopa može doseći i deseterostruki iznos nazivne struje transformatora, a moguća je pojava struja uklopa iznosa 90 % struje kratkog spoja [3]. Ovi najgori slučajevi mogu se očekivati u otprilike 10 % uklopa. Kao posljedica izobličenja valnog oblika napona tijekom prijelazne pojave mogu nastati oštećenja na osjetljivim trošilima spojenim na mrežu. Konačno, sve navedeno pridonosi bitnom smanjenju kakvoće električne energije u mreži.

Navedeni problemi pri uklopu transformatora mogu se izbjeći upravljanim uklopom. U ovom radu obrađena je metoda određivanja optimalnog trenutka uklopa na osnovi trenutnog napona mreže odnosno njegove faze i zaostalog magnetskog toka iz prethodnog isklopa. U svrhu istraživanja optimalnog trenutka uklopa napravljen je matematički model transformatora s uračunatim efektom zaostalog magnetizma. Također je izrađena i laboratorijska maketa na kojoj su mjerenjem potvrđeni rezultati simulacija.

2 POJAVA UDARNIH STRUJA

Magnetski tok u jezgri transformatora razmjeran je integralu napona napajanja, što znači da za njim zaostaje za 90°. Ako se transformator uklopi u trenutku prolaska napona kroz nulu onda je maksimalni magnetski tok dvostruko veći od nazivnog, a tome se pridoda i zaostali magnetski tok. Amplituda toka uvijek je ista, ali tok posjeduje istosmjernu komponentu čije trajanje ovisi o radnom i induktivnom otporu kruga [4]. Na slici 1 prikazana je ovisnost električnih i magnetskih veličina u nelinearnom magnetskom krugu i načelni prikaz formiranja unutarnje putanje magnetiziranja (označeno crvenom bojom). Maksimalni tok označen je točkom 1. Kako se u toj točki mijenja derivacija magnetskog toka, ta točka pripada vrhu odgovarajuće putanje magnetiziranja, a odgovarajuća struja magnetiziranja označena je točkom 1'. Kao posljedica ekstremnog zasićenja, omjer udarne struje uklopa i nazivne struje magnetiziranja

1 INTRODUCTION

Random power transformer energization is accompanied by high asymmetry of the flux in the iron core. Due to such flux asymmetry, significant distortion of the magnetizing current waveform, very high inrush currents and a very high DC component of the inrush currents occur [1] and [2]. Problems caused by inrush currents can result in unnecessary failures or the blowing of fuses, tripping of protective relays and other types of protective devices in a power system. Inrush currents can also cause mechanical damage. Maximum inrush currents can reach ten times the amount of the rated current of a transformer as well as 90 % of the short-circuit current [3]. These worst-case scenarios can be anticipated approximately 10 % of the time. As a consequence of the distortion of the voltage waveform, damage may occur during the transient state to the sensitive loads connected to the network. Finally, all the aforementioned contributes to a significant reduction in the quality of the electricity in the network.

Such problems during the energization of a transformer can be avoided by controlled energization. In this article, a method is discussed for determining the optimal instant of energization (switching on) based upon the instantaneous network voltage, i.e. its phases, and the remanent magnetic flux from the previous de-energization. For the investigation of the optimal instant of energization, a mathematical model of a transformer was derived, incorporating the calculated effect of remanent magnetism. Furthermore, a circuit model was developed for confirming simulation results by measurement.

2 THE PHENOMENON OF IN-RUSH CURRENTS

Magnetic flux in the transformer core is proportional to the integral of the supply voltage, which means that it lags 90° behind the voltage. If the transformer is energized at the instant when the voltage goes through zero, the maximum magnetic flux is two times that of the rated magnetic flux, to which the remanent magnetic flux is also added. The amplitude of the flux is always the same but the flux has a dc component, the duration of which depends on the active and inductive circuit resistance [4]. In Figure 1, the relation between the electric and magnetic parameters in a nonlinear magnetic circuit is presented as well as the principle of the formation of internal minor magnetization trajectories (indicated in red). The maximum flux is indicated by Point 1. Since the derivation of the magnetic flux changes at Point 1, it corresponds to the peak of the corresponding magnetization trajectory and the corresponding magnetizing current is indicated by Point 1'. As a consequence of extreme saturation, the ratio

veći je nekoliko puta od omjera udarnog toka pri uklopu i nazivnog magnetskog toka.

of the peak inrush current and the rated magnetizing current is several times greater than the ratio of the peak flux at the instant of energization and rated magnetic flux.

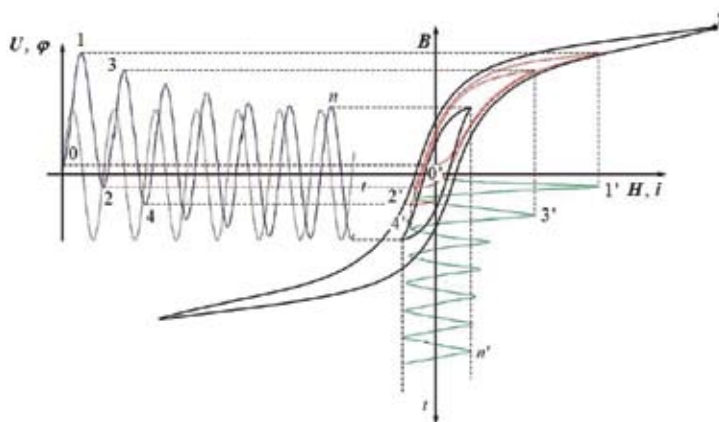

Slika 1 — Prikaz zavisnosti električnih i magnetskih veličina u nelinearnom magnetskom krugu i načelni prikaz formiranja unutarnje putanje magnetiziranja

Figure 1 — The relation between the electric and magnetic values in a nonlinear magnetic circuit and the principle of the formation of minor magnetization trajectories

Na istoj slici ilustrirano je nekoliko ciklusa unutarnje putanje magnetiziranja. Ako je zaostali magnetizam iznosa B_0 , putanja magnetiziranja kreće iz točke 0 s pripadajućim koordinatama, $H = 0$, $B = B_0$. Kako je prirast magnetske indukcije pozitivan, putanja magnetiziranja formira se približavanjem uzlaznoj grani petlje histereze potpunog zasićenja. Prije dosezanja grane potpunog zasićenja, tj. točke S, promijeni se predznak prirasta magnetske indukcije (točka 1), pa i putanja magnetiziranja promijeni smjer. Sada se putanja počinje formirati približavanjem silaznoj grani petlje histereze potpunog zasićenja. Primjenom opisanog algoritma dolazi se u točku 2 u kojoj se ponovo mijenja predznak prirasta magnetske indukcije kao i smjer putanje magnetiziranja.

Ovaj proces se nastavlja te se konačno, završetkom prijelazne pojave, formira trajna putanja magnetiziranja odnosno petlja histereza za nazivni magnetski tok. Ta petlja nalazi se unutar petlje potpunog zasićenja i simetrična je s obzirom na ishodište koordinatnog sustava.

In the same figure, several cycles of the minor magnetization trajectories are illustrated. If the remanent magnetism is B_0 , the magnetization trajectory starts from Point 0 with the corresponding coordinates, $H = 0$, $B = B_0$. Since the increment in the magnetic induction is positive, the magnetization trajectory is formed by approaching the upward trajectory of the fully saturated hysteresis loop, reaching complete saturation, i.e. Point S. The sign of the magnetic induction increment (Point 1) changes, so that the magnetization trajectory changes direction. Now the trajectory starts to be formed by approaching the downward trajectory of the fully saturated hysteresis loop. Through the application of the described algorithm, Point 2 is reached in which the sign of the magnetic induction increment changes again, as well as the direction of the magnetization trajectory.

This process continues and finally, after the transient phenomena have stopped, a magnetization curve or hysteresis loop at the rated magnetic flux is obtained. This loop is located inside the fully saturated loop and is symmetrical regarding the center of the coordinate system.

3 MATEMATIČKI MODEL UKLOPA TROFAZNOG TRANSFORMATORA

Matematički model trofaznog transformatora izveden je za najčešće korišteni tip transformatora, trostupni (europski) model kojem su pri-

3 MATHEMATICAL MODEL OF THE ENERGIZATION OF A THREE-PHASE TRANSFORMER

A mathematical model of a three-phase transformer was developed for the most frequently used type of transformer, the three-legged (European) model in

marni namoti spojeni u zvijezdu s nul vodičem [5] i [6]. Sekundar nije potrebno uzimati u obzir jer se opisuje model transformatora u praznom hodu, (otvoren sekundar), što je najnepovoljniji slučaj s gledišta udarnih struja uklopa.

3.1 Naponske jednadžbe

Na slici 2 prikazana je pojednostavljena shema trofaznog transformatora s primarnim namotima spojenim u zvijezdu s nul vodičem.

which the primary windings are star connected. The star point is conducted to a neutral conductor [5] and [6]. It is not necessary to take the secondary winding into consideration because the transformer model described operates under no load (open secondary), which is the worst-case scenario from the viewpoint of inrush currents.

3.1 Voltage equations

In Figure 2, a simplified diagram is presented of a three-legged three-phase transformer whose primary windings are star connected.

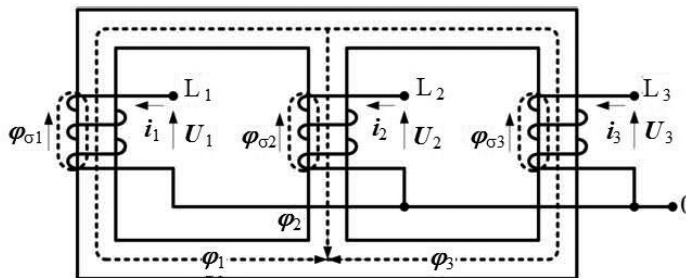

Slika 2 — Pojednostavljena shema trofaznog transformatora u praznom hodu
Figure 2 — A simplified diagram of a three-phase transformer operating under no load

Jednadžbe električnog kruga za navedeni transformator su:

The electric circuit equations for the transformer are as follows:

$$\begin{aligned} u_1 &= Ri_1 + N \frac{d(\varphi_1 + \varphi_{\sigma 1})}{dt} = Ri_1 + N \frac{d\varphi_1}{dt} + L_{\sigma} \frac{di_1}{dt} \\ u_2 &= Ri_2 + N \frac{d(\varphi_2 + \varphi_{\sigma 2})}{dt} = Ri_2 + N \frac{d\varphi_2}{dt} + L_{\sigma} \frac{di_2}{dt} \\ u_3 &= Ri_3 + N \frac{d(\varphi_3 + \varphi_{\sigma 3})}{dt} = Ri_3 + N \frac{d\varphi_3}{dt} + L_{\sigma} \frac{di_3}{dt} \end{aligned} \quad (1)$$

gdje je:

N — broj zavoja primarnog namota,
 R — djelatni otpor primarnog namota,
 L_{σ} — rasipna reaktancija primarnog namota.

Vektori u , i , φ predstavljaju napon, struju i magnetski tok.

Svatom stupu magnetske jezgre odgovara jedan tok, φ_1 , φ_2 , φ_3 . Suma tokova daje tok φ_0 koji se zatvara kroz zrak. Magnetski krug trofaznog trofaznog transformatora može se prikazati nadomjesnom shemom, slika 3.

where:

N — the number of turns of the primary winding,
 R — the active resistance of the primary winding,
 L_{σ} — the leakage reactance of the primary winding.

Vectors u , i and φ represent voltage, current and magnetic flux.

Each flux corresponds to a leg of the magnetic core, φ_1 , φ_2 , φ_3 . The sum of the fluxes yields the flux φ_0 which is closed through the air. The magnetic circuit of the three-legged three-phase transformer can be represented by an equivalent diagram, Figure 3.

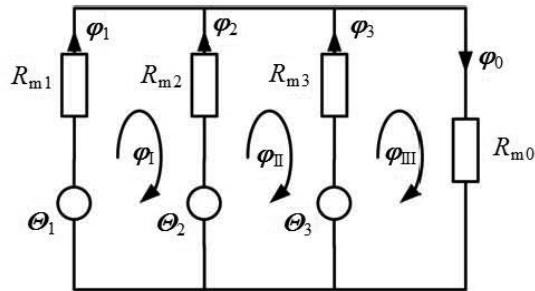

Slika 3 — Nadomjesna shema magnetskog kruga trofaznog transformatora
Figure 3 — Equivalent diagram of the magnetic circuit of a three-phase transformer

Neka je presjek magnetske jezgre S konstantan. Duljine l_1, l_2, l_3 su srednje duljine magnetskog puta odgovarajućeg stupa. Na temelju nadomjesne sheme prikazane na slici 3, mogu se postaviti jednadžbe magnetskih krugova trofaznog trostupnog transformatora. Uz usvojene oznake:

Let the cross-section of the magnetic core S be constant. The lengths l_1, l_2, l_3 are the mean lengths of the magnetic path of the corresponding leg. On the basis of the equivalent diagram presented in Figure 3, it is possible to write the equations of the magnetic circuits of the three-phase three-legged transformer. With the following symbols,

$$\begin{aligned}
 \Theta_1 &= Ni_1 & \varphi_1 R_{m1} &= H_1 l_1 \\
 \Theta_2 &= Ni_2 & \varphi_2 R_{m2} &= H_2 l_2 \\
 \Theta_3 &= Ni_3 & \varphi_3 R_{m3} &= H_3 l_3
 \end{aligned} \tag{2}$$

jednadžbe magnetskih krugova su:

the magnetic circuit equations are as follows:

$$\begin{aligned}
 Ni_1 - H_1 l_1 &= \varphi_0 R_{m0} \\
 Ni_2 - H_2 l_2 &= \varphi_0 R_{m0} \\
 Ni_3 - H_3 l_3 &= \varphi_0 R_{m0} \\
 \varphi_0 &= \varphi_1 + \varphi_2 + \varphi_3
 \end{aligned} \tag{3}$$

Zbog nelinearne ovisnosti između magnetskog polja i magnetskog toka, odnosno magnetske indukcije rješavanje sustava jednadžbi (1) i (3) moguće je samo numeričkim postupcima. Poznajući iznos i tendenciju magnetskog toka ($\frac{d\varphi}{dt} > 0$ ili $\frac{d\varphi}{dt} < 0$), odnosno magnetske indukcije može se za svaki pojedini trenutak, pomoću krivulje histereze, odrediti iznos magnetskog polja H , a time i iznos faznih struja promatranog trofaznog transformatora. Zbog jednostavnijeg modeliranja pogodno je petlju histereze aproksimirati pomoću dva polinoma, koji predstavljaju uzlazni i silazni dio petlje. Dio petlje pri kojoj magnetsko polje raste je uzlazni dio, a silazni dio je onaj pri kojem magnetsko polje pada.

Due to the nonlinear relation between the magnetic field and magnetic flux, i.e. magnetic induction, the solution of the system of equations (1) and (3) is only possible by numerical procedures. Knowing the amount and tendency of the magnetic flux ($\frac{d\varphi}{dt} > 0$ or $\frac{d\varphi}{dt} < 0$), i.e. the magnetic induction for each individual instant, it is possible to determine the value of the magnetic field H using the hysteresis curve and thereby the values of the phase currents of the three-phase transformer. For simplified modeling, it is useful to approximate the hysteresis loop using two polynomials, which represent the upward and downward parts of the loop. The part of the loop at which the magnetic field increases is the upward part and the downward part is where the magnetic field decreases.

3.2 Modeliranje unutarnjih putanja magnetiziranja

Prilikom uklopa električnih krugova s nelinearnom magnetskom karakteristikom, dakle pri prijelaznoj pojavi, mora se poznavati hodograf [7], odnosno unutarnja putanja magnetiziranja.

U opisanom modelu pretpostavljeno je da se formiranje unutarnje putanje magnetiziranja odvija približavanjem odgovarajućem vanjskom dijelu histereze po kvadratnoj funkciji. Kako iz jedne točke putanje doći u drugu točku, uz pomoć odgovarajućeg dijela petlje histereze potpunog zasićenja, opisuje sljedeći algoritam, a ilustriran je na slici 4. Funkcija $\Delta H = f(\mathbf{B})$, kvadratna je funkcija, a njeno tjeme nalazi se u točki $\mathbf{S}(\mathbf{B}_s, \mathbf{H}_s)$, gdje se spajaju grane petlje histereze potpunog zasićenja. Pretpostavimo da znamo koordinate točke $\mathbf{T}_1(\mathbf{B}_1, \mathbf{H}_1)$, i neka se točka $\mathbf{S}_1(\mathbf{B}_1, \mathbf{H}_{s1})$ nalazi na odgovarajućem dijelu petlje potpunog zasićenja. Vrijednost funkcije ΔH_1 , koja predstavlja udaljenost između točke \mathbf{T}_1 i točke \mathbf{S}_1 je:

$$\Delta H_1 = a(\mathbf{B}_1 - \mathbf{B}_s)^2 \quad (4)$$

Vrijednost iste kvadratne funkcije po kojoj se vrši približavanje odgovarajućem dijelu petlje histereze potpunog zasićenja u točki $\mathbf{B}_2 = \mathbf{B}_1 + \Delta \mathbf{B}$, bit će:

$$\Delta H_2 = a(\mathbf{B}_2 - \mathbf{B}_s)^2 \quad (5)$$

Dakle nova vrijednost funkcije na mjestu \mathbf{B}_2 bit će:

$$\Delta H_2 = \Delta H_1 \frac{(\mathbf{B}_2 - \mathbf{B}_s)^2}{(\mathbf{B}_1 - \mathbf{B}_s)^2} = \Delta H_1 \frac{(\mathbf{B}_1 + \Delta \mathbf{B} - \mathbf{B}_s)^2}{(\mathbf{B}_1 - \mathbf{B}_s)^2}, \quad (6)$$

pa nova vrijednost magnetskog polja na mjestu \mathbf{B}_2 , iznosi $\mathbf{H}_2 = \mathbf{H}_{s2} - \Delta \mathbf{H}_2$.

3.2 Modeling of minor magnetization trajectories

During the energization of electric circuits with non-linear magnetic characteristics, i.e. during transient phenomena, it is necessary to know the hodograph [7] or the minor magnetization trajectories.

In the described model, it is assumed that the minor magnetization trajectories are formed by approaching the corresponding part of the outer hysteresis according to the square function. The following algorithm describes how to come from one trajectory point to another, using the corresponding part of the fully saturated hysteresis loop, and is illustrated in Figure 4. The function $\Delta H = f(\mathbf{B})$ is a square function and its peak is at Point $\mathbf{S}(\mathbf{B}_s, \mathbf{H}_s)$, where the branches of the fully saturated hysteresis loop meet. We assume that we know the coordinates of Point $\mathbf{T}_1(\mathbf{B}_1, \mathbf{H}_1)$, and let Point $\mathbf{S}_1(\mathbf{B}_1, \mathbf{H}_{s1})$ be located on the corresponding part of the fully saturated loop. The value of function ΔH_1 , which represents the distance between Points $\mathbf{T}_1, \mathbf{S}_1$ is

The value of the same square function, according to which the approach to the corresponding part of the fully saturated hysteresis loop is performed at Point $\mathbf{B}_2 = \mathbf{B}_1 + \Delta \mathbf{B}$, will be as follows:

Thus, the new value of the function at Point \mathbf{B}_2 will be

and the new value of the magnetic field at Point \mathbf{B}_2 will be $\mathbf{H}_2 = \mathbf{H}_{s2} - \Delta \mathbf{H}_2$.

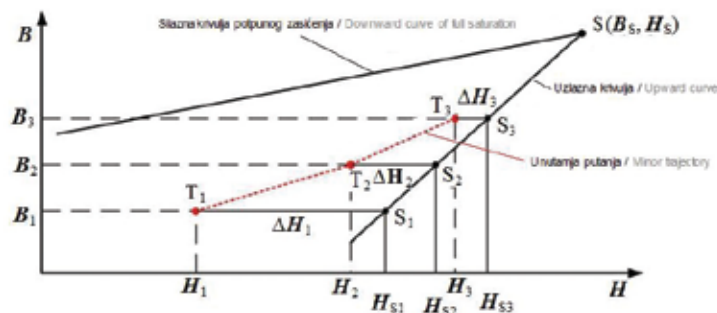

Slika 4 – Shematski prikaz algoritma za određivanje unutarnjih putanja
Figure 4 – Diagram of the algorithm for determining the minor trajectories

Na opisani način unutarnja putanja se približava odgovarajućoj krivulji potpunog zasićenja, ali je nikada ne dosegne, jer se promijeni predznak prirasta magnetske indukcije. U tom trenutku referentna krivulja postaje silazna krivulja, a postupak se odvija analogno u suprotnom smjeru. Dakle da bi se opisani algoritam mogao primijeniti potrebno je poznavati petlju histereze potpunog zasićenja.

U stacionarnom stanju vezu između magnet-skog polja $H(t)$ i magnetske indukcije $B(t)$ opisuje jedinstvena petlja histereza koja pripada točno određenom naponu napajanja. Za promatrani transformator, moguće ju je odrediti mjereći struju magnetiziranja $i(t)$ i inducirani napon na sekundaru $u_2(t)$. Uz poznati broj zavoja na primaru N_1 i srednju duljinu l_{sr} magnetskog puta može se izračunati magnetsko polje:

$$H(t) = \frac{N_1 i(t)}{l_{sr}} \quad (7)$$

Uz poznati broj zavoja sekundara N_2 i površinu presjeka magnetskog puta S , može se izračunati magnetska indukcija:

$$B(t) = \frac{1}{N_2 S} \int_0^t u_2(t) dt + B_0 \quad (8)$$

Grafičkim prikazom magnetske indukcije $B(t)$ u ovisnosti o magnetskom polju $H(t)$ dobije se hodograf koji predstavlja petlju histereze. Na slici 5 prikazano je nekoliko petlji histereze, svaka za različiti iznos struje magnetiziranja.

In the manner described, the minor trajectory approaches the corresponding curve of full saturation but never reaches it because the increment sign of the magnetic induction changes. At this instant, the reference curve becomes a downward curve and the procedure takes place analogously in the opposite direction. Thus, in order to apply the described algorithm, it is necessary to know the fully saturated hysteresis loop.

In the stationary state, the relation between the magnetic field $H(t)$ and the magnetic inductance $B(t)$ is described by a single hysteresis loop, which belongs to a precisely specified supply voltage. For the transformer under consideration, it is possible to determine this hysteresis loop by measuring the magnetizing current $i(t)$ and the induced voltage at the secondary winding $u_2(t)$. When the number of turns of the primary winding N_1 and the mean length of the magnetic path l_{sr} are known, it is possible to calculate the magnetic field:

When the number of turns of the secondary winding N_2 and the area of the cross section of magnetic path S are known, it is possible to calculate the magnetic induction:

From the graphic representation of the magnetic induction $B(t)$ as a function of the magnetic field $H(t)$, a hodograph is obtained that represents the hysteresis loop. In Figure 5, several hysteresis loops are presented, each for a different magnetizing current value.

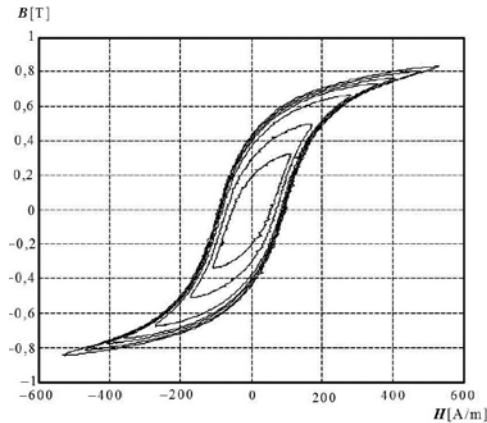

Slika 5 — Izmjerene petlje histereze pri različitim strujama magnetiziranja
Figure 5 — Measured hysteresis loops at various magnetizing currents

Magnetski krugovi energetskih transformatora projektirani su tako da im je radna točka blizu područja zasićenja, ali dovoljno daleko od područja potpunog zasićenja. Da bi ispitivana magnetska jezgra ušla u područje zasićenja potrebna je relativno velika struja magnetiziranja. Povećavajući struju magnetiziranja, osim pojačanog zagrijavanja, na krajevima namota pojavljuju se povišeni naponi koji prijete probom izolacije. Stoga metoda snimanja potpunog zasićenja trajnom strujom nije prihvatljiva. Ukoliko se snimanje petlje histereze vrši pri uklopu transformatora, na početku prijelazne pojave koja je karakterizirana velikom udarnom strujom, moći će se u gruboj aproksimaciji smatrati da je izmjerena petlja histereze potpunog zasićenja.

Prilikom mjerenja mora se voditi računa i o efektu zaostalog magnetskog toka u transformatorskoj jezgri. Pošto se zaostali magnetski tok u jezgri ne može pouzdano izmjeriti, najjednostavnije rješenje je da on bude jednak nuli. Ovaj uvjet osigurava se razmagnetiziranjem jezgre postupno smanjujući struju magnetiziranja na nulu. Osiguravši da je zaostali tok jednak nuli izvršen je uklop transformatora u najnepovoljnijem trenutku, tako da se osigura velika udarna struja uklopa, odnosno potpuno zasićenje. Na slici 6 prikazan je graf na kojem se vidi putanja magnetiziranja koja se formira na početku prijelazne pojave (prikazana debljom crtom) te trajna petlja histereze za nazivni napon (prikazana tanjom crtom).

Magnetic circuits of power transformers are designed so that the operating point is near the saturation area but sufficiently far from the full saturation area. In order for the tested magnetic core to enter the area of saturation, relatively high magnetizing current is required. In addition to increased heating, increasing the magnetizing current results in higher voltages at the ends of the windings, which can result in insulation breakdown. Therefore, a method to record full saturation with continuous current is not acceptable. If the recording of the hysteresis loop is performed during the energization of the transformer at the beginning of the transient phenomena characterized by high inrush current, it is possible to assume that the fully saturated hysteresis loop has been measured approximately.

During measurement, it is also necessary to take the effect of the remanent magnetic flux in the transformer core into account. Since the remanent magnetic flux in the core cannot be measured reliably, the simplest solution is for it to be equal to zero. This condition is fulfilled by demagnetization, gradually decreasing the magnetizing current to zero. By insuring that the remanent flux equals zero, the energization of the transformer is performed at the most unfavorable instant, thereby assuring a high inrush current, i.e. full saturation. In Figure 6, a graph presents the magnetization trajectory formed at the beginning of the transient phenomena (thick line) and the permanent hysteresis loop at the rated voltage (thin line).

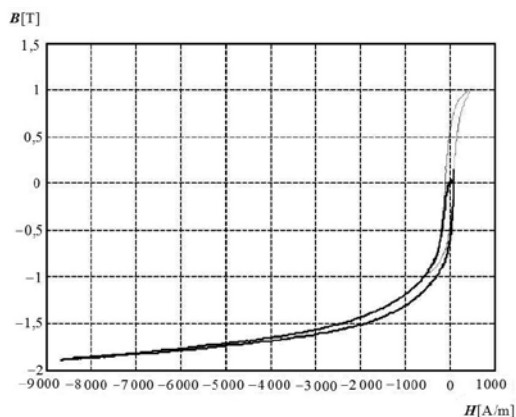

Slika 6 — Izmjerena putanja magnetiziranja za jedan period nakon uklopa (deblja crta), petlja histereza za nazivnu struju magnetiziranja (tanja crta)

Figure 6 — Measured magnetization trajectory for one period after the start of energization (thick line), hysteresis loop for rated magnetizing current (thin line)

Putanja magnetiziranja formira se između ishodišta i dijela ekstremnog zasićenja. Naravno, s vremenom se sve skupa pomiče prema ishodištu te se na kraju prijelazne pojave dobiva trajna putanja, odnosno petlja histereze koja je simetrična. Može se primijetiti da je razlika između najviše i najniže točke, u bilo kojem ciklusu, odnosno periodu ista, što je posljedica toga da je izmjenična komponenta magnetskog toka konstantna. Pomak od centra prema zasićenju posljedica je istosmjerne komponente magnetskog toka. Kako se tijekom prijelazne pojave istosmjerna komponenta prigušuje vremenskom konstantom ovisnom o radnom otporu primarnog namota, tako se i putanja magnetiziranja pozicionira oko ishodišta. Osim ove dvije komponente, na formiranje putanje magnetiziranja u prijelaznoj pojavi, utječe i zaostali (remanentni) magnetizam. Struja kao posljedica novonastalog toka, počinje se formirati iz nule. Iz navedenog slijedi da se početna točka putanje magnetiziranja općenito nalazi na osi magnetske indukcije i to unutar granica iznosa remanentnog magnetizma.

3.3 Rezultati simulacije

Opisani matematički model implementiran je u programskom paketu Matlab koristeći solver ode 113, a testiran je za transformator čiji su podaci prikazani u tablici 1. Na osnovi nazivnih podataka, standardni parametri mogu se dobiti dobro poznatim pokusima kratkog spoja i praznog hoda, a postupak određivanja petlje potpunog zasićenja opisan je u prethodnom poglavlju.

The magnetization trajectory is formed between the center of the coordinate system and the region of extreme saturation. Naturally, with time everything shifts toward the center of the coordinate system and a permanent loop or a symmetrical hysteresis loop will be formed at the end of the transient phenomena. It can be noted that the difference between the highest and the lowest points in any cycle or period is the same, which is because the AC component of the magnetic flux is constant. The shift from the center toward saturation is a consequence of the dc component of the magnetic flux. Since during the transient phenomena the dc component is damped with a time constant, which depends on the active resistance of the primary winding, the magnetization trajectories are positioned around the center of the coordinate system. In addition to these two components, remanent magnetism also affects the formation of the magnetization trajectories in transient phenomena. As a consequence of the new flux, the current starts from zero. Therefore, it follows that the starting point of the magnetization trajectory is generally located on the magnetic induction axis and within the limit of the remanent magnetism value.

3.3 Simulation results

The mathematical model described has been implemented using the Matlab software package with the ODE 113 solver, and tested for the transformer for which the data are presented in Table 1. On the basis of the rated values, the standard parameters can be obtained using the well-known short-circuit and no-load tests. The procedure for determining the fully saturated loop was described in the previous chapter.

Tablica 1 — Nazivni podaci i standardni parametri trofaznog transformatora
 Table 1 — Rated values and standard parameters of the three-phase transformer

Nazivna snaga / Rated power	$P = 1\ 645\ \text{VA}$
Nazivni napon / Rated voltage	$U_n = 380\ \text{V}$
Nazivna struja / Rated current	$I_n = 2,5\ \text{A}$
Broj zavoja primara / Number of turns of the primary winding	$N_1 = 557$
Broj zavoja sekundara / Number of turns of the secondary winding	$N_2 = 162$
Impedancija kratkog spoja / Short-circuit impedance	$Z_k = 8,54\ \Omega$
Napon kratkog spoja / Short-circuit voltage	$u_k = 9,74\ \%$
Radni otpor primara pri 50 Hz / Active resistance of the primary winding at 50 Hz	$R_1 = 7,4\ \Omega$
Rasipni induktivitet primara / Leakage inductance of the primary winding	$L_\sigma = 3,105\ \text{mH}$
Ekvivalentna duljina magnetskog puta / Equivalent length of the magnetic path	$l_m = 0,381\ \text{m}$
Površina presjeka magnetske jezgre / Cross-section area of the magnetic core	$S = 21,01\ \text{cm}^2$

Opisani matematički model poslužio je pri istraživanju algoritma za određivanje optimalnog trenutka uklopa s ciljem smanjenja udarnih struja uklopa. Na slici 7 prikazane su struje uklopa trofaznog transformatora pri simulaciji nepovoljno odabranog trenutka uklopa transformatora.

The described mathematical model was used in the investigation of the algorithm for the determination of the optimal instant of energization, with the goal of reducing the inrush currents. In Figure 7, the simulated inrush currents of the three-phase transformer during unfavorable energization are shown.

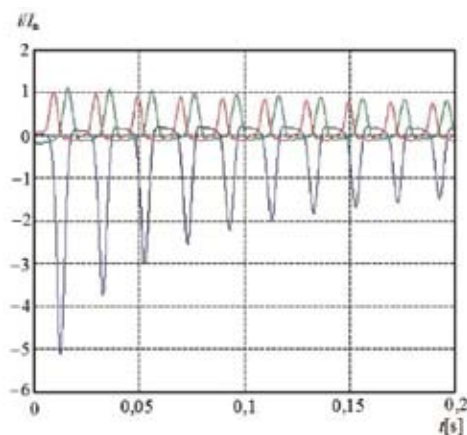

Slika 7 — Struje transformatora pri nepovoljno odabranom trenutku uklopa
 Figure 7 — Transformer inrush currents during unfavorable energization

4 ODREĐIVANJE ZAOSTALOG MAGNETSKOG TOKA U JEZGRI

Temeljni problem određivanja optimalnog trenutka uklopa je mjerenje zaostalog magnetskog toka. Zaostali magnetni tok je konstantan i veoma ga je teško mjeriti uobičajenim metodama za mjerenje toka. Uobičajeni senzori magnetskog polja koji rade na načelu Hallova efekta ne ugrađuju se u jezgru zbog tehnoloških i ekonomskih razloga. Teoretski moguća mjerenja tangencijalne komponente magnetskog polja neposredno na površini željezne jezgre nepouz-

4 DETERMINATION OF THE REMANENT MAGNETIC FLUX IN THE CORE

The fundamental problem in determining the optimal instant of energization is the measurement of the remanent magnetic flux. Remanent magnetic flux is constant and very difficult to measure using the customary methods for measuring flux. The usual magnetic field sensors that operate on the principle of the Hall effect are not installed in the core due to technological and economic considerations. The theoretical feasibility of measuring the tangential components of a magnetic field directly on the surface of the iron

dano je zbog značajnih rasipnih tokova koji kvare sliku polja. Zato je, za detekciju zaostalog toka, prihvatljivo rješenje mjerenje napona sekundara prilikom isklopa [8]. U praznom hodu integral sekundarnog napona upravo je proporcionalan magnetskom toku u jezgri. Ako se zaostali tok ne mijenja za vrijeme dok transformator nije pod naponom, znači da će prilikom sljedećeg uklopa biti poznat njegov iznos. Na slici 8 prikazano je nekoliko izmjerenih karakterističnih stanja zaostalih magnetskih tokova prilikom isklopa trofaznog transformatora.

core are unreliable due to significant flux leakage that distorts the image of the field. Therefore, an acceptable solution for the detection of remanent flux is the measurement of the voltage at the secondary winding during de-energization [8]. During no-load operation, the integral of the secondary voltage is proportional to the magnetic flux in the core. If the remanent flux does not change during the time that the transformer is not connected to the supply voltage, its amount will be known at the time of the next energization. In Figure 8, several measured characteristic states of remanent magnetic fluxes are presented during the de-energization of the three-phase transformer.

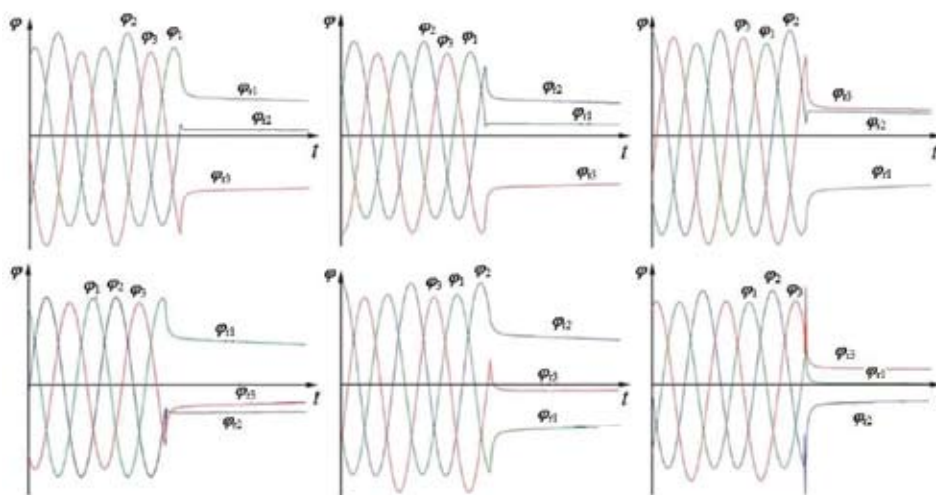

Slika 8 — Nekoliko karakterističnih izmjerenih magnetskih tokova prilikom isklapanja trofaznog transformatora
Figure 8 — Several characteristic measured magnetic fluxes during the de-energization of the three-phase transformer

Kako se isklop ne može ostvariti trenutačno, struje isklopa donekle razgrade zaostali magnetizam. Kod većine magnetskih materijala iznos zaostalog magnetskog toka prilikom isklopa ne prelazi 50 % maksimalnog magnetskog toka koji vlada u stacionarnom stanju.

Since de-energization cannot be achieved instantaneously, de-energization currents somewhat decrease the remanent magnetism. For the majority of magnetic materials, the value of remanent magnetic flux during de-energization does not exceed 50 % of the maximum magnetic flux present in the stationary state.

5 ODREĐIVANJE OPTIMALNOG TRENUTKA UKLOPA

U slučaju trenutačnog (idealnog) isklopa zaostali magnetski tok bio bi jednak magnetskom toku u jezgri koji je vladao neposredno prije isklopa. Tada bi optimalni trenutak uklopa bio jednak cjelobrojnom višekratniku perioda napona napajanja. U odnosu na prolaz kroz nulu sinkronizacijskog signala, fazni kut idealnog uklopa je jednak faznom kutu prethodnog isklopa. Drugim riječima, optimalni trenutak uklopa je kada se pretpostavljeni tok, koji bi u jezgri vladao da je transformator uklopljen, izjednači sa zaostalim magnetskim tokom [9]. Optimalan

5 DETERMINATION OF THE OPTIMAL INSTANT OF ENERGIZATION

In the case of instantaneous (ideal) de-energization, remanent magnetic flux would be equal to the magnetic flux in the core immediately prior to de-energization. The optimal instant of energization would then be equal to the multiple integer of the supply voltage period. The phase angle of the ideal instant of energization referenced to the zero crossing of the synchronizing signal is equal to the phase angle of the previous de-energization. In other words, the optimal instant of energization is when the assumed flux that

trenutak uklopa ilustriran je na slici 9 za idealni jednofazni slučaja.

would be present in the core if the transformer were energized is equal to the remanent magnetic flux [9]. The optimal instant of energization is illustrated in Figure 9 for an ideal single-phase case.

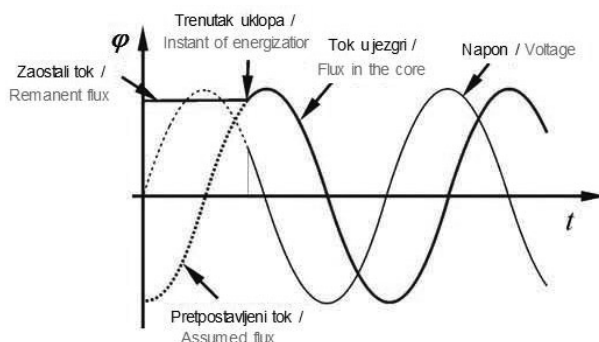

Slika 9 – Idealni trenutak uklopa jednofaznog transformatora uz zaostali magnetski tok
Figure 9 – The ideal instant of the energization of a single-phase transformer with remanent magnetic flux

Kod trofaznog transformatora, u realnoj situaciji, kada se prilikom isklopa dio zaostalog toka razmagnetizira, praktično ne postoji idealni trenutak uklopa. Za rješenje većine problema koji se javljaju prilikom uklopa, dovoljno je udarnu struju svesti na iznos manji od nazivne struje transformatora. Ova činjenica nam dopušta odabir trenutka koji nije strogo uvjetovan zahtjevom da budući magnetski tok mora biti jednak zaostalom.

For a three-phase transformer in an actual situation when a part of the remanent flux is demagnetized during de-energization, there is practically no ideal instant of energization. For the solution of the majority of problems that occur during energization, it is sufficient to reduce the inrush current to a value lower than the rated current of the transformer. This fact permits us to choose an instant that is not strictly determined by the requirement that the future magnetic flux must be equal to the remanent flux.

Čak i ako isklon nije nastupio u istom trenutku, u sve tri faze, zbog zajedničkih magnetskih puteva za očekivati je da suma zaostalih tokova bude jednaka nuli. Uz ovu pretpostavku moguće je odrediti trenutak u kojem će budući izmjenični tokovi nakon uklopa biti dovoljno blizu zaostalim tokovima, što je na karakterističnom primjeru ilustrirano slikom 10.

Even if switching off does not occur at the same instant in all three phases, due to the common magnetic paths the sum of the remanent fluxes can be expected to be equal to zero. According to this assumption, it is possible to determine the instant when the future AC fluxes after energization will be sufficiently close to the remanent fluxes, as illustrated for a characteristic example in Figure 10.

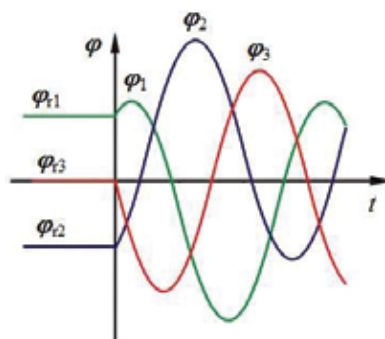

Slika 10 – Magnetski tokovi u jezgri trofaznog transformatora pri povoljno odabranom trenutku uklopa
Figure 10 – Magnetic fluxes in the core of a three-phase transformer during optimal energization

Za slučaj sa slike 10, najpovoljniji fazni kut uklopa je 180° u odnosu na magnetski tok treće faze. Ako je sinkronizacijski signal napon prve faze, koji prethodi toku iste faze za 90° , proizlazi da je najpovoljniji fazni kut uklopa 150° u odnosu na sinkronizacijski signal. U realnom slučaju treba uračunati i vrijeme odziva sklopnog aparata.

Analizom isklopa transformatora uočeno je šest karakterističnih rasporeda, zaostalog magnetskog toka. Ako je zaostali magnetski tok u prvoj fazi izrazito pozitivnog polariteta, tada zaostali magnetski tok u drugoj fazi može biti izrazito negativan, ili u blizini nule, a u trećoj fazi obrnuto. U trećem slučaju, ako je zaostali magnetski tok u prvoj fazi u blizini nule, tada zaostali magnetski tok u drugoj fazi može biti izrazito pozitivan, ili izrazito negativan, a u trećoj fazi obrnuto. U petom slučaju ako je zaostali magnetski tok u prvoj fazi izrazito negativan, tada zaostali magnetski tok u drugoj fazi može biti u blizini nule ili izrazito pozitivan, a u trećoj fazi obrnuto. Na slici 11, različitim bojama predstavljena su područja u kojima se može nalaziti zaostali magnetski tok za pojedinu fazu.

For the case in Figure 10, the most optimal phase angle for energization is 180° in reference to the magnetic flux of the third phase. If the synchronization signal is the voltage of the first phase, which leads by 90° in reference to the flux of the same phase, the most optimal phase angle for energization is 150° in reference to the synchronization signal. In an actual case, it is also necessary to take the response time of the switching unit into account.

Through analysis of the de-energization of the transformer, six characteristic patterns were noted for the remanent magnetic flux. If the remanent magnetic flux in the first phase was of markedly positive polarity, the remanent magnetic flux in the second phase could be markedly negative or near zero, and the opposite occurred in the third phase. In the third case, if the remanent magnetic flux was near zero in the first phase, the remanent magnetic flux in the second phase could be markedly positive or markedly negative, and the opposite occurred in the third phase. In the fifth case, if the remanent magnetic flux in the first phase was markedly negative, the remanent magnetic flux in the second phase could be near zero or markedly positive, and the opposite occurred in the third phase. In Figure 11, the various colors indicate the areas in which remanent magnetic flux can be found for an individual phase.

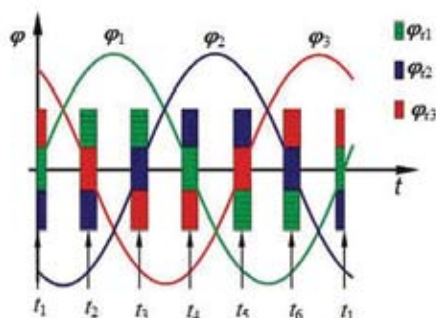

Slika 11 — Realno mogući rasporedi zaostalih tokova s pripadajućim optimalnim trenucima uklopa
Figure 11 — Actual feasible patterns of remanent fluxes with the corresponding optimal instants for energization

Dakle, svakom od šest realno mogućih stanja zaostalih tokova odgovara jedan od šest (t_1 do t_6) pripadajućih trenutaka uklopa, odnosno faznih kutova uklopa.

Thus, each of the six actual feasible states of remanent fluxes correspond to one of the six (t_1 to t_6) instants of energization, i.e. the phase angles of energization.

6 MAKETA SUSTAVA ZA UPRAVLJANI UKLOP

Za eksperimentalnu provjeru rezultata realizirana je laboratorijska maketa uklopa transformatora nazivnih podataka prikazanih u tablici 1. Uklop je izvršen pomoću sklopnika s vremenom odziva 9,2 ms. Sustav za mjerenje zaosta-

6 CIRCUIT MODEL FOR CONTROLLED ENERGIZATION

For the experimental testing of the results, a circuit model was developed for the energization of the transformer with the rated values presented in Table 1. Energization was performed using a switch with a response time of 9,2 ms. The system for measuring

log magnetskog toka realiziran je pomoću RC člana (analogni integrator), pri čemu napon kondenzatora u određenom mjerilu predstavlja magnetski tok. Za određivanje povoljnog trenutka uklopa dovoljno je mjerenje magnetskog toka u dvije faze, jer je suma magnetskih tokova jednaka nuli. Na osnovi izmjerenih tokova te napona sinkronizacije u_{sink} , logički krug određuje trenutak uklopa. Na slici 12 prikazana je shema sustava za upravljeni uklop transformatora i mjerenje struje.

remnant magnetic flux was prepared using RC units (analogue integrators), where the voltage on the capacitors is proportional to the magnetic flux. For the determination of the optimal instant of energization, it is sufficient to measure the magnetic fluxes in two phases because the sum of the magnetic fluxes is equal to zero. On the basis of the measured fluxes and synchronizing voltage u_{sink} , a logic circuit determines the instant of energization. In Figure 12, a diagram of a system for the controlled energization of a transformer and current measurement is presented.

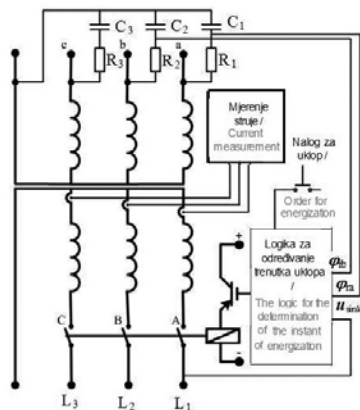

Slika 12 — Shema laboratorijske makete sustava za upravljeni uklop transformatora
Figure 12 — Circuit diagram of a system for the controlled energization of a transformer

Na slici 13 prikazane su izmjerene struje u sve tri faze pri nepovoljno odbranom trenutku uklopa, a na slici 14 prikazana je vremenska promjena harmoničkog sastava struje jedne faze. Sa slika je vidljivo da je udarna struja nekoliko puta veća od nazivne struje transformatora te je bogata višim harmonicima od kojih je najizraženiji drugi.

In Figure 13, measured currents are presented in all three phases during unfavorable energization. In Figure 14, the time changes of the harmonic content of single-phase current are presented. From the figures, it is evident that the inrush current is several times greater than the rated current of the transformer and is rich in high harmonics, of which the second is predominant.

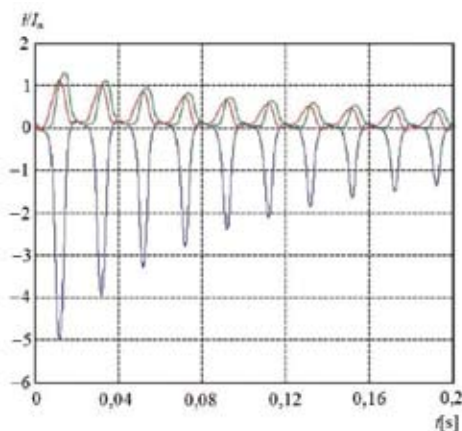

Slika 13 — Izmjereni valni oblici struja pri nepovoljno odbranom trenutku uklopa
Figure 13 — Measured current waveforms during unfavorable energization

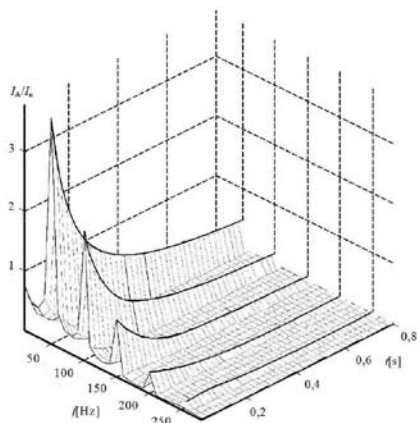

Slika 14 – Vremenska promjena harmoničkog sastava struje jedne faze pri nepovoljno odabranom trenutku uklopa
 Figure 14 – Time changes of the harmonic content of single-phase current during unfavorable energization

Na slici 15 prikazane su izmjerene struje u sve tri faze pri povoljno odabranom trenutku uklopa, pri čemu je vidljivo da u slučaju dobro odabranog trenutka uklopa gotovo ne postoje udarne struje.

Figure 15 presents the measured currents in all three phases during optimal energization. It is evident that in the case of a well chosen energization instant, there is nearly no inrush current.

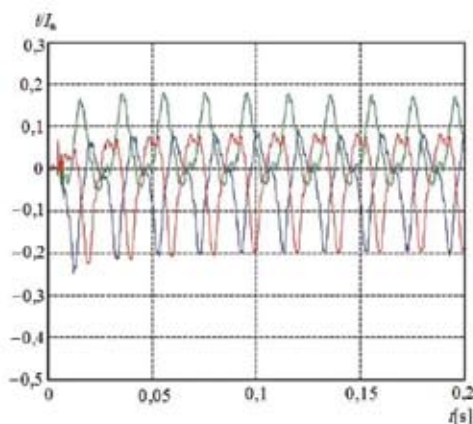

Slika 15 – Izmjereni valni oblici struja pri povoljno odbranom trenutku uklopa
 Figure 15 – Measured current waveforms during optimal energization

Važan pokazatelj kakvoće izrađene makete i odabranog algoritma za određivanje optimalnog trenutka uklopa trofaznog transformatora europskog tipa, je mjerenje udarnih struja uklopa pri nekoliko uzastopnih uklopa. Radi preglednosti na slici 16 prikazana je samo envelope struje jedne faze, tijekom nekoliko uzastopnih uklopa. Vidljivo je da pri upravljanoj udarnoj struji ne prelaze 50 % iznosa nazivne struje transformatora.

An important quality index of the circuit model and selected algorithm for the determination of the optimal instant of the energization of a three-phase transformer of the European type is the measurement of energization inrush currents at several consecutive energizations. To simplify presentation, in Figure 16 only the single phase current envelope is presented during several consecutive energizations. It is evident that the inrush currents during controlled energization do not exceed 50 % of the values of the rated current of the transformer.

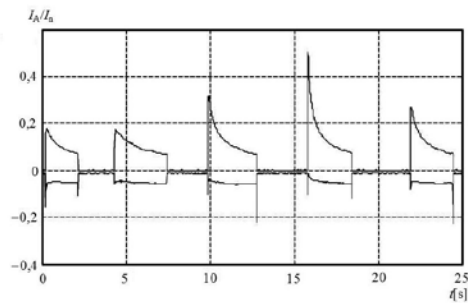

Slika 16 — Anvelopa struje jedne faze pri nekoliko uzastopnih upravljanih uklopa
 Figure 16 — The envelope of a single-phase current during several consecutive controlled energizations

7 ZAKLJUČAK

U ovom radu opisan je matematički model uklopa trofaznog transformatora uz uračunate efekte petlje histereze i zaostalog magnet-skog toka, za što je razvijen i poseban model za određivanje putanje krivulje magnetiziranja u prijelaznoj pojavi.

Također je opisan i sustav za mjerenje zaostalog magnetskog toka na osnovi mjerenja napona prethodnog isklopa, te je predložen algoritam za određivanje najpovoljnijeg trenutka uklopa.

Razvijena je laboratorijska maketa sustava za upravljeni uklop trofaznog transformatora. Najvažniji pokazatelj kakvoće izrađene makete i odabranog algoritma za određivanje optimalnog trenutka uklopa trofaznog transformatora europskog tipa je mjerenje iznosa udarnih struja pri nekoliko uzastopnih uklopa.

Iz izmjerenih struja pri upravljanim uklopima može se zaključiti da predloženo rješenje eliminira pojavu udarnih struja koje su veće od iznosa nazivne struje transformatora.

7 CONCLUSION

In this article, a mathematical model is described for the energization of a three-phase transformer, taking into account the effects of hysteresis and remanent magnetic fluxes, for which a separate model has been prepared for determining magnetization trajectories during transient phenomena.

A system is also described for the measurement of remanent magnetic flux on the basis of measuring the voltage of the previous de-energization and an algorithm is proposed for the determination of the optimal instant of energization.

A circuit model has been developed for the controlled energization of a three-phase transformer. The most important index of the quality of the circuit model and algorithm presented for the determination of the optimal instant of the energization of a three-phase transformer of the European type is the measurement of the value of inrush currents during several consecutive energizations.

From the measured currents during controlled energizations, it is possible to conclude that the proposed solution eliminates the occurrence of inrush currents that are greater than the values of the rated transformer current.

LITERATURA

- [1] LIN, C.E., CHENG C.L., HUANG, C.L, Investigation of Magnetizing Inrush Current in Transformers, IEEE Transactions on Power Delivery, Vol 8, No. 1, January 1993
- [2] Working Group 13.07, Controlled Switching of HVAC Circuit Breakers, Electra No. 185, August 1999
- [3] BRUNKE, J.H., FROLICH, K.J., Elimination of Transformer Inrush Currents by Controlled Switching – Part I & II, IEEE Transactions on Power Delivery, Vol. 16, No. 2, April 2001
- [4] YACAMINI, R., ENG, C., ABU-NASSER, A., The Calculation of Inrush Current in Three-phase Transformers, IEE Proceedings, Vol. 133, No. 1, January 1986
- [5] RAHMAN M.A., GANGOPADHYAY, A., Digital Simulation of Magnetizing Inrush Current in Three-phase Transformers, IEEE Transactions on Power Delivery, Vol 1, No. 4, October 1986
- [6] DOLINAR, D., PIHLER, J., GRČAR, B., Dynamic Model of Three-phase Power Transformer, IEEE Transactions on Power Delivery, Vol. 8, No. 4, October 1993
- [7] ABDULSALAM, S. G., WILSON XU, NEVES, A., XIAN LIU, Estimation of Transformer Saturation Characteristics From Inrush Current Waveforms, IEEE Transactions on Power Delivery, Vol. 21, No. 1, January 2006
- [8] PETROVIC, G., Inrush current transients of three phase power transformers, (Tranzijentne struje uklopa energetskog trofaznog transformatora), Master's thesis, University of Split, Faculty of Electrical Engineering and Mechanical Engineering and Naval Architecture, 2002
- [9] ABDULSALAM, YU CUI, SHIUMING CHEN, S.G., WILSON XU, A sequential phase energization technique for transformer inrush current reduction – Part I: Simulation and experimental results, IEEE Transactions on Power Delivery, Vol. 20, Issue 2, Part 1, April 2005

Adrese autora:

Authors' Adresses:

Dr. sc. **Goran Petrović**
goran.petrovic@fesb.hr
Izv. prof. dr. sc. **Tomislav Kilić**
tomislav.kilic@fesb.hr
Doc. dr. sc. **Ozren Bego**
ozren.bego@fesb.hr
Sveučilište u Splitu
Fakultet elektrotehnike, strojarstva i bro-
dogradnje
R. Boškovića bb
21000 Split
Hrvatska

Goran Petrović, PhD
goran.petrovic@fesb.hr
Assoc. Prof. **Tomislav Kilić**, PhD
tomislav.kilic@fesb.hr
Asst. Prof. **Ozren Bego**, PhD
ozren.bego@fesb.hr
University of Split
Faculty of Electrical Engineering, Mechanical En-
gineering and Naval Architecture
R. Boškovića bb
21000 Split
Croatia

Uredništvo primilo rukopis:
2008-04-09

Manuscript received on:
2008-04-09

Prihvaćeno:
2008-05-08

Accepted on:
2008-05-08