

NEW TECHNOLOGY FOR THE PRODUCTION OF MAGNESIUM STRIPS AND SHEETS

Received – Prispjelo: 2007-08-26

Accepted – Prihvaćeno: 2008-03-10

Preliminary Note – Prethodno priopćenje

A new production technology for magnesium strip, based on twin-roll-casting and strip rolling was developed in Freiberg Germany. By means of this economic method it is possible to produce strips in deep drawing quality with good forming properties in order to satisfy the request for low cost Mg sheets in the automotive and electronic industry. Both, coils as single sheets, were manufactured and rolled to a thickness of 1 mm (0,5 mm). The technology of the new process and the properties of the twin-roll-casted material and the final sheets are presented.

Key words: Twin-roll-casting, Mg-alloy AZ31, strip-rolling and sheets, texture, mechanical properties

Nova tehnologija proizvodnje magnezijevih traka i limova. Nova tehnologija proizvodnje magnezijevih traka utemeljena dvostruko-valjanje-lijevanje i valjanje trake je razvijeno u Freibergu-Njemačka. Motri se, ovom ekonomičnom metodom je moguća proizvoditi trake za duboko izvlačenje, sa dobrim plastičnim svojstvima uz zadovoljavajući zahtjev za nisku cijenu Mg trake za automobilsku i elektronsku industriju. Oboje, svitak i pojedinačne trake su proizvedene i valjane do debljine stjenke 1 mm (0,5 mm). Prikazuje se tehnologija novog postupka i svojstva dvostrukog valjanog-lijevačkog materijala i završnih traka.

Ključne riječi: dvostruko valjanje-lijevanje, Mg legura AZ31, valjanje trake i limova, tekstura, mehanička svojstva

INTRODUCTION

The growing significance of the material magnesium is closely associated with the progressive development in the field of automotive lightweight construction. The announcement of the VW AG of constructing an one-litre-automobile can be deemed to be a proof of the actuality of research and development in the field of magnesium alloy processing. That automobile, whose frame structure is widely made of magnesium, shall be mass-produced before end of 2010 [1]. The material magnesium does not compete only with other metallic materials, also in particular with novel material concepts of the plastics industry. In this connection the better recyclability and therefore the better environmental compatibility compared to the plastics is an essential advantage of magnesium.

The production of semi-finished Mg-parts with continuously working mills leads to substantial advantages compared to conventional processes due to the omission of production steps. Therefore, many different continuous strip casting processes have been an object of development efforts. The strip casting process for the production of wide strips has already been developed in the aluminium industry; however, the transfer from the alu-

minium materials to the magnesium materials is difficult. There are open problems regarding the systems engineering such as the tundish and tip construction as well as the material itself. For several years many development institutes and industrial companies have been working on the application of strip casting processes for the processing of magnesium wrought alloys. In cooperation with the MgF Magnesium Flachprodukte GmbH the twin-roll-casting technology has been developed to series-production readiness. It enables a continuous production of near-net shape strips compared to the conventional light metal casting. So far the twin-roll-casting technology has successfully been tested on the pilot plant in Freiberg with the alloys AZ21 and AZ31 [2, 3, 4].

EXPERIMENTAL PROCEDURES

Within the scope of an integrated research project supported by the Development Bank of Saxony (SAB - Sächsische AufbauBank), the Institute of Metal Forming at the Freiberg University of Mining and Technology and the MgF Magnesium Flachprodukte GmbH have built a twin-roll-casting plant (Figure 1) in Freiberg. The twin-roll-casting plant consists of a gas-fired melting furnace with a melting capacity of approximately 750 kg/h, an electrically heated feeding system, a twin-roll-casting mill stand with water-cooled rolls, a pinch roll unit, a cross-cut shear and a coiler. With that

R. Kawalla, M. Oswald, C. Schmidt, M. Ullmann Institute of Metal Forming, Freiberg University of Mining and Technology, Freiberg, Germany, H.-P. Vogt, N. D. Cuong MgF Magnesium Flachprodukte GmbH, Freiberg, Germany

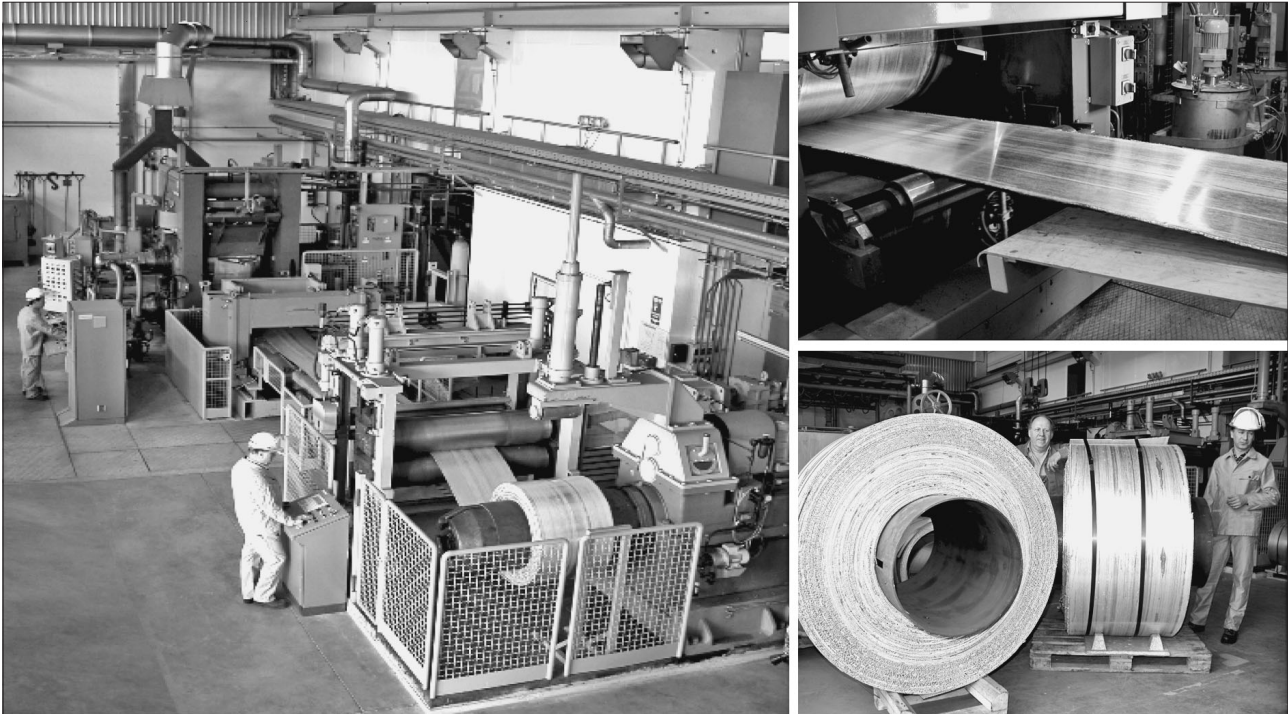

Figure 1. Twin roll casting plant of the MgF Magnesium Flachprodukte GmbH in Freiberg.

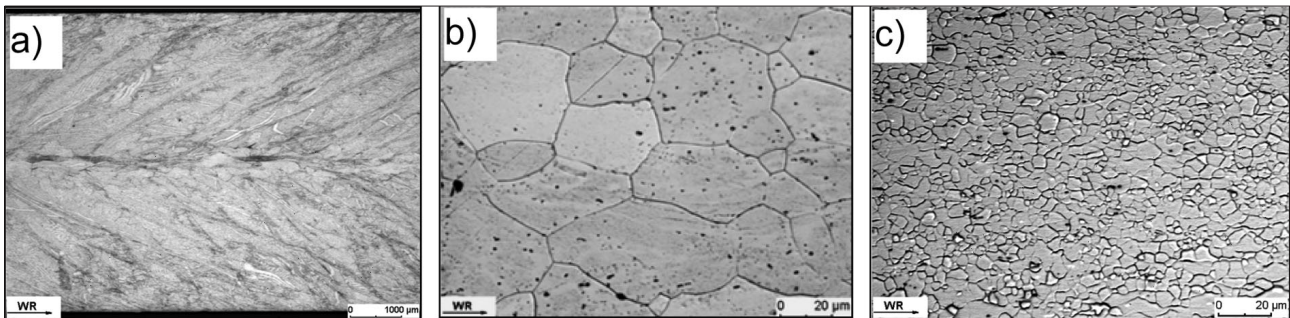

Figure 2. Microstructure of the twin-roll-casted AZ21 strip after slow cooling down to room temperature (a) and after homogenization at 480°C, 1 h (b), as well as the microstructure of the final strip (c).

twin-roll-caster, strips with 700 mm width and 4 to 7 mm thickness can be produced.

The investigated alloys are Mg-alloys AZ21 and AZ31. The AZ31 alloys consist of 2,5 – 3,0 % Aluminium and 0,6 – 1,0 % Zn, the other elements according to ASTM B90/B90M-93. The AZ21 alloys have lower Al-contents (~ 1,8 %).

The strip rolling of the twin-roll-casted material to strips with a thickness down to 1 mm takes place on industrial hot rolling mills. A substantial part of the research activities regarding the rolling technology of the twin-roll-casted material is carried out on the pilot mills at the Institute of Metal Forming in Freiberg [5, 6].

RESULTS AND DISCUSSION

Twin-roll-casted material

During twin-roll-casting the microstructure is primary defined by the rapid cooling and the subsequent partial forming in the roll gap. Figure 2a shows the microstructure of the twin-roll-casted material. The

twin-roll-casted Mg-strip shows a relatively inhomogeneous structure across the strip thickness. The area between the surface and the middle of the strip is mainly characterized by a dendritic solidification structure. During solidification the dendrites grow against the main heat transfer direction. The dendritic solidification structure gets deformed after its complete solidification by partial rolling in the roll gap. After subsequent annealing the eutectic phases are dissolved, the material is homogenized and a fine grain structure develops (see Figure 2b).

The grain refining of the microstructure is a result of the plastic deformation during twin-roll-casting and the incipient recrystallization during annealing. It is noticeable that a temperature of 400°C is too low for a complete homogenization. However, higher temperatures show very uniform grains. With increasing temperatures the grain size rises, which limits the process window upwards.

The texture analyses of the twin-roll-casted condition shows differences between the mid layer and the surface-close layer (80% of strip thickness) of the strip. The mid layer of the twin-roll-casted strip exhibits a

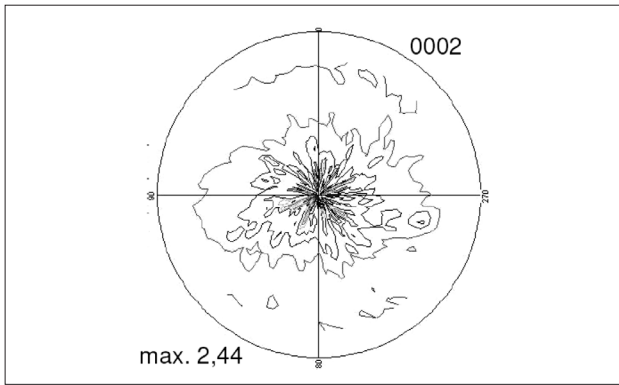

Figure 3. Initial texture of twin-roll-casted Mg-strip, centre of strip.

quiet low textured structure which can almost be considered as isotropic (Figure 3).

In the layer close to the surface, however, significant extrema can be found. Its texture shows that most of the crystals are orientated with its basal planes tilted by about 45° across the twin-roll-casting direction. Smaller extrema are also recognizable in twin-roll-casting direction tilted by 35° to the sheet normal. It seems to be of importance that none of the preorientations are of a basal character. Hence, the twin-roll-casted condition is not tainted with unfavorably orientated crystals for the following forming steps.

Figure 4 shows exemplarily the temperature and deformation degree dependence of the flow stress for the twin-roll-casted condition of AZ21 alloy at a strain rate of 1 s⁻¹.

The characteristics of all flow curves reveal a decreasing trait. The decrease of the curves is described by an interaction of hardening and softening mechanism, at which the dynamic recrystallization exerts a stronger influence seen in the decline of the curve. Both conditions have in common that with increasing temperature the flow curves run lower with a less developed maximum, which means that hardening decreases with increasing temperature because of the dominant influence of thermal activated processes.

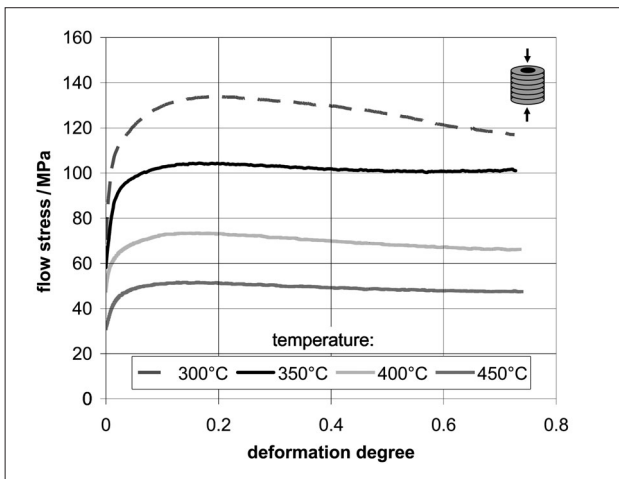
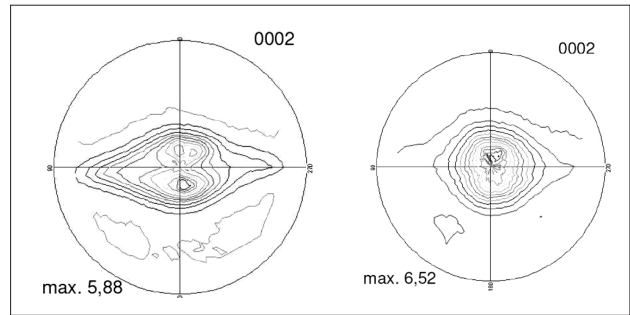

Figure 4. Flow curves of twin-roll-casted magnesium sheets at elevated temperatures; strain rate 1 s⁻¹, determined in ferrule compression test.



a) 1 m/s b) 5 m/s
Figure 5. Influence of final rolling speed on texture after 3rd pass, rolling temperature 400°C, (RD...rolling direction).

Final sheet (twin-roll-casted, rolled and annealed)

After rolling and subsequent annealing a very fine grained homogeneous microstructure is available (Figure 2c). The developing texture after rolling at 400°C initial temperature and a final rolling speed of 1 m/s is characterized by two peaks tilted by 15° to the sheet normal in and against rolling and twin-roll-casting direction, respectively (see Figure 5). It is conspicuous that two local extrema tilted by 45° across the rolling direction have developed.

The increase in rolling speed up to 5 m/s final rolling speed causes, compared to the observations at 1 m/s, at the end of rolling not a lens-shaped but a circular distribution around the basal pole of the pole figures. The two split maxima are almost combined in the basal pole.

Hence, it can be stated that the activation of the particular slip systems and consequently the texture development too, is influenced to a sustainable degree by the strain rate.

The cause of the throughout observed pole splitting can be found in the intensified activated pyramidal slip systems <c+a>. As the crucial factor for the development or more precisely the continuance of the local extrema at 45° across the rolling direction the initial orientation can be seen. Considering the rolling texture it stands out that these local extrema are at the same position as in the feedstock (twin-roll-casted strip). Thus, those initial texture components are passed on to a certain extent to the rolled texture. Orientations in that polfigure area point at intensive dislocation moment on prismatic slip systems. It can be assumed, that additionally to its general activation, prismatic slip <a> seems to be advantaged due to the feedstock pre-orientation. Even though the examined local maxima across the rolling direction are dissolved at the end of the rolling process, they still have influenced the overall texture development during rolling leaving a lens-shaped 0002-polfigure which is evidence of non-basal texture components.

In the following the properties of the sheets produced by twin-roll-casting and hot rolling are explained. In all cases the results were achieved on sheets with a thickness of 1,5 to 0,6 mm.

At room temperature those Mg sheets offer yield points of 140-200 MPa, tensile strengths above 240

MPa and total elongations (A_{80}) above 17%, whereas total elongations of 25% are achievable, too. The level of strength and forming behaviour depends on the Al-content in the case of AZ-alloys. Thus, AZ-alloys with an Al-content of 2% can achieve yield points of approximately 150 MPa and A_{80} -elongations of 20% for example (see Figure 6).

Figure 7 clarifies the better forming behaviour in tensile test at elevated temperatures. An increase in temperature from 20 to 100°C leads to a remarkable increase of total elongation. In the area of 100 to 200°C there is no nameable improvement in total elongation. Above 200°C an increase of total elongation with increasing temperature is noticeable again, due to additionally activated slip systems in the hexagonal lattice and the interaction with thermal activated processes in the microstructure. At a deformation temperature of 300°C total elongations of 80% are achievable. Even in the area of 150 and 200°C total elongations of 45 to 50% are possible.

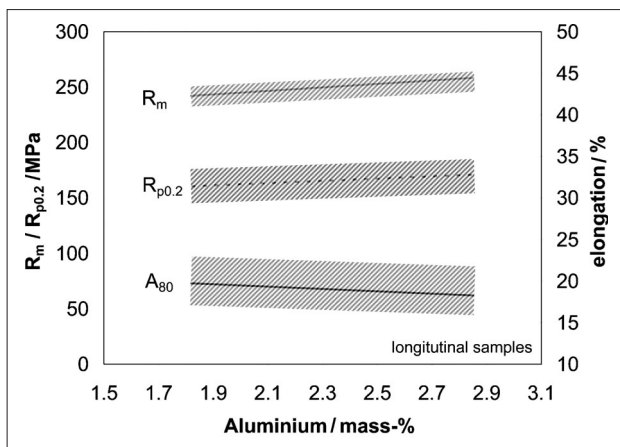

Figure 6. Mechanical properties of twin-roll-casted, rolled and annealed magnesium sheets (1,5 mm) depending on the Aluminium content.

Besides temperature the strain rate is an important influencing factor (see Figure 8). The raise of strain rate from 1 to 500 s^{-1} leads to an increase in strength values of 35-40%. The total elongation decreases by only 2%

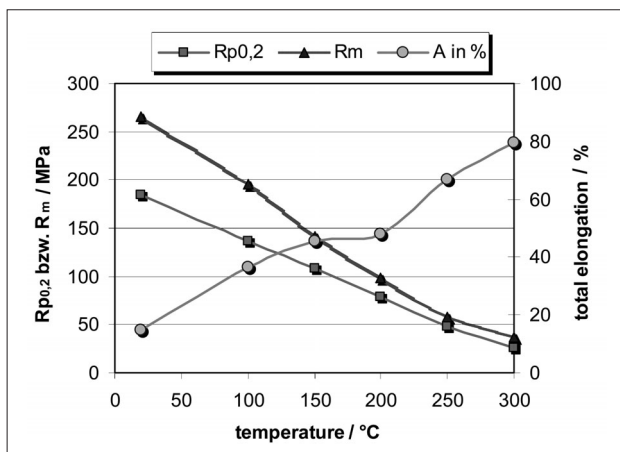

Figure 7. Influence of temperature on the mechanical properties in tensile test, rolled and annealed twin-roll-casted strip AZ31.

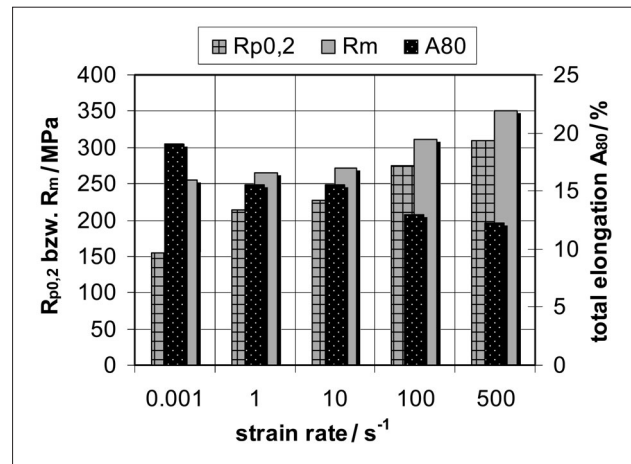

Figure 8. Influence of deformation rate on the mechanical properties in tensile test, rolled and annealed twin-roll-casted strip AZ21.

which complies with a relative reduction of 15%. The increase in strength with increasing strain rate is important for crash-relevant components.

CONCLUSION

Our the investigations give: based on twin-roll-casting and strip rolling of Magnesium, these strips show already at room temperature and for wide range of deformations rates a good correlation between strength and elongation.

Acknowledgement – The authors thank the Saxony State Ministry for Economic Affairs and Labor (SMWA) - technology promotion (Development Bank of Saxony, SAB) and the German Research Foundation (Deutsche Forschungsgemeinschaft DFG, KA1591/11-2) for the financial support.

REFERENCES

- [1] Reisener, T.: VW baut Ein-Liter-Auto, Rheinische Post, 09.10.2007
- [2] Engl, B., Kawalla, R.: Entwicklung eines neuartigen kostengünstigen Verfahrens zur Herstellung von Magnesiumband; MEFORM 2006, Freiberg, p. 96-117
- [3] Kawalla, R.; Lehmann, G.; Vogt, H.-P.: Magnesiumhalbzeuge für den Fahrzeugbau; proceedings 14. Sächsische Fachtagung Umformtechnik, 2007, Freiberg, p. 1 - 10
- [4] B. Engl, "Potential uses and new production technology for magnesium sheet", Steel Grips, 1 (2003), p. 413-418
- [5] R. Kawalla, M. Ullmann, M. Oswald, C. Schmidt, "Properties of Strips and Sheets of Magnesium Alloy Produced by Casting-Rolling Technology", Proceedings of the 7th International Conference on Magnesium Alloys and Their Applications, K. U. Kainer, Dresden, p. 364-369
- [6] R. Kawalla, M. Oswald, C. Schmidt, N.D. Cuong, „Magnesiumfeinbleche für den Leichtbau“, 12. Sächsische Fachtagung Umformtechnik SFU, Leichtbau durch Umformtechnik, Proceedings, Dresden, 2005, p. 231-243

Note: The responsible for English language is Author R. Kawalla.