

PRORAČUN GODIŠNJIH GUBITAKA RADNE ENERGIJE U DISTRIBUCIJSKOJ MREŽI S PRIKLJUČENOM VJETROELEKTRANOM

CALCULATION OF ANNUAL ACTIVE ENERGY LOSSES IN A DISTRIBUTION NETWORK WITH A CONNECTED WIND POWER PLANT

Dr. sc. Ranko Goić, Damir Jakus, dipl. ing., Dr. sc. Eugen Mudnić,
Sveučilište u Splitu, Fakultet elektrotehnike, strojarstva i brodogradnje,
R. Boškovića b.b, 21000 Split, Hrvatska

Priključak distribuiranih izvora energije na distribucijsku mrežu, između ostalih utjecaja, ima za posljedicu preraspodjelu tokova snaga u mreži, a time i promjenu iznosa gubitaka radne energije. U određenom trenutku, ovisno o potrošnji u mreži i snazi koju u mrežu injektira vjetroelektrana, gubici radne snage mogu biti veći ili manji u odnosu na stanje bez priključene elektrane. Međutim, trenutačna vrijednost gubitaka radne snage nije bitna, već prvenstveno ukupni gubici radne energije na godišnjoj razini. Zbog toga je u radu razrađena metodologija proračuna godišnjih gubitaka radne energije u distribucijskoj mreži u uvjetima priključenog distribuiranog izvora, pri čemu se polazi od poznatih kronoloških krivulja opterećenja i proizvodnje. Odgovarajući proračuni su izvršeni na primjeru realne distribucijske mreže i vjetroelektrane koja se planira priključiti na nju. Connecting distributed generation to a distribution network affects the load flows in the network, resulting in the redistribution of load flows in the network and thereby changing the amount of active energy losses. At a given moment, depending upon the network consumption and the power injected from a wind power plant into the network, the active power losses can be higher or lower than they were before the wind power plant was connected. However, the aggregate annual energy losses, rather than instantaneous active power losses, are of significance. Therefore, a methodology has been developed for calculating the annual active energy losses in a distribution network in the case of a distributed generation connection, assuming the known chronological consumption and production curves. The corresponding calculations have been performed for an existing distribution network and a wind power plant scheduled to be connected to it.

Ključne riječi: distribuirani izvor, gubici radne energije, vjetroelektrana
Key words: Distributed generation, wind power plant, active energy losses



1 UVOD

U proteklih 10-tak godina svjedoci smo relativno velikog rasta udjela distribuiranih izvora električne energije, tj. elektrana priključenih na distribucijsku mrežu, što je primarno rezultat:

- otvaranja tržišta električne energije, praćenog odgovarajućom zakonskom regulativom za slobodan pristup distribucijskoj mreži, što omogućava privatnim (malim) investitorima ulaganje i izgradnju manjih elektrana,
- poticajnih cijena električne energije (najčešće u obliku fiksnih i garantiranih otkupnih cijena) koje se također odgovarajućom zakonskom regulativom redovito propisuju za obnovljive izvore energije i kogeneracijsku proizvodnju,
- tehnološkog napretka, odnosno razvoja efikasnijih i jeftinijih elektrana, posebice onih manjih nazivnih snaga za koje prije, bez prethodne dvije stavke, nije postojala dovoljna motivacija za razvoj.

U zadnjih nekoliko godina, posebno je intenzivan rast novih distribuiranih izvora ostvaren u vjetroelektranama. Razlog tome je bio prvenstveno ekonomske naravi, tj. najkraće vrijeme povrata investicije u odnosu na ostale obnovljive izvore, ali i ostali faktori, kao što su zanemariv utjecaj na okoliš, kratko vrijeme izgradnje (tipski proizvod), veliki potencijalni resursi energije vjetra itd. Iako takvo stanje vrijedi i danas, tendencije razvoja vjetroagregata idu prema većim jedinicama i većim vjetroelektranama koje se u tom slučaju priključuju na prijenosnu mrežu.

Priključak elektrane na distribucijsku mrežu [1] i [2], bez obzira na snagu elektrane i naponsku razinu, odnosno mjesto priključka, dovode do značajnih promjena pogonskih značajki distribucijske mreže, koje se mogu grupirati u stacionarne i dinamičke značajke. Promatrajući samo stacionarne značajke, valja istaknuti dva osnovna aspekta:

- naponske prilike duž radialnog kraka distribucijske mreže na koju je priključen jedan ili više distribuiranih izvora,
- utjecaj na gubitke snage i energije u distribucijskoj mreži.

Oba navedena aspekta mogu imati pozitivne i negativne utjecaje, ovisno o tipu i režimu rada distribuiranog izvora s jedne strane, te režimu opterećenja i tehničkim karakteristikama distribucijske mreže s druge strane. U ovom radu ukratko su opisane teoretske osnove utjecaja distribuiranih izvora na gubitke snage i energije u distribucijskoj mreži, te mogućnosti njihova izračuna. Pri tome je od primarnog značenja što točniji izračun promje-

1 INTRODUCTION

During the past decade, we have witnessed a relatively high increase in the share of distributed generation, i.e. power plants connected to a distribution network, primarily due to the following:

- electricity market liberalization, accompanied by the corresponding legislative framework for open access to the distribution network, which has made it possible for private (small) investors to invest in and build small power plants,
- incentive electricity prices, most commonly in the form of fixed and guaranteed feed-in tariffs, which are also regularly stipulated by the legislation governing renewable energy sources and cogeneration,
- technological achievements, i.e. the development of more efficient and less expensive power plants, especially those with lower nominal power, for which there had been little inducement prior to the above-mentioned market liberalization and price incentives.

Recently the growth of new distributed power sources from wind power plants has been particularly intensive. The reason for this is primarily of an economic nature, i.e. the shortest period of investment return among the other renewables as well other factors, such as negligible environmental impact, short construction time (standardized product), the great potential of wind energy resources etc. Although all this still applies today, the trend in wind turbine development is toward large units and wind power plants that are connected to a transmission network.

The connection of a power plant to a distribution network [1] and [2], irrespective of the rated power, voltage level and connection point of the power plant, results in significant changes in the operating features of the distribution network, which can be classified as either stationary or transient features. Regarding the stationary features, two basic aspects should be emphasized:

- the voltage profile along the distribution network radial feeder, to which one or more distributed sources are connected,
- the impact on power and energy losses in the distribution network.

Both of these aspects can have positive or negative repercussions, depending upon the type of distributed generation and operating conditions, on the one side, and the technical characteristics of the distribution network and load conditions, on the other side. In this work, the theoretical foundations of the basic impact of distributed generation upon power and energy losses in a distribution network

ne (povećanja/smanjenja) gubitaka radne energije na godišnjoj razini nakon priključka distribuiranog izvora na distribucijsku mrežu. Također, vrlo je značajno iznalaženje prave razine kompromisa između detaljnog točnog proračuna koji zahtijeva veliku količinu ulaznih parametara i aproksimativnih izračuna koji traže manji opseg ulaznih parametara uz brži i jednostavniji proračun, ali uz nešto veću grešku u proračunu.

Primjer takvog proračuna dan je za realnu distribucijsku mrežu i vjetroelektranu koja se planira priključiti na nju, na način da je napravljen detaljni i aproksimativni izračun.

2 GUBICI SNAGE I ENERGIJE U DISTRIBUCIJSKOJ MREŽI

2.1 Općenito o gubicima snage i energije u distribucijskoj mreži

Prema načinu nastanka, gubici električne snage i energije [3] dijele se na:

- tehničke gubitke koji su direktna su posljedica stavljanja postrojenja pod napon i protjecanja električne struje kroz elemente električne mreže. Veličina ovih gubitaka ovisi o tehničkim karakteristikama elemenata električne mreže. Tehnički gubici se mogu vrlo točno ustanoviti mjerenjem ili proračunom na odgovarajućem računalnom modelu, iako obje metode mogu biti vrlo zahtjevne. Mjerenje zahtijeva instaliranje mjernih uređaja koje se uobičajeno ne koriste, tako da implicira dodatne troškove. Mjerenjem se ne mogu ustanoviti gubici radne energije u fazi planiranja priključka distribuiranog izvora, dok je nakon priključka to moguće, ali samo uz dodatne računske tehnike kojima je moguće sa zadovoljavajućom razinom točnosti ustanoviti promjenu u odnosu na stanje bez distribuiranog izvora. Međutim, općenito mjerenjem nije moguće ustanoviti tehničke gubitke u mreži, prvenstveno zbog utjecaja komercijalnih gubitaka,
- komercijalne (netehničke) gubitke koji nastaju zbog neispravnosti mjernih uređaja i neovlaštene potrošnje električne energije. Redovito ih nije moguće direktno prepoznati i alocirati, već samo izračunati kao razliku ukupno registriranih gubitaka (razlika obračunate električne energije na mjestima preuzimanja i isporuke električne energije) i izračunatih tehničkih gubitaka pomoću računalnog modela.

Tehnički gubici, s obzirom na način nastanka mogu se podijeliti na [4]:

are briefly described, as well as possibilities for their calculation. Following the connection of a distributed power plant to a distribution network, it is of primary importance to calculate the changes (increases/decreases) in energy losses on the annual level as precisely as possible. Furthermore, it is very important to find the right level of compromise between detailed and precise calculation, requiring a large number of input parameters, and approximate calculation, requiring fewer input parameters and facilitating faster and simpler calculation but with a somewhat higher margin of error.

An example is provided for an existing distribution network and wind power plant scheduled to be connected to it, for which both detailed and approximate calculations have been performed.

2 POWER AND ENERGY LOSSES IN DISTRIBUTION NETWORKS

2.1 Power and energy losses in distribution networks

Power and energy losses are classified according to the manner in which they occur [3], as follows:

- technical losses are a direct consequence of energizing electrical facilities and current flows through the electrical network elements. The majority of these losses depend upon the technical characteristics of the network elements. Technical losses can be determined very precisely by measurement or calculation using a suitable computer model, although both methods can be highly demanding. Measurement requires the installation of measuring equipment, which is generally not used and therefore implies additional costs. Measurement cannot determine active energy losses during the preparatory phase of a distributed generation connection. Measurement can be used after connection but a satisfactory level of accuracy in determining change in comparison to the situation without the distributed source requires the use of additional calculation techniques. However, it is generally not possible to determine technical losses in a network through measurement, primarily due to the influence of commercial losses,
- commercial (non-technical) losses occur due to the malfunctioning of the measuring equipment and illegal electricity consumption. They cannot be recognized and allocated by regular means but only as the difference between the total registered losses (the difference between the accounted energy at delivery points and the energy delivered to final customers) and the

- naponski ovisni gubici (tzv. gubici neovisni o opterećenju) nastaju na poprečnim elementima ekvivalentne sheme promatranog elementa električne mreže. Tipičan i najznačajniji primjer su gubici praznog hoda transformatora koji su u ekvivalentnoj shemi predloženi u poprečnom granom. Općeniti izraz za naponski ovisne gubitke snage dan je izrazom:

$$\Delta S^{\text{pop}} = \Delta P^{\text{pop}} + j\Delta Q^{\text{pop}} = 3 \cdot |V|^2 \cdot Y^*, \quad (1)$$

gdje je:

- ΔS^{pop} – gubici prividne snage u poprečnoj grani elementa mreže,
- ΔP^{pop} – gubici radne snage u poprečnoj grani elementa mreže,
- ΔQ^{pop} – gubici jalove snage u poprečnoj grani elementa mreže,
- V – fazni napon elementa mreže,
- Y – poprečna admittancija elementa mreže.

Ukupni naponski ovisni gubici snage u promatranom dijelu distribucijske mreže dani su sumiranjem izraza (1) po svim čvorovima mreže (N):

$$\Delta S_{\text{UK}}^{\text{pop}} = \Delta P_{\text{UK}}^{\text{pop}} + j\Delta Q_{\text{UK}}^{\text{pop}} = 3 \cdot \sum_{i=1}^N |V_i|^2 \cdot Y_i^*. \quad (2)$$

- Strujno ovisni gubici (tzv. gubici ovisni o opterećenju) nastaju na uzdužnim elementima ekvivalentne sheme promatranog elementa mreže. Tipični i najznačajniji primjeri su gubici u vodičima zračnih, odnosno kabelskih vodova i namotima transformatora. U ekvivalentnoj shemi predloženi su uzdužnom granom elementa mreže. Općeniti izraz za strujno ovisne gubitke snage dan je izrazom:

$$\Delta S^{\text{uzd}} = \Delta P^{\text{uzd}} + j\Delta Q^{\text{uzd}} = 3 \cdot |I|^2 \cdot Z, \quad (3)$$

technical losses calculated using a computer model.

Technical losses are classified according to the manner in which they occur [4], as follows:

- voltage-dependent losses (so-called load-independent losses) occur in parallel elements of the network under consideration. The typical and most significant examples are transformer iron losses, shown by a cross branch in equivalent schemes. The general expression for voltage-dependent losses is as follows:

where:

- ΔS^{pop} – apparent power losses in a parallel network element branch,
- ΔP^{pop} – active and reactive power losses in a parallel network element branch,
- ΔQ^{pop} – reactive power losses in a parallel network element branch,
- V – phase voltage of the network elements,
- Y – parallel admittance of the network elements.

The total voltage-dependent power losses in the part of the distribution network under consideration is obtained as the sum of expression (1) for all the network nodes (N):

gdje je:

- ΔS^{uzd} – gubici prividne snage u uzdužnoj grani elementa mreže,
- ΔP^{uzd} – gubici radne snage u uzdužnoj grani elementa mreže,
- ΔQ^{uzd} – gubici jalove snage u uzdužnoj grani elementa mreže,
- I – struja koja protječe kroz element mreže,
- Z – uzdužna impedancija elementa mreže.

Ukupni strujno ovisni gubici snage u promatranom dijelu distribucijske mreže dani su sumiranjem izraza (3) po svim granama mreže (M):

$$\Delta S_{\text{UK}}^{\text{uzd}} = \Delta P_{\text{UK}}^{\text{uzd}} + j\Delta Q_{\text{UK}}^{\text{uzd}} = 3 \cdot \sum_{i=1}^M |I_i|^2 \cdot Z_i \quad (4)$$

U razmatranju utjecaja distribuiranog izvora na gubitke snage u distribucijskoj mreži, poprečni gubici se mogu zanemariti, bez obzira što se naponske prilike u mreži ipak mijenjaju. Naime, naponi u mreži u realnom slučaju trebali bi biti u granicama $\pm 5\%$, što prema (1) znači moguće varijacije naponski ovisnih gubitaka u granicama $\pm 10\%$. To je daleko manje od mogućih varijacija gubitaka ovisnih o strujnom opterećenju mreže koje može varirati u rasponu 0 do 100%. Zbog toga se dalje u tekstu promatraju samo strujno ovisni gubici, pa je iz oznaka izostavljen indeks ^{uzd} koji je označavao komponentu uzdužnih gubitaka, što se dalje podrazumijeva.

Izrazi (3) i (4) mogu se izraziti i preko snage koja prolazi kroz element mreže, tj.:

where:

- ΔS^{uzd} – apparent power losses in a series branch of the network element,
- ΔP^{uzd} – active power losses in a series branch of the network element,
- ΔQ^{uzd} – reactive power losses in a series branch of the network element,
- I – network element current,
- Z – network element series impedance.

The total current-dependent power losses in the part of the distribution network under consideration is obtained as the sum of expression (3) for all the network branches (M):

Considering the impact of the distributed source on the power losses in the distribution network, voltage-dependent losses can be ignored, although the voltage conditions in the network nonetheless change. Voltages in the existing situation should be within the limits of $\pm 5\%$, which according to (1) signify possible voltage-dependent power loss variation within the limits of $\pm 10\%$. This is far less than the possible variations in loss, depending upon the network current loads that can vary within a range of 0 to 100%. Therefore, only the current-dependent losses will be considered henceforth. The superscript ^{uzd}, which indicates the parallel power loss component, will not be written in the expressions but should be assumed.

The expressions (3) and (4) can also be expressed as power through the network element, i.e.:

$$\Delta S = \Delta P + j\Delta Q = 3 \cdot \left| \frac{S^*}{\sqrt{3}U^*} \right|^2 \cdot Z = \frac{Z}{U^2} (P^2 + Q^2) = \frac{R}{U^2} (P^2 + Q^2) + j\frac{X}{U^2} (P^2 + Q^2), \quad (5)$$

$$\Delta S_{\text{UK}} = \Delta P_{\text{UK}} + j\Delta Q_{\text{UK}} = \sum_{i=1}^M \left(\frac{Z_i}{U_i^2} \cdot (P_i^2 + Q_i^2) \right) = \sum_{i=1}^M \left(\frac{R_i}{U_i^2} \cdot (P_i^2 + Q_i^2) \right) + j\sum_{i=1}^M \left(\frac{X_i}{U_i^2} \cdot (P_i^2 + Q_i^2) \right), \quad (6)$$

gdje je:

- P – radna snaga koja protječe kroz element mreže,
- Q – jalova snaga koja protječe kroz element mreže,
- R – radni otpor elementa mreže,
- X – induktivni otpor elementa mreže,
- U – linijski napon elementa mreže.

where:

- P – active power through the network element,
- Q – reactive power through the network element,
- R – the resistance of the network element,
- X – the reactance of the network element,
- U – the phase-to-phase voltage of the network element.

Tokovi radnih i jalovih snaga kroz elemente elektroenergetske mreže, te naponi svih čvorova, dobiju se standardnim proračunom tokova snaga i naponskih prilika, pod pretpostavkom da su poznati tehnički parametri mreže, topologija i uklopno stanje, te opterećenje mreže u svakom čvoru. Redovito se u programima za proračun tokova snaga implementira i proračun za automatsko izračunavanje gubitaka radne i jalove snage za svaki element mreže, te eventualno zbirno po naponskim nivoima, istovrsnim elementima mreže, distribucijskim (napojnim) područjima, izvodima itd. [5] i [6]. Zbog toga je proračun gubitaka snage u distribucijskoj mreži zapravo trivijalan zadatak, kojeg je za manju distribucijsku mrežu moguće izvesti čak i ručno. Međutim, poznavanje – izračun gubitaka snage u distribucijskoj mreži za promatrano opterećenje, općenito nije dovoljan pokazatelj, bez obzira što se može izvesti primjerice za dva krajnja karakteristična stanja maksimalnog i minimalnog opterećenja. Pravi značajni pokazatelj su gubici energije u određenom vremenskom razdoblju, primjerice u jednoj kalendarskoj godini.

Točan izračun gubitaka električne energije znatno usložnjava proračun i to najmanje iz dva (međusobno povezana) razloga:

- potrebno je poznavati karakteristiku potrošnje u svim čvorovima promatrane distribucijske mreže, tj. kronološke krivulje opterećenja linearno diskretizirane na veće ili manje vremenske podintervale (primjerice sate) ili odgovarajuće krivulje trajanja opterećenja. Prva aproksimacija, bez većih utjecaja na grešku proračuna, može se napraviti i korištenjem navedenih krivulja promatrane distribucijske mreže u cjelini, uz odgovarajuću raspodjelu potrošnje po čvorovima koja odgovara potrošnji u trenutku vršnog opterećenja ili u trenutku za koje raspolažemo izmjerenim podacima opterećenja svih čvorišta,
- s obzirom na promjenljivost potrošnje, proračun tokova snaga potrebno je napraviti za svaki promatrani vremenski podinterval ili eventualno reducirati potreban broj proračuna na način da se koristi krivulja trajanja opterećenja i njena linearizacija na veće podsegmente (u odnosu na bazni vremenski podinterval), pri čemu je onda za očekivati određenu pogrešku u rezultatu zbog takve aproksimacije.

Dakle, ukupni gubici energije u promatranom vremenskom razdoblju T mogu se dobiti iz izraza (6), sumiranjem gubitaka energije po svim vremenskim podintervalima unutar ukupno promatranog razdoblja, pod pretpostavkom konstantnog opterećenja u svakom podintervalu i istog trajanja svakog podintervala (Δt):

The flows of active and reactive power through the power network elements and all the node voltages are obtained using the standard calculations of the load flow and voltage drop, assuming that the technical parameters of the network, topology, network configuration and network loads in each node are known. In power flow software, automatic active and reactive calculations of power losses are regularly performed for each network element, and eventually totaled according to voltage levels, the same types of network elements, distribution areas, feeders etc. [5] and [6]. Therefore, the calculation of the power losses in a distribution network is actually a trivial task, which can even be performed manually for a small distribution network. However, the power loss in a distribution network for a particular load is generally not a sufficient indicator, although calculation can be performed, e.g. for two characteristic states of maximum and minimum loads. The truly significant indices are energy losses during a specific time period, e.g., during one calendar year.

The precise calculation of electrical energy losses significantly complicates analysis, for at least two related reasons:

- it is necessary to know the load characteristics for all the nodes of the distribution network considered, i.e. the chronological load curves linearly discretized into larger or smaller time subintervals (e.g., hours) or corresponding load duration curves. The first approximation, without a major impact on the calculation error, can be performed by using the aforementioned curves of the considered distribution network in its entirety, with the corresponding load allocation on the nodes, which corresponds to consumption at the moment of peak load or at the moment for which we have measured load data available for all the nodes,
- due to load variability, load flow calculation should be performed for each time subinterval considered or eventually the required number of calculations should be reduced in such a manner that the load duration curve and its linearization are used on large subsegments (in relation to the basic time subinterval), although a certain degree of error should be expected in the result due to such approximations.

Therefore, total energy losses during the time period T under consideration can be obtained using expression (6), by totaling the energy losses according to all the time subintervals within the total period under consideration, assuming a constant load at each subinterval and the same duration of each subinterval (Δt):

$$\Delta W_{\text{UK}} = \Delta W_{\text{UK}}^r + j\Delta W_{\text{UK}}^j = \Delta t \cdot \sum_{i=1}^M Z_i \sum_{t=1}^T \left(\frac{P_i^2(t) + Q_i^2(t)}{U_i^2(t)} \right). \quad (7)$$

U gornjem izrazu, napon se može pretpostaviti jednak nazivnom naponu bez većeg utjecaja na točnost izračuna. U slučaju proračuna gubitaka energije pomoću programa za tokove snaga, nema potrebe za takvom aproksimacijom. Ako se proračun radi temeljem aproksimirane krivulje trajanja opterećenja, vremenski podintervali Δt općenito ne moraju biti jednaki, tako da je u izrazu (7) faktor Δt potrebno uvesti u sumu.

2.2 Utjecaj priključka distribuiranog izvora na gubitke snage i energije u distribucijskoj mreži

U tzv. pasivnoj distribucijskoj mreži radne i jalove snage u granama $P_i(t)$, $Q_i(t)$ rezultat su isključivo potrošnje, odnosno potrošača priključenih iza (u odnosu na pojnu točku) promatrane grane mreže, te gubitaka snage u granama (koji su obično reda veličine do nekoliko postotaka). Zbog toga se na radijalnom izvodu distribucijske mreže (npr. izvodu 10 kV ili 20 kV) snage u granama smanjuju kako se kreće od pojne točke prema kraju izvoda, pa se i gubici koncentriraju na početnim granama, te opadaju prema kraju izvoda. Na slici 1 je prikazan primjer 10(20) kV-nog izvoda napajanog iz TS x/10(20) kV sa 5 čvorova (mjesto priključka TS x/0,4 kV) i 5 grana (vodova). Grafikonom su prikazani tokovi radnih i jalovih snaga duž izvoda, tj. po svim granama. Potrošnja radne i jalove snage u i -tom čvorištu označena je sa P_{p-i} , odnosno Q_{p-i} .

Ako se npr. u čvoru 4 priključi elektrana, ona će u trenutku t proizvoditi radnu snagu $P_G(t)$ i jalovu snagu $Q_G(t)$, pa se takva mreža, odnosno dio mreže od pojne točke do čvora s priključenom elektranom, naziva aktivna distribucijska mreža. U slučaju da nema potrošnje na izvodu, radna i jalova snaga koju proizvede elektrana ima tijekom prema pojnoj točki i to u jednakom iznosu preko svih grana 1 do 4 (također zanemareni gubici). Superpozicijom tokova snaga u granama koje su rezultat potrošnje i tokova snaga koje su rezultat proizvodnje elektrane, dobije se situacija prikazana na slici 2. Odabran je slučaj kad je radna snaga elektrane upravo jednaka potrošnji na izvodu, dok je jalova snaga elektrane jednaka nuli, budući da je najčešći slučaj da distribuirani izvori rade s faktorom snage $\cos \varphi = 1$. Međutim, u nekim slučajevima radi se o asinkronim generatorima bez kompenzacije jalove snage, tako da elektrana u tom slučaju predstavlja dodatnog potrošača jalove snage, povećavajući na taj način opterećenje grana jalovom snagom.

In the above expression, the voltage can be assumed to be equal to the rated voltage, without major impact upon the precision of the calculation. In the calculation of energy losses using load flow software, there is no need for such approximation. If the calculation is based upon the approximated load duration curve, the time subintervals Δt generally do not have to be equal, so that in expression (7), factor Δt must be entered into the sum.

2.2 The impact of the connection of a distributed source on power and energy losses in a distribution network

In a so-called passive distribution network, the active and reactive power in branches $P_i(t)$ and $Q_i(t)$ are exclusively the result of the loads connected behind the feeder supply point of the network branch considered, and the power losses in the branches (which are usually of an order of magnitude of up to several percentage points). Therefore, on the radial distribution feeder, e.g., a 10 kV or 20 kV feeder, the power in the branches decreases as we move away from the feeder supply point toward the feeder end, so that the losses are concentrated at the beginning branches and decrease toward the end of the feeder. Figure 1 presents an example of a 10(20) kV feeder supplied from an x/10(20) kV substation with 5 nodes (the connection points of the x/10(20) kV substation) and 5 branches (lines). The graphs present the active and reactive power flows along the feeder, i.e. along all the branches. The active and reactive consumption in the i^{th} node is indicated by P_{p-i} or Q_{p-i} .

If, for example, a power plant is connected to Node 4, it will generate active power $P_G(t)$ and reactive power $Q_G(t)$ at the moment of time t . Such a network, i.e. the part of the network from the feeder supply point to the node with the power plant connection, is called the active distribution network. In the event that there are no loads on the feeder, the active and reactive power generated by the power plant will flow toward the feeder supply point in equal amounts along all the branches 1 to 4 (also with negligible losses). By superposition of the branch power flows resulting from consumption and the power flows resulting from power plant generation, the situation presented in Figure 2 is obtained. A case has been selected in which the active power of the power plant is equal to the loads on the feeder, while the reactive power of the power plant is equal to zero, since the distributed sources usually operate with a power factor of $\cos \varphi = 1$.

However, some cases involve induction generators lacking reactive power compensation, so that a power plant represents an additional reactive power load, thereby increasing the reactive power load of the branches.

Slika 1
Tokovi snaga u granama pasivne distribucijske mreže
Figure 1
Power flows in a passive distribution network

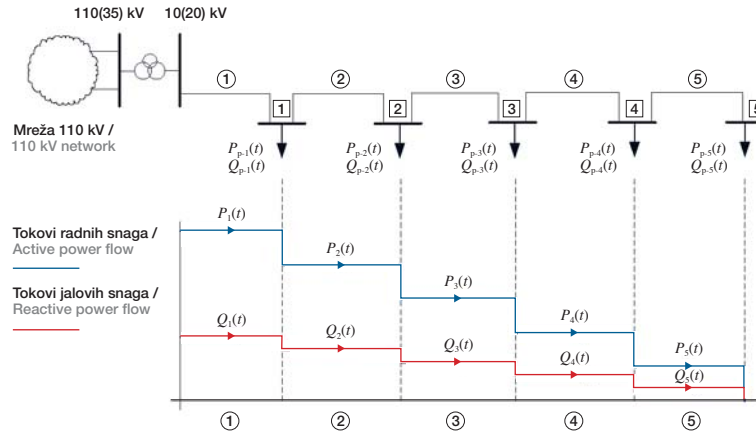

Slika 2
Tokovi snaga u granama aktivne distribucijske mreže
Figure 2
Power flows in an active distribution network

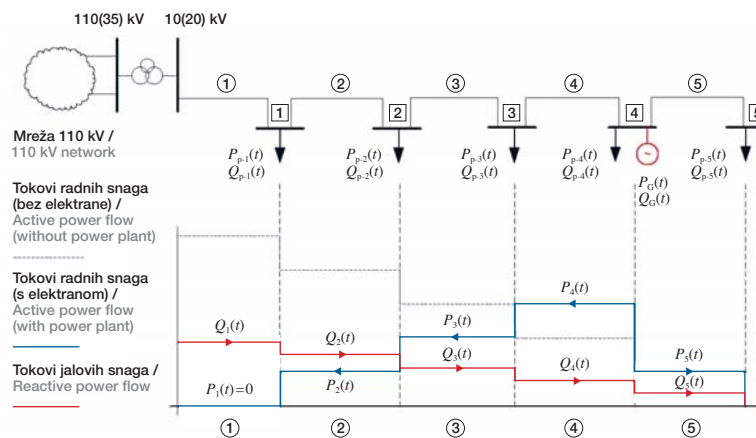

Prikazani primjer ilustrira tipičnu situaciju u aktivnoj distribucijskoj mreži, u kojoj se mijenja iznos i smjer tokova radnih snaga u svim granama od pojne točke do mjesta priključka elektrane u mreži. Sa stanovišta gubitaka radne snage, elektrana u ovakvom slučaju ima pozitivan učinak, budući da u cjelini smanjuje tokove radnih snaga u mreži, pa tako i gubitke radne snage. Međutim, u slučaju da je proizvodnja radne snage elektrane znatno veća od ukupne potrošnje radne snage na izvodu, dobit će se obrnuti efekt, tj. povećanje ukupnih tokova radne snage po granama, tako da će ukupni gubici radne snage biti veći.

Doprinos rada priključene elektrane na smanjenje/povećanje gubitaka radne snage na promatranom

The example shown illustrates a typical situation in an active distribution network, in which the amount and direction of the active power flows change in all the branches from the feeder supply point to the point at which the power plant is connected to the network. From the standpoint of active power losses, in such a case the power plant has a positive impact, since it decreases the active power flows in the network as a whole, and thereby also the active power losses. However, in the event that the generation of active power by the power plant is significantly greater than the total active power load at the feeder, the opposite effect occurs, i.e. the increase of the total active power flows of the branches, so that the total active power losses will be greater.

izvodu distribucijske mreže za promatrani trenutak lako se izračunava na način da se gubici izračunaju u obje varijante (bez elektrane i sa elektranom). Međutim, za izračun gubitaka radne energije u dužem vremenskom razdoblju, takav proračun je potrebno ponoviti za sve kombinacije potrošnje na izvodu i proizvodnje elektrane, budući da su potrošnja i proizvodnja promjenljive u vremenu i u načelu ne postoji nikakva međusobna ovisnost (korelacija). Dakle, prilikom računanja gubitaka radne energije bitno je uvažiti kronološku podudaranost potrošnje s proizvodnjom distribuiranog izvora [7] i [8], pri čemu smanjenju gubitaka pridonosi njihova vremenska podudaranost (maksimalno opterećenje – maksimalna proizvodnja, minimalno opterećenje – minimalna proizvodnja).

3 PRORAČUN GUBITAKA RADNE SNAGE U DISTRIBUCIJSKOJ MREŽI S PRIKLJUČENOM VJETROELEKTRANOM

3.1 Ulazni parametri

Primjer proračuna utjecaja priključka elektrane na gubitke radne snage u distribucijskoj mreži izrađen je na realnoj mreži 30 kV, tj. zračnom vodu TS Bilice – Primošten – Rogoznica. Na taj vod se planira, kao jedna od opcija, priključak vjetroelektrane Orlice snage 11 x 900 kW (9,9 MW), koji bi se izveo kabelom presjeka 3x185 mm² Al od lokacije vjetroelektrane do priključnog mjesta na jednom stupu navedenog nadzemnog voda 30 kV koji se koristi se za napajanje TS 30/10 kV Primošten i TS 30/10 kV Rogoznica.

Jednopolna shema promatrane distribucijske mreže i VE Orlice prikazana je na slici 3. Plavom bojom prikazana je transformacija 110/30 kV u TS 220/110/30 kV Bilice odakle se napaja DV 30 kV Bilice – Primošten – Rogoznica koji je prikazan zelenom bojom. Crvenom bojom prikazana je interna kabelska mreža 30 kV VE Orlice zajedno s priključnim kabelom. Topologija interne kabelske mreže VE Orlice rezultat je posebne analize kojom su definirane trase, presjeci i način povezivanja vjetrogeneratora s obzirom na pozicije vjetrogeneratora i pristupne ceste. Oznake vjetrogeneratora VE I-x i VE II-x odnose se na prvu fazu (6 VG) i drugu fazu (5 VG) izgradnje VE Orlice, uz izostavljene vjetrogeneratore druge faze VE II-3 i VE II-4.

The contribution of the operation of the connected power plant to the decrease/increase in the active power losses at a distribution network feeder at a given moment can be easily determined by calculating the losses for both variants, with and without the power plant. However, for the calculation of the active power losses over a longer period of time, it is necessary to repeat such calculations for all the combinations of feeder loads and power plant generation, since consumption and generation are variable in time and in principle are not correlated. Therefore, when calculating active energy losses, it is essential to take the chronological correlation of consumption and generation into account [7] and [8]. Losses are decreased when consumption and generation are synchronous (maximum load – maximum generation, minimum load – minimum generation).

3 CALCULATION OF ACTIVE POWER LOSS IN A DISTRIBUTION NETWORK WITH A CONNECTED WIND POWER PLANT

3.1 Input parameters

An example of the calculation of the impact of power plant generation on the active power losses in a distribution network has been performed for an existing 30 kV network, i.e. the overhead line supplying the Primošten and Rogoznica 30/10 kV substations from the Bilice 110/30 kV substation. Among the options is the connection of the Orlice Wind Power Plant (WPP) with a rated power of 11 x 900 kW (9,9 MW) using a 3x185 mm² aluminum cable from the wind power plant site to the connection point at one of the poles of the 30 kV overhead line used to supply the Primošten and Rogoznica substations.

A single-line diagram of this distribution network at the Orlice WPP is presented in Figure 3. Transformation of 110/30 kV is shown in blue at the Bilice 220/110/30 kV substation, which supplies the Bilice – Primošten – Rogoznica 30 kV line, shown in green. The 30 kV internal cable network of the Orlice WPP together with the connection cable is shown in red. The internal cable network topology of the Orlice WPP is the result of a separate analysis according to which the routes, cross-sections and wind turbine interconnection method are defined, regarding the positions of the wind turbines and access roads. The designations VE I-x and VE II-x of the wind turbines refer to the first phase (6 wind turbines) and the second phase (5 wind turbines) of the construction of the Orlice Wind Power Plant,

Mjesto priključka je oko 15 km od početka voda. Tehnički parametri srednjonaponske (SN) mreže i interne kabelaške mreže vjetroelektrane dani su u tablicama 1 i 2.

omitting the VE II-3 and VE II-4 wind turbines of the third phase.

The connection point is approximately 15 km from the beginning of the overhead line – feeder. The technical parameters of the medium-voltage network and internal cable network of the wind power plant are presented in Tables 1 and 2.

Slika 3
Jednopolna shema distribucijske mreže 30 kV Bilice-Primošten-Rogoznica i VE Orlice
Figure 3
Single-line diagram of the Bilice-Primošten-Rogoznica 30 kV network and the Orlice WPP

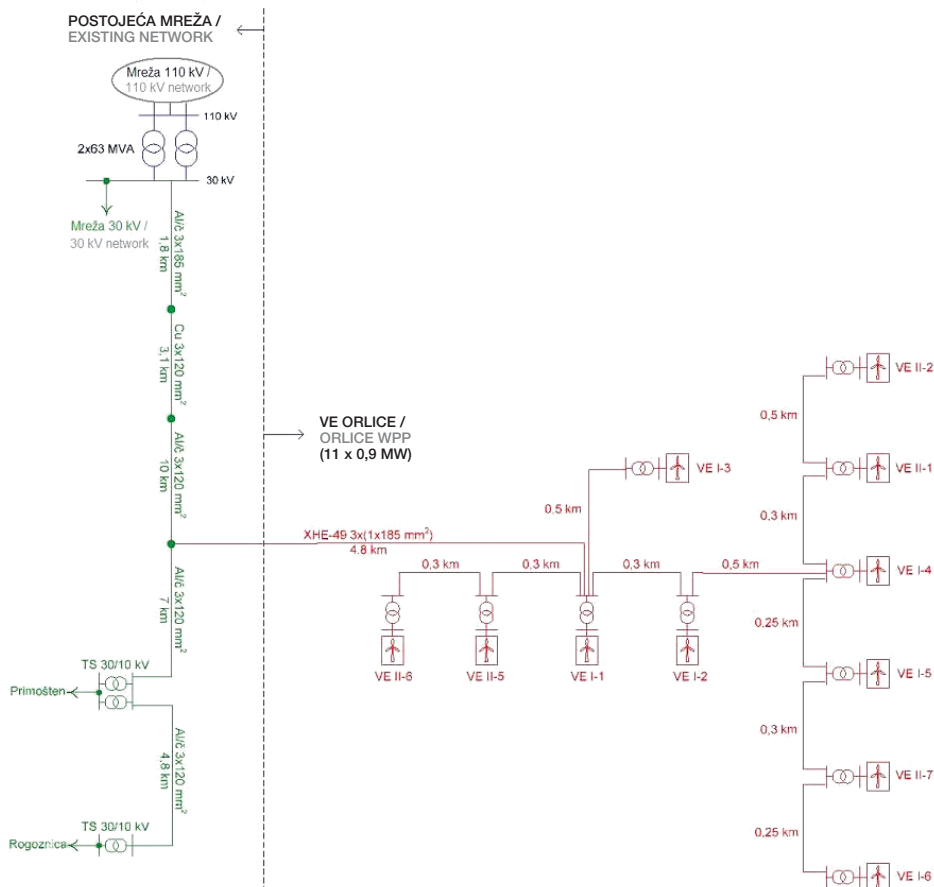

Tablica 1 – Parametri vodova
Table 1 – Power line data

Tip voda / Line type	I_{\max} (A)	R_d / R_0 (Ω/km)	X_d / X_0 (Ω/km)	B_d / B_0 ($\mu\text{S}/\text{km}$)
Al/Č 3x185	535	0,157 / 0,471	0,38 / 1,14	3,25 / 3,25
Al/Č 3x120	345	0,253 / 0,403	0,35 / 1,47	3,3 / 1,98
Cu 3x120	440	0,155 / 0,465	0,38 / 1,14	3,08 / 3,08
XHE 49 3x185	361	0,164/1,07	0,11/0,36	88/88

Tablica 2 – Parametri transformatora
Table 2 – Transformer data

Transformator / Transformer	Komada / Number	$U_{n1}/U_{n2}/U_{n3}$ (kV)	$S_{n1}/S_{n2}/S_{n3}$ (MVA)	$P_{kSP-S}/P_{kSP-T}/P_{kS-T}$ (KW)	$u_{kP-S}/u_{kP-T}/u_{kS-T}$ (%)	P_0 (kW)	I_0 (%)	Grupa spoja / Connection
Bilice	2	110 / 30 / 10	63 / 63 / 21	310 / 80 / 67	11 / 12 / 7,7	52,5	0,5	YynOd11
Primošten	2	30 / 10	8	54	7	9,4	4	Yd5
Rogoznica	1	30 / 10	8	54	7	9,4	4	Yd5
VE Orlice	11	0.4 / 30	1	10	6	1,1	2	Yd5

Vršna snaga TS 30/10 kV Primošten iznosi 6 + j 2 MVA, a TS 30/10 kV Rogoznica 2,5 + j 0,8 MVA, tako da je ukupno neistodobno vršno opterećenje izvoda 8,5 + j 2,8 MVA, a faktor istodobnosti je blizu 1, budući da se radi o ljetnom vršnom opterećenju konzuma praktički istih karakteristika. U odnosu na maksimalnu planiranu snagu VE Orlice, vršno radno opterećenje je oko 15 % manje. Budući da se radi o ljetnom vršnom opterećenju u kojem se vrlo rijetko može očekivati maksimalni angažman VE Orlice, za očekivati je relativno česte situacije:

- maksimalne distribucijske potrošnje i minimalne proizvodnje VE Orlice (ljeti),
- minimalne distribucijske potrošnje i maksimalne proizvodnje VE Orlice (proljeće, jesen).

Svi proračuni gubitaka radne snage i energije u distribucijskoj mreži ograničeni su na DV 30 kV Bilice – Primošten – Rogoznica i transformatore 30/10 kV Primošten i Rogoznica, dakle bez transformacije 110/30 kV i prijenosne mreže.

3.2 Rezultati proračuna

Proračun gubitaka radne snage u prethodno opisanoj mreži 30 kV napravljen je uz pretpostavku priključene VE Orlice, pri čemu je pretpostavljen režim potpune kompenzacije jalove snage, tj. svaki vjetroagregat radi s faktorom snage $\cos \varphi = 1$. Proračuni su napravljeni na modelu u programskom paketu PowerCAD za različite kombinacije potrošnje u mreži i proizvodnje VE Orlice.

Tablica 3 prikazuje izračunate gubitke radne snage u ovisnosti o opterećenju (potrošnja TS Primošten i TS Rogoznica), što je osnovna referenca za daljnje proračune gubitaka radne snage i energije.

The peak power of the Primošten 30/10 kV substation amounts to 6 + j 2 MVA, and that of the Rogoznica 30/10 kV substation is 2,5 + j 0,8 MVA, so that the total non-simultaneous feeder peak load is 8,5 + j 2,8 MVA, and the coincidence load factor is close to 1, since this is a case of a summer peak load of two substations supplying similar loads. In relation to the maximum planned power rating of the Orlice WPP, the active power peak load is approximately 15 % lower. Since this is a case of a summer peak load in which the maximum generation of the Orlice WPP will occur very rarely, the following situations can be expected to occur relatively often:

- maximum distribution consumption and minimum generation of the Orlice WPP (summer),
- minimum distribution consumption and maximum generation of the Orlice WPP (spring and autumn).

All the calculations of the active power and energy losses in the distribution network are limited to the Bilice – Primošten – Rogoznica 30 kV overhead line and the Primošten and Rogoznica 30/10 kV transformers, i.e. without 110/30 kV transformation and the transmission network.

3.2 Calculation results

Calculations of active power losses in the previously described 30kV network have been performed under the assumption that the Orlice WPP is connected, and it was also assumed that the reactive power was fully compensated, i.e. each wind generator operates at a power factor of $\cos \varphi = 1$. The calculations were performed on a model using PowerCAD software for various load combinations in the network and generation of the Orlice WPP.

Table 3 presents the calculated load-dependent active power losses (consumption of the Primošten and Rogoznica substations), which is the basic reference for the further calculation of the reactive power and energy losses.

Tablica 3 – Gubici snage u mreži 30 kV bez VE Orlice
Table 3 – Power losses in the 30 kV network without the Orlice WPP

Potrošnja / Load (%)	30	40	50	60	70	80	90	100
Gubici snage / Active power loss (kW)	87	127	176	240	318	412	524	656

U tablici 4, prikazani su rezultati proračuna gubitaka radne snage u mreži 30 kV na način da je varirana proizvodnja VE Orlice od 10 % P_n do P_n , te potrošnja od 30 % P_{peak} do P_{peak} . Gubici radne snage računati su za svaku kombinaciju potrošnje i proizvodnje, tako da su rezultati prikazani u matricnom obliku. Prvi redak približno odgovara stanju bez VE Orlice (proizvodnja VE Orlice = 0), ali su gubici radne snage neznatno manji u odnosu na vrijednosti iz tablice 3, budući da kabela mreža 30 kV VE Orlice u praznom hodu proizvodi jalovu snagu i injektira je u zračni vod 30 kV, smanjujući na taj način tokove jalovih snaga.

In Table 4, the results of the calculation of the active power losses in the 30 kV network are presented in such a manner that the Orlice WPP generation varied from 10 % P_n to P_n , and the load from 30 % P_{peak} to P_{peak} . Active power losses were calculated for each combination of load and generation and the results were presented in matrix form. The first row approximately corresponds to the situation without the Orlice WPP (Orlice WPP generation = 0). The active power losses are insignificantly lower than the values from Table 3, since the unloaded 30 kV cable network of the Orlice WPP generates reactive power and injects it into the 30 kV overhead line, thereby reducing the reactive power flows.

Tablica 4 – Gubici radne snage u mreži 30 kV ovisno o angažiranju VE Orlice (kW)
Table 4 – Active power losses in the 30 kV network in relation to generation of the Orlice WPP

		Potrošnja / Load (%)							
		30 %	40 %	50 %	60 %	70 %	80 %	90 %	100 %
Snaga VE Orlice / Orlice WPP power (MW)	0	82	121	169	231	308	400	510	640
	0,99	67	99	140	195	264	348	449	568
	1,98	59	84	119	167	229	304	397	507
	2,97	58	77	106	147	201	270	353	455
	3,96	65	77	100	135	182	243	319	412
	4,95	78	85	101	130	170	224	293	378
	5,94	97	99	109	131	166	213	274	352
	6,93	124	120	124	140	168	209	264	334
	7,92	156	147	145	156	178	213	261	324
	8,91	195	181	172	178	195	223	265	322
	9,90	240	221	206	206	218	241	277	327

Rezultati iz tablice 4 prikazani su grafički na slikama 4, 5 i 6. Na slici 4 prikazana je krivulja gubitaka radne snage u mreži 30 kV ovisno o opterećenju mreže i proizvodnji VE Orlice. Tamno plava linija prikazuje gubitke radne snage kad VE Orlice nije priključena na distribucijsku mrežu. Područje osjenčano svjetlo plavom bojom prikazuje granicu u kojoj se kreću gubici radne snage u mreži 30 kV u slučaju da je priključena VE Orlice, a raspon se odnosi na angažiranje VE Orlice 0 do P_n .

The results from Table 4 are presented graphically in Figures 4, 5 and 6. Figure 4 presents the active power loss curve in the 30 kV network as a function of the network load and generation of the Orlice WPP. The dark blue line shows the active power losses when the Orlice WPP is not connected to the distribution network. The light blue shaded area shows the range of the active power losses in the 30 kV network when the Orlice WPP is connected, as a function of its generation, 0 to P_n .

Na slikama 5 i 6 prikazane su apsolutne, odnosno postotne promjene ukupnih gubitaka snage na DV Bilice – Primošten – Rogoznica, ovisno o opterećenju mreže i veličini angažiranja VE Orlice. Kao referenca za promjenu gubitaka uzeti su podaci iz tablice 3, tj. gubici bez VE Orlice, prema postojećem stanju mreže.

Iz slika 4 do 6 jasno se uočava uglavnom pozitivan utjecaj priključka VE Orlice u smislu smanjenja gubitaka radne snage u distribucijskoj mreži na koju se priključuje. Priključak VE Orlice povećava gubitke radne snage jedino u kombinacijama niske potrošnje i visoke proizvodnje.

Figures 5 and 6 present the absolute or percentage changes in the total power losses on the Bilice – Primošten – Rogoznica overhead line, as a function of network load and generation of the Orlice WPP. Data from Table 3, i.e. energy losses prior to the connection of the Orlice WPP, were used as reference values indicating the existing status of the network.

From Figures 4 to 6, the generally positive impact of the connection of the Orlice WPP is evident in reducing active power losses in the distribution network to which it is connected. Connection of the Orlice WPP only increases active power losses in combinations of low loads and high generation.

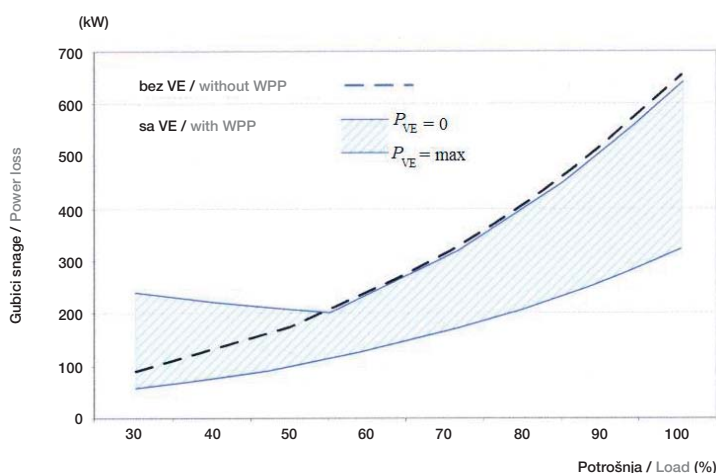

Slika 4
 Raspon gubitaka radne snage u mreži 30 kV u slučaju priključka VE Orlice
 Figure 4
 Active power losses in the 30 kV network with the Orlice WPP connected

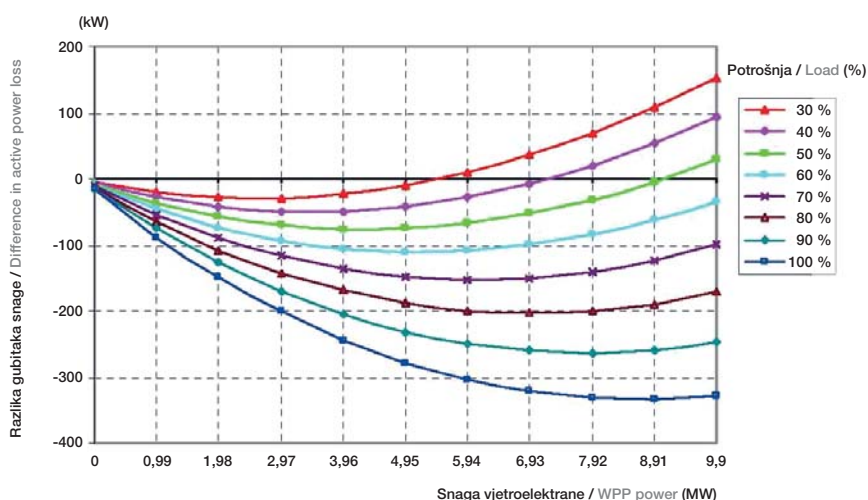

Slika 5
 Apsolutne promjene gubitaka radne snage u mreži 30 kV u slučaju priključka VE Orlice
 Figure 5
 Absolute active power loss changes in the 30 kV network with the Orlice WPP connected

Slika 6

Postotne promjene gubitaka radne snage u mreži 30 kV u slučaju priključka VE Orlice

Figure 6

Active power losses in the 30 kV network with the Orlice WPP connected (%)

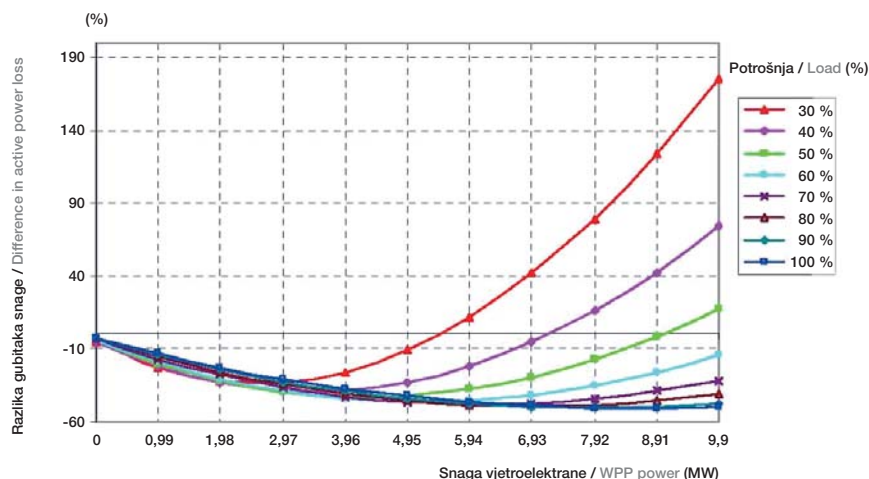

4 PRORAČUN GODIŠNJIH GUBITAKA RADNE ENERGIJE U DIŠTRIBUCIJSKOJ MREŽI S PRIKLJUČENOM VJETROELEKTRANOM

4.1 Ulazni parametri

Za točan proračun godišnjih gubitaka radne energije u istom primjeru iz prethodnog poglavlja potrebno je poznavati:

- kronološku krivulju opterećenja TS 30/10 kV Primošten i TS 30/10 kV Rogoznica, tj. satne potrošnje u razdoblju od 1 godine,
- kronološku krivulju proizvodnje VE Orlice, tj. satne proizvodnje u razdoblju od 1 godine.

S obzirom da za promatranu mrežu nije bila dostupna kronološka krivulja potrošnje, korišteni su izmjereni podaci iz druge TS 35/10 kV (prosječna satna opterećenja), normirani po vršnoj snazi na poznato vršno opterećenje DV 30 kV Bilice – Primošten – Rogoznica. Jalova snaga potrošača pretpostavljena je proporcionalna radnoj, uz konstantan faktor snage $\cos \varphi = 0,95$.

Za simulaciju proizvodnje VE Orlice nisu korišteni podaci o brzinama vjetra s lokacije Orlice, već su korišteni izmjereni jednogodišnji podaci s druge lokacije (brzina vjetra usrednjena na satne intervale). Zbog toga se izračunati parametri ne mogu direktno primijeniti na promatranu mrežu i vjetroelektranu, već samo kao ilustracija opisane metodologije.

4 CALCULATION OF ANNUAL ACTIVE ENERGY LOSS IN A DISTRIBUTION NETWORK WITH A WIND POWER PLANT CONNECTED

4.1 Input parameters

For the precise calculation of annual active energy losses in the same example from the previous chapter, it is necessary to know the following:

- the chronological load curve of the 30/10 kV Primošten and 30/10 kV Rogoznica substations, i.e. hourly loads during a 1-year period,
- the chronological generation curve of the Orlice WPP, i.e. hourly generation during a 1-year period.

Since a chronological load curve was not available for the network considered, measured data (average hourly loads) from another 35/10 kV substation were used, normalized according to peak power for the known peak load of the 30 kV Bilice-Primošten-Rogoznica line. The reactive power loads were assumed to be proportional to the active power loads, with a constant power factor of $\cos \varphi = 0,95$.

For the simulation of the Orlice WPP generation, wind speed data from the Orlice location were not used. Instead, data measured for one year from another location were employed (wind speed averaged at hourly intervals). Therefore, the calculation parameters cannot be applied directly to the considered network and wind power plant but only as an illustration of the described methodology.

Kronološka krivulja proizvodnje VE Orlice slijedi iz kronološke krivulje brzina vjetra i P - v karakteristike vjetroagregata Enercon E-44 koji je pretpostavljen za VE Orlice. Radi se o sinkronom generatoru nazivne snage 900 kW, s direktnim pogonom i indirektnim priključkom na mrežu (preko pretvarača). U proračunu je pretpostavljena jednaka brzina vjetra na svih 11 lokacija vjetroagregata, te režim potpune kompenzacije jalove snage vjetrogeneratora VE Orlice ($\cos \varphi = 1$).

Da bi se reducirala potreba za izvođenjem 8 760 proračuna tokova snaga na razumnu mjeru, proračun je izveden pomoću krivulje trajanja potrošnje i krivulje trajanja proizvodnje VE Orlice, aproksimacijom krivulja na manji broj segmenata konstantne snage. Međutim, istodobnost distribucijske potrošnje i proizvodnje VE Orlice nije na taj način izgubljena, već je modelirana izdvojeno zasebnim proračunom koji će naknadno biti opisan.

Godišnja krivulja trajanja potrošnje formirana je na osnovi kronološke krivulje potrošnje, te je segmentirana na 8 diskretnih iznosa snaga u rasponu od 30 % do 100 % vršnog opterećenja s korakom 10 % (slika 7). Pri tome svaki segment koji je predstavljen snagom P_i reprezentira (aproksimira) snage u rasponu $P_i - 5\%P_{\text{peak}} \leq P_i < P_i + 5\%P_{\text{peak}}$. Sa P_{peak} označena je snaga koja odgovara prvom segmentu i nešto je manja od stvarnog maksimalnog opterećenja.

The chronological generation curve of the Orlice WPP is derived from the chronological wind speed curve and P - v curve of the Enercon E-44 Wind Generator, which is assumed for the Orlice WPP. This is a synchronous generator with a rated power of 900 kW, direct drive and an indirect network connection using a converter. In the calculation, a uniform wind speed was assumed for all 11 wind generator locations, and the reactive power of the Orlice WPP was fully compensated ($\cos \varphi = 1$).

In order to reduce the necessary 8 760 load-flow calculations to a reasonable number, calculation was performed using the load duration curve and the generation duration curve of the Orlice WPP, with an approximated curve for a smaller number of segments with constant power. However, the coincidence of the distribution consumption and generation of the Orlice WPP was not lost in this manner but modeled separately by a calculation that will be described subsequently.

The annual load duration curve is formed on the basis of the chronological load curve and segmented into 8 discrete parts with constant power, ranging from 30 % to 100 % of the peak load, with a 10 % increment (Figure 7). Moreover, each segment designated by power P_i represents (approximates) power in the range of $P_i - 5\%P_{\text{peak}} \leq P_i < P_i + 5\%P_{\text{peak}}$. P_{peak} stands for power that corresponds to the first segment and is somewhat lower than the existing maximum load.

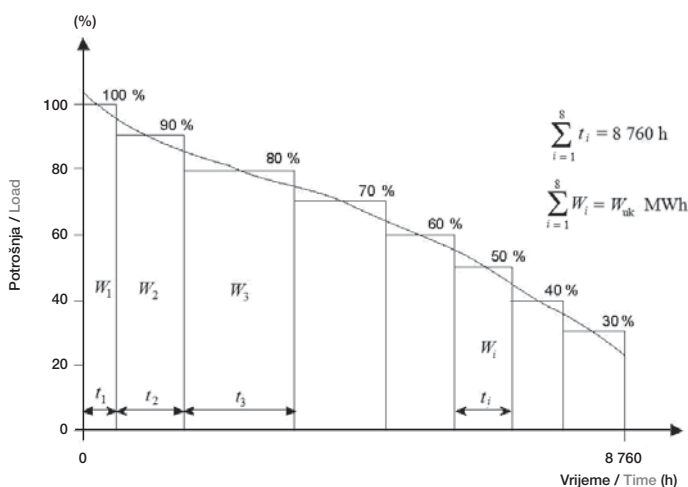

Slika 7
Aproksimacija krivulje trajanja potrošnje
Figure 7
Approximated load duration curve

Godišnja krivulja trajanja proizvodnje VE Orlice također je formirana na osnovi kronološke krivulje trajanja proizvodnje izračunate preko kronološke krivulje brzine vjetra i P - v krivulje odabranog vjetroagregata, a segmentirana je na 11 diskretnih iznosa snaga pojedinačnog vjetroagregata u rasponu od 0 do 900 x 11 kW uz korak 90 x 11

The annual generation duration curve of the Orlice WPP is also formed on the basis of the chronological generation curve calculated using the chronological wind speed curve and the P - v curves of the selected wind turbine, and segmented into 11 discrete power units of an individual wind power plant ranging from 0 to 900 x 11 kW, with an increment

kW (slika 8), tj. u rasponu od 0% P_n do 100% P_n s korakom 10% P_n . Svaki segment predstavljen snagom P_j reprezentira (aproksimira) proizvodnju VE Orlice u rasponu $P_j - 5\%P_n \leq P_j < P_i + 5\%P_n$, osim prvog i zadnjeg segmenta za koje je $P_1 = P_n$, odnosno $P_{11} = 0$.

of 90 x 11 kW (Figure 8), i.e. ranging from 0 % P_n to 100 % P_n , with an increment of 10 % P_n . Each segment designated by power P_j represents (approximates) the generation of the Orlice WPP with a range of $P_j - 5\%P_n \leq P_j < P_i + 5\%P_n$, with the exception of the first and last segments, for which $P_1 = P_n$ and respectively $P_{11} = 0$.

Slika 8
Aproximacija
krivulje trajanja
proizvodnje VE Orlice
Figure 8
Approximated Orlice
WPP generation
duration curve

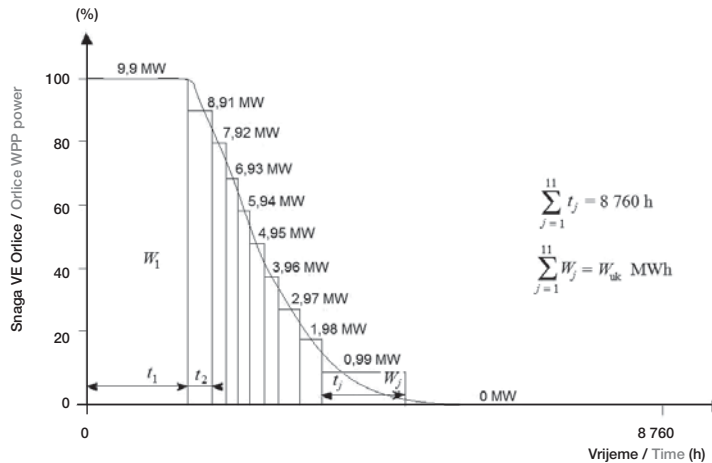

4.2 Modeliranje istodobnosti distribucijske potrošnje i proizvodnje vjetroelektrane

Istodobnost distribucijske potrošnje i proizvodnje VE Orlice uvažena je formiranjem matrice učestalosti istodobne pojave opterećenja koji odgovara i -tom segmentu krivulje sa slike 7 i proizvodnje VE Orlice koja odgovara j -tom segmentu krivulje sa slike 8. Dakle, na temelju kronoloških krivulja opterećenja distribucijske mreže i proizvodnje VE Orlice određuje se godišnji postotni iznos vremena za svaku kombinaciju opterećenja distribucijske mreže i proizvodnje VE Orlice kako slijedi:

- formiraju se vektori prosječne satne snage distribucijske mreže i satne snage VE Orlice:
 - $[P_{\text{distr}}]_{(8760 \times 1)}$, gdje je $P_{\text{distr}}(k)$ prosječna satna snaga distribucijske potrošnje u k -tom satu
 - $[P_{\text{VE}}]_{(8760 \times 1)}$, gdje je $P_{\text{VE}}(k)$ prosječna satna snaga VE Orlice u k -tom satu,

- računaju se dvije matrice:

$$[p_{\text{distr}}]_{(8760 \times 8)},$$

gdje je element matrice definiran sa:

$$p_{\text{distr}}(k, i) = \begin{cases} 1, & \text{ako je / if } P_i - 5\% P_{\text{peak}} \leq P_{\text{distr}}(k) < P_i + 5\% P_{\text{peak}} \\ 0, & \text{inače / otherwise} \end{cases}$$

4.2 Modeling of the coincidence of the distribution consumption and wind power plant generation

The coincidence of distribution consumption and Orlice WPP generation has been taken into account in the formation of a frequency matrix of the coincidence of consumption, corresponding to the i -th curve segment in Figure 7, and Orlice WPP generation, corresponding to the j -th curve segment in Figure 8. Therefore, based upon the chronological load curves of the distribution network and Orlice WPP generation, the annual percentages of the duration of each combination of loads on the distribution network and Orlice WPP generation are determined, as follows:

- the vectors of the average hourly load of the distribution network and wind power plant generation are formed as follows:

- $[P_{\text{distr}}]_{(8760 \times 1)}$, where $P_{\text{distr}}(k)$ is the average hourly load of the distribution network at hour k
- $[P_{\text{VE}}]_{(8760 \times 1)}$, where $P_{\text{VE}}(k)$ is the average Orlice WPP generation at hour k

- two matrices are calculated:

$$[p_{\text{distr}}]_{(8760 \times 8)},$$

where the matrix element is defined as:

$$[p_{VE}]_{(8760 \times 11)},$$

gdje je element matrice definiran sa:

$$p_{VE}(k,1) = \begin{cases} 1, & \text{ako je / if } P_{VE}(k) = P_n \\ 0, & \text{inače / otherwise} \end{cases}$$

$$p_{VE}(k,j) = \begin{cases} 1, & \text{ako je / if } P_j - 5\% P_n \leq P_{VE}(k) < P_j + 5\% P_n \\ 0, & \text{inače / otherwise} \end{cases}, \text{ za } j = 2, \dots, 10.$$

$$p_{VE}(k,11) = \begin{cases} 1, & \text{ako je / if } P_{VE}(k) = 0 \\ 0, & \text{inače / otherwise} \end{cases}.$$

Jedinica u matricama $[p_{distr}]$ i $[p_{VE}]$ zapravo predstavlja pojavljivanje odgovarajuće potrošnje/proizvodnje u k -tom satu unutar odgovarajućeg segmenta aproksimiranih krivulja potrošnje i proizvodnje. Dakle, u svakom retku navedenih matrica pojavljuje se točno jedna jedinica, i to u onom stupcu koji predstavlja i -ti odnosno j -ti segment aproksimirane krivulje distribucijske potrošnje, odnosno proizvodnje VE Orlice. Množenjem matrica $[p_{VE}]^T$ i $[p_{distr}]$ dobije se matrica učestalosti istodobne pojave opterećenja distribucijske mreže i proizvodnje VE Orlice:

$$[p_{distr_VE}]_{(11 \times 8)} = \frac{[p_{VE}]^T \cdot [p_{distr}]}{8760},$$

za koju vrijedi:

- $p_{distr_VE}(j,i)$ predstavlja vjerojatnost istodobnog pojavljivanja proizvodnje VE Orlice u j -tom intervalu aproksimirane krivulje trajanja proizvodnje s distribucijskom potrošnjom u i -tom intervalu aproksimirane krivulje trajanja potrošnje,
- $\sum_{j=1}^{11} \sum_{i=1}^8 p_{distr_VE}(j,i) = 1.$

4.3 Rezultati proračuna

Izračunata matrica $[p_{distr_VE}]$ prikazana je u tablici 5, na način da su njeni elementi (odgovarajuće vjerojatnosti) dani u postotnim iznosima, a također je izračunata i suma vjerojatnosti po redcima i stupcima, što odgovara udjelima pojedinih segmenata aproksimirane krivulje trajanja distribucijske potrošnje i proizvodnje VE Orlice (slike 9 i 10).

$$[p_{VE}]_{(8760 \times 11)},$$

where the matrix element is defined as:

In the matrices $[p_{distr}]$ and $[p_{VE}]$, the integer 1 actually represents load/generation at hour k within the corresponding segments of the approximated load/generation curves. Thus, in each row of these matrices, the integer 1 occurs only once, in the column representing the i -th or j -th segment of the approximated load distribution curve or the Orlice WPP generation curve. By multiplying matrices $[p_{VE}]^T$ and $[p_{distr}]$, the frequency matrix of the simultaneous distribution network power load and Orlice WPP generation is obtained:

$$[p_{distr_VE}]_{(11 \times 8)} = \frac{[p_{VE}]^T \cdot [p_{distr}]}{8760},$$

for which the following apply:

- $p_{distr_VE}(j,i)$ represents the probability of the simultaneous occurrence of Orlice WPP generation in the j -th interval of the approximated generation duration curve and distribution consumption in the j -th interval of the approximated load duration curve.
- $\sum_{j=1}^{11} \sum_{i=1}^8 p_{distr_VE}(j,i) = 1.$

4.3 Calculation results

The calculated matrix $[p_{distr_VE}]$ is presented in Table 5 in such a manner that its elements (corresponding values) are given in percentages and the sums of the probabilities are calculated for the rows and columns, corresponding to the percentages of the individual segments of the approximated distribution consumption duration curve and the Orlice WPP generation curve (Figures 9 and 10).

Tablica 5 – Matrica učestalosti istovremenog pojavljivanja distribucijske potrošnje i proizvodnje VE Orlice
 Table 5 – Frequency matrix of the simultaneous distribution network power load and Orlice WPP generation

		Potrošnja / Load (%)								
		30 %	40 %	50 %	60 %	70 %	80 %	90 %	100 %	Σ
Snaga VE Orlice / Orlice WPP power (MW)	0	0,93 %	1,83 %	2,11 %	2,36 %	3,50 %	3,47 %	1,57 %	0,14 %	15,9 %
	0,99	2,75 %	4,95 %	5,16 %	6,48 %	10,53 %	9,42 %	4,07 %	0,53 %	43,9 %
	1,98	0,51 %	0,90 %	0,65 %	1,11 %	1,60 %	2,25 %	0,76 %	0,19 %	8,0 %
	2,97	0,39 %	0,39 %	0,72 %	0,83 %	1,25 %	1,25 %	0,60 %	0,00 %	5,4 %
	3,96	0,42 %	0,63 %	0,46 %	0,81 %	0,88 %	1,16 %	0,56 %	0,07 %	5,0 %
	4,95	0,23 %	0,37 %	0,39 %	0,58 %	0,74 %	1,02 %	0,46 %	0,07 %	3,9 %
	5,94	0,28 %	0,46 %	0,42 %	0,65 %	0,86 %	0,83 %	0,32 %	0,05 %	3,9 %
	6,93	0,14 %	0,44 %	0,35 %	0,35 %	0,60 %	0,53 %	0,32 %	0,00 %	2,7 %
	7,92	0,14 %	0,32 %	0,35 %	0,37 %	0,76 %	0,65 %	0,16 %	0,02 %	2,8 %
	8,91	0,21 %	0,44 %	0,76 %	0,56 %	1,18 %	1,09 %	0,53 %	0,07 %	4,8 %
	9,90	0,12 %	0,49 %	0,49 %	0,60 %	0,76 %	0,76 %	0,44 %	0,07 %	3,7 %
Σ	6,11 %	11,23 %	11,85 %	14,70 %	22,66 %	22,43 %	9,81 %	1,20 %	100 %	

Slika 9

Postotni udjeli trajanja
 segmenta krivulje
 trajanja opterećenja
Figure 9
 Frequency of load
 duration curve
 segments

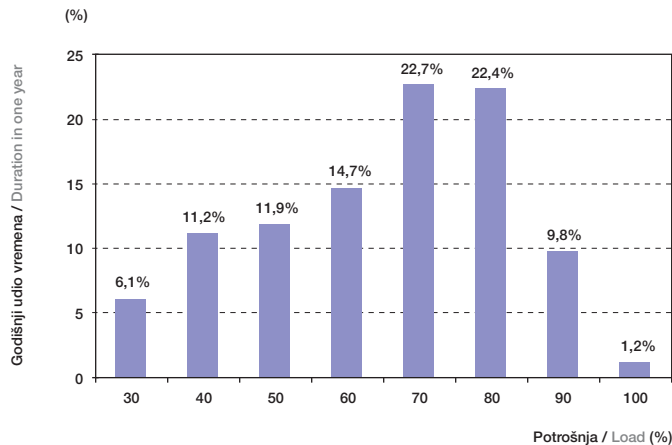

Slika 10

Postotni udjeli trajanja
 segmenta krivulje
 trajanja proizvodnje
Figure 10
 Frequency of
 generation duration
 curve segments

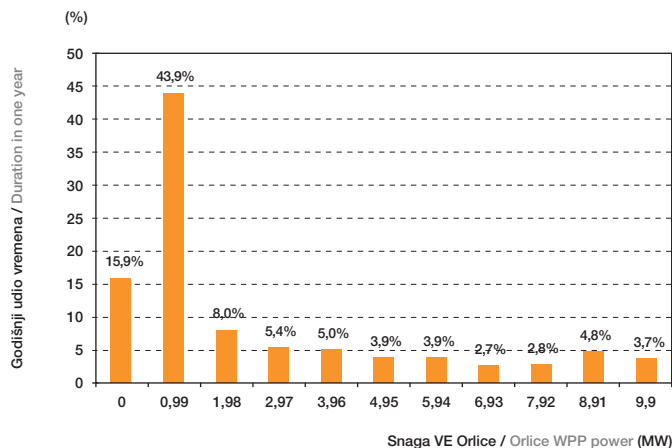

Znajući matricu učestalosti $[p_{\text{distr_VE}}]$, izračun godišnjih gubitaka radne energije u promatranom dijelu distribucijske mreže svodi se na proračun $11 \times 8 = 88$ varijanti tokova snaga, za svaku kombinaciju distribucijske potrošnje P_i i snage VE Orlice P_j . Množenjem u svakoj varijanti izračunatih gubitaka radne snage s odgovarajućim vjerojatnostima definiranim preko matrice $[p_{\text{distr_VE}}]$ i ukupnim brojem sati u godini, dobiju se gubici radne energije u podrazdobljima. Konkretno vrijednosti gubitaka radne snage za svaku kombinaciju već su izračunate u poglavlju 3 i prikazane u tablici 4. Sumiranjem gubitaka energije za sve kombinacije dobiju se ukupni godišnji gubici radne energije u promatranom dijelu distribucijske mreže:

If the frequency matrix $[p_{\text{distr_VE}}]$ is known, the calculation of annual active energy losses in part of the distribution network considered is reduced to the calculation of $11 \times 8 = 88$ variants of the power flows, for each combination of load P_i and the power rating of the Orlice WPP P_j . By multiplying the calculated active power losses in each variant by the corresponding probabilities defined by the matrix $[p_{\text{distr_VE}}]$ and the total number of hours in a year, the active energy losses are obtained for the subintervals. The values of the active power losses for each combination have already been calculated in Chapter 3 and presented in Table 4. By adding together the energy losses for each combination, the total annual active energy losses for the part of the distribution network considered are obtained:

$$\Delta W_{\text{UK}}^r = 8\,760 \cdot \sum_{j=1}^{11} \sum_{i=1}^8 p_{\text{distr_VE}}(j,i) \cdot \Delta P(j,i), \quad (8)$$

gdje je:

where:

$\Delta P(j,i)$ oznaka za gubitke radne snage u mreži za kombinaciju proizvodnje P_j i potrošnje P_i .

$\Delta P(j,i)$ designates the active power losses in the network for the combination of generation P_j and load P_i .

U tablici 6 prikazani su godišnji gubici radne energije u promatranom dijelu distribucijske mreže u varijanti kad nije priključena VE Orlice, dok su u tablici 7 prikazani odgovarajući gubici radne energije u slučaju priključka VE Orlice izračunati prethodno opisanom metodom.

Table 6 presents the annual active energy losses in the considered part of the distribution network when the Orlice WPP is not connected, while Table 7 presents the corresponding active energy losses when the Orlice WPP is connected, as calculated by the previously described method.

Tablica 6 – Ukupni godišnji gubici energije u mreži 30 kV bez VE Orlice
Table 6 – Annual active energy losses in the 30 kV network without the Orlice WPP (MWh)

Potrošnja / Load (%)	30	40	50	60	70	80	90	100	–
Gubici energije / Energy losses (MWh)	46,66	124,90	182,72	309,03	631,29	809,54	450,52	69,17	2 624

Tablica 7 – Ukupni godišnji gubici energije u mreži 30 kV sa VE Orlice (MWh)
Table 7 – Annual active energy losses in the 30 kV network with the Orlice WPP (MWh)

		Potrošnja / Load (%)								
		30 %	40 %	50 %	60 %	70 %	80 %	90 %	100 %	Σ
Snaga VE Orlice / Orlice WPP power (MW)	0	6,68	19,38	31,19	47,78	94,31	121,67	70,32	7,79	399,1
	0,99	16,14	42,95	63,31	110,72	243,58	287,21	160,24	26,49	950,6
	1,98	2,63	6,67	6,76	16,25	32,04	59,80	26,57	8,22	158,9
	2,97	2,01	2,66	6,66	10,73	22,01	29,57	18,61	0,00	92,3
	3,96	2,35	4,24	4,06	9,58	14,02	24,64	15,52	2,51	76,9
	4,95	1,57	2,75	3,48	6,59	11,03	19,99	11,88	2,30	59,6
	5,94	2,37	4,01	3,98	7,44	12,45	15,55	7,78	1,43	55,0
	6,93	1,51	4,62	3,77	4,26	8,86	9,75	7,49	0,00	40,3
	7,92	1,90	4,17	4,41	5,06	11,91	12,09	3,70	0,66	43,9
	8,91	3,56	6,97	11,51	8,66	20,17	21,25	12,36	1,96	86,4
	9,90	2,43	9,41	8,77	10,86	14,59	16,13	10,67	1,99	74,9
	Σ		43,2	107,8	147,9	237,9	485,0	617,6	345,2	53,3

Dakle, izračunati godišnji gubici radne energije u promatranom dijelu mreže 30 kV bez VE Orlice iznose 2 624 MWh (što je u odnosu na ukupnu godišnju distribucijsku potrošnju oko 5,3 %), dok se u slučaju priključka VE Orlice smanjuju na 2 038 MWh, tj. za 22 %.

S obzirom da ukupna godišnja proizvodnja VE Orlice iznosi 41 % distribucijske potrošnje, smanjenje godišnjih gubitaka radne energije je bilo i intuitivno za očekivati zbog smanjenja opterećenja distribucijske mreže.

Neproporcionalno smanjenje gubitaka u odnosu na smanjenje ukupno preuzete energije iz transformacije 110/30 kV rezultat je povećanja gubitaka u razdobljima visokog angažmana VE Orlice i niskog opterećenja u mreži, te prvenstveno činjenice da su gubici na DV 30 kV i transformatorima 30/0,4 kV dalje od mjesta priključka VE Orlice (oko 40 % od ukupnih gubitaka radne energije) ostali nepromijenjeni. Ukoliko bi promatrali samo dio mreže 30 kV od pojne točke do mjesta priključka VE Orlice, godišnji gubici radne energije se smanjuju za 37 %.

Značajan doprinos smanjenju godišnjih gubitaka radne energije zbog rada VE Orlice može se također očekivati i u transformatoru 110/30 kV, što nije uključeno u prethodni proračun. Naime, kod transformatora 110/30 kV gubici radne snage u svakom trenutku se smanjuju injektiranjem snage iz VE Orlice, budući da je minimalno opterećenje transformacije 110/30 kV veće od maksimalne snage VE Orlice.

Thus, the calculated annual active energy losses in the considered part of the 30 kV network without the Orlice WPP amount to 2 624 MWh, which is approximately 5,3 % of the total annual distribution network consumption and is reduced to 2 038 MWh, i.e. 22 %, when the Orlice WPP is connected.

Since the total annual generation of the Orlice WPP amounts to 41 % of the distribution consumption, reduction of the annual active energy losses could be anticipated intuitively due to the reduced distribution network load.

Disproportional reduction in losses in comparison to the reduction in the total energy input from the 110/30 kV substation is due to increased losses during periods of high generation by the Orlice WPP and low network consumption, and especially the fact that the losses on the 30 kV overhead lines and the 30/0,4 kV transformers after the connection point of the Orlice WPP (approximately 40 % of the total active energy losses) remained unchanged. If we consider only the part of the 30 kV network from the supply point to the connection point of the Orlice WPP, annual active energy losses are reduced by 37 %.

A significant contribution to the reduction in the annual active energy losses due to the operation of the Orlice WPP can also be anticipated in the 110/30 kV transformer, which was not included in the previous calculation. The active power losses of the 110/30 kV substation are continuously being reduced by the injection of power from the Orlice WPP, since the minimum substation loading is greater than the maximum power of the Orlice WPP.

4.4 Mogućnosti daljnjeg pojednostavljenja proračuna

Prikazana metoda pruža mogućnost točnog izračuna godišnjih gubitaka radne energije u distribucijskoj mreži na koju je priključena vjetroelektrana, na način da se znatno reducira potreban broj proračuna tokova snaga (u primjeru sa 8 760 na 88 proračuna). Međutim, još uvijek je u velikoj mjeri vremenski zahtjevna i nepraktična, jer je ipak potrebno poznavati godišnju kronološku krivulju trajanja opterećenja i godišnju kronološku krivulju trajanja brzina vjetra (snaga vjetroelektrane), što često nije raspoloživo. Zbog toga se može postaviti pitanje koliko je pogrešku za očekivati u slučaju potpunog zanemarenja istodobnosti distributivne potrošnje i proizvodnje vjetroelektrane, tj. ukoliko se proračun vrši samo na osnovi aproksimiranih krivulja trajanja distribucijske potrošnje i proizvodnje VE. U tom slučaju izračun je moguć na način da se formira fiktivna matrica $[p_{\text{distr_VE}}]^f$ direktno iz iznosa udjela pojedinog segmenta aproksimirane krivulje trajanja distribucijske potrošnje, odnosno proizvodnje vjetroelektrane:

$$[p_{\text{distr_VE}}]^f = [p_{\text{VE}}]^T \cdot [p_{\text{distr}}],$$

gdje su:

- $[p_{\text{VE}}]_{(1 \times 11)}$ – vektor koji sadrži jediničnu vrijednost vremenskog trajanja segmenata aproksimirane krivulje trajanja proizvodnje vjetroelektrane ($t_j/8\ 760$),
- $[p_{\text{distr}}]_{(1 \times 8)}$ – vektor koji sadrži jediničnu vrijednost vremenskog trajanja segmenata aproksimirane krivulje trajanja distribucijske potrošnje ($t_i/8\ 760$).

Na takav način fiktivna matrica $[p_{\text{distr_VE}}]^f$ ima isto značenje kao i stvarna matrica $[p_{\text{distr_VE}}]$ i vrijedi:

$$\sum_{j=1}^{11} \sum_{i=1}^8 p_{\text{distr_VE}}^f(j, i) = 1,$$

samo što vjerojatnosti pojave distribucijske potrošnje i proizvodnje vjetroelektrane ne odgovaraju stvarnim vrijednostima budući da nisu dobivene iz kronoloških krivulja.

Godišnji gubici radne energije izračunati preko matrice $[p_{\text{distr_VE}}]^f$, na isti način kao i preko matrice $[p_{\text{distr_VE}}]$, za promatranu distribucijsku mrežu iznose 2 050 MWh, što je u odnosu na točnu vrijednost od 2 038 MWh zanemariva razlika, neusporedivo manja od reda veličine nepouzdanosti ulaznih podataka. Također, čak i u točnom proračunu dobiveni rezultat je primjenjiv samo na godinu za koju raspoložemo s kronološkom krivuljom brzina vjetra

4.4 Possibilities for further simplifying calculation

The method presented facilitates the precise calculation of the annual active energy losses in a distribution network to which a wind power plant is connected, in a manner that significantly reduces the required number of power flow calculations (from 8 760 to 88 in the example provided). However, it still takes considerable time and is impractical because it requires the annual chronological load duration curves and the annual chronological wind speed curves, i.e. annual chronological WPP generation curves, which are frequently not available. Therefore, the question may be asked how great a margin of error can be expected if the coincidence of the distribution consumption and the wind power plant generation are completely ignored, i.e. if the calculation is performed solely on the basis of the approximated distribution consumption duration and wind power plant generation curve. In this case, calculation is possible if a fictive matrix $[p_{\text{distr_VE}}]^f$ is directly formed from the percentage of an individual segment of an approximated curve of distribution consumption duration or wind power plant generation:

$$[p_{\text{distr_VE}}]^f = [p_{\text{VE}}]^T \cdot [p_{\text{distr}}],$$

where:

- $[p_{\text{VE}}]_{(1 \times 11)}$ – is a vector containing the p.u. values of the segment duration of an approximated generation duration curve ($t_j/8\ 760$) for a wind power plant, and
- $[p_{\text{distr}}]_{(1 \times 8)}$ – is a vector containing the p.u. values of the segment duration of an approximated distribution consumption duration curve ($t_i/8\ 760$).

In this manner, the fictive matrix $[p_{\text{distr_VE}}]^f$ has the same significance as the actual matrix $[p_{\text{distr_VE}}]$, and therefore

$$\sum_{j=1}^{11} \sum_{i=1}^8 p_{\text{distr_VE}}^f(j, i) = 1,$$

except that the probabilities of the distribution consumption and wind power plant generation do not correspond to the actual values, since they are not obtained from chronological curves.

Annual active power losses calculated using the matrix $[p_{\text{distr_VE}}]^f$, in the same manner as if using matrix $[p_{\text{distr_VE}}]$, amount to 2 050 MWh for the distribution network considered. The difference between this value and the more precise value of 2 038 MWh is negligible. Furthermore, even with more precise calculation, the result obtained is only applicable for the year that a chronological wind speed curve

na lokaciji promatrane vjetroelektrane, što može značajno varirati iz godine u godinu.

Zbog toga se može zaključiti da je za praktične (i brze) izračune, sasvim dovoljna (čak i vrlo točna) metoda s fiktivnom matricom $[p_{\text{distr_VE}}]^T$, bez obzira što je teoretski netočna. Jasno, ovisno o karakteristikama konkretne distribucijske mreže i distribuiranog izvora (mjesto priključenja, omjer nazivne snage distribuiranog izvora i vršnog opterećenja izvoda, omjer godišnje proizvodnje distribuiranog izvora i godišnje potrošnje na izvodu, režim rada distribuiranog izvora itd.), ipak je moguće očekivati i veće pogreške pri takvoj zanemarenosti.

5 ZAKLJUČAK

U ovom radu opisan je utjecaj priključka distribuiranog izvora električne energije na povećanje/smanjenje godišnjih gubitaka radne energije u distributivnoj mreži. Utjecajni faktori su brojni, a prvenstveno konfiguracija (topologija) distributivne mreže, njene tehničke karakteristike, vrsta distribuiranog izvora, odnosno režim rada, mjesto priključka na mrežu itd.

Uz teoretske osnove nužne za razumijevanje problema, razrađena je metodologija izračuna godišnjih gubitaka radne energije u distribucijskoj mreži na koju je priključena vjetroelektrana, što je ilustrirano na primjeru realne distribucijske mreže 30 kV i vjetroelektrane nazivne snage 9,9 MW. Metodologija zahtijeva poznavanje kronološke krivulje distribucijske potrošnje i kronološke krivulje brzina vjetra na lokaciji vjetroelektrane, što je nužan preduvjet za točan izračun gubitaka koji uvažava istodobnost potrošnje i proizvodnje. Iako je potreban broj proračuna tokova snaga reduciran na prihvatljiv broj, opisana metoda je ipak vremenski zahtjevnija i nepraktična ako nisu poznate navedene kronološke krivulje. Međutim, pokazano je da u slučaju potpunog zanemarivanja istodobnosti potrošnje i proizvodnje, pogreška u rezultatu može biti praktički zanemariva, tako da se proračun može znatno pojednostavniti korištenjem samo aproksimiranih krivulja trajanja potrošnje i proizvodnje.

Iako u promatranom primjeru priključak distribuiranog izvora smanjuje gubitke radne energije u SN mreži, to nikako ne može biti i generalni zaključak. Obrnuti efekt se može očekivati u slučaju većeg iznosa ukupno injektirane energije od strane distribuiranog izvora (što je u primjeru iznosilo oko 41 % ukupne distribucijske potrošnje).

is available for the location of the WPP site, which can significantly vary from year to year.

Therefore, it can be concluded that for practical and rapid calculations, the method with the fictive matrix $[p_{\text{distr_VE}}]^T$ is quite sufficient and even very precise, albeit theoretically imprecise. Depending on the characteristics of the specific distribution network and the distributed source (connection point, the ratio of the rated power of the power plant and the feeder peak load, the ratio of annual power plant generation and feeder consumption, the power plant operating regime etc.), a greater degree of error can clearly be anticipated from such simplified calculations than in the example presented.

5 CONCLUSION

In this article, the impact of a connected distributed energy source on increasing/decreasing annual active power losses in a distribution network is described. There are numerous influential factors, primarily the configuration (topology) of the distribution network, the technical characteristics thereof, types of the distributed source or power plant operation regime, connection point to the network etc.

In addition to the theoretical foundations essential for understanding the problem, a methodology has been developed for the calculation of annual active energy losses in a distribution network to which a wind power plant is connected, illustrated using the example of an existing 30 kV distribution network and a wind power plant with a rated power of 9,9 MW.

The methodology requires the chronological load distribution curve and the chronological wind speed curve at the site of the wind power plant, which are essential prerequisites for the precise calculations of losses that take the coincidence of consumption and generation into account. Although the necessary power flow calculations have been reduced to an acceptable number, the method described still requires considerable time and is impractical if the aforementioned chronological curves are not available. However, it has been shown that when the coincidence of consumption and generation are completely ignored, the error in the result can be practically negligible. Therefore, calculation can be significantly simplified by using only the approximated load and generation duration curves, without taking account of load and generation coincidence.

Although the connected distributed source reduced active energy losses in the medium-voltage network in the example presented, this result can in no way

Također, ne može se ni približno ocijeniti gdje bi bila granica pri kojoj je utjecaj priključka distribuiranog izvora neutralan s obzirom na godišnje gubitke radne energije u mreži, i to zbog brojnih utjecajnih parametara: topologija mreže, tehničke karakteristike mreže, mjesto priključka distribuiranog izvora, režim rada distribuiranog izvora u odnosu na distributivnu potrošnju itd.

be taken as a general conclusion. The opposite effect can be expected when a large amount of total energy is injected from a distributed source (which amounted to approximately 41 % of the total distribution consumption in the example presented).

Furthermore, it is not possible to make even an approximate determination of the point at which the impact of a connected distributed source would be neutral in relation to the annual active power losses in a network, due to a number of parameters: the topology of the network, the technical characteristics of the network, the site of the connection of the distributed source, the operation regime of the distributed source in relation to the distribution consumption etc.

LITERATURA / REFERENCES

- [1] Solutions for the connection and operation of distributed generation, Technical report, EA Technology Ltd. & DTI, London, 2003
- [2] BEGOVIĆ, M. et al, Impact of Renewable Distributed Generation on Power Systems, Proc. of the 34th Hawaii International Conference on System Sciences, 2001
- [3] PAVIĆ, A., TRUPINIĆ, K., Gubici električne energije u distribucijskoj mreži, *Energija*, god. 56(2007), br. 2., 2007.
- [4] Network losses and distribution generation, Technical report, EA Technology Ltd. & DTI, London, 2006
- [5] GOIĆ, R., MUDNIĆ, E., JADRIJEV, Z., Primjena programskog paketa PowerCAD za analizu gubitaka snage i energije u distributivnim mrežama, V. savjetovanje HK CIGRE, Cavtat, 2001.
- [6] GOIĆ, R., MUDNIĆ, E., MILUN, D., Struktura gubitaka snage i energije u sredjenaponskoj distributivnoj mreži, IV. simpozij o elektrodistribucijskoj djelatnosti HK CIGRE, Pula, 2002.
- [7] GOIĆ, R., Utjecaj vjetrogeneratora na varijacije napona i gubitke snage u razdjelnoj mreži, V. simpozij o elektrodistribucijskoj djelatnosti HO CIGRE, Zadar, 2004.
- [8] RAKIĐIJA, T., Utjecaj rada vjetroelektrana na statičke varijacije napona i gubitke u distribucijskoj mreži, diplomski rad, FESB, 2005.

Uredništvo primilo rukopis:
2007-11-26

Manuscript received on:
2007-11-26

Prihvaćeno:
2008-01-15

Accepted on:
2008-01-15