

12-1949

Design and construction of earth dams.

Panthragadi Bhyravamurthy
University of Louisville

Follow this and additional works at: <https://ir.library.louisville.edu/etd>

Part of the [Civil Engineering Commons](#)

Recommended Citation

Bhyravamurthy, Panthragadi, "Design and construction of earth dams." (1949). *Electronic Theses and Dissertations*. Paper 2345.
<https://doi.org/10.18297/etd/2345>

This Master's Thesis is brought to you for free and open access by ThinkIR: The University of Louisville's Institutional Repository. It has been accepted for inclusion in Electronic Theses and Dissertations by an authorized administrator of ThinkIR: The University of Louisville's Institutional Repository. This title appears here courtesy of the author, who has retained all other copyrights. For more information, please contact thinkir@louisville.edu.

UNIVERSITY OF LOUISVILLE

DESIGN AND CONSTRUCTION
OF EARTH DAMS

A Thesis

Submitted to the Faculty
of the Graduate School
of the University of Louisville
in Partial Fulfillment
of the Requirements
for the Degree of

MASTER OF CIVIL ENGINEERING

Department of Civil Engineering

Panthragadi
Panthragadi
Bhyravamurthy

December 1949



This PDF document is a scanned copy of a paper manuscript housed in the University of Louisville (UofL) Libraries. The quality of this reproduction is greatly dependent upon the condition of the original paper copy. Indistinct print and poor quality illustrations are a direct reflection of the quality of materials that are available for scanning. The UofL Libraries greatly appreciates any better copies that can be made available for replacement scans.

**DESIGN AND CONSTRUCTION
OF EARTH DAMS**

P. Bhyravamurthy

Approved by the Examining Committee.

Director	<u>W. B. Wendt</u>
	<u>M. G. Northrop</u>
	<u>W. R. McIntosh</u>
	<u>G. C. Williams</u>
	<u>R. C. Ernst</u>

December 1949

CONTENTS

	Page
List of Tables.....	iv
List of Figures.....	v
Acknowledgement to the Director.....	vii
Abstract.....	ix
Introduction.....	1
Historical.....	5
Theoretical.....	8
Design.....	59
Construction.....	65
Summary and Conclusions.....	87
References Cited.....	93
Bibliography.....	95
List of Symbols.....	97
Appendix.....	101
Vita.....	106

LIST OF TABLES

	Page
I Calculation for Probability Plotting of Flood Discharges at Athens, Ohio (Hocking River).....	18
II Working Data for Hiram Reservoir.....	26
III Dimensions of Drill Rods.....	32

LIST OF FIGURES

1. Site Map - Hirakud Dam.....	11
2. Relation between Gauge and Discharge.....	15
3. Relation Between Rainfall and Months.....	15
4. Relation between Rainfall and Run-off.....	16
5. Relation between Elevation, Reservoir and Storage.....	16
6. Flood Curve.....	19
7. Probable Flood Curve.....	19
8. Mass Curves for Inflow and Outflow.....	20
9. Probability Curve.....	20
10. Soils Classification by Triangle.....	34
11. Soils Classification by Mechanical Analysis.....	35
12. Plasticity Chart.....	36
13. Effect of Number of Blows on Density.....	37
13A. Quarry Area and Borrow Area.....	38
14. Cross Section of Hirakud Dam.....	41
15. Failure of Embankment in Circular Arc.....	44
16. Forces Acting on a Sliding Surface.....	45
17. Derivation of Formula to Find Factor of Safety.....	46
18. Simplification of Formula.....	47
19. Method of Computing Factor of Safety.....	49
20. Numerical Example.....	50
21. Approximate Position of Centre of Slip Circle for Minimum Factor of Safety.....	51

LIST OF FIGURES (continued)

22.	Explanation of Line of Saturation.....	52
23.	Method of Drawing Line of Saturation.....	53
24.	Mathematical Representation of Line of Saturation.....	54
25.	Construction of Line of Saturation.....	55
26.	Equivalent Weights.....	56
27.	Results of Computations for Sudden Drawdown Case.....	60
28.	Seepage Calculations.....	61
29.	Construction Drawing.....	62
30.	Sample Procter Sheet for Earth Compaction.....	69
31.	Modified A.A.S.H.O. Compaction Curves.....	70
32.	Type of Roller and Its Effect on Thickness of Layer.....	74
33.	Sheepsfoot Roller Action on Compacting a Fill.....	75
34.	Construction Plan.....	78
35.	Sample Computation Sheet.....	102
36.	McNary Dam.....	104
37.	South Holston Dam.....	105

A C K N O W L E D G E M E N T

The author wishes to acknowledge
the kind assistance and helpful guidance
of Professor W. B. Wendt
who directed this research.

A B S T R A C T

This thesis deals with the design and construction of rolled-fill earth dams with the standard methods of practice, taking the Hirakud Dam as the basis. The field operations of the investigation to obtain observational information and to secure samples for the laboratory testing include observation of rain gauge and river gauge readings, taking river water samples, digging test pits, drilling grout holes, opening drifts, digging borrow pits and conducting detailed topographical surveys. Laboratory tests are conducted on the samples and the results are plotted in graphs. Rainfall and run-off statistics are plotted in graphs. Observational information of geology is plotted in log sheets and the field data of survey works is made use of for the preparation of the topographical maps.

From the results of the investigation it is found that the Hirakud Dam has a firm foundation and there is sufficient quantity of material for the embankment at site. The annual rainfall is 47.49 inches yielding a run-off of 50 million acre feet over a catchment area of 32,200 square miles. The stability of the embankment is computed by the slip circle method and the seepage water from the flow net method.

The dam is designed for 100 years with a reservoir capacity of 5.98 million acre feet at the maximum water level elevation 625 feet, the bed level being elevation 500 feet. The dead storage is 2.24 million acre feet corresponding to elevation 590 feet, and the maximum submerged area corresponding elevation 625 feet is 150,380 acres. The minimum factor of safety for the upstream slope is 1.68 and that for the downstream slope is 1.19. The seepage water is 0.264 cubic feet per lineal foot per year.

The dam is to be constructed as per the design and the specifications.

The compaction is attained by the mechanical effort at the optimum moisture content. The mechanical effort is influenced by the type of roller, its weight and the number of passes. Field control is affected by vigilant supervision, needle penetration, ring test and sand test. The construction is to be carried out according to a plan of seven stages.

A comparison and contrast is drawn between the U.S.A. and India to bring out the inherent difficulties of construction operations of large dams in India. Importance is given to the sequence of the subject matter since no text book gives all the relevant portions as used in practice. Reference is given to the text books from which the formulas are taken so that a student who is interested in theory, derivation and explanation of the formulas may study the available literature.

The procedures employed and the conclusions drawn are based on the experience, observation and the research study of the author both in India and the United States of America.

I N T R O D U C T I O N

The subject "Design and Construction of Earth Dams" is a vast one and demands a knowledge in other branches of science such as Hydrology, Surveying, Soil Mechanics, Geology and Concrete. As the engineer is called upon to make decisions upon the various solutions of different problems connected with the project, his knowledge about the above branches of science must be sound and practicable. It is proposed to present the three phases: Investigation, Design, and Construction of a rolled-fill earth dam.

The purpose of the thesis is twofold: (1) To give a complete explanation of the procedure involved in the actual design and construction of dams, and (2) To indicate the practical difficulties encountered at the various stages of construction with reference to the conditions in India so that a student of Civil Engineering who wants to pursue his career in Engineering of Dams, as well as a responsible engineer of the Central Water Power, Irrigation and Navigation Commission (C.W.I.N.C.), Government of India, may find this a useful reference work.

India's progress depends only upon the realisation of the various schemes of construction of the multipurpose dams. The vital statistics of India in 1946 are: (1)

Total area	- 1,581,410 square miles
Area under cultivation	- 406,250 square miles
Total population	- 388,997,955
Net yearly increase in population (Birth rate - Death rate)	- 7.2 for every thousand
Population attending schools every year	- 4.15%
Illiterate population	- 85%

India has long been an agricultural country, and in recent years the Government budgets show an increasing deficit of food production for its

people. Its population is growing and illiteracy and poverty are rampant. So India has to strain every nerve to increase her production and to become industrialized to raise the standard of the living of her people. To achieve this, India has the potentialities. It has more than two-thirds of the area uncultivated, normal annual rainfall 44.78 inches and a total annual run-off of 1,307 million acre feet with a catchment area of 1,258,598 square miles. By harnessing the water resources of 1,307 million acre feet, that is 1.8 million cubic feet per second (cusecs) throughout the year, the uncultivated land can be irrigated and sufficient hydroelectric power can be generated for industrialization. The only method of harnessing the water resources is by constructing high dams across the many rivers of India. To construct these dams, each Province has its program and the Centre has created two organizations, the C.W.I.N.C. and the Damodar Valley Authority (D.V.A.)

Some portion of earth embankment is included in every project, either for the dikes or for a part of main dam across the river for the reasons that the soils are available at the site and the cost is reduced approximately one-half as compared to a concrete dam. There is a great future for the earth dam construction in India. The construction of high dams is a novel experiment in India, and it is quite imperative that those concerned with construction should possess good engineering knowledge and considerable experience.

In this thesis no attempt has been made to write every detail of any topic which a text book gives. But the relevant points concerning the particular problems are specified. The actual case of the Hirakud Dam has

been computed throughout. The data used is taken from the Project Report of the same, and where the data is not available, reasonable values are assumed.

Much of the matter is based on the experience of the author on the Hirakud Dam in C.W.I.N.C. (India), on the McNary Dam, United States Corps of Engineers (U.S.A.), and on the South Holston Dam, Tennessee Valley Authority (U.S.A.) in addition to the knowledge gained by the advanced courses in Concrete, Soil Mechanics and Mathematics taken in Speed Scientific School, University of Louisville, as well as by the study of the literature in the Transactions of the American Society of Civil Engineers and many other references which the Technical Sections in T.V.A., Bureau of Reclamation and the Speed Library (University of Louisville) placed at his disposal.

H I S T O R I C A L

Orissa is a small Province in India with an area of 50,349 square miles and population of 11,752,275 so that the average density of the population is 233 per square mile. Its rivers are the Mahanadi, the Brahmani, the Baitharini, the Burahalong, and the Subernareka. The latter two are relatively small. The three principal rivers, the Mahanadi, the Brahmani and the Baitharini, have their origin in the hilly regions of Orissa and Central Provinces and extend parallel to the sea shore line. These rivers carry 107 million acre feet of water every year, a volume three times greater than that of Lake Mead (capacity 32 million acre feet), the greatest man made lake formed by the Hoover Dam in U.S.A.

The problem of Orissa is that these waters which constitute the potential wealth of the Province are running to waste, causing destruction and disease in their passage to sea. There is too much water during the rainy season and too little of it during the rest of the year, with result that "Orissa is haunted by spectre of flood and drought and of these the latter is more terrible." (2)

Terrible famines occurred in 14th, 15th and 16th centuries. In the famine of 1770, people were reported to be dying in thousands. In the year 1865, rains failed and nearly one million people died of famine in Cattack District alone. Then followed the flood of 1866. Crops and property were destroyed and what the drought had spared was engulfed in the flood waters. Hundreds of square miles were submerged from five to forty five days, water standing to a depth of ten feet.

The Orissa Government was very concerned and in 1855 Bihar and Orissa appointed a Flood Enquiry Committee. In 1937, Sir M. Viswesaraya visited the Province and submitted his report, and on the basis of his recommendations

the Orissa Government appointed another Flood Enquiry Committee in 1938. Sir M. Viswesaraya again visited Orissa in 1939 and the Flood Enquiry Committee submitted its report in 1940.

Finally in 1945 the problem was referred to the Government of India who passed it to the C.W.I.N.C. The Chairman of the Commission, Shri A. N. Khosla, visited Orissa in 1945 and his recommendations that three dams be constructed on the Mahanadi river were approved both by the Central and Provincial Governments at the instance of Dr. B. R. Ambedkar, who was then the Member of the Labour Department, Government of India.

The proposed three multipurpose dams are the Hirakud Dam, the Thickerapara Dam and the Naraj Dam, and these constitute the Mahanadi Valley Development Scheme. The first one to be constructed is the Hirakud Dam and then the other two in the order named. The Hirakud Dam is the project which forms the basis of the design and construction of this thesis.

T H E O R E T I C A L

A dam may be constructed for preventing flood, for power generation, for water supply, for irrigation, or for navigation. Though the construction of the dam is controlled by one of these factors, it is often possible to derive other benefits to some extent. In such a case the dam is called a multipurpose dam. The Hirakud Dam is a multipurpose dam, the controlling factor being the flood. Before reconnaissance, the engineer should have a general idea of the following:

- (1) The maximum run-off of the river for the year, which is obtained from a study of the rainfall statistics and catchment area.
- (2) The maximum flood level, which is obtained by local inquiry about the old flood marks.
- (3) The extent of the water to be stored and the extent of the land to be submerged. This can be arrived at from item (1) and a study of the contour maps.

The reconnaissance party consists of the engineer, two or three supervisors and ten or fifteen local coolies. Before starting the reconnaissance survey, the party spends one or two weeks in the office in arriving at a rough idea of the above items (1) to (3) and marking the different sites on the topographical maps of the Survey of the India Department.

The party takes to site the maps, a compass, a chain (100'), arrows, ranging rods, binoculars, axes, picks, drinking water, umbrellas, a hand camera and an aneroid barometer.

While traversing the different sites, the engineer bears in mind the following points:

- (1) The accessibility of the site.
- (2) The suitability of the diversion works.

- (3) The suitability of abutments and dikes.
- (4) The suitability of the foundation.
- (5) The availability of the construction materials.

After traversing the different sites, a careful office study enables the engineer to eliminate all but one or two sites. Preliminary investigation of those chosen sites is to be made. The party now includes an experienced geologist (can be requisitioned for a certain period from the Geological Survey of India Department) and a soil technician. Necessary work is as follows:

- (1) Aligning the axes of the dam by ranging rods and compass so that the party can walk from one end to the other.
- (2) Digging test pits along the axes at reasonable intervals.
- (3) Digging borrow pits in borrow areas.
- (4) Sampling the test pits and borrow pits.

By careful observation at site and analyzing the samples in the laboratory, the geologist and the soil technician assist the engineer in final selection of the axis of the dam as well as the borrow areas for the detailed investigation. The positions of the three dams of the Mahanadi Valley Development Scheme marked for final investigation are shown in Figure 1. All the proposed dams in India are shown in the same figure.

The detailed investigation comprises: (1) Establishing the hydraulic data, (2) Determining the suitability of the foundation, (3) Ascertaining the quality and quantity of the material at site for embankment, (4) Determining and furnishing data for the design, and (5) Completion of all detailed surveys.

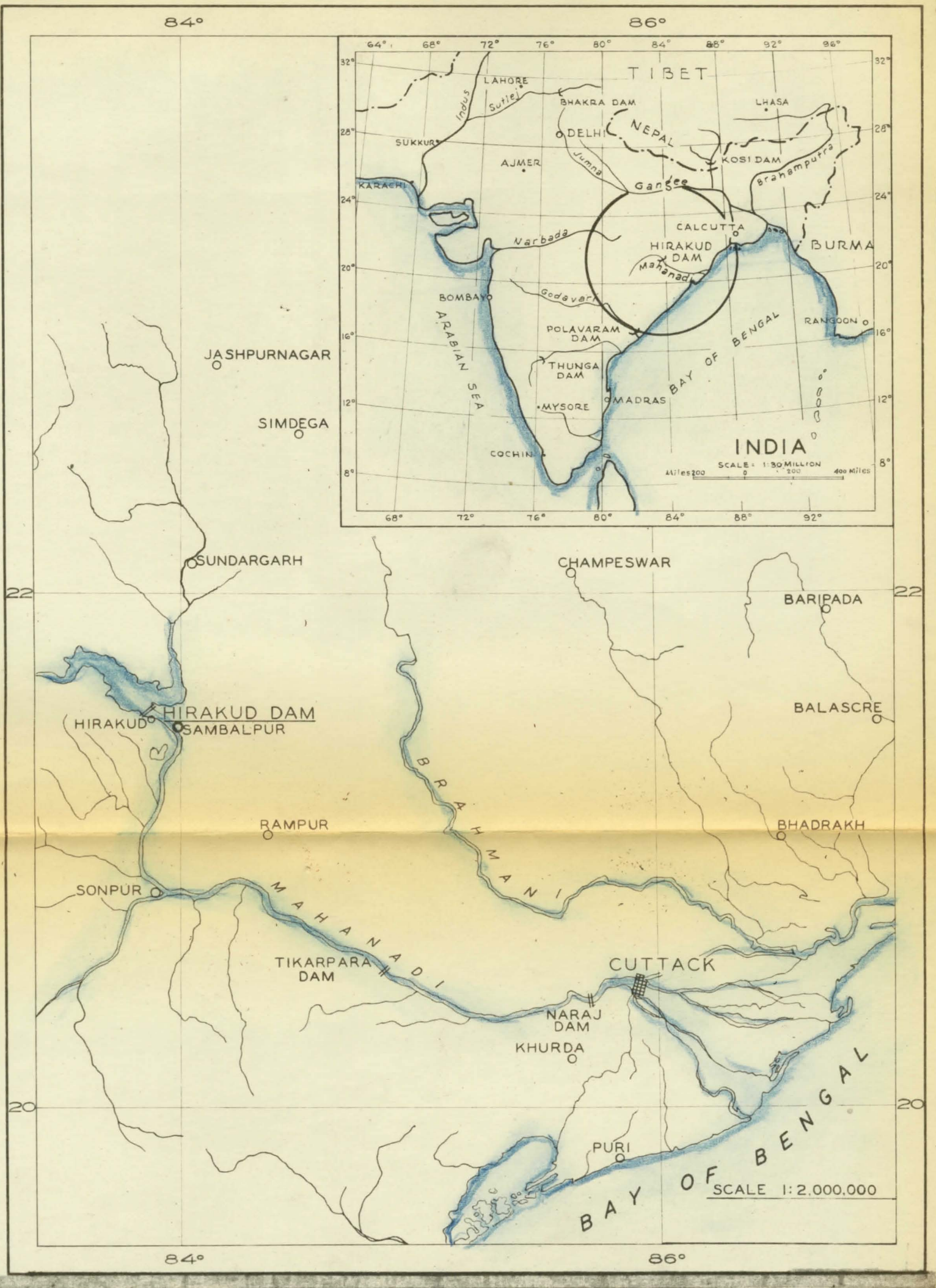

FIG. I SITE MAP — HIRAKUD DAM

The basic hydraulic data to be determined will be: (1) Maximum reservoir level, (2) dead storage level, (3) gross storage, (4) dead storage, (5) live storage, and (6) submerged area.

Before arriving at definite conclusions, careful meteorological and hydrological studies have to be made. Since rainfall is the basis of all flow of water, rain gauge readings are carefully recorded for a number of years at suitable places to be representative of the whole catchment area. To compute the run-off of the catchment area, the net rainfall has to be known. The difference between the precipitation and losses is the net rainfall. The losses are mainly due to temperature and percolation and since these do not permit an accurate measurement, there are many formulae employed at different places, each formula involving one or more constants to be determined from the local conditions. The formula $R = P - T/2 + C$ is used in case of the Hirakud Dam; where R is run-off in inches, P is precipitation in inches, T is in degrees Fahrenheit and C is a constant (it is 12.5 in case of the Hirakud Dam). This is derived from Khosla's general formula $R_A = P_A - KT_A$; where R_A is annual run-off, P_A is annual precipitation, K is a constant depending on the catchment area and T_A is annual temperature in Fahrenheit.

The more reliable method of computing run-off is by the river gauge readings. The gauge readings are recorded three times daily and the mean is taken as the reading for the day. The mean velocity of the stream is determined in a similar manner. The Price current-meter is used during normal flow but when the current is strong during flood, the boat cannot be kept under control, and in such a case the velocity rods at 0.6d are advantageously used. The sum of the products obtained by multiplying the

area of each cross section of the total section and the mean velocity of flow gives the total discharge for the day.

Even though river gauge readings are available for a number of years, the rainfall statistics are important to draw the graphs to show the relation between the incidence of rainfall and the run-off of catchment area. The graphs serve as a guide to see through the implications in the event of storm or failure of rains.

In actual project the first thing to do is to establish a relation between the river gauge and discharge as shown in Figure 2. A graph of this type established in a good flood year can be used in subsequent years for discharge computations corresponding to any gauge reading. The discharge corresponding to the safe gauge reading and the height to which the river water can rise for a maximum probable flood can be read from this graph.

From the meteorological records, mean monthly rainfall is computed for a number of years and a graph showing the relation between the months of the year and rainfall is drawn as shown in Figure 3. This graph shows the amount of run-off that can be expected in any month.

A graph showing the relation between the yearly rainfall and the corresponding run-off is drawn as shown in Figure 4. Knowing the total rainfall for the year, the corresponding run-off can be read for the particular catchment area to which the graph is referred.

The curve to fit a set of points is satisfactorily drawn by the method of least squares (3). Referring to Figure 4, the equation of the curve can be written as $y' = a - m(x - \bar{X})$ Eq. 1

where a and m are parameters, y' is the ordinate of the graph corresponding to the value of the variable y to be estimated, x is the coordinate

corresponding to y coordinate of the point and (\bar{X}, \bar{Y}) is the mean point.

From the Principle of Least Squares

$$\sum_1^n (y - \bar{y}^1)^2 \quad \text{must be a minimum}$$

$$\text{i.e.} \quad \sum_1^n [y - a - m(x - \bar{X})]^2 \quad \text{must be a minimum}$$

Since this is a function of (a, m) , it can be represented as

$$F(a, m) = \sum [y - a - m(x - \bar{X})]^2$$

Since the value of the function is a minimum, its partial derivatives with respect to a and m are equal to zero.

$$\frac{dF}{da} = \sum_1^n [y - a - m(x - \bar{X})] [-1] = 0, \quad \frac{dF}{dm} = \sum_1^n [y - a - m(x - \bar{X})] [-(x - \bar{X})] = 0$$

$$\text{Therefore, } an + m \sum (x - \bar{X}) = \sum y$$

$$a \sum (x - \bar{X}) + m \sum (x - \bar{X})^2 = \sum (x - \bar{X}) y$$

$$\text{and since } \sum (x - \bar{X}) = 0, \quad a = \bar{y} \quad \text{and } m = \frac{\sum (x - \bar{X}) y}{\sum (x - \bar{X})^2}$$

Now the equation of the least square line can be written as

$$y^1 - \bar{Y} = \frac{\sum (x - \bar{X}) y}{\sum (x - \bar{X})^2} (x - \bar{X}) \quad \text{Eq. 2}$$

This line is often called the regression line of y on x and it passes through the mean point (\bar{X}, \bar{Y}) . For computational purposes m can be written as

$$\frac{\sum xy - n\bar{X}\bar{Y}}{\sum x^2 - n\bar{X}^2}$$

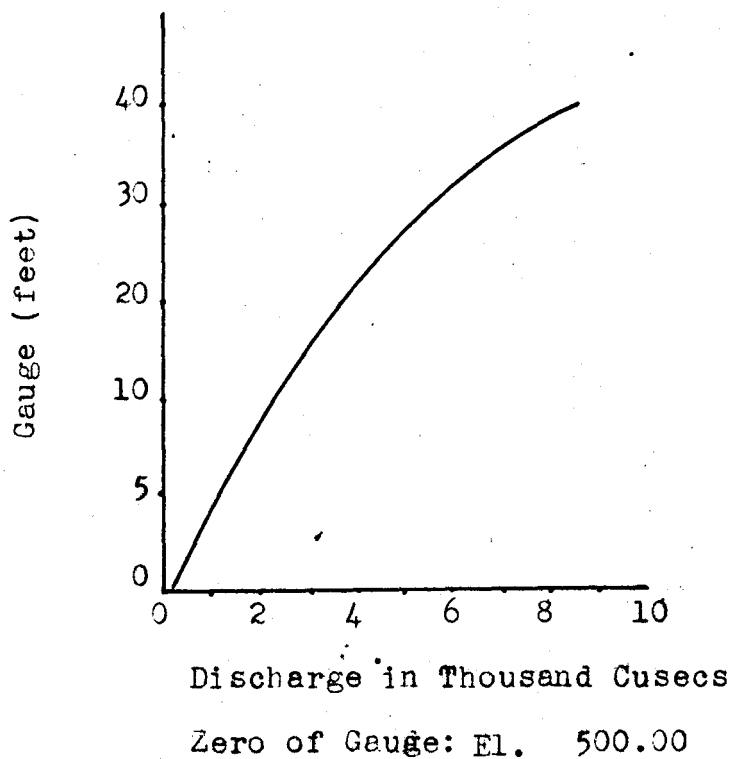

FIG. 2 - RELATION BETWEEN GAUGE AND DISCHARGE

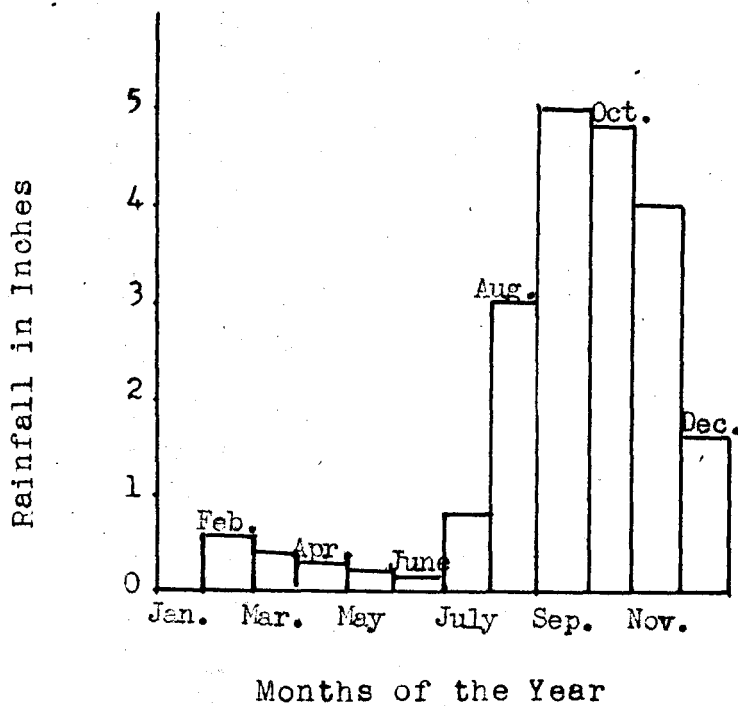

FIG. 3 - RELATION BETWEEN RAINFALL AND MONTHS

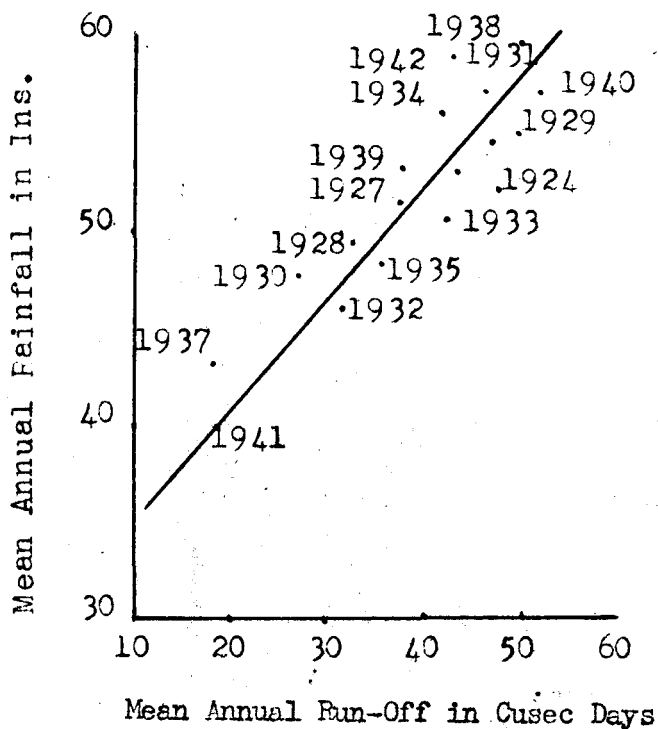

FIG. 4 - RELATION BETWEEN RAINFALL AND RUN-OFF

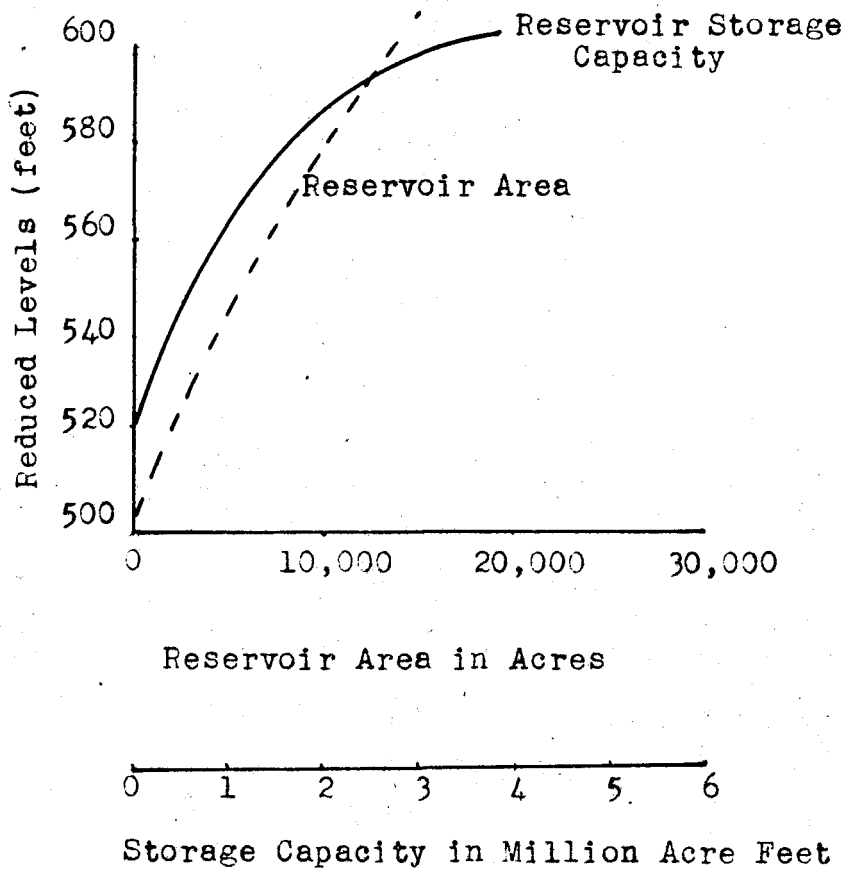

FIG. 5 - RELATION BETWEEN ELEVATION, RESERVOIR AREA

The areas under different contours can be measured with a planimeter from the topographical maps of the Survey of India Department and the storage corresponding to the contour levels can be computed. Then Figure 5 is plotted as shown. This graph is used to read the reservoir levels and the areas submerged for different storages. During flood time, gauge readings are carefully recorded as long as the flood lasts. The corresponding discharges are read from Figure 2. A graph connecting the discharges and the number of days of flood is drawn as shown in Figure 6. This graph is used to construct a corresponding graph for a probable peak discharge. Suppose the peak discharge of the flood from Figure 6 is Q_1 and a thousand year flood gives a peak discharge Q_2 , then the ordinates of the graph of the 1000 year flood are obtained by multiplying every ordinate of the graph by the ratio Q_1/Q_2 . A probable 1000 year flood graph is shown in Figure 7. The maximum ordinate of the graph is the maximum probable flood discharge.

Safe gauge reading is that reading which, when exceeded, causes damage to villages and crops. The discharge of the river corresponding to this level can be read from Figure 2 and this is the optimum discharge that can be allowed by constructing a dam. Since the flood discharge is very much in excess of this optimum discharge, the excess inflow has to be accommodated by the reservoir. A graph showing the mass curves for inflow and outflow during probable flood is shown in Figure 8 so that the accumulated discharge of inflow is computed by the measure of the maximum ordinate distance between the two curves.

The peak discharge of the probable flood is arrived at by the type of graph shown in Figure 9 and it is drawn from the table of computations as shown below. (4)

Table I

CALCULATIONS FOR PROBABILITY PLOTTING OF FLOOD DISCHARGES OF
HOCKING RIVER AT ATHENS, OHIO, 1916-1957

1	2	3	4	5	6	7	8	9
Year	Maximum 24-hr Average Yearly Peak, Q, (sec-ft)	Same as Col.2, but Arranged in order of Magnitude	Number of Times, n, Peak Was Equalled or Exceeded	Per- centage of Years p	Future Flood Fre- quency, 1 (years)	Col. 3 in Terms of Mean Flood	Variation from Mean V	V ²
1916	10,000	6,200	22	100.0	1.00	0.436	-0.564	0.318
1917	9,960	6,700	21	95.3	1.05	0.471	-0.529	0.280
1918	12,800	6,800	20	90.8	1.10	0.479	-0.521	0.271
1919	16,100	9,960	19	86.3	1.16	0.701	-0.299	0.089
1920	16,500	10,000	18	81.7	1.22	0.704	-0.296	0.038
1921	24,000	10,100	17	77.2	1.29	0.710	-0.290	0.084
1922	28,700	10,300	16	72.7	1.37	0.724	-0.276	0.076
1923	10,300	11,200	15	68.1	1.47	0.787	-0.213	0.045
1924	14,600	11,300	14	63.6	1.57	0.794	-0.206	0.042
1925	6,700	11,700	13	59.0	1.69	0.822	-0.178	0.032
1926	11,200	11,900	12	54.5	1.83	0.837	-0.163	0.027
1927	14,000	12,800	11	50.0	2.00	0.900	-0.100	0.010
1928	13,700	13,700	10	45.4	2.20	0.963	-0.037	0.001
1929	11,300	14,000	9	40.9	2.44	0.984	-0.016	0.000
1930	11,700	14,600	8	36.3	2.75	1.026	-0.026	0.001
1931	10,100	16,100	7	31.8	3.14	1.131	-0.131	0.017
1932	6,200	16,500	6	27.3	3.67	1.160	-0.160	0.026
1933	18,200	17,000	5	22.7	4.40	1.195	-0.195	0.038
1934	6,800	18,200	4	18.2	5.50	1.279	-0.279	0.078
1935	17,000	24,000	3	13.6	7.33	1.687	-0.687	0.472
1936	11,900	28,700	2	9.1	11.00	2.017	-1.017	1.034
1937	30,900	30,900	1	4.5	22.00	2.172	-1.172	1.374

312,660

4.403

$$\text{Mean Flood} = \frac{312,660}{22} = 14,200$$

$$\sum V^2 = 4.403$$

$$CV = \sqrt{\frac{4.403}{21}} = 0.457$$

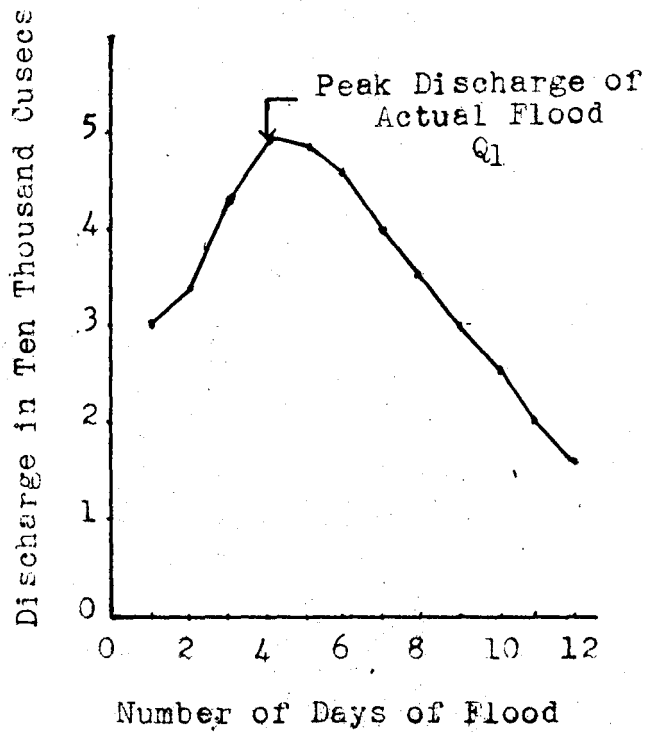

FIG. 6 - FLOOD CURVE

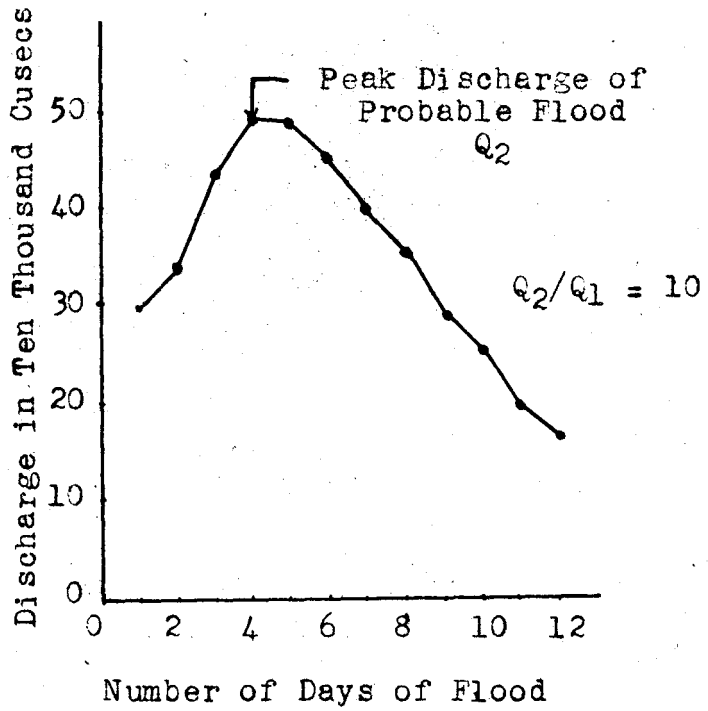

FIG. 7 - PROBABLE FLOOD CURVE

Sedimentary rocks such as sandstones, clays and shales give greater silt than igneous ones. This is due to disintegration. Forest and vegetable cover cannot hold silt from being eroded in times of intense rainfall. Regions of igneous and precarboniferous rocks are regions of clear water streams, and regions of recent sedimentary and alluvial deposits give rise to streams heavily laden with silt.

Difference in texture, cementation value, and chemical composition of rocks, vegetation and incidence of climate are important factors in weathering of rocks. Erratic rainfall accelerates erosion and transporting of the silt. If rain is gentle and evenly spread over a large catchment area, stream supplies are less heavily silt-laden on account of sustained vegetable cover. An arid climate combined with torrential rainfall results in heavy flows of silt. Snow-fed supplies do not appreciably add to silt load of stream but supplies derived from rainfall are in proportion to the amount of rain. Glacial supplies are silt-laden. The topographical features also add to the amount of silt in a stream. Steep hills contribute debris more quickly than flat sloping ones.

Rate of Silting. To determine the rate of silting of any particular reservoir there are other factors to be considered. These are the areas of the catchment basin, annual run-off, storage capacity, period of storage, location of the sluices and outlet works and the method of release of supplies through the dam. Of these the most important factor is the area of catchment. The Columbia River above the Grand Coulee Dam with a catchment area of 74,000 square miles and a mean annual run-off of 80 million acre feet carries practically no silt. The Nile River above the Aswan Dam with a catchment area of 620,000 square miles and a mean annual

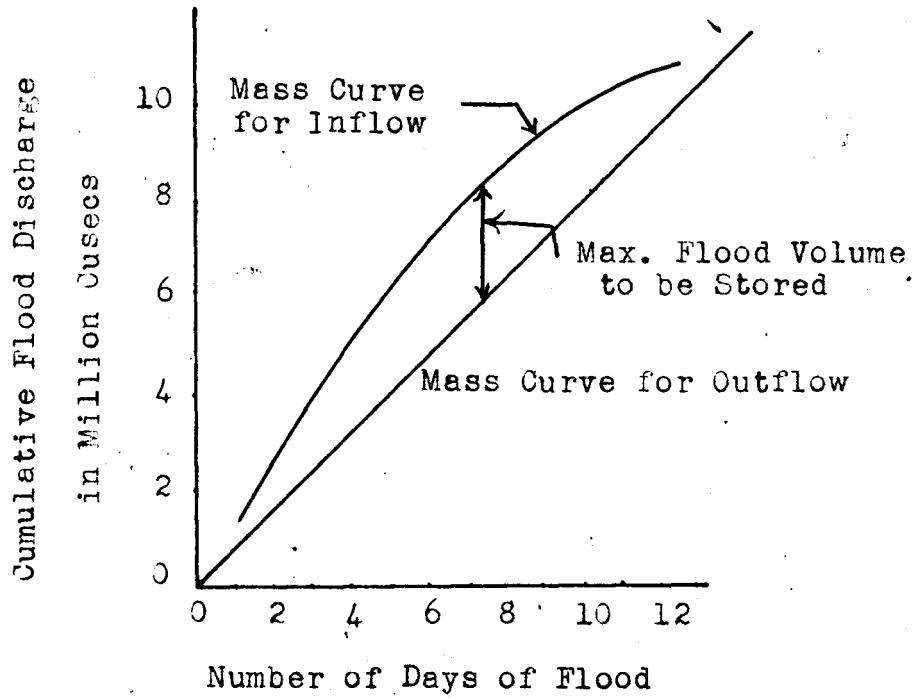

FIG. 8 - MASS CURVES FOR INFLOW AND OUTFLOW

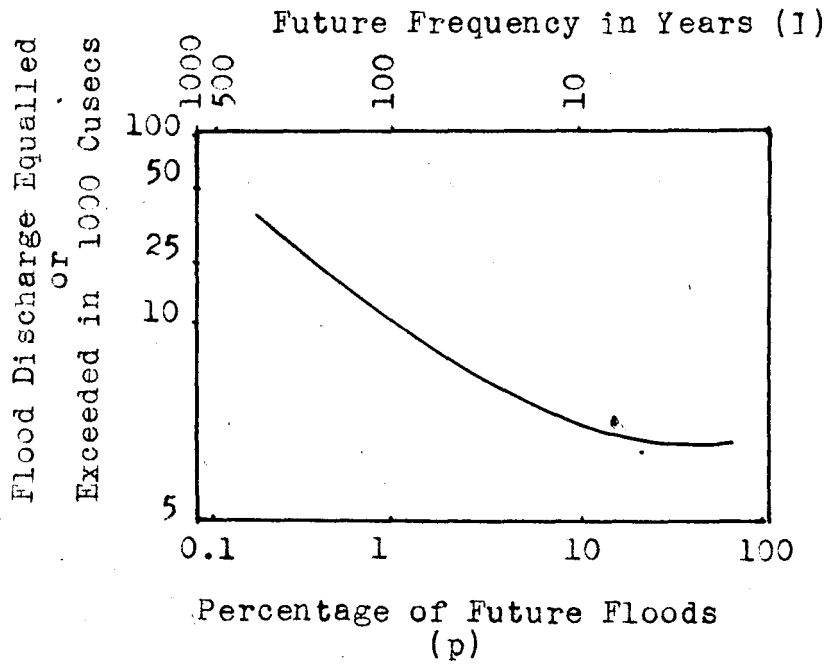

FIG. 9 - PROBABILITY CURVE

$$p = \frac{100n}{y} \quad \text{Eq. (1)}$$

p = the probable percentage of future years in which a flood equal or greater than a discharge Q occurs.

n_1 = the number of years during the period of record that a flood Q is equalled or exceeded as shown by Col. 2.

y = the total number of years of record (22 years in this case).

$$I = \frac{100}{p} \quad \text{Eq. (2)}$$

where I is future frequency in years.

The Problem of Silt

The study of the problem of silting of reservoirs is of vital importance for any undertaking on stored supplies. Each reservoir should have a certain minimum storage capacity which must remain undiminished for a minimum specified period, usually 50 years. Hence the full capacity must not be less than this minimum plus the probable volume of the silt deposit during that period. The correct determination of this probable silt reserve is, therefore, of the utmost importance for any storage scheme. The rate of annual storage depends on the annual silt load brought down by the stream and to the extent to which the latter is retained in the reservoir.

Origin of Silt. Silt is the material derived by the disintegration of rocks carried down by the flowing water of the stream. The factors that constitute the disintegration are the seasonal variations in temperature, wind, rainfall and the chemical agencies in the air and water. Disintegration, erosion, transportation and sedimentation are the different stages leading to silting.

run-off of 66 million acre feet carries approximately 100 million tons of silt per year. Wide divergences in rates of silting account for the wide variations of the rock formations of the catchment area, and artificial interference with the normal characteristics of the catchment area such as construction of check dams in tributaries and growing large scale forests and denudation.

Silt Loads. The silt carried by the stream is of two kinds:

(1) Suspended solids and (2) bed loads. In most cases the bed load is considered proportionately very small. The magnitude of the suspended silt is capable of being measured accurately by the standard methods of sampling and analysis. The samples are taken at $0.6d$, where d is the depth of the section where the sample is taken.

The bed load is the material which rolls along the bottom of the river by the action of the flowing water. No practical way has been devised to measure this amount. The amount is usually assumed to vary from 1% to 25% by weight of the suspended silt. The unit weight of silt varies from 20 lbs. to 110 lbs. per cubic foot. In estimating the rate of silting, a value of 85.9 lbs. per cubic foot was adopted at the Boulder Dam and that at the Bhakra Dam was 90 lbs. per cubic foot.

The rate of silting decreases in reservoir with age due to shrinkage on exposure of the deposits and to the gradual formation of the deltas at the mouth of the tributaries which help to hold the silt above reservoir level.

To fix the basic hydraulic data, the maximum water level must correspond to the maximum quantity of water to be stored. The maximum water to be stored is the dead storage plus the live storage. Dead storage Q_d (million acre feet) = NS_a , where S_a (million acre feet) is the annual silt deposit

and N is the number of years for which silt reserve is provided. Corresponding to quantity Q_d , the reduced level (R.L.) can be read from Figure 5. This fixes the dead storage level of the reservoir.

The quantity required to be stored during probable flood period is read from Figure 8. Let this quantity be Q_g (million acre feet). This quantity is called the live storage. Gross storage (the maximum storage of the reservoir) is $Q = Q_d + Q_g$ (million acre feet). Corresponding to Q , the R.L. can be read from Figure 5. This fixes the maximum water level of the reservoir. The area that can be read from the same figure corresponding to the maximum storage is the submerged area of the reservoir.

In case of the Hirakud Dam, the mean monthly run-off is worked out from the gauge readings for 21 years as follows:

<u>Months</u>	<u>Run-off</u>
January	225,500
February	194,295
March	161,709
April	107,847
May	80,245
June	725,067
July	5,908,210
August	8,439,580
September	5,840,918
October	2,337,958
November	692,093
December	<u>298,143</u>
Total -	25,011,186 cusec days
	= 80 million acre feet.

The total silt carried down by an annual run-off of 39.18 million acre feet for the year 1947 is computed to be 33,235 acre feet. Therefore, for the average of 50 million acre feet of run-off, the silt yield is $(33,235/39.18)(50) = 42,500$ acre feet. Allowing 50% through deep-set sluices, the amount retained in the reservoir is 21,250 acre feet per year. Therefore, for a hundred years the silt deposit is 2,125,000 acre feet = 2.125 million acre feet and this is the silt reserve.

The dead pond level corresponding to 2.24 million acre feet is elevation 590 feet. Corresponding to safe gauge reading elevation 90.2 feet at Naraj, the regulated flood discharge at Hirakud is 78,000 cusecs. The probable peak discharge of a hundred year flood gives 1,110,000 cusecs. So, from the mass diagrams, the quantity to be stored during flood period is found to be 3.74 million acre feet. This is the live storage. Therefore, the total quantity to be stored by the Hirakud Reservoir = $3.74 + 2.24 = 5.94$ million acre feet and this corresponds to elevation 625 feet. Therefore, the maximum water level of the reservoir is elevation 625 feet. Corresponding to this level, the area that is submerged is 150,380 acres.

A working table has to be prepared for the whole year. The mean values of the months for the period for which gauge readings are available are taken to represent a mean year, and computations are based on this year. The working table for 1938-39 for the Hirakud Dam is shown in Table II. Column (7) is worked out on the basis of precedence under similar conditions in other parts of India. Columns (8) and (9) have been arrived at on a detailed study of the existing conditions in India. Column (13) is computed by converting the million acre feet of column (8) in cubic feet per second.

TABLE II

WORKING DATA FOR HIRAKUD RESERVOIR

(Average Inflow 1938-39)

Year	Month	Reservoir Level at beginning of month R.L.	Capacity of the Reservoir at the beginning of the month M.A. ft.	Inflow during the month M.A. ft.	Total Quantity Available M.A. ft.	Evaporation losses M.A. ft.	Quantity required for Irrigation M.A. ft.	Quantity Available for Power M.A. ft.	Total Drawoff from Reservoir M.A. ft. (7-8-9)	Net capacity at end of the Month M.A. ft. (6-10)	Reservoir Level at end of the Month R.L.	Discharge available for power generation Cusecs.	Head (H)	Power Generated at 56% monthly L.F. K.W. in thousands.
1	2	3	4	5	6	7	8	9	10	11	12	13	14	15
1938	Nov.	625	5.98	1.01	6.99	0.04	0.37	0.74	1.15	5.84	624	12,400	112	184
	Dec.	624	5.84	0.57	6.41	0.03	0.15	0.68	0.86	5.55	622	10,900	111	160
1939	Jan.	622	5.55	0.45	6.00	0.04	0.15	0.68	0.87	5.13	619	11,050	108	157
	Feb.	619	5.13	0.36	5.48	0.03	0.13	0.63	0.79	4.69	615	11,350	104	156
	Mar.	615	4.69	0.33	5.02	0.05	0.15	0.73	0.73	4.09	610	11,650	99	154
	Apr.	610	4.09	0.23	4.32	0.05	0.10	0.74	0.89	3.43	604	12,250	93	150
	May	604	3.43	0.10	3.53	0.07	0.10	0.80	0.97	2.56	594	13,000	85	146
	June	594	2.56	0.73	3.29	0.05	0.15	0.84	1.04	2.25	590	14,000	79	146
	July	590	2.25	10.93	13.17	0.06	0.44	1.02	1.52	3.08	600	16,400	83	180
	Aug.	600	3.08	18.02	21.10	0.06	0.33	0.97	1.36	3.08	600	15,600	88	181
	Sept.	600	3.08	20.66	23.74	0.07	0.43	0.97	1.47	3.24	602	15,700	88	182
	Oct.	602	3.24	4.09	7.33	0.06	0.44	0.86	1.35	5.98	625	13,900	101	184

R.L. = Reduced Level

M.A. ft. = Million Acre Feet

Column (14) is the difference of level between the head-race and tail-race. Column (15) is computed as below. The efficiency of the turbine and the generator varies with the load factor. A graph connecting the load factor and the efficiencies of the turbine and the alternator is drawn and from such a graph, for example, the efficiency of the turbine = 91% at 100% load factor, the efficiency of the generator is 97% at 100% load factor. Then taking the first row, the power generated at 56% load factor is:

$$\left(\frac{WH}{550}\right) (0.746) \left(\frac{91}{100}\right) \left(\frac{97}{100}\right) \left(\frac{100}{56}\right) \text{ Kilowatts}$$

$$= \frac{(62.4) (12400) (112) (0.746) (91) (97) (100)}{(550) (100) (100) (56)} = 184,000 \text{ Kilowatts,}$$

where W is weight of the water falling per second in lbs. and H is the difference of the head between the head-race and the tail-race in feet.

FOUNDATION EXPLORATION

Foundation exploration is a part of the comprehensive soil exploration which is necessary in case of large projects. The cost involved for extensive soil exploration is comparatively small with respect to overall cost of a large project, but the gains derived by the results of the exploration may result in large savings since the design can be made economically and the construction program adopted accordingly. In case the magnitude of the work is so small that it is not worthwhile to spend much money in soil exploration, a liberal factor of safety has to be adopted in the design.

In order to adopt a suitable exploratory program to get the required data at the minimum expense of time and cost, the engineer in charge must have a good knowledge of the tools and the methods of soil exploration, of the methods of analyzing and digesting of the results of the laboratory and field tests and of the uncertainties involved in the results obtained by the different methods.

Since the geology of the site exercises decisive influence, the first step in a soil exploration program is to have thorough inspection of the site to investigate the geological character of the site and the second step is to make exploratory drill holes that furnish more specific information regarding the general character and the thickness of the individual strata. These two steps are obligatory while all others depend on the magnitude of work and the character of the soil profile.

The foundation of a dam, that is the valley floor and the abutments, may fail through crushing, sliding, piping or scouring. Therefore, thorough investigation has to be done on the foundation before a dam is designed

and built. The investigation consists of digging test pits, drilling holes and opening drifts.

Test Pits: From a study of the topographical map, the geologist in his office marks the position where he wants a test pit which the supervisor locates at site with a peg. Then the geologist visits the site and changes the position either to the right or left according to the geological features at site and once the location of the pit is fixed to the satisfaction of the geologist, the digging of the pit is started. The usual size of the pit is 8' x 8' or 5' x 5'. There must be careful supervision as the work progresses. The different strata of the earth are heaped separately as excavated and a sign board stating the position of the strata is placed on each heap. The geologist visits the test pit from time to time to log the work. The digging is continued until hard rock is reached, when the geologist requires no further digging. When the pit is completed the supervisor takes soil samples from the pit and sends them to Soils Testing Laboratory. The samples are taken cutting along the four sides of the pit from top to bottom, one foot wide, $\frac{3}{4}$ inch to one inch thick. Usually four samples of the size of a cement bag each are taken from the four sides of the pit and these four bags are thoroughly mixed in the laboratory and out of it only one bag is taken by cone and quarter-out method or by a sample splitter. This one bag is the most representative of the whole soil of the test pit for mechanical analysis.

When the samples are taken, the location of the pit is transferred to topographical map and its elevation and coordinates are fixed. During the digging, if there is any water percolating, the direction of the percolating water is noted. At the start of the work, the water is bailed out daily

after noting the level of the water. Even after the samples of the pit are taken, the recording of the daily water levels continues for a long time. Fencing is erected around the pit so that cattle and wild animals may not fall into the pit and the pit and heaps are carefully maintained until the final inspection is completed. The following record is carefully maintained about each pit:

- (1) Test pit number
- (2) Location (coordinates with reference to origin at one end of the axis of the dam)
- (3) Elevation
- (4) Depth
- (5) Date of commencement of the work
- (6) Date of samples taken
- (7) Date of completion of work
- (8) Record of water levels

It is advantageous if all the test pits can be completed before monsoon. These test pits are usually dug along the axis, the toe-line and the cut-off line. When all the test pits are completed, the geologist prepares the log sheets for all the test pits in his office and furnishes them to the engineer. The soils samples sent to the laboratory are subjected to the tests, chemical analysis, mechanical analysis, Atterberg limits, shear, permeability and compaction. The results of the tests in the shape of graphs and charts are conveyed to the engineer who studies them in conjunction with the log sheets so as to come to certain conclusions as regards the suitability of the foundation.

Drill Holes: The purpose of drilling is (1) to make sure that the ledge

rock is sound for 30 feet to 50 feet below the foundation, (2) to supplement the geological data secured by the test pits and (3) to provide imperviousness to the foundation by grouting.

Two types of drilling operations are known respectively as Calyx drilling and Diamond drilling. A hole with a diameter of about three feet can be made by the Calyx drill whereas that by the Diamond drill varies from one to three inches. The engineer can go down the Calyx drill hole and study the geological formation underlying the foundation by visual inspection. But the Calyx drilling is limited to one or two holes because of its cost and the time taken for each hole. Since the Diamond drilling is cheap and quick, it is one of the most important operations in dam construction.

Before starting a drill hole, it is located just as a test pit and the drill is shifted to the point and connected with a pipe line to the pump placed at a water source. A tractor or bulldozer is found to be very useful to clear the way and convey the drill to the point. After washing the overburden, the operator drives the Nx casing, the largest sized steel tube, and as the work proceeds the core is removed and placed in a core box. The change of strata, the change of colour of the wash-water, the loss of water and any operational peculiarities are carefully recorded as the work progresses. The geologist visits the drill hole from time to time to log the work. The work is stopped when the geologist finds that there is no change in the uniformity of the rock and that there is no change in fissures, faults, strike and dip of the underlying strata, as the drilling proceeds deeper and deeper. The seepage test is performed and the casing removed before the drill is shifted to the other point. The dimensions of the drill rods are as shown in Table III.

TABLE III

<u>Type</u>	<u>Inside diameter</u>	<u>Outside diameter</u>
Nx	2-1/8"	2-15/16"
Bx	1-5/8"	2-5/16"
Ax	1-1/8"	1-13/16"
Ex	7/8"	1-7/16"

The following record is maintained for each drill hole:

- (1) Drill hole number
- (2) Location
- (3) Elevation
- (4) Date of commencement
- (5) Depth of overburden
- (6) Depth where hard rock is encountered
- (7) Total depth of the hole
- (8) Date on which seepage test is conducted
- (9) Date of completion of the work
- (10) Record of daily water levels
- (11) Record of core boxes

The drill holes are usually located at 50 feet to 100 feet intervals along the axis, the toe-line and the cut-off line. The grout holes along the cut-off line may be even 15 feet to 25 feet apart. The geologist prepares the log sheets of all the holes and furnishes them to the engineer who correlates the results to study and arrive at certain conclusions as regards the suitability of the foundation, based on his experience and knowledge of the site.

The core and log sheets are placed before the bidders for satisfying them about the subgrade and foundation conditions. Even after the inspection of the bidders and construction of the dam, the core and log sheets are

carefully preserved for a long time.

Drifts: Drifts are tunnels of about 8' x 7' opened in hills to investigate the suitability of the foundation for abutments of the dam. The location, the execution of work and the purpose are the same as those of the test pits except that the tunnel work proceeds horizontally.

QUANTITY SURVEY OF THE MATERIAL

Before surveying the quantities of material for the construction of the dam and before designing the dam, the engineer draws a tentative cross section of the embankment with due consideration to the basic hydraulic data, the availability of the material at dam site and the practical requirements. Afterwards he checks the sufficiency of the quantity of the material by the borrow area investigation and the suitability during design. The cross section contains different zones such as rock-fill, riprap, semi-pervious zones and impervious centre core. Knowing the length of the dam and the areas of the different zones, the quantity of the different classes of the soil can be computed. Then the borrow area at the dam site is traversed and the soils explored. The exploration consists of digging borrow pits (usually of the size 5' x 5' and to a depth below which it is not possible to excavate with ordinary pick axes) at different places so that the soil samples taken from these pits are to be representative of the whole area. The average depth of all pits multiplied by the area gives the total quantity of the material. The percentages of the different classes of the material for the different zones of the embankment are computed by the mechanical analysis of the samples. The soil samples taken from the borrow pits are tested in the Soils Laboratory for chemical analysis, mechanical analysis, Atterberg limits, shear, permeability and compaction.

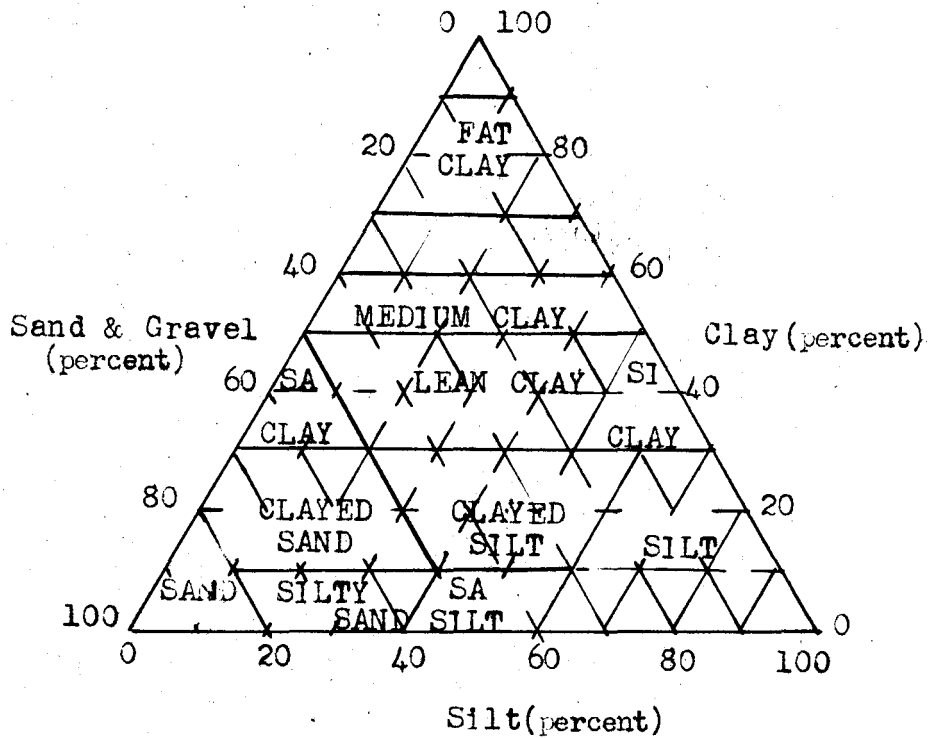

FIG. 10 - SOILS CLASSIFICATION BY TRIANGLE

Soils containing more than 25% gravel and more than 15% silt and clay are described as gravelly.

Soils containing gravels and less than 15% silt and clay are sands and gravels.

Gravel: 85% or more gravel.

Gravel and Sand: 50% or more gravel.

Sand and Gravel: 25% or more gravel.

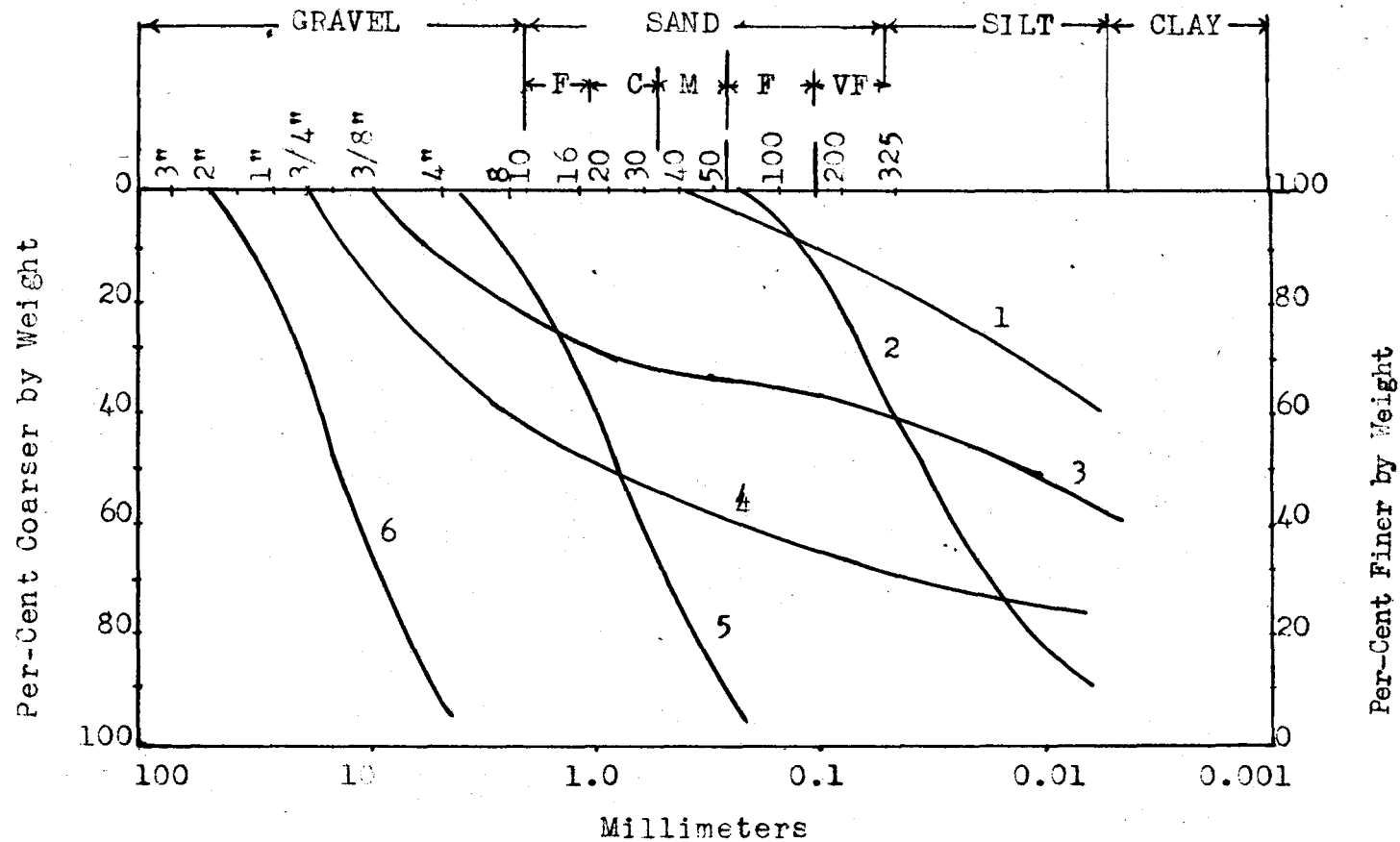

FIG. 11 - SOILS CLASSIFICATION BY MECHANICAL ANALYSIS

- | | |
|------------------|-------------------------|
| 1. Medium Clay | 4. Gravelly Clayey Sand |
| 2. Sandy Silt. | 5. Sands and Gravel |
| 3. Gravelly Silt | 6. Gravel. |

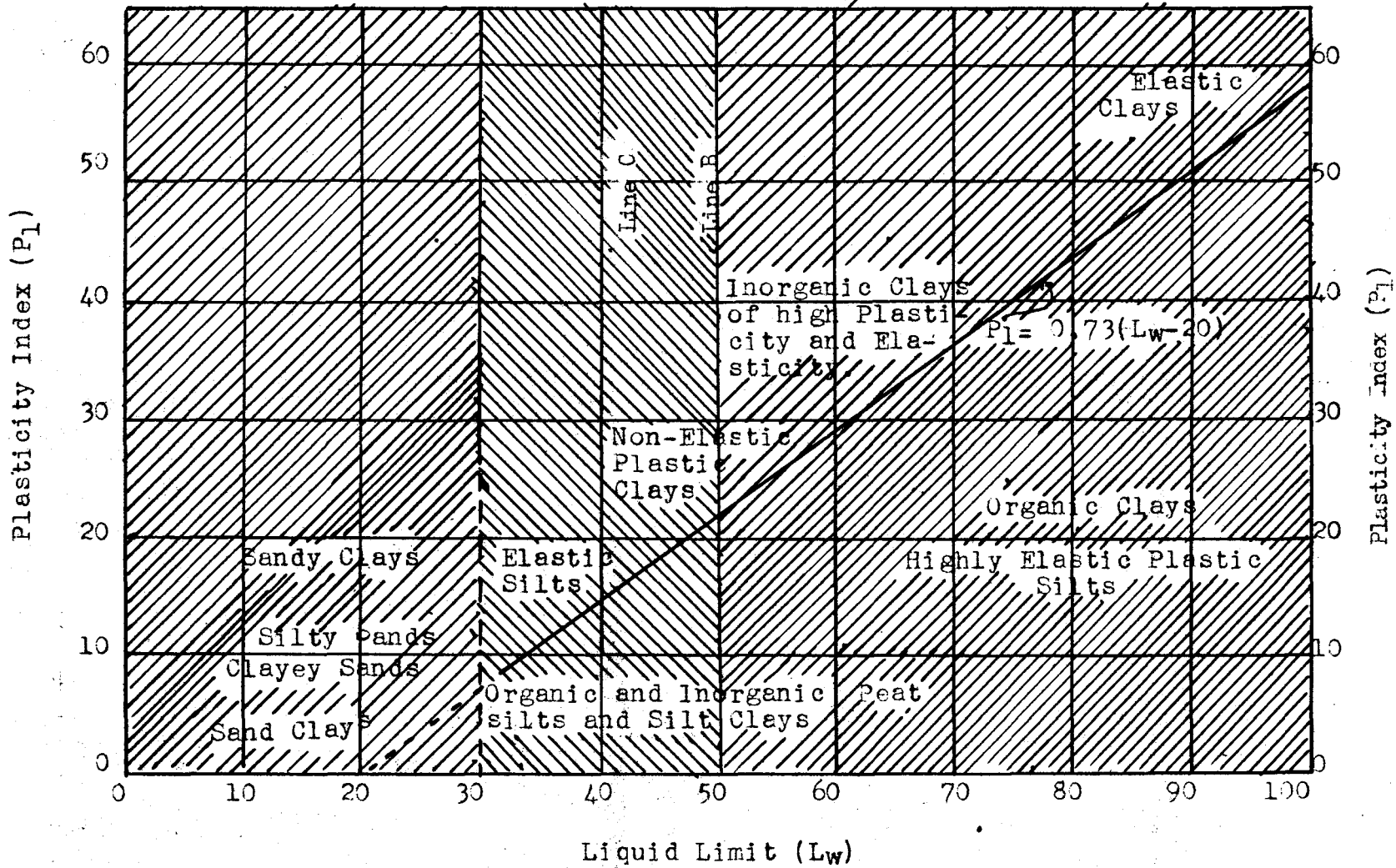

FIG. 12 - PLASTICITY CHART

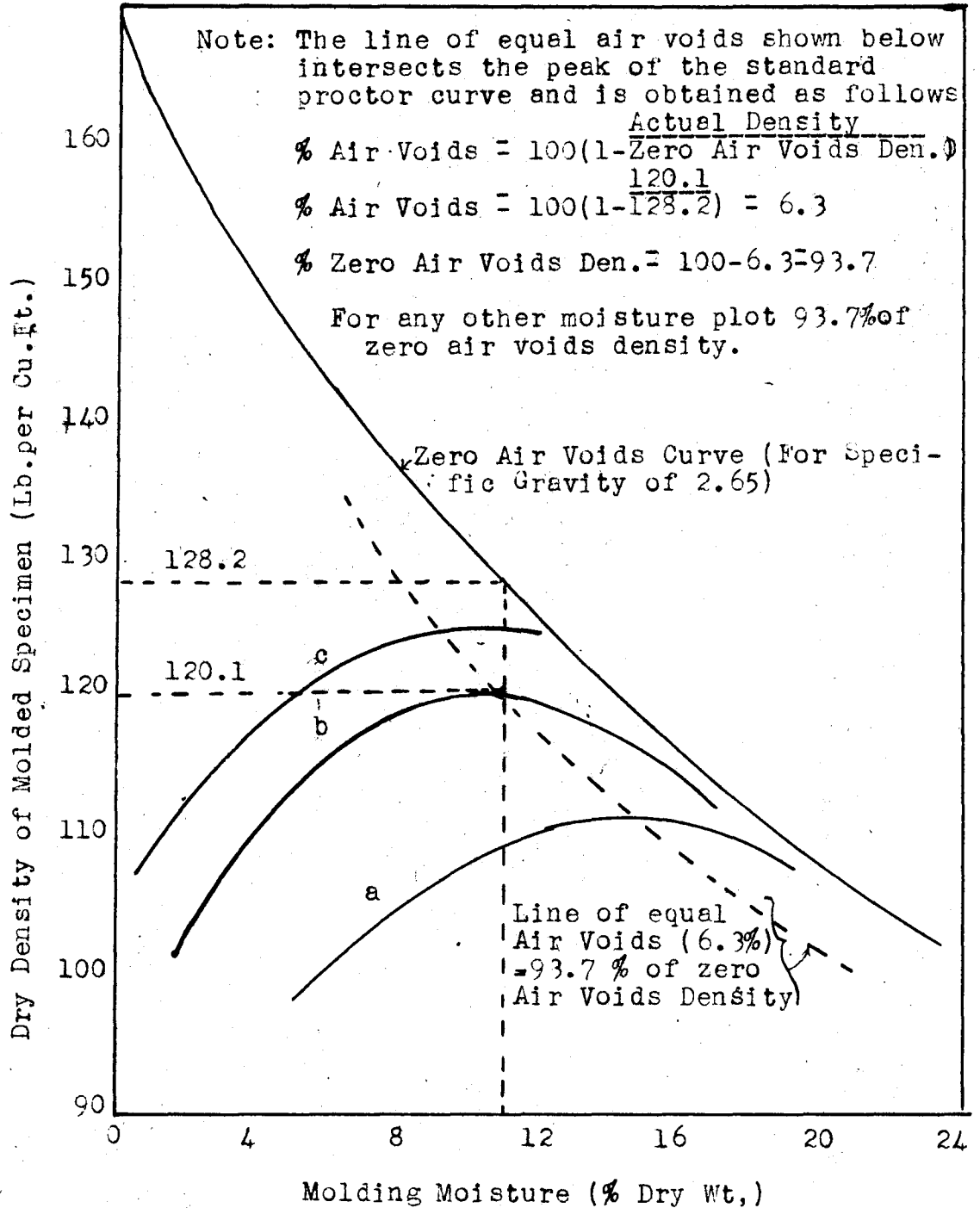

FIG. 13 - EFFECT OF NUMBER OF BLOWS ON DENSITY

- a: 15 Blows per Layer
- b: 25 Blows per Layer
- c: 40 Blows per Layer

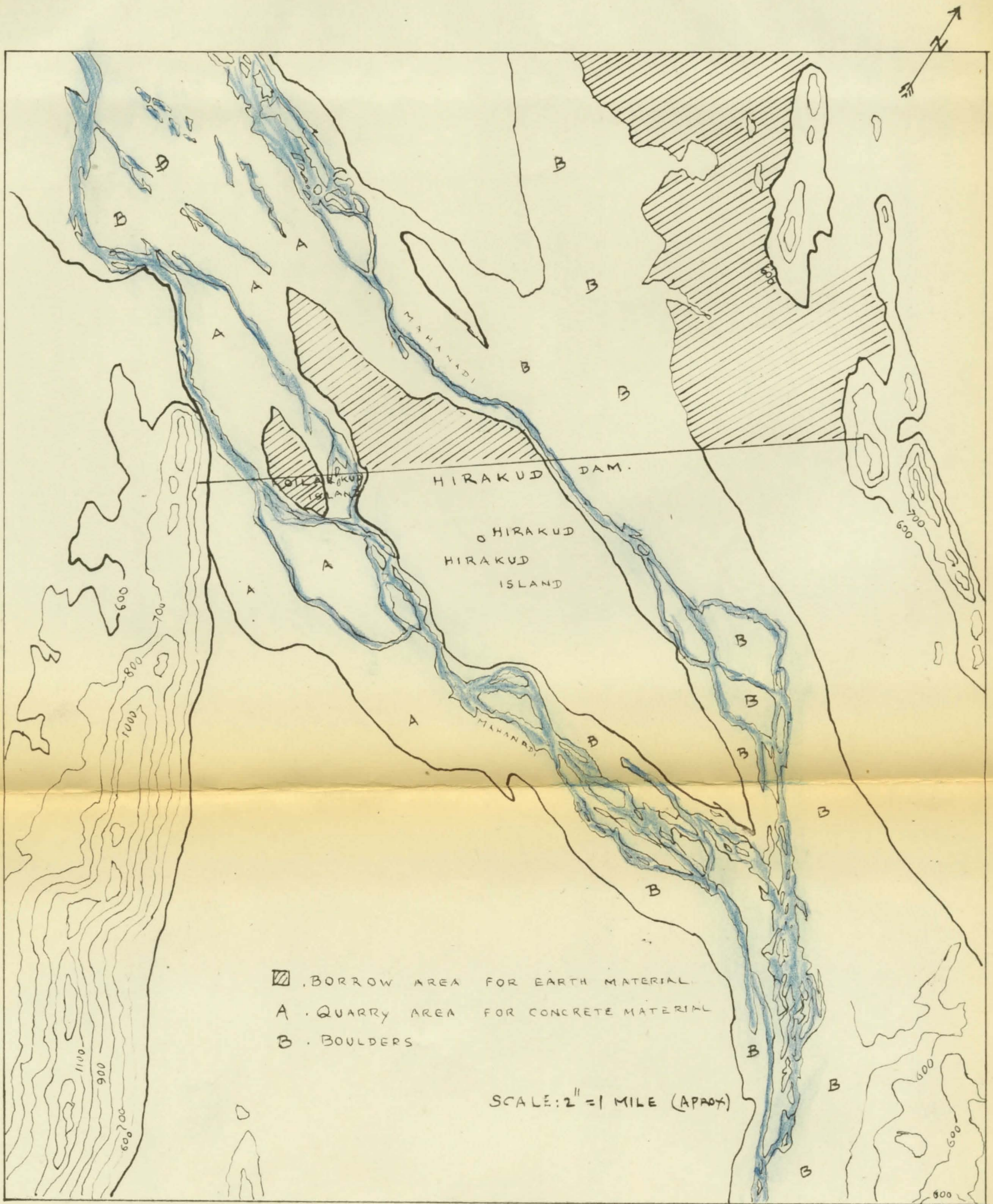

FIG.13A QUARRY AREA AND BORROW AREA

Figures 10 and 11 show the soil classification tests and Figure 12 shows the compaction test as used by the U. S. Corps of Engineers. The quarry area for riprap and rock-fill is blasted in drifts or in pits to find out whether the rock is suitable and sufficient.

In case of the Hirakud Dam it is found by investigation that sufficient quantities of materials for earth dam as well as for spillway are available at dam site. Figure 13A shows the quarry areas and the borrow areas for concrete aggregate and earth dam materials.

SURVEYS

All surveys are classified into three categories as follows:
(1) reconnaissance surveys, (2) preliminary surveys, and (3) final surveys. These surveys belong either to horizontal control or vertical control. The surveys that come under horizontal control are the transit stadia traverse methods, the triangulation methods, and the coordinate or grid system methods. The surveys that come under vertical control are those of establishing the standard bench marks at convenient points for reference.

The error in elevation is not to exceed $1/5$ of the contour interval.

DESIGN OF FOUNDATION

After the foundation investigation is completed the design of the foundation is affected by a consideration of the control of the seepage and the control of the stability. The seepage is controlled by cut-off walls, sheet piling cut-offs, abutment contacts, grouting and upstream impervious blankets. The cut-off trenches, one or two, are provided on

upstream side and are to be dug to hard impervious bed rock. The grouting material is a mixture of cement and water in a suitable proportion, usually 1 : 3, or a mixture of clay, cement and water in a suitable proportion. The slope of the upstream impervious blanket varies from 1 : 6 to 1 : 8, or even flatter. The required thickness varies with the permeability of the material and the head of water to which it is subjected. The usual thickness is about 1 to 4 feet. The purpose of the upstream blanket is to decrease the slope of the line of percolation whereas the one in downstream is to protect the material from being scoured away. The control of the stability is affected by the removal of the unstable material, by unwatering the foundation, by providing the downstream inverted filter, by providing drains and by employing stabilizing fills.

DESIGN OF EMBANKMENT

The essentials of an embankment are:

- (1) Adoption of a cross section and scheme of material distribution so that the stability of the structure is insured under all conditions of saturation and loading.
- (2) Necessary water tightness and resistance to percolation.
- (3) Protection of embankment slopes against sloughing and erosion.
- (4) Adequate insurance against overtopping.

The cross section adopted for the Hirakud Dam is shown in Figure 14 to meet the requirements (1), (2) and (3). The different zones fulfill condition (1), the impervious centre core fulfills condition (2), and the rock-fill and riprap together with the flat slopes fulfill condition (3). The fourth condition is met by the provision of adequate length of the

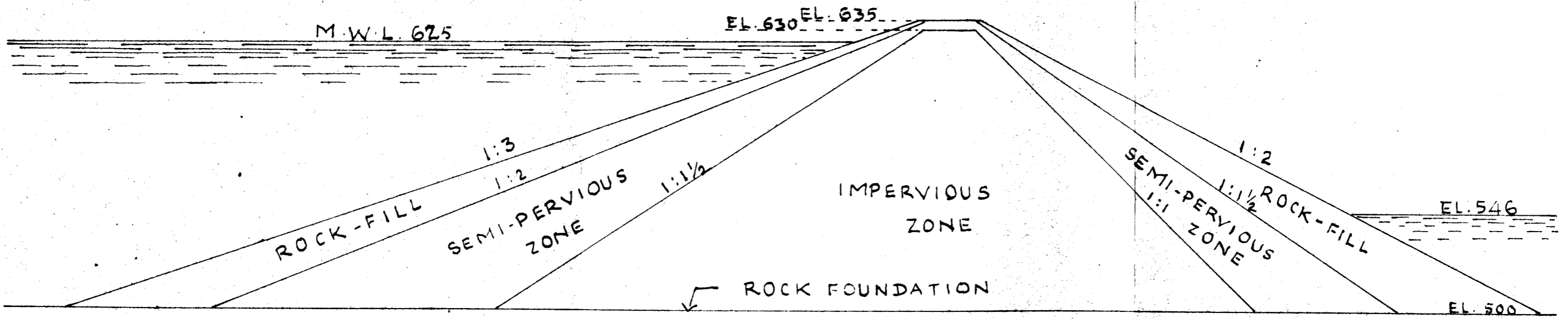

FIG.14 CROSS SECTION OF HIRAKUD DAM

SCALE: 1" = 50'

spillway and free board with consideration of the basic hydraulic data.

Though there are many theoretical methods to determine the stability of an embankment, only the "slip circle method" adopted by the T.V.A. and the Bureau of Reclamation, is described here.

The strength of an earth dam is described by the term "factor of safety" (F.S.) and is equal to the ratio of the resisting moment to the overturning moment. It is generally assumed that the shape of an embankment failure is that of a circular arc. The rupture plane follows the circle of the least factor of safety under all adverse conditions of failure of the embankment and the design is, therefore, a process of trial and error to determine the circle of the least factor of safety.

Referring to Figure 15:

$$\begin{aligned} \text{F.S.} &= \frac{\text{Resisting moment (M}_R\text{)}}{\text{Overturning moment (M}_T\text{)}} \\ &= \frac{W_2 l_2 + Fr}{W_1 l_1} \end{aligned}$$

G = Centre of gravity of the slip

G₁ = Centre of gravity of the portion right of the vertical through O,
the centre of the circle

G₂ = Centre of gravity of the portion left of the vertical through O,
the centre of the circle

l₁ = Distance of G₁ from the vertical

l₂ = Distance of G₂ from the vertical

W₁ = Weight of the portion right of the vertical acting through G₁

W₂ = Weight of the portion acting left of the vertical through G₂

r = Radius of the slip circle

F = Resisting force acting along the line of rupture

The resisting force F is the sum of the shearing resistance of the cohesionless particles and the apparent cohesion of the cohesive particles.

Figure 15 to 25 show the explanation for the different steps for the design computations of the Hirakud Dam.

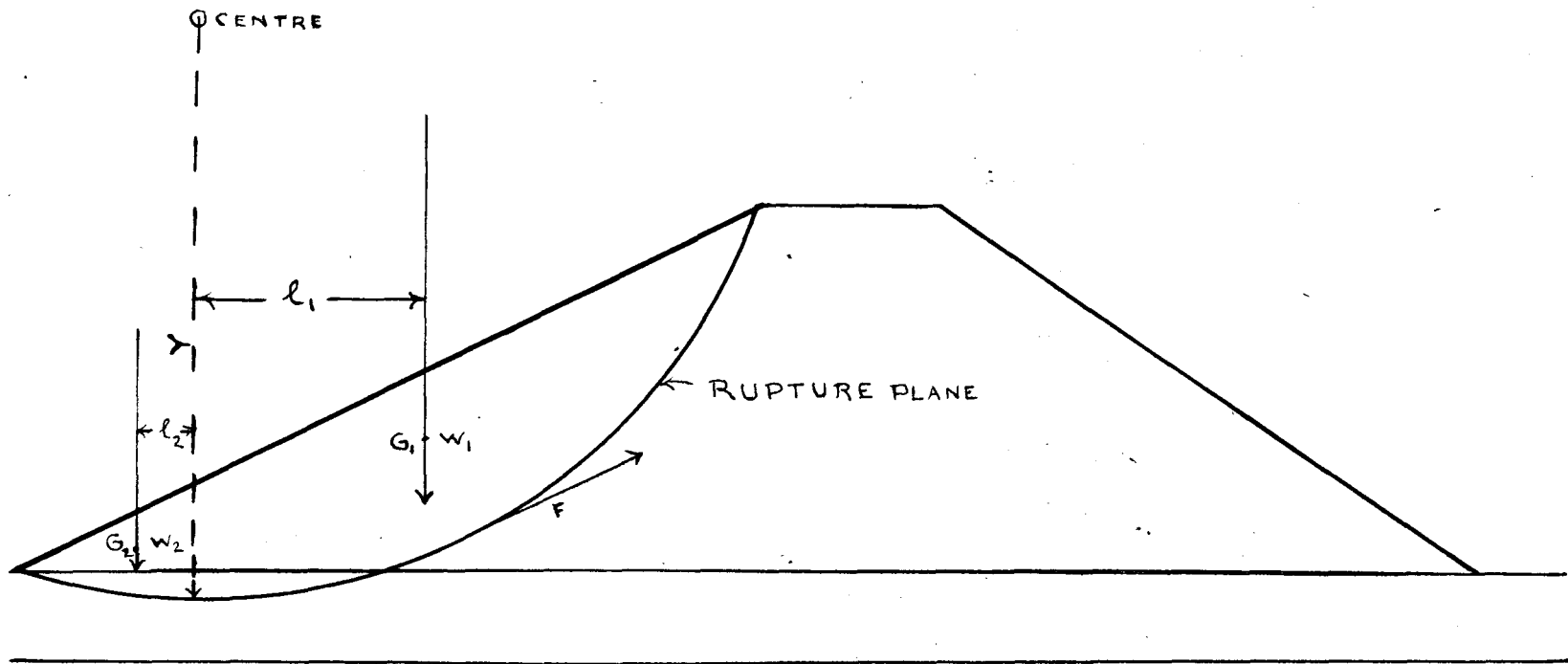
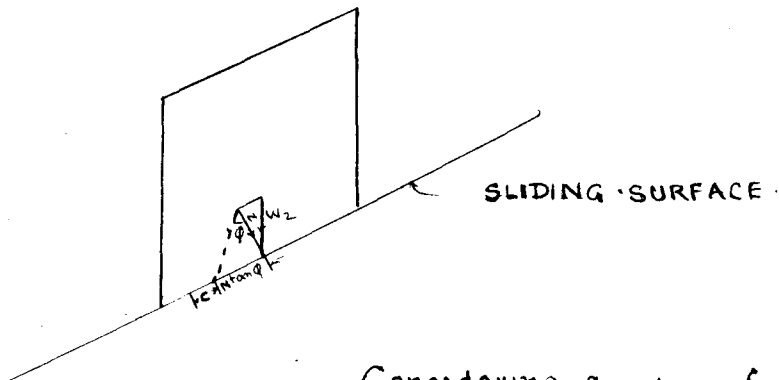

FIG.15 FAILURE OF EMBANKMENT IN CIRCULAR ARC

$$F.S. = \frac{M_R}{M_T} = \frac{W_2 l_2 + F Y}{W_1 l_1}$$



Considering a slice of the slip as shown in figure, W_2 is the weight of slice No.2.

N = Component weight of the slice normal to the sliding plane.

ϕ = Angle of the internal friction of the soil

$N \tan \phi$ = Resistance of cohesionless soil.

c = Resistance of cohesive soils.

These resisting forces are applied to the slip circle as shown in figure 17

FIG.16 FORCES ACTING ON A SLIDING SURFACE

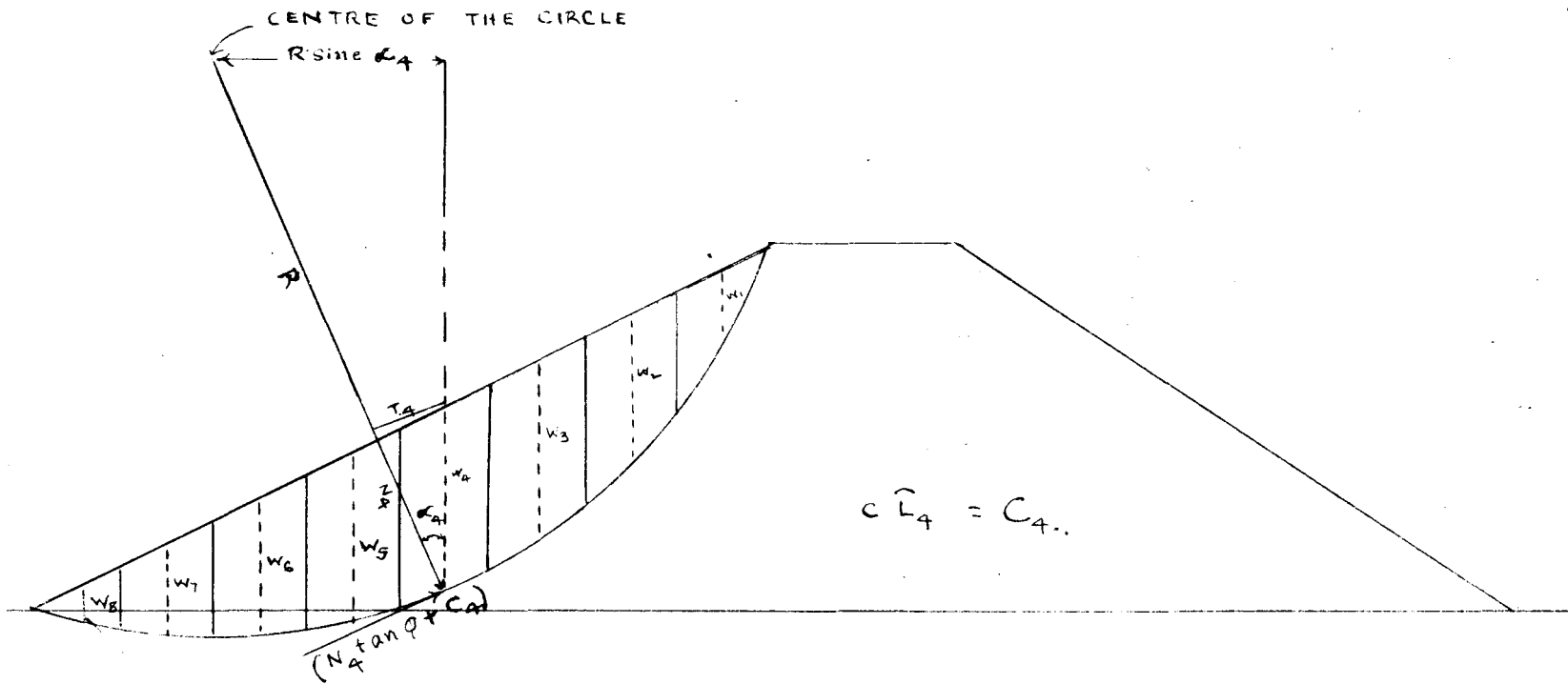

FIG. 17 DERIVATION OF FORMULA TO FIND FACTOR OF SAFETY (F.S). \bar{L}_4 = Length of arc of slice 4

c = cohesion per unit area

α = angle between the radius and the vertical through the centroid of a slice.

$$M_{R_4} = (N_4 \tan \phi)(R) + (C_4)(R) \quad \text{and} \quad M_{O_4} = (W_4)(R \sin \alpha_4)$$

$$= (W_4 \cos \alpha_4 \tan \phi)(R) + (C_4)(R)$$

\therefore The total resisting moment is $M_R = \sum_1^B WR \cos \alpha \tan \phi + \sum_1^B CR$

The total overturning moment $M_O = \sum_1^B WR \sin \alpha$

$$F.S = \frac{M_R}{M_O} = \frac{\sum WR \cos \alpha \tan \phi + \sum CR}{\sum WR \sin \alpha} = \frac{\sum W \cos \alpha \tan \phi + \sum C}{\sum W \sin \alpha}$$

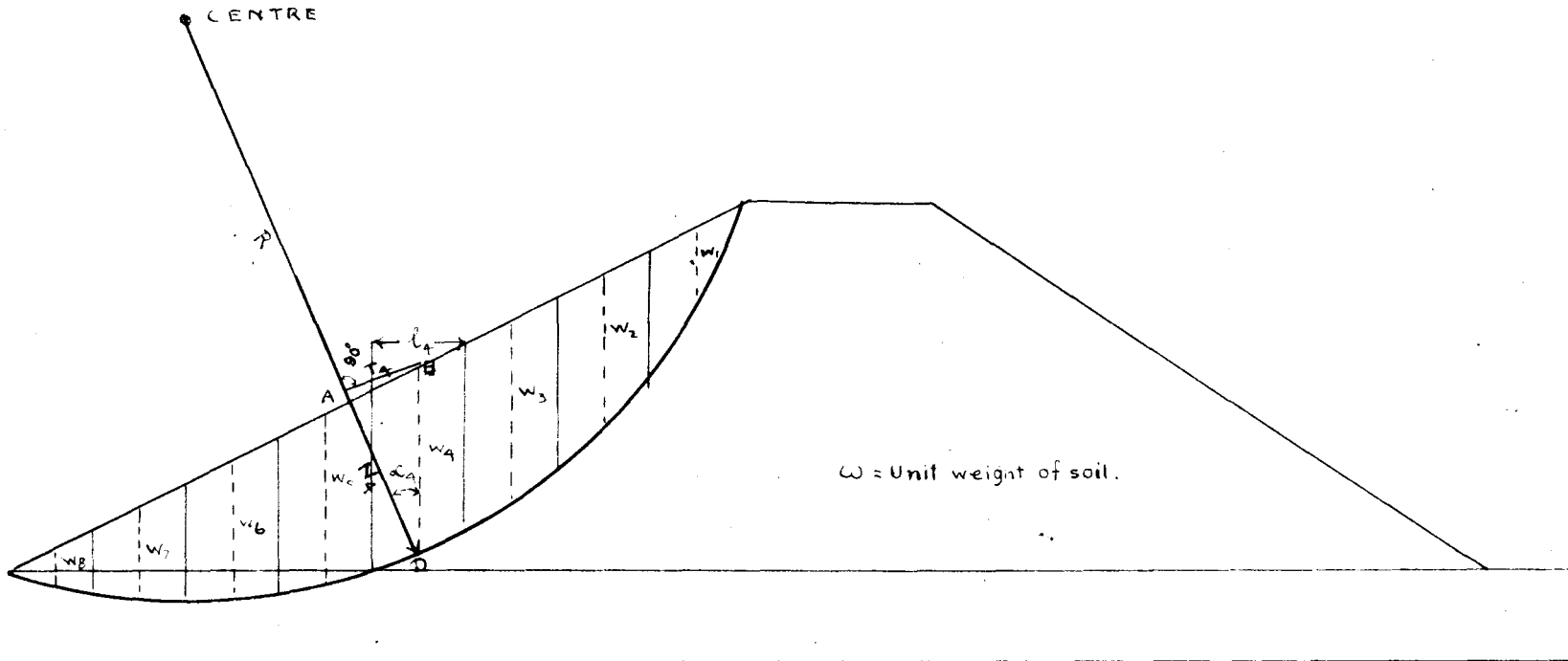

Referring to the figure, w_4 is resolved into its normal component (N_4) and tangential component (T_4). From the force polygon ABD, $AB = T_4$; $AD = N_4$ and $BD = w_4$

$$w_4 = w BD l_4 = \text{weight of slice.}$$

$$N_4 = w_4 \cos \alpha_4 = BD w l_4 \cos \alpha_4 = AD w l_4 = \text{normal force.}$$

$$T_4 = w_4 \sin \alpha_4 = BD w l_4 \sin \alpha_4 = AB w l_4 = \text{tangential force.}$$

$$F.S = \frac{\sum W \cos \alpha \tan \phi + \sum c}{\sum W \sin \alpha} = \frac{\sum N \tan \phi + \sum c}{\sum T} = \frac{\sum AD w l \tan \phi + \sum c}{\sum AB w l}$$

FIG.18 SIMPLIFICATION OF FORMULA

The procedure of the slip circle method is formulated below. (See Figure 19)

1. The cross section of the earth dam is drawn to the largest convenient scale.
2. A trial point representing the centre of the slip circle is assumed.
3. A trial circle is assumed to cut through the dam section.
4. The cut section is divided into eight to twelve convenient slices.
5. The centre line of each slice is drawn and numbered.
6. The radii to intersections of centre lines and circle are drawn.
7. The tangent and normal lines at each slice are drawn.
8. The tangents and normals are scaled and recorded in a table.
9. The summations of the tabulated values are used in the formula for determining the factor of safety.

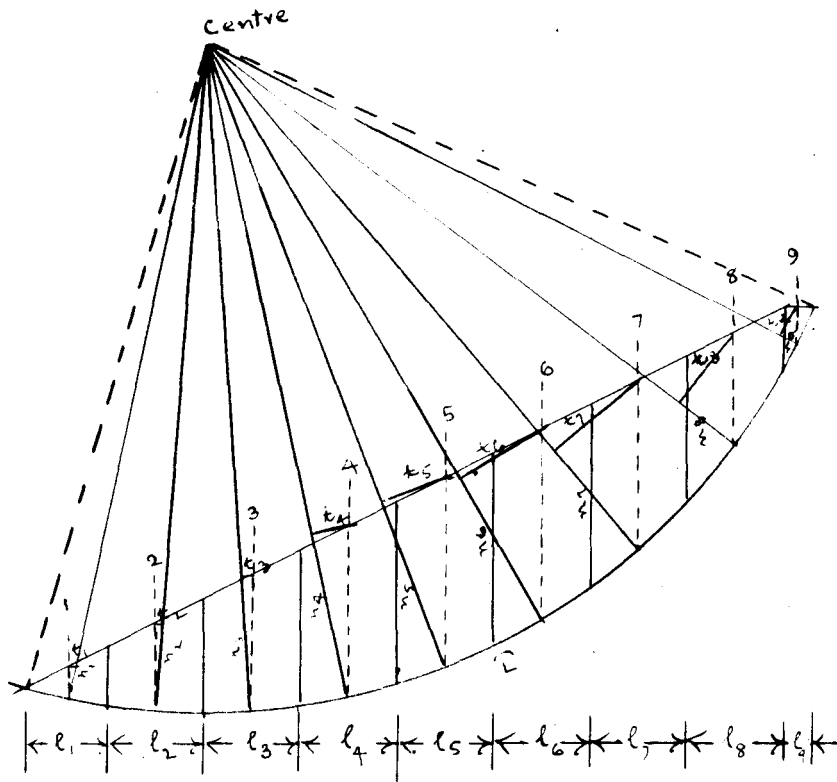

Slice	t	n
1	$-t_1 \times \frac{l_1}{L}$	$n_1 \times \frac{l_1}{L}$
2	$-t_2$	n_2
3	$+t_3$	n_3
4	$+t_4$	n_4
5	$+t_5$	n_5
6	$+t_6$	n_6
7	$+t_7$	n_7
8	$+t_8$	n_8
9	$+t_9 \times \frac{l_9}{L}$	$n_9 \times \frac{l_9}{L}$
Σ	Σt	Σn

$$L = l_2 = l_3 = l_4 = l_5 = l_6 = l_7 = l_8$$

$$\begin{aligned} \Sigma t \omega l &= \omega \Sigma t l = \omega (t_1 l_1 + t_2 l_2 + t_3 l_3 + \dots + t_9 l_9) \\ &= \omega L (t_1 \frac{l_1}{L} + t_2 + t_3 + \dots + t_9 \frac{l_9}{L}) \end{aligned}$$

$$\begin{aligned} \text{similarly } \Sigma n \omega l \tan \phi &= \omega L \tan \phi (n_1 \frac{l_1}{L} + n_2 + n_3 + \dots + n_9 \frac{l_9}{L}) \\ \Sigma C &= c \bar{L} \end{aligned}$$

$$F.S. = \frac{\Sigma n \omega l \tan \phi + \Sigma C}{\Sigma t \omega l}$$

$$= \frac{\omega L \tan \phi (n_1 \frac{l_1}{L} + n_2 + n_3 + \dots + n_9 \frac{l_9}{L}) + c \bar{L}}{\omega L (t_1 \frac{l_1}{L} + t_2 + t_3 + \dots + t_9 \frac{l_9}{L})}$$

FIG.19 METHOD OF COMPUTING FACTOR OF SAFETY

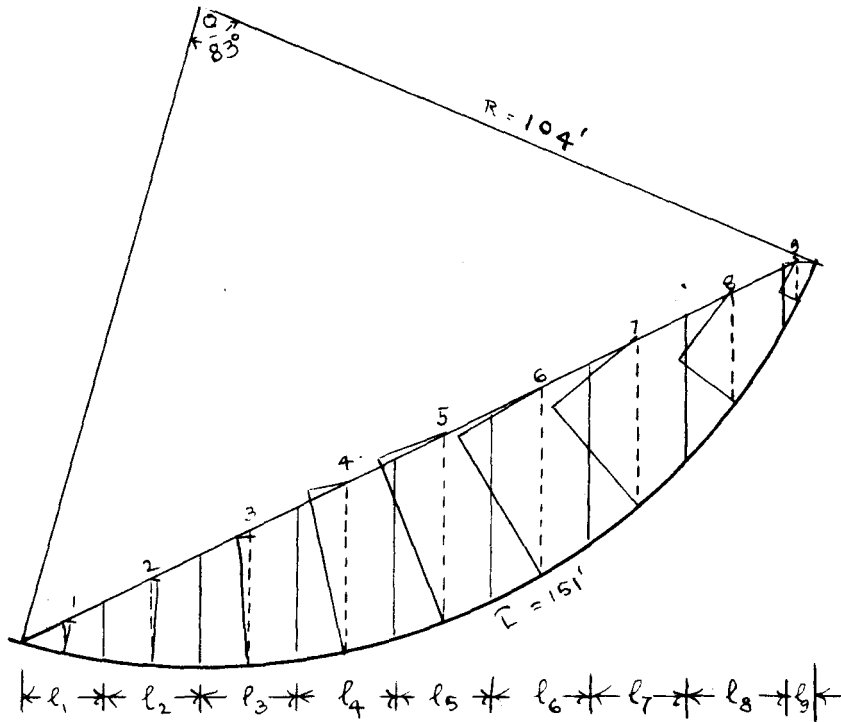

SLICE	t	n
1	- 0.75	3.75
2	- 1.00	11.00
3	+ 1.50	17.50
4	+ 5.50	25.00
5	+ 10.50	27.50
6	+ 15.00	25.00
7	+ 17.50	20.00
8	+ 15.00	11.00
9	+ 1.66	1.00
Σ	64.91	141.75

$L = 151'$
 $w = 120 \text{ lbs/cu. ft.}$
 $c = 700 \text{ lbs/sq. ft.}$
 $L = 151'$
 $\tan \phi = 0.3$

$$\begin{aligned}
 F.S. &= \frac{wL \tan \phi (n_1 \frac{l_1}{L} + n_2 + n_3 + n_4 + \dots + n_9 \frac{l_9}{L}) + cL}{wL (t_1 \frac{l_1}{L} + t_2 + t_3 + \dots + t_9 \frac{l_9}{L})} \\
 &= \frac{(120)(151)(0.3)(141.75) + (700)(151)}{(120)(151)(64.91)} = 1.58
 \end{aligned}$$

FIG. 20 NUMERICAL EXAMPLE SCALE: 1"=30'

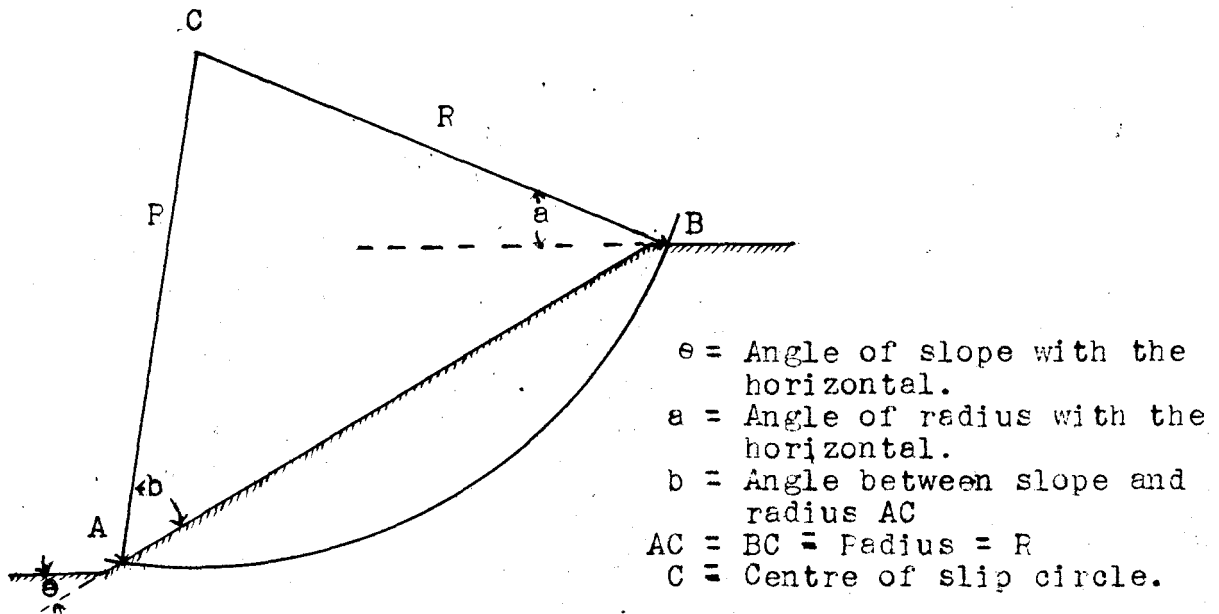
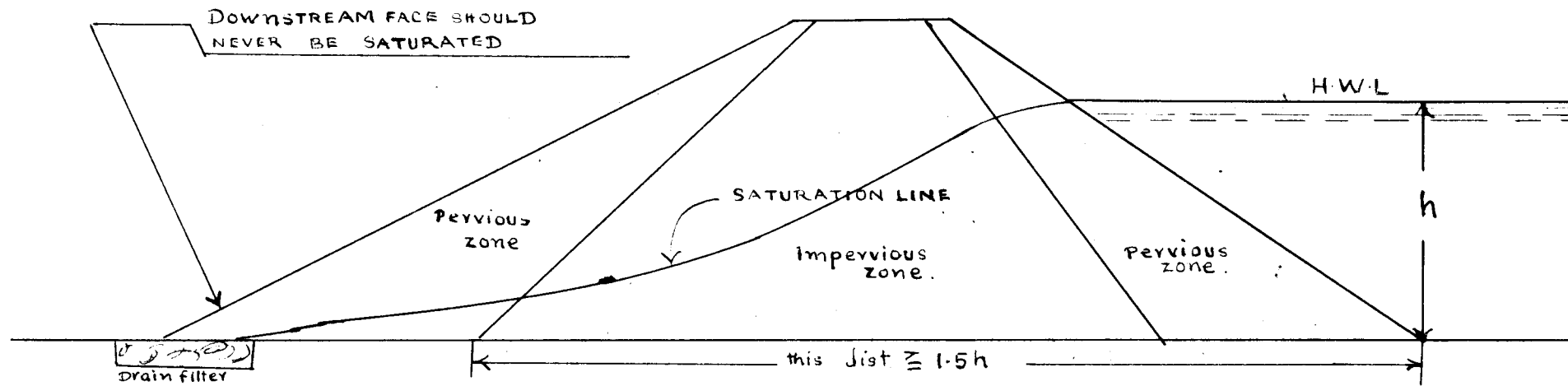

FIG. 21 - APPROXIMATE POSITION OF THE CENTRE OF SLIP CIRCLE FOR MINIMUM FACTOR OF SAFETY

TABLE (5)

Slope	e	a	b
1:0.58	60°	20°	40°
1:1	45°	28°	37°
1:1.5	$33^{\circ}47'$	26°	35°
1:2	$26^{\circ}34'$	25°	35°
1:3	$18^{\circ}26'$	25°	35°
1:5	$11^{\circ}19'$	25°	37°



The figure shows the ideal location of the line of saturation in an earth dam. However it is not always possible or economical to obtain the right amount of pervious or impervious material for a dam, so artificial means are used to control the saturation line.

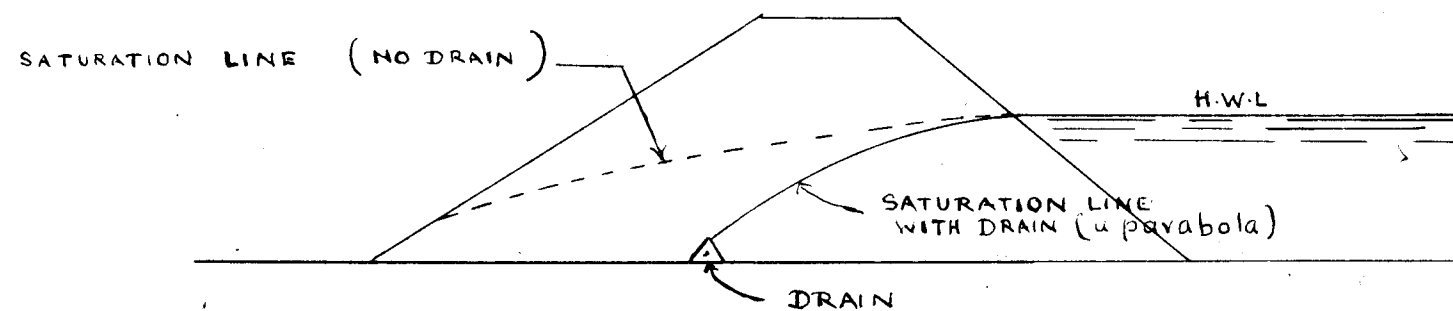
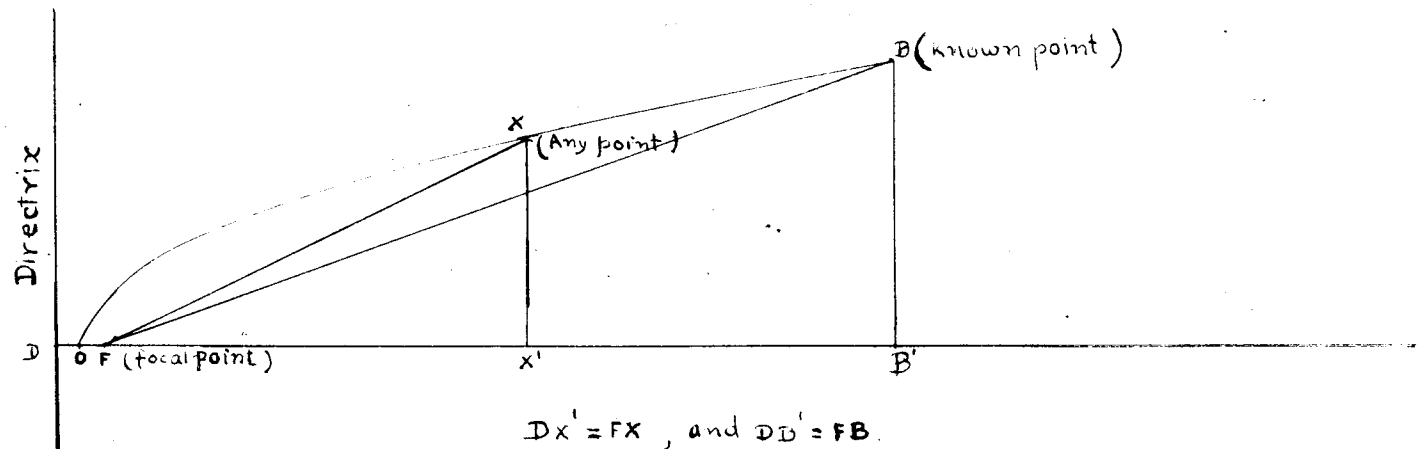

FIG. 22 EXPLANATION OF LINE OF SATURATION

CONSTRUCTION OF BASIC PARABOLA

By definition the distance of any point on a parabola from its directrix is equal to the distance of the same from its focal point.



In applying the basic parabola to a saturation line, the point "O" should fall in the drain and the known point "B" is taken at a point = 0.3m.

FIG.23 METHOD OF DRAWING LINE OF SATURATION

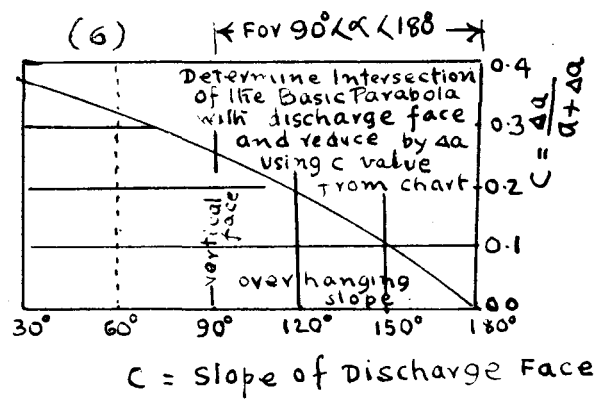
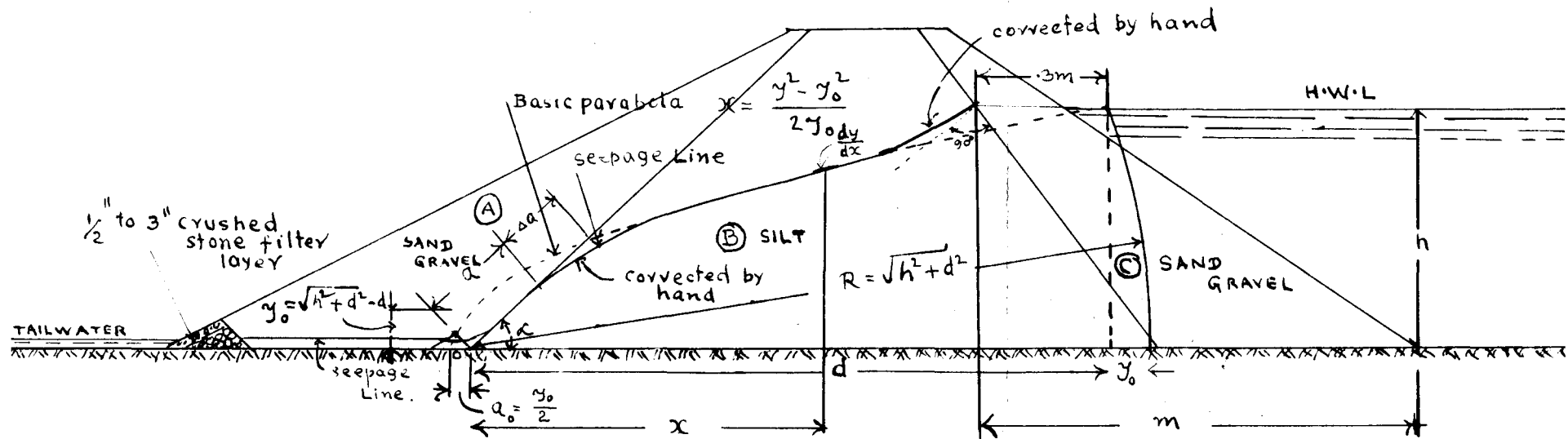

Basic Parabola

$$x = \frac{y^2 - y_0^2}{2 y_0 \frac{dy}{dx}}$$

$$y_0 = \sqrt{a^2 + h^2} - d$$

$$a_0 = \frac{y_0}{2}$$

$$a + \Delta a = \frac{y_0}{1 - \cos \alpha}$$

$$C = \frac{\Delta a}{a + \Delta a}$$

FIG.24 MATHEMATICAL REPRESENTATION OF LINE OF SATURATION

Correction for $\frac{K_H}{K_V}$

K_H = Coefficient of permeability in horizontal direction
 K_V = Coefficient of permeability in vertical direction.

Let $\frac{K_H}{K_V} = 9$, base of dam = 600', height = 100'

Then horizontal scale = $\frac{1}{\sqrt{\frac{K_H}{K_V}}} \times \text{Vertical scale}$
 $= \frac{1}{3} \times \text{Vertical scale}$.

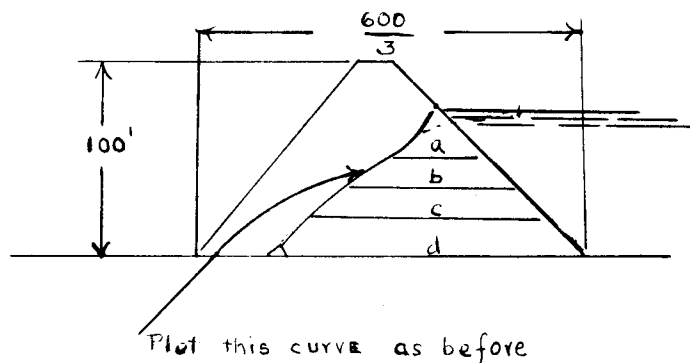

SECTION DRAWN TO REDUCED SCALE

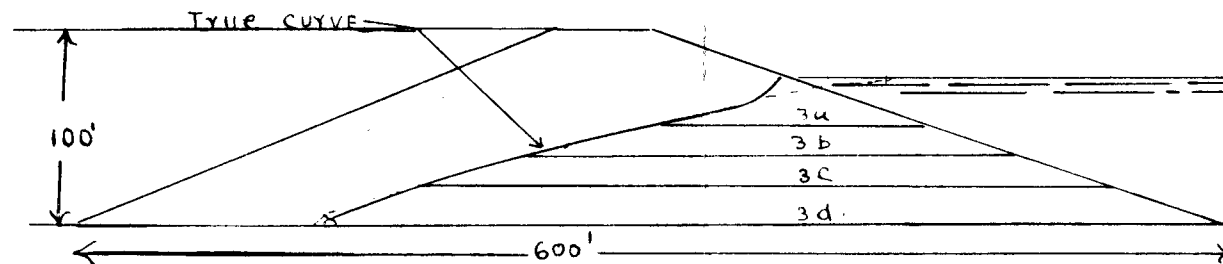

SECTION DRAWN TO NATURAL SCALE.

FIG.25 CONSTRUCTION OF LINE OF SATURATION.

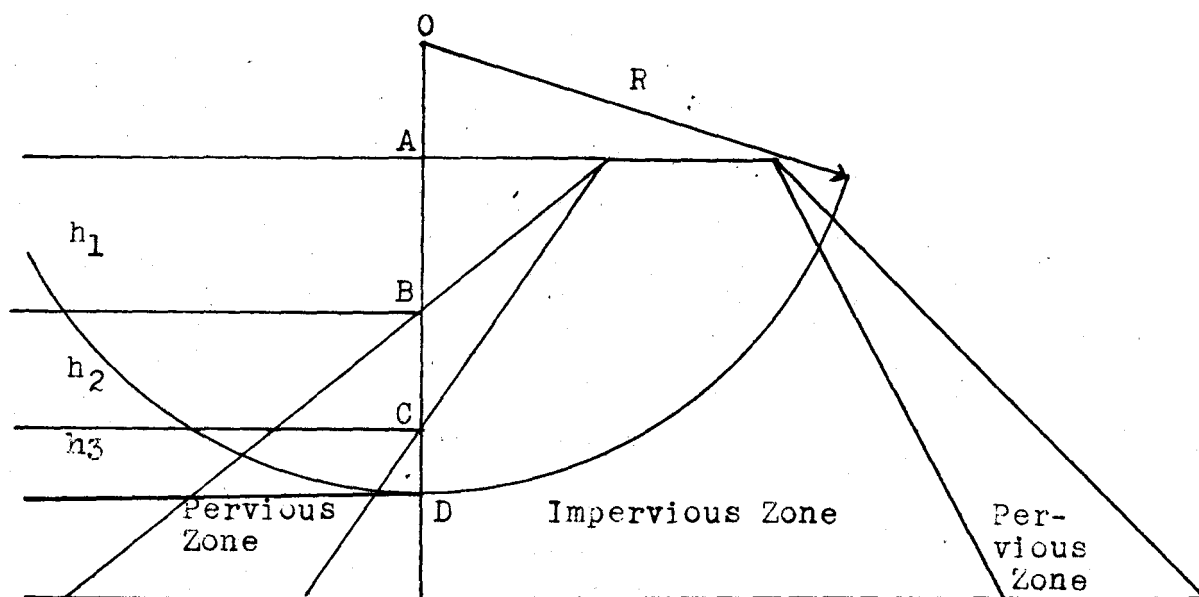

FIG. 26 - EQUIVALENT WEIGHTS

EQUIVALENT WEIGHTS

Equivalent weights for dam section of more than one type of material are found in the following manner: (See Figure 26)

W = weight of dry fill

W_w = weight of water

W_b = buoyant weight

W_s = saturated weight

Let the subscripts 1 and 2 indicate the pervious and impervious material respectively.

Submerged Case: The fill is completely saturated.

$$\begin{aligned} \text{Forces acting down} & W_w h_1 + W_{s2} h_2 + W_{s3} h_3 \\ & W_w h_1 + W_{b2} h_2 + W_w h_2 + W_{b3} h_3 + W_w h_3 \\ & W_w (h_1 + h_2 + h_3) + W_{b2} h_2 + W_{b3} h_3 \end{aligned}$$

Contact force or friction creating force = (Forces acting down) - (Uplift)

$$\begin{aligned} &= W_w (h_1 + h_2 + h_3) + W_{b2} h_2 + W_{b3} h_3 - W_w (h_1 + h_2 + h_3) \\ &= W_{b2} h_2 + W_{b3} h_3 \end{aligned}$$

Note: Since the resultant uplift acts through the centre of the circle there is no moment due to uplift.

The overturning moment is based on the overturning force

$$W_w (h_1 + h_2 + h_3) + (W_{b2} h_2 + W_{b3} h_3)$$

Since the uplift is not effective, the overturning is based on $W_{b2} h_2 + W_{b3} h_3$.

The resisting moment is based on the friction creating force $W_{b2} h_2 + W_{b3} h_3$.

Therefore both the overturning and friction are computed for buoyant weights.

Sudden Drawdown Case: The water can escape through h_1 and h_2 but it cannot escape through the impervious material.

$$\begin{aligned} \text{Forces acting down} &= (W_w h_1 + W_{s2} h_2 + W_{s3} h_3) - (W_w h_1 + W_w h_2) \\ &= (W_{s2} - W_w) h_2 + W_{s3} h_3 = W_{b2} h_2 + W_{s3} h_3 \end{aligned}$$

$$\begin{aligned} \text{Uplift} &= W (h_1 + h_2 + h_3) - W_w (h_1 + h_2) \\ &= W_w h_3 \end{aligned}$$

$$\begin{aligned} \text{Contact force} &= W_{b2} h_2 + W_{s3} h_3 - W_w h_3 \\ &= W_{b2} h_2 + W_{b3} h_3 \end{aligned}$$

Since there is no overturning moment due to uplift, the overturning is based on the force $W_{b2} h_2 + W_{b3} h_3$

The resisting moment is based on the contact force $W_{b2} h_2 + W_{s3} h_3$.

Therefore, overturning is computed on saturated weight whereas the friction is computed on buoyant weight.

In practice, the factor of safety is computed on the basis of the drawdown case which is found in many cases to be the most critical for the rolled-fill earth dams. The design computations for the factor of safety and the seepage calculations of the Hirakud dam are shown in Figures 27 and 28. The construction drawing of the cross section of the Hirakud Dam is shown in Figure 29.

1.79 1.69
 1.70 2.2
 1.68 1.82
 1.98
 2.01 1.68
 2.31

1.27
 1.20
 1.45 1.35
 1.19 1.35
 1.32 1.32 1.35
 1.25

ω = Unit weight
 ω_s = Saturated weight
 ω_b = Bouyant weight
 c = Cohesion
 ϕ = Angle of internal friction

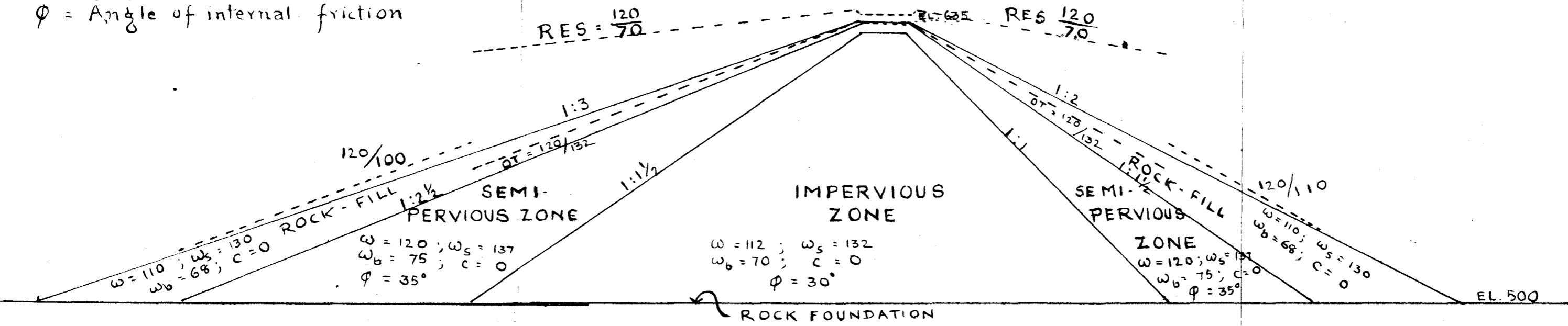

Minimum Factor of Safety = 1.68 (upstream)
 " " " = 1.19 (downstream)

FIG.27 RESULTS OF COMPUTATIONS FOR
 SUDDEN DRAWDOWN CASE

SCALE: 1"=50'

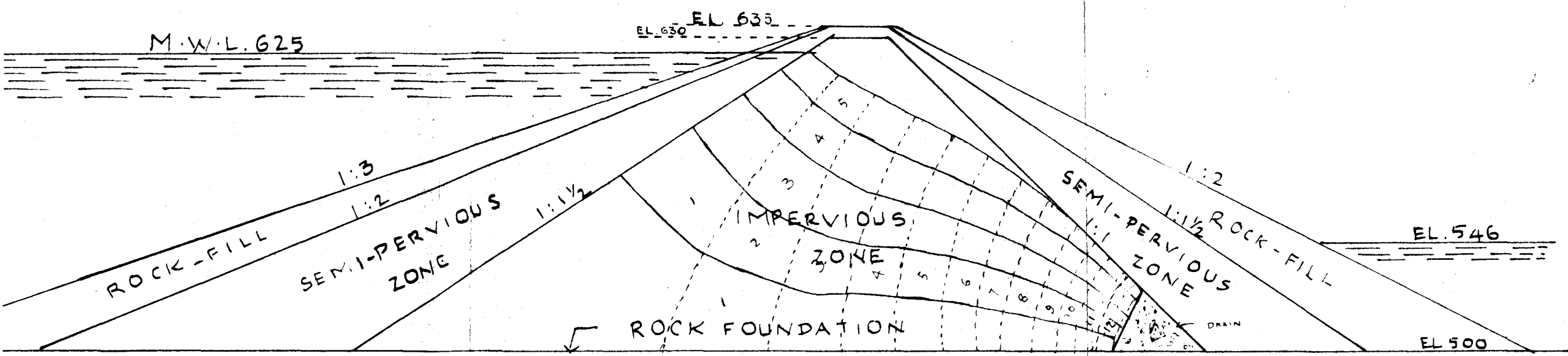

FIG. 28 SEEPAGE CALCULATIONS

SCALE: 1" = 50'

Laplace's Equation for Flow-net.

$$\frac{\partial^2 \phi}{\partial x^2} + \frac{\partial^2 \phi}{\partial z^2} = 0$$

$$\phi = Kh$$

K = Coefficient of permeability = 0.008 ft/year

h = Head of water = 79 ft.

$$Q = Kh \frac{N_f}{N_d}$$

$$= (0.008)(79)(5/12)$$

$$= 0.264 \text{ cubic foot per lineal foot per year}$$

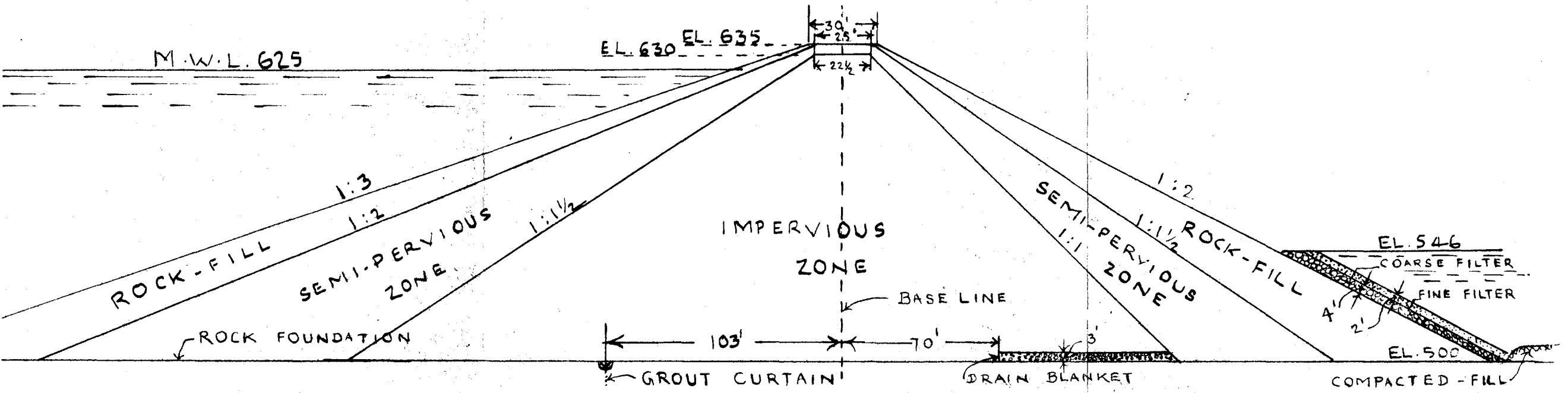

FIG. 29 CONSTRUCTION DRAWING
SCALE : 1" = 50'

DESIGN

INTERPRETATION OF DATA

The critical case for the dam failure for the design is assumed to be the sudden drawdown case. Though the sudden drawdown takes place at the upstream side, it is assumed from the point of worst situation and practice that the downstream slope also experiences the same condition and the whole section is saturated.

From the computed data of the factor of safety and seepage quantity it is known that the factor of safety for the upstream slope is 1.68 and the same for the downstream slope is 1.19. The seepage water is 0.264 cubic feet per lineal foot per year. The minimum factor of safety usually allowed is 1.30. Since the downstream slope has a factor of safety of 1.19, it is desirable to change the slope from 1 : 2 to 1 : 3. But in computing the factor of safety it is assumed that the downstream slope is also subjected to sudden drawdown just as the upstream slope. In reality it is not and if the factor of safety is computed from its actual state of condition when the upstream is subjected to sudden drawdown, the factor of safety naturally rises to a higher value. It is desirable to compute the factor of safety for the actual situation so that it is assured that the section passes the allowable limits of the design.

From the knowledge of the site, taking the rains into consideration, it may be that the high level state during continued rainstorm is more critical than the sudden drawdown. So the minimum factor of safety for this condition may be computed and verified for surety.

The seepage quantity of water is to be such that the loss of water is not excessive and the rate of flow does not cause erosion of the soil.

The quantity of water flowing through the dam per annum is $10700 \times 0.264 = 2825$ cubic feet, where 10700 feet is the length of the dam. This much seepage is negligible and the energy of the seepage water can be destroyed and the soil protected from erosion by providing a downstream filter blanket. "Experiments have shown that a material satisfies the essential requirements for a filler if its 15 per cent size D_{15} is at least four times as large as that of the coarsest layer of soil in contact with the filter, and not more than four times as large as 85 per cent size D_{85} of the finest adjoining layer of soil." (8) Assuming the factor of safety of the downstream slope satisfies the design requirements from the actual situation of the drawdown case and the knowledge of site, the cross section for the construction is drawn as shown in Figure 29.

In practice, a number of alternate cross sections are designed and the cost is compared after estimating the quantities of the different materials. The section which is most economical, consistent with the practical uses and the stability requirements, is adopted for construction.

C O N S T R U C T I O N

The stabilization of an earth dam depends upon the inherent resistance of the material to displacement, the cohesion of the binder, the compaction of the fill and proper drainage. The shearing resistance depends upon the gradation and angularity of the particles. The cohesion is due to the fine grained particles of soil binding the bigger sized particles by filling the voids. A binder may be fine grained soils, bituminous material, cement or a chemical. Proper compaction is the action over which the inspector in the field has the greatest control. Good drainage is an essential factor for stabilization. Evaporation is also a type of drainage which should not be overlooked.

From the gradation curves of the soils of the borrow area, the different quantities of the material to suit the different zones of the fill are determined. Shear, cohesion, unit weight, angle of internal friction and permeability are determined from the laboratory tests. With this data, the designer in the office proceeds with his design in checking the stability of the cross section of the dam. When the factor of safety is within the allowable limits, the design is passed on to the field to start construction. While constructing the dam, the proper density obtained at the optimum moisture at the field should check with the designed weight in the office.

COMPACTION

Though compaction is the only factor of stabilization which can be obtained with minimum effort, the majority of failures of embankments by settlement can be attributed directly to poor compaction. For any soil, there exists a particular type of structure in which the particles

are arranged with respect to each other so as to give maximum density. This volume is, however, theoretical and can never be obtained. In spite of it, the theoretical value can be approached, and the term compaction is used to designate any method of increasing the density of a soil by mechanically reworking and compressing the material. Increasing the density of soil mass increases its strength and decreases the detrimental effect of excess moisture.

Compaction depends on two variables, the mechanical reworking and the optimum moisture content. Compaction of coarse-grained non-cohesive soils, such as sand and gravels, can be accomplished only by a combination of tamping and vibration. For best compaction, the material must be either dry or saturated. Compaction of the sand can best be accomplished if it is saturated first and then vibrated. Small quantity of moisture content is a detriment. Compaction requirements for the cohesive soils are just the opposite so far as moisture content is concerned. The moisture content acts as a lubricant allowing the particles to slide over each other and thereby readjust themselves into a structure of high unit weight. But it must be remembered that a deficiency of moisture content results in poor lubrication, whereas an excess of it gets trapped into voids of the soil, thereby minimizing the action of the compacting load. In either case, only a particular percentage of the compaction that could have been obtained for the mechanical effort expended had the moisture content been ideal is obtained. It, therefore, follows that for any material there is a moisture content at which the maximum density can be obtained for a specific degree of mechanical effort. This moisture content is known as the optimum moisture content of that material.

As stated previously, there are two variables, the moisture content and the mechanical effort, and if the mechanical effort is held constant and the moisture content is varied, a curve is obtained as shown in Figure 30, which clearly shows that the unit weight increases until the optimum moisture is reached and then decreases with increased moisture. As the purpose of the compaction is to obtain the maximum density of the soil particles, the dry weight curve is used to determine the optimum moisture. Figure 31 illustrates the effect of varying the mechanical effort. In this case the number of blows which can be compared to number of passes of a roller is varied. The maximum unit weight and the optimum moisture content vary with the mechanical effort.

As the theoretical maximum weight cannot be obtained, some form of standard test is necessary for the purpose of comparing and controlling field compaction. The mechanical effort employed in the test must duplicate as nearly as possible the mechanical effort of field compaction. This standard test can be performed to suit the place, climate and the type of available equipment to be used on the particular job. In America, on most of the jobs, the Proctor Standard test or the American Association of State Highway Officials test is used. In both these tests the principle employed is that the moisture content is kept varying, the mechanical effort being the same. When the dry unit weight is plotted against the moisture content, the optimum moisture content is found as that moisture content which produces the maximum dry weight.

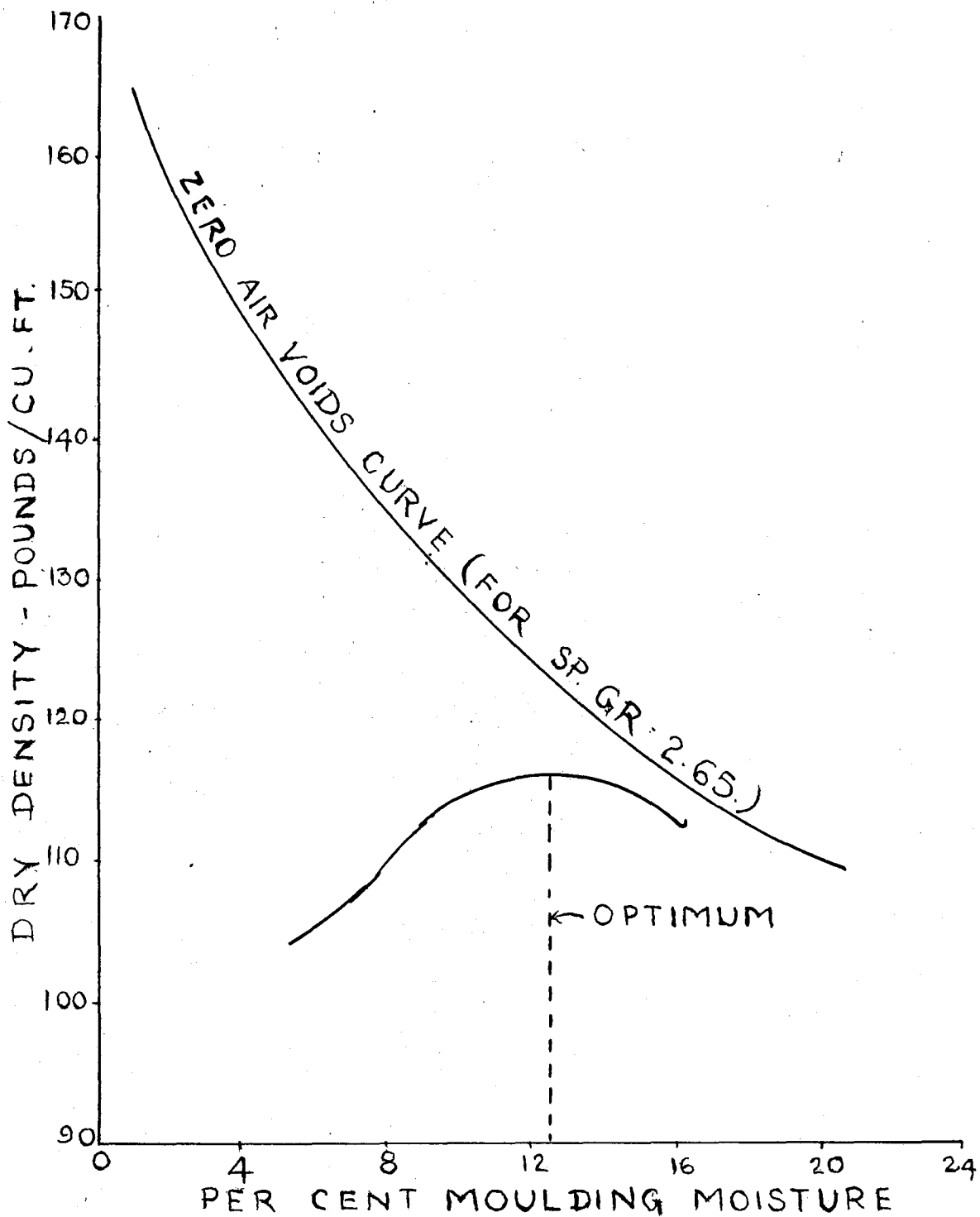

FIG.30 SAMPLE PROCTER SHEET
FOR EARTH COMPACTION

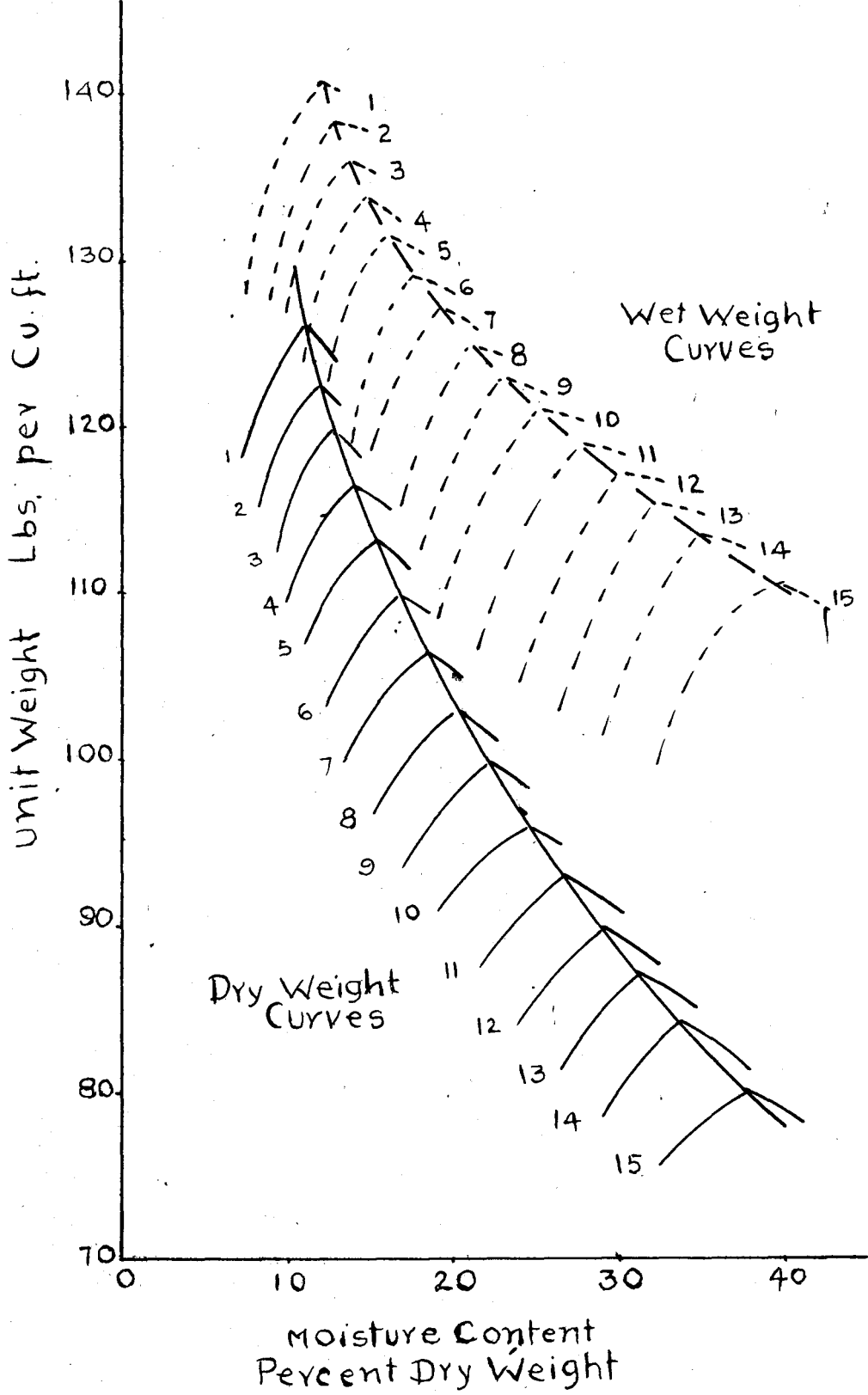

FIG. 31 MODIFIED A. A. S. H. O. COMPACTON CURVES.

FIELD OPERATIONS IN CONSTRUCTING AN EARTH DAM

Preparation of Foundation: The first thing to be done to start the construction is to demarcate the plan of the dam at site. This is done by a transit with reference to control lines that are established before starting the construction. The lines are marked by whitewashing or by tying the ropes to pegs. After that, the excavation of the overburden and the preparation of the foundation begins. The foundation bed may be hard rock or an overburden layer itself. If it is the former case, the rock surface is properly cleaned and the fissures and cracks well grouted. The surface is wetted by sprinkling with water before the first layer of the earth material is spread on it. Since the embankment consists of different zones such as the impervious, the semi-pervious and the riprap, the different zones are carefully demarcated according to the plans and the work is carried out according to specifications.

Since the work involves dumping, grading and compacting of the material in the fill, the whole job is so arranged that it is continuous, and one operation does not interfere with another.

Rock-fill: Rock-fill consists of big stones of size 6" or above. The blasted stones at the quarry are loaded in trucks and these trucks dump the material in the particular zone of the fill and in proper order. The dumped stones are graded by a tractor. A jet of water is directed while the stones are dumped and graded for cleaning the dirt and for better compaction. The number of the passes by the grader depends upon the size and type of material, weight of the tractor and the impact of the water jet.

Filter: The filter material consists of sand and gravel. The material

is spread in layers and the compaction is affected by mechanical vibration.

Semi-pervious zone: The material is dumped and graded just as the rock-fill with better compaction or by spreading 8" to 12" layers and passing the sheepsfoot roller.

Impervious core: The foundation bed is thoroughly cleaned by an air blast and is wetted with a sprinkling of water before the first layer of the material is spread. The compaction of the first layer to a level surface is affected by mechanical hand tamping. The level surface is scarified before an eight inch or ten inch layer of the material is spread and then compaction is secured by means of the proper number of passes of the sheepsfoot roller. Before the spreading of the earth for the next layer commences, proper compaction of the preceding layer is verified. This is done by penetration needle, or by ring test or by sand test at different places to give a representative idea for the whole area. If it is found, upon verification, that the compaction is poor, moisture is added or the material is allowed to dry as the case may be. The inspector on the job is competent to tell by mere visual inspection or feel of the hand, after some experience, whether proper compaction is attained or not, whether the moisture is too much or too little, or whether the number of passes of the roller should be increased. The best way of maintaining the required water content is to pool the water on the surface of the borrow area for some time before the material is excavated to be conveyed and dumped in the fill.

The different mechanical operations are: removing the top layer on the borrow areas by a scraper, then excavating the material and loading in Euclid trucks or Western trucks by the shovels. The trucks carry the material to the fill and dump in the right place in a direction parallel to the axis of the dam. The dumped material is levelled by a bulldozer

in 6" to 10" layers. When each layer is ready, the sheepfoot roller compacts the material. The rolling is always done parallel to, and along the axis. Before the next layer is spread, the compaction is verified by the penetration needle at different places. Also, samples are taken (by sand and ring tests), for the field control tests. Two undisturbed samples from each compacted layer are taken to the laboratory for shear and permeability tests. The main factors that influence the field compaction of the soils are: the thickness of the layers; the number of roller passes; the depth of the penetration of the pongs of the roller; the pressure of the compacting equipment; and, the spacing of the tamping feet. The inspector is usually familiar with all these factors to achieve the best and most economical results.

The daily log that is prepared by the inspector contains the following information:

- (1) Date
- (2) Weather conditions
- (3) Equipment used
- (4) Skilled labor
- (5) Unskilled labor In man hours
- (6) Compaction obtained
- (7) Optimum moisture
- (8) Elevations of the different zones of the compacted fill.

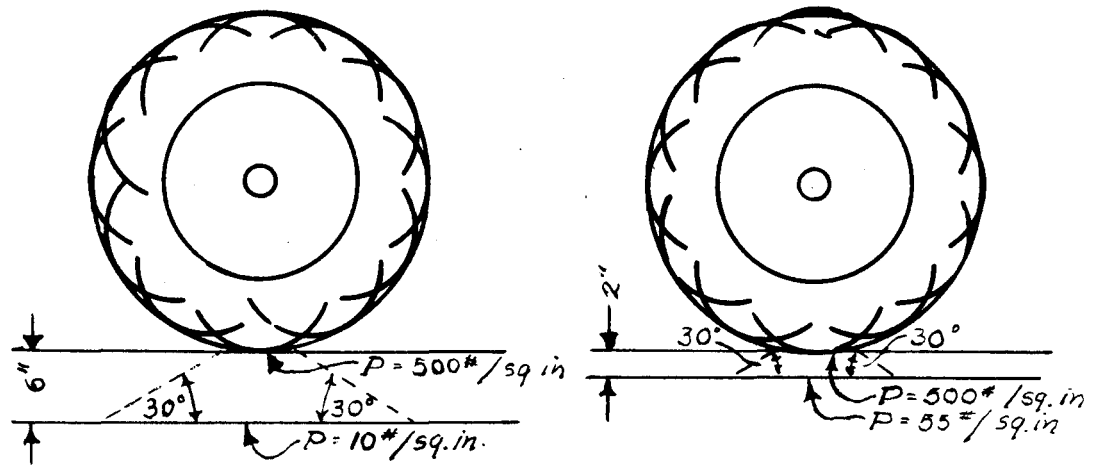

FLAT ROLLER

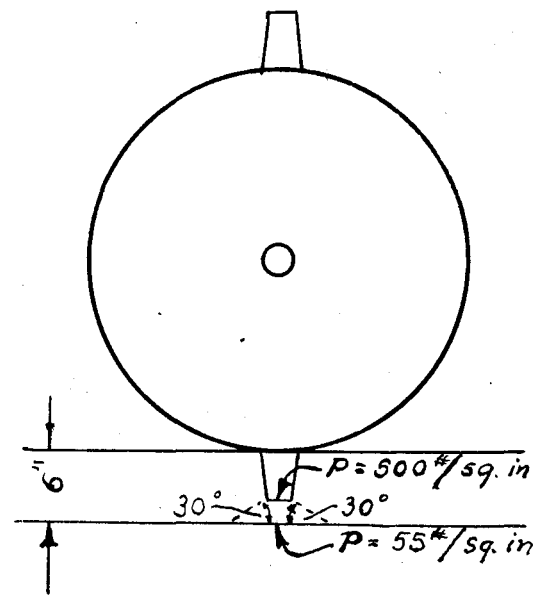

SHEEPSFOOT ROLLER

FIG. 32
 TYPE OF ROLLER &
 ITS EFFECT ON
 THICKNESS OF LAYER

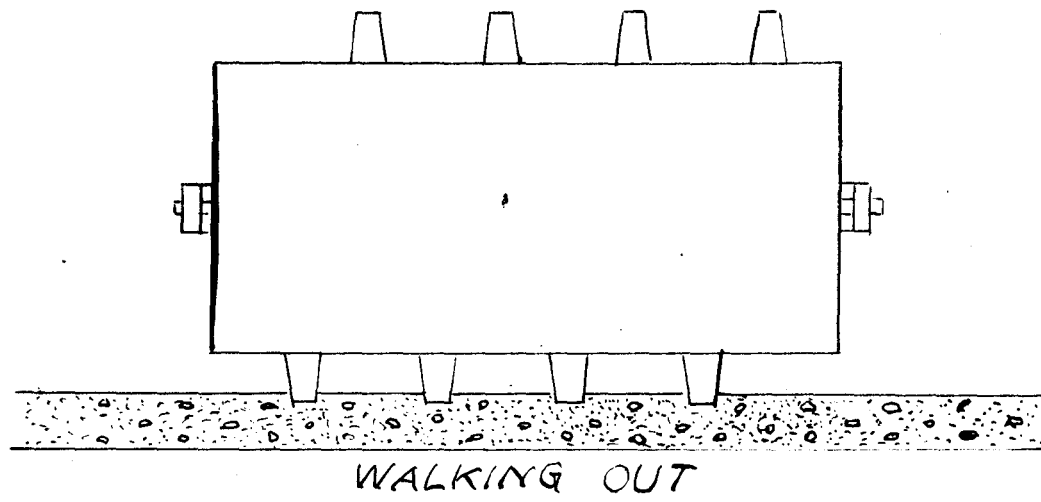
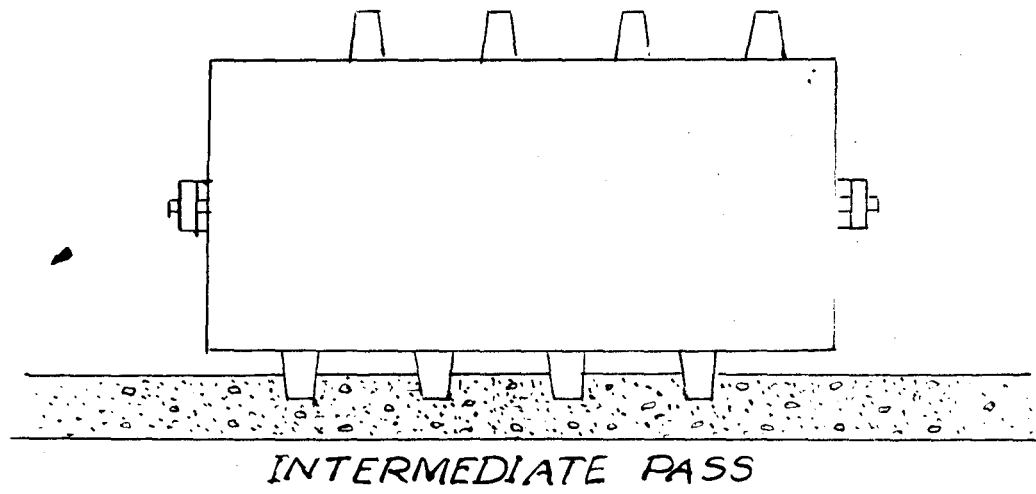
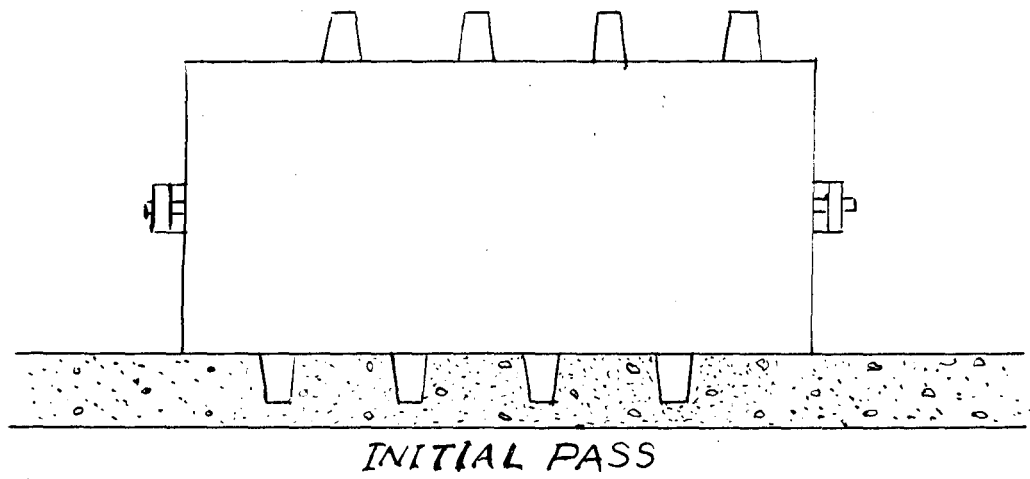

FIG 33
SHEEPSFOOT ROLLER
ACTION ON COM-
PACTING A FILL

CONSTRUCTION PLAN OF THE HIRAKUD DAM PROJECT

The Hirakud Dam Project consists of: (1) Construction of right and left dikes of seven miles and six miles respectively; (2) Construction of a comprehensive canal irrigation system; (3) Construction of transmission lines; (4) Construction of three miles of main dam across the river. The purpose of the description of this plan of construction is to give the overall picture of the project and the plan of organization of work, and to bring home to the reader the magnitude of the earth dam construction involved in the project. The scheme of organization of the work is proposed without going into technical details or construction techniques of any phase of the job. It is assumed that all phases of the job are being performed by the Departmental work of the Central Water Power, Irrigation and Navigation Commission except that of power house construction and installation of eight units of power generation which is assumed as being done by a contractor.

The different divisions of the whole project are: the construction of the left dike, the right dike, the canals, the transmission lines and the dam. The construction of the left dike, the right dike, the canals and the transmission lines do not present many varieties of construction operations as in the case of main dam. So all the works can be started simultaneously, and the work is carried out continuously without stop to completion. So far as the main dam is concerned, it is proposed to be constructed in different stages as the main dam consists of 10,700 feet length of earth embankment from left abutment to the midway of the Hirakud Island, and a concrete dam, spillway, power house, fishladder, navigation lock and a pump house - all comprising the length of dam from

the midway of Hirakud Island to the right abutment.

PLAN OF CONSTRUCTION OF THE HIRAKUD DAM
(See Fig. 34)

- First Stage: (a) Construction of the coffer dam C_1 and C_1^1 upstream and downstream of right channel and from the axis of dam to the toe of Hirakud Island for the diversion of all waters of the Mahanadi to the left channel.
- (b) Construction of the embankment from left abutment to the river.
- (c) Commencement of aggregate production (this work is to be continuous until the completion of the whole dam).
- Second Stage: (a) Construction of the spillway.
- (b) Construction of the fishladder and the Navigation lock.
- (c) Construction of Power House.
- Third Stage: (a) Construction of the earth dam on Hirakud Island.
- (b) Construction of concrete dam.
- (c) Installation of two units of power generation.
- Fourth Stage: (a) Demolition of the First Stage coffer dam C_1 across the right channel and construction of the Second Stage coffer dam C_2 in the left channel.
- (b) Installation of two units of power generation.
- Fifth Stage: (a) Construction of the earth dam up to Second Stage coffer dam.
- (b) Construction of a pump house coffer dam C_p and commencement of the pump house construction for the lift irrigation.
- (c) Installation of two units of power generation.

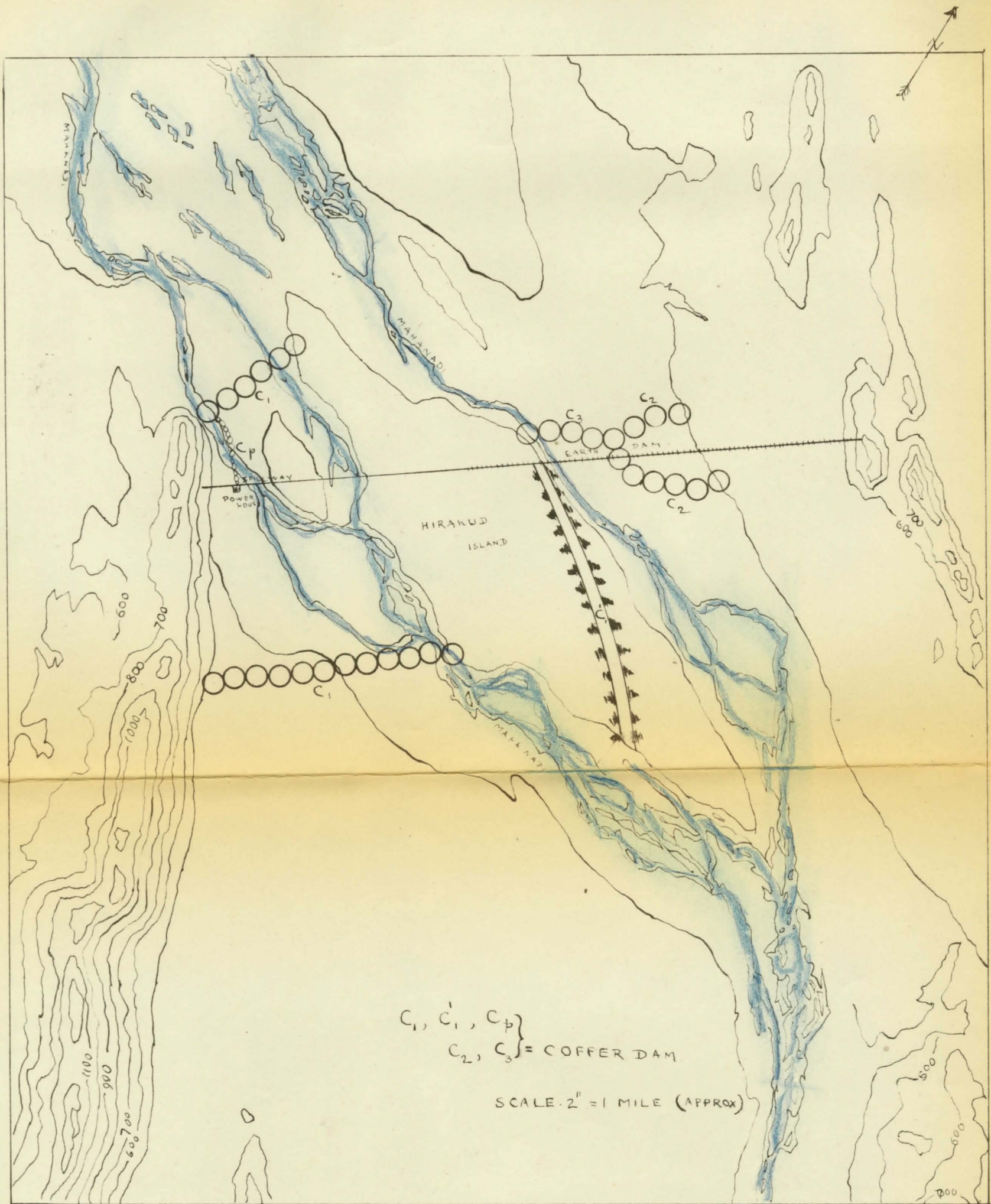

FIG.34 CONSTRUCTION PLAN

Sixth Stage: (a) Demolition of the Second Stage coffer dam C_2 and the one C_1^1 on Hirakud Island. Construction of the Third Stage coffer dam C_3 in the left channel.

(b) Construction of the earth dam to the finish.

(c) Installation of the final two units of power generation.

Seventh Stage: (a) Completion of the construction of the pump house, the head-works, and the installation of the pumps for the lift irrigation at the upstream end of the right abutment.

The project includes the construction of dikes with earth materials including that of the earth dam.

DEPARTMENTAL PROCEDURES

Since all of the projects in India are being expedited by the Government Agencies, it is proposed to give here the Departmental Procedures. A project consists of four distinct stages: conception, investigation, design, and construction. The first three stages of the work are usually done by Departmental work, although contract work is not unusual to some limited items. The construction is mostly done by contract work, although Departmental work is used in a few instances. Investigation is a long, tedious task. It may extend anywhere from two to twenty years. Temporary quarters for the personnel, field laboratories, workshops and approach roads are built during this period. When the design is completed, bid drawings, detailed estimates and specifications are prepared. Then tenders are called for from competitive bidders among the contractors. The lowest bidder is awarded the job by the contracting officer of the department. Then the contracting officer and the contractor enter a contract for the satisfactory

performance of the job according to certain established rules and regulations. After the contract is entered, the contracting officer issues a written notice to the contractor for commencing the work. The work is then performed according to detailed working plans and specifications under the direction, supervision, and inspection of the officers representing the contracting officer.

Specifications for construction consists of statement of work, general conditions, special conditions and technical provisions. During construction when a discrepancy arises between plans and specifications, generally the specifications govern, but the decision of the contracting officer is final.

Many difficulties arise as construction proceeds, and successful operation of the job depends upon the mutual understanding and appreciation of the difficulties for better cooperation between the contractor and the contracting officer.

UNITED STATES OF AMERICA AND INDIA

Since the United States of America is the leading country in the world in dam construction, and the Government of India wants to benefit by having American consultants, by sending her personnel to America for study and training for specialization in this field, and by buying American construction equipment, a comparison of the controlling factors in both countries is important. For the successful performance of the construction of large projects, the factors that control are: (1) Organization, (2) Personnel, (3) Material, (4) Equipment, (5) Cooperation and team work, and (6) Philosophy of life of the people.

The leading organizations in the U.S.A. are: U. S. Corps of Engineers,

the Bureau of Reclamation and the Tennessee Valley Authority (T.V.A.) Almost all of the dams in the country are built by these three organizations. The Corps of Engineers builds dams for flood control and navigation, whereas the Bureau of Reclamation does the same for power generation and irrigation. The T.V.A. confines its activities to the full development of the Tennessee Valley. The Corps of Engineers and the Bureau of Reclamation perform their construction operations usually by contract work, whereas the T.V.A. does the same mostly by departmental work. It cannot be said which organization is better than the other, as the three organizations are complementary to one another for the nation's development. Each organization has different divisions, branches and sections to suit the different functions of work to be done on a project. The duties and responsibilities of every employee are clearly specified in organization charts.

The personnel of these organizations are mostly experienced, specially qualified, and right people in the right place. The clerical work is mostly done by women. The equipment is the most efficient and modern available, designed with advanced scientific principles. The country manufactures more than enough to satisfy its own needs. The T.V.A. owns its equipment for its needs, whereas the Corps of Engineers and the Bureau of Reclamation do not, for the reason that the contractor furnishes his own equipment. The spirit of cooperation and team work in these organizations is marvelous. Every person does his or her job with a willingness and for the joy of it.

Philosophy of Life of the People: The philosophy of life of the people is the most important of all factors, and it is this factor that is reflected in a nation's life. This influences all other factors, such as organization, personnel, cooperation and team work, and invention

and production of modern equipment. What a philosophy of life is, does not permit an exact definition; but it is manifested in the way of living of the people. Today, as seen the way of living of the American people, it is full of life, more and richer life, everywhere cooperation and team work. The factors that contribute to philosophy of life are: tradition, religion, law and education. The people of the United States are the white people and the colored people. The white people are immigrants, mostly from Europe, with small percentages of American Indians, Chinese, Japanese, and other nationalities of the world. The colored people are exclusively negroes, who form 9.8 per cent of the total population (9). The tradition of the people drawn from Europe is one of adventure, religious freedom, equality, cooperation and team work; and, since these people form the overwhelming majority, the country is reflected in their tradition. The American people have as their religion Christianity, which instills love of neighbor, equality and freedom of worship. Politics are not allowed to mix with religion. The American people have the Democratic law, which was defined by Abraham Lincoln as "Government of the people, by the people, and for the people." (10) The American people are 98 per cent literate. All these factors: tradition, religion, law and education contribute to happiness, growth of personality, knowledge, and clear and calm thinking. The result is excellent research for new inventions and cooperative action for more and better production.

The picture of India compared to the U. S. A. is a gloomy one. The Government of India has recently created two organizations: The Central Water Power, Irrigation and Navigation Commission (C.W.I.N.C.) and the Damodar Valley Authority (D.V.A.). The former has its set-up based partly

on the model of the T.V.A. and partly on the model of the U. S. Corps of Engineers. The latter has its set-up based fully on the model of the T.V.A. India has an abundance of potential natural resources such as: vast areas of land, minerals, waters and large population. But the organisations do not have experienced men or specialized technical knowledge or the right men in the right place. They do not possess the equipment, nor is there a chance of manufacturing the same in the near future.

So far as the spirit of cooperation and team work are concerned, it is very disappointing. The system of an organisation is based on economical gradation of pay from a peon to the Prime Minister, and the same is also true in the U. S. A. The striking contrast is in the conduct and discharge of duties of the personnel. In the United States, the personnel behave like human beings with a sense of respect, courtesy and duty, so that there is a willing cooperation and joy in one's job. But in India, the attitude of a high salaried officer to a low salaried officer is that of a master to his slave. This mental attitude of discrimination is manifested from a peon to a high salaried officer, each in his own level. The result is that the officers are always haunted with a feeling of humiliation and fear so that the chances of calm thinking, originality and initiative which are so essential to the progress of the country are wanting. People do not discharge their duties with a willingness and for the joy of it as the relationship between officer and his subordinate is that of dictatorship and servitude. The same attitude prevails in laborers too. In 1947, a supervisor was building the temporary rest house at the Hirakud. He employed about one hundred coolies (laborers) comprising both men and women (untouchable women). In the midst of the work for the day, the coolies

stopped the work. The reason was that the masons refused to mix the lime mortar since the water was being brought from the Mahanadi by Harijan women (untouchable women). The supervisor had to separate the work and the laborers into two groups. In 1948, when a temporary bridge was being constructed, the supervisor had to divide the hundreds of laborers into two groups as before. All laborers look alike in all respects. It is a Herculean task for all those responsible officers in charge of construction operations to make the laborers work together, whether they work willingly or not. Everybody feels the worst of this mental attitude, and nobody knows the real root of this trouble or how to remedy it. Most learned people say it is the legacy of the British rule. If that were the case, all of the drawbacks would soon vanish if the people of India have a philosophy of life that is creative or productive. Today, as seen in India, the philosophy of life of people is manifested by their way of living in different communities, in a mental attitude of discrimination, in illiteracy and in superstition. As the building of a nation depends entirely upon the philosophy of life of the people, it is necessary to investigate the causes of disruption and remedy them by taking proper precautions and measures to elevate the ideals which lead to higher philosophy of life.

As has already been said, the factors that contribute to a philosophy of life are tradition, law and education. Though all these factors are distinct and different in the United States of America, they are all mixed up in India. The Hindus have a tradition of Caste System, a religion which has an ocean of literature and a variety of ways of worship of God, a law left by the British rule and a population 85 per cent illiterate.

Caste System is a social order of graded inequality based on the mental attitude of discrimination between man and man. This order is deriving its inspiration from the ocean of Hindu religious literature wherein it is very difficult to find the injunctions for unity, equality and brotherhood. People are so contented with their lot that they do not have any aspirations for the betterment of the standard of living. Every Hindu believes in Karma Theory and it is popularly understood that a man is born in a particular caste by virtue of his deeds in his past birth and everything happens to him in this world according to his Karma, the record of his work in his past birth. Since the Hindus have been living in castes for thousands of years, the people have developed different complexes and today a Brahmin is suffering from the superiority complex as much as a Harijan is suffering from the inferiority complex.

The law of the British as left in India is meant for a slave nation and it is akin to the rule of a king. It brings home the memories of domination, servitude and the fruits of the freedom cannot be imagined until it is changed.

Of all the resources of a country the man power is considered supreme by every nation at every time. But in India the population is becoming a burden rather than an asset to the country. The reason is simple. The man power is measured by its productivity but not by numbers. The productive capacity of the population increases only by education. So the burden of the population can be removed by eliminating the 85 per cent illiteracy in India. From a study of history of India and the Hindu religious literature it is known that Hinduism is not only a religion but the way of living of the Hindus. So the inherent defects to improve

the philosophy of life of the people is in Hinduism.

Then to apply the remedies for the improvement of the philosophy of life, the first thing to be done is the abolition of Caste System. This can be done by destroying all the Hindu religious literature after compiling the essence of it. The people have to adopt a constitution of democracy and the Government has to follow a program of compulsory education and intensive industrialisation.

S U M M A R Y A N D C O N C L U S I O N S

After a project has been conceived, then investigation, design and construction are the different stages that follow. During investigation the hydrological and meteorological observations are made; the foundation exploration and the geological studies are conducted; the material surveys and the topographical surveys are completed.

From the data obtained by investigation, the dam is designed for the factor of safety by the slip circle method and the seepage computed from the flow net method. Alternate designs are made from the economical studies and the design which costs the least is adopted for construction. Working drawings, estimates and specifications are then prepared for the adopted design.

The construction consists of constructing the dam at site according to the working plans and specifications. Compaction of the fill at the optimum water content is the most important feature that requires vigilant supervision.

When the Government agencies cannot do the construction by their own equipment and personnel, the departmental procedure consists of calling for tenders from competitive bidders, awarding the job to the one who bids the lowest and entering a contract between the contractor and the contracting officer. The contractor then performs the construction under the direction, supervision and inspection of the contracting officer according to the plans and specification.

The United States of America is the leading country of the world in dam construction. The Corps of Engineers, the Bureau of Reclamation and the Tennessee Valley Authority are the three organizations that build dams in the United States of America. These organizations have experienced

personnel and the spirit of cooperation and team work are manifested in their activities. The achievements of these organizations are solely due to the people. The people have a tradition of adventure and freedom, a religion of Christianity, a government of democracy and a philosophy of life for more and richer life. Religion, education and government are three distinct matters which are not allowed to mix.

India has been very backward in dam construction and it has recently instituted the two organizations the Central Water Power, Irrigation and Navigation Commission and the Damodar Valley Authority for this purpose. The Centre and the Provinces have many schemes for the construction of large dams and their success depends upon the people of India and not upon a few individuals. The people of India have a tradition of Caste System, a government of kingship and a philosophy of life which thrives on the graded inequality of the society. The people do not have the spirit of cooperation and team work, and the relation between man and man is one of domination and servitude. The greatest obstacle to the progress of the nation is Hinduism which embodies the way of living of the Hindus religiously, socially and economically. The Karma Theory and the Caste System are the life blood of the Hindu Society. The bulk of the population do not have the aspirations of life for creative work and better production on account of the Karma Theory. Caste is a mental attitude of discrimination between man and man resulting in complexes of the mental outlook. Therefore, today a Harijan is suffering from an inferiority complex as much as a Brahmin in suffering from a superiority complex.

A nation's asset is its philosophy of life and all nations are built by it. India cannot build itself to a great nation unless the Karma Theory

and the Caste System are annihilated. The only method to eradicate these evils is to apply remedies to the causes. The causes are the Hindu religious literature, rule of kings, illiteracy and poverty. So the remedies to be applied are the destruction of all Hindu religious literature after compiling a Bible out of it, the adoption of a constitution of democracy and the adoption of a policy of the government for compulsory education and an intensive program of industrialization.

The author has taken the case of the Hirakud Dam as the basis for this thesis. The salient features of the project are that the annual rainfall is 47.49 inches over a catchment area of 32,200 square miles yielding a run-off of 50 million acre feet just below dam site. The dam is designed for 100 years with a reservoir capacity of 5.98 million acre feet. The elevation of the lowest bed above mean sea level is 500 feet and the maximum water level of the reservoir is 625 feet. The elevation of the top of the dam is 635 feet and the submerged area is 150,380 acres. The minimum factor of safety for the upstream is 1.68 and that for the downstream is 1.19. The seepage is 0.264 cubic feet per lineal foot per year.

Importance is given to the sequence of the subject matter since no text book gives all the relevant portions as used in practice. The procedures and the methods described are of established practice, the knowledge of which was gained by the author from his experience on the investigation of the Hirakud Dam and the practical training on the construction of the McNary Dam and the South Holston Dam. The advanced courses taken in Soil Mechanics, Mathematics and Concrete in Speed Scientific School and the research study of the various references

have helped the author to have a sound foundation on the theory of the practice of the subject.

As regards the Hindu way of living, the author himself is a Hindu, and ever since he passed his High School in 1937, he has been studying the Hindu religious literature in addition to the critical observation of the religious ceremonies, customs, habits and convictions of the Hindus. The author had the opportunity of dealing with the people of India from an ordinary coolie to a high salaried engineer both in Madras Public Works Department and in the Central Water Power, Irrigation and Navigation Commission, Government of India. The author also had the opportunity to deal with the students and to associate with the teaching staff of the College of Engineering, Guindy, Madras. The author spared no pains to study the Caste System in a critical way as this stands as an obstacle in the way of India's progress in every direction. After coming to the United States of America, the author observed with critical eyes the American ways of living both at school and on the major construction operations of the McNary Dam and the South Holston Dam so that he has had a good opportunity to compare and contrast the Hindu way of living with that of the Americans.

From the experience of his life as a Hindu, from the many baffling problems of the construction difficulties encountered during his career in the Madras Public Works Department and in the Central Water Power, Irrigation and Navigation Commission, Government of India, from a critical observation of the traditions, customs, habits and convictions of the Hindu social order and from a research study of the Hindu religious literature, the author strongly feels that India's political independence

is of little practical value to her until and unless she achieves the social democracy without which the nation's progress in any direction is only a dream.

REFERENCES CITED

- (1) Kieran, John, Information Please Almanac, 1st, I, 902. New York, Farrar, Straus and Company, 1949.
- (2) C.W.I.N.C., Preliminary Report on the Hirakud Dam Project, 1st, I, 7. Simla (India), Government of India Press, 1947.
- (3) Paul G. Hoel, Introduction to Mathematical Statistics, 4th, I, 7. New York, John Wiley and Sons, 1948.
- (4) Creager, Justin and Hinds, Engineering for Dams, 3rd, I, 133. New York, John Wiley and Sons, 1947.
- (5) National Resources Committee, Low Dams, 2nd, I, 309. Washington, D.C., U. S. Printing Office, 1938.
- (6) Creager, Justin and Hinds, Engineering for Dams, 3rd, III, 665. New York, John Wiley and Sons, 1948.
- (7) Terzaghi and Peck, Soil Mechanics in Engineering Practice, 2nd, I, 221. New York, John Wiley and Sons, 1948.
- (8) Ibid, p. 50.
- (9) Jessie Parkhurt, Negro Year Book, 1st, I, 1. Alabama, The Department of Records and Research, Tuskegee Institute, 1947.
- (10) Lincoln, Encyclopaedia Britannica, 1st, 14, 141. Chicago, Encyclopaedia Britannica, INC., 1949.

B I B L I O G R A P H Y

1. Khosla, A. N., Appraisal of Water Resources, 1st, I, 1. Simla (India), Research Committee of the Central Board of Irrigation, 1942.
2. Ellis, W. M., Irrigation, 1st, I, 1. Madras (India), Government Press, 1931.
3. C.W.I.N.C., Mahanadi Valley Development, Hirakud Dam Project, 1st, I, 1. Simla (India), Government of India Press, 1947.
4. Khosla, A. N., Silting of Reservoirs, 1st, I, 1. Simla (India), Research Committee of the Central Board of Irrigation, 1940.
5. C.W.I.N.C., Report of the Expert Committee on the Hirakud Dam, 1st, 1, 1. Simla (India), Government of India Press, 1948.
6. Justin, Joel D., Transactions of the American Society of Civil Engineers, LXXXVII, 1531 (May), 1, 1924.
7. Lee, Charles H., Transactions of the American Society of Civil Engineers, 103, 1980 (July), 1, 1938.
8. Meyer, Otto H., Transactions of the American Society of Civil Engineers, 105, 2057 (Nov.), 83, 1940.
9. Knappan, T. T., Engineering News-Record, 116, 19 (May), 666, 1936.
10. Proctor, R. R., Engineering News-Record, 111, 9 (Aug.), 245, 1933.
11. U. S. Department of the Interior, Dams and Control Works, 2nd, I, 252. Washington, D. C., U. S. Printing Office, 1938.
12. U. S. Department of the Interior, Treatise on Dams, 1st, III, 1. Denver, Bureau of Reclamation, 1949.
13. U. S. Department of the Interior, Slip Circle Method, 1st, I, 1. Knoxville, T.V.A., 1946.

LIST OF SYMBOLS

A.A.S.H.O. = American Association of State Highway Officials

C.W.I.N.C. = Central Water Power, Irrigation and Navigation Commission

c = Cohesion

cusec = Cubic feet per second

C_L = Vertical through the centre of the circle

d = Depth of flow of water

D.V.A. = Damodar Valley Authority

F = Resisting force acting along the line of rupture

F.S. = Factor of Safety

Fig = Figure

G = Centre of gravity of the slip

G_1 = Centre of gravity of the portion right of C_L

G_2 = Centre of gravity of the portion left of C_L

h = Head of water

H.W.L. = High Water Level

I = Future frequency in years

K = Constant

K_h = Coefficient of permeability in a horizontal direction

K_v = Coefficient of permeability in a vertical direction

lbs. = Pounds

l_1 = Distance of G_1 from C_L

l_2 = Distance of G_2 from C_L

l or L = Width of slice

\bar{L} = Length of arc

L_w = Liquid limit

M.A. ft. = Million acre feet

M_0 or M_T = Overturning moment

M_R = Resisting moment

M.W.L. = Maximum Water Level

n = Normal component of the slice

n_1 = Number of years during the period of record that a flood Q was equalled or exceeded

N = Number of years for which silt reserve is provided

P = Probable percentage of future years during the period in which a flood equal or greater than a discharge Q will occur

p_1 = Plasticity index

P = Precipitation

P_A = Mean annual precipitation

q = Angle of internal friction of the soil

Q = Gross storage

Q_1 = Flood discharge

Q_2 = Probable flood discharge of 1000 years

Q_d = Dead storage

Q_e = Live storage

r = Radius of the circle

R = Run-off

R_A = Mean annual run-off

R.L. = Reduced Level

S_a = Annual silt deposit

t = Tangential component of slice

T = Temperature in Fahrenheit

T_A = Mean annual temperature in Fahrenheit

T.V.A. = Tennessee Valley Authority

U.S.A. = United States of America

w = Unit weight of soil

w_b = Buoyant weight

w_s = Saturated weight

w_w = Unit weight of water

W_1 = Weight of the portion right of C_L acting through G_1

W_2 = Weight of the portion left of C_L acting through G_2

y = Total number of years of record

A P P E N D I X

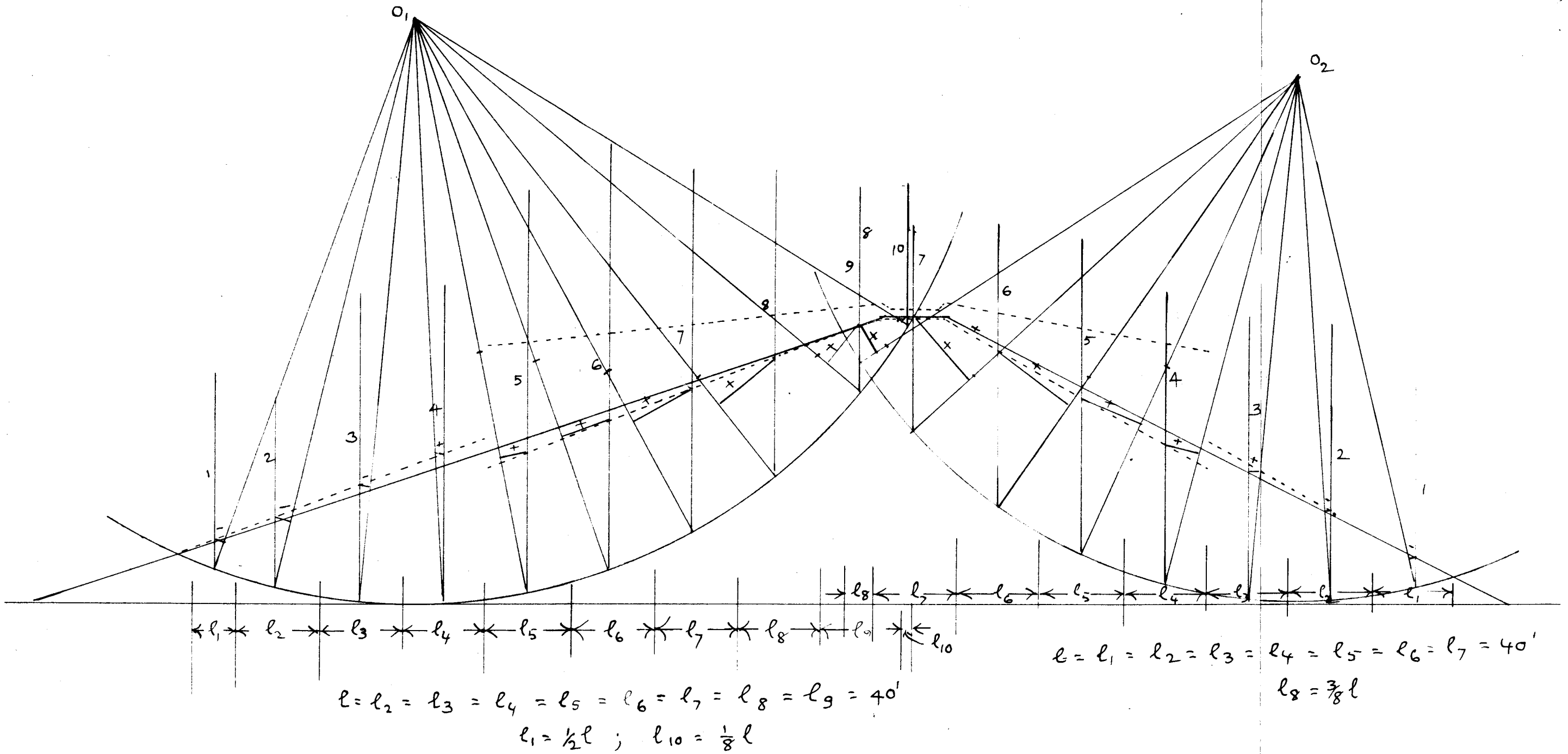

FIG. 35 SAMPLE COMPUTATIONS SHEET

SCALE. 1"=50'

COMPUTATIONS WITH REFERENCE TO FIG. 35

Slice	N_{110}	N_{70}	T_{110}	T_{132}
1	6		-3	
2	32		-7	
3	35		-5	
4	71		+4	
5		115		13
6		105		25
7		86		33
8		60		36
9		27		23
10		1		0.5
Σ	164	394	-11	130.5

$$\begin{aligned}
 110 \omega l &= 110 \times 40 = 4400 \\
 110 \omega l \tan 35^\circ &= 4400 \times 0.7 = 3080 \\
 70 \omega l &= 70 \times 40 = 2800 \\
 70 \omega l \tan 35^\circ &= 2800 \times 0.58 = 1640 \\
 132 \omega l &= 132 \times 40 = 5280
 \end{aligned}$$

$$\begin{aligned}
 F.S. &= \frac{\Sigma N \omega l \tan \phi + \Sigma c l}{\Sigma T \omega l} \\
 &= \frac{\Sigma N \omega l \tan \phi + c l}{\Sigma T \omega l}
 \end{aligned}$$

Slice	N_{110}	N_{70}	T_{110}	T_{132}
1	15		-3	
2	40		-3	
3	60		+5	
4		110		16
5		98		30
6		75		42
7		40		40
8		6		6
Σ	115	329	-1	134

$$\begin{aligned}
 (1) \quad F.S. &= \frac{\Sigma N \omega l \tan \phi + c l}{\Sigma T \omega l} \\
 &= \frac{(164)(3080) + (394)(1640)}{(-11)(4400) + (130.5)(5280)} \\
 &= \frac{(164)(3.08) + (394)(1.64)}{(-11)(4.4) + (130.5)(5.28)} = \frac{1150}{642} = \underline{\underline{1.79}}
 \end{aligned}$$

$$\begin{aligned}
 (2) \quad F.S. &= \frac{(115)(3.08) + (329)(1.64)}{(-1)(4.4) + (134)(5.28)} \\
 &= \frac{354 + 540}{-4 + 710} \\
 &= \frac{894}{706} = \underline{\underline{1.27}}
 \end{aligned}$$

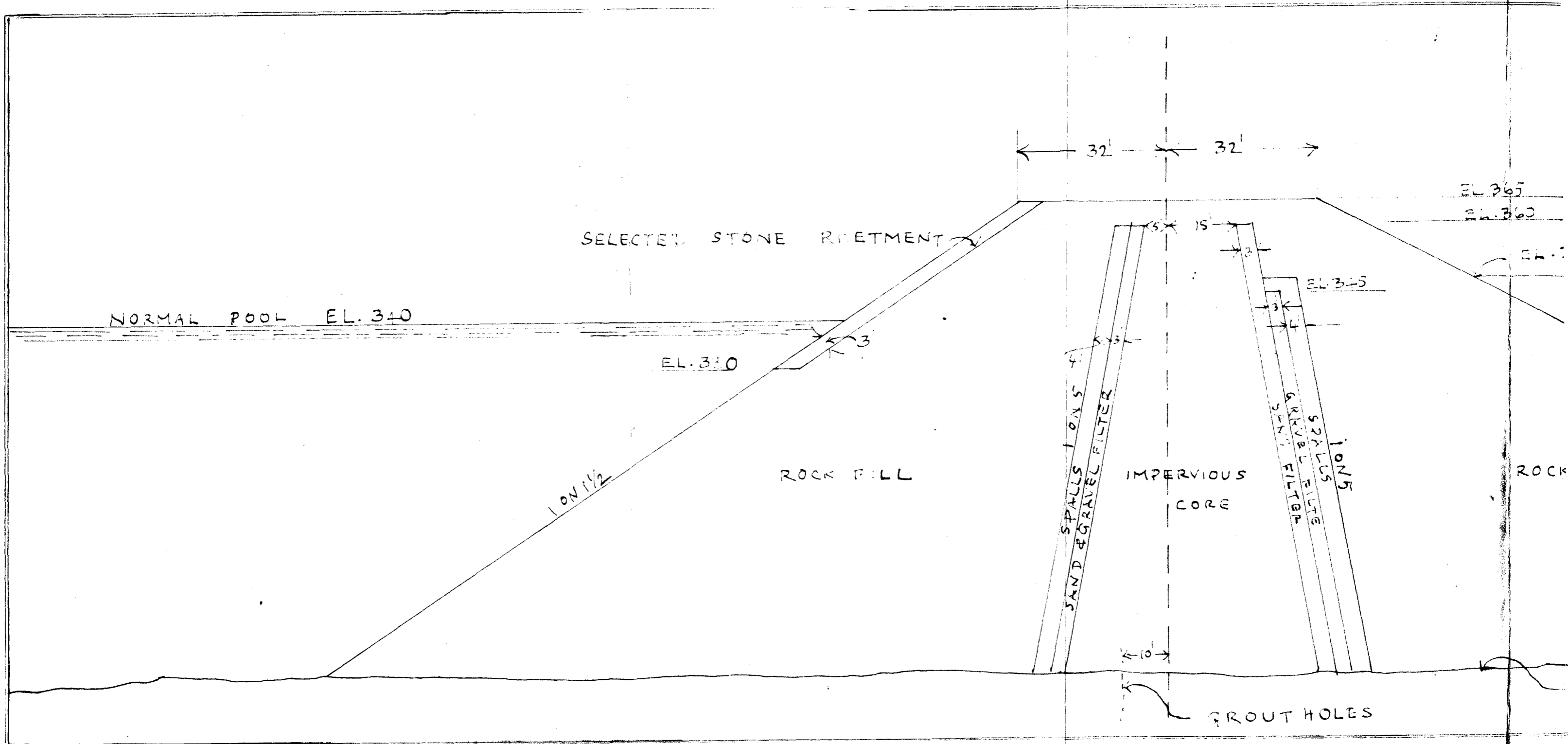

FIG. 36 McNARY DAM (U.S. CORPS OF ENGINEERS)

SCALE :

DRY DENSITY = 108 lbs
OPTIMUM MOISTURE = 17%

EL 365
EL 360

EL 348

0.5% slope

RANDOM FILL
SAND & GRAVEL
OR
ROCK.

ROCK FILL

1 ON 2

1 ON 1 1/2

EL 265

ROCK LINE

SCALE: 1" = 20'

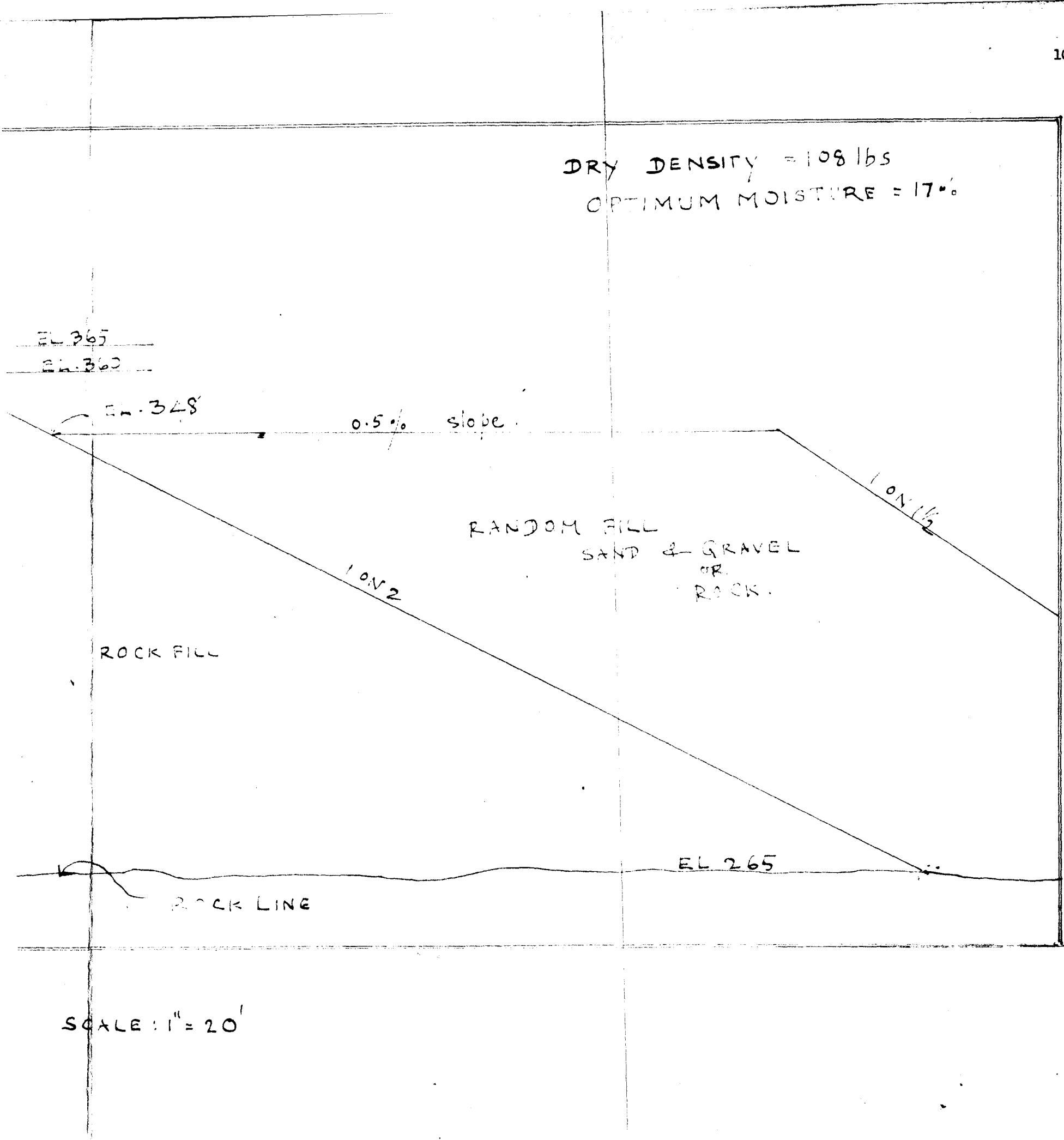
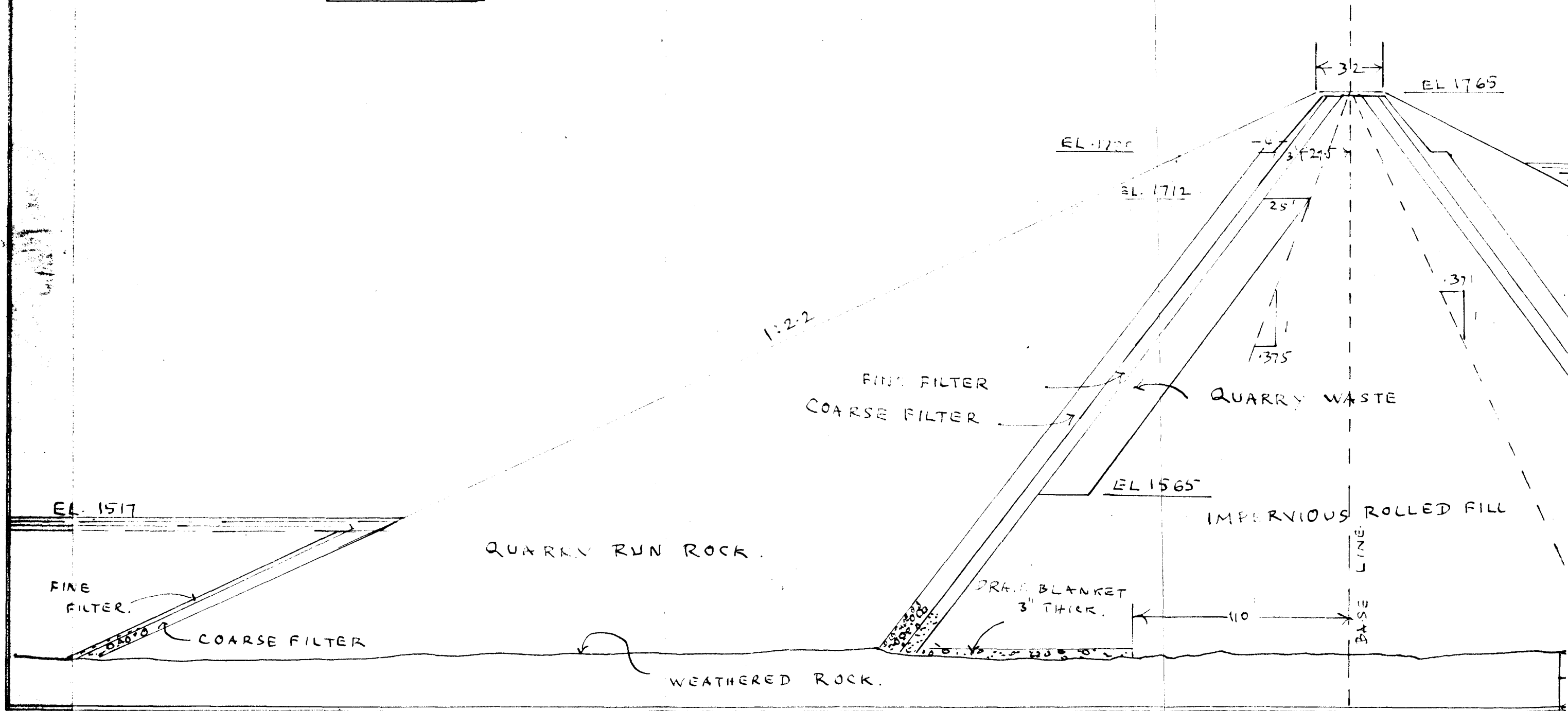
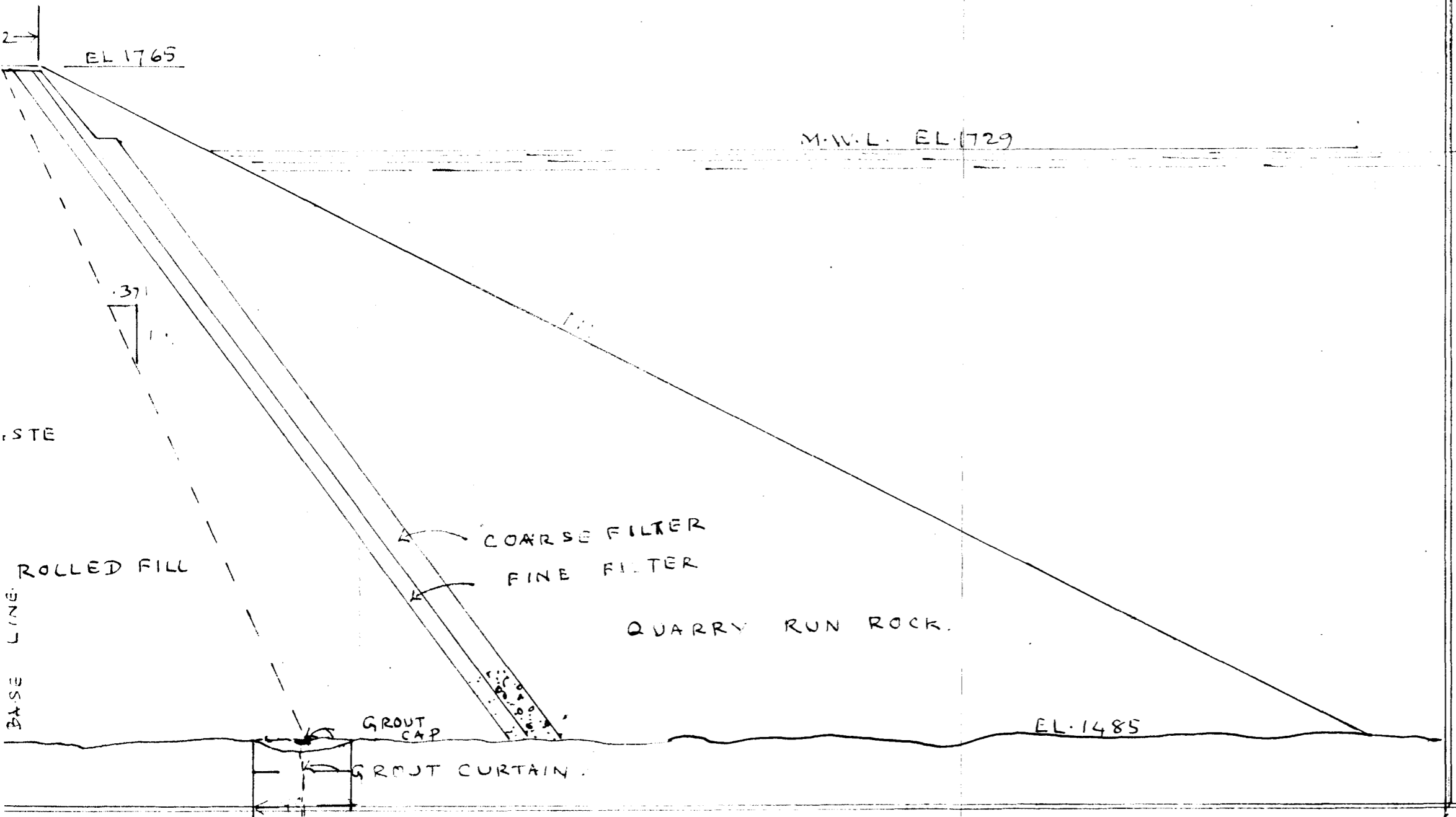

FIG. 37 SOUTH HOLSTON DAM. (T.V.A.)

SCALE 1"=50'



DRY DENSITY = 90 LB/FT³
OPTIMUM MOISTURE = 30%



V I T A

The author was born on January 4, 1920 in the village of Guthinadive, Madras Province, India; his parents are Panthagadi Ramaswamy and Panthagadi Subhashini. He went to the Elementary Board School of his village from 1926 to 1928, where he studies up to third standard in his mother tongue, Telugu. Afterwards, he went to Moulmein, Burma, and attended the American Baptist Mission Mispah Hall School, (a middle school), from 1929 to 1933, where he studied from first standard to fifth standard. He then returned to India and was admitted to Third Form by a private examination in R. R. Bh. R. High School, Pithapuram, Madras Province. The author studied in this High School from 1934 to 1937 and passed his S.S.L.C. (Secondary School Leaving Certificate) Examination with Mathematics his Optional Subject. Then he joined Pithapur Raja's College, Cocanada, Madras Province and studied his First of Arts (F.A.) from 1937 - 1939. He passed his F. A. Examination with his Optional Group, Mathematics, Physics and Chemistry. He then obtained admission to the College of Engineering, Guindy, studied for the period 1939 - 1942 and obtained the Diploma in Civil Engineering as well as the Bachelor of Engineering in Civil Engineering degree (B.E. Degree). He underwent the training in the 1st (Madras) Bn. University Officers' Training Corps, Sappers and Miners' Detachment from 1940 to 1942.

The Madras Government appointed him as a Section Officer in the Madras Public Works Department, where he served the Government from February 1943 to August 1944, when he was transferred to the College of Engineering, Guindy, Education Department. He worked as the Assistant in Strength of Materials Laboratory in the college from August 1944 to September 1946, when he was promoted to the post of Instructor of

Surveying and Drawing in the same college. In March 1947, the services of the author were loaned to the Central Water Power, Irrigation and Navigation Commission, Government of India, by the Government of Madras. From March 1947 to August 1948, the author was working as a Subdivisional Officer on the investigation of the Hirakud Dam, Orissa Province, India. He was relieved from his duties on August 11, 1948 to enable him to proceed to the U. S. A. for the specialized studies and training in the subject, Irrigation and Dam Design.

The author came to the Speed Scientific School, University of Louisville, on September 21, 1948 and was under the guidance of Professor W. B. Wendt, Head of the Civil Engineering Department, until the completion of his Master's Degree in December 1949. He has studied selected advanced courses in Concrete, Soil Mechanics, Structural Engineering and Mathematics, and has taken practical training in the construction of the McNary Dam and the South Holston Dam. He has completed this thesis on "Design and Construction of Earth Dams" under the guidance and supervision of Professor W. B. Wendt, Head of Civil Engineering Department.

The author was elected an Associate Member of the American Society of Civil Engineers on September 6, 1949.