

.... Solár, Mamoň, Kurjatko, Lang, Vacek: A simple method for determination of kinetics...

Solár Rastislav, Mamoň Miroslav, Kurjatko Stanislav, Lang Richard, Vacek Vladimír<sup>1</sup>

# A simple method for determination of kinetics of radial, tangential and surface swelling of wood

## Jednostavna metoda određivanja kinetike radijalnog, tangencijalnog i površinskog bubrenja drva

### Preliminary paper • Prethodno priopćenje

Received - prispjelo: 29. 11. 2005.

Accepted - prihvaćeno: 6. 7. 2006.

UDK: 630\*812.23

**ABSTRACT** • The aim of this paper is to introduce an objective method for monitoring the swelling rates and the final values of swelling of hard and soft woods in the polar media. As can be concluded from the presented kinetic plots of sound and biodegraded beech wood and of mature and juvenile spruce wood, the method provides a possibility of recording the dimensional alterations of wood specimens from the first instant of their contact with polar media. The method provides the possibility of monitoring the swelling kinetics of wood within temperatures ranging between 20 and 60 °C. The data obtained by the presented method may be used for the assessment of wood behaviour in the environment with changing humidity and temperature, or in a direct contact with polar media.

**Key words:** beech-wood, spruce-wood, tension and bio-degraded wood, kinetics of swelling, relative rate constants.

**SAŽETAK** • Cilj rada bio je predstaviti objektivnu metodu za promatranje procesa bubrenja i konačnih vrijednosti bubrenja tvrdoga i mekog drva u polarnome mediju. Kao što će pokazati prezentirani kinetički grafikoni zdrave i biodegradirane bukovine te adultne i juvenilne smrekovine, metodom se mogu bilježiti promjene dimenzija uzoraka drva od njihovoga prvog dodira s polarnim medijem. Metoda omogućuje promatranje kinetike bubrenja drva u temperaturnom rasponu od 20 do 60 °C. Podaci dobiveni prezentiranom metodom mogu služiti za procjenu ponašanja drva u okolišu u kojemu se mijenja vlaga i temperatura, ili u izravnom dodiru s polarnim medijem.

**Ključne riječi:** bukovina, smrekovina, tenzijsko i biodegradirano drvo, kinetika bubrenja, relativne konstante

## 1 INTRODUCTION

### 1. UVOD

Wood in dry and air-dry state and wood with the moisture content below FSP interacts with water and other polar and non-polar media. These interactions are

accompanied by its swelling in longitudinal, radial and tangential directions. The dimensional changes of wood when exposed to an environment with changing relative humidity may result in the cracks formation and deformations due to different rates of its swelling in different directions. This problem becomes more typi-

<sup>1</sup> Authors are professor, assistant, professor, assistant and professor at the Department of Chemistry and Chemical Technologies, Faculty of Wood Sciences and Technology, Technical University in Zvolen, Slovak Republic.

<sup>1</sup> Autori su redom profesor, asistent, profesor, asistent i profesor u Zavodu za kemiju i kemijske tehnologije, Fakultet za znanost o drvu i tehnologiju Tehničkog Sveučilišta u Zvolenu, Slovačka.

cal in case of materials containing tension and pressure wood as well as mature and juvenile wood. (Požgaj et al. 1993, Lang et al. 2004).

Wood bio-degraded by white-rot fungi exhibits extremely quick interactions with water and pulping media (Solár et al. 2001), and the rate of its facial swelling increases almost by two orders (Solár et al. 2003, Kurjatko et al. 2005).

The above mentioned phenomenon may result in deformation and numerous cracks of partially bio-degraded wood due to tensions arising on the interface between sound and degraded wood given by different rates of its swelling.

There are some other known methods for measuring the swelling of wood in water and other media (ČSN 480126, Kurjatko 2000), however their disadvantage is the impossibility of recording the instant initial period of wood/medium interactions, and in case of ČSN, there is also the need of periodical measurements of the specimen dimensions by a micrometer.

The proposed method provides the possibility of monitoring the first-faster pseudo-linear phase of tangential, radial as well as facial swelling of wood taking place in the first seconds of its contact with water or other polar media.

## 2 DESCRIPTION OF PROPOSED METHOD

### 2. OPIS PREDLOŽENE METODE

#### 2.1 Principle and function

##### 2.1. Temeljne postavke metode

The principle of monitoring dimensional alterations of the analysed materials lies in transformation of dimensional changes of wood in a liquid medium registered by sensors as electric signals. The sensors are in contact with wood specimens via glass supporting prisms placed on the specimens in directions perpendicular to plane of radial and tangential cuts. The signals are processed by PC. The dimensional changes of wood specimens are monitored by the sensors with an accuracy of 0.2 %.

The obtained signals processed by a PC are plotted against the elapsed time of swelling. The monitored dimensional alterations can be plotted in sub-second, second and minute intervals. The swelling (no matter whether it is radial, tangential or surface one) is expressed as the difference between the actual and initial dimensions of the specimens expressed as per-cent. Computation of the course of the specimens' surface swelling in plane perpendicular to grain was performed continually by use of the following formula:

$$S_s = \frac{(F_{ii} - F_0)}{F_0} \cdot 100 \quad (\%)$$

Where

$S_s$  - surface swelling in direction perpendicular to grain (površinsko bubrenje u smjeru okomitom na vlakanca),



**Figure 1** Device for the determination of radial and tangential swelling including monitoring unit (photograph – top view)  
**Slika 1.** Uređaj za određivanje radijalnoga i tangencijalnog bubrenja, uključujući uređaj za praćenje (fotografija – pogled odozgo)

**Table 1** Construction materials used for the assembly of the instrument

**Tablica 1.** Konstrukcijski materijali upotrijebljeni za sastavljanje instrumenta

No. Br.	Name Naziv	Material Materijal	Dimension Dimenzije	Pieces Komada
1	Bottom Donji dio	Glass staklo	190 x 154 x 8	1
2	Right side wall Desna stijenka	Glass staklo	84 x 154 x 8	1
3	Left side wall Lijeve stijenka	Glass staklo	84 x 154 x 8	1
4	Rear wall Stražna stijenka	Glass staklo	92 x 190 x 8	1
5	Front wall Predna stijenka	Glass staklo	92 x 190 x 8	1
6	Ramp Rampa	Glass staklo	130 x 154 x 8	2
7	Guide rail Vodilica	Glass staklo	8 x 8 x 50	8
8	Fixed bearing Fiksirani ležaj osovine	Glass staklo	40 x 30 x 8	3
9	Work rest 1 Odmorište 1	Glass staklo	30 x 8 x 8	4
10	Work rest 2 Odmorište 2	Glass staklo	38 x 8 x 8	4
11	Support prism Suporna prizma	Glass staklo	30 x 40 x 20	4
12	Holder and fixing screw Držać i vijak za učvršćenje	Metal metal	20 x 20 x 8	4
13	Specimen Uzorak	Wood drvo	30 x 30 x 10	2
14	Stopper of outlet Zauštvlač izljeva	Rubber guma	Ø 8	1
15	Tensometer (EDK 93) Tenzometar (EDK 93)	Metal metal		4

**Note:** Silicon glue resistant to water was used as an adhesive, as well as organic solvents and temperature.

**Napomena:** Silikonsko ljepilo otporno na vodu, organska otapala i temperaturu upotrijebljeno je kao adheziv.

$F_0$  - initial area of the specimen at the initial moisture content below FSP, and (*početna površina uzorka pri početnom sadržaju vlage nižem od TZV, i*)

$F_{t_i}$  - area of the specimen during monitoring, where  $t_i$  is any time within the interval from 0 to 86 400 s (24 h) (*površina uzorka pri promatranju, gdje je  $t_i$  bilo koje vrijeme unutar intervala 0 - 86 400 s*).

The relative rate constant of the first-fast phase of swelling (regardless of its direction) is computed as the function of a tangent drawn through the steep linear part of the kinetic plot. The beginning and end of the linear part in the plot can be determined by graphical method, numerical derivation of the first order or by the regression method. In case of regression method (used for the plots evaluation in this paper) the initial point of the linear part was equal to 10 %, and its end point to 50 % of the final value of swelling after 24 h of swelling.

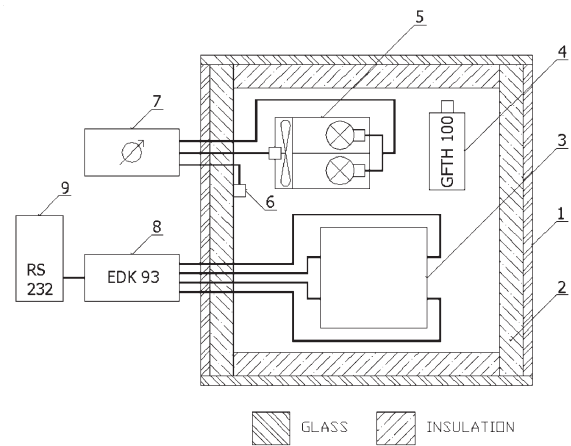
Though the regression method is not as precise as the derivation method, the loss of accuracy is negligible as compared to variability of the monitored wood properties. Moreover, the selected interval (10 to 50 % of total swelling) represents the intersection of linear parts of all plots presented.

The applied formula for the calculation of the relative rate constants is as follows:  $\Delta y/\Delta x$ . Both values  $\Delta y$  (%) and  $\Delta x$  (s) are related to extremes of the linear phase of the kinetic plot.

## 2.2 Instrument

### 2.2. Instrument

The instrument records simultaneously the alterations in the linear dimensions (tangential and radial) of the monitored specimens from the instant of their con-



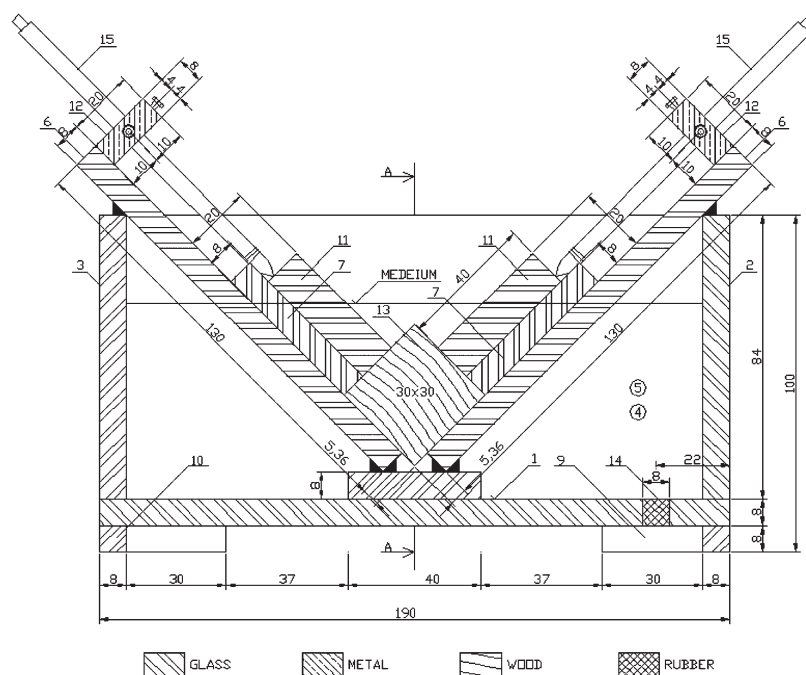
**Figure 2** Electric scheme of the air conditioning chamber and monitoring unit

**Slika 2.** Shema električnog sustava klimatizirane prostorije i uređaja za praćenje

Description of parts in Figure 2 (*Opis dijelova na slici 2*):

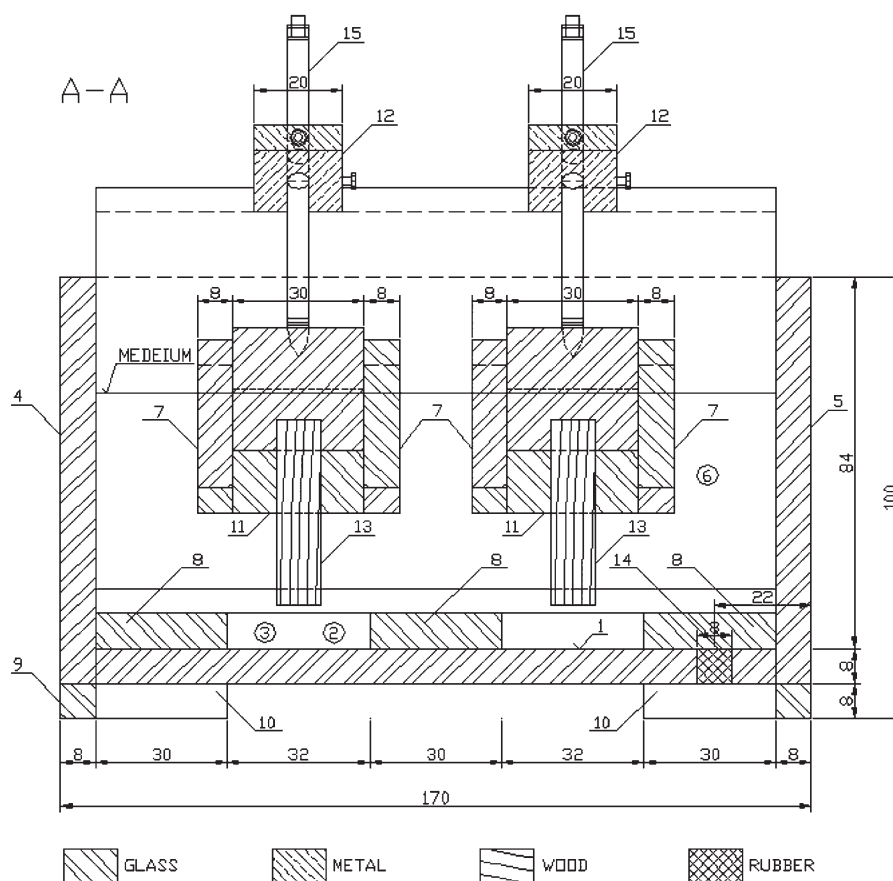
- 1 - glass walls – 8 mm (*stakleni zid – 8 mm*)
- 2 - polystyrene foam – 25 mm (*polistirenska pjena – 25 mm*)
- 3 - monitoring unit (*uređaj za praćenje*)
- 4 - digital hygrometer “GFTH 100” (*digitalni higrometar GFTH 100*)
- 5 - thermostat heating unit with ventilator (*termostatski uređaj za grijanje s ventilatorom*)
- 6 - thermistor monitoring the inner chamber temperature (*termistor koji prati unutarnju temperaturu sobe*)
- 7 - thermostat control unit (*kontrolna jedinica termostata*)
- 8 - range finder with induction sensors “EDK 93” unit – product of IMECO ltd. Brno, CZ (*tražilo raspona s indukcijskim senzorima EDK 93 – proizvod tvrtke IMECO ltd. Brno, CZ*)
- 9 - PC with an RS 232 interface (*PC s RS 232 sučeljem*)

tact with water or other liquid media. For monitoring the swelling of the tested wood specimens, a non-commercial air conditioning chamber was applied for main-

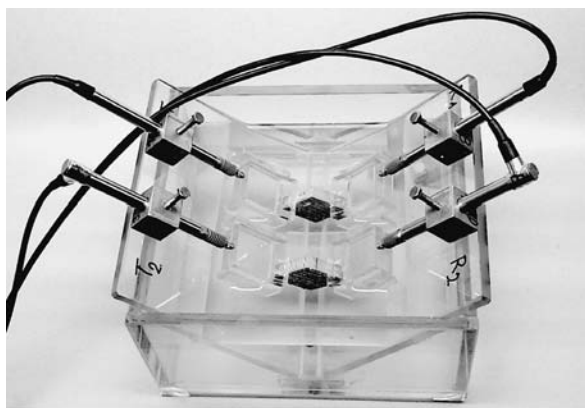


**Figure 3** Schematic description of the monitoring unit, dimensions in millimeters (front view)

**Slika 3.** Shematski prikaz uređaja za praćenje; dimenzije su iskazane milimetrima (pogled srijeda)



**Figure 4** Schematic description of the monitoring unit, dimensions in millimeters (side view)  
**Slika 4.** Shematski prikaz uređaja za praćenje; dimenzije su iskazane milimetrima (pogled sa strane)



**Figure 5** The photograph of the monitoring unit for measurement of radial and tangential swelling  
**Slika 5.** Fotografija kontrolne jedinice za mjerenje radialnoga i tangencijalnog bubrenja

taining precisely the temperature of the environment. The chamber with the monitoring unit was designed and constructed at the Department of Wood Science of the Faculty of Wood Sciences and Technology of Technical University of Zvolen.

The accurate thermostat temperature was maintained by a thermistor stabiliser. The applicable temperature range of the device ranges between 20 and 70 °C with hysteresis of 0.2 °C.

The instrument is proposed for measurements performed with the specimens with dimensions of 30 x 30 x 10 mm, the shortest dimension parallel to grain.

The photograph of the instrument (thermostatic chamber with monitoring instrument and digital hygrometer inside), electric scheme, the schematic drawings of the monitoring unit and its photograph are presented in Figs. 1, 2, 3, 4 and 5.

The electric scheme of the device and the description of its basic components (climatic chamber with assembly, monitoring unit and digital hygrometer) are given in Fig. 2:

The dimensional alterations of wood specimens were monitored by a couple of sensors for each specimen. This intelligent 4-channel sensor is connected to PC via RS 232 interface. The obtained data are processed using a home-made software in the Pascal programming language. The EDK 93 parameters are as follows:

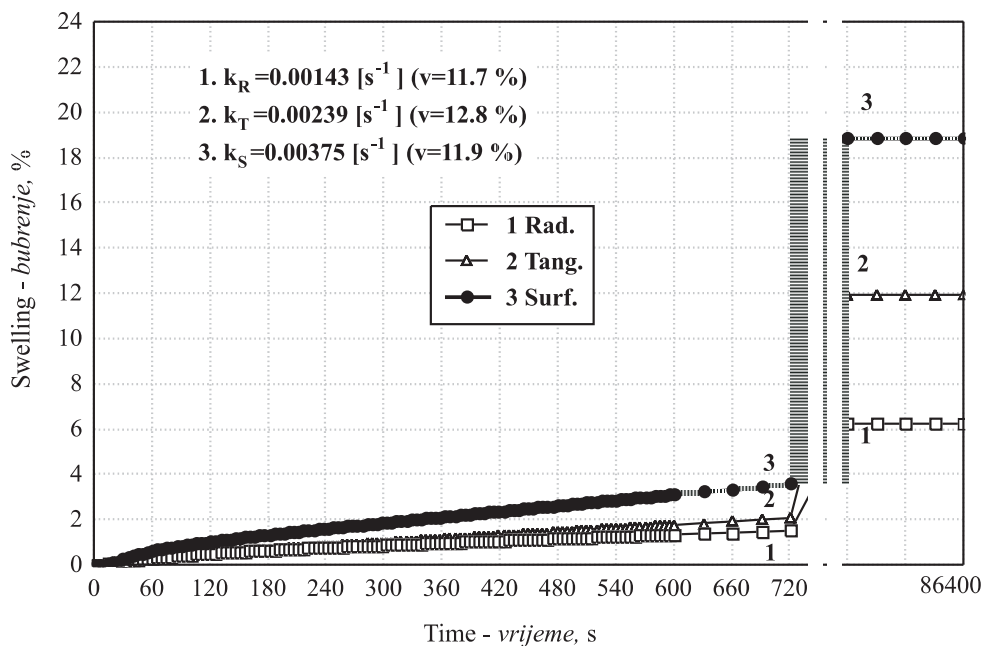
- accuracy 0.2 %
- resolution 10 nm
- maximum sampling frequency 10 Hz

### 3 EXAMPLES OF APPLICATION AND DISCUSSION

#### 3. PRIMJERI PRIMJENE I DISKUSIJA

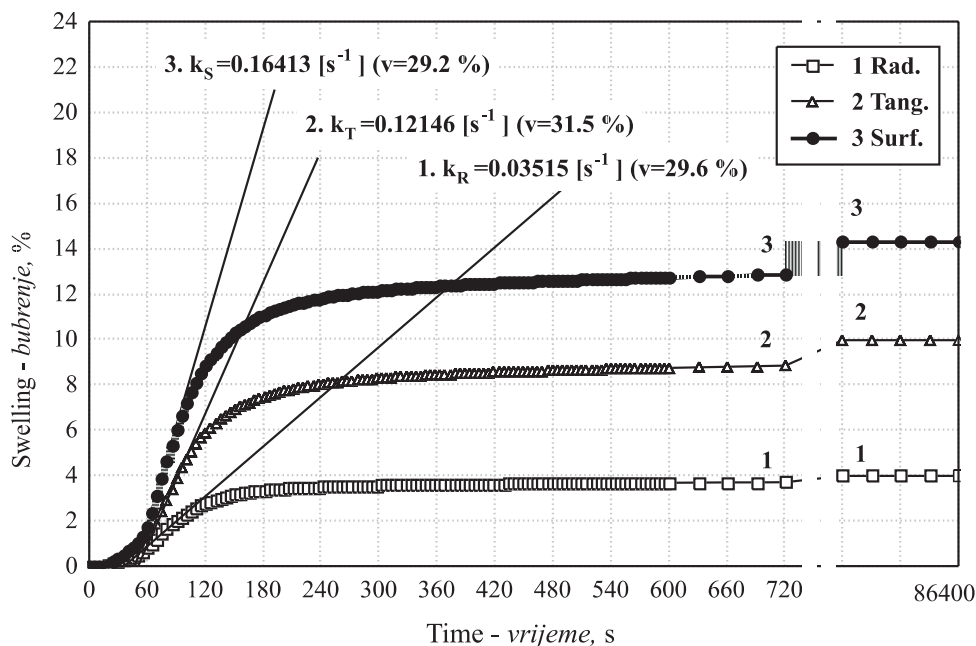
To illustrate the applications of the described method, Figs. 6 – 12 present some experimental plots expressing the rates of tangential, radial and surface swelling of different samples of sound and bio-degraded wood.

Figs. 6, 7 and 8 present the kinetic plots of swelling of sound beech wood and beech wood degraded by



**Figure 6** Kinetic plots of normal beech wood swelling in radial and tangential directions and its surface swelling in plane perpendicular to grain ( $T = 25\text{ }^{\circ}\text{C}$ ; initial moisture content 3.5 %)

**Slika 6.** Kinetički dijagrami bubrenja bukovine u radijalnome i tangencijalnom smjeru te dijagram njezina površinskog bubrenja u ravnini okomitoj na smjer vlaknaca ( $T = 25\text{ }^{\circ}\text{C}$ , početni sadržaj vode 3,5 %)



**Figure 7** Kinetic plots of normal beech wood swelling (15-day degradation by brown-rot fungus *Coniophora putanea*) in radial and tangential directions and its surface swelling in plane perpendicular to grain ( $T = 25\text{ }^{\circ}\text{C}$ ; average weight loss of specimens 11.10 %, v. coeff. 20.33 %; initial moisture content 3.5 %)

**Slika 7.** Kinetički dijagrami bubrenja bukovine (15-dnevna degradacija gljivom smeđe truleži *Coniophora putanea*) u radijalnome i tangencijalnom smjeru te dijagram njezina površinskog bubrenja u ravnini okomitoj na smjer vlaknaca ( $T = 25\text{ }^{\circ}\text{C}$ ; prosječni gubitak težine uzorka 11,10 %, koef.  $v = 20,33\text{ }%$ ; početni sadržaj vode 3,5 %)

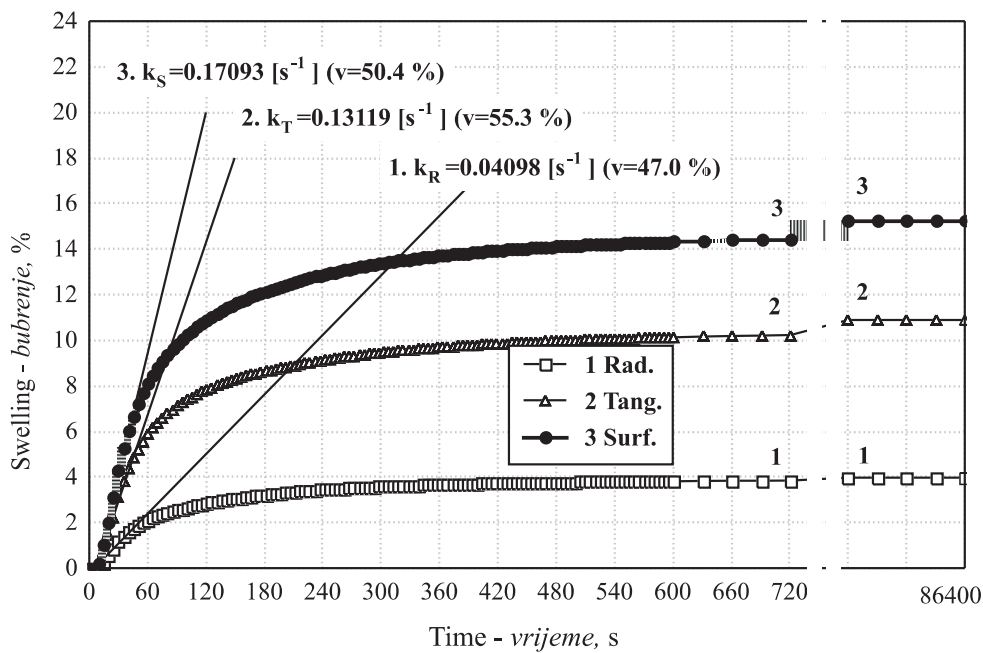
brown- and white-rot fungi in distilled water. The sets of beech wood specimens (each of three pieces) were selected so as to obtain comparable series of specimens with approximately the same density and number of annual rings per cm.

As seen from the comparison of variation coefficients of the relative rate constants of swelling (no matter whether it is radial, tangential or surface one), in case of bio-degraded beech wood they are increased.

The explanation of this fact probably lies in an uneven course of attack of the applied fungi due to relatively short time of their action.

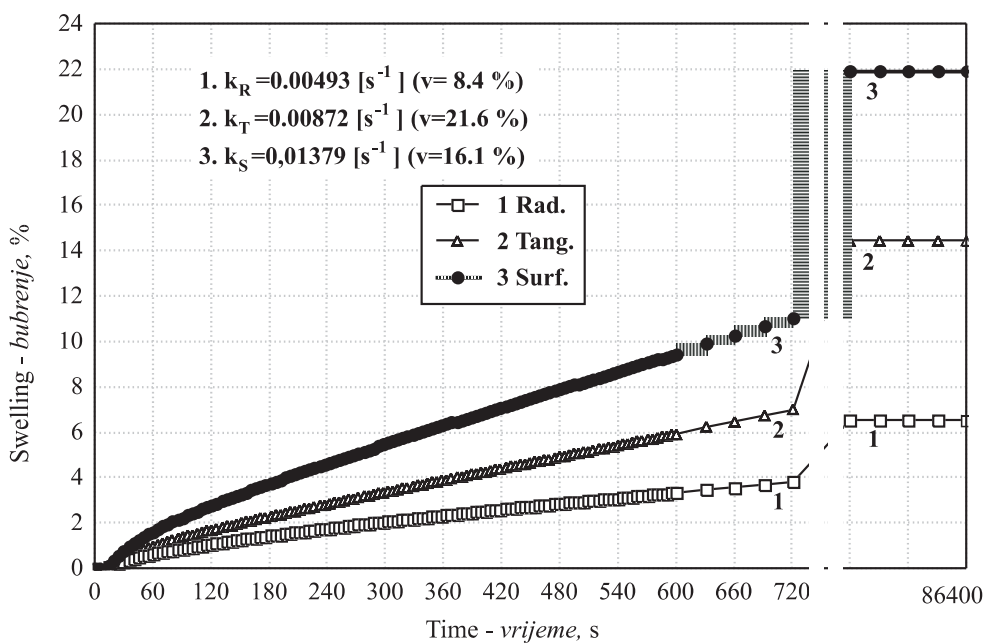
Fig. 9 represents kinetic plots of swelling at the temperature of  $50\text{ }^{\circ}\text{C}$ , the set of three comparable specimens was used.

The kinetic plots of swelling of comparable beech wood specimens monitored at elevated temperature (Fig. 9) point out a marked increase in the swelling ki-



**Figure 8** Kinetic plots of normal beech wood swelling (15-day degradation by white-rot fungus *Trametes versicolor*) in radial and tangential directions and of surface swelling in plane perpendicular to grain ( $T = 25\text{ }^{\circ}\text{C}$ ; average weight loss of the specimens 4.0 %, v. coeff. 10.37 %; initial moisture content 3.5 %)

**Slika 8.** Kinetički dijagram bubrenja bukovine (15-dnevna degradacija gljivom bijele truleži *Trametes versicolor*) u radijalnome i tangencijalnom smjeru te dijagram površinskog bubrenja u ravnini okomitoj na vlakanca ( $T = 25\text{ }^{\circ}\text{C}$ ; prosječni gubitak težine uzorka 4,0 %, koef.  $v = 10,37\%$ ; početni sadržaj vode 3,5 %)



**Figure 9** Kinetics plots of radial, tangential and surface swelling of comparable specimens of sound beech wood at the temperature of  $50\text{ }^{\circ}\text{C}$  (initial moisture content 3.5 %)

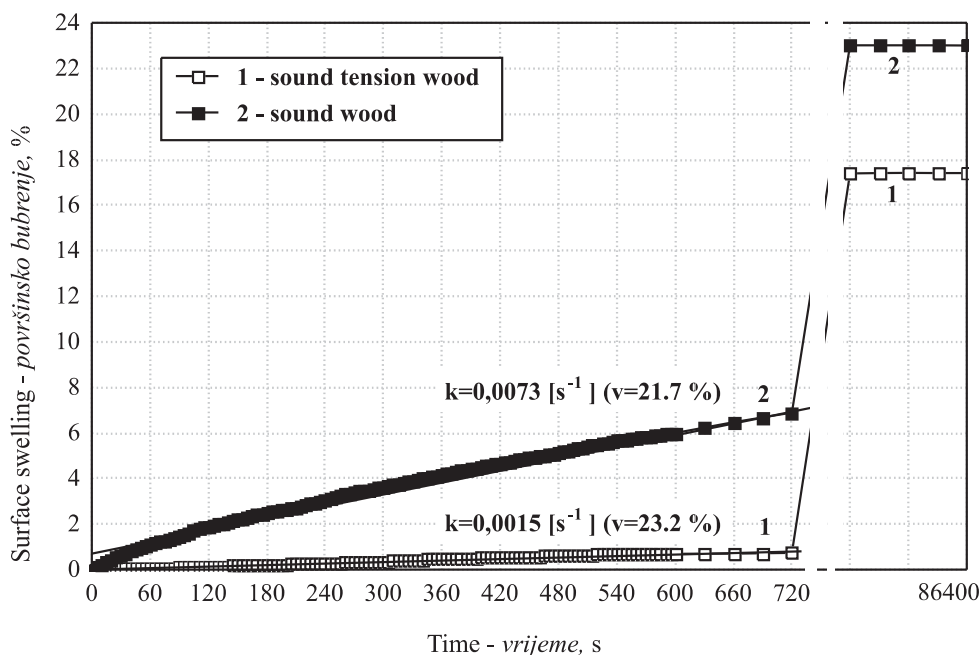
**Slika 9.** Kinetički dijagram radijalnoga, tangencijalnoga i površinskog bubrenja usporedivih uzoraka bukovine pri temperaturi  $50\text{ }^{\circ}\text{C}$  (početni sadržaj vode 3,5 %)

netics with the temperature increase of  $25\text{ }^{\circ}\text{C}$ , and also the values of linear as well as surface swellings were much higher after 24 h of dipping in water (compare with the plots in Fig. 6).

Fig. 10 shows the different swelling kinetics of sound normal and tension beech wood measured in distilled water as a medium. The sets of specimens (each

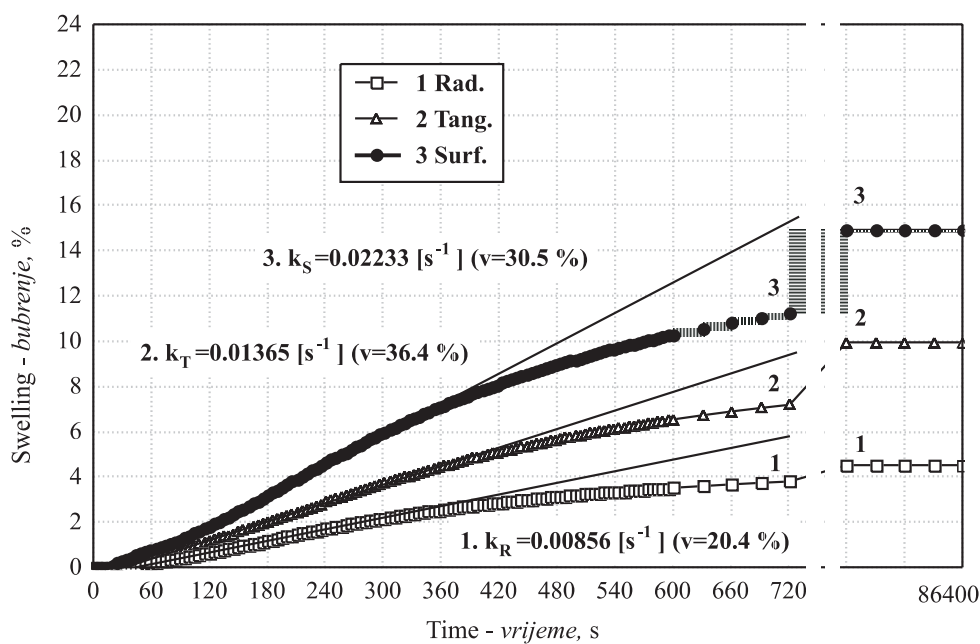
consisted of three pieces) were selected by the method of random choice, and samples of wood were taken from a different stem than specimens monitored in case of Figs 6, 7, 8 and 9.

High variation coefficients of relative rate constants of swelling in case of plots given in Fig 10 result from the method of wood specimen selection.



**Figure 10** Kinetic plots of facial swelling of normal and tension beech wood in plane perpendicular to grain ( $T = 28\text{ }^{\circ}\text{C}$ ; initial moisture content 2.5 %)

**Slika 10.** Kinetički dijagram bubrenja normalne i tenzijske bukovine u ravnini okomitoj na vlakanca ( $T = 28\text{ }^{\circ}\text{C}$ ; početni sadržaj vode 2,5 %)



**Figure 11** Kinetics of surface swelling of sound mature spruce wood in plane perpendicular to grain ( $T = 20\text{ }^{\circ}\text{C}$ ; initial moisture content 3.50 %)

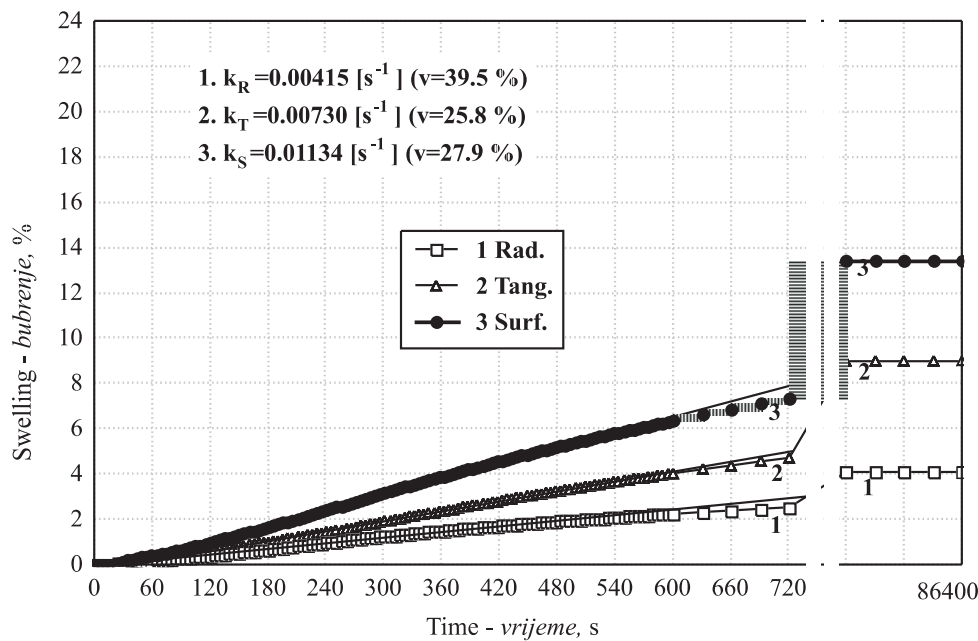
**Slika 11.** Kinetika površinskog bubrenja zdrave adultne smrekovine u ravnini okomitoj na vlakanca ( $T = 20\text{ }^{\circ}\text{C}$ ; početni sadržaj vode 3,50 %)

The example showing the differences in the swelling kinetics of mature and juvenile spruce wood in water are given in Figs. 11 and 12. Three specimens chosen by the method of random choice were used for each monitoring.

The high variation coefficients of relative rate constants of swelling in case of plots given in Figs 11 and 12 are due to the applied method of the specimens selection (non-comparable densities and numbers of annual rings in each specimen used).

#### 4 CONCLUSION 4. ZAKLJUČAK

The presented method and the described device open the possibility of monitoring the dimensional changes of wood samples immersed into polar media (no matter whether it is hard or soft wood or wood bio-degraded by fungi to a different degree). The advantage of the described method is the possibility of monitoring the rate of wood/medium interactions from the first instant of wood contact with the applied medium.



**Figure 12** Kinetics of surface swelling of sound juvenile spruce wood in plane perpendicular to grain ( $T = 20\text{ }^{\circ}\text{C}$ ; initial moisture content 3.50 %)

**Slika 12.** Kinetika površinskog bubrenja zdrave juvenilne smrekovine u ravnini okomitoj na vlakanca ( $T = 20\text{ }^{\circ}\text{C}$ ; početni sadržaj vode 3,50 %)

The drawback of the method is that the obtained data cannot be considered as the absolute ones, and may depend on the origin of wood sample, its density, inner surface, chemical composition, contents of extractives, initial moisture content, polarity of the liquid used and on experimental temperature, as well. Despite this disadvantage given by variation of wood properties even within the same wood species and stem - which cannot be avoided, we consider the method to be useful for monitoring wood interactions with liquids. In addition, such a “drawback” influences the results of any method of measurement of wood physical properties.

As it can be seen from the presented illustrative plots, the method provides the possibility of an unbiased quantification of dimensional alterations (expressed as “relative rate constants” of swelling) of different kind of wood within the selected periods of monitoring. The obtained data may also be used for the determination of “differential” swelling ( $K_{\beta} = \beta_v/\beta_r$ ) of wood at any moment of its interaction with a liquid.

The method may also be used for predicting the impact of polar wood protective liquids or disperse paints on the surface of sound, chemically and bio-chemically damaged wooden objects.

## 5 REFERENCES

### 5. LITERATURA

- Požgaj, A.; Chovanec, D.; Kurjatko, S.; Babiak, M. 1993: Štruktúra a vlastnosti dreva, 1. vydanie, Príroda a.s. (Editors), Bratislava, 485 p.
- Solár, R.; Kurjatko, S.; Liptáková, E.; Mamoň, M.; Vacek, V. 2001: Influence of hornbeam wood pre-treatment by white-rot fungus *Phanerochaete chrysosporium* on the course of organosolv, kraft and neutral sulphite delignifi-

cations (Part. 2: Selected properties of the biodegraded material). Wood Research (Drevársky výskum) 46(4): 9-21.

- Solár, R.; Kurjatko, S.; Liptáková, E.; Mamoňová, M. 2003: Alterations of beech wood (*Fagus sylvatica* L.) physical properties in the course of degradation by selected white rot-fungi. Wood Research (Drevársky výskum) 48(1/2): 1-14.
- Lang, R., Solár, R.; Mamoňová, M.; Hudec, J. 2004: Selected properties of mature and juvenile spruce wood from the viewpoint of cooking pulps. Acta facultatis xylogologicae XLVI: 13-24.
- Kurjatko, S.; Solár, R.; Babiak, M.; Mamoňová, M.; Hudec, J. 2005: Swelling and permeability of beech wood biodegraded by white-rot fungi. International conference on “Hardwood and utilisation in Europe” - Second European conference on hardwood. September 2005, Sopron.
- ČSN 490126, 1988: Skúšky vlastností rastlého dreva – Metóda zist'ovania napúčavosti.
- Kurjatko, S. 2000: Kinetika napúčania bukoveho dreva vo vode (The kinetics of beech wood swelling in water). Proceedings of symposium “Interakcia dreva s rôznym formami energie”. Technická univerzita vo Zvolene, Zvolen 2000, 17-19.

### Corresponding address:

prof. Ing. RASTISLAV SOLÁR, PhD

Dept. of Chemistry and Chemical Technologies  
Faculty of Wood Sciences and Technology  
Technical University of Zvolen  
T.G. Masaryka 24  
96053 Zvolen  
Slovak Republic  
e-mail: rsolar@vsld.tuzvo.sk