

| | | | | | | |
|--------------|------|----------|----------|--|-------|-------------|
| GEOL. CROAT. | 52/2 | 99 - 108 | 10 Figs. | | 1 Pl. | ZAGREB 1999 |
|--------------|------|----------|----------|--|-------|-------------|

New Congerian Species and Their Similarity with *Congerina banatica* from the Pannonian Sediments in Northern Croatia

Davor VRSALJKO¹ and Jasenka SREMAC²

Key words: Pannonian Lake, Miocene, Pannonian Basin, NW Croatia, *Congerina*, Bivalvia, New species, Endemic evolution.

Abstract

Congerina baschi n.sp. and *Congerina susedana* n.sp. are two new species from the Pannonian sediments of the Medvednica Mts. (NW Croatia). *C. baschi* n.sp. was found in the Lower Pannonian limestones, and *C. susedana* n.sp. was collected from the Upper Pannonian marls.

Relationships with the affiliated taxa enable reconstruction of a phyletic lineage beginning with *Congerina soceni* JEKELIUS, through *C. baschi* n.sp. to *Congerina banatica* HÖRNES. *C. banatica* is the ancestor of two branches, leading to *C. susedana* n.sp. and *C. vugroveci* SREMAC, respectively. *Dreissenomya digitifera* (ANDRUSOV) is the probable descendant of *C. vugroveci*.

The accompanying assemblages of fossil molluscs and ostracods from the same horizons facilitate the precise stratigraphic and palaeoenvironmental positioning of the new taxa.

1. INTRODUCTION

Study of the Pannonian sediments in the southwestern part of the Medvednica Mts. (Fig. 1) and their relationship with underlying Sarmatian deposits, revealed two entirely new forms of the genus *Congerina*. GORJANOVIĆ-KRAMBERGER (1890) noticed and briefly described a new congerian form from the "Praepontian white marls" from the Vrapče locality, but he did not establish and name a new species, because of the small number of specimens and their poor preservation. During this study, a collection of approximately 20 specimens of this form has enabled the establishment of a new species, *Congerina baschi* n.sp., which can be clearly identified and positioned in a stratigraphically narrow interval. The presumption has been made, that *C. baschi* n.sp. represents the ancestral form of the forthcoming radiation of congerian species (see Fig. 10).

SREMAC (1981) described *C. vugroveci* as a new species from the Upper Pannonian marls of Vugrovec in the southeastern part of the Medvednica Mts. (North-

ern Croatia), distinguishing it from the previously known *C. banatica* HÖRNES. Several specimens have been collected during this study, thus confirming the validity of *C. vugroveci*. Previous authors dealing with *C. banatica* (HÖRNES, 1875; KOCHANSKY-DEVIDÉ, 1976; SREMAC, 1981; VRSALJKO, 1997) noticed the variability of this form and its separation into three main morphological varieties. In this study, we will discuss this variability and use the biometrical statistics (see Fig. 8) to describe one of these forms as the entirely new species, *Congerina susedana* n.sp.

ANDRUSOV (1964) described congerian taxa belonging to the group *Subglobosae* as "indicative of calm and sheltered, oligohaline lacustrine palaeoenvironments", stratigraphically positioned within the Pannonian stage. According to the morphology of the shell, the new species described in this paper could belong to the *Subglobosae*. The term "group", although not found in the ICZN (International Codex of Zoological Nomenclature), has been applied to congerian bivalves by many authors since ANDRUSOV (1964), in order to express the typical morphotypes. There have been several attempts to equate congerian "groups" with legal taxonomical categories (e.g. genus, subgenus), but the collected fossil material is rarely preserved well enough to enable this task.

Populations of *Congerina baschi* n.sp. can commonly be found in the Lower Pannonian limestones and marls (Fig. 3) which were deposited in an almost freshwater (VRSALJKO, 1997), shallow lacustrine palaeoenvironment. From the same horizon, a rich molluscan community has been collected including: *Radix (Radix) croatica* (GORJANOVIĆ), *R. (R.) extensa* (GORJANOVIĆ), *Gyraulus (Gyraulus) praeponticus* (GORJANOVIĆ), *Orygoceras laevis* GORJANOVIĆ, *Limnocardium praeponticum* (GORJANOVIĆ), *L. spinosum* (LÖRENTHEY), *L. plicataeformis* (GORJANOVIĆ) and others. An associated ostracod assemblage from the same horizons contains *Hungarocypris auriculata* (REUSS), *Amplocypris abscisa* (REUSS), *Candona (Pontoniella) croatica* SOKAČ, *C. (Thaminocypris) hodonensis* POKORNY and others.

In the uppermost sections of the Upper Pannonian marls, rare specimens of *Congerina susedana* n.sp. have been found (Fig. 4). These marls were deposited in the relatively deep, distal parts of the lake (VRSALJKO,

¹ Institute of Geology, Sachsova 2, HR-10000 Zagreb, Croatia.

² Department of Geology and Palaeontology, Faculty of Science, University of Zagreb, Ul. kralja Zvonimira 8, HR-10000 Zagreb, Croatia.

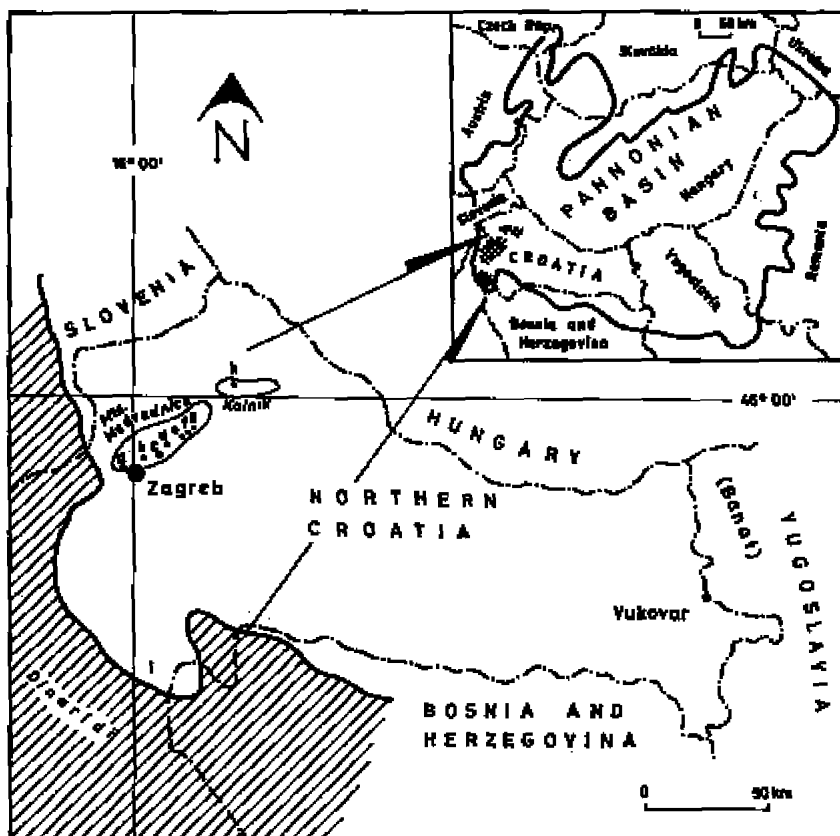

Fig. 1 Location map: a) Podsused; b) Bol-fani; c) Vrapče; d) Medvedski Breg; e) Vugrovec; f) Goranec; g) Moravče; h) Korovići; i) Banovina region.

1997). Among the accompanying molluscs, the most important taxa are: *Gyraulus (G.) tenuistriatus* (GORJANOVIĆ), *Limnocardium winkleri* (HALAVATS), *Paradacna syrmiense* (HÖRNES), ?*Cerastoderma margaritacea* (BRUSINA), and ?*C. protracta* (GORJANOVIĆ). Among the numerous ostracods, the following taxa are extremely abundant: *Hungarocypris hieroglyphica* (MEHES), *Amplocypris dorsobrevis* SOKAČ, *Cyprina dorsoconcava* KRSTIĆ, *Candona (Pontoniella) sagittosa* KRSTIĆ and *C. (Lineocypris) pupini* KRSTIĆ.

2. MATERIAL AND METHODS

Numerous specimens of *Dreissenidae* mussels were collected during facies research of Neogene sediments of Mt. Medvednica (NW Croatia). Several Pannonian localities were investigated, including Vrapče and Podsused in SW Medvednica Mt., where detailed stratigraphical columns were reconstructed (Figs. 1, 3 and 4).

Previously collected Pannonian congerian specimens from the Croatian Museum of Natural History (GORJANOVIĆ, 1890) and Faculty of Science in Zagreb (SREMAC, 1981), as well as the sketches published by HÖRNES (1875) were taken into consideration.

Shells of the available fossils were measured with calipers (20 specimens of *C. banatica*, 17 specimens of *C. baschi* n.sp., 6 specimens of *C. susedana* n.sp. and 5 specimens of *C. vugroveci*). Specimens published by

HÖRNES were measured from sketches. Angles were also measured from shells or from sketches, but only on completely preserved specimens.

The shell material is, unfortunately, poorly preserved. Impressions and moulds are more common than

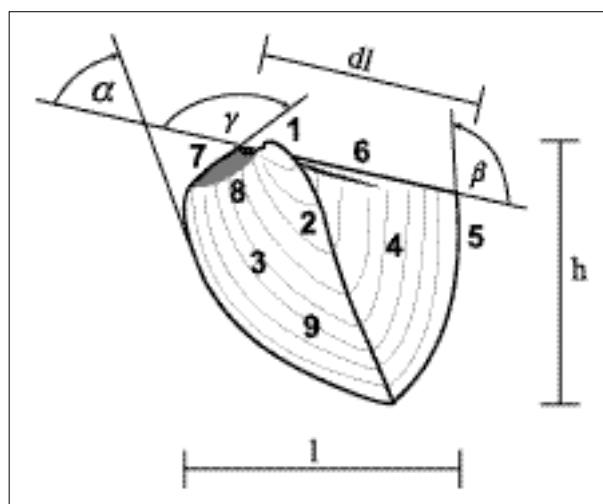

Fig. 2 Schematic sketch of the morphometric shell elements in the genus *Congeria*: h) height; l) length; c) convexity; dl) length of the dorsal edge; k (h/l) elongation rate; α) angle between the ventral and the dorsal edge; β) angle between the dorsal and the anal edge; γ) angle between the dorsal edge and the border of the pseudolunular field; 1) beak; 2) main ridge; 3) ventral field; 4) dorsal field; 5) wing shaped extension; 6) mould of the ligament lamella; 7) pseudolunular field; 8) secondary ridge; 9) growth lines.

complete shells. Therefore most of the conclusions were based on the external shell morphology.

A disperse diagram for *C. banatica* and *C. susedana* n.sp. considering height/length ratio versus the length of the dorsal edge was prepared. Biometry in this case was just an auxiliary method, because the number of specimens (except for *C. banatica*) was too small for the relevant statistical conclusions to be drawn.

3. TAXONOMY

Class BIVALVIA

Subclass **Heterodonta** NEUMAYR 1884

Order **Veneroida** ADAMS & ADAMS 1856

Family **Dreissenidae** GRAY & TURTON 1840

Genus ***Congerina*** PARTSCH 1835

(Group ***Subglobosae*** ANDRUSOV 1897)

***Congerina baschi* n.sp.**

(Pl. I, Fig. 1)

1890. *Congerina* sp. GORJANOVIĆ-KRAMBERGER;
GORJANOVIĆ-KRAMBERGER, p. 163, pl. 6, fig. 21.

1964. *Congerina* sp. GORJANOVIĆ-KRAMBERGER;
ANDRUSOV, p. 425, pl. 1, fig. 20.

1997. *Congerina* sp. GORJANOVIĆ-KRAMBERGER;
VRSALJKO, p. 40, type 8.

Holotype (Fig. 5 - 1*) is stored in the Department of Geology and Palaeontology of the Croatian Museum of Natural History in Zagreb (Inventory No. 290). It was found at Vrapče locality, in the southwestern part of Medvednica Mts., and was presented by GORJANOVIĆ-KRAMBERGER (1890; p. 163, pl. 6, fig. 21).

GORJANOVIĆ-KRAMBERGER (1890) was the first to find two specimens in the "Praeponian" (= Lower Pannonian) marls from the surroundings of Vrapče village in the Medvednica Mts. He determined them as belonging to the genus *Congerina*, offering a short description of the smaller specimen: "Specimen is 8.5 mm long, and 5 mm wide, triangular in outline. Posterior edge is slightly extended, ridge is blunt, and the beak is weakly pointed out and incurved". The same author furthermore claimed that, due to the small number of specimens and their poor preservation, which made the reconstruction of the shell impossible, he could not offer a more detailed description, and determined this form to be only *Congerina* sp.

After collecting twenty new specimens, we can conclude that this small congerian taxon always appears within the *Radix croatica* Zone. Due to its morphological features it deserves to be described in detail, and acquire the status of a new species.

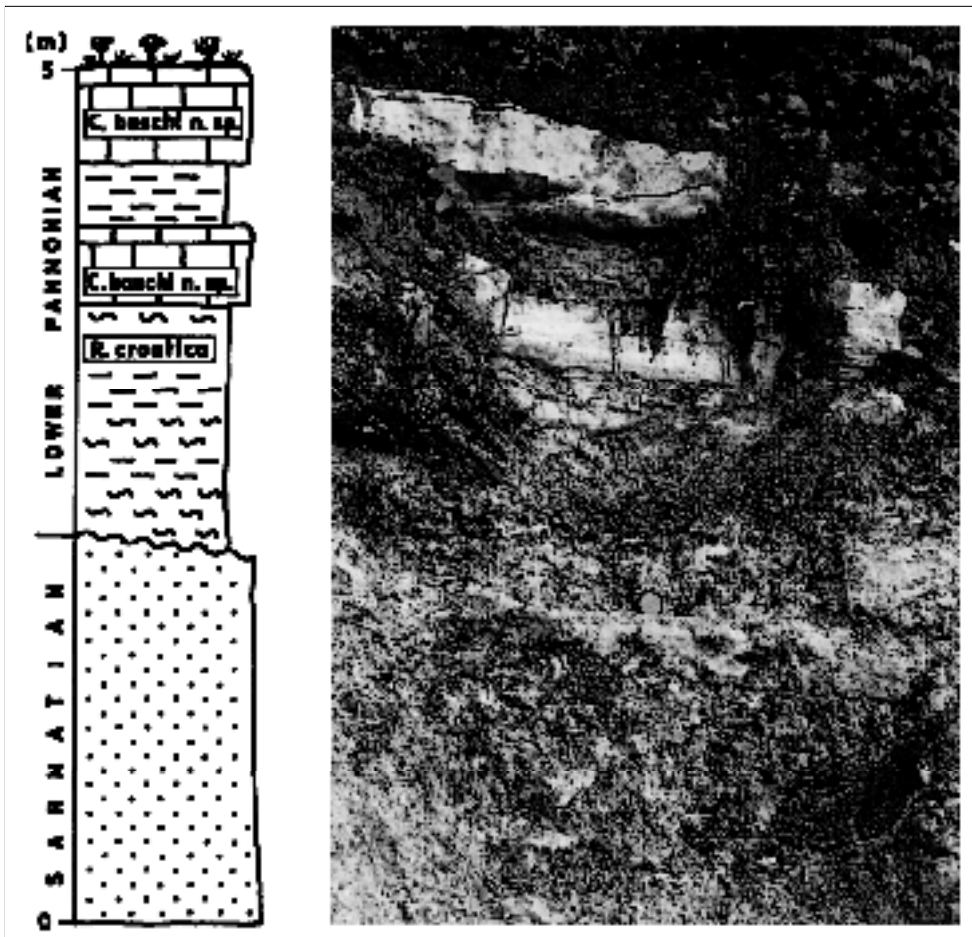

Fig. 3 Vrapče - type locality of *Congerina baschi* n.sp. Lithological column (For legend see Fig. 10): 2) sand; 3) marl; 4) clay; 5) limestone.

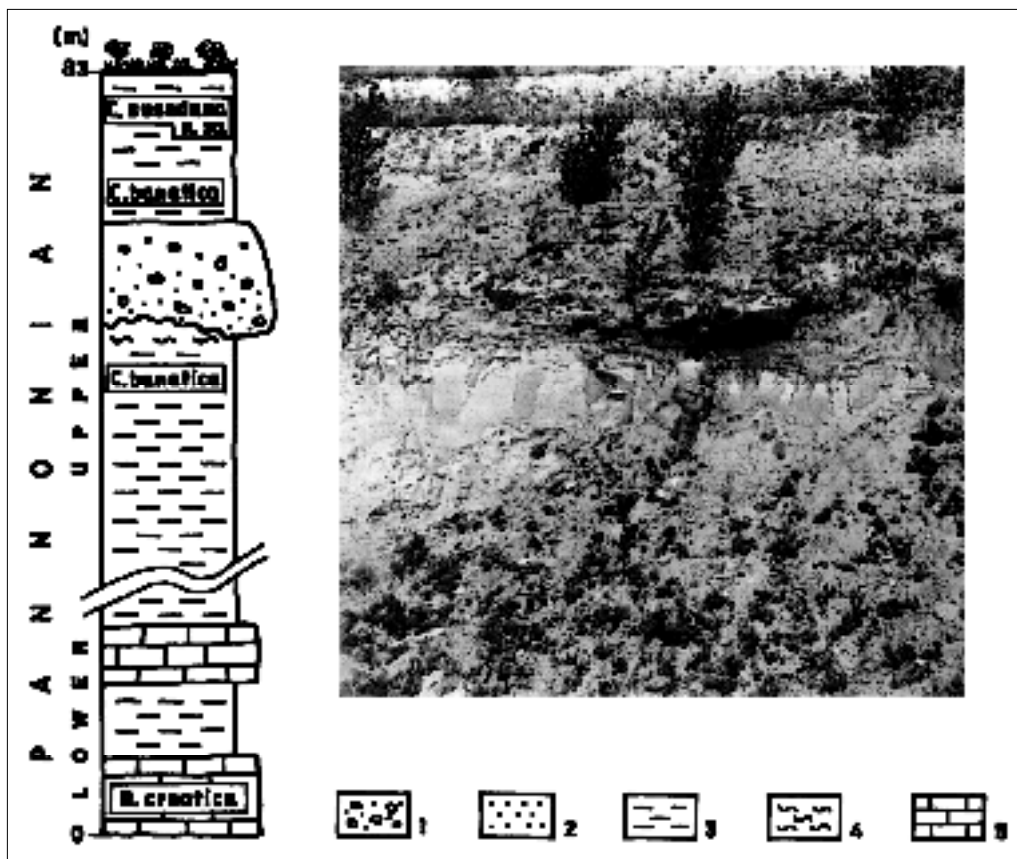

Fig. 4 Podused - type locality of *Congerius susedana* n.sp. Lithological column: 1) gravel; 3) marl; 4) clay; 5) limestone.

Derivatio nominis: The species is dedicated to the well known Croatian palaeontologist Oto Basch, employed in the Institute of Geology in Zagreb, who, with his encyclopedic knowledge, strongly influences the education of young geologists, and makes significant contributions to Croatian geology with his published papers.

Locus typicus: Specimens No. 1 and 2 have been collected near Vrapče village in the western part of the Medvednica Mts., at the same locality which was first studied by Gorjanović-Kramberger (holotype 1*), and consists of thin-bedded limestones (ca. 20 cm), immediately above the Sarmatian/Pannonian boundary (Fig. 3). Most of the other specimens have been also found in

the vicinity of Vrapče village, and several of them were collected in the Banovina district.

Stratum typicum: Lower Pannonian, *Radix croatica* Zone.

Diagnosis: Very small, in most cases triangular, significantly convex shell. Outer shell surface with primary ridge close to the anterior field, and extremely weak secondary ridge close to the posterior field. Posterior field with weakly pronounced wing-shaped extension.

Description: Small-sized, rather convex shell, triangular in outline, with clearly developed growth lines and indistinct wing-shaped extension on the posterior

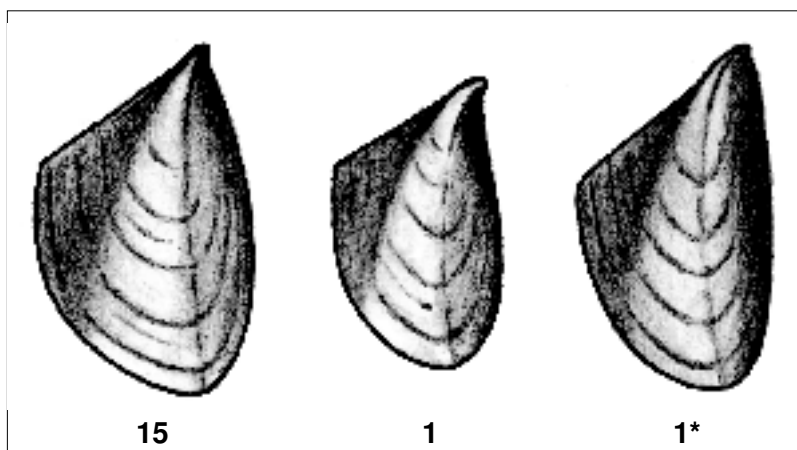

Fig. 5 Specimens of *Congerius baschi* n.sp. from the Vrapče locality: 15) adult form; 1) juvenile specimen; 1*) holotype from GORJANOVIĆ-KRAMBERGER (1890).

field, which becomes well developed in older specimens. No specimen with preserved shell material has been found. Imprint of the ligament lamella, extending along the dorsal edge, almost half of its length, can often be observed. Umbo small, sharp, slightly incurved forward. The median, most convex part of the shell, bears two ridges. Main (primary) ridge is well developed, situated closer to the anterior field, straight to slightly incurved, and rounded in cross section. Secondary ridge is situated at the posterior field, it is more rounded, and is particularly well-developed in younger specimens. Elongation rate (k), defined in Fig. 2, is almost constantly 1.5. The sum of the angles between the dorsal edge and the edge of the anterior field () and the angle between the dorsal edge and the edge of the posterior field () is almost always 180° (see Fig. 2). In adult shells, due to the weak winglike extension, this angle decreases in value by ca. 10 degrees.

Dimensions:

| Spec. | h (mm) | l (mm) | dl (mm) | c (mm) | (°) | (°) | k | Locality |
|-------|-----------|-----------|------------|-----------|-----|-----|-----|----------|
| 1* | 8.5 | 5.0 | 4.0 | 2 | 60 | 120 | 1.7 | Vrapče |
| 1 | 3.0 | 2.0 | 1.5 | 1 | 50 | 130 | 1.5 | Vrapče |
| 2 | 3.0 | 2.0 | 1.5 | 1 | 50 | 130 | 1.5 | Vrapče |
| 3 | 3.0 | 2.0 | - | - | - | - | 1.5 | Bolfani |
| 4 | 7.0 | 4.5 | - | - | - | - | 1.5 | Banovina |
| 5 | 9.0 | 5.5 | 5.0 | 2 | 60 | 120 | 1.6 | Bolfani |
| 6 | 5.0 | 3.0 | - | - | - | - | 1.6 | Banovina |
| 7 | 5.0 | 3.0 | - | - | - | - | 1.6 | Vrapče |
| 8 | 7.0 | 4.5 | - | - | - | - | 1.5 | Vrapče |
| 9 | 8.0 | 5.0 | - | - | - | - | 1.6 | Vrapče |
| 10 | 8.0 | 5.0 | - | - | - | - | 1.6 | Vrapče |
| 11 | 6.5 | 4.0 | - | - | - | - | 1.6 | Vrapče |
| 12 | 9.0 | 5.5 | - | - | - | - | 1.6 | Vrapče |
| 13 | 4.0 | 2.5 | - | - | - | - | 1.6 | Vrapče |
| 14 | 8.0 | 5.0 | - | - | - | - | 1.6 | Vrapče |
| 15 | 7.5 | 4.5 | 4 | 2 | 60 | 120 | 1.5 | Vrapče |
| 16 | 12.0 | 7.5 | - | - | - | - | 1.6 | Banovina |
| 17 | 4.5 | 3.0 | - | - | - | - | 1.5 | Banovina |

Comparison: *Congerina baschi* n.sp. strongly resembles *C. neumayri* ANDRUSOV (ranging from the "Helvetian" to the Pliocene) in its shape, and the position of the main ridge. ANDRUSOV (1964) reports the presence of typical specimens from the marine Miocene at the Laa locality (of Karpatian age), and PAPP (1954) considers *C. neumayri* to be persistent in a wide salinity range. According to its main features, *C. baschi* strongly resembles *C. jadrovi* BRUSINA, from the Lower Pliocene freshwater sediments of Sinjsko polje, although. ANDRUSOV (1964) related *C. neumayri* and *C. jadrovi* with the group *Mytiliformes*, thus making a comparison with *C. baschi* n.sp. barely possible. It is more probable to presume the origin of *C. baschi* from similar older Sarmatian taxa, such as *C. soceni* JEKELIUS and/or *C. moesia* JEKELIUS, scarce brackish representatives of the group *Subglobosae*. PAPP (1954) collected and described these taxa from the Sarmatian

and the Pannonian (Zones A and B) of the Vienna basin.

Congerina banatica HÖRNES

(Pl. 1, Fig. 2)

1875. *Congerina banatica* nov.sp.; HÖRNES, p. 75, pl. 3, figs. 3-5.

1964. *Congerina banatica* HÖRNES; ANDRUSOV, p. 132-133, pl. 11, figs. 18-20.

1990. *Congerina banatica* HÖRNES; VRSALJKO, p. 38, type 1.

Short description:

Adult form - Type A (HÖRNES, 1875; pl. 3, fig. 3)

Small-sized shell, rather convex, elongate-trapezoidal in outline. Shell material usually not preserved. Well exposed, dense growth lines; impression of the ligament lamella following the dorsal edge, almost half of its length. Posterior field with small wing-shaped extension. Ridge well-defined, sharp in the umbonal portion, becoming string-like in adult specimens, slightly rounded, slightly incurved towards the anterior field. Umbo small, weak, incurved forward.

Juvenile form - Type B (HÖRNES, 1875; pl. 3, fig. 2)

Shell smaller and less convex than in the A-type. Numerous, weaker growth lines. Trapezoidal outline, without the winglike extension. Ridge well defined, sharp, string-like, rounded only in the youngest portion of the shell, incurved as the elongate "S" and dislocated towards the anterior portion. Umbo weak, sharper than in A-type, and incurved forwards.

Adult form - Type C (VRSALJKO, 1997; p. 38, type 1)

Similar to type A, but shell more elongate and more convex. Elongate-trapezoidal in outline. Ridge situated almost in the middle of the outer shell.

Common features: Younger specimens possess well-developed and sharp ridge, while the adult shells bear string-like ridges and wing shaped extensions at the posterior field.

Dimensions:

| Spec. | h (mm) | l (mm) | dl (mm) | c (mm) | (°) | (°) | k | Locality |
|--------------------|-----------|-----------|------------|-----------|-----|-----|-----|-----------|
| From HÖRNES (1875) | | | | | | | | |
| Type A | 17 | 16 | 13 | ? | 70 | 110 | 1.0 | Banat |
| Type B | 13 | 9 | 9 | ? | 70 | 120 | 1.4 | Banat |
| This study | | | | | | | | |
| 1 | 16 | 13 | 13 | 2.0 | 70 | 100 | 1.1 | Medv.Breg |
| 2 | 18 | 12 | 10 | 3.0 | 80 | 130 | 1.5 | Moravče |
| 3 | 21 | 18 | 14 | 2.0 | 70 | 110 | 1.1 | Korović |
| 4 | 19 | 14 | 12 | 3.0 | 80 | 120 | 1.2 | Podsused |
| 5 | 20 | 15 | 12 | 3.0 | 80 | 120 | 1.3 | Podsused |
| 6 | 18 | 15 | 12 | 3.0 | 90 | 120 | 1.2 | Podsused |
| 7 | 18 | 13 | 12 | 3.0 | 80 | 110 | 1.3 | Podsused |
| 8 | 14 | 10 | 8 | 1.5 | 80 | 120 | 1.4 | Podsused |

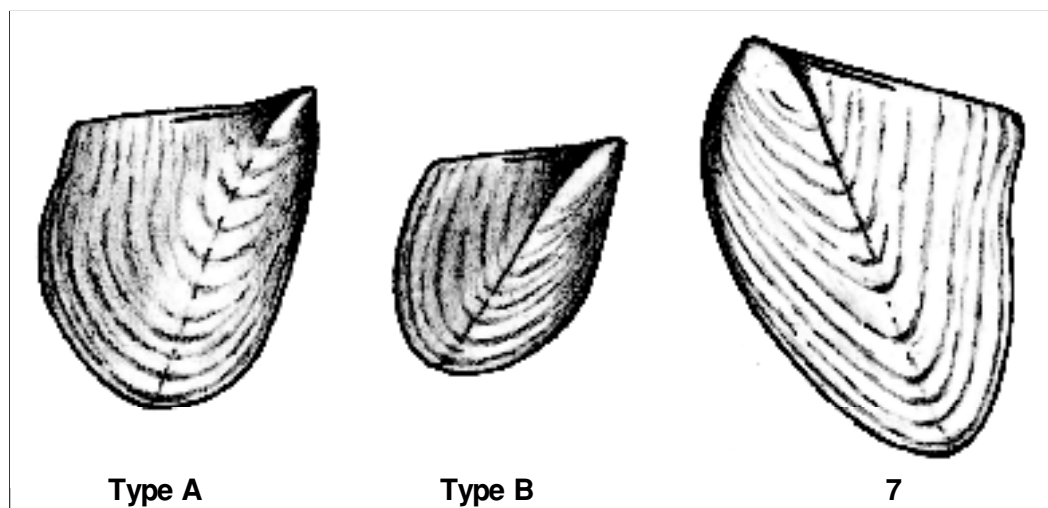

Fig. 6 Specimens of *C. banatica* HÖRNES (HÖRNES, 1875): Type A - adult specimen, from the Banat district and Type B - juvenile form, from the Banat district; 7) adult specimen from Podsused.

| | | | | | | | | |
|----|----|----|----|-----|----|-----|-----|----------|
| 9 | 15 | 10 | 9 | 1.5 | 70 | 120 | 1.5 | Podsused |
| 10 | 12 | 9 | 8 | 2.0 | 70 | 120 | 1.3 | Podsused |
| 11 | 15 | 10 | 9 | 3.0 | 80 | 120 | 1.5 | Goranec |
| 12 | 16 | 11 | 9 | 2.5 | 90 | 120 | 1.4 | Goranec |
| 13 | 17 | 12 | 8 | 2.5 | 70 | 110 | 1.4 | Vugrovec |
| 14 | 15 | 11 | 8 | 2.0 | 80 | 110 | 1.3 | Vugrovec |
| 15 | 22 | 18 | 12 | 3.0 | 70 | 130 | 1.2 | Banovina |
| 16 | 21 | 18 | 12 | 2.5 | 70 | 130 | 1.1 | Banovina |
| 17 | 18 | 15 | 12 | 3.0 | 90 | 130 | 1.2 | Banovina |
| 18 | 20 | 16 | 13 | 3.0 | 80 | 110 | 1.2 | Banovina |
| 19 | 21 | 17 | 13 | 2.5 | 70 | 110 | 1.2 | Banovina |
| 20 | 22 | 19 | 14 | 3.0 | 70 | 100 | 1.1 | Banovina |

***Congerina susedana* n.sp.**

(Pl. 1, Fig. 4)

1997. *Congerina* aff. *banatica* HÖRNES; VRSALJKO, p. 38, type 2.

Derivatio nominis: Species has been named after the famous historic fortress Susedgrad, near which the abandoned quarry of cement marls with most of the described specimens is located.

Holotypus: Specimen No. 1.

Locus typicus: Podsused, western part of Zagreb, widely exposed profile of marly sediments near the former cement factory (Fig. 4).

Stratum typicum: Upper Pannonian; uppermost part of deepwater lacustrine marls, in the *Congerina banatica* Zone.

Diagnosis: Very small, rather convex shell, trapezoidal in outline, with wide dorsal field and distinct wing shaped extension.

Description: Small-sized shell, prominently convex, trapezoidal in outline, with distinct, closely-spaced growth lines and well-developed wing shaped extension

at posterior field. In most cases a thin calcite shell layer is preserved. Cast of the ligament lamella along the dorsal edge is well developed and extends over half its length. Umbo small, sharp and weakly incurved forward. Almost in the middle of the outer shell, a distinct ridge can be observed, rather sharp near the umbo, and weakly rounded and arcuate forward at the front. Adult specimens are slightly more elongate.

Dimensions:

| Spec. | h (mm) | l (mm) | dl (mm) | c (mm) | ° | ° | k | Locality |
|-------|-----------|-----------|------------|-----------|----|-----|-----|-----------|
| 1 | 11 | 12 | 10 | 2 | 80 | 120 | 0.9 | Podsused |
| 2 | 9 | 10 | 7 | 2 | 80 | 120 | 0.9 | Podsused |
| 3 | 10 | 11 | 8 | 3 | 80 | 120 | 0.9 | Podsused |
| 4 | 11 | 10 | 7 | 3 | 80 | 120 | 1.1 | Podsused |
| 5 | 12 | 11 | 8 | 2 | 80 | 120 | 1.1 | Medv.Breg |
| 6 | 12 | 11 | 8 | 2 | 80 | 120 | 1.1 | Medv.Breg |

Comparison: *Congerina susedana* n.sp. strongly resembles *C. banatica* HÖRNES in shape and ridge position, but the difference appears in the decreased size of the shell, arcuate ridge and longer mould of the ligament lamella. According to its appearance in similar facies and somewhat younger horizons, a narrow link of the new species with *C. banatica* is proposed (see Fig. 10). Some similarities in size and outline with *C. vugroveci* SREMAC can be observed, but the latter is characterised by the appearance of the pseudolunular field.

Many previous authors considered *C. susedana* to be a variety of *C. banatica*, but, according to the pronounced biometric difference this form deserves to be established as a new palaeontological species.

***Congerina vugroveci* SREMAC**

1981. *Congerina vugroveci* n.sp.; SREMAC, p. 109, pl. 1, figs. 1-4.

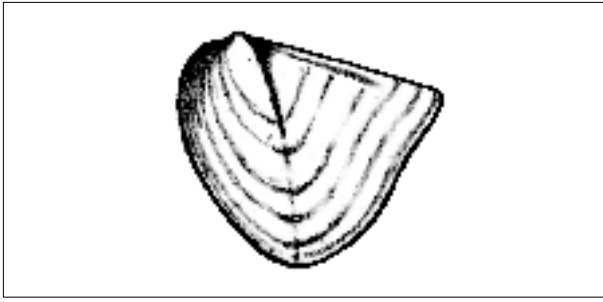

Fig. 7 Specimen of the *Congerina susedana* n.sp.; reconstruction of the holotype.

Short description: Shell small-sized, rather inflated, trapezoidal in outline, with distinct, closely spaced growth lines. Mould of the ligament lamella can often be observed along the entire dorsal edge. Imprint of the posterior lamella extends almost half the length of the dorsal edge, and the anterior mould is weakly developed and very short. At the anterior side a weak ridge can be observed, thus producing a small pseudolunular field. Ridge is distinct, sharp and very slightly incurved in shape of the elongate “S” form, dividing the outer shell surface into two almost equal portions. Umbo is weak, rather wide, blunt, and very slightly incurved toward the anterior portion of the shell.

Dimensions:

| Spec. | h (mm) | l (mm) | dl (mm) | c (mm) | (°) | (°) | k | Locality |
|-----------------|-----------|-----------|------------|-----------|-----|-----|-----|--------------|
| 1 | 6.5 | 6 | 5 | 1.0 | 60 | 100 | 120 | 1.0 Med.Breg |
| 2 | 8.0 | 6 | - | - | - | - | - | 1.2 Med.Breg |
| 3 | 7.0 | 5 | - | - | - | - | - | 1.2 Med.Breg |
| 4 | 14 | 13 | 12 | 2.0 | 70 | 110 | 110 | 1.0 Goranec |
| Holotype | | | | | | | | |
| 1* | 8 | 9 | 8 | 1.5 | 75 | 105 | 130 | 0.9 Vugrovec |

According to the development of the anterior margin and the appearance of the pseudolunular field, this form can be closely related to the genus *Dreissenomya* (FUCHS, 1870 - from BASCH & ŽAGAR-SAKAČ, 1992). Considering the similarity and its appearance in older sediments (Upper Pannonian), *C. vugroveci* could be the possible ancestral form for some younger Pannonian species, such as *Dreissenomya digitifera* ANDRUŠOV.

4. DISCUSSION AND CONCLUSIONS

In this paper two new species of congerians from the Pannonian marls from northern Croatia, *Congerina baschi* n.sp. and *C. susedana* n.sp. are described and figured (Figs. 5 and 7; Pl. I, Figs. 1, 3, 4 and 5). For *Congerina vugroveci* SREMAC (Fig. 9) a partial revision and completion of the description has been made.

Reconsidering the variability of *C. banatica* HÖRNES, as noticed by most of the previous authors, a reconstruction of the types of HÖRNES (1875; Pl. 3, Figs. 2 and 3) is offered and compared with our specimens (Fig. 6; Pl. I, Figs. 2 and 6). We have found that *C. banatica* is a variable form, but *C. susedana* n.sp. described here can hardly be considered just a variety of *C. banatica* due to the completely different morphometrical features of the shell. According to the rather short stratigraphic range of *C. banatica*, as well as its constant palaeoenvironmental characteristics, it is hard to envisage considerable variability. Studying the 20 specimens of *C. banatica* collected during our research a common feature can be observed. The ridge of the younger specimens is sharper and distinct, while in adult shells it becomes rounded, and the posterior field extends into a wing-shaped form. The elongation rate in adult shells is decreasing.

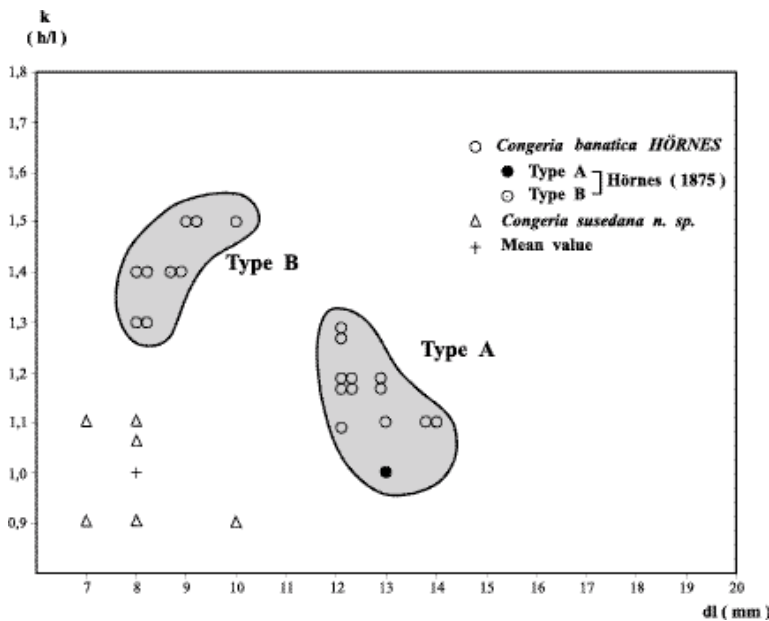

Fig. 8 Scatter plot showing the relationship between the elongation rate (k) and the length of the dorsal edge (dl).

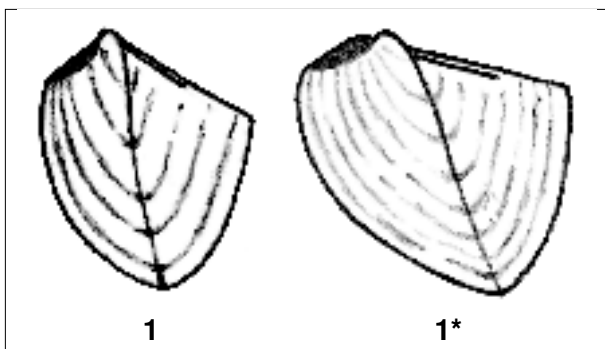

Fig. 9 Specimens of *Congeria vugroveci* SREMAC: 1) juvenile form from Medvedski Breg; 1*) adult specimen, reconstruction of the holotype.

Special attention has been paid to the *C. banatica* HÖRNES, and its relationship with *C. vugroveci* SREMAC and *C. susedana* n.sp. These two species are the possible descendents of *C. banatica*. For the Early Pannonian *C. baschi* n.sp. there are indications that it origi-

nates from some similar Sarmatian brackish forms, introduced by PAPP (1954). This small species from the lowermost Pannonian beds is almost the unique representative of *Congeria* (in lacustrine sediments) and, knowing that most congerian species appear first in the Late Pannonian substage, it could be considered one of the possible ancestral forms for the later explosion and divergence of the species (Fig. 10).

The main ecological factor influencing the variability of brackish and freshwater faunas, including congerians, is geographical isolation and decrease of salinity. The diversification of congerian taxa into the groups (sensu ANDRUSOV, 1964) obviously needs critical revision based on morphological features and new palaeoenvironmental data (I. MAGYAR, personal communication). Such revision would provide better foundation for the reconstruction of phylogenetic relationships within the family *Dreissenidae*.

Studying the associated assemblage of fossil molluscs and ostracods from the same horizons, newly established congerian forms can be placed in the previ-

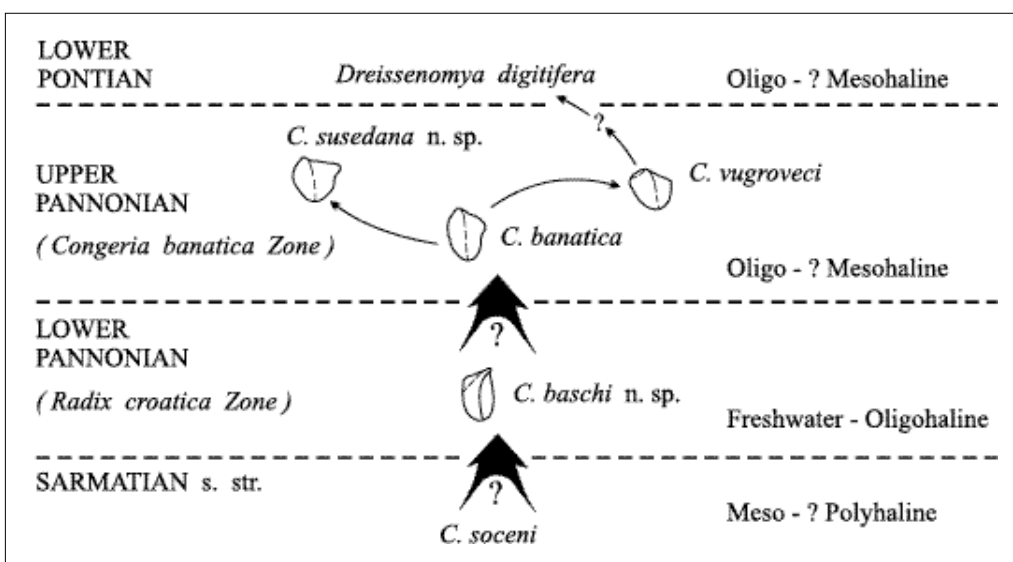
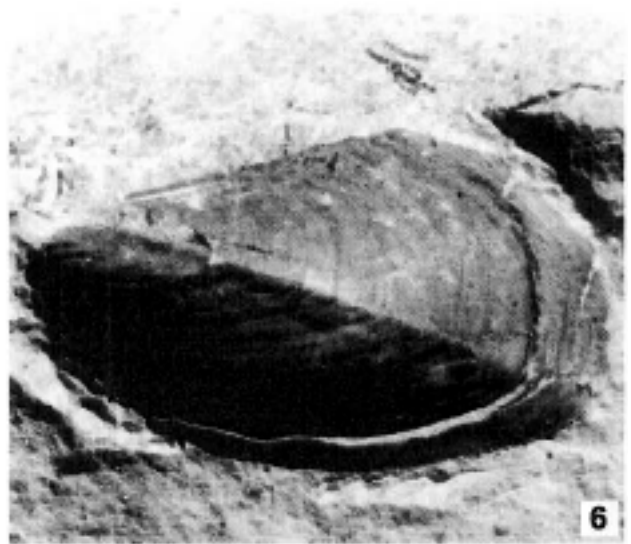
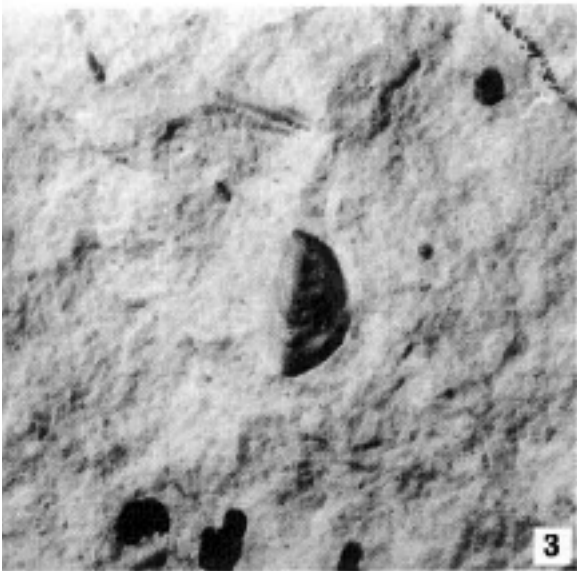
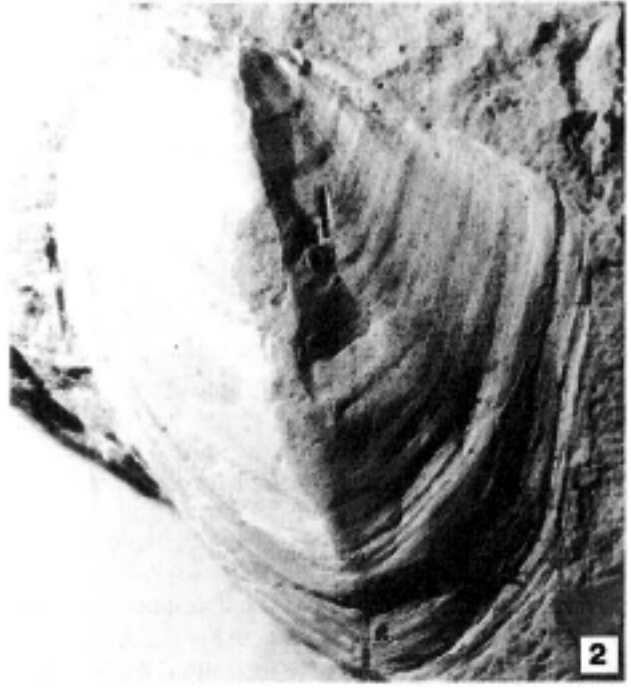

Fig. 10 Stratigraphic range and the suggested relationship among the congerian species.

PLATE I

- 1 and 3 *Congeria baschi* n.sp., Early Pannonian, from the Vrapče locality; 1) x10, 3) x2.
 2 and 6 *Congeria banatica* HÖRNES, Late Pannonian, from the Podsused locality; 2) x6, 6) x4.
 4 and 5 *Congeria susedana* n.sp., Late Pannonian, from the Podsused locality; 4) x6, 5) x4.



ously defined biostratigraphic zones for the Pannonian stage. So *Congeria baschi* n.sp. belongs to the B (?AB) Zone according to PAPP (1953), or (?) - phase (according to SOKAČ, 1972), and *C. susedana* n.sp. the D Zone or ? - phase.

Acknowledgements

Most of the fossil molluscs were collected during the year 1993, within the project "Facies and physical features of the Neogene carbonate sediments", when, at the suggestion of the project manager M. PIKIJA the idea for this research was born. We thank K. ŠIKIĆ for the fossil material from the wider area of Banovina. Determination of ostracods has been performed by Mrs. Valentina HAJEK-TADESSE. We express our gratitude to Mrs. Zlata JURIŠIĆ-POLŠAK from the Croatian Museum of Natural History who allowed us to reconsider the type congerian specimens from the Gorjanović collection.

5. REFERENCES

- ANDRUSOV, N. (1964): Fossil and living *Dreisseni - dae* from Europe and Asia.- Izbrannije trudi, 3, Collected works (reprint edition), 1-404, Moskva.
- BASCH, O. & ŽAGAR-SAKAČ, A. (1992): Pontian *Dreissenidae* (*Mollusca, Lamellibranchiata*) from Croatia.- Acta geologica, 22/1, 31-60, Zagreb.
- GORJANOVIĆ-KRAMBERGER, D. (1890): Die Fauna der praepontischen Bildungen von Vrabče.- Glasnik hrv. narav. društva, 5, 154-163, Zagreb.
- HÖRNES, R. (1875): Tertiär-Studien (VI).- Jahrbuch Geol. Reichsanst., 25/1, 63-87, Wien.
- KOCHANSKY-DEVIDÉ, V. (1976): Über die wiederholung gleichartiger Formen in der Entwicklungsgesichte der Organismen, mit besonderer Berücksichtigung der Congerien (*Bivalvia*).- Geol. vjesnik, 29, 75-89.
- PAPP, A. (1953): Die Molluskenfauna des Pannon im Wiener Becken.- Mitt. Geol. Ges., 44, 85-222, Wien.
- PAPP, A. (1954): Die Molluskenfauna im Sarmat des Wiener Beckens.- Mitt. Geol. Ges., 45, 63-68, Wien.
- SOKAČ, A. (1972): Pannonian and Pontian ostracod fauna of Mt. Medvednica.- Palaeont. Jugosl., 11, 1-140, Zagreb.
- SREMAC, J. (1981): Some new and less known species of molluscs of the *Croatica*-beds and *Banatica*-beds in Northern Croatia.- Geol. vjesnik, 33, 107-121.
- VRSALJKO, D. (1997): Pannonian stratigraphy in the southwestern part of the Medvednica Mt.- Unpublished M.Sc. Thesis, University of Zagreb, 80 p.

Manuscript received September 20, 1999.

Revised manuscript accepted November 12, 1999.