

Review paper
UDC 551.465

A new approach to sea level observations in Croatia

*Ivica Vilibić¹, Mirko Orlić², Srđan Čupić³, Nenad Domijan³, Nenad Leder³,
Hrvoje Mihanović³, Miroslava Pasarić², Zoran Pasarić², Mladen Srdelić³
and Goran Strinić³*

¹ Institute of Oceanography and Fisheries, Split, Croatia

² Department of Geophysics, Faculty of Science, University of Zagreb, Zagreb, Croatia

³ Hydrographic Institute of the Republic of Croatia, Split, Croatia

Received 21 March 2005, in final form 8 June 2005

The paper comprises an overview of recent international and national efforts and activities directed towards the improvement of tide gauge network on the eastern coast of the Adriatic Sea. A brief overview of the available measuring techniques is given first. Then the characteristics of Adriatic sea level are outlined, followed by a note on the history of sea level measurements and research in the Adriatic. The present sea level related activities are introduced by the institutional structure in Croatia, followed by a summary of recent projects and programmes (European Sea Level Service – Research Infrastructure (ESEAS-RI), Mediterranean Global Observing Sea Level System (MedGLOSS), Project Adriatic and Adriatic Tides and Sea Level On-line). Concrete activities on the upgrade of Croatian tide gauges, data acquisition and maintenance, and on-line data presentation are presented in detail. In addition, the initiation of measurements of vertical land movements is documented, as a Continuous GPS antenna and receiver (CGPS) has been installed in 2004 at the roof of the Split Harbour tide gauge. A lot of effort has been put into the rescue of historical sea level records, both by digitising and scanning of the charts, which will prevent data loss in case of their ruination or disappearance. Finally, the impact of the recent activities on the scientific exploration of high-frequency resonant coupling of air pressure disturbances with the eastern Adriatic waters is highlighted in the paper, as such research is not possible to carry out properly with the measuring systems based on the analog records.

Keywords: Adriatic Sea, tide gauge, sea level, projects, upgrade, data maintenance and archaeology, scientific outcome.

1. Why observe sea level?

The phenomenon of the tides has fascinated people since ancient times, particularly those whose activities are related to the sea. The studies of the

Sun's and Moon's actions on the water movements have been enhanced during the last centuries, particularly in recent times when entire human race is faced with the problem of global climate change. Long-term sea level oscillations (periods exceeding 1 min) are basically caused by tidal and atmospheric forces, primarily by air pressure and wind, as well as by water and heat exchange at the surface on the monthly time scale and tectonic movements on the climatic time scales.

Sea level is an important oceanographic parameter which describes primarily sea and near sea surface dynamics, but also feels the processes occurring in the deep ocean areas. For example, the changes in the bottom hydrographic properties may affect sea level, which combined with steric expansion of the upper ocean regions strongly contribute to the recent global sea level rise (as recognized by the Intergovernmental Panel for Climate Change, IPCC, 2001). Namely, it is expected that the sea level will rise about 50 cm in this century, affecting a considerable part of the Earth population which lives close to the seashore and on the lowlands prone to sea flooding. Moreover, sea level is a parameter widely used in coastal oceanography (Prandle, 2000), especially to calibrate numerical models and to document the vulnerability of the coastal areas to the sea level trends and variations. The changes in sea level can occur from one minute period (resonant waves and tsunamis, e.g. Rabinovich, 1993; Bryant, 2001) via tides and storm surges to seasonal changes and interannual variations (Pugh, 1987, 2004). Therefore, the measurements should be performed continuously over decades, in order to fully understand the character of the temporal and spatial variability. In the Adriatic, sea level measurements have been continuously carried out for almost a century, creating the data series long enough to extract their major characteristics.

The sea level data are necessary for a wide range of activities related to the sea. Major application fields are as follows:

- Safety of navigation (passenger and cargo ships traffic, especially when manoeuvring in harbours, nautical tourism, fisheries and mariculture, small craft navigation);

- Hydrographic survey and other sea and undersea researches (bathymetric survey and charting, especially when laying various submarine installations – fibre optic and power cables, pipelines and sewage outfalls; offshore platforms; dredging activities; coastal engineering projects);

- Impact on the coastal infrastructure (the analyses of extreme sea levels, flooding estimates, vulnerability analyses coupled with other oceanographic parameters, particularly surface waves);

- Tsunami monitoring and warning system;

- Calibration of satellite altimeters;

- Scientific and expert analyses of the sea level changes with particular emphasis on the current problem of global sea level rise;

- Geodesy (definition of vertical datums);
- Legislative application, especially when defining the maritime law terminology *e.g.* the coastline, maritime demesne and territorial sea (*e.g.* coastline in Croatia is defined as Mean High Water – MHW on nautical charts).

The above listed applications are relevant for the worldwide coastal and open-ocean areas, being a concern of the seashore countries particularly in their low-land areas. Yet, most developing countries have no resources to carry out sea level observations and research at appropriate level, having as a consequence severe damages and human losses induced by large sea level changes (*e.g.* Indian Ocean Tsunami in 2004, flooding in Bangladesh in 1970). Even richer countries (except maybe some of them such as USA and Japan) are not capable to carry out a development in sea level research solely. Therefore, a need for collaboration on the international and global scale has been recognized as a major factor in improving of sea level monitoring and research, including transfer of knowledge and collaborative actions and research in a number of international programmes and projects. Global Sea Level Observing System (GLOSS, <http://www.pol.ac.uk/psmsl/programmes/gloss.info.html>) is one of them, together with its regional densification, and a part of Croatian tide gauge network is contributing to the GLOSS regional implementation in the Mediterranean (MedGLOSS). European Sea Level Service (ESEAS) is another regional sea level network initiated in 2001 (see details in Section 5.2.1), in which Croatian institutions and observing sites actively participate and follow the trends which are present in worldwide sea level monitoring and research activities.

2. An overview of present sea level measuring techniques

Sea level measuring techniques have changed remarkably in the last decades, due to the development of computer-based technologies which enabled the digital recording, storage of large amount of data and remote data acquisition and measurements. Two major approaches are in use nowadays:

- in-situ sea level measurements by a tide gauge, measuring sea level at a single point in time, and
- satellite sea level measurements by an altimeter, which measures spatial and temporal characteristic of sea level changes, but with coarse resolution in time compared to the tide gauge systems.

Tide gauges are in-situ instruments which measure sea level changes by using direct or indirect approach. Direct methods include the data retrieval by measurements of sea level displacement, by floating system in stilling wells (Fig. 1) or by acoustic/radar pulses from a fixed point. Indirect methods are based on the measurements of hydrostatic pressure at sea bottom and computing sea level height by hydrostatic equation (*e.g.* Gill, 1982; Stewart, 2002) knowing the density profile and atmospheric pressure at the measur-

ing point. A comprehensive review of older and modern sea level measuring techniques and requirements are given in Intergovernmental Oceanographic Commission (IOC) Manuals and Guides (UNESCO, 1985, 1994, 2002).

Float-type tide gauges in stilling wells with ink recording devices have been solely operating along the Croatian coast till 2000 (Fig. 2), when pressure-based gauge was installed at Split in the framework of MedGLOSS project (Vilibić et al., 2001). All of these tide gauges, which are still operational at Rovinj, Bakar, Zadar, Split Harbour, Split Marjan, Ploče and Dubrovnik, are situated in rocky and concrete housing, well-protecting the instrumentation from the influences of the oceanic and meteorological forcings (Fig. 3). The advantage of float-type gauges is their long-term operational service,

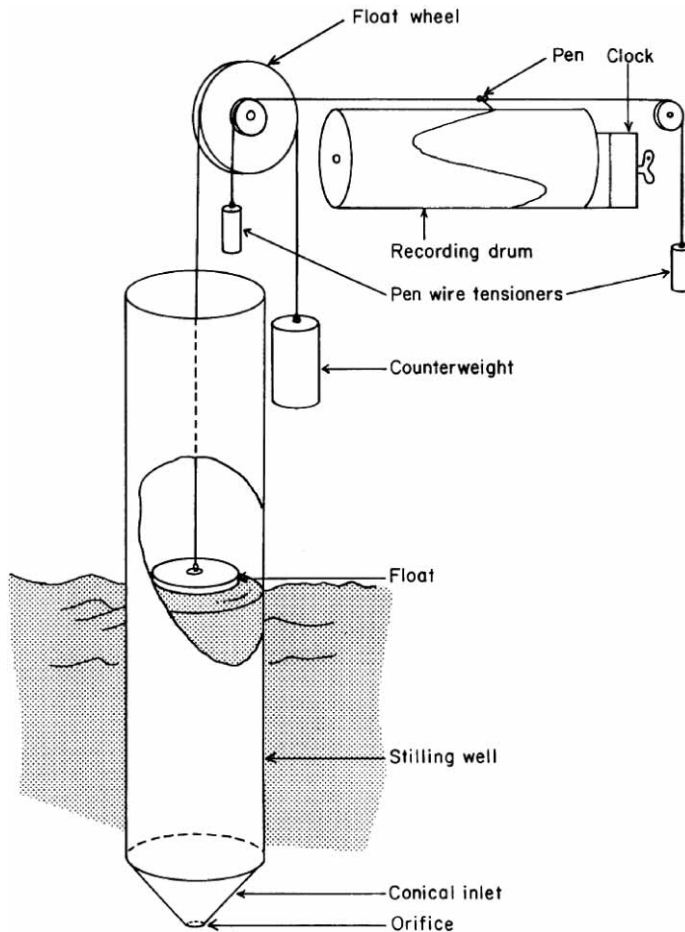

Figure 1. A scheme of float type tide gauge in stilling well with cone-like orifice and ink recording device (after UNESCO, 1985).

which allows the studies of regional and global sea level changes. However, the problem with chart-recording gauges is relatively high maintenance costs, including a person which has to change the charts on a weekly or daily basis. Then, when the charts are retained at the archive, they need to be digitised in order to obtain sea level values, which further increase the costs. Next, the errors may be rather substantial when digitising the charts, being a result of clock errors, inaccurate positioning in time during the digitising process and subjective smoothing of high-frequency seiches in a record. Finally, the data is available with a large phase lag, a month or more, resulting in no operational possibilities of such tide gauge. However, analog-to-digital (a/d) converters may be installed at such gauges, upgrading them to the operational



Figure 2. Adriatic Sea map with tide gauges operational at the present time (filled circles) and in the last 50 years (blank circles) along the Croatian coast.

level and having the continuity in the long-term observation at the same time, annulling most of the problems mentioned before. This approach has been used in the Adriatic, and it will be further commented in the following sections.

Pressure-gauge systems can measure directly sea pressure by a probe at a certain depth, or by measuring equivalent pressure by a so-called »bubbler system« (UNESCO, 1994). Permanent pressure systems are usually measuring the pressure at few metres depth below the lowest tide and, in the case of no large variability in density, the density may be set to a constant value, having no significant impact on the measurements. The problem may arise in the river deltas prone to large variability in salinity. For example, the change of 10 kg/m^3 in density results in change of 1 mm in sea level for every meter of the water column. This may be a rather large problem when measuring bottom pressure far from shore at a large depth, and vertical profiling of thermohaline parameters may be done in such case in order to make sea level data more precise.

Acoustic and radar systems determine sea level by measuring the travel time of pulses reflected vertically from the sea surface. Both sounding tubes



Figure 3. Photos of the tide gauges at Dubrovnik (upper left), Split (bottom left), Zadar (upper right) and Rovinj (bottom right).

and open-air acoustic measuring systems are in operation – the first one having the major problem of temperature gradients and sound velocity profiles within the tube, and the latter having problems in collecting the reflected signal which may be lost due to a large dissipation. The reflection of the signal from the surface in open-air conditions is solved by switching the frequency to the microwave band, this being exactly the principle of radar tide gauges. The advantage of radar systems is relatively low installation and maintenance cost as compared to other systems, however the problem may be the stability of the instrumentation and housing in long-term operation.

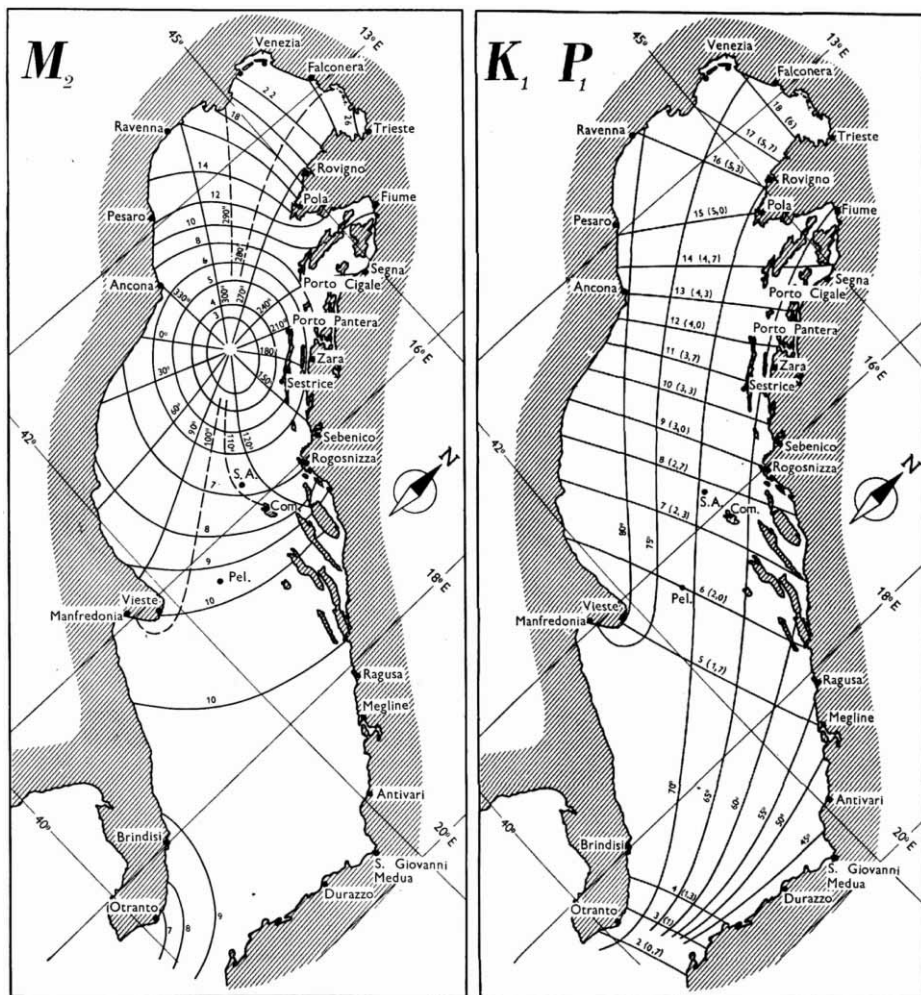

Figure 4. The spreading of major semi-diurnal M_2 and diurnal K_1 tides in the Adriatic Sea (after Polli, 1960).

3. Sea level phenomena in the Adriatic Sea

3.1. Tides

Spreading of tides in the Adriatic is usually described by the largest M_2 and K_1 constituents (Fig. 4, Polli, 1960; Cushman-Roisin and Naimie, 2002), while other semidiurnal and diurnal constituents behave similarly to M_2 and K_1 , respectively. Their amplitudes are higher than in the rest of the Mediterranean (Tsimplis et al., 1995), especially in the northern Adriatic, primarily due to near-resonant coupling of the equilibrium tide with the Adriatic topography through the co-oscillation with the Ionian and Eastern Mediterranean tides. A common characteristic of the semidiurnal tides is rotation around the so-called amphidromic point that is positioned between Ancona and Šibenik, having small amplitudes there. The amplitudes increase rapidly from that point to the northwest, with the maximum values inside the Gulf of Trieste (M_2 tide amplitude equals 26 cm). Semidiurnal amplitudes also increase from the amphidromic point to the southeast, reaching the maximum between Pelješac peninsula and Italian coast, but their values are less than half of the maximum ones occurring in the North Adriatic.

Diurnal tides propagate from the Croatian to the Italian coast, whereas the amplitudes increase from the South to the North Adriatic. K_1 amplitude varies from 5 cm at Dubrovnik to 18 cm in the Gulf of Trieste.

Mean daily tidal range along the eastern Adriatic coast, based on the long-term sea level measurements, is estimated to be 22 cm at Dubrovnik, 23 cm at Split, 25 cm at Zadar, 30 cm at Bakar and 47 cm at Rovinj (Hydrographic Institute, 1955–2002).

3.2. Storm surges

Forced oscillations of sea level – storm surges – are aperiodic changes in sea level that are mainly caused by the forcing of long-lasting and strong winds or pronounced air pressure disturbances. Sea level theoretically adjusts to air pressure as an inverted barometer (IB) – an increase of air pressure by 1 hPa results in a decrease of sea level by 1 cm, and vice versa. Yet, IB factor is significantly larger than theoretical one in the Adriatic Sea, especially for the planetary-scale and seasonal oscillations (>10 days), due to synchronised acting of the wind and other contributors to the sea surface variability (e.g. Pasarić et al., 2000). The action of wind on the sea surface is complex, depending on the topography of the basin and on the wind speed, direction and duration. In the Adriatic Sea the southeast winds (Sirocco) raise the sea level, especially in the North Adriatic (e.g. Orlić et al., 1994; Pasarić et al., 2000; Orlić, 2001), where a long-lasting Sirocco and low air pressure can raise the water level up to 1 m. Wind influence is less important in the South Adriatic, where the air pressure influence is dominant giving rise to sea level changes of up to 30 cm (Leder, 1988).

Storm surges are relatively well examined in the Adriatic Sea (*e.g.* Robinson et al., 1972; Leder, 1988; Raicich, 2003), and are generated by synoptic systems and planetary waves (Pasarić and Orlić, 2001) in the atmosphere. As the surges are usually coupled with high surface wave activity, due to long fetch for the surge-favourable Sirocco wind, the damages appearing on the coastal infrastructure can be huge, as happened in November 1999 in the region of Split (Fig. 5, Vilibić et al., 2000).



Figure 5. Photo of the Riva promenade at Split, flooded during the storm of 19 November 1999.

3.3. *Seiches*

Free oscillations – seiches – occur as a sea response to sharp changes of meteorological parameters over the basin, especially the wind and air pressure (Wilson, 1972). Along-basin winds can surge up the water at the closed end of a basin, creating a sea level difference between the open and closed ends of the basin. If the wind suddenly changes in speed and/or direction, the equilibrium tends to be restored by periodical oscillations of sea level. The seiches of smaller basins and harbours may be excited by the waves incoming from the open sea and resonantly exciting free oscillations in the basin (Rabinovich, 1993). Seiche periods are determined by the dimensions and topography of the basin, whereas the amplitudes depend on the changes of the wind speed and direction.

The most pronounced seiche in the Adriatic Sea is the uninodal seiche having a period of 21.2 h (Kasumović, 1963; Cerovečki et al., 1997; Raicich et

al., 1999 – see an example in Fig. 6; Vilibić, 2000; Leder and Orlić, 2004), but the second mode with a period of 10.8 h is significant as well. The main Adriatic seiche represents a uninodal oscillation with nodal line placed in the Otranto Strait, while the second mode has nodal lines in the Otranto Strait and on the section Pelješac – Monte Gargano. In addition, the seiches of the Middle and North Adriatic treated as a single basin can appear notably as well, having periods of 8.2 and 6 h. Seiches also occur in smaller semi-enclosed regions, such as Middle Adriatic – 4 h, Rijeka Bay – 2 h (Goldberg and Kempny, 1938) and Kaštela Bay – 1 h (Zore, 1955), but also in small bays and harbours: Ploče Harbour – 30 min, Vela Luka Bay – 15 min (Hodžić, 1979/1980), Stari Grad Bay – 11 min (Vilibić et al., 2004), Split Harbour – 7 min (Vilibić and Mihanović, 2002), Zadar harbour – 4 min (Vilibić and Orlić, 1999), etc.

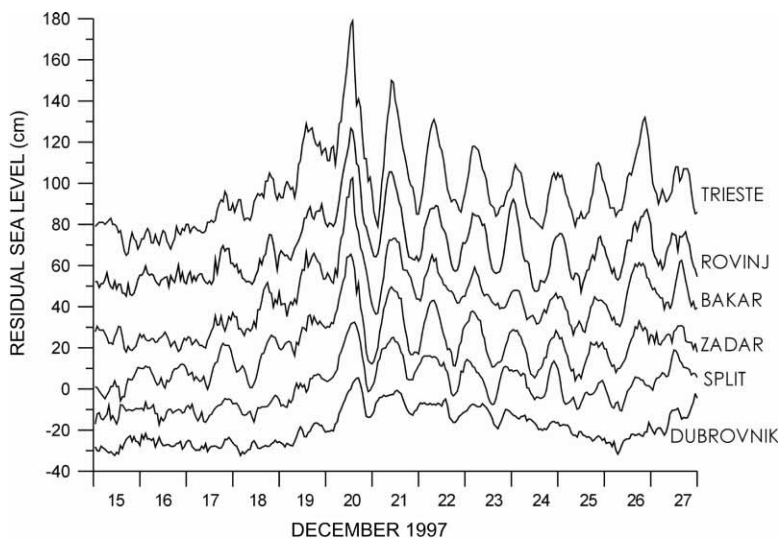

Figure 6. Residual sea level time series (observed sea level minus tides) collected at stations distributed along the east Adriatic coast, during the storm surge and seiche episode in December 1997 (after Raichich et al., 1999).

3.4. Seasonal and interannual changes

Seasonal oscillations of the Adriatic sea level are dominantly driven by the annual course of the heat and water budget at the sea surface, having as a consequence expanding and contracting of the upper layers and changes in sea level height (so called steric effect). Large seasonal variations in heat budget over the Adriatic (Supić and Orlić, 1999) are dominantly manifested in generation, development and destruction of thermocline and thermal expansion (Buljan and Zore-Armanda, 1976). The highest sea levels occur dur-

ing the pycnocline destruction in autumn (October–December), whereas the lowest ones are found in the spring and summer seasons (Orlić and Pasarić, 1994; Vilibić et al., 1997, see Fig. 7). However, seasonal variations can also result from air pressure and wind changes.

Interannual sea level changes are driven by climatic fluctuations of the meteorological parameters, *e.g.* of the air pressure, surface heat flux, precipitations etc. Such changes are estimated at several centimetres in the Adriatic Sea (I. Vilibić, pers. comm.), which makes it impossible to calculate precisely the sea level trends. However, the sea level trends reveal a deceleration of the sea level rise in the Adriatic till 1990s (Orlić and Pasarić, 1994; Orlić, 2001, see Fig. 8; Woodworth, 2003), presumably being a result of a negative trend in precipitation and the fresh water inflow into the sea (Gajić-Čapka and Zaninović, 1998), and of changes in the bottom circulation and water masses in the Mediterranean Sea (Tsimplis and Baker, 2000; Tsimplis and Rixen, 2002). Conversely, recent satellite and hydrographic measurements indicate rapid rising of sea level in the whole Mediterranean due to the increase in sea surface temperature (Cazenave et al., 2002).

In addition, vertical crustal movements cannot be neglected when calculating the trends, as they can enlarge the sea level trends at some places and cause a high rate of the sea level fall at others (*e.g.* Scandinavia). In the Adriatic, crustal movement rates are of order of 1 mm/year (Joó et al., 1981), but vary spatially, complicating the estimation of absolute sea levels.

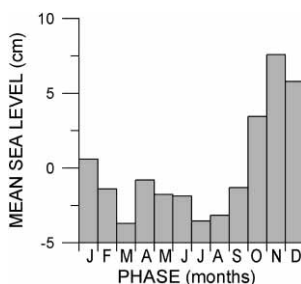

Figure 7. Annual course of mean sea level at Split in the 1956–2001.

4. History of Adriatic sea level observations

Systematic measurements of sea level in the Adriatic Sea started in 1854 at Trieste. Tidal observations were carried out under administration of Accademia Nautica and later of Osservatorio Marittimo (Godin and Trotti, 1975). It is an interesting fact that until 2004, the official Geodetic Datum, which is used for referencing the land heights, was defined as the mean sea level at Trieste measured in 1875. Next, the investigations of sea level were conducted at Rijeka in 1860 by J. R. Lorenz, while the station at Pula was es-

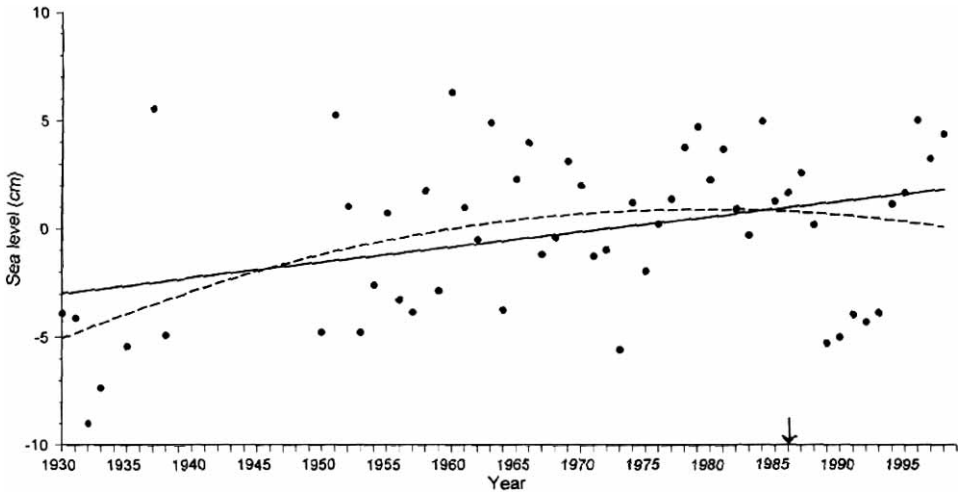

Figure 8. Linear (solid line) and nonlinear (dashed line) fit to the annual mean sea levels (dots) recorded at Bakar between 1930 and 1938 and from the year 1950 onward (after Orlić, 2001).

established in 1868. A number of stations along the eastern Adriatic coast were put in operation thereafter, and the data collected served for the calculations of tidal elements at some sites and regions. A big step forwards was done by Sterneck (1914, 1919) and Kesslitz (1910, 1913) at the beginning of 20th century when, on the basis of records from 33 tide gauge stations, harmonic constants have been computed for a number of stations, and free modes of a number of small bays and basins have been determined.

Between two world wars, tide gauges at Split Harbour and Bakar were established in 1929 by Hydrographic Institute and Geophysical Institute at Zagreb, respectively. The tide gauge at Split Harbour had no fortune in the

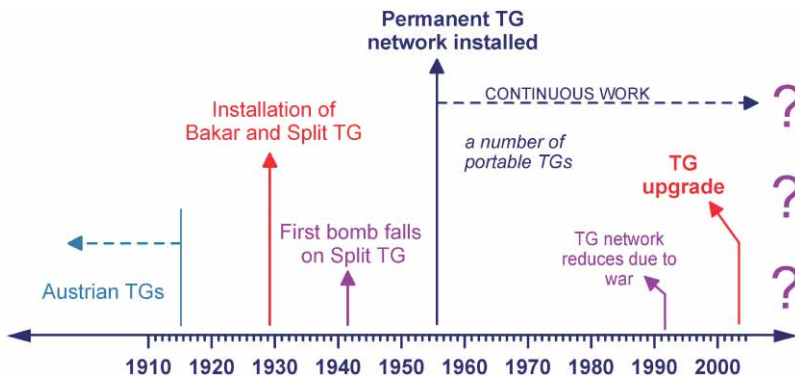

Figure 9. Schematic history of sea level observations in the Adriatic Sea.

2nd world war: »the first bomb« which was dropped on Split hit the tide gauge house and destroyed it (Tešić, 1955). After the war, a network of permanent tide gauge stations was established in 1950s, comprising 5 stations: Dubrovnik, Split Harbour and Split Marjan, Bakar and Rovinj. These stations have continuous records up to the present, but a number of portable gauges were set up for at least a few months to a decade (Fig. 2). Three tide gauges were destroyed during the last war in 1991, but herein should be emphasized the fact that, during the siege of Dubrovnik which lasted for more than one year, the tide gauge station worked continuously, with only two weeks without the records during the strongest bombardment of the city. A scheme of history of sea level measurements in the Adriatic Sea is given in Fig. 9.

5. The present activities on sea level in Croatia

5.1. *The structure of sea level network*

Three institutions are presently involved in collecting and maintenance of sea level and related data in Croatia: Hydrographic Institute of the Republic of Croatia (HIRC) at Split (<http://www.hhi.hr>), Andrija Mohorovičić Geophysical Institute (AMGI) at Zagreb (<http://www.gfz.hr>) and Institute of Oceanography and Fisheries (IOF) at Split (<http://www.izor.hr>). The scheme of tide gauges and sea level data management is shown in Fig. 10.

Presently HIRC owns and maintains tide gauges at Rovinj, Zadar, Split Harbour, Split MedGLOSS (lighthouse), Sućuraj, Ploče and Dubrovnik. As HIRC is governmental institution responsible at the national level for the development of navigational safety service in the Adriatic Sea, in conformity with the recommendations of International Hydrographic Organisation and other maritime management organisations, one of the important segments is the collection and maintenance of sea level data and their use in bathymetric surveying, sounding reduction and marine cartography. Three persons (an engineer, a technician and an informatician) are directly engaged in the maintenance of sea level network, promptly responding (up to a few days) to all needs and failures in the network. Also they are involved in data control and archiving, keeping the data at a high quality level. In addition, a few other employees are engaged in the recent enlarged activities such as data archaeology/digitisation and tide gauge upgrade, and additional person is responsible for the upload and maintenance of CGPS data collected at the Split station.

Both AMGI and IOF conduct sea level measurements primarily for scientific examination of sea level behaviour in the Adriatic Sea. This research spans from a minute sea level oscillations such as seiches and resonance, through Adriatic tides and surges, up to planetary waves and seasonal/inter-annual changes and trends in Adriatic sea level (see Section 3 and reference list). Therefore, both institutions initiated sea level measurements rather

early (AMGI in 1929, IOF in 1954), and used them for the early sea level studies in the Adriatic (e.g. Goldberg and Kempni, 1938; Zore, 1955; Kasumović, 1963). Nowadays the maintenance of these stations is carried out by the scientific and technical staff, which is largely engaged in other oceanographic studies and related instrumentation (current meters, multiprobes, oceanographic buoys and automatic stations), keeping the stations and sea level data at the appropriate quality level.

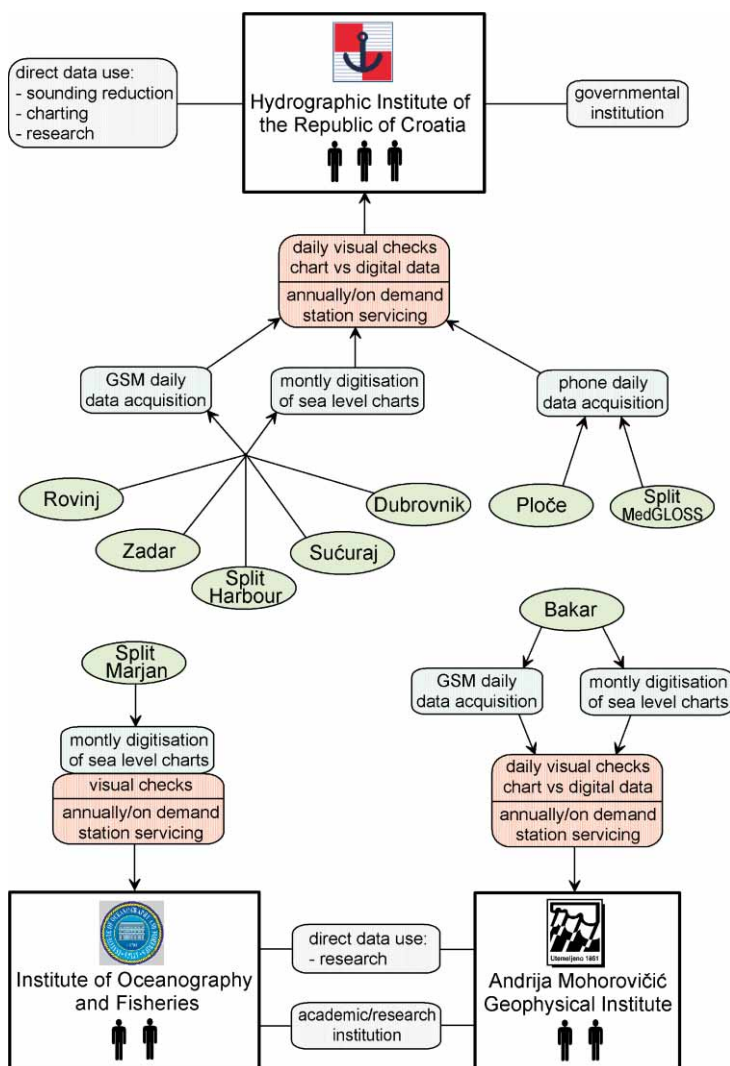

Figure 10. A scheme of present sea level network in Croatia. The number of permanent persons dealing with sea level observations and research is given for each institution.

All of tide gauge stations are regularly serviced on the annual basis. This includes the calibration of tide gauge constant, levelling to the Tide Gauge Benchmark and cleaning of the instrumentation and housing. In addition, prompt response and repair of the tide gauge system is achieved in a few days after a breakdown caused by the minor problems (float sinking, wire blowouts, etc.). That may be prolonged only after the major destructions of the measuring equipment, such as ruination of the measuring units or housing breakdowns. The problems in GSM or phone communication have been solved less promptly, as the stations are capable to store at least 3 weeks of one minute data, and field activities are conducted only after extensive attempts to solve the problem from the data acquisition centre.

5.2. Sea level projects

5.2.1. European Sea Level Service – Research Infrastructure (ESEAS-RI)

In 1990s the European Cooperation in the field of Scientific and Technical Research – COST Action 40 »European Sea Level Observing System« (Plag et al., 2000) has successfully initiated the establishment of the European Sea Level Service (ESEAS), which started its pilot period in mid 2001. ESEAS brings together a major fraction of sea level observing and research institutions in Europe into a coordinated research organization, with access to more than 50 individual sea-level databases in European countries. The next step was to improve sea level monitoring and research in Europe, and ESEAS formulated a project which is trying to improve the coordination and technology transfer in all aspects of sea level and related studies. Therefore, ESEAS – Research Infrastructure project (ESEAS-RI) has been launched in late 2002, financed within 5th EU Framework Programme, and comprising 21 partners all over the Europe. Project consortium includes national authorities responsible for tide gauge operation and/or the geodetic control of tide gauges as well as research institutes involved in research and operational activities related to sea level.

Primary technological objective of the ESEAS-RI project is to support the research infrastructure and to facilitate the transnational coordination, to upgrade the network of observing sites and to develop and standardize operational routines and quality control procedures, as a prerequisite for a full scientific exploitation of the present and future sea level observations. Primary scientific objective of the project is to study sea level variations at inter-annual to century time scales and to quantify potential future changes in mean sea level. Both technological and scientific objectives are planned to be fulfilled through five work packages, namely WP1: Quality control of sea level observations, WP2: Absolute sea level variations, WP3: Decadal to inter-decadal sea level variations, WP4: Improving the sea level observing system, and WP5: Project management.

Two Croatian scientific institutes participate in ESEAS-RI project. Hydrographic Institute of the Republic of Croatia, which owns tide gauges at

Dubrovnik, Split Harbour, Zadar and Rovinj, has allocated most of the efforts to technological part of the project, in particular to Task 1.4 – Data archaeology, Task 4.2 – Upgrading of tide gauges and T4.3 – Collocation of tide gauges with CGPS. Andrija Mohorovičić Geophysical Institute at Faculty of Sciences, Zagreb, put considerable work in digitization and quality control of historical records of Bakar tide gauge, in WP3 – Decadal to inter-decadal sea level variations, but also in upgrading the Bakar tide gauge through T4.2 by installing new OTT-Kalesto radar device. More about the project could be found at <http://www.eseas.org/eseas-ri>.

5.2.2. Mediterranean Sea Level Observing System (MedGLOSS)

In the same year when COST40 Action has been initiated at the European level, a demand on sustainable sea level cooperation and research in the Mediterranean and Black Seas came into focus, trying to get together various organisations which conduct sea level measurements both in the European, Asian and African side. As a result, the IOC and the Commission Internationale pour l'Exploration Scientifique de la mer Mediterranee (CIESM), have agreed in 1996 to jointly cooperate in this important subject by establishing a long-term monitoring network system for systematic sea-level measurements. The system is named MedGLOSS (Mediterranean regional subsystem of the Global Sea Level Observing System), and it is based on basic GLOSS requirements and methodology downscaled to the regional issues and demands.

MedGLOSS activities include the common issues of sea level measurements and research carried out on the global level (GLOSS), and partially overlapping with ESEAS objectives. The result is a strong interconnection of the two programmes, and participation of MedGLOSS community in the ESEAS-RI project. However, MedGLOSS has been concentrated more on the reinforcement of third countries' sea level measuring capacities, in particular by upgrading selected analog tide gauge sites to the digital ones with real or near-real time data acquisition and processing. MedGLOSS is still in the pilot phase, with a network of 27 stations in 13 countries which have expressed their interest in joining this international research network. Split and Rovinj tide gauges are included in MedGLOSS, the first site being chosen for installation of a pressure-based tide gauge equipment donated through IOC/CIESM programme. More about MedGLOSS can be found at <http://medgloss.ocean.org.il>.

5.2.3. National monitoring project »Adriatic«

The project »Adriatic« encompasses currently existing national monitoring and data collection activities, as well as international activities in which Croatian institutions participate. The scope of the Project is determined primarily by the specific requirements for solution of various constraints hampering the sustainable development of the Croatian Adriatic region, but also

with issues of regional and global significance whenever they come forth as a part of Croatia's international obligations.

Between a number of activities carried out within the project, Task 3.4 »Exceptional sea levels and flooding of the Adriatic coastal areas« was aimed at detection, analysing and forecasting exceptional sea levels induced by tides, storm surges, seiches and resonant oscillations, as well as by extreme surface waves in the coastal areas. Operational forecasting of such events, which is the final aim of this task, was not possible to reach with old analog tide gauge devices and the first mission was to upgrade existing sea level network to the operational level, by allowing data acquisition in real or near-real time. The upgrade has been performed in 2003 at all Croatian tide gauges (Dubrovnik, Sućuraj, Split Harbour, Zadar, Bakar, Rovinj), jointly with ESEAS-RI project, and sea level network is presently on the near-real time operational level (see more in the following sections). More about Project Adriatic can be found at <http://www.izor.hr/jadran>.

5.2.4. Project »Adriatic Tides and Sea Level On-line«

Due to the lack of www pages in Croatia which contain the description of sea level behaviour, in general and more specifically in the Adriatic Sea, project »Adriatic Tides and Sea Level On-line« has been launched in November 2001, led by Hydrographic Institute of the Republic of Croatia and sponsored by Ministry of Science and Technology of the Republic of Croatia. Main project goals were to supply any potential user with the information about tidal predictions for any location along the Croatian coast of the Adriatic Sea, to provide the real-time information about the measured sea levels at one tide gauge station and to inform the users about the characteristics of sea level in the Adriatic Sea. More information about the status of the project can be found at http://www.hhi.hr/mijene/mijene_en/index.htm.

5.3. Tide gauge upgrade

5.3.1. The upgrade of old tide gauge devices

5.3.1.1. Instrument choice and installation

As already mentioned, regular network of Croatian tide gauges, operational since 1950s, consisted of float-type chart-recording devices in concrete housing and stilling well. Therefore, a particular attention has been paid to choosing the upgrade technique which will produce no differences in recorded sea level data. The upgrade with a/d converters has been selected, choosing OTT-Thalimedes shaft encoders, which allows *in-situ* comparison between the conventional chart recorder and the new digital one. Thalimedes is designed for continuous, unattended monitoring of water level in ground and surface water, being a solution for the combination with conventional mechanical chart recorder, a cost effective upgrade from a mechanical system to digital technology. Yet, some problems in Thalimedes recording system have

been reported by UK and Spanish sea level community (P. Woodworth, personal communication), but they are documented for the Atlantic Ocean and high-tidal area. This is the reason why we have paid additional attention on the data quality, keeping the old recording system till the removal of all recording problems, some of them being described in Section 5.3.1.3.

The chosen configuration consists of Thalimedes shaft encoder, housing with wall or pole fixing, power supply of 50 Ah battery or $\sim 220V$ and GSM modem Siemens M20, with direct data transfer of 2400 or 9600 bits/s (Fig. 11). Only Zadar tide gauge has been equipped with $\sim 220V$ electricity, whereas other stations (Rovinj, Bakar, Zadar, Split Harbour, Sućuraj, Dubrovnik) have no electricity cables in or near the tide gauges. Therefore, battery supply has been chosen, as the energy consumption of Thalimedes recording device is negligible. Still, the problem is GSM modem energy consumption, which is significant during data transfers. The problem is solved by the manufacturer: GSM modem is operational only during a short interval (*e.g.* 20 min) in a day when data transfer is in progress, being shut down by the Thalimedes during the rest of a day. Of course, that solution is possible for near-real time data downloads, once or twice a day, as daily files are downloaded in less than 1 minute. This solution works even for files with 1-minute sampling intervals, which are chosen at all of upgraded tide gauges.



Figure 11. OTT Thalimedes instrument with additional equipment before and after the installation.

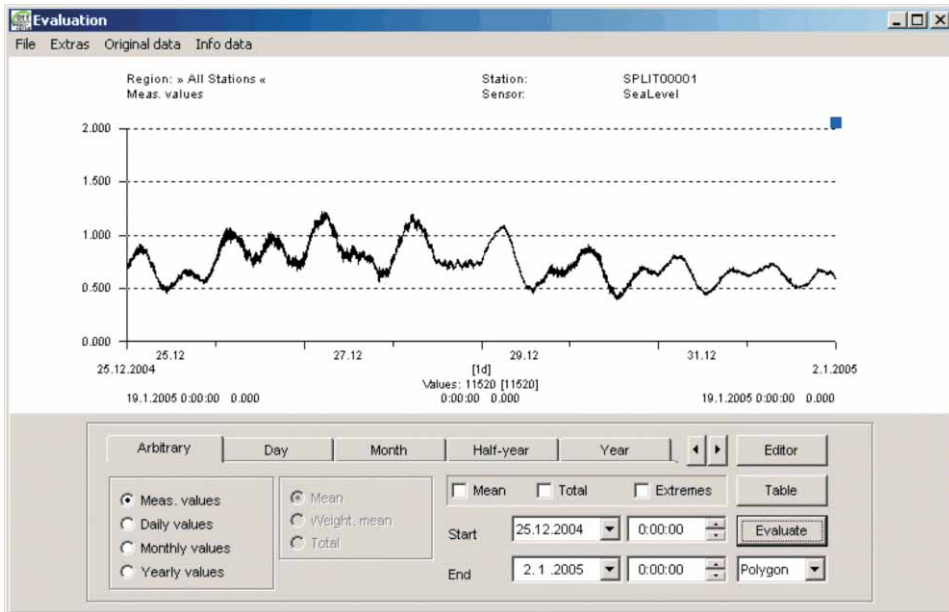

Figure 12. Screenshot of the HYDRAS software package with data visualisation window.

With current configuration, autonomy of this equipment is about 8 months. In order to increase autonomy as much as possible, assemblies were installed to keep the power supply of the largest consumer interrupted, except during the time of data collection, which is pre-set for each tide gauge station. Central computer – Data Acquisition Server – is fitted with two modems through which tide gauge stations are called once at a time, to download the data. Automatic processing of data is done using several applications, some of which were developed by the Hydrographic Institute of the Republic of Croatia.

The upgrade of all tide gauges was carried out in spring/summer 2003. Although the weather was severely hot (up to 37 °C), the equipment was successfully installed and tested *in-situ* with the notebook applications. Two approaches have been followed: (1) Thalimedes has been installed independently from the old chart recorder at Bakar, but in the same stilling well, and (2) Thalimedes encoder has been put on the same wire as the analog device, so the same changes in sea level have been recorded simultaneously at the old and the Thalimedes device. Sampling interval has been set up at 1 minute at all stations, enabling the investigations of high-frequency phenomena (see the chapter about scientific outcomes).

5.3.1.2. Data acquisition and maintenance

Data acquisition and transfer to the central computers at Split and Zagreb have been performed daily by using HYDRAS III software, with the

possibility of alarming through SMS messages sent to a mobile phone if no GSM connection is established or data acquisition is incomplete or in case of other station problems.

Hydras III software, besides collecting data from OTT Thalimedes tide gauges, serves for adjustment of station parameters, display of data in numerical and graphic form, data calculations, statistical and numerical analyses, and export of data (Fig. 12). Therefore, visual checks for various data errors, like spikes, drifts, gaps etc., may be performed via this software. Another package has been developed in Hydrographic Institute, that is TIDE4WEB, with the following modules: (1) module for data transfer into appropriate folders on hard disc (storing), creating daily, weekly and monthly files, (2) graphic module used for a graphic display of the measured data on web pages or for saving them into archive, and (3) control module sending information about availability of data and proper operation of the device by e-mail or SMS to mobile phones of the responsible persons (administrator, tide gauge supervisor...), so that they could take a timely action in case of error. In an effort to build an intelligent system, the development of other modules is under way. The system is conceived so as to solve some problems in everyday work or suggest to its users solutions based upon knowledge learned from experience so far. It should be mentioned that TIDE4WEB application is completely automatic.

5.3.1.3. The problems that occurred in the first year of operation

A number of problems have been recorded in the first year of operation, although substantial improvements have been achieved through the upgrade of tide gauges (removal of clock errors, chart positioning and digitising errors, availability of high-frequency data, easier and cheaper maintenance). The major problems were shifts and drifts in sea level records, which have been observed at Split Harbour and Bakar. A constant drift in Thalimedes sea level series, compared with the series obtained from the old recording system, was detected at Bakar, with the drift rate of more than 20 cm per year (Fig. 13). It must be pointed out that the drift probably does not originate from the original instrument, but more likely from modifications made (by adding a pulley) in order to install the instrument in the limited space of the Bakar tide-gauge station. A similar problem has been noticed at Split Harbour, where a few sharp drops in Thalimedes data occurred in the first 4 months of recording, decreasing the recorded values by more than 20 cm. The problem may lie in the diameter and quality of the original wire which was installed at both tide gauges. In fact, the wire at Split Harbour was changed 6 months after the installation of Thalimedes, by putting elastic stitched steel-wire with larger diameter instead of the original one, and the shifts or drifts in the Thalimedes data have not been recorded after that. In addition, the stitched steel-wire with larger diameter has been installed at Dubrovnik during the upgrade in June 2003, and no data drifts or shifts may be noticed during the first year of operation (Fig. 13).

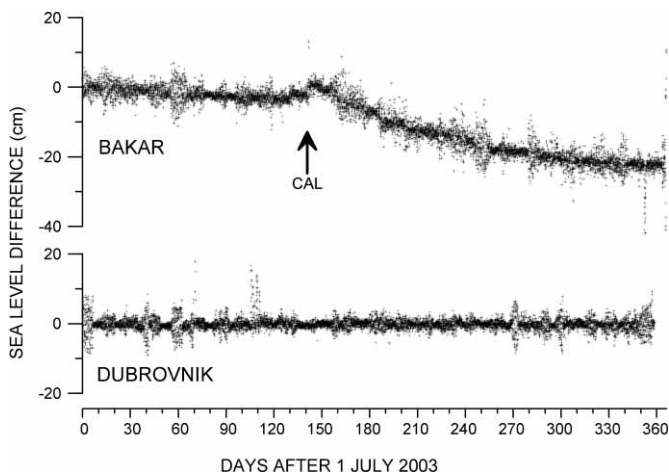

Figure 13. The difference between hourly sea levels recorded by Thalimedes and digitised from the charts, as computed for Bakar and Dubrovnik tide gauges between July 2003 and July 2004. CAL marks the correction in Thalimedes recording, done during the calibration of the tide gauge.

Another problem has been reported at Rovinj, where the old instrument has not been set properly after the tide gauge upgrade in June 2003. The result was tooth-like data recording, which was corrected about 5 months after the installation. Such artificial high-frequency oscillations may be filtered out if one wants to obtain hourly sea level data, but no shifts and drifts in Thalimedes data occurred between the calibrations of the instrument. A communication problem was also reported at Rovinj, as the antenna received no GSM signal at some times, which may be a problem if the interval is longer than 20 days (that is the capacity of Thalimedes memory for 1-min sampling interval). Therefore, a new elevated antenna has been installed at the roof of the tide gauge house, which satisfactorily solved the communication problem.

5.3.2. The installation of radar gauge

The oldest, still operating Croatian tide gauge, Bakar, was equipped until recently with a float operated chart recorder only. The stilling well, situated in an old building, originally harbourmaster's office, now a customhouse, was constructed in 1929. The station was established and is continuously maintained by Geophysical Institute, which is located 200 km away. These facts had to be taken into account when it was decided to upgrade the station with a new instrument that would be independent of the old tide gauge. The pressure-gauge systems were unsuitable since Bakar Bay is ample of freshwater springs. A radar instrument offered a good solution due to ease of installation and maintenance. Among different models, Kalesto by the OTT company seemed appropriate, due to satisfactory results in intercomparison measure-

ments with other technologies (Woodworth and Smith, 2003; Shirman, 2003), good experience with old instruments of the same manufacturer and relatively low cost.

Kalesto is a compact instrument (Fig. 14) which transmits a radar pulse within a $\pm 5^\circ$ deg cone, with a claimed accuracy ± 1 cm over a measuring range of 1.5 to 30 m. The minimum distance required from the instrument to sea surface is 1.5 m. However, if this cannot always be fulfilled, the instrument can be installed horizontally within a metal arm supplied by the manufacturer that acts as a reflecting mirror. The minimum sampling interval is 1 min; the measured value is obtained by averaging 40 reflections of a radar pulse within a 17 second window. The instrument is managed, along with

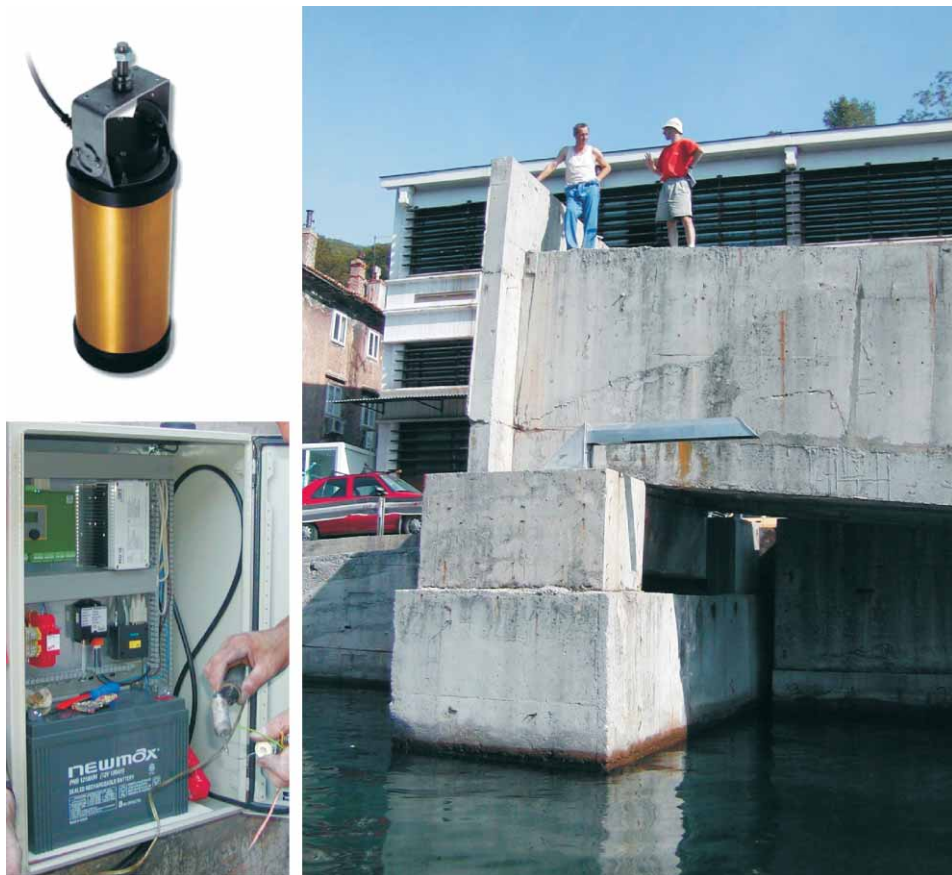

Figure 14. The radar-operated tide gauge station at Bakar; the radar sensor Kalesto by Ott Messtechnik (*top left*), metal housing enclosing data logger, power supply unit, a barograph and GSM modem (*bottom left*), the reflecting-mirror arm with Kalesto, installed at the Bakar Port (*right*).

other optional sensors, by LogoSens operating unit, which serves for adjustment of measuring parameters, data collection and storage. The data can be read out directly into a computer or transmitted by (GSM) modem. The data handling is performed, as for Thalimedes, by Hydras III software. It should be mentioned that the adjustment of parameters for Kalesto cannot be done (through Hydras III, as for Thalimedes) from a remote computer, but only locally (through LogoSens). Power is supplied by a 12 V battery.

The site for the radar tide gauge was chosen within court of the Bakar Port, which is only a few hundred meters away from the existing station. The instrument is installed on a big concrete block, once a part of a transportation tunnel. The reflecting mirror arm is mounted onto a self-constructed steel fixing, with Kalesto placed horizontally inside, to secure the minimal distance to sea surface. The station is also equipped with a barograph, which is, together with the LogoSens operating unit, power control unit and GSM modem, placed within a metal housing. Power battery is charged through solar panels, so the station can work autonomously for a longer period. The sampling interval for sea level was set to 1 minute, to capture the high harmonics of the Bakar Bay seiches having a period on the order of a minute (Goldberg and Kempni, 1938), and avoid aliasing in hourly time series. The air pressure is sampled at a 10-minute interval. The data are transmitted automatically once a day to Geophysical Institute, where, upon low-pass filtering and subsampling, hourly series of sea level and air pressure are obtained. In the next period, careful analysis and intercomparison between the radar-measured sea levels and those recorded by the float-operated instrument has to be carried out before the data from the new instrument become available for all types of applications.

5.4. Vertical land movement measurements

In the framework of the ESEAS-RI Project (Work Package 4) continuously operating GPS station (CGPS) was installed on the concrete roof of Split Harbour tide gauge building (Fig. 15). This instrument will enable determination of the absolute sea level changes, along with the tide gauge measurements and satellite altimetry. Satellite altimeters measure absolute sea level which is defined as the position of the sea surface with respect to a global datum, such as the ITRF ellipsoid (Bevis et al., 2002). CGPS data provide information about vertical velocity at a certain point of the coastline, while tide gauge at the same or nearby point measures relative sea level. By using this collocated information, relative sea level can be transformed into absolute sea level.

The goal of this project is to determine vertical velocity of a tide gauge with accuracy better than 1 mm/year. This is a very demanding task, and at least a decade of CGPS observations is needed. Still, these calculations and transformations have to be examined very carefully. The first important

thing that has to be taken into account is the location of the CGPS. The site selection has to follow certain requirements, including clear view of the sky in all directions for elevation angles above 15 degrees, security of the equipment, accessibility of the electrical power and telecommunication networks, etc. Another important matter that has to be studied when selecting proper site is the local ground stability. If the ground is stable, the antenna can be placed near the tide gauge and vertical offset between the antenna and the gauge can be considered as constant. Vertical motion of the CGPS station represents the motion of the region close to the tide gauge. Precise levelling is easy to perform and has not to be very frequent. In many cases it is not possible to collocate tide gauge with CGPS because underlying bedrock is not stable, so the station has to be moved further away and frequent levelling between CGPS and tide gauge has to be done.

Historical precise levelling of Split Harbour tide gauge auxiliary benchmark (R-1) and tide gauge benchmark located on the wall of the Harbour Master building (PN-165) showed that there were no significant changes in height (Mihanović et al., 2004). Hence, an antenna monument was constructed on the roof of the TG building, since there are no obstacles around



Figure 15. The photo of CGPS antenna mounted on top of the roof of the Split tide gauge.

the gauge with elevation angle above 15 degrees and the ground is stable. It is also important to emphasize that GSM modem can be used for downloading the data and communicating with the receiver, and for that purpose, electrical power has been installed very recently in the building (April 2005).

Given the circumstances, an optimal choice for Split Harbour tide gauge was Ashtech Micro-Z CGRS receiver with Dorne-Margolin antenna, enabling geodetic precision. The coordinates are recorded into daily files with 30 seconds sampling rate. CGRS station was installed on 4 May 2004, and daily files (station name SPLT) are available starting from 5 May 2004 (day 126). Batteries are being replaced on a weekly basis, and RINEX files obtained from the instruments are compressed using Hatanaka compression software and uploaded to ESEAS-RI Data Archive. Preliminary analysis of the data, carried in the Norwegian Mapping Authority, showed that:

- the number of measurements and the number of outliers is normal,
- the mean residual for the code measurements is very good,
- the mean residual for the phase measurements is acceptable.

Installation of the CGRS station in Split is a new important step in sea level related measurements in Croatia. It will take some time until the data will enable estimates of absolute sea level changes, but so far it can be concluded that the site selection was optimal with respect to location, levelling procedures and data transmission possibilities.

5.5. Data archaeology

As Croatian tide gauge network has been analog till 2000s, the digitising of the curves has been needed to obtain digital sea level values at a station. Such work has been continuously carried out in the last two decades, particularly in Hydrographic Institute, resulting in hourly sea level values together with low/high waters and extremes, digitised on a monthly scale. However, database of sea level values did not comprise the data recorded before 1986, yielding to more than 150 station-years of chart-records being not digitised and stored only in the analog format. Therefore, one of the important tasks in ESEAS-RI project, which initiated the rescue of historical sea level data in Europe, encompasses (i) the digitising, quality-control and archiving of the historical charts in order to prevent the lost of the data, (ii) and scanning of sea level charts, to prevent ruination and loss of the originals.

Before 2002 the digitising of the charts has been performed using VAX-oriented software package, with old FORTRAN software which did not allow to control and change the digitised values during the digitising process. Therefore, the data has been prone to digitising errors, especially when digitising the last day on a weekly chart when software bugs come up frequently, building the false record in a sea level file. However, the change in operational system gave an opportunity to change the software, orienting it to the PC-based platforms.

PC-based software package, developed in 2001 and 2002, consists of (i) AutoCAD digitising package, (ii) dxf-xyz conversion program, and (iii) FORTRAN based program DIGMAR which calculates the same parameters (hourly values, high/low data) and produces the same data files as the older package. The package allows for direct changes of digitised curves if necessary, and therefore it is expected to result in more accurate data than the older one. AutoCAD module consists of a number of layers which represent the sea level curve, high and low waters and extremes, and may be changed and corrected for clock shifts and drifts which may occur on a chart. The conversion program transforms an AutoCAD file to a file with ASCII Cartesian coordinates of the digitised values, both for large charts (recording ratio 1:5) collected at the principal tide gauges as well as small charts (recording ratio 1:10) recorded at portable tide gauges. Finally, linear transformation and fitting is performed in the DIGMAR module, resulting in the sea level file with the same format as the files obtained by old VAX based software. Therefore, the continuity of the sea level series is preserved, by increasing the quality of the data only.

The software is being used to obtain sea level data measured at major permanent stations first (Split Harbour, Dubrovnik, Rovinj) before 1986. Then, charts collected at portable tide gauges are going to be digitised, at a number of stations which were operational from a few months to a decade (see Fig. 2). After that, the data will be qualitatively controlled by the procedures recommended by ESEAS, and finally stored in a database. Simultaneously with the efforts made at the Hydrographic Institute, forty years of analog records from Bakar tide gauge are being digitized, processed and quality controlled at the Geophysical Institute.

Another rescue program has been initialized through ESEAS-RI in Croatia. That is the rescue of the original charts, which has been carried out by scanning performed with A0 scanner. Scanned files are stored in a graphic format, possessing enough quality to be reproduced in the future. Therefore, the ruination of originals cannot result in loss of the charts, and the scanned files may be additionally analysed in the future by appropriate software package.

5.6. *Web interface*

Due to the lack of appropriate Internet sites covering sea level characteristics of the Adriatic Sea, an idea of putting down sea level and related measurements on-line occurred in late 2000, after the installation of pressure gauge station at Split in the framework of MedGLOSS programme. The project »Adriatic Tides and Sea Level On-line« started in 2001, having the major objective to supply any potential user with the information about tidal predictions for any location along the Croatian coast of the Adriatic Sea. Next, it provides real-time information about the measured sea levels at one tide gauge station (Split). The idea has been expanded in late 2003 by putting all

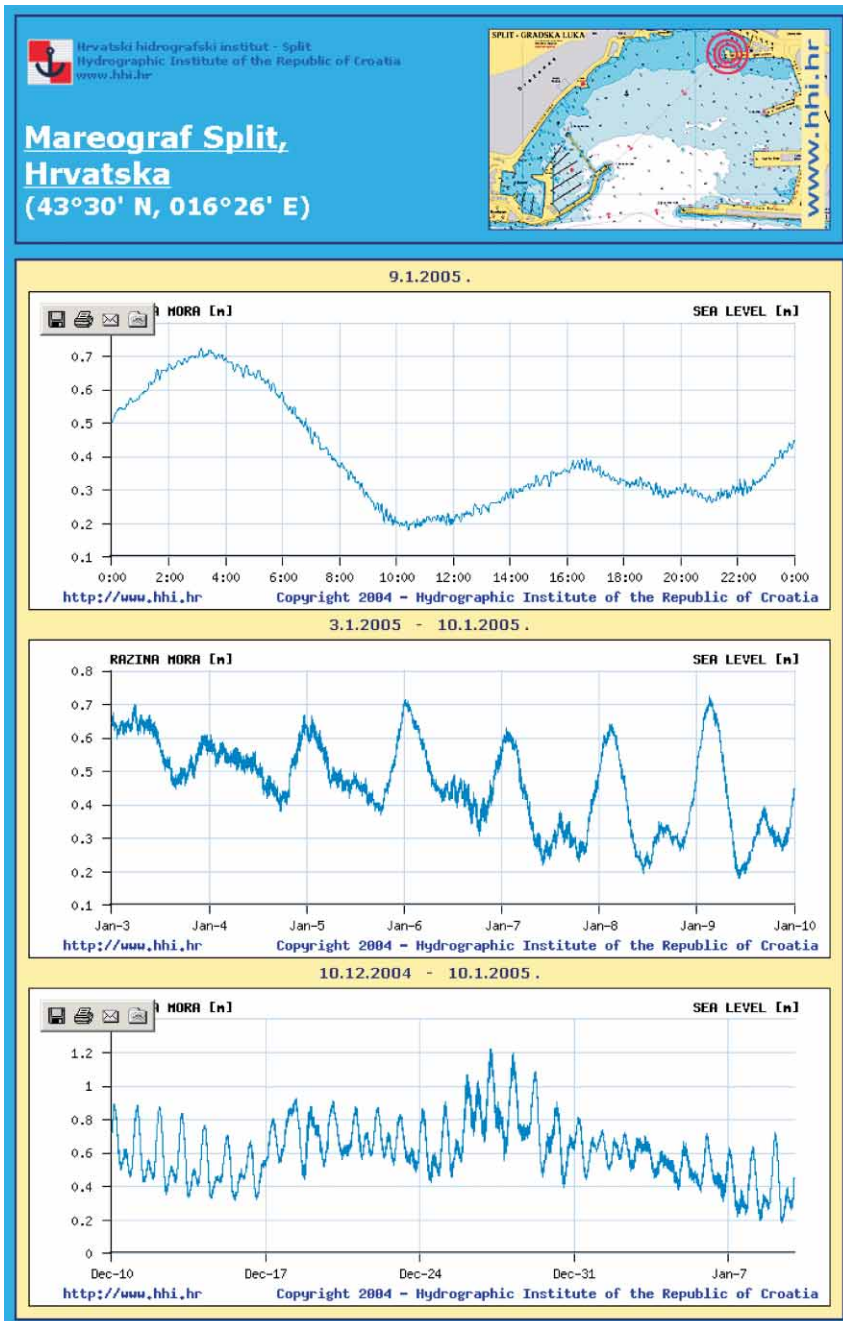

Figure 16. Dynamic web pages (<http://www.mijeneonline.hhi.hr>) of near-real time sea level records collected along the Croatian coast – example of Split.

of tide gauges on the web, after their upgrade through ESEAS-RI project. Sea level portal can be found at <http://www.mijeneonline.hhi.hr>, containing tidal forecasts for 7 forthcoming days and for 7 major Croatian ports, as well as measured 1 min values recorded at tide gauges Dubrovnik, Sućuraj, Split Harbour, Zadar and Rovinj in the preceding month, week and day (Fig. 16). The pages are dynamically refreshed each day, as data retrieval is set up to be once a day. In addition, the graphs of air pressure and sea temperature data at Split may be reached through <http://www.hhi.hr/mijene>, also dynamically refreshed once a day.

6. A scientific outcome: air-sea resonant coupling

The upgrade of Croatian tide gauges and choice of 1-min resolution in sea level measurements has been fully justified shortly after the installation of new equipment in early June 2003. Namely, exceptional sea-level oscillations and strong current reversals were observed in several east Adriatic coastal basins on 27 June 2003, characterized by high frequencies ($0.01 - 0.1 \text{ min}^{-1}$) which are not properly recorded by analog tide gauge devices. Particularly dramatic were reports coming from Mali Ston Bay which is sandwiched between mainland and Pelješac peninsula, and from Stari Grad Bay on the island of Hvar. There, according to the eyewitness reports, maximum sea-surface elevation amounted to 1.3 m, resulting in the flooding of seafront. The reports in Mali Ston Bay documented the damage done to shellfish farms by severe currents. The phenomenon was strongly reminiscent of the flooding which occurred on 21 June 1978 in Vela Luka Bay on the island of Korčula due to a wave having period close to 15 min and crest-to-trough height of about 6 m at the head of the bay.

The event of June 2003 has been documented in a paper by Vilibić *et al.* (2004) and herein will be given major characteristics of the event, as appropriate investigations were enabled by the upgrade of tide gauges in the region just two weeks prior to the event, giving the possibility to measure high-frequency sea level displacements. Although there were no instruments in the most affected bays, a number of tide gauges were operational in the region. High-frequency oscillations were increasing when going from deeper western areas towards narrow and shallow Mali Ston Bay, as seen on tide gauge records at Split Harbour, Sućuraj and Ploče (Fig. 17). At the same time, there were no strong oscillations outside the area, *e.g.* at Dubrovnik, which is situated on the shore of deep South Adriatic Pit.

Almost no winds were measured during the event, but a cosine-like wave in air-pressure series was captured by all barographic stations (Fig. 18). It is estimated that the air pressure wave travelled over the region to the ESE with an average speed of 22 m/s. Therefore, as found by applying a numerical model and suggested in earlier works (Orlić, 1980), the phenomenon has been caused by resonant coupling between air pressure travelling distur-

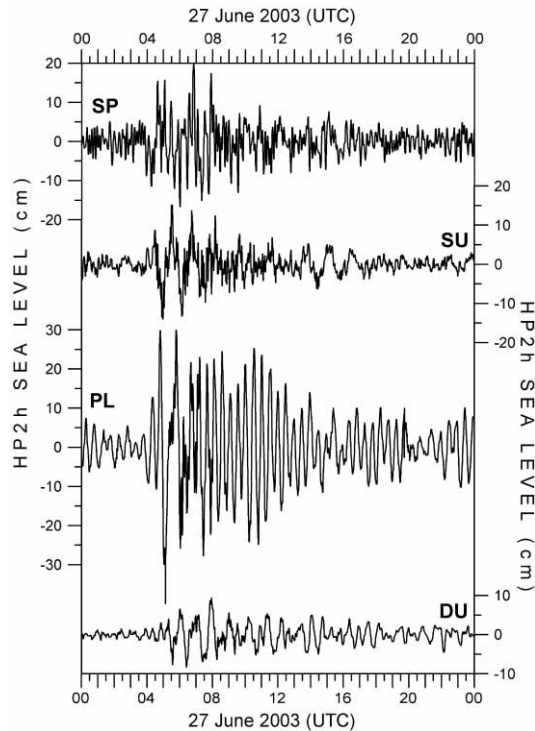

Figure 17. High-frequency component of sea-level time series at Split (SP), Sućuraj (SU), Ploče (PL) and Dubrovnik (DU). Low-frequency oscillations were removed by using a high-pass digital filter (after Vilibić et al., 2004).

bance and sea, first over the plateau where the speed of the atmospheric disturbance had the same velocity as long waves in the sea. This process is called Proudman or open-sea resonance (Proudman, 1929, 1953), and it is responsible for dynamical response and enhancement of wave in the channel waters of Middle Adriatic coastal area at depths of about 50 m. The forced wave hit bays and harbours in the area and, having broadband spectral characteristics, it excited normal modes of the coastal basins through the mechanism called harbour resonance. This resonance has been particularly large in Stari Grad Bay, having the fundamental bay free modes at 11 and 6 minutes, with maximum amplitude of 1.3 m at the head of the basin (Stari Grad Harbour). However, the amplitude decreased rapidly towards the entrance. For example, modelled sea level displacement at the entrance to Stari Grad Harbour (1 km west from the head) was 3–4 times lower than at the head of the harbour, relating the flood of the harbour and city dominantly to the harbour 6-min mode.

Since several bays in the area have a funnel-shaped form and are opened to the west, the forced wave was further amplified due to the imposed topo-

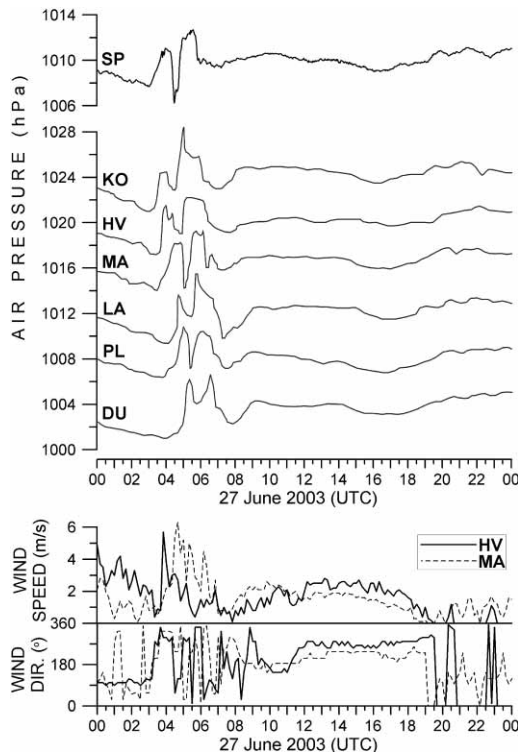

Figure 18. Time series of the air pressure measured on 27 June 2003 at Split (SP) with 2 min sampling interval, together with digitized barograph records originating from Komiza (KO), Hvar (HV), Makarska (MA), Lastovo (LA), Ploče (PL) and Dubrovnik (DU) stations. In the lower part of the Figure wind speed and direction, averaged over 10 min intervals, are given for HV and MA stations (after Vilibić et al., 2004).

graphic constraint. This effect was particularly strong in Mali Ston Bay, resulting in strong currents at the constraints inside the bay, which were modelled to be up to 150 cm/s (Fig. 19). Before and after the event, the currents were modelled to be normal (below 30 cm/s). Consequently, the largest impact of the air pressure induced wave on the shellfish farms in Mali Ston Bay is modelled to occur within the constrictions, exactly at the locations where severe damages in shellfish farms were reported.

Another extreme event with the travelling air pressure disturbance occurred on 21 August 2004 (Vilibić et al., 2005), however no floods were reported at that time. Relatively strong wind (up to 15 m/s) accompanied the travelling disturbance, which had a box-like shape, travelling towards the east with a speed of 18 m/s. The response of the sea was quite different: the energy of a 4-hour oscillation was dominant (Fig. 20), whereas high frequency parts (periods lower than 1 h) were minor and therefore no floods oc-

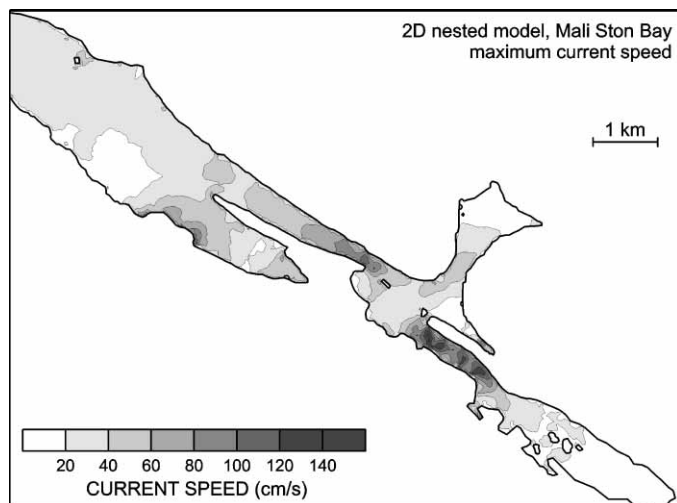

Figure 19. The distribution of maximum current speed as modelled for Mali Ston Bay and the air-pressure disturbance of 27 June 2003 (after Vilibić et al., 2004).

curred in the region. Different response is probably a result of different distribution in air-pressure energy: box-like disturbance has a maximum of energy in low-frequency domain, whereas cosine-like disturbance has a maximum at the fundamental cosine frequency (Bracewell, 1999). Therefore, the June 2003 event was characterized by large harbour resonance, whereas August 2004 event was characterized by large low-frequency resonance, having most of the energy at the fundamental 4-h mode of the whole coastal Middle Adriatic region. In addition, it is shown that the winds were still a minor contributor to the observed oscillations. Although blowing with large speed (15 m/s), the major indicators of the strength of the event were the shape, amplitude and travelling speed and direction of the air pressure disturbance.

7. Conclusions and future needs

All of the aspects of sea level measurements have been overviewed in the recent activities related to the Croatian tide gauge network, which was successfully operational over the last half-century. A major technological step occurred in the sea level recording, acquisition and data storage through the upgrade of tide gauges with a/d converters and GSM communication package. Therefore, the availability of the data is shortened from a couple of months, which were needed to collect and digitise the charts, to a day, as the data is downloaded once a day. What should be done next is the construction of zero/first level quality-control software which will automatically perform basic check of the data just after the acquisition (spikes, max-min values, shifts, etc.), and rise the alarm when data are bad or not retrieved due to

malfunction of the system. Next, the data should be smoothed by using a 2-hour low-pass digital filter and subsampled at 1-hour time step, in order to preserve the continuity between historical data, collected by analog devices and by digitising, and new data collected by the a/d device. Finally, the comparison between analog records and digital data should be extended over a longer time interval and all stations, in order to check the systems on shifts in recorded sea level heights. At stations where a problem is reported, such as the record drift at Bakar, the system should be adapted until all the problems have been removed and data consistency between historical and new sea level data is established.

Simultaneously with the maintenance of long-term permanent tide gauges, an effort should be done to acquire new sea level technologies, such as pressure and radar systems. Therefore, new equipment should be installed in parallel to the existing network, properly validated, and then used in the regular sea level measurements along the eastern Adriatic coast. This includes real-time data acquisition technologies necessary *e.g.* for tsunami warning and mitigation system, as might be relevant for the south Adriatic where

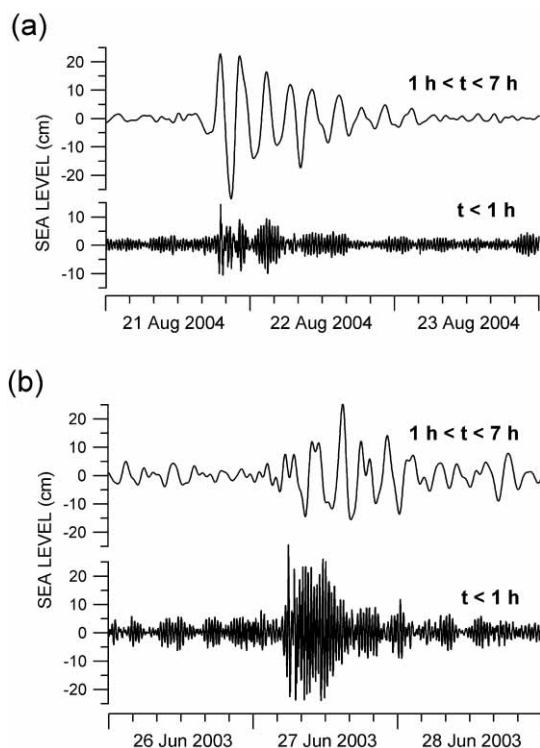

Figure 20. Sea level series at PL filtered by band-pass (cutoffs at 1 and 7 h) and high-pass (cutoff at 1 h) filters, for the (a) 21–23 August 2004 and (b) 26–28 June 2003 intervals.

strong tsunami events were observed in the past (Orlić, 1983/1984; Tinti and Piatanesi, 1996).

The measurements of vertical land movements have been initiated recently, a concept which was introduced a decade ago, being a modern tool for determining absolute sea level measurements. Such measurements comprise a lot of technological problems, which can be handled only in appropriate centres where collected data may be properly processed. Therefore, the CGPS station, which has been installed at the Split Harbour tide gauge, may be maintained by Croatian personnel, but the computations and determination of sea level height related to the geodetic references should be performed in the regional European centres or through International Geodetic Service (IGS). However, such a process will be done in the national centres in the future, especially after the initiation of vertical land-movement measurements at other Croatian tide gauges. This will enable proper computation of absolute sea level changes in the Adriatic Sea, followed by the projections of sea level behaviour and risk/vulnerability analyses in the future.

The rescue of historical data, initiated through ESEAS-RI, should be continued by digitising and scanning all of the charts and storing them in the digital format. A comprehensive control of these data should be carried out, as a number of problems may occur during the process, due to the subjective smoothing done by a technician or due to the problems that occurred during the measurements (clock errors, shifts and drifts, ink problems, etc.). The data which fail the quality control standards should be additionally digitised/scanned, trying to find out and avoid the problems which resulted in low-quality data in the first attempt. A new software may be developed, enabling the extraction of the records from a scanned chart, geo-referencing them both in time and space, computing sea level data and comparing them to the one obtained by digitising. Such approach will be more objective; however, a lot of technical problems should be solved first, especially for processing of low-quality records at harbour stations where high frequency oscillations frequently occur.

Finally, the presentation of all these activities should be followed by an appropriate Internet pages, in order to easily spread the information to the potential users. Hopefully, the high-quality systems and automated tide gauge network will be established fully in the near future, controlled and maintained by permanent service and high-tech personnel. Such service will enable high-quality scientific research of the Adriatic Sea dynamics and proper estimates of vulnerability and flood risks in low-land coastal area such as river deltas and coastal cities along the eastern Adriatic shore.

Acknowledgements – The work presented in the paper is a result of international projects »European Sea Level Service – Research Infrastructure« (Contract EVR1-CT-2002-40025), »MedGLOSS«, as well as of national projects funded by the Ministry of Science, Education and Sports of the Republic of Croatia (grants 0119330, 0001001, monitoring project »Adriatic« and IT project »Adriatic Tides and Sea Level On-line«). The suggestions of two anonymous reviewers are highly appreciated.

References

- Bevis, M., Scherer, W., Merrifield, M. (2002): Technical issues and recommendations related to the installation of continuous GPS stations at tide gauges. *Mar. Geod.*, **25**, 87–99.
- Bracewell, R. N. (1999): *Fourier Transform and Its Applications*. Mc-Graw Hill, New York, 640 pp.
- Bryant, E. (2001): *Tsunami. The Underrated Hazard*. Cambridge University Press, Cambridge, 350 pp.
- Buljan, M., Zore-Armanda, M. (1976): Oceanographical properties of the Adriatic Sea. *Oceanogr. Mar. Biol.*, **14**, 11–98.
- Cazenave, A., Bonnefond, P., Mercier, F., Dominh, K., Toumazou, V. (2002): Sea level variations in the Mediterranean Sea and Black Sea from satellite altimetry and tide gauges. *Global Planet. Change*, **34**, 59–86.
- Cerovečki, I., Orlić, M., Hendershott, M. C. (1997): Adriatic seiche decay and energy loss to the Mediterranean, *Deep-Sea Res. I*, **44**, 2007–2029.
- Cushman-Roisin, B., Naimie, C. E. (2002): A 3D finite-element model of the Adriatic tides. *J. Marine Syst.*, **37**, 279–297.
- Gajić-Čapka, M., Zaninović, K. (1998): Secular variations of climate in Croatia in relation to European changes (in Croatian). In: Bajić, A. (Ed.), Proceedings of Workshop Andrija Mohorovičić, 140 Birthday Anniversary, State Hydrometeorological Service, Zagreb, 219–234.
- Gill, A. E. (1982): *Atmosphere-Ocean Dynamics*. Academic Press, Orlando, 662 pp.
- Godin, G., Trotti, L. (1975): Trieste, water levels 1952–1971: a study of the tide, mean level and seiche activity. Miscellaneous Special Publication, **28**, Ottawa, 1–24.
- Goldberg J., Kempni K. (1938): On Bakar-Bay oscillations and general problem of bay seiches (in Croatian). Prirodoslovna istraživanja Kraljevine Jugoslavije, **21**, 9–235.
- Hodžić, M. (1979/1980): Occurrences of exceptional sea-level oscillations in the Vela Luka Bay (in Croatian). *Priroda*, **68** (2–3), 52–53.
- Hydrographic Institute (1955–2002): Report on sea level measurement along the eastern Adriatic coast. Split.
- IPCC (2001): Third Assessment Report of the International Panel on Climate Change. Volumes 1–3, Cambridge University Press, Cambridge, 2665 pp.
- Joó, I., Csati, E., Jovanović, P., Popescu, M., Somov, V. I., Thurm, H., Thury, J., Totomanov, I. N., Vanko, J., Wyrzykowski, T. (1981): Recent vertical crustal movements of the Carpatho-Balkan region. *Tectonophysics*, **71**, 41–52.
- Kasumović, M. (1963): Free oscillations of long period in the Adratic (in Croatian). Rasprave odjela za matematičke, fizičke i tehničke nauke JAZU, **2**, 4, 121–166.
- Kesslitz, W. (1910): Das Gezeitenphaenomen im Hafen von Pola. Mitteilungen aus dem Gebiete des Seewesens, **38**, 445–477, 557–608.
- Kesslitz, W. (1913): Die Gezeiten im Adriatischen Meere. Mitteilungen aus dem Gebiete des Seewesens, **41**, 1413–1436.
- Leder, N. (1988): Storm surges along the east coast of the Adriatic Sea. *Acta Adriatica*, **29**(1/2), 5–20.
- Leder, N., Orlić, M. (2004): Fundamental Adriatic seiche recorded by current meters. *Ann. Geophys.*, **22**, 1449–1464.
- Mihanović, H., Leder, N., Domijan, N., Čupić, S., Strinić, G., Vilibić, I., Kierulf, H.-P. (2004): CGPS Station collocated at Split tide gauge (Croatia). Workshop on Observing and Understanding Sea Level Variations, Book of Abstracts, St. Julians, Malta, 1–3 November.
- Orlić, M. (1980): About a possible occurrence of the Proudman resonance in the Adriatic. *Thalassia Jugoslavica*, **16**(1), 79–88.

- Orlić, M. (1983/1984): Are there tsunamis in the Adriatic Sea? (in Croatian). *Priroda*, **72**, 310–311.
- Orlić, M. (2001) Anatomy of sea level variability – and example from the Adriatic. In: El-Hawary, F. (Ed.), *The Ocean Engineering Handbook*, CRC Press, London, 1–13.
- Orlić M., Pasarić, M. (1994): Adriatic sea level and global climatic change (in Croatian). *Pomorski zbornik*, **32/94**, Rijeka, 481–501.
- Orlić, M., Kuzmić, M., Pasarić, Z. (1994): Response of the Adriatic Sea to the bora and sirocco forcing. *Cont. Shelf Res.*, **14**, 91–116.
- Pasarić, M., Orlić, M., 2001. Long-term meteorological preconditioning of the North Adriatic coastal floods. *Cont. Shelf Res.*, **21**, 263–278.
- Pasarić, M., Pasarić, Z., Orlić, M. (2000): Response of the Adriatic sea level to the air pressure and wind forcing at low frequencies (0.01–0.1 cpd). *J. Geophys. Res.*, **105**, 11423–11439
- Plag, H.-P., Axe, P., Knudsen, P., Richter, B., Verstraeten, J. (2000): European Sea Level Observing System (EOSS): Status and future developments, Volume EUR 19682. Office for Official Publication of the European Communities, Luxembourg, 72 pp.
- Polli, S. (1960): Le propagazione delle maree nell' Adriatico. *Atti del IX Convegno dell' Associazione Geofisica Italiana*, Roma, 1–11.
- Prandle, D. (2000): Introduction – Operational oceanography in coastal waters, *Coast. Eng.*, **41**, 3–12.
- Proudman, J. (1929): The effects on the sea of changes in atmospheric pressure. *Geophysical Supplement to the Monthly Notices of the Royal Astronomical Society*, **2(4)**, 197–209.
- Proudman, J. (1953): *Dynamical Oceanography*. Methuen – John Wiley, London, 409 pp.
- Pugh, D. T. (1987): *Tides, Surges and Mean Sea-Level: A Handbook for Engineers and Scientists*. Wiley, Chichester, 472 pp.
- Pugh, D. T. (2004): *Changing Sea Levels. Effects of Tides, Weather and Climate*. Cambridge University Press, Cambridge, 280 pp.
- Rabinovich, A. B. (1993): *Long Ocean Gravity Waves: Trapping, Resonance and Leaking* (in Russian). *Gidrometeoizdat*, St.Petersburg, 325 pp.
- Raicich, F. (2003): Recent evolution of sea-level extremes at Trieste (Northern Adriatic). *Cont. Shelf Res.*, **23**, 225–235.
- Raicich, F., Orlić, M., Vilibić, I., Malačić, V. (1999) A case study of the Adriatic seiches (December 1997). *Il Nuovo Cimento C*, **22**, 715–726.
- Robinson, A. R., Tomasin, A., Artegiani, A. (1972): Flooding of Venice – phenomenology and prediction of the Adriatic storm surge. *J. Roy. Meteorol. Soc.*, **99**, 686–692.
- Shirman B. (2003): Comparison of a radar and float gauge at Haifa. Available online at <http://www.pol.ac.uk/psmsl/reports.gloss/ge8/presentations/BorisShirman.ppt>.
- Sterneck, R. V. (1914): Ueber »Seiches« an den Kuesten der Adria. *Sitzungsberichte der Kaiserliche Akademie der Wissenschaften*, Wien, **IIa/123**, 2199–2232.
- Sterneck, R. V. (1919): Die Gezeitenerscheinungen in der Adria. *Akademie der Wissenschaften in Wien, Denkschriften Mathematisch-Naturwissenschaftliche Klasse*, **96**, 277–324.
- Stewart, R. H. (2002): *Introduction to Physical Oceanography*. Department of Oceanography Texas A&M University, 340 pp.
- Supić N., Orlić, M. (1999): Seasonal and interannual variability of the Northern Adriatic surface fluxes. *J. Marine Syst.*, **20**, 205–229.
- Tešić, M. (1955): Tide observations in the Adriatic Sea (in Croatian). *Hidrogr. god.* 1954, 1–26.
- Tinti, S., Piatanesi, A. (1996): Numerical simulations of the tsunami induced by the 1627 earthquake affecting Gargano, Southern Italy. *J. Geodyn.*, **21**, 141–160.
- Tsimplis, M. N., Baker, T. F. (2000): Sea level drop in the Mediterranean Sea: An indicator of deep water salinity and temperature changes? *Geophys. Res. Lett.*, **27(12)**, 1731–1734.

- Tsimplis, M. N., Rixen, M. (2002): Sea level in the Mediterranean Sea: the contribution of temperature and salinity changes. *Geophys. Res. Lett.*, **29**(23), 2136, doi:10.1029/2002GL015870.
- Tsimplis, M. N., Proctor, R., Flather, R. (1995): A two-dimensional tidal model for the Mediterranean Sea. *Geophys. Res. Lett.*, **100**, C8, 16223–16239.
- UNESCO (1985): Manual on Sea Level Measurement and Interpretation: Vol. 1 – Basic Procedures. IOC Manuals and Guides, **14**, 76 pp.
- UNESCO (1994): Manual on Sea Level Measurement and Interpretation: Vol. 2 – Emerging Technologies. IOC Manuals and Guides, **14**, 50 pp.
- UNESCO (2002): Manual on Sea Level Measurement and Interpretation: Vol. 3 – Reappraisals and Recommendations as of the Year 2000. IOC Manuals and Guides, **14**, 49 pp.
- Vilibić, I. (2000): A climatological study of the uninodal seiche in the Adriatic Sea. *Acta Adriatica*, **41** (2), 89–102.
- Vilibić, I., Mihanović, H. (2002): A study of seiches in the Split harbour (Adriatic Sea). *Acta Adriatica*, **43** (2), 59–68.
- Vilibić, I., Orlić, M. (1999): Surface seiches and internal Kelvin waves observed off Zadar (east Adriatic). *Estuar. Coast. Shelf S.*, **48**, 125–136.
- Vilibić, I., Leder, N., Smirčić, A. (2000): Storm surges in the Adriatic Sea: an impact on the coastal infrastructure, *Period. Biol.*, **102**, Supplement 1, 483–488.
- Vilibić, I., Domijan, N., Čupić, S. (2005): Wind versus air pressure seiche triggering in the Middle Adriatic coastal waters. *J. Marine Syst.*, **57**, 189–200.
- Vilibić, I., Leder, N., Smirčić, A., Gržetić, Z. (1997): Long-term sea-level changes along the Croatian coast of Adriatic (in Croatian). In: Finka, B. (Ed.), *Tisuću godina prvoga spomena ribarstva u Hrvata*, Zagreb, 437–445.
- Vilibić, I., Domijan, N., Orlić, M., Leder, N., Pasarić, M. (2004): Resonant coupling of a traveling air-pressure disturbance with the east Adriatic coastal waters, *J. Geophys. Res.*, **109**, C10001, doi:10.1029/2004JC002279.
- Vilibić, I., Leder, N., Mihanović, H., Smirčić, A., Gržetić, Z. (2001): MedGLOSS pressure gauge in the Split harbour: installation and preliminary analysis of the data. *Rapports et proces-verbaux des réunions CIESM*, **35**, 97.
- Wilson, B. W. (1972): Seiches. *Advances in Hydrosci.*, **8**, 1–94.
- Woodworth, P. L. (2003): Some comments on the long sea level records from the Northern Mediterranean. *J. Coast. Res.*, **19**, 212–217.
- Woodworth, P.L., Smith, D. E. (2003): A one year comparison of radar and bubbler tide gauges at Liverpool. *Int. Hydrogr. Rev.*, **4**, 42–49.
- Zore, M. (1955): On the seiches occurring in the Bay of Kaštela. *Acta Adriatica*, **7**, 1–18.

SAŽETAK

Novi pristup motrenju promjena razine mora u Hrvatskoj

Ivica Vilibić, Mirko Orlić, Srđan Čupić, Nenad Domijan, Nenad Leder, Hrvoje Mihanović, Miroslava Pasarić, Zoran Pasarić, Mladen Srdelić i Goran Strinić

Rad sadrži pregled novijih međunarodnih i domaćih aktivnosti usmjerenih prema poboljšanju mareografske mreže na istočnoj obali Jadranskog mora. Najprije su prikazani dostupni mjerni sustavi. Zatim su ukratko prikazana svojstva razine Jadranskog mora, te povijesni razvoj mareografije i istraživanja kolebanja razine mora. Sadašnje aktivnosti u tim istraživanjima prikazane u ovom radu obuhvaćaju institucionalnu

strukturu u Republici Hrvatskoj, te pregled novijih projekata i programa (Europska mareografska mreža – istraživačka infrastruktura (ESEAS-RI), Mediteranska implementacija Globalnog sustava za praćenje razine mora (MedGLOSS), Morske mijene i razina Jadrana on-line, Projekt Jadran). Detaljno su prikazane aktivnosti koje su dovele do nadogradnje hrvatskih mareografa, prijenosa i obrade podataka, te internet-skog prikaza podataka u realnom vremenu. Osim toga, u radu se dokumentira uspostava mjerenja vertikalnih pomaka tla, koja je inicirana postavljanjem CGPS sustava na krovu splitskog mareografa tijekom 2004. godine. Prilično truda je uložena u spašavanje povijesnih mareografskih zapisa, koristeći digitalizaciju i skeniranje zapisa, što će spriječiti trajan gubitak podataka u slučaju uništenja originalnih zapisa. Naposljetku, prikazana su najnovija istraživanja visokofrekventnih oscilacija razine mora i rezonantnog prijenosa energije iz atmosfere u more, omogućena uspostavom 1-minutnih mjerenja na mareografskim postajama, a koja nisu bila moguća s prethodnim analognim sustavima mjerenja.

Ključne riječi: Jadransko more, mareografi, razina mora, projekti, modernizacija, servis podataka i arhiva, znanstvena istraživanja.

Corresponding author's address: Ivica Vilibić, Institute of Oceanography and Fisheries, Šetalište I. Meštrovića 63, 21000 Split, Croatia, fax: +385-21-358650, e-mail: vilibic@izor.hr