

Wilfrid Laurier University

Scholars Commons @ Laurier

---

Theses and Dissertations (Comprehensive)

---

2016

## Age-Related Changes in Hippocampal Arc Expression Following Minimal Behavioural Induction

Irina V. Odintsova

Wilfrid Laurier University, [odin5240@mylaurier.ca](mailto:odin5240@mylaurier.ca)

Follow this and additional works at: <https://scholars.wlu.ca/etd>



Part of the [Biological Psychology Commons](#)

---

### Recommended Citation

Odintsova, Irina V., "Age-Related Changes in Hippocampal Arc Expression Following Minimal Behavioural Induction" (2016). *Theses and Dissertations (Comprehensive)*. 1803.

<https://scholars.wlu.ca/etd/1803>

This Thesis is brought to you for free and open access by Scholars Commons @ Laurier. It has been accepted for inclusion in Theses and Dissertations (Comprehensive) by an authorized administrator of Scholars Commons @ Laurier. For more information, please contact [scholarscommons@wlu.ca](mailto:scholarscommons@wlu.ca).

Age-Related Changes in Hippocampal *Arc* Expression Following Minimal Behavioural  
Induction

by

Irina V. Odintsova

Bachelor of Arts, Honours Psychology, Wilfrid Laurier University, 2012

Wilfrid Laurier University, 2015

THESIS

Submitted to the Department of Psychology in partial fulfillment of the requirements for Master

of Science in Psychology

Wilfrid Laurier University

© (Irina V. Odintsova) 2015

## Abstract

Normal ageing is associated with significant changes in cognitive function, including the decline of some forms of memory. The hippocampal formation is critical to learning and memory function, and plasticity in this region declines with age. Additionally, age-related differences in plasticity are greatest at lower levels of stimulation, thus peri-threshold plasticity may be of the greatest relevance for age-related changes in cognition. Moreover, the hippocampus is prone to changes in the expression of gene products that mediate plasticity with age. The current thesis attempts to link these observations by measuring hippocampal expression of *Arc*, an immediate-early gene that is critical for both plasticity and memory function, using a behavioural analogue of minimal stimulation. In this paradigm, adult (11 months) and aged (23 months) F344 rats traversed a varying number of laps (i.e., 1, 3, or 5) in a triangular track. To test cholinergic influences on these dynamics, animals were also injected with physostigmine, a cholinergic agonist, which has been shown to modulate hippocampal physiology. Consistent with previous studies, a greater number of laps induced *Arc* in more cells across the hippocampus. In addition, age altered the *Arc* expression that followed different stimulation levels, but not in the way hypothesized. Aged animals, in fact, expressed more *Arc* following fewer laps. Additionally, we did not show any evidence of one-trial learning as has previously been demonstrated. Finally, physostigmine administration significantly increased cellular recruitment selectively in the dorsal regions of the hippocampus. These data suggest that age-related changes in neural activation are present, but complex. Additionally, these data show that physostigmine appears to augment IEG dynamics.

## Table of Contents

Abstract.....	2
Table of Contents.....	3
List of Tables .....	5
Age-Related Changes in <i>Arc</i> Transcription Following Minimal Behavioural Induction.....	8
Memory Function is Impaired during Normal Ageing.....	8
Studying Memory in the Brain .....	11
Hippocampus as a Memory Hub.....	13
Age-Related Changes in the Hippocampus .....	16
Cholinergic Hypothesis of Ageing.....	17
Place Cells and the Mental Map .....	19
Place Field Dynamics are mediated by Plasticity.....	21
Age-Related Changes in Plasticity.....	23
Immediate-Early Genes Mediate Plasticity .....	25
Immediate-Early Gene Expression can be Assessed using catFISH .....	26
<i>Arc</i> Expression is altered by Age.....	27
Present Study .....	29
Methodology.....	31
Subjects.....	31
Behavioural Training .....	31
Tissue Extraction .....	32
Fluorescence In Situ Hybridization .....	32
Microscopy .....	33
Image Analysis.....	34
Statistical Analysis.....	34
Results.....	35
Recruitment.....	35
Intensity.....	37
Discussion.....	38
Age Differences in Electrotranscriptional Coupling.....	38

Functional Gradients in Arc Expression and Hippocampal Function .....	39
Arc and One-Trial Learning.....	41
Integrated Intensity of Arc Expression .....	42
Limitations .....	43
Implications.....	44
References.....	66

List of Tables

Table 1. List of independent variables assessed for each dependent variable.

## List of Figures

<i>Figure 1.</i> The hippocampal formation, composed of the dentate gyrus (DG) and <i>Cornu Ammonis</i> (CA) subregions CA1-CA4, is located in the medial temporal lobe and has been implicated in learning and memory (Squire, 1992). .....	47
<i>Figure 2.</i> Hippocampal tri-synaptic loop. The pathway of information processing through the hippocampal formation including input from various layers of the entorhinal cortex (EC) that travel through the dentate gyrus (DG), CA subregions, and back through the subiculum (Sub) to the EC is shown. ....	48
<i>Figure 3.</i> Integrated intensity collection. A) Collected images are three-dimensional in nature, providing information about neurons over many individual planes. Eighty-percent of positive cells were randomly selected for assessment from each image. B) For each <i>Arc</i> -positive cell, integrated intensity is collected from each plane showing gene expression. C) To assess integrated intensity for each condition/animal, each of the summed cellular values was averaged to give a single representative value. ....	49
<i>Figure 4.</i> Overall data for cellular recruitment across all regions for the first exposure to the environment. ....	50
<i>Figure 5.</i> Overall data for cellular recruitment across regions for the second exposure to the environment. ....	51
<i>Figure 6.</i> Overall data for integrated intensity of <i>Arc</i> across regions for second environmental exposure. ....	52
<i>Figure 7.</i> The proportion of cells expressing <i>Arc</i> after different numbers of laps around the track. Three and five laps were associated with significantly higher levels of cellular recruitment as compared to controls. * $p < 0.05$ , ** $p < 0.001$ .....	53
<i>Figure 8.</i> The proportion of cells expressing <i>Arc</i> across different regions of the hippocampus. A trend was observed across regions such that CA3c was associated with the lowest levels of cellular recruitment followed by a gradual increase at each subsequent stage of the tri-synaptic loop to the mCA1. This pattern reflects the path of information flow through the hippocampus.	54
<i>Figure 9.</i> Cellular recruitment was significantly higher in CA1 subregions as compared to CA3 subregions. ** $p < 0.001$ .....	55
<i>Figure 10.</i> Dorsal regions were associated with increased cellular recruitment compared to ventral regions. ** $p < 0.001$ .....	56
<i>Figure 11.</i> Physostigmine appears to be associated with significantly higher levels of cellular recruitment within subjects. ** $p < 0.001$ .....	57
<i>Figure 12.</i> In adult animals, 5 laps induced significantly higher levels of cellular recruitment as compared to controls. In aged animals on the other hand, three laps was associated with higher cellular recruitment. ....	58
<i>Figure 13.</i> Regional differences in cellular recruitment were only present following physostigmine administration. ....	59

<i>Figure 14.</i> While both ventral and dorsal regions showed an increase in cellular activity following physostigmine administration, the increase was greater for dorsal regions than ventral regions.....	60
<i>Figure 15.</i> Dorsal regions were associated with significantly increased cellular recruitment following 3 and 5 laps while ventral regions did not appear to influence cellular recruitment....	61
<i>Figure 16.</i> The age-related effect of laps occurred mostly in dorsal rather than ventral regions, thus creating a three-way interaction. ....	62
<i>Figure 17.</i> Three and five laps induced significantly higher quantities of <i>Arc</i> transcription in individual cells relative to cage controls. * $p < 0.05$ , ** $p < 0.001$ .....	63
<i>Figure 18.</i> Integrated intensity of <i>Arc</i> was significantly higher in dorsal regions than ventral regions. * $p < 0.05$ .....	64
<i>Figure 19.</i> Dorsal and Ventral place field size differences. Dorsal cells tend to encode smaller place fields that are not likely to overlap, while ventral cells tend to encode larger place fields that do overlap. Due to the increased sensitivity of dorsal cells to spatial information, dorsal place fields tend to mediate cellular activity more than ventral place fields. ....	65



### Age-Related Changes in *Arc* Transcription Following Minimal Behavioural Induction

Normal ageing is associated with many changes in physical and cognitive abilities even in the absence of pathology (Burke & Barnes, 2006). Age-related changes in cognition include impairments to sensory-motor coordination, attention, as well as some learning and memory processes. As the proportion of individuals over 65 years old around the world continues to rise (United Nations, 2013), ageing has become a large area of research. Amongst the cognitive faculties that are sensitive to age, memory is one of the most integral as it is at the core of many other cognitive abilities. While not all individuals suffer profound cognitive and memory impairments (Rapp & Amaral, 1992), many experience some degree of cognitive decline. Since it stands to reason that the preservation of memory function throughout life is likely associated with significantly improved quality of life, research that addresses the mechanisms of memory function, and how these mechanisms are altered with age, is important.

### *Memory Function is Impaired during Normal Ageing*

Studies of memory and ageing have established that not all types of memory are degraded with age; memory for facts and skills are generally spared while memories of events and spatial orientation are prone to impairment (Moscovitch, Nadel, Winocur, Gilboa, & Rosenbaum, 2006). The two latter examples of memory are part of the broader category of episodic memories. Episodic memories are formed from a combination of internal and external stimuli and are characterized by contextual information (i.e., often described as the what, where, and when, about a specific event). In humans, episodic memories are also auto-noetic – that is, we are able to consciously place ourselves into past memories and also place ourselves into hypothetical future scenarios. This ability for mental time-travel (i.e., to purposefully place one's self into non-

present situations) can only be assessed in humans and thus testing in tasks that require the binding of what, where, and when information memory in animals can only be labelled as episodic-like (Tulving, 1972). Despite this limitation, animal models are useful research tools. Although it is not possible to ask an animal about its experience during or after an event, elegant experimental designs permit researchers to answer specific questions through observation under controlled conditions not possible with human participants.

As a function of these designs, experiments using animal models have fewer confounding variables than human studies that could interfere with results. For example, if animals are being tested in a task where food reward is present, controlling their diet prior to the start of testing may lead to fewer confounding variables, thus allowing researchers to suggest that performance is driven more by learning rather than motivation. While this level of control is not absolute, it is challenging to achieve within human populations as it is difficult to control participant behaviour outside of the testing environment. Additionally, the use of rodent models facilitates greater control of an animal's history. This becomes particularly relevant in the context of ageing. Many lifestyle factors including diet, exercise, and personal history cannot be controlled in human studies. These factors can influence an individual's overall abilities thereby making it difficult to study specific age-related changes in humans. Animal models do not suffer from this as much because many aspects of an animal's life can be controlled, thus allowing experimental groups to be equivalent in all aspects save the one being studied. Episodic-like memory is frequently studied through spatial tasks as these incorporate aspects of what, where, and when memory, simultaneously.

Spatial processing and memory are critical to the survival of most creatures in the wild. Animals must be able to navigate their local habitat to procure food and shelter while avoiding

predators and other dangers within their environment. Moreover, this ability requires the integrated recall of what, where, and when information. Thus, by using methods that tap into spatial abilities, researchers can assess episodic-like memory in animals. The Morris Water Maze (MWM) is a robust spatial task that can test many aspects of spatial processing and memory. In a common variant of the MWM, animals are required to swim in a circular pool until they locate a hidden platform, located in a specific quadrant, to escape the water (Morris, 1984). Rodents are able to locate the hidden platform by way of external cues, and over a number of trials, are able to swim to the correct location with ease by remembering the location of the platform in the environment. Many studies have demonstrated that aged animals are not as proficient at this task as their younger counterparts (Brandeis, Brandys, & Yehuda, 1989; Gage, Chen, Buzsaki, & Armstrong, 1988; Markowska, Price, & Koliatsos, 1996; Martínez-Serrano, Fischer, Söderström, Ebendal, & Björklund, 1996; Stewart, Mitchell, & Kalant, 1989). Further research has demonstrated that aged animals take longer to acquire a task, such as the MWM, than their younger counterparts and are limited in their ability to retain previously learned information (Barnes, Suster, Shen, & McNaughton, 1997; Gage, Dunnett, & Björklund, 1984). While aged animals may exhibit arthritic joints that could impair movement, there is evidence to suggest that age-related differences in the MWM were not a function of either sensory or motor deficits such as visual acuity or swim speed (Gage, Dunnett, & Björklund, 1989). These behavioural results suggest that episodic and episodic-like memories are strongly affected by the ageing process. However, while behavioural data can provide a wealth of information, it is important to understand how changes in the brain mediate the cognitive deficits that are revealed through these behavioural paradigms.

*Studying Memory in the Brain*

Memory has been a large area of investigation within the field of neuroscience for several decades. During that time there have been many advances in the way researchers study this critical facet of cognition. Studying memory in humans usually involves techniques such as electroencephalography (EEG) and functional magnetic resonance imaging (*fMRI*) to determine how brain activity, as measured by electrical fluctuations and changes in blood-oxygen levels, is altered during the performance of specific tasks. However, while these methods can provide great insights into brain activity, they are only correlational in nature and lack cellular resolution. Information gathered from low-resolution studies of the brain does not provide insight into the mechanisms that underlie cognitive function, they simply allow for the visualization of the byproducts of these mechanisms. While *fMRI* and EEG give researchers an idea of how broad regions of the brain respond to a given stimulus, techniques that reveal how specific genes, proteins, or neurotransmitters are mediated by that same stimulus provide much more information about the types of mechanistic changes that occur in the brain. These observations can not be obtained from a human population, so animal models are frequently used to gain insight into these aspects of brain activity. Such a mechanistic account of how neuronal activity changes with experience, and how these plasticity mechanisms develop across the lifespan, may provide information critical to the development of interventions or treatments for age-related cognitive decline. In recent decades, many high-resolution techniques have been developed with this purpose in mind.

Technical innovations have made it significantly easier to visualize minute changes in brain physiology. Electrophysiological techniques such as patch-clamp and single- or multi-cell

recordings are used to examine neuronal activity in freely-moving animals, while *in situ* hybridization or immuno-histochemical techniques can assess physiological changes within large populations of cells post mortem. Newer techniques such as optogenetics in which cells can be isolated through the selective expression of light-sensitive receptors and subsequently controlled through light exposure can provide a wealth of information about how cells act. In the current thesis, cellular activity is analyzed using the technique referred to as cellular compartment analysis of temporal activity by fluorescence *in situ* hybridization (catFISH). This technique can assess cellular activity during two distinct time points within the same subject and provide advanced insight into the impact of cellular activity on cognitive function. This is possible because some markers of cellular activity have different characteristics at different time points in their activation, thus allowing researchers to distinguish between activity during the different epochs. This is a valuable asset of catFISH as it leads to the ability to assess the effect of an intervention on cellular activity by way of a direct, within animal comparison of cellular activity before and after the intervention. This eliminates the need for multiple groups of animals to assess differences between pre-intervention and post-intervention states and thusly reduces between subject variability by having within subject comparisons.

Various techniques have identified the hippocampal formation as a critical structure for learning and memory (Driscoll et al., 2006). This brain area is complex, and is composed of several regions that each contributes to information processing in different ways. Since this is a functionally heterogeneous brain area, it is important to understand its morphological qualities and how they influence its function.

*Hippocampus as a Memory Hub*

The hippocampal formation is located in the medial temporal lobe and has been the center of memory research in many species (Driscoll et al., 2006). This region is implicated in a wide variety of information processing, including the formation and retrieval of short-term, long-term, episodic, and spatial memories (Geinisman, DeToldo-Morrell, Morrell, & Heller, 1995; Morris, Garrud, Rawlins, & O'Keefe, 1982). The hippocampal formation, located ventral and medial to the cerebral cortex, is composed of two main cell types: granule cells in the dentate gyrus (DG), and pyramidal cells of the hippocampus proper which includes the *Cornu Ammonis* areas 1-4 (CA1-CA4) that are composed primarily of pyramidal cells, as illustrated in Figure 1. Collectively the CA subregions make a horn-like shape and have varying cellular density. Together with the entorhinal cortex (EC), these areas make up the tri-synaptic loop (Figure 2), which has been theorized to be one of the most important pathways for memory-related information processing. Each of the aforementioned hippocampal regions have unique properties and as a result of these properties are thought to make unique contributions to information processing.

The first of these regions is the DG which receives inputs along the perforant path from layer II of the EC, which is the main interface between the hippocampus and the neocortex. The DG has been implicated in pattern separation (Myers & Scharfman, 2009), the computational process in which cells are able to generate distinct and uncorrelated representations of events even when much of the external stimuli perceived during those events are identical (Deng et al, 2010). Pattern separation is an important aspect of information processing and has been implicated in novelty detection. The DG is also one of the few brain regions to display large-

scale neurogenesis (Zhao, Teng, Summers, Ming, & Gage, 2006), and this continuous addition of granule cells has been theorized to contribute to learning flexibility (Zhao, Deng, & Gage, 2008). The next subregion in the hippocampal formation is the sparsely populated CA3 which, unlike the DG, is composed of pyramidal cells. The CA3 subregion can be broken down further into subsections: CA3a, CA3b, and CA3c (see Figure 1). The subsections of CA3 are not heterogeneous as once thought (Rolls, 1996; Rolls & Kesner, 2006; Samsonovich & McNaughton, 1997) with evidence suggesting that subsection CA3c is more critical to spatial discrimination than subsections CA3a and CA3b (Hunsaker et al, 2008). Inputs from the DG are localized primarily at the CA3c subsection. Collectively, the subsections of CA3 have also been shown to play a critical role in pattern completion (Marr, 1971; Treves & Rolls, 1994) and one-trial learning (Lee & Kesner, 2002; Miyashita, Kubik, Haghghi, Steward, & Guzowski, 2009; Nakazawa et al., 2003). In the memory research literature, pattern completion can be defined as the process by which a memory for an event can be retrieved from a partial cue. This process is thought to be supported by the large number of recurrent CA3 projections which are thought to aid in thoroughly processing and completing memory traces (Rolls, 2013). Although not typically considered in the classical description of the tri-synaptic circuit, the relatively small CA2 subregion (located between the CA3 and the CA1) has recently been implicated in memory for social information (Hitti & Siegelbaum, 2014). The final hippocampal subregion in the tri-synaptic loop is CA1, which receives input from the CA3 via the Shaffer collateral pathway. More densely packed than CA3, CA1 pyramidal cells also receive direct input from EC layer III. In contrast to the other hippocampal subregions, the CA1 has major output projections to regions outside of the hippocampus, including the EC and the subiculum. Hippocampal projections also exist from a variety of other regions including, but not limited to, the mammillary body, which

has a role in recollective memory, the septal nucleus, which is associated with reward and reinforcement, and the prefrontal cortex via the nucleus reuniens, which is linked to decision making and personality traits. The hippocampal formation also receives projections from many important sensory-motor regions. Moreover, the majority of these connections are reciprocal and thus the hippocampal formation can be considered a nexus for information travelling through the brain.

As a result of its organization, the hippocampus is an ideal structure for information processing and memory formation. With the DG implicated in pattern separation, and the CA3 being associated with pattern completion and one-trial learning, the hippocampus has all the necessary properties to encode a large amount of information.

In considering the response of hippocampal neurons during behavior, it is typical to refer to cellular recruitment – that is, the number of neurons activated (or *recruited*) by a single event or environment. Although the sparsity of recruitment changes reliably as one moves along the tri-synaptic circuit with the greatest sparsity in the DG, even in CA1 the number of activated cells is a small fraction of the total hippocampal neuronal population (Gheidi, Satvat, & Marrone, 2012). Thus, there are many possible patterns of cellular activation that could be used to store arbitrary associations. This ability to encode many different pieces of information in an efficient and unique neural code is thought to be fundamental for spatial cognition. Based on the functional and neurophysiological properties of the hippocampus, it is not surprising that hippocampal lesions impair recognition of environmental features and changes (Eichenbaum, Yonelinas, & Ranganath, 2007; Geinisman et al., 2004; Smith & Mizumori, 2006; Squire, 1992). This, combined with the large number of place cells (sensitive to spatial information) and grid cells (sensitive to an animal's position within the environment) within the EC demonstrate that



the region is critical for the processing of spatial information (Moser, Kropff, & Moser, 2008). Age-related changes in memory function, particularly with respect to spatial memory, are thought to be mediated by changes in hippocampal function.

#### *Age-Related Changes in the Hippocampus*

Initially, it was thought that cognitive decline during normal ageing was associated with cell loss within the hippocampal formation (West, 1993). However, further investigation, aided by more rigorous and unbiased stereology (Gundersen, Jensen, Kiêu, & Nielsen, 1999; Sterio, 1984; West, 1999) has revealed no significant differences in hippocampal cell numbers across the lifespan (Calhoun et al., 1998; Rapp & Gallagher, 1996; Rasmussen, Schliemann, Sørensen, Zimmer, & West, 1996; Von Bohlen und Halbach & Unsicker, 2002; West, 1993). While changes to the complement of hippocampal cells have been generally rejected as a major contributing factor in normal, non-pathological cognitive ageing, attention has turned to investigating more subtle changes, both at the level of individual neurons as well as at the level of neuronal network architecture and activity.

Some research has demonstrated important age-related changes in the physiology of individual hippocampal neurons. Calcium concentrations have been shown to increase with age in pyramidal cells (Toescu, Verkhratsky, & Landfield, 2004) and it is thought that this disruption in  $\text{Ca}^{2+}$  homeostasis is linked to age-related plasticity impairment (Foster & Norris, 1997; Landfield, 1988). Pyramidal cells in both subregions CA1 and CA3 of the senescent hippocampus have an increased after-hyperpolarization potential (AHP), caused by  $\text{Ca}^{2+}$  activated  $\text{K}^{+}$  currents (Kerr, Campbell, Hao, & Landfield, 1989; Landfield & Pitler, 1984; Moyer, Thompson, Black, & Disterhoft, 1992). These changes may be associated with decreased

neuronal excitability over longer periods of time. Since firing during behavior in the hippocampus tends to occur in bursts, and refractory time can increase because of the prolonged AHP and its associated  $\text{Ca}^{2+}$  current, this may lead to a decline in neuronal firing over time. It should be noted, however, that firing rates of aged CA3 pyramidal neurons are slightly higher than those in young animals (Wilson, Ikonen, Gallagher, Eichenbaum, & Tanila, 2005) and it has been proposed that hyper-excitability may be in part responsible for cognitive decline due to impairment in the accurate representation of a single memory trace. In addition to intracellular changes, there are also age-related differences in cell to cell interaction. The number of synaptic contacts per neuron in the middle molecular layer of the dentate gyrus is reduced with age (Geinisman, DeToledo-Morrell, Morrell, Persina, & Rossi, 1992), with the loss occurring primarily at excitatory, but not inhibitory, junctions (Geinisman et al., 1992).

Electrophysiological studies of synaptic activity in the DG have provided evidence (Barnes & McNaughton, 1980) to suggest that with age, there are fewer fibers, but these fibers increase in synaptic drive and are able to elicit a large postsynaptic current (Burke & Barnes, 2006; Foster, Barnes, Rao, & McNaughton, 1991). These data suggest that while the number of synapses is reduced, compensatory mechanisms lead to decreased cellular specificity, and thereby functional efficacy, of remaining synapses. These data again highlight the greater impact of functional, rather than solely structural, changes as the key to age-related cognitive decline.

### *Cholinergic Hypothesis of Ageing*

The cholinergic system is implicated in spatial processing, attention and synaptic plasticity (Everitt & Robbins, 1997; Hasselmo, 2006; Micheau & Marighetto, 2011). Each of these cognitive aspects are related to information processing and memory function. Rodent

lesion studies have demonstrated that a physical inactivation of the cholinergic system also leads to memory impairment (Gray & McNaughton, 1983). When cholinergic transmission is impaired, spatial processing also appears to be impaired (Lamberty & Gower, 1991; Opello, Stackman, Ackerman, & Walsh, 1993; Wishaw, 1985) which implicates this neuromodulatory system in spatial tasks. When acetylcholine is increased following disruption, spatial impairments are reversed (Hagan et al. 1989; Janas et al. 2005; Wang & Tang, 1998).

Acetylcholine release has been shown to mediate attention by inhibiting non-reinforced responses (Carlton, 1963), with research demonstrating that cholinergic agonists are associated with processing impairments through decreased inhibition of the cholinergic system (Hunsaker et al. 2007; Rogers & Kesner 2003). Memory encoding, retrieval and novelty detection have been linked to fluctuations in theta oscillations (Jutras & Buffalo 2010; Klimesch et al. 2001; Jeewajee et al. 2008), while gamma oscillations show increased amplitude during exploratory behaviours such as movement and sniffing (Bragin et al. 1995; Csicsvari et al. 2003). Neural oscillations can be visualized as waves that describe repetitive neural activity in the brain, and can be caused by the internal mechanisms of single neurons, or the interaction between neighboring neurons.

Theta (~4-8 Hz) and gamma (~30-70 Hz) oscillations are frequently studied in the brain as they are linked to information processing and learning (Nyhus & Curran, 2010). As various aspects of memory have been shown to be impaired as a result in changes in neural oscillations, and research has demonstrated that cholinergic function is also altered by changes in neural oscillations (Jacobson et al., 2013), then it seems apparent that studying the cholinergic system may lead to insight regarding memory deficits. Importantly, the efficacy of the cholinergic system in the brain is impaired with age, thus leading researchers to suggest that age-related changes in cholinergic function may underlie age-related cognitive deficits.

The cholinergic hypothesis of ageing posits that impairment in the cholinergic system are among the primary causes of age-related memory decline (Bartus et al., 1982). In turn, this idea suggests that augmenting the cholinergic system could reduce age-associated cognitive impairments. Aged rodents that demonstrate spatial learning deficits have a decline in choline acetyltransferase (ChAT) activity, as well as a decrease in the size and number of cholinergic neurons (Fischer, Chen, Gage, & Björklund, 1992; Fischer, Gage, & Björklund, 1989; Fischer, Nilsson, & Björklund, 1991; Koh, Chang, Collier, & Loy, 1989; Luine & Hearn, 1990). Additionally, age-related differences in neural oscillations associated with learning and memory have also been reported (Barry et al. 2012), and these oscillations can be restored through the systemic administration of cholinergic agonists (Jacobson et al., 2013). Since these alterations augment neural oscillations, and these oscillations are correlated with memory function, cholinergic agonists such as physostigmine likely contribute to the restoration of cognitive function.

### *Place Cells and the Mental Map*

When attempting to link changes in cholinergic system dynamics to cognitive deficits occurring during normal ageing, it is intuitive to use a system-level approach. A system-level approach in this case implies that a large portion of the memory system is being observed at the same time. This provides a comprehensive view of how the system is responding as a whole to a stimulus. Using a system level approach makes it easier to determine how the dynamics of the hippocampal tri-synaptic loop are altered with age. One way to assess cellular changes on a systems level is to use the place-cell system as a type of memory code. Place cells are, by their namesake, cells that respond selectively to specific places within an environment. Since a single

place cell is unable to encapsulate a complete representation of an environment, place cells operate as part of ensembles that activate concurrently to code information. When place cell ensembles become tied to a specific location, they are only recruited when the animal is in that region. Otherwise, they remain relatively silent. Importantly, while cellular ensembles usually represent a single location in the environment, this does not imply that individual cells within that group are not activated as part of other cellular ensembles. Since individual cells can be a part of multiple ensembles, the number of possible coded locations is quite high thereby making the place cell system ideal for coding spatial information. When an animal is placed into a novel environment, or introduced to a previously hidden part of an environment, place cell activity is observed within a few minutes (Frank, Stanley, & Brown, 2004; Wilson & McNaughton, 1993). Interestingly, place fields within two similar environments are not correlated (Muller & Kubie, 1987) and neighboring effects between place cells are not retained, even if the spatial geometry of the environments is the same (Kentros et al., 1998). For example, if a region of environment A is represented by two ensembles that are next to each other, a similar region in environment B may not have the same pattern of neighboring ensembles. These findings suggest that place cells activity reflects recent experience and that place fields are reset between different environments. Patterned activation of place cell ensembles has been seen in CA1 and CA3 pyramidal (Jung & McNaughton, 1993; O'Keefe, 1999) as well as dentate granule (Jung & McNaughton, 1993) cells. The spatial firing pattern of a group of place cells within a discrete area of an environment is called a place field. Place fields are formed rapidly following exposure to a novel environment and continue to change in response to changes in the environment after the initial exposure event (Frank et al., 2004; Wilson & McNaughton, 1993). By using tetrode recordings (probes that can detect distinct neuronal firing in the brain) to examine cellular activity, researchers have been

able to visualize many place fields within a single environment. By superimposing cellular spike data onto behavioural data, map out an animal's cellular representation of the environment with relative accuracy (Wilson & McNaughton, 1993). These 'place maps' differ between environments and are thought to be driven by a combination of external information in the environment and internal information (Markus et al., 1995; McNaughton, Barnes, & O'Keefe, 1984; Muller, Bostock, Taube, & Kubie, 1994). While place fields are highly driven by external visual cues, they can also be altered by internal cues. Locomotor activity, including speed, distance travelled, and bearing all contribute to an animal's internal information about an environment and have been shown to alter place field activity (Mizumori, 2006). This suggests that place maps are not generated by sensory cues alone. Non-sensory cues such as the internal representations of movement, spatial relationships between environmental features, and localized behavioural determinates, such as when an animal is trained to perform a certain task at a specific location, also contribute to the formation and alteration of place maps (O'Keefe & Nadel, 1978). Since place fields are sensitive to both internal and external stimuli, and episodic memory incorporates both types of information, the place cell system acts as a comprehensive memory code that can be used to model episodic memory in animal models. However, studying place cell dynamics alone does not provide a mechanistic explanation for the changes that take place with experience. For this, it is important to assess plasticity as it provides a model to understand the mechanisms that mediate place cell dynamics.

#### *Place Field Dynamics are mediated by Plasticity*

Plasticity, in the context of neuroscience, is the process by which the brain adapts to changing external and internal conditions. Neural plasticity is frequently studied at the cellular

level and is studied through long-term potentiation (LTP) and long-term depression (LTD). Long-term potentiation and depression represent changes in the strength of synapses that are activated in response to a stimulus. Long-term potentiation has two phases: induction (early-phase LTP) and maintenance (late-phase LTP) which are responsible for different elements of neuronal activity. Long-term potentiation is not a necessary component for many of the basic properties of place fields. An important aspect of spatial processing and memory is the ability to respond to changing conditions within an environment. While place cells do not depend on LTP to facilitate accurate representations of an environment initially, LTP is critical for place fields to adapt to changing circumstances. The ability to adapt to changing environmental conditions is an important cognitive function that is impaired with age. Assessing age-related changes in LTP provides insight into the effect of age on place field dynamics.

Some research has demonstrated that when animals are trained in an environment, and the environment is altered after initial training, place cells are able to adapt to this new information by reorganizing previously formed place fields (Smith & Mizumori, 2006). Research has demonstrated that NMDA alters synaptic plasticity, and that NMDA blockades eliminate existing LTP within hippocampal place cells (Kentros, Hargreaves, Hawkins, Kandel, Shapiro, & Muller, 1998; Tonegawa, Tsien, McHugh, Huerta, Blum, and Wilson, 1996). Additional work has shown that protein synthesis, a process known to be driven by LTP, is necessary for long-term stability of hippocampal place fields (Agnihotri, Hawkins, Kandel, & Kentros, 2004). Place field expansion is an important type of place field adaptation. It refers to the observed place field shift in the direction opposite of the one travelled, in combination with an increase in the size of the place field. Place field expansion occurs in response of repeated exposure to a closed environment, specifically during track running tasks (Lee, Rao, & Knierim, 2004; Mehta et al.,

1997). Track running tasks typically involve a closed environment where the animal travels in a circular fashion in the same direction, and in so doing passes repeatedly through each part of the maze. Place field expansion has been observed in the CA1 and is episode specific, resetting between epochs of track running (Mehta et al., 1997). It is suspected that this reset is related to entorhinal cortex activity during the rest period, as it has been observed that the EC Layer III-CA1 synapse can override and abolish LTP that is induced at the Shaffer Collateral to CA1 synapse (Izumi & Zorumski, 2008). This can be interpreted to suggest that EC to CA1 synapses may be responsible for not only the initiation of LTP, but also the resetting of LTP between trials (Burke & Barnes, 2010).

#### *Age-Related Changes in Plasticity*

Normal ageing is associated with aberrant changes in plasticity and these changes reliably correlate with changes in memory performance. In spatial tasks such as the water maze, a binary pattern of location acquisition can often be observed early in training such that animals are either able to find the platform locations efficiently or not across trials (Barnes et al., 1997). When tested over many days, young animals develop a relatively unimodal pattern, as they appear to recall the target location and swim to it directly. In contrast, aged animals tend to retain a bimodal pattern for the duration of trials, suggesting that their learning of the target location is impaired throughout training (Barnes et al., 1997), though there has been some evidence for alternate learning strategies that do not conform to this model (Gallagher et al., 2006). Such learning deficits are thought to be errors in map retrieval caused by flaws in LTP processes. When this type of paradigm was replicated with young animals that had NMDA-receptor blockades (Kentros et al., 1998) and protein synthesis inhibitors (Agnihotri, Hawkins, Kandel, &



Kentros, 2004) a similar bimodal pattern emerged. As both NMDA-receptor activation and protein synthesis are required for successful LTP, these results suggest that LTP impairments underlie spatial learning deficits in aged animals. In addition to behavioural evidence for age-related LTP deficits, there is also evidence for age-related deficits in place field adaptation that are thought to be driven by LTP impairment.

In both CA1 and CA3 sub-regions it appears that aged animals occasionally do not alter place fields in response to changes in context, even when presented with dramatically altered environments (Tanila, Shapiro, Gallagher, & Eichenbaum, 1997; Tanila, Sipilä, Shapiro, & Eichenbaum, 1997). Some research has suggested that impairments in communication between DG granule cells and CA3 pyramidal cells are responsible for age-associated impairments in CA3 place field adaptation (Burke & Barnes, 2006). In hippocampal subregion CA1 of young rats, place fields tend to expand during repetitive movement through an environment, for example during movement around a closed track in a single direction. The mass of place fields that are formed during repetitive movement in a single bearing tends to shift in the direction opposite of that traversed trajectory (Mehta, Barnes, & McNaughton, 1997). Additionally, aged animals sometimes show impairments in the maintenance of place fields after a period of time (Barnes, Suster, Shen, & McNaughton, 1997) perhaps reflecting age-related deficits in place field stability (Barnes et al., 1997). Interestingly, aged animals seem to retain more rigid CA3 place fields even when the environment is vastly different (Wilson, Ikonen, Gallagher, Eichenbaum, & Tanila, 2005) as compared to young animals that are able to establish distinct place maps (Head et al., 1995; Wilson et al., 2005). These changes are thought to be a downstream consequence of alterations to granule cell activity in the DG, which is particularly

vulnerable to the ageing process (Small, Chawla, Buonocore, Rapp, & Barnes, 2004; Small, Tsai, DeLaPaz, Mayeux, & Stern, 2002). Another important aspect of plasticity is induction level.

Researchers are able to induce changes in cellular activity by direct stimulation with an electrode. When robust, high-frequency and high-amplitude stimulation is used, aged animals can display intact LTP induction in various areas of the hippocampus including the perforant path-granule cell synapse (Barnes, 1979; Diana, Domenici, Loizzo, Scotti de Carolis, & Sagratella, 1994; Diana, Scotti de Carolis, Frank, Domenici, & Sagratella, 1994), the CA3-CA1 Schaffer Collateral synapse (Landfield & Lynch, 1977; Landfield, McGaugh, & Lynch, 1978) and the perforant path to CA1 pyramidal cell synapse (Dieguez & Barea-Rodriguez, 2004). However, it appears that age-related differences in plasticity induction are most notable at lower induction levels, referred to as peri-threshold stimulation (Deupree, Turner, & Watters, 1991; Moore, Browning, & Rose, 1993; Rosenzweig, Rao, McNaughton, & Barnes, 1997; Tombaugh, Rowe, Chow, Michael, & Rose, 2002).

As behavioural and cellular data demonstrate, plasticity deficits appear to underlie changes in the dynamic function of hippocampal place cells. Thus, one way to search for mechanisms for age-related changes in place cell dynamics is to examine the gene products that mediate plasticity.

#### *Immediate-Early Genes Mediate Plasticity*

Commonly studied mediators of synaptic plasticity are immediate-early genes (IEGs). Immediate-early genes are markers of neuronal activity within the brain and are expressed during activity. Immediate-early genes are expressed following LTP induction (Cole, Saffen, Baraban, & Worley, 1989; Dragunow et al., 1989; Wisden et al., 1990) and appear to be dynamically

regulated by the specific patterns of synaptic activity that have been thought to underlie learning and information processing in the brain (Cole et al., 1989) and patterns of IEG expression are tightly coupled to spatial processing in particular (Guzowski, McNaughton, Barnes, & Worley, 1999). Activity-regulated cytoskeletal gene (*Arc/Arg3.1*) is a well-studied immediate-early gene that has been repeatedly implicated in hippocampal-dependent learning and memory (Burke & Barnes, 2006, 2010). It is thought that *Arc* is involved in the structural rearrangement of activated dendrites (Lyford et al., 1995). Importantly, *Arc* is necessary for the maintenance of both LTP as well as long-term memory (Guzowski et al., 2000). Importantly, tying these changes in gene expression to system-wide changes in place cell dynamics requires a technique that is able to provide information about a large number of cells simultaneously in the behaving animal with cellular resolution.

#### *Immediate-Early Gene Expression can be Assessed using catFISH*

One way to examine IEG activity in the behaving animal is by using cellular compartment analysis of temporal activity by fluorescence *in situ* hybridization (catFISH). Simply put, catFISH is a temporally sensitive technique that is used to examine gene expression following behaviorally based spatial tasks (Guzowski et al., 1999). However, the true benefit of this technique is that it assesses electrotranscriptional coupling (ETC). Electrotranscriptional coupling is the association between neural activity and IEG transcription (Guzowski et al., 2006). Knowing about ETC is important because it provides a direct link between neuronal activity, gene expression, and behaviour. Once the dynamics of ETC are known for a specific gene product, a specific behaviour can be linked to distinct patterns and amounts of neuronal activity across widespread brain regions by quantifying gene expression. Since the expression of *Arc* is

tightly coupled to neuronal activity, examining this gene product permits the visualization of behaviorally-induced plasticity. Two features of this approach are particularly advantageous. The first is temporal sensitivity – catFISH – allows the resolution of cellular activity during two distinct time points within the same animal. In the case of *Arc* expression, the IEG is transcribed in the nucleus of neurons within five minutes of activation and takes approximately 30 minutes to translocate to the cytoplasm of the cell (Vazdarjanova, McNaughton, Barnes, Worley, & Guzowski, 2002). The way in which ETC in relation to *Arc* might change with age remains relatively uncharacterized, and this provides part of the rationale for the current study. Moreover, the few data points that have addressed this issue suggest ways in which *Arc* ETC may be different in aged animals relative to younger ones.

#### *Arc Expression is altered by Age*

A recent study (Penner et al., 2011) examined age-related changes in *Arc* transcription in the hippocampus (DG and CA1) using catFISH and reverse transcription quantitative polymerase chain reaction (RT-qPCR) following a standard open-field spatial exploration task. In this experiment, researchers used a common spatial task (Guzowski et al., 1999) in which animals were permitted to explore an open field for five minutes then immediately sacrificed. In addition to cellular analysis using catFISH, RT-qPCR was used to examine the amount of gene transcription taking place within cells by assessing the quantity of mRNA within the brain. Using this with catFISH is extremely powerful because it provides information about which cells are active, and how much activity is present within cells. The study found no difference between young and aged animals in the proportion of cells recruited. However, there were differences in the amount of transcription taking place per cell, as measured by RT-qPCR. Comparing the

resting levels of *Arc* transcription in CA1 from caged control animals that did not experience the maze, aged animals had lowered resting levels of *Arc* transcription than adult animals. However, when caged controls were compared to experimental animals of the same age, there was an equal increase in *Arc* transcription in both adult and aged animals. That is, there was a difference in *Arc* transcription between adult and aged animals, and this difference was driven by resting rates of gene transcription. In the DG, there was no difference in resting *Arc* transcription levels; however there was an observed difference in the increase of *Arc* transcription following the behavioural exploration. Aged animals showed a smaller increase in *Arc* relative to caged control, thus leading to decreased *Arc* transcription compared to young adult animals. This difference was driven by the behavioural exploration rather than baseline levels. Age-related differences in DG gene transcription may also be mediated by the glutamatergic system. The dentate gyrus and CA3 sub-regions of the hippocampal formation undergo various changes during normal ageing, including an increased capacity for the clearance of glutamate. Glutamate release is increased with age as a result of gliosis induced excitotoxic trapping, and age-induced increases in the release capacity of DG perforant path terminals (Stephens, Quintero, Pomerleau, Huettl, & Gerhardt, 2011). The present study aims to assess age-related differences in gene expression as well, but instead of using robust behavioural stimulation, as was done previously (Penner et al., 2011), the present study used a behavioural analogue of limited LTP induction because previous work has suggested that age-related differences in LTP are more apparent at lower levels of induction (Moore et al., 1993; Deupree et al., 1993).

*Present Study*

The purpose of this study is to examine age-related differences in IEG-expression following limited behavioural induction. There are several lines of research that feed into the present study. First, this study aims to assess age-related changes in gene expression, similar to Penner and colleagues (2011) work. However, rather than using a spatial exploration task that may be a behavioural analogue of robust stimulation, the present study aims to examine age-related changes in gene expression following a behavioural task that represents minimal LTP induction. Using a behavioural paradigm is ideal for examining system-level changes in neuronal activity by way of IEG expression. Since age-related differences in LTP are more evident at lower levels of stimulation, we used a behavioural analogue of minimal induction to assess age-related differences in cellular recruitment and gene expression. Animals traversed 1, 3, or 5 laps around an enclosed track, similarly to previous work (Miyashita et al., 2009). Due to the nature of place fields, the number of laps in this paradigm corresponds to the number of neuronal spikes which can be used as a measure of LTP. Previous work examined IEG expression in young animals (Miyashita et al., 2009). In the present study, *Arc* expression will be assessed in adult and aged animals instead. We hypothesize that adult and aged animals would have equal proportions of *Arc*-positive cells, but the amount of gene transcription within cells would differ between groups. In this study, levels of gene transcription in the cell will be assessed through fluorescence analysis which has been shown to be analogous to RT-qPCR (Miyashita et al., 2009). Limited behavioural induction was achieved by having rats traverse a varying number of times (1 lap, 3 laps, or 5 laps) around a triangular track. Subsequent cellular analysis was performed to assess the IEG *Arc* within the hippocampal region. The limited behavioural

exposure to the environment is a behavioural analogue of minimal stimulation and has been used previously to mimic such induction thresholds behaviorally (Miyashita et al., 2009). In contrast to the open field exploration task, which can be considered a behavioural analogue of supra-threshold stimulation, used by Penner and colleagues (2011) to assess age related changes in *Arc* transcription, Miyashita and colleagues (2009) used a track running paradigm, similar to the one used in the present study, as a behavioural analogue of peri-threshold LTP induction. In their study, young (3 months) and adult (9 months) rats traversed a rectangular track between 1 and 16 times over the course of 4 days (Miyashita et al., 2009). They found that one lap, representing a single pass through a single place field (Mehta, Barnes, & McNaughton, 1997), was enough to elicit robust gene expression in a complete CA3 neural ensemble, reflecting the sub-region's propensity for rapidly encoding one-trial learning (Lee et al., 2004; Lee and Kesner, 2002; Nakazawa et al., 2003). The CA1, in contrast, did not show robust gene expression until 4 laps were traversed on a single day (Miyashita et al., 2009).

We repeated this paradigm with adult (11 months) and aged (23 months) F344 rats to assess possible age-related differences in *Arc* transcription in a behavioural approximation to peri-threshold plasticity induction. Additionally, to test cholinergic effects on these dynamics, animals were also administered physostigmine, a cholinergic agonist, which has been shown to modulate hippocampal physiology (Jacobson et al., 2013). We expect that aged animals that are administered physostigmine will show levels of IEG transcription that are comparable to their younger counterparts, reflecting improvement in spatial processing and memory function.

## Methodology

### *Subjects*

Twenty-four male F344 rats (Harlan Laboratories, Indianapolis, IN) were used; 12 adult (13 months) and 12 aged (23 months) animals were separated into three experimental groups. An additional 5 caged control animals were used, with both age groups being represented. Both cage control and experimental animals were single housed. While experimental animals were exposed to the lap-running task, cage-control animals were not removed from the colony room until they were sacrificed.

Behavioural training, testing, tissue extraction and brain slicing was performed at the University of Connecticut.

### *Behavioural Training*

Control animals were sacrificed from their home cage, with no exposure to the maze.

Experimental animals were handled and acclimated with the mazes for five days prior to testing. All behavioral testing was completed in a large room that contained an equilateral triangular maze (112.4cm-side, 10.8cm-wide runways) in the center of the room. Animals in each experimental condition were transported from the colony room to the experimental room in covered cages. Once in the procedure room they were released onto the track at a fixed location and completed 1, 3, or 5 laps around the track. Thereafter, animals were injected with physostigmine (0.1 mg/kg sc) and after 25 minutes, the animal ran 1, 3, or 5 laps on the same track. This experience was counterbalanced, such that some animals ran 1 lap in their first bout of track running and then ran 5 laps (4 animals/age group), a second group ran 5 laps in their first bout of track running and then ran 1 lap (4 animals/age group), and a third group ran 3 laps in



each session (4 animals/age group). In order to provide enough time for *Arc* transcripts to be produced, rats were given 5 minutes to complete their laps around the track. Any animal completing in less than 5 minutes was returned to their home-cage until 5 minutes had elapsed since the start of their second track running experience. If a rat took 5 minutes or more to traverse their laps they were sacrificed immediately after exploration.

#### *Tissue Extraction*

Following the second exposure, animals were deeply anesthetized with isoflourane and decapitated. Tissue was extracted within 3 minutes and flash-frozen in isopentane (Sigma-Aldrich, Oakville, ON) and stored at -80°C until used. Coronal sections were obtained using a cryostat (20 µm thick slices) and thaw-mounted onto slides (Superfrost Plus, VWR) such that all experimental groups were represented on each slide. Slides were subsequently air dried and stored a -80°C until processing.

#### *Fluorescence In Situ Hybridization*

This technique was conducted by the me at Wilfrid Laurier University, as described previously (Guzowski et al., 1999). A full-length *Arc* riboprobe was synthesized from a commercially available transcription kit (Ambion Austin, TX). Randomly selected sections from the dorsal and ventral hippocampus were selected (Guzowski et al., 1999; Vazdarjanova & Guzowski, 2004). *Arc* riboprobes were conjugated to digoxigenin-labeled UTP, purified using a mini-quick spin column (Roche) and verified by electrophoresis. Slides were thawed, fixed using 4% formaldehyde, then bathed in 0.5% acetic anhydride, 1;1 methanol/ethanol, and saline-sodium citrate (SSC). Slides were then incubated at room temperature for 30 minutes with 110µl

prehybridization buffer (Sigma, St Louis, MO). The riboprobe was then diluted in hybridization buffer (Sigma), denatured at 90°C, chilled on ice, and 110µl was pipetted onto each slide. Slides were incubated in a humid chamber at 56°C for 18 hours. Once the incubation was complete, slides were cooled to room temperature and bathed several times in SSC. Next, slides were soaked in RNase A (10mg/ml) for 15 minutes at 37°C, quenched with H<sub>2</sub>O<sub>2</sub> and blocked with tyramide signal amplification blocking buffer (Perkin-Elmer, Boston, MA) containing 5% normal sheep serum. Slides were then incubated for 2 hours at room temperature with anti-digoxigenin-HRP (Roche Applied Sciences, Montreal, PQ). Following this incubation, slides were washed with Tris-buffered saline containing 0.05% Tween 20 (TBS-T). Slides were then incubated for 35 minutes at room temperature with CY3 (cyanine-3) signal amplification kit (Perkin-Elmer). Slides were then washed with TBS-T several times, and counterstained with 4'-6-Diamidino-2-phenylindole. Vectashield anti-fade medium (Vector Laboratories, Burlington, ON) was applied to tissue, and coverslips were sealed with nail polish.

### *Microscopy*

A FV-1000 laser scanning confocal microscope (Olympus Canada, Mississauga, ON) was used to collect images from dorsal and ventral hippocampal areas. Dorsal regions were contained between -3.60 and -4.52mm from Bregma, while ventral regions range from -4.80 and -5.80mm from Bregma. To ensure consistency between images, pinhole size, photomultiplier tube assignments, and contrast values were kept constant for all slides. Three-dimensional z-stacks (optical thickness, 1.1µm; interval, 0.7µm) were collected at 40x magnification through the entire slice. Three slides were used for each animal.

### *Image Analysis*

All image analysis was done using Metamorph Offline Image Analysis Software (Molecular Devices). Cellular recruitment was quantified by separately examining the proportion of cells transcribing *Arc* during each exploration. Cells active in the first epoch expressed *Arc* in the cytoplasm and cells active in the second epoch expressed *Arc* in the nucleus. The amount of gene transcription was assessed by calculating the mean integrated intensity of *Arc* within many individual cells. Eighty percent of cells that had nuclear gene expression were selected from each image. For each selected cell, measurements of signal intensity were taken from every plane that contained signal (see Figure 3). After collection was done, the intensities for each plane of a cell were summed up and all cells in an image were averaged to give a mean representation of intensity in each image. This method is comparable to previously used methods and is shown to be highly correlated with qPCR (Miyashita et al., 2009). Importantly, since physostigmine was administered prior to the second epoch, any effects observed during the second epoch can be interpreted as an effect of physostigmine administration.

### *Statistical Analysis*

Analyses for the dependent variables, cellular recruitment and integrated intensity, were separated because the total number of observations for each was different (cellular recruitment  $N = 432$ ; integrated intensity  $N = 216$ ). Each observation represented the cellular recruitment or the integrated intensity of a single region in a single animal within either the first or second epoch. Independent variables for cellular recruitment include Age, Drug, Laps, hippocampal region along the dorsoventral (DV) axis (also known as the septo-temporal axis) and region along the transverse (TV) axis, while independent variables for integrated intensity include Age, Laps, as

well as DV and TV regions (see Table 1 for details). An *a priori* contrast was also included in the model to assess differences between CA3 sub-regions and CA1 subregions since previous work has demonstrated differences in cellular recruitment between these hippocampal areas (Vazdarjanova & Guzowski, 2004). To assess main effects and interactions of all variables on cellular recruitment and integrated intensity, two univariate ANOVAs were performed. Post hoc tests were performed using Fisher's least significant difference to assess specific differences for non-binary variables (i.e., TV region and laps). Because drug administration was a within-subject manipulation, a paired t-test was performed to assess differences in cellular recruitment before and after physostigmine administration.

## Results

Main effects and interactions of each independent variable are provided for cellular recruitment during epoch 1 (i.e., 30 minutes prior to the sacrifice of the animal, Figure 4) and epoch 2 (i.e., 5 minutes prior to the sacrifice of the animal, Figure 5) as well as the integrated intensity of *Arc* expression during epoch 2 (Figure 6) below.

### *Recruitment*

Cellular recruitment was mediated by various factors, with several significant main effects and interactions observed among the variables tested, with drug administration, laps, and both TV and DV regions having an effect. Adult and aged animals did not significantly differ in levels of cellular recruitment,  $F(1, 304) = 1.437, p = 0.232$  with an observed power of 0.223. However, a significant main effect of laps was observed,  $F(3, 304) = 4.102, p = 0.007$ . Post hoc tests revealed that three ( $p < 0.001$ ) and five laps ( $p = 0.002$ ) differed from cage controls (see Figure 7). A main effect of TV region was observed  $F(4, 304) = 12.436, p < 0.001$  (see Figure

8). Post hoc tests revealed a gradual increase in cellular recruitment from the CA3c to the mCA1, with significant differences between the CA3c and the CA3a ( $p = 0.031$ ), ICA1 ( $p < 0.001$ ), and mCA1 ( $p < 0.001$ ). Additionally, CA3b was associated with significantly lower levels of cellular recruitment than ICA1 ( $p = 0.011$ ) and mCA1 ( $p = 0.001$ ). The *a priori* contrast assessing differences between CA3 and CA1 subregions was found to be significant  $F(1, 304) = 40.991, p < 0.001$  (see Figure 9), with CA1 subregions being associated with significantly more cellular recruitment than CA3 subregions. Cellular recruitment was also significantly higher in dorsal regions relative to ventral regions,  $F(1, 304) = 54.127, p < 0.001$  (see Figure 10). A within-subject effect of physostigmine was observed such that cellular recruitment was significantly higher after physostigmine administration,  $t(215) = 9.393, p < 0.001$  (see Figure 11).

Several two-way interactions were also observed. A significant two-way interaction was observed between Laps and Age,  $F(3, 304) = 2.646, p = 0.049$ . Adult animals displayed significantly increased levels of cellular recruitment following 5 laps compared to caged controls, while aged animals showed significantly increased cellular recruitment relative to caged control only following 3 laps, as illustrated in Figure 12. A significant Region by Drug interaction was observed  $F(4, 304) = 2.871, p = 0.023$ . As illustrated (Figure 13), an increase in cellular recruitment across regions was only observed following physostigmine administration. A significant Drug by DV interaction was found,  $F(1, 304) = 5.342, p = 0.021$ . While cellular recruitment in both dorsal and ventral regions was increased as a function of physostigmine administration, the increase from the first epoch to the second was greater in dorsal regions (see Figure 14). A significant interaction between Laps and DV was observed,  $F(3, 304) = 4.682, p = 0.003$ . No differences were observed across laps in ventral regions, while in dorsal regions, 3 and

5 laps were associated with significantly more cellular recruitment compared to cage controls (Figure 15).

A significant three way interaction was observed between DV, Age, and Laps,  $F(3, 304) = 6.986, p < 0.001$ . As illustrated in Figure 16, a difference exists in the nature of the interaction between age and laps across DV. Figure 16a illustrates the interaction between age and laps in ventral regions, where no age or laps differences were observed with regard to cellular recruitment. In dorsal regions, aged animals had significantly more cellular recruitment relative to cage controls following 3 laps, while adult animals display increased cellular recruitment following 5 laps (see Figure 16b).

### *Intensity*

Integrated intensity was mediated by the number of laps traversed and DV region. A significant difference in integrated intensity was observed as a function of Laps,  $F(3, 152) = 5.322, p = 0.002$ . Post Hoc tests revealed that one ( $p = 0.05$ ), three ( $p < 0.001$ ), and five laps ( $p = 0.005$ ) were associated with significantly higher integrated intensity of *Arc* relative to caged controls (see Figure 17). Additionally, as illustrated in Figure 18, dorsal regions were associated with significantly higher integrated intensity of *Arc* as compared to ventral regions,  $F(1, 152) = 8.439, p = 0.004$ . No significant effect of TV region,  $F(4, 152) = 2.179, p = 0.072$ , or Age,  $F(1, 152) = 3.450, p = 0.065$ , on integrated intensity were observed.

## Discussion

*Age Differences in Electrotranscriptional Coupling*

While aged animals did not differ significantly from adults in the proportion of cells recruited under any of the individual conditions of the present experiment, several significant interactions indicated that age may play a complex role in determining the pattern of *Arc* expression during behavior. Cellular recruitment was higher following either three or five laps overall relative to caged controls, consistent with previous literature on *Arc* expression. In addition, the observation of a significant interaction between age and the number of laps suggests that, as hypothesized, ageing alters *Arc* expression. Because the basic biophysical properties of individual hippocampal pyramidal cells are preserved in senescence and these cells express normal place fields (Sharp, Barnes, & McNaughton, 1987; Barnes & McNaughton, 1989), and because no difference in *Arc* expression is seen with longer bouts of exploratory activity (Penner et al., 2011), this is not likely to be due to a change of the activity that these cells receive from cortical inputs. The more likely explanation is that the age-related shift in *Arc* expression is a result of a change in electrotranscriptional coupling – the transcriptional response that occurs in reaction to a set amount of stimulation (Guzowski et al., 2006). The direction of this effect, however, is contrary to what is predicted on the basis of previous literature.

In posthoc testing, the number of cells expressing *Arc* in the hippocampus of adult rats was significantly higher than caged controls only in the group that completed five laps. In contrast, aged animals showed a significant increase in the number of cells expressing *Arc* relative to caged controls after three laps on the track and not after five. This discrepancy suggests that comparable stimulation levels may induce different levels of cellular recruitment in

adult and aged animals. Assuming that three laps results in lower levels of stimulation than five laps, and that stimuli that induce LTP will consistently also induce *Arc*, these data suggest that aged cells are more sensitive to lower levels of stimulation than adult cells. This result, however, is inconsistent with previous electrophysiological data. Previous work has demonstrated that with peri-threshold stimulation, lower levels of LTP are induced in CA1 pyramidal cells of senescent animals relative to CA1 cells of young adults (Deupree, Bradley, & Turner, 1993; Moore, Browning, & Rose, 1993).

Although these data are not consistent with the hypothesized effect, and are difficult to explain at this time, it remains intriguing that age-related differences were observed. These differences, while counterintuitive, do lend support to the idea that an analogue of minimal stimulation provides insights that are different from those obtained from examining animals that have engaged in unrestricted exploration for several minutes. Importantly, the interaction between age and stimulation was only observed in dorsal, but not ventral, hippocampal regions (see Figure 16). These observations can be explained by differences in the spatial tuning of dorsal and ventral hippocampus.

#### *Functional Gradients in Arc Expression and Hippocampal Function*

Along the septotemporal axis, a functional gradient exists such that within more dorsal regions many more cells will express place fields in a given environment (Strange, Witter, Lein, & Moser, 2014). Consistent with the tight coupling between *Arc* expression and place cell activity, dorsal hippocampal regions show more *Arc*-expressing cells than their ventral counterparts (Figure 10). Moreover, there is a difference in place field size along the septotemporal axis that is of relevance to the current observations. A single cell in the dorsal



hippocampus will express a place field that will cover a very small fraction of the arena, typically 20-25 cm<sup>2</sup> (Maurer et al., 2006), while a single place field in the ventral hippocampus may cover most or all of the track, up to 1 m<sup>2</sup> (Kjelstrup et al., 2008). As a result, for a dorsal hippocampal pyramidal cell that expresses a place field on the track, a single lap through the track will result in high frequency firing on the order of a dozen spikes over the course of a second. This amount of stimulation is within the same magnitude as two theta-bursts, a protocol that is often used to induce minimal LTP (Albensi, Oliver, Toupin, & Otero, 2007). In contrast, a single lap around the track may result in a place cell in the ventral hippocampus firing during most or all of the lap (Figure 19). Thus, even in the current minimal stimulation paradigm, only the dorsal hippocampus exhibits an amount of activity that is likely to be peri-threshold. This inherent difference in the amount of activity may explain both why the dorsal hippocampus is more sensitive to both the number of laps run (Figure 15) and physostigmine administration (Figure 14).

These inherent differences may also help explain the types of cognitive tasks that the dorsal and ventral hippocampus are critical for. While the dorsal hippocampus is critical for spatial tasks, the ventral hippocampus is thought to mediate associations between contexts and affective states (Fanselow & Dong, 2010). Additionally, since ventral hippocampal cells also code for emotion and stress, they allow in interface between affective information and a low-resolution spatial processing system. The fact that the ventral hippocampus is inherently low-resolution is thought to explain why, following contextual fear conditioning, animals show a fearful response to a context in general and do not respond only to the corner of the enclosure that they happened to be in when they received footshock (Radulovic, Kammermeier & Spiess, 1998). Intuitively, having associations with threatening stimuli be inherently more generalized

may be a more fit strategy to react appropriately. The fact that no age-related differences were observed in the ventral hippocampus suggests that performance on tasks that are dependent upon the ventral hippocampus, like contextual fear conditioning, should be relatively preserved with age. Recent data shows that, at least under most circumstances, this seems to be the case (Houston, Stevenson, McNaughton, & Barnes, 1999).

Differences in cellular recruitment (i.e., the proportion of *Arc*-expressing cells) were also observed between regions across the transverse (TV) axis. Overall, it appears that cellular recruitment increased along this axis in a pattern that reflects the path of information through the tri-synaptic circuit, increasing gradually from CA3c through to mCA1 (see Figure 8). This is consistent with the idea that there is an initial compression of input as cortical information enters the hippocampus, with gradual decompression within the tri-synaptic loop aids in the discrimination of similar contexts and events (Guzowski, Knierim, & Moser, 2004) and is consistent with previous observations of *Arc* expression (e.g, Gheidi et al., 2012).

### *Arc and One-Trial Learning*

The present study did not show evidence that a single lap was sufficient to induce robust *Arc* expression in either adult or aged animals. This finding is not consistent with the previous study that this experiment was meant to replicate (Miyashita et. al., 2009). The data from Miyashita and colleagues showed that a single lap around a track was enough to induce robust *Arc* expression in the CA3 sub-region of the hippocampus, and this observation was used to argue that rapid *Arc* expression in CA3 may support this region's role in one-trial learning tasks. Several differences exist, however, between the paradigm used here and the methods of Miyashita and colleagues that warrant discussion.

Unlike Miyashita's experiment, the present study included several days of handling before testing began. This handling is associated with decreased levels of stress, which can in turn alter gene expression (Mikkelsen & Larsen, 2006). In addition, Miyashita and colleagues (2009) did not pre-train animals on the track-running task, so the environment was novel to the animals. Previous work has shown that novelty does not affect the pattern of hippocampal *Arc* expression (Chawla et al., 2005; Guzowski et al., 2006), however, so this factor is unlikely to account for the discrepancy between the current data and the observations of Miyashita and colleagues. In addition to handling, animals were pre-trained to run on a track similar to the one used for the experiment prior to the start of the experiment. In contrast, the animals in Miyashita's study were naïve and had to be guided along the track by the researcher. This may have influenced the speed at which animals traversed the track, which has been shown to influence gene expression, and presumably neuronal firing, in both adult (Hunsberger et al., 2007; Molteni, Ying, & Gómez-Pinilla, 2002; Tong, Shen, Perreau, Balazs, & Cotman, 2001) and aged (Stranahan et al., 2010) animals. While this seems the most likely cause for the differences in the results obtained, no data regarding the speed of travel were published by Miyahita to corroborate this hypothesis.

#### *Integrated Intensity of Arc Expression*

Integrated intensity of *Arc* is measured by calculating the brightness of nuclear foci signal within a cell and provides a quantitative measure of the amount of *Arc* that has been transcribed in an individual cell. In the present study, both DV region and the number of laps traversed affected the integrated intensity of *Arc* expression. Integrated intensity values were significantly different in previous work as compared to prior findings. Previous studies (Miyashita et al.,

2009; Penner et al 2011) use an automated algorithm to determine upper and lower bounds of fluorescent signals that correspond to *Arc* expression. Once upper and lower limits are set, the program determines the integrated intensity level of each signal. Using this technique, the previous findings demonstrated that the integrated intensity typically falls between 1000 and 4000 arbitrary units. However, this range was not replicated here despite using the same program, with the exception that measurements were made manually. In the present study, integrated intensity values ranged from 3500 to 75000 units. The most likely explanation for this discrepancy is physostigmine administration. Because the only quantitative assessment of the intensity of *Arc* expression is after the administration of physostigmine (see below) and physostigmine increased the number of cells expressing *Arc* in general across the hippocampus, it is likely that physostigmine also increased the amount of *Arc* being produced in individual cells, and thus the integrated intensity of fluorescence. Testing this hypothesis, however, is outside the scope of the current thesis.

### *Limitations*

Due to a series of technical difficulties, this study contains an incomplete dataset. Originally, the project was intended to involve double-labelling with *Arc* and *Homer1a*. Since *Arc* is expressed in the nucleus after 5 minutes, and *Homer1a* is expressed in the nucleus after 30 minutes, measuring the expression of both of these gene products would have provided many advantages. Because the quantitative measurement of cytoplasmic gene expression is both labor-intensive and inaccurate, labeling of only *Arc* in the present study meant only having a quantitative gene expression measurement of intra-nuclear *Arc* generated after physostigmine administration. The addition of an intra-nuclear *Homer1a* fluorescent signal would have allowed

a comparable assessment of the intensity of gene expression (and thus activity) prior to physostigmine injection and thus would have allowed a direct comparison of the amount of gene expression in the two behavioural epochs. As result of our inability to successfully obtain this label, this comparison cannot be made here. Due to the lack of Homer1 staining, no data on the integrated intensity of *Arc* was obtained for the first epoch. This means that no comparison can be made between the intensity of cells with or without physostigmine administration. In addition, a freezer malfunction destroyed the remaining tissue so that no further protocol development is possible.

### *Implications*

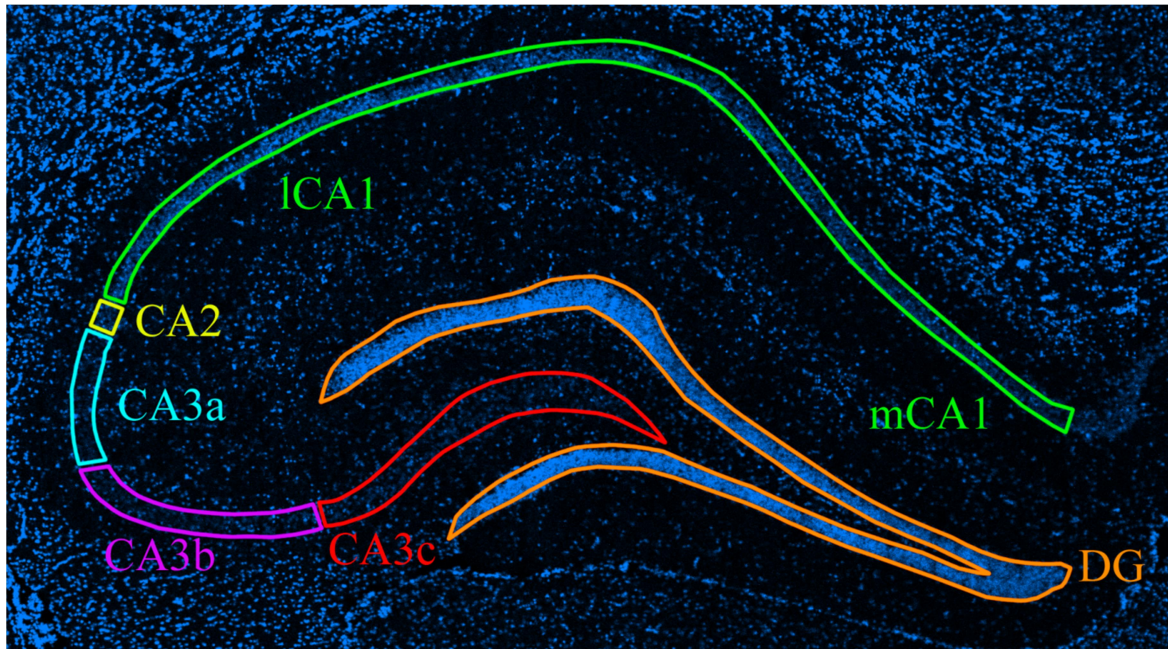
The current data have several implications for future investigations. Among these, the most important is that minimal behavioral induction is a useful paradigm to study activity-related gene expression. Despite the fact that the pattern of results obtained here are counter-intuitive and difficult to explain, they are significantly different from those found when animal navigate through spatial environments for more prolonged periods. As a result, this behavioral paradigm provides a novel tool to assess changes in gene expression across a wide range of manipulations that may affect memory formation and neural plasticity. Additionally, this work provides further evidence of the differences in the response of hippocampal cells along both the dorsoventral and transverse axes during spatial processing. These data adds to a growing body of evidence that continues to reveal functional gradients in the hippocampus.

While the current data failed to replicate previous studies in several regards, these assessments are important to refining our knowledge of hippocampal function. This is particularly true in the case of age-related cognitive change. The continuing increase in the

mean age of the world's population, along with the risk of cognitive decline, creates great impetus to understand the way that the brain's memory system evolves across the lifespan. Continued investigation in this area may inform the development of therapeutic interventions that will permit more individuals to avoid age-related cognitive decline.

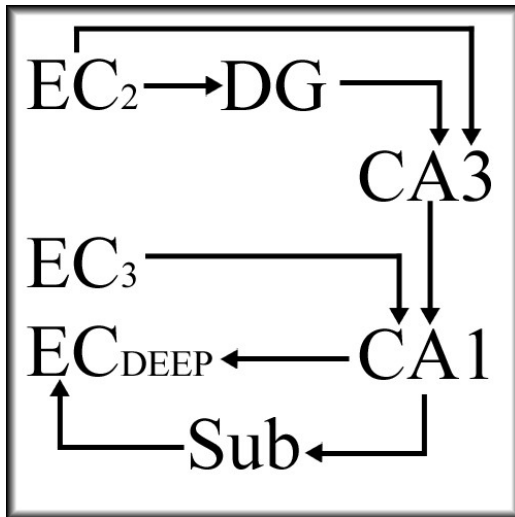
Table 1. List of independent variables assessed for each dependent variable.

Cellular Recruitment		Integrated Intensity	
Independent Variable	Levels	Independent Variable	Levels
Age	Adult (13 mo) Aged (23 mo)	Age	Adult (13 mo) Aged (23 mo)
Drug	Drug Control Physostigmine		
Laps	Cage Control 1 Lap 3 Laps 5 Laps	Laps	Cage Control 1 Lap 3 Laps 5 Laps
TV Region	CA3c CA3b CA3a lCA1 mCA1	TV Region	CA3c CA3b CA3a lCA1 mCA1
DV Region	Dorsal Ventral	DV Region	Dorsal Ventral

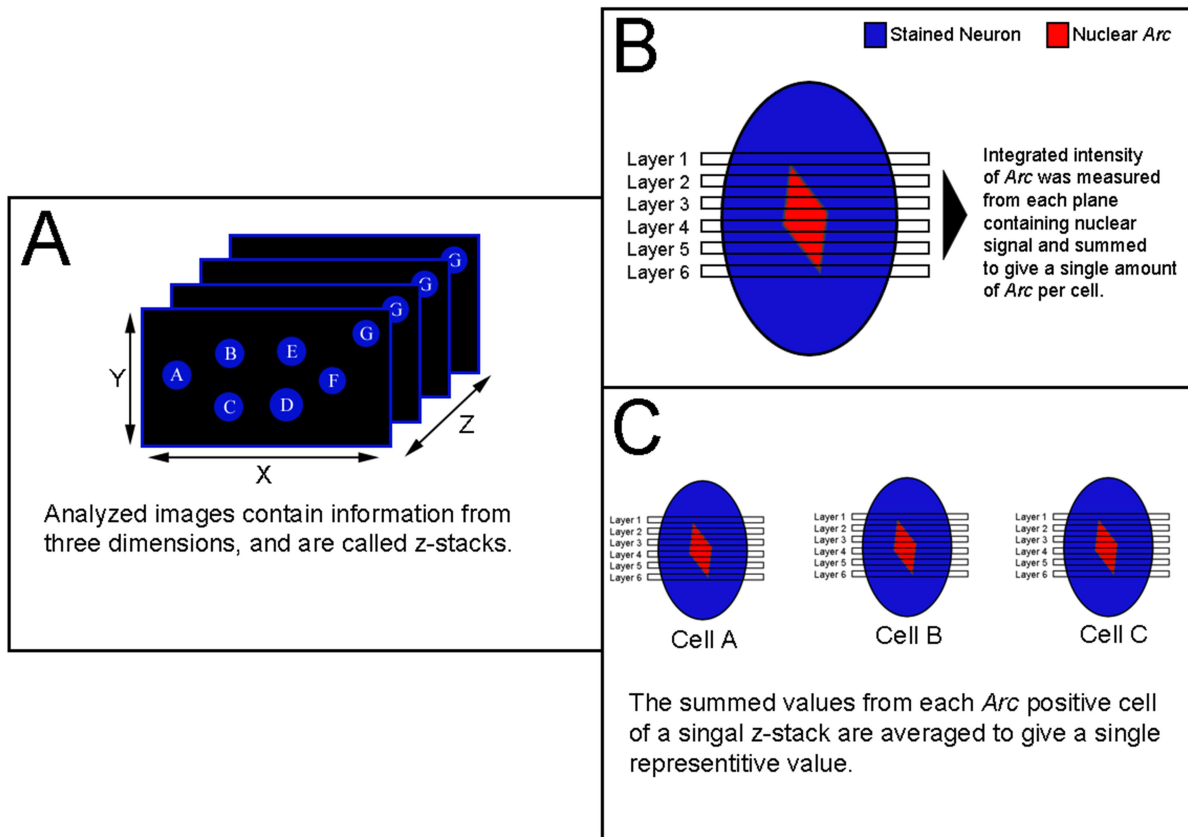


*Figure 1.* The hippocampal formation, composed of the dentate gyrus (DG) and *Cornu Ammonis* (CA) subregions CA1-CA4, is located in the medial temporal lobe and has been implicated in learning and memory (Squire, 1992).





*Figure 2.* Hippocampal tri-synaptic loop. The pathway of information processing through the hippocampal formation including input from various layers of the entorhinal cortex (EC) that travel through the dentate gyrus (DG), CA subregions, and back through the subiculum (Sub) to the EC is shown.



*Figure 3.* Integrated intensity collection. A) Collected images are three-dimensional in nature, providing information about neurons over many individual planes. Eighty-percent of positive cells were randomly selected for assessment from each image. B) For each *Arc*-positive cell, integrated intensity is collected from each plane showing gene expression. C) To assess integrated intensity for each condition/animal, each of the summed cellular values was averaged to give a single representative value.

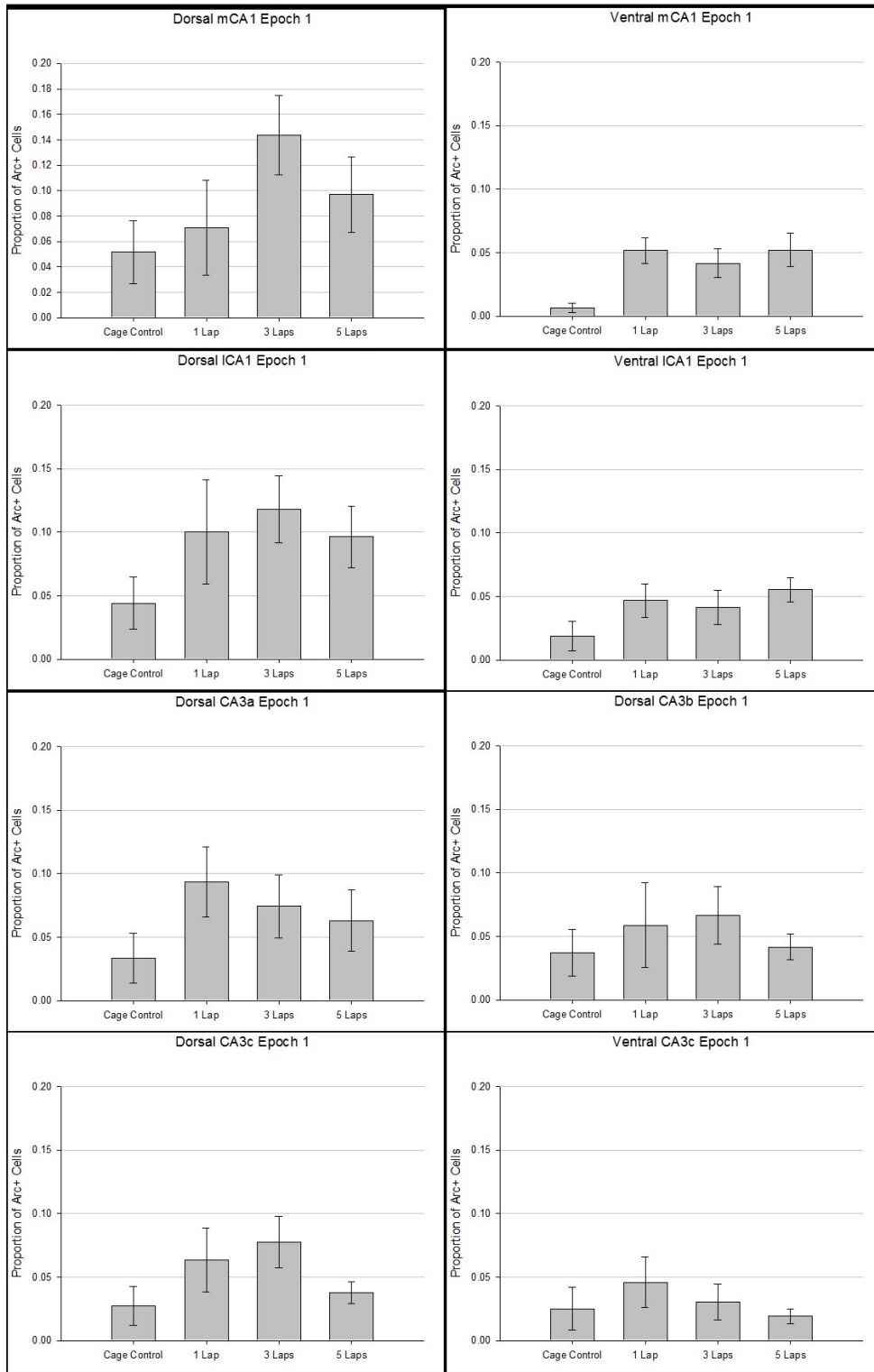


Figure 4. Overall data for cellular recruitment across all regions for the first exposure to the environment.

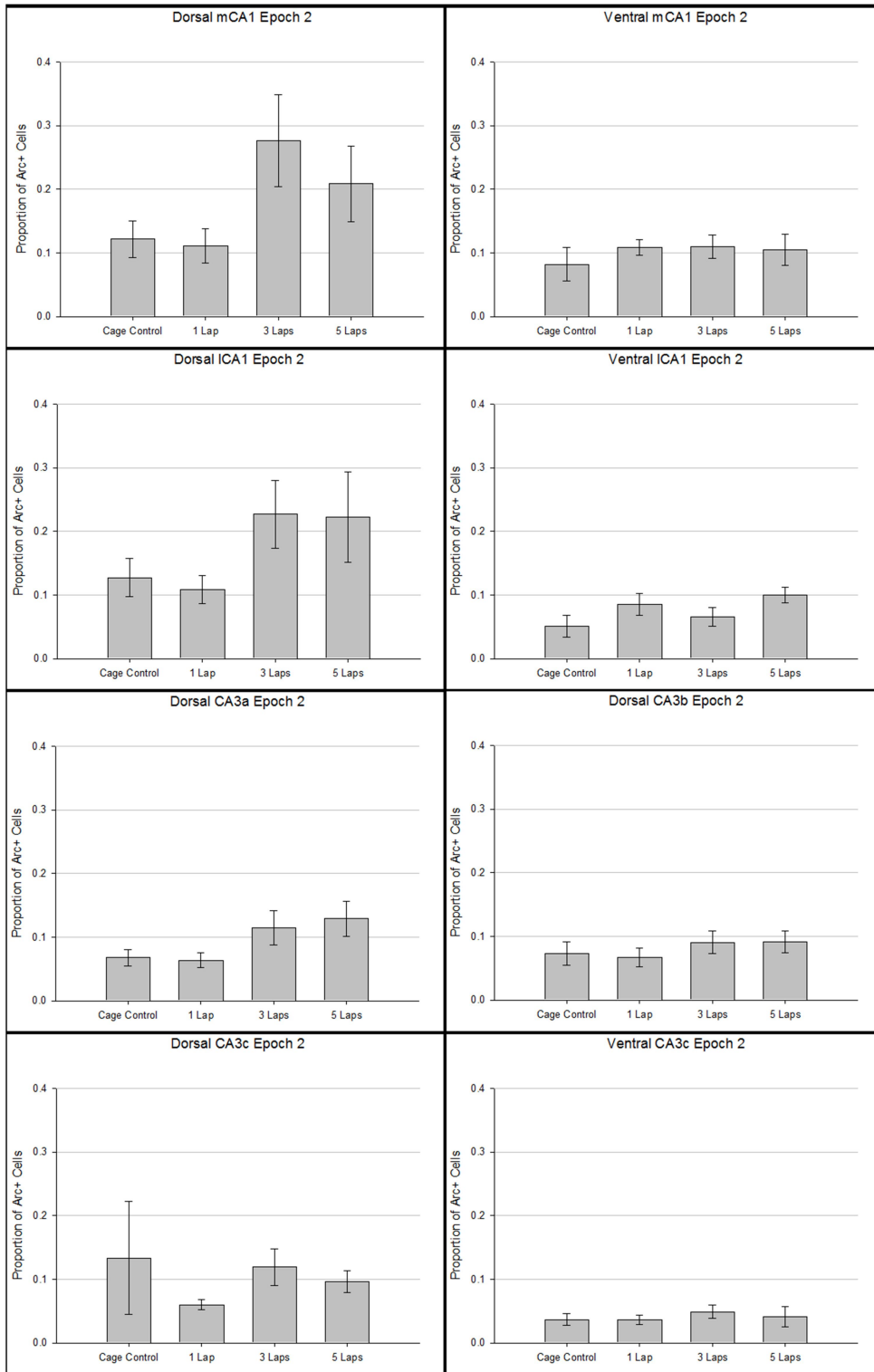


Figure 5. Overall data for cellular recruitment across regions for the second exposure to the environment.

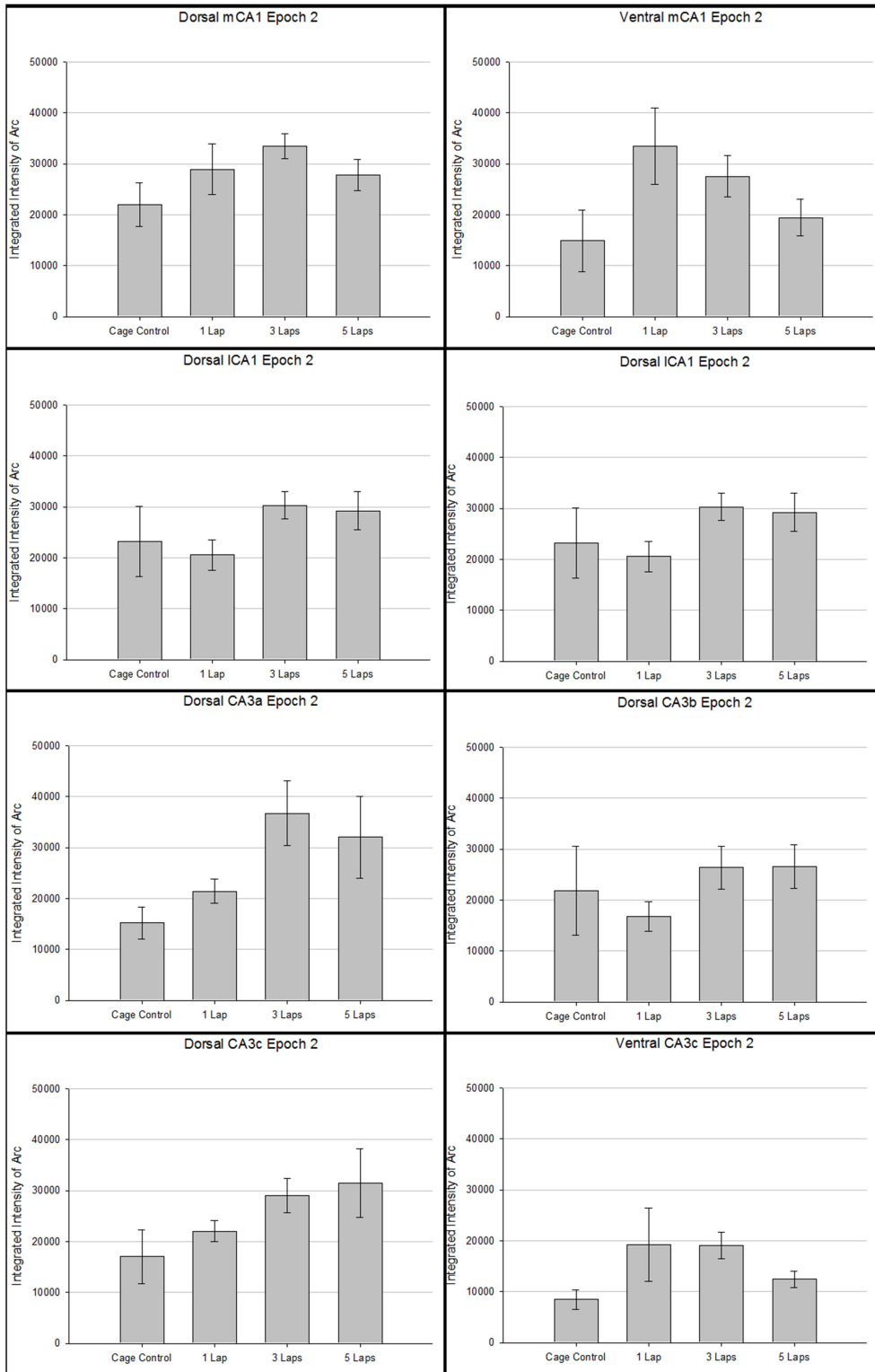
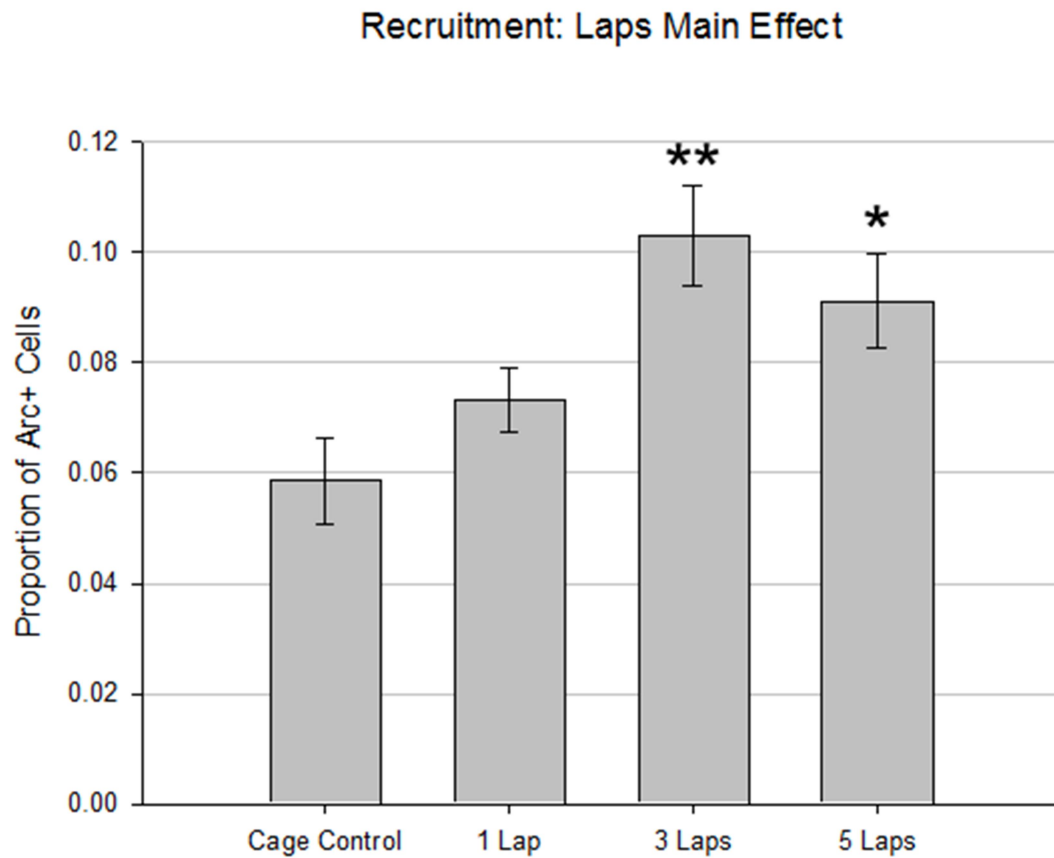
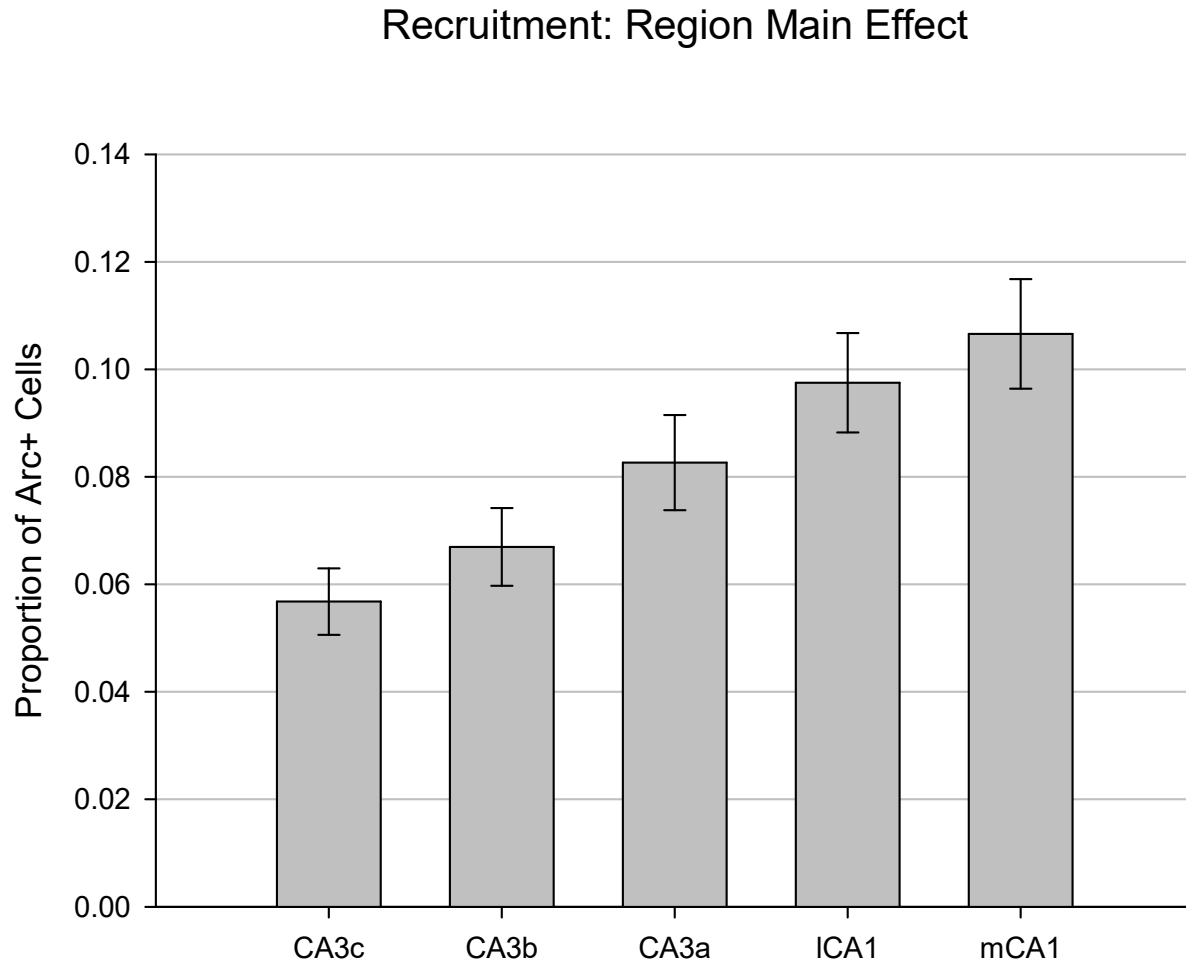


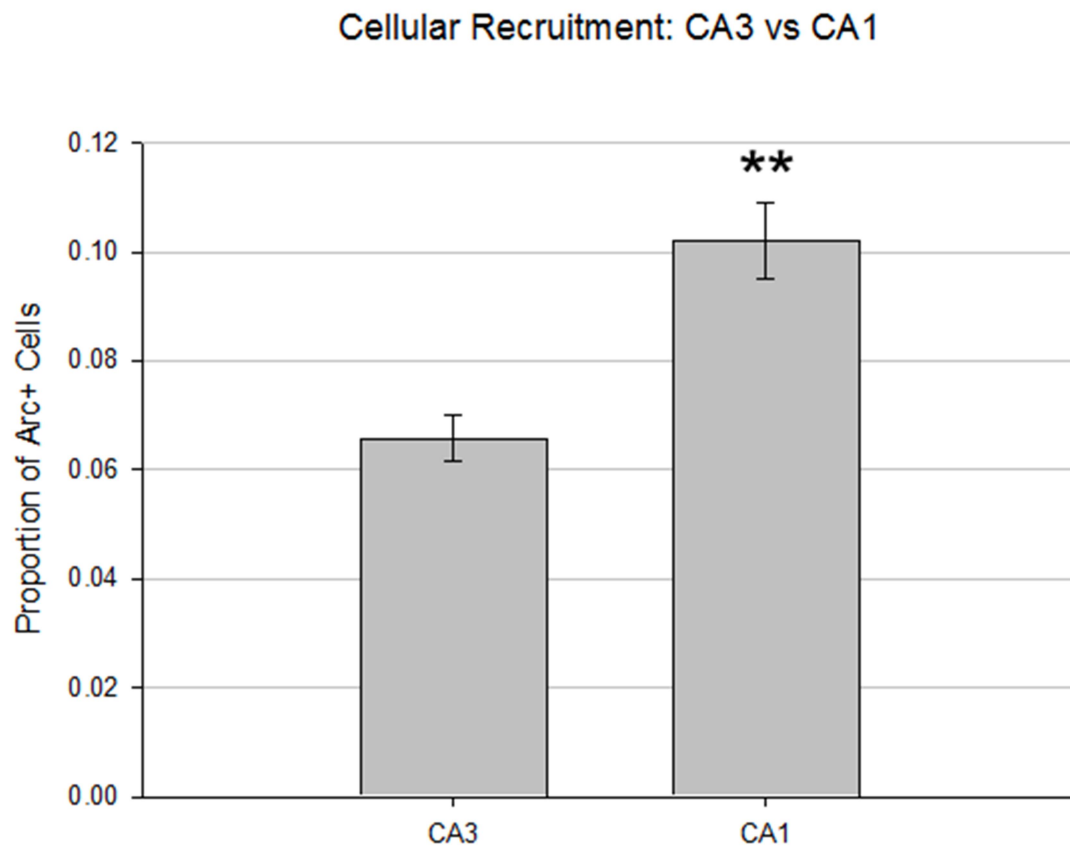
Figure 6. Overall data for integrated intensity of *Arc* across regions for second environmental exposure.



*Figure 7.* The proportion of cells expressing *Arc* after different numbers of laps around the track. Three and five laps were associated with significantly higher levels of cellular recruitment as compared to controls. \*  $p < 0.05$ , \*\*  $p < 0.001$

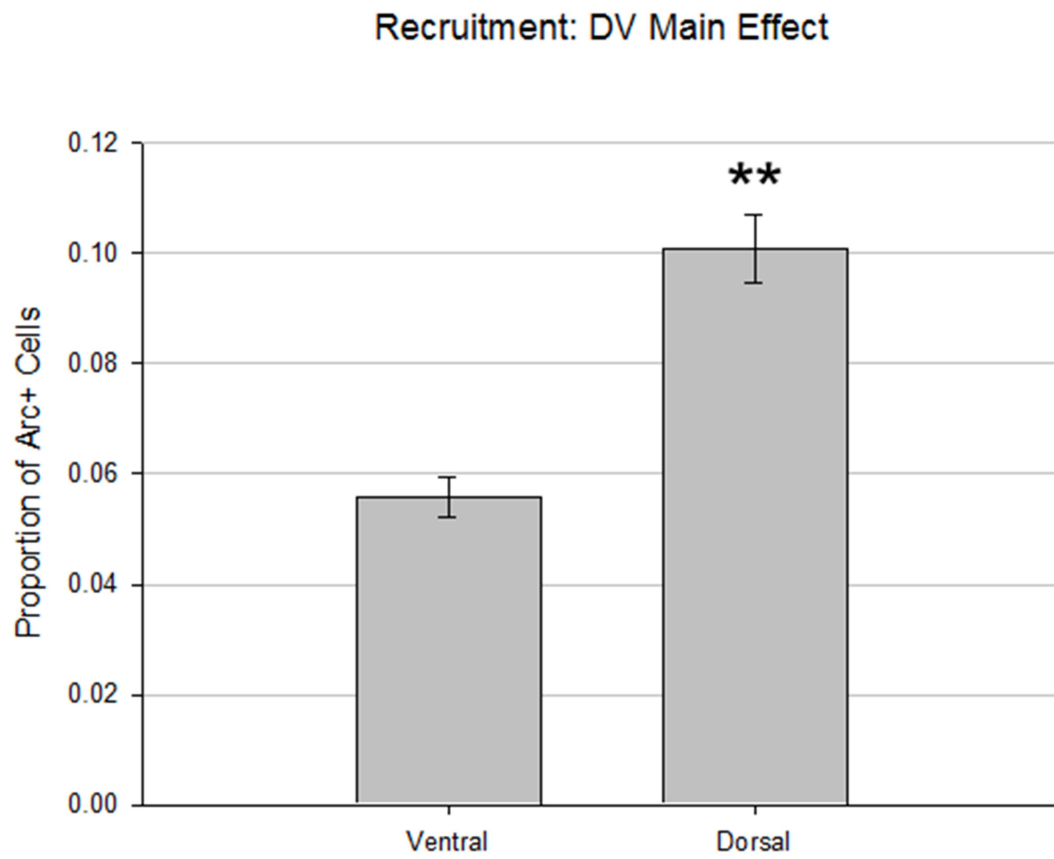


*Figure 8.* The proportion of cells expressing *Arc* across different regions of the hippocampus. A trend was observed across regions such that CA3c was associated with the lowest levels of cellular recruitment followed by a gradual increase at each subsequent stage of the tri-synaptic loop to the mCA1. This pattern reflects the path of information flow through the hippocampus.

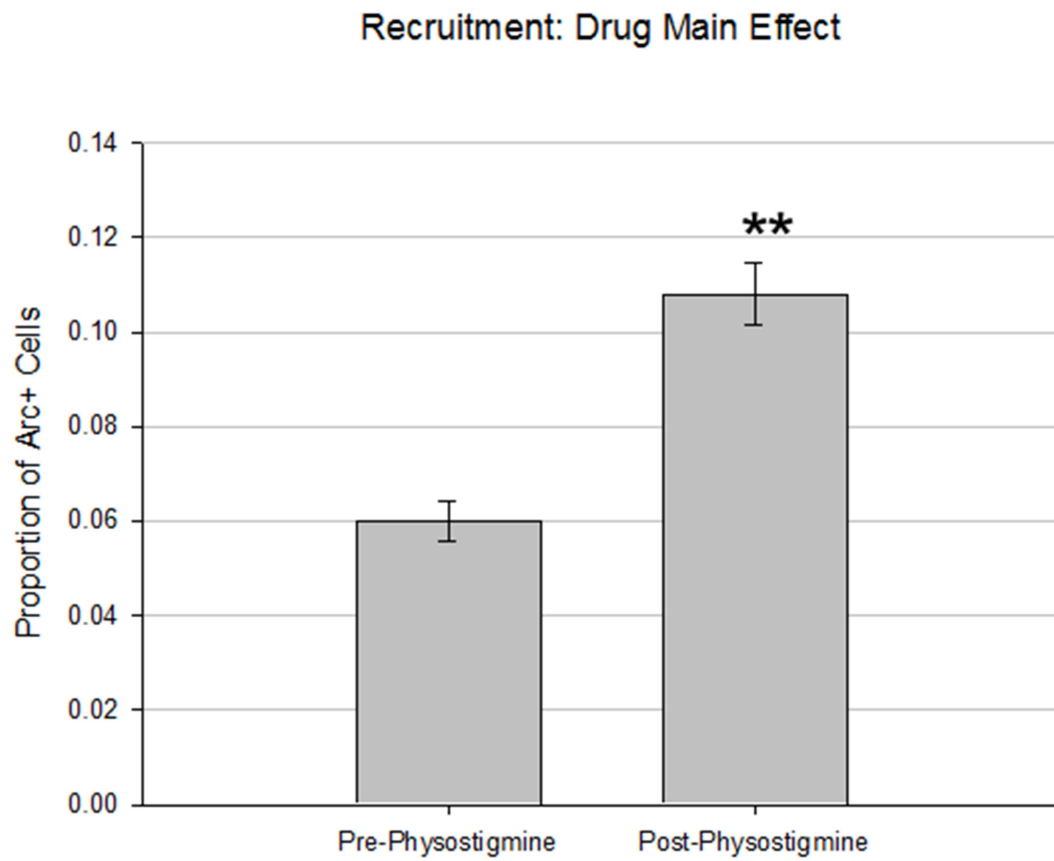


*Figure 9.* Cellular recruitment was significantly higher in CA1 subregions as compared to CA3 subregions. \*\*  $p < 0.001$

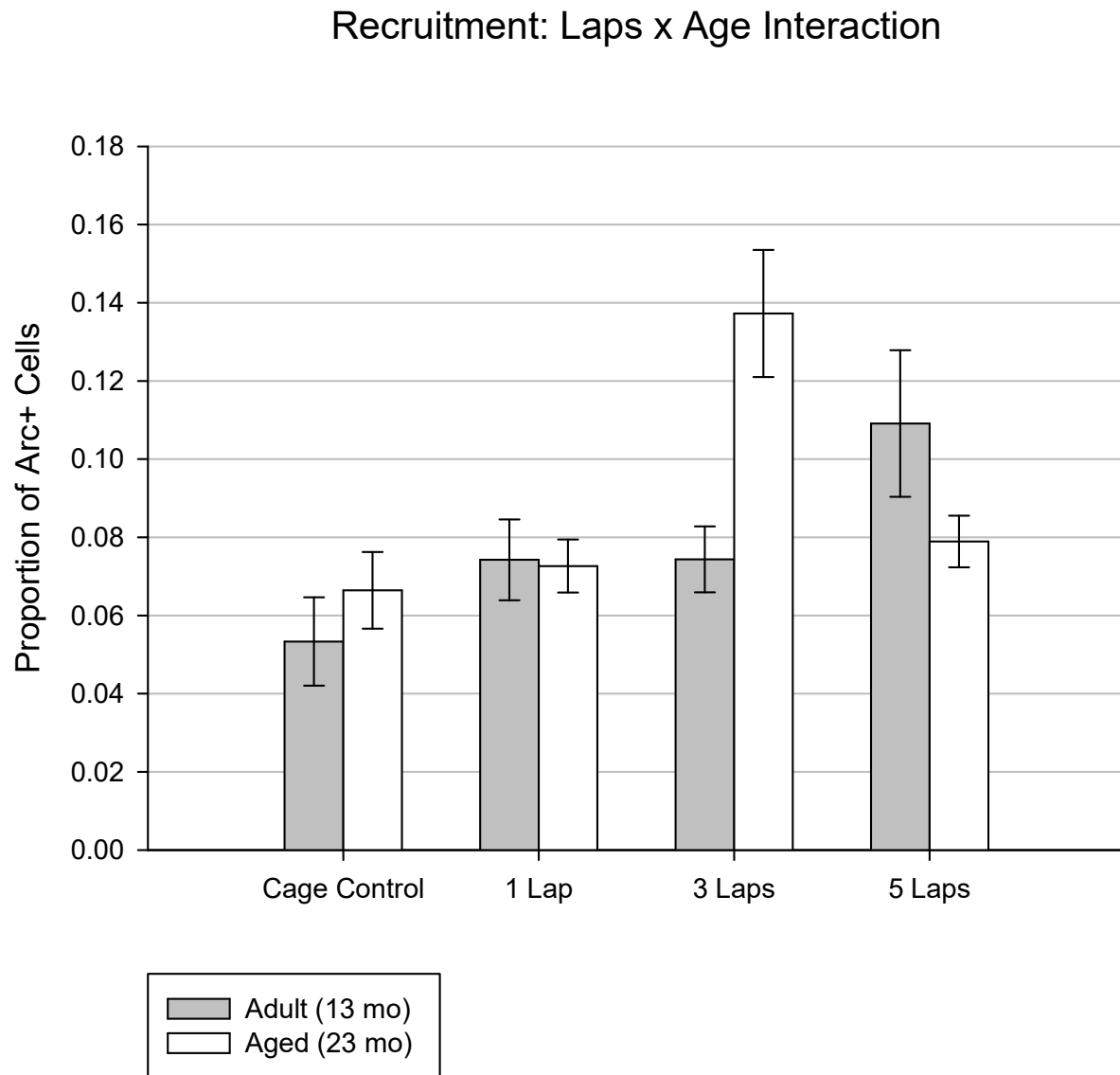




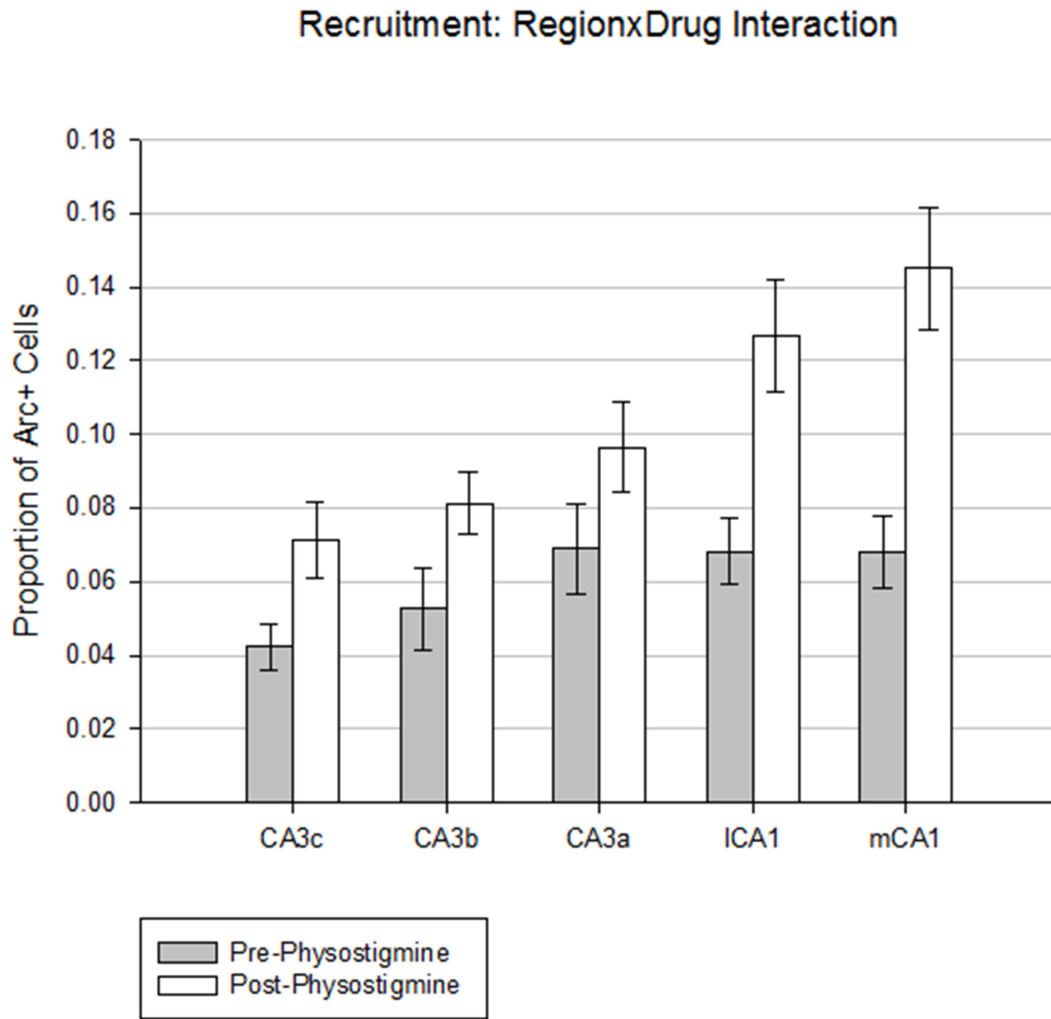
*Figure 10.* Dorsal regions were associated with increased cellular recruitment compared to ventral regions. \*\*  $p < 0.001$



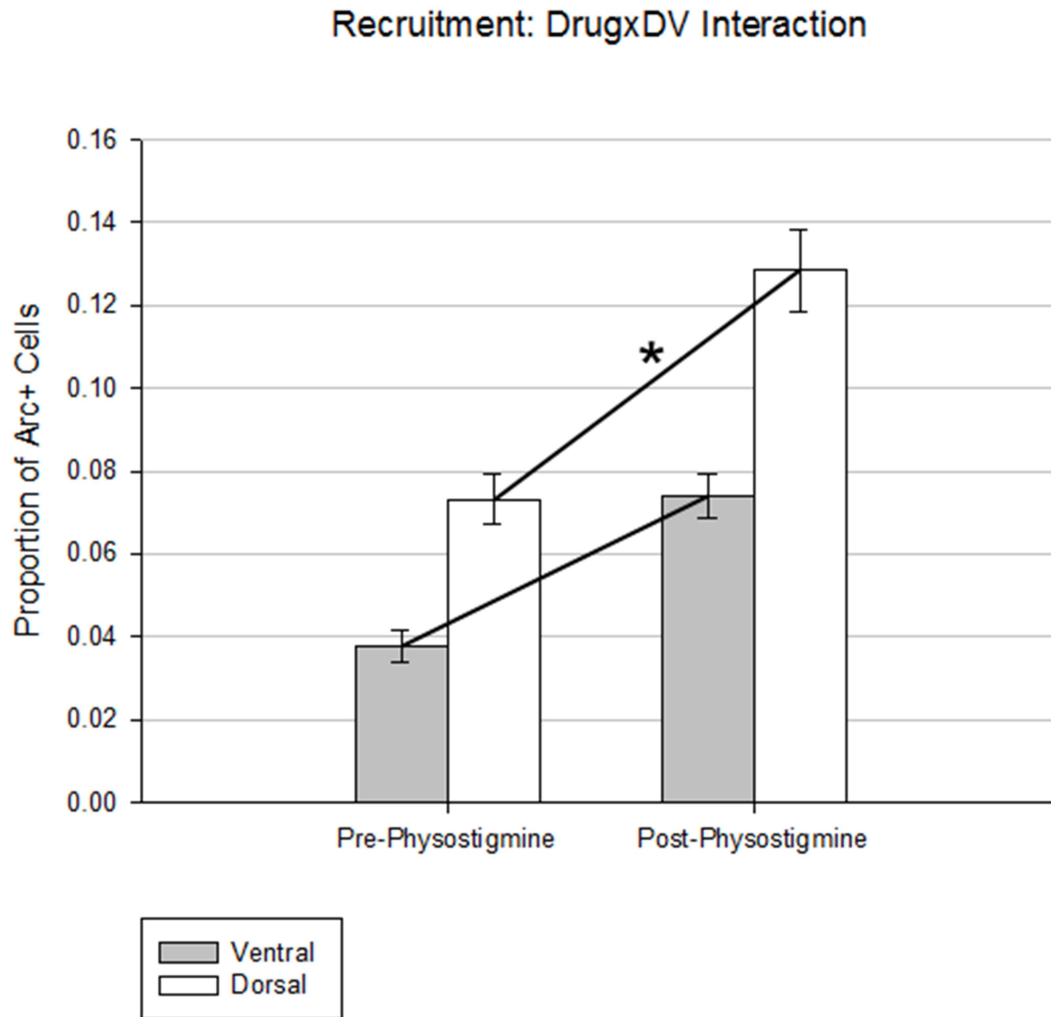
*Figure 11.* Physostigmine appears to be associated with significantly higher levels of cellular recruitment within subjects. \*\*  $p < 0.001$



*Figure 12.* In adult animals, 5 laps induced significantly higher levels of cellular recruitment as compared to controls. In aged animals on the other hand, three laps was associated with higher cellular recruitment.



*Figure 13.* Regional differences in cellular recruitment were only present following physostigmine administration.



*Figure 14.* While both ventral and dorsal regions showed an increase in cellular activity following physostigmine administration, the increase was greater for dorsal regions than ventral regions.



*Figure 15.* Dorsal regions were associated with significantly increased cellular recruitment following 3 and 5 laps while ventral regions did not appear to influence cellular recruitment.

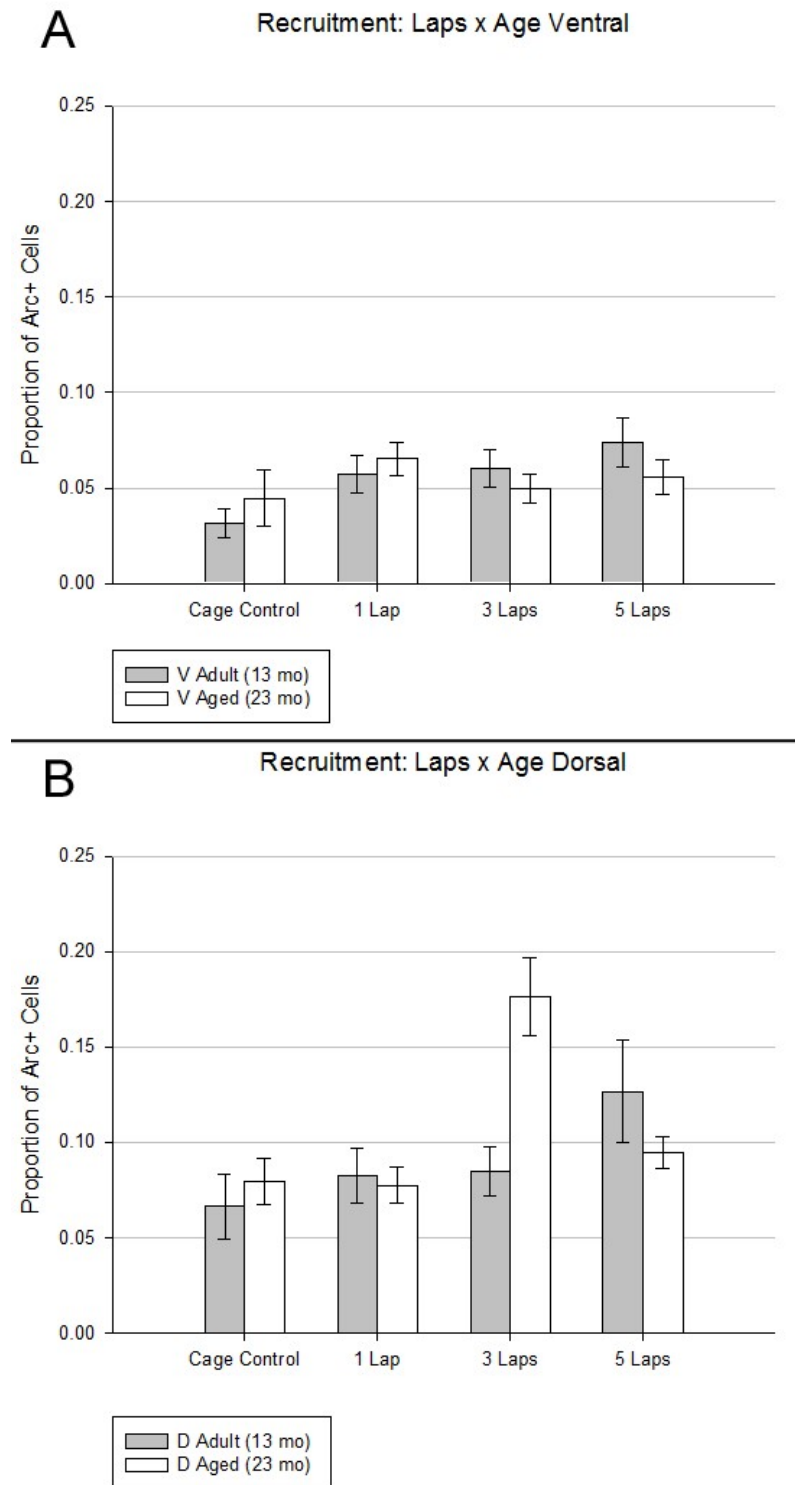
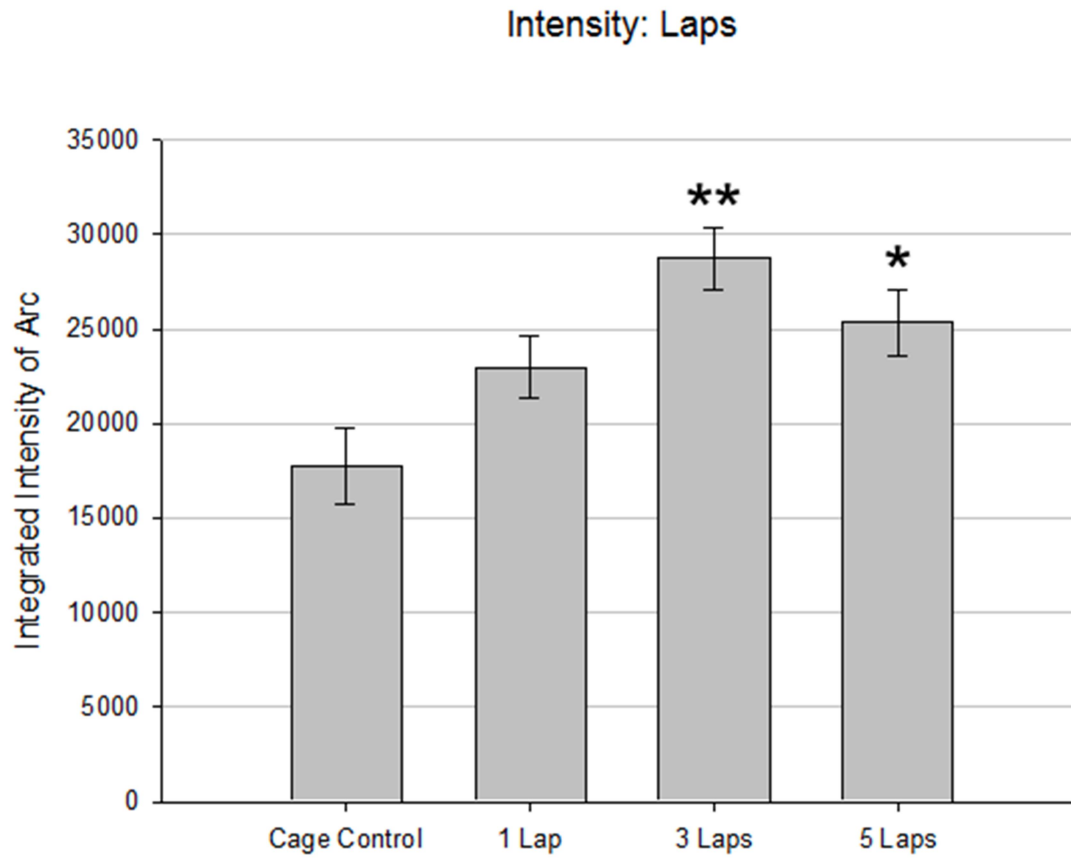


Figure 16. The age-related effect of laps occurred mostly in dorsal rather than ventral regions, thus creating a three-way interaction.



*Figure 17.* Three and five laps induced significantly higher quantities of Arc transcription in individual cells relative to cage controls. \*  $p < 0.05$ , \*\*  $p < 0.001$



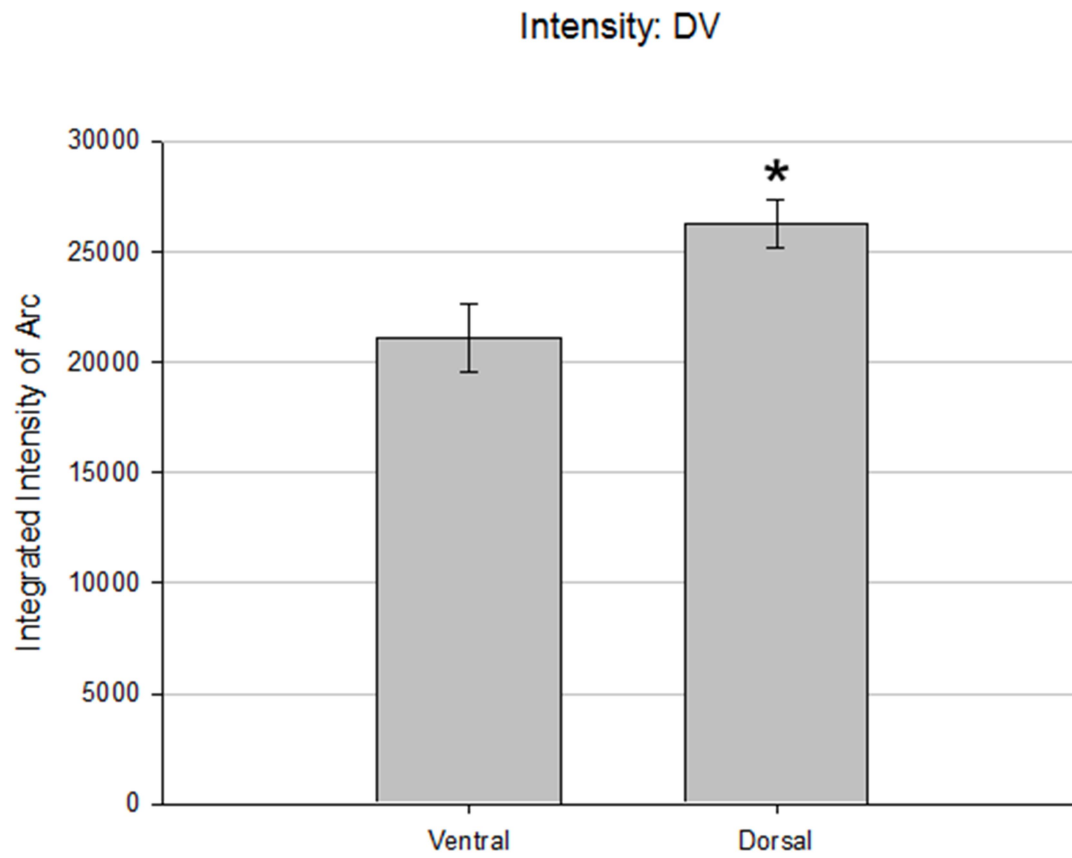
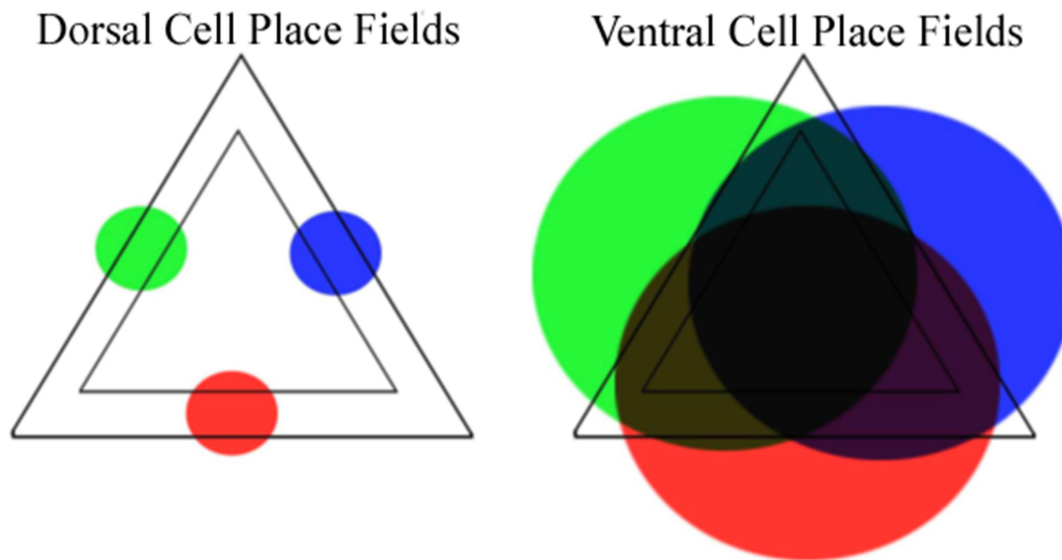


Figure 18. Integrated intensity of *Arc* was significantly higher in dorsal regions than ventral regions. \*  $p < 0.05$



*Figure 19.* Dorsal and Ventral place field size differences. Dorsal cells tend to encode smaller place fields that are not likely to overlap, while ventral cells tend to encode larger place fields that do overlap. Due to the increased sensitivity of dorsal cells to spatial information, dorsal place fields tend to mediate cellular activity more than ventral place fields.

## References

- Agnihotri, N. T., Hawkins, R. D., Kandel, E. R., & Kentros, C. (2004). The long-term stability of new hippocampal place fields requires new protein synthesis. *Proceedings of the National Academy of Sciences of the United States of America*, 101: 3656–3661.
- Albensi, B. C., Oliver, D. R., Toupin, J., & Odero, G. (2007). Electrical stimulation protocols for hippocampal synaptic plasticity and neuronal hyper-excitability: are they effective or relevant? *Experimental Neurology*, 204: 1-13.
- Barnes, C. A. & McNaughton, B. L. (1979). Neurophysiological comparison of dendritic cable properties in adolescent, middle-aged, and senescent rats. *Experimental Aging Research*, 5: 195–206.
- Barnes, C. A., & McNaughton, B. L. (1980). Physiological compensation for loss of afferent synapses in rat hippocampal granule cells during senescence. *Journal of Physiology*, 309: 473–485.
- Barnes, C. A., Suster, M. S., Shen, J., & McNaughton, B. L. (1997). Multistability of cognitive maps in the hippocampus of old rats. *Nature*, 388: 272–275.
- Bartus, R. T., Dean, R. L. 3rd, Beer, B., & Lippa, A. S. (1982). The cholinergic hypothesis of geriatric memory dysfunction. *Science*, 217: 408-414.
- Brandeis, R., Brandys, Y., & Yehuda, S. (1989). The use of the Morris Water Maze in the study of memory and learning. *International Journal of Neuroscience*, 48: 29–69.
- Brandeis, R., Dachir, S., Sapir, M., Levy, A., Fisher, A. (1990). Reversal of age-related cognitive impairments by an M1 cholinergic agonist, AF102B. *Pharmacology, Biochemistry, and Behavior*, 36: 89–95.
- Burke, S. N., & Barnes, C. A. (2006). Neural plasticity in the ageing brain. *Nature Reviews Neuroscience*, 7: 30–40.
- Burke, S. N., & Barnes, C. A. (2010). Senescent synapses and hippocampal circuit dynamics. *Trends in the Neurosciences*, 33: 153–161.
- Calhoun, M. E., Kurth, D., Phinney, A. L., Long, J. M., Hengemihle, J., Mouton, P. R., ... Jucker, M. (1998). Hippocampal neuron and synaptophysin-positive bouton number in aging C57BL/6 mice. *Neurobiology of Aging*, 19: 599–606.
- Chawla, M. K., Guzowski, J. F., Ramirez-Amaya, V., Lipa, P., Hoffman, K. L., Marriott, L. K., Worley, P. F., McNaughton, B. L., & Barnes, C. A. (2005). Sparse, environmentally selective

expression of *Arc* RNA in the upper blade of the rodent fascia dentata by brief spatial experience. *Hippocampus*, 15: 579-586.

Clayton, D. F. (2000). The genomic action potential. *Neurobiology of Learning and Memory*, 74(3), 185–216.

Cole, A. J., Saffen, D. W., Baraban, J. M., & Worley, P. F. (1989). Rapid increase of an immediate early gene messenger RNA in hippocampal neurons by synaptic NMDA receptor activation. *Nature*, 340: 474–476.

D'Hooge, R., & De Deyn, P. P. (2001). Applications of the Morris water maze in the study of learning and memory. *Brain Research Reviews*, 36: 60–90.

Deupree, D. L., Bradley, J., & Turner, D. A. (1993). Age-related alterations in potentiation in the CA1 region in F344 rats. *Neurobiology of Aging*, 14: 249–258.

Dragunow, M., Abraham, W. C., Goulding, M., Mason, S. E., Robertson, H. A., & Faull, R. L. (1989). Long-term potentiation and the induction of *c-fos* mRNA and proteins in the dentate gyrus of unanesthetized rats. *Neuroscience Letters*, 101: 274–280.

Driscoll, I., Howard, S. R., Stone, J. C., Monfils, M. H., Tomanek, B., Brooks, W. M., & Sutherland, R. J. (2006). The aging hippocampus: A multi-level analysis in the rat. *Neuroscience*, 139: 1173–1185.

Eichenbaum, H., Yonelinas, A. P., & Ranganath, C. (2007). The medial temporal lobe and recognition memory. *Annual Review of Neuroscience*, 30: 123–152.

Everitt, B. J., & Robbins, T. W. (1997). Central cholinergic systems and cognition. *Annual Review of Psychology*, 48: 649–684.

Fanselow, M. S., & Dong, H.-W. (2010). Are the dorsal and ventral hippocampus functionally distinct structures? *Neuron*, 65: 7–19.

Fischer, W., Chen, K. S., Gage, F. H., & Björklund, A. (1992). Progressive decline in spatial learning and integrity of forebrain cholinergic neurons in rats during aging. *Neurobiology of Aging*, 13: 9–23.

Fischer, W., Gage, F. H., & Björklund, A. (1989). Degenerative Changes in Forebrain Cholinergic Nuclei Correlate with Cognitive Impairments in Aged Rats. *European Journal of Neuroscience*, 1: 34–45.

Fischer, W., Nilsson, O. G., & Björklund, A. (1991). In vivo acetylcholine release as measured by microdialysis is unaltered in the hippocampus of cognitively impaired aged rats with degenerative changes in the basal forebrain. *Brain Research*, 556: 44–52.

- Foster, T. C. (2002). Regulation of synaptic plasticity in memory and memory decline with aging. *Progress in Brain Research*, 138: 283–303.
- Foster, T. C., Barnes, C. A., Rao, G., & McNaughton, B. L. (1991). Increase in perforant path quantal size in aged F-344 rats. *Neurobiology of Aging*, 12: 441–448.
- Foster, T. C., & Norris, C. M. (1997). Age-associated changes in  $ca^{2+}$ -dependent processes: Relation to hippocampal synaptic plasticity. *Hippocampus*, 7: 602–612.
- Frank, L. M., Stanley, G. B., & Brown, E. N. (2004). Hippocampal plasticity across multiple days of exposure to novel environments. *Journal of Neuroscience*, 24: 7681–7689.
- Gage, F. H., Chen, K. S., Buzsaki, G., & Armstrong, D. (1988). Experimental approaches to age-related cognitive impairments. *Neurobiology of Aging*, 9: 645–655.
- Gage, F. H., Dunnett, S. B., & Bjorklund, A. (1989). Age-related impairments in spatial memory are independent of those in sensorimotor skills. *Neurobiology of Aging*, 10: 347–352.
- Gage, F. H., Dunnett, S. B., & Björklund, A. (1984). Spatial learning and motor deficits in aged rats. *Neurobiology of Aging*, 5: 43–48.
- Gallagher, M., Colantuoni, C., Eichenbaum, H., Haberman, R. P., Rapp, P. R., Tanila, H., & Wilson, I. A. (2006). Individual differences in neurocognitive aging of the medial temporal lobe. *Age*, 28: 221–233.
- Geinisman, Y., Detoldo-Morrell, L., Morrell, F., & Heller, R. E. (1995). Hippocampal markers of age-related memory dysfunction: Behavioral, electrophysiological and morphological perspectives. *Progress in Neurobiology*, 45: 223–252.
- Geinisman, Y., DeToledo-Morrell, L., Morrell, F., Persina, I. S., & Rossi, M. (1992). Age-related loss of axospinous synapses formed by two afferent systems in the rat dentate gyrus as revealed by the unbiased stereological dissector technique. *Hippocampus*, 2: 437–444.
- Geinisman, Y., Ganeshina, O., Yoshida, R., Berry, R. W., Disterhoft, J. F., & Gallagher, M. (2004). Aging, spatial learning, and total synapse number in the rat CA1 stratum radiatum. *Neurobiology of Aging*, 25: 407–416.
- Gheidi, A., Satvat, E., & Marrone, D. F. (2012). Experience-dependent recruitment of Arc expression in multiple systems during rest. *Journal of Neuroscience Research*, 90: 1820–1829.
- Gundersen, H. J. G., Jensen, E. B. V., Kiêu, K., & Nielsen, J. (1999). The efficiency of systematic sampling in stereology - Reconsidered. *Journal of Microscopy*, 193: 199–211.

Guzowski, J. F., Knierim, J. J., & Moser, E. I. (2004). Ensemble dynamics of hippocampal regions CA3 and CA1. *Neuron*, 44: 581–584.

Guzowski, J. F., Lyford, G. L., Stevenson, G. D., Houston, F. P., McGaugh, J. L., Worley, P. F., & Barnes, C. A. (2000). Inhibition of activity-dependent arc protein expression in the rat hippocampus impairs the maintenance of long-term potentiation and the consolidation of long-term memory. *Journal of Neuroscience*, 20: 3993–4001.

Guzowski, J. F., McNaughton, B. L., Barnes, C. A., & Worley, P. F. (1999). Environment-specific expression of the immediate-early gene *Arc* in hippocampal neuronal ensembles. *Nature Neuroscience*, 2: 1120–1124.

Guzowski, J. F., Miyashita, T., Chawla, M. K., Sanderson, J., Maes, L. I., Houston, F. P., Lipa, P., McNaughton, B. L., Worley, P. F., & Barnes, C. A. (2006). Recent behavioral history modifies coupling between cell activity and *Arc* gene transcription in hippocampal CA1 neurons. *Proceedings of the National Academy of Sciences of the United States of America*, 103: 1077–1082.

Hasselmo, M. E. (2006). The role of acetylcholine in learning and memory. *Current Opinion in Neurobiology*. 16: 710-715.

Hernandez, C. M., Gearhart, D. A., Parikh, V., Hohnadel, E. J., Davis, L. W., Middlemore, M. L., Warsi, S. P., Waller, J. L., & Terry, A. V. Jr. (2006). Comparison of galantamine and donepezil for effects on nerve growth factor, cholinergic markers, and memory performance in aged rats. *Journal of Pharmacology and Experimental Therapy*, 316: 679–694.

Hitti, F. L., & Siegelbaum, S. A. (2014). The hippocampal CA2 region is essential for social memory. *Nature*, 508: 88–92.

Hollup, S. A., Molden, S., Donnett, J. G., Moser, M. B., & Moser, E. I. (2001). Accumulation of hippocampal place fields at the goal location in an annular watermaze task. *Journal of Neuroscience*, 21: 1635–1644.

Houston, F. P., Stevenson, G. D., McNaughton, B. L., & Barnes, C. A. (1999). Effects of age on the generalization and incubation of memory in the F344 rat. *Learning and Memory*, 6: 111–119.

Hunsberger, J. G., Newton, S. S., Bennett, A. H., Duman, C. H., Russell, D. S., Salton, S. R., & Duman, R. S. (2007). Antidepressant actions of the exercise-regulated gene VGF. *Nature Medicine*, 13: 1476–1482.

Jacobson, T. K., Howe, M. D., Schmidt, B., Hinman, J. R., Escabí, M. a, & Markus, E. J. (2013). Hippocampal theta, gamma, and theta-gamma coupling: effects of aging, environmental change, and cholinergic activation. *Journal of Neurophysiology*, 109: 1852–1865.

- Jones, M. W., Errington, M. L., French, P. J., Fine, a, Bliss, T. V, Garel, S., Charnay, P., Bozon, B., Laroche, S., & Davis, S. (2001). A requirement for the immediate early gene *Zif268* in the expression of late LTP and long-term memories. *Nature Neuroscience*, 4: 289–296.
- Kentros, C., Hargreaves, E., Hawkins, R. D., Kandel, E. R., Shapiro, M., & Muller, R. V. (1998). Abolition of long-term stability of new hippocampal place cell maps by NMDA receptor blockade. *Science*, 280: 2121–2126.
- Kerr, D. S., Campbell, L. W., Hao, S. Y., & Landfield, P. W. (1989). Corticosteroid modulation of hippocampal potentials: increased effect with aging. *Science*, 245: 1505–1509.
- Kjelstrup, K. B., Solstad, T., Brun, V. H., Hafting, T., Leutgeb, S., Witter, M. P., Moser, E. I., Moser MB. (2008). Finite scale of spatial representation in the hippocampus. *Science*, 321: 140–143.
- Koh, S., Chang, P., Collier, T. J., & Loy, R. (1989). Loss of NGF receptor immunoreactivity in basal forebrain neurons of aged rats: correlation with spatial memory impairment. *Brain Research*, 498: 397–404.
- Landfield, P. W. (1988). Hippocampal neurobiological mechanisms of age-related memory dysfunction. *Neurobiology of Aging*, 9: 571–579.
- Landfield, P. W., & Pitler, T. A. (1984). Prolonged  $Ca^{2+}$ -dependent afterhyperpolarizations in hippocampal neurons of aged rats. *Science*, 226: 1089–1092.
- Lee, I., & Kesner, R. P. (2002). Differential contribution of NMDA receptors in hippocampal subregions to spatial working memory. *Nature Neuroscience*, 5: 162–168.
- Lenck-Santini, P. P., Save, E., & Poucet, B. (2001). Evidence for a relationship between place-cell spatial firing and spatial memory performance. *Hippocampus*, 11: 377–390.
- Lenck-Santini, P.-P., Muller, R. U., Save, E., & Poucet, B. (2002). Relationships between place cell firing fields and navigational decisions by rats. *Journal of Neuroscience*, 22: 9035–9047.
- Luine, V., & Hearn, M. (1990). Spatial memory deficits in aged rats: Contributions of the cholinergic system assessed by ChAT. *Brain Research*, 523: 321–324.
- Lyford, G. L., Yamagata, K., Kaufmann, W. E., Barnes, C. A., Sanders, L. K., Copeland, N. G., Gilbert, D. J., Jenkins, N. A., Lanahan, A. A., & Worley, P. F. (1995). *Arc*, a growth factor and activity-regulated gene, encodes a novel cytoskeleton-associated protein that is enriched in neuronal dendrites. *Neuron*, 14: 433–445.

- Markowska, A. L., Price, D., & Koliatsos, V. E. (1996). Selective effects of nerve growth factor on spatial recent memory as assessed by a delayed nonmatching-to-position task in the water maze. *Journal of Neuroscience*, 16: 3541–3548.
- Marr, D. (1971). Simple Memory: A Theory for Archicortex. *Philosophical Transactions of the Royal Society B: Biological Sciences*, 262: 23–81.
- Martínez-Serrano, A., Fischer, W., Söderström, S., Ebendal, T., & Björklund, A. (1996). Long-term functional recovery from age-induced spatial memory impairments by nerve growth factor gene transfer to the rat basal forebrain. *Proceedings of the National Academy of Sciences of the United States of America*, 93: 6355–6360.
- Maurer, A. P., Cowen, S. L., Burke, S. N., Barnes, C. A., & McNaughton, B. L. (2006). Organization of hippocampal cell assemblies based on theta phase precession. *Hippocampus*, 16: 785–794.
- Mehta, M. R., Barnes, C. A., & McNaughton, B. L. (1997). Experience-dependent, asymmetric expansion of hippocampal place fields. *Proceedings of the National Academy of Sciences of the United States of America*, 94:, 8918–8921.
- Micheau, J., & Marighetto, A. (2011). Acetylcholine and memory: A long, complex and chaotic but still living relationship. *Behavioural Brain Research*, 221: 424–429.
- Mikkelsen, J. D., & Larsen, M. H. (2006). Effects of stress and adrenalectomy on activity-regulated cytoskeleton protein (*Arc*) gene expression. *Neuroscience Letters*, 403: 239–243.
- Miyashita, T., Kubik, S., Haghighi, N., Steward, O., & Guzowski, J. F. (2009). Rapid activation of plasticity-associated gene transcription in hippocampal neurons provides a mechanism for encoding of one-trial experience. *Journal of Neuroscience*, 29: 898–906.
- Mizumori, S. J. Y. (2006). Hippocampal place fields: A neural code for episodic memory? *Hippocampus*, 16: 685–690.
- Molteni, R., Ying, Z., & Gómez-Pinilla, F. (2002). Differential effects of acute and chronic exercise on plasticity-related genes in the rat hippocampus revealed by microarray. *European Journal of Neuroscience*, 16: 1107–1116.
- Moore, C. I., Browning, M. D., & Rose, G. M. (1993). Hippocampal plasticity induced by primed burst, but not long-term potentiation, stimulation is impaired in area CA1 of aged Fischer 344 rats. *Hippocampus*, 3: 57–66.
- Morris, R. G. M. (1984). Developments of a water-maze procedure for studying spatial learning in the rat. *Journal of Neuroscience Methods*, 11: 47–60.



- Morris, R. G., Garrud, P., Rawlins, J. N., & O'Keefe, J. (1982). Place navigation impaired in rats with hippocampal lesions. *Nature*, 297: 681–683.
- Moscovitch, M., Nadel, L., Winocur, G., Gilboa, A., & Rosenbaum, R. S. (2006). The cognitive neuroscience of remote episodic, semantic and spatial memory. *Current Opinion in Neurobiology*, 16: 179–190.
- Moser, E. I., Kropff, E., & Moser, M.-B. (2008). Place cells, grid cells, and the brain's spatial representation system. *Annual Review of Neuroscience*, 31: 69–89.
- Moyer, J. R., Thompson, L. T., Black, J. P., & Disterhoft, J. F. (1992). Nimodipine increases excitability of rabbit CA1 pyramidal neurons in an age- and concentration-dependent manner. *Journal of Neurophysiology*, 68: 2100–2109.
- Muller, R. U., & Kubie, J. L. (1987). The effects of changes in the environment on the spatial firing of hippocampal complex-spike cells. *Journal of Neuroscience*, 7: 1951–1968.
- Myers, C. E., & Scharfman, H. E. (2009). A role for hilar cells in pattern separation in the dentate gyrus: a computational approach. *Hippocampus*, 19(4), 321–337.
- Nakazawa, K., Sun, L. D., Quirk, M. C., Rondi-Reig, L., Wilson, M. A., & Tonegawa, S. (2003). Hippocampal CA3 NMDA receptors are crucial for memory acquisition of one-time experience. *Neuron*, 38: 305–315.
- O'Brien, R. J., Desheng, X., Petralia, R. S., Steward, O., Huganir, R. L., & Worley, P. (1999). Synaptic clustering of AMPA receptors by the extracellular immediate-early gene product Narx. *Neuron*, 23: 309–323.
- O'Keefe, J. (1979). A review of the hippocampal place cells. *Progress in Neurobiology*, 13: 419–439.
- O'Keefe, J., & Speakman, A. (1987). Single unit activity in the rat hippocampus during a spatial memory task. *Experimental Brain Research*, 68: 1–27.
- Penner, M. R., Roth, T. L., Chawla, M. K., Hoang, L. T., Roth, E. D., Lubin, F. D., Sweatt, J. D., Worley, P. F., & Barnes, C. A. (2011). Age-related changes in Arc transcription and DNA methylation within the hippocampus. *Neurobiology of Aging*, 32: 2198–2210.
- Pláteník, J., Kuramoto, N., & Yoneda, Y. (2000). Molecular mechanisms associated with long-term consolidation of the NMDA signals. *Life Sciences*, 67(4): 335–364
- Quirion, R., Wilson, A., Rowe, W., Aubert, I., Richard, J., Doods, H., Parent, A., White, N., & Meaney, M. J. (1995). Facilitation of acetylcholine release and cognitive performance by an M2-

- muscarinic receptor antagonist in aged memory impaired rats. *Journal of Neuroscience*, 15: 1455–1462.
- Radulovic, J., Kammermeier J., & Spiess, J. (1998). Generalization of fear response in C57BL/6N mice subjected to one-trial foreground contextual fear conditioning. *Behav Brain Res.*, 95(2): 179-189.
- Rapp, P. R., & Amaral, D. G. (1992). Individual differences in the cognitive and neurobiological consequences of normal aging. *Trends in Neurosciences*, 15: 340–345.
- Rapp, P. R., & Gallagher, M. (1996). Preserved neuron number in the hippocampus of aged rats with spatial learning deficits. *Proceedings of the National Academy of Sciences of the United States of America*, 93: 9926–9930.
- Rasmussen, T., Schliemann, T., Sorensen, J. C., Zimmer, J., & West, M. J. (1996). Memory impaired aged rats: No loss of principal hippocampal and subicular neurons. *Neurobiology of Aging*, 17: 143–147.
- Reti, I. M., Reddy, R., Worley, P. F., & Baraban, J. M. (2002). Prominent Narp expression in projection pathways and terminal fields. *Journal of Neurochemistry*, 82: 935–944.
- Rolls, E. T. (1996). A theory of hippocampal function in memory. *Hippocampus*, 6: 601–620.
- Rolls, E. T. (2013). The mechanisms for pattern completion and pattern separation in the hippocampus. *Frontiers in Systems Neuroscience*, 7: 74
- Rolls, E. T., & Kesner, R. P. (2006). A computational theory of hippocampal function, and empirical tests of the theory. *Progress in Neurobiology*, 79: 1–48.
- Samsonovich, A., & McNaughton, B. L. (1997). Path integration and cognitive mapping in a continuous attractor neural network model. *Journal of Neuroscience*, 17: 5900–5920.
- Sharp, P. E., Barnes, C. A., & McNaughton, B. L. (1987). Effects of aging on environmental modulation of hippocampal evoked responses. *Behavioral Neuroscience*, 101: 170-178.
- Smith, D. M., & Mizumori, S. J. Y. (2006). Hippocampal place cells, context, and episodic memory. *Hippocampus*, 16: 716–729.
- Squire, L. R. (1992). Memory and the hippocampus: a synthesis from findings with rats, monkeys, and humans. *Psychological Review*, 99: 195–231.
- Sterio, D. C. (1984). The unbiased estimation of number and sizes of arbitrary particles using the disector. *Journal of Microscopy*, 134: 127–136.

- Steward, O., Wallace, C. S., Lyford, G. L., & Worley, P. F. (1998). Synaptic activation causes the mRNA for the leg *Arc* to localize selectively near activated postsynaptic sites on dendrites. *Neuron*, 21: 741–751.
- Stewart, J., Mitchell, J., & Kalant, N. (1989). The effects of life-long food restriction on spatial memory in young and aged Fischer 344 rats measured in the eight-arm radial and the Morris water mazes. *Neurobiology of Aging*, 10: 669–675.
- Stranahan, A. M., Lee, K., Becker, K. G., Zhang, Y., Maudsley, S., Martin, B., Cutler, R.G., & Mattson, M. P. (2010). Hippocampal gene expression patterns underlying the enhancement of memory by running in aged mice. *Neurobiology of Aging*, 31: 1937–1949.
- Toescu, E. C., Verkhatsky, A., & Landfield, P. W. (2004).  $Ca^{2+}$  regulation and gene expression in normal brain aging. *Trends in the Neurosciences*, 27: 614–620.
- Tonegawa, S., Tsien, J. Z., McHugh, T. J., Huerta, P., Blum, K., I., & Wilson, M. A. (1996). Hippocampal CA1-region-restricted knockout of NMDAR1 gene disrupts synaptic plasticity, place fields, and spatial learning. *Cold Spring Harbour Symposium on Quantitative Biology*, 61: 225-238.
- Tong, L., Shen, H., Perreau, V. M., Balazs, R., & Cotman, C. W. (2001). Effects of exercise on gene-expression profile in the rat hippocampus. *Neurobiology of Disease*, 8: 1046–1056.
- Treves, A., & Rolls, E. T. (1994). Computational analysis of the role of the hippocampus in memory. *Hippocampus*, 4: 374–391.
- Tulving, E. (1972). Episodic and Semantic Memory. In: *Organization of Memory* (pp. 381–402).
- Vazdarjanova, A., & Guzowski, J. F. (2004). Differences in hippocampal neuronal population responses to modifications of an environmental context: evidence for distinct, yet complementary, functions of CA3 and CA1 ensembles. *Journal of Neuroscience*, 24: 6489–6496.
- Vazdarjanova, A., McNaughton, B. L., Barnes, C. A., Worley, P. F., & Guzowski, J. F. (2002). Experience-dependent coincident expression of the effector immediate-early genes *arc* and *Homer 1a* in hippocampal and neocortical neuronal networks. *Journal of Neuroscience*, 22: 10067–10071.
- Von Bohlen und Halbach, O., & Unsicker, K. (2002). Morphological alterations in the amygdala and hippocampus of mice during ageing. *European Journal of Neuroscience*, 16: 2434–2440.
- West, M. (1993). New stereological methods for counting neurons. *Neurobiology of Aging*, 14: 275–285.

West, M. J. (1993). Regionally specific loss of neurons in the aging human hippocampus. *Neurobiology of Aging*, 14: 287–293.

West, M. J. (1999). Stereological methods for estimating the total number of neurons and synapses: Issues of precision and bias. *Trends in Neurosciences*, 22: 51–61.

Wilson, I. A., Ikonen, S., Gallagher, M., Eichenbaum, H., & Tanila, H. (2005). Age-associated alterations of hippocampal place cells are subregion specific. *Journal of Neuroscience*, 25: 6877–6886.

Wilson, M. A., & McNaughton, B. L. (1993). Dynamics of the hippocampal ensemble code for space. *Science*, 261: 1055–1058.

Wisden, W., Errington, M. L., Williams, S., Dunnett, S. B., Waters, C., Hitchcock, D., ... Hunt, S. P. (1990). Differential expression of immediate early genes in the hippocampus and spinal cord. *Neuron*, 4: 603–614.

Zhao, C., Deng, W., & Gage, F. H. (2008). Mechanisms and functional implications of adult neurogenesis. *Cell*, 132: 645–60.

Zhao, C., Teng, E. M., Summers, R. G., Ming, G.-L., & Gage, F. H. (2006). Distinct morphological stages of dentate granule neuron maturation in the adult mouse hippocampus. *Journal of Neuroscience*, 26: 3–11.