



**MIEEC 2015**

**U. PORTO**  
**FEUP** FACULDADE DE ENGENHARIA  
UNIVERSIDADE DO PORTO

# **EVALUATION OF COORDINATED PROTECTION SCHEMES FRAMED IN SELF- HEALING SCHEMES**

**EDUARDO NUNO RUANO RODRIGUES**  
DISSERTAÇÃO DE MESTRADO APRESENTADA  
À FACULDADE DE ENGENHARIA DA UNIVERSIDADE DO PORTO EM  
ENERGIA

**Faculdade de Engenharia da Universidade do Porto**



**Evaluation of Coordinated Protection Schemes  
Framed in Self-Healing Schemes**

Eduardo Nuno Ruano Rodrigues

FINAL VERSION

Master Dissertation in Electrical and Computers Engineering  
Major in Energy

Supervisor: Prof. Dr. Helder Filipe Duarte Leite  
Co-Supervisor: Dr. Nuno Filipe Gonçalves da Silva

July 2015

© Eduardo Nuno Ruano Rodrigues, 2015

A Dissertação intitulada

**“Evaluation of Coordinated Protection Schemes Framed in Self-healing Schemes”**

foi aprovada em provas realizadas em 20-07-2015

o júri



Presidente **Professor Doutor Manuel António Cerqueira da Costa Matos**  
Professor Catedrático do Departamento de Engenharia Eletrotécnica e de Computadores da Faculdade de Engenharia da Universidade do Porto



**Professor Doutor Sérgio Augusto Pires Leitão**  
Professor Auxiliar do Departamento de Engenharias da Escola de Ciências e Tecnologias da Universidade de Trás-os-Montes e Alto Douro



**Professor Doutor Helder Filipe Duarte Leite**  
Professor Auxiliar do Departamento de Engenharia Eletrotécnica e de Computadores da Faculdade de Engenharia da Universidade do Porto

O autor declara que a presente dissertação (ou relatório de projeto) é da sua exclusiva autoria e foi escrita sem qualquer apoio externo não explicitamente autorizado. Os resultados, ideias, parágrafos, ou outros extratos tomados de ou inspirados em trabalhos de outros autores, e demais referências bibliográficas usadas, são corretamente citados.



**Autor - Eduardo Nuno Ruano Rodrigues**

Faculdade de Engenharia da Universidade do Porto

# Abstract

This dissertation addresses the service restoration problem in distribution networks through Self-Healing strategies. With the growing dependence of electric power by residential, commercial and industrial sectors, achieving an uninterrupted electric supply becomes a major challenge faced by power system engineers. A smart power grid that is reliable, safe and with high standards of quality of service is the main goal for system operators worldwide. To accomplish these objectives the automation of the distribution network is essential.

In the sequence of an outage, Fault Detection Isolation and Restoration algorithms proceed to network reconfiguration, allowing service restoration from alternative sources. In this context, the optimal deployment of power switchgear is an important matter. Reclosers offer fault-interrupting capability but bring additional challenges of coordination.

In this work a methodology is presented that aims to find the best strategy for reclosers deployment in overhead distribution networks, based in a techno-economic analysis. The technical analysis proposes the assessment of the network reconfiguration strategy, based in a power flow study, to prevent overloads and excessive voltage dropping. The economic analysis proposes the assessment of the benefit related with the quality of service improvement. This is achieved by opposing the capital expenditures and the operational expenditures against the savings due to the reduction with the cost of energy not supplied, with the total compensation to customers and with the penalties of incentive to quality of service. The economic analysis is performed over the recloser's life cycle, assessing the net present value, the payback period and the internal rate of return, finding the number and the location of reclosers in the network.



# Resumo

Esta dissertação aborda o problema da reposição de serviço em redes de distribuição através de estratégias de *Self-Healing*. Com a crescente dependência de energia elétrica por parte dos sectores residencial, comercial e industrial, alcançar um fornecimento ininterrupto torna-se o desafio principal para os engenheiros de sistemas elétricos de energia. Uma rede inteligente, fiável, segura e com padrões elevados de qualidade de serviço é o principal objetivo dos operadores do sistema elétrico a nível mundial. Para alcançar estes objetivos a automação da rede de distribuição é essencial.

Na sequência de uma interrupção, os algoritmos de detecção, isolamento e reposição de serviço procedem à reconfiguração da rede, permitindo repor o serviço através de pontos de injeção alternativos. Neste contexto, o posicionamento ótimo de órgãos de corte de rede é uma questão fundamental. Os reclosers (órgãos de corte de rede de 3ª geração) proporcionam poder de corte de correntes de curto-circuito mas acarretam desafios adicionais de coordenação.

Neste trabalho é apresentada uma metodologia que visa determinar a melhor estratégia de implantação de reclosers em redes de distribuição aéreas, com base numa análise técnico-económica. A análise técnica propõe uma avaliação da estratégia de reconfiguração da rede com base num estudo de trânsito de potências, de forma a prevenir sobrecargas e quedas de tensão excessivas. A análise económica propõe a avaliação do benefício associado à melhoria da qualidade de serviço, contrapondo os custos de capital e os custos operacionais às reduções de custo com a energia não fornecida, com a compensação total aos clientes e com as penalidades de incentivo à qualidade de serviço. A análise económica é realizada ao longo do ciclo de vida dos dispositivos, avaliando o valor atual líquido, o período de recuperação do investimento e a taxa interna de rentabilidade, determinando o número e a localização estratégica dos reclosers na rede.





# Acknowledgments

I want to thank to my supervisors, Professor Helder Leite and Dr. Nuno Silva, for their advise and trust.

I want to thank to Eng. Ismael Miranda for his support, availability and encouragement, his contribution was essential to my work.

I want to thank to EFACEC, in particular to the colleagues of Smart Grids and Platforms department, for the welcome and good atmosphere.

I dedicate this work to my family, to my girlfriend, to my friends and especially to the Faculty of Engineering of the University of Porto.

Eduardo Rodrigues



# Contents

<b>Abstract</b> .....	<b>iii</b>
<b>Resumo</b> .....	<b>v</b>
<b>Acknowledgments</b> .....	<b>vii</b>
<b>Contents</b> .....	<b>ix</b>
<b>List of figures</b> .....	<b>xi</b>
<b>List of tables</b> .....	<b>xiii</b>
<b>Abbreviations and Symbols</b> .....	<b>xv</b>
<b>Chapter 1</b> .....	<b>1</b>
Introduction .....	1
1.1 - Smart Grid Concept and Distribution Automation Benefits .....	1
1.2 - Service Restoration Relevance and Self-Healing Challenges .....	3
1.3 - Motivation and Objectives: The rationale behind this work .....	4
1.4 - Structure of the Dissertation.....	4
1.5 - Dissemination of Results .....	5
<b>Chapter 2</b> .....	<b>7</b>
Medium Voltage Distribution Networks: Quality of Service .....	7
2.1 - Technical Quality of Service .....	7
2.2 - Reliability Indices .....	8
2.3 - Power Outages Economic Impact.....	14
2.4 - Self-Healing Implementation Strategies.....	17
2.5 - Summary .....	21
<b>Chapter 3</b> .....	<b>23</b>
Power Switchgear in Overhead Distribution Networks .....	23
3.1 - Power Switchgear Solutions .....	23
3.2 - Power Switchgear Coordination .....	26
3.3 - Power Switchgear Optimal Deployment.....	33
3.4 - Summary .....	37
<b>Chapter 4</b> .....	<b>39</b>
Techno-Economic Assessment of Reclosers Deployment in Medium Voltage Distribution Networks.....	39

4.1 - Methodology Description .....	39
4.2 - Technical Analysis of Quality of Service .....	47
4.3 - Economic Analysis of Recloser’s Deployment .....	48
4.4 - Summary .....	51
<b>Chapter 5 .....</b>	<b>53</b>
Case Study: Description and Analysis of the Results .....	53
5.1 - Case Study: Description.....	53
5.2 - Results Analysis .....	61
5.3 - Summary .....	71
<b>Chapter 6 .....</b>	<b>73</b>
Conclusions and Future Work .....	73
6.1 - Conclusions .....	73
6.2 - Work Contribution and Methodology Limitations .....	75
6.3 - Future Work .....	77
<b>References .....</b>	<b>79</b>

# List of figures

Figure 1.1 - The Smart Grid paradigm.....	2
Figure 2.1 - Penalty/Incentive IQS mechanism related with the ENS [7].....	11
Figure 2.2 - Incremental cost of reliability [4]. ....	14
Figure 2.3 - Cost of reliability from a customer and a system operator perspective [4]. ....	15
Figure 2.4 - Customer Damage Functions for a set of relevant types of customers [4]. ....	16
Figure 2.5 - Comparison of response time between a Self-Healing capable network and a conventional network [10]. ....	17
Figure 2.6 - DGA with several feeders and possible reconfiguration strategies [13]. ....	20
Figure 2.7 - Several DGAs and their status in a distribution network [19]. ....	21
Figure 3.1 - Recloser module for overhead distribution networks. ....	25
Figure 3.2 - Recloser installed in a utility pole. ....	25
Figure 3.3 - Time coordination of protections in network's normal state of operation.....	27
Figure 3.4 - Time coordination of protections in network's reconfigured state of operation..	27
Figure 3.5 - Normal and reverse protection settings of reclosers in MV network [44]. ....	30
Figure 3.6 - Block signal multicast by IEDs to fault isolation in a radial feeder. ....	31
Figure 3.7 - Overhead distribution network with GOOSE capable IEDs. ....	32
Figure 3.8 - Latency evolution of communication networks [50]. ....	32
Figure 3.9 - Faulted network [29]. ....	35
Figure 3.10 - Restored network [29]. ....	35
Figure 3.11 - FDIR procedure between two interconnected feeders from the same primary source. ....	37
Figure 4.1 - Methodology flowchart. ....	40

Figure 4.2 - Network zones definition.....	42
Figure 4.3 - First recloser deployed. ....	44
Figure 4.4 - Second reclosers deployed. ....	44
Figure 4.5 - Third recloser deployed. ....	44
Figure 4.6 - Assessment of the ENS levels in the sequence of a fault. ....	47
Figure 5.1 - Case study network real scheme.....	54
Figure 5.2 - Case study network one-line scheme.....	55
Figure 5.3 - Case study network one-line scheme including the solution with 4 reclosers deployed.....	59
Figure 5.4 - ENS evolution for the base case scenario.....	62
Figure 5.5 - SAIDI evolution for the base case scenario. . ....	62
Figure 5.6 - SAIFI evolution for the base case scenario. ....	63
Figure 5.7 - MAIFI evolution for the base case scenario.....	63
Figure 5.8 - Contributions for the total economic benefit achieved in the first year for the base case scenarion. ....	64
Figure 5.9 - NPV and PbP evolution for the base case scenario.....	65
Figure 5.10 - Cumulative Cash Flows evolution for the base case scenario. ....	65
Figure 5.11 - ENS evolution for the three different load scenarios.....	66
Figure 5.12 - NPV and PbP evolution for the max load scenario. ....	67
Figure 5.13 - NPV and PbP evolution for the min load scenario.....	67
Figure 5.14 - ENS evolution for the two different scenarios, base case and longer restoration and repair times. ....	68
Figure 5.15 - NPV and PbP evolution for the alternative scenario with longer restoration and repair times.....	68
Figure 5.16 - NPV evolution for the alternative scenarios with max and min recloser costs and for the base case. ....	69
Figure 5.17 - NPV evolution for the alternative scenario with 30 and 15 years of reclosers' lifetime and for the base case. ....	70
Figure 5.18 - Influence of the load growth rate in the number of reclosers in the network. ..	70
Figure 5.19 - Influence of the value of ENS in the number of reclosers in the network. ....	71

# List of tables

Table 2.1 - Values of the parameters related with the IQS improvement in 2013 [8].	12
Table 2.2 - Values of the parameters FC and KC in the MV distribution network in 2013 [8].	13
Table 2.3 - Reference Values of SAIDI and SAIFI in the MV distribution network per year, in 2013 [8].	13
Table 2.4 - Reference Values of NI and DI in the MV distribution network per customer in 2013 [8].	14
Table 2.5 - Main advantages and disadvantages of Self-Healing implementation schemes.	19
Table 3.1 - Comparison of functionalities and impact of reclosers and fault interrupters framed in Self-Healing schemes.	26
Table 3.2 - Protection levels of IEEE ANSI 50 functions for a 30 kV main feeder protection [41].	29
Table 3.3 - Comparison between several FDIR technologies [18].	36
Table 5.1 - Feeder's utilization factors and thermal capacity.	55
Table 5.2 - Feeder's main section length and conductors.	56
Table 5.3 - Cable's electric parameters.	56
Table 5.4 - Load characteristics.	57
Table 5.5 - CENS and Benefit of the solution in the first year.	59
Table 5.6 - IQS and Benefit of the solution in the first year.	60
Table 5.7 - Economic analysis over the twenty years with 4 reclosers deployed.	61





# Abbreviations and Symbols

## List of abbreviations

CAPEX	Capital Expenditures
CBA	Cost Benefit Analysis
CENS	Cost of Energy Not Supplied
DA	Distribution Automation
DG	Distributed Generation
DGA	Distribution Grid Area
DMS	Distribution Management System
DSO	Distribution System Operator
EDA	Electricity of Azores
EMS	Energy Management System
ENS	Energy Not Supplied
ERSE	Energy Services Regulatory Authority
FDIR	Fault Detection Isolation and Restoration
GOOSE	Generic Object Oriented Substation Event
HV	High Voltage
IEEE	Institute of Electrical and Electronics Engineering
IEC	International Electrotechnical Commission
IED	Intelligent Electronic Device
IQS	Incentive to the Quality of Service
IRR	Internal Rate of Return
MAIFI	Momentary Average Interruption Frequency Index
MV	Medium Voltage
NOP	Normally Open Points
NPV	Net Present Value
OMS	Outage Management System
OPEX	Operation Expenditures
PbP	Payback Period
QoS	Quality of Service
RAA	Region Autonomous of Azores
RTU	Remote Terminal Unit
SAS	Substation Automation System
SAIDI	System Average Interruption Duration Index
SAIFI	System Average Interruption Frequency Index

SCADA	Supervisory Control And Data Acquisition
SSC	Smart Substation Controller
TC	Total Compensation
TIEPI	Time Interruption Equivalent of the Power Installed

#### List of symbols

A	Ampere
h	Hour
int	Interruption
min	Minute
s	Seconds
ss	Secondary Substation
V	Volt
W	Watt
$\Omega$	Ohm
S	Siemens
km	Kilometre
p.u.	Per Unit

# Chapter 1

## Introduction

The main objective of this work is to study the problem of service restoration in distribution networks using properly coordinated automatic circuit reclosers framed in Self-Healing schemes. A methodology was developed to assess the techno-economic impact of recloser in the operation of distribution network, assessing the number and location for the deployment of reclosers in overhead medium voltage distribution networks that leads to the best investment strategy.

In this first Chapter, the motivation, the objectives and the structure of the dissertation are presented.

### **1.1 - Smart Grid Concept and Distribution Automation Benefits**

Smart Grid represents the next generation of electric power utilities, characterized by the increased use of communications and information technologies, in generation, transmission, distribution and consumption of electricity [1]. The network's automation provides real time monitoring, analysis and control of all the supply chain, allowing a more efficient system operation. Through Smart Grids, the reduction of operational costs while improving the reliability and the safety of the electric power supply is achievable. Smart Grids allow two-way communications, centralized and distributed generation, extensive customer interaction, automated power flow control, preventive protection strategies and Self-Healing schemes for service restoration, through multiple power flow pathways provided by the exploration of the network in an open mesh topology. The evolution from a conventional grid to a Smart Grid paradigm brings great benefits, increasing the integration of renewable energy sources in a larger scale, including customer-owner Distributed Generation (DG) systems and storage systems, reducing the restoration times after

## 2 Introduction

disturbances and increasing the quality of service of the system due to reliability improvement.

Communication standards and protocols are crucial to the Smart Grid's implementation, as interoperability is fundamental. A single company approach is not economically effective, due to massive systems with different technologies, requiring the perfect integration of several solutions that must be future-proof. Smart Grid's implementation includes system planning and engineering, as well as utility operation, system operation and customer's management, involving several functions of the Supervisory Control And Data Acquisition (SCADA) system such as the Energy Management System (EMS), the Distribution Management System (DMS) and the Outage Management System (OMS). These centralized functionalities must be able to interoperate with the Substation Automation Systems (SAS) and with the Smart Metering systems. The Smart Grid cuts across many sectors of power systems, involving several solutions as illustrated in Figure 1.1.

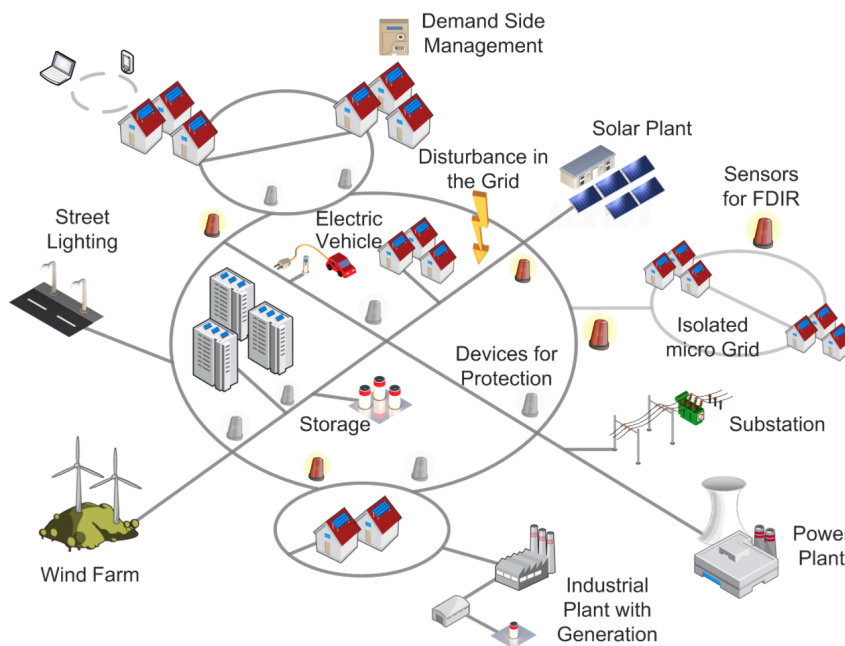

**Figure 1.1 - The Smart Grid paradigm.**

Distribution Automation (DA) plays a central role in the evolution of the power grid and, particularly, distribution networks. DA aims to optimize the utility's operation of distribution systems improving the system's reliability, incorporating the provided functionalities in the existing SCADA systems and in the communication infrastructures [2]. DA refers to a set of technologies that provide capability of remote operation in real time, taking advantage of the latest high-speed communication technologies to best exploit the network's current assets. Utilities deploying DA technologies benefit from a significant reduction in the outage times and in the number of switching manoeuvres required to circuit's reconfiguration. The feeder's automation makes the fault detection easier and the fault isolation and the service

restoration procedures more rapid and automatic, reducing the global response time to outages.

## **1.2 - Service Restoration Relevance and Self-Healing Challenges**

The growing efficiency in service restoration is a result of Smart Grid's implementation as the investment in DA empowers the network with solutions capable of promptly respond to disturbances, minimizing the outage's impact. Unplanned service interruptions are a great concern, entailing additional costs for both system operators and customers. The occurrence of faults in the network cause stability problems and power shortages, decreasing the Quality of Service (QoS). The impact of power failures in the different sectors has an intangible nature. Despite this, the costs are borne by system operators that must pay compensations to the affected customers and the penalties imposed by the regulator, as well as bearing the costs of the energy not supplied.

In Portugal, the Energy Services Regulatory Authority (ERSE) has the responsibility to monitor and regulate the power systems agent's activities, applying the penalties and the incentives related with QoS patterns.

The investment in efficient service restoration solutions has to follow the growing requirement from regulators and customers. As the QoS's improvement appears as a constant need for the Distribution System Operator (DSO) the network automation arises as a relevant solution.

Supplying the maximum load affected by a fault and reducing the load restoration time to minimum are the Self-Healing main goals. This must be accomplished while preserving the network operation within the limits of current, voltage and power. Self-Healing provides automatic operation, taking advantage of the remote operability of the power switchgear, or assistance to the DSO. However, the Self-Healing implementation presents technical and economic challenges. The network's automatic reconfiguration is one of the Self-Healing's main features in the service restoration process. The network's topology strongly influences the performance of the Self-Healing strategy. Meshed networks, with Normally Open Points (NOP) linking several feeders are more suitable for the Self-Healing implementation. The network's high-speed communication capability is another important requirement. Power switchgear solutions as reclosers bring benefits to the Self-Healing implementation but also bring new coordination challenges. All these challenges entail investment costs that must be justified by the global revenue achieved from the system operation.

### **1.3 - Motivation and Objectives: The rationale behind this work**

Related with the Self-Healing implementation other intrinsic objectives arise like the deployment of power switchgear in distribution networks and the evaluation of the economic impact of QoS improvement.

This work addresses these two problems together, aiming to assess the number of reclosers to deploy in a Distribution Grid Area (DGA) and the location of those reclosers, in order to achieve the maximization of several reliability indices and find the most adequate investment strategy.

In order to assess the strategy of reclosers deployment the network is divided in zones where, each zone represents a Medium Voltage (MV) feeder and the recloser deployment splits the zone's load in equal parts. To evaluate the economic impact of reliability improvement it is necessary to measure the savings due to the reduction of the Cost of Energy Not Supplied (CENS), the reduction of the Total Compensation (TC) to costumers and the reduction of penalties or increase of incentives due to the Incentive to the Quality of Service (IQS). Opposing these savings against the Capital Expenditures (CAPEX) and to the Operational Expenditures (OPEX), the economic outcome is determined.

Furthermore, this work addresses the technical challenges of the Self-Healing implementation. In order to allow the proper operation of the protection systems a group of setting must be defined, assuring selectivity and bidirectional coordination.

The methodology is implemented in a real distribution network. The case study is based in a Portuguese overhead MV distribution operated by Electricity of Azores (EDA). The appropriate number and location of reclosers for this network are determined and the solution robustness to key parameters is assessed through a sensitivity analysis.

### **1.4 - Structure of the Dissertation**

The dissertation consists of six Chapters. In Chapter 1 the work's theme is introduced together with the main topics and problems addressed over the next Chapters, which are: the Smart Grid concept, the distribution automation benefit, the service restoration relevance and the Self-Healing challenges to deal with it.

The Chapter 2 focuses in the quality of service of medium voltage distribution networks. The technical quality of service is addressed and the relevant reliability indices are presented. The power outages economic impact and the contribution of the distribution system are discussed. The several Self-Healing implementations strategies and solutions to the technical quality of service improvement are analysed.

Later, in Chapter 3, the power switchgear technologies used in the Self-Healing implementation are presented. The characteristics of the available solutions are presented

and the advantages and disadvantages are discussed. The coordination challenges, with significant impact in the service restoration procedure, are addressed. The power switchgear optimal deployment problem is introduced and the techniques and methods to deal with it are discussed.

The Chapter 4 includes the presentation and the description of the methodology developed to define the deployment strategy of reclosers in overhead distribution networks based in a cost benefit analysis considering technical and economic aspects. The methodology is presented and described step by step and the specific analysis of the technical quality of service and the economic impact of recloser's deployment is explained separately.

In Chapter 5 the case study used to validate the methodology is presented. The results of the base case and the sensitivity analysis are presented and commented critically.

The last Chapter, Chapter 6, includes the main conclusions of the developed work, the work contributions, the methodology limitations and the future work perspectives.

## **1.5 - Dissemination of Results**

The work developed in the ambit of this dissertation resulted in a paper that will be submitted to the IEEE ENERGYCON 2016, the International Energy Conference sponsored by the Institute of Electrical and Electronics Engineering (IEEE). The conference will be held on April 4-8, 2016 in Leuven, Belgium. The paper's title is "*Reclosers to Self-Healing Schemes in Distribution Networks: A Techno-Economic Assessment*", and presents a methodology to assess the benefit of the deployment of reclosers in Overhead Distribution Networks through a techno-economic analysis.





## Chapter 2

# Medium Voltage Distribution Networks: Quality of Service

In Portugal, the government regulator for electricity ERSE, takes the responsibility for monitoring the activity of the power system agents, producers, transmission system operators, distribution system operators, last resource retailers and customers. This entity regulates the Distribution System Operators' (DSO) operational activity, promoting the appropriate levels of Quality of Service (QoS) [3]. The QoS evaluation is divided into the technical and the commercial components. In the ambit of this work, only the technical component will be analysed.

This Chapter presents the QoS characterization and the reliability indices defined to assess it. The analysis of the economic impact of power outages and the Self-Healing contribution for the QoS improvement are addressed as well.

### 2.1 - Technical Quality of Service

The distribution system makes the greatest individual contribution to the unavailability of supply to customers, as presented in [4] (Section 7.1), mainly due to unplanned service interruptions at the Medium Voltage (MV) level of the networks, i.e. from 1 kV to 35 kV. Power shortages are a great concern for DSOs and have a significant impact in the QoS.

According to [7] the technical QoS of the electric energy supply is related with the analysis of the continuity of service and the quality of the voltage wave. The continuity of service is associated with the number and duration of supply interruptions. The quality of the voltage wave is associated with evolution of its frequency, amplitude, voltage dips, voltage swells, flickers, imbalance and harmonic distortion. The QoS report aims at setting the rules and the minimum quality levels in the customer supply. It establishes the responsibilities and

the obligations of the entities involved, defining the indicators and the quality standards, establishing the compensations to be paid when the individual indicators are not met and identifying the customers with special needs and the priority customers.

The DSO is responsible for the technical QoS to customers connected to the distribution network, regardless of the commercial entity with which the customer has contract. For this reason the DSO should monitor and assess the evolution of disturbances in their networks.

The power supply and the provision of related services may be interrupted for the following reasons:

- Public interest;
- Service reasons;
- Security reasons;
- Fortuitous cases or cases of force majeure;
- Reasons attributable to the customers;
- Interruptions agreed with the customer;

The interruptions are classified in long interruptions and short interruptions. Long interruptions are interruptions that last more than three minutes while short interruptions are the ones that present 3 or less minutes of duration.

In order to apply this regulation, QoS zones are established. There are three different zones [49]:

- Zone A - district capitals and towns with more than 25000 clients;
- Zone B - towns with a number of clients between 2500 and 25000 clients;
- Zone C - other towns;

Related with continuity of service, there are two types of indices: general and individual indices. General indices refer to an entire network explored by a DSO or to a group of customers. Individual indices refer to every electrical installation at the delivery points, including customers.

## 2.2 - Reliability Indices

The reliability indices characterize the continuity of service of the network. The indices differ depending on the voltage level. In this work only the indices related to the continuity of service are considered, namely the reliability indices that characterize the MV network.

In Subsection (2.2.1) and Subsection (2.2.2) the general indices and the individual indices are presented, as well as the mechanisms to the IQS. In the Subsection (2.2.3) the reference values of both general and individual indices are presented.

### 2.2.1 General Indices

For MV distribution networks, according to the respective QoS zone, the DSO must perform the characterization of the continuity of service based on the following indices:

- TIEPI - Time Interruption Equivalent of the Power Installed;
- SAIFI - System Average Interruption Frequency Index;
- SAIDI - System Average Interruption Duration Index;
- ENS - Energy Not Supplied;
- MAIFI - Momentary Average Interruption Frequency Index;

These indices should be made available annually by the DSOs. In order to characterize the MV networks performance, reference values are set every year for the general indices SAIDI and SAIFI. The referred reference values are grouped by QoS zone. In the case of the Region Autonomous of Azores (RAA) the reference values are also set for each island. These reference values refer to long accidental interruptions, except for interruptions resulting from exceptional events.

- I. TIEPI index indicates the equivalent time of interruption of the installed power, regarding long interruptions, over a predefined period of time (e.g. one year). According to [7] the formula is given by:

$$TIEPI = \frac{\sum_{j=1}^y \sum_{i=1}^x (DI_{i,j} \times PI_j)}{\sum_{j=1}^y (PI_j)} \text{ [min]} \quad (2.1)$$

where  $DI_{i,j}$  is the duration (in minutes) of the long interruption  $i$  in the delivery point  $j$ ;  $PI_j$  is the power installed (in kVA) in the delivery point  $j$ ;  $y$  is the total number of delivery points in the MV network and  $x$  is the number of long interruptions at the delivery point  $j$  in the predefined period of time.

- II. SAIFI index indicates the average number of long interruptions in the delivery points of the MV network, including private and public secondary substations, over a predefined period of time. According to [7] the formula is given by:

$$SAIFI = \frac{\sum_{j=1}^y (FI_j)}{y} \quad (2.2)$$

where  $FI_j$  is the number of long interruptions at the delivery point  $j$  in the predefined period of time and  $y$  is the total number of delivery points in the MV network.

- III. SAIDI index indicates the average duration of long interruptions in the delivery points of the MV network, including private and public secondary substations, over a predefined period of time.

According to [7] the formula is given by:

$$SAIDI = \frac{\sum_{j=1}^y \sum_{i=1}^x (DI_{i,j})}{y} [min] \quad (2.3)$$

where  $DI_{i,j}$  is the duration (in minutes) of the long interruption  $i$  in the delivery point  $j$ ;  $y$  is the total number of delivery points in the MV network and  $x$  is the number of long interruptions at the delivery point  $j$  in the predefined period of time.

- IV. ENS index indicates the estimated value of the energy not supplied in the delivery points of the MV network, including private and public secondary substations, due to long interruptions over a predefined period of time.

According to [7] the formula is given by:

$$ENS = \frac{TIEPI \times ES}{T} [MWh] \quad (2.4)$$

where  $ES$  is the energy (in Mega Watt-hour) supplied to the MV network and  $T$  is the predefined period of time (in hours).

- V. MAIFI index indicates the average number of short interruptions in the delivery points of the MV network, including private and public secondary substations, over a predefined period of time.

According to [7] the formula is given by:

$$MAIFI = \frac{\sum_{j=1}^y (BI_j)}{y} \quad (2.5)$$

where  $BI_j$  is the number of short interruptions at the delivery point  $j$  in the predefined period of time and  $y$  is the total number of delivery points in the MV network.

The incentive mechanisms to the improvement of the continuity of service aim to promote the suitable evolution of the network's performance. This mechanism is applicable to the MV DSO with the objective of, on one hand, promoting the global continuity of service in the electric energy supplying; and, on the other hand, encourages the improvement of the

continuity of service to the most affected customers. The Incentive to Quality of Service (IQS) targets the Energy Not Supplied (ENS) reduction, with incentives or penalties being applied depending of the value of the ENS. A reference ENS is set and if the assessed ENS stays below the limit set by a margin of tolerance around the reference, i.e. if  $ENS < ENS_{Ref} - \Delta ENS$  an incentive is applied. According to [7] the incentive is given by the next formula:

$$IQS = \text{Min}\{IQS_{max}; (ENS_{Ref} - \Delta ENS - ENS) \times V_{ENS}\} [\text{€}] \quad (2.6)$$

A reference ENS is set and if the assessed ENS exceed the limits set by a margin of tolerance around the reference, i.e. if  $ENS > ENS_{Ref} + \Delta ENS$  a penalty is applied. According to [7] the penalty is given by the next formula:

$$IQS = \text{Max}\{IQS_{min}; (ENS_{Ref} + \Delta ENS - ENS) \times V_{ENS}\} [\text{€}] \quad (2.7)$$

where,  $IQS_{max}$  is the maximum value of the incentive (in euros),  $IQS_{min}$  is the minimum value of the penalty (in euros), ENS is the energy not supplied (in kWh),  $ENS_{Ref}$  is the energy not supplied of reference (in in kilo Watt-hour),  $\Delta ENS$  is the margin of tolerance of the energy not supplied (in kilo Watt-hour) and  $V_{ENS}$  is the value of the energy not supplied (in euros per kilo Watt-hour).

The IQS mechanism related with the ENS is represented in Figure 2.1.

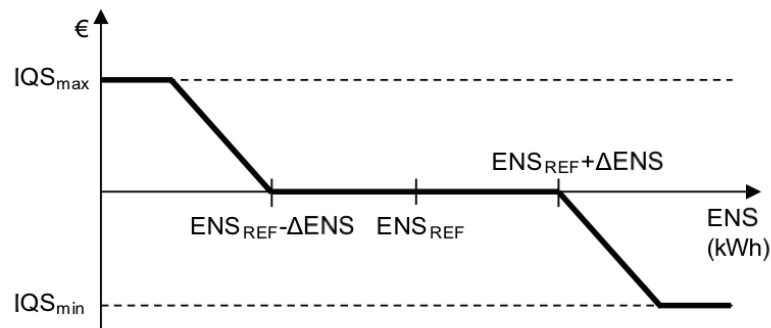

Figure 2.1 - Penalty/Incentive IQS mechanism related with the ENS [7].

According to [8] the values of  $IQS_{max}$ ,  $IQS_{min}$ ,  $ENS_{Ref}$ ,  $\Delta ENS$  and  $V_{ENS}$  are presented in Table 2.1.

**Table 2.1 - Values of the parameters related with the IQS improvement in 2013 [8].**

Parameter	Value
$IQS_{max}$ [€]	5 000 000
$IQS_{min}$ [€]	-5 000 000
$ENS_{Ref}$ [kWh]	$0,000134 \times ES^1$
$\Delta ENS$ [kWh]	$0,12 \times ENS_{Ref}$
$V_{ENS}$ [€/kWh]	1,5

### 2.2.2 Individual Indices

For MV distribution networks, according to the respective QoS zone, reference values are set every year for the following individual indices:

- NI - Number of Interruptions;
- DI - Duration of the Interruptions;

The reference values for these indices also refer to long accidental interruptions, except for interruptions resulting from exceptional events.

- NI index indicates the total number of long interruptions at a delivery point of the MV network in a predefined period of time.

Whenever the number of interruptions is exceeded, the compensation value (CN) is calculated as follows [7]:

$$CN = (NI - NIP) \times FC \text{ [€]} \quad (2.8)$$

where NIP is the reference value of the number of long interruptions and FC is the unitary value of the compensation (in euros per interruption) of the number of interruptions. The ERSE publishes the values of FC annually.

- DI index indicates the average total duration of long interruptions in a delivery point of the MV network in a predefined period of time.

Whenever the total duration of interruptions is exceeded, the compensation value (CD) is calculated as follows [7]:

$$CD = (DI - DIP) \times PC \times KC \text{ [€]} \quad (2.9)$$

<sup>1</sup> Energy Supplied (ES) by the network in a year

where DIP is the reference value of the duration (in hours) of long interruptions, PC is the average value the contracted power (in kW) and KC is the unitary value of the compensation (in euros per kWh) of the duration of interruptions. The ERSE publishes the values of KC annually.

According to [8] the values of FC and KC are presented in Table 2.2.

**Table 2.2 - Values of the parameters FC and KC in the MV distribution network in 2013 [8].**

Parameter	Value
FC [€/int]	24
KC [€/kWh]	0,35

### 2.2.3 Reference Values of Reliability Indices

The general and individual indices have reference values associated. These reference values aim to ensure the preservation of the QoS within the limits prescribed by the regulator.

The values defined for the general indices in each island of the RAA are presented in Table 2.3.

**Table 2.3 - Reference Values of SAIDI and SAIFI in the MV distribution network per year, in 2013 [8].**

Parameter	QoS Zone	Reference
SAIDI [h]	A	3
	B	5
	C	12
SAIFI [int]	A	4
	B	8
	C	12

The reference values defined for the individual indices in the RAA are presented in Table 2.4.

**Table 2.4 - Reference Values of NI and DI in the MV distribution network per customer in 2013 [8].**

Parameter	QoS Zone	Reference
NI	A	8
	B	15
	C	30
DI [h]	A	4
	B	8
	C	16

## 2.3 - Power Outages Economic Impact

Service interruptions have an economic impact for power system agents. This impact is not only associated with the loss of revenue by the DSO or with energy not supplied to the customers.

Reliability costs and reliability welfare value are significant matters to define the power system operating strategy. Assessing the investment cost, as well as defining where that investment should be made and in what equipments in order to achieve the maximum reliability improvement is fundamental. The economics plays a major role in the decision making process [4]. Assessing the incremental cost ( $\Delta C$ ) necessary to achieve a given increase in the distribution network's reliability ( $\Delta R$ ) is what defines whether an investment is worth. The incremental cost of reliability ( $\Delta C/\Delta R$ ) is shown in Figure 2.2.

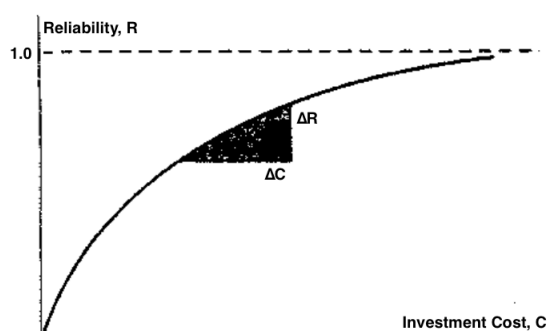

**Figure 2.2 - Incremental cost of reliability [4].**



The incremental cost of reliability does not reflect the benefits for customers or DSOs. As presented in [4], the reliability-cost and the reliability-worth evolution is presented in Figure 2.3.

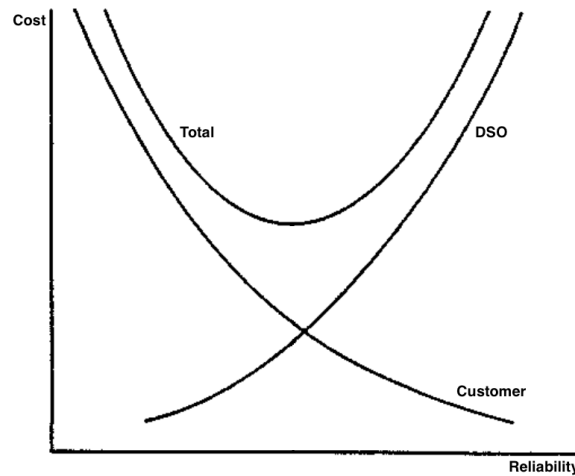

**Figure 2.3 - Cost of reliability from a customer and system operator perspective [4].**

For the investor i.e. the DSO, the cost increases with higher reliability, due to expenses with the acquisition of new equipment and with the operation and maintenance of the network. For the customer, the cost related with power outages decreases with higher reliability. The sum of these two curves results in the total cost whose minimum value represents an optimal commitment. In Subsection (2.3.1) and Subsection (2.3.2) the economic impact of QoS for customers and for DSOs is analysed.

### 2.3.1 Economic Impact for the Customer

The measure of the costs for customers following a power outage is important for the process of assessing power outages economic impact. Several methods are used to evaluate the impacts on customers due to power outages. As presented in [4], based on the methodological approach, these methods are divided into: indirect analytical evaluation, blackout case studies and customer surveys. In [9] different types of survey approaches promoted by distribution companies are presented, namely the assessment of the customer's willingness to accept and to pay the investments for the system QoS improvement. The level of response to outages of the system strongly depends on the investment made in the reliability improvement. The customers benefit from increased QoS, therefore, their willingness to pay for the necessary investments is very important for the DSO. As mentioned in [10], the capability of assessing the necessary cost to achieve a certain level of reliability is well established, through investment studies based on load growth forecasting. On the other hand, assessing the value of providing a certain level of reliability is a different and

more complicated problem. In order to evaluate this value it is necessary to measure the interruption damages to customers.

A preliminary step for the determination of power outages costs is the assessment of the diversity of customers and the nature of the impact resulting from the electric energy supply interruption. As presented in [4], impacts may be classified as direct or indirect, economic or otherwise (e.g. social and environmental), and short-term or long-term. Direct impacts result from the suspension of supply while indirect impacts result from the response to the interruption. Direct economic impacts include loss of production, process restart costs and spoilage of raw material. Indirect losses are difficult to categorize as social or economic, but may include, for example, looting in the sequence of a blackout or need of evacuation in the sequence of safety mechanisms failure. Regarding the duration of the impact, the distinction is made between short-term and long-term impacts. Mitigation measures to reduce or avoid future outage costs include the installation of protective devices such as power switchgear devices.

As stated in [4], from the perspective of customers the cost of an interruption is related with the degree of dependence of electric supply that the performed activity by the customers presents. This dependency is a function of both customer and interruption characteristics. Figure 2.4 shows the customer damage functions for a set of activities that present high expression in the electricity consumption.

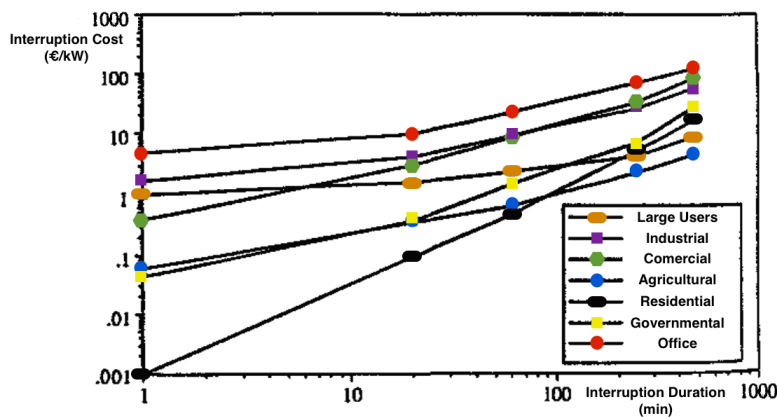

Figure 2.4 - Customer Damage Functions for a set of relevant types of consumers [4].

### 2.3.2 Economic Impact for the Distribution System Operator

The economic impact of power outages is logically extensible to the DSOs. As presented in the Section 2.2, besides the Cost of Energy Not Supplied (CENS), the DSO is responsible for paying the Total Compensation (TC) to customers and the IQS penalties to the regulator. According to [12], there are three categories in which the economic costs can be divided: faulted and damaged components repair or replacement costs; compensations paid to customers and penalties paid to regulators; and loss of revenue because of the ENS. The first

category depends on the type and location of the fault and the damage components. The second category depends on the rules and laws established to regulate the DSO operational activity. The third category depends exclusively on the amount of affected load and on the effectiveness of service restoration.

In order to minimize their economic losses due to power outages, DSOs must define investment strategies. Network’s automation arises as an efficient and effective way to achieve a more secure and reliable network. DA offers Self-Healing functionalities to assist the DSO in the power restoration process.

The Self-Healing contribution to the mitigation of power outages impact based on the DGA concept and in algorithms of Fault Detection Isolation and Restoration (FDIR) is addressed in the next Section.

### 2.4 - Self-Healing Implementation Strategies

In the previous Section the economic impact of power outages is analysed. This problem entails losses to customers and DSOs, therefore minimizing its impact through QoS improvement strategies is of general interest. DA provides network remote operation in real time as well as Self-Healing capability [13]. Self-Healing advanced functionalities improve the system’s reliability, allowing automatic detection and isolation of faults and fast service restoration through the network reconfiguration, as well as other additional features such as load balancing and power losses minimization. The effectiveness of service restoration plans depend on the fitness to restore as much load as possible in the out-of-service area in order to reduce the number of affected customers and the duration of power outages [14]. Figure 2.5 shows the differences between a network with Self-Healing and a conventional network, regarding the response times at service restoration.



Figure 2.5 - Comparison of response time between a Self-Healing capable network and a conventional network [10].

Different approaches can be adopted in the Self-Healing implementation, regarding the control strategy and the communications and power switchgear technologies [15] [21]. The influence of DG (Distributed Generation) in service restoration with Self-Healing is addressed in [20], where the optimal deployment of distributed generators along the network is assessed together with the protection devices placement to enhance system's reliability.

In this Section the Self-Healing contribution to QoS improvement is presented. The benefits of Self-Healing assisted service restoration as well as the DGA concept and the FDIR implementation strategies are addressed and discussed.

### 2.4.1 Centralized and Decentralized Self-Healing Implementation

Self-Healing FDIR algorithms arise as an alternative to the traditional disturbance report systems used by DSOs to detect faults in the network. When customers experience power outages they report it and the DSO dispatches maintenance crews to investigate the fault location and proceed to isolation and power restoration. This procedure may take some time, depending on fault reports, network extension and access roads. DA investments in network high-speed communication empowering and power switchgear outfitting allow the implementation of advanced Self-Healing schemes. The capabilities of these equipments to measure, communicate and operate in real time make them suitable for FDIR implementation, significantly improving the system's reliability [18]. On one hand, the automatic fault detection, location and isolation are relatively easier to achieve. Fault detectors deployed along the network provide accurate information to the system's operator. The operator executes remote controlled switching manoeuvres, opening the devices immediately upstream and downstream of the fault, isolating the faulted section. On the other hand, the automatic service restoration is a more challenging task due to the network reconfiguration problem complexity.

The Self-Healing implementation may occur through more centralized or more decentralized solutions [15]. Centralized schemes are control centre centric, with all the modelling, maintenance and intelligence concentrated in the control centre, taking advantage of all SCADA/DMS system features. This approach is based on telemetry and remote control capability of wide areas, running complete network models and being capable of analysing simultaneously multiple scenarios of disturbances. Decentralized schemes use feeder distributed Remote Terminal Units (RTU) with dedicated communication infrastructures to monitor the network and operate existing switching devices based on predefined automation procedures. This solution is cost effective and achieves fast response levels but is unable to deal with multiple disturbances or operating under non-standard network topologies. Decentralized schemes struggle to adapt to topological changes in the network's operation. Contrary to the centralized solution the decentralized solution lacks of flexibility to deal with DG penetration in the distribution network. The lack of perception of

the system as a whole makes difficult to control the DG output and to match it with the network's needs. There are semi-decentralized schemes, based on DA substation centric solutions with micro-DMS running on a Smart Substation Controller (SSC) in real time, with full awareness of downstream actual topology and operational state. The intelligence is centred at the primary substation level, coordinating a group of feeders and neighbouring substations that constitute the DGA. Together with the control centre centric, this mixed solution is the most suitable approach to deal with the Smart Grid paradigm, offering improved Self-Healing solutions [17].

The automation algorithms may be implemented at the control centre level, at the primary substation level or at the feeder level. The main differences between the presented schemes of Self-Healing implementation are listed in Table 2.5.

**Table 2.5 - Main advantages and disadvantages of Self-Healing implementation schemes.**

Centralized	Semi-decentralized	Decentralized
Allow any type of RTU	Allow any type of RTU	Specific RTUs
High area scalability	High area scalability	Reduced area scalability
Slow response time	Average response time	Fast response time
High complexity	Medium complexity	Low complexity
Applicable to any type of remote control	Applicable to any type of remote control	Distributed intelligence

Independently of the implemented architecture, the Self-Healing control system includes: a base layer composed by the grid infrastructures and equipments; a support layer composed by the data and the high-speed, bidirectional and integrated communication system; and an application layer, including the monitoring systems, the warning analysis, the decision making and control acting [24].

#### 2.4.2 Distributed Grid Area Concept

The concept of Distributed Grid Area (DGA) represents an operational area of the distribution network that is defined by a range of primary substations and their feeders, with possibility of automatic reconfiguration in the event of a fault [15] [16] [19]. In spite of being planned with meshed topology, these DGAs are operated in a radial topology with Normally Open Points (NOP) at the end of the feeder, as shown in Figure 2.6.

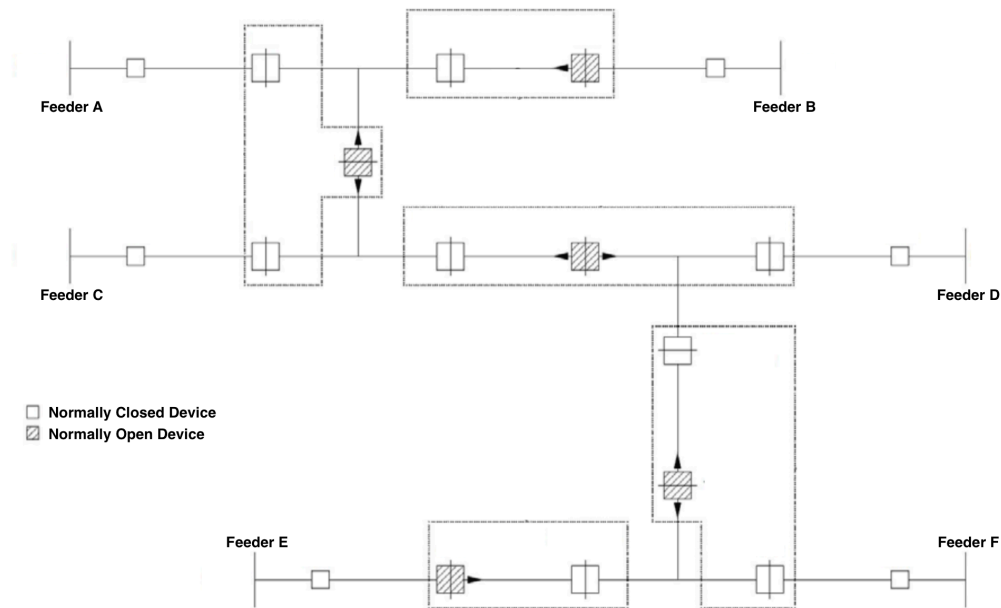

**Figure 2.6 - DGA with several feeders and possible reconfiguration strategies [13].**

Within a DGA the load restoration process is achievable with few switching manoeuvres, being the load transferred between feeders safely and rapidly. The distribution network can be seen as a set of several DGAs controlled simultaneously by the DSO which assigns different levels of autonomy to each area according to the system status and the severity of active disturbances. The DGA control system is placed at the primary substation level, in one of the DGA's substations. The SSC performs the master role, integrating the data models of all downstream feeders including the NOP between feeders, power switchgear deployed and DG assets in the DGA. The SSC is a complementary system to the Substation Automation Systems (SAS), running the DGA network model and implementing topology features based on real time data acquisition. The aggregation of the information and the decision-making are performed at the same level. The equipments deployed along the network need to report data, operation state and act according to the FDIR system's control signals [16].

The centralized SCADA/DMS system performs the network assessment of all the DGAs, sending coordination setups and operational control settings to each one. The SSC of each DGA becomes aware of its status thus being capable of operating in disable mode, enable mode or advisory mode [15] [19].

When in disabled mode, the DGA SSC does not have permission to perform any automatic action nor setting. Only the SCADA/DMS may instruct the SSC to perform specific manoeuvres or topology changing. The SSC only reports metering data to the DGA. When in enabled mode, the DGA SSC is fully autonomous and able to perform FDIR actions whenever a fault is detected. It will report metering and topology changes to the SCADA/DMS. When in advisory mode, the DGA SSC is able to perform Self-Healing plans and propose corrective actions to

the SCADA/DMS control centre. The SSC will then wait for the authorization from the SCADA/DMS to perform the proposed actions.

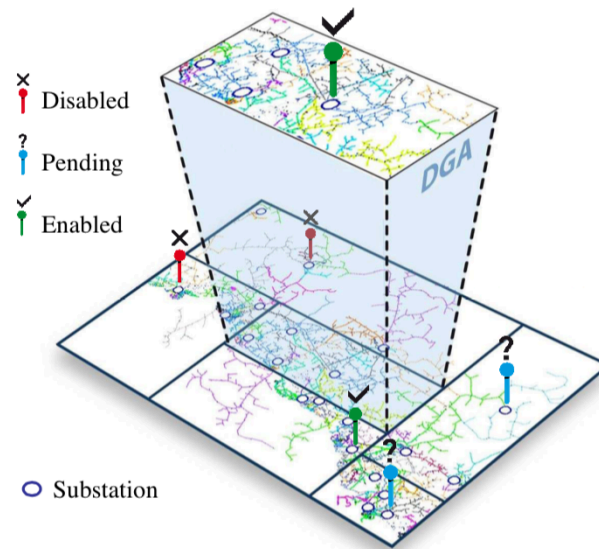

**Figure 2.7 - Several DGAs and their status in a distribution network [19].**

The SSC modes of operation are also able to perform or propose adaptive protections settings and dynamic changes in specific operational settings such as protections coordination.

A Self-Healing preventive assessment approach that is known by the strategy of “think global, act local” is suitable to be performed in distribution networks, where the SCADA/DMS represents the role of the gatherer of system’s operation awareness. Substation-centric self-healing solutions have the faster response level to any fault conditions in the DGA, due to their local perception of the network’s model [15].

The DGA provides flexibility in DG management, enhancing the role and performance of DG by controlling their outputs to meet the system needs in real time thus improving reliability while contributing to the system’s stability [19]. The optimal deployment of distributed generators minimizes the load to be restored and contributes to the control of voltage dropping along the feeders due to network reconfiguration. Isolated branches with DG that are inaccessible from alternative paths, may operate in island mode thus minimizing the affected load and the disturbance’s global impact due to voltage dropping, branches overload and frequency excursions.

## 2.5 - Summary

In Section 2.1 the technical quality of service is characterized. The Section 2.2 presents the relevant reliability for the technical quality of service, the general indices, the individual indices and their reference values. In the Section 2.3 the economic impact of power outages

is discussed and the distinct impacts for customers and for distribution system operators are addressed. The Section 2.4 addresses the Self-Healing implementation strategies. The Self-Healing features and schemes are presented. The centralized and decentralized implementation strategies are discussed and compared and the distributed grid area concept is presented and described.



## Chapter 3

# Power Switchgear in Overhead Distribution Networks

The investment in Distribution Automation (DA) covers the network's communication empowering and the hardware and software outfitting. In Section 1.2 and Section 2.4 the relevance of remotely operable power switchgear for the service restoration plans based in Self-Healing schemes is introduced. At the Medium Voltage (MV) network level, these devices are strategically deployed along the network, taking advantage of their remotely or automatic operability to rapidly detect and eliminate faults thus improving Quality of Service (QoS). However, the deployment of power switchgear with fault interruption capability brings challenges related to the coordination of selectivity between the distributed devices and the main feeder protection at the primary substation.

The available solutions of power switchgear devices for the implementation of Self-Healing strategies, the coordination challenges and the optimal deployment of power switchgear devices are the main topics presented and discussed in the present Chapter. Moreover, the network reconfiguration problem and the Fault Detection Isolation and Restoration (FDIR) schemes are addressed as well.

### 3.1 - Power Switchgear Solutions

Concerning power switchgear devices [45], the most suitable solutions for Self-Healing implementation comprises combined solutions of reclosers [46] and fault interrupters. In Subsection 3.1.1 and Subsection 3.1.2 these devices are presented and described. The power switchgear solutions in the Portuguese distribution network are listed and presented in [38], including disconnecters, load break switches, fault interrupters and reclosers.

The remote controlled switching devices which are strategically placed along the network, are able to detect and isolate faults by performing switching manoeuvres and by acting in order to restore the service to healthy zones of the network transferring load between feeders or between interconnected substations. Equipped with intelligent modules conceived to measure current and voltage and detect faults, automated power switchgear devices provide advanced protection and control settings including switching and reclosing functions as well as feeder isolation and restoration algorithms for loop configurations. These characteristics are required to the Self-Sealing implementation, as well as to the full communication capabilities and automatic or remote operability. This Section addressed two power switchgear technologies, fault interrupters and reclosers, both widely used in Self-Healing schemes.

### 3.1.1 Fault Interrupters

A fault interrupter is a self-controlled mechanical switching device capable of carrying, and automatically interrupting an alternating current that is known as fault interrupter [45]. It includes an assembly of control elements to detect overcurrents and control the fault interrupter.

The fault interrupter is remotely and manually operable. According to the specifications of the Portuguese Distribution System Operator (DSO) [43] the fault interrupter shall be capable of perform a complete closing manoeuvre in less than 100 ms. The isolating atmosphere in which circuit interruption is performed may be gas, SF<sub>6</sub> (sulphur hexafluoride), or vacuum. The installation of this type of device in overhead distribution networks is made in the utility poles. However, this device is unable to interrupt short circuit currents. For stipulated voltages of 15,5 kV, 27 kV and 38 kV the maximum interrupting rating is 560 A [43].

Using only fault interrupters, short circuit current's interruption must be performed by the main feeder breaker at the primary substation, leading to longer interruption times. The fault interrupters cannot adequately handle temporary faults which leads to the disconnection of the entire load of the feeder while the breaker at primary substation eliminates the disturbances. Nonetheless, fault interrupters solutions are widely used in Self-Healing implementation. Fault interrupters have impact in the SAIDI and ENS reduction and are easily coordinated with the main protection at the primary substation, using time intervals and voltage levels as settings V-T (voltage-time) and O-T (open-tie) commands addressed in Subsection 3.2.1.

### 3.1.2 Reclosers

A Recloser is a self-controlled device that is capable of automatically interrupting and reclosing an alternating-current circuit, with a predetermined sequence of opening and

reclosing actions followed by resetting, hold-closed, or lock-out operation [45]. This device includes an assembly of control elements required to detect overcurrents and to control the recloser operation. It is a fault-interrupter recloser that is capable of interrupt short circuit currents [46].

Reclosers are automatically, remotely and manually operable. Their range of manoeuvre allows the isolation of permanent and temporary faults. According to the specifications of the Portuguese DSO [44], the recloser shall be capable of performing over 10.000 complete open/close operations. The isolating atmosphere in which circuit interruption is performed may be gas, SF<sub>6</sub> (Sulphur Hexafluoride), or vacuum. The recloser shall be capable of performing a complete closing manoeuvre in less than 100 ms. The recloser clearing time shall be less than 100 ms in any operation conditions. The device shall provide the operation as recloser or as sectionalizer. The installation of this type of equipment in overhead distribution networks is performed at the utility poles. Figure 3.1 and Figure 3.2 shows a recloser module and the device installed in MV overhead power line, respectively.



**Figure 3.1 - Recloser module for overhead distribution networks.**

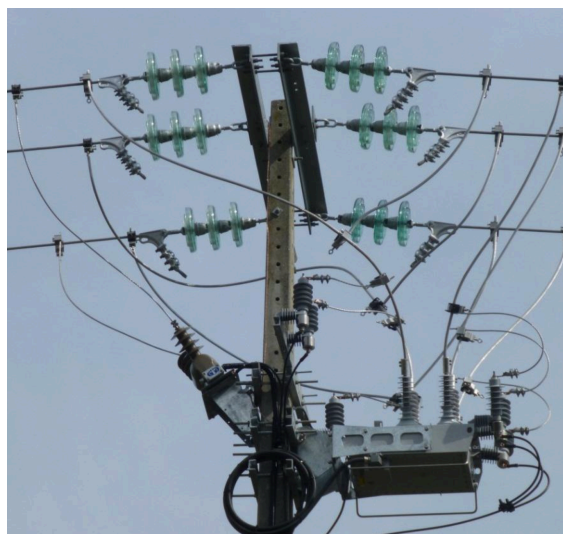

**Figure 3.2 - Recloser installed in a utility pole.**

Reclosers are capable of interrupt short circuit currents, thus reducing the affected load. For stipulated voltages of 12 kV, 17,5 kV and 36 kV the maximum interrupting rating is 12.500 A [44]. Capable of performing a predetermined sequence of reclosing actions, followed by resetting, hold-closed, or lock-out operations, reclosers are very effective in the mitigation of the impact of temporary faults [26]. In fact, temporary faults represents 75% to 80% of the total faults in overhead distribution networks [17], making reclosers effective in the global reliability improvement, in particular in the reduction of reliability indices SAIFI and MAIFI [23]. However, the number of reclosers in series is limited due to coordination issues. The time coordination with the main feeder protection at the primary substation limits the number of reclosers possible of deploy in a single feeder and thus the network reconfiguration in the sequence of service restoration entails additional challenges such as bidirectional coordination and selectivity [40]. The recloser solution is more complex than the fault interrupter solution although presenting a superior performance. Communication based protection schemes can overcome these limitations, increasing the number of reclosers that are possible of deploy in series. Peer-to-peer Generic Object Oriented Substation Event (GOOSE) messaging emerges as an alternative communication based protection scheme. This challenge is addressed in Subsection 3.3.2. Table 3.1 shows the main differences between reclosers and fault interrupters with and without self-healing implementation.

**Table 3.1 - Comparison of functionalities and impact of reclosers and fault interrupters framed in Self-Healing schemes.**

Characteristic	Fault Interrupter	Recloser
Remote and manual operability	✓	✓
Fault automatic isolation	✓	✓
Network's automatic reconfiguration	✓	✓
TIEPI decrease	$\frac{3}{4}$	1
ENS decrease	$\frac{3}{4}$	1
MAIFI decrease	0	1

## 3.2 - Power Switchgear Coordination

Power switchgear coordination is a relevant challenge for the effective implementation of Self-Healing schemes. The network's safety depends on the proper coordination and correct operation of protection systems. With the DA's penetration the achieved benefits entail several challenges due to the growing complexity of solutions. These challenges include the search for the most suitable settings and technologies for the protection system's implementation.

Power systems protection engineers deal with the problem of constantly incorporating new solutions into existing infrastructures. Some of these protection systems problems are not new such as the miscoordination issue, which occurs when multiple devices act in response to the same fault or a device overreaches another device protective zone. The problem increases with the increasing number of devices deployed in the network. The diversity of possible operating topologies due to network reconfiguration, which results in bidirectional power flows, brings additional coordination challenges. Miscoordination correction through multiple protective profiles that are suitable to be adapted to different topologies, is important to ensure the maximization of the system's protection in a Self-Healing environment [37]. The ability to adapt to changes in the network topology is important for the protection features, in order to ensure the optimization of the actuation times and the avoidance of misscoordination. Figure 3.3 and Figure 3.4 illustrate the adaptive protection process of the protections in a open mesh feeder's system.

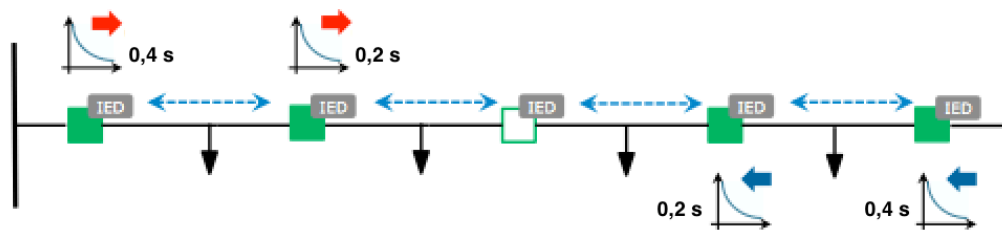

Figure 3.3 - Time coordination of protections in network's normal state of operation.

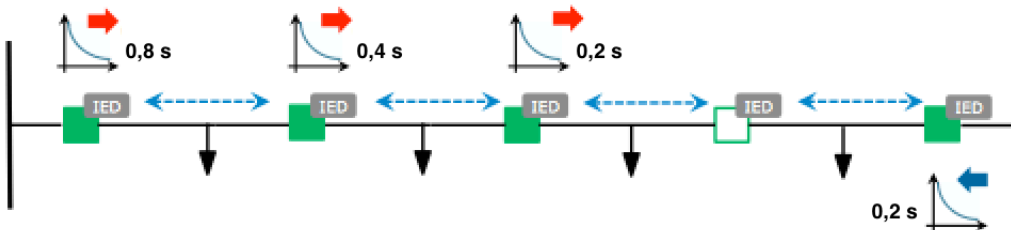

Figure 3.4 - Time coordination of protections in network's reconfigured state of operation.

After the change in the network topology, the midpoint Intelligent Electronic Device (IED) must be coordinated with the IEDs on the left feeder. To achieve the proper coordination, the two IEDs on the left feeder must change their time settings, increasing their time delay. The IED on the right feeder may be adjusted to act faster against faults that occurring on the right side of the tie-point device. Other protection coordination considerations are addressed

in [22], including time-overcurrent coordination as well as voltage and load influence. Communication technologies can also be implemented to improve selectivity in reconfigurable networks, using fault detectors with high-speed communication capability and supervisory controllers to update the protection setting when the networks configuration changes thus maintaining the selectivity [36]. The Distributed Generation (DG) interface with the network it also influences the coordination logic. The impact of DG in the distribution network includes bidirectional power flows and their protections make the network more sensitive to disturbances. In order to implement logic selectivity and fault detection, protection systems must exchange information and commands [39].

As stated in Subsection 3.1.2, the number of reclosers that are possible of coordinate in series limits their deployment. Flexible time-current characteristics that are redesigned to support autocoordination algorithms taking into account the particular characteristics of the feeder are a solution to perform the proper coordination of series reclosers installed in overhead distribution networks [40].

In Subsection 3.2.1 are described the V-T control the O-T control and the recloser's coordination settings that are used to coordinate power switchgear in overhead distribution networks. In Subsection 3.2.2, the communication based peer-to-peer GOOSE messaging scheme to coordinate protections is detailed.

### 3.2.1 Voltage-Time Control, Open-Tie Control and Reclosers Coordination

- **Power switchgear with V-T controls:**

The V-T command [42] is used to coordinate power switchgear devices that are unable to interrupt short circuit currents, with the main feeder protection at the primary substation. The objective is to isolate the faulted zone in order to restore the supply of power to the healthy sections of the feeder.

When a fault occurs the primary circuit breaker at the primary substation will open and the V-T control will recognize the loss of voltage therefore opening the device during the circuit breaker's dead time. After the reclosing of the circuit breaker, the V-T control will acknowledge the voltage restoration and after the close time will order the device's closure and an adjustable lockout time starts. If the V-T control recognizes another voltage loss during the lockout time, the device shall open and lockout. If no voltage loss occurs during the lockout time, the V-T control will reset after the lockout time. After lockout the device may be closed manually or by remote supervisory signal.

- **Power switchgear with O-T controls:**

The O-T command [42] is used to coordinate the power switchgear operating in Normally Open Points (NOP) in open loop systems. It operates with a modified V-T control. Upon loss of voltage on one side of the device a restraint timer is energized. If voltage is restored during

the restraint timer operation, the timer resets and the device remains open. If the restraint timer completes its running time a close order is given to the device and it starts to operate as a V-T control. After both sources are restored the device may be opened manually or by remote supervisory signal.

- **Reclosers coordination:**

Reclosers are capable of interrupting short circuit currents and for this reason the coordination with main feeder protection at the primary substation must be performed differently. According to [44] the device may operate in recloser mode or in sectionalizer mode, which means that the coordination settings will differ. The recloser mode is more challenging because it requires coordination with the main feeder protection at the primary substation. In recloser's mode, the Portuguese DSO establishes two different types of coordination for instantaneous overcurrents (IEEE ANSI code 50): defined current and defined time. The protection settings differ depending on the network topology [41]. With defined current, if the detected current is greater than the defined current, the action is instantaneous. The coordination of protection systems based on defined current presents the disadvantage of losing the validity of the settings if the upstream short circuit power is changed. With defined time, an instantaneous element will be parameterized and time delays will be defined. In order to ensure selectivity, the operation time of an upstream protection is incremented by the time delay in relation to a downstream protection. The coordination of protection systems based on defined time presents the disadvantage of increasing the operation time of upstream protections i.e. those who deal with the more severe currents as a consequence of time discrimination. In meshed networks the protections must be directional due to bidirectional power flows. Table 3.2 presents the three levels ( $I>$ ,  $I>>$  and  $I>>>$ ) of protection against instantaneous overcurrents for the main feeder protection at the primary substation (30 kV at the MV side) [41].

**Table 3.2 - Protection levels of IEEE ANSI 50 functions for a 30 kV main feeder protection [41].**

	Operation Current	Operation Time (s)
Threshold 1 ( $I>$ )	$1,4 \times I_N$	1,0
Threshold 2 ( $I>>$ )	$2 \times I_N$	$0,5^2$
Threshold 2 ( $I>>>$ )	1500 A	$0,1^3$

<sup>2</sup> May be increased to 0,7 s, for coordination with downstream protections

<sup>3</sup> May be increased to 0,3 s, for coordination with downstream protections

The recloser's coordination challenges will result in a limitation of the number of reclosers possible of deploy in a single feeder. The Portuguese DSO adopts a defined time coordination strategy against instantaneous overcurrents, which depend on the fault current intensity. For instantaneous earth overcurrents (IEEE ANSI code 50N) a defined time setting is implemented at the primary substation level. In order to ensure the coordination with the protections of the HV network, the operation time must be less than 1 s. In MV networks, for instantaneous overcurrents greater than 2.000 A, the operation time shall be instantaneous. These considerations are the greatest challenges of the coordination between the main feeder protection and the reclosers. For both instantaneous overcurrents (50) and instantaneous earth overcurrents (50N), a 200 ms coordination time delay is considered for the first level of protection ( $I >$ ) [11]. The operation time at the primary substation level for overcurrents greater than 2.000 A should be increased from 100 ms to 300 ms. The number of series reclosers will be limited to four per open loop (i.e. the network reconfiguration procedure for service restoration will open the tie-point between two feeders and close a mid-point recloser to isolate the fault, establishing a new series of up to three reclosers, to be coordinated) and three per feeder, which is in accordance with a maximum number of three reclosers in series possible of being coordinated. This will ensure the proper coordination between the recloser closer to the end of the feeder and the main feeder protection, regardless of network configuration.

In order to take advantage from all features of the recloser, the reclosing automatism at the primary substation should perform only two slow reclosing attempts of 15 s of isolation time. This allows reclosers to more adequately handle temporary interruptions. According to [44] the recloser must provide switch-on to fault functionality, i.e. by switching on to fault mode the recloser shall be tripped and lockout without performing any reclosing attempt. The reclosers at NOP may operate in automatic or manual mode. In automatic mode the recloser will close automatically after detecting loss of voltage from the normal power flow side. In manual mode the recloser shall provide switch on to fault functionality. Regarding power flow directions, the recloser must be automatically adaptable, changing between two groups of settings that are normally power flow setting or reverse power flow setting. Figure 3.5 shows normal and reverse settings for recloser's coordination against instantaneous overcurrents ( $I >$ ).

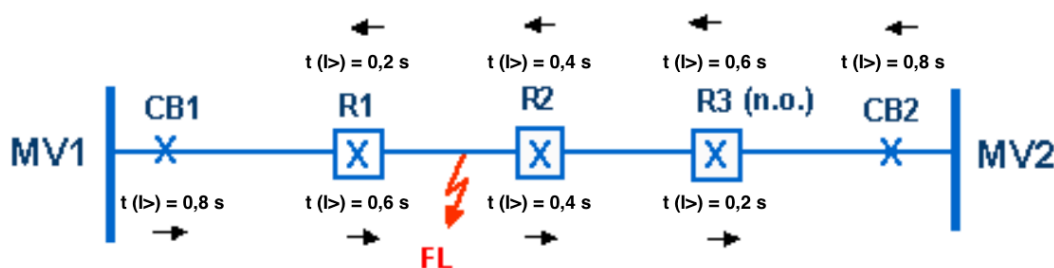

Figure 3.5 - Normal and reverse protection settings of reclosers in MV network [44].



### 3.2.2 Communication Based Peer-to-Peer GOOSE Messaging

Several problems related to the coordination of reclosers presented in the previous Section can be overcome through the use of IT technologies and communication infrastructures. Communication based protection schemes emerge, as an alternative to schemes that use time intervals and voltage levels that are widely implemented but that reveal some limitations with the DA integration. Communications are already used to assist protection selectivity in reconfigurable systems, helping in the relay's settings update to adapt them to bidirectional power flows [36].

The International Electrotechnical Commission (IEC) 61850 is an important standard for the substation automation implementation and can extend communications impact to the protection systems coordination. New requirements include high-speed IED-to-IED communication features that are capable of supporting GOOSE to fast data exchange, status and commands [35].

Peer-to-peer GOOSE messaging allows fast communication between devices and can therefore be used in a communication based coordination scheme, ensuring proper selectivity and faster performance in fault response. With all devices controllers being IEC 61850 capable, IEDs can exchange GOOSE messages among them. When a disturbance occurs a publisher device recognizes it and send a message to the network, multicasting data over the local area network. All the subscriber devices receive the message and process it in order to take the required actions [18]. Figure 3.6 shows the multicasting of a block signal by the IED immediately upstream of the fault, in order to prevent the actuation of upstream devices.

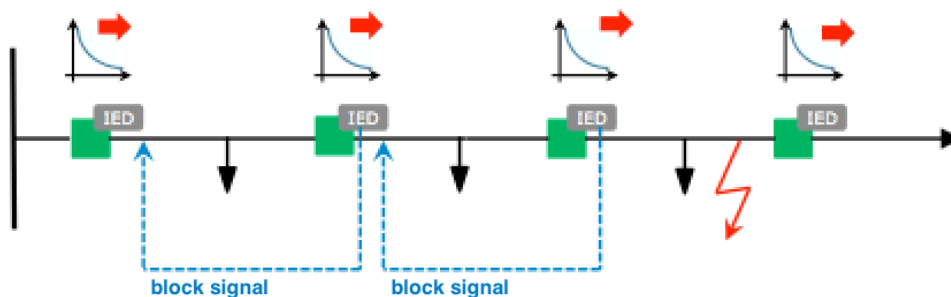

**Figure 3.6 - Block signal multicast by IEDs to fault isolation in a radial feeder.**

Deterministic time intervals are defined in the device's coordination, where the defined time delays depend exclusively on the communications speed [17]. Reclosers with peer-to-peer communication will achieve the fastest isolation and power restoration to healthy zone of the distribution feeder [13]. Figure 3.7 illustrates an overhead distribution network between three primary substations with GOOSE capable reclosers deployed.

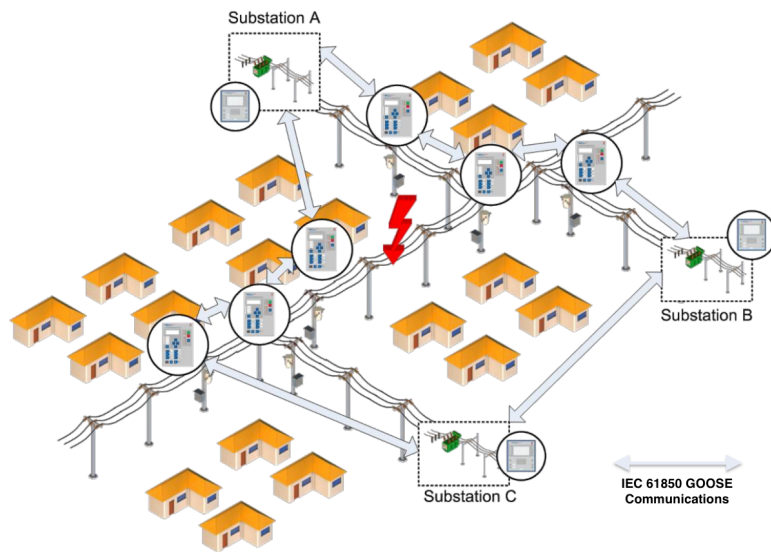

**Figure 3.7 - Overhead distribution network with GOOSE capable IEDs.**

Reducing restoration times through communications based protection schemes depends primarily on the available communication’s latency. Coordination schemes based in time delay settings may be replaced by signal multicasting between IEDs. The communication provides rapid adaptive coordination features allowing selectivity definition in real time. The performance will depend on the communications speed and on the Self-Healing implementation solution, more centralized or more decentralized. A lower latency enables the deployment of a larger number of reclosers in series, increasing the number of devices possible of deploy in a single feeder. Several communication technologies may perform the required high-speed data transmission. Figure 3.8 presents the latency evolution in operational telecommunication networks, with Long Term Evolution (LTE) wireless communication presenting the fastest performance.

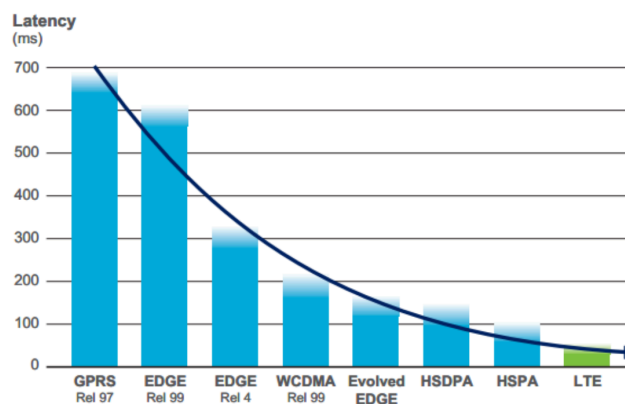

**Figure 3.8 - Latency evolution of communication networks [50].**

Communication based protection schemes are suitable to be implemented in centralized architectures as well. Wide area automatic control takes advantage of the IED's communication capabilities to achieve some control objectives such as: service restoration, miscoordination detection, loss reduction, dynamic load balancing and load shedding [22]. GOOSE based FDIR may present higher operating speed although, as presented in Section 2.4, the additional information provided by SCADA/DMS solutions or even by substations centric solutions allow that FDIR to be based in more reliable data thus producing better decisions.

### 3.3 - Power Switchgear Optimal Deployment

From a Self-Healing approach, service restoration efficiency depends on the effectiveness of the FDIR algorithms implementation. After detecting and isolating a fault, the service restoration procedure relies on the network's secure reconfiguration that is performed automatically or manually through the manoeuvre of power switchgear devices. Power switchgear optimal deployment influences the network reconfiguration and consequently has impact in the FDIR performance. The power switchgear optimal deployment is a combinatorial optimization problem solved taking into consideration both technical and economic aspects. Since both economic and technical factors (Section 3.2) limit the number of devices possible of deploy, the optimal solution translates the highest possible improvement in the system's reliability [31]. Nonetheless, a cost benefit analysis must be performed to assess the cost of reliability improvement.

Deterministic approaches have been implemented to address the optimal deployment of power switchgear devices. The network decomposition in elementary parts [32] and the Bellman's optimality principle (i.e. the principle that an optimal sequence of multistage decisions lead to the final optimal solution regarding the initial decisions) as a sequential optimization algorithm, using an avoided costs objective function [25] or thinning techniques to diminish the computational effort [33], were used to address this problem. The devices relocation in radial distribution feeders is also related with the optimal deployment problem and is addressed by a particle of swarm optimization and fuzzy sets upon interruption risk analysis [28]. As DG plays an important role on the service restoration problem reliability constrained strategies to assess the optimal deployment of power switchgear devices and distributed generators is assessed as well, through an ant colony system algorithm [20]. The assessment of the optimal number of power switchgear devices to deploy in a distribution network and the optimal location of those devices depends on many factors, such as reliability indices, load variations, maintenance and installation costs. This range of factors requires the use of a Cost Benefit Analysis (CBA) in order to achieve the maximization of reliability and find the most adequate investment strategy.

The network reconfiguration problem is related with the optimal deployment and is by itself another combinatorial problem with impact in the network operation under normal and

fault conditions. Several methodologies use probability based metaheuristics like simulated annealing to address different problems related with: the network planning [30]; power switchgear deployment [34]; and multi-objective network reconfiguration with the objective of loss reduction and service restoration [29]. Other techniques have been also used to address this multi-objective combinatorial optimization problem. A decomposition of out-of-service area is used to formulate the problem and genetic algorithms are used to address it in [27]. A mathematical programming approaches based on the integer programming method of the interior point technique is used to perform a cost benefit analysis over the reconfigured distribution system under contingencies [14].

The two problems presented i.e. power switchgear optimal deployment and network reconfiguration, are related with the problem of service restoration. In the next two Subsections, the main challenges of network reconfiguration and the description of the events in a FDIR algorithm are presented.

### 3.3.1 Network Reconfiguration Challenges

The network reconfiguration problem has been addressed considering different objectives such as service restoration, load balancing, voltage deviation and loss minimization [14]. Distribution system reconfiguration is achieved by the switching of power switchgear devices deployed along the network and thus depends on the optimal deployment of these devices. From the service restoration perspective, switching operations clear the network abnormal conditions by isolating the disturbed zones and restoring power to healthy zones.

The success of service restoration depends on an adequate approach to the network reconfiguration problem. This is a constrained optimization problem that is limited by different types of constraints [27]:

- Network topology constraints that are related with the requirement of operating the network in a radial structure. These constraints impose that a close-switching manoeuvre must always be preceded by an open-switch manoeuvre.
- Power limit constraints that are related with the network load capacity. The load demand after the reconfiguration cannot exceed the capacity limits of the alternative power sources.
- Voltage and current constraints that are related with the need of maintain the voltage and current magnitudes within their operational limits. According to the European standard (EN 50160) the voltage should be within  $\pm 10\%$  of the nominal value. Current magnitude shall not exceed the thermal limit of the line conductors.

The fault location and the loading levels influence the reconfiguration possibilities and therefore the service restoration range and effectiveness. The goal is to reconfigure the

network in order to restore the maximum possible load performing the fewest number of switching operations and without violating the operational limits of the network [29]. Figure 3.9 and Figure 3.10 illustrate the network reconfiguration procedure in order to achieve for service restoration. In this case the initial configuration represents the distribution network with the fault isolated (see Figure 3.9) and the final network configuration to restore power to affected loads in healthy zones (see Figure 3.10).

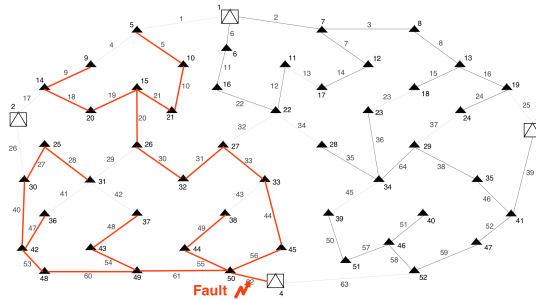

Figure 3.9 - Faulted network [29].

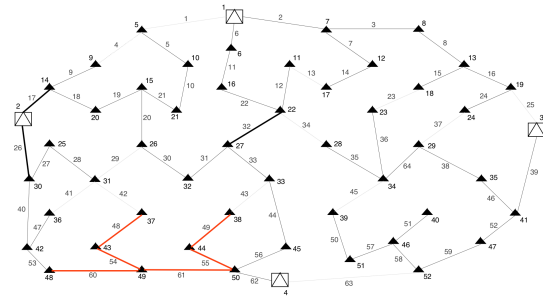

Figure 3.10 - Restored network [29].

### 3.3.2 Fault Detection, Isolation and Restoration Algorithms

FDIR algorithms refer to automatic methods of feeder power restoration. FDIR functionality provides the ability of automatically respond to disturbances by detecting, locating and isolating faults based on real time metering and proper coordinated protection schemes. This sequence precedes the network reconfiguration for service restoration. FDIR may be implemented based on centralized or decentralized schemes, as presented in Section 2.4, using several types of technologies and presenting different levels of effectiveness and implementation complexity. As discussed in the Section 3.2, the coordination of the power switchgear devices may be based in voltage and current levels, peer-to-peer GOOSE based communications solution or substation computer and SCADA/DMS solutions [17]. Several loop schemes for service restoration are presented in [13], depending on feeders topology. Loop control schemes, IEC 61850 peer-to-peer GOOSE schemes and decentralized schemes are discussed for FDIR implementation in [18].

In Table 3.3 the comparison between different FDIR schemes is presented [18].

**Table 3.3 - Comparison between several FDIR technologies [18].**

	External V-T and O-T Controls	Remote Communications	Scalability	Flexibility
FDIR Loop Scheme	Yes	No	Low	Low
FDIR IEC 61850 peer- to-peer Scheme	No	Yes	Medium	Medium
FDIR Substation based Scheme	No	Yes	High	High

The algorithm procedure depends on the location of the fault. The FDIR operation changes if the fault is located between the primary substation protection and a mid-point device, if the fault is located between mid-point devices or if the fault is located between a mid-point device and the tie-point device.

The FDIR should only operate in specific circumstances in order to ensure selectivity. The procedure must start only following a short circuit in the feeder or in the facilities that normally supply the feeder. Feeder's de-energization due to manual switching actions or system wide emergencies that trigger under-frequency or under-voltage load shedding must be ignored by the FDIR operation. These requirements are achieved through fault detectors deployed along the network. The FDIR sequence of actions is as follows [21]:

- **Fault detection:**

In order to find the feeder zone where the fault occurs there are fault circuit indicators in the power switchgear devices that determine if the fault is upstream or downstream. FDIR uses the fault circuit indicators status and the knowledge of the current feeder topology to find the affected zone.

- **Fault isolation:**

The FDIR algorithm then performs control actions to open the devices located immediately upstream and downstream of the fault thus isolating the fault. The recloser's (Subsection 3.1.2) controls will wait until the automatic reclosing sequence is completed in order to ensure that the feeder reconfiguration is only performed following a permanent fault therefore allowing the self-clearing of temporary faults.

- **Service restoration:**

Once the affected zone of the feeder is isolated, FDIR starts the service restoration procedure, attempting to restore power to as many healthy feeder zones as possible.

Available supply sources are analysed including the normal source of supply and the backup sources from the NOP. The FDIR benefit depends on the existence of alternative backup sources. FDIR compares the pre-fault load on each healthy feeder zone with the spare capacity on backup sources. If enough capacity exists, the tie-point device will close and the power is restored. If not, that zone will remain de-energized until the damage zone has been repaired and the feeder is back to normal, i.e. without faults or unsupplied load in the network.

Integrating advanced technologies of power switchgear devices, coordination schemes and large bandwidth and high-speed communications allows the FDIR procedure to be completed in less than one minute without manual intervention (Figure 2.5 Section 2.4). Figure 3.11 shows the final result of the FDIR procedure.

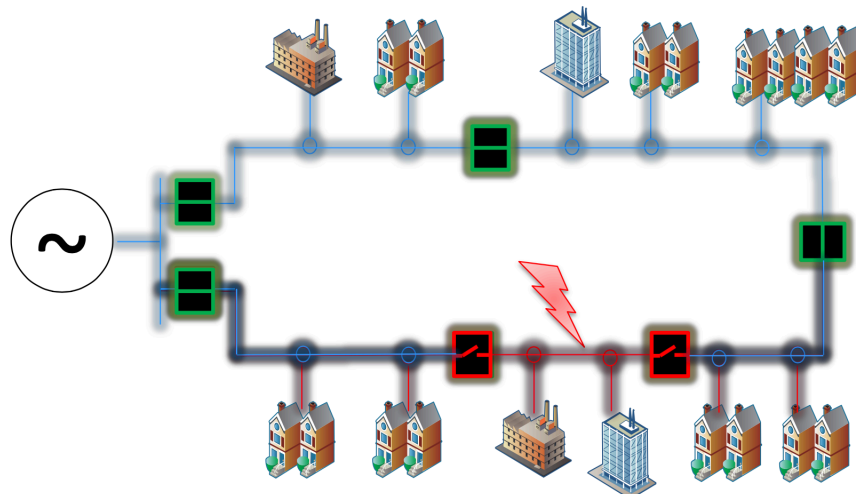

**Figure 3.11 - FDIR procedure between two interconnected feeders from the same primary source.**

Using advanced technologies of power switchgear devices, coordination schemes and large bandwidth and high-speed communications, the described procedure may be complete in less than one minute, without manual intervention, as presented in Figure 2.5 in Section 2.4.

### 3.4 - Summary

The Chapter 3 addresses the power switchgear solutions used in the Self-Healing implementation. Two solutions are analysed in Section 3.1, fault interrupters and reclosers. These devices are the two most recent generations of power switchgear solutions used by the Portuguese DSO. Both solutions are characterized and compared. The power switchgear coordination is addressed in Section 3.2. The contemporary coordination methods, based in voltage levels, current levels and time delays are discussed. Future solutions based in communication schemes are also presented and the particular impact of these solutions in

recloser's coordination is analysed, since the reclosers are the last generation of distributed power switchgear in the network. In Section 3.3 the power switchgear optimal deployment problem is addressed as well as the related challenges: network reconfiguration for service restoration and FDIR implementation.



## Chapter 4

# Techno-Economic Assessment of Reclosers Deployment in Medium Voltage Distribution Networks

The main challenges of Self-Healing implementation under a Smart Grid context as well as the relevance of service restoration in distribution networks are introduced in Section 1.2. Introducing Self-Healing schemes in a distribution network aims at increasing the technical Quality of Service (QoS) hence improving network's reliability. The Self-Healing implementation strategies are addressed in Section 2.4. Power switchgear technologies as well as their coordination and optimal deployment play an important role in the Self-Healing strategy. These challenges are detailed in Chapter 3. The purpose of the advanced methodology is to find a strategy for the deployment of reclosers in overhead distribution networks, defining the number and the location of the reclosers based in a techno-economic analysis. Firstly, the methodology general description, including all the assumptions is presented in Section 4.1. Section 4.2 and Section 4.3 present the technical and economic analysis respectively.

### 4.1 - Methodology Description

The present Section describes the methodology developed to address the problem of recloser's deployment in Medium Voltage (MV) overhead distribution networks. The advanced methodology comprises a technical assessment of the service restoration feasibility through network reconfiguration and an economic assessment based on a Cost Benefit Analysis (CBA) over the devices life cycle. The adopted strategy follows an approach based in the network decomposition in elementary parts, i.e. Distribution Grid Areas (DGA) comprising several feeders connected through Normally Open Points (NOP). A subproblem related with the

deployment of a new recloser in the network, considering the previously deployed reclosers is addressed in each iteration. Therefore, the final solution results from the resolution of each one of the subproblems. Figure 4.1 shows the methodology flowchart.

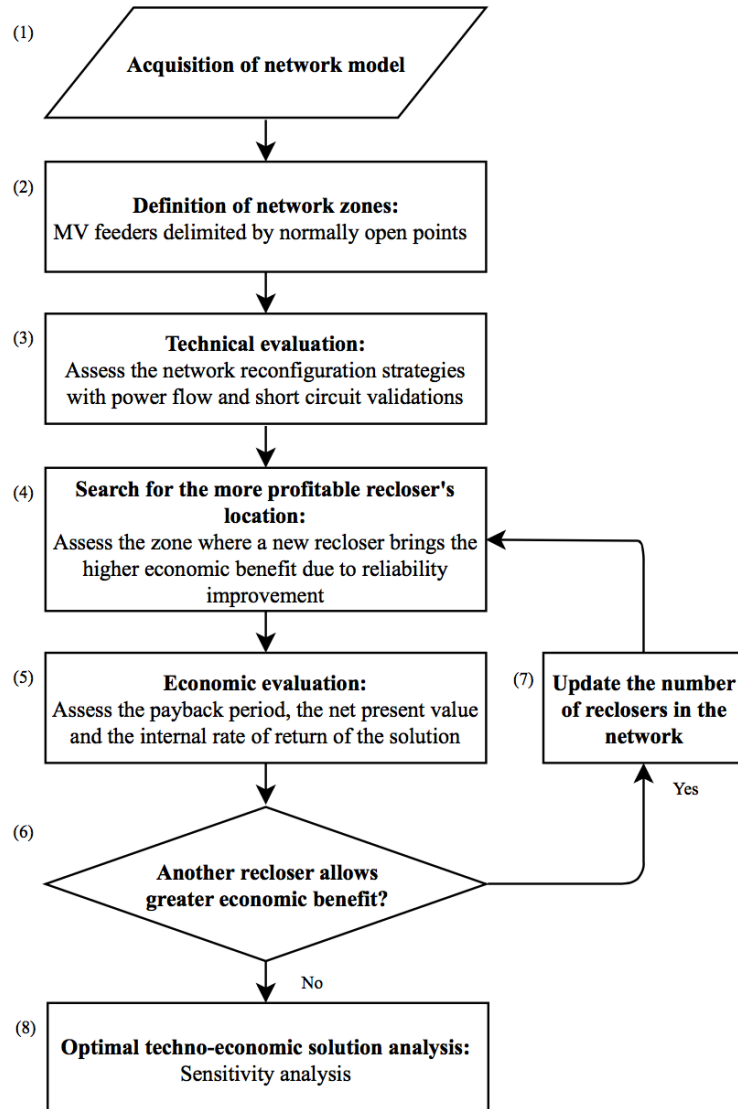

Figure 4.1 - Methodology flowchart.

#### 4.1.1 Acquisition of the Network Model

The algorithm starts with the acquisition of the network model, step (1). The modelling comprises the following features:

- DGA topology survey including, the feeder’s connections and NOP’s locations;
- Line parameters including, length, resistance, reactance, susceptance, maximum current and maximum transmission power capabilities;
- Load characteristics including, installed power, power factor and load factor at secondary substations and number of delivery points;

- Reliability data including the reliability indices, ENS, SAIFI, SAIDI and MAIFI, as well as the failure rate per kilometre, restoration and repair times;

The DGA is identified and its topological characteristics are assessed, including the survey of the number of primary substations involved and the number of interconnected feeders through NOP. It is assumed that all devices in NOP may be remotely operated.

The electric parameters are acquired in order to modelling the network in the software used to perform the power flow study and the short-circuit validation. The line length is used with a dual propose, modelling the network and defining the number of faults to be considered in a year in each feeder, based on the failure rate per kilometer.

The load characteristics are used to determine the profile of the energy consumption in the network. This data is required to assess the load distribution along the feeder, to estimate the total Energy Supplied (ES) to the network in a year and to estimate the Energy Not Supplied (ENS) in the sequence of a fault. The number of delivery points in the network is used to calculate several reliability indices such as SAIFI, SAIDI and MAIFI. The power factors of each feeder are estimated from the average power factors verified in a typical day of each season. A typical day refers to a standard day for the season in terms of load level, based in historical recorded values.

Reliability indices are used to characterize the networks performance in its initial state, i.e. without reclosers deployed. Repair and restore rates are used to estimate the distinct ENS thresholds in the sequence of a fault (see Figure 4.6). Failure rate is used to define the number of faults per year in the network. Together with the feeder's length, the failure rate allows to define the number of faults to be considered in each feeder every year. The considered failure rate per kilometre is calculated based in the average of a set of historical values recorded for that DGA. It is assumed that all faults are three-phase faults, regardless of their nature. The possibility of the occurrence of multiple faults as well as faults in protection systems is not considered.

#### 4.1.2 Definition of Network Zones

In step (2) the network zones are defined. Each MV feeder represents a network zone that starts in the primary substation exit and ends in the delimiter NOP. Figure 4.2 illustrates the procedure of network zones definition.

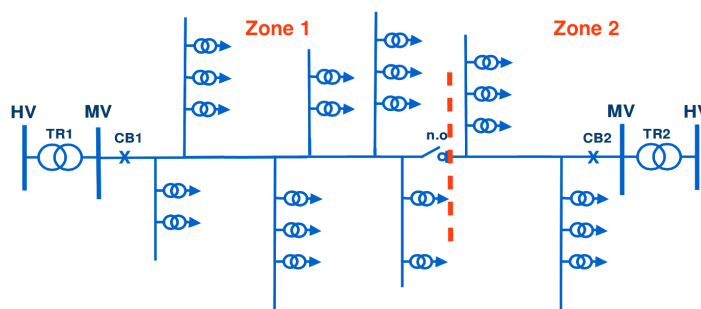

Figure 4.2 - Network zones definition.

The network zones definition is important to ensure the application of the constraint that limit the maximum number of recloser possible of deploy in series, per feeder and per open loop. The division of the networks in several zones also allows the assessment to the feeders where the recloser deployment will bring the higher economic benefit due to reliability improvement. The reliability of each zone may be assessed and compared with its previous state, i.e. the reliability presented by the feeder with minus one reclosers deployed, in order to find the most suitable location for the recloser's deployment. The DGA is divided into as many zones as feeders with reconfiguration possibility from NOP.

#### 4.1.3 Evaluation of Network Reconfiguration for Service Restoration

The evaluation of the network reconfiguration strategy is performed in step (3) through a power flow study and a short circuit analysis, in order to ensure that technical constraints related with voltage dropping and current limits are not violated.

The software Power Transmission System Planning (PSS®E) by Siemens is used to perform the power flow study over the network reconfiguration strategies, analysing the service restoration in each feeder through backup supplying from Normally Open Points (NOP), preventing excessive voltage dropping and line's overload.

- $V^{\min} \leq V \leq V^{\max}$ , where  $\Delta V^{\min} = V^{\min} - V \geq -0,1$  pu and  $\Delta V^{\max} = V^{\max} - V \leq +0,1$  pu;
- $P \leq P^{\max}$ ;

A set of power flow studies is performed for each zone, considering the possibilities of backup supplying from all of the NOP of the feeder. The validation of each reconfiguration strategy consists in determining the last delivery point that can be restored from a certain NOP without violating operational constraints. This assessment provides information that is used to determine the load out of service till automatic restoration, till manual restoration, or till fault repair. All the network zones must be addressed by the power studies in order to define the last delivery point possible of being backup restored from each NOP connection of the feeder.

The short circuit analysis aims to ensure that all network reconfiguration strategies enabled by the recloser's deployment are compatible with the short circuit power levels of the backup power source. To achieve this purpose the network reconfiguration strategies are evaluated through a short circuit analysis, comprising the calculation of the short circuit current under different fault conditions (PSS®E IEC 60909 Short Circuit Current Analysis).

#### 4.1.4 Search for the more Profitable Recloser Location

In step (4) the reliability improvement in each zone due to the deployment of a new recloser is assessed. The effective reliability improvement is translated into economic value, which enables the consideration of the joint contribution of several indices for the total reliability improvement. In this step, the reliability improvement in each index is assessed as follows:

- In the first iteration the deployment of one recloser in each zone is considered. The reliability indices are calculated and the reliability improvement is assessed comparing the present indices, with a recloser in each zone, with the previous indices, without the recloser i.e. network's initial state. The reliability improvements are compared and the more profitable location for the recloser's deployment is assessed.
- In the next iterations the deployment of one recloser in the zone chosen in the previous iteration is considered. The reliability indices of that zone are calculated and the reliability improvement is assessed comparing the present indices, with the new recloser, with the previous indices, presented in the previous iteration, without the new recloser. The reliability improvements are compared and the more profitable location for the recloser's deployment is assessed.

The recloser's deployment follows a zone dividing approach based on a load splitting technique, i.e.  $n$  reclosers split the feeder's load in  $n+1$  zones, dividing the feeders load in  $1/(n+1)$  fractions. As discussed in Section 3.2, the number of reclosers in series is limited to four per open loop and three per feeder. The considered reclosers operation is in accordance with the settings for recloser's coordination explained on that Section.

When a new recloser is deployed in a revisited zone the location of the reclosers already deployed is updated. This procedure is illustrated by the next sequence.

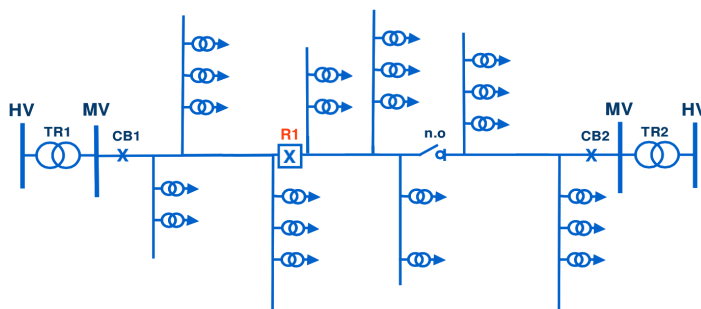

Figure 4.3 - First recloser deployed.

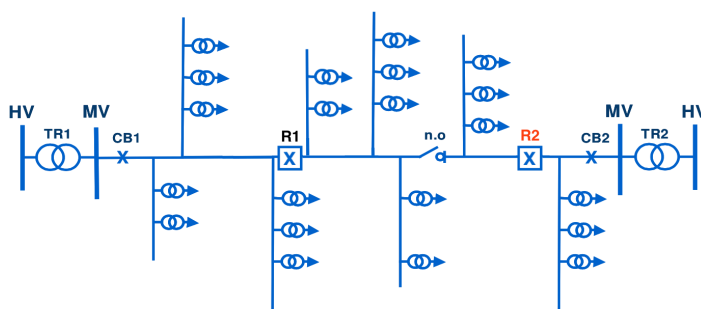

Figure 4.4 - Second recloser deployed.

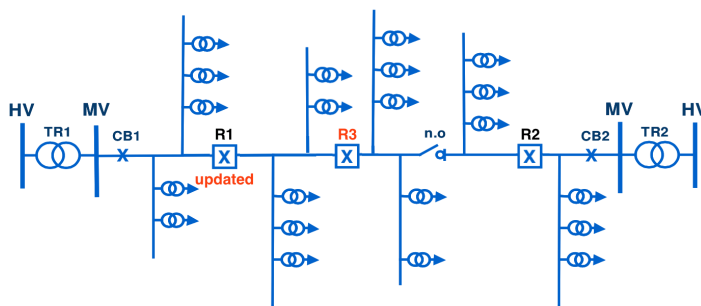

Figure 4.5 - Third recloser deployed.

The first reliability assessment is performed with the network in its initial state, i.e. without reclosers deployed yet. In the first iteration another reliability assessment is performed, comprising the deployment of one recloser in each zone. The reliability assessment comprises the determination of the indices SAIFI, SAIDI, MAIFI and ENS. In the sequence of a defined number of temporary and permanent faults, based on the feeder's length and failure rate per kilometre, the number of affected delivery points, the duration of the interruptions at those delivery points and the ENS is assessed. The delivery points and their load are divided into four groups:

- Delivery points not affected by the fault;
- Delivery points affected until automatic service restoration, performed by the Fault Detection Isolation and Restoration (FDIR) algorithms;

- Delivery points affected until manual service restoration, performed by the field crews;
- Delivery points affected until the fault repair and the feeder is back to normal;

Determining the out of service load until the automatic service restoration, until the manual service restoration and until fault repair is performed to assess the reliability. In the sequence of a fault, there are delivery points in healthy sections of the feeder that will remain out of service until the faulted zone is isolated and the service restoration is restored by the FDIR algorithms. There are other delivery points that must remain out of service until the isolation of the specific section where the fault occurred. This process will take more time because is performed by field crews, by opening the line's sectionalizers. The rest of the delivery points, that are impossible to restore by normal or alternative power flow pathways, will remain out of service until the fault is repaired and the feeder backs to normal. The technical constraints imposed by the power flow limit the network's automatic reconfiguration for service restoration thus influencing the affected load.

The reliability assessment is based on the simulation of a set of faults in each one of the predefined zones. The considered faults locations include the worst cases from the service restoration point of view, i.e. in the beginning of each zone or ramification and in the end of each zone and ramification.

Whenever a network zone is assessed to deploy another recloser, the locations of the reclosers already placed in the zone are updated (see Figure 4.5). The number of reclosers deployed in series in an open loop must respect the limitation of the number of reclosers in series able to be coordinated (4 reclosers maximum).

The reliability improvements assessment is based on a comparison between the reliability that the zone presents before and after a new recloser is deployed. The impact of each recloser in the reliability indices of the DGA is assessed, allowing the selection of the best solution.

#### 4.1.5 Economic Evaluation of the Solution

The reliability improvements are quantified and translated into economic benefits in terms of the Cost of Energy Not Supplied (CENS), the Incentive to Quality of Service (IQS) and the Total Compensation (TC) to customers. After the most suitable feeder for the deployment of the new recloser is found, in step (4), the current solution is economically assessed through a Cost Benefit Analysis (CBA) and evaluated over the recloser's life cycle in step (5). This analysis comprises the opposition of the economic benefits achieved with the reduction of CENS, TC and IQS penalties (or increase if a reward is applicable), against the Capital Expenditures (CAPEX) and the Operational Expenditures (OPEX). After the determination of the total benefit achieved during the equipment's lifecycle it is possible to assess the Net

Present Value (NPV) of the solution and thus assess the its economic viability. The Internal Rate of Return (IRR) and the Payback Period (PbP) of the investment are assessed as well.

#### 4.1.6 Stopping Criterion Check and Network's Number of Reclosers Updating

In step (6), when the NPV decreases more than once in the last three iterations or the number or the maximum number of reclosers possible of deploy in the DGA is reached the algorithm stops. The maximum number of reclosers possible of deploy in the DGA is variable, depending on the previous selected locations for the recloser's deployment. In theory a maximum number of  $2 + (\text{number of NOP connections} - 1)$  is possible of deploy in a DGA. However, if the algorithm has already chosen a feeder with multiple NOP connections to deploy 4 recloser in series regardless the network configuration, will be impossible of deploy reclosers in the other feeders, and the total maximum number of reclosers possible of deploy in the DGA decreases.

If the stopping criterion is not reached the number of reclosers is updated in step (7) and the search of the location for the deployment of an additional recloser starts. Updating the number of reclosers in the network will only have impact in the reliability assessment of the zone chosen in the last iteration.

#### 4.1.7 Optimal Solution Analysis

When the best solution is found its robustness to key parameters is assessed in step (8) through a sensitivity analysis. The technical parameters addressed by the sensitivity analysis are: load level, restoration/repair times and load growth rate. The economic parameters addressed by the sensitivity analysis are: the recloser's acquisition costs, the recloser's lifetime period and the value of ENS.

Apart from the base case where an average load scenario is considered, another two scenarios are taken into consideration, a maximum load level and a minimum load level. The considered load factors are estimated by the ratio between: the total maximum power verified in a feeder and the total installed power of the feeder; the total average power verified in a typical day in a feeder; the total installed power of the feeder and the total minimum power verified in a feeder and the total installed power of the feeder.

An alternative scenario is considered in the sensitivity analysis, comprising longer restoration time and longer repair time. It is considered a variation of about  $\pm 20\%$  in the recloser's acquisition costs. The influence of the recloser's lifetime is also taken into consideration by the sensitivity analysis. An economic analysis is performed considering a lifetime period 10 years longer.



## 4.2 - Technical Analysis of Quality of Service

In this Section the technical analysis of the QoS is explained. The developed approach is based on a techno-economic analysis since both factors limit the number of reclosers and their optimal deployment. The optimization procedure uses the networks decomposition in elementary parts, evaluating each zone through a CBA.

The assessment of the reliability improvement is based in the evaluation of the affected load. The affected load is considered to be the electric demand that is: out of service until automatic service restoration; out of service until manual service restoration, after the fault is isolated by the field crews; and out of service until the feeder is back to normal i.e. after the repair of the fault. Figure 4.6 illustrates the assessment of the ENS to the affected load.

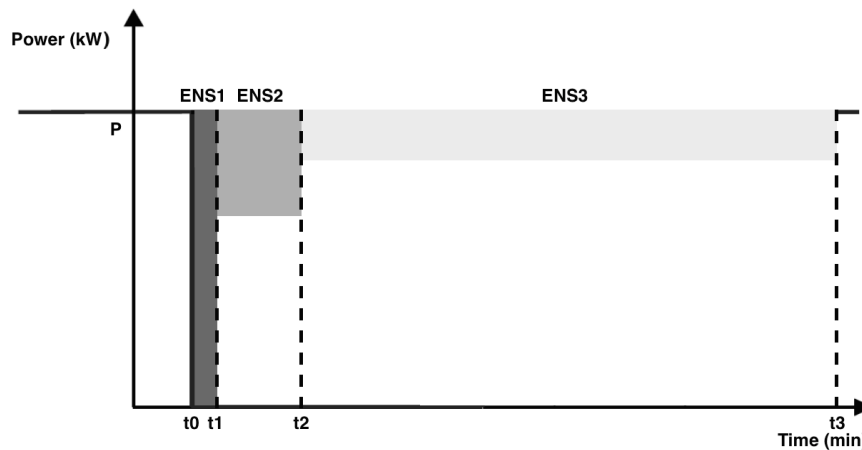

Figure 4.6 - Assessment of the ENS levels in the sequence of a fault.

If it is not possible to backup restore the entire feeder from a NOP due to power flow constraints, the service restoration will be made in stages. ENS1 represents the energy not supplied to the load until automatic service restoration ( $t_1$ ). ENS2 represents the energy not supplied to the load until manual service restoration ( $t_2$ ). ENS3 represents the energy not supplied to the load until the fault is repaired ( $t_3$ ).

The network reconfiguration strategy to perform service restoration is assessed beforehand, through a power flow study and a short circuit analysis. For any network reconfiguration scenario, the voltage on every busbar should be between 0,9 p.u. and 1,1 p.u. and no line may be overloaded. After validating the network reconfiguration strategy the reliability of each zone can be assessed. The considered reliability indices are SAIDI, SAIFI, MAIFI [7] and ENS [4] (Subsection 7.3.3). The equations for the calculation of SAIDI, SAIFI and MAIFI are presented in Subsection 2.2.1, respectively equation (2.3), equation (2.2) and equation (2.5). The ENS is given as follows:

$$ENS = \sum_{j=1}^y \sum_{i=1}^x (DI_{i,j} \times L_j \times lf) \quad [MWh] \quad (4.1)$$

where  $DI_{i,j}$  is the duration (in hours) of the long interruptions  $i$  in the delivery point  $j$ ;  $L_j$  is the load (in MW) connected to the delivery point  $j$ ;  $lf$  is the load factor of the delivery point  $j$ ;  $y$  is the total number of delivery points in the MV network; and  $x$  is the number of long interruptions at the delivery point  $j$  in the predefined period of time (e.g. one year).

### 4.3 - Economic Analysis of Recloser's Deployment

In this Section the economic analysis of the reclosers deployment solution is explained.

The reliability improvements due to the deployment of each new recloser are translated into economic benefits. SAIFI is affected by a coefficient that represents the unitary value for the compensation related with the number of interruptions in the year  $n$ ,  $FC_n$  (€/int). SAIDI is affected by a coefficient that represents the unitary value for the compensation related with the duration of the interruptions in the year  $n$ ,  $KC_n$  (€/kWh) and by the average value of the contracted power in the year  $n$ ,  $PC_n$  (kW). The calculation of the total contracted power of a feeder is based on the average of the total installed power of the feeder multiplied by the maximum load factor. ENS is affected by a coefficient that represents the unitary value for the kilo Watt-hour of energy not supplied,  $V_{ENS}$  (€/kWh).

The economic impact of the improvement in each reliability index, in each zone  $k$ , from the iteration  $i-1$  to the iteration  $i$ , is given by:

$$\Delta SAIDI^k = (SAIDI_{i-1}^k - SAIDI_i^k) \times y^k \times PC_n \times KC_n \quad [€] \quad (4.2)$$

where SAIDI is in hours, per secondary substation; PC is in kW; KC is in euros per kWh, and where  $y$  is the total number of delivery points (secondary substations) in the MV network.

$$\Delta SAIFI^k = (SAIFI_{i-1}^k - SAIFI_i^k) \times y^k \times FC_n \quad [€] \quad (4.3)$$

where SAIFI is in interruptions, per secondary substation; FC is in euros per interruption; and where  $y$  is the total number of delivery points (secondary substations) in the MV network.

$$\Delta ENS^k = (ENS_{i-1}^k - ENS_i^k) \times V_{ENS} \quad [€] \quad (4.4)$$

where ENS is in kWh; and  $V_{ENS}$  is in euros per kWh.

The objective function to assess the most suitable recloser location includes the economic benefits related with the SAIDI, SAIFI and ENS improvements. These are related with the value of the compensation per unitary interruption (€/int), per unitary interruption

duration (€/h) and per kilo Watt-hour of ENS (€/kWh). MAIFI is not taken into consideration in the objective function that defines the most suitable zone to deploy the reclosers because it is not a target of the regulatory mechanisms thus is not quantifiable. However, this index is evaluated as it is related with the reduction of momentary interruptions, which is an important goal of the DSO. The Objective Function (OF) that aims to determine the most suitable feeder to deploy a new recloser in each iteration  $i$ , is represented as follows:

$$OF_i = \text{Max}(F_k) \text{ [€]} \quad (4.5)$$

where  $F_k$  in euros (€), is given by:

$$F_k = (\Delta SAIDI^k + \Delta SAIFI^k + \Delta ENS^k) \text{ [€]} \quad (4.6)$$

After selecting the location for the new recloser deployment the economic benefit of the present solution can be assessed. In each iteration the actual solution comprises the new recloser deployed and all the reclosers already deployed in feeders chosen in previous iterations i.e. the solution in iteration  $n$  is composed by the reclosers deployed in the network in previous iterations and the  $n^{\text{th}}$  recloser deployed at iteration  $n$ . The total benefit corresponds to the sum of three parameters that are the CENS (€), IQS (€) and TC (€). The equations provided for by Portuguese regulation [7] to calculate these parameters are presented in Subsection 2.2.1, in equation (2.6) and equation (2.7), for the IQS. The CENS is calculated as in equation (4.7) and the TC is calculated by equation (4.8):

$$CENS = ENS \times V_{ENS} \text{ [€]} \quad (4.7)$$

$$TC = CN + CD \text{ [€]} \quad (4.8)$$

where CN and CD are respectively the compensation value due to the exceed of number of interruptions and the compensation value due to the exceed of the total duration of interruptions, as presented in Subsection 2.2.2, respectively by equation (2.8) and by equation (2.9).

The economic benefit of the solution achieved in each iteration is determined by the combined reduction of the CENS, IQS penalties and TC. Those economic benefits are given by:

$$B_{CENS} = CENS_{initial} - CENS_i \text{ [€]} \quad (4.9)$$

$$B_{IQS} = IQS_{initial} - IQS_i \text{ [€]} \quad (4.10)$$

50 Techno-Economic Assessment of Reclosers Deployment in Medium Voltage Distribution Networks

$$B_{TC} = TC_{initial} - TC_i \text{ [€]} \quad (4.11)$$

The total costs of project are calculated by the sum of CAPEX and OPEX. CAPEX includes acquisition and installation costs. The OPEX represents the maintenance of the reclosers that are assumed to be 2% of the CAPEX per year.

$$CAPEX = Cost_{acquisition} + Cost_{installation} \text{ [€]} \quad (4.12)$$

$$OPEX = Cost_{maintenance} = CAPEX \times i_{maintenance} \text{ [€]} \quad (4.13)$$

where  $i_{maintenance}$  (%) represents the considered percentage of CAPEX spend every year in the equipment's maintenance.

The sum of all the benefits achieved throughout the recloser's life cycle is opposed to its CAPEX and OPEX (i.e. maintenance costs). The global CBA is concluded with the assessment of the difference between the total benefits and the total costs, given by:

$$(B_{CENS} + B_{IQS} + B_{TC}) - (CAPEX + OPEX) \text{ [€]} \quad (4.14)$$

The load growth is also taken into consideration. The CBA culminates in the determination of the NPV, IRR and PbP of the investment, which allows the assessment to the economic viability of the solutions achieved in each iteration. The load growth rate is considered as well as the capital cost updating rate. The benefits and the costs in each year of the project are updated according to the equation (4.15):

$$FV_n = PV \times (1 + i)^n \quad (4.15)$$

where FV represents the future value; PV represents the past value;  $i$  (%) represents the considered rate; and  $n$  represents the number of periods of capitalization.

The NPV is the sum of all of the present cash flows, updated according to the equation (4.16):

$$PV = FV_n \times \left(\frac{1}{1+i}\right)^n \quad (4.16)$$

where FV represents the future value; PV represents the past value;  $i$  (%) represents the considered rate; and  $n$  represents the number of periods of capitalization.

## 4.4 - Summary

In this Chapter the developed methodology is advanced. The Section 4.1 comprises the methodology description, including the explanation of all the steps that constitute the iterative process, step by step. In Section 4.2 the technical analysis of the quality of service is explained and the variables that influence the analysis are identified. This Section includes the explanation of how the out off service load is divided and how the ENS is assessed in every circumstance. The Section 4.3 includes the explanation of the economic analysis of the recloser's deployment. The economic assessment equations are advanced in this Section. The developed methodology assures the definition of the best strategy for recloser's deployment in a DGA, considering technical and economic aspects simultaneously.



# Chapter 5

## Case Study: Description and Analysis of the Results

The developed methodology is validated in a real Portuguese Medium Voltage (MV) overhead distribution network. This Chapter provides a detailed description of the assessed case study and the technical and economic results of the developed methodology implementation.

In Section 5.1 the case study is presented, including the network characterization and modelling as well as the techno-economic assessment of the recloser's deployment in the network. The base results of the case study and their sensitivity analysis to variation of key parameters such as load levels, restoration and repair times, load growth rate, recloser's acquisition costs, recloser's lifetime and value of ENS are presented in Section 5.2.

### 5.1 - Case Study: Description

The case study is based on a real distribution network that is located in the island of Faial, in the Region Autonomous of Azores (RAA).

The investment in reliability is important to achieve the desire standards of Quality of Service (QoS). The distribution systems must be outfitted with solution capable of rapidly detect, isolate and restore faulted sections of the networks in order to improve reliability and keep the normal network operation. The Self-Healing implementation is able of providing the necessary features to achieve these goals, based on powerful service restoration schemes known as Fault Detection Isolation and Restoration (FDIR) algorithms. Island distribution systems are even more delicate, due to fewer machines in the generation system, which makes them unstable. The advanced methodology was implemented in a network with similar

characteristics. The entire MV distribution network of the island is presented in the Figure 5.1.

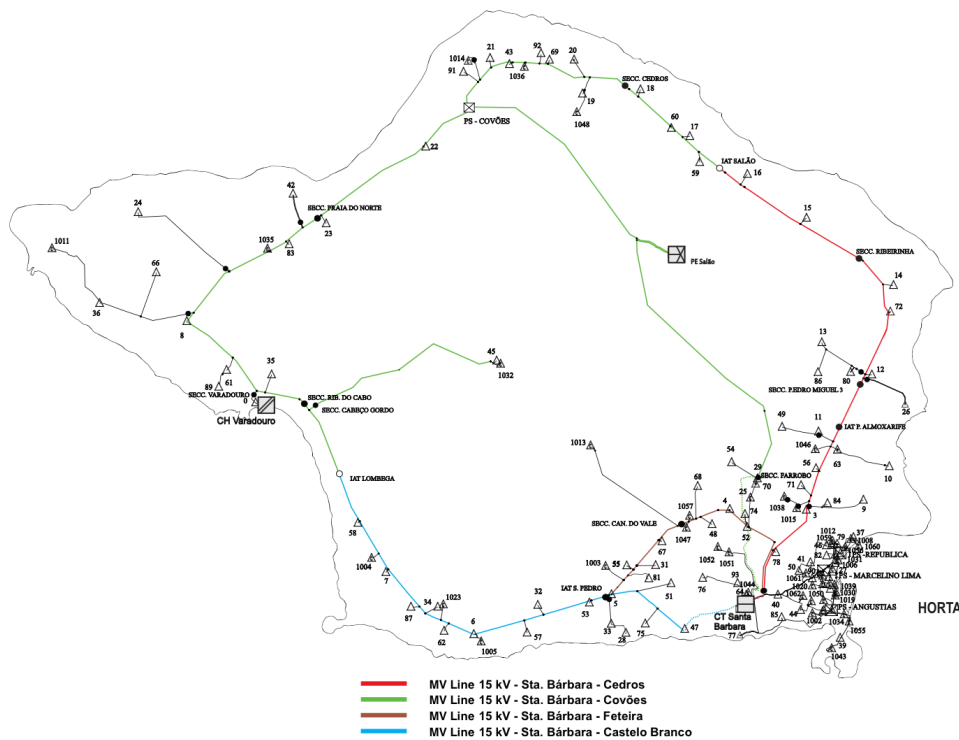

Figure 5.1 - Case study network real scheme.

The case study includes only the MV overhead distribution network of the island, composed by four 15 kV lines, since the reclosers are suitable to be implemented only in overhead distribution networks. The MV feeder described in Figure 5.1 represent the overhead distribution feeders addressed by the methodology.

The analysed part of the distribution network includes four MV feeders of 15 kV that are connected to the same primary substation. Moreover, three Normally Open Points (NOP) connects these four feeders:

- Feeder 1 (F1) - Sta. Bárbara - Cedros (red line in Figure 5.1) is connected through a NOP to the Feeder 2 (F2);
- Feeder 2 (F2) - Sta. Bárbara - Covões (green line in Figure 5.1) is split in two branches each one connects through a NOP to the Feeder 1 (F1) and to the Feeder 4 (F4);
- Feeder 3 (F3) - Sta. Bárbara - Feteira (brown line in Figure 5.1) is connected through a NOP to the Feeder 4 (F4);
- Feeder 4 (F4) - Sta. Bárbara - Castelo Branco (blue line in Figure 5.1) is connected through a NOP to the Feeder 2 (F2);



The network is constituted by 71 public secondary substations with a total of 8.593 kVA of installed capacity and by 16 private secondary substations with a total of 3.101 kVA of installed capacity. The four feeders in analysis present the following utilization factors and thermal capacities.

**Table 5.1 - Feeder’s utilization factors and thermal capacity.**

Feeder	Utilization Factor (%)	Thermal Capacity of the Main Section (kVA)
F1 (connected to F2)	16	6240
F2 (connected to F1 and F4)	16	6240
F3 (connected to F4)	28	3120
F4 (connected to F2)	32	3120

### 5.1.1 Network Modelling

The distribution network is a Distribution Grid Area (DGA), with four feeders connected by three NOP. The feeder F2 is the longest one (37 km), being divided in two branches. At the end of these branches it is connected through a NOP with the feeder F1 and with the feeder F4. The feeder F3 is the shortest one (7 km) and it is connected with the feeder F4 through NOP. The network was divided in four zones wherein each feeder represents a zone. Figure 5.2 shows the scheme of the network topology.

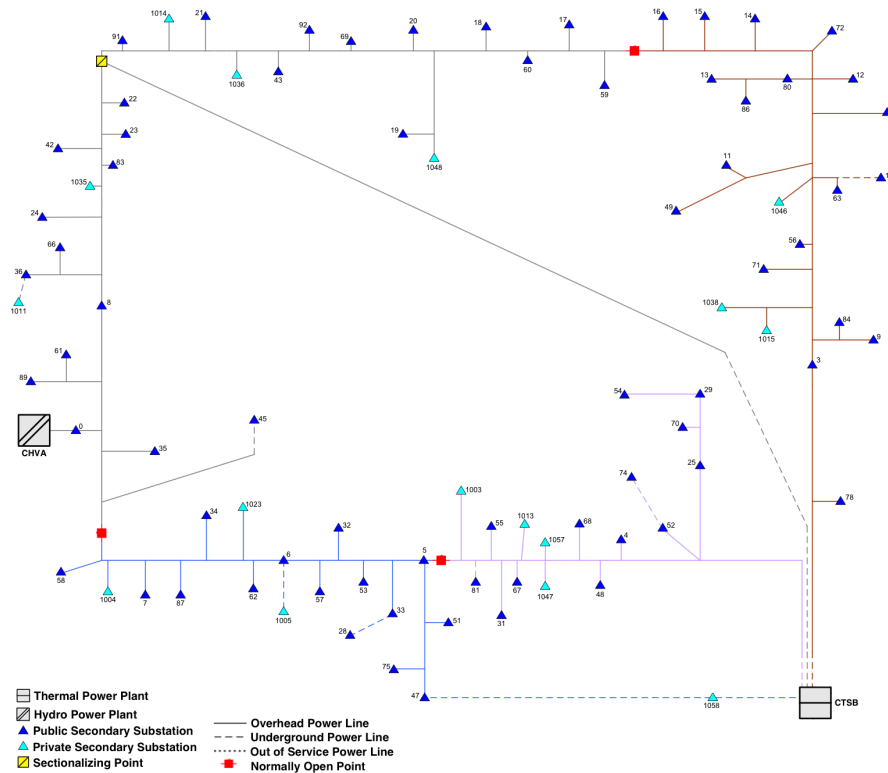

**Figure 5.2 - Case study network one-line scheme.**

The line parameters are presented in Table 5.2.

**Table 5.2 - Feeder's main section length and conductors.**

Feeder	Total Length of the Main Section (km)	Conductors of the Main Section
F1	13,0	CU 16 mm <sup>2</sup>
		CU 50 mm <sup>2</sup>
F2	37,0	CU 16 mm <sup>2</sup>
		CU 25 mm <sup>2</sup>
		CU 50 mm <sup>2</sup>
F3	7	CU 16 mm <sup>2</sup>
F4	12,5	CU 16 mm <sup>2</sup>
		CU 25 mm <sup>2</sup>
		CU 50 mm <sup>2</sup>

The conductors' parameters are presented in Table 5.3.

**Table 5.3 - Cable's electric parameters.**

	Resistance ( $\Omega/\text{km}$ )	Reactance ( $\Omega/\text{km}$ )	Susceptance (S/km)	Current (A)	Thermal Capacity (MVA)
CU 50 mm <sup>2</sup>	0,402075018	0,38362498	0,00000298	240	6,24
CU 25 mm <sup>2</sup>	0,733275005	0,40387502	0,00000282	165	4,29
CU 16 mm <sup>2</sup>	1,218375034	0,41917498	0,00000271	120	3,12

The load characteristics are presented in Table 5.4.

**Table 5.4 - Load characteristics.**

	Number of Secondary Substations	Installed Power (kVA)	Power Factor	Average Load Factor (%)
F1	23 (public)	3063	0,9	29,2
	3 (private)	478	0,85	
F2	20 (public)	2022	0,9	27,4
	6 (private)	1363	0,8	
F3	13 (public)	1793	0,9	29,5
	4 (private)	410	0,85	
F4	15 (public)	2075	0,95	28,5
	3 (private)	850	0,85	

The power factors of each feeder are estimated from the average power factors verified in a typical day of each season.

The power flow study was performed over the network reconfiguration strategies, depending on the load factor. Three load scenarios are considered: a maximum load scenario, a minimum load scenario and an average load scenario. For each scenario, the reconfiguration of the network for service restoration from NOP was analysed.

The considered load factors are estimated by the ratio between: the total maximum power verified in a feeder and the total installed power of the feeder; the total average power verified in a typical day in a feeder; the total installed power of the feeder and the total minimum power verified in a feeder and the total installed power of the feeder.

Given the total installed power in each feeder (Table 5.4) and the average power verified in a typical day in each feeder: 1.033 kVA, (F1) 928 kVA (F2), 649 kVA (F3) and 833 kVA (F4); the average load factor result in: 29,2% (F1), 27,4% (F2), 29,5% (F3) and 28,5% (F4).

### 5.1.2 Techno-Economic Assessment

- The considered failure rate per kilometre is 0,075 faults/km, resulting from the average of the values recorded in the years 2011, 2012 and 2013 and presented in [47];
- The considered restoration times for both automatic and manual procedures are respectively, 1 min and 45 min;
- The considered repair time was 1 h;

- The considered unitary value for the compensation with the number of interruptions is 24 €/int;
- The considered unitary value for the compensation with the duration of the interruptions is 0,35 €/kWh;
- The considered unitary value for the kilo Watt-hour of energy not supplied with is 1,5 €/kWh;
  
- The considered investment costs are 10.000€ per recloser;
- The considered period for the recloser's life is twenty years;
- The considered load growth rate is 1% [48];
- The considered capital cost rate is 10% [9];

Starting from a base scenario without reclosers deployed in the network and considering the failure rate per kilometer and the total length of each feeder, 10 permanent faults and 20 temporary (considering that nearly 65% of the faults are temporary [17]) faults were considered per year, with a proportional distribution to the feeder's length.

The feeder's total length is: 21 km (F1), 61 km (F2), 15 km (F3) and 20 km (F4). Considering a failure rate of 0,075 faults/km, the number of fault to consider in each feeder is: 2 faults (F1), 5 faults (F2), 1 fault (F3) and 2 faults (F4).

In each iteration, the indices ENS, SAIFI, SAIDI and MAIFI are assessed to select the zone in which the recloser shall be deployed. With the new recloser placed, the economic benefits were assessed through Cost of Energy Not Supplied savings (CENS), Total Compensation (TC) savings and reduction of the penalties or increase of the rewards of Incentive to Quality of Service (IQS).

The economic benefits are compared with the investment costs and updated over the twenty years, corresponding to the recloser's life period, resulting in a series of cash flows thus allowing the assessment of the economic profitability of the investment through the calculation of the Net Present Value (NPV).

The implementation of the methodology in the case study resulted in the deployment of 4 reclosers in the locations shown in Figure 5.3.

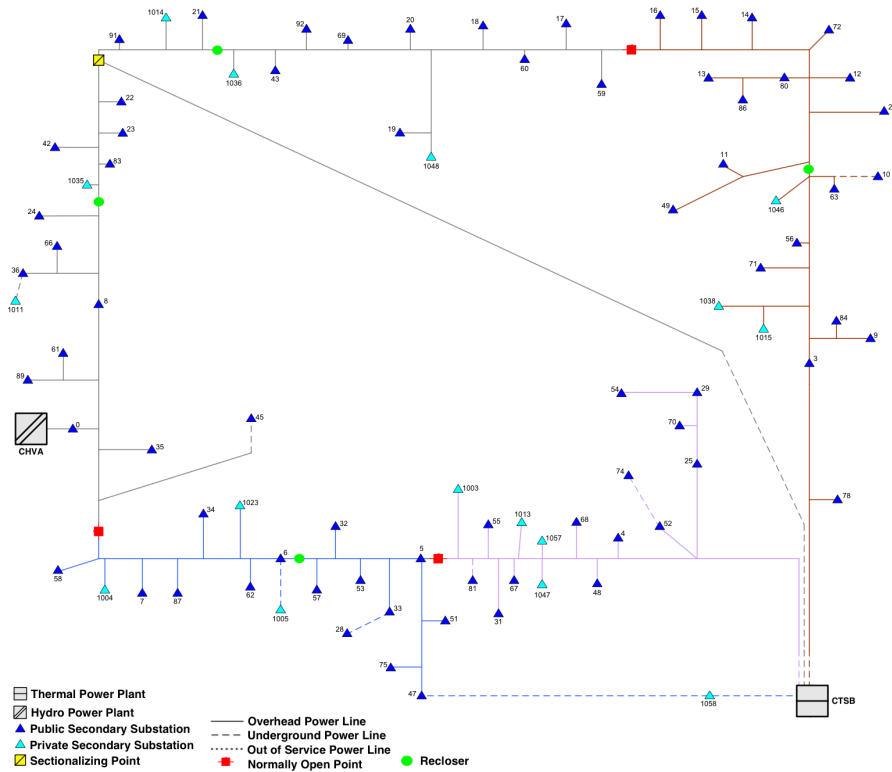

**Figure 5.3 - Case study network one-line scheme including the solution with 4 reclosers deployed.**

As shown in Figure 5.3, the feeder F2 is divided in three sections by the 2 reclosers deployed in it and the feeders F1 and F4, that present similar length, are divided in two sections as a recloser is deployed in each one.

Table 5.5 presents the results of the CENS analysis.

**Table 5.5 - CENS and Benefit of the solution in the first year.**

Number of Reclosers Deployed	0	1	2	3	4	5	6
CENS [€/year]	10149	7534	6385	5459	4765	4260	3897
Benefit [€/year]	-	2614	3763	4690	5473	5888	6251

The CENS values in each scenario result from the ENS due to the faults occurred in the first year. The benefit is calculated by applying the equation (4.9). With zero reclosers deployed means that 10.149€ represents the impact that CENS has for the DSO in the first year.

Table 5.6 presents the results of the IQS assessment.

**Table 5.6 - IQS and Benefit of the solution in the first year.**

<b>Number of Reclosers Deployed</b>	<b>0</b>	<b>1</b>	<b>2</b>	<b>3</b>	<b>4</b>	<b>5</b>	<b>6</b>
<b>IQS [€]</b>	-3359	-745	0	0	659	1074	1437
<b>Benefit [€]</b>	-	2614	3359	3359	4018	4433	4796

The IQS values in each scenario result from the ENS being below the minimum set by the ERSE for the first year or being above the maximum value. The benefit is calculated by applying the equation (4.10). For the first two scenarios, with zero and one recloser deployed, the DSO pays a penalty that results from the violation of the upper limit of the reference ENS. With 2 and 3 reclosers deployed there is no penalty or reward applied in the first year. With 4 reclosers deployed a reward begins to be applied as the ENS stays below the inferior limit of the reference ENS.

None of the indices exceeded the reference values for the total number of interruptions in a single delivery point (30 interruption Table 2.4) and for the total duration of interruptions in a single delivery point (16 hours Table 2.4), resulting in the inexistence of compensation to be paid to customers.

The NPV calculation of the solution presented in Figure 5.3 resulted in 55.587€ over the twenty years of the planning horizon. Moreover, this solution presents an Internal Rate of Return (IRR) of 24% with the initial investment of 40.000€ being paid in 6 years. Table 5.7 shows the economic analysis over the twenty years of useful lifetime of the devices with 4 reclosers strategically deployed in the network.

Table 5.7 - Economic analysis over the twenty years with 4 reclosers deployed.

Year	Benefit CENS [€]	Benefit IQS [€]	Costs [€]	Total [€]	Cash Flows Present Value [€]	Accumulative Cash Flows [€]
0	-	-	-40000	-40000	-40000	-40000
1	5473	4018	-800	8691	8691	-31309
2	5528	4132	-808	8851	8047	-23262
3	5583	4244	-816	9010	7447	-15815
4	5639	4458	-824	9273	6967	-8849
5	5695	4806	-832	9669	6604	-2245
6	5752	5145	-841	10056	6244	3999
7	5810	5475	-849	10435	5890	9890
8	5868	5797	-858	10807	5546	15435
9	5926	5926	-866	10987	5125	20561
10	5986	5986	-875	11097	4706	25267
11	6046	6046	-884	11208	4321	29588
12	6106	6106	-893	11320	3967	33555
13	6167	6167	-901	11433	3643	37198
14	6229	6229	-910	11547	3345	40543
15	6291	6291	-920	11663	3071	43614
16	6354	6354	-929	11779	2820	46434
17	6418	6418	-938	11897	2589	49023
18	6482	6482	-947	12016	2377	51400
19	6547	6547	-957	12136	2183	53583
20	6612	6612	-966	12257	2004	55587

For the economic analysis the capital cost rate considered was 10% [9] and the load growth rate considered was 1% [48].

## 5.2 - Results Analysis

The results obtained from the methodology implementation are analysed by evaluating the technical and economic benefits achieved. In the present Section, the base case is presented and the impact of the reclosers' deployment in the reliability indices improvement is addressed. The economic assessment of the benefits achieved with the reliability

improvement is assessed as well. The influence that the technical and economic components have in the final solution determination is assessed through a sensitivity analysis.

### 5.2.1 Base Case Results

The base case results are obtained considering an average load scenario defined by the average power verified in a typical day per feeder.

The implementation of the developed methodology in the base case scenario results in the deployment of 4 reclosers, which are located as presented in Figure 5.3. The iterative process stopped after six iterations, after NPV decrease in the iterations five and six, and the solution corresponding to the deployment of 4 reclosers was found to be the most adequate technical and economic solution. The improvements in the reliability indices are presented next for the six iterations performed.

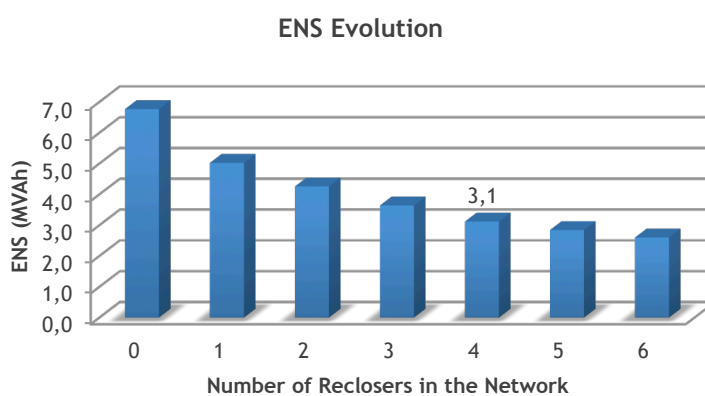

**Figure 5.4 - ENS evolution for the base case scenario.**

With 4 reclosers strategically deployed in the distribution network the ENS is reduced by 54%. The ENS reduction is more noticeable with the deployment of the first reclosers. When the recloser 1 is deployed the ENS is reduced by 26%. When the recloser 6 is deployed the ENS is reduced only 7%.

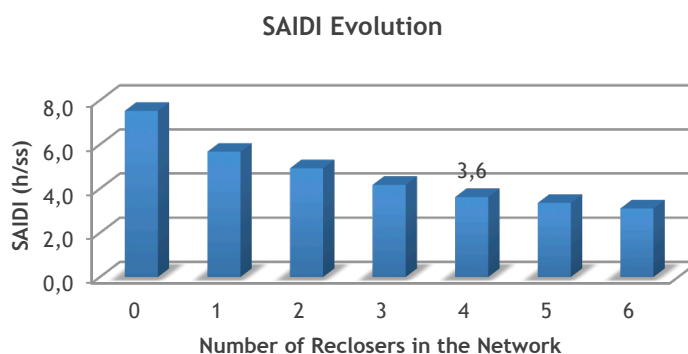

**Figure 5.5 - SAIDI evolution for the base case scenario.**



Reclosers provide distributed fault-interruption capability to the distribution network, presenting a positive impact in both the frequency of long interruptions experienced by customers and the average duration of those interruptions. The deployment of one recloser reduces the affected load and consequently the total duration of long interruption events thus improving the SAIDI. The deployment of 4 reclosers allows a reduction of 52% in SAIDI, from 7,5 h/ss to 3,6 h/ss Figure 5.5.

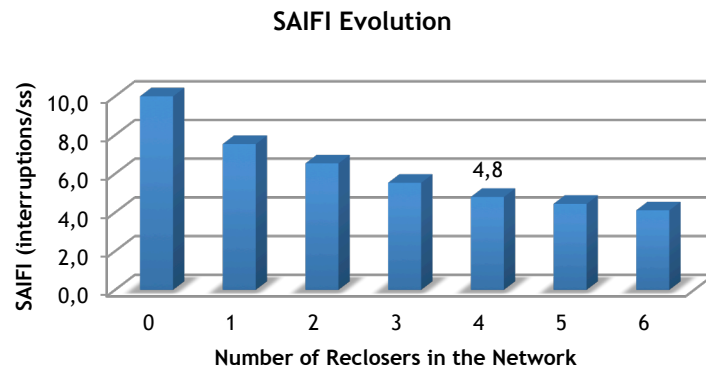

**Figure 5.6 - SAIFI evolution for the base case scenario.**

The frequency of long interruptions experienced by the delivery benefits with the fault-interruption capability. In a feeder with one reclosers deployed, in the sequence of a fault located in the second half of the feeder, all the load located upstream of the recloser will not experience any service interruption. The deployment of 4 reclosers allows a reduction of 52% in SAIFI as well, from 10 int/ss to 4,8 int/ss Figure 5.6.

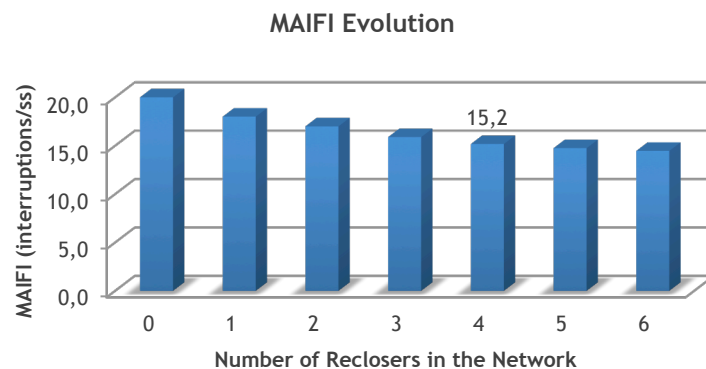
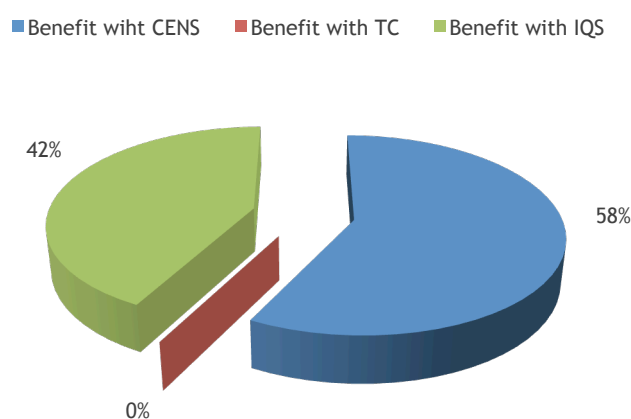

**Figure 5.7 - MAIFI evolution for the base case scenario.**

The reduction of the MAIFI represents the major advantage of the deployment of reclosers in distribution networks in comparison with other power switchgear devices. The combined fault-interruption and reclosing features allow the reduction of the number of

temporary faults experienced by the customers. The reclosers perform a predefined set of reclosing attempts to clear temporary faults, which is usually performed only at the primary substation level. As a consequence, the frequency of temporary interruptions is reduced since the recloser reduces the number of delivery points exposed to temporary faults. With 4 reclosers deployed along the network the MAIFI is reduced by 24%, from 20 int/ss to 15,2 int/ss Figure 5.7.

The contribution of the CENS and the IQS to the total economic benefit is presented in Figure 5.8. There is no economic benefit from the TC since none of the individual patterns of the addressed indices SAIDI and SAIFI are violated thus resulting in the inexistence of compensation to customers. The presented CENS and IQS contributions for the total benefit achieved in the first year are with 4 reclosers deployed. The economic benefit due to CENS reduction has a higher impact in the total benefit, with a contribution of 58% compared to the IQS contribution of 42%.



**Figure 5.8 - Contributions for the total economic benefit achieved in the first year for the base case scenario.**

The CENS calculation takes into account the total value of the ENS that presents a cost of 1,5 €/kWh. The IQS calculation considers the amount of ENS that exceeds the limits defined by  $ENS_{Ref} \pm \Delta ENS$ . This is the reason why the benefit due to the CENS reduction makes a higher contribution to the total economic benefit than the remuneration due to the IQS penalty reduction, in the first year.

The economic assessment of the NPV and Payback Period (PbP) over the recloser's life cycle is presented in Figure 5.9, revealing that the solution comprising the deployment of 4 reclosers is effectively the more profitable solution considering the base case scenario. The higher NPV achieved is 55.587€, with a PbP of 6 years and a IRR of 24%.

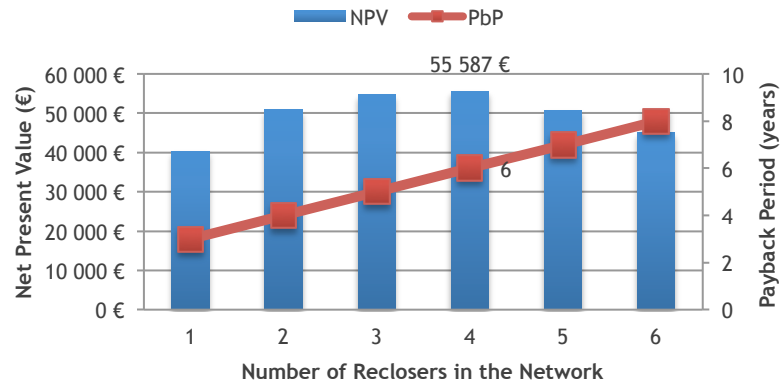

Figure 5.9 - NPV and PbP evolution for the base case scenario.

A higher number of reclosers present increased reliability improvement however it implies higher investments. With more than four reclosers in the network the reliability improvement that result from deploying an additional recloser is not sufficient to surpass its consequent capital and operational costs.

The evolution of the accumulative cash flows whose sum constitutes the NPV of each solutions achieved in each iteration of the algorithm for the base case scenario is presented in Figure 5.10.

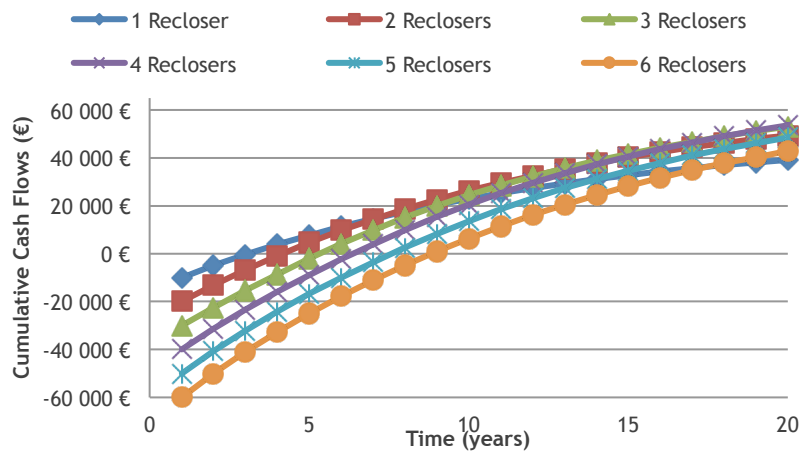

Figure 5.10 - Cumulative Cash Flows evolution for the base case scenario.

### 5.2.2 Sensitivity Analysis

The sensitivity analysis aims to assess the solution robustness to key technical and economic parameters.

Regarding the technical parameters, the sensitivity analysis regard:

- The load levels;
- The restoration and repair times;

- The load growth rate;

Regarding the economic parameters, the sensitivity analysis focus on:

- The recloser’s investment costs;
- The recloser’s lifetime;
- The value of ENS;

The considered variations in load levels include two scenarios, a maximum load scenario and a minimum load scenario. The considered load factors are estimated by the ratio between the total maximum power verified in a feeder and the total installed power of the feeder and by the ratio between the total minimum power verified in a feeder and the total installed power of the feeder. The considered load factors for the maximum/minimum load scenario are:

- Feeder 1: 53%/12%;
- Feeder 2: 46%/20%;
- Feeder 3: 38%/17%;
- Feeder 4: 34%/15%;

Figure 5.11 compares the ENS evolution with the number of reclosers for the two load variation scenarios and for the base case scenario (average load scenario).

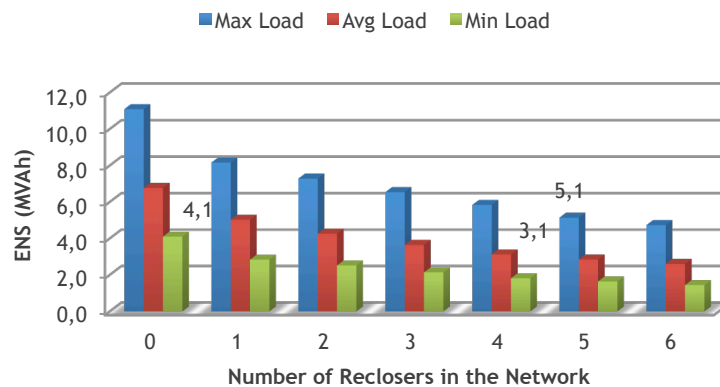

Figure 5.11 - ENS evolution for the three different load scenarios.

The ENS reduction is higher with a higher electric demand in the distribution network. For the base case solution with 4 recloser deployed, the ENS is reduced in 3,7 MVAh considering the average load scenario and is reduced in 5,3 MVAh considering the maximum load scenario.

Considering the maximum load scenario the economic assessment shows that the most profitable solution consists in the deployment of 5 reclosers as shown in Figure 5.12.

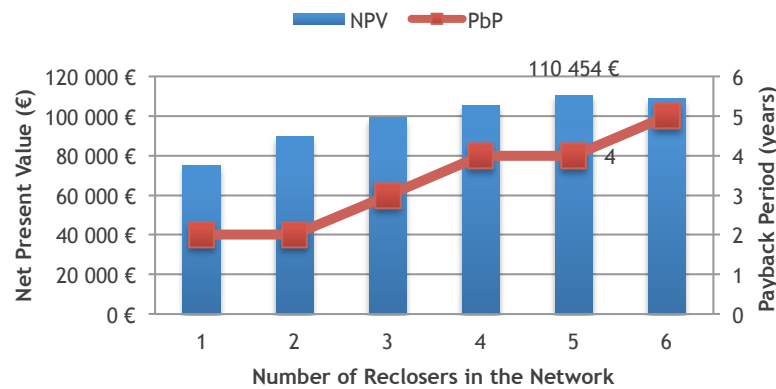

Figure 5.12 - NPV and PbP evolution for the max load scenario.

The best solution comprises the deployment of 5 reclosers and presents a NPV of 110.454€, with a PbP of 4 years. In the maximum load scenario the most profitable solution presents a NPV 99% higher that the NPV of the best solution considering an average load scenario. The PbP decreases from 6 to 4 years.

Considering the minimum load scenario the economic assessment shows that the most profitable solution consists in the deployment of 1 recloser.

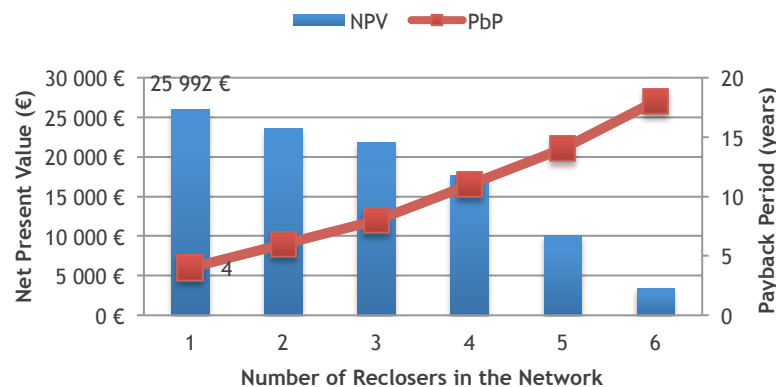

Figure 5.13 - NPV and PbP evolution for the min load scenario.

Figure 5.13 shows that the higher NPV is achieved with only 1 recloser deployed, for a total NPV of 25.992€ and a PbP of 4 years.

In a minimum load scenario the NPV of the most profitable solution decreases 53% in comparison with best solution considering an average load scenario. With only 1 recloser deployed the PbP is 4 years. The best solution achieved in an average load scenario with 4 reclosers deployed presents a PbP of 11 years with a minimum load scenario.

The considered variations in restoration and repair times consider the maximum values presented in [17] and in [21]:

- The considered restoration times for both automatic and manual procedures are respectively, 5 min and 75 min;
- The considered repair time is 4 h;

Figure 5.14 compares the ENS evolution with the number of reclosers for the two scenarios, the base case scenario and the alternative scenario considering longer restoration and repair times.

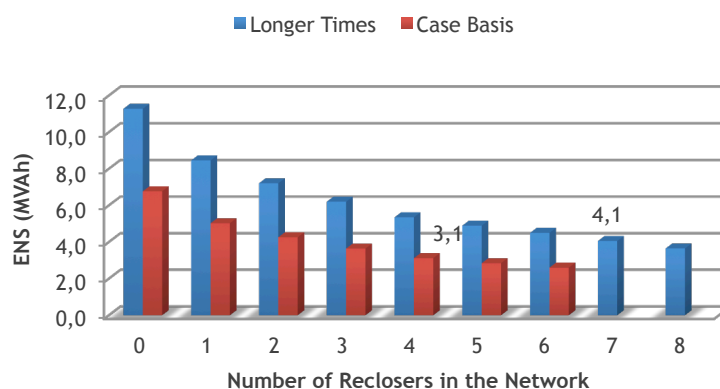

Figure 5.14 - ENS evolution for the two different scenarios, base case and longer restoration and repair times.

The algorithm applied to the base case stops with 6 reclosers deployed. In the addressed scenario with longer times the algorithm stop with 8 reclosers deployed. In the scenario with longer restoration and repair times the CENS and the IQS are higher. For the longer times scenario, with 7 reclosers strategically deployed the ENS is reduced by 64%. This corresponds to the most profitable solution, with a NPV of 131.698€ and PbP of 4 years.

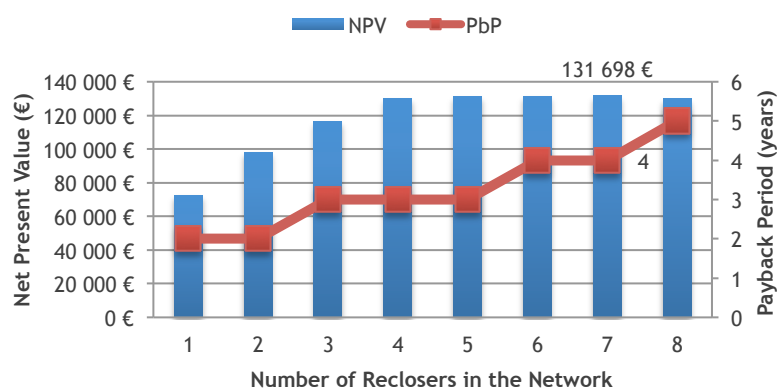
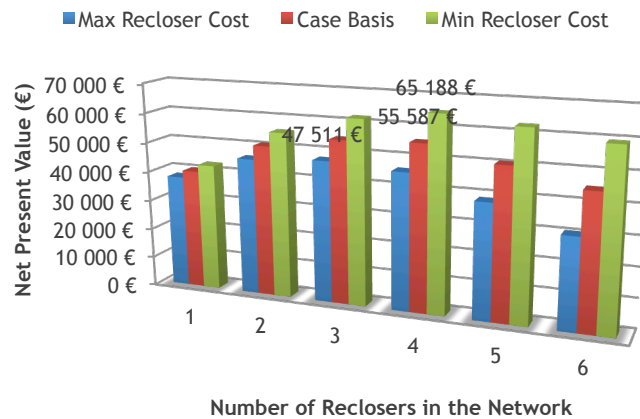

Figure 5.15 - NPV and PbP evolution for the alternative scenario with longer restoration and repair times.

The considered variations in the recloser's investment cost include two scenarios, a maximum recloser cost and a minimum recloser cost. The considered costs are:

- 12.000€ of maximum cost;
- 8.000€ of maximum cost;

Figure 5.16 compares the NPV evolution with the number of reclosers for the two recloser's cost scenarios and for the base case scenario.



**Figure 5.16 - NPV evolution for the alternative scenarios with max and min recloser cost and for the base case.**

The investment cost reduction from 10.000€ to 8.000€ is not enough to justify the deployment of another recloser. With the minimum recloser cost the best solution remains the deployment of 4 reclosers, but the NPV of the solution is now 65.188€ up from 55.587€. With a cost of 5.500€ the most profitable solution will be the deployment of 5 reclosers. With increased investment costs, the NPV of the best solution is 47.511€, achieved with the deployment of 3 reclosers.

The considered variations in the recloser's in the recloser's lifetime include two scenarios: 30 years lifetime period and 15 years lifetime period.

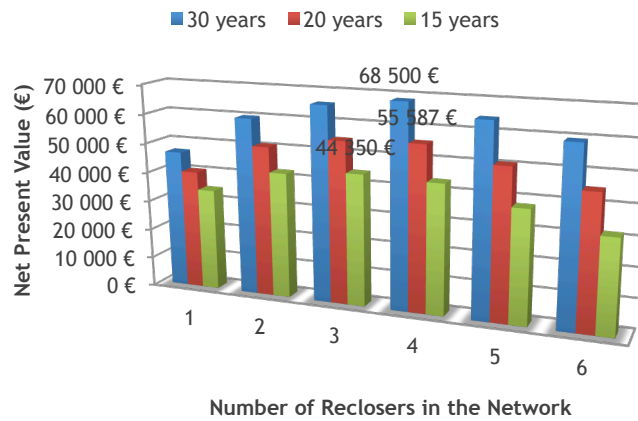

**Figure 5.17 - NPV evolution for the alternative scenarios with 30 and 15 years of reclosers' lifetime and for the base case.**

On one hand, a longer lifetime period increases the NPV of the best solution that corresponds to the scenario with 4 reclosers deployed in the network. On the other hand, a shorter useful lifetime period changes the best solution from a scenario of 4 reclosers deployed to 3 reclosers deployed, thus corroborating the results from the analysis of Figure 5.10.

The load growth rate influence in the definition of the number of recloser to deploy is assessed as well. Figure 5.18 shows the necessary variations in the load growth rate per year to influence the optimal number of reclosers in the network.

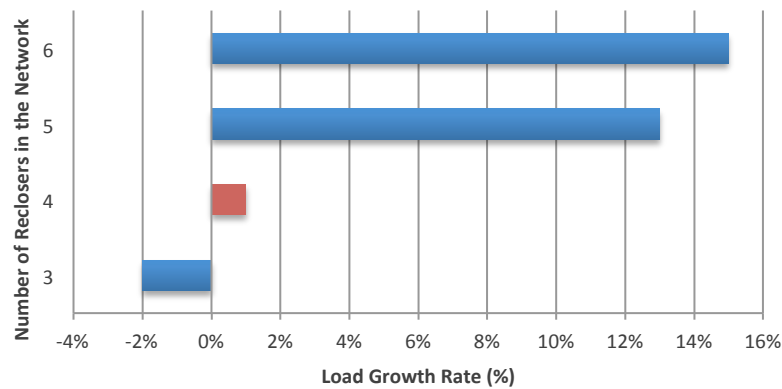
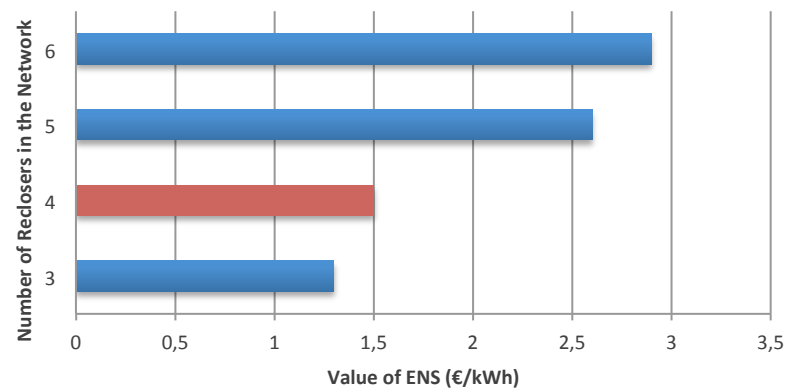

**Figure 5.18 - Influence of the load growth rate in the number of reclosers in the network.**

Comparatively to the base case scenario (1% of load growth rate per year), the load demand needs to increase 13% per year in order to justify the deployment of 5 reclosers in the network. The deployment of another recloser, for a total of 6 reclosers, is achieved with a 15% of load growth rate per year. A decrease in the load demand of -2% per year limits the number of recloser in the network to 3.



Figure 5.19 shows the influence that the value of ENS has in the definition of the optimal solution.



**Figure 5.19 - Influence of the value of ENS in the number of reclosers in the network.**

The value of the ENS considered in the base case is 1,5 €/kWh. Considering an increase in the  $V_{ENS}$  of 1,1 €/kWh, the optimal number of reclosers will be 5 and if the increase is 100%, to 3 €/kWh, the number of reclosers in the network increases to 6. With a 1,3 €/kWh the number of devices which is the most profitable solution will decrease to 3 reclosers.

### 5.3 - Summary

The results of the application of the methodology advanced in Chapter 4 to the case study are addressed in this Chapter. In Section 5.1 the case study is presented. The addressed network is characterized and the modelling process is explained. The techno-economic assumptions and the techno-economic assessment of the base case are presented. The obtained results are presented and analysed in Section 5.2.

The methodology implementation to this case study, considering an average load scenario as base case, resulted in a solution characterized by the deployment of 4 reclosers in the medium voltage overhead distribution network of the island of Faial, in the Autonomous Region of the Azores.

The results analysis comprises the base case results and the sensitivity analysis of the solution robustness to key parameters. The most profitable solution, comprising 4 reclosers strategically deployed in the network, allows a reduction on the ENS of 3,7 MVAh in the first year. With reclosers, a reduction of 24% in the MAIFI is achieved in the first year. The expected NPV of the solution is 55.587€ over the 20 years of the reclosers' lifecycle. The payback period of the investment is 6 years and the IRR of the investment project is 24%.

The performed sensitivity analysis includes the load level variation of the network. The influence of two scenarios, considering a maximum load factor and a minimum load factor, in the best solution definition is assessed. In a maximum load scenario the NPV of the most

profitable solution increases up to 99% (110.454€). This solution comprises the deployment of 5 reclosers in the network. A minimum load scenario increases the NPV of the solution to 25.992€, that comprises only 1 recloser in the network. The restoration time and the repair time are also covered by the sensitivity analysis. These parameters are assumed for the base case and its increase is considered in this analysis. With longer times the reliability indices are degraded but the savings increase with the cost of ENS and with the incentives to quality of service improve the total economic benefit due to the reclosers' deployment. The most profitable solution is achieved with the deployment of 7 reclosers, resulting in a NPV of 131.698€.

Some economical parameters as the recloser's cost and the recloser's lifetime period are assessed by the sensitivity analysis. Performing the economic evaluation based on costs 20% higher and 20% lower assesses the influence of the reclosers' investment costs in the solution definition. Considering 10.000€ of investment costs per recloser the NPV of the best techno-economic solution, with 3 reclosers deployed, dropped to 47.511€. The low cost scenario (8.000€ of reclosers' costs) increases the NPV up to 65.188€ and the most profitable solution comprises the same number of reclosers as the base case (4 reclosers). The reclosers' lifetime influence in the investment project analysis is assessed through an economic evaluation over 30 years, resulting in a 23% increase in the NPV of the best techno-economic solution, that still comprising the deployment of 4 reclosers.

# Chapter 6

## Conclusions and Future Work

In this work a methodology is developed to assess the number and the strategic location of reclosers to deploy in Distribution Grid Areas (DGA) based in a Cost Benefit Analysis (CBA) and comprising technical and economic aspects. The technical analysis assesses the reliability improvement due to the recloser's deployment, allowing network reconfiguration for power restoration. The economic analysis assesses the economic benefit by reducing the Cost of Energy Not Supplied (ENS), the Total Compensation (TC) to customers and the penalties of Incentive to Quality of Service (IQS), or increasing the incentives. By Opposing the Capital Expenditure (CAPEX) and the Operational Expenditure (OPEX) against the achieved economic benefits is possible to assess the profitability of the investment through the Net Present Value (NPV) evaluation.

This Chapter presents the final remarks of this work, in particular the conclusions resulting from the methodology implementation to a case study of a real distribution network. The developed methodology is evaluated and its limitations are also described. Furthermore, this Chapter addresses the possible improvements to the developed methodology and future work.

### 6.1 - Conclusions

The advanced methodology assesses a DGA from the perspective of the Self-Healing in service restoration. The techno-economic benefits of the strategic deployment of reclosers framed in Self-Healing schemes are assessed, considering the contribution of the improvement of several reliability indices in the optimal solution definition, that comprises the optimal number of recloser to deploy in the DGA and their locations, considering technical and economic aspects.

The proposed goal was to define a methodology capable of deal with the contemporary challenges related with the service restoration in distribution networks. The idea was to

address these challenges in a investment planning perspective, assessing the possibility of investment in the distribution networks' automation. Starting from this idea, the implementation of Self-Healing schemes for service restoration was addressed, based in Fault Detection Isolation and Restoration Algorithms through reclosers strategically deployed along the network. The established process to the assessment of the economic viability of these types of investment was a CBA. The objective of the proposed algorithm is to assess the optimal solution in terms of the number and strategic location of recloser to deploy in a DGA that leads to the profits' maximization during the lifecycle of the reclosers. The strategic deployment of reclosers in overhead distribution networks allows improvement in Quality of Service (QoS) which results in economic benefits for the Distribution System Operator (DSO).

The distribution network's empowering with distributed reclosers allow the improvement of the technical QoS, reducing the Energy Not Supplied (ENS), the number and the duration of permanent service interruptions. The reclosing capability also allows the reduction of the frequency of temporary service interruptions. Reclosers framed in Self-Healing schemes allow faster fault detection, isolation and service restoration thus minimizing the number of affected customers.

The base case revealed that strategic deployment of 4 reclosers leads to the ENS reduction by 54% in the first year which resulting in a NPV of 55.587€ over the device's lifetime of twenty years. The Payback Period (PbP) of the investment is 6 years.

Regarding the technical constraints, the main limitation is the number of reclosers possible of coordinate in series, a challenge discussed in Section 3.2. However, when applying the methodology to the case study this limitation never influenced the final solution, neither in the base case nor in the sensitivity analysis since the assessment of the investments' profitability limited the number of deployed reclosers.

Other technical aspects are addressed in the sensitivity analysis, such as the impact of the load level of the distribution network. The load level of the network influences the economic return of the investment and the PbP due to variations caused in the savings with CENS and IQS. On one hand, the CENS presents the higher contribution to the total benefit achieved and the load level significantly influences it by changing the level of electric demand and consequently the energy supplied to the network and the ENS in the sequence of a fault. On the other hand, the IQS rewards/penalties calculation depends on the reference ENS, which in turn depends on the amount of energy supplied in the distribution network in a year. Therefore, the applicable IQS reward/penalty depends on the network's load level, which limits the influence that the load level has in this parameter and in the associated benefit. The influence of the restoration and repair times in the solution definition is also evaluated in the sensitivity analysis. These times affect the response speed to power outages and the impact of those outages for customers and DSOs. The improvement of the system's response times to outages is a fundamental objective of the Self-Healing implementation.

The manual and automatic restorations times and the fault repair time vary with the technologies and the architectural schemes used to implement the Self-Healing strategies, which are discussed in Sections 2.4 and later in Section 3.3. In the sensitivity analysis, the impact that longer times present in the solution's definition was analysed, with the consideration of the maximum values for the times of restoration and fault repair. Longer restore and repair times increase the ENS and degrade the QoS. Since the fault repair time as increased from 1 hour to 4 hours and as the recloser's deployment effectively decreases the load affected till the fault repair, the impact in the investment project profitability is positive, increasing the NPVs. The best solution achieved is characterized by the deployment of 7 reclosers, reducing in 64% the ENS. The corresponding investment presents a NPV of 131.698€ and a PbP of 4 years. Compared to the base case, increasing the times of restoration and fault repair, the NPV increases 137% and the deployment of 3 additional reclosers is paid back 2 years in advance.

Regarding economic aspects, the scenarios addressed in the sensitivity analysis include the variation in the recloser's investment cost and in the recloser's lifetime. These two aspects present a more reduced influence on the definition of the final solution. The considered variation in the recloser's price was  $\pm 20\%$ . The cost reduction increases in 17% the NPV of the best solution, which remains the deployment of 4 reclosers. The increased cost results in 3 reclosers deployed for a 15% less NPV. The considered lifetime variation comprises the operational activity of the reclosers for a period of 30 years and is compared with the base case scenario and with a shorter lifetime period of 15 years. This resulted in an increase of 23% in the NPV and in a decrease of 20% NPV, for the 30 years lifetime period and for the 15 years lifetime period respectively, in comparison with the base case.

The methodology was applied on a real case scenario and the results achieved support the increased availability for investments in the distribution network automation, in particular in Self-Healing schemes using reclosers.

Self-Healing strategies increase the distribution system reliability and improve the technical QoS. Reclosers provide additional contribution to the reduction of the ENS and the number and duration of service interruptions, with particular interest to the decrease of temporary faults, a current concern for the DSOs worldwide.

## 6.2 - Work Contribution and Methodology Limitations

The differentiating aspects of this work are related with:

- The approach to the distribution system in the service restoration perspective, addressing the distribution networks as DGAs, consisting in operational areas defined by a range of primary substations and their feeder, with possibility of automatic reconfiguration in the event of a fault;
- The power switchgear technology addressed i.e. automatic circuit reclosers presenting remote operation capability;
- The combined consideration of several reliability indices in the process of assessment the network zone where the recloser presents the highest impact in the QoS improvement;

The developed methodology allows the assessment of the number of reclosers possible of deploy in a DGA and allows the assessment of the best location of those reclosers in the DGA. It also allows the assessment of the reliability indices of distribution networks and the assessment of the economic impact of those reliability levels to the DSO.

The contributions of this work cover the network reconfiguration in the service restoration perspective, the deployment of power switchgear devices in distribution networks, the reliability assessment in distribution networks and the economic assessment of the viability of investments in distribution network's planning and operation.

Some limitations of the methodology are related to the assumptions and considerations taken into account. The load split approach to find the recloser's deployment spots presents some difficulties when the method deals with distribution networks that does not have a uniform load distribution along the feeders. For example, whenever a feeder presents a large load concentration at the beginning, the most suitable location for the recloser's deployment will be after the first great load agglomerate, in order to enable the separation between the most loaded zone and the zone with the highest probability of fault occurrence, i.e. the longest section in the end of the feeder with less load connected. An exhaustive search, comparing all the possible locations for the recloser's deployment would be the best solution, but increases the computational effort. Alternatively, a Monte Carlo simulation could be performed, consisting in a stochastic simulation of a draw of samples that characterize the discrete states of residence of a system. The repeated simulation produces a set of samples allowing to obtain the probabilistic distribution of a specific event. Based on the failure rate and on the draw of the locations of a series of faults in the network, the reliability of each state is assessed. Nonetheless, the initial objective of this work is assessing the number of reclosers possible of deploy in a DGA in order to achieve the maximization of the operating profits over the total duration of the investment project. Thus, the problem of the optimal placement of reclosers on the same feeder was simplified, considering that the reclosers will always be deployed uniformly, regardless of the number of devices installed. That is the main reason why a Monte Carlo simulation was not advanced in this work. This simulation would be more suitable to solve the problem of the optimal location of  $n$  reclosers in a single feeder, a

distinct problem simplified over the goal initially proposed, assess the optimal number of reclosers possible of deploy in a DGA, considering technical and economic aspects.

### **6.3 - Future Work**

The continuity of this work may be related with the improvement of the developed methodology, covering, for example, the inclusion of Distributed Generation (DG) and storage systems in the self-healed service restoration problem.

Self-Healing implementation also comprises the power losses reduction, through network reconfiguration. The recloser's deployment can be addressed to a multi-objective approach, service restoration and losses minimization through network reconfiguration. The adaptation of the advanced methodology to other network topologies, such as radial networks, may also be a way forward in making the methodology more generic and useful for the planning of different types of distribution systems.





# References

- [1] IEEE Smart Grid definition. Available in <http://smartgrid.ieee.org> -> About IEEE Smart Grid.
- [2] Power Systems Distribution Automation definition. Available in <http://www.powersystems.org> -> Communications, IT, and Smart Grid Automation -> Utility Automation -> Distribution Automation.
- [3] Portuguese Quality of Service Regulation. Available in <http://www.erse.pt/eng/Paginas/ERSE.aspx> -> Electricity -> Quality of Service.
- [4] R. Billinton and R. N. Allan, "*Reliability Evaluation of Power Systems*," New York: Plenum Press, 1996.
- [5] T. Gönen, "*Electric Power Distribution Systems Engineering*," New York: McGraw-Hill Inc., 1986.
- [6] Y. G. Paithankar and S. R. Bhide, "*Fundamentals of Power Systems Protection*," New Delhi: Prentice-Hall of India Private Limited, 2003.
- [7] ERSE - Energy Services Regulatory Authority, "*Regulamento de Qualidade de Serviço do Setor Elétrico*," (in Portuguese) "Diário da República", 2th Series - Nº232 Nov. 2013: pp.34814-34900.
- [8] ERSE - Energy Services Regulatory Authority, "*Parâmetros de Regulação da Qualidade de Serviço do Setor Elétrico*," (in Portuguese) "Diário da República", 2th Series - Nº227 Nov. 2013: pp.34305-34313.
- [9] R. Moreira, "*Análise Técnico-Económica de Estratégias de Self-Healing em Smart Grids*," (in Portuguese) MSc. Dissertation Dept. Electrical and Computers Eng., Faculty of Engineering, Univ. Porto, 2011.
- [10] L. Moreira, "*Avaliação Técnico-Económica na Implementação de Estratégias de Otimização Distribuída em Smart Grids*," (in Portuguese) MSc. Dissertation Dept. Electrical and Computers Eng., Faculty of Engineering, Univ. Porto, 2013.
- [11] J. Ferreira, "*Os Órgãos de Corte de Rede de 3ª Geração nas Redes de Distribuição de Média Tensão*," (in Portuguese) MSc. Dissertation Dept. Electrical and Computers Eng., Faculty of Engineering, Univ. Porto, 2013.
- [12] Stojkov, Nikolovski and Mikuličić, "*Estimation of Electric Energy Not Supplied in Reliability Analysis of Distribution Networks*," in IEEE MELECON 2004.
- [13] Biyawerwala, Terziysky and Rajan, "*Distribution Automation: Multiple Scheme Complexity & Benefits - An overview of the benefits in implementing schemes with multiple reclosers*," 2014.
- [14] Momoh and Caven, "*Evaluation of Cost Benefit Analysis for the Reconfigured Distribution System*," in IEEE 2003.

- [15] Bernardo, Silva, Carrapatoso and Ockwell, “*Preventive Assessment for Combined Control and Substation-Centric Self-Healing Strategies*,” in 21<sup>st</sup> CIRED International Conference on Electricity Distribution 2011.
- [16] Melo, Cândido, Fortunato, Silva, Campos and Reis, “*Distribution Automation on LV and MV Using Distributed Intelligence*,” in 22<sup>nd</sup> CIRED International Conference on Electricity Distribution 2013.
- [17] Angelo and Selejan, “*Technologies of the Self Healing Grid*,” in 22<sup>nd</sup> CIRED International Conference on Electricity Distribution 2013.
- [18] Mekic, Alloway, Angelo and Goodin, “*Fault Detection Isolation and Restoration on the Feeder (FDIR): Pick Your Technology*,” in 21<sup>st</sup> CIRED International Conference on Electricity Distribution 2011.
- [19] Bernardo, Silva, Delgado, Jorge and Carrapatoso, “*DG Behaviour and Protection Schemes in Case of Disturbances Within the Concept of Distribution Grid Area*,” in CIRED Workshop 2012.
- [20] Wang and Singh, “*Reliability-Constrained Optimum Placement of Reclosers and Distributed Generators in Distribution Networks Using an Ant Colony systems Algorithm*,” in IEEE Transactions on Systems, MAN, and Cybernetics - Part C: Applications and Reviews, 2008: pp.757-764.
- [21] Uluski, “*Using Distribution Automation for a Self-Healing Grid*” 2012.
- [22] Greer, Allen, Schnegg and Dulmage, “*Distribution Automation Systems With Advanced Features*,” in IEEE 2011.
- [23] Rosa, Abalroado, Sousa, Marques, Oliveira, Gama, Ramalheira, Morgado and Duarte, “*EDP Distribution Automation (R)Evolution*,” in 21<sup>st</sup> CIRED International Conference on Electricity Distribution 2011.
- [24] Jia, Meng and Song, “*Study on technology systems of self-healing control in smart distribution grid*,” in The International Conference on Advanced Power Systems Automation and Protection IEEE 2011.
- [25] Tuglie, Scala, Patrono, Pugliese and Torelli, “*An Optimal Strategy for Switching Devices Allocation in Radial Distribution Networks*,” in IEEE AFRICON 2004: pp.683-690.
- [26] Heinrich, Brewis and Cain, “*Application of Reclosers for Reliable Supply in Rural Overhead Distribution Networks*,” in 20<sup>th</sup> CIRED International Conference on Electricity Distribution 2009.
- [27] Toune, Fudo, Genji, Fukuyama and Nakanishi, “*Comparative Study of Modern Heuristic Algorithms to Service Restoration in Distribution Systems*,” in IEEE Transactions on Power Delivery, Vol. 17, 2002: pp.173-181.
- [28] Kurutach and Tuppadung, “*Feeder-Switch Relocation Based upon Risk Analysis of trees-Caused Interruption and Value-Based Distribution Reliability Assessment*,” in IEEE 2004.
- [29] Matos and Melo “*Multiobjective Reconfiguration for Loss Reduction and Service Restoration Using Simulated Annealing*,” in IEEE Power Tech '99 Conference, 1999.
- [30] Montoya, Grajales, Hincapié, Granada and Gallego, “*Methodology for Optimal Distribution System Planning Considering Automatic Reclosers to Improve Reliability Indices*,” in IEEE 2014.
- [31] Wenyu, Jian, Jianmin, Haipeng and Meng, “*Optimal Allocation of Switches in Distribution Networks*,” in Proceeding of the 5<sup>th</sup> World Congress on Intelligent Control and Automation, 2004: pp.5155-5159.

- [32]Noce, “*Optimal Placement of Automation Devices in ENEL Distribution Network*,” in 20<sup>th</sup> CIRED International Conference on Electricity Distribution 2009.
- [33]Celli and Pilo, “*Optimal Sectionalizing Switches Allocation in Distribution Networks*,” in IEEE Transactions on Power Delivery, Vol. 14, 1999: pp.1167-1172.
- [34]Billinton and Jonnavithula, “*Optimal Switching Device Placement in Radial Distribution Systems*,” in IEEE Transactions on Power Delivery, Vol. 11, 1996: pp.1646-1651.
- [35]Mackiewicz, “*Overview of IEC 61850 and Benefits*,” in IEEE 2006.
- [36]Best, Morrow and Crossley, “*Communication Assisted Protection Selectivity for Reconfigurable and Islanded Power Networks*,” in IEEE 2009.
- [37]Roth, “*Maximizing Protection Coordination with Self-Healing Technology*,” in IEEE 2012.
- [38]Santos, Martins and Marques, “*Metodologia de Localização de OCR’s*,” (in Portuguese) in “Seminário Técnico Linhas Aéreas de AT MT” (in Portuguese).
- [39]Belloni, Chiumeo, Gandolfi and Villa, “*A protection coordination scheme for active distribution networks*,” 2012.
- [40]Chaly, Gutnik, Testoedov and Astrakhantsev, “*Autocoordination of Protection Settings of Series Reclosers*,” in CIGRE 2008, Technical Session 3 Protection, Control Communication and Automation of Distribution Network, 2008.
- [41]EDP Distribution - Energy of Portugal, “*Guia Geral de Proteções e Automação da RND*,” (in Portuguese) Jun. 2011.
- [42]EDP Distribution - Energy of Portugal, “*Reclosing Sectionalizers Technical specifications*,” DMA-C64-156/E, Jul. 1991.
- [43]EDP Distribution - Energy of Portugal, “*Materiais Para Redes - Aparelhagem AT e MT: Órgãos de corte de rede tipo 2 - OCR2*,” (in Portuguese) DMA-C64-154/N, May. 2007.
- [44]EDP Distribution - Energy of Portugal, “*Materiais Para Redes - Aparelhagem AT e MT: Órgãos de Corte de Rede Tipo 3 (OCR3)*,” (in Portuguese) DMA-C64-157/N, Set. 2014.
- [45]IEEE Standard Definition for Power Switchgear, IEE Std. C37.100-1992, Oct 1992.
- [46]IEC and IEE International Standard: High-voltage switchgear and controlgear - Part 111: Automatic circuit reclosers and fault interrupters for alternating current systems up to 38 kV, IEC Std. 62271-11, IEEE Std. C37.60-2012, Sep. 2012.
- [47]EDP Distribution - Energy of Portugal, “*Relatório da Qualidade de Serviço 2013*,” (in Portuguese) May. 2014.
- [48]EDP Distribution - Energy of Portugal, “*Relatório e Contas 2013*,” (in Portuguese) July. 2014.
- [49]Direção-Geral de Geologia e Energia, “*Despacho nº 5255/2006 Regulamento da Qualidade de Serviço*,” (in Portuguese) 2th Series - Nº48 Nov. 2006: pp.3334-3362.
- [50]Blajić, Nogulić and Družijanić, “*Latency Improvements in 3G Long Term Evolution*,” 2011.