

• •

-

2006

539.3

12

30.121.2

· · · · · ;
· · · · ·

12

· · ·
: .— : - , 2006.—147 .

ISBN 966-657-087-4

· -

« » ,

,

30.121.2

ISBN 966-657-087-4

© . . , 2006

© - , 2006



			.
		5
1		7
	1.1	7
	1.2	19
2		25
	2.1	25
	2.2	26
	2.3	27
	2.4	29
	2.5	-	30
3		35
	3.1	35
	3.2	36
	3.3	37
	3.4	49
	3.5	62
	3.6	76
	3.7	102



4	109
4.1	109
4.2	121
	147

,

-
-

.

, ,

,

.

-
-

,

-

.

-

,

,

-

,

,

.

(),

-

.

-

(, , .),

.

-

,

,

.

,

.

1

1.1

1.1.1

, : ,

$$A = \begin{bmatrix} a_{11} & a_{12} & \dots & a_{1j} & \dots & a_{1n} \\ a_{21} & a_{22} & \dots & a_{2j} & \dots & a_{2n} \\ \dots & \dots & \dots & \dots & \dots & \dots \\ a_{i1} & a_{i2} & \dots & a_{ij} & \dots & a_{in} \\ \dots & \dots & \dots & \dots & \dots & \dots \\ a_{m1} & a_{m2} & \dots & a_{mj} & \dots & a_{mn} \end{bmatrix}. \quad (1.1)$$

i j

i - j - .

(1.1) m n ;

ij i - j - . ,

$m \times n$.

1.1.2

- $1 \times n$ -

$$b = \{b_1 \ b_2 \ \dots \ b_n\}. \quad (1.2)$$

- $m \times 1$

$$c = \begin{Bmatrix} c_1 \\ c_2 \\ \dots \\ c_m \end{Bmatrix}. \quad (1.3)$$

$$N = \begin{bmatrix} 0 & 0 & \dots & 0 \\ 0 & 0 & \dots & 0 \\ \dots & \dots & \dots & \dots \\ 0 & 0 & \dots & 0 \end{bmatrix}. \quad (1.4)$$

$$D = \begin{bmatrix} d_{11} & d_{12} & \dots & d_{1n} \\ d_{21} & d_{22} & \dots & d_{2n} \\ \dots & \dots & \dots & \dots \\ d_{n1} & d_{n2} & \dots & d_{nm} \end{bmatrix}. \quad (1.5)$$

$$a_{ij} = \begin{cases} a, & i = j; \\ 0, & i \neq j, \end{cases} \quad (1.6)$$

$$A = \begin{bmatrix} a & 0 & 0 \\ 0 & a & 0 \\ 0 & 0 & a \end{bmatrix}. \quad (1.7)$$

$$I_{ij} = \begin{cases} 1, & i = j; \\ 0, & i \neq j. \end{cases} \quad (1.8)$$

3×3

$$I = \begin{bmatrix} 1 & 0 & 0 \\ 0 & 1 & 0 \\ 0 & 0 & 1 \end{bmatrix}. \quad (1.9)$$

$$d_{ij} = \begin{cases} d_{ii}, & i = j; \\ 0, & i \neq j, \end{cases} \quad (1.10)$$

$$D = \begin{bmatrix} d_{11} & 0 & \dots & 0 \\ 0 & d_{22} & \dots & 0 \\ \dots & \dots & \dots & \dots \\ 0 & 0 & \dots & d_{nn} \end{bmatrix}. \quad (1.11)$$

$$A = \begin{bmatrix} a_{11} & a_{12} & 0 & 0 & 0 & \dots & 0 & 0 & 0 \\ a_{21} & a_{22} & a_{23} & 0 & 0 & \dots & 0 & 0 & 0 \\ 0 & a_{32} & a_{33} & a_{34} & 0 & \dots & 0 & 0 & 0 \\ \dots & \dots & \dots & \dots & \dots & \dots & \dots & \dots & \dots \\ \dots & \dots & \dots & \dots & \dots & \dots & \dots & \dots & \dots \\ 0 & 0 & 0 & 0 & 0 & \dots & a_{n-1,n-2} & a_{n-1,n-1} & a_{n-1,n} \\ 0 & 0 & 0 & 0 & 0 & \dots & 0 & a_{n,n-1} & a_{nn} \end{bmatrix}. \quad (1.12)$$

L), U),

$$U = \begin{bmatrix} u_{11} & u_{12} & u_{13} & \dots & u_{1n} \\ 0 & u_{22} & u_{23} & \dots & u_{2n} \\ 0 & 0 & u_{33} & \dots & u_{3n} \\ \dots & \dots & \dots & \dots & \dots \\ 0 & 0 & 0 & \dots & u_{mn} \end{bmatrix}; \quad (1.13)$$

$$L = \begin{bmatrix} l_{11} & 0 & 0 & \dots & 0 \\ l_{21} & l_{22} & 0 & \dots & 0 \\ l_{31} & l_{32} & l_{33} & \dots & 0 \\ \dots & \dots & \dots & \dots & \dots \\ l_{n1} & l_{n2} & l_{n3} & \dots & l_{nm} \end{bmatrix}. \quad (1.14)$$

— ,

,

-

, ,

$$a_{ij} = a_{ji}. \quad (1.15)$$

—

,

-

:

$$a_{ij} = \begin{cases} 0, & i = j; \\ -a_{ji}, & i \neq j. \end{cases} \quad (1.16)$$

:

$$A = \begin{bmatrix} 0 & a_{12} & a_{13} \\ -a_{12} & 0 & a_{23} \\ -a_{13} & -a_{23} & 0 \end{bmatrix}. \quad (1.17)$$

—

,

$$a_{ij} = \begin{cases} a_{ii}, & i = j; \\ -a_{ji}, & i \neq j. \end{cases} \quad (1.18)$$

:

$$A = \begin{bmatrix} a_{11} & a_{12} & a_{13} \\ -a_{12} & a_{22} & a_{23} \\ -a_{13} & -a_{23} & a_{33} \end{bmatrix}. \quad (1.19)$$

:

$$A = \left[\begin{array}{c|c|c|c} a_{11} & a_{12} & a_{13} & a_{14} \\ a_{21} & a_{22} & a_{23} & a_{24} \\ a_{31} & a_{32} & a_{33} & a_{34} \\ \hline a_{41} & a_{42} & a_{43} & a_{44} \end{array} \right] = \begin{bmatrix} A_{11} & A_{12} & A_{13} \\ A_{21} & A_{22} & A_{23} \end{bmatrix}, \quad (1.20)$$

$11, 12, 13, 21, 22, 23$

$$A_{11} = \begin{bmatrix} a_{11} \\ a_{21} \\ a_{31} \end{bmatrix}; \quad A_{12} = \begin{bmatrix} a_{12} \\ a_{22} \\ a_{32} \end{bmatrix}; \quad A_{13} = \begin{bmatrix} a_{13} & a_{14} \\ a_{23} & a_{24} \\ a_{33} & a_{34} \end{bmatrix}; \quad (1.21)$$

$$A_{21} = a_{41}; \quad A_{22} = a_{42}; \quad A_{23} = [a_{43} \quad a_{44}]$$

1.1.3

$$C = A + B, \quad c_{ij} = a_{ij} + b_{ij}. \quad (1.22)$$

:

$$\begin{bmatrix} 2 & -1 & 0 \\ 3 & -2 & -4 \\ 1 & 2 & 1 \end{bmatrix} + \begin{bmatrix} -3 & 1 & 1 \\ 2 & 4 & 0 \\ 0 & 1 & -2 \end{bmatrix} = \begin{bmatrix} 2-3 & -1+1 & 0+1 \\ 3+2 & -2+4 & -4+0 \\ 1+0 & 2+1 & 1-2 \end{bmatrix} = \begin{bmatrix} -1 & 0 & 1 \\ 5 & 2 & -4 \\ 1 & 3 & -1 \end{bmatrix}. \quad (1.23)$$

$$C = A - B, \quad c_{ij} = a_{ij} - b_{ij}. \quad (1.24)$$

$$A + B = B + A, \tag{1.25}$$

$$(A + B) + C = A + (B + C). \tag{1.26}$$

$$A = \begin{bmatrix} a_{11} & a_{12} \\ a_{21} & a_{22} \\ a_{31} & a_{32} \end{bmatrix}, \tag{1.27}$$

$$A^T = \begin{bmatrix} a_{11} & a_{21} & a_{31} \\ a_{12} & a_{22} & a_{32} \end{bmatrix}. \tag{1.28}$$

(1.20)

$$A = \begin{bmatrix} A_{11} & A_{12} & A_{13} \\ A_{21} & A_{22} & A_{23} \end{bmatrix} \tag{1.29}$$

$$A^T = \begin{bmatrix} A_{11}^T & A_{21}^T \\ A_{12}^T & A_{22}^T \\ A_{13}^T & A_{23}^T \end{bmatrix}. \tag{1.30}$$

$$A^T = A. \tag{1.31}$$

$$A^T = -A. \quad (1.32)$$

λ

λ :

$$B = \lambda \cdot A, \quad b_{ij} = \lambda \cdot a_{ij}. \quad (1.33)$$

:

$$2 \cdot \begin{bmatrix} -1 & 2 & 5 \\ 3 & -4 & 6 \end{bmatrix} = \begin{bmatrix} 2 \cdot (-1) & 2 \cdot 2 & 2 \cdot 5 \\ 2 \cdot 3 & 2 \cdot (-4) & 2 \cdot 6 \end{bmatrix} = \begin{bmatrix} -2 & 4 & 10 \\ 6 & -8 & 12 \end{bmatrix}. \quad (1.34)$$

$m \times k$

$k \times n$:

$$C = A \cdot B, \quad c_{ij} = \sum_{q=1}^k a_{iq} \cdot b_{qj}. \quad (1.35)$$

$m \times n$.

,

$$A = \begin{bmatrix} 2 & -1 & 1 \\ 3 & 0 & 4 \end{bmatrix}; \quad B = \begin{bmatrix} 1 & 0 & 2 \\ 5 & 1 & -2 \\ 0 & 3 & 4 \end{bmatrix} \quad (1.36)$$

= . :

$$C = \begin{bmatrix} 2 \cdot 1 + (-1) \cdot 5 + 1 \cdot 0 & 2 \cdot 0 + (-1) \cdot 1 + 1 \cdot 3 & 2 \cdot 2 + (-1) \cdot (-2) + 1 \cdot 4 \\ 3 \cdot 1 + 0 \cdot 5 + 4 \cdot 0 & 3 \cdot 0 + 0 \cdot 1 + 4 \cdot 3 & 3 \cdot 2 + 0 \cdot (-2) + 4 \cdot 4 \end{bmatrix} = \begin{bmatrix} -3 & 2 & 10 \\ 3 & 12 & 28 \end{bmatrix}. \quad (1.37)$$

,

:

$$D = A \cdot B \cdot C. \quad (1.38)$$

$m \times n$ $m \times p$ $p \times q$ $q \times n$

-

-

:

$$(AB)C = A(BC) = ABC; \tag{1.39}$$

$$A(B+C) = AB + AC. \tag{1.40}$$

:

$$AB \neq BA. \tag{1.41}$$

.

.

-

-

$|A|$

()

.

L_{ij} a_{ij}

$(-1)^{i+j}$ $ij,$ $i-$ -

$j-$.

,

$$A = \begin{bmatrix} 2 & 1 & -3 \\ -1 & 0 & -2 \\ 1 & 3 & 2 \end{bmatrix} \tag{1.42}$$

$$A = \begin{vmatrix} 2 & 1 & -3 \\ -1 & 0 & -2 \\ 1 & 3 & 2 \end{vmatrix}. \tag{1.43}$$

a_{11}, a_{12}, a_{13} :

$$M_{11} = \begin{bmatrix} 0 & -2 \\ 3 & 2 \end{bmatrix}; \quad M_{12} = \begin{bmatrix} -1 & -2 \\ 1 & 2 \end{bmatrix}; \quad M_{13} = \begin{bmatrix} -1 & 0 \\ 1 & 3 \end{bmatrix}, \tag{1.44}$$

:

$$L_{11} = \begin{vmatrix} 0 & -2 \\ 3 & 2 \end{vmatrix}; \quad L_{12} = - \begin{vmatrix} -1 & -2 \\ 1 & 2 \end{vmatrix}; \quad L_{13} = \begin{vmatrix} -1 & 0 \\ 1 & 3 \end{vmatrix}. \tag{1.45}$$

$$\begin{aligned}
 |A| &= 2 \cdot \begin{vmatrix} 0 & -2 \\ 3 & 2 \end{vmatrix} + 1 \cdot \left(- \begin{vmatrix} -1 & -2 \\ 1 & 2 \end{vmatrix} \right) + (-3) \cdot \begin{vmatrix} -1 & 0 \\ 1 & 3 \end{vmatrix} = \\
 &= 2 \cdot (0 \cdot 2 + (-2) \cdot (-3)) - 1 \cdot ((-1) \cdot 2 + (-2) \cdot (-1)) + (-3) \cdot ((-1) \cdot 3 + 0 \cdot (-1)) = 21.
 \end{aligned} \tag{1.46}$$

λ

λ

λ

λ

λ

λ

λ

λ

λ

λ

$$A^{-1}A = I. \tag{1.47}$$

$$|A| \neq 0. \tag{1.48}$$

$$|A| = 0. \tag{1.49}$$

$$(A^{-1})_{ij} = b_{ij} = \frac{L_{ji}}{|A|}. \tag{1.50}$$

$$\begin{aligned}
& , \qquad (1.42) \qquad : \\
b_{11} &= \frac{\begin{vmatrix} 0 & -2 \\ 3 & 2 \end{vmatrix}}{21} = \frac{2}{7}; & b_{12} &= -\frac{\begin{vmatrix} 1 & -3 \\ 3 & 2 \end{vmatrix}}{21} = -\frac{11}{21}; & b_{13} &= \frac{\begin{vmatrix} 1 & -3 \\ 0 & -2 \end{vmatrix}}{21} = -\frac{2}{21}; \\
b_{21} &= -\frac{\begin{vmatrix} -1 & -2 \\ 1 & 2 \end{vmatrix}}{21} = 0; & b_{22} &= \frac{\begin{vmatrix} 2 & -3 \\ 1 & 2 \end{vmatrix}}{21} = \frac{1}{3}; & b_{23} &= -\frac{\begin{vmatrix} 2 & -3 \\ -1 & -2 \end{vmatrix}}{21} = \frac{1}{3}; \\
b_{31} &= \frac{\begin{vmatrix} -1 & 0 \\ 1 & 3 \end{vmatrix}}{21} = -\frac{1}{7}; & b_{32} &= -\frac{\begin{vmatrix} 2 & 1 \\ 1 & 3 \end{vmatrix}}{21} = -\frac{5}{21}; & b_{33} &= \frac{\begin{vmatrix} 2 & 1 \\ -1 & 0 \end{vmatrix}}{21} = \frac{1}{21},
\end{aligned} \tag{1.51}$$

$$B = A^{-1} = \begin{bmatrix} \frac{2}{7} & -\frac{11}{21} & -\frac{2}{21} \\ 0 & \frac{1}{3} & \frac{1}{3} \\ -\frac{1}{7} & -\frac{5}{21} & \frac{1}{21} \end{bmatrix}. \tag{1.52}$$

$$, \qquad (1.47) \qquad :$$

$$A^{-1}A = \begin{bmatrix} 1 & 0 & 0 \\ 0 & 1 & 0 \\ 0 & 0 & 1 \end{bmatrix} = I. \tag{1.53}$$

$$, \qquad = (t) - \qquad m \times n:$$

$$A(t) = \begin{bmatrix} a_{11}(t) & a_{12}(t) & \dots & a_{1n}(t) \\ a_{21}(t) & a_{22}(t) & \dots & a_{2n}(t) \\ \dots & \dots & \dots & \dots \\ a_{m1}(t) & a_{m2}(t) & \dots & a_{mn}(t) \end{bmatrix}, \tag{1.54}$$

$$D(A) = \frac{dA(t)}{dt} = \begin{bmatrix} \frac{da_{11}(t)}{dt} & \frac{da_{12}(t)}{dt} & \dots & \frac{da_{1n}(t)}{dt} \\ \frac{da_{21}(t)}{dt} & \frac{da_{22}(t)}{dt} & \dots & \frac{da_{2n}(t)}{dt} \\ \dots & \dots & \dots & \dots \\ \frac{da_{m1}(t)}{dt} & \frac{da_{m2}(t)}{dt} & \dots & \frac{da_{mn}(t)}{dt} \end{bmatrix}. \quad (1.55)$$

$$\int A(t)dt = \begin{bmatrix} \int a_{11}(t)dt & \int a_{12}(t)dt & \dots & \int a_{1n}(t)dt \\ \int a_{21}(t)dt & \int a_{22}(t)dt & \dots & \int a_{2n}(t)dt \\ \dots & \dots & \dots & \dots \\ \int a_{m1}(t)dt & \int a_{m2}(t)dt & \dots & \int a_{mn}(t)dt \end{bmatrix}. \quad (1.56)$$

$(t), B(t) \quad C(t)$

$$D(A + B) = D(A) + D(B); \quad (1.57)$$

$$D(AB) = D(A) \cdot B + A \cdot D(B); \quad (1.58)$$

$$D(ABC) = D(A) \cdot BC + A \cdot D(B) \cdot C + AB \cdot D(C); \quad (1.59)$$

$$D(A^{-1}) = -A^{-1}D(A)A^{-1}. \quad (1.60)$$

$$X = \begin{Bmatrix} x_1 \\ x_2 \\ \dots \\ x_n \end{Bmatrix}; \quad Y = \{y_1 \quad y_2 \quad \dots \quad y_m\}, \quad (1.61)$$

$$\begin{aligned}\frac{\partial Y}{\partial x_1} &= \left\{ \frac{\partial y_1}{\partial x_1} \quad \frac{\partial y_2}{\partial x_1} \quad \dots \quad \frac{\partial y_m}{\partial x_1} \right\}; \\ \frac{\partial Y}{\partial x_2} &= \left\{ \frac{\partial y_1}{\partial x_2} \quad \frac{\partial y_2}{\partial x_2} \quad \dots \quad \frac{\partial y_m}{\partial x_2} \right\}; \\ \frac{\partial Y}{\partial x_n} &= \left\{ \frac{\partial y_1}{\partial x_n} \quad \frac{\partial y_2}{\partial x_n} \quad \dots \quad \frac{\partial y_m}{\partial x_n} \right\}\end{aligned}\quad (1.62)$$

$$\frac{\partial Y}{\partial X} = \begin{bmatrix} \frac{\partial y_1}{\partial x_1} & \frac{\partial y_2}{\partial x_1} & \dots & \frac{\partial y_m}{\partial x_1} \\ \frac{\partial y_1}{\partial x_2} & \frac{\partial y_2}{\partial x_2} & \dots & \frac{\partial y_m}{\partial x_2} \\ \dots & \dots & \dots & \dots \\ \frac{\partial y_1}{\partial x_n} & \frac{\partial y_2}{\partial x_n} & \dots & \frac{\partial y_m}{\partial x_n} \end{bmatrix}. \quad (1.63)$$

$A, X, Y \quad Z$

,

:

$$\frac{\partial Y}{\partial X} = \left(\frac{\partial Y^T}{\partial X^T} \right)^T; \quad (1.64)$$

$$\frac{\partial X^T}{\partial X} = \frac{\partial X}{\partial X^T} = I; \quad (1.65)$$

$$\frac{\partial (X^T A X)}{\partial X} = 2AX; \quad (1.66)$$

$$\frac{\partial (X^T A X)}{\partial X^T} = 2X^T A; \quad (1.67)$$

$$\frac{\partial (X^T A)}{\partial X} = A, \quad A \neq f(x_i); \quad (1.68)$$

$$\frac{\partial (YZ)}{\partial X} = \frac{\partial (ZY)}{\partial X} = \frac{\partial Z^T}{\partial X} Y^T + \frac{\partial Y}{\partial X} Z; \quad (1.69)$$

$$\frac{\partial (YZ)}{\partial X^T} = \frac{\partial (ZY)}{\partial X^T} = Y \frac{\partial Z}{\partial X^T} + Z^T \frac{\partial Y^T}{\partial X^T}. \quad (1.70)$$

1.2

1.2.1

()

$$\begin{cases} a_{11}x_1 + a_{12}x_2 + \dots + a_{1n}x_n = b_1; \\ a_{21}x_1 + a_{22}x_2 + \dots + a_{2n}x_n = b_2; \\ \dots \\ a_{n1}x_1 + a_{n2}x_2 + \dots + a_{nn}x_n = b_n, \end{cases} \quad (1.71)$$

$$AX = B, \quad (1.72)$$

$$A = \begin{bmatrix} a_{11} & a_{12} & \dots & a_{1n} \\ a_{21} & a_{22} & \dots & a_{2n} \\ \dots & \dots & \dots & \dots \\ a_{n1} & a_{n2} & \dots & a_{nn} \end{bmatrix}; \quad (1.73)$$

$$X = \begin{Bmatrix} x_1 \\ x_2 \\ \dots \\ x_n \end{Bmatrix}; \quad (1.74)$$

$$B = \begin{Bmatrix} b_1 \\ b_2 \\ \dots \\ b_n \end{Bmatrix}. \quad (1.75)$$



1.2.2

LDL^T-

$$U, \quad (1.72)$$

$$UX = C. \quad (1.76)$$

$$(1.76). \quad (n-1)-$$

$n-1 \dots$

$$LDL^T-$$

$L, \quad D$

U

$$A = LDU. \tag{1.77}$$

$$U = L^T. \tag{1.78}$$

(1.77)

$$A = LDL^T,$$

(1.72)

$$LDL^T X = B, \tag{1.79}$$

$$LC = B, \tag{1.80}$$

$$C = DL^T X. \tag{1.81}$$

$$(1.80)$$

(1.81)

$D \quad L$

$$\begin{cases} d_{ii} = a_{ii} - \sum_{q=1}^{i-1} l_{iq}^2 \cdot d_{qq}; \\ l_{ii} = 1; \\ l_{ij} = \frac{1}{d_{ii}} \left(a_{ij} - \sum_{q=1}^{j-1} d_{iq} \cdot l_{jq} \cdot d_{qq} \right); \\ l_{ij} = 0 \quad i < j, \end{cases} \tag{1.82}$$

$$\begin{cases} c_i = b_i - \sum_{p=1}^{i-1} l_{ip} \cdot c_p; \\ x_i = \frac{1}{d_{ii}} \left(c_i - \sum_{q=i+1}^p d_{ii} \cdot l_{qi} \cdot x_q \right), \end{cases} \tag{1.83}$$

$$A = LL^T, \tag{1.84}$$

$L -$

(1.72)

$$LL^T X = B, \tag{1.85}$$

:

$$LC = B; \tag{1.86}$$

$$L^T X = C. \tag{1.87}$$

(1.86)

,

(1.87)

.

$$\begin{cases} l_{ii} = \sqrt{a_{ii} - \sum_{j=1}^{i-1} l_{ij}^2}; \\ l_{ij} = \frac{1}{l_{jj}} \left(a_{ij} - \sum_{m=1}^{j-1} l_{jm} \cdot l_{im} \right); \\ l_{ij} = 0 \quad i < j, \end{cases} \tag{1.88}$$

,

-

1.2.3

:

-

;

-

;

-

.

$$\begin{aligned} & \vdots, \quad , \quad , \quad - \\ & , \quad \cdot \\ & \qquad \qquad \qquad (1.72) \end{aligned}$$

$$X^k = G_k X^{k-1} + R_k, \quad (1.89)$$

$$G_k, \quad G_{k-1} - \quad k- \quad (k-1)- \quad -$$

;

$$G_k - \quad , \quad B;$$

$$R_k - \quad - \quad .$$

$$\lim_{k \rightarrow \infty} X^k = X = A^{-1}B, \quad (1.90)$$

(1.89)

$$A^{-1}B = G_k A^{-1}B + R_k, \quad (1.91)$$

$$R_k = (I - G_k)A^{-1}B, \quad (1.92)$$

$I -$

(1.89)

$$X^k = G_k X^{k-1} + M_k B, \quad (1.93)$$

$$M_k = (I - G_k)A^{-1}. \quad (1.94)$$

$$G_k \quad k \cdot$$

$$L, \quad D \quad U \quad -$$

:

$$A = L + D + U. \quad (1.95)$$

()

:

$$\begin{cases} G = -D^{-1}(L+U); \\ M = D^{-1}. \end{cases} \quad (1.96)$$

$$x_i^k = d_i + \sum_{j=1}^n g_{ij} \cdot x_j^{k-1}, \quad (1.97)$$

$i, g_{ij}, d_i - , G, D^{-1}B ;$
 $n - .$

$$\begin{cases} G = (D + \omega L)^{-1}[(1 - \omega)D - \omega U]; \\ M = \omega(D + \omega L)^{-1}. \end{cases} \quad (1.98)$$

:

$$x_i^k = (1 - \omega)x_i^{k-1} + \omega \left(\sum_{j=1}^{i-1} g_{ij} \cdot x_j^k + \sum_{j=i+1}^n g_{ij} \cdot x_j^{k-1} + d_i \right). \quad (1.99)$$

$\omega - , -$
 $.$

$1,85 \leq \omega \leq 1,92.$

$$(1.72) -$$

$$F = X^T AX - 2B^T X. \quad (1.100)$$

2

2.1

$$S = \begin{bmatrix} \sigma_x & \tau_{xy} & \tau_{xz} \\ \tau_{yx} & \sigma_y & \tau_{yz} \\ \tau_{zx} & \tau_{zy} & \sigma_z \end{bmatrix}. \quad (2.1)$$

$\sigma_x, \sigma_y, \sigma_z$ — ,
 $\tau_{xy}, \tau_{xz}, \tau_{yx}, \tau_{yz}, \tau_{zx}, \tau_{zy}$ —
 2.1);
).

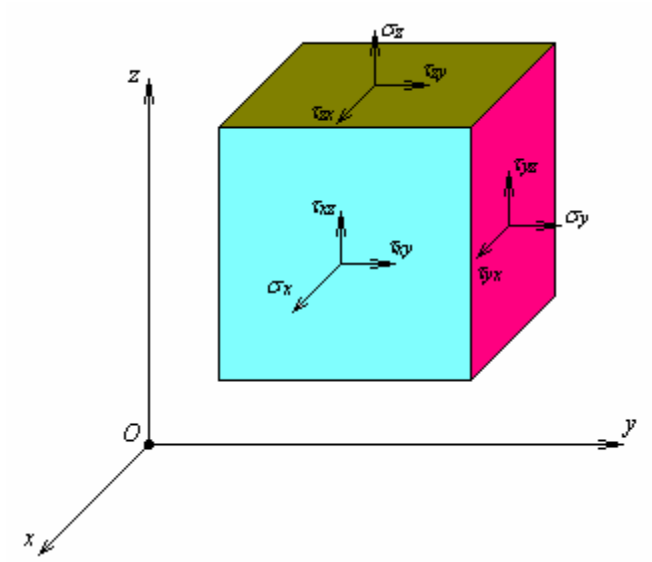

2.1 —

$$S^T = S, \quad (2.2)$$

$$\begin{cases} \tau_{yx} = \tau_{xy}; \\ \tau_{zy} = \tau_{yz}; \\ \tau_{xz} = \tau_{zx}. \end{cases} \quad (2.3)$$

$S,$ -

$$\sigma = \begin{cases} \sigma_x \\ \sigma_y \\ \sigma_z \\ \tau_{xy} \\ \tau_{yz} \\ \tau_{zx} \end{cases}. \quad (2.4)$$

2.2

$$T = \begin{bmatrix} \varepsilon_x & \gamma_{xy} & \gamma_{xz} \\ \gamma_{yx} & \varepsilon_y & \gamma_{yz} \\ \gamma_{zx} & \gamma_{zy} & \varepsilon_z \end{bmatrix}, \quad (2.5)$$

$\varepsilon_x, \varepsilon_y, \varepsilon_z$ -

(2.2);

$\gamma_{xy}, \gamma_{xz}, \gamma_{yx}, \gamma_{yz}, \gamma_{zx}, \gamma_{zy}$ -

(2.2).

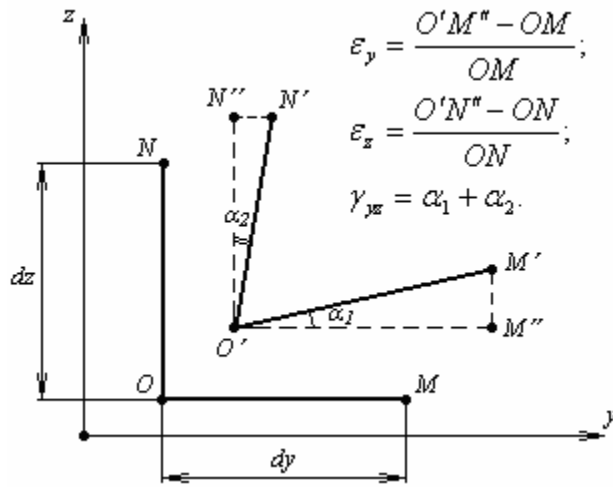

2.2

$$T^T = T, \tag{2.6}$$

$$\begin{cases} \gamma_{yx} = \gamma_{xy}; \\ \gamma_{zy} = \gamma_{yz}; \\ \gamma_{zx} = \gamma_{xz}. \end{cases} \tag{2.7}$$

T, -

- :

$$\varepsilon = \begin{Bmatrix} \varepsilon_x \\ \varepsilon_y \\ \varepsilon_z \\ \gamma_{xy} \\ \gamma_{yz} \\ \gamma_{zx} \end{Bmatrix}. \tag{2.8}$$

2.3

, , (2.3), -

$$\vec{s} = u\vec{i} + v\vec{j} + w\vec{k}, \quad (2.9)$$

u, v, w —

x, y, z —

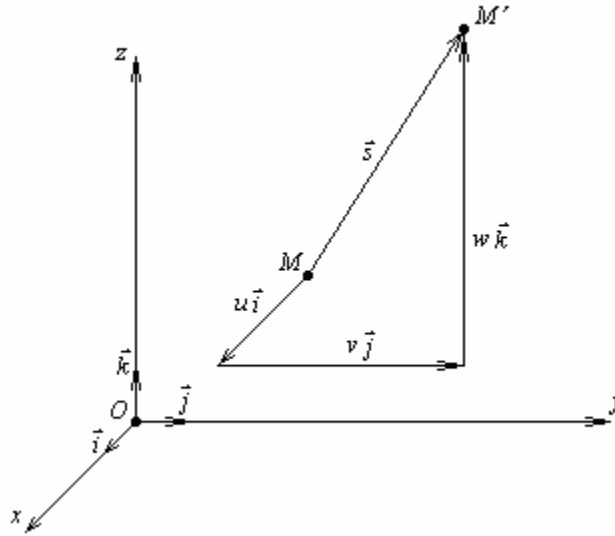

2.3

$$u = \begin{Bmatrix} u \\ v \\ w \end{Bmatrix}. \quad (2.10)$$

$$\begin{cases} \varepsilon_x = \frac{\partial u}{\partial x}; & \gamma_{xy} = \frac{\partial u}{\partial y} + \frac{\partial v}{\partial x}; \\ \varepsilon_y = \frac{\partial v}{\partial y}; & \gamma_{yz} = \frac{\partial v}{\partial z} + \frac{\partial w}{\partial y}; \\ \varepsilon_z = \frac{\partial w}{\partial z}; & \gamma_{zx} = \frac{\partial u}{\partial z} + \frac{\partial w}{\partial x}, \end{cases} \quad (2.11)$$

$$\varepsilon = Du, \quad (2.12)$$

$D -$

:

$$D = \begin{bmatrix} \frac{\partial}{\partial x} & 0 & 0 \\ 0 & \frac{\partial}{\partial y} & 0 \\ 0 & 0 & \frac{\partial}{\partial z} \\ \frac{\partial}{\partial y} & \frac{\partial}{\partial x} & 0 \\ 0 & \frac{\partial}{\partial z} & \frac{\partial}{\partial y} \\ \frac{\partial}{\partial z} & 0 & \frac{\partial}{\partial x} \end{bmatrix}. \quad (2.13)$$

2.4

-

(

-

$\sigma \quad \varepsilon)$

:

$$\begin{cases} \varepsilon_x = \frac{1}{E} [\sigma_x - \nu(\sigma_y + \sigma_z)] \\ \varepsilon_y = \frac{1}{E} [\sigma_y - \nu(\sigma_z + \sigma_x)] \\ \varepsilon_z = \frac{1}{E} [\sigma_z - \nu(\sigma_x + \sigma_y)] \end{cases} \quad \begin{cases} \gamma_{xy} = \frac{\tau_{xy}}{G} \\ \gamma_{yz} = \frac{\tau_{yz}}{G} \\ \gamma_{zx} = \frac{\tau_{zx}}{G} \end{cases} \quad (2.14)$$

-

;

$G -$

;

$\nu -$

.

$\nu, E \quad G:$

$$G = \frac{E}{2(1+\nu)}. \quad (2.15)$$

(2.14)

:

$$\varepsilon = M\sigma, \quad (2.16)$$

:

$$M = \frac{1}{E} \begin{bmatrix} 1 & -\nu & -\nu & 0 & 0 & 0 \\ -\nu & 1 & -\nu & 0 & 0 & 0 \\ -\nu & -\nu & 1 & 0 & 0 & 0 \\ 0 & 0 & 0 & 2(1+\nu) & 0 & 0 \\ 0 & 0 & 0 & 0 & 2(1+\nu) & 0 \\ 0 & 0 & 0 & 0 & 0 & 2(1+\nu) \end{bmatrix}. \quad (2.17)$$

(2.16)

$$\sigma = A\varepsilon, \quad (2.18)$$

$$A = M^{-1} = \frac{E}{(1+\nu)(1-2\nu)} \begin{bmatrix} 1-\nu & \nu & \nu & 0 & 0 & 0 \\ \nu & 1-\nu & \nu & 0 & 0 & 0 \\ \nu & \nu & 1-\nu & 0 & 0 & 0 \\ 0 & 0 & 0 & \frac{1-2\nu}{2} & 0 & 0 \\ 0 & 0 & 0 & 0 & \frac{1-2\nu}{2} & 0 \\ 0 & 0 & 0 & 0 & 0 & \frac{1-2\nu}{2} \end{bmatrix}. \quad (2.19)$$

2.5

2.5.1

2.4).

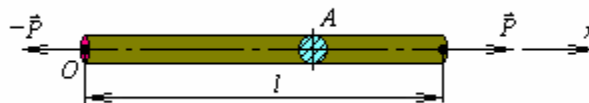

2.4 –

$$\sigma_x = E\varepsilon_x. \quad (2.20)$$

$$\varepsilon_x = \frac{du}{dx}. \quad (2.21)$$

$$\sigma_x = \frac{P}{A}, \quad (2.22)$$

— , (—) ;
 — , (2.20)

$$\frac{P}{A} = E \frac{du}{dx}, \quad (2.23)$$

$$\frac{du}{dx} = \frac{P}{EA}. \quad (2.24)$$

2.5.2

,
 () , —
 (2.5).

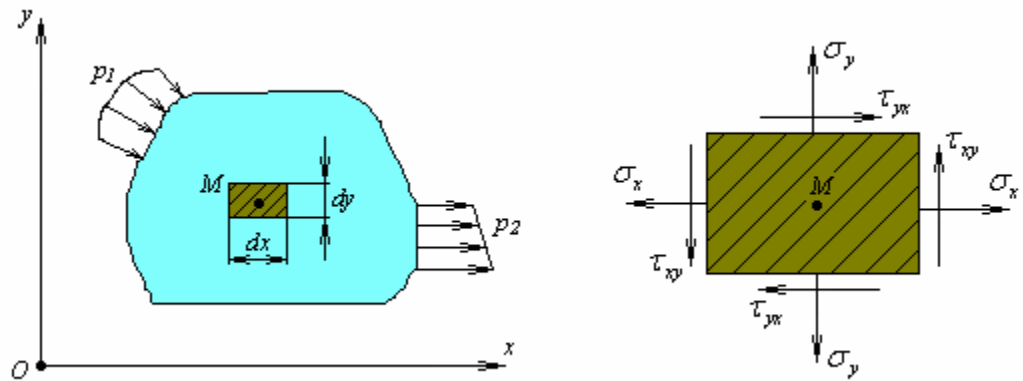

2.5 –

$$\begin{cases} \varepsilon_x = \frac{\partial u}{\partial x}; \\ \varepsilon_y = \frac{\partial v}{\partial y}; \\ \gamma_{xy} = \frac{\partial u}{\partial y} + \frac{\partial v}{\partial x}, \end{cases} \quad (2.25)$$

$$\varepsilon = Du, \quad (2.26)$$

$\varepsilon -$ -

$$\varepsilon = \begin{Bmatrix} \varepsilon_x \\ \varepsilon_y \\ \gamma_{xy} \end{Bmatrix}; \quad (2.27)$$

- -

$$u = \begin{Bmatrix} u \\ v \end{Bmatrix}; \quad (2.28)$$

D –

$$D = \begin{bmatrix} \frac{\partial}{\partial x} & 0 \\ 0 & \frac{\partial}{\partial y} \\ \frac{\partial}{\partial y} & \frac{\partial}{\partial x} \end{bmatrix}. \quad (2.29)$$

$$\begin{cases} \varepsilon_x = \frac{1}{E}(\sigma_x - \nu\sigma_y); \\ \varepsilon_y = \frac{1}{E}(\sigma_y - \nu\sigma_x); \\ \gamma_{xy} = \frac{\tau_{xy}}{G}. \end{cases} \quad (2.30)$$

$$\sigma = A\varepsilon, \quad (2.31)$$

σ - -

$$\sigma = \begin{Bmatrix} \sigma_x \\ \sigma_y \\ \tau_{xy} \end{Bmatrix}; \quad (2.32)$$

-

$$A = \frac{E}{1-\nu^2} \begin{bmatrix} 1 & \nu & 0 \\ \nu & 1 & 0 \\ 0 & 0 & \frac{1-\nu}{2} \end{bmatrix}. \quad (2.33)$$

2.5.3

, (2.6).

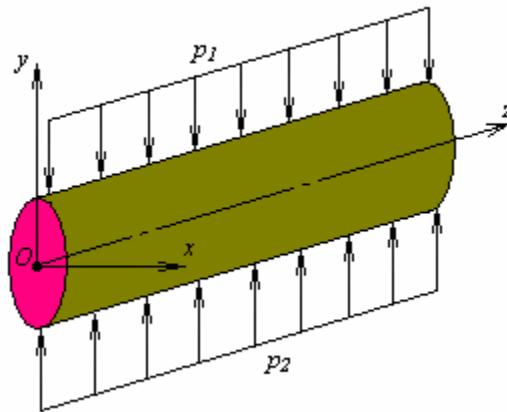

2.6 –

(2.25),

:

$$\begin{cases} \varepsilon_x = \frac{1}{E_1} (\sigma_x - \nu_1 \sigma_y); \\ \varepsilon_y = \frac{1}{E_1} (\sigma_y - \nu_1 \sigma_x); \\ \gamma_{xy} = \frac{\tau_{xy}}{G}, \end{cases} \quad (2.34)$$

:

$$E_1 = \frac{E}{1-\nu^2}; \quad (2.35)$$

$$\nu_1 = \frac{\nu}{1-\nu}. \quad (2.36)$$

$$\sigma = A_1 \varepsilon, \quad (2.37)$$

$$A_1 = \frac{E_1}{1-\nu_1^2} \begin{bmatrix} 1 & \nu_1 & 0 \\ \nu_1 & 1 & 0 \\ 0 & 0 & \frac{1-\nu_1}{2} \end{bmatrix}. \quad (2.38)$$

3

3.1

,
- ,
.
:
-
,
;
- ;
-
,
.
, ,
,
,
,
.
,
,
,
.
.

3.2

() (3.1).

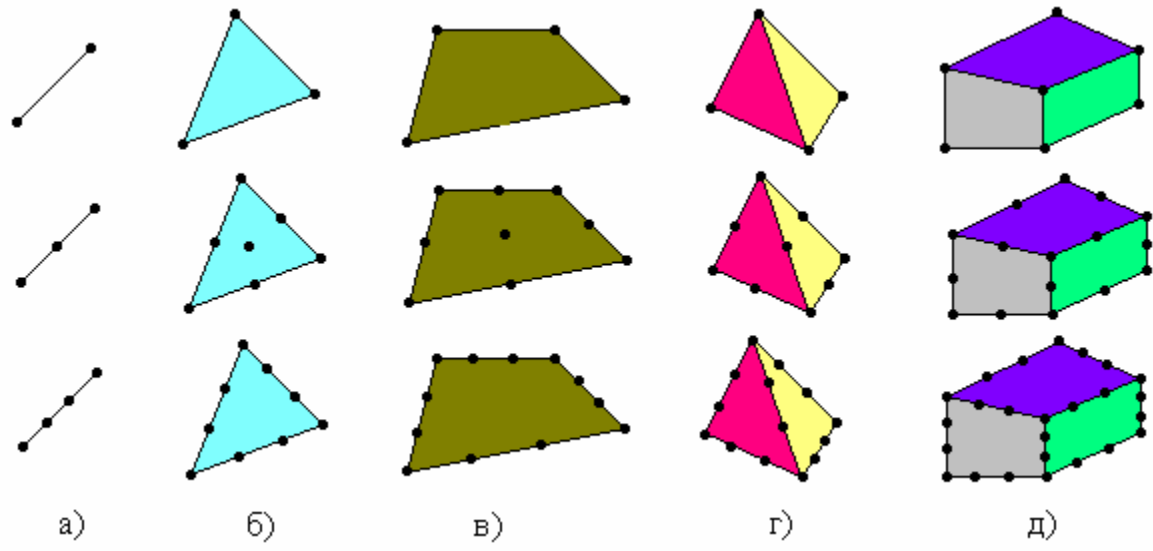

3.1 –

(3.1).

(, , , .).

(3.1, -)

(3.1, -)

3.3

3.3.1

3.2).

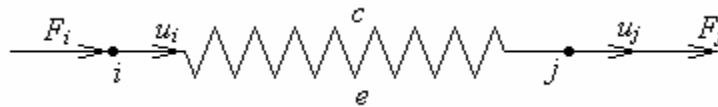

3.2 -

$$F_i \quad F_j, \quad \begin{matrix} i & j, \\ i & j. \end{matrix}$$

$$\begin{cases} F_i = c \cdot (u_i - u_j), \\ F_j = c \cdot (u_j - u_i). \end{cases} \quad (3.1)$$

(3.1)

$$\begin{bmatrix} c & -c \\ -c & c \end{bmatrix} \begin{Bmatrix} u_i \\ u_j \end{Bmatrix} = \begin{Bmatrix} F_i \\ F_j \end{Bmatrix}, \quad (3.2)$$

$$Ku = F, \quad (3.3)$$

$$u = \begin{Bmatrix} u_i \\ u_j \end{Bmatrix}; \quad (3.4)$$

$F -$

$$F = \begin{Bmatrix} F_i \\ F_j \end{Bmatrix};$$

$$K = \begin{bmatrix} c & -c \\ -c & c \end{bmatrix}. \quad (3.5)$$

3.3.2

1 2 (3.3).

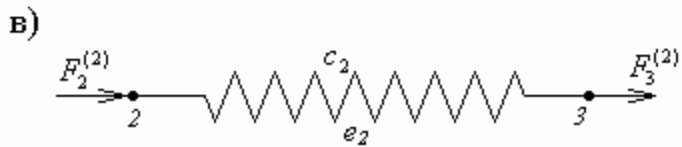
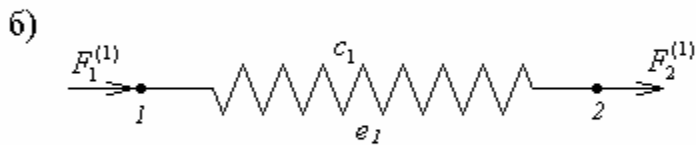
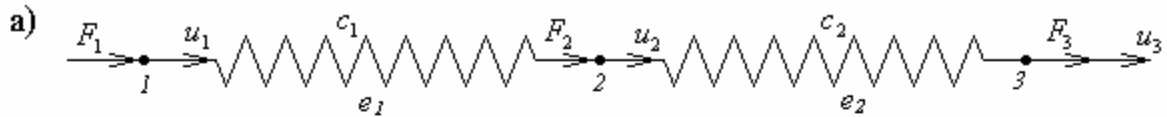

3.3 –

1 (3.2)

$$\begin{bmatrix} c_1 & -c_1 \\ -c_1 & c_1 \end{bmatrix} \begin{Bmatrix} u_1 \\ u_2 \end{Bmatrix} = \begin{Bmatrix} F_1 \\ F_2^{(1)} \end{Bmatrix}, \quad (3.6)$$

$F_2^{(1)}$ — , j — 1.

, 2

$$\begin{bmatrix} c_2 & -c_2 \\ -c_2 & c_2 \end{bmatrix} \begin{Bmatrix} u_2 \\ u_3 \end{Bmatrix} = \begin{Bmatrix} F_2^{(2)} \\ F_3 \end{Bmatrix}, \quad (3.7)$$

$F_2^{(2)}$ — , i — 2.

3.3

$$\begin{cases} F_1 = F_1^{(1)}; \\ F_2 = F_2^{(1)} + F_2^{(2)}; \\ F_3 = F_3^{(2)}, \end{cases} \quad (3.8)$$

$$\begin{pmatrix} F_1^{(1)} \\ F_3^{(2)} \end{pmatrix} = \begin{pmatrix} c_1 & -c_1 & 0 \\ -c_1 & c_1 + c_2 & -c_2 \\ 0 & -c_2 & c_2 \end{pmatrix} \begin{pmatrix} u_1 \\ u_2 \\ u_3 \end{pmatrix} = \begin{pmatrix} F_1 \\ F_2 \\ F_3 \end{pmatrix} \quad (3.9)$$

$$Ku = F, \quad (3.10)$$

$$u = \begin{pmatrix} u_1 \\ u_2 \\ u_3 \end{pmatrix}; \quad (3.11)$$

$$F = \begin{pmatrix} F_1 \\ F_2 \\ F_3 \end{pmatrix}; \quad (3.12)$$

$$F = \begin{pmatrix} F_1 \\ F_2 \\ F_3 \end{pmatrix}; \quad (3.13)$$

$$K = \begin{bmatrix} \begin{array}{cc|c} u_1 & u_2 & u_3 \\ c_1 & -c_1 & 0 \end{array} \\ \hline \begin{array}{c|cc} & c_1+c_2 & -c_2 \\ -c_1 & & \end{array} \\ \hline \begin{array}{cc|c} 0 & -c_2 & c_2 \end{array} \end{bmatrix}. \quad (3.14)$$

$$K = K_{e_1} + K_{e_2}, \quad (3.15)$$

$$K_{e_1} = \begin{bmatrix} \begin{array}{cc|c} u_1 & u_2 & u_3 \\ c_1 & -c_1 & 0 \\ -c_1 & c_1 & 0 \\ 0 & 0 & 0 \end{array} \end{bmatrix}; \quad K_{e_2} = \begin{bmatrix} \begin{array}{cc|c} u_1 & u_2 & u_3 \\ 0 & 0 & 0 \\ 0 & c_2 & -c_2 \\ 0 & -c_2 & c_2 \end{array} \end{bmatrix}. \quad (3.16)$$

F

$$K^T = K. \quad (3.17)$$

3.3.3

(3.5)

3.3.1

(3.1),

$$K_{i,j} = \frac{\partial^2 U}{\partial u_i \partial u_j},$$

$U -$;

$-$. $U.$

,

$$U = \frac{1}{2}c(u_i - u_j)^2 = \frac{1}{2}cu_i^2 - cu_iu_j + \frac{1}{2}cu_j^2.$$

,

$$K = \begin{bmatrix} \frac{\partial^2 U}{\partial u_i^2} & \frac{\partial^2 U}{\partial u_i \partial u_j} \\ \frac{\partial^2 U}{\partial u_j \partial u_i} & \frac{\partial^2 U}{\partial u_j^2} \end{bmatrix} = \begin{bmatrix} c & -c \\ -c & c \end{bmatrix},$$

(3.5).

3.3.4

(3.11)

.

,

-

$$\frac{\partial}{\partial} = 0,$$

-

.

$$= U - V,$$

$U -$;

$V -$.

$$U = \frac{1}{2}c(u_i - u_j)^2.$$

$$V = F_i u_i + F_j u_j.$$

$$\begin{cases} \frac{\partial U}{\partial u_i} = cu_i - cu_j - F_i = 0; \\ \frac{\partial U}{\partial u_j} = -cu_i + cu_j - F_j = 0, \end{cases}$$

$$\begin{bmatrix} c & -c \\ -c & c \end{bmatrix} \begin{Bmatrix} u_i \\ u_j \end{Bmatrix} = \begin{Bmatrix} F_i \\ F_j \end{Bmatrix}.$$

(3.2).

3.1

2, 3

1, 4.

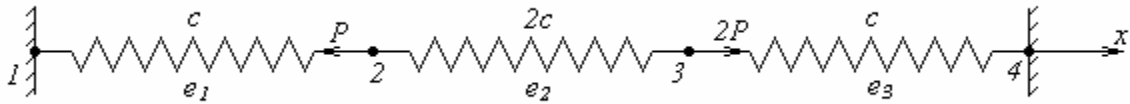

1

$$K_{e1} = \begin{matrix} & \begin{matrix} u_1 & u_2 & u_3 & u_4 \end{matrix} \\ \begin{matrix} c & -c & 0 & 0 \\ -c & c & 0 & 0 \\ 0 & 0 & 0 & 0 \\ 0 & 0 & 0 & 0 \end{matrix} \end{matrix}$$

2

$$K_{e2} = \begin{matrix} & \begin{matrix} u_1 & u_2 & u_3 & u_4 \end{matrix} \\ \begin{matrix} 0 & 0 & 0 & 0 \\ 0 & 2c & -2c & 0 \\ 0 & -2c & 2c & 0 \\ 0 & 0 & 0 & 0 \end{matrix} \end{matrix}$$

3

$$K_{e3} = \begin{matrix} & \begin{matrix} u_1 & u_2 & u_3 & u_4 \end{matrix} \\ \begin{matrix} 0 & 0 & 0 & 0 \\ 0 & 0 & 0 & 0 \\ 0 & 0 & c & -c \\ 0 & 0 & -c & c \end{matrix} \end{matrix}$$

$$K = K_{e1} + K_{e2} + K_{e3} = \begin{matrix} & \begin{matrix} u_1 & u_2 & u_3 & u_4 \end{matrix} \\ \begin{matrix} c & -c & 0 & 0 \\ -c & 3c & -2c & 0 \\ 0 & -2c & 3c & -c \\ 0 & 0 & -c & c \end{matrix} \end{matrix}.$$

$$u_1 = 0;$$

$$u_4 = 0.$$

$$F_2 = -P;$$

$$F_3 = 2P.$$

$$\begin{matrix} & \begin{matrix} u_1 & u_2 & u_3 & u_4 \end{matrix} \\ \begin{bmatrix} c & -c & 0 & 0 \\ -c & 3c & -2c & 0 \\ 0 & -2c & 3c & -c \\ 0 & 0 & -c & c \end{bmatrix} \begin{Bmatrix} 0 \\ u_2 \\ u_3 \\ 0 \end{Bmatrix} = \begin{Bmatrix} F_1 \\ -P \\ 2P \\ F_4 \end{Bmatrix} \end{matrix}.$$

$$\begin{bmatrix} 3c & -2c \\ -2c & 3c \end{bmatrix} \begin{Bmatrix} u_2 \\ u_3 \end{Bmatrix} = \begin{Bmatrix} -P \\ 2P \end{Bmatrix},$$

$$\begin{cases} u_2 = \frac{1}{5} \frac{P}{c}; \\ u_3 = \frac{4}{5} \frac{P}{c}. \end{cases}$$

$$\begin{Bmatrix} F_1 \\ F_4 \end{Bmatrix} = \begin{bmatrix} c & -c & 0 & 0 \\ 0 & 0 & -c & c \end{bmatrix} \begin{Bmatrix} 0 \\ \frac{1}{5} \frac{P}{c} \\ \frac{4}{5} \frac{P}{c} \\ 0 \end{Bmatrix} = \begin{Bmatrix} -\frac{1}{5} P \\ -\frac{4}{5} P \end{Bmatrix}.$$

$$F_1 + F_2 + F_3 + F_4 = -\frac{1}{5} P - P + 2P - \frac{4}{5} P = 0.$$

3.2

2

1, 3, 4.

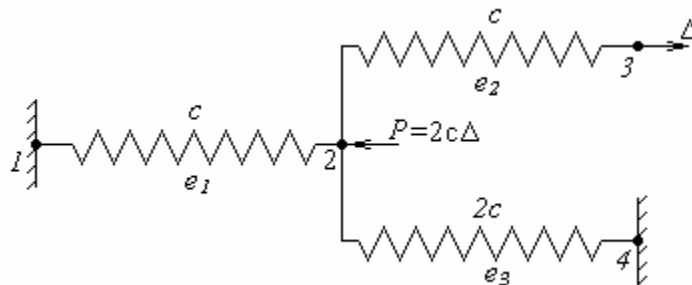

1

$$K_{e1} = \begin{array}{c} u_1 \quad u_2 \quad u_3 \quad u_4 \\ \begin{bmatrix} c & -c & 0 & 0 \\ -c & c & 0 & 0 \\ 0 & 0 & 0 & 0 \\ 0 & 0 & 0 & 0 \end{bmatrix} \end{array}$$

2

$$K_{e2} = \begin{array}{c} u_1 \quad u_2 \quad u_3 \quad u_4 \\ \begin{bmatrix} 0 & 0 & 0 & 0 \\ 0 & c & -c & 0 \\ 0 & -c & c & 0 \\ 0 & 0 & 0 & 0 \end{bmatrix} \end{array}$$

3

$$K_{e3} = \begin{array}{c} u_1 \quad u_2 \quad u_3 \quad u_4 \\ \begin{bmatrix} 0 & 0 & 0 & 0 \\ 0 & 2c & 0 & -2c \\ 0 & 0 & 0 & 0 \\ 0 & -2c & 0 & 2c \end{bmatrix} \end{array}$$

$$K = K_{e1} + K_{e2} + K_{e3} = \begin{array}{c} u_1 \quad u_2 \quad u_3 \quad u_4 \\ \begin{bmatrix} c & -c & 0 & 0 \\ -c & 4c & -c & -2c \\ 0 & -c & c & 0 \\ 0 & -2c & 0 & 2c \end{bmatrix} \end{array}$$

:

$$u_1 = 0;$$

$$u_3 = ;$$

$$u_4 = 0.$$

$$F_2 = - = -2 .$$

$$\begin{array}{cccc} u_1 & u_2 & u_3 & u_4 \\ \left[\begin{array}{cccc} c & -c & 0 & 0 \\ -c & 4c & -c & -2c \\ 0 & -c & c & 0 \\ 0 & -2c & 0 & 2c \end{array} \right] \begin{array}{c} \left[\begin{array}{c} 0 \\ u_2 \\ \Delta \\ 0 \end{array} \right] & = & \begin{array}{c} \left[\begin{array}{c} F_1 \\ -2c\Delta \\ F_3 \\ F_4 \end{array} \right] \end{array} \end{array}$$

$$\{4c \quad -c\} \begin{Bmatrix} u_2 \\ \Delta \end{Bmatrix} = \{-2c\Delta\},$$

$$u_2 = -\frac{1}{4}\Delta.$$

$$\begin{Bmatrix} F_1 \\ F_2 \\ F_3 \end{Bmatrix} = \begin{bmatrix} c & -c & 0 & 0 \\ 0 & -c & c & 0 \\ 0 & -2c & 0 & 2c \end{bmatrix} \begin{Bmatrix} 0 \\ -\frac{1}{4}\Delta \\ \Delta \\ 0 \end{Bmatrix} = \begin{Bmatrix} \frac{1}{4}c\Delta \\ \frac{5}{4}c\Delta \\ \frac{1}{2}c\Delta \end{Bmatrix}.$$

$$F_1 + F_2 + F_3 + F_4 = \frac{1}{4}c\Delta - 2c\Delta + \frac{5}{4}c\Delta + \frac{1}{2}c\Delta = 0.$$

3.3

3.2,

$$\begin{aligned}
 U &= \frac{1}{2}c(u_1 - u_2)^2 + \frac{1}{2}c(u_2 - u_3) + \frac{1}{2} \cdot 2c(u_2 - u_4) = \\
 &= \frac{1}{2}cu_1^2 - cu_1u_2 + 2cu_2^2 - cu_2u_3 - 2cu_2u_4 + \frac{1}{2}cu_3^2 + cu_4^2.
 \end{aligned}$$

:

$$\frac{\partial^2 U}{\partial u_1^2} = c; \quad \frac{\partial^2 U}{\partial u_1 \partial u_2} = -c; \quad \frac{\partial^2 U}{\partial u_1 \partial u_3} = 0; \quad \frac{\partial^2 U}{\partial u_1 \partial u_4} = 0;$$

$$\frac{\partial^2 U}{\partial u_2 \partial u_1} = -c; \quad \frac{\partial^2 U}{\partial u_2^2} = 4c; \quad \frac{\partial^2 U}{\partial u_2 \partial u_3} = -c; \quad \frac{\partial^2 U}{\partial u_2 \partial u_4} = -2c;$$

$$\frac{\partial^2 U}{\partial u_3 \partial u_1} = 0; \quad \frac{\partial^2 U}{\partial u_3 \partial u_2} = -c; \quad \frac{\partial^2 U}{\partial u_3^2} = c; \quad \frac{\partial^2 U}{\partial u_3 \partial u_4} = 0;$$

$$\frac{\partial^2 U}{\partial u_4 \partial u_1} = 0; \quad \frac{\partial^2 U}{\partial u_4 \partial u_2} = -2c; \quad \frac{\partial^2 U}{\partial u_4 \partial u_3} = 0; \quad \frac{\partial^2 U}{\partial u_4^2} = 2c.$$

$$K = \begin{array}{c} \begin{array}{cccc} u_1 & u_2 & u_3 & u_4 \\ \hline c & -c & 0 & 0 \\ -c & 4c & -c & -2c \\ 0 & -c & c & 0 \\ 0 & -2c & 0 & 2c \end{array} \end{array} .$$

3.2.

3.4

3.1.

($u_1 = u_4 = 0$):

$$= \frac{1}{2} u_2^2 + \frac{1}{2} \cdot 2 (u_2 - u_3)^2 + \frac{1}{2} u_3^2 - (-P)u_2 - 2Pu_3.$$

$$\begin{cases} \frac{\partial}{\partial u_2} = 3cu_2 - 2cu_3 + P = 0; \\ \frac{\partial}{\partial u_3} = -2cu_2 + 3cu_3 - 2P = 0, \end{cases}$$

$$\begin{bmatrix} 3c & -2c \\ -2c & 3c \end{bmatrix} \begin{Bmatrix} u_2 \\ u_3 \end{Bmatrix} = \begin{Bmatrix} -P \\ 2P \end{Bmatrix}.$$

(. 3.1).

3.4

3.4.1

(3.4).

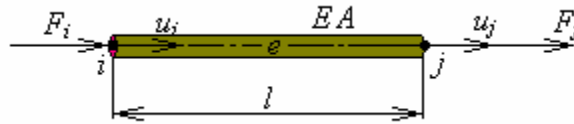

3.4 –

l ,

(2.24)

$$u(x) = \frac{P}{EA}x + C, \quad (3.18)$$

$= 0$:

$$u(0) = u_i = \frac{P}{EA} \cdot 0 + C, \quad (3.19)$$

$$C = u_i. \quad (3.20)$$

(3.18)

$$u(x) = \frac{P}{EA}x + u_i. \quad (3.21)$$

$= l$:

$$u(l) = u_j = \frac{P}{EA}l + u_i, \quad (3.22)$$

$$\frac{P}{EA} = \frac{u_j - u_i}{l}. \quad (3.23)$$

(3.23) (3.21)

$$u(x) = \frac{u_j - u_i}{l}x + u_i, \quad (3.24)$$

$$u(x) = \left(1 - \frac{x}{l}\right)u_i + \frac{x}{l}u_j. \quad (3.25)$$

(3.25)

$$\varepsilon = \frac{du}{dx} = \frac{d}{dx} \left[\left(1 - \frac{x}{l}\right)u_i + \frac{x}{l}u_j \right] = \frac{u_j - u_i}{l}, \quad (3.26)$$

$$\varepsilon = Bu, \quad (3.27)$$

$$u = \begin{Bmatrix} u_i \\ u_j \end{Bmatrix}, \quad (3.28)$$

$$B = \left\{ -\frac{1}{l} \quad \frac{1}{l} \right\}. \quad (3.29)$$

(2.20)

$$\sigma = E\varepsilon = EBu = \frac{E}{l}(u_j - u_i). \quad (3.30)$$

:

$$\sigma = \frac{F}{A}, \quad (3.31)$$

$F -$,

$$F = \sigma A = \frac{EA}{l}(u_j - u_i) = c \cdot \Delta u, \quad (3.32)$$

-

$$c = \frac{EA}{l}; \quad (3.33)$$

$\Delta u =$

$$\Delta u = u_j - u_i. \quad (3.34)$$

$$K = \begin{bmatrix} \frac{EA}{l} & -\frac{EA}{l} \\ -\frac{EA}{l} & \frac{EA}{l} \end{bmatrix} = \frac{EA}{l} \begin{bmatrix} 1 & -1 \\ -1 & 1 \end{bmatrix}. \quad (3.35)$$

$$\frac{EA}{l} \begin{bmatrix} 1 & -1 \\ -1 & 1 \end{bmatrix} \begin{Bmatrix} u_i \\ u_j \end{Bmatrix} = \begin{Bmatrix} F_i \\ F_j \end{Bmatrix}. \quad (3.36)$$

3.4

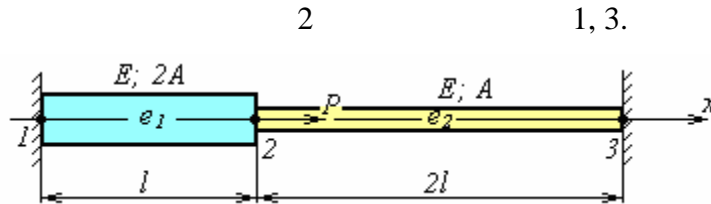

1:

$$K_{e1} = \frac{EA}{2l} \begin{bmatrix} u_1 & u_2 & u_3 \\ 4 & -4 & 0 \\ -4 & 4 & 0 \\ 0 & 0 & 0 \end{bmatrix}$$

2:

$$K_{e2} = \frac{EA}{2l} \begin{bmatrix} u_1 & u_2 & u_3 \\ 0 & 0 & 0 \\ 0 & 1 & -1 \\ 0 & -1 & 1 \end{bmatrix}$$

$$K = K_{e1} + K_{e2} = \frac{EA}{2l} \begin{bmatrix} u_1 & u_2 & u_3 \\ 4 & -4 & 0 \\ -4 & 5 & -1 \\ 0 & -1 & 1 \end{bmatrix}$$

$$u_1 = 0;$$

$$u_3 = 0.$$

$$F_2 = \quad .$$

$$\frac{EA}{2l} \begin{matrix} & \begin{matrix} u_1 & u_2 & u_3 \end{matrix} \\ \begin{bmatrix} 4 & -4 & 0 \\ -4 & 5 & 0 \\ 0 & -1 & 1 \end{bmatrix} & \begin{bmatrix} 0 \\ u_2 \\ 0 \end{bmatrix} \end{matrix} = \begin{bmatrix} F_1 \\ P \\ F_3 \end{bmatrix}.$$

$$\frac{EA}{2l} \cdot 5u_2 = P,$$

$$u_2 = \frac{2 Pl}{5 EA}.$$

$$\begin{bmatrix} F_1 \\ F_3 \end{bmatrix} = \frac{EA}{2l} \begin{bmatrix} 4 & -4 & 0 \\ 0 & -1 & 1 \end{bmatrix} \begin{bmatrix} 0 \\ \frac{2 Pl}{5 EA} \\ 0 \end{bmatrix} = \begin{bmatrix} -\frac{4}{5}P \\ -\frac{1}{5}P \end{bmatrix}.$$

$$F_1 + F_2 + F_3 = -\frac{4}{5}P + P - \frac{1}{5}P = 0.$$

1 2:

$$\sigma_{e1} = E \begin{bmatrix} -\frac{1}{l} & \frac{1}{l} \end{bmatrix} \begin{bmatrix} 0 \\ \frac{2 Pl}{5 EA} \end{bmatrix} = \frac{2 P}{5 A};$$

$$\sigma_{e2} = E \begin{bmatrix} -\frac{1}{l} & \frac{1}{l} \end{bmatrix} \begin{bmatrix} \frac{2 Pl}{5 EA} \\ 0 \end{bmatrix} = -\frac{1 P}{5 A}.$$

:

$$\sigma_{e1} = \frac{-F_1}{2A} = \frac{\frac{4}{5}P}{2A} = \frac{2 P}{5 A};$$

$$\sigma_{e2} = \frac{F_3}{A} = \frac{-\frac{1}{5}P}{A} = -\frac{1 P}{5 A}.$$

,

1

,

2 -

3.5

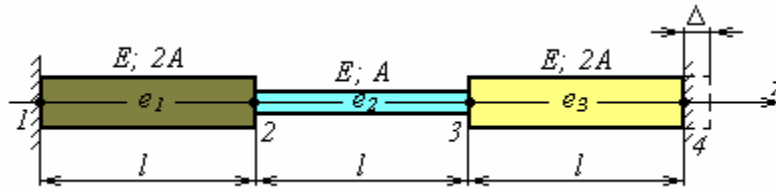

1:

$$K_{e1} = \frac{EA}{l} \begin{bmatrix} u_1 & u_2 & u_3 & u_4 \\ 2 & -2 & 0 & 0 \\ -2 & 2 & 0 & 0 \\ 0 & 0 & 0 & 0 \\ 0 & 0 & 0 & 0 \end{bmatrix}$$

2:

$$K_{e2} = \frac{EA}{l} \begin{bmatrix} u_1 & u_2 & u_3 & u_4 \\ 0 & 0 & 0 & 0 \\ 0 & 1 & -1 & 0 \\ 0 & -1 & 1 & 0 \\ 0 & 0 & 0 & 0 \end{bmatrix}$$

3:

$$K_{e3} = \frac{EA}{l} \begin{bmatrix} u_1 & u_2 & u_3 & u_4 \\ 0 & 0 & 0 & 0 \\ 0 & 0 & 0 & 0 \\ 0 & 0 & 2 & -2 \\ 0 & 0 & -2 & 2 \end{bmatrix}$$

$$K = \frac{EA}{l} \begin{bmatrix} u_1 & u_2 & u_3 & u_4 \\ 2 & -2 & 0 & 0 \\ -2 & 3 & -1 & 0 \\ 0 & -1 & 3 & -2 \\ 0 & 0 & -2 & 2 \end{bmatrix}$$

$$u_1 = 0;$$

$$u_4 = - \quad .$$

$$F_2 = 0;$$

$$F_3 = 0.$$

$$\frac{EA}{l} \begin{array}{c} \begin{array}{cccc} u_1 & u_2 & u_3 & u_4 \\ \hline 2 & -2 & 0 & 0 \\ -2 & 3 & -1 & 0 \\ 0 & -1 & 3 & -2 \\ 0 & 0 & -2 & 2 \end{array} \begin{array}{c} \left[\begin{array}{c} 0 \\ u_2 \\ u_3 \\ -\Delta \end{array} \right] \end{array} = \begin{array}{c} \left[\begin{array}{c} F_1 \\ 0 \\ 0 \\ F_4 \end{array} \right] \end{array} \end{array}.$$

$$\frac{EA}{l} \begin{bmatrix} 3 & -1 & 0 \\ -1 & 3 & -2 \end{bmatrix} \begin{Bmatrix} u_2 \\ u_3 \\ -\Delta \end{Bmatrix} = \begin{Bmatrix} 0 \\ 0 \end{Bmatrix},$$

$$\begin{cases} u_2 = -\frac{1}{4}\Delta; \\ u_3 = -\frac{3}{4}\Delta. \end{cases}$$

:

$$u_2 + u_3 = -\Delta;$$

$$-\frac{1}{4}\Delta - \frac{3}{4}\Delta = -\Delta.$$

$$\begin{Bmatrix} F_1 \\ F_2 \end{Bmatrix} = \frac{EA}{l} \begin{bmatrix} 2 & -2 & 0 & 0 \\ 0 & 0 & -2 & 2 \end{bmatrix} \begin{Bmatrix} 0 \\ -\frac{1}{4}\Delta \\ -\frac{3}{4}\Delta \\ -\Delta \end{Bmatrix} = \begin{Bmatrix} \frac{\Delta}{2l}EA \\ -\frac{\Delta}{2l}EA \end{Bmatrix}.$$

$$F_1 + F_2 + F_3 + F_4 = \frac{\Delta}{2l} EA + 0 + 0 - \frac{\Delta}{2l} EA = 0.$$

1, 2 3:

$$\sigma_{e1} = E \left\{ \begin{array}{cc} -\frac{1}{l} & \frac{1}{l} \end{array} \right\} \left\{ \begin{array}{c} 0 \\ -\frac{1}{4}\Delta \end{array} \right\} = -\frac{\Delta}{4l} E;$$

$$\sigma_{e2} = E \left\{ \begin{array}{cc} -\frac{1}{l} & \frac{1}{l} \end{array} \right\} \left\{ \begin{array}{c} -\frac{1}{4}\Delta \\ \frac{3}{4}\Delta \end{array} \right\} = -\frac{\Delta}{2l} E;$$

$$\sigma_{e3} = E \left\{ \begin{array}{cc} -\frac{1}{l} & \frac{1}{l} \end{array} \right\} \left\{ \begin{array}{c} -\frac{3}{4}\Delta \\ -\Delta \end{array} \right\} = -\frac{\Delta}{4l} E.$$

:

$$\sigma_{e1} = \frac{-F_1}{2A} = -\frac{\Delta}{4l} E;$$

$$\sigma_{e2} = \frac{F_3}{A} = -\frac{\Delta}{4l} E.$$

,

.

3.4.2

, ,

q

l (3.5),

q .

a)

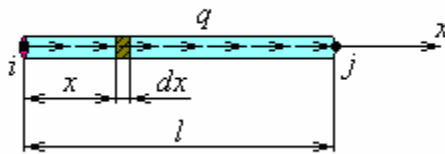

b)

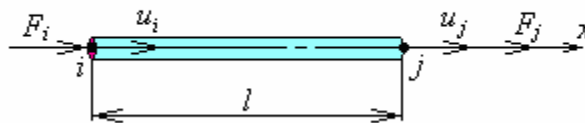

3.5

$$dF = q \cdot dx \quad (), -$$

(3.25),

$$\delta W = u(x) \cdot dF = \left[\left(1 - \frac{x}{l} \right) u_i + \frac{x}{l} u_j \right] \cdot q dx. \quad (3.38)$$

$$W = \int dW = \int_0^l \left[\left(1 - \frac{x}{l}\right) u_i + \frac{x}{l} u_j \right] \cdot q dx = q \left[\left(x - \frac{x^2}{2l}\right) u_i + \frac{x^2}{2l} u_j \right] \Big|_0^l = \frac{ql}{2} u_i + \frac{ql}{2} u_j. \quad (3.39)$$

$$F_i = F_j, \quad i = j \quad (3.5)$$

$$W = F_i u_i + F_j u_j. \quad (3.40)$$

$$(3.39) \quad (3.40),$$

$$F_i u_i + F_j u_j = \frac{ql}{2} u_i + \frac{ql}{2} u_j, \quad (3.41)$$

$$\begin{cases} F_i = \frac{ql}{2}; \\ F_j = \frac{ql}{2}. \end{cases} \quad (3.42)$$

3.6

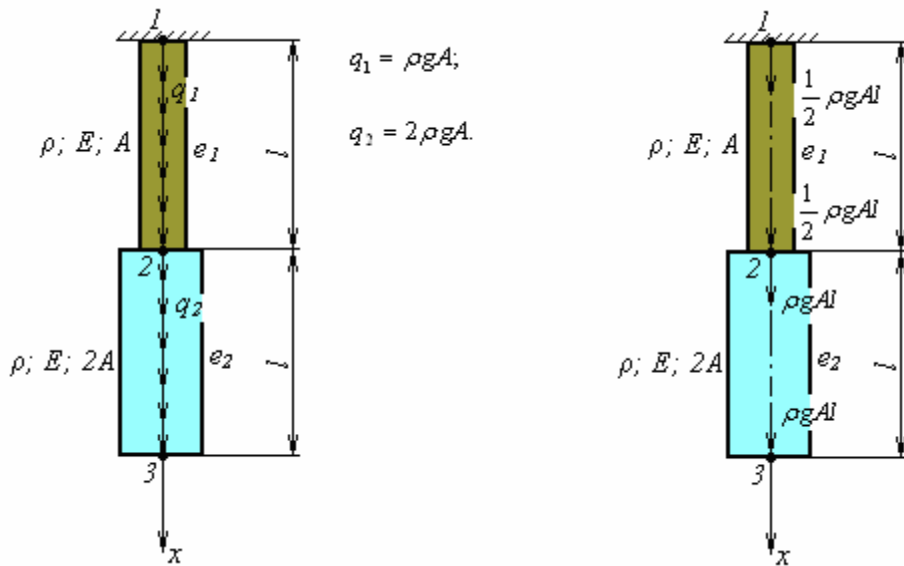

1:

$$K_{e1} = \frac{EA}{l} \begin{bmatrix} u_1 & u_2 & u_3 \\ 1 & -1 & 0 \\ -1 & 1 & 0 \\ 0 & 0 & 0 \end{bmatrix}$$

2:

$$K_{e2} = \frac{EA}{l} \begin{bmatrix} u_1 & u_2 & u_3 \\ 0 & 0 & 0 \\ 0 & 2 & -2 \\ 0 & -2 & 2 \end{bmatrix}$$

$$K = \frac{EA}{l} \begin{bmatrix} u_1 & u_2 & u_3 \\ 1 & -1 & 0 \\ -1 & 3 & -2 \\ 0 & -2 & 2 \end{bmatrix}$$

$$u_1 = 0;$$

$$u_3 = 0.$$

$$\begin{cases} F_1 = R_1 + \frac{1}{2} \rho g A l; \\ F_2 = \frac{3}{2} \rho g A l; \\ F_2 = R_3 + \rho g A l. \end{cases}$$

$$\frac{EA}{l} \begin{bmatrix} u_1 & u_2 & u_3 \\ 1 & -1 & 0 \\ -1 & 3 & -2 \\ 0 & -2 & 2 \end{bmatrix} \begin{bmatrix} 0 \\ u_2 \\ 0 \end{bmatrix} = \begin{bmatrix} R_1 + \frac{1}{2} \rho g A l \\ \frac{3}{2} \rho g A l \\ R_3 + \rho g A l \end{bmatrix}.$$

$$\frac{EA}{l} \cdot 3u_2 = \frac{3}{2} \rho g A l,$$

$$u_2 = \frac{\rho g A l^2}{2EA}.$$

$$P = \rho g A l + 2 \rho g A l = 3 \rho g A l,$$

$$u_2 = \frac{Pl}{6EA},$$

$$\begin{cases} q_1 = \frac{P}{3l}; \\ q_2 = \frac{2P}{3l}. \end{cases}$$

$$\begin{Bmatrix} R_1 + \frac{1}{2} \rho g A l \\ R_3 + \rho g A l \end{Bmatrix} = \frac{EA}{l} \begin{bmatrix} 1 & -1 & 0 \\ 0 & -2 & 2 \end{bmatrix} \begin{Bmatrix} 0 \\ \rho g A l^2 \\ 2EA \\ 0 \end{Bmatrix};$$

$$\begin{Bmatrix} R_1 \\ R_3 \end{Bmatrix} + \begin{Bmatrix} \frac{1}{6} P \\ \frac{1}{3} P \end{Bmatrix} = \begin{bmatrix} 1 & -1 & 0 \\ 0 & -2 & 2 \end{bmatrix} \begin{Bmatrix} 0 \\ \frac{1}{6} P \\ 0 \end{Bmatrix} = \begin{Bmatrix} -\frac{1}{6} P \\ -\frac{1}{3} P \end{Bmatrix};$$

$$\begin{Bmatrix} R_1 \\ R_3 \end{Bmatrix} = \begin{Bmatrix} -\frac{1}{3} P \\ -\frac{2}{3} P \end{Bmatrix}.$$

$$R_1 + q_1 l + q_2 l + R_3 = -\frac{1}{3} P + \frac{P}{3l} \cdot l + \frac{2P}{3l} \cdot l - \frac{2}{3} P = 0.$$

$1 \quad 2:$

$$\sigma_{e1} = E \begin{Bmatrix} -\frac{1}{l} & \frac{1}{l} \end{Bmatrix} \begin{Bmatrix} 0 \\ Pl \\ 6EA \end{Bmatrix} = \frac{P}{6A};$$

$$\sigma_{e2} = E \begin{Bmatrix} -\frac{1}{l} & \frac{1}{l} \end{Bmatrix} \begin{Bmatrix} Pl \\ 6EA \\ 0 \end{Bmatrix} = -\frac{P}{6A}.$$

, l , $2-$.

3.5

3.6).

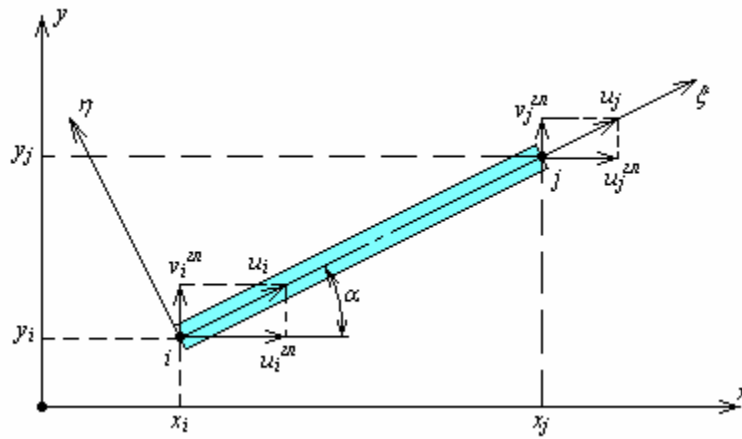

3.6 –

– $\xi\eta$, ;

– . $i j$

$$\begin{cases} u_i = u_i \cos \alpha; \\ v_i = u_i \sin \alpha. \end{cases} \quad (3.43)$$

(3.43) $\cos \alpha$, – $\sin \alpha$

$$u_i \cos \alpha + v_i \sin \alpha = u_i \cos^2 \alpha + u_i \sin^2 \alpha. \quad (3.44)$$

$$(\cos^2\alpha + \sin^2\alpha = 1),$$

$$u_i = u_i \cos\alpha + v_i \sin\alpha. \quad (3.45)$$

$$u_j = u_j \cos\alpha + v_j \sin\alpha. \quad (3.46)$$

$$v_i = -u_i \sin\alpha + v_i \cos\alpha. \quad (3.47)$$

$$v_j = -u_j \sin\alpha + v_j \cos\alpha. \quad (3.48)$$

$$(3.45) - (3.48)$$

$$\begin{Bmatrix} u_i \\ v_i \\ u_j \\ v_j \end{Bmatrix} = \begin{bmatrix} \cos\alpha & \sin\alpha & 0 & 0 \\ -\sin\alpha & \cos\alpha & 0 & 0 \\ 0 & 0 & \cos\alpha & \sin\alpha \\ 0 & 0 & -\sin\alpha & \cos\alpha \end{bmatrix} \begin{Bmatrix} u_i \\ v_i \\ u_j \\ v_j \end{Bmatrix}, \quad (3.49)$$

$$u = Tu, \quad (3.50)$$

;

$$T = \begin{bmatrix} \cos\alpha & \sin\alpha & 0 & 0 \\ -\sin\alpha & \cos\alpha & 0 & 0 \\ 0 & 0 & \cos\alpha & \sin\alpha \\ 0 & 0 & -\sin\alpha & \cos\alpha \end{bmatrix}. \quad (3.51)$$

$$F = TF, \quad (3.52)$$

F -

$$F = \begin{Bmatrix} F_{xi} \\ F_{yi} \\ F_{xj} \\ F_{yj} \end{Bmatrix}. \quad (3.53)$$

$$Ku = F, \quad (3.54)$$

$$K = \begin{bmatrix} \frac{EA}{l} & 0 & -\frac{EA}{l} & 0 \\ 0 & 0 & 0 & 0 \\ -\frac{EA}{l} & 0 & \frac{EA}{l} & 0 \\ 0 & 0 & 0 & 0 \end{bmatrix}. \quad (3.55)$$

$$(3.50) \quad (3.52) \quad (3.54) \quad -$$

$$KTu = TF. \quad (3.56)$$

$$T^T T = I, \quad (3.57)$$

$$T^T KT u = F, \quad (3.58)$$

$$K u = F, \quad (3.59)$$

$$K = T^T K T = \frac{EA}{l} \begin{bmatrix} \cos^2 \alpha & \cos \alpha \sin \alpha & -\cos^2 \alpha & -\cos \alpha \sin \alpha \\ \cos \alpha \sin \alpha & \sin^2 \alpha & -\cos \alpha \sin \alpha & -\sin^2 \alpha \\ -\cos^2 \alpha & -\cos \alpha \sin \alpha & \cos^2 \alpha & \cos \alpha \sin \alpha \\ -\cos \alpha \sin \alpha & -\sin^2 \alpha & \cos \alpha \sin \alpha & \sin^2 \alpha \end{bmatrix}. \quad (3.60)$$

$$\sigma = E\varepsilon = E \left\{ -\frac{1}{l} \quad \frac{1}{l} \right\} \begin{Bmatrix} u_i \\ u_j \end{Bmatrix} = E \left\{ -\frac{1}{l} \quad \frac{1}{l} \right\} \begin{bmatrix} \cos \alpha & \sin \alpha & 0 & 0 \\ 0 & 0 & \cos \alpha & \sin \alpha \end{bmatrix} \begin{Bmatrix} v_i \\ v_j \end{Bmatrix}, \quad (3.61)$$

$$\sigma = \frac{E}{l} \left\{ -\cos \alpha \quad -\sin \alpha \quad \cos \alpha \quad \sin \alpha \right\} \begin{Bmatrix} v_i \\ v_j \end{Bmatrix}. \quad (3.62)$$

3.7

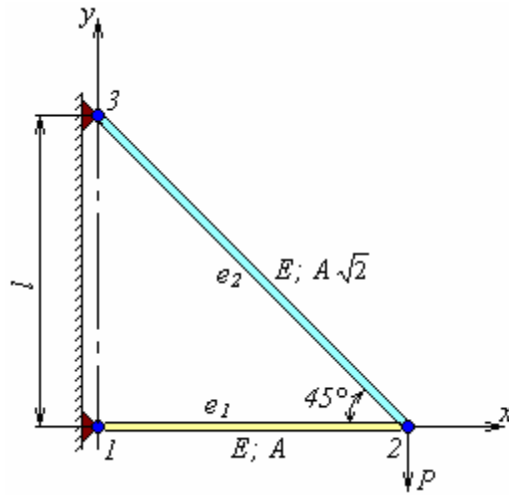

1 (« »):

$$K_{e1} = \frac{EA}{l} \begin{bmatrix} u_1 & v_1 & u_2 & v_2 \\ 1 & 0 & -1 & 0 \\ 0 & 0 & 0 & 0 \\ -1 & 0 & 1 & 0 \\ 0 & 0 & 0 & 0 \end{bmatrix}$$

2:

$$K_{e2} = \frac{EA}{2l} \begin{bmatrix} u_2 & v_2 & u_3 & v_3 \\ 1 & -1 & -1 & 1 \\ -1 & 1 & 1 & -1 \\ -1 & 1 & 1 & -1 \\ 1 & -1 & -1 & 1 \end{bmatrix}$$

$$K = \begin{matrix} & \begin{matrix} u_1 & v_1 & u_2 & v_2 & u_3 & v_3 \end{matrix} \\ \begin{matrix} 2 & 0 & -2 & 0 & 0 & 0 \\ 0 & 0 & 0 & 0 & 0 & 0 \\ -2 & 0 & 3 & -1 & -1 & 1 \\ 0 & 0 & -1 & 1 & 1 & -1 \\ 0 & 0 & -1 & 1 & 1 & -1 \\ 0 & 0 & 1 & -1 & -1 & 1 \end{matrix} & \end{matrix}.$$

:

$$u_1 = 0;$$

$$v_1 = 0;$$

$$u_3 = 0;$$

$$v_3 = 0.$$

:

$$F_{x2} = 0;$$

$$F_{y2} = -P.$$

$$\frac{EA}{l} \begin{matrix} & \begin{matrix} u_1 & v_1 & u_2 & v_2 & u_3 & v_3 \end{matrix} \\ \begin{matrix} 2 & 0 & -2 & 0 & 0 & 0 \\ 0 & 0 & 0 & 0 & 0 & 0 \\ -2 & 0 & 3 & -1 & -1 & 1 \\ 0 & 0 & -1 & 1 & 1 & -1 \\ 0 & 0 & -1 & 1 & 1 & -1 \\ 0 & 0 & 1 & -1 & -1 & 1 \end{matrix} & \begin{matrix} 0 \\ 0 \\ u_2 \\ v_2 \\ 0 \\ 0 \end{matrix} \end{matrix} = \begin{matrix} F_{x1} \\ F_{y1} \\ 0 \\ -P \\ F_{x3} \\ F_{y3} \end{matrix}.$$

$$\frac{EA}{l} \begin{bmatrix} 3 & -1 \\ -1 & 1 \end{bmatrix} \begin{Bmatrix} u_2 \\ v_2 \end{Bmatrix} = \begin{Bmatrix} 0 \\ -P \end{Bmatrix},$$

$$\begin{cases} u_2 = -\frac{Pl}{EA}; \\ v_2 = -\frac{3Pl}{EA}. \end{cases}$$

$$\begin{Bmatrix} F_{x1} \\ F_{y1} \\ F_{x3} \\ F_{y3} \end{Bmatrix} = \frac{EA}{l} \begin{bmatrix} 2 & 0 & -2 & 0 & 0 & 0 \\ 0 & 0 & 0 & 0 & 0 & 0 \\ 0 & 0 & -1 & 1 & 1 & -1 \\ 0 & 0 & -1 & 1 & -1 & 1 \end{bmatrix} \begin{Bmatrix} 0 \\ 0 \\ -\frac{Pl}{EA} \\ -\frac{3Pl}{EA} \\ 0 \\ 0 \end{Bmatrix} = \begin{Bmatrix} P \\ 0 \\ -P \\ P \end{Bmatrix}.$$

$$\begin{cases} F_{x1} + F_{x2} + F_{x3} = P + 0 - P = 0; \\ F_{y1} + F_{y2} + F_{y3} = 0 - P + P = 0. \end{cases}$$

$$\sigma_{e1} = \frac{E}{l} \begin{Bmatrix} -1 & 0 & 1 & 0 \end{Bmatrix} \begin{Bmatrix} 0 \\ 0 \\ -\frac{Pl}{EA} \\ -\frac{3Pl}{EA} \\ -\frac{Pl}{EA} \end{Bmatrix} = -\frac{P}{A};$$

$$\sigma_{e2} = \frac{E}{l\sqrt{2}} \begin{Bmatrix} \frac{1}{\sqrt{2}} & -\frac{1}{\sqrt{2}} & -\frac{1}{\sqrt{2}} & \frac{1}{\sqrt{2}} \end{Bmatrix} \begin{Bmatrix} -\frac{Pl}{EA} \\ -\frac{3Pl}{EA} \\ 0 \\ 0 \end{Bmatrix} = \frac{P}{A}.$$

, 1 , 2 - .

3.8

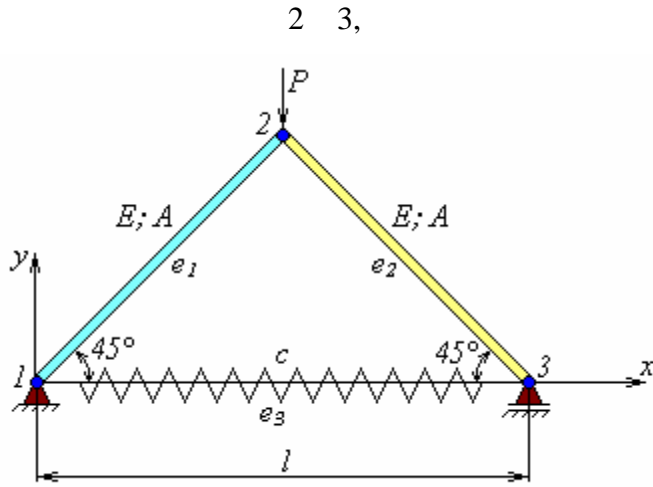

1:

$$K_{e1} = \frac{EA}{2l} \begin{matrix} & \begin{matrix} u_1 & v_1 & u_2 & v_2 \end{matrix} \\ \begin{bmatrix} 1 & 1 & -1 & -1 \\ 1 & 1 & -1 & -1 \\ -1 & -1 & 1 & 1 \\ -1 & -1 & 1 & 1 \end{bmatrix} \end{matrix}.$$

2:

$$K_{e2} = \frac{EA}{2l} \begin{matrix} & \begin{matrix} u_2 & v_2 & u_3 & v_3 \end{matrix} \\ \begin{bmatrix} 1 & -1 & -1 & 1 \\ -1 & 1 & 1 & -1 \\ -1 & 1 & 1 & -1 \\ 1 & -1 & -1 & 1 \end{bmatrix} \end{matrix}.$$

3:

$$K_{e3} = \begin{matrix} & \begin{matrix} u_1 & v_1 & u_3 & v_3 \end{matrix} \\ \begin{bmatrix} c & 0 & -c & 0 \\ 0 & 0 & 0 & 0 \\ -c & 0 & c & 0 \\ 0 & 0 & 0 & 0 \end{bmatrix} \end{matrix}.$$

$$K = \begin{bmatrix} \frac{EA}{2l} + c & \frac{EA}{2l} & -\frac{EA}{2l} & -\frac{EA}{2l} & -c & 0 \\ \frac{EA}{2l} & \frac{EA}{2l} & -\frac{EA}{2l} & -\frac{EA}{2l} & 0 & 0 \\ -\frac{EA}{2l} & -\frac{EA}{2l} & \frac{EA}{l} & 0 & -\frac{EA}{2l} & \frac{EA}{2l} \\ -\frac{EA}{2l} & -\frac{EA}{2l} & 0 & \frac{EA}{l} & \frac{EA}{2l} & -\frac{EA}{2l} \\ -c & 0 & -\frac{EA}{2l} & \frac{EA}{2l} & \frac{EA}{2l} + c & -\frac{EA}{2l} \\ 0 & 0 & \frac{EA}{2l} & -\frac{EA}{2l} & -\frac{EA}{2l} & \frac{EA}{2l} \end{bmatrix}$$

:

$$u_1 = 0;$$

$$v_1 = 0$$

$$v_3 = 0.$$

:

$$F_{x2} = 0;$$

$$F_{y2} = -P;$$

$$F_{x3} = 0.$$

$$\begin{bmatrix} \frac{EA}{2l} + c & \frac{EA}{2l} & -\frac{EA}{2l} & -\frac{EA}{2l} & -c & 0 \\ \frac{EA}{2l} & \frac{EA}{2l} & -\frac{EA}{2l} & -\frac{EA}{2l} & 0 & 0 \\ -\frac{EA}{2l} & -\frac{EA}{2l} & \frac{EA}{l} & 0 & -\frac{EA}{2l} & \frac{EA}{2l} \\ -\frac{EA}{2l} & -\frac{EA}{2l} & 0 & \frac{EA}{l} & \frac{EA}{2l} & -\frac{EA}{2l} \\ -c & 0 & -\frac{EA}{2l} & \frac{EA}{2l} & \frac{EA}{2l} + c & -\frac{EA}{2l} \\ 0 & 0 & \frac{EA}{2l} & -\frac{EA}{2l} & -\frac{EA}{2l} & \frac{EA}{2l} \end{bmatrix} \begin{Bmatrix} 0 \\ 0 \\ u_2 \\ v_2 \\ u_3 \\ 0 \end{Bmatrix} = \begin{Bmatrix} F_{x1} \\ F_{y1} \\ 0 \\ -P \\ 0 \\ F_{y3} \end{Bmatrix}$$

$$k = \frac{EA}{l}.$$

$$\begin{bmatrix} k & 0 & -\frac{k}{2} \\ 0 & k & \frac{k}{2} \\ -\frac{k}{2} & \frac{k}{2} & \frac{k}{2} + c \end{bmatrix} \begin{Bmatrix} u_2 \\ v_2 \\ u_3 \end{Bmatrix} = \begin{Bmatrix} 0 \\ -P \\ 0 \end{Bmatrix},$$

$$\begin{cases} u_2 = \frac{P}{4c}; \\ v_2 = -\frac{P(k+4c)}{4kc}; \\ u_3 = \frac{P}{2c}. \end{cases}$$

$$\begin{cases} u_3 = 2u_2; \\ \frac{P}{2c} = 2 \cdot \frac{P}{4c}. \end{cases}$$

).

$$\begin{Bmatrix} F_{x1} \\ F_{y1} \\ F_{y3} \end{Bmatrix} = \begin{bmatrix} \frac{k}{2} + c & \frac{k}{2} & -\frac{k}{2} & -\frac{k}{2} & -c & 0 \\ \frac{k}{2} & \frac{k}{2} & -\frac{k}{2} & -\frac{k}{2} & 0 & 0 \\ 0 & 0 & \frac{k}{2} & -\frac{k}{2} & -\frac{k}{2} & \frac{k}{2} \end{bmatrix} \begin{Bmatrix} 0 \\ 0 \\ \frac{P}{4c} \\ -\frac{P(k+4c)}{4kc} \\ \frac{4kc}{P} \\ \frac{P}{2c} \\ 0 \end{Bmatrix} = \begin{Bmatrix} 0 \\ \frac{1}{2}P \\ \frac{1}{2}P \end{Bmatrix}.$$

$$\begin{cases} F_{x1} + F_{x2} + F_{x3} = 0 + 0 + 0 = 0; \\ F_{y1} + F_{y2} + F_{y3} = \frac{1}{2}P - P + \frac{1}{2}P = 0. \end{cases}$$

3.9

2 3,

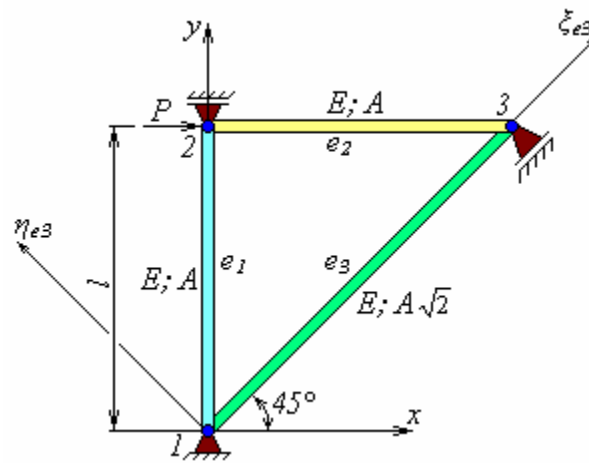

1:

$$K_{e1} = \frac{EA}{l} \begin{bmatrix} u_1 & v_1 & u_2 & v_2 \\ 0 & 0 & 0 & 0 \\ 0 & 1 & 0 & -1 \\ 0 & 0 & 0 & 0 \\ 0 & -1 & 0 & 1 \end{bmatrix}$$

2:

$$K_{e2} = \frac{EA}{l} \begin{bmatrix} u_2 & v_2 & u_3 & v_3 \\ 1 & 0 & -1 & 0 \\ 0 & 0 & 0 & 0 \\ -1 & 0 & 1 & 0 \\ 0 & 0 & 0 & 0 \end{bmatrix}$$

3:

$$K_{e3} = \frac{EA}{l} \begin{bmatrix} u_1 & v_1 & u_3 & v_3 \\ 1 & 1 & -1 & -1 \\ 1 & 1 & -1 & -1 \\ -1 & -1 & 1 & 1 \\ -1 & -1 & 1 & 1 \end{bmatrix}$$

$$K = \frac{EA}{2l} \begin{bmatrix} u_1 & v_1 & u_2 & v_2 & u_3 & v_3 \\ 1 & 1 & 0 & 0 & -1 & 1 \\ 1 & 3 & 0 & -2 & -1 & -1 \\ 0 & 0 & 2 & 0 & -2 & 0 \\ 0 & -2 & 0 & 2 & 0 & 0 \\ -1 & -1 & -2 & 0 & 3 & 1 \\ -1 & -1 & 0 & 0 & 1 & 1 \end{bmatrix}.$$

:

$$u_1 = 0;$$

$$v_1 = 0;$$

$$v_2 = 0;$$

$$v_3 = 0,$$

$$v_3 = - \quad 3$$

$\xi_{e3} \eta_{e3}$:

$$v_3 = -u_3 \sin 45^\circ + v_3 \cos 45^\circ = \frac{v_3 - u_3}{\sqrt{2}} = 0,$$

$$v_3 = u_3.$$

:

$$F_{x2} = P;$$

$$F_{x3} = 0,$$

$$F_{x3} = F_{x3} \cos 45^\circ + F_{y3} \sin 45^\circ = \frac{F_{x3} + F_{y3}}{\sqrt{2}},$$

$$F_{y3} = -F_{x3}.$$

$$\frac{EA}{2l} \begin{bmatrix} u_1 & v_1 & u_2 & v_2 & u_3 & v_3 \\ 1 & 1 & 0 & 0 & -1 & 1 \\ 1 & 3 & 0 & -2 & -1 & -1 \\ 0 & 0 & 2 & 0 & -2 & 0 \\ 0 & -2 & 0 & 2 & 0 & 0 \\ -1 & -1 & -2 & 0 & 3 & 1 \\ -1 & -1 & 0 & 0 & 1 & 1 \end{bmatrix} \begin{Bmatrix} 0 \\ 0 \\ u_2 \\ 0 \\ u_3 \\ u_3 \end{Bmatrix} = \begin{Bmatrix} F_{x1} \\ F_{y1} \\ P \\ F_{y2} \\ F_{x3} \\ -F_{x3} \end{Bmatrix},$$

$$\begin{cases} \frac{EA}{2l} \cdot (-u_3 - u_3) = F_{x1}; \\ \frac{EA}{2l} \cdot (-u_3 - u_3) = F_{y1}; \\ \frac{EA}{2l} \cdot (2u_2 - 2u_3) = P; \\ 0 = F_{y2}; \\ \frac{EA}{2l} \cdot (-2u_2 + 3u_3 + u_3) = F_{x3}; \\ \frac{EA}{2l} \cdot (u_3 + u_3) = -F_{x3}. \end{cases}$$

$$\begin{cases} u_2 = \frac{3 Pl}{2 EA}; \\ u_3 = \frac{1 Pl}{2 EA}; \\ v_3 = \frac{1 Pl}{2 EA}, \end{cases}$$

$$\begin{cases} F_{x1} = -\frac{1}{2} P; \\ F_{y1} = -\frac{1}{2} P; \\ F_{y2} = 0; \\ F_{x3} = -\frac{1}{2} P; \\ F_{y3} = \frac{1}{2} P. \end{cases}$$

:

$$\begin{cases} \sum_{i=1}^3 F_{xi} = F_{x1} + F_{x2} + F_{x3} = -\frac{1}{2}P + P - \frac{1}{2}P = 0; \\ \sum_{i=1}^3 F_{yi} = F_{y1} + F_{y2} + F_{y3} = -\frac{1}{2}P + 0 + \frac{1}{2}P = 0; \\ \sum_{i=1}^3 M_3(\vec{F}_i) = F_{x1} \cdot l - F_{y1} \cdot l - F_{y2} \cdot l = -\frac{1}{2}Pl + \frac{1}{2}Pl - 0 = 0. \end{cases}$$

3.6

3.6.1

, (3.7).

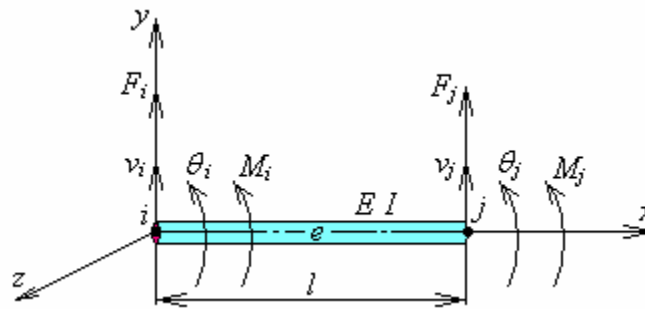

3.7 -

l , I -

.

(3.7)

i j ,

: v

θ

z .

$$\theta = \frac{dv}{dx}. \quad (3.63)$$

F

-

z .

$$EI \frac{d^2v(x)}{dx^2} = M(x). \quad (3.64)$$

$$EI \frac{d^2v}{dx^2} = F_i \cdot x - M_i. \quad (3.65)$$

$$EIv(x) = F_i \frac{x^3}{6} - M_i \frac{x^2}{2} + C_1 x + C_2, \quad (3.66)$$

1, 2 -

$$\begin{cases} v(0) = v_i; \\ \theta(0) = \theta_j. \end{cases} \quad (3.67)$$

$$\begin{cases} C_1 = EI\theta_i; \\ C_2 = EIv_i, \end{cases} \quad (3.68)$$

$$EIv(x) = F_i \frac{x^3}{6} - M_i \frac{x^2}{2} + EI\theta_i x + EIv_i; \quad (3.69)$$

$$EI\theta(x) = F_i \frac{x^2}{2} - M_i x + EI\theta_i. \quad (3.70)$$

$$(3.64)$$

$$EI \frac{d^2 v}{dx_1^2} = F_j \cdot x_1 + M_j, \quad (3.71)$$

$$x_1 = l - x,$$

(3.8).

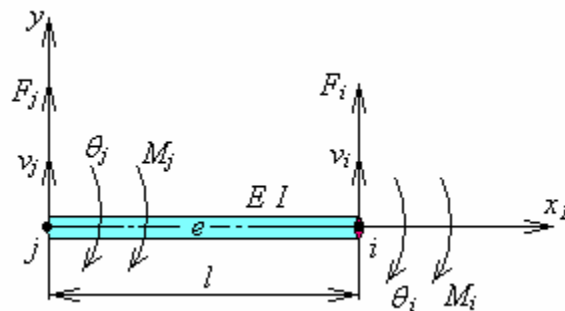

3.8 -

$$(3.71) \quad ,$$

$$EIv(x_1) = F_j \frac{x_1^3}{6} + M_j \frac{x_1^2}{2} + C_3 x_1 + C_4, \quad (3.72)$$

3, 4 -

$$\begin{cases} v(0) = v_j; \\ \theta(0) = -\theta_j. \end{cases} \quad (3.73)$$

$$\begin{cases} C_3 = -EI\theta_j; \\ C_4 = EIv_j, \end{cases} \quad (3.74)$$

$$EIv(x_1) = F_j \frac{x_1^3}{6} + M_j \frac{x_1^2}{2} - EI\theta_j x_1 + EIv_j; \quad (3.75)$$

$$EI\theta(x_1) = F_j \frac{x_1^2}{2} + M_j x_1 - EI\theta_j. \quad (3.76)$$

(3.69), (3.70) v_j θ_j :

$$EIv_j = F_i \frac{l^3}{6} - M_i \frac{l^2}{2} + EI\theta_i l + EIv_i; \quad (3.77)$$

$$EI\theta_j = F_i \frac{l^2}{2} - M_i l + EI\theta_i. \quad (3.78)$$

(3.75), (3.76) v_i θ_i :

$$EIv_i = F_j \frac{l^3}{6} + M_j \frac{l^2}{2} - EI\theta_j l + EIv_j; \quad (3.79)$$

$$-EI\theta_i = F_j \frac{l^2}{2} + M_j l - EI\theta_j. \quad (3.80)$$

(3.77) – (3.80)

$F_i, M_i, F_j, M_j,$

$$\begin{cases} F_i = \frac{12EI}{l^3}v_i + \frac{6EI}{l^2}\theta_i - \frac{12EI}{l^3}v_j + \frac{6EI}{l^2}\theta_j; \\ M_i = \frac{6EI}{l^2}v_i + \frac{4EI}{l}\theta_i - \frac{6EI}{l^2}v_j + \frac{2EI}{l}\theta_j; \\ F_j = -\frac{12EI}{l^3}v_i - \frac{6EI}{l^2}\theta_i + \frac{12EI}{l^3}v_j - \frac{6EI}{l^2}\theta_j; \\ M_j = \frac{6EI}{l^2}v_i + \frac{2EI}{l}\theta_i - \frac{6EI}{l^2}v_j + \frac{4EI}{l}\theta_j, \end{cases} \quad (3.81)$$

$$Ku = F, \quad (3.82)$$

$$u = \begin{Bmatrix} u_i \\ \theta_i \\ u_j \\ \theta_j \end{Bmatrix}; \quad (3.83)$$

$F =$

$$F = \begin{Bmatrix} F_i \\ M_i \\ F_j \\ M_j \end{Bmatrix}; \quad (3.84)$$

$$K = \frac{2EI}{l^3} \begin{bmatrix} 6 & 3l & -6 & 3l \\ 3l & 2l^2 & -3l & l^2 \\ -6 & -3l & 6 & -3l \\ 3l & l^2 & -3l & 2l^2 \end{bmatrix}. \quad (3.85)$$

3.6.2

(3.9).

$$v(x) = a_0 + a_1x + a_2x^2 + a_3x^3. \quad (3.86)$$

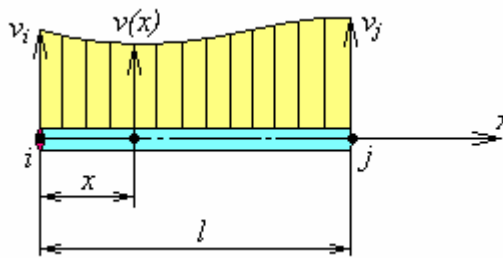

3.9 –

$$\theta(x) = a_1 + 2a_2x + 3a_3x^2. \quad (3.87)$$

0, 1, 2, 3

$$\begin{cases} v(0) = v_i; \\ \theta(0) = \theta_i; \\ v(l) = v_j; \\ \theta(l) = \theta_j. \end{cases} \quad (3.88)$$

$$\begin{cases} v_i = a_0; \\ \theta_i = a_1; \\ v_j = a_0 + a_1l + a_2l^2 + a_3l^3; \\ \theta_j = a_1 + 2a_2l + 3a_3l^2. \end{cases} \quad (3.89)$$

(3.89)

$$\begin{cases} a_0 = v_i = \{1 & 0 & 0 & 0\} u; \\ a_1 = \theta_i = \{0 & 1 & 0 & 0\} u; \\ a_2 = -\left[\frac{2\theta_i + \theta_j}{l} + \frac{3(v_i - v_j)}{l^2}\right] = \left\{-\frac{3}{l^2} & -\frac{2}{l} & \frac{3}{l^2} & -\frac{1}{l}\right\} u; \\ a_3 = \frac{\theta_i + \theta_j}{l^2} + \frac{2(v_i - v_j)}{l^3} = \left\{\frac{2}{l^3} & \frac{1}{l^2} & -\frac{2}{l^3} & \frac{1}{l^2}\right\} u. \end{cases} \quad (3.90)$$

$$v(x) = v_i + \theta_i x - \left[\frac{2\theta_i + \theta_j}{l} + \frac{3(v_i - v_j)}{l^2}\right] x^2 + \left[\frac{\theta_i + \theta_j}{l^2} + \frac{2(v_i - v_j)}{l^3}\right] x^3; \quad (3.91)$$

$$\theta(x) = \theta_i - 2\left[\frac{2\theta_i + \theta_j}{l} + \frac{3(v_i - v_j)}{l^2}\right] x + 3\left[\frac{\theta_i + \theta_j}{l^2} + \frac{2(v_i - v_j)}{l^3}\right] x^2, \quad (3.92)$$

$$v(x) = u; \quad (3.93)$$

$$\theta(x) = \frac{d}{dx}u, \quad (3.94)$$

$$= \left\{1 - 3\xi^2 + 2\xi^3 \quad (\xi - 2\xi^2 + \xi^3)l \quad 3\xi^2 - 2\xi^3 \quad (-\xi^2 + \xi^3)l\right\}, \quad (3.95)$$

$$\frac{d}{dx} = \left\{\frac{6}{l}(-\xi + \xi^2) \quad 1 - 4\xi + 3\xi^2 \quad \frac{6}{l}(\xi - \xi^2) \quad -2\xi + 3\xi^2\right\}. \quad (3.96)$$

$$\xi = \frac{x}{l}. \quad (3.97)$$

3.6.3

(3.85)

3.6.1

,
 , -
 :

$$K_{i,j} = \frac{\partial^2 U}{\partial q_i \partial q_j}, \quad (3.98)$$

$U -$;
 $q -$ $(q_1 = v_1; q_2 = \theta_1; q_3 = v_2; q_4 = \theta_2; \dots)$.

$$U = \frac{1}{2} \int_0^l EI \left[\frac{d^2 v(x)}{dx^2} \right]^2 dx. \quad (3.99)$$

(3.86).

$$U = \frac{1}{2} \int_0^l EI \left[\frac{d^2}{dx^2} (a_0 + a_1 x + a_2 x^2 + a_3 x^3) \right]^2 dx = 2EI (a_2^2 l + 3a_2 a_3 l^2 + 3a_3^2 l^3), \quad (3.100)$$

(3.90)

$$U = 2EI \left(\frac{3}{l^3} v_i^2 + \frac{3}{l^2} v_i \theta_i - \frac{6}{l^3} v_i v_j + \frac{3}{l^2} v_i \theta_j + \frac{1}{l} \theta_i^2 - \frac{3}{l^2} \theta_i v_j + \frac{1}{l} \theta_i \theta_j + \frac{3}{l^3} v_j^2 - \frac{3}{l^2} v_j \theta_j + \frac{1}{l} \theta_j^2 \right). \quad (3.101)$$

(3.98)

$$K = \begin{bmatrix} \frac{12EI}{l^3} & \frac{6EI}{l^2} & -\frac{12EI}{l^3} & \frac{6EI}{l^2} \\ \frac{6EI}{l^2} & \frac{4EI}{l} & -\frac{6EI}{l^2} & \frac{2EI}{l} \\ -\frac{12EI}{l^3} & -\frac{6EI}{l^2} & \frac{12EI}{l^3} & -\frac{6EI}{l^2} \\ \frac{6EI}{l^2} & \frac{2EI}{l} & -\frac{6EI}{l^2} & \frac{4EI}{l} \end{bmatrix}, \quad (3.102)$$

(3.85).

3.10

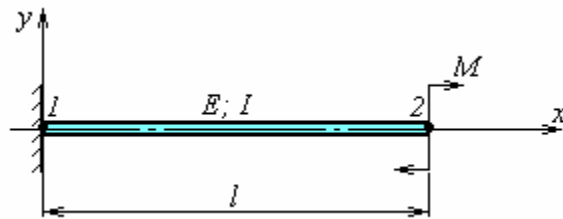

$$K = \frac{2EI}{l^3} \begin{bmatrix} v_1 & \theta_1 & v_2 & \theta_2 \\ 6 & 3l & -6 & 3l \\ 3l & 2l^2 & -3l & l^2 \\ -6 & -3l & 6 & -3l \\ 3l & l^2 & -3l & 2l^2 \end{bmatrix}$$

$$v_1 = 0;$$

$$\theta_1 = 0.$$

:

$$F_2 = 0;$$

$$M_2 = -M.$$

$$\frac{2EI}{l^3} \begin{bmatrix} v_1 & \theta_1 & v_2 & \theta_2 \\ 6 & 3l & -6 & 3l \\ 3l & 2l^2 & -3l & l^2 \\ -6 & -3l & 6 & -3l \\ 3l & l^2 & -3l & 2l^2 \end{bmatrix} \begin{Bmatrix} 0 \\ 0 \\ v_2 \\ \theta_2 \end{Bmatrix} = \begin{Bmatrix} F_1 \\ M_1 \\ 0 \\ -M \end{Bmatrix}$$

$$\frac{2EI}{l^3} \begin{bmatrix} 6 & -3l \\ -3l & 2l^2 \end{bmatrix} \begin{Bmatrix} v_2 \\ \theta_2 \end{Bmatrix} = \begin{Bmatrix} 0 \\ -M \end{Bmatrix},$$

$$\begin{cases} v_2 = -\frac{Ml^2}{2EI}; \\ \theta_2 = -\frac{Ml}{EI}. \end{cases}$$

$$\begin{Bmatrix} F_1 \\ M_1 \end{Bmatrix} = \frac{2EI}{l^3} \begin{bmatrix} 6 & 3l & -6 & 3l \\ 3l & 2l^2 & -3l & l^2 \end{bmatrix} \begin{Bmatrix} 0 \\ 0 \\ -\frac{Ml^2}{2EI} \\ -\frac{Ml}{EI} \end{Bmatrix} = \begin{Bmatrix} 0 \\ M \end{Bmatrix}.$$

$$\begin{cases} \sum_{i=1}^2 F_{yi} = F_{y1} + F_{y2} = 0 + 0 = 0; \\ \sum_{i=1}^2 M_1(\overleftarrow{F}_i) = M_1 + M_2 = M - M = 0. \end{cases}$$

$$\begin{cases} a_0 = v_1 = 0; \\ a_1 = \theta_1 = 0; \\ a_2 = -\left[\frac{2\theta_1 + \theta_2}{l} + \frac{3(v_1 - v_2)}{l^2} \right] = -\frac{M}{2EI}; \\ a_3 = \frac{\theta_1 + \theta_2}{l^2} + \frac{2(v_1 - v_2)}{l^3} = 0. \end{cases}$$

$$v(x) = a_0 + a_1x + a_2x^2 + a_3x^3 = -\frac{Mx^2}{2EI}.$$

$$\theta(x) = \frac{dv(x)}{dx} = -\frac{Mx}{EI}.$$

3.11

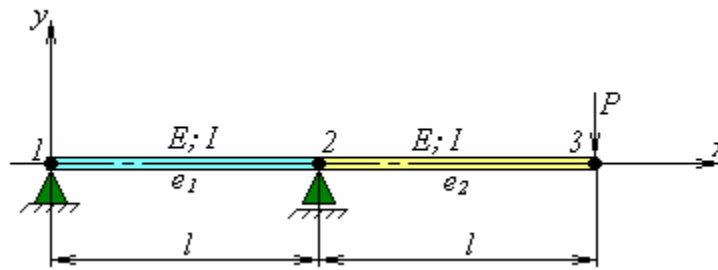

1:

$$K_{e1} = \frac{2EI}{l^3} \begin{bmatrix} v_1 & \theta_1 & v_2 & \theta_2 \\ 6 & 3l & -6 & 3l \\ 3l & 2l^2 & -3l & l^2 \\ -6 & -3l & 6 & -3l \\ 3l & l^2 & -3l & 2l^2 \end{bmatrix}$$

2:

$$K_{e2} = \frac{2EI}{l^3} \begin{bmatrix} v_2 & \theta_2 & v_3 & \theta_3 \\ 6 & 3l & -6 & 3l \\ 3l & 2l^2 & -3l & l^2 \\ -6 & -3l & 6 & -3l \\ 3l & l^2 & -3l & 2l^2 \end{bmatrix}$$

$$K = \frac{2EI}{l^3} \begin{bmatrix} v_1 & \theta_1 & v_2 & \theta_2 & v_3 & \theta_3 \\ 6 & 3l & 6 & 3l & 0 & 0 \\ 3l & 2l^2 & 3l & l^2 & 0 & 0 \\ -6 & -3l & 12 & 0 & -6 & 3l \\ 3l & l^2 & 0 & 4l^2 & -3l & l^2 \\ 0 & 0 & -6 & -3l & 6 & -3l \\ 0 & 0 & 3l & l^2 & -3l & 2l^2 \end{bmatrix}$$

:

$$v_1 = 0;$$

$$v_2 = 0.$$

:

$$M_1 = 0;$$

$$M_2 = 0;$$

$$F_3 = -P;$$

$$M_3 = 0.$$

$$\frac{2EI}{l^3} \begin{bmatrix} v_1 & \theta_1 & v_2 & \theta_2 & v_3 & \theta_3 \\ 6 & 3l & 6 & 3l & 0 & 0 \\ 3l & 2l^2 & 3l & l^2 & 0 & 0 \\ -6 & -3l & 12 & 0 & -6 & 3l \\ 3l & l^2 & 0 & 4l^2 & -3l & l^2 \\ 0 & 0 & -6 & -3l & 6 & -3l \\ 0 & 0 & 3l & l^2 & -3l & 2l^2 \end{bmatrix} \begin{Bmatrix} 0 \\ \theta_1 \\ 0 \\ \theta_2 \\ v_2 \\ \theta_2 \end{Bmatrix} = \begin{Bmatrix} F_1 \\ 0 \\ F_2 \\ 0 \\ -P \\ 0 \end{Bmatrix}$$

$$\frac{2EI}{l^3} \begin{bmatrix} 2l^2 & l^2 & 0 & 0 \\ l^2 & 4l^2 & -3l & l^2 \\ 0 & -3l & 6 & -3l \\ 0 & l^2 & -3l & 2l^2 \end{bmatrix} \begin{Bmatrix} \theta_1 \\ \theta_2 \\ v_3 \\ \theta_3 \end{Bmatrix} = \begin{Bmatrix} 0 \\ 0 \\ -P \\ 0 \end{Bmatrix},$$

$$\begin{cases} \theta_1 = \frac{1}{6} \frac{Pl^2}{EI}; \\ \theta_2 = -\frac{1}{3} \frac{Pl^2}{EI}; \\ v_3 = -\frac{2}{3} \frac{Pl^3}{EI}; \\ \theta_3 = -\frac{5}{6} \frac{Pl^2}{EI}. \end{cases}$$

$$\begin{Bmatrix} F_1 \\ F_2 \end{Bmatrix} = \frac{2EI}{l^3} \begin{bmatrix} 6 & 3l & 6 & 3l & 0 & 0 \\ -6 & -3l & 12 & 0 & -6 & 3l \end{bmatrix} \begin{Bmatrix} 0 \\ \frac{1}{6} \frac{Pl^2}{EI} \\ 0 \\ \frac{1}{3} \frac{Pl^2}{EI} \\ \frac{2}{2} \frac{Pl^3}{EI} \\ -\frac{3}{3} \frac{EI}{EI} \\ -\frac{5}{5} \frac{Pl^2}{EI} \\ \frac{6}{6} \frac{EI}{EI} \end{Bmatrix} = \begin{Bmatrix} -P \\ 2P \end{Bmatrix}.$$

$$\begin{cases} \sum_{i=1}^1 F_{yi} = F_{y1} + F_{y2} + F_{y3} = -P + 2P - P = 0; \\ \sum_{i=1}^3 M_1(\vec{F}_i) = F_2 \cdot l - P \cdot 2l = 2Pl - P \cdot 2l = 0; \\ \sum_{i=1}^3 M_2(\vec{F}_i) = -F_1 \cdot l - P \cdot l = -P \cdot l - P \cdot l = 0. \end{cases}$$

1

$$\begin{cases} a_0 = v_1 = 0; \\ a_1 = \theta_1 = \frac{1}{6} \frac{Pl^2}{EI}; \\ a_2 = -\left[\frac{2\theta_1 + \theta_2}{l} + \frac{3(v_1 - v_2)}{l^2} \right] = 0; \\ a_3 = \frac{\theta_1 + \theta_2}{l^2} + \frac{2(v_1 - v_2)}{l^3} = -\frac{1}{6} \frac{P}{EI}. \end{cases}$$

$$v_{e1}(x) = a_0 + a_1 x + a_2 x^2 + a_3 x^3 = \frac{1}{6} \frac{Pl^2}{EI} x_1 (l^2 - x_1^2).$$

$$\theta_{e1}(x) = \frac{dv_{e1}(x)}{dx_1} = \frac{1}{6} \frac{Pl^2}{EI} (l^2 - 3x_1^2).$$

$$\begin{cases} b_0 = v_2 = 0; \\ b_1 = \theta_2 = -\frac{1}{3} \frac{Pl^2}{EI}; \\ b_2 = -\left[\frac{2\theta_2 + \theta_3}{l} + \frac{3(v_2 - v_3)}{l^2} \right] = -\frac{1}{2} \frac{Pl}{EI}; \\ b_3 = \frac{\theta_2 + \theta_3}{l^2} + \frac{2(v_2 - v_3)}{l^3} = \frac{1}{6} \frac{P}{EI}. \end{cases}$$

$$v_{e2}(x) = b_0 + b_1x + b_2x^2 + b_3x^3 = -\frac{1}{6} \frac{P}{EI} x_2 (2l^2 + 3lx_2 - x_2^2).$$

$$\theta_{e2}(x) = \frac{dv_{e2}(x)}{dx_2} = -\frac{1}{6} \frac{P}{EI} (2l^2 + 6lx_2 - 3x_2^2).$$

$$(x_1 = x; x_2 = x + l)$$

$$\begin{cases} v_{e1}(x) = \frac{1}{6} \frac{Pl^2}{EI} x(l^2 - x^2); \\ \theta_{e1}(x) = \frac{1}{6} \frac{Pl^2}{EI} (l^2 - 3x^2); \\ v_{e2}(x) = -\frac{1}{6} \frac{P}{EI} (x-l)(5lx - 2lx - x^2); \\ \theta_{e2}(x) = -\frac{1}{6} \frac{P}{EI} (12lx - 7l^2 - 3x^2). \end{cases}$$

3.6.4

q , (3.10),
 (3.10).

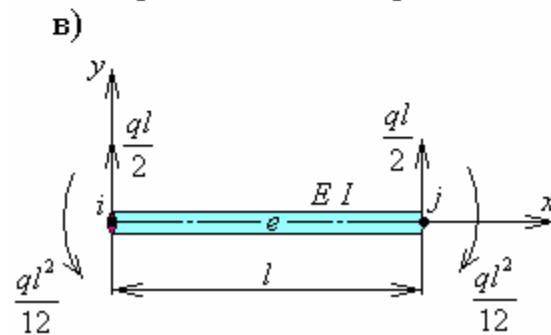
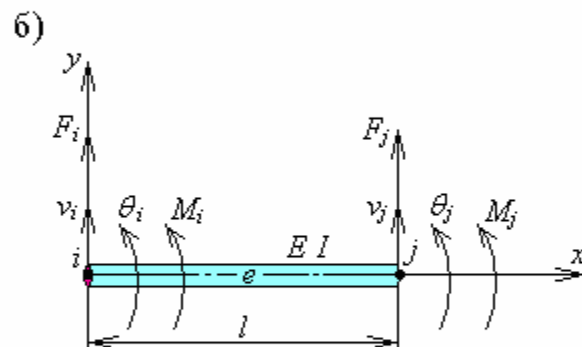
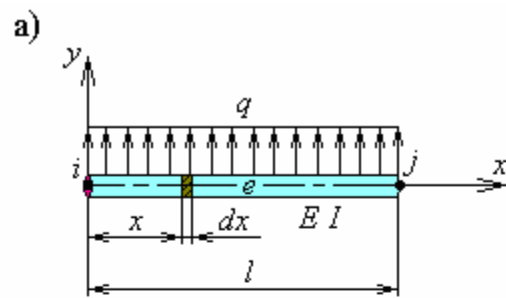

3.10 –

$d :$

$$dF = qdx. \quad (3.105)$$

$v() :$

$$\delta W = v(x) \cdot dF = v(x) \cdot qdx = u qdx. \quad (3.106)$$

$$W = \int \delta W = \int_0^l u qdx = ql \cdot \left(\int_0^1 d\xi \right) u = \left\{ \frac{ql}{2} \quad \frac{ql^2}{12} \quad \frac{ql}{2} \quad -\frac{ql^2}{12} \right\} u. \quad (3.107)$$

(3.10)

$$W = F_i v_i + M_i \theta_i + F_j v_j + M_j \theta_j = F^T u = \{ F_i \quad M_i \quad F_j \quad M_j \} u. \quad (3.108)$$

(3.107) (3.108), (3.10)

$$\begin{cases} F_i = \frac{ql}{2}; \\ M_i = \frac{ql^2}{12}; \\ F_j = \frac{ql}{2}; \\ M_j = -\frac{ql^2}{12}. \end{cases} \quad (3.109)$$

3.12

2 3

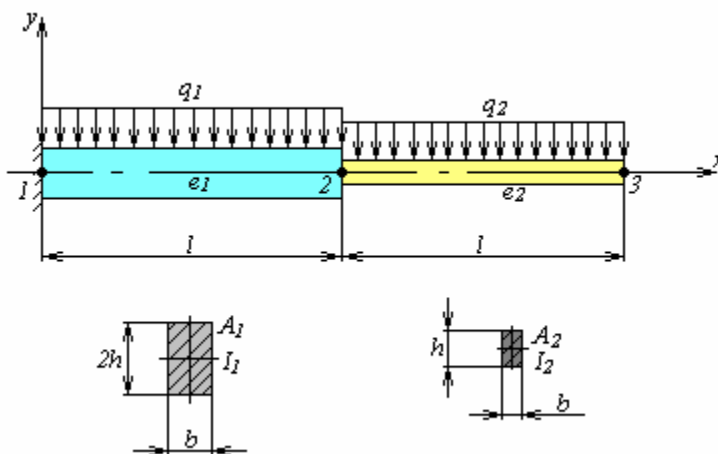

— :

$$A_1 = b \cdot 2h = 2bh;$$

$$A_2 = bh.$$

— :

$$I_1 = \frac{b \cdot (2h)^3}{12} = \frac{2}{3}bh^3;$$

$$I_2 = \frac{1}{12}bh^3.$$

— :

$$A = bh;$$

$$I = \frac{1}{12}bh^3.$$

— :

$$A_1 = 2A;$$

$$A_2 = A,$$

$$I_1 = 8I;$$

$$I_2 = I.$$

$$q_1 = \frac{P_1}{l} = \frac{m_1 g}{l} = \frac{\rho A_1 l g}{l} = \rho A_1 g = 2\rho A g;$$

$$q_2 = \frac{P_2}{l} = \frac{m_2 g}{l} = \frac{\rho A_2 l g}{l} = \rho A_2 g = \rho A g.$$

$$q = \rho A g.$$

$$q_1 = 2q;$$

$$q_2 = q.$$

$$q_1 \quad q_2$$

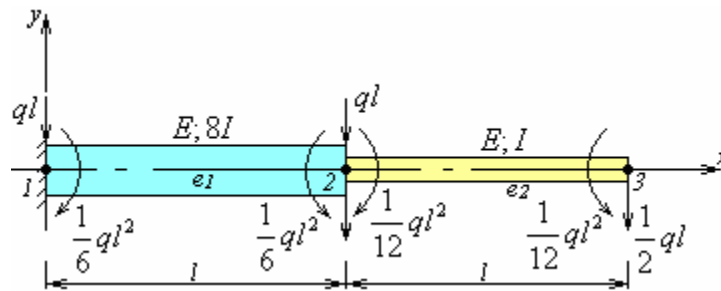

$$K_{e1} = \frac{2EI}{l^3} \begin{bmatrix} v_1 & \theta_1 & v_2 & \theta_2 \\ 48 & 24l & -48 & 24l \\ 24l & 16l^2 & -24l & 8l^2 \\ -48 & -24l & 48 & -24l \\ 24l & 8l^2 & -24l & 16l^2 \end{bmatrix}$$

$$K_{e2} = \frac{2EI}{l^3} \begin{bmatrix} v_2 & \theta_2 & v_3 & \theta_3 \\ 6 & 3l & -6 & 3l \\ 3l & 2l^2 & -3l & l^2 \\ -6 & -3l & 6 & -3l \\ 3l & l^2 & -3l & 2l^2 \end{bmatrix}$$

$$K = \frac{2EI}{l^3} \begin{bmatrix} v_1 & \theta_1 & v_2 & \theta_2 & v_3 & \theta_3 \\ 48 & 24l & -48 & 24l & 0 & 0 \\ 24l & 16l^2 & -24l & 8l^2 & 0 & 0 \\ -48 & -24l & 54 & -21l & -6 & 3l \\ 24l & 8l^2 & -21l & 18l^2 & -3l & l^2 \\ 0 & 0 & -6 & -3l & 6 & -3l \\ 0 & 0 & 3l & l^2 & -3l & 2l^2 \end{bmatrix}.$$

:

$$v_1 = 0;$$

$$\theta_1 = 0.$$

:

$$F_1 = F_{1R} - ql;$$

$$M_1 = M_{1R} - \frac{1}{6}ql^2;$$

$$F_2 = -\frac{3}{2}ql;$$

$$M_2 = \frac{1}{12}ql^2;$$

$$F_3 = -\frac{1}{2}ql;$$

$$M_3 = \frac{1}{12}ql^2.$$

$$\frac{2EI}{l^3} \begin{bmatrix} v_1 & \theta_1 & v_2 & \theta_2 & v_3 & \theta_3 \\ 48 & 24l & -48 & 24l & 0 & 0 \\ 24l & 16l^2 & -24l & 8l^2 & 0 & 0 \\ -48 & -24l & 54 & -21l & -6 & 3l \\ 24l & 8l^2 & -21l & 18l^2 & -3l & l^2 \\ 0 & 0 & -6 & -3l & 6 & -3l \\ 0 & 0 & 3l & l^2 & -3l & 2l^2 \end{bmatrix} \begin{Bmatrix} 0 \\ 0 \\ v_2 \\ \theta_2 \\ v_3 \\ \theta_3 \end{Bmatrix} = \begin{Bmatrix} F_{1R} - ql \\ M_{1R} - \frac{1}{6}ql^2 \\ -\frac{3}{2}ql \\ \frac{1}{12}ql^2 \\ -\frac{1}{2}ql \\ \frac{1}{12}ql^2 \end{Bmatrix}.$$

$$\frac{2EI}{l^3} \begin{bmatrix} 54 & -24l & -6 & 3l \\ -24l & 18l^2 & -3l & l^2 \\ -6 & -3l & 6 & -3l \\ 3l & l^2 & -3l & 2l^2 \end{bmatrix} \begin{Bmatrix} v_2 \\ \theta_2 \\ v_3 \\ \theta_3 \end{Bmatrix} = \begin{Bmatrix} -\frac{3}{2}ql \\ \frac{1}{12}ql^2 \\ -\frac{1}{2}ql \\ \frac{1}{12}ql^2 \end{Bmatrix},$$

$$\begin{cases} v_2 = -\frac{5}{48} \frac{ql^4}{EI}; \\ \theta_2 = -\frac{1}{6} \frac{ql^3}{EI}; \\ v_3 = -\frac{19}{48} \frac{ql^4}{EI}; \\ \theta_3 = -\frac{1}{3} \frac{ql^3}{EI}. \end{cases}$$

$$\begin{Bmatrix} F_{1R} \\ M_{1R} \end{Bmatrix} = \begin{Bmatrix} ql \\ \frac{1}{6}ql^2 \end{Bmatrix} + \frac{2EI}{l^3} \begin{bmatrix} -48 & 24l \\ -24l & 8l^2 \end{bmatrix} \begin{Bmatrix} -\frac{5}{48}l \\ -\frac{1}{6} \end{Bmatrix} \cdot \frac{ql^3}{EI} = \begin{Bmatrix} 3ql \\ \frac{5}{2}ql^2 \end{Bmatrix}.$$

$$\begin{cases} \sum_{i=1}^3 F_{xi} = 3ql - 2q \cdot l - q \cdot l = 0; \\ \sum_{i=1}^3 M_1(\vec{F}_i) = \frac{5}{2}ql^2 - 2q \cdot l \cdot \frac{l}{2} - q \cdot l \cdot \left(l + \frac{l}{2}\right) = 0; \\ \sum_{i=1}^3 M_2(\vec{F}_i) = \frac{5}{2}ql^2 - 3ql \cdot l + 2q \cdot l \cdot \frac{l}{2} - q \cdot l \cdot \frac{l}{2} = 0. \end{cases}$$

3.6.5

m ,
3.11),

(3.11).

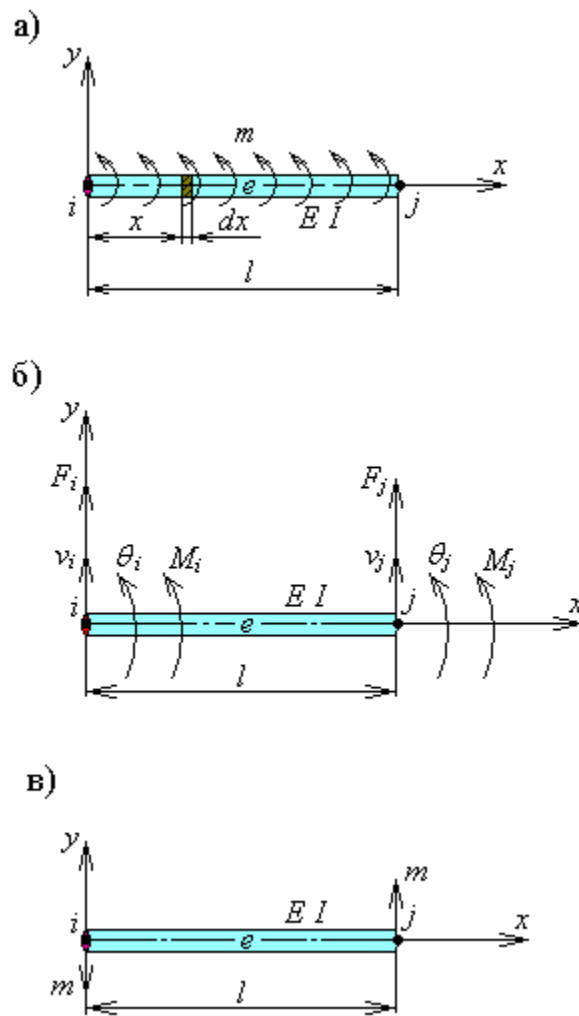

3.11 –

d :

$$dM = m dx. \quad (3.110)$$

$\theta(x)$:

$$\delta W = \theta(x) \cdot dM = \theta(x) \cdot m dx = \frac{d}{dx} u \cdot m dx. \quad (3.111)$$

$$W = \int \delta W = \int_0^l \frac{d}{dx} u m dx = ml \cdot \left(\int_0^1 \frac{d}{dx} d\xi \right) u = \{-m \ 0 \ m \ 0\} u. \quad (3.112)$$

(3.11)

$$W = F_i v_i + M_i \theta_i + F_j v_j + M_j \theta_j = F^T u = \{F_i \ M_i \ F_j \ M_j\} u. \quad (3.113)$$

(3.112) (3.113), (3.11)

$$\begin{cases} F_i = -m; \\ M_i = 0; \\ F_j = m; \\ M_j = 0. \end{cases} \quad (3.114)$$

3.6.6

(3.12).

— — — — —
 · — — — —
 , — — — —
 () — — — —
 (— — — —

3.12).

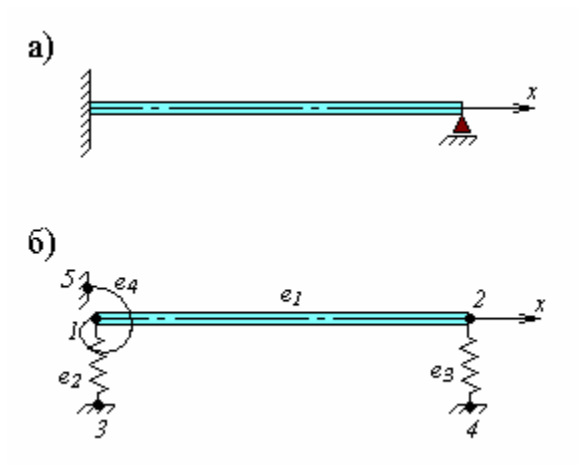

3.12 –

3.13),

$$K = \begin{bmatrix} c & -c \\ -c & c \end{bmatrix} \quad (3.115)$$

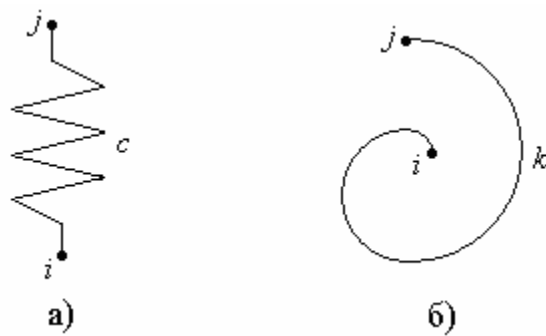

3.13 –

k (3.13),

$$K = \begin{bmatrix} k & -k \\ -k & k \end{bmatrix} \quad (3.116)$$

3.13

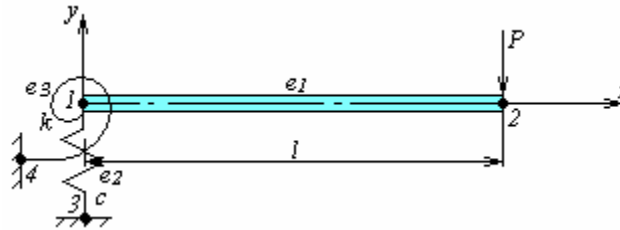

1:

$$K_{e1} = \frac{2EI}{l^3} \begin{bmatrix} \frac{v_1}{6} & \frac{\theta_1}{3l} & \frac{v_2}{-6} & \frac{\theta_2}{3l} \\ 3l & 2l^2 & -3l & l^2 \\ -6 & -3l & 6 & -3l \\ 3l & l^2 & -3l & 2l^2 \end{bmatrix}.$$

2:

$$K_{e2} = \begin{bmatrix} \frac{v_1}{c} & \frac{v_3}{-c} \\ -c & c \end{bmatrix}.$$

3:

$$K_{e3} = \begin{bmatrix} \frac{\theta_1}{k} & \frac{\theta_4}{-k} \\ -k & k \end{bmatrix}.$$

$$K = \begin{matrix} & \begin{matrix} v_1 & \theta_1 & v_2 & \theta_2 & v_3 & \theta_4 \end{matrix} \\ \begin{matrix} \frac{12EI}{l^3} + c & \frac{6EI}{l^2} & -\frac{12EI}{l^3} & \frac{6EI}{l^2} & -c & 0 \\ \frac{6EI}{l^2} & \frac{4EI}{l} + k & -\frac{6EI}{l^2} & \frac{2EI}{l} & 0 & -k \\ -\frac{12EI}{l^3} & -\frac{6EI}{l^2} & \frac{12EI}{l^3} & -\frac{6EI}{l^2} & 0 & 0 \\ \frac{6EI}{l^2} & \frac{2EI}{l} & -\frac{6EI}{l^2} & \frac{4EI}{l} & 0 & 0 \\ -c & 0 & 0 & 0 & c & 0 \\ 0 & -k & 0 & 0 & 0 & k \end{matrix} \end{matrix}.$$

:

$$v_3 = 0;$$

$$\theta_4 = 0.$$

:

$$F_1 = 0;$$

$$M_1 = 0;$$

$$F_2 = -P;$$

$$M_2 = 0.$$

$$\begin{matrix} & \begin{matrix} v_1 & \theta_1 & v_2 & \theta_2 & v_3 & \theta_4 \end{matrix} \\ \begin{matrix} \frac{12EI}{l^3} + c & \frac{6EI}{l^2} & -\frac{12EI}{l^3} & \frac{6EI}{l^2} & -c & 0 \\ \frac{6EI}{l^2} & \frac{4EI}{l} + k & -\frac{6EI}{l^2} & \frac{2EI}{l} & 0 & -k \\ -\frac{12EI}{l^3} & -\frac{6EI}{l^2} & \frac{12EI}{l^3} & -\frac{6EI}{l^2} & 0 & 0 \\ \frac{6EI}{l^2} & \frac{2EI}{l} & -\frac{6EI}{l^2} & \frac{4EI}{l} & 0 & 0 \\ -c & 0 & 0 & 0 & c & 0 \\ 0 & -k & 0 & 0 & 0 & k \end{matrix} \end{matrix} \begin{matrix} \left. \begin{matrix} v_1 \\ \theta_1 \\ v_2 \\ \theta_2 \end{matrix} \right\} = \begin{matrix} 0 \\ 0 \\ -P \\ 0 \end{matrix} \right. \\ \left. \begin{matrix} 0 \\ 0 \end{matrix} \right\} = \begin{matrix} F_3 \\ M_4 \end{matrix} \right.$$

$$\begin{bmatrix} \frac{12EI}{l^3} + c & \frac{6EI}{l^2} & -\frac{12EI}{l^3} & \frac{6EI}{l^2} \\ \frac{6EI}{l^2} & \frac{4EI}{l} + k & -\frac{6EI}{l^2} & \frac{2EI}{l} \\ -\frac{12EI}{l^3} & -\frac{6EI}{l^2} & \frac{12EI}{l^3} & -\frac{6EI}{l^2} \\ \frac{6EI}{l^2} & \frac{2EI}{l} & -\frac{6EI}{l^2} & \frac{4EI}{l} \end{bmatrix} \begin{Bmatrix} v_1 \\ \theta_1 \\ v_2 \\ \theta_2 \end{Bmatrix} = \begin{Bmatrix} 0 \\ 0 \\ -P \\ 0 \end{Bmatrix},$$

$$\begin{cases} v_1 = -\frac{P}{c}; \\ \theta_1 = -\frac{Pl}{k}; \\ v_2 = -\frac{P}{c} - \left(\frac{1}{k} + \frac{l}{3EI}\right) Pl^2; \\ \theta_2 = -\frac{Pl}{k} - \frac{Pl^2}{2EI}. \end{cases}$$

($c \rightarrow \infty; k \rightarrow \infty$) -

$$\begin{cases} v_2 = -\frac{Pl^3}{3EI}; \\ \theta_2 = -\frac{Pl^2}{2EI}, \end{cases}$$

:

$$v_1 = 0;$$

$$\theta_1 = 0.$$

$$\begin{Bmatrix} F_3 \\ M_4 \end{Bmatrix} = \begin{bmatrix} -c & 0 \\ 0 & -k \end{bmatrix} \begin{Bmatrix} -\frac{P}{c} \\ \frac{Pl}{k} \end{Bmatrix} = \begin{Bmatrix} P \\ Pl \end{Bmatrix}.$$

-

1:

$$F_{1R} = -F_3 = -P;$$

$$M_{1R} = -M_4 = -Pl,$$

3.7

3.7.1

3.14).

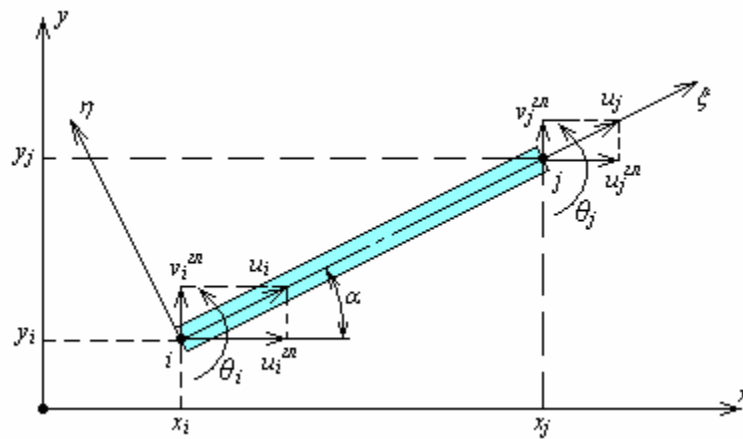

3.14 –

– $\xi\eta$, ;

– .

$i \quad j$

(. .3.5):

$$u_i = u_i \cos \alpha + v_i \sin \alpha, \quad (3.117)$$

$$u_j = u_j \cos \alpha + v_j \sin \alpha, \quad (3.118)$$

$$v_i = -u_i \sin \alpha + v_i \cos \alpha, \quad (3.119)$$

$$v_j = -u_j \sin \alpha + v_j \cos \alpha. \quad (3.120)$$

, $i \quad j$ -

:

$$\theta_i = \theta_i ; \quad (3.121)$$

$$\theta_j = \theta_i . \quad (3.122)$$

(3.117) – (3.122)

$$\begin{Bmatrix} u_i \\ v_i \\ \theta_i \\ u_j \\ v_j \\ \theta_j \end{Bmatrix} = \begin{bmatrix} \cos \alpha & \sin \alpha & 0 & 0 & 0 & 0 \\ -\sin \alpha & \cos \alpha & 0 & 0 & 0 & 0 \\ 0 & 0 & 1 & 0 & 0 & 0 \\ 0 & 0 & 0 & \cos \alpha & \sin \alpha & 0 \\ 0 & 0 & 0 & -\sin \alpha & \cos \alpha & 0 \\ 0 & 0 & 0 & 0 & 0 & 1 \end{bmatrix} \begin{Bmatrix} u_i \\ v_i \\ \theta_i \\ u_j \\ v_j \\ \theta_j \end{Bmatrix}, \quad (3.123)$$

$$u = Tu , \quad (3.124)$$

– – – ; –

$$T = \begin{bmatrix} \cos \alpha & \sin \alpha & 0 & 0 & 0 & 0 \\ -\sin \alpha & \cos \alpha & 0 & 0 & 0 & 0 \\ 0 & 0 & 1 & 0 & 0 & 0 \\ 0 & 0 & 0 & \cos \alpha & \sin \alpha & 0 \\ 0 & 0 & 0 & -\sin \alpha & \cos \alpha & 0 \\ 0 & 0 & 0 & 0 & 0 & 1 \end{bmatrix}. \quad (3.125)$$

(3.60)

$$K = T^T K T, \quad (3.126)$$

() N_i N_j –
 Q_i Q_j i j

$$\mathbf{K}^{2e} = \begin{pmatrix}
 \frac{E \cdot A}{L} & 0 & 0 & -\frac{E \cdot A}{L} & 0 & 0 \\
 0 & \frac{12E \cdot I}{L^3} & \frac{6E \cdot I}{L^2} & 0 & -\frac{12E \cdot I}{L^3} & \frac{6E \cdot I}{L^2} \\
 0 & \frac{6E \cdot I}{L^2} & \frac{4E \cdot I}{L} & 0 & -\frac{6E \cdot I}{L^2} & \frac{2E \cdot I}{L} \\
 -\frac{E \cdot A}{L} & 0 & 0 & \frac{E \cdot A}{L} & 0 & 0 \\
 0 & -\frac{12E \cdot I}{L^3} & -\frac{6E \cdot I}{L^2} & 0 & \frac{12E \cdot I}{L^3} & -\frac{6E \cdot I}{L^2} \\
 0 & \frac{6E \cdot I}{L^2} & \frac{2E \cdot I}{L} & 0 & -\frac{6E \cdot I}{L^2} & \frac{4E \cdot I}{L}
 \end{pmatrix} \quad (3.127)$$

3.14

2 3,

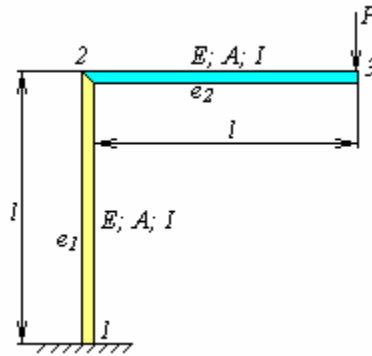

i :

$$K_{e1} = \begin{bmatrix} \frac{12EI}{l^3} & 0 & -\frac{6EI}{l^2} & -\frac{12EI}{l^3} & 0 & -\frac{6EI}{l^2} \\ 0 & \frac{EA}{l} & 0 & 0 & -\frac{EA}{l} & 0 \\ -\frac{6EI}{l^2} & 0 & \frac{4EI}{l} & \frac{6EI}{l^2} & 0 & \frac{2EI}{l} \\ -\frac{12EI}{l^3} & 0 & \frac{6EI}{l^2} & \frac{12EI}{l^3} & 0 & \frac{6EI}{l^2} \\ 0 & -\frac{EA}{l} & 0 & 0 & \frac{EA}{l} & 0 \\ -\frac{6EI}{l^2} & 0 & \frac{2EI}{l} & \frac{6EI}{l^2} & 0 & \frac{4EI}{l} \end{bmatrix}$$

2:

$$K_{e2} = \begin{matrix} & \begin{matrix} u_2 & v_2 & \theta_2 & u_3 & v_3 & \theta_3 \end{matrix} \\ \begin{matrix} \frac{EA}{l} \\ 0 \\ 0 \\ -\frac{EA}{l} \\ 0 \\ 0 \end{matrix} & \begin{bmatrix} 0 & 0 & -\frac{EA}{l} & 0 & 0 \\ \frac{12EI}{l^3} & \frac{6EI}{l^2} & 0 & -\frac{12EI}{l^3} & \frac{6EI}{l^2} \\ \frac{6EI}{l^2} & \frac{4EI}{l} & 0 & -\frac{6EI}{l^2} & \frac{2EI}{l} \\ 0 & 0 & \frac{EA}{l} & 0 & 0 \\ -\frac{12EI}{l^3} & -\frac{6EI}{l^2} & 0 & \frac{12EI}{l^3} & -\frac{6EI}{l^2} \\ \frac{6EI}{l^2} & \frac{2EI}{l} & 0 & -\frac{6EI}{l^2} & \frac{4EI}{l} \end{bmatrix} \end{matrix}.$$

$$K = \begin{matrix} & \begin{matrix} u_1 & v_1 & \theta_1 & u_2 & v_2 & \theta_2 & u_3 & v_3 & \theta_3 \end{matrix} \\ \begin{matrix} \frac{12EI}{l^3} \\ 0 \\ -\frac{6EI}{l^2} \\ \frac{12EI}{l^3} \\ 0 \\ -\frac{6EI}{l^2} \\ 0 \\ 0 \\ 0 \end{matrix} & \begin{bmatrix} 0 & -\frac{6EI}{l^2} & -\frac{12EI}{l^3} & 0 & -\frac{6EI}{l^2} & 0 & 0 & 0 & 0 \\ \frac{EA}{l} & 0 & 0 & -\frac{EA}{l} & 0 & 0 & 0 & 0 & 0 \\ \frac{4EI}{l} & \frac{6EI}{l^2} & \frac{6EI}{l^2} & \frac{2EI}{l} & \frac{6EI}{l^2} & \frac{2EI}{l} & 0 & 0 & 0 \\ 0 & \frac{6EI}{l^2} + \frac{EA}{l} & 0 & \frac{6EI}{l^2} & \frac{6EI}{l^2} + \frac{EA}{l} & \frac{6EI}{l^2} & -\frac{EA}{l} & 0 & 0 \\ -\frac{EA}{l} & 0 & 0 & \frac{12EI}{l^3} + \frac{EA}{l} & \frac{6EI}{l^2} & \frac{6EI}{l^2} & 0 & \frac{12EI}{l^3} & \frac{6EI}{l^2} \\ \frac{2EI}{l} & \frac{6EI}{l^2} & \frac{6EI}{l^2} & \frac{2EI}{l} & \frac{6EI}{l^2} & \frac{2EI}{l} & 0 & -\frac{6EI}{l^2} & \frac{2EI}{l} \\ 0 & 0 & 0 & -\frac{EA}{l} & 0 & 0 & \frac{EA}{l} & 0 & 0 \\ 0 & 0 & 0 & 0 & -\frac{12EI}{l^3} & -\frac{6EI}{l^2} & 0 & \frac{12EI}{l^3} & -\frac{6EI}{l^2} \\ 0 & 0 & 0 & 0 & \frac{6EI}{l^2} & \frac{2EI}{l} & 0 & -\frac{6EI}{l^2} & \frac{4EI}{l} \end{bmatrix} \end{matrix}.$$

:

$$\begin{aligned} u_1 &= 0; \\ v_1 &= 0; \\ \theta_1 &= 0. \end{aligned}$$

:

$$\begin{aligned}
F_{x2} &= 0; \\
F_{y2} &= 0; \\
M_2 &= 0; \\
F_{x3} &= 0; \\
F_{y3} &= -P; \\
M_3 &= 0.
\end{aligned}$$

$$\begin{array}{ccccccccc}
u_1 & v_1 & \theta_1 & u_2 & v_2 & \theta_2 & u_3 & v_3 & \theta_3 \\
\left[\begin{array}{ccccccccc}
\frac{12EI}{l^3} & 0 & -\frac{6EI}{l^2} & -\frac{12EI}{l^3} & 0 & -\frac{6EI}{l^2} & 0 & 0 & 0 \\
0 & \frac{EA}{l} & 0 & 0 & -\frac{EA}{l} & 0 & 0 & 0 & 0 \\
-\frac{6EI}{l^2} & 0 & \frac{4EI}{l} & \frac{6EI}{l^2} & 0 & \frac{2EI}{l} & 0 & 0 & 0 \\
-\frac{12EI}{l^3} & 0 & \frac{6EI}{l^2} & \frac{12EI}{l^3} + \frac{EA}{l} & 0 & \frac{6EI}{l^2} & -\frac{EA}{l} & 0 & 0 \\
0 & -\frac{EA}{l} & 0 & 0 & \frac{12EI}{l^3} + \frac{EA}{l} & \frac{6EI}{l^2} & 0 & \frac{12EI}{l^3} & \frac{6EI}{l^2} \\
-\frac{6EI}{l^2} & 0 & \frac{2EI}{l} & \frac{6EI}{l^2} & \frac{6EI}{l^2} & \frac{2EI}{l} & 0 & -\frac{6EI}{l^2} & \frac{2EI}{l} \\
0 & 0 & 0 & -\frac{EA}{l} & 0 & 0 & \frac{EA}{l} & 0 & 0 \\
0 & 0 & 0 & 0 & -\frac{12EI}{l^3} & -\frac{6EI}{l^2} & 0 & \frac{12EI}{l^3} & -\frac{6EI}{l^2} \\
0 & 0 & 0 & 0 & \frac{6EI}{l^2} & \frac{2EI}{l} & 0 & -\frac{6EI}{l^2} & \frac{4EI}{l}
\end{array} \right] \begin{array}{c} 0 \\ 0 \\ 0 \\ u_2 \\ v_2 \\ \theta_2 \\ u_3 \\ v_3 \\ \theta_3 \end{array} = \begin{array}{c} F_{x1} \\ F_{y1} \\ M_1 \\ 0 \\ 0 \\ 0 \\ -P \\ 0 \end{array}
\end{array}$$

$$\left[\begin{array}{cccccc}
\frac{12EI}{l^3} + \frac{EA}{l} & 0 & \frac{6EI}{l^2} & -\frac{EA}{l} & 0 & 0 \\
0 & \frac{12EI}{l^3} + \frac{EA}{l} & \frac{6EI}{l^2} & 0 & \frac{12EI}{l^3} & \frac{6EI}{l^2} \\
\frac{6EI}{l^2} & \frac{6EI}{l^2} & \frac{2EI}{l} & 0 & -\frac{6EI}{l^2} & \frac{2EI}{l} \\
-\frac{EA}{l} & 0 & 0 & \frac{EA}{l} & 0 & 0 \\
0 & -\frac{12EI}{l^3} & -\frac{6EI}{l^2} & 0 & \frac{12EI}{l^3} & -\frac{6EI}{l^2} \\
0 & \frac{6EI}{l^2} & \frac{2EI}{l} & 0 & -\frac{6EI}{l^2} & \frac{4EI}{l}
\end{array} \right] \begin{array}{c} u_2 \\ v_2 \\ \theta_2 \\ u_3 \\ v_3 \\ \theta_3 \end{array} = \begin{array}{c} 0 \\ 0 \\ 0 \\ 0 \\ -P \\ 0 \end{array}$$

$$\begin{cases} u_2 = \frac{1}{2} \frac{Pl^3}{EI}; \\ v_2 = -\frac{Pl}{EA}; \\ \theta_2 = -\frac{Pl^2}{EI}; \end{cases} \quad \begin{cases} u_3 = \frac{1}{2} \frac{Pl^3}{EI}; \\ v_3 = -\frac{Pl}{EA} - \frac{4}{3} \frac{Pl^2}{EI}; \\ \theta_3 = -\frac{3}{2} \frac{Pl^2}{EI}. \end{cases}$$

$$\begin{cases} F_{x1} \\ F_{y1} \\ M_1 \end{cases} = \begin{bmatrix} -\frac{12EI}{l^3} & 0 & -\frac{6EI}{l^2} & 0 & 0 & 0 \\ 0 & -\frac{EA}{l} & 0 & 0 & 0 & 0 \\ \frac{6EI}{l^2} & 0 & \frac{2EI}{l} & 0 & 0 & 0 \end{bmatrix} \begin{bmatrix} u_2 \\ v_2 \\ \theta_2 \\ u_3 \\ v_3 \\ \theta_3 \end{bmatrix} = \begin{bmatrix} 0 \\ P \\ Pl \end{bmatrix}$$

$$\begin{cases} \sum_{i=1}^3 F_{xi} = F_{x1} + F_{x2} + F_{x3} = 0 + 0 + 0 = 0; \\ \sum_{i=1}^3 F_{yi} = F_{y1} + F_{y2} + F_{y3} = P + 0 - P = 0; \\ \sum_{i=1}^3 M_1(\vec{F}_i) = M_1 + F_{x3} \cdot l = Pl - Pl = 0. \end{cases}$$

4

4.1

4.1.1

(4.1).

a)

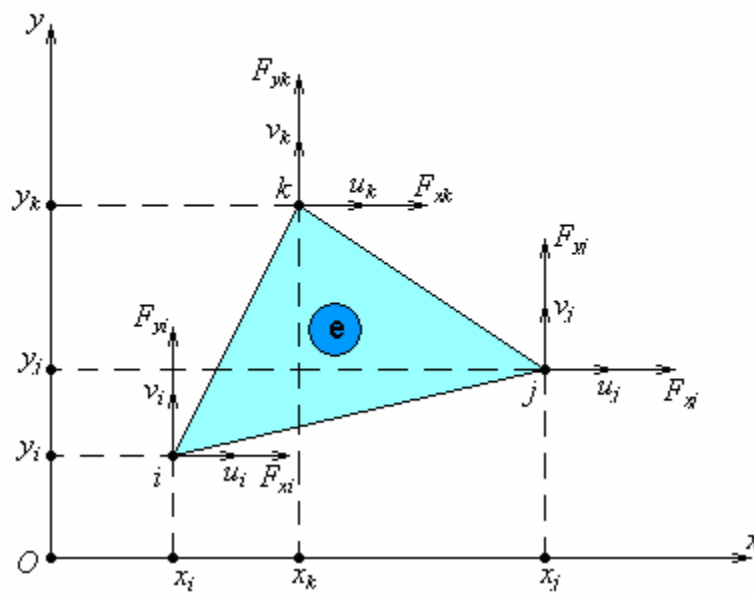

б)

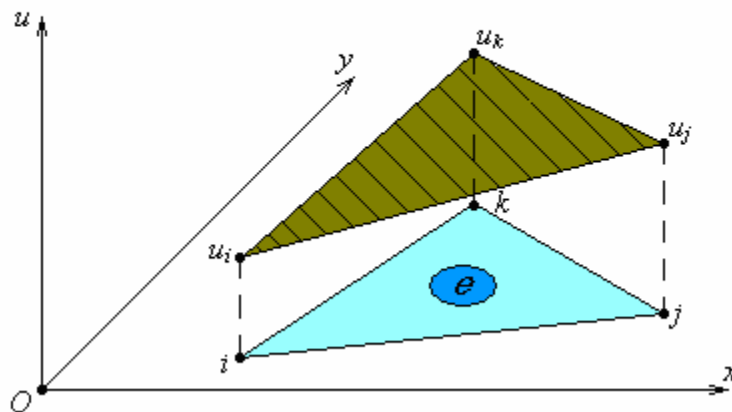

4.1 -

4.1):

$$u(x, y) = \alpha_1 + \alpha_2 x + \alpha_3 y; \quad (4.1)$$

$$v(x, y) = \beta_1 + \beta_2 x + \beta_3 y. \quad (4.2)$$

$\alpha_1, \alpha_2, \alpha_3, \beta_1, \beta_2, \beta_3$:

$$\begin{cases} u(x_i, y_i) = u_i; \\ u(x_j, y_j) = u_j; \\ u(x_k, y_k) = u_k; \end{cases} \quad (4.3)$$

$$\begin{cases} v(x_i, y_i) = v_i; \\ v(x_j, y_j) = v_j; \\ v(x_k, y_k) = v_k, \end{cases} \quad (4.4)$$

, (4.1) (4.2):

$$\begin{cases} \alpha_1 + \alpha_2 x_i + \alpha_3 y_i = u_i; \\ \alpha_1 + \alpha_2 x_j + \alpha_3 y_j = u_j; \\ \alpha_1 + \alpha_2 x_k + \alpha_3 y_k = u_k; \end{cases} \quad (4.5)$$

$$\begin{cases} \beta_1 + \beta_2 x_i + \beta_3 y_i = v_i; \\ \beta_1 + \beta_2 x_j + \beta_3 y_j = v_j; \\ \beta_1 + \beta_2 x_k + \beta_3 y_k = v_k, \end{cases} \quad (4.6)$$

:

$$\begin{bmatrix} 1 & x_i & y_i \\ 1 & x_j & y_j \\ 1 & x_k & y_k \end{bmatrix} \begin{Bmatrix} \alpha_1 \\ \alpha_2 \\ \alpha_3 \end{Bmatrix} = \begin{Bmatrix} u_i \\ u_j \\ u_k \end{Bmatrix}; \quad (4.7)$$

$$\begin{bmatrix} 1 & x_i & y_i \\ 1 & x_j & y_j \\ 1 & x_k & y_k \end{bmatrix} \begin{Bmatrix} \beta_1 \\ \beta_2 \\ \beta_3 \end{Bmatrix} = \begin{Bmatrix} v_i \\ v_j \\ v_k \end{Bmatrix}. \quad (4.8)$$

(4.7) (4.8)

$\alpha_1, \alpha_2, \alpha_3,$

$\beta_1, \beta_2, \beta_3$

(4.1) (4.2), :

$$u(x, y) = \frac{1}{2\Delta} [(a_i + b_i x + c_i y)u_i + (a_j + b_j x + c_j y)u_j + (a_k + b_k x + c_k y)u_k] \quad (4.9)$$

$$v(x, y) = \frac{1}{2\Delta} [(a_i + b_i x + c_i y)v_i + (a_j + b_j x + c_j y)v_j + (a_k + b_k x + c_k y)v_k] \quad (4.10)$$

:

$$a_i = \begin{vmatrix} x_j & y_j \\ x_k & y_k \end{vmatrix}; \quad a_j = \begin{vmatrix} x_k & y_k \\ x_i & y_i \end{vmatrix}; \quad a_k = \begin{vmatrix} x_i & y_i \\ x_j & y_j \end{vmatrix}; \quad (4.11)$$

$$b_i = \begin{vmatrix} y_j & 1 \\ y_k & 1 \end{vmatrix}; \quad b_j = \begin{vmatrix} y_k & 1 \\ y_i & 1 \end{vmatrix}; \quad b_k = \begin{vmatrix} y_i & 1 \\ y_j & 1 \end{vmatrix}; \quad (4.12)$$

$$c_i = \begin{vmatrix} 1 & x_j \\ 1 & x_k \end{vmatrix}; \quad c_j = \begin{vmatrix} 1 & x_k \\ 1 & x_i \end{vmatrix}; \quad c_k = \begin{vmatrix} 1 & x_i \\ 1 & x_j \end{vmatrix}; \quad (4.13)$$

$$\Delta = \frac{1}{2} \begin{vmatrix} 1 & x_i & y_i \\ 1 & x_j & y_j \\ 1 & x_k & y_k \end{vmatrix}. \quad (4.14)$$

Δ

:

$$(2.31)$$

$$\sigma = A\varepsilon, \quad (4.15)$$

$$(2.12)$$

$$\varepsilon = Du, \quad (4.16)$$

$D -$

:

$$D = \begin{bmatrix} \frac{\partial}{\partial x} & 0 \\ 0 & \frac{\partial}{\partial y} \\ \frac{\partial}{\partial y} & \frac{\partial}{\partial x} \end{bmatrix}. \quad (4.17)$$

$$(4.9) \quad (4.10)$$

$$\begin{Bmatrix} u \\ v \end{Bmatrix} = \frac{1}{2\Delta} \begin{bmatrix} 1 & 0 & 2 & 0 & 3 & 0 \\ 0 & 1 & 0 & 2 & 0 & 3 \end{bmatrix} \begin{Bmatrix} u_i \\ v_i \\ u_j \\ v_j \\ u_k \\ v_k \end{Bmatrix}, \quad (4.18)$$

$1, 2, 3 -$ (4.2):

$$1(x, y) = a_i + b_i x + c_i y; \quad (4.19)$$

$$2(x, y) = a_j + b_j x + c_j y; \quad (4.20)$$

$$3(x, y) = a_k + b_k x + c_k y. \quad (4.21)$$

, $1 \quad 1 \quad i$
 $0 \quad j, k; \quad 2 \quad 1 \quad j \quad 0$
 $k, i; \quad 3 \quad 1 \quad k \quad 0$
 $i, j.$

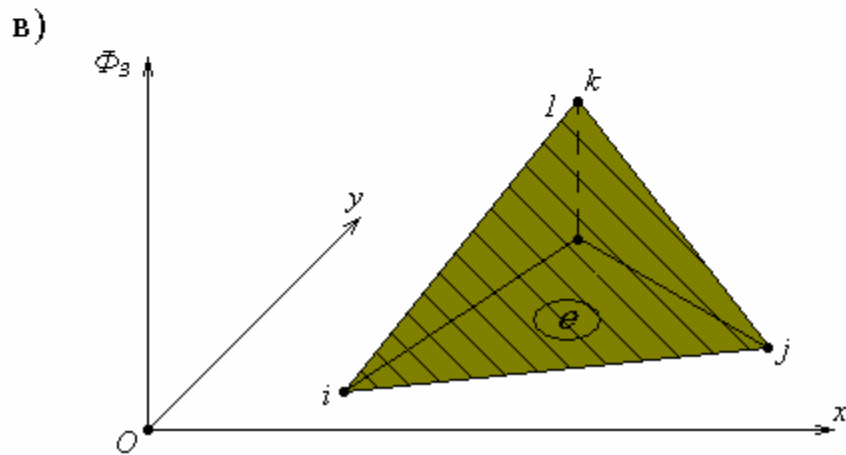
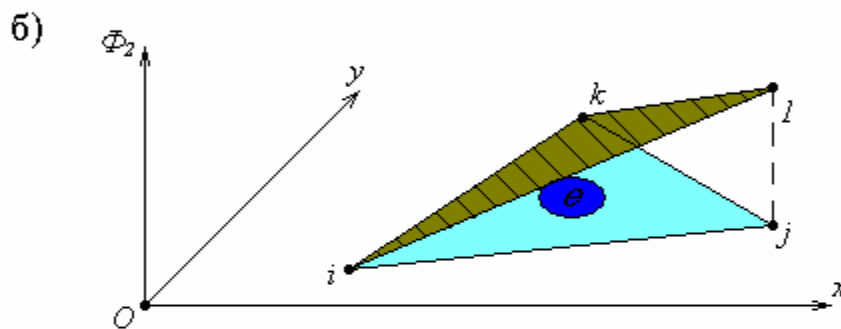
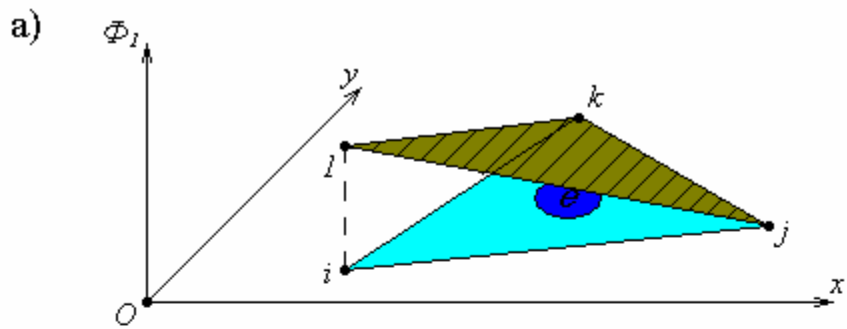

4.2 –

(4.18)

(4.16)

$$\begin{Bmatrix} \varepsilon_x \\ \varepsilon_y \\ \gamma_{xy} \end{Bmatrix} = \begin{bmatrix} \frac{\partial}{\partial x} & 0 \\ 0 & \frac{\partial}{\partial y} \\ \frac{\partial}{\partial y} & \frac{\partial}{\partial x} \end{bmatrix} \cdot \frac{1}{2\Delta} \begin{bmatrix} 1 & 0 & 2 & 0 & 3 & 0 \\ 0 & 1 & 0 & 2 & 0 & 3 \end{bmatrix} \cdot \begin{Bmatrix} u_i \\ v_i \\ u_j \\ v_j \\ u_k \\ v_k \end{Bmatrix}, \quad (4.22)$$

$$\begin{Bmatrix} \varepsilon_x \\ \varepsilon_y \\ \gamma_{xy} \end{Bmatrix} = \frac{1}{2\Delta} \begin{bmatrix} b_i & 0 & b_j & 0 & b_k & 0 \\ 0 & c_i & 0 & c_j & 0 & c_k \\ c_i & b_i & c_j & b_j & c_k & b_k \end{bmatrix} \begin{Bmatrix} u_i \\ v_i \\ u_j \\ v_j \\ u_k \\ v_k \end{Bmatrix}, \quad (4.23)$$

$$\varepsilon = Bu, \quad (4.24)$$

$$B = \frac{1}{2\Delta} \begin{bmatrix} b_i & 0 & b_j & 0 & b_k & 0 \\ 0 & c_i & 0 & c_j & 0 & c_k \\ c_i & b_i & c_j & b_j & c_k & b_k \end{bmatrix}. \quad (4.25)$$

$$U = \iiint_{\Omega} U \, d\Omega, \quad (4.26)$$

$$U = \frac{1}{2} (\sigma_x \varepsilon_x + \sigma_y \varepsilon_y + \tau_{xy} \gamma_{xy}) = \frac{1}{2} \sigma^T \varepsilon. \quad (4.27)$$

$$U = U \cdot h \Delta = \frac{h\Delta}{2} \sigma^T \varepsilon. \quad (4.28)$$

$$V = (F_{xi}h)u_i + (F_{yi}h)v_i + (F_{xj}h)u_j + (F_{yj}h)v_j + (F_{xk}h)u_k + (F_{yk}h)v_k = hu^T F, \quad (4.29)$$

$$F_i \cdot h, F_j \cdot h, F_k \cdot h - \quad , \quad -$$

;

$$F - \quad -$$

$$F = \begin{Bmatrix} F_{xi} \\ F_{yi} \\ F_{xj} \\ F_{yj} \\ F_{xk} \\ F_{yk} \end{Bmatrix}. \quad (4.30)$$

()

$$U = \frac{1}{2}V, \quad (4.31)$$

(4.28) (4.29) :

$$\frac{h\Delta}{2} \sigma^T \varepsilon = \frac{h}{2} u^T F, \quad (4.32)$$

$$\sigma^T \varepsilon \cdot \Delta = u^T F. \quad (4.33)$$

(4.15)

$$(A\varepsilon)^T \varepsilon \cdot \Delta = u^T F, \quad (4.34)$$

()

$$\varepsilon^T A \varepsilon \cdot \Delta = u^T F. \quad (4.35)$$

(4.24)

$$(Bu)^T A(Bu) \cdot \Delta = u^T F, \quad (4.36)$$

$$u^T (B^T AB) u \cdot \Delta = u^T F, \quad (4.37)$$

$$(B^T AB \Delta) u = F, \quad (4.38)$$

$$Ku = F, \quad (4.39)$$

$K -$

$$K = B^T A B \Delta. \quad (4.40)$$

4.1.2

() .

(4.3)

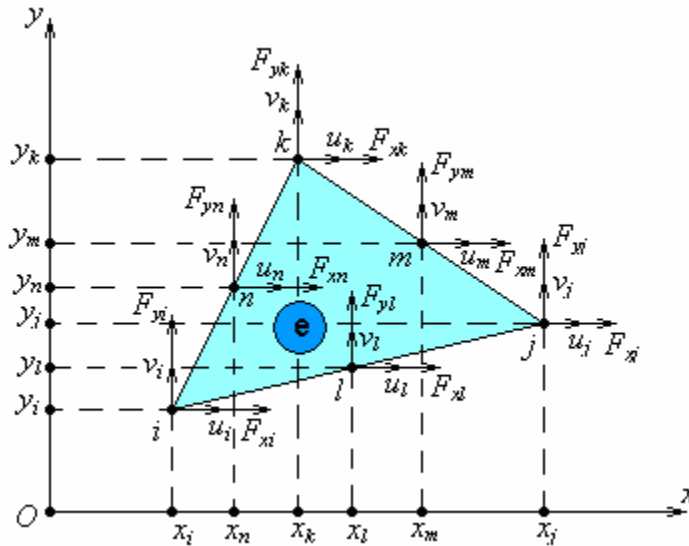

4.3 -

$$u(x, y) = \alpha_1 + \alpha_2 x + \alpha_3 y + \alpha_4 x^2 + \alpha_5 xy + \alpha_6 y^2; \quad (4.41)$$

$$v(x, y) = \beta_1 + \beta_2 x + \beta_3 y + \beta_4 x^2 + \beta_5 xy + \beta_6 y^2. \quad (4.42)$$

$$\alpha_1, \alpha_2, \dots, \alpha_6 \quad \beta_1, \beta_2, \dots, \beta_6$$

:

$$\begin{cases} u(x_i, y_i) = u_i; \\ u(x_j, y_j) = u_j; \\ \dots \\ u(x_n, y_n) = u_n; \end{cases} \quad (4.43)$$

$$\begin{cases} v(x_i, y_i) = v_i; \\ v(x_j, y_j) = v_j; \\ \dots \\ v(x_n, y_n) = v_n, \end{cases} \quad (4.44)$$

(4.41) (4.42):

$$\begin{cases} \alpha_1 + \alpha_2 x_i + \alpha_3 y_i + \alpha_4 x_i^2 + \alpha_5 x_i y_i + \alpha_6 y_i^2 = u_i; \\ \alpha_1 + \alpha_2 x_j + \alpha_3 y_j + \alpha_4 x_j^2 + \alpha_5 x_j y_j + \alpha_6 y_j^2 = u_i; \\ \dots \\ \alpha_1 + \alpha_2 x_n + \alpha_3 y_n + \alpha_4 x_n^2 + \alpha_5 x_n y_n + \alpha_6 y_n^2 = u_n; \end{cases} \quad (4.45)$$

$$\begin{cases} \beta_1 + \beta_2 x_i + \beta_3 y_i + \beta_4 x_i^2 + \beta_5 x_i y_i + \beta_6 y_i^2 = v_i; \\ \beta_1 + \beta_2 x_j + \beta_3 y_j + \beta_4 x_j^2 + \beta_5 x_j y_j + \beta_6 y_j^2 = v_i; \\ \dots \\ \beta_1 + \beta_2 x_n + \beta_3 y_n + \beta_4 x_n^2 + \beta_5 x_n y_n + \beta_6 y_n^2 = v_n, \end{cases} \quad (4.46)$$

:

$$\begin{bmatrix} 1 & x_i & y_i & x_i^2 & x_i y_i & y_i^2 \\ 1 & x_j & y_j & x_j^2 & x_j y_j & y_j^2 \\ \dots & \dots & \dots & \dots & \dots & \dots \\ 1 & x_n & y_n & x_n^2 & x_n y_n & y_n^2 \end{bmatrix} \begin{Bmatrix} \alpha_1 \\ \alpha_2 \\ \dots \\ \alpha_n \end{Bmatrix} = \begin{Bmatrix} u_i \\ u_j \\ \dots \\ u_n \end{Bmatrix}; \quad (4.47)$$

$$\begin{bmatrix} 1 & x_i & y_i & x_i^2 & x_i y_i & y_i^2 \\ 1 & x_j & y_j & x_j^2 & x_j y_j & y_j^2 \\ \dots & \dots & \dots & \dots & \dots & \dots \\ 1 & x_n & y_n & x_n^2 & x_n y_n & y_n^2 \end{bmatrix} \begin{Bmatrix} \beta_1 \\ \beta_2 \\ \dots \\ \beta_n \end{Bmatrix} = \begin{Bmatrix} v_i \\ v_j \\ \dots \\ v_n \end{Bmatrix}. \quad (4.48)$$

(4.47), (4.48)

$$\alpha_1, \alpha_2, \dots, \alpha_6 \quad \beta_1, \beta_2, \dots, \beta_6$$

$$(4.41), (4.42),$$

:

$$\begin{aligned}
u(x, y) = & (a_i + b_i x + c_i y + p_i x^2 + q_i xy + r_i y^2)u_i + \\
& + (a_j + b_j x + c_j y + p_j x^2 + q_j xy + r_j y^2)u_j + \dots \\
& \dots + (a_n + b_n x + c_n y + p_n x^2 + q_n xy + r_n y^2)u_n;
\end{aligned} \tag{4.49}$$

$$\begin{aligned}
v(x, y) = & (a_i + b_i x + c_i y + p_i x^2 + q_i xy + r_i y^2)v_i + \\
& + (a_j + b_j x + c_j y + p_j x^2 + q_j xy + r_j y^2)v_j + \dots \\
& \dots + (a_n + b_n x + c_n y + p_n x^2 + q_n xy + r_n y^2)v_n,
\end{aligned} \tag{4.50}$$

$$\begin{aligned}
\begin{Bmatrix} u(x, y) \\ v(x, y) \end{Bmatrix} = \begin{bmatrix} 1 & 0 & 2 & 0 & 3 & 0 & 4 & 0 & 5 & 0 & 6 & 0 \\ 0 & 1 & 0 & 2 & 0 & 3 & 0 & 4 & 0 & 5 & 0 & 6 \end{bmatrix} \begin{Bmatrix} u_i \\ v_i \\ u_j \\ v_j \\ \dots \\ u_n \\ v_n \end{Bmatrix}, \tag{4.51}
\end{aligned}$$

$$i, j = 1, 2, \dots, 6 \tag{4.4}$$

$$\begin{cases} u_1(x, y) = M_{1,1} + M_{2,1}x + M_{3,1}y + M_{4,1}x^2 + M_{5,1}xy + M_{6,1}y^2; \\ u_2(x, y) = M_{1,2} + M_{2,2}x + M_{3,2}y + M_{4,2}x^2 + M_{5,2}xy + M_{6,2}y^2; \\ \dots \\ u_6(x, y) = M_{1,6} + M_{2,6}x + M_{3,6}y + M_{4,6}x^2 + M_{5,6}xy + M_{6,6}y^2; \end{cases} \tag{4.52}$$

$$p, q = 1, 2, \dots, 6$$

$$M = \begin{bmatrix} 1 & x_i & y_i & x_i^2 & x_i y_i & y_i^2 \\ 1 & x_j & y_j & x_j^2 & x_j y_j & y_j^2 \\ \dots & \dots & \dots & \dots & \dots & \dots \\ 1 & x_n & y_n & x_n^2 & x_n y_n & y_n^2 \end{bmatrix}^{-1}. \tag{4.53}$$

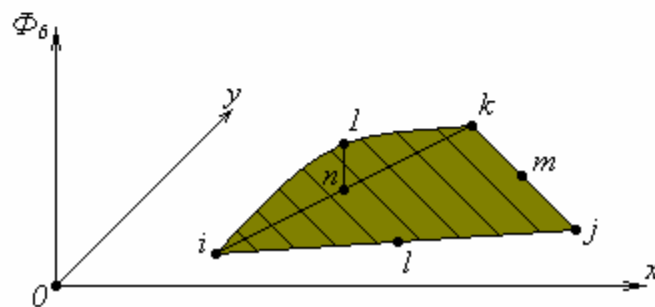
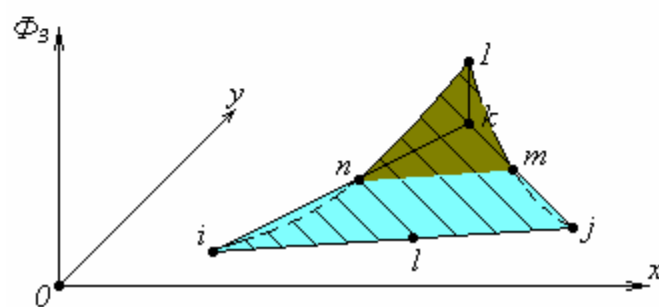
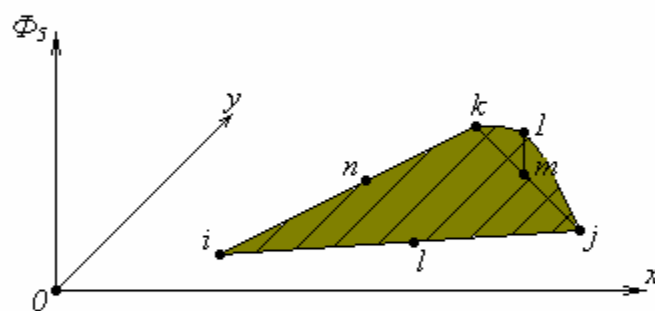
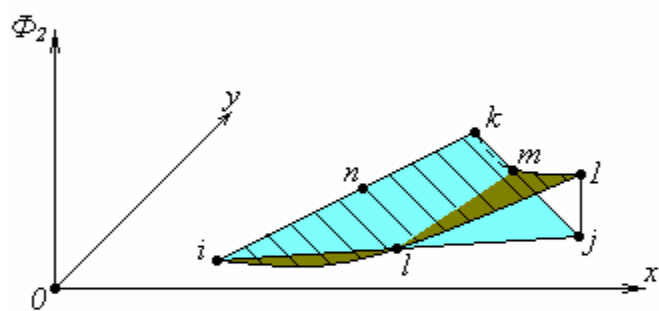
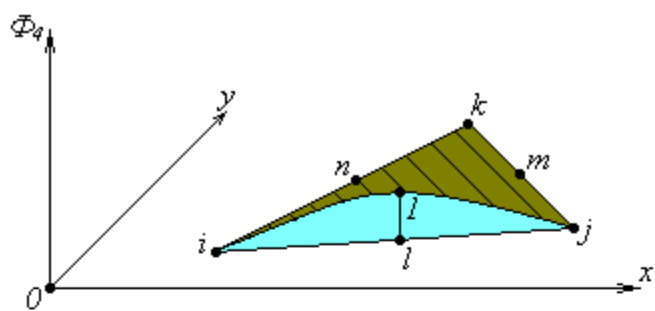
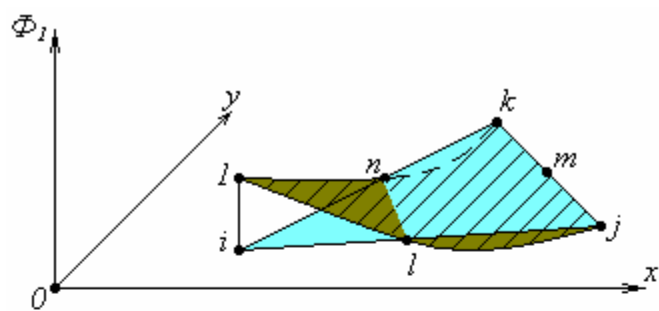

4.4 -

$$B(x, y) = \begin{bmatrix} \frac{\partial}{\partial x} & 0 \\ 0 & \frac{\partial}{\partial y} \\ \frac{\partial}{\partial y} & \frac{\partial}{\partial x} \end{bmatrix} \begin{bmatrix} 1 & 0 & 2 & 0 & \dots & 6 & 0 \\ 0 & 1 & 0 & 2 & \dots & 0 & 6 \end{bmatrix}. \quad (4.54)$$

(4.26)

(4.27), (4.15) (4.24)

$$\begin{aligned}
U &= \iiint_{\Omega} U \, d\Omega = \iiint_{\Omega} \frac{1}{2} \sigma^T \varepsilon \, d\Omega = \iiint_{\Omega} \frac{1}{2} (A\varepsilon)^T \varepsilon \, d\Omega = \iiint_{\Omega} \frac{1}{2} \varepsilon^T A \varepsilon \, d\Omega = \\
&+ \iiint_{\Omega} \frac{1}{2} (Bu)^T A (Bu) \, d\Omega = u^T \left(\iiint_{\Omega} \frac{1}{2} B^T A B \, d\Omega \right) u = \frac{1}{2} h u^T \left(\iint_S B^T A B \, dS \right) u,
\end{aligned} \tag{4.55}$$

$$V = h u^T F, \tag{4.56}$$

 $F =$

$$F = \left\{ \begin{array}{c} F_{xi} \\ F_{yi} \\ F_{xj} \\ F_{yj} \\ \dots \\ F_{xm} \\ F_{ym} \end{array} \right\}. \tag{4.57}$$

(4.31)

$$\frac{1}{2} h u^T \left(\iint_S B^T A B \, dS \right) u = \frac{1}{2} h u^T F, \tag{4.58}$$

$$K u = F, \tag{4.59}$$

 $K =$

$$K = \iint_S B^T A B \, dS. \tag{4.60}$$

4.2

4.2.1

(4.5). -

$$u(x, y) = \alpha_1 + \alpha_2 x + \alpha_3 y + \alpha_4 xy; \quad (4.61)$$

$$v(x, y) = \beta_1 + \beta_2 x + \beta_3 y + \beta_4 xy. \quad (4.62)$$

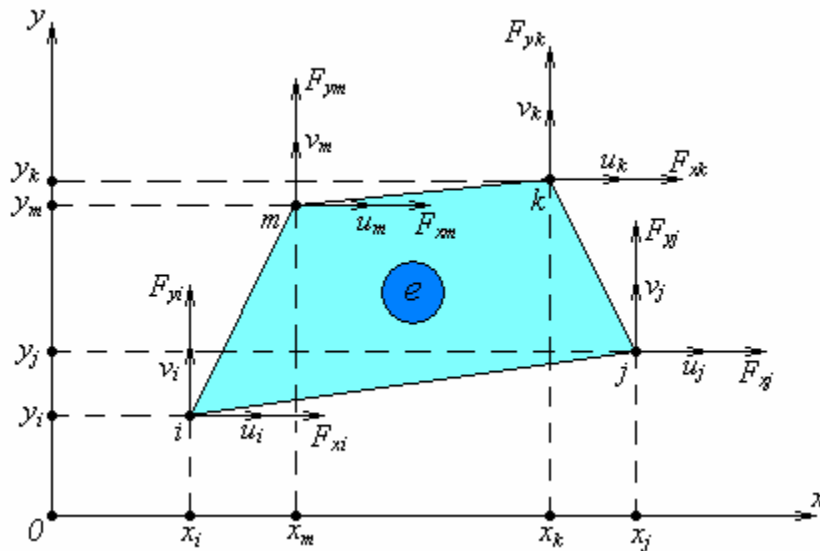

4.5 -

$$\alpha_1, \alpha_2, \alpha_3, \alpha_4 \quad \beta_1, \beta_2, \beta_3, \beta_4$$

:

$$\begin{cases} u(x_i, y_i) = u_i; \\ u(x_j, y_j) = u_j; \\ u(x_k, y_k) = u_k; \\ u(x_m, y_m) = u_m; \end{cases} \quad (4.63)$$

$$\begin{cases} v(x_i, y_i) = v_i; \\ v(x_j, y_j) = v_j; \\ v(x_k, y_k) = v_k; \\ v(x_m, y_m) = v_m, \end{cases} \quad (4.64)$$

(4.61) (4.62):

$$\begin{cases} \alpha_1 + \alpha_2 x_i + \alpha_3 y_i + \alpha_4 x_i y_i = u_i; \\ \alpha_1 + \alpha_2 x_j + \alpha_3 y_j + \alpha_4 x_j y_j = u_j; \\ \alpha_1 + \alpha_2 x_k + \alpha_3 y_k + \alpha_4 x_k y_k = u_k; \\ \alpha_1 + \alpha_2 x_n + \alpha_3 y_n + \alpha_4 x_n y_n = u_m; \end{cases} \quad (4.65)$$

$$\begin{cases} \beta_1 + \beta_2 x_i + \beta_3 y_i + \beta_4 x_i y_i = v_i; \\ \beta_1 + \beta_2 x_j + \beta_3 y_j + \beta_4 x_j y_j = v_j; \\ \beta_1 + \beta_2 x_k + \beta_3 y_k + \beta_4 x_k y_k = v_k; \\ \beta_1 + \beta_2 x_n + \beta_3 y_n + \beta_4 x_n y_n = v_m, \end{cases} \quad (4.66)$$

$$\begin{bmatrix} 1 & x_i & y_i & x_i y_i \\ 1 & x_j & y_j & x_j y_j \\ 1 & x_k & y_k & x_k y_k \\ 1 & x_m & y_m & x_m y_m \end{bmatrix} \begin{Bmatrix} \alpha_i \\ \alpha_j \\ \alpha_k \\ \alpha_m \end{Bmatrix} = \begin{Bmatrix} u_i \\ u_j \\ u_k \\ u_m \end{Bmatrix}; \quad (4.67)$$

$$\begin{bmatrix} 1 & x_i & y_i & x_i y_i \\ 1 & x_j & y_j & x_j y_j \\ 1 & x_k & y_k & x_k y_k \\ 1 & x_m & y_m & x_m y_m \end{bmatrix} \begin{Bmatrix} \beta_i \\ \beta_j \\ \beta_k \\ \beta_m \end{Bmatrix} = \begin{Bmatrix} v_i \\ v_j \\ v_k \\ v_m \end{Bmatrix}. \quad (4.68)$$

(4.67), (4.68)

$\alpha_1, \alpha_2, \alpha_3, \alpha_4 \quad \beta_1, \beta_2, \beta_3, \beta_4 \quad (4.61), (4.62), \quad -$

:

$$u(x, y) = (a_i + b_i x + c_i y + d_i xy)u_i + (a_j + b_j x + c_j y + d_j xy)u_j + \dots \quad (4.69)$$

$$\dots + (a_k + b_k x + c_k y + d_k xy)u_k + (a_m + b_m x + c_m y + d_m xy)u_m;$$

$$v(x, y) = (a_i + b_i x + c_i y + d_i xy)v_i + (a_j + b_j x + c_j y + d_j xy)v_j + \dots \quad (4.70)$$

$$\dots + (a_k + b_k x + c_k y + d_k xy)v_k + (a_m + b_m x + c_m y + d_m xy)v_m,$$

:

$$\begin{cases} u(x, y) \\ v(x, y) \end{cases} = \begin{bmatrix} 1 & 0 & 2 & 0 & 3 & 0 & 4 & 0 \\ 0 & 1 & 0 & 2 & 0 & 3 & 0 & 4 \end{bmatrix} \begin{cases} u_i \\ v_i \\ u_j \\ v_j \\ u_k \\ v_k \\ u_m \\ v_m \end{cases}, \quad (4.71)$$

$$i, j, k, m = 1, 2, 3, 4 \quad (4.6)$$

$$\begin{cases} u_1(x, y) = M_{1,1} + M_{2,1}x + M_{3,1}y + M_{4,1}xy; \\ u_2(x, y) = M_{1,2} + M_{2,2}x + M_{3,2}y + M_{4,2}xy; \\ u_3(x, y) = M_{1,3} + M_{2,3}x + M_{3,3}y + M_{4,3}xy; \\ u_4(x, y) = M_{1,4} + M_{2,4}x + M_{3,4}y + M_{4,4}xy; \end{cases} \quad (4.72)$$

$$p, q = 1, 2, 3, 4$$

$$M = \begin{bmatrix} 1 & x_i & y_i & x_i y_i \\ 1 & x_j & y_j & x_j y_j \\ 1 & x_k & y_k & x_k y_k \\ 1 & x_m & y_m & x_m y_m \end{bmatrix}^{-1}. \quad (4.73)$$

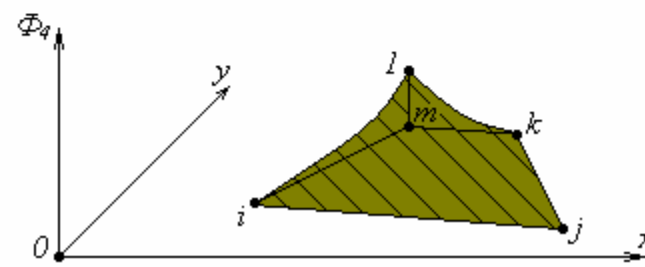
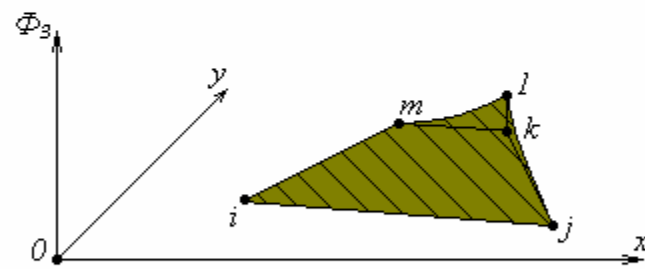
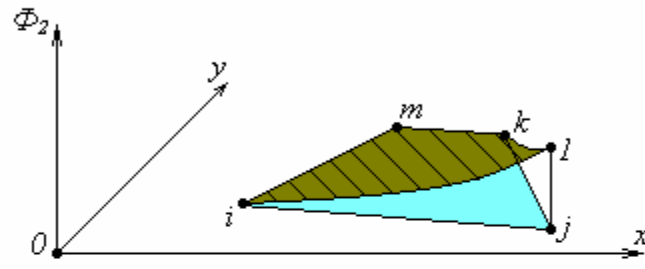
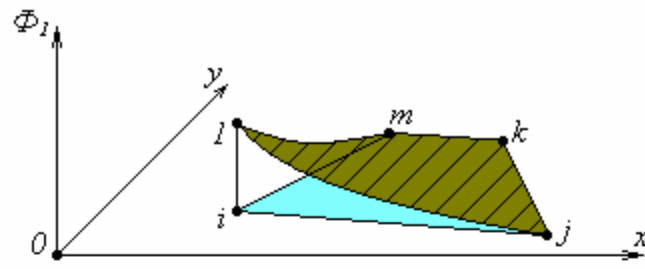

4.6 –

$$B(x, y) = \begin{bmatrix} \frac{\partial}{\partial x} & 0 \\ 0 & \frac{\partial}{\partial y} \\ \frac{\partial}{\partial y} & \frac{\partial}{\partial x} \end{bmatrix} \begin{bmatrix} \phantom{\frac{\partial}{\partial x}} & \phantom{\frac{\partial}{\partial y}} & \phantom{\frac{\partial}{\partial x}} & \phantom{\frac{\partial}{\partial y}} \\ \phantom{\frac{\partial}{\partial x}} & \phantom{\frac{\partial}{\partial y}} & \phantom{\frac{\partial}{\partial x}} & \phantom{\frac{\partial}{\partial y}} \\ \phantom{\frac{\partial}{\partial x}} & \phantom{\frac{\partial}{\partial y}} & \phantom{\frac{\partial}{\partial x}} & \phantom{\frac{\partial}{\partial y}} \\ \phantom{\frac{\partial}{\partial x}} & \phantom{\frac{\partial}{\partial y}} & \phantom{\frac{\partial}{\partial x}} & \phantom{\frac{\partial}{\partial y}} \end{bmatrix} = \quad (4.74)$$

$$= \begin{bmatrix} \frac{\partial}{\partial x} & 0 & \frac{\partial}{\partial x} & 0 & \frac{\partial}{\partial x} & 0 & \frac{\partial}{\partial x} & 0 \\ 0 & \frac{\partial}{\partial y} & 0 & \frac{\partial}{\partial y} & 0 & \frac{\partial}{\partial y} & 0 & \frac{\partial}{\partial y} \\ \frac{\partial}{\partial y} & \frac{\partial}{\partial x} & \frac{\partial}{\partial y} & \frac{\partial}{\partial x} & \frac{\partial}{\partial y} & \frac{\partial}{\partial x} & \frac{\partial}{\partial y} & \frac{\partial}{\partial x} \end{bmatrix} \cdot \quad (4.55)$$

$$U = \frac{1}{2} h u^T \left(\iint_S B^T A B dS \right) u, \quad (4.75)$$

$$V = h u^T F, \quad (4.76)$$

$F =$

$$F = \begin{Bmatrix} F_{xi} \\ F_{yi} \\ F_{xj} \\ F_{yj} \\ F_{xk} \\ F_{yk} \\ F_{xm} \\ F_{ym} \end{Bmatrix} \quad (4.77)$$

(4.31)

$$\frac{1}{2} h u^T \left(\iint_S B^T A B dS \right) u = \frac{1}{2} h u^T F, \quad (4.78)$$

$$Ku = F, \quad (4.79)$$

$K -$

$$K = \iint_S B^T A B dS. \quad (4.80)$$

4.2.2

(4.7)

$$u(x, y) = \alpha_1 + \alpha_2 x + \alpha_3 y + \alpha_4 x^2 + \alpha_5 xy + \alpha_6 y^2 + \alpha_7 x^3 + \alpha_8 y^3; \quad (4.81)$$

$$v(x, y) = \beta_1 + \beta_2 x + \beta_3 y + \beta_4 x^2 + \beta_5 xy + \beta_6 y^2 + \beta_7 x^3 + \beta_8 y^3. \quad (4.82)$$

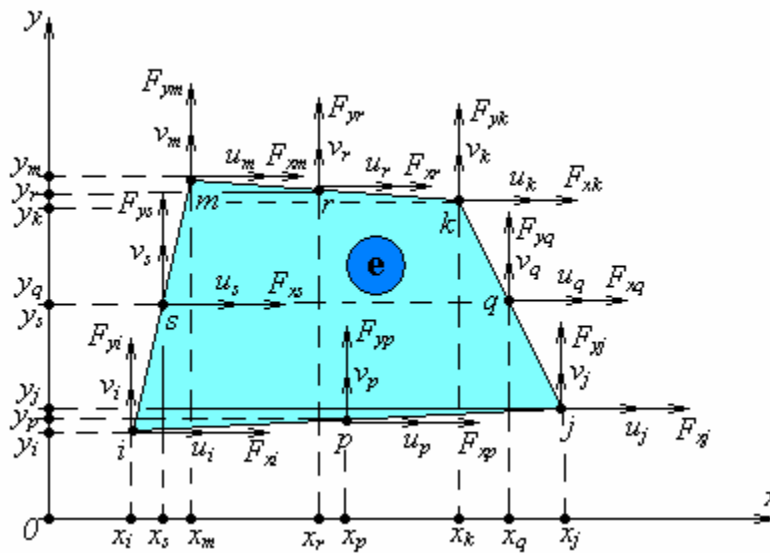

4.7 -

:

$$\begin{cases} u(x_i, y_i) = u_i; \\ u(x_j, y_j) = u_j; \\ \dots \\ u(x_s, y_s) = u_s; \end{cases} \quad (4.83)$$

$$\begin{cases} v(x_i, y_i) = v_i; \\ v(x_j, y_j) = v_j; \\ \dots \\ v(x_s, y_s) = v_s, \end{cases} \quad (4.84)$$

(4.81) (4.82):

$$\begin{cases} \alpha_1 + \alpha_2 x_i + \alpha_3 y_i + \alpha_4 x_i^2 + \alpha_5 x_i y_i + \alpha_6 y_i^2 + \alpha_7 x_i^3 + \alpha_8 y_i^3; \\ \alpha_1 + \alpha_2 x_j + \alpha_3 y_j + \alpha_4 x_j^2 + \alpha_5 x_j y_j + \alpha_6 y_j^2 + \alpha_7 x_j^3 + \alpha_8 y_j^3; \\ \dots \\ \alpha_1 + \alpha_2 x_s + \alpha_3 y_s + \alpha_4 x_s^2 + \alpha_5 x_s y_s + \alpha_6 y_s^2 + \alpha_7 x_s^3 + \alpha_8 y_s^3; \end{cases} \quad (4.85)$$

$$\begin{cases} \beta_1 + \beta_2 x_i + \beta_3 y_i + \beta_4 x_i^2 + \beta_5 x_i y_i + \beta_6 y_i^2 + \beta_7 x_i^3 + \beta_8 y_i^3; \\ \beta_1 + \beta_2 x_j + \beta_3 y_j + \beta_4 x_j^2 + \beta_5 x_j y_j + \beta_6 y_j^2 + \beta_7 x_j^3 + \beta_8 y_j^3; \\ \dots \\ \beta_1 + \beta_2 x_s + \beta_3 y_s + \beta_4 x_s^2 + \beta_5 x_s y_s + \beta_6 y_s^2 + \beta_7 x_s^3 + \beta_8 y_s^3, \end{cases} \quad (4.86)$$

:

$$\begin{bmatrix} 1 & x_i & y_i & x_i^2 & x_i y_i & y_i^2 & x_i^3 & y_i^3 \\ 1 & x_j & y_j & x_j^2 & x_j y_j & y_j^2 & x_j^3 & y_j^3 \\ \dots & \dots & \dots & \dots & \dots & \dots & \dots & \dots \\ 1 & x_s & y_s & x_s^2 & x_s y_s & y_s^2 & x_s^3 & y_s^3 \end{bmatrix} \begin{bmatrix} \alpha_1 \\ \alpha_2 \\ \dots \\ \alpha_8 \end{bmatrix} = \begin{bmatrix} u_i \\ u_j \\ \dots \\ u_s \end{bmatrix}; \quad (4.87)$$

$$\begin{bmatrix} 1 & x_i & y_i & x_i^2 & x_i y_i & y_i^2 & x_i^3 & y_i^3 \\ 1 & x_j & y_j & x_j^2 & x_j y_j & y_j^2 & x_j^3 & y_j^3 \\ \dots & \dots & \dots & \dots & \dots & \dots & \dots & \dots \\ 1 & x_s & y_s & x_s^2 & x_s y_s & y_s^2 & x_s^3 & y_s^3 \end{bmatrix} \begin{bmatrix} \beta_1 \\ \beta_2 \\ \dots \\ \beta_8 \end{bmatrix} = \begin{bmatrix} v_i \\ v_j \\ \dots \\ v_s \end{bmatrix}. \quad (4.88)$$

-

1, 2, ..., 8, 1, 2, ..., 8 (4.81)

(4.82), :

$$\begin{aligned}
u(x, y) = & (a_i + b_i x + c_i y + d_i x^2 + f_i xy + g_i y^2 + h_i x^3 + t_i y^3)u_i + \\
& + (a_j + b_j x + c_j y + d_j x^2 + f_j xy + g_j y^2 + h_j x^3 + t_j y^3)u_j + \dots \quad (4.89) \\
& .. + (a_s + b_s x + c_s y + d_s x^2 + f_s xy + g_s y^2 + h_s x^3 + t_s y^3)u_s;
\end{aligned}$$

$$\begin{aligned}
v(x, y) = & (a_i + b_i x + c_i y + d_i x^2 + f_i xy + g_i y^2 + h_i x^3 + t_i y^3)v_i + \\
& + (a_j + b_j x + c_j y + d_j x^2 + f_j xy + g_j y^2 + h_j x^3 + t_j y^3)v_j + \dots \quad (4.90) \\
& .. + (a_s + b_s x + c_s y + d_s x^2 + f_s xy + g_s y^2 + h_s x^3 + t_s y^3)v_s,
\end{aligned}$$

$$\left\{ \begin{matrix} u(x, y) \\ v(x, y) \end{matrix} \right\} = \begin{bmatrix} 1 & 0 & 2 & 0 & \dots & 8 & 0 \\ 0 & 1 & 0 & 2 & \dots & 0 & 8 \end{bmatrix} \left\{ \begin{matrix} u_i \\ v_i \\ u_j \\ v_j \\ \dots \\ u_s \\ v_s \end{matrix} \right\}, \quad (4.91)$$

$i, j = 1, 2, \dots, 8$ (4.8):

$$\left\{ \begin{aligned}
u_1(x, y) &= u_{11} + u_{21}x + M_{31}y + M_{41}x^2 + M_{51}xy + M_{61}y^2 + M_{71}x^3 + M_{81}y^3; \\
u_2(x, y) &= u_{12} + u_{22}x + M_{32}y + M_{42}x^2 + M_{52}xy + M_{62}y^2 + M_{72}x^3 + M_{82}y^3; \\
&\dots \\
u_8(x, y) &= u_{18} + u_{28}x + M_{38}y + M_{48}x^2 + M_{58}xy + M_{68}y^2 + M_{78}x^3 + M_{88}y^3.
\end{aligned} \right. \quad (4.92)$$

$$M = \begin{bmatrix} 1 & x_i & y_i & x_i^2 & x_i y_i & y_i^2 & x_i^3 & y_i^3 \\ 1 & x_j & y_j & x_j^2 & x_j y_j & y_j^2 & x_j^3 & y_j^3 \\ \dots & \dots & \dots & \dots & \dots & \dots & \dots & \dots \\ 1 & x_s & y_s & x_s^2 & x_s y_s & y_s^2 & x_s^3 & y_s^3 \end{bmatrix}^{-1}. \quad (4.93)$$

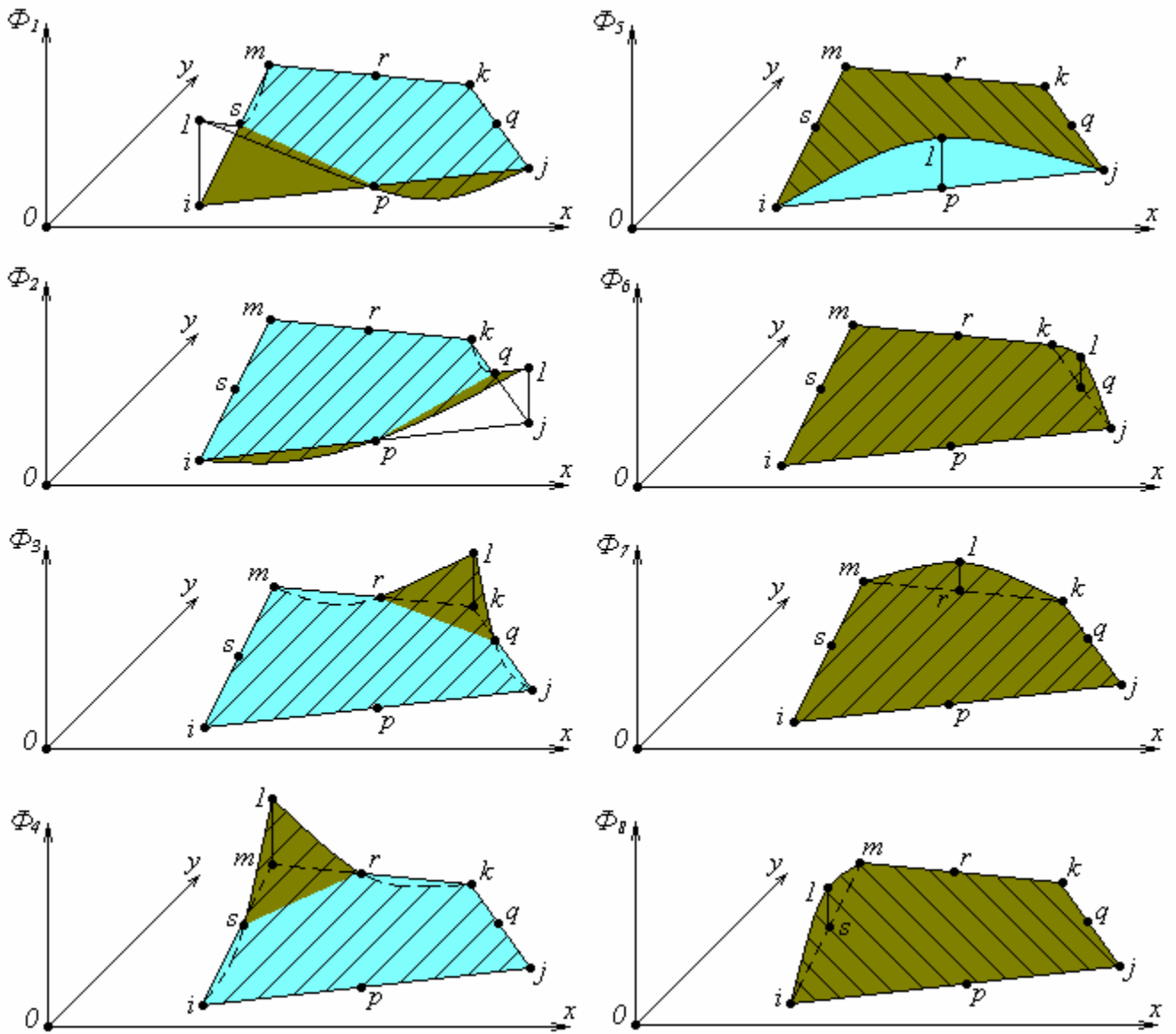

4.8 -

$$B(x, y) = \begin{bmatrix} \frac{\partial}{\partial x} & 0 \\ 0 & \frac{\partial}{\partial y} \\ \frac{\partial}{\partial y} & \frac{\partial}{\partial x} \end{bmatrix} \begin{bmatrix} 1 & 0 & \dots & 8 & 0 \\ 0 & 1 & \dots & 0 & 8 \end{bmatrix} = \begin{bmatrix} \frac{\partial}{\partial x} & 0 & \dots & \frac{\partial}{\partial x} & 0 \\ 0 & \frac{\partial}{\partial y} & \dots & 0 & \frac{\partial}{\partial y} \\ \frac{\partial}{\partial y} & \frac{\partial}{\partial x} & \dots & \frac{\partial}{\partial y} & \frac{\partial}{\partial x} \end{bmatrix} \quad (4.94)$$

h

(4.55)

$$U = \frac{1}{2} h u^T \left(\iint_S B^T A B dS \right) u, \quad (4.95)$$

$$V = h u^T F, \quad (4.96)$$

F –

$$F = \begin{Bmatrix} F_{x1} \\ F_{y1} \\ F_{x2} \\ F_{y2} \\ \dots \\ F_{x8} \\ F_{y8} \end{Bmatrix}. \quad (4.97)$$

(4.31)

$$\frac{1}{2} h u^T \left(\iint_S B^T A B dS \right) u = \frac{1}{2} h u^T F, \quad (4.98)$$

$$K u = F, \quad (4.99)$$

K –

$$K = \iint_S B^T A B dS. \quad (4.100)$$

4.1

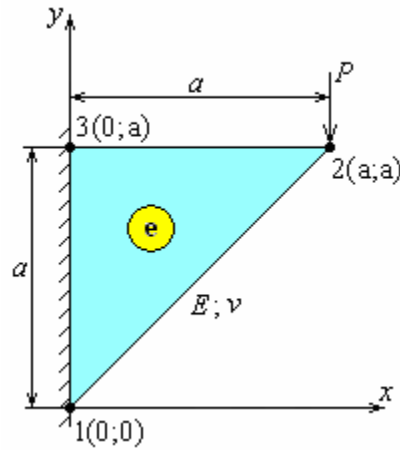

$$\Delta = \frac{1}{2} \begin{vmatrix} 1 & x_1 & y_1 \\ 1 & x_2 & y_2 \\ 1 & x_3 & y_3 \end{vmatrix} = \frac{1}{2} \begin{vmatrix} 1 & 0 & 0 \\ 1 & a & a \\ 1 & 0 & a \end{vmatrix} = \frac{a^2}{2}.$$

:

$$a_1 = \begin{vmatrix} x_2 & y_2 \\ x_3 & y_3 \end{vmatrix} = \begin{vmatrix} a & a \\ 0 & a \end{vmatrix} = a^2;$$

$$a_2 = \begin{vmatrix} x_3 & y_3 \\ x_1 & y_1 \end{vmatrix} = \begin{vmatrix} 0 & a \\ 0 & 0 \end{vmatrix} = 0;$$

$$a_3 = \begin{vmatrix} x_1 & y_1 \\ x_2 & y_2 \end{vmatrix} = \begin{vmatrix} 0 & 0 \\ a & a \end{vmatrix} = 0;$$

$$b_1 = \begin{vmatrix} y_2 & 1 \\ y_3 & 1 \end{vmatrix} = \begin{vmatrix} a & 1 \\ a & 1 \end{vmatrix} = 0;$$

$$b_2 = \begin{vmatrix} y_3 & 1 \\ y_1 & 1 \end{vmatrix} = \begin{vmatrix} a & 1 \\ 0 & 1 \end{vmatrix} = a;$$

$$b_3 = \begin{vmatrix} y_1 & 1 \\ y_2 & 1 \end{vmatrix} = \begin{vmatrix} 0 & 1 \\ a & 1 \end{vmatrix} = -a;$$

$$c_1 = \begin{vmatrix} 1 & x_2 \\ 1 & x_3 \end{vmatrix} = \begin{vmatrix} 1 & a \\ 1 & 0 \end{vmatrix} = -a;$$

$$c_2 = \begin{vmatrix} 1 & x_3 \\ 1 & x_1 \end{vmatrix} = \begin{vmatrix} 1 & 0 \\ 1 & 0 \end{vmatrix} = 0;$$

$$c_3 = \begin{vmatrix} 1 & x_1 \\ 1 & x_2 \end{vmatrix} = \begin{vmatrix} 1 & 0 \\ 1 & a \end{vmatrix} = a.$$

$$\begin{aligned} B &= \frac{1}{2\Delta} \begin{bmatrix} b_1 & 0 & b_2 & 0 & b_3 & 0 \\ 0 & c_1 & 0 & c_2 & 0 & c_3 \\ c_1 & b_1 & c_2 & b_2 & c_3 & b_3 \end{bmatrix} = \frac{1}{2 \cdot \frac{a^2}{2}} \begin{bmatrix} 0 & 0 & a & 0 & -a & 0 \\ 0 & -a & 0 & 0 & 0 & a \\ -a & 0 & 0 & a & a & -a \end{bmatrix} = \\ &= \frac{1}{a} \begin{bmatrix} 0 & 0 & 1 & 0 & -1 & 0 \\ 0 & -1 & 0 & 0 & 0 & 1 \\ -1 & 0 & 0 & 1 & 1 & -1 \end{bmatrix}. \end{aligned}$$

$$A = \frac{E}{1-\nu^2} \begin{bmatrix} 1 & \nu & 0 \\ \nu & 1 & 0 \\ 0 & 0 & \frac{1-\nu}{2} \end{bmatrix}.$$

$$K = \Delta \cdot B^T A^T B = \frac{E}{4(1-\nu^2)} \begin{bmatrix} 1-\nu & 0 & 0 & -(1-\nu) & -(1-\nu) & 1-\nu \\ 0 & 2 & -2\nu & 0 & 2\nu & -2 \\ 0 & -2\nu & 2 & 0 & -2 & 2\nu \\ -(1-\nu) & 0 & 0 & 1-\nu & 1-\nu & -(1-\nu) \\ -(1-\nu) & 2\nu & -2 & 1-\nu & 3-\nu & -(1+\nu) \\ 1-\nu & -2 & 2\nu & -(1-\nu) & -(1+\nu) & 3-\nu \end{bmatrix}.$$

:

$$u_1 = 0; \nu_1 = 0; u_3 = 0; \nu_3 = 0.$$

:

$$F_{x_2} = 0; F_{y_2} = -P.$$

$$\frac{E}{4(1-\nu^2)} \begin{matrix} & \begin{matrix} u_1 & v_1 & u_2 & v_2 & u_3 & v_3 \end{matrix} \\ \begin{matrix} 1-\nu & 0 & 0 & -(1-\nu) & -(1-\nu) & 1-\nu \\ 0 & 2 & -2\nu & 0 & 2\nu & -2 \\ 0 & -2\nu & 2 & 0 & -2 & 2\nu \\ -(1-\nu) & 0 & 0 & 1-\nu & 1-\nu & -(1-\nu) \\ -(1-\nu) & 2\nu & -2 & 1-\nu & 3-\nu & -(1+\nu) \\ 1-\nu & -2 & 2\nu & -(1-\nu) & -(1+\nu) & 3-\nu \end{matrix} \end{matrix} \begin{matrix} \left[\begin{matrix} 0 \\ 0 \\ u_2 \\ v_2 \\ 0 \\ 0 \end{matrix} \right] \end{matrix} = \begin{matrix} \left\{ \begin{matrix} F_{x1} \\ F_{y1} \\ 0 \\ -P \\ F_{x3} \\ F_{y3} \end{matrix} \right\} \end{matrix}.$$

$$\frac{E}{4(1-\nu^2)} \begin{bmatrix} 2 & 0 \\ 0 & 1-\nu \end{bmatrix} \begin{Bmatrix} u_2 \\ v_2 \end{Bmatrix} = \begin{Bmatrix} 0 \\ -P \end{Bmatrix},$$

$$\begin{cases} u_2 = 0; \\ v_2 = -4(1+\nu)\frac{P}{E}. \end{cases}$$

= 0,3

$$\begin{cases} u_2 = 0; \\ v_2 = -5,2\frac{P}{E}. \end{cases}$$

$$\begin{Bmatrix} F_{x1} \\ F_{y2} \\ F_{x3} \\ F_{y3} \end{Bmatrix} = \frac{E}{4(1-\nu^2)} \begin{bmatrix} 0 & -(1-\nu) \\ -2\nu & 0 \\ -2 & 1-\nu \\ 2\nu & -(1-\nu) \end{bmatrix} \begin{Bmatrix} 0 \\ -4(1+\nu)\frac{P}{E} \end{Bmatrix} = \begin{Bmatrix} P \\ 0 \\ -P \\ P \end{Bmatrix}.$$

$$\begin{cases} F_{x1} + F_{x2} + F_{x3} = P = 0 - P = 0; \\ F_{y1} + F_{y2} + F_{y3} = 0 - P + P = 0; \\ \sum m_3(\vec{F}_k) = F_{x1} \cdot a - P \cdot a = P \cdot a - P \cdot a = 0. \end{cases}$$

$$\begin{Bmatrix} \varepsilon_x \\ \varepsilon_y \\ \gamma_{xy} \end{Bmatrix} = \frac{1}{a} \begin{bmatrix} 0 & 0 & 1 & 0 & -1 & 0 \\ 0 & -1 & 0 & 0 & 0 & 1 \\ -1 & 0 & 0 & 1 & 1 & -1 \end{bmatrix} \begin{Bmatrix} 0 \\ 0 \\ 0 \\ -4(1+\nu)\frac{P}{E} \\ 0 \\ 0 \end{Bmatrix} = \begin{Bmatrix} 4(1+\nu)\frac{P}{Ea} \\ 0 \\ -4(1+\nu)\frac{P}{Ea} \end{Bmatrix}.$$

$$\nu = 0,3$$

$$\begin{cases} \varepsilon_x = 5,2 \frac{P}{Ea}; \\ \varepsilon_y = 0; \\ \gamma_{xy} = -5,2 \frac{P}{Ea}. \end{cases}$$

$$\begin{Bmatrix} \sigma_x \\ \sigma_y \\ \tau_{xy} \end{Bmatrix} = \frac{E}{1-\nu^2} \begin{bmatrix} 1 & \nu & 0 \\ \nu & 1 & 0 \\ 0 & 0 & \frac{1-\nu}{2} \end{bmatrix} \begin{Bmatrix} 4(1+\nu)\frac{P}{Ea} \\ 0 \\ -4(1+\nu)\frac{P}{Ea} \end{Bmatrix} = \begin{Bmatrix} \frac{4P}{(1-\nu)a} \\ \frac{4P}{(1-\nu)a} \\ -\frac{2P}{a} \end{Bmatrix}.$$

$$\nu = 0,3$$

$$\begin{cases} \sigma_x = 5,714 \frac{P}{a}; \\ \sigma_y = 5,714 \frac{P}{a}; \\ \tau_{xy} = -2 \frac{P}{a}. \end{cases}$$

4.2

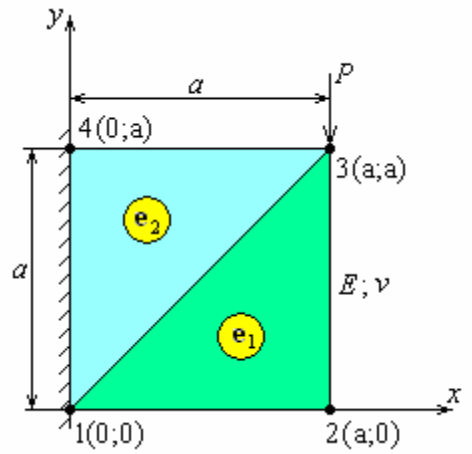

1 2.

:

$$\Delta_{e_1} = \frac{1}{2} \begin{vmatrix} 1 & 0 & 0 \\ 1 & a & 0 \\ 1 & a & a \end{vmatrix} = \frac{a^2}{2};$$

$$\Delta_{e_2} = \frac{1}{2} \begin{vmatrix} 1 & 0 & 0 \\ 1 & a & a \\ 1 & 0 & a \end{vmatrix} = \frac{a^2}{2}.$$

1:

$$a_1^{e_1} = a^2; a_2^{e_1} = 0; a_3^{e_1} = 0;$$

$$b_1^{e_1} = -a; b_2^{e_1} = a; b_3^{e_1} = 0;$$

$$c_1^{e_1} = 0; b_2^{e_1} = -a; b_3^{e_1} = a.$$

2:

$$a_1^{e_2} = a^2; a_2^{e_2} = 0; a_3^{e_2} = 0;$$

$$b_1^{e_2} = 0; b_2^{e_2} = a; b_3^{e_2} = -a;$$

$$c_1^{e_2} = -a; b_2^{e_2} = 0; b_3^{e_2} = a.$$

$$B_{e1} = \frac{1}{a} \begin{bmatrix} -1 & 0 & 1 & 0 & 0 & 0 \\ 0 & 0 & 0 & -1 & 0 & 1 \\ 0 & -1 & -1 & 1 & 1 & 0 \end{bmatrix} \quad 1:$$

$$B_{e2} = \frac{1}{a} \begin{bmatrix} 0 & 0 & 1 & 0 & -1 & 0 \\ 0 & -1 & 0 & 0 & 0 & 1 \\ -1 & 0 & 0 & 1 & 1 & -1 \end{bmatrix} \quad 2:$$

$$A = \frac{E}{1-\nu^2} \begin{bmatrix} 1 & \nu & 0 \\ \nu & 1 & 0 \\ 0 & 0 & \frac{1-\nu}{2} \end{bmatrix}$$

$$K_{e1} = \frac{E}{4(1-\nu^2)} \begin{array}{c} 1: \\ \begin{array}{cccccc} u_1 & v_1 & u_2 & v_2 & u_3 & v_3 \\ \hline 2 & 0 & -2 & 2\nu & 0 & -2\nu \\ 0 & 1-\nu & 1-\nu & -(1-\nu) & -(1-\nu) & 0 \\ -2 & 1-\nu & 3-\nu & -(1+\nu) & -(1-\nu) & 2\nu \\ 2\nu & -(1-\nu) & 1(1+\nu) & 3-\nu & 1-\nu & -2 \\ 0 & -(1-\nu) & -(1-\nu) & 1-\nu & 1-\nu & 0 \\ -2\nu & 0 & 2\nu & -2 & 0 & 2 \end{array} \end{array}$$

$$K_{e2} = \frac{E}{4(1-\nu^2)} \begin{array}{c} 2: \\ \begin{array}{cccccc} u_1 & v_1 & u_3 & v_3 & u_4 & v_4 \\ \hline 1-\nu & 0 & 0 & -(1-\nu) & -(1-\nu) & 1-\nu \\ 0 & 2 & -2\nu & 0 & 2\nu & -2 \\ 0 & -2\nu & 2 & 0 & -2 & 2\nu \\ -(1-\nu) & 0 & 0 & 1-\nu & 1-\nu & -(1-\nu) \\ -(1-\nu) & 2\nu & -2 & 1-\nu & 3-\nu & -(1+\nu) \\ 1-\nu & -2 & 2\nu & -(1-\nu) & -(1+\nu) & 3-\nu \end{array} \end{array}$$

$$K = \frac{E}{4(1-\nu^2)} \begin{bmatrix} u_1 & v_1 & u_2 & v_2 & u_3 & v_3 & u_4 & v_4 \\ 3-\nu & 0 & -2 & 2\nu & 0 & -(1+\nu) & -(1-\nu) & 1-\nu \\ 0 & 3-\nu & 1-\nu & -(1-\nu) & -(1+\nu) & 0 & 2\nu & -2 \\ -2 & 1-\nu & 3-\nu & -(1+\nu) & -(1-\nu) & 2\nu & 0 & 0 \\ 2\nu & -(1-\nu) & -(1+\nu) & 3-\nu & 1-\nu & -2 & 0 & 0 \\ 0 & -(1+\nu) & -(1-\nu) & 1-\nu & 3-\nu & 0 & -2 & 2\nu \\ -(1+\nu) & 0 & 2\nu & -2 & 0 & 3-\nu & 1-\nu & -(1-\nu) \\ -(1-\nu) & 2\nu & 0 & 0 & -2 & 1-\nu & 3-\nu & -(1+\nu) \\ 1-\nu & -2 & 0 & 0 & 2\nu & -(1-\nu) & -(1+\nu) & 3-\nu \end{bmatrix}$$

:

$$u_1 = 0; v_1 = 0; u_4 = 0; v_4 = 0.$$

:

$$F_{x2} = 0; F_{y2} = 0; F_{x3} = 0; F_{y4} = -P.$$

$$\frac{E}{4(1-\nu^2)} \begin{bmatrix} u_1 & v_1 & u_2 & v_2 & u_3 & v_3 & u_4 & v_4 \\ 3-\nu & 0 & -2 & 2\nu & 0 & -(1+\nu) & -(1-\nu) & 1-\nu \\ 0 & 3-\nu & 1-\nu & -(1-\nu) & -(1+\nu) & 0 & 2\nu & -2 \\ -2 & 1-\nu & 3-\nu & -(1+\nu) & -(1-\nu) & 2\nu & 0 & 0 \\ 2\nu & -(1-\nu) & -(1+\nu) & 3-\nu & 1-\nu & -2 & 0 & 0 \\ 0 & -(1+\nu) & -(1-\nu) & 1-\nu & 3-\nu & 0 & -2 & 2\nu \\ -(1+\nu) & 0 & 2\nu & -2 & 0 & 3-\nu & 1-\nu & -(1-\nu) \\ -(1-\nu) & 2\nu & 0 & 0 & -2 & 1-\nu & 3-\nu & -(1+\nu) \\ 1-\nu & -2 & 0 & 0 & 2\nu & -(1-\nu) & -(1+\nu) & 3-\nu \end{bmatrix} \begin{bmatrix} 0 \\ 0 \\ u_2 \\ v_2 \\ u_3 \\ v_3 \\ 0 \\ 0 \end{bmatrix} = \begin{bmatrix} F_{x1} \\ F_{y1} \\ 0 \\ 0 \\ 0 \\ -P \\ F_{x4} \\ F_{y4} \end{bmatrix}$$

$$\frac{E}{4(1-\nu^2)} \begin{bmatrix} 3-\nu & -(1+\nu) & -(1-\nu) & 2\nu \\ -(1+\nu) & 3-\nu & 1-\nu & -2 \\ -(1-\nu) & 1-\nu & 3-\nu & 0 \\ 2\nu & -2 & 0 & 3-\nu \end{bmatrix} \begin{bmatrix} u_2 \\ v_2 \\ u_3 \\ v_3 \end{bmatrix} = \begin{bmatrix} 0 \\ 0 \\ 0 \\ -P \end{bmatrix},$$

$$\begin{cases} u_2 = -\frac{4(1-\nu^2)}{7+2\nu-\nu^2} \frac{P}{E}; \\ v_2 = -\frac{4(1+\nu)(4+\nu-\nu^2)}{7+2\nu-\nu^2} \frac{P}{E}; \\ u_3 = \frac{4(1-\nu^2)(1+\nu)}{7+2\nu-\nu^2} \frac{P}{E}; \\ v_3 = -\frac{4(1+\nu)(5-\nu^2)}{7+2\nu-\nu^2} \frac{P}{E}. \end{cases}$$

$$= 0,3$$

$$\begin{cases} u_2 = -0,46 \frac{P}{E}; \\ v_2 = -2,92 \frac{P}{E}; \\ u_3 = 0,63 \frac{P}{E}; \\ v_3 = -3,14 \frac{P}{E}. \end{cases}$$

$$\begin{Bmatrix} F_{x1} \\ F_{y1} \\ F_{x4} \\ F_{y4} \end{Bmatrix} = \frac{E}{4(1-\nu^2)} \begin{bmatrix} -2 & 2\nu & 0 & -(1+\nu) \\ 1-\nu & -(1-\nu) & -(1+\nu) & 0 \\ 0 & 0 & -2 & 1-\nu \\ 0 & 0 & 2\nu & -(1-\nu) \end{bmatrix} \begin{Bmatrix} u_2 \\ v_2 \\ u_3 \\ v_3 \end{Bmatrix} = \begin{Bmatrix} \frac{2(1-\nu^2)}{7+2\nu-\nu^2} P \\ -P \\ \frac{5+2\nu+\nu^2}{7+2\nu-\nu^2} P \end{Bmatrix}$$

$$= 0,3$$

$$\begin{cases} F_{x1} = P; \\ F_{y1} = 0,24P; \\ F_{x4} = -P; \\ F_{y4} = 0,76P. \end{cases}$$

1:

$$\begin{cases} \varepsilon_x^{e1} \\ \varepsilon_y^{e1} \\ \gamma_{xy}^{e1} \end{cases} = \frac{1}{a} \begin{bmatrix} -1 & 0 & 1 & 0 & 0 & 0 \\ 0 & 0 & 0 & -1 & 0 & 1 \\ 0 & -1 & -1 & 1 & 1 & 0 \end{bmatrix} \begin{cases} u_1 \\ v_1 \\ u_2 \\ v_2 \\ u_3 \\ v_3 \end{cases} = \begin{cases} -\frac{4(1-\nu^2)}{7+2\nu-\nu^2} \frac{P}{Ea} \\ -\frac{4(1-\nu^2)}{7+2\nu-\nu^2} \frac{P}{Ea} \\ -\frac{8(1+\nu)^2}{7+2\nu-\nu^2} \frac{P}{Ea} \end{cases}$$

= 0,3

$$\begin{cases} \varepsilon_x^{e1} = -0,49 \frac{P}{Ea}; \\ \varepsilon_y^{e1} = -0,49 \frac{P}{Ea}; \\ \gamma_{xy}^{e1} = -1,8 \frac{P}{Ea}. \end{cases}$$

2:

$$\begin{cases} \varepsilon_x^{e2} \\ \varepsilon_y^{e2} \\ \gamma_{xy}^{e2} \end{cases} = \frac{1}{a} \begin{bmatrix} 0 & 0 & 1 & 0 & -1 & 0 \\ 0 & -1 & 0 & 0 & 0 & 1 \\ -1 & 0 & 0 & 1 & 1 & -1 \end{bmatrix} \begin{cases} u_1 \\ v_1 \\ u_3 \\ v_3 \\ u_4 \\ v_4 \end{cases} = \begin{cases} -\frac{4(1-\nu^2)(1+\nu)}{7+2\nu-\nu^2} \frac{P}{Ea} \\ 0 \\ -\frac{4(5-\nu^2)(1+\nu)}{7+2\nu-\nu^2} \frac{P}{Ea} \end{cases}$$

= 0,3

$$\begin{cases} \varepsilon_x^{e2} = 0,63 \frac{P}{Ea}; \\ \varepsilon_y^{e2} = 0; \\ \gamma_{xy}^{e2} = -3,4 \frac{P}{Ea}. \end{cases}$$

1:

$$\begin{Bmatrix} \sigma_x^{e1} \\ \sigma_y^{e1} \\ \tau_{xy}^{e1} \end{Bmatrix} = \frac{E}{1-\nu^2} \begin{bmatrix} 1 & \nu & 0 \\ \nu & 1 & 0 \\ 0 & 0 & \frac{1-\nu}{2} \end{bmatrix} \begin{Bmatrix} \varepsilon_x^{e1} \\ \varepsilon_y^{e1} \\ \gamma_{xy}^{e1} \end{Bmatrix} = \begin{Bmatrix} \frac{4(1+\nu)}{7+2\nu-\nu^2} \frac{P}{a} \\ \frac{4(1+\nu)}{7+2\nu-\nu^2} \frac{P}{a} \\ \frac{4(1+\nu)}{7+2\nu-\nu^2} \frac{P}{a} \end{Bmatrix}.$$

$$= 0,3$$

$$\begin{cases} \sigma_x^{e1} = 0,69 \frac{P}{a}; \\ \sigma_y^{e1} = 0,69 \frac{P}{a}; \\ \tau_{xy}^{e1} = 0,69 \frac{P}{a}. \end{cases}$$

2:

$$\begin{Bmatrix} \sigma_x^{e2} \\ \sigma_y^{e2} \\ \tau_{xy}^{e2} \end{Bmatrix} = \frac{E}{1-\nu^2} \begin{bmatrix} 1 & \nu & 0 \\ \nu & 1 & 0 \\ 0 & 0 & \frac{1-\nu}{2} \end{bmatrix} \begin{Bmatrix} \varepsilon_x^{e2} \\ \varepsilon_y^{e2} \\ \gamma_{xy}^{e2} \end{Bmatrix} = \begin{Bmatrix} \frac{4(1+\nu)}{7+2\nu-\nu^2} \frac{P}{a} \\ \frac{4(1+\nu)}{7+2\nu-\nu^2} \frac{P}{a} \\ -\frac{2\nu(5-\nu^2)}{7+2\nu-\nu^2} \frac{P}{a} \end{Bmatrix}.$$

$$= 0,3$$

$$\begin{cases} \sigma_x^{e2} = 0,69 \frac{P}{a}; \\ \sigma_y^{e2} = 0,21 \frac{P}{a}; \\ \tau_{xy}^{e2} = -1,31 \frac{P}{a}. \end{cases}$$

4.3

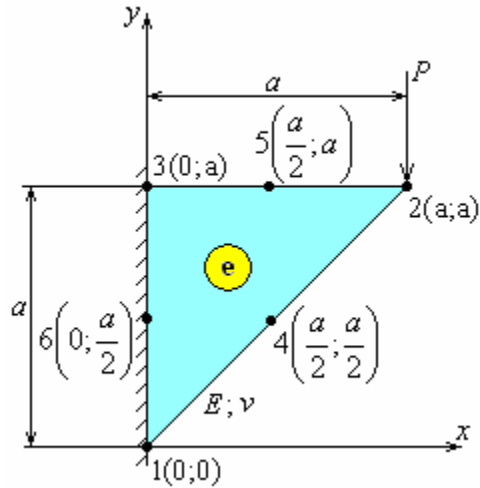

$$M = \begin{bmatrix} 1 & 0 & 0 & 0 & 0 & 0 \\ 1 & a & a & a^2 & a^2 & a^2 \\ 1 & 0 & a & 0 & 0 & a^2 \\ 1 & \frac{a}{2} & \frac{a}{2} & \frac{a^2}{4} & \frac{a^2}{4} & \frac{a^2}{4} \\ 1 & \frac{a}{2} & a & \frac{a^2}{4} & \frac{a^2}{2} & a^2 \\ 1 & 0 & \frac{a}{2} & 0 & 0 & \frac{a^2}{4} \end{bmatrix}^{-1} = \begin{bmatrix} 1 & 0 & 0 & 0 & 0 & 0 \\ 0 & -\frac{1}{a} & \frac{1}{a} & \frac{4}{a} & 0 & -\frac{4}{a} \\ -\frac{3}{a} & 0 & -\frac{1}{a} & 0 & 0 & \frac{4}{a} \\ 0 & \frac{2}{a^2} & \frac{2}{a^2} & 0 & -\frac{4}{a^2} & 0 \\ 0 & 0 & -\frac{4}{a^2} & -\frac{4}{a^2} & \frac{4}{a^2} & \frac{4}{a^2} \\ \frac{2}{a^2} & 0 & \frac{2}{a^2} & 0 & 0 & -\frac{4}{a^2} \end{bmatrix}$$

:

$$u_1(x, y) = 1 - \frac{3}{a}x + \frac{2}{a^2}y^2;$$

$$u_2(x, y) = -\frac{1}{a}x + \frac{2}{a^2}x^2;$$

$$u_3(x, y) = \frac{1}{a}x - \frac{1}{a}y + \frac{2}{a^2}x^2 - \frac{4}{a^2}xy + \frac{2}{a^2}y^2;$$

$$u_4(x, y) = \frac{4}{a}x - \frac{4}{a^2}xy;$$

$$s_5(x, y) = -\frac{4}{a^2}x^2 + \frac{4}{a^2}xy;$$

$$s_6(x, y) = -\frac{4}{a}x + \frac{4}{a}y + \frac{4}{a^2}xy - \frac{4}{a^2}y^2.$$

$$B(x, y) = \begin{bmatrix} 0 & 0 & -\frac{3}{a} + \frac{4}{a^2}y \\ 0 & -\frac{3}{a} + \frac{4}{a^2}y & 0 \\ -\frac{1}{a} + \frac{4}{a^2}x & 0 & 0 \\ 0 & 0 & -\frac{1}{a} + \frac{4}{a^2}x \\ \frac{1}{a} + \frac{4}{a^2}x - \frac{4}{a^2}y & 0 & -\frac{1}{a} - \frac{4}{a^2}x + \frac{4}{a^2}y \\ 0 & -\frac{1}{a} - \frac{4}{a^2}x + \frac{4}{a^2}y & \frac{1}{a} + \frac{4}{a^2}x - \frac{4}{a^2}y \\ \frac{4}{a} - \frac{4}{a^2}y & 0 & -\frac{4}{a^2}x \\ 0 & -\frac{4}{a^2}x & \frac{4}{a} - \frac{4}{a^2}y \\ -\frac{8}{a^2}x + \frac{4}{a^2}y & 0 & \frac{4}{a^2}x \\ 0 & \frac{4}{a^2}x & -\frac{8}{a^2}x + \frac{4}{a^2}y \\ -\frac{4}{a} + \frac{4}{a^2}y & 0 & \frac{4}{a} + \frac{4}{a^2}x - \frac{8}{a^2}y \\ 0 & \frac{4}{a} + \frac{4}{a^2}x - \frac{8}{a^2}y & -\frac{4}{a} + \frac{4}{a^2}y \end{bmatrix}^T.$$

$$k = B^T A B:$$

$$k_{1,1} = \frac{1}{2}(3a - 4y)^2 \frac{E}{(1 + \nu)a^4};$$

$$k_{1,2} = 0;$$

$$k_{1,3} = 0;$$

$$k_{1,4} = \frac{1}{2}(a - 4x) \frac{3a - 4y}{(1 + \nu)a^4};$$

...

$$k_{12,11} = \frac{8(y-a)}{1-\nu} \cdot \frac{(a+x-2y)E}{a^4};$$

$$k_{12,12} = -8E \cdot \frac{\nu(a-4)^2 - 3a^2 + (10y-4x)a + 8xy - 9y^2 - 2x^2}{(1-\nu^2)a^4}.$$

$$K = \frac{E}{12(1-\nu^2)} \begin{bmatrix} u_1 & v_1 & u_2 & v_2 & u_3 & v_3 & u_4 & v_4 & u_5 & v_5 & u_6 & v_6 \\ 3(1-\nu) & 0 & 0 & 1-\nu & 1-\nu & -(1-\nu) & 0 & -4(1-\nu) & 0 & 0 & -4(1-\nu) & 4(1-\nu) \\ & 6 & 2\nu & 0 & -2\nu & 2 & -8\nu & 0 & 0 & 0 & 8\nu & -8 \\ & & 6 & 0 & 2 & -2\nu & 0 & -8\nu & -8 & 8\nu & 0 & 0 \\ & & & 3(1-\nu) & -(1-\nu) & 1-\nu & -4(1-\nu) & 0 & 4(1-\nu) & -4(1-\nu) & 0 & 0 \\ & & & & 3(3-\nu) & -3(1+\nu) & 0 & 0 & -8 & 4(1-\nu) & -4(1-\nu) & 8\nu \\ & & & & & 3(3-\nu) & 0 & 0 & 8\nu & -4(1-\nu) & 4(1-\nu) & -8 \\ & & & & & & 8(3-\nu) & -4(1+\nu) & -8(1-\nu) & 4(1+\nu) & -16 & 4(1+\nu) \\ & & & & & & & 8(3-\nu) & 4(1+\nu) & -16 & 4(1+\nu) & -8(1-\nu) \\ & & & & & & & & 8(3-\nu) & -4(1+\nu) & 0 & -4(1+\nu) \\ & & & & & & & & & 8(3-\nu) & -4(1+\nu) & 0 \\ & & & & & & & & & & 8(3-\nu) & -4(1+\nu) \\ & & & & & & & & & & & 8(3-\nu) \end{bmatrix}$$

$$K_{i,j} = \int_0^a dx \int_x^a k_{i,j} dy.$$

:

$$u_1 = 0; v_1 = 0; u_3 = 0; v_3 = 0; u_6 = 0; v_6 = 0.$$

:

$$F_{x2} = 0; F_{y2} = -P; F_{x4} = 0; F_{y4} = 0; F_{x5} = 0; F_{y5} = 0.$$

$$\frac{E}{12(1-\nu^2)} \begin{bmatrix} u_1 & v_1 & u_2 & v_2 & u_3 & v_3 & u_4 & v_4 & u_5 & v_5 & u_6 & v_6 \\ 3(1-\nu) & 0 & 0 & 1-\nu & 1-\nu & -(1-\nu) & 0 & -4(1-\nu) & 0 & 0 & -4(1-\nu) & 4(1-\nu) \\ & 6 & 2\nu & 0 & -2\nu & 2 & -8\nu & 0 & 0 & 0 & 8\nu & -8 \\ & & 6 & 0 & 2 & -2\nu & 0 & -8\nu & -8 & 8\nu & 0 & 0 \\ & & & 3(1-\nu) & -(1-\nu) & 1-\nu & -4(1-\nu) & 0 & 4(1-\nu) & -4(1-\nu) & 0 & 0 \\ & & & & 3(3-\nu) & -3(1+\nu) & 0 & 0 & -8 & 4(1-\nu) & -4(1-\nu) & 8\nu \\ & & & & & 3(3-\nu) & 0 & 0 & 8\nu & -4(1-\nu) & 4(1-\nu) & -8 \\ & & & & & & 8(3-\nu) & -4(1+\nu) & -8(1-\nu) & 4(1+\nu) & -16 & 4(1+\nu) \\ & & & & & & & 8(3-\nu) & 4(1+\nu) & -16 & 4(1+\nu) & -8(1-\nu) \\ & & & & & & & & 8(3-\nu) & -4(1+\nu) & 0 & -4(1+\nu) \\ & & & & & & & & & 8(3-\nu) & -4(1+\nu) & 0 \\ & & & & & & & & & & 8(3-\nu) & -4(1+\nu) \\ & & & & & & & & & & & 8(3-\nu) \end{bmatrix} \begin{bmatrix} 0 \\ 0 \\ u_2 \\ v_2 \\ 0 \\ 0 \\ u_4 \\ v_4 \\ u_5 \\ v_5 \\ 0 \\ 0 \end{bmatrix} = \begin{bmatrix} F_{x1} \\ F_{y1} \\ 0 \\ -P \\ F_{x3} \\ F_{y3} \\ 0 \\ 0 \\ 0 \\ 0 \\ F_{x6} \\ F_{y6} \end{bmatrix}$$

$$\frac{E}{12(1-\nu^2)} \begin{bmatrix} 6 & 0 & 0 & -8\nu & -8 & 8\nu \\ 0 & 3(1-\nu) & -4(1-\nu) & 0 & 4(1-\nu) & -4(1-\nu) \\ 0 & -4(1-\nu) & 8(3-\nu) & -4(1+\nu) & -8(1-\nu) & 4(1-\nu) \\ -8\nu & 0 & -4(1+\nu) & 8(3-\nu) & 4(1+\nu) & -16 \\ -8 & 4(1-\nu) & -8(1-\nu) & 4(1+\nu) & 8(3-\nu) & -4(1+\nu) \\ 8\nu & -4(1-\nu) & 4(1-\nu) & -16 & -4(1+\nu) & 8(3-\nu) \end{bmatrix} \begin{bmatrix} u_2 \\ v_2 \\ u_4 \\ v_4 \\ u_5 \\ v_5 \end{bmatrix} = \begin{bmatrix} 0 \\ -P \\ 0 \\ 0 \\ 0 \\ 0 \end{bmatrix}$$

$$= 0,3$$

$$\begin{cases} u_2 = 5,87 \frac{P}{E}; \\ v_2 = -19,40 \frac{P}{E}; \\ u_4 = -1,26 \frac{P}{E}; \\ v_4 = -4,51 \frac{P}{E}; \\ u_5 = 4,20 \frac{P}{E}; \\ v_5 = -5,19 \frac{P}{E}. \end{cases}$$

$$\begin{Bmatrix} F_{x1} \\ F_{y1} \\ F_{x3} \\ F_{y3} \\ F_{x6} \\ F_{y6} \end{Bmatrix} = \frac{E}{12(1-\nu^2)} \begin{bmatrix} 0 & 1-\nu & 0 & -4(1-\nu) & 0 & 0 \\ 2\nu & 0 & -8\nu & 0 & 0 & 0 \\ 2 & -(1-\nu) & 0 & 0 & -8 & 4(1-\nu) \\ -2\nu & 1-\nu & 0 & 0 & 8\nu & -4(1-\nu) \\ 0 & 0 & -16 & 4(1+\nu) & 0 & -4(1+\nu) \\ 0 & 0 & 4(1+\nu) & -8(1-\nu) & -4(1+\nu) & 0 \end{bmatrix} \begin{Bmatrix} u_2 \\ v_2 \\ u_4 \\ v_4 \\ u_5 \\ v_5 \end{Bmatrix}$$

$$= 0,3$$

$$\begin{cases} F_{x1} = -0,088P; \\ F_{y1} = 0,600P; \\ F_{x3} = -2,088P; \\ F_{y3} = 0,688P; \\ F_{x6} = 2,176P; \\ F_{y6} = -0,288P. \end{cases}$$

$$\begin{cases} \sum \vec{F}_{kx} = F_{x1} + F_{x2} + F_{x3} + F_{x4} + F_{x5} + F_{x6} = -0,088 + 0 - 2,088 + 0 + 0 + 2,176 = 0; \\ \sum \vec{F}_k = F_{y1} + F_{y2} + F_{y3} + F_{y4} + F_{y5} + F_{y6} = 0,600P - P + 0,688P + 0 + 0 - 0,288P = 0; \\ \sum m_3(\vec{F}_k) = F_{x1} \cdot a + F_{y2} \cdot a + F_{x4} \cdot \frac{a}{2} + F_{y4} \cdot \frac{a}{2} + F_{y5} \cdot \frac{a}{2} + F_{x6} \cdot \frac{a}{2} = -0,088P \cdot a - P \cdot a + \\ + 0 \cdot \frac{a}{2} + 0 \cdot \frac{a}{2} + 0 \cdot \frac{a}{2} + 2,176P \cdot a = 0. \end{cases}$$

$$\begin{Bmatrix} \varepsilon_x \\ \varepsilon_y \\ \gamma_{xy} \end{Bmatrix} = B(x, y) \cdot \begin{Bmatrix} u_1 \\ v_1 \\ u_2 \\ v_2 \\ \dots \\ u_6 \\ v_6 \end{Bmatrix} = \begin{Bmatrix} \frac{12(1+\nu)(8\nu^2+3\nu-9)}{8\nu+9} \cdot \frac{P}{Ea^2} (x-2y+a) \\ -\frac{24(1+\nu)}{8\nu+9} \cdot \frac{P}{Ea^2} x \\ -\frac{12(1+\nu)}{8\nu+9} \cdot \frac{P}{Ea^2} [8(1+\nu)x+2y-a] \end{Bmatrix}$$

$$\begin{Bmatrix} \sigma_x \\ \sigma_y \\ \tau_{xy} \end{Bmatrix} = \frac{E}{1-\nu^2} \begin{bmatrix} 1 & \nu & 0 \\ \nu & 1 & 0 \\ 0 & 0 & \frac{1-\nu}{2} \end{bmatrix} \begin{Bmatrix} \varepsilon_x \\ \varepsilon_y \\ \gamma_{xy} \end{Bmatrix} = \begin{Bmatrix} -\frac{12P}{a^2}(x-2y+a) \\ -\frac{12P}{a^2} \left[\frac{8\nu^2+11\nu+2}{8\nu+9}x + \nu(2y-a) \right] \\ -\frac{6P}{a^2} \cdot \frac{8(1+\nu)x+2y-a}{8\nu+9} \end{Bmatrix}.$$

$$\begin{cases} \varepsilon_x = 0: & x-2y+a=0; \\ \varepsilon_y = 0: & x=0; \\ \gamma_{xy} = 0: & 8(1+\nu)x+2y-a=0. \end{cases}$$

$$\begin{cases} \sigma_x = 0: & x-2y+a=0; \\ \sigma_y = 0: & \frac{8\nu^2+11\nu+2}{\nu(8\nu+9)}x+2y-a=0; \\ \tau_{xy} = 0: & 8(1+\nu)x+2y-a. \end{cases}$$

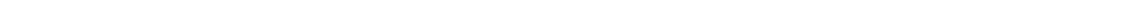

1. -
: .- .: , 1979.
2. . . .- .:
, 1970.-288 .
3. .- ., .- .
. . .- .: , 1989.-190 .
4. Gallagher R.H. Finite Element Analysis.- New Jersey: Prentice-Hall, 1975.
5. , , : : 3 .- .:
, 1968.- .1.-567 .
6. . ., . ., . . ANSYS
: .- .: , 2004.
7. . ., . . . -
. - ., 1964.-608 ., .

()

,

.
60×84/16.
.
350 . . . 175.
.

40007, - , 2

2365 08.12.2005 .

40007, - , 2