

# Multi Operator BTS Aesthetic Tower Design for Metropolitan City

A. Windharto, A. Setiawan

ITSDC (Institute Technology Sepuluh nopember Design Center)

DESIGNCENTER building 2<sup>nd</sup> floor, Jl. Teknik Sipil no, 1 Kampus ITS, Surabaya 60111, Indonesia,

South East Asia

itsdesigncenter@yahoo.com, andset1@gmail.com

## Abstract

The growth of wireless and mobile technology stimulate development of telecommunication infrastructure, Placement of BTS (Base Transceivers Station) tower in the city cause environmental problems by inadequate space while operators install their own Tower lead to "tower forest" that caused aesthetic disruption and other social problems.

The method is Concurrent engineering-Integrated Digital Design for good quality, cost, delivery and so all important process can be conducted simultaneously. The result is 3D geometry and photorealistic image for decision makers. The Implementation are Aesthetic BTS Tower as lighting tower, church tower and adaptable for any city needs of icon and landmark.

## Keywords:

Aesthetic BTS City Tower – Design – Multi operator

## 1 INTRODUCTION

BTS as telecommunication infrastructure product growth along with increasing of wireless and mobile technology demand. In the implementation, placement of the BTS (Base Transceivers Station) tower in the city often caused many environmental problems in the residential areas. Inadequate space of the city limits telecommunication infrastructure building progress.

Every BTS Tower has own operator from telecommunication company. Each operator can install their own BTS tower, we can imagine if this condition continuous, there will be "tower forest" in the city that will be followed with other problems such as, disruption for city aesthetic, maintenance, and other social problems.

Other considerable aspects are legal aspect and manufacturing aspect. for example Indonesian authorities have prepared to launch new regulation to provide multi user telecommunication operator in the same BTS. In other hand, local manufacture does not ready to accommodate it yet. They do not have any design solution of BTS Tower that meet requirement of multi operator need, aesthetic and cost effectiveness. to import total product would be very expensive and not considered at all by local operators.

The aim of this research is to answers the problems trough cooperation with manufacturer that hopefully will produce aesthetic multi operator tower (e-tower). This e- tower is designed into city aesthetic element and regulation tools in city planning. This product is meant to be alternative product for local manufacture in order to compete in global market for telecommunication infrastructure. This research will also support to local manufacturer and authority.

The design research method is Concurrent engineering - Integrated Digital Design using digital process design (CAD-CAM-CAE) in order to gain shorter lead-time, better product quality and competitiveness that meet good QCD

(Quality, Cost and Delivery). With this method, design activities, engineering analysis, marketing activities and cost estimation can be conducted simultaneously. Resumed digital geometry data from this research will be useful for CNC machine for prototyping activity.

The result in form 3D solid model and photorealistic image can be used as comprehensive presentation for business decision makers.

The Implementation of the design solutions are Aesthetic BTS Tower (E-Tower) as City lighting tower, mosque/ church tower, city signage, landmark, city clock tower, and adaptable for any city need and characteristic, icon and city landmark.

## 2 BTS INFRASTRUCTURE IMPLEMENTATION AND DESIGN

### 2.1 Problems in Indonesian cities caused by BTS placement

Indonesia has ten telecommunication operators, and each of them has their own BTS tower and can place it anywhere they want as they got the permit action by regulator. This uncoordinated action cause sometime conflict both for the operators and authority. Single tower for single operator cause business confrontation for BTS coverage area and local permit conflict. The tower itself has bad shape, structure and construction and becoming disruption to city plan. Worse case happened in settlement area which causes other social environmental problem. Discomfort, accident, not well maintained tower often happened and become more complicated problem.

### 2.2 Existing BTS tower in Indonesia

BTS Tower design in Indonesia is dividing into two kinds which are conventional and camouflage tower.

The conventional BTS tower is tower with commonly metal structural that only meet technical requirement to holds the

radio transceivers that define a cell and coordinates of the radio link to protocols with the mobile device. The BTS just become networking component of a mobile communications system from which all signals are sent and received.

The conventional BTS Design is would not be discuss here because of it design and technically aspect would not meet the requirement of being Multi Operator BTS Aesthetic Tower (e-tower).

E-tower design would refer to camouflage tower design in concealment but give better aesthetic and availability for local manufacturing ability and multi operator usage. The existing camouflage tower can be derivate as lighting tower monopole, city clock tower & monument, tree tower, street light & flag pole.

**2.3 Camouflage tower design: monopole lighting tower and city clock monument tower**

This monopole design is concept idea by Duta Cipta Konsultama Indonesia emphasize in aesthetic and meant to be blend to local environmental. This Tower meant to be designed in order to reduce environmental and social hazard that begin to appear in Indonesia.

Descriptions of the structure are:

- Qualified as Safety Requirements Thru Compliance of TIA / EIA -222-E Standard Design Criteria & Loading (Dead & Wind load)
- Height maximum 36 m, accommodate Mounting Floodlights Single / Multiple Levels
- Positioning & Adjustment of Lights for Optimum Lighting
- Mounting of Hidden Radio Antennas
- Mounting Option for Billboard
- Mounting Option for Security Surveillance Cameras
- Ease access for maintenance

This Monopole towers designed for: Public Walkways, Public Transportation Meeting Areas, Shopping and Parking Areas, Recreation Areas, Residential Areas, Business Premises, Roadway

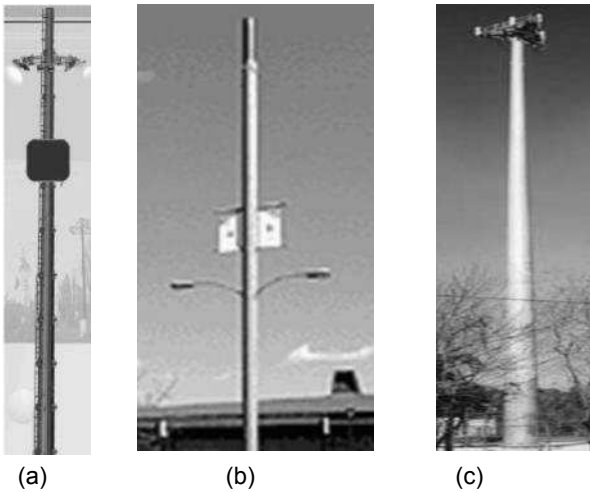

Figure 1 : existing monopole design

**2.4 Camouflage tower design : city clock and monument**

There are existing BTS with idea of combining its function as City clock and city monument although some product was not designed very well. This idea seems become preferable for city authority because of its flexibility and idea of using existing building or city monument offer easier implementation and lower cost production.

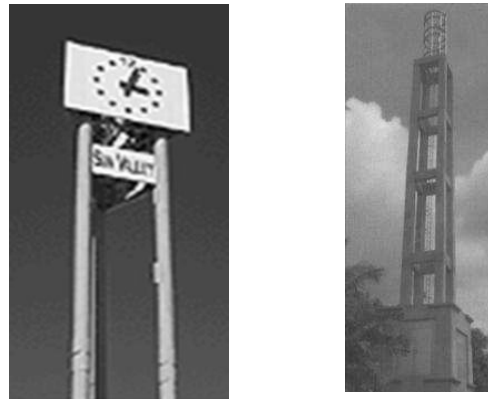

Figure 2: existing city clock and monument

**2.5 Camouflage tower design : tree tower**

These are existing product of Alan Dick Co. That camouflage BTS Tower into natural object as local common tree i.e.: Palm Tree, Pine Tree, and Conifer Lightning Tree

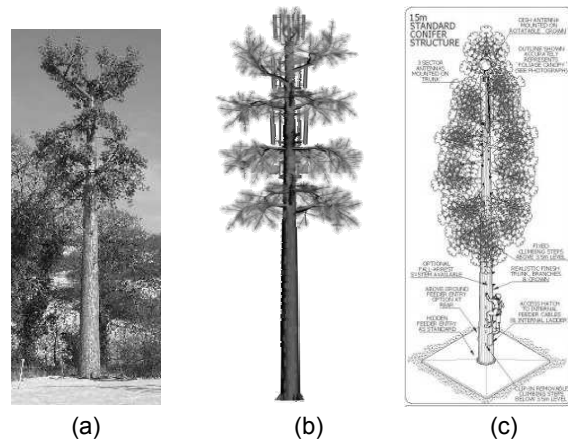

Figure 3: Camouflage tower design as tree

**2.6 Camouflage tower design : mosque tower**

Other Alan Dick design in Malaysia and Indonesia is mosque tower that camouflage Tower BTS into mosque tower in some cities.

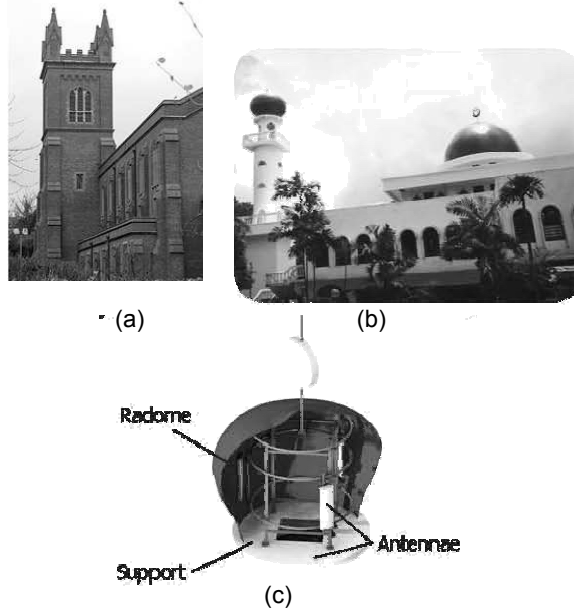

Figure 4: Camouflage mosque tower

## 2.7 Camouflage tower design : street light and flag pole.

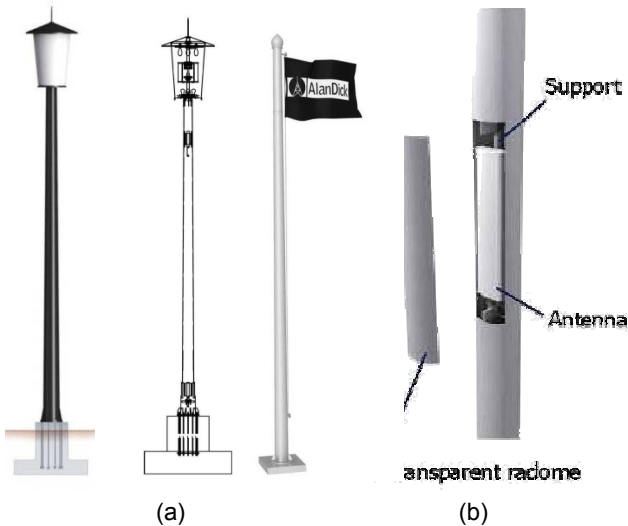

Figure 5: Camouflage pole towers

Based on these existing design of camouflage tower, the design of e-tower are developed.

## 3 CITY REGULATION AND DESIGN SOLUTION

### 3.1 Public regulation research

Indonesia as an archipelago country with varies geological, ecological and social condition and its cities planning are very complicated. The focus of this research would be the two biggest cities that are Jakarta and Surabaya.

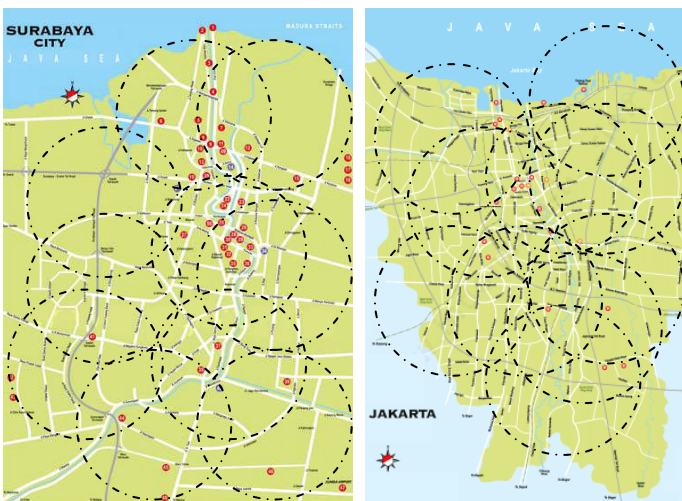

Figure 6: distribution BTS placement in Indonesia caused environmental problems, business and regulation conflict

Jakarta's and Surabaya's spatial planning authority will allow base transceiver stations to be attached to the tops of buildings to reduce the number of BTS towers in the capital. Jakarta authority had determined several areas, including Jl. Sudirman in Central Jakarta and South Jakarta, Jl. Thamrin in Central Jakarta and Jl. Rasuna Said in South Jakarta, where numerous high-rise buildings are located.

Areas with large concentration of high-rises are called "white areas", There will be BTS devices attached to the tops of buildings, approximately in 250 different locations situated in the white areas,"

## 3.2 Public regulation and Aesthetic design that accommodate multi operator (1-10 operators)

Indonesian government agency had made the option available for cellular operators, which would be required to share monopole BTS towers.

"A monopole BTS tower needs to be built around 40-50 meters above the ground to work correctly. Otherwise, the signal will be blocked by high-rise buildings".

The Jakarta administration plans to replace between 2,500 and 3,000 existing BTS towers with 850 newer monopole towers.

The newer towers will be occupied by at least two cellular operators, as stipulated in a 2001 gubernatorial decree on tower-sharing, which is backed by a 2008 regulation from the Communications and Information Ministry.

Jakarta's and Surabaya's property management and control agency stopped issuing licenses for new towers in 2006 and has taken down 75 illegally built BTS towers.

In 2006, the licenses for 1,508 towers expired but were temporarily extended earlier this year as the authorities wait for the completion of tower-sharing studies, which will be available by the end of this year.

There are at least 2,750 towers in need of temporary licenses, which will expire when the administration starts implementing the new monopole towers.

Indonesian Telecommunications Regulatory has warned that the administration's plan to dismantle BTS towers could cause all cellular connections to be disrupted as operators may be forced to move from one BTS tower to another. They also said the plan was a breach of the 2008 ministry of communications regulation that says "old cellular operators should strengthen their towers by 2010 to share them with new players in anticipation of additional load".

Several cellular operators have declared that they will support the city administration's multi operator BTS plan, although they claim to have received very little information on the switch. This situation solution would be good supported by E-Tower design and local manufacturing because the demand and regulation implementation are urgent.

## 4 METHODOLOGY

### 4.1 Design Methodology

The design method is **Concurrent engineering - Integrated Digital Design (IDD) using digital process design (CAD-CAM-CAE)**.

This method expected to be able to help gaining shorter lead-time, better product quality and competitiveness that meet good QCD (Quality, Cost and Delivery). With this method, design activities, engineering analysis, marketing activities and cost estimation can be conducted simultaneously. Resumed digital geometry data from this research will be useful for manufacturer machine for prototyping activity. The result is in form of 3D solid model and photorealistic images.

- The expectation of this method are : creating product that capable in integrating 5-10 telecommunication operators in one Tower
- Solving environmental problems in landscape, safety, health, in by making city icon in form of aesthetic tower along context in city need.
- Superiority In engineering process with integrated digital design with concurrent engineering. Concurrent engineering is the simultaneous consideration of product and process downstream requirements by

multidisciplinary teams." (NASA Systems Engineering Handbook SP6105)

- Produce design that lead to QCD (Quality Cost & Delivery) standard, shortening *lead-time* (time consumption for design engineering process).
- Accomplish comprehensive design: result in form of data that ease any level of decision maker to decide next important decision

#### 4.2 Design engineering process

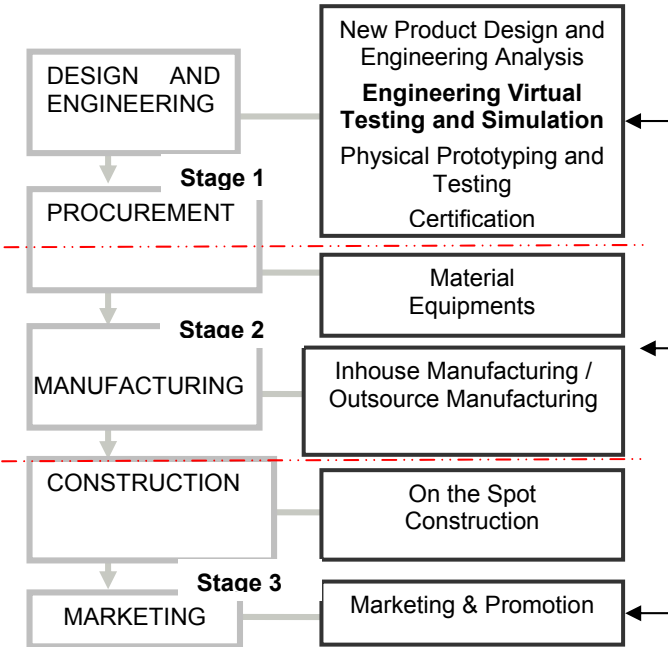

Figure 7: Integrated process diagram

The development divides in three stages.

**Stage 1:** Technology acquiring for digital Design-prototyping and city landscape study

**Stage 2:** Implementation in prototyping, preproduction, publication and patent

**Stage 3:** To do manufacturing and commercialization Produce publication and patent, formulating economic added value, application in form of regulation and public rule advices. All design manufacture and Marketing stages can be conducted in the same time because the process using 3D solid and realistic product data that make impossible to use in every stag.

#### 4.3 Design Requirement & Objectives (DR&O)

- BTS tower with Hi-Tech design functionally as city landmark, signage , city light giving added value as aesthetic City information facilities.
- Camouflage with visual concept that differ from Conventional BTS tower.
- Approach to modular construction & Completely Knock Down system
- Cheaper production cost.
- Consider both society and operator security and safety.
- Ease of installation and maintenance.

Main Concept: To be solution for environmental impact that caused by BTS structural installation in the city, Meet demand of visual aesthetic environment in the city

#### 4.4 Partnership

Partnership would be conducted between researchers (ITS design centre), local authorities and manufacturer PT Bukit Jaya Abadi (PT.BJA). Main job description areas are basic concept by ITS Design Center, manufacturing and testing

by PT. BJA engineering department, public regulation formula by local authority of Surabaya and Jakarta city.

#### 4.5 Scope of research work

Implementation of IDD method and process formulation, the Scope of research work (SOW) work was be defined. The scope of work are:

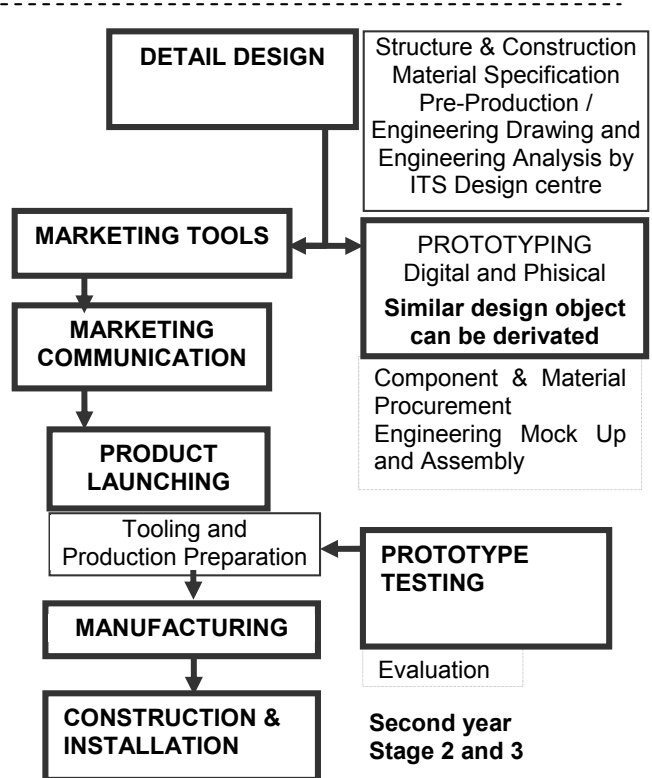
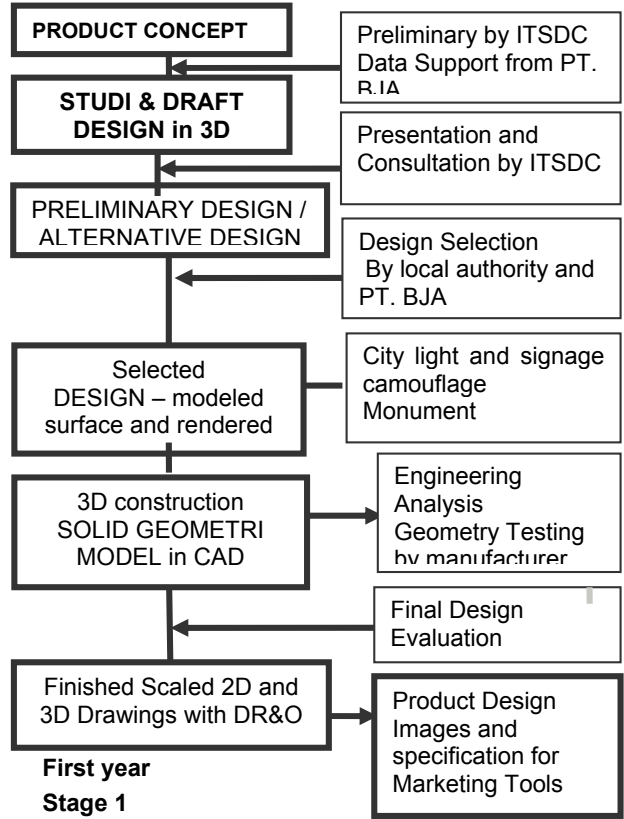

Figure 8: implementation of IDD - Concurrent engineering methods



This SOW is collaboration between research team and local manufacture in order to gain optimum result suitable to production capability and raw materials readiness.  
 . The design process involve local partner PT BJA as engineering and prototyping manufacturer industry for telecommunication

Product concept analysis and usage function, aesthetic concept analysis, Preliminary Design, Detail Design & Engineering aspect:, Prototyping, Testing & Evaluation. Mass Production, Marketing & Promotion plan.

**5 BTS TOWER DESIGN**

**5.1 Study for E-tower Design**

Basic consideration for e tower design is the study of required component and dimensions as technical engineering limitation.

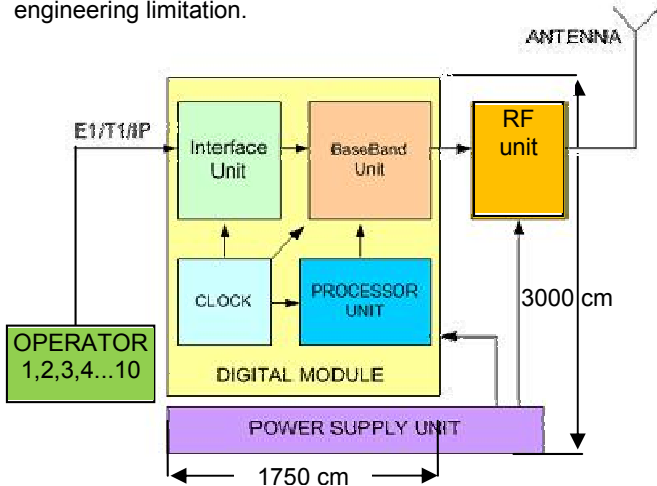

Figure 9: BTS component

The main configuration of equipments inside the BTS are :  
**Main Processor Unit** initialization and self-testing, configuration, O&M signaling, software download, collection and management of external and internal data  
**Clock Source Unit** : Deliver a stable clocking pulse to all digital equipment inside BTS.

**Interface Unit** : Interface unit have function to translate between Source data which has specific Electrical Standard (E1, T1 or IP) to digital data and this data will deliver to other digital unit to be next processed

**Base Band Unit** : In the base band unit, the digital data will be processed and following the GSM standard, this unit creates a data which ready to be feed to RF Unit.

**Power Supply Unit** : produce a power for whole equipments in the BTS. With input the AC voltage unit produce DC voltage as a power. **RF Unit** : RF Unit converts the digital signal to Radio Frequency --RF-- Signal (air interface signal) following the GSM Standard. This signal type is still as an electrical signal.

**Antenna Unit** :Antenna as a traditional unit, have a function to convert electrical signal to electromagnetic signal. This unit is very important unit for creating cell dimension. Combination of horizontal - vertical polarization, antenna height and antenna tilting influence the radiation pattern of cell.

**5.2 Preliminary idea**

For preliminary idea, e-tower design are City monument tower, City lighting & information signage, City clock & information signage, Big Ben / Building clock tower. Next figures are 3D solid model E- tower designed for Jakarta and Surabaya for multi operator purpose.

**City monument tower**

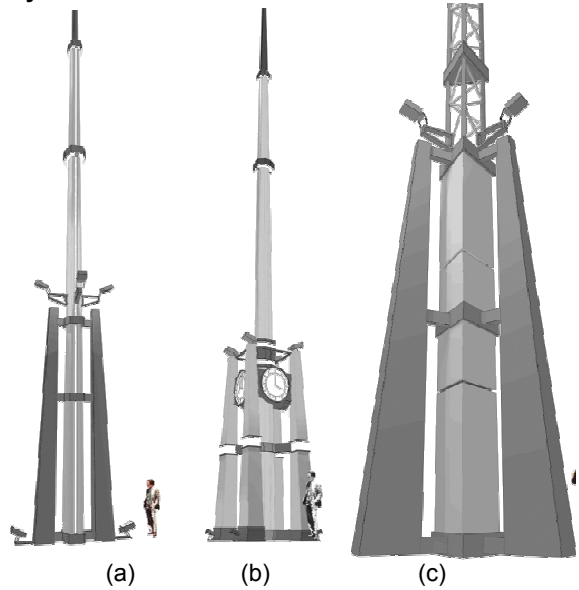

Figure 10: city monument design idea

**City lighting, city clock and information signage**



Figure 11: city BTS signage design

Visual Concept : Main structure consist of Polygonal monopole structure somehow camouflage added with support by structure function as aesthetic element and based of beautiful lighting pole to give artistic touch along with city landmark style. Additional structure made of concrete, galvanized steel, and composite panel.

**Mosque/church tower**

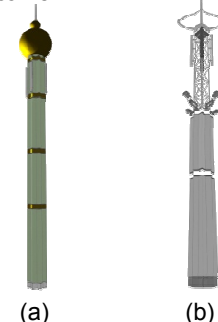

Figure 12: mosque/church BTS tower design

Visual Concept : BTS Tower main structure adjusting to building structure and camouflage with other building component as well become aesthetic element function.

### 5.3 Design refinement

After comprehensive discussion among researcher, local authorities and manufacturer, the design refinement can be defined.

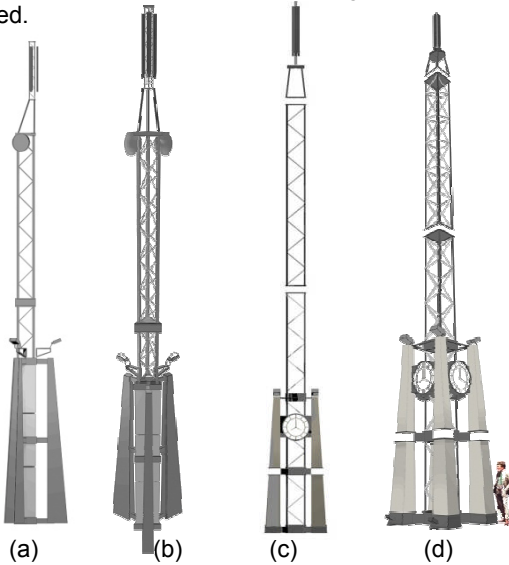

Figure 12: type design of based e-tower

As discussion with metropolitan local authority and manufacturer, the design of E-tower for independent product focused on tree legs and four legs support.

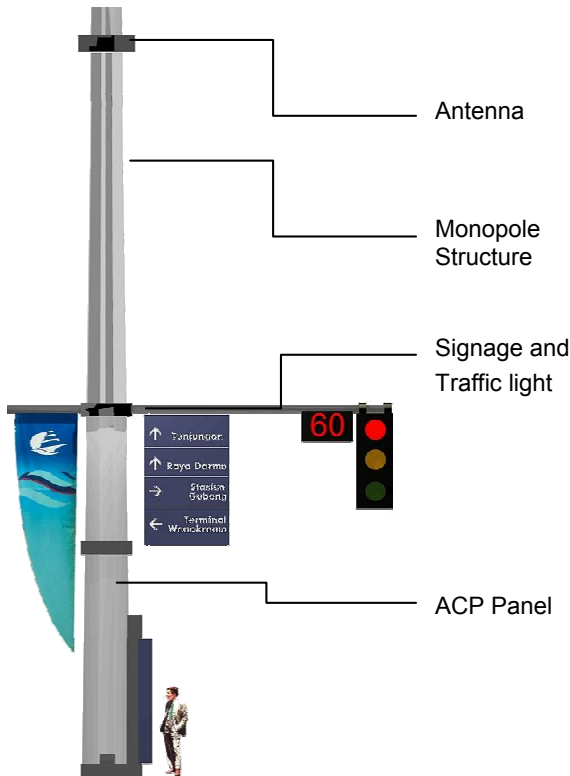

Figure 13: one of chosen e-tower design

### 5.4 Detail Design integrated with manufacturing

Example of integrated digital design result that simultaneously generate design both for marketing tools and detail manufacturing shows on next figure.

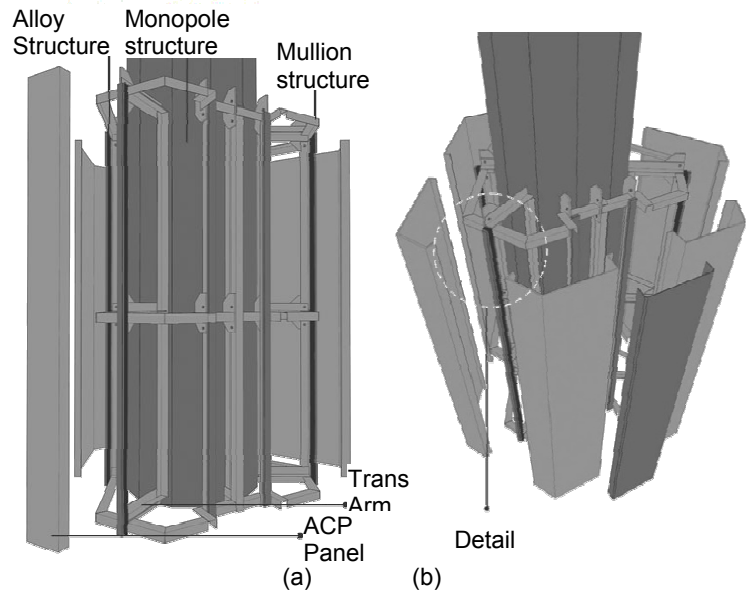

Figure 14: 3D Geometry for detail design

As IDD method the solid 3D geometry available to be used for other such as marketing tool and CAD document

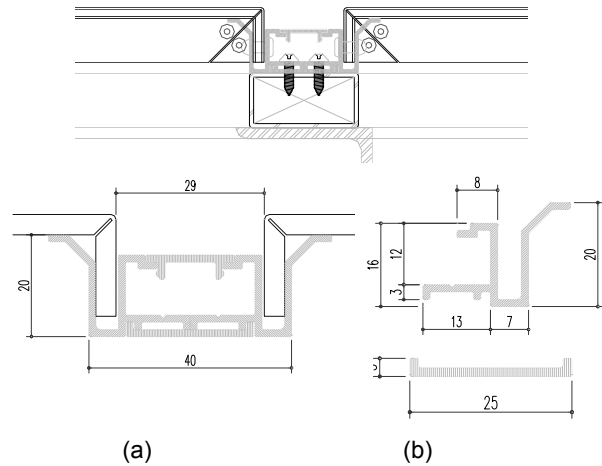

Figure 15: example of detail CAD drawing derivate from IDD method of 3D solid BTS geometry.

## 6 FINAL DESIGN & DISCUSSION

### 6.1 Design solution

Final designs that have been proofed by local authority, able to be manufactured by PT.BJA are independent e-tower attached to building that suitable for Indonesia metropolitan. Independent design to be made the prototype is City-street light-banner-signage E-tower. The other proofed e-tower is big clock city building. Both would need more exploration in aesthetic and design development as it is still prototype design.

### 6.2 Design Implementation.

Other factors that influence the implementation for multi operator E-tower is the good will of authority and local operators. Yet the E tower design couldn't give any solution alone. Help from local authorities to promote and socialize program for sharing and built trust between operators is absolute. The special committee are needed chosen among operators in order to guarantee good operation and maintenance for E-tower. Environmental oriented regulation that support E-tower considered to be most important component inn implementation since the product design of E-tower has already prepared.

Big Clock City building E-tower

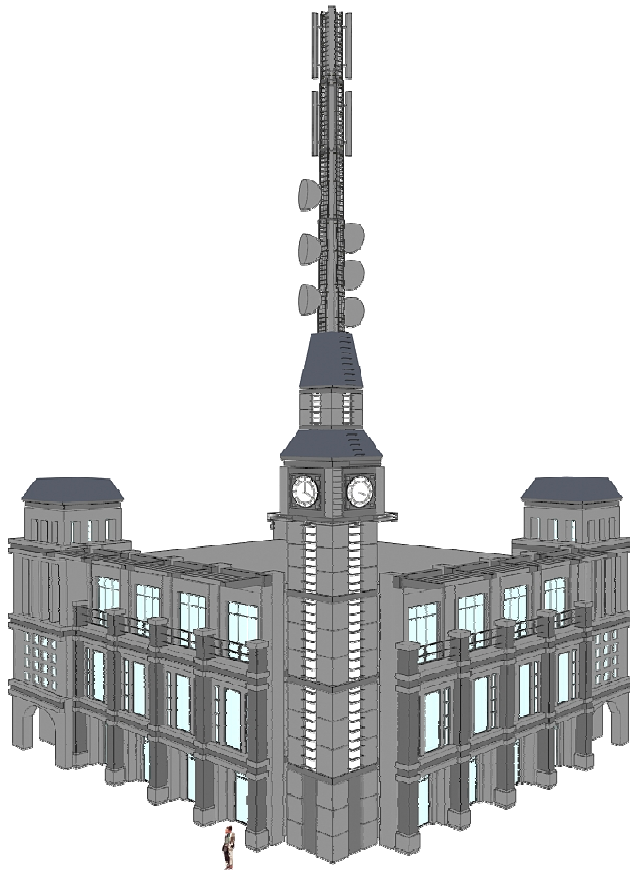

(a)

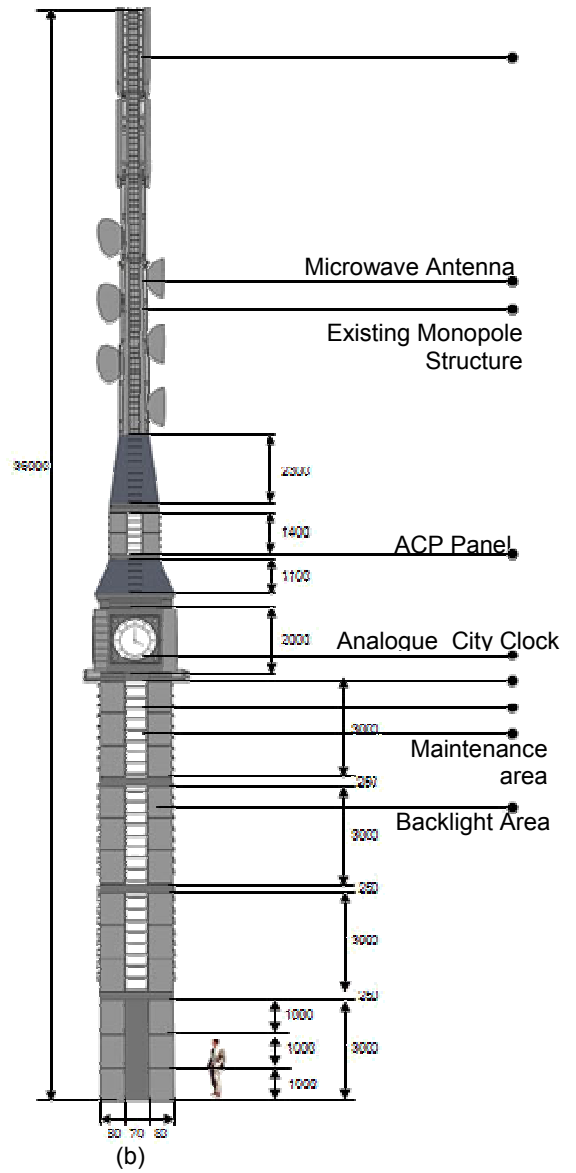

(b)



(c)

Figure 16: E-tower design as Big Clock City

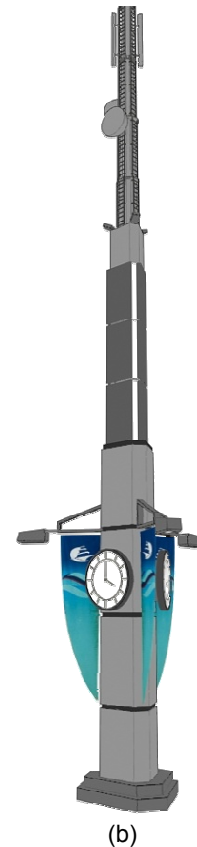
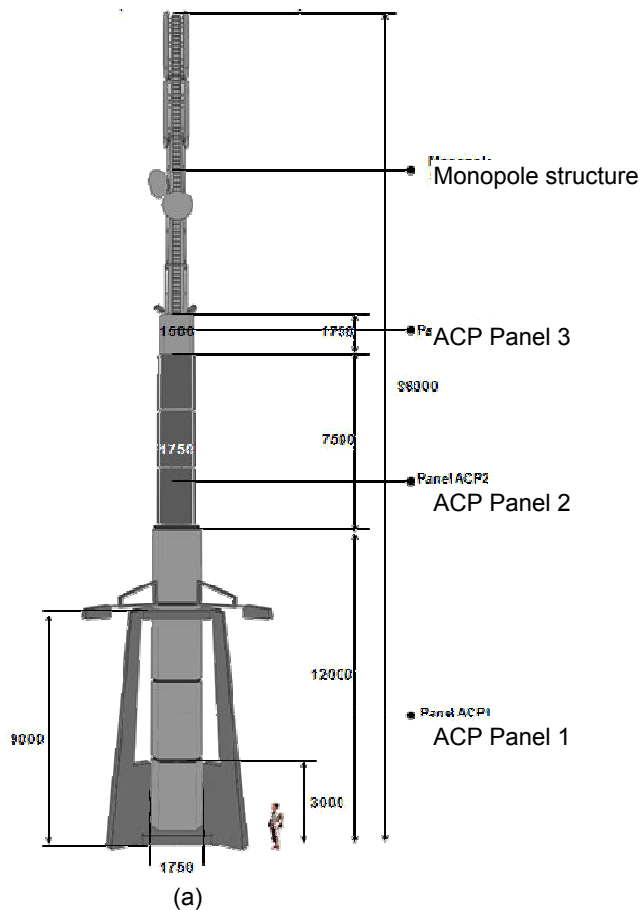

Figure 17: E-tower design as City light, signage and monument.

## 7 SUMMARY

This research conducted as Indonesian characteristic and need for design solution to environmental problem as BTS implementation. By Using research method Concurrent engineering - Integrated Digital Design using digital process design (CAD-CAM-CAE) in order to gain shorter lead-time, better product quality and competitiveness that meet good QCD (Quality, Cost and Delivery). With this method, design activities, engineering analysis, marketing activities and cost estimation can be conducted simultaneously. Resumed digital geometry data from this research will be useful for CNC machine for prototyping activity. The result in form 3D solid model and photorealistic image can be used as comprehensive presentation for business decision makers. The Implementation of the design solutions are Aesthetic BTS Tower (E-Tower) as City lighting tower, mosque/ church tower, city signage, landmark, city clock tower, and adaptable for any city need and characteristic, icon and city landmark. This design of E-tower is expected to solve every possible problem such as "tower forest" in the city that will be followed with other problems such as, disruption for city aesthetic, maintenance, and other social problems.

## 8 ACKNOWLEDGMENTS

We extend our gratitude to Jakarta's and Surabaya authority, PT. Bukit Jaya Abadi and to all who contribute to this research. Many thanks to CIRP IPS2 '09 International Conference that give such a honour for Indonesian researcher to participate in this design conference.

## 9 REFERENCES

[1] Americans Planning Association, November 1995, "Cellular Tower Survey." APA, Washington D.C

- [2] Bell Atlantic NYNEX, April 1996, "Cellular Fact Book" ..
- [3] Cassity, Pratt, November / December 1996, "When Historic Meets High Tech.", Historic Preservation Forum News Volume 3. No.1
- [4] Gregory, Michelle, June 1995, "Local Planning Issues in Sitting Cellular Towers." Zoning News.
- [5] May 1996, "Wireless: A Planning Information Report on Mobile Communication Facilities", New Jersey Planning Officials Report.
- [6] Lai, H. -H., Lin, Y. C., Yeh, C. H., & Wei, C. H. (2006), User-oriented design for the optimal combination on product Design. *International Journal of Production Economics*, 100(2), 253-267.
- [7] Llinares, C., & Page, A. (2007). Application of product Differential semantics to quantify purchaser perceptions in housing assessment. *Building and Environment*, 42(7), 2488-2497.
- [8] Moore, W. L., & Pessemier, E. A. (1993). *Product planning and management: Designing and delivering value*. New York: McGraw-Hill.
- [9] Nagamachi, M. (2002). Kansei engineering as a powerful consumer-oriented technology for product development. *Applied Ergonomics*, 33(3), 289-294.
- [10] Norman, D. A. (1990). *The design of everyday things*. New York: Doubleday.
- [11] Norman, D. A. (2004). *Emotional design*. New York: Basic Books.
- [12] Osgood, C. E., Suci, G. J., & Tannenbaum, P. H. (1957). *The measurement of meaning*. Urbana: University of Illinois Press