

## Industrialization of Polymer Solar Cells – phase 1

Lauritzen, Hanne; Bork, Jakob; Andersen, Rasmus B.; Bentzen, Barbara ; Krebs, Frederik C

*Publication date:*  
2012

*Document Version*  
Publisher's PDF, also known as Version of record

[Link back to DTU Orbit](#)

*Citation (APA):*

Lauritzen, H., Bork, J., Andersen, R. B., Bentzen, B., & Krebs, F. C. (2012). Industrialization of Polymer Solar Cells – phase 1. Department of Energy Conversion and Storage, Technical University of Denmark.

## DTU Library

Technical Information Center of Denmark

---

### General rights

Copyright and moral rights for the publications made accessible in the public portal are retained by the authors and/or other copyright owners and it is a condition of accessing publications that users recognise and abide by the legal requirements associated with these rights.

- Users may download and print one copy of any publication from the public portal for the purpose of private study or research.
- You may not further distribute the material or use it for any profit-making activity or commercial gain
- You may freely distribute the URL identifying the publication in the public portal

If you believe that this document breaches copyright please contact us providing details, and we will remove access to the work immediately and investigate your claim.

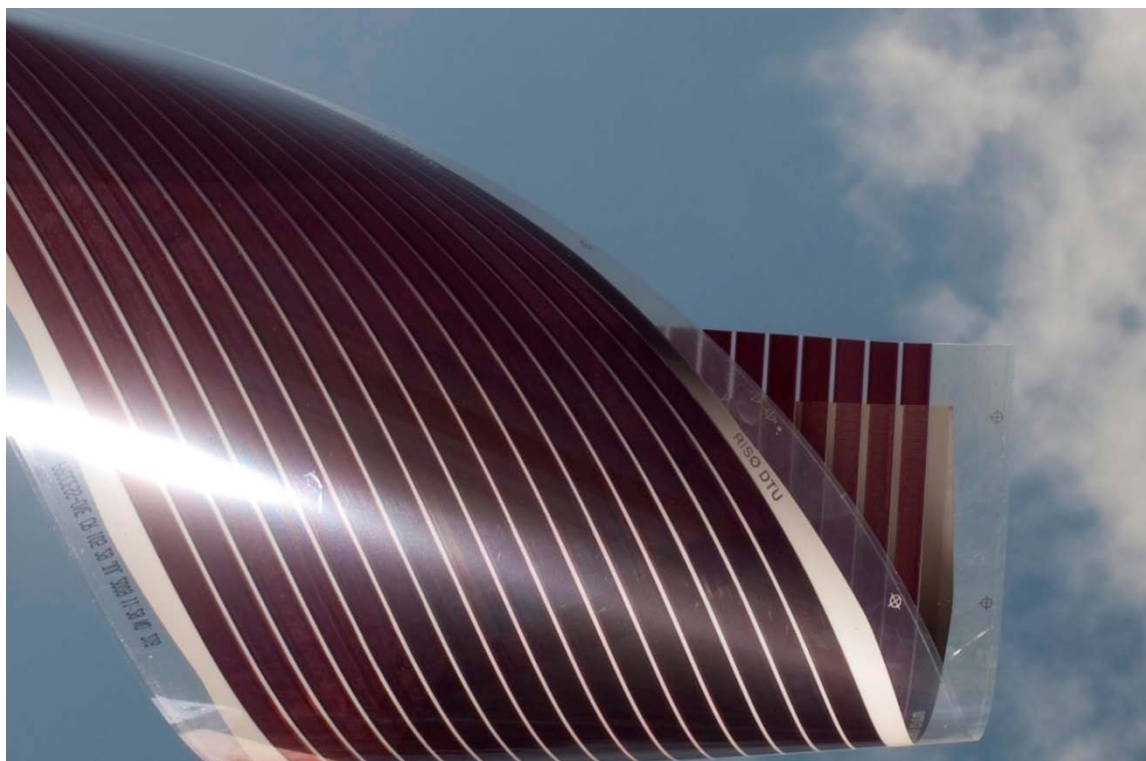

# Industrialization of Polymer Solar Cells

**EUDP project 64009-0050**

Marts 2012

**Industrialization of Polymer Solar Cells – phase 1**

EUDP project 64009-0050

2012

By Hanne Lauritzen, Jakob Bork, Rasmus B. Andersen, Barbara Bentzen, Frederik C. Krebs

Copyright:       Reproduction of this publication in whole or in part must include the customary bibliographic citation, including author attribution, report title, etc.

Cover photo:     Polymer solar cells produced at DTU

Published by:    Department of Energy Conversion and Storage, Frederiksborgvej 399, Building 775, DK-4000 Roskilde, Denmark

# Content

Summary .....	1
Summary in Danish – dansk resumé .....	3
Conclusion.....	5
1. Introduction .....	6
2. Defining the baseline .....	7
2.1 The ProcessOne solar cell.....	7
2.2 From individual cells to serial connected modules .....	8
2.3 ProcessOne: from materials to devices .....	10
3. Experimental set-up .....	12
3.1 In-line coater and printer for OPV processing.....	13
3.2 Laminator and laser cutter for post processing.....	14
3.3 Functional testing .....	14
3.4 Life-time tester .....	15
4. Optimization of the solar cell.....	17
4.1 Miniaturized devices .....	17
4.2 Barriers for low- and medium demanding applications.....	18
4.3 Rigid encapsulations for demanding applications.....	19
4.4 Life cycle analysis and energy pay-back time .....	21
4.5 The OPV learning curve.....	24
5. Industrial implementation .....	25
5.1 The coating line.....	25
5.2 Implementation and challenges .....	26
5.3 Process control .....	27
5.4 Production cost .....	27
6. Product design .....	29
6.1 The electronic system .....	31
6.2 Design for assembly .....	32
6.3 Mechanical robustness versus flexibility .....	34
6.4 ON/OFF switches for robust environments.....	35
6.5 Dimensioning the system .....	37
6.6 Shaping the product for maximum functionality.....	37
6.7 LCA analysis for the lamp .....	39
7. Approaching the market.....	43
7.1 Product demonstrations .....	43
7.2 The quality required by the customer .....	46

7.3	The performance profile .....	48
7.4	The market .....	49
7.5	Competitors on the market.....	50
7.6	Patents and freedom to operate.....	51
7.7	Supporting technologies.....	52
7.8	From demonstration product to the first commercial products.....	53
	References .....	59
	Annex 1: Demonstration .....	60
	Annex 2: Dissemination.....	74
	Acknowledgements .....	77

## Summary

Polymer solar cells have unique features such as low weight, slim outline, robustness against breakage and excellent adaptability of size, shape and curvature to the actual application. These features open, not only for cost- and energy effective application of the cell, but also for aesthetic solutions. The potential for reaching low production cost at high production volumes is significant, as the polymer solar cell is produced in a roll-to-roll process. The potential for low-cost processing relates not only to the solar cell itself but also to the further processing of the solar cells into more refined products. Such refined products might be self-powered electronic devices designed for easy integration in the customer's production or solar-powered products for the end-user.

A three-phased project with the objective to industrialize DTU's basic polymer solar cell technology was started in the summer of 2009. The technology comprises a specific design of the polymer solar cell and a corresponding roll-to-roll manufacturing process. This basic technology is referred to as ProcessOne in the open literature.

The present report relates to the project's phase 1. The key tasks in phase 1 are to stream-line DTU's technology for the industrial utilization, to demonstrate production according to this stream-lined technology at Mekoprint A/S and finally to fertilize the market for polymer solar cells by demonstrating their use in applications that harmonize with their present maturity level.

The main focus in the stream-lining of DTU's technology has been to demonstrate a convincing rate of reduction for the production cost, and thereby make a competitive price plausible. This has been materialized as a learning curve showing that the polymer technology presently develops considerably faster than the silicon technology. The polymer solar cells will, under the assumption that both technologies follow a projection of the learning curve, gain a cost-leading position within a reasonable time. A production cost of 5 €/W<sub>p</sub> has already been demonstrated in DTU's pilot plant, and a road map for the further decrease to 1 €/W<sub>p</sub> is drawn. This target is expected to be reached in 2013 in the ongoing phase 2 of the project.

Another activity essential for the industrialization has been the launch of specialized materials, equipment and services required for the processing of DTU's polymer solar cells. Relevant products and services are made available for sale on DTU's homepage, [www.energyconversion.dtu.dk](http://www.energyconversion.dtu.dk).

A production line for polymer solar cells has been established at Mekoprint. For this a retrofit solution was chosen where the core of an existing screen-printing line was dismantled and fitted to a slot-die printing head manufactured in DTU's workshop. The line was at the same time adjusted and updated to handle the new production. The very first solar cells produced on this line appeared in July 2010. The line has subsequently been upgraded on a running basis, and Mekoprint's operators have been trained. The technology transfer is continued in the project's phase 2, where the goal is that Mekoprint fully masters both the production process and the production line.

During the course of the project several applications for polymer solar cells have been investigated from a technical -, a design -, and a market point of view. Faktor 3 has sketched and visualized a range of ideas. The ideas are communicated to a broader audience by means of a brochure. An on-line version of the brochure and a computer tool developed for guiding the designer through the process of dimensioning the

electronic system comprising a polymer solar cell, a battery and the electronic function to be powered, are available on Faktor 3's homepage, [www.faktor-3.dk](http://www.faktor-3.dk).

Small LED torches have served as a case for gaining experiences with development and production of solar powered products. A range of conceptual lamps have been evaluated, and two lamps have been produced in large series and demonstrated in public. Some hundred lamps targeted at school children in non-electrified areas in 3<sup>rd</sup> world countries were produced and distributed to target users in Asia, Africa and South America in collaboration with the Strømme Foundation (NO). The feedback received was highly positive and proves the necessity for low-cost, off-grid lightening to replace the presently used kerosene lamps.

A small credit-card sized lamp was produced in a series of 10.000 units in order to test the production setup's ability to handle large series. Several thousands of the lamps were handed out at an international conference for printed electronics, (LOPE-C, 2011). The response from this audience, who is well qualified to judge the news value of lamp's, has also been highly positive.

Based upon the positive demonstration events, two products are launched for sale on Mekoprint's homepage; a laser-pointer and a LED flashlight, see [www.mekoprint.com](http://www.mekoprint.com). Both Mekoprint and Faktor 3 have more products in their pipelines.

## Summary in Danish – dansk resumé

Plastsolceller har unikke egenskaber som lav vægt, lav tykkelse og mekanisk robusthed. Endvidere kan solcellens størrelse, form og krumning i stor udtrækning tilpasses dens anvendelse. Dette åbner for design af omkostnings- og energi-effektive anvendelser samt for æstetiske løsninger. Plastsolcellen fremstilles i en rulle-til-rulle proces, hvilket giver et stort potentiale med henblik på produktionsomkostninger i den helt lave ende ved høje produktionsvolumener. Dette gælder ikke kun for selve solcellen, men også for den videre fremstilling af produkter med integrerede plastsolceller. Dette kan være produkter til slutbruger eller elektroniske komponenter med integrerede solceller.

Sommeren 2009 initierede DTU et projektforsøg med det formål at industrialisere den plastsolcelleteknologi, DTU løbende har udviklet over de sidste ti år. Forsøget involverer DTU's grundlæggende teknologi som omfatter en specifik opbygning af solcellen, en rulle-til-rulle fremstillingsproces samt materialer til denne. Denne grundlæggende teknologi benævnes "ProcessOne" i den åbne litteratur.

Projektforsøget er inddelt i tre faser. Denne rapport omhandler fase 1. De vigtigste opgaver i fase 1 har været at tilpasse DTU's teknologi til den industrielle fase, videre at implementere denne teknologi hos Mekoprint A/S og endelig at demonstrere anvendelser som er tilpasset den producerede solcelles specifikke kvalitet.

Essentielt for den industrielle udbredelse af plastsolcellen er at produktionsomkostningerne reduceres i takt med at teknologien modnes. For at illustrere udviklingspotentialet har DTU udarbejdet en "learning curve" for plastsolcellerne og sammenlignet denne med den tilsvarende kurve for silicium teknologien. Sammenligningen viser, at produktionsprisen for den plastbaserede teknologi, målt som €/W<sub>p</sub>, falder langt hurtigere end den tilsvarende pris for siliciumbaseret teknologi. Dette betyder, at udsigten til en konkurrencedygtig produktionspris er god. P.t. kan plastsolcellerne produceres til en pris på 5 €/W<sub>p</sub> i DTU's pilotanlæg. Prisen forventes at falde til 1 €/W<sub>p</sub> i 2013.

Et andet vigtigt element i industrialiseringsprocessen har været at udvikle og lancere produkter og tjenester, som er relevante for aktører, som ønsker at udvikle, producere eller sælge plastsolceller. DTU har lanceret en stribe materialer, udstyr og tjenester til salg på hjemmesiden [www.energyconversion.dtu.dk](http://www.energyconversion.dtu.dk).

En produktionslinje for plastsolceller er etableret hos Mekoprint. Der er valgt en løsning, hvor trykkestationen i en eksisterende linje til silketryk er demonteret og udskiftet med en enhed til slot-die coating. Selve slot-die trykkehovedet er fremstillet på DTU's værksted. Hele linjen er samtidig justeret og opdateret i henhold til den nye produktion. De første solceller fra denne linje så dagens lys i 2010. Linjen er siden løbende opgraderet, og Mekoprint's operatører er blevet oplært til den nye produktion. Teknologioverførelsen fortsættes i projektets fase 2, hvor målet er at Mekoprint ved udgangen af fase 2 fuldt ud mestrer processen og produktionsudstyret.

I løbet af projektet er en stribe aktuelle anvendelser for plastsolceller undersøgt ud fra både teknisk og kommerciel synsvinkel. Baseret på dette har Faktor 3 udviklet produkt idéer, som er dokumenteret i form af skitser, mock-ups og prototyper. Idéerne er formidlet til et bredt publikum via et idékatalog. En online version af kataloget findes på Faktor 3's hjemmeside, [www.faktor-3.dk](http://www.faktor-3.dk). Her findes også et design støtteværktøj, som vejleder designeren gennem processen med at dimensionere solcelle, batteri og det tilhørende elektroniske system.



For at opbygge erfaring med produktudvikling, design og produktion af plastsolcelleprodukter, er der i projektet arbejdet aktivt med solcelle-drevne LED lamper. En række koncepter er evalueret, og to lamper er produceret i større serier og demonstreret offentligt. Nogle hundrede små læselamper er produceret og distribueret til skolebørn i underudviklede områder i Asien, Afrika og Sydamerika i samarbejde med Strømme Stiftelsen (NO). Tilbagemeldinger fra brugerne viser at der er et stort behov for billige lamper, som kan erstatte de gængse petroleumlamper. Tilbagemeldingerne viser også at brugerne overvejende er meget positive over for lampen, men at der er rum for forbedringer af lampens funktion.

En lommelygte på størrelse med et kreditkort er fremstillet i en serie på 10.000 stk. for at teste det udviklede og etablerede produktionsset-up's evne til at håndtere store produktioner. Flere tusind af disse lamper blev distribueret på en international konference for "Organic and Printed Electronics" (Lope-C, 2011). Tilbagemeldinger fra dette publikum, som er velkvalificeret til at vurdere lommelygtens nyhedsværdi, var gennemgående meget positive.

Baseret på de positive tilbagemeldinger fra demonstrationsaktiviteterne og projektets øvrige formidlingsaktiviteter, er en laser pointer og en LED lommelygte lanceret til salg på Mekoprint's hjemmeside [www.mekoprint.com](http://www.mekoprint.com)., og flere produkter er under udvikling i regi af Mekoprint og Faktor 3.

## Conclusion

The project has given the four partners valuable knowledge about polymer solar cells and a unique position for creating business in this field.

Mekoprint has successfully implemented DTU's basic production technology for polymer solar cells, ProcessOne. Mekoprint has subsequently built the experiences needed for running an industrial production according to the ProcessOne technology and on the production line built for that purpose. The involvement of DTU in the daily operation of this line has over the course of the project gradually been reduced, and is expected not to be needed when the ongoing phase 2 of the project is terminated.

Faktor 3 has positioned themselves as a design company with a spearhead competence in polymer solar cells. This position relates to their expertise in cost- and energy-effective utilization of polymer solar cells in solar-powered products. Faktor 3 appreciates the polymer technology and its high degree of adaptability, as this gives to the designer and the hardware/software engineer a comfortable freedom in the design process.

Gaia Solar has via the project obtained a qualified view on an emerging solar cell technology that in some years might become a competitor to the conventional PV technologies and thus might perfectly well be a part of Gaia's future product palette.

DTU's learning curve for the polymer solar technology proves that the polymer technology at present develops at a convincingly faster learning rate than the silicon technology. The learning curve thus strengthens the plausibility of low-cost production at high accumulated production volumes. The project's targeted production cost of 5 €/W<sub>p</sub> is reached, and a realistic roadmap towards 1 €/W<sub>p</sub> in 2013 is worked out.

The polymer solar technology's ability to adapt the size to the actual need has been demonstrated by the production of small credit-card sized devices and large PV panels encapsulated in glass. DTU has successfully implemented food-packaging barriers as the preferred encapsulation for small devices. The cost-structure of the glass-encapsulation is, however, in conflict with the polymer solar cell's low-cost profile, and alternative strategies are therefore needed. Such strategies are under investigation. Life-cycle analysis has proven to be a strong tool for guiding the R&D work towards to most energy-effective solutions.

The production of 10.000 small LED lamps powered by polymer solar cells has demonstrated the technology's ability to scale to industrial volumes.

The project's demonstration – and dissemination activities have resulted in numerous inquiries from potential customers. The response received points at a go-to-market strategy that takes virtue in identifying the applications where polymer solar cells already have a competitive edge. This might be in applications where the delivery of solar cells on rolls opens for cost-effective further processing into semi-finished or finished products, or it might be applications where the polymer solar cell's high degree of adaptability is essential for developing cost-effective and energy-effective products or where the adaptability is essential for the aesthetics of the product.

# 1. Introduction

The objective of the project “Industrialization of polymer solar cells” is to bring DTU’s underlying 8-year strategic research effort to an industrial level with ensuing commercialization in a Danish context. The project is divided into two or more phases.

This report relates to the project’s initial phase and its three key activities: to streamline the polymer solar technology for the commercialization phase, to transfer this technology to the industry, and to demonstrate the use of polymer solar cells in low-demanding applications. All these relate to the basic technology called ProcessOne in the literature and to the present maturity level of the polymer solar cell. At this present maturity level the cell is suited for low-demanding applications, for example charging of batteries in consumer electronics.

In this first phase the consortium comprises four partners: DTU, Mekoprint A/S, Gaia Solar A/S and Faktor 3 A/S, all having a clearly defined role in the project. DTU serves as technology provider, whereas Mekoprint is responsible for implementation of the provided technology. This means to set up and run in an industrial production line for pre-production of solar cells, and furthermore to assess the present and near-future market opportunities for the polymer solar cells produced on this line. Faktor 3’s role is to investigate the same market but from a designer’s point. This is to be done by exploring and developing realistic product opportunities. The role of Gaia Solar’s role is to benchmark the polymer solar cells and its applications on the market place for conventional solar cells.

The tasks in phase 1 revolve around three key deliverables. The first is a demonstration of the polymer solar technology’s potential for cost reductions, which has been materialized as learning curve showing how the production cost decreases with increasing accumulated production. A considerable R&D effort in DTU’s laboratories has during the course of the project optimized the technology to the point where the project’s target production cost of 5 €/W<sub>p</sub> has been reached. Highlights from this R&D effort are described in the report’s Chapter 4, whereas a complete review of the achievements is to be found in the referred literature. A considerable fraction of the text in Chapter 4 is taken directly from the underlying paper, and this is found acceptable as the corresponding authors of the actual papers are employed at DTU.

The next key deliverable is a demonstration of roll-to-roll production of polymer solar cells at Mekoprint in the production line established in this project. The first roll of polymer solar cells from Mekoprint’s line appeared in June 2010. Chapter 5 describes not only this event, but also the activities preparing for it and the further work targeted at full implementation of the technology which is defined as the point where Mekoprint fully masters their new production facility and the related production.

The third key deliverable is a demonstration of applications where the polymer solar cells already today can play a commercial role. Small LED torches powered by polymer solar cells are chosen as a case for the demonstration. Chapter 6 uses these LED torches as an example in a review of the process for designing well-functioning polymer solar products, whereas Chapter 7 considers the market for polymer solar cells and the polymer solar technology’s strength on this market.

While searching, investigating and promoting these initial applications, the R&D resources should be dedicated to maturing and improving the technology and with strong focus on the key PV qualities; cost, efficiency and operational life time. This is fully in line with the objective of the ongoing phase 2.

## 2. Defining the baseline

This chapter defines the system studied in this project and implemented at Mekoprint. This baseline system is a bulk heterojunction polymer solar cell of inverted geometry produced according to DTU's already published process for roll-to-roll coating and printing of the solar cell, the so-called "ProcessOne", (Krebs F. C., Gevorgyan, S. A., Alstrup J., 2009).

When nothing else is noted in the text, the terms "polymer solar cell" and "solar cell" refer to this baseline solar cell, and all manufacturing is, when nothing else is noted, performed according to the ProcessOne procedure.

### 2.1 The ProcessOne solar cell

The ProcessOne polymer solar cell is a structure comprising 5 layers of individual functionality; a transparent front electrode facing the sun, an electron-transporting layer, a photoactive layer, a hole-transporting layer and finally a metallic back electrode, see Figure 1.

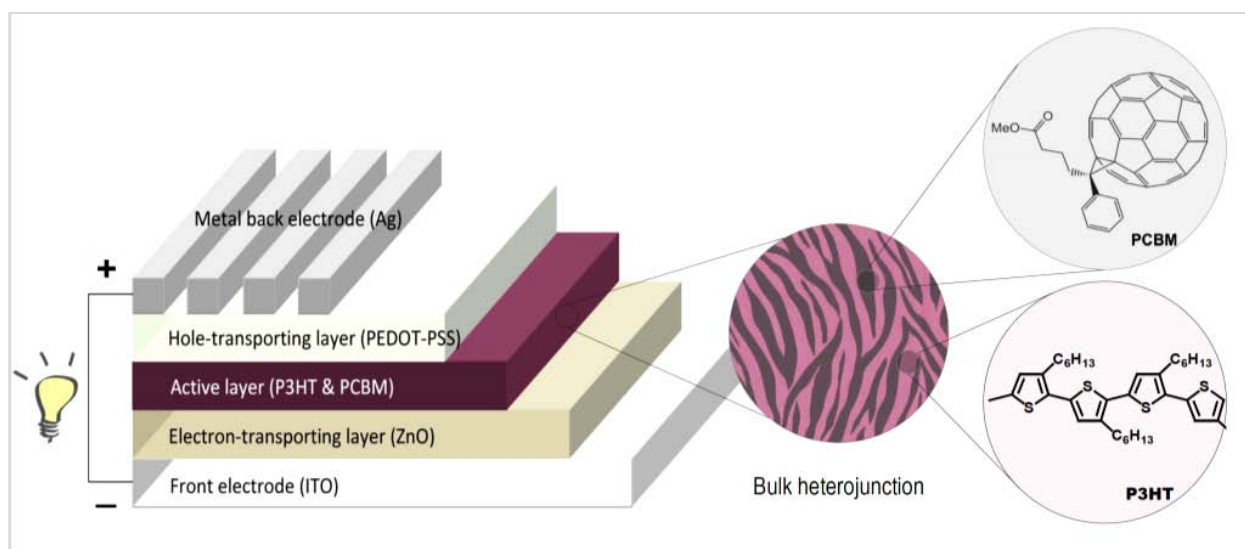

**Figure 1:** The multilayered ProcessOne solar cell comprises the following layers; a transparent front electrode, a electron-transporting layer, and active layer, a hole-transporting layer and a metal back electrode. The "heart" of the solar cells is the active layer which is an intimate mixture of an electron donor (P3HT) and an electron acceptor (PCBM) forming a bulk heterojunction.

The "heart" of the ProcessOne solar cell is the active layer where the sunlight is absorbed and converted to an electrical current. The active layer consists of an intimate blend of an electron donor material and an electron acceptor material, respectively the light-absorbing P3HT (poly(3-hexylthiophene) and PCBM (phenyl-C61-butyric acid methyl ester). This blend is chosen, because it is well researched and serves as a standard blend for any work within polymer solar cells.

When light shines on the active layer blend, electrons in the light-absorbing donor material P3HT will be photoexcited leaving behind positively charged holes. If the electrons are not physically removed from the site of excitations, they will sooner or later recombine with their counterpart, the positively charged hole. However, as the active layer is an intimate blend, the regions of the P3HT donor - and the PCBM acceptor

material are separated only by some nanometers, the charge carrier can thus readily diffuse from the point of excitation to the boundary between the donor - and the acceptor material where charge separation takes place. The blend forms a three-dimensional junction between the donor – and acceptor material, a so-called bulk heterojunction, which is the equivalent of the silicon solar cell's planar p-n junction. The interfacial area of the bulk heterojunction is, however, orders of magnitude larger than the planar heterojunction.

At the junction where the negatively charged electrons are separated from the positively charged holes, a photocurrent is constituted that has to be extracted from structure. For this reason the active layer is sandwiched between two current-transporting layers separated by an engineered potential. The engineered potential ensures that the electrons move into the electron-transport layer and the holes into the hole-transport layer from which they are collected by the two electrodes. The materials of the two electrodes, respectively the front - and the back electrode, are chosen to match the potential of the two current transport layers.

As the sunlight has to enter unhindered through several layers to reach the photoactive layer embedded in the middle of the cell, it is necessary for the layers in front of the active layer to be transparent for light within the spectrum absorbed by the photoactive layers. This factor limits the choice of materials for the front electrode and the electron-transporting layer drastically. ProcessOne's electron-transporting ZnO layer is by means of nano-particles formulated to be transparent. ITO serves presently as the standard material for the transparent front electrode, due to its availability. ITO is however expensive and requires energy-intensive vacuum processing. Finding more cost- and energy-effective alternatives is accordingly a hot R&D topic, and the effort is most likely to pay off in the near future.

ProcessOne applies, PEDOT-PSS as hole conductor, transparent ITO as front electrode and a silver back electrode. The silver back electrode might be either a grid or fully covering.

Polymer solar cells of basically four different geometries are reported in the literature, see Figure 2. The four geometries differ in the side from which the electrons are extracted and the side from which the illumination is entering the solar cell. The ProcessOne solar cell belongs to the family of front-side illuminated cells of inverted geometry meaning that the cell is illuminated through the ITO front electrode and that the electrons are extracted from the front electrode. This geometry is chosen, because it favors roll-to-roll processing of all layers starting from a flexible substrate onto which the individual layers are successively coated.

## 2.2 From individual cells to serial connected modules

Due to the relatively high sheet resistivity of the ITO, it is necessary to pattern the ITO layer on the substrate such that smaller cells can be connected in series and form modules, Figure 3. In this way the Ohmic losses are reduced at the expense of the active area. Figure 3 shows the principle whereby the ITO is patterned into stripes that are serially connected via the ensuing printing processes. The serial connection is achieved in the final printing step.

The width of the stripes should be much smaller than the length of the stripes, so that all charge transport occurs across the stripes from right to left in Figure 3, and there is thus no Ohmic loss associated with the length of the stripes. Ideally the stripes should be as narrow as possible to minimize the Ohmic loss. However since the serial connection of the stripes takes up some of the areas the increased performance due to narrowing the stripes is quickly lost due to the inactive area from the serial connection. The gap between the ITO stripes which is necessary to electrically isolate the individual stripes should also be as small as possible.

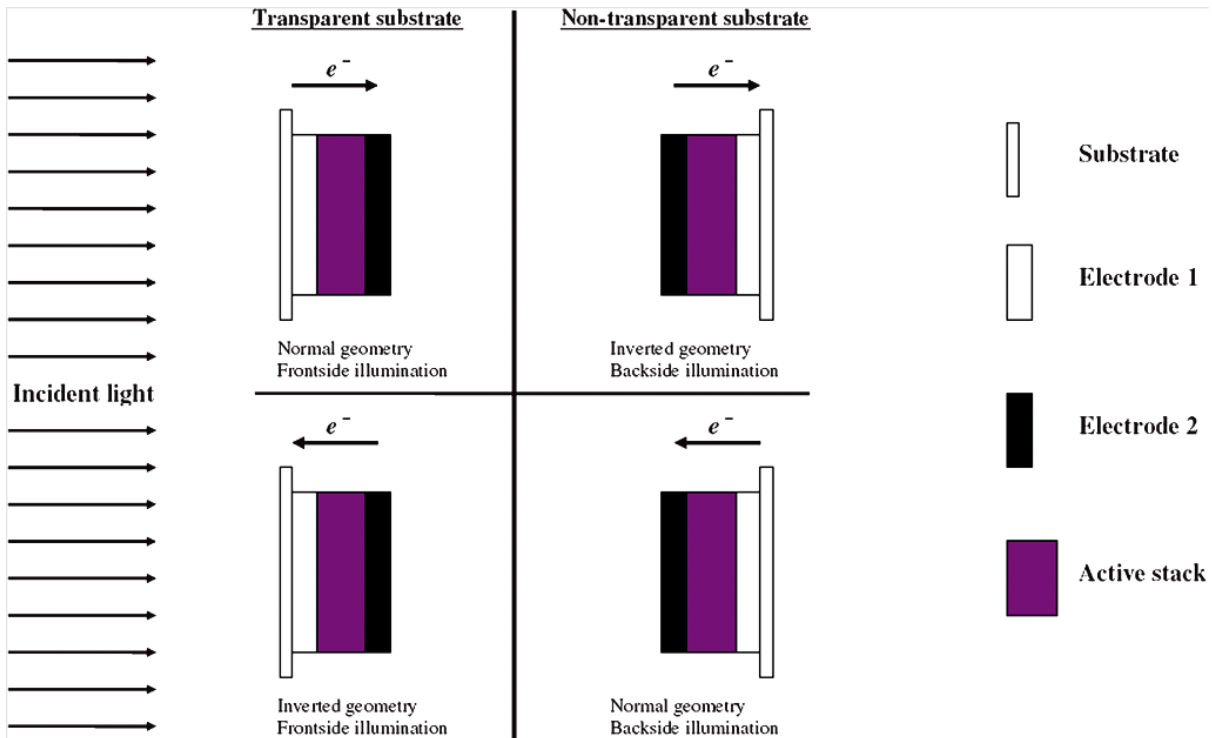

Figure 2: The four possible device geometries for multilayered polymer solar cells. Frontface illumination requires a transparent substrate whereas backside illumination does not forcibly require so, from (Krebs F. C., Gevorgyan, S. A., Alstrup J., 2009)

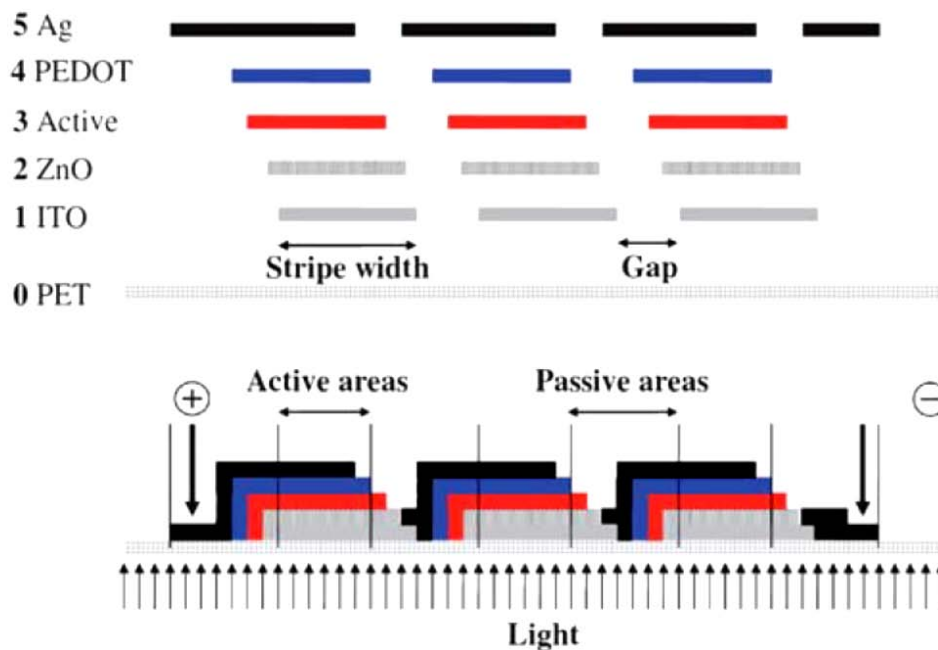

Figure 3: The PET substrate shown along with the position and order of the layers. The connected module is shown schematically (below) as three serial connected stripes where the active layer and the passive areas are highlighted, from (Krebs F. C., Tromholt T., Jørgensen M., 2010)

The optimum cell and module geometry will depend on the optical transparency and electrical resistivity of the transparent electrode and the tolerances that can be handled in the processing of the individual layers.

### 2.3 ProcessOne: from materials to devices

Figure 4 shows an overview of the various steps in ProcessOne, starting from the purchased PET substrate coated by a fully covering layer of ITO.

The first step in ProcessOne is a patterning of the ITO, in an etching process which removes the conducting ITO in thin strips that defines the boarder of each cells. This is done by screen printing an etch resist onto the ITO, Figure 4 a). The film is then taken through an etch bath with  $\text{CuCl}_2$  acid which effectively etch away areas not covered with the etch resist, Figure 4 b). The resist is subsequently chemically stripped off, Figure 4 b) and the film is dried. The now patterned ITO is now run through the slot coating line three consecutive times, Figure 4 c-d). This is the essential part of the process as it is where the three OPV specific layers are processed, the electron-transporting layer, the active layer and the hole –conducting layer. Subsequently and in a separate line the metal back electron is screen-printed onto the slot-die coated layers, Figure 4 f) and the foil is finally laminated in a moisture and oxygen protective barrier by means of a pressure-sensitive adhesive, Figure 4 g).

The output from ProcessOne is a foil comprising individual solar modules laminated in a protective barrier, see Figure 5. The band is ready to be cut into individual cells or ready to be further roll-to-roll processed into more refined products.

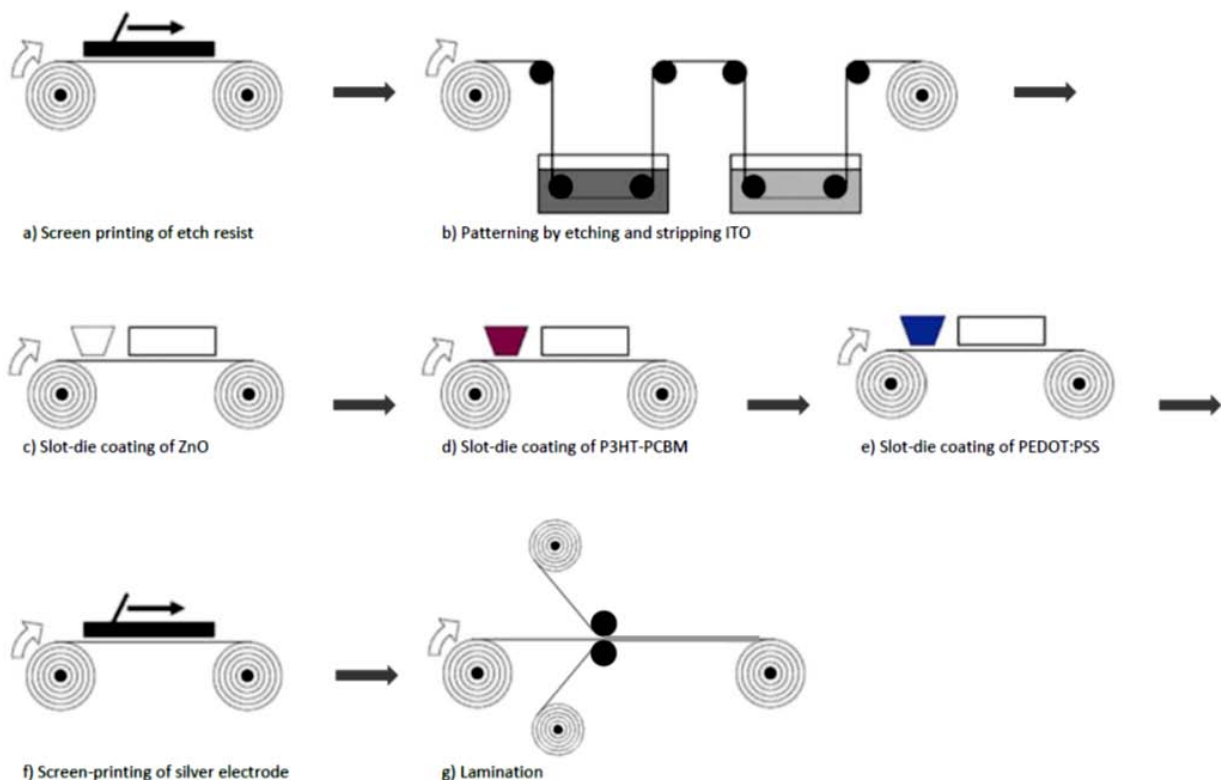
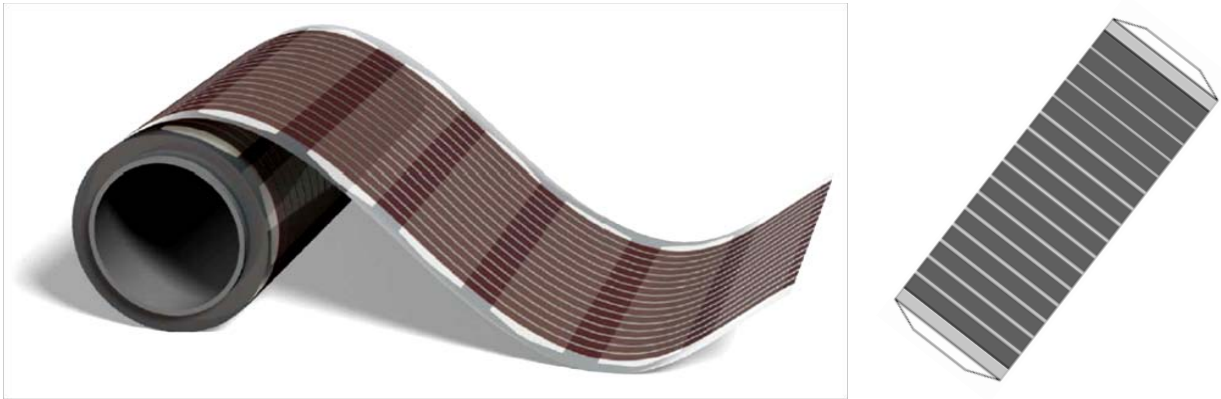

Figure 4: ProcessOne comprises 7 individual steps shown from a) to g).

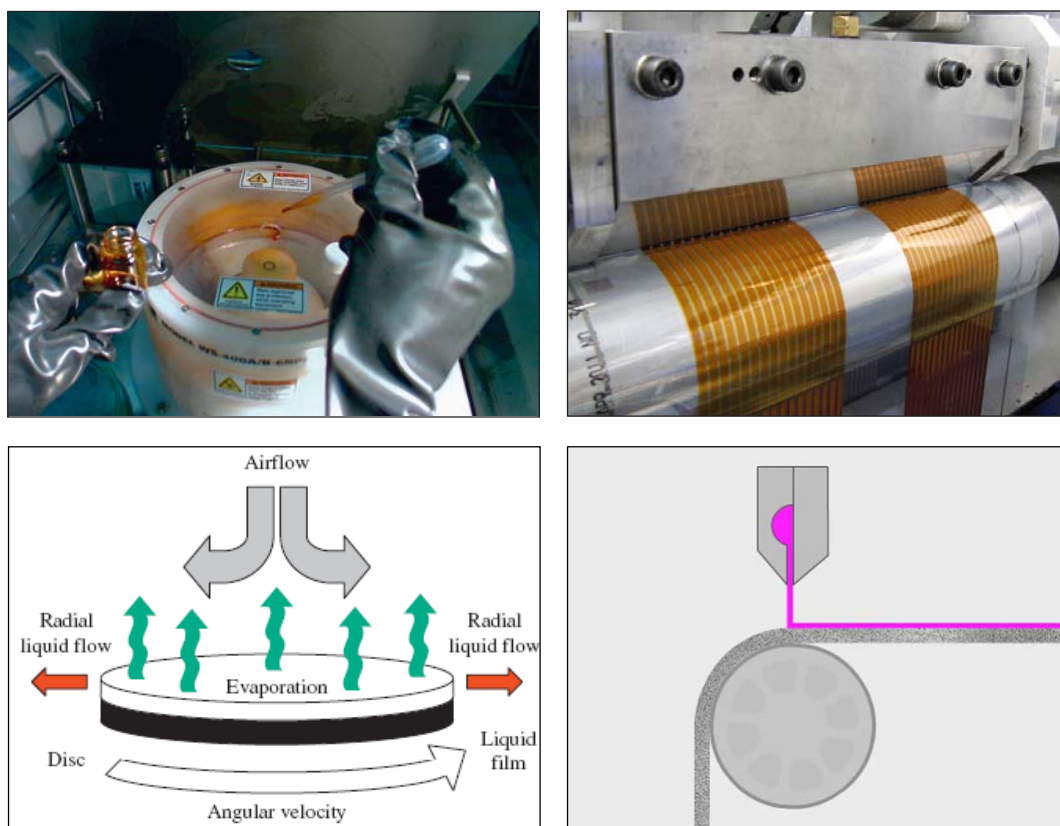

**Figure 5: The roll of laminated solar module coming out of ProcessOne (left) and close-up of one individual module consisting of 16 strip-shaped cells connected in series.**



### 3. Experimental set-up

The vision of low-cost polymer solar cells rests on the vision of scalable printing and coating techniques enabling high-speed roll-to-roll production. Laboratory investigations are however often in direct conflict with this vision as the cells are produced one by one by means of doctor blading or spin-coating; see Figure 6 (left). These methods are widely used, because of their simplicity in use and the relatively low capital investment required for establishing production facilities, and despite the fact that they are not suited for scaling up to volumes associated with mass production. Doctor blading and spin coating are furthermore applicable only for continuous film. Consequently any patterning of the film has to be achieved post film formation, which inherently will add to cost and material usage.



**Figure 6: Processing of individual polymer solar cells by means of spin-coating (left) and mass production of polymer solar cells by roll-to-roll slot-die coating (right).**

An essential F&U task in this project has been to mature DTU's ProcessOne for high-speed, scalable processing of polymer solar cell to the level needed for transfer of the technology to industry. The main production platform of ProcessOne is slot-die coating, see Figure 6 (right), supported by screen printing for applying the metallic black electrode. An experimental roll-to-roll production platform has been established at DTU. The set-up serves the purpose of maturing ProcessOne and of investigating the more advanced processes that gradually will replace the basic ProcessOne. The advanced processes will give access to reduced cost, reduced embedded energy and improved working environment.

The roll-to-roll production platform established in the project comprises the following equipment:

- An in-line roll-to-roll printer/coater for processing all the layers of the solar cells, starting from the patterned ITO-PET substrates
- A roll-to-roll laminator
- A roll-to-roll IV tester for annealing and characterization of the rolled band of solar modules
- A roll-to-roll laser cutter for cutting the processed band into individual modules

Furthermore is a prototype life-time tester designed and built. The set-up allows for testing up to 100 devices under indoor light conditions.

### 3.1 In-line coater and printer for OPV processing

An inline coating and printing machine from Grafisk Maskinfabrik A/S has been installed at DTU, see Figure 7. The line comprises unwinder, edge guide/slicing table, double sided web cleaning (TekNek), 4-roller flexographic printer, slot-die coating head with automated registration, vertical double pass oven (2 metre lengths), rotary screen printer (STORK, RSI compact), vertical double pass over (2 metre lengths), cutter and rewinder.

The system has three tension zones where the web tension can be set individually. Zone 1 is from the unwinder to the flexographic printer, zone 2 is between the flexographic printer and the cutter, whereas zone 3 is between the cutter and the rewinder.



Figure 7: In-line printer comprising unwinder (1), edge guide/slicer (2), double-sided cleaner (3), flexographic printer (4), slot-die coater (5), oven (6), rotary screen printer (7), oven (8), cutter (9) and rewinder (10).

The machine complements DTU's already existing roll-to-roll slot-die coater and roll-to-roll flat-bed screen printer, Figure 8. In these machines the application of one single layer requires one pass. In this already existing set-up, processing the complete solar cells requires thus the foil to be processed by three runs in the slot-die coater, one for each of the three slot-die coated layers and one run in the screen-printer for the screen-printed layer. Ideally all layers of the polymer solar cells are to be printed in one run. The new in-line machine allows for experimenting with this, i.e. by applying more layers in one run.

The new machine also gives access to flexographic printing and thereby patterning in two dimensions. This is a freedom not offered by slot-die coating. Flexographic printing plays already a key role for DTU's development of an ITO replacement that can be roll-to-roll processed under ambient conditions.



Figure 8: Existing roll-to-roll flat-bed screen printer and roll-to-roll slot-die coater

### 3.2 Laminator and laser cutter for post processing

The installed laminator and laser cutter are standard pieces of equipment delivered by Grafisk Maskinfabrik A/S, see Figure 9. The laminator comprises unwinder, edge guide and cutting table, laminator, laminate unwinder, longitudinal cutting knives and re-winder. A close-up of the edge-guide system is shown in Figure 9 b). The laser cutter is used for cutting the processed foil into individual devices.

### 3.3 Functional testing

A roll-to-roll IV tester has been built for rational quality control and annealing of the roll-to-roll produced solar cells modules. The tester is designed to run automatically through all the modules on the roll, test the individual modules, collect the test results and present the data in an easy readable format. The roll-to-roll IV tester is shown in Figure 10.

The roll-to-roll tester is built from three units; a modified roll-to-roll system from Alraun, DTU's general setup for IV characterization of polymer solar cells and a control unit developed for running the IV tests not one by one but automatically in a roll-to-roll process.

The modified roll-to-roll system from Alraun comprises un-winder, positioning camera, vacuum table with electrical connections, pneumatics contacting pads, video camera, transport rollers, dancing tension roller and re-winder. The vacuum table is illuminated by a Steuernagel KHS1200 solar simulator providing approximately AM 1.5 G solar spectrum and  $1000 \text{ W/m}^2$  at the module during the testing. The temperature of the devices during testing is  $72 \text{ }^\circ\text{C}$ .

The roll-to-roll control unit forwards the modules to be tested to the vacuum table either one by one or in groups. The modules are correctly positioned for electrical contacting by means of the camera and vacuum is subsequently applied to keep the modules in position during testing. Contact is made by pneumatic cylinders that force contact between a conducting strip to the vacuum table and the device. It is possible to employ both top and bottom contacting schemes in the system.

The IV measurements are carried out using a Keithley 2400 sourcemeter. The computer program allows for tracing multiple curves and for annealing the device i.e. prolonged exposure to the light. A set of criteria can be determining for when the next module should be tested. For each device a report is generated in Excel format including the data which may include the latest IV curve, a photograph of the device and annealing behaviour



of  $I_{sc}$ ,  $V_{oc}$ , FF, PCE,  $R_s$  and  $R_{sh}$  as function of time. In addition, a summary report for the entire roll is generated. This enables the quick identification of devices on the roll that behaves abnormally.

Roll-to-roll IV characterization is implemented as a standard procedure in every production run at DTU. This saves valuable resources in the lab as the characterization, processing and presentation of the huge amount of data is performed automatically, typically over night.

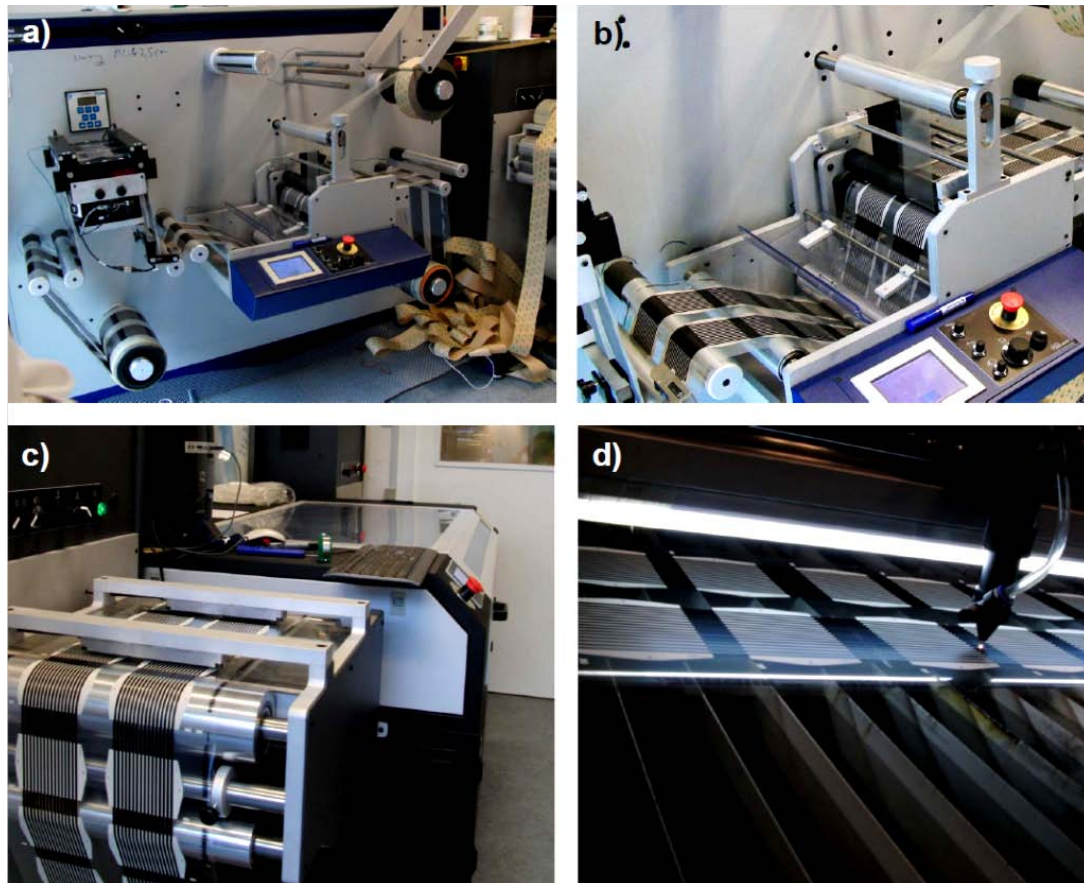

Figure 9: Equipments for roll-to-roll post processing: laminator (a, b) and laser cutter (c, d).

### 3.4 Life-time tester

The unique property of polymer solar cells is to perform rather efficient under low light illumination, and this allows for using the technology for various indoor applications. This creates a need for testing the cell's performance in environments similar to for example working offices or living rooms. Guidelines for such testing procedures have already been published in ISOS protocols (Reese M. O. et al, 2011). Following the protocols, a specialized setup has been developed at DTU for characterizing under indoor conditions using low intensity light.

The setup, see Figure 11, comprises light sources, stages for placing the samples to be tested and measuring source units. The light sources comprise fluorescent or halogen lamps generating light intensities in the range of  $100 - 200 \text{ W/m}^2$ . Devices with geometric sizes as large as  $700 \text{ mm} \times 100 \text{ mm}$  can be measured under the setup. The measuring unit allows carrying out both quick IV tests and long-term lifetime tests using software developed at DTU.

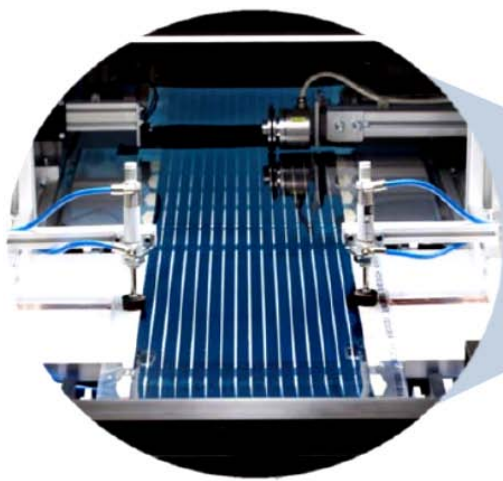

Figure 10: Roll-to-roll IV tester general view.

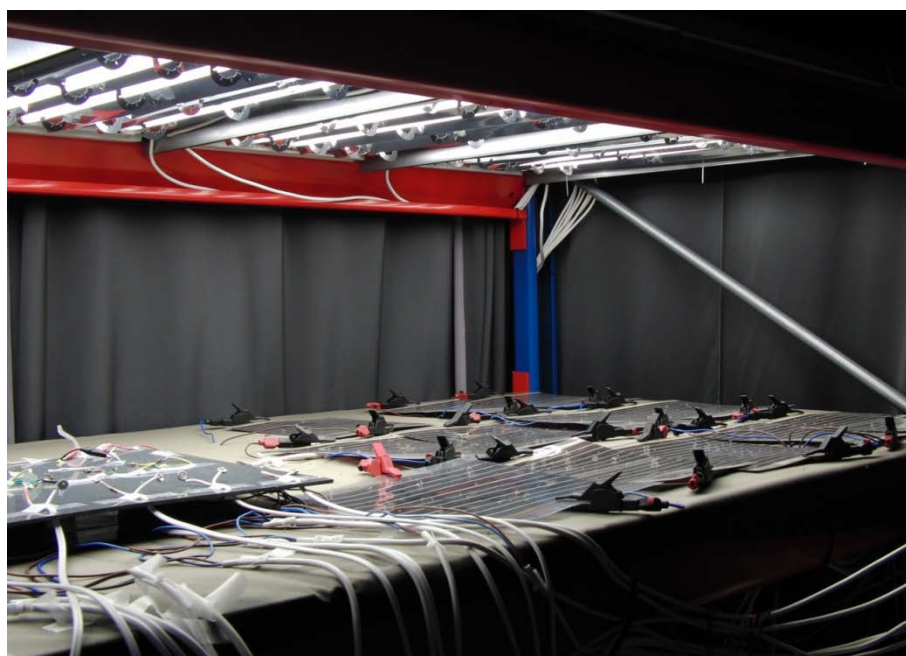

Figure 11: Test stand for indoor light soaking designed in accordance with the ISOS protocols for testing of OPV.

## 4. Optimization of the solar cell

This chapter describes how the polymer solar cells are turned into usable devices. This is a matter of shaping and sizing the modules for use in products, and a matter of protecting the modules by barriers. The chapter describes furthermore the polymer technology's learning curve and the environmental impact of the ProcessOne devices that are both of vital importance for the market acceptance. The analysis of the environmental impact provides furthermore valuable information for the further development of the devices into fully sustainable products.

### 4.1 Miniaturized devices

Many potential applications for polymer solar modules require highly limited current, for example charging of small Li-polymer batteries. For such applications a small credit-card sized module was developed. The module comprises 16 serial connected solar cells spaced by 1 mm. Three sets of 16 stripes were prepared simultaneously on the standard 305 mm wide web. Each printed motif (305 mm x 305 mm) presented 15 independent modules. The processing of the credit-card sized cell device is shown in Figure 12.

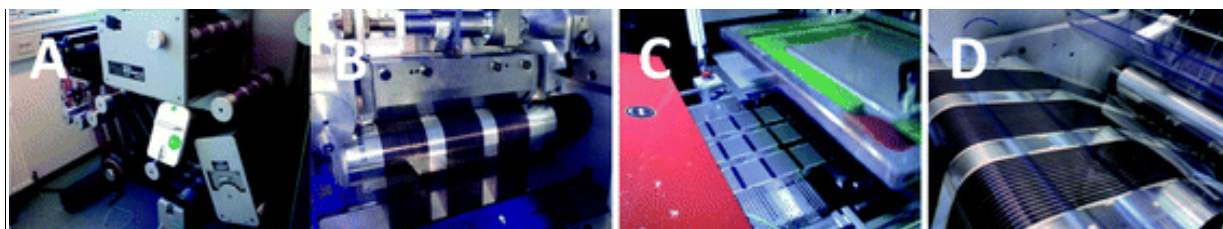

**Figure 12:** R2R manufacture of the credit-card sized devices. A. The PET foil with ITO, ZnO, P3HT:PCBM. B: Slot-die coating of PEDOT:PSS. C. Screen printing of the electrical connection between the individual cells. D. Lamination, from (Krebs F. C. et al, 2011)

The narrow stripe wide (3 mm) and the relatively high conductivity of PEDOT-PSS enabled the successful preparation of this devices without a metal back electrode. Silver was only printed in thin stripes to connect cells and thus not formally as a back electrode. The miniaturization brings the challenge of being able to keep the registration marks that are printed along the web for correct juxtaposition of subsequent layers with respect to the patterned ITO, see Section 2.2. This challenge is however slightly eased as the metal back electrode is left out.

The use of PEDOT-PSS as back electrode implies that the initial performance of the device is significantly higher than what could be obtained with the standard geometry's printed silver back electrode, both full and grid. This implies also that the device performance presents an initial drop due to a drop in conductivity of the PEDOT-PSS back electrode, see Figure 13. Humidity and variations in humidity surrounding the device during operation have previously been shown to cause phase separation in the PEDOT-PSS layer (Krebs F. C. et al, 2011) which will cause a drop in conductivity and a corresponding drop in device performance.

The initial power conversion efficiency (PCE) of the solar cells was found to be around 2 % when tested at 1.5 suns. Upon 3 months storage<sup>1</sup> on the roll the performance dropped significantly, see Figure 13. The main degradation happens to the generated current and not to the module voltage which is critical for the

---

<sup>1</sup>) at room temperature (22±5 °C) and ambient humidity (40±10 % rh)



charging of a battery. This implies that even though the charging efficiency will decrease over time, it will not lead to complete failure as would be the case if the voltage dropped below the charging voltage of 4.7-5.2 V. It would have been possible to print full silver back electrodes and maintain a higher performance over time, but on the expense of a higher materials cost and lower technical yield for such miniaturized devices.

The paper “The OE-A OPV demonstrator anno domini 2011” (Krebs F. C. et al, 2011) refers all further details of the credit-card sized device.

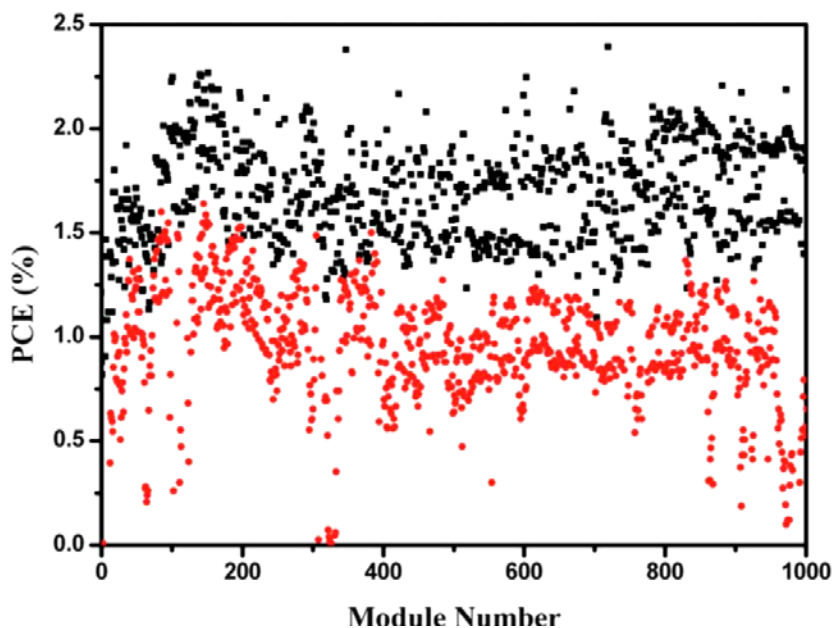

Figure 13: The performance of 1000 modules as prepared (black) and the same modules after 3 month storage on the roll, from (Krebs F. C. et al, 2011)

## 4.2 Barriers for low- and medium demanding applications

Standard ProcessOne prescribes the use of a food packaging barrier from Amcor which is laminated on both sides of the modules in a roll-to-roll process by means of an optically clear pressure sensitive adhesive, 467 MPF from 3M. This encapsulation has been chosen, because its cost/performance ratio harmonizes with the polymer solar cell's cost-performance profile.

The food packaging barrier is suited for applications where the operational life length of the device is not critical, and where the device is not exposed to mechanical stress. For more demanding applications, an additional outer encapsulation might be required in the form of a protection against the unavoidable repetitive bending and buckling that might damage flexible devices over time, or in the form of more sophisticated encapsulations designed for products that shall last for many years under outdoor conditions, see Section 4.3.

The performance of the miniaturized devices which was protected with the Amcor foil and had a PEDOT-PSS back electrode has been observed to drop over time, see Section 4.1. This behaviour is not observed for the standard device, and it is explained by humidity variations in the PEDOT-PSS layer, see Section 4.1. In order to search for a better protection against humidity two alternatives to the Amcor barriers have been tested for the miniaturized device; a barrier from FujiFilm and a self-made barrier based on a 100  $\mu\text{m}$  thick PEN foil coated by 150 nm silicon nitride ( $\text{Si}_x\text{Ni}_y$ ).

The stability of the miniaturized devices when protected by the three foils is shown in Figure 14. The two dashed lines mark the acceptance threshold for respectively stability,  $T_{80}^2$  and open circuit voltage,  $V_{oc}$ . It is notable the Fuji barrier and the home-made barrier (PEN/Si<sub>x</sub>N<sub>y</sub>) samples are bimodal in performance with half of the devices above and half below the  $T_{80}$  threshold of 100 hours. In comparison 7 out of 8 Amcor samples are above the  $T_{80}$  threshold, promising a more consistent performance.

The paper “The OE-A OPV demonstrator anno domini 2011” (Krebs F. C. et al, 2011) gives a comprehensive view of the work on the various barriers.

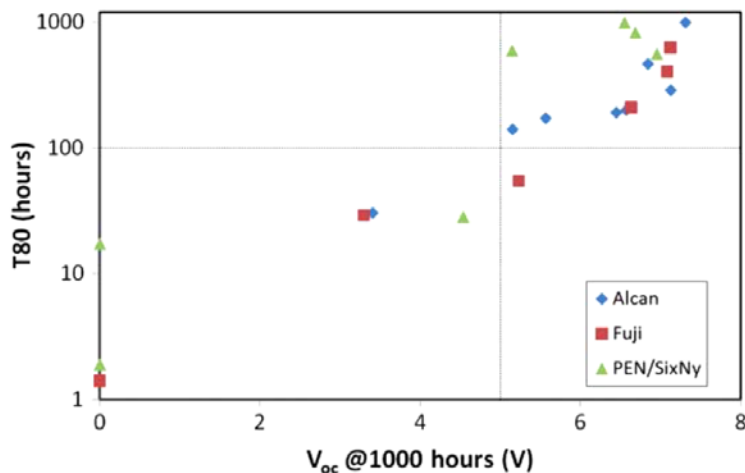

Figure 14: Stability of credit card sized devices represented by  $T_{80}$ . The devices were protected by three different barriers with two different barriers from respectively Alcan and Fuji, and one home-made barrier (PEB/SixNy). The dashed lines represent thresholds for satisfactory devices;  $T_{80} > 100$  hours and  $V_{oc} > 5V$ , from (Krebs F. C. et al, 2011)

### 4.3 Rigid encapsulations for demanding applications

The ultimate goal for the polymer solar technology is to compete with existing photovoltaic technologies for electricity production. One strategy for reaching this demanding application might be to encapsulate the polymer solar modules as it is done for conventional solar panels.

For this reason large area glass encapsulated panels (1 m x 1.7 m) were manufactured from standard ProcessOne modules, see Figure 15. The general procedure for encapsulating the polymer solar modules in such panel is outlined in Figure 16. The panels were subsequently sealed inside a weatherproof aluminium frame using silicon sealant. Both the encapsulation and the framing followed procedures analogous to the ones used for silicon solar panels.

The cost of producing the polymer solar panels was found to be about 300 €/panel, which is fairly competitive to the corresponding cost for silicon panels (350-500 €/panel). However when the cost is normalized to power, the cost for the polymer panel is 36 €/W<sub>p</sub>, which is far from being competitive with silicon panels. The situation is even worse when the expected operational life length is taken into account. The

<sup>2</sup>) the time at which the cell has degraded to 80 % of its peak efficiency



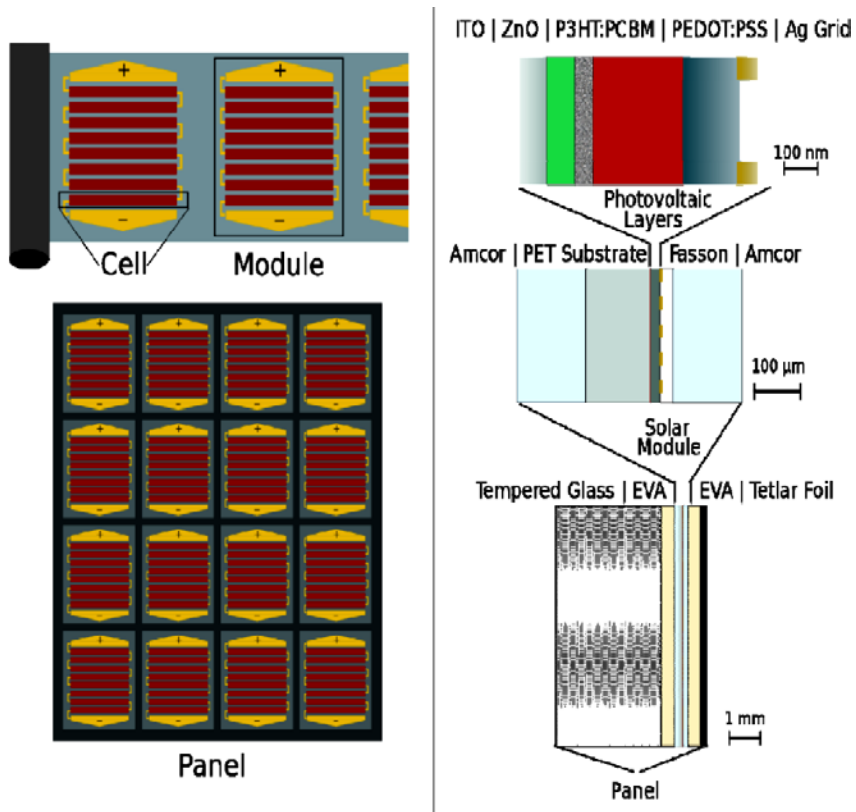

Figure 15: Schematic of the process to the polymer solar modules into full size solar panels (left) and a section through the panel's thickness showing the individual layers, approximately scale (right), from (Medford A. J. et al, 2010).

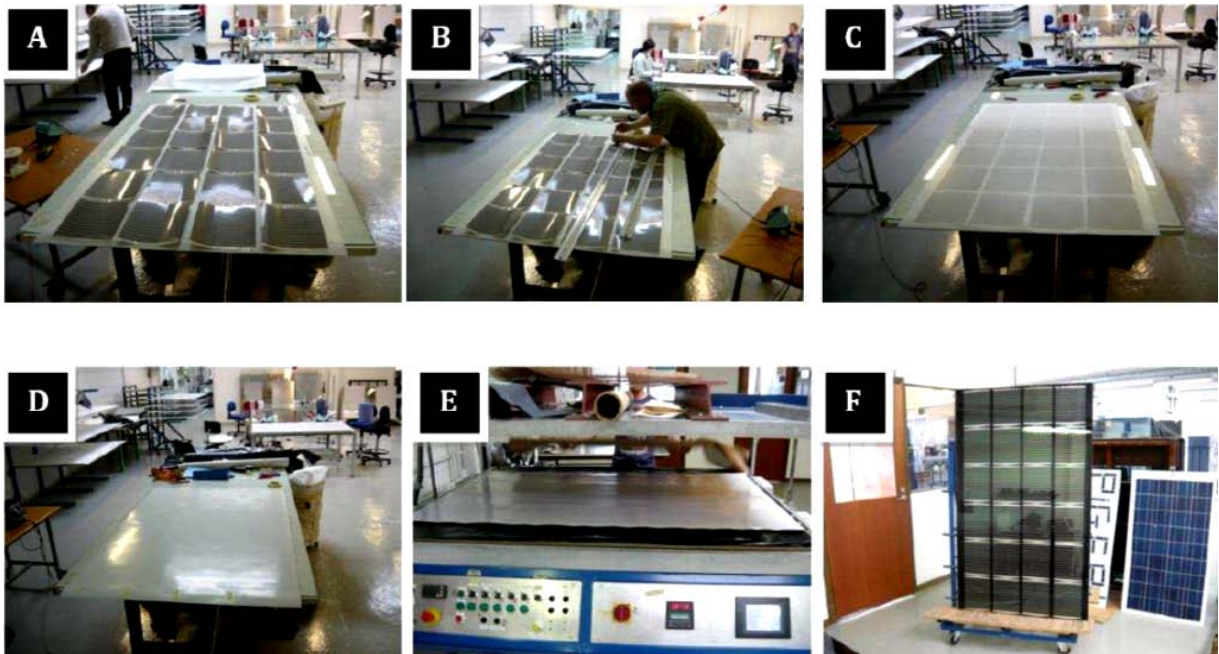

Figure 16: The assembly of the panel starts with placing the individual polymer modules onto a glass pane covered with an EVA lamination sheet (A). Subsequently is the individual polymer modules electrically connected in series or parallel by soldering (B) and covered by EVA laminate sheet (C) plus a tetlar backing foil (D). The entire structure is then laminated under vacuum at 150 °C (E) resulting in a panel ready for framing (F), from (Medford A. J. et al, 2010)

silicon panels will retain 80 % of their initial performance after 20 years, whereas the stability of the first glass encapsulated polymer solar panels lost about 50 % of their performance over the first 6 months.

A breakdown of the cost, Figure 17, shows that the cost of fabricating the modules into the panels actually exceeds the cost of producing the modules. Although the panel cost, especially the labour, is overestimated due to lab-scale production, it must be considered that the materials portion of this cost, which accounts for 27 % of the total cost, will be similar for panels made from polymer solar cell and panels made from silicon solar cell. If this substantial fixed cost is included in the comparison it is apparent that polymer solar cells production must undergo even more substantial cost reduction in order to be competitive in the market for highly stable, large-area PV panels. This implies that strategies bypassing the fabrication of large panels should be pursued for polymer solar cells.

The mechanical robustness of polymers in comparison with silicon may allow for encapsulation and support setups which require far less post processing than what is involved in conventional panel's manufacturing. Use of advanced flexible barriers may allow polymer solar cells to be mounted directly on a rigid support thus avoiding the majority of panel cost.

The paper "Grid-connected polymer solar panels: Initial considerations of cost, lifetime and practicality" (Medford A. J. et al, 2010) gives a complete review of the work on large polymer solar panels.

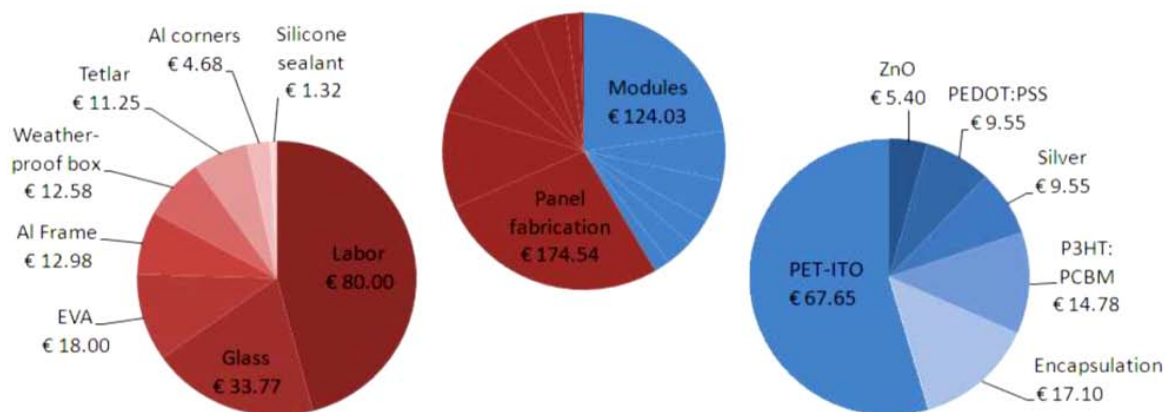

Figure 17: Graphical representation of total cost of polymer solar panels (centre), cost of panel fabrication (left) and cost of module production (right), from (Medford A. J. et al, 2010)

#### 4.4 Life cycle analysis and energy pay-back time

The environmental impact of the baseline device produced has been critically reviewed in a life cycle assessment following a standard approach, (Espinosa N., Garcia-Valverde R., Urbina A.; Krebs F. C., 2010). The study has focused on the following issues:

- Material inventory for the production of an organic solar module, including solvents and other materials not present in the finished module
- Energy embedded in the manufacture of materials from raw materials to an initial input into the manufacturing machinery
- Energy embedded in the direct process.

Decommissioning procedures have not been taken into account. Polymer solar cells are still at a preliminary stage of deployment, and a lack of solid knowledge of recycling procedures for some of the materials included in the final module makes it unreliable to perform a calculation of the energy embedded in the decommissioning steps. Nevertheless, the recycling of some materials (especially solvents such as methanol) during manufacturing has been taken into account in the calculations. Balance of System analysis is also outside the purpose of this LCA analysis, therefore the comparison with other PV technologies is performed at module level.

The analysis revealed that ITO is the far most energy intensive materials in terms of processing, as ITO represents about 87 % of the total energy involved in processing of materials, see Figure 18. ITO is thus the most important bottle neck both in ProcessOne. Intensive research is carried out to find alternative transparent conducting layers, and ProcessOne will presumably be phased out in favour of DTU's newly developed ITO-free process when this is ready.

The direct process energy is the sum of the energy consumption in the different steps in ProcessOne starting from input materials; PET, ITO, inks, barriers and adhesive. Figure 18 shows the distribution of energy consumption in ProcessOne's unit operations. The coating of PEDOT-PSS is the most energy consuming step, followed closely by the screen printing of the silver electrode and patterning of ITO. All energy results have been converted to Equivalent Primary Energy (EPE) and compared in Figure 19. As the embodied energy in materials accounts for significant fraction of the total embedded energy, less energy intensive materials are and will be an important issue in further studies.

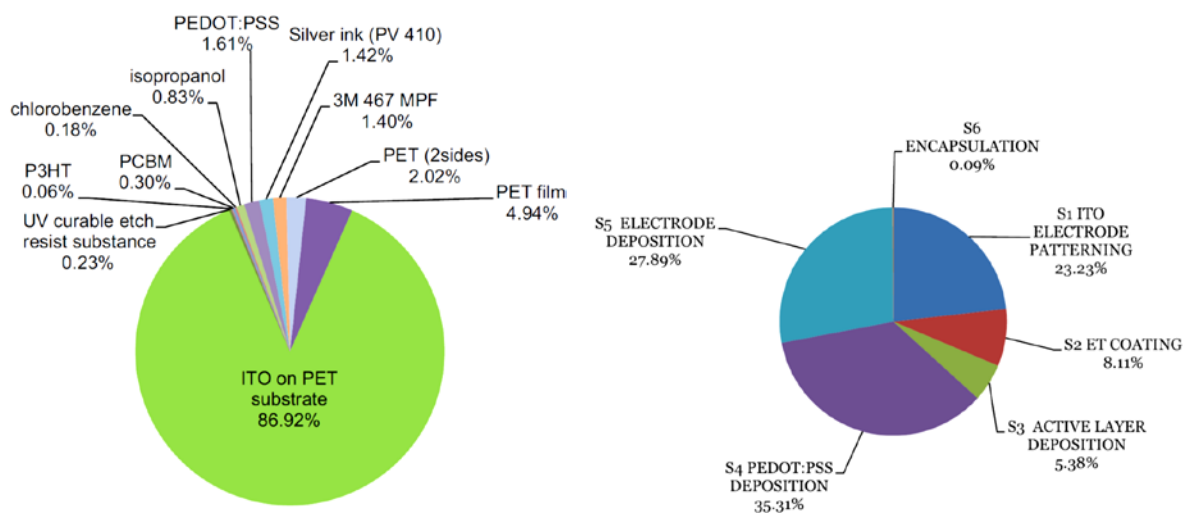

**Figure 18:** Calculated share of the embedded energy in the input materials to the direct production (left) and calculated distribution of the energy consumption in the preparation of the solar cells various layers, from (Espinosa N., Garcia-Valverde R., Urbina A.; Krebs F. C., 2010)

Upon assumption of power conversion efficiencies, percentage active area and lifetime of the modules, a calculation of energy pay-back time allows for the comparison of the ProcessOne technology with other organic and hybrid PV technologies see Figure 20. The results show that an energy pay-back time (EPBT) of 2 years can be achieved for an organic solar module of 2 % efficiency, which could be reduced to 1.4 years, if the efficiency is increased to 3 %.

The life cycle analysis emphasize that more efficient use of the ITO covered substrates has to be addressed. This will imply a rethinking of the etching process, where 62.5 % of the initial amount of an ITO is

lost. Avoiding the etching process and substituting it with a directly patterned deposition method for at ITO would be a step forward. In the end, all use of ITO as electrode material should be avoided, as the share of energy embedded that arise from the use of an ITO as electrode is the highest of all input materials, almost 87 %. Also the economical cost of Indium and its scarcity make this element a bottleneck for a competitive price per watt peak.

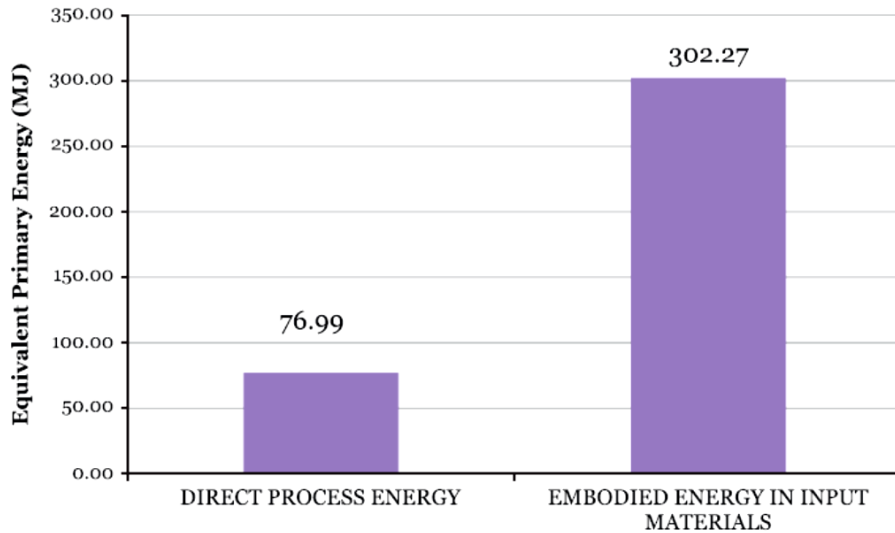

Figure 19: Embedded energy in 1 m<sup>2</sup> processed surface of a polymer solar module with active area of 67 %. The energy is given in Equivalent Primary Energy (EPE), from (Espinosa N., Garcia-Valverde R., Urbina A.; Krebs F. C., 2010)

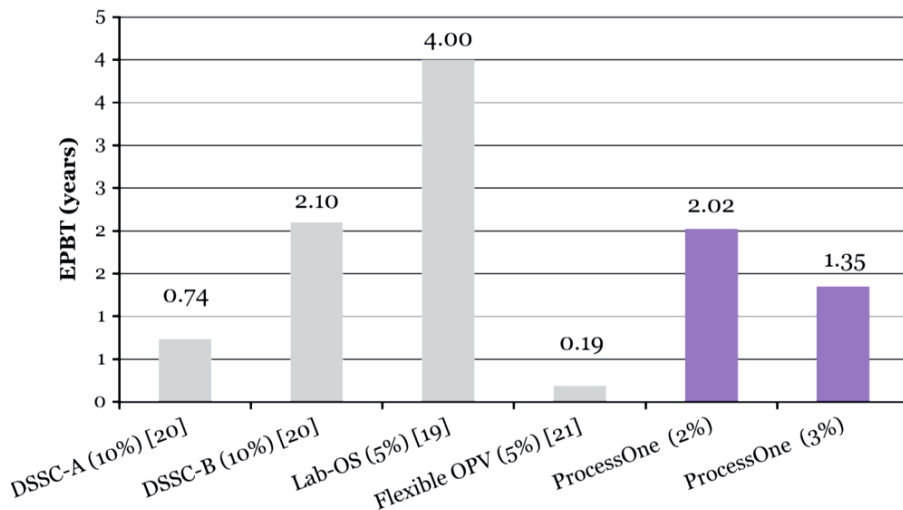

Figure 20: Energy payback time for various organic and hybrid PV modules. South Mediterranean irradiance (1700 kWh/year) and a performance ratio<sup>3</sup> of 0.8 are assumed. The module efficiency is shown in brackets. DS denotes Dye Sensitized modules, whereas A and B refer to respectively low and high values, from (Espinosa N., Garcia-Valverde R., Urbina A.; Krebs F. C., 2010).

<sup>3</sup>) the ration between the actual and theoretical energy outputs of the PV plant

Finally, since the embedded energy in the modules (materials and direct process) has been steadily reduced during the past few years for all PV technologies, the relative share of BOS data is increasing when the full PV generator system is considered. In the near future, a more energy efficient process for all components included in the BOS will be mandatory for the final environmental impact of the PV system for electricity production at large scale to be further reduced.

#### 4.5 The OPV learning curve

Several projections have highlighted polymer solar cell as a potentially very low cost technology with a watt peak cost significantly less than 1 €. There has until now been no firm documentation of how this low cost potential can be realized.

The lowest cost achieved with ProcessOne during the course of this project is 5 € per watt peak, and while this may seem promising it should be emphasized that more than 80 % of the total cost is from materials and before any further cost reduction can be realized the technology must evolve further to eliminate the most expensive components such as ITO. In addition the electricity cost should ideally be quoted as the levelized cost of electricity.

In terms of a learning curve for total manufacturing cost it is possible to make a comparison between crystalline silicon solar cells and polymer solar cells while neglecting the problem of the operational lifetime. The result is shown in Figure 21 where the cumulative produced volume of respectively crystalline silicon - and polymer solar cells is plotted versus the production cost. Even though the volumes produced by the two technologies are far from being comparable, it is possible to make a quite conservative estimate of the reduction of manufacturing cost as a function of time.

One of the findings is that polymer solar cells exhibit a much steeper learning curve than crystalline solar cells with the possibility for manufacture at quite low cost on a small scale. Based on the finding and assuming linearity it should be possible to achieve a manufacturing cost of 1 €/W<sub>p</sub> with cumulative W<sub>p</sub> produced of around 100 kW<sub>p</sub>.

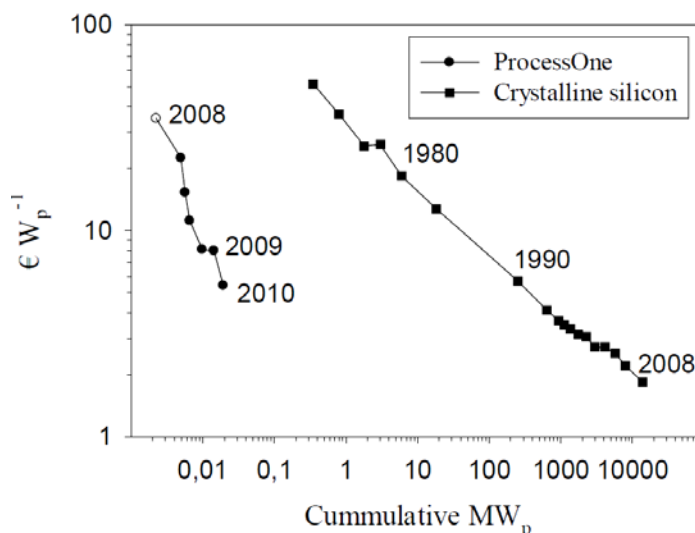

Figure 21: A comparison between the learning curves for polymer solar cells based on ProcessOne devices and crystalline silicon solar cells. The curve until 2009 was first published in (Krebs F. C., Fyenbo J., Jørgensen M., 2010) and has later been updated with the 2010 data.



## 5. Industrial implementation

After a carefully planning period, Mekoprint's new line for production of solar cells was opened in June 2010. A retrofit solution were chosen where the core of an existing screen-printing line, was dismantled and fitted to a slot-die print head manufactured in DTU's workshop. In parallel the remaining line was adjusted and updated to handle the new production.

After reconstruction, the very first solar cells were produced at Mekoprint in July 2010 by Mekoprint's operators but under DTU's supervision. Subsequent coating trials to tune the production and train the operators at Mekoprint have been both with and without the supervision of DTU as seen in Figure 22.

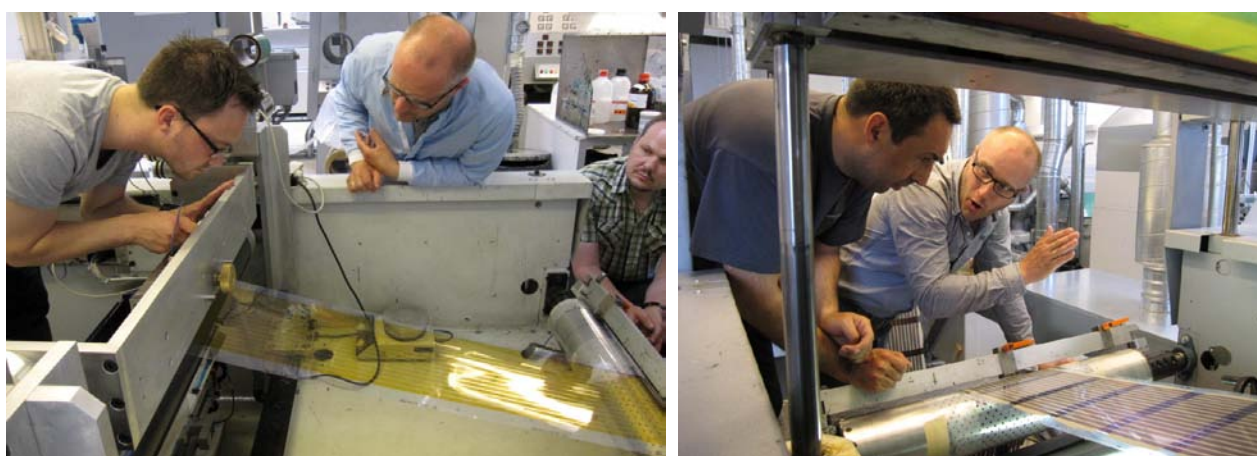

Figure 22: Coating of active layer under supervision from Prof. Krebs at Mekoprint

Mekoprint has during 2011 invested further in equipment for the retrofitted coating line. Additional pumping equipment has made the production more stable and given the opportunity to dedicate one pump to each coated layer. This drastically reduces maintenance cost for the equipment.

During the first year of coating trials, it was found necessary to improve the stability of the registration when coating the different layers. A new web guide system from the company BST has then been installed on the coating line. The web guide system can follow a printed line and this improves the registration of the coated layers with respect to the printed layers. An improved registration enables Mekoprint to increase the module efficiency. Mekoprint has furthermore carefully assessed the precautions needed for handling the solvents contained in the coating ink in the production environment and made arrangements here for.

### 5.1 The coating line

The coating line at Mekoprint is a completely rebuilt screen printing line from Klemm. The line was removed from the production setup and the changes were implemented. This option was chosen to lower the capital investment before starting to coat the first polymer solar cells and to await further improvements before investing in larger-scale processing equipment that might become obsolete before commercialization.

The coating line consists of three sections. The first section consists of an un-winder, a slicing table, web edge guide system from BST for stable un-winding, a Corona surface treatment system, and a web cleaner with static charge removal. The middle section is the coating section. It consists of three vacuum rollers for forward feeding, another BST web guide system combining edge guided with camera guided technology, a

surface treatment station with a static bar for neutralizing static charge. The middle section also contains the coating unit which is a slot-die coating head built by DTU and a preheater unit for fast heating directly after coating.

The final section of the coating line is the oven, the inspection table and the re-winder. The oven-section consists of two vertical ovens with each 4 m of active heating length for a total of 8 m oven. Further ovens can be included if the need for higher process speeds deems it necessary. After the ovens, an inspection table makes it possible to perform manual inspection of the finished coated layer before the web is pulled on to the re-winder.

The entire production line at Mekoprint is built for a web width of 720 mm, but the slot-die coating head is only 240 mm wide for coating on 305 mm web width. This can be expanded in the future, but a wider slot-die head is a complicated component.

The R2R etching equipment at Mekoprint is for 610 mm wide web, so as long as the process of manufacturing polymer solar cells include etched ITO, this web width is the limiting factor at Mekoprint. In Table 1 an overview of the specifications of the coating line at Mekoprint is shown.

**Table 1: Specifications for the Mekoprint coating line for phase 1**

<b>Proper</b>	<b>Value</b>	<b>Units</b>
<b>Web width</b>	720	mm
<b>Coating width (2011)</b>	240	mm
<b>Coating speed minimum</b>	0.1	m/min
<b>Coating speed maximum</b>	5	m/min
<b>3 x Web guide (edge and camera)</b>		
<b>Piston pump</b>	Yes	
<b>Diaphragm pump</b>	Yes	
<b>Tube pump</b>	Yes	
<b>Heating of coating head</b>	Yes	
<b>Oven temperature max</b>	150	°C
<b>Oven length</b>	8	m
<b>Oven type</b>	contact+convection	
<b>Corona treatment</b>	Yes	
<b>Web cleaner</b>	Yes	
<b>Automatic prewashing</b>	Yes	
<b>Inspection table</b>	Yes	

## 5.2 Implementation and challenges

In the production of polymer solar cells, many details around the slot-die coating head needs to be manually fine-tuned to perfection before the result is just adequate. This can be details such as static electricity, clean substrate, continuous pumping speed, continuous web speed without vibrations, adequate cleaning of the substrate before coating, or adequate drying of the coated layer. Mekoprint have been through this process and can coat continuously within a stable process window.

The main challenges in the production at Mekoprint currently, are the particle pollution from the environment and correct registration during coating. Some of these problems can be solved manually by cleaning, covering, and fine-tuning, but a more robust solution will take larger investments.

The essential slot-die coating mask has been sought optimized within the internal processes at Mekoprint. The work is still ongoing, but this will definitively lead to a mask that significantly reduces the start-up - and cleaning time.

Between February and September 2011 Mekoprint has run 17 coating trials with an average of 25 m each trial. The production has been stabilized and one operator has been trained to control the machine – so far under supervision and help from one extra engineer. The goal is to automate the machine to the extent that the operator can handle the production alone. This target will not be reached in Phase 1. Phase 1 has shown the feasibility of a simple production of polymer solar cells at Mekoprint.

Mekoprint has currently successfully slot-die coated all three layers constituting the solar cell and has finalized the cell with screen-printed silver contacts and encapsulation without the presence of DTU at Mekoprint. The electrical properties of the produced polymer solar cells at Mekoprint are acceptably close to the level the cells produced by DTU, but large improvements are still needed in order to be completely in control of the production process. Furthermore, substantial improvements in efficiency, lifetime, and cost are needed before the polymer solar cell can be competitive against other similar flexible PV technologies. Mekoprint will thus continue to train machine operators and work out manufacturing procedures to follow in an industrial environment.

### 5.3 Process control

During production of each of the three coated layers in a polymer solar cell, the operator faces challenges such as the correct coated wet thickness, thickness distribution across the film, stripe edge sharpness, and many other important parameters. In order to reduce the work load of the operator and increase the stability of the production setup, extensive logging equipment has been installed. This equipment continuously saves various directly available data such as coating speed, current barcode/position on the web, temperature and relative humidity in the manufacturing room, etc. This data is stored for traceability and can later be compared against the performance of individual polymer solar cells when tested. This will yield extensive statistical data correlating manufacturing conditions and performance of polymer solar cells. This data will be used both to optimize the manufacturing process and to ensure traceability for the end consumer. The former will reduce the cost and the latter will help us put this new technology faster into new markets, when feedback from end users can be directly related to manufacturing issues.

At the end of phase 1 the data logging platform has been established and the production data are saved. A complete traceability from end-user back to production with the specific supplied materials is outside the scope of phase 1, but can be built on the foundation laid out in phase 1. In Figure 23 a graph is shown with the vital production data from a coating trial.

### 5.4 Production cost

Polymer solar cells are still more expensive than other solar cells when produced at Mekoprint under commercial conditions. The cost distribution is shown in Figure 24 for a production of 4500 credit-card sized cells. The total cost is distributed on materials, process cost (man and machine time) and start-up costs:

The start-up and processing cost is expected to be significantly reduced pending process development. The cost distribution for the materials is detailed as follows.

The material cost is dominated by the coated layers (ZnO, active layer and PEDOT:PSS) representing 61% of the material costs. The active layer and PEDOT:PSS comprises highly specialized polymers, which have a small world market, which leads to high cost. They require significant volume expansion for cost reduc-



tion. For PEDOT:PSS, the OLED market will drive volumes up, while the active layer polymers (currently PCBM and P3HT) have no similar volume boosting application. With future development in active layer materials, we might see even more specialized polymers, which implies a risk of cost-deadlock; high volume requires low prices, while low prices requires high volumes. The two solutions to this problem chosen is to produce solar cells with a loss for some time until cost goes down or finding niche market, where the higher price can be justified.

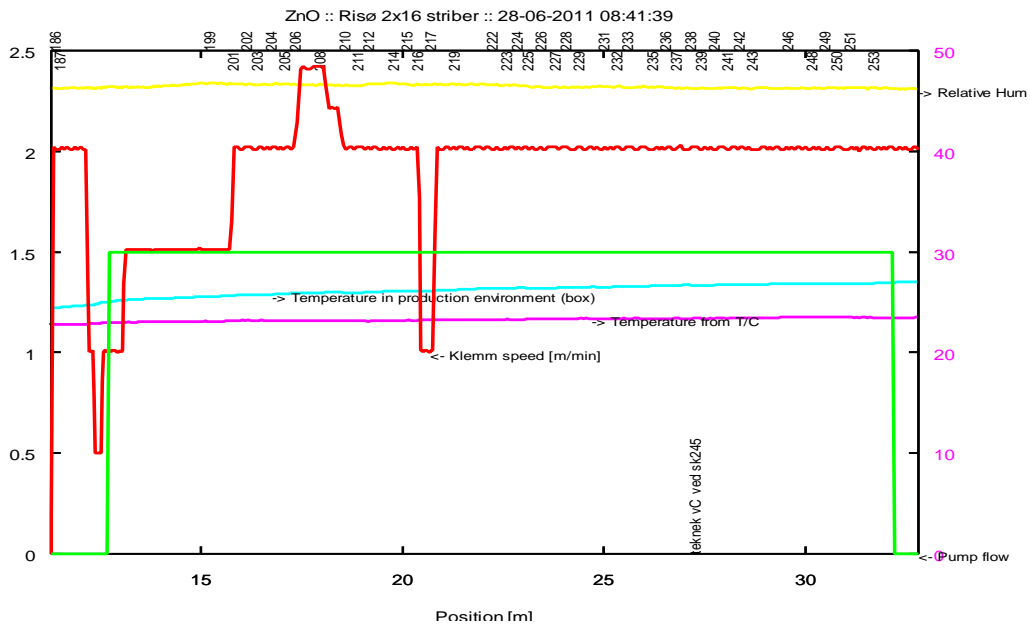

Figure 23: Graphs showing vital logged data from a typical coating trial at Mekoprint. Above the chart are barcodes read during production.

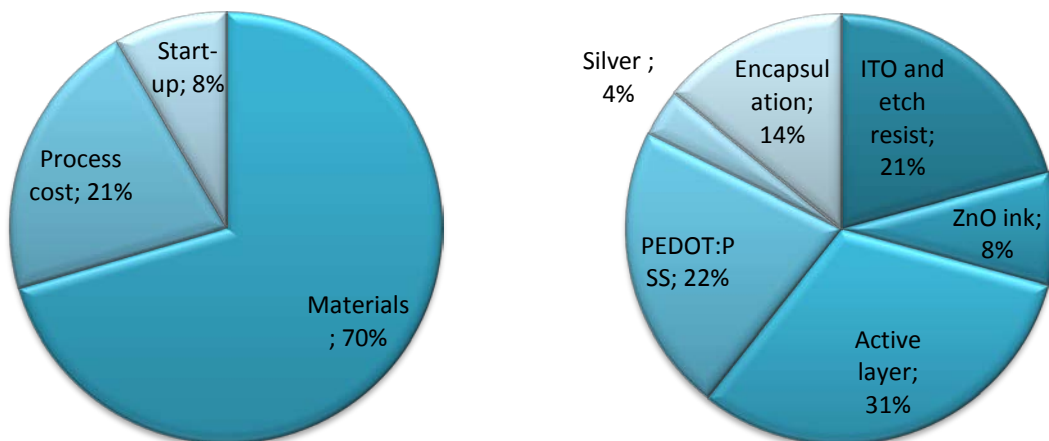

Figure 24: Breakdown of production cost (left) and materials cost (left) for a production of 4500 credit-card sized solar cells

## 6. Product design

When designing well-functioning products with polymer solar cells (OPV), one needs to go through a design process generic to all solar-powered products. Furthermore one has to consider relevant OPV specific qualities and issues, in order to take maximum benefit from these, both in the product design and in the manufacturing process.

The main challenges in design of all solar-powered products are first of all supplying the required power by means of the solar cell and storing this energy intelligently on a battery, secondly driving the specified functions with minimum energy consumption and finally shaping the product for appropriate integration of the solar cell without compromising the product's operation, user interface and aesthetics. This process is illustrated in Figure 25.

The qualities to be considered in the OPV-specific design are issues such as the polymer solar cell's flexibility, its light weight, its slim outline and its adaptability to the specific product, which are key qualities not matched by other solar cells, see Figure 26. Another important issue is the roll-to-roll processing, which is not restricted to the manufacturing of the solar cell itself, but might, if considered already in the design phase, be extended to the further processing of the cell into more refined products. A neat example of this is the integration of roll-to-roll printed electronics and roll-to-roll manufactured solar cells. Such a setup enables cost-effective production of solar-powered electronics, as the units to be handled in the production are the primarily rolls and not individual devices.

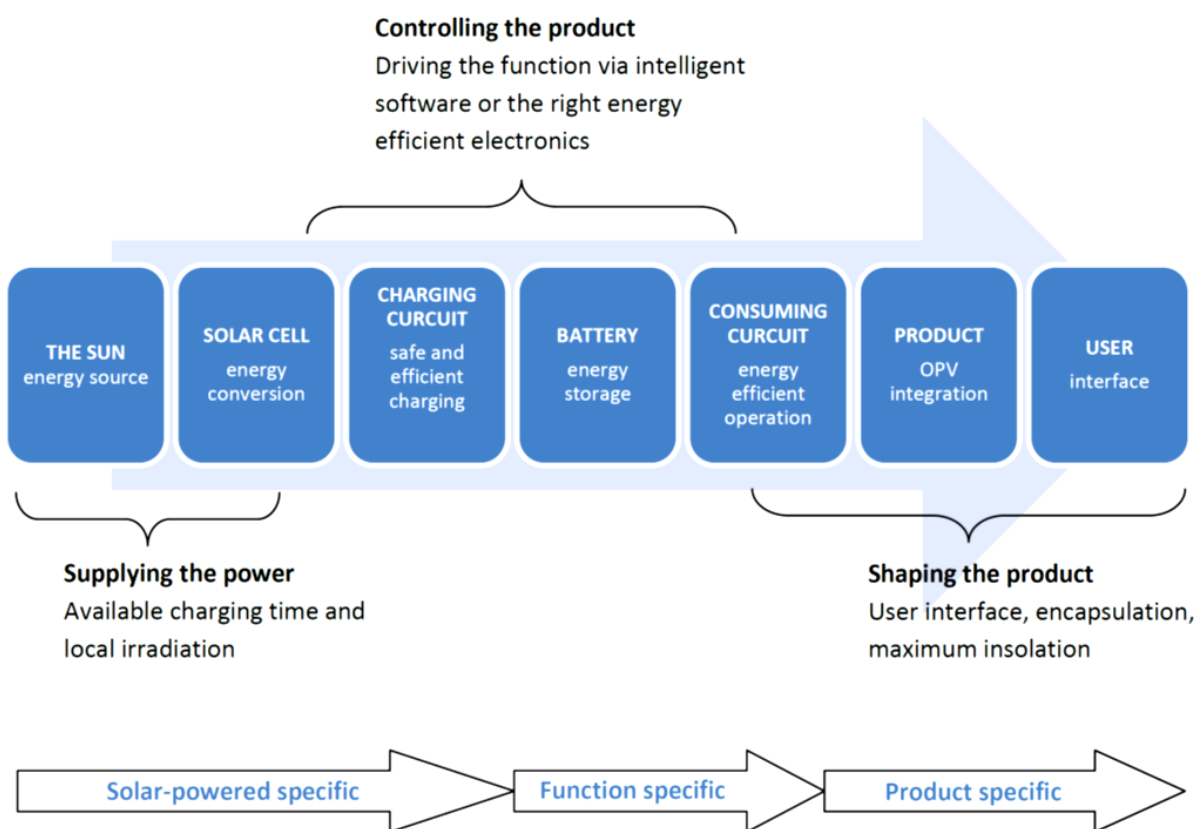
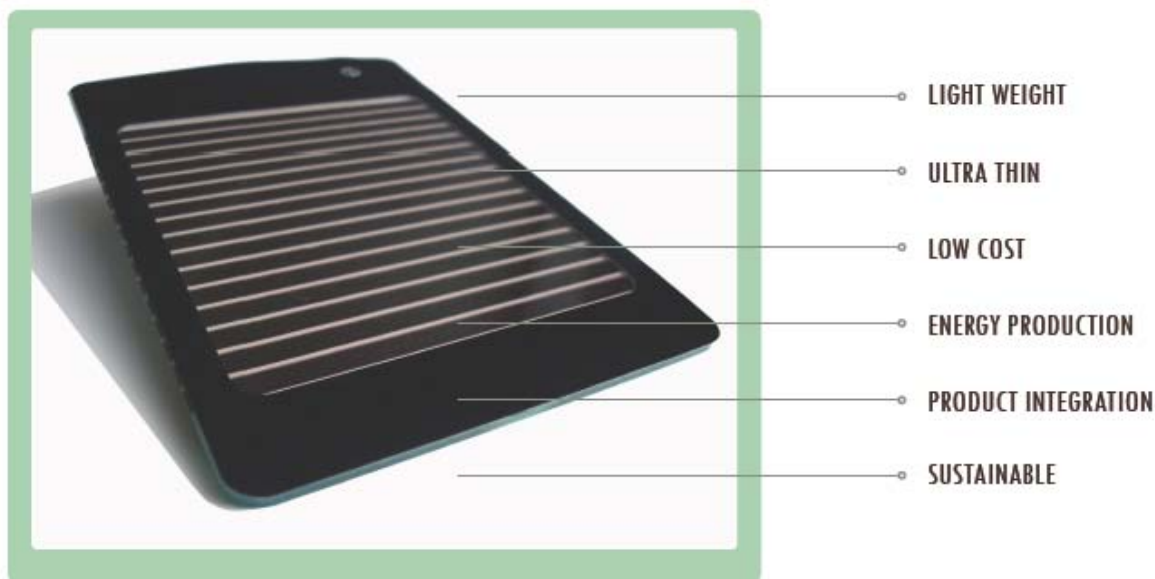

Figure 25: The generic process for design of solar-power products



**Figure 26: An example of an OPV-powered product, a LED flashes light, which benefits from the polymer solar cell's low weight, slimness, mechanical robustness. This product might in a later version demonstrate an all-integrated roll-to-roll production spanning from the input materials to the finished product.**

During the course of work a range of products have been sketched and the selected ones have been further detailed as mock-up models, as prototypes and in small-series production. The purpose of this has been to gain knowledge and experience in design and development of OPV products, and furthermore to fertilize the market via product demonstrations, see Chapter 7.

Figure 27 shows a range of product ideas for which the integration of solar cells makes a difference, as it opens for new and improved functionality. A common feature with these product ideas is that they all benefit from the characteristics of the polymer solar cells either from the characteristics of the solar cell itself or from its high-volume processing. Most of these applications are within reach already today, whereas a few of them ask for a higher cell performance than what is industrially achievable today. Consequently, the realization of these few ones will need some patience.

The product ideas belong to three categories; communication (C), aid (A) and lifestyle (L):

- C.1. Energy supply to RFID's in fast moving consumer goods
- C.2. Solar-powered laptop
- C.3. Solar-powered smart phones
- C.4. Easy to install electronic parking watch
- A.1. OPV-powered handheld light
- A.2. OPV-powered hanging light and head light
- L.1. Outdoor sun shading such as awnings, parasols etc
- L.2. Sponsor cards for conferences
- L.3. OPV-powered electronic games: Sudoku, Word feud etc.
- L.4. Business cards with OPV and the possibility of communicating
- L.5. Indoor sun shading such as blinds, curtains etc
- L.6. OPV-powered garden lamp



**Figure 27: A range of product ideas for which the polymer solar cell makes a difference coming from three market segments: communication, aid and lifestyle.**

Despite the wide range of possible application for the polymer solar cells, prime focus in the project has been solar-powered LED light for use in non-electrified 3<sup>rd</sup> world countries, i.e. a product targeted to customers having highly limited or almost no purchasing power. This is done in order to force all design and product development efforts onto cost-effectiveness, and thereby maintain and stress the low-cost profile of the polymer solar cell also in the finished product.

The following sections report the project's work on design and development of low-cost LED light sources. Regardless of the narrow focus, most results reported are of general validity and applies thus for a wide range of OPV-powered products.

## 6.1 The electronic system

The basic electronics in a solar-powered LED light source is a system comprising two independent sub circuits:

- The charging circuit designed for efficient and safe charging of the battery by means of the solar cell.
- The consuming circuit designed for effective operation of the LED by means of the battery.

Two versions of charging circuit have been tested in the project. The simplest circuit includes a blocking diode (MMSD701, Schottky Diode) in series connection with the solar cells and the battery. The diode blocks any possible current running from the battery and backwards into the solar cell. The diode thus prevents discharging of the battery when the lamp is not in use.

A slightly more advanced system includes a Zener diode in parallel with the battery. The purpose of this diode is to protect the battery from overcharging. Two different Zener diodes, ONSMMSZ5231BT1G from ON Semiconductor and LM4040D41IDBZR from Texas Instruments, with Zener voltages of respectively 5.1 V and 4.2 V, have been tested. The diode from Texas Instruments has a better voltage match with the battery and should therefore give an improved protection against overcharging.

All systems, i.e. with and without protection against overcharging and overcharge protection by means of the two Zener diodes, have been realized in LED lamps. The lamps have widely distributed both in Western countries and in non-electrified 3<sup>rd</sup> world areas, see section 7.1. No catastrophic failure of the battery has been reported by the users, even not for the simplest system with no protection against overcharging. This shows that the solar cell due to its highly restricted current production effectively prohibits overcharging. For systems with larger and more efficient solar cells, protection against overcharging of the battery might however become an issue, and as protection against overcharging is a security issue it should always be considered.

To optimize the consuming circuit and overall function of the LED lamp a software solution was designed, see Figure 28. The solution includes a maximum power point tracker and a constant current LED driver with battery boost ensuring that the current does not drop as a consequence of the gradual discharge of

the battery, but are held constant until the battery is almost discharged. By this is possible to maintain a constant light in the LED for a prolonged period. Testing of the system showed an increase by a factor 2. For the specific lamp this meant an increased in the user's access to light from two hours to four hours a day, without increasing the size of the battery or the size of the solar cell.

Other optimization of the consuming circuit has not been a focused area in the project, as this is not specific for polymer solar cells, but generic for development of all solar-powered products. It should however be emphasized that energy-efficient operation is a critical issues in the design of any solar-powered product.

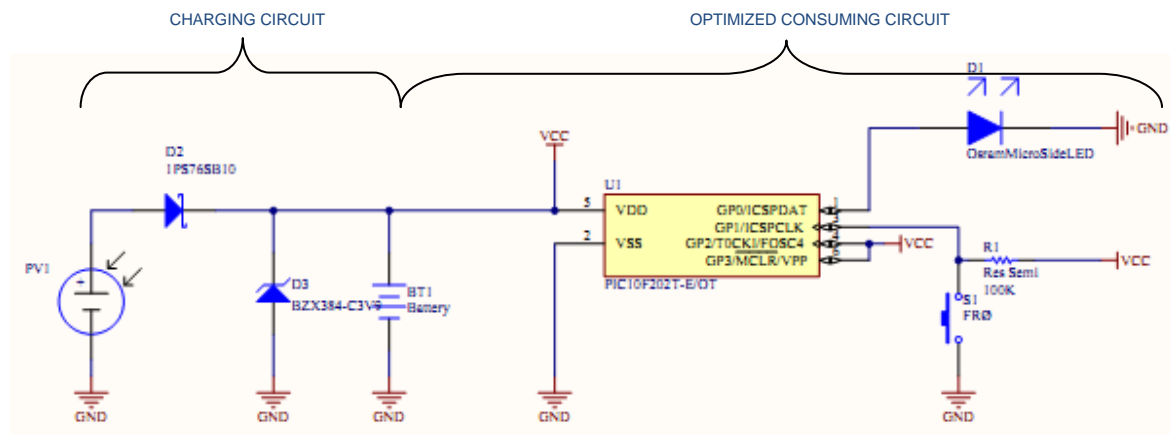

Figure 28: The schematic for the lamp including the charging circuit optimized consuming circuit with max power point tracker, constant LED driver, battery boost, and on/off latch function.

## 6.2 Design for assembly

Design for assembly means to design the LED lamp for cost-effective and reliable assembly, i.e. the assembly of a system comprising the polymer solar cell, the electronic circuitry and the electronic components; the battery, the diodes, the LED, an ON/OFF switch and eventually also other components. The project has evaluated three different production/assembly principles for this system:

- Principle 1 where the solar cell acts as substrate onto which the circuitry is printed and the electronic components are mounted,
- Principle 2 where the solar cell is a discrete component that is mounted onto the a substrate holding the printed circuitry and the electronic components,
- Principle 3 where the lamp is assembled from two separately produced components: the solar cells and a printed circuit board (PCB) holding all electronics.

Principle 1, see Figure 29, is the most attractive one seen from a theoretical point of view, as it allows the roll of already processed solar cells to be fed directly into the roll-to-roll printing of the electronic circuitry. Handling of discrete components is thus restricted to the final processing step where the electronic components are mounted, whereas all other handling is on the rolls.

The application of the electronics onto the solar cell entails extra handling for the cell; printing of the circuitry including drying, mounting of the discrete components by means of conducting epoxy glue and drying of the glue in the oven and finally mounting of vias and contacts. Destruction or failure of the solar cells in spite of this extra handling has not been observed.

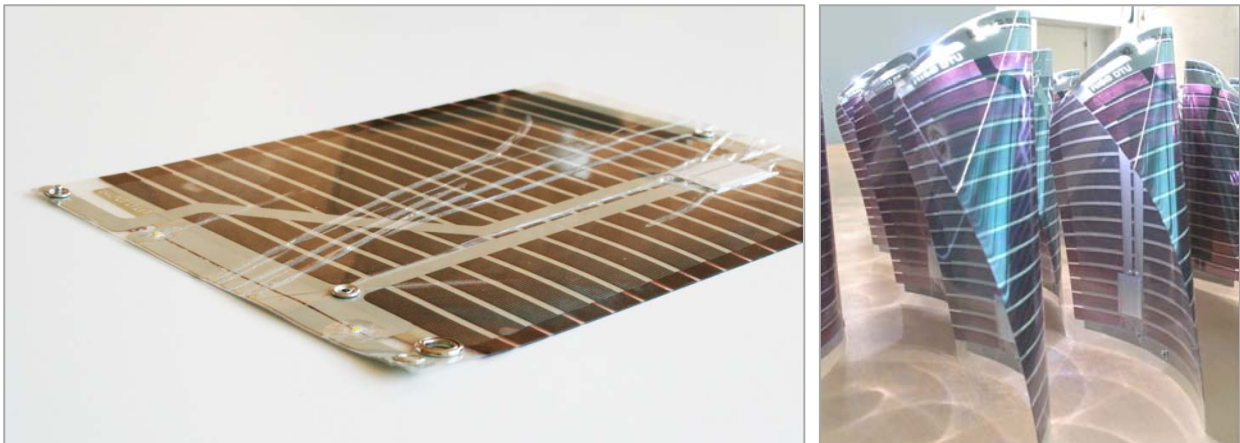

Figure 29: The produced according to principle 1 (left) and the printed circuitry on the back side (right).

Principle 1 was, however, found to be problematic at the present stage of maturity, where many of the functional solar cell modules had to be discarded due to misalignment of the subsequently printed circuit. Based on the relative high cost of the solar cells with respect to the overall cost of the lamp, it is more rational to handle the solar cells as a discrete component and insert it into the lamp circuit after manufacturing. When and if the solar cell has a significant lower cost than the overall cost of the product or when the discard rate in the post processing of the solar cell is negligible, will it be advisable to use the solar cell as a substrate for printing the circuitry.

Due to the experiences with principle 1, an alternative principle 2 was developed. Here the lamp is constructed from three functional layers; a PET foil holding the circuitry and the electronic components, the solar cell and a spacer with laser-cut room for the flat battery, see Figure 30. These three layers are processed individually and subsequently sandwiched by means of two adhesive layers. Contact between the solar cells and the circuit is achieved in the final step by crimping.



Figure 30: The lamp produced according to principle 2, exploded view to the right, from (Krebs F. C., Fyenbo J., Jørgensen M., 2010)



Principle 2 was tested in the production of 10.000 credit-card sized lamps; see Figure 31. All steps in the preparation of the solar cell, the circuitry and the overlays for this lamp were by roll-to-roll processing. The mounting of the discrete components, such as the LED, the blocking diode and the Zener diode, was performed sheet by sheet (15 units per sheet) in a fully automated SMD<sup>4</sup> mounting machine, whereas the mounting of the battery and the contacts were done manually. Finally the individual lamps were laser cut into their final shape. The technical yield was 89 % overall which is regarded as highly satisfactory at this early stage of industrialization.

Principle 3 was tested in order to try out a completely different strategy, i.e. a strategy where the lamp is assembled from two units; the solar cells and a printed circuit board (PCB) holding all electronics. Production of PCBs are main-stream technology and gives thus an attractive freedom in design of the electronics, as the range of components complying with the PCB is much wider than the range complying with Meko-print's SMD mounting machine.

Trials with a lamp constructed from a PCB and a polymer solar cell, see Figure 32, was however not successful, as the process involves joining of the flexible solar cell and the rigid PCB. Joining a rigid and a flexible structure gives inherently a weak construction prone to delaminating along the interface between the two components. Another disadvantage of this system is that it does not facilitate any integration of the production or the electronics with the production of the solar cell.

The conclusion is that principle 2 is the most applicable at the present stage of development of the polymer solar cell until principle 1 eventually is viable due to a significant cost-reduction for the solar cell or due to a significant reduction of the discard rate for the post processing of the solar cell.

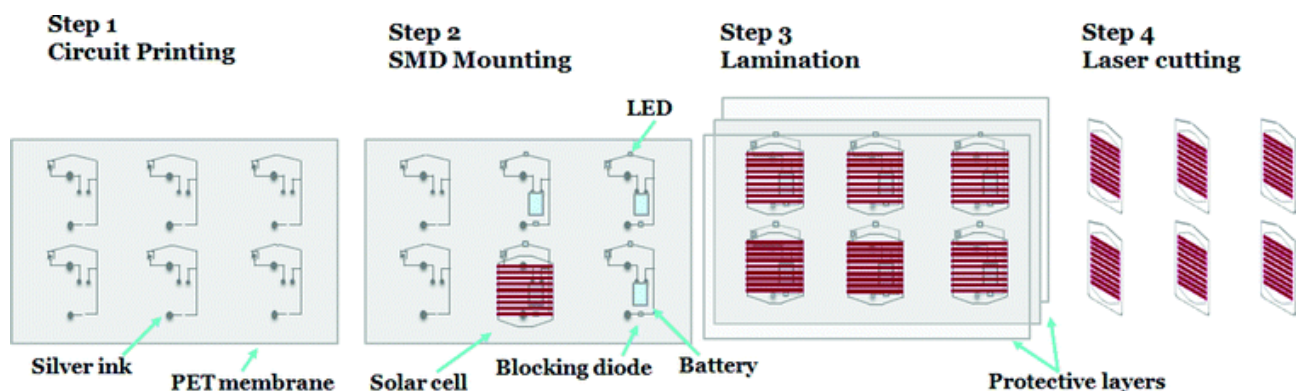
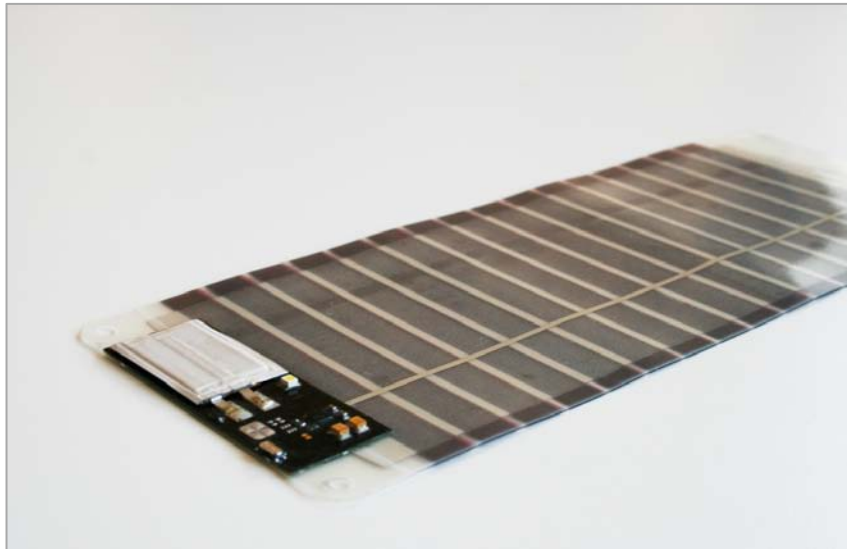

Figure 31: Production of lamps according to the recommended principle 2, from (Espinosa N., Garcia-Valverde R., Krebs F. C., 2011)

### 6.3 Mechanical robustness versus flexibility

The first LED lamp produced had push buttons in two of the corners. Closing the push buttons means shaping the flat solar cells into a three-dimensional structure (Figure 29) that can stand on a flat surface. Closing the push buttons means also switching the light on as electrical contact is achieved through the metallic buttons. This is a great idea, as the low-cost, easy-to-operate push buttons serves two functions, and furthermore as the lamp appears flat and switched off during both distribution and charging.

<sup>4</sup> Surface-Mounted Device



**Figure 32: The conceptual lamp consisting of a solar cells and a separately printed circuit board containing all electronics and a battery.**

Field testing of the lamps revealed, however, that the structure is not robust enough for the intended use. The repeated folding and unfolding were seen to stress the lamp and result in mechanical failure in various parts of the lamp. Most pronounced failures were delimitation and breakage of electrical connection.

The next versions of the lamp were thus designed to be flat and protected by a semi-rigid plastic overlay in order to avoid unintended bending and buckling of the structure, see Figure 30. This effectively eliminated the mechanical failures observed for the flexible lamp.

The flexibility of the ProcessOne solar cell should be regarded solely as a quality in the production phase as it opens for roll-to-roll processing and as it allows the solar cell to be mounted on a curved but support surface. Applying Process One solar cell on a truly flexible product is, on the other hand not recommended, as any flexible structure will, intended or not, be subjected to repetitive buckling and bending, that will over time will introduce damages.

The more advanced polymer solar cells that gradually will replace the ProcessOne solar cell will be significantly thinner. As thinner structures inherently are more flexible than their less thin counterparts, these new cells might be suited for applications where flexibility is an issue.

#### **6.4 ON/OFF switches for robust environments**

Identification of energy-efficient, low-cost ON/OFF switches has appeared to be a challenge in the product development. More concepts have been evaluated, both mechanical and electronic ON/OFF switches. The mechanical switches are attractive from an energy point of view as they, in contrast to their electronic counterparts, do not require an electrical signal for operation.

The metallic push buttons used in the foldable lamp are attractive as they are extremely low cost and highly robust, but they require a flexible cell for serving the purpose of serving as an ON/OFF witch.

Conventional mechanical switches, Figure 33, have also been evaluated but with negative result. The switches are typically bulky and rigid and thus not highly compatible with the polymer solar cell's flexible and slim layout. Such unprotected mechanical contacts relay furthermore on moving parts that involuntarily

will be contaminated by the sand, dirt and moisture present in the target environment (non-electrified areas in 3<sup>rd</sup> world countries). Their robustness is therefore questionable.

Mechanical foil buttons were also evaluated and used as switches in prototypes. The high IP-class, i.e. good particle – and water proofness, makes these switches attractive for the purpose but these buttons lack a latch-function.



**Figure 33: Conventional unprotected on/off buttons is part of a mechanical design tradition and is known in many variations of hard plastic products.**

Electronic touch buttons are highly suited for use in OPV products as they, due to their flexibility, are readily integrated in a flexible structure and as they can be covered by suitable protective foil, for example the encapsulation of the product. The touch buttons are operated by a gentle touch, and the more advanced versions solely by the proximity of a finger<sup>5</sup>, see Figure 34. The touch technology allows for intelligent integration in electronic products. An example of this is a head light with a touch button facing the forehead. When the user puts the head light on, it is automatically turned on by the gentle touch off the forehead. When the user takes the head light off, the light is automatically switched off, see Figure 35 .



**Figure 34: Touch buttons need no or only light handling by the user.**

<sup>5</sup> Capacitive sensing

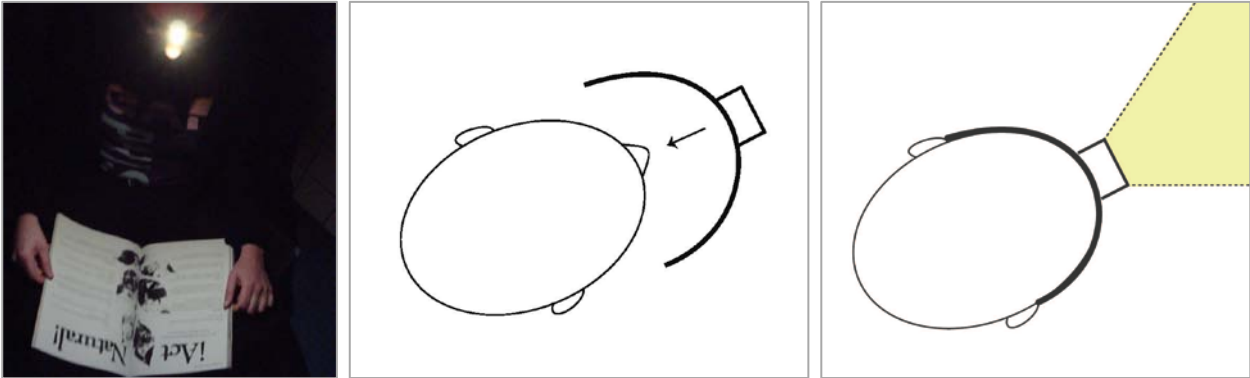

**Figure 35:** The head light directs the light in the seeing direction (left picture). The head light turns on automatically when it touches the forehead thanks to the touch technology implemented in the product.

## 6.5 Dimensioning the system

Any solar-powered product needs a matching of the capacity of the battery, the solar cells and the specified functionality. This means ensuring that the charged battery can supply the energy required for driving the electrical load according to the product specifications and furthermore ensuring that the solar cell is able to charge the battery adequately during the time available for charging and under the solar conditions at the actual geographic site.

A computer tool, Integration Methodology Tool, has been developed in order to assist in the dimensioning of the system. The system also serves as a “bank” holding data on both relevant components (LEDs and batteries) and on systems already evaluated. The electronic circuitry is also represented in the “Input reduction factor in %”. This drop down menu enables the user to set a certain loss in the system according the estimated loss in the electronic system, representing diodes, resistors and other components. The loss factor is to be set by measurements or alternatively be estimated by a person qualified in electronics.

Figure 36 illustrates the use of the tool for dimensioning a solar-powered LED lamp. The tool allows the designer to pick an actual geographic site (here Ghana) and relevant components (here an LED, a battery and a solar cell) from a drop down menu, giving relevant options.

The tool can be used to calculate the average daily time with light from the lamp. The example in Figure 36 shows how this time depends on the size of the solar cell when everything else is kept constant. When a solar cell of a size corresponding to the size of an A5 sheet of paper is used, the access to light is on average 0.4 hours per day, whereas an increase of the solar cell to A3 format gives an access time of 1.5 hours light a day.

## 6.6 Shaping the product for maximum functionality

An important aspect in the design of any solar-powered product is a strict focus on, not the general functionality, but the functionality perceived by the user. For a lamp this means guiding the light to precisely the area where the user gets maximum benefit of the light. Cost-effective directing and focusing of the light has thus been an issue in the project. Proper directing is a matter shaping the lamp, whereas focusing and defocusing of the light is a matter of lenses.

In the first versions of lamps the LED was placed open to the atmosphere in order to minimize the light absorbed by the lamp and thereby maximize the optical output. This open construction resulted however occasionally in malfunction. It is thus desirable to place the LED such that it is mechanically protected, but in

a way that the protection does not adversely affect the optical output. As the lamps are to be prepared according to the principle 2 for manufacturing scheme (section 6.2) which means in sheets that subsequently are cut into shape in the final step, the optical path of the emitted light goes through a laser-cut area. It is naïve to think that perfect optics can be prepared by direct laser cutting. Here this was solved by developing a ray-tracing algorithm which was used for positioning of the LED and for designing a laser-cut optical lens in the encasement. Both a spreading and a focusing lens were designed, see Figure 37. Only the lamps with the focusing lens were produced, and these worked as intended.

IMT	
Calculation of illumination time per day, based on chosen site, light system and OPV characteristics	
Choose site from the menu	Ghana
Choose LED type from the menu	Osram
Input number of LEDs	4
Choose OPV dimension from the menu	A3_
Input OPV efficiency in [%]	1,00%
Input reduction factor in [%]	50%
Based on your inputs, illumination time is calculated to:	
Illumination time of LED(s)	1,5 h

IMT	
Calculation of illumination time per day, based on chosen site, light system and OPV characteristics	
Choose site from the menu	Ghana
Choose LED type from the menu	Osram
Input number of LEDs	4
Choose OPV dimension from the menu	A5_
Input OPV efficiency in [%]	1,00%
Input reduction factor in [%]	50%
Based on your inputs, illumination time is calculated to:	
Illumination time of LED(s)	0,4 h

Figure 36: An example of the use of IMT for optimization of a LED lamp to be used in Ghana. Two designs are compared, for which everything is equal except the size of the solar cell. The system calculates the effect of this change on the average time the lamp can be used per day.

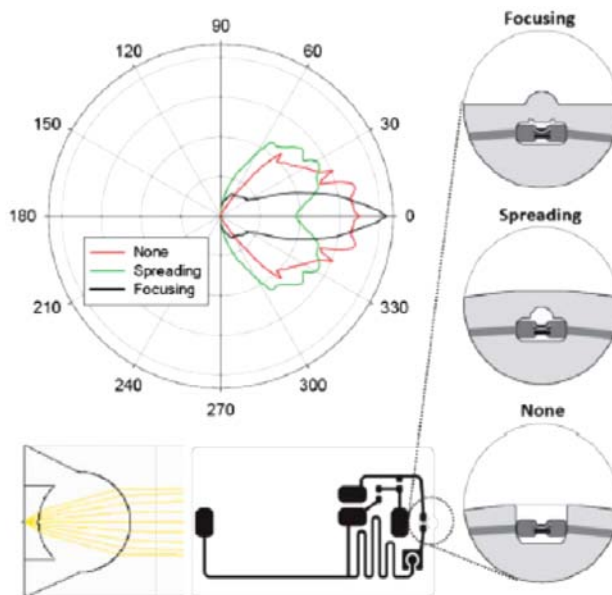

Figure 37: The laser-cut lens system. The actual lens designs are shown (right) along with the irradiation (upper left) from the lamps having no laser-cut optics (bottom right), a spreading lens (middle right) and the focusing lens (top right). The final focusing lamp design outline is shown schematically (bottom centre), from (Krebs F. C. et al, 2011)



An alternative approach to diffuse the pointed LED light is to apply a diffusive screen or foil in front of the light source. Figure 38 shows how frosted materials can be used for diffusion of the light.

Three low-cost concepts for directing the light have also been investigated and tested:

- The 3D standing lamp which directs the light onto the surface where the lamp is placed
- A head lamp, which directs the light in the viewing direction
- A hanging lamp, for which the direction of the light is adjusted by means of four holes and a string, lash or similar

All three systems have been realized as prototypes; see Figure 39. Field testing reveal that the standing lamp is of restricted usability in rural 3<sup>rd</sup> world areas, as there is not many sufficiently flat surfaces available, whereas the two other concepts, hanging lamp and head lamp, works as intended.

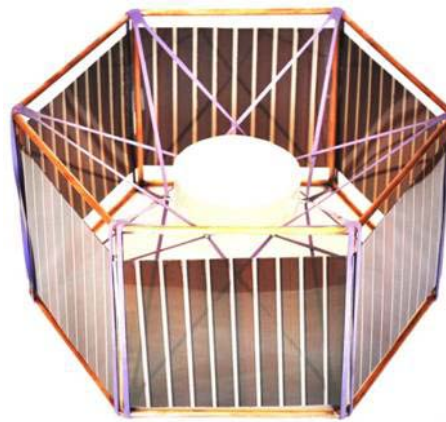
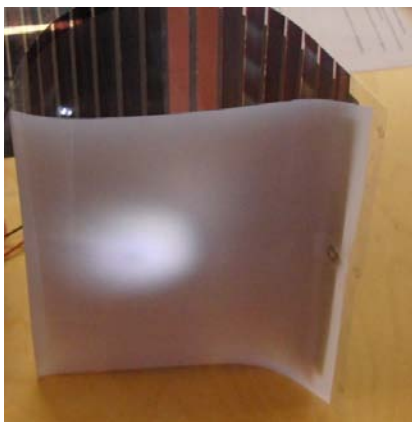

**Figure 38: Diffusion of the pointed LED light by means of frosted paper (left) and a frosted polymer material (right). The lamps are inspired by Chinese rice-paper lamps.**

## 6.7 LCA analysis for the lamp

In order to illustrate the environmental impact of OPV-powered products in general, a full LCA analysis was performed for the lamp shown in Figure 30. The analysis was performed according to ISO 14040 guidelines and was focused on energy payback time and green-house gas emissions. The system boundaries were set to include both the raw materials production and the end-of-life management, i.e. decommissioning, see Figure 40.

The production of the lamp was assumed to take place in Europe and assembled from an OPV module produced in Denmark. The LCA data for the OPV modules was taken from the LCA analysis referred in Section 4.4. The other components, blocking diode, LED, battery, electric and electronic components are commonly manufactured in China of East Asia. However as it is impossible to quantify the emissions from these locations, the components were assumed fabricated from a European energy supply, adding the transport from the Far East locations to the place of manufacturing (Denmark) and the place of use (Africa).

For OPV there is no previous experience in recycling procedures. Until a recycling system is established or eventually a biodegradable OPV is developed, it is assumed in the analysis that the lamps will be land filled and no recycling processes are considered to be available either for the electronic subcomponents or the solar cell itself. In EU and USA however plants for recycling spent batteries are available, but in developing countries systems for collection and recycling are seldom established.



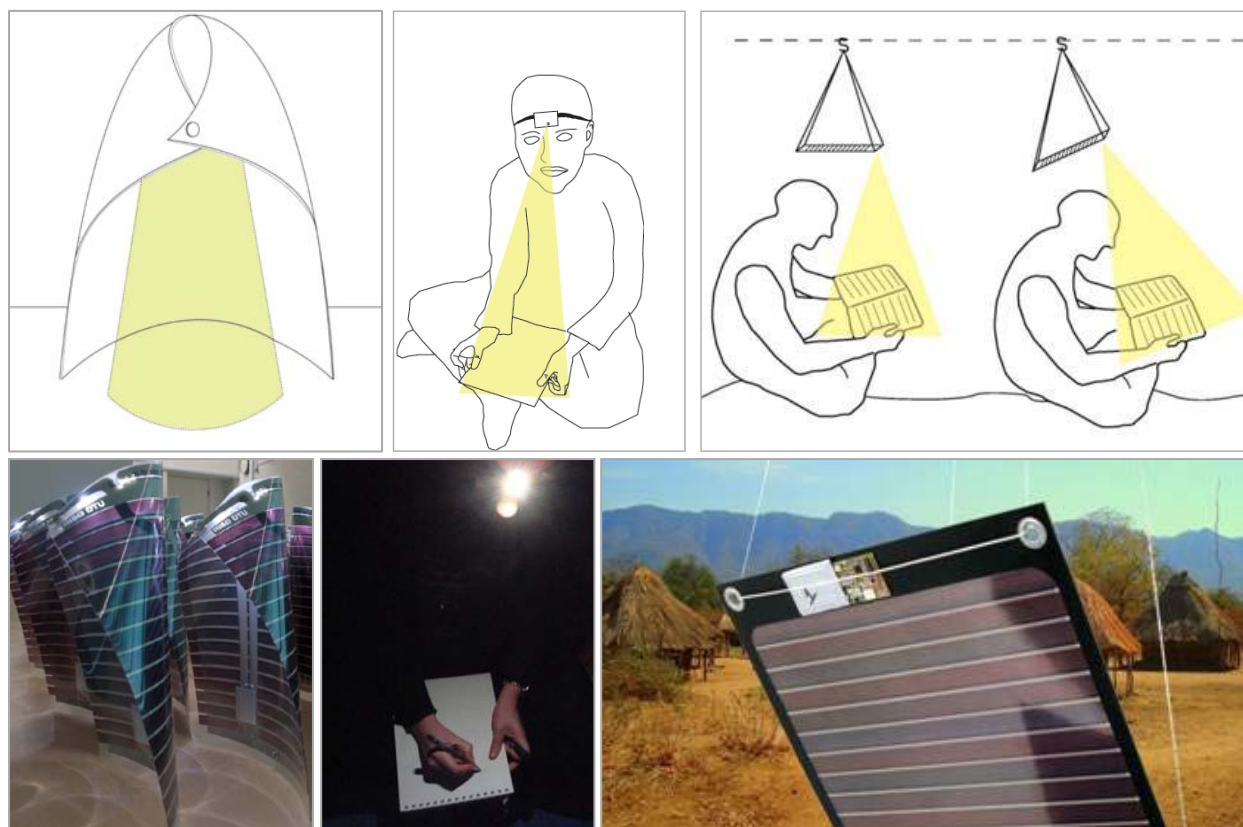

**Figure 39: The three design concepts for guiding the light where it is needed; a three dimensional standing lamp (left), the head lamp (middle) and the hanging lamp (right).**

The LCA revealed that that almost 80 % of the total energy associated with the lamp when it is produced in Europe and used in Africa, is embedded in the materials. The analysis shows furthermore that the solar cell is responsible for 42 % of the lamp's total energy. The solar cell is followed by the electronic board, the protective layers and the LED, each representing about 15-20 % of the total energy. The contribution from the battery and the assembly of the components are both minor, respectively 5 % and 2 %.

The energy pay-back time for the lamp is calculated to about 10 years, when assuming that the lamp is used 3 hours per day. This lamp will thus generate less energy over its lifetime (estimated to 2 years) than it produces, and from this point of view the lamp does not pay a positive environmental impact. However, the OPV lamp was not designed for earning back the energy involved in its manufacturing, but for providing a service causing significant less damage to the environment than today's options. The impact of the lamp is thus more realistically evaluated by comparing it to the alternative options, because avoided emissions depend on the electricity, or in this case lighting supply, the OPV lamp possibly can replace. The key issue is thus the energy and emissions saved every year by replacing the alternative by the OPV lamp. Four alternatives to the present solar lamp have been considered; kerosene light, a lantern including a-Si solar panel and a rechargeable battery, a torch powered by primary battery and light source powered by a battery that is charged at a battery charging station. The comparison is made for Ethiopian conditions. Ethiopia is chosen due to its excellent solar conditions ( $< 2000 \text{ kWhm}^{-2}\text{year}^{-1}$ ), low electrification rate (1 %) and large share of inhabitants living in rural areas (85 %) making it an interesting target marked for the lamp.

Calculations show that an energy payback time of 0.12 years is obtained, when the polymer lamp substitutes a kerosene lamp, meaning that the OPV lamp already after 1.5 months operation has saved an

amount of energy corresponding to the energy used for manufacturing and transportation, and will thus pay a positive energy contribution from then on. When the polymer lamp replaces more energy intensive systems as a standard torch (none rechargeable battery powered device) or the solution involving a battery charging station, positive energy contribution occurs even faster, see Figure 41.

By proceeding similarly, the effect on the greenhouse gas (GHG) emissions caused by a switch to the OPV lamp has been calculated. This shows that a switch from a kerosene lamp gives a positive impact on the GHG emissions already after 5 hours operation (1.5 days/ 3 hours a day). For the two options; torch and the battery charging station, positive impact on the emission will be achieved within the first 5-10 days of operation, see Figure 41.

An important difference between the polymer solar lamp and the kerosene lamp is where and when emissions are released. Whereas all OPV related emissions are linked to manufacturing and transportation, releases the kerosene lamp emissions during its entire life cycle. The kerosene lamp causes thus indoor air pollution in households and creates fire hazard, and a switch to the OPV lamp or one of the other considered alternative will ancillary provide health benefits.

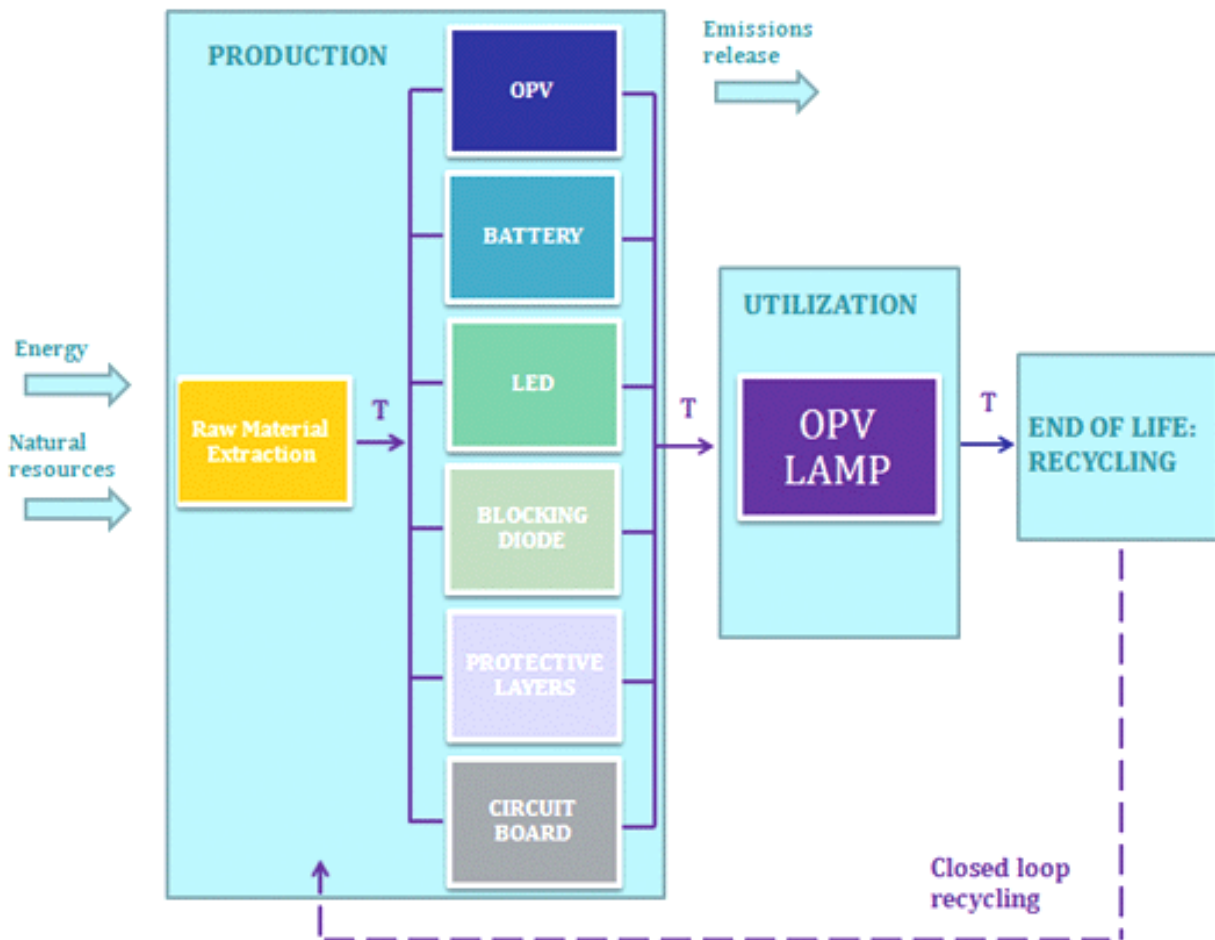

Figure 40: System boundaries for the LCA analysis of the OPV powered lamp, (Espinosa N., Garcia-Valverde R., Krebs F. C., 2011)

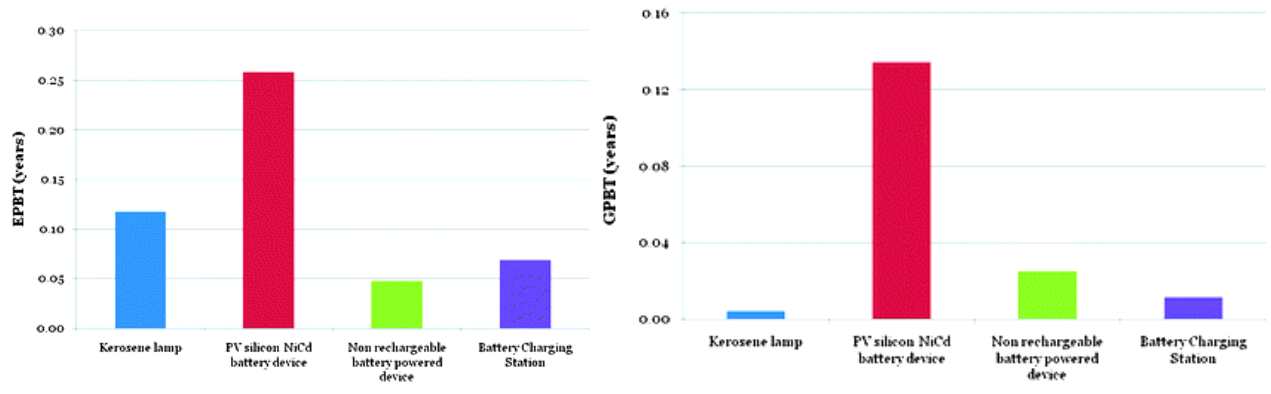

Figure 41: The environmental impact of a switch from different lighting systems to an OPV lamp; the energy payback time (top) and greenhouse gas payback time (bottom), from (Espinosa N., Garcia-Valverde R., Krebs F. C., 2011).

## 7. Approaching the market

This chapter describes the activities undertaken in order to identify and fertilize the initial markets for polymer solar cells. First, two demonstration products were developed, produced and presented on two different target markets, respectively light sources for use in non-electrified 3<sup>rd</sup> worlds countries and cheap electronic gadgets for industrialized countries. These two demonstrations were backed up by a broad communication effort targeted at industrial users of polymer solar cells, i.e. companies who might have an interest in integrating polymer solar cells in their products. The feed backs received were subsequently analyzed in order to describe the customer's requirements to an attractive polymer solar cell, and this description was finally compared with the polymer solar cell's performance profile in order to describe the competitive strength of the OPV technology.

### 7.1 Product demonstrations

The two products developed, produced and demonstrated in the project was two LED torches. One targeted at school children in underdeveloped countries who today read their homework in the poor light from a kerosene lamp, and the other one a small “easy-to-carry-with-you” torch targeted at the western consumer market for low-cost electronic devices, see Figure 42.



Figure 42: The two LED torches demonstrated: the reading lamp for school children (top) and the “easy-to-carry-with-you” torch targeted at the western market.

Both lamps consist of a solar cell, a white LED, a Lithium polymer battery and the electronics required for proper operation of the lamps. These components were sandwiched between two layers of plastic overlays giving mechanical support. The main differences between the two torches are the size, and the on/off function. The lamp targeted to school children has an electronic latch function which turns the lamp on when the on/off button is pressed once. The lamp is turned off by repressing the same buttons. The small give-away torch does not include this latch function meaning that it shines light only when the button is actively held in the pressed condition. This saves energy as the latch function consumes energy, and as the light is only on when the user is active, i.e. pressing the button. Design details for the two lamps are given in Chapter 6 .

The demonstration of the reading lamp for school children was a following up of an earlier demonstration of a lamp in Zambia in 2009. In the present study, 190 lamps were shipped to the Norwegian humanitarian organization, the Strømme Foundation, who distributed the lamp to target users in Peru, Mali, Burkina Faso, Niger, Tanzania and Bangladesh.

A questionnaire compiled for the purpose of receiving feedback from the users, was distributed together with each lamp. 80% of the questionnaires was answered and returned. The feedback revealed that the lamp, even though it was given to school children with the purpose of providing light for their home work, the lamp was used for more purposes and by more users, see Figure 43. The main usage was reported to be to generate light for general house work (49% of replies) and generate light for reading homework (34% of replies). The lamp's light is considered sufficient for reading by 69% of the pupils; whereas it fails when used to generate general light in the houses, see Figure 44. Despite this, as much as 85% of the users state that they like the lamp, and 48% would buy a new one, if it is lost. A price of 1-2 € was quoted as acceptable for such a lamp, Figure 45.

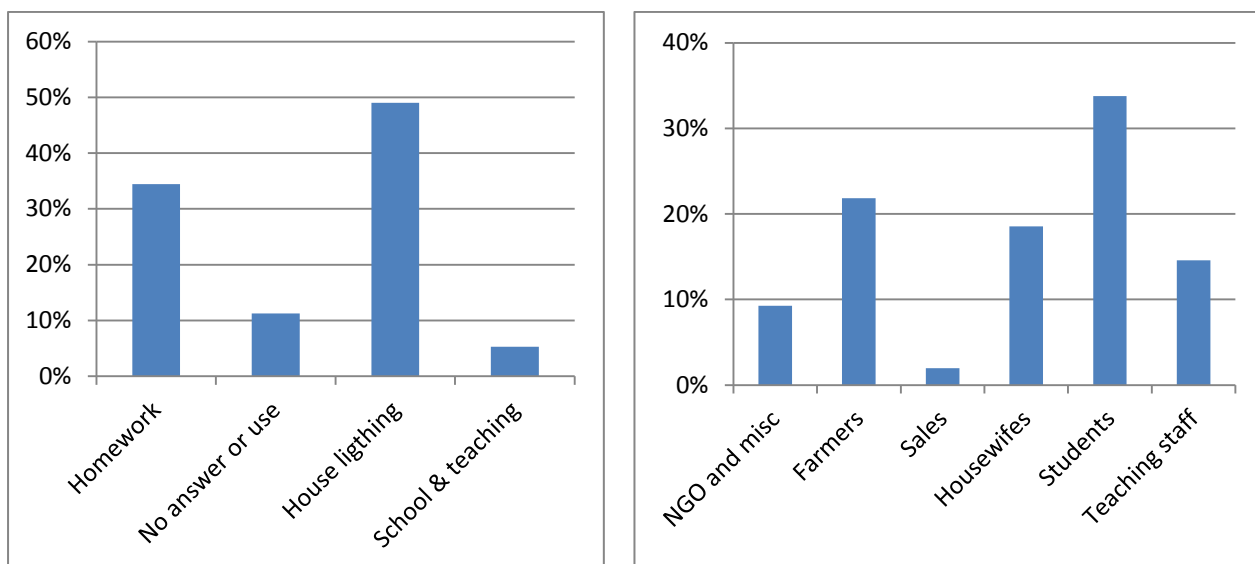

Figure 43: The actual usage of the reading lamp (left) and the occupation of the user (right)

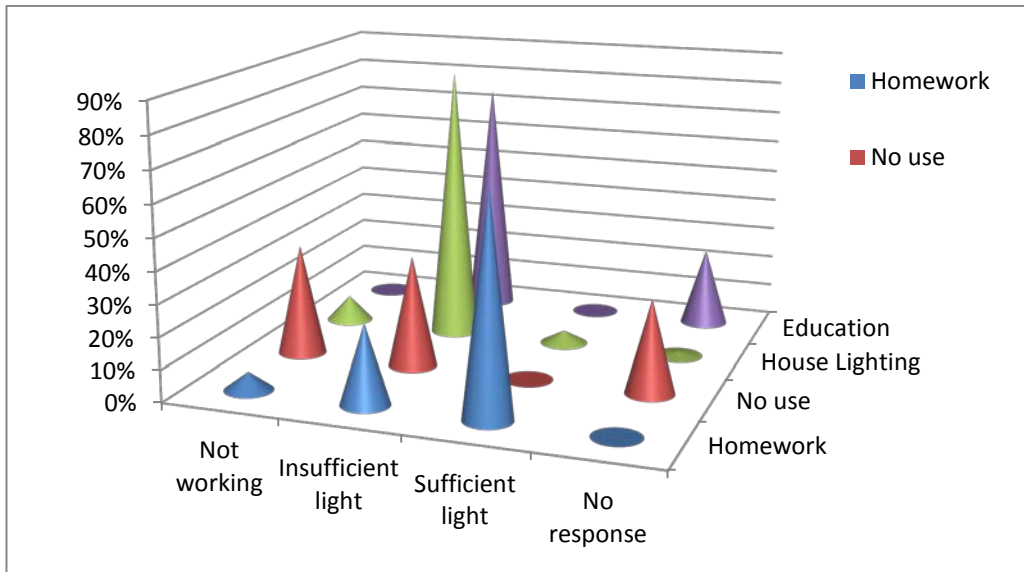

Figure 44: Evaluation of the reading lamp according to various uses.

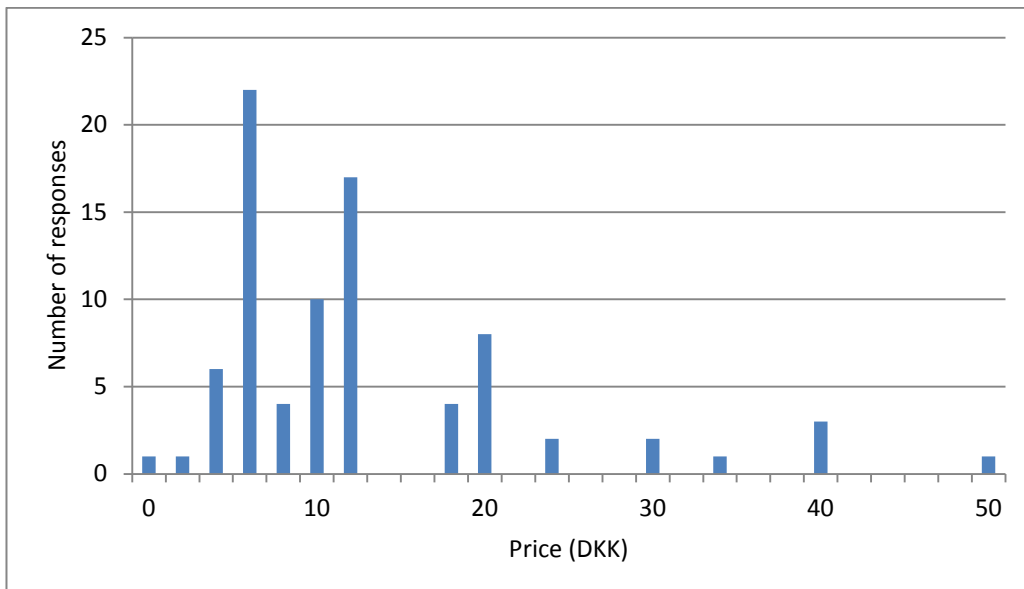

Figure 45: A survey of the cost the target customer in underdeveloped countries is willing to pay for a new lamp.

The feedback received proves the necessity for low-cost, off-grid lightening systems in the third world.

Based on the user feedback the most important improvement points for the lamp to become more attractive for this market are:

- More powerful light source as the lamp is used for any conceivable purpose in the absence of alternatives
- Higher charging capacity to provide sufficient daily operational time
- More rugged design including protection against rain and battery failures
- Protection from theft – any feature in the lamp that makes it harder to steal is welcome.

The full report from the field test is available as Annex 1.



For demonstration of the lamp targeted at the western market for low-cost consumer electronics, the project teamed up with Organic Electronics Association (OE-A) who presented the lamp as a free gift to the participants at the LOPE-C Conference on Large-area Organic and Printed Electronics Convention (Frankfurt, June 28-30, 2011). The lamp was thus distributed to an audience qualified to judge its news value both technically and commercially. The handing out of lamps was not followed up by a systematic collection of user's response, but the reactions received leaves a strong impression of that this demonstration is by the branch considered as a break-through for commercial application of polymer solar.

## 7.2 The quality required by the customer

The two demonstration activities were backed up by a broad communication effort targeted at potential professional users of polymer solar cells at its present stage of maturity, i.e. any enterprises having applications that potentially can be powered by the ProcessOne polymer solar cell. The cornerstones in this communication were presentations at trade fairs, seminars and conferences and publication of two brochures. Hard-copy information materials were produced for supporting the communication effort, see Figure 46.



**Figure 46: The communication has reached out to many potential clients: (from top left) A brochure has been produced by the EUDP project team explaining the main opportunities of polymer solar cells, Mekoprint has made their own brochure for their clients and (the far left) a brochure for the oe-a conference was given out together with the small lamp.**

The effort and especially the distribution of several thousand small lamps at the OEA conference resulted in massive interest from potential customers. The majority of these requests come from customers seeking a conventional PV panels but at a lower cost. All such requests were politely refused, whereas all requests harmonizing with the technology's present maturity level was carefully discussed with the companies. The most relevant requests received by Mekoprint, totally 17 cases, were carefully analyzed in order to pinpoint these customers' requirements to the solar cells. No similar survey was worked out for the requests received by Faktor 3 and DTU.

The 17 requests, albeit not a large group, is assumed to relevantly represent the target customers to polymer solar cells at present maturity level. The requests show that the potential customers typically are concerned about the solar cell's flexibility, its operational lifetime and its performance both under outdoor and indoor lightening conditions, see Figure 47 and Figure 48.

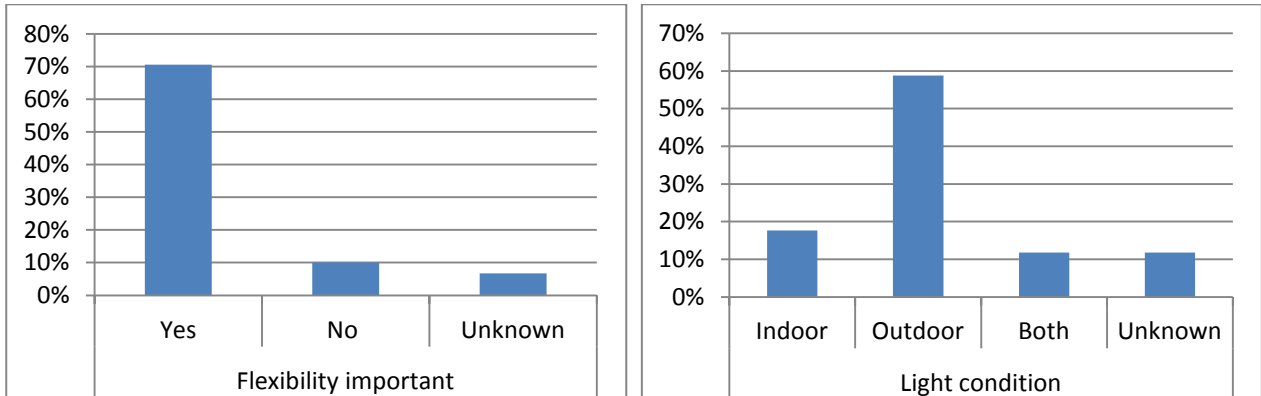

**Figure 47: Customer expressed interest in flexibility of solar cells and the light condition, the product is designed for.**

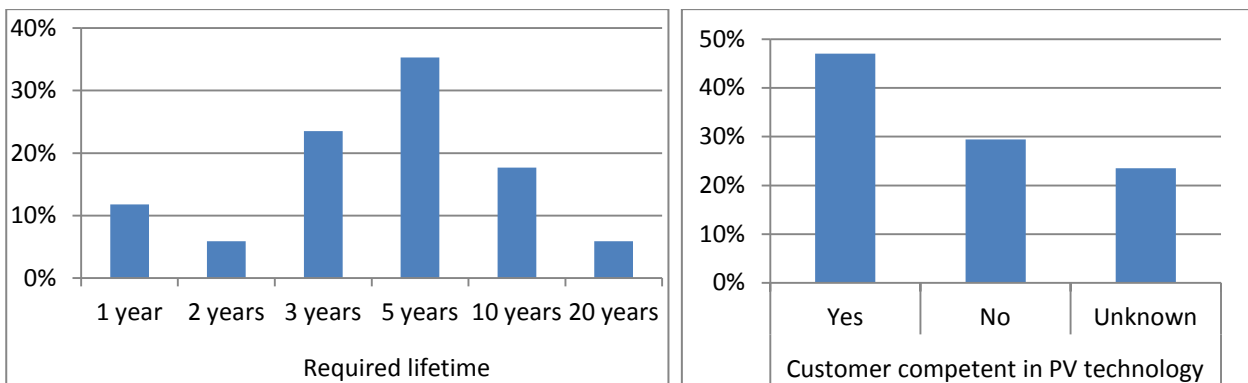

**Figure 48: Required lifetime for solar cells and customer competence in PV design.**

A majority of the customers are asking for flexible solar cells. The main reasons are: first of all to enable mounting on curved (and hard) surfaces, secondly for an easy mounting method of the cell onto the product and finally to ensure robustness according to breakage, as a flexible cell does not break as easily as a rigid one. Those who do not ask for flexibility may still benefit from low weight and thinness.

Most customers ask for solar cells for outdoor applications, but there are also request for cells for indoor use or both. When coming to the operational lifetime, the majority of the customers ask for 5 years as this life length matches the typical life of rechargeable batteries for the consumer market and also a typical life-length for many consumer products.

There is, however, also a market for cells with shorter operational life. This market is expected to experience major growth due to synergy with other technologies in the field of printed electronics. The market for cells with less than 5 years life length is therefore judged to grow and become larger than what is reflected in this investigation.

The last important learning from the analysis of the customer's requests is their need for support. About 50 % of the potential customers claim that they have the required competences for working with solar cells themselves (Figure 48). Such customers are requesting nothing but data sheets and product samples. As much as 30 % of the customers will however need more assistance, typically in dimensioning the system, see Section 6.5, and in designing the appropriate electronic circuitry, see Section 6.1. This 30 % is in contradiction to Faktor3's experience, who judge that the great majority of the customers ask for such support.

For both category of customers, the sellable product can be rolls of solar modules to be further R2R processed by the customer, high volumes of individual solar modules as cut from the rolled band or more advanced components comprising the solar module and relevant electronics customized directly to the customer's need.

### 7.3 The performance profile

In order to analyse the competitive edge of the polymer solar cell, its performance profile has been compared to its main competitor; crystalline silicon solar cells, thin film solar cells and emerging dye-sensitized solar cells, see Table 2.

**Table 2: Performance profile of polymer solar cells as compared to competing solar cells**

TECHNOLOGY	FLEXIBLE vs. RIGID	COMMERCIAL AVAILABILITY	MATURITY LEVEL	OPERATIONAL LIFE TIME	PCE Industry <sup>6</sup>	PCE Research <sup>7</sup>
Crystalline Si	Rigid	Yes	High	>20 years	13-20%	27.6%
Thin film	Rigid	Yes	Medium/High	>20 years	6-12%	20.3%
	Flexible	Yes	Medium/Low	<10 years	~3-7 %	
Polymer	Rigid	No	Low	<<10 years	-	8.6%
	Flexible	Limited	Low	<<10 years	~1-3%	
Dye-sensitized	Rigid	Limited	Low	<<10 years	-	11.4%
	Flexible	Limited	Low	<<10 years	~ 2 %	

The polymer solar cell is not competitive in applications where high power conversion efficiency and/or long operational life are the key competitive parameters, and this will be the situation in the foreseeable future. Cost competitiveness, measured as cost per  $W_p$ , will furthermore require a significantly higher production volume than what is viable in this early industrial phase. The competitiveness of the polymer solar cells hinge thus in this initial phase on other qualities such as adaptability, cost-effective integration in products, flexibility, weight, slimness and a non-positive temperature coefficient.

From the customers' requests it is clear that flexibility is a clear quality parameter. Flexible solar cells are generally less performing and more expensive than their rigid counterparts, but the polymer solar cells is still in the low end when compared to the commercially available flexible thin film cells. When considering flexibility as a quality parameter it is important to bear in mind that flexibility is a highly "flexible" term used

<sup>6</sup>) Cells produced under industrial conditions

<sup>7</sup>) NREL, Best research cell efficiencies (Dec. 2011)

for products ranging from slightly bendable to a devices that can withstand repetitive bending over a small bending radius, i.e. flexibility is used both for fully roll-able solar cells and for solar cells that can be mounted on a curved but supported surface. The present ProcessOne solar cell belongs to the latter category, but the development is moving fast towards thinner and thus truly flexible and highly roll-able devices.

Indoor use is challenging for most solar cells, and currently polymer solar cells work best in strong daylight (100-1000W/m<sup>2</sup>). If future PSCs can maintain high conversion efficiency below 10W/m<sup>2</sup>, it would provide them with a unique market position as most competitors are not efficient under low light condition. Naturally, at low light, the output power from the solar cell is correspondingly low, but applications for such cells exist; especially for wireless sensors in building automation.

Crystalline silicon – and thin film solar cells have all a negative temperature coefficient meaning that the performance of the cells is reduced when the temperature is increased. This limits the output of the cell in many applications as the cell temperature inherently increases with increasing insolation. A non-negative temperature coefficient is a unique feature shared by polymer solar cells (Krebs F. C. et al, 2009), and dye-sensitized solar cells (Jensen, 2008).

Differences in the temperature coefficient imply that the performance difference between the polymer solar cell and conventional solar cells in many applications is less pronounced than what is expected from the specifications that yield for 20°C. Figure 49 illustrates this effect by comparing the output power from a 1 m<sup>2</sup> device of different types of solar cells as function of temperature.

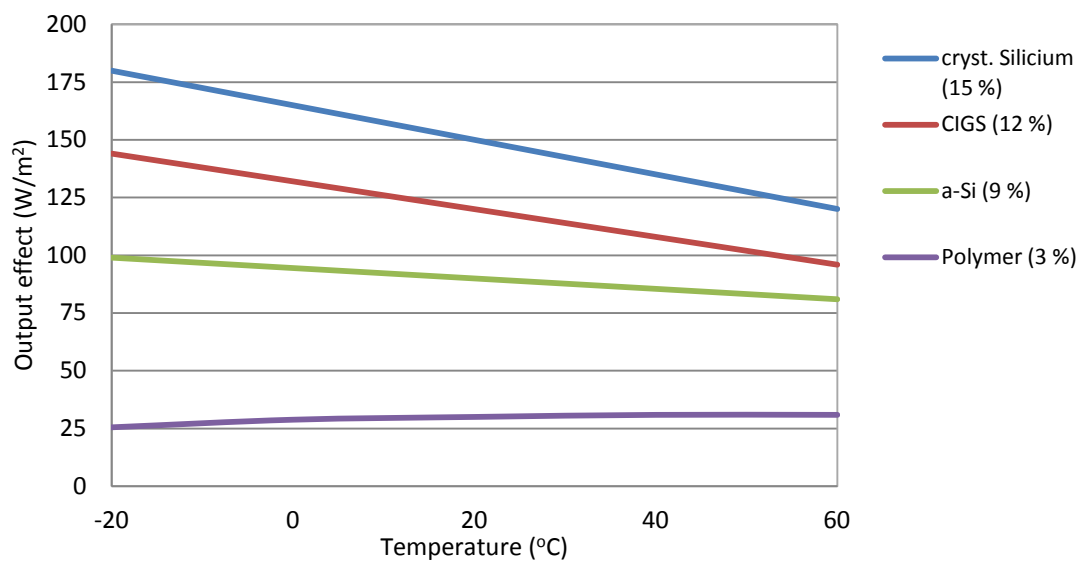

Figure 49: Calculated power output from a 1 m<sup>2</sup> polymer solar cell device with 3 % efficiency compared as function of temperature. The output is compared to corresponding calculations for other solar cells.

## 7.4 The market

The first market that will, or already is, open for polymer solar is the market where the quality profile of the cell gives an added value large enough to compensate for the weaknesses, i.e. the present production cost (€/W<sub>p</sub>), the operational life time and the power conversion efficiency. Gradually as the production cost decreases and the performance increases more and more markets will open.

An interesting initial market is where delivery of solar modules on rolls, as stickers or as plug-and-play electronic components, favours cost-effective integration of the solar cell into its final setting. Other interesting

initial market is where the solar cell's low weight, its thin outline, its flexibility or its adaptability with respect to size, shape and transparency are essential.

The low weight points at portable products. In this segment products targeted at for example trekking, climbing and aviation are interesting, as the end-users here are typically willing to pay a high premium for extra low weight. The flexibility points at the general category of products with curved surfaces. The cell's thin outline in combination with the low weight makes it suitable for application on a range of sheet materials; cardboard, plastic, fabrics, leather etc. Applications in this field is already suggested and on their way to the market. Of special interest for the polymer solar cell are settings where the preferred sheet does not give sufficient support for the heavier or more brittle solar cell.

If short lifetime can be combined with correspondingly low price, the lifetime does not pose a problem for particular applications. An interesting product is off-grid lighting for non-electrified areas in 3<sup>rd</sup> world countries. In such markets with extremely low and almost no purchasing power; the customers have no ability to generate the saving needed for buying a high-quality, lasting lamp, even if this is the most economic solution on a time horizon of more than some months. The only viable solution is cheap products, i.e. products with a cost profiles that is not too different from the kerosene lamps, i.e. a cheap lamp is acceptable even if it has to be replaced after a certain period. This focus on low cost gives the polymer solar lamp an advantage on this market as compared to the far more expensive high-quality lanterns made from conventional solar cells.

Other markets suited for low-cost solar cells are consumable as PR materials, packaging, "give-aways" etc. A recent example from this market is the German magazine "TV Movie Limited Edition" Ausgabe 12/2011, who introduces flashing LEDs powered by a silicon solar cell as an eye catcher on the front page. Here the thin and flexible polymer solar cells will have an extra advantage as it can be delivered as an "easy-to-apply" sticker and because OPV adds minimum weight for the benefit of the distribution.

Gradually as the polymer solar cells gets more mature and the production cost correspondingly lower, more markets will open up and will gradually also comprise the main-stream market for conventional solar cells.

## 7.5 Competitors on the market

The main competitors on the market for polymer solar cells are other suppliers of flexible solar cells. The strongest present competitors are Ascent Solar (US) supplying flexible CIGS modules, PowerFilm Inc. (US) and Flexcell (CH) both supplying a-Si modules. These three companies are already well established on the market.

Ascent Solar offers customization of module size, voltage, current, form factor and flexibility, and is targeting at applications spanning from small consumer electronic devices to large-scale portable or permanent power applications. Their standard products span from 170 mm x 344 mm modules (4 W) to 5 meters long bands (140 W). The module's power conversion efficiencies derived from their data sheets is in the range 4.5-7.7% depending on the module size.

PowerFilm supplies OEM solar modules specifically developed to recharge AA, AAA, 6 volt and 12 volt batteries (0.1–3 W), and modules in custom length for use in architectural fabrics. The module efficiency is in the range 2.6-4.0%.

Flexcell offers solar charges (7W, 14 W and 27 W) with or without integrated batteries (Li-ion) and larger units developed for rooftop installations (150 W, 160 W and 170 W). Flexcell's products have an efficiency of 2.9-3.2% (for the module) derived from their datasheets.

The performance and price of sample modules from PowerFilm and Ascent Solar are compared in Figure 50. Crystalline silicon is included as reference even though it is not flexible. The two prices referred for silicon are disclosed by Mekoprint's potential customers and yield for respectively the lowest Chinese quality and high-end cells. In order to compete with the flexible solar modules on the market, the polymer solar cells has to undercut the price of the Ascent modules (presently 28 DKK/W<sub>p</sub>) or perform better with respect to the specific qualities sought by the actual customer.

Upcoming competitors working with emerging PV technologies are:

- Konarka (US), with their printed Power Plastic (polymer solar cells)
- Eight19 (UK) who are active within development of printed polymer solar cells but are not claiming any products for sale yet
- G24 Innovations promoting roll-to-roll processed dye-sensitized solar modules.

No samples from these companies were available at the time of writing, and their ability to deliver real products at the time of writing are thus questioned. Discussions, conference presentations and web pages reveal that these companies seek to launch products targeted at buildings, electronic products and lighting for non-electrified regions in 3<sup>rd</sup> world countries and for powering electronic products.

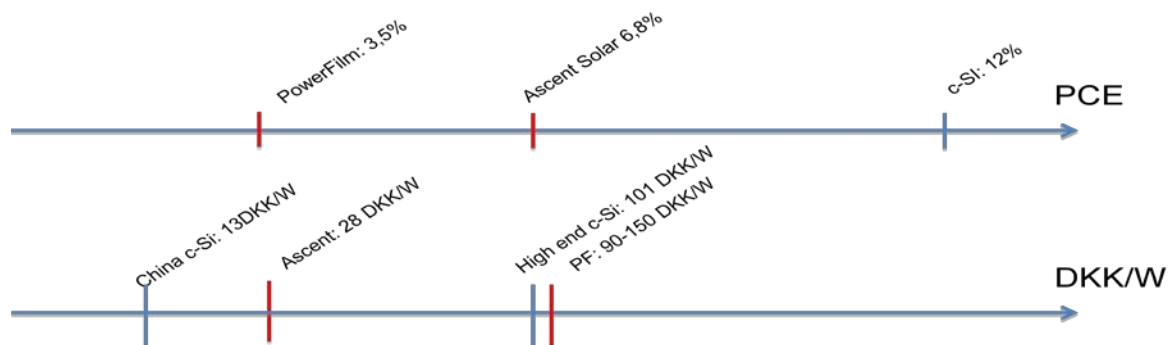

Figure 50: Power conversion efficiency and price per W for flexible solar cells from respectively Ascent Solar and PowerFilm (red) and for rigid silicon modules (blue).

## 7.6 Patents and freedom to operate

An initial patent analysis of the polymer solar cell technology field was conducted in 2009, with the intention to create an overview of the patent landscape in order to develop an understanding of freedom to operate, key patents, patent holders and licensees that allows for strategic positioning of this consortium among its competitors. Patent analysis and patent monitoring is an essential tool to establish a strategic stronghold in a long term research effort like polymer solar cells, in order to secure the long term commercial consistency and applicability of the patented intellectual property. It is therefore necessary that strategic and commercial patent decisions are made during the research phase of technology development.

The analysis shows a steep increase in the number of granted patents over a period of 10 year. It is estimated that between 10.000-25.000 patents can be related to the field of polymer solar cells, depending on where definitions and borderlines are drawn. The patents are categorized in A) Primary patents on generic materials and device structure, also known as composition of matter patents, B) Secondary patents on processing, application etc., and C) Peripheral patents not directly invented for application in polymer solar cells. Primary patents are the Holy Grail and extremely hard to develop.



The identified 962 category A and B key patents published or granted between 1997 and 2007 are strongly dominated by material and device structure patents. This was more or less expected, as development of polymer solar cells relies on materials research. But as the technology matures, manufacturing and the underlying processing related knowledge becomes the key in the attempt to industrialize technology. This finding supports the strategy to strongly focus on processing and materials as set forward by DTU, securing a position as the leading global processing knowhow institution.

As expected the dominant patent holders are from USA, Germany and Japan and represented by known assignees, the individual, organization or company to which rights under the patents is transferred, like Konarka, Merck, Universal Display Corp. and Siemens - in total 230 assignees holds the 962 key patents identified up until 2007.

From a business point of view the potential of polymer solar cells is strongly underlined by the patent distribution between the primary patent holders USA, EU and Japan with approximately 1/3 each – indicating that all major industrial development regions understand the potential and the perspectives of cheap solar power based on polymer materials.

One of the key findings was that freedom to operate is significant in EU, with the exclusion of Germany, UK, France and the Netherlands. Also markets like India, Africa and South America are more or less completely open. The patent analysis was an initial investigation that provided a functional overview. A continuous effort will secure a constant insight in the development of patents and the distribution of rights among licensees.

## 7.7 Supporting technologies

The successful application of polymer solar cells hinges also on the development of supporting technologies. In most cases, an application will need the following functionality: energy storage, charging circuit and the consuming circuit, see Chapter 6.

For energy storage, conventional rechargeable batteries: Lithium Ion, Lithium Polymer, and NiMH, are the most relevant, while NiCd is unusable due to memory effect. More advanced technologies like super capacitors and solid-state batteries are presently considered as too expensive for polymer solar products.

For the charging circuit, more the large semiconductor companies offer solutions with maximum power-point tracking for low-power products. To mention a few, Linear Technology announced the LTC3105 charger October 2010 and lately, Texas Instruments joined with BQ25504, which is a complete charging controller for several types of energy storage devices. Faktor 3 has a patent pending for a sun power management system called SOLVEI®. Among others SOLVEI® offers an energy-efficient microcontroller, a maximum power point tracker, a battery controller and a user-friendly software setup.

EnOcean is an important player who has shown the way by using a small solar cell together with wireless links to monitor room temperature and other parameters.

For the consuming circuit, many products – even some flashlights – use a microcontroller to control the functionality. This microcontroller must be highly energy-efficient and are designed specifically to reduce standby current consumption and thereby allow for prolonged operation. Simple energy-efficient microcontrollers are available from e.g. Microchip and Texas Instruments, and Energy Micro in Norway has recently developed highly energy-efficient microcontrollers with the powerful ARM-Cortex M0 and M3 processors, which allows for complex functionality in solar powered products. Many microcontrollers are now paired with wireless interface to enable wireless products for example for building supervision.

Supporting technologies are generally under intense development and new and improved applications for polymer solar cells are progressively opened.

## 7.8 From demonstration product to the first commercial products

Based upon the successful high-volume production of the credit-card sized lamp three solar products are launched for sale on Mekoprint's homepage [www.mekoprint.dk](http://www.mekoprint.dk); a laser pointer and a flash light available in two different sizes, see Figure 51. The products are available with a customized print making them suited as a marketing tool.

**Solar Cells Products**

Mekoprint A/S offers the following demonstration and marketing products, which all employ an organic solar cell and provides space for custom full colour print. The products are sold strictly business to business with the customers' logo or other print. See the individual product specifications for further details.

**Pricing and order information**  
The demonstration products are prepared for customisation through different prints. Both the front frame and the full back side are available for full colour printing. The pricing depends on type and quantity of the lamps and the complexity of the print. Please contact Mekoprint A/S with a description of the desired print for a discussion of the possibilities and a quote.

	SCF3	SCL3	SCF2
Type	Small Flashlight	Small Laserpointer	Large Flashlight
Function	On while pressed	On while pressed	On while pressed
Documentation			
250 pieces	€ 13.73	€ 17.60	€ 22.25
1.000 pieces	€ 9.58	€ 13.44	€ 18.42
3.000 pieces	€ 8.65	€ 12.52	€ 17.56
5.000 pieces	€ 8.47	€ 12.33	€ 17.39

Price indication with simple print at quantities 250-5.000 pieces (Minimum order quantity is 250)

For purchase inquiries please contact: Connie Simonsen - (+45) 9936 5511 - [csi@mekoprint.dk](mailto:csi@mekoprint.dk)

Read more  
[Technology](#)

**Quick Response**  
Response within 24 hours

**Products**

- User interface solutions
- Flexible printed circuit (FPC)
- EMC shielding
- Cable harnessing
- Graphic overlays
- Metal nameplates
- Metal parts
- Solar Cells**
  - Applications
  - Solar Technology
  - Acknowledgements
  - ITO patterning
  - Coating service
- Technical Data
- Brochures

**Solar Cells Brochure**

Solar Cells EN

Figure 51: Products launched on Mekoprint's homepage, [www.mekoprint.com](http://www.mekoprint.com)

At the homepage of Faktor 3, [www.faktor-3.dk](http://www.faktor-3.dk), free downloads and tools are available for everyone who is interested in getting started with integrating polymer solar cells into their products, see Figure 52.

Faktor 3 has designed and developed the "Spider Light", Figure 53, in collaboration with a worldwide lighting company. The lamp is to be assembled by the buyer by means of disclosed rubber bands that both holds the light source in position and allows the buyer to introduce a personal touch by choosing among rubber bands in various colours. The lamp is targeted at the affluent and social responsible customer. The business model chosen encompasses both the Spider Light and a reading lamp for school children in 3<sup>rd</sup> world countries. The model is closely connected to the ambition of also approaching the "Bottom of the Pyramid" (BOP) market in an innovative way. Economical specialists all over the world preach that the BOP market need to be addressed with completely new business models as it is based on billions of people living for less than 1 USD a day. Spider Light is sold in a design shop in a modern city in the Western world. The price covers the Spider Lamp plus sufficient margin to cover production and distribution of a large amount of the lamps for 3<sup>rd</sup> world countries. These lamps could for example be distributed through NGOs

or the Lighting Africa initiative<sup>8</sup>. Three more products are suggested for this initial phase: a school folder with integrated reading light targeted at school children in the 3<sup>rd</sup> world, “Sunny Slide” an easy-to-install and low cost parking watch and an active RFID tag to be use in intelligent packaging. Also a range of the products of tomorrow are showed for a larger perspective of what the OPV will be able to offer to the world. These products are present on the three following pages (p.55-57).



**Figure 52: Download a free tool (IMT) for designing products with polymer solar cells, get a free catalogue explaining the possibilities of the technology or download this EUDP report at Faktor 3’s homepage [www.faktor-3.dk](http://www.faktor-3.dk)**

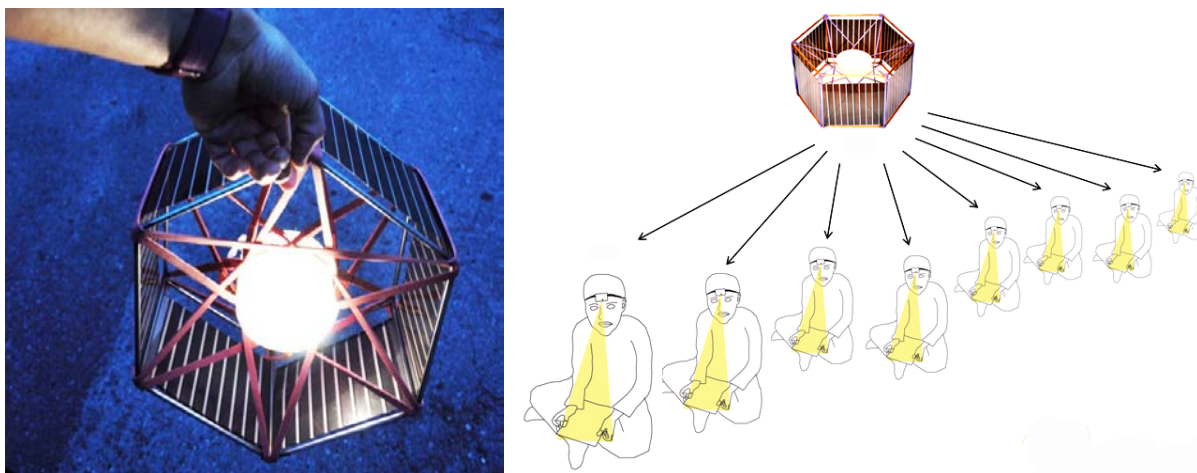

**Figure 53: Spider Light (left) is target at the affluent and social responsible customer on the western market. The price of the Spider Light should cover the lamp itself plus sufficient margin to cover production and distribution of a number simple lamps on a “bottom of the pyramid” market, for example the replacement of kerosene lamps.**

<sup>8</sup> ) The worldwide project “Lighting Africa” is a initiative by the World Bank focus on the replacement the health damaging kerosene lamps with sustainable, safe and affordable lighting, [www.lightingafrica.org](http://www.lightingafrica.org)

AID



## SCHOOL FOLDER



### PROBLEM:

Kerosene lamps are the most common light source in African countries, but they are very toxic. Wood can also be used for creating light, but it is a scarce resource. This often results in the African school children not reading their home work in the evening.

### SOLUTION:

The school folder with solar cells for school children is both cheap and gives free non toxic lighting. It is also the child's own property which gives the child the feeling of responsibility.

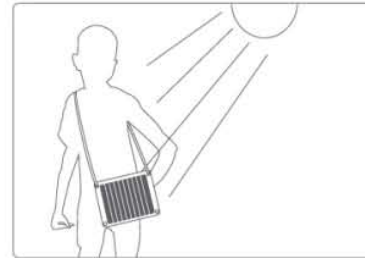

1) Carried as a bag on the way to school



2) Writing in the folder in the school

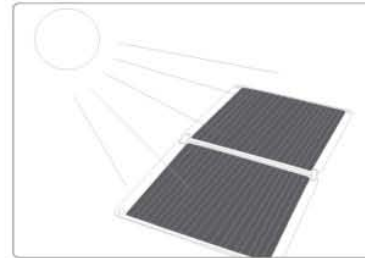

3) The polymer solar cells charges in the sun



4) The light source is easily flipped up and in use

### MULTI FUNCTIONAL SCHOOL FOLDER WITH:

- Polymer solar cells
- Flip up LED light that lies flat behind papers when not in use
- The school folder can also hang from ceiling as a lamp



## LIFESTYLE



### SUNNY SLIDE



#### PROBLEM:

P- watch systems either need change of battery or installation in the car by the auto mechanic.

#### SOLUTION:

Sunny Slide with polymer solar cell is glued onto the windshield of your car like a normal sticker. Charged by the sun, it always makes sure you don't get parking fines - for only 1/3 of the price of a conventional P-watch.

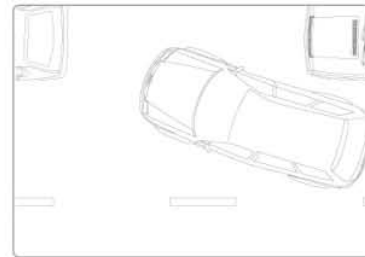

1) Park your car

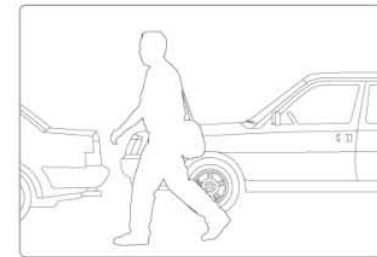

2) Leave your car

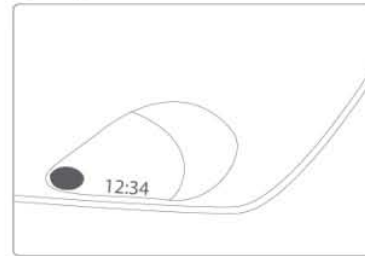

3) Sunny Slide sets time automatically

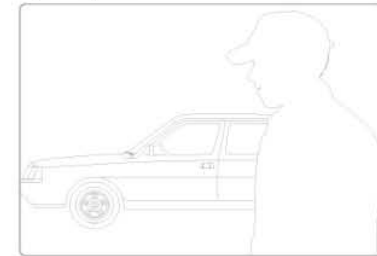

4) Traffic warden is happy - no fines

#### SANDWICH CONSTRUCTION OF:

- Polymer solar cell sticker
- Flexible printed circuit board and flexible screen
- Ultra thin rechargeable battery



Sunny Slide comes in 3 different colors



## COMMUNICATION



## INTELLIGENT PACKAGING



### PROBLEM:

Everyday huge amounts of fast moving consumer goods are wasted due to bad logistics and too little information.

### SOLUTION:

Polymer solar cells in combination with RFID tags can optimize logistics and give the right information to the consumer and make the store manager able to "communicate" with products and work with flexible principles, eg. discount when close to expiration date, healthy diet etc.

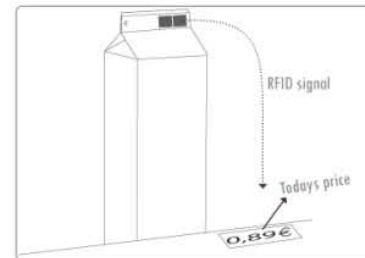

1) Flexible price principle



2) Possibility of reading prices out loud



3) Fully automatic grocery scanning



4) Easy update of the prices by the store manager

### POLYMER SOLAR CELLS STICKERS WITH THE FOLLOWING OPTIONS:

- Flexible digital screen
- Colored LEDs indicating information to the consumer
- Energy for power demanding RFID tags

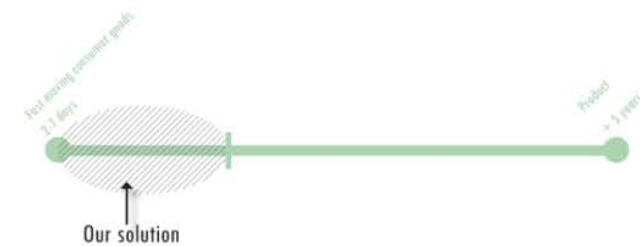



## PERSPECTIVE // TYPES OF PRODUCTS



**URBAN**  
Solar-powered blinds



**TELE MEDICINE**  
Wireless heart rate monitor

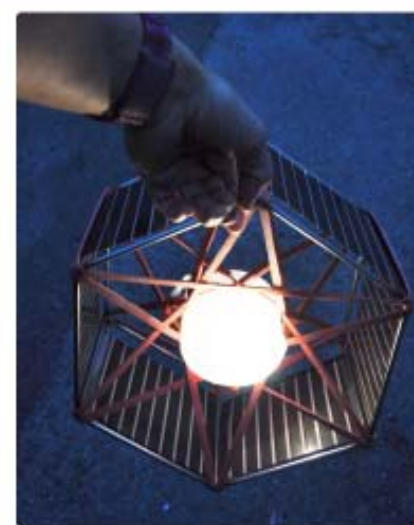

**HOME**  
Lamp for the garden

## References

- Espinosa N., Garcia-Valverde R., Krebs F. C. (2011). Life-cycle analysis of product integrated polymer solar cells. *Energy Environ. Sci.* , 1547-1557.
- Espinosa N., Garcia-Valverde R., Urbina A.; Krebs F. C. (2010). A life cycle analysis of polymer solar cells modules prepared using roll-to-roll methods under ambient conditions. *Sol. Energy Mater. Sol. Cells* , doi: 10.1016/j.solmat.2010.08.020.
- Jensen, K. F. (2008). Performance comparison of a Dye-Sensitized and a Silicon Solar Cell under Indoor and Outdoor Conditions". *DTU Master Thesis* .
- Krebs F. C. et al. (2009). A round robin study of flexible large area roll-to-roll processed polymer solar cell modules. *Solar Energy Materials and Solar Cells* , 1968-1977.
- Krebs F. C. et al. (2011). The OE-A OPV demonstrator anno domini 2011. *Energy Environ. Sci.* , 4116-4123.
- Krebs F. C., Fyenbo J., Jørgensen M. (2010). Product integration of compact roll-to-roll processed polymer solar cell modules: methods and manufacture using flexographic printing, slot-die coating and rotary screen printing. *J. Mater. Chem.* , 8994-9001.
- Krebs F. C., Gevorgyan, S. A., Alstrup J. (2009). A roll-to-roll process to flexible polymer solar cells: model studies, manufacture and operational stability studies. *J. Mater. Chem.* , 5442-5451.
- Krebs F. C., Tromholt T., Jørgensen M. (2010). Upscaling of polymer solar cell fabrication using full roll-to-roll processing. *Nanoscale* , 873-886.
- Medford A. J. et al. (2010). Grid-connected polymer solar panels: Initial considerations of cost, lifetime and practicality. *Optics Express* , A272-A285.
- Reese M. O. et al. (2011). Consensus stability testing protocols for organic photovoltaic materials and devices. *Sol. Energy Mater. Sol. Cells* , doi: 10.1016/j.solmat.2011.01.036.

## Annex 1: Demonstration

### LIGHTING AFRICA DEMONSTRATION

The Lighting Africa demonstrators are part of the project “Industrialization of polymer solar cells” which is funded by EUDP under the Danish Energy Agency. This report sums up the results from the 2011 solar lamp, which was tested in several development countries.



Pupils from Tanzania with the Lighting Africa 2011 solar lamp (used by permission from Strømme Foundation)

### Purpose

The purpose of the project is to enable students in development countries to study at night and at the same time test lamps with polymer solar cells in a range of different environments.

The field test is carried out in cooperation between Mekoprint and Strømme Foundation (Norway). The role of Strømme Foundation was to distribute solar lamps and collect user feedback.

### THE LAMP

The lamp is 84x125x2.5mm and comprises a polymer solar cell with an illuminated area of 58.3cm<sup>2</sup>, a 105mAh Lithium Polymer Battery, a charging circuit, a white LED, and a microcontroller based light controller.

The battery is charged through a few components, which limits the charging voltage to 4.1V and thus prevents overcharging. The solar cell inherently limits the charging current to safe values, but there is no protection against over-discharging of the battery.

The user can turn the light on and off using a switch, and a microcontroller keeps the light on after the switch is released, as no mechanical switch with a hold function is available for the given construction thickness. The microcontroller could be programmed for more advanced operation than just holding the light, but this was not implemented in this design to keep the lamp very simple to operate.



**The Lighting Africa 2011 solar cell lamp**

### **Production**

The solar cells were produced by Risø DTU and the microcontrollers were programmed by Faktor 3 before assembly at Mekoprint. The production method is similar that used for the OE-A demonstrator, but the microcontroller was not suited for Mekoprint's SMD mounting equipment, so it was hand-mounted, and this reduced the yield considerably. 224 lamps were produced, of which 189 lamps were approved for the field test. Of the 35 defect lamps 30 were rejected due to electrical failure and 5 due to solar cell de-lamination. The latter is due to rough handling in the manual mounting process, where a misaligned solar cell is forcefully removed from the lamp and reattached.

### **Questionnaire**

A questionnaire for the end users was compiled at Mekoprint and was put on the internet to provide a unified entry of responses for all end users or local contacts. It turned out that not all end users or local contacts speak English, so a Spanish version of the questionnaire has been created by Strømme foundation, and the answers reported back after translation to English. Only Peru has used the online questionnaire, which means that multiple choice answers has been grouped by the author of this report to provide manageable answer categories. The answers in



general shows a careful effort by Strømme Foundation and their local contacts to provide quality feedback, and the answers are in general considered genuine and reliable.

### Distribution and questionnaire feedback

The table below shows the distribution of the 179 lamps and the number of responses we have received.

Country	Regions/cities	Lamps	Responses	Defect
Peru	2 locations	31	29	2
Bangladesh	7 locations	25	19	2
Niger	7 locations	17	16	2
Burkina Faso	11 locations	17	16	1
Mali	2 locations	32	30	7
Tanzania	1 location	23	23	1
Uganda	1 location	28	18	13
Sudan	?	15	0	0
Norway	1 location	1	0	0
	<b>Total</b>	<b>189</b>	<b>151</b>	<b>28</b>

There are 151 sets of answers, corresponding to an answering percentage of 80%, which is considered remarkably good given the many locations involved and the fact that the information infrastructure is not always reliable. The defect rate of 19% is large and will be covered later in this document.

The distribution of the lamps was largely determined by Strømme Foundation based on their activities and contacts and this has led to a good spread in locations.

### END USER PROFILE

This section aims at giving a background on the end users participating in the field test.



Students from West Africa (Used by permission from Strømme Foundation)

### Age and gender

From the questionnaire, we have the distribution of age and gender of the end users. It shows that the lamps have been tested by approximately equal distribution between males (53%) and females (47%).

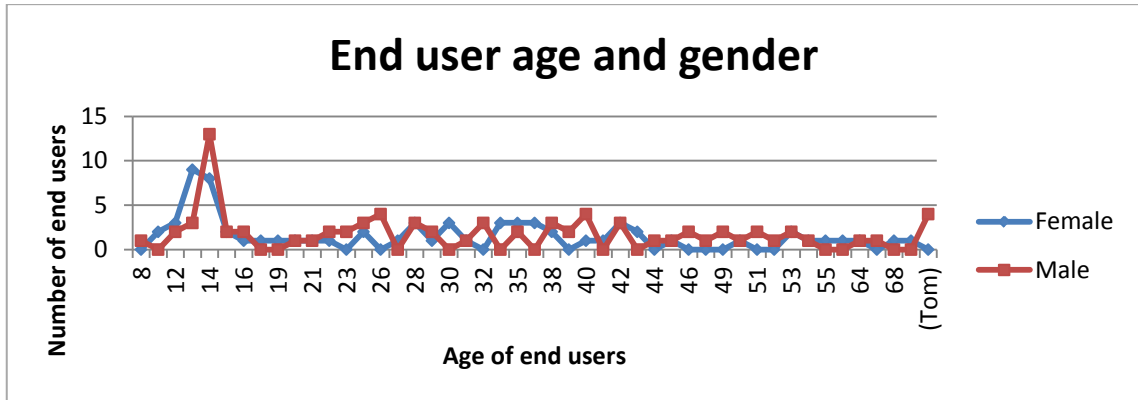

### Occupation and use

The occupations of the end users are shown below.

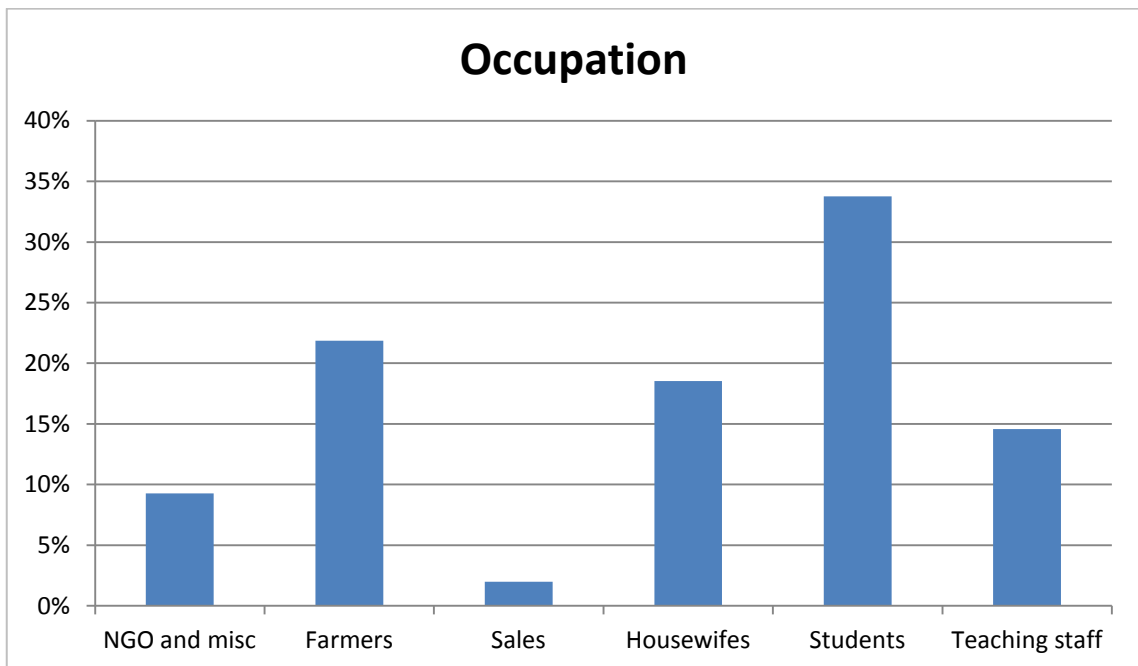



The primary usage of the lamps is shown below:

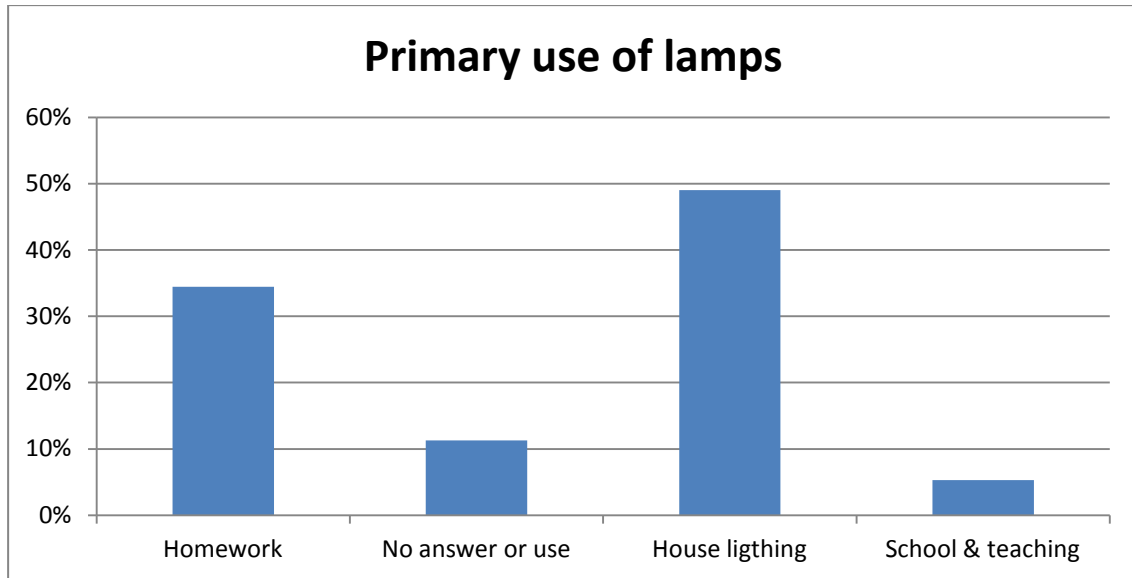

These two graphs shows that the lamps are used in three main applications, which are quite different when it comes to light requirements.



Light is not only needed for homework but also general house work at night. Picture from Tanzania. (Used by permission from Strømme Foundation)

## PERFORMANCE

Below is a selection of graphs capturing the performance of the lamp in the trials.

### Primary use VS light amount

It is interesting to know if the amount of light is sufficient. Only 26% of the end users report that the light is sufficient or more than sufficient. But the interesting thing is how the lamp performs in different applications. This is shown below, where percentages are calculated for each of the four applications.

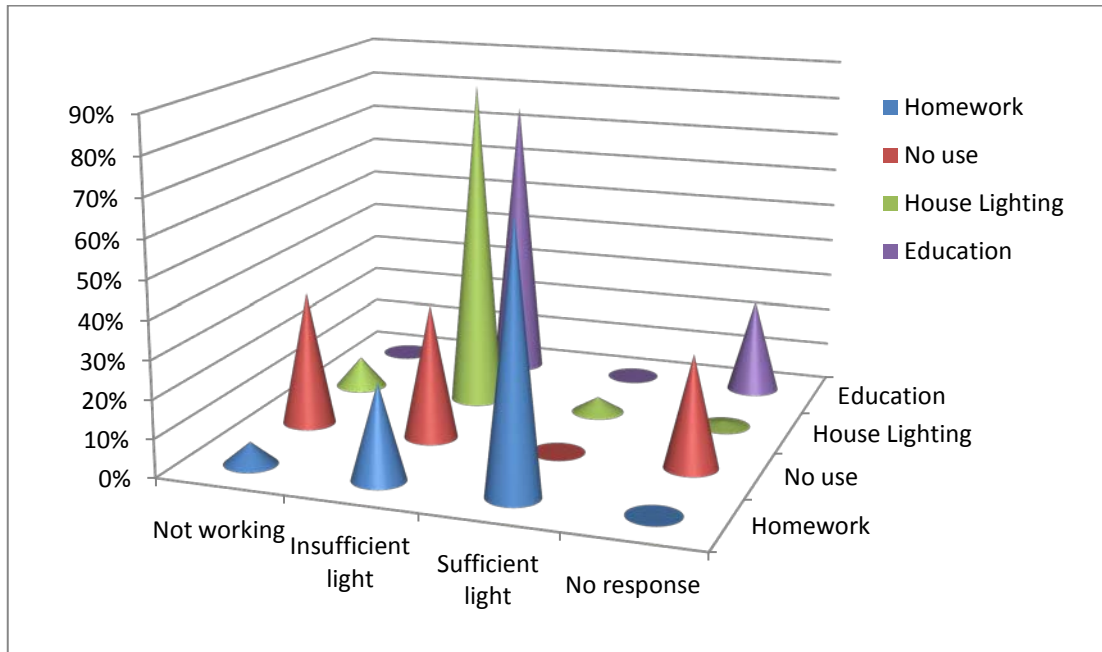

We see that the lamp is not providing enough light for educational use nor for house lighting (which is hardly surprising) but the lamp is deemed sufficient for homework by 69% of the students.

### Light time

The users were asked whether the light time of the lamp is sufficient, which is an indirect measure of the charging capacity. Almost half the users have sufficient light time, while the other half is annoyed by the short light time. We have no data on how much time, the lamp is charged, although several students from Uganda points to the possibility that the lamps are not necessarily put in the sun as long time as possible.

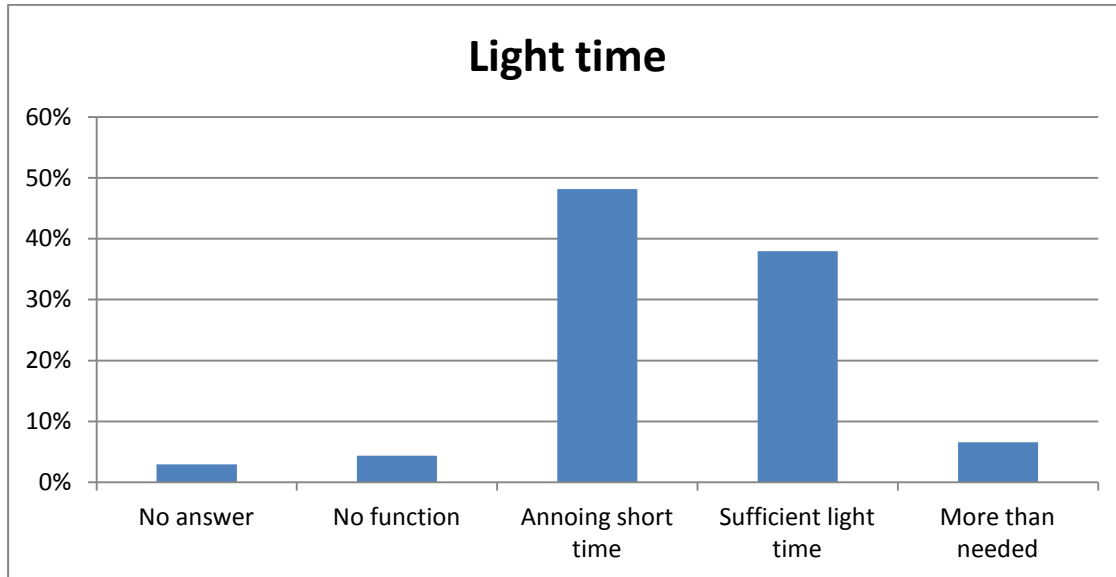

### Performance progress

The users were asked whether the lamp degraded or improved during use. The response shows that almost half the lamps were stable in use, and some apparently got better during use. This can only be explained by careful recharging of the lamps by the end users, as a fully charged lamp will provide more light for longer time, and the safety margin for battery degradation is maximized.

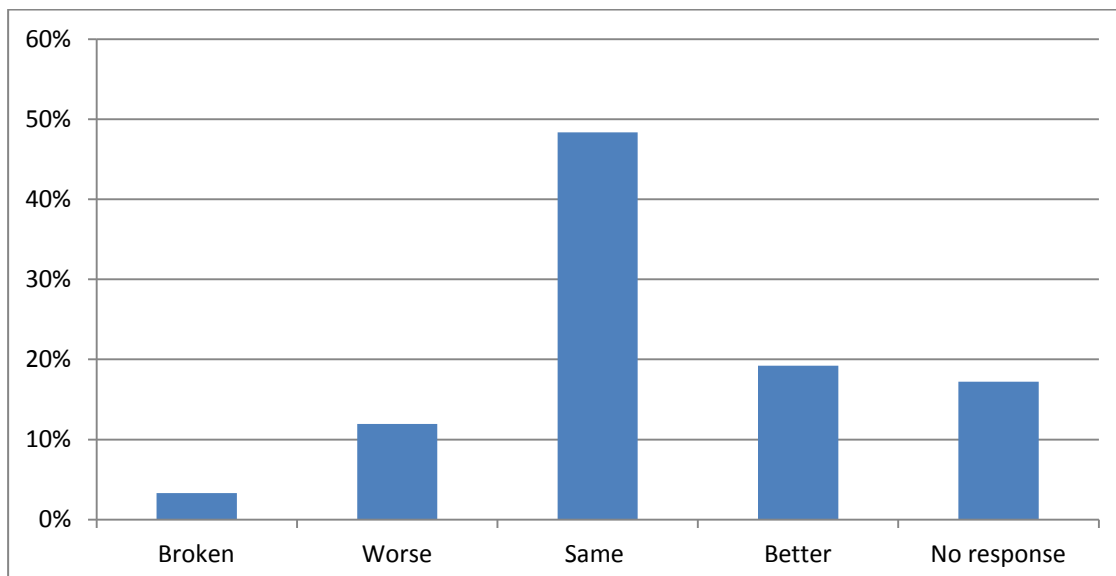

### End user judgment of the lamps

We asked user if they like the lamp and the response was overwhelming; even those who complain about light amount like the idea of solar powered light:

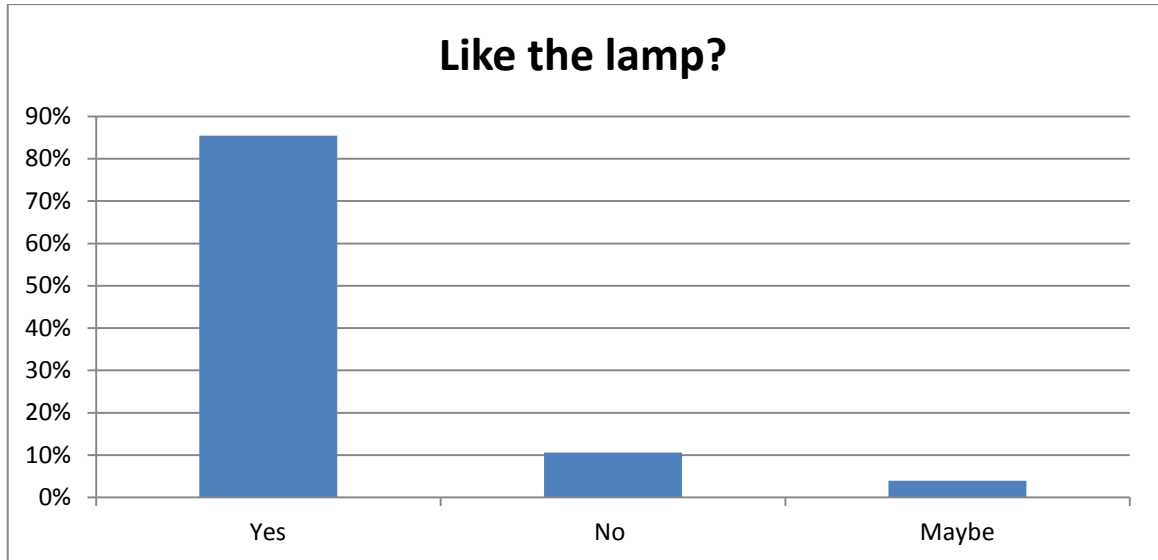

### Interested in buying again

The end users were asked if they would buy the lamp again if they lost it. The response is shown below:



When asked for the amount of money, the end users are willing to pay for a similar lamp, the result is best presented by a histogram. All local currencies are converted to Danish currency.



The low suggested price reflects the range of applications, the lamp is suitable for. We cannot judge from the data, how much the users will be willing to pay for a lamp that is capable of lighting a room for several hours, here comparisons with the price of alternative energy sources - kerosene and primary batteries - will be a better basis.

It is interesting to note that those who claim willing to buy the lamp again on average will pay 10DKK for the lamp whereas those who reject buying the lamp set the price at 22DKK on average.

### PROBLEM ANALYSIS

Of the 151 responses, 28 reported functionality defects, which correspond to 19%. This is clearly not satisfactory for a future product. This section aim at capturing what went wrong.

#### Geographical problem segmentation

The figure below shows the geographical distribution of defects. Excluded from the defect counts are the cases where the lamps are criticized for low light and there is no other indication of a failure.

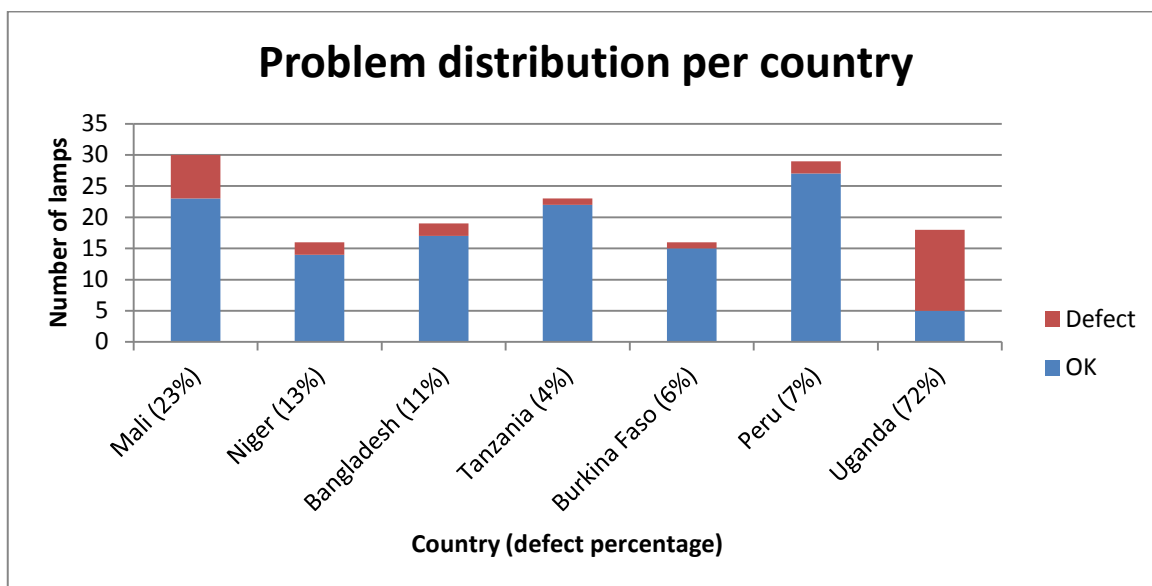

Obviously, something went terribly wrong in Uganda, where 72% of the lamps fail. Considering this country a special case, the rest of the countries have an average error rate of 11%, which is still unacceptable.

### Uganda

Uganda has the below error distribution:

Category	Problem reported	Units	Likely cause	Fault origin	Correction
Intermediate fault	At times not light completely	1	Flex circuit damage	Physical stress	More rugged design
Never worked	Never worked	1	Transport damage	Physical stress	More rugged design
OK	No	2			
	Sometimes low light	1			
	No response	2			
On/Off related problems	At times, switch refuse to work	4	Flex circuit damage	Physical stress	More rugged design
	Hard to turn on	1			
	Problem turning on	1			
Swelling	De-lamination, swelling	3	Over-discharge	User	Undervoltage protection
	Swelling	2			
Total		18			

From Uganda we have 8 users responding that to enhance performance, they should put it in the sun longer. It is very likely that these young people have used the lamp after the light has started to fade and thereby ruined the battery. All 5 lamps which swell are correlated with the statement that the lamp should charge for longer time. This points at the battery protection circuit, which should be improved to protect the battery against over-discharge.



The remainder of the problems relate to functionality problems, and the most obvious reason for these is the this back overlay, which acts both as external back barrier for the lamp and as base material for the printed circuit board (silver on PET). This construction is too fragile for the application as it transfers physical stress from the user to the conductor traces and the component contacts, which are considered the most vulnerable joints in the design. There is no explanation to why these faults are so frequent in Uganda.

### Mali

In Mali, we have the following fault distribution:

Category	Problem reported	Units	Likely cause	Fault origin	Correction
Failure in use	After the first night, the lamp refused to light.	1	Flex circuit damage	Physical stress	More rugged design
Never worked	The lamp didn't work	6	Transport damage	Physical stress	More rugged design

This distribution differs from the Uganda case by having a majority of lamps, which were faulty when received. This fault does not relate to the solar cell itself, but rather to the battery, flex circuit, LED or microcontroller connections.

### Bangladesh

Lamps were tested during the rainy season, which means lower light conditions compared to other locations. Also, the lamps were first tested by one group of students, where the lamps were proposed to light a class room. This failed, and the lamps were returned and tested by primarily Strømme Foundation staff and educational professionals. We have sparse information from this group of users.



Classroom situation from Africa (Used by permission from Strømme Foundation)

## COMMENTS FROM END USERS

Below is an edited list of comments from end users. There are many similar entries, and those have been cut down to a few distinct sentences.

### General opinion

Question: "Do you like the lamp? Why / Why not?"

No, it doesn't have enough light  
Yes, because it doesn't use battery  
Yes, as long as it is improved  
Yes, because it uses solar energy  
Yes, because it may help to do my work  
Yes, because it provides light  
Yes, because there is not electricity in this town  
Yes, because we need lighting  
Yes, because we spend a lot of money buying candles  
Yes, because is easy to carry  
yes, because I need it  
Yes, because it can light a room  
I like the lamp, but the light is insufficient  
I like the lamp, because it is portable. It sounds as if you have nothing in your pocket. It is directly supplied by the sun.  
I like the lamp because it is directly supplied by the sun. Also it is not heavy  
I like the lamp because it doesn't require any expense  
Yes, because it can slightly lit a room  
I really like the lamp because it can be easily manipulated and it doesn't require any other expense for supply  
The lamp is easy to be taken out everywhere. It doesn't require other expenses  
I like the lamp because once you have it there is no need to buy batteries. You only need to let it under the sun.  
The lamp seems to be easy to be used  
I don't like it because it refused to light  
I like it even if the light produced is insufficient  
I like the lamp because it is practical and fits the campaign. Also there is no need to buy petrol or battery. You only have to let it under the sun to have light for a certain period  
I like the lamp because it gives light at zero CFA (local currency, red). It is very easy to use it  
I like the lamp because it can give a small light at night. Even if the light is insufficient it is worth than nothing  
I may like the lamp if it is improved in the design and the amount of light produced  
Yes, because the lamp helps me to find out everything I need in my house  
Yes, because the lamp doesn't require any other expense. Also the lamp is nice.  
Yes I like the lamp, because thanks to it I can find out my way in my house by night  
Yes, it is useful whenever I have to move in my house  
Not really, because of its small size  
Yes I like this lamp, because I do not buy batteries. Also it provides sufficient light for me. This lamp really fits to poor people  
Yes I really appreciate the shape of the lamp  
Yes, this lamp is different from the other lamps I have seen so far. Also it is really easy to manipulate  
Yes I like it because it is not cumbersome  
We don't pay anything for charging. I like the lamp  
Fragile and insufficient light  
could not charge for rain  
difficult to charge  
whole day was in the sun but wasn't charged  
Lamp should help also my family at large.  
Lamp should be provided to all pupil's who are expected to sit for an exams

The system of charging should be more convenient, The better hanging system putting the light on. Less time for charging will enable charging during the rainy season  
Not practical in monsoon  
Should be given to all pupils - most cannot afford to buy fuel  
Give to all students - others are jealous

### **Suggestions for improvement**

Question: "What should be done to make the lamp better?"

Should provide more light and be bigger

There should provide more light and be easy to charging

It should be bigger

To make the lamp resistant to the rain, because it may rain while we are in the farm.

To improve the capacity of the lamp so that it can be so useful otherwise with such a light nobody will buy it because even the light of a telephone is much more better

You really have to increase the light otherwise the lamp will be useless

The initiative is good. However the lamp should be more solid, more bigger with much more light.

To reinforce its light so that it becomes a real lamp

To make it more solid and more resistant

Regarding the form, it is good for me; but you have to increase the capacity of the light

To make it resistant to the rain. To make the test from February to May; because this is the hottest period of the year in West Africa

Nowadays because of the high cost of energy, any kind of innovation in matter of solar energy is beneficial. However the light should be satisfactory

The initiative is good because it is set in the framework of fighting against poverty

The lamp will correspond to our financial capacity, because once you have it you don't have any problem of battery

Nothing special, just to mention that I have been deceived by the lamp

I think this lamp fits well in rural areas if the weaknesses mentioned above are taken into account

The lamp is really practical and fit to villages. I would ask the initiators to still work on the amount of light produced by the lamp.

You have to try to make the lamp more resistant. It can easily be broken by children. Also to add other bulbs in order to have more light.

To increase the capacity of the lamp by adding other bulbs more efficient. To add a battery and make the lamp more resistant

For the time being this lamp cannot really us. It is not possible to neither read nor write in the light. The light is not sufficient even for cooking.

To make the lamp available for everybody and increase its light

My desire is that you improve the quality of the lamp so as to increase its light. I'm sure it will be appreciated, because it doesn't require any other expense

To revise the design of the lamp so that It can be used day and night

To provide a handle to the lamp. To make it more resistant and heavy

## CONCLUSION

The Lighting Africa demonstrator project 2011 has successfully shown that a solar powered lamp can be produced and is usable in development countries. Enabling children to do home-work in the evening is an important step in the fight against poverty, and the solar lamp has proved usable albeit not perfect for this application.

The project has also uncovered a general need for room and work lighting in many parts of the world. In these applications, a stronger light is needed, and with stronger light comes increased demands for charging meaning larger solar cells and higher price. The feasibility of such a future product area is outside the scope of this work.

Kerosene used to be an important fuel for lighting in development countries, but prices have recently gone up, enabling a range of new electrical light sources. Some of these are based on solar cells, others on primary batteries.

The project has uncovered the weak spots of the solar lamp design, and a revised design will at least require the following:

- More powerful light source
- Higher charging capacity
- More rugged design, so the lamp can endure transportation and use by children
- Better battery protection – especially against over-discharge
- Protection against rain

We would like to thank the Strømme Foundation and their local partners and the end users for a dedicated effort to provide us with information during this project.

There is a great demand for solar lamps in development countries.

*Report finished 18/11 2011*

*Rasmus B. Andersen, Mekoprint A/S.*

## Annex 2: Dissemination

### Press releases

- 2011, June 27  
"Mekoprint and Risø DTU shine the light on organic photovoltaic cells by giving away 10.000 OPV-powered flashlights"
- 2010, June 30  
"Mass production of polymer solar cells is within reach" / "Masseproduktion af plastsolceller er nu mulig"

### Press coverage

- National TV/DR 2: "Danskernes Akademi", presentation of the project, Dec. 2011
- Ingeniøren: "Ny satsning: Mekoprint printer plastsolceller i lange baner", 2010, July 2
- Ingeniøren: "Milepæl for Risø DTU: Plastsolceller går i masseproduktion", 2010, April 20
- National TV/DR2: "Gal eller genial", review of the invented Lighting Africa lamp, 2010, April 6

### Published articles in peer reviewed journals

- Helgesen, M. et al: "Thermally reactive Thiazolo[5,4-d]thiazole based copolymers for high photochemical stability in polymer solar cells", *Polymer Chemistry*, 2, p. 2536-2542 (2011).
- Nan, Y. et al: "Generation of native polythiophene/PCBM composite nanoparticles via the combination of ultrasonic micronization of droplets and thermocleaving from aqueous dispersion", *Nanotechnology*, 22, 475301, (2011).
- Carlé, J. E., et al: "Fused thiophene/quinoxaline low band gap polymers for photovoltaic's with increased photochemical stability", *Sol. Energy Mater. Sol. Cells*, 95, p. 3222-3226 (2011)
- Krebs, F. C.: "The OE-A OPV demonstrator anno domini 2011", *Energy & Environmental Science*, 4, p. 4116-4123 (2011).
- Azzopardi, B. et al: "Economic assessment of solar electricity production from organic-based photovoltaic modules in a domestic environment", *Energy & Environmental Science*, 4, p. 3741-3753 (2011).
- Manor, A., et al: "Electrical and Photo-Induced Degradation of ZnO Layers in Organic Photovoltaics", *Advanced Energy Materials*, 1, p. 836-843 (2011)
- Jensen, J, et al: "Flexible substrates as basis for photocatalytic reduction of carbon dioxide", *Sol. Energy Mater. Sol. Cells*, 95, p. 2949-2958 (2011).
- Siram, R. B. K. et al: "Synthesis and Self-Assembly of Donor-Acceptor-Donor Based Oligothiophenes and Their Optoelectronic Properties", *J. Phys. Chem. C*, 115, p. 14369-14376 (2011).
- Madsen, M. V, et al: "Ellipsometry as a Nondestructive Depth Profiling Tool for Roll-to-Roll Manufactured Flexible Solar Cells", *J. Phys. Chem. C*, 115, p. 10817-10822 (2011).
- Andersen, T. R.: "Aqueous Processing of Low-Band-Gap Polymer Solar Cells Using Roll-to-Roll Methods", *ACS Nano*, 5, p. 4188-4196. (2011).
- Helgesen, M. et al: "Photochemical stability and photovoltaic performance of low-band gap polymers based on dithiophene with different bridging atoms", *Polymer Chemistry*, 2, p. 1355-1361. (2011).
- Espinosa, N. et al: "Life-cycle analysis of product integrated polymer solar cells", *Energy & Environmental Science*, 4, p. 1547-1557 (2011).

- Manor, A. et al: "Origin of size effect on efficiency of organic photovoltaics", *J. Appl. Phys.*, 109, 074508, p. 9 (2011).
- Tromholt, T. et al: "Reversible degradation of inverted organic solar cells by concentrated sunlight", *Nanotechnology*, 22, 225401 p. 6 (2011).
- Espinosa, N. et al: "Roll-to-Roll Processing of Inverted Polymer Solar Cells using Hydrated Vanadium(V)Oxide as a PEDOT:PSS Replacement", *Solar Energy Materials & Solar Cells*, 97, p. 3-13 (2012).
- Søndergaard, R. et al: "Fabrication of Polymer Solar Cells Using Aqueous Processing for All Layers Including the Metal Back Electrode", *Advanced Energy Materials*, 1, p. 68-71 (2011).
- Larsen-Olsen, T. et al: "A solution process for inverted tandem solar cells", *Organic Electronics*, 12, p. 364-371 (2011).
- Espinosa, N. et al: "A life cycle analysis of polymer solar cell modules prepared using roll-to-roll methods under ambient conditions", *Sol. Energy Mater. Sol. Cells*, 95, p. 1293-1302, (2011).
- Gevorgyan, S. A. et al: "An inter-laboratory stability study of roll-to-roll coated flexible polymer solar modules", *Sol. Energy Mater. Sol. Cells*, 95, p. 1398-1416 (2011).
- Hermenau, M et al: "Water and oxygen induced degradation of small molecule organic solar cells"  
*Sol. Energy Mater. Sol. Cells*, 95, p. 1268-1277 (2011).
- Krebs, F. C. et al: "Printed metal back electrodes for R2R fabricated polymer solar cells studied using the LBIC technique", *Sol. Energy Mater. Sol. Cells*, 95, p. 1348-1353, (2011).
- Tromholt, T. et al: "Degradation of semiconducting polymers by concentrated sunlight", *Sol. Energy Mater. Sol. Cells*, 95, p. 1308-1314, (2011).
- Carlé, J. G et al: "Low band gap polymers based on 1,4-dialkoxybenzene, thiophene, bithiophene donors and the benzothiadiazole acceptor", *Solar Energy Materials & Solar Cells*, 94(5), p. 774-780 (2010).
- Helgesen, M. P. et al: "Photovoltaic Performance of Polymers Based on Dithienylthienopyrazines Bearing Thermocleavable Benzoate Esters", *Macromolecules*, 43(3), p. 1253-1260 (2010).
- Krebs, F. C. et al: "Using Light-Induced Thermocleavage in a Roll-to-Roll Process for Polymer Solar Cells"  
*A C S Applied Materials and Interfaces*, 2(3), p. 877-887 (2010).
- Krebs, F. C. et al: "Upscaling of polymer solar cell fabrication using full roll-to-roll processing", *Nanoscale*, 2(6), p. 873-886 (2010).
- Medford, A. J. et al: "Grid-connected polymer solar panels; initial considerations of cost, lifetime, and practicality", *Optics Express*, 18 (S3), p. A272-285 (2010).
- Nielsen, T. D. et al: "Business, market and intellectual property analysis of polymer solar cells",  
*Solar Energy Materials & Solar Cells*, Solar Energy Materials & Solar Cells, 94, p. 1553-1571 (2010).
- Krebs, F. C. et al: "Manufacture, integration and demonstration of polymer solar cells in a lamp for the Lighting Africa initiative", *Energy & Environmental Science*, 3(5), p. 512-525 (2010).
- Manceau, M. et al: "Thermo-cleavable polymers: Materials with enhanced photochemical stability", *Polymer Degrad. Stability*, 95, p. 2666-2669 (2010).
- Norrman, K. et al: "Degradation Patterns in Water and Oxygen of an Inverted Polymer Solar Cell", *J. Am. Chem. Soc.*, 132, p. 16883-16892 (2010).
- Alstrup, J. et al: "Ultra Fast and Parsimonious Materials Screening for Polymer Solar Cells Using Differentially Pumped Slot-Die Coating", *ACS Appl. Mater. Interfaces*, 2, p. 2819-2827 (2010).



- Krebs, F. C. et al: "Product integration of compact roll-to-roll processed polymer solar cell modules: methods and manufacture using flexographic printing, slot-die coating and rotary screen printing", *J. Mater. Chem.*, 20, p. 8994-9001 (2010).
- Lilledal, M. R., et al: "The effect of post-processing treatments on inflection points in current-voltage curves of roll-to-roll processed polymer photovoltaics", *Sol. Energy Mater. Sol. Cells*, 94, p. 2018-2031 (2010).
- Senkovskyy, V. et al: "Hairy Poly(3-hexylthiophene) Particles Prepared via Surface-Initiated Kumada Catalyst-Transfer Polycondensation", *J. Am. Chem. Soc.*, 131(45), p. 16445-16453 (2009).

### Presentations at conferences

- Ries, K.: "EUDP projekt – Industrialisation of polymer solar cells", *EnergiForsk 2011*, Copenhagen, Denmark, 22 June 2011.
- Kowalski, S.: "Industrialization of the OPV technology", *SMT/HYBRID/PACKAGING conference*, Nurnberg, Germany, 4 May 2011.
- Lauritzen, H.: "Product Integration of Polymer Solar cells - from Circuitry to Functional Units" *Printed Electronics Europe 2011*, Düsseldorf, Germany, 5-6 April 2011.
- Lauritzen, H.: "Plastsolceller – fra kemi laboratorium til industriel produktion", *Temadag om plast i solcellemoduler*, Toftlund, Denmark, 16 March 2011.
- Bork, J.: "Mekoprint OPV progress so far", *OE-A work group meeting on Upscaling Production*, Stuttgart, Germany, 1 March 2011.
- Nielsen, T. D.: "Integration in Final Products - the Risø DTU OPV solar lamp", *OE-A 21st Working Group Meeting*, Munich, Germany, 16-17 November 2010.
- Nielsen, T. D.: "Lab to Fab – the Risø DTU OPV solar lamp", *OE-A 11th North American OE-A Working Group Meeting*, Santa Clara, USA, 30 November 2010.
- Lauritzen, H.: "Fabrication and Processing of Polymer and Organic Solar Cells", *CIMTEC 2010*, 5<sup>th</sup> Forum for New Materials, Montecatini Terme, Italy, 13-18 June 2010
- Nielsen, T. D.: "Polymer Solar Cells; Processing, Demonstration and Market", *LOPE-C International Conference and Exhibition of the Organic and Printed Electronics Industry*, Frankfurt, Germany, 31 May – 2 June 2010
- Riis, K.: "Roll-to-roll Manufacturing of OPV Products", *LOPE-C International Conference and Exhibition of the Organic and Printed Electronics Industry*, Frankfurt, Germany, 31 May 31 – 2 June 2010.
- Lauritzen, H.: "Polymersolceller – udvikling, økonomi og marked", *Danvak Dagen 2010*, Kgs, Lyngby, Denmark, 21 April 2010.
- Nielsen, T. D.: "Large Scale Industrial Processing of Polymer Solar Cells and Application in Demonstration Projects + Products", *Eastern Europe Link – Athens*, Greece, November 2009.

## Acknowledgements

The project group would like to thank

**Energy Technology Development and Demonstration Program (EUDP)** for financing the projects

**Strømme Foundation** for arranging the demonstration of the small LED lamp with polymer solar cells in Asia, Africa and South America

**Organic Electronics Association** for arranging the distribution of the credit-card sized LED flash light with polymer solar cells at the LOPE-C conference 2011