



Energy efficiency initiatives, strategies and effects in Denmark, Europe and worldwide

Halsnæs, Kirsten

Published in:

DTU International Energy Report 2012: Energy efficiency improvements

Publication date:

2012

Document Version

Publisher's PDF, also known as Version of record

[Link back to DTU Orbit](#)

Citation (APA):

Halsnæs, K. (2012). Energy efficiency initiatives, strategies and effects in Denmark, Europe and worldwide. In DTU International Energy Report 2012: Energy efficiency improvements: A key element in the global transition to non-fossil energy (pp. 25-29). Technical University of Denmark (DTU).

DTU Library

Technical Information Center of Denmark

General rights

Copyright and moral rights for the publications made accessible in the public portal are retained by the authors and/or other copyright owners and it is a condition of accessing publications that users recognise and abide by the legal requirements associated with these rights.

- Users may download and print one copy of any publication from the public portal for the purpose of private study or research.
- You may not further distribute the material or use it for any profit-making activity or commercial gain
- You may freely distribute the URL identifying the publication in the public portal

If you believe that this document breaches copyright please contact us providing details, and we will remove access to the work immediately and investigate your claim.

DTU International Energy Report 2012

Technical University of Denmark



Energy efficiency improvements

A key element in the global transition to non-fossil energy

Edited by Hans Hvidtfeldt Larsen and Leif Sønderberg Petersen
DTU National Laboratory for Sustainable Energy

November 2012



Energy efficiency improvements

A key element in the global transition to non-fossil energy

Increased energy efficiency can reduce global CO₂ emissions over the period to 2050 with up to 25%. On the top of that large profits can be gained for very little investment. Energy efficiency improvements can save investment in new energy infrastructure, cut fuel costs, increase competitiveness and increase consumer welfare. Thus, it is natural for DTU International Energy Report 2012 to take up this issue and analyze the global, regional and national challenges in exploiting energy efficiency and promote research and development in energy efficiency.

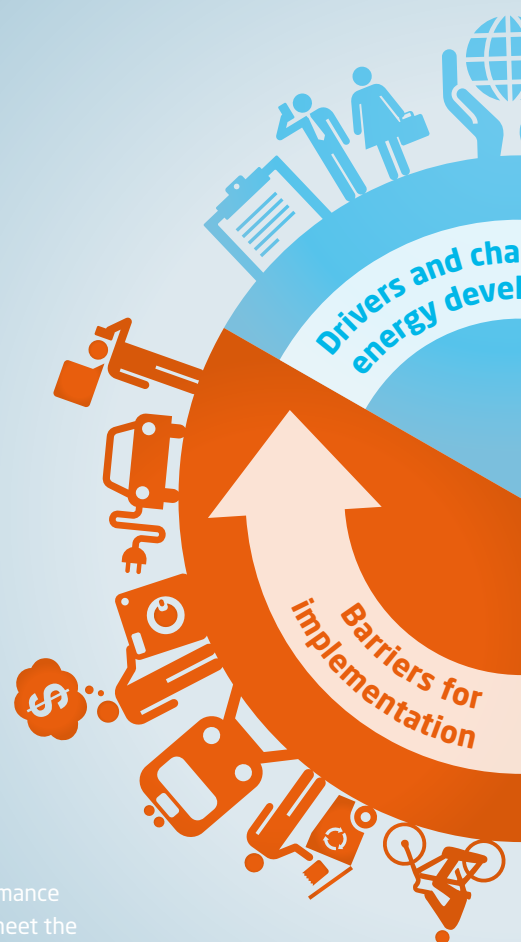

Barriers for implementation

9. The process of designing low energy buildings according to the Energy Performance of Buildings Directive needs to be improved in order to ensure that buildings meet the requirements of energy performance and for indoor environment.
10. If the EVs should get a real market share in Denmark it is necessary to establish a charging infrastructure in public and semi public areas. With an acceptable fast charging infrastructure at least 85% of the one car families can be potential EV customers.
11. Initiatives for efficiency improvements should be based on a diverse range of incentive schemes as suggested by the heterogeneous ways in which energy is used. Buildings, private households, industry, public services, private services and transport all have quite different technical potentials and barriers for implementation.
12. Stricter requirements should be imposed for efficiency improvements in household appliances, as technical developments and rising energy prices over the last decade have increased the economic potential for improvement.

Drivers and challenges for energy development

1. Efficiency improvements should be promoted vigorously as one of the most important contributions to the development of a global non-fossil energy system and to the benefit of energy security and climate change.
2. Public policies and instruments should be developed in such a way that they support a transition to higher efficiency and the introduction of renewable energy.
3. The world community should be encouraged to support policies to improve energy efficiency in the industrial sectors of developing countries, since these nations account for 60% of the energy used by industry worldwide.



Systems and technology

4. It is of paramount importance to achieve dramatic efficiency improvements in fossil-fuel-based means of transportation since fossil fuels are likely to remain the main energy source in the global transport sector for many years ahead.
5. It is important to promote research and demonstration in the new power train technologies needed to take us beyond the global transport demands of 2050.
6. It is important to strengthen the development of methods to convert waste products into bioenergy, since land-use for production of biomass for bioenergy often competes with the production of other goods necessary to society like food, fodder and fibres. Such waste products include household waste, organic waste from food production and animal manure.
7. R&D in energy storage technologies should be promoted, because energy storage is crucial for the optimal and efficient performance of future intelligent energy systems.
8. To realise the full potential for efficiency improvements through the introduction of solid-state lighting, further R&D needs to be carried out to increase the light extraction of semiconductor materials, provide better and cheaper production technology, and create advanced optical systems for optimised light distribution.

DTU International Energy Report 2012

Energy efficiency improvements

A key element in the global transition to non-fossil energy

EDITED BY

Hans Hvidtfeldt Larsen and Leif Sønnderberg Petersen, DTU National Laboratory for Sustainable Energy

REVIEWED BY

Dr. Marc A. Rosen, Faculty of Engineering and Applied Science, University of Ontario, Canada

Professor Asgeir Tomasgard, Department of Industrial Economics and Technology Management,
Norwegian University of Science and Technology, Norway

Editorial consultant

Charles Butcher, Science Journalist, UK

COPYRIGHT

Technical University of Denmark, November 2012

ISBN 978-87-550-3965-0

Contents

1	Preface	3
2	Summary and recommendations	5
3	The global energy scene - role of energy efficiency	11
4	Energy efficiency improvements: scope and definition	21
5	Energy efficiency initiatives, strategies and effects in Denmark, Europe and worldwide	25
6	Residential and commercial buildings	31
7	Energy efficient Solid State Lighting	39
8	Energy consumption in communication infrastructures	43
9	Efficiency improvements in transport	47
10	Renewable energy technologies	59
10A	Wind energy efficiency improvements	61
10B	Photovoltaics efficiency improvements	67
10C	Bioenergy efficiency improvements	73
11	Energy efficiency improvements in energy supply and industry	79
12	Nuclear energy efficiency improvements	87
13	Energy enabling technologies	93
13A	The role of fuel cells and electrolysers in future efficient energy systems	95
13B	Low-grade energy resources for heating, cooling and power	103
14	Systems, distribution and storage	109
15	Energy savings, potentials and policies	119
16	Synthesis	127
17	Index	137
18	The DTU International Energy Reports series	139
19	References	143

Preface

Increasing energy efficiency, much of which can be achieved through low-cost measures, offers huge potential for reducing CO₂ emissions during the period up to 2050.

At a time of crisis in both global climate and global finance the world needs new opportunities for green growth, as well as a revolution in energy and industry in the form of a transition from fossil to non-fossil fuels.

Energy efficiency is an important link in this transition, as improvements in energy efficiency can reduce the need to invest in energy infrastructure, cut fuel costs, increase competitiveness and improve consumer welfare.

The sectors responsible for global emissions – power generation, industry, transport, buildings and construction – all have large potentials for saving energy.

As the International Energy Agency (IEA) notes in "Energy Technology Perspectives 2012", it is difficult to overstate the importance of energy efficiency. As well as helping to cut emissions and enhance energy security, energy efficiency is nearly always cost-effective in the long run, says the IEA.

In its "roadmap for moving to a competitive low-carbon economy in 2050" the European Commission pinpoints energy efficiency as the key driver for the transition to renewable energy. The Danish Commission on Climate Change Policy points out in its 2010 report that energy efficiency improvements alone can reduce overall energy consumption in Denmark by up to 25%.

With this background this Report addresses the global, regional and national challenges in pursuing these targets, together with the main topics in research and development for energy efficiency. The Report also analyses a selection of barriers hindering the broader implementation of energy efficiency improvements. Finally it gives examples of how more stringent performance standards and codes, as well as economic incentives, can unlock energy efficiency potential and scale up the financing of energy efficiency improvements.

DTU International Energy Report series

The DTU International Energy Report 2012 is a continuation of the former Risø Energy Report series, first published in 2002.

The series deals with global, regional and national perspectives on current and future energy issues. The individual chapters are written by DTU researchers in cooperation with leading Danish and international experts. Each report is based on internationally-recognised scientific material and is fully referenced. The reports are refereed by an independent panel of international experts, and are edited and published in accordance with the highest international quality standards.

The target group is colleagues, collaborating partners and customers, as well as funding organisations, institutional investors, ministries and authorities as well as international organisations such as the EU, WEC, the IEA and the UN.

Summary and recommendations

Hans Hvidtfeldt Larsen and Leif S nderberg Petersen, DTU National Laboratory for Sustainable Energy

Energy efficiency on the global energy scene

Energy security and climate change remain the major drivers for energy policy in most countries around the world. Studies at global and national levels show the significant potential for energy efficiency improvements to be a major contributor in our efforts to address both of these issues. Efficiency improvements in both the production and consumption of energy constitute key elements in most scenarios addressing climate and energy security concerns. Energy efficiency is also at the heart of the EU 2020 strategy.

Energy efficiency is likewise a high priority for the IEA and the IPCC. The IEA believes end-use energy efficiency improvements could contribute about one-third of the world's total CO₂ emission reductions in 2050. The IPCC has shown that there is a relatively large and economically attractive potential for energy efficiency improvements up to 2030.

The social costs of energy efficiency improvements will be lower than the private costs simply because there is a social value associated with decreased global warming. Taken together, this makes a strong case for introducing a wide range of public policies and instruments that support that the private costs and other incentives for policy implementation.

Energy efficiency presents a challenge – and provides an opportunity – in that it is relevant to most sectors and requires the engagement of a large and often diverse group of actors.

It should be stressed that energy efficiency is not the same as energy conservation. Efficiency means providing the same service with a lower input of energy, while conservation includes a reduced demand for energy services, including the possibility of changes in consumer lifestyle.

With regard to buildings, the focus in OECD countries is mostly on renovating the extensive existing building stock. For many developing countries the situation is more mixed, with new construction playing a bigger role.

Industry worldwide accounts for approximately one-third of global final energy use. Of this, OECD countries are responsible for around 40% and the remaining 60% is consumed in developing countries.

Road transport dominates energy use in passenger transport. The picture for land based freight transport is slightly more mixed, it is still trucks that are used for the great

majority of land-based freight movement. While the focus here is on increasing energy efficiency, it is important to note that for the transport sector there is a parallel interest in alternative fuels and engines.

Electric vehicles represent another development that is still largely at the demonstration stage. Hybrid and plug-in hybrid vehicles are globally an important path between today's vehicle technology and the transition to future electric vehicles.

Denmark plans to be fossil-free by 2050

In Denmark the ambition of being independent of fossil fuels by 2050 is high on the agenda. This was most recently shown in the Danish government's plan Our Future Energy, which foresees the production of heat and power 100% from renewables by 2035, and by 2050 the entire energy system, including transport, supplied only by renewable sources. But renewable sources are limited in amount and the change to independence will be unnecessary costly if not a strong effort for energy efficiency is carried out in parallel with the development of a renewable energy system.

Energy efficiency in buildings

Low-energy buildings can make a major contribution to sustainable development in general by providing a solution to problems related to the use of fossil fuels. Based on experience with passive houses, low-energy buildings built according to the EU Energy Performance of Buildings Directive (EPBD) are expected to cost only a few percent more to build than standard constructions. Energy-saving technologies added during "deep renovation" could in the future cut the heating needs of existing buildings to levels close to those of new buildings.

The process of designing low-energy buildings according to the EPBD needs to be improved to make sure that buildings meet the requirements for both energy performance and indoor environment quality in an optimal way.

Energy efficiency in lighting

Lighting has been an integral part of human civilization since before recorded history. Today artificial lighting is a critical part of modern life, but traditional methods such as fuel-based and incandescent lighting are highly inefficient. This has led to a situation where lighting takes up 6.5% of

total energy usage worldwide. As a consequence, many countries are phasing out the use of inefficient lighting products.

Even though vast improvements have been made on efficiency and light quality, SSL (solid state lighting) is still in its infancy. One of the barriers to market introduction is price, which is still around five times higher than that of traditional lighting technologies.

Energy efficiency in communication networks

It is currently estimated that about 2–4% of global energy consumption is used to operate communications infrastructure – mainly the Internet. Even though this figure might not be alarmingly high in itself, it will soon become important when it is combined with a growth rate of 30–40% due to a similar growth rate of the required capacity implemented to serve user and application demand. Today the Internet shows a linear relation between capacity and power consumption, with no clear path towards reduction. More intensive use of optical technology is currently the best long-term solution, but this requires a complete restructuring of the way networks are researched and implemented.

Energy efficiency in transport

Motor fuels have been based almost entirely on crude oil for the last century. Over the last couple of decades engines for traditional fuels have evolved towards more advanced and efficient types. This has reduced fuel consumption on the order of 40%. Only during the latest couple of decades we have begun to look at alternatives to fossil fuels, while at the same time the engines for traditional fuels have developed towards more advanced and efficient types.

Several factors have combined to reduce the fuel consumption of cars based on combustion engines. The current efficiency target for both diesel and petrol engines is 50% in light-duty vehicles, and even higher efficiencies for heavy-duty vehicles.

With regard to electric vehicles (EVs), Denmark is better prepared than other nations due to major Danish incentives. Still, EVs have several barriers to overcome. The price of vehicles and batteries is still too high and the driving range is too short for long distance travels. By establishing charging poles in the dense city areas it is possible to serve the need for daily charging of EVs. Infrastructure for EVs

battery charging and switching has to be established. When the needed infrastructure is in place at least 85% of the Danish one-car families and most of the two car families could be potential EV customers. Electric vehicles are more energy efficient than other kind of passenger cars but improvement of energy efficiency is still relevant, also to enhance the travel range of a battery.

Biofuels such as biodiesel, bioethanol, biomethanol and biogas can substitute gasoline and diesel, which is especially relevant for heavy-duty vehicles that are not suitable for plug-in electricity. In recent years algae have also shown potential as diesel fuel. Development of higher energy efficiency and development of second generation biofuels should go hand in hand.

Efficient exploitation of wind energy

Energy efficiency improvements as a tool for achieving a sustainable energy future will have a different character in the context of the development of renewable energy technologies such as wind energy compared to other technologies in, for example, industry, transport and traditional power generation.

Efficient deployment of wind turbines is associated with deployment of turbines in large wind farms, whereby infrastructure can be consolidated. Massive offshore development will require corresponding investment in the power grid infrastructure just to connect the offshore wind turbines to the transmission grids on land. At the same time it is becoming feasible to increase the interconnection capacity between European countries as a way to support an integrated, pan-European electricity market. Such developments will allow wind energy to become the backbone of the global power system and to play a major role in the creation of an efficient and sustainable power system.

Efficient exploitation of solar energy

Solar power technologies are being deployed at increasing speeds but they still exploit only a fraction of the solar energy resource available. Bottlenecks in terms of materials, capital investment in production machinery, land and infrastructure will also become important as solar power continues to grow. The photovoltaic (PV) market in 2011 showed a 40% increase in installed capacity compared to 2010.

When considering energy performance standards for new low-energy buildings, the question of whether power from PV systems should count towards a building's net energy balance remains to be decided. The risk is that low-cost PV will displace long-term passive energy improvements.

PV and concentrating solar power (CSP) are among the renewable energy technologies with the highest energy production per unit area. Utility-scale PV and CSP installations have additional requirements for land and water for cooling or cleaning.

Efficient exploitation of bioenergy

Energy return on energy invested (EROI) relates the energy content of a fuel to the energy – direct and indirect – required to produce it. EROI is therefore an important indicator in the efficient exploitation of bioenergy. The EROI of the fossil fuels which have powered our society for more than a century has decreased from about 100 to about 10 during this period, implying that the net energy service provided to society has decreased from 99 times to 9 times the energy input. A primary energy source for transport may require an EROI of at least 3 to ensure that it can power the infrastructure needed to manufacture and supply the fuel, as well as the fuel itself. Estimates of EROI for bioethanol from maize are in the range 0.8–1.6, which means that the energy output in some cases is less than the input.

Biomass for bioenergy is most often grown on land that could be used to produce other goods needed by society, such as food, fodder and fibres, or to provide other ecosystem services. Thus it is necessary to strengthen the development of methods for conversion of “waste” products into bioenergy, i.e. products not currently used by society or valued for environmental purposes. These could include household waste, organic waste from food production and manure from animal husbandry.

Examples of energy efficiency potential in industry

Distillation is a common refinery process in industry. Since it accounts for 4% of all energy consumption in the western world, substantial reductions in the energy used for distillation are desirable, and new energy-integration technologies can make this possible, for instance by including separation and heat exchange within the same equipment. An example of such integration is diabatic distilla-

tion, which can cut the energy needed for distillation by up to 80% and operating costs by 60%.

Waste-to-energy (WtE) technology provides high-efficiency, clean and sustainable heat and power production from the thermal conversion of waste. The electrical efficiency of current grate-fired WtE units seldom exceeds 24–27%, compared to 46–48% for the best coal-fired power stations. The ultimate commercial success criterion is in the first place to develop a new generation of clean and flexible incineration-based WtE plants with electrical efficiencies above 30%.

Biomass gasification already has a relatively high electrical efficiency, but it also has significant potential for better energy utilization, mainly in relation to ash handling and the use of fibre-rich biofuels. The high efficiency of small CHP plants based on biomass gasification and gas engines provides a new opportunity to convert existing biomass-fired heating plants into efficient CHP plants. An advantage of such a conversion is that infrastructure and buildings are already at hand.

Efficient exploitation of nuclear energy

Nuclear energy is characterised by its very high energy density and is well suited to large-scale baseload electricity supply. As with renewable energy sources such as wind, solar and biomass, nuclear power benefits from an abundant supply of its primary energy source, uranium. The total efficiency of nuclear energy could be greatly increased by using heat generated in fission reactions to drive industrial processes directly, as well as to produce electricity.

Fuel cells and electrolysis in an efficient energy system

Fuel cells may lead to energy savings thanks to their high electrical efficiency. The electrical efficiency of a high-temperature fuel cell plant may be as high as 60% and up to 70–75% if the fuel cell is combined with a steam cycle. From an energy efficiency perspective there is a synergy in combining fuel cells with heat pumps and heat storage. An important future application for fuel cells is transport, since the efficiency of a fuel cell is roughly double of that of a combustion engine.

Electrolysis, based on fuel cells operated in reverse mode, may act as an enabling technology facilitating the substitution of fossil energy by alternatives in several different ways. These include storing energy from intermittent renewable sources and producing synthetic fuels for transport.

Utilization of waste heat for heat and power production in an efficient energy system

Waste heat may be used as an energy source for both heat engines, which produce power, and heat pumps, which transform heat from a low-temperature source to a temperature that is high enough to be useful. The coefficient of performance (COP) of a heat pump measures the amount of heat transferred for a given amount of energy needed to drive the pump. From a technical viewpoint the COP of a domestic electric heat pump could be increased to 10–20, compared to 3–4 today.

A significant potential for higher efficiency of energy conversion in power cycles exists. By innovation of more cost-effective waste heat recovery systems, these options may be utilized to reach the target of a society without fossil fuel consumption.

Energy storage and markets in an efficient energy system

Energy storage can play an important role in alleviating the problem posed by variable demand, since energy can be stored when demand is low and utilised when demand is high. An issue with electricity storage is its potential investment cost, since most technologies have high capital requirements. Beyond electrical storage, thermal storage can also play an important role in the markets. Technological development is taking place especially in batteries and ultracapacitors, but thermal storage is also expected to take on a significant role in stabilising the energy system.

Grid storage in distribution grids and low-voltage networks is currently considered vital for the integration of renewable energy and is attracting much research attention. The main aims are to maintain the power/energy balance, provide voltage support, preserve power quality and manage congestion. Storage also plays an important role in off-grid applications for the more than 1 billion people around the world who are not yet connected to the electricity grid.

The role of behavioural changes for efficiency improvements

The problems of efficiency improvements are quite heterogeneous. Different categories of consumption – buildings, private households, industry, public and private services, transport – have quite different technical potentials and barriers to implementation, and need to be targeted through different incentive schemes. In addition, it is difficult to assess the importance of issues such as uncertainty in future energy prices and capital costs.

Households account for about one-third of the total electricity consumption in Denmark, and here efficiency improvements have been substantial. However, as the number of appliances continues to increase, the total demand has remained almost constant. Stricter requirements should be imposed for efficiency improvements in household appliances, as technical development and increasing energy prices has increased the economic potentials during the last decade.

Incentive schemes for energy saving in Denmark are mainly in the form of energy taxes. On average in 2008 the tax per GJ was about 70% larger in Denmark than the EU average. Danish transport taxes are not that different from the rest of the EU, but electricity and fuel taxes are on average about six times those of other EU countries.

Recommendations	
<p>Drivers and challenges for energy development</p> 	<ol style="list-style-type: none"> 1. Efficiency improvements should be promoted vigorously as one of the most important contributions to the development of a global non-fossil energy system and to the benefit of energy security and climate change. 2. Public policies and instruments should be developed in such a way that they support a transition to higher efficiency and the introduction of renewable energy. 3. The world community should be encouraged to support policies to improve energy efficiency in the industrial sectors of developing countries, since these nations account for 60% of the energy used by industry worldwide.
<p>Systems and technology</p> 	<ol style="list-style-type: none"> 4. It is of paramount importance to achieve dramatic efficiency improvements in fossil-fuel-based means of transportation since fossil fuels are likely to remain the main energy source in the global transport sector for many years ahead. 5. It is important to promote research and demonstration in the new power train technologies needed to take us beyond the global transport demands of 2050. 6. It is important to strengthen the development of methods to convert waste products into bioenergy, since land-use for production of biomass for bioenergy often competes with the production of other goods necessary to society like food, fodder and fibres. Such waste products include household waste, organic waste from food production and animal manure. 7. R&D in energy storage technologies should be promoted, because energy storage is crucial for the optimal and efficient performance of future intelligent energy systems. 8. To realise the full potential for efficiency improvements through the introduction of solid-state lighting, further R&D needs to be carried out to increase the light extraction of semiconductor materials, provide better and cheaper production technology, and create advanced optical systems for optimised light distribution.
<p>Barriers for implementation</p> 	<ol style="list-style-type: none"> 9. The process of designing low energy buildings according to the Energy Performance of Buildings Directive needs to be improved in order to ensure that buildings meet the requirements of energy performance and for indoor environment. 10. If the EVs should get a real market share in Denmark it is necessary to establish a charging infrastructure in public and semi public areas. With an acceptable fast charging infrastructure at least 85% of the one car families can be potential EV customers. 11. Initiatives for efficiency improvements should be based on a diverse range of incentive schemes as suggested by the heterogeneous ways in which energy is used. Buildings, private households, industry, public services, private services and transport all have quite different technical potentials and barriers for implementation. 12. Stricter requirements should be imposed for efficiency improvements in household appliances, as technical developments and rising energy prices over the last decade have increased the economic potential for improvement.



The global energy scene – role of energy efficiency

John Christensen, DTU UNEP Risoe Centre; Gustau Manez & Michael Scholand, UNEP

Major drivers for energy development

This section briefly outlines the latest global energy development trends and examines some of the major drivers for future energy development like:

- Energy security
- Climate change
- Green growth and job creation

Improved access to clean and efficient energy services for the poorest populations in the world is also an important priority for both the affected countries and the global community. But while enhanced access may be essential for further economic development, the magnitude of energy required to achieve this objective would not affect the larger global energy sector development trends.

The articulation of energy development priorities vary between countries and regions. A brief extract from the recent EU energy strategy for 2020 [1] has been included as illustration.

Climate change concerns are usually presented either in terms of the global challenge articulated as the political target of max. 2°C temperature increase in the next century included in the so-called Copenhagen Accord; or at the national level in terms of specific reduction targets for national or sectoral GHG emissions.

In comparison the energy security and employment priorities are more diverse and harder to assess analytically, but generally related to issues like:



- Changes in global distribution of demand and supply driving national and regional concerns about security of supply and energy prices
- Increasing import ratios of fossil fuels is a cause for concern in many OECD countries but also in major emerging economies like China and India
- Employment opportunities in development and production of new energy technologies as part of the trend towards a greening of industry and being competitive in the emerging world market for energy efficiency and renewable energy technologies
- Importance of stable energy supply resulting in political focus on national control of supply and production
- Affordability of fossil fuel imports for low income countries
- Access to affordable and reliable supply of energy for the poor in developing countries

Energy efficiency improvement will generally have positive impacts on all these aspects although the employment effects will vary greatly between countries. It is, however, important to note that efficiency improvements e.g. in the industry sector will lead to increased competitiveness and therefore potentially indirect employment benefits.

Role of energy efficiency in global energy development

It is evident from most, if not all, recent global energy studies examined for this paper that there are clear efficiency improvements opportunities on both the supply and demand side of energy systems. Energy efficiency improvement therefore constitute key elements in any strategy trying to address both climate and energy security concerns. The EU strategy quoted above also notes that "...energy efficiency is at the heart EU 2020 Strategy..."

- Analysis done by the IEA in the World Energy Outlook for 2010 [2] is shown in Figure 1 presenting global scenarios for the following political cases: business as usual, new policies (existing policies fully implemented) and a so-called 450 scenario (targeting a maximum concentration of GHGs in the atmosphere of no more than 450 ppm). The latter is largely consistent with the political climate target of a maximum 2°C change in global mean temperature over this century. In 2035, energy demand is 8% higher in the Current Policies Scenario and 11% lower in the 450 Scenario than in the New Policies Scenario.

The underlying technical and policy categories analyzed to achieve the 450 scenario results are presented in Figure 2 [2] and clearly show the significant potential estimated to come from efficiency improvements, especially in the first decades. After 2020, the share of energy efficiency in total abatement declines, while more costly options like renewables and especially CCS increase their share.

In a parallel analysis UNEP [3] has examined the opportunities for achieving the same 2 degree target with an emissions peak in 2020, which means that global emissions should not exceed 44 Gt of CO₂ equivalents at that time to ensure feasibility of necessary emissions reductions in the following decades. Figure 3 show the indicative contributions for key sectors but does not detail out the efficiency part, as it varies between the participating study groups depending on model assumptions. But reductions of energy use in key sectors like buildings, industry and transport may go as far as 10% by 2020 in some studies.

While this will be a steep challenge globally, it is worth noting that the EU countries have already agreed on national targets aimed at reducing primary energy consumption by 2020 with 20% and many of the member countries have had national legislation supporting energy efficiency measures for decades forming a strong basis for the new enhanced action.

Figure 1
Scenarios for World Primary Energy Demand (IEA; 2010).

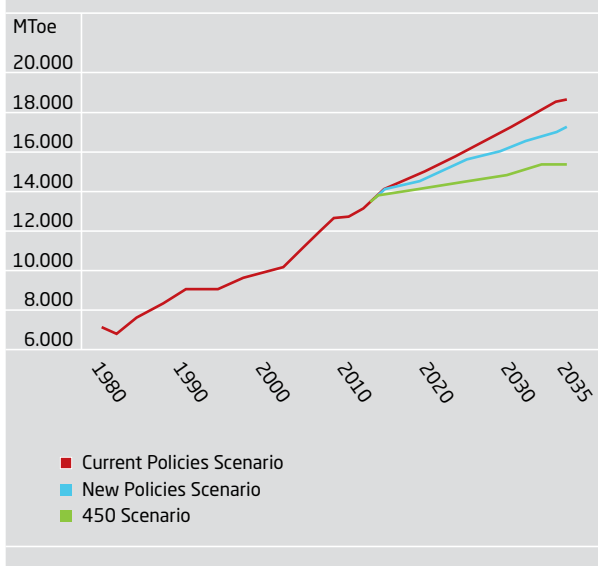

Similarly many other countries like the US, China, India, South Africa, etc. have experiences with a variety of energy efficiency legislation and in most cases also forward looking political targets for selected key sectors like building or industry [4], [5], [6]. The sectoral efforts and focus generally reflect the relative importance of their energy consumption, so in the EU and to some extent the US there is relatively stronger focus on efforts targeting the buildings and transport sectors while China, India and South Africa have the strongest focus on the industrial sector where the majority of commercial energy is consumed in these countries.

In a recent report the IEA [7] has analyzed links between emission reduction scenarios and short and longer term energy security and even if it is hard to generalize it is evident that the longer term security issues benefit from reduced consumption of fossil resources and in most cases increasing the use of domestic renewable sources and increasing efficiency. The short term aspect will depend very much on the design of the national and regional energy systems esp. power sector integration and design. But overall there is a positive correlation between low carbon energy development and enhanced long-term energy security.

Opportunities and challenges for increased energy efficiency

The combined challenge and opportunity with energy efficiency is that it is relevant for most sectors and requires engagement of a large and often very diverse group of actors. Increasing energy efficiency therefore presents a very different challenge in terms of implementation compared to changes on the supply side of energy where decision makers in most cases are quite centralised in large energy companies or government ministries.

In view of the diversity of the options for energy efficiency improvements, it is hard to present general global trends and overviews, but it is possible to generalise somewhat at the sector level and show examples of progress around the world.

This section will therefore present some of the major options for key sectors along with possible barriers to enhanced implementation and relevant policy instruments where some are broadly used already and others may be used to facilitate enhanced implementation. In addition lighting efforts are presented as a specific case example, because it is an area where more global approaches look successful.

Figure 2

Technical and policy options in a 450 Scenario (IEA, 2010).

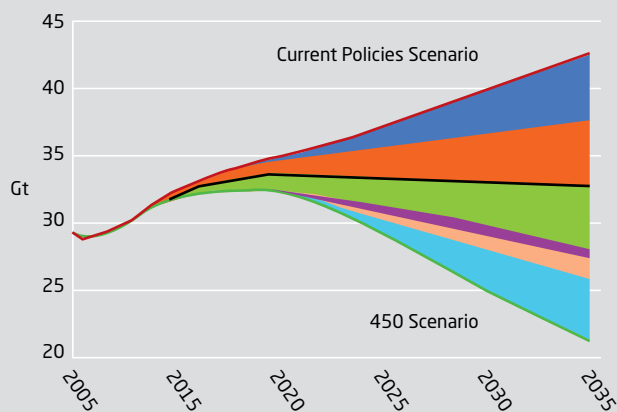

Abatement

	2020	2030	2035
Efficiency	71%	49%	48%
■ - End-use (direct)	34%	24%	24%
■ - End-use (indirect)	33%	23%	23%
■ - Power plants	3%	2%	1%
■ Renewables	18%	21%	21%
■ Biofuels	1%	3%	3%
■ Nuclear	7%	9%	8%
■ CSS	2%	17%	19%
Total (Gt CO₂)	3,5	15,1	20,9

Buildings and appliances

The challenges associated with improving energy efficiency for buildings and appliances are quite different, but they have been combined here to keep the sector focus and because some of the involved decision makers are the same.

The building sector is extremely diverse and complex varying between uses (residential, commercial, public), climatic zones, and economic development level; and for efficiency considerations also between existing building stock and new constructions. One of the barriers for enhancing energy efficiency of buildings is the fact that construction is often delinked from use, meaning that the design, construction and often ownership of buildings are often separated from the users or tenants. This creates a series of split incentives where the investor and the eventual users may have different interests in the construction and running cost of the building i.e. avoided investments in efficiency improvement will come at the cost of higher energy bills for occupants. In view of the long lifetime of buildings and the fact that the original design may limit future refurbishment options, it is very important to create policy incentives for building construction to address energy efficiency

Focus in OECD countries is mostly on renovation of the extensive existing building mass, while for many developing countries the situation is more mixed and new constructions are more dominating in the picture.

Broadly speaking the knowledge and technologies required to increase energy efficiency in buildings is available and have been demonstrated both in state-of-the-art “zero energy” houses and green building renovations around the world. The challenges are therefore related to overcoming the various barriers to enhanced implementation [8]:

- Large number of small reduction opportunities
- Fragmentation of the sector
- “First cost” and split incentives (as mentioned above)

Figure 3

How to bridge the emissions gap - what the sectoral studies show [3]

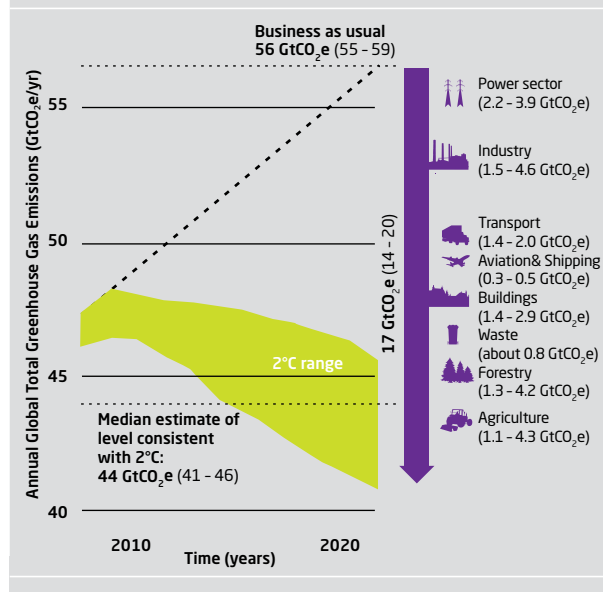

- Lack of awareness about measures and cost
- Capacity limitations in design and construction of energy efficient (EE) buildings
- Limited indicators to monitor performance
- Competence gap in building and construction companies

Different policy tools are available and have been implemented in a number of countries with varying degrees of success. Regulation efforts include building codes and performance standards, mandatory audits and certification programs while economic and market based instruments include for example capital subsidies or tax exemptions for high efficiency buildings, certificate schemes, cooperative procurement, etc. These policy tools may then be combined with awareness campaigning and education and training programs for the building sector. The experience with the different tools will be further discussed in the next chapters for Denmark and the EU, but as mentioned above efforts are not restricted to industrialised countries and significant efforts are undertaken in many of the medium and large emerging economies using exactly the policy instruments described.

Broadly speaking the energy use in buildings can be divided into end-uses where heating, cooling and lighting are related the building design and can be addressed through design and building materials while other like electrical appliances and water heating are relatively independent of the building design and apart from the water heating systems have a much shorter lifetime and often decisions on changing equipment rests with the actual user. Lighting is a combined area where the lighting needs depend to some degree on the building design while the actual lighting systems are more in the appliance domain.

The area of appliances has been subject to policy interventions for several decades in many countries around the world with a strong focus on standards and labelling. Some countries have combined standards with economic incentives like reduced VAT of efficient equipment or similar. large public procurement programs have also in several countries been used to enhance efficiency of selected appliances.

Figure 4

Percentage of estimated electricity savings relative to national annual consumption in 2010

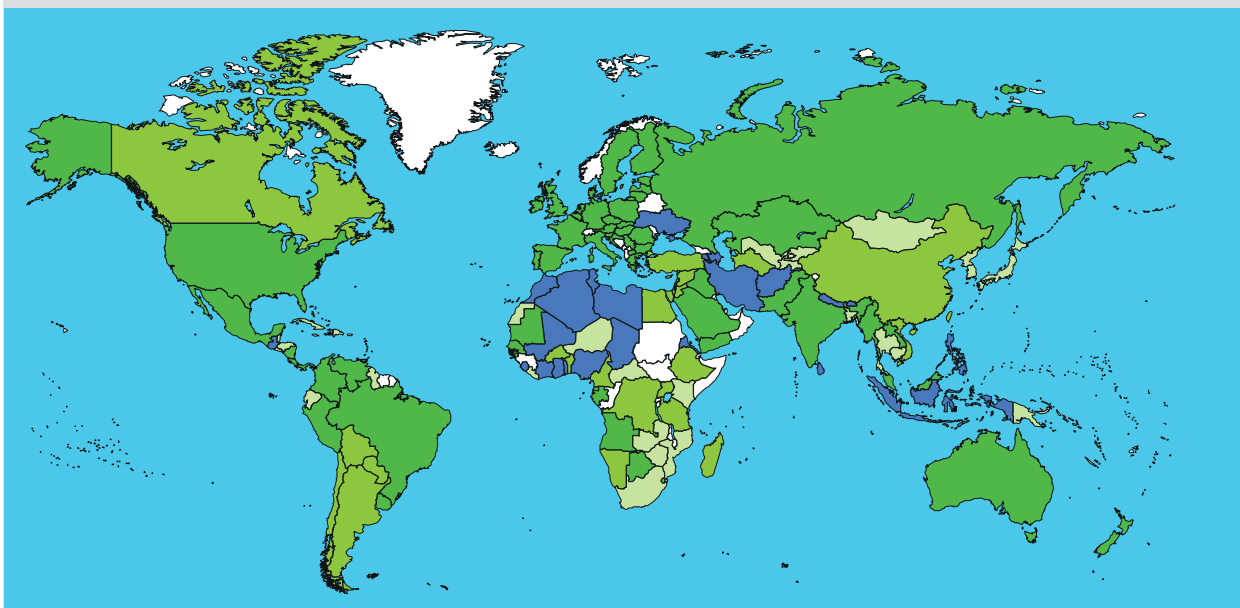

% of national energy saved: ■ <4.00% ■ 4.01-5.00% ■ 5.01-6.00% ■ >6.01%

Case of lighting

One of the most important appliance areas where there is significant potential for progress on energy efficiency is lighting. With its importance for quality of life services around the world, it enables advancement of education and commerce, encourages social interaction etc. In addition electricity for lighting has been estimated to account for as much as 15 to 20 per cent of global electricity consumption and close to 6 per cent of worldwide greenhouse gas (GHG) emissions.

Figure 4 [9] illustrates the potential electricity savings for countries around the world, if inefficient lighting systems are substituted with high efficiency products such as compact fluorescent lamps (CFLs), light emitting diodes (LEDs) and advanced fluorescent and high intensity discharge lamps, combined with use of improved luminaries and controls such as sensors and dimmers.

Although it is already cost-effective for consumers to use a range of energy efficient lighting options rather than standard inefficient lamps, there are a number of challenges that need to be overcome to accelerate the transition; these can be classified into five categories [9].

- Availability – do lamps and luminaries exist to meet the wide variety of lighting applications in each of the market segments?

- Awareness – in each of the market segment, do stakeholders (i.e., distributors, retailers, designers, electrical contractors, and end-users) know about the more energy-efficient options?
- Accessibility – in each of market segment, do the stakeholders have access to the energy-efficient products through the traditional lighting supply channels? Do contractors have easy access to the technology, and does maintenance staff have easy access to spare parts?
- Affordability – for the end-user, is the lamp or luminaire affordable? Is it economically attractive in all market segments (increased investment cost vs. electricity savings over what period?)
- Acceptance – once the end-user owns the product, do they accept it – the form, fit and function of a product? These attributes can include product attributes such as operating life, actual performance, shape/size Issues and less tangible factors such as brand name and maintenance requirements. Acceptance barriers typically lead to programs or solutions being carried out in one or more of the preceding four As

There are various ways of overcoming these barriers and Figure 5 illustrates some of the possible action areas.

Countries like Australia, Canada, the European Union Member Countries and the United States have actively analyzed the financial and energy savings potential of lighting and adopted so-called phase-out programs combining regulations and market transformation to promote a move towards more efficient lighting technologies. Other countries such as Argentina, Brazil, Colombia, Cuba, Ecuador, Ghana, Mexico, Senegal and South Africa are similarly making progress on incandescent lamp phase-out activities. China has for example announced that it will complete its phase-out of incandescent lamps by 2016.

Examples of national programs for transition to efficient lighting [9]

Australia

The first stage of a national incandescent phase-out scheme was the introduction of an import restriction on inefficient incandescent general lighting service lamps starting on 1 February 2009. The phase-out is to save Australia approximately 30 terawatt hours of electricity and 28 million tonnes of greenhouse gas emissions between 2008 and 2020. This is equivalent to decommissioning a small coal-fired power station or taking more than 500,000 cars off the road permanently. The Australian government estimates that phasing out incandescent lamps will result in savings to the Australian economy of around 388 million USD per

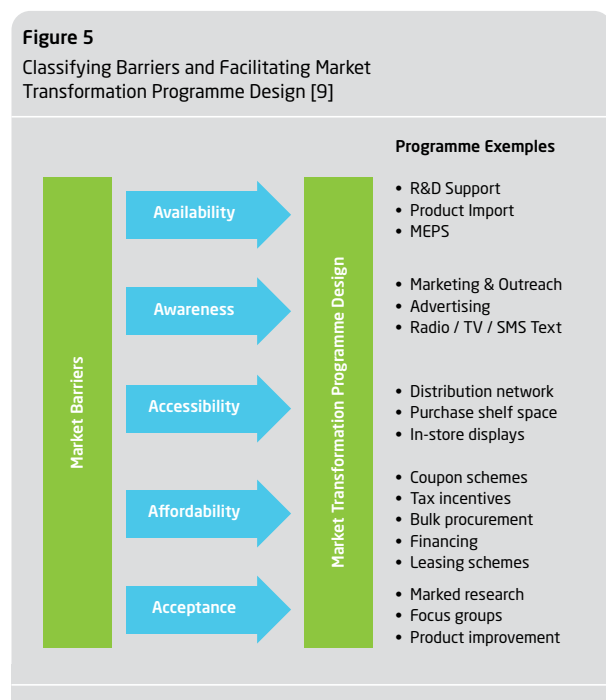

year by 2020 and result in net savings of more than 50 USD per year for each household that changes its incandescent lamps to good quality CFL or LED replacement lamps.

The European Union

In 2005, the European Union issued the Ecodesign Directive. An Implementing Measure to the Directive established requirements for non-directional lamps in the Commission Regulation (EC) No 244/2009 of 18 March 2009. The requirements of this implementing measure take effect in several stages, between 2009 and 2016, resulting in the phase-out of incandescent lamps in general lighting applications. The regulation also includes product information requirements to inform consumers about alternative light sources such as halogen, CFL and LED. As a result of this regulation the EU will expect to reduce the electricity needs by 2020 by as much as 37 TWh worth around 7.4 billion USD in reduced electricity bills and 15 Mt of CO₂.

Brazil

Driven by a national energy crisis the Brazilian government published on December 2010, minimum energy performance standards (MEPS), which will effectively phase-out inefficient incandescent lamps in a gradual manner until 2016. The program began on June 30, 2012, starting with 150 watt lamps and will finish four years later with 25 watt (or less) sources. The manufacturers and importers will have six months from these deadlines to deplete their stock and wholesalers and retailers will have one year to do the same. The country will save approximately 13.5 TWh annually, which equates to 2 billion USD in reduced electricity bills and approximately 1 Mt of CO₂.

In the Australian, Brazilian and European contexts the MEPS were supported by a wide-ranging awareness raising campaigns and programmes designed to distribute energy efficient lamps. In addition in both settings compliance systems were put in place to protect the market from products that fail to perform as required and ensure that consumer satisfaction is in line with their expectations.

In spite of these national best practice example there is still a large number of countries that have not examined the potential benefits from efficient lighting programs. Every country needs to determine their own priorities in the national context but a number of global initiatives have been established to assist both in the planning process and facilitate implementation afterwards. The UNEP/GEF enlighten initiative is only one of these initiatives, but the only one which works across all countries and addresses both on-grid and off-grid lighting.

Industry

Worldwide the industry sector is accounting for approximately one third of final energy use [10] with OECD countries being responsible for around 40% and the rest being consumed in developing countries. The chemical and petrochemical, and the iron and steel sectors are in combination responsible for half of the total industrial energy use distributed fairly evenly between the two country groupings, so efforts in these sectors are clearly very important.

Energy use in industry is still expanding in spite of quite successful efficiency programs due to increasing global demand for resources, material and products. Within the EU the energy intensity of industrial production has declined approximately 30% over the last two decades (EU, 2011) and similarly China has had roughly a 20% reduction in energy use per unit of GDP over the last decade [4].

The potential for enhanced efficiency globally is, however, still very significant and IEA and UNIDO [11], [12] estimate that there is an efficiency improvement potential of around 25% globally if current best practice technologies [10] were fully implemented. If the best available technologies were to be fully applied it [10] would add another 10% reduction but also increase the associated costs significantly (for definitions of BPTR and BAT please see [10]).

As for the building sector there are a number of specific barrier that prevent the achievement of the full efficiency potential some of these include limited technical know-how on efficiency benefits by decision makers, relative importance of energy savings compared to other opportunities for gain in productivity (i.e. is energy is an important cost factor), access to capital and potential risk aversion by investors, transaction costs involved, subsidized energy prices for many industries lowering the profitability, etc.

A number of traditional policy tools exist and are being implemented in a number of countries these include energy audits and management programs either mandatory or combined with some economic incentive scheme, norms and standards for industrial equipment and appliances and various targeted support programs esp. aimed at small and medium enterprises who more often face more financing barriers than the larger industries where access to capital is less of a problem.

In the last decade or so a number of market based efficiency schemes have been introduced either in the form of certificates or GHG emissions trading schemes like the EU Emission Trading Scheme. The use of these market based instruments is increasing around the world and recently

Australia and several US States have launched GHG trading scheme and countries like China and Korea are in the process of establishing national schemes.

Management of market based schemes does require strong institutional structures and good data availability so it is not likely to be relevant for medium or low income countries where more traditional approaches may be applied successfully. A country like China evidently also has a number of parallel approaches ranging from closing down inefficient factories by law to incentive schemes for major companies like the so-called “top 1000 energy-consuming enterprises program” which had a relatively modest reduction target (100 Mtce by 2010 [4]) but in addition contributed to increase awareness about energy efficiency in large enterprises.

Transport

The transport sector globally accounts for around 20% of global final energy use [13] and is the fastest growing sector in terms of energy use. Road transport is dominating the picture for passenger transport and even if the picture for freight is slightly more mixed, it is still trucks that are used for the large majority of freight movement. Aviation, shipping and railways also contribute to the energy consumption in the transport sector and in some countries constitute significant shares, but globally road transport is dominating and will be the focus here.

With this clear dominance of road transport and there is in generally strong political focus on the three key parameters – number of vehicles, travel distances and fuel efficiency. Ideally action is required simultaneously in the following areas:

- improving vehicle technology leading to increased vehicle energy efficiency;
- changing driver behaviour to use less fuel per kilometre driven;
- reducing the distances travelled per vehicle; and
- shifting travel to the most sustainable modes of transport.

Since transport is a complex and heterogeneous sector in terms of users and suppliers, development of mobility needs, personal preferences and multi-faceted decision criteria. For the freight component of transportation decisions are usually quite straightforward about getting good from one point to another in the most cost efficient way with variations related to type of good and required conditions for handling. For personal transport preferences and criteria are much more complex. For many developing countries the basic question is often just to ensure a minimum level of mobility typically through some form of bus trans-

port. But with increasing income both in developing and in most developed countries the choice of transport mode is increasingly affected by social norms and standards. Car preferences are beyond mobility functions often determined by a combination of price, safety, comfort and prestige. Fuel efficiency has gradually become an important factor as a result of fuel price increases and enhanced awareness.

So the policy tools to enhance transport efficiency need to reflect both the possible action areas and the decision criteria of the users and suppliers of vehicles. Therefore the most effective approach seems to be policy packages combining different tools in an integrated manner, including aspects like:

- Mandatory vehicle efficiency information and labelling
- Fuel economy standards possibly with some minimum level for specific vehicle types
- Awareness campaigns on fuel economy, including focus on “eco-driving” and importance for fuel consumption
- Fiscal measures like taxing different vehicle types based on energy efficiency criteria, road pricing related to vehicle use, fuel pricing as a general measure.
- Promoting and subsidizing public transport options including creating the necessary infrastructure to facilitate intermodal make connections.

Many of these policy tools are already used to varying degrees mainly in OECD countries and the major developing economies. The IEA in their recent report [14] note significant progress recently on transport policy implementation in member OECD countries. Similarly China with a rapidly growing fleet of vehicles have for the last decade had policies including fuel efficiency standards, tax related to engine size and performance, etc.

So there is a significant number of national experience to build future efforts on and the combination of increasing fuel price and tightening policies have in the last decade resulted in significant increases of fuel efficiency for many car types and the market for small and efficient cars has increased significantly. But in spite of these efforts energy consumption in the transport sector is still increasing globally and there is a need for significantly enhanced efforts. IEA estimates [15] that there is a potential for cost-effective technical improvement in new vehicle fuel economy of 50% by 2030, if current best available technologies are fully implemented. The challenge will be ensuring implementation and as noted above the transport sector is in most countries politically very sensitive and voters often react strongly decisions affecting their choice of transport mode

or form, so the information and awareness parts are very important for the success of the whole set of policies.

While focus here is on increasing energy efficiency, it is important to note that for the transport sector there is a parallel focus on alternative fuels and engines. The area of biofuels is well developed and many countries use smaller blends of biofuels in petrol to reduce fossil fuel consumption and Brazil as the leading example has now a larger consumption of biofuels than petrol for transport and almost all new cars have what is called flex-fuel engines that can run on any blend from all petrol to all ethanol. A move towards ethanol does not necessarily mean any improvement in energy efficiency, but will reduce GHG emissions from transport and depending on local circumstances like in Brazil mean a contribute to national energy security and local employment.

Electric vehicles either as fully electric driven or in the form of hybrids where fuel and electric engines are combined are other development directions which are still largely at the demonstration stage with several different concepts competing and most automakers experimenting with design and technical performance aspects. Changing to electricity for road transport will require a major change not only on the vehicle side, but the necessary electricity infrastructure will need to be developed both a micro (fueling) level and at the power system level to accommodate a possible demand increase and load structure. These aspects and the potential for overall efficiency improvements with more integrated and “smart” electricity systems will be further discussed in subsequent chapters.

With the international parts of aviation and shipping to some extent being outside of the national policy framework with a few exceptions like the recent EU ambition to introduce a cap on GHG emissions from international flights entering or leaving EU airports, the focus in this section has been on road transport.

The international reactions to the EU initiative illustrate the problems involved in setting political efficiency rules for both aviation and shipping, but it does not mean that the aviation and shipping industries do not focus on energy efficiency.

With current oil prices most airlines and shipping companies have introduced a number of efficiency measures to reduce energy use. These are less well documented in the literature but a recent study by the World Bank [12] on air transport and energy efficiency documents that efforts have been made on several fronts to improve efficiency through better technology, optimized operation, as well as energy-saving infrastructure. One specific example for illustration from the WB report is one of the most common jet aircrafts the Boeing 737, which was first introduced in 1967, and where the most recent version 737-800 uses almost 50% less fuel per seat than the original model. Further progress will probably still be market driven but the EU policy initiative mentioned above may present a new set of policy opportunities, if fully implemented.

Conclusions and reflections

- Energy security and climate change remain the major driving factors for energy policy in most countries around the world and both global and national studies show the significant potential for energy efficiency improvements for being a major part of addressing both factors
- Potential for energy efficiency improvements exist in literally all sectors and in many areas there are reductions potentials of more than 50% by full implementation of best available technology. At the same time on-going R & D are likely to increase this potential over the coming years, an issue which is further addressed in the subsequent chapters
- This initial section has focused on global and sector issues, but it should be understood that there are many other areas where important energy efficiency improvements can be achieved. The whole energy supply infrastructure can be significantly improved to increase efficiency and similarly use of more “intelligent” networks that integrate production and consumption is an area with a lot of recent interest
- Lighting is identified as one specific end-use application where global programmes right now are creating a number of significant shifts in national policy with commensurate gains in efficiency. Similar phase-out programmes would also be feasible in other areas where efficient equipment is or can be made available e.g. air conditioning which is a rapidly growing appliance worldwide, and which has large performance differences between the best practice and average installed technology

Further references

[16], [17]

Energy efficiency improvements: scope and definition

Poul Erik Morthorst, DTU Management Engineering; Søren Dyck Madsen, the Ecological Council, Denmark

The importance of energy efficiency

The ambition to be independent of fossil fuels by 2050 is high on the agenda in Denmark. This is most recently shown in the Danish Government's Plan "Our Energy", which foresees that renewables will supply all heat and power by 2035, and the complete energy system, including transport, by 2050. But renewable sources are limited in availability¹⁾, and the change-over will be unnecessarily costly unless a strong drive for energy efficiency and energy conservation takes place in parallel with the development of a renewable energy system.

Following a request by the former Danish Government the Danish Commission on Climate Change Policy addressed the possibility of long-term independence from fossil fuels. The Commission's main conclusions were that this would require radical changes to the energy system, including determined efforts in energy efficiency and energy conservation. As Figure 6 shows, by 2050 between one-third and half of the energy currently used should be replaced by increases in energy efficiency.

The European Commission has for a long time indicated the importance of energy efficiency and conservation. Its original targets for 2020 assume a voluntary 20% increase in energy efficiency compared to a reference development. Recently, however, the EU has proposed a new Energy Efficiency Directive which would make this a binding target.

This directive was agreed on at the EU Council meeting June 27.th.

In a briefing paper prepared for an informal meeting of the European Council in Horsens on 20 April 2012, the Commission calculated that a 20% increase in energy efficiency by 2020 would boost the EU's combined GDP by €34 billion and increase net employment by 400,000 full time workers. The expected consequences for the energy sector would be a substantial increase in investment in energy efficiency (such as building insulation, energy management and control systems), while the investment needed in energy generation and distribution would decrease, and so too would the cost of the energy used. As a result, over the period 2011–2020 the Energy Efficiency Directive would produce an annual average reduction in overall spending on energy of about €20 billion.

The concept of energy efficiency

Important for our welfare is that we get the benefits we demand in return for our consumption of energy. These include heating houses, cooling refrigerators, driving cars, watching televisions and so on. As long as these benefits are delivered with the right quality, then in general it can only be advantageous to reduce the energy consumption needed to provide them.

Figure 6

Required increases in energy efficiency by 2050 according to energy use sector, as foreseen by the Danish Commission on Climate Change Policy. The blue bars show current energy use in each sector as an index equal to 100; the red bars show the fraction that should be replaced by increased energy efficiency [18].

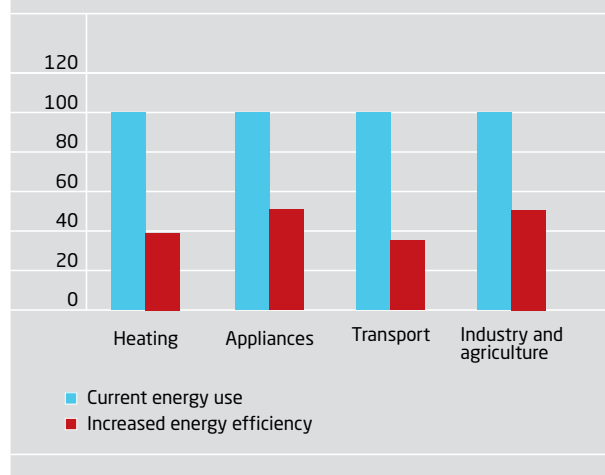
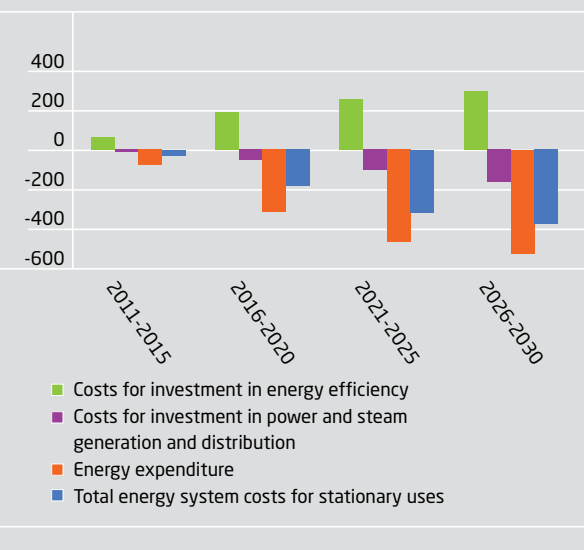

Figure 7

The net effect of the EU target of a 20% increase in energy efficiency by 2020 would be a significant saving in energy-related costs.



¹⁾ Among other things because of limited space for windturbines and photovoltaics etc.

Energy efficiency operates at a number of different levels in the energy supply and demand chain. The most important of these are:

- At the supply level, efficiency improvements in the generation of energy imply a lower fuel input for the same amount of energy produced. Such improvements can be created not only by making energy transformation processes more efficient, but also by changing the mix of primary energy sources, for instance by switching to renewable energy sources.
- At the transmission and distribution level, heat and power losses can be minimised.
- At the end-use level, the efficiency of local conversion and end-use appliances can be improved substantially, so that less energy is needed. This affects all sectors of society: households, industry, agriculture, trade and services, and transport.

It is important to realise that energy efficiency is not the same as energy conservation. An increase in energy efficiency means that a lower input of energy is able to provide the same service. Energy conservation, on the other hand, also implies a lower demand for an energy-using service. Energy conservation includes the possibility of changes in consumer behaviour leading to a lower demand for energy-intensive services; thus, switching off the light to save energy is an energy conservation measure, not an efficiency improvement. Finally, it should be mentioned that in general, economic growth will imply a stronger demand for different kinds of energy services; however, this stronger demand will also lead to increased costs, especially for fossil fuels, and people will be better off in economic terms if they increase their investment in new equipment that uses energy more efficiently.

The shift to renewable energy will also bring much more fluctuation in energy supplies. None of the existing definitions of energy efficiency and energy conservation takes into account the trend towards energy intelligence – the smart grid – that is becoming more and more needed to integrate energy production with energy consumption in a cost-effective way. There is no doubt that the introduction of new techniques to monitor energy use in real time will by itself increase consciousness of energy consumption and probably lead to lower energy use.

In most cases energy efficiency and conservation measures are assessed in relation to a reference or baseline case (“business as usual”). How this baseline is defined has a huge impact on the calculated amount of energy saved by efficiency improvements and conservation. For fair com-

parisons it is important to define baselines clearly and transparently.

International and national instruments

Since the European Commission issued its Green Paper on energy in 2000, the EU has paid much attention to the two energy “sources” with the greatest growth potential, namely energy savings and renewable energy production.

This means that much subsequent EU legislation has focused on mandating energy efficiency (such as the Energy Performance of Buildings Directive, the Eco-design of Energy-Related Products Directive and the just agreed Energy Efficiency Directive), energy taxation (the Energy Taxation Directive), reduction of CO₂ emissions (the 20% GHG Reduction Directive) and increasing the share of renewables (the 20% Renewables Directive).

These Directives, among others, have to be transferred to national legislation. In Denmark this process – together with added national measures – has resulted in many legal obligations to improve energy efficiency in terms of both primary and end-use energy consumption:

- obligatory energy saving schemes for energy companies;
- feed-in tariffs for wind turbines to replace electricity from fossil fuels;
- energy taxes;
- standards for products;
- energy requirements in building codes; and
- support schemes for investment in “energy renovation”.

Examples of energy-efficient development

Saving money and energy at pump manufacturer Grundfos

The Danish company Grundfos is world-famous for its energy-efficient pumps and motors. Grundfos has for years pointed out the economic benefits of its energy-saving products, but not until 2009 did the company seriously address its own manufacturing.

At that time Grundfos still had many old production conveyors with chain drives, which ran whether or not the line was in use. Many of these have now been replaced by variable-frequency drives which slow down when they are not needed. Energy savings for individual motors have been in the range 25–70%. The first batch of replacements paid for itself in less than two years.

Grundfos also replaced its first-generation laser welders, which used 90 kW of electricity to yield a laser power of about 3 kW. The new ones only use 14 kW to achieve the same effect, which is a saving of 84%, plus extra savings because the new lasers need less cooling. Checking compressed air systems for leaks produced large savings in both energy and money, with a payback time of less than a year. So far, CO₂ emissions from energy consumed at the eight Grundfos factories in Bjerringbro has in the period 2009 and until now fallen by 10%, from 61,000 to 55,000 tonnes/y.

On the existing production lines Grundfos picked the low-hanging fruit. When establishing new production lines the company has the opportunity to achieve even better results by re-thinking the way in which the plant is built. Often it is not expensive to create an energy-efficient facility if this is planned from the start. For instance, new Grundfos production lines will include a “master switch” to put the entire line into sleep mode whenever the staff takes a break.

Win-win at pharmaceutical company Lundbeck

In 2010 the Danish pharmaceutical company Lundbeck cut its energy consumption by around 10%. The project was carried out with Niels Chr. Weigelt as project leader working together with energy supplier Lokalenergi. The reduction was achieved by:

- reducing pressures and flows in ventilation systems in laboratories and fume cupboards;
- regulating ventilation airflows in both animal and human facilities based on occupancy;
- replacing traditional lighting with LED lamps where possible;
- adding a preheater and economiser to the main boiler; and
- adding variable-frequency drives to vacuum pumps.

Some of these energy savings were achieved with zero investment. Adjusting the ventilation systems, for instance, required only checks on flowrates and occupancy levels. This project, which included Lokalenergi as part of the Danish obligation for energy distribution companies, has saved Lundbeck money and so improved the company's competitiveness. Most of the projects had a payback of less than two years and none was more than three years. The focus on energy in Lundbeck is seen as a win-win situation: saving energy is good business, and showing carefulness with resources strengthens the Lundbeck brand.

Conclusions and recommendations

By 2050 Denmark's entire energy needs, including transport, should be met from renewable sources, implying an energy system totally independent of fossil fuels – this is the ambition of the Danish Government as shown in the recently launched plan “Our Energy”. Achieving this target is expected to require a substantial contribution from energy efficiency and energy conservation. According to estimates from the Danish Commission on Climate Change Policy, by 2050 between one-third and half – depending on the sector considered – of all the energy we use today should be eliminated through gains in energy efficiency.

The following recommendations can be given:

- New technologies that improve energy efficiency are being marketed at an increasing rate, and in general most people are very willing to use these new products. However this requires:
 - a high level of information to make people aware of the new opportunities;
 - new policy measures to make sure that these new energy savings potentials are implemented.
- Today, energy efficiency improvements are scattered across a large number of small contributions. A market set-up that facilitates the implementation of energy savings potentials is needed.
- Strong measures to promote energy efficiency have been put forward by the EU. It is important that these measures are transformed and supplemented in the right way by national policies.
- We need analyses of the economic trade-off between those initiatives that attempt to increase renewable energy use and those promoting energy efficiency.

Energy efficiency initiatives, strategies and effects in Denmark, Europe and worldwide

Kirsten Halsnæs, DTU Management Engineering

Introduction

This chapter assesses the potential for energy efficiency and discusses the competitiveness of energy efficiency options relative to other policy options in meeting various objectives. These objectives include cost-effectiveness, energy security and climate change mitigation, as well as indirect effects related to sustainable development and green growth. The discussion of competitiveness addresses the cost-effectiveness of energy efficiency options relative to other policy options such as conventional fossil fuels, carbon capture and storage (CCS), nuclear energy and renewable energy. The timing of the introduction of the different policies is one of the key issues.

Energy efficiency in the context of this chapter is understood to include fuel and final energy savings resulting from efficiency improvements in energy conversion and in end-use technologies, assuming constant energy services. The chapter introduces cost-effectiveness, and other direct and indirect policy objectives, from the perspectives of both private and social cost, and discusses the implementation of energy efficiency measures based on studies from Denmark, Europe and internationally.

Private and social costs of energy efficiency

Energy efficiency measures related to energy conversion and end use will impose both private and social costs. Private costs are those facing private agents (households, companies etc.), and can be estimated from market prices and discount rates. Social costs represent the sum of private costs plus the value of externalities such as air pollution, greenhouse gas (GHG) emissions, and the social value of energy security. The prices used to assess social cost are derived from market prices, taking opportunity costs into account. One example of an opportunity cost arises when market failure creates unemployment. If a particular policy increases employment, the cost to society of using labour is then less than the actual wages paid.

Seen in the context of public policy choice, the appropriate measure is social cost, because this reflects the welfare of society created by implementing specific policy options. However, private agents face market prices and interest rates. To get the choices of private agents to reflect social welfare, therefore, policies need to be supported by economic instruments such as externality taxes or regulatory options. In the context of energy efficiency improvements, implementation depends on the decisions of many individual agents. There are therefore some specific complexities

in making the economics of efficiency improvements attractive, and these will be discussed in the last part of the chapter.

Conventional economic models of energy systems generate only part of what ideally should be included in a social cost assessment. Typical “measures” in such models are direct sectoral costs of policy options based on a sectoral assessment of capital costs, fuels, and operation and maintenance costs. Many studies also include GHG emissions and local air pollutants, adding another key component of social cost. A further reflection of other social policy objectives – such as job creation, energy security and specific sustainable development impacts – requires supplementary assessments with other tools, for example macro-economic models. Some examples of such supplementary studies will be presented below.

Danish energy efficiency potentials

The Danish Government’s Commission on Climate Change Policy (the Climate Commission) in 2010 issued a report on how the Danish energy system could be transformed to use 100% renewable energy by 2050 [19]. Energy efficiency improvements on both the supply and demand sides will play a big part in meeting these objectives.

The report includes a number of reference scenario combinations reflecting global climate change policy efforts and their implications for fuel prices. One of these reference scenarios assumes that far-reaching global climate policies will drive down fossil fuel prices and create high biomass prices. With this particular global reference scenario, the Danish policy scenario involving 100% renewable energy assumes that as much as 80% of Danish power production in 2050 will be covered by wind energy. Biomass is here assumed to be the dominant remaining power sector fuel, providing stable baseload CHP.

Since in this scenario biomass is scarce and expensive, energy efficiency plays an important role in the Danish energy system. In particular, demand-side efficiency improvements are important in the Danish policy scenario. On the supply side, in contrast, the reference scenario assumes that most efficiency improvements have already been implemented, and that almost all coal power capacity has been phased out between 2020 and 2030.

Figure 8, Figure 9, Figure 10 and Figure 11 show the role of energy efficiency improvements in reducing the final energy demand (by sector: buildings, service sector, indus-

try and transport) in the Danish 100% renewable energy scenario. Each graph shows two main scenarios: a reference (blue line) and a policy” scenario (red line). Both scenarios are characterised by low imports of biomass.

As Figure 8, Figure 9, Figure 10 and Figure 11 show, the reference scenario of the Climate Commission report predicts large differences between sectors in the projected trends for final energy consumption. From 2008 to 2050 buildings final energy consumption is assumed to decrease by about 25%, the service and transport sectors are expected to see small increases, and industry is assumed to grow by almost 30%. The particularly high growth expected for industry reflects the fact that energy intensity reductions for this sector, due for example to structural changes, are not well reflected in the macroeconomic forecast behind the energy demand projection.

For all the sectors there is a tendency to higher growth in the latter part of the period than in the first part. This reflects assumptions in the Reference Scenario, where efficiency policies approved in government energy plans only operate until 2020 or 2030, on this background the scenarios should for the period after 2030 be seen as a high case of potential final energy demand.

The policy scenario similarly includes large differences between the sectors in terms of expectations about final energy efficiency improvements. The household sector is assumed to show more than 25% efficiency improvement relative to the Reference Scenario, while the corresponding figure for the service sector is 15%, industry as much as

39%, and transport 27%. The principle for determining the magnitude of these potential efficiency improvements has been to assume that all efficiency improvements with lower social costs than the corresponding supply systems are included in the policy scenarios. This assessment was done based on detailed technology studies sector by sector. Taking all four sectors together, the prediction is that final energy consumption by 2050 would be almost 30% lower under the policy scenario compared to the reference scenario.

The energy savings included in the policy scenario for the buildings sector are assumed to result from tighter building codes, faster renovation of existing buildings, and better insulation of ceilings and walls. Ventilation heat recovery is also included. In industry, electricity savings and substitution of process heat from fossil fuels to biomass and electricity with higher efficiency are major contributors. In the transport sector faster and higher efficiency improvements in vehicles with conventional engines are a major efficiency improvement factor together with high efficiency of electric vehicles.

The 100% renewable energy scenario was estimated to cost DKK 2–12 billion/y, with the highest costs coming at the end of the scenario period, 2050, when the most expensive policy options in the transport sector are introduced (Climate Commission, 2010). It is assumed that fuel costs include a CO₂ tax corresponding to the marginal CO₂ price under a global 2°C stabilisation scenario, and in this way climate change priorities are included in the social cost.

Figure 8

Buildings: final energy consumption (PJ) as projected by the Danish Climate Commission.

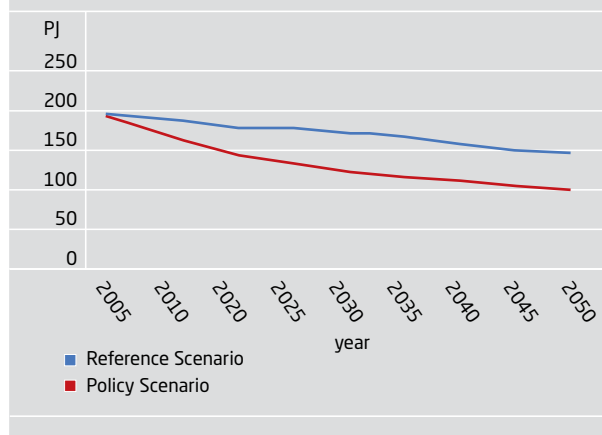
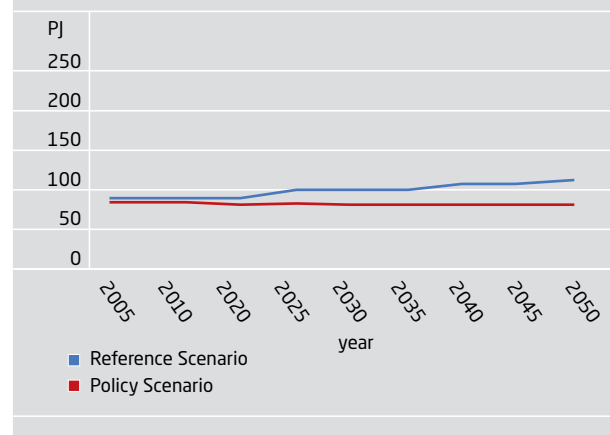

Figure 9

Service sector: final energy consumption (PJ) as projected by the Danish Climate Commission.



The researchers subsequently looked at the implied reductions in health costs thanks to reduced local pollution under the 100% renewable energy scenario. They assessed the financial benefits of reduced air pollution and other health impacts at DKK 2–3 billion/y [20]. The total health costs associated with air pollution are estimated to be halved in the 100% renewable energy scenario compared to the reference scenario, with the reduction mostly related to efficiency improvements in vehicles and substitution of industrial boilers by heat pumps. As well as human health benefits, the 100% renewable energy scenario would also reduce the damage air pollution causes to buildings and ecosystems, which are not included in the calculations.

As noted above, implementing the 100% renewable energy scenario would raise investment costs, notably in the power sector but also in the various energy-using sectors. This is a somewhat short-term effect, however, that would also increase employment.

From a private cost perspective, introduction of the 100% renewable energy system in Denmark implies increasing energy costs whose magnitude very much depends on the extent to which the buildings and business sectors are able to implement the many cost-effective energy efficiency measures suggested by the Climate Commission. From a social cost perspective the economics are more attractive, since it is expected that a 100% renewable Danish energy system will yield big gains associated with reduced GHG emissions and local air pollution, while the necessary investment will generate jobs and business. Many of these benefits to Danish society, however, depend on interna-

tional commitments to reduce global warming, with the consequent demand for Danish clean technologies and renewable energy solutions.

International energy efficiency potential

In its Energy Technology Perspectives (ETP) [21] the IEA looked at energy efficiency potential as part of the so-called Blue Map scenario, which aims to stabilise the global average temperature increase at 2°C [21]. In this scenario, end-use energy efficiency improvements contribute about one-third of the total CO₂ emission reductions in 2050 and make up very similar shares of the reduction effort in the four major regions: OECD Europe, USA, China, and India. End-use fuel efficiency contributes 26–28% of CO₂ emission reductions across the regions in 2050; most of the balance would be achieved through end-use electricity efficiency improvements.

Energy efficiency improvements contribute about 30% of the CO₂ emission reductions in the buildings sector in the Blue Map scenario. The main contributors here are savings in electric appliances and improvements to the building shell. The additional investment costs for most of these options are offset by fuel savings according to the IEA study. Specific pay back periods are not specified in this model based study.

Energy efficiency improvement is the main CO₂ reduction option in industry, contributing about 40% of the reductions in the Blue Map scenario [21], and the IEA concludes

Figure 10

Industry: final energy consumption (PJ) as projected by the Danish Climate Commission.

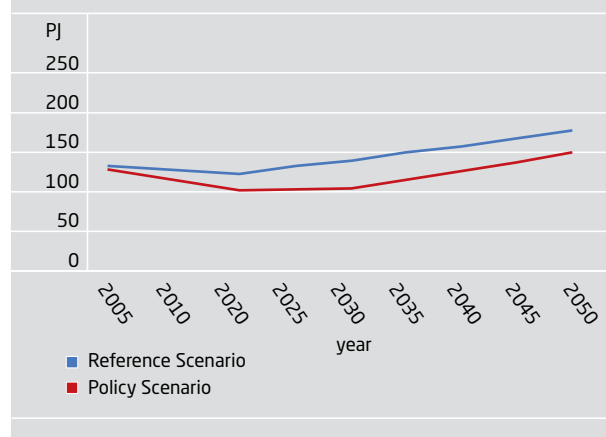
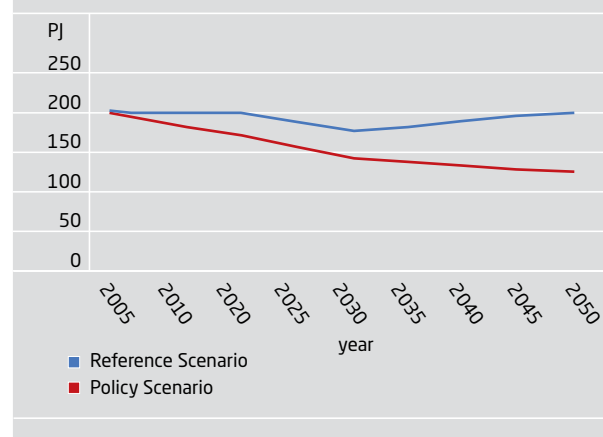

Figure 11

Transport: final energy consumption (PJ) as projected by the Danish Climate Commission.



that energy efficiency will be the cheapest way to reduce emissions from industry. The study assumes that the costs of most energy efficiency improvements will be either negative zero or very low, thanks to the associated fuel savings. A few very energy- and emission-intensive sectors, however, are expected to face large increases in investment costs to meet the Blue Map scenario; these include the cement, iron and steel, and chemical industries. The cost-effectiveness of CO₂ emission reductions in these sectors depends strongly on the potential to integrate energy improvements into the regular investment turnover.

Efficiency improvements similarly play a large role in the transport sector in the Blue Map scenario, and vehicle efficiency improvements would contribute about 50% of the required CO₂ emissions reduction in 2050 [21]. The cost conclusions are that investment in this sector would be about 10% higher in the Blue Map scenario compared to the baseline, and that this cost can be offset by fuel savings, assuming increasing fuel prices over time.

Efficiency improvements in power production are important in both the baseline and Blue Map scenarios over the whole period from 2007 to 2050. The starting point is that

in 2007 there was a big efficiency gap in power production around the world: coal-fired power plants in countries such as India recorded an average efficiency of about 25%, for instance, while Japan and Denmark boasted efficiencies of up to 43%. Significant efficiency differences also characterised power production from natural gas between non-OECD and OECD countries in 2007.

Efficiency improvements in power production are expected to be very large in all parts of the world under both the baseline and Blue Map scenarios. The projections for 2050 show a significant increase in efficiency for the Blue Map scenario compared to the baseline, but the comparison is not always simple. The introduction of carbon capture and storage (CCS) in the Blue Map scenario lowers the efficiency of coal-fired power plants to the same level as in the baseline scenario, and gas-fired plants with CCS would be even less efficient than their baseline counterparts [21]. The Blue Map scenario is estimated to require in total 40% more investment in power plants, transmission and maintenance compared with the baseline. Some of these costs would be offset by fuel cost savings, but the IEA gives no figures for the net costs taking all these factors into consideration.

Figure 12

Contribution of different mitigation options to cumulative GHG emission reductions for the periods 2000-2030 and 2000-2100. Based on four international studies using four different models: Image, Message, AIM and IPAC. Solid bars denote reductions to 650 ppmv CO₂eq; hatched bars denote reductions to 490-540 ppmv CO₂eq. Based on IPCC, 2007. [22].

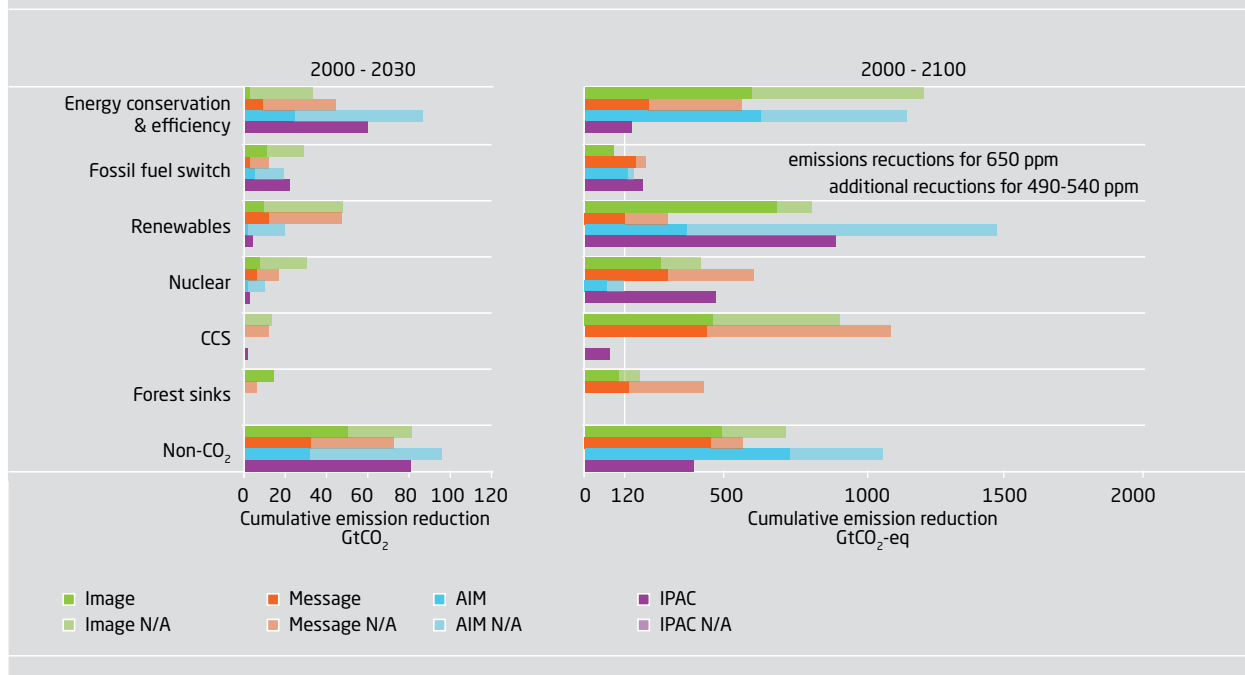

The Blue Map scenario has large indirect effects on local and regional air pollution as well as environmental impacts on water systems and land use. The scenario analysis includes a specific quantitative assessment of the number of life-years lost due to air pollution by small particulates (PM_{2.5}). It concludes that in the baseline scenario the EU, China, India and the European part of Russia would see a 70% increase in small particulate, PM 2.5 emissions from 2005 to 2030. In the Blue Map scenario this increase would be only 35%, and more than 1.2 billion life-years would be saved as a result.

The Blue Map scenario will also have a number of other indirect economic effects on energy access, employment and international markets for sophisticated clean energy technologies. The Energy Technology Perspectives 2010 does not assess these, and it must also be concluded that such economic impacts will be very context-specific and will differ between regions. However, it is worth recognising that for many countries the prospect of economic growth through green technologies is an important motivator. This is true not just of emerging economies like India and China but also for EU countries. The Danish government, for example, emphasises the “green growth” benefits associated with the 100% renewable energy scenario.

The increase in private costs resulting from the Blue Map scenario is expected to be higher than the increase in social cost including capital, O&M, and fuel costs. Businesses and private building owners will face increasing energy costs whose magnitude will depend greatly on how much improvement in energy efficiency is actually implemented, compared to the amount that has been identified as cost-effective. Altogether, the negative balance of private over social costs, together with market failures, means that policy instruments will be required to support the energy system changes included in the Blue Map scenario.

Competitiveness and timing of energy efficiency options

In chapter 4 of its AR4 WGIII the IPCC looks at which technical options will come into play depending on the stringency and timing of the CO₂ mitigation target. Energy efficiency, renewable energy, CCS and other mitigation options are all assessed against a background that also include the forestry sector and GHGs other than CO₂.

Figure 12 from the IPCC shows the contribution of energy conservation and energy efficiency in four studies based around two CO₂ stabilisation scenarios: the first at 650 ppmv CO₂eq and the second, more stringent, at 490–540 ppmv

CO₂eq. It can be seen that energy conservation and efficiency improvements (together with non-CO₂ gases) play a major role in GHG emission reductions in the period up to 2030, especially in the more stringent of the two reduction scenarios. In the longer term, up to 2100, the roles of nuclear energy, renewable energy and CCS increase. This difference in timing shows two things: first that there is a relatively larger and economically attractive potential for energy conservation and efficiency improvements up to 2030, and second that the models assume the efficiency of energy conversion and consumption to increase over time and to become more similar around the world. It is also expected that the costs of renewable energy and CCS will decrease over time, giving these options an increasing role. Finally, stringent mitigation scenarios imply very large cuts in emission, and so will require a very broad menu of options.

Conclusions

Studies for Denmark by the Climate Commission and internationally by the IEA [21] show that energy efficiency measures would play a very important role in stabilising the average global temperature rise at low levels as for example 2 degrees. In these studies, energy efficiency provides around 30% or more of the total climate change mitigation in all regions and sectors. In some cases the contribution of energy efficiency is as much as 50%, for example in Danish industry in 2050 in the 100% renewable energy scenarios.

Energy efficiency measures have been shown to have great potential for low-cost solutions in which the value of the fuel savings offsets – or nearly so – the costs of installing and maintaining energy-efficient equipment. This is particularly true of the time horizon up to 2030, and to a lesser extent up to 2050. With increasing energy prices resulting from increased fossil fuel scarcity, and the introduction of new renewable energy sources, the actual energy costs facing businesses and households will depend very much on to what extent cost-effective energy efficiency measures are implemented.

The social costs of meeting stringent stabilisation targets will be lower than the private costs simply because there is a social value associated with decreased global warming, reduced air pollution, increased energy security, and probably also some green growth benefits from using cleaner technologies.

Altogether this makes a strong case for introducing a wide range of policies and instruments to ensure that private costs and other incentives for private sector initiatives are aligned.

Residential and commercial buildings

Svend Svendsen and Simon Furbo, DTU Civil Engineering

Introduction

Status of energy use in buildings

Energy is mainly used in buildings to provide the occupants with a satisfactory indoor environment with respect to heating and cooling, fresh air and electric light, and to provide domestic hot water. In Europe, these energy uses characterise the energy performance of buildings.

Energy is also used in buildings by electrical equipment such as white goods, radio and TV, office equipment and elevators.

The total energy used in buildings typically represents about 40% of all energy used in society. The majority of this is used for space heating.

Energy for heating can be reduced by energy-saving technologies that are mainly based on:

- improved thermal insulation of the building envelope;
- windows with low heat loss and high solar gain;
- airtight building envelope and windows;
- ventilation with heat recovery;
- efficient and optimally controlled heating systems.

Energy-saving technologies installed during “deep renovation” projects can cut the energy used to heat existing buildings to a level close to that of new buildings. Danish studies [23] indicate that the energy used to heat existing buildings can be reduced by a factor of four, and German full-scale demonstration projects [24] showed a reduction factor of 10. Energy use for space heating will be reduced to about 15 kWh/m² per year and may be reduced to an even lower level of about 5-10 kWh/m² per year in new buildings.

A building which gets all its energy from renewable sources becomes a “zero fossil energy building”. The most economic way to eliminate the use of fossil energy from all buildings is of course a combination of energy savings and renewable energy.

Many different definitions have been proposed – including Net Zero Energy Buildings [25], Zero Emission Buildings [26] and Energy Supplying Buildings [27] – based on different balances between energy saving and renewable energy supply, different timescales (hourly, yearly or life-time) and different geographical boundaries (building footprint, neighbourhood, electricity supply network, country), but the zero fossil energy building is the most relevant as it focuses on the elimination of the use of fossil energy. In the long term, when fossil fuels are fully phased out globally, the situation becomes simpler as the optimal balances

between energy savings and energy supply technologies “just” have to be based on the cheapest overall solution.

Policies on energy-efficient buildings

International recommendations highlight the potential to make buildings much more energy-efficient [28], [29]. At EU level the revised Directive on Energy Performance of Buildings (EPBD recast) plans to require all new buildings to be Nearly Zero Energy Buildings [30]. In Denmark, recent investigations into the possibility of sustainable development without the use of fossil fuels have led to recommendations that buildings are made much more energy-efficient [31]. The government’s energy strategy [32] requires all building to be fossil-free by 2035. This target is to be implemented through a combination of extensive energy savings and renewable energy.

To accomplish these political goals it is important to establish how energy savings may be achieved in new and existing buildings.

The solutions

To phase out the use of energy from fossil fuels completely, a combination of energy savings and renewable energy has to be used in both new and existing buildings. The challenge is to find the optimum balance between these two options.

Large and rapid improvements in the energy performance of buildings are a challenge for the building sector, but one that can be solved through improved methods of product development, building design, construction and operation. Simulation-based analysis and optimisation of solutions with respect to energy use, indoor environment and durability are key techniques.

Low-energy buildings may be developed by combining new building components – featuring improved energy performance – with new and improved design methods. Integrated design methods can yield optimal combinations of insulation (the building envelope), window systems, and ventilation and heating systems, all with improved energy performance. An example of such a new low-energy building is shown on figure 13.

Figure 13

Navitas is Aarhus' new centre for energy, innovation and education in the docklands of Aarhus. Navitas has two energy objectives: The building achieves classification as energy class 1-construction, which means that the operating energy consumption should be 50% of the Building Regulations of 2008. Students, teachers, researchers and entrepreneurs should actively be involved in reducing the behavioural related energy consumption.



The optimal balance between energy savings and renewable energy supply is found by comparing the cost of saving energy in the building with the cost of supplying renewable energy to the building. The optimal solution for low-energy buildings should fit with the overall sustainable energy solution for every sector of society, based on general energy plans for sustainable development with a focus on energy-related problems.

The building sector may in the process be transformed from an experience-based sector to one based on knowledge and research, with high-quality sustainable products and a profitable business model.

Energy-efficient building components and systems for low-energy buildings

Manufacturers of energy-related materials, components and systems for buildings are challenged to develop products with improved energy performance, thus making it cheaper and easier for designers and contractors to build low-energy buildings.

The sections below summarise a recent investigation into potential developments in materials, components and systems with improved energy performance that could be on the market by 2020 [33].

The insulated building envelope

Insulated building envelopes (floors, walls and ceilings/roofs) can reduce U-values (heat transfer coefficients) by using thicker insulation or insulation materials with lower thermal conductivity. However, design issues may limit the maximum insulation thickness. If we assume a maximum wall thickness of 0.7 m, an insulation thickness of about 0.6 m is possible, yielding a U-value of about 0.06 W/m² K if conventional insulating materials with thermal conductivities of 0.035 W/m K are used. The same U-value may be obtained with an insulation thickness of 0.5 m by using insulating materials with a thermal conductivity of 0.030 W/m K, which is possible, for instance, by adding graphite to expanded polystyrene. Even lower thermal conductivities (0.020–0.012 W/m K) may be obtained by adding aerogels to mineral wool or using pure aerogels. However the current price of aerogels does not make them competitive with conventional insulation for ordinary buildings.

Windows

Windows may be improved by reducing their U-value and by increasing their transmittance of solar heat and light. It is expected that existing triple glazing units – sealed, argon-filled and with low-e coatings – may be further improved by the use of low-iron glass with anti-reflection coatings. The study assumed that by 2020 we will have U-values of $0.45 \text{ W/m}^2 \text{ K}$ and total solar transmittances of 63%. In the last decade, window frames have been improved by introducing composite materials based on glass-fibre reinforced polyester or polyurethane. Figure 14 shows three examples of slim well-insulated frame profiles developed in composite materials.

Windows with composite frames have U-values below $0.8 \text{ W/m}^2 \text{ K}$ and total solar transmittances of about 50%. It is expected that by 2020 further improvements to the frame profiles and improved glazing units may yield U-values of $0.6 \text{ W/m}^2 \text{ K}$ and total solar transmittances of 56% based on the total window area.

An alternative is to use non-sealed glazing units with three separate panes in coupled frames. The spaces between the frames can accommodate integral sunshades and vacuum-insulated shutters, resulting in a window that combines good energy performance with long life.

Ventilation systems

To provide the high levels of heat recovery required for low-energy buildings, ventilation systems need mechanical assistance. The electrical energy used by the fans may be minimised by designing the ventilation unit and the duct system with a much lower pressure drop than is usual. In

this way ventilation systems with specific fan power factors (SFPs) of about 300 J/m^3 may be realised for office buildings. With such low use of electrical power the ventilation system may also be used to cool the building at night, and for certain constructions and climates this can eliminate the need for a mechanical cooling system. Making suitable assumptions about ventilation needs and the availability of night cooling, the energy used by fans in office buildings is predicted to fall below $3 \text{ kWh/m}^2 \text{ pr year}$ without any primary energy factors.

Ventilation systems in other kinds of buildings are assumed to be capable of similar performance. In single-family buildings, simple duct systems and smaller airflows may reduce the energy used by the fans even further.

Heating systems

It is important to improve the functionality and efficiency of heating systems in low-energy houses. The basic job of the heating system is to maintain a suitable air temperature in each room, and to heat the tiled floors of bathrooms so that they are comfortable for bare feet.

One way to achieve this is through heating systems built into concrete or wooden floors and individually controlled for each room. The efficiency of such a heating system can be very high if heat losses from distribution pipes are minimised – by placing the pipes above the floor insulation – and the lowest possible water temperatures are used: just $1\text{--}2^\circ\text{C}$ above the required room temperature is sufficient. Such a low temperature differential makes the floor heating system self-controlling, since heating stops as soon as solar gain causes the temperature of the room to rise. Smart control systems can set the temperature of the water based on weather forecasts and the simulated thermal behaviour of the room.

The energy needed to circulate the water may be minimised by using ultra-low-power pumps. These have a typical power consumption of 3 W for a single-family house. In this way the heating system can be almost 100% efficient and operate at very low temperatures.

Domestic hot water

Domestic hot water systems in large buildings typically have long pipes which lose large amounts of heat. In low-energy buildings, with their short heating seasons, only a small fraction of this lost heat will be useful for room heating. To reduce heat loss, domestic hot water systems may use lower temperatures and better-insulated pipes. Domestic hot water does not need to be warmer than 40°C for comfortable use in washing, so the supply temperature may

Figure 14

Window profiles made from composite materials [34].

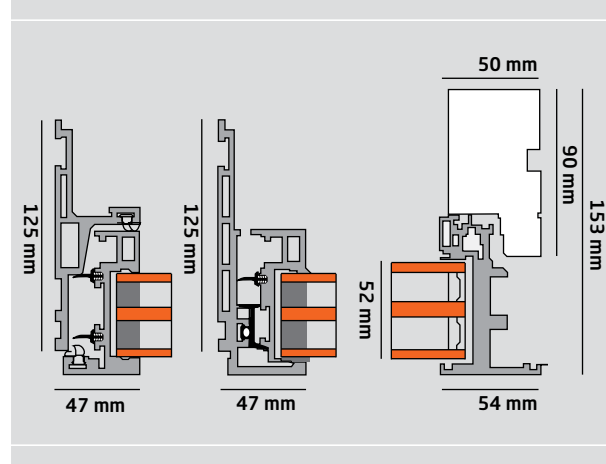

be as low as 45°C and the risk of Legionella bacteria may be eliminated either by having less than 3 litres of water in the system or by continuous sterilisation using local high temperatures or Advanced Oxidation Technologies based on UV-radiation and photocatalytic surfaces of titanium dioxide. Such low temperatures can allow low-temperature district heating systems to supply the heat required to produce domestic hot water.

Integrated design and optimisation of low-energy buildings

The process of designing low-energy buildings to suit the energy performance requirements of 2020 needs to be improved to make sure that the building will live up to the requirements of energy performance and indoor environment in an optimal way.

The Energy Performance of Buildings Directive [30] specifies the building's maximum energy use but leaves a lot of freedom in deciding how this requirement will be met. Of course the building must provide a comfortable indoor environment as well as meeting the energy target, and durability may also influence the design decisions. But the substantial cuts in energy use required by the Directive means that it is important to develop a robust optimisation process to handle the introduction of new solutions in building design.

The traditional design process relies very much on experience and simple guidelines. On the other hand, to design buildings with both a very good indoor environment and a total energy use of less than 25 kWh/m² – at minimum cost – requires an improved design process taking into account a thorough analysis of all the options. A recent PhD project on office buildings [35] concludes that an integrated design process based on simulation-supported analysis could lead to better design and greater energy efficiency. The design process proposed is expected to be useful for all types of low-energy buildings.

The economically optimal solution is determined early in the design process based on the cost of conserved energy for each part used in the building. The method is described in [36] and the principle is illustrated in Figure 15. For each commercially-available building part, component or service system, curves show the contribution of that specific building part to the energy used by the whole building, as a function of the marginal cost of conserved energy. The result is a series of optimal solutions, each of which delivers the same marginal cost of conserved energy as well as fulfilling the requirements for energy use and indoor environment quality. These solutions are specific to each room and are simply first estimates of good possible designs, but the process is useful since it clearly illustrates the influence of each building part, component and service system on energy use and the cost of reducing this.

Figure 15

Optimisation of low-energy buildings through analysis of the cost of conserved energy (CCE) for individual components. CCE is calculated as the investment cost of a particular energy-saving measure divided by the total resultant energy savings over the life of that measure. The diagram on the left shows the CCE for a wall as a function of the annual energy lost through the wall. Not surprisingly, CCE rises as energy falls. On the right are curves of CCE against energy use for different elements of the building, calculated in terms of floor area. Comparing the energy use of each element at the same CCE value helps to find the optimal mix of energy-saving measures.

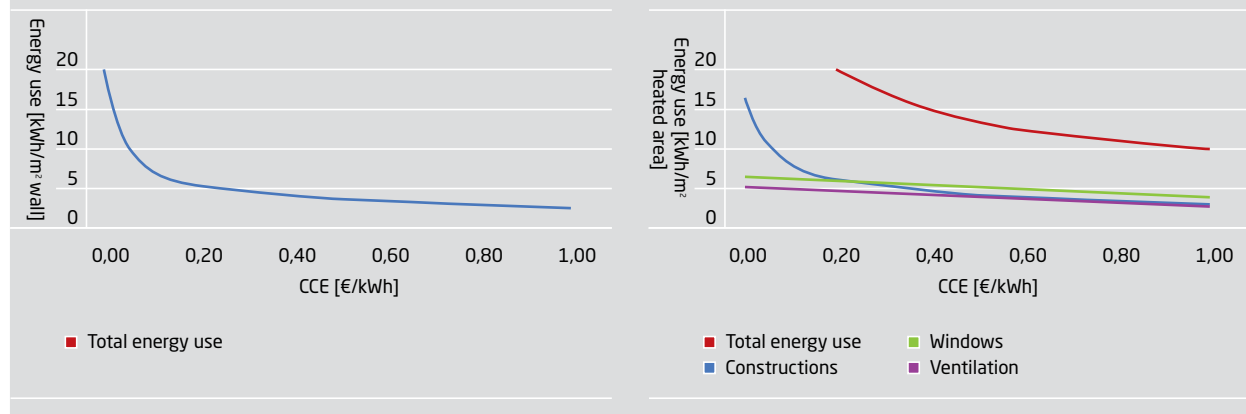

Figure 16 shows an example of integrated design supported by simulations of energy use and indoor environment. Such an approach benefits the whole design group by providing insight into how various parameters influence the costs and performance of individual rooms. This makes it much easier to find good solutions in the design of the whole building.

Renewable energy supply systems for low-energy buildings

In the future, heat supplies to low-energy buildings should be based only on renewable energy. This may be accomplished in two ways depending on the density of buildings in the local environment. Buildings in cities can take their heat from low-temperature district heating systems based on renewable energy from incineration plants, waste heat from industrial processes and commercial buildings, geothermal plants and solar heating plants. Buildings outside cities may take their heat supply from heat pumps operated by electricity from wind turbines and other renewable power sources.

In both cases the cost of energy for both space heating and domestic hot water can be reduced through the use of systems designed to operate at low temperatures and low power.

Low-temperature district heating

A new generation of low-temperature (50/20°C) district heating systems with small pipes (Figure 17) have demonstrated acceptable efficiency and cost compared to heat pumps [37]. The benefit of district heating is that it is very flexible with respect to heat sources, including low-temperature sources.

The challenge of using district heating systems is the need to have a sufficiently strong planning process that ensures that all buildings within the area of the district heating system are connected to the system and get all their energy for heating from the system.

The implementation of low temperature district heating based on renewable energy can be combined with renovation of the existing buildings and in this way the existing buildings can become fossil free heated.

Figure 16

Parametric analysis in the design of a small office: for different sizes of overhang, simulation reveals the influence on energy performance, daylight, temperature and indoor air quality in relation to the accepted standards.

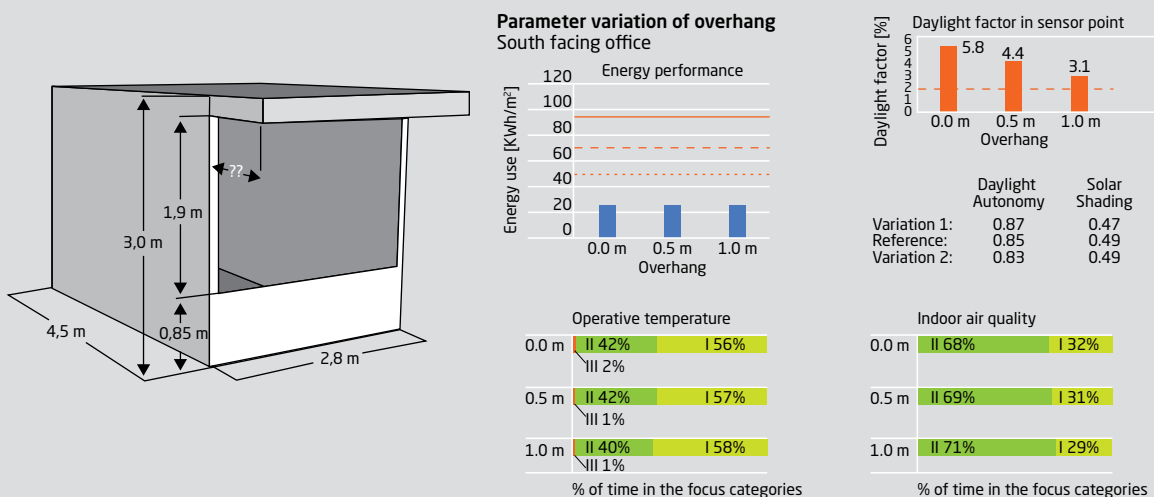

Category	Explanation
I	High level of expectation and is recommended for spaces occupied by very sensitive and fragile persons with special requirements like handicapped, sick, very young children and elderly persons
II	Normal level of expectation and should be used for new buildings and renovations
III	An acceptable, moderate level of expectation and may be used for existing buildings
IV	Values outside the criteria for the above categories. This category should only be accepted for a limited part of the year

Figure 17

District heating pipe with flexible supply and return tubes (10 mm ID/14 mm OD) encased in a single insulating jacket. The right-hand diagram shows the temperature distribution in the insulation surrounding the supply (S) and return (P) tubes; in this case the tubes are 16 mm in diameter and the jacket diameter is 110 mm [37].

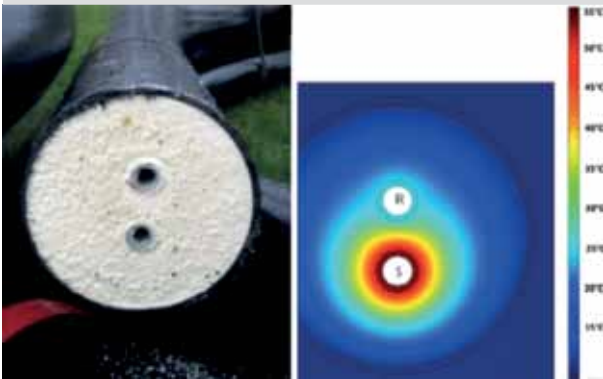

Heat pumps

Heat pumps running on electricity from renewable sources are another source of heat for room heating and domestic hot water. It is important to avoid using outdoor air as the energy source for room heating since cold weather produces a negative coupling: when the air temperature is very low the need for room heating is greatest, yet the efficiency of the heat pump is at its lowest. A ground-source heat pump may therefore be the best choice.

Figure 18

Total worldwide installed capacity and energy production for the main renewable energy sources in 2010.

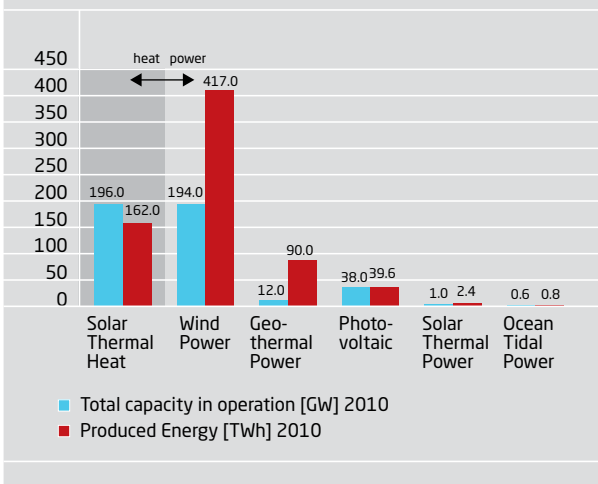

Solar heating

Solar energy is the largest renewable energy source in the world. The hourly solar radiation on the surface of the Earth corresponds approximately to the world’s annual energy consumption. Especially solar thermal systems are of great interest.

Figure 18 shows the total worldwide installed capacity and energy produced worldwide for the main renewable energy sources in 2010, [38]. It shows that solar heating systems are among the most important renewable energy systems in terms of both economics and energy. Annual growth in the world market for solar thermal systems, which is completely dominated by China, has been in the range 20-45% for every year of the last decade.

This rapid growth looks set to continue in the future, and it is expected that solar heating will play an important role in the future energy system. For instance, according to ESTTP (European Solar Thermal Technology Platform’s) 50% of Europe’s heating and cooling demand can be covered by solar thermal systems by 2050, [39]. Solar cooling can for instance be based on solar heat forcing evaporation/condensation processes for cooling. The ESTTP vision is ambitious, and it can only be realized with strong support from governments. For instance, a strong focus on education of key personnel such as installers and engineers for development, manufacturing and planning of solar heating systems and components of solar heating systems, is needed. Increased efforts in R&D are also needed to accelerate the development of attractive solar heating and cooling systems.

Figure 19

Drake Landing Solar Community solar heating plant.



Today four types of solar heating systems are used in large numbers:

- solar domestic hot water (SDHW) systems;
- solar combi systems for combined space heating and domestic hot water supply
- solar district heating plants for neighbourhoods or whole towns
- air collectors which heat air to ventilate and dehumidify houses.

SDHW systems can typically cover the hot water consumption totally in sunny summer periods resulting in no need for a back up energy system and consequently in high energy savings. Solar combi systems can cover a low or a high part of the yearly heat demand of buildings, depending on the size of the solar heating system and the heat demand of the building. Solar heating plants can cover a low or a high part of the heat demand of a town. Figure 2 shows a photo of some of the solar collectors for the solar heating plant of Drake Landing Solar Community, in the town of Okotoks, Alberta, Canada. 90% of the yearly heat demand of the buildings of the community is covered by the solar heating plant, [40]. The heat produced by the solar collectors is transferred to the buildings by means of a district heating network. In periods with a surplus of solar heat production heat is transferred to a seasonal borehole heat storage, where heat is stored from the sunny summer period to the cold winter period. In periods where the solar collectors can not provide enough heat to the buildings, heat is transferred from the heat storage to the buildings.

Today simple financial payback times of typical solar heating systems are in the range from 5 years to 15 years, and merely by making technological improvements they can be halved [41].

Research and development in the field of small solar heating systems should concentrate on hot water tanks, smart system designs and interplay between solar collectors and other renewable energy sources. The development of larger systems should concentrate on solar collectors and seasonal heat storage.

Conclusion

Low-energy buildings can make a major contribution to general sustainable development by providing a solution to problems related to the use of fossil fuels.

The EPBD requirements that by 2020 new building shall be constructed to use nearly zero energy, and no fossil fuels, can be accomplished by combining low-energy buildings with renewable energy via low-temperature district heating in cities and suburbs, and via heat pumps for low-density settlements.

Based on experience with passive houses, low-energy buildings meeting the energy performance requirements of 2020 are expected to cost only a few percent more than conventional buildings.

The very large and rapid changes needed in the energy performance of buildings is a challenge for the building sector, but one that can be overcome by better methods of developing products and designing, constructing and operating buildings. Simulation-based analysis and optimisation, and considerations of durability, will be important here.

Building may thus be transformed from an experience-based sector to one based on knowledge and research, with high-quality sustainable products and good business opportunities.

Energy efficient Solid State Lighting

Carsten Dam-Hansen and Paul Michael Petersen, DTU Fotonik

Energy usage for lighting - introduction

Lighting has been an integral part of human civilization since before recorded history. Today artificial lighting is a critical part of modern life. However, traditional methods of lighting, such as fuel-based and incandescent lighting are highly inefficient. This has led to a situation, where lighting takes up to 6.5% of the total energy usage world-wide. Energy savings are becoming increasingly important, given that easily accessible energy resources are becoming scarce. As a consequence, use of inefficient lighting products is being phased out across the industrialized world as for instance in the Australia and the European Union. By September 2012 the final step of phasing out was carried out, so now it is no longer allowed to produce or import incandescent bulbs in the EU.

LED technology for Solid State Lighting (SSL)

Solid-state lighting (SSL) technology is the term for using semi-conductor materials to convert electricity into light. SSL is an umbrella term encompassing both light-emitting diodes (LEDs) and organic light-emitting diodes (OLEDs). SSL has the potential of being the most energy efficient lighting technology known today.

Long after the discovery of electroluminescence by Henry Joseph Round in 1907, the first practical LEDs appeared in the early 1960s. They were red LEDs with very low luminous flux that were used as indicator light and in displays of pocket calculators. 20 years after the first observation of blue light emission from GaN in 1972, the first practical blue LED was made in 1992. Soon thereafter two ways of white light generation by LED technology was demonstrated; white LEDs were made by coating blue LEDs with phosphor and white light generation by colormixing of light from red, green and blue LEDs.

With this progress the basis for using LED technology for general lighting was set, however vast improvements on flux and efficiency had to be made. Researchers and product developers have made extraordinary strides in improving the flux and efficacy of LED components, lamps and luminaires. In the beginning of the 2000's the efficiency of LEDs were no higher than that of incandescent bulbs. Since then a dramatic increase in luminous flux and energy efficiency has been seen. A doubling of these figures has been seen every third year and LED's are expected, within the near future, to become more energy efficient than the most efficient conventional lighting sources. In addition to the energy savings, LED's have a number of other advantages:

small, compact and robust emitters with high flux, no mercury content, easily controllable, no emission of UV or IR radiation and long lifetimes (20000 - 100000 hours) provided proper thermal management. Furthermore, choice of correlated colour temperature over a very wide range from 2700 – 7000 K and high colour rendering is possible to achieve either through proper choice of wavelength converters or through colour mixing.

Energy efficiency and light quality of SSL vs. traditional lighting technologies

Research results in LED technology have resulted in demonstrating energy efficiencies above 200 lm/W. In May 2011 LED manufacturer Cree, Inc. claimed a new R&D record for power-LED efficacy of 231 lm/W. The value was measured for a single-die component at a correlated colour temperature of 4500 K operating at 350 mA and at standard room temperature. At these operating conditions commercially available LEDs in 2012 exhibit efficiencies of around 150 lm/W. The highest efficiencies are found for cold white LEDs with correlated colour temperatures above 5000 K. Warm white LEDs with correlated colour temperatures of 2700 – 3500 K have slightly lower have efficiencies with values around 120 lm/W. For LEDs to present a true replacement for incandescent bulbs they have to emit warm white light around 2700 K with high colour rendering properties characterized by a colour rendering index, CRI, over 90. Due to the need for higher spectral contents in the red region such LEDs have only a luminous efficiency of around 90-110 lm/W. This is close to 9 times higher than that of incandescent bulbs.

These efficiency values are for standard and ideal operating conditions. In practical SSL products like LED based lamps and luminaires corresponding efficiencies are 20-30% lower due to optical, electrical and thermal losses. This means that normal SSL products for replacement of incandescent and halogen bulbs have efficiencies in the range of 40-70 lm/W. Due to the thermal losses and limited size of replacement bulbs the total luminous flux are often not high enough in order to present a true incandescent replacement. A typical 60W incandescent lamp has a flux output around 800 lm. The department of Energy, DOE, in USA has awarded the first L-price for a 60W-replacement LED lamp. The lamp from Philips Lighting North America outputs 910 lm at 9.7W delivering an efficacy of 93.4 lm/W, a CCD of 2727, and a CRI of 93. This lamp should be commercially available in 2012 and shows that high efficiency and high light quality is achievable.

Therefore SSL products already presents efficient replacements for incandescent and halogen bulbs with efficiencies 10-22 lm/W. Compact fluorescent lamps, CFLs, have efficiencies around 50-80 lm/W and may be replaced by SSL products of equal efficiencies, but with higher lighting quality due to the continuous spectral distribution of LED light. Larger SSL products e.g. luminaires and troffers for office lighting have higher operating efficiencies of up to 110 lm/W. This is due to better thermal properties in the luminaires and the efficiencies are comparable to that of novel fluorescent tubes. According to DOE roadmaps, LED luminaires will be capable of luminaire efficiencies approaching 150 lm/W by 2015, more than twice that of a typical fluorescent fixture.

Quality assurance and standardisation

The number of SSL products on the market is increasing drastically. Unfortunately, not all exhibit the high efficiencies and quality as described above. There is a large variation in the quality and performance of these products and some of the products have an unacceptable quality as they do not perform better than the products they are supposed to replace. The marking of SSL products is often misleading or non-existent. Investigations in USA, Holland and in Denmark through work carried out at DTU Fotonik, show that less than 20% of the products that live up to their own marking. Low-quality products and false information are severely threatening to ruin the consumers' trust in the LED technology delaying its market penetration and acceptance. In the efforts to promote quality SSL products to implement the potential energy savings, there is a need

to capitalize on lessons learned from the introduction of CFLs. Here, quality and technical problems delayed full market acceptance for decades. With the phasing-out of incandescent and halogen light sources we stand before an immediate need to ensure the high quality of light sources replacing them. Therefore, we need to set high standards for the quality of LED products, whether it is a requirement of minimum efficiency, light quality or lifespan. We have seen such demands set in the American Energy Star program and the EU Quality Charter for LED lamps. The main issue is that we have a global market but no international standards for testing and characterizing these products. A new annex under IEA 4E Implementing Agreement, IEA 4E-SSL, has been established in the fall of 2010 with Denmark as one of the members. It has focus on providing tools to governments, to use as a basis for political initiatives ensuring the quality of SSL products on the national markets. These tools include performance tables for quality assurance and work on new international standards for testing SSL products. Important differences between LED technology and conventional lighting have created a gap in the industry standards and test procedures that complicates typical product comparisons and ratings. One of the aims of this work is to harmonize SSL quality testing in a worldwide network of national and industrial light measurement laboratories through round robin measurement campaigns. Further, a standardisation on LED light engine is required in order to ensure exchangeability of light source in the future. The industrial organisation Zhaga is working on such a standardisation. The goal is to define LED light engines for different purposes, with standardized optical, mechanical and electrical interfaces; the power consumption will be reduced over time.

Figure 20

The treasures in Rosenborg castle in Copenhagen are illuminated with LED lights developed in collaboration between DTU Fotonik and the company Lumodan. It is demonstrated that it is possible to spectrally design new LED light sources that can replace the incandescent bulbs with the desired colour qualities and without the heat radiation that is an inherent part of the light from incandescent bulbs. There has been observed an energy saving of up to 80%.



Conclusion and outlook

Even though vast improvements have been made on efficiency and light quality, SSL is still in its infancy. One of the barriers for a market introduction is the price, which still is around 5 times higher than traditional lighting technologies. In order to fulfil the potential of SSL, further research and development needs to increase the light extraction from semiconductor materials, provide better and cheaper production and packaging, and advanced optical systems for optimized light distribution and new thermal solutions for SSL lamps and luminaires.

Nanotechnology and applied research at DTU Fotonik in close collaboration with industry are essential parts in the development of new enhanced LED optical systems and LEDs with higher light extraction efficiency. Photonic crystals can help to efficiently extract light from LEDs and to form a desired emission profile. Future directions are devoted to the next generation of LEDs, in which the spontaneous emission is photon enhanced. One realization of this idea is using LEDs with a layer of nanocrystals, which are coupled to the quantum well of the LED. Such R&D work is ongoing all over the world and DOE roadmaps foresee luminous efficiencies by 2020 that are close to 250 lm/W for both cold and warm white light from LEDs, and prices in the order of one dollar per kilolumen. Such figures will drastically reduce the energy consumption worldwide for lighting, and hence a marked reduction in carbon emissions.

Energy consumption in communication infrastructures

Lars Dittmann, DTU Fotonik

Introduction

It is currently estimated that about 2-4% of the global energy consumption is used to operate the global communication infrastructure – mainly the Internet. Even though this figure might not be alarmingly high in itself it becomes extremely important when it is combined with a growth rate of 30-40% per year due to a similar growth rate of the required capacity implemented to serve user and application demand.

This kind of growth rate has been observed for many years (in some years even higher) and is expected to continue for many years to come. Currently the growth is driven by video application that is used more intensively and with higher and higher picture quality (resolution). The next wave of capacity growth is probably to be seen in relation to “Internet of things” where everything in our environment is Internet connected such as light poles, trash cans, cloths with health sensors etc., smart supply systems for power and heating, smart cities with direct traffic control of cars and trains and intensive information system for example for deaf and blind citizens, telemedicine and so on.

In the way communication networks are implemented today there is an almost linear relation between capacity and power consumption. Even though the electrical power consumption for communication networks – and especially its growth – is acknowledge as a significant problem, no clear path is seen on how to ensure a reduction.

However, two kinds of scenarios can be identified: an evolutionary path that builds on current ways of building networks but with focus on reducing energy consumption as

much as possible and a more disruptive approach that to a larger extend tries to rethink the way networks are implemented. It is important to highlight that both approaches requires time (years/decades) to implement as they both requires international consensus and standardization – as standardization is mandatory for global interoperability and cost efficiency.

Evolutionary approach

In the evolutionary approach the focus is on how unnecessary energy consumption can be minimized – and how renewable energy can be applied.

Applying new technology can to some extent break the linear relation between capacity and power consumption. However, even better saving is expected to be obtained by dynamically adjusting the momentary capacity to the actual need rather than having an over provisioned infrastructure based on peak situations.

These elastic networks will adjust link capacity by using different transmission concepts and node capacity by turning on and off processing and fabric elements. In wireless segments of the networks (that is one of most power consuming domains) entire base stations/access point can be disabled if not needed for capacity coverage.

Mobile or cellular network are already very advanced in respect to power management and control, but that is more driven by interference problems rather than power savings as such – even though power cost has become a significant expense for mobile network operators.

Figure 21

Distribution of power consumption in different parts of a communication network. Source: “Energy Efficiency in the Future Internet” by Raffaele Bolla et al. in IEEE Communication Surveys and tutorials

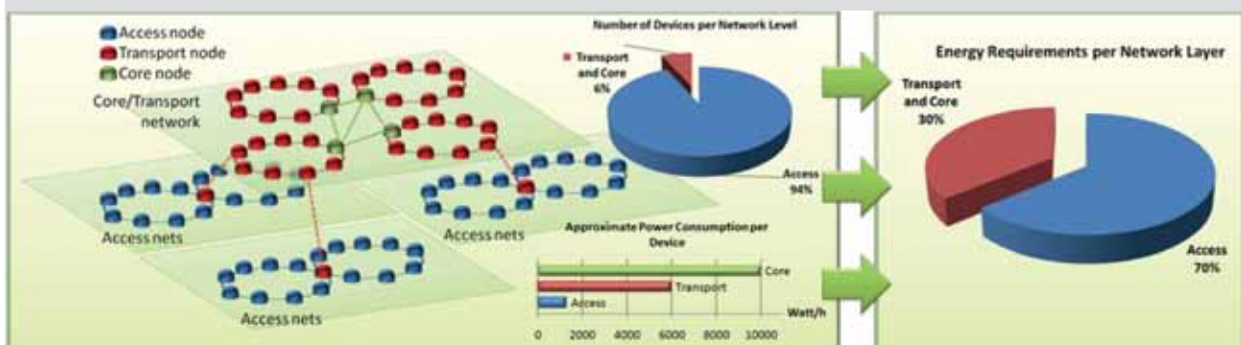
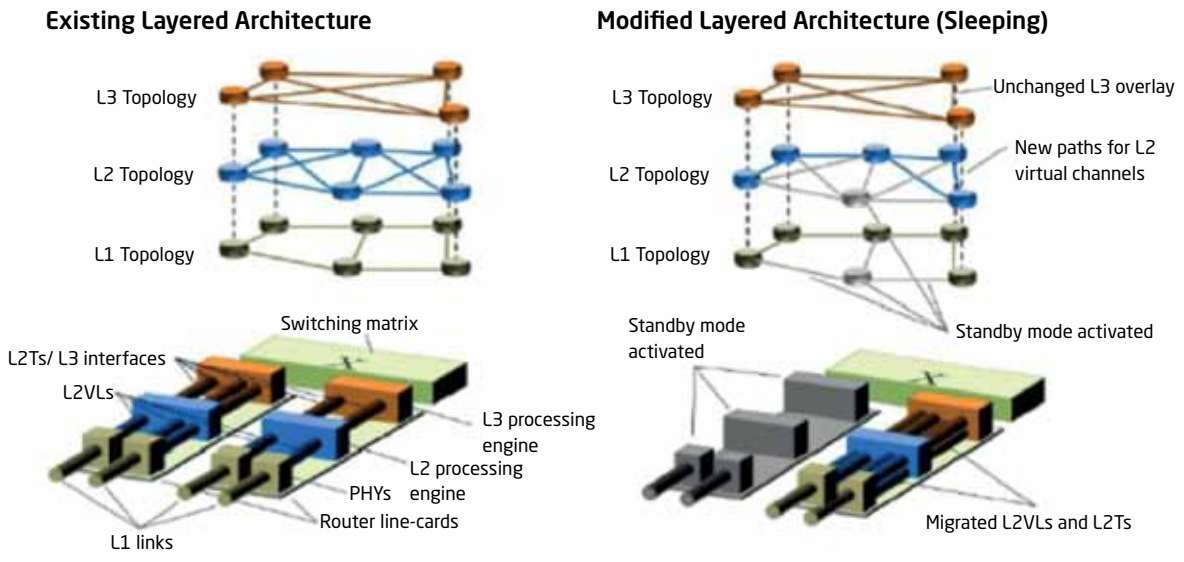

Figure 22
Sleep mode enabled network, Source: "Enabling backbone networks to sleep" by Raffaele Bolla et al in IEEE Network, March 2011.



In the common core network, that support the different service infrastructures such as the Internet, the elasticity can be exploited by routing the information through different paths depending not only on available bandwidth capacity, but just as well the available energy sources. A concept called "follow the sun – follow the wind" proposes to use the availability of renewable energy in path selection for the Internet topology. This is not a trivial approach to implement as the Internet today has a fairly complex topology that can become unstable if changed to frequent.

In addition to the use of a dynamic network, where link and node capacity can be reduced or completely put in sleep mode, the concept of traffic off load is also capable of reducing power.

In traffic off load the user data is kept in a lower layer as long as possible as processing in higher layers are far more power consuming than that lower layers. In the figure below it is outlined how intelligent routing and traffic aggregation can enable a significant amount of traffic to avoid a power expensive processing in a majority of networks nodes.

Figure 23
Traffic of loading in major core nodes. Source NokiaSiemens Whitepaper "Optical Transport Network Switching" 2011.

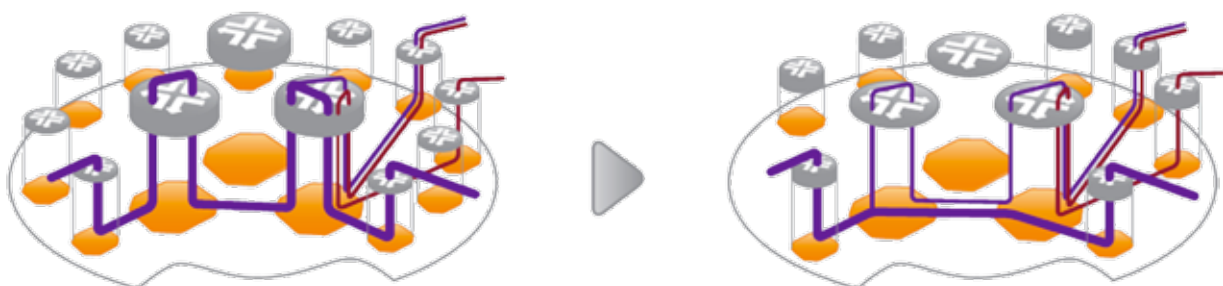

Disruptive approach

In the disruptive approach the incremental evolution, that to a large extent was used in the migration from voice centric telecommunication network to data centric Internet, is re-evaluated in a holistic way that incorporate power consumption as an important parameter just as performance, reliability, availability etc. By looking at the characteristics of the most demanding applications and considering technologies with a better power performance an infrastructure is defined, that can incorporate power usage as a flexible and weighted parameter.

Optical technology has for long been seen as an appropriate technology to reduce power consumption (and provide the needed capacity expansion) – but this technology is mainly beneficial for a disruptive approach as optics is unlikely to replace electronic counterparts directly.

The Internet as build today is extremely flexible towards application integration. The datagram used by the IP network is very efficient for smaller messages (like emails etc.) or communication types that are often interrupted (like web browsing with few activity periods and long periods without network activity). But when the communication starts to last second or minutes it is no longer an efficient way to handle data due to the large amount of processing overhead for each datagram. If the communication at the same time request a relatively high capacity – as for instance for video communication – the power consumption problem gets even more significant.

The classical telephone was optimized for permanent low bitrate connections on an end to end basis. However the concept did not scale well into higher bitrates and was inefficient as it was too complex for the end-user to exploit the flexibility of data networks.

However by moving the circuit end-point to edge equipment and exploiting optical circuits such a wavelength or sub-wavelength a significant power savings can potentially be made for the future internet driven by video applications.

Conclusion

Despite communication infrastructures (excluding computer and storage center) are “only” consuming 2-4% of the global power usage, the concern arise from the growth rate of around 40%. Unless action is taken the power provided to operate the Internet, the cellular mobile network, the WiFi hotspots will be so significant that usage restrictions might be applied - and economic growth limited.

The evolutionary and the disruptive approach is not a choice as the implementation of the disruptive approach has a timeline of at least 10 years and the evolutionary approach is unlikely to cope with demand growth in a longer perspective.

A more intensive use of optical technology is currently the best solution for the long term future but requires a complete restructuring of the way networks are researched and implemented as optics are unlikely to provide the same flexibility as the electronic/software solution used in current networks.

Efficiency improvements in transport

Jesper Schramm, DTU Mechanical Engineering; Linda Christensen and Thomas C. Jensen, DTU Transport

Introduction

Transport of people, personal belongings and goods in private cars is fundamental to our modern welfare society and economic growth, and has grown steadily over many decades. At the moment it is not possible to point out a winning technology that will adequately replace fossil fuels in our present transport system, and most likely no single new technology will be able to cover the entire range of future transport needs.

The World Economic Forum suggests that the global transport sector will consume roughly 40% more energy in 2030 than it uses today [42].

In the WEO 2011 [43] central scenario, oil demand rises from 87 million barrels per day (mb/d) in 2010 to 99 mb/d in 2035. This net growth comes from the transport sector in emerging economies, for instance as the passenger vehicle fleet doubles to about 1.7 billion in 2035. A broad range of alternative technologies including hybrid, fuel cells and electric vehicles continue to advance but they are penetrating the markets only very slowly.

Driven by increases in all modes of travel, the World Energy Council expects that in 2050 the energy consumption of the transport sector will have risen by 80–130% above today's level [44].

In addition, the transport sector alone could consume more than one-third of global energy supplies, including more than half of all oil produced. Most of this demand is expected to come from regions undergoing strong economic and population growth: China, India, Russia, Latin America, and the Middle East.

Total fuel demand for all modes of transport will by 2050 have increased by up to 82% above the 2010 level. This growth will be driven mainly by trucks, buses, trains, ships, and aeroplanes [44].

Even with improved technologies and fuels it is expected that petroleum will retain its dominant share of the transport fuel market, and that transport GHG emissions will continue to increase, into the foreseeable future. Only large changes in economic growth or behaviour, with or without major policy interventions, could substantially cut transport GHG emissions. In 2050 petrol, diesel, fuel oil and jet fuel are still expected to account for up to 88% of the transport fuel market [44].

Alternative transport solutions range from fully electric vehicles to hydrogen-fuelled individual and mass rapid transit systems. Some of the solutions planned for the future have their roots in concepts and pilot projects being developed and tested today, but the everyday application of these innovative transport solutions may very well lie 40–50 years in the future.

Given these facts, the challenge for transport researchers and professionals will be to achieve dramatic efficiency improvements in fossil-fuel-based transport, if we want to maintain our current high level of mobility for goods and people in the years up to 2050. At the same time it is necessary to promote research and demonstration of new power train technologies to look beyond the demands of 2050. The following sections give an overview of the possibilities as they look right now.

This chapter focuses mainly on road transport, which is reasonable since this sector is by far the largest user of transport fuel. We must take into account, however, the fact that compared to road transport, sectors such as shipping and aviation have fewer possible solutions for reducing fuel consumption and CO₂ emissions. Biofuels are particularly important in helping these sectors to reduce their CO₂ emissions.

New Fuels and Vehicle Concepts

Motor fuels have been based almost entirely on crude oil for the last century. During the latest couple of decades we have begun to look at alternatives to these fuels, and at the same time the engines for traditional fuels have evolved towards more advanced and efficient types. Figure 24 compares Volkswagen Golf cars from 1976 and 2011. The power output from the engine has doubled – along with the weight of the vehicle – but at the same time the fuel consumption has fallen by 40%. Emissions in general, except CO₂, decreased by more than 90% in the same period.

The numbers reflect the intensive development in technology. This has been driven by factors like environmental and safety demands, but also by the desire for comfort and fun. Given a higher priority, fuel consumption could have been lowered much more through the same level of technological development. In the future, fuel economy and CO₂ emissions will receive much higher priority, and the sections below describes briefly how this can be achieved.

Figure 24

Comparative data for the VW Golf diesel from 1976 and 2011 [45].

	VW Golf VI diesel 2011	VW Golf diesel 1978
Displacement (l)	1.6	1.5
Max output (kW)	77	37
Torque (Nm)	250	84
Max speed (km/h)	190	144
Acceleration 0-100 km/h (s)	11.3	18
Kerb weight	1318	780
Fuel consumption (EU comb. l/100 km)	3.8	6.4
CO ₂ emission (g/km)	99	163
Particulate filter	yes	no



Internal combustion engines

Today two major types of internal combustion (IC) engines dominate: the spark ignition engine, more commonly referred to as the petrol engine, and the compression ignition or diesel engine.

Several factors have reduced the fuel consumption of cars based on IC engines. First of all, cars are increasingly based on diesel engines, which are more efficient (Figure 25 and Figure 26). In 1998 sales of diesel fuel for the first time exceeded the sale of petrol in Europe. Sales of new diesel passenger cars overtook new petrol cars in 2004.

Figure 25

Trends in diesel and petrol fuel sales in Europe [48]

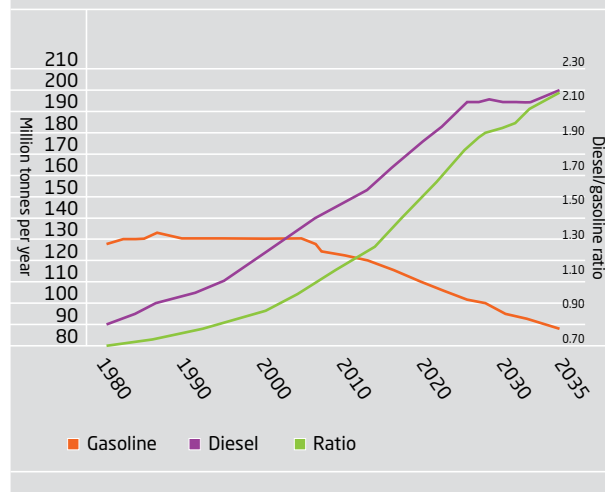

Next, electronic control combined with technologies such as common rail, piezoelectric fuel nozzles and improved turbochargers has improved the ability to switch between different combustion principles during operation and allowed the use of smaller engines for the same duty. The result has been simultaneous improvements in fuel economy and cuts in emissions. The current development target for both diesel and petrol engines is 50% efficiency in light-duty vehicles and even higher efficiencies in heavy-duty vehicles. [46], [47].

Biofuels

The advantage of biofuels is their potential to save CO₂ emissions, arising from the fact that the plant material consumes the same amount of CO₂ during growth as the vehicle emits during combustion.

Biofuels that could replace petrol in transport include bioethanol, biomethanol and biogas. For diesel engines, biofuels include pure vegetable oils, FAMES (fatty acid methyl esters, produced from vegetable oils), and HVOs (hydrotreated vegetable oils, which are more paraffinic). In recent years algae have also shown potential as a source of diesel fuel.

A diesel engine cannot run solely on unmodified vegetable oil, since cold oil is too viscous to flow through the fuel system. To preheat the oil, the engine has to start up on some other fuel – typically diesel – until the fuel system reaches the necessary temperature. Esterifying the oil avoids this problem. Esterification involves chemical treatment with

Figure 26

Diesel cars as a percentage of total sales of new cars in Western Europe [48]

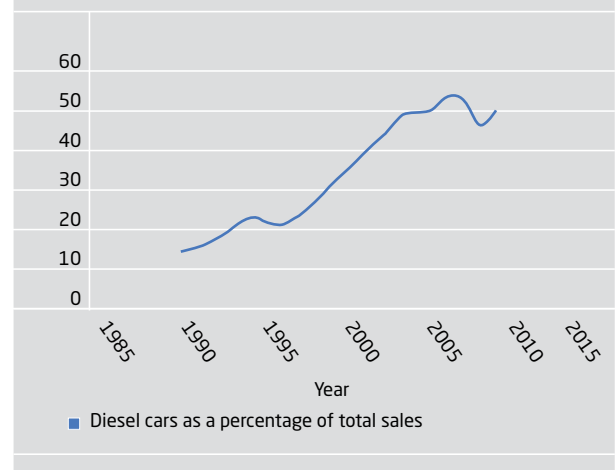

methanol, which typically is produced from natural gas. Methanol can, however, also be produced from biomass.

Vegetable oil esters and especially pure vegetable oils tend to dissolve in the engine oil, which must therefore be changed more frequently than normal. It therefore seems likely that other fuels will be more important for diesel engines in the future. An example of this is HVO, which due to its paraffinic nature behaves more like ordinary diesel. HVO is made by the catalytic addition of hydrogen to vegetable oil. Currently hydrogen comes mainly from natural gas, though in future it could be produced by electrolysis of water using renewable electricity. It is obvious that the more the biomass has to be chemically modified before use, the more expensive it becomes.

Bioethanol is traditionally produced through fermentation of biomass such as sugar cane and maize. This is not desirable, however, since the use of these food resources for bioethanol gives rise to ethical questions. A better long-term solution is “second-generation” bioethanol produced from waste biomass such as straw. The development of enzymes that can convert these cellulosic wastes into fermentable biomass has been an important step in the move towards second-generation bioethanol.

Methanol is typically produced from natural gas and coal, but it can also be made from biomass through a gasification step in which biomass is thermo-chemically converted into a synthetic fuel gas mixture which can then be catalytically converted into methanol. Other possibilities include the conversion of glycerine, a by-product of FAME production, into methanol.

Alcohols like methanol and ethanol are excellent fuels for spark ignition engines due to their high octane numbers. However, there are some concerns that have to be taken care of in the engine/fuel system. Today most car manufacturers produce FFVs (flex-fuel vehicles) which can handle all these concerns in vehicles that can run on various combinations of alcohol and petrol. However, since FFVs must be able to handle both fuels they cannot realise the full potential of the high octane number available from pure alcohol. A vehicle running only on pure alcohol would be able to achieve even better fuel economy.

Recently, researchers have attempted to run diesel engines on alcohols. At first sight this might seem a bad idea, since alcohols have very low cetane numbers. However, the addition of small amounts of “ignition improvers” can make it possible, and Scania buses in Sweden have run successfully on alcohol since the 1980s. The additives are expensive, but

in a world where fuel economy is increasingly the keyword, alcohol diesels may have a future. Further encouragement comes from the increasing demand for diesel fuel for road vehicles, as mentioned above, and the fact that the marine and aviation sectors have few other options to replace fuels based on crude oil, whereas road vehicles might switch to electric propulsion.

Natural gas (NG) is becoming an interesting fuel due to its quite large resources. NG is an excellent fuel in spark ignition engines, but it can also be used in compression ignition engine as long as small amounts of diesel are used to ignite the fuel.

The main fuel component in NG is methane, which is also the main component in biogas produced from the digestion of farming wastes or sewage sludge. Biogas also contains carbon dioxide, but this is fairly easy to remove. Methane from biogas can thus be used in vehicles designed for NG, as seen in some recent demonstrations [48]. Biogas has the largest carbon dioxide saving potential of all biofuels.

Algae represent a substantial new source of biomass for the potential production of engine fuels via several routes. Algae contain very high amounts of lipids, sometimes exceeding 50%. This oil, as with other vegetable oils, can be burned directly in modified diesel engines or converted to biodiesel. Other ways to use biomass from algae include gasification, fermentation, anaerobic digestion and hydro-processing. Apart from the high lipid content, other advantages of algae include very high growth rates and a diverse number of species that can thrive in a wide range of environments.

GTL, CTL and BTL

- GTL (gas to liquids), CTL (coal to liquids) and BTL (biomass to liquids) are generic names for processes yielding liquid fuels from solid or gaseous raw materials. Originally the terms were applied to synthetic diesel and petrol produced from coal, natural gas or solid biomass via gasification followed by Fischer-Tropsch reactions; this technology was pioneered in Germany during the Second World War and in South Africa during the Apartheid years. The resulting fuels are in many respects similar to crude oil based fuels, so they are easily used in combustion engines without big investments in infrastructure and vehicles. They are expensive to produce, however, and GTL – and especially CTL – produce large amounts of CO₂. The definitions of GTL, CTL and BTL have now expanded to include any liquid fuel produced from coal, natural gas or biomass, respectively.

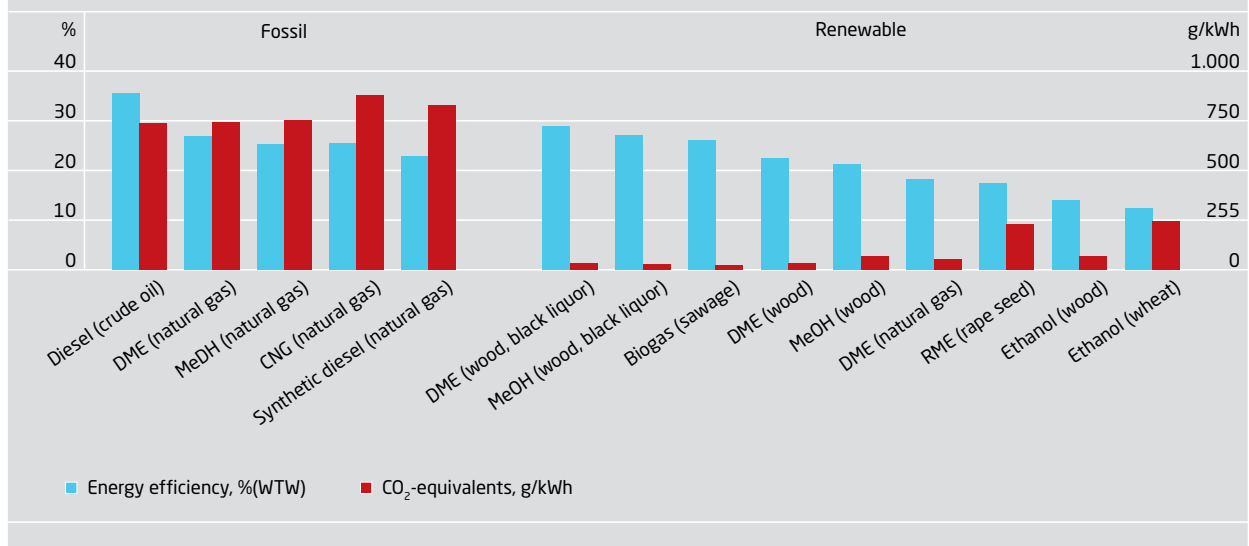
Figure 27Well-to-wheel (WTW) energy efficiency and associated CO₂ emissions from different fossil and renewable fuels. [49]

- DME (dimethyl ether) is an important energy carrier since it is an excellent fuel for diesel engines and burns with very low emissions of particulate matter. It can be produced from natural gas, coal and biomass. Production is similar to that of methanol, with adjustments to the catalytic process controlling the ratio of methanol to DME. Methanol and DME from biomass are among the fuels most effective at reducing CO₂ emissions, and at the same time the most energy-efficient renewable fuels. Figure 27 shows the “well-to-wheel” (WTW) efficiency and associated CO₂ emissions of different fossil and renewable fuels.

Fuel cell vehicles

Fuel cells for road vehicles are of the PEM (proton exchange membrane) type. These are generally fuelled by hydrogen, though other fuels are possible.

In the case of hydrogen, electricity is created through the low-temperature combustion of hydrogen in air. The fuel cell is coated with catalytic material which encourages hydrogen molecules to split into positively-charged ions and negatively-charged electrons. The hydrogen ions are transported through a membrane, while the electrons are collected by electrodes which feed power to the vehicle’s motor.

The obvious advantage of fuel cells is their high efficiency compared to IC engines. This is because the temperature is kept at around 70°C, and heat loss is therefore low. Figure

28 [50] shows the fuel economy of Honda’s fuel cell car [52] and other vehicle technologies. The data for USA vehicles are taken from US Environmental Protection Agency for 2009 [51]. A second advantage is the potentially low CO₂ emissions, since the hydrogen fuel contains no carbon.

There are, however, several barriers to the implementation of fuel cell vehicles (FCVs). First of all the necessary hydrogen infrastructure has to be developed, including low-carbon manufacturing routes: today hydrogen is produced from natural gas, giving rise to higher CO₂ emissions than vehicles fitted with combustion engines. Second, the materials required for the fuel cell catalysts may not be available in sufficient quantities. Third, the price of a fuel cell car is far higher than that of a conventional car, though this is to be expected with any new technology due to the limited market in the early phase of development. Finally, the working life of fuel cells is currently not satisfactory when compared to conventional engines.

Electric vehicles and hybrid electric vehicles

An electric vehicle (EV) is powered purely by an electric motor supplied with energy from a battery. The advantage with this type of power train is that the energy conversion is centralised at the power plant, where it can be carried out at optimum levels of efficiency and emissions. Moreover, EVs are not dependent on expensive liquid fuels, either alternative or petroleum-based.

Figure 28

Comparison of fuel economy (km/l petrol equivalent) for vehicles using various technologies, 2009. The performance of European cars appears somewhat higher than their US counterparts due to differences in the test procedures and car models [50].

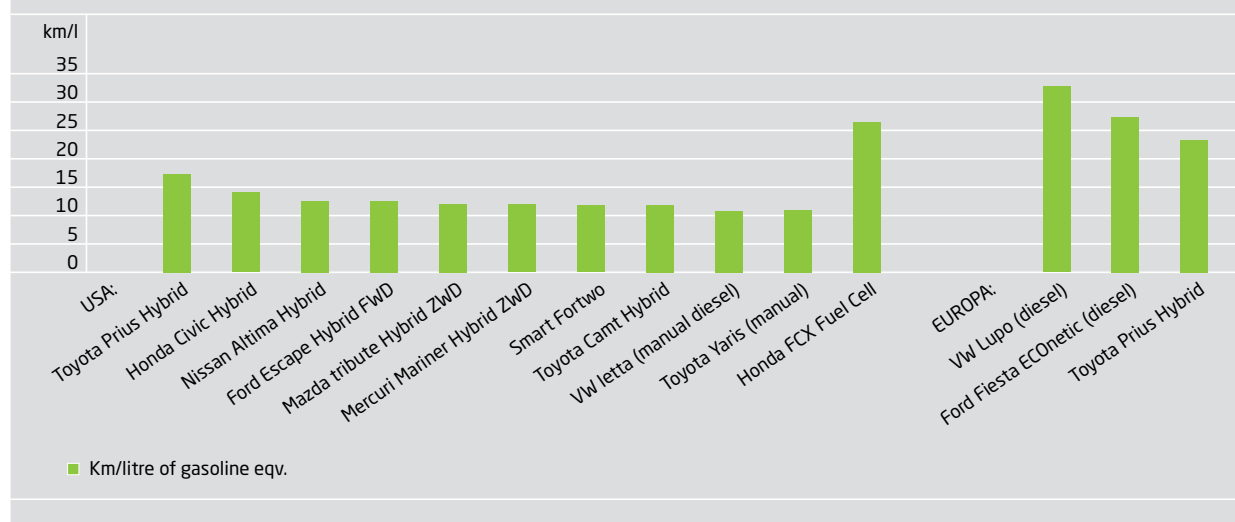

Estimates of EV efficiency and emissions are thus very dependent on the way in which power is produced. Denmark produces quite a high proportion of its electricity by sustainable means, in the form of wind energy, and so electric vehicles have gained particular interest there.

The implementation of EVs has several barriers to overcome. EV batteries have to be charged or exchanged at dedicated facilities analogous with conventional filling stations. As with other new technologies the development of the infrastructure is very expensive and the vehicles themselves are expensive too. The capacity of today's battery technology limits the operating range of EVs to about 100 km per charge, making EVs best suited for shorter urban trips.

An obvious way to extend the operating range is via a transitional form, the hybrid electric vehicle (HEV), which combines an electric motor with a small combustion engine. The engine charges the battery which powers the electric motor, and can also drive the wheels directly. Plug-in hybrid electric vehicles (PHEVs) add the flexibility of being able to charge the battery from the mains supply. Many experts see this form as a necessary transition to future EVs.

Scenarios for the penetration of electric vehicles based on economic models

In these years the automobile industry is competing on getting new EVs designed and produced from scratch to the market. In this respect, Denmark is better prepared than other nations. To promote EVs the Danish government decided not to impose the normal vehicle registration tax of 180% until 2012 – since prolonged to 2015 – and to provide drivers with free parking in downtown Copenhagen. These initiatives have accelerated the introduction of EVs in Denmark, and for this reason EVs receive special attention in the present report.

The need to charge EVs

The most important difference between an EV and a conventional car is that the EV has to be charged at home every night instead of being fuelled at a filling station, say every 500 km. More than half of the need to charge away from home can even be overcome when the driver is participating in different activities during the day. Only a few percent of the cars need to be charged en route.

The proportion of the EV fleet that needs to be charged while away from home depends on the travel range of the cars and of the number of family members sharing a car or cars. The common assumption is that a two-car family can manage an EV more easily than a one-car family because an EV that is not the sole vehicle does not need to be charged as often as it would if the family relied on it com-

pletely. However, more rigorous analyses [53] show that on average a two-car family has to charge both its cars away from home just as often as a one-car family where two or more adults share the car; only singles need to charge less when away from home. The analyses are based on data from the Danish National Travel Survey [54].

Of the cars with a 150 km range which belongs to families with two or more drivers, a little less than 10% of the cars being driven on a given day will need to be charged away from home. If the range in practice is only 120 km – perhaps because of speeds higher than the assumed 80 km/h, or the need for heating – around 15% of the cars being driven on a given day will need to be charged away from home. For singles the corresponding figure is only 11%. If the range falls to 80 km, 33% of the cars driven that day (29% for singles) will need to be charged away from home.

Analyses based on a dataset, which was collected by GPS from 350 one-car households over periods of 4–12 weeks [55], refute the theory that some families would often need to charge their EVs away from home while others would not. Over a two-week period, 82% of the one-car families with two drivers would need to charge away from home once or more, assuming their average range is 120 km. If the range is only 80 km, 95% of families will need to charge away from home at least once a fortnight.

In Denmark, 70% of all car-owning families have only one car. Thus if EVs are ever to gain a market share higher than the current figure of next to nothing, it will be absolutely necessary to establish some sort of charging infrastructure in public and semi-public areas.

The need for fast charging on long trips is much less: if the battery range is 120 km, only 3.3% of the cars on the road that day will need a fast charge, and for a range of 150 km the figure is only 2% [56]. But again, the AKTA data shows that over a longer period a much higher proportion of vehicles will need to fast charge. Over a month, only a little less than two-third of the one-car families could do without fast charging if the battery range is 120 km, and if it is only 80 km the corresponding proportion is only a little more than 50%. Very often drivers who need to fast charge will need to do this at least twice a day. Families who need to fast charge on more than 1–2 days a month are probably not potential EV customers.

The conclusion is that with an acceptable fast charging infrastructure at least 85% of Denmark's one-car families could be potential EV customers.

Demand for electric vehicles

An electric fleet of a certain size is necessary to provide a base from which to finance the necessary infrastructure. EVs are a new technology and much effort will be needed to shift consumers away from their familiar petrol and diesel cars. These facts alone will make it difficult to build up a large fleet of EVs in the short period up to 2020, unless the government actively supports their introduction. The infrastructure will not be profitable if there are only few electric vehicles and sales will be restricted if there is no infrastructure. There is a need for policy intervention if this vicious circle is to be broken,

The Danish government has supported electric vehicles by exempting them from the very high registration tax and the circulations tax. A number of other policy measures like subsidies for electric vehicles, exemption from excise duties on electricity, government support for infrastructure investments exist. In Denmark, the Government has also granted electric cars for ordinary families to use for three months both to boost the sales and to make consumers accustomed to the new technology. And soon electric vehicles will have free parking in the cities where parking is rather expensive.

To investigate the potential role of EVs DTU Transport has constructed an economic car choice model. The objective is to estimate future sales of EVs and assess the effect of various political initiatives. The current simple logit model is a development of the 2009 model used in a report published by Danish Energy Association and DTU Transport in 2009 and revised in 2011 [57].

Data for the car choice model comes from a Danish stated preference experiment carried out in 2010. In the experiment, people are presented with scenarios in which they

Table 1
Attributes in the car choice model.

Conventional vehicle	Electric vehicle
Purchase price	Purchase price
Fuel cost	Fuel cost
Top speed	Top speed
Driving range	Driving range
Carbon emissions	Carbon emissions
Acceleration	Acceleration
	Battery life
	Recharge at home
	Recharge at work
	Public charging poles

must choose between a conventional petrol or diesel car and an electric car. The “buyer’s” choice is influenced by characteristics such as price, driving range, top speed and options for battery charging, including charging at home, at work, at public parking facilities, and at battery switch or quick charging facilities (Table 1).

Each respondent is asked eight times to choose between a conventional car and an EV. At each choice, the two vehicles presented are assumed to be similar in all respects except for the attributes included in the survey; the basic assumption is that EVs comparable to conventional cars in terms of quality and size are available. Reference [58] describes the experiment in more detail.

The main limitation in any analysis of the EV market is the data: the number of observations relating directly to EVs is very small. The results of the car choice experiment are subject to considerable uncertainty, as is always the case with statistical models. However, DTU Transport believes

that the results obtained fall within a credible range, and researchers are now working to increase the amount of data available. It is worth noting that the car choice experiment only considered situations in which there were 30 or fewer quick charging stations, which is well below the number actually expected to be built in the near future.

The results from the choice experiment are the basis for a multinomial logit model. The output of the model is the market share for EVs and the attributes listed above are the inputs. The attributes are forecasted and the model thus projects the EV market share. Together with an estimate of total future cars sales, the number of EVs sold can be forecasted. The model is calibrated so that its forecast of 1,500 EVs sold in Denmark in 2012 matches expected sales figures. A figure of 25 fast charging stations was also used in the calibration, although this number hasn’t been fully reached yet.

Table 2

Projected values of the assumptions in the DTU car choice model for 2012, 2020 and 2030.

	Unit	2012	2020	2030
Conventional car				
Price including tax	DKK 1,000	269	260	248
Fuel costs	DKK/km	0.60	0.54	0.47
CO ₂ emission	g/km	127	114	99
Top speed	km/h	160		
Driving range	km	700		
Acceleration	seconds 0-100 km/h	12		
Electric vehicle				
Price including tax but without battery	DKK 1,000	198	163	150
Price of battery including tax	DKK 1,000	81	50	50
Electricity costs	DKK/km	0.26	0.24	0.22
Fast charging and battery exchange stations		0		
Distance to home charging	km	0.05		
CO ₂ emission	g/km	60	56	52
Top speed	km/h	130	130	160
Battery life	1,000 km	200		
Access to charging at work	%	90%		
Public car parks with charging facilities	%	80%		
Driving range	km	150	150	350
Acceleration	seconds 0-100 km/h	14		

All prices are from 2010 (€1 ≈ DKK 7.45)

Table 2 shows the forecast values of the various assumptions for 2012, 2020 and 2030. Since one of the main purposes is to analyse the effect of building fast charging and battery exchange stations, the baseline forecast assumes that the number of these is zero. The other assumptions are based on many sources; some relate to the characteristics of vehicles on the market today, while others (e.g. the prices of fuel and power) come from economic forecasts by the Ministry of Transport [59].

Table 3 shows the effects of these assumptions about charging stations on the size of the resulting EV fleet in 2020 and 2030.

Today, EVs are more costly to produce than conventional cars, but in Denmark they are exempt from registration tax until 2015; since this tax is so large, EVs are actually cheaper for Danish consumers. By 2020 EVs are assumed to cost the same to produce as conventional cars, due to economies of scale, but because of their high energy efficiency the registration tax will be relatively low. The batteries are assumed to improve a great deal; this is assumed to lead to lower costs up to 2020, and after 2020 to yield longer driving ranges for the same cost. The CO₂ emission figures are those seen by average consumers, based on the actual Danish power generation mix. Both types of cars are assumed to improve their energy efficiency a little every year.

With the chosen calibration and the assumptions from Table 1 the model predicts market shares for EVs of 0.8%, 2.0% and 6.2% in 2012, 2020 and 2030 respectively. This corresponds respectively to 0.07%, 0.8% and 3.2% of the total car stock if we assume an EV lifetime of 13 years. Using the current official Danish estimate for the future car stock made for the Infrastructure Commission [60] and the annual sales derived from this, predicted sales of EVs will be 3,500 in 2020 and 11,700 in 2030, at which time the Danish fleet of EVs will number 86,000.

Table 3

The projected size of the EV fleet in the seven scenarios covering different numbers of stations for fast charging and battery exchange.

EVs in the Danish fleet	2020	2030
Base case	19,000	86,200
15 fast charging stations	24,200	109,300
30 fast charging stations	30,100	135,300
50 fast charging stations	39,100	173,800
15 battery exchange stations	26,100	117,700
30 battery exchange stations	34,500	155,000
50 battery exchange stations	47,600	209,100

This is the base scenario without fast charging or battery exchange stations. Six alternative scenarios examine what would happen if various numbers of stations were to be deployed from 2012 onwards. The scenarios cover the existence of 15, 30 and 50 stations, respectively, and assume that these are either fast charging stations (20 minutes to charge to 80% of the battery capacity) or battery exchange stations (5 minutes for a fully charged battery). It is assumed that for consumers the utility of a fast charging station is only 75% of that for a battery exchange station, because of the extra delay and the 20% reduction in driving range before another charge is needed. Battery exchange stations therefore result in more EVs sold.

The assumed number of charging stations is far below the number of conventional filling stations today, but since most charging will take place overnight at home, or at work, this comparison is not the most relevant.

The number of stations has a moderate but significant effect on sales. 15 fast charging stations increases the stock by only 25% compared to the base case, for instance, whereas 50 such stations doubles the number of EVs. The main reason for the large increase in EVs from 2020 to 2030 is the projected increase in their driving range. The model has a weakness at this point since we would expect a large driving range to diminish the importance of the number of stations and vice versa, but this is not captured by the model.

The uncertainty of the results should be stressed here. The model relies on hypothetical conditions and the results are highly dependent on a fairly arbitrary calibration. One important condition is that there should be a sufficient supply of different types and sizes of EVs. If this is not the case, demand will be smaller.

Perspectives up to 2050

There is a general agreement between experts that no single solution exists for the transport demands of the future, and that we will have to focus on every possible option. Combustion engines fuelled by petrol or diesel dominate the market right now, leaving the alternative power train concepts discussed above to be implemented in the years to come – and the degree to which this will happen cannot be foreseen exactly. Alternative liquid fuels for combustion engines seem to be straightforward, thanks to their ability to use the existing infrastructure. According to the International Energy Agency (IEA), transport up to 2050 will rely heavily on combustion engines using these alternative fuels.

Figure 29
Background assumptions for the different IEA transport scenarios.

ETP Transport Scenarios

- Baseline - business as usual through 2050
- ACT - measures costing up to \$50/tonne; stabilization of CO₂
 - Efficiency measures dominate
- BLUE - measures costing up to \$200-500; reduction of global CO₂ to below 2005 levels with downward trend
 - BLUE Map - mix of biofuels, fuel cell vehicles (FCVs), and electric vehicles (EVs) for cars and light trucks in 2050
 - BLUE Conservative - no FCVs or EVs (only plug-ins)
 - BLUE FCV Success - FCVs dominate by 2050
 - BLUE EV Success - EVs dominate by 2050

Figure 30
Worldwide CO₂ emissions in 2050 according to the various IEA transport scenarios.

ETP Transport GHG Emissions
(well-to-wheels CO₂-equivalent emissions)

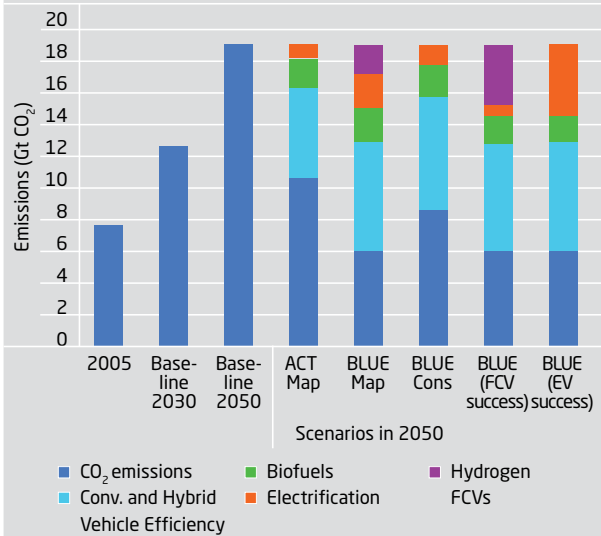

Figure 29 and Figure 30 show different IEA forecasts for CO₂ reduction from transport worldwide, with their background assumptions. The different scenarios range from conservative (Baseline – business as usual) to highly optimistic (BLUE EV and BLUE FCV). The most realistic scenario is probably BLUE Map, which represents the most versatile approach. Even in the most optimistic technology-

switch scenarios, however, up to 2050 our efforts to reduce CO₂ emissions will remain heavily dependent on efficiency improvements to today's combustion engine technology.

Figure 31
Yearly sales of different vehicle technologies as predicted by the IEA baseline and BLUE Map scenarios.

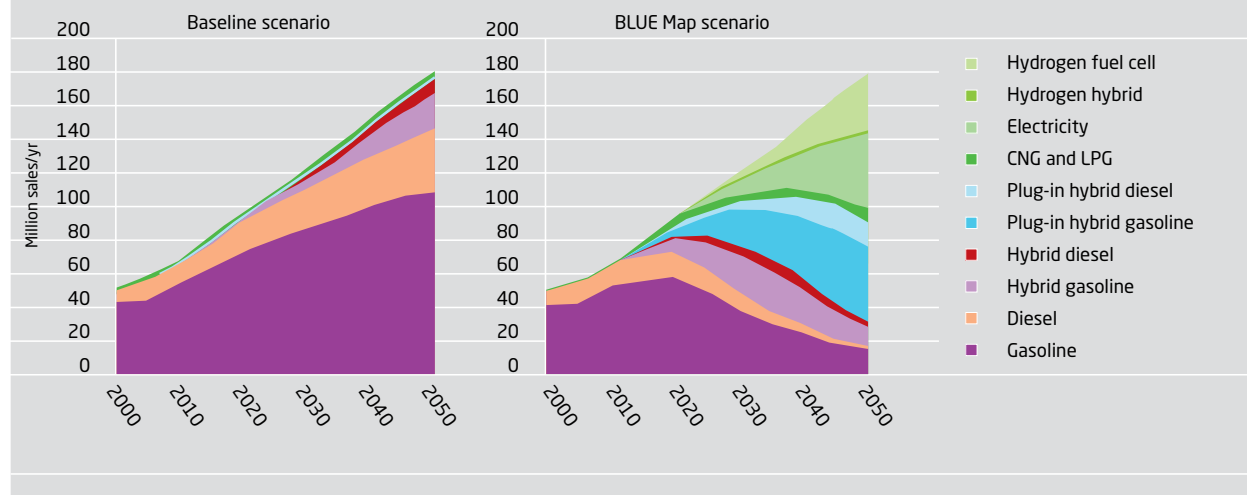

Figure 31 shows the vehicle technology mixes that follow the IEA baseline and BLUE Map scenarios. It is clear that PHEVs will be very important in the transition from today's vehicle technology to the EVs and FCVs of the future.

Conclusions

Transport of people, personal belongings and goods in private cars is fundamental to our modern welfare society and economic growth, and has grown steadily over many decades. Motor fuels have been based almost entirely on crude oil for the last century. During the last couple of decades engines built for traditional fuels have become more advanced and efficient; this has reduced fuel consumption by around 40% and emissions by more than 90%.

Only in the same time span have we begun to look at alternatives to fossil fuels. Biofuels such as biodiesel, bioethanol, biomethanol and biogas can replace petrol and diesel, and in recent years algae have shown a new potential for diesel fuel.

Natural gas is also becoming an interesting fuel due to its large resources worldwide.

GTL, CTL and BTL are liquid fuels produced from solid or gaseous sources. GTL and CTL are expensive to produce and not very CO₂-friendly, but they are easily introduced and need little investment in infrastructure and vehicles. DME is an excellent fuel for diesel engines. Methanol and DME produced from biomass are among the most CO₂-reducing fuels and at the same time the most energy-efficient renewable fuels.

Fuel cell vehicles (FCVs) are currently fuelled by hydrogen, but other fuels are also possible. There are, however, several barriers to the implementation of fuel cell vehicles. In particular, a hydrogen infrastructure needs to be developed.

Electric vehicles (EVs) have the advantage that energy conversion is centralised at the power plant where it can be done at optimum efficiency and emissions. EVs have to be charged at home, and also away from home when travelling longer distances. With an acceptable fast charging infrastructure at least 85% of the one-car families in Denmark could be potential EV customers. Range improvements resulting from better batteries are expected to create a large increase in the number of EVs in Denmark between 2020 and 2030.

The replacement of some conventional cars by EVs would cut Danish CO₂ emissions in 2020 by 0.16 million tonnes if there were 15 fast charging stations, increasing to 0.87 million tonnes with 50 battery exchange stations. This emphasises the very large CO₂ reduction potential of EVs. If all conventional passenger cars were replaced by EVs, the reduction would be 5 million tonnes of CO₂ or about 10% of total Danish emissions.

The hybrid electric vehicle (HEV) has two different power sources: an electric motor and a small combustion engine to extend the operating range. Plug-in hybrid electric vehicles (PHEVs) add the ability to charge the battery from the mains. Many experts see PHEVs as a necessary transition to future EVs.

The challenge for transport researchers and professionals will be to achieve dramatic efficiency improvements in modes of transport based on fossil fuels. At the same time it is necessary to promote research and demonstration of new power train technologies which can be used beyond 2050.

Renewable energy technologies

10A Wind energy efficiency improvements

10B Photovoltaics efficiency improvements

10C Bioenergy efficiency improvements

Wind energy efficiency improvements

Peter Hauge Madsen, Jake Badger, Flemming Rasmussen and Poul Sørensen, DTU Wind Energy

Introduction

A discussion of energy efficiency improvements as a tool for achieving a sustainable energy future will have a different character in the context of the development of a renewable energy technology such as wind energy than in the context of other technologies applied in, for example, industry, transport and traditional power generation.

The marginal cost of energy in the wind is nil, and the energy balance of a wind turbine is such that an operating period of 3–6 months [61] is sufficient to recover all the energy consumed in manufacturing, operation, transport, dismantling and disposal over the lifetime of the turbine. Wind energy's primary impact on global energy efficiency therefore lies in its degree of penetration – the proportion of energy generated from the wind – and how this affects the energy efficiency of other generating sources. These factors in turn depend on how well we exploit the wind resource, choose appropriate technologies and integrate wind effectively into the power system. In this chapter we discuss these issues for wind energy development with reference to selected research activities at DTU.

Accurate assessment of wind resources

The efficient exploitation of wind energy on a global scale requires a chain of knowledge about the wind resource. The start of the chain lies in gathering information about the wind climate across the globe. This provides a foundation for assessing the technical potential of wind power – though this potential depends heavily on many assumptions, the validity of which may change in time, due to changes in priorities (for example land use) and rapidly developing wind turbine technologies.

The IPCC Special Report on Renewable Energy Sources and Climate Change Mitigation [62] summarises estimates of wind's technical potential, revealing a dramatic range of values (19–125 PWh/y for onshore and near-shore). To address this uncertainty the Global Wind Atlas, funded by the Danish Energy Agency, will provide new improved datasets of wind climatologies which will be freely and publicly available. These climatologies will account for the effects of terrain at high resolution (<1 km, see Figure 32 for an example map), an aspect which is missing from existing studies with the result that the global wind resource has until now been underestimated. This underestimate is especially dramatic considering that wind turbines are typically placed in locally favourable sites. The new datasets will be used for aggregated wind resource

studies which energy planners can use to determine technical wind energy potential in areas of interest. These estimates will guide planning and policy decisions, and will be used in constructing scenarios for the future energy mix.

The Global Wind Atlas fits into a larger Clean Energy Ministerial (CEM) initiative for global mapping of renewable energy resources, coordinated by the International Renewable Energy Agency (IRENA) and building on the Global Earth Observing System of Systems (GEOSS) organisational structure with its conformity to open standards. Thus the integration of wind resource information into other energy sources, infrastructure and socio-economic data provides an efficient method to get an overview of the complex energy system. However, these datasets are not appropriate for precise local planning and site assessment. For that the next link in the chain is required.

The next link in the knowledge chain is mesoscale modelling, typically at national scale, accompanied by high-quality measurement campaigns. A mesoscale model is an atmospheric flow model of the kind typically used for daily weather forecasting. The Wind Atlas for South Africa [63] is a good example of such a wind mapping project. Mesoscale modelling first provides information at, typically, 5 km resolution. The products of the model are not simply mean wind statistics, but contain information about the wind direction distribution and direction-dependent information about the wind speed distribution at a number of heights above the ground. This aspect is important because it allows the connection to the next link in the chain, namely microscale modelling.

Via microscale modelling it is possible to apply the data from mesoscale modelling to estimate the wind conditions at a specific site. When the site is equipped with instrumentation it is possible to compare the modelling estimate with the actual measurements. This verification is important in improving the modelling methodologies; this gives us better estimates of wind potential, and hence improves the efficiency of wind energy deployment by minimised unexpected losses.

Improving the estimate of wind resource at microscale is the challenge addressed by the continuing development of DTU Wind Energy's WAsP software. WAsP can use measurement data and mesoscale model output, and has many internal models for calculating the expected annual energy production from wind turbines. Changes in orography (elevation) and roughness have large impacts on the vertical wind profile, as does boundary layer stability, i.e. how the temperature changes with height in the lowest several

hundred metres of the atmosphere. The latest version of WAsP includes an improved stability model [64]. Another development is WAsP CFD, in which the linear flow model within WAsP is complemented by computational fluid dynamics modelling, which improves flow modelling in complex terrain. All of these features aim to improve wind resource estimation at the siting decision stage.

The full chain is required to minimise uncertainty and risk and allow optimal exploitation in terms of planning, use of the resource, energy production and cost of energy.

Optimising wind farm layout

Efficient deployment of wind turbines is associated with the building of large wind farms to make effective use of the necessary infrastructure. Wherever wind turbines are installed in large groups, accurate prediction of wake effects within the wind farm becomes important. This is true not only for estimating energy production but also for predicting the mechanical loads on the turbines themselves, both during extreme conditions and in terms of everyday fatigue.

Wake modelling development is moving rapidly. One way in which wake models can be distinguished is by their different scales. Microscale wake models aim to model wake effects within wind farms and over a limited area downstream. One example of a microscale wake model being developed at DTU is FUGA. It is a very fast model with very good accuracy.

Mesoscale wake models, on the other hand, aim to model wake effects over longer distances downstream, relevant for example where there are several large wind farms located near each other (a wind farm cluster). The mesoscale wake model DTU is developing is, in fact, not a standalone model but a parameterisation within a mesoscale weather model. Accurate prediction of wake effects within wind farms and across wind farm clusters is essential for accurate configuration of wind turbines within a farm and of wind farms within a wind farm cluster, respectively.

Until now, the siting of wind turbines within a wind farm was based on a simplified optimisation which concentrates on the power output, while the load aspect was treated in a rudimentary manner only. A complete wind farm optimisation, however, needs to include both loading and production aspects. An optimum wind farm layout with respect to both energy production and fatigue lifetime requires a systems engineering approach which takes into account the

applied cost functions and constraints concerning factors such as grid infrastructure and cabling, foundations versus water depth, operation and maintenance. DTU has developed a wind farm topology optimisation methodology and tool, TOPFARM, based on detailed dynamic multiple-wake modelling. TOPFARM includes turbulence structure and wake meandering, plus full aeroelastic simulations of all the turbines in a wind farm and numerous cost functions. Such optimisation studies of wind farm layout, so far carried out only for offshore sites, show that the ideal wind farm should have a rather irregular layout compared to the regular rows of turbines which characterise most existing wind farms.

Trends in wind turbine efficiency and turbine development

Another aspect to be optimised for the efficient implementation of wind energy is appropriate design specification for the turbines themselves. Assessment of site design conditions is often based on measurement of wind and other design parameters, national design standards and – a relatively new approach – analysis based on computer simulations to optimise the accuracy of the assessment and the time required. The DTU software WAsP Engineering has been developed to assess site conditions relating to design requirements, based on calculation of expected turbulence intensity, turbulence spectra and 50-year extreme wind. These estimates are used to determine the correct turbine design type (according to international standards). The aim is to avoid using turbines that are either inadequately specified or over-engineered for the particular site, both of which would increase the cost of wind energy.

Figure 32

New DTU software calculates wind climate statistics and wind resources at high resolution over large geographic areas.

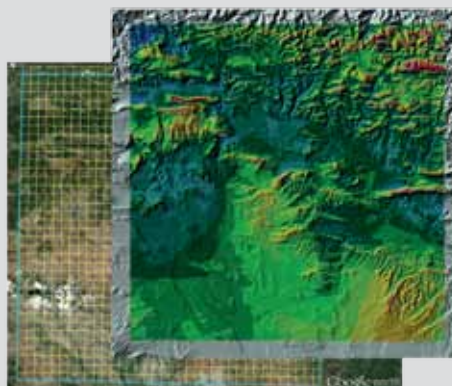

Much effort during the development of the wind industry has been devoted to optimising the cost of wind turbines, including the installation and operating costs. Pure cost optimisation in principle shows only the cheapest way to generate wind energy under the present conditions; it may disregard issues like energy efficiency in a broader context, and consumption of materials, if the long-term impact of these is not properly reflected in present-day prices. This means that wind energy could be more or less sustainable depending upon the technology and designs applied. As wind power increases its penetration and changes its role to become the backbone of a future secure sustainable energy supply, turbine technology will also change.

Wind turbines need to become more active and intelligent elements in the energy supply, and there is already a trend towards higher capacity factors and multivariable control. The idea is to develop concepts for smart wind turbines with significantly longer blades – and therefore lower wind speed ratings, so boosting energy production and capacity factor – than those seen today, without increasing the design loads and costs compared to a conventional turbine with the same rated power. Significant reductions in the cost of energy and in material consumption will be obtained through new intelligent down-rating strategies, both for isolated turbines and for complete wind farms. These will dynamically adjust their mechanical loads and power production according to market prices, combining active distributed blade load control with built-in passive load reduction via structural couplings in the blades. Inflow measurements from “look-ahead” LIDAR-anemometers will allow optimal control, and downrating will be considered part of normal operation, providing a power reserve for immediate feed-in when needed.

Wind power plant capabilities

Traditional power systems rely for their stability on ancillary services supplied by conventional power plants. These ancillary services include the basic ability to follow changes in demand, and control of reactive power to ensure that the voltage is maintained within acceptable margins. In the case of a large system disturbance such as a short circuit in the transmission network, tripping of a power plant or separation of a synchronous area into two or more areas, conventional power plants also provide a dynamic response which ensures that the situation is handled securely.

Before 2000, wind generation was dominated by wind turbines designed and controlled to provide maximum energy production, with the constraint that mechanical loads

remained within design limits. These operational objectives were typically obtained by autonomous controls in the individual wind turbines.

In the last decade or so, however, wind farms have gradually evolved from being “only” sources of energy to becoming power plants – that is to say they contribute actively to power system control and security. The first significant step in this direction was the world’s first large (160 MW) offshore wind power plant, Horns Rev, commissioned in 2002 (Figure 33). Kristoffersen and Christiansen [65] describe how the individual wind turbines and the main wind farm controller at Horns Rev ensured that the project met the first specific grid connection requirements for wind farms connected directly to the transmission network. These requirements included power control, frequency control, voltage control, dynamic stability, protection, communication, verification and testing. Since then, national grid codes have continuously added to these requirements, both in terms of increased ranges and through the introduction of new types of requirements.

The need for economic operation of power systems containing large amounts of wind power is a strong driver to make wind generation at all levels – from individual turbines, through single wind farms, to wind farm clusters – behave more like conventional power plants. Especially at times when wind generation is high and consumption is low, the ability to run the grid using a minimum of conventional power plants has a significant influence on operating costs and emissions, and so increases the socio-economic value of wind power. This is strongly facilitated by the ability to forecast wind energy production and to use wind power plants to supply ancillary services to the power system.

The accuracy of wind power forecasts has an important impact on the operation of power systems with large-scale wind power. Wind power forecasts are used in day-ahead forecasts to trade wind power on spot markets, but also at shorter timescales, down to real time, where they ensure the secure operation of the grid. Improving the accuracy of wind power forecasting systems is therefore of great value to power system operators.

Current systems can be improved by the use of mesoscale models to customise global weather forecasts for smaller geographical areas matching the power systems of interest. Another way to improve forecasts is through online monitoring of wind power generation, which enables forecasting systems to calibrate their predictions against reality.

Figure 33

Horns rev offshore windfarm, Denmark. Photographer: Heidi Lundsgaard. Copyright: Vattenfall A/S.



Offshore grids and power balancing

The present offshore wind power capacity is expected to develop explosively in the coming decades. According to the European Wind Energy Association (EWEA), the present 3.8 GW of offshore wind power in Europe is expected to grow to 40 GW by 2020 and 150 GW by 2030. To harvest this offshore wind power efficiently it is necessary to build new and reliable offshore grids.

This massive offshore development will require corresponding investments in the power grid infrastructure just to connect the offshore wind plants to the transmission grids on land. At the same time it is becoming increasingly feasible to expand the interconnection capacity between European countries as a way to develop an integrated, pan-European market for electricity. The development of high-voltage direct current (HVDC) technologies from the existing two-terminal connections towards multi-terminal HVDC grids has great potential. Whereas two-terminal connections must be either interconnectors or dedicated wind power transmission lines, multi-terminal technology will make it possible to combine offshore interconnectors with grid connection of wind power, and thus utilise the capacity of the offshore cables much more efficiently.

Interconnectors are already important to the socio-economic value of wind power, especially when they connect wind power to areas with large amounts of flexible hydro-power generation. The hydro capacity in Norway is already

connected to both Denmark and the Netherlands, and the potential to increase Norwegian hydro generation and storage capacity will make more interconnectors feasible. The EU TWENTIES project shows that the existing 29.6 GW of hydro capacity in Norway can potentially be increased by 16.5 GW, and that there is a potential for 10–25 GW of pumped storage capacity [66].

Wind power variability and storm control

Experience with existing large offshore wind farms has shown that the output power from the wind farm fluctuates much more than the sum of the outputs of wind turbines dispersed over a larger area [67]. This is true not only when the wind speed is below the nominal value (typically 13–15 m/s) at which the turbines produce their full rated power, but also when a storm front passes. There have been cases where offshore wind farms have shut down from full production to zero in just three minutes as a storm arrives. With the growth of wind power such variability may require more “spinning reserve” in the operation of future power systems; this in turn would mean that more conventional power plants would operate at lower capacities, where efficiency is lower and emissions are higher.

The reason for the increased wind power variability offshore is first of all that offshore wind farms concentrate large capacities in relatively small geographic areas [68]. When the same amount of wind power is dispersed over

larger areas, the correlation between wind speeds at the different turbines becomes smaller, and this results in significant smoothing of the fluctuations in total wind power compared to those from a single wind turbine. The planned development of large-scale offshore wind power is therefore expected to increase wind power variability significantly. In the case of storms, offshore wind power variability could even become critical to power system security, because sudden decreases in wind power production may exceed the capacity of the system's automatic frequency-controlled reserves. The wind power industry is therefore developing controls which ensure that turbines will shut down more gradually, thus reducing the disturbances to the total power system.

DTU Wind Energy has developed the simulation tool CorWind, which simulates wind power time series based on input files specifying the location of the wind power plants. CorWind takes account of the spatial and temporal correlation between wind speeds at different locations, and is therefore able to quantify the expected variability in the sum of wind power generation, which influences the need for reserves in the power system. CorWind simulations can also be used in grid planning studies, where the simulated wind power time series can be used in power flow studies showing power flow from wind generation to power consumption.

Conclusions

As we have shown above, wind energy can help to secure energy efficiency in power generation, and research results and tools are being developed that will increase the role of wind energy in the global energy supply. An important instrument is the development of wind turbine technology to reduce capital and operational costs. This has not been the emphasis in this chapter, though; instead we have focused on equally important instruments, namely making best use of the wind resource and available sites, adapting wind farm layout and technology to the increased exploitation of wind, and improving the interaction between wind farms and the power system. With these developments we expect that wind energy can become the backbone of the power system globally and play a major role in creating an efficient and sustainable power system.

Photovoltaics efficiency improvements

Peter Sommer-Larsen, DTU Energy Conversion and Storage; Francesco Roca, ENEA - Portici Research Centre, P.le E.Fermi, Località Granatello, 80055 Portici NA, Italy 2; Frederik C. Krebs, DTU Energy Conversion and Storage

Solar energy is by far the most abundant energy resource available to mankind. Solar power technologies are being deployed at increasing speeds but still, they exploit but a fraction of the resource available. This section describes the potential for photovoltaics to cover a substantial share of the global power production. Forecast for global installations, production prices, and levelized cost of energy (LCOE) are commonly in focus when the short term potential for solar power is evaluated. However the bottlenecks in terms of resources use, capital investments in production machinery, land and infrastructure will also become important as solar power technologies precede along their present path. We report the current understanding of the potential of the two technologies and give examples of resource use, energy payback time, energy return ratio, possible bottlenecks, infrastructure needs and the infrastructure particularities for a subset of the technologies.

The PV market in 2011 corresponded to 27.7 GWp new installations, which is a 40% increase in installation compared to 2010. The accumulated global capacity of PV is 67.4 GWp by the end of 2011. For CSP, figures for the accumulated capacity range from 1.3 to 1.9 GW.

CSP technologies appear to be more costly to install although the LCOE are the same as for utility scaled PV installations. None of the two technologies are expected to break even cost wise with fossil power production before 2020, but in the long run, particular PV has the option to become one of the cheapest sources of energy. Solar energy technologies are expected to cover 25% of global power consumption with PV being the major part of installations.

Photovoltaics

A variety of PV technologies exist, and few other renewable energy technologies boast such a portfolio of available technical options at different levels of maturity. This is one of the premises behind the expectation that the cost of PV will continue to fall for a long time.

Crystalline silicon solar cells (c-Si) and thin-film solar cells are well-established, yet roadmaps for these technologies still identify clear potential for improvements in performance and substantially lower production costs in the next decade.

In addition, emerging technologies promise better efficiencies, high-volume production and even ultra-low costs. These technologies include cheap organic solar cells, high-

efficiency multi-junction concentrator cells, quantum dot structures and other novel semiconductor technologies. Many forecasts for the development of the PV area exist but none holds. One example: the European Union's Strategic Energy Technologies Information Systems has recently published its 2011 Technology Map of the European Strategic Energy Technology Plan (SET-Plan). This publication reports prices for residential systems in Europe of 2,6 €/Wp and Levelized Costs of Electricity (LCOE) - over 25 years lifespan - of 0,16€/KWh in Southern Europe [69]. Now, today, in Denmark, residential system costs are as low as 1,7 €/Wp (owner self-mounted) and 2,1 €/Wp installed. Pricewise, PV costs are already dropping low of forecasts for 2020 in reports dating a few years back. There are no signs of deviation from this trend even though the drastic price reduction in the past two years is partly caused by a global production overcapacity and good availability of materials and electronic components.

Energy savings and solar cell co-generation

PV grid-connected installations are often divided into three classes: residential; commercial or industrial; and utility scale systems. Each segment typically operates with different electricity prices. Residential systems compare with utility prices for private householders; industry is offered lower prices or tax refunds; and LCOE for utility scale systems must be compared to average electricity generation costs. Residential installations have already reached grid parity in Southern of Europe and in countries with high electricity prices; e.g., Denmark where also the commercial segments will reach grid parity in few years [70].

Point-of-use harvesting of energy by solar cells is an option almost everywhere on earth and is often an important part of the net-energy balance for Zero-Energy buildings. Industry and commercial entities are often so energy intensive that the limited area for PV installations on e.g. production hall or office building roof-tops only allows the PV system to reduce energy costs. Subsidies for residential PV systems often allow for balancing the production and consumption. In Denmark; e.g., net-metering is used for systems under 6 kWp saving around 0.3 €/kWh and net production is bought by the utility for 0.08 €/kWh. Hence a small over-capacity is still profitable. When considering the energy performance frameworks for new low energy building, it is an open question whether PV systems should count in the net energy balance of buildings. The risk is that being sufficiently cheap; PV may oust long term passive energy improvements. The potential is however that buildings and factories become truly zero-energy entities

clearly reducing the loads on the utilities grids. A report written in Danish by Danish Building Research Institute [71] finds that reasonable passive energy improvements are not sufficient to meet the coming Danish framework for Class 2020 buildings and that a small PV system is indispensable in meeting the demands. In fact, a PV system of 6 KWp will nearly make energy improvements obsolete.

In production environments, off-grid point-of-use harvesting examples include de-salination plants - PV-powered reverse osmosis and water pumps. An interesting suggestion for a zero-energy entity concerns a polymer solar cell factory with point-of-use co-generation of solar thermal medium temperature heating for drying processes and PV electricity generation for driving printing machinery. These may be used to establish an autonomous solar cell factory where only the embedded energy of the raw materials for PV modules counts in the prediction of polymer solar cell production with as low as a single day's energy payback time! [72]

Utility scale PV

For PV to become a major power source all segments of installation must be utilized and the real challenge is the utility scale PV systems. Worldwide, there is much focus on utility scale photovoltaic power plants. More than 6000 power plants with a capacity above 200 kWp is e.g. included in Pvresources.com's database with a total capacity of approximately 10 GWp by 2010. In 2011-2012, more than 20 parks larger than 25 MWp have been completed or partly completed adding an additional 1.3 GWp of grid connected power. Many new thin-film and c-Si plants are planned or under construction and the typical plant capacity increases drastically: in the US a number of plants greater than 500 MWp are under construction; e.g., Desert Sunlight solar Farm (US) 550 MWp, and India, US and China is planning GWp plants. Several companies and industry associations update information on existing and planned projects [73]. A number of studies in the US have analyzed the cost of installing utility scale parks. Recently, NREL reported 2010 data and the report concludes that it is unlikely to reach price parity with other energy sources before 2020 but also that economy of scale matters for PV plants where regulatory costs, project transaction costs, and engineering design are fixed independent of system size [74]. The SunShot vision study operates with a 75% price reduction of PV systems by 2020 projected to make PV competitive with conventional sources and reach a LCOE of 0,06\$/Wp (2010 US \$). According to the study, PV technologies, could then meet 11% of contiguous U.S. electricity demand in 2030 and 19% in 2050 [75].

Figure 34 shows a breakdown of costs for a 187,5 MWp one-axis tracker park in 2010. The modules are only 43% of total costs. The study also calculates the modules to be 38% and 45% of total system costs for residential and commercial PV systems respectively. In order to reach the SunShot targets, all cost categories has to be reduced. The study concludes that installation materials costs may be reduced with 20%, inverter cost with up to two third, and by comparing US to the more mature German market, installation cost may be reduced with up to 50%. More than 60% of the full cost reduction will however come from more efficient module fabrication and increased module efficiency, which will still be the key factor.

Figure 34
Breakdown of cost/Wp for a 187,5 MWp one-axis tracker park in 2010 [76].

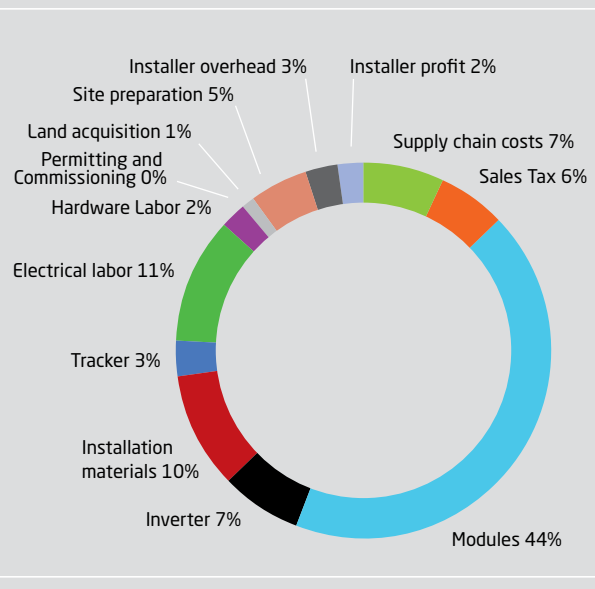

Box 1:**THIN FILM SOLAR CELLS**

Thin film science has grown world-wide into a major research area. It is no understatement to say in recent years the importance of coatings and the synthesis of new materials for industry have resulted in a tremendous increase of innovative thin film processing technologies fundamentally changed both condensed solid state physics and everyday life. Thin-film for PV modules recognized as 2nd PV generation directly deposited on large area substrates, such as glass panels or foils are cheaper to manufacture owing to their reduced quantity of material, less energy (<1.0-1.5 years energy pay back time) and handling costs because suited to fully integrated processing and high throughputs. Thin film solar cells have enhanced versatility because they offer a wide variety of choices in terms of device design, fabrication methods and a great variety of substrates (flexible or rigid, metal or insulator). Such versatility allows tailoring and engineering of the layers in order to match solar spectrum and to improve device performance in tandem and multijunction configuration. Thin film solar cells show also improved performance in indirect light and good performance with higher PV module working temperature and thin film

solar panels often have an actual output that's very close to the one they're rated for which make planning a solar power system much easier. Three major existing inorganic thin-film technologies of very high interest worldwide are available on the market: i) amorphous/microcrystalline silicon (TFSi - 8-12% module efficiency), ii) the polycrystalline semiconductors CdTe (15.3% module efficiency) and iii) CIGSS (the abbreviation of Cu(In,Ga)(S,Se)_2 - 15.7% module efficiency). Manufacturing technology from Oerlikon Solar, Applied Material, and Global Solar are widely used. During the polysilicon bottleneck peak between 2004 and 2009, the thin-film PV's market grew from 68 MW in 2004 to 2 GW in 2009 with a share of 18% of the total market with no signs of slowing. While thin-film shipments continued to grow to 3.7 GW in 2011, cheap crystalline silicon dominated the industry from 2010 onward and market share of thin-film PV dropped. In 2012 crystalline silicon PV prices drop by over 40% undermining thin film Solar PV technology sector but in the long term, the fundamental value proposition of thin-film solar - low costs, versatile and high speed production - will improve market penetration again.

Figure 35

First Solar El Dorado and Copper Mountain solar projects, Boulder City, Nevada, USA. 58 MW AC CdTe thin film modules.
Copyright: First Solar, Arizona, USA.



**Box 2:
Organic Photovoltaics - short energy payback time**

The polymer solar cell is a potentially very low cost and scalable technology that does not require elements with low abundance. The drawback is a likely limitation in performance linked to the main constituent which is organic/elemental carbon. Even if the Organic Photovoltaic (OPV) technology will never enable performance that approaches i.e. crystalline silicon it is likely to reach a performance similar to amorphous silicon. The question is then what other advantages the technology offers and what conditions must be fulfilled to take advantage of OPV: is it at all possible for a technology that is inferior in performance to compete with higher performing PV technologies such as crystalline silicon? The energy density per area will hence be moderate for OPV, which currently makes it unlikely that OPV is competitive when it comes to building integration. There is however no reason that OPV could not be competitive when considering production of energy in a power plant positioned where land mass and insolation is available. The technology enables ultrafast manufacture using printing and coating technology with a very low materials cost and thermal input.

Many of the steps can be carried out around room temperature or at around 100 oC making it highly suited for manufacture using only solar energy (both solar thermal and solar electric). This significantly impacts the energy payback time and it is possible to calculate the size and requirements of a manufacturing capacity of 1Gwp/day which is smaller in investment and footprint than a corresponding silicon PV manufacturing plant, possibly by as much as a factor of 10. A small example in the figure illustrates a manufacturing plant that is powered entirely by solar energy. This enables an energy payback time with the current technology on the order of a month and even if lifetime is short (1-2 years outside) this enables an energy return factor of around 20 which is competitive with other PV technologies. Projecting the increase in performance (lifetime and efficiency) places OPV far above any other energy producing method with respect to capital investment, carbon footprint and manufacturing speed.

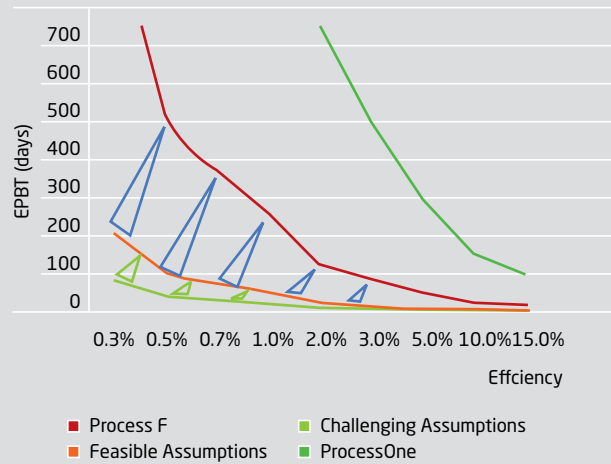
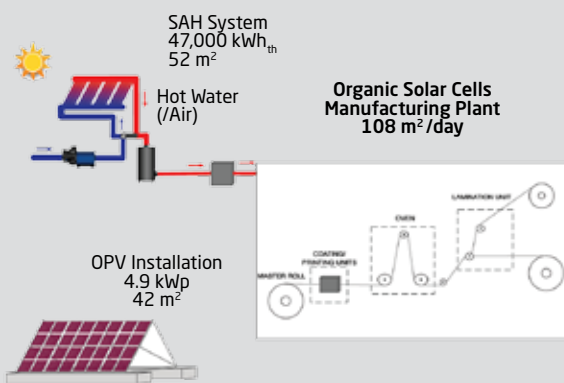

Land use

PV and CSP are among the renewable energy technologies with the highest energy production per area used. They compare favorably with wind energy but PV installations are inland. The option for using the existing building mass makes PV unique. Risø Energy Report 10 concludes that roof-top installations of PV can cover 15% of a major cities electricity demand and that 25% of all roof-tops could be utilized for electricity generation. Basically there is no additional resource or land use beside the PV system and the direct area occupied on the roof. Viewing a city as an energy source, we have added the assumption of 40% building coverage ratio and 25% suited roofs and an average roof-top slope of 30%. We have disregarded other areas of the city.

For utility scale installations of PV and CSP there are additional requirements for land and water for cooling or cleaning. The land use per average energy generation depends upon the capacity factor; For PV, the panels take up 33%-50% of the total area. For CSP, the collector coverage ratio is even lower. For both roof-top installations and utility scale systems, the area per kW capacity depends directly on module efficiency.

Table 4 shows the energy density as calculated based on the assumptions and examples given in this report. In addition we have put in our own assumptions on panel or collector coverage ratios. The data stated are gross energy densities. Comparing with other renewable energy technologies the energy consumption in the lifetime cycle should be subtracted. If so, today's technologies are reduced by a factor determined by the energy payback time (EPT) and the lifetime of the system. In 2020, EPT for PV is supposedly reduced to very low values. Some reports [76] operate with more than 50% difference between the gross and net energy densities for PV today. Even if the 2020 estimates for CSP are halved, they are still on the level of wind energy.

Table 4

Land use for PV and CSP. Extracted from data in referenced reports and project descriptions. Power conversion efficiency (PCE). Capacity factor (CF).

Technology	Technical specification	Panel or collector area / land area	Energy density GJ/Ha/y ¹⁾	Land quality / other resources
2012 reference				
PV roof-top	c-Si, 15% PCE	15% ²⁾	690	Roof
PV utility	c-Si, 15% PCE	33%	1530	Flat field
PV utility	Thin film, 12% PCE	33%	1230	Flat field
CSP utility	Through, CF 37%	25%	2800	Flat desert, water cooled
CSP utility	Tower, CF 63%	15%	2240	Flat desert, water cooled
2020 scenario				
PV roof-top	c-Si, 23% PCE	15% ²⁾	1050	Roof
PV utility	C-Si, 23% PCE	50%	3550	Flat field
PV utility	Thin film, 18% PCE	50%	2800	Flat field
PV Utility	OPV, 10% PCE	67%	2040	Field
CSP utility	Through, CF 60%	25%	4540	Flat desert, dry cooled
CSP utility	Tower, CF 67%	25%	3730	Flat desert, dry cooled

¹⁾ 15% system losses for PV. 1000 kWh/kW insulation for roof-top PV systems. 1500 kWh/kW for utility scale PV.

²⁾ Building coverage ratio x% suited roofs x roof slop correction

Bioenergy efficiency improvements

Hanne Østergård, Henrik Hauggaard-Nielsen, and Kim Pilegaard, DTU Chemical Engineering

Introduction

Biomass is the oldest source of energy exploited by mankind. Recently there has been a lot of debate about replacing fossil fuels with biomass. Certainly biomass has great potential, but although it is a renewable resource it is not unlimited. Thus biomass alone cannot solve the world's energy problems, though if used wisely it can be part of the solution.

Of the many issues relating to biomass that need to be taken into account, the most obvious is to evaluate the energy conversion efficiency of the complete cycle from production of biomass to delivery of the biofuel. Energy return on (energy) invested (EROI) is an important indicator here, since it relates the energy content in the biofuel to the energy required – both directly and indirectly – to produce it. Estimates of EROI for bioethanol from maize, for instance, are in the range 0.8–1.6 [77]. For comparison, the EROI of the fossil fuels which have powered our society for more than a century has decreased from about 100 to about 10 during this period, implying that the net energy service provided to society has decreased from 99 times to 9 times the energy input required to extract and process the fuel [77]. A primary energy source used for transport may require an EROI of at least 3 to provide the energy needed to run the transport infrastructure as well as the vehicles themselves [77].

Producing biomass at high yield requires fertiliser, the production of which is one of the most energy-consuming processes in the chain. This raises several problems in relation to greenhouse gas balance and resource use. The use of nitrogen compounds produced artificially by the Haber-Bosch process [78] releases nitrous oxide (N_2O) that might offset the positive effect on the greenhouse gas balance of the sequestration of CO_2 by plants [79]. Another important element in fertiliser is phosphorus (P), of which the world's commercially available stocks will eventually become scarce [80] and possibly depleted in as little as 50–100 years [81]. Phosphorus is essential for all living matter, is often the limiting factor in crop yields, and should be regarded as a critical global resource alongside water and energy.

To be able to continue to produce biomass efficiently it will be necessary to recycle the carbon and nutrients as much as possible. Recirculation of nutrients to soils to maintain fertility is especially important for those nutrients produced from essentially non-renewable resources such as phosphorus [81]. In our present urbanised society such cycles are broken, so that carbon and valuable nutrients are often not brought back to the soil. This threatens long-term soil fer-

tility and hence food security. The concept of emergy [84]²⁾, which distinguishes and measures the different qualities of energy derived from different sources, takes into account the use of both natural resources and resources from society in calculating solar energy required to provide a given product or service.

Production of biomass for bioenergy most often occupies land that could be used to produce other goods necessary to society, such as food, fodder or fibres, or to provide other ecosystem services. It is necessary to strengthen the development of ways to produce bioenergy from “waste” products, i.e. products not currently used by society or the environment. This includes household waste, organic waste from food production and manure from animal husbandry.

Below are examples of technologies which convert agricultural residues or energy crops into bioenergy and at the same time enable the recycling of nutrients. The use of resources by these technologies are compared in terms of EROI and emergy indicators. For a complete evaluation of these technologies, other aspects such as economic feasibility and environmental impacts like GHG emissions need also to be taken into account.

Efficiency of bioenergy technologies in a systems perspective

Fermentation (first- and second-generation bioethanol)

Bioethanol is a liquid fuel which very much resembles petrol and can therefore easily be used within the present transport infrastructure. The present commercially available first-generation (1G) technology for producing bioethanol is based on sugars from crops like sugarcane, wheat and maize, which compete strongly with food and animal feed. Much effort is therefore being made to develop economically feasible second-generation (2G) technologies using non-edible lignocellulosic material such as wheat straw and other agricultural residues.

There have been many studies of fossil energy use and GHG emissions from 1G bioethanol production, and requirements to cut GHG emissions are part of the EU regulation of sustainable biofuels [82]. Less commonly, 1G and 2G technologies are compared with respect to their resource use during the complete cycle from biomass production to delivery of the biofuel. This has been studied in a model based on wheat (Figure 36), using data from Danish organic and conventional agriculture and with emergy accounting to evaluate resource use efficiency [83].

²⁾ Emergy (spelled with an “m”) is a measure of available energy used in the past, which is different from energy available in the present. Emergy is measured in solar equivalent joules (sej) to distinguish it from energy available now, which is measured in joules [84].

Figure 36:

Supply of energy and materials needed for the production of bioethanol via first-generation (A) and second-generation (B) technology. Flows given by dashed lines are only considered in the scenarios that include recycling and use of co-products. DDGS means (Dried Distillers Grains with Solubles) and CHP (Combined Heat and Power). Figure adapted from [83].

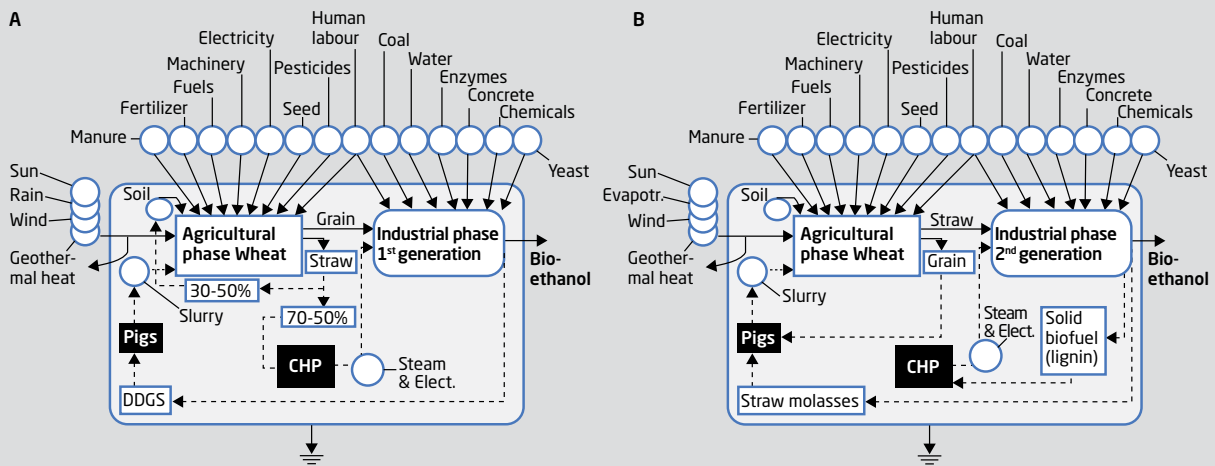

This study showed that the most resource-efficient way to produce biofuel is with 1G technology based on grain produced by conventional management of fertile land, using the straw for soil fertility and as fuel for combustion in the CHP (Figure 36A and Figure 37); the effluent from the bioethanol plant (DDGS) is used to feed pigs, whose manure is then returned to the land. This scenario is characterised by a resource use of $1.07 \cdot 10^5$ sej/J of bioethanol not much different from $1.25 \cdot 10^5$ sej/J which is required using the same technology but a biomass produced by organic management (Figure 37). Compared to organic management, conventional management uses, in general, 10–50% less resources (solar equivalent joules) to produce 1 J of bioethanol.

However, conventional management uses more non-renewable resources and purchased goods (relative to local renewable resources) than the organic system, even when co-products are recycled and used. For 1G (orange or green inner squares, Figure 37), the use of conventional rather than organic management on a specific soil type may more than double the ratio of use of non-renewable resources and purchased goods to local renewable resources (ELR). Only on fertile land with 2G technology, and using grain and straw molasses as fodder (green inner circles and dark blue outer circle, Figure 37), can conventional production nearly match the organic system in terms of this ratio.

Figure 37

Comparison of total resource use (measured as solar equivalent joules (sej) per joule of bioethanol produced) and the ratio between non-renewable resources and purchased goods to local renewable resources (ELR) for the production of bioethanol under 12 different scenarios. Each scenario is characterized by the chosen bioethanol technology (1G or 2G), the use of co-products (recycling or no recycling), crop management (conventional or organic) and soil fertility (fertile or less fertile).

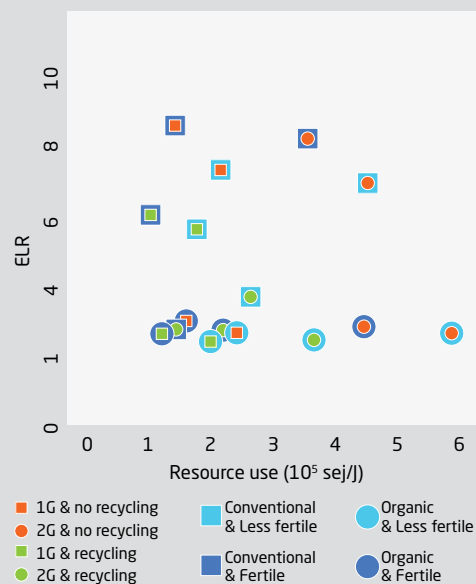

The same scenarios can also be evaluated on the basis of EROI. For the most resource-efficient management, i.e. conventional production on fertile soils with recycling, the EROI of 1G bioethanol is about 3.5. Without recycling of straw and use of DDGS, the EROI is only 1.3.

Thermal conversion (syngas and bio-oil)

Thermal conversion technologies use biomass as a raw material for the production of syngas and bio-oil in different proportions, depending on the technology used. In addition, a nutrient-rich material known as ash or biochar, depending on its carbon content, is produced as a co-product. Syngas and bio-oil can be used to generate energy, while the ash fraction enhances soil fertility and at the same time mitigates climate change by sequestering carbon in the soil [85].

Different conversion strategies yield different ratios of energy carriers to soil improvers. In general, the availability to plants of nutrients from ash varies and depends very much on the feedstock, the specific thermal conversion technology, the soil type and the crop [86]. The best way to proceed in future may be to optimise the performance of the system (Figure 38) as a whole, allowing small inefficiencies in each part of the process so as to create a cycle with optimum overall efficiency, as nature does [87].

Again it is important to consider the EROI of the full chain, from production of the biomass to the production of the bioenergy carrier. A study based on literature values and model results for the conversion of willow pellets has shown that EROI varies from 10 in high-temperature gasification to 5 for bio-oil produced via dedicated pyrolysis [88]. Between these two extremes is a low-temperature gasification process for which the EROI is around 7. For this and the pyrolysis process the residues can be used for nutrient cycling, whereas this is not the case for high-temperature gasification due to the risk of generation of hazardous organic pollutants such as polycyclic aromatic hydrocarbons (PAHs).

Anaerobic digestion (biogas)

Anaerobic digestion in biogas plants is a promising way to generate renewable energy in the form of methane, and also to improve short-term plant nutrient availability through the use of digested material as fertiliser [89]. This also improves the environmental performance of food production by reducing GHG emissions and the risk of nitrate leaching [90]. Anaerobic digestion is a robust technology able to convert a wide range of resources, including urban and industrial organic wastes and agricultural materials such as manure, crop and fodder residues.

Anaerobic digestion converts some of the original organic nitrogen to mineral nitrogen, which can improve the synchrony between soil mineral availability and crop demand, and so reduce potential nitrogen losses. The digested material also contains organic carbon, which potentially increases soil microbial activity. This in turn can immobilise mineral nitrogen and increase N_2O emissions if oxygen becomes depleted.

Nutrient allocation can be targeted more precisely if organic matter is removed from the mineral nitrogen by separating the residue into solid and liquid phases. The liquid fraction is low in fibres and high in potassium and mineral nitrogen. The solid fraction, rich in organic carbon and phosphorus, can improve the supply of phosphorus and preserve soil carbon. The solid fraction has even been shown to be a promising feedstock for low-temperature gasification, producing ash with a plant availability of phosphorus equivalent to that of superphosphate fertiliser [86].

Figure 38

Production of syngas, biogas and bio-oil from waste materials and agricultural residuals, with emphasis on recycling nutrients and carbon.

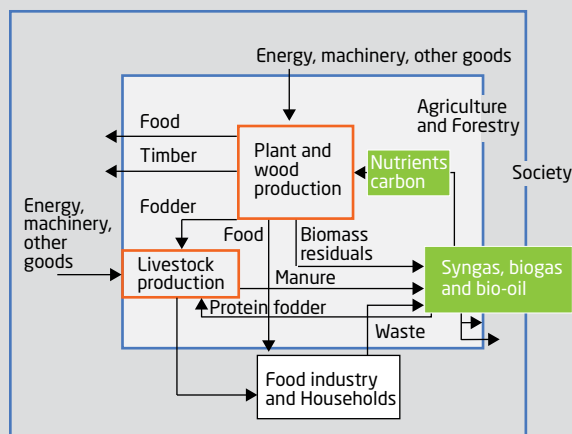

The energy return on energy invested (EROI) for biogas depends to large extent on the nature of the biomass and how the impacts of co-products are calculated. For example, will a proportion of the resources used to produce pigs be allocated to their manure when it is used in a biogas plant? How will resource use be distributed, for instance between biogas and fertiliser? A Danish organic cropping system has been developed which in addition to producing biodiesel from oilseed rape and biogas from grass clover mixtures also produces cereals, peas, oil cake and enough fertiliser to meet its own needs [91]. This system achieves an EROI of 11 before any credit is given for the co-products.

Conclusion

A prerequisite for biomass-based energy carriers should be that they support sustainable development. The EU has set up requirements for sustainable biofuels (1G) in Directive 2009/28/EU. These include requirements on reductions in GHG emissions compared to fossil fuels, and on the land used to produce biomass. They do not directly include requirements on energy invested, as measured by EROI, nor on recycling of nutrients. As commercial fertiliser is very energy-intensive and recycling would reduce the need for other fertilisers, more emphasis on recycling would contribute to the energy efficiency of bioenergy.

In this chapter we have considered various technologies with emphasis on how each can help to support the cycling of nutrients while also producing energy at the highest possible efficiency. In most cases the EROI is much lower than what we are used to from fossil energy production. However, if we combine different conversion processes and integrate the resulting energy production and nutrient flows into the agricultural management system we can expect better returns [91].

To characterize biomass for bioenergy, different chemical analyses are carried out. One of these is ethanol soxlet extraction where lipids and wax are extracted from the biomass. Photo: Klaus Holsting.



Energy efficiency improvements in energy supply and industry

Jens Abildskov, Jesper Ahrenfeldt, Ulrik Henriksen and Flemming Frandsen, DTU Chemical Engineering

This chapter deals with some aspects of:

- energy optimisation in industrial processes and optimisation of energy yield in the use of biomass for energy;
- energy savings in fluid separation processes;
- increasing energy yield in waste incineration;
- increasing energy yield in thermal gasification of biomass for heat and power.

We focus on optimising energy conversion and minimising energy use in industrial processes. As an example, consider the thermal conversion of a fuel (Figure 39).

The aim is to use as much as possible of the energy originally bound as chemical energy in the fuel to produce heat and power, while also creating the least amounts of solid residues and harmful emissions. That is an optimisation problem.

Examples are the gasification of biomass or the incineration of waste – both processes that require optimisation to maximise conversion while minimising emissions. The same principles also apply to processes which are not directly concerned with energy conversion. Examples of the latter include product purification by chemical means – for instance in a distillation column – and energy intensification, such as by drying biomass to increase its energy density.

DTU Chemical Engineering is active in optimising such processes in cooperation with Danish and international industry. Theoretical tools including thermodynamics,

chemical kinetics, heat and mass transfer and fluid dynamics are applied and tested at laboratory, pilot-plant and even production scales.

This chapter outlines the challenges in creating high-efficiency, low-energy processes for distillation, waste incineration, and heat and power production from the gasification of biomass.

Energy savings in fluid separation processes

Jens Abildskov, DTU Chemical Engineering

Distillation is a common separation process in oil refineries and chemical plants, accounting for 4% of all energy consumption in the western world [92]. Substantial reductions in the energy consumed by distillation are therefore desirable. This can be achieved via energy integration, for example by integrating separation and heat exchange within the same equipment. An example of such integration is diabatic distillation, which can cut the energy needed for distillation by up to 80% and operating costs by 60% [93]. The industrial application of diabatic distillation is still very limited, however, partly because it is difficult to find economic designs. This challenge is currently being addressed at DTU.

Global demands to reduce the CO₂ emissions and other environmental impacts of the process industries can be met in a number of ways, including new energy sources, more efficient processing and flue gas treatment – notably carbon capture and storage (CCS). One route to energy savings and CO₂ reductions is via energy-integrated processes running on renewable fuels or electricity from renewable sources.

Most conventional (continuous) distillation columns (CDiCs, on the left in Figure 40) operate adiabatically, which is to say without the transfer of heat within the column. Such columns are mounted vertically, with a reboiler at the bottom and a condenser at the top. In between are the adiabatic trays on which the separation takes place. In such columns, heat is supplied only to the reboiler and extracted only from the condenser. Energy efficiency in purification is commonly enhanced by energy integration between distillation columns and related equipment, based on heat exchanger networks and the technique known as pinch analysis [94].

To improve the efficiency of a single column, a heat pump can be used to integrate the reboiler and condenser, at the

Figure 39

In the thermal conversion of fuel to power, heat or other energy carriers, the trick is to utilise as much as possible of the energy originally bound in the fuel as chemical energy, at the lowest possible cost and with the least production of solid residues and harmful emissions.

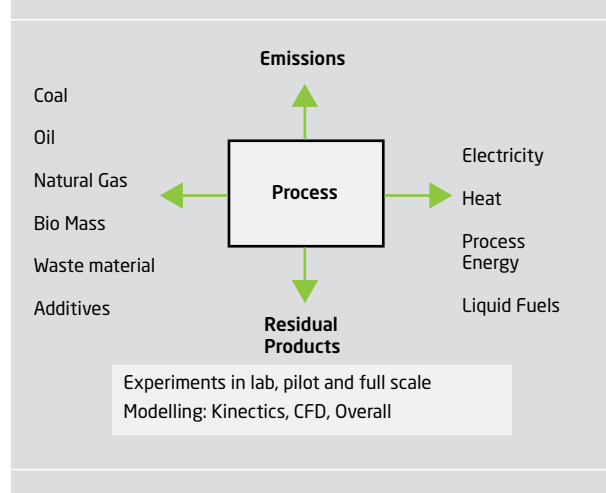
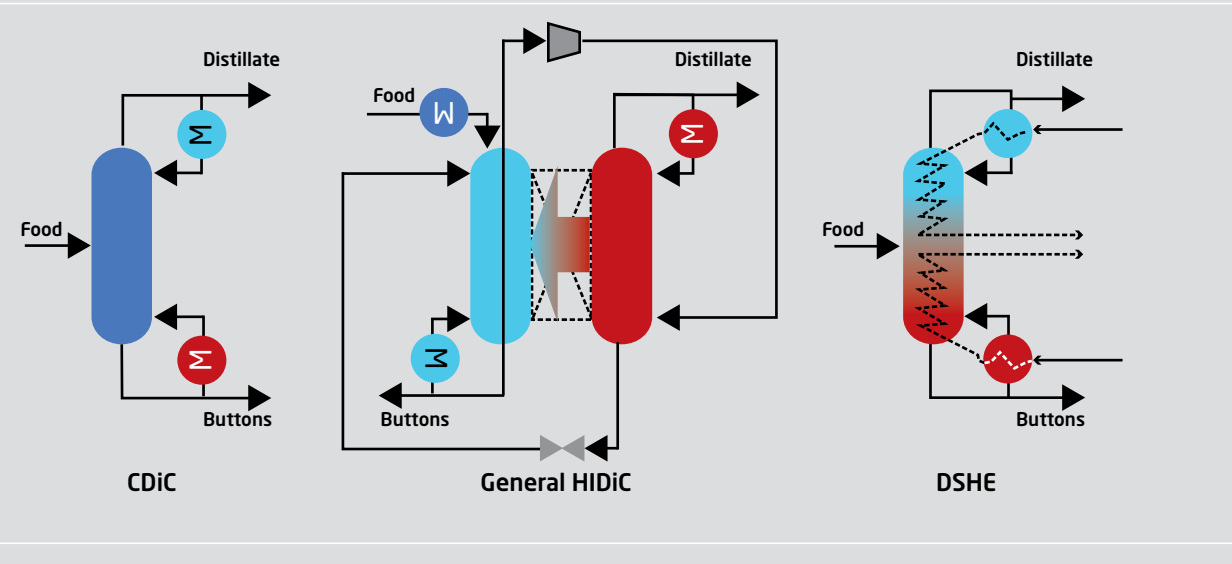

Figure 40

Adiabatic and diabatic distillation columns.



cost of more complex dynamic behaviour as explored theoretically and experimentally at the DTU Department of Chemical and Biochemical Engineering [95]. Internal heat integration in the separation of multi-component mixtures, such as in three- or four-product Petlyuk columns, can be achieved with a design having one or two dividing walls inside the column [96]. In a diabatic (“heat-integrated”) distillation column (HiDiC, Figure 40 middle) heat is exchanged between sections to reduce exergy degradation and increase second-law efficiency [97], [98], [99].

An alternative diabatic configuration explored in the literature is the direct sequential heat exchange column (DSHE, Figure 40 right). Since the energy saving potential of diabatic distillation (of the order of 50–70%) was demonstrated by Mah and co-workers in the late 1970s, research has intensified strongly due to the increased focus on environmental issues and the availability of faster computers [100], [101]. Research at the National Institute of Advanced Industrial Science and Technology (AIST, Japan) has even led to the construction of a diabatic pilot plant – resembling the HiDiC in Figure 40 – at the Chiba plant of Maruzen Petrochemical (Figure 41).

Yet the best-known vertical diabatic column designs [102], [103], [104] have seen only very limited industrial exploitation. This may be due to their high capital costs and the operating costs of the compressor which replaces the reboiler on the second column. The conventional vertical

(adiabatic) distillation column is also so well established that a “newcomer” such as diabatic distillation will not succeed unless it can demonstrate substantial reductions in operating expenditure, and capital costs too if possible.

Lately, as part of an EU-sponsored project [105] the Danish company Biosystemer ApS [93], [106] has calculated that the energy savings for a horizontal HiDiCs would be greater than those reported for vertical HiDiCs. Splitting the recti-

Figure 41

Maruzen Petrochemical's pilot-scale HiDiC column at Chiba, Japan.



Figure 42

Improvements in the net efficiency of coal-fired power stations over the last 40 years. These efficiencies are very much higher than the 24–27% reached by incineration-based WtE technology in 2012.

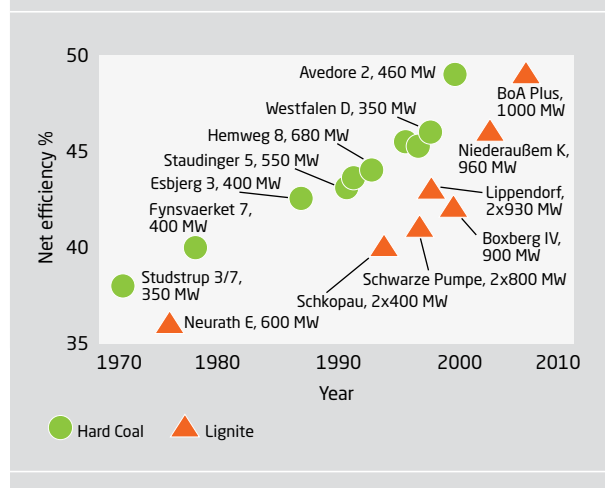

fier up into sections allows the use of several smaller compressors which in turn produce a smaller temperature increase, so the capital and operating costs should be less. Quantitative studies to validate these claims are ongoing.

Improving the electrical efficiency of incineration-based WtE plants

Flemming Frandsen, DTU Chemical Engineering

The vision is of future waste-to-energy (WtE) technology that will facilitate high-efficiency, clean and sustainable heat and power production through the thermal conversion of waste. Unfortunately, waste materials are typically difficult to use in terms of the pre-treatment required, the actual thermal conversion, and the handling of solid residues afterwards.

Waste materials contain large amounts of volatile heavy metals, alkali metals, chlorine and sulphur. To reduce the amounts of these that have to be removed from the exhaust gases, the final superheater steam temperature in WtE plants is usually kept below 450°C, which results in a relatively low electrical generating efficiency. The electrical efficiency of current grate-fired WtE units seldom exceeds 24–27%, compared to 46–48% for coal-fired power stations. There is thus significant potential for improvement (Figure 42).

The ultimate commercial success criteria is in the first place to develop a new generation of clean, flexible and highly-

efficient incineration-based WtE plants with electrical efficiencies above 30% (Figure 42). This will require coordinated innovation and R&D involving academia, power industry and boiler manufacturers.

The major drivers for the implementation of energy from waste are:

- independent, local, energy supply;
- lower CO₂ emissions;
- the EU Landfill Directive, which bans landfilling of biodegradable waste by 2016/2019.

The amount of waste produced links strongly to economic growth. Over the last 50 years, waste production has grown by 1–1.5% annually on a mass basis and is forecast to increase by 1.3% a year up to 2030. According to the Danish environmental authorities (MST), approximately 14 million tonnes of waste was produced in Denmark in 2010, of which 3.4 million tonnes was incinerated. MST foresees that in 2050 Denmark will produce 17.5 million tonnes of waste, of which 4.7 million tonnes will have to be incinerated. Thus 40 years from now there will still be a significant need for waste incinerators.

The Danish WtE market is mature, and new plants are needed mainly to replace old ones. At the same time there

Figure 43

Simulated gross electrical efficiency vs. steam temperature and pressure in incineration-based WtE plants. Higher efficiencies require increased steam quality (i.e. higher temperatures and pressures). With an air-cooled condenser, a gross electrical efficiency of 35% can be reached at 500°C and 130 bar [107].

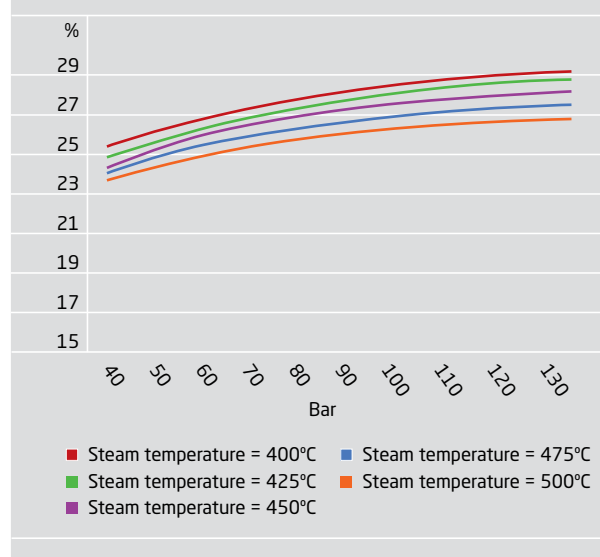

is a big market for the maintenance of furnace lines: Denmark currently operates 29 WtE plants, some of which have several furnace lines. Maintenance and extension of operating life for existing Danish plants is worth around DKK 500 million annually.

Internationally, the market for incineration-based WtE plants is significant. In the short term there will be a huge market for incineration-based WtE technology in the UK, and after that Eastern Europe is expected to increase its investment in WtE. Markets for incineration-based WtE technology are also well established in Japan, Korea, Taiwan, Canada, and USA, while China and Eastern Europe are rapidly emerging markets.

The key way to increase electrical efficiency is to raise the final temperature and pressure in the steam cycle. In current WtE plants these parameters are limited by deposit formation and corrosion.

Controlled release of flame-volatile critical elements

Most of the corrosive elements such as Cl, Na, K, Pb, Zn and S are released along the first section of the grate, i.e. in the front of the furnace, where ignition, pyrolysis and devolatilisation take place. The rear end of the furnace is characterised by the burnout of a low-chlorine char which produces relatively clean and much less corrosive combustion products. This phenomenon is used to advantage in technologies such as the Vølund SteamBoost™ (PCT/IB2006/053560), in which the flue gas is split into two or more fractions, one of which exhibits high heat flux and low chlorine content. An extra superheater section inserted into the cleaner of the flue gas fractions can operate at higher steam temperatures, thanks to the relatively non-corrosive nature of the gas, so increasing the generating efficiency of the plant.

The main parameters controlling the release of critical ash-forming elements, their secondary capture in the fuel bed and residual fly ash formation are:

- actual combustion temperature;
- residence time;
- stoichiometry (pyrolysis/combustion/gasification);
- fuel type (coal, biomass, waste fraction, blends) and particle size; and
- association of inorganic elements (organic vs. inorganic) in the actual fuel.

Release studies conducted by DTU Chemical Engineering indicate that it is possible to reduce the net release of metals, sulphur and chlorine by taking advantage of secondary interactions with char and ash inclusions in the fuel bed.

By reducing deposition and corrosion, and so allowing higher steam temperatures, this could increase electrical efficiency in WtE plants.

Less corrosion and better materials

When steel is exposed to an oxidising environment at high temperature, a scale made up of thermodynamically stable oxides will gradually form on the surface of the metal. This oxide layer acts as a barrier to further diffusion of oxygen to the metal. However, chlorine may be able to diffuse through the scale and react with iron, chromium and other metals in the alloys from which the superheater tubes are made.

The presence of SO₂ (or SO₃) in the flue gas may cause sulphation of alkali metal chlorides in the deposits, for example in the case of KCl:

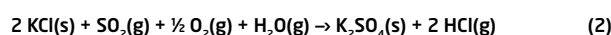
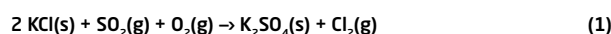

As a result of this sulphation reaction, chlorine or HCl released from the innermost layer of deposits, close to the heat transfer surface, may increase the corrosion rate through active oxidation.

Generally, waste fractions (with the exception of PVC) have low contents of K, S and Cl, but compared to other solid fuels such as annual biomass, chemically untreated wood chips and coal, the concentrations of heavy metals such as zinc and lead are much higher in several of the waste fractions fired. The presence of heavy metals such as zinc and lead in deposits, especially as chlorides but also as sulphates, is important. These elements form low-melting eutectics within the deposits, and this may result in severe corrosion as both the metal and the oxide scale dissolve in the melt.

Potential for increased energy yield in CHP through thermal gasification of biomass

Jesper Ahrenfeldt, DTU Chemical Engineering

The move from energy systems based on fossil fuels to those based on renewable and sustainable fuels involves a transition from a stock-based system to one based on flow. The new flow-based energy resources are to a large extent incompatible with the current energy infrastructure, and require a new and more complex infrastructure. Meeting future demand for electricity, heat, cooling, fuels and mate-

rials through highly limited and fluctuating resources will require carefully planned allocation of resources in a highly flexible system.

One of the few renewable resources that is capable of meeting all the needs mentioned above is biomass. However, biomass resources are scarce and will deplete rapidly if over-exploited, and it is therefore important to use these resources efficiently and with care. Gasification has proved a highly efficient way to use biomass on a small or medium scale for various purposes and in processes with one or several useful outputs. Gasification technology has received increasing attention in recent years thanks to its combination of flexibility and efficiency when converting biomass. This section reviews the most stable state-of-the-art gasification technologies and describes some of the possibilities for combined heat and power (CHP, cogeneration) through gasification of biomass.

Decentralised CHP based on wood gasification

Biomass gasification for CHP is a promising technology which provides an attractive alternative to biomass combustion, especially in small plants with power outputs below 10 MW. Gasification makes it possible to build decentralised biomass CHP plants at a scale that has not previously been efficient. Even in small plants, the combination of biomass gasification and a gas engine for CHP promises a biomass-to-power efficiency potential of 35–40%, which is high compared to conventional technology and which would make these plants very competitive.

The prospect of using biomass for decentralised CHP at high efficiency is appealing in a country like Denmark where district heating is widespread. It is not only applicable to new plants; there is also huge potential to convert existing biomass-fuelled heating plants and CHP plants with gas engines fuelled by natural gas.

Figure 44 is a map of all the heating and power plants in Denmark in 2004. It shows a substantial number of biomass-fired heating plants and decentralised CHP plants fuelled by natural gas; almost all of the latter use gas engines. Data from 2009 shows that more than 15 PJ of biomass and 8 PJ of natural gas was burned in heating plants, while decentralised CHP plants used 30 PJ of natural gas and 18 PJ of biomass.

The high power efficiency of small biomass gasification CHP plants based on gas engines provides a new opportunity to convert biomass-fired heating plants into efficient CHP plants. An advantage of such a conversion is that infrastructure and buildings are already at hand. Natural-

Figure 44

CHP and heating plants in Denmark, 2004.

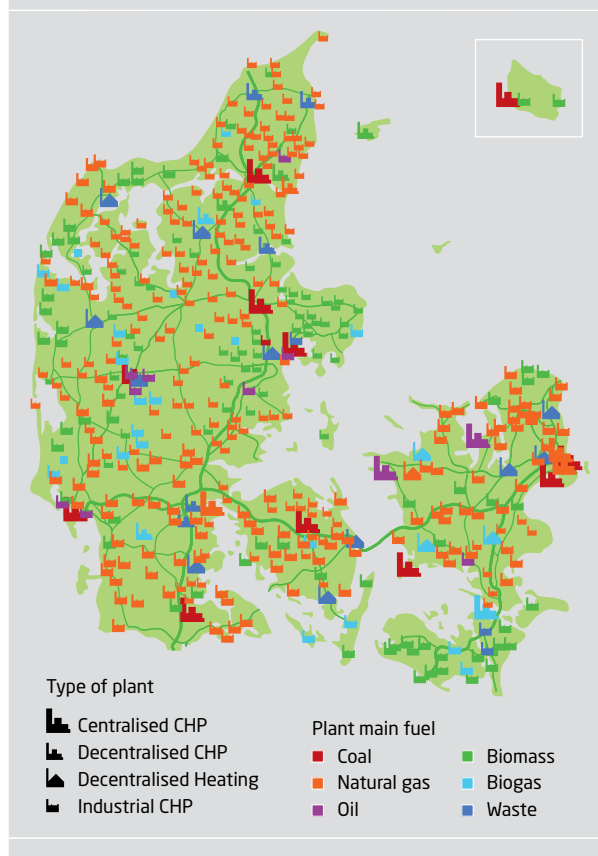

gas-fuelled gas engine CHP plants could be converted into either pure biomass plants or dual-fuel plants operating on producer gas, natural gas or mixtures of both. The main advantage in converting gas engine plants is that the engine itself – a major part of the investment for a new plant – is already installed.

Large-scale cogeneration with PYRONEER

The biomass resource is scarce and highly diverse, so energy technologies which can use a broad variety of biomass types are desirable. The PYRONEER [108] low-temperature circulating fluid bed gasifier is such a platform.

PYRONEER has been designed specifically to gasify biomass which produces large amounts of low-melting ash and which has proven difficult to convert in other processes. Examples include straw, manure fibres, sewage sludge and organic waste such as residues from industrial pectin production. The process is based on separate pyrolysis and gasification reactors (Figure 45), with a suitable

Figure 45

The PYRONEER gasifier is a low-temperature process designed especially for difficult types of biomass.

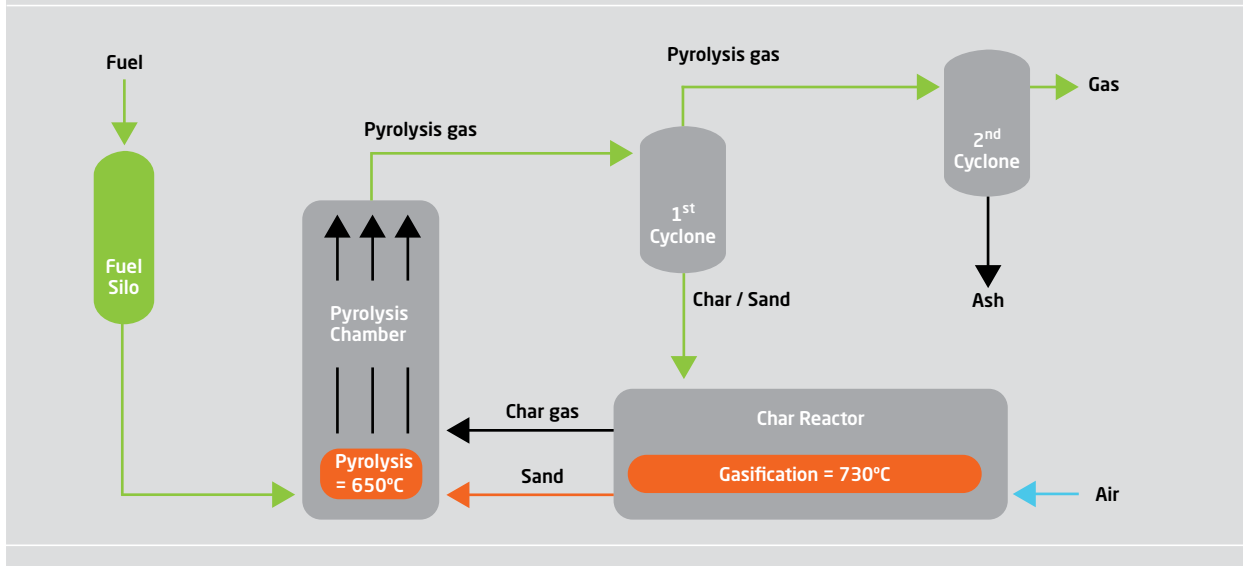

heating medium to transfer heat from the gasifier to the pyrolyser. The maximum temperature is kept to around 700–750°C, below the melting point of the ash components. This avoids sintering of the ash and subsequent fouling (e.g. from potassium) or corrosion (e.g. from chlorine), since the troublesome compounds leave the process in solid form deposited on ash particles.

A drawback of the PYRONEER process is that the gas has a very high concentration of tar particles, making it unsuitable for synthesis processes, fuel cells and gas engines. In its present form, PYRONEER is therefore used in cooperation with large power plants, where the PYRONEER gas can be co-fired into conventional furnaces for efficient production of electricity and district heating. In Denmark such a setup has been constructed by DONG Energy in Kalundborg, where a 6MWt PYRONEER will gasify straw and supply the resulting process gas to unit 2 of the 1,000 MW Asnæs-værket coal-fired power plant. If this trial with straw is successful, other difficult types of biomass will be tested. Operation began in March 2011 and the project will finish in 2013, to be succeeded by a full-scale plant. The first phase where the produced gas was burned in a flare has been successfully ended and the second phase where the gasifier is being integrated with a one of the power plant boilers is initiated [108]

PYRONEER is a very scalable concept, with potential plant sizes of 5–100 MW depending on the fuel. There are practically no limits to the types of fuel that PYRONEER can convert, as long as particle size is kept low (3–4 mm) and water content is limited (<30 wt%). Successful operation on two different types of straw, chicken manure, two types of pig manure, two types of degassed manure residues from biogas plants and one type of wood have been demonstrated on a small-scale PYRONEER at DTU. These fuels had ash contents as high as 44 wt% (dry basis) and high contents of potassium, chlorine and phosphorus.

In addition to using troublesome and marginal biomass resources, the PYRONEER design has a series of additional selling propositions. These include low construction and maintenance costs due to its simple and robust design, high scalability, and avoidance of toxic PAH compounds (polycyclic aromatic hydrocarbons) in the solid residue.

PYRONEER's ability to suppress PAH production by operating at low temperatures opens up potential uses of the ash fraction that might otherwise be prohibited. The ash fraction includes some organic carbon and nutrients, especially phosphorus. Recycling it would significantly increase the long-term sustainability of the process and could also improve the facility's life cycle assessment and overall carbon-balance.

Conclusions

DTU Chemical Engineering is very active in energy-optimised processes such as integrated distillation processes using internal heat sources to minimise the cost of operation, and maximising the electrical efficiency of combustion-type WtE plants.

There is significant potential to optimise energy use in fluid separation processes. Distillation accounts for about 4% of all energy consumption in the western world, so there is a huge desire to reduce its energy consumption. One way to do this is through thermal integration and the use of internal heat sources, for instance by using heat taken from the condenser to supply the reboiler instead of relying on an external source. Such processes have been demonstrated at pilot scale but have been slow to take off commercially, perhaps simply because of engineers' conservatism.

Waste typically contains a significant fraction of flame-volatile ash-forming elements which may cause deposition and subsequent corrosion in waste incinerators, depending on the feedstock and process conditions (time, excess air, mixing, flow, residence time etc.). Due to the chemically aggressive nature of the ash in waste, these plants operate with electrical efficiencies of around 24–27%, which is much lower than the 46–50% obtainable in coal-fired power stations. There is therefore significant potential to improve the electrical efficiency of such plants.

Gasification plants have relatively high electrical efficiencies and can handle wastes that are challenging for conventional combustion processes. They also offer significant potential for increased energy utilisation, mainly in relation to the handling of ash. There remains the issue of scaling up the existing small-scale gasifier demonstration plants to sizes suitable for straw combustion (20–50 MW) and ultimately to utility-scale units (100–500 MW).

Gasifier gas may also be used to produce liquid fuels, but that will require optimisation with respect to soot formation, which is another subject of importance in this technology.

Figure 45A

PYRONEER has been designed specifically to gasify biomass which produces large amounts of low-melting ash and which has proven difficult to convert in other processes. Examples include straw, manure fibres, sewage sludge and organic waste such as residues from industrial pectin production.



Nuclear energy efficiency improvements

Bent Lauritzen, Erik Nonbøl, DTU Nutech; Riitta Kyrki-Rajamäki, Lappeenranta University of Technology, Finland

Introduction

Nuclear energy is a major source of carbon-free electricity. In Europe it is the largest single source of baseload electricity production that does not emit greenhouse gases, and worldwide it constitutes approximately 14% of all power generation. At present, nuclear energy is almost entirely used for generating electricity.

Nuclear energy has the potential to contribute even further to the decarbonisation of society, through expansion of its share of power generation and through non-electrical applications. The latter include process heat for industrial applications and desalination, and the use of nuclear heat as well as electricity to produce alternative energy carriers such as hydrogen and biofuels for transport. Another application of nuclear energy is ship propulsion; naval ships and civilian icebreakers use nuclear energy to provide long operating periods without the need for refuelling.

In nuclear fission, uranium or other heavy elements are split into fragments, releasing huge amounts of energy. This means that nuclear fuel has a very high energy density: replacing a typical 1,000 MWe nuclear power plant with, say, a coal-fired power plant would require the mass of fuel to be increased by a factor of more than 100,000. Replacing the same nuclear plant with wind energy would typically require several thousand wind turbines. The high energy content makes nuclear suitable for large-scale generation of electricity even in countries which do not have own fuel resources because the effort of transporting nuclear fuel is minimal. Due to the high capital costs nuclear power is predominantly used for baseload electricity. Nuclear energy being essentially CO₂-free contributes to reducing greenhouse gas emissions. As uranium resources are abundant and available from politically stable countries around the world, nuclear energy also can be a key element in energy security with reduced dependence on imported hydrocarbons, as well as providing an economically competitive alternative to renewable energy. However, important challenges remain on key issues such as the safety of nuclear installations, radioactive waste management, non-proliferation and public acceptance. At a time when nuclear power was already controversial in many countries the Fukushima Daiichi accident in Japan following the 2011 Tohoku earthquake and tsunami off the Japanese Pacific coast, further reduced public confidence in the safety of nuclear energy.

Electricity production from nuclear can be expected to grow in the future. In the Blue Map scenario of the IEA's 2010 Energy Technologies Perspective nuclear capacity will reach 1,200 GWe by 2050, making nuclear power a major

contributor to cutting energy-related CO₂ emissions [109]. Such growth would require nuclear new build at a rate of approximately 20 GWe/y in the 2020s, increasing to more than 40 GWe in the 2040s, which is twice the growth rate observed before the Fukushima accident [110]. Large-scale deployment of nuclear power will only happen, however, if the technology can demonstrate improved safety, successful waste management and, especially in the USA and Europe, improved economics [111].

Current technology

Globally, nuclear power is employed in 31 countries with a total installed capacity of 370 GWe. Most of the current power reactors were constructed in the late twentieth century and constitute an important source of energy in countries with limited domestic resources of fossil fuels. Especially in Europe, the USA and Japan, the expansion of nuclear power accelerated under the influence of the oil crisis in the 1970s. Following the accidents at Three Mile Island (Pennsylvania, USA) in 1979 and at Chernobyl (Ukraine) in 1986, however, nuclear power faced stagnation, especially in the USA and western Europe, while expansion continued in the Far East, especially Japan and South Korea.

While a few countries (Germany, Switzerland, Belgium) have adopted a policy of phasing out nuclear, other nations are expanding their existing nuclear power generation, in particular in China, Russia, India, South Korea and countries in eastern Europe, and other countries in Asia and the Middle East plan to introduce nuclear power [112]. In 2012 the USA launched the first new nuclear power projects since the Three Mile Island accident by granting combined construction and operating licenses (COL) to four units at two locations.

Almost all operational nuclear power reactors are of the thermal neutron type, classified according to the neutron energies involved in the fission process. Of these almost 80% are light water reactors, the class which constitutes pressurised and boiling water reactors (PWR, BWR). Other thermal reactors include the pressurised heavy water reactor (CANDU) and gas cooled reactors (GCR). The Soviet-developed RBMK reactor, which was used at Chernobyl, is now only deployed within Russia as RBMK reactors elsewhere in eastern Europe have been closed. Only a few fast neutron reactors, in which the chain reaction is maintained by fast or energetic neutrons, are in operation today, the largest being the 600 MWe BN-600 reactor unit at Beloyarsk in Russia.

Fuel cycle

Two options in principle exist for the nuclear fuel cycle. One is the so-called “once-through” or open fuel cycle, in which the spent fuel discharged from the reactors is treated as waste targeted for geological disposal. The other is the closed fuel cycle, in which spent fuel is reprocessed and the plutonium and unused uranium are recovered. The recovered plutonium is mixed with depleted uranium to produce mixed oxide fuel (MOX) which can be used in light water reactors. Approximately 2% of the world’s nuclear fuel production is currently based on MOX [113].

The advantage of reprocessing spent fuel is better utilisation of the uranium resources, with the bonus that the radiotoxicity of the spent fuel is greatly reduced. Reprocessing plants exist in France (La Hague), UK (Sellafield), Russia and Japan. However, reprocessing is expensive, and with thermal reactor technology the limited improvement in fuel economics does not in itself justify adding to the existing reprocessing capacity [114]. In contrast, using the recovered plutonium to fuel fast breeder reactors can dramatically increase uranium utilisation, substantially reducing the need to mine uranium ore.

An intermediate step in reprocessing spent fuel is the production of almost pure plutonium which could be diverted to make nuclear weapons. To ensure non-proliferation, a mechanism to detect and prevent the diversion of even

small amounts of plutonium should therefore be in place, or alternatively, a fuel cycle should be developed in which plutonium is not extracted as such but mixed with minor actinides making it unsuitable for weapons production.

Both the open and closed fuel cycles ultimately require a final repository for spent fuel or high-level waste. The preferred option is deep geological disposal, such as in a stable rock formation several hundred metres below the earth’s surface, but no country has yet established such a facility. Finland and Sweden, however, are preparing deep geological repositories that are planned to be commissioned in 2020 and 2025, respectively (Figure 46) [115].

Energy efficiency

Improving the energy efficiency of nuclear power plants has traditionally not been an important goal in itself, in part because of the low cost of uranium compared to the overall costs of nuclear electricity generation. The thermal efficiency of second- or third-generation nuclear power plants based on light water reactors is typically around 33% [116], which is low compared to fossil-fuel thermal power plants and even those burning biomass. However, for existing nuclear power plants the emphasis has been on competitiveness through minimising the overall costs. The economics of nuclear generation are dominated by plant construction costs, which typically account for 50–65% of

Figure 46

Timeline for planned geological disposal of nuclear waste [115].

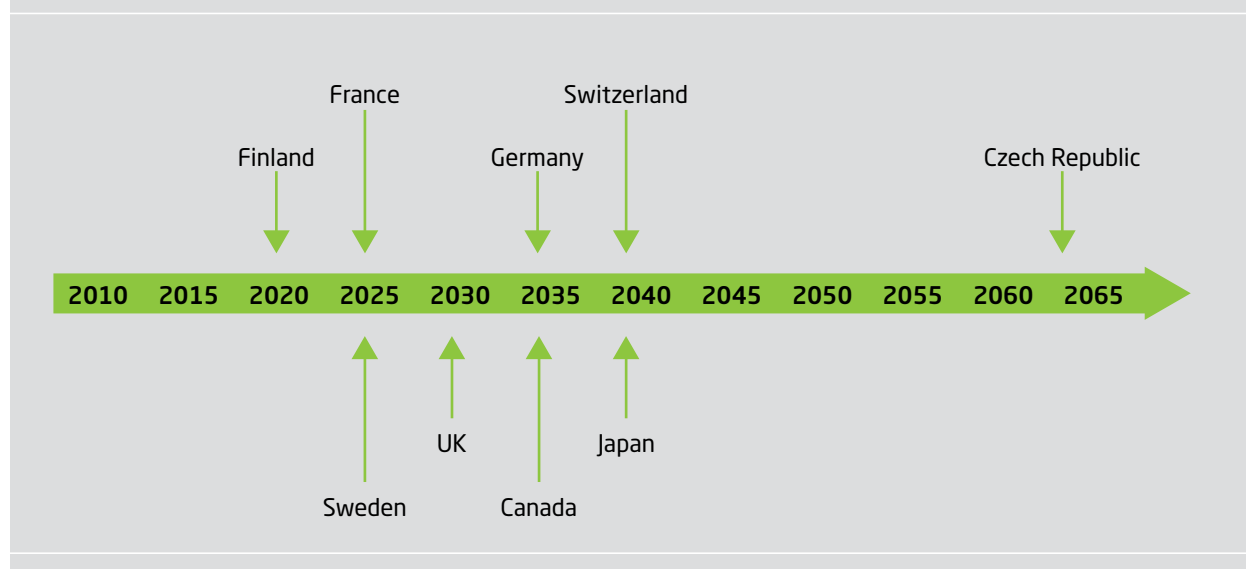

the total cost of nuclear electricity. The uranium fuel elements contribute 14% of the total costs, and the uranium itself only 6% [117].

Designers and operators of power reactors work continuously to decrease their consumption of uranium and increase their energy efficiency. Optimisation of nuclear fuel assemblies, especially in boiling water reactors, has increased the amount of energy harvested from natural uranium by 25% since the 1980s. Modernisation programmes have also boosted electrical efficiency by renewing high- and low-pressure steam turbines, reheaters and generators, resulting in a typical increase of 30 MWe per unit.

Besides improving the thermal efficiency of nuclear power plants, key issues in improving the economics of nuclear power have been to increase the capacity factor or availability factor of plants and extend their lives. Capacity factors have traditionally been low, especially in the USA, due to poor plant performance and surplus generating capacity. In recent years, however, capacity factors have risen to a world average of around 80%, and for new plants a capacity factor of 90% is envisaged. Extending the lifetime of nuclear power plants also reduces costs considerably. Most existing plants operate under time-limited licenses, originally for 30 or 40 years, which in many cases are being extended to 60 years. New plants being constructed today have a design lifetime of 60 years.

The total efficiency of nuclear plants could be greatly increased by using their waste heat to run industrial processes as well as to generate electricity. Most of the world's operating nuclear power reactors are water-cooled and do not yield temperatures high enough for typical industrial applications. The best possibility to radically increase the energy efficiency of these plants would therefore be to use their waste heat for district heating. Desalination is another application already being planned as part of nuclear energy projects in countries where fresh water is scarce.

Sustainable nuclear energy development

In the context of sustainable development, electricity generation should meet criteria for environmental, economic and standards-of-living performance. For nuclear energy, key issues in sustainable development will be the ability to further improve safety and the management of radioactive waste, while developing new technologies which may improve energy efficiency and the utilisation of natural resources [118].

Generation IV reactors

The Generation IV International Forum (GIF) is a global cooperative endeavour organised to carry out the R&D needed to establish the feasibility and performance capabilities of the next generation ("Generation IV") of nuclear energy systems.

GIF's goals are:

- nuclear energy systems must be sustainable;
- they must be economic compared with other energy systems;
- they must be safe and reliable; and
- they must be resistant to proliferation and show good physical protection.

These goals provided the basis on which six nuclear energy systems were chosen for further development. These six systems cover a variety of reactor, energy conversion and fuel cycle technologies. Their designs feature thermal and fast neutrons, closed and open fuel cycles, and a wide range of reactor sizes from very small to very large. Depending on their respective degrees of technical maturity, Generation IV reactors are expected to become commercially available from 2020 to 2030 and beyond.

The six reactor systems selected by GIF are:

- Sodium-cooled Fast Reactor (SFR)
- Gas-cooled Fast Reactor (GFR)
- Very High Temperature Reactor (VHTR)
- Super Critical Water-cooled Reactor (SCWR)
- Lead-cooled Fast Reactor (LFR)
- Molten Salt Reactor (MSR)

SFR, GFR and LFR are based on fast neutrons, MSR on epithermal neutrons, and VHTR and SCWR on thermal neutrons (SCWR may also run in a fast neutron mode). The operating temperatures of the six systems range from 500°C to 1,000°C, which are all high compared to the 300°C typical of most present-day reactors. The higher temperatures yield higher thermal efficiency and also open up the possibility of entirely new applications of nuclear energy, either through direct supply of process heat or from the combined use of electricity and high-temperature heat.

The three fast reactor systems all require closed fuel cycles, thus utilising uranium resources more efficiently and minimising the amount of waste. Recycling and recovering uranium and plutonium from the spent fuel to make new fuel also reduces the amount of mining and fuel enrichment required. In addition, reactors can be designed to transmute long-lived heavy elements in nuclear waste, making the waste less toxic, reducing its volume and cutting the

time needed for its radioactivity to decay to relatively safe levels.

The Sodium-cooled Fast Reactor is the most mature of the Generation IV reactor systems [119]. Much of the basic technology has been established in former fast reactor programmes in France and the ongoing development of BN-800 in Russia. SFR is also considered to be the system closest to deployment for reducing the amount of actinides in existing waste stockpiles, which will help to reduce the waste storage capacity needed.

A VHTR predecessor concept, the pebble bed type High Temperature Reactor (HTR) was developed in Germany already during 1960s. Two reactors were built and operated until the late 1980s in Germany and there is currently an operational test reactor HTR-10 in China, where the reactor type is most actively developed at the moment and the deployment of a fleet of pebble bed reactors is planned [119].

The GIF is foreseen to develop new safety design criteria for Generation IV systems that incorporate lessons learned from Fukushima. The completion of the safety criteria for SFR is expected during 2012 [120].

SNETP

At EU level the Sustainable Nuclear Energy Technology Platform (SNETP) steers the development of fission technologies. SNETP represents about 80 European stakeholders from industry, research institutes, technical safety organisations and others, together with the EU Commissioner for Science and Research and the Commissioner for Energy. SNETP was launched in 2007 to address the role of nuclear energy in the European Commission's Strategic Energy Technology Plan (SET-Plan), which aims to reduce reliance on fossil hydrocarbons while increasing energy security and maintaining European competitiveness in electricity production.

The key issues for nuclear fission under the SET-Plan are by 2020 to "maintain competitiveness in fission technologies, together with long-term waste management solutions", and by 2050 to have developed Gen-IV fast neutron reactors with closed fuel cycle for increased sustainability [121]. This implies lifetime management of Generation II light water reactors (LWR) and the renewal of the nuclear generating fleet by deployment of Generation III LWRs, as well as the development and construction of Generation IV prototypes. The EU has a stake in all six of the GIF reactor concepts but its focus is on the SFR, which is the reference Generation IV technology, with the GCR and LFR as alternatives.

The Nuclear Cogeneration Industrial Initiative (NC2I) also falls within the SNETP remit.

Non-electricity applications

The use of nuclear energy has mostly concentrated on producing electricity. Another established but much smaller application has been as a power source for ships: submarines, icebreakers and even merchant ships. Electricity, however, represents only about 16% of the energy market at the EU level. Non-electricity applications based on direct use of heat generated in the fission process could include process heat for various industrial applications, desalination and district heating.

Light water reactors have operating temperatures that are too low for most industrial processes but may be used for district heating. A modern unit with a generating capacity of 1,800 MWe could also produce 1,000 MW of heat for district heating. In this case the electrical output would fall by about 200 MW, but the total efficiency would increase from less than 40% to almost 60%. This in turn would cut CO₂ emissions by 2 million tonnes a year if the use of the waste heat from the nuclear plant avoided the need to burn an equivalent amount of natural gas and coal. The system is economically viable only if the distance between the production and use of the heat is not too great; clearly it should be less than 100 km.

The efficiency of electricity production can be increased by using higher temperatures, but this also expands the range of possible applications for process heat. Industrial processes which need process heat at high temperatures include wood pulp manufacture (around 400°C); desulphurisation of heavy oil in petroleum refining (around 500°C); production of syngas, styrene, ethylene and hydrogen via steam reforming, Copper-Chlorine (around 550°C) or Iodine-Sulphur thermochemical processes (around 800°C); and the manufacture of iron, cement and glass (around 1,000°C) [122]. In nuclear terms such temperatures can only be achieved by the various Generation IV reactors, which also introduce entirely new operating principles and safety features. [123]

The creation of entirely new applications for nuclear power, such as process heat and hydrogen, is one of the main objectives in the development of Generation IV technologies. However, not every type of Generation IV reactor will be suitable. For processes requiring temperatures in the range 500–900°C, the gas-cooled HTR (High Temperature

Table 5

Design data and applications for Generation IV candidates.

	Neutron spectrum	Temperature	Fuel cycle	Size (MWe)	Non-electricity applications
SFR	Fast	550°C	Closed	300-1,500	Wood pulp production
GFR	Fast	850°C	Closed	1,200	Petrochemicals, hydrogen
VHTR	Thermal	900-1,000°C	Open	250-300	Hydrogen, cement, glass, steel
SCWR	Thermal	500-600°C	Open	1,000-1,500	Oil refining
LFR	Fast	400-800°C	Closed	600-1,000	Petrochemicals, hydrogen
MSR	Epithermal	700-800°C	Closed	1,000	Petrochemicals, hydrogen

Reactor) and VHTR (Very High Temperature Reactor) have the clearest potential in the near future (Table 5).

The high-temperature Pebble Bed Reactor (PBR) is especially designed for cogeneration. With its innovative fuel, ceramic core structures and helium coolant the reactor is designed for safe operation at much higher temperatures than water-cooled reactors. Current demonstrator designs feature coolant temperatures of 750°C and future VHTRs are planned to achieve temperatures close to 1,000°C. For comparison, the modern light water reactor under construction at Olkiluoto in Finland has a design outlet temperature of 328°C for the water coolant.

HTRs could extend the use of nuclear fission beyond electricity production, replacing fossil fuels in supplying heat to petrochemical plants, steel plants and paper mills, and producing energy carriers such as hydrogen. A nuclear reactor capable of producing both electricity and high-temperature heat would open up additional industrial applications. These include the possibility of producing hydrogen in industrial quantities and very efficiently, based on high-temperature electrolysis or thermal decomposition of water.

Plans for the future energy economies of the EU, Japan and the USA place hydrogen as the second energy carrier, in parallel with electricity. Hydrogen has special advantages when used as a transport fuel, and it is politically popular since it can be produced by several means and is clean to use. Hydrogen can also be stored. Widespread use of hydrogen as a fuel requires the use of fuel cells which convert hydrogen directly into electricity.

Conclusions

Nuclear energy already today plays an important role in decarbonisation of the electricity sector while providing energy security and being economically competitive. Nuclear energy is characterized by its very high energy density and is well suited for large-scale, baseload electricity supply. Similar to renewable energy sources such as wind, solar or biomass, nuclear power is characterized by an abundant supply of its primary energy source, uranium, but is not limited to the same extent as these renewable energy sources from being an intermittent energy supply or imposing severe restrictions on land-use.

Improving energy efficiency of nuclear power plants has contributed to a better utilization of the uranium resources and has helped improving the economic performance of nuclear power plants. This is to a large degree accomplished through optimisation of nuclear fuel assemblies as well as renewing turbines and generators. More importantly however, the overall economy of nuclear power has improved through better plant management leading to higher capacity factors and by extending the lifetimes of existing nuclear power plants.

Provided that improved safety, economics and successful waste management can be demonstrated nuclear power is likely to grow in the future. Non-electricity applications may further boost the growth of nuclear energy, especially with the development of new reactor systems allowing for cogeneration of electricity and hydrogen or biofuels for transport.

Energy enabling technologies

13A The role of fuel cells and electrolysers in future efficient energy systems

13B Low-grade energy resources for heating, cooling and power

The role of fuel cells and electrolysers in future efficient energy systems

Peter Vang Hendriksen DTU Energy Conversion, Brian Vad Mathiesen, Department of Development and Planning, Aalborg University, Allan S. Pedersen and Søren Linderth, DTU Energy Conversion;

Working principle

A fuel cell is an electrochemical cell that converts the chemical energy in a fuel to electricity and heat. The electrical efficiency of the conversion is not limited by the Carnot efficiency and hence may be very high compared to power production based on combustion processes.

Fuel cells possess a number of other characteristics which make them relevant to many different applications in the future energy system. They are by nature modular and may thus be used at a wide variety of scales: from battery replacements (0.1–1 kW), through combined heat and power (CHP) for single houses (1–10 kW) and decentralised units (100 kW–5 MW), to large centralised power and CHP plants (100–500 MW). Fuel cells may also be operated in reverse mode, as electrolysers, to convert electrical energy to chemical energy. An example is the reduction of steam to hydrogen and CO₂ to CO; using well-known catalytic routes the resulting gases can be further converted to a range of hydrocarbons which may be used as transport fuels, such as methanol, DME and even synthetic diesel [124].

Several different types of fuel cells exist. They can be classified by the type of electrolyte used (Table 6). All have their advantages and disadvantages, but none has to date matured to a level where fuel cells are in widespread commercial use or play a significant role in the energy system.

Alkaline fuel cells have been used for space and military applications but are expensive and challenging to use in other applications. Phosphoric acid (PAFC), molten carbonate (MCFC) and alkaline (AFC) fuel cells have historically attracted a lot of R&D, but still face a number of challenges for commercial use. Low- and high-temperature PEM and solid oxide (SOFC) fuel cells are currently attracting the largest development efforts for CHP and transport applications. Domestic CHP units based on both PEMFCs and SOFCs have recently been launched by industrial suppliers [125, 126] as have larger units for distributed generation [127].

Fuel cells and electrolysis cells are still to enter a wide spread use, but the technologies have great potential in a future more efficient and more sustainable energy system.

Fuel cells in a more efficient and sustainable future energy system

Fuel cells can save energy thanks to their high electrical efficiency. Whenever electricity is generated from fossil resources and the accompanying heat is not used, the electrical efficiency of the process determines the energy input required to meet the power demand. Most centralised fossil power plants worldwide operate with no or limited use of their waste heat. The electrical efficiency of a high-temperature fuel cell plant may be as high as 60% and if the fuel

Table 6
Characteristics of the main five different types of fuel cells.

Acronym	AFC	PEMFC	PAFC	MCFC	SOFC
Fuel cell type, electrolyte	Alkaline, Potassium hydroxide	Polymer membrane	Phosphoric acid	Molten carbonate	Solid oxide
Catalyst	Nickel	Platinum	Platinum	Nickel	Perovskites/Ni
Operating temperature	40–100°C	60–200°C	180–220°C	550–700°C	500–1,000°C
Fuel(s)	Pure H ₂	Pure H ₂ or CH ₃ OH	Pure H ₂	H ₂ , CO, NH ₃ , hydrocarbons, alcohols	H ₂ , CO, NH ₃ , hydrocarbons, alcohols
Intolerant to	CO, CO ₂	CO, S, NH ₃	CO, S, NH ₃	S	S
Potential electric efficiency ¹⁾	~45%	~45%	~45%	~60%	~60%
Potential applications	Mobile units, space, military	Mobile units, micro-CHP	Smaller CHP units	Larger CHP units	CHP from micro- to large-scale

¹⁾ The achievable electrical efficiencies depend on stack load. The numbers in the table are indicative. Under special conditions higher electrical efficiencies may be achievable. For high-temperature PEMFCs a 55% net system efficiency has been achieved. The higher efficiencies quoted for the high temperature technologies (MCFC, SOFC) lie primarily in their suitability for using hydrocarbon fuels. MCFCs and SOFCs can achieve electrical efficiencies of 70–75% when combined with gas turbines or steam turbines. Total efficiency may be more than 90%, but depends on the cooling system and the operating temperature.

cell is combined with a steam cycle the overall efficiency may be as high as 70–75% [128]. This is higher than that of advanced condensing power plants and gas turbines, so the use of fuel cells may save energy by reducing losses during electricity production.

Making use of the heat produced during electricity generation turns power plants into CHP plants (combined heat and power). In Denmark there is a long tradition of using CHP to heat houses via district heating networks. In 2010, 61% of all the electricity produced in Danish thermal plants was accompanied by use of the waste heat. In a future energy system incorporating fuel cells, the use of heat from power plants will remain important.

The modular character of the technology and the fact that CHP units may be made as small as 1–10 kW to several 100 MW allows both local and decentralised power generation based on fuel cells. This provides another way to save energy, since local generation reduces transmission losses for both power and heat. Losses in the electrical grid depend on the transmission voltage and distance; at ~400 kV the losses are in the range from 4% - 9%/1000km [129, 130]. In Denmark the total loss associated with electricity transmission is estimated to be 6% [131]. Heat losses depend on system size; as an example, in a 20 MW system supplying around 6,000 houses, around 20% of the heat is lost in transmission [132]. Local production in CHP units eliminates these losses. Whether the energy saving economically will warrant the extra investments depends on assumed future energy and technology costs. System simulations [133] (see further below) show that despite the potential for reduced transmission losses with local fuel cell CHPs introduction in larger units (0,5-5MW) is more favourable from a system perspective.

Increased amounts of fluctuating power production on the grid from solar and wind will further increase the need for both load balancing and backup generating capacity. It is crucial that this capacity is flexible and can start up quickly [133]. Future energy systems may need several types of fuel cells within both the heat and power sector and the transport sector. To identify feasible applications for fuel cells it is important to see them as part of the entire energy system, and not just the isolated role they play in supplying consumers directly with power and heat.

Integration studies of fuel cells in the Danish energy system

A recent study examined the use of fuel cells and electrolysis in future energy systems, with a focus on Denmark [133]. For isolated houses domestic fuel cells units (1–10 kW)

based on natural gas is an option that does expand the amount of CHP in the system and increases the efficiency compared to boilers. However, the analysis points out that the best way to expand CHP based on fuel cells is through use in de-central plants (>0.5 MW) [133]. These plants are more efficient than the local ones and allows for more extensive use of heat pumps locally where district heating grids are not feasible. The latter is beneficial as the heat pumps via their high efficiencies (“heat out”/“electricity in”) exceeding one allows the heat-demand to be covered using less fossil resources and a larger share of intermittent power production (wind, solar) in the system. Fuel cells in decentralised CHP plants give higher fuel savings when used in integrated energy systems with large shares of intermittent renewable energy, compared to conventional energy systems. The reason is that the high electrical efficiency of fuel cells reduces the amount of heat produced by CHP plants. In conventional energy systems this means that more heat would have to be produced by boilers, whereas in integrated systems incorporating wind power the extra heat demand can be met by large heat pumps for district heating, increasing the overall fuel efficiency of the system.

From an energy efficiency perspective, combining fuel cells with heat pumps and heat storage creates synergy with intermittent production based on renewable resources. In decentralised CHP plants with district heating grids, fuel cells are especially promising as replacements for conventional simple cycle gas turbines. Fuel cells have higher efficiencies, even at part load, and like gas turbines they can be combined with heat pumps and heat storage. It is harder for fuel cells to compete with combined cycle gas turbines. Fuel cells can become important in the move towards future 100% renewable energy systems, because in such integrated energy systems they are able to reduce our dependence on fossil fuels to a greater extent than combustion technologies. It should be noted that above conclusions on where fuel cells may be best placed from an energy system perspective depends on a number of assumptions regarding technology availability and importantly on expected costs and efficiencies of the applied technologies.

Fuel cells in the transport sector

Fuel cells may also improve energy efficiency in services other than power production. A particularly important example is transport. Transport accounts for around 33% of the total annual energy consumption in Denmark [134] and there is a huge potential to save energy in this sector, as discussed in Chapter 9. One route is via fuel cell cars.

The efficiency of a fuel cell is roughly double of that of a combustion engine. Subtracting the energy losses associ-

ated with producing the fuel (hydrogen or methanol), the overall well-to-wheel energy saving is reduced to around 15–25% (for hydrogen from natural gas) [135]. For hydrogen derived from biomass there is no efficiency gain compared to diesel, but of course there is a dramatic benefit in terms of emissions [136, 137, 128, 138].

Several car manufacturers including Honda, Hyundai, Daimler and Ford have development programmes on fuel cell cars, though commercial fuel cell cars are not yet available. Small demonstration fleets exist in several places in the world, including buses [139] as well as cars [140]. Development has proved to be much slower than expected a decade ago, but several developers have announced that they expect market introduction around 2015 [141].

For transport with improved environmental performance, fuel cell vehicles are in strong competition with battery-based electric vehicles. Whereas fuel cell vehicles provide longer drive ranges – around 500 km – than battery EVs [142], the latter are technically more mature and nearer commercial availability. At the current state of development, battery EVs are also more fuel-efficient and cheaper than fuel cell vehicles. Due to their limited range, battery EVs may be best suited to covering only certain parts of the transport demand. For long journeys a hybrid solution may be the best option, combining the high fuel efficiency of battery EVs with efficient fuel cells to increase the range. In this case fuel cells would compete with the small combustion engines used in current hybrid vehicles [133].

Large-scale introduction of both technologies is hampered by the higher cost of the vehicles as well as the large investments needed for new infrastructure (hydrogen fuelling stations and charging/battery replacement stations, respectively). From an emission reduction perspective an interesting alternative is to run conventional combustion engines on synthetic fuels produced by electrolysis (see below) [143].

Besides their use for power production in CHP plants and transport, as discussed above, fuel cells may reduce energy losses by replacing inefficient existing technologies in a number of specific niches. One example is the auxiliary power units which long-distance trucks use to generate electricity for cargo refrigeration and driver comfort. Conventional auxiliary power units based on generators driven by the main engine are very inefficient (<15%), so fuel cells could be an attractive alternative.

Electrolysis in the future energy system

In the specific context of saving energy by replacing fossil fuels, fuel cells may have even greater potential when used in reverse, for electrolysis. Electrolysis converts electrical energy to chemical energy, so for instance water may be split electrochemically into hydrogen and oxygen.

Electrolysis may act as an “enabling technology” facilitating substitution of fossil energy by alternatives in several different ways. These include storing energy from intermittent renewable sources such as wind and solar power, and producing synthetic fuels for transport. The latter will be important in a future sustainable system where biomass resources will be scarce [144].

The energy efficiency of electrolysis can be very high, at around 90–95% (based on higher heating value) [143, 145]. The exact value of the efficiency depends on temperature, current loading, and the chosen electrolysis cell technology (Table 6).

Energy storage

An increasing share of power production that relies on fluctuating sources like solar and wind places increasing demands on load balancing on the electricity grid. This is true both at short timescales, to keep the frequency constant, and for longer-term storage of surplus electricity so that the system can cover periods when consumption exceeds production. Both objectives can be met by electrolysis, with storage of the gases produced and conversion back to electricity as required. For ease of storage and reuse it may be best to produce either methane or liquid fuels. Methane can be produced in two steps. Syngas (a CO/H₂ mixture) is first produced either via co-electrolysis of CO₂ and H₂O or by reacting CO₂ with hydrogen from steam electrolysis [146], and then catalytically converted to methane. Both routes to syngas have been demonstrated [145,146] and the conversion of syngas to methane is well established in the chemical industry.

From a number of detailed analyses of how to realise a totally fossil-free Danish energy system by 2050, transmission grid manager Energinet.dk has assessed the amount of extra wind power capacity needed (among other renewable sources) as well as the required storage capacity [147]. Energinet.dk concluded that an extra 17 GW of installed wind capacity is needed, plus around 3.5 TWh of storage. (Interestingly, the capacity of the existing Danish natural gas grid, including two storage sites, is about 11 TWh.) Energy storage in batteries on board a fleet of EVs is another option, though of rather low capacity. Around 1.5

million EVs would be able to store on the order of 50 GWh, which could match hour-to-hour fluctuations but would not be enough to cover weeks of low wind generation.

Electrolysers can thus become important in the transition to renewable energy. In this transition it is very important to integrate the electricity sector with the heating sector and the transport sector as will be discussed further below

Transport fuels

Extensive use of electrolysis may also play a role in reducing consumption of fossil energy and emissions from the transport sector.

Hydrogen for fuel cell vehicles may be produced by steam electrolysis using power from renewable sources like wind and solar. An alternative which also avoids the problems associated with hydrogen storage is to produce synthetic fuels – methanol, DME or synthetic diesel – via Fischer-Tropsch processes. These liquid fuels can be produced from syngas, which in turn is made via electrolysis powered by renewables.

The synthetic fuels route has the disadvantage that it does not bring the efficiency improvements possible by replacing combustion engines with fuel cells. However, it has several advantages: the existing liquid fuel infrastructure can still be used, and future sustainable non-fossil energy systems will still need liquid fuels, for example for aviation and shipping. A detailed techno-economic analysis shows that this route can produce synthetic fuels at an energy efficiency of around 70% (electricity to liquid fuel). Assuming an electricity price of \$0.04–0.05 /kWh, which is close to the average wholesale electricity price in the USA, the process would break even at a fuel price of \$3 /gallon (DKK 4.25 /l) [143].

Carbon sources and biomass upgrades

The synfuels discussed above need a source of carbon. An appealing option from a sustainability point of view is to use biomass as the carbon source. However, biomass is scarce and is estimated to cover only around 20% of total energy requirements [148], so it is important to use this resource efficiently. Furthermore, one should be careful in replacing food production with energy crops.

An interesting option in this context is “carbon capture and reuse”, where one first burns the biomass to produce electricity and heat, and then uses the resulting CO₂ to produce synfuels via electrolysis. This is a way to produce transport fuels from biomass efficiently in terms of both energy and

carbon yield [149,143]. Effectively it uses the CO₂ to carry electricity from wind, solar or hydro to the transport sector in the form of synfuels.

In the short term, sources of CO₂ apart from biomass could include industrial point sources such as cement plants, which contribute 5% of total global anthropogenic CO₂ emissions. In the longer term it might be possible to capture CO₂ from air [150].

Electrolysis in the Danish energy system

Detailed systems analyses of fossil-free future Danish energy systems [133,144] have also pointed out the potential of electrolysis to balance fluctuating power production and to provide a route to synthetic fuels for heavy transport, shipping and aviation. In the long term some applications of electrolysis are more suitable than others, and other energy storage technologies – such as large heat pumps in combination with heat storages in CHP plants and battery electric vehicles – may well precede large-scale electrolysis because of high efficiency and lower cost at the present stage of development [144].

Fuel from electrolysers combined with fuel cells in CHP plants can supplement other fuels, such as biogas or syngas, in energy systems with high shares of intermittent renewable energy. When the share of renewable electricity from wind or PV exceeds 50% of the supply, the advantage of electrolysers for hydrogen and synthetic fuel production improves significantly. If electrolysis is introduced to a system with a smaller share of fluctuating renewable electricity there is a risk that conventional power plants would sometimes have to supply electricity for electrolysis which is undesirable as it reduces overall efficiency of the system [133].

The Danish government aims for 50% of the electricity demand coming from wind power by 2020. Although electrolysis is not the only balancing or storage option for the Danish system, it has the potential to become important because of its ability to supply transport fuels and to sidestep the biomass resource limit outlined above.

Technology status

All the fuel cell types listed in Table 6 have similar (or even identical) counterparts in electrolysers.

Alkaline electrolysis systems have been commercially available for many decades from a number of suppliers. Megawatt-scale plants are in operation, typically for on-site use in industrial processes where scale or transport costs make conventional hydrogen processes more expensive. By far

the largest share of global hydrogen production comes from fossil fuels, however.

Recently PEM electrolysis systems have also become available from industrial suppliers, though so far only a few plants exist.

As yet there are no commercial suppliers of solid oxide electrolysis (SOEC) plants, but standard SOFCs have been shown to work well for electrolysis at modest current densities [151]. The development and marketing of SOECs can therefore be expected to follow a few years behind that of SOFCs, with the same industrial players involved. Though it has only been demonstrated at a scale of 15 kW this technology has great potential to become cost-competitive; the high operating temperatures allow the use of expensive noble metals to be avoided, and high volumetric production can be achieved without compromising efficiency [143,145].

Both fuel cells and electrolysis cells can play important roles in the future energy system, where the focus is on saving energy and replacing fossil resources. Which of the technologies mentioned will be developed and used on a global scale depends eventually on their availability on the right scale at the right time, and most importantly on their costs compared with competing technologies. In our view the most promising systems, which are also the ones currently attracting most of the development funding, are:

- alkaline electrolysis;
- low- and high-temperature PEMFCs and PEMECs; and
- SOFCs/SOECs.

Denmark's transition to a smart energy system

This section presents the results of systems analyses of a future Danish energy system based on 100% renewable energy by 2050. The analysis balances supply and demand under a range of assumptions about future trends in consumption and availability and the estimated costs of supply technologies. The work was carried out under the CEESA (Coherent Energy and Environmental System Analyses) project funded by the Strategic Research Council [144]. In the analyses the energy system analyses model EnergyPLAN has been used. EnergyPLAN [152] is a deterministic simulation model ensuring that the system balances from hour to hour throughout the year.

Increasing penetration of intermittent renewable resources in the electricity grid increases the demand for smart energy systems. In a smart energy system the focus is not only on the electricity grid and its balance of supply and

demand, but also on sector integration through demand flexibility and various storage options:

- heat storage and district heating with CHP plants and large heat pumps;
- new electricity demands from large heat pumps, and electric vehicles for electricity storage;
- electrolyzers and synthetic, liquid fuels for the transport sector, enabling energy storage in a dense liquid form;
- gas storage and gas grids for biogas and syngas/methane.

Smart energy systems enable flexible and efficient integration of large amounts of fluctuating electricity production from sources such as wind turbines. The whole idea of building wind turbines or PV systems is to cut use of fossil energy sources. The gas grid's storage facilities and liquid fuels provide long-term storage, while electric vehicles and large heat pumps in combination with thermal heat storage contribute shorter-term storage and flexibility. If the large-scale integration of renewable energy is accompanied by the integration of sectors, the increased fuel efficiency can potentially decrease the costs of the total energy system.

The first and most important step is the integration between the heating and power sectors. This is already in place to some extent in Denmark, where approximately 60% of the electricity demand is met by CHP plants and more than 60% of heat demand is supplied by district heating. This integration requires thermal storage, which is currently installed in more than 500 small and medium-sized CHP plants to enable them to operate more flexibly (present thermal storage capacity in the Danish district heating system is estimated to be approx 50 GWh). This can reduce fuel consumption in the overall energy system by replacing condensing power plants and helping to integrate fluctuating wind power effectively. More important than the content of the storage is that the storage allows for flexible production and an unbundling of the heat demand and the electricity production.

20–25% of wind power on the grid can be integrated without significant changes to the energy system. With more than 20–25% of wind power, the analysis points to installation of large heat pumps in district heating plants in combination with the heat storages as the next needed step in integrating the heating and power systems. With wind power levels above 40–45% the transport sector also needs to be integrated with the electricity system [153]. Integration with the transport sector will be a significant challenge in the coming years. Electric vehicles can be important in this integration, as they provide flexibility on the demand side. Exceeding 50–60% fluctuation renewable energy in the system electrolysis becomes important as really large capaci-

ties have to be put in place to balance supply and demand [133,153]. This will introduce extra losses in the system, but has the advantages that larger shares of fluctuating production can be tolerated and biomass consumption is reduced.

A smart energy system strategy implies the development and integration of a wide range of supply and end-use technologies, markets and control systems, including electric boilers and heat pumps in distributed generation, electric vehicles, mechanical and electrochemical storage systems, flexible demand mechanisms, and more. Denmark and the Nord Pool already have systems in place to operate smart energy markets, specifically on electricity markets that also enable smaller technologies to participate. These can be further developed in the coming years to accommodate more and more integration technologies. A recent study has documented that systems with large amounts of renewable energy and flexible integration technologies will perform equally well or better (i.e. make more money) on the Nord POOL market than a reference system similar to the one we have today [154].

By 2050, when the Danish energy system is envisaged to be fossil-free, new technologies will be needed to make sure that renewable energy can meet all the demands placed on the system. Hence the CEESA 2050 analysis has a scenario where after 2030, electrolyzers producing hydrogen for bio-DME or biomethanol are gradually increased in volume to provide large amounts of liquid fuels to the transport sector. At the same time, co-electrolyzers begin to produce feedstocks for DME and methanol using carbon captured from power plants, CHP plants or other sources. Figure 47 shows the energy flows in a 100% fossil-free Danish energy system in 2050 according to the CEESA 2050 scenario [144]. In these scenarios methanol is used as an example of how it is possible to use electrolyzers to make synthetic fuels; turning wind energy into liquid fuels. There are more technologies that enable this, however this principle will become increasingly important as other biofuels for transport put a larger strain on the limited biomass resource. In the specific scenario the electrolyzers produce more than 20 TWh of hydrogen or more than 70 PJ. This amount of energy would have to be replaced by at least as much biomass if we did not have the electrolyser technology in the system.

Figure 47

Energy flows in a 100% fossil-free Danish energy system in 2050, according to the CEESA 2050 scenario. The flows represent the annual aggregated values; however every single hour for all demands and production technologies is accounted for in energy system analyses.

Reference: Preliminary 2011 version of results presented in Mathiesen, B.V. et.al. "CEESA 100% Renewable Energy Scenarios towards 2050". Aalborg University, 2012 [144].

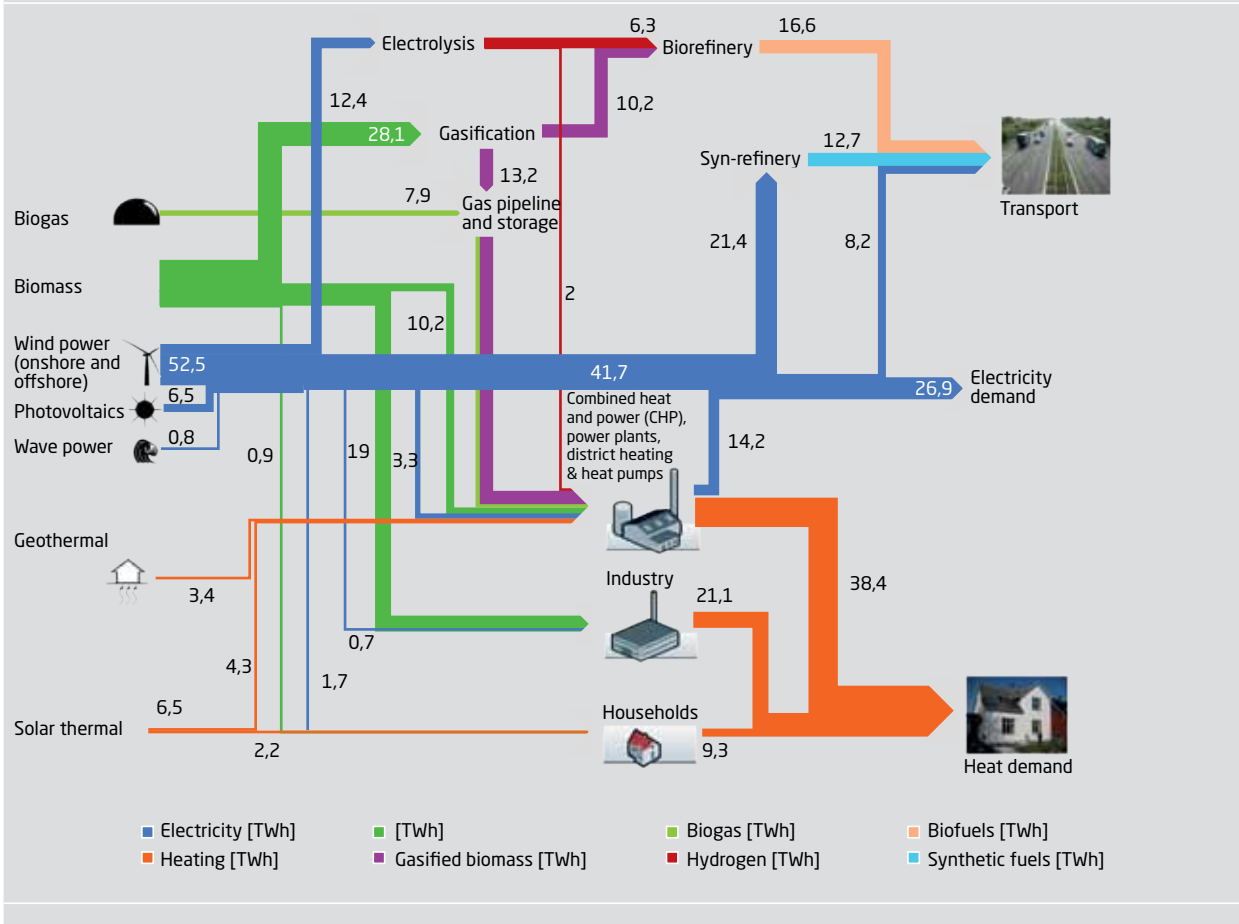

Low-grade energy resources for heating, cooling and power

Brian Elmegaard, Fredrik Haglind and Henrik Carlsen, DTU Mechanical Engineering

Availability of low-grade energy resources

The society of the future will become far more dependent on electricity as our energy supply moves towards renewable sources such as solar, wind, hydro and wave power. Increasing demands for electricity to run appliances and for comfort, plus falling heat demand due to improved building insulation, will also change the energy system. This will mean that consumers will receive a significantly larger proportion of their total energy supply in the form of electricity. We should therefore expect that any way to improve the utilisation of surplus heat should be pursued if society is to reach the best possible energy efficiency overall.

Waste heat may be used as an energy source for heat engines producing power and for heat pumps which supply heat by maintaining a temperature difference between a low-temperature energy source and a high-temperature heat demand. Sources of low-temperature heat range from marine diesel engines, refrigeration plants and production industry equipment, to geothermal and solar installations.

In industrial plants energy is often supplied for heating and cooling purposes. Heat is typically produced by burning fuel to produce steam or hot water. The heat is used at a high temperature and rejected at a lower temperature after use. Cooling is usually produced by compression refrigeration systems, which remove energy from the product by lowering its temperature. The energy from the cooling load and from the compressor is rejected by the condenser at temperatures slightly above ambient. Thus many industries have significant surplus energy at relatively low temperatures [155].

Waste heat can be recovered by refrigeration systems or heat pumps based on absorption or adsorption cycles. Sorption refrigerators use waste heat sources above ambient temperature to generate cooling, with a minimal need for electricity. Operated as heat pumps they raise the temperature of energy taken from low-temperature sources [156]. To operate a sorption cycle a high-temperature heat source is required to drive the cycle.

The most efficient machinery system available today for large ships is a two-stroke, low-speed diesel engine with a waste heat recovery (WHR) system featuring water/steam as the working fluid. The WHR system boosts the power of the main engine by about 10% [157].

Geothermal heat sources are abundant in the Earth's crust and these are used to a limited extent for heating. For low-temperature geothermal sources this can be done using heat pumps. Small-scale and domestic solar thermal and biomass power plants with moderate maximum temperatures can use organic Rankine cycles, in which the working fluid is an organic compound. The same working fluids may also be used in heat pumps, which can take their energy from heat sources close to ambient temperature, including condenser heat from cooling plants and wastewater treatment.

Utilisation of waste heat

Thermodynamic cycles

Figure 48, Figure 49 and Figure 50 show the basic thermodynamic cycles for making use of waste heat.

Figure 48 illustrates a heat engine based on a Rankine or similar cycle. Waste heat is used to evaporate a working fluid which is then expanded in a turbine or cylinder, condensed and pressurised by a pump. Some heat is rejected at low temperature in the condenser according to the second law of thermodynamics. The cycle is normally characterised by a thermal efficiency which is the ratio of the power produced to the heat consumed.

Figure 49 shows a heat pump driven by mechanical compression. The cycle is usually a reversed Rankine cycle. Waste heat introduced at low temperature evaporates a working fluid at an even lower temperature. Mechanical energy introduced by a compressor then raises the pressure of the vapour, allowing it to provide useful heat for applications such as space heating by condensing it. The condensate is expanded through a throttling valve to the evaporator pressure. State-of-the-art heat pumps can produce heat at temperatures up to about 100°C [157]. Usually, heat pumps are characterised by a coefficient of performance (COP) defined as the ratio of the high-temperature heat output to the mechanical energy consumed by the compressor.

Figure 48

Power production based on utilisation of waste heat.

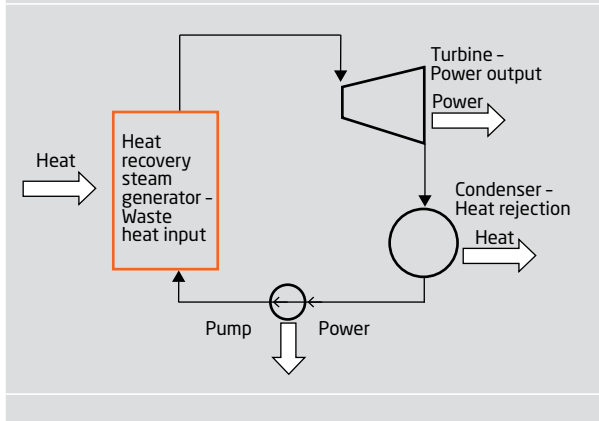

Figure 49

Mechanical compression heat pump for utilisation of waste heat.

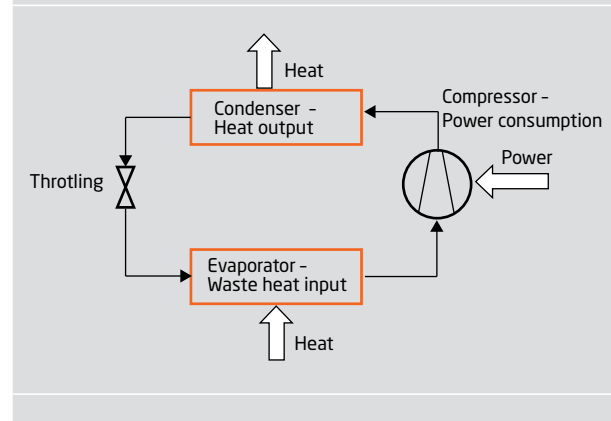

Figure 50 illustrates an absorption heat pump. This raises the temperature of waste heat using thermal compression rather than the mechanical compressor of the previous example. The absorption heat pump thus runs almost entirely on waste heat, power is only required for pumping. In addition, low temperature heat will be absorbed at ambient temperature and below, thus two heat sources are required. The COP for an absorption heat pump is the ratio of the heat supplied at intermediate temperature to the heat released at high temperature. This COP is not comparable to that for a mechanical heat pump and will have a significantly different value.

Both types of heat pump cycle may be used to produce cold as well. In this case the low-temperature energy source is the heat that is removed from cooled space and the high-temperature heat is rejected to the ambient at higher temperature as energy surplus. For cooling, only the heat-driven cycle is a waste heat consumer using driving heat the high temperature level.

Exergy for quantification of energy resource consumption

Exergy is a concept derived from thermodynamic theory and defined as the maximum amount of work that can be generated by bringing an energy source into equilibrium with the environment. Thermodynamic equilibrium is specified as mechanical (same pressure), thermal (same temperature) and chemical (same composition) equilibriums. Exergy can similarly be decomposed into these constituents [159].

It can be shown that any primary energy source – fossil and non-fossil fuels, and renewable sources such as wind and direct solar radiation – is close to being a source of pure exergy. This means that exergy analysis may be used as a general tool to analyse the efficiency of energy conversion. Exergetic efficiency defined exergetic output of the product(s) of a plant divided by its exergetic inputs, e.g., fuel or waste heat, is thus a generally applicable figure of merit for energy conversion. It may be used to compare the utilisation of different sources to provide a given product or vice versa.

For waste heat sources the exergy content is determined by its temperature by the relation $E = Q (1 - T_{amb}/T)$, where E is the exergy content, Q is the energy content, T_{amb} is the ambient temperature and T is the thermodynamic average of the heat source temperature. Temperatures are expressed in absolute units (K). The expression shows that low-temperature sources have lower exergy content and thus lower theoretical limits of efficiency, to the point where energy at ambient temperature has no exergy content. In general, exergetic efficiencies in the 30–60% range are reasonable values to be found in real examples of waste heat utilisation.

Examples in power generation

Practical power production from waste heat is done using several types of cycles [160], of which conventional Rankine steam cycles are the most common. In particular, waste heat recovery is a state-of-the-art technology in combined cycle gas turbine plants [161] and for diesel engines in e.g.

Figure 50

Thermal compression heat pump utilising two temperature levels of waste heat.

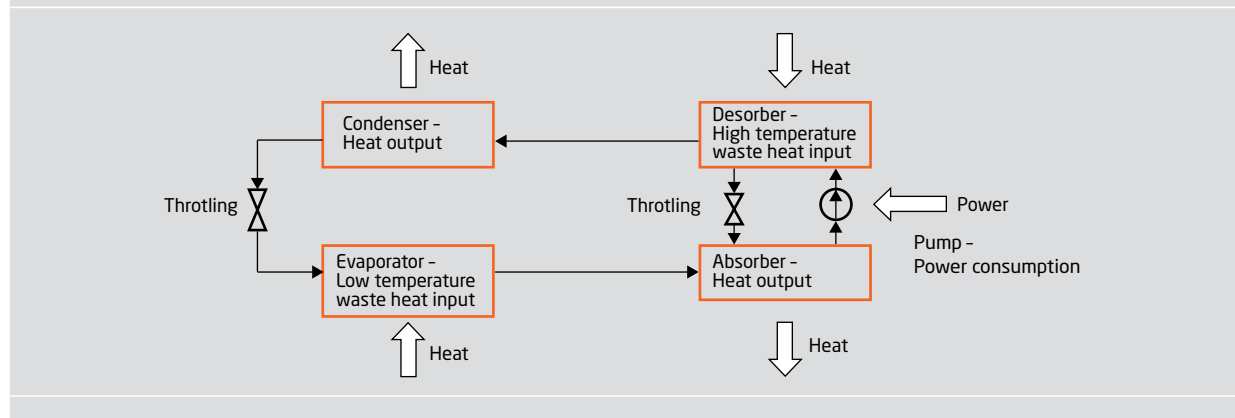

ship machinery [162]. Other working fluids are found in Organic Rankine Cycles (ORCs) [163], [164] and the Kalina cycle, which uses mixtures of ammonia and water [164]. The thermal efficiency and exergetic efficiency of these cycles are related by the exergy content of the heat source.

Examples in heat production

The main applications of waste heat for heat pumping in mechanical compression cycles are found in industry and in district heating. Mechanical compression technology for waste heat recovery is receiving significant attention currently, thanks to new technical solutions which utilises refrigerants that are natural substances which do not harm the ozone layer and have little or no greenhouse potential.

Examples include two district heating plants based on conventional reversed Rankine cycles. The first is a compression heat pump plant with CO_2 as the working fluid, installed at Frederikshavn in Denmark and using wastewater from the town as its heat source [166]. The second, in Drammen, Norway, uses ammonia as the working fluid and seawater as the heat source, and has been in operation since 2011 [167]. A less conventional absorption/compression cycle using a mixture of ammonia and water is used in dairies for both heating and cooling [168]. This cycle is closely related to the Kalina power cycle.

Heat-driven cycles are used in low-temperature geothermal systems to provide the temperatures needed to supply district heating networks [169]. The driving heat for the absorption process is steam from a conventional power cycle, which may or may not qualify as waste heat.

Perspectives in waste heat utilisation

There is great potential for saving fuel and other resources, and reducing emissions of pollutants, by maximising our use of waste heat. The increasing number of electric appliances and the move to heat pumps for heating and electric vehicles for transport will result in a steady increase in our consumption of electricity. The use of every available source of energy to generate electricity with the highest feasible efficiency may thus be an important contribution to Denmark's aim of eliminating fossil fuels. The ability of heat pumps to make better use of electricity will also be significant, since about 40% of our total energy consumption is used for heating [170]. It is clear that from a technical viewpoint the coefficient of performance (COP) of a domestic heat pump operating between 5°C ambient and 20°C may be increased to 10–20 from its current value of 3–4.

As for marine applications, it is expected that by using more advanced designs the power contribution from the waste heat recovery system can be increased from 10% to about 25%, corresponding to a 20% improvement in efficiency. Considering that the shipping industry in Denmark is responsible for CO₂ emissions of similar magnitude to those of the rest of Danish society, such improvement would allow immense fuel savings and cuts in CO₂ emissions.

Manufacturing industry accounts for 15% of total Danish energy consumption. Making use of only 25% of the resulting waste energy as a heat source for electricity production or heat pumps may thus contribute significantly to lower primary energy demand.

Both power plants and heat pumps are based on similar thermodynamic cycles and component technology. The cycles involve state changes of a working fluid selected from many possible substances, and may operate in both liquid and gaseous states as well as in the supercritical, transcritical and subcritical regimes. Both pure substances and mixtures can be used.

There are many technological options for the use of waste heat for different purposes, while many diverse applications share some fundamental characteristics [Table 7]. The available energy of different waste heat sources at different temperature levels has been determined to some extent, but the data is not readily available. Moreover, there is significant opportunity to use the same technological developments in different fields. The observations above show that the potential of waste heat is not being used to full advantage and that there is an unexploited potential to transfer technology between power generation systems and heat pumps.

Table 7

Overview of low-temperature energy sources and their application areas.

Acronym	Temperature level			Product		
	Very low (20-50°C)	Low (50-150°C)	Medium (150-250°C)	Power	Heat	Cold
Waste heat - maritime		X	X	X		X
Waste heat - industrial			X	X		X
Geothermal - low temperature		X		X		X
Geothermal - very low temperature	X				X	
Solar		X		X	X	X
Biomass			X	X		
Wastewater treatment	X				X	
Industrial refrigeration	X				X	
Commercial refrigeration	X				X	

Systems, distribution and storage

Argyrios Altiparmakis, Claus Nygaard Rasmussen, Alessandro Pensini, Francesco Marra and Guang Ya Yang, DTU Electrical Engineering

Energy storage and markets

Fossil fuels are effective energy storage media with high energy density and long-term storage capabilities, and these factors provide almost full controllability to fossil-fuelled power plants. A power system containing a high fraction of stochastic energy sources, on the other hand, will most likely have to incorporate various types of energy storage. The need for energy storage also applies to other areas such as heating and transport. If those sectors are to be based on stochastic renewable sources, some sort of buffer must be introduced to ensure stability and security of supply.

Electricity provision, unlike most markets, operates under physical constraints that require a real-time balance between supply and demand. This peculiar characteristic of electricity markets means that a typical feature for most products – the ability to maintain an inventory and distribute stored content according to seasonal demand – is absent. This raises the question of how to maintain stability when the source fluctuates. Furthermore, as electricity demand is subject to some volatility, the stability of the power system requires expensive generating units to satisfy sudden surges in electricity consumption and other contingencies. The integration of renewable energy into the power system amplifies the problem of volatility, since most forms of renewable energy, such as wind and solar, operate intermittently and so require more forceful adjustments of the power system to match supply and demand. Additionally, ensuring grid stability by reducing rates of power change is of major importance, and this issue becomes important even at modest levels of renewable power. This also leads to a large divergence in electricity prices between times of high and low demand.

Energy storage can play an important role in alleviating the problem posed by variable demand, since energy can be stored when demand is low and utilised when demand is high. On a technical level, this helps in maintaining balance in the power system, efficiently and smoothly. It also has a direct implication for energy markets, since it tends to curb the high prices associated with high demand and generally makes prices more homogeneous across time. Depending on the scale of the storage this can lead to greater market efficiency, potentially eliminating the need for investment in expensive units designed only to serve peak demand and so leading to large system-wide savings. Additionally, energy storage has a role to play in the market for ancillary services such as power quality, frequency and voltage regulation, and reserve provision. Finally, energy storage means that renewable energy sources can be more

successfully integrated into the power network, since the problem of intermittent operation is somewhat reduced by introducing storage.

An issue with electricity storage is its cost. Most forms of energy storage have high capital requirements and their profitability is closely tied to geographical location and their particular characteristics [171], [172]. The lack of economies of scale and industry standards, as different technologies with divergent characteristics contend for market position, means that most storage systems are not yet profitable for commercial use. However, this also means that, at least for battery systems, the emergence of an industry standard could bring significant cost reductions that will make future storage much more viable than it is today.

Another potential problem for energy storage is that peak-shaving power plants will be less profitable. The economics of such plants are very sensitive to the number of operating hours, and significant reductions will create a strong disincentive for companies to invest. However, the power system will still require backup units to cover contingencies such as line faults and the sudden loss of front-line plants. Not all of this backup capacity can be delegated to storage units, which through their very nature will be depleted for part of the time. An important challenge for a power system with extensive storage capabilities is therefore to balance two needs: on one hand to cut costs by replacing peaking units with storage, while on the other hand ensuring enough investment in peaking units to cover the system's needs.

As well as electrical storage, thermal energy storage (TES) can also play an important role in the markets. Denmark's experience with a high penetration of wind power shows that overproduction is a frequent problem. This could be partially mitigated by the introduction of thermal storage. Research at DTU aims to find ways to couple the excess production of electricity with heat pumps and thermal energy storage, so as to replace a large portion of the thermal energy demand – otherwise met by fossil fuels – in the residential and commercial sectors. We have found that it would be economically feasible to replace almost all the fossil-fuel boilers with a combination of a heat pump driven by renewable electricity and an energy storage system. Figure 51 shows the results of an attempt to find the optimal size of thermal storage and heat pump when excess electricity is present in the power system.

The European project EcoGrid, which aims to test a real-time market for balancing system capacity, will include testing of TES coupled with heat pumps. A key role will fall

Figure 51

Optimum economic size for heat pumps (HPs) and thermal energy storage (TES) in a scenario with high levels of renewable electricity. In the model, HP-TES installations cover part of the heating requirement while the rest is met by boilers burning natural gas.

The presence of TES allows both cost reduction and lower consumption of fossil fuels. Colours indicate the total cost of meeting the heating demand for a given area; blue (lowest cost) shows the most conveniently sized combinations of HP and TES. The optimum solution (dark blue) is for the combination of large TES and HP.

Costs take into account installation of the heat pumps, network pipelines, storage tanks and backup gas-fired boilers. Electricity was assumed to be in surplus, and therefore free (courtesy of Center for Electric Power and Energy - CEE).

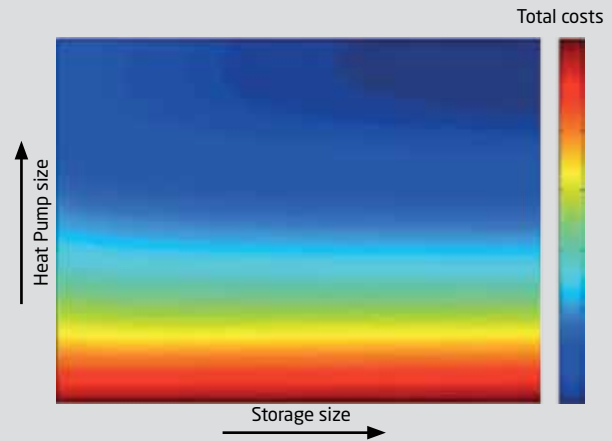

Figure 52

Optimisation schedule for space heating based on a heat pump coupled with a hot water storage tank. The upper diagram shows how the electricity price varies with time. The middle diagram shows (in red) the heating requirement and (in blue) the optimal power schedule to minimise running costs. The bottom diagram shows the energy content of the storage tank (courtesy of Center for Electric Power and Energy - CEE).

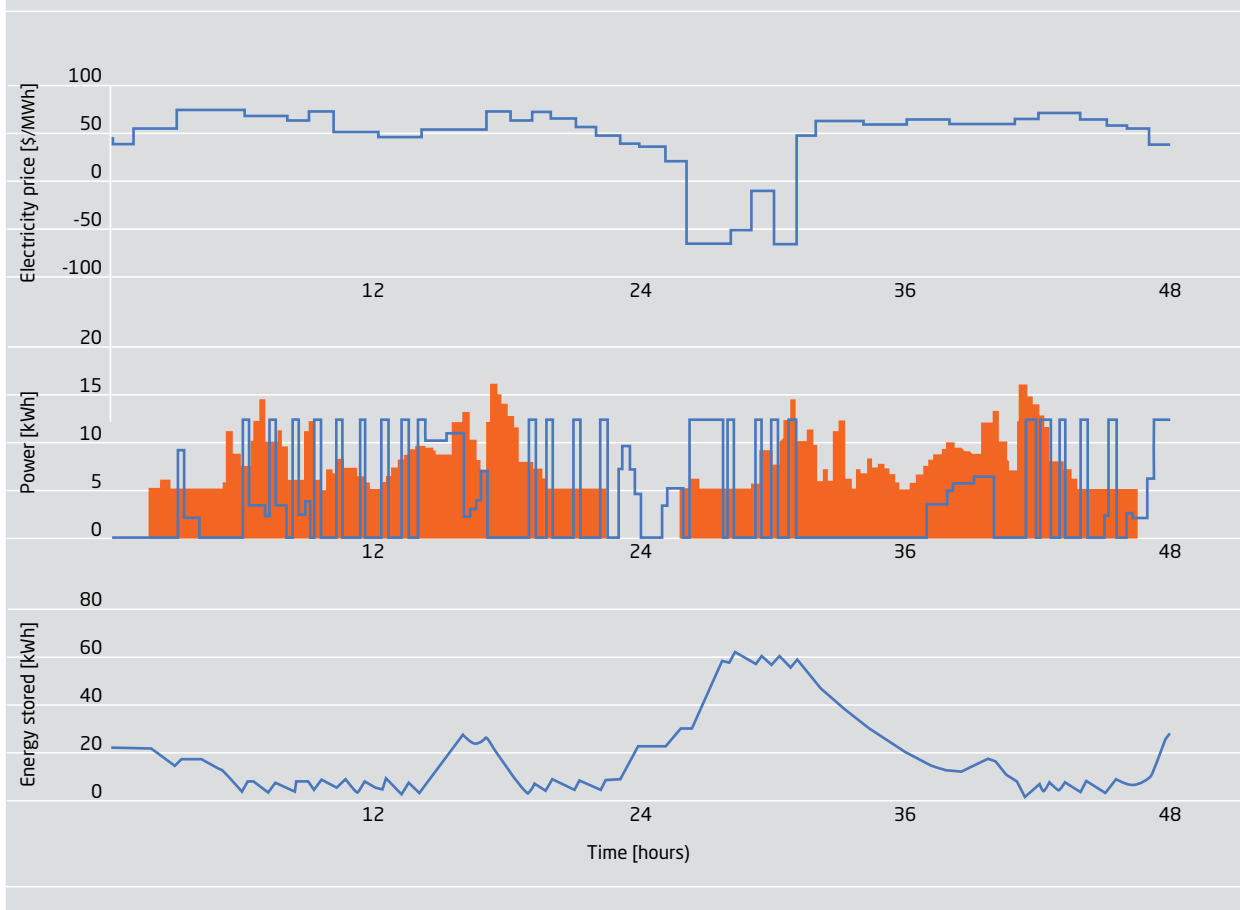
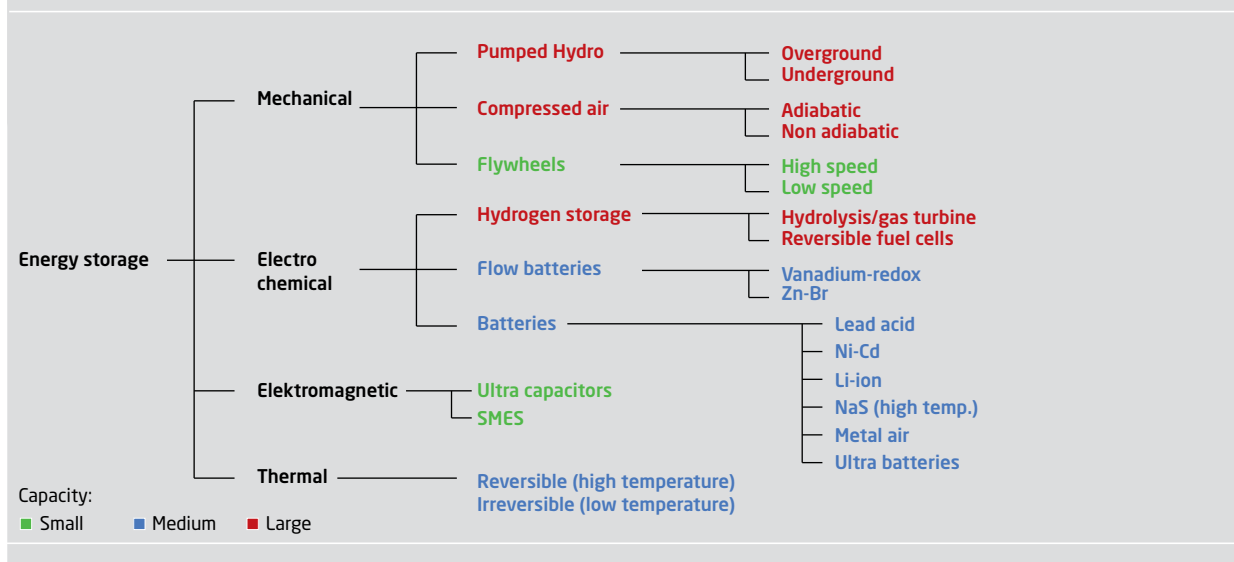

Figure 53

Energy storage technologies grouped according to the form of energy stored and the typical storage capacity [153].



to electricity prices and weather forecasts, which will be exploited by algorithms to control the heating schedule. TES allows thermal energy to be stored when electricity is cheap and released when the price is high (Figure 52).

To conclude, energy storage is as yet somewhat unprofitable due to its high capital costs and the immaturity of the technology. However, it shows great promise because of its expected ability to cut costs, deal with issues of excess energy supply from intermittent renewable sources, and capture profits from price arbitrage in electricity and heat markets.

Technology overview

Energy storage technologies can be classified according to the form of energy stored: mechanical, electrochemical, electromagnetic or thermal. Mechanical storage includes hydroelectric storage, compressed air energy storage (CAES) and flywheels. Electrochemical storage includes batteries, flow batteries and fuel cells in combination with hydrogen or hydro-carbon gas. Electromagnetic storage includes ultra capacitors and superconducting magnetic energy storage (SMES). Each technology has certain attributes with regard to storage capacity, power, reaction time and cost (Figure 53). A reasonably clear distinction between technologies with short, medium and long timescales, respectively, can be made because of marked differences between the technologies with regard to energy and power

density. All of the technologies mentioned are in use to some extent today, but their influence on the power system is limited. The exception is hydropower, which plays a large role as a buffer, for example in the Nordic power system.

At the moment the fastest technological development is taking place in batteries and ultracapacitors. Thermal storage is also expected to take on a significant role in stabilising the energy system.

Figure 54

An ultracapacitor stores electrical energy in the form of electrostatic charge, not chemical energy as in a battery [174].

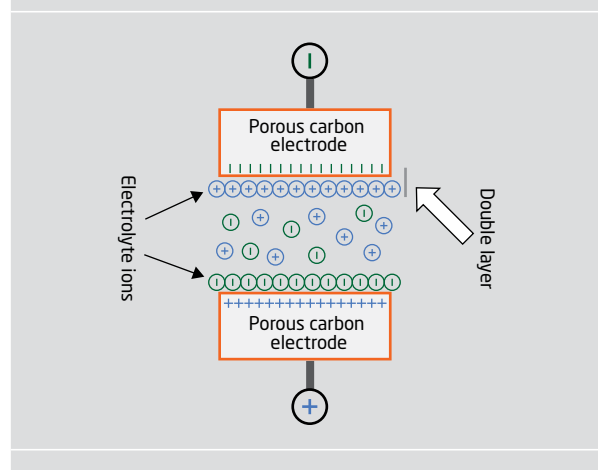

Ultracapacitors

Ultracapacitors (also known as supercapacitors or double layer capacitors) provide storage at timescales of a few minutes or less. Ultracapacitors are of little relevance to the overall management of energy because of their high cost per unit of stored energy and their relatively small capacity, leading to short storage timescales. But their power densities are often very high and their reaction times very short, and this makes them well suited for power quality management and emergency related services in the power system. Similar arguments apply to other energy storage technologies with short timescales, including superconducting magnetic energy storage and flywheels.

An ultracapacitor (UC, Figure 54) is similar to a battery, with electrodes immersed in an electrolyte but separated by an ion-permeable membrane. The difference is that no electrochemical reactions take place; instead the energy is stored in an electrostatic field. Ultracapacitors are made with nano-scale structured electrodes, which results in very large electrode surface areas. Energy is stored in the form of opposite electric charges on the two surfaces, creating intense electric fields.

Ultracapacitors are a rapidly advancing technology and at medium timescales they may soon challenge batteries because of their advantages with regard to power density, reaction time, lifetime and temperature requirements. Energy densities of 10 kWh/m³ have been reached, and since virtually no degradation takes place as a result of charging, the number of charge/discharge cycles is in excess of 300,000. The cycle efficiency of ultracapacitors is high (in the range of 90–95%). The losses are mainly resis-

tive losses related to the electrodes and connections, and are therefore proportional to the charge/discharge power.

Ultracapacitors self-discharge at a rate proportional to the square of the voltage, typically around 2% a day. However, since ultracapacitors will in most cases be used for relatively fast charge/discharge power conditioning applications, the effect of self-discharge will be small. In such power conditioning applications only a small fraction of the total energy handled actually “passes through” the ultracapacitor. This means that the overall losses from ultracapacitors used for power conditioning in renewable energy systems will be just 1–2%.

Batteries

An electrochemical cell converts chemical energy to electrical energy and vice versa. A battery is a group of cells connected in series and/or parallel to provide the desired voltage and capacity. Batteries are rated in terms of their energy capacity and power rating. For most battery types these two characteristics are not independent but are fixed by the design of the battery.

Battery technology is a fast-moving field. Many different types of batteries are being developed, of which some are available commercially while others are still at the experimental stage. Large-scale stationary batteries with capacities of more than 100 MWh have been introduced in power systems, though so far only in a few places. Electric vehicles capable of bidirectional power exchange with the grid (“Vehicle-to-Grid”) may also play a significant role if their numbers become large enough. The following sections describes the most interesting battery technologies for power system applications.

Sodium-sulphur (NaS)

A sodium-sulphur battery consists of molten sulphur at the positive electrode and molten sodium at the negative electrode, separated by a solid ceramic electrolyte made from beta alumina. The electrolyte allows only the positive sodium ions to pass through it, after which they combine with sulphur atoms to form sodium polysulphides. During discharge, sodium ions flow through the electrolyte and electrons flow in the external circuit of the battery, producing about 2 Volts per cell. The battery needs a temperature of about 300° C to operate. Figure 55 shows a 34 MW/240 MWh NaS battery installation in Japan.

Figure 55

A 34 MW/240 MWh sodium-sulphur battery in Japan.



Lithium-ion (Li-ion)

The cathode in a lithium-ion battery is a metal oxide, while the anode is made of graphitic carbon with a layered structure. The electrolyte consists of lithium salts dissolved in organic carbonates. When the battery is being charged, lithium atoms in the cathode become ions and migrate through the electrolyte toward the carbon anode, where they combine with external electrons and are deposited between carbon layers as lithium atoms. This process is reversed during discharge.

Lithium-ion batteries have high energy density and high efficiency compared to other batteries. These properties make them attractive for electric vehicles.

Metal-air

The anodes in metal-air batteries are commonly available metals with high energy densities, such as aluminium or zinc, which release electrons when oxidised. The cathodes or air electrodes are often made of porous carbon or a metal mesh covered with a catalyst. The electrolyte is often a good conductor of hydroxide (OH^-) ions such as potassium hydroxide (KOH). The electrolyte may be a liquid or a solid polymer membrane saturated with KOH. This type of battery technology is still in the very early stages of development and currently has several drawbacks including a low number of charge/discharge cycles.

Figure 56

Prototype of a liquid metal battery, a high-temperature design which may one day offer very high energy density [175].

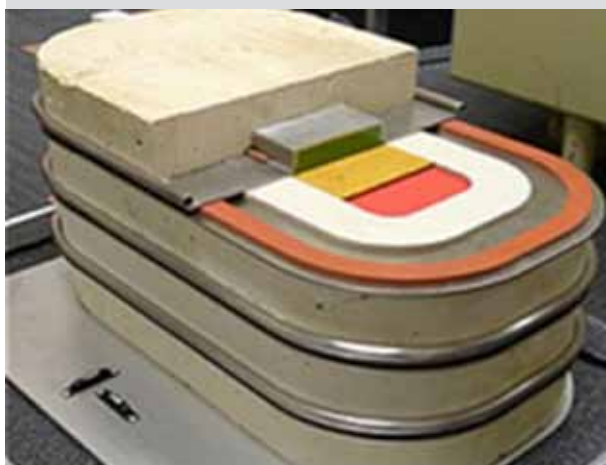

Flow batteries

In a flow battery, pumps move two liquid electrolytes through an electrochemical cell comprising a cathode, an anode and a membrane separator. The chemical energy is converted to electricity in the electrochemical cell as the two electrolytes flow through it. Both electrolytes are stored separately in large tanks outside the electrochemical cell. The size of the tanks, and hence the quantity of electrolytes, determines the energy capacity of these batteries. The power density, on the other hand, depends on the rates of the reactions occurring at the anode and cathode. Flow batteries are often called redox flow batteries since they depend on a redox (reduction-oxidation) reaction between the two electrolytes.

Characteristics of flow batteries include decoupling of power rating from storage capacity, easy replacement of electrolytes, short response time, and relatively low efficiency (due to the energy needed to circulate the electrolytes as well as losses due to chemical reactions). Flow batteries do not self-discharge, since the electrolytes cannot react when they are stored separately.

Liquid metal batteries

A liquid metal battery, as its name implies, is a battery in which all the active materials – cathode, anode, and electrolyte – are in liquid form at high temperatures. The all-liquid approach reduces the degradation of electrodes that can reduce the performance of other battery types, and allows high current density. In addition, a liquid metal battery can be built using relatively cheap components.

Prototypes with liquid metal electrodes and a liquid electrolyte made of molten salt have been tested. MIT is researching batteries based on liquid sodium, and prototypes have indicated that energy densities of up to 1,000 times that of present days Li-ion batteries may be obtained. Figure 56 shows a prototype liquid metal battery.

Summary

Li-ion and NaS batteries seem to represent the leading technologies in high-power battery applications.

Li-ion possesses the greatest potential for future development and optimisation. In addition to small size and low weight, Li-ion batteries offer the highest energy density and storage efficiency (close to 100%), which makes them ideally suited for transport applications. The major drawback of Li-ion technology continues to be its high cost.

NaS batteries operate at 300°C and require constant heat input to maintain the molten states of the electrolytes, but during normal operation internal losses may supply the required heat input.

Metal-air batteries have low cost and high energy densities but are very difficult to recharge.

Flow batteries are also promising for applications which require long-duration storage, due to the fact that they do not self-discharge. The main challenge in developing flow batteries is increasing their power and energy density.

Liquid metal batteries have great potential for future power system applications but the technology is in the early stages of development.

Thermal energy storage

Most heat requirements are for space heating, hot water and industrial processes. The main source for heat production is still fossil fuels, but traditional biomass and renewable sources met 27% of the world's total heat demand in 2008 and this share is increasing. Heat accounts for almost 50% of the 8,500 Mtoe/y total final energy demand worldwide [176, 177]. This is significantly more than electricity, which accounts for 17% of world energy demand [176].

For cooling, electricity is the usual energy source. Electricity used for air conditioning accounts for about 16% of the total electricity consumption in the USA [178].

Given these figures, it is clear that efficient use of heat and cooling could provide large and consistent energy savings.

The production and consumption of both heat and cooling are often mismatched in terms of timing. There is great potential for thermal energy storage (TES) to bridge the gaps between when heat (or cooling) is produced and when it is required.

The advantages of TES within the energy system include:

- better overall efficiency by avoiding operation at partial loads;
- equipment capital costs can be reduced by shaving peak loads and so reducing the size of the equipment;
- better exploitation of renewable sources can be achieved by storing energy when it is abundant and releasing it when it is required;

- waste energy (as both waste heat and surplus electricity) that would otherwise be lost, can be stored until needed.
- when electricity is used for heating and cooling, the electric grid will enjoy all the benefits associated with load shifting;
- TES can provide backup when equipment such as boilers, heaters and refrigerators are down for maintenance.

Technologies

Most thermal energy storage systems can be categorised into two main groups, according to how addition or removal of heat affects the system.

- **Sensible heat storage** (water, bricks, soil): Heat transfer to and from the storage medium causes the temperature to vary. This is the case with, for example, hot water tanks.

Figure 57

(a) Microcapsules containing phase change materials (PCMs) are integrated into the plaster to increase the storage capacity of a wall. (b) Scanning electron microscope image of PCM microcapsules in gypsum plaster. The PCM microcapsules, with an average diameter of 8 µm, are homogeneously dispersed between the gypsum crystals [180].

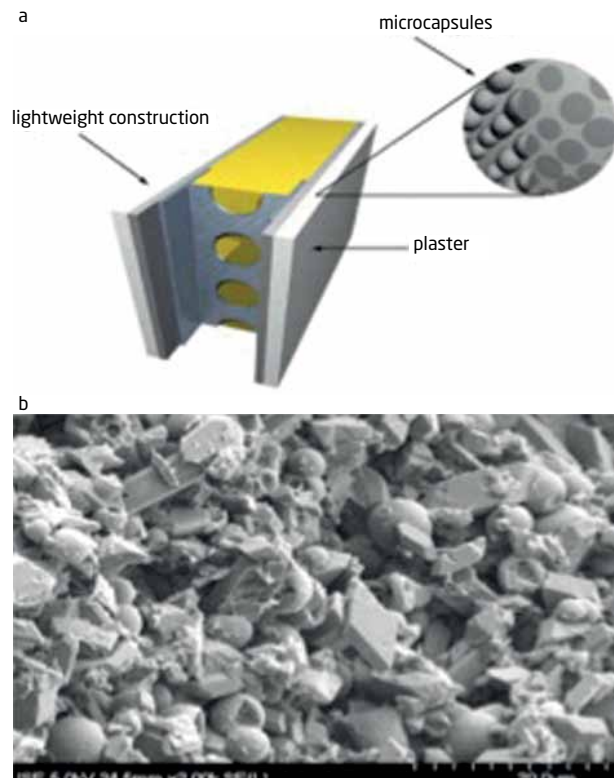

- **Latent heat storage** (phase change materials (PCMs), ice): Heat transfer to and from the storage medium takes place at constant temperature while the storage medium itself changes from a solid to a liquid, a liquid to a gas, or vice versa. Latent heat storage has the advantage of higher energy density than sensible heat storage, so smaller volumes and masses are needed to store the same amount of energy. The constant temperature at which heat transfer takes place also makes for easier control, and higher safety in special applications (e.g. food and pharmaceuticals).

While sensible heat storage is a well-known and mature technology, its use is limited to certain applications.

Recent R&D has brought PCMs into large-scale commercial use. Nowadays, PCMs are widely used in many different areas at temperatures ranging from -100°C up to almost 900°C [179]. The materials used are of different types and vary mostly according to the temperature at which the phase change takes place: eutectics, salt hydrates and organic fluids are among the most common solutions. Among others, the main areas of interest for PCMs are:

- buildings;
- temperature-controlled packaging and transport;
- passive cooling and thermal shock absorption in electronics; and
- hot water production.

Figure 58

The district heating plant in Brædstrup, Denmark, stores heat in the ground during the summer. In winter the stored heat is released to consumers [185].



PCMs are especially common in the building sector. Encapsulated into shells measuring microns or millimetres across, they can be handled like sand and embedded into construction materials such as plaster.

Used in this way PCMs can increase the thermal inertia of light buildings and so reduce temperature swings. As an example, under intense solar radiation the use of microencapsulated PCMs can reduce peak indoor temperatures by up to 4°C [180].

District heating and cooling

District heating (DH) is the delivery of heat via a network which links individual consumers to a relatively large heating plant. The advantage of DH lies in the high efficiency of large industrial heating plants compared to household-size boilers and heaters. DH plants can also burn a variety of fuel types ranging from traditional fossil fuels to municipal waste and biomass. DH accounts for about 5% of the total energy delivered to the building sector worldwide [181], with peaks as high as 70% in certain areas such as Scandinavia [182].

While TES has been used for optimisation and backup purposes in traditional DH systems based on fossil fuels, its role is of major importance when coupled with new renewable-based DH installations.

The efficiency of a traditional DH facility (one that is not coupled with renewable energy sources) is easy to define: it is the ratio between the energy content of the fuel (input) and the actual energy delivered to the final user (output), and is normally above 80%. When a DH plant takes in a certain amount of renewable (e.g. solar or wind) energy, however, efficiency becomes harder to define and very dependent on the particular technology exploited.

TES inevitably adds some losses to a DH system but these are small compared with losses from other sources, and are more than balanced by the benefits introduced. As an example, a typical 400 m^3 water tank used for TES, which can store about 14 MWh of thermal energy, loses only around 5 kW to the environment and would take almost four months to lose all its stored energy.

An important example of TES in solar-based DH can be found in Brædstrup, Denmark. Here one of the world's largest solar-thermal installations meets part of the heating needs of about 1,300 households [183]. The plant's main fuel is natural gas, but solar thermal collectors provide around 20% of the energy input. The solar collectors, which occupy an area of about $16,000\text{ m}^2$, are used to heat up the

ground during the warm season. In the winter, the heat stored underground is then extracted at a temperature of 40–50°C. An increase in the solar collector area to 50,000 m² is planned [184].

Energy storage in the electricity grid

Energy storage brings various opportunities for better utilisation of electricity transmission assets in systems which integrate renewable energy. The benefits of energy storage in power grids include power balancing, voltage support, power quality and congestion management. Apart from hydro, applications of centralised energy storage to support the operation of transmission systems are still in their infancy. However, the next decade is likely to bring progress in this direction.

In distribution grids and low-voltage networks, storage is now seen as vital for the large-scale integration of renewable power sources and is attracting much research attention. The main purposes of storage here are to:

- maintain the power/energy balance;
- provide voltage support;
- preserve power quality; and
- help to manage congestion.

Storage also plays an important role in off-grid applications. In some areas it is challenging and expensive to create an electrical infrastructure large enough to support a full-scale power plant, and more than 1 billion people around the world are not yet connected to the electricity grid. In this context, isolated networks with energy storage are a handy way to provide access to electric power. For instance, batteries can store energy generated by wind turbines and solar panels during the day, and supply loads at night.

Micro-grids with storage form another interesting area. The world has several examples of micro-grids, in which PV and wind power are often combined with energy storage to provide continuous power. Energy storage in isolated networks can supply power to buildings, factories and houses, with recent storage installations rated at up to 300 kW of peak power. Linking energy storage to both renewable power sources and diesel generators is a way to ensure reliable and self-sustaining operation of the micro-grid.

Since 2011, two hybrid systems combining energy storage with solar power have been supplying electricity to around 850 homes in two villages in Mali, Africa. The power is used by a school, workshops, a bakery and other businesses.

Energy savings, potentials and policies

Frits Møller Andersen and Kenneth Karlsson, DTU Management Engineering; Mikael Tøgeby, Ea Energianalyse A/S

Introduction

Energy plans which aim to cut consumption of fossil fuels and lower CO₂ emissions foresee a massive replacement of fossil fuels by renewable energy, increased use of electricity and considerable improvements in energy efficiency. That is, projections show an increase in the demand for energy services and a much lower increase, or even a decrease, in the demand for energy. Many studies show that it is feasible to move demand away from fossil fuels and to integrate considerable amounts of renewables into the energy system, with electricity in a central role. How to improve energy efficiencies and reduce the aggregate demand for energy is less clear, and efficient instruments to achieve this are not yet necessarily in place.

In the EU's Energy Road Map 2050 (Figure 59) [186] the "business as usual" projection includes a continuation of the historical efficiency trend and implies an increase in the demand for energy. The projection which includes the most recent policy initiatives shows an almost constant demand for primary energy in the period up to 2020. A considerable additional effort is therefore required to achieve the EU target of a 20% reduction in primary energy consumption by 2020.

In June 2012 the EU decided on a new Energy Efficiency Directive. The 2020 primary energy target of 1,474 Mtoe has been maintained, but now it is also expressed in terms of final energy – 1,078 Mtoe – with an implied improve-

Figure 59

EU Energy Road Map 2020: even with the most recent policies in place, primary energy demand will not fall before 2020 without the help of the new Energy Efficiency Directive [187].

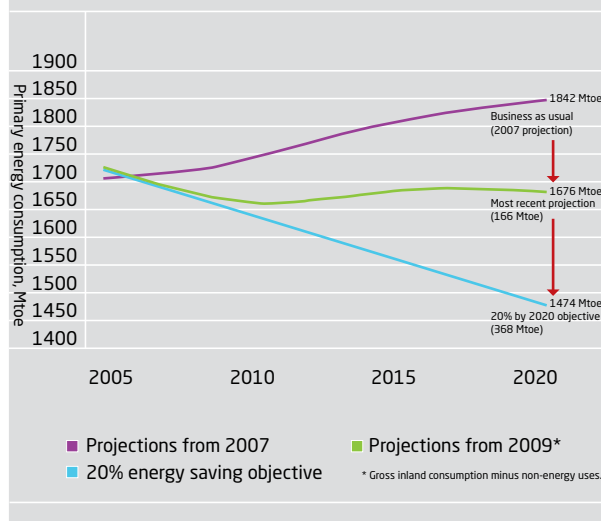

ment in overall energy efficiency. The Directive introduces some new efficiency measures, though it is expected that others may be needed to meet the target. The target is set in absolute terms, so the reduction in economic activity because of the economic crisis will make it easier to achieve [188].

Figure 60

Danish energy consumption (in PJ) and energy intensity by sector. While energy use by households, industry and the service sector is expected to remain relatively constant, energy for transport is rising rapidly [190].

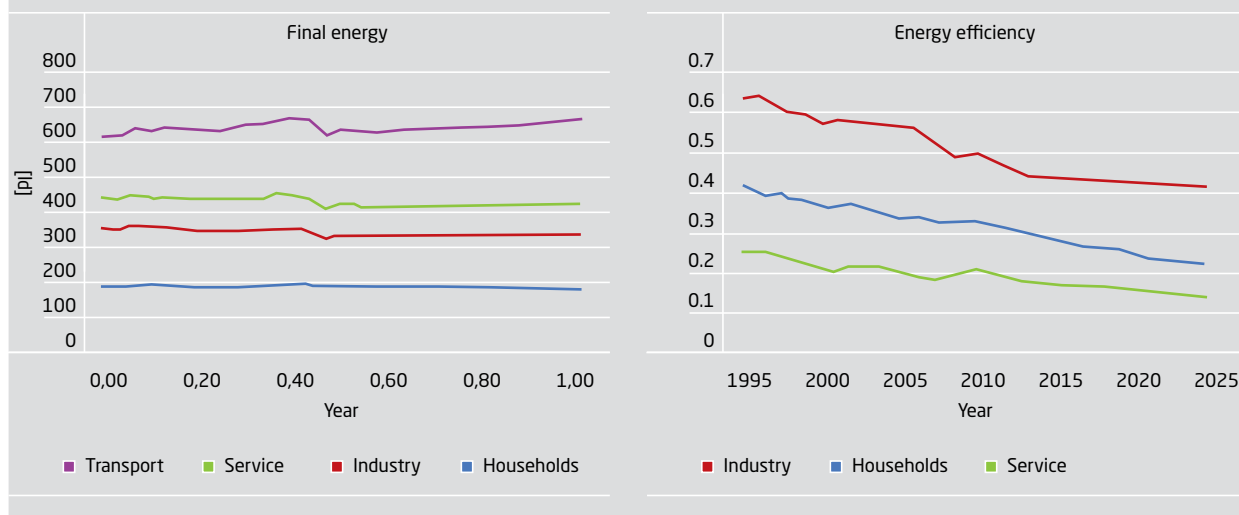

For Denmark, Figure 60 shows historical observations and the latest baseline projection of energy consumption [189]. Historically, consumption by households has been increasing slightly but is expected to fall slightly due to considerable efficiency improvements. For industry the picture is reversed: since 2000 consumption has fallen due to very large aggregated efficiency improvements (including structural changes which have seen the closure of a number of energy-intensive plants), and production fell sharply in 2009 and 2010. The efficiency improvements are expected to continue, but total consumption will increase due to an expected upturn in business. The service sector has shown increasing consumption, with a minor drop in 2009 and 2010 due to the economic crisis. Efficiency improvements in this sector have been moderate and are expected to remain that way, so total consumption will be almost constant. The main reason to expect increasing aggregated consumption in the baseline projection is a continued massive increase in energy use by transport.

As Figure 59 shows, the target of reducing energy consumption by 20% in 2020 will not be met in the baseline projection, so additional initiatives are required. To reach the target, the political agreement of March 2012 introduced additional initiatives [191]. The central elements of the agreement related to energy efficiency are:

- a doubling of the energy-saving obligations for energy companies;

- improved efficiency standards for new buildings (increases of 50% in 2015 and 75% in 2020 compared to current levels);
- a strategy to cut energy consumption in existing buildings; and
- savings in the public sector.

As Figure 61 shows, by 2020 the agreement is expected to reduce primary energy consumption by about 35 PJ/y relative to the baseline projection.

The challenges of efficiency improvement are quite heterogeneous across different categories of consumption. Buildings, private households, industry, public and private services and transport have quite different technical potentials and barriers to implementation, and should be targeted through quite different incentive schemes. In addition, it is hard to assess the importance of issues such as rebound and lock-in (see below), additionality of efficiency improvements, and uncertainties in price trends for energy and capital goods. At the macroeconomic level increased investment in energy savings should increase employment and GDP, and decrease fuel costs, but “crowding-out” effects related to other investments will at least partly negate these benefits. This chapter explores some of these issues in relation to specific analyses.

Terms and economic concepts

Before we look at potential for efficiency improvements and energy savings a few concepts should be made clear.

Efficiency improvement means providing the same energy service with the use of less energy. Energy savings, on the other hand, could also include behavioural changes which imply a lower demand for energy services.

When talking about potential we should distinguish between technology and economics. Technical potential changes with the development of new technologies and energy solutions. Economic potential refers to the subset of technical potential that is profitable under given economic conditions. That is, economic potential changes with changing prices and costs, as well as with technical developments.

We may also distinguish between private and societal profitability when considering whether prices and costs should include taxes and subsidies. Considering a specific improvement in efficiency, the direct economic effect is a reduced cost of the energy service. This has both an income

Figure 61

Relative to the baseline projection, the latest agreement is expected to reduce primary energy consumption in 2020 by about 35 PJ/y.

<http://www.ens.dk/da-DK/Politik/Dansk-klima-og-energi-politik/regeringsklimaogenergipolitik/forhandling11/Documents/PPT%20Energieeffektivisering.pdf>

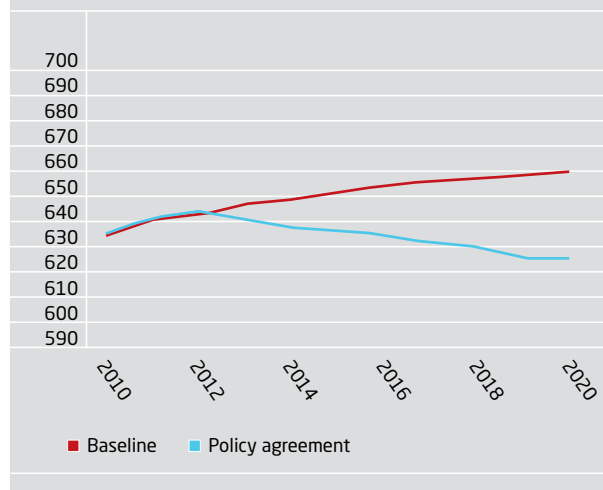

and a price effect, both of which imply increased demand for that energy service. This effect is called the rebound effect, and its size depends on the income - and price elasticity of energy demand. For Denmark the rebound effect is thought to be moderate, but for some low-income developing countries it may be substantial. In such countries, high income and price elasticities of energy demand mean that higher efficiency may not reduce demand, though it will still improve welfare.

A final concept to introduce before we look at specific potentials is that of lock-in. The potential savings from a given initiative or technology very much depend on which other technologies are available, and once a given initiative with a given lifetime has been implemented, the potentials for other initiatives change. For example, installing a heat pump in a house may save a certain amount of money. If we first insulate the house, however, the potential savings from the heat pump will fall – or from another viewpoint, the existence of the heat pump will reduce the profitability of subsequent insulation projects. This tendency of one technology to make others uneconomic is known as the lock-in effect.

Potential for improvements by sector

About 30% of all energy consumed is used for heating, ventilation and lighting in buildings, and the potential savings in this category are quite substantial. New buildings are subject to legal efficiency standards and, as mentioned above, the March 2012 agreement will make these more stringent. However, most of our existing buildings will remain in use until after 2050, since turnover in the building stock is only around 1%-2% a year.

Efficiency improvements in existing buildings can be costly and pose a number of challenges depending on architecture, age and ownership. Typically, considerable savings may be achieved by changing windows, increasing insulation thickness and optimising heating and ventilation systems. The construction of the building may limit the feasible changes, however, and lock-in effects may be substantial. A plan for the energy renovation of existing private dwellings is therefore recommended.

The March 2012 agreement decided that a strategy for energy renovation of existing buildings should be developed before the end of 2013. The strategy should especially address two issues: first, the need for deep renovations as opposed to minor technical and behavioural changes, and second, how to resolve asymmetries between rented and

Table 8

Potential energy saving in manufacturing industry from various process operations over different payback periods [192].

Technologies	Energy consumption			Potential savings with pay-back period of		
	TJ/year	Fuels	Electricity	2 years	4 years	10 years
Losses in boilers and net	11.212	11.212	-	3%	5%	10%
Heating/cooking water	27.208	25.552	1.656	8%	12%	28%
Drying	17.995	17.233	762	7%	13%	26%
Evaporation	5.759	5.759	-	16%	30%	57%
Burning	12.491	12.467	24	6%	8%	20%
Sub-sum	74.665	72.223	2.442	7%	12%	26%
Light	13.716	-	13.716	12%	17%	68%
Pumping	5.364	-	5.364	14%	22%	34%
Cooling/freezing	7.604	-	7.604	12%	18%	39%
Ventilation	10.648	-	10.648	19%	27%	36%
Compressed air	4.580	-	4.580	23%	28%	43%
Electrical engines	10.247	-	10.247	8%	12%	19%
Sub-sum	52.159	-	52.159	14%	20%	42%
Sum	126.824	72.223	54.601	10%	15%	32%

privately owned buildings, and how to divide costs and savings between tenants and owners of rented buildings.

In household consuming, which consume about one-third of the total electricity used in Denmark, efficiency improvements have been quite substantial (15–30% over the last 10–15 years). However, the number of appliances continues to increase, so aggregated demand has been almost constant. Technical efficiency improvements are made by equipment manufacturers, most of who are outside Denmark, according to requirements negotiated internationally and at EU level. Specific Danish requirements will have little effect on technical efficiency, so Danish policy should aim to influence EU rules, labelling and similar information, so as to give consumers the ability to choose energy-efficient appliances. The EU's Ecodesign Directive imposes energy efficiency requirements on appliances including motors, refrigerators, freezers, dishwashers, washing machines, fans, air conditioning units and pumps. One of the most significant changes is the EU ban on traditional incandescent light bulbs, which is expected to cut electricity consumption for lighting by about 70%.

Turning to manufacturing industry, Table 8 shows the potential energy savings available from various process operations. The savings are shown as percentages with payback times of 2, 4, and 10 years respectively. Savings of 7% in fuel and 14% in electricity could be achieved with a payback of only two years, and with a payback of 10 years the corresponding savings amount to 26% in fuel and 41% in electricity.

An interesting observation is that economic potentials have increased since a former evaluation in 2000. The reason for this is both the technical development and increasing energy prices.

As mentioned above, energy consumption in transport is expected to continue to increase, mainly due to increased demand for transport services. However, over the last couple of years the efficiency of new cars has increased considerably. Many new cars in Denmark have become relatively cheap as the registration fee for small energy-efficient cars has been reduced. However, the general belief is that it is difficult to persuade people to change their transport habits.

Incentive schemes

The most important policy to increase energy savings in Denmark is energy taxes. On top of the basic energy tax fall separate taxes for CO₂, NO_x and SO₂, plus a public service obligation (PSO) payment for electricity. On average in 2008 the tax per kJ or per GJ was about 70% higher in Denmark than the EU average [193]. Transport taxes are not that different from the rest of the EU, but Danish taxes on electricity and fuels are on average about six times higher than in other EU countries. Private energy consumption, heating and process energy are taxed at different rates, with the rates for the first two categories being about 10 times higher than those for process energy [194]. The argument for this differentiation is that taxes reduce energy consumption, but that taxes on industry also reduce the competitive power of Danish products.

In addition to taxes, Danish energy policy includes normative instruments such as efficiency requirements for new buildings and renovation of existing buildings, energy-labelling of buildings, products, and appliances, and a number of information campaigns and requirements.

The rest of this chapter focuses on the energy-saving obligations of energy companies according to a recent evaluation [195].

Energy-saving obligations for Danish utilities

Danish energy utilities have been working on energy efficiency since 1990. After 2006 the framework was fundamentally changed to increase its focus on actual energy savings achieved. At the same time requirements were changed so that energy companies were allowed to implement energy savings related to any type of energy in all parts of Denmark; only transport is excluded. Flexibility was also introduced in terms of the types of instruments the energy companies could use (for instance, allowing subsidies) and trading in savings was allowed.

All this has some similarities with a white certificate system such as those used in France and Italy [196]. However, in the Danish system the energy companies must document the fact that savings have been correctly calculated and fulfil the requirements. In the Italian white certificate system, in contrast, the regulator approves all projects and there is a public trading platform for white certificates.

Figure 62
Reported savings by categories generated by the Danish obligation scheme for energy companies.

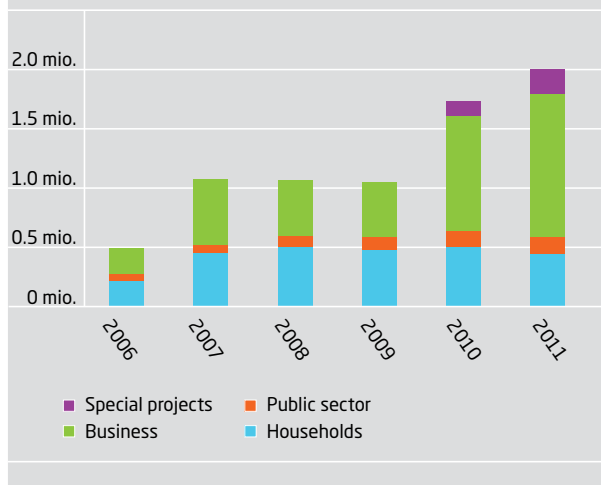

Today Danish companies supplying electricity, natural gas and district heating have an obligation to be active in energy saving projects. The oil companies have also joined the system. In total, these energy companies must achieve savings of 6.1 PJ (1,694 GWh) in 2012, increasing to 12.2 PJ in 2015 [197]. The 2012 obligation corresponds to 1.5% of the energy consumption covered by the scheme. Energy-saving projects are assessed in terms of the savings

achieved in their first year, so the long-term impact of the system will depend on the lifetime and additionality of the projects carried out.

For an energy efficiency project to be included, the energy company or an external player must have been active in relation to an end-user before the project is initiated.

More than 500 energy companies fall under the obligation, including 428 district heating companies. The energy companies are spending €100 million/y (2010) to meet their obligations, and this amount is expected to double by 2015.

The energy companies typically use subsidies to get their customers to reduce energy use; subsidies have been used in 86% of all registered savings. In some cases advice is given alone or in combination with a subsidy.

The obligation system has been evaluated in 2008 and 2012 [198], [199]. The focus of these evaluations has been to assess the social economy of the activity and estimate its net impact. Many different methods have been used in the evaluations, including telephone interviews; in the latest evaluation, for instance, 209 end-users were interviewed.

Figure 62 shows the savings by sector. Savings among businesses, especially manufacturing industry, are large and increased rapidly in 2010 and 2011. 65% of all registered saving in 2011 were in the commercial, service or industrial sectors. Based on interviews and a document review,

Figure 63
Average additionality of savings in business and households.

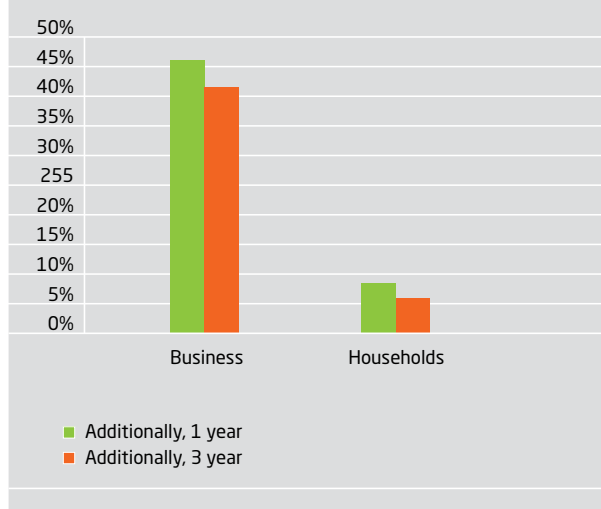
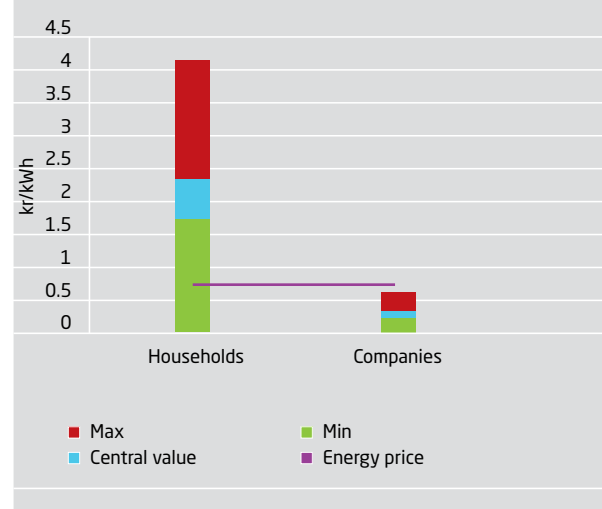

Figure 64
Social costs of the savings obtained.



45% of these savings can be considered as additional (Figure 63). The total capital costs to both energy companies and end-users are estimated to be half of the net present value of the net impact of the savings achieved (Figure 64). Many of the projects have very attractive economics, with payback times as short as 1–2 years. In some cases subsidies have been paid to companies even for projects with payback times of less than a year, and the evaluators recommended that this practice should stop.

For dwellings the results are much less promising. On average only 20% of the registered savings are estimated to be additional. This is especially true of apartment buildings, where the average additionality is below 10%; for single-family houses the figure is a little better, at 30–35%. The total cost of an average project is estimated to be three times the value of the energy saved over the life of the project (net present value, socio-economic value excluding taxes, 5% discount rate, 10-year horizon). Typically payback times for households are 10–20 years including taxes and 20–40 years excluding taxes (as in the calculation of socio-economic value).

It is generally recognised that it is a challenge to find economic ways to reduce energy consumption in existing buildings. The Danish government will in 2013 publish a strategy for how to renovate existing buildings [197]. One of the main challenges is the timing of the policy instruments. If it is possible to influence households at the exact time when they plan to renovate their houses, this can improve the economics significantly because the marginal cost of improving efficiency is much lower than the total cost of the renovation [200]. One way to achieve this could be to work with installers and suppliers in the building sector. This is the goal of the Danish Knowledge Centre for Energy Savings in Buildings (www.byggeriogenergi.dk), which recently received a positive review. The Centre targets installers and provides information on 48 classes of energy-saving solutions. More than half of the installers questioned during the review knew of the Centre, and its documents received high marks for usability [201].

A comprehensive study of the energy labelling system for single-family houses could not document any impact [202]. This system is based on individual advice from a consultant who audits the building at a typical cost of €900. The label, which carries a letter from A (best) to G (worst), must be advertised whenever a house is sold, and this has increased buyers' interest in the scheme.

Conclusion

Baseline projections show that additional initiatives are needed to meet the EU's 2020 target of a 20% reduction in energy consumption. Economic potentials for savings are fairly large in the long term: about 40% in buildings, 30% for household appliances and 30% for manufacturing industry. However, obtaining these savings poses different challenges, and requires quite different policy initiatives, for each sector.

For energy efficiency in buildings the issue is that existing buildings will stand for many years and are costly to renovate. Appliances have a shorter life, so they will be replaced within 10–15 years. In manufacturing, the challenge is that costly savings will decrease the competitiveness of products. Targeting these different saving potentials therefore requires different initiatives.

For buildings, timing and planning are important: energy savings should be included when buildings are renovated for other reasons, and lock-in effects can be significant. For household appliances, energy labelling and information is important. In manufacturing, subsidies may be important to preserve competitiveness.

Energy-saving obligations on Danish energy companies, which combine consultancy with subsidies, have been fairly successful in obtaining savings in small and medium-sized firms, where about 45% of the reported savings are additional.

Transport continues to be a challenge. Over the last 10 years, however, the efficiency of cars has increased, and in the long run electric vehicles may improve energy efficiency and help in the move away from fossil fuels.

Synthesis

Hans Hvidtfeldt Larsen and Leif Sønderberg Petersen, DTU National Laboratory for Sustainable Energy

Energy efficiency on the global energy scene

Energy security and climate change remain the major driving factors for energy policy in most countries around the world. Global and national studies show that energy efficiency improvements have significant potential to address both issues.

Efficiency improvements in the production and consumption of energy constitute key elements in most scenarios addressing climate and energy security concerns. Energy efficiency is also at the heart of the EU 2020 strategy.

Analysis by the IEA in its World Energy Outlook for 2010 concludes that the 450 scenario (a maximum atmospheric CO₂ concentration of 450 ppm) requires a major contribution from efficiency improvements, especially in the next decades.

The combined challenge and opportunity associated with energy efficiency is that it is relevant to most sectors and so requires the engagement of a large and often very diverse group of actors.

Buildings and appliances

With regard to buildings, the focus in OECD countries is mostly on renovating the existing building stock. For many developing countries the situation is more mixed and new construction plays a larger role.

One of the most important appliance areas in terms of potential for progress on energy efficiency is lighting. Lighting is important for quality of life, education, commerce and social interaction. Electricity for lighting has been estimated to account for as much as 15–20% of global electricity consumption.

After analysing the financial and energy savings potential of lighting, countries including Australia, Canada, the EU member states and the USA have adopted programmes combining regulation and market transformation to promote efficient lighting technologies. Now other countries such as China are making similar progress in phasing out incandescent lamps.

Industry

The industrial sector worldwide accounts for approximately one-third of global final energy use, with OECD countries being responsible for around 40% of this and the remaining 60% being consumed in developing countries. The chemical, petrochemical, iron and steel sectors are responsible for half of total industrial energy use, distributed fairly evenly

between the two country groupings, so efforts in these sectors are clearly very important. In spite of quite successful efficiency programmes, energy use in industry is still expanding due to increasing global demand.

Transport

The transport sector accounts for around 20% of global final energy use and is the fastest-growing sector in terms of energy use. Road transport dominates passenger transport. Though the picture for land-based freight transport is slightly more mixed, trucks still carry the great majority of land freight.

This clear dominance of road transport brings strong political interest in the three key parameters: number of vehicles, travel distances and fuel efficiency.

While this report concentrates on increasing energy efficiency, it is important to note that for the transport sector there is a parallel focus on alternative fuels and engines.

Electric cars are another development direction which is still largely at the demonstration stage. Several different concepts are competing and most automotive manufacturers are still experimenting with design and technical performance. Using electricity for road transport will require major changes not just to vehicles but also to infrastructure; the latter will need to be developed at both micro (fuelling) level and at the power system level to accommodate a possible demand increase and changing load patterns.

Denmark plans to be fossil-free by 2050

In Denmark the ambition of being independent of fossil fuels by 2050 is high on the agenda. This was most recently shown in the Danish Government's plan Our Future Energy, which foresees the production of heat and power 100% from renewables by 2035, and the entire energy system, including transport, supplied only by renewable sources by 2050. But renewable sources are limited in amount and the change to independence will be unnecessary costly if not a strong effort for energy efficiency and conservation is carried out in parallel with the development of a renewable energy system.

It should be stressed that energy efficiency is not the same as energy conservation. Efficiency refers to providing the same services with a lower input of energy, while conservation includes lower demand for energy services. Energy conservation includes the possibility of changes in consumer lifestyle (behaviour), leading to lower demand for energy-intensive services; thus, switching off lights to save

energy is not an efficiency improvement, but an energy conservation measure.

The Danish Commission on Climate Change Policy (the Climate Commission) between one-third and half of the by 2050 required energy services should be supplied in terms of increased energy efficiency depending on the sector considered. The scenarios analysed in the Climate Commission report assume that by 2050 efficiency in the household sector will improve by more than 25% compared to the reference scenario; for the service sector the corresponding figure is 15%, for industry as much as 39%, and transport 27%.

The energy savings included in the policy scenario for the buildings sector are assumed to result from tighter building codes, faster renovation of existing buildings and better insulation of ceilings and walls. Ventilation heat recovery is also included.

In industry, electricity savings and substitution of process heat from fossil fuels with more efficient biomass and electricity are major contributors. In the transport sector, faster and higher efficiency improvements in vehicles with conventional engines are a major efficiency improvement factor together with high efficiency of electric vehicles.

Energy efficiency is a high priority for the IEA and IPCC

The IEA has assessed the potential for energy efficiency as part of its Blue Map scenario. In this scenario, end-use energy efficiency improvements contribute about one-third of the total CO₂ emission reductions in 2050, a proportion that is very similar across the four major regions of OECD Europe, the USA, China and India. End-use fuel efficiency is forecast to contribute 26–28% of the CO₂ emission reductions in these regions in 2050, with further reductions achieved through end-use electricity efficiency improvements.

IPCC also shows that there is a relatively larger and economic attractive potential for energy conservation and efficiency improvements up to 2030.

The social costs of mitigation scenarios for targets involving CO₂ stabilization at low levels will be lower than the private costs simply because there is a social value associated with decreased global warming, reduced air pollution and increased energy security, and probably also some green growth benefits from using cleaner technologies.

Taken together, this makes a strong case for introducing a wide range of public policies and instruments to support

private costs and create other incentives aligned with the objectives of visions such as the Danish 100% renewable energy plan and the Blue Map scenario.

Energy efficiency in buildings

The energy used in buildings typically represents about 40% of all energy used in society. The majority of this is used for space heating and cooling.

Low-energy buildings can make a major contribution to general sustainable development by providing a solution to problems related to the use of fossil fuels.

The EU's Energy Performance of Buildings Directive (EPBD) requires that by 2020 new buildings shall be constructed to use nearly zero energy and no fossil fuels. This can be accomplished by combining low-energy buildings with renewable energy via low-temperature district heating in cities and suburbs, or heat pumps for low-density settlements.

Based on experience with passive houses, low-energy buildings to the EPBD standard are expected to cost only a few percent more to construct than conventional buildings.

Through the use of energy saving technologies as part of deep renovation, the heating requirements of existing buildings can also be reduced to levels close to those of new buildings in the future.

Insulated building envelopes (floors, walls, ceilings and roofs) may cut their heat losses further by using thicker insulation or insulating materials with lower thermal conductivity.

Windows may be improved by reducing heat losses and increasing the transmission of light and solar energy.

Ventilation systems need to have highly efficient heat recovery and accordingly mechanical ventilation is necessary.

Domestic hot water systems in large buildings with circulation pipes typically have large heat losses. Lower temperatures and better pipe insulation can reduce these losses.

The process for designing low-energy buildings to meet the EPBD standards needs to be improved in order to make sure that buildings will live up to the requirements for both energy performance and indoor environment in an optimal way.

Energy efficiency in lighting

Lighting has been an integral part of human civilization since before recorded history. Today artificial lighting is a critical part of modern life. However, traditional fuel-based and incandescent lighting is highly inefficient. This has led to the situation in which lighting takes up 6.5% of all the energy used worldwide. As a consequence, inefficient lighting products are now being phased out.

Research in LED lighting technology has demonstrated energy efficiencies above 200 lm/W. Due to the need for higher spectral contents in the red region such LEDs have only a luminous efficiency of around 90-110 lm/W. This is close to 9 times higher than that of incandescent bulbs. LED products presents efficient replacements for incandescent and halogen bulbs with efficiencies 10-22 lm/W.

Even though vast improvements have been made in efficiency and light quality, LED light is still in its infancy. One of the barriers to market introduction is price, which is still around five times higher than traditional lighting technologies.

To fulfil the potential of LEDs and similar light sources, further R&D needs to increase the amount of light that can be extracted from semiconductor materials and optimise the light distribution.

Energy efficiency in communications networks

It is estimated that about 2–4% of global energy consumption is used to operate communications infrastructure – mainly the Internet. Even though this figure might not be alarmingly high in itself, it becomes extremely important when it is combined with the annual growth rate of 30–40% due to a similar growth rate of the required capacity implemented to serve user and application demand.

Today's communications networks show an almost linear relation between capacity and power consumption. Even though the electrical power consumed by communications networks – and especially its growth – is acknowledged as a significant problem, as yet there is no clear path to reduction.

More intensive use of optical technology is currently the best solution for the long-term future. This would require a complete restructuring of the way networks are researched and implemented, however, since optics are unlikely to provide the same flexibility as the electronic/software solutions used in current networks.

Energy efficiency in transport

Transport of people, personal belongings and goods in private cars is a fundamental part of modern society and economic growth, and has grown steadily over many decades.

Motor fuels have been based almost entirely on crude oil for the last century. Over the last couple of decades engines for traditional fuels have evolved towards more advanced and efficient types. This has reduced fuel consumption on the order of 40%. Natural gas is becoming an interesting fuel due to the availability of large new resources.

Only during the latest couple of decades we have begun to look at alternatives to fossil fuels, while at the same time the engines for traditional fuels have developed towards more advanced and efficient types.

Biofuels such as biodiesel, bioethanol, biomethanol and biogas can substitute gasoline and diesel. In recent years algae have also shown potential as diesel fuel.

Several factors have combined to reduce the fuel consumption of cars based on combustion engines. First, cars increasingly use diesel engines, which are more efficient than those based on gasoline. The current efficiency target for both diesel and gasoline engines is 50% in light-duty vehicles, and even higher efficiencies for heavy-duty vehicles.

One of the future innovative solutions is fuel cells for road vehicles of the PEM (proton exchange membrane) type. Fuel cells for this purpose are fuelled by hydrogen, but other fuels are possible as well. The resulting process is low temperature combustion of hydrogen with air.

A technology that is closer to market penetration is electric vehicles (EVs). In this respect, Denmark is better prepared than other nations. To promote EVs the Danish government decided not to impose the normal vehicle registration tax of 180% until 2015 – and to provide drivers with free parking in downtown Copenhagen. These initiatives have accelerated the introduction of EVs. Still, EVs have several barriers to overcome for the moment. First of all the price of vehicles and batteries is still too high and the driving range is a little short in practice for long distance travels. By establishing a few charging poles at city centres and other places with many activities combined with charging poles in public and semi-public areas in the dense city areas where the inhabitants haven't got private parking lot it is possible to serve the need for daily charging of EVs. Infrastructure for EVs battery charging and switching has to be

established. When the needed infrastructure is in place at least 85% of the Danish one-car families and most of the two car families could be potential EV customers.

A transition form of EV, the hybrid electric vehicle (HEV), has two different power sources: an electric motor and a small combustion engine to extend the operating range. The combustion engine charges the battery which powers the electric motor, and can also drive the wheels directly. Plug-in hybrid electric vehicles (PHEVs) also offer the ability to charge the battery from the grid.

Efficient exploitation of wind energy

Energy efficiency improvements as tools to create a sustainable energy future have a different character in the context of renewable energy generation, such as wind power, than in applications like industry, transport and traditional power generation.

Efficient deployment of wind turbines is associated with deployment of turbines in large wind farms, whereby infrastructure can be consolidated. With the deployment of turbines in large wind farms, accurate prediction of wake effects within a wind farm becomes important in predicting both energy production and the mechanical loads on the turbines.

Wind turbines need to become more active and intelligent elements in the energy supply, and there is already a trend towards higher capacity factors and multivariable control systems. In the last decade or so wind farms have gradually evolved from being just sources of energy to become power plants that contribute actively to the control and security of the power system.

Massive offshore development will require corresponding investment in the power grid infrastructure just to connect the offshore wind plants to the transmission grids on land. At the same time it is becoming more feasible to increase the interconnection capacity between European countries to support an integrated, pan-European market for electricity. Interconnectors are already important to the socio-economic value of wind power, especially when they connect wind power to areas with large amounts of flexible hydro generation. Hydro capacity in Norway, for example, is already connected to both Denmark and the Netherlands, but the potential to increase Norwegian hydro generation and storage capacity will make more interconnectors feasible.

With this development wind energy can become the backbone of power systems globally and play a major role in the move towards efficient and sustainable power.

Efficient exploitation of solar energy

Solar power technologies are being deployed at increasing speeds but they still exploit only a fraction of the resource available. Bottlenecks in resources, capital investment in production machinery, land and infrastructure will also become important as solar power continues its rapid growth.

The amount of new photovoltaic (PV) capacity installed in 2011 was 27.7 GWp, a 40% increase compared to 2010. The total installed global PV capacity was 67.4 GWp by the end of 2011.

Crystalline silicon (c-Si) and thin-film solar cells are well established, yet roadmaps for these technologies still identify clear potential for improvements in performance and substantially lower production costs in the next decade.

Solar cells are an option almost everywhere on Earth and are often an important part of the net energy balance for zero-energy buildings.

It is an open question whether building-integrated PV systems should count towards the net energy balance of new low-energy buildings. The risk is that cheap PV may oust long term passive energy improvements.

Worldwide, much attention is being paid to utility-scale PV power plants. The leading global database includes more than 6,000 plants with capacities above 200 kWp, giving a total capacity of approximately 10 GWp by 2010.

PV and concentrating solar power (CSP) are among the renewable energy technologies with the highest energy production per unit of land area.

Utility-scale PV and CSP installations have additional requirements for land and water for cooling or cleaning.

Efficient exploitation of bioenergy

Biomass is the oldest source of energy exploited by mankind. Recently there has been a lot of debate on substituting biomass for fossil fuels. Certainly biomass has great potential, but although it is a renewable resource it is not unlimited. Thus biomass alone cannot solve the world's energy problems, though if used wisely it can be part of the solution.

Many issues need to be taken into account, the most obvious of which is the energy conversion efficiency of the complete cycle: from growing the biomass to delivering the biofuel. Energy return on energy invested (EROI) is an important indicator, relating the energy content in the biofuel to the energy, direct and indirect, required to produce it. The EROI of the fossil fuels which have powered our society for more than a century has decreased from about 100 to about 10 during this period, implying that the net energy service provided to society has decreased from 99 times to 9 times the energy input from society. A primary energy source for transport may need an EROI of at least 3 to provide the energy needed to run the necessary infrastructure as well as the vehicles themselves. Estimates of EROI for bioethanol from maize are in the range 0.8–1.6, which means that in some cases the energy output is less than the input.

Producing biomass with high yield requires fertiliser, and the production of fertiliser is one of the most energy-consuming processes in the chain.

To be able to continue to produce biomass efficiently it will be necessary to recycle the carbon and nutrients as much as possible. Recirculation of nutrients to soils to maintain fertility is especially important for those nutrients produced from essentially non-renewable resources such as phosphorus.

Production of biomass for bioenergy most often occupies land that could be used to produce other goods necessary to society – food, fodder and fibres – or to provide other ecosystem services. Thus it is necessary to strengthen the development of methods for conversion of “waste” products into bioenergy, i.e. products not currently used by society or required to maintain environmental quality. These include household waste, organic waste from food production and manure from animal husbandry.

Energy efficiency in industry

Distillation is a common refinery process in industry, accounting for 4% of all energy consumption in the western world. Substantial reductions in the energy needed for distillation are therefore desirable. This is achievable via energy integration, for example by integrating separation and heat exchange within the same equipment. Though industrial application is still very limited, such techniques can cut the energy consumption of distillation by up to 80% and operating costs by 60%.

Waste typically contains a significant fraction of flame-volatile ash-forming elements which may cause deposition and subsequent corrosion in equipment such as waste incinerators. Due to the chemically aggressive nature of the ash from waste, these plants operate with electrical efficiencies of around 24–27%, which is much lower than the 46–50% obtainable in coal-fired power stations. There is therefore significant potential to improve the electrical efficiency of such plants.

The future vision is to develop waste-to-energy (WtE) technology that will deliver highly efficient, clean and sustainable heat and power through the thermal conversion of waste.

The first commercial success criterion is to develop a new generation of clean and flexible incineration-based WtE plants with electrical efficiencies above 30%. This will require coordinated R&D among academia, power companies and boiler manufacturers.

Internationally, the market for incineration-based WtE plants is significant. On a short timescale there will be a huge market for incineration-based WtE technology in the UK, with Eastern Europe following. The market for incineration-based WtE technology is also well established in Japan, Korea, Taiwan, Canada, and the USA, while China and eastern Europe are rapidly emerging markets.

Biomass gasification plants offer relatively high electrical efficiency and also significant potential for increased energy utilisation, mainly in relation to their handling of ash and fibre-rich biofuels. The current small-scale gasifier demonstration plants need to be scaled up to match the size of conventional plants now used for straw combustion (~20–50 MW) and ultimately full-scale coal-fired units (~100–500 MW).

Biomass gasification for combined heat and power production (CHP) is a promising technology which provides an attractive alternative to biomass combustion, especially in small-scale plants with an electric power output below 10 MW. The prospect of using biomass for high-efficiency decentralised CHP is appealing in a country like Denmark, where district heating is widespread. Gasification is not limited to new plants; there is also huge potential to convert existing heating plants fuelled by biomass and gas engine CHP plants running on natural gas.

The high electrical efficiency of small biomass gasification CHP plants based on gas engines provides a new opportunity to convert biomass-fired heating plants into efficient CHP plants. An advantage of such conversions is that infrastructure and buildings are already at hand.

Efficient exploitation of nuclear energy

Nuclear energy is characterized by its very high energy density and is well suited to large-scale baseload electricity supply. As with renewable energy sources such as wind, solar and biomass, nuclear power is characterized by an abundant supply of its primary energy source, uranium.

Operators of power reactors work continually to decrease their uranium consumption and increase energy efficiency. Optimisation in the design and use of nuclear fuel assemblies, especially in boiling water reactors, has increased the amount of energy harvested from the same amount of natural uranium by 25% since the 1980s. Electrical efficiency has also increased, thanks to modernisation programmes including the renewal of steam turbines, economisers and generators, resulting in a typical increase of 20 MWe per unit.

The total efficiency of nuclear energy could be greatly increased by making direct use of the heat generated in fission reactors to drive industrial processes as well as to generate electricity.

The efficiency of electricity production can be increased by using reactor designs that operate at higher temperatures. This would open up additional industrial applications, including the possibility of producing hydrogen efficiently in industrial quantities through high-temperature electrolysis or thermochemical decomposition of water.

Fuel cells and electrolysis in an efficient energy system

Fuel cells may lead to energy savings thanks to their high electrical efficiency. The electrical efficiency of a high-temperature fuel cell plant may be as high as 60% and up to 70–75% if the fuel cell is combined with a steam cycle. These efficiencies are higher than those of advanced boilers and gas turbines, so fuel cells could save energy by reducing losses in electricity production.

From an energy efficiency perspective there is a synergy in combining fuel cells with heat pumps and heat storage. In decentralised CHP plants with district heating grids, fuel cells are especially promising as replacements for conventional gas turbines. Fuel cells have higher efficiencies than single cycle gas turbines, including when operating at part load, and can be combined with heat pumps and heat storage.

Fuel cells may also improve energy efficiency when used in services other than power production. An important example is transport, since the efficiency of a fuel cell is roughly double of that of a combustion engine.

Fuel cell vehicles (FCVs) are in strong competition with battery-based electric vehicles. Although less mature than battery-based EVs, and not yet commercially available, FCVs provide longer driving ranges (on the order of 500 km).

Electrolysis may act as an enabling technology to facilitate the substitution of fossil energy by alternatives in several ways, including storage of energy from intermittent sources and production of synthetic fuels for transport. An increased share of power production from intermittent sources like solar and wind increases the demand for load balancing on the electricity grid; this is true both at short timescales – to keep frequency constant – and longer periods where surplus electricity needs to be stored for times when consumption exceeds production. Such balancing can be achieved by using electricity to produce hydrogen, which is then stored for later conversion. For ease of storage and re-use it may instead of hydrogen be advantageous to produce methane allowing use of the large storage capacity of the existing natural gas grid, or high energy density liquid fuels.

An interesting option in this context is the concept of carbon capture and reuse. This involves burning biomass to produce electricity and heat, capturing the resulting CO₂ and using this as a raw material for synfuels produced via

electrolysis. This is a way to produce transport fuels from biomass efficiently in terms of both energy and carbon yield.

Utilization of waste heat for heat and power production in an efficient energy system

Waste heat may be used as an energy source to drive heat engines producing power and heat pumps supplying heat. Heat pumps work by taking in heat energy from a source at low temperature and boosting its temperature to a level sufficient to meet a particular application, such as space heating.

Suitable low-temperature heat sources include waste heat from marine diesel engines, refrigeration equipment and other industrial plant, geothermal sources and solar heat.

Since about 40% of total energy consumption in Denmark is used for heating, better utilisation of electricity via heat pumps could contribute significantly to energy saving. The coefficient of performance (COP) of a heat pump shows how much heat it can transfer for each unit of energy used to drive the pump. From a technical viewpoint it is possible to increase the COP of a domestic electric heat pump to 10–20, compared to 3–4 today.

In marine applications it is expected that more advanced systems for waste heat recovery can improve the efficiency with 20%.

Manufacturing industry accounts for 15% of total Danish energy consumption. Using just 25% of the waste heat currently rejected by industry as an energy source for electricity production or heat pumps may thus contribute significantly to cutting demand for primary energy.

Energy storage and markets in an efficient energy system

Energy storage can play an important role in alleviating problems posed by variable demand, since energy can be stored when demand is low and recovered when demand is high.

An issue with electricity storage is its investment cost. Most forms of energy storage have high capital requirements and their profitability prospects are closely tied to geographical location as well as the characteristics of the particular technology.

Thermal storage too can also play an important role in the markets. The Danish experience of high wind penetration in the power system shows that transmission system operators (TSOs) frequently have to deal with the problem of overproduction. This could be partially mitigated by the introduction of thermal storage.

Energy storage technologies can be classed according to the form of energy stored: mechanical, electrochemical, electromagnetic or thermal storage. Mechanical storage includes hydroelectric storage, compressed air energy storage (CAES) and flywheels. Electrochemical storage includes batteries and flow batteries; electromagnetic storage includes superconducting magnetic energy storage (SMES).

Technological development is especially strong in batteries and ultracapacitors, but thermal storage is also expected to have a significant role in stabilising the energy system.

Ultracapacitors have high cycle efficiency (90–95%). Their self-discharge rate is proportional to voltage and is typically around 2% per day. Since ultracapacitors will in most cases be used for power conditioning applications involving relatively fast charge and discharge cycles, the effect of self-discharge will be small.

Batteries including Li-ion and NaS types offer the highest energy density and storage efficiency (close to 100%), which makes them ideally suited to transport applications. The major drawback of Li-ion technology continues to be high cost.

Thermal energy storage (TES) may help to enable consistent energy savings. Both heating and cooling are often most available at times when consumption is low. There is great potential for TES to correct this mismatch by storing heat (or cooling capacity) when it is abundant and releasing it during periods of high demand.

Grid storage in the distribution grid and low-voltage networks is currently considered essential for the integration of renewables and is attracting much research attention. Its main objectives are to maintain the power/energy balance, provide voltage support, preserve power quality and manage congestion.

Storage is also important for off-grid applications. More than a billion people around the world who are not yet connected to an electricity grid. In the context as such, energy storage based isolated networks are a handy solution to provide the access to electric power.

Micro-grids with storage form another interesting area. Several examples of micro-grids can be found worldwide, in which PV and wind systems are often combined with energy storage to provide reliable power. Energy storage in isolated networks can supply power to buildings, factories, houses and potentially any other type of load.

Behavioural changes for efficiency improvements

The problems of efficiency improvements are heterogeneous: different categories of consumption – buildings, private households, industry, public and private services, transport – have quite different technical potentials and barriers to implementation, and should be targeted through quite different incentive schemes. In addition, the importance of a number of issues is difficult to assess; these include lock-in effects, rebound effects, additionality of efficiency improvements, and uncertainties about future energy prices and capital costs.

The rebound effect expresses the idea that energy efficiency improvements may indirectly cause us to use more energy, not less. For any specific efficiency improvement, the direct economic effect is that the cost of a given energy service decreases. This lowers the cost of that energy service, and also means that people have more money to spend; both of these effects imply an increased demand for energy services. The size of the rebound effect depends on incomes and the price elasticity of energy demand. In Denmark the rebound effect is thought to be moderate, but for some low-income developing countries with high income and price elasticities of energy demand the effect may be substantial – though there will still be welfare gains from improved energy efficiency.

The lock-in effect recognises that money and time invested in a particular energy-saving measure will reduce the incentive to adopt other measures. For example, installing a heat pump in a house will save a certain amount of energy, and the resulting financial savings may justify the cost of the project. If we previously spend money on insulating the house, however, the incentive to install the heat pump decreases. Looking at it the other way around, within the lifetime of the heat pump the financial return on improved insulation decreases.

The lock-in effect is especially important when we look at buildings. The turnover in the building stock in Denmark is only around 2% annually, so it is important to improve the efficiency of existing buildings. Upgrading windows,

increasing insulation and optimising heating and ventilation systems can achieve big energy savings, but such improvements are often subject to challenges depending on the architecture, age, and ownership of the building. As a result, energy renovation projects are costly and lock-in effects may be substantial. For individual houses a policy framework for energy renovations is therefore recommended.

Households account for about one-third of all electricity consumption in Denmark. Efficiency improvements to date have been quite substantial, but the number of appliances is increasing, so aggregate demand has remained almost constant. Technical efficiency improvements are determined by international producers of equipment, with requirements negotiated internationally and at EU level. Because specific Danish efficiency requirements would have limited direct influence on manufacturers, Danish policy targets EU requirements and labelling so that consumers are able to choose energy-efficient appliances.

One of the most significant changes is the ban on traditional incandescent bulbs, which is expected to reduce electricity consumption for lighting by about 70%.

The economic potential for energy saving in household appliances has increased since a previous evaluation in 2000. The reasons for this include both technical developments and increasing energy prices.

Incentive schemes for saving energy in Denmark mainly take the form of energy taxes. On average in 2008 the tax per GJ was about 70% higher in Denmark than the EU average. Transport taxes are not that different in Denmark, but for electricity and fuels Danish taxes are on average about six times higher than in other EU countries.

Index

2°C stabilisation scenario, page 27

450 scenario, page 11, 12

Blue Map scenario, page 27, 28, 29, 55, 56, 87

BTL, page 49, 56

CCS, page 12, 25, 28, 29, 79

CFLs, page 15, 16, 40

CHP, page 7, 25, 74, 83, 95, 96, 97, 99, 100

DME, page 50, 56, 96, 98, 100

EVs, page 6, 9, 50, 97

FCVs, page 50, 55, 57

GHG, page 11, 15, 17, 19, 23, 25, 27, 29, 47, 55, 73, 75, 77

GTL, page 49, 56

IC engines, page 61, 64

IEA, page 11, 12, 27, 29, 40, 54, 56, 87

LED, page 15, 39, 41

Low-energy buildings, page 31, 32, 33, 35, 37

OECD, page 11, 13, 17, 27, 29

PV, page 67, 69, 71, 98

Solar thermal, page 36, 68, 70, 101, 103, 115

SSL, page 39, 40

The DTU International Energy Reports series

The reports can be downloaded from http://www.natlab.dtu.dk/English/Energy_Reports.aspx

Energy for smart cities in an urbanised world, 2011

Volume 10 takes as its point of reference the rapid urbanisation of the world. The report addresses energy related issues for smart cities, including energy infrastructure, onsite energy production, transport, economy, sustainability, housing, living and governance, including incentives and barriers influencing smart energy for smart cities.

November 2011. ISBN 978-87-550-3905-6

Non-fossil energy technologies in 2050 and beyond, 2010

The report analyses the long-term outlook for energy technologies in 2050 in a perspective where the dominating role of fossil fuels has been taken over by non-fossil fuels, and CO₂ emissions have been reduced to a minimum.

Against this background, the report addresses issues like: How much will today's non-fossil energy technologies have evolved up to 2050? Which non-fossil energy technologies can we bring into play in 2050, including emerging technologies? What are the implications for the energy system? Further the report analyses other central issues for the future energy supply: The role of non-fossil energy technologies in relation to security of supply and sustainability; System aspects in 2050; Examples of global and Danish energy scenarios in 2050. November 2010. ISBN 978-87-550-3812-7

The intelligent energy system infrastructure for the future, 2009

The report takes its point of reference in the need for the development of a highly flexible and intelligent energy system infrastructure which facilitates substantial higher amounts of renewable energy than today's energy systems. The report presents a generic approach for future infrastructure issues on local, regional and global scale with focus on the energy system. September 2009. ISBN 978-87-550-3755-7

Future low carbon energy systems, 2008

The report presents state-of-the-art and development perspectives for energy supply technologies, new energy systems, end-use energy efficiency improvements and new policy measures. It also includes estimates of the CO₂ reduction potentials for different technologies. The report outlines the current and likely future composition of energy systems in Denmark, and examines three groups of countries: Europe and the other OECD member nations; large and rapidly growing developing economies; typical least developed countries, such as many African nations. The report emphasises how future energy developments and systems might be composed in these three country groupings, and to what extent the different technologies might contribute. October 2008. ISBN 978-87-550-3690-1

Future options for energy technologies, 2007

Fossil fuels provide about 80% of global energy demand, and this will continue to be the situation for decades to come. In the European Community we are facing two major energy challenges. The first is sustainability, and the second is security of supply, since Europe is becoming more dependent on imported fuels. These challenges are the starting point for the report. November 2007. ISBN 978-87-550-3611-6

Renewable energy for power and transport, 2006

The report addresses trends in renewable energy and gives an overview of the global forces that will transform our energy systems in the light of security of supply, climate change and economic growth. The report discusses the status of, and trends in, renewable energy technologies for broader applications in off-grid power production (and heat). November 2006. ISBN 87-550-3515-9

The future energy system: Distributed production and use, 2005

The coming decades will bring big changes in energy systems throughout the world. These systems are expected to change from central power plants producing electricity and sometimes heat for customers, to a combination of central units and a variety of distributed units such as renewable energy systems and fuel cells. October 2005. ISBN 87-550-3474-8

Hydrogen and its competitors, 2004

The hydrogen economy has drawn shifting awareness over the years. Countries with long traditions of activity in hydrogen research and development have been joined by a large number of newcomers. The main reason for the interest is that the hydrogen economy could be one of the answers to a future sustainable energy system. October 2004. ISBN 87-550-3350-4

New and emerging bioenergy technologies, 2003

Three growing concerns – sustainability (particularly in the transport sector), security of energy supply and climate change – have combined to increase interest in bioenergy. This trend has been further encouraged by technological advances in biomass conversion and significant changes in energy markets. We even have a new term, “modern bioenergy”, to cover those areas of bioenergy technology – traditional as well as emerging – which could expand the role of bioenergy. November 2003. ISBN 87-550-3262-1

New and emerging technologies: Options for the future, 2002

All over the world, increasing energy consumption, liberalisation of energy markets and the need to take action on climate change are producing new challenges for the energy sector. At the same time there is increasing pressure for research, new technology and industrial products to be socially acceptable and to generate prosperity. The result is a complex and dynamic set of conditions affecting decisions on investment in research and new energy technology. October 2002. ISBN 87-550-3082-3

References

1. European Commission (2011): Energy Efficiency Plan 2011, EC COM (2011) 109, 2011
2. World Energy Outlook 2010, IEA, Paris 2010
3. Bridging the Emissions Gap. United Nations Environment Programme (UNEP), Kenya 2011
4. Zhou, N. Levine, M.D., Price, L. (2010): Overview of Current Energy Efficiency policies in China. Energy policy, Vol 38, Issue 11, Nov. 2011
5. Department of Minerals and Energy (2005): Energy efficiency strategy of the Republic of South Africa, Pretoria 2005.
6. Trends in Global Energy Efficiency – India Country report, ABB, Zürich 2011
7. Energy Technology Perspectives 2012, IEA, Paris, 2012
8. Buildings and Climate Change, UNEP DTIE, Paris 2009
9. En.lighten website - <http://www.enlighten-initiative.org>
10. Global Industrial Energy Efficiency Benchmarking, UNIDO, Vienna 2010
11. Worldwide Trends in Energy Use and Efficiency, IEA, Paris 2008
12. World Bank (2012): Air Transport and Energy Efficiency, WB TP-38, Washington DC 2012
13. Joint Public-Private Approaches for Energy Efficiency Finance, IEA, Paris 2011
14. Transport Energy Efficiency – an information paper, IEA, Paris 2010
15. Transport, Energy and CO₂: Moving Toward Sustainability, IEA Paris 2009
16. G-20 Clean Energy and Energy Efficiency Deployment and Policy Progress, IEA, Paris 2011
17. UN Foundation Expert Group on Energy Efficiency (2007): Realizing the Potential of Energy Efficiency: Targets, Policies, and Measures for G8 Countries. United Nations Foundation, Washington DC, 2007
18. Green Energy, the report of the Danish Commission on Climate Change Policy
19. Danish Commission on Climate Change Policy, Copenhagen, 2010
20. CEEH's beregning af helbredsomkostninger fra luftforurening i Klimakommissionens fremtidsforløb. Roskilde 2011.
21. Energy Technology Perspectives ETP 2010. IEA Paris.
22. Mitigation Policies. Contribution of Working Group III of the Intergovernmental Panel on Climate Change to the Fourth Assessment Report. Cambridge University Press.
23. Danske bygningers energibehov i 2050. SBI 2010:56. Statens Byggeforskningsinstitut, Aalborg Universitet, 2010.
24. Energetische Gebäudesanierung mit Faktor 10. Dr. Burkhard Schulze Darup, Deutsche Bundesstiftung Umwelt DBU. 2004.
25. <http://www.iea-shc.org/publications/task.aspx?Task=40>
26. <http://www.zeb.no/index.php/about-zeb>
27. <http://activehouse.info/about-active-house/active-house-vision>
28. Intergovernmental Panel on Climate Change (IPCC) (2007). Fourth Assessment Report, Climate Change 2007: Synthesis Report. Summary for Policymakers. www.ipcc.ch/pdf/assessment-report/ar4/syr/ar4_syr_spm.pdf
29. International Energy Agency (IEA). Energy efficiency requirements in building codes, energy efficiency policies for new buildings. <http://www.iea.org/publications/freepublications/publication/name,3780,en.html>
30. Directive 2010/31/EU of the European Parliament and of the Council of 19 May 2010 on the energy performance of buildings (recast)
31. Danish Commission on Climate Change Policy. 2010. Green energy – the road to a Danish energy system without fossil fuels. Published by the Danish Commission on Climate Change Policy. <http://www.klimakommissionen.dk/en-US/AbouttheCommission/TheDanishClimateCommissionreport/Sider/Forside.aspx>

32. Our Future Energy
The Danish Government
November 2011
<http://ens.netboghandel.dk/publikationer/publikationsdetaljer.aspx?PID=5308989e-ea64-436b-8346-4e29c8a84d62>
33. Svendsen S. 2011. Analyse 6. Komponentkrav, konkurrence og eksport. En kortlægning af innovation i byggekomponenter. DTU. Kgs. Lyngby
http://www.ebst.dk/file/144424/kortlaegning_af_innovation_i_bygnings.pdf
34. The two first from <http://www.xframe.dk> and the third from http://www.velfac.dk/Global/VELFAC200_Helo?opendocument
35. S. Petersen, Simulation-based support for integrated design of new low-energy office buildings, PhD thesis, Technical University of Denmark, 2011
36. Petersen S. and Svendsen S. Method for component-based economical optimisation for use in design of new low-energy buildings. *Renewable Energy* 38(1) (2012) 173-180
37. Olsen P K. 2008. A new low temperature district heating system for low energy buildings. The 11. International Symposium on district heating and cooling
38. Solar Heat Worldwide. Markets and Contribution to the Energy Supply 2009. Werner Weiss and Franz Mauthner. SHC Programme IEA. 2011 edition.
39. Solar Heating and Cooling for a Sustainable Energy Future in Europe. Vision. Potential. Deployment Roadmap. Strategic Research Agenda. Sixth Framework Programme.
40. <http://www.dlsc.ca/index.htm>
41. Større solvarmeanlæg til varmt brugsvand. Potentiale for forbedret udformning. Erhvervsstyrelsen. Simon Furbo & Elsa Andersen, 2011.
42. Repowering Transport, Project White Paper, World Economic Forum, 2011
43. World Energy Outlook 2011, OECD/IEA 2011
44. Global Transport Scenarios 2050. World Energy Council, 2011
45. Nylund, N.-O., "Outlook for Passenger Cars", Presented at DTU Climate Change Technologies, Workshop on Transport – renewable energy in the transport sector, Technical University of Denmark, March 2009.
46. Nylund, N.-O., Report from JSAE Annual Congress, Yokohama 2012, presented at The 43rd IEA Advanced Motor Fuels Executive Committee Meeting, Zürich, Switzerland, May 2012.
47. Eckerlee, W. "Innovative Approaches to Improving Engine Efficiency", 2007 Diesel Engine Efficiency and Emissions Research (DEER) Conference, August 13-16, U.S. DoE, Detroit, USA 2007.
48. Nylund, N.-O. "Future powertrain technology and fuel issues" Presented at IEA Advanced Motor Fuels ExCo meeting Istanbul 25 – 27 October, 2011.
49. Danielsson, P., "Well-to-wheel analysis - Volvo Study" Presentation based on Well-to-Wheels analysis of future automotive fuels and powertrains in the European context WELL-to-WHEELS Report 2007.
50. Schramm, J., "Perspectives for Ecocars – is 100 kilometers per litre possible?", Presented at DTU Climate Change Technologies, Workshop on Transport – renewable energy in the transport sector, Technical University of Denmark, March 2009.
51. "Fuel Economy Guide 2009", U.S. Department of Energy, U.S. Environmental Protection Agency, 2009.
52. Matsunaga, M., Fukushima, T., Ojima, K., "Powertrain System of Honda FCX Clarity Fuel Cell Vehicle", *World Electric Vehicle Journal* Vol. 3, pp 1-10, 2009.
53. Christensen, L., (2011): Electric vehicles and the costumers. Report WP 1.3 version 0.1, EDISON project. http://www.edison-net.dk/Dissemination/Reports/Report_011.aspx
54. Transportvaneundersøgelsen (2011): Unpublished raw data of The Danish National Travel Survey. <http://www.dtu.dk/centre/Modelcenter/TU.aspx>
55. AKTA data (2001–2003): Unpublished raw data on The AKTA Road Pricing Experiment in Copenhagen. Technical University of Copenhagen, Denmark. (AKTA means Alternative Kørsels- og Trængsels Afgifter (Alternative driving and congestion fees))

56. Christensen, L., Kaplan, S., Jensen, T.C., RØPKE, S., Olsen, A (2012): The recharging infrastructure needs for long distance travel by electric vehicles: a comparison of battery-switching and quick-charging stations. Under preparation
57. Lærke Flader, Ole Kveiborg and Thomas C. Jensen (2011): "Reduction in CO₂ emissions by increased use of electric vehicles – A socio-economic analysis" 2011 update. Dansk Energi (Danish Energy Association)
58. Anders Fjendbo Jensen: "Development of a Stated Preference Experiment for Electric Vehicle Demand." Master Thesis, DTU Transport, 2010.
59. Transportministeriet: "Transportøkonomiske enhedspriser 2010" (Transport Economic Unit Prices), 2010. www.dtu.dk/centre/Modelcenter/Samfunds%20b8konomi/Transport%20b8konomiske%20Enhedspriser.aspx
60. Danish Infrastructure commission: "Danmarks transportinfrastruktur 2030." (Danish Transport Infrastructure 2030), 2008.
61. Wind Energy – The facts. A guide to the technology, economics and future of wind power. European Wind Energy association (EWEA), Earthscan, London, 2009.
62. The Special Report for Renewable Energy Sources and Climate Change Mitigation (SRREN), IPCC Working Group III, available at <http://srren.ipcc-wg3.de/report>.
63. www.wasaproject.info
64. Kelly, M., S-E Gryning, 2010. Long-term mean wind profiles based on similarity theory. *Boundary-Layer Meteorol.* 136:377–390. DOI 10.1007/s10546–010–9509–9.
65. Kristoffersen JR, Christiansen P. Horns rev offshore windfarm: its main controller and remote control system. *Wind Eng* 2003;27(5):351–66.[3]
66. Ingeborg Grabaak, Maria Daniela Catrinu, Magnus Korpås. TWENTIES Task 16.2.2 "Hydro potential and barriers". <http://www.twenties-project.eu/node/18>
67. V. Akhmatov, H. Abildgaard, J. Pedersen, P. B. Eriksen, "Integration of Offshore Wind Power into the Western Danish Power System," in Proc. Copenhagen Offshore Wind 2005, CD.
68. Sørensen, P; Cutululis, N.A.; Viguera-Rodriguez, A.; Jensen, L.E.; Hjerrild, J.; Donovan, M.H.; Madsen, H., Power fluctuations from large wind farms. *IEEE Trans. Power Systems* (2007) 22, 958–965
69. 2011 Technology Map of the European Strategic Energy Technology Plan (SET-Plan); EUR 24979 EN; JRC 2011
70. C. Breyer; A. Gerlach; Global overview on grid-parity, *Prog. Photovolt: Res. Appl.* (2012); DOI: 10.1002/pip.1254
71. S. Aggerholm; *Energikrav til Nybyggeriet 2020 – økonomisk analyse*; Statens Byggeforskningsinstitut (SBI); 2011:18
72. N. Espinosa et al.; Solar cells with one-day energy payback for the factories of the future; *Energy Environ. Sci.*, 2012, 5, 5117
73. solarplaza.com; Pvresources.com; Epia.org; Seia.org
74. A. Goodrich, et al.; Residential, Commercial, and Utility-Scale Photovoltaic (PV) System Prices in the United States: Current Drivers and Cost-Reduction Opportunities, Technical Report NREL/TP-6A20-53347, February 2012
75. SunShot Vision Study; DOE/GO-102012-3037; 2012
76. T.J. Dijkman, R.M.J. Benders; *Renewable and Sustainable Energy Reviews* 14 (2010) 3148–3155
77. Murphy DJ and Hall CA (2010): Year in review – EROI or energy return on (energy) invested. *Ann. N.Y. Acad. Sci.* 1185, 102–118
78. Erisman, J. W., Sutton, M. A., Galloway, J., Klimont, Z., Winiwarter, W. How a century of ammonia synthesis changed the world. *Nature Geoscience* 1, 636–639, 2008.
79. Crutzen, P. J., Mosier, A.R., Smith, K. A. And Winiwarter, W. N₂O release from agro-biofuel production negates global warming reduction by replacing fossil fuels. *Atmos. Chem. Phys.*, 8, 389–395, 2008.
80. Neset TS and Cordell D (2012) Global phosphorus scarcity: identifying synergies for a sustainable future. *J Sci Food Agric.* 92, 2–6

81. Cordell, D., Drangert, J.-O., et al. 2009 The story of phosphorus: global food security and food for thought. *Global Environmental Change* 19, 292–305.
82. Directive 2009/28/EU
83. Coppola, F., Bastianoni, S., and Østergård, H. 2009. Sustainability of bioethanol production from wheat with recycled residues as evaluated by Emergy assessment. *Biomass and Bioenergy*, 33, 1626–1642
84. Odum, H.T. 1996, *Environmental Accounting, Emergy and Decision Making*, John Wiley, NY.
85. Bruun, E.W., Hauggaard-Nielsen, H., et al. 2011 Influence of fast pyrolysis temperature on biochar labile fraction and short-term carbon loss in a loamy soil. *Biomass and Bioenergy* 35, 1182–1189.
86. Kuligowski, K.; Poulsen, T.G., et al. 2010 Plant-availability to barley of phosphorus in ash from thermally treated animal manure in comparison to other manure based materials and commercial fertilizer. *European Journal of Agronomy* 33, 293–303.
87. Marris E (2006) Putting the carbon back: Black is the new green. *Nature* 442, 624–626
88. Thomsen pers. comm.
89. Möller, K. and Stinner, W. (2010): Effects of Organic Wastes Digestion for Biogas Production on Mineral Nutrient Availability of Biogas Effluents. *Nutrient Cycling in Agroecosystems* 87, 395–413.
90. Michel, J., Weiske, A. and Möller, K. (2010): The effect of biogas digestion on the environmental impact and energy balances in organic cropping systems using the life-cycle assessment methodology. *Renewable Agriculture and Food Systems* 25, 204–218.
91. Østergård H and Markussen MV (2011) Energy Self-sufficiency from an Emergy Perspective Exemplified by a Model System of a Danish Farm Cooperative. Proceedings of the Sixth Biennial Emergy Research Conference, January 2010. The Centre for Environmental Policy, University of Florida, Gainesville, FL. Eds MT Brown and S Sweeney. pp 311–322
92. M. Gadella, L. Jiménez, Z. Olujić and P.J. Jansens, 2007, *Comp. Chem. Eng.* 31:1346
93. Biosystemer A/S; Børge Holm Christensen. Personal Communication.
94. Biegler L.T. et al., 2005. “Systematic Methods of Chemical Process Design”, Prentice-Hall.
95. a) Li H., Andersen T.R., Gani R., Jørgensen S.B., 2006. *Ind. & Eng. Chem. Research*, 45, pp. 8310–8318; b) Eden M.R., Koggersbøl A., Hallager L., Jørgensen S.B., 2001. *Comp. Chem. Eng.*, 24 (2–7), pp. 1091–1097; c) Koggersbøl A., Andersen T. R., Jørgensen J.B., Jørgensen S.B., 1996. *Comp. Chem. Eng.*, 20B: S835–S840; d) Koggersbøl A., Andersen B.R., Nielsen J.S., Jørgensen S.B., 1996. *Comp. Chem. Eng.*, 20S: S853–S858.
96. Halvorsen I.J., 2001. “Minimum Energy Requirements in Complex Distillation Arrangements”, PhD thesis, NTNU, Dept. of Chem. Eng.
97. Jimenez E.S., Salamon P., Rivero R., Rendon C., Hoffmann K.H., Schaller M., Andresen B., 2004. *Ind. Eng. Chem. Res.*, 43: 7566.
98. Fitzmorris R.E., Mah R.S.H., 1980. *AIChE J.*, 26(2): 265.
99. Mah Jr. R.S.H., Nicholas Jr. J.J., Wodnik, R.B., 1977. *AIChE J.*, 23(5): 651.
100. Liu X., Qian J., 2000. *Chem. Eng. Technol.*, 23(3): 235.
101. de Koeijer G., Rivero R., 2003. *Chem. Eng. Sci.*, 58: 1587.
102. Naito K., Nakaiwa M., Huang K., Endo A., Aso K., Nakanishi T., 2000. *Comp. Chem. Eng.*, 24: 495
103. Nakaiwa M., Huang K., Endo A., Ohmori T., Akiya T., Takamatsu T., 2003. *Trans. IChemE*, 81(A): 162.
104. Nakaiwa M., Ohmori T., 2009. *Translation from Synthesisology*, 2(1): 51.
105. HYPE: EU-Project Grant agreement no: 213139.
106. US-Patent No.: US 7,972,423 B2. Date of Patent: Jul. 5, 2011.
107. Babcock & Wilcox, Vølund A/S
108. <http://www.dongenergy.com/pyroneer/Pages/index.aspx>

109. the International Energy Agency (IEA) 2010 Energy technologies Perspective
110. <http://www.oecd-nea.org/nsd/reports/2012/nea6887-role-nuclear-low-carbon.pdf>
111. The Future of Nuclear Power, MIT (2003), <http://web.mit.edu/nuclearpower/>
112. <http://www.world-nuclear.org/info/inf102.html>
113. World Nuclear Association, Mixed Oxide Fuel (<http://www.world-nuclear.org/info/inf29.html>)
114. The Future of Nuclear Power, MIT (2003), <http://web.mit.edu/nuclearpower/>
115. Radioactive waste management programmes in OECD/NEA member countries: <http://www.oecd-nea.org/rwm/>
116. EU Energy Policy for Europe SEC (2007)
117. IAEA
118. EU Energy Policy for Europe SEC (2007)
119. GIF-016–00 Generation IV Roadmap Description of Candidate Gas-cooled Reactor Systems Report Issued by the Nuclear Energy Research Advisory Committee and the Generation IV International Forum December 2002.
120. NEA annual report 2011 p. 40, ISBN 978–92–64–99179–8
121. EU, A European Strategic Energy Technology Plan (SET-Plan), COM(2007)723
122. Kyrki-Rajamäki, Riitta; Heikinheimo, Liisa; Hyvärinen, Juhani; Vuori, Seppo; Salomaa, Rainer; Auterinen, Iiro (eds.) Finnish research network for generation four nuclear energy systems 2008. VTT, Espoo. 64 s. + liitt. 46 s. VTT Working Papers: 90 ISBN 978–951–38–7149–9
123. A Technology Roadmap for Generation IV Nuclear Energy Systems, GIF-002–00, December 2002, Issued by the U.S. DOE Nuclear Energy Research Advisory Committee and the Generation IV International Forum.
124. J. G. Price, B. Jager, L. Dancuart, M. J. Keyser and J. van der Walt, Ch. 4 in Handbook of Fuel Cells, Fundamentals Technology and Applications, Vol. 3. Fuel Cell Technology and Applications Part 1. Editors Vielstich, Lamm and Gasteiger, Wiley, 2003.
125. http://techon.nikkeibp.co.jp/english/NEWS_EN/20111223/202951/
126. <http://www.fuelcelltoday.com/news-events/news-archive/2012/march/osaka-gas-to-launch-sofc-ene-farm-next-month-with-world-leading-efficiency>
127. <http://www.bloomenergy.com/fuel-cell/es-5700-data-sheet/>
128. M. Pehnt, Ch. 94 in Handbook of Fuel Cells, Fundamentals Technology and Applications, Vol. 4. Fuel Cell Technology and Applications Part 2. Editors Vielstich, Lamm and Gasteiger, Wiley, 2003
129. R. Wurster and J. Schindler Ch. 5 in Handbook of Fuel Cells, Fundamentals Technology and Applications, Vol. 3. Fuel Cell Technology and Applications Part 1. Editors Vielstich, Lamm and Gasteiger, Wiley, 2003.
130. <http://www.abb.com/industries/db0003db004333/fd32594c4d4dea8cc1257481004a6140.aspx>
131. <http://www.indexmundi.com/facts/denmark/electric-power-transmission-and-distribution-losses>
132. <http://www.skjf.dk/showpage.php?pageid=847>
133. B. V. Mathiesen, “Fuel cells and electrolyzers in future energy systems”, Ph.D. Thesis, Aalborg University, 2008.
134. <http://www.ens.dk/da-dk/klimaogCO2/transport/genereltomtransportogenergiforbrug/Sider/Forside.aspx>
135. B. Höhle, G. Isenberg, R. Edinger and T. Grube, Ch. 21 in Handbook of Fuel Cells, Fundamentals Technology and Applications, Vol. 3. Fuel Cell Technology and Applications Part 1. Editors Vielstich, Lamm and Gasteiger, Wiley, 2003.
136. Full Fuel Cycle Assessment: Well-To-Wheels Energy Inputs, Emissions, And Water Impacts, Prepared by: TIAX LLC for California Energy Commission, 2007, CEC-600–2007–004-REV, available from <http://cafc.org/welltowheels>

137. J. M. Ogden, Ch.1, p. 3 in Handbook of Fuel Cells, Fundamentals Technology and Applications, Vol. 3. Fuel Cell Technology and Applications Part 1. Editors Vielstich, Lamm and Gasteiger, Wiley, 2003.
138. R. Edinger, G. Isenberg and B. H ohlein, Ch.3. p. 39 in Handbook of Fuel Cells, Fundamentals Technology and Applications, Vol. 3. Fuel Cell Technology and Applications Part 1. Editors Vielstich, Lamm and Gasteiger, Wiley, 2003.
139. H. P. Schmid, J. Ebner, Ch 84, p.1167 in in Handbook of Fuel Cells, Fundamentals Technology and Applications, Vol. 4. Fuel Cell Technology and Applications Part 2. Editors Vielstich, Lamm and Gasteiger, Wiley, 2003
140. <http://automobiles.honda.com/fcx-clarity/drive-fcx-clarity.aspx>
141. <http://www.pikeresearch.com/research/fuel-cell-vehicles>
142. "A portfolio of power-trains for Europe: a fact-based analysis, The role of Battery Electric Vehicles, Plug-in Hybrids and Fuel Cell Electric Vehicles", McKinsey & Company, 2011.
143. C. Graves, S. Ebbesen, M. Mogensen, K. S. Lackner, Renewable and Sustainable Energy Reviews 15 (2011) 1–23.
144. Mathiesen et al.; "CEESA 100% Renewable Energy Scenarios towards 2050". Aalborg University, 2011. Available from: <http://www.ceesa.plan.aau.dk>. (to be published 2012).
145. A. Hauch, S. D. Ebbesen, S. H øjgaard Jensen and M. Mogensen, J. Mater. Chem., 2008, 18, 2331–2340
146. S. K. Hoekman, A. Broch, C. Robbins, R. Purcell, International Journal of Greenhouse Gas Control 4 (2010) 44–50
147. "Energi 2050 – Vindsporet", 2011, can be downloaded from: www.energinet.dk
148. K. Hedegaard, K. A. Thy , H. Wenzel, Environ. Sci. Technol., (2008), 42, 7992-7999
149. H. Wenzel, "Breaking the biomass bottleneck of the fossil free society", CONCITO 2010.
150. Lackner KS (2009) Carbon dioxide capture from ambient air. In: Blum W, Keilhacker M, Platt U, Roether W (eds) The physics perspective on energy supply and climate change – a critical assessment. Eur. Phys. J. Special Topics, Springer Verlag, Bad Honnef, 2009
151. S. D. Ebbesen, J. H ogh, K. A. Nielsen, J. U. Nielsen, M. Mogensen, International journal of hydrogen energy 36 (2011) 7363.
152. <http://energy.plan.aau.dk/EnergyPLAN-Version10-August2012.pdf>, www.energyPLAN.eu
153. Lund, H, Andersen, AN, Østergaard, PA, Mathiesen, BV & Connolly, D 2012, 'From electricity smart grids to smart energy systems: A market operation based approach and understanding' Energy, vol 42, nr. 1, s. 96-102.
154. Mathiesen, BV, Lund, H & Karlsson, K 2009, IDA's klimaplan 2050: Tekniske energisystemanalyser og samfunds konomisk konsekvensvurdering - Baggrundsrapport. Ingeni rforeningen i Danmark, IDA, K benhavn V.
155. Ibrahim Dincer, Marc A Rosen, Energy, environment and sustainable development, Applied Energy, Volume 64, Issues 1–4, 1 September 1999, Pages 427–440, ISSN 0306–2619, 10.1016/S0306–2619(99)00111–7. (<http://www.sciencedirect.com/science/article/pii/S0306261999001117>)
156. F. Ziegler, Sorption heat pumping technologies: Comparisons and challenges, International Journal of Refrigeration, Volume 32, Issue 4, June 2009, Pages 566–576, ISSN 0140–7007, 10.1016/j.ijrefrig.2009.03.007.
157. http://www.maerskline.com/link/?page=news&path=/news/story_page/11/Technology_harnesses
158. Thermoeconomic comparison of industrial heat pumps. Ommen, Torben Schmidt ; Markussen, Christen Malte ; Reinholdt, L. ; Elmegaard, Brian part of: ICR 2011, 2011.
159. Adrian Bejan, George Tsatsaronis, Michael Moran, Thermal Design and Optimization. ISBN: 978–0–471–58467–4

160. Huijuan Chen, D. Yogi Goswami, Elias K. Stefanakos, A review of thermodynamic cycles and working fluids for the conversion of low-grade heat, *Renewable and Sustainable Energy Reviews*, Volume 14, Issue 9, December 2010, Pages 3059–3067, ISSN 1364–0321, 10.1016/j.rser.2010.07.006.
161. Siemens, Combined Cycle Power Plants, <http://www.energy.siemens.com/us/en/power-generation/power-plants/gas-fired-power-plants/combined-cycle-power-plant-concept/>
162. Yoshihiro Ichiki, Keiichi Shiraishi, Takayuki Kanaboshi, Yoshihisa Ono, Yuji Ohta, Development of Super Waste-Heat Recovery System for Marine Diesel Engines, *Mitsubishi Heavy Industries Technical Review* Vol. 48 No. 1 (March 2011)
163. Quoilin, Sylvain, Lemort, Vincent, Technological and Economical Survey of Organic Rankine Cycle Systems, in *Proceedings of European Conference on Economics and Management of Energy in Industry*, 2009, <http://orbi.ulg.ac.be/handle/2268/14609>
164. A. Schuster, S. Karellas, E. Kakaras, H. Spliethoff, Energetic and economic investigation of Organic Rankine Cycle applications, *Applied Thermal Engineering*, Volume 29, Issues 8–9, June 2009, Pages 1809–1817, ISSN 1359–4311, 10.1016/j.applthermaleng.2008.08.016.
165. Mirolli, M.D., "Cementing Kalina cycle effectiveness," *Industry Applications Magazine*, IEEE, vol.12, no.4, pp. 60- 64, July-Aug. 2006, doi: 10.1109/MIA.2006.1678332
166. <http://ing.dk/artikel/102000-nu-koerer-danmarks-foerste-kaempe-varmepumpe-paa-billig-moellestroem>
167. "Ammonia Heat Pumps for District Heating in Norway -- a case study " by Kenneth Hoffmann MSc and David Forbes Pearson MInstR, The Institute of Refrigeration official "Proceedings" for 2010-11 (vol 107) <http://www.ammonia21.com/web/assets/link/Hoffman7thApril2011London%20colour.pdf>
168. http://www.hybridvarmepumpe.dk/files/4113/1308/2531/Dk_Brondum_final.pdf
169. http://www.ens.dk/en-us/info/news/factsheet/documents/geotermi_engelsk.pdf
170. http://www.ens.dk/da-DK/Info/TalOgKort/Statistik_og_noegletal/Aarsstatistik/Documents/Energistatistik%202011.pdf
171. Economics of electric energy storage for energy arbitrage and regulation in New York. Apt, J, R, Mancini and Walawalkar, R. 2006, *Energy Policy*, pp. 2558–2568.
172. Valuation framework for large scale electricity storage in a case with wind curtailment. Loisel, R, et al. 2010, *Energy Policy*, pp. 7323–7337.
173. Rosen, Marc. *Energy Storage*. Ontario: Nova Science Publishers Inc, 2011.
174. Natowitz, J.B and Ngô, C. *Our Energy Future – Resources, alternatives and the environment*. s.l.: Wiley, 2009.
175. LaMonica, M. *Green Tech CNET News*. CNET News. [Online] 5 20, 2011. [Cited: 4 30, 2012.] http://news.cnet.com/8301-11128_3-20064404-54.html.
176. International Energy Agency. *World Energy Outlook 2010*. Paris: s.n., 2010. p. 339.
177. *Key World Energy Statistics 2011*. p. 28.
178. US Energy Information Administration. *Regional Energy Profiles: U.S. Household Electricity Report*. [Online] July 14, 2005. [Cited: April 27, 2012.] http://www.eia.gov/emeu/repse/enduse/er01_us_figs.html#2.
179. PCM Materials. *PCM Energy Storage – Product Catalogue*. [Online] [Cited: April 30, 2012.] www.pcm-products.net.
180. Development of phase change materials based micro-encapsulated technology for buildings: A review. Tyagia, V. V., et al. 15, 2011, *Renewable and Sustainable Energy Reviews*, pp. 1373–1391.
181. International Energy Agency. *Technology Roadmap: Energy-efficient Buildings: Heating and Cooling Equipment*. [Online] June 23, 2011. [Cited: April 27, 2012.] page 8 http://www.iea.org/publications/freepublications/publication/buildings_roadmap.pdf

182. District Heating and Cooling Plus Technology Platform. District Heating and Cooling: a Vision Towards 2020–2030–2050. [Online] May 2009. [Cited: April 27, 2012.] page 7
http://heating.danfoss.com/PCMNews/2860/Vision_DHC.pdf
183. Ellehaguge, Klaus and Pedersen, Thomas. Solar Heat Storages in District Heating Networks. PreHeat – Heat Storage Technologies. [Online] July 2007. [Cited: April 30, 2012.] page 39
http://www.preheat.org/fileadmin/preheat/documents/reports/Solar_heat_storages_in_district_heating_networks.pdf.
184. Municipality of Horsen. Sustainability Activities 2012. [Online] February 15, 2012. [Cited: April 30, 2012.] page 22
<http://www.institutioner.horsenskom.dk/EU2012/Arrangementer/~media/Institutioner/EU2012/Sustainabilitypdf.ashx>.
185. <http://www.solarge.org>
186. EU-Energy Road Map http://ec.europa.eu/energy/observatory/countries/doc/key_figures.pdf
187. http://ec.europa.eu/energy/observatory/countries/doc/key_figures.pdf slide 31
188. <http://eur-lex.europa.eu/LexUriServ/LexUriServ.do?uri=COM:2011:0370:FIN:EN:PDF>
189. Energistyrelsen (2012), Energistatistik.
http://www.ens.dk/DA-DK/INFO/TALOGKORT/STATISTIK_OG_NOEGLETAL/AARSSTATISTIK/Sider/Forside.aspx Figurer 2010.xls
190. http://www.ens.dk/DA-DK/INFO/TALOGKORT/STATISTIK_OG_NOEGLETAL/AARSSTATISTIK/Sider/Forside.aspx Figure 2010.xls.
191. <http://www.ens.dk/DA-DK/POLITIK/DANSK-KLIMA-OG-ENERGI-POLITIK/POLITISKEAFTALER/Sider/Marts2012Aftalefor2012-2020.aspx>
192. Energibesparelser I erhvervslivet, Energistyrelsen, Februar 2010
193. Skatteministeriet. Energiafgifter for erhverv og konkurrenceevne Tabel I 8 p. 20. <http://www.skm.dk/publikationer/notater/konkurrenceevnerapport.html>
194. Skatteministeriet. Energiafgifter for erhverv og konkurrenceevne Tabel III 2 p. 48.
195. Energistyrelsen 2012
196. Togeby, M., K. Dyhr-Mikkelsen and E. James-Smith (2007): Design of White Certificates. Comparing UK, Italy, France and Denmark
197. Political agreement (2012): Aftale mellem regeringen (Socialdemokraterne, Det Radikale Venstre, Socialistisk Folkeparti) og Venstre, Dansk Folkeparti, Enhedslisten og Det Konservative Folkeparti om den danske energipolitik 2012–2020. (Agreement about the Danish Energy polity 2012–2020.
198. Togeby, M., K. Dyhr-Mikkelsen, A. Larsen, P. Bach (2011): A Danish Case: Portfolio Evaluation and Its Impact on Energy Efficiency Policy. Energy Efficiency. Springer. Volume 5, Number 1, 37–49.
199. Togeby, M (ed) (2012): Evaluering af energiselskabernes energispareaktiviteter (Evaluation of energy efficiency obligations). With Niras and Viegand & Maagøe.
200. Kragh, J. og K. B. Wittchen (2010): Danske bygningers energibehov i 2050. SBI 2010:56.
201. Togeby, M., S. S. Bundgaard and A. E. Larsen (2012): Videncenter for energibesparelser i bygninger. En evaluering (Evaluation of the Danish Knowledge Center for Energy Savings in Buildings)
202. Kjærbye, Vibeke H. (2008): Does Energy Labelling on Residential Housing Result in Energy Savings? Anvendt Kommunal Forskning (AKF).

The expert team behind DTU International Energy Report 2012

The individual chapters in DTU International Energy Report 2012 are written by DTU researchers in cooperation with leading Danish and international experts. The report is edited and published in accordance with the highest international quality standards. Finally the report was refereed by an independent panel of international experts.



Alessandro Pensini
PhD student
DTU Electrical Engineering



Allan S. Pedersen
Head of Programme
DTU Energy Conversion
and Storage



Argyrios Altiparmakis
Research Assistant
DTU Electrical Engineering



Asgeir Tomasgard
Professor
Norwegian University of
Science and Technology



Bent Lauritzen
Head of Programme
DTU Nutech



Brian Elmegaard
Head of Section,
Associate Professor
DTU Mechanical
Engineering



Brian Vad Mathiesen
Associate Professor
Aalborg University



Carsten Dam-Hansen
Senior Researcher
DTU Fotonik



**Claus Nygaard
Rasmussen**
Associate Professor
DTU Electrical Engineering



Erik Nonbøl
Senior Scientist
DTU Nutech



Flemming Frandsen
Associate Professor
DTU Chemical Engineering



Flemming Rasmussen
Head of Section
DTU Wind Energy



Francesco Marra
PhD student
DTU Electrical Engineering



Francesco Roca
Dr.
ENEA - Portici Research
Centre, Italy



Frederik C. Krebs
Professor
DTU Energy Conversion
and Storage



Fredrik Haglind
Associate Professor
DTU Mechanical
Engineering



Frits Møller Andersen
Head of Programme
DTU Management
Engineering



Guang Ya Yang
Researcher
DTU Electrical Engineering



Gustau Mañez Gomis
Programme Officer
UNEP



Hanne Østergård
Professor
DTU Chemical Engineering



Hans Hvidtfeldt Larsen
Vice Dean
DTU National Laboratory
for Sustainable Energy



Henrik Carlsen
Head of Department
DTU Mechanical
Engineering



**Henrik Hauggaard-
Nielsen**
Senior Scientist
DTU Chemical Engineering



Jake Badger
Senior Scientist
DTU Wind Energy



Jens Abildskov
Associate professor
DTU Chemical Engineering



Jesper Ahrenfeldt
Senior Scientist
DTU Chemical Engineering



Jesper Schramm
Associate professor
DTU Mechanical
Engineering



John Christensen
Head of UNEP Risø Centre
DTU UNEP Risoe Centre



Kenneth Karlsson
Senior Scientist
DTU Management
Engineering



Kim Pilegaard
Professor
DTU Chemical Engineering



Kirsten Halsnæs
Head of Programme
DTU Management
Engineering



Lars Dittmann
Professor, Group Leader
DTU Fotonik



**Leif Sønderberg
Petersen**
Chief Consultant
DTU National Laboratory
for Sustainable Energy



Linda Christensen
Senior Researcher
DTU Transport



Marc Rosen
Dr.
University of Ontario,
Canada



Michael Scholand
Lighting Consultant
UNEP



Mikael Togeby
PhD
Ea Energianalyse A/S



Paul Michael Petersen
Professor
Group Leader
DTU Fotonik



Peter Hauge Madsen
Head of Department
DTU Wind Energy



Peter Sommer-Larsen
Head of Programme
DTU Energy Conversion
and Storage



Peter Vang Hendriksen
Professor,
Head of Programme
DTU Energy Conversion
and Storage



Poul Erik Morthorst
Professor,
Head of Division
DTU Management
Engineering



Poul Sørensen
Professor
DTU Wind Energy



Riitta Kyrki-Rajamäki
Professor
Lappeenranta University
of Technology, Finland



Simon Furbo
Associate professor
DTU Civil Engineering



Søren Dyck Madsen
Master of Science in
Engineering
The Ecological Council,
Denmark



Søren Linderoth
Head of Department,
Professor
DTU Energy Conversion
and Storage



Svend Svendsen
Professor
DTU Civil Engineering



Thomas C. Jensen
Senior adviser
DTU Transport



Ulrik Henriksen
Associate Professor
DTU Chemical Engineering

