

Technical University of Denmark



Optics and Fluid Dynamics Department annual progress report 1 January - 31 December 1991

Rasmussen, Jens Juul; Hanson, Steen Grüner

Publication date:
1992

Document Version
Publisher's PDF, also known as Version of record

[Link back to DTU Orbit](#)

Citation (APA):
Juul Rasmussen, J., & Hanson, S. G. (1992). Optics and Fluid Dynamics Department annual progress report 1 January - 31 December 1991. (Denmark. Forskningscenter Risoe. Risoe-R; No. 611(EN)).

DTU Library

Technical Information Center of Denmark

General rights

Copyright and moral rights for the publications made accessible in the public portal are retained by the authors and/or other copyright owners and it is a condition of accessing publications that users recognise and abide by the legal requirements associated with these rights.

- Users may download and print one copy of any publication from the public portal for the purpose of private study or research.
- You may not further distribute the material or use it for any profit-making activity or commercial gain
- You may freely distribute the URL identifying the publication in the public portal

If you believe that this document breaches copyright please contact us providing details, and we will remove access to the work immediately and investigate your claim.

**Optics and Fluid Dynamics
Department
Annual Progress Report
1 January - 31 December 1991**

Risø-R-611(E~~N~~)

Edited by J. Juul Rasmussen and S.G. Hanson

**Risø National Laboratory, Roskilde, Denmark
March 1992**

Abstract

Research in the Optics and Fluid Dynamics Department covers quasi-elastic light scattering, optical and electronic information processing, continuum physics and activities in connection with the Euratom fusion association. A summary of activities in 1991 is presented.

Optical diagnostic methods based on quasi-elastic light scattering have been developed. Beam propagation in random and nonlinear media has been investigated. Spatial and temporal processing schemes, especially for pattern recognition, have been investigated.

Within the area of fluid dynamics spectral models for studying the dynamics of coherent structures have been developed. Coherent structures have been investigated in a plasma and are now also investigated in a rotating fluid.

Fusion relevant work performed under the Euratom association includes investigations of turbulent transport and the development of diagnostic methods.

A special activity is concentrated on the development of pellet injection systems for fusion research.

This report contains unpublished results and should not be quoted without permission from the authors.

ISBN 87-550-1790-8
ISSN 0106-2840
ISSN 0906-1797

Grafisk Service · Risø · 1992

Contents

1	Applied Laser Physics Section	6
1.1	Introduction to the work in the Applied Laser Physics Section	6
1.1.1	The NAOPIA Project	6
1.1.2	The Impact of Quadratic Phase Factors on Optical Fourier Transforms and Imaging	8
1.1.3	Displacement Invariant Computer-generated Filters	8
1.1.4	Generation of Sub-Poisson Distribution of Light	10
1.1.5	Detection of Squeezed States of Light	11
1.1.6	Photon Statistics	12
1.1.7	Measuring Viscoelastic Parameters with a Low-cost Surface Laser Light Scattering Spectrometer	12
1.1.8	Limits to Turbulence Measurements	14
1.1.9	Speckle Statistics and Decorrelation Based on Complex ABCD-Matrices	16
1.1.10	Brite Project B/E-4152	17
1.1.11	The CONNECT Project	18
1.1.12	EUREKA Project HERA	19
1.1.13	Cognitive Entropy and Self-Organizing Learners	22
1.1.14	Optical Neural Networks	23
1.1.15	Fluid Dynamics and Quantitative Coronary..	24
1.2	Participants in the work in Applied Laser Physics	26
2	Publications and educational activities in the Applied Laser Physics Section	27
2.1	Publications	27
2.2	Conference contributions	27
2.3	Lectures	28
3	Plasma Physics Section	31
3.1	Introduction to the work in plasma physics and fluid..	31
3.1.1	Luminescence from pure and impure solid hydrogens during electron bombardment	32
3.1.2	Sputtering yields from ion-bombarded condensed..	32
3.1.3	Secondary electron emission from solids	33
3.1.4	Studies on fundamental processes of laser sputtering and ablation from solid deuterium	34
3.1.5	The multishot injectors for FTU, Frascati, and RFX..	34
3.1.6	A multishot pellet injector for RTP, Rijnhuizen	34
3.1.7	Fast ion and α -particle diagnostics for JET	35
3.1.8	Investigations of density fluctuations and ELMs in the JET tokamak	36
3.1.9	Two-frequency plasma reflectometry; a performance analysis	36
3.1.10	Plasma equilibria calculated on the basis of magnetic compressive and tensile stresses	37
3.1.11	Coincidence analysis of coherent structures in..	38
3.1.12	Turbulent transport in the scrape-off layer of tokamak plasmas	39

3.1.13	Computational studies of flute mode self-organization in a magnetized plasma	39
3.1.14	Localized vortices in η_i -modes	40
3.1.15	Dynamics of nonstationary coherent structures in the Hasegawa-Mima/Charney equation	41
3.1.16	Numerical simulation of magnetic electron vortices	42
3.1.17	Visualization of numerical flow calculations by automated video animation	43
3.1.18	Refutation of stability proofs for dipole vortices	43
3.1.19	Existence and nonlinear stability of single vortices in an external shear flow	44
3.1.20	Nonlinear interactions of low-frequency electrostatic waves in the polar cap E-region	45
3.1.21	On the existence of Kawahara solitons	46
3.1.22	Numerical investigations of dipole vortex interactions with curved walls	48
3.1.23	Difference between monopole vortices in planetary flows and laboratory simulations	48
3.1.24	Vortical structures in rotating fluids	49
3.2	Participants in the work in plasma physics	50
4	Publications and educational activities in the Plasma Physics Section	52
4.1	Publications	52
4.2	Conference contributions	54
4.3	Lectures	56

INTRODUCTION

The department performs basic and applied research within continuum physics and optics. The scope is both understanding of basic physical phenomena and specific applications. The activities incorporate the development of methods and equipment for diagnostic purposes. The activities are often performed in collaboration with other research groups and industry. The training of students at a graduate level is an integral part of the work and so is the dissemination of the results to research and industry. The results are important to the understanding of the dynamics of fluids, fusion plasmas, as well as to the understanding of optical diagnostic systems and optical and electronic information processing. Several of the results are exploited by industry.

The department was established in connection with the restructuring of the research activities at Risø National Laboratory. Plasma physics was merged with the activities in optics and neural networks of the former Department of Information Technology. This is the second annual report of the department.

The work described in this report falls within the following categories:

Fluid dynamics and plasma physics are concentrated on basic physical phenomena with relevance to a number of processes related to energy conversion and environmental effects. Some of the activities are performed under the fusion energy programme of the Euratom association. Theoretical, computational and experimental activities are pursued.

Quasi-elastic light scattering and beam propagation. Diagnostic methods for probing the state of both fluid mechanical systems and systems based on solids are investigated.

Optical and electronic information processing incorporates work on two-dimensional optical transforms applied to pattern recognition. Schemes for proper data reduction and neural networks are also investigated.

Pellet injection systems for fusion research have been investigated for a number of years. Injection systems have been developed and are now supplied to other fusion research laboratories.

Of milestones passed in 1991 can be mentioned:

- The NAOPIA ESPRIT project on optoelectronic information processing was completed.
- A pellet injection system for fusion research was supplied to Holland.
- Measurements of coherent structures in a rotating fluid flow were initiated to complement analytic and numerical results now obtained with a new code implemented on a supercomputer.
- Information measures were established and applied in conjunction with neural networks and measuring systems.
- It was shown that relativistic effects play a major role in several plasma-physics measurements.

1 Applied Laser Physics Section

1.1 Introduction to the work in the Applied Laser Physics Section

The scientific work of the Applied Laser Physics Section during 1991 has been divided into four major topics: optical processing, optical materials, applied laser physics, and electronic processing including neural networks.

Optical processing has primarily been dealt with under the EEC "ESPRIT" programme in collaboration with German and French industrial research laboratories. The project was successfully terminated during 1991 and a demonstration model of the integrated optical processor was demonstrated during the ESPRIT Technical Week. A follow-up project employing the acquired results has been defined.

A system for direct recording and exposure of computer-generated holograms (CGHs) has been established and some aspects of the applications have been investigated. Effective generation of squeezed light and the inherent benefits associated with its use have been considered along with a fundamental study of the ultimate limitations in optical measurement systems due to photon statistics.

Various small tasks have been completed in the field of applied laser physics. A system for in situ measurement of strain components of rigid bodies by speckle interferometry has been demonstrated and the inherent limitations due to speckle decorrelation have been treated analytically. Simultaneous measurement of viscosity and surface tension has been demonstrated in a low-cost self-aligning configuration.

Two major projects have been initiated in which electronic neural networks play the essential role. Both projects are supported by the EEC. A national project in which the Applied Laser Physics Section investigates optical implementations of neural networks and a Ph.D. project in the same field have been initiated.

1.1.1 The NAOPIA Project

(A. Skov Jensen)

The Applied Laser Physics Section has been involved in Esprit projects P534 and P2208 concerning optical vision for the following two periods: (1) 1985-88 and (2) 1989-91. The project and the work concerning the optical vision system have now been finished. The result of the work has been the development of an industrial prototype of the system and concept developed at Risø. The prototype system was shown at the Esprit Technical Week exhibition in Brussels in November 1991. One of the posters and handouts from the exhibition are shown overleaf.

ROBOTVISION

PERFORMED BY OPTICAL FOURIER TRANSFORM AND LOG - POLAR MAPPING

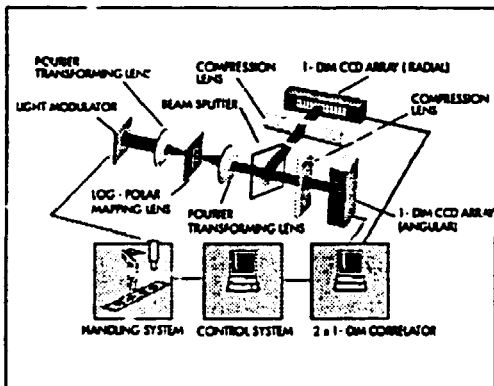

ARCHITECTURE

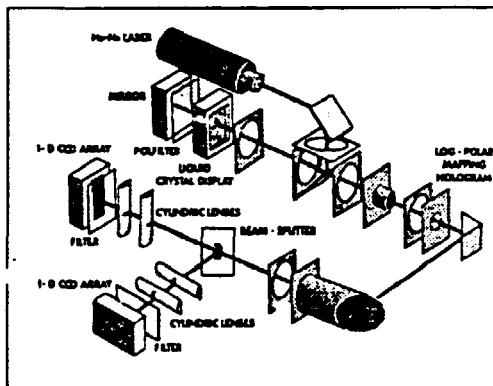

OPTICAL SET - UP

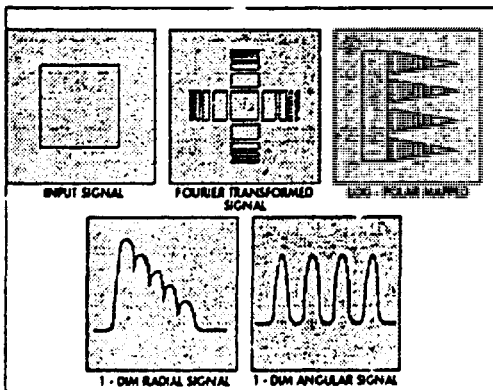

SIGNAL PROCESSING

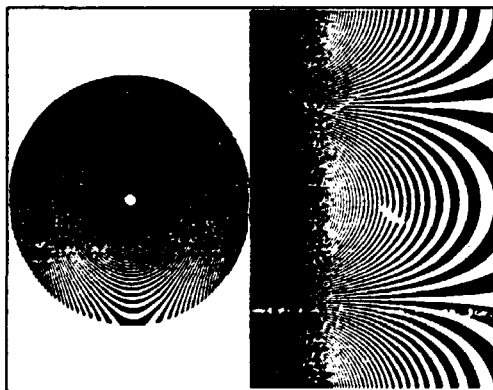

EXAMPLE OF LOG - POLAR - MAPPING HOLOGRAMS

NAOPIA

KRUPP FORSCHUNGSINSTITUT • THOMSON CSF • UNI ERLANGEN • NURNBERG • RISØ NATIONAL LABORATORY



1.1.2 The Impact of Quadratic Phase Factors on Optical Fourier Transforms and Imaging

(A. Skov Jensen)

In the design of lens systems for coherent light processing the occurrence of quadratic phase factors in the path of propagation is important to determination of imaging and Fourier planes. The impact and propagation of quadratic phase factors can be described by simple fractional formulas similar to the well known lens formula.

The tools are especially useful in the design of optical lens systems that involves construction of a Fourier lens system and correlators. With the development of spatial light modulators, real-time Fourier transforming systems, and optical correlators this has been emphasized. The total design of such systems requires an optimized layout of the lens system with respect to size and length and a lens design study with respect to aberration effects.

IMAGING	
$\frac{1}{f} = \frac{1}{z_1} + \frac{1}{z_2}$	input/output planes
$F_2 = \frac{F_1 f^2}{(z_1 - f)(F_1 - z_1 - f)}$	quadratic phase
$M = -\frac{f}{z_1 - f}$	magnification
FOURIER TRANSFORMATION	
$\frac{1}{f} = \frac{1}{z_1 + F_1} + \frac{1}{z_2}$	input/output planes
$F_2 = -\frac{F_1 f^2}{(z_1 - f)(F_1 + z_1 - f)}$	quadratic phase
$f_{FT} = \frac{f F_1}{z_1 - f + F_1}$	focal length

1) Jensen, A. Skov (1991). Opt. Lett. 16, 12.

1.1.3 Displacement Invariant Computer-generated Filters

(S. Hanson)

The first observations of self-imaging of synthetic periodic objects were made by Talbot in 1836 using gratings and white light. The theoretical background for the phenomena was later given by Rayleigh who in 1881 derived the mathematical expressions for the position of the images.

The application of self-imaging has regained new interest with the advent of the laser and the possibility of creating high resolution computer-generated holograms in various media. The use of self-imaging for optical testing, interferometry and

dedicated laser focusing is apparent.

We have analyzed the properties of "imaging" where two identical optical structures are used in series to perform the desired transformation of a spatially and/or temporally incoherent source. The basic structures analyzed here are those which will have invariance properties for translation and rotations as experienced by an observer at a distance from the filter.

A pattern observed at a distance can suffer three perpendicular translations and three orthogonal rotations. Only two of the three translations are inherently different. The two in-plane translations give rise to the same type of invariant filter, whereas the translation along the optical axis (line of sight) provides a new circular symmetric invariant filter. The three rotations as well only give rise to two basically different filters, arising from a rotation about an axis perpendicular to the line of sight (in the plane of the filter) and one filter arising from a rotation about an in-plane axis.

The four basic patterns can be shown to be:

Invariance	Type	Expression for the phase
1: In-plane translation	Linear grating	$\phi(x) = \omega x$
2: Translation along the line of sight	Circular symmetric log filter	$\phi(x) = \omega \text{Log}[r]$
3: Rotation about in-plane axis	Log. grating	$\phi(x) = \omega \text{Log}[x]$
4: Rotation about the line of sight	Spoke target	$\phi(\varphi) = \omega \varphi$

The basic filters as sketched above are eigenfunctions to the equation:

$$\hat{D}_r \{ \phi(r) \} = \phi(r) + \phi_0,$$

where the operator $\hat{D}_r \{ \}$ denotes the effect of the translation/rotation on the perceived phase at point r . The invariance is thus determined by finding the eigenfunctions to the above equation, neglecting boundary effects.

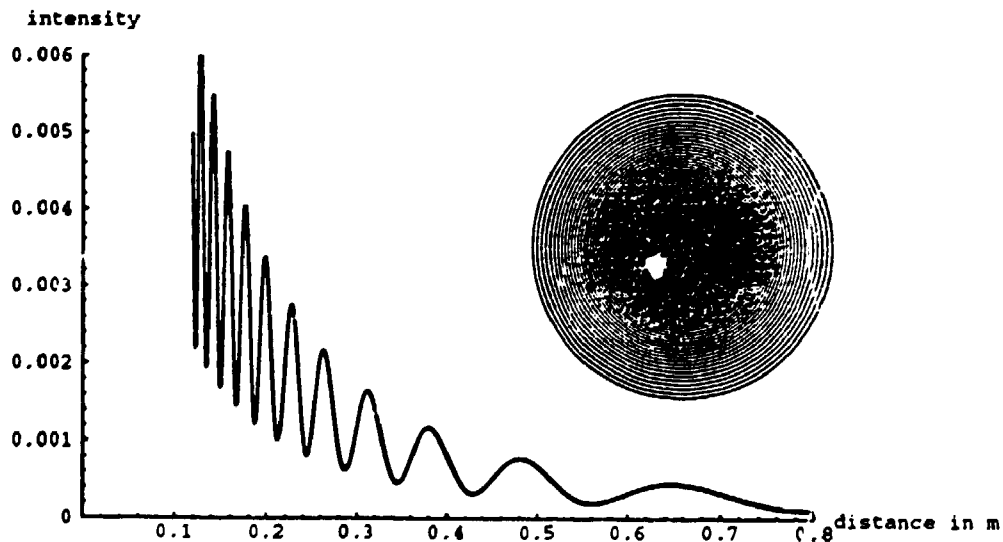

Circular symmetric logarithmic filter and associated on-axis intensity distribution achieved in incoherent illumination.

Application of spatially separated filters in conjunction with spatially and temporally incoherent light has been investigated. The figure shows the structure of

the rotational symmetric logarithmic filter and the on-axis intensity distribution for illumination of two spatially separated filters with fully incoherent light. The filter combination will provide a strong modulation of the on-axis intensity and thus act as a nonimaging concentrator of the incoherent radiation irrespective of the incoming wavelength. Little modulation of the intensity distribution is experienced at off-axis positions.

A linear logarithmic grating will likewise give rise to lines perpendicular to the optical axis of varying intensity depending on the distance of the line from the two linear filters. If illuminated with incoherent light, two identical spoke targets will create an on-axis line of constantly decreasing intensity.

The application of the filters in the form of highly efficient computer-generated holographic optical elements will provide focusing systems with dedicated properties unattainable with conventional lenses. Likewise, the elements could be employed in specialized Moiré systems to deduce various translations and rotations.

1.1.4 Generation of Sub-Poisson Distribution of Light

(P.S. Ramanujam)

With funds obtained from the Danish Natural Science research Council, the construction of a nonlinear Mach-Zehnder interferometer to produce sub-Poisson distribution of light (number-phase minimum uncertainty states) is under way.

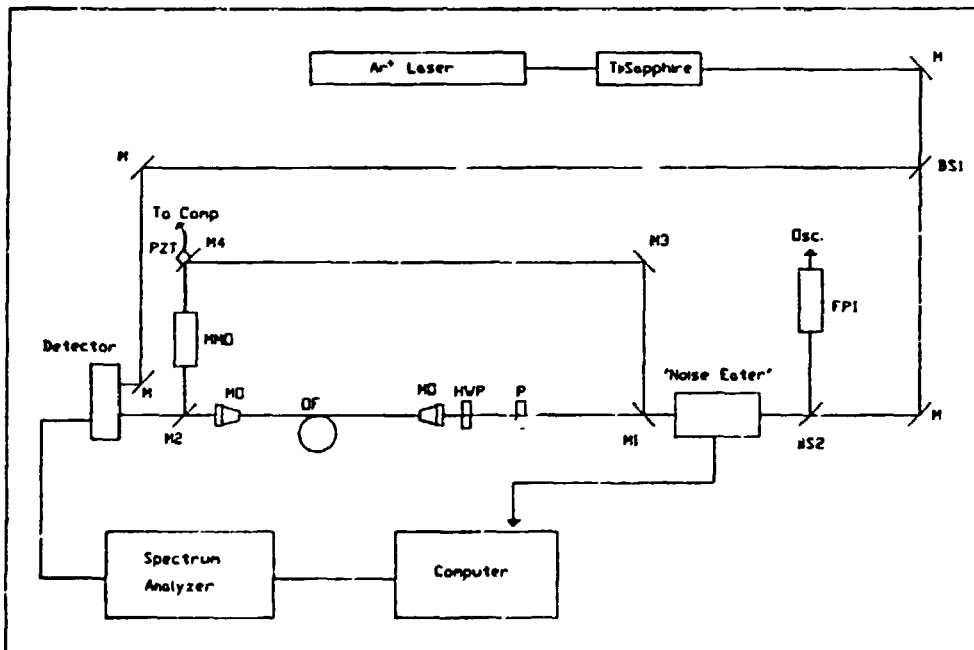

The source of coherent light is a cw Ti: sapphire passive single frequency laser with an estimated linewidth of 10 MHz. The laser produces about 500 mW in single frequency. The nonlinear Kerr medium is a 100 m long polarization-preserving optical fibre. One of the mirrors of the interferometer has been mounted on a piezoelectric crystal so as to change the relative phases of the two interfering beams. We are developing a nearly 100% quantum-efficient detection system based on two sets of trap-configured diodes so that the extraneous fluctuations from the laser are completely cancelled, allowing us to reach the shot noise floor. Although the glass fibre has its advantages such as the existence of high intensities due to

small core diameter and low loss even for long interaction lengths, its nonlinearity is appallingly low. We are also working with other materials such as dye-doped glasses and multiple quantum-well structures as possible substitutes for the glass fibre.

1.1.5 Detection of Squeezed States of Light

(P.S. Ramanujam and N. Grønbech-Jensen (Stanford University, U.S.A))

We have investigated the case of inefficient detection of quadrature squeezed states. The effect of losses such as limited quantum efficiencies of detectors in the two arms of a two-port homodyne detection scheme has been calculated treating the mixing at the beamsplitter as a quantum mechanical interaction. The losses are modelled as a lossless beamsplitter mixing coherent vacuum fluctuations in an otherwise lossless system. The figure shows the signal-to-noise ratio as a function of the quantum efficiency for a squeezed photon number of 10^6 , a local oscillator coherent state photon number of 10^{16} for squeezing parameter $r = 0, 1$ and 10 . It can be seen that the system must be lossless when detecting hard squeezing in order to obtain the best signal-to-noise ratio. We have also investigated the case when a squeezed state undergoes losses before being mixed with the local oscillator. This result is found to be identical to the above case.

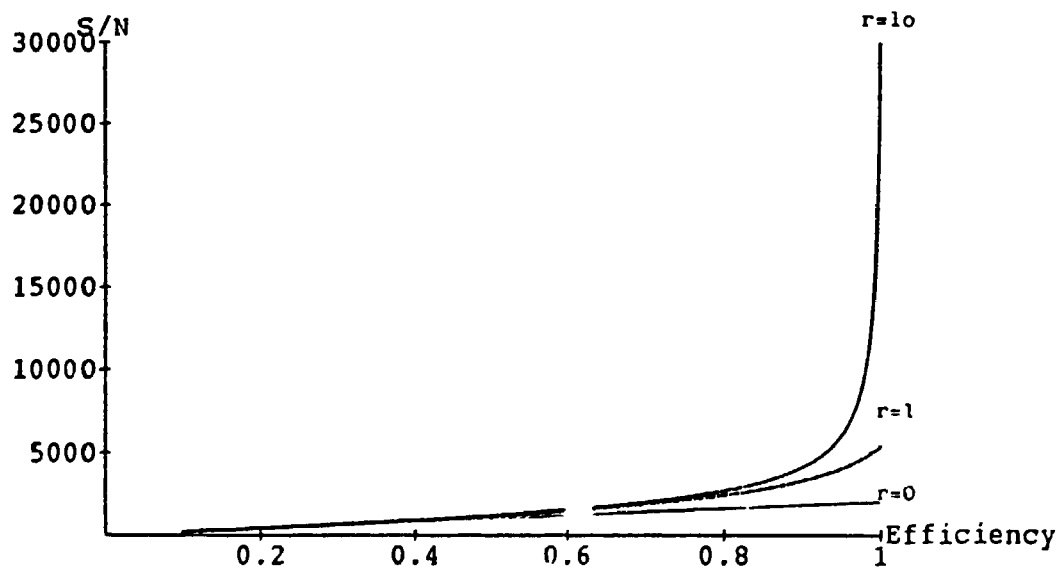

1.1.6 Photon Statistics

(L. Lading and T. Martini Jørgensen)

Optical measurements are ultimately limited by the statistics of the photons interacting with the object of the measurement. However, for a given measurement task different schemes have large differences in interaction efficiencies. Methods for synthesizing optimum optical configurations for diagnostics based on quasi-elastic light scattering are being developed. Synthesis of spatial configurations assuming coherent light has been performed for simple particle velocity measurements¹. In view of the interest in nonclassical light it appears relevant to investigate the potential use of light with statistics differing from that of coherent light. However, coherent light is generally preferable, but light exhibiting photon bunching may have advantages in some cases! Nonclassical light appears only to have a potential for the detection of pure phase objects. For the detection of a weak transient phase object it appears that a relevant figure of merit exhibits a dependence on the mean photon rate as illustrated in the figure.

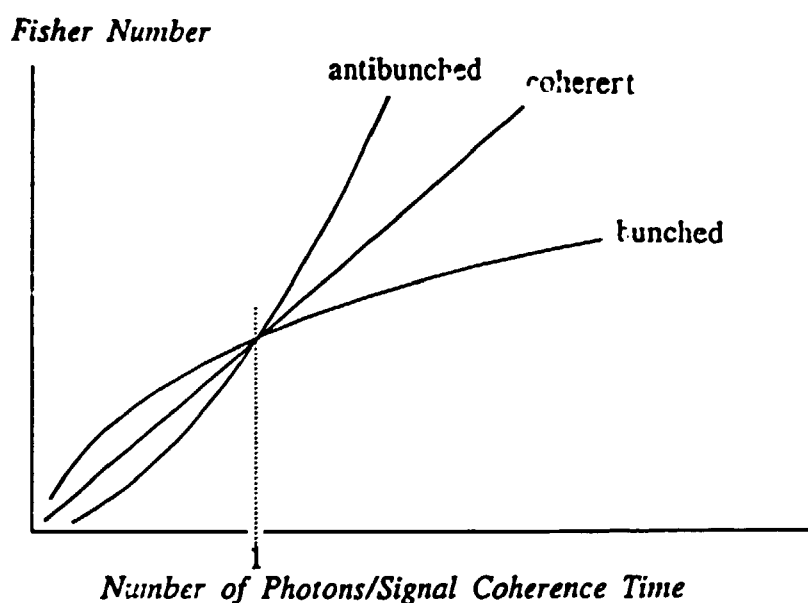

Figure of merit versus mean photon rate for the detection of changes in a weak phase object. (a) is for antibunched light with a coherence time longer than the coherence time of the object, (b) is for coherent light, and (c) is for bunched light.

1) Lading, L. and Jørgensen, T. Martini (1990). J. Opt. Soc. Am. A7, No. 7, 1324-1331.

1.1.7 Measuring Viscoelastic Parameters with a Low-cost Surface Laser Light Scattering Spectrometer

(T. Martini Jørgensen and L. Lading)

Surface light scattering instruments can noninvasively probe the dynamics of the thermally induced fluctuations on a liquid-liquid or a liquid-gas interface^{1,2}. From the spectrum of these miniature waves viscoelastic properties like surface tension and viscosity can be determined. This is of great importance, especially in order to study surfaces covered by viscoelastic monomolecular films.

In order to obtain a simple relationship between the spectrum of the scattered

light and the viscoelastic parameters of interest, it is necessary only to detect the light scattered by a particular wave vector of the surface. A robust way to select a specific wave vector is to place a grating onto the surface. The selected wave vector is determined only by the period, L , of the grating, and not by the wavelength of the laser. A spectrometer based on this principle is therefore insensitive to the slow drift in the centre frequency, which often occurs with semiconductor lasers. The grating selects the wave number in such a way that a reference beam is automatically created, and it is therefore a heterodyning configuration.

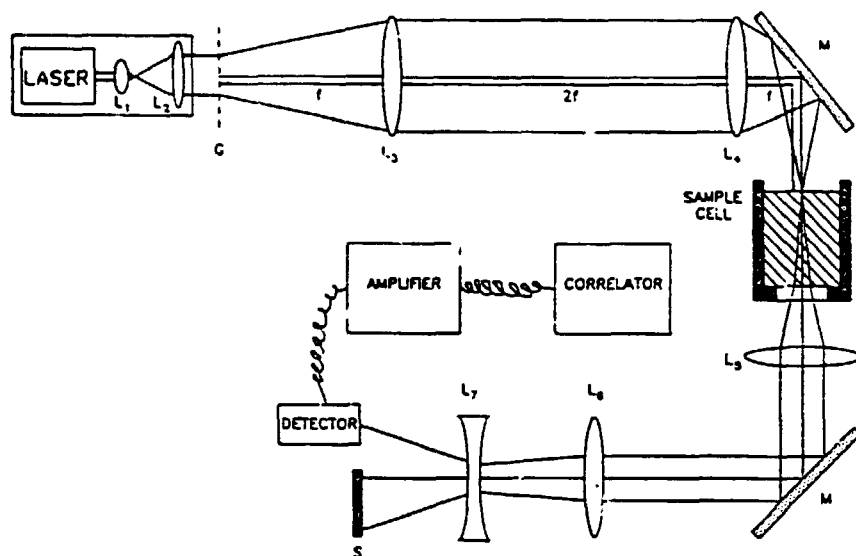

Fig. 1. The experimental setup. L denotes a lens, M a mirror, and S a spatial filter. G denotes a phase grating, whereas f is the focal length of L_3 and L_4 .

We have constructed an experimental setup based on the grating principle² (see Fig. 1). In most surface light beating spectroscopy experiments a high-cost gas laser and a high-cost photomultiplier tube have been used. Instead we have based the spectrometer on a low-cost semiconductor laser and a normal photodiode without internal gain. Using a semiconductor laser makes it possible to build a more compact spectrometer but what is more important is that the so-called intensity noise gets remarkably reduced by using a multimode semiconductor laser. This is essentially because the use of a gas laser implies a strong intensity noise originating from the power supply. Such a contribution is avoided when using semiconductor lasers, which can be operated by a simple battery. In addition it causes no problem to use a photodiode as detector. The reason is that it is a heterodyning configuration; a fact that makes the detector gain of a photomultiplier tube superfluous.

The experimental setup has been used for measuring surface tension and viscosity for hexane and water in contact with air. Figure 2 shows the autocorrelation function of the detected photocurrent obtained from a measurement performed on hexane. The autocorrelation function can be shown to be approximately an exponentially decaying cosinus. The decaying constant and the frequency of the cosinus determine the viscosity and the surface tension, respectively. The two viscoelastic parameters can therefore be determined by fitting the measured data to such a function. The fitted curve is also shown in Fig. 2. Our results show that it is possible to obtain a degree of accuracy which is at least as good as that obtained with the high-cost spectrometers. In the case of hexane the accuracy of the measured surface tension is within 2% whereas the results obtained for the viscosity typically deviated 5-7% from the accepted values.

We have found that the most devastating problem with our configuration is the effect of low frequency vibrations of the liquid surface which cause the light spots to fluctuate at the detector. By proper acoustical isolation of the sample cell it should be possible to overcome such problems. Based on our results we therefore believe that light beating spectroscopy can provide a cheap way of studying more sophisticated fluid-fluid interfaces, where the classical mechanical probe techniques fail.

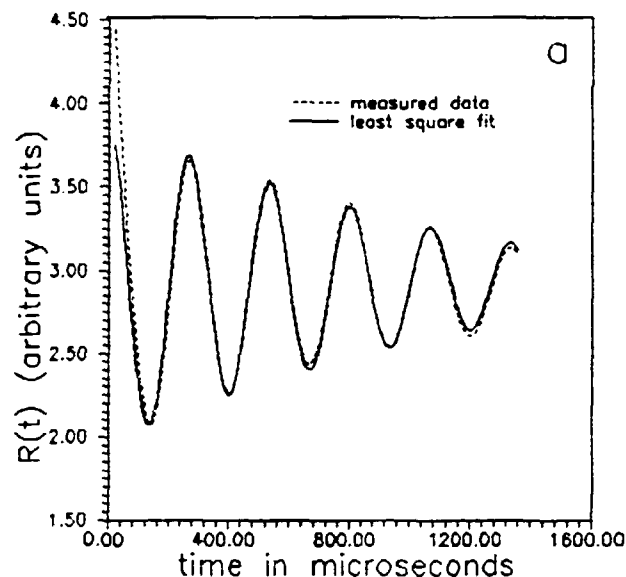

Fig. 2. Measured and fitted autocorrelation for hexane at 25 C.
 $2\pi/L = 273(\text{cm})^{-1}$.

- 1) Edwards, R.V., Sihori, R.S., Mann, J.A., Shih, L.B., and Lading, L. (1982). *Appl. Opt.* **21**, 3555-3568.
- 2) Lading, L., Mann, J.A. and Edwards, R.V. (1989). *J. Opt. Soc. Am. A* **6**, 1692-1701.
- 3) Jørgensen, T.M., "A Low-Cost Surface Laser Light Scattering Spectrometer," submitted for publication in *Measurement Science and Technology Journal*.

1.1.8 Limits to Turbulence Measurements

(L. Lading)

Turbulence measurements have traditionally been a sticky problem. The hot wire anemometer used to be the prime choice. It has to a large extent been succeeded by the laser Doppler anemometer that does not appear to have some of the basic shortcomings of the hot wire.

However, it does need small scatterers suspended in the flow. It is the velocity of the scatterer that is measured. The random distribution of the particles in conjunction with the finite measuring volume causes so-called phase noise.

An analysis based on Rice's work on narrowband noise processes showed that the "instantaneous" frequency (defined as the derivative of the phase of the signal) contained a noise component proportional to the bandwidth of the signal and that this defined limits to the space-time resolution of a laser Doppler anemometer¹. These findings were confirmed and amended by several investigations. The results were based on the assumption of a large number of scatterers in the measuring volume (i.e. $\gg 1$). In practical measurements the number of particles in the measuring volume is often considerably below one. Measurements are performed on

single bursts with no phase noise (assuming negligible photon and/or electron noise). In such cases it is not the phase noise that is the primary problem. But the random sampling of the flow implies that a true tracking of the velocity cannot be performed. The fact that the sampling rate in general is correlated with the velocity (and often several other quantities) gave rise to what is generally known as the bias problem.

In order to investigate the transition region between high and low particle concentration and in order to compare the Doppler configurations with other concepts - notably time-of-flight configurations - a rederivation of the statistical uncertainties was found to be necessary. This was done both for the Doppler configuration and for the time-of-flight configuration.

Nonlinear processing in the form of amplitude conditioned sampling may reduce the standard Rice-George & Lumly noise without introducing a bias error but it will generate "holes" in the velocity record. For the time-of-flight configuration it appears that only detecting the zero crossings of the dynamic part of the signal can significantly reduce the estimated time-of-flight and thus the estimated velocity. In fact, with no photon/electron noise and a completely frozen pattern passing through the measuring volume (Taylor's hypothesis) an arbitrarily small uncertainty can be obtained.

The performances were investigated by evaluating a so-called coherence factor defined by

$$\gamma \equiv \langle v \hat{v} \rangle^2 / \langle v^2 \rangle \langle \hat{v}^2 \rangle,$$

where v is the true fluctuating velocity and \hat{v} the estimated (measured) velocity. The maximum value of γ is 1. The figure shows the coherence factor versus the particle concentration for the Doppler and time-of-flight configurations, respectively.

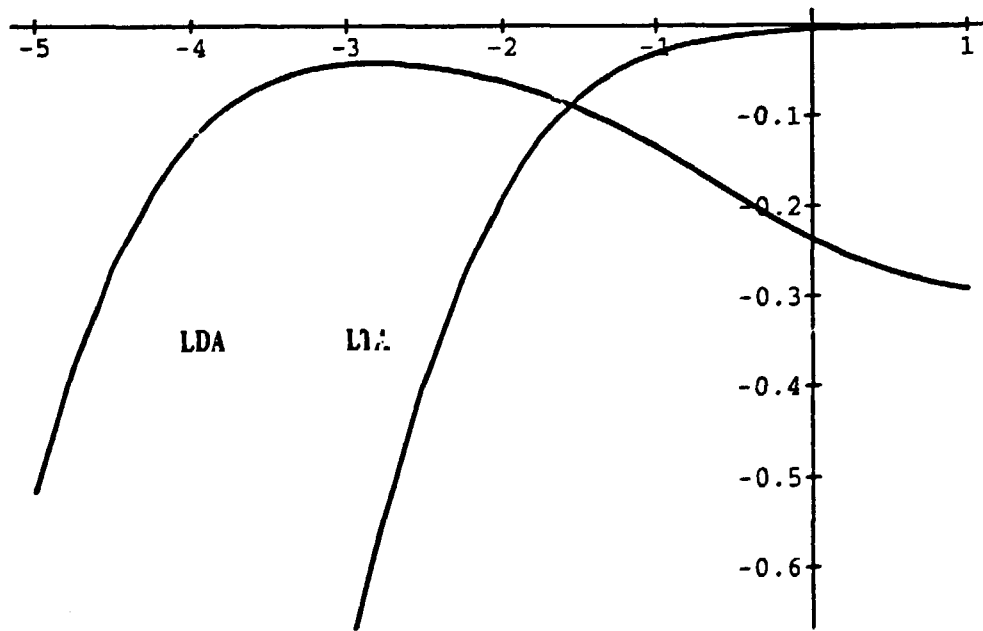

The coherence factor versus the particle concentration (arrival rate for the LDA) for the LDA and the LTA, respectively. Log-log plot. The temporal and spatial turbulence scales are assumed to be 100 times the passage time through the measuring region and the length of the measuring volume for the LDA, respectively. $kt = 10.1$ (a) 10% turbulence; axis: 2 div. per decade; y-axis: 5 div. per decade.

It is noted that for the Doppler configuration there is in general an optimum particle concentration.

The effect of additive noise has also been investigated. The minimum uncertainty versus the signal-to-noise ratio is established.

Initial reporting is given in Ref. ².

1) George, W.K. and Lumley, J.L. (1983). *J. Fluid Mech.* **60**, 321-362.

2) Lading, L. (1991). "The fundamental limits to turbulence measurements - revived", (*Laser Anemometry, Advances and Applications*, Eds. A. Dybbs and B. Gorashi, ASME 1991).

1.1.9 Speckle Statistics and Decorrelation Based on Complex ABCD-Matrices

(H. T. Yura and S. Hanson)

Complex ABCD ray matrix techniques combined with the paraxial approximation of the Huygens-Fresnel formulation of wave optics are a useful tool in analyzing analytically the performance of a rather general class of optical systems. This method expresses the complex optical field in the output plane as an integral over an input plane of the given source distribution multiplied by a propagation kernel, which is a function of the complex ABCD matrix modelling thin lenses, field stops, free space and finite sized measurement apertures. The formalism has previously been shown to give analytical expressions useful for engineering purposes, analytical expressions for the influence of optical turbulence and useful insight into the influence of alignment errors in various parts of an optical train of elements.

We have now considered homogeneous media and derived expressions for the mean, variance and correlation function of the irradiance distribution resulting from an incoherent source that has propagated through a complex (axially symmetric) ABCD optical system. In particular, we obtain a general expression for the mutual coherence function which can be regarded as a generalization of the VanCittert-Zernike theorem to complex paraxial ABCD systems; an expression which relates the number of speckle correlation cells contained within a measurement area to the parameters of the ABCD system. In particular, an expression for the maximum number of independent intensity measurements that the optical system allows is obtained.

A scientific programme funded by the Danish Technical Research Council to investigate the application of various *Electronic Speckle Interferometers (ESPI)* and their limitations has been conducted throughout the year. ESPI provides most of the benefits of holographic interferometry in the way that real-time monitoring of various displacements can be conducted without having some of the inherent drawbacks of holography. No photographic or chemical processes are involved but all recording and fringe analyses are performed electronically. This facilitates the employment of the technique in areas previously inaccessible. To take the full advantage of the technique, the limitations have to be investigated.

The ESPI relies on the effect of recording two speckle patterns from an object which is mechanically deformed between the two exposures. For small mechanical deformations the individual speckles will initially change phases, the phases revealing some desired aspects of the mechanical distortion. Various types of ESPI interferometers which will reveal some element of the total strain tensor can be designed. Common to all interferometers is the maximum mechanical displacement which can be tolerated before the speckle pattern will decorrelate.

The basic optical setups for the various types of interferometers are different in that some rely on imaging, some are based on defocusing, whereas others em-

ploy Fourier transforming layouts. An analytical expression for the decorrelation criteria in terms of the ABCD matrix for the optical system in question has been found. Three primary translations have been considered. Two displacements - one along the optical axis and one perpendicular to the optical axis - have been treated as well as rotation of the object about an axis perpendicular to the optics axis.

Central to the quality of the secondary interference fringes formed when two speckled images are subtracted is the correlation coefficient of the complex fields in the observation plane before and after loading. This quantity is defined as

$$\gamma = \frac{\langle U_b U_a^* \rangle}{\sqrt{\langle |U_a|^2 \rangle} \sqrt{\langle |U_b|^2 \rangle}},$$

where indices *a* and *b* indicate before and after loading. As the general expression for the field in the output plane in a circular symmetric ABCD system can be written

$$U(\underline{p}) = \left[-\frac{ikto}{2\pi B} \right] \exp(-ikL) \int d^2r U_s(\underline{r}) \\ \times \exp \left[-\frac{ik}{2B} (Dp^2 - 2\underline{r} \cdot \underline{p} + Ar^2) \right],$$

we can calculate the field correlation function. The displacement/rotation of the object can be introduced by multiplying the original field $U_b(\underline{r})$ by a linear phase factor (tilt), shift the field (displacement \perp optics axis) or convolve with a quadratic phase factor (translation along optics axis) to get the second field $U_a(\underline{r})$. The correlation coefficient can now be analytically calculated assuming delta correlation of the original field.

Any conventional optical system used for interferometric measurements can thus be analyzed by calculating the appropriate ABCD matrix which may include astigmatic elements. This task can analytically be performed in a Mathematica-based program. Knowing the complex matrix elements and the analytical expressions for the decorrelation coefficients facilitates the immediate determination of the speckle statistics and the limitation of the system.

1.1.10 Brite Project B/E-4152

(S. Sloth Christensen)

The strategic aim of the project is to improve quality and productivity in handling and processing of flexible materials by the development of advanced automation techniques with evisceration of pig carcasses as a model process.

Partners in the project are The University of Bristol (UK), SAC Hitec Ltd. (UK), Siemens AG (Germany), The Danish Meat Research Institute (DK) and Risø National Laboratory.

In this project the task of Risø is to develop an image processor which will locate important feature points on the pig carcass. A high degree of precision is required to accommodate the quality demands of the Danish meat industry. This

combined with the great variations of biological materials possess a challenge to the speed, precision and robustness of the image processor.

A method called 'active foveal search' has been developed to meet the challenge. The method has to a great extent been inspired by neurological data for the human eye and takes advantage of artificial neural network generalization capabilities.

The image of the pig is recorded by a CCD-camera. The pixel values are transmitted to an artificial eye, AE. The AE emulates the fovea found in real eyes. The fovea is a spot with high resolution in the centre of the visual field. The resolution outside the fovea decays with the distance to the centre.

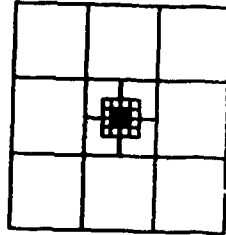

Resolution of eye with fovea.

This concept has the advantage that the AE performs a huge data compression (1:512) still maintaining maximum resolution in the centre of the visual field. In order to compensate for differences in illumination another principle is adopted from real eyes, contrast normalization. This method maintains information about shape and eliminates illumination dependency.

The compressed and normalized image is transferred to an artificial neural network. The network has been trained to identify specific features. The output from the network indicates the direction and distances from the centre of view to the relevant feature. This signal is used to move the focus of the artificial eye towards the feature point. This process is repeated until the artificial eye is looking straight at the feature point.

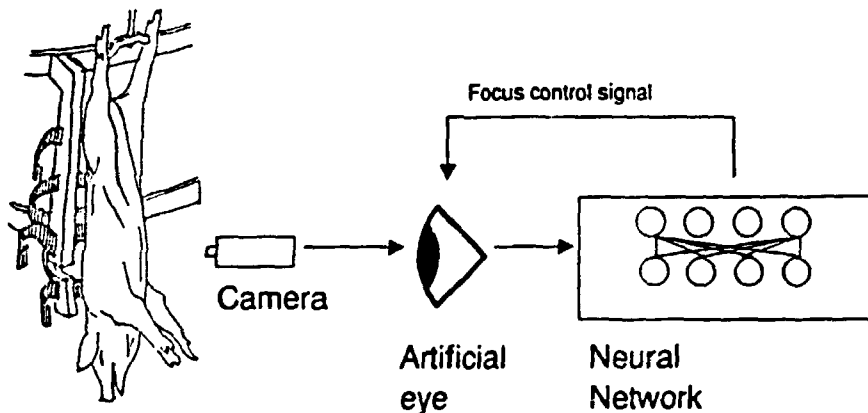

The method mentioned above is expected to be fast, precise and robust. The speed is achieved through the data compression performed in the artificial eye. The excellent generalization capabilities of neural networks are responsible for the robustness of the system.

1.1.11 The CONNECT Project

(C. Ljissberg)

CONNECT is the acronym for: *CO*mputational *Ne*ural *NE*twork *Cen*Ter.

In the spring 1991 the CONNECT research centre was started as a collaboration between four research institutions in the Copenhagen area: The Niels Bohr

Institute in Copenhagen, the Electronics Institute at the Technical University of Denmark, the Institute for Physics and Materials at the Technical University of Denmark, and The Optics and Fluid Dynamics Department at Risø National Laboratory.

The centre was founded by the Danish government and will employ two to three persons in the Optics and Fluid Dynamics Department at Risø for the next three years.

The aim of the research collaboration is to explore and exploit the area of artificial neural networks, both in theory and practice. The role of the Optics and Fluid Dynamics Department is:

- (1) to develop optical implementations of artificial neural networks,
- (2) to develop methods and theoretical foundation for self-organising neural network architectures,
- (3) to develop neural network methods for early vision processing.

The CONNECT centre is still in its infancy but has already achieved the following results:

- A network simulation software system for simulation of the optical TAG-network (and other types of network) has been developed by Steen Sloth Christensen and Jesper Glückstad.

- A methodology for early vision processing to be utilized in the BRITE project (see elsewhere) has been developed by Steen Sloth Christensen.

- A methodology and theoretical foundation for self-organising architectures have been developed by Thomas Martini Jørgensen and Christian Liisberg (the SOLE system). These results are to be utilized in the HERA project (see elsewhere).

- Knowledge gathered recently in connection with a CONNECT sponsored conference travel (NIPS 1991) will form the basis for a new project on real time motion detection for diagnostic purposes to be carried out by Christian Liisberg.

Connect and conquer!!

1.1.12 EUREKA Project HERA

(C. Liisberg)

HERA is the acronym for: *H*ierarchically organised *E*nsembles of *R*atified sparse *A*rtificial neural networks.

Overview

Together with Rambøll & Hannemann Informatik and IIC (The Institute for Artificial Intelligence at the Technical University of Madrid) The Optics and Fluid Dynamics Department at Risø has established an EUREKA project. The project has been approved by the EEC EUREKA committee, and the Danish EUREKA office has funded the Danish partners. The project will call for two new employees at Risø.

The HERA project is an attempt to make a low-cost, quick and reliable system for off-line recognition of handwritten figures and characters, a system which in respect of quality is up to the standard of human recognition of characters.

The state of the art of handwritten character recognition

By off-line recognition of characters is meant "ordinary" recognition based on the visual information which is available when the characters have been written. By on-line recognition the characters are read while they are being written so that information about writing direction and sequences also forms the basis for interpretation of the written characters.

We perform off-line computer recognition which is more difficult than on-line recognition and, to our knowledge, it has not yet been possible to make off-line systems for recognition of handwritten figures which in respect of quality and speed can come up to the human recognition of characters. Typically, the rejection rate for the best systems are 5 to 10% with an error rate of 1% whereas human beings have rejection rates of 1% and error rates of less than 1%. These numbers depend of course heavily on the test set and no standard test procedures exist.

The basic idea used by attempts to machine read handwritten characters is to, somehow, extract some characteristic features from a digitized image of the character and then perform a classification based on the extracted features. For a broader review see ^{1,2}.

Neural networks and machine reading of handwritten digits

Earlier attempts to use neural networks directly on binary images of handwritten digits failed because the input space (the number of possible images) is so vast that no generalizing mapping could be generated. Different forms of feature extraction were then tried in order to reduce input space and improve generalization capability. Examples of hand-tailored feature extraction combined with neural network classification (there are numerous) can be seen in^{3,4}.

More interesting approaches are the ones which try to let the feature extraction become an automatic part of a network optimization procedure based on some internal quality measure and a network architecture with some hand-tailored constraints in it. Those approaches are the state of the art and have been demonstrated in⁵.

The methods mentioned above make use of a quality measure for the individual connections in the network, named 'relevance' or 'saliency'. The basic idea is to iteratively train the network to a certain performance criterion, compute a measure of relevance that identifies which input, hidden units or connections are most critical to performance, and automatically remove the least relevant units or connections^{6,7}.

Attempts to attack the problem of network design from the outside by estimating the complexity of the problem and the desired classification have been tried via the theory of learnability and the so-called Vapnik Chervonenkis dimension which has given some good bounds on the number of examples needed to make a given network generalize well (Probably Approximately Correct Learning)⁸⁻¹⁰.

A strategy using feature space optimization by minimal entropy coding as well as using Shannon entropy as a quality measure (a method external to the network) and a minimal growth algorithm to ensure a minimized network (an internal method) was implemented in the ZEUS program by C. Liisberg, Risø. (ZEUS is a hybrid neural network expert system shell.)¹¹

Some very interesting work on ensembles of neural networks has been carried out¹². The work shows that by organizing networks in ensemble structures one can improve the system performance considerably, even if the single networks are rather primitive. This is especially interesting because the modular and limited nature of dedicated neural network chips can be overcome by organizing hardware modules in appropriate structures¹².

The new concept of cognitive entropy

Based on the experience from ZEUS (a former project carried out by the Optics and Fluid Dynamics Department at Risø) a new quality measure named cognitive entropy has been developed at Risø. By doing an external analysis of the training examples this new measure can determine the optimal internal structure of single networks as well as the optimal configuration of ensembles and hierarchies of (modular) networks. The optimization is done with respect to generalization in connection with a given set of training examples.

By means of the cognitive entropy measure a hierarchical structure of sparsely connected neural networks (called HERA) has been generated. This system builds on the SOLE system described elsewhere.

Further perspectives, novelty and international status

The cognitive entropy seems very promising because it gives us a quality measure and thus a control mechanism for both automatic knowledge acquisition (it can tell a system where to exhibit curiosity) and for self-organization of both network structures and structures of networks (as well as structures of networks in combination with other methods - hybrid systems).

The HERA networks, which are only the beginning of utilization of the cognitive entropy, are suitable for pattern recognition within the area of large binary amounts of data such as digitalized images and sound sequences. Furthermore, "intelligent" search in large text data bases is also estimated to be possible.

"Ordinary" neural networks are only suitable for processing of small amounts of data and it is consequently necessary to carry out preprocessing and feature extraction prior to the solution of a classification task. By means of the thirv connected, hybrid neural networks described above (HERA), it is possible to make self-organizing, robust, and low-cost preprocessing and feature extraction combined with the well known classification capability of neural networks.

- 1) Tappert, C.C, Suen, C.Y., and Wakahara, T. (1990). IEEE Transactions on Pattern Analysis and Machine Intelligence **12**, No. 8.
- 2) Govindan, V.K. and Shivaprasad, A.P. (1990). Pattern Recognition **23**, No. 7. Pergamon Press.
- 3) Schmitt, L. (1990). Neural networks for OCR. Photonics Spectra.
- 4) Rajavelu, A., Musavi, M.T., and Shirvaikar, M.V. (1989). Neural Networks **2**, pp. 387-393.
- 5) Le Cun, Y., Boser, B., Denker, J.S., Henderson, D., Howard, R.E., Hubbard, W. and Jakel, L.D. (1989). Neural Computation **1**, 541-551.
- 6) Mozer, M.C. and Smolensky, P. (1989). Connection Science **1**, No. 1.
- 7) Thodberg, H.H. Occams razor - improving generalisation of neural networks. Danish Meat Research Institute. Internal report.
- 9) Baum, E.B. & Haussler, D. (1989). Neural Computation **1**, No. 1.
- 9) Lineal, N., Mansour, Y. & Rivest, R.L. (1988). Colt '88. Proceedings of the 1988 Workshop on Computational Learning Theory. Cambridge, MA: MIT 56-68.
- 10) Blumer, A., Ehrenfeucht, A., Haussler, D. & Warmuth, M.K. (1987). Technical Report USCS-CRL-87-20, U.C. Santa Cruz Computer Science Laboratory, November.
- 11) Liisberg, C. (1991). Expert Systems with Applications **3**, pp. 249-257.
- 12) Hansen, L.K. and Salomon, P. (1990). IEEE Transactions on Pattern Analysis and Machine Intelligence **12**, No. 10.

1.1.13 Cognitive Entropy and Self-Organizing Learners

(T. Martini Jørgensen and C. Liisberg)

The Cogentropy Measure

In many tasks involving classification of objects into known classes the key problem is how to extract only the important features from a given set of examples within a description space of high dimension.

In order that a neural network may generalize optimally from the training set to other examples, it is important to have as few connections as possible between the input parameters and the processing units¹ and to be aware that the distribution of the examples in the training set cannot generally be associated with the distribution governing the total example space.

To cope with the problems presented above, we have constructed a new figure of merit, called cogentropy (cognitive entropy). It measures the knowledge obtained by the neural network when presented to an unknown example. The cogentropy takes on a negative value in case the unknown object is misclassified. It is a useful figure of merit whenever the neural network is based upon look-up tables which have the advantage that a crossvalidating test can easily be incorporated in the process of constructing the network.

The cogentropy has close relations to Shannon's information measure based on entropy². However, the essential problem with using the Shannon entropy is that it is based on knowing the probability of having a specific feature for a given class of objects. But the only probability distribution available is the distribution of features among the objects belonging to the training set.

Instead of using the actual probability distribution of features among the training objects, the cogentropy measure is based on the following two concepts:

(1) If a given feature exists in m classes out of N in the training set, we attribute to each of the m classes an equal probability for having the actual feature (rectangular distribution). In this way we do not a priori favour any of the m classes with respect to this specific feature.

(2) If a given feature does not exist in a specific class in the training set, then we associate a zero probability for this to happen.

Self-Organizing LEarner (SOLE)

The SOLE system is a feedforward network based on cogentropy. The main benefits of the system are that it ensures high generalization capability for a given example set independent of the size of the parameter space and that training and recall are fast.

We have demonstrated that several SOLE networks can cooperate in a democratic fashion to gain a better result. This is possible by using random search which causes the networks to make different mistakes³.

We have tested the SOLE system on recognition of 7,000 handwritten digits, which have been scaled to uniform size. 5,000 of these digits were used as a training set and 2,000 as a test set. The test set is guaranteed to origin from other persons than the training set.

A one-layer network typically makes 65% correct classifications and 34% rejections on the test set with a 1% error rate, whereas an ensemble of forty networks has 86.1% correct classifications, 1% errors and 12.9% rejections. The training set has 0.5% errors and 7.2% rejections in a crossvalidation test. It takes approximately four hours to train such a system on a 25 MHz 486 PC. The results are comparable with the ones obtained in⁴, but our method is faster and more general

(does not exploit any a priori knowledge of the problem domain).

- 1) Baum, E.B. and Hausler, D. (1989). *Neural Computation* **1**, 151-160.
- 2) Yu, Francis T.S. (1976). *Optics and Information Theory*, John Wiley & Sons, New York, 1976.
- 3) Hansen, L.K. and Salamon, P. (1990). *IEEE Transactions on Pattern Analysis and Machine Intelligence* **12**, No. 10.
- 4) Le Cun, Y. et al. (1989). *Neural Computation* **1**, 541-551.

1.1.14 Optical Neural Networks

(J. Glückstad)

The capability of optics of processing massive data in parallel has generated great interest in the implementation of neural network architectures by means of optics.

In optical neural networks photons are used instead of electrons as the carriers of information. The advantage of doing this stems from the fact that photons do not interact mutually. Unlike electrons in wires on an integrated circuit chip, light rays do therefore not affect one another when they are close to or even cross each other. Consequently millions of light rays can carry data simultaneously into a processing device by free space propagation using the third dimension, whereas electronic devices on a chip are limited to accepting input from a few wires restricted to a common 2D plane.

Most optical neural networks have two phases: (1) the training phase and (2) the retrieval phase. In the case of associative memories, e.g., a number of pictures are stored in the network during the training phase. Afterwards the data are retrieved by showing the network one of its stored pictures or a degraded or partial version of it (for example part of a digit). If the network is an autoassociative memory, it then outputs the corresponding corrected data (the full digit). We have simulated an optical architecture showing this kind of behaviour in order to examine its capabilities before deciding on the hardware architecture (cf. the figure).

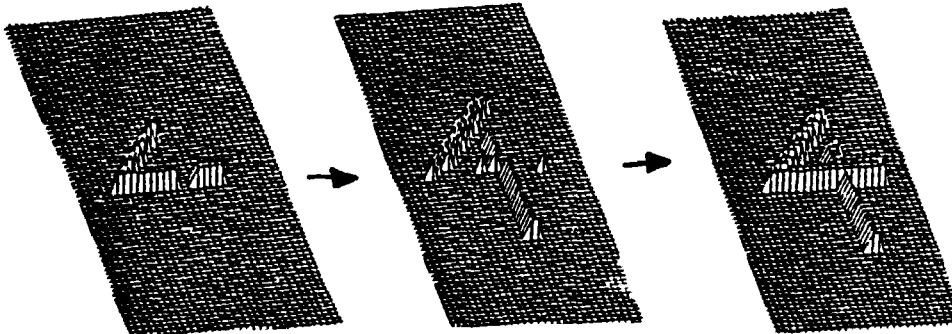

Three steps in the retrieval phase of partial digit.

An associative memory only includes a single layer of fully interconnected neurons and is not capable of doing real learning. We have therefore been investigating learning algorithms suitable for optical multi-layer network implementations. A recently proposed backpropagation algorithm (trainability by adaptive gain²) has been modified and found very useful in simulation experiments.

With respect to the optical implementation we have proposed a new compact opto-electronic hardware architecture based upon fixed random-symmetric holographic interconnects and adaptive gain elements adjacent to the neurons. The system is expected to be capable of doing both forward propagation (retrieval phase) and backward error propagation (training phase) for a given number of hidden layers by using just one single computer-generated hologram, one spatial

light modulator, and one 2-dimensional CCD-array. The results obtained by our computer simulations are so promising that we have decided to construct this optoelectronic architecture in the near future.

1) Kyuma, K. (1991). *Nonlinear Optics* 1, 39-49.

2) Lee, H.-J., Lee, S.-Y., Shin, S.-Y. and Koh, B.-Y. (1991). *Neural Computation* 3, 135-143.

1.1.15 Fluid Dynamics and Quantitative Coronary Angiography

(P.S. Ramanujam, D. Atar, K. Saunamäki and S. Haunsø (University Hospital, Copenhagen))

Partial or total occlusion of arteries due to stenotic obstructions is frequently responsible for heart failure. Although the causes for the initial development of stenosis remain unknown, an obstruction of blood flow is inevitable once the development of the stenosis takes place. Traditionally, visual inspection of coronary arteriograms has been used to assess the severity of the coronary disease. However, a more precise method for evaluation is necessary to judge whether a surgical operation is essential. It is known that the haemodynamic significance of a coronary artery stenosis can be determined by measuring all stenotic dimensions. The pres-

Correlation P_{meas.}:P_{calc.}

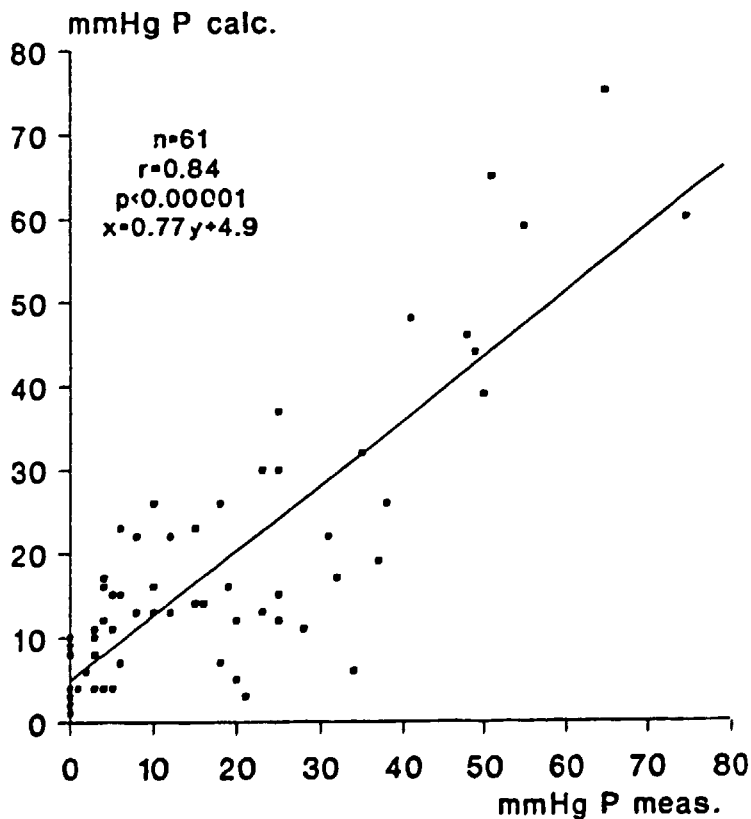

sure loss across a stenosis due to the friction and sudden expansion is determined from classical fluid dynamics equations once the stenotic dimensions are known and this provides a quantitative measure of the expected biological effects due to the obstructed flow.

Experiments in the laboratory in tubes with controlled diameter and in anesthetized dogs have shown that the fluid dynamics equations can be applied to blood flow. However, quantitative coronary angiography has not been incorporated into clinical practice. In a collaborative effort with the University Hospital, Copenhagen, a study has been undertaken in which the pressure loss across a stenosis in over 60 patients was measured invasively using a catheter. The aim of the present work is to correlate the measured pressure drop with those calculated from stenotic dimensions through fluid dynamics equations. The improvements in the present calculations include the effects of the exit geometry of the stenosis on the pressure loss due to sudden expansion and include the frictional loss due to the catheter. In 87% of the cases the calculated and invasively measured pressure gradients agreed to within 15 mm Hg. A correlation coefficient of 0.84 was obtained between the measured and calculated values.

1.2 Participants in the work in Applied Laser Physics

Scientific Staff

Christensen, Steen Sloth
Hanson, Steen Grüner
Jensen, Arne Skov
Johansen, Per Michael (until 28 February)
Lading, Lars
Liisberg, Christian
Ramanujam, P.S.

Ph.D. Students

Jørgensen, Thomas Martini
Lindvold, Lars (working at "DANTEC Electronics")
Kristensen, Jesper Glückstad

Technical Staff

Berendt, Ricky (until 31 July)
Eilertsen, Erik
Hansen, Bengt Hurup
Kristensen, Kim
Rasmussen, Erling
Weimar, Bjørn

Secretaries

Astradsson, Lone
Skaarup, Bitten
Toubro, Lene

Guest Scientists

Yura, H.T., Aerospace Corporation, Los Angeles, U.S.A.

Short time visitors

Caulfield, J., University of Alabama, Huntsville, Alabama, U.S.A.
Teich, M., Columbia University, New York, N.Y., U.S.A.

2 Publications and educational activities in the Applied Laser Physics Section

2.1 Publications

JOHANSEN, P.M. and SKOV JENSEN, A. (1991). Space-Charge Field in Photorefractive Media with a Constant Applied Magnetic Field. *J. Opt. Soc. Am. B* 8, 2342-2354.

JØRGENSEN, T.M. (1991). Derivation of the Vectorial Wave Equation from a Variational Point of View. *J. Opt. Soc. Am. A/Vol. 8, No. 5*.

LADING, L. (1991). The Fundamental Limits to Turbulence Measurements - Revived. In: *Laser Anemometry - Advances and Applications 1. Fourth International Conference on Laser Anemometry, Advances and Applications, Cleveland OH, 5-9 August.* (Eds. A. Dybbs and B. Ghorashi). American Society of Mechanical Engineers, New York, 53-62.

LADING, L. and ANDERSEN, K. (1991). Burst Detection in a Phase/Frequency Processor. In: *Laser Anemometry - Advances and Applications 2. Fourth International Conference on Laser Anemometry, Advances and Applications, Cleveland OH, 5-9 August.* (Eds. A. Dybbs and B. Ghorashi). American Society of Mechanical Engineers, New York, p. 709-717.

LIISBERG, C. (1991). Possible Low-Priced, Robust Expert Systems Using Neural Networks and Minimal Entropy Coding. *Expert Systems With Applications* 3, pp. 245-257.

SKOV JENSEN, A. (1991). Impact of Quadratic Phase Factors on Optical Fourier Transforms and Imaging. *Opt. Lett.* 16, 886-888.

SKOV JENSEN, A. and RASMUSSEN, E. (1991). Performance of a Hybrid Optical Vision System. *Risø-M-2895*, 39 pp.

SKOV JENSEN, A. and RASMUSSEN, E. (1991). New Architectures for Optical Processing in Industrial Applications. *Risø-M-2911*, 70 pp.

SKOV JENSEN, A. (1991). Optisk tracker til afstandsmåling (Optical tracker for range finding). *Risø-M-2950*, 29 pp.

SKOV JENSEN, A. and HAUGAARD NIELSEN, R. (1991). Roboter der kan se (Robots who can see). *Risø Nyt* (March).

SKOV JENSEN, A. and HAUGAARD NIELSEN, R. (1991). Maskin Aktuelt (Machine News). *Risø Nyt* (August).

2.2 Conference contributions

ATAR, D., RAMANUJAM, P.S., SAUNAMÄKI, K., and HAUNSØ, S., Flow gennem koronararteriestenoser: invasiv måling af trykgradienter versus hydrodynamiske beregning ved kvantitativ koronararteriografi (Flow through coronar artery stenosis: invasive measurement of pressure gradients vs. hydrodynamic calculations through quantitative coronar arteriography). Foreningen af Yngre Cardiologer, Fall meeting, Copenhagen, Denmark (October).

ATAR, D., RAMANUJAM, P.S., SAUNAMÄKI, K., and HAUNSØ, S., Estimering af koronararteriestenoser: Invasiv trykgradientmåling versus hydrodynamiske beregning ved kvantitativ koronararteriografi (Estimation of coronar artery stenosis: Invasive pressure gradient measurement vs. hydrodynamic calculation through quantitative coronar arteriography). Dansk Cardiologisk Selskab's 137. møde, Copenhagen, Denmark (November).

GEISLER, T., ROSENKILDE, S., WIJEKON, K., PRASAD, P.N., and RAMANUJAM, P.S. (1991). Second Harmonic Generation in Langmuir-Blodgett Films of N-docosyl-4-nitroaniline. The First International Conference on Frontiers of Polymer Research, New Delhi, India (January).

GLÜCKSTAD, J., Optical Associative Memory. The annual meeting of the Danish Optical Society, Odense, Denmark (November).

GRØNBECH-JENSEN, N., JØRGENSEN, T.M., and RAMANUJAM, P.S., System Efficiency in the Detection of Nonclassical Light. The ESPRIT workshop on Quantum Noise Reduction in Optical Systems, Paris, France (September).

HANSON, S. and HANSEN, B. HURUP, Realtidsbestemmelse af svingningsmønstre ved differentielt elektronisk speckle interferometri (Real time determination of fluctuation patterns in differential electronic speckle interferometry). Eksperimentel Mekanikdag, a joint arrangement between DTH/AUC and Risø, Risø, Denmark (November).

JØRGENSEN, T.M., Measuring viscoelastic parameters with a low-cost light-scattering spectrometer. The annual meeting of the Danish Optical Society, Odense, Denmark (November).

LADING, L., The Fundamental Limits to Turbulence Measurements - Revived. Fourth International Conference on Laser Anemometry - Advances and Applications, Cleveland, OH., U.S.A. (August).

LADING, L. and ANDERSEN, K., Burst Detection in a Phase/Frequency Processor. Fourth International Conference on Laser Anemometry - Advances and Applications, Cleveland, OH., U.S.A. (August).

LADING, L., How to make the Best Use of Photons in Diagnostics. XIV International Conference on Coherent and Nonlinear Optics, Leningrad/St. Petersburg, Russia (September).

LINDVOLD, L., A method for monitoring the photoinduced redox process in dichromated gelatin. The Holographic Conference "Holographic Systems, Components and Applications, The Institution of Electrical Engineers, The Heriot-Watt University, Edinburgh, Scotland (September).

LINDVOLD, L., Dyed gelatin film as a storage material for volume phase holograms. Symposium on Holographic Optics Technologies and Applications I. The Optical Society of America, Annual meeting, San José, California, U.S.A. (November).

PAULSEN, J.L. and LIISBERG, C. (1991). Expert Systems and Plant Conditions. Presented at the World Congress of Expert Systems. Orlando, U.S.A. 16-19 December 1991.

RAJBENBACH, H., BANN, S., REFREGIER, Ph., JOFFRE, P., HUIGNARD, J.P., BUCHKREMER, H.S., JENSEN, A. SKOV, RASMUSSEN, E., BRENNER, K.H., and LOHMAN, G. (1991). An Optical Correlator for Robotic Applications. ESPRIT technical week, Brussels, Belgium., 25-29 November.

RAMANUJAM, P.S., Solitons in Optical Communication. Short Course, Conference on Emerging Optoelectronic Technologies, Bangalore, India (December).

RAMANUJAM, P.S. and GRØNBECH-JENSEN, N., Generation of Sub-Poisson Distribution of Light. Conference on Emerging Optoelectronic Technologies, Bangalore, India (December).

2.3 Lectures

HANSON, S., Colloquium on Small Angle Scattering. JET, Abingdon, U.K. (January).

HANSON, S., *Lys og lasere (Light and Lasers)*. The University Extension, Copenhagen, Denmark (April).

HANSON, S., Business visits covering lectures and presentation of the work of the section.

- 1 N. Foss Electric, Roskilde, Denmark (May).
- 2 Danfoss, Als, Denmark (August and October).
- 3 Radiometer, Copenhagen, Denmark (August).
- 4 Ferroperm, Copenhagen, Denmark (August).
- 5 Brüel og Kjær, Nærum, Denmark (September).
- 6 Jydsk Telefon, Roskilde, Denmark (September).
- 7 Bang & Olufsen, Skive, Denmark (September).

LADING, L., Dynamic Light Scattering. Danish Physical Society, Winter School in Modern Physics, Risø National Laboratory, Roskilde, Denmark (January).

LADING, L., Operational modes of LDA. Dantec, Skovlunde, Denmark (March).

LADING, L., Signal processing schemes for very high accuracy in Laser Anemometry. Dantec, Skovlunde, Denmark (August).

LADING, L., Presentation of the Department for industry (February, April, September, October).

LIISBERG, C., Lectures related to neural network.

- 1 "HERA - et nyt koncept for neurale netværk og maskinsyn" (HERA - a new concept for neural network and machine vision) Laboratoriet for Billedanalyse, AUC, Aalborg, Denmark (April).
- 2 "ZEUS - en neural expertsystembygger" (ZEUS - a neural expert system builder). Seminar on NN og ZEUS. RUC hus 3.1.3., Roskilde, Denmark (April).
- 3 "Neurale netværk til (visuel) kvalitetskontrol" (Neural network for (visual) quality control). Microtronic, Roskilde, Denmark (May).
- 3 "Neurale netværk til klassificering af makrokulhydrater" (Neural network for classification of macro carbon hydrates). Danisco, Biotech Research division, Glostrup, Denmark (May).
- 4 "ZEUS og HERA" (ZEUS and HERA). Lecture on NN for representatives from FOSS Electric, Risø National Laboratory, Roskilde, Denmark (May).
- 5 "Financial Forecasting with Neural Networks". Lecture on NN for representatives from Den Danske Bank and Den Danske Børs, Rambøll & Hanneman Informatik, Virum, Denmark (June).
- 6 "Hvis Gud er emergent, så hold på hat og briller" (If God is emergent, then hold on to your hats). Rambøll & Hanneman Informatik, Virum, Denmark (August).
- 7 "Genkendelse af fingeraftryk. Resultater fra forsøg med HERA" (Recognition of finger-prints. Results from experiments with HERA). Presentation of NN for representatives from Jysk Telefon, Risø National Laboratory, Roskilde, Denmark (September).
- 8 "Neurale netværk" (Neural network). Visitors from Danfoss, Risø National Laboratory, Roskilde, Denmark (October).
- 9 "Fremtidens neurale netværk" (The future of neural network). Prolog Development Center, Hotel Scandinavia, Copenhagen, Denmark (November)

LINDVOLD, L., Laseren og dens anvendelser (The laser and the use of it). Dansk Metal, Department 13, Copenhagen, Denmark (January).

LINDVOLD, L., Laseren og dens anvendelser (The laser and the use of it). Dansk Metal, Department 13, Copenhagen, Denmark (January).

LINDVOLD, L., Holografi og medicinske anvendelser af lasere (Holographic and medical use of lasers). The University Extension, Copenhagen, Denmark (April).

RAMANUJAM, P.S., Generation of Sub-Poisson Distribution of Light. Niels Bohr Institute, Copenhagen, Denmark (November).

SKOV JENSEN, A., Optical Robot Vision. Lebedev Institute of Physics, Moscow, U.S.S.R. (April).

3 Plasma Physics Section

3.1 Introduction to the work in plasma physics and fluid dynamics

During 1991 the scientific programme included the following topics:

(1) A study related to pellet-plasma interaction with the aim of assessing possibilities of refuelling a fusion reactor by shooting deuterium-tritium pellets into the plasma.

The study is divided into the following subsections.

(a) A detailed study of the interaction between charged particles of various energies and solidified gases. This comprises, e.g., investigations of the luminescence from solid hydrogens irradiated by electrons and of the sputtering of solid hydrogens by light ions. In addition studies of laser sputtering and ablation from solid hydrogens have been initiated.

(b) Pellet handling, acceleration and injection. The main activity is concerned with developing and testing multishot pellet injectors for the European fusion programme.

(2) Studies of the fundamental physics of plasmas with relation to fusion research. The main activities are investigations of turbulence, turbulent transport and nonlinear effects in general. The study is based on a combination of theoretical, numerical and experimental work. The following items are included: turbulence in the edge region of magnetically confined plasmas, coherent structures in turbulence, particle dynamics in turbulent plasmas, anomalous cross-field diffusion due to electrostatic turbulence, nonlinear evolution of modulated waves and scattering of microwaves by density fluctuations in tokamaks. In addition the possibility of calculating equilibria for plasmas in magnetic field by means of magnetic stresses is investigated.

(3) Studies of the dynamics of coherent vortical structures in two-dimensional flows. The investigations combine theoretical, computational and experimental work. Studies are performed on existence and stability of vortical structures and of their mutual interactions as well as their interaction with boundaries. The computational studies are based on advanced spectral codes implemented on supercomputers. Initial experimental studies are performed in a rotating tank filled with water, where vortices are excited externally.

(4) Participation in the scientific work at JET (Joint European Torus). This work comprises studies of ELMs (edge localized modes) in the scrape off layer (SOL) and of diagnosing the ion velocity distribution function by means of μ -wave scattering.

3.1.1 Luminescence from pure and impure solid hydrogens during electron bombardment

(J. Schou (Physics Department), B. Stenum, H. Sørensen, P. Gürtler (HASYLAB, DESY, Germany), and R.L. Brooks (University of Guelph, Canada))

The study of luminescence from particle-irradiated solid deuterium does not only yield information about the electronic excitations in the solid, but may also lead to data that are useful for the pellet-plasma interaction in plasma experiments. The previous work at the Risø setup has demonstrated that solid deuterium exposed to electron irradiation emits bands which do not play any role for electron-bombarded hydrogen gas¹.

An intense new emission continuum in the red and near-infrared regime has been observed. This broadband peaking at about 815 nm has never been seen from the gas phase. It is observed already around 650 nm and falls off slowly from the maximum with increasing wavelength. This fall-off is mainly determined by the decreasing sensitivity of our detection system.

The line has been identified as radiative association of D-atoms in the solid. This process is possible since the concentration of neutral atoms in the solid from dissociative recombination may approach 1 per thousand. The atoms perform a quantum diffusion in the solid by fast atom exchange in the molecules. The recombination of the atoms has to take place in the neighbourhood of an ion because the wavelength of the emitted light shows that the distance between atoms before association is much smaller than expected from the known atom-atom distance in the solid deuterium lattice.

¹ J. Schou, B. Stenum, H. Sørensen, K-V. Weisberg and P. Gürtler (1991), Nucl. Fusion **31**, 589.

3.1.2 Sputtering yields from ion-bombarded condensed gases

(J. Schou (Physics Department), B. Stenum, H. Sørensen, O. Ellegaard (The University of Odense, Denmark), and R. Pedrys (Jagellonian University, Krakow, Poland))

The studies of sputtering of the solid hydrogens have been continued with particular emphasis on the most volatile isotope, solid hydrogen. Sputtering by hydrogen ions is important for the lifetime of fuel pellets of hydrogenic material injected into plasma devices. The fast hydrogen ions generated by the neutral beam heating are very efficient in eroding the hydrogenic pellets. The yield for a 10 keV H^+ is about 150 D_2/H , 450 HD/H and 800 H_2/H for the three stable isotopes. This high yield is primarily caused by the very low binding energy of the hydrogen molecules in the solid.

The yields for all three isotopes increase strongly with energy in the region from 5 to 10 keV. This behaviour is a strong argument for electronic sputtering rather than knockon (ordinary collision) sputtering. All known models for knockon sputtering indicate that the yield would decrease with increasing energy. Electronic sputtering, i.e. erosion via electronic transitions, is correlated to the electronic stopping power. The yield for D_3^+ - and H_3^+ -ions incident on solid hydrogen shown in the figure is approximately a linear function of energy, i.e. the electronic stopping

power squared. It is noted that the yield in the figure for ions of equal velocity is practically identical and that all the data points lie on one curve. This confirms the assumption of electronic sputtering being responsible for the erosion.

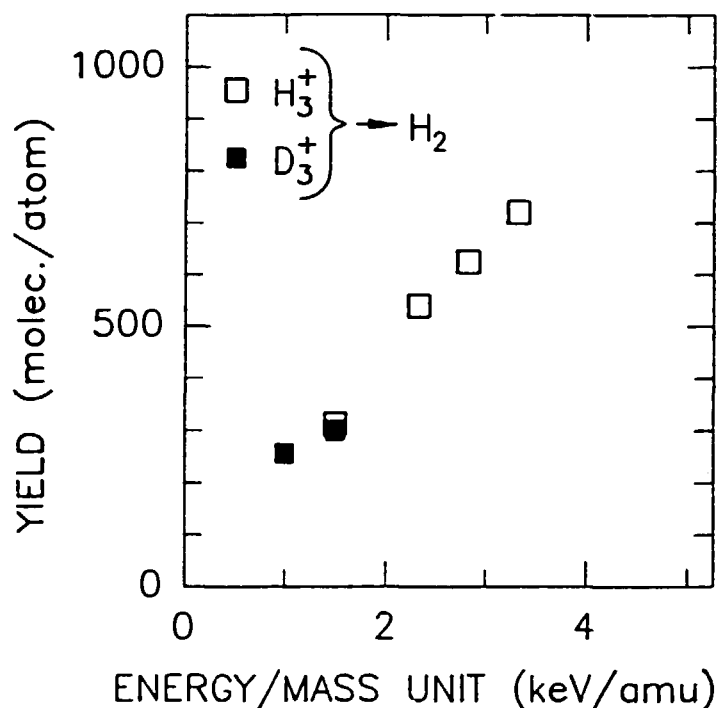

The sputtering yield per atom as a function of the energy per mass unit from solid H₂. Film thickness: 3¹⁸ H₂/cm².

3.1.3 Secondary electron emission from solids

(J. Schou (Physics Department) and H. Rothard (Institut für Kernphysik der J.W. Goethe-Universität, Frankfurt, Germany))

The studies of secondary electron emission induced by charged-particle or photon bombardment on surfaces have been concentrated on the energies that are relevant to plasma-surface interaction. The collected data and the description of the physical processes comprise a review chapter in a book on the physical properties of the interaction of fusion plasma with solids.

A parallel effort has been made to extend an existing transport theory of Schou¹ for secondary electron emission from solids to heavy ions as well. This theory has been feasible for proton and electron bombardment and partly for other light ions, whereas the results from heavy-ion impact have turned out to deviate significantly from the predictions. The analysis has demonstrated that the deviations are primarily caused by excitations of the projectile, but the instantaneous charge state of the primary ion also plays an important role.

1) Schou, J. (1980). Phys. Rev. B 22, 2141.

3.1.4 Studies on fundamental processes of laser sputtering and ablation from solid deuterium

(J. Schou (Physics Department), K-V. Weisberg, and O. Ellegaard (The University of Odense, Denmark))

An existing setup is being prepared for laser irradiation of simple frozen gases and metallic test samples. A simple nitrogen laser with an emission in the ultraviolet region, 337 nm, with a peak energy of about 100 μJ within a period of a few ns will be applied. This laser has turned out to be sufficient even for making holes in aluminium foils. The laser erosion will be studied with mass collection on microbalances and by optical spectroscopy in the region from 120 to 900 nm. Solid deuterium and the two "standard" molecular gases, solid nitrogen and oxygen, will be irradiated with laser beams of varying power area densities and wavelengths. The erosion rate and the optical emission features will be compared with the existing results from electron-irradiated frozen gases.

3.1.5 The multishot injectors for FTU, Frascati, and RFX, Padova

(H. Sørensen, J.E. Hansen, A. Michelsen, A. Petersen, K-V. Weisberg, and J. Bundgaard (Department of Electronics and Mechanics))

Following the decision in 1990 that the project should be supported by priority support from Euratom a new tender was worked out and submitted to ENEA in December 1990.

A number of negotiations of administrative and technical nature have subsequently been conducted and a contract document has been drawn up by ENEA.

The work with detailed design and planning has been continued. The technical negotiations with ENEA mentioned above resulted in a number of changes to be taken into account. During the work with the injector for RTP, Rijnhuizen, a number of improvements were made and these improvements are entered in the design.

3.1.6 A multishot pellet injector for RTP, Rijnhuizen

(H. Sørensen, J.E. Hansen, H. Kossek, A. Michelsen, J. Thorsen, and K-V. Weisberg)

The work with the multishot pellet injector for the tokamak RTP at the FOM Institute for Plasma Physics at Rijnhuizen in the Netherlands has been continued.

Pursuant to the agreement Risø should deliver an 8-shot unit with requested pellet parameters, a diagnostic unit for pellets masses and velocities together with electronics equipment for running the 8-shot unit, while RTP should supply all other parts in agreement with Risø.

The 8-shot unit completed in December 1990 was tested and the electronics equipment for operation of the 8-shot unit was produced.

Following this an acceptance test was made at Risø in June. The parts made by Risø were transported to RTP in September and mounted and test runs were made. More test runs were performed later when more of the electronics equipment made by RTP had been installed.

The uplining of the 8-shot unit was checked in November and a number of runs were performed partly to train the operator at RTP, partly to make a collection of operation parameters needed to give a number of wanted pellet parameters, and partly to find the limits for obtainable pellet parameters.

The requested parameters were:

Four hydrogen pellets of $5 \cdot 10^{18}$ atoms/pellet with velocities between 800 and 1200 m/s.

Four hydrogen pellets of $2 \cdot 10^{19}$ atoms/pellet with velocities between 400 and 600 m/s.

For the small pellets the sizes could be reduced to around 25% below the nominal value while the velocities could be varied between 900 and 1150 m/s.

For the large pellets the sizes could be varied between $5 \cdot 10^{18}$ and $3 \cdot 10^{19}$ atoms/pellet while the velocities could be varied between 350 and 900 m/s.

It should here be remembered that when pellets are made much smaller than the nominal size, the firing accuracy may be reduced with the result that pellets may not pass the guide tube system.

During the work a number of reports on the development work were made and a number of manuals describing maintenance, start-up and operation, PLC program, variation of pellet parameters, electronics equipment, etc., were made and prepared.

3.1.7 Fast ion and α -particle diagnostics for JET

(H. Bindslev)

Work on the development of a fast ion and alpha particle diagnostic (KE4) at the European fusion research centre JET in Oxfordshire, U.K., has been continued. The diagnostic, which is based on collective Thomson scattering of 2 mm waves, has briefly been described in Ref. 1. The project is now a formal collaboration between JET and the gyrotron scattering group at Massachusetts Institute of Technology (and the US Department of Energy) with one MIT scientist permanently stationed at the KE4 group at JET. Risø remains part of the project with one staff member permanently stationed in the group.

The principal components of KE4 are a gyrotron for generating 2 mm waves at high power cw (or long pulse), low loss overmoded transmission lines with mode filtering properties for transmitting the microwaves from source to plasma and back to the detection system, invessel quasi-optical steerable mirrors for launching the input and receiver beams into the plasma, universal polarizers for producing general elliptical polarizations required for coupling to the characteristic plasma modes, and a heterodyne detection system.

KE4 was expected to come into operation in August 1991 but has suffered a number of technological setbacks, the most serious of which was the damage of the 400 kW, 140 GHz gyrotron during final testing at the manufacturer, Varian, U.S.A. A 60 kW substitute gyrotron has been found and installed, and required modifications to the rest of the system due to the changed specifications of the gyrotron are being carried out. Commissioning of invessel components, universal polarizers and detection system are well under way. Codes have been developed for setting up the diagnostic in preparation of a plasma shot and for analysing results. Work continues on improving these codes. Particular attention has been given to extending the parameter range in which relativistic dielectric effects can be calculated reliably. (A relativistic treatment of the dielectric effects is now considered indispensable.) KE4 is expected to come into operation in January 1992 with a month of operation before the long JET shutdown (also delayed).

On a different front, following the surprising relativistic dielectric effects in Thomson scattering, relativistic effects in reflectometry and ray tracing have been investigated and substantial effects at realistic temperatures found.

1) Optics and Fluid Dynamics Department, Annual Progress Report 1990 Risø-R-583, p. 31.

3.1.8 Investigations of density fluctuations and ELMs in the JET tokamak

(A. Lindholm Andersen (married name A.L. Colton per 30.3.91))

This year the work has fallen in two parts determined by JET's operation schedule. During the shutdown period from January to June the work has been concentrated on development of data processing software and evaluation of the diagnostic requirements for the planned experimental studies of ELMs (edge localised modes) and the L-H mode transition. In the operation period from July onwards the work has been concentrated on collection of experimental data. This involved participation in planning the operation programme for JET, as well as coordinating and running the multichannel reflectometer, the ECE heterodyne radiometer, the fast magnetic pick-up coils and other diagnostic systems.

The work on the data processing software for the reflectometer has been continued from last year. The analysis method for fixed frequency phase data based on a linear density profile has been further improved, and a related method with a higher spatial resolution has been developed in order to study the propagation of density pulses radially and temporally.

A problem with jumps in the measured phase data from the multichannel reflectometer has been investigated, and a routine to correct the data for phase jumps has been developed and installed in the processing software. The idea is to calculate the time derivative of the data. On this any phase jumps show up as large spikes that can be removed before the data are integrated back to the original form.

During JET's operation period, most of the time has been dedicated to obtain the necessary experimental data. A preliminary analysis of data taken during ELMs shows a rapid decrease in both the radial density and temperature gradient at the onset of an ELM, followed by a slower recovery of the gradients. Furthermore, the ELMs are localised to a narrow radial region just inside the last closed flux surface, and a density pulse is seen propagating radially outwards in the outer part of the ELM region. Fluctuation measurements show a burst of broadband turbulence during the ELM, and in some cases a narrowband precursor at 50-80 kHz is observed several ms before the onset of the ELM.

3.1.9 Two-frequency plasma reflectometry; a performance analysis

(P. Michelsen and H.L. Pécseli)

A two-frequency reflectometer has been suggested as a possible diagnostic for studying microturbulence in tokamaks¹. Two microwave beams with a slight difference in frequency are launched against a density profile, where they are reflected at their respective cut-off layers. The phases of the two waves are monitored as functions of time. Since these phases contain the information of the position of the two cut-off layers, it is possible in principle to follow the motion of perturbations in local plasma density, for instance by correlation techniques.

We have carried out a performance study of a model of a two-frequency reflectometer. Using a realistic and tractable model for the plasma fluctuations we have derived some analytical results for correlation and crosscorrelation functions for the temporally varying phase of the reflected signals. Numerical simulations have been performed to illustrate the practical applicability of the basic ideas of the reflectometer. The studies have been carried out mainly for incoming electromagnetic waves in ordinary polarization. A level of random plasma density fluctuations has been modelled in plane geometry by superimposing moving density pulses on a given density profile. By proper choice of the shapes of these pulses, we are able, in principle, to model any spectrum for disturbances propagating in the direction along the density gradient. With the speed of propagation known in the experiment we can determine the accuracy of the predictions of the characteristic velocity deduced from the crosscorrelation of the fluctuating phase signals of the reflectometer. Studies have been carried out for statistically distributed disturbance velocities and for varying levels of a superimposed small-scale random noise component. The analysis uses a fullwave solution but the accuracy of a somewhat simpler WKB solution has also been tested.

1) Costly, A.E. and Crippwell, P. (1989). JET-P(89)82.

3.1.10 Plasma equilibria calculated on the basis of magnetic compressive and tensile stresses

(V.O. Jensen)

It is well known that a magnetic field can be conceived as a medium where an isotropic compression stress, $B^2/2\mu_0$, is superimposed on a tensile stress, B^2/μ_0 , parallel to the lines of force. When an ideal MHD plasma is present in the magnetic field, the particle pressure adds to the magnetic stresses to form a combined pressure tensor. The concept of magnetic stresses has been derived and discussed in many textbooks, but it has been presented more as a matter of curiosity than as a useful tool for understanding and analysis of specific problems. The concept has, however, been used to explain the restoring forces responsible for propagation of Alfvén waves.

We first present an analysis of the magnetic stress concept. This analysis is somewhat more detailed than the ones normally given, as we aim at using the concept for studies of equilibria for ideal MHD plasmas. The concept is first tested by rederiving the equilibrium equations for the linear screw pinch. Finally, the concept is used to derive the Grad-Shafranov shift of a circular tokamak plasma confined in a flux-conserving vessel with circular cross section. For the outer Grad-Shafranov shift, i.e. the displacement of the centre of the plasma column with respect to the centre of the vessel, the well known result is rederived. An expression is also found for the inner Grad-Shafranov shift, i.e. for the displacement of the magnetic axis with respect to the centre of the plasma column.

The advantages of using the concept of magnetic stress rather than the Grad-Shafranov equation for calculating tokamak equilibria are:

- the calculations become very simple and straightforward,
- the validity range for the approximations is easy to assess,
- the physical interpretation of the various terms in the expression for the shift becomes very clear.

It appears that the concept of magnetic stress can be useful also for calculations of noncircular tokamak plasmas and of problems including stability, dynamics, and wave phenomena.

3.1.11 Coincidence analysis of coherent structures in two-dimensional turbulence

(A.H. Nielsen, H.L. Pécseli, and J. Juul Rasmussen.)

We have continued the experimental investigations of low frequency, two-dimensional plasma turbulence¹. The investigations are performed in the Q-machine plasma. Turbulent fluctuations are generated by the Kelvin-Helmholtz instability due to a strongly sheared azimuthal flow of the residual plasma surrounding the main plasma column. We have demonstrated the presence of relatively long-lived coherent vortical structures in the background of wideband turbulent fluctuations by employing a conditional sampling technique, where the azimuthal electric field fluctuations have been used as the reference signal. Depending on the plasma parameters the dominant structures can appear as monopole or multipole vortices, dipole vortices in particular. Monopoles with negative potential tend to dominate in the cases with strong radial electric fields. The properties (such as growth or damping) of the averaged vortical structures obtained by the conditional sampling method need not reflect the properties of the vortices in individual realizations. Thus an apparent damping of the averaged structures may simply be caused by a "smearing-out" due to a spread in the velocities of the individual structures. This problem has been resolved by performing a coincidence counting of the occurrence of local extrema in the fluctuating potential signal at two points in space separated by a distance, L , in the direction of propagating, the azimuthal direction. In the figure we show the distribution of time delays Δt between local minima occurring at two probes (with $L = 14.6$ mm) subject to the condition that the value of

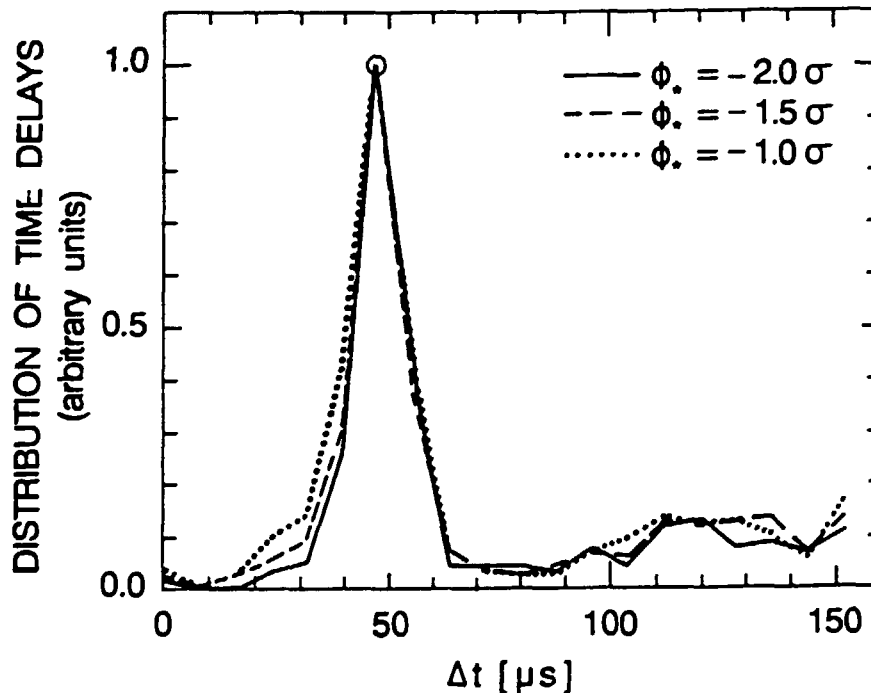

the minimum at one probe, A, exceeds $\phi_1 = -1\sigma, -1.5\sigma$ or -2σ , respectively. Here σ is the rms value of the fluctuations. Subsequently the signal at the other probe, B, is searched in a suitably chosen time interval for the deepest minimum which defines Δt . The distribution obtained for the three values of ϕ_1 is essentially identical giving an averaged value of the velocity corresponding to 300 m/s. From results as those shown in the figure we have derived velocity distributions, and

we observed that the potential wells, corresponding to the vortical structures, propagate with a moderate spread in velocity. Thus it may be argued that the evolution of the conditionally averaged structures of negative potential reflects the properties of individual structures, and is not just a consequence of a spread in their velocity. For these plasma parameters, where monopolar vortices with negative potential were found to dominate, a similar analysis of the occurrences of local maxima gave a different result. Although a peak in the distribution of time delays could be discriminated, it was not significantly above the background level, and it was not possible to assign a velocity distribution for potential humps.

1) Huld, T., Nielsen, A.H., Pécseli, H.L. and Rasmussen, Juul J. (1991). Phys. Fluids B3, 1609.

3.1.12 Turbulent transport in the scrape-off layer of tokamak plasmas

(A.H. Nielsen, H.L. Pécseli, and J. Juul Rasmussen)

Investigations of density and potential fluctuations in various tokamaks (e.g. AS-DEX, TEXT, ISX-B, Doublet-III (see Ref. 1)) strongly indicate that the dynamics in the scrape-off layer (SOL) is dominated by an enhanced level of low frequency, flute-type, electrostatic turbulent fluctuations. The anomalous transport due to such fluctuations is found to account for the major part of the transport in the SOL. The basic characteristics of the turbulent fluctuations we are investigating in the Q-machine plasma² (see 3.1.11) are very similar to the ones found in the SOL of the mentioned tokamaks. This indicates that we are dealing with a universal phenomenon, and our results will be of relevance to the overall understanding of the turbulence and the turbulent transport. Our investigations are included in the ITER R&D programme 1991/92. In particular we have emphasized that the appearance of dominant coherent vortical structures in the turbulence implies that it will not be possible to utilize quasi-linear predictions for the saturated turbulent spectrum and the associated transport. The coherent structures may give rise to burst-like transport rather than a diffusion-like process. These bursts can be significantly larger than the mean turbulent flux out of the plasma. Such bursts of hot plasma hitting the wall or other objects near the wall may have lasting influence due to, e.g., the resulting sputtered material.

1) "Transport Task Force" (1990). Phys. Fluids B2, 2869.

2) Huld, T., Nielsen, A.H., Pécseli, H., and Rasmussen, J. Juul (1991). Phys. Fluids B3, 1609.

3.1.13 Computational studies of flute mode self-organization in a magnetized plasma

(E.A. Coutsias (University of New Mexico, U.S.A), J.P. Lynov, and A.H. Nielsen)

The dynamical evolution of shear flow instability in a magnetized plasma has been studied computationally with a fully de-aliased, spectral scheme. The numerical scheme solves the electrostatic flute mode equations in annular geometry. A viscosity term is included in order to suppress, in a controlled manner, the short wavelength ringing that is otherwise produced due to the finite spatial resolution of the numerical approximation. This viscosity may be thought of as representing damping due to finite Larmor radius effects.

The investigations have been concentrated on situations which are similar to the physical conditions in the Q-machine experiments see (3.1.11). It has been found that setting up a charge distribution corresponding to the average distribution in the experiments gives rise to an unstable situation. The flow quickly develops a

short wavelength mode in correspondence with theoretical predictions from linear perturbation analysis. However, this high mode number instability continues to evolve nonlinearly demonstrating the inverse cascade behaviour, characteristic of two-dimensional turbulence. The instability saturates when a single azimuthal mode is developed. This mode corresponds to what is observed experimentally and is far from the result of the linear perturbation analysis mentioned above.

3.1.14 Localized vortices in η_i -modes

(J. Nycander (University of Uppsala, Sweden), J.P. Lynov, and J. Juul Rasmussen)

The existence and stability of steadily propagating monopole vortex solutions for drift waves driven by the ion temperature gradient have been investigated. These waves, which are usually called η_i -modes, are thought to play a dominant role in the anomalous transport in tokamak experiments. Our study has been motivated by recent high resolution numerical simulations of η_i -turbulence, where coherent vortical structures were observed to develop spontaneously. These structures had a dominating influence on the turbulence, and the associated anomalous transport was found to be significantly reduced as compared with predictions from quasi-linear theory. The necessary conditions for the existence of localized vortical structures have been found by employing a method devised by Nycander and Pavlenko¹. It is based on the fact that localized structures must have velocities outside the region of the phase velocity for linear waves. Otherwise, the structure

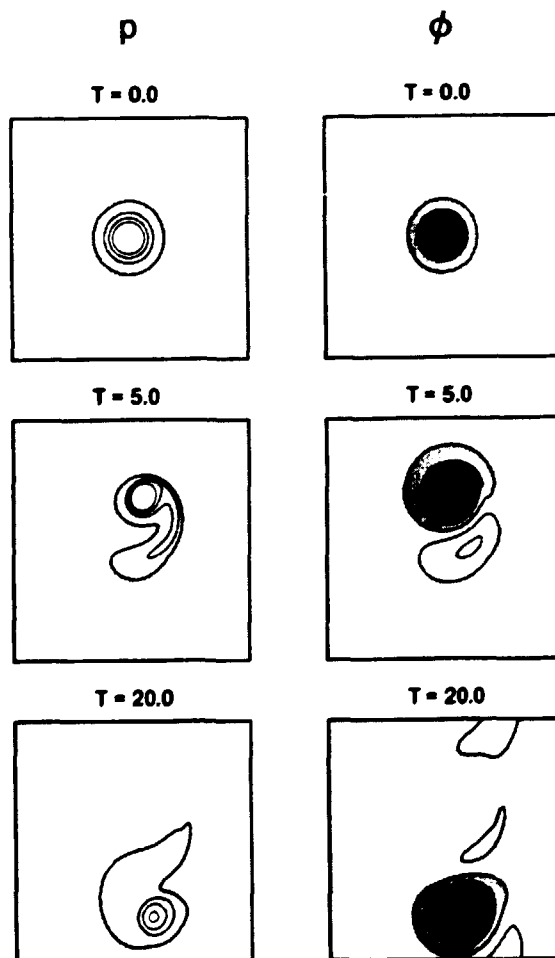

will couple to the linear waves and thereby radiate energy and gradually disperse. Thus, it can neither be localized nor stationary. By assuming that localized solutions do exist, their velocities are obtained as the "centre of mass" velocity by using integral relations. This velocity depends on the ratio of the ion pressure perturbation, τ , to the electrostatic potential, ϕ , and we found that localized vortical structures propagating in the direction perpendicular to the background gradients may exist in a broad parameter regime. Numerical solutions of the governing equations show that these structures are indeed stationary and stable when they have velocities outside the linear regime. A typical example of the evolution of a such a structure, a monopole vortex, is shown in the figure, where the evolution of both p and ϕ is shown. Structures with velocities coinciding with linear waves are found to radiate strongly and disperse as predicted.

We have also investigated the interaction among two vortices which revealed a new type of interaction. The observed behaviour is markedly different from what is observed for the vortex interaction in two-dimensional flows. Here like-signed vortices are found to coalesce to form a larger vortex, while vortices of different sign are found to pair and form a dipole vortex.

1) Nycander, J. and Pavlenko, V.P.(1991), Phys. Fluids B3, 1386.

3.1.15 Dynamics of nonstationary coherent structures in the Hasegawa-Mima/Charney equation

(J.S. Hesthaven, J.P. Lynov, and J. Nycander (University of Uppsala, Sweden))

The Hasegawa-Mima equation describes the evolution of nonlinear drift waves caused by low frequency electrostatic fluctuations in a magnetically confined plasma with a density gradient. A similar equation, the Charney equation, is used as a simple model of large-scale phenomena in the atmosphere and oceans in the mid-latitudes of large planets, e.g. the earth.

Coherent structures, being defined as long-lived self-organized structures, can be formed by nonlinear processes under conditions described by the Hasegawa-Mima/Charney equation. Coherent structures are thought to play an important role in anomalous plasma transport. In geophysics they are known to be important to transport properties and long-time dynamics of the atmosphere/ocean system.

In these studies the emphasis has been on the long-time dynamics of nonstationary dipole vortices. The equation has been solved numerically in a two-dimensional domain with periodic boundary conditions by using a fully de-aliased, spectral collocation method which gives high accuracy in the numerical solution. The numerical scheme has been implemented on an IBM 3090/VF vector processor, situated at the Technical University of Denmark, in order to get sufficient computational power.

The governing equation has a dipole vortex solution which is exact and stationary if propagating perpendicularly to the gradient of the inhomogeneity. A study of dipole vortices propagating in arbitrary directions has been performed. The trajectories are then curved (see the figure). It has been shown that the results

express good agreement with a recently published theory¹, and the main deviations can be explained by loss of energy and enstrophy from the dipole vortex. In the long-time limit the dipoles are strongly affected by the loss mechanisms and are found to either disintegrate or relax toward stationary dipole vortices propagating in the opposite direction of the linear waves in the system.

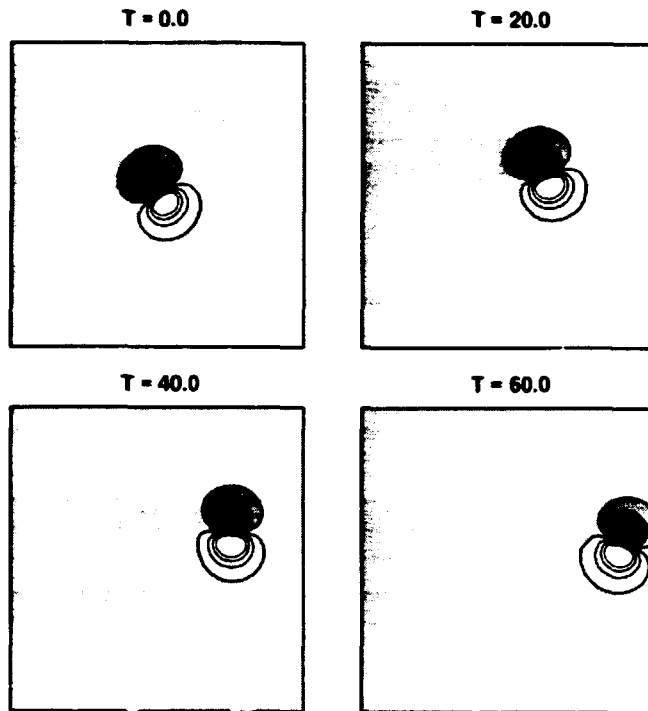

1) Nycander, J. and Isichenko, M.B. (1990). Phys. Fluids B 2, 2042.

3.1.16 Numerical simulation of magnetic electron vortices

(J.P. Lynov and J. Nycander (University of Uppsala, Sweden))

Magnetic electron modes in an unmagnetized plasma can be responsible for fast generation of magnetic fields in laser fusion. The nonlinear equations describing these modes are¹

$$\frac{\partial}{\partial t}(B - \nabla^2 B) - \{B, \nabla^2 B\} = -v_\theta \frac{\partial T}{\partial y},$$

$$\frac{\partial T}{\partial t} + \{B, T\} = -v_\theta \frac{\partial B}{\partial y},$$

where $B\hat{z}$ is the magnetic field, T the perturbation of the electron temperature and $\{, \}$ denotes the Poisson bracket (i.e. Jacobian). It has earlier been shown theoretically by perturbation analysis that these equations have approximate, stationary monopole vortex solutions². Along the axis of the vortex a local magnetic field is generated. The vortex travels with a speed that is determined by a general integral relation, and is proportional to the ratio of the temperature perturbation to

the magnetic field in the vortex. The condition for stationarity is that this speed should be larger than the phase velocity of the linear waves present in the system so that energy of the vortex is not lost by radiation of linear waves.

In the present work the dynamics of such vortices is studied numerically. It is found that mixing of the temperature field in combination with the heat conduction present in the numerical code has a strong effect on the vortex, which was not predicted. The result is that the amplitude of T quickly decreases. Because of the integral relation mentioned above the speed of the vortex therefore rapidly decreases and reaches the region of linear wave propagation, and the vortex disintegrates.

1) Nycander, J., Pavlenko, V.P., and Stenflo, L. (1987). *Phys. Fluids* **30**, 1367.

2) Nycander, J. and Pavlenko, V.P. (1991). *Phys. Fluids B* **3**, 1386.

3.1.17 Visualization of numerical flow calculations by automated video animation

(L. Bäckmark and J.P. Lynov)

In order to obtain a profound insight into the numerical results from large flow calculations, a pc-based video animation system has been built up. The numerical results are typically obtained on a supercomputer and are first visualized on a Sun SPARC station 2 by means of the UNIRAS graphics software. This software is then used to produce several hundred data files containing the graphical data describing the instantaneous flow fields in the TARGA format which is suited for a high resolution pc-video board.

The collection of TARGA files are subsequently transferred to a 33 MHz 80486 pc, which is used to control a JVC BR-S811E Super VHS video editing recorder. Each TARGA picture is recorded on the video tape separately with a DiaQuest video control board and special software. A high degree of precision is needed in order to maintain the frame and colour synchronism on the tape. The whole process of recording the TARGA files to the video tape may take several hours but is fully automated so it can run during night. There is no limit to how long video sequences can be produced in this manner, the natural limitation set by the length of the video tape.

The video animations have proved to be a very valuable diagnostic for the numerical studies of complex dynamical systems and they clearly show whether processes with different time scales are present simultaneously.

3.1.18 Refutation of stability proofs for dipole vortices

(J. Nycander (University of Uppsala, Sweden))

The Hasegawa-Mima equation,

$$\frac{\partial}{\partial t}(\phi - \nabla^2 \phi) - \beta \frac{\partial \phi}{\partial x} - \{\phi, \nabla^2 \phi\} = 0, \quad (1)$$

describes both nonlinear drift waves in a plasma and large-scale planetary flows. Here $\{, \}$ denotes the Poisson bracket (or Jacobian). It has an exact stationary solution with the form of a travelling dipole vortex. Five stability proofs for such dipole vortices have been presented by various authors¹⁻⁵. In the present work it is shown that all these proofs are incorrect.

In all five proofs variational methods are used to prove Lyapunov stability. This means that one tries to show that the stationary solution maximizes or minimizes some integral invariant of the equation.

In two of the proofs^{1,2} this is done by linearizing the equation for the perturbation and choosing the invariant so that the perturbation part of it is quadratic. This part is called the "Arnold invariant" or the "pseudoenergy", and the stability proof amounts to showing that it is of definite sign. It is, however, easily seen that the pseudoenergy is not of definite sign for the dipole vortex. The authors of both articles argue that if one imposes linear constraints originating from the linear conservation laws, all functions for which the pseudoenergy is negative are excluded, thus making it positive definite.

This is incorrect. A perturbation with the amplitude δ^2 and the spatial extent δ^{-1} makes a finite contribution to the linear integrals in the limit $\delta \rightarrow 0$, while the contribution to quadratic integrals (such as the pseudoenergy or the norm) is negligible in this limit. Thus, by adding such a correction it can be seen that the linear constraints do not change the lower (or upper) bound of the pseudoenergy at all. Furthermore, these proofs predict stability for westward propagating dipole vortices and for dipole vortices with a large amplitude "rider", respectively, which contradicts numerical simulations.

In the next article³ stability is proved for dipole vortex solutions of the homogeneous Hasegawa-Mina equation, with $\beta = 0$. Here, too, the authors argue that an integral (in this case the energy) is maximized for the dipole vortex if a linear constraint is imposed. However, also in this case a perturbation can be found (but of a different kind than in the previous case) that makes negligible contribution to the energy, but a finite contribution to the linear integral. Thus, as before, the linear constraint does not affect the upper bound of the energy.

The fourth proof⁴ is done for the shallow water equations that contain the dynamics described by Eq. (1) as a subclass, but also include other effects, in particular gravity waves. Stability is predicted not only for all dipole vortices, but for all stationary solutions obeying the conventional quasi-geostrophic scaling which is clearly wrong. The proof is done in an abstract space of Hamiltonian gauge variables, where an arbitrariness in the variables is removed by imposing a gauge condition. The error is in the treatment of this gauge constraint to second order.

The last proof⁵ has already earlier been shown to be wrong⁶ and is only included in this work for completeness.

- 1) Laedke, E.W. and Spatschek, K.H. (1986). *Phys. Fluids* **29**, 133.
- 2) Gordin, V.A. and Petviashvili, V.I. (1985). *Dokl. Akad. Nauk SSSR* **285**, 857 [*Sov. Phys. Dokl.* **30**, 1004].
- 3) Filippov, D.V. and Yan'kov, V.V. (1986). *Fiz. Plazmy* **12**, 953 [*Sov. J. Plasma Phys.* **12**, 548].
- 4) Sakuma, H. and Ghil, M. (1990). *J. Fluid Mech.* **211**, 393; *Phys. Fluids A* **3**, 408 (1991).
- 5) Swaters, G.E. (1986). *Phys. Fluids* **29**, 1419.
- 6) Carnevale, G.F., Vallis, G.K., Purini, R., and Briscolini, M. (1988). *Phys. Fluids* **31**, 1567.

3.1.19 Existence and nonlinear stability of single vortices in an external shear flow

(J. Nycander (University of Uppsala, Sweden))

Coherent vortices often appear spontaneously in two-dimensional shear flows, both in laboratory experiments and in geophysical flows. The vortices are almost always elongated in the direction of the external flow, and then their vorticity anomaly has the same sign as the external shear.

In the present work the existence and stability of stationary vortices in a back-

ground flow of constant shear have been studied. The flow is governed by the two-dimensional Euler equation,

$$\frac{\partial q}{\partial t} + \left\{ \frac{Sy^2}{2} + \psi, q \right\} = 0,$$

where $\{, \}$ denotes the Poisson bracket (or Jacobian), $q = \nabla^2 \psi$ is the vorticity anomaly of the vortex, and S is the shear of the external flow.

An infinite family of integral invariants, the Casimirs,

$$C_F = \int F(q) dx dy,$$

where F is arbitrary, constrains the flow to a symplectic leaf, also called isovortical surface. It is shown that on every symplectic leaf such that the vorticity anomaly everywhere has the same sign as the external shear, there is one particular flow that maximizes the energy. This flow is therefore a stationary and nonlinearly stable solution. It has the form of a localized vortex which is elongated in the direction of the external flow.

3.1.20 Nonlinear interactions of low-frequency electrostatic waves in the polar cap E-region

(H.L. Pécseli, J. Trulsen (University of Tromsø, Norway), A. Bahnsen⁺, and F. Primdahl⁺ (⁺Danish Space Research Institute, Lyngby, Denmark))

Low frequency electrostatic fluctuations in the polar cap E-region have been detected by an instrumented rocket payload. The basic characteristics of the fluctuations were obtained by a correlation analysis. In particular the triple correlation function or its Fourier transform, the bispectrum, has provided evidence for nonlinear wave couplings. The figure shows contour lines for the absolute value of the bispectrum. Redundant information outside the basic triangular region has been removed. The peaks in the bispectrum are indicators of interaction between waves with frequencies having simple integer relations. Such harmonic wave interactions were observed to be persistent in a wide altitude range.

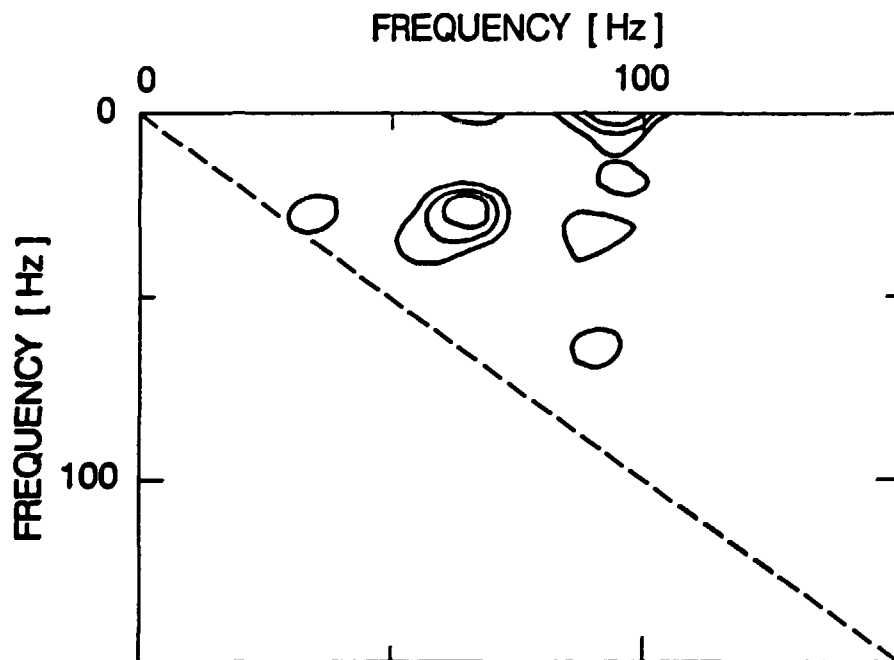

3.1.21 On the existence of Kawahara solitons

(V.I. Karpman (IZMIRAN, Moscow, Russia))

We consider the equation

$$\partial_t U + \frac{1}{2} \partial_x (U^2) + \beta \partial_x^3 U + \gamma \partial_x^5 U = 0 \quad (1)$$

describing nonlinear waves in weakly dispersive media (e.g. shallow water, plasma, etc.). For $\gamma = 0$ Eq. (1) is the KdV equation. For small amplitudes, when the nonlinear term can be neglected, the solution of (1) is a superposition of plane waves with the phase velocities

$$V(k) = -\beta k^2 + \gamma k^4, \quad (2)$$

where k is the wavenumber. From the plots of $V(k)$ shown in Figs. 1 and 2 it is clear that the fifth derivative term may play an important role for $\gamma\beta > 0$. It leads to a minimum (for $\gamma > 0$) or maximum (for $\gamma < 0$) at $k = k_m = (\beta/2\gamma)^{1/2}$ with

$$V_m = V(k_m) = -\beta^2/4\gamma. \quad (3)$$

The soliton solution of Eq. (1) can be written as $u = aF(\xi)$, where $\xi = |\alpha/\beta|^{1/2}(x - x_0)$, $dx_0/dt = a$. Then $F(\xi)$ satisfies the equation

$$\text{sign}(\beta\gamma)\epsilon^2 F^{(IV)} + F''' + \text{sign}(\beta a) \left(\frac{1}{2} F^2 - F \right) = 0, \quad (4)$$

where $\epsilon^2 = |\gamma\alpha|\beta^{-2}$. Kawahara, who solved Eq. (4) numerically, concluded that solitons exist in the following cases¹

$$\gamma\beta > 0, \quad a\beta > 0, \quad \epsilon < \epsilon_{max}, \quad (5)$$

$$\gamma\beta > 0, \quad a\beta < 0, \quad \epsilon > 1/2, \quad (6)$$

$$\gamma\beta < 0, \quad a\beta > 0. \quad (7)$$

Considering existence of the solitons from basic principles, one should require that the soliton velocity a be different from the plane wave velocities (2) for any k , i.e. the equation

$$V(k) = 0 \quad (8)$$

cannot have real roots k . Otherwise, the soliton would resonantly interact with the wave moving with the velocity $V(k)$. It is easy to check that cases (6) and (7) satisfy this principle, but (5) does not. Indeed, as is seen from Fig. 1, there is always a wave with k , satisfying Eq. (8), though: for $\gamma = 0$ condition $a\beta > 0$ ensures existence of the KdV solitons.

A radiation field resonantly emitted by the Kawahara "quasi-soliton" in case (5) and the consequent damping rate of its amplitude are found for $\epsilon \ll 1$.

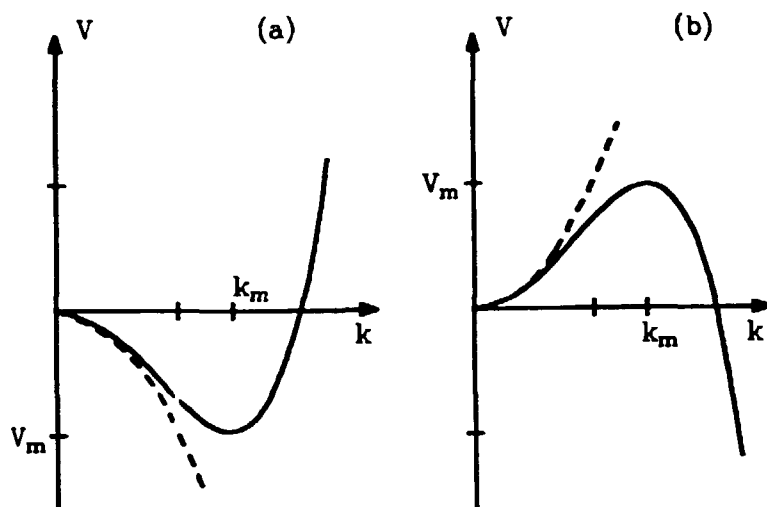

Fig. 1. Plots of $V(k)$ for $\gamma\beta > 0$ (a) $\gamma > 0, \beta > 0$; (b) $\gamma < 0, \beta < 0$. Dashed lines show $V(k)$ for $\gamma = 0$.

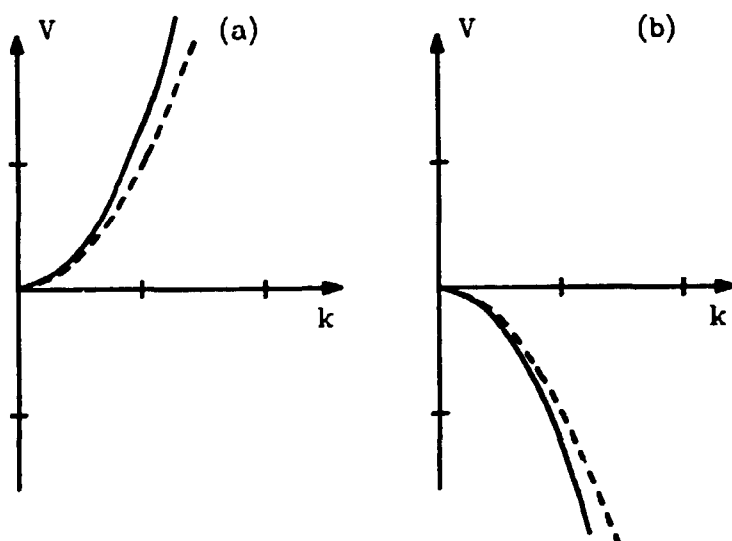

Fig. 2. The same as in Fig. 1, but for $\gamma\beta < 0$ (a) $\gamma > 0, \beta > 0$, (b) $\gamma < 0, \beta > 0$.

1) Kawahara, T. (1972). J. Phys. Soc. Japan 33, 260.

3.1.22 Numerical investigations of dipole vortex interactions with curved walls

(E.A. Coutsias (University of New Mexico, U.S.A), J.P. Lynov, and A.H. Nielsen)

The spectral algorithm by Coutsias and Lynov¹ for the solution of the incompressible Navier-Stokes equations in periodic channel geometry has been generalized to solve the dynamical equations in annular geometry. As in the case of a periodic channel, the vorticity-stream formulation is employed and the fields are expanded in Chebyshev-Fourier functions. The no-slip conditions at the walls are also enforced with an integral solvability constraint. Numerical studies are initiated of dipolar vortices interacting with the boundary layers at the curved walls of the annulus. Depending on the Reynolds number of the flow and the ratio of the diameter of the dipole to the radius of curvature of the wall (which could be both concave and convex), several new types of interaction processes are identified. These studies are being continued.

1) E.A. Coutsias and J.P. Lynov (1991), *Physica D* 51, 482-497.

3.1.23 Difference between monopole vortices in planetary flows and laboratory simulations

(J. Nycander (University of Uppsala, Sweden))

This work is an attempt to explain observations of vortices in experiments in shallow water in rotating paraboloidal vessels¹. The most long-lived vortices are invariably anticyclones, while cyclones quickly disperse. These experiments are meant to simulate geophysical flows, where large, long-lived, anticyclonic vortices are common.

The general condition for vortices to be stationary is that they propagate faster than linear Rossby waves which are caused by the beta-effect (i.e. the dependence of the Coriolis force on the latitude). If this is satisfied, the vortex energy is not dispersed by coupling to linear waves. The propagation velocity is determined by a general integral relation for the velocity of the centre of mass. In geophysical flows, to lowest order in the Rossby number, the difference between the centre-of-mass velocity and the maximum phase velocity of the Rossby waves is proportional to the beta parameter and to the vortex amplitude². Thus, anticyclones may be stationary since for them the difference is positive, but not cyclones.

In the laboratory experiments this velocity difference is cancelled because of the dependence of the effective gravity on the latitude, caused by the centrifugal force. To the next order in the Rossby number, however, there is another nonlinear contribution so that anticyclones (but not cyclones) still propagate faster than the linear Rossby waves, and may thus be stationary. The velocity difference is smaller than for geophysical flows and vanishes in the limit of small Rossby number. The existence conditions also show that we can expect the experimental vortices to be smaller (as measured by the Rossby radius) than the planetary vortices.

The analysis is carried out using the shallow-water equations in full paraboloidal geometry.

1) Nezlin, M.V. (1986). *Sov. Phys. Usp.* 29, 807.

2) Nycander, J. and Sutyrin, G.G. (1991). *Dyn. Atm. Oceans*, in print.

3.1.24 Vortical structures in rotating fluids

(M. Nielsen, J. Juul Rasmussen, and B. Stenum)

Coherent vortical structures form in neutral fluids and gases as well as in plasmas. In particular, it is a fundamental property of two-dimensional flows that vortical structures may be supported for times much longer than their turnover time. These structures have important influence on the development of the flow and in particular on the evolution of two-dimensional turbulence.

In order to support our studies on two-dimensional turbulence in plasmas a simple setup for experimental studies of vortical structures in a rotating fluid has been built. The rotation of the fluid is important for the formation of two-dimensional vortical structures¹.

The setup consists of a table which can be rotated at rates up to about 10 rotations per minute. The system can easily be changed to higher rotation rates. Onto this table a water filled tank is placed. Two tanks, a cylindrical tank with a diameter of 1 m and a quadratic tank with 1 m sides, have been utilized for preliminary studies. The tank is surveyed by a video camera following the rotating system. The video camera is coupled to a TV screen via a set of slip rings.

In the preliminary studies vortical structures have been produced by applying a jet of dyed water through a slit in a tube placed vertically in the water tank. The studies have shown that the vortical structures produced in this way become dipole-like with a two-dimensional structure. The dynamics of the structures and their interactions with walls are found to be in qualitative accordance with numerical studies². The reproducibility of the dipole structures produced in this simple way is found to be surprisingly good.

The setup has been designed for additional equipment as a system for producing well defined water jets to excite the dipoles and velocity measurements by means of particle tracking. Small particles will be followed by a high resolution video camera and the length of their tracks in a given time period will be determined by image processing.

1) R.C. Kloosterziel and G.J.F van Heijst (1991), *J. Fluid Mech.* **223**, 1.

2) E.A. Coutsiias and J.P. Lynov (1991), *Physica D* **51**, 482.

3.2 Participants in the work in plasma physics

Scientific Staff

Ellegaard, Ole (part time (25%))
Jensen, Vagn O.
Lynov, Jens-Peter
Michelsen, Poul
Pécseli, Hans (until 31 October)
Rasmussen, Jens Juul
Schou, Jørgen (until 1 April)
Stenum, Bjarne
Sørensen, Hans
Weisberg, Knud V.

Ph.D. Students

Andersen, Annette (At present working at JET, U.K.)
Bindslev, Henrik (At present working at JET, U.K.)
Hesthaven, Jan
Nielsen, Anders Henry

Technical Staff

Bækmark, Lars
Hansen, John (until 30 April)
Kossek, Henryk (until 31 October)
Michelsen, Agnete (from 1 May)
Nielsen, Mogens O.
Petersen, Andreas Dietrich (from 1 November)
Reher, Børge
Sass, Bjarne
Thorsen, Jess

Secretaries

Astradsson, Lone
Skaarup, Bitten
Toubro, Lene

Guest Scientists

Coutsias, E.A., University of New Mexico, U.S.A.
Karpmann, V.I., Izmiran, Moscow, U.S.S.R.
Nycander, J., University of Uppsala, Sweden

Short time visitors

Gürtler, P., Hasylab, Hamburg, Germany

Jovanovich, D., Institute of Physics, Belgrade, Yugoslavia

Nezlin, M.V., I.V. Kurchatov Institute, Moscow, U.S.S.R.

Pedrys, R., Jagellonian University, Cracow, Poland

Turitsyn, S.K., USSR Academy of Sciences, Novosibirsk, U.S.S.R.

Sutyryn, G., Institute of Oceanology, Moscow, U.S.S.R.

Degrees

Nielsen, A.H., Ph.D. degree

Stenum, B., Ph.D. degree

Hesthaven, J., Master degree

4 Publications and educational activities in the Plasma Physics Section

4.1 Publications

BINDSLEV, H. (1991). Collective Thomson scattering in a relativistic magnetized plasma. In: 18th European Conference on Controlled Fusion and Plasma Physics. Contributed papers, part 4. (Eds. P. Bachmann and D.C. Robinson), European Physical Society, Geneva, Switzerland. (Europhysics Conference Abstracts, Vol. 15 C, part 4) p. 9-12.

BINDSLEV, H. (1991). Dielectric effects on Thomson Scattering in a Relativistic Magnetized Plasma. *Plasma Physics and Controlled Fusion* **33**, 1775-1804.

BINDSLEV, H. and HANSEN, F. (1991). Numerical investigations of the propagation of electromagnetic millimeter waves in fluctuating plasma. JET internal report JET-IR(91)02, 95 pp.

CHANG, C.T. (1991). Pellet-plasma interactions in tokamaks. *Phys. Rep.* **206**, 143-196.

COUTSIAS, E.A. and LYNOV, J.P. (1991). Fundamental interactions of vortical structures with boundary layers in two-dimensional flows. *Physica D* **51**, 482-497.

HIRSCH, K., SALZMANN, H., KOECHEL, M., HAMAN, K., GOWERS, C., EBERHARDT, H., BUNDGAARD, J., HANSEN, K.B., and WEISBERG, K. (1991). Detectors for LIDAR type Thomson scattering diagnostics. In: IAEA Technical Committee meeting on Lidar Thomson scattering. IAEA Technical Committee meeting on Lidar Thomson scattering, Abingdon, U.K. (Joint European Torus, Abingdon, U.K.),

HULD, T., NIELSEN, A.H., PÉCSELI, H.L., and RASMUSSEN, J. JUUL (1991). Coherent structures in two-dimensional plasma turbulence. *Phys. Fluids B3*, 1609-1625.

HULD, T., NIELSEN, A.H., PÉCSELI, H.L., and RASMUSSEN, J. JUUL (1991). ITER related Physics R and D reporting mid 91. *Risø-I-562*, 5 pp.

JENSEN, V.O. (1991). The Grad-Shafranov Shift Calculated on the Basis of magnetic Compressive and Tensile Stresses. In: 18th European Conference on Controlled Fusion and Plasma Physics. Contributed papers, part 4. (Eds. P. Bachmann and D.C. Robinson), European Physical Society, Geneva, Switzerland. (Europhysics Conference Abstracts, vol. 15 C, part 4, p. 181-184. 3-7 June.

JENSEN, V.O. and HAUGÅRD, R. NIELSEN (1991). Nu prøver JET med tritium brændsel (Now JET introduces tritium fuel). *Ing. niøren* No. 43, October 25, p. 15

JENSEN, V.O. (1991). Havet som energikilde (The ocean as energy source). *Sletten*, November 12, p. 8.

JENSEN, V.O. (1991). Fusionsreaktoren bliver ikke en helt ren energikilde (The fusion reactor will not be a completely clean energy source). *Læserbrev i Berlingske Tidende*, 20 November 1991.

LYNOV, J.P., NIELSEN, A.H., PÉCSELI, H.L., and RASMUSSEN, J. JUUL (1991). Studies of the Eulerian - Lagrangian transformation in two-dimensional random flows. *J. Fluid Mech.*, **224**, 485-505.

MICHELSSEN, P. and PÉCSELI, H.L. (1991). A Numerical Study of Reflectometer Performance. *Risø-R-592 (EN)*, 29 pp.

MIKKELSEN, T., KRISTENSEN, L., THYKIER-NIELSEN, S., PÉCSELI,

- H.L., and JORGENSEN, H.E. (1991). Validation experiments for near-site region atmospheric dispersion models. Final report. In: Radiation protection programme. Progress report 1985-89. Vol. 3, EUR-13268, p. 2969-2982.
- PÉCSELI, H.L. (1991). Turbulent diffusion in strongly magnetized plasmas. *Trends Plasma Sci.* 1, 39-50.
- PÉCSELI, H.L. and TRULSEN, J. (1991). Phase-space diffusion in turbulent plasmas: The random acceleration problem revisited. *Phys. Fluids B3*, 3271-3276.
- PÉCSELI, H.L. and TRULSEN, J. (1991). Analytical expressions for conditional averages: a numerical test. *Phys. Scripta* 43, 503-507.
- PÉCSELI, H.L. and WANDEL, C.F. (1989). Otto Kofoed-Hansen 25 April 1921 - 21 July 1990. *Fys. Tidsskr.* 87, 145-149.
- RASMUSSEN, J. JUUL and SCHRITTWIESER, R.W. (1991). On the current-driven electrostatic ion-cyclotron instability: A Review. *IEEE Trans. Plasma, Science* 19, 457-501.
- RASMUSSEN, J. JUUL and RYPDAL, K. (1991). On the similarity structure of wave collapses (abstract). *Physica D52*, 1.
- SAEKI, K. and RASMUSSEN, J. JUUL (1991). Stationary solution of coupled electron hole and ion soliton in a collisionless plasma. *J. Phys. Soc. Jap.* 60, 735-738.
- SCHOU, J. (1991). Erosion of Volatile Elemental Condensed Gases by keV Electron and Light-Ion Bombardment. *Risø-R-591*, 1-159.
- SCHOU, J., KRUIT, P., and NEWBURY, D.E. (Eds.), (1991). Fundamental Electron and Ion Beam Interactions with Solids for Microscopy, Microanalysis and Microlithography, Proceedings of the 8th Iffeferkorn Conference. *Scanning Microscopy Supplement 4*, 1-370.
- SCHOU, J., STENUM, B., SØRENSEN, H., WEISBERG, K.-V., GÜRTLER, P. (1991). Radiation in the wavelength range 120-900 nm from keV electron bombardment of solid hydrogens. *Nucl. Fus.* 31, 589-591.
- STENUM, B., ELLEGAARD, O., SCHOU, J., SØRENSEN, H., and PEDRYS, R. (1991). Sputtering of Frozen Gases by Molecular Hydrogen Ions. *Nucl. Instr. Methods B* 58, 399-403.
- STENUM, B., SCHOU, J., ELLEGAARD, O., SØRENSEN, H., and PEDRYS, R. (1991). Sputtering of Solid Hydrogenic Targets by keV Hydrogen Ions. *Phys. Rev. Lett.* 67, 2842-2845.
- SØRENSEN, H. (1991). Development report for multishot injector for RTP, *Risø-I-548*, 9 pp.
- SØRENSEN, H. (1991). Acceptance test report for the multishot pellet injector for RTP, *Risø-I-549*, 7 pp.
- SØRENSEN, H., BUNDGAARD, J., HANSEN, J.E., KRISTENSEN, E., SASS, B., and WEISBERG, K.-V. (1991). A compact multishot pellet injector design for FTU and RFX. In: *Fusion technology 1990*, Vol. 1. 16th SOFT, London, 3-7 September 1990. (Eds. B.E. Keen, M. Huguet, and R. Hemsworth). (North-Holland, Amsterdam, 1991) SOFT 16, p. 665-669.
- SØRENSEN, H., HANSEN, J.E., KOSSEK, H., MICHELSEN, P., SASS, B., THORSEN, J., and WEISBERG, K.-V. (1991). A multishot pellet injector feasibility study. In: *Fusion technology 1990*, Vol. 1. 16th SOFT, London, 3-7 September 1990. (Eds. B.E. Keen, M. Huguet, and R. Hemsworth). (North-Holland, Amsterdam, 1991) SOFT 16, p. 622-626.
- SØRENSEN, H., HANSEN, J.E., and SASS, B. (1991). A flow cryostat for cooling of eight independent pipe guns. *Rev. Sci. Instr.* 62, 1783-1786.
- SØRENSEN, H., MICHELSEN, A., SASS, B., and WEISBERG, K.-V. (1991). Manuals for start up and shut down and maintenance of 8-shot unit. *Risø-I-546*, 25 pp.

SØRENSEN, H., SASS, B., and WEISBERG, K.-V. (1991). On the development of an 8-shot unit for use at RTP, Risø-I-550, 19 pp.

SØRENSEN, H., SASS, B., and WEISBERG, K.-V. (1991). Note on Si diode thermometers. Risø-I-551, 4 pp.

SØRENSEN, H., SASS, B., and WEISBERG, K.-V. (1991). The PLC program for the multishot pellet injector for RTP. Risø-I-552, 21 pp.

TURITSYN, S.K., RASMUSSEN, J. JUUL, and RAADU, M.A. (1991). Stability of weak double layers. TRITA-EPP-91-01 Dept. Plasma Phys., The Royal Institute of Technology, Stockholm, Sweden, 27 pp.

4.2 Conference contributions

BINDSLEV, H., Collective Thomson Scattering in a Relativistic Magnetized Plasma. 26th Nordic Plasma and Gas Discharge Symposium, Geilo, Norway (February).

BINDSLEV, H., Developments in the Theory of Collective Thomson Scattering. First workshop on "Alpha Physics in TFTR", Princeton, U.S.A. (March).

BINDSLEV, H., Collective Thomson Scattering in a Relativistic Magnetized Plasma. The 18th EPS Conference on Controlled Fusion and Plasma Physics. Berlin, Germany (June).

BINDSLEV, H., Relativistic Dielectric Effects in Millimeter Wave Diagnostics for Large Tokamaks. The International School of Plasma Physics "Piero Caldirola", Varenna, Italy (August-September).

COLTON, A.L., SIPS, A.C.C., and PORTE, L., Measurement Techniques for Plasma Edge Parameters related to the H-Mode in JET. The International School of Plasma Physics "Piero Caldirola", Course and Workshop on Diagnostics for Contemporary Fusion Experiments, Varenna, Italy, (August-September).

COSTLEY, A.E., BINDSLEV, H., COMISKEY, M., FESSEY, J., HOFKZEMA, J.A., HUGHES, T., MACHUZAK, J., STOTT, P., and WOSKOV, P., A Collective Scattering Diagnostic to Measure Fast-Ion and Alpha Particle Distributions in JET. The International School of Plasma Physics "Piero Caldirola", Varenna, Italy (August-September).

ELLEGAARD, O., STENUM, B., SCHOU, J., SØRENSEN, H. and PEDRYS, R., Enhanced sputtering of condensed gases by molecular ions. The 14th International Conference on Atomic Collisions in Solids, Salford, UK, (July-August).

HESTHAVEN, J.S., LYNØV, J.P., and NYCANDER, J., Dynamics of dipoles in the Hasegawa-Mima/Charney equation. Danish Physical Society, Topical Meeting on Nonlinear Physics. Niels Bohr Institute, Copenhagen, Denmark (October).

HULD, T., NIELSEN, A.H., PÉCSELI, H.L., and RASMUSSEN, J. JUUL, Coherent structures in two-dimensional flows. 26. Nordic Plasma and Gas Discharge Symposium, Geilo, Norway (February).

HULD, T., NIELSEN, A.H., PÉCSELI, H.L., and RASMUSSEN, J. JUUL, Experimental investigations of two-dimensional plasma turbulence. (Invited paper). 1991. International Workshop on Plasma Physics, Schladming, Austria (February-March).

HULD, T., NIELSEN, A.H., PÉCSELI, H.L., and RASMUSSEN, J. JUUL, Coherent structures in two-dimensional flows. European Geophysical Society. XVI General Assembly, Wiesbaden, Germany (April).

HULD, T., NIELSEN, A.H., PÉCSELI, H.L., and RASMUSSEN, J. JUUL, Evolution of Coherent Structures in Two Dimensional Turbulent Flows. Danish Physical Society, Topical Meeting on Nonlinear Physics, Niels Bohr Institute, Copenhagen, Denmark (October).

JENSEN, V.O., The work in plasma physics at Risø after the reorganization. The 26. Nordic Plasma and Gas Discharge Symposium, Geilo, Norway (February).

JENSEN, V.O., Plasma equilibrium calculations based on magnetic stresses. 26. Nordic Plasma and Gas Discharge Symposium, Geilo, Norway (February).

JENSEN, V.O., The Grad-Shafranov Shift Calculated on the Basis of Magnetic Compressive and Tensile Stresses. The 18th European Conference on Controlled Fusion and Plasma Physics, Berlin, Germany (June).

JENSEN, V.O., Plasma Equilibria Calculated on the Basis of Magnetic Compressive and Tensile Stresses. The 4th European Fusion Theory Conference, Göteborg, Sweden (June).

KERNER, W., CAMPBELL, D., JANESCHITZ, G., ZWINGMANN, W., HUYSMANS, G.T.A., GOEDBLOED, J.P., ALI-ARSHAD, S., de BLANK, H.J., COLTON, A.L., CRIPWELL, P., and NAVE, M.F.F., MHD Model of FLMs in JET. Annual meeting of the Plasma Physics, Division of the American Physical Society, Tampa, Florida (November).

LYNOV, J.P. and COUTSIAS, E.A., Fundamental interactions of vortical structures with walls in two-dimensional flows. Danish Physical Society, Topical Meeting on Nonlinear Physics. Niels Bohr Institute, Copenhagen, Denmark (October).

MICHELSSEN, P. and PÉCSELI, H.L., Two-frequency plasma reflectometer; a performance analysis. The 4th European Fusion Theory Conference, Aspenäs, Göteborg, Sweden (June).

NYCANDER, J., Stationary vortices in oceans and laboratory experiments. European Geophysical Society, XVI General Assembly, Wiesbaden, Germany (April).

NYCANDER, J., LYNOV, J.P., and RASMUSSEN, J. JUUL, Stationary vortices in η_i -modes. The 4th European Fusion Theory Conference, Aspenäs, Göteborg, Sweden, (June).

PÉCSELI, H.L., Low frequency turbulence in the ionospheric E-region (Invited paper). European Geophysical Society, XVI General Assembly, Wiesbaden, Germany (April).

PEDRYS, R., WARCZAK, B. and SCHOU, J., Erosion of heavy water by electron impact. The 6th Conference on Radiation Effects in Insulators, Weimar, Germany (June).

ROTHARD, H., SCHOU, J., KOSCHAR, P. and GROENEVELD, K.-O., Electron yields from solids - a probe for the energy loss of charged particles? International Workshop on Stopping of low- and high-Z Ions, STOP91, Middelfart, Denmark (August).

SCHOU, J., Tracks of electrons within solids (invited paper). 80. WE-HERAEUS-SEMINAR, Radiation Physics: Electron Tracks in Matter, Bad Honnef, Germany (August)

SCHOU, J., STENUM, B., ELLEGAARD, O., SØRENSEN, H. and PEDRYS, R., Sputtering of solid hydrogenic targets by keV hydrogen ions. Spring Meeting of the Danish Physical Society, Nyborg, Denmark (May).

SCHOU, J., ELLEGAARD, O., PEDRYS, R. and SØRENSEN, H., Sputtering of solid neon and argon by medium mass ions. The 6th Conference on Radiation Effects in Insulators, Weimar, Germany (June).

SIGS, A.C.C., COLTON, A.L., COSTLEY, A.E., KRAMER, G.J., and PRENTICE, R., Electron Density Profile Measurements in JET with the O-Mode Reflectometer. International School of Plasma Physics "Piero Caldirola", Course and Workshop on Diagnostics for Contemporary Fusion Experiments, Varenna, Italy, 1991.

SØRENSEN, H., The Multishot Pellet Injector Program at Risø. Annual meeting of the Plasma Physics Division of the American Physical Society, Tampa, Florida (November).

4.3 Lectures

BINDSLEV, H., Collective Thomson Scattering in a Relativistic Magnetized Plasma. Princeton Plasma Physics Laboratory, Princeton, U.S.A. (March).

BINDSLEV, H., Collective Thomson Scattering in a Relativistic Magnetized Plasma. MIT Plasma Fusion Center, U.S.A. (April).

BINDSLEV, H., Relativistic Dielectric Effects in Millimeter Wave Diagnostics for Large Tokamaks. Department of Engineering Science, University of Oxford, U.K. (November).

JENSEN, V.O., 56 double lectures on the courses of Plasma Physics I and Plasma Physics II at the Technical University of Denmark, Lyngby.

JENSEN, V.O., TV-interview om JET's tritiumforsøg (TV-interview on JET's tritium experiment). TV1. Broadcasted (November).

JENSEN, V.O., Interview om fusionsenergiens muligheder i DR's series Refleks (Interview on the possibilities of the fusion energy in DR's series Refleks). Broadcasted (November).

JENSEN, V.O., Lecture on Fusion Energy for High School and HF teachers. Nykøbing Falster, Denmark (November).

JENSEN, V.O., Interview om fusionsenergien (Interview on fusion energy). Broadcasted in Roskilde Local Radio (November).

JENSEN, V.O., Introduktion til fusionsforskningen. Generelt om studie- og jobtilbud (Introduction to fusion research. Generally on study and job supply). Lecture at an information meeting on fusion research for Danish students at the Technical University of Denmark, Lyngby (November).

NIELSEN, A.H., Elektrostatisk turbulens i et stærkt magnetiseret plasma (Electrostatic turbulence in a strongly magnetized plasma). The Technical University of Denmark, Lyngby, Denmark (December).

NYCANDER, J., Stationary vortices in planetary flows. Royal Institute for Technology, Stockholm, Sweden (June).

NYCANDER, J., Plasma vortices. University of Uppsala, Sweden (June).

NYCANDER, J., Steadily propagating vortices in geophysical flows and in plasmas. DAMTP, University of Cambridge, U.K. (October).

PÉCSELI, H.L., Coherent structures in two dimensional turbulence. Danish Technical University, Lyngby, Denmark (February).

STENUM, B., Particle bombardment of solid hydrogens. H.C. Ørsted Institute, University of Copenhagen, Denmark (July).

Bibliographic Data Sheet **Risø-R-611(EN)**

Title and author(s)

**Optics and Fluid Dynamics Department
Annual Progress Report
1 January - 31 December 1991****J. Juul Rasmussen and S.G. Hanson**

ISBN	ISSN
87-550-1790-8	0106-2840
	0906-1797

Dept. or group	Date
Optics and Fluid Dynamics Department	March 1992

Group's own reg. No(s)	Project/contract No
-------------------------------	----------------------------

Pages	Tables	Illustrations	References
56	1	20	37

Abstract (Max. 2000 characters)

Research in the Optics and Fluid Dynamics Department covers quasi-elastic light scattering, optical and electronic information processing, continuum physics and activities in connection with the Euratom fusion association. A summary of activities in 1991 is presented.

Optical diagnostic methods based on quasi-elastic light scattering have been developed. Beam propagation in random and nonlinear media has been investigated. Spatial and temporal processing schemes, especially for pattern recognition, have been investigated.

Within the area of fluid dynamics spectral models for studying the dynamics of coherent structures have been developed. Coherent structures have been investigated in a plasma and are now also investigated in a rotating fluid.

Fusion relevant work performed under the Euratom association includes investigations of turbulent transport and the development of diagnostic methods.

A special activity is concentrated on the development of pellet injection systems for fusion research.

Descriptors INIS/EDB

DYNAMICS; FLUIDS, LASERS, NEURAL NETWORKS; OPTICS; PLASMA; PROGRESS REPORT; RISØ NATIONAL LABORATORY; THERMONUCLEAR REACTIONS

Available on request from Risø Library, Risø National Laboratory,
(Risø Bibliotek, Forskningscenter Risø), P.O.Box 49,
DK-4000 Roskilde, Denmark.

Telephone +45 42 37 12 12, ext. 2268/2269

Telex 43 116. Telefax +45 42 36 06 09.

Available on request from:
Risø Library
Risø National Laboratory,
P.O. Box 49, DK-4000 Roskilde, Denmark
Phone +45 42 37 12 12, ext. 2268/2269
Telex 43116, Telefax +45 46 75 56 27

ISBN 87-550-1790-8
ISSN 0106-2840
ISSN 0906-1797