

Fukushima - Update November 2011

Nonbøl, Erik

Publication date:
2011

Document Version
Publisher's PDF, also known as Version of record

[Link back to DTU Orbit](#)

Citation (APA):
Nonbøl, E. (2011). Fukushima - Update November 2011. Paper presented at Videnberedskabsseminar, Risø (DK), 15 Nov, .

DTU Library

Technical Information Center of Denmark

General rights

Copyright and moral rights for the publications made accessible in the public portal are retained by the authors and/or other copyright owners and it is a condition of accessing publications that users recognise and abide by the legal requirements associated with these rights.

- Users may download and print one copy of any publication from the public portal for the purpose of private study or research.
- You may not further distribute the material or use it for any profit-making activity or commercial gain
- You may freely distribute the URL identifying the publication in the public portal

If you believe that this document breaches copyright please contact us providing details, and we will remove access to the work immediately and investigate your claim.

Fukushima Update 1/11-11

Erik Nonbøl

VBR seminar 15. november 2011, DTU Risø campus

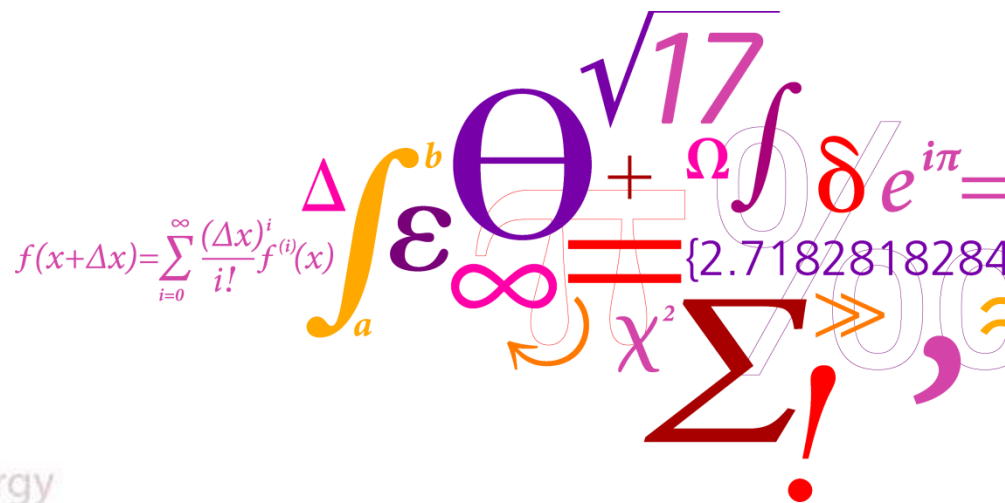

Outline

- Accident progressing (new information)
11/11-2011
- Update 10/11-2011

Boiling Water Reactor Design At Fukushima Daiichi

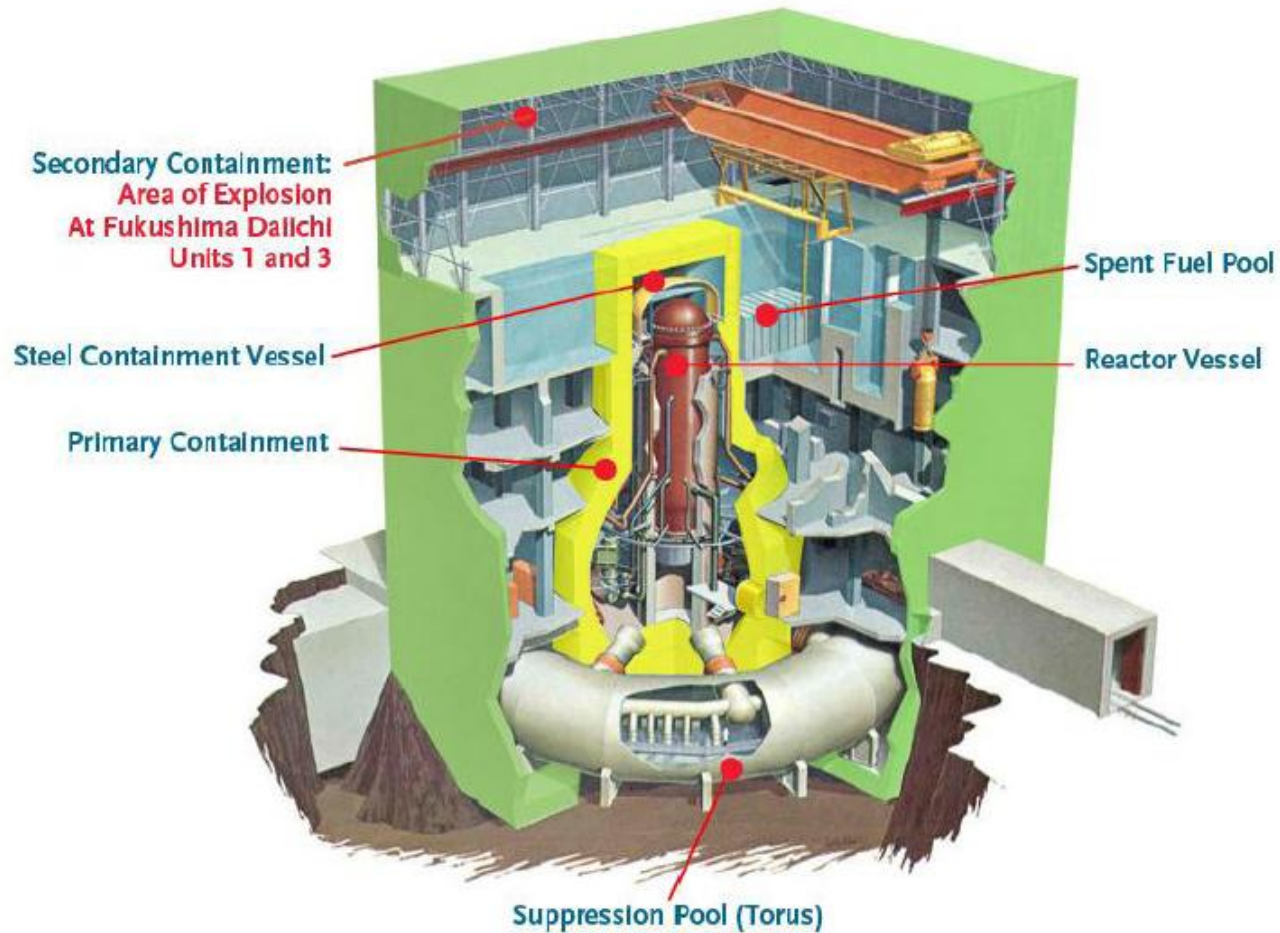
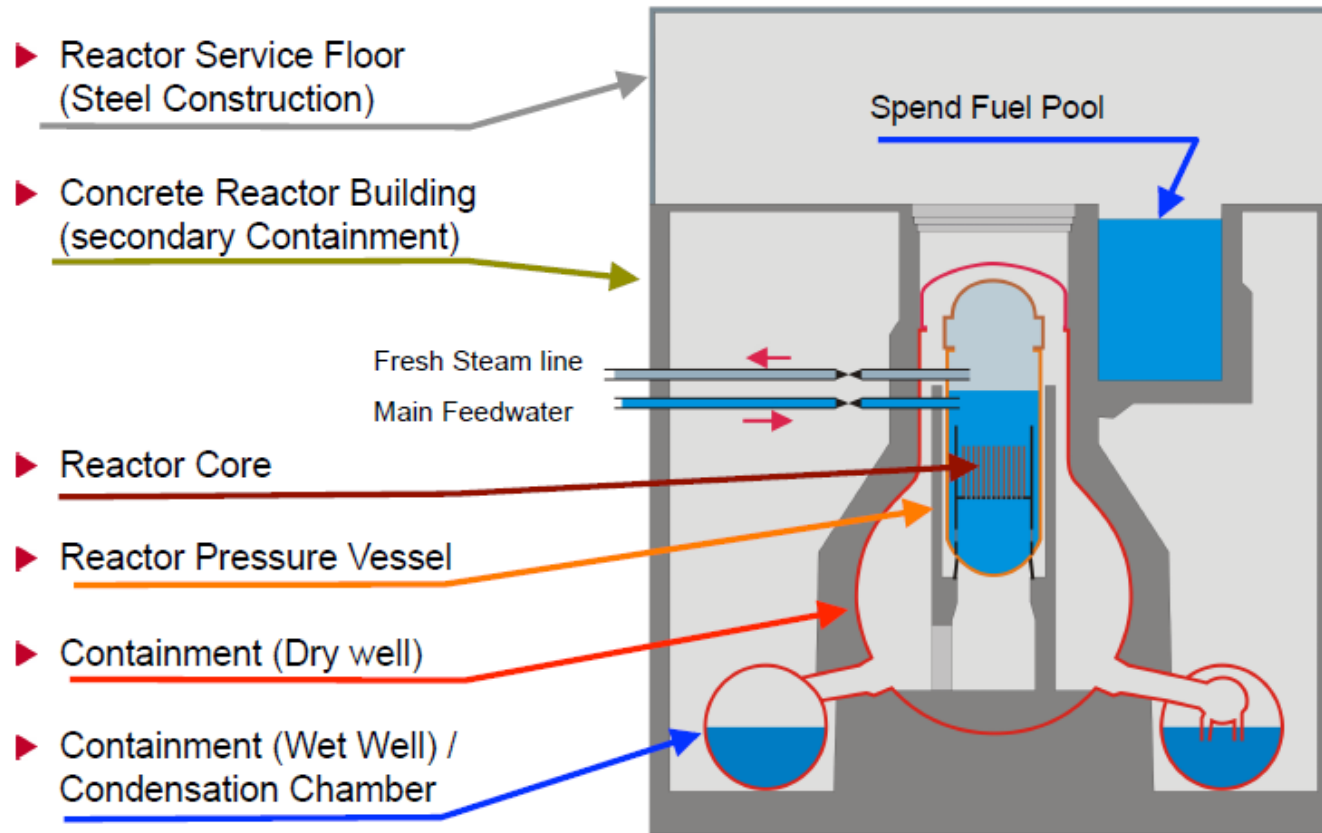

Figure 7.4-8: Generic cross-section of a BWR4 with a Mark I containment (similar to Fukushima Daiichi)

Plant design

The Fukushima Daiichi Incident 1. Plant Design



1. Plant Design

► Emergency Core Cooling Systems

- 1) Residual Heat Removal System
- 2) Low-Pressure Core Spray (for LOCA)
- 3) High-Pressure Core Injection (for LOCA)
- 4) Reactor Core isolation cooling (Unit 2,3 [BWR4])
- 5) Isolation Condenser (Unit 1 [BWR3])
- 6) Borating System

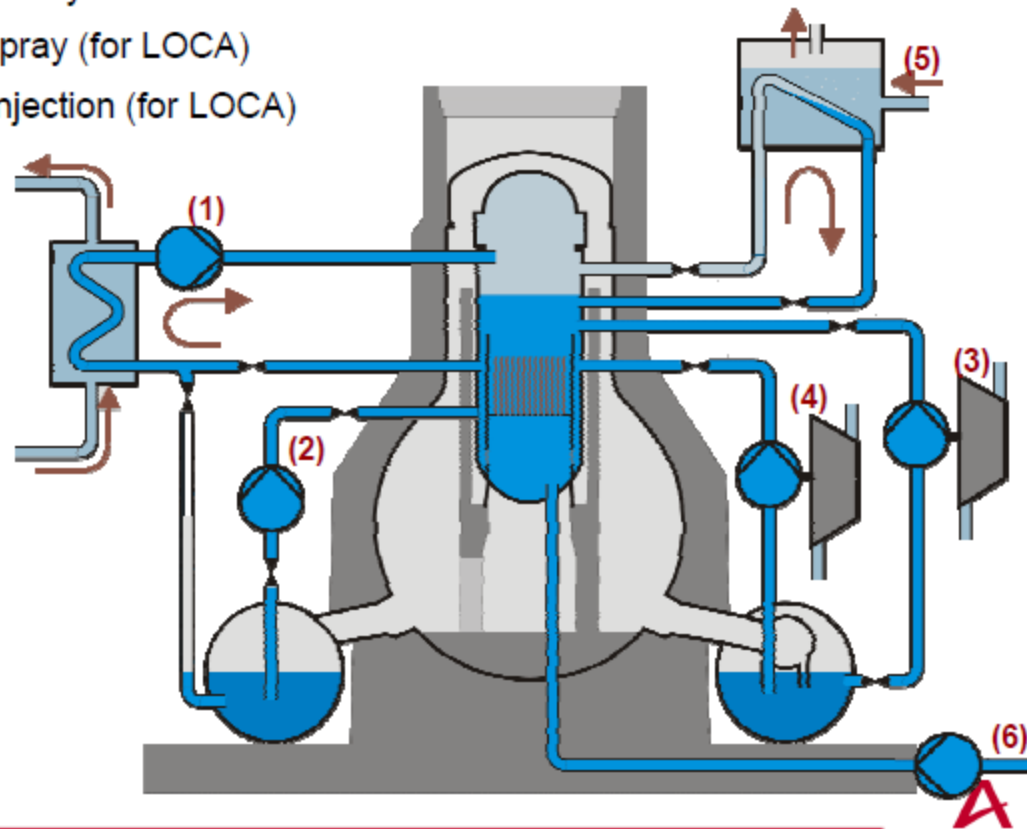

The Fukushima Daiichi Incident 2. Accident progression

- ▶ 11.3.2011 14:46 - Earthquake
 - ◆ Magnitude 9
 - ◆ Power grid in northern Japan fails
 - ◆ Reactors itself are mainly undamaged

- ▶ SCRAM
 - ◆ Power generation due to Fission of Uranium stops
 - ◆ Heat generation due to radioactive Decay of Fission Products
 - After Scram ~6%
 - After 1 Day ~1%
 - After 5 Days ~0.5%

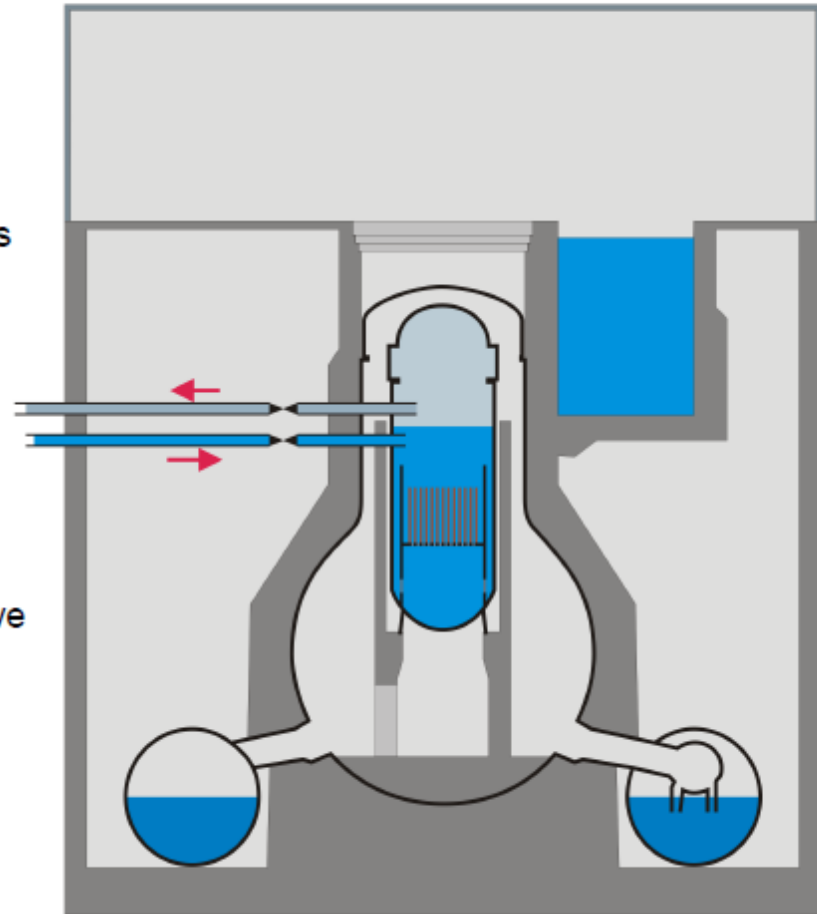

The Fukushima Daiichi Incident 2. Accident progression

- ▶ Containment Isolation
 - ◆ Closing of all non-safety related Penetrations of the containment
 - ◆ Cuts off Machine hall
 - ◆ If containment isolation succeeds, a large early release of fission products is highly unlikely

- ▶ Diesel generators start
 - ◆ Emergency Core cooling systems are supplied

- ▶ Plant is in a stable save state

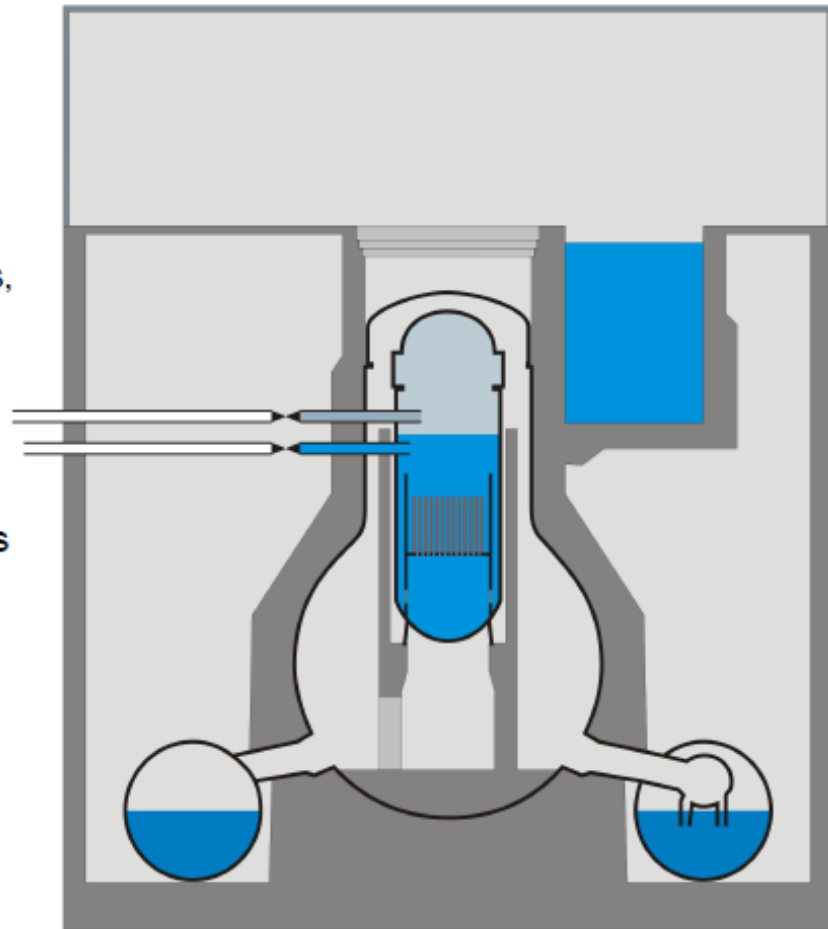

Accident progression

The Fukushima Daiichi Incident 2. Accident progression

- ▶ 11.3. 15:41 Tsunami hits the plant
 - ◆ Plant Design for Tsunami height of up to 6.5m
 - ◆ Actual Tsunami height >7m
 - ◆ Flooding of
 - Diesel Generators and/or
 - Essential service water building cooling the generators

- ▶ Station Blackout
 - ◆ Common cause failure of the power supply
 - ◆ Only Batteries are still available
 - ◆ Failure of all but one Emergency core cooling systems

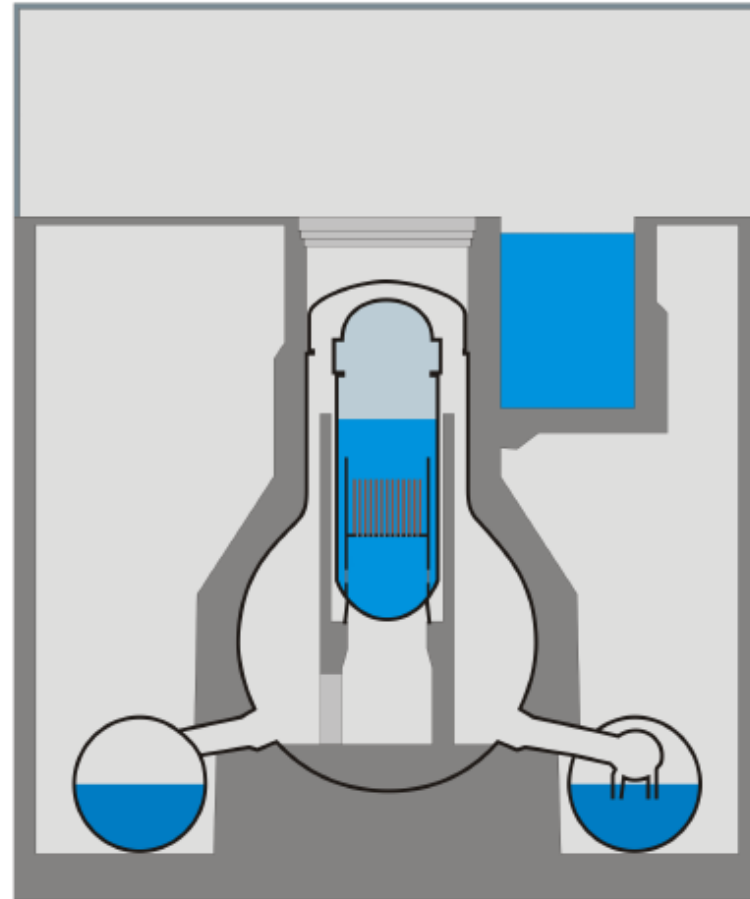

Accident progression

The Fukushima Daiichi Incic 2. Accident progres

- ▶ Reactor Core Isolation Pump still available (unit 2+3)
 - ◆ Steam from the Reactor drives a Turbine
 - ◆ Steam gets condensed in the Wet-Well
 - ◆ Turbine drives a Pump
 - ◆ Water from the Wet-Well gets pumped in Reactor
 - ◆ Necessary:
 - Battery power
 - Temperature in the wet-well must be below 100°C
- + Isolation condenser (unit1)
- ▶ As there is no heat removal from the building, the Core isolation pump cant work infinitely

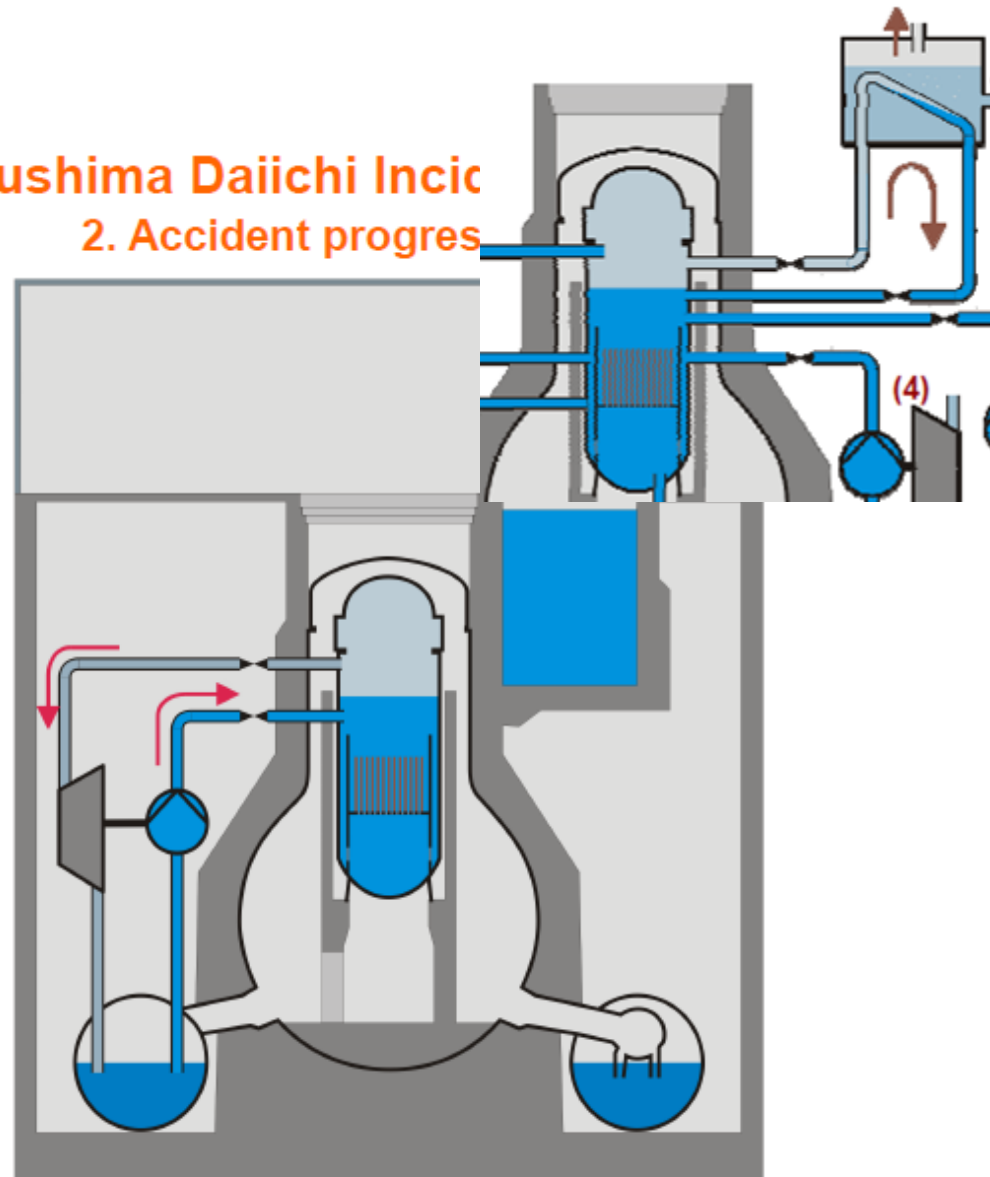

Accident progression

The Fukushima Daiichi In 2. Accident progr

- ▶ Reactor Isolation pump stops

Isolation condenser valves closed

- ◆ 11.3. 16:36 in Unit 1 (Batteries empty)
- ◆ 14.3. 13:25 in Unit 2 (Pump failure)
- ◆ 13.3. 2:44 in Unit 3 (Batteries empty)

- ▶ Decay Heat produces still steam in Reactor pressure Vessel

- ◆ Pressure rising

- ▶ Opening the steam relieve valves

- ◆ Discharge Steam into the Wet-Well

- ▶ Descending of the Liquid Level in the Reactor pressure vessel

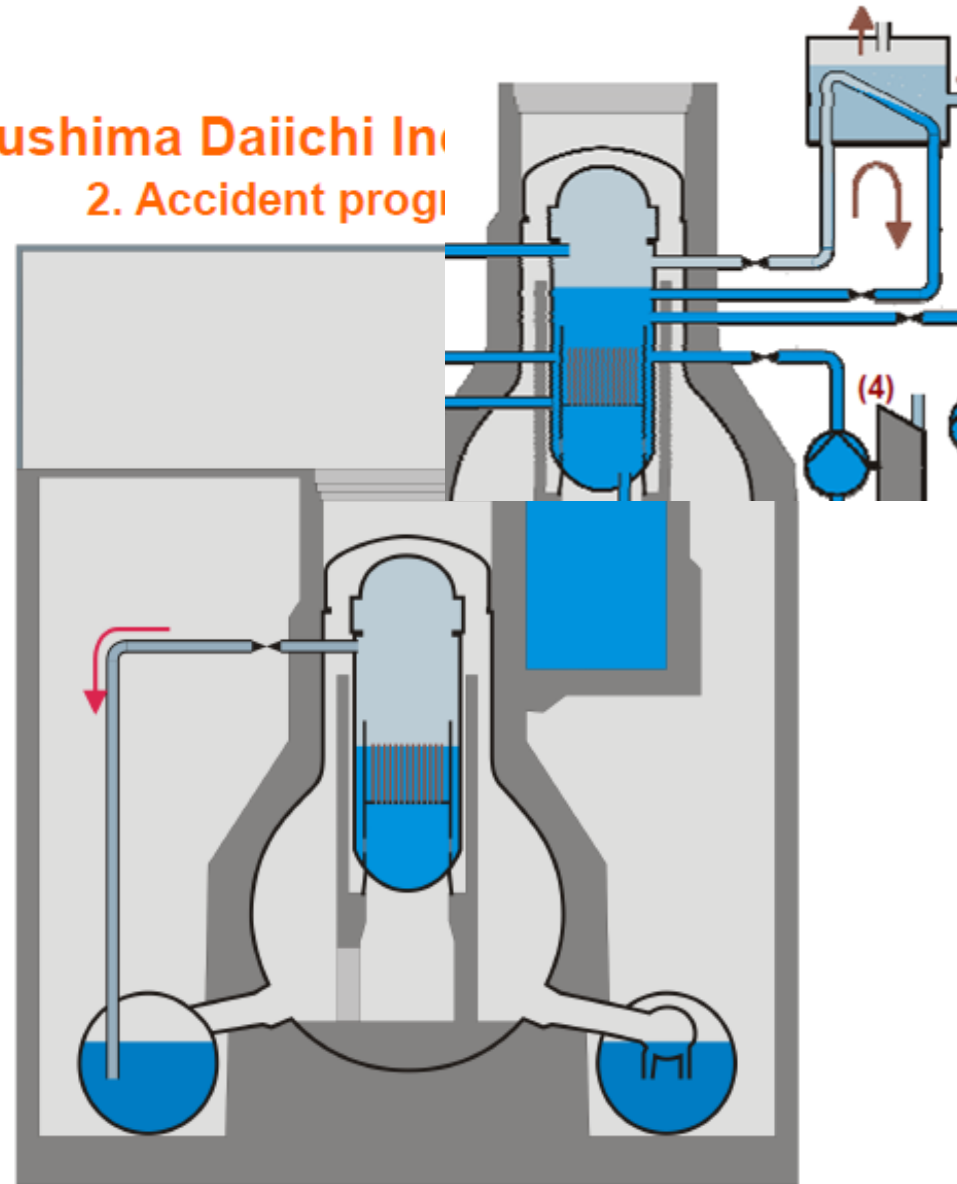

Accident progression

The Fukushima Daiichi Incident 2. Accident progression

- ▶ Measured, and here referenced Liquid level is the collapsed level. The actual liquid level lies higher due to the steam bubbles in the liquid
- ▶ ~50% of the core exposed
 - ◆ Cladding temperatures rise, but still no significant core damage
- ▶ ~2/3 of the core exposed
 - ◆ Cladding temperature exceeds $\sim 900^{\circ}\text{C}$
 - ◆ Ballooning / Breaking of the cladding
 - ◆ Release of fission products from the fuel rod gaps

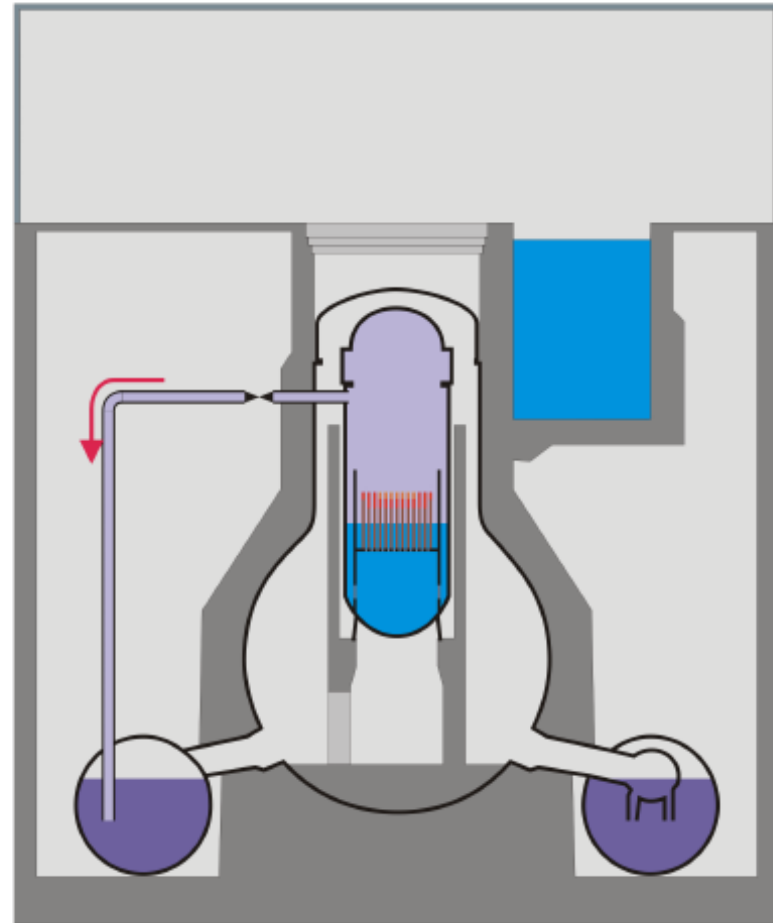

The Fukushima Daiichi Incident 2. Accident progression

- ▶ at ~1800°C [Unit 1,2,3]
 - ◆ Melting of the Cladding
 - ◆ Melting of the steel structures

- ▶ at ~2500°C [Block 1,2]
 - ◆ Breaking of the fuel rods
 - ◆ debris bed inside the core

- ▶ at ~2700°C [Block 1]
 - ◆ Melting of Uranium-Zirconium eutectics

- ▶ Restoration of the water supply stops accident in all 3 Units
 - ◆ Unit 1: 12.3. 20:20 (27h w.o. water)
 - ◆ Unit 2: 14.3. 20:33 (7h w.o. water)
 - ◆ Unit 3: 13.3. 9:38 (7h w.o. water)

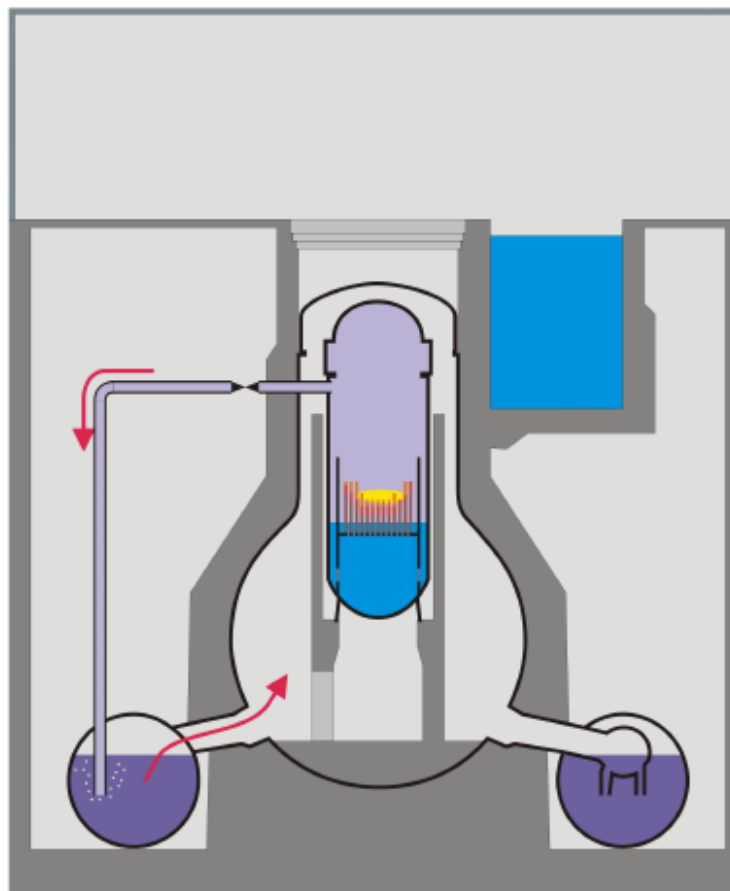

Accident progression

The Fukushima Daiichi Incident 2. Accident progression

- ▶ Release of fission products during melt down
 - ◆ Xenon, Cesium, Iodine,...
 - ◆ Uranium/Plutonium remain in core
 - ◆ Fission products condensate to airborne Aerosols
- ▶ Discharge through valves into water of the condensation chamber
 - ◆ Pool scrubbing binds a fraction of Aerosols in the water
- ▶ Xenon and remaining aerosols enter the Dry-Well
 - ◆ Deposition of aerosols on surfaces further decontaminates air

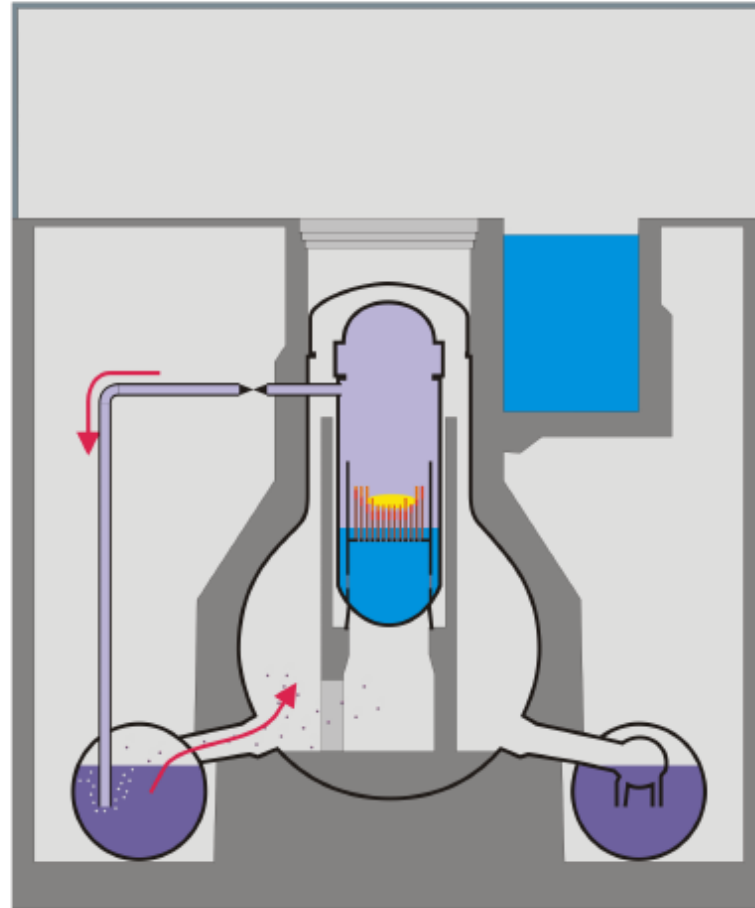

Accident progression

The Fukushima Daiichi Incident 2. Accident progression

- ▶ Containment
 - ◆ Last barrier between Fission Products and Environment
 - ◆ Wall thickness ~3cm
 - ◆ Design Pressure 4-5bar

- ▶ Actual pressure up to 8 bars
 - ◆ Normal inert gas filling (Nitrogen)
 - ◆ Hydrogen from core oxidation
 - ◆ Boiling condensation chamber (like a pressure cooker)

- ▶ Depressurization of the containment
 - ◆ Unit 1: 12.3. 4:00
 - ◆ Unit 2: 13.3 00:00
 - ◆ Unit 3: 13.3. 8.41

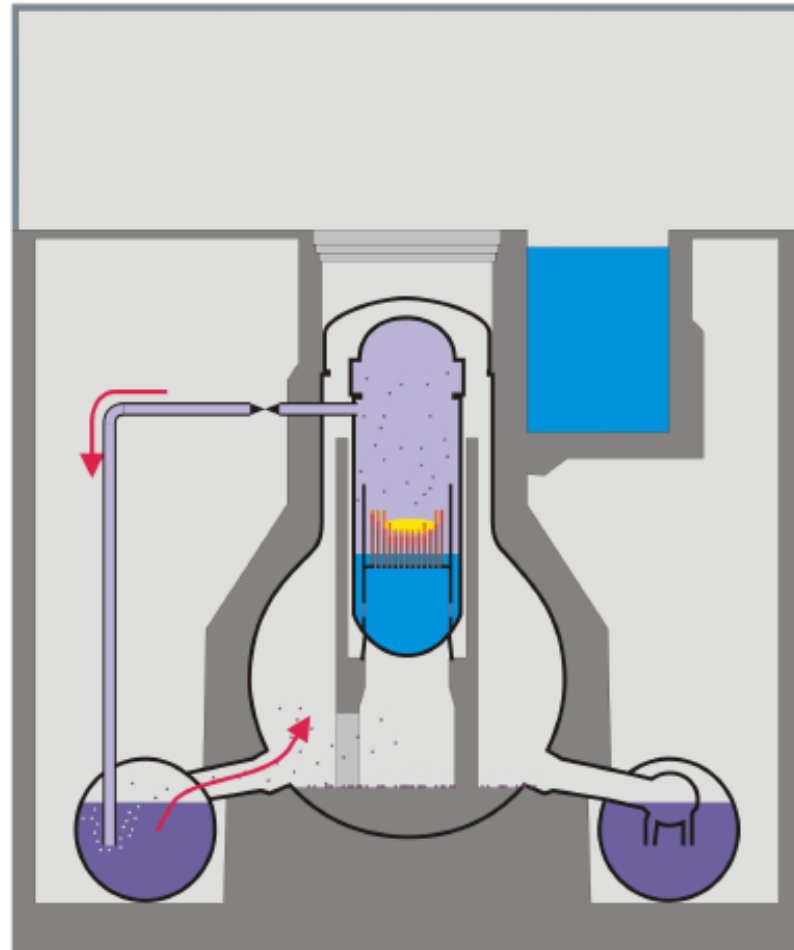

The Fukushima Daiichi Incident

2. Accident progression

- ▶ Positive and negative Aspects of depressurizing the containment
 - ◆ Removes Energy from the Reactor building (only way left)
 - ◆ Reducing the pressure to ~4 bar
 - ◆ Release of small amounts of Aerosols (Iodine, Cesium ~0.1%)
 - ◆ Release of all noble gases
 - ◆ Release of Hydrogen

- ▶ Gas is released into the reactor service floor
 - ◆ Hydrogen is flammable

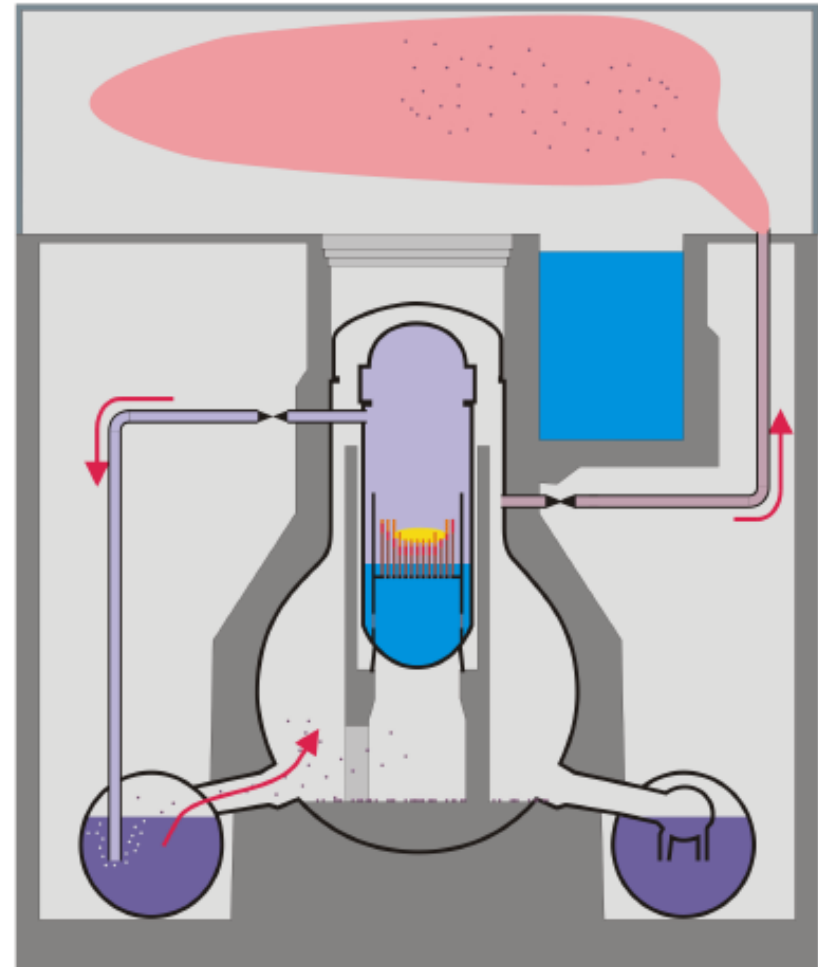

The Fukushima Daiichi Incident

2. Accident progression

► Unit 1 und 3

- ◆ Hydrogen burn inside the reactor service floor
- ◆ Destruction of the steel-frame roof
- ◆ Reinforced concrete reactor building seems undamaged
- ◆ Spectacular but minor safety relevant

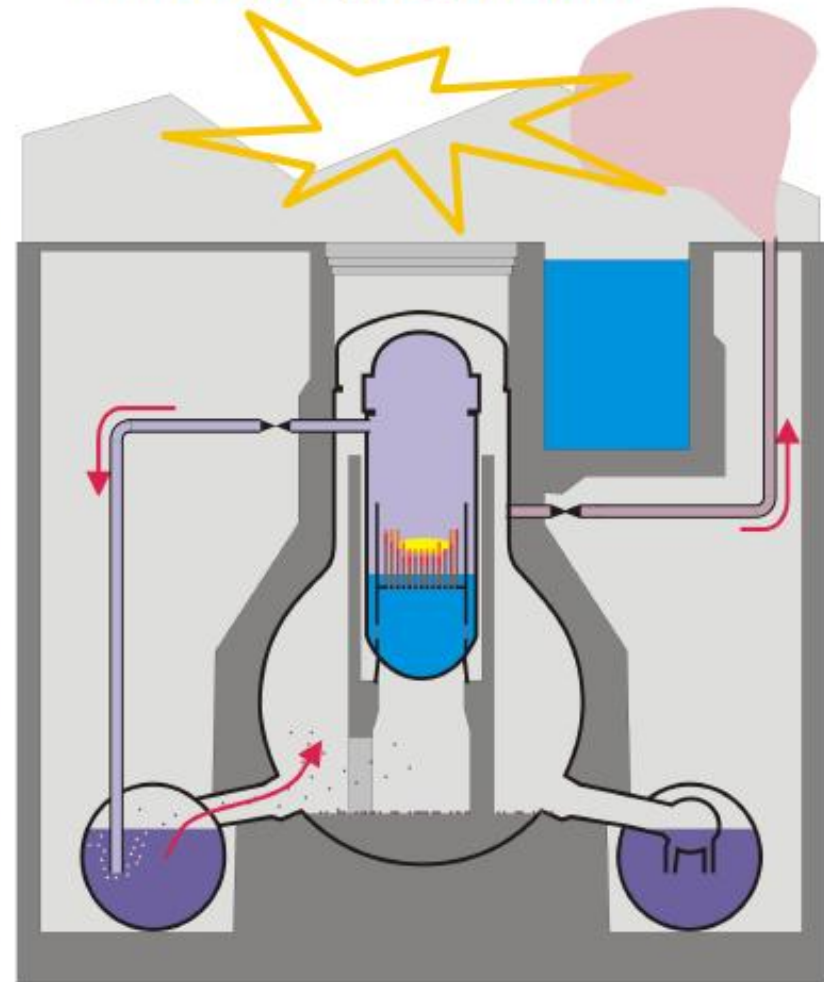

The Fukushima Daiichi Incident

2. Accident progression

- ▶ Unit 2
 - ◆ Hydrogen burn inside the reactor building
 - ◆ Probably damage to the condensation chamber (highly contaminated water)
 - ◆ Uncontrolled release of gas from the containment
 - ◆ **Release of fission products**
 - ◆ Temporal evacuation of the plant
 - ◆ High local dose rates on the plant site due to wreckage hinder further recovery work

- ▶ No clear information's why Unit 2 behaved differently

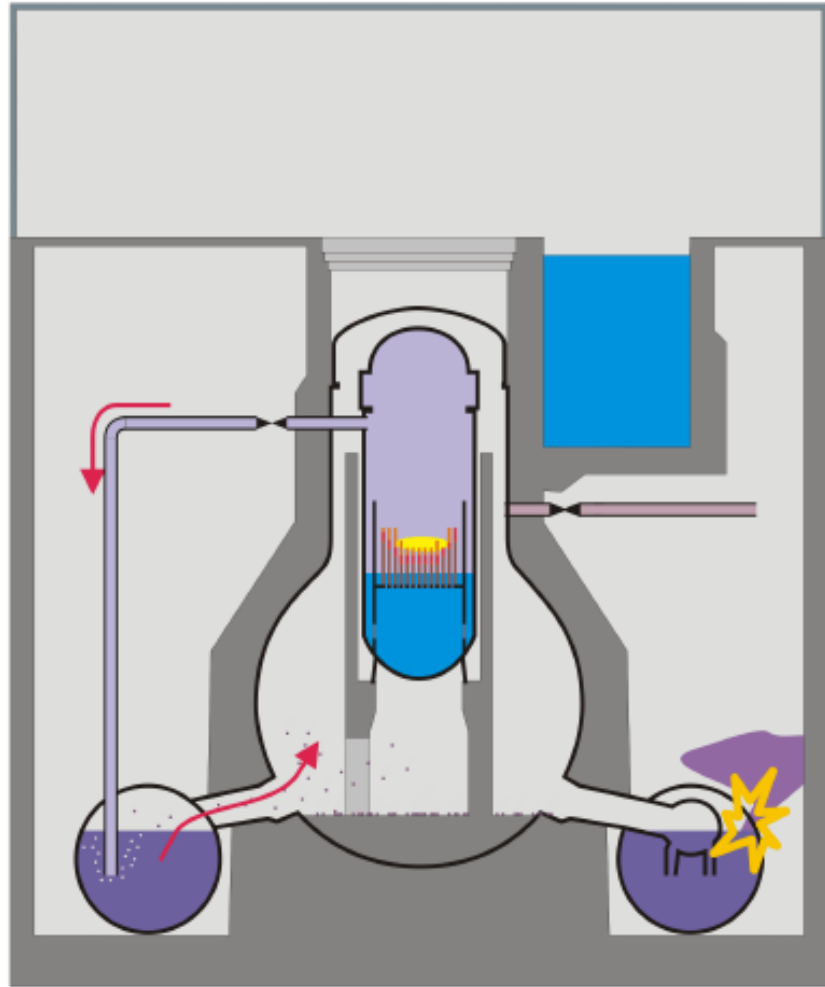

4. Spent fuel pools

- ▶ Spent fuel stored in Pool on Reactor service floor
 - ◆ Due to maintenance in Unit 4 entire core stored in Fuel pool
 - ◆ Dry-out of the pools
 - Unit 4: in 10 days
 - Unit 1-3,5,6 in few weeks
 - ◆ **Leakage of the pools due to Earthquake?**

- ▶ Consequences
 - ◆ Core melt „on fresh air “
 - ◆ Nearly no retention of fission products
 - ◆ Large release

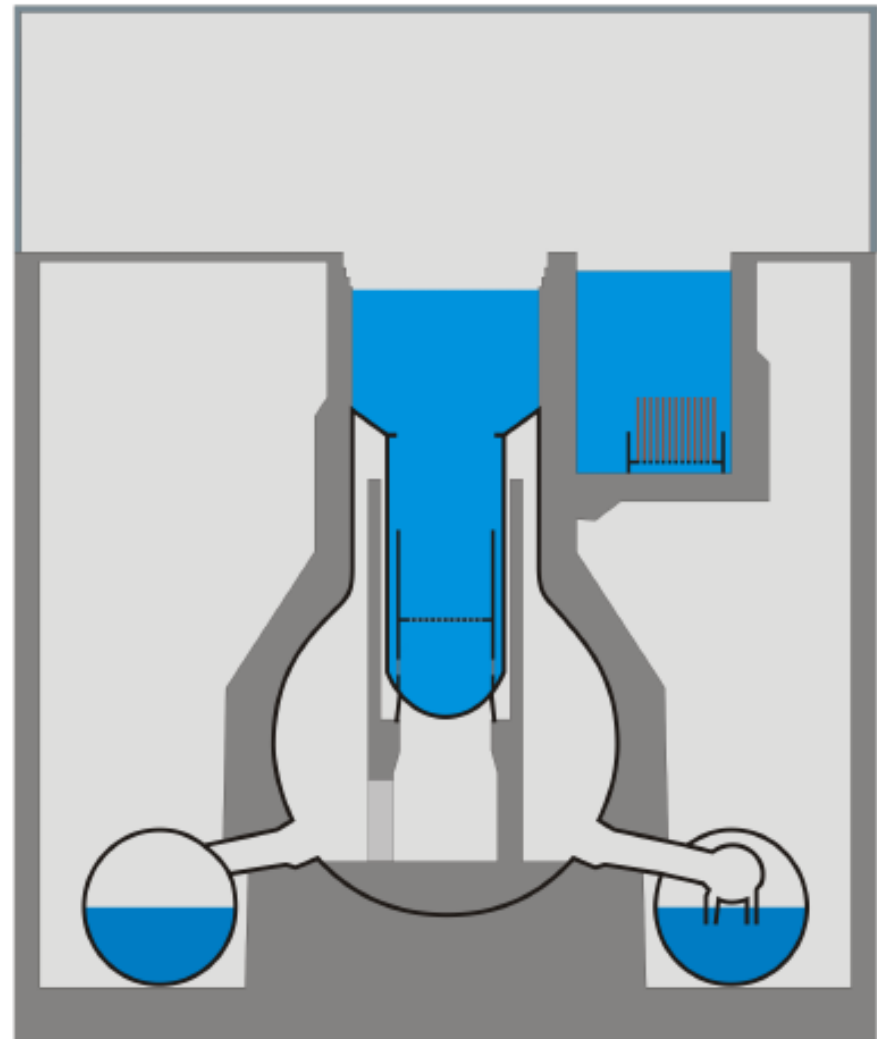

4. Spent fuel pools

- ▶ Spent fuel stored in Pool on Reactor service floor
 - ◆ Due to maintenance in Unit 4 entire core stored in Fuel pool
 - ◆ Dry-out of the pools
 - Unit 4: in 10 days
 - Unit 1-3,5,6 in few weeks
 - ◆ **Leakage of the pools due to Earthquake?**
- ▶ Consequences
 - ◆ Core melt „on fresh air “
 - ◆ Nearly no retention of fission products
 - ◆ Large release
- ▶ **It is currently unclear if release from fuel pool already happened**

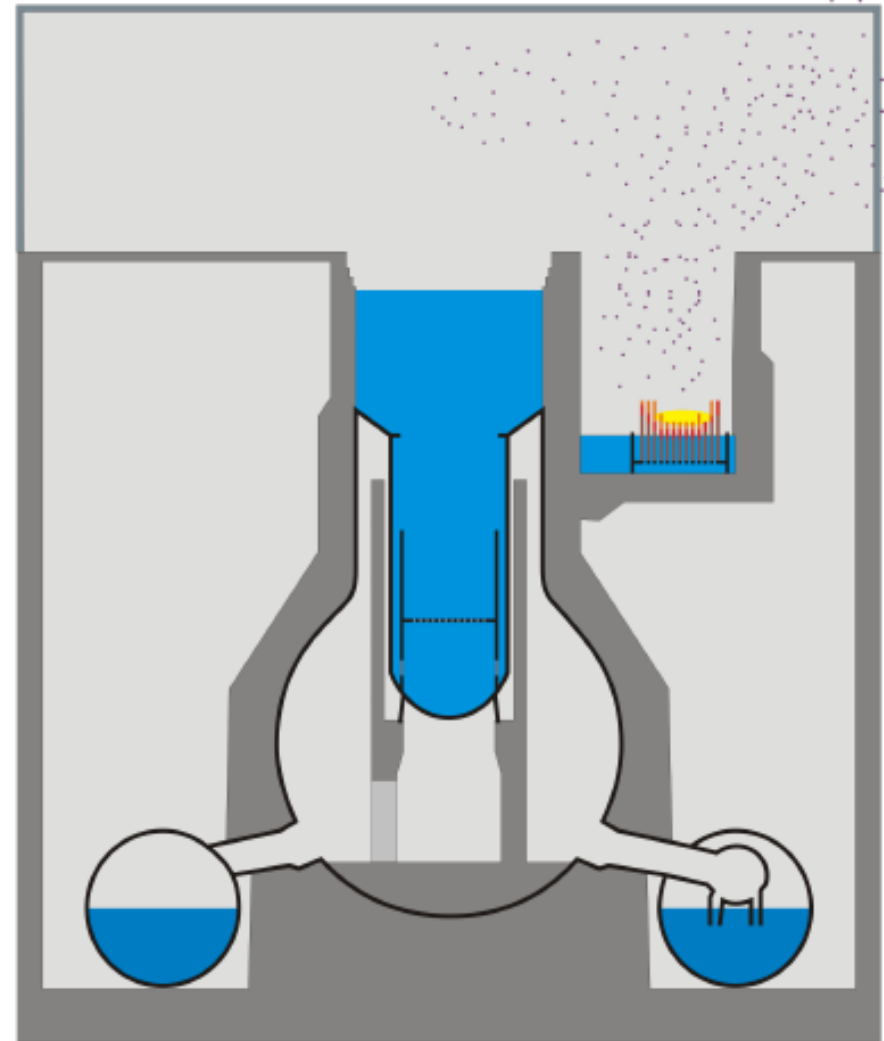

Simulation

Unit 1: Reactor Water Level, Maximum Core Temperature (Analysis Result)

Key assumption: IC lost its function after the tsunami arrived at around 15:30

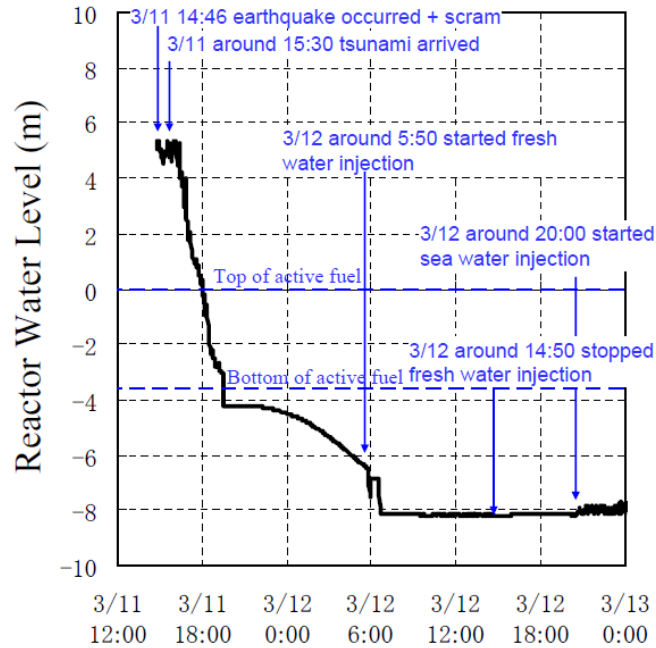

- reached top of active fuel in 3 hours (around 18:00) after the scram
- reached bottom of active fuel in 4 and a half hours (around 19:30) after the scram

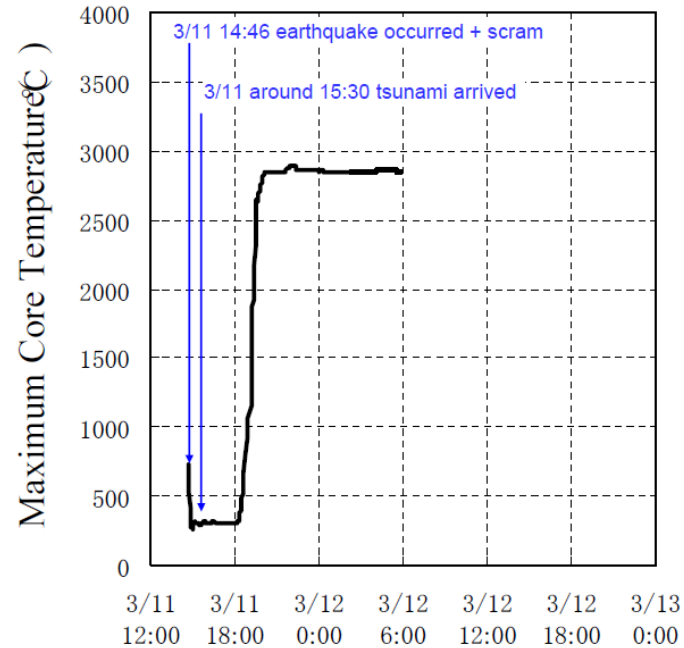

The core temperature started increasing when the reactor water level became lower than top of active fuel, then reached the core melting temperature.

Time and operations described herein might be revised according to the accident investigation in the future.



Unit 1: Transition of Core Status (analysis result)

Degree of fuel damage

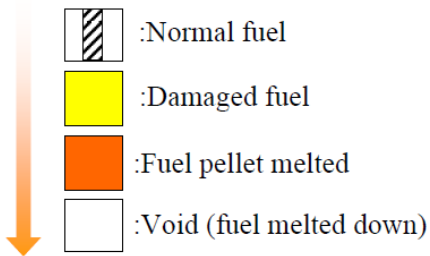

- Melting starts from the central part of the core.
- In 16 hours after scram (around March 12th 6:50), most part of the core fell down to the RPV bottom.
- Although RPV is damaged in this provisional analysis, the actual damage of RPV is considered to be limited according to the temperatures presently measured around the RPV.

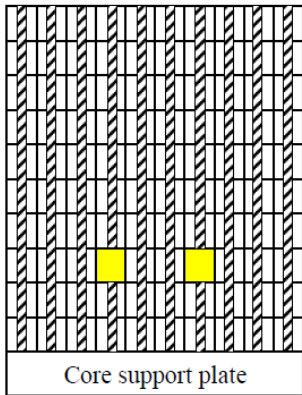

4.8 hours after scram
(around March 11th 19:30)

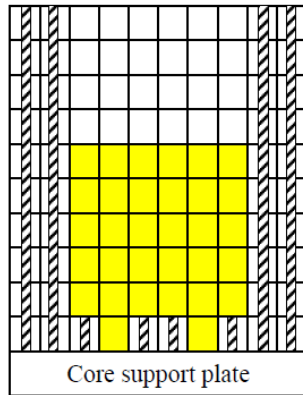

5.1 hours after scram
(around March 11th 19:50)

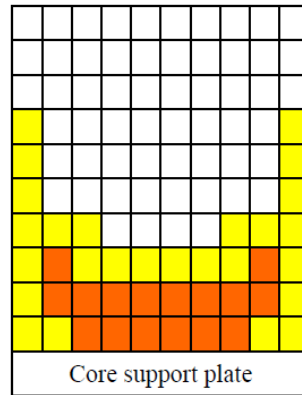

15.1 hours after scram
(around March 12th 6:00)

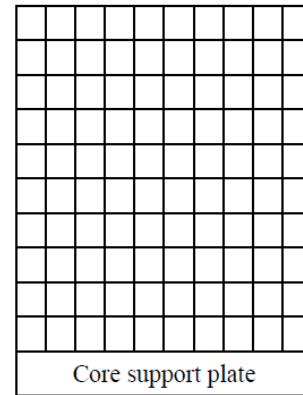

16.0 hours after scram
(around March 12th 6:50)

- Update 10/11-2011

Plant parameters for reactor units

Table 6: Units 1, 2 and 3 – Plant Parameters

Parameter / Indications	Unit	Fukushima Daiichi		
		Unit 1	Unit 2	Unit 3
Water Injection to the reactor	Feed water system (m ³ /h)	7.8	3.0	2.9
	Core Spray (m ³ /h)	n/a	7.2	7.9
Reactor Pressure Vessel (RPV) Pressure	MPa	0.111 (A)	0.107 (A)	Downscale (A)
		- (B)	(D)	Downscale (C)
	atm	1.11 (A)	1.07 (A)	Downscale (A)
		- (B)	(D)	Downscale (C)
Containment Vessel (Drywell) Pressure	kPa	121	115	102
	atm	1.21	1.15	1.02
RPV Temperature (feed water nozzle)	°C	40.8	67.8	61.8
RPV Lower Head Temperature	°C	43.8	71.4	70.7
Suppression Pool Pressure	kPa	84	Below scale	187
	atm	0.84		1.87
Date/Time of Data Acquisition		09-Nov 12:00 UTC	09-Nov 12:00 UTC	09-Nov 12:00 UTC

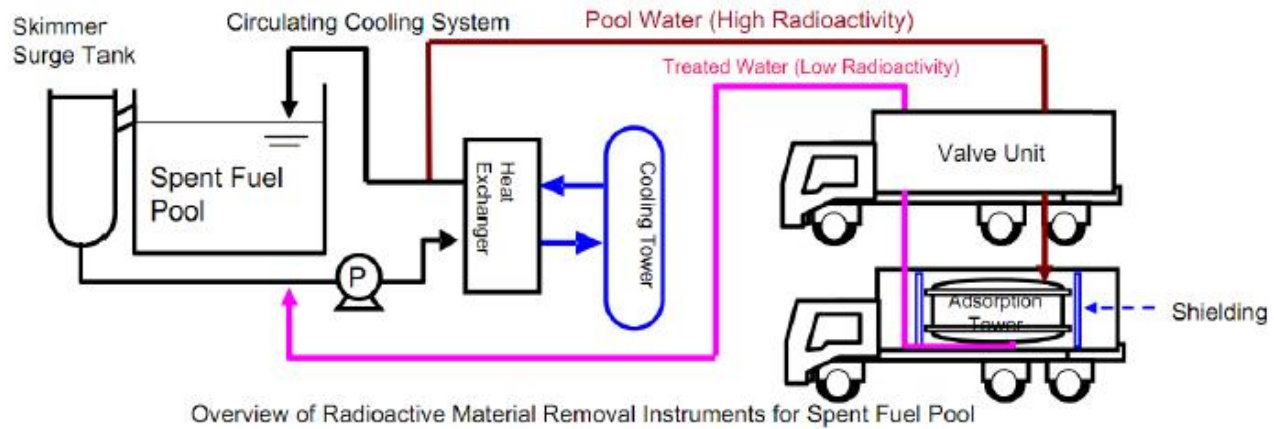

Figure 3: Schematic of contamination removal process for Unit 2 Spent Fuel Pool



Figure 4: Caesium absorption apparatus inside shielding container

Table 7: Contamination measured in samples from Spent Fuel Pool for Units 1-4 (Samples taken on 5 November)

Spent Fuel Pool	All samples taken on 5 November				
	pH	Cl ppm	I-131 Bq/L	Cs-134 Bq/L	Cs-137 Bq/L
Unit 1	8.1	3	ND	1.3×10^7	1.8×10^7
Unit 2	9.2	1600	ND	9.5×10^7	1.1×10^8
Unit 3	9.8	1800	ND	6.0×10^7	7.4×10^7
Unit 4	10.1	150	ND	3.5×10^3	5.1×10^3

Table 8: Contamination measured in samples from Spent Fuel Pool for Units 1-4 (Samples taken on between 19 and 20 August)

Spent Fuel Pool	Sampling date	pH	Cl ppm	I-131 Bq/L	Cs-134 Bq/L	Cs-137 Bq/L
Unit 1	19 August	8.2	3.9	ND	1.8×10^7	2.3×10^7
Unit 2	19 August	7.5	1508	ND	1.1×10^8	1.1×10^8
Unit 3	19 August	9.2	1769	ND	7.4×10^7	8.7×10^7
Unit 4	20 August	7.7	1944	ND	4.4×10^4	6.1×10^4

Table 9: Most recently reported temperatures in the Fukushima Daiichi Spent Fuel Pools

Location	Water Temperature	
	Temperature °C	Date measured
Unit 1	22.0	09 November
Unit 2	24.9	09 November
Unit 3	22.6	09 November
Unit 4	31.0	09 November
Unit 5	24.1	09 November
Unit 6	24.0	09 November
Common Spent Fuel Pool	25.0	09 November

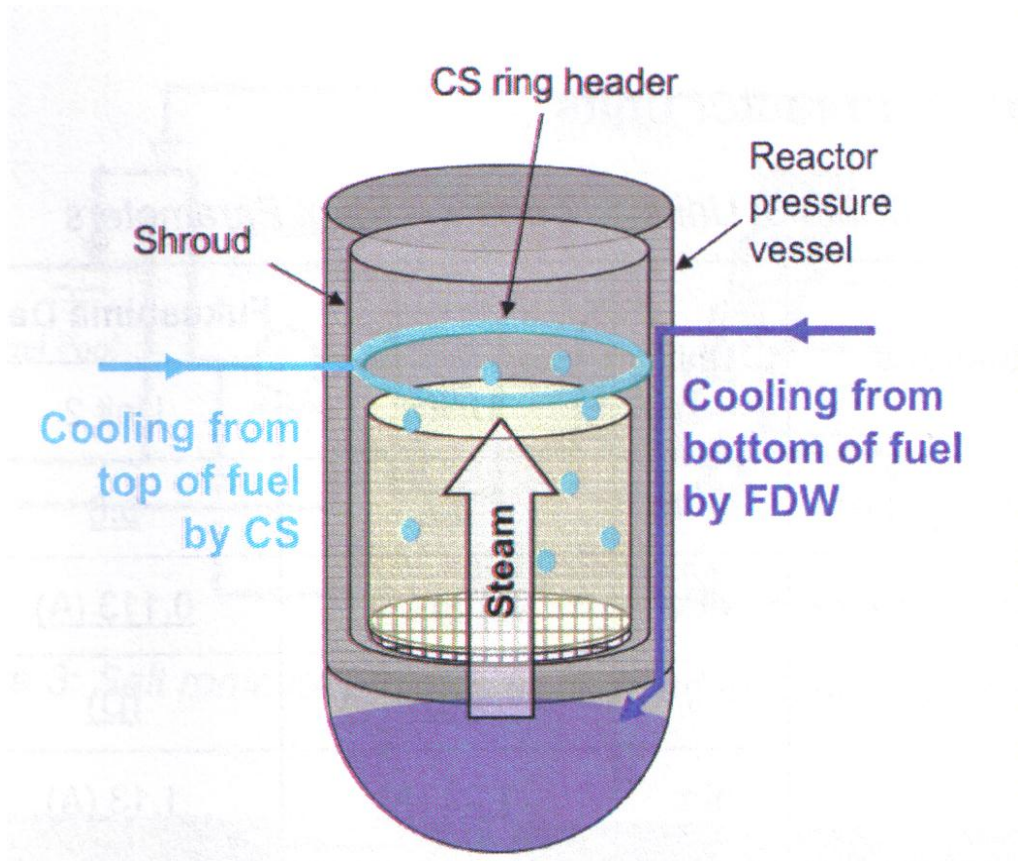

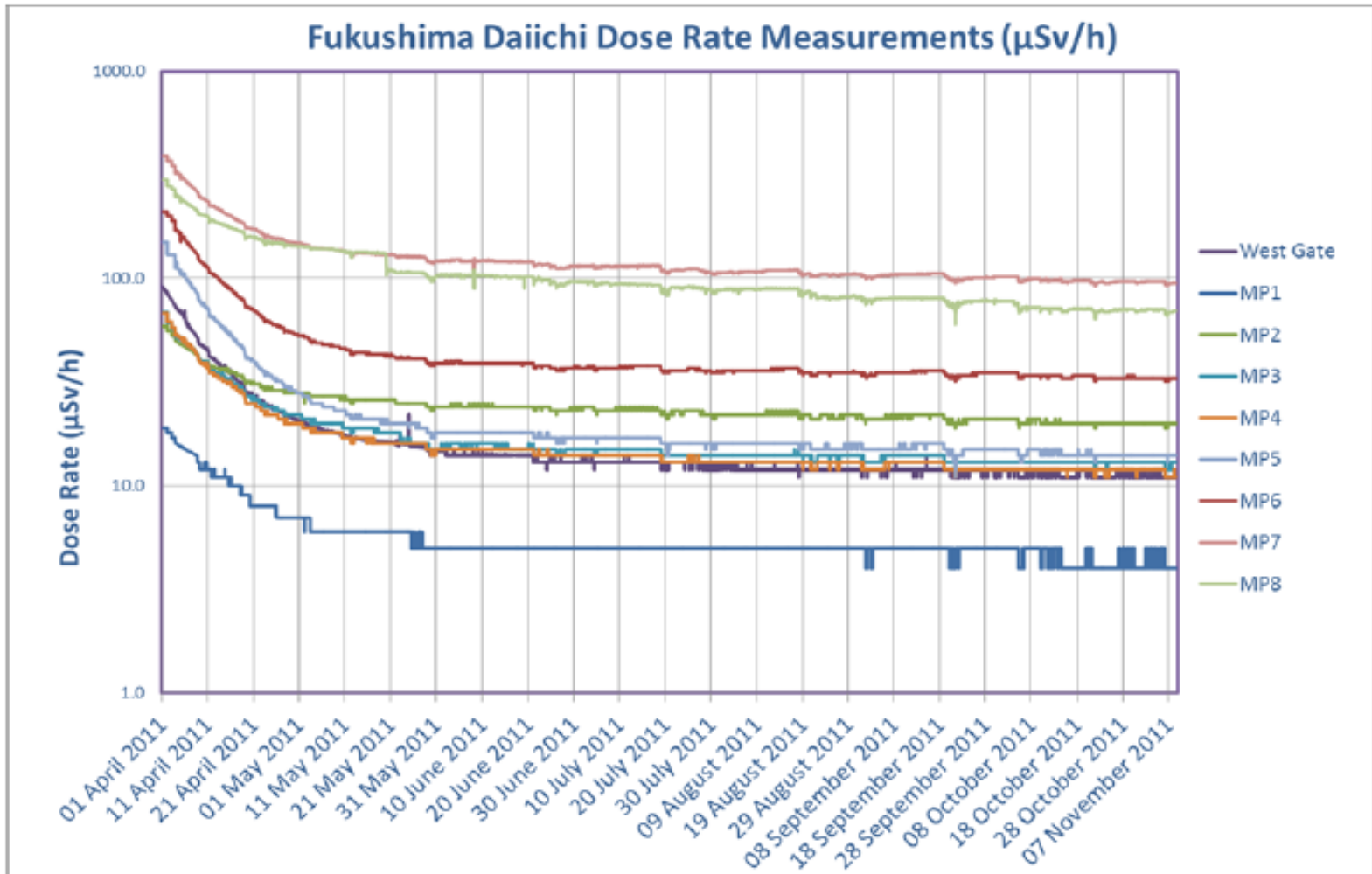

Figure 9: Onsite dose rate measurements ($\mu\text{Sv/h}$) at Fukushima Daiichi



Figure 8: Onsite monitoring posts at Fukushima Daiichi

Radiological releases

- ▶ Directly on the plant site
 - ◆ Before Explosion in Unit Block 2
 - Below 2mSv / h
 - Mainly due to released radioactive noble gases
 - Measuring posts on west side. Maybe too small values measured due to wind

 - ◆ After Explosion in Unit 2 (Damage of the Containment)
 - Temporal peak values 12mSv / h
 - (Origin not entirely clear)
 - Local peak values on site up to 400mSv /h (wreckage / fragments?)
 - Currently stable dose on site at 5mSv /h
 - Inside the buildings a lot more

 - ◆ Limiting time of exposure of the workers necessary

Radiological releases

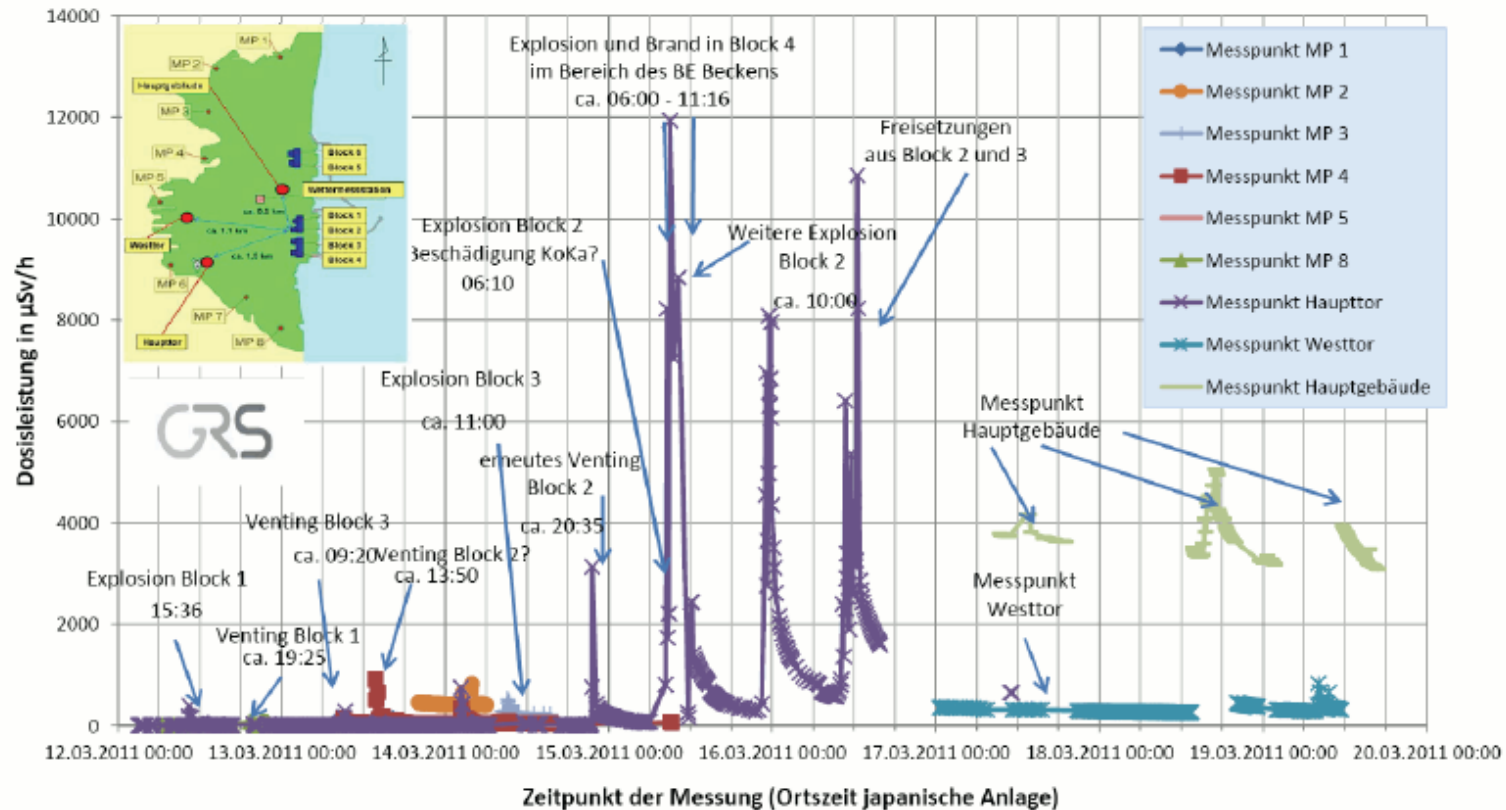

BWR – Emergency cooling systems

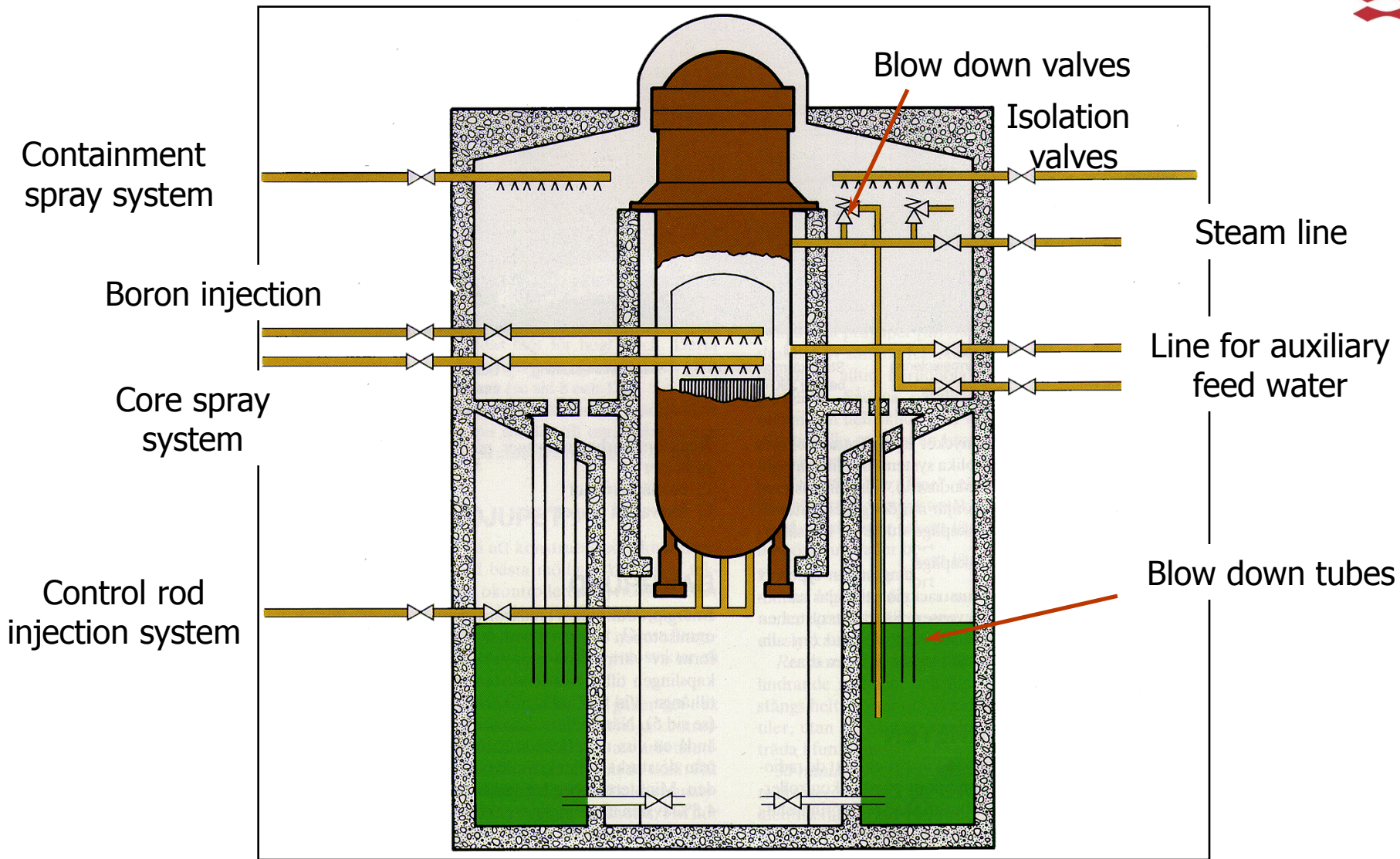

BWR – System for fast shutdown SCRAM

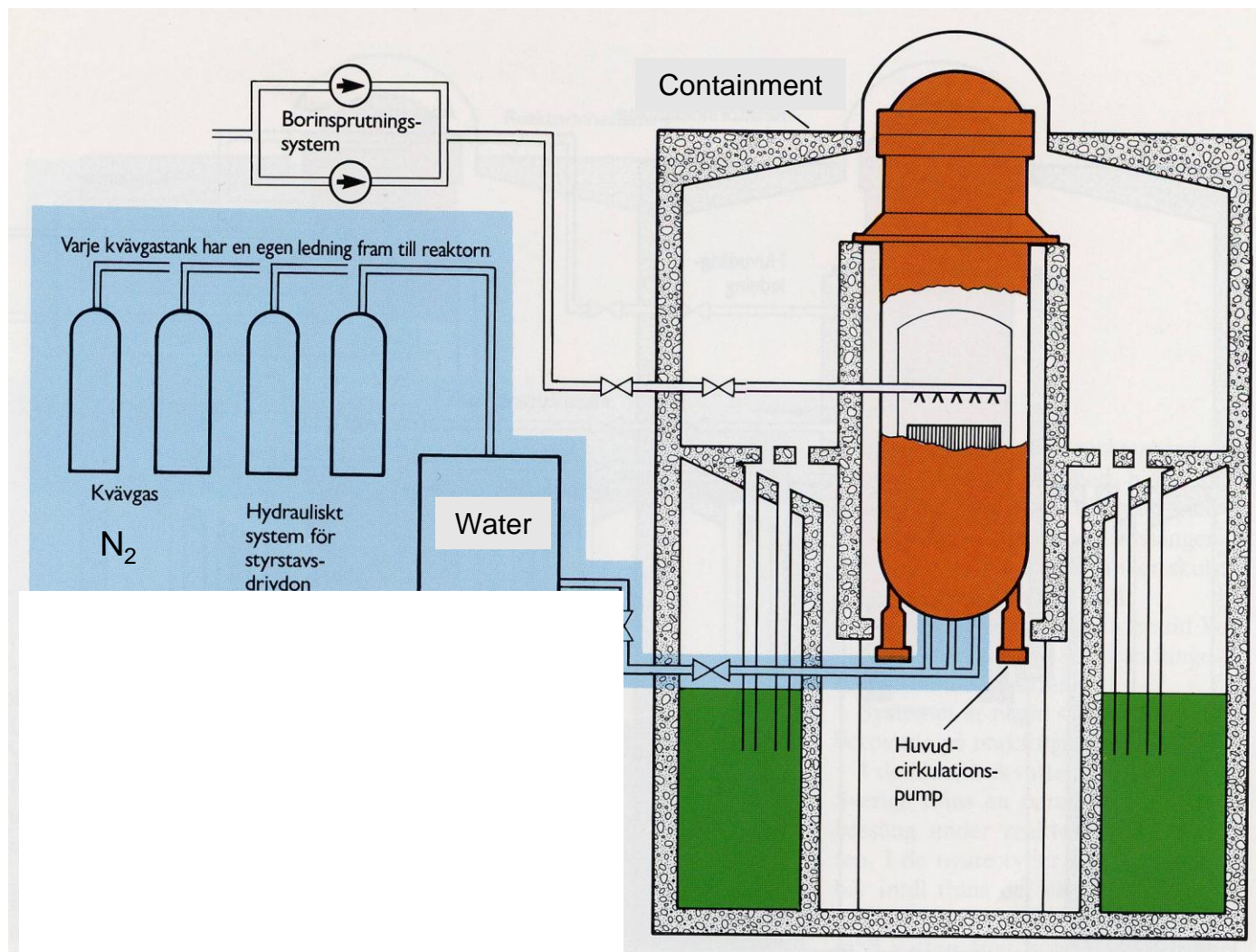

BWR – Steam- and feed water system

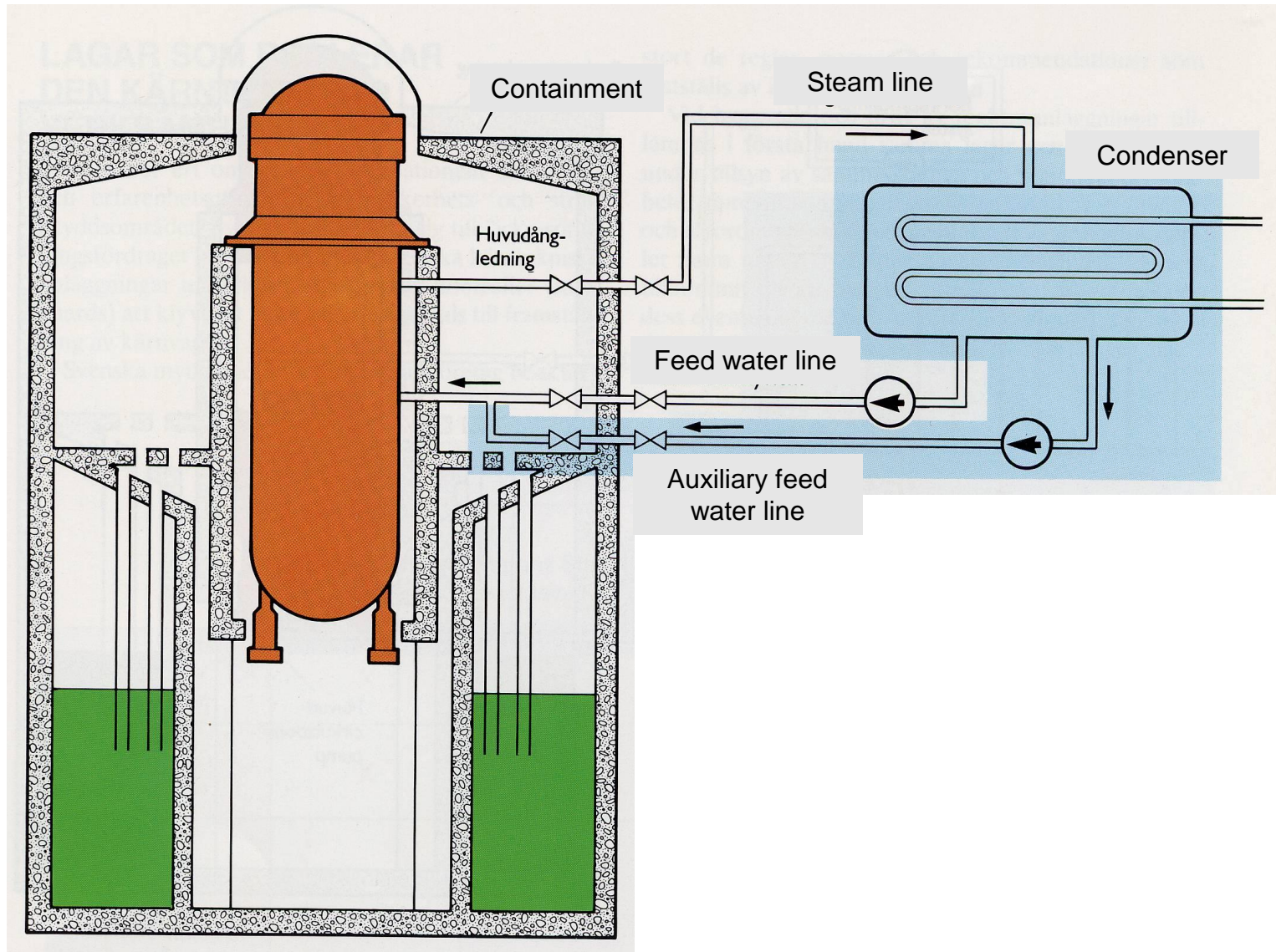

BWR – Blow down system

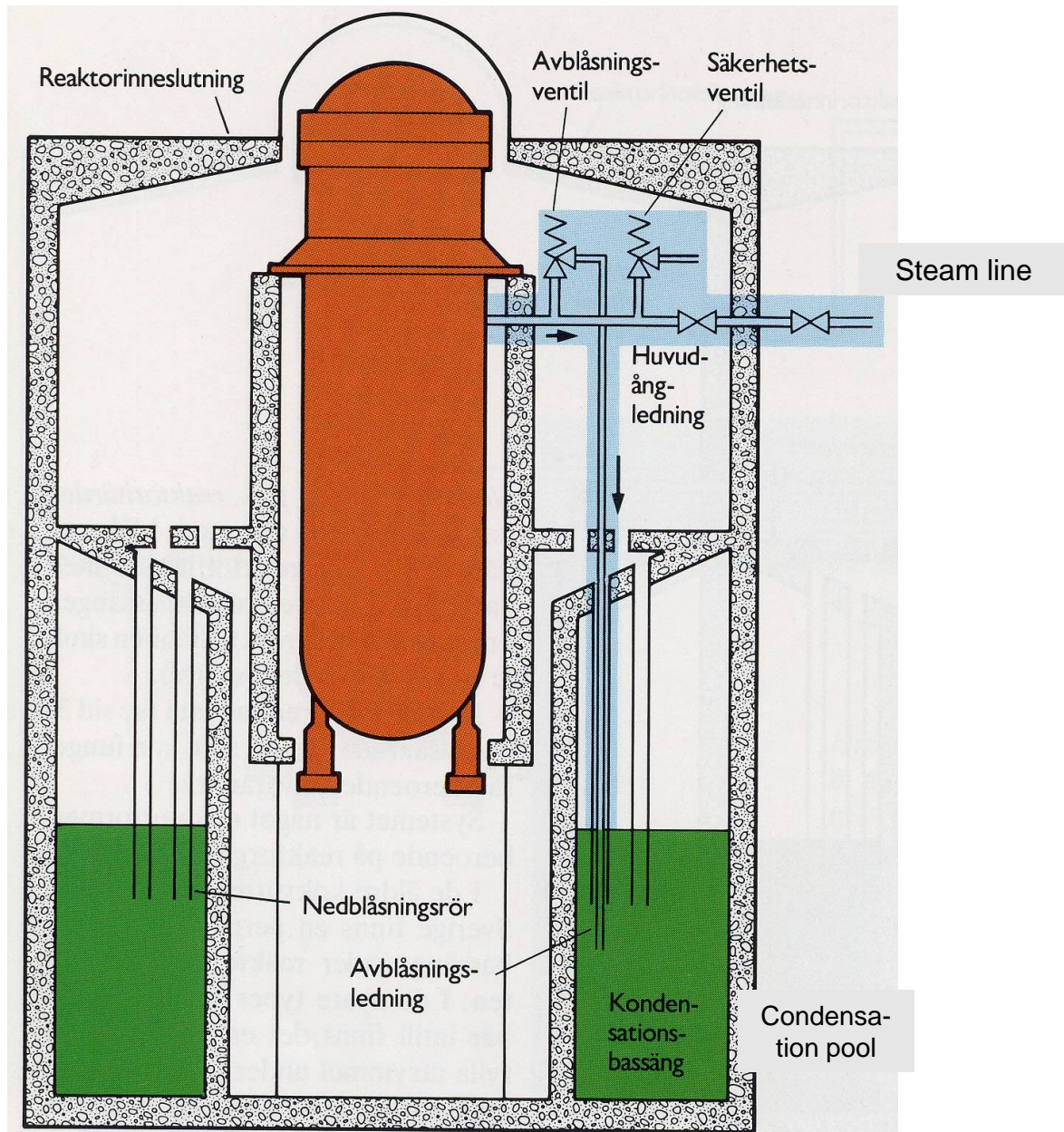

BWR – Core emergency cooling system

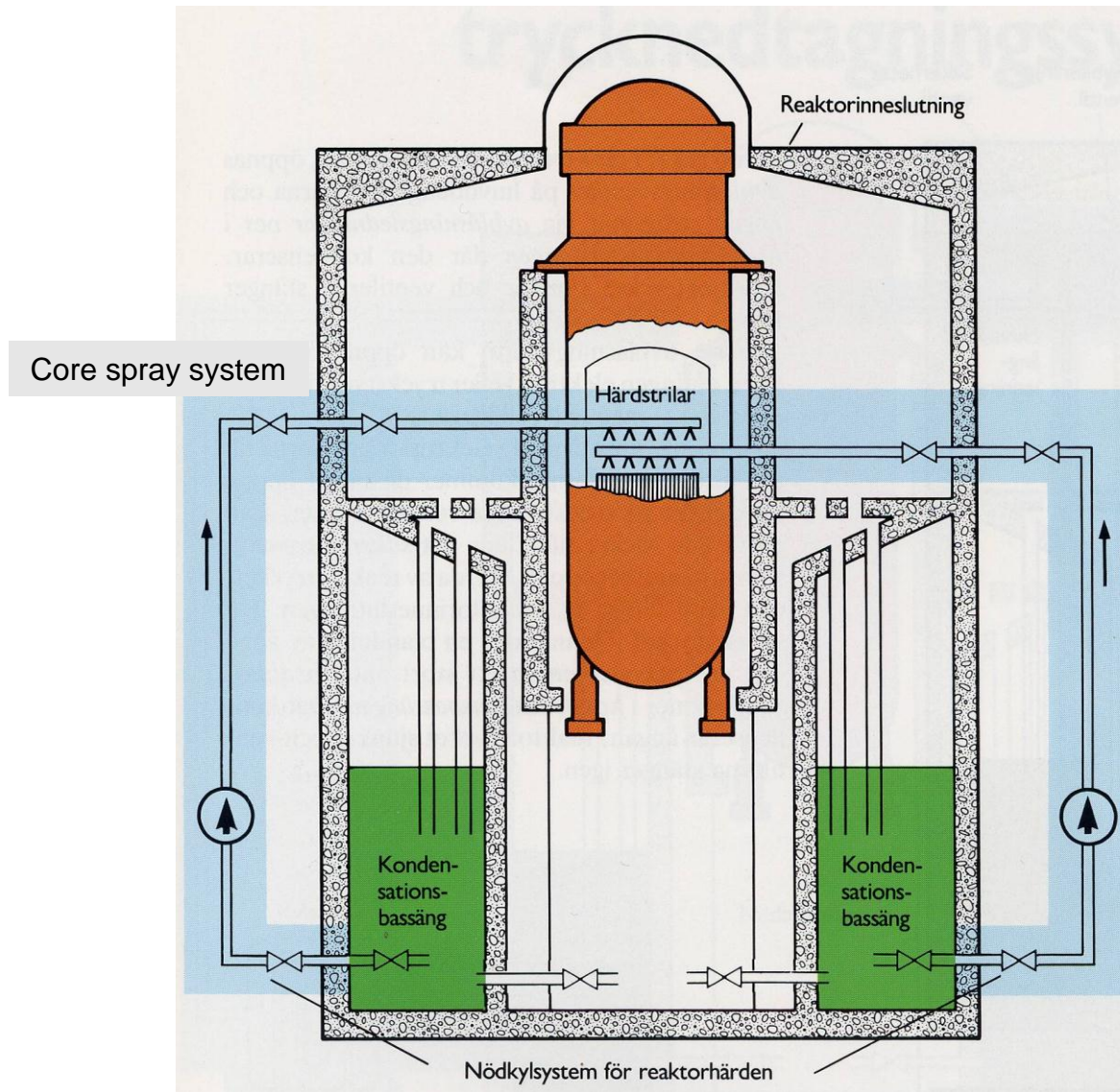

BWR – Containment emergency cooling system

Containment spray system

