



The Cool 100 Book

Haselip, James Arthur; Pointing, David Scott

Publication date:
2011

Document Version
Publisher's PDF, also known as Version of record

[Link back to DTU Orbit](#)

Citation (APA):

Haselip, J. A., & Pointing, D. S. (2011). The Cool 100 Book. Roskilde: Danmarks Tekniske Universitet, Risø Nationallaboratoriet for Bæredygtig Energi.

DTU Library

Technical Information Center of Denmark

General rights

Copyright and moral rights for the publications made accessible in the public portal are retained by the authors and/or other copyright owners and it is a condition of accessing publications that users recognise and abide by the legal requirements associated with these rights.

- Users may download and print one copy of any publication from the public portal for the purpose of private study or research.
- You may not further distribute the material or use it for any profit-making activity or commercial gain
- You may freely distribute the URL identifying the publication in the public portal

If you believe that this document breaches copyright please contact us providing details, and we will remove access to the work immediately and investigate your claim.

THE COOL
100
BOOK

The number '100' is rendered in a large, white, sans-serif font. The interior of the two zeros is filled with a photograph of a rugged coastline. The scene shows dark, jagged rocks in the foreground, with white-capped waves crashing against them. In the background, there are steep, snow-capped mountains under a sky with soft, yellowish light, suggesting a sunrise or sunset. The overall composition is centered on a solid black background.

THE COOL
100 BOOK

The Cool 100 Book

Edited by James Haselip and David Pointing

UNEP Risø Centre on Energy, Climate and Sustainable Development
Risø DTU National Laboratory for Sustainable Energy
P.O. Box 49,
4000, Roskilde
Denmark
Phone +45 4677 5129
Fax +45 4632 1999
www.uneprisoe.org

Publication information

ISBN 978-87-550-3880-6 (printed book)

ISBN 978-87-550-3881-3 (internet PDF)



Graphic design and production by Phoenix Design Aid A/S, CSR certified according to DS 49001, ISO 9001/ ISO 14001 certified and approved CO₂ neutral company. This publication is printed on FSC certified paper using vegetable-based inks and approved under the Nordic environmental label. The printed matter is CO₂ neutral and recyclable.

Disclaimer

The findings, opinions, interpretations and conclusions expressed in this book are entirely those of the authors and should not be attributed in any manner to the UNEP Risø Centre, the United Nations Environment Programme, the Technical University of Denmark, nor to the respective organisations of each individual author.

CONTENTS

Foreword	5
Executive Summary	6
Introduction	7
Promoting Unst Renewable Energy (PURE) Project	10
EDISON – Study on optimal grid integration of electric vehicles	16
Remote metering in Sarfannguaq	26
The Renewable Energy Croft and Hydrogen Facility	33
Samsø – A 100% Renewable Energy Island	38
The Hydrogen Office Project	45
The Northern Sustainable House	51
Runde Environmental Centre (REC)	60
Web-based calculators for vehicle costs and emissions	66
The H2SEED Project	72
The Chaninik Wind Group	78
Technology demonstration projects	86
Community based sustainable energy initiatives	106
Education and Outreach focused activities	116
Regional and national initiatives and networks	126
Specific information resources and tools	132
Notes	136



FOREWORD

There are many challenges surrounding the supply of energy to isolated communities in cold regions. There is a big need for heat and light and energy supplies are often based on traditional energy sources. In many cases there is no electricity network that connects the smaller communities. This results in high energy costs and often fragile and unstable supply. The long-term increase in energy prices, the desire for a greener image and climate changes are all factors that push energy production, energy supply and energy savings into a more sustainable direction, economically and environmentally.

The Cool 100 book is a well thought out initiative that illustrates how the task of switching to sustainable energy has been approached in a number of countries with isolated communities and/or cold climates. The book takes a practical approach to describing the various initiatives, including the energy needs and technical solutions arrived at, community organization and the educational challenges associated with the introduction of new energy supply solutions.

One of the strengths of the book is that it is the result of a broad geographical cooperation, drawing on experiences from around the world. As such, the reader is able to appreciate the diversity of economic and cultural contexts in which various technical sustainable energy solutions are possible. The Cool 100 book is both a book and an on-going “wiki-styled-knowledge hub” with an open opportunity for anyone interested to supplement the book with new case studies and experiences. In that way The Cool 100 book is able to influence the discussion and exchange of ideas and experiences in a more dynamic and ‘live’ manner, compared to a traditional publication.

Enjoy reading!

Professor Arne Villumsen

Head of the Arctic Technology Centre, Danish Technical University (DTU)
www.arktiskcenter.gl

EXECUTIVE SUMMARY

The aim of The Cool 100 book is to document 100 inspiring, educational and practical examples of sustainable and accessible energy supply solutions created by, or suitable for, isolated communities in the cooler regions of the world. The book features the following projects, explored in detail:

- 1.** Promoting Unst Renewable Energy (PURE) project, a pioneering project that demonstrates how wind power and hydrogen technologies can be combined to meet the energy needs of a remote industrial estate on the island of Unst in the British Isles
- 2.** The EDISON project, or Electric vehicles in a Distributed and Integrated market using Sustainable energy and Open Networks that explored increased renewable energy use and electric vehicle operation in Denmark, with a case study on the island of Bornholm
- 3.** The Sarfannqvit Wireless Electricity Reading project, which has significantly improved utility metering and enabled improved energy management, reduced electricity demand, and the introduction of renewable energy technologies in the isolated villages of Greenland
- 4.** The Renewable Energy Croft and Hydrogen facility, which uses innovative technologies to support a gardening facility in the Outer Hebrides (Scotland), and is also a working laboratory for students of the local university to develop a hydrogen energy economy
- 5.** The Samsø Renewable Energy Island

in Denmark, an iconic example of how an island community can consume only green electricity by using a range of innovative technologies and behavioural changes to reduce demand and to harness green energy resources

- 6.** The Hydrogen Office Project which demonstrates how a commercial office in the coastal town of Methil in Scotland can be supported by a novel renewable, hydrogen and fuel cell energy system, and how the local community is engaged with the project
- 7.** The Northern Sustainable House in Nunavut, Canada, which explores the process and results of a project to design and implement housing for local families that substantially reduced energy use and costs and supported the lifestyles and needs of communities
- 8.** The Runde Environmental Centre on Norway's western coast, which supports research into impacts on the marine environment and the development of innovative and sustainable technologies for fisheries and aquaculture, marine transport and renewable ocean energy
- 9.** A suite of online calculators, developed by the Energy Agency Iceland, that assist consumers in selecting cars for purchase or hire, planning trips, and neutralising associated carbon emissions, based on the fuel consumption data of almost all modern cars
- 10.** The H2SEED project, which reduces fossil fuel use in the Western Isles of Scotland, an area where the electricity grid can't support

more renewable energy, by producing hydrogen for energy storage and as a transport fuel, from renewable energy sources

- 11.** The Chaninik Wind Group project, a collaboration between Native communities in remote areas of Alaska that harnesses wind power to reduce energy costs, promotes self-sufficiency and economic development

An additional 89 projects are examined in less detail, though each entry provides relevant links to further information. These projects range from examples of successfully operating sustainable energy systems in isolated communities around the world, to community education and outreach-focused programs, regional and national initiatives and networks, and other specific information resources and tools. The locations of the projects featured in the book range across the northern hemisphere, but also Antarctica, and less cold regions of the planet, but have a particular focus on communities in the northern hemisphere.

In addition to the printed publication, the Cool 100 is also an evolving database of practical and sustainable energy solutions for isolated communities in cooler regions. All projects featured in the book are located on an online, wiki-style portal, which anyone can edit and/or make contributions to (updates on projects, new projects etc).

Visit www.nordsesil.wikispaces.com and make your contribution today!

INTRODUCTION

Communities in the isolated and cold climate regions of the world are increasingly motivated to reduce their dependence on fossil fuels for their heating, electricity, transport and industry needs. These motivations range from the increasing cost of fossil fuels, to the increasing cost for and vulnerability of transporting these fuels to remote locations, or the local and global pollution (noise, contamination, carbon emissions etc.) that results from their use.

Whilst these issues are common to communities around the world, they are particularly significant for communities in isolated and cold climates due to the demand for energy for heating and unavoidable need to transport small volumes of goods, fuels, people and equipment to isolated locations. The global imperative to reduce carbon emissions from fossil fuel use also applies to isolated communities in cold climate regions, but such communities are also currently motivated to reduce their dependence on fossil fuels because they are already dealing with the impacts of climate change (and interconnections between these impacts and the cost and security of supply of their fossil fuel consumption).

The Village of Shishmaref in Alaska, for example, is noted as one of the most heavily impacted by climate change in the world. The village has been inhabited for 400 years but is facing evacuation due to rising temperatures, which are causing a reduction in sea ice and thawing of permafrost along the coast. The reduced sea ice allows higher storm surges to reach shore and thawing permafrost makes the shoreline more vulnerable to erosion. The town's homes, water system and infrastruc-

ture are being undermined. Even as these impacts consume the limited financial resources of the community's small economy, the cost of the diesel fuel that is used to meet 100% of the town's electricity and heating needs is pushed higher by rising world oil prices. The impact of the storm surges on infrastructure such as the harbour restricts their ability to take deliveries of fuel and can force them to purchase fuel during periods of higher prices to ensure a viable delivery window.

Whilst there are few isolated and cold climate communities that are in the same extreme situation as Shishmaref with regard to severe climate change impacts, less direct changes are already having significant impacts on other isolated cold climate communities. The shift in productive fishing grounds to locations further away from traditional areas (and communities and factories) due to changes in water temperatures, for example, are increasing the fuel demands of fishing fleets operating in the North Atlantic.

Small, isolated, cold climate communities are also motivated by a number of other factors to reduce their dependency on fossil fuels: they have small economies that are often lacking diversity (generally a dependence on one or several key industries such as fishing or tourism) and can be heavily and directly impacted by increases in fuel prices. Their household and community incomes are lower relative to other socio-economic groups in less isolated locations, a relatively higher proportion of household income is spent on fuels, and there is often limited access to skills and information in smaller communities due to a lack of education, research and training facilities. Small and

isolated communities also often exhibit a loss of youth to more compelling opportunities in larger communities (including youth leaving for better education opportunities and not returning as few skilled jobs are available).

Fortunately for such communities there are opportunities to access technological and behaviour solutions that can increase the efficiency with which energy is used (whether produced from fossil fuels or otherwise), that can enable improved management of energy demand (thereby reducing demand), or which can harness local sources of renewable and sustainable energy for power, heating and transport solutions.

In the case of Shishmaref, the town is in the process of physically relocating and aims to reduce its dependence on fossil fuels during and after the move through energy efficiency improvements and the introduction of alternative energy technologies such as wind. Analysis has shown, however, that for communities in many isolated parts of the world, including those in the Nordic region, many barriers do exist that prevent the communities from understanding the options available to them and from identifying and accessing appropriate and sustainable solutions.

These barriers include technical, social and economic issues but have a common foundation of a lack of effective energy-specific communication and knowledge-sharing between the communities and stakeholders with interests in delivering sustainable energy solutions. Some technology related issues do continue to influence the viability of renewable energy technologies – and issues such as the storage of intermittent renewable energy resources are paramount – but

the social barriers to accessing these energy alternatives are significant. Most efforts to improve the uptake of sustainable energy solutions focus on the development of 'better' technologies, or addressing problem areas.

There are positive examples of isolated and cold climate communities that have managed to overcome these barriers to information access, and have developed world-leading projects that have reduced dependence on fossil fuels and created other positive benefits for the communities. Anecdotal evidence of some of the indirect benefits that have resulted from the harnessing of local and sustainable energy resources are the development of local skills that are then exported, the retention and attraction back of youth who see interesting things happening in the community and the opportunity for new, green jobs, and even in-bound "green energy tourism" to see the systems that have been developed.

Two such examples, the PURE Energy Centre in the Shetland Islands, and the Danish "green energy island" of Samsø, are featured in this book, and in fact served as inspirations for the creation of the book. There are now (in 2011) many other examples of communities and organisations taking positive steps to identify and develop appropriate and sustainable energy solutions. Many are not as progressive or as bold, or do not even focus on the installation of new technologies but on reducing energy use or building relevant skills. Some are in environments far more extreme than the Shetlands or southern Denmark. Each of these examples, however, could be a valuable component in assisting other communities to understand their options and what is involved in making positive progress towards reduced dependence on fossil fuels (both the challenges and the benefits).

Despite the existence of such examples,

however, finding information has been a challenge, even for professional researchers with expertise in isolated and cold climate energy systems, and information on the "how, why and what happened" is even harder to find. Whilst the internet is a wonderful resource, the over-abundance of information presents an additional challenge and finding useful information on even a single sustainable energy project from an isolated and cold climate community can be time consuming. Sadly, too few projects see value in documenting and sharing their experiences with the world!

This book was conceived as one mechanism to contribute to overcoming this challenge through expert identification, selection and documentation of projects that fit under a common banner of being relevant to isolated communities. The formal aim of The Cool 100 Book was "to document 100 inspiring, educational and practical examples of sustainable and accessible energy supply solutions created by, or suitable for, isolated communities in the cooler regions of the world".

As the internet is a wonderful resource for documenting information, and for interacting and communicating around information, the Cool 100 Book is also an online, wiki-style database of practical and sustainable energy solutions for isolated communities in cooler regions. All projects featured in the book, and others, are located online and anyone can edit and/or make contributions to the information on a project or the site as a whole. People involved in the projects, or the host communities, featured in this book are encouraged to add their perspectives on the projects, to provide updates on ongoing performance or expansions (or failures) or anything else they believe is relevant. Developers of new projects, or students and researchers

who are investigating projects featured on the site (or otherwise) are also encouraged to share their work. The editors and contributors of the Cool 100 book hope that it will continue as an evolving reference point for sustainable energy solutions for isolated and cold climate communities around the world.

The approach taken in developing the book was to review 100 projects, in the format of "featured" projects explored in detail and other projects reviewed in less detail (each profile includes relevant links to other resources). These characteristics were based on the constraints of the resources available to collect and edit detailed projects and the size and cost of a printed publication, balanced by the desire to identify a sizable group of projects.

The featured projects have been contributed by, or have directly captured information from, people involved in each project using a common set of questions and guidelines. These projects range from community-based energy systems (such as PURE and Samsø) that target whole island communities, industrial estates, greenhouse facilities or office buildings, to efforts to increase the use of renewable energy by developing alternative transport fuels or to measure and manage electricity use more effectively. Also online tools to better understand how a choice of car impacts economic costs and carbon emissions, and efforts to build sustainable and culturally appropriate housing in Arctic communities, or to develop innovative and sustainable technologies for maritime-based industries and communities. These featured projects are based in Canada, Denmark, Iceland, Greenland, Norway, Scotland and the US.

The shorter project summaries range from examples of successfully operating sustainable energy systems in isolated communities

around the world, to community education and outreach-focused programs, regional and national initiatives and networks, and other specific information resources and tools. The locations of the projects featured in the book range across the Arctic, down to Antarctica, and also to communities in less cold regions, but have a focus on isolated and cold climate communities in the northern hemisphere. Most of these projects were identified by David Pointing (PhD), an engineer and researcher who has over a decade of experience investigating sustainable energy solutions for isolated and cold climate communities, and documented by David and colleagues at the UNEP Risø Centre for Energy, Climate and Sustainable Development in Denmark (the URC).

It must be noted that the Cool 100 book project was derived from the NordSESIL project (the Nordic Network for Sustainable Energy Systems in Isolated Communities). NordSESIL was a research and networking project that was funded by the Nordic Energy Research organisation in collaboration with the UNEP Risø Centre and a consortium of industry and community partners from 2007

to 2010. The goal of the NordSESIL project was to improve the capacity of communities in isolated areas of the Nordic region to access sustainable energy solutions by creating and stimulating a network of relevant and motivated stakeholders. The network aimed to provide a framework for communication and knowledge sharing and to become a forum for motivated participants who wanted to find relevant partners and the knowledge and skills required to “get sustainable energy projects happening” in isolated areas of the Nordic region.

The creation of an online wiki-styled “Knowledge Hub” for the documentation of relevant projects and activities was a key element of the project, and was developed in a manner that would ensure the information would remain available and open for on-going contributions upon the completion of the formal project. The Cool 100 book is located on this hub as a PDF document, and the individual projects are each featured on their own project pages. See the “knowledge hub”, and the Cool 100 book, at www.nordsesil.wikispaces.com.

Please feel free to visit the site and add an additional project or updated information on a current project (including links to other projects). The NordSESIL project and the Cool 100 book were created in response to an identified need for communities in isolated communities to gain access to relevant information. Through the creation of the book and the associated “Knowledge Hub” wiki, a solid foundation of information has been consolidated into a central location, but the true value of this resource and the investment of funding and energy involved in making it happen will only be realised if the site is used and the resource grows so that communities can truly gain useful knowledge from one another.

Consider making a contribution of your own in the spirit of the United Nation’s 2012 “International Year for Sustainable Energy for All.”

David Pointing
November 2011

ACKNOWLEDGEMENTS

The editors would like to thank Nordic Energy Research and the UNEP Risø Centre (URC) for their financial support for the Cool 100 book and associated NordSESIL.net project. Also to the partners of the NordSESIL.net project who assisted in building the networks needed to make contributors aware of the project, and in identifying the need for this book. The editors are particularly grateful to

the contributors of the featured projects for volunteering their time and knowledge, particularly Daniel Aklil and Elizabeth Johnson at the PURE Energy Centre for their efforts in engaging contributors and in writing content. Finally, the editors would like to thank their colleagues at URC, particularly Andreas Flensburg, Maija Bertule (especially for her heroic efforts in sourcing most of the photos

included in the book), Susanne Haunstrup Kirkegaard, Tine Bech Flanagan, Mette Annelie Rasmussen, and Gordon Mackenzie, for their support and for contributions to the development of the book project and the material included in the book and NordSESIL website.

PROMOTING UNST RENEWABLE ENERGY (PURE) PROJECT:

“FROM WIND TO GREEN FUEL”

PROJECT TIME SPAN:

Ongoing since 2001

PROJECT BUDGET:

£400k

OVERVIEW OF FUNDING SOURCES:

Highlands and Islands Enterprise,
European Regional Development Fund,
Shetland Islands Council, Shetland
Development Trust, Unst Partnership

GENERAL PROJECT INFORMATION

KEYWORDS:

Education, skill development, technology transfer, renewable energy,
hydrogen, fuel cells, green transport, energy storage

GEOGRAPHIC AREA:

Shetland, United Kingdom

SPECIFIC LOCATION:

Unst, Shetland Islands

LEAD ORGANISATION/ENTITY:

Unst Partnership

PROJECT WEBSITE:

www.pure.shetland.co.uk



▲ Operational PURE Energy system on Unst, Shetland

The Promoting Unst Renewable Energy or ‘PURE’ project as it is most commonly known, is the first community owned renewable hydrogen energy project of its kind in the world, and represents an important milestone in the development of green energy systems at a community level. The PURE project started in 2001, located on the windswept island of Unst, the most northerly island in the British Isles.

The main aim of the project is to introduce sustainable renewable energy to Unst, in order to enhance its “Green Island” image and help it work towards energy sustainability. As a first step towards the island’s sustainability, a local industrial estate was selected to become a green estate. The estate’s offices were identified as suitable for green

energy due to their location near an empty field, where green technologies could be installed.

The high quality wind resources of the Shetlands, viewed as some of the best wind resources in Europe, offer the potential to generate renewable electricity for the industrial estate. However, the intermittent and unpredictable nature of the wind resource means that it requires a significant amount of load management and storage in order to provide a dependable supply. Moreover, the limitations of the isolated Shetland electricity grid (Shetland is not connected to the United Kingdom electricity network), mean that the distribution cannot accommodate any more supply from renewable sources.

The risk of grid instability if more renewables are incorporated onto the Shetland grid means that for the foreseeable future, any renewable energy project must either be developed as an off-grid supply or must incorporate a substantial amount of storage to provide stable and predictable supply. In principle, hydrogen can provide such an energy storage medium for the surplus energy produced by the wind turbines. The hydrogen can then be used as and when required, either for conversion back to electricity via a fuel cell, or directly as fuel in much the same way as Liquid Petroleum Gas (LPG) or natural gas.

The motivation for this project, therefore, was the lack of electrical grid connection, hence the need for an innovative solution for integrating green technologies on the island. The combination of cutting edge renewable and hydrogen technology provided an accelerated learning environment for those involved in the project. The project aims can be summarised as follows:

- To provide a renewable energy solution to the local industrial estate

- To provide a demonstration model for renewable energy packages that can be applied in a number of situations
- To provide an off-grid solution for other communities
- To use the latest hydrogen technologies
- To enhance marketability of products and services powered from renewable energy
- To promote the image of Unst as a “Green Island”
- To provide a focus for accumulating knowledge of renewable energy within the Shetland Islands
- To “Kick-Start” a Renewable Energy based industry in Unst
- To provide learning opportunities for students
- To provide access to training and knowledge transfer

While there are other electricity storage media (e.g. lead acid batteries) that could be used to iron out electricity supply, hydrogen was (and still is) attracting massive amounts of public and private investment at the start of the project. The formal commitment by the US, Canada, the EU, Iceland, Japan and Australia to develop hydrogen economies is already generating jobs, creating new businesses



▲ The Shetland Islands are the most northerly point of the British Isles

PROJECT GOAL

To introduce sustainable renewable energy to Unst, in order to enhance its “Green Island” image and help it work towards energy sustainability, by developing a complete off-grid renewable energy solution that can deliver a reliable source of electrical and heating energy for an industrial estate.

PROJECT SUMMARY

The PURE project is a pioneering project on the windswept island of Unst, the most northerly island in the British Isles. The project demonstrates how wind power and hydrogen technology can be combined to provide the energy needs for a remote rural industrial estate, at a relatively low cost. It was developed by a community development agency established by the Unst Community Council to support local economic development and regeneration. The Unst Partnership saw the project as helping to address some of the principal needs of the community. In laying the foundations in Unst of an embryonic hydrogen economy, the PURE Project has created jobs, new business opportunities, and attracted new technical skills to the island.



▲ Two wind turbines provide the primary power source for PURE

and supporting economic development in the areas prepared to embrace hydrogen technology by supporting demonstration projects. During the time the PURE Project has been in existence it has created over 10 full time equivalent jobs on Unst, attracted around £400,000 of inward investment, transferred new high level technical skills to local graduates, and established a new business sector.

Being the most northerly island in the UK, Unst is effectively at the end of the supply chain for all externally produced commodities – specifi-

THE PROJECT

The PURE project shows how wind power and hydrogen technology can be combined to provide the energy needs for five small businesses. This is the first community-owned renewable energy project of its kind in the world. It represents an important milestone in the development of green energy systems as well as hydrogen technologies. The PURE Hydrogen system has been installed in a container called the 'HyPod':

Significant differences between the PURE project

cally it has among the highest fuel costs in the country. A recent survey by the Shetland Islands Council Social Services indicated that the average household income of Unst, at £16,860, is the lowest in Shetland. Moreover an energy balance study, conducted in Shetland's north isles, identified the fact that an average Unst household spends over 15% of household income on fuel (fuel poverty is defined as anything over 10% of household income spent on fuel).

A high demand for fuel on the Shetland Islands is compounded by the costs of heating during the severe winter weather, where wind chill penetrates even the best-insulated buildings. Hence the local and regional interest in the PURE Project which aims to produce on Unst an alternative to fossil fuel (namely hydrogen). Hydrogen is produced by electrolysing water powered by plentiful supplies of wind power. The successful implementation of this project has demonstrated that a viable alternative to fossil fuel, which produces zero carbon emissions, can be produced locally from a renewable energy source – even in such a remote rural community.

and other hydrogen energy systems deployed around the world are the scale and the low budget within which the PURE system has been developed. The PURE project has been developed with a comparatively small project budget of less than £500,000. This budget included all the engineering and consultancy works surrounding the project, as well as the hardware.

At present wind turbine technology offers the most cost effective method for generating green

electrical energy. This technology was therefore selected to be deployed as the primary power source within the PURE project system, although it was designed so that any type of renewable resource can be connected to it, for example wave, tidal, solar and hydro power.

The PURE project consists of two 15kW wind turbines. It has a 3.55Nm³ per hour high-pressure hydrogen electrolyser, high-pressure hydrogen storage system and a hydrogen dispensing facility. This facility is used to fill cylinders in a fuel cell/battery hybrid vehicle and other hydrogen applications.

A back-up power supply has been installed and is based on a 5kW fuel cell and an inverter to supply the offices with electrical power, when there is no wind. The hydrogen used by the fuel cell is produced from the electrolyser. The inverter was installed to convert the output power of the fuel cell from Direct Current (DC) into mains equivalent Alternating Current (AC).

A wind-to-heat system was designed and implemented to heat the five business properties. It has been found that the best use of the wind power is to directly connect the wind power to the heating system warming up the buildings with green energy. The rationale behind this is the direct correlation between high wind speeds and the need for space heating. As such, most of the electrical power generated by the wind turbine is directed to heat up the buildings, providing a stable energy supply when most needed.

Storage heater units have been installed in the buildings to store excess energy in the form of heat. Two types of storage heaters have been installed: wet and dry. In the wet system, standard



▲ Pure Project official opening day, 2005

radiators are used to heat up a building. In the dry system, bricks are used to heat up the buildings. Comparison between the two systems has shown that the wet heater provides lasting heating energy (4 days) while the dry system only provides a heat storage option of 12 hours. Though the wet system is better in heat storage terms, it is bulky, heavier and more expensive than the dry system.

A novel and intelligent electronic management system was specifically developed to maximize the efficiency of the PURE system, including a remote monitoring system.

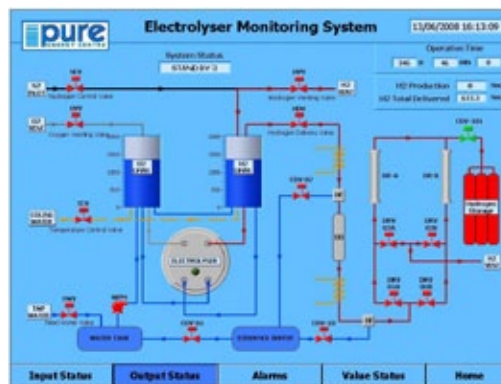

◀ Schematic of the PURE energy remote monitoring system



▲ The PURE hydrogen car with the then Scottish Transport Minister Tavish Scott MSP and then Rural Affairs Minister Ross Finnie MSP, outside the Cabinet Office at Bute House in the Centre of Edinburgh

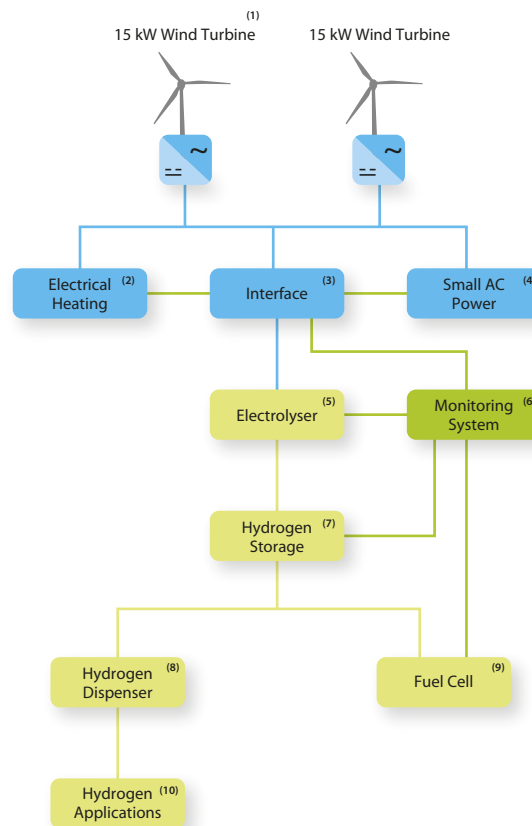

- 1 Two wind turbines
- 2 Electrical space heating system
- 3 Electronic System Control
- 4 AC Power conversion system
- 5 High pressure electrolysis
- 6 Data logging and monitoring
- 7 pressurized hydrogen storage
- 8 refueling point for hydrogen car
- 9 PEM Fuel Cell
- 10 Hydrogen car, cooking, and on-demand power applications

Overview of PURE Project system

A battery based electric vehicle was converted to run with a hydrogen fuel cell. This electric/fuel cell hybrid car is fully fuelled by the PURE system, using hydrogen produced from the renewable source and the battery charged from wind power. This makes the electric car one of the few 100% carbon free vehicles on British roads and the first fuel cell vehicle fully licensed to operate on UK roads.

In summary, the PURE Project contains the following elements:

- Cavity wall insulation and other energy saving measures designed to improve energy efficiency at Haggdale industrial Estate by 30%
- Direct supply of wind power for all heating of industrial units
- A high pressure electrolysis system for the production of pure hydrogen gas
- A pure hydrogen storage and a hydrogen dispensing facility to fill hydride bottles for use in fuel cell vehicles and other hydrogen applications as an alternative to fossil fuels
- Back-up supply of electricity to the industrial estate through 5 kW PEM fuel cell
- Intelligent electronic management system

to ensure optimised efficiency of interfaces between all elements of the hybrid system, (including hydrogen fuel cells)

- Detailed monitoring and analysis of performance of the system to maximise learning opportunities and further development
- An electric / hydrogen fuel cell hybrid car fuelled exclusively by the PURE system

While the direct impact of the PURE Project on reduction of carbon emissions is relatively small (c. 110 tonnes of CO₂ per year), its real value is that it aims to provide a replicable model of:

- A community-embedded energy scheme producing zero carbon emissions
- A small-scale community-run hydrogen production facility offering the opportunity to demonstrate and develop applications which use this locally produced fuel in a remote rural location which has zero carbon emissions
- An off-grid facility for storing energy from an intermittent renewable source and re-using it in the form of electricity as and when required.

- An employment generating project which provides local residents with opportunities to gain new skills in the emerging hydrogen economy
- A project which can demonstrate to the community the potential of renewable-based hydrogen energy in Shetland
- An embryonic hydrogen study centre that can attract investment to develop skills, jobs and businesses required to support a hydrogen economy

The PURE project has generated considerable interest from other island communities in Shetland, Orkney, the Western Isles and Argyll, as well as rural communities in the UK and overseas. Although it may take some time for the capital costs of the plant to become cheap enough to attract a broad customer base, the scale of fossil fuel price increases over recent years and predictions of future supply shortages may make wind-hydrogen energy systems commercially viable, especially in remote locations, much sooner than expected.

▼ International team of graduates receive hands-on training with the PURE System



CONTACT INFORMATION:

Pure Energy Centre
Hagdale, Baltasound
Unst, Shetland
ZE 2 9TW
United Kingdom
Telephone: +44 (0) 1957 711 410
Fax: +44 (0) 1957 711 838
Web: www.pureenergycentre.com
Email: info@pureenergycentre.com

CONTRIBUTORS

Elizabeth Johnson, Business Development Manager, PURE Energy Centre

Daniel Akilil, Managing Director, PURE Energy Centre

The Pure Energy Centre Ltd has a team of professionals that combine a range of skills and expertise in hydrogen technologies, health and safety issues and global experience in Renewable Energy Systems. The combination of professional skills enable the Pure Energy Centre team to provide a combination of products and training. Since the Pure Energy Centre was established in May 2005 it has been involved in off-grid energy projects and renewable hydrogen developments in 4 continents, has delivered specialist training in hydrogen and fuel cell technologies to over 100 students, and has hosted visits, conducted workshops and delivered presentations to businesses, politicians of all parties, investors, engineers, school students, academic researchers, and public agencies.

EDISON

– STUDY ON OPTIMAL GRID INTEGRATION OF ELECTRIC VEHICLES

PROJECT TIME SPAN:

March 2009 to January 2012

PROJECT BUDGET:

Approximately 49 million DKK,
equivalent to 6,5M Euro

OVERVIEW OF FUNDING SOURCES:

Partly publicly funded through the Danish transmission system operator (TSO) and Energinet.dk's research programme FORSKEL

REFERENCES AND RELATED

RESOURCES:

Disseminated reports and publications can be found on website

GENERAL PROJECT INFORMATION

KEYWORDS:

Electric vehicles, power system, renewable energy, wind power, smart grids, ICT infrastructure, dynamic prices, regulation services, batteries, open standards

GEOGRAPHIC AREA:

Denmark

SPECIFIC LOCATION:

Bornholm island

LEAD ORGANISATION/ENTITY:

Danish Energy Association

PARTNER ORGANISATIONS/ENTITIES:

Technical University of Denmark, IBM, Siemens, Eurisco, Østkraft and Dong Energy

PROJECT WEBSITE:

www.edison-net.dk

The Danish EDISON project has been launched to investigate how a large fleet of electric vehicles (EVs) can be integrated in a way that supports the electric grid while benefitting both individual car owners, and society as a whole through reductions in CO₂ emissions. The consortium partners include energy companies, technology suppliers and

research laboratories and institutes. The aim is to perform a thorough investigation of the challenges and opportunities of EVs and then to deliver a technical platform that can be demonstrated on the Danish island of Bornholm. To reach this goal, a vast amount of research is done in various areas of EV technology by the project partners.

THE DANISH ISLAND OF BORNHOLM AS REAL-LIFE TEST-BED

The EDISON project is part of a vision of making Bornholm a real life test bed for sustainable power system technology. The power system on Bornholm is ideal for the following reasons:

- Bornholm is an island, and the system only has one high-voltage interconnection to the Nordic power system via Sweden. This cable gets occasionally damaged, e.g. by ship anchors

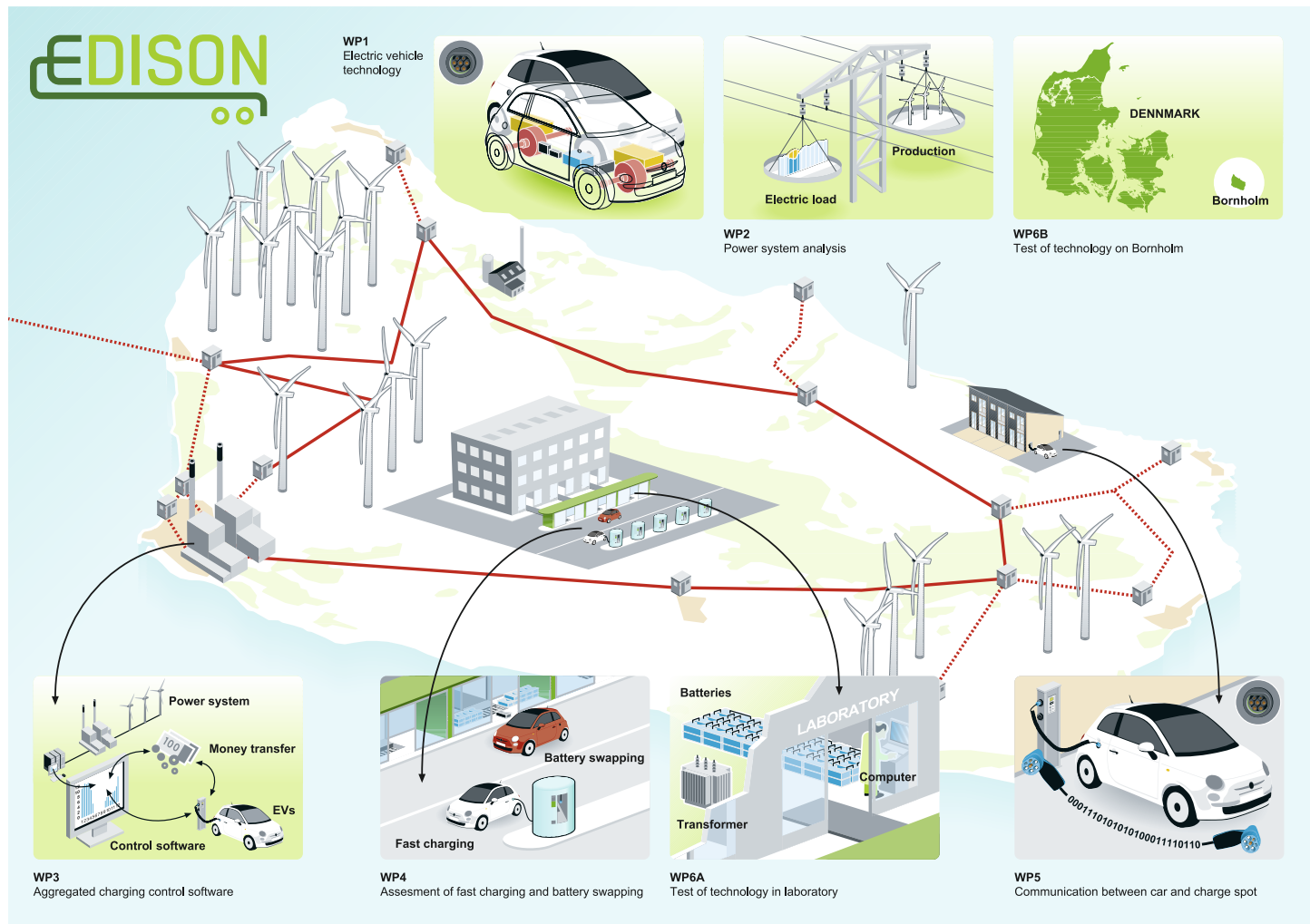

- Hence the system must be able to operate in a stable way on “islanding” mode
- The average available energy produced with wind turbines amounts to approximately 30% of the total electric energy consumed, compared to all of Denmark which has approximately 20%
- The large amount of wind turbines on Bornholm means that the production of electricity

sometimes exceeds the island’s consumption. This often implies, especially when operating on “islanding” mode, the curtailment of wind power production in order to maintain a stable balance between production and consumption

- According to consortium partner Østkraft which operates the grid of Bornholm, experiments in “island” mode confirm that the traditional grid

PROJECT GOAL

The EDISON project aims to develop solutions and technologies for electric vehicles (EVs) which enable a sustainable, economic and reliable energy system using substantial but fluctuating renewable energy sources; the preparation of a technical platform for Danish demonstrations of EVs with emphasis on power system integration aspects; participation in global standardisation utilising Danish leading knowledge, and releasing the potential for export of technology, system solutions, and knowledge.

PROJECT SUMMARY

EDISON (Electric vehicles in a Distributed and Integrated market using Sustainable energy and Open Networks) is a Danish R&D project with international participation, applying technology to operate within a national energy system, while addressing the challenge of how to maintain security of supply in an electric grid that incorporates a high percentage of green, but fluctuating wind energy and also has a significant number of mobile EVs which present both a challenge and a huge storage/regulation potential. The work packages of the EDISON project focus on developing technology towards a final field test on Bornholm island in 2011.

stability becomes exposed when wind energy exceeds 15% of generation due to large output volatilities that can stress the frequency and voltage stability of supply

The goal of the EDISON project is to develop Smart Grid technologies that enables the batter-

ies of grid-connected electric vehicles to play an active role in the balancing of power production and consumption, as well as in the near real-time regulation services and vehicle-to-grid scenarios required, especially in islanding mode. The following sections give an introduction to some of the key aspects of the EDISON solution.

CAN EVS COVER THE TRANSPORTATION NEEDS OF DANISH FAMILIES?

A fundamental prerequisite for using the batteries of EVs to balance the network is that people are willing to buy fully electric vehicles. To a large extent, this depends on the EVs' ability to fulfil the transport needs of the costumers. To be able to evaluate the possibilities, data regarding the use of conventional cars has been analysed as there are not enough EVs in operation and hence not enough data to directly analyse the use of EVs.

The problem of using data from conventional car use is partly that people may very well change their transportation pattern when they get used to using an electric car, and partly that it will not be a random selection of the population that will buy an electric car, but rather those people with a transportation pattern that is suitable for using EVs. This means that an analysis based on conventional car use is likely to underestimate the potential and realistic use and up-take of EVs.

HOW OFTEN DO EVs NEED INTRADAY CHARGING?

In the first years until the charging infrastructure is established outside the user's own home, it will be important for potential owners of EVs to consider whether they can avoid charging during the day. As the charging infrastructure becomes available at workplaces, in city centres etc., the need to charge the car away from home will only, on rare occasions, be considered a barrier to their use. Based on existing data, the first line of the table below indicates the share of cars on Bornholm not being used on any given day. The line below shows the share of cars that require intraday charging, depending on their operational range:

variation in more details, a GPS data set for the Copenhagen region is analysed. This shows that over a two week period 90 percent of families with one car and two drivers will need intraday charging one or more days if the car only has a driving range of 120 km. With a range of 160 km 70 percent need intraday charging. Cars with a driving range of only 80 km will need to be charged outside home several days a week. These results cannot be compared directly with the above-mentioned average numbers for the entire population because they only comprise the working age population. But they indicate that the market for

Number of cars and number of people with driving license in household	1 car · 1 driver	1 car · 2 drivers	2 cars · 2 drivers
Share of cars not in use	38% [45%]	12% [21%]	27% [25%]
Share of cars that need to charge outside home, as function of battery range:			
80 km	22% [20%]	30% [81%]	33% [18%]
120 km	10% [4%]	15% [4%]	16% [0%]
160 km	5% [0%]	8% [1%]	9% [0%]

With an assumed range of 120 km only 15 percent of cars need to charge intraday if two drivers share the vehicle. If cars have a large 160 km range – as often promised by the vehicle manufacturers – less than 10 percent require intraday charging. For families on Bornholm less than 20 percent will need to charge intraday, even if the range is just 80 km. With a longer driving range very few users will need to charge intraday on Bornholm.

However, based on these numbers, it is not possible to assess how much intraday charging is needed over a longer period. To assess this

EVs will be very small if no charging infrastructure is established within cities like Copenhagen.



◀ Charging station

THE OCCASIONAL NEED FOR FAST CHARGING

Sometimes families need to drive further in one trip than the range of an electric vehicle will allow. As such, they will need some kind of fast charging where they can recharge their car in an acceptable time, which could be from 5 to perhaps 20-30 minutes. According to the analyses of the GPS data, less than half of the drivers that can avoid fast charging during a month if their cars have a driving range of 80 km. If the driving range is 120 km, a little more than 60 percent can do without fast charging. And even when assuming a large battery range of 200 km, 20 percent would still need fast

charging over a two week period. And several need to charge more than once during the day.

The conclusion is therefore that a charging infrastructure with both fast charging and swapping stations and charging poles at working places and in city and shopping centres is necessary to get EVs on the market. But on Bornholm the need is much smaller because of shorter daily distances and fast charging is only needed nearby, or on, the ferry.

THE VISION OF EVs READY TO PROVIDE GRID SERVICES

Most cars are used for less than an hour a day and 21 percent are not used at all; average driving distance in Denmark is about 48 km. And if only the driving times are considered as unavailability periods, then EVs are, for over 90 percent

of the time, ready to support the grid with smart charging implying time-shifted consumption and potentially reversed power flow also known as V2G grid services.

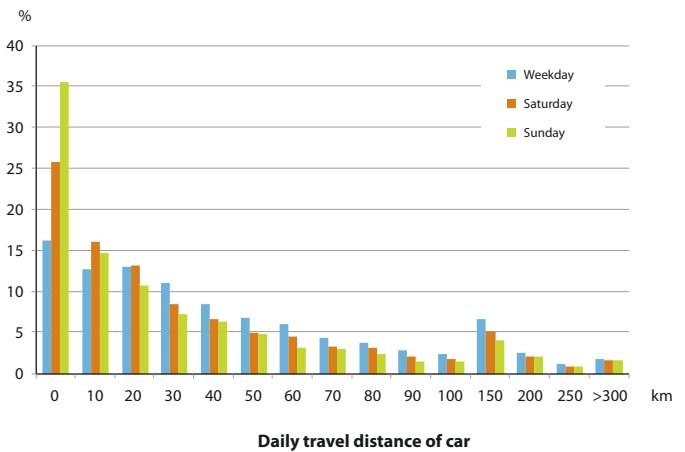
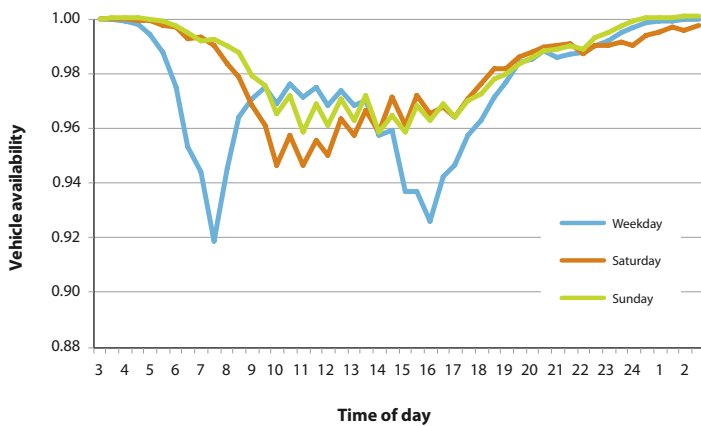

GRID-OPTIMISED SMART-CHARGING WITH MUTUAL BENEFIT

With constant end-user prices, charging is likely to be executed immediately and day-time peaks would increase as the number of EVs grows. This might require dramatic grid enforcements. Dynamic end-user energy prices should vary according to the overall power market situation comprising the forecast of availability of wind power, hence providing a better market economy. On the other hand the charging must also be controlled according to local grid conditions. In the EDISON Virtual Power Plant (VPP) a two-way information exchange enables optimal planning of EV charging with respect to grid resources and

market costs including the cost of the environmental impact.

This makes it necessary to build a potentially distributed management system to control the charging of cars in accordance with the power markets and the availability of wind energy while enabling optimal use of the electricity grid. The EDISON partners have developed simulation and prediction technologies for both offline planning and operational real-time control.

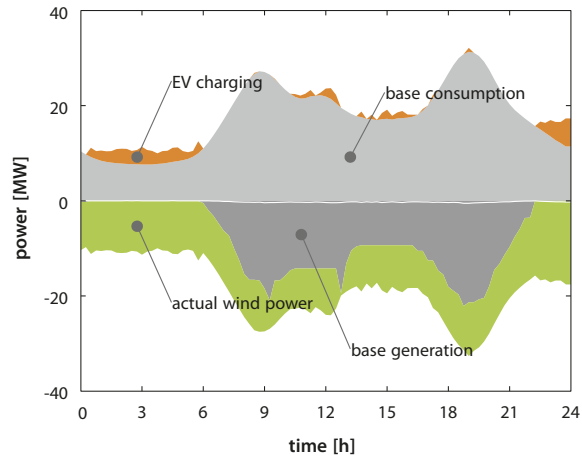
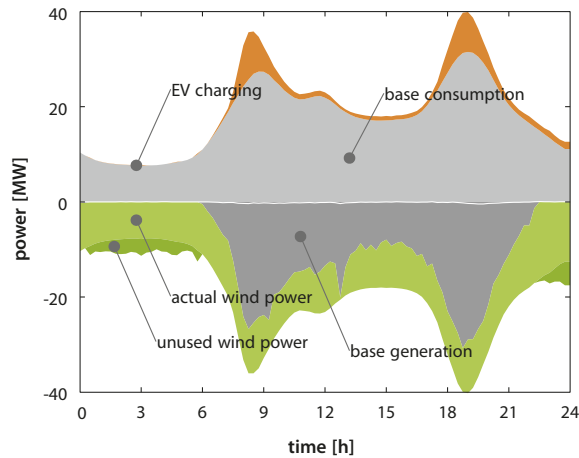

Theoretical example of small system in islanding mode without/with smart charging

THE EDISON VIRTUAL POWER PLANT (EVPP) CONTROL SOFTWARE

ICT-based software integration plays a major role for the success of smart grids. A VPP describes an aggregated system in which many distributed energy resources (DERs) with small power generation output are partly or fully controlled by a single coordinating entity. In this way, small DERs can be actively integrated into the power system and market, for which they individually would be too small – in terms of rated power and availability – to participate.

A VPP can be described as either being centralised or distributed. A VPP is centralised if the control and decision making is delegated to a common VPP coordinator and each DER is directly controlled by this coordinator. The aggregation platform is referred to as the EDISON EV virtual VPP

which can be described as both a market-oriented (and thus commercial) and a technical VPP using a centralised approach for DER control.

For the EVPP architecture, we have considered two integration variants into the actual Danish power system. One option is to integrate the EVPP into an already existing market player, for example, a power-generation company or any other party that is involved in the electric energy market and can act as a Balancing Responsible Party (BRP). We call this the integrated architecture. This architecture provides the integration company with a powerful tool to respect their committed energy schedules and also gives it the ability to act in the market for ancillary, balancing, and spare capacity services.

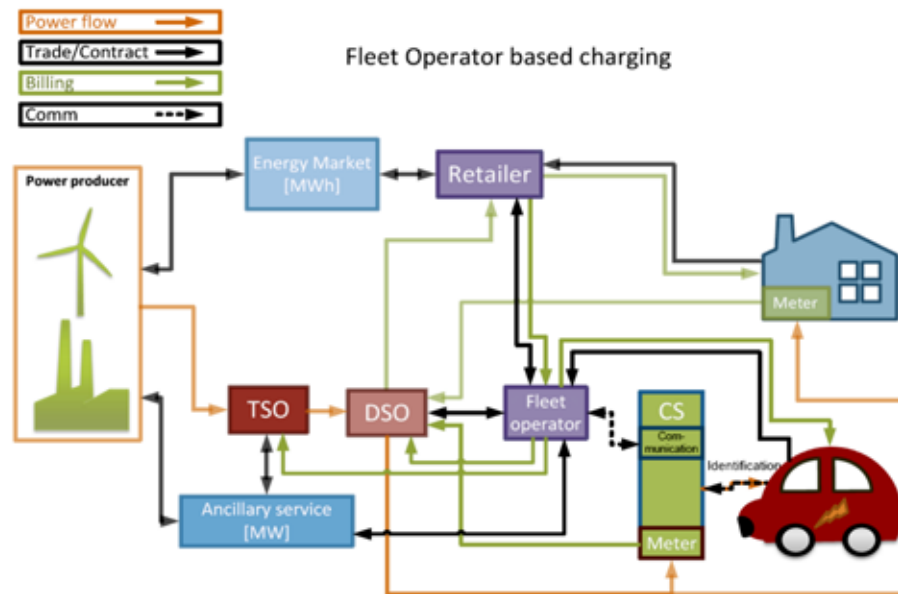

SMART-CHARGING COMMUNICATIONS

The EVPP's operation is based on market prices. The EVPP optimises the charging of vehicles without limiting driving behaviour. The EVPP adjusts its optimisation to local grid constraints.

When the EV connects to the charging infrastructure, the state-of-charge (SOC) is used to compute the required charging time. The proposed charging schedule is negotiated with the infrastructure side which in the EDISON case always regresses to the EVPP in Secondary Actor role (backend server).

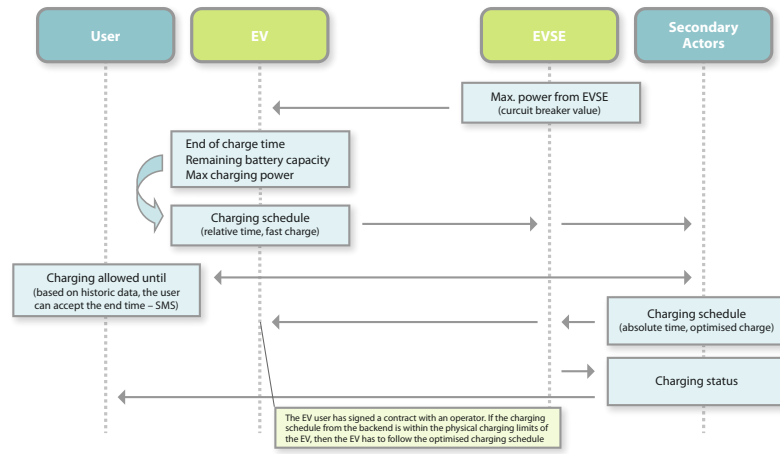

EDISON IS SUPPORTING OPEN STANDARDS

AC charging with low-level control signals. The IEC 61851 charging standard and SAE J1772 proposes a simple PWM (pulse width modulated) signal system for "mode 3"-type charging that allows the charge spot to signal the available electric power to the vehicle, thus enabling simple load control by an external energy controller.

High level communication using an IP protocol would be required for more sophisticated services

including: exchange of Contract-ID, charging schedules, price signals and added value services.

An ISO / IEC joint working group is presently preparing a new standard IEC/ISO 15118 for EV to charge spot communication destined to establish common data structures that should be used for EV needs using high level communication. The standard will also propose the hardware for communication using the charging cable.

IEC 61850-7-420 DER EXTENSION

This International Standard defines the IEC 61850 information models to be used in the exchange of information with distributed energy resources (DER), which comprise dispersed generation devices and dispersed storage devices, including reciprocating engines, fuel cells, micro turbines, photo voltaics, combined heat and power, and energy storage (i.e.: for EV).

The duration of the test is approximately 6 months, and during the test period electric vehicles for different purposes will be involved. Although the number of vehicles will not be very large, it will still be sufficient to fully prove that the developed technologies could support the power system if a large percentage of electric vehicles are introduced on the Danish market.

INVOLVING THE EV OPERATOR

Technical standards do not typically deal directly with user aspects, but may do so indirectly through Human Machine Interface (HMI) or functional safety issues. The EV user is of course an important part of the EV communication, which could include the following areas:

- Response in relation ID and payment
- Response in relation to acceptance of load leveling and demand response services

EV BATTERY CHARACTERISTICS

A battery is a power source that converts chemical energy directly into electrical energy. Many different battery types find applications in our everyday life. Batteries can be categorised by the electrochemical principles behind, by recharge-ability, size, shape, etc. Primary batteries are for one time use, while secondary batteries can be recharged and reused for hundreds and thousands of times depending on the battery type. Important performance parameters for secondary batteries are operating voltage, capacity, energy density, power capability, cycle life, temperature characteristics,

BATTERY TESTING INFRASTRUCTURES

The charging infrastructure for electric vehicles is essential to a successful introduction of EVs and the market growth thereafter. Electric vehicles can be charged electrically from an AC or DC power source, supplemented by mechanically switching the used battery with a recharged battery. A test

- Response in relation to safety and charging procedures (lock/unlock of charging couplers, start/stop charging, request status information from charging process)

These parameters are important constraints in the charging process and should be considered in the business models and system integration which will use the technical standards within this scope.

charging speed, cost, safety features and environmental profile.

Batteries suited for EVs are the secondary battery types with strong power, high energy density, good safety features and long service life. Cost is one of the challenging factors for the development of EV batteries. At present, hybrid electric vehicles (HEV) typically use Nickel metal hydride (NiMH) battery, whereas plug-in hybrid electric vehicles (PHEV) and pure electric vehicles (EV) use lithium ion (Li-ion) battery types.

laboratory has been established in the EDISON project in order to simulate, test and evaluate various types of batteries and different charging methods for electric vehicles to prepare for an intelligent charging infrastructure, paving the way towards smart grids.

RECOMMENDATIONS

The bright green future is close but not here yet, hence R&D projects are required to focus on technology development and demonstrate early results to educate the public and help steer the political discussion. Mass roll-out of EVs is starting in 2011, but charging must be properly managed. EU regulation ensures a massive growth in renewable energy production. This means that more countries will experience a growth in fluctuating production units in the power system, thus “*ceteris paribus*” increasing the value of power regulation capacity.

On the power system side, stakeholders including Power Producers, Retailers, Transmission System Operators, Distribution System Operators and Balance Responsible Entities all benefit from pre-aggregation of the massive amount of expected individual smart household power-appliances and in particular as individual EVs by Fleet Operators (FOs). Abstracted as VPPs, this enables the pooling of resources for the power system ancillary service markets. The EDISON project tries to find the optimal match of battery technology and grid services to enable the promotion of EVs via the grid-integration business case.

CONTRIBUTOR CONTACT AND AFFILIATION INFORMATION

For further information on the EDISON consortium, feel free to contact coordinator *Jørgen Christensen* jsc@danskenergi.dk or *Anders Holm Foosnæs* afo@danskenergi.dk at Danish Energy Association, Rosenørns Allé 9, DK-1970 Frederiksberg Copenhagen, Denmark.

The full list of partners and respective contact information is available on our consortium website www.edison-net.dk

In order to reap all benefits of EVs it is essential that all relevant actors (energy and automobile sector) focus on standardised solutions to ensure compliance with smart charging and interoperability, so that all EV users can use all charge spots both nationally and internationally.

Due to the limited driving range, pure EVs are probably more suited for local fleet services rather than long distance driving in the initial phase of EV market introduction. For the same reason island societies can be one of the early movers on e-mobility. It can be seen as a municipality's role to leap-frog society with public vehicle procurements. The e-mobility concept is nevertheless scalable and as well applicable to smarter-city environments that benefit as much from the positive environmental aspects of compact and green e-mobility.

As EVs are becoming part of our everyday life in the new electric transport age, there is a growing need to prepare the society and ordinary citizens. Politicians, local governments, the industry and the academic world should work together on this task.

CONTRIBUTOR BIO

Anders Holm Foosnæs of Danish Energy Association holds a M.Sc. in power system engineering and leads EDISON WP1 on EV Technology. He is also a member of the Eurelectric TF EV, the Danish standardisation committee for EVs and Cigré WG6.20 and board member of the Danish Electric Vehicle Association.

Claus Amtrup Andersen is director of company Eurisco and EDISON WP5 leader while serving as Danish Standards representative for IEC/ISO JWG V2G Cl: Joint Working Group for Vehicle to Grid Communication Interface.

Linda Christensen is a Senior Researcher in the DTU Transport department, specialist on Danish driving requirements.

Dieter Gantenbein is a senior research staff member at IBM Research – Zurich and leads the EDISON server side WP3 on Distributed integration technology development.

Ningling Rao of DONG Energy holds a Ph.D. in chemistry and leads the EDISON WP6a on Battery technology testing.



◀ An engineer from Nukissioffit installs remote meters in the village of Sarfannguaq

REMOTE METERING IN SARFANNGUAQ

GENERAL PROJECT INFORMATION

KEYWORDS:	Remote metering, installation pilot project
GEOGRAPHIC AREA:	Greenland
SPECIFIC LOCATION:	Sarfannnguaq settlement, near Sisimiut
LEAD ORGANISATION/ENTITY:	Nukissiorfit
PARTNER ORGANISATIONS/ENTITIES:	Kamstrup
PROJECT WEBSITE:	www.nukissiorfit.gl

PROJECT TIME SPAN:

05/2007 – 12/2007

PROJECT BUDGET:

DKK 650,000 in 2007

OVERVIEW OF FUNDING SOURCES:

Half by Nukissiorfit, half by Greenland Home Rule Government

Sarfannnguaq (also known as Sarfannguut or Sarfán-guaq) is a settlement in the Qeqqata municipality in central-western Greenland. The settlement was founded in 1843. Its population is 126, supporting a small fishing fleet and fish processing factory. Sarfannnguaq is located on the eastern promontory of an island of the same name, approximately 36 km (22 mi) east of Sisimiut, the second largest town in Greenland. The electricity needs of the community are met using diesel generators. The first windmill in Greenland was constructed in Sarfannnguaq in 2010, saving 6,000 litres of diesel fuel per year.

The remote metering project in Sarfannnguaq was started in 2007 by the Greenlandic electricity and water supply company (Nukissiorfit) as a side proj-

ect that would deliver a technical solution for the accurate collection of energy consumption and production data. It was hoped that this data would enable other energy development projects in the village to be more easily implemented. The main reasons for installing the remote meters were:

1. There was no tradition of collecting consumer data
2. There was a growing focus on energy consumption and energy awareness, which required information
3. There were demands from government for more information on energy usage

4. There was a company demand for increased customer service
5. Reading existing meters was difficult in some remote areas
6. There was no tradition of self reading and so every meter had to be read by staff
7. The metering equipment in use was old
8. Reopening and closing of meters was difficult and expensive in remote areas

The advantages of using remote meters were seen to include:

1. Collection of high resolution data on consumption and production
2. Improved customer service, which would include:
 - The possibility of more understandable bills
 - Faster settling of accounts
3. Minimised risk of human errors

4. Increased knowledge on
 - Energy consumption
 - Energy production
 - Losses

The use of the meters was also expected to create the following opportunities:

- Energy consulting: opportunity for analysis of domestic energy consumption which could assist in conserving household energy and help make energy savings in public buildings/institutions
- Energy analysis: enable high resolution analysis of the operation of the grid in order to find the grid-load, enabling potential postponement of the expansion of power plants, and to explore the potential for further expansion in electrical heating (as a replacement for other more expensive forms of heating). Also the analysis of production/consumption to identify losses in the grid, including the possibility of energy theft
- Reopening and closing of meters: faster reopening and less expensive closing of meters, both for consumers and Nukissiorfiit

PROJECT GOAL

The project “Remote metering in Sarfannguaq” aimed to install a system that more accurately documents the energy consumption and production in a typical Greenland village. The successful collection of detailed and accurate data on energy production and consumption has enabled efficiency gains for both consumers and the utility, and reveals the possibility of incorporating renewable energy at a lower than expected cost.

PROJECT SUMMARY

In May 2007, approximately 100 electricity meters in the small Greenlandic community of Sarfannguaq were replaced by the utility Nukissiorfiit, who installed remote-metering technology in order to improve the resolution of the energy consumption data collected in the village. In the past, four readings a year were collected from households and 12 readings a year from industry meters. This number of readings was not good enough to understand energy usage and to investigate improvements to the energy system. Nukissiorfiit chose to replace all its meters to a type that could be remotely and simultaneously read, up to 35,040 times per year.



▲ Waterfront at Sarfannguaq

Before the remotely-read meters were installed, only quarterly readings of the meters were undertaken, so the data could not be used for much other than to print bills for individual customers. To improve this Nukissiorfit investigated the market for meters and meter reading, and came up with a system which had the specifications to meet the following requirements:

1. To take readings every hour or quarter-hour
2. Access to data via the Internet, both for consumer and Nukissiorfit

3. To operate in the special climate and infrastructure conditions found in Greenland

4. Reliability

The final system opted for was a complete solution provided by the Danish company Kamstrup, which used a combination of radio and GSM systems to communicate with the meters.

TECHNOLOGY

All new meters contain a radio module that enables the meters to communicate with each other and with the central collection unit. It runs on a licensed spectrum, so communication does not interfere with other devices using radio technology. The central unit is called a concentrator and is the entity that gives commands to the meters and simultaneously collects the data coming from the meters. The concentrator contacts Nukissiorfiit at the headquarters in Nuuk, via the GSM mobile phone network, and is thus only reachable when

the GSM network is functioning (although data is stored locally until a connection is made). All data is placed on a central server, which then can be contacted via an online client. From the same server Nukissiorfiit customers can access their own meter data via the company website. Besides being able to retrieve readings it is also possible to obtain the maximum load for each meter and to control the power quality and length of power outages.



▲ Local residents viewing information about the metering project and energy use

COMMUNITY INFORMATION AND ENGAGEMENT

Nukissiorfiit took care to inform the village population about the meter project and held public meetings and placed posters in the village to inform the community, both on the project, the technology and when the old meters would be

replaced. This is important since a replacement may mean that supply is briefly interrupted. The villagers were very positive about the project, which also was featured in all the national media.

BILLING AND INFORMATION TO CONSUMERS

The data gathered by the new meters enabled the creation of an “advanced” electricity bill that is provided to all customers and includes specified daily consumption down to the last 15 minutes.

The new bills also contain advice on saving energy, and company related information. All information is provided in Greenlandic and Danish language.

RESULTS

Early on in the project there was speculation that the system would not work in the special conditions in Greenland, for example in the low temperatures and if the radio technologies could be used in the hilly and rocky terrain. However the system has now been running for almost five years without serious problems and the radio technol-

ogy has been shown to work better than expected, even by the service provider. Since the meters also detect power outages Nukissiorfiit it was possible to demonstrate that in a period of 10 months the system had an uptime of 99.992%.

Once the new meters were installed and sufficient data collected, various assessments were made, including an analysis of the proportion of total consumption that a renewable energy source could supply the settlement. Three diesel generators provide Sarfannguit with an individual output of around 120 kW, including the spare capacity needed to ensure continued operation in the event of a malfunction or accident. It was therefore quite surprising to learn that with a renewable energy installation at 30 kW as base load, it would be possible to cover more than 85% of consumption. At 40 kW as base load, it would be possible to cover more than 95% of consumption. A small renewable energy plant could therefore easily cover a large part of the baseline consumption in the village. If the numbers are converted to oil savings, a renewable energy unit of 30 kilowatts each year could save Nukissiorfiit from purchasing and burning more than 40,000 litres of oil.

From the beginning there was great interest in the project from the village inhabitants and many have since followed their energy consumption. The local school has also used it as a subject in teaching.

In fact the project in Sarfannguaq worked so well that Nukissiorfiit decided to use the system throughout the country, both for electricity, water and heat. The replacement of all meters began in early 2008. In total, there are about 43,000 meters in Greenland, all of which will be replaced by 2012 which makes it likely that Greenland will become the first country in the world where all meters have a remote reading function. This task is being conducted by Nukissiorfiit's own crew, who travel around Greenland replacing the meters.

In February 2010 the Nukissiorfiit customer portal was revised to enable energy information to be released as part of the existing website. Customers can now request to access data from their own meter, a functionality that has been used by many customers. On the website customers can follow their electricity consumption down to hours, and thus can immediately see whether possible saving measures in the household have had an effect. The website is updated daily, so yesterday's consumption is available the next day. Since its launch, more than 99.5% of the electricity meters are read on an hourly basis.

The new meters also have a functionality that makes it possible to remotely close them. As such,

“The project in Sarfannguaq worked so well that Nukissiorfiit decided to use the system throughout the country, both for electricity, water and heat... it is likely that Greenland will become the first country in the world where all meters have a remote reading function.”

meters can be closed / opened centrally in cases of payment arrears or cancellation. This has meant that the fee for closing / opening accounts is reduced by 75%.

The meter replacement project has also had other positive impacts for Nukissiorfiit. As the old meter system with outdated and inaccurate meters is replaced there will be 100% overview of all meters. It has, for example, shown that several meters were incorrectly configured, so the customer has either paid too little or too much and these errors have now been rectified.

CONTACT AND AFFILIATION INFORMATION

Jens H. Nielsen
Operations Consultant,
Planning & Development
E-mail: jeni@nukissiorfiit.gl
Dir. tlf. +299 349562

Nukissiorfiit
P.O. Box 1080
3900 Nuuk
Tlf. +299 349500
Fax +299 349660

CONTRIBUTOR BIO

Peter Kjeldmann holds an M.Sc. in Environmental Management from Aalborg University. He has worked at Nukissiorfiit on a range of projects including development projects, remote reading and now with hydro and feasibility studies.

Jens-Peter B. Henriksen worked as a Development Adviser in Nukissiorfiit focusing on renewable energies and energy storage. He is also a member of the board of the North Atlantic Hydrogen Association (NAHA) and of the Greenlandic Regional Advisory Group (RAG) to the Northern Periphery Programme (NPP).

PROSPECTS

Upgrading to remotely-read meters with data capture every quarter or every hour enables energy production and consumption to be understood with an unprecedented level of detail and simultaneity. Such information is often called a “Community Energy Profile (CEP);” and the process of preparing them the “Community Energy Profiling.”

When production and consumption patterns have been described, it is possible to create targeted

RECOMMENDATIONS

In order to upgrade and convert relatively small energy systems to operate on renewable energy sources, it is necessary to obtain detailed data that allows for a proper analysis to be performed.

BRIEF PROFILE OF NUKISSIORFIIT

Nukissiorfiit means “where energy is generated.” Nukissiorfiit is one of Greenland’s largest companies, and its main job is to produce and distribute electricity, water and heat to the country’s population. This is handled by 15 local branches that are responsible for 17 towns and 54 settlements. Nukissiorfiit’s vision is to develop sources of energy that are environmentally friendly in the best and least expensive possible manner for society, and to reduce dependency on oil. 60 % of the energy that



interventions, first, to reduce consumption and secondly to smooth consumption. Similarly, it is possible to optimise energy production. Once that is done you have a CEP, which describes the actual energy requirements for local renewable energy sources. Furthermore CEPs identify options for partial integration of renewable energy for peak shaving, then elimination of consumption, and basic loads.

Likewise, it is enormously important to keep local people informed about the project, so as to achieve a sense of ownership.

Nukissiorfiit produces comes from hydroelectric power plants. Today, Nukissiorfiit operates four hydroelectric power facilities that supply five towns with clean, green energy. A fifth hydroelectric plant is under construction and will be ready for full production in the year 2013. There are also ongoing efforts to build additional hydroelectric facilities in the country. Nukissiorfiit employs approximately 400 people.

THE RENEWABLE ENERGY CROFT AND HYDROGEN FACILITY

GENERAL PROJECT INFORMATION

KEYWORDS:	Renewable energy, hydrogen, technology transfer, education
GEOGRAPHIC AREA:	Scotland, United Kingdom
SPECIFIC LOCATION:	Stornoway, Outer Hebrides
LEAD ORGANISATION/ENTITY:	Lews Castle College
PROJECT WEBSITE:	www.lews.uhi.ac.uk

PROJECT TIME SPAN:

5 years

PROJECT BUDGET:

£1,000,000

FUNDING SOURCES:

EU, Scottish Government, Comhairle nan Eilean Siar (Western Isles Council)

There is an increasing demand for the development of renewable energy schemes in Europe, including the United Kingdom (UK), in order to help reduce EU-wide CO₂ emissions by 20 percent and to meet renewables targets set-out by the European Union for 2020. The Western Isles of Scotland have an abundance of renewable energy resources which could be used to meet the renewable energy targets that both the UK Government and Scottish Executive have set. In addition the Outer Hebrides has shown the highest level of Fuel Poverty and Extreme Fuel Poverty in Great Britain, current estimates are that around 50 percent of all households experience fuel poverty. Given this scenario the development of a renewable energy croft and hydrogen facility in Stornoway creates a unique opportunity for the early deployment of

a low carbon economy supported by renewable energy and hydrogen infrastructure.

The Renewable Energy Croft and Hydrogen facility project has been developed by the Lews Castle College. The college is part of the University of the Highlands and Islands (UHI) Millennium Institute and specialises in providing a broad range of undergraduate and postgraduate courses for the achievement of academic qualifications and professional development.

The Renewable Energy Croft includes a mixture of renewable energy sources generating the electricity required to power the heating and lighting system of a cluster of poly-tunnels and greenhouses, extending the growing season. The Croft has



▲ The Renewable Energy Croft

demonstrated that the intermittent nature of renewable sources can be efficiently balanced by the integration of hydrogen storage technologies. This combination has provided a real-life example of a completely off-grid reliable energy system with zero carbon emission.

“The Renewable Energy Croft includes a mixture of renewable energy sources generating the electricity required to power the heating and lighting system of a cluster of poly-tunnels and greenhouses, extending the growing season.”

THE PROJECT

The project has created the basis for the development of an energy generation demonstration system that combines available cutting-edge technologies for an off-grid energy system. The Croft incorporates solar photovoltaic and collectors panels, wind turbines, a ground source heat pump and a micro hydro system. It was nominated and shortlisted as a finalist for the prestigious Scottish Green Energy Awards 2009, as the most innovative project in Scotland.

There are six wind turbines at the Croft, three of which were fabricated during the college workshops by members of the public attending evening classes. The wind turbines can produce up to 5 kW. As the wind source is highly unpredictable, a diversity of energy sources is required to improve the stability and reliability of energy generation. For this reason wind energy is combined with solar panels for a further utilisation of the renewable sources available on site. The system includes

PROJECT GOAL

To increase knowledge on renewable energy sources and hydrogen technologies and to improve their penetration in the Outer Hebrides Community.

PROJECT SUMMARY

The Renewable Energy Croft and Hydrogen Facility project has been developed by the Lews Castle College, part of the University of the Highlands and Islands (UHI) Millennium Institute. The Croft includes a mixture of renewable energy sources generating the electricity required to power the heating and lighting system of a cluster of poly-tunnels and greenhouses, extending the growing season. The facility provides a working laboratory for students and a foundation for delivering the Hydrogen economy to which the Outer Hebrides Community Planning Partnership is committed, and provides a real-life example that will inspire people and promote new opportunity on the Island.

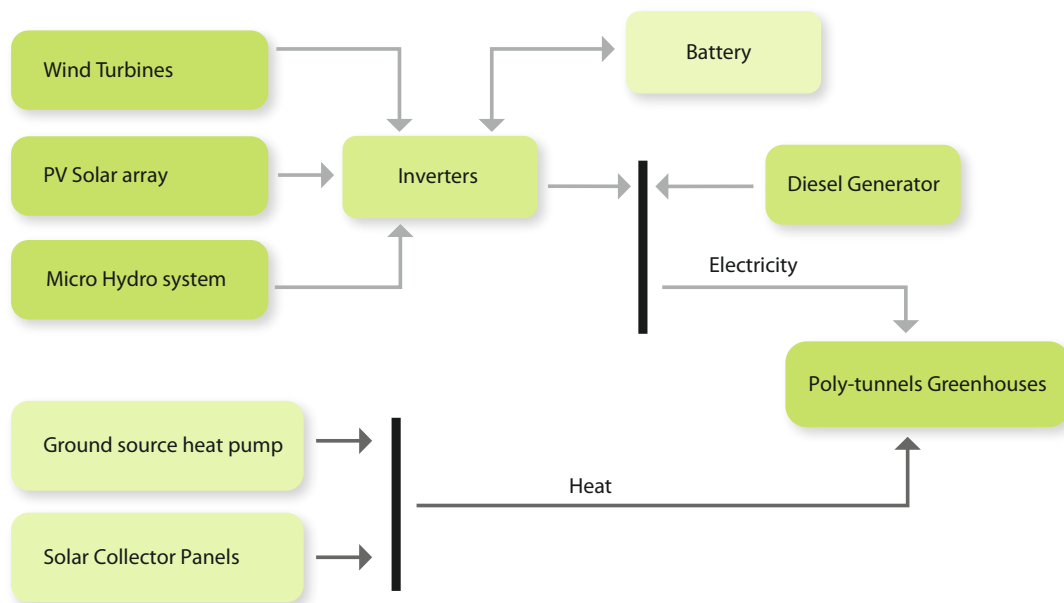

◀ Schematic diagram of the Renewable Energy Croft

four PV arrays that can produce 5 kW. In addition a micro-hydro scheme is currently under construction on the stream running through the facility and it is predicted to be able to provide 2 kW of generating capacity.

Complementing the electricity production, the Renewable Energy Croft includes a heating system powered from renewable sources. This is provided by a ground source heat pump together with a range of solar collectors located on tiles and slated roofs have been included in the project.

The intermittency of the load is balanced by a large battery bank, and as a last resort, by a backup biodiesel generator which uses fuel processed on site. The project has demonstrated that it is possible to deliver a reliable energy supply from what are fundamentally unreliable sources of energy.

The schematic below shows the flow of energy production and consumption at the Renewable Energy Croft.

The on-site Hydrogen facility also provides an advanced research centre for hydrogen applications. It includes the latest technologies available for hydrogen production and a hydrogen laboratory to conduct research and teaching activities for the Lews Castle College.

Hydrogen (H_2) is produced via the electrolysis of water. The electrolyser is a 5 Nm³/hour system (or 5000 litres of hydrogen per hour), which uses the electricity supplied from the grid to split pure water into hydrogen and oxygen gas. Despite the energy used for this process being derived from the public grid, the presence of the Renewable Energy Croft within the Lewis Castle facility



▲ Pure® Hydrogen production system

containing renewable energy sources could theoretically supply the excess energy produced locally to the electrolyser.

The unique characteristic of hydrogen is that it is the only carbon-free or zero-emission chemical energy carrier when produced from renewable sources. It is one of the most promising alternative fuels for future transport applications, stationary and portable electrical power generation. As an energy storage system, hydrogen acts as a bridge between all major sectors of an energy system: the electricity, heat, cooling and transport sectors. It is the only energy storage system that allows this level of interaction between these sectors and hence it is becoming a very attractive option for integrating large quantities of intermittent renewable energy such as wind and solar.

The H₂ produced at the Croft is stored in pressurised tanks and used for the development of new applications and research activities within the hydrogen laboratory. Among the research taking place at the Croft is a project intended to reduce the fuel costs on fishing vessels by converting to hydrogen. The aim of this research activity is to

develop a system that will inject small amounts of hydrogen along with the normal fuel to aid combustion in large diesel engines with the aim of saving of 10-20 percent on fuel costs. Another significant application is the use of hydrogen as fuel for a Fuel Cell in order to produce electricity, heat and cooling. The applications for this new technology can cover several fields from automotive transportation to power supply for portable and stationary applications.

One of the successes of the Renewable Energy Croft and Hydrogen Facility is that the public have been able to access learn firsthand how these devices work, encouraging them to consider installing similar devices on their own buildings or land. The technologies used at the Croft are coherent and complementary, and presents all the choices available to householders and community group. The output from the generation devices is continuously monitored and the production data are available on the internet.

The hydrogen and micro-generation facilities have been used for teaching and supporting the development of new courses on renewable energy technologies, including a unique online professional development award (PDA) in Renewable Energy, accredited by the Scottish Qualifications Authority and accessible by everyone, online. The presence of the Renewable Energy Croft on the Island has made the Lews Castle College a centre of community focus, driving an interest in renewable technologies. The number of students has increased rapidly, most of them from remote rural areas. The facility is used daily for training students and members of the public to obtain knowledge and technical skills in renewable energy systems to a level appropriate for industry application.



▲ Students at the Renewable Energy Croft



Lews Castle College UHI principal David Green said: "Our current and future engineering students will be well-trained in renewable technologies and in the safe use and applications of hydrogen, and this is an important contribution to a low carbon future for us all."

The Renewable Energy Croft and the Hydrogen Facility has benefited the Outer Hebrides communities. It has provided the opportunity:

- To develop knowledge and understanding of the broad issues relating to current and future energy production and consumption

- To develop knowledge and understanding of the science and engineering of a wide range of energy extraction systems used in the renewable energy sector
- To demonstrate the application of renewable technologies for solving energy problems
- To train people as specialists in the areas of Renewable Energy Systems, issuing academic and professional qualifications
- To enhance employment prospects
- To allow the community to see what renewable energy technologies can be used today, raise public awareness and interest in renewable technologies

CONTACT INFORMATION:

Pure Energy Centre
Hagdale, Baltasound
Unst, Shetland
ZE 2 9TW
United Kingdom
Telephone: +44 (0) 1957 711 410
Fax: +44 (0) 1957 711 838
Email: info@pure.shetland.co.uk

CONTRIBUTORS

Elizabeth Johnson, Business Development Manager, Pure Energy Centre
Daniel Aklil, Managing Director, Pure Energy Centre

The Pure Energy Centre Ltd has a team of professionals that combine a range of skills and expertise in hydrogen technologies, health and safety issues and global experience in Renewable Energy Systems. The combination of professional skills enable the Pure Energy Centre team to provide a combination of products and training. Since the Pure Energy Centre was established in May 2005 it has been involved in off-grid energy projects and renewable hydrogen developments in 4 continents, has delivered specialist training in hydrogen and fuel cell technologies to over 100 students, and has hosted visits, conducted workshops and delivered presentations to businesses, politicians of all parties, investors, engineers, school students, academic researchers, and public agencies.

SAMSØ

– A 100% RENEWABLE ENERGY ISLAND

PROJECT TIME SPAN:

1997 to 2007

PROJECT BUDGET:

EU60 million

OVERVIEW OF FUNDING SOURCES:

Danish public subsidies, banks, community, local investments

REFERENCES AND RELATED RESOURCES:

Information can be found on the website, published papers

GENERAL PROJECT INFORMATION

KEYWORDS:

Renewable Energy, offshore wind turbines, biomass, district heating, solar water heating, skill development, technology transfer, green island

GEOGRAPHIC AREA:

Denmark

SPECIFIC LOCATION:

Samsø

LEAD ORGANISATION/ENTITY:

The Energy Office

PROJECT WEBSITE:

www.energiakademiet.dk

The oil crises of the 1970s led to significant changes in the Danish energy system, transforming it from one relying heavily on oil to a more diverse system based on a mix of fossil fuel and renewables. National energy policy and planning focussed on using large thermal power plants, initially coal-fired but increasingly fuelled by natural gas, with a high degree of combined heat and power for district heating, along with direct use of natural gas for space heating in some areas, in combination with renewable energy and direct electrical heating in residual areas. Renewable energy was given high priority along with support programmes for both manufacturers and purchasers of renewable energy systems. This led to a period of very strong innovation in renewables,

which in turn indicated a need for a full-scale test site.

In 1997 the island of Samsø was chosen to become a full-scale test site for the conversion of a community to 100% green energy. Samsø was selected as it has an independent community of 4200 people, it is an independent municipality isolated from the rest of Denmark, and is thereby easy to monitor and investigate with regard to the energy transformation.

At the time it was selected, most of the people on Samsø knew very little about the plan to convert the island to 100% renewable energy. The level of public information was quite low so local citizens

were not aware of how the decision would affect them personally. Although some degree of public interest existed, there was a need for an entity to channel the flow of information on the various options and opportunities. The island community is still by and large conservative in nature, and new developments are often met with hesitation, with typical phrases such as “let’s just wait and see what happens” and “I don’t want to be the first one”

The project needed a much faster pace to be able to achieve the target of 100% RE in just 10 years, so a local NGO called The Energy Office was established in 1998. This led to more direct contact with the public, which in turn enabled a fast uptake of renewable energy. The existence of a campaign office with a single purpose, to inform and engage the local population, was crucial for the progress and success of the project.

Three of Samsø’s eleven onshore wind turbines ▶



PROJECT GOAL

Conversion of the energy supply system in a small Danish island to 100% renewable energy within 10 years, using existing and proven technology, Danish subsidy programmes, laws and regulations, and involving widespread public participation and ownership.

PROJECT SUMMARY

The Danish island of Samsø was selected in 1997 to become a full-scale test site for converting an entire community to using 100% green energy. Samsø, a community of 4200 people, was selected because it is an independent municipality, isolated from the rest of Denmark, and is thereby easy to monitor and investigate with regard to transforming its energy production and consumption. A local NGO, The Energy Office, was established in 1998 to engage and lead the local community through the transformation process. Samsø now utilises solar water heating systems for many individual houses, solar photovoltaic systems, onshore and offshore wind turbines and biomass driven district heating. In addition, several green transport activities are under trial. By 2007 the island had reached its objective of using 100% green electricity.

Since the establishment of the NGO, eleven on-shore turbines have been installed. These turbines have allowed Samsø to achieve its 100% green electricity target. In addition to this, the Samsø community have installed several solar water heating systems for individual houses, solar photovoltaics, onshore wind turbines, district heating and several green transport activities are under trial.

ACHIEVING ENERGY INDEPENDENCE BY HARNESSING WIND ENERGY

In 1997 Samsø island had one single objective: to become energy independent by 2007. By the year 2002, with its 11 onshore turbines, Samsø's electricity sector had reached this objective. On calm days, when the turbines cannot generate enough electricity to power the island, energy flows from Denmark's main energy grid to the island's network. In turn, on windy days the island exports wind-generated energy to the national

Samsø has learned substantial lessons which are now being shared with other communities. In order to do so, the Samsø community opened an Energy Academy in addition to The Energy Office, both of which support first the islanders and then the visitors in all energy-related matters.

grid. As such, the island has a positive annual net electricity balance, as it exports far more energy to the mainland than it receives.

Historically, wind power was well known in Denmark and on Samsø. There have been windmills in Denmark for more than 300 years, and in modern times the first electricity-producing wind turbines were erected in the 1930s. It was therefore easy to convince communities that modern windmills were useful for the energy island project. The only questions were who should own them and where to install them.

The community decided to launch The Energy Office with the aim of leading the transformation to green energy. The Energy Office produced a development plan that ensured strong local community ownership for any green development on the island. For instance, this plan ensured that whoever wanted to invest in wind power was allowed to do so. By developing such a plan, The Energy Office demonstrated to the community the real benefits of the establishment of wind power. Everyone in the community could own a share in a cooperative windmill and this was crucial for wide community acceptance for windmills on the island's surrounding landscape. Of course, if you are part

▼ Foreign visitors tour one of Samsø's straw-fired district heating plants

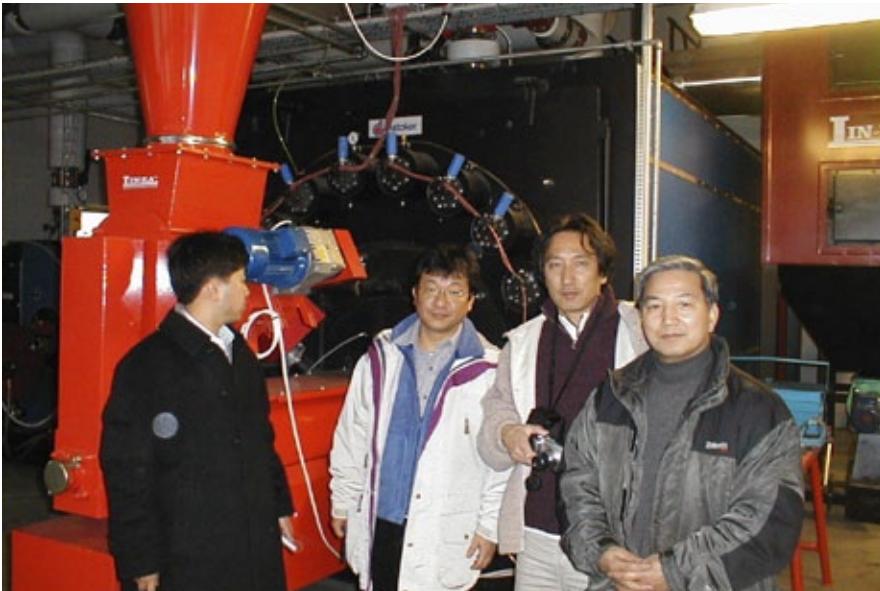



▲ One of the solar hot water plants on the island

owner, the wind turbines look much better than if they are owned by somebody else from outside the community (very often an energy company). Environmental questions, such as the impact on landscape and birdlife, were investigated seriously by the community and discussed thoroughly among the owners, indicating that there was no disagreement.

Since the development plan was launched by The Energy Office, 450 local citizens became owners of 11 windmills with a combined 11 MW of generation capacity. These produce 100% of the island's electricity consumption with a net export to mainland Denmark, a first of its kind in the country.

Having developed such strong green credentials, the islanders moved onto developing further green energy projects. For instance biomass is a resource that consists of "waste" products from farming and forest industry. The community decided that any waste straw from wheat fields was to be collected and used for heating. Also, woodchips produced from small pieces of wood left over from tree felling was, and still is, used for heating. 60% of the island's houses are heated

from district heating plants, pumping hot water to houses using biomass as fuel. Significantly, Samsø has reduced imports of fossil fuel by more than 75%. Hence, 75% of heating fuel costs stay on the island instead of going to large energy corporations, thereby twice benefiting the community and making it a bit richer.

For the remaining 40% of the houses, and in remote places or single houses, a combination of solar thermal for hot water, biomass or heat pumps for space heating and ventilation as well as small shared windmills were installed. The Energy Academy building also demonstrates the everyday use of solar water heating, photo voltaic and small wind turbines.

▼ A roof-mounted solar hot water system





▲ The offshore wind turbines that enable Samsø to offset carbon emissions from transport



◀ Students inspect a wind turbine on Samsø island

As a community, Samsø also looked at its transport sector and found that it was very difficult to 'go green' given existing technologies. Electric cars were considered inappropriate for ordinary people. So instead the community decided to offset the energy used in its transport sector by installing more wind turbines. To date, the community has erected 10 offshore windmills with a combined capacity of 23 MW. All of this wind generation is exported to the Danish national grid, which in turn further reduces the country's national carbon emission from coal fired power plants. This simply means that Samsø has offset more than 100% of its carbon emission. Each Samsø citizen has in fact an annual emission of -3.7 tonnes of CO₂ while the average Danish per capita emission is +10 tonnes of CO₂.

THE ROLE OF GOVERNMENT POLICY IN DRIVING GREEN ENERGY DEVELOPMENT

The secret of this Danish success story in green energy development is that Danish energy policy has been very progressive over the past 30 years. Denmark does not consider itself as an energy producing nation. We depend on imported fuel. This has led to an energy tax system to control the Danish consumption of fossil fuels. Some of the tax revenues from fossil fuel consumption are directed to science and research as well as direct subsidies to the establishment of renewable energy technologies. This is different from a number of other nations where the general policy is to provide very cheap energy for consumers and then actually make a barrier for the financing of green technology.

The Samsø project proves that the high energy tax in Denmark makes it possible to control consumption and to make new energy systems a reality. When it comes to making the right choice the bottom line makes a difference for a private family economy.

SUMMARY FACTS

- In 1997, Samsø was named Denmark's first renewable energy island.
- Samsø's ambition was to become energy independent by 2007.
- In 2006, Samsø met 100% of its electricity needs with energy from wind turbines and 70% of its heating needs with renewable fuels.
- Samsø has received several awards for its commitments to renewable energy.
- The island has its own Energy Academy and Energy Office, which supports the island and its visitors with information on renewable energy

The project has also shown that a common family needs a forum for asking questions, to get help for calculations and planning as well as relevant information in general. The market is flooded by products heavily marketed by companies who are more interested in increasing market shares rather than in selling green products.

The Samsø project also proves that people are ready to make changes but they need political guarantees for their investments, not only for four year election periods but for at least ten years payback periods.

4200 people from Samsø have invested approximately €60 million over a period of less than 10 years. That's a lot of money per capita but it has been bank financed and will be paid within about ten years. By then Samsø will be one of the greenest places on earth when it comes to carbon emissions.

technologies and energy savings.

- Samsø's Energy Academy is equipped with sustainable energy solutions, including solar panels that provide the facility with electricity as well as a rainwater-based grey water system.
- With wind turbines and a straw-burning district heating plant just outside its doors, the Energy Academy provides a meeting point for researchers and students.
- All of Samsø's district heating is based on renewable energy sources that include straw, solar power and woodchips.



▲ Photos of the Samsø community

CONTRIBUTOR BIO

Søren Hermansen is the director of Samsø Energy Academy. As a pioneer of the Samsø Renewable Energy Island project he is an experienced process and project manager. Søren was born and raised on Samsø so being a real islander he is often invited to speak at world wide conferences and projects regarding renewable energy.

CONTRIBUTOR CONTACT AND AFFILIATION INFORMATION

Name: Søren Hermansen

Organization/Institution:
Samsø Energy Academy

Contact Address:
Strandengen 1, 8305 Samsø

Email: sh@energiakademiet.dk

Website: www.energiakademiet.dk

ENERGI
AKADEMIET | 

- Every year, each of the island's offshore wind turbines produces enough electricity to power 2000 Danish homes.
- The Samsø wind turbines generate enough clean energy each year to compensate for all the fossil fuel used in transportation and heating on the island. This includes the diesel consumed by the island's three ferries.
- Many homes on Samsø generate their own

RECOMMENDATIONS

Economic, policy and innovation

It is a very good start to create a master plan for sustainable development of the community. It makes it easier to present for politicians and technology and furthermore it makes it possible to calculate a budget. This master plan will then be the recipe for the transformation starting with the political level. Agreements and frameworks will then fit the ambition of the master plan. When there is a political support for the master plan, then turn the process from top down to bottom up and start engaging the local community.

Technology implementation

In the master plan there will be a number of recommendations. It is a good idea to break down the master plan in smaller projects. Divide the project in wind, heating/cooling/transport/individual houses/companies. This makes it much easier to

energy through small scale wind turbines and solar panels.

- A large proportion of Samsø's home oil burners have been replaced with pellet stoves, solar heaters, ground-source heat pumps and other renewable heating technologies.
- Samsø is investigating the use of rapeseed and elephant grass for heating purposes.

explain to stakeholders. When you present the full master plan for citizens it sometimes feels irrelevant for the individual.

Technology development and testing

Local communities are very much aware of the financial aspect of new investments. If one or two projects turn out to be financially negative it will scare off local investors. It can therefore be dangerous to make too many test plants. But as a show-case the test plants can work as door openers for a full scale project. And there is the potential for job creation if a test site is established, so it is indeed valuable.

Information and knowledge sharing

Visit the Samsø Energy Academy website to find out more about the project:
www.energiakademiet.dk

THE HYDROGEN OFFICE PROJECT

GENERAL PROJECT INFORMATION

KEYWORDS:	Education, skill development, technology transfer, renewable energy, hydrogen, fuel cell, green transport, energy storage.
GEOGRAPHIC AREA:	Scotland, UK
SPECIFIC LOCATION:	Methil, Fife
LEAD ORGANISATION/ENTITY:	The Hydrogen Office Ltd
PARTNER ORGANISATIONS/ENTITIES:	The Pure Energy Centre, St Andrews University
PROJECT WEBSITE:	www.thehydrogenoffice.com

The Hydrogen Office project has been developed by the Hydrogen Office Ltd, a not-for-profit organisation whose primary aim is to support the accelerated development of the Hydrogen and Fuel cell sector in Scotland by raising the visibility of the technology.

Based in Fife, on the east coast of Scotland, the project is an hour's drive north of Edinburgh. Situated on the Methil 3 Dock, the project represents the next generation of energy technologies in an area for which the energy sector has been one of the most significant local employers for well over a hundred years. At the start of the last century the area was a major coal mining and exporting area,

and more recently a key location for the development of offshore oil and gas platforms. The Hydrogen office project is seeking to develop a cluster of renewable, energy storage and fuel cell activities which will see the area lead the transition from the old carbon based fuels of the past, to the new low or zero carbon based fuels of the future.

The main project aim of the Hydrogen Office was to design, develop and construct a completely green commercial office using state of the art renewable and hydrogen storage technologies. Today the Hydrogen Office is operational and provides a key location for promoting green hydrogen storage and buildings.

PROJECT TIME SPAN:

2007 to present

PROJECT BUDGET:

£3.6M

OVERVIEW OF FUNDING SOURCES:

Scottish Enterprise, European Regional Development Fund, The Scottish Communities Renewable Household Initiative.

REFERENCES AND RELATED

RESOURCES:

Information can be found on website and partner website



▲ Landscape view of the Hydrogen Office, including 'Poppy' the wind turbine

The project includes a 750kW wind turbine supplied by Global Wind Power of India, and a cutting edge hydrogen and fuel cell system developed by the Pure Energy Centre of Unst, Scotland. The system allows the project to store zero carbon energy from renewables when available, for use when it

is not available. The wind turbine (named 'Poppy' by the local pupils at school), generates electricity. The wind electricity is used to power all lighting, computers and coffee and tea making as needed in the Hydrogen Office building. Some of the surplus wind electricity is then used to produce

PROJECT GOAL

The Hydrogen Office project has been set up to support the accelerated development of the renewable, hydrogen, fuel cell and energy storage industries. The goal is to inspire people; promote the opportunity; improve access to and understanding of the technology; promote sector development; facilitate research and development; and enhance educational opportunities.

PROJECT SUMMARY

The project has involved the development of a commercial office supported by a novel renewable, hydrogen and fuel cell energy system. The wind turbine (named 'Poppy'), generates electricity which is used directly by the Hydrogen Office while available. Surplus electricity is used to generate hydrogen through a hydrogen system developed by the Pure Energy Centre. The hydrogen is stored for periods where there is insufficient wind to meet the demands of the Hydrogen Office. During calm periods the hydrogen fuel cell provides the electricity for the Demonstration Centre in a process whose only by-products are heat and water.

hydrogen from water using a 30kW Electrolyser. This hydrogen is stored in a pressurised tank at up to 12bar.

When there is insufficient wind or even when there is no wind at all to supply the Hydrogen Office, then the hydrogen is used in a fuel cell. The fuel cell generates electrical power, which is then used to supply electricity to the Hydrogen Office Building. The only by-products of the fuel cell are heat and water, thereby providing a unique working environment for businesses to set up where a truly clean, non-polluting and green building is a reality.

In a Scottish context these technologies are key to supporting the transition to a low carbon economy supported by renewable energy. It is estimated that Scotland has six times more renewable energy potential than it currently uses in electrical energy annually. Energy storage technologies such as hydrogen increase Scotland's capability to more fully harness its vast renewable energy resources, offering significant long-term employment and carbon reduction benefits. Notably, energy storage technologies bring into play opportunities not currently open to intermittent renewable energy sources, including: grid balancing and peak power provision; demand for renewable electricity during surplus production; a scalable low carbon transport fuel with capacity to power heavy and long distance transport needs; and the production of industrial feedstock's (such as ammonia for fertilizer). As demonstrated at the Hydrogen Office, this technology is operational now and is a technology that Scotland has a competitive advantage in. Fuel cells offer significant efficiency and carbon benefits. They are already technically viable (and becoming ever-more commercially viable) for a wide

range of applications using a range of primary fuel sources, including natural gas, biogas, methanol and hydrogen, and are capable of delivering zero carbon energy.

In short, energy storage technologies enable Scotland to harness its vast renewable energy resources with greater ambition, scope and reliance by bringing into play new uses for this energy. Hydrogen is a technically proven and versatile energy vector that covers a wide range of applications, and through companies like the Pure Energy Centre, is a technology in which Scotland enjoys a genuine competitive edge. Fuel cells offer significant efficiency and carbon reduction benefits.

The Hydrogen Office was formally opened in January 2011 and has already started to achieve its aims of raising the visibility of the sector in Scotland, and was delighted to be nominated and shortlisted as a finalist for the prestigious Scottish Green Energy Awards 2010. The Office is part of Fife's flagship Energy Park, which is expected to become one of Europe's leading locations for innovation and development of renewable technology. Also housed at the Office is a 100% green electric vehicle charging station. The charging station, like the building, is powered by the wind turbine when there is sufficient wind or the fuel cell when there is little or no wind.

Derek Mitchell, project manager of the Hydrogen Office, stated: "The opening of the Hydrogen Office project by the First Minister marks the completion of the first phase of this exciting project and we can now start raising the profile of hydrogen and fuel cell technologies. Scotland has the potential to produce far more renewable energy than it currently generates for all its electrical needs;



▲ The Hydrogen Office, situated on the Methil 3 Dock, occupies land that has strong historical ties to the fossil fuel energy business



◀ In 2010 the Hydrogen Office set up and ran the 'Hydrogen Challenge' where teams from six local primary and secondary schools competed to build and race miniature hydrogen fuel cell powered buggies

yet because we can't control when we generate energy from some renewable sources this huge potential is still limited. There is no need for such a limit and this breakthrough charts the future to realising Scotland's full potential."

To achieve its aims of supporting the accelerated development of the hydrogen and fuel cell sector within Scotland the project has three primary areas of focus: education, skills development, and research and development. To support these goals the project has undertaken significant community engagement activities which are summarised below.

COMMUNITY ENGAGEMENT

The project wind turbine, which is currently Fife's largest turbine and the only turbine on a dock wall in Scotland was named Poppy by the children of the local Childcare Centre. The turbine naming ceremony was officiated by local Fife Council Councillors, Douglas Chapman and Jim Young and the children of the local Childcare Centre. The Childcare Centre manager commented that "The children have all shown great interest in the turbine and we have watched it arriving, being constructed and even saw the men coming out of the top of it before the blades were attached! It's great to have something so interesting right on our doorstep as it gives us so many opportunities to talk to the children about looking after our planet. We are all excited to be part of the official naming ceremony."

The project has also been working with Adam Smith College. The Hydrogen Office and Adam Smith College are jointly providing 'Roadshows' for schools in Fife. These provide young learners with

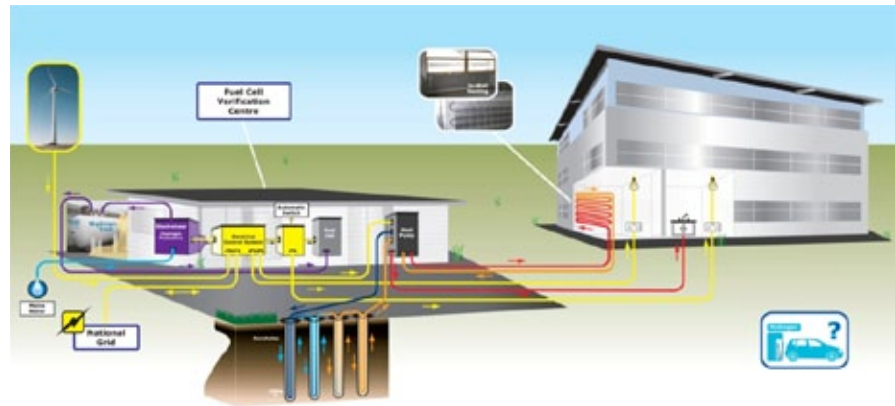

▲ Vision of the Hydrogen Office, including fuel cell verification centre

the opportunity to learn more about renewables and sustainability and to gain an understanding of present and future jobs in the renewable industry. The partnership has been established to provide expertise and innovation for energy education by the two organisations, both of whom champion learning in the renewables and new clean energy sector. The Roadshows are being run throughout Fife with pupils aged 12 to 15 years, highlighting the benefits of new energy sources and inspiring youngsters about careers in this dynamic industry.

The Hydrogen Office Ltd has also set up and run the 2010 Hydrogen Challenge sponsored by Babcock. The competition saw teams from six local primary and secondary schools build miniature hydrogen fuel cell powered buggies. As well as producing a poster exhibition detailing how the team had designed their vehicle, the teams had to prepare for a sprint challenge with buggies timed over a set distance, an endurance test to see how far they travel on one tank of hydrogen and

CONTRIBUTOR BIO

Derek Mitchell has project managed the Hydrogen Office from its inception. He is a key supporter of renewable energy technologies, but is strongly of the view that on their own, intermittent renewable energy technologies cannot enable the transition to a low carbon future. Derek is also a Director of the Scottish Hydrogen Fuel Cell Association and sits on the Scottish Government's advisory group for Hydrogen and fuel cell technologies¹.

¹ Since writing this article Derek has moved on from the Hydrogen Office. His successor, David Hogg, is happy to take your enquiries and explain the current work of the Hydrogen Office.

CONTRIBUTOR CONTACT AND AFFILIATION INFORMATION

Name: David Hogg

Organization/Institution:

The Hydrogen Office Ltd

Contact Address: The Hydrogen Office, Ajax Way, Methil Docks Business Park, Methil, Fife, KY8 3RS.

Email: info@thehydrogenoffice.com

Website: www.thehydrogenoffice.com



manoeuvrability, weight and measurement assessments of each buggy. One of the judges for the event was Dr Daniel Aklil, Managing Director of the Pure Energy Centre and one of the world's leading experts on hydrogen systems. Dr Aklil commented that "it was fantastic to see such innovation and enthusiasm shown by the competing teams, what a great way for school children to learn about this exciting technology." The winners' certificates were presented by Robert Dick, Energy & Support Services Manager of Babcock, which sponsored the Challenge who stated "this competition has been very exciting and inspiring, it's great to see how it has fired the pupils' imaginations and interest in

RECOMMENDATIONS

Economic, policy and innovation

The ability to store intermittent renewable energy while available, for use when it is not available, is one of the greatest challenges in making our transition to a low carbon future. It therefore requires a step change in the policy support offered to the development and uptake of these technologies. Communities in particular stand to benefit most from these technologies and should champion and push for policy changes that support the accelerated development of renewable energy storage technologies.

Technology implementation

Energy storage and fuel cell technologies are technically viable and in the right circumstances

engineering and energy. As a company we were very happy to sponsor the Challenge and support scientists and engineers of the future."

Renewables, energy storage and fuel cell technologies are key for the transition to a low carbon future. Today's children are central to this transition as they are the generation that will both have to manage the consequences of the global changes driven by climate change, and are also the generation that will have to implement and live with what is likely to be the most significant change in energy technologies since the industrial revolution.

are increasingly commercially viable. Find out how these technologies may be able to benefit you.

Technology development and testing

Find out what other communities have done and the opportunities and benefits they have achieved. The development and success of the Pure Energy Centre on the Island of Unst in the Shetland Islands is a great example of the positive impact communities can have.

Information and knowledge sharing

Visit the www.hydrogenoffice.com or www.pureenergycentre.com to find out more about the technologies mentioned in this article.

THE NORTHERN SUSTAINABLE HOUSE

GENERAL PROJECT INFORMATION

KEYWORDS:	Energy Efficiency, Cultural Appropriateness, Design Process
GEOGRAPHIC AREA:	Nunavut and the Canadian Arctic and Sub-Arctic
SPECIFIC LOCATION:	Arviat, Nunavut
LEAD ORGANISATION/ENTITY:	Canada Mortgage and Housing Corporation (CMHC)
PARTNER ORGANISATIONS/ENTITIES:	Nunavut Housing Corporation (NHC), Emercor Corporation

Increasingly, with rising energy costs, it has become clear to northerners¹ that current energy use and utility service costs are neither affordable nor sustainable. In addition to energy costs, there is a growing recognition that many housing models used in the north have not adequately reflected the culture and lifestyle of northern communities. On the whole, housing delivered to isolated aboriginal communities in the north has been dominated by designs from the south that do not address the needs of aboriginal families or communities.

In an effort to redress this situation, the Canada Mortgage and Housing Corporation (CMHC) part-

¹ Inhabitants of the northern territories of Canada

nered with northern housing providers to finance and carry out an integrated design, construction and monitoring of a model Northern Sustainable House (NSH), in each of Canada's northern territories. The goal of the project was to design a northern housing prototype that would reflect the cultural needs of the community in each of the northern territories that consumes, at a minimum, 50% less energy than the Model National Energy Code for Houses (MNECH).

This project examines the Northern Sustainable House that was designed for the community of Arviat, Nunavut, an Inuit community located on western shore of Hudson Bay in the eastern Canadian Arctic. The project illustrates important issues for designers working on housing in aboriginal com-

PROJECT TIME SPAN:

Jan 2010 to Dec 2013

PROJECT BUDGET:

CAD \$1,000,000

OVERVIEW OF FUNDING SOURCES:

\$150,000 from CMHC for the design, energy modelling, solar study and monitoring. \$700,000 from NHC for the Construction of Northern Sustainable Houses and \$150,000 from Emercor Corporation, the SIPs supplier

PROJECT GOAL: The goal of the project was to design a northern housing prototype that would reflect the cultural needs of the community in each of the northern territories that consumes, at a minimum, 50% less energy than the Model National Energy Code for Houses (MNECH).

PROJECT SUMMARY: CMHC partnered with northern housing providers to carry out the design, construction and monitoring of a Northern Sustainable House (NSH) in each of Canada's northern territories. The project was designed to address two issues in the north, the need to dramatically improve the energy efficiency of northern housing, and the need to improve the design of housing to better reflect the life styles and needs of Inuit and First Nations families. This project examines the Northern Sustainable House that was designed for the community of Arviat, Nunavut, an Inuit community located on western shore of Hudson Bay in the eastern Canadian Arctic.

munities and cold climates, and provides insights for designers and builders interested in buildings that significantly reduce energy consumption. This article provides a review of the technical considerations and details regarding the alternative construction, solar analysis, energy modelling and energy monitoring that was carried out to evaluate

the performance of the house. It also provides a overview of the integrated design workshop that was used to gather and incorporate community input into the design process, followed by some reflections on the influence that the project has had on the design and energy performance of housing in remote communities in the Canadian north.

THE ARVIAT HOUSE DESIGN PROCESS

To ensure the participation of community members and technical input from the Nunavut Housing Corporation (NHC), a design workshop for the Arviat house was held over three days. This allowed participants to speak comfortably on issues that were important to them and explore important ideas in more detail. A blend of technical and cultural considerations were addressed with discussions covering a range of topics, including changes in the Inuit society, energy efficiency, water supply and disposal, mechanical systems, foundations, and the use of space in the home. Spaces for storage, for sewing and working on skins, and for large family gatherings were highlighted in these discussions.

To create a forum that would encourage the free flow of ideas, the workshop facilitators, Joe Karatek, an Inuit from the community, and the author recognized that the participants coming to this charrette² had a variety of communication skills. One of the challenges was to make design concepts understandable to all members of the community, including elders, women and students, many from a very traditional background. To nomadic peoples, the western concept of a fixed house is unknown. Traditionally, the places where they lived changed according to the seasons, and their lifestyles

▼ Existing houses have inadequate storage (photo courtesy of Peter Dawson)



² A charrette, sometimes called a design charrette, refers to an intense period of design activity.



▲ Kitchens are typically too small in conventional modern housing (photo courtesy of Peter Dawson)

changed as well. The shift to living in fixed houses year-round has been a significant challenge for Inuit families and family and community life in general. As noted by Joe Karetok "The Inuit think of winter housing and summer housing differently. If you ask a design question in the wrong way, you might get stares instead of answers." This is because to the Inuit a single question may have two answers, depending on what season is being referred to. "The big problem with existing housing is that the design pretends that the seasons never

Sketch representing importance of seasonal housing for Inuit families ►

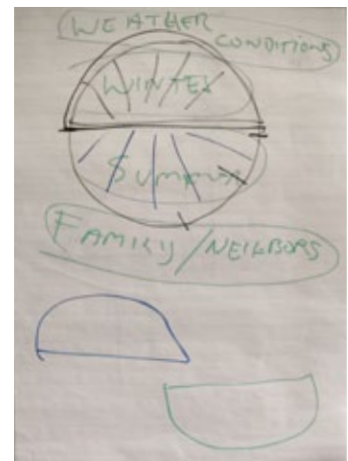



- ▲ Community members need a place for carving or sewing skins (photo courtesy of Peter Dawson)

change.” During discussions, Joe Karetak illustrated these seasonal differences in a sketch.

Some other significant design issues identified during the workshop included the need for:

- Rooms that allow for large family gatherings
- Spaces to store winter clothing and equipment for going onto the land
- Spaces for sewing skins and other crafts
- A place to work on snowmobiles and other equipment

THE DESIGN OF THE ARVIAT NORTHERN SUSTAINABLE HOUSE

The design of the NSH was carried out by a team organized and led by the author. The design addresses a number of local cultural needs and climatic conditions and allows for the easy

incorporation of alternative energy technologies, either at the time of construction or to be added at a later date as the costs of solar technologies continue to fall.

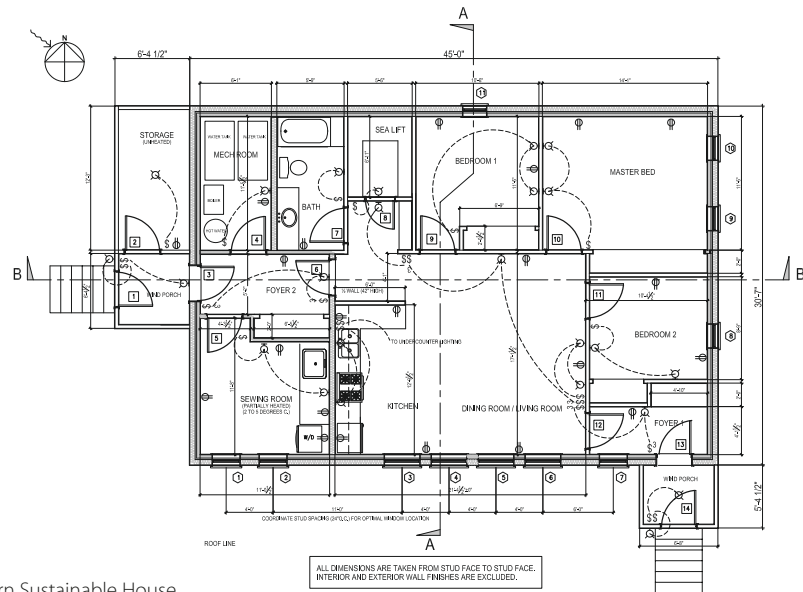

▲ Floor Plan for the Northern Sustainable House

The design was developed by evaluating and consolidating the cultural design ideas that were identified in the design workshop and incorporating these features into the design of the NSH. Important features include:

- A large, open living room/dining room/kitchen
 - Many houses, designed with small kitchens for southern families, do not provide enough space for larger extended families to gather
- Summer and winter entrances – The winter entrance needs to be kept clear of snow by the prevailing winds
- Warm, cool and cold spaces – Includes a cool room for sewing skins, insulated and on a separate heating loop to be kept an optimum temperature of 2 to 5 degrees C.
- A laundry area with a large laundry tub adjacent to the house entrance
- A Sea Lift Room for bulk purchases at the annual sea lift
- An isolated mechanical room for easy maintenance
- Desk/counter space for students: a place both to work and be near the family to hear the stories of the elders.



▲ Computer generated views of the large open living area/Student study area

ENERGY EFFICIENT CONSTRUCTION DETAILS

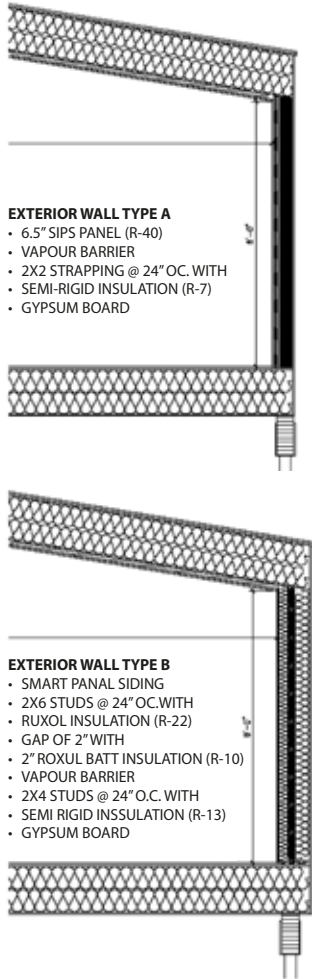

▲ Wall System A & B

Based on current building practices and input gathered from the design workshops, several wall systems were designed leading to the final selection and development of two alternative wall systems. 'Wall System A' utilises Structural Insulated Panels (SIPs) with additional strapping, a vapour barrier, and insulation added on site to the inside of the system to ensure long-term air tightness, provide a chase to run all electrical wiring and to improve energy performance. The SIP option was evaluated for its potential to speed up the process of construction, particularly in smaller isolated communities.

'Wall System B' utilises a double-framed wall. In both cases the floor insulation was maintained at R40 (RSI 7.04)³, with ceiling insulation increased

3 The R-value is a measure of thermal resistance used in the building and construction industry. The present author uses the US definition in customary units of $\text{ft}^2 \cdot \text{F} \cdot \text{h} / \text{Btu}$. The conversion between SI and US units of R-value is $1 \text{ ft}^2 \cdot \text{F} \cdot \text{h} / \text{Btu} = 0.176110 \text{ K} \cdot \text{m}^2 / \text{W}$, or $1 \text{ K} \cdot \text{m}^2 / \text{W} = 5.678263 \text{ h} \cdot \text{ft}^2 \cdot \text{F} / \text{Btu}$. To disambiguate between the two, some authors use the abbreviation "RSI" for the SI definition.

from R 40 (RSI 7.04) to R 67 (RSI 11.79). The existing wall insulation level of approx R 28 (RSI 4.93) was increased to approximately R 50 (RSI 8.8) in Wall System A and R 48 (RSI 8.45) in Wall System B. The design used a typical unvented Arctic Roof to prevent damage to overhangs from the high winds and prevent the fine powdered snow found in the Arctic from entering through the ceiling.

Other energy efficient construction details of the NSH include:

- Triple glazed, argon filled, fibreglass windows
- Advanced framing details to reduce materials and thermal bridging
- Highly energy-efficient florescent lighting fixtures
- Highly energy-efficient oil boiler for space heating and hot water, a Heat Recovery Ventilator (HRV) with an ECM motor for ventilation

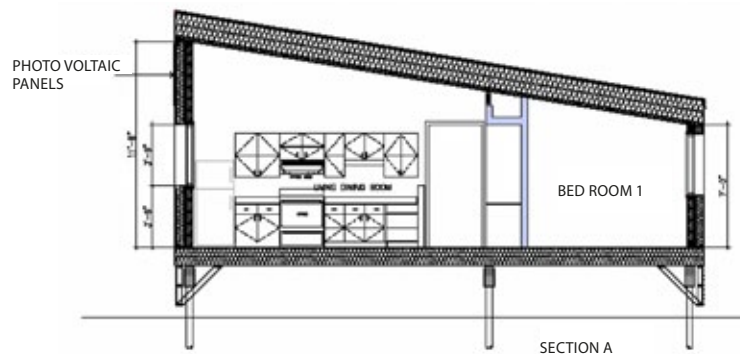

▲ North – South Section

ENERGY EFFICIENT DESIGN DETAILS

A number of additional design details were incorporated to improve the overall energy performance of the house. These include:

- A southern orientation and with large south windows and a taller profile for the installation of photovoltaic or solar water heating panels
- Reducing the north elevation to 7 feet (2.13 m.) to reduce the northern exposure, thus deflecting the prevailing winter winds

- Clustering the bathroom/laundry/kitchen to reduce plumbing runs
- Low water consumption stacking washer/dryer
- Isolated foyers at each entrance
- An efficient footprint that reduces the floor area of the house

The design addresses a number of local cultural needs and climatic conditions and allows for the easy incorporation of alternative energy technologies, either at the time of construction or to be added at a later date as the costs of solar technologies continue to fall.

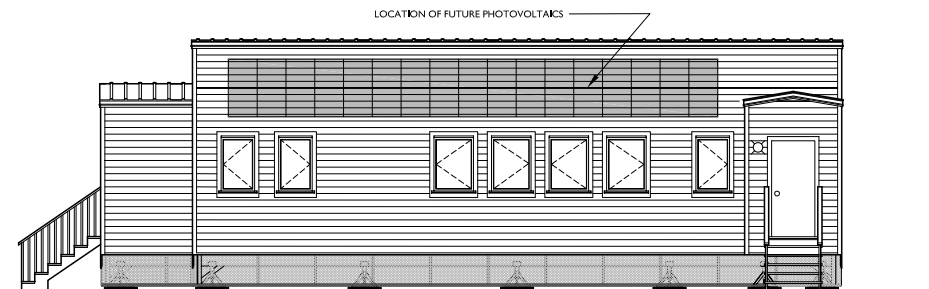

▲ South Elevation

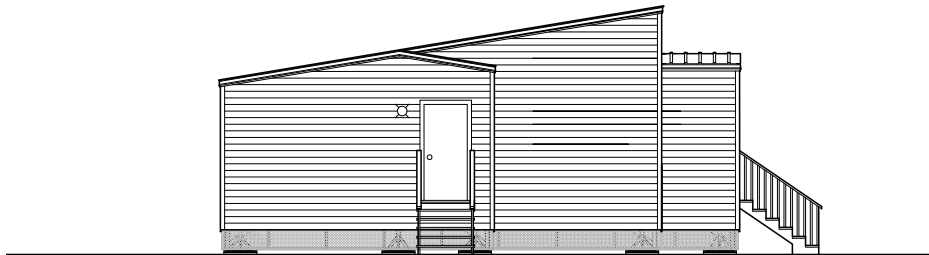

▲ North Elevation

Col #	1	2	3	4	5	6	7	8	9	10	11
	Consumption	R2000	R2000	Elec	Elec	Oil	Oil	Energy	Energy	Energy	Energy
Option	MJ/yr	Consumption	Target	KWH	Cost	Litres	Cost	MJ	%	Cost	Save
		MJ/yr	MJ/yr	/yr	\$/yr	L/yr	\$/yr	Save/yr	of Base	\$/yr	\$/yr
MNECH-78% Oil	299,599	268,026	90,683	17,367	\$9,378	6,154	\$6,154	0	100%	\$15,532	\$0
MNECH-71% Oil	339,322	307,749	90,683	17,405	\$9,398	7,172	\$7,172	-39,723	113%	\$16,570	-\$1,038
Existing 2.0 ach50	183,213	151,666	90,683	16,647	\$8,990	3,200	\$3,200	116,386	61%	\$12,190	\$3,342
Existing 1.5 ach50	175,025	143,478	90,683	16,610	\$8,969	2,991	\$2,991	124,574	58%	\$11,960	\$3,572
Type A	111,833	88,172	90,683	10,527	\$5,685	1,919	\$1,919	187,766	37%	\$7,604	\$7,928
Type B	114,893	91,231	90,683	10,539	\$5,691	1,998	\$1,998	184,706	38%	\$7,689	\$7,843
Type B-LweHard	114,228	90,566	90,683	10,537	\$5,690	1,981	\$1,980	185,371	38%	\$7,670	\$7,862

Column 1 Lights + Appliances + Heat + Hot Water

Column 2 Heat + Hot Water Only (R2000 Target Criteria)

Column 3 R2000 Target (Heat + Hot Water), equivalent to EnerGuide 80

▲ Energy Modelling for the Northern Sustainable House

SOLAR STUDY

To evaluate the potential for the use of solar technologies on the house, RETScreen⁴ was used to evaluate the potential solar gain from the installation of solar thermal and photovoltaics arrays on the house. This analysis took into account two

⁴ The RETScreen Clean Energy Project Analysis Software is a clean energy decision-making software, provided free-of-charge by the Government of Canada as part of Canada's recognition of the need to take an integrated approach in addressing climate change and reducing pollution. www.retscreen.net

▼ Potential Solar Installation

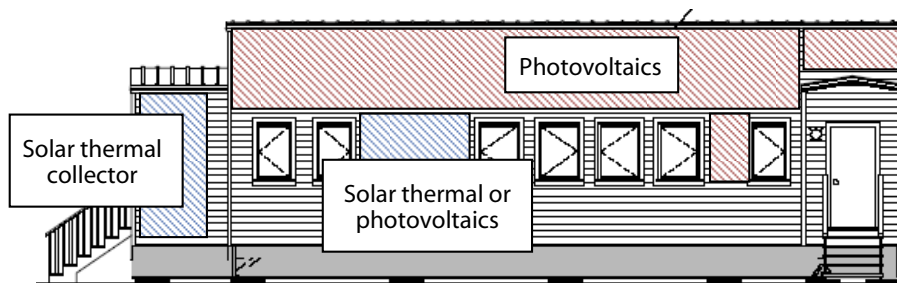

ENERGY MODELLING

To evaluate the energy performance of the house, energy modelling of the existing and proposed wall systems was carried out and evaluated against the Model National Energy Code for Houses (MNECH). The results of the modelling confirm that the both Wall Types A and B would attain the targeted energy performance levels.

variables that are common in northern houses – a much higher occupancy rate (higher than the normal four persons per house) and the much lower water consumption rates that are typical for homes where truck delivery of water is the norm (national average of 240 litres per person per day versus 100 litres per person per day in the north).

It is important to note that vertical surfaces work well for solar performance in the far north, by avoiding the accumulation of snow, combined with the lower height of the sun in the sky, outside of summer. It is expected that lost efficiencies in the angle of solar panels will be made up through gains from solar bounce from the snow-covered ground. In addition, vertical installations protect solar panels from the high winds found in many of these communities, which is the reason for the complete absence of roof overhangs.

Several scenarios for utilising solar power were evaluated. In one scenario a combination of solar hot water collectors and photovoltaics would be

used with two solar thermal collectors and 16 PV panels. While there would be some shading with this configuration, the solar thermal collectors

NEXT STEPS

Materials for the NHC/CMHC Northern Sustainable House have been shipped to Arviat, with houses being constructed during the 2012 building season. Two models of the house will be built – one using the double wall system and the second using a SIPs system. The energy performance of both these houses will be monitored for a period of one year, with the energy savings translated into

CONCLUSIONS

Designing and building houses in the far north is an enormous challenge, and it is important to address all aspects and considerations in order to ensure success. While addressing technical issues is a significant challenge in the severe Arctic climate, attempting to do so without carefully considering the cultural context of the north is likely to result in failure.

The efforts being carried out in these and other NSH projects are motivated by the realisation in the north that climate change will have a tremen-

would not lose significantly less than the PV. With this combination, approximately 18% of the annual energy loads of the house can be met.

monthly cost savings and compared to the running and maintenance costs of conventional housing. The challenges and training for each building system are being documented and evaluated with the technical staff of the NHC. The occupants of the houses will also be interviewed regarding their views of the houses and how the designs meet the needs of the families.

dous impact on the sustainability and survivability of northern communities. To the peoples of the north, climate change and its impacts are being talked about in a way that goes beyond the measurable – to the Inuit; climate change is a human rights issue, a threat to their identity and their way of life. The author has been in conversations where Inuit elders have wondered whether their communities would have to move farther north so that they can continue to hunt the animals that still provide the majority of their diet, so they can continue to live in the land of ice.

CONTRIBUTOR BIO

Bill Semple is a Senior Researcher responsible for Northern Housing with the Canada Mortgage and Housing Corporation (CMHC). As an architect and builder, with a background in design, building science, construction and environmental planning, Bill has extensive experience in the Canadian housing industry and on international development projects. His work has focused on addressing issues in cultural and environmental sustainability, through both building and community design.

Bill sits on the Board of Directors of the Cold Climate Housing Research Centre (CCHRC) in Fairbanks, Alaska, is a Research Associate with the Arctic Institute of North America (AINA) and a member of the World Society for Ekistics.

CONTRIBUTOR CONTACT AND AFFILIATION INFORMATION

Name: Bill Semple, Senior Researcher
Education title: Master in Environmental Design (Architecture)
Affiliated organization: Canada Mortgage and Housing Corporation
Address/City/Postal code: 700 Montreal Road, Ottawa, Ontario, Canada K1A 0P7
Email: bsemple@cmhc-schl.gc.ca
Website: www.cmhc.ca

RUNDE ENVIRONMENTAL CENTRE (REC)

PROJECT TIME SPAN:

2009 -

PROJECT BUDGET:

1 million EUR per year

OVERVIEW OF FUNDING SOURCES:

Runde Miljøsenster AS (Runde Environmental Centre): Shareholder Company – with private shareholders, possibly public ones in the future (regional government), organized as ‘public-similar’ body, largely project-funded

Runde Miljøbygg (Runde Environmental Building): Shareholder Company owning the building – with both private and public shareholders (local businesses, municipality and regional governments)

REFERENCES AND RELATED RESOURCES:

NORA project report (Runde Group, 2004)

GENERAL PROJECT INFORMATION

KEYWORDS:

Norwegian West Coast, Renewable Ocean Energy, Marine Resources, Marine Natural History, Sustainable Building Technology

GEOGRAPHIC AREA:

Norway

SPECIFIC LOCATION:

Runde, west coast of Norway, 62° N

LEAD ORGANISATION/ENTITY:

Runde miljøsenster AS

PARTNER ORGANISATIONS/ENTITIES:

Runde miljøbygg AS

PROJECT WEBSITE:

www.rundecentre.no

The Runde Environmental Centre is a research and educational facility on the island of Runde on the west coast of Norway. Runde has an area of 5km² and is a dynamic and interesting place in a unique geographical location. The steep cliffs on its western side are home to many thousands of breeding seabirds – the most southerly seabird colonies in Norway – one of the reasons the island is a major international tourist attraction.

Furthermore, the ocean environment surrounding Runde is highly unique and plays a key role in the Norwegian Sea ecosystem: The island is close to the continental shelf, which means that the deep ocean basins are within reach, and the

waters off Runde are characterised by some of the most productive fish populations in the Northern hemisphere. More recently, oil and gas resources

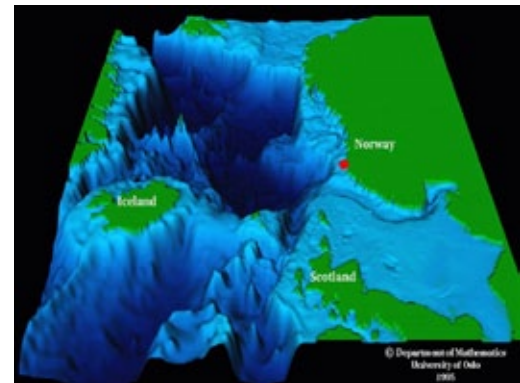



have become equally important in providing a livelihood to humans and sustaining an active and profitable maritime industry in the area.

The diversity of life in the oceans and fjords near Runde is outstanding and includes lush kelp for-

ests, deep water coral reefs and numerous marine mammals. The spectacular fjord region where vertical rock walls drop from 1000m mountaintops to many hundreds of metres below the water's surface has received UNESCO world heritage status.

▲ Sea bird colonies on Runde attract researchers and tourists from around the world

PROJECT GOAL

The main goal of REC is to create an understanding of the key role Runde and its surroundings play in the Norwegian Sea ecosystem. With the oceans as the basis of life in the region, REC aims at facilitating sustainable resource use and innovative technology development.

PROJECT SUMMARY

Runde Environmental Centre provides environmental research and education infrastructure on the island of Runde, Western Norway. The location is key to the Norwegian Sea ecosystem and humans in the region have lived off the ocean for generations. REC facilitates scientific research on the natural environment and contributes to the development of innovative and sustainable technologies for fisheries and aquaculture, marine transport and renewable ocean energy. By engaging society in understanding 'their ocean', and using the centre as a test bed for novel ideas and unconventional approaches to future challenges, REC is a meeting place for everyone interested in the oceans, especially as they sustain human life.



▲ The ecological features and resources in the local environment, and the potential for conflict among multiple resource users, were key inspirations for the founding of the REC

AGAINST MANY ODDS – STARTING RUNDE ENVIRONMENTAL CENTRE

Despite the uniqueness of the environment at Runde, environmental research and education in the region, especially with regard to the ocean, have been limited as environmental research facilities are largely associated with the nearest universities in Trondheim to the north and Bergen to the south. However, the combination of outstanding ecological features and natural resources both above and below the water create a risk of conflict that is focussing attention on the region, for example ship traffic accidents and oil spills. The need to address this concern was a key inspiration for founding the Runde Environmental Centre.

A small group of marine scientists from the area started developing the idea of a marine research

station at Runde in the late 1990s. Their main goal was to provide research and educational facilities on the location which was so unique in terms of environmental features, but which had received far too little attention compared to areas more closely associated with the larger universities. They started a shareholder company and began raising interest and funds for their concept both regionally and nationally. At a time when the major trends of migration in Norway were away from rural areas to the larger cities, and when more and more islands were faced with depopulation and loss of infrastructure, the so-called 'Runde Group' was promoting the establishment of a research facility on a remote island with half a million seabirds and 90 human inhabitants.

BUILDING AND INFRASTRUCTURE

After more than ten years in the development and planning process, the Runde Environmental Centre opened its doors in October 2009. At that

▼ The centre includes offices and laboratories, conference facilities eight apartment units for visitors



time, the centre consisted of a building complex in a spectacular location overlooking the Norwegian Sea. 'Runde Miljøbygg AS' (Runde Environmental Building) is a shareholder company owning the infrastructure of the centre which includes offices and laboratories for the permanent staff of the centre, conference facilities for various meetings and events and eight apartment units for visitors of the centre. The facilities may be used both in connection with the centre's own activities and are also rented for private or public functions.

With a mandate to put sustainability into practice, the building was designed to reflect the centre's environmental principles and provides a suitable backdrop to the breath-taking land and seascapes that play a key role in the centre's activities.

The architect, Siri Lykke Kolstad, explains some of her thoughts about the building as follows:

“There has always been an association to Rundebrenden, Runde’s bird cliff. At the same time, I wished to draw the ocean into the building as much as possible. The windows are designed as purposeful icons, with a variety of shapes and functions, – some to sit in, others to stand in. Some windows have been composed just to catch a glimpse of wind, moving clouds, a bird. It is quite lovely to hear how the astounding view from inside the building evokes something close to sacredness in visitors.”



▲ Views of and from the windows (or ‘purposeful icons’) in the centre

ENVIRONMENTAL BUILDING TECHNOLOGY

With support from a government grant for energy-efficient design, the building at Runde Environmental Centre has become a show piece for sustainable building technologies and solutions. Aside from implementing state-of-the-art energy-conserving and sustainable technologies, REC

- ▼ The centre’s vacuum toilets reduce demand for water and are part of a research project exploring nutrient recycling and energy production (biogas)



also uses the building as a focus of its educational work.

The building is extremely well insulated, using half as much energy as a standard commercial building. The materials used are mostly local and recyclable, and heat will be provided from a heat exchanger based on extracting energy from sea water (it is here that the Gulf Stream first comes ashore in Norway). Other sources of energy – for example solar energy and wave power – can be easily added to the system as provisions have been made to upgrade the current energy supply as new technologies become available.

The sanitary system, based on water-conserving vacuum toilets, represents an ongoing research and development project by the centre’s staff together with a local manufacturer, with the sewage-component being evaluated for future nutrient recycling and energy production (biogas).



▲ Substantial wall insulation and energy efficient windows and lighting systems reduce the energy consumption of the centre

FACILITIES AND FACILITATORS

A second shareholder company – Runde Miljøsententer AS (Runde Environmental Centre) is separate and independent from the company owning the infrastructure, and organises the centre's work and activities. REC has grown to a staff of 10, with several researchers, conference service personnel and technical support staff.



▲ An outdoor stage may be used for different types of events – here during the 'Environmental Rock Concert' in September 2010.

With a focus on the unique environment at Runde, especially the marine environment, the centre seeks to facilitate research and education in the region. Strategically placed among the three main societal sectors – public authorities, private marine and maritime industries and research and educational institutions, Runde Environmental Centre aims to strengthen communication about core environmental issues affecting all stakeholders.

In practice, this includes:

- Long-term monitoring of environmental parameters in the ocean (e.g. water quality, sea water temperature and acidity, biological diversity, ocean currents)

- Providing research facilities to visiting scientists
- Facilitating research in the context of Integrated Coastal Zone Management
- Offering research and monitoring services to regional stakeholders
- Engaging the local marine and maritime industry in a dialogue on sustainable technology development
- Providing test facilities for new sustainable technologies, especially in the fields of fisheries and aquaculture, marine transport, renewable ocean energies and the building industry
- Providing environmental assessment support to stakeholders testing novel environmental technologies
- Providing networking and logistical support to research and development customers using the centre's facilities
- Providing facilities for seminars and conferences on environmental challenges for the region
- Offering environmental education and teaching to specific target groups, including schools and universities, local businesses, administrators and the general public

▼ Experiential learning is an integral part of public communication work at Runde Environmental Centre – here students attend a workshop on renewable energy





With regard to ocean energy, Runde Environmental Centre has been selected as one of three regional competence centres for renewable energy – alongside one for wind- and one for bio-energy. The primary mandate of this competence centre is to be an information hub on ocean renewables, the most relevant at Runde being wave power. In addition, national and international industries are starting to test various wave power technologies at Runde as the wave here are among the most powerful in Europe and the infrastructure in the region is highly developed through the industrial maritime cluster.

In general, Runde Environmental Centre works within a 'glocal' framework, i.e. uses a global vision and perspective for acting and responding locally. Hence, a strong international network is important as a reference point and so as not to act in isolation. In addition, one of the core traits of the people of the region Sunnmøre is a legendary

ability to simply start a new enterprise, against all odds, has had an impact on Runde Environmental Centre: Not letting the fear of failure prevent action has been part of REC's success story to date and appears to be an equally inspiring concept as the spectacular natural surroundings at Runde remain the key for both the centre's own work, and for its users and visitors.

CONTRIBUTOR CONTACT AND AFFILIATION INFORMATION

Annelise Chapman
Runde Miljøsenster AS (Runde Environmental Centre)

Runde Environmental Centre
6096 Runde
Norway
lise@rundecentre.no
www.rundecentre.no



- ▲ Runde Environmental Centre has been selected as a regional competence centre for renewable energy, focusing on ocean renewables (particularly wave power)

CONTRIBUTOR BIO

Dr Annelise Chapman joined Runde Environmental Centre as research scientist in 2008 and hence has followed the establishment of the centre from its infancy. She is a benthic marine ecologist who completed her training and PhD in Germany and has worked in Europe and Canada before she came to Norway. Annelise has conducted fundamental and applied research within both public and private sectors, and is excited about the opportunity of diversifying her work by contributing to this innovative project in a unique location.

WEB-BASED CALCULATORS FOR VEHICLE COSTS AND EMISSIONS

PROJECT TIME SPAN:

not specified

PROJECT BUDGET:

not specified

OVERVIEW OF FUNDING SOURCES:

Intelligent Energy Europe and Icelandic government

GENERAL PROJECT INFORMATION

KEYWORDS:	Emissions, cost, cars, transport, Iceland, calculators, internet
GEOGRAPHIC AREA:	Iceland
SPECIFIC LOCATION:	Akureyri
LEAD ORGANISATION/ENTITY:	The Icelandic Energy Agency
PROJECT WEBSITE:	www.orkusetur.is/id/4887

The first energy agency in Iceland was formally opened at the end of 2006 and is located in the town of Akureyri in North Iceland. The main role of the agency is to increase awareness about energy efficiency in households and industry, including the creation and introduction of educational material about different energy issues. The agency is fully autonomous and works as a link between the public, private companies, institutions and the authorities.

During its first three years the Icelandic energy agency was partially financed by the Intelligent Energy Europe programme (IEE) whose broader aim is to promote policies for smart energy use and renewable energy, mostly within the European Union, as a means to address today's energy

challenges and develop new energy business opportunities and technologies.

The agency is managed by a board and politically supervised by the Icelandic Government. The five representatives of the management board are appointed by the Minister of Industry and Commerce, the Association of Local Authorities in Iceland, The Federation of Icelandic Energy and Water Works and finally by the Consumers Association of Iceland.

The main objectives of the agency are:

- To provide consumers and public authorities with information in the fields of energy



- To promote rational use of energy for space heating, with emphasis on areas where geothermal energy is limited
- To create and introduce educational material for schools and consumers
- To help small and medium sized companies and municipality to plan strategies for facilitating energy efficiency
- To promote a reduction in the intensive use of fossil fuel in the transport section

The agency established the web-based calculators project in order to serve consumers with impor-

tant information in an easy and interactive way. This enables a small organisation like the energy agency (staffed by only two employees) to reach and serve many users. The project is very efficient given that many different calculators are built around the same database, making updates easy. A user deciding what vehicle to buy, a user planning a trip with minimum emission or a biker calculating his effort and environmental savings are therefore all using the same database with different layouts and formulas. A maximum sustainability is reached by offering this service on the internet because then they are available everywhere in

▲ Despite its popular image of sustainability, the Icelandic car fleet is, per capita, one of the largest in the world and the average registered fuel consumption value of the fleet is the highest in Europe

PROJECT GOAL

To provide consumers with reliable and objective information on the economic and environmental cost of using different types of vehicles and fuels, via an efficient and flexible online format, so as to influence their selection of vehicle purchases, travel modes and destinations

PROJECT SUMMARY

The Icelandic Energy Agency has created interactive web calculators to help the public decide what vehicles to buy, plan their trips and estimate how to off-set their emissions. The calculators have been extremely successful, are widely used and promoted by national newspapers, radio and television. The data used for the calculators comes from The Road Traffic Directorate and all the technical specifications of the vehicles are based on European standards and are therefore fully comparable. The calculators were upgraded and translated into all of the seven Nordic languages and English, with the aim of attracting more users.

the world, all the time without any transport or publishing with enormous paper use.

The project is very innovative in terms of how the information is displayed in a diverse but simple way. Many layers are built on the same database so as to reach a broader group of consumers. Only the most important information is highlighted and the user does not have to spend a lot of time filling out facts to reach the numbers. The calculators are extremely user-friendly and users do not have to learn about how the calculators work. In Iceland, a country with many small and remote communities and settlements, the internet is the easiest way to reach consumers. Around 90% of people in Iceland have access to the internet. There is a need for calculators with a common user interface, central maintenance, and different languages. The calculators are naturally modular; therefore the collection can be expanded in the future, driven by demand.

The calculator project is very important economically because most of the imported fossil fuels in Iceland are used in the transport sector. The agency has therefore defined the transport sector as the most important sector in which to focus its attention. Per capita, the Icelandic car fleet is one of

the largest in the world and the average registered fuel consumption value of the fleet is the highest in Europe. Reducing fuel use through more efficient vehicle will strengthen the economy when less money is spent on foreign fossil fuel. One of the economic threats facing Iceland is a lack of foreign currency, and today too much of this 'scarce resource' is spent on petroleum for transport.

One of the successes of the project is the replication potential of the calculators. When the calculators were designed the aim was to use as little text as possible to make it easier to translate. Recently the calculators were translated into all of the seven Nordic languages, including Greenlandic and Faroese. The translation was very easy because only the words and phrasing had to be translated. All the text around the database and technical specification for the vehicles did not have to change for different countries. The calculators were programmed in the way that allows other agencies, institutions, companies or individuals can launch them on their own websites. The updates are constant because there are always new vehicle types coming into the market. The updates are performed centrally in Iceland, and so foreign partners displaying the calculators do not have to

worry about updating the website. The next step is to secure more foreign partners to use and display the calculators, and translate them to even more languages.

The vehicle emissions calculator project can contribute a lot for climate protection, in an efficient and inexpensive way. It is interesting to analyze the effect that minor changes in the personal vehicle fleet in the Nordic countries will have on CO₂ emission. Passenger cars in the Nordic countries total

about ten million. If the average emission values decreases from 180 to 150 CO₂ g / km over the next ten years it would reduce emissions from cars by 5 million tonnes of CO₂ per year. This is equivalent to the the total annual emissions of Iceland and so the climate relevance of well-informed consumers is clear to see. It is also important to get the calculators in use in the Nordic countries, and hopefully they will affect some of the 10 million decisions made on automobile purchases in the Nordic Region.

CALCULATOR 1: VEHICLE COMPARISONS

Buying a vehicle is one of the biggest environmental decisions an individual can make. The impact of the decision will last throughout the lifespan of the vehicle. During the next ten years, around 10 million decisions to purchase new vehicles will be made in the Nordic countries. Tools such as the emissions/cost calculator can influence those decisions.

The Icelandic car fleet is very inefficient and contains many large vehicles. The most effective way to reduce fossil fuel consumption and CO₂ emissions is to get people to switch to more efficient vehicles. The first calculator shows comparisons between vehicles. With this calculator it is possible to compare the fuel cost and the emissions of two different vehicles, i.e. between large and small vehicles, diesel, petrol and hybrid engines etc. It is possible to adjust the fuel price, annual driving and the time of use. The data specific to each vehicle comes from the Road Traffic Directorate. All of the numbers for the technical specifications of the vehicles are European standards and are therefore fully comparable.

Several changes were made to the vehicle calculator to make it more user friendly and simple. New

fuel alternatives were added, including methane, ethanol and electricity. The calculators have now been updated and translated to all of the seven Nordic languages and English. The new system can detect the country in which the tool is opened and automatically adjust to the national language, currency and fuel price.

The calculators have been extremely well received and are widely used by the public in Iceland, influencing the people's decisions of which vehicle to buy. Since it was launched, the vehicle calculator has been visited over 40,000 times in Iceland, a country whose population is only 300,000. Traders that sell efficient vehicles have invited the employees of the agency to introduce the calculators in their showrooms. In the beginning the agency needed to contact auto shops to get confirmation about some technical vehicle specifications. Now that the calculators have become prominent and are in common use, it is the auto shops that contact the agency to introduce new vehicles they want added to the database.

THE H2SEED PROJECT

PROJECT TIME SPAN:

2006 -

PROJECT BUDGET:

£700,000

OVERVIEW OF FUNDING SOURCES:

Comhairle Nan Eilean Siar (CnES),
Scottish Government.

GENERAL PROJECT INFORMATION

KEYWORDS:	Renewable Energy, biogas, skill development, technology transfer, green hydrogen, hydrogen vehicle, green transport, energy storage
GEOGRAPHIC AREA:	Scotland, UK
SPECIFIC LOCATION:	Western Isles
LEAD ORGANISATION/ENTITY:	Comhairle Nan Eilean Siar (CnES) or the Western Isles Council
PARTNER ORGANISATIONS/ENTITIES:	HIE–Innse Gall (UK), Lews Castle College (UK), The Stornoway Trust (UK), The Pure Energy Centre (UK), NTDA Energia (Spain)
PROJECT WEBSITE:	www.hydrogenhebrides.com www.cne-siar.gov.uk



▲ Location of the Outer Hebrides

The islands of the Outer Hebrides make up the administrative area of the Western Isles, and are located off the North West coast of Scotland. Their land extension is of the order of 3,100 km², with a population of nearly 27,000 inhabitants; Stornoway is home to about 9,000 inhabitants. The local authority Comhairle nan Eilean Siar (CnES) initiated a series of hydrogen projects, of which H2 SEED is the first project covering the whole value chain of hydrogen (H₂) technologies: H₂ production from biogas, H₂ storage, H₂ filling station and H₂ use in both stationary and transport applications. H2 SEED aims to provide an innovative solution to utilising excess electricity produced by a biogas engine in the Creed Waste Treatment Plant, while being the starting point for the creation of a H₂ infrastructure in the island.

In common with other Scottish island groups, the Outer Hebrides have some of the highest fuel costs and the highest prevalence of Fuel Poverty in the UK. Over 97 percent of the energy consumed by the islands' inhabitants is imported, while the average energy cost is over 13 percent higher than the UK average. With the changing economic climate of energy supply it is anticipated that imported fuel costs will continue to rise. Unfortunately, only one 33 kV line connects the islands to the UK National Grid. This severely inhibits the capacity to export power to the Grid and causes significant instability and a lack of reliability of electrical supply. The economics and logistics of fuel supply in the Outer Hebrides create a unique opportunity for the early deployment of hydrogen infrastructure for demonstrating the pre-commercial hydrogen economy.

In parallel with their reliance on imported fuel, the Outer Hebrides have one of the richest renewable resources in the world, which if harnessed to produce hydrogen, offers a viable alternative to fossil fuel supplies. In 2006, the Scottish Executive commissioned an assessment of the extent to which wave and tidal stream energy could contribute towards the national energy mix without significant effects on the environment. The study concluded that the Scottish wave power resource that could be extracted without undue environmental impact was between 525 and 1800 MW of installed capacity. Around 50 percent of this national total is predicted to be located off the Outer Hebrides. Additionally, the islands are also home to the best wind power resource in Europe; with an annual mean average offshore wind power density in excess of 1200 W/m².



In this context, CnES constructed the Creed Waste Treatment Plant, the first plant in the United Kingdom to combine anaerobic digestion technology and in-vessel composting to process biodegrad-

able wastes. In short, the Creed Waste Treatment Plant processes household daily waste to produce biogas. From this biogas, it is easy to generate electrical power.

PROJECT GOAL

To support the accelerated development of green transport and increase the penetration of renewable energy in the Outer Hebrides. Specifically, to create an embryonic Hydrogen Transport Project of international, national, regional and local significance that will help to place the Outer Hebrides at the centre of the global drive to create a low carbon and self sufficient economy.

PROJECT SUMMARY

The H2SEED project was designed to address two problems; (a) reduce costly imported hydrocarbon based fuel; and (b) to provide a solution to a grid lock problem, where renewables cannot be connected to the weak electrical grid network. To solve the first issue, the Comhairle Nan Eilean Siar (CnES – Western Isles Council) aimed to develop and use state of the art hydrogen technologies to dramatically reduce the isles dependence on imported fuel, hydrogen being the new fuel. To solve the second problem, the CnES aimed to store excess renewable energy generation and use this excess in a set of applications such as cooking, heating, and others. The overarching aim was to equip the Outer Hebrides with knowledge, competences and technologies that will increase the penetration of renewable energy, provide a green alternative for imported fuel, create new job and business opportunities and enhance educational prospects.

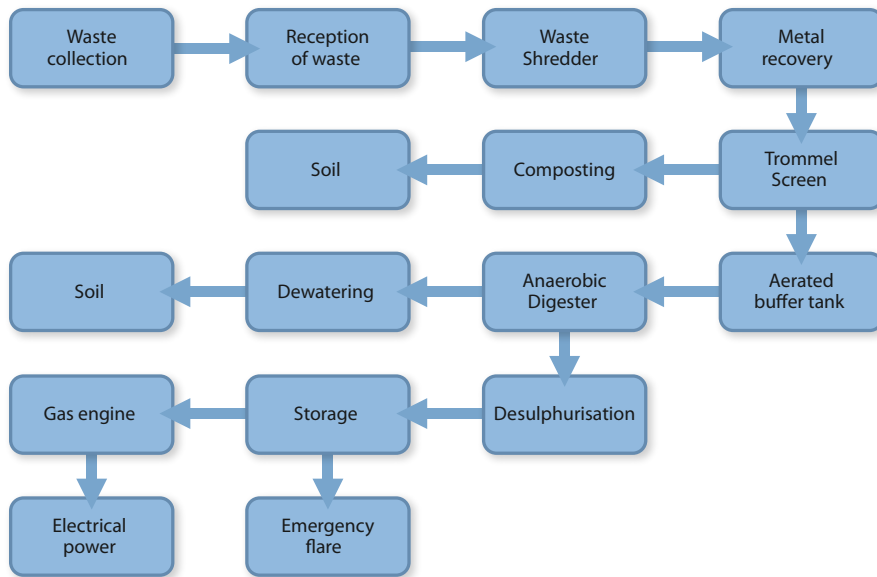

▲ Schematic diagram of Creed waste treatment process

Although it is easy to produce electricity from the biogas, the Creed plant cannot be connected to the grid as the Outer Hebrides electrical grid infrastructure is weak. Therefore the CnES decided to store the excess green energy from the plant by producing hydrogen. This hydrogen would then be used to fuel a set of vehicles. CnES subsequently extended the biogas system to incorporate



▲ The Biogas storage tank

H2SEED – A WORLD FIRST IN HARNESSING HYDROGEN FROM BIOGAS DERIVED FROM MUNICIPAL WASTE

The H2SEED project is the world's first hydrogen (H₂) infrastructure project to harness H₂ produced from biogas derived from municipal waste. It is also the first project of its type and size delivered in the Outer Hebrides community covering the whole value chain of H₂ technologies: H₂ production from biogas, H₂ storage, H₂ filling station and H₂ use in both stationary and transport applica-

hydrogen technologies. The hydrogen project is called the H2SEED project.

The innovative Creed and H2SEED projects are a leading example of the decentralised energy infrastructure solutions that will be required to respond to the inevitable and long term decline in global hydrocarbon resources and energy security. CnES has supported this development by investing £450,000 and the CnES has attracted £250,000 of funding from the Scottish Executive Renewable Hydrogen and Fuel Cell Scheme, and an additional £21,000 from the Stornoway Trust.

The H2SEED project, in conjunction with the Creed Waste Treatment Plant, provides a world-class hydrogen infrastructure and a unique process to utilise house waste to turn it into clean fuel for vehicles through hydrogen technologies. The H2SEED project itself is an international example of a low carbon, sustainable and highly energy-efficient facility for refuelling cars. Built to future hydrogen standards of "iconic" design, with a very low environmental footprint and low energy life cycle costs, the objective is for the facility to encourage cutting-edge research and development into low carbon energy systems.

tions. At present, the annual biogas production from the Creed Waste Management Plant accounts for 1,382,400 Nm³/year, with a methane content around 60%. This biogas is used to power a turbine producing electricity and heat. The plant is not authorised to export electricity to the grid due to technical constraints, forcing the engine to operate at partial load. Operating at partial load,



▲ Hydrogen production and storage systems

the engine temperature is reduced and the sulphur contained in the biogas corrodes the engine, considerably reducing its lifetime.

At current levels of biogas production, the engine can operate for 8 hours per day from Monday to Friday at a partial load, close to 80 percent. With these 8 hours of operation the match between the

Waste Treatment Plant requirements and electricity production from the engine is maximised, providing, during this time, 100 percent of the Waste Plant electric requirements plus a 40 percent excess. The heat produced by the engine could also be used for heating requirements of the plant, accounting for around 30 percent of total heating needs. The excess of electric energy generated

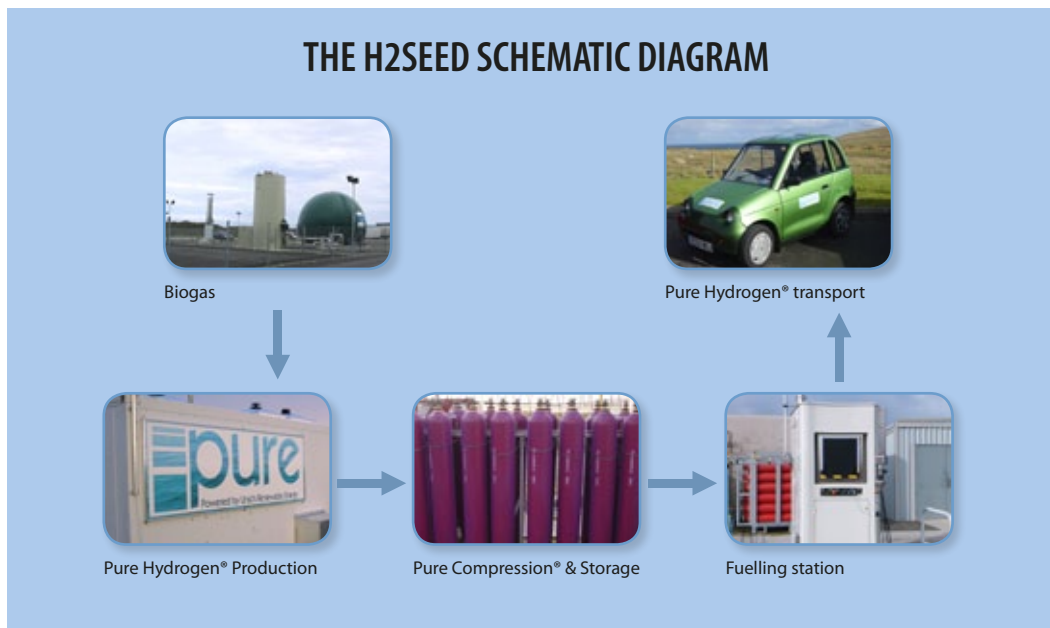

◀ Schematic diagram of the H2SEED project

amounts to around 700 kWh per day. Since this electricity cannot be exported to the grid, the innovative nature of this project consists of installing an electrolyser that will absorb this surplus.

Several different technologies for hydrogen generation were considered to use the excess energy, including the use of a natural gas reformer,

“The H2SEED project, in conjunction with the Creed Waste Treatment Plant, provides a world-class hydrogen infrastructure and a unique process to utilise house waste to turn it into clean fuel for vehicles through hydrogen technologies”

a biogas purifier and the selected option, an electrolyser. The electrolyser is a 5 Nm³/hour system (or 5000 litres of hydrogen per hour), working at

100% of its capacity. The system was designed to allow for an increase production capacity when the Waste Plant is expanded. The H₂ produced is compressed to 430 bars and stored in a high pressure compressed tank. The storage capacity of the tank is around 700 Nm³ of hydrogen.

The initial main application selected for the use of stored hydrogen fuel is transport. The rationale behind this is simple. The CnES needed to demonstrate to the local community that the installed Creed and H2SEED systems were both operational. The obvious choice was a high visibility application, such as a vehicle operating on hydrogen. In order to further capitalise on the hydrogen system, the Royal Mail provided a hydrogen vehicle, shown below. The aim was to collect and distribute mail all over the island with green fuel, hence lowering the carbon footprint of both the islanders and the Royal Mail.



Royal Mail vehicle, converted to hydrogen, distributes mail over the island

Below is a list of the main benefits of the H2SEED and CREED projects to the Outer Hebrides communities:

- Increase the lifetime of the biogas engine currently installed in the Creed Waste Treatment Plant
- Produce a new, renewable, autochthonous and clean fuel (H₂) that will be used in vehicles
- Reduce the need for importing fuel
- Agreement with major fleet owner, the Royal Mail, to supply one of its vehicles with hydrogen hence providing a commercial customer for locally produced fuel
- Enable the community to see that energy storage technologies can be used today
- Allow the community to start developing plans for the installation of renewable infrastructure, without the need for the grid. H2SEED has indirectly unlocked the electrical grid.
- Creation of an embryonic hydrogen infrastructure in the islands that could grow and be supplied by other renewable energy sources, such as wind energy
- Raise public awareness, especially owing to the high visibility of the H₂ public vehicle fleet
- Provide training in state-of-the-art H₂ technologies and the establishment of a specialist skills base in the Outer Hebrides (the islands suffer from a high rate of brain drain as people pursue better education and job opportunities, whilst at the same time the islands' secondary school educational attainment is double the UK average)
- Creation of an attractive (innovative, environmentally friendly, dynamic) image of the islands that could be beneficial in terms of tourism, attraction of industry / investments, promotion of the islands as a potential "HY-COM" community

The H2SEED project has had a unique media coverage and has put the Western Isles communities at the forefront of the renewables and hydrogen agenda. Some of the project outcomes were discussed at the National Hydrogen Association (NHA) conference and exhibition, the world's largest hydrogen conference held in the USA. The project has had a strong televised media coverage including BBC broadcasting, web based articles and many newspaper articles. The Western Isles communities understand that hydrogen is key to demonstrating the innovativeness of the islanders and local community groups are already drafting plans to further develop the concept. Leader of Comhairle nan Eilean Siar, Cllr Angus Campbell, said: "I am delighted that the Outer Hebrides is pioneering the demonstration of hydrogen technology. The Islands have the potential to be a centre for green energy if the available resources can be harnessed effectively and hydrogen is one way of achieving this. The outcomes of the trial are nationally significant and will form the basis for future developments in this revolutionary energy carrier."

CONTRIBUTOR BIO

Dr Ruairi MacIver is a Project Manager (Renewable Energy) at Comhairle nan Eilean Siar responsible for developing and managing the local authority's portfolio of renewable energy projects. He has 14 years research experience in maritime (wave and tide) renewable energy.

CONTRIBUTOR CONTACT AND AFFILIATION INFORMATION

Dr. Ruairi MacIver
Comhairle nan Eilean Siar
Comhairle nan Eilean Siar, Stornoway,
Isle of Lewis HS1 2BW
ruairi.maciver@cne-siar.gov.uk
www.cne-siar.gov.uk

THE CHANINIK WIND GROUP

PROJECT TIME SPAN:

2005-2014

PROJECT BUDGET:

U.S. \$16 million

OVERVIEW OF FUNDING SOURCES:

Alaska public subsidies, community, local investments

REFERENCES AND RELATED

RESOURCES:

Alaska Isolated Wind-Diesel Systems:

- www.iser.uaa.alaska.edu/Publications/wind_diesel10022010.pdf
- www.iser.uaa.alaska.edu/Publications/researchsumm/wind-diesel_summary.pdf

GENERAL PROJECT INFORMATION

KEYWORDS:

GEOGRAPHIC AREA:

United States of America, Alaska

SPECIFIC LOCATION:

Villages of Kongiganak, Kipnuk, Kwigillingok, and Tuntutuliak; Yukon Kuskokwim Region, Alaska

LEAD ORGANISATION/ENTITY:

Village electric utilities

PARTNER ORGANISATIONS/ENTITIES:

Institute of Social and Economic Research and Center for Economic Development, University of Alaska Anchorage; Intelligent Energy Systems LLC; Alaska Energy Authority; Denali Commission

PROJECT WEBSITE:

None as of 2011, but in planning stages

BACKGROUND

Alaska began to electrify its remote rural villages in the 1960s, with the state government providing villages with small diesel-generator sets. These systems were the most cost effective way to generate power in communities with few customers – anywhere from ten to a few hundred – and with no inter-connecting roads or transmission lines. The systems were relatively simple, easy to operate and repair, and the cost of diesel was comparatively low at the time. But as a result of their small scale and limited customer base, these electric utilities

are now expensive to operate and are especially vulnerable to rising and fluctuating fuel prices. Almost all rural utilities receive subsidies from the State of Alaska, most recently through the Power Cost Equalisation Program.

Villages have come to depend on electric power, and their electric utilities are often among the largest community enterprises. These utilities generate significant income by selling electricity and are an important part of the small mixed cash-sub-

PROJECT GOAL

To develop a four-community village utility collaboration to improve economies of scale by working together to reduce dependency on fossil fuel, lower energy costs, and foster economic opportunities. In particular, this project seeks to reduce the cost of electricity and space heating, and potentially transportation, by using wind energy to replace part of the high-cost diesel the villages currently rely on. The project will use savings from reduced energy costs to improve operator training and other local human capacity, so local residents can maintain and operate the new, more complex energy systems. In addition, by providing new skills regionally, the project will improve local and regional self-sufficiency, increase regional sustainability, and improve cultural viability.

PROJECT SUMMARY

Remote rural communities in Alaska rely on fossil fuels for almost their entire energy usage. Energy costs in remote rural Alaska more than quadrupled in the last decade, threatening the viability of communities. In 2005, leaders of four Native Alaska Yup'ik villages in western Alaska formed the Chaninik Wind Group (CWG), to combine their strengths and reduce energy costs by using their substantial wind resources. The State of Alaska and the U.S. federal government provided funds to build four small-scale smart grids incorporating wind power with existing diesel generation. (Smart grids are digitally controlled electrical grids that balance energy suppliers and consumers, controlling the flow of electricity through a wireless system.) CWG communities harness what are some of the best wind resources in the U.S. to help satisfy electricity needs, as well as some residential and community heating requirements. The new wind-diesel smart grid systems have the potential to markedly reduce community energy costs, but they are also more complex and will only operate efficiently if well maintained. By late 2011, the installation of the new systems was nearly complete. CWG member communities are currently developing a collaborative support organisation that will train local specialists and provide operation, maintenance, and administrative support for the community-owned energy systems.

sistence economies of rural Alaskan villages. Most villages are remote and isolated, and jobs and cash are typically scarce. Local residents still rely heavily on subsistence hunting, fishing, and gathering. Small local economic bases become even smaller when income generated by the utilities immediately drains out of the local area. That happens when the utilities hire outside contractors to install, maintain, and overhaul their energy systems and purchase fuel, spare parts, and supplies from outside the community or the region. Some of the income does go to village residents who are plant operators, bookkeepers and administrative staff for the utilities. But reducing fuel costs for electricity and space heating will result in more income recirculating locally, supporting additional local jobs and boosting cash income.

The sharp increases and volatility in fuel prices in recent years have caused federal, state, and tribal governments – as well as village utilities – to explore ways to reduce energy costs. One opportunity is using new renewable energy technologies to improve energy efficiencies and supplement diesel power generation. The State of Alaska and the U.S. federal government support these efforts by providing grants and incentives to install renewable generating capacity and newer, more efficient diesel systems. By late 2011, 27 projects using wind power – including the CWG projects – had been constructed and commissioned in Alaska.

“The communities harness what are some of the best wind resources in the U.S...”

ACHIEVING ENERGY INDEPENDENCE BY HARNESSING WIND ENERGY

On-site monitoring of wind resources in CWG communities showed that the four villages have excellent wind energy potential, with particularly high winds in winter months when temperatures drop as low as minus thirty degrees Celsius. The villages created CWG as part of a successful effort to obtain grant funding to build wind-generation systems and integrate those systems into their existing power systems. Forming the group was also an acknowledgement of the many potential benefits from working together.

CWG's approach to installing wind systems was driven by a village focus. As CWG installed the wind systems, outside hiring was kept to a minimum and local workers were hired for much of the

tower construction and turbine installation. This village focus also led CWG to conduct household surveys to measure the entire energy demand of their member villages, including electricity, residential space heating, community water and space heating, and transportation. The mean annual household income in CWG communities is currently U.S. \$35,000, and households spend 27% of that on energy—10% for electricity, 10% for space heat, and 7% for boat, ATV, and snowmobile gasoline. With so much of overall energy costs devoted to residential and community heating, CWG communities realised that they needed to be able to use wind power not only to help generate electricity but also for space heating, and potentially transportation. The solution was adding small-

▼ Community members installing wind turbine towers



scale smart grid systems that turn off oil-fired heaters in homes and turn on ceramic electric stoves that store electricity as thermal energy. A study by the Institute of Social and Economic Research at the University of Alaska Anchorage estimated that this system could cut residential heating fuel use in half for households with electric stoves. (In late 2011, not all households owned electric stoves). Each village is expected to save more than 35,000 gallons of fuel oil per year for residential and community heating.

Installing the wind and smart grid systems also required upgrading the existing diesel power plant and distribution systems. These upgrades will lead to additional savings through efficiency gains. Once CWG completes the wind and smart grid systems, each village will be able to reduce diesel consumption for electricity generation by 20,000 gallons, cutting current diesel use by a quarter.

WIND-DIESEL SMART GRID: SYSTEM DESIGN AND COMPONENTS

The CWG community leaders made it clear they wanted certain features in local wind systems:

- As many wind turbines as they could get for their money
- A mechanical turbine their residents could work on
- Similar turbines across all communities

The system architecture is based on five refurbished Windmatic 17-S wind turbines equipped with new inverter-based controllers. In each village these turbines were integrated into the stand-alone power grid, using distributed load control to manage system frequency. Below is a graphic showing the general conceptual design of the

As a result of these improvements, the villages will reduce fuel costs but will also depend more on their electric generation systems – which in turn will be more complex and will require workers with additional skills to operate at peak efficiency. The additional complexity of smart grids will increase costs of utility operations and training. With this in mind, CWG is exploring how to collectively reduce operation and maintenance costs by employing locals as well as centralising and standardising their operations.

Most of the money spent on energy currently leaves the villages. Some of the savings resulting from reduced fuel consumption for diesel generators and space heating will remain in the villages, and savings from reduced electricity costs will be shared between the village and the state government, as subsidies tied to fuel costs decrease.

smart grid system. It provides an overview of the components of the wind-diesel power system and how those components benefit individual residential customers.



◀ Utility managers of the Chaninik Wind Group in front of wind turbines installed in Kongiganak

WIND-DIESEL SMART GRID: SYSTEM ARCHITECTURE

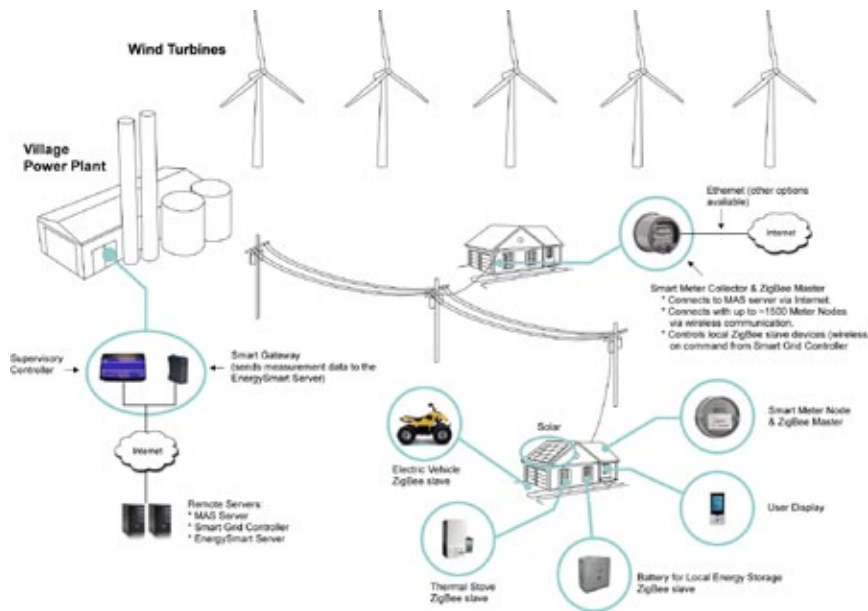

Each village in the CWG currently has systems with:

1. Two new electronically fuel-injected diesel generator sets, each rated at 260 kW
2. Five Windmatic 17-S wind turbines, remanufactured, each rated at 95 kW for a total installed capacity of 475kW
3. A fast-acting controllable 300 kW electric boiler for load balancing
4. Distributed residential energy storage in the form of 20 to 30 ceramic electric stoves each with 9.6kW (currently, one third of all households have these electric stoves installed)
5. Power system supervisory controls with data collection, remote monitoring, and remote control
6. Smart metering system to account for different rates charged for heat and electricity

BUILDING INSTITUTIONS FOR COMMUNITY DEVELOPMENT THROUGH RENEWABLE ENERGY SAVINGS

With the additional complexity of operating and maintaining wind-diesel smart grid systems, CWG realised that its member utilities needed to develop new ways of operating. CWG is currently focused on forming a collaborative support organisation for member utilities – to identify work-force development needs, increase self reliance, train local specialists, and provide operation, maintenance and administrative support.

Just as it did during the project installation phase, CWG used a community-oriented approach reflecting the Yup'ik traditional way of life in the

business planning aspect of the project. A diverse set of participants, ranging from utility managers to community members and elders, met during four planning sessions led by a professional facilitator trained in an organisational development method designed to engage all levels of an organisation to renew, change, and improve performance. This collaborative approach identifies positive aspects of an organisation and tries to find ways in which existing capacity can be used to adapt to change within the organisation. The planning sessions were held in English and in the indigenous Yup'ik language, which virtually all local residents also speak.



▲ Utility operators familiarising themselves with the new wind turbines and control equipment



Additional technical support during planning sessions was provided by Intelligent Energy Systems, LLC the private firm designing and installing the wind-diesel smart grid systems, and by researchers in energy economics and community development from the University of Alaska Anchorage. These technical experts helped estimate current costs of operations and project future income and operating costs, to establish financially sustainable rate structures for electric heat and electricity sales as well as to establish future utility budgets.

The outcome of the planning sessions was a three-year work plan for a pilot project that will use the savings from reduced use of high-cost diesel to improve operator training. CWG will create a local training program focused on continuous quality improvement in maintaining and operating the complex wind-diesel smart grid systems. Local training will be linked with one or two travelling wind-diesel specialists that CWG will hire to serve the four communities and provide on-site training to local operators.

Since all member utilities have standardised wind-diesel smart grid systems, CWG will establish a

central purchasing and inventory department that will allow CWG to negotiate lower prices and minimise its inventories of supplies and spare parts. The smart grid system will allow each member utility to sell excess power for heating as well as provide necessary data for their bookkeeping and billing departments. Finally, CWG will provide each member utility with administrative support for applying for energy grants and receiving energy subsidies. An additional goal is administering local weatherisation and energy efficiency programs benefitting utility customers.

The construction of wind-diesel smart grid systems created temporary jobs in the four CWG member communities and identified local talent that all the utilities can use during future operation of the energy systems. With a focus on improving skills for operating and maintaining the new systems, CWG is on its way not only to improving local self-sufficiency and cultural viability, but also contributing to a stronger regional economy – by offering job opportunities for local people in the Yukon Kuskokwim Delta of Western Alaska.

▼ Chaninik Wind Group collaborative organisational planning meeting



SUMMARY CHANINIK WIND GROUP:

- Energy costs in remote rural Alaska more than quadrupled in the last decade, threatening the viability of communities and their traditional way of life
- The Chaninik Wind Group was formed in 2005 by leaders of four Yup'ik villages in western Alaska who recognised that only by combining their strengths and working together could they best use their wind resources to reduce energy costs
- Chaninik Wind Group is the first organisation to develop a high-penetration wind-diesel smart grid system for a remote arctic isolated grid. High-penetration systems have the potential to supply a large share of electric demand and also provide considerable energy for heating or other uses.

“The construction of wind-diesel smart grid systems created temporary jobs in the four CWG member communities and identified local talent that all the utilities can use during future operation of the energy systems”

- The State of Alaska and the U.S. federal government provided funds to assist in the development of the four CWG community systems; that funding was critical to project success
- As part of the planning process, CWG conducted a community survey of energy use that showed almost half of community energy expenses are for heating – not surprising in this extreme arctic climate. CWG realised its members needed a smart grid system that could use any excess wind-generated power for heating; smart grids turn off oil-fired heaters and turn on ceramic electric stoves, which store electricity as thermal energy. This system could cut residential heating fuel use in half.
- Member villages of CWG are the first in Alaska to use excess power from wind turbines to heat homes and hot water heaters used in community laundry and bathhouses
- The new wind-diesel, smart grid systems have the potential to markedly reduce community energy costs, but they are also more complex and will operate efficiently only if well maintained – which requires a skilled workforce
- Savings realised through use of renewable energy offer opportunities for investment in building local human capacity
- CWG member communities are currently developing a collaborative support organisation that will train local specialists and provide operation, maintenance, and administrative support to the community-owned energy systems
- A community-oriented energy development and planning approach needs to be conscious of culture and traditional ways of life
- Collaboration among isolated villages from the beginning of planning energy projects can result in standardisation and improved economies of scale, even though individual utilities remain isolated and not connected by a common grid
- Being self reliant is critical for successful utilities in isolated villages
- The construction of energy systems creates temporary jobs in remote rural communities and can identify local talent, leading to long-term local job opportunities
- Technology solutions that reduce reliance on fossil fuels can improve local self-sufficiency and cultural viability and contribute to stronger regional economies

RECOMMENDATIONS

Economic policy and innovation

In cold climates, particularly coastal regions with abundant wind resources, using wind power to displace diesel fuel can be used for both power generation and residential home heating. This requires the integration of electric thermal storage (electric stoves) distributed across each community. Smart metering and standardised operations result in additional efficiency gains and cost reductions for operations of the entire group of communities. By focusing on community needs, renewable energy projects can lead to long-term community and economic development and thus contribute to sustainability and community viability in remote isolated regions with indigenous peoples and cultures.

Technology implementation

Complex wind-diesel smart grid technology

requires local utility operators to adopt new technologies and new ways of doing business. The savings realised through renewable energy technology can be used to implement local site and technology specific training programs.

Technology development and testing

The development of technology needs to focus on local needs, which are driven by environmental, economic, and cultural factors. Community-oriented approaches recognising local knowledge and traditional ways of life are very important in the development and testing of new energy systems in indigenous communities.

Information and knowledge sharing

Visit www.iser.uaa.alaska.edu/research/energyenvironment/ to find out more about alternative energy projects in Alaska.

CONTRIBUTOR CONTACT AND AFFILIATION INFORMATION

Name: Tobias Schwörer and Ginny Fay
Organisation/Institution: Institute of Social and Economic Research, University of Alaska Anchorage
Contact Address: 3211 Providence Dr room DPL 501 Anchorage AK 99508
Email: tobias@uaa.alaska.edu, vfay@alaska.edu
Website: www.iser.uaa.alaska.edu

Name: Dennis Meiners
Organisation/Institution: Intelligent Energy Systems, LLC
Contact Address: 110 W. 15th Ave Anchorage AK 99509
Email: dennis@iesconnect.net

CONTRIBUTOR BIO

Tobias Schwörer and Ginny Fay are energy economists at the Institute of Social and Economic Research (ISER) at the University of Alaska Anchorage. *Ginny Fay* has more than thirty years of experience analyzing energy projects throughout Alaska, particularly renewable energy projects constructed in Alaska in the past decade. *Tobias Schwörer* focuses on developing economic models used in analyzing alternative energy options for rural Alaska. Both authors have recently published a report on the performance of wind-diesel systems in Alaska; see www.iser.uaa.alaska.edu/Publications/wind_diesel10022010.pdf.

Dennis Meiners is CEO of Intelligent Energy Systems, LLC and has more than twenty years of experience in finding alternative energy solutions specific to Alaska. Intelligent Energy Systems, LLC specialises in project development and coordination and support services for rural communities. He focuses on systems integration, technology selection, financial management, and ongoing technical support.

**TECHNOLOGY
DEMONSTRATION
PROJECTS**

FIRST LARGE WIND TURBINES IN ANTARCTICA

In 2003, Australia became the first country to obtain the majority of its electricity supply at one of its Antarctic stations from renewable energy

Mawson Station has been operating in the harsh Antarctic environment since 1954, and is the longest continuously operating research station south of the Antarctic Circle. Technical studies conducted in the 1990s confirmed that the constant katabatic winds which blow from inland Antarctica make Mawson ideally situated for the generation of reliable wind power. In 2003, the Australian government installed two 300kw wind turbines at Mawson – the first installation of “large” turbines on the continent – which now supply the majority of its electricity needs and replace several hundred thousand litres of imported diesel fuel each year. To install the turbines and their computerised control systems, the Australian Antarctic Division

worked closely with Enercon, a German turbine manufacturer, and Powercorp Pty Ltd, an Australian company. Live information on the station’s wind power generation and energy usage can be accessed online.

MORE INFORMATION:

- www.aad.gov.au
- www.aad.gov.au
- www.polarpower.org



Wind turbines are currently in use at several research stations in Antarctica¹

LOLLAND HYDROGEN COMMUNITY

The Lolland Hydrogen Community was launched in May 2007 as Denmark’s first large-scale test facility plant for wind-hydrogen energy production and use

Located in the city of Nakskov in the southern island of Lolland, the Lolland Hydrogen Community is the first Hydrogen Community Demonstration facility in the EU that utilizes residential Fuel Cell Combined Heat and Power (CHP). Currently there are two small PEM fuel cell CHP stations, with a

combined capacity of 8.5 kW. These installations, funded by the Danish Energy Authority, were set up in partnership with the Municipality of Lolland and two private companies, IRD Fuel Cells and Baltic Sea Solutions, using excess wind power to electrolyze water for hydrogen production. The Lolland project has plans for later phases whereby hydrogen will be distributed directly to 35 homes in the village of Vestenskov, each installed with a 2 kW fuel cell system.

MORE INFORMATION:

- www.hydrogen-community.dk

UTSIRA WIND-HYDROGEN PLANT

MORE INFORMATION:

- www.hydro.com

Set up in 2004, the island of Utsira was home to the world's first full-scale autonomous renewable energy system based on wind power with hydrogen production and storage

Norsk Hydro chose Utsira, a small island community located 18km off the west coast of Norway with approximately 220 inhabitants, as the site for a wind-hydrogen test facility. The aim was to demonstrate how renewable energy (in this case wind power) could provide a safe and efficient means to produce hydrogen via electrolysis for energy use and storage in remote locations. The test facility was highly successful, with two 600 kW turbines providing electricity to the local community, with excess output used to power hydrogen

production for use in fuel cells in ten homes when the wind doesn't blow. In 2004, Utsira was awarded 'Renewables Project of the Year' by Platts.



Utsira wind-hydrogen plant, Norway²

PRINCESS ELISABETH STATION, ANTARCTICA

MORE INFORMATION:

- nordsesil.wikispaces.com
- www.antarcticstation.org

The first Antarctic research station operating solely on renewable energy was inaugurated in February 2009

In 2004 the Belgian Federal Government commissioned the International Polar Foundation to build a new research station in Antarctica. Five years later the Princess Elisabeth Station was completed. The research station is remarkable in many respects but is especially notable for its innovative technology which makes Princess Elisabeth the first "zero emissions" facility in Antarctica. The main purposes of Princess Elisabeth are research and education. The research programme covers several

areas including: glaciology, seismic and geomagnetic activity, geophysical processes, climate process observations, atmospheric processes, and biology.



Princess Elisabeth Station, Antarctica³

UNALAKLEET VALLEY ELECTRIC COOPERATIVE WIND FARM

Since November 2009 Unalakleet's six wind turbines have supplied electricity to the Unalakleet community, in Alaska

Unalakleet's wind farm is owned and operated by Unalakleet Valley Electric Cooperative (UVEC) and was built with financial support from the State of Alaska's Renewable Energy Fund, as well as financial assistance from several other donors. The wind farm is expected to deliver 1,500 MWh of

wind generated electricity annually, which covers approximately 35% of the electricity needs for the community. As UVEC is a non-profit member's organization, the reduced cost of energy from avoiding diesel fuel expenditures benefits the whole community in Unalakleet. The approximately 750 residents of Unalakleet together with local businesses can thus expect substantial annual savings on their electricity bill.

MORE INFORMATION:

- northernpower.kiosk-view.com
- alaskarenewableenergy.org

LARGEST WIND FARM IN ALASKA UP AND RUNNING

The Banner Wind farm in Nome, Alaska, provides local residents with significant fuel cost savings

In December 2008, the Banner Wind Project was completed. The wind turbines have a total capacity of 1.17 MW, displacing up to 125,000 gallons of diesel fuel a year, thus minimizing the city's dependency on oil and increasing power reliability as well as creating local jobs. In December 2009, the owners, a joint venture between Sitnasuak

Native Corporation (SNC) and Bering Straits Native Corporation (BSNC), signed a power purchase agreement with the Nome Joint Utility System, providing Nome city with Wind Power. BSNC has further agreed to dedicate 50 percent of its profits to help finance other renewable energy projects in the villages around Nome.

MORE INFORMATION:

- www.actionatlas.org
- alaskarenewableenergy.org
- www.b-e-f.org

HELICOPTER-PORTABLE REMOTE AREA POWER SYSTEM FOR ISLANDS IN THE SUB-ANTARCTIC

MORE INFORMATION:

• www.antarctica.gov.au

A safer, greener power supply for remote arctic areas is the outcome of a safety and environmental audit at Macquarie Island, Australia

The new transportable modular power supply system, called Remote Area Power System (RAPS) has been developed in response to a safety and environment audit on the condition of the electrical installations in the field huts located on the remote Macquarie island. The RAPS units provide a safer and more environmentally friendly way of delivering power to remote areas. The system

includes solar and wind generation so as to minimise the need for fuel usage in fragile and isolated areas. The modules incorporate batteries, petrol generator, fuel storage, refuelling pumps, solar PV panels, wind turbines using a collapsible mast, instrumentation for monitoring battery condition and charging, full electrical protection, and capacity to drop out to protect battery cells from excessive discharge. The RAPS units have been designed to minimise and contain any accidental fuel spills which may occur in the sensitive environment of Macquarie Island and others like it.

SOLAR-POWERED VENTILATION AT QAQORTOQ TOWN HALL, GREENLAND

MORE INFORMATION: (IN DANISH)

• dk.nanoq.gl

At Qaqortoq town hall ventilation panels driven by solar power help improve indoor air quality

When the offices at Qaqortoq town hall were built, it was discovered that the indoor temperature was often too high due to the buildings facing south. Therefore five small ventilation panels were installed, which operate on solar power. When the sun shines the panels can power the ventilation of up to 40 m³ fresh air per hour, keeping the office temperature comfortable and stable. Before the ventilation panels were installed the only option for keeping the temperature down was to open the windows which caused the radiators to acti-

vate, thus wasting energy and money.



"Kangaamiut in April" by Destination Arctic Circle⁴

ASSAQUAQ DEMONSTRATION PROJECT

A small renewable energy system in Qeqqata commune, Greenland, demonstrates the use of green technologies in harsh environments

The small and isolated settlement of Assaqtuq, Qeqqata commune, Greenland is not permanently occupied, but is used by school groups throughout the year. The electricity supplied to this isolated settlement is provided by a small hybrid stand-alone system, which includes photovoltaic panels, wind turbines and a diesel generator. The two wind turbines and solar cells are used to charge a battery, which then provides the house with electricity. The diesel generator is only used as a back supply option. All the elements used for this hybrid system are temperature sensitive and so the performance of the elements is monitored under hazardous arctic conditions, thus provid-

ing useful knowledge and understanding of how these technologies can be used in similar environments.

MORE INFORMATION:

• nordsesil.wikispaces.com



The stand-alone home energy system in Assaqtuq, Greenland⁵

HVALBA VILLAGE WIND TURBINE

A wind turbine in the village of Hvalba, Faroe Islands, is to replace all oil-fired boilers

Hvalba's population of 730 inhabitants mostly live in single-family houses, heated by oil-fired boilers. The construction of a wind turbine of 1.6 MW will,

through an established grid, supply all heating elements in the village. These elements will heat water tanks containing 1 to 3 tons of water, replacing the current oil consuming boilers.

MORE INFORMATION: (ONLY IN DANISH)

• nordsesil.wikispaces.com

KALDARA GREEN ENERGY

MORE INFORMATION:

- nordsesil.wikispaces.com
- www.kaldara.com

Small electrical power units, suited to the surrounding environment, are lowering the construction time and costs of generating power from geothermal wells

The KAPS (Kaldara Power System) is a small, modular and transportable electrical power generating unit that utilises pollution-free geothermal energy. KAPS are container-based 5 MW geothermal power plants that can operate as stand-alone units and are also capable of working in parallel with larger plants. Because of their small size, KAPS can be more easily adapted to the environment than large power plant structures and the installation timeframe is lowered to months, thereby opening the possibility of utilising temporary access to geothermal wells. KAPS on-surface units can be used for all types of Wet/Dry and Binary/Flash

geothermal systems. The KAPS concept is to house a miniature power station in standard sized containers next to the production boreholes, and by appropriate arrangement and planning, designed to minimise their impact on the environment and landscape.



Geothermal power station in Iceland⁶

KASIGLUK WIND POWER PROJECT

MORE INFORMATION:

- nordsesil.wikispaces.com
- www.avec.org

The remote Alaskan village of Kasigluk installed three wind turbines to substitute expensive and polluting diesel generators

Three relatively small Northwind wind turbines (100kW) were installed in the village of Kasigluk, Alaska, owned and operated by the non-profit organisation Alaska Village Electric Cooperative (AVEC). The power generated is being fed to the local grid providing power to the village of Kasigluk and nearby village Nunapitchuk. The Northwind Power 100 turbines are low maintenance and

require a minimum of technical expertise from the local communities to operate them, making them a financially viable alternative to conventional diesel generation.



Kasigluk, Alaska⁷

REORGANISATION OF POWER ON KOLTUR ISLAND, FAROE ISLANDS

The small island of Koltur is reorganising its power supply, harnessing 'mountain heat'

A collaboration between the electric company SEV, the main energy supplier in the Faroe Islands, and Jarðfeingi, an institute under the Ministry of Industry, is designing an environmentally friendly and renewable energy supply on the island of Koltur, using wind turbines and heat from the mountains. The project will cover the island's heat demand, by transporting heat from inside the mountains to inside the houses using underground heat pumps. The electricity supply will come from a Vanadium

battery charged by a wind turbine and backed up by a diesel generator.



View of Koltur Island, Faroe Islands⁸

MORE INFORMATION:

- nordsesil.wikispaces.com
- www.koltur.com

RECYCLING ENERGY FOR HEATING

Mosjøen Fjernvarme, a new installation in Norway, will supply district heating to large parts of downtown Mosjøen, using recycled waste energy



Mosjøen, Norway⁹

The plant Mosjøen Fjernvarme is currently recycling wasted energy from the foundry at Elkem Aluminium Mosjøen to supply the consumers of Mosjøen with green district heating at competitive prices. The plant recycles 15 GWh of energy from the foundry, which is equivalent to the thermal energy requirements of 1500 houses. The project Director Ronny Vatland at Elkem Aluminium is pleased with the development of the new district heating system in Mosjøen, noting that "energy-intensive industry should use energy as efficiently as possible. Now we have an opportunity to free up and re-use green energy, which is totally in accordance with the EU's new guidelines in this area."

MORE INFORMATION:

- www.elkem.com

LOW CARBON COMMUNITY IN GREENLAND THROUGH DISTRICT HEATING

MORE INFORMATION:

- www.energymap.dk

The total efficiency of imported light oil for electricity generation and heating is around 85% in the arctic settlement of Qaanaaq (Greenland)

The highly efficient use of imported light oil is possible due to a fully developed district heating network, which distributes all the waste heat from the diesel generator. This surplus energy, which would normally be lost, now covers around 70% of

the total heat production. An important precondition for the success of the heating system is that the heating density is sufficient and that the costs of the district heating pipes are modest, as they are placed in ducts above ground together with other infrastructure so as not to disturb the fragile arctic ecosystem.

WIND POWER AT GREENLAND'S SUMMIT STATION

MORE INFORMATION:

- www.polarpower.org

Wind power used to supply remote scientific research station located on the highest point of the Greenland ice cap

Summit Station, Greenland, is located on the highest point of the Greenland ice cap, and is one of the primary year-round research facilities supported by the National Science Foundation's Arctic Program. This location provides an excellent platform for the study of snow and atmospheric chemistry, ice core analysis, and other research focused principally on global climate change and long-term environmental studies. In 2006, a pilot project attempting to implement wind power was started, in order to cut down the summit station's emissions. The project included the installation of a grid-tied 6kW Proven wind turbine, along with an

efficient generator that uses waste heat to supply the buildings. The project has been a success and has provided valuable experience and lessons to the researchers at the summit station.



Windmill at the Summit Station, Greenland¹⁰

CAMP RAVEN RENEWABLE ENERGY SYSTEM

Wind turbines provide electricity to Camp Rawen, Greenland

From late April until mid-August, Camp Raven, Greenland, serves as a training facility for the New York Air National Guard (NYANG), the primary logistical aircraft support provider for the United States Polar Programs. In this arctic climate an off-grid, photovoltaic (PV)/wind hybrid system has

been created to power the site during the summer when it is staffed by two individuals. Although the electrical system at Camp Raven has the ability to use a backup generator, this has not been necessary for the last three years as the renewable energy system generates plenty of energy to meet the needs of the camp.

MORE INFORMATION:

- www.polarpower.org

AUTONOMOUS POWER AND COMMUNICATIONS SYSTEMS, ALASKA

Two autonomous power and communications systems supply instrument towers that measure gases and meteorological data in Imnavait Creek, Alaska

Imnavait's autonomous power and communications systems were initially installed in 2007 as a temporary pilot project to supply year-round power as well as data telemetry to the area. The systems are designed with efficiency as a key driver, using wind power in the winter and solar energy in the summer. The Imnavait Creek power systems have been deemed to be a success, fulfilling the power requirements set by the initial project.

Solar and wind-powered power station at Imnavait Creek, Alaska¹¹



MORE INFORMATION:

- www.polarpower.org

SAINT PAUL ISLAND WIND-DIESEL SYSTEM FOR INDUSTRIAL CHP DEMAND

MORE INFORMATION:

- www.windpoweringamerica.gov
- energy-alaska.wikidot.com
- www.iser.uaa.alaska.edu

The native Aleut communities of Saint Paul Island utilise wind power through business innovation

Tanadgusix (TDX) Corporation is an Alaskan Native Village Corporation, the business arm of the Aleut/Native people of St. Paul. TDX Power Inc. is an independent power producer with a hybrid wind-diesel power plant in St. Paul. The St. Paul project is located in the Pribilof Islands in the Bering Sea, whose stand-alone system provides heat and

power via a 500-kW high-penetration hybrid system, comprised of a 225-kW wind turbine and two 150-kW diesel generators. TDX Power is in the process of commencing feasibility studies for wind power at its electric utility in Sand Point and has also been asked by the Alaska Energy Authority to assist with the design engineering for a wind-diesel facility in Nikolski, a small community on the far west end of the Aleutian chain.

CHANINIK WIND GROUP VILLAGES

MORE INFORMATION:

- apps1.eere.energy.gov
- www.legfin.state.ak.us

Chaninik Wind Group in Alaska brings intelligent wind power and metering to rural communities

This project is the second phase of a broad plan to bring wind power generation to the south-west Alaska vilages of Kongiginak, Kwigillingok, Tuntutuliak and Kipnuk. A similar system has been installed in nearby Kongiginak. The villages will be connected to Wind Diesel Smart Grids, using a metering and thermal storage unit system, to improve the regulation of heating, especially among elderly inhabitants. According to the Alaska Energy Authority, the Chaninik Wind Group Area of south-west Alaska has one of the highest potential for wind energy to be found in Alaska and in the U.S. Escalating fuel costs have crippled the economies in the region and so even modest wind power

generation systems can displace over 35,000 gallons of diesel fuel annually.



Chaninik Wind Group, Alaska¹²

ENERGY RECOVERY FROM WASTE IN LERWICK, SCOTLAND

Lerwick Energy Recovery Plant uses waste to heat in Shetland's largest town

The Energy Recovery Plant in Lerwick generates hot water by burning waste for the Lerwick District Heating Scheme which is operated by Shetland Heat Energy and Power Ltd (SHEAP). The Plant, with the generation capacity of 7MW, burns 22,000 tonnes of waste per year. The waste needed to supply the plant comes from Shetland, Orkney and Offshore. By early 2007, 840 properties had

been connected to the plant, including a sports centre with swimming pool, three schools, the largest pelagic fish factory in Europe, a dairy (using heat for pasteurisation), residential care centres, a library, the main hospital, offices, retail premises, a museum, hotels and guest houses, public buildings, council and private housing. A new housing scheme currently under construction will have 120 houses connected to the network via a pumping station.

MORE INFORMATION:

- www.shetland.gov.uk
- www.chpa.co.uk

SOLAR WATER HEATING IN THE ARCTIC

In Qaqortoq, Greenland, a private household initiative uses solar panels to heat domestic water consumption

The water heating system provides a private household with warm water for more than five years and has saved the household 400-500 litres of oil consumption per year. Taking into account the low winter temperatures, MPG-glycol has been added to the sun collector liquid to prevent the liquid from freezing. The household's warm water supply is therefore secured by the water heating system even during temperatures as low as minus 30 degrees.



Solar Hot Water Panels, Qaqortoq, Greenland¹³

MORE INFORMATION:

- dk.nanoq.gl

TOKSOOK BAY VILLAGE WIND ENERGY SYSTEM

MORE INFORMATION:

- www.avec.org

With support from the Alaska Village Electric Cooperative (AVEC) and funding assistance received from the Denali Commission and Coastal Villages Region Fund, Toksook Bay received a stable and sustainable electricity supply

Toksook Bay is one of three villages located on Nelson Island, which lies 115 miles northwest of Bethel. It is on Kangirvar Bay across the water from Nunivak Island. The area is only accessible by air or sea but has been inhabited by Yup'ik Eskimos for thousands of years. Toksook Bay was established in 1964 and the population now counts around 600 individuals. The location of the community has

made it difficult to ensure a stable electricity supply but now thanks to funding assistance received from the Denali Commission and Coastal Villages Region Fund, Toksook Bay has a new bulk fuel tank farm, an automated, fuel-efficient power plant, and four Northwind 100 wind turbines with a generating capacity of 400 kW. A new cable was laid between Toksook Bay and two nearby communities which allowed AVEC to realize substantial cost savings by being able to shut down the old power plants in both communities. This tieline cable allows all three communities to reap the benefit of reduced diesel fuel costs.

LED STREETLIGHT TEST PROJECT IN BANFF TOWNSHIP

MORE INFORMATION:

- www.banff.ca

Since 2007 the town of Banff in Canada has tested the latest LED technology in streetlamps, achieving approximately 30 percent savings in energy costs per year

Banff began testing the latest LED technology in streetlamps in 2007. Since then the town has installed additional energy-saving lamps on several locations around the town, including six Lumisave multi-chip LED fixtures which were installed in November 2010 and six Think induction fixtures installed on 12 existing poles to compare their light output, effects on light pollution, colour and definition, and electricity usage. While the light output should be the same, energy consumption by the 160-200 watts replacement fixtures (instead of the

conventional 400 watt streetlamps), promises to be at least 50 percent lower. The lifespan is equally impressive. Both multi-chip LED and induction technologies require no maintenance and should last 10 years.



Banff Park Museum lit with low-energy LED lights¹⁴

SELAWIK VILLAGE WIND ENERGY SYSTEM

Electricity supplied to the village of Selawik in rural Alaska is provided by an automated power plant with fuel-efficient engines and four wind turbines

Located at the mouth of the Selawik River and very close to the Selawik National Wildlife Refuge, the village Selawik is isolated and not accessible by road. Electricity to the community has for many

years been supplied by an inefficient and unstable power plant. Thanks to Alaska Village Electric Co-operative (AVEC) and funding assistance received from the Denali Commission, Selawik now has a state-of-the-art, automated power plant, elevated bulk fuel tank farm and four 65-kW Atlantic Orient Corporation wind turbines.

MORE INFORMATION:

- www.avec.org

IN-STREAM HYDROKINETIC TURBINE IN RUBY, ALASKA (FIRST IN ALASKA)

Low impact hydroelectric technologies are attracting great interest among the rural population in Alaska, who still rely heavily on expensive diesel power

Hydrokinetic devices are powered by moving water and are different from traditional hydropower turbines in that they are placed directly in a river, ocean or tidal current. They generate power only from the kinetic energy of moving water (current). This power is a function of the density of the water and the speed of the current, cubed. The available hydrokinetic power depends on the speed of the river, ocean, or tidal current. In contrast, traditional hydropower uses a dam or diversion structure to supply a combination of hydraulic head and water volume to a turbine to generate power. In the summer of 2008, a 5kW hydrokinetic turbine was installed in the Yukon River village of Ruby, Alaska – one of the first in-stream turbines successfully

installed in the US. The Ruby project has provided valuable information regarding “proof of concept” for the viability of in-stream hydrokinetic power generation and has also identified challenges that will need to be overcome before widespread deployment occurs.

Partially submerged hydrokinetic turbine at Eagle Creek, Alaska¹⁵



MORE INFORMATION:

- www.waterpowermagazine.com
- energy-alaska.wikidot.com
- www.yritwc.org

SUSTAINABLE BEER BREWING WITH WIND TURBINES AND HEAT PUMPS

MORE INFORMATION:

• www.shetlandtimes.co.uk

The Valhalla Brewery is Britain's most northerly brewery, located in Unst, Shetland, the most northerly island in Britain. The brewery has explored the integration of wind turbine technology and heat pump technology to significantly reduce the demand for carbon based energies, including hosting an undergraduate student in 2010 who completed a feasibility study. It is anticipated that 36.6 tonnes of CO₂ can be saved annually along

with up to 87MWh of electrical energy. This will not only reduce the operating overheads of the brewery, but will also significantly improve the sustainability of its end use products. The brewery has also redeveloped an abandoned military base to accommodate increased brewing capacity with greatly enhanced sustainability both in terms of water use and energy use.

LINKING CLIMATE CHANGE, CLEAN ENERGY AND HEALTH THROUGH A PERSONAL CARBON TRADING SCHEME

MORE INFORMATION:

• www.scu.edu.au

The world's first Personal Carbon Trading program conducted in a 'closed system' island environment started in 2011 on Norfolk Island, located 1700

km off the east coast of Australia. The main goals of the project are to test the effectiveness of a Personal Carbon Trading scheme over a three year period, reduce per capita carbon emissions and reduce obesity and obesity related behaviours. "This is a project for looking at reducing climate change and obesity in one hit. It is recognising that both obesity and climate change have similar drivers so we are tackling two of the world's biggest problems at the moment with one project that is quite unique. Norfolk island was selected as it is an isolated community with a small population living a similar lifestyle to people on mainland Australia. The island is also fully self-contained and "you can measure everything that goes in and out"



Norfolk Island, Australia¹⁶

BIOGAS FROM PIG FARMING FOR PORK PRODUCTION ON NORFOLK ISLAND

The currently 1,800 inhabitants and 35,000 annual visitors of Norfolk are supplied with electricity by diesel engines meeting an average 900 kW load (a power requirement of 0.5 kW per capita, which is low in comparison with other islands). Electricity is supplied from a central power plant that houses six 1 MW diesel generators. The base load of the island is 650 kW and the maximum load is 1,750 kW. The rise in demand for electricity is around 2% per decade, which is low. It is expensive to import diesel and as a result the cost of electricity is high. A pig farm at the northern tip of Norfolk Island produces bacon, ham, and other pork products and also vegetables and fruit. The main business objectives expressed by its operator are providing jobs for local people, producing all year round, and

minimising the dependence on imported inputs. The farm reduces energy costs and dependence on imported fuel by using an anaerobic digester that captures methane emanating from the effluent of the pig pen. The captured methane is used as biogas to provide heat for cooking and drying. While very effective for this role, current laws limit the extent to which businesses can generate electricity from alternative sources, preventing the farm from also generating electricity from the biogas. Instead it draws approximately 48,000 kWh/year from the island grid, mostly for freezing and cooling, but also for various mechanical tasks such as curing, mincing, filling, slicing, and vacuum packing.

MORE INFORMATION:

- www.isa.org.usyd.edu.au

SUSTAINABLE ARCTIC NURSERY IN GREENLAND

Narsaq Greenhouse is a pilot project using sustainable energy in Narsaq, South Greenland. Knowledge from the Upernaviarsuk Research Station and the Kan-Jime method from Japan, is to be used to establish a 1056 m² commercial greenhouse in Narsaq town. The energy supply is a power heating station – a diesel motor with a generator but the long term aim is to get the energy from a vacuum solar collector and a biogas system in order to reduce oil consumption. A commercial greenhouse is the beginning of a new industry in Greenland based upon a sustainable energy supply.



Narsaq Harbor, Greenland¹⁷

MORE INFORMATION:

- www.adm.dtu.dk
- www.nunalerineq.gl
- www.mamartut.gl
- artek.byg.dtu.dk

GARBAGE TO GREEN FUEL – BIOGAS VEHICLES IN ICELAND

MORE INFORMATION:

- www.or.is
- www.nordicenergysolutions.org

There are a growing number of compressed natural gas vehicles in Iceland, which has only 300,000 inhabitants (of which 180,000 live in the Reykjavik capital area). These include CNG-only vehicles, bi-fuel vehicles (such as from VW, Citroen, Volvo, and Ford) and dedicated heavy-duty natural gas vehicles (NGVs). The heavy duty vehicles serve roles as waste trucks, as container trucks (haulers),

and as buses. These vehicles are fuelled using bio-methane (gas) that is produced from emissions from the Reykjavik capital area's waste landfill site, operated by the waste management company SORPA. The landfill gas contains on average 50-60% methane and is upgraded with a water scrubber.

KOTZEBUE ELECTRIC ASSOCIATION – ALASKA'S FIRST UTILITY WIND FARM

MORE INFORMATION:

- www.kea.coop
- www.alaska.edu

The consumer owned Kotzebue Electric Association's wind project is the largest in the state of Alaska, and has received national attention – and awards – for its design and high percentage of power provided to the community

Since the 1950's Kotzebue Electric Association (KEA) has ensured that the rural community of the Kotzebue area, Alaska, had access to electricity. In recent years, KEA has spent much time and energy on developing new sources of energy for the future. Because of the high costs of fuel, and because of declining support from the state legislature to keep energy costs in rural Alaska at reasonable levels, KEA has worked to become a pioneer in the use of wind energy in an arctic environment. Thus Alaska's first utility wind farm was built and ready

to use in 1997. The consumer owned wind farm is hoped and expected to bring more affordable electricity and jobs to rural Alaska.



Kotzebue Wind Farm, Alaska¹⁸

LOW LOAD DIESEL AND WIND ENERGY FOR ROTTNEST ISLAND IN AUSTRALIA

Rottneest Island is about 20 kilometres off the coast from Perth, on Australia's west coast, and has its own diesel fuelled power station which supplies electricity to the popular holiday accommodation and tourist services on the island. Perth is one of the windiest cities in the world, and wind energy now supplies a significant percentage of the electrical load on Rottneest Island. A 600 kW wind turbine was installed in December 2004 but the energy it could contribute to the existing power system was limited. The existing power station was upgraded during 2005/06 and the company

D&WS installed a new power system incorporating a single 600kW wind turbine, two 320kW low load diesel (LLD™) generators and two 100kW devices for managing power quality (DGI™s). From July 2006 wind energy is making a more significant contribution to the electricity supply. In addition, when there is excess wind energy it is used to power a water desalination plant. Diesel fuel savings of around 37% are expected. In addition there will be fewer fuel deliveries to this sensitive and highly valued environment, decreasing the risk of fuel spillages.

MORE INFORMATION:

- www.daws.com.au
- www.rottnestisland.com

INTEGRATED WIND, SOLAR, STORAGE AND BIODIESEL FOR ISLAND ENERGY SYSTEM IN NEWFOUNDLAND

Ramea, Newfoundland, is a small village located on Northwest Island, one of a group of five major islands located off the south coast of Newfoundland, Canada. The Island is approximately 3.1 km long by 1 km wide. The community, originally settled in the early 19th century for its proximity to rich fishing grounds and safe anchorages, was once a thriving fishing village but has struggled to survive, having declined to about 50 percent of its peak population of 1,120 in the 1970s. In 2004 Ramea was chosen for the site of Canada's first wind-diesel demonstration project. Six 65 kW wind turbines were installed on the island. The objective of the project was to demonstrate that the Wind-Diesel Integrated Control System (WDICS)

can be used to displace diesel power generation by introducing wind to the island's grid and to show significant energy efficiency and reliability for northern, remote or isolated locations. The wind-diesel pilot program generates around 1 million kWh electricity per year and offsets approximately 750 tonnes of carbon emissions annually. Ramea was also selected as the pilot site for a Wind-Hydrogen power system. Three Northwind 100B 100 kW wind turbines were installed as part of the project. The turbines have a total installed capacity of 300 kW. The project also includes a 250 kW hydrogen-fuelled generator. The system has the capacity to generate electrical energy for up to 34 homes in Ramea, per year.

MORE INFORMATION:

- www.nalcor.org

INTEGRATED WIND, SOLAR, STORAGE AND BIODIESEL FOR TASMANIAN ISLAND ENERGY SYSTEM

MORE INFORMATION:

- www.dier.tas.gov.au
- minister.ret.gov.au



WoolNorth Wind Farm, Tasmania¹⁹

King Island is located about half way between the mainland of Australia and the island state of Tasmania, in the Roaring Forties of Bass Strait. The island has a population of about 1700 people and is noted for its production of cheese, lobsters, bottled rain water, kelp, and beef. Electricity on the island is primarily provided with diesel generators but also a growing amount of wind energy. The Huxley Hill Wind Farm on King Island was the second commercial wind farm to be established in Australia. Commissioned in 1998, the Wind Farm originally consisted of three 250 kW Nordex wind turbines. In 2003, two new 850 kW Vestas turbines were added, bringing the total installed capacity to 2.45 MW. The Wind Farm is a significant contribution to King Island's electricity system, now accounting for 35 percent of the Island's electricity generation capacity, saving some \$AUS 1 million per year on diesel fuel. The wind turbine generators on King Island are restricted to providing a

maximum of 70 per cent of the Island's energy needs at any one time, because of the inherent variability in wind and the inability of the wind turbines to independently manage system frequency and voltage. A project to integrate wind, solar and energy storage with a biodiesel generator was announced in February 2010, receiving \$AUS 15.28 million from the Australian Government's Renewable Energy Demonstration Program. The project will provide baseload and peak power for the King Island mini grid system. It is hoped that up to 90 percent of King Island's power will be from renewable sources by the end of the project. Use of biodiesel as an alternative to diesel is also being considered along with the integration of a smart grid system at the consumer end of the grid to assist in load control and to decrease overall energy requirements. If successful, this technology will help to refine similar projects in regional and remote locations across Australia.

BANFF SWITCHES TO HYBRID BUSES

MORE INFORMATION:

- www.canada.com
- www.banff.ca

Banff is putting four bio-diesel electric buses into service, likely making the town the first municipality in Canada to have an entire public transit fleet made up of hybrid vehicles

Concerns over climate change and rising fuel prices pushed the municipality of Banff in Canada to invest in four hybrid buses. According to the

deputy mayor of Banff Karen Sorensen it is hoped that the buses will encourage the community of Banff, as well as tourists, to use public transportation. To make the buses more notable, they are all "wrapped" with a selection of Banff National Park wildlife photographs. The new Banff hybrid buses are expected to reduce fuel consumption by 30 percent.

ENERGY EFFICIENT HOUSE IN SISIMIUT, GREENLAND

The first arctic energy efficient house aimed to minimizing the energy usage by fifty percent, was constructed in 2004 in Sisimiut, Greenland

In the town of Sisimiut in Greenland, the first arctic energy efficient house was constructed in 2004. The house was constructed by ARTEK, collaboration between Sanaartornermik Ilinniarfik, a Building and Construction School in Sisimiut, and the Technical University of Denmark in Lyngby. The house is incorporated into a research project on low energy technology in Greenlandic constructions, where it is functioning as a demonstration to monitor different climate parameters in accordance with the consumer and comfort parameters of the inhabitants. The primary focus of the project

is to optimize the energy usage by utilisation of natural resources through solar panels, construction geometry, heat recovery from ventilation, and adjustment to the surrounding terrain, along with the dissemination of research results.



The Low Energy House by Destination Arctic Circle²⁰

MORE INFORMATION:

- www.greenland-innovation.com
- www.arktiskcenter.gl

MICRO COGENERATION FROM LPG USED IN AN OFF-GRID NURSING HOME

The old oil-fired heating system in a nursing home in Middletown, Ireland, was upgraded to a Combined Heat and Power (CHP) system that was fuelled with liquefied petroleum gas (LPG). The nursing home is not connected to the mains grid, making it difficult to find a constant, reliable and controllable heat source, yet the versatility and portability of the CHP and LPG system was able to provide a solution. The system uses a 20.5 kW heat input to deliver a constant 5.5 kW of electricity and 12.5 kW of heat. In addition, it provides a back-up to the solar panels that are the primary source of hot water. A key advantage of the CHP

system is the efficiency it provides. Heat from the combustion process is captured and used in the heating system, resulting in reduced running costs and lower CO₂ emissions. Efficiency is further enhanced with the installation of a 750 litre 'buffer' tank, where thermal energy is stored during low demand periods for heating and hot water and released when required. On top, the CHP unit has a condenser in addition to its internal heat exchanger, extracting maximum heat from the exhaust gases. This returns an additional 2.5 kW of energy back to the system, boosting efficiency from a minimum of 88% to a maximum efficiency of 99%.

MORE INFORMATION:

- www.rural-energy.eu

**COMMUNITY
BASED SUSTAINABLE
ENERGY INITIATIVES**

BORNHOLM: BRIGHT GREEN ISLAND

The Danish island of Bornholm has set out a plan to become 100% energy independent as part of a larger vision to be a 'Bright Green Island'

As of 2010, 24 percent of Bornholm's total energy consumption was supplied by renewable sources, including 33 percent of total electricity demand. However the island, which is home to 43,000 people, plans to supply 77 percent of its energy demand from renewable sources by 2025, partly through supply-side measures, but also through greater energy efficiency. To this end, the island is promoting public-private partnerships, the active involvement of its citizens, and welcoming national and international energy research projects. For example, in 2009, Bornholm was chosen as a site

for one of the EDISON projects (electric vehicles in a distributed and integrated market using sustainable energy and open networks – see in depth article in this book), taking advantage of island's relatively large wind power capacity to develop intelligent energy systems.



Christiania bike on Bornholm island, Denmark²¹

MORE INFORMATION:

- www.bornholm.dk

SCANDINAVIAN HYDROGEN HIGHWAY PARTNERSHIP

Making the Scandinavian Region one of the first regions in Europe where hydrogen is available and used in a network of refuelling stations

The Scandinavian Hydrogen Highway Partnership (SHHP) constitutes a transnational networking platform that catalyses and coordinates collaboration between three national networking bodies – HyNor (Norway), Hydrogen Link (Denmark) and Hydrogen Sweden (Sweden). Furthermore, the collaboration consists of regional clusters involving major and small industries, research institutions and local/regional authorities. The SHHP vision is to make the Scandinavian region one of the first

regions in Europe where hydrogen is commercially available and used in a network of refuelling stations.



Hydrogen fuelling Station in Copenhagen, Denmark²²

MORE INFORMATION:

- www.vatgas.se

H2 MOVES SCANDINAVIA

MORE INFORMATION:

- ec.europa.eu
- www.energymap.dk

H2MOVES Scandinavia – demonstration of large-scale hydrogen refuelling station in Oslo

H2MOVES is funded by the European Fuel Cells & Hydrogen Joint Undertaking programme to ensure that Scandinavia becomes one of the markets for international hydrogen car manufacturers by 2015. A state-of-the-art hydrogen refuelling station

has already been integrated in a conventional petrol and diesel refuelling station in Oslo, thus fulfilling all requirements and offering the typical service profile of today's conventional refuelling stations. The objective is to provide hydrogen fuel in a normal retail setting and in an urban environment with probably the densest hydrogen fuelling station network anywhere in Europe.

HYNOR HYDROGEN HIGHWAY ON SOUTHERN NORWEGIAN COAST

MORE INFORMATION:

- www.hynor.no

The Hydrogen highway is an important step in making hydrogen an easy eco-friendly alternative to petroleum fuels for Norwegian car owners



The project of establishing a hydrogen highway in Norway started in 2003 and was supported by different private industries, public transport, regional authorities and organizations. The highway is part of the Norwegian hydrogen infrastructure, and several hydrogen refuelling stations have already been built along the 580-kilometer (360-mile) route. The goal is to make hydrogen for cars more available and thereby make hydrogen vehicles a sustainable alternative to conventional transport.

Mazda RX-8 Hydrogen RE, part of the HyNor Project²³

ECOLOGICAL CITY TRANSPORT SYSTEM IN REYKJAVÍK (ECTOS)

Technological progress and demonstration projects for hydrogen-powered transport from renewable sources were made possible by long-term government targets

In 1998 the Icelandic Parliament agreed a plan to convert the Island's vehicle and fishing fleets to run on 100 percent hydrogen from renewable sources by 2050. To this end, Icelandic New Energy Ltd was set up as a local venture with investment and minority stakes held by Daimler, Norsk Hydro and Shell Hydrogen. Since 1999 Icelandic New Energy has implemented various demonstration projects including ECTOS (2001 to 2005) which operated three hydrogen fuel cell buses and one fuel station in Reykjavík, and was extended for one year by the EU-funded HyFLEET:CUTE project. All of the hydrogen produced in Iceland comes from

electrolysis powered by renewable energy sources, mainly the island's highly-developed geo-thermal resources.

MORE INFORMATION:

- www.newenergy.is
- ec.europa.eu

Hydrogen fuel cell buses in Reykjavík, Iceland²⁴



PATAGONIA WIND AIDS REMOTE COMMUNITIES

The use of wind energy makes life easier for a number of isolated communities, many of them home to indigenous people

In the Argentine province of Chubut, small-scale wind turbines provide electricity to more than 300 isolated villages, used mostly to power domestic

applications, lighting and communications equipment. The Chubut Regional Centre for Wind Power, based in Rawson, is working to expand the use of wind power in what is one of the world's windiest regions with many isolated communities located far from the grid.

MORE INFORMATION:

- organismos.chubut.gov.ar

COLD CLIMATE HOUSING RESEARCH CENTRE'S HYBRID MICRO ENERGY PROJECT

MORE INFORMATION:

• www.cchrc.org

The goal of the non-profit Cold Climate Housing Research Centre (CCHRC) is to promote and advance the development of healthy, durable, and sustainable shelter for Alaskans and other circum-polar people

Among other activities, the CCHRC is participating in hybrid micro-energy research through an umbrella project initially funded by a \$500,000 grant from BP. The project is designed to determine and demonstrate how a variety of renewable energy sources can be integrated so as to power

single family and residential cluster-scale energy demands in Alaska, on a year-round basis. The solar photo-voltaic and thermal components of the programme have been operational at CCHRC's Research and Testing Facility since late 2007. With a recent grant from the Denali Commission, hybrid micro-energy programme is growing to encompass other energy technologies such as biomass gasification, geothermal heat pumps, and gas and wood-fuelled combined heat and power appliances.

Passive solar home in Fairbanks, Alaska²⁵



ALASKA VILLAGE ELECTRIC COOPERATIVE (AVEC)

The non-profit electricity utility Alaska Village Electric Cooperative (AVEC) provides electricity to 53 member villages in rural Alaska



AVEC produces electric power for the 53 member villages using around 150 diesel generators and numerous wind turbines. The cooperative is currently shifting focus towards renewable energy and has won several prizes in this context, i.e.: The U.S. Department of Energy announced – in partnership with the National Rural Electric Cooperative Association – its selection of the Alaska Village Electric Cooperative as the winner of the 2007 Wind Cooperative of the Year Award.

High Penetration Wind System in Wales, Alaska, by ACEP UAF²⁶

MORE INFORMATION:

- www.avec.org
- nordsesil.wikispaces.com

PRINCE EDWARD ISLAND'S 10 POINT PLAN FOR SECURING THEIR ENERGY FUTURE

The government of Prince Edward Island in Canada has a goal to install 500 MW of wind energy capacity by 2013

Prince Edward Island's wind energy is its strongest and most valuable natural asset. In order to secure that the Island develops its wind energy resources in a careful, thoughtful, and focused manner the government of Prince Edward Island has elaborated a "10 Point Plan to Securing Our Future." The plan includes but is not limited to goals of maximizing energy security, independence and price stability for islanders which will provide economic

benefits to the local economy that has historically depended upon energy imports.



Prince Edward Island, Canada²⁷

MORE INFORMATION:

- www.gov.pe.ca

ECOCITY SKIVE – GOAL TO BECOME ENERGY SELF SUFFICIENT BY 2029

MORE INFORMATION:

- eng.energibyenskiye.dk
- skive.illumi.dk



Skive Harbour, Denmark²⁸

For more than 30 years the Danish municipality of Skive has been engaged with climate and environmental issues, and in 2008 was designated to become one of Denmark's six 'Ecocities'

The overall goal of the Skive Ecocity is to become CO₂-neutral and energy self-sufficient by the year 2029. Thus far, the municipality has been able to generate 40 percent profit on its investments in sustainable energy. The Ecocity project's overall vision is to create a platform where Skive Municipality, its citizens and businesses focus their collective efforts on using sustainable energy supplies and

promoting the rational use of energy through learning, attitude change, and the development of new low-energy buildings. Innovative approaches to achieve this vision are used. For example, inspired by the Tupperware marketing method, home parties are being used to share information on issues such as how to calculate the use and cost of domestic and business energy use, household energy ratings, simple design and architectural solutions to lower energy use, cost-cutting measures and available funding opportunities.

FOSSIL FUEL FREE KRISTIANSTAD, SWEDEN

MORE INFORMATION:

- www.managenergy.net
- www.kristianstad.se

Community organisation has been central to helping achieve a vision of a 'fossil-fuel free' municipality in Sweden where bio-energy plays a big role

Kristianstad is the capital of the Skåne region in southern Sweden, with a population of approximately 79,000 people. Surrounding this is an unusually large number of smaller towns and villages, of which the six largest function as industrial, service and residential hubs for their particular part of the region. In 1999, the executive committee of Kristianstad municipality pledged to become a Fossil Fuel Free Municipality. In order to achieve this goal, different projects within were funded by the municipality and by state grants. Reducing

the dependence on fossil fuels is being achieved primarily by the use of bio-fuels, both biomass as fuel for heating and production of electricity and biogas as fuel for local buses and other vehicles. Other activities include efforts to increase field of energy efficiency and change consumer behaviour patterns. Community planning is an important instrument to promote a Fossil Fuel Free municipality and the target audience is all sectors of the society, including companies, households and children etc. Yearly CO₂-emissions have been reduced by an average of 123,000 tonnes. Experience thus far suggests that it is easier to reduce emissions from the heating sector than from transport.

THE ISLAND OF SPIEKEROOG, GERMANY – SELF SUFFICIENT ENERGY IN A NATIONAL PARK

An island National Park in Germany has become energy self-sufficient through a combination of energy conservation and energy use from renewable sources that ensure minimal damage to the local environment

The Municipality of Spiekeroog is developing a strategy for a self sufficient supply of energy for the island of Spiekeroog. The island's status as a national park presents a number of challenges as many renewable energy technologies are considered invasive by the municipality which aims to preserve the special ecological and cultural features on the island. For example, additional wind turbines cannot be built; the production of bio-gas

is not possible because there is no agriculture; to install photovoltaic cells on every suitable roof could detract from the character of the historical townscape; geothermal heat systems can damage the fresh water supply. The municipality also aims to initiate social-cultural sustainable initiatives, to strengthen environmental education and to assure that the water supply on the island will be self sufficient and independent from the mainland on a long-term basis. This special situation requires particular strategies for using energy on the island that combine energy conservation and energy use from renewable sources that ensure minimal damage to the local environment.

MORE INFORMATION:

• c2cislands.org

The Island of Spiekeroog, Germany²⁹



WINDSWEEP CHATHAM ISLANDS IN NEW ZEALAND REDUCE FOSSIL FUEL DEPENDENCE BY INTEGRATING WIND ENERGY

MORE INFORMATION:

• www.edinenergy.org

The remote island community on New Zealand's Chatham Islands has discovered that wind energy is a lower-cost alternative to diesel powered electricity generation

The Chatham Islands are a remote and windswept outpost of New Zealand, located 750 km east of the South Island of New Zealand. Almost all of the residents live on the main Chatham Island, which is 90 square kilometers of mostly low-lying pasture and scrub with a wild coastline surrounded by rich fishing grounds. The main island has a diesel-based electricity grid servicing approximately 80 percent of its residents (260 households) and businesses, with a total grid electricity demand of

2,370 MWh in 2010. Various attempts to get renewable energy options off the ground over the years had proved unsuccessful, however by 2008 rising energy prices were crippling the local economy. In particular, hydropower had been repeatedly investigated and promoted for more than 25 years, but the options were expensive and called for significant government funding that was not feasible. In early 2008, the utility sought advice as to whether wind power could be supplied on a commercial basis at a cheaper rate than diesel. Today, two 225 kW wind turbines are supplying power to the local grid. The turbines are expected to supply 47 percent of the islands' electricity, reducing diesel use by around 300,000 litres each year.

BIOGAS VÄST – THE WORLD'S FIRST REGIONAL PROJECT FOR BIOGAS AS FUEL

MORE INFORMATION:

• www.managenenergy.net

Businesses and non-profit organisations worked together in creating Sweden's most developed area in terms of biogas production, filling stations and gas-powered vehicles

Project Biogas Väst started in 2001 in western Sweden (Göteborg region and Västra Götaland region) to drive forward market development in the whole biogas chain – from biogas production and distribution to the expansion of gas filling stations and the use of gas-powered vehicles – in order to

create more jobs while reducing greenhouse gas emissions. In addition to three biogas municipalities (Borås, Göteborg and Trollhättan), there were a number of businesses and organisations in the region pushing the formation of Biogas Väst. Together they represented all aspects of the biogas chain. When Biogas Väst was founded there were only nine gas stations and 800 gas-powered vehicles in the region. Today, western Sweden is country's most developed area in terms of biogas production, filling stations and gas-powered vehicles.

HADYARD HILL COMMUNITY ENERGY PROJECT, SCOTLAND, UK

Simple energy conservation measures have enabled the Scottish community of Hadyard Hill, and others, to drastically reduce energy bills and thus enrich the local residents and local economy

The Hadyard Hill Community Energy Project was established to reduce energy demand, decrease fuel poverty and obtain maximum community benefits in the South Ayrshire region in Scotland. An Energy Efficiency Fund, created by Scottish and Southern Energy, provided £300,000 for the project. The project initially targeted 828 rural properties, including private, rented, council, Housing Association and small businesses. Doorstep surveys were conducted to gather data, determine appropriate insulation, and an ecological / carbon footprint analysis of each household. 90 percent of the community took part in the project with 63

percent of surveyed households benefiting from free insulation measures.

Solar PV systems were installed in three schools in the area. Approximately half the school pupils in these schools also received energy lessons as part of an education project for the whole of south west Scotland. All measures were free for everyone. As a result of this project, the average energy efficiency of households was increased by 21 percent. With 80 percent of households committing to adopt simple tips to reduce energy consumption by a further £215 per household, the project has brought a total of £250,000 of additional disposable income to the community, per year. The project has successfully been repeated in other communities in Scotland.

MORE INFORMATION:

• www.managenergy.net



Hadyard Hill Wind Farm, Scotland³⁰

**EDUCATION AND
OUTREACH FOCUSED
ACTIVITIES**

HOVE FESTIVAL

First held in 2007, the Hove music festival in Norway aims to raise awareness about climate change and the need to achieve environmental sustainability

The Hove music festival is held yearly on an island off Arendal city, southern Norway. In partnership with UNEP and CO2focus, the festival organizers have devoted special effort to raising the level of environmental awareness among the festival goers, as well as taking measure to reduce the event's carbon footprint. The festival has access to renewable energy sources through a direct connection to the hydro-powered electricity grid. In addition, solar and wind energy is used to power free mobile phone charging stations. A dedicated camping area – *the Zero Footprint Camp* – has also been established, where the festival guests

can sort their waste, use the free renewable energy charging stations and camping showers fuelled by energy efficient oil water heaters, solar power and biodiesel.



Drum kit at Hove Festival, Norway³¹

MORE INFORMATION:

- nordsesil.wikispaces.com
- www.unep.org

ALASKA SOLAR TOUR

Locals teach locals how to benefit from green technology

The Alaska Solar Tour is an annual event that features homes and businesses showcasing installations of solar thermal, solar photovoltaic, wind turbines, hydro power, and green building

features. The event is funded by the Alaska Centre for Appropriate Technology in conjunction with the American Solar Energy Society and local tour hosts. The aim of the project is to showcase how individuals are adjusting their living situations to become greener and more sustainable, especially in terms of energy usage.

MORE INFORMATION:

- www.alaskasolartour.org
- alaskasolartour.org

GOLDEN VALLEY ELECTRIC ASSOCIATION'S INCENTIVE PROGRAM FOR RENEWABLE ENERGY

MORE INFORMATION:

- nordsesil.wikispaces.com
- www.gvea.com

Alaska's Golden Valley Electric Association runs the SNAP (Sustainable Natural Alternative Power) programme which brings local renewable energy producers into contact with local consumers

GVEA (Golden Valley Electric Association) is a locally owned cooperative, whose main activity is to bring electric services to Interior Alaska. In 2005, the cooperative decided to increase its output of renewable energy and thus established the SNAP (Sustainable Natural Alternative Power) program.

The SNAP program encourages members to install renewable energy generators and connect them to the utility's electrical distribution system by offering a performance incentive calculated on a dollar per kilowatt-hour (\$/kWh) basis. The renewable power produced is measured separately from existing home or business energy use by a separate meter. GVEA has also developed specific standards for the connection of SNAP generators to its distribution system.

SESSELJA HOUSE SUSTAINABLE BUILDING AND EDUCATION CENTRE

MORE INFORMATION:

- www.nordicenergysolutions.org
- www.sesseljuhus.is

The Icelandic eco-village of Solheimar, has created a house made of driftwood, sheep wool and paper

Sesselja House, a Center for Sustainable Development, is itself a very sustainable building, designed by the architects in ASK Arkitektar. During construction only environmentally friendly building materials were used. Insulation of the walls and floors is made of natural sheep's wool, while the roof is insulated with paper. The outdoor cladding is made from driftwood originating from Siberia, carried to Iceland by the ocean currents. Interior surfaces consist of plywood, Icelandic larch, natural greystone, linoleum and recycled materials. The

building has a natural air-ventilation system, where fresh air is channelled under the building by a flow induced by the difference in temperature between the exterior and inside of the building, thus significantly reducing energy demand. Air enters through ducts in the floor and leaves through vents in the roof. All energy used in the building originates from sustainable resources. Electricity comes from solar and hydro power, as well as from a generator that produces electricity from the temperature difference between hot and cold water. Heating comes from geothermal hot water from a nearby borehole.



Sesselja House, Iceland³²

SMALLEST PROJECT

Empowering the smallest communities through renewable energy

The SMALLEST project aims to boost the scale and quality of training, mentoring and support for rural communities seeking to convert from traditional energy generation to renewable energy generation across all of Europe's Northern Periphery Programme (NPP) partner regions. The project adds value by integrating existing advisory services, filling any gaps in community training and

mentoring regarding the conversion to renewable energy generation, and providing support to business modelling solutions relating to the generation of community renewable energy. The project delivers transnational benefits by standardising a support process for converting communities from traditional energy generation to renewable energy generation, drawing upon pooled skills and shared knowledge across the region, and potentially can be offered to rural communities across the EU.

MORE INFORMATION:

- www.smallestnpp.eu
- www.northernperiphery.eu

THE INTERNATIONAL CENTRE FOR ISLAND TECHNOLOGY (ICIT)

Scotland's International Centre for Island Technology (ICIT) was established in 1989 to conduct advanced research, postgraduate training and consultancy in marine resource management and related issues

The Centre provides a unique teaching and research facility based in Orkney, one of the most renewable energy-rich areas of the Scottish Highlands and Islands, and forms an integral part of Heriot-Watt University's prestigious Institute of Petroleum Engineering. ICIT is one of the UK's top

teaching centres for renewable energy studies; its flagship training course (MSc in Renewable Energy) is a conversion course for graduates wishing to complement existing subject specialisms in engineering, environmental sciences, economics, finance, construction or related disciplines. The course is designed to help plug the emerging skills gap in the renewables sector where both private and public sector employers require graduates with core skills and knowledge of renewable energy.

MORE INFORMATION:

- www.icit.hw.ac.uk
- www.hi-energy.org.uk

ENERGY SAFARI – SUSTAINABLE ENERGY TOURS IN DENMARK

MORE INFORMATION:

- www.energysafari.dk

An educational tourism project that focuses on “good energy and environment stories, told in a different way” by providing insight into Danish experiences on sustainable energy solutions and communities. Customised programs can be developed with visits to the island community of Samsø and the Ecocity of Skive. Participants can tour demonstration plants, learn about processes and local experiences, participate in workshops on topics including climate and energy strategies, and

climate investments, and meet with local people working behind the scenes on community energy projects.



Windmill and solar collectors at a community on Samsø island, Denmark³³

MANAGENERGY EDUCATION CORNER DATABASE OF EDUCATION RESOURCES

MORE INFORMATION:

- learn-energy.net

ManagEnergy Education Corner, funded by the European Union, includes a wealth of information and links to renewable energy sources, energy saving, sustainable transport, climate change, energy careers and vocational training. The Kids Corner section provides educational resources for children (under 11), young adults (12-16) and their teachers, in 27 languages. This includes a new ManagEnergy Database of Energy Education Resources, encompassing vocational training in the Sustainable Energy field. The ManagEnergy Education Corner provides:

- A free online database for parents, teachers and local energy actors, including supporting information and links to energy education websites providing energy management tools, case studies, lesson plans, activities, games, animations, videos and award schemes
- “Energy Magic” – web pages for children aged 7-11 including information, photos, animations, games, web links and downloads in many languages
- “Energy – It’s Your Future!” – web pages for children aged 12-16 including information, photos, web links, video links, games, animations, facts and figures in many languages

GREENLEARNING RESOURCE FOR TEACHING STUDENTS ABOUT ENERGY AND ENVIRONMENT

GreenLearning provides a learning resource for Canadian teachers interested in teaching their students about today's complex energy and environmental issues

GreenLearning is an innovative education program focusing on current energy and environmental challenges. The programme provides eLearning activities, hands-on activities at a school

based in Alberta, Canada, curriculum-aligned web-based resources for students grades 4 and up, and professional development workshops for Canada's innovative teachers. The GreenLearning website contains several learning modules and exercises all related to clean energy and environmental issues. The site also provides links to several related on-line educational resources, all of which is ready to use and free of charge.

MORE INFORMATION:

- www.greenlearning.ca

GREENLANDIC EDUCATION CAMPAIGN FOR ENERGY AND WATER SAVINGS

Greenland's utility provider offers advice on the best and easiest ways to save energy and water

Nukissiorfit is the producer and distributor of electricity, water and heating to the Greenlandic population. The main office is located in Nuuk and several smaller offices are located across Greenland. To inspire the Greenlanders to decrease their consumption of energy and water Nukissiorfit has developed and promotes a 'best practice' guide on how to save energy and water.



Tap house in Greenland³⁴

MORE INFORMATION:

- www.nukissiorfit.gl

NORWEGIAN FUNDING FOR ENERGY EFFICIENT HOUSING AND RETRO-FITTING

**MORE INFORMATION:
(ONLY IN NORWEGIAN)**

• naring.enova.no

Norway's Enova SF is helping private and public companies become environmentally friendly energy users

Enova SF is an organisation working on strengthening the efforts of public and private companies to become environmentally friendly energy users.

One tool Enova is working with is the program 'Støtteprogrammet' (the support programme) which aims to provide investment support for the construction of low energy buildings in Norway. The programme also provides support for 'rehabilitation projects', which aim to reduce energy consumption in older buildings.

UARCTIC

MORE INFORMATION:

• www.uarctic.org

The University of the Arctic (UArctic) is a cooperative network of universities, colleges, and other organizations committed to higher education and research in the North

The overall goal of UArctic is to create a strong, sustainable circumpolar region by empowering

northerners and northern communities through education, shared knowledge and identity awareness. The learning institutes partnering in University of the Arctic offer a wide range thematic networks including Indigenous Thematic Network on Community-based Natural Resource Co-management, Arctic Engineering and Science, Arctic Medicine and Indigenous Arts and Crafts. The goal of UArctic is to strengthen northern institutions by sharing resources, facilities, and expertise through thematically focused networks of traditional and/or discipline-based knowledge experts. Ultimately, the aim of UArctic is to enhance the role of northern higher education institutions' as creators, holders and communicators of knowledge regarding northern issues and regions.



A group of students from the University of the Arctic³⁵

ARTEK

A research collaboration between the Technical University of Denmark (DTU) and Greenland's Sanaartornermik Ilinniartfik

The Arctic Technology Centre, Artek, was formally established in summer 2000 to teach and provide in-service training for Greenlandic and Danish students and businessmen in Arctic technology. Artek also runs courses and seminars about Arctic conditions and contributes to research into Arctic technology. As a forerunner to the centre, various courses have been held about Arctic conditions in recent years. The centre will be run by Sanaartornermik Ilinniartfik (the Building and Construction School) in the Greenland town of Sisimiut and by the Technical University of Denmark in Lyngby, Copenhagen. Research is one of the most

important activities at the Arctic Technology Centre. The basic aim is to promote research based on the needs and wishes of the Arctic population and conducted in close cooperation with relevant partners in Greenland. The main areas of research include the engineering aspects of building and construction technology, the environment, natural resources and energy generation.



MORE INFORMATION:

- www.sanilin.gl
- www.arktiskcenter.gl

A new dormitory for engineering students at ARTEK in Sisimiut, Greenland, uses solar energy to heat hot water and the building itself³⁶

SCHOOL FOR RENEWABLE ENERGY SCIENCE IN ICELAND

The School for Renewable Energy Science (RES) unites private industry with science to expand the role of renewable energy in Iceland

RES is an international graduate school devoted to education in renewable energy science and technology. RES is affiliated with both the University of Akureyri and University of Iceland. RES currently offers five specializations of study: Geothermal Energy; Hydropower; Fuel Cell Systems & Hydrogen; Biofuels & Bioenergy; and Energy Systems. Other Specializations to be offered in the near future will include Wind & Wave Power and Solar Energy. RES

teaching staff and thesis advisors come from a large number of foreign technical universities, two domestic universities, energy companies, research institutions and governmental organizations.



MORE INFORMATION:

- www.res.is

Geothermal energy in Iceland³⁷

DATABASE OF SKILLS AND VOCATIONAL TRAINING BODIES FOR SUSTAINABLE AND RENEWABLE ENERGY TRADES

MORE INFORMATION:

- learn-energy.net

The EU's ManagEnergy Vocational Training Corner provides comprehensive links to websites with details of skills and training agencies and organisations that offer support and advice in renewable and sustainable energy skills for plumbers, electricians, installers and the construction trades. It also

provides links to websites with reports, presentations and case studies on vocational training and skills for sustainable energy trades and professions, and an overview on EU legislation relevant to vocational training and skills for sustainable energy and construction.

COMMUNITY ENERGY SCOTLAND

MORE INFORMATION:

- www.communityenergyscotland.org.uk

A community outreach project in Scotland uses sustainable energy as a tool for local development

Community Energy Scotland is a charitable organisation promoting renewable energy for rural communities in Scotland. Their aim is to assist local communities in exploring the potential and opportunities for sustainable energy development, for local development. Their work focuses on micro-generation technologies for community facilities and larger-scale technologies, such as community owned wind-farms and hydro-projects, with the aim of providing additional income for local communities. Alongside supporting local energy projects Community Energy Scotland is also promoting the cause of its members at governmental level, regulators and funders.



Solar panel installation on a church roof³⁸

AMERICAN WIND FOR SCHOOLS PROGRAM

To raise awareness in rural America about the benefits of wind energy the U.S. Department of Energy has developed an educational program called “Wind for Schools”

By 2030 wind will provide 20 percent of U.S. electricity. This is a scenario developed in 2008 by more than 70 U.S. organizations –led by the U.S. Department of Energy. To achieve the 20 percent scenario the U.S. will need skilled workers and experts on wind energy in the near future. The U.S. Department of Energy has thus launched the “Wind for Schools” program. The program installs small wind turbines in rural elementary and secondary schools while developing Wind Application Centres at higher education institutions. The main purpose of the program is to educate and raise awareness about the benefits of wind energy.



MORE INFORMATION:

- www.uaf.edu
- www.windpoweringamerica.gov

Wind turbine at a school participating in the “American wind for schools program,” USA³⁹

ALASKA WIND DIESEL APPLICATIONS CENTRE

The Centre for Wind-Diesel promotes the use of sustainable energy sources for Alaska’s rural population

The Alaska Center for Energy and Power (ACEP), together with its partners the Alaska Energy Authority and the US National Renewable Energy Laboratory (NREL), has established a centre in wind-diesel technology that analyzes technology options, tests state-of-the-art hardware and control software, educates engineers, trains operators,

and provides technical assistance to wind–diesel stakeholders both within and outside the State of Alaska. The purpose of the Alaska Wind-Diesel Applications Center (WiDAC) is to support the broader deployment of cost-effective wind-diesel technologies to reduce and/or stabilize the cost of energy in Alaska’s rural communities. WiDAC is organized around the following three focus areas: Independent Analysis and Testing, Technical Support and Workforce Development and Education.

MORE INFORMATION:

- www.uaf.edu

**REGIONAL AND
NATIONAL INITIATIVES
AND NETWORKS**

RENEWABLE ENERGY ALASKA PROJECT (REAP)

The Renewable Energy Alaska Project (REAP) is a coalition of energy stakeholders working to facilitate the development of renewable energy in Alaska through collaboration, education, training, and advocacy. REAP believes that the develop-

ment of renewable energy resources will be both economically and environmentally beneficial for Alaska, The United States and the Earth in general. REAP thus believes that Alaska should and can be a leader the development of renewable energy.

MORE INFORMATION:

• alaskarenewableenergy.org

ALASKA SUN COALITION – A RENEWABLE FUTURE FOR ALASKA

Alaska Sun is a coalition of solar businesses, academics, and other interested individuals working towards a renewable future for Alaska. On their website the coalition shares information on wind and solar energy focusing especially on projects implemented in Alaska. The Alaska Sun website also provides teacher resources and links to other sources of information concerning renewable energy e.g. lectures and publications.



MORE INFORMATION:

• www.alaskasun.org

Glacier Bay Basin in southeastern Alaska⁴⁰

INTERNATIONAL PARTNERSHIP FOR ENERGY DEVELOPMENT IN ISLAND NATIONS (EDIN)

An international partnership, EDIN aims to advance the deployment of renewable energy and energy efficiency technologies in islands across the globe. By bringing together policy advisors, technical experts, and financial leaders, EDIN works to guide clean energy development and deployment in specific regions and islands. EDIN offers islands the following resources to help them develop: policies to help remove barriers to clean energy develop-

ment and create incentives for growth. Financing; this assistance is designed to attract private capital and project developers to islands for renewable energy and energy efficiency projects. Clean; EDIN helps island industries develop a knowledge base through technical assistance and training, and by promoting the transfer of new renewable energy and energy efficiency technologies into the marketplace.

MORE INFORMATION:

• www.edinenergy.org

CRADLE TO CRADLE ISLANDS (C2CI) FOR INNOVATION

MORE INFORMATION:

- c2cislands.org

The Cradle to Cradle Islands project (C2CI) has 22 partners from six countries around the North Sea. The leading vision of the project is “islands as innovation centres that implement sustainable and Cradle to Cradle solutions.” The main goal of the project is to develop innovative solutions in the field of energy, water and materials, using ‘Cradle to Cradle’ principles as a guide. The project duration is from January 1 2009 to Summer 2012, with a total budget of €3.5 million (50 percent European funding, 50 percent co-financing by partners). The Cradle to Cradle (C2C) concept is an approach for designing intelligent products, processes and sys-

tems taking into account the entire life cycle of the product, optimizing material health, recyclability, renewable energy use, water efficiency and quality, and social responsibility. C2C design takes its inspiration from nature, in which all materials used can provide ‘nutrition’ for nature or industry, maximize material value and safeguard ecosystems. As such, the concept of waste is eliminated. The purpose of the C2C Design is to restore continuous cycles of biological as well as technical nutrients with long-term positive effects on profitability, the environment and human health.

FUTURE OF RURAL ENERGY IN EUROPE (FREE) NETWORK AND RESOURCES FOR RURAL COMMUNITIES

MORE INFORMATION:

- www.rural-energy.eu

Over 50 percent of European citizens live in rural areas. They occupy over 90 percent of Europe’s territory and contribute 43 percent of Europe’s gross value. And yet, despite their importance, rural communities are rarely considered by politicians and regulators when developing energy policies. People living in the more remote parts of Europe rarely have access to the natural gas grid, and the grid-connected electricity supply can be unreliable and hugely inefficient. As a consequence they often have to rely on relatively high carbon solid

and liquid fuels which are being used with ageing technologies.

The Future of Rural Energy in Europe (FREE) initiative gives a voice to all those who believe that rural energy needs are important issues both for those who live in the countryside and for European society as a whole. The initiative aims to raise awareness of the energy options available to rural homes and businesses that do not have access to the same energy infrastructure, solutions and support as urban areas. The website provides an overview of relevant solutions.



Event promoting the Future of Rural Energy in Europe (FREE) network⁴¹

MICRE: MICRO ENERGY TO RURAL ENTERPRISES

Established with funding from the EU's Northern Periphery Programme 2007-2013 (NPP), the MicrE provides a service that exploits technologies for renewable energy solutions, as well as energy generation from by-products and waste. MicrE is a transnational service that will make small scale renewable energy generation available to small and medium-sized enterprises (SMEs) in rural regions of the Northern Periphery on a scale that is viable and economically feasible. MicrE service and network will help SMEs use renewable energy technologies in an affective, appropriate and beneficial manner.

Rural areas in the Northern Periphery have traditionally been very resource intensive and

dependent on fossil energy due to their remote location and long winters. Even micro-generation of renewable energy has been dominated by urban demand, because the suppliers, retailers and service companies require a high volume of sales in order to be profitable. Small-scale biomass- and waste based energy solutions are able to answer the challenges of resource availability, while progressively reducing the impact of human activities on the environment. The aim is to increase the use of renewable energy and onsite energy generation from a business' own wastes and by-products, solving simultaneously the waste disposal problems and diminishing GHG emissions.

MORE INFORMATION:

- www.micre.eu

A boiler installed under the EU's MicrE programme⁴²



OPPORTUNITIES FOR COMMUNITY GROUPS THROUGH ENERGY STORAGE (OCTES)

The OCTES project was initiated early in 2011 under the EU's Northern Periphery Program (NPP). The project goal is to develop a business model that can deliver a new Integrated Renewable Energy Management Service (IREMS) that can be adapted to suit local needs in a transnational context. The developed Renewable Energy Management Service incorporating smart grid technology with existing renewable energy (RE) know-how will be made available to existing advisory services across the NPP region.

The components of OCTES' Integrated renewable energy management service will enable new and

existing advisory services to offer solutions to community renewable energy groups involved with RE developments with particular focus on micro generation. This will permit community groups and/or individual house holders to plan and design their system to function with new smart grid technologies, tailored to individual needs. This will enable the most economic renewable energy storage mechanisms to be identified and integrated into existing renewable energy projects as well as projects at a planning stage.

MORE INFORMATION:

- clients.fadesign.net
- www.northernperiphery.eu

RASLRES: REGIONAL APPROACHES TO STIMULATING LOCAL RENEWABLE ENERGY SOLUTIONS

MORE INFORMATION:

- www.northernperiphery.eu
- www.raslres.eu

The RASLRES project aims to increase the use of renewable energy technologies in rural economies in the EU's Northern Periphery region. The initial focus will be on the bio-energy sector. The project brings together partners from Ireland, Scotland, Northern Ireland and Sweden. RASLRES will design, pilot and market the best support products and services for creating and sustaining local renewable bio-energy markets in rural areas. The project will help markets provide sustainable economic growth for local employment, businesses and revenue. RASLRES will design and deliver a number of pilot projects that will be used to inform an overall model to stimulate renewable bio-energy use in

rural areas. The project will focus on bio-energy fuels – such as energy from wood, energy from crops (specifically reed canary grass) and energy from marine biomass technologies. Using the pilot projects as trial areas, RASLRES will also incorporate measurement tools that can be used for calculating greenhouse gas emissions to support rural energy businesses in lowering CO₂ emissions and also reducing business costs through realising the offset value of these efforts. The project will also establish a network for the transnational exchange of knowledge, policy initiatives, technology and methodologies, which can later be used across the entire Northern Periphery region.

ALASKA CENTER FOR ENERGY AND POWER

MORE INFORMATION:

- www.uaf.edu

The Alaska Center for Energy and Power (ACEP) is an applied energy research program based at the University of Alaska. ACEP recognizes that Alaska has more fossil and renewable energy resources than any other state in the USA and that Alaska therefore has the potential for long-term sustainable energy production through development of its natural gas, coal, oil, hydropower, tidal, geothermal and wind resources to meet the energy needs of the state and beyond. Because Alaska's energy picture is so unique it requires a forward looking, innovative approach, which ACEP aims to provide.



Village water pump in Alaska⁴³

ARCTIC ENERGY ALLIANCE

Arctic Energy Alliance (AEA) helps northern communities in Canada towards Carbon Neutral Standards. The AEA is a not-for-profit society with a mandate “to help communities, consumers, producers, regulators and policymakers to work together to reduce the costs and environmental impacts of energy and utility services in the Northwest Territories.” The society’s aim is to promote and facilitate the adoption of efficient, renewable and carbon neutral energy practices by all members of the Northwest Territories. Their main activities are centred on the dissemination

of information to local communities, public and commercial institutions.



MORE INFORMATION:

- www.aea.nt.ca

An oil rig off Greenland's coast⁴⁴

RTS: RURAL TRANSPORT SOLUTIONS FOR THE NORTHERN PERIPHERY

The RTS project aims to develop innovative and sustainable rural and coastal transport schemes and services reducing social exclusion and enhancing the vitality and sustainability of sparsely populated areas in the Northern Periphery. The rationale of this project is that community paid or subsidised public transport is a considerable financial burden for small and rural/coastal municipalities. Furthermore long distances in rural and coastal areas increase the need for cost-efficiency as well as minimizing pollution from transports.

Key actions in the project are:

- Profile the existing transport services and the utilisation rate and identify the transport needs of different groups
- Identify new and existing solutions to make rural and coastal transport accessible to all residents. This includes combining normally separate transport services such as provisions for disabled citizens, elderly transport service, hospital travel, school transports and commuting to work.
- Utilise the new and existing transport products and services and raise awareness by promoting them

MORE INFORMATION:

- www.northernperiphery.eu
- www.rtsnpp.eu

**SPECIFIC
INFORMATION RESOURCES
AND TOOLS**

10 YEARS OF WIND-DIESEL SYSTEMS IN ALASKA: ANALYSIS OF ECONOMIC BENEFITS

The authors of the report “*Alaska Isolated Wind-Diesel Systems: Performance and Economic Analysis*” evaluate the economic benefits of the use of wind-diesel systems in rural Alaska. Since wind-diesel systems were first introduced more than a decade ago, interest among the rural population of Alaska has been growing. An increasing number of rural communities are now building wind-diesel systems— both to reduce energy costs and to provide local, renewable, sustainable energy.



MORE INFORMATION:

• www.iser.uaa.alaska.edu

Wind-diesel system in Toksook Bay, Alaska⁴⁵

DECISION TOOL ON ENERGY RENOVATION OF BUILDINGS (RENOVA)

RENOVA is inspired by the Cradle to Cradle design concept with a strong focus on (holiday) houses in the North Sea Region. It is a guide and a database, providing the steps, methods and technologies to be followed during the energy-renovation of a house. Its content is presented in a user-friendly manner, giving decision-makers the opportunity to get informed on latest technological advancements, use the tool to make decisions for a specific project and also contribute to its enrichment. It provides six steps to be followed during the energy renovation of a house. It includes a review of methods and technologies that can be

implemented during each step. The six steps are: 1: Analyze and set an energy demand target, 2: Reduce energy demand, 3: Reuse energy flows, 4: Provide clean and renewable energy supply with micro-generation, 5: Interconnect energy, water, materials, and 6: Evaluate the scenarios and select the final renovation design. There are 74 energy related methods and technologies that can be used, including (dis)advantages, seasonal potentials, efficiency, an indicator on the Cradle to Cradle design principles, technology producers and an indicator on the level of potential for holiday houses.

VISIT THE WEBSITE:

• renova-tool.org

THE WEST NORDIC RENEWABLE ENERGY SOURCE – MINI GREEN BOOK

**DOWNLOAD THE BOOK FOR FREE (IN
DANISH AND ENGLISH):**

• www.norden.org

The Mini Green Book explores the potential for expanding the use of renewable energy in the sparsely populated West Nordic region. The Publication aims to be a catalyst for establishing contacts with neighbouring countries about an extended energy co-operation for the areas and regions that are characterized by isolated and sparsely populated communities.

Solar panel installation at a house in Nuuk, Greenland⁴⁶



YAFFLE ONLINE INDEX OF ACADEMIC AND COMMUNITY PROJECTS ON SUSTAINABLE ENERGY SOLUTIONS

MORE INFORMATION:

• www.yaffle.ca

In February 2009 Memorial University of Newfoundland launched a new online resource called Yaffle. This innovative online resource is aimed at providing greater accessibility to the university's research expertise and research projects. Yaffle enables users, including individuals, community

groups, and governments, to search for expertise in a variety of fields. It contains nearly 1,000 summaries on various projects being carried out by the Memorial University of Newfoundland, including project on sustainable energy solutions.

MANAGENERGY TECHNICAL SUPPORT INITIATIVE BY THE EUROPEAN COMMISSION

ManagEnergy is a technical support initiative of the Intelligent Energy – Europe (IEE) programme of the European Commission which aims to assist actors from the public sector and their advisers working on energy efficiency and renewable energy at the local and regional level. The initiative targets:

- Local and regional energy agencies
- Local and regional public authority energy specialists
- Urban planners and elected officials (municipal, provincial and regional)
- Other local and regional organizations with a public mission that are working on sustainable energy

The ManagEnergy initiative includes:

- The ManagEnergy website, which offers data-

bases on case studies and good practices as well as a directory of energy agencies

- Information on relevant European policy and legislation
- Electronic newsletters
- Capacity building workshops
- Other networking facilities, such as online events, an Annual Conference and awards

The website includes a partner search system containing some 4000 organisations, including almost 475 energy agencies, which can provide valuable expertise and partnerships on energy initiatives at local and regional levels. ManagEnergy also offers access to live internet broadcasts and video archive of past events, which integrates individual video presentations, speeches and interviews on topical energy matters.

VISIT THE WEBSITE:

- www.managenergy.net

NOTES

- 1 Photo references and credits
"Ob Hill Hike" by Eli Duke <http://www.flickr.com/photos/elisfanclub/4345359788/sizes/o/in/photostream/>
- 2 <http://www.hydro.com/en/Welcome-to-Hydro-OLD/Press-room/Historic-news-archive/2004/April/Power-from-the-hydrogen-plant-on-Utsira/>
- 3 http://www.eusew.eu/index.php?option=com_see_eventview&view=see_eventdetail&eventid=1131
- 4 <http://www.flickr.com/photos/arcticcircleregion/5597228367/sizes/o/in/photostream/>
- 5 <http://www.flickr.com/photos/arcticcircleregion/5517221427/in/set-72157624513413843>
- 6 http://upload.wikimedia.org/wikipedia/commons/3/3b/Krafla_geothermal_power_station_wiki.jpg
- 7 <http://v7.lscache3.c.bigcache.googleapis.com/static.panoramio.com/photos/original/282105.jpg>
- 8 <http://v21.lscache7.c.bigcache.googleapis.com/static.panoramio.com/photos/original/42618467.jpg>
- 9 <http://upload.wikimedia.org/wikipedia/commons/d/dd/Mosjoen.jpg>
- 10 http://polarpower.org/examples/summit/Proven_WT6000.jpg
- 11 <http://polarfield.com/blog/wp-content/uploads/2010/01/2009-june-imnavait-creek-011.jpg>
- 12 <http://v17.lscache8.c.bigcache.googleapis.com/static.panoramio.com/photos/original/21726094.jpg>
- 13 http://lh6.ggpht.com/-fUeWNkQVRMo/TFQ0VupzMQI/AAAAAAAAGSc/sr3vOcZNVjg/_DSC0117.jpg
- 14 http://huffstrategy.com/MediaManager/Media/Photo/1264451158_Banff+Museum+1.jpg
- 15 "TP-10-2823-638" by ACEP UAF: http://www.flickr.com/photos/acep_uaf/5396570358/
- 16 <http://upload.wikimedia.org/wikipedia/commons/1/10/Norfolk-Island-Pines.jpg>
- 17 <http://v21.lscache3.c.bigcache.googleapis.com/static.panoramio.com/photos/original/19597288.jpg>
- 18 <http://sites.google.com/site/sarfannguit/Home/news-and-other-announcements/northatlanticp2psustainableenergyandmusic/Assaqaqa%20installation.JPG>
- 19 http://www.avalook.com/tasmania2010/img_1487.jpg
- 20 <http://www.flickr.com/photos/arcticcircleregion/5516912109/sizes/o/in/photostream/>
- 21 <http://timeatihanyi.blogspot.com/2010/09/bornholm-project.html>
- 22 <http://www.hydrogenlink.net/kobenhavn/brintbil-brinttank-koebenhavn.jpg>
- 23 <http://europeanmotornews.com/wp-content/uploads/2010/06/020610-b-maz.jpg>
- 24 http://www.global-hydrogen-bus-platform.com/data/Image/ECTOS/ECTOS%20FC%20Buses_A%20gomlum%20slodum3%20copy.jpg
- 25 http://makinghouseswork.cchrc.org/wp-content/uploads/2011/09/DSC_0107.jpg
- 26 http://www.flickr.com/photos/acep_uaf/5219164350/sizes/o/in/photostream/
- 27 <http://www.gov.pe.ca/wallpaper/index.php3?number=news%E3%80%88=E>
- 28 <http://www.skivesejklub.dk/wp-content/uploads/2011/03/Skive-Havn-Morgen.jpg>
- 29 <http://v21.lscache6.c.bigcache.googleapis.com/static.panoramio.com/photos/original/52806384.jpg>
- 30 <http://static.panoramio.com/photos/original/14192232.jpg>
- 31 <http://v1.lscache1.c.bigcache.googleapis.com/static.panoramio.com/photos/original/12097159.jpg>
- 32 <http://v14.lscache5.c.bigcache.googleapis.com/static.panoramio.com/photos/original/42494746.jpg>
- 33 http://ec.europa.eu/avservices/download/photo_download_fr.cfm?id=248743
- 34 http://www.nukissiorfiit.gl/fileadmin/user_upload/images/billeder/Pressen/Taphus_Kullorsuaq.jpg
- 35 http://www.melissarahde.com/wp-content/uploads/2011/03/IMG_3665.jpg
- 36 "The urban Arctic" by Destination Arctic Circle: <http://www.flickr.com/photos/arcticcircleregion/5517501982/>
- 37 <http://v3.lscache4.c.bigcache.googleapis.com/static.panoramio.com/photos/original/56532257.jpg>
- 38 http://www.ecocongregationscotland.org/wp-content/uploads/2011/07/IMG_1439.jpg
- 39 <http://www.xconomy.com/wordpress/wp-content/images/2009/06/wind-for-schools.jpg>
- 40 <http://besttraveltipsexpert.com/wp-content/uploads/2010/09/Alaska-August-2010-364.jpg>
- 41 Photo: FREE
- 42 Photo: Jouko Parviainen, MicrE
- 43 http://ine.uaf.edu/accap/Photos/WaterPump_Pict0035.JPG
- 44 <http://hazimiai.files.wordpress.com/2011/05/9304291.jpg>
- 45 <http://www.akenergyauthority.org/programwindssystem.html>
- 46 Photo: Margrethe Sørensen

...100 INSPIRING, EDUCATIONAL AND PRACTICAL EXAMPLES OF SUSTAINABLE AND ACCESSIBLE ENERGY SUPPLY SOLUTIONS CREATED BY, OR SUITABLE FOR, ISOLATED COMMUNITIES IN THE COOLER REGIONS OF THE WORLD...



norden
Nordic Energy Research

**UNEP
RISØ
CENTRE**
ENERGY, CLIMATE
AND SUSTAINABLE
DEVELOPMENT

Technical University of Denmark

