

Photovoltaics

Markvart, T.; Castaner, L.; Ahm, P.; Krebs, Frederik C

Published in:

Risø energy report 5. Renewable energy for power and transport

Publication date:

2006

Document Version

Publisher's PDF, also known as Version of record

[Link back to DTU Orbit](#)

Citation (APA):

Markvart, T., Castaner, L., Ahm, P., & Krebs, F. C. (2006). Photovoltaics. In H. Larsen, & L. Sønderberg Petersen (Eds.), *Risø energy report 5. Renewable energy for power and transport* (pp. 37-40). (Denmark. Forskningscenter Risoe. Risoe-R; No. 1557(EN)).

DTU Library

Technical Information Center of Denmark

General rights

Copyright and moral rights for the publications made accessible in the public portal are retained by the authors and/or other copyright owners and it is a condition of accessing publications that users recognise and abide by the legal requirements associated with these rights.

- Users may download and print one copy of any publication from the public portal for the purpose of private study or research.
- You may not further distribute the material or use it for any profit-making activity or commercial gain
- You may freely distribute the URL identifying the publication in the public portal

If you believe that this document breaches copyright please contact us providing details, and we will remove access to the work immediately and investigate your claim.

Risø Energy Report 5

Renewable energy for power and transport

Edited by Hans Larsen and Leif Sønderberg Petersen,



Risø-R-1557(EN)
ISBN 87-550-3515-9
ISBN 87-550-3517-5 (Internet)
ISSN 0106-2840

Risø Energy Report 5

Edited by Hans Larsen and Leif Sønderberg Petersen, Risø National Laboratory, Denmark

Reviewed by

Dr. Göran A. Persson, IVA, Sweden

Univ.-Prof. Dr. Christoph Weber, Universität Duisburg-Essen, Germany

Professor Ralph Sims, Centre for Energy Research, Massey University, New Zealand

Consultant

Science Journalist Charles Butcher

Design: Kühl+co A/S · 4229

Printing: Schultz Grafisk

Copyright: Risø National Laboratory

Risø-R-1557(EN)

ISBN 87-550-3515-9

ISBN 87-550-3517-5 (Internet)

ISSN 0106-2840

Risø Energy Report 5

Renewable energy for power and transport

Edited by Hans Larsen and Leif Sønnderberg Petersen

Reviewed by

Dr. Göran A. Persson, IVA, Sweden

Univ.-Prof. Dr. Christoph Weber,
Universität Duisburg-Essen, Germany

Professor Ralph Sims,
Centre for Energy Research,
Massey University, New Zealand

Consultant

Science Journalist Charles Butcher

Risø-R-1557(EN)

ISBN 87-550-3515-9

ISBN 87-550-3517-5 (Internet)

ISSN 0106-2840

1	PREFACE	3
2	SUMMARY, CONCLUSIONS AND RECOMMENDATIONS	5
3	GLOBAL DRIVERS FOR TRANSFORMATION OF ENERGY SYSTEMS	7
4	RENEWABLE ENERGY OUTLOOK FOR SELECTED REGIONS	13
5	INNOVATION IN ENERGY TECHNOLOGIES	21
6.1	WIND	29
6.2	BIOMASS	33
6.3.1	PHOTOVOLTAICS	37
6.3.2	SOLAR THERMAL	41
6.4	HYDRO, OCEAN AND GEOTHERMAL	43
7	RENEWABLE-BASED FUELS FOR TRANSPORT	47
8	NEW AND EMERGING TECHNOLOGIES FOR RENEWABLE ENERGY IN THE TRANSPORT SECTOR	51
9	TECHNICAL CHALLENGES TO ENERGY SYSTEMS' OPERATION AND MARKETS	55
	INDEX	61
	REFERENCES	63
	RISØ ENERGY REPORT SERIES	67

1 Preface

The global energy policy scene today is dominated by three concerns, namely security of supply, climate change and energy for development and poverty alleviation. This is the starting point for Risø Energy Report 5 that addresses status and trends in renewable energy, and gives an overview of global driving forces for transformation of the energy systems in the light of security of supply, climate change and economic growth. More specifically status and trends in renewable energy technologies, for broader applications in off grid power production (and heat) will be discussed. Furthermore the report will address wider introduction of renewable energy in the transport sector, for example renewable based fuels, hybrid vehicles, electric vehicles and fuel cell driven vehicles.

The report is volume 5 in a series of reports covering energy issues at global, regional and national levels.

Individual chapters of the report have been written by Risø staff members and leading Danish and international experts. The report is based on internationally recognised scientific material, and is fully referenced and refereed by an international panel of independent experts. Information on current developments is taken from the most up-to-date and authoritative sources available.

Our target groups are colleagues, collaborating partners, customers, funding organisations, the Danish government and international organisations including the European Union, the International Energy Agency and the United Nations.

Hans Larsen and Leif Sønderberg Petersen, Risø National Laboratory, Denmark

2 Summary, conclusions and recommendations

HANS LARSEN AND LEIF SØNDERBERG PETERSEN, RISØ NATIONAL LABORATORY, DENMARK

The global energy policy scene today is dominated by three concerns:

- *Security of supply*: the recent dramatic increase in oil and gas prices has given rise to concern about security of supply;
- *Climate change*: the energy sector is the main contributor to global greenhouse gas emissions;
- *Energy for development and poverty alleviation*: in 2002, almost 1.6 billion people in developing countries did not have access to electricity in their homes.

The International Energy Agency (IEA) predicts that by 2030, if governments stick to their current energy policies, global energy demand will be more than 50% higher than at present. This will present significant challenges, in terms of both energy security and climate change, to every region of the world.

The European Commission recently launched a new strategy for “sustainable, competitive and secure energy” that sets out some visions for Europe’s energy development priorities in the coming decades. One of its main objectives is the development of renewable energy, particularly biomass, wind power and other low-net-carbon energy sources, and especially for alternative transport fuels. Curbing energy demand and giving Europe a leading role in the global climate change effort are other key points of the strategy.

Among the East Asian nations, China stands out. In line with the country’s rapid economic growth, Chinese energy consumption is increasing dramatically. Renewable energy resources already have an important strategic role in maintaining the balance between energy supply and demand in China.

In North America, the USA has several times taken the lead in early development, especially for wind power and photovoltaics (PV). US manufacturing industry, however, has not been able to keep up with developments abroad—leaving the country with low global market shares despite significant domestic demand. To a certain extent this can be explained by the government’s “stop and go” approach to supporting renewable energy.

In Denmark, wind is already a major contributor to power supply, and the aim is to increase the share of wind power in the years to come. Transport is singled out as a special challenge, not least because energy use in this sector is increasing steadily, compared with stabilization or even decrease in other sectors.

In line with the need for change in the global energy supply, innovation in energy technologies is high on the political agenda in many countries. A recent report from

the OECD points out that innovation in energy technologies has widespread implications not only for member countries’ energy policies but also for their economies in general.

In Denmark it is generally acknowledged that the use of energy innovation policies was very successful when the Danish wind power industry evolved during the 1980s and 1990s. This reasoning is used to support similar policies for the development of biofuels, photovoltaics, fuel cells and hydrogen.

Conclusions

Securing a global energy development path, especially one that will be compatible with climate change concerns, is clearly a major challenge that requires coordinated action from all countries. The EU has shown leadership in tackling climate change, and with its new energy strategy is also taking a proactive approach to the other areas of concern.

New renewables are expanding rapidly, with annual growth rates of more than 25% for technologies such as PV and wind power—though they still account for less than 1% of the world’s energy supply today. The increasing efficiency and reliability of renewable technologies, alongside high oil and natural gas prices, are paving the way for further development.

Stimulating the deployment of renewable energy demonstration projects is important for the pioneer and introduction phases of new energy technologies. As well as providing real-world tests, it is obvious that demonstration projects are fundamental to gaining public acceptance of new technologies.

Innovation in energy technologies is high on the political agenda in many countries. During the innovation process it is important to keep in mind that the role of research is always significant, but that it changes over the product lifecycle. It is also important to provide optimum conditions for private investment capital in the energy technology market.

Wind energy has developed rapidly over the past 20 years. Some players have stayed in the market throughout this period, but many new very large companies have entered more recently. Wind energy has proven itself as a viable and increasingly economic means of generating electricity.

The growth of the PV industry has also been rapid: more than 30% annually over the past decade. New technologies are now emerging which speed up the production of solar cells and reduce the costs. This could transform PV into a winning energy source within a short time, from its current position of being suitable only for niche applications.

2

Denmark has been active in developing wave power technology, and could also contribute to the development of geothermal heating technology. For all renewable energy technologies, there should be ample opportunities for Danish industry and consulting firms to contribute to Clean Development Mechanism (CDM) projects around the world.

Biofuels can help reduce greenhouse gas emissions from the transport sector, increase the security of energy supply, and encourage innovation and development within the agricultural sector and associated industries. There seems to be global political interest in making biomass a significant energy resource within the next 10–20 years. The introduction and use of renewable energy sources in transport need more attention. In the short term it will be more expensive to fuel the transport sector with renewables than with traditional fossil fuels. In the longer view the picture may be just the reverse, as fossil fuel prices are expected to rise further. R&D investment in new biofuel technologies could generate large paybacks in the long run, and hybrid and electric vehicles will become common.

Major technical challenges to the operation of energy systems and markets are mainly linked with how to maintain a stable and reliable power system in which a large proportion of renewable energy replaces conventional power plants.

Recommendations

To address the three main concerns listed in the Preface—security of supply, climate change, and energy for development and poverty alleviation—renewables must contribute significantly to global energy supply in the long run. This requires action to be taken now, including R&D, demonstration projects and deployment measures. Denmark should take the opportunity to consolidate its good position with a world leading role in this development.

Denmark was one of the early movers in renewable energy technologies, and still has a leading role in their development. But to maintain this role, the country needs to intensify its R&D in new renewable technologies:

- Denmark should preserve its world leadership in wind power;
- a similar position can be gained in the developing field of wave power technology;
- polymer solar cells could easily find substantial niche markets around the world in the short term and enter the electrical power production market in the long term;

- before fuels based on renewable sources can play a significant role, existing second-generation technologies need to be scaled up;
- hydrogen produced from renewables should be pursued as a long-term option.

A prerequisite to expanding the use of renewables in the energy system is the development of more flexible ways of operating power systems that are characterised by high proportions of distributed, intermittent energy sources. This is true of the overall Danish energy grid, including electricity, natural gas, heat and, in the long run, hydrogen.

- The methods used to increase the share of renewable energy should not compromise the security and reliability of the system.
- These methods should also aim to reduce energy production costs, and the overall pollution created by the energy system.

To promote renewable energy it is important to better understand how research and policymaking can create technological innovation.

- To move down the learning curve requires markets to learn from. Governments can promote these markets, initially through demonstration programmes.
- Sometimes market stimulation programmes are more efficient policy instruments than research programmes.
- Energy R&D programmes and other government policy instruments should put more emphasis on application and business development.

To stimulate progress towards a substantial percentage of renewables in the energy system it is necessary to establish partnerships and consortia that bring together society, research and industry. Such partnerships can form the basis for developing and introducing new energy technologies, which will always be initially more expensive than established technologies.

Partnerships are also natural platforms for renewable energy demonstration projects, which are important during the pioneer and introduction phases of new energy technologies. It is obvious that demonstration projects are fundamental in gaining public acceptance of new energy technologies, and will lead to more rapid deployment than might otherwise be the case.

3 Global drivers for transformation of energy systems

JOHN M. CHRISTENSEN, RISØ NATIONAL LABORATORY, DENMARK; MARK RADKA, UNEP, FRANCE

THE SECTION ON GLOBAL ISSUES HAS BENEFITTED FROM CONSULTATIONS WITH DR. FATIH BIROL, IEA, FRANCE

Major global driving forces for energy development

Energy policies and the development of the energy sector have in recent years returned to the forefront of national and international political priorities. After the oil price shocks of the 1970s and early 1980s, when interest in energy increased rapidly, falling oil prices and increasing reliance on natural gas and coal, combined with stable market conditions in the 1980s and much of the 1990s, have led to significantly reduced political attention.

Sector development in the 1980s and 1990s focused to a large extent on reforms of institutions and markets and on increased involvement of the private sector, especially in the power sector. Concerns about security of supply decreased as a consequence of stable and expanding markets, and the focus shifted towards economic efficiency and environmental concerns.

With climate change gradually emerging as a major global environmental concern, illustrated by the establishment of the UN Framework Convention on Climate Change (UNFCCC) and later the negotiation of the Kyoto Protocol (KP)—the role of the energy sector as the main emitter of greenhouse gases has brought a new political rationale for the development of more climate-friendly energy supply and increased efficiency.

The last couple of years have seen the increasing importance in the global energy market of rapidly-expanding national economies, notably China and India. Together with other geopolitical developments such as political changes in some of the major oil producing regions, this has produced strong political concerns about future security of supply. This has been compounded by simultaneous dramatic increases in oil and gas prices.

The role of energy supply as a key facilitator for economic development in the poorer regions of the world has been increasingly recognised over the last decade. Developing countries are devoting more attention to securing their future energy supplies for a variety of uses: industry, and urban uses and for the poorer communities in both rural and peri-urban areas communities.

Global energy policy is therefore dominated by three overriding concerns making them drivers for future energy development activities:

- security of supply;
- climate change;
- energy for development and poverty alleviation.

The three areas are in several ways interlinked, and every energy policy or programme should ideally promote them all—or at least not have negative effects in any area. In practice, however, many national policy landscapes have been dominated by just one of these factors. This section of the report analyses how the three drivers are addressed at the levels of global, regional (EU) and Danish energy policy.

The subsequent technical sections of this report do not discuss these drivers directly, but their focus is on renewable energy technologies that have the potential to make positive contributions to addressing all of the three concerns. This is not solely the domain of renewable technologies, of course; energy efficiency, nuclear and clean fossil technologies all have a role to play, not withstanding that this role may vary depending on national circumstances.

The driving forces have been summarised in [1] as:

- (a) security of energy supply: Oil and gas importers are becoming ever more dependent on imports. Rising demand for oil in particular heightens concerns over whether additions to reserves are keeping pace with rising production. The recent dramatic increase of oil and gas prices compounds worries about security of supply. Not least, it has caused financial problems in many oil-importing developing countries and countries with economies in transition, where rising bills for imported energy affect the poor in particular. In terms of security of supply, countries and individual consumers face the same challenge: ensuring continued access to affordable quantities of energy;
- (b) energy for development: In 2002, almost 1.6 billion people in developing countries, representing about one-quarter of the world's population, did not have access to electricity in their homes. An additional 800 million rely on traditional biomass for cooking and heating purposes. It is unlikely that the internationally agreed goals of the United Nations Millennium Declaration for poverty reduction will be achieved unless access to modern forms of energy is dramatically increased in the developing world. Doing so, however, is a great challenge;
- (c) climate change: The energy sector is the main contributor to global greenhouse emissions. In order to meet the aims of the United Nations Framework Convention on Climate Change it is necessary to reduce dramatically the carbon intensity of energy production and use. For countries with obligations

3

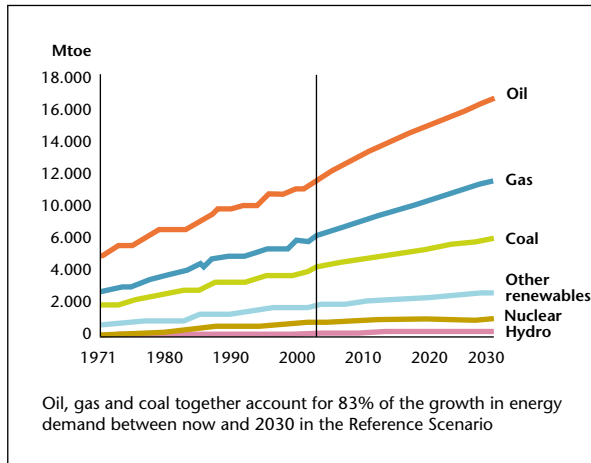

Figure 1. World primary energy demand till 2030: the “business as usual” scenario.

under the Kyoto Protocol this process has already been initiated—although at a different pace in different countries. This notwithstanding, even aggressive emission reduction policies do not obviate the need for increased impetus for adaptation measures, mainly through technology support and international cooperation.

Global energy development and priorities

The following section will briefly assess how these three concerns manifest themselves at the global level.

The International Energy Agency (IEA) in its World Energy Outlook for 2005 [2] predicts that if governments stick to current policies in the energy sector over the coming decades, global energy demand will be more than 50% higher by 2030 (Figure 1). This will evidently clearly present significant challenges in terms of both energy security and climate change.

The increase in demand will be combined with a marked shift in the relative importance of the different country groupings: the OECD countries are predicted to decrease their share of global energy demand by around 10%, while developing countries will increase their share by almost the same amount, overtaking the OECD countries in terms of share of global demand. This primarily reflects the rapid growth expected in countries like Brazil, China and India, but it should be stressed that OECD per-capita energy consumption will remain significantly higher than that of the developing countries.

The IEA expects that the increase in consumption will increasingly be met by fossil resources located outside the OECD countries. Most will come from the Middle East, North Africa and Russia, plus a few other countries.

Meeting the projected demand growth mainly from fossil resources will inevitably lead to a significant increase in greenhouse gas emissions: up to 50% by 2030. This would accelerate existing climate change, and create an energy infrastructure that would be unable to deal with the climate issue even in the long term.

The IEA concludes that the “business as usual” scenario is not sustainable in terms of neither energy security nor climate change. The IEA’s 2005 World Energy Outlook [2] therefore includes an alternative policy scenario in which current new considerations are fully implemented and energy-efficient technologies are more rapidly deployed in non-OECD countries. Under this scenario, demand growth would be reduced by at least 10%, with corresponding reductions in greenhouse gas emissions and reduced pressure on oil and gas supplies.

The alternative scenario also shows that the cost of the required energy efficiency measures and renewable energy technology would be more than offset by savings in fossil fuel consumption. Since this alternative scenario is not anticipating new specific policies aimed at reducing greenhouse gas emissions, or other more ambitious efforts in security or development, it can be argued that further cuts in both fuel demand and greenhouse gas emissions could be achieved if the political will were present.

Geopolitical drivers notwithstanding, development in the coming decades will face a major challenge in finding enough investment capital to meet the anticipated growth in demand—whether under “business as usual” or an alternative path. Many developing countries, especially the rapidly-growing economies of China, India and parts of South-east Asia, will need to invest heavily in new energy supply, at the same time as many European countries and North America will be replacing their aging energy infrastructure. This will in itself represent a significant challenge to the national and international investment institutions. A much smaller but no less challenging task will be to ensure that capital is available for energy investment in the poorer parts of the world, especially sub-Saharan Africa.

Key investment figures from the IEA World Energy Investment Outlook 2003 [3] are:

- US\$16 trillion needed over the next 30 years for energy sector investment;
- US\$10 trillion (60% of the total) needed for electricity investment;
- approximately US\$5 trillion needed for developing countries and transition economies (CEITs), where risks are perceived as high and private investment is currently declining.

In this brief section it is not possible to present details of alternative development paths at the global level, but it is clear that every country and region will need to play its part in changing the current energy development path. Some of the general issues affecting energy are outlined by the World Business Council on Sustainable Development (WBCSD) in its analysis Pathways to 2050 [4]. This study identifies five “mega-trends” which highlight the main areas where action is required to achieve long-term sustainable development:

3

1. Electricity generation: All predictions forecast that electricity will increasingly act as the final energy carrier;
2. Industry and manufacturing: Together with electricity generation, the manufacturing sector presents the main challenge in carbon emission reductions for the short and medium term;
3. Mobility: The need for transport and mobility is increasing all around the world. To address this, there is an urgent need to develop new transport and engine technologies and to find ways of stimulating changes in needs and preferences related to mobility;
4. Buildings: Existing technologies for energy-efficient buildings need to be used on a much larger scale. Appliances must be made more energy-efficient. A major challenge will be to cope with rapid urbanization in Asia and Africa;
5. Consumer choices: Changes in consumer behaviour need to be part of future energy strategies, although this does not have to imply restrictions on energy services. This area is politically sensitive and has received limited attention to date.

EU strategic approach

The following sections will briefly discuss how the global energy challenges manifest themselves at regional level, in the European Union, and especially in Denmark, as an example of actions relevant to individual countries. The European Commission recently launched a new “strategy for sustainable, competitive and secure energy” [5] that sets out strategic visions for European energy development in the coming decades.

The EU strategy reflects the global concerns referred to above: energy security, climate change and the need for major infrastructure investment. In addition the full implementation of an open and competitive internal European energy market is seen as an important tool in achieving these long-term objectives. A practical restriction, however, is the reluctance of many countries to treat energy security as a regional, and not purely national, issue.

The strategy also recognises that the EU should help developing countries make the best use of energy for development and access.

The strategy identifies three main objectives for energy policy in European countries:

1. Sustainability: Developing renewable energy and other low-carbon energy sources, particularly alternative transport fuels; curbing demand; and playing a leading role in the global climate change effort;
2. Competitiveness: Creating an integrated electricity and gas market, supplemented by policies to stimulate investment in new clean supply technologies and energy efficiency, and being a technology leader in general;
3. Security of supply: Reducing Europe’s increasing import dependency through the actions referred to

above, plus efforts to secure long-term stable energy supplies and increase the robustness of energy systems to cope with emergencies.

Figure 2 and Figure 3 clearly show the challenges facing the EU countries.

Figure 2 shows clearly that without dedicated policy action over the coming decades, EU dependence on energy imports would increase significantly, especially for natural gas and solid fuels, while the import ratio for oil is already very high and increasing. This is in view of the increasing prices and recent events with external supply disturbances not considered sustainable.

Figure 3 shows that at the current rate of progress, Europe is a long way from meeting its agreed targets for greenhouse gas emission reductions, and certainly not putting in place a trend which would comply with the necessary strengthened commitments that will be needed after the first Kyoto commitment period ends in 2012.

The new strategy is therefore a direct response to the global challenges as seen from an EU perspective. Its policy focus will be on:

- improving energy efficiency and increasing the use of renewable energy sources, using a broad span of policy tools including national targets, standards, and market incentives such as emissions trading. The existing short-term target for the share of renewable energy in overall energy use (10% by 2010) and in electricity production (22% by 2010) will need to be revised in the longer term along with potential mandatory measure in the efficiency area;
- creating a more competitive market for electricity and gas in the EU member states is seen as an important way to increase the overall efficiency of the system, and is expected to reduce consumer prices. This is currently constrained by inadequate interconnections and by member states’ desire to maintain supply security at the national level;

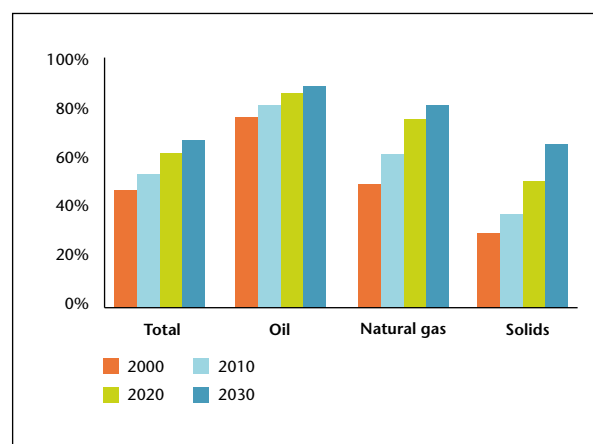

Figure 2. Projections of the fractions of energy from different sources that the EU 25 will need to import if no significant policy changes are made over the next 25 years. [5]

3

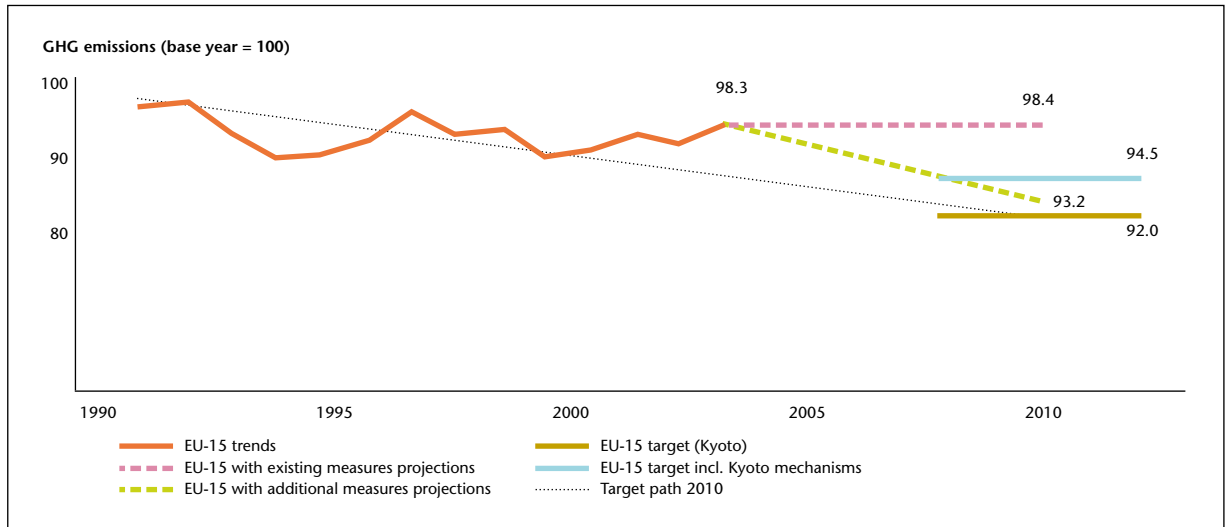

Figure 3. Greenhouse gas emissions projections and Kyoto targets.

- strengthening supply security through political dialogue and partnerships with major oil and gas producing countries, and by re-examining the role of nuclear power. The latter is an area with significant divergence among the member states, so it has no common EU policy.

The challenge of energy for development is addressed separately through new EU instruments. The first of these will be a new Energy Facility with three priorities:

- delivery of energy services: The largest financial contribution from the Facility will be spent on improving rural people's access to modern energy services, particularly in Africa. Priority will be given to people in areas that do not yet have electricity or gas. Proposals should ensure that investment is economically, socially and environmentally sustainable;
- creating an enabling environment: Where appropriate governance conditions are not in place for delivery-oriented intervention in the field, up to 20% of the Facility will support the development of an enabling environment for the energy sector based on good governance principles. The Facility will promote the implementation of sound national energy policies and strategies, improve the institutional, legal and regulatory framework, strengthen the capacity of key stakeholders, and improve monitoring and evaluation capacity;
- supporting future large-scale investment programmes: Up to 20% of the Facility resources will be devoted to the preparatory activities needed for future large-scale investment in cross-border interconnections, grid extensions and rural distribution, preparing them for financing by international finance institutions.

In parallel, the European Commission is working with partner countries to integrate energy development as a

priority in its new development cooperation agreement, which will provide much larger and better-sustained support for energy and development needs.

National strategies: Denmark

In 2005 the Danish Government presented a new "Energy strategy 2025" [6] outlining the country's major energy challenges over the next two decades, and possible ways of meeting them.

Since Denmark is part of the EU and has been one of the active countries in the articulation of the EU strategy discussed above, it is not surprising that the main challenges are similar to those of the EU as a whole, though naturally with a national perspective:

- security of supply;
- climate change;
- economic growth and competitiveness.

The strategies used to address these challenges are similar to those of the EU as a whole, again with some specific Danish angles.

Renewable energy, especially wind, is already a major contributor to the Danish power supply with approximately 24% in 2003. If district heating is also taken into consideration, the percentage of renewable energy is even higher, due to the use of agricultural residues. Denmark's ambition is that the share of renewable energy should grow to 35-40% over the next 20 years, especially if new initiatives on energy efficiency are fully implemented.

Transport is singled out as a special challenge. Energy use in the transport sector has increased steadily, compared with stabilisation or even decrease in other sectors. Since Danish taxes on cars and fuel are already among the highest in the world, additional taxation on its own is not believed to be a viable instrument. Instead, changing the tax system to better reflect the energy consump-

3

tion and environmental loads of products and industries could be a way to stimulate the development of more efficient cars and alternative fuels.

In the climate area the above efforts will contribute but in addition a number of specific instruments are being implemented and will be expanded. These include the flexibility mechanisms known as Joint Implementation (JI), Clean Development Mechanism (CDM) and Emissions Trading (ET), including expansion of the quota system to include more sectors and entities.

Increased integration and market orientation of the Danish power and gas market is also seen as a way to increase the technical and economic efficiency of the energy system.

Conclusions

Political, economic and environmental drivers have pushed energy to the forefront of international politics in recent years. There is increasing concern about security of energy supply, climate change, and the role of energy in alleviating poverty. These three concerns are interlinked in many ways, and it is desirable that individual policies and programmes should benefit them all—or at least avoid harming any of them.

As the previous sections have shown, however, decisions on energy policy are subject to many regional and na-

tional priorities. Finding a global energy development path that satisfies all three concerns, especially climate change, is a major challenge that requires coordinated action from all countries. The EU has shown leadership in mitigating climate change, and now its new energy strategy is addressing the other two areas of concern.

Recommendations for Danish society

During the 1990s Denmark was a leader within the EU on climate issues and renewable energy development, but new political priorities in recent years have changed this position somewhat.

With a significant share of renewables in its power supply and domestic oil and gas resources, Denmark is in a good position to deal with energy security issues in the short and medium term. Long-term resource availability remains a concern, especially in the transport sector, which has been growing rapidly with no clear policies in place to change the situation to reduce its dependence on oil.

This seems an opportune moment to stimulate the development of bioenergy resources, especially biofuels, as a way to deal with both energy security and climate issues at the same time. Some of the following chapters will expand on this.

4 Renewable energy outlook for selected regions

POUL ERIK MORTHORST, RISØ NATIONAL LABORATORY, DENMARK; DR. GAO HU, ENERGY RESEARCH INSTITUTE (ERI) OF NATIONAL DEVELOPMENT AND REFORM COMMISSION (NDRC), CHINA; DR. MARIO RAGWITZ, FRAUNHOFER INSTITUTE FOR SYSTEMS AND INNOVATION RESEARCH, GERMANY

Introduction

Renewable resources, once almost insignificant, are now gradually expanding their role in global energy supply. In 2004, renewable energy from all sources accounted for approximately 13% of global primary energy supply. The biggest contributors were large hydropower (approximately 2%) and biomass (a little more than 10%). Around 1% of global primary energy came from new renewable sources such as photovoltaics, solar thermal, wind power, small-scale hydropower, geothermal, biogas and new biomass (Table 1).

But while the two large contributors are increasing only slowly in absolute terms, or even staying constant, contributions from new renewable sources are expanding rapidly. Today, the fastest-growing energy technology is photovoltaics, which over the last five years has increased by 35% annually—albeit starting from a very low level. Other new renewables are following the same line: over the same period wind power has increased by 28%, biodiesel by 25%, and solar hot water heating by 17%, all calculated as average annual growth rates [1].

Technology	EJ	Share
Hydro	10.0	2.1%
Geothermal power	1.9	0.4%
Wind power	0.3	0.1%
Solar power	0.005	0.001%
Geothermal heat	0.2	0.0%
Solar heat	0.2	0.0%
Biomass	48.3	10.4%
Total renewable	60.9	13.1%
Total global primary energy consumption	465.4	100.0%

Table 1. The contribution of renewables in global primary energy supply. [2]

The reasons for the success of new renewable sources are many, amongst these not least an important policy support. A recent European Commission communication on support for electricity from renewable energy sources [3] says:

“Increasing the share of renewables in EU electricity has well recognised benefits, in particular:

- improved security of energy supply;
- enhanced competitive edge for the EU in the renewable energy technology industries;
- mitigation of greenhouse gas emissions by the EU power sector;
- mitigation of regional and local pollutant emissions;

- improved economic and social prospects especially for rural and isolated areas.”

Similar benefits are to be expected all over the world, giving rise to global, regional and national initiatives promoting new renewables.

In South Africa, for example, the Johannesburg Renewable Energy Coalition (JREC) was established in 2002. The JREC “focuses on international, regional, and national political initiatives that help foster an enabling environment for the promotion of renewable energy” [4]. By now 87 countries have joined the JREC and still others have expressed an interest in participating.

In 2005 the Renewable Energy Policy Network for the 21st Century (REN21) was launched in Copenhagen to provide a forum for the development of renewable energy sources. The objective of REN21 is “to allow the rapid expansion of renewable energy in developing and industrial countries by bolstering policy development and decision-making on sub-national, national and international levels” [5].

Within the EU, the non-binding targets for the development of renewable sources in the EU-25 countries give general guidance to member states’ policies on supporting renewables. These targets are about to be extended to 2020.

The rest of this chapter describes in more detail the status of renewables, including policy, in three important regions: the EU, China and the USA.

Policy status and development of renewable energy in Europe

In the last ten years Europe has seen a rapid development of renewables, and is now in the lead in wind power, photovoltaics, biomass and biogas. Although only a few countries have actually been driving the development of renewables, policies in Europe have been reasonably stable and continuous, and this has helped to sustain fairly rapid development.

Back in 2001 the European Commission established non-binding targets for renewable energy sources in the EU-15, and in 2004–05 these targets were extended to the new member states of the EU-25. Although these targets are not binding, they play a large part in driving renewable policies in the individual member states. The overall targets are for renewables to cover 12% of the EU’s gross inland energy consumption by 2010 [6], and 21% of electricity consumption by 2010 [7].

In 2003 renewables provided approximately 13% of the electricity consumed in the EU-25, while approximately

4

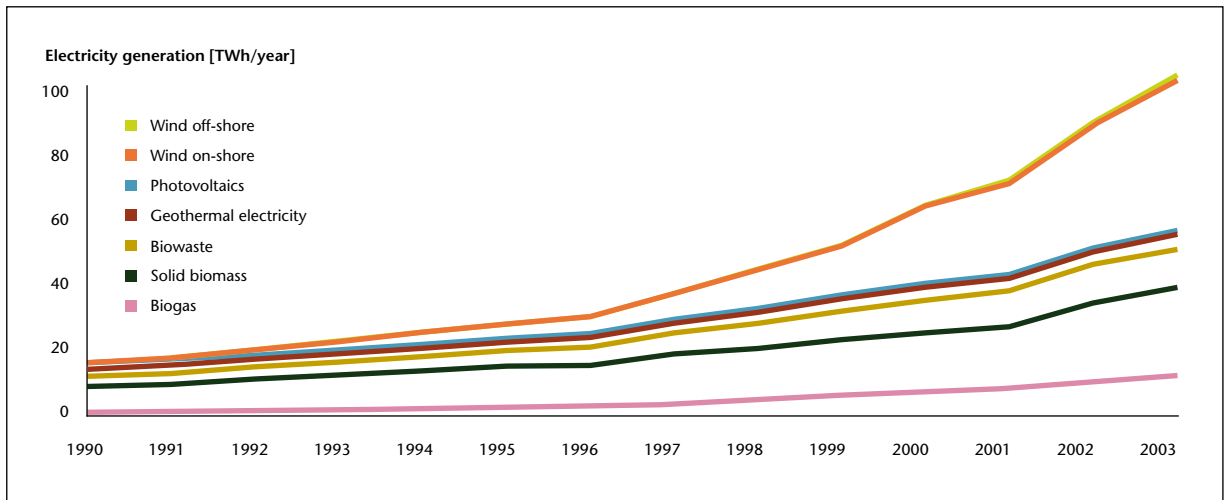

Figure 4. The development of electricity generation from new renewables in the EU-25 from 1990 to 2003. [8]

6% of total primary energy was supplied by renewables. Figure 4 shows the historical development of electricity generation from new renewables.

A number of different instruments are presently used in the member states to support the development of renewable energy. Quota obligations with tradable green certificates, feed-in tariffs, tender procedures and tax measures dominate national support systems at the moment.

At present, most support schemes are national in scope, and cross-border trade of green power or green certificates is limited. The only exception was a system under which the Netherlands imported green certificates; this had some adverse effects, not least because most of the certificates came from existing plants, and the system was abandoned after a few years. The general picture of EU support mechanisms is rather fragmented (Figure 5). Figure 5 shows that the most common support system is the feed-in tariff, followed by quota obligation schemes accompanied by green certificates. According to the recent EU communication on support for renewable sources [3] the most effective scheme in general is the feed-in tariff because investors perceive this to have the lowest risk.

Feed-in tariffs have been highly effective in the deployment of wind power in Germany, Spain and Denmark, and also for photovoltaics in Germany. Nevertheless, the effectiveness of the support system depends heavily on the specific design of the scheme. Other schemes might be just as effective in particular cases, for instance tendering in the case of offshore wind farms.

Not only are the support schemes quite different between member states, but the level of support also varies significantly between countries. To a certain extent this may match the different opportunities for renewable sources in the countries, but it is not always the case, as Figure 6 shows for biomass power generation.

Figure 6 makes it clear that levels of support do not necessarily match long-term generating costs. In a number of countries the support levels are either below or significantly above generation costs, signalling that there still is room for improvement of support policies for renewables in the EU.

Although the EU has considerably increased energy production from renewables, significant potential still exists across the member states (Figure 7).

Figure 5. Renewable electricity support systems in Europe. The “old” EU-15 countries are on the left and the “new” EU-10 countries plus Bulgaria and Romania on the right. [8]

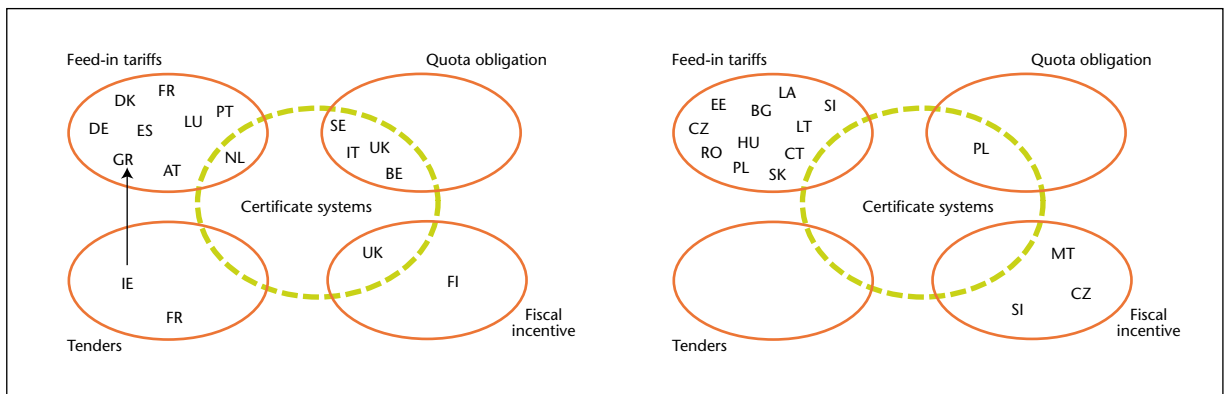

4

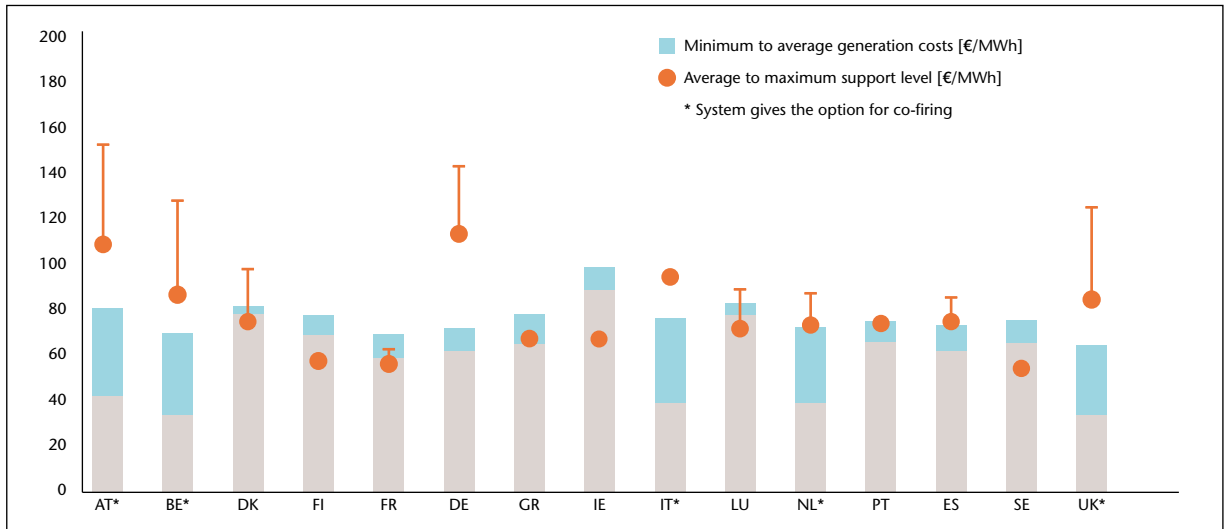

Figure 6. Support levels compared to long-term marginal generating costs for biomass electricity based on forestry residues in the "old" EU-15. [8]

Except for traditional large-scale hydro, significant potentials¹ exist for all renewable sources. Biomass and wind power (both onshore and offshore), especially, have great scope to contribute to the EU's energy supply. But although the potential is there, will the current rapid expansion of renewables in the EU continue, and what direction will future EU policy take?

According to the EU itself, there is no need at present to change EU policy in order to meet the 2010 targets. What is needed is closer links between national policies. In the medium term this should create clusters of countries or regions with similar support regimes, which in turn will provide benefits such as cross-border trade in renewable energy production and green certificates.

The EU has huge potential for developing renewable energy sources, and has established a strong foundation for this in recent years. Nevertheless, renewables within the

EU are dominated by just a few countries; if the EU is to reach its indicative targets for renewables, more countries will have to contribute significantly.

A long-term vision for renewables development in the EU is needed, including long-term milestones for each of the member states and an outline of how the support systems for renewables should develop. The integration of renewables in Europe's energy systems should be studied more thoroughly, especially the possibilities of establishing stronger interconnectors between member states, to facilitate the cross-border trade of green power.

Renewable technologies in China

Renewable energy resources play a key strategic role in maintaining the balance between energy supply and demand in China. At present, traditional and non-commercial renewable energy, such as fuel wood, provides

¹ Potentials are calculated using the Green-X model, which takes into account both technical and economic considerations

Figure 7. Actual (2004) and additional potential by 2020 for renewable electricity in the "old" EU-15.

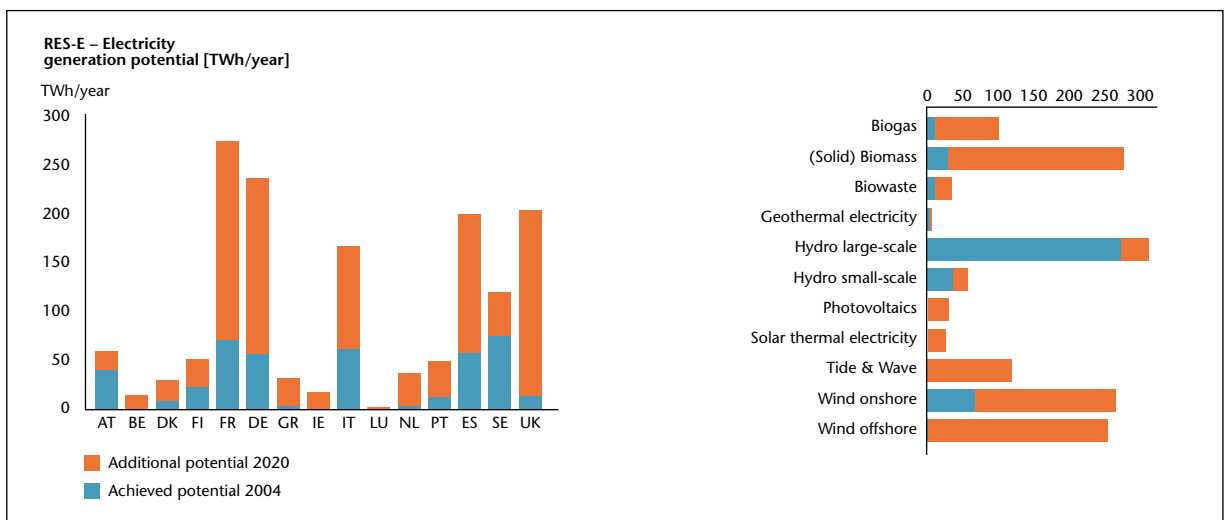

4

China with the equivalent of more than 300 million tons of coal (TCE) annually. Roughly 328 TWh of electricity comes from hydropower stations, accounting for 17% of China's total electricity output. Excluding traditional uses of biomass, China's total use of renewable energy in 2004 was more than 130 million TCE, accounting for 7% of the nation's total energy consumption. [9]

China possesses plenty of hydropower, biomass, wind and solar energy resources, which could provide a sound basis for large-scale development of renewables. By 2004, the installed hydropower capacity was 108 GW, which is only 25% of the economically exploitable potential.

Despite its huge inland area and long coastline, China is still in the initial stages of exploring its wind resources. By the end of 2004, only 43 grid-connected wind farms and a total capacity of 760 MW had been installed in China. Moreover, China has only fully mastered the manufacture of wind turbines with capacities up to 750 kW, compared to the multi-MW machines available in Europe and the USA.

Two-thirds of China's land area has more than 2,200 hours of sunshine a year. Solar water heaters (SWHs) are extensively used by both urban and rural households. The country also has 30 MW of solar photovoltaic systems, of which half are used to supply domestic electricity in remote rural areas and another half are used in commercial and industrial areas as power supply. Grid-connected photovoltaic systems on roofs and major buildings are mostly pilot projects in a few big cities.

Most of China's biomass energy is used for heating in conventional furnaces and boilers. New technologies, such as gasification, liquid fuels, and biomass for power generation, are developing only gradually and are still small in scale.

Policies and plans for renewable energy

The Chinese government has for many years seen renewable energy as important. In the 1980s China formulated many policies and programmes to support the development of renewable energy in rural and poor regions. In the 1990s the government announced several policies to encourage renewables generally, but these proved unsustainable; they were either applied only in limited areas, or were too general and lacked concrete systems for implementation.

In 2003 the government began work on a new Renewable Energy Law, which came into force on 1 January 2006. As well as highlighting the strategic significance of renewable energy, the new law attempts to remove barriers to development, and through institutional innovations to create a market atmosphere conducive to renewables. Actions include:

- identifying national targets;
- priority and preferential tariffs for grid-connected renewables schemes;

- co-sharing system to cover extra costs of renewable energy productions;
- a special fund for renewable energy development;
- favourable loans and tax policies for renewables.

The Renewable Energy Law is a high-level policy that needs to be backed up by detailed and practical measures. So far, several of the most urgent of these have been worked out. One example is the feed-in tariff for electricity produced from biomass. The tariff has two components: a benchmark in line with generating costs at Chinese coal-fired power stations fitted with flue gas desulphurisation (FGD), in the range €0.023–0.044 /kWh, and a subsidy of €0.025 /kWh.

Tariffs for grid-connected wind power are set through a bidding process. For other solar, wave, tidal and geothermal power projects, which so far remain small in scale, prices are in principle set by the government on the basis of costs plus reasonable profits.

The extra cost of grid-connected electricity from renewable sources, plus the costs of extending the grid, and operating and maintenance costs for stand-alone renewable-energy power stations in remote areas, will be shared by all power consumers through a small surcharge on the price of electricity.

To give the market clear signals on what kind of technology will be encouraged, the government has issued a Guidance Catalogue on renewable energy industry. Other detailed regulations for practical implementation of the law, such as quota obligation for major generators, and incentive instruments, are in preparation and are scheduled to be issued soon. The 11th Five Year Plan (2006–2010), to be issued shortly, will also help to guide the development of renewable energy in the near term.

In line with the new law, central and provincial government agencies are required to make plans to develop renewable energy. The central government has created a draft plan for medium- and long-term renewable energy development (up to 2020), and is expected to issue it before the end of 2006. The plan proposes to increase the fraction of renewable energy (including large hydro) in the country's energy mix from its present level of 7% to 10% by 2010, and to 16% by 2020.

Hydro, wind, solar and biomass power generation will be the dominant technologies. By 2020, the plan is to increase hydro capacity to 300 GW, and wind and biomass power capacity to an ambitious 30 GW each. Grid-connected photovoltaic capacity should reach more than 1 GW by 2010, mainly in large cities.

The future of renewables in China

As the world's second-largest producer and consumer of energy, China is experiencing great energy-related pressures because of its huge population and rapid economic development.

With limited oil and natural gas reserves, China is one of the few countries to depend mainly on coal. Nearly 90%

4

of the energy for power generation comes from coal, which also accounted for 67% of the national energy mix in 2004. Such heavy use of coal has severely damaged the environment.

Renewable energy resources are important for China's sustainable development, and have the advantage that they are located mainly in rural regions. Nearly 20 million people in remote and poor regions do not yet have access to electricity, and it is economically viable as well as desirable to use renewable energy to help close this gap.

Electrification in rural areas promotes local development, reduces poverty and increases the quality of life. According to the medium- and long-term renewable energy plan, this will be achieved through a combination of off-grid generation from renewable resources, and extension of the existing grid. As well as facilitating improvements in the energy infrastructure and environment protection that are critical for China's development, renewable energy can therefore also play an important role in rural development and in creating a harmonious and well-off society. These strategic points have been adopted by the government.

Challenges remain for the future development of renewable energy in China. For instance, domestic manufacturing capability is quite weak, particularly in the wind industry. The current Wind Concession Programme requires at least 70% of components to come from Chinese companies, which benefits industry in the long term and even may influence development of wind power in the short-term.

Chinese production capacity for photovoltaic cells and modules is booming and has reached nearly 100 MW per year. However, both the silicon needed as a raw material and the market for photovoltaic devices depend heavily on foreign countries. R&D activities too, in areas such as grid connection for wind power and roof-mounted photovoltaic modules, need to be strengthened to support large-scale development. Most important of all, the set of policy instruments needed to support the law remains incomplete, and this will inevitably slow down the development of renewable energy.

Despite these issues, renewable energy in China has a prosperous future. Encouraging factors are the government's proven commitment to renewable energy, and the critical problems affecting fossil-fuel energy systems in China.

Renewable technologies in the USA

The USA has been developing and deploying renewable energy technologies since the first oil crisis back in 1973. Policies and support for renewables, however, have been subject to discontinuities that have hindered progress. US policy has been characterised by three main issues [10]:

- the basic policy rationale is to ease the development of renewables by avoiding market failures and removing commercial barriers. Externalities, including the level

of environmental damage, are therefore one of the main determinants of the level of support;

- federal renewable energy policies are complemented by state policies which often differ considerably from one another;
- voluntary green power programmes, which allow consumers to support renewable energy by paying a surcharge on their electricity bills, are becoming increasingly popular.

Research and development in renewable technologies are supported at federal level. The federal government also sets the Production Tax Credit (PTC), a subsidy that has significantly influenced the development of renewable technologies, especially wind power. Although the PTC is in principle good for wind power, the "stop-and-go" way in which it has been implemented have created significant uncertainty in the industry and delayed investment decisions (Figure 8). The PTC is also closely intertwined with US tax policy, making it difficult to calculate the actual level of support for renewable technologies [11].

With the exception of California, not much R&D on renewable technologies is supported at state level. However, more and more policy initiatives to support renewables are being taken at state level. Broadly, four kinds of market-push programmes are being pursued [10]: quotas for renewables, subsidies, utility and information programmes (Table 2).

Policy measure	Number of states
Renewable portfolio standard	18 plus Washington DC
Net metering for utilities	48
Disclosure programmes for customers	24
Public benefit funds for financing	16

Table 2. Renewable energy policy measures in place in 2000 at state level. [12]

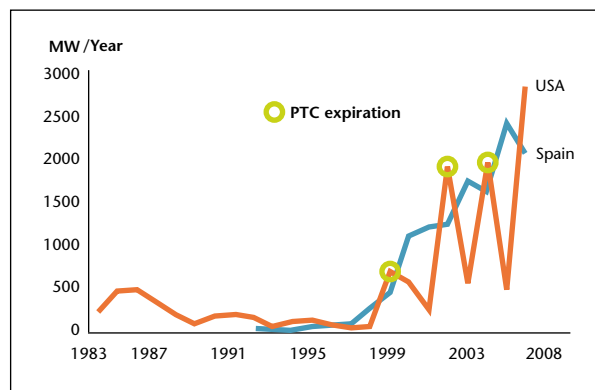

Figure 8: The effect of the Production Tax Credit (PTC) on the development of wind power in the USA, compared to the much more stable support regime in Spain.

4

The Renewable Portfolio Standard (RPS) is similar to the tradable green certificates used in Europe: it basically introduces a quota of renewables, typically expressed as a minimum share of power production.

Net metering specifies the conditions under which utility companies must buy electricity from their customers. This includes installations where the meter is allowed to run backwards for part of the time, which is especially relevant for photovoltaics on buildings.

Disclosure Programmes ensure that consumers have information about the technologies and fuels used to generate their electricity, while Public Benefit Funds make finance available for renewables and other energy programmes [10].

Four types of renewables are currently important in the USA: wind power, photovoltaics, biofuels for transport, and biomass for power and heat. As mentioned above, the development of wind power has been seriously affected by delays in extending the PTC. In the 1980s and early 1990s the USA was in the lead of developing wind power. Discontinuities in support for wind power caused problems for US equipment manufacturers, however, and by the end of the 1990s only one wind turbine manufacturer was left in the USA: the wind energy division of Enron, which later became GE Wind.

Recently the development of US wind power has soared, with more than 2,400 MW installed in 2005, and the country is now the world's largest market for wind power. The main reasons for this success are that wind power is getting closer to being economically competitive with conventional power generation, and that more timely extensions of the PTC have created a more stable commercial environment.

The net metering programmes introduced by a number of states have also paved the way for the rapid development of photovoltaics since the mid-1990s. Between 2002 and 2004 a number of states also implemented specific "set-asides" for photovoltaics in their RPSs, resulting in the installation of 75 MW of grid-connected photovoltaic capacity during the period 1999–2003 [11]. Although the market continued to grow, the US photovoltaics manufacturing industry suffered a downturn in 2003 and several manufacturers reduced their production. At the end of 2004 US manufacturers held only 11% of the world market for photovoltaics, compared to a peak of 46% in 1995 [11], while German and especially Japanese manufacturers have increased their market shares.

Tax incentives have been used intensively to promote the development and use of biofuels in the USA. In 1979 the Energy Security Act created a federal ethanol tax credit of up to 60 cents per gallon, proportional to the percentage of ethanol in the fuel, and in 2004 this was extended until 2010 [11]. In 2006 the USA overtook Brazil as the largest producer of ethanol in the world.

Biomass for power and heat still constitutes more than 90% of all renewable energy used in the USA, but biomass use saw virtually no increase in the period 1996–2004.

In summary, renewable development in the USA has been affected significantly by the stop-and-go policies pursued by the government. This is true not only for the amount of renewable energy used, but also for the development of the renewables industry itself. Several times—especially in wind power and photovoltaics—the USA has taken the lead in early development, but domestic manufacturing has not been able to keep up with developments abroad. The result is that the USA has low market shares in many renewable technologies, even though the country has a significant domestic demand. The USA has a large potential for new renewable energy capacity, and perhaps the recent surge in wind power heralds a better future for the US renewables industry.

The future of renewable energy sources

What will be the global role of renewables in the long run? Can renewables contribute a significant share of future energy supplies, or will they remain a niche area compared to conventional energy? Successful development of renewables requires at least six issues to be carefully considered:

1. Stability and continuity in government support policies are of the utmost importance for the development of renewable technologies. Many of these technologies have large upfront investment costs, which increase the risk for investors, even though they have low costs for fuel, operation and maintenance. To make the risk premium as low as possible it is important to have a long-term framework for support. The importance of this is clearly seen by comparing the situation in Europe and the USA.
2. Long-term targets for renewables development signal political willingness to increase the share of renewables in the energy mix, which increases the long-term confidence of investors. Both the EU and China are sending out strong signals in the form of goals established for renewable energy, whilst the USA as yet shows no such clear picture at Federal level (although several states have clear policies).
3. An appropriate level of payments should be set. Subsidies that are too low will result in no development of renewable energy. Subsidies that are too high simply increase the cost of development. In the worst case, the resulting lack of competition could keep renewable energy costs high, by hindering renewable technologies to slide down the learning curve towards lower prices.
4. The development in renewable energy should be reviewed every year, and support policies adjusted if necessary.
5. It is very important that new renewable technologies are assured access to the grid, and that plants are built in the right places. Lack of planning about where to site investments can hinder development, as in the case of wind power in the UK.

4

6. Cost-sharing mechanisms are important for renewable energy development in developing countries like China, since large subsidies are needed in rural and poor areas.

As the previous sections have shown, renewable technologies are capable of delivering a significant share of the world's energy. The increasing efficiency and reliability of renewable technologies, alongside high prices for oil and natural gas, pave the way for much greater use of renewables.

A number of renewable technologies are not yet economically mature, however, and need a period of support before they can be considered economically competitive with conventional fossil fuel technologies. A value for carbon emissions placed on fossil fuels would assist in this matter.

Experience in Europe has shown that a strong renewable energy industry can develop, given a climate of transparent payment mechanisms and long-term political targets. This contrasts with the USA, where the domestic renewables industry has suffered under stop-and-go support policies. The Chinese experience seems promising, with its strong long-term goals and huge efforts to expand the use of renewables and create a domestic industry. Only the future, however, will show whether China can sustain this enthusiastic start.

In the long term, renewable energy will be important in achieving national and international targets for cutting carbon dioxide emissions, ensuring security of supply and contributing to economic growth worldwide, including rural areas. To achieve this, renewables will need to be fully integrated into the mainstream global energy markets.

Conclusions

Although their contribution to global energy supply is still small, new renewables are expanding rapidly, with annual growth rates above 25% for technologies such as photovoltaics and wind power. The increasing efficiency and reliability of renewable technologies, alongside high

oil and gas prices, pave the way for increased development. More countries are becoming aware of business opportunities in renewables, and the environmental benefits are also important driving factors.

Renewable energy is now growing rapidly in the EU and the USA, and the signals for faster growth in China are promising. Nevertheless, the development of renewable energy remains vulnerable, and a number of barriers could slow or even stop the process. It is important to tackle these barriers at an early stage, and to set up long-term goals and coordinated support schemes for renewables. Renewables will remain a niche area of the world's energy supply for some years, but in the long run they can make a significant contribution that should not be missed.

Recommendations for Denmark

Denmark was one of the early movers in renewable energy technologies, but current work needs to be intensified if the country is to retain its leading role.

For new renewable technologies, continuity and stability in support policies are important if the investor risk—and thus costs—are to be kept low. The Danish government should develop a long-term strategy to support renewables. The strategy should contain medium- and long-term milestones for reducing costs, so that manufacturers would know at an early stage what they would have to live up to.

Danish politicians should also develop long-term targets for renewables in the national energy mix. Long-term goals signal political willingness to increase the share of renewables in the energy supply, which in turn increases the confidence of investors.

A domestic market for renewable technologies is important for Danish manufacturers. This is not so much in terms of turnover, but mainly because the home market allows manufacturers to get rapid feedback from their customers. For the same reason it is important to have domestic demonstration facilities that allow manufacturers to test new products.

5 Innovation in energy technologies

PER DANNEMAND ANDERSEN, MADSS BORUP AND MICHAEL HOLM OLESEN, RISØ NATIONAL LABORATORY, DENMARK

Introduction

Innovation in energy technologies is high on the political agenda in many countries. President Bush, in his State of the Union speech in January 2006, said that the USA is “addicted to oil”, and later announced a 22% increase in clean-energy research at the US Department of Energy [1]. The European Union in its Seventh Framework Programme is expected to increase energy R&D budgets, not only for reasons of energy and climate policy, but also to help increase the EU’s overall competitiveness (the “Lisbon Agenda”) through initiatives such as the Competitiveness and Innovation Framework Programme (CIP). In this sense “Lisbon” has become as relevant as “Kyoto” in European energy technology policies.

As argued elsewhere in this report, there is a long-term need for introducing new and renewable energy technologies to the energy markets. It is generally acknowledged that this need will increase over the decades to come. A recent report from the OECD states that innovation in energy technologies has widespread implications, not only for OECD members’ energy policies but also for their economies in general [2]. As a result, understanding how to stimulate innovation in energy technologies is of growing importance.

In the following several important aspects for an improved understanding are discussed: the concept of innovation and innovation systems in general, the role

of business clusters, models for the innovation process, the role of demonstration projects in innovation, the concept of learning curves and the possible role of venture capital in innovation. Finally, we will discuss the changed framework for energy technology innovation in Denmark.

Innovation and innovation systems

Innovation can be defined generally as changes in ways of doing things. The process of innovation is often complex and uncertain. It involves both technical and commercial uncertainties and risks. One way to mitigate these risks and uncertainties is to share the innovation process with other stakeholders—not just other companies, but all the different actors that make up the surrounding environment or framework. This means that technological innovation is not solely a matter of technology, manufacturers and markets. Policy makers, analysts and innovators also have to address the wider framework or environment in which companies operate, and in which innovation and new technologies emerge. The concept of an “innovation system” takes this broad view of the process of innovation.

An innovation system can be defined as the “elements and relationships which interact in the production, diffusion and use of new and economically useful knowl-

Figure 9. Linkages within a national system of innovation [4].

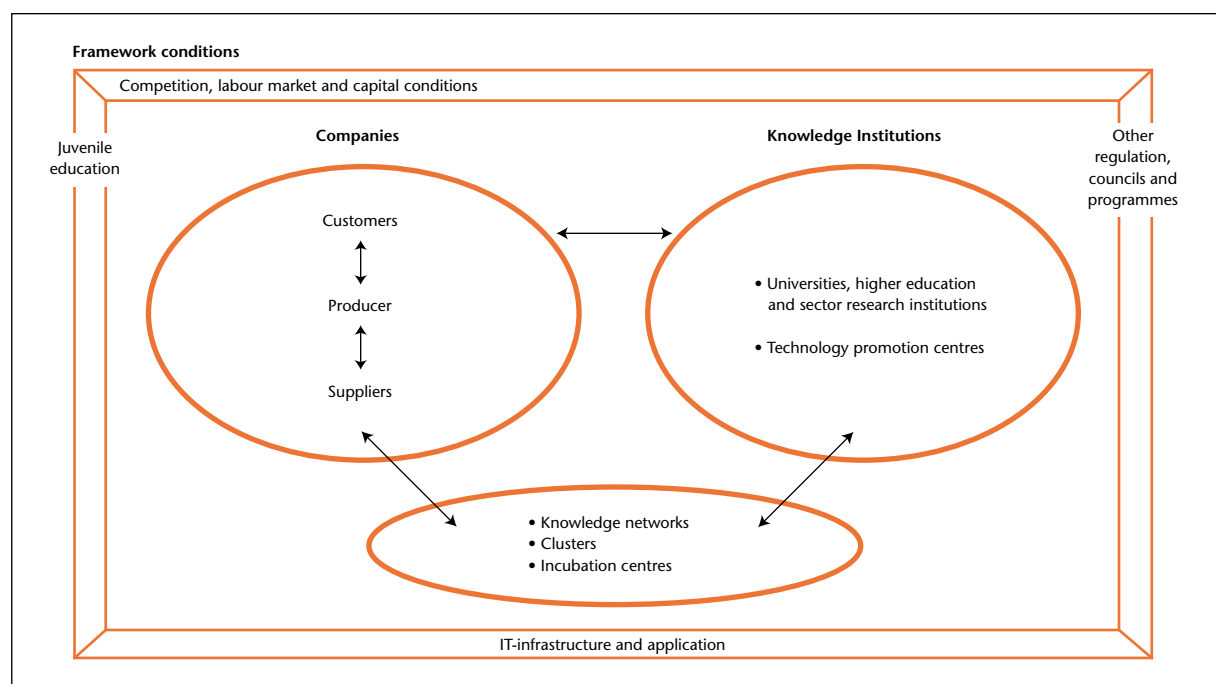

5

edge" [3]. In this understanding of innovation, the core is knowledge production and learning processes centred on industrial products in companies and markets. The knowledge processes are not limited to a single company, but must be seen in a broader institutional context, including not only subcontractors and customers in the product supply chain, but also knowledge networks and knowledge institutions such as universities, research centres, and institutions for innovation support and technology diffusion.

The innovation framework also includes the legislation, regulations and structures that govern competition, labour markets, capital investments, and more. It includes the information technology infrastructure and the ways in which it is used, because these are important to the knowledge transfer and learning within the innovation system. Finally, international cooperation and knowledge inflows are also very important factors in an innovation system. The characteristics and interdependencies of innovation systems can be summarised as in Figure 9.

The role of clusters

Innovation systems are not restricted to the national level; they can be found at regional and even local levels. They also appear within industry sectors, where they are often known as clusters.

The influential American economist Michael Porter defines clusters as "geographic concentrations of interconnected companies, specialised suppliers and service providers, firms in related industries, and associated institutions (e.g. universities, standards agencies, and trade associations) in particular fields that compete but also cooperate" [5].

Clusters are often found to act as the driving force in both regional and national economies (a famous example is Silicon Valley). The concept of a cluster gained support at the beginning of the 1990s, when Porter published his "Diamond of Advantage" model [6]. Porter argued that the competitiveness of a nation or region is based on the capacity of its industries to become part of a network with a geographical concentration of companies, institutions, customers and complementarities—in other words, a cluster. In his framework, Porter identifies four key determinants of industrial competitiveness: factor conditions; home demand conditions; related and supporting industries; and industry strategy, structure and competitiveness. These are the key determinants in cluster analysis and in the ability of a nation or a region to remain competitive over time.

Companies benefit from being part of a cluster by gaining access to specialised inputs, such as components, services or human resources, from related companies and industries. Another potential benefit is access to information about the needs of demanding buyers or end-users. Companies also benefit from the often fierce internal competition within the cluster. The cluster leads

to increasing productivity, higher competitiveness, and a high degree of entrepreneurial activity [7].

There is no doubt that a wind power cluster exists in the Danish peninsula of Jutland. Foreign wind turbine manufacturers (Spanish Gamesa and Indian Suzlon) and wind power consultancies (Garrad Hassan and Partners) have opened branches in Jutland so that they can benefit from the competences of the cluster.

Inspired by the success of the Danish wind turbine industry and the many good jobs the industry has created in thinly-populated Western Denmark—and because clusters seem to be powerful tools in promoting innovation and regional growth—many regions and local authorities strive to establish themselves as hubs of energy technology clusters. Several cities and regions in Denmark, for instance, are trying to establish a Danish hydrogen energy hub. Regional and local politicians all over Europe have similar visions for clusters in hydrogen, fuel cells, bioethanol and other emerging energy technologies. In any case, energy innovation policy must take cluster effects into account, but there are still a lot of open questions about how to do this. Ideally, policy might even extend to the creation of new clusters.

Innovation policy

While the innovation system directs our attention to the framework conditions, the challenge for innovation policies is to make the many different actors, learning activities, institutions, and framework conditions work together efficiently. Johnson and Jacobsson [8] have identified a set of basic functions that need to be served in a technological innovation system if a new industry is to develop successfully around a particular technology (see Box).

Basic functions that need to be served in a technological innovation system [8]

- To create and diffuse "new" knowledge;
- To guide the direction of the search process among users and suppliers of technology, i.e. to influence the direction in which actors employ their resources;
- To supply resources, including capital and competencies;
- To create positive external economies through the exchange of information, knowledge and vision; and
- To facilitate the formation of markets.

It is important to note that from the perspective of innovation systems, the rationale behind innovation policy (government intervention in the innovation system) moves beyond merely correcting market failures, to ensuring that actors and linkages in the innovation system works effectively as a whole, and removing blockages that hinder the effective networking of its components [9]. Thus there are a number of ways in which government schemes can support an emerging energy technology, depending on the maturity, by improving the efficiency of the innovation system.

5

The assumption behind policies that support innovation is that creating stronger innovation systems can bring considerable benefits both to the economy and to society. This means that the key challenge is not to speed up the flow of knowledge and technology from government R&D laboratories to the market; instead, it is to develop markets and business opportunities. This contradicts traditional thinking on policymaking in energy technology.

Innovation processes and the relations between academic research and industrial innovation

As mentioned above, innovation is often a complex and uncertain process. To make policy for innovation in energy technology, one needs to understand the innovation process, or at least to have a mental model; false mental models give rise to poor policy recommendations.

Around the middle of the 20th century, a classification of R&D activities was introduced that was subsequently to become widely used. This classification had five groups: pure science, basic science, industrial research, development, and design [10]. Others have added production and marketing to this classification, linked the groups, and referred to this model as the “linear model of innovation”.

The policy implication of this linear model was that if public money was funnelled into pure science at universities and other research organisations, the knowledge created would trickle down the model, through strategic and applied research in firms, and end up as products on the market. The result, ran the argument, would be innovation, competitiveness and prosperity for firms and nations. In the linear model, science-based learning takes place at the upper end, within institutions for science and research, or in the research departments of large firms.

The linear model of innovation has in many ways proved to be useful in energy policy studies. But because innovation is not solely a matter of technologies, firms and markets the role of other actors have to be included in the models of innovation. Typically, the role of govern-

ment and investors are included (see Figure 10). Through policy interventions governments can stimulate innovation. Governments can apply both instruments oriented towards science and technology and market oriented instruments. Also private investors play important roles through debt (i.e. bank loans) and equity (i.e. venture cap). The roles of government instruments and venture capital will be discussed later in this article.

Despite its usefulness in science and technology policy studies, the linear model has been challenged ever since its appearance [5], but the criticism gathered pace during the 1980s. With better understanding of industrial innovation processes, the linear model has been replaced by more advanced—and more complicated—models.

In the mid-1980s Stephen Kline of Stanford University suggested an alternative model that later became quite influential in innovation studies: the chain-linked model [12]. Kline was not a professor of innovation, sociology or economics, but of mechanical engineering and thermodynamics, and he had practical experience of technological innovation and the relation between science and innovation.

Kline’s model suggests a more complicated relationship between research, invention, innovation and production, and shows that at least six paths link a firms’ knowledge pool to the central innovation process and its research activities. The central element in Kline’s chain-linked innovation model focused on what takes place within a firm, and one of his main points was that science does not necessarily play a role in industrial innovation: “Any modern technical person beginning a task in innovation will not turn first to research. On the contrary, one turns first to the current state of the art, then to personal knowledge about the governing principles of the field. After that, one goes to the literature, consults, and calls in leading experts. Only when all that does not suffice does one start research.” [13]. This statement also proved to be true for innovation in the Danish wind turbine industry during the 1980s and early 1990s [14].

Even though Kline’s innovation model has been influential, several newer models of the innovation process re-

Figure 10. Linear model of the innovation chain indicating different actors’ role [11].

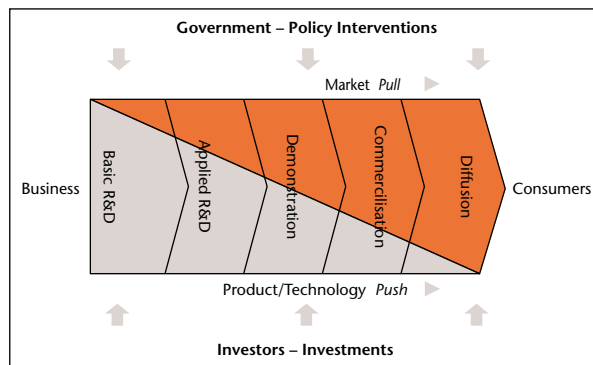
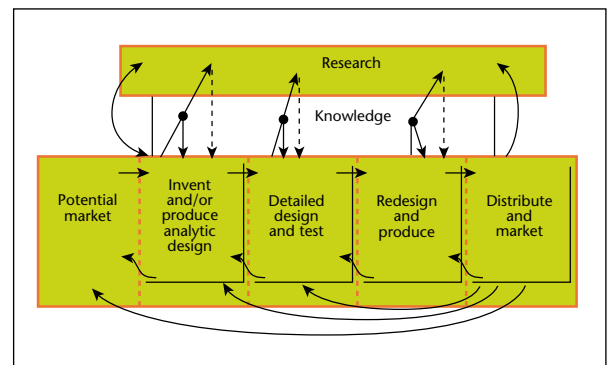

Figure 11. Kline’s chain-linked model of innovation [12].



5

turn to the idea that all innovation starts with scientific research. This idea is wrong. But research has a part to play in every stage of a technology's progress towards the marketplace. This also means that research has different roles during the innovation process in firms.

Demonstration projects

As indicated in Figure 11 demonstration projects form an important phase between R&D and market introduction of new energy technologies. As well as testing the technology in "real world" situations (and thereby give valuable feed-back to refinement of the technology), high-profile demonstration projects also play a fundamental role in gaining public confidence in the technology (and thereby stimulate the market creation).

If, for example, hydrogen is to become a realistic alternative to conventional fuels and energy carriers, demonstration projects will be an essential part of the market learning process. This can drive hydrogen technologies to acceptable levels of performance and cost.

The market learning that results from the deployment of a new technology is a necessary step in commercialisation and cost reduction. In principle, market learning provides manufacturers with a feedback loop as they refine and improve their products. Large-scale demonstration projects should be seen as the crossover point from R&D to the market.

Market-wide commercialisation and diffusion of a new technology occur after the technology has been successfully tested in large-scale demonstration projects and user feedback has been incorporated. Innovation literature argues that users play an important, sometimes crucial, role in improving a given technology [15].

Learning curves and government instruments

Research, development and demonstration can not alone make a new energy technology competitive at a commercial market. From early market introduction to more widespread diffusion of a new energy technology cost reductions through industrial manufacturing are vital. The concept of learning curves formalises the empirical observation that the cost of an industrially manufactured product decreases by a more or less constant percentage each time the cumulative volume of the product is doubled. This percentage is usually referred to as the Learning Rate (LR). The Progress Rate (PR) is equal to $1 - LR$ and describes the multiplier for the cost level when the cumulative manufactured volume is doubled. It is typically in the range 80–90%. Recent interest in learning curves for energy technologies has aimed to establish models for the balance between public expenditure on science and technology instruments (i.e. R&D programmes) on one hand, and on the other, market oriented policy instruments for new energy technologies that are not yet fully competitive.

Much effort has been spent in finding and analysing empirical data for learning curves in different renewable en-

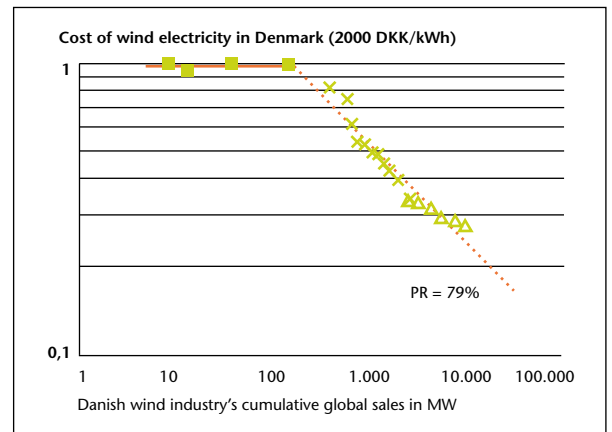

Figure 12. Experience curve for Danish wind turbine technology, 1981–2000 [17].

ergy technologies. In general, though, these studies face a shortage of reliable empirical data. One of the more comprehensive is the European EXTOOL study, which looked at the cost of electricity from wind turbines. In this case the progress ratio was found to be 83% for the period 1981–2000 [16]. The Danish figures are shown in Figure 12. The bold line covers the period 1981–1984 where iterations between demonstration and early commercialisation took place. The dotted line covers the period from 1985 to 2000 where learning through industrial manufacturing took place.

As the amount and quality of data is often limited, we should be careful when drawing detailed conclusions from learning curve analyses. There are, however, some generic implications for policymaking. First of all, as Clas-Otto Wene noted, "a system that has no output will not learn—meaning that a technology that is not produced and deployed cannot start the ride down the experience curve. Technologies cannot become cost-efficient through laboratory R&D alone" [18]. Trade literature and policy analyses often include graphs showing that the cost of renewable energy, such as the cost per kWh of electricity from wind turbines, decreases with time. This sometimes leads to the flawed policy conclusion that "we should postpone the use of this technology until it has become more competitive". The learning curve approach however indicates that technology becomes cheaper not as a function of time, but of market experience and deployment.

Another implication is that public policy on energy innovation should focus not only on scientific R&D and on facilitating knowledge flow between academia and industry, but also on policy instruments to support stable markets for the technology in question. Danish policies for wind power from the late 1970s included both elements: science and technology oriented instruments (largely corresponding to the technology push part in Figure 10) and market oriented instruments (largely corresponding to the market pull part in Figure 10). From

5

Table 3 can be seen examples of policy instruments applied to promote wind turbine technology and installation in Denmark from the late 1970s (not all policy instruments were used simultaneously).

Instruments oriented towards science and technology	Market-oriented instruments
Financial incentives: R&D programmes Dedicated research centres Test facilities Support for international cooperation	Financial incentives: Investment subsidies Production subsidies Taxation schemes Soft loans Foreign aid programmes (CDM projects)
Other forms of regulation and legislation: Approval schemes Certification Standardisation	Other forms of regulation and legislation: Physical planning schemes for regions or municipalities Resource assessment Local ownership Agreements with utilities Regulation of grid connection Feed-in laws (and tariffs) Green certificates Information and public acceptance programmes

Table 3. Policy instruments used to promote wind turbine technology and installation in Denmark [19].

Venture capital in energy innovation

As Figure 11 indicates private investors have a role to play in bringing new energy technologies to the market. Two types of private capital are available: debt (soft loans, bank debt, bonds) and equity (stock markets, venture capital, business angels).

Debt is usually only available for low-risk investments, such as financing the deployment of new energy technologies where equity might be available for start-ups. The “food chain” here is often that business angels provide the first private capital or seed money in the early commercialisation phase. It is important to note, however, that government R&D programmes can often play the same role in establishing seed money for R&D in startup companies.

The next step is venture capital, and finally stock market capital once the business is established. Venture capital and stock market capital supported the develop-

ment of the Danish wind power industry (Nordtank Energy Group A/S and Vestas Wind Systems A/S). Business angels and venture capitalists may need only the promise of a future market, but to attract stock market capital more often requires actual manufacturing and sales activity.

Innovation literature as well as policy considerations have recently set focus on especially the role of venture capital in developing energy technologies. Venture capital plays a key role in high-tech areas such as biotechnology, software and telecoms, so it might be expected to finance R&D in energy technologies too (Figure 13). However, private investors are often reluctant to invest in new and environmentally sustainable energy technologies, and the situation in Europe is even worse than in the USA. A survey in 2004 by the consultancy firm New Energy Finance showed that of nearly 3,500 organisations active in the “clean energy industry”, two-thirds of all startups were in the USA and only a quarter in Europe. Danish experience is that only 1% of Danish venture capital is invested in energy and environmental technologies, compared to 2.6% in the USA [20].

Denmark faces a dilemma. On one hand, the country has fostered a number of new renewable energy technologies, and government energy R&D programmes have had a significant effect over the years. On the other hand, venture capitalists have had difficulties finding Danish project ideas to invest in. Too many potential projects are driven by technology, environmental issues or energy policy concerns, and too few by a good understanding of business development.

A recent OECD study on fuel cells highlighted a number of reasons why venture capital has limited interest in this area [22]. In the discussion below, we dare to extend this thinking to other energy technologies, too.

Energy technologies are highly capital-intensive compared to software or telecoms. This makes investment less attractive to venture capitalists.

The energy sector has long time horizons. Power plants last for 30–40 years, which is much longer than the timescales of interest to venture capitalists. Many new energy technologies also have long time spans from early development and to full market penetration—fuel cells in cars, for instance, are anticipated to take 10–20 years to become fully commercial. Other industrial sectors offer much faster returns.

For governments, the return on investment in renewable energy technologies includes a cleaner environment and security of supply. Private investors cannot appropriate such returns. The OECD study points out that it is often unclear at what point in the value chain or innovation process investors will see their returns.

As many firms in the energy sector are still dominated by a “public utility” mindset (either with themselves or with their customers), the route to commercialisation is often unclear. Public research organisations also often have less experience in business plans and commerciali-

5

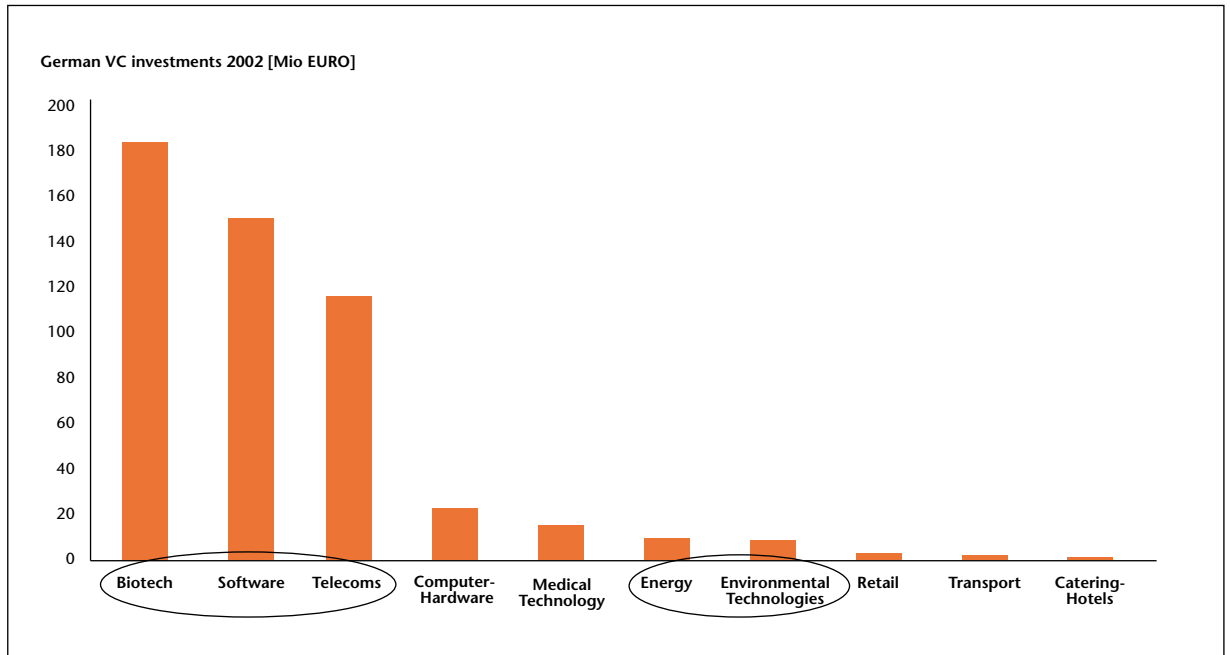

Figure 13. Venture capital investment in various technologies in Germany [21]

sation strategies. Such uncertainties reduce investors' interest.

Markets for sustainable energy technologies are heavily influenced by government policies, and energy markets themselves are also highly regulated. With uncertainties about the stability and profitability of energy markets, few private investors are willing to take the risks when there are more reliable options elsewhere.

The OECD report notes that public research organisations (PROs) perform much of the world's fuel cell research and development, and argues that this leads investors to channel capital to such institutions rather than to smaller companies. We could add that this might not be a great problem as long as PROs could spin-out startups or efficiently transfer knowledge to existing firms.

Policies for renewable energy in most countries emphasise research and technology (technology push). Some countries also include market stimulation schemes (market pull), such as the feed-in laws that have helped wind technology in Denmark, Germany and Spain. Business development, user-driven innovation and interest in consumer needs seem to be less important for European national innovation policies.

Changed frameworks for energy innovation policy in Denmark

It is generally acknowledged that energy innovation policies were quite successful when the Danish wind power industry evolved during the 1980s and 1990s. Similar success stories can be told about energy-saving technologies, clean coal and district heating.

Today the "industrial fairytale" of the Danish wind turbine industry is still used to argue for similar policies on

biofuels, photovoltaics, fuel cells and hydrogen. However, many of the characteristics of the Danish innovation system relating to energy innovations have changed dramatically in the last decade.

First of all, the energy sector has been liberalised and deregulated. In the 1980s the public power utilities played a key role in financing the development and demonstration of modern wind energy technology. Today the concept of "national power utilities" has been replaced by a number of private firms, often internationally-owned, with no national obligations beyond legislation and governmental regulation. Private capital (i.e. venture capital) is expected to play an increasing role in developing new energy technologies.

Where as small and medium sized enterprises (SMEs) with a background in traditional industrial or "artisan" production formed the backbone of energy technology innovation in the 1980s, today's energy industry is characterised more by large international companies and small high-tech start up firms.

Danish R&D programmes were dramatically amended after the change of government in 2001. The level of public funded R&D in renewable energy was cut and a number of programmes targeted at renewable energy and environmental technology were terminated in 2001. Though government R&D funding for renewable energy has now regained its 2001 level, the principles under which it is administered have changed. The latest increase in government spending on energy research is channelled through (or coordinated with) the research councils. The research council system has itself been changed. Furthermore the regulations governing Danish universities and higher education have changed and the whole Danish knowledge production and higher educa-

5

tion system (including universities and research centres) has undergone a consolidation process.

In the 1980s and parts of 1990s there was a surplus of engineers on the Danish labour market. The Danish Test Station for Wind Turbines was established in 1978 partly as a job creation project for unemployed engineers. Today the situation is very different: Denmark, like other OECD countries, faces a decline in the number of young people wanting to study engineering and natural sciences. Moreover, the economy is strong. The result is that unemployment among engineers in Denmark is at its lowest in decades.

International collaboration has changed, too. Danish energy innovators of the 1980s did co-operate with their counterparts abroad, both within and outside Europe, but the internet and cheap flights have made knowledge production today much more international than it was 20 years ago.

One could also argue that the progress of World Trade Organization (WTO) agreements and the single European market put the concept of stable domestic markets in an ambiguous light. New renewable energy technologies are being developed in an international context. When Danish SMEs started manufacturing wind turbines in the late 1970s, no-one gave a thought to international competition until the Californian wind turbine market boomed in the early 1980s. Today, a fledgling Danish ethanol industry must consider competition from Brazil and elsewhere. Table 4 shows some of the other changes affecting the innovation framework over the last two decades.

1980s	Today
Public sector	Private sector
Power utilities	Power industry
National champions	Multinationals
Oil, gas, heat and power companies	Energy conglomerates
Centralised electricity production	Dispersed electricity production
Self financing	Equity, private finance, venture capital

Table 4. Differences between the energy technology innovation system of 20 years ago and that of today.

The implication of these changes is that effective innovation policies for renewable energy technologies demand that comprehensive analysis is undertaken of the new characteristics of the energy innovation systems in Denmark as well as in other countries and regions and

abroad. This includes systematic and detailed case studies within different industry sectors and technology areas.

Examination is also needed of the conditions affecting the contents of knowledge networks, and the position of energy in the education system and research institutions. Furthermore, an analysis of policy regimes and the relationship between different policy efforts and their consequences for energy innovation is needed.

Conclusions and recommendations

As mentioned in the introduction the understanding of how to stimulate innovation in energy technologies is of growing importance. In this chapter we have introduced some of the most important discussions in contemporary innovation literature in relation to innovation in energy technologies.

A few policy recommendations can be drawn:

- research alone cannot do the job. To climb down the learning curve requires application experiences and market experiences to learn from. Governments can stimulate the creation of such experiences, initially through demonstration programmes and strategic arenas for niche application;
- policies for speeding up the flow of knowledge from universities and government labs to industry might be important, but policies for developing markets and business opportunities are more important;
- a qualified articulation of the demands and needs is crucial to research and technology development. Policies shall ensure arenas for matching of scientific opportunities and needs. The mutual integration of opportunities and needs is a continuous process between the actors;
- energy R&D programmes and other government policy instruments should put more emphasis on application and business development.

Still there are many aspects not yet fully described or understood. Some of the areas that innovation studies must examine in the years to come are:

- a better understanding of energy technology innovation in the changed framework conditions;
- a better understanding of the balance and interplay between market oriented and research oriented policy instruments;
- a better understanding of the possible roles that private investment capital can play in developing energy technologies;
- a better understanding of demonstration programmes' role in bringing technologies to the market and in stimulating regional clusters and growth.

6.1 Wind

ANDREW GARRAD, GARRAD HASSAN AND PARTNERS LTD, UK; PETER HJULER JENSEN AND LARS LANDBERG, RISØ NATIONAL LABORATORY, DENMARK

Status

In the past 20 years wind energy has proved itself as a viable and increasingly economic means of generating electricity. The transition from the early days of smocks and sandals activity in the backyards of Denmark and America, to the present day, when turbines are manufactured by household names such as GE and Siemens and bought by other household names such as Shell and BP, is a fantastic achievement (Table 5).

It is particularly interesting to concentrate on what has happened since the mid-1990s when the market incentives in Spain and Germany began. The result, in Spain from a virtually standing start, is that wind now generates some 14% of electricity and provides 7% of all energy used, and a brand new, vibrant manufacturing industry has been established. The power of market incentives is apparent both from these two markets and also from the wild oscillatory behaviour seen in the USA. When there is a market incentive in place there is dramatic activity. When there is none, there is none! It is clear that demand can be turned on and off by incentives.

It is equally clear that when an incentive is in place, the industry will respond to it, in terms of both volume and technological innovation. Not only has the volume increased with time but so, even more dramatically, has the size of wind turbines, from 50 kW in the late 1980s to 5 MW today (Figure 14). At the same time prices have reduced dramatically, and availability and quality have improved in parallel. The incentives work, the technology base exists; both are responsive and the prices are falling. The energy is clean and the fuel is free and secure, immune from political intervention by other countries.

Trends and perspectives

Despite all these achievements, wind energy remains on the fringes of power generation. For people working in the wind industry this is difficult to believe, but step out-

side and it is still easy to find both ignorance and emotional opposition. Wind energy is far from having been proved to lay people, large generating companies, fossil fuel producers or the nuclear industry that it is a viable means of producing cheap electricity.

In order to understand the market, we see it as being affected mainly by four forces: the technological, legislative, political and public relations (PR). These will be discussed below.

The problems facing our society are starting to be painted on a bigger canvas: security of supply and climate change. Political forces are therefore affecting the market via incentives (such as the German, Spanish and Danish feed-in laws) and legislation.

Globally the incentives are changing such that wind is being forced to operate under near-market conditions, with a premium for its contribution to Kyoto goals. This move towards market conditions can cause problems in at least two ways. First, increased demand for turbines means that prices are going up, making wind less competitive. In areas with lower wind potential this could make the use of wind energy impossible. Second, as mentioned in the introduction, we have seen from experience that when incentives are present, demand results, but also that when they are not, demand vanishes.

Concerning legislation, there is a tendency in all discussions of electricity generation to start from the assumption that wind energy can only ever play on the fringes, that it can never make a substantial contribution, and that people who believe otherwise are naïve idealists. The wind energy business has not been good at grasping that nettle. The industry has occupied, in its own view at least, the moral high ground of electricity generation and has felt that consumers, grids and system operators should accept wind-generated electricity simply because it is clean. As levels of penetration increase that approach has to be radically altered.

Table 5. World market growth for wind power 2000–2005. [1]

Year	Installed MW	Increase %	Cumulative MW	Increase %
2000	4,495		18,449	
2001	6,824	52%	24,927	35.0%
2002	7,227	6%	32,037	29.0%
2003	8,344	15%	40,301	26.0%
2004	8,154	-2%	47,912	19.0%
2005	11,407	40%	59,264	24.0%
Average growth – 5 years		20.5%		26.3%

6.1

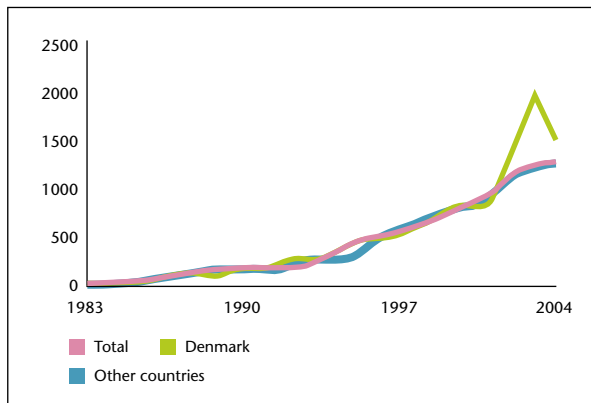

Figure 14. Average wind turbine power rating (kW). [2]

With respect to PR, wind generation has to convince the incumbent generators that it is serious, through producing reliable, good-quality electricity. This means adapting wind power to look like conventional generation as much as possible. The industry is taking this seriously, through, for example, the new grid code requirements for “fault ride-through” and power quality, and the increasing importance of short-term forecasting. Manufacturers have shown that wind energy can comply when given sensible, practical and regulatory requirements.

The wind industry must work in conjunction with the transmission service operators (TSOs) and other utility groups to allow wind energy to reach its full potential. In recent years there has been evidence that the attitude of the TSOs to the wind industry has been moving towards cooperation, and it is vital that the wind industry seizes on this and builds on it as a foundation for future high-level exploitation.

In April 2006 the UK Energy Research Council (UKERC) published a seminal document on intermittency issues [3], though it is debatable whether “variable” would be a better term than “intermittent”. This report was produced by impartial experts following a systematic search of the literature. Their conclusion is that, whilst variability is clearly a feature of wind-generated electricity, its implication can be quantified in terms of both peak load requirements and spinning reserve. The cost of covering these requirements turns out to be relatively modest, even for levels of grid penetration up to 20% or more. The report opens the door for a rigorous and objective debate about what constitutes the proper mix of generating technologies.

Society should not be considering what level of wind penetration can be made such that it will not require modifications to any particular grid; society should be considering what modifications to the grid can be made to allow the maximum penetration of wind energy. There is little or no pan-European activity in the development of a network to allow the maximum use of all renewables, including wind.

A characteristic of renewables is that the energy source is located in a specific place and the energy must be trans-

ported to the load. A luxury of fossil fuel generation is that generation can be built close to the load. It will be necessary to invest in substantial infrastructure if wind is to reach its true potential. All the impartial evidence from areas with high levels of penetration, without the baggage of conflicting commercial interest, has demonstrated that much higher levels of penetration from wind are possible than generally believed when discussions are based purely on paper studies.

Proponents of wind energy therefore need to precipitate radical changes in thinking by the people responsible for the strategic planning of our future energy industry. The wind energy industry has shown that it is possible to develop large-scale onshore plants and GW-scale offshore plants. It is possible to predict accurately the output of individual wind farms and hence, given the appropriate infrastructure, it will be possible for wind energy to make an enormous contribution to our electricity demands. Accurate prediction and geographical dispersion of large wind power plants across large areas will increase the industry’s ability to produce large amounts of reliable power.

A technology trend that is becoming very noticeable is that wind turbine manufacturers are concentrating on reliability, rather than continuing to increase the sizes of their turbines. Not many new types of turbines are appearing at the moment, though a new generation of machines—including towers, foundations and other equipment—tailored for the increasingly important offshore environment is foreseen.

It is important to differentiate between development onshore and offshore. There are logistical limitations to the development of much larger turbines on land: transport can be uneconomic and in some places impossible. Visual intrusion and the resulting public resistance can be overwhelming, again to the degree of making construction of the very large wind farms on land impossible. Offshore wind power, though more expensive, avoids these disadvantages.

To sum up, it is important to stress, as the chairman of Eltra said in the company’s annual report for 2003, that culture is the biggest obstacle to obtaining high wind penetration even in the modest Danish grid. The biggest obstacle to obtaining high penetration of wind in the global grid is neither technology, nor economics or geography, just imagination.

International R&D plans

Globally there are many plans for wind energy R&D [4, 5], but here we will focus on two: one European and one from the USA.

UpWind is an EU-supported Integrated Project (IP) and the largest EU initiative in wind energy R&D to date. UpWind looks towards future wind power, including the design of very large turbines (8–10 MW) standing in wind farms of several hundred MW, both on- and offshore. The challenges inherent in the creation of such power

6.1

stations necessitate the highest possible standards in design; complete understanding of external design conditions; the use of materials with extreme strength to mass ratios; and advanced control and measuring systems—all geared towards the highest degree of reliability, and, critically, reduced overall turbine mass.

Wind turbines larger than 5 MW and wind farms of hundreds of MW necessitate the re-evaluation of the core unit of a wind energy power plant, the turbine itself. UpWind will develop the accurate, verified tools and component concepts the industry needs to design and manufacture this new breed of turbine.

UpWind will focus on design tools for the complete range of turbine components. It will address the aerodynamic, aero-elastic, structural and material design of rotors, and critical analysis of drive train components.

In 2003, European companies supplied 90% of the global market for wind power technology. UpWind will help to maintain this position, meet EU renewable electricity targets for 2010, and attain the main objective of the Lisbon Agenda.

The main technical and scientific components of the programme have been integrated through a visionary organisational structure which will ensure that the research carried out answers the needs of the industry. This has been achieved by organising the project in such a way that the (industrial) integration work packages will play a large part in guiding the scientific work (vertical integration) (Figure 15).

The findings of the project will be disseminated through a series of workshops and through the dedicated website www.UpWind.org.

In the USA the Department of Energy (DoE) has laid out a five-year plan for wind energy R&D [6] that follows three paths:

- land-based electricity path: here the focus is on low-wind-speed technology and machines in the range 2–6 MW. The main barriers are transmission, and the goal for 2012 is \$0.03 /kWh at 13 mph sites;
- offshore electricity path: the focus is on both shallow and deep water, with turbine sizes of 6 MW and larger. The main barriers are cost and regulation, and the goal for 2012 is \$0.05 /kWh;
- emerging applications path: here the focus is not on wind alone, but also on hydrogen and clean water. The barriers are cost and infrastructure, and the 2020 goals are custom turbines for electricity, hydrogen production and desalination.

Conclusions

Wind energy has developed very rapidly over the past 20 years. Some players have stayed in the market, but many new and very large players have also recently entered. Wind energy has developed into a very significant player in the post-Kyoto era of CO₂ reduction.

Recommendations for Denmark

It is important that research, industry and the political system, both now and in the long term, continue to support wind energy through incentives (such as support for CO₂ reduction measures), support for prototype development, and research funding. We are facing a magnificent challenge in securing the planet for future generations, and wind energy has a critical role to play.

Figure 15. UpWind’s project matrix structure. Horizontal work packages are “scientific work packages” and vertical ones are “integration tasks”. The integration tasks have their own budgets, and it is planned that on average 60% of the activity in each scientific work package will directly support the integration tasks.

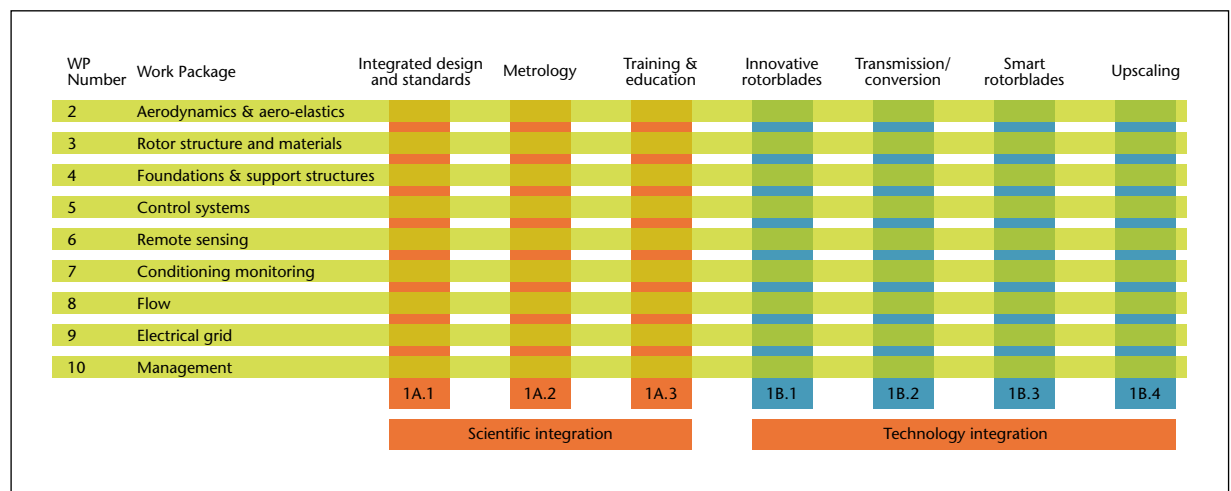

6.2 Biomass

LARS HENRIK NIELSEN AND ERIK STEEN JENSEN, RISØ NATIONAL LABORATORY, DENMARK; MICHAEL MADSEN AND HAKON MOSBECH, VATTENFALL, DENMARK

Biomass is one of few non-fluctuating renewable energy resources that can be easily stored, so it can be used at times determined by the needs of the overall energy system. Alongside stored hydro and geothermal, this sets biomass apart from most other renewables such as wind power, which must be used when available. A proportion of biomass is therefore attractive in a sustainable energy system. Conversion efficiency, flexibility, sustainability and economics are key issues for biomass technology.

Solid biomass is compatible with most conventional combustion technologies developed for coal or other solid fuels. Adjustments need to be made to accommodate the low energy density of biomass compared to coal, the high moisture content, and for agricultural biomass in particular the presence of inorganic constituents such as chlorine and alkali metals. These inorganics can cause corrosion, heavy deposition on heat transfer surfaces, and emission of sub-micron particles (aerosols) of HCl and SO₂. Wood may also contain heavy metals (cadmium in particular) that accumulate in the ash.

In general biomass is a geographically dispersed resource, which means of course that handling and transport costs are important. Biomass covers a broad range of resource categories, including energy crops, straw, wood residues, other byproducts, and all kinds of solid and wet waste of plant or animal origin. Municipal waste typically contains about 80% biomass and 20% fossil energy [1].

Conversion of biomass to electricity and heat offers attractive CO₂ reduction options for the heat and power supply sectors, and increases the security of energy supplies. The use of biomass can also create jobs in rural areas.

Technologies range from large-scale combined heat and power (CHP) plants supplying power to regional grids and district heating to large communities, down to very small CHP units in the kilowatt range for use by individual households. Biomass conversion technologies may be divided into thermal and biological processes. Thermal conversion may be subdivided according to the two main process characteristics: combustion and thermal gasification.

Thermal conversion

Combustion and co-combustion

Biomass conversion schemes are often said to be subject to political uncertainty, because their economic viability may depend on subsidies, green certificates and tax rebates. This is especially important given the long lifetimes—20—40 years—of many power plants. To reduce the economic risk, investors prefer flexible plants that

can change to alternative fuels if biomass becomes uneconomic.

Co-combustion of biomass with fossil fuels is an attractive way to reduce uncertainty, and plants built from start with this option are very much in focus. Biomass and fossil fuels are burned to produce steam from a boiler, and the steam drives a turbine to produce electricity. Co-combustion plants are often quite large, to take advantage of economies of scale. Large plants can also afford to be more complex, which boosts the efficiency of electricity production. Modern biomass co-combustion plants reach electricity generating efficiencies of about 45% at full load, and about 90% total efficiency.

Boilers in biomass-fired plants have traditionally been de-rated compared to their counterparts in coal-fired plants. To avoid slagging and high-temperature corrosion from aggressive components in some biomass resources, especially straw, boiler temperatures have been kept relatively low. However, recent breakthroughs in materials and boiler design mean that the newest plants have fairly high steam temperatures and boiler efficiencies [1].

Gasification and pyrolysis

As an alternative to direct combustion, biomass can be subjected to partial combustion (“gasification”) to create a fuel gas that can then be burned in a gas engine, gas turbine or even a fuel cell. Because this fuel gas is relatively clean, gasification avoids the corrosion problems that can affect direct combustion systems. It also provides high efficiencies, even on relatively small plants.

Fluidised bed gasification plants for power production are relatively large units of capacities typically above 10MWe. In fluidised beds the solid fuels are combusted imbedded in a fluid or sand bed through which air is blown. Fluidised bed combustion and gasification is attractive due largely to the technology’s fuel flexibility. Almost any combustible material, from coal and biomass to municipal waste, may be converted in such type of plants. Furthermore, fluidised bed combustion has the capability of meeting sulphur dioxide and nitrogen oxide emission standards without the need for expensive add-on controls.

A number of plant concepts and designs have been developed for specific fuels and purposes, and using different gas cleaning methods. Recent fluidised bed gasification development efforts have mainly focussed on oxygen and steam blown biomass gasification, aiming to produce hydrogen and monoxide rich syngas for production of liquid bio fuels and for power production e.g.

6.2

via combined cycle plants and fuel cells. Very high electric efficiencies can be achieved e.g. from biomass-IGCC (Integrated Gasification Combined Cycle) plants.

Updraft gasifiers are characterised by a downward flow of fuel and an upward flow of gas. This basic type of gasifier has been used for a century to generate electricity, heat, steam and town gas. The gas has a low temperature but a large tar content (typically 30–100 g/Nm³), which cause problems in gas engines and gas turbines. A small updraft gasifier with an integrated 1.4 MWe gas engine has an electric efficiency close to 30% and a high total efficiency; both figures are higher than for direct combustion plants of the same size [1].

The shortcomings of updraft gasifiers have brought forward new biomass gasification designs. Of particular interest are staged gasification processes, which are promising in the capacity range 0.1-10 MW_e. These use two reactors, one for pyrolysis and the other for gasification, to convert the tar into fuel gas. As a result, they yield gas with very low tar content (below 0.1 g/Nm³).

Fuels for staged gasifiers may be wood chips, industrial wood residues, straw, and energy crops in the form of chips, briquettes or pellets. Requirements for moisture content and size of the fuel depend on the design of the reactor and the process.

Small staged gasifiers used with the best modern gas engines have electric efficiencies of about 35% and high total efficiencies. Such good performance is partly due to the use of heat recovered from the product gas and the engine to dry and pyrolyse the biomass (“external heating”). Part-load operation is good, too, with respectable performance down to 10% of peak capacity.

Barriers for gasification technology are high investment costs: about €3.5 million/MW in 2004. Economies of scale are important. R&D in biomass gasification is focused on scale-up, load regulation, corrosion and soot formation [1, 5, 6].

External combustion engines

External combustion (Stirling) engines generate mechanical power from direct combustion of biomass. Stirling engines can become very attractive for small scale biomass based CHP in the capacity range of about 1kW to 100kW.

Stirling engines are externally heated, i.e. heat is transferred through heat exchangers to a working fluid (e.g. helium) within sealed cylinders. This is unlike ordinary internal combustion engines (ICE) where the combustion takes place within a cylinder. Stirling engines, therefore, are very flexible as to the type of fuel used, and they can in principle use any kind of solid, liquid or gaseous fuel, including solid biomass such as wood chips etc. Furthermore, e.g. industrial waste heat may be utilised for power production using Stirling engines.

The external and continuous combustion in Stirling engines enable good control options to minimise the emission of pollutants. Stirling engines operate quietly with

low noise and low vibration and have good performance at partial load. Critical issues mainly concern heat exchanger durability and sealing of the working fluid, which during the cycle may attain maximum pressure of about 80-150bar and temperatures of 600C to 700C. Encouraging engine and system design development is ongoing e.g. in Scandinavia where efforts in particular are directed towards utilisation of solid biomass for CHP.

Stirling based CHP units using wood chips may have electric efficiencies of about 25% and a total efficiency close to 90% [7, 8, 9 10].

Biological conversion

Anaerobic fermentation

Biomass that is too wet to burn, such as animal manure and food processing waste, can be used to produce biogas via anaerobic fermentation. Biogas contains 60–70% methane (CH₄), 30-40% carbon dioxide (CO₂) and up to 500 ppm H₂S. It can be burned directly for heat, or used to fuel a gas engine for electricity production.

Biogas plants are established primarily for agricultural and environmental reasons, as a way to create value from wastes that would otherwise be difficult to dispose of. Although biogas is typically not of interest to energy companies, however, it is a significant local energy resource [1].

Biogas output from Danish plants in 2002 averaged 41m³ per tonne of biomass. Output depends mainly on the type of waste used: for manure it is typically 20–22 m³/t, and for industrial waste it is 50–200 m³/t.

If not treated, wastes that are suitable for biogas plants tend to produce methane and nitrous oxide (N₂O), which are powerful greenhouse gases, as well as carbon dioxide. This means that biogas schemes are very effective at reducing greenhouse gas emissions: in Denmark, 40% of the emissions reduction potential comes from substituting for fossil fuels, and the other 60% by eliminating wastes that would otherwise act as uncontrolled sources of greenhouse gases.

Studies show that large Danish biogas schemes using best practices reduce greenhouse gas emissions by the equivalent of 90 kg CO₂ per tonne of biomass. This reduction is achieved at costs that are very attractive to society, if not to industry [3].

Conclusions

Bioenergy based technologies for power production are increasingly important and have internationally caught renewed attention due to concerns about the security of energy supplies and threats of climate change. Considerable development of the technologies has steadily taken place during the past two decades, and is ongoing, and today power production from biomass can be considered a mature option.

6.2

Recommendations for Denmark

Denmark has a strong position within this area, e.g. on co-combustion of biomass/coal for large-scale CHP, on medium to smaller scale biomass gasification for CHP, smaller scale Stirling technology CHP on biomass, and anaerobic biogas technology. Danish research and devel-

opment programmes have stimulated this development during more than 20 years.

To maintain this position for Danish industry, it is important not to interrupt but to strengthen research efforts, and to support promising initiatives and prototype development.

6.3.1 Photovoltaics

TOM MARKVART, UNIVERSITY OF SOUTHAMPTON, UK; LUIS CASTAÑER, UNIVERSITAT POLITÈCNICA DE CATALUNYA, SPAIN; PETER AHM, PA ENERGY LTD, DENMARK; FREDERIK KREBS, RISØ NATIONAL LABORATORY, DENMARK

The market for photovoltaics (PV, or solar cells) has grown at an average of more than 30% annually over the last ten years. Can similar growth be sustained into the future?

Crystalline silicon remains the standard PV technology, with a market share that has increased from 85% in 1995 to 94% in 2004. Further growth is threatened by a shortage of silicon feedstock, however.

The European Photovoltaic Industry Association estimates that the share of thin-film technologies in the total PV market will reach 20% by 2010. A major obstacle to this expansion, however, was pointed out more than 20 years ago [1]: the need for efficiencies is consistently above 10% at competitive costs with retail power prices (if installed on buildings).

Although efficiencies of research solar cells continue to rise (Figure 16), high cost remains the principal barrier to PV as a large-scale energy producer.

The global market for traditional PV has grown at almost 40% annually in the last five years, and in 2004 it grew by more than 60% (Figure 17). Even though the amount of energy produced is still quite small, this is a market that was worth more than €10 billion in 2004.

About 90% of the PV modules produced in 2004 were based on crystalline silicon, with polycrystalline silicon accounting for about 60% and traditional single-crystal silicon technology the remainder. In 2004 and 2005

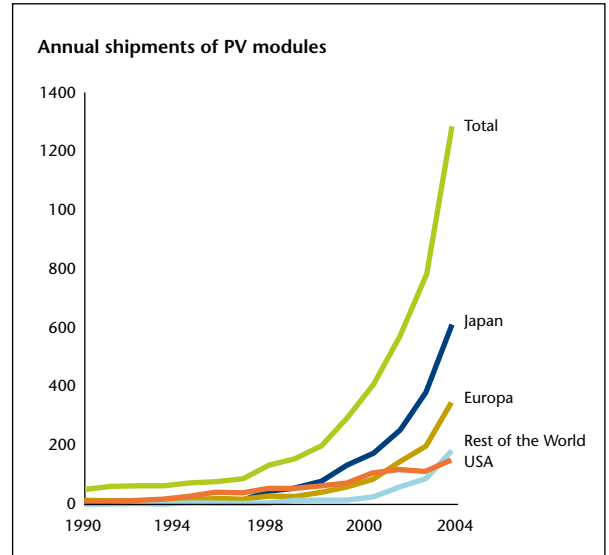
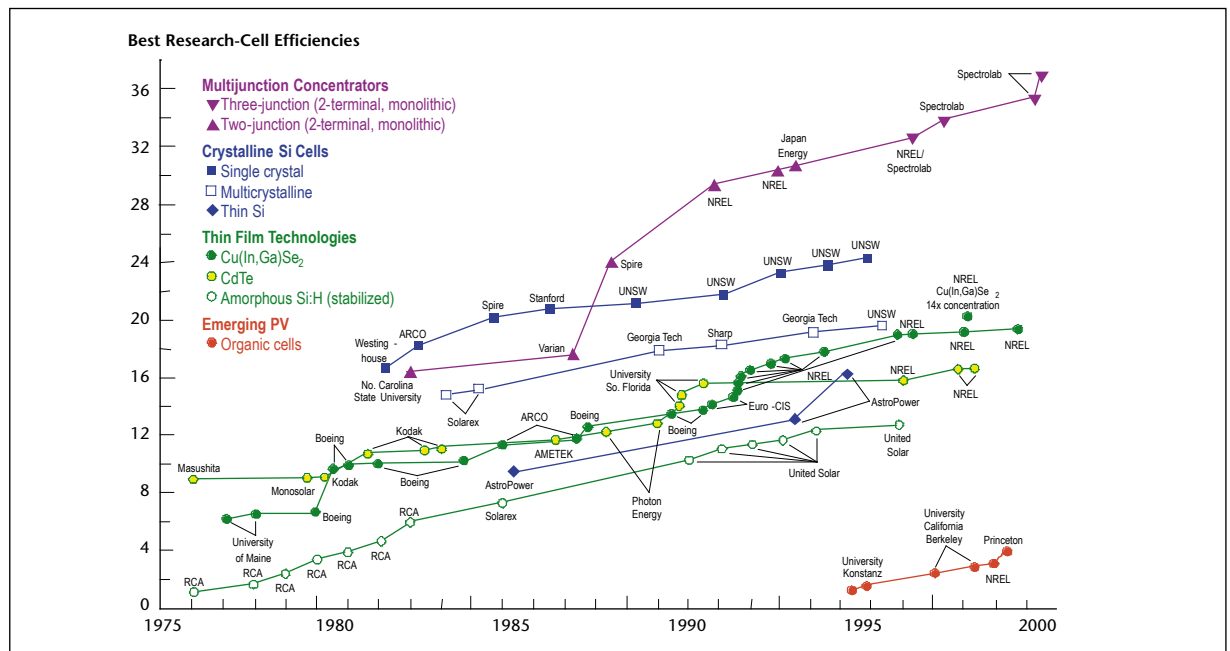

Figure 17. Production of PV modules is rising by 40–60% every year.

the shortage of silicon produced a seller’s market, but the industry invested heavily in silicon production during 2005 and the feedstock bottleneck is expected to be cleared during 2007.

Crystalline silicon cells and modules are expected to dominate the global market for the next 10–15 years, and only after about 20 years are they expected to cover

Figure 16. Efficiencies of research solar cells continue to rise, but cost is still an issue.



6.3.1

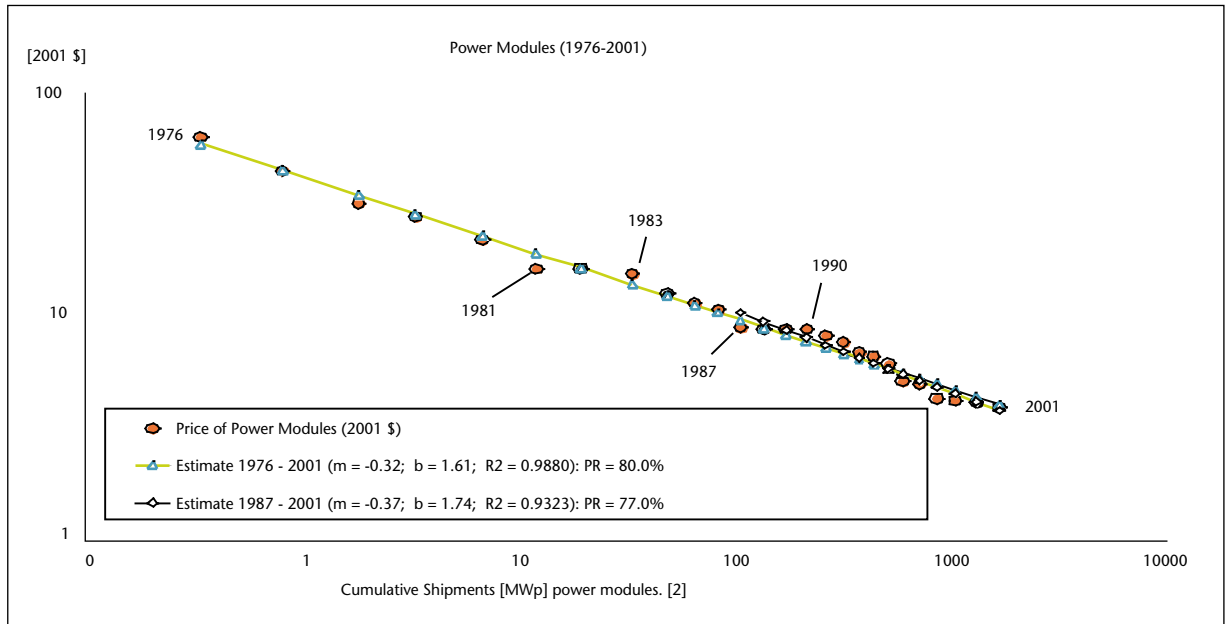

Figure 18. Cumulative shipments of PV power modules (MW_p): cost has fallen consistently by 20% for every doubling in volume [2].

less than half the market. Figure 18 shows that the cost of traditional PV technology has fallen by 20% for every doubling of production volume. This trend is expected to continue for 10–15 years through a combination of reduced silicon consumption and improved manufacturing processes.

The EU regards PV as a significant future energy technology and in 2005 launched a PV Technology Platform to stimulate growth. It seems likely that the EU goal of 3 GW of installed PV capacity by 2010 (1% of EU electricity consumption) will be exceeded, perhaps by an extra 1.5 GW. Denmark published a national PV strategy in 2005 and Danish R&D and industry will certainly benefit from this fast-growing renewable energy technology. By the end of 2005 Denmark had an installed PV capacity of about 0.4 W per person, compared to Germany with 9 W/person and Japan with 7 W/person.

Figure 19. Annual production of semiconductor feedstocks.

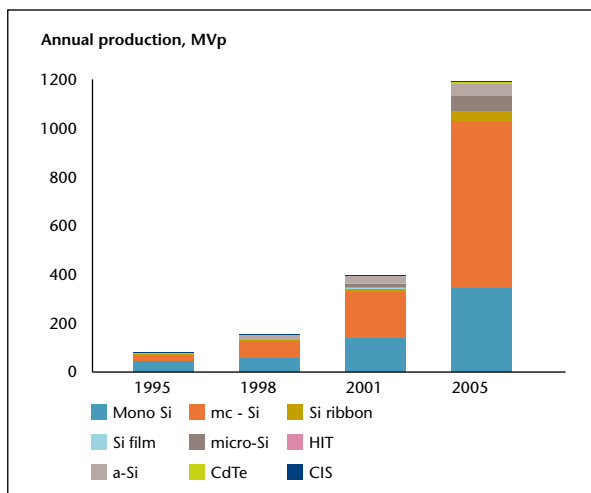

Figure 19 shows world production of commercial semiconductor solar cells over the last ten years, classified by technology [3].

Cells manufactured from wafers cut from cast polycrystalline silicon ingots hold the largest share of the market (56% in 2004). With typical module efficiencies of 11–13%, this technology has gradually surpassed its close cousin, the single-crystal silicon solar cell.

Thin-film solar cells, a newer technology, are cheaper but also less efficient, and are often used to power small consumer products. The traditional type of thin-film solar cell based on amorphous hydrogenated silicon, now often seen as a multijunction device, has been supplemented by thin films based on cadmium telluride (CdTe) and, more recently, copper indium diselenide (CIS) and its derivatives. Figure 20 shows the market shares of different manufacturing technologies in 2004.

Space solar cells, which are not included in Figure 20, are now often based on III-V semiconductors and multijunc-

Figure 20. Market shares for different PV technologies.

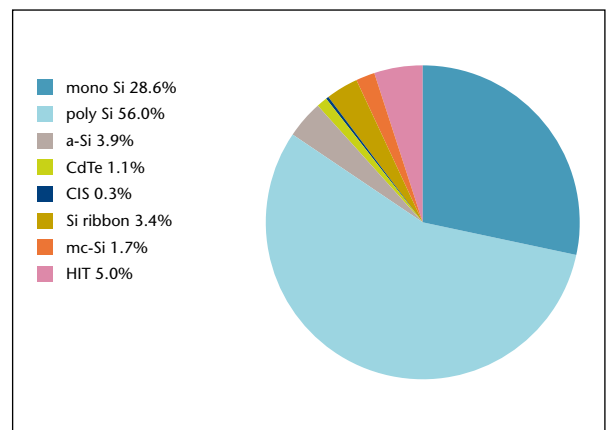

6.3.1

tions, and their highest efficiencies now approach 30%. Rohatgi [4] has outlined a strategy to halve the cost of crystalline silicon solar cells in the short to medium term. The two main ways this can be achieved—increasing efficiency and reducing the amount of silicon required—are well known, but the strategy helps to show how the technology is evolving.

Production by BP Solar of laser-grooved buried-contact high-efficiency solar cells (Figure 21), developed at the University of New South Wales, has been increasing since they were launched in 1993 [5].

Sanyo’s Heterojunction with Intrinsic Thin Layer (HIT) technology (Figure 22) is reported to have average cell efficiencies above 19%, and the company aim to reach a production capacity of 1 GW by 2010 [6].

Based on its “concentrator” technology, Sunpower has started to manufacture the Stanford rear point-contact solar cell for flat plate modules, with cell efficiencies exceeding 20%. Ribbon technologies used in Evergreen Solar or RWE Schott modules offer the promise of more efficient silicon usage by avoiding kerf loss.

More substantial reduction in material can be achieved by Kaneka’s solar cell based on microcrystalline silicon [7] or by moving to more exotic technologies, such as the Canadian Spherul Solar Power design or “sliver cells” from Origin Energy of Australia.

New technologies

Traditional photovoltaics have demonstrated steady growth and price reduction over the years, but the learning curve is slow. A cost of US\$1/W_p, which is often taken as target, will not be reached by silicon solar cells for a decade or so.

This has justified research into alternative or “third-generation” PV technologies, encompassing both inorganic and organic thin-film technologies. Organic PV cells, where the active material is a polymer, show particular promise as a low-cost alternative to traditional technologies, though some barriers remain to be overcome.

PV technologies are most easily compared in terms of their cost, lifetime and power conversion efficiency: the three measures that need to be right if the technology is to succeed in high volumes [8, 9]. Any technology that fails to perform well in all three aspects will only reach niche markets. This is illustrated by silicon solar cells, which have excellent lifetime and commercial module efficiencies above 20%, but which are still too expensive to create a large market.

Polymer solar cells may succeed where silicon has failed because they are cheap to make. The equipment needed is cheaper than for silicon cells, and the production speed is expected to be 1,000–10,000 times faster for the same area (Figure 23). Because polymer cells are flexible, they can also be used in applications such as clothing, where silicon is impractical [10].

With respect to stability and efficiency, polymer PV has been an inconsistent performer until recently. Efficien-

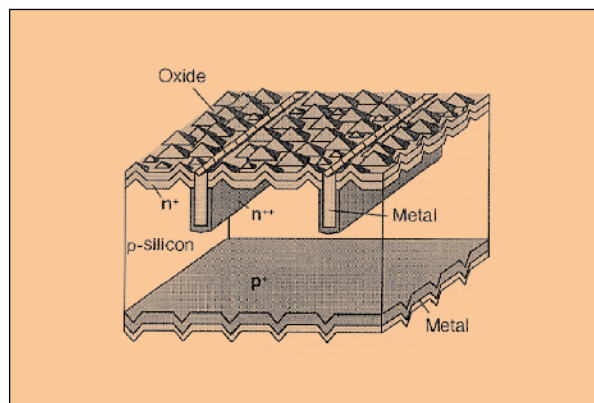

Figure 21. Laser-grooved buried-contact solar cells from BP Solar.

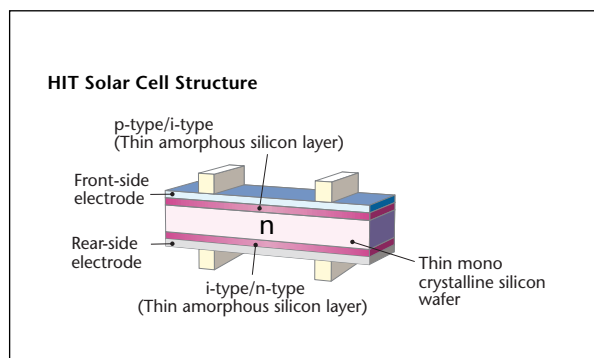

Figure 22. Sanyo HIT solar cell.

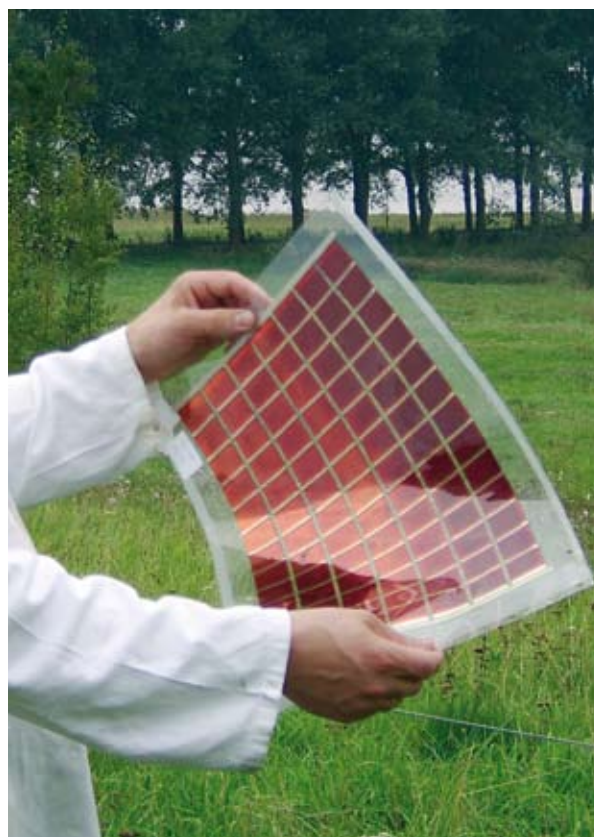

Figure 23. A flexible 0.1 m² polymer PV module.

6.3.1

gies have now reached around 5% [11], and operation lifetimes of 2-5 years under outdoor conditions can be anticipated from accelerated test data [12]. Polymer PV modules have now reached 1 m² in size.

Polymer PV is now suitable for niche markets, and the only remaining barrier seems to be finding and exploiting a suitable commercial application. But although costs are bound to fall as the technology reaches the market, it is not clear when third-generation PV will be able to compete with silicon for mainstream electricity production, which demands stability under outdoor conditions for extended periods of time. Judging by the learning curve for traditional photovoltaics, however, the new technologies still have time before entering the market.

Conclusions

Grid-connected electricity from solar cells remains limited by the high cost of current PV technologies, coupled

with slow production speed and bottlenecks in the supplies of raw materials. This has not stopped the PV industry from growing rapidly and consistently over the past decade. New technologies that offer a solution to the problems of production speed and cost are emerging. These could quickly become winners, even though at the moment they are only suitable for niche applications.

Recommendations for Denmark

As a small country, Denmark has little chance of breaking into the field of traditional semiconductor-based PV. With the new third-generation PV technologies, however, a relatively small research effort could place Denmark in a leading position.

6.3.2 Solar thermal

PETER AHM, PA ENERGY LTD, DENMARK; FREDERIK KREBS, RISØ NATIONAL LABORATORY, DENMARK

By the end of 2004 about 110 million m² of solar thermal collectors were installed worldwide. Figure 24 illustrates the energy contribution from this technology, using the IEA's recently-adopted conversion factor of 1 m² ≈ 0.7 kW_{th}. About 25% of this area is unglazed collectors, mainly serving swimming pools. The remaining 75% comprises flat-plate and evacuated-tube collectors, predominantly for hot water and space heating. The average annual market growth rate has been 17–20% in recent years.

The most dynamic market areas are China and Europe. By 2004 China had about 65 million m² of installed capacity, corresponding to 50 m² per 1000 inhabitants. At the same time the EU had about 14 million m² installed capacity, with wide variation from country to country. The leaders are Greece and Austria, each with some 260 m²/1000 inhabitants, while Denmark has about 60 m²/1000 inhabitants. Israel probably has the highest penetration of solar thermal installations, with about 740 m²/1000 inhabitants.

In absolute terms the European solar thermal market is dominated by Germany (~50%), followed by Greece and Austria (~12% each). Europe's present solar thermal capacity provides around 0.15% of the overall EU requirements for hot water and space heating.

Used predominantly for hot water and space heating, solar thermal units are typically mounted on roofs. They are quite visible, and this has encouraged the development of their architectural qualities as well as their technical performance.

The EU goal for solar thermal units is 100 million m² by 2010. However, with the present market trends only about 40 million m² is likely to be reached by 2010. In general, costs per unit area decrease with the size of the

system. Solar thermal systems connected to a district heating network are therefore more cost-effective than systems for single family houses.

Solar thermal systems traditionally include short-term hot water storage capacity in the range 50–75 l per m² of collector. Seasonal storage of around 2,000 l per m² has been investigated, but is still considered to be at the R&D stage.

A relatively new market for solar thermal units is industrial process heat. Low-temperature process heat, in the range achievable by traditional solar collectors, is needed in many industries (Table 6) [1, 2, 3].

Industrial sector	Process	Temperature (°C)	
Food and beverages	drying	30– 90	
	washing	40– 80	
	pasteurizing	80– 10	
	boiling	95–105	
	sterilizing	140–150	
	heat treatment	40– 60	
	Textiles	washing	40– 80
		bleaching	60–100
Chemicals	dyeing	100–160	
	boiling	95–105	
	distillation	110–300	
All sectors	various chemical processes	120–180	
	pre-heating of boiler feed water	30–100	
	space heating	30– 80	

Table 6. Process heating applications for solar thermal collectors.

Figure 24. Global installed solar thermal heating capacity (2001).

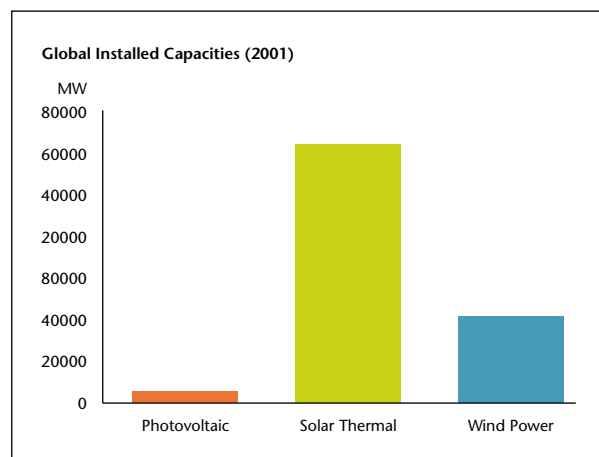

Conclusions

Solar thermal heating is a long-established technology for space heating and domestic hot water. New applications are emerging for industrial processes, where solar energy could replace fossil fuels or electricity.

Recommendations for Denmark

Research into process heating would show whether solar thermal collectors could be profitable in this area. This work should be within the competence of the existing solar thermal industry.

6.4 Hydro, ocean and geothermal

JØRGEN FENHANN AND HANS LARSEN, RISØ NATIONAL LABORATORY, DENMARK

This chapter gives an overview of the development of other renewable energy technologies such as hydro, ocean and geothermal. These technologies are making important contributions to energy supply in selected areas of the world, but only ocean power and geothermal energy are relevant to Denmark.

Hydro

Hydro has little potential in the low lying terrain of Denmark. At present, OECD and non-OECD countries produce roughly equal amounts of hydroelectricity (Figure 25). Little growth is expected in OECD countries, where most hydro potential has already been realised: on average, capacity has increased by 0.5% annually since 1990. The OECD nations produced 1343 TWh of hydroelectricity in 2003; the largest hydropower generating countries were Canada (338 TWh), the USA (306 TWh) and Norway (106 TWh).

Large hydro remains one of the lowest-cost power technologies, although environmental constraints, resettlement impacts and the limited availability of sites have restricted further growth in many countries. Large hydro supplied 16% of global electricity in 2004, down from 19% a decade ago. Large hydro capacity totalled about 720 GW worldwide in 2004 and has grown historically at slightly more than 2% annually. China installed nearly 8 GW of large hydro in 2004 to become number one in terms of installed capacity (74 GW) [2]. With the completion of the Three Gorges dam project, China will add some 18,200 MW of hydro capacity in 2009 [1].

Small hydropower has developed worldwide for more than a century. More than half of the world's small hydropower capacity of 61 GW is in China, where an ongoing boom in small hydro construction added nearly 4 GW of capacity in 2004. Other countries with active

efforts include Australia, Canada, Nepal, and New Zealand.

Small hydro is the second most popular project type in the global Clean Development Mechanism (CDM) pipeline. 169 out of the 996 projects in the pipeline (as of 9 August 2006) are hydro projects. Table 7 shows that most of these projects are in Brazil, India and China.

Hydro CDM projects		
Country	MW	Projects
Brazil	1042	28
India	627	45
China	1001	32
Peru	183	4
Chile	182	3
Guatemala	153	7
Bolivia	119	3
Vietnam	70	3
Mexico	68	4
Others	342	40
All developing countries	3787	169

Table 7. Hydroelectric projects in the CDM pipeline, and their capacity by host country.

Ocean

Tidal

Tidal energy is driven by the gravitational pull of the moon. The only large, modern example of a tidal power plant is the 240 MW La Rance plant built in France in the 1960s. An 18 MW tidal barrage system was commissioned in 1984 at Annapolis Royal in Nova Scotia, Canada, and two systems of about 0.5 MW each have been built in Russia and China. Numerous studies have been completed for potentially promising locations with unusually high tidal ranges, such as the 8.6 GW scheme for the Severn estuary in the UK, but no decision has been made to build these [3].

However, the first tidal CDM project has now been registered by the Executive Board of the CDM, and is therefore listed on the UNFCCC CDM website at www.unfccc.int. This is the 254 MW Sihwa Tidal Power Plant project on the west coast of South Korea. Electricity will be generated by the seawater flowing into Sihwa Lake, an artificial body of water behind an embankment. The mean difference between the high and low water levels is 5.6 m. The plant will consist of 10 one-way-flow bulb turbine generators, and the total projected amount of electricity produced will be 553 GWh/year.

Figure 25. Regional share of hydroelectricity production in 2003. [1]

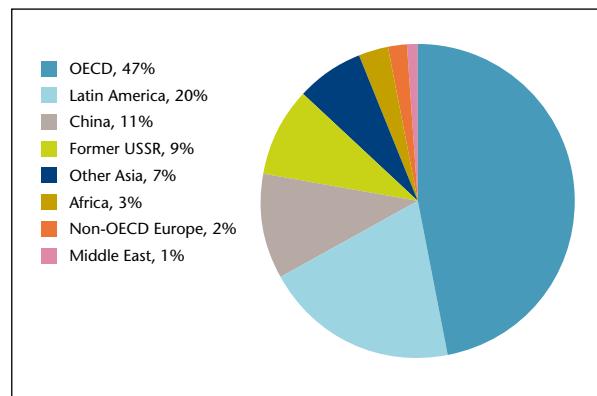

6.4

Wave

Wave energy can be seen as stored wind energy, and could therefore form an interesting partnership with wind energy when there is a need for energy storage. Wave power could in the long term make an important contribution to the world's energy demand, if it can be developed to the point where it is technically and economically feasible. A potential 2000 TWh/year, or 10% of global electricity consumption, has been estimated, with predicted electricity costs of €0.08/kWh [4].

The oceanic wave climate—the waves found far offshore—offers enormous levels of energy; power levels vary from well over 60 kW per metre of wave front in the North Atlantic to around 20 kW/m at the foreshore (Figure 26) [3].

There are two categories of wave power plants: onshore and offshore. In Denmark, the relatively flat coast means that only offshore installations are interesting. These in turn can be grouped into five main classes: Point absorber, line absorber, overtopping plant, oscillating water column and turbine systems.

Since 1973 there have been development initiatives and programmes for wave power in the UK, Japan, the USA, Portugal, Norway, Sweden, and Denmark. At present, the front runners are Portugal and the UK.

The world's first commercial wave farm project is being installed during 2006 off northern Portugal. It consists of three 750 kW Pelamis wave energy converters, each 120 m long and 3.5 m in diameter, from Ocean Power Delivery in Scotland. This 2.25 MW scheme will be the first stage of a planned 24 MW plant.

This first project was located in Portugal because the Portuguese government has put in place a feeder market

Figure 26.

Wave power levels (kW/m of crest length) in European waters [4].

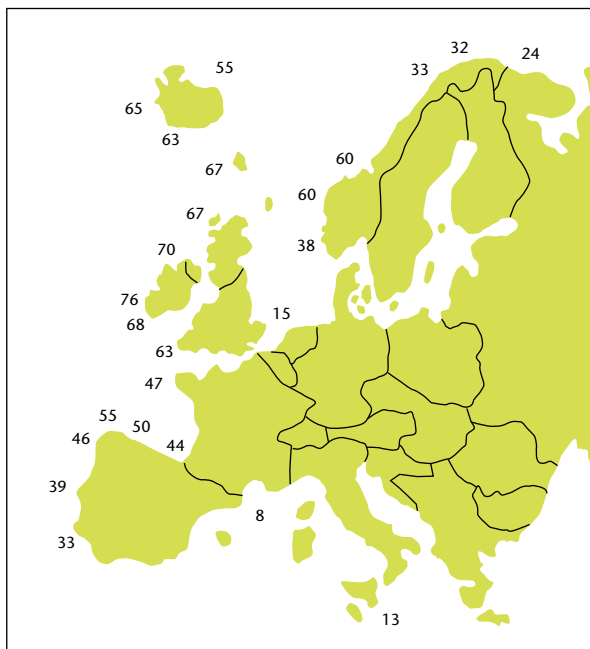

Figure 27: The Wave Dragon, a Danish wave power device.

that pays a premium price for electricity generated from waves compared to more mature technologies such as wind power [5]. A full-scale prototype has been tested at the European Marine Centre (EMEC) in the Orkney Islands. In addition to the wave test facility, which started in 2003, a tidal test facility is now being built on Orkney.

The UK has made R&D grants available for wave power. A recent report [6] concludes that wave and tidal energy could provide 20% of the UK's current electricity needs. The report says that wave power could be cost-competitive with conventional generation in the long term—once several hundred MW of capacity has been installed—providing the right level of investment is made now.

The Wave Dragon is a wave power device developed in Denmark. It has been tested in Nissum Bredning since 2003 as a 1:4.5-scale prototype. The first full-scale version (4–7 MW) is expected to be built in Wales in 2007 as a first part of a 77 MW plant.

Geothermal

There are at least 76 countries using geothermal heating and 24 countries producing electricity from geothermal energy. The present installed generating capacity of more than 8900 MWe produces 56.8 TWh/year (0.3% of global electricity production) and is growing at around 20% annually. Over 10,000 MW of proven resources are not yet utilised. In developed countries, most of this unused geothermal capacity exists in Italy, Japan, New Zealand, and the USA [2].

There are now six geothermal projects in the CDM pipeline with capacities in the range of 20–110 MW, with a total capacity of 323 MWe. The JI pipeline contains four projects, one of these has a generating capacity of 39 MWe and the other three are heating projects.

Geothermal heating capacity nearly doubled between 2000 and 2005, representing an increase of 13 GW_t. Iceland is leading internationally in geothermal heating, which supplies some 85% of the country's space-heating needs. About half of the existing geothermal heat

6.4

capacity exists as geothermal heat pumps. These are increasingly used to heat and cool buildings, with nearly two million heat pumps installed in over 30 countries [2]. This is also the way geothermal energy is used in Denmark.

Future perspectives

Table 8 shows the growth in installed generating capacity of the energy sources covered in this chapter. Historically, this capacity—primarily from hydro—has grown at about 15 GW per year [7], and this rate is expected to continue until 2030 [8]. The growth of geothermal power is high, but starting from a low value, while tidal and wave power were just beginning to be visible by 2003.

GW	1972	1990	2005	IEA 2030, Ref.
Hydroelectricity	312	646	862	1216
Geothermal electricity	1	6	9	25
Tidal and wave power	0	0.3	0.3	9

Table 8. Installed capacity (GW) of hydro, ocean and geothermal power.

Conclusions and recommendations

For Denmark, hydropower and geothermal energy have only niche applications. Denmark has been active in developing wave power technology, in the form of the Wave Dragon, but to give Danish industries a chance to share in the coming wave power market, government support is needed. Denmark could also contribute to the development of geothermal heating technology. For all the technologies discussed here, Danish manufacturers and consulting firms should have ample opportunities to contribute to CDM projects around the world.

7 Renewable-based fuels for transport

WARREN E. MABEE, JACK N. SADDLER, UNIVERSITY OF BRITISH COLUMBIA, CANADA; CHARLES NIELSEN, DONG ENERGY, DENMARK; LARS HENRIK NIELSEN AND ERIK STEEN JENSEN, RISØ NATIONAL LABORATORY, DENMARK

Introduction

By 2030 the European Union and the USA plan to meet 25–30% of their transport fuel needs with sustainable and CO₂-efficient renewable biofuels [20, 21]. The aim is to increase energy security, decrease CO₂ emissions and create new opportunities for biomass providers and the biofuel processing industry. This chapter describes existing and future technologies for renewable fuel production.

First-generation biofuels

Most “first-generation” biofuels are made using commercial processes that have already been widely adopted by industry, and the raw materials come from agriculture and food processing. These raw materials include vegetable oils, sugars, and starch available in excess of food demand, and residues from food processing or consumption. The availability of feedstocks is partly a consequence of the “green revolution”, which saw crop returns increase dramatically in the 1960s and 1970s. The overall potential of first-generation biofuels to contribute to renewable fuel demand is limited by crop ranges, climate, and current and future nutritional demands [1].

Vegetable oils

Vegetable oils, which contain fatty acids and glycerides, come from the seeds of plants including soybeans, oil palm, oilseed rape, and sunflower. Production stages include cleaning and drying the oilseed, pressing, filtration, and refining. Worldwide production of vegetable oil was about 90 million tonnes in 2000 mainly for edible purposes.

Vegetable oil may be used as a fuel in unmodified diesel engines, but low temperatures can cause the oil to congeal, clogging the filters and injectors (particularly when the engine is stopped with vegetable oil still in the system). Contamination of the lubricating oil by uncombusted fuel entering the sump can result in gel formation over time. Modified diesel engines have different fuel injectors and fuel preheating to overcome this problem; some commercial kits are available for this purpose in Germany [2]. These technologies have not been employed on a large scale, in part because the cost to consumers is higher than other fuels. Specialised uses, including fuel for tractors in agricultural settings, are considered where oil might be processed locally at a lower cost by avoiding distribution, but at the risk of a range of quality if produced on a small scale [3].

Biodiesel

Converting vegetable oils to biodiesel is a common approach to overcome the problems with direct use of vegetable oils. Interesterification of the glyceride molecule using an alcohol, usually methanol, produces esters with properties similar to mineral diesel and some glycerine by-product. Usually as a methyl ester biodiesel can be used in any diesel engine with little or no modification, and sold as a blend with petroleum-based diesel fuels. As the name implies, this fuel is made through a transesterification process, in which methanol is reacted with glycerides to produce glycerin and methyl esters. Biodiesel may also be made using other processes, including dilution of raw vegetable oils with conventional diesel as a way to reduce viscosity, or through a micro-emulsion system [5].

Vegetable oil may be used as the basis for biodiesel production; it has the advantage of being relatively low in saturated fats compared to animal fats. The most common feedstock for biodiesel is rapeseed, although sunflower, palm and soybean oils are also widely used. Vegetable-oil-based biodiesel is more commonly found in Europe, where fuel taxation policies have prompted more development of diesel alternatives, and where agricultural subsidies can be used to ensure oilseed supplies for production.

Residues including animal fats derived from rendering may also be used to make biodiesel; this is particularly important as the waste from these operations may be a vector for the transmission of dangerous disease, such as bovine spongiform encephalopathy (BSE). Waste cooking oils, which may be either vegetable or animal-based, can also be recovered from industrial deep fryers and used for fuel production. The primary advantage of these feedstocks is their lower cost, but they may contain relatively high levels of impurities.

Biodiesel is a commonly used biofuel with global production levels at about 2.7 billion litres per year. Most production capacity is found in Europe; Germany is the world’s largest producer (>1.2 billion l/year), followed by Italy and France [4]. Uptake of biodiesel in North America has been slower, due to fuel taxes that favour gasoline engines over diesel engines, and thus limit consumer demand for renewable diesel alternatives.

Bioethanol

Bioethanol is most commonly produced by fermenting simple sugars from biomass. Brazil has historically dominated global bioethanol production from sugarcane, but in recent years the USA has added significant capacity

7

from maize and now matches Brazilian output. Canadian and European production has climbed as well, but is constrained by feedstock availability. Asian production, primarily in China and India is also increasing, mainly from rejected food crops. Worldwide production of bioethanol was about 36 billion litres in 2005.

Sugar-based bioethanol

The most basic feedstock for bioethanol production is simple sugars from sugar cane or sugar beet. Brazil is in the lead internationally in the production of sugar-based bioethanol, with capacity of about 15.7 billion litres [6]. This fuel accounts for about 40% of domestic consumption, and is sold in blends of about 22–24% ethanol. Production in Brazil was initially driven very much by a domestic fuel policy designed to reduce the purchase of foreign oil; in recent years it has been driven by the expansion of export markets for ethanol and rising world oil prices [7].

The production of sugar-based bioethanol involves four steps, including a pretreatment in which the sugar cane or sugar beet is chopped, shredded, and crushed to release the sucrose. A fractionation stage separates the sucrose from the lignocellulosic residues (e.g. bagasse from sugarcane), and breaks down the sucrose into glucose and fructose. These C6 sugars are then fermented to ethanol using commercial yeasts, and the ethanol is concentrated by distillation. Increases in productivity are mostly related to improving the production of sugar cane per hectare. Since 1975, productivity has risen by about 60%, to 80 tonnes/ha, which yields about 17,600 litres of ethanol (about 220 litres per tonne) [8].

Starch-based bioethanol

Another source of simple sugars for fermentation to bioethanol is starch, a storage molecule primarily found in cereal crops, including wheat and particularly corn (maize). The USA has a large corn-based bioethanol industry with a capacity of over 15 billion litres per year; production capacity is anticipated to continue rising to about 28 billion litres per year by 2012, as dictated by the Energy Policy Act of 2005 [9]. In the USA, bioethanol is most commonly blended at 10% with gasoline (“E10”), and accounts for about 1.5% of fuel demand.

The production of bioethanol from starch requires an extra step in which the starch is hydrolysed to liberate glucose. Commercially this step is carried out using enzymes. The starch-based ethanol industry has been commercially viable for about 30 years; in that time, tremendous improvements have been made in enzyme efficiency, reducing process costs and time, and increasing ethanol yields [10].

ETBE

Ethyl tertiary-butyl ether (ETBE) is used as a fuel oxygenate in gasoline, as also are methyl tertiary-butyl ether (MTBE) and ethanol. Bio-based ETBE is produced

by mixing bioethanol and isobutylene over a catalyst. MTBE is seen to be toxic so it is being phased out worldwide. The primary difference between ethanol and ETBE is that the latter is insoluble in water, so it does not present the issues with water contamination that can cause problems when blending and transporting ethanol-gasoline blends [9].

Bio-oil

A final commercial option for biofuel production is bio-oil, which is generated through the thermochemical conversion of biomass. Using this platform, the only pretreatment required involves drying, grinding, and screening the material so that it can easily be fed into the reactor.

In the primary processing stage, the volatile components of the biomass are subjected to pyrolysis—combustion in the absence of oxygen—at temperatures of 450–600°C. If this is carried out quickly (“fast pyrolysis”), it produces a mixture of vapours, condensable vapours and char. Condensation of these products creates a bio-oil, which under ideal conditions can make up 60–75% of the original fuel mass. The oil produced is transportable and can be used as feedstock for value-added chemical products, or possibly as a biofuel [11]. While not yet commercially viable, some research has explored a micro-emulsion process that allows bio-oil to be mixed with conventional diesel [12].

Biogas

Biogas can be used as a transport fuel in engines suitable for compressed natural gas (cng) but will first need to be scrubbed to remove H₂S and CO₂. Anaerobic fermentation of organic waste, animal manures, crop residues and energy crops can produce biogas, a mixture of gases including methane, CO₂ and H₂S. After upgrading by scrubbing out the CO₂ and H₂S and compression to 200 bars, it can be used as an engine fuel. Many thousand cars e.g. in Sweden are fuelled by biogas. Biogas production in agriculture can contribute to diversification of the agricultural sector business, while nutrients in animal manures are recycled to cropping systems with less impact on the environment. In Europe there seems to be an increasing interest in developing an integrated process for bioethanol and biogas production from crop residues and energy crops, using pretreatment of the biological resources to improve conversion efficiency [22].

See also Section 6.2.

Second-generation biofuels

Second-generation biofuels are derived from non-food feedstocks, including lignocellulosic biomass, and may be used within existing infrastructure, including distribution networks, filling stations, and vehicles, with a minimum of modification. Two transformative technologies, both on the verge of commercial viability, are currently

7

being explored for the production of second-generation biofuels: 1) bioconversion systems that can isolate the building-block chemicals of wood, straw, and vegetative grasses, and 2) advanced thermochemical systems that reduce lignocellulosic materials to their most basic gaseous components through pyrolysis or gasification.

Bioconversion platform

The bioconversion platform, already used in the production of starch-based bioethanol, may be modified to produce ethanol from lignocellulosic materials such as wood, crop residues and household waste. Process stages include pretreatment, fractionation, enzymatic hydrolysis, fermentation and distillation.

Pre-treatment is needed to expose the cellulose and hemicellulose and increase the surface area of the substrate so that it can be attacked by enzymes. To improve the effectiveness of the pretreatment stage, a number of non-traditional pulping techniques are being examined by a consortium of Canadian and US researchers [13]. Some have observed that different pretreatments seem to be better suited to different types of lignocellulosic feedstocks [1]. In the EU-funded IBUS project (Figure 28), a pre-treatment plant using hydrothermal technology can process 1 tonne/hour of straw [19].

Once pretreated, the cellulose and hemicellulose components can be hydrolyzed. Almost all commercial hydrolysis systems today use enzymes to facilitate fast, efficient, and economic bioconversion of the wood. Enzymatic hydrolysis of lignocellulosics uses cellulases, most commonly produced by fungi such as *Trichoderma*, *Penicillium*, and *Aspergillus* [14]. A cocktail of cellulases is required to break down cellulose into its carbohydrate components. The enzymatic hydrolysis step may be completely separate from the other stages of the bioconversion process, or it may be combined with the fermentation of carbohydrate intermediates to end-products [1,14,15].

Ethanol production from cellulose requires both C6 and C5 sugars to be fermented. While C6 fermentation is well understood, significant research challenges remain in achieving commercial C5 fermentation on realistic substrates. It is estimated that ethanol yields from lignocellulosics will be in the range 0.12–0.32 l/kg of undried feedstock, depending upon the efficiency of C5 sugar conversion [15–17].

One of the advantages of bioconversion with lignocellulosics is the opportunity to create a biorefinery, producing value-added co-products plus fuel ethanol. For instance, sugars may be subjected to bacterial fermentation under aerobic and anaerobic conditions, producing a variety of other products including lactic acid, which in turn may be processed into plastics and other products. The non-carbohydrate components of lignin also have potential for use in value-added applications.

Thermochemical platform

The thermochemical platform, already discussed above under bio-oil, may be used to create a number of second-generation liquid biofuels, including synthetic diesel. If pyrolysis is carried out at a slower rate (“slow pyrolysis”), the vapours that form are less likely to condense into bio-oil. The vapours themselves consist of carbon monoxide, hydrogen, methane, carbon dioxide and water (collectively known as syngas), as well as volatile tars and a solid residue of char, which comprises about 10–25% of the original fuel mass. Processing this material requires a second gasification stage at temperatures of 700–1200C, during which the char oxidises to carbon monoxide [12,18].

After the production of syngas, a number of pathways may be followed to create second-generation biofuels or other chemical, heat, or energy products.

Significant technical hurdles remain in creating second-generation biofuels through the thermochemical platform. These include syngas cleanup, char accumulation, and catalyst inhibition. Raw syngas must be cleaned up in order to remove inhibitory substances that would inactivate the catalyst. These include compounds containing sulphur, nitrogen or chlorine, as well as any remaining tars.

Lignocellulosic materials are already used for direct combustion in combined heat and power plants. Thus second-generation technologies for biofuels will most likely increase the competition for feedstock. In integrated concepts, such as the IBUS biorefinery [19] the sugars are used for biofuel and then lignin and other residues are used as a fuel in the CHP, which are likely to improve the energy and CO₂-balances of the technology.

Methanol

Methanol is a potential biofuel that can be generated from syngas, although most methanol today is derived from natural gas. Methanol has a high octane number (129) but a relatively low specific energy content (about 14.6 MJ/l) compared to gasoline (91–98 octane, 35 MJ/l). Conceivably, methane could be used as a stand-alone fuel, although this would require significant infrastructure changes as well as modifications to conventional engines. Because methanol has a favourable hydrogen:carbon ratio (4:1), it is often touted as a potential hydrogen source for future transport systems.

Fischer-Tropschs (biosyn) diesel

Another biofuel that can be produced through the thermochemical platform is Fischer-Tropsch (FT) diesel (biosyn diesel). This fuel was first manufactured in 1923 and is commercially based on syngas made from coal, although the process could be applied to biomass-derived syngas. The process of converting CO and H₂ mixtures to liquid hydrocarbons over a transition metal catalyst has become known as FT synthesis. Most existing production of FT diesel was carried out in South Africa, in part

7



Figure 28. The Integrated Biomass Utilisation System (IBUS) for pre-treatment and processing of lignocellulosic materials can process 1 t straw/hour based on hydrothermal treatment. Photo: Elsam.

because the country was under UN trade sanctions for many years and had no available source of petroleum for fuel production.

DME

Dimethylether (DME) is for diesel what LPG is for gasoline. It is gaseous at ambient conditions but can be liquefied at moderate pressure. As a fuel for diesel engines it has very attractive characteristics, burning very cleanly and producing virtually no particulates. DME is therefore favoured by vehicle manufacturers as a replacement for diesel.

DME can be produced from biomass with better energy and GHG results than other biofuels.

The pulp and paper industry may provide a promising route for making significant amounts of DME from woody material. This is the so-called “black liquor” route. Black liquor is a by-product of paper pulping that contains the lignin part of the wood. It is commonly used as an internal fuel to power the paper mills. Through gasification

of the black liquor rather than simple burning one can generate syngas and therefore synthetic fuels. DME being the sole product, the yield of the fuel is high.

The energy balance of the paper mill must then be re-established by burning additional waste or low value wood. The net result is production of synthetic fuels from wood at a very high combined efficiency. If all Swedish pulp plants used black liquor gasification the production of DME could replace 25% of the present fuel demand in the domestic transport sector.

Third-generation biofuels

A third generation of biofuels may eventually become viable. An example of these might be the production of renewable bio-based hydrogen for use in fuel-cell vehicles, perhaps from a methanol or bioethanol carrier. Third-generation biofuels are based on technologies that have not yet been commercialised. They will most likely require new infrastructure, including distribution networks, filling stations, and vehicles, and they will certainly need significant technical and political support during their introduction and uptake by consumers.

Research needs and recommendations

Significant process developments and scale-up are required before second-generation technologies can be commercialised. This involves developing pre-treatment technologies with lower energy use, detoxification of hydrolysates, and creating micro-organisms that can ferment xylose and arabinose efficiently.

Analyses and forecasts of the availability of biological resources for conversion to renewable fuels are required at the domestic and regional scales. In the longer term, biofuels are likely to be produced in biorefineries which could make efficient use of the complete biomass feedstock resource. Biorefineries would use a variety of conversion technologies, including biochemical and gasification technologies, to create a range of bio-based products.

Biofuels can help to reduce greenhouse gas emissions, although in some cases only slight reductions, from the transport sector, increase the security of supply, and enhance innovation and development in agriculture and its associated industries. There seems to be a global political interest in making biomass a significant resource within the energy supply sector in the coming 10–20 years but the cost of achieving this may well be high in some regions.

8 New and emerging technologies for renewable energy in the transport sector

GIOVANNI PEDE, ENEA, ITALY; ALLAN SCHRÖDER PEDERSEN AND MOGENS MOGENSEN, RISØ NATIONAL LABORATORY, DENMARK

Energy consumption for transport accounts for approximately 20% of all energy used worldwide [1], and approximately 25% in many OECD countries like Denmark [2]. Energy for transport is currently supplied almost exclusively by oil. Concern over the carbon dioxide emissions associated with this use of energy, rising oil prices and future security of supply have created strong efforts to find new transport technologies and fuels based on renewable energy sources.

Primary renewable energy sources and their conversion

With the prominent exception of biomass, renewable energy resources—solar, wind, ocean, hydro—and nuclear power produce their energy mainly in the form of electricity. This means that if we want to decouple transport from the use of fossil fuels, we must find ways to use electric energy in vehicles.

Electric trains are a good example of electricity use in transport. Since trains get their electricity from wires, however, this solution is not generally acceptable for other forms of transport.

Energy storage

Fossil fuels happen to be excellent energy stores in terms of energy density, measured on both volumetric and gravimetric bases. Until now it has proven extremely difficult to develop artificial energy stores with performance data—price, energy density and speed of loading and unloading—comparable to gasoline (Table 9). Nevertheless, this is a problem that has to be solved if we are to use renewable energy in the transport sector.

System	kJ/ml	kJ/g
Hydrogen, gaseous at 200 bar	2.4	141.0
Hydrogen, liquid	10.0	141.0
Complex hydride	16.9	17.0
Methanol	18.0	22.7
Gasoline	33.4	47.6
Advanced battery	0.5	0.7
Liquid ammonia	17.9	25.2
Flywheel	0.25	0.5

Table 9. Energy densities of different energy storage systems. The numbers are based on higher heats of combustion and do not include the weight or volume of containers and system components.

Hydrogen

Hydrogen is an effective way to store electricity because it can be produced directly by the electrolysis of water. Low-temperature electrolysis, mainly based on aqueous electrolytes, has been used widely for industrial production of hydrogen, and the technology is commercially available with conversion efficiencies of about 70%. New high-temperature systems based on solid ceramic electrolytes are under development, and may lead to even higher efficiency. In addition, high-temperature water electrolysis in the presence of CO₂ also seems to show potential for producing hydrocarbons for use as a green synthetic fuel.

Batteries

Batteries, especially those based on lithium-ion technology, have improved greatly in recent years. In terms of energy density, though, batteries are still at least an order of magnitude below hydrocarbons and advanced hydrogen storage technologies. On the other hand, batteries have other attractive features, notably the direct loading and unloading of electricity.

Road transport

Car manufacturers all over the world are running development programmes aiming at fuelling vehicles by renewable energy. For the long term, most companies are betting on hydrogen in combination with fuel cells, although some, including BMW, are also working on internal combustion engines using hydrogen as fuel. In the shorter term, several car manufacturers have already marketed so-called hybrid cars using both electric motors and gasoline engines. These show considerably better fuel economy than traditional cars.

Hybrid vehicles

Hybrid vehicles are based on dual traction technology, as illustrated by the Toyota Prius. This combines a low-power gasoline engine (57 kW for a total vehicle weight of 1300 kg) with a 50 kW electric motor coupled to a 6.5 Ah 200–300 V hydride battery system [3]. The excellent fuel economy of the Prius (4.3 l/100 km in the European combined cycle) is a consequence of the small gasoline engine and the use of energy released during deceleration to charge the battery.

All the hybrid buses designed to date can charge their batteries from the mains as well as by using the vehicle's own internal combustion engine. This kind of hybrid is called a "charge depleting" or "plug-in" design [4], and

8

their use has been proposed in the USA to help balance the load on the electric grid. Charging the battery from the mains is also a way to use the renewable power component of the grid as a transport fuel.

In 2005, Toyota exhibited a concept house in Japan that included a plug-in Prius [3]. The house was designed to be able to use the Prius as its sole energy source for up to 36 hours in emergencies, and to recharge the car as needed. At the time, Toyota said it expected such technologies to be in use by 2010.

Fuel cells

The internal combustion engine (ICE) is not very efficient at converting chemical energy (fuel) into mechanical energy (traction). As a result, there is great interest in using fuel cells in ordinary cars. Fuel cells typically show chemical to mechanical energy conversion efficiencies close to 50% of the heat of combustion of the fuel, which is considerably more than the efficiency of an internal combustion engine.

The type of fuel cell that is most obviously suitable for cars is the low-temperature design, which is based on a polymer electrolyte with platinum electrodes. It has been calculated that the known reserves of platinum are not enough to provide fuel cells for every car in the world. However, strenuous R&D efforts are going on to develop new, cheaper and more abundant electrode materials for low-temperature fuel cells, and this may create a breakthrough in the transport market.

Today's high-temperature fuel cells (solid oxide fuel cells or SOFCs) operate at around 650C, which is too high to allow SOFCs to act as the only conversion technology in ordinary cars. It would simply not be possible to start the car without keeping the SOFC at high temperature whenever the vehicle was stationary, and this would be an extravagant use of energy. However, SOFCs may well be used in cars for non-traction auxiliary power units, which have already been demonstrated in sizes up to 5 kW units by companies like Delphi. SOFCs could also be used for trucks and buses that effectively keep running continuously.

Batteries

As mentioned above, batteries have a rather low energy density compared to liquid fuels. Cars powered solely by batteries suffer from serious range limitations, and this is one reason why battery cars have never obtained a significant market share. This situation is unlikely to change in the foreseeable future, but hybrids and plug-in hybrids may provide a growing market.

Biofuels

Biomass can readily be used to produce gaseous as well as liquid fuels. Liquid biofuels like bio-methanol, bio-ethanol and bio-diesel are attractive because they can be used more or less directly in the existing transport infrastructure, including fuel distribution system and engine technology.

One tonne of biomass produces only 200–250 litres of ethanol. This means that biomass will not be able to cover the total current demand for transport fuel, at least not in countries like Denmark. Biofuels may, however, be a good and straightforward way to introduce a percentage of renewable energy into the transport sector. This is especially true if the biomass in question is a waste product such as straw, instead of a purpose-grown energy crop.

Energy efficiency in the transport sector

Energy should be distributed and used with the highest efficiency. The transport sector is no exception.

A problem with biofuels is that they are less energy-efficient than conventional ones. The reason is that synthesis of biofuels requires considerably more energy than producing fossil fuels from crude oil. A positive factor is that the biomass-to-liquid processes involve very little fossil energy and therefore produce little GHG emissions because the synthesis processes are fuelled by the biomass itself.

A way to both improve the energy efficiency and reduce GHG emissions in the transport sector is to use electricity from renewable sources, e.g. hydro, wind and solar. Pending further development and cost reductions of

Table 10. A selection of railway fuel cell projects.

Country	Participants
Japan	JR East; Hitachi; Tokyu Car Corporation; Railway Technical Research Institute of Tokyo
USA	Vehicle Projects LLC of Denver; US Army Research, Development, and Engineering Command's National Automotive Center
France	French Transport Ministry; Alstom; SNCF
Italy	Trenitalia; ENEA; University of Pisa; others
Denmark	VLJT–Lemvigbanen; H2 Logic; HIRC; Teknologisk Institut

8

lithium-ion batteries the plug-in hybrid is a natural next step. With a 100 kg lithium-ion battery the range is 50–80 km without recharging and the fuel economy would be twice that of existing hybrids. In addition zero emissions in urban areas are achieved.

Hydrogen is often mentioned as the future energy carrier in the transport sector. But in comparison with using renewable electricity directly via batteries and the alternative to produce hydrogen for fuel cells the direct use of electricity gives 4–5 times better energy efficiency. This is why the hydrogen economy is questioned [6].

Rail transport

The railway sector has several opportunities to reduce its environmental impact through the use of renewable energy. One of the most promising areas is fuel cells which, as with road vehicles, offer clean and efficient energy without sacrificing performance.

Many fuel cells are powered by hydrogen, and the need for safe, efficient and cost-effective hydrogen storage is currently a significant problem. Trains have fewer weight constraints than cars, though, and much more room for hydrogen storage vessels. The need for a hydrogen infrastructure and specialist maintenance should also be easier to solve in a railway system than in the automotive sector.

For a standard railcar, the required daily range of 350–400 km could be achieved using high-pressure compressed hydrogen. For extended range, high-temperature fuel cells systems and on-board reformers to produce hydrogen from methanol or hydrocarbon fuels will probably be the best choice.

Some of the possible applications are:

- electric locomotives driven by high-power (8 MW) fuel cells;
- dual-mode (diesel and electric) commuter trains and light railways for cities and suburbs;
- shunting locomotives retrofitted with fuel cell power units to reduce noise pollution in urban areas;
- auxiliary power units (50–70 kW) for occasional use or emergencies;
- on-site hydrogen production, storage and distribution plants operated by the railways.

There are several projects on fuel cell applications in the railway sector (Table 10).

It has been estimated that a single 2 MW wind turbine could produce enough hydrogen to power four locomotives at 1,800 MWh/year each.

Marine and air transport

The application of renewable energy to ship propulsion is in many ways similar to the situation with trains. Weight, and to some extent bulk, are not generally an issue in marine transport, so there is no problem with on-board fuel storage. Iceland, which is a leader in hydrogen applications, has carried out many feasibility studies on converting the country's large fishing fleet from imported fossil fuels to hydrogen produced from clean domestic hydropower.

Hydrogen is an excellent rocket fuel and has been used in space programmes for decades. Hydrogen has also been used as a fuel for jet engines, and both American and Russian hydrogen-fuelled aircraft have flown. The idea of using hydrogen in aeroplanes dates back to the 1930s [5], when designers realised that hydrogen has the highest chemical energy density of any substance (Table 9). The high specific volume and price of hydrogen are probably the reasons that hydrogen has never been used commercially in air transport, but there is little doubt that a future hydrogen society will include hydrogen-fuelled aircrafts.

Summary and recommendations

Renewable energy is perfectly feasible for transport, as shown by the number of technologies considered here. Some of these, like the use of biofuels in internal combustion engines and wind energy for rail transport, are already commercial or nearly so, and more will follow. Renewable energy for transport will undoubtedly be more expensive than fossil fuels, at least in the short term. In the long term the opposite may be true, as fossil fuel prices might rise dramatically because of growing demand and depletion of resources. With this perspective, renewables will enter the transport sector purely through existing market mechanisms.

However, the introduction of renewables will be strongly facilitated by support through publicly-subsidised research and demonstration projects. Different forms of support will be needed for the various technologies, with their different levels of commercial maturity. Fortunately this point of view is reflected in many national support strategies, e.g. in Denmark

9 Technical challenges to energy systems' operation and markets

POUL SØRENSEN, PETER MEIBOM AND OLIVER GEHRKE, RISØ NATIONAL LABORATORY, DENMARK; JACOB ØSTERGAARD, TECHNICAL UNIVERSITY OF DENMARK

A future energy system that includes a high proportion of renewable energy will be expected to meet the same requirements for security of supply and economic efficiency as the energy systems of today, while delivering better environmental performance, especially with regard to CO₂ emissions. Security of supply refers to the long-term reliability of fuel supply; especially in power systems, it also covers short-term requirements for system stability and adequacy. Economic efficiency is concerned with getting the best from the significant amounts of money, human capital and natural resources involved in an energy system. Integral to economic efficiency in energy systems is the presence of well-functioning markets for energy services.

The variability and reduced predictability of a number of renewable energy sources, notably wind power, create specific challenges for future energy systems compared to those of today. Power transmission will also become an issue, as the areas with good potential for wind power and wave energy are often located some distance from the centres of power consumption.

This chapter describes the challenges involved, and possible solutions to these, with a focus on power systems. The chapter is divided into two sections reflecting the fact that some challenges relate to managing the power system in its normal operation mode, whereas others are specific to fault conditions.

Managing power systems in normal operation

Power control of wind power plants

Large wind farms such as the 160 MW Horns Rev and the 165 MW Nysted offshore wind farms in Denmark are connected to the transmission system, in that sense these wind farms are comparable to conventional power plant blocks.

To obtain the maximum benefit from an overall power system, wind power should be able to replace the operation of conventional thermal power plants, so that the fuel consumption and emissions can be reduced. To do this effectively, wind power plants need to be equipped with some major characteristics of conventional power plants.

One of these characteristics is the ability to control the amount and quality of the power produced. Modern wind turbine technologies make it possible to control both active and reactive power.

The possible power production from a wind power plant is obviously limited by the available power in the wind. Since there are no fuel savings the cost reduction of a wind farm is very limited if the produced power is reduced below the available power in the wind. Still, such reduced production can be beneficial in the overall system for periods where the market price of electricity is low or zero. In Denmark, this regularly happens in cold and windy periods. The electricity supply is increased in cold periods because the local CHP plants combine electri-

Figure 29. The general structure of a wind farm control system.

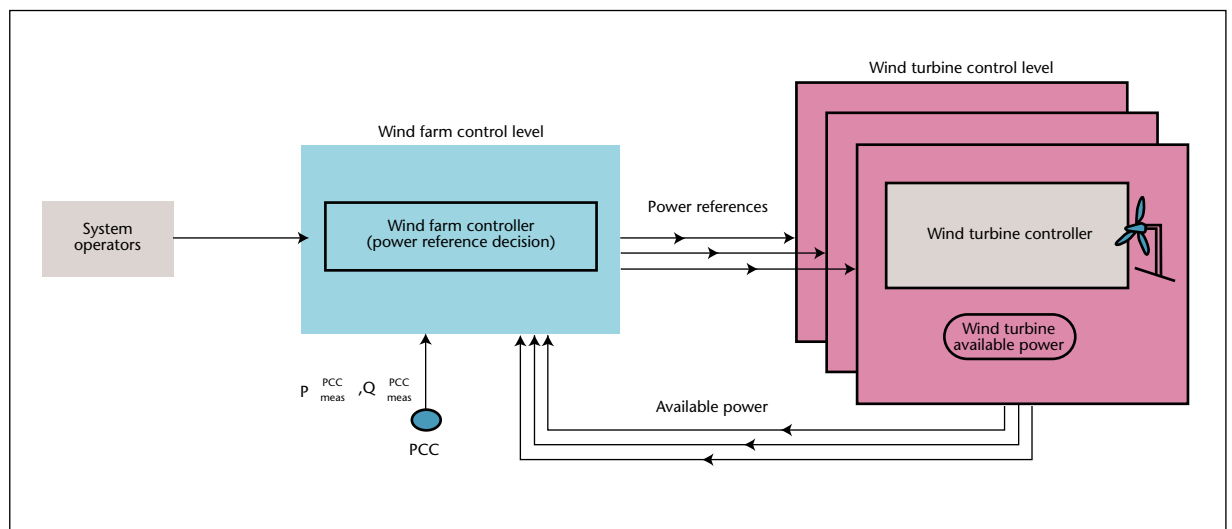

9

city and heat production to obtain maximum efficiency. Therefore, cold and windy periods result in high bound generation from wind turbines and local combined heat and power plants.

Horns Rev was the first large wind farm in Denmark. It is equipped with capable power control features, implemented through a wind farm main controller with remote access [1]. Similar control features are provided at Nysted. The wind turbine technologies used at Horns Rev and Nysted are quite different, so the two wind farms may differ in their dynamic response to control requests. Their power control behaviour is quite similar, however, and has now become part of the Danish Technical Regulations for wind farms connected to the transmission system [2].

Risø and Aalborg University have developed dynamic simulation models for wind farms. These models include wind farm controllers, individual wind turbine controllers, and the dynamics of the wind turbines themselves [3]. Figure 29 shows the general control structure of these models, which is similar to what is actually implemented in the large Danish offshore wind farms.

Requests from the power system operator or the wind farm owner are specified as input to the wind farm controller. The wind farm controller measures the characteristics of the power generated by the wind farm at the point of common coupling to the grid (PCC). It then controls this power by issuing instructions to the individual wind turbines, each of which has its own controller. The wind farm controller also receives information from the turbines about the maximum amount of power available.

Models have been developed for many different wind turbine technologies, taking into account different electrical design and control strategies. Thus, the models have a generic character, which allows them to represent specific wind farms in studies of power system stability and control. The models were developed using the Power Factory power system simulation tool, which means that they include the dynamics of the grid.

Power fluctuations and need for regulating power

A fundamental issue in the control and stability of electric power systems is to maintain the balance between generated and consumed power. This must be done with a relatively small time resolution, typically down to a few seconds.

Wind speeds and wave heights can vary rapidly, so the output power from a wind turbine or wave generator is characterised by short-term fluctuations. Large wind farms or wave power installations concentrated in relatively small geographical areas show a high degree of correlation between the power fluctuations from individual generators, and this causes large fluctuations in the total power produced by the installation. Distributing wind power production over a wider geographical

area has an overall smoothing effect, but the smoothing is less for large installations such as offshore wind farms concentrated in relatively small geographic areas.

An example of this is the experience of energinet.dk, the Danish transmission system operator, with the West Danish power system. Today more than 2,400 MW of installed wind power supplies approximately 20% of the electricity handled by the West Danish power system. Energinet.dk has found that the active power supplied by the first large offshore wind farm in this system, the 160 MW Horns Rev A, is characterised by more intense fluctuations in the minute range than previously observed from the dispersed wind turbines on land, even though Horns Rev A is small compared to the total wind power capacity in the system [4]. A neighbouring wind farm, the 200 MW Horns Rev B, is scheduled to be commissioned in 2008, and energinet.dk is concerned about how this will influence the ability to regulate power in the system.

Power fluctuations on a timescale of minutes are balanced by regulating power from generating plants that have a high degree of flexibility. The effect of power fluctuations from wind turbines on the need for regulating power should therefore be considered during long-term planning and cost optimisation, as well as in short-term planning such as the scheduling of maintenance.

To better quantify the power fluctuations from existing and future large wind farms, Risø and the Technical University of Denmark (DTU) are building mathematical models in cooperation with the large power producers Elsam and Energi E2. The models are being validated against measurements from Horns Rev A and Nysted. The measurements are comprehensive, based on a year's worth of data, sampled every second, on the wind speed and power measured at each turbine.

Figure 30 compares the power output from a large wind farm to that from a single turbine, measured over a two-

Figure 30. Power fluctuations from a single wind turbine compared to a large wind farm.

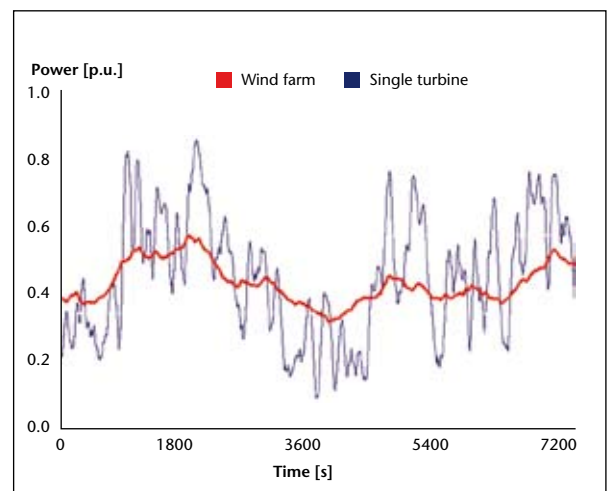

9

hour period. It shows that summing the outputs from many wind turbines effectively smoothes out fluctuations in the short term, but that over a rather longer timescale the fluctuations persist.

Risø's power fluctuation simulation models [5] simulate typical and worst-case fluctuations based on the geographical positions of the wind turbines. If the positions and ratings of all the individual wind turbines of a future wind farm are known, the models can be used to simulate how power fluctuations from the wind farm will affect the grid. Thus, the models can be applied to study the consequences of developing future wind farms on expected power fluctuations, taking into account the significant influence of the geographic distribution of the wind turbines.

The power fluctuation models are based on the wind speed fluctuation model developed by Sørensen et. al. [6]. This wind speed model uses a power spectral density (PSD) of wind speed to quantify the variability of wind speed measured at a single point, and a coherence function to quantify the correlation between wind speeds at different points. The coherence function is the key to quantifying the geographical smoothing effect, which explains why a 160 MW wind farm can contribute more power fluctuations than 2,400 MW of wind turbines distributed over a much larger area. Accurate quantification of the large-scale coherence effect is therefore essential to ensure reliable models.

If wave power generation proves commercially successful, wave power plants could be analysed in a similar way to wind farms. Since waves typically build up over a very large area, however, wave height is expected to vary over a considerably longer timescale than the minutes-long fluctuations seen in wind farms.

State estimation

With an increasing amount of power being generated by small, dispersed units connected to the distribution grid, the ability to obtain accurate information about the state of the power system becomes a key issue. Without better data, and the capacity to process it, the growing complexity of a distributed generation system becomes more and more of a burden, while its potential benefits, such as flexibility, remain difficult to harvest.

The life cycles of power transmission and distribution hardware—switches and circuit breakers, transformers, protection equipment, cables and lines—are measured in decades. While it is common for the latest generation of devices to provide remote monitoring and control services, the majority of units currently in service either completely lack these capabilities, or barriers such as vendor-specific communication and missing networkability reduce their usefulness. This is particularly severe at the lower voltage levels of the distribution system which are essentially invisible to system operators today.

Until a significant fraction of the older units have been replaced in the course of system development and main-

tenance—real-time information available through the system itself will be sparse. Distributed generating units could mitigate this problem, because their own controllers often measure system variables close to the grid connection point. Two new communication standards under development, IEC61400–25 for wind turbines and IEC62350 for distributed energy resources such as diesel generators, fuel cells and photovoltaic systems, are designed to provide access to these measurements in a standardised way.

New types of state estimators are required to integrate the different data sources into a coherent picture, to deal with continuity in a dynamic environment with many appearing and disappearing data sources, and to address issues related to the quality of data provided by power system end users, such as the owners of household CHP plants. To prevent bottlenecks and avoid creating new single points of failure in the face of a growing number of data sources, state estimation should be emancipated. From being a capability of the system operator's control room, state estimation must be built into the system itself to provide a true ancillary service that is jointly provided at different locations in the grid, in a distributed fashion.

State estimation forms the foundation for different types of higher-level services, such as real-time assessment of security margins, fault detection, and on-line calculation of market-relevant data, such as identification of transmission congestions. Detailed, locally generated state information is also a precondition for advanced power system implementations, such as self-islanding/cells or meshed distribution networks.

Demand response

The balance between generated and consumed power in a power system is maintained on an hourly timescale by the electricity spot market, and on a shorter timescale by various types of automatic or manual reserves provided by other markets. Consumption has a very low price-elasticity, and does in general not contribute to maintaining the balance of the system. Therefore, the generation system and cross-border exchange provide the needed flexibility and reserves.

Today's consumers are generally not provided with price signals from the markets, so they have limited chances to participate actively in keeping the balance. On the other hand, a wide range of loads—including electric heating, refrigeration, freezing and pumping—could potentially be moved from high-price to low-price periods at very low cost and without reducing service levels. Active participation of the demand side can thus provide a more efficient power system at lower cost.

Large scale development of wind power increases the need for active reserves in the system. First of all, reserves are needed to balance the wind power forecast errors on a timescale of hours. But also within the hour, on a timescale of minutes, wind power increases the need

9

for reserves as discussed in the power fluctuation section above. These reserves are normally requested by the system operator, based on a market for regulating power. The demand side can also participate in such a market, provided that the necessary communication between the consumers and the market is available.

Another promising possibility is to use demand as a frequency-activated reserve operating on a timescale of seconds. Without any communication a simple electronic device can disconnect a load when the frequency is low and reconnect it when the frequency is again normal [7]. This arrangement does not need a dedicated communication channel.

In the Nordic power system the frequency is outside the normal operating range for approximately 1% of the time; these excursions typically last for less than five minutes. Frequency-activated demand reserve would help to protect the system at times when it is most vulnerable, and would be especially helpful in recovering from faults such as the loss of a generator or a cross-border link. The benefits include:

- nearly instantaneous response would improve the frequency stability of the system;
- the distributed grid connection points of the reserve improve stability;
- low cost and best use of the available resources.

A wide range of research is being carried out in Denmark to increase demand response. This includes a project to design a system for managing demand as a frequency-activated reserve [8]. This will answer questions including how to monitor and perhaps control the available reserve, whether some kind of communication is needed, for instance to set the trigger levels, the nature of the business models for transmission system operators, equipment suppliers and end users, and whether a market-based approach can be used.

Reactive power planning with distributed generation

Distributed generation from wind turbines and small combined heat and power (CHP) plants has taken an increasingly large share of the Danish power system over the last 20 years. This has not caused noticeable problems with system stability or control so far.

Local CHP plants can operate at different power factors without affecting the production of heat or active power. The power factor of these plants is often varied to suit the requirements of the grid, as the load profile changes during the day. New wind power plants are typically designed to be neutral with respect to reactive power, that is, they have a unity power factor.

However, knowledge of the actual power flows in the distribution system is limited. From both an economic and a technical point of view it may well be a good idea to improve control, especially of reactive power.

This topic is being addressed by an ongoing PhD study at Risø [9] in cooperation with DTU and energinet.dk. The

study includes an analysis of power flows in the distribution system at Brønderslev. This system is characterised by a large proportion of wind power, as well as local CHP plants, so it regularly exports power to the transmission system.

To analyse the power flow, a model of the medium-voltage grid is supplied with electrical data collected from feeders and other key points in the system, plus wind data. This information already exists in the control rooms at the distribution centre and the wind power plants. The study will be followed by an analysis of the possible benefits from introducing a more advanced system of reactive power control for distributed generation.

Challenges for power market design

Power is traditionally traded in a series of forward markets, so the amount of power to be produced and consumed within any given hour needs to be determined beforehand. In the case of Denmark, for instance, the Nordic power pool's day-ahead market (Nord Pool Spot) operates 12–36 hours in advance.

A higher share of power that is only partly predictable, such as wind power, creates more deviations between the production planned in the forward markets and the actual power produced during the hour in question. Making up any shortfall requires calling on short-term regulating power, which is more expensive than power bought in the day-ahead market.

The extra costs of using regulating power are paid either by the producers or by the consumers, according to specific "imbalance settlement" rules set by the market. Whoever pays, it is important to ensure that the amount accurately reflects the cost of keeping the system in balance. A wind power producer, for instance, should not have to pay more than the actual costs incurred by wind power prediction errors [10]. Risø is the coordinator of WILMAR, an EU-funded research project that is developing a planning tool for analysing the operational consequences of wind power prediction errors (www.wilmar.risoe.dk).

The shorter the timescale at which the power market can function, the more accurate the wind power forecasts will be. It will therefore become increasingly important to create intra-day markets that can trade closer to the actual delivery. A requirement for well-functioning intra-day markets should be for all power producers to make their regulation capabilities available for the intra-day as well as for the regulating power markets.

The use of flexible power consumption (demand management) in the regulating power market can decrease regulation costs, so the development of market-based solutions to allow this should be continued [10].

Managing power systems in fault mode

Fault ride-through

The fault behaviour or "fault ride-through" capability of wind power plants is a key issue in the large-scale use of wind power in a power system. This is reflected in the

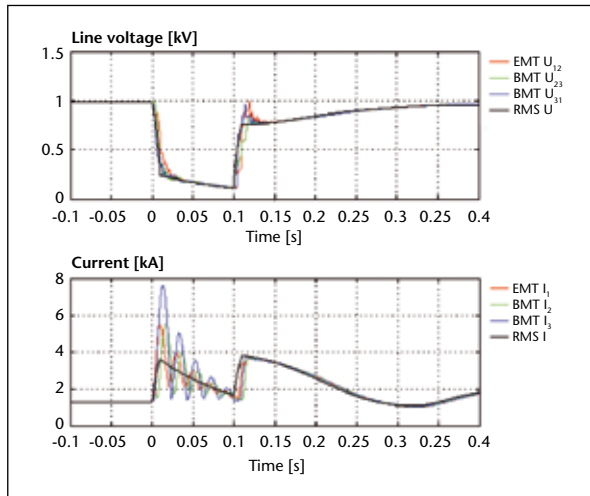

Figure 31. Voltage (top) and current (bottom) at the terminals of a wind turbine generator during a simulated transient short-circuit fault. The red, green and blue lines represent a detailed (EMT) model, while the black lines show a simplified (RMS) model.

grid codes—the rules that govern the behaviour of grid-connected wind turbines that are now in force in every country planning to develop wind power

The purpose of fault ride-through is to ensure that wind turbines are able to stay connected to the grid during and after a grid fault. If the turbines are not able to stay connected through and after the fault, the consequence is a sudden loss of generation which must be replaced by fast reserves from other generators to prevent loss of load. Fault ride-through is not unique to wind turbines; similar capabilities are required of conventional generators to ensure that the system will continue to operate if one generating unit fails.

When modelling the dynamic behaviour of grids and generators, it is important to take into account the purpose of the model. Studying the stability of a complete power system, for instance, requires different information from that needed to design a wind turbine.

Figure 31 shows simulations of the current and voltage at the terminals of a wind turbine generator during a transient short circuit ($t = 0$ to $t = 0.1$ s). For a very short period right after the initial voltage dip, a detailed electromagnetic transient (EMT) model reveals very high current pulses that may be important for detailed electrical design. A simplified root-mean-square (RMS) model does not show these current pulses, but it follows the EMT model almost exactly once the fault is cleared. The RMS model is therefore adequate for most studies of power system stability, and has the advantage of running much faster.

Akhmatov has made comprehensive studies of the dynamic behaviour of electric power systems containing large amount of wind power during grid faults [11–13]. These publications provide very detailed information about the modelling of power systems and different

wind turbine technologies. Risø has recently published a number of papers [14–16] on the modelling and control of active stall-controlled (fixed-speed) wind turbines during and after grid faults. Risø's work on the modelling and control of variable-speed wind turbines is in the process of being published.

Power system stabilisation

A fault or another disturbance on the grid causes the synchronous generators of large conventional power plants in one area to start oscillating against the synchronous generators in other areas. These oscillations affect the speeds of the synchronous generators, and hence the grid frequency. To dampen the oscillations, conventional power plants are often equipped with power system stabilisers.

It may be a requirement for future large-scale renewable generation that it too is able to support power system stabilisation. Risø has developed stabilisation-promoting controllers for both fixed-speed active stall-controlled and variable-speed wind turbines. Descriptions of these controllers and simulation results are expected to be published in the near future.

Black start and isolated operation

Another fault mode arises when part of the grid becomes isolated from the main synchronous system. If the isolated area is able to control its own frequency and voltage, a blackout can be avoided and the reliability of the power system improves.

If the part of the system that is isolated is dominated by renewable and decentralised generation, then the contribution of these generators to the control of frequency and voltage can be the key to avoid substantial load shedding or even a blackout. If a blackout cannot be avoided, then it is important to re-start the system as fast as possible. This “black start” process can be supported by renewable and distributed generation, provided that these generators support frequency and voltage control. In cases like these, the dynamics of the power system control can be very important. Risø has run a number of simulations of wind farm models connected to simplified grid models, to test the ability of wind farm power controllers to provide the necessary grid support [17]. Although the initial results were not sufficient, it is expected that it will be possible to develop the controllers—especially those for variable-speed wind turbines—to the point where the wind farm is able to control the local grid if it becomes isolated, and ensure that the supply of power is maintained.

Reliability

The reliability of wind power is an issue in normal operation as well as under fault conditions. From the point of view of the wind farm owner, reliability is considered mainly as the ability to sell power. In this case, a simple measure of reliability is the ratio of actual production

9

to the energy available according to wind and power curves, taking into account failures in wind turbines and the grid itself. From the point of view of the system operator, reliability is mainly about the risk that all or some of the predicted wind power will not be produced. A number of factors affect this measure of reliability:

- power forecasting errors caused by wind speed forecast errors—which generally cannot be avoided but probably reduced;
- if the wind speed rises to the “cut-out” speed of the turbines, production drops suddenly from rated power to zero;
- failures in the transmission line linking the wind farm to the transmission system;
- failures in the power collection grid within the wind farm;
- failures of wind turbines.

The three first mentioned are the most severe, because they typically involve the whole output from the wind farm. Failures of the internal grid or single wind turbines typically affect only a fraction of the production.

A major research challenge is to build reliability models that combine general reliability factors, such as grid failures, with factors specific to wind power, such as wind forecast errors and cut-outs at high wind speeds.

Conclusions

The technical challenges to system operation and the power market are mainly about building a stable and reliable power system that contains a large scale of renewable energy to replace conventional power plants.

In this context, a more specific challenge is to reduce the need to run conventional power plants at low output during periods when generation from wind power or other renewables is high. In such periods, conventional plants are kept running to provide ancillary services such as voltage and frequency support. The cost of the resulting power is high, in environmental as well as economic terms, because plants running below full capacity tend to be less efficient and more polluting.

From an overall system point of view, therefore, it could sometimes be useful to use renewable generators to provide these ancillary services, even though this would reduce the total production from renewables.

Recommendations for Denmark

It is recommended to develop more flexible methods of operating and controlling power systems that are characterised by a high penetration of distributed and intermittent renewable energy sources. These methods should make it possible to increase the proportion of renewable energy in the system without compromising security and reliability.

They should also aim to reduce production costs and pollution for the power system as a whole. In general, it is likely that the best way to do this may be to maximise the annual energy production of individual renewable generators such as wind turbines. In some cases, for instance with high wind speeds and low loads, there are probably better methods of control.

Index

- batteries 51, 52, 65
- bio-oil 48, 49
- biodiesel 13, 47, 64, 65
- bioenergy 11, 65
- bioethanol 47, 48, 49, 50, 65
- bio fuels 5, 6, 11, 18, 26, 33, 47, 48, 49, 50, 52, 53, 65
- biogas 13, 34, 35, 48, 64
- biomass 3, 5, 6, 7, 13, 14, 15, 16, 18, 33, 34, 35, 47, 48, 49, 50, 51, 52, 64, 65
- biosyn diesel 49
- black start 59
- CDM 6, 11, 25, 43, 44, 45
- CIP 21
- Clean Development Mechanism 6, 11, 43
- Competitiveness and Innovation Framework Programme 21
- Danish Government 10
- demand response 58
- distributed generation 57, 58, 59
- district heating 10, 26, 33, 41
- emissions Trading 11
- energy storage 44, 51
- ET 11
- ethanol 18, 27, 48, 49, 52, 64, 65
- EU 5, 7, 9, 10, 11, 13, 14, 15, 18, 19, 21, 30, 31, 38, 41, 49, 58
- European Commission 5, 9, 10, 13, 63, 65
- European Union 9, 21, 47, 65
- fault ride-through 30, 58, 59
- feed-in tariff 14, 16
- fuel cells 5, 22, 25, 26, 33, 34, 51, 52, 53, 57
- geothermal 2, 6, 13, 16, 43, 44, 45
- heat pumps 45
- hydro 2, 13, 15, 16, 33, 43, 45, 51
- hydroelectric 43
- hydrogen 5, 6, 22, 24, 26, 31, 33, 49, 50, 51, 53, 65
- hydropower 13, 16, 43, 45, 53
- IEA 5, 8, 41, 45, 63, 64, 65
- innovation 5, 6, 21, 22, 23, 24, 25, 26, 27, 29, 50, 63, 64
- International Energy Agency 5, 8
- Jl 11, 44
- Johannesburg Renewable Energy Coalition 13, 63
- Joint Implementation 11
- JREC 13
- KP 7
- Kyoto commitment 9
- Kyoto Protocol 7, 8
- Lisbon Agenda 21, 31
- methanol 47, 49, 50, 51, 52, 53
- new biomass 13, 34
- new renewable 6, 13, 18, 19, 25
- oceanic wave climate 44
- OECD 5, 8, 21, 25, 26, 27, 43, 51, 63, 64
- photovoltaic 16, 17, 18, 57, 64
- photovoltaics 5, 13, 14, 18, 19, 26, 37, 39, 40, 64
- polymer solar cells 6
- power fluctuation 57, 58
- Production Tax Credit 17
- PTC 17, 18
- PV 5, 37, 38, 39, 40, 64
- quota obligations 14
- REN21 13, 63, 64
- renewable energy 2, 5, 6, 7, 8, 9, 10, 11, 13, 14, 15, 16, 17, 18, 19, 21, 24, 25, 26, 27, 33, 38, 43, 51, 52, 53, 55, 59, 60, 63, 64
- Renewable Energy Policy Network for the 21st Century 13
- renewable energy resources 5, 15, 17
- renewable energy technologies 6, 7, 17, 19, 21, 24, 25, 27, 43, 63
- Renewable Portfolio Standard 18
- renewable resources 13
- renewables 5, 6, 11, 13, 14, 15, 16, 17, 18, 19, 30, 33, 53, 60
- renewable technologies 5, 6, 7, 17, 18, 19
- RPS 18
- second-generation biofuels 49
- second-generation technologies 6, 49, 50
- solar energy 16, 41
- solar thermal 13, 41
- solar water heaters 16
- SWHs 16
- tax measures 14
- tender procedures 14
- third generation 50

tidal energy 43

tradable green certificates 14, 18

transport fuels 5, 9

UN FCCC 7

wave energy 44, 64

wave power 6, 44, 45, 56, 57

WBCSD 8

wind energy 5, 29, 31

wind power 5, 6, 13, 14, 15, 16, 17, 18, 19, 22, 24, 25, 26,
29, 30, 31, 33, 44, 55, 56, 57, 58, 59, 60, 65

wind resources 16

World Business Council on Sustainable Development 8, 63

Worldwatch Institute 63

References

References for Chapter 3

1. UNEP. (2006). *Background paper for the ministerial-level consultations on energy and environment for development*. Ninth special session of the Governing Council/Global Ministerial Environment Forum. Dubai, 7–9 February 2006.
2. IEA. (2005). *World energy outlook 2005*. Paris: IEA.
3. IEA. (2003). *World energy investment outlook*. Paris: IEA.
4. World Business Council on Sustainable Development. (2005). *Pathways to 2050 – Energy and climate change*. Geneva.
5. Commission of the European Communities. (2006). *Green Paper - A European strategy for sustainable, competitive and secure energy*. Brussels.
6. Danish Ministry for Transport and Energy. (2005). *Energy strategy 2025*. Copenhagen.

References for Chapter 4

1. Worldwatch Institute. (2005). REN21 Renewable Energy Policy Network. *Renewables 2005 Global status report*. Washington DC.
2. ENERDATA. (2004). www.enerdata.fr
3. European Commission. (2005). Communication from the Commission. The support of electricity from renewable energy sources.
4. The Johannesburg Renewable Energy Coalition. (2005). Information Note N°1. *Members, objectives and roadmap* (Version 2.5 dd.).
5. Renewable Energy Policy Network for the 21st Century. (2005). www.ren21.net
6. European Commission. (1997). *Energy for the future: renewable sources of energy*. White Paper for a Community Strategy and Action Plan. COM(1997) 599.
7. European Commission. (2001). Directive 2001/77/EC of The European Parliament and of the Council of 27 September 2001 on the promotion of electricity produced from renewable energy sources in the internal electricity market.
8. Ragwitz, M. et al. (2005). *OPTrenewable energy: Assessment and optimisation of renewable support schemes in the European electricity market*.
9. National Development and Reform Commission. (2005). www.ndrc.gov.cn
10. Kline, D. et. al. (2005). *Renewable energy and climate change in the US*.
11. Martinot, E. et. al. (2005). *Renewable energy policy and markets in the United States*.
12. Union of Concerned Scientists. (2004). www.ucsusa.org

References for chapter 5

1. <http://www.nrel.gov/features/>
2. OECD. (2006). *Innovation in energy. Comparing national innovation systems at the sectoral level*. Paris: OECD.
3. Lundvall, B.A (Ed.). (1992). *National systems of innovation: Towards a theory of innovation and interactive learning*. London: Pinter Publishers.
4. Elaborated from Andersen, M.M. (2004). An innovation system approach to eco-innovation - Aligning policy rationales. In: *The green-*

5. Porter, M. E. (2000/2003). Location, clusters, and company strategy. In: Gordon L. Clark, Maryann P. Feldman, and Meric S. Gertler (Eds.), *The Oxford handbook of economic geography* (p. 253-274). Oxford: Oxford University Press.
6. Porter, M. E. (1990). *The competitive advantage of nations*. New York: Basic Books.
7. Porter, M. E. (1998). Clusters and the new economics of competition. *Harvard Business Review*, November 1.
8. Johnson, A.; Jabobsson, S. (2001). Inducement and blocking mechanisms in the development of a new industry: The case of renewable energy technology in Sweden. In Coombs, Green, Walsh & Richards, *Technology and the market: Demand, users and innovation*. Edward Elgar.
9. Foxon et al. (2005). UK innovation systems for new and renewable energy technologies: drivers, barriers and systems failures. *Energy Policy* 33, 2123-2137.
10. Burns, T.; Stalker, G.M. (1961). *Management of innovation*. London: Tavistock Publications.
11. Foxon, T. (2003). *Inducing innovation for a low-carbon future: drivers, barriers and policies*. The Carbon Trust.
12. Kline, S. (1985). Innovation is not a linear process. *Research Management*, 28 (2), 36-45. See also Kline, S. J. and N. Rosenberg. (1986) An Overview of Innovation. In: R. Landau and N. Rosenberg (eds): *The positive sum strategy. Harnessing technology for economic growth*. Washington D.C.: National Academy Press.
13. Kline, S. (1985) p41.
14. Dannemand Andersen, P. (1993). *En analyse af den teknologiske innovation i dansk vindmølleindustri*. København: Samfundslitteratur (Ph. D. Serie 9.93). See also: Karnøe, P. (1991). *Dansk Vindmølleindustri – en overraskende international succes*. København: Samfundslitteratur.
15. Von Hippel, E. (1988). *The Sources of Innovation*. New York: Oxford University Press.
16. Neij, L.; Dannemand Andersen, P.; Durstewitz, M.; Helby, P.; Hoppe-Kilpper, M.; Morthorst, P.E. (2003). *Experience curves: A tool for energy policy assessment*. Lund: Lund University, Department of Technology and Society, Environmental and Energy Systems Studies. (IMES/EESS Report; 40).
17. Based on data behind Dannemand Andersen, P. (2004) Sources of experience - theoretical considerations and empirical observations from Danish wind energy technology. *Int. J. Energy Technol. Pol.*, 2 (1/2).
18. Wene, C.O. (2000). *Experience curves for energy technology policy*. Paris: OECD/IEA. See also: IEA/OECD. (2002). *Creating markets for energy technologies*.
19. Update from Dannemand Andersen, P. (1998). *Wind power in Denmark. Technology, policies and results*. Copenhagen: Danish Energy Agency.
20. DI Indsiget, no. 13, Sep 15, 2005.
21. Wüsterhagen, R.; Teppo, T. (2006). Do venture capitalists really invest in good industries? Risk-return perceptions and path dependence in the emerging European energy VC market. *Int. J. Technology Management*, 34 (1/2).

- OECD. (2006). Innovation in energy. Comparing national innovation systems at the sectoral Level. Paris: OECD.

References for Chapter 6.1

- BTM Consult. (2006). *International Wind Energy Development*.
- Danish Wind Industry Association. (2006). www.windpower.org
- UKERC. (2006). *The costs and impacts of intermittency*. London: Imperial College. www.ukerc.ac.uk
- www.ewea.org
- www.eawe.org
- U.S. Department of Energy. (2004). *Wind energy multi year program plan for 2005-2010*.

References for Chapter 6.2

- Danish Energy Authority. (2004). *Technology Data 2004*.
 - Biomass Gasification Group, Technical University of Denmark, and COWI A/S, November 2004
 - TK Energi, November 2004.
- Sønderberg Petersen, L.; Larsen, H. (2003). *Risø Energy Report 2*. Roskilde: Risø National Laboratory.
- Nielsen, L.H.; Hjort-Gregersen, K.; Thygesen, P.; Christensen, J. (2002). (Socio-economic analysis of centralized biogas plants – with technical and corporate economic analysis. In Danish.). *Samfund-søkonomiske analyser af biogasfællesanlæg - med tekniske og selskab-søkonomiske baggrundsanalyser*. Frederiksberg: Fødevareøkonomisk Institut. (Fødevareøkonomisk Institut, rapport nr. 136).
- Kwant, K. W.; Knoef, H. (2004). *Status of gasification in countries participating in the IEA and GasNet activity*. IEA.
- Gøbel, B. (2004). *Two-Stage BMG (Viking Gasifier and the Weiss project) and System Integration for Power Generation and Heat Recovery*. Workshop 2, Gas Cleaning and Gas Engines for Small-scale Applications, IEA Bioenergy Agreement, Task 33: Thermal Gasification of Biomass, Task Meeting, October 25, Copenhagen, Denmark. www.gastechnology.org/iea.
- Koch, T. (2004). Three-stage BMG Projects. Workshop 2, Gas Cleaning and Gas Engines for Small-scale Applications, IEA Bioenergy Agreement, Task 33: Thermal Gasification of Biomass, Task Meeting, October 25, Copenhagen, Denmark. www.gastechnology.org/iea
- Persson, C.; Olsson, J. (2002). *Jamforelse mellan olika kraftvarmeteknologier*. Svenskt Gasteknik Center.
- de Wit, J. (2006). *Stirling-motorer*. Dansk Gasteknik Center, a/s (DGC).
- Carlsen, H.; Fentz, J. (2004). *Development of a 9 kW Stirling Engine*. International Gas Research Conference (IGRC), Vancouver.
- www.Stirling.dk.

References for Chapter 6.3.1

- Maycock, P. Proc. *IEEE Photovoltaic Specialists Conf.*
- Strategies Unlimited. (2003). <http://su.pennet.com>
- Maycock, P. *PV News*.
- Rohatgi, A. (2003). Cost and technology roadmap for cost-effective crystalline silicon photovoltaics. *Proc. 3rd World Conf. on Photovoltaic Energy Conversion, Osaka, 2003*.
- Chong, C.M.; Wenham, S.R.; Green, M.A. (1988). High efficiency laser grooved buried contact solar cell. *Appl. Phys. Lett.*, 52, 407–4 09.
- Tanaka, M.; Okamoto, S.; Tsuge, S.; Kiyama, S. (2003). Development of HIT solar cells with more than 21% conversion efficiency and commercialization of highest performance HIT modules. *Proc. 3rd World Conf. on Photovoltaic Energy Conversion, Osaka, 2003*.

- Yamamoto, K. (2003). Microcrystalline silicon solar cells, in T. Markvart and L. Castañer, *Practical handbook of photovoltaics: Fundamentals and applications*. Oxford: Elsevier.
- Brabec, C. J. (2004). Organic photovoltaics: technology and market. *Solar Energy Materials and Solar Cells*, 83, 273–292.
- Krebs, F. C. (2005). Alternative PV. Large scale organic photovoltaics. *Refocus*, 6 (3), 38–39.
- Krebs, F. C.; Biancardo, M.; Winther-Jensen, B.; Spanggaard, H.; Alstrup, J. (2006). Strategies for incorporation of polymer photovoltaics into garments and textiles. *Solar Energy Materials and Solar Cells*, 90, 1058–1067.
- Li, G.; Shrotriya, V.; Huang, J.; Yao, Y.; Moriarty, T.; Emery, K.; Yang, Y. (2005). High efficiency solution processable polymer photovoltaic cells by self-organization of polymer blends. *Nature Mat.* 4, 864–868.
- Krebs, F. C.; Spanggaard, H. (2005). Significant improvement of polymer solar cell stability. *Chem. Mater.* 17, 5235–5237.

References for Chapter 6.3.2

- Werner Weiss – various papers.
- IEA SHC Implementing Agreement.
- Renewable Energy World – various papers.

References for Chapter 6.4

- OECD. (2006). *Renewables information. IEA statistics*. Paris.
- Martinot, E. (2005). *Renewables, 2005 Global status report, REN21*.
- EUREC Agency. (2002). *The future for renewable energy 2, prospects and directions*. London: Earthscan.
- Centre for Renewable Energy Sources. (2002). *Wave energy utilization in Europe – Current status and perspectives*. European thematic network on wave energy.
- Ocean Power Delivery. (2006). *World's first wave farm – shipping of first machine to Portugal*. Press release 14 March 2006, www.oceanpd.com
- Carbon Trust. (2006). *Future marine energy. Results of the marine energy challenge: Cost competitiveness and growth of wave and tidal stream energy*.
- ENERDATA. (2006). *Global energy statistics*.
- OECD. (2004). *World energy outlook*. Paris.
- Christensen, J.M. (2005). *Changing Climates, The role of renewable energy in a carbon-constrained world*. Roskilde: UNEP Risoe Centre.
- T B Johansson.
- Energistyrelsen; Elkraft; Eltra. (2005). *Bølgekraftteknologi, Strategi for forskning og udvikling*.
- BWEA. (2006). *Power & opportunity. A directory of wave and tidal energy devices & UK support*.
- IEA. (2006). *Renewables in Global Energy Supply, an IEA fact sheet*.

References for Chapter 7

- Mabee, W.E.; Gregg, D.J.; Arato, C.; Berlin, A.; Bura, R.; Gilkes, N.; Mirochnik, O.; Pan, X.; Pye, E. K.; Saddler, J.N. (2006). Update on softwood-to-ethanol process development. *Appl. Biochem. Biotechnol.*, 129–132, 55–70.
- WOLF Pflanzenöltechnik. (2006). Available online at <http://www.wolf-pflanzenoel-technik.de/>
- Ammerer, A.; Rathbauer, J.; Wörgetter, M. (2003). *Rapeseed oil as fuel for farm tractors*. Vancouver, BC, IEA Bioenergy Task 39.
- (S&T)2 Consultants Inc. and Meyers Norris Penny. (2004). *Economic, financial, social analysis and public policies for biodiesel*. Ottawa: Natural Resources Canada Office of Energy Efficiency.

5. Körbitz, W.; Friedrich, St.; Waginger, E.; Wörgetter, M. (2003). *Worldwide review on biodiesel production*. Vancouver, BC, IEA Bioenergy Task 39.
6. Empresa de Pesquisa Energética. (2005). *Brazilian energy balance 2005: year 2004*. Rio de Janeiro: Ministério de Minas e Energia.
7. Viera de Carvalho, A. (2003). *The Brazilian ethanol experience as fuel for transportation*. Washington, DC, World Bank Energy Week 2003, Biomass Workshop (Presentation).
8. Pereira de Carvalho, E. (2006). *Sugarcane ethanol in Brazil*. São Paulo, Brazil, União da Agroindústria Canavieira de São Paulo (Presentation).
9. Renewable Fuels Association. (2006). *From niche to nation: Ethanol industry outlook 2006*. http://www.ethanolrfa.org/objects/pdf/outlook/outlook_2006.pdf. Last accessed Mar. 25/06.
10. (S&T)0 Consultants Inc. and Meyers Norris Penny. (2004). *Economic, financial, social analysis and public policies for fuel ethanol*. Ottawa: Natural Resources Canada Office of Energy Efficiency.
11. Garcia, L.; French, R.; Czernik, S.; Chornet, E. (2000). Catalytic steam reforming of bio-oils for the production of hydrogen: effects of catalyst composition. *Applied Catalysis A: General*. 201 (2), 225–239.
12. CANMET. (2005). Gasification Research. Ottawa, ON: CANMET Energy Technology Centre. http://www.nrcan.gc.ca/es/etb/cetc/cetc01/htmldocs/factsheet_gasification_research_e.html. Last accessed Dec. 28/05.
13. Wyman, C.E.; Dale, B.E.; Elander, R.T.; Holtzapple, M.; Ladisch, M.R.; Lee, Y.Y. (2005). Coordinated development of leading biomass pretreatment technologies. *Bioresource Technol.*, 96 (18), 1959–1966.
14. Galbe, M.; Zacchi, G. (2002). A review of the production of ethanol from softwood. *Appl. Microbiol. Biotechnol.* 59 (6), 618–628.
15. Gregg, D.J.; Boussaid, A.; Saddler, J.N. (1998). Techno-economic evaluations of a generic wood-to-ethanol process: Effect of increased cellulose yields and enzyme recycle. *Bioresource Technology* 63 (1), 7–12.
16. Lawford, H.G.; Rousseau, J.D.; Tolan, J.S. (2001). Comparative ethanol productivities of different *Zymomonas* recombinants fermenting oat hull hydrolysate. *Applied Biochemistry and Biotechnology* 91–93, 133–146.
17. Wingren, A.; Galbe, M.; Zacchi, G. (2003). Techno-economic evaluation of producing ethanol from softwood: Comparison of SSF and SHF and identification of bottlenecks. *Biotechnol. Prog.* 19, 1109–1117.
18. Cetin, E.; Moghtaderi, B.; Gupta, R.; Wall, T.F. (2005). Biomass gasification kinetics: Influences of pressure and char structure. *Combustion Sci. Technol.* 177 (4), 765–791.
19. Thomsen, M.H.; Thyngensen, A.; Jørgensen, H.; Larsen, J.; Holm Christensen, B.; Thomsen, A.B. (2006). Preliminary results on optimization of pilot scale pretreatment of wheat straw used in co-production of bioethanol and electricity. *Appl. Biochem. Biotechnol.*, 129–132, 448–460.
20. Perlack, R.D.; Wright, L.L.; Turhollow A.F.; Graham, R.L.; Stokes, B.; Erbach, D.C. (2005). *Biomass as feedstock for bioenergy and byproducts industry: The technical feasibility of a million ton annual supply*. Tennessee: US department of Energy, Oak Ridge National Laboratory.
21. European Commission. (2006). *Biofuels in the European Union. A vision for 2030 and beyond*. Final Draft report of the Biofuels Research Advisory Council. EC.
22. Ahring, B.K.; Thomsen, A. B. (2000). *A method for processing lignocellulosic materials*. PA 2000 00256.

References for chapter 8

1. IEA. (2004). *World energy outlook 2004*. p.68.
2. Danish Energy Authority. (2004). *Energistatistik 2004*.

3. <http://www.toyota.com/prius/specs.html>
4. EPRI. (2004). *Advanced batteries for electric-drive vehicles. A technology and cost-effectiveness assessment for battery electric vehicles, power assist hybrid electric vehicles, and plug-in hybrid electric vehicles 1009299 Final Report, May 2004*.
5. <http://www.aircraftenginedesign.com/custom.html3.html>
6. Bossel, U.; Eliasson, B.; Taylor, G. (2003). *The future of the hydrogen economy. Bright or bleak*. www.efcf.com/reports.

References for Chapter 9

1. Kristoffersen, J.R.; Christiansen, P. (2003). Horns Rev offshore wind farm: its main controller and remote control system. *Wind Engineering*. 27 (5), p 351–360.
2. Elkraft System; Eltra. (2004). *Wind turbines connected to grids with voltages above 100 kV. Technical regulation for the properties and the regulation of wind turbines*. (Regulation TF 3.2.5. Doc. No. 214439v3. December 2004).
3. Sørensen, P.; Hansen, A.D.; Iov, F.; Blaabjerg, F.; Donovan, M.H. (2005). *Wind farm models and control strategies*. (Risø-R-1464(EN)).
4. Akhmatov, V.; Abildgaard, H.; Pedersen, J.; Eriksen, P.B. (2005). Integration of offshore wind power into the western Danish power system. *Copenhagen Offshore Wind, Conference Proceedings (CD)*.
5. Sørensen, P.; Cutululis, N.A.; Hjerrild, J.; Jensen, L.; Donovan, M.; Christensen, L.E.A.; Madsen, H.; Viguera-Rodríguez, A. (2006). Power fluctuations from large offshore wind farms. *Nordic Wind Power Conference NWPC 2006. Helsinki May 2006*.
6. Sørensen, P.; Hansen, A.D.; Rosas, P.A.C. (2002). Wind models for simulation of power fluctuations from wind farms. *J. Wind Eng. Ind. Aerodyn.*, (90), 1381–1402.
7. Kintner-Meyer, M.; Guttromson, R.; Oedingen, D.; Lang, S. (2003). *Final report for California Energy Commission: Smart load and grid-friendly appliances*. Prepared by Architecture Energy Corporation and Battelle Memorial Institute.
8. <http://www.oersted.dtu.dk/Centre/cet/English/research/projects/06-ea.aspx>
9. http://www.oersted.dtu.dk/English/research/eltek/res_projects/06-10/tlu.aspx
10. Holttinen, H., et. al. (2005). *WILMAR - WP9 Recommendations*. Available from www.wilmar.risoe.dk/Results.htm, December 2005.
11. Akhmatov V. (2003). *Analysis of dynamic behaviour of electric power systems with large amount of wind power*. PhD Thesis. Lyngby: Technical University of Denmark.
12. Akhmatov V.; Knudsen H.; Nielsen A.H. (2000). Advanced simulation of windmills in the electric power supply. *International Journal of Electrical Power & Energy Systems*, 22 (6), 421–434.
13. Akhmatov V.; Knudsen H.; Nielsen A.H.; Pedersen J.K.; Poulsen N.K. (2003). Modelling and transient stability of large wind farms. *Electrical Power and Energy Systems*, 25, 123–144.
14. Jauch, C.; Sørensen, P.; Bak-Jensen, B. (2005). Simulation model of a transient fault controller for an active-stall wind turbine. *WIND ENGINEERING*, 29 (1), 33–48.
15. Jauch, C.; Sørensen, P.; Bak-Jensen, B. (2005). The relevance of the dynamic stall effect for transient fault operations of active-stall wind turbines. *WIND ENGINEERING*, 29 (4), 353–364.
16. Jauch, C.; Sørensen, P.; Norheim, I.; Rasmussen, C. (2006). Simulation of the impact of wind power on the transient fault behavior of the Nordic power system. *Electric Power Systems Research*, accepted for publication, 2006.
17. Sørensen, P.; Hansen, A.D.; Iov, F.; Blaabjerg, F. (2005). *Initial results of local grid control using wind farms with grid support*. (Risø-R-1529(EN)).

Risø Energy Report Series

New and emerging technologies: options for the future

Risø Energy Report 1

EDITED BY HANS LARSEN AND LEIF SØNDERBERG PETERSEN

Risø National Laboratory, October 2002, 64 p., ISBN 87-550-3082-3

Risø-R-1351(EN) (515 Kb)

All over the world, increasing energy consumption, liberalisation of energy markets and the need to take action on climate change are producing new challenges for the energy sector. At the same time there is increasing pressure for research, new technology and industrial products to be socially acceptable and to generate prosperity. The result is a complex and dynamic set of conditions affecting decisions on investment in research and new energy technology. To meet these challenges in the decades ahead, industrialists and policymakers need appropriate analyses of energy systems, plus knowledge of trends for existing technologies and prospects for emerging technologies. This is the background for this first Risø Energy Report, which sets out the global, European and Danish energy scene together with trends in development and emerging technologies.

New and emerging bioenergy technologies

Risø Energy Report 2

EDITED BY HANS LARSEN, JENS KOSSMANN AND LEIF SØNDERBERG PETERSEN

Risø National Laboratory, November 2003, 48 p., ISBN 87-550-3262-1

Risø-R-1430(EN) (1 Mb)

Three growing concerns – sustainability (particularly in the transport sector), security of energy supply and climate change – have combined to increase interest in bioenergy. The trend towards bioenergy has been further encouraged by technological advances in biomass conversion and significant changes in energy markets. We even have a new term, “modern bioenergy”, to cover those areas of bioenergy technology – traditional as well as emerging – which could expand the role of bioenergy. Besides its potential to be carbon-neutral if produced sustainably, modern bioenergy shows the promise of covering a considerable part of the world’s energy needs, increasing the security of energy supply through the use of indigenous resources, and improving local employment and land use. To make these promises a reality, however, requires further R&D.

Hydrogen and its competitors

Risø Energy Report 3

EDITED BY HANS LARSEN, ROBERT FEIDENHANS’L AND LEIF SØNDERBERG PETERSEN

Risø National Laboratory, October 2004, 76 p., ISBN 87-550-3350-4

Risø-R-1469(EN) (643 Kb)

Interest in the hydrogen economy has grown rapidly in recent years. Countries with long traditions of activity in hydrogen research and development have now been joined by a large number of newcomers. The main reason for this surge of interest is that the hydrogen economy may be an answer to the two main challenges facing the world in the years to come: climate change and the need for security of energy supplies. Both these challenges require the development of new, highly-efficient energy technologies that are either carbon-neutral or low emitting technologies.

Alternative fuels could serve as links between the different energy sectors, especially between the power system and the transport sector, to facilitate the uptake of emerging technologies and increase the flexibility and robustness of the energy system as a whole.

The future energy system: distributed production and use

Risø Energy Report 4

EDITED BY HANS LARSEN AND LEIF SØNDERBERG PETERSEN

Risø National Laboratory, October 2005, 62 p., ISBN 87-550-3474-8

Risø-R-1534(EN) (4 Mb)

The coming decades will bring big changes in energy systems throughout the world. The systems are expected to change from central power plants producing electricity and maybe heat for the customers to a combination of central units and a variety of distributed units such as renewable energy technologies or fuel cells. Furthermore the following developments are expected:

- closer link between supply and end-use
- closer link between the various energy carriers distributed through grids such as electricity, heat, natural gas and maybe hydrogen in the future
- increased energy trade across national borders.

