

## Preliminary environmental impact statement for the Kvanefjeld uranium mine

**Pilegaard, Kim**

*Publication date:*  
1990

*Document Version*  
Publisher's PDF, also known as Version of record

[Link back to DTU Orbit](#)

*Citation (APA):*  
Pilegaard, K. (1990). Preliminary environmental impact statement for the Kvanefjeld uranium mine. (Risø-M; No. 2875).

## DTU Library

Technical Information Center of Denmark

---

### General rights

Copyright and moral rights for the publications made accessible in the public portal are retained by the authors and/or other copyright owners and it is a condition of accessing publications that users recognise and abide by the legal requirements associated with these rights.

- Users may download and print one copy of any publication from the public portal for the purpose of private study or research.
- You may not further distribute the material or use it for any profit-making activity or commercial gain
- You may freely distribute the URL identifying the publication in the public portal

If you believe that this document breaches copyright please contact us providing details, and we will remove access to the work immediately and investigate your claim.

# **Preliminary Environmental Impact Statement for the Kvanefjeld Uranium Mine**

**Kim Pilegaard**



Risø-M-2875

## **Preliminary Environmental Impact Statement for the Kvanefjeld Uranium Mine**

Kim Pilegaard

### **Abstract.**

The sources of pollution from a proposed uranium mining and milling complex at Kvanefjeld in South Greenland have been evaluated. The environmental impact assessment was part of a pre-feasibility study. The main aims of this study have been to identify potential pollutants and critical pathways, to evaluate the environmental impact of technical alternatives, and to provide guide-lines for pre-operational environmental studies.

The study has identified the open pit, waste dump and tailings impoundment as the most important sources of pollution. The mobility of non-radioactive elements was lower in the tailings than in the ore, whereas the reverse was true for the radioactive elements.

The potential pollutants include: Be, F, V, Cr, Mn, Fe, Co, Ni, Zn, As, Se, Rb, Nb, Zr, Mo, Cd, Sb, REE, Hg, Pb, Th, U, Ra-226, Pb-210 and Po-210. This list was based on abundance and mobility in the ore and tailings and general toxicity of the elements. Fluorine is the most mobile of the elements in both ore and tailings. The concentration in ore and tailings may be up to 1% and in combination with its high toxicity, F can then be regarded as the most serious pollutant.

September 1990

Risø National Laboratory, DK-4000 Roskilde, Denmark

This report was prepared in 1983 as part of the documentation for the Kvanefjeld Uranium Project funded by the Danish Ministry of Commerce. By this publication the report is made available to a broader audience.

ISBN 87-550-1654-5

ISSN 0418-6435

Grafisk Service, Risø 1990

## Contents

1.	SUMMARY .....	v
2.	INTRODUCTION .....	1
3.	DESCRIPTION OF THE SITE .....	2
	3.1. Site Location .....	2
	3.2. Geology and geochemistry .....	4
	3.3. Population distribution .....	8
	3.4. Land/water use .....	8
	3.5. Conservation areas .....	11
	3.6. Meteorology .....	13
	3.7. Hydrology .....	15
	3.8. Ecology .....	21
	3.8.1. Terrestrial ecology .....	22
	3.8.1.1. Vegetation .....	22
	3.8.1.2. Fauna .....	23
	3.8.2. Aquatic ecology .....	23
	3.8.2.1. Freshwater ecology .....	23
	3.8.2.2. Marine ecology .....	24
	3.8.3. Chemical and radiological characteristics ..	28
4.	PROPOSED ACTIVITIES .....	35
	4.1. Mining .....	36
	4.2. Milling .....	39
	4.3. Disposal of tailings .....	39
5.	SOURCES OF POLLUTION .....	41
	5.1. Gaseous effluents .....	41
	5.2. Solid effluents .....	44
	5.3. Liquid effluents .....	47
	5.3.1. Mine .....	47
	5.3.2. Waste Dump .....	55
	5.3.3. Mill .....	55
	5.3.4. Tailings disposal .....	61
	5.3.4.1. Characterization of tailings .....	62
	5.3.4.2. Tailings experiments .....	65
	5.3.4.3. Treatment plant .....	74
	5.3.4.4. Effluents from tailings pond .....	74
	5.3.5. Summary of element mobility .....	78

6. ENVIRONMENTAL EFFECTS .....	84
6.1. Identification of harmful elements .....	84
6.2. Aquatic environment .....	86
6.2.1. Pollution .....	86
6.2.2. Effects .....	93
6.3. Terrestrial environment .....	95
6.3.1. Pollution .....	95
6.3.2. Effects .....	97
6.4. Physical disturbances .....	99
6.5. Choice of alternatives .....	100
7. REHABILITATION .....	102
7.1. Mine and waste dump .....	102
7.2. Tailings pond .....	102
8. ENVIRONMENTAL SURVEILLANCE .....	104
8.1. Preoperational monitoring .....	105
8.1.1. Technical aspects .....	105
8.1.1.1. Mining .....	105
8.1.1.2. Milling .....	107
8.1.1.3. Tailings .....	108
8.1.2. Environmental aspects .....	110
8.1.2.1. Marine environment .....	114
8.1.2.2. Freshwater environment .....	115
8.1.2.3. Terrestrial environment .....	116
8.2. Operational monitoring .....	116
8.3. Post-operational monitoring .....	117
9. CONCLUSION .....	117
10. REFERENCES .....	119

## 1. SUMMARY

The assessment of the environmental impacts of the mining and milling of uranium from the Kvanefjeld is a part of a pre-feasibility study, performed by the Risø National Laboratory for the Ministry of Energy. The aims of the investigation are:

- to provide a general description of the Narssaq area, with special reference to the ecological aspects,
- to identify potential pollutants, and if possible to quantify these,
- to identify critical pathways and populations,
- to evaluate the technical design of the mine and mill in relation to the environment,
- to evaluate alternatives,
- to provide guidelines for preoperational environmental studies.

The Kvanefjeld is situated near the township of Narssaq in South Greenland at the position 60°59'N, 46°00'W. The mountain has an altitude of 690 m and is surrounded by a landscape characterized by high mountains and deep fiords. In Kvanefjeld an amount of 56 million tons of mineralized material with an average grade of 365 ppm U has been found.

Mining of 136 million tons of rock (including 88 million tons of waste rock and low-grade (<250 ppm) ore)) will be from an open pit. The expected life-time of the mine is 15 years. The uranium will be recovered by a carbonate pressure leaching process developed especially for the alkaline ore.



The open pit and the tailings pond will be the quantitatively most important sources of pollutants. In order to evaluate these, the ore and tailings has been subjected to chemical analyses and leaching studies. These have shown that a number of elements in both ore and tailings are relatively water-soluble. Generally the solubility is much lower in the tailings than in the ore. Another important source of pollutants is upwhirling of dust by blasting, transport and crushing of ore.

Due to the many different types of sources of pollutants almost all parts of the surrounding environment may be affected by the mining and milling. It has not been possible to give a satisfactory assessment on the basis of the existing information. Based on the chemical analyses and knowledge of the toxicity of individual elements, the following elements have been identified as potential pollutants: Be, F, V, Cr, Mn, Fe, Co, Ni, Zn, As, Se, Rb, Nb, Zr, Mo, Cd, Sb, rare earth elements, Hg, Pb, Th, U, Ra-226, Pb-210, and Po-210. This list is not necessarily complete and may include elements which later turn out to be unimportant. Of the elements listed, F will probably be the most important pollutant. This element is present in the ore mainly as a water-soluble mineral, and will therefore be easily mobilized. In the tailings the element is present in another, yet unknown, chemical form and will be mobilized much slower. F is toxic in low concentrations for both trout and sheep.

The situation of pollution will be different in the operative and the post-operative phase. The pollution can be controlled in the operative phase, but after the cease of operation the areas should be rehabilitated in such a way that further treatment is unnecessary. Immediately after the cease of operation seepage of contaminated water from the open pit will be the most important source of pollutants. In the long-term (>100 years) perspective the tailings pond will be the most important.

It is therefore of great importance that environmental aspects are included in the technical design of the mine and mill. Two

alternative options of placement have been considered. In Alternative 1 the process plant is placed in the upper part of the Narssaq Valley and the tailings in Lake Taseq. In Alternative 2 the process plant is placed at the peninsula Nugssuaq, 18 km NE of Kvanefjeld and the tailings in the nearby inlet Tasiussarssuq. Pollutants from the tailings will do least harm in the marine environment due to precipitation (esp. F) and dilution. The disposal of tailings in Tasiussarssuq is therefore to be preferred for the disposal in Taseq. If Alternative 2 is chosen there will be an additional advantage, because the pit can be drained directly to Bredefjord, whereby the pollution of Narssaq River will be reduced.

The present investigation has shown, that although much information is already available, there is a great lack of knowledge on several items essential for the environmental assessment. Guidelines have therefore been provided for the forthcoming environmental studies. These relate to the technical design as well as the existing environment. The two parts of the study should be closely interrelated in order to adjust the technical design to the environmental requirements.



## 2. INTRODUCTION

The uranium mineralization at Kvanefjeld in the alkaline Ilimaussaq intrusion in South Greenland has been the subject of investigation since 1955. This year the late president of the Danish Atomic Energy Commission (AEK), Niels Bohr, initiated radiometric exploration within the area. After drilling and mapping programmes 180 tons of ore was mined in 1962. This ore sample was the subject of metallurgical studies, and a sulphating roasting technique was developed. This technique was, however, not suitable for the major part of the uranium mineralized rocks. Therefore a new carbonate pressure leaching process was developed. This process gave uranium yields in the order of 70-90%.

The Kvanefjeld Uranium Project (financed by the Ministry of Energy) was started in 1978 in order to study the new process in a pilot plant at Rissø. For this purpose 4000 tons of ore was mined in 1979-1980 from a new 1000 m long adit. In 1981 a pre-feasibility study was connected to the pilot plant studies. The purpose of the pre-feasibility study is to provide information and evaluation of the geological, engineering, environmental and economic aspects of uranium mining at Kvanefjeld. This report is the result of the environmental studies.

The aims of the environmental assessment are:

- to provide a general description of the Narssaq area, with special reference to the ecological aspects,
- to identify potential pollutants, and if possible to quantify these,
- to identify critical pathways and populations,
- to evaluate the technical design of the mine and mill in relation to the environment,

- to evaluate alternatives,
- to provide guidelines for pre-operational environmental studies.

The available literature of the environment in the Narssaq area are compiled in chapter 3. The emphasis has been put on information relevant for the evaluation of the effects of the mine and mill. Chapter 4 gives an outline of the proposed activities. These are described in details in other reports from the Kvanefjeld Uranium Project. In chapter 5 the sources of pollution are evaluated. The basis for this evaluation is chemical and radiological studies of ore and tailings. The possible effects of emissions from the pit and tailings pond are considered in chapter 6, which also includes a discussion of the different alternatives proposed. Chapter 7 deals with the necessary rehabilitation of the affected areas in the post-operational phase. Chapter 8 gives general and specific guidelines for the environmental surveillance with emphasis on the preoperational environmental studies.

### 3. DESCRIPTION OF THE SITE

This section gives brief information concerning the physical, chemical and biological characteristics of the area environment that might be affected by the construction and operation of the uranium mine and mill. The different subjects are treated in varying details according to the available information and the relevance for the environmental impact assessment.

#### 3.1. Site location

Kvanefjeld is situated 8 km NE of the town of Narssaq in South Greenland at 60°59' N, 46°00' W. The peak is 690 m a.s.l. The surrounding landscape is characterized by deep fiords (down to about 600 m depth) and high mountains (up to 1400 m a.s.l.) (Figure 3-1).

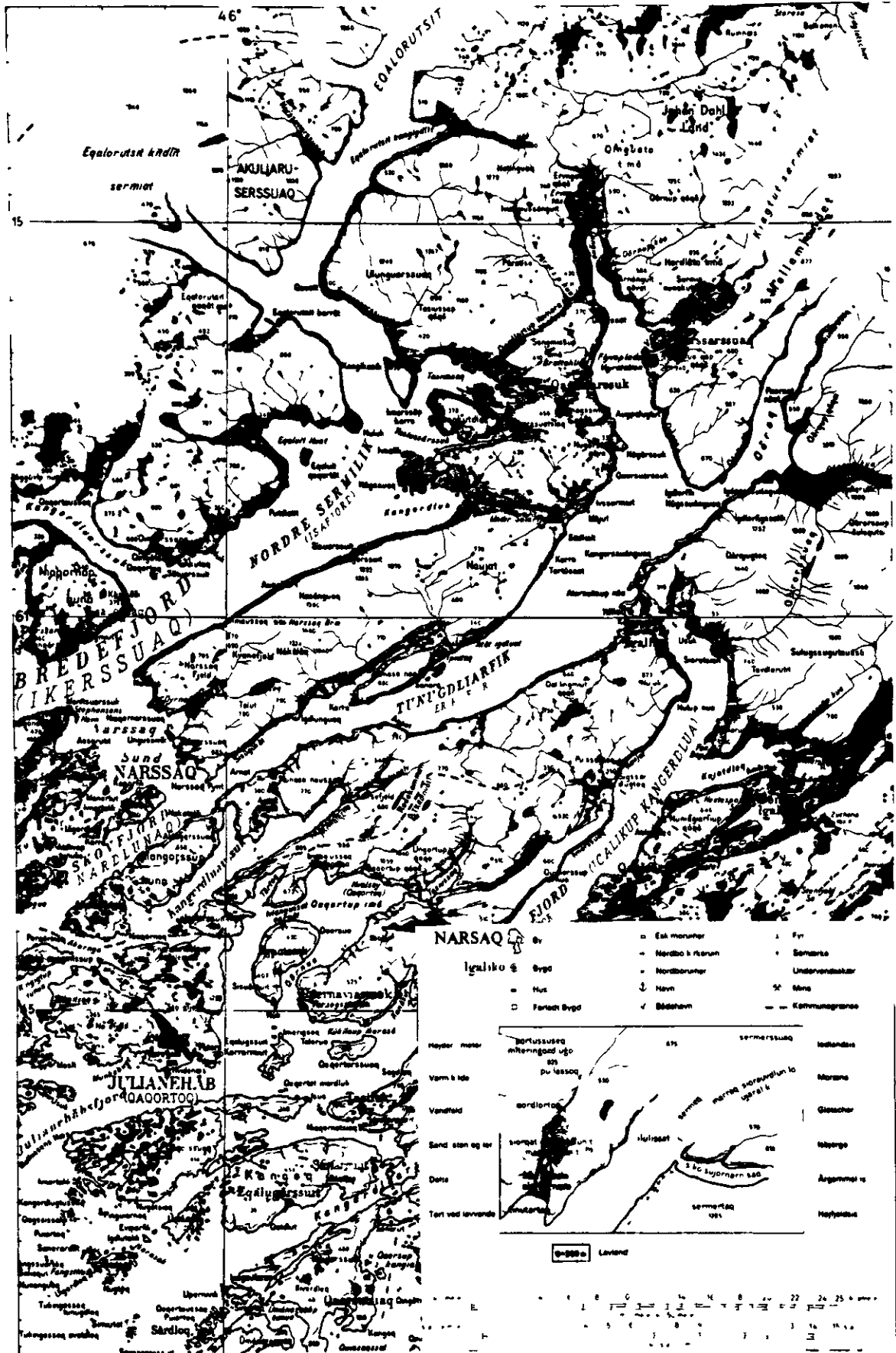

Figure 3-1: Topographic map of the Narssaq area.

The areas involved in the proposal for mining and milling of uranium are:

- 1) The mine and waste dump, covering an area of about 2 km<sup>2</sup> at the Kvanefjeld plateau.
- 2) The process plant, which can be placed either in the upper Narssaq Valley, or at the peninsula Nugssuaq 18 km NE of Kvanefjeld.
- 3) The tailings disposal system, which can be placed either in Lake Taseq 3 km SE of Kvanefjeld or in the inlet Tasiussarssuq close to Nugssuaq, 18 km NE of Kvanefjeld.

These areas are shown in Figure 3-2. The above given names will be used in the following.

### 3.2. Geology and geochemistry

The geology of the Kvanefjeld area has been investigated since the late part of the last century and an overview of the aspects related to uranium mining is given by Kalvig (1983) as another report from the Kvanefjeld Uranium Mine Project. Therefore only a short description will be given here.

Kvanefjeld is part of the Ilimaussaq intrusion (Figure 3-3). This consists of an older series of alkaline syenites and a younger series of nepheline syenites. The latest derivatives (especially the so called naujaites and lujavrites) are strongly enriched in a number of elements, such as Li, Be, F, P, S, Cl, Zn, Ga, Rb, Zr, Nb, Mo, Sn, Cs, REE, Ta, Tl, Pb, Th, and U (Table 3-1).

The granites surrounding the intrusion are relatively unaffected by weathering, whereas the syenites form mountains covered by loose debris of syenitic material with only scattered vegetation (Ussing 1912). The lujavrites weather into sand-sized end products and constitute a fairly stable geomorphological element compared to areas of naujaite, kakortokite and augitesyenite.

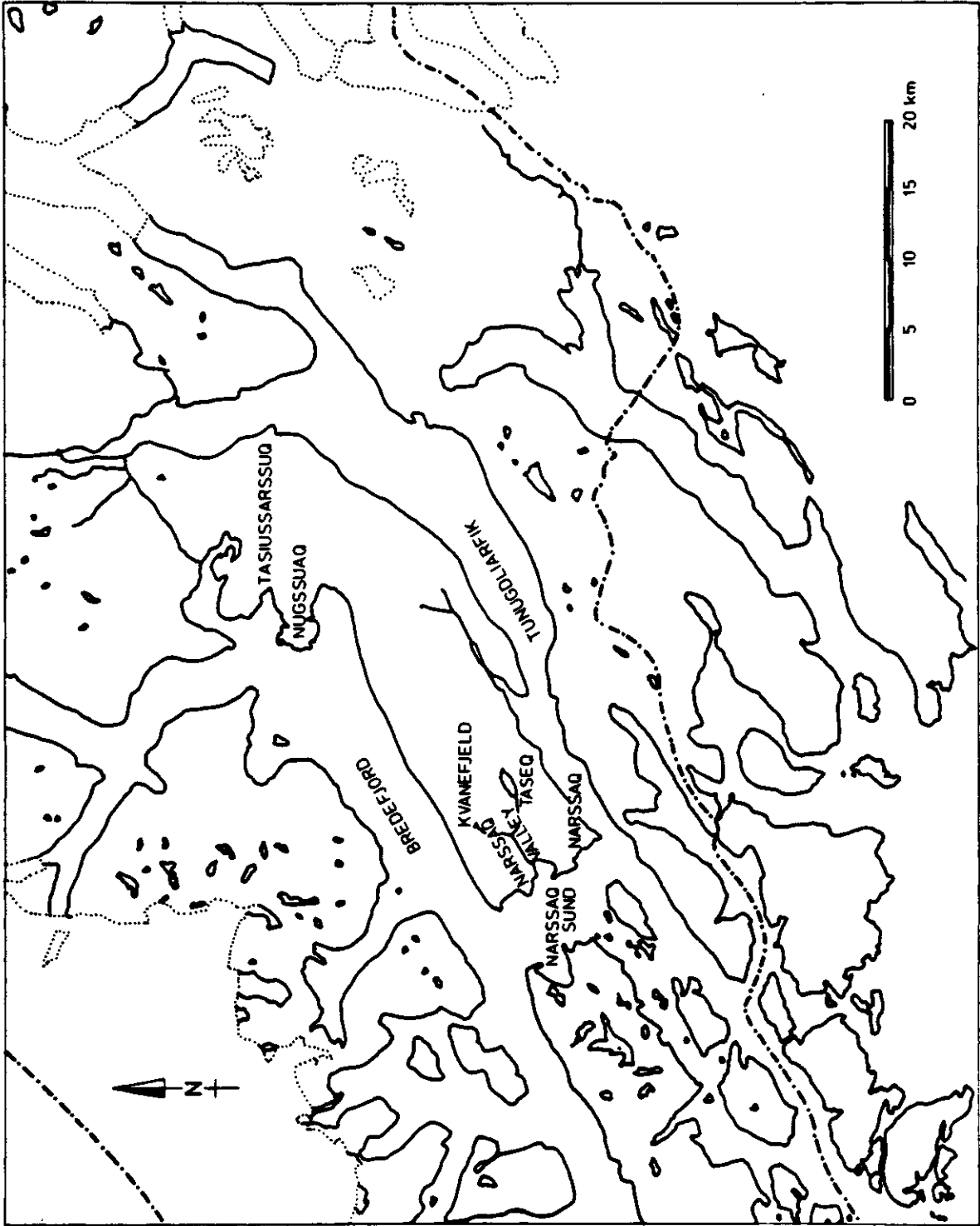

Figure 3-2: Map of the localities that might be affected by uranium mining and milling.



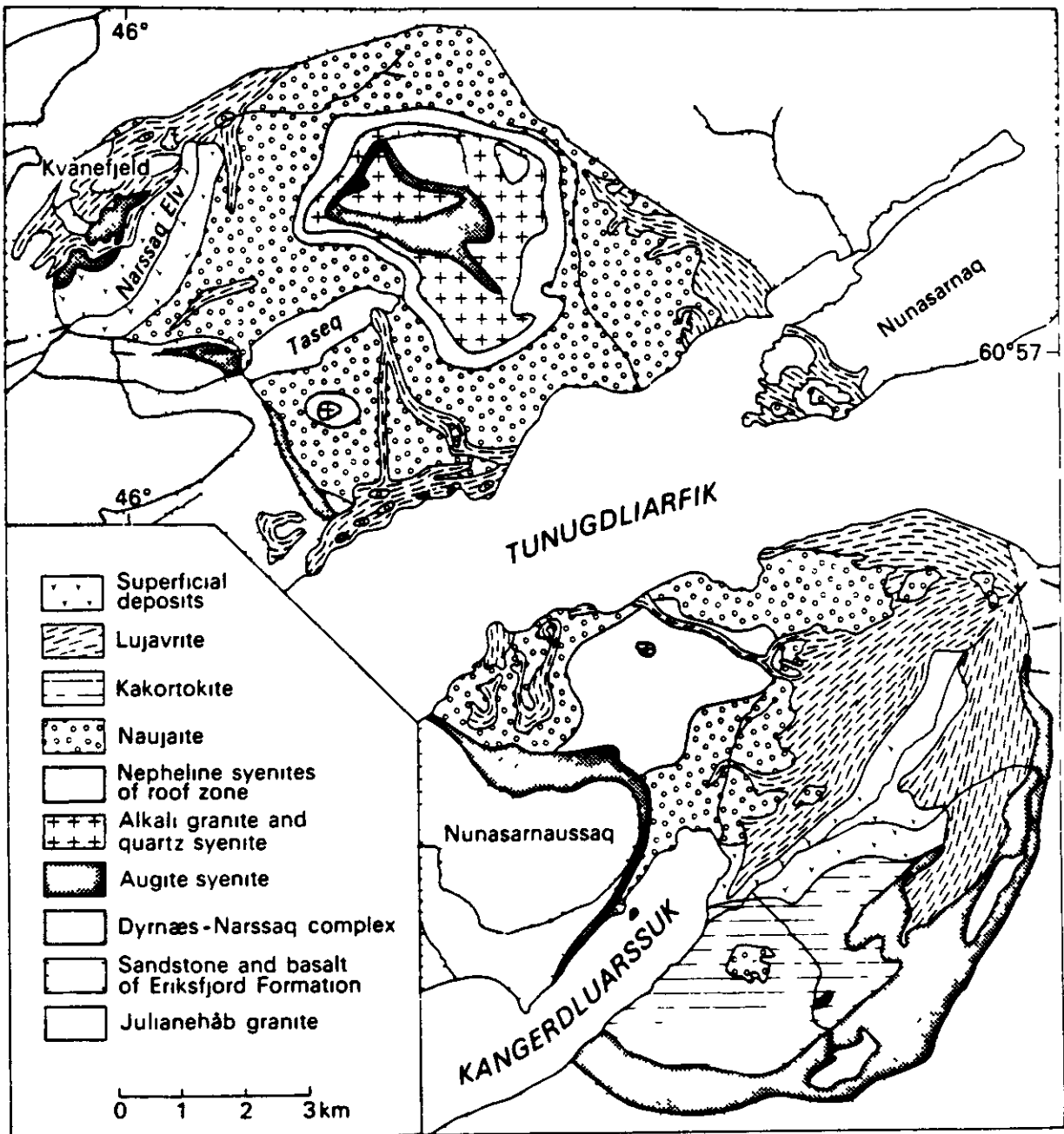

Figure 3-3: Geological map of the Ilimaussaq intrusion (after Ferguson 1964).

These medium- to coarse-grained rocks show an extreme degree of disintegration of the surface into pebble-sized polymineralic grains. The bottom of the Narssaq Valley is covered with superficial deposits of material eroded from the slopes mainly due to alluvial fan sedimentation (Emeleus & Upton 1976, Rose-Hansen et al. 1979). The geological basement in the Nugssuaq area is coarse-grained biotite granite.

Table 3-1: Average concentrations (ppm) of elements in the Ilimaussaq intrusion\* as compared to crustal average\*\*.

Element	Ilimaussaq	Crustal average	Ratio Ilimaussaq/crust
Li	310	20	16
Be	30	2.8	11
B	10	10	1.0
F	2100	625	3.4
Na	86000	28300	3.0
Mg	2200	20900	0.11
Al	93100	81300	1.1
Si	236400	277200	0.85
P	214	1050	0.20
S	910	260	3.5
Cl	8800	130	68
K	33500	25900	1.3
Ca	7780	36300	0.21
Ti	2070	4400	0.47
V	(100)	135	(0.74)
Cr	(29)	100	(0.29)
Mn	1900	950	2.0
Fe	70300	50000	1.5
Ni	(41)	75	0.55
Zn	870	70	12
Ga	110	15	7.3
Rb	590	90	6.6
Sr	(47)	375	0.13
REE	3680	200	18
Zr	4735	165	29
Nb	525	20	26
Mo	14	1.5	9.3
Sn	110	2	55
Cs	8.5	3	2.8
Ba	(100)	425	(0.23)
Hf	97	3	32
Ta	32	2	16
Tl	3.0	0.5	6
Pb	225	13	17
Th	38	7.2	5.3
U	62	1.8	34

\* Gerasimovskii 1968

\*\* Mason 1966

### 3.3. Population distribution

The community of Narssaq has a total population of 2090 inh. (1981). Most of these live in the town of Narssaq (1725 inh.), 146 live at the airport Narssarssuaq, 83 in the village Qagssiarssuk, 52 in the village Igaliko, and the rest (84) at 22 farmsites throughout the country. In the summer a number of tourists are visiting the area. The total population of South Greenland (the communities Narssaq, Qaqortoq and Nanortalik) is 8008 inh.

### 3.4. Land/water use

The main occupations in the Narssaq area are fishing, hunting, and sheepfarming. The areas of sheepfarming and the farmsites are shown in Figure 3-4. An investigation of the capacity for extension of the sheepfarming has revealed 16 new farmsites in the area (Egede 1982). The vegetation of the whole Narssaq area has been mapped (see sect. 3.8.1.) and the grazing capacity estimated. The present (1980) number of sheep in Narssaq Municipality is 13700. The proposed extension would bring the stock up to about 19000 sheep.

Fishing is one of the main occupations in Narssaq. The fleet consists of 1 trawler, some ten cutters and a large number of dinghys. The dinghys and some of the cutters are fishing in the local area.

The economically most important fishing products are cod (including Greenland cod) and shrimps. There is also commercial fishing of halibut and trout. The most important local fishing grounds are shown in Figure 3-5.

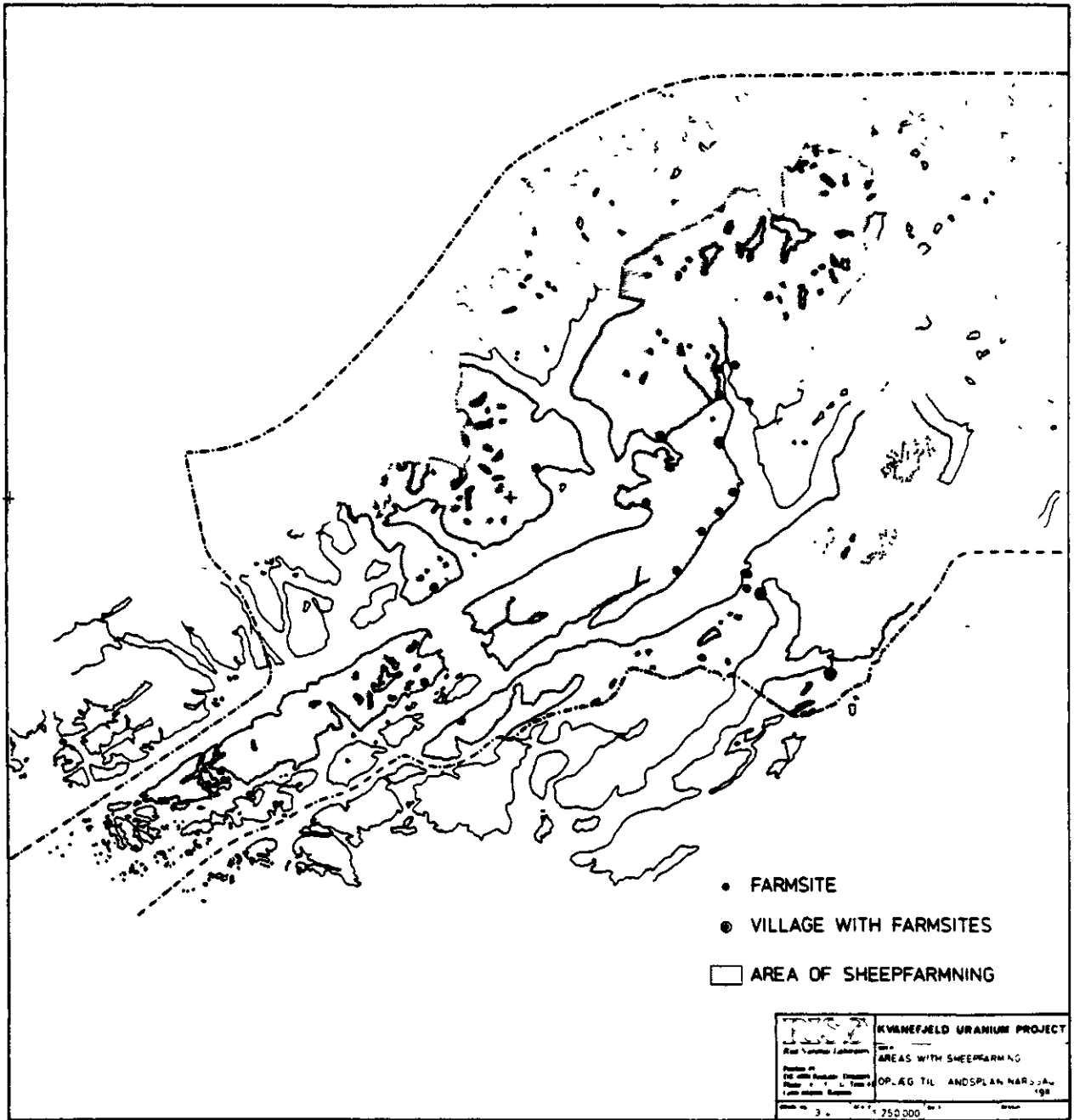

Figure 3-4: The sheep farming areas in the community of Narssaq.

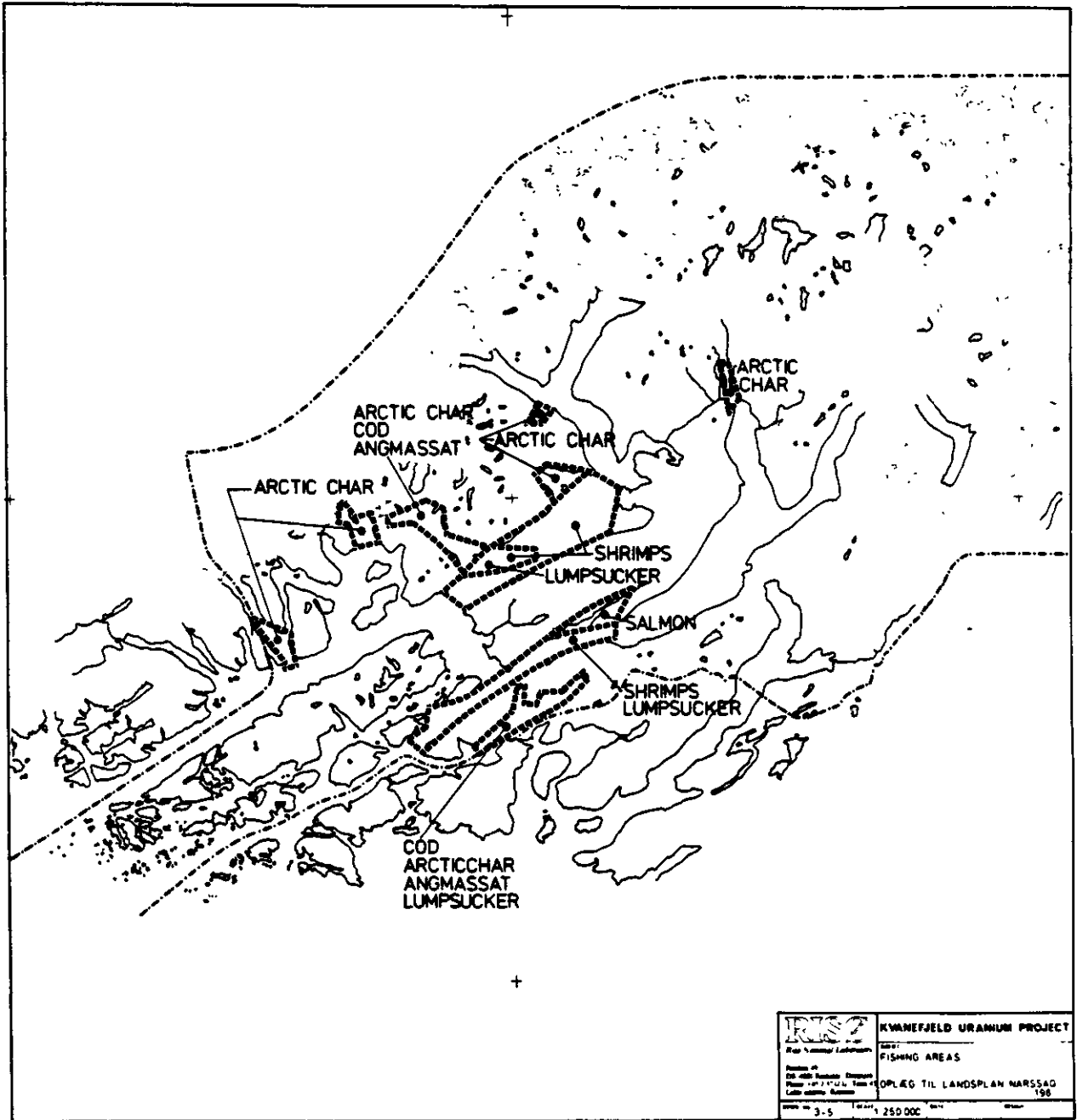

Figure 3-5: The most important fishing areas around Narssaq.

In addition to fishing there is hunting for seal and seabirds. This contributes to the households and the seal skins are sold to the Royal Greenland Trade Department (KGH) or privately. In 1980 50 seal skins were sold to KGH.

### 3.5. Conservation areas

Scattered around in the area there are ruins of eskimo and norse settlements. These are protected by law and there is a 20 m limit within which no disfiguring activities must be undertaken.

Figure 3-6 shows the present and proposed nature conservation areas as well as recreational areas used by residents and tourists.

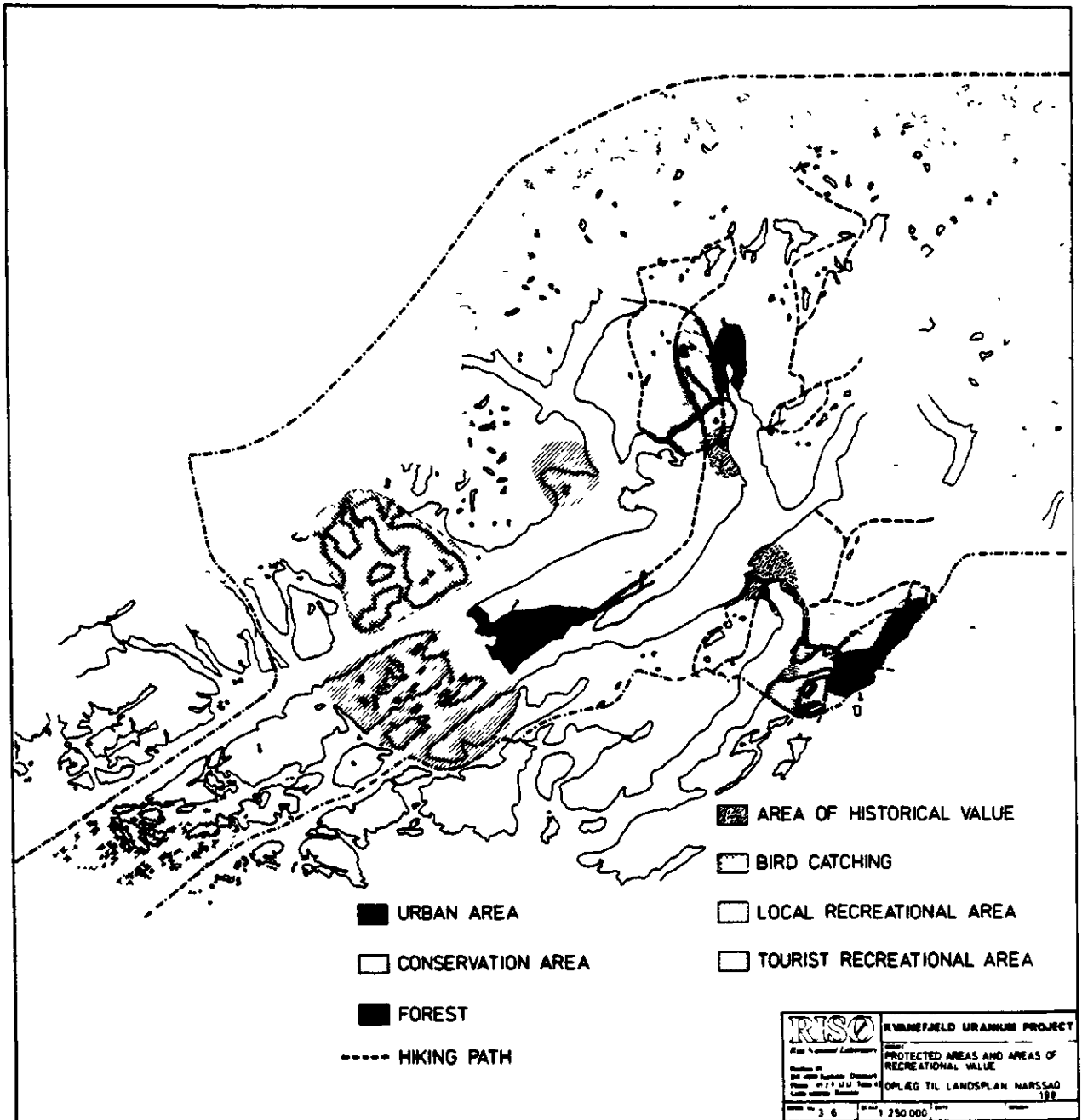

Figure 3-6: Protected areas and areas of recreational value.

### 3.6. Meteorology

The meteorology of the Narssaq area has been investigated by the Danish Institute of Meteorology (stations at Julianehåb, Narssaq and Narssarssuaq); during the International Hydrological Decade (Larsen 1973); in connection with the investigations of the potential for hydroelectric power (Thomsen 1982); and as part of the Kvanefjeld Uranium Mine Pre-Feasibility Study (Kristensen 1983).

The meteorology of the Narssaq area is dominated by the low pressure system extending from Hudson Bay to the east coast of Iceland. Air masses responsible for most of the weather situations in the area are of two general types: continental polar air, which is cold and dry, and maritime polar air, which is cool and relatively humid (Larsen 1973). The katabatic easterly and north-easterly winds from the inland ice dominate in the wintertime resulting in a lower relative humidity than in the summer. In the summer westerly and south-westerly winds dominate. Generally the average wind speed of the westerly winds are lower than that of the easterly winds.

The yearly average temperature at sea level (1961-1974) is 0.7°C, with the highest mean temperature in July (7.3°C) and the lowest in December (-6.3°C). From May to October the monthly mean temperatures are above zero, but freezing may occur at any time during the summer. The growing season (temperatures above 5°C) lasts from late May to mid September.

A special weather phenomena in the area is the föhn wind. This is a warm dry wind arising through adiabatic compression of the air sweeping down from the inland ice. Its relative humidity drops to 30-40% and the temperature rises up to 15-20°C within an hour and remains very high for a day or two. The effect of the föhn wind is marked in winter, resulting in a rapid melting of the snow.

The precipitation has been measured in Narssaq (Danish Meteorological Institute) from 1958-1969, and is continuously



measured in Narssarssuaq and Julianehåb. An extrapolation of the Narssaq series has been made by Thomsen (1982) on the basis of the data from Narssarssuaq and Julianehåb. The average yearly precipitation during the 22-year period from 1958 is 890 mm (range 534-1151 mm). The precipitation increases with the height; this increase has been calculated to 5%/100m during July and August (Larsen 1973). The precipitation at Tasiussarssuq has not been measured, but it is somewhere between the values in Narssaq (890 mm/y) and Narssarssuaq (617 mm/y), probably closest to the latter.

As part of the Kvanefjeld Uranium Mine Prefeasibility Study the meteorology of the Narssaq Valley and the Kvanefjeld Plateau has been studied during the period September 1979 to August 1983. The results of this study is reported in details by Kristensen (1983). In connection with these measurements, a tracer experiment was carried out in the summer 1981 in order to measure the dilution of gases (Gryning & Lyck 1983). The specific results of this experiment will be dealt with in sect. 5.1. The experiment revealed however some general information on the wind pattern in the valley. On clear summer nights the wind pattern in the valley is characterized by drainage winds. Radiational cooling of the sloping surface causes the air adjacent to the surface to cool more than the free air at the same elevation. This results in a pressure gradient which drives the cool air down the slopes. The water temperature in the fiord will, however, often be close to zero due to the ice and thus colder than the land-surface. This drives a wind up the valley. Depending on the strength of the drainage wind, the resulting wind-direction will be up or down the valley. In fact the wind-direction changes 180° every 1/2 hour. Around sunset the radiation from the sun starts to heat the ground and initiates winds that blow up through the valley. They will continue the whole day until sunset, when radiation cooling of the ground again initiate drainage winds. During winter, down valley flow is well established both day and night (Gryning & Lyck 1983).

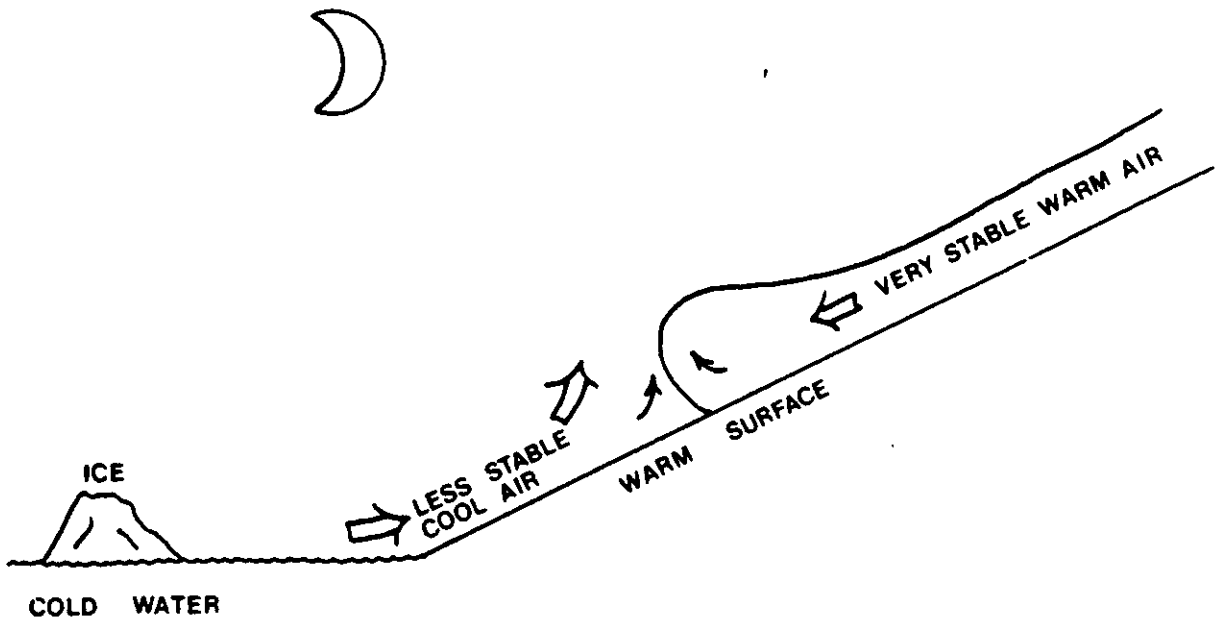
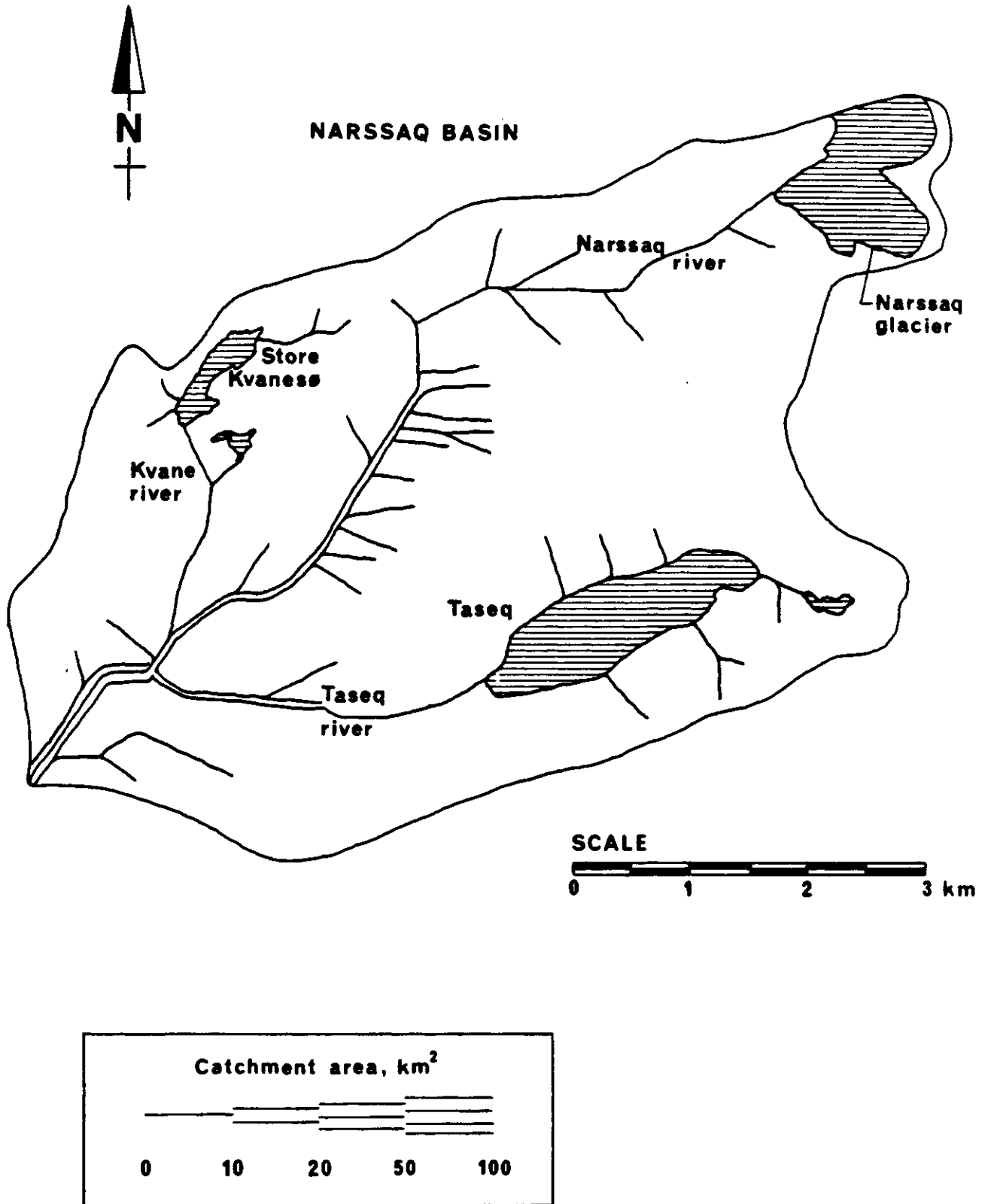

Figure 3-7: Illustration of the wind field in the Narssaq Valley (after Gryning & Lyck 1983).

### 3.7. Hydrology

The hydrology of the Narssaq area has been intensively studied during the International Hydrological Decade (Larsen 1973) and later because of plans for hydroelectric power (Thomsen 1982). The Narssaq River basin forms a fourth order drainage network (42-11-3-1) (Figure 3-8) with a total length of 42 km draining an area of 27.6 km<sup>2</sup>. The mean annual precipitation over the entire basin is 1520 mm, the actual evapotranspiration is 288 mm, and the runoff 1223 mm, 87.5% of which takes place from May to October. Normally the river is frozen to the bottom from December to March. The average discharge in the period from May to October is  $35.529 \cdot 10^6$  m<sup>3</sup>, and in the period from November to April  $3.475 \cdot 10^6$  m<sup>3</sup> (Larsen 1973). The Narssaq Glacier contributes with an amount of approximately  $0.5 \cdot 10^6$  m<sup>3</sup>.



**Figure 3-8:** Distribution of catchment areas. Although simplified, the map shows the location and approximate length of each watercourse. (After Larsen 1973).

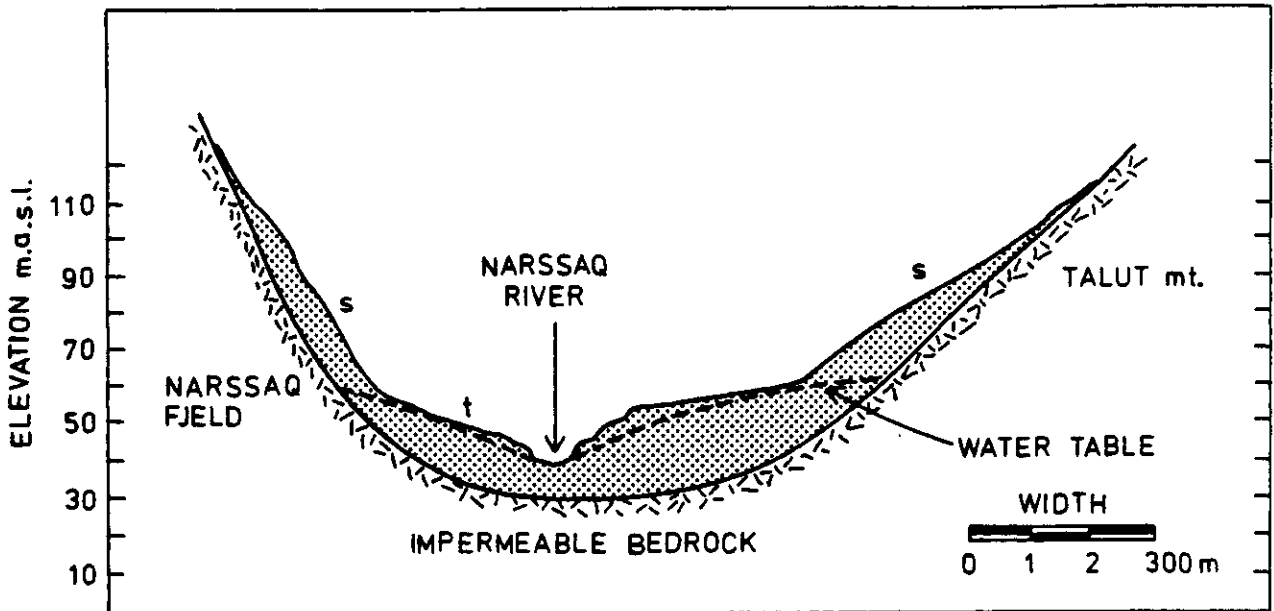

Figure 3-9: Cross-section of the Narssaq river valley.

The surface of the bedrock is estimated from morphological features of the main valley. t: main terrace, and s: screes. The impermeable boundary conditions characterize the entire aquifer. (After Larsen 1973).

Although there are many springs and seeps from the superficial deposits and from joints in the bedrock, all aquifers of any significance is found in the main valley, where the permeable deposits cover an area of approximately 8 km<sup>2</sup>, with a storage capacity of about 7·10<sup>6</sup> m<sup>3</sup>. A cross section of the valley is shown in Figure 3-9. The depth of the ground water table varies from 2.5 m in the summer to 4 m in the winter. The permeability of the marine deposits in the valley has been measured to 0.00125-0.87 cm/sec (Larsen 1973).

The chemistry of the freshwater has been examined in several studies (Asmund 1983, Christensen 1980, Hovmand 1979, Larsen 1973, Lindegaard et al. 1978). Generally the quality of the water is typical for waters draining igneous rocks. There are however unusual high concentrations of some of the elements enriched in the intrusion. Especially fluorine is found in high

concentrations (0.5-30 ppm F) as compared to normal concentrations (0.1-0.2 ppm F).

The concentrations of fluorine has been investigated by Asmund (1983), Larsen (1973) and Sørensen (1983). The fluorine originates from the water soluble mineral villiaumite (NaF). The highest concentrations in the Narssaq River are found in the winter when the waterflow is low; and correspondingly low concentrations in the summer, when the waterflow is high. The explanation for this is probably that water seeping through the bedrock brings the fluoride into solution, and the rather constant amounts are then diluted to different extents in the river water. This problem is treated in details by Christensen (1981) and Sørensen (1983).

The hydrology of the Taseq Lake is described in details by Thomsen (1982). Taseq is a part of the Narssaq River drainage basin (Figure 3-8). The lake has a water surface at 517 m a.s.l. and a drainage area of 8.3 km<sup>2</sup>. The lake covers an area of 1.2 km<sup>2</sup> (Figure 3-10). The content of water is 16.5·10<sup>6</sup> m<sup>3</sup> and the annual discharge 6.9·10<sup>6</sup> m<sup>3</sup>; giving an average retention time of 2.4 years.

The hydrology of the Tasiussarssuq area has not been investigated. However, some information can be extracted from the topographical maps and the information on precipitation. The drainage area is 14 km<sup>2</sup>. With an average annual precipitation of 750 mm and an evapotranspiration of 290 mm the total waterflow to Tasiussarssuk will be approximately 6.5·10<sup>6</sup> m<sup>3</sup>/year. The chemistry of the water in the drainage basin and in the Tasiussarssuk Inlet has not been examined.

The hydrography of the surrounding marine area has been investigated by the Danish Hydraulic Institute (DHI 1979). The Narssaq Peninsula is surrounded by Bredefjord to the North, Narssaq Sund to the west and Tunugdliarfik to the South (Figure 3-1). The fiords are separated from each other by a shallow at 80 m in Narssaq Sund and from Julianehåb Bugt by shallows at 140 m (Bredefjord) and 70 m (Tunugdliarfik). There is a deep shallow in Bredefjord (585 m) at Narssaq Sund.

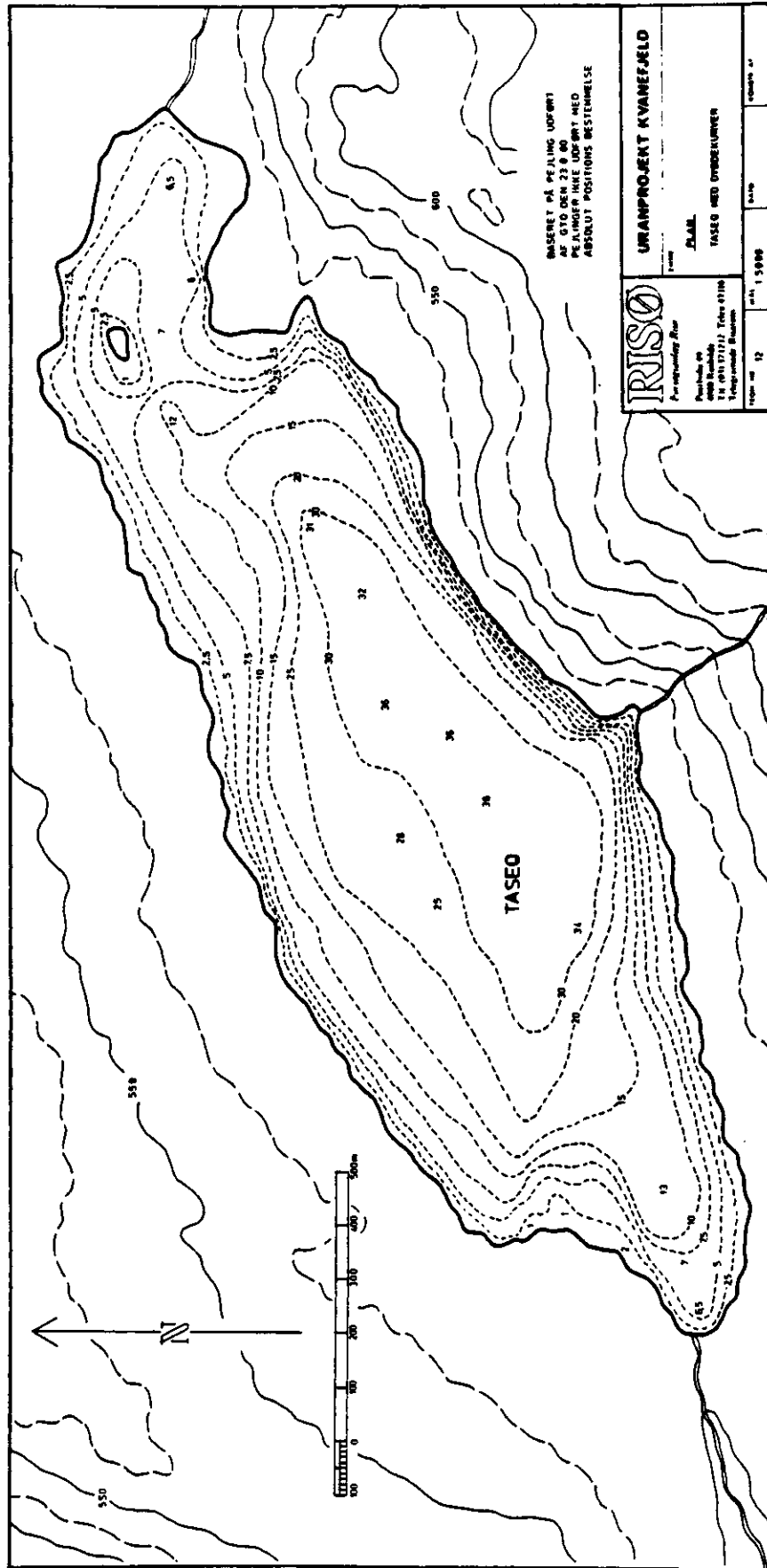

Figure 3-10: Map of Lake Taseq (depth in m).

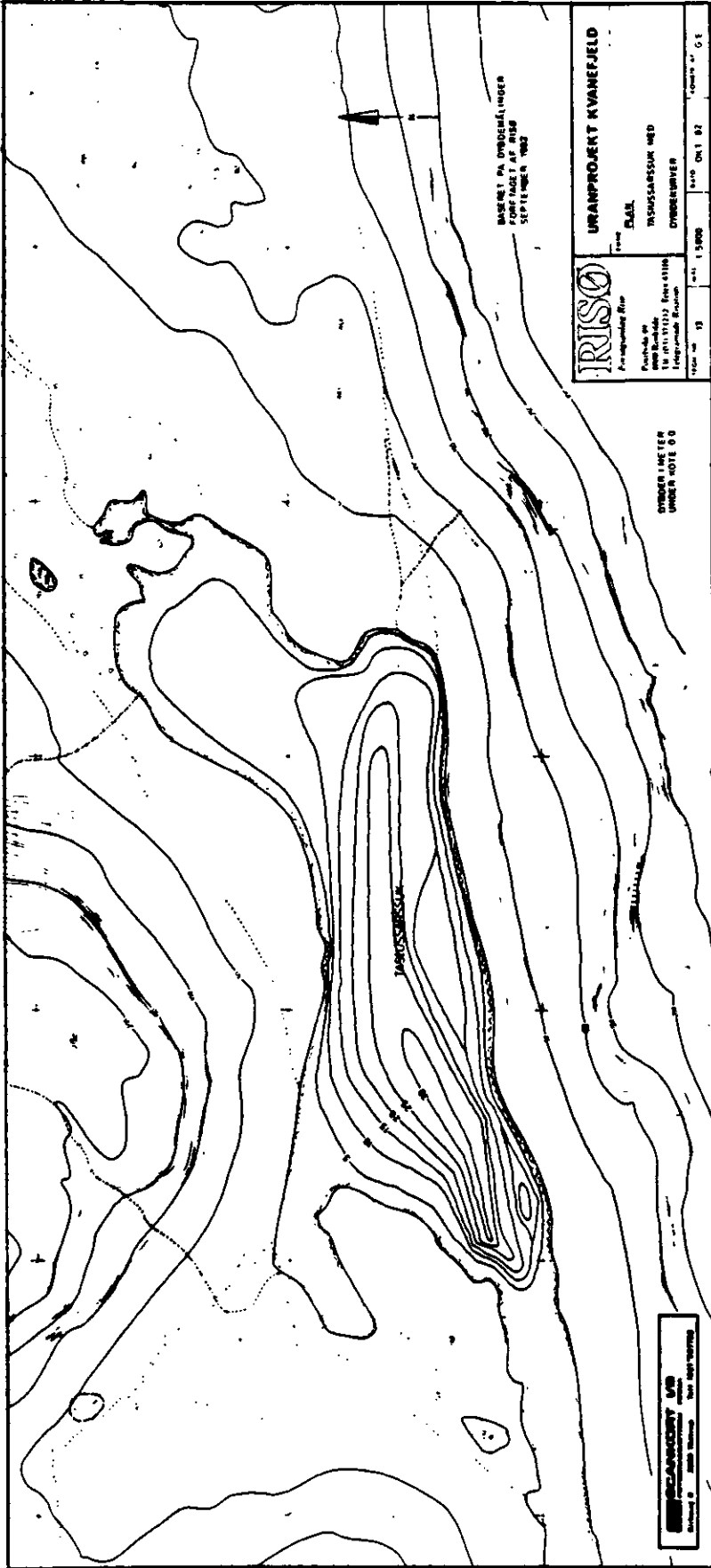

Figure 3-11: Map of Tasiussarssuq and environs. (Heights and depths in m).

There is a stable stratification in both fiords i.e. increasing density with depth. This is partly due to local supply of freshwater. The movement of water is determined by horizontal, stratified currents with velocities of approximately 1 cm/s in a depth of 180 m and approximately 8 cm/s near the surface. The vertical transport is described as a diffusion with a coefficient of 2-10 cm<sup>2</sup>/s. The water transport is subjected to considerable seasonal variation.

There is water with higher salinity and temperature in the deepest parts of both fiords than in the sea outside. This is probably due to occasional inflow of ocean water, most likely in the autumn.

The salinity in the surface water can be as low as 12 o/oo and in the deep part of the fiords (> 250 m) approximately 35 o/oo. The temperature of the surface is varying from - 1.5°C in the winter to an absolute summer maximum of 11°C. In the deep parts of the fiords the temperature is about 2-3°C.

The water level in the fiords are determined by the tides; amounting to about 3 m at springtide. The fiords are covered to varying degrees by ice in the winter, and Bredefjord can be filled with glacier ice in the summermonths.

### 3.8. Ecology

One of the most important parameters for the ecology of the area is the climate. The climate is arctic as the temperature of the warmest month does not exceed 10°C. The climate is very much influenced by the closeness of the ocean resulting in a rather low temperature difference (14°C) between the coldest and warmest months. Going from W to E the climate gets more continental resulting in warmer summer temperatures, lower winter temperatures, and lower precipitation. The areas of the inland are subarctic (warmest month slightly above 10°C).



### 3.8.1. Terrestrial ecology

3.8.1.1. Vegetation. The flora generally consists of widely distributed and oceanic species whereas few continental and no high-arctic species occur (Rose-Hansen et al. 1977). The area belongs to the flora province S (Bøcher et al. 1966).

Specific investigations of the vegetation in the area has been performed during the Narssaq Project (Rose-Hansen et al. 1977) and as part of the investigations concerning the expansion of the sheepfarming. (Thorsteinsson 1978, 1979, 1980). During the latter the vegetation of a great part of South Greenland was mapped and classified in communities and degree of cover. On the basis of this the areas were classified regarding to the grazing capacity for sheep. The following description of the vegetation in the Narssaq-area is mainly based on the work by Thorsteinsson et al. (1980).

The vegetation changes very strongly with the altitude. The diversity is generally much higher in the lower altitudes than in the higher. The number of plant societies were 27 in the altitude 0-200 m a.s.l. and only 3 in the altitude 1000-1200 m a.s.l. From 0-400 m a.s.l. shrub is dominating. In the lowest altitudes (up to 200 m) the shrub is mixed of willow (*Salix glauca* L.) and birch (*Betula pubescens*, Ehr.); but the birch has almost disappeared above 200 m. The plant communities dwarf shrub heath and grass moss heath are common up to about 600 m, whereas herb slopes are only common up to 400 m. Above 400 m lichen heath is the dominating community. Within the Ilimaussaq intrusion the plant cover is generally sparse due to the high weathering rate of the rocks (see sect. 3.2).

On the Kvanefjeld Plateau lichen heath with dwarf shrubs is dominating. The degree of plant cover is low (16.5-50%). In protected areas grass moss heath is also found. In the Upper Narssaq Valley there is a relatively rich vegetation of grass heath with shrubs on the slopes facing south, whereas the north-facing slope (the Taseq Slope) is almost bare rock.

The west end of the Taseq Lake is surrounded by areas of bare rock, the middle and eastern part is surrounded by heath with grasses, sedges and dwarf shrubs. The degree of vegetation cover is generally low, apart from a few areas on the slopes facing south.

Lichen heath with dwarf shrubs dominates the western part of the Nugssuaq peninsula, although an area with birch shrub is also found. The southern slopes of the eastern part of the peninsula are covered by a rich vegetation of willow-shrub with an under-vegetation of grass. The north facing slopes have a vegetation of low willow-shrub (< 0.5 m) with a rather high (50-83.5%) degree of cover.

The Tasiussarssuk inlet is surrounded by a rich vegetation of willow-shrub to the south and east and grass heath and low willow shrub to the north.

3.8.1.2. Fauna. No specific investigations have been made in the area regarding the land-fauna. The only wild land-mammals in the area are the arctic fox (*Alopex lagopus coeruleus*) and the mountain hare (*Lepus arcticus*). In addition to the wild mammals there are sheep (see sect. 4.4.) and a few horses.

Most of the birds in Greenland are connected to water. Of the real land birds the dominating species are the snow bunting (*Plectrophenax nivalis*), the wheatear (*Oenanthe oenanthe*), the raven (*Corvus corax*) and the grouse (*Lagopus mutus*). The birds mainly living from the sea are dealt with in the next section.

### 3.8.2. Aquatic ecology

3.8.2.1. Freshwater ecology. The main freshwaters of interest in the present context are the Narssaq River and the Taseq Lake, the hydrology of which has been described in sect. 3.7.

In connection with the investigations for the potential of hydroelectric power the Greenland Fishery Investigation has made a survey of the stock of arctic char (*Salvelinus alpinus* L.) in the Narssaq river, and of the feed organisms for this species (Grønlands Fiskeriundersøgelse 1981 and 1982). The arctic char population utilize all water-covered areas below the rapids at the mouth of Kvane River in elev. 80 m a.s.l. and in the lower reach of Taseq River. Fish has not been observed in Taseq Lake. A population in Kvane river is regarded as isolated. Spawning takes place mainly in the main stream at the stretch between Kvane River and Leo Larsen's Bridge (elev. about 35 m a.s.l.). The density of fish may be up to 2 fish/m<sup>2</sup> in August. The main food for the arctic char is larvae and puppae of midges (chironomids).

3.8.2.2. Marine ecology. The dominant fish species in the fiords are cod (*Gadus morhua*), Greenland halibut (*Reinhardtius hippoglossoides*), and salmon (*Salmo salar*). The position of these species in a simplified food web is shown in Figure 3-12. It is seen, that the species range from bottom dwellers (catfish) eating bottom organisms, to pelagic fishes (salmon) feeding mainly on smaller fish and zooplankton. Cod and halibut take intermediate positions. The deep sea shrimp (*Pandalus borealis*) is an important species both as food organism for fish and as an economic species. This species is very abundant on the bottom of the fiords 200 m - 1000 m b.s.l. The most important fishing grounds are shown in Figure 3-5.

Two species of seal, common seal (*Phoca vitulina*) and ringed seal (*Phoca hispida*) are found in the area, the latter is the most abundant. The most important breeding localities and winter-open waters for these species are shown in Figure 3-13. The seals feed mainly on fish.

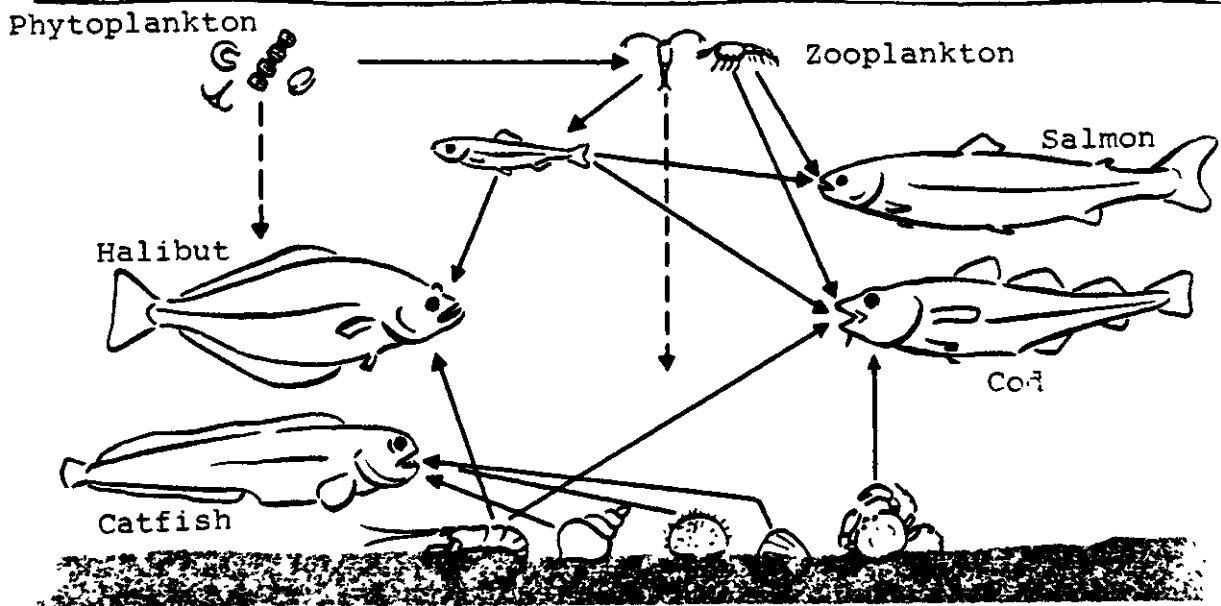

Figure 3-12. Generalized food-web of the fish fauna in Greenlandic waters. (From Nørrevang et al. 1971).

The amount of marine birds in the arctic areas is very large due to the high production in the sea. In the inner-fiords the most abundant species are kittiwake (*Rissa tridactyla*) and glaucous gull (*Larus hyperboreus*) both species feeding on fish and shrimps. The glaucous gull is also known to eat berries in the autumn. The black guillemot (*Cepphus grylle*) is also common in all coastal areas. Closer to the ocean arctic tern (*Sterna paradisaea*) and eider (*Somateria mollissima*) get common. The eider feeds on mussels and snails whereas the main food for the arctic tern, black guillemot and other guillemots living in the area are small fish and crustaceans. The main breeding grounds for the sea birds are shown in Figure 3-14.



Figure 3-13. Areas of importance for seals.

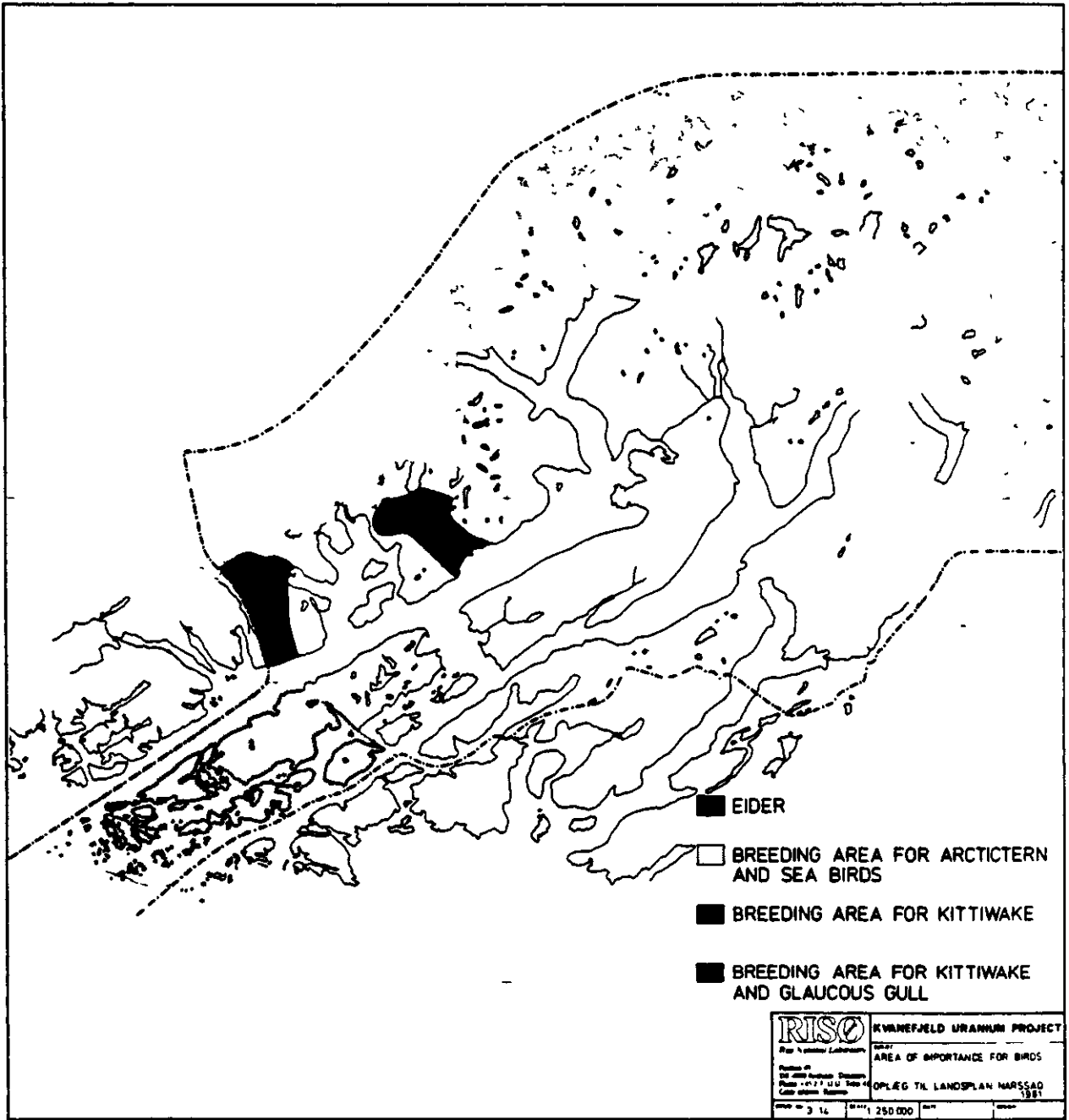

Figure 3-14: Areas of importance for birds.

### 3.8.3. Chemical and radiological characteristics

It was mentioned in section 3.2 that the environment is characterized by an unusual geological structure, the Ilimaussaq intrusion. The rare geochemistry of the intrusion is also reflected in the biota. This has been subject to a geochemical-ecological project (The Narssaq Project) initiated in 1974 (Rose-Hansen et al. 1977). One of the main purposes of this project was to investigate key geochemical and ecological parameters in order to facilitate monitoring of the environment after initiation of mining in the district. During the project 3000 samples of rock, weathering products, soil, plants, animals, sediments, water (rain-, river-, lake-, and sea water) and suspended material were analyzed for a long range of elements. The samples were taken from localities within the Ilimaussaq intrusion and from reference localities. The information is saved in a database. Although the field work was finished in 1979, the bulk of the results are as yet unpublished, and will therefore not be quoted in this report.

In general the results from the Narssaq Project showed that the rare geochemistry of the Ilimaussaq Intrusion was reflected in all the compartments studied. Elevated concentrations of a long range of elements could also be found in the surrounding environment due to transport from the intrusion, particularly with run-off.

In 1979 the Ministry for Greenland initiated supplementary investigations in order to get some information about the chemical and radiological characteristics of some key ecological elements. During this investigation samples of sea water, river water, sediments, plankton, seaweed, fish, mussels, and lichens and mosses were taken and analyzed for a long range of elements. The results of this investigation is not fully reported, but examples of the analyses will be given.

Table 3-2: Concentrations of Ra-226 (pCi/kg w.w.) in plants and animals from the Narssaq area.

		within intrusion *			outside intrusion		
		$\bar{x}$	s.d.	n	$\bar{x}$	s.d.	n
Arctic char ( <i>Salvelinus alpinus</i> )	meat	3.7	2.2	3	0.21	0.05	3
	bone	79	9	3	2.5	10	6
Catfish ( <i>Anarchias minor</i> )	meat				0.32	0.17	10
	bone				37	14	10
Greenland halibut ( <i>Reinhardtius hippoglossoides</i> )	meat				0.18	0.06	5
	bone				7.1	3.0	6
Cod ( <i>Cadus morhua</i> )	meat				1.1	0.4	4
	bone				53	17	4
Greenland cod ( <i>Gadus odac</i> )	meat				1.8	1.4	10
	bone				75	28	10
Plancton					0.5		2
Shrimps ( <i>Pandalus borealis</i> )	meat				1.1	1.4	4
	shells				29	11	7
Mussels ( <i>Mytilus edulis</i> )	meat				1.9	0.7	17
	shells				30	8	17
Seaweed ( <i>Fucus vesiculosus</i> )					16	6	6
Moss ( <i>Racomitrium lanuginosum</i> )		554		1	53	12	5

\* for Arctic char i.e. Narssaq River.

In Table 3-2 the results of analyses of Ra-226 are given. The results show as could be expected that much higher Ra-concentrations are found in hard tissues (bone and shells) than in soft tissues (meat). It can also be seen that there are differences between the species.

Notice especially that the concentrations in halibut are much lower than in the other sea-fish species. This might be due to differences in food. It is also seen from the few samples of



arctic char and moss, that significantly higher concentrations are found in samples directly influenced by the intrusion, than in samples outside of this.

In Table 3-3 the element concentrations of the moss, *Hylocomium splendens*, are given. The element content of this moss species reflects material deposited from the air, either as dissolved elements in precipitation or as particulates carried by the wind. It can be seen from the table that a long range of elements are found in significantly higher concentrations in samples taken within the intrusion than in samples taken outside. However, as mentioned in sect. 3.2. the weatherability within the intrusion is much higher than outside. The effect of this higher weatherability can be seen in the concentration increases of the elements Sc, Cr and Fe, which in general are not found in higher concentrations in the rocks of the intrusion. But even if the ratios are corrected for the increase in concentrations due to the higher weatherability a large number of elements are found in increased concentrations. These elements correspond very well to those which are increased in the rocks cfr. Table 3-1.

Figure 3-15 shows sampling sites for sediments and results of analyses are given in Table 3-4. Many elements are clearly enriched in the sediments sampled closest to the outlet of the Narssaq River. This holds for Be, Mn, Fe, Zn, Rb, Cs, REE, Hf, Ta, Pb, Th, and U. These are elements which are all highly enriched in the rocks of the intrusion as compared to average rocks.

In general it can be concluded that the radiological and chemical characteristics of the ecological compartments in the area around Kvanefjeld are highly influenced by the special geochemical properties of the Ilimaussaq intrusion.

Table 3-3: Element concentrations (ppm d.w.) in the moss (*Hylocomium splendens*) sampled within (w) and outside of (O) the Ilimaussaq intrusion.

		$\bar{x}$	N	ratio W/O	F
Na	W	1560	6	1.5	2.43 n.s.
	O	1010	8		
K	W	3870	5	1.1	1.71 n.s.
	O	3390	8		
Sc	W	0.42	6	1.4	1.23 n.s.
	O	3.8	8		
<u>Fe</u>	W	2780	6	1.9	4.58 *
	O	1450	8		
Co	W	0.53	6	0.9	0.27 n.s.
	O	0.59	8		
<u>Zn</u>	W	202	6	4.3	9.41 **
	O	47	8		
As	W	0.48	3	2.7	2.7 n.s.
	O	0.18	3		
Se	W	0.30	5	1.4	0.32 n.s.
	O	0.21	5		
Br	W	9.3	6	1.0	0.02 n.s.
	O	8.9	8		
<u>Rb</u>	W	30	6	3.3	53.45 ***
	O	9	7		
Sr	W	46	3	1.1	0.06 n.s.
	O	43	7		
Zr	W	91	4	4.0	2.82 n.s.
	O	23	3		
<u>Cd</u>	W	0.31	7	1.8	4.651 *
	O	0.17	8		
<u>Sb</u>	W	0.14	4	1.4	6.57 *
	O	0.10	5		
<u>Cs</u>	W	0.44	6	2.9	6.02*
	O	0.15	7		
Ba	W	65	5	1.7	1.06 n.s.
	O	38	6		

(Cont.)

Table 3-3: (Contd.)

		$\bar{x}$	N	ratio W/O	F
<u>La</u>	W	26	6	5.2	7.90 **
	O	5	8		
<u>Ce</u>	W	46	6	4.6	9.41 **
	O	10	8		
Nd	W	16	6	3.2	1.42 n.s.
	O	5	3		
<u>Sm</u>	W	2.3	6	3.3	5.91 *
	O	0.7	8		
<u>Eu</u>	W	0.22	6	2.4	3.94 *
	O	0.09	8		
<u>Tb</u>	W	0.26	6	4.3	6.58 *
	O	0.06	7		
<u>Yb</u>	W	0.88	6	4.9	13.25 ***
	O	0.18	8		
Lu	W	0.096	6	3.1	2.59 n.s.
	O	0.031	3		
<u>Hf</u>	W	1.4	6	2.3	4.76 *
	O	0.6	8		
<u>Ta</u>	W	0.52	6	3.5	7.39 **
	O	0.15	8		
Au	W	0.004	5	0.8	0.48 n.s.
	O	0.005	5		
Hg	W	0.09	5	1.0	0.15 n.s.
	O	0.09	5		
<u>Pb</u>	W	17.5	7	12.5	11.81 **
	O	6.9	9		
<u>Th</u>	W	3.5	6	5.8	12.69 **
	O	0.6	8		

n.s. = non significant

\* =  $p < 0.05$

\*\* =  $p < 0.01$

\*\*\* =  $p < 0.001$

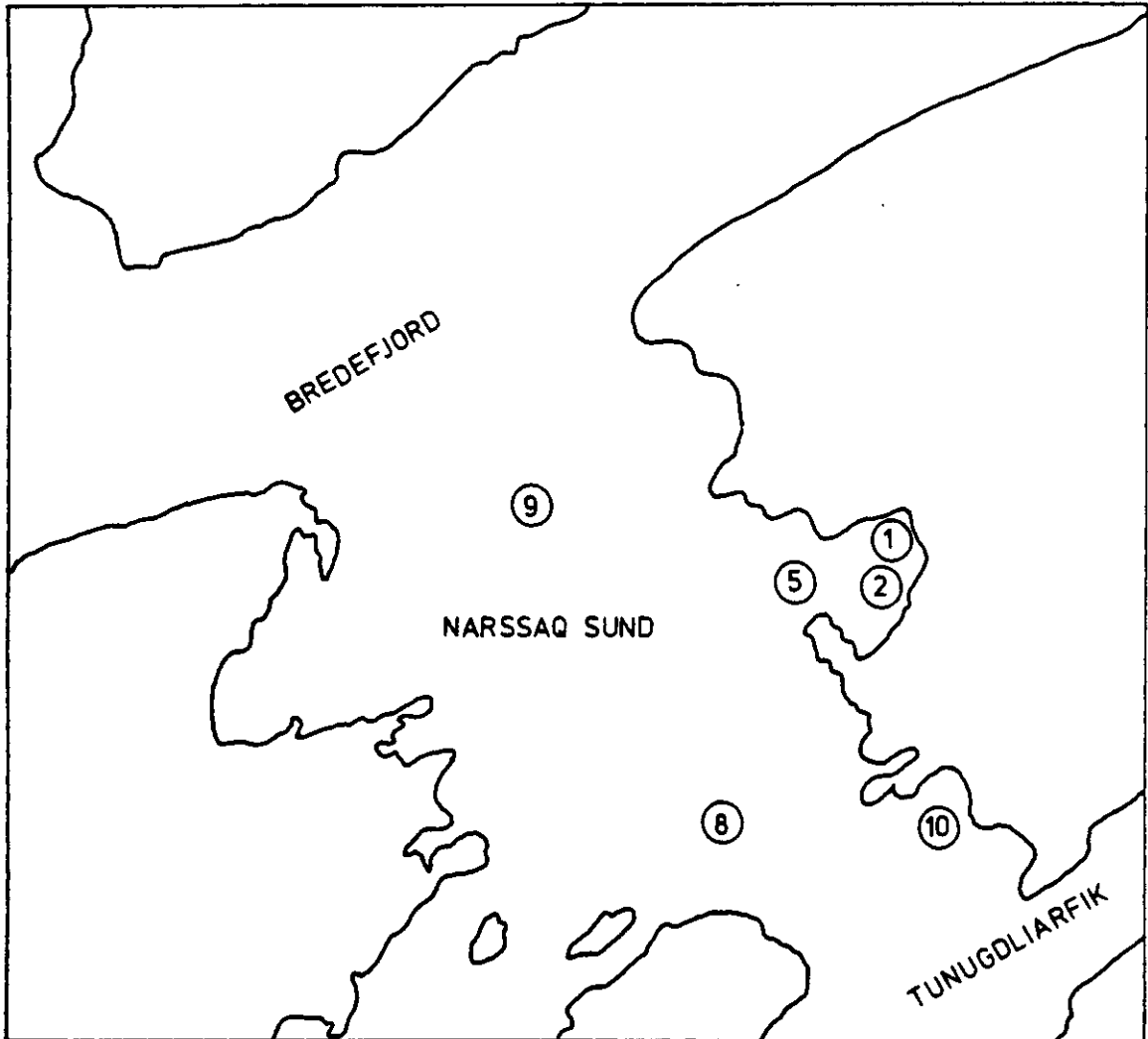

Figure 3-15: Map of localities for sediment samples.

Table 3-4: Element concentrations in sediments.

Element:	Method	Locality					
		1	2	5	8	9	10
Be ppm	AAS	60.1	54.9	3.5	2.0	1.0	2.5
Na %	INAA	6.7	6.3	3.6	3.1	3.2	3.2
Al %	INAA	8.0	8.6	7.9	8.1	7.6	7.8
Ca %	AAS	1.25	0.41	0.66	0.65	0.55	0.98
Sc ppm	INAA	7.3	7.3	8.9	10.5	9.2	10.9
Cr ppm	AAS	4.01	3.66	6.62	6.11	5.28	6.87
Mn ppm	AAS	2500	1800	711	555	502	653
Fe %	INAA	9.86	7.50	4.1	3.4	3.1	4.0
Co ppm	INAA	7.0	6.1	10.0	9.6	10.2	10.7
Ni ppm	AAS	38.1	34.8	41.9	43.8	57.1	49.2
Cu ppm	AAS	13.8	9.8	113	15.0	5.2	17.3
Zn ppm	INAA	677	555	134	101	92	111
As ppm	INAA	<26	<11	2.5	<2	<5	3.1
Se ppm	INAA	<2	3	<0.7	<1	<1	<1
Br ppm	INAA	<11	<7	37	39	23	69
Rb ppm	INAA	290	295	108	91	82	90
Sr ppm	INAA	210	<130	395	279	287	365
Cd ppm	AAS	0.30	0.13	1.04	0.51	-	0.30
Sb ppm	INAA	<0.8	<1	0.29	0.16	<0.2	0.41
Cs ppm	INAA	6.5	6.6	1.6	1.1	1.0	1.2
La ppm	INAA	1050	659	105	52	58	71
Ce ppm	INAA	1430	1020	226	127	123	159
Sm ppm	INAA	88	62	14	8	7	10
Eu ppm	INAA	6.8	5.3	1.8	1.3	1.2	1.5
Tb ppm	INAA	8.3	6.7	1.5	0.9	0.8	1.2
Yb ppm	INAA	25	16	4.4	3.4	2.2	3.7
Lu ppm	INAA	4.0	2.8	0.6	0.4	0.3	0.6
Hf ppm	INAA	62	51	20	11	7	22
Ta ppm	INAA	25	20	3.1	1.4	1.2	2.1
Hg ppm	INAA	<0.9	<0.8	2	<0.4	<0.4	1.5
Pb ppm	AAS	145	92	55	51	53	57
Th ppm	INAA	158	108	15	8	8	10
U ppm	INAA	46	38	<13	<18	<18	<20

\*AAS = Atomic Absorption Spectrometry

INAA = Instrumental Neutron Activation Analysis

#### 4. PROPOSED ACTIVITIES

The Uranium Mine Project involves mining at the Kvanefjeld and two alternatives for the placement of process plant and tailings. The first alternative is to place the process plant in the Narssaq Valley close to the mine and the tailings in Lake Taseq (Figure 4-1). The other alternative is placement of the process plant 18 km NE of the Kvanefjeld at the peninsula Nugssuaq with the tailings in the inlet of Tasiussarssuq (Figure 4-2). The combination of a process plant in the Narssaq Valley and tailings disposal in Tasiussarssuq has also been discussed.



Figure 4-1: The siting of the mine, process plant and tailings in alternative 1.

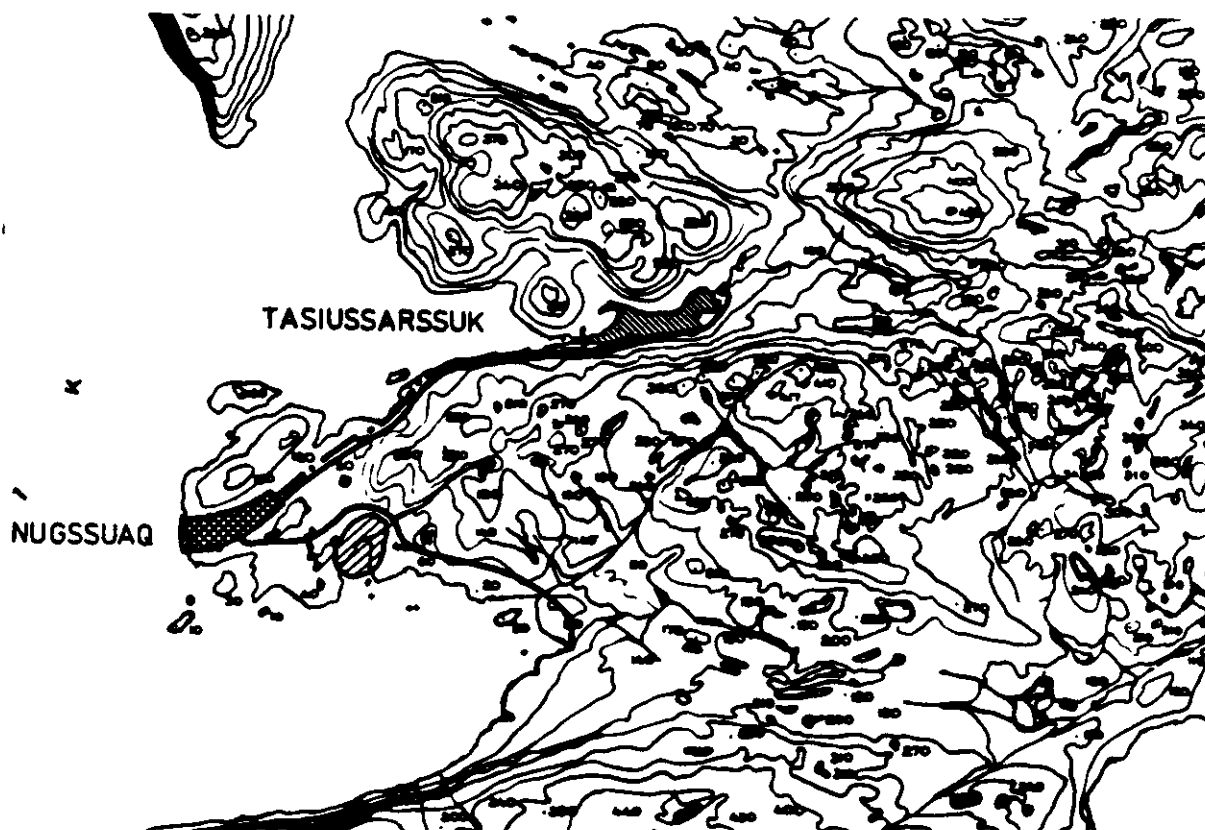

Figure 4-2: The siting of the process plant and tailings in alternative 2.

#### 4.1. Mining

The Kvanefjeld uranium deposit contains a mineable resource of 56 million tonnes and a mill feed grade of 365 ppm U, i.e. about 20.500 tonnes of U. The overall ore:waste ratio is 1.0:1.4, corresponding to about 80 million tonnes of waste. The expected life-time of the mine is 15 years; data for the individual years are given in Table 3-1.

The topography of the ultimate pit and waste dumps are shown in figure 4-3. The highest and lowest altitudes of the pit are 710 m a.s.l., and 450 m a.s.l., respectively.

The waste will be stored W and N of the pit, and the estimated volume after disposal is  $42 \cdot 10^6$  m<sup>3</sup>.

**Table 4-1: Production figures for the entire life of mine, based on the Northern area model data (Kalvig 1983).**

Year	1	2	3	4	5	6-14	15	Total
Total mined material (x 10 <sup>6</sup> tonnes)	1.279	7.209	8.879	9.943	10.398	91.854	6.438	136.000
Mineralized material fed to the mill (x 10 <sup>6</sup> tonnes)	1.000	3.100	4.200	4.200	4.200	37.800	1.500	56.000
Waste (x 10 <sup>6</sup> tonnes)	0.279	4.109	4.679	5.473	6.198	54.054	4.938	80.000
Mill feed grade (ppm)	405	384	375	374	378	359	359	365
Uranium to mill (tonnes U)	405	1190	1575	1571	1588	13.571	539	20.440
Mineralized material to waste ratio	1.0:0.28	1.0:1.33	1.0:1.11	1.0:1.37	1.0:1.48	1.0:1.43	1.0:3.29	1.0:1.43



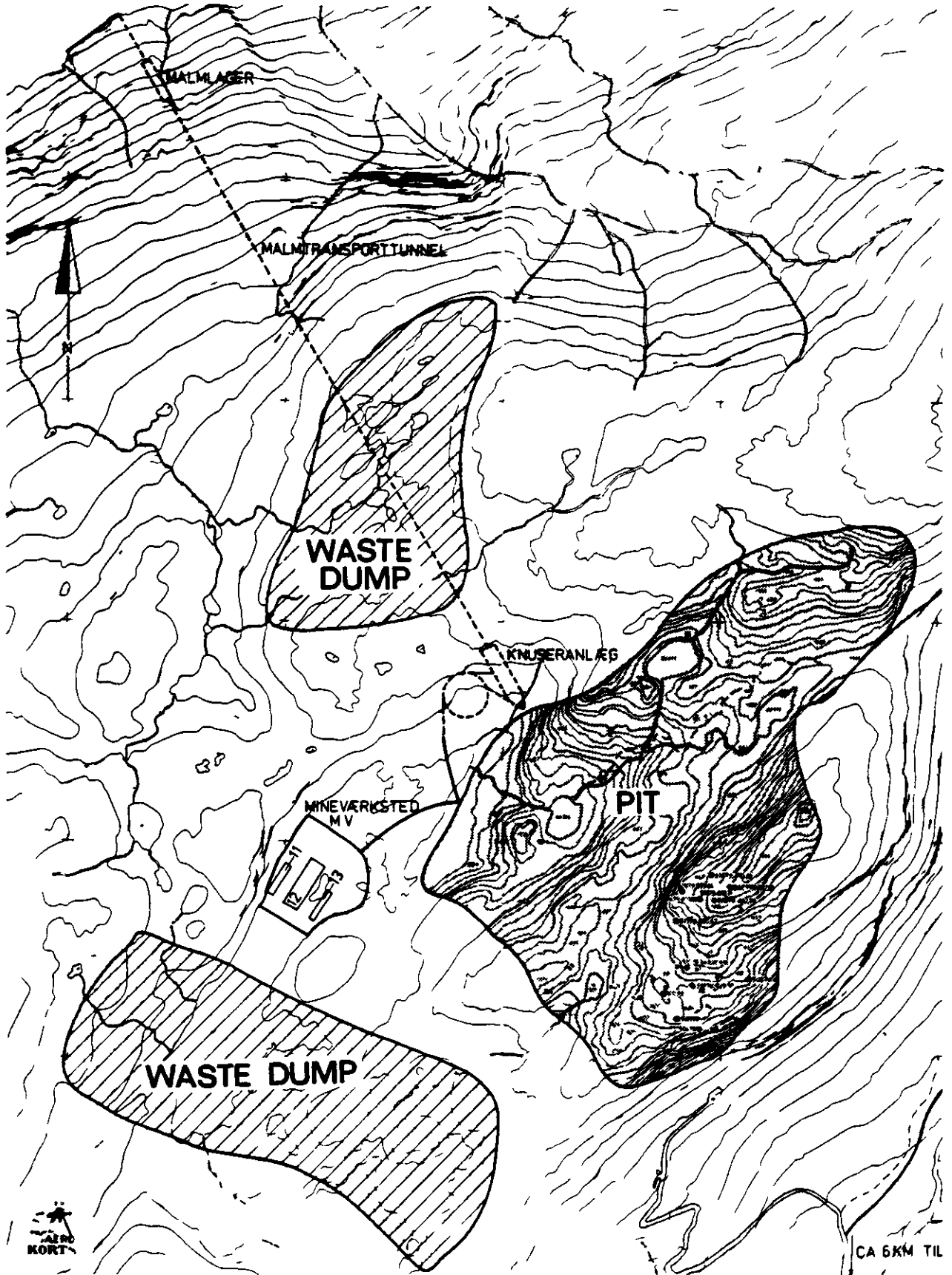

Figure 4-3: Open pit and waste dumps.

The waste might be placed in different heaps due to the chemical classification. Waste water from the pit and waste dumps will be collected and treated if necessary.

In both placement alternatives the ore will be crushed underground and transported by conveyors either to the process plant in the valley or to the place of disembarkation to the process plant at Nugssuaq.

#### 4.2. Milling

The process for the extraction of the uranium is a carbonate pressure leaching in which the uranium is extracted with  $\text{NaHCO}_3$  and  $\text{Na}_2\text{CO}_3$  in a pipe autoclave at high temperature ( $260^\circ\text{C}$ ) and high pressure (130 bar). The flow-sheet is shown in Figure 4-4. The uranium rich liquor is separated from the tailings by filtration. The main part of this liquor is returned directly to the extraction cycle in order to obtain a higher concentration of uranium, while the remainder is first passed through a U-precipitation loop.  $\text{NaF}$  which constitutes about 1% of the rock will saturate the liquor in the closed circuit and then end up in the tailings.

#### 4.3. Disposal of tailings

The tailings management system chosen for the Kvanefjeld Uranium Mine is a saturated tailings management system in which the tailings slurry (50% solids by weight) is discharged in a water cover (Taseq or Tasiussarssuq), which is maintained during the operational phase. After the cease of the operation the tailings pond is drained, covered, and revegetated.

Other options of tailings disposal have been discussed, but not investigated in details. These are deep sea disposal in Bredefjord (depth 660 m) and dry tailings disposal on land.

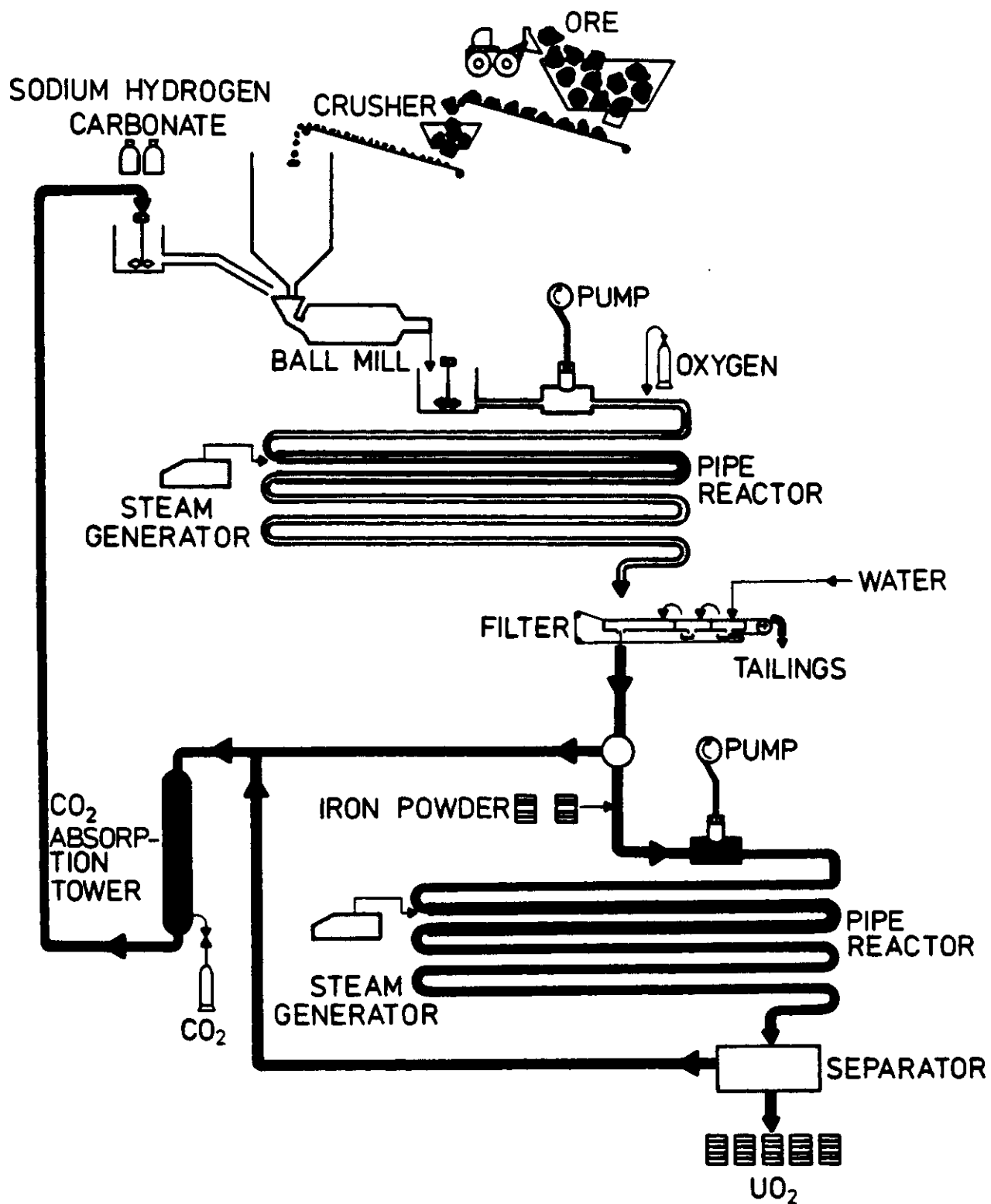

Figure 4-4: Flow-sheet for the uranium extraction process.

The saturated tailings management offers several advantages. By moving the outlet of the tailings pipe the tailings can be placed in a deposit of roughly horizontal surface over the entire area of the pond. This results in a minimum of segregation of the coarse and fine fractions. Therefore the permeability becomes reasonable uniform in both vertical and horizontal directions.

The tailings are fine-grained which ensures a low permeability blanket over the floor of the tailings impoundment. This reduces seepage losses. Due to the watercover the radon-emanation is very much reduced and no wind-erosion can occur.

The outlet from the tailings pond goes through a treatment plant, where it is controlled and treated regarding dissolved Ra, F and suspended particles. Other kinds of treatment can be performed if necessary. A part of the water is recycled to the process plant and the rest discharged to the recipients (Narssaq River/Tunugdliarfik or Bredefjord). Engineering design details of the tailings management systems are given by Erlendsson et al. (1983).

## 5. SOURCES OF POLLUTION

An attempt to identify the sources of pollution as well as the quality and quantity of pollutants is done in this section. Figure 5-1 gives a generalized flow sheet in which the effluents to the environment from various operations in the process of mining and milling are characterized in three categories: gaseous effluents, solid effluents (as dusts) and liquid effluents.

### 5.1. Gaseous effluents

The most important effluent in the gaseous phase is the radioactive gas, radon, which is exhaled from several sources in the

mining and milling operation. This is treated in a separate report by Sørensen (1983). Other gases emitted are carbon monoxide and nitrous gases from blasting in the mine, and gases from the steam generator. The steam generator is fired with coal and the flue gas is rinsed because the carbon dioxide is used in the extraction process. The emission of pollutants from this source is therefore not of great importance.

The potential spread of gaseous pollutants from Kvanefjeld has been investigated in a tracer experiment by Gryning & Lyck (1983). The tracer ( $\text{SF}_6$ ) was released at Kvanefjeld during nighttime in the summer of 1981 and sampled in the Narssaq Valley at Dyrnæs Bay and at Narssaq. On the basis of the tracer concentrations in the airsamples the dilution factor (i.e. the maximum measured concentration in each experiment divided by the tracer release rate) was calculated. The dilution of gases that were released from Kvanefjeld was very different in the 6 experiments performed. The highest value of the dilution factor (i.e. lowest dilution) was  $0.62 \cdot 10^{-6} \text{ s/m}^3$ . Thus a continuous release of 1 g/s under similar meteorological conditions will result in concentrations around  $0.6 \text{ } \mu\text{g/m}^3$  at the lowest part of the valley. The highest value of the dilution factor in the part of the sampling series just outside Narssaq was  $0.53 \cdot 10^{-6} \text{ s/m}^3$ . The dilution of the tracer was found to correspond to the dilution at ground level of a plume from a stack of 100-200 m in atmospheric neutral conditions (wind speed 5 m/s).

The experiments are representative for the dilution that can be found during a substantial part of the summer under clear sky conditions during the night. During the day the upvalley wind prevents the pollutants from being transported to Narssaq. Also at night under overcast conditions the transport velocity will be very small. At situations with föhn-wind, the high wind speeds will increase the dilution of the gases, but also reduce the transport time from the Kvanefjeld to Narssaq, resulting in higher pollutant concentrations than found under the conditions in the experiments.

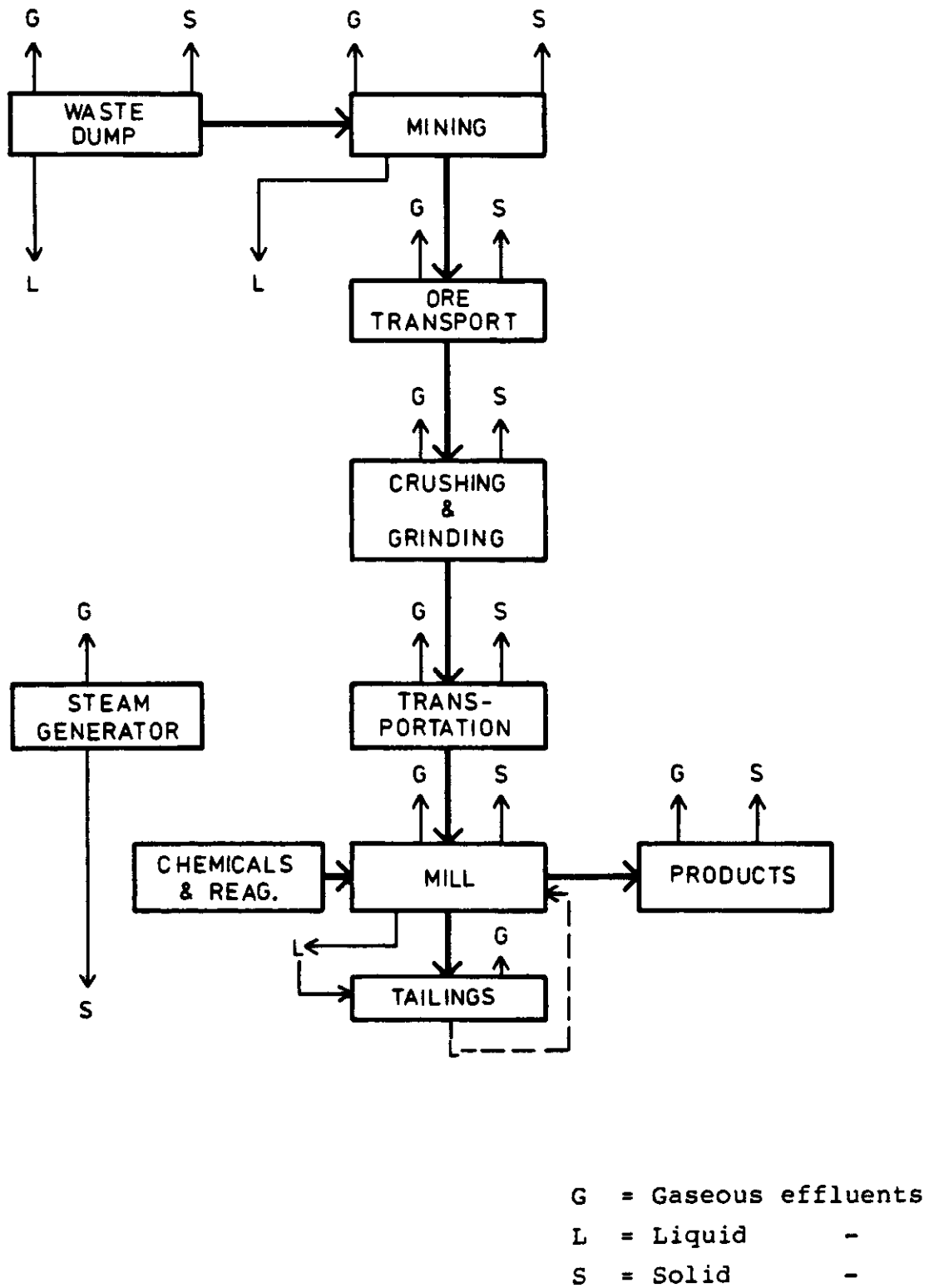

Figure. 5-1. Types of effluents from various operations.

During winter, downvalley flow is well established both day and night. The flow tends to be more developed than in the summer and the daily cleaning by the upvalley flow is absent. Therefore higher concentrations than measured in the experiments can well occur in the winter.

## 5.2. Solid effluents

The solid effluents are dusts which can be produced during blasting and by upwhirling of small particles from the pit, ore storage heaps, waste rock heaps and from ore loading, transportation, crushing and grinding. The tailings slurry is dealt with in section 5.3.4.

The quantity of dust depends on the particle size distribution, the humidity and the wind velocity. Winds greater than 3 m/sec. (considered to be the overall threshold value for upwhirling of dry mineral dust) occurs 25% of the time (Kristensen 1983). Spread of particles lifted by blasting and hauling can, however, occur at lower wind velocities.

The amount of dust raised by the mining activity is difficult to estimate. Knight (1980) estimates that the potential airborne dust in the respirable size range is 23 g/t broken rock with a maximum size of 75  $\mu$ m. For the Kvanefjeld mine this amounts to 184 t/y with a mining of 8 mill. tons of ore and waste.

A study by Blanchard et al. (1982) is concerned specially with the emission of dust from uranium mines. Using their values for a surface mine (sandstone) the dust emission from the Kvanefjeld mine would amount to 405 t/y. In addition to the dust raised by mining, the ore stock piles and waste rock piles would release 540 t/y. So the total dust emission from the mining activity can be in the order of 1000 t/y provided no dust suppression actions are taken. It is however presumed that the pit will be sprayed with water when necessary.

Table 5-1: Element content of waste and ore.

Element	WASTE			ORE
	gabbro/lava	naujaite	lujavrite	lujavrite
Be ppm				60
F ppm				9600
Na %				12
Mg ppm				70
Al %				9
Ca ppm				190
Sc ppm	13	1		0.6
Cr ppm	70	50		70
Mn ppm	3000	1800	4500	4500
Fe %				8
Co ppm	15	0.6		1(30)
Ni ppm	30	20	10	10(30)
Cu ppm	50	60	60	60
Zn ppm	800	600		1500
Ga ppm	80	140		150
As ppm				30
Se ppm				10
Rb ppm	600	700	700	700
Sr ppm	260	70	80	70
Y ppm	250	600		950
Zr ppm	500	4600	2700	2700
Nb ppm	1800	1500	900	700
Mo ppm	10	0	10	
Cd ppm				6
Sn ppm	50	90		260
Sb ppm	10	6	20	20
Cs ppm	20	10		10
La ppm	800	600		3000
Ce ppm	1300	2700	5500	5500
Sm ppm	110	140	200	200
Eu ppm	10	10	15	15
Tb ppm	10	15	20	20
Yb ppm	10	40	60	60
Lu ppm	2	4	7	7
Hf ppm	10<	70	30	30
Ta ppm	20	40	10	10
Pb ppm	60	90	200	200
Th (NAT) ppm	150	40	700	700
U (NAT) ppm	70	60	250	300
U-238 pCi/g				190
U-235 pCi/g				8
Th-232 pCi/g				109
Th-230 pCi/g				160
Ra-228 pCi/g				80
Th-228 pCi/g				120
Ra-226 pCi/g				150



Table 5-2: Chemical analysis of ore-particles (lujavrite) in different size-classes.

	< 45 $\mu$	45-71 $\mu$	71-100 $\mu$	100-200 $\mu$	200-300 $\mu$	$\bar{x}$
Na %	8.08	8.56	8.23	9.36	-	8.6
Sc ppm	0.45	0.35	0.36	0.35	0.35	0.37
Cr ppm	126	74.9	97.5	84.1	93.2	95
Fe %	9.08	10.5	8.56	8.76	6.61	8.7
Co ppm	1.83	1.08	0.986	1.01	0.974	1.2
Zn %	0.196	0.186	0.186	0.200	0.235	0.20
Rb ppm	658	678	768	694	697	700
Zr %	0.486	0.412	0.484	0.486	0.601	0.49
Sn ppm	130	-	-	-	-	-
Sb ppm	12.9	7.25	8.31	8.27	5.48	8
Cs ppm	7.46	6.82	8.21	7.34	9.16	7.8
La %	0.242	0.220	0.260	0.278	0.148	0.23
Ce %	0.373	0.309	0.344	0.377	0.451	0.37
Nd %	0.157	0.143	0.162	0.171	0.220	0.17
Sm %	0.222	0.011	0.012	0.014	0.018	0.014
Eu ppm	12.6	10.7	11.8	12.2	15.6	13
Tb ppm	18.1	15.2	16.6	16.8	21.2	18
Yb ppm	46.1	41.0	43.8	33.0	511.0	41
Lu ppm	6.4	4.5	4.96	6.26	6.44	5.7
Hf ppm	16.4	13.0	14.5	14.0	14.9	15
Ta ppm	10.1	7.75	7.4	6.94	7.44	8
Th ppm	705	697	542	350	647	600
U ppm	378	341	384	378	497	400

The chemical composition of the dust is in general equal to that of the waste and ore and is given in Table 5-1. Samples of ground ore has been sieved, and the different size-classes analyzed separately in order to investigate whether any elements are concentrated on small particles. The results are shown in Table 5-2. It is seen that there is no tendencies for any of the analyzed elements to be especially concentrated on small particles.

The emission of pollutants can be calculated by multiplication of the total amount of dust and the concentration of the particular element of interest. The total amount of waste is known, but not the amount of the individual rock types.

The ore will be transported by trucks to the underground crushing and grinding facility and from there by a conveyor to the mill (alternative 1) or to the place of disembarkation by barges to the process plant at Nugssuaq (alternative 2). The types of effluents are principally radon and dusts. The underground crushing and grinding facility reduces the amount of dust, but a small amount may escape through ventilation exhausts, even if they are equipped with filters. The dusting potential are greater after the crushing ( $50\% < 1500 \mu$ ). Alternative 2 gives rise to many more sources of dust upwhirling than alternative 1, but in neither case the amount can be estimated on the basis of the present knowledge.

### 5.3. Liquid effluents

#### 5.3.1. Mine

A flowsheet for water draining the mine is shown in Figure 5-2. The amount of water draining from the mine is mainly dependent on the net precipitation. Minor sources of water are run off from the area around the pit, groundwater inflow and water used in the mine for drilling and dust suppression. A small amount of water percolates through cracks and fissures in the mountain. The amount of water draining from a pit of  $1 \text{ km}^2$  will be  $1 \cdot 10^6 \text{ m}^3/\text{y}$ . This water will be mixed with the water from the drainage area outside the pit and passed through a treatment plant (in the operative phase). The water will run through Kvane River and join Narssaq River, whereafter the mine drainage water will be diluted 25 times and after the inflow of Taseq River 35 times. Alternatively the water from the pit could be drained to the northern side of the pit and then to Bredefjord. This alternative will be discussed later.

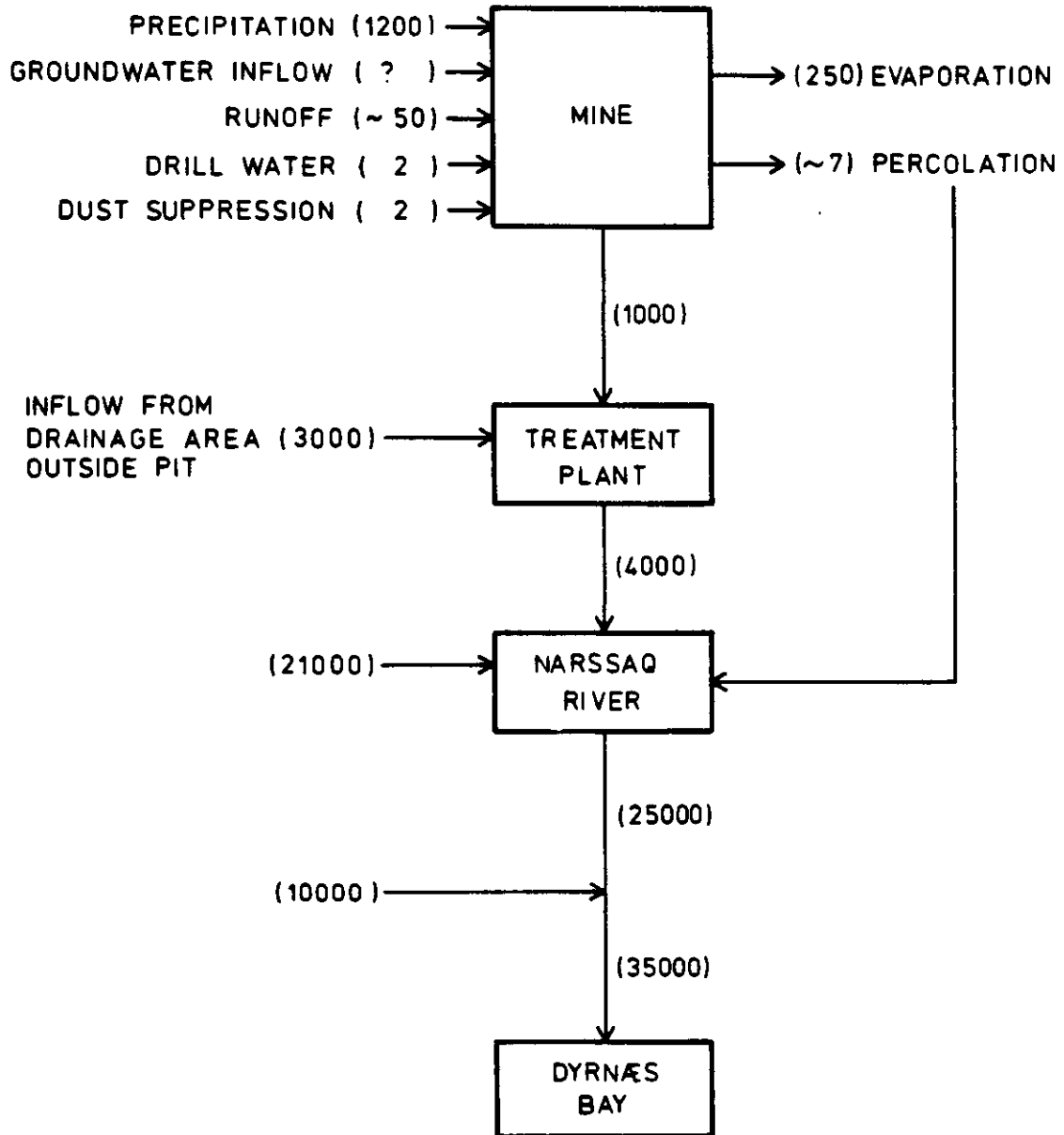

Figure 5-2: Water balance ( $10^3 \text{ m}^3/\text{y}$ ) for the Kvanefjeld mine.

Table 5-3: Water-solubility of elements in ore.

	Ore* (total) mg/kg	Ore (water soluble) mg/kg	Ratio (water soluble/ total)	Initial percolate mg/l	Secondary percolate mg/l
TDS	1000000	17900	0.0179	82240	54340
Be	55	0.56	0.010	2.6	1.4
N-tot		1.4		6.3	4.03
NO <sub>3</sub>		0.46		2.1	0
NO <sub>2</sub>		0		0	0
F	3500	3500	1	10260	10260
Na	117000	5214	0.045	26200	10500
Mg	115				
Al	88000	1.1	0.000013	5.8	(1.2)
S-tot	1620				
SO <sub>4</sub> -S		167		-	22900
Cl		19.5		102	29
Ca	228				
Sc	1				
V		0.23		0.62	1.82
Cr	15	0.29	0.019	1.6	0.3
Mn	5800	0.11	0.000019	0.6	(0.1)
Fe	80000	0.52	0.0000065	2.82	0.52
Co	32	0.67	0.021	3.6	(0.8)
Ni	34	0.84	0.025	4.6	0.8
Cu	17	0.09	0.005	0.5	0.1
Zn	2850	4.7	0.0016	26.6	2.2
As	30	0.14	0.0047	0.64	
Se	10	0.015	0.0015	0.071	
Rb	540	3.35	0.0062	15.4	

(Cont.)

Table 5-3: Water-solubility of elements in ore (Contd.)

	Ore* (total) mg/kg	Ore (water soluble) mg/kg	Ratio (water soluble/ total)	Initial percolate mg/l	Secondary percolate mg/l
Cd	6	0.015	0.0025	0.086	0.0026
Sn	275				
Sb	18	0.17	0.0094	0.76	
Cs	3	0.0057	0.0019	0.027	
La	3080	0.037	0.000012	0.17	
Ce	4100	0.135	0.000033	0.62	
Eu	12				
Tb	15				
Yb	45				
Lu	4				
Hf	11	0.0035	0.00032	0.016	
Ta	6	0.0039	0.00065	0.018	
Hg				<0.002	
Pb	390	6.2	0.016	34.5	4.2
Th(NAT)	700	0.0091	0.000013	0.042	
U(NAT)	450	0.24	0.00053	1.1	
	pCi/g	pCi/g		pCi/l	pCi/l
U-238	220				
U-235	7				
Th-232	110				
Th-230	160				
Ra-228	90				
Th-228	120				
Ra-226	150	0.006	0.000035	29	5

\*Analyses represent sample brought to Risø for the pilot plant investigations.

The mine drainage water will be contaminated by the elements in the exposed ore and waste rock and by elements from explosives and other materials used in the mine. The chemical quality of the water can be estimated by studying the water-soluble substances in the ore and waste rock. It is, however, not possible at present to quantify the pollutants due to the lack of knowledge of the exposed surface area. This is the area of the pit and the additional area due to blasted material.

The water-soluble substances have been investigated in an experiment by Sørensen (1982) in which 1000 kg of ore (lujavrite) were extracted with water. Although the results were not related to the surface area, they give some idea of the waste water quality that can be expected from the mine. The results are given in Table 5-3.

One of the most important water-soluble substances in the ore from an environmental point is villiaumite (NaF). The concentration in the percolate was 2.28% which was saturation. Since the NaF is highly water-soluble it is in general absent from the upper layers of the rock. It is, however, not possible at the basis of the existing data to delimit the exact level below which the NaF is present (Kalvig 1983).

During the operative phase the water will always be in contact with freshly exposed surfaces. The water may thus be saturated with F provided the time is sufficient. The concentration of saturation is approx. 10,000 ppm based on the experiment by Sørensen (1982). The maximum theoretical discharge per year will therefore be 10,000 t. It should, however, be noted that the most important fluoride mineral, villiaumite, is not present in all of the ore. The time required to saturate a water-layer of 1 mm is 3 hours calculated by the formula presented below. Saturation is therefore not likely to occur always. The estimated total resource of fluorine is 470,000 t (Kalvig 1983). During the operative phase the leached fluorine will be precipitated in the mine effluent plant.

The leaching of sodium fluoride from a freshly exposed rock surface has been investigated by Asmund (1980), who derived the following formula:

$$x = 10^{-2} C_s \sqrt{\left(\frac{28,5}{C_s} + 3.724\right) t}$$

$x$  = mg F leached per cm<sup>2</sup> exposed surface

$C_s$  = mg F/cm<sup>3</sup> rock

$t$  = time in hours

By this formula the maximum amount of fluorine leached from the abandoned open pit can be calculated. Assuming a concentration of F of 1% (i.e. 27 mg/cm<sup>3</sup>) and a constant leaching from a pit of 1 km<sup>2</sup> the rate is 550t F/y the first year after mining has ceased.

The amount of water running from the mine is 1·10<sup>6</sup> m<sup>3</sup>/y. The concentration of F in the run-off will thus be 550 ppm. Values for successive years are given in Table 5-4.

The present discharge of fluorine through the Narssaq river is calculated to 142 t F/y based on a discharge of 35.5·10<sup>6</sup> m<sup>3</sup> during May-October (average 3.2 ppm F) and 3.5·10<sup>6</sup> m<sup>3</sup> during November to April (average 8.0 ppm F). Discharge values are from Larsen (1973) and F-concentrations from Asmund (1981). Larsen calculated the discharge of F on the basis of his measurements of concentrations to 83 t F/y.

The present discharge of fluorine is supposed to be a result of dissolved fluoride in the water seeping through the rocks. The fluoride originates not only from the Kvanefjeld area but also from other areas e.g. the Taseq slope. The calculated discharges from the pit were based on the model by Asmund which supposes diffusion to the surface of the rock. At some time after the cease of the mining, the rock will be leached to a depth where

Table 5-4: Leaching of fluorine from the abandoned pit.

Years after mining	Leaching rate mg/cm <sup>2</sup> ·h	Leached depth cm	Amount (t) leached per year from 1 km <sup>2</sup>	Concentration (ppm) in run off*
1	0.0032	2.1	550	550
2	0.0022	2.9	229	229
3	0.0018	3.5	176	176
5	0.0014	4.6	130	130
10	0.0010	6.5	90	90
25	0.0006	10.2	56	56
100	0.0003	20.5	28	28
500	0.0001	45.8	12	12
1000	0.0001	64.7	9	9

\*Supposing a continuous draining.

no diffusion to the surface will occur. At that time the situation will be as before mining except for the fact that the blasting probably have resulted in cracks and fissures in the mountain and the seepage therefore increased.

The water solubility of other elements than F, Na and Si are generally low. A number of elements could, however, be of interest from an environmental point of view. The maximum discharge of the elements can be calculated by the use of their concentration in the initial percolate. In Table 5-5 the concentrations of some of the elements in the run off from the pit are given.



Table 5-5: Discharge (t/y) and concentrations (mg/l) of elements in mine drainage water ( $1 \cdot 10^6$  m<sup>3</sup>/y).

Element	Maximum discharge t/y	Maximum concentration mg/l
Be	2.6	2.6
Al	5.8	5.8
Cl	102	102
Cr	1.6	1.6
V	0.6	0.6
Mn	0.6	0.6
Fe	2.82	2.82
Co	3.6	3.6
Ni	4.6	4.6
Cu	0.5	0.5
Zn	26.6	26.6
As	0.64	0.64
Se	0.071	0.071
Zr		
Nb		
Mo		
Cd	0.086	0.086
Sn		
Sb	0.76	0.76
La	0.17	0.17
Ce	0.62	0.62
Hb	<0.002	<0.002
Pb	34.5	34.5
Th	0.042	0.042
U	1.1	1.1

### 5.3.2. Waste dump

The flowsheet for the water draining through the waste dump are shown in Figure 5-3. The water is discharged to Bredefjord. The chemical composition of the drainage water depends on the solubility of the elements from the rocks constituting the waste. The chemical composition of some of these rocks were given in Table 5-1. Generally the concentrations of potential pollutants in the waste are lower or of the same magnitude as in the ore. No investigations of the solubility of the elements and no estimates of the total surface area of the waste have been made. Therefore the discharge of elements cannot be estimated. The dilution in Bredefjord will, however, be very high.

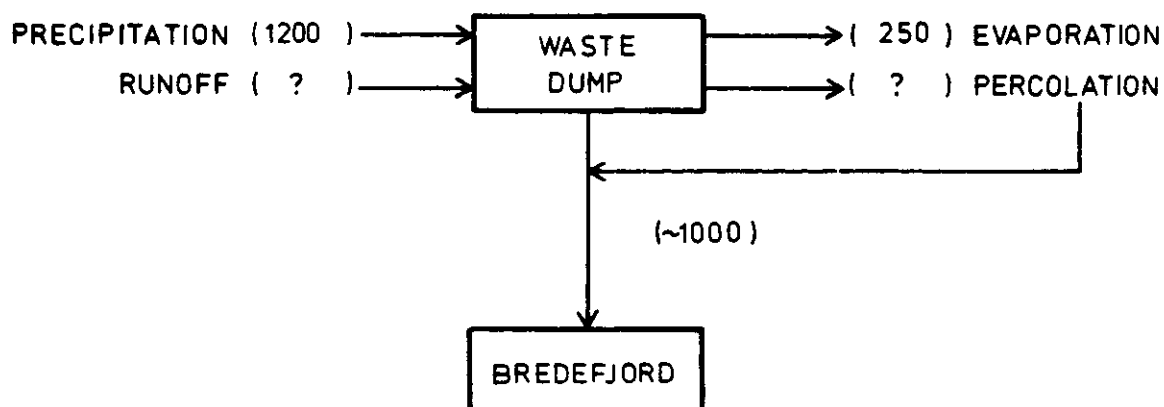

Figure 5-3: Water balance ( $10^3 \text{ m}^3/\text{y}$ ) for the waste dump.

### 5.3.3. Mill

The water flow sheet for the mill and tailings pond is shown in Figure 5-4. The general principle is a recirculation of water between the mill and tailings pond. All effluents from this is running through the treatment plant before reuse or discharge.

The values given in the flow sheet are for alternative 1. The tailings pond used in alternative 2 receives only  $2.8 \cdot 10^6$  m<sup>3</sup>/y as precipitation. The water flow to the treatment plant is thus  $7.2 \cdot 10^6$  m<sup>3</sup>/h and the discharge  $0.7 \cdot 10^6$  m<sup>3</sup>/y.

Figure 5-5 gives a diagram of the water consumption of the individual steps in the extraction process. The quality of the effluent water from the process plant is dependent on several factors. The most important are the chemical reactions during the carbonate leach process and the efficiency of the filter washings.

The element flow in the process is given in Figure 5-6. The carbonate leach process dissolves sodium fluoride, sodium silicate, sphalerite (ZnS) as well as the uranium bearing mineral steenstrupine. A sulphur containing mineral (hackmanite) and some aluminium-containing minerals are partly dissolved. Other minerals are only very little affected.

During the process the bonds between oxides of metals and silicate resp. phosphate are broken in the mineral steenstrupine.  $UO_2^{++}$ ,  $CeO_2$ ,  $MnO_2$ , and  $Fe_2O_3$  are formed by oxidation.  $UO_2^{++}$  is dissolved as a carbonate complex, whereas the other products reprecipitate. The rare earth elements and Th precipitate as carbonates. Silicic acid precipitates apart from a colloidal residue of approx. 150 ppm Si. Sphalerite (ZnS) is oxidized to sodium sulphate and zinc carbonate, which are not dissolved.

Fluoride which is readily water soluble in the ore is dissolved during the process, but reprecipitated again or maybe just adsorbed on the particles.

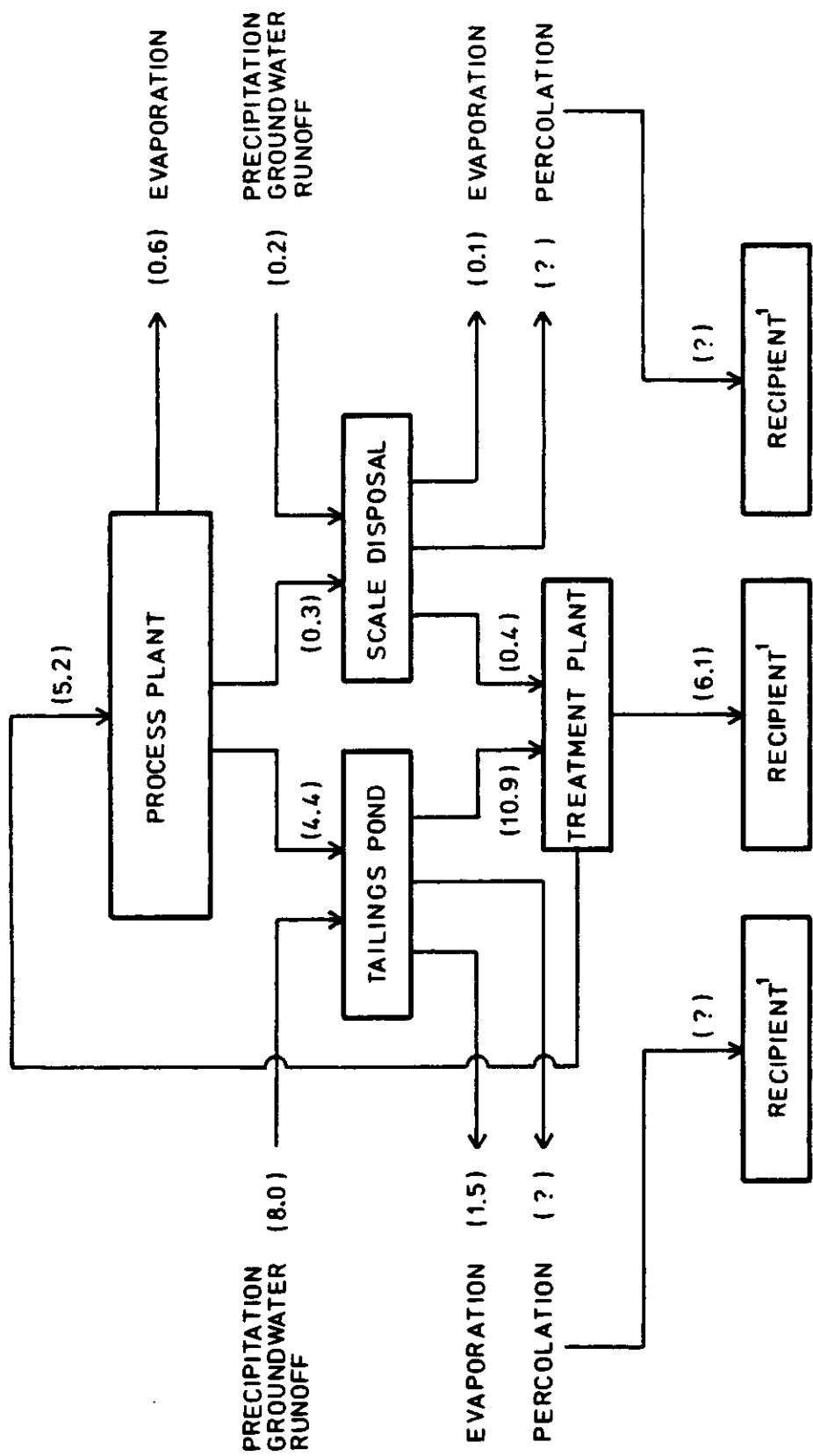

1) Recipients for different alternatives:

Alt. 1a. Alt. 1b. Alt. 2

Treatment plant	Tunugdliarfik	Narssaq R	Breddefjord
Percolation from tailings pond	Narssaq R	Narssaq R.	Breddefjord
Percolation from scale disposal	Narssaq R.	Narssaq R.	Breddefjord

Figure 5-4: Water balance (106 m<sup>3</sup>/year) for the process plant and tailings pond.

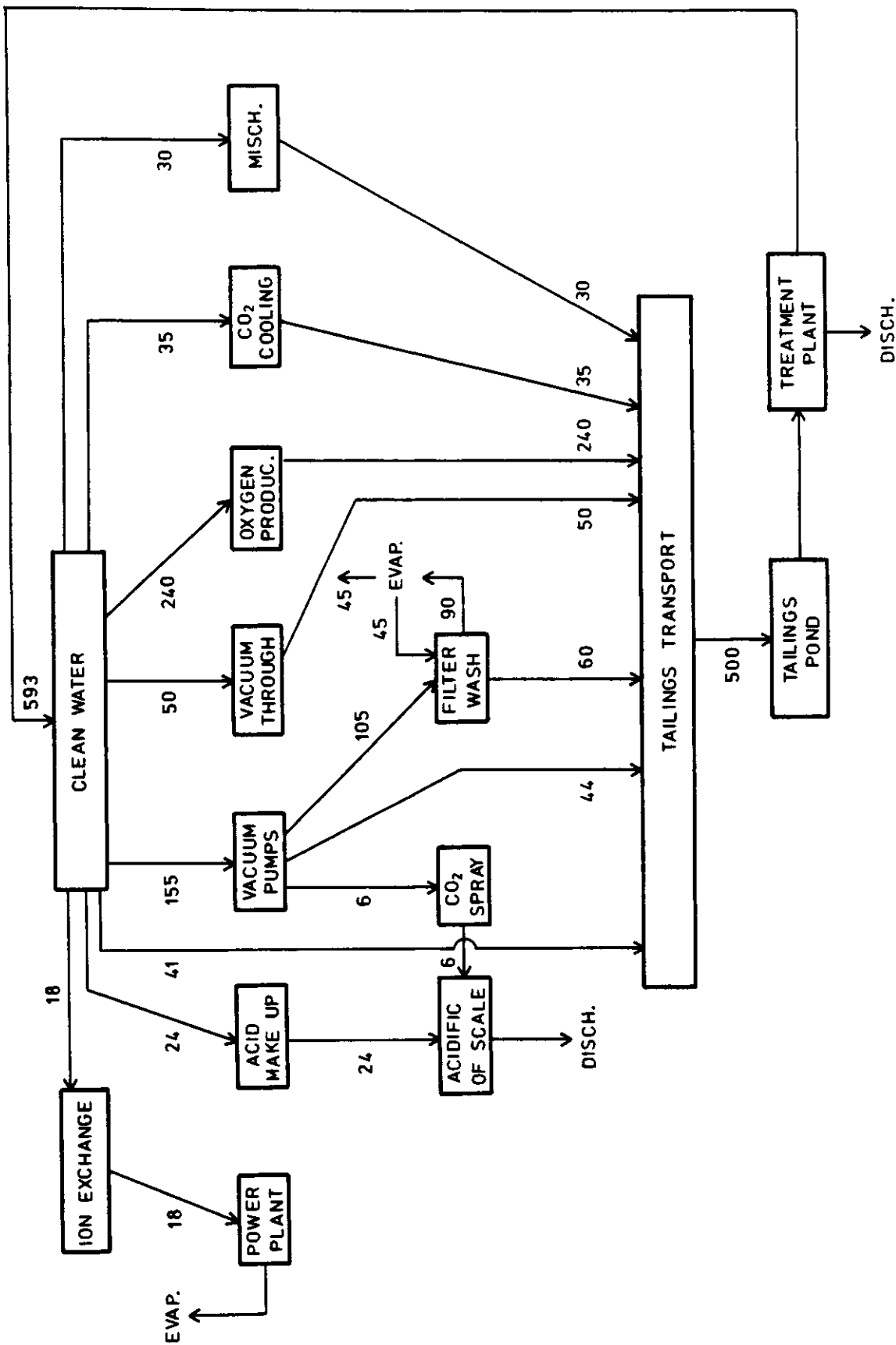

Figure 5-5: Water consumption (m<sup>3</sup>/hour) in the process plant.

Table 5-6: Composition of scale in the pipe autoclave.

Compound	Weght %
SiO <sub>2</sub>	25.7%
MnO <sub>2</sub>	19.9%
LOI	12.4%
ZnO	10.4%
Fe <sub>2</sub> O <sub>3</sub>	8.2%
RE	8.2%
Na <sub>2</sub> O	7.4%
Al <sub>2</sub> O <sub>3</sub>	3.1%
PbO	1.45%
ThO <sub>2</sub>	0.8%
MgO	0.13%
U <sub>3</sub> O <sub>8</sub>	0.040%
Total	97.7%

The reprecipitated compounds are found on the undissolved mineral grains, but also as scale on the pipes in the autoclave. This scale amounts to 0.5-1% by weight of the processed ore. The chemical composition is given in Table 5-6. The scale will be removed by regular washings with sulphuric acid. Some of the compounds will reprecipitate, but Mn, Zn, Fe, Mg and U will stay in solution as sulphates.

The consumption of acid will probably be 0.1% - 0.2% conc. H<sub>2</sub>SO<sub>4</sub> of the amount of processed ore i.e. 2100-4200 t H<sub>2</sub>SO<sub>4</sub>/year and the amount of coating removed will be 21000 - 42000 t/year. To neutralize the consumed acid CaCO<sub>3</sub> in equal amounts is used. The effluent containing water, suspended scale and acid will be deposited in a special enclosure of the tailings pond. The effluent from this disposal will be treated separately in the tailings pond treatment plant.

The concentration and mobility of trace elements in this waste is unknown at present, so the pollution source cannot be evaluated but should be considered very important.

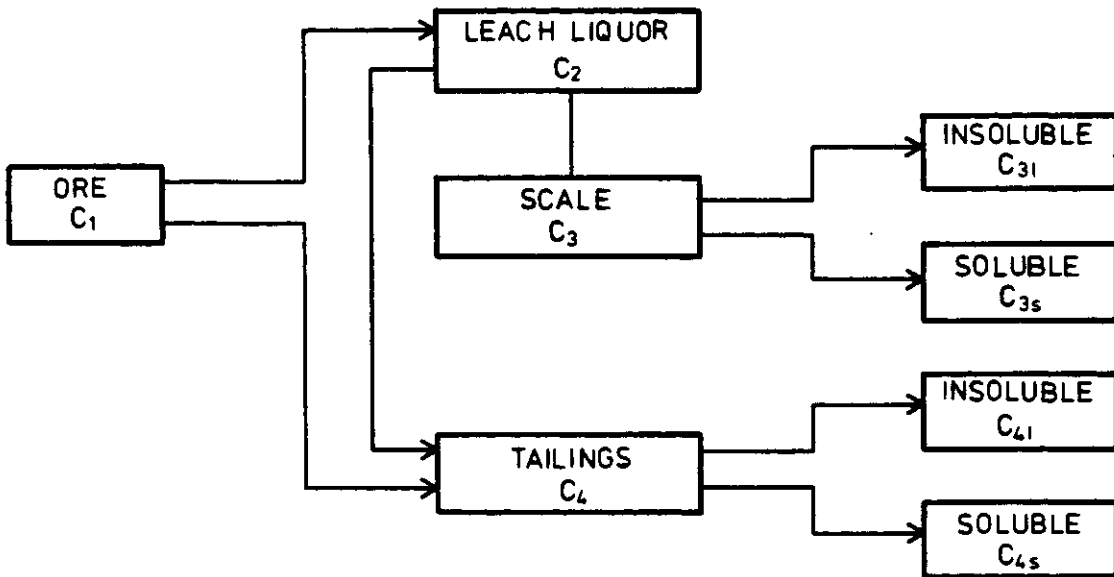

Figure 5-6: Element flow in the carbonate leach process.

The pollutants which could be discharged to the environment are thus the soluble elements from the tailings and scale and the elements in the part of the leach liquid which are lost together with the tailings.

The loss of leach liquor is dependent on the efficiency of the filter washings. Experiments have shown (Sørensen et al. 1983), that the loss may be up to 7%. The loss is different for individual elements, due to their ability to adsorb on particle surfaces.

In a short time perspective (i.e. during the operative phase) the element concentrations in the lost leach liquid will probably be of greatest importance. In the long time perspective the solubility of elements from the tailings and scale will be the most important.

#### 5.3.4. Tailings disposal

The tailings disposal system was briefly described in sect. 3.3. Details of the engineering design are given in Erlendsson et al. (1983). The water flow sheet for the tailings pond in alternative 1 (Taseq) is shown in Figure 5-7 and for alternative 2 (Tasiussarssuq) in Figure 5-8. The outlet from the treatment plant at Taseq can be either to Narssaq River or to Tunugdliarfik. The choice between these two alternative recipients will be discussed later. The present water volume ( $16.5 \cdot 10^6 \text{ m}^3$ ) in Taseq will be discharged gradually over 18 years. The saline water of Tasiussarssuq will be pumped out before tailings disposal.

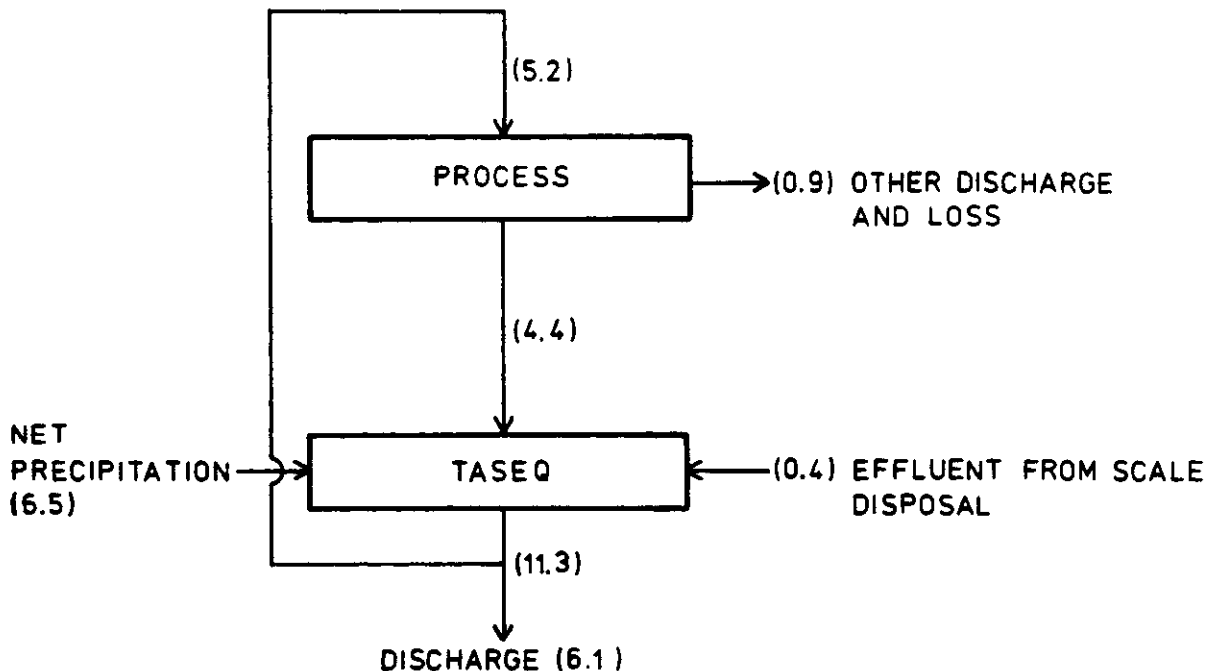

Figure 5-7: Water balance ( $10^6 \text{ m}^3/\text{y}$ ) for the tailings disposal in Taseq.



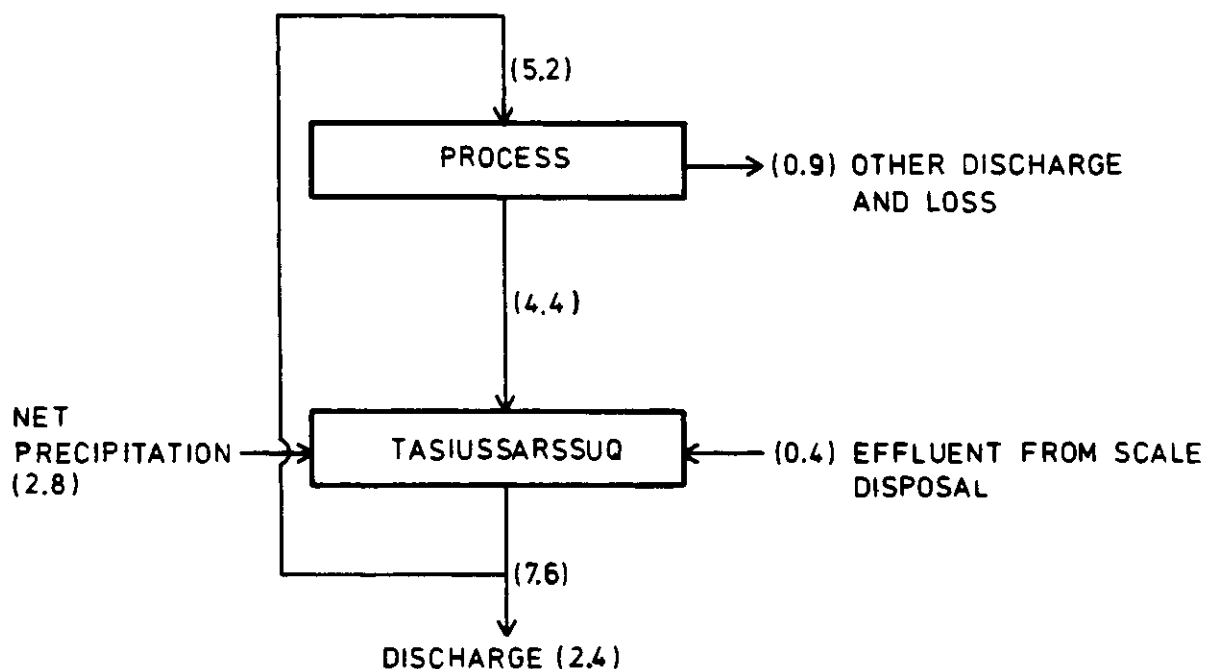

Figure 5-8: Water balance ( $10^6$  m<sup>3</sup>/y) for the tailings disposal in Tasiussarssuq.

5.3.4.1. Characterization of tailings. The tailings is a finely ground material transported as a slurry with a solid/liquid ratio (W/W) of 1:1. The chemical composition is in general equal to that of the ore except for compounds extracted by the process (U) or added ( $\text{NaHCO}_3$ ,  $\text{Na}_2\text{CO}_3$ ). The physical and chemical characteristics of the tailings are given in Tables 5-7 and 5-8.

In Table 5-8 a range is given for the concentration of U. The lower value is the optimal value possible in the process, the higher value is the actually measured. For the other elements average values are given. For the elements not actually measured in tailings samples, ore values are given.

Table 5-9 shows the results of neutron activation analyses on a number of tailings samples. The sample from March was subdivided into four size classes. A number of elements are clearly concentrated on the small particles: Cr, Zn, Sb, REE, Hf, Ta and Th. The reason for this is possibly that they have been in solution and reprecipitated during the process.

Table 5-7: Physical characterization of tailings.

Particle size distribution:	<u>Size</u>	<u>weight %</u>
	> 210 $\mu$	0.4 %
	100 $\mu$ - 210 $\mu$	10.8 %
	71 $\mu$ - 100 $\mu$	12.5 %
	40 $\mu$ - 71 $\mu$	40.0 %
	< 40 $\mu$	39.3 %
Density: actual	1.6 g/cm <sup>3</sup>	
- : absolute	2.7 g/cm <sup>3</sup>	
Porosity	41 %	
Annual amount	4.2·10 <sup>6</sup> t/y	
	~ 2.6·10 <sup>6</sup> m <sup>3</sup> /y	
Total amount	71·10 <sup>6</sup> t	
	~ 44·10 <sup>6</sup> m <sup>3</sup>	

Table 5-8: Chemical characterization of tailings.

pH	10	La ppm	3000
Eh mV	180	Ce ppm	4500
		Sm ppm	200
Be ppm	(60)	Eu ppm	14
F ppm	3500-10000	Tb ppm	18
Na %	8	Yb ppm	130
Mg ppm	(70)	Lu ppm	5
Al %	(9)	Hf ppm	12
P ppm		Ta ppm	8
S ppm	1600	Hg ppm	
Cl ppm		Tl ppm	
K ppm		Pb ppm	(400)
Ca ppm	(190)	Th ppm	700
Sc ppm	0.4	U ppm	50-150
V ppm			
Cr ppm	30	U-238 pCi/g	90
Mn ppm	(6000)	U-235 pCi/g	2
Fe %	9	Th-232 pCi/g	(110)
Co ppm	0.9	Th-230 pCi/g	(160)
Ni ppm	(30)	Ra-228 pCi/g	80
Cu ppm	(20)	Th-228 pCi/g	90
Zn ppm	2000	Ra-226 pCi/g	90
As ppm	(30)	Pb-210 pCi/g	
Se ppm	(10)	Po-210 pCi/g	
Rb ppm	700		
Sr ppm			
Y ppm			
Zr ppm	(2700)		
Nb ppm			
Mo ppm			
Cd ppm	(6)		
Sn ppm	(300)		
Sb ppm	9		
Cs ppm	8		

( ) = ore values

Table 5-9: Element concentrations measured in tailings by neutronactivation analysis.

	Tailings 23 March 1983				Tailings	Tailings
	<40 $\mu$	40-71 $\mu$	71-100 $\mu$	>100 $\mu$	primo 1983	May 19th 1983
Na%	8.8	7.8	11.6	10.1	8.5	6.6
Sc ppm	0.48	0.39	0.35	0.34	0.43	0.42
Cr ppm	44	24	19	11	31	34
Fe%	6.9	9.0	5.8	4.0	8.3	8.3
Co ppm	1.4	0.6	0.5	0.6	0.9	0.9
Zn ppm	3370	824	639	560	1950	1940
Rb ppm	759	747	869	880	705	722
Sb ppm	15	4	3	2	9	8
Cs ppm	10.7	7.7	10.0	12.3	7.8	8.1
La ppm	3460	2310	1560	960	2800	3060
Ce ppm	6180	2910	2460	1710	4250	4725
Sm ppm	225	124	95	68	184	205
Eu ppm	19.5	10.2	8.3	6.1	13.3	14.0
Tb ppm	24.7	13.7	11.3	8.3	17.5	18.3
Yb ppm	24	32	28	25	139	126
Lu ppm	9.0	3.8	3.2	2.5	4.6	4.8
Hf ppm	17.7	10.8	10.6	9.8	12.3	13.0
Ta ppm	11.1	6.6	5.7	4.8	7.9	7.7
Th ppm	895	433	343	232	672	510
U ppm	149	155	150	112	115	206

5.3.4.2. Tailings experiments. In order to evaluate the water solubility of radioactive and non-radioactive elements from the tailings two experiments were performed. The data for the experimental setup are given in Table 5-10. In addition to these, small experiments were made in the laboratory for special purposes.

The two experiments were designed to simulate the situation in the tailings pond and treatment plant. The tailings used for the experiment were taken from the pilot plant in which the tailings were washed on a belt filter. The tailings (approx. 800 kg) were mixed with 5 m<sup>3</sup> of deionized water and stirred for 4-5 days. Hereafter the particles were allowed to settle and after 6-8 days the liquid were decanted to another stirring tank where 25 ppm flocculant (Floerger FO 9107) were added. The optimal amount of flocculant was determined by experiments in the laboratory. After the addition of flocculant the formed particles were allowed to settle for 7-10 days and the liquid decanted to a clean stirring tank.

Table 5-10: Data for tailings experiments.

	<u>Exp. 1</u>	<u>Exp. 2</u>
Tailings (dry weight)	813 kg	828 kg
Solution water	5.124 m <sup>3</sup>	5.222 m <sup>3</sup>
Stirring time	5 d	4 d
Settling time	8 d	6 d
Flocculant	25 ppm	25 ppm
Settling time	7	10
Resulting liquid	4.097 m <sup>3</sup>	3.460 m <sup>3</sup>
BaCl <sub>2</sub>	15 ppm	30 ppm
Na <sub>2</sub> SO <sub>3</sub> ·7H <sub>2</sub> O	0	227.4 g
Na <sub>2</sub> SO <sub>4</sub>	0	26.4 kg

In experiment 1, 15 ppm of Ba were added in order to precipitate Ra as (Ba,Ra)SO<sub>4</sub>. After the addition of Ba as BaCl<sub>2</sub> the solution was stirred for 5 minutes. Samples were taken before and after the addition with increasing intervals (Table 5-11). Also samples of the tailings, of the solid matter formed by flocculation, and of the (Ba,Ra)SO<sub>4</sub> precipitate were taken.

Table 5-11: Samples in tailings experiment 1.

1.	Before addition of BaCl <sub>2</sub>		
2.	After addition of BaCl <sub>2</sub> and 0 minutes after stirring		
3.	5 minutes after stirring		
4.	10	-	-
5.	15	-	-
6.	30	-	-
7.	1 hour	-	-
8.	3 hours	-	-
9.	24	-	-
10.	48	-	-
11.	120	-	-
12.	312	-	-

Four samples were taken at a time. The first sample (1 litre) was used for Ra-226 analyses. This sample was filtered through a 0.45 $\mu$  filter in order to distinguish between Ra in solution and particle-bound Ra. The second sample (20 l) was spray-dried and the dry sample was analyzed in a gamma-spectrometer for U, Th and Ra. This sample was also analyzed for a long range of elements by instrumental neutron activation analysis (INAA). The third sample (5 l) was used for general water analyses (S, N, P, pH, alkalinity, conductivity, total dissolved substances (TDS) and total suspended solids (TSS)). The fourth sample (1 litre) was filtered (0.45 $\mu$ ) and analyzed by atomic absorption spectrophotometry (AAS) for a number of elements. The elements analyzed for both by INAA and AAS showed a good agreement between the two methods although the samples for the INAA were unfiltered. In Tables 5-12 and 5-16 it can be seen that the amount of total suspended solids is very small compared to the amount of total dissolved solids.

Table 5-12: Concentration of elements (mg/l) in tailings liquid from experiment 1.

Element	Method*	1	2	3	4	5	6	7	8	9	10	11	12
Be	AAS	0.0037	0.0039	0.0039	0.0040	0.0039	0.0040	0.0040	0.0040	0.0038	0.0037	0.0033	0.0027
NO <sub>3</sub> -N		0	2.8	0	0	0	0	0	0	1.4	0	0	0
NO <sub>2</sub> -N		0	0	0	0	0	0	0	0	0	0	0	0
N-tot		3.85	3.33	3.33	3.85	3.85	3.85	3.85	3.85	7.18	7.18	7.18	7.18
F	ISE	195	188	188	188	188	188	188	188	188	170	188	188
Na	AAS	304	296	298	296	296	296	296	296	296	298	296	294
Al	AAS	166	121	104	110	109	99	100	100	104	98	90	83
P-ortho		0.252	0.407	0.407	0.233	0.233	0.233	0.233	0.233	0.155	0.155	0.155	0.155
SO <sub>4</sub>		20	30	30	30	30	30	30	30	30	30	30	30
Ca	AAS	0.07	0.11	0.11	0.11	0.11	0.11	0.11	0.11	0.11	0.11	0.11	0.13
V	AAS	<0.2	<0.2	<0.2	<0.2	<0.2	<0.2	<0.2	<0.2	<0.2	<0.2	<0.2	<0.2
Cr	AAS	<0.001	<0.001	<0.001	<0.001	<0.001	<0.001	<0.001	<0.001	<0.001	<0.001	<0.001	<0.001
Mn	AAS	0.034	0.032	0.042	0.034	0.032	0.032	0.032	0.032	0.036	0.037	0.046	0.061
Fe	AAS	0.62	0.08	0.08	0.08	0.08	0.08	0.08	0.08	0.08	0.08	0.08	0.08
Co	INAA	0.0010	0.0024	0.0024	0.0024	0.0024	0.0024	0.0024	0.0024	0.0016	0.0016	0.0016	0.0016
Ni	AAS	<0.02	<0.02	<0.02	<0.02	<0.02	<0.02	<0.02	<0.02	<0.02	<0.02	<0.02	<0.02
Cu	AAS	<0.002	<0.002	<0.002	<0.002	<0.002	<0.002	<0.002	<0.002	<0.002	<0.002	<0.002	<0.002
Zn	INAA	0.043	0.053	0.053	0.060	0.060	0.060	0.060	0.060	0.0067	0.0067	0.0067	0.0067
As	AAS	0.013	0.004	0.006	0.004	0.006	0.004	0.002	0.003	0.001	0.0009	0.0005	0.0003
Se	INAA	0.00055	<0.001	<0.001	<0.0005	<0.0005	<0.0005	<0.0005	<0.0005	0.00060	0.00060	0.00060	0.00060
Br	INAA	<0.00004	<0.00005	<0.00005	<0.00004	<0.00004	<0.00004	<0.00004	<0.00004	<0.00004	<0.00004	<0.00004	<0.00004
Rb	INAA	0.034	0.045	0.045	0.046	0.046	0.046	0.046	0.046	0.039	0.039	0.039	0.039

Contd.

Table 5-12 Contd.

Element	Method*	1	2	3	4	5	6	7	8	9	10	11	12
Sr	INAA	<0.0002	<0.0002	<0.00008	<0.00008	<0.00003	<0.00003	<0.00003	<0.0002	<0.0002	<0.0002	<0.0002	<0.0002
Ag	INAA	<0.0003	-	-	<0.0003	<0.0003	<0.0003	<0.0003	<0.0002	<0.0002	<0.0002	<0.0002	<0.0002
Cd	AAS	0.0020	0.0025	0.0024	0.0026	0.0027	0.0026	0.0026	0.0026	0.0025	0.0025	0.0026	0.0026
Sn	INAA	<0.0003	<0.0003	<0.0003	<0.0003	<0.0003	<0.0003	<0.0003	<0.0002	<0.0002	<0.0002	<0.0002	<0.0002
Sb	INAA	0.018	0.018	0.045	0.045	0.045	0.045	0.023	0.016	0.016	0.016	0.016	0.016
Cs	INAA	<0.00004	<0.00004	<0.0002	<0.0002	<0.0002	<0.0002	0.000091	0.000066	0.000066	0.000066	0.000066	0.000066
La	INAA	0.012	0.012	0.042	0.042	0.042	0.042	0.042	0.0046	0.0046	0.0046	0.0046	0.0046
Ce	INAA	0.060	0.060	0.113	0.113	0.113	0.113	0.116	0.031	0.031	0.031	0.031	0.031
Sm	INAA	<0.0001	<0.0001	<0.0002	<0.0002	<0.0002	<0.0002	<0.0001	<0.0001	<0.0001	<0.0001	<0.0001	<0.0001
Eu	INAA	<0.00002	<0.00002	0.00019	0.00019	0.00019	0.00019	0.00020	<0.00002	<0.00002	<0.00002	<0.00002	<0.00002
Tb	INAA	<0.00006	<0.00006	0.00033	0.00033	0.00033	0.00033	0.00039	0.000075	0.000075	0.000075	0.000075	0.000075
Dy	INAA	<0.00007	<0.00007	<0.00009	<0.00009	<0.00009	<0.00009	<0.00009	<0.00008	<0.00008	<0.00008	<0.00008	<0.00008
Yb	INAA	<0.00008	<0.00008	0.00040	0.00040	0.00040	0.00040	0.00053	<0.00001	<0.00001	<0.00001	<0.00001	<0.00001
Lu	INAA	<0.0001	<0.0001	<0.00007	<0.00007	<0.00007	<0.00007	0.000037	<0.00001	<0.00001	<0.00001	<0.00001	<0.00001
Hf	INAA	0.00014	0.00014	<0.0001	<0.0001	<0.0001	<0.0001	0.00019	0.00012	0.00012	0.00012	0.00012	0.00012
Ta	INAA	<0.00006	<0.00006	<0.0002	<0.0002	<0.0002	<0.0002	<0.0009	<0.00006	<0.00006	<0.00006	<0.00006	<0.00006
Au	INAA	<0.0002	<0.0002	0.0035	0.0035	0.0035	0.0035	<0.0002	<0.0002	<0.0002	<0.0002	<0.0002	<0.0002
Hg	AAS	<0.002	<0.002	<0.002	<0.002	<0.002	<0.002	<0.002	<0.002	<0.002	<0.002	<0.002	<0.002
Pb	AAS	<0.002	<0.002	<0.002	<0.002	<0.002	<0.002	<0.002	<0.002	<0.002	<0.002	<0.002	<0.002
Th	INAA	0.0025	0.0025	0.012	0.012	0.012	0.012	0.013	0.00052	0.00052	0.00052	0.00052	0.00052
U	INAA	0.151	0.151	0.144	0.144	0.144	0.144	0.133	0.094	0.094	0.094	0.094	0.094
TDS		6090	6090	5780	5780	5780	5780	6070	6080	6080	6080	6080	6080
TSS		<5	<5	32.5	32.5	32.5	32.5	13.3	0	0	0	0	0



Table 5-12 gives the results of the chemical analyses of the liquid samples. A number of elements were only analyzed in 4 of the samples, and a number of elements were below detection limit as indicated in the table.

The results of the Ra-226 analyses are given in Table 5-13. The values for dissolved Ra fluctuates but do not indicate any precipitation of Ra after the addition of Ba. The values for Ra in particulates show that the stirring after BaCl<sub>2</sub> addition raises particles which are slowly settling. This can also be seen from the TSS-values in Table 5-12. The reason for the failing (Ba,Ra)SO<sub>4</sub>-precipitation was by laboratory experiments found to be the low SO<sub>4</sub>-concentration (20-30 mg/l). Bittel et al. (1978) state that a minimum of 0.6 g SO<sub>4</sub>/l should be present in order to form a stable precipitate. In the laboratory experiments it was found that increasing the SO<sub>4</sub>-concentration to 1 g/l and the Ba-concentration to 30 ppm gave an almost complete precipitation of Ra.

Table 5-13: Ra-226 in tailings experiment 1.

	<u>Ra-226 pCi/l</u>		Total
	Dissolved	Particulates	
1. Before addition	1.25	0.83	2.08
2. 0 m	1.03	6.26	7.29
3. 5 m	0.25	2.70	2.95
4. 10 m	0.89	5.78	6.67
5. 15 m	0.62	6.53	7.15
6. 30 m	1.18	5.21	6.39
7. 60 m	3.88	4.20	8.08
8. 3 h	1.75	3.12	4.87
9. 24 h	1.25	1.19	2.44
10. 48 h	1.44	1.16	2.60
11. 5 d	1.37	0.62	1.99
12. 13 d	1.15	0.21	1.36

		<u>Ra-226 pCi/g</u>
Tailings	< 40 $\mu$	86
-	40-71 $\mu$	113
-	71-100 $\mu$	62
-	> 100 $\mu$	57
Precipitate after flocculation		115
Precipitate after Ba-addition		56

Table 5-14 gives the results of the gamma-analyses in the tailings liquid. The Th and Ra values follow the pattern described above which reflects the upwhirling of particles due to stirring.

Table 5-14: Gamma-analyses in tailings experiment 1.

Sample	<u>pCi/l</u>				
	Ra-228	Th-228	U-235	U-238	Ra-226
1	0.47	0.36	2.70	49	0.1
3	1.38	1.52	2.52	47	1.2
7	1.62	1.53	2.41	47	0.9
11	0.40	0.16	1.76	35	0.7

Tailings experiment 2 was designed on the basis of experiment 1 and new thoughts regarding recycling of process water. Thus the waste water from the CO<sub>2</sub>-production (containing Na<sub>2</sub>SO<sub>3</sub>) and from the fluoride precipitation (containing Na<sub>2</sub>SO<sub>4</sub>) should contribute to the tailings slurry. The amounts originating from the process are 0.087 g SO<sub>3</sub>/kg ore and 17.8 g SO<sub>4</sub>/kg ore ~ 2.8 g/l. Thus a sufficient amount of SO<sub>4</sub> for the (Ba,Ra)SO<sub>4</sub> precipitation should be present. The SO<sub>4</sub>-analyses (Table 5-16) gave slightly higher values, maybe indicating a loss of leach liquid. The pH is slightly reduced by the addition of SO<sub>3</sub>. Before addition the pH was 9.3 after addition it dropped to 8.7. The samples taken in the experiment are listed in Table 5-15 and the results of general water analyses and Ra-226 analyses in Tables 5-16 and 5-17. It can be seen that the stirring raises particles which are slowly settling. The values for dissolved Ra dropped to non-detectable values after the addition of BaCl<sub>2</sub>.

Table 5-15: Samples in tailings experiment 2.

1. Before stirring
2. After 5 minutes stirring
3. After addition of BaCl<sub>2</sub> and after 5 minutes stirring
4. 24 hours after addition
5. 5 days           -       -
6. 13 days         -       -
7. 52 days         -       -

Table 5-16: Water analyses on tailings liquid in experiment 2.

	1	2	3	4	5	6
SO <sub>4</sub> (g/l)	3.21	3.26	3.19	3.33	3.05	3.33
NO <sub>3</sub> (mg N/l)	-	-	-	-	0.21	0.07
NO <sub>2</sub> (mg N/l)	0.012	0.015	0.025	0.028	0.008	0.004
NH <sub>4</sub> (mg N/l)	0.07	0.07	0.04	-	0.21	0.07
N-tot (mg/l)	0.21	0.07	0.84	-	0.42	0.42
ortho P (mg/l)	0.271	0.465	0.640	0.698	0.155	0.078
pH	8.7	8.7	8.7	8.6	8.6	8.5
P-alkalinity (meq/l)	0.12	0.10	0.10	0.11	0.19	0.12
M-alkalinity (meq/l)	5.82	5.87	5.90	5.84	7.95	5.82
Conductivity ( $\mu$ S)	7000	7000	6880	6995	7020	7080
TDS (g/l)	5.14	5.17	5.24	5.17	5.17	5.21
TSS (mg/l)	18	33	90	51	34	24

Table 5-17: Ra-226 in tailings experiment 2.

	<u>Ra-226 pCi/L</u>		
	Dissolved	Particulates	Total
1. Before stirring	3.04	7.08	10.12
2. After stirring	1.91	8.61	10.52
3. 0 minutes	0	4.34	4.34
4. 24 hours	0	4.00	4.00
5. 5 days	0	3.81	3.81
6. 13 days	1.06	1.21	2.27

5.3.4.3. Treatment plant. The tailings effluent treatment plant serves two main purposes. Firstly the waste water from the tailings pond should be purified in order to be used as process water and secondly in order to meet acceptable concentration levels for discharge. The waste water treated is both the effluent from the tailings pond and from the scale disposal impoundment. The design of the treatment plant is based on an operating plant in Elliot Lake (Averill et al. 1982) and is adjusted to meet the special requirements at the Kvanefjeld site.

The flow sheet for the treatment plant is shown in Figure 5-9. The acid effluent from the scale disposal is neutralized with  $\text{CaCO}_3$  and mixed with the effluent from the tailings pond.  $\text{CaSO}_4$  is then added in order to precipitate dissolved F and to bring the  $\text{SO}_4$ -concentration up to 0.6g/l, required for the  $(\text{Ba,Ra})\text{SO}_4$ -precipitation. The next step is an addition of polymer in order to settle the suspended particles. The particles are filtered in a deep bed filter containing sand and anthracite. The purified water is then partly recycled to the process plant and partly discharged. Figure 5-9 shows the situation in Taseq. If Tasiussarssuq is used the discharge will be 300 m<sup>3</sup>/h.

5.3.4.4. Effluents from tailings pond. The concentrations of dissolved elements in the tailings slurry are calculated on the basis of the tailings experiments (Table 5-18). These values are used to calculate the concentrations in the effluent from the two alternative tailings ponds. The difference between these two are only due to different dilutions. It should be noted that dissolved elements present in waste water from the scale disposal and elements present in rainfall are not included. The latter is considered to be of minor importance. The concentration of F is determined by the efficiency of the precipitation in the treatment plant and independent of the concentration in the tailings slurry, at least when this is higher than 25 ppm. The  $\text{SO}_4$ -concentration is the required concentration for the  $(\text{Ba,Ra})\text{SO}_4$ -precipitation.

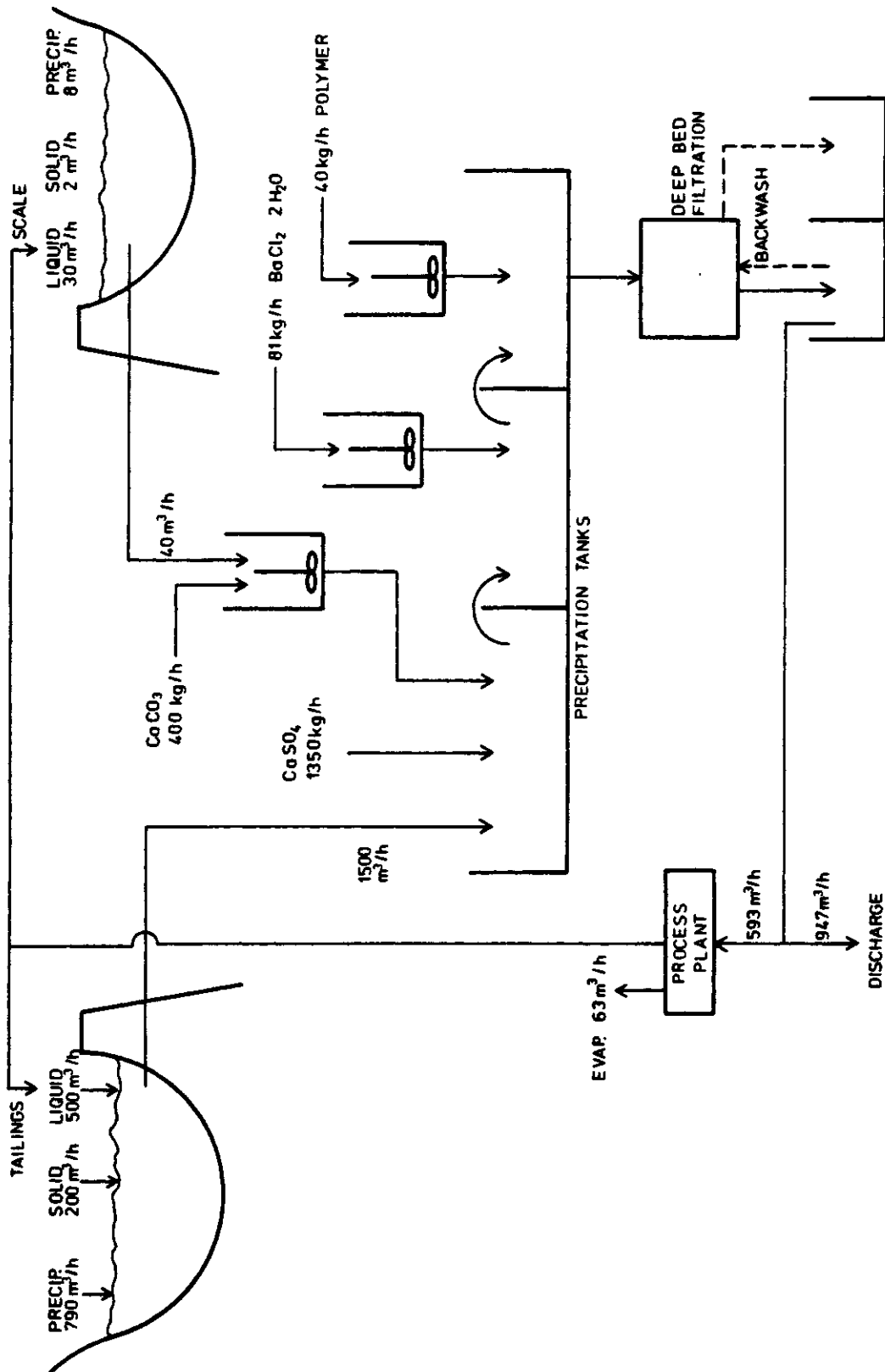

Figure 5-9: Flow sheet for the tailings effluent treatment plant.

The figures given in Table 5-18 are only valid during the operative phase. After this the concentrations of most elements will drop. There is almost no oxidizable sulphides left in the tailings, so there should be no risk of acidification. The most serious problem is the fluoride. The NaF, which is transformed during the carbonate leach process, might not be leached out during the time of operation. When the treatment is stopped the concentration of F may therefore increase.

The concentration of dissolved Ra-226 is already before entering the treatment plant very close to the required Canadian limit of 3 pCi/l. After precipitation it will probably be lower than 1 pCi/l.

Table 5-18: Concentrations of elements (mg/l) in tailings slurry and tailings pond effluent.

Element	Tailings slurry	Effluent from	
		Taseq*	Tasiussarssuq*
Be	0.023	0.0084	0.014
No <sub>3</sub>	8.8	3	5
No <sub>2</sub>	-	-	-
N-tot	45	16	30
F	1200	25**	25**
Na	1870	700	1100
Al	0.69	0.2	0.4
ortho P	2.1	1	1
SO <sub>4</sub>		600**	600**
Ca	0.69	0.2	0.4
V	<1	<0.4	<0.6
Cr	<0.006	<0.002	<0.004
Mn	0.23	0.08	0.1
Fe	4.3	1.6	3
Co	0.010	0.004	0.006
Ni	<0.1	<0.04	<0.006
Cu	<0.01	<0.004	<0.006
Zn	0.042	0.015	0.03
As	0.025	0.0090	0.02
Se	0.004	0.001	0.002
Br	<0.0003	<0.0001	0.0002
Rb	0.25	0.09	0.2
Sr	<0.001	<0.0004	<0.0006
Ag	<0.002	<0.0007	<0.001
Cd	0.02	0.007	0.01
Sn	<0.002	<0.0007	<0.001
Sb	0.10	0.04	0.006
Cs	0.00042	0.0002	0.0003
La	0.029	0.01	0.02
Ce	0.20	0.07	0.1
Sm	<0.0006	<0.0002	<0.0004
Eu	<0.0001	<0.0004	<0.0006
Tb	0.00047	0.0002	<0.0003
Dy	<0.0006	<0.0002	<0.0004
Yb	<0.0006	<0.0002	<0.0004
Lu	<0.0006	<0.0002	<0.0004
Hf	0.00076	0.0003	0.0005
Ta	<0.0006	<0.0002	<0.0004
Au	<0.001	<0.0004	<0.0006
Hg	<0.01	<0.004	<0.006
Pb	<0.01	<0.004	<0.006
Th	0.0033	0.001	0.002
U	1	0.4	0.6
TDS	3800		
pH	8.7	8.7	8.7

\* Dilution in Taseq (after 5 years of operation): 2.78, in Tasiussarssuq: 1.64.

\*\* Adjusted according to process and treatment plant



### 5.3.5. Summary of element mobility

Based on the experiments with water solubility of elements in ore and tailings the effect of the carbonate leaching process can be evaluated. The absolute water solubility of the non-radioactive elements are given in Table 5-19. Also the solubility relative to the total concentration is given. The same values are given in Figures 5-10 and 5-11. Here the elements are ranked according to the solubility in the ore.

It is seen that for most elements the solubility is reduced by the process. The only elements showing a clear increase in solubility after processing are Fe, Mn, and U. The increased concentration of Fe is probably due to wearing of the machinery. Na and F are both absolutely and relatively the most soluble in as well ore as tailings. These two are the only elements with a solubility in the tailings above 1% of the total concentration. A few elements Co, Cd, Ni, Rb and U are above 1 o/oo and the rest below this value. Thus in general the solubility of elements in the tailings is low and generally much lower than that of the ore. The reason for this is probably that many elements although dissolved during the process are reprecipitated, probably as carbonates.

It should however be noted that the comparison of the ore and the tailings are done on samples with different particle size distributions. The ore was crushed to 90% < 7mm, whereas the tailings were crushed to 90% < 100 $\mu$ . This means that the total surface area of the tailings is much greater than that of the ore. If the ore had been crushed to the same size as the tailings, the difference in solubility would probably have been much greater.

In Table 5-20 a summary of the solubility of radioactive elements in ore and tailings is given. The solubility in the tailings is generally slightly higher than in the ore. The solubility of all elements are, however, below 1%.

Table 5-19: Solubility of elements in ore and tailings.

	Solubility mg/kg		Relative solubility*	
	Ore	Tailings	Ore	Tailings
TDS	17900	3788	0.02	0.004
Be	0.56	0.023	0.01	0.0004
F	3500	1180	1	0.3
Na	5214	1870	0.05	0.02
Hg				
Al	1.1	0.69	0.00001	0.000008
Ca		0.69		0.003
V	0.23	<1		
Cr	0.29	<0.006	0.02	<0.0002
Mn	0.11	0.23	0.00002	0.00004
Fe	0.52	4.29	0.000007	0.00005
Co	0.67	0.010	0.02	0.01
Ni	0.84	<0.01	0.005	<0.0005
Zn	4.7	0.042	0.002	0.0002
As	0.14	0.025	0.005	0.0008
Se	0.015	0.004	0.002	0.0004
Rb	3.35	0.25	0.006	0.004
Cd	0.015	0.02	0.003	0.003
Sb	0.17	0.1	0.009	0.01
Cs	0.0057	0.004	0.002	0.0005
La	0.037	0.29	0.00001	0.00001
Ce	0.135	0.195	0.00003	0.00004
Tb		0.0005		0.00005
Hf	0.0035	0.00076	0.0003	0.00006
Ta	0.0039	<0.0006	0.0007	<0.00008
Hg		<0.01		
Pb	6.2	<0.01	0.02	<0.00003
Th	0.0091	0.003	0.00001	0.000004
U	0.24	0.59	0.0005	0.004

\* i.e. total concentration in ore resp. tailings divided by water soluble concentration.

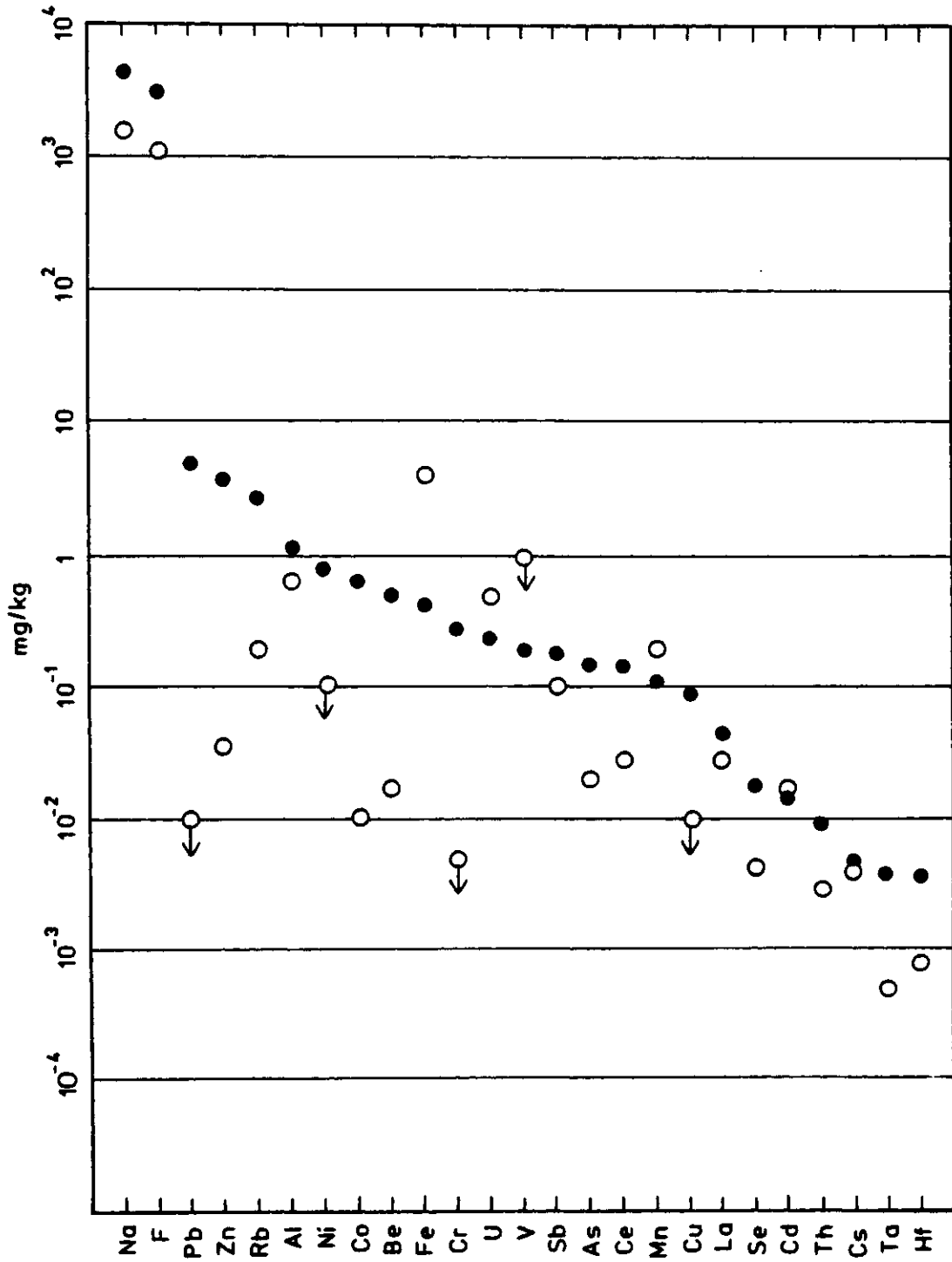

Figure 5-10: Solubility (mg/kg) of elements in ore (●) and tailings (○). ←○ = below detection limit.

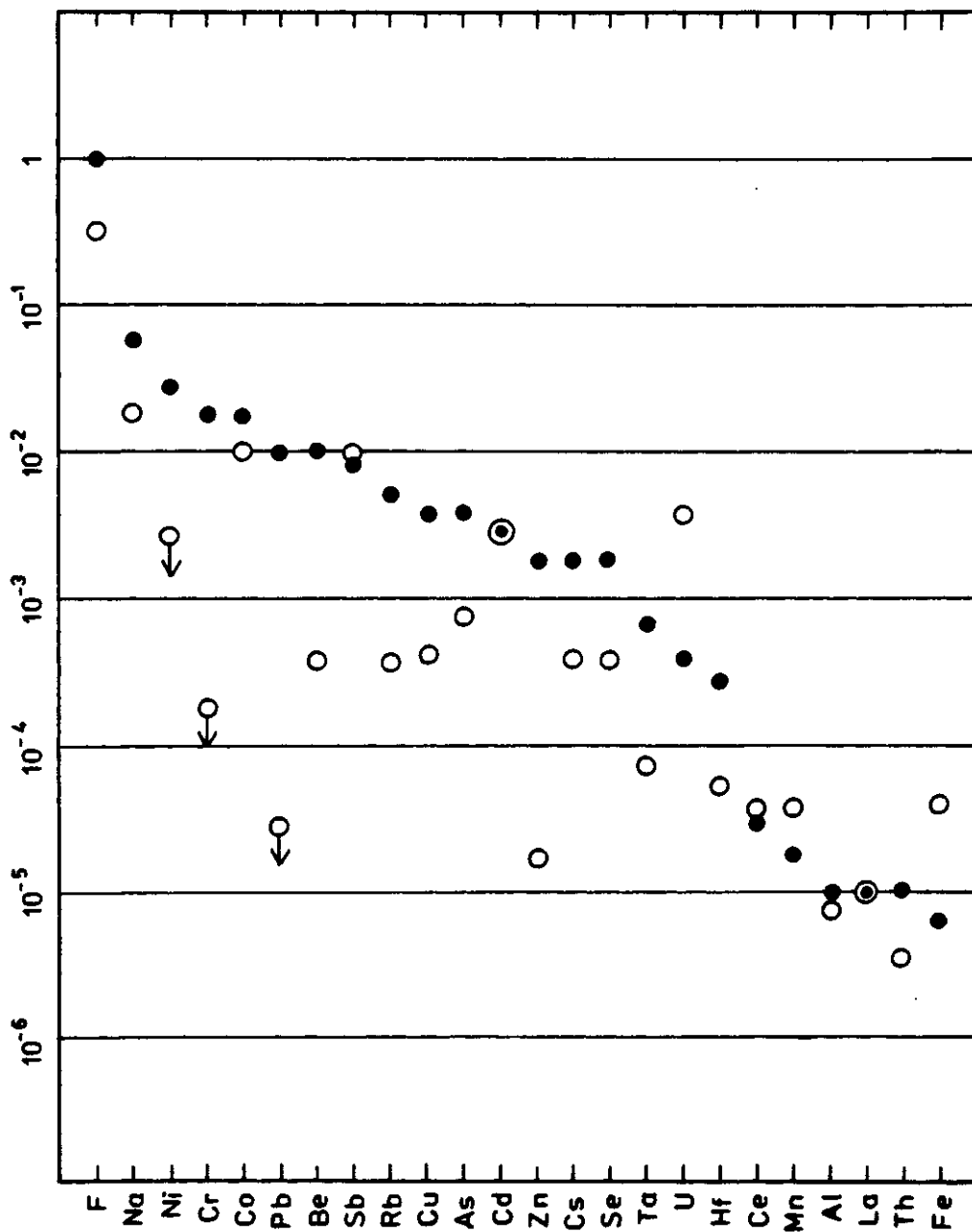

Figure 5-11: Relative solubility of elements in ore (●) and tailings (○)  $\leftarrow$  = below detection limit.

Table 5-20: Solubility of radioactive elements in ore and tailings.

	pCi/g		pCi/g		Relative Ore	solubility Tailings
	Total Ore	Tailings	Soluble Ore	Tailings		
U-238	220	90	0.15	0.22	0.0007	0.002
U-235	6	2	0.007	0.011	0.001	0.006
Th-232	110					
Th-230	160					
Ra-228	90	80	0.006	0.0025	0.00007	0.00003
Th-228	120	90	0.004	0.010	0.00003	0.0001
Ra-226	140	80	0.006	0.010	0.00004	0.0001

Table 5-21 gives an incomplete element balance for the process. The table is constructed on the basis of analyses of element concentrations in the different compartments shown in Figure 5-6. It is assumed that the scale constitutes 0.5 weight % of the processed ore. It can be seen that of the analyzed elements Mn, Zn, REE, Pb, Th and Ra-226 are clearly concentrated in the scale. The loss of leach liquid may be a significant pollution source of some elements, and is here demonstrated for Cr and U.

Table 5-21: Element balance for the process. Concentrations in mg/kg ore (Ra-226 in pCi/g ore).

	Ore C <sub>1</sub>	Leach liquid C <sub>2</sub>	Scale C <sub>3</sub>	Tailings C <sub>4</sub>	Soluble from tailings C <sub>4s</sub>
Be	60				0.023
F	3500			3500	1200
V					<1
Cr	15	6		30	<0.006
Mn	5800		630		0.23
Fe	80000		287	83000	4.3
Co	1.2			0.9	0.01
Ni	34				<0.01
Zn	2850	3.5	418	1950	0.042
As	30	0.5			0.025
Se	10				0.004
Nb					
Mo					
Cd	6				0.02
Sb	18			9	0.1
ΣREE	7850		410	4630	0.49
Hg					<0.01
Pb	390		67		<0.01
Th	700		40	590	0.003
U	400	300	2	100	0.59
Ra-226	140		50	80	0.01

## 6. ENVIRONMENTAL EFFECTS

This section focuses on the potential most toxic elements and a few examples of the effects in the most critical pathways are given. The effect of physical disturbances is briefly outlined, and in the final part the different alternatives of placement of mill and tailings pond are discussed in relation to the effects on the environment.

### 6.1. Identification of harmful elements

In order to reduce the number of elements to take into consideration, only the potentially most important pollutants shall be treated in the following chapters. These elements are selected on the basis of the knowledge of their abundance in the ore, their mobility and their toxicity. Data on abundance and mobility have been given in the preceding text. The relative toxicity of the elements has been reviewed by Bowen (1966), Laveskog (1976), van Hook (1979), and Wood (1974). On this basis the following elements have been selected as potential pollutants from the Kvanefjeld mine and mill: Be, F, V, Cr, Mn, Fe, Co, Ni, Zn, As, Se, Rb, Nb, Zr, Mo, Cd, Sb, REE, Hg, Pb, Th, U, Ra-226, Pb-210, Po-210. This list is based on present knowledge and is therefore probably not complete and may include elements which later turn out to be unimportant.

In Table 6-1 the abundance, mobility (i.e. water solubility) and general toxicity in the terrestrial and aquatic environments are summarized for the selected elements. The highest priority should be given to elements with a combination of high abundance, mobility and toxicity. This might be different for the terrestrial and aquatic environment. Greatest priority in both environments should be given to fluorine which has a high abundance, extremely high mobility and high toxicity. No priority is given for the other elements.

**Table 6-1: Abundance, mobility and toxicity of elements.**

Element	Abundance (ppm)			Mobility (ppm)		Toxicity*		
	Ore	Scale	Tailings	Ore	Scale	Plant	Animal	Aquatic
Be	55			0.56		medium	high	low
F	3500-9600		1000-6000	3500		high	high	low
V				0.23		high	low	medium
Cr	15-70		30	0.29		high	medium	medium
Mn	5000-6000	126000		0.11		low	low	low
Fe	80000	57400	90000	0.52		low	low	low
Co	1-30		0.9	0.67		high	medium	high
Ni	10-35			0.84		high	high	medium
Zn	1500-3000	83600	2000	4.7		low	medium	medium
As	30			0.14		low	low	low
Se	10			0.015		medium	high	low
Rb	540-700			0.004		low	low	low
Zr	2700		700	3.35		medium	low	low
Nb	700					medium	low	low
Mo						medium	medium	low
Cd	6			0.015		low	high	high
Sb	20		9	0.17		high	high	low
REE	9000	82000	8000	0.172		medium	low	low
Hg						0.02	high	high
Pb	200-400	13500		6.2		0.1	high	low
Th	700-1000	7030	700	0.009		0.224	low	high
U	300-450	340	50-150	0.24		<0.01	high	medium
		pCi/g			pCi/g	<0.01	medium	medium
Ra-226	140	1000-10000	80	0.006		0.010	high	high
Pb-210	~100						high	high
PO-210	~100						high	high



## 6.2. Aquatic environment

The aquatic environment that might be affected by the uranium mining and milling constitutes of the Taseq Lake, Narssaq River, Tasiussarssuq and the fiords Tunugdliarfik, Narssaq Sund and Bredefjord.

### 6.2.1. Pollution

The sources of pollutants which can reach the aquatic environment are given in Table 6-2. The quantitatively most important sources are the runoff from the pit and the waste dumps and the discharge from the tailings pond. Minor sources are percolation from the pit and tailings pond and waste water from the scale disposal. The recipients for these effluents depend on the choice of alternative.

Information is only available on the effluents from the pit and tailings pond. These two sources are considered in Table 6-3, where the concentrations in the waste water are compared to standards for drinking water, standards for mine effluent and the average concentration in river and sea water.

The concentrations of the radioactive elements in the waste water from the pit are below the standards for drinking water, Hg is probably close to the standard. No standards are available for the elements Rb, Nb, Zr, Mo and REE. The rest of the elements can all be found in concentrations above the standards. The most pronounced ones are those of Be, F, Ni and Pb, exceeding the drinking water standards by a factor of 13000 to 690. It should, however, be noted that the proposed EPA standard (for protection of soft freshwater) for Be is 0,01 mg/l thus reducing the exceeding factor to 260.

The waste water from the tailings disposal has in general much lower element concentrations and only a few are exceeding the drinking water standards. These are F, Fe, and Sb, which exceed the standards by factors of 16 to 5. No information is available for Rb, Nb, Zr, Mo, and REE.

Table 6-2: Sources of liquid wastes.

Source	Amount m <sup>3</sup> /y	Reipients
Pit: run-off percolation	1·10 <sup>6</sup> ?	Narssaq River or Bredefjord Narssaq River
Waste dump	1·10 <sup>6</sup>	Bredefjord
Process plant: scale dep.	0,4·10 <sup>6</sup>	Narssaq River or Tunugdliarfik or Bredefjord
Tailings pond: discharge percolation	2.4-6.1·10 <sup>6</sup> ?	Narssaq River or Tunugdliarfik or Bredefjord Narssaq River

Table 6-3: Concentration of elements (mg/l) in waste water, standards, and natural waters.

Element	Pit	Outlet from: Taseq	Tasiussarsuq	Drinking water standards*	Acceptable effluent CDN Mines**	Average river water***	Average sea water***
mg/l							
Be	2.6	0.0084	0.014	0.0002		<0.001	0.0000006
F	<10000	25	25	1.5		0.09	1.3
V	0.6	<0.4	<0.6	0.1		0.001	0.002
Cr	1.6	<0.002	<0.004	0.05		0.00018	0.00005
Mn	0.6	0.08	0.1	0.05		0.012	0.002
Fe	2.82	1.6	3	0.2		0.67	0.01
Co	3.6	0.004	0.006	1.0		0.0009	0.00027
Ni	4.6	<0.004	<0.06	0.001	0.5	0.01	0.0054
Zn	26.6	0.015	0.03	5.0	0.5	0.01	0.01
As	0.64	0.009	0.02	0.05	0.5	0.0004	0.003
Se	0.071	0.001	0.002	0.01		<0.02	0.00009
Rb	-	0.09	0.2	-		0.0015	0.12
Nb	-	-	-	-		?	0.00001
Mo	-	-	-	-		0.00035	0.01
Cd	0.086	0.007	0.01	0.005		<0.08	0.00011
Sb	0.76	0.04	0.06	0.01		?	0.00033
REE	0.79	0.08	0.12	-		?	0.0005
Hg	<0.002	<0.04	<0.06	0.001		0.00008	0.00003
Pb	34.5	<0.04	<0.06	0.05	0.2	0.005	0.00003
pCi/l							
Th-232				2000			
U-238		16	27	600			
Ra-226	1.1	0.3	0.4	10	10		

\* Danish standards except Be, V, Co where Russian standards are quoted, and Th, U, Ra where ICRP-standards are quoted. Sources: Miljøministeriet 1980, Laveskog et al. 1976, ICRP 2 & ICRP 6.

\*\* Canada Gazette Part II, Vol. III, No. 5.

\*\*\* Bowen 1966

In order to evaluate the discharges, the possible dilution in the recipients should be considered. Five alternative situations are considered:

- A: Discharges from both pit and tailings pond to Narssaq River.
- B: Discharge from pit to Bredefjord and from tailings pond to Narssaq River.
- C: Discharge from pit to Narssaq River and from tailings pond to Tunugdliarfik.
- D: Discharge from pit to Bredefjord and from tailings pond to Tunugdliarfik.
- E: As A but with precipitation of fluoride from the pit.

Placement of tailings in Tasiussarssuk would resemble situation C and D. The water flow in the river system is given in Table 6-4. After dilution in the river below the point of inflow of the Taseq River only 6 elements can occur in higher concentrations than the standards for drinking water. These are Be, F, Fe, Ni, Sb, and Pb. The resulting concentrations in the Narssaq River for the different alternatives are given in Table 6-5.

Table 6-4: Water flow ( $10^6 \text{ m}^3$ ) in the Narssaq River System.

	Summer*	Winter**
Water from pit	0.9	0.1
Water from tailings pond	3.1	3.0
Residual river flow	28.4	2.9
<b>Total</b>	<b>32.4</b>	<b>6.0</b>
<b>Present total</b>	<b>35.5</b>	<b>3.5</b>

\* May to October

\*\* November to April

Table 6-5: Probable maximum concentrations (mg/l) of critical elements in the Narssaq River below the inflow of Taseq River with respect to different discharge alternatives and seasons. The values are representative for the period of operation.

		Discharge to Narssaq River				
		Pit	Tailings pond	Summer	Winter	
A:	+	(untreated)	+ (treated)**	Be	0.073	0.048
				F	<280	<180
				Fe	0.28	0.87
				Ni	~0.13	~0.079
				Sb	0.025	0.033
				Pb	~0.96	~0.60
B:	-		+ (treated)**	Be	0.00080	0.0042
				F	5	17
				Fe	0.20	0.84
				Ni	<0.00039*	<0.0020
				Sb	0.0039*	0.020
				Pb	<0.0048*	<0.021
C:	+	(untreated)	-	Be	0.080	0.087
				F	<310	<340
				Fe	0.14*	0.14*
				Ni	0.14	0.15
				Sb	0.023	0.025
				Pb	1.1	1.2
D:	-		-	Be	-	-
				F	4	10
				Fe	0.05*	0.06*
				Ni	-	-
				Sb	-	-
				Pb	0.0008*	0.0013*
E:	+	(treated)**	+ (treated)**	Be	0.073	0.048
				F	6	17
				Fe	0.28	0.87
				Ni	~0.13	~0.079
				Sb	0.025	0.033
				Pb	~0.96	~0.60

\* concentrations below standards for drinking water.

\*\* treatment refers only to the precipitation of fluoride.

The following concentrations in the present river water are used in the calculations: Be: ~0, F: summer: 3.2 mg/l, winter: 8 mg/l, Fe: 0.05 mg/l, Ni: ~0, Sb: ~0, Pb: 0.001 mg/l. In general it can be seen from Table 6-5 that in alternative A the concentrations of all 6 elements exceed the standards both summer and winter. Only the situation with no discharges to the river meets the standards except for F, which also at present are elevated. Apart from Fe the greatest contribution could come from the pit. The values for the pit are, however, maximum discharges as pointed out in section 5.3.1. The value used for F (10.000 ppm) is thus the upper limit for dissolved fluorine in ore percolate. Also it should be noted that the fluorine is not present in the upper part of the deposit. Measurements in water draining from the tunnel driven in 1979-1980 showed fluorine concentrations in the range 200-3000 ppm. Measurements at the ore storage at Risø after a period of heavy rain showed concentrations of 700-1400 ppm (Brodersen & Sørensen, 1981). Thus a value of 1000 ppm would probably be a realistic average value. Using this value the fluorine concentrations in the river for alternatives A and C are recalculated and given in Table 6-6.

Table 6-6: Fluorine concentration (mg/l) in the Narssaq River calculated on the basis of a concentration in the effluent from the pit of 1000 mg/l.

	Discharge to Narssaq River		Summer	Winter
	Pit	Tailings pond		
A	+	+	33	33
C	+	-	34	41

Using this method of calculation the fluorine concentrations are evidently much reduced. They probably represent minimum values since saturation of the water in the pit is likely to occur now and then.

The discharge of fluorine from the pit in the period after mining was shown in Table 5-4. Table 6-7 gives the resulting concentrations in the river if alternative C is chosen and is maintained after the operative period. The table does, however, not include contribution of fluorine due to seepage through the mountain and from the tailings if they are placed in Lake Taseq. Also seepage from waste dumps is not included.

Table 6-7: Fluorine concentration (mg/l) in the Narssaq River due to effluent from the pit after the cease of operation.

Years after mining	Summer	Winter
1	17	24
2	9	14
3	8	13
5	6	12
10	5	10
25	5	9
100	4	9
500	3	8
1000	3	8

It is seen from the table that elevated levels would persist for about 100 years. Higher concentrations can be found due to contributions from the sources mentioned above.

In conclusion the fluorine concentration in the lower part of the Narssaq River will be within 35-360 mg/l during operation if the worst case is considered. After the operation the concentration will probably be close to the original once in 100 years.

Above only the elements in solution have been considered. Pollutants might, however, also be spread as particulate material. This is probably a minor problem from the tailings

pond since the treatment plant is equipped with a filter. The treatment plant proposed for the pit would also include a F-precipitation step and a filter. Particulate material should therefore not be a problem during the operative phase.

Another problem might be the binding of dissolved elements in the sediment. These may later be released due to changing environmental conditions. Thus the pollution of e.g. the Narssaq River might be extended for a much longer period than expected at first.

The pollution of the seawater due to discharges from pit and tailings pond is difficult to evaluate due to lack of exact knowledge of the dilution in the sea. The most critical element, F, would probably precipitate due to the high Ca-concentration in the sea.

Since the waste waters from the pit and tailings pond are fresh-water they have a lower density than the seawater. This means that the mixing will be slower, and the pollutants might be dispersed in the surface water.

#### 6.2.2. Effects

An extensive knowledge of the aquatic ecosystems and element transfer between the different compartments should be available in order to assess possible effects of pollution in the aquatic environment. Since this information is not available and furthermore only a part of the pollution sources can be quantified, only examples of the possible effects can be given. The arctic char (*Salvelinus alpinus*) is the most conspicuous member of the ecosystem in Narssaq River and is therefore chosen as an example.

Two main types of effects should be considered:

- 1) Effects due to direct toxicity.
- 2) Effects due to accumulation of elements in the ecosystem.



The only elements which could be found in concentrations high enough to be directly toxic to the arctic char are fluorine and lead. Investigations cited by Christensen (1981) and Nielsen (1983) have shown that trout species are rather sensitive to fluorine. The lethal concentration (LC<sub>50</sub>) in soft water is 2.7-4.7 ppm F with an exposure time of 20 days. The sensitivity is dependent on temperature, Ca-concentration and age. In USA there are, however, natural trout populations in areas with a F-concentration of 13-14 ppm. The fish are specially adapted by having a higher amount of goblet cells. This might also be the case in Narssaq River. It is unknown whether the adaptation is physiological or due to genetic selection. It is impossible at present to judge whether the absence of a population of arctic char in Narssaq River above the inflow of Kvane River is due to the high concentrations during the winter. In Kvane River, which also shows high concentrations, a population is found.

A rise in the concentrations from the present level to 35-360 ppm F would probably be detrimental to the population of arctic char. Only alternatives which prevent effluent of fluorine from the pit would be acceptable in order to preserve the fish populations in the Narssaq River.

The LC<sub>50</sub> values of Pb for trout is in the range 0.20-2.4 mg/l as found in investigations cited by Nielsen (1983). Values within this range could be found in the Narssaq River in those cases, where it receives effluent water from the pit.

A number of other elements could be accumulated in the fish and thereby contribute to the load of toxic elements in human beings. This could be of importance for the radionuclides Ra-226 (see also Table 3-3), Po-210 and Pb-210 and maybe for some of the other elements listed in Table 6-1, whereof the most critical probably are Be and Sb. The present available information does, however, not justify calculations of resulting concentrations in the fish.

The effects on seawater species due to the outlets from the mining and milling are impossible to assess at present. It

should, however, be noted that the dilution in the sea is much greater than in the river. The F will probably precipitate and furthermore the toxicity of F in seawater is lower than in freshwater. Effects would eventually be highest in organisms living in shallow water due to little vertical mixing.

### 6.3. Terrestrial environment

The terrestrial area that could be affected by the mining and milling are first of all the area immediately around the mine, mill and tailings pond. If alternative 1 is chosen this area is concentrated around Kvanefjeld and Lake Taseq; if alternative 2 is chosen also the area of Nugssuaq and Tasiussarssuq will be affected.

#### 6.3.1. Pollution

The main pollutants reaching the terrestrial environment are dusts produced by blasting, loading, transportation and crushing of the ore. Other sources are the production of yellow cake or uranium dioxide and the handling of chemicals. The tailings should not give rise to particulate pollutants because of the wet management procedure during the operative phase and the ultimate covering of the tailings. Other sources of particulates are the waste dumps and the ore storage areas.

The quantitatively most important pollution source will be the mine itself. The quality of the pollutants is thus equal to that of the ore and the waste given in Table 5-1. In order to identify the most critical pollutants Table 6-8 gives a list of proposed maximum concentrations of elements in plants and soils compared with the concentration in ore.

A direct comparison of the proposed maximum values identifies the elements As, Cr, F, Fe, Mn, Pb, U and Zr as the most critical. However, the solubility of the elements must also be considered. From Table 5-3 it can be seen that the solubility of Fe and Mn is very low and the solubility of F very high. Thus F

can once again be identified as the most critical non-radioactive pollutant.

Table 6-8: Comparison of tolerable concentrations of elements (ppm d.w.) in soils and plants with the concentrations in ore.

Element	Soil* ppm d.w.	Plants** ppm d.w.	Ore ppm d.w.
As	20	2	30
Ba		200	
B	25	150	
Be	10		60
Br	10		
Cd	3	3	6
Co	50	5	1
Cr	100	2	70
Cu	100	150	60
F	200	10	3500-10000
Fe	750		80000
Hg	2	0.04	
Mn		300	4500
Mo	5	3	10
Ni	50	3	10
Pb	100	10	200
Sb	5		20
Se	10	3	10
Sn	50		260
U	5		365
V	50	2	
Zn	300	300	1500
Zr	300		2700

\* Kloke 1980

\*\* NUREG 1980

### 6.3.2. Effects

As an example of the possible effect of pollutants in the terrestrial ecosystem it is chosen to focus on sheep. Sheep are on a high level in the terrestrial ecosystem, are a source of food for man, and are the basis of living for a substantial part of the population in the area. The sources of elements for sheep are illustrated in Figure 6-1.

As seen from the figure there are many sources of elements for sheep. It is therefore a complex task to estimate the potential pollutant burden. Because the input to the terrestrial environment is not estimated quantitatively no calculations can be performed. However, some qualitative estimations can be made.

The acute toxicity of fluoride to sheep has been investigated by Egyed & Shlosberg (1974). They gave sheep doses of sodium fluorosilicate, and found that mild symptoms (grinding of teeth, dulness, diarrhea) occurred following a dose of 25-50 mg/kg body weight and the sheep recovered 3-5 days later.

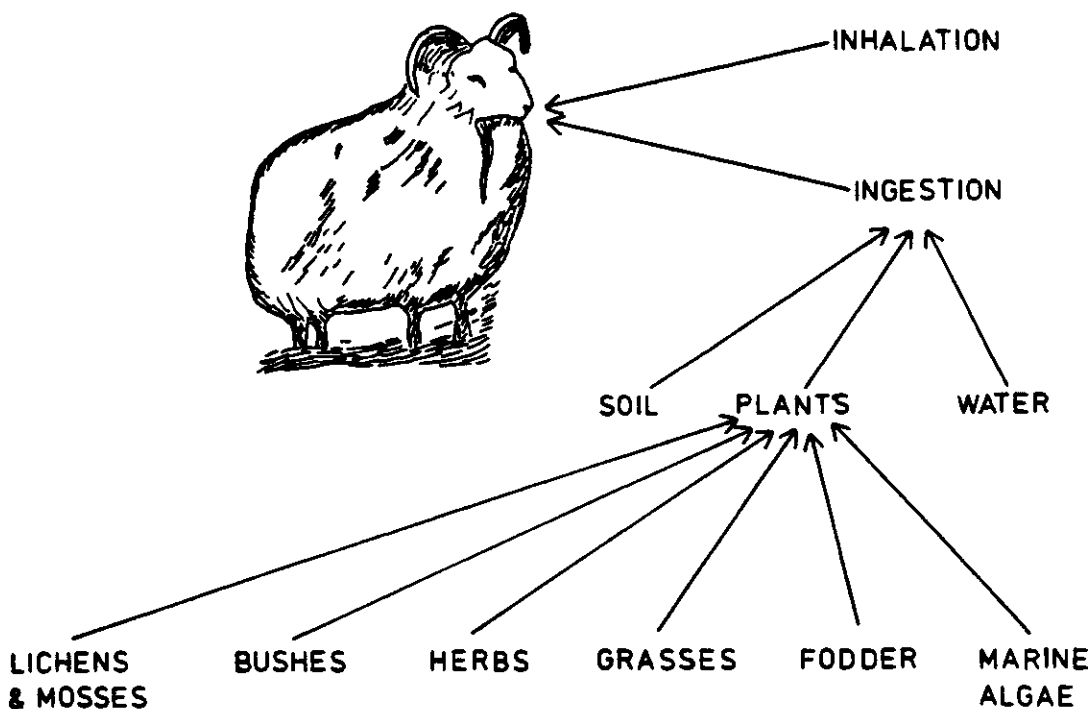

Figure 6-1: Sources of elements for sheep.

The mode of action and toxicity of sodium fluorosilicate is similar to that of sodium fluoride. The LD<sub>50</sub> of sodium fluoride for lambs is 140 to 150 mg/kg. Suttie (1969) has summarized data for farm animals and on this basis proposed a limit of 40 ppm F in forage.

Both inhalation of dust particles and ingestion of contaminated soil, plants and water may be sources of F to the sheep. The ingestion will probably be of greatest importance. The ingestion of soil has been investigated by Healy et al. (1970, 1974) and Suttle et al. (1975). The soil can constitute 10-40% of the dry matter intake of sheep, highest in the winter months. Elements present in the soil can be absorbed by the animals. This was shown for Mo, Se, Zn, Co and Mn. The fraction absorbed is dependent on the solubility and thus the chemical form of the element. In the experiment by Healy et al. (1970) it was found that the absorption of isotopes held in the soil expressed as a percentage were: Se 34%, Zn 14%, Co 1% and Mn 0.4%. Since the NaF present in the Kvanefjeld ore is very soluble, the absorption would probably be high. On the other hand the fluoride will be removed rather quickly from the dust particles by rain.

Fluoride in solution in rainwater may be taken up by plants directly through the leaves. Also root uptake of fluoride may contribute to the concentration in the plants. The availability of F in the soil will depend on a number of factors. The concentration of Ca in the soil solution is of great importance because of immobilization as CaF<sub>2</sub>. Lichens are known to be accumulators of F. In the vicinity of a fertilizer factory Takala et al. (1978) measured 940 ppm F in lichens. Perkins et al. (1980) measured concentrations up to 1500 ppm in the vicinity of an aluminium reduction plant.

In spring and summer the sheep in Greenland mainly eat grasses and herbs, in the autumn leaves from bushes, and in the winter the diet is supplemented with mosses lichens and imported fodder (Heerfordt et al. 1980).

Water might also be a source of F. The amount of water taken in by sheep varies with the water content of the food, but may be as large as 3.5 l/kg dry matter of ingested food (Herfordt et al. 1980).

It can thus be concluded that F may be present in all parts of the diet for sheep and also as particles in the inhaled air. There is, however, not sufficient information for a quantitative estimate.

Other elements deposited in the terrestrial environment due to mining and milling may be transferred to and accumulated by the consumers. Higher vertebrates have the ability to regulate their body burden of many of the essential trace elements, but for some metals including the most toxic (e.g. Cd and Pb), an increased intake with the same proportional absorption is not compensated for by an increase in excretion. Such metals therefore progressively accumulate in particular tissues. Attention should here also be paid to the radioactive isotopes of U, Pb and Po.

#### 6.4. Physical disturbances

The physical activities of the mine might affect the environment in different ways. First of all some land will be used for the mining, milling and tailings storage and will therefore be unavailable for sheepgrazing. The areas occupied for the different alternatives were outlined in figures 4-1 and 4-2. The Kvanefjeld plateau and the upper Narssaq Valley as well as the peninsula of Nugssuaq have low grazing capacities for sheep. The area around the Tasiussarssug Inlet has a very high grazing value and is at present intensively grazed (Thorsteinsson et al. 1980). The tailings disposal here would, however, not include any substantial part of the surrounding land. In conclusion the grazing potential for sheep farming should be only little affected by the mining and milling.

The construction of roads and the noise from blasting and transportation might affect the wildlife. One of the most sensitive species would probably be the white-tailed eagle (*Haliaeetus albicilla*) which nests in a small number in the area (Hansen, 1979).

#### 6.5. Choice of alternatives

On the basis of the above given estimate of environmental effects the different placement and operation alternatives can be evaluated. The place of the mine is fixed, whereas the mill and tailings pond theoretically can be placed freely.

The disposal of tailings has been determining for the presented alternatives. Because naturally impoundments are believed to be the most stable and also less expensive, the area was searched for these. Several valleys and lakes exist in the area and could be used technically for tailings disposal. However, the impoundment should also be close to the mine or at least to a site where a mill could be built. Thus the search ended up with the focusing on two areas, the Taseq Lake and the Tasiussarssuq Inlet. Both these impoundments can easily be confined by dams.

They represent the two main alternatives but also different philosophies. The first alternative concentrated the activities to the area around Kvanefjeld close to the town of Narssaq. The intention of the second alternative is to keep the activities away from the most populated areas; i.e. transport of the ore through the little used Bredefjord to the peninsula Nugssuaq and disposal of tailings nearby the mill.

The two tailings disposal sites occupy very different positions in the fluvial system. Taseq is situated high up in the drainage system, whereas Tasiussarssuq is at the end of it, i.e. the sea. Thus seepage from Taseq would affect the whole fluvial system whereas seepage from Tasiussarssuq only affects the sea.

The principal pollutants from the tailings pond will do less harm in the marine ecosystem due to precipitation (e.g. F) and dilution. The placement in Tasiussarssuq is therefore to be preferred. A further advantage is, that although placed in the marine environment, where the pollutants will eventually end, the tailings can still be controlled and reprocessed if necessary. The close proximity to some of the best areas for sheep farming in Greenland could, however, be a disadvantage.

The choice of Tasiussarssuq implies that the best placement of the process plant is Nugssuaq. The process plant itself should not give rise to major environmental pollutants and the area occupied by buildings, housing etc. is not of any great value for sheep farming.

The resulting transport of the ore from the mine to the mill could, however, increase the amount of particulate pollution if careful precautions are not taken against it.

The place of the mine is fixed and only alternatives for the outlet of drainage water can be discussed. Obviously outlet of untreated mine water to Narssaq River will be detrimental to its ecosystems. A treatment plant might be installed, but if it is only in function during the operative phase, the problem will arise and persist for many years after the cease of operation. The pit will end up as a lake with a depth of about 80 m, partly filled with waste. Naturally this will drain to Narssaq River when the height of the pass is reached.

The water will contain high concentrations of a number of toxic elements which could then pollute the river. The best alternative would therefore be to establish a drain from the pit to Bredefjord. This drain should be constructed to last so long that the concentrations in the drainage water would be acceptable for the river as a recipient. If alternative 2 is chosen the tunnel to Bredefjord could be used as a drain.

If it is chosen to place the tailings in Taseq, the outlet should be to Tunugdliarfik where it will do least harm. After



the cease of operation the percolating water will run through the Narssaq River system. Great care should therefore be taken to minimize the amount of infiltration by a suitable surface cover. Also the dam should be very carefully and solidly constructed so that there would not be any risk of the tailings sliding down the valley and dispersed.

## 7. REHABILITATION

The term rehabilitation designates the restoring of the lands disturbed by uranium mining as well as the tailings pond. The areas should ideally be brought back to the situation which existed before the commencement of the mining and milling. The areas should also be restored in such a way, that the continuing hazard to the environment is in agreement with the requirements.

### 7.1. Mine and waste dump

The waste will be placed at different sites around the pit. Part of it may be backfilled and part of it may be used as cover material for the tailings if this is placed in Taseq. The rehabilitation of the pit is an open question because it could be abandoned either as a lake or as a drained partly landscaped area. If the last solution is chosen an attempt should be made to revegetate the area in order to prevent dust formation and erosion. This might, however, be difficult due to the lack of soil formation and the rather rough climate of that altitude.

### 7.2. Tailings pond

The tailings pond should be rehabilitated in such a way that it is assured that its future performance will continue to meet the requirements of public health and safety. There are three main problems associated with the long term stability of tailings:

1. Radiation (radon exhalation and gamma radiation).
2. Erosion.
3. Seepage.

The solution to these problems is to place a cover above the tailings. This cover can be constructed of several different materials e.g. asphalt, clay, gravel. The determining factor will normally be the reduction of the radon emanation.

Calculations of the theoretical radon release from the tailings piles at the pilot plant at Risø gave a value of 100 pCi/m<sup>2</sup>·sec, based on an ore grade of 340 ppm U and secular equilibrium of the radioactive isotopes (Sørensen, 1979). Investigations have, however, shown that not all the radium end up in the tailings. A fraction of about 1/3 is retained in the scale formed in the pipe autoclave. The rest (80 pCi/g) is found in the tailings.

Actual measurements in the summer of 1983 (Sørensen pers. comm.) gave values of the radon emanation of approx. 25 pCi/m<sup>2</sup>·sec, which is lower than expected. The reason for this is probably the humidity and great compaction of the tailings.

The emanation rate of radon from tailings is primarily dependent on the radium concentration but is strongly influenced by the moisture content, the particle size and texture, temperature, pressure, atmospheric stability and weather conditions. Snow cover, rainfall and weather conditions may change the emanation rate by a factor of 10 or more (EPS 1978). If saturation is complete, no air is available in the pore spaces, and most of the radon atoms which escaped from the solid phase will decay before reaching the free atmosphere. Only the radon emanated by a layer of a few tenths of a metre is released to the atmosphere in situations where the moisture is maintained (IAEA 1981).

The tailings ponds of both Taseq and Tasiussarssuq are situated in natural impoundments, so most of the tailings will be saturated with water. The ultimate heights of the tailings will be greater than the present water level, but a new elevated water table will probably be formed. Thus radon will only emanate from the upper dry part of the tailings.

The highest emanation rate will be found in dry periods of the summer and will probably not exceed the rate measured at the tailings pile at Risø.

The U.S. Nuclear Regulatory Commission has proposed a limit for radon emanation of 2 pCi/m<sup>2</sup>·sec. If this limit is to be achieved in Greenland an attenuation factor of at least 10 should therefore be required. The thickness of a cover required to achieve the necessary reduction in radon flux will usually be more than sufficient to reduce gamma radiation to background levels.

The most probable cover material to be used in Greenland is finely ground rock material (e.g. waste rock). No soil or clay will be available. The attenuation factor of sand and gravel is, however, rather low so a relatively thick layer is required. The thickness cannot be estimated without relevant experiments, but a guess is that it should be in the order of 3-6 m. It may turn out to be better and more economic to use an effective barrier like an asphalt emulsion system covered by a thin layer (1 m) of sand and gravel in which vegetation can be established.

Thorsteinsson (1980) has made experiments of fertilizing and revegetation of unvegetated gravel plains at Narssarssuaq. He found that establishment of a vegetation cover could easily be achieved by the application of 500 kg NPK-fertilizer/ha and the use of an appropriate grass seed mixture.

These results could be applied for the Tasiussarssuq tailings pond, but whether they are applicable for the Taseq area is doubtful. The revegetated area of Tasiussarssuq could probably be used for sheep grazing.

## 8. ENVIRONMENTAL SURVEILLANCE

It will be necessary to monitor the concentration and flow of critical elements in the environment both before, during, and

after the operation of the mine and mill. In this section emphasis will be put on the preoperational investigations. These should be rather extensive since there is a great lack of knowledge of several items as pointed out in the previous sections.

### 8.1. Preoperational monitoring

The preoperational investigations can be divided in two parts. One which relates to the existing environment and one which relates to the technical aspects of the mine and mill. These two parts of the investigations should be carried out in parallel in order to have the opportunity to adjust the mining and milling process to the environmental conditions.

#### 8.1.1. Technical aspects

8.1.1.1. Mining. The general problems related to the mining of the Kvanefjeld ore are emission of gases, spread of particulate pollutants, leaching of toxic elements, and radiation. These items relate to the pit, waste rock piles and ore storage piles. From an environmental point of view the most important is the particulate pollutants and the leaching of toxic elements.

In order to assess the extent of particulate emissions, the dustability of the ore and waste should be investigated. This can be done by studies of crushed ore in wind tunnel experiments. In this way the pick-up velocities can be determined and the results related to wind speeds at Kvanefjeld. Other upwhirling forces are the passage of vehicles and the transport of the ore. Also studies of the effect of spraying the pit with water should be performed. Both laboratory and field studies (at the ore brought to Risø, or better at the ore storage at Kvanefjeld) should be performed. Once the source strength is determined it can be related to models of spread in the area.

An attempt to determine the actual dilution of gases released from Kvanefjeld has been done by Gryning & Lyck (1983). It should also, however, be necessary to make such experiments with particles, and all types of weather conditions should be considered. Only on this basis will it be possible to model the spread of particles.

Leaching of toxic elements poses one of the biggest problems for the aquatic environment, and should therefore be investigated in details. The chemical composition of the ore is rather well-known, but some information is lacking on the composition of the waste. The waste is a more heterogenous group ranging from lujavrites with a low U-content to xenoliths of the gabbro/lava and syenitic rock-types. Hopefully the proposed geological investigations (Kalvig 1983) will give information on the amounts of the individual waste rock types.

Although extensive chemical analyses have been performed there is still a need for information on potential toxic elements. Among these are As, Se, Co, Mo, Hg, and Tl. Future work should not be directed by the immediate available analytical techniques, but should be guided by a more holistic approach with the periodic table as a basis. This would help to identify otherwise neglected problems. Bearing this in mind, it should be noted that some elements already have been identified as potential pollutants, and obviously the work should include these.

Leaching experiments should be performed in the laboratory with the different rock types crushed to different size classes. A range of extractants should be used to differentiate between chemical pools: water soluble, easily exchangeable, complexed or adsorbed, occluded by or coprecipitated with metal oxides, carbonates or phosphates and other secondary minerals, and held in primary minerals. Jones et al. (1983) have given examples of reagents, which can be used for such a fractionation.

Experiments of the rate of weathering would be useful for the evaluation of the long term effects. These should include

petrographic studies of the rocks before and after artificial weathering (e.g. temperature shocks) and also of the natural occurring weathering products. Some of this has been investigated during the Narssaq Project, and maybe this information could be included.

Percolation of contaminated water from the pit through cracks and fissures in the rock is one of the uncontrollable spreads of pollutants. The present percolation has not been determined. The activities in the mine will increase the permeability of the mountain, and some estimates should be made due to the possibility of pollution of the Narssaq River. The percolation could perhaps be quantified by radioactive tracers, natural or artificial.

8.1.1.2. Milling. The technical design of the mill is determinative for the conditions in the surrounding environment. Therefore a detailed knowledge of this is necessary for the assessment. The pilot plant study at Risø was intended to end with suitable technical solutions. Some problems are, however, as yet unsolved and two of these are of outstanding importance.

Formation of scale in the pipe autoclave is the first problem. This was not anticipated in the pilot plant studies, and is still subject to some uncertainty. Since many elements including radio isotopes are concentrated in the scale and the so far proposed method of removal is by sulphuric acid, it could be regarded as a serious pollutant in the environment. It could, however, also be regarded as an advantage that toxic elements are concentrated in a small volume. This makes the handling and disposal easier, and also gives a possibility of extraction of potential by-products.

Behaviour of fluoride in the process is the other major problem. Initially it was believed that almost all fluoride was dissolved in the process, and could be precipitated as a by-product. Later it was learned that the fluoride after solution precipitated in another (unknown) chemically form, which only slowly dissolves

in water. Therefore the fluoride leaching and precipitation steps are no longer included in the process plant design, and the fluoride will end up in the tailings. More experiments are therefore needed to enlighten this problem. The omission of the fluoride precipitation also means that there is not sufficient sulphate for the  $(\text{Ba,Ra})\text{SO}_4$  precipitation.

Element balance studies will be necessary for the full understanding of the element behaviour in the process. The results of an attempt of these were given in Table 5-21. More precise measurements in representative leaching experiments will be useful for the prediction of elements released to the environment.

8.1.1.3. Tailings. The method of tailings disposal is of crucial importance for the long-term environmental effects. The main environmental problems related to the tailings are radiation and seepage of percolated water. It is therefore important to design experiments which could give information on the long-term behaviour of the tailings. Some experiments have been presented in this report, but because the technical layout is not final it can be discussed how representative the experiments are for the situation in Greenland.

New experiments with tailings can be performed with material from the basins at Risø, but tailings from realistic leaching in the laboratory autoclaves should also be included. Flowing pore water is the dominant potential means of transport of the toxic components as ionic species from tailings into the surrounding environment. Some of the ions may be present in the mobile aqueous phase, whereas others are partitioned into the immobile phases, thereby unavailable for transport. The evaluation of the mobility (potential to be transported) and migration (actual occurrence of transport) is necessary for the prediction of the behaviour of the tailings. Investigations should be made of the geochemical transfer processes of ions between mobile and immobile phases. Abrupt changes take place at interfaces between two chemically different conditions where large changes occur in

pH, reduction-oxidation potential, ionic strength, concentration of ion and the type of complexing ligand of the solvent. Precipitation reactions of electroactive species are best represented in Eh-pH diagrams as proposed by Markos & Bush (1982).

The behaviour of tailings in sea water should be the subject of a special investigation. Disposal of the tailings in Bredefjord at depths of 600 m might be the best solution for the Kvanefjeld Uranium Mine. Tailings placed here will gradually be covered by natural sediments and after some years no exchange with the seawater will occur. The radon exhalation problem will be totally eliminated. Some information about marine disposal can be gained from the tailings disposal at the Pb-Zn mine in Marmorilik.

A treatment plant for the outlet from the tailings pond has been proposed. Only very few experiments were made in relation to this, and no exact definition of the water quality requirements of the process plant was presented. Experiments with purification of the tailings effluent water can be made in connection with the tailings basins at Risø. The experiments should include precipitation of Ra and F and settling and filtration of particles. Precipitation of other potential pollutants should also be considered.

Percolation of water through the tailings pile could present a problem for the disposal of tailings in Taseq. Therefore investigations of the permeability of the tailings itself and the surrounding bedrock are suggested. During the investigations of the possibility of a hydroelectric power plant (Thomsen 1982) some measurements of the permeability were made, but the results are rather sparse.

In order to chose a suitable method for covering of the tailings pond experiments should be made in the laboratory, at the tailings ponds at Risø and in the field in Greenland. The experiments should include measurements of radon flux from the surface of the bare tailings at different tailings thickness,



moisture content, and temperature. The appropriate thickness of different cover materials can be determined in the following way (proposed by Berlin & Skoski (1978)): A sufficient amount of tailings is permitted to dry to a moisture content similar to that expected for the pile, and the tailings are then covered to a predetermined depth with the selected cover material. After steady state conditions have been established (4-6 weeks) radon flux determinations can be made at the surface of the cover material. A fixed amount of cover is then removed, and additional determinations are made. In this manner a curve of radon flux as a function of cover thickness may be established. The measurements of the covered tailings should be repeated for each of the potential cover materials. These experiments should ideally be carried out on location in Greenland over the course of several seasons to determine the variation in flux as a function of meteorological parameters.

Revegetation experiments on bare sand and gravel should be made at Kvanefjeld, Taseq and Tasiussarssuq. Different amounts of fertilizer and different plant species should be used. Experience from the revegetation experiments by Thorsteinsson (1980) should be included. During the Narssaq Project in 1975 some areas in the lower Narssaq Valley were cleared of vegetation and top soil and the natural revegetation studied. The results of these experiments have not been reported, but the development of vegetation in the areas could be followed also in the future.

#### 8.1.2. Environmental aspects

In order to determine if there is an environmental effect caused by the mining and milling activity and the storage of tailings, it is necessary to know the quality of the environment prior to the operation. The preoperational, or baseline phase is the most significant because the data generated in this phase is the determining factor for evaluation of the effects of construction, process operation and post-operational assessment of the facility.

According to Mahon et al. (1980) the preoperational phase of the assessment consists of: 1) an initial survey of the area to determine the best (i.e. most suited from an environmental, engineering and public health standpoint) site for the tailings disposal area, and to identify potential alternative tailings disposal sites; and 2) to collect data for an assessment based on the known site position and most likely disposal method to be employed. The interrelationship between baseline studies and the licensing and operational phase of a mine/mill facility is illustrated in Figure 8-1.

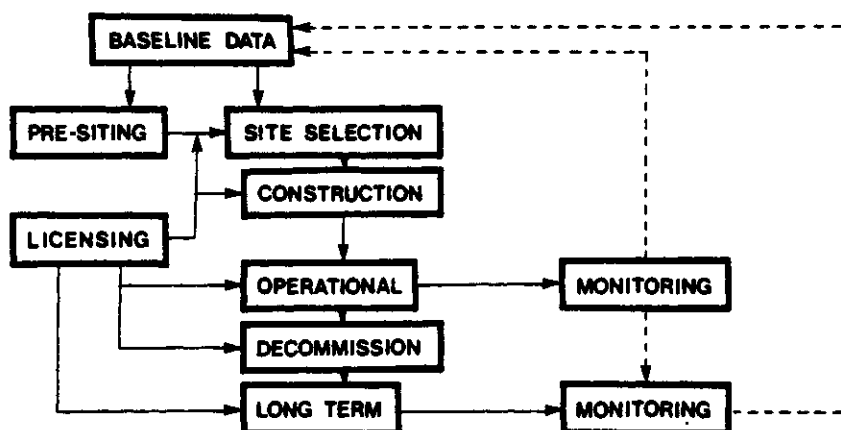

Figure 8-1: Interrelationship between baseline data programme, licensing and monitoring program during and after operation. (From Mahon et al. 1980).

The present report has given some of the data needed for a preoperational assessment, but it has also shown that much more data should be provided. The assessment of the environmental implications must define the rate of operational and post abandonment contamination release and trace the movement of these contaminants through the natural environment and possibly into man or man's immediate environment. The last part is called a pathway analysis. By this analysis a model can be constructed for the pathways of the contaminants through the environment, their residence time in each pathway component and the ultimate sink.

The objective of a critical pathway analysis is to collect empirical field data for targeted critical species or abiotic components within a given environment over a variety of seasons and controlling variables in order to determine a range of transfer coefficients necessary for the analysis (Lush & Swanson 1981). The transfer coefficient is defined as the ratio between the concentration of the contaminant in the observed compartment and the concentration in the reference media (often soil or water). Pathway analysis by the application of transfer coefficients has been extensively used in radioecological studies. The use of transfer coefficients has been sophisticated by the development of the exposure commitment concept (Barry 1979), in which the transfer coefficients are used in a dynamic model. This approach will probably provide the optimal basis for the environmental assessment. The mathematical development of the model and the collection of baseline-data should be closely connected. Variables affecting the transfer coefficients should be carefully monitored. Lush & Swanson (1981) have given this list of the main variables in the aquatic environment:

Concentration of a particular element in a given environment.

The transfer coefficient for a given element in a given environment is not necessarily linear and will generally tend to decrease with higher environmental concentrations. For example, transfer coefficients in the ocean, with some notable exceptions, are lower than those in fresh water.

Environmental concentration of chemically similar elements. The transfer coefficient has been noted to decrease with increasing concentration of chemically similar elements.

Chemical speciation. The speciation of an element will control to a very large degree its rate of uptake or transfer of living systems, and hence its toxicity.

Seasonal and annual temperatures. The uptake rates decrease with decreasing temperature. The eventual steady state level attained at equilibrium is not directly controlled by temperature.

Light intensity. The metabolic activity of photosynthetic algae and bacteria is light dependent and the transfer coefficient can therefore increase as the amount of light increases.

Total suspended solids. The transfer coefficients tend to be higher in clear waters than in turbid waters. The reason for this might be the effect on light penetration and/or the levels of colloidal bound elements.

Other general water quality variables. pH, Eh, total dissolved solids and dissolved nutrients levels are expected to have an effect upon transfer coefficients principally though the control they exert on trace element speciation.

The spatial and trophic niche. The niche occupied by the organism is an important controlling variable in determining transfer coefficients.

Concentration of elements which can affect uptake of other elements. Complex interactions can take place between various elements which affect both uptake and utilization.

Another important factor that should be taken into consideration is the association of elements with non-living organic and inorganic particulates. Thus the solute-solid phase partition coefficients should be determined.

The above mentioned general variables should be included in the site-specific preoperational base-line study. As pointed out in section 3.8.3. both the biotic and abiotic environment around the Ilimaussaq intrusion is influenced by its rare geo-chemistry. It is therefore possible already now to find areas with different loads of the potential pollutants, and transfer coefficients and partition coefficients can be determined before operation of the mine and mill is initiated.

It will not be possible to measure the concentrations of all elements in all compartments. Therefore the most critical should be selected. Initially the efforts should be laid on the

elements listed in Table 6-1, but the selection of elements should be adjusted according to the current investigations and technical solutions for the process plant. The food chains to be investigated should also be carefully selected. Based on the findings in the present report, some critical abiotic factors, pollutants, compartments and pathways can be identified. The following gives an outline of the most important items to be studied in the base-line study.

8.1.2.1. Marine environment. Some hydrologic investigations were made in 1979 by the Danish Institute of Hydrology (1979). Guidelines for future investigations were given in their report. They pointed out that although some information already exists, there is a gap in the knowledge of seasonal and spatial variations of temperature, salinity and oxygen concentrations. The input of freshwater is important for the transport of pollutants, but the total input to the fiord systems is not actually measured. The assessment of concentrations, transport and accumulation within local areas can be performed on the basis of local freshwater discharges. It may be difficult to delimit a marginal discharge in an area with large amounts of freshwater. Therefore it could be necessary to use an artificial tracer (fluorescent), emitted from the appropriate point of discharge. The depth of Bredefjord has not been measured. Information on this is essential, especially for the assessment of disposal of tailings in or at Bredefjord.

The rate of sedimentation is an important factor for the immobilization of pollutants. This can probably be determined by Pb-210 measurements.

The following abiotic and biotic compartments are suggested to be included in the base-line study:

- water
- suspended particulates
- sediment
- phytoplankton
- zooplankton
- shrimp (*Pandalus borealis*)
- mussel (*Mytilus edulis*)
- catfish (*Anarchias minor*)
- cod (*Gadus morhua*)
- salmon (*Salmo salar*)
- seal (*Phoca sp.*)

These compartments cover a wide range of spatial and trophic levels, and include economically important species.

8.1.2.2. Freshwater environment. The water balance for the watersheds that could be affected by mining and milling should be monitored. Measurements should provide information of seasonal variations and should include a period of some years to find year to year fluctuations. A very important factor is the precipitation which has not been included in the three year meteorological programme, which was linked to the pilot-plant studies (Kristensen 1983).

The compartments suggested for monitoring in the waterbodies are:

- water
- suspended particulates
- sediment
- midge larvae and puppae
- arctic char (*Salvelinus alpinus*)

Special attention should be paid to the monitoring of fluorine in the Narssaq River. Also it is suggested to make toxicological tests of fluorine on members of the local population of arctic char.

8.1.2.3. Terrestrial environment. The baseline studies in the terrestrial environment should include a geomorphological study of the areas that could be affected by the mining and milling. The chemical-ecological studies should be concentrated on the main pathways leading to man. The compartments selected for monitoring in the terrestrial environment are:

- particulate fall-out
- soil
- lichens & mosses
- grasses
- herbs
- bushes (incl. berries)
- sheep
- arctic fox (*Alopex lagopus*)

Special attention should be paid to the food-chain of sheep. An investigation should be set up to investigate the diet of the sheep including the variations during the seasons. Also the chemical composition of imported fodder should be assessed in order to calculate the trace element load of the sheep.

## 8.2. Operational monitoring

The operational monitoring should be concentrated on the discharge of pollutants from the mine, mill and tailings pond and on key compartments of the ecosystems. After the preoperational baseline study a scheme can be set up for the monitoring which should precisely define the compartments to be monitored, the factors to be analyzed, methods of analysis and time schedule.

### 8.3. Post-operational monitoring

The post-operational surveillance and monitoring should include the physical performance and stability of engineered structures, the release of contaminants from the abandoned pit and tailings pond, and the transfer of contaminants to biota. The post-operational monitoring can probably be limited to a few critical sources, pathways and chemical elements, which will be defined during the preoperational and operational phases.

## 9. CONCLUSION

The sources of pollution from the proposed uranium mining and milling complex at Kvanefjeld has been evaluated. It was found that the most important sources will be the pit, waste dump and tailings impoundment. Other sources are upwhirling of dust by blasting, transportation and crushing, and the disposal of scale from the pipe reactor.

In order to evaluate two of the most important sources, studies of the mobility of elements in the ore and tailings have been performed. Fluorine was the most mobile of the elements studied in both ore and tailings. In general the mobility of non-radioactive elements was lower in the tailings than in the ore. The most noticeable exceptions were uranium and iron. Uranium is selectively extracted in the process, and iron probably results from wearing of the machinery. The mobility of the radioactive elements was slightly higher in tailings than in ore.

A list of potential pollutants has been made based on the abundance and mobility of the elements and their general toxicity. Because of the limited information, the list is probably not complete and may include elements, which later turn out to be unimportant. The list includes:

Be, F, V, Cr, Mn, Fe, Co, Ni, Zn, As, Se, Rb, Nb, Zr, Mo, Cd, Sb, REE, Hg, Pb, Th, U, Ra-226, Pb-210, and Po-210.



The pollution sources give rise to both liquid and dust emissions. Due to this and to the placement alternatives for the mining and milling complex almost all parts of the environment may be affected. The most critical pathway in the terrestrial environment is believed to be: dust → soil and vegetation → sheep; in the freshwater environment: elements in solution in waste water → arctic char; in the marine environment: elements in solution in waste water → various food organisms → commercial fish species.

It was chosen to focus on two placement alternatives in the pre-feasibility study. In Alternative 1 the process plant is placed in the upper Narssaq Valley and the tailings in Lake Taseq. In Alternative 2 the process plant is placed on the peninsula, Nugssuaq, 18 km NE of Kvanefjeld, and the tailings in the nearby inlet, Tasiussarssuq. From an environmental point of view, Alternative 2 should be preferred, because the tailings are disposed close to the ultimate recipient, the sea, where the pollutants will be less harmful due to precipitation (esp. F), dilution, and lower transfer rates. However, the placement close to some of the best sheep-farming areas of Greenland should be carefully considered.

This study has shown that there is a considerable lack of knowledge on both the technical aspects of exploitation of the uranium resource and the environmental characteristics of the area. Some guidelines for the preoperational environmental assessment are therefore given. Two items of the technical aspects should be emphasized: the formation of scale in the pipe autoclave, and the behaviour of fluoride in the process. The environmental base-line study should be related to mathematical modeling e.g. according to the exposure commitment concept. The development of the technical solutions and the environmental assessment should be closely interrelated in order to meet the environmental requirements.

## 10. REFERENCES

- AVERILL, D.W., SCHMIDT, J.W., MOFFET, D., WEBBER, R.T. and BARNES, E. (1982). Development of a precipitation process for radium-266 removal. IAEA-SM-262/10. Management of wastes from uranium mining and milling, 353-364.
- ASMUND, G. 1980. Udludning af fluor fra Kvanefjeldsmalmen. (Grønlands Geogiske Undersøgelse). 23 pp.
- ASMUND, G. 1983. Personal communicaton.
- BARRY, P.J. 1979. An introduction to the exposure commitment concept with reference to environmental mercury. (Monitoring and Assessment Research Centre, Chelsea College, University of London). Technical Report No. 12, 93 pp.
- BERLIN, R. and SKOSKI, L. 1978. Alternative approaches for the disposal and stabilization of uranium mill tailings to control airborne radiological effluent releases. Symposium on Uranium Mill Tailings Management, Fort Collins, Colorado, November 1978. (Colorado State University). p 47-57.
- BITTEL, R., FOURCADE, N. and ZETTWOOG, P. 1978. Environmental and site problems in the uranium ore mining and processing industry. (Commission of the European Communities, Environment and Consumer Protection Service). Contract ENV/223/76-F, 211 pp.
- BLANCHARD, R.L., FOWLER, T.W., HORTON, T.R. and SMITH, J.M. 1982. Potential health effects of radioactive emissions from active surface and underground uranium mines. Nuclear Safety, 23, 439-450.
- BRODERSEN, K. and SØRENSEN, A. 1981. Udledning af overfladevand fra lagerplads for malm, december 1980. (Risø National Laboratory, Kvanefjeld Uranium Project). KB/AS/HL/771.518.69 1981.03.05., 9 pp.
- BØCHER, T.W., HOLMEN, K. and JAKOBSEN, K. 1966. Grønlands Flora. København.
- CANADA GAZETTE. 1977. Part II, Vol. III, No. 5 SOR/DORS/77-178.
- CHRISTENSEN, B. 1981. Miljømæssig vurdering af dispositionsforslag til vandkraftværk Taseq. (Grønlands Fiskeriundersøgelser, November 1981) 21 pp.

- CHRISTENSEN, N.P. 1980. The hydrochemistry of three drainage basins in South Greenland. (Institute of Petrology, University of Copenhagen). Thesis, 111 p.
- DANSK HYDRAULISK INSTITUT. 1979. Hydrografiske undersøgelser, Narssaq 1979. (Grønlands Tekniske Organisation).
- EGEDE, K. 1982. Detailplan for fåreavlen i Sydgrønland. (De samvirkende Fåreholderforeninger, Upernaviarssuk). 185 pp.
- EGYED, M.N. and SHLOSBERG, A. 1974. Acute sodium fluorosilicate poisoning in domestic animals with special reference to sheep. *Fluoride*, 8, 134-143.
- EMELEUS, C.H. and UPTON, B.G.J. 1976. The Gardar period in Southern Greenland. In: Escher, A. and Watt, W.S. (eds.): *Geology of Greenland*. (The Geological Survey of Greenland), pp. 152-181.
- ENVIRONMENTAL PROTECTION SERVICE. 1978. Monitoring program design recommendations for uranium mining localities. Report EPS 3-EC-78-10, 111 pp.
- ERLENDSSON, G., JENSEN, J., KOEFOED, S. and PAULSEN, J.L. 1983. Skitseprojekt, Mine- og oparbejdningsanlæg. (Risø National Laboratory, Kvanefjeld Uranium Project).
- FERGUSON, J. 1964. Geology of the Ilimaussaq alkaline intrusion, South Greenland. *Meddr. Grønland*, 172, 4.
- GERASIMOVSKII, V.I. 1968. Geochemistry of agpaitic nepheline syenites. *Proceedings of the XXIII International Geological Congress*, 6, 259-265.
- GRYNING, S.E. and LYCK, E. 1983. A tracer investigation of the atmospheric dispersion in the Dyrnæs Valley, Greenland. (Risø National Laboratory). Risø R-481, 67 pp.
- GRØNLANDS FISKERIUNDERSØGELSER. 1981. Ferskvandsbiologiske undersøgelser i Narssaq elv, 1981. 48 pp.
- GRØNLANDS FISKERIUNDERSØGELSER. 1982. Fjeldørredundersøgelser i Narssaq elv, 1981. 36 pp.
- HANSEN, K. 1979. Status over bestanden af Havørn, *Haliaetus albicilla groenlandicus* Brehm, i Grønland i årene 1972-1974. *Dansk orn. Foren. Tidsskr.*, 73, 107-130.
- HEALY, W.B., McCABE, W.J. and WILSON, G.F. 1970. Ingested soil as a source of microelements for grazing animals. *N.Z.J. agric. Res.*, 13, 503-21.

- HEALY, W.B., RANKIN, P.C. and WATTS, H.M. 1974. Effect of soil contamination on the element composition of herbage. N.Z.J. agric. Res., 17, 59-61.
- HEERFORDT, L. et.al. 1980. Fåreavl i Grønland. Projekt i arktisk biologi. (University of Copenhagen). 109 pp.
- HOVMAND, M. 1979. Personal communication.
- IAEA. 1981. Current practices and options for confinement of uranium mill tailings. (International Atomic Energy Agency). Technical Reports Series No. 209, 102 pp.
- ICRP. 1959. Recommendations of the International Commission on Radiological Protection. ICRP Publication No. 2. (Pergamon Press).
- ICRP. 1964. Recommendations of the International Commission on Radiological Protection. ICRP Publication No. 6. (Pergamon Press).
- JONES, K.C., PETERSON, P.J. and DAVIES, B.E. 1983. Silver and other heavy metals in Welsh soils contaminated by metalliferous mine spoil waste. Proceedings of the International Conference Heavy Metals in the Environment, Heidelberg 1983, 980-983.
- KALVIG, P. 1983. Preliminary mining assessment of the uranium resource at Kvanefjeld, the Ilimaussaq intrusion, South Greenland. (Risø National Laboratory, Kvanefjeld Uranium Project).
- KLOKE, A. 1980. Personal Communication.
- KNIGHT, G. 1980. Generation and control of mine airborne dust. CANMET Report 80-27E, 20 pp.
- KRISTENSEN, L. 1983. Meteorological measurements at Kvanefjeld in the period September 1979-March 1983. (Risø National Laboratory, Kvanefjeld Uranium Project).
- LARSEN, L.B. 1973. Water balance investigations in the Narssaq River basin, South Greenland. A contribution to the international Hydrological Decade. (Institute of Petrology, University of Copenhagen). Thesis, 159 pp.
- LAVESKOG, A. 1976. Om metaller. (Statens Naturvårdsverk, Stockholm). 262 pp.
- LINDEGAARD, C., MÆHL, P. and NIELSEN, B.M. 1978. Zoobenthos of lakes located within and outside the Ilimaussaq intrusion in South Greenland. Verh. Internat. Verein Lemnol. 20, 159-164.

- LUSH, D. and SWANSON, S. 1981. Pathway analyses and transfer coefficients. Proceedings of Seminar Comparative Ecotoxicity of Uranium Mining and Milling Emissions. (Saskatchewan Research Council). SRC Publication No. A-751-10-D-81, pp. 108-144.
- MAHON, D.C., SAGERT, P.G. and LEGYET, M.R. 1980. An analysis of environmental baseline data programmes for uranium tailings storage. Proceedings of the First International Conference on Uranium Mine Waste Disposal, Brawner, C.O. (ed.), pp. 75-86.
- MARKOS, G. & BUSCH, K.J. 1982. Geochemical processes in uranium mill tailings and their relationship to contamination. IAEA-SM-262/23. Management of wastes from uranium mining and milling, 231-246.
- MASON, B. 1966. Principles of Geochemistry. Wiley. 329 pp.
- MILJØMINISTERIET. 1980. Bekendtgørelse om vandkvalitet og tilsyn med vandforsyningsanlæg. Miljøministeriets bekendtgørelse nr. 6 af 4. januar 1980.
- NARSSAQ KOMMUNE. 1981. Oplæg vedrørende arealanvendelsen i Narssaq Kommune.
- NIELSEN, J.S. 1983. Uranet i Kvanefjeld. En miljømæssig vurdering af den planlagte uranminedrift ved Narssaq, Sydgrønland. (Institute of Plant Ecology, University of Copenhagen). Thesis, 261 pp.
- NUREG. 1980. Final Generic Environmental Impact Statement of uranium milling. Vol. I-III (Office of Nuclear Material Safety and Safeguards. U.S. Nuclear Regulatory Commission). NUREG-0706.
- NØRREVANG, A. (red.). 1971. Danmarks Natur. Bind 10, Grønland og Færøerne. Politikens Forlag.
- PERKINS, D.F., MILLAR, R.O. and NEEP, P.E. 1980. Accumulation of airborne fluoride by lichens in the vicinity of an aluminium reduction plant. Environ. Pollut. (Ser.A.), 21, 155-168.
- ROSE-HANSEN, J., OVERGAARD NIELSEN, C. and SØRENSEN, H. 1977. The Narssaq Project. A geochemical-ecological research project. Progress Report No. 1. Vol. 1 and 2. Copenhagen.
- SUTTIE, J.W. 1969. Air quality standards for the protection of farm animals from fluorides. J. Air. Poll. Contr. Ass. 19, 239-242.

- SUTTLE, N.F., ALLOWAY, B.J. and THORNTON, I. 1975. An effect of soil ingestion on the utilization of dietary copper by sheep. *J. agric. Sci. Camb.*, 84, 249-254.
- SØRENSEN, A. 1979. Oplagring af udludningsrest fra CPL-uran-udvindingsprocessen. (Risø National Laboratory, Kvanefjeld Uranium Project). AS/hl/771.514.90, 1979.02.08.
- SØRENSEN, A. 1983. Måling af fluorid-koncentrationen i Narssaq elv i forbindelse med tunneldrivningen i Kvanefjeld 1979-1981. (Risø National Laboratory, Kvanefjeld Uranium Project).
- SØRENSEN, A. 1983. Strålingshygiejniske problemer i forbindelse med brydning af uranmalm i Kvanefjeld og oparbejdning af uran (Risø National Laboratory, Kvanefjeld Uranium Project).
- SØRENSEN, E. 1982. Water-soluble substances in Kvanefjeld lujavrite. (Risø National Laboratory, Kvanefjeld Uranium Project).
- SØRENSEN, E., KOEFOED, S., LUNDGAARD, L. and PAULSEN, J.L. 1983. Uranudvinding ved udludning med natriumcarbonat under højt tryk og temperatur. (Risø National Laboratory, Kvanefjeld Uranium Project).
- TAKALA, K., KAURANEN, P. and OLKKONEN, H. 1978. Fluorine content of two lichen species in the vicinity of a fertilizer factory. *Ann. Bot. Fennici* 15, 158-166.
- THOMSEN. 1982. Forundersøgelse vandkraft 1981, hydrologi, Taseq, Narsaq. (Grønlands Tekniske Organisation). 22 pp.
- THORSTEINSSON, I. 1978, 1979, 1980. Undersøgelser vedrørende fåreavl i Grønland I-III. (Landbrugets forskningsinstitut, Island og Forsøgsstationen Upernaviarssuk, Grønland).
- USSING, N.V. 1912. Geology of the country around Julianehåb, Greenland. *Meddr. Grønland* 38, 1-426.
- VAN HOOK, R.I. 1979. Potential health and environmental effects of trace elements and radionuclides from increased coal utilization. *Environ. Health Persp.*, 33, 227-247.
- WOOD, J.M. 1974. Biological cycles for toxic elements in the environment. *Science*, 183, 1049-1052.



<p>Title and author(s)</p> <p>Preliminary Environmental Impact Statement for the Kvanefjeld Uranium Mine.</p> <p>Kim Pilegaard</p>	<p>Date September 1990</p> <p>Department or group Chemistry</p> <p>Groups own registration number(s)</p> <p>Project/contract no.</p>
<p>Pages 130    Tables 34    Illustrations 32    References 63</p>	<p>ISBN 87-550-1654-5</p>
<p>Abstract (Max. 2000 char.)</p> <p>The sources of pollution from a proposed uranium mining and milling complex at Kvanefjeld in South Greenland have been evaluated. The environmental impact assessment was part of a pre-feasibility study. The main aims of this study have been to identify potential pollutants and critical pathways, to evaluate the environmental impact of technical alternatives, and to provide guide-lines for pre-operational environmental studies.</p> <p>The study has identified the open pit, waste dump and tailings impoundment as the most important sources of pollution. The mobility of non-radioactive elements was lower in the tailings than in the ore, whereas the reverse was true for the radioactive elements.</p> <p>The potential pollutants include: Be, F, V, Cr, Mn, Fe, Co, Ni, Zn, As, Se, Rb, Nb, Zr, Mo, Cd, Sb, REE, Hg, Pb, Th, U, Ra-226, Pb-210 and Po-210. This list was based on abundance and mobility in the ore and tailings and general toxicity of the elements. Fluorine is the most mobile of the elements in both ore and tailings. The concentration in ore and tailings may be up to 1% and in combination with its high toxicity, F can then be regarded as the most serious pollutant.</p>	
<p>Descriptors - INIS</p> <p>CONTAMINATION; ENVIRONMENTAL IMPACTS; FLUORINE; GREENLAND; MILL TAILINGS; MILLING; MINING; MOBILITY; POLLUTANTS; URANIUM ORES</p> <p>Available on request from Riso Library, Riso National Laboratory, (Riso Bibliotek, Forskningscenter Riso), P.O. Box 49, DK-4000 Roskilde, Denmark. Telephone 42 37 12 12, ext. 2268/2269. Telex: 43116, Telefax: 46 75 56 27</p>	







**Available on exchange from:  
Risø Library,  
Risø National Laboratory, P.O. Box 49,  
DK-4000 Roskilde, Denmark  
Phone + 45 42 37 12 12, ext. 2268/2269  
Telex 43 116, Telefax +45 46 75 56 27**

**ISBN 87-550-1654-5  
ISSN 0418-6435**