



## Improved High Temperature Superconductor Materials for Wind Turbine Generators

**Mozhaev, Peter; Khoryushin, Alexey; Mozhaeva, Julia; Andersen, Niels Hessel; Grivel, Jean-Claude; Hansen, Jørn Bindslev; Jacobsen, Claus Schelde**

*Published in:*  
Energy Systems and Technologies for the coming Century

*Publication date:*  
2011

*Document Version*  
Publisher's PDF, also known as Version of record

[Link back to DTU Orbit](#)

*Citation (APA):*  
Mozhaev, P., Khoryushin, A., Mozhaeva, J., Andersen, N. H., Grivel, J-C., Hansen, J. B., & Jacobsen, C. S. (2011). Improved High Temperature Superconductor Materials for Wind Turbine Generators. In Energy Systems and Technologies for the coming Century: Proceedings (pp. 238-247). Roskilde: Danmarks Tekniske Universitet, Risø Nationallaboratoriet for Bæredygtig Energi. (Denmark. Forskningscenter Risoe. Risoe-R; No. 1776(EN)).

## DTU Library

Technical Information Center of Denmark

---

### General rights

Copyright and moral rights for the publications made accessible in the public portal are retained by the authors and/or other copyright owners and it is a condition of accessing publications that users recognise and abide by the legal requirements associated with these rights.

- Users may download and print one copy of any publication from the public portal for the purpose of private study or research.
- You may not further distribute the material or use it for any profit-making activity or commercial gain
- You may freely distribute the URL identifying the publication in the public portal

If you believe that this document breaches copyright please contact us providing details, and we will remove access to the work immediately and investigate your claim.

# Energy Systems and Technologies for the Coming Century

Proceedings

Risø International Energy Conference 2011, May 10 - 12



Edited by Leif Sønnerberg Petersen and Hans Larsen  
Risø-R-1776(EN)  
May 2011



Editors: Leif Sønnerberg Petersen and Hans Larsen  
**Title:** Energy Systems and Technologies for the coming Century  
Proceedings. Risø International Energy Conference 2011  
**Division:** Systems Analysis

**Risø-R-1776(EN)**  
**May 2011**

**Abstract (max. 2000 char.):**

Risø International Energy Conference 2011 took place 10 – 12 May 2011.

**ISBN 978-87-550-3903-2**

The conference focused on:

- Future global energy development options, scenarios and policy issues
- Intelligent energy systems of the future, including the interaction between supply and end-use
- New and emerging technologies for the extended utilisation of sustainable energy
- Distributed energy production technologies such as fuel cells, hydrogen, bioenergy, wind, hydro, wave, solar and geothermal
- Centralised energy production technologies such as clean coal technologies, CCS and nuclear
- Renewable energy for the transport sector and its integration in the energy system

The proceedings are prepared from papers presented at the conference and received with corrections, if any, until the final deadline on 20-04-2011.

Information Service Department  
Risø National Laboratory for  
Sustainable Energy  
Technical University of Denmark  
P.O.Box 49  
DK-4000 Roskilde  
Denmark  
Telephone +45 46774005  
[bibl@risoe.dtu.dk](mailto:bibl@risoe.dtu.dk)  
Fax +45 46774013  
[www.risoe.dtu.dk](http://www.risoe.dtu.dk)

## Contents

Sessions overview	1
Programme	2
Scientific programme committee	5
Local organising committee	5
Session 2A - Scenario and Policy Issues	6
Session 2B – Sustainable Energy Planning	22
Session 2C - Planning Energy Supply without CO <sub>2</sub>	38
Session 2D – Economic Planning for a Low-carbon Society	66
Session 3A - Energy Systems	116
Session 3B - Smart Grids	150
Session 4 – Efficiency Improvements	186
Session 5A - Wind Energy I	204
Session 5B - Wind Energy II	226
Session 6A - Bioenergy I	248
Session 6B - Bio Energy II	274
Session 8 - Fuel Cells and Hydrogen	287
Session 11 - Mechanisms and Markets	309
Session 12 - Energy for Developing Countries	334
Session 13 - Energy Storage	406



## Preface

### Risø International Energy Conference 2011, 10-12 May 2011

#### Energy systems and technologies for the coming century

The world faces a major challenge as global CO<sub>2</sub> emissions must be reduced dramatically, in the long term even below zero, in order to limit climate change. At the same time, however, it is necessary to provide energy services to accommodate economic growth and, in particular, to meet the growing needs of the developing countries and to ensure secure energy supplies.

Furthermore, the energy sector has to cope with the current financial crisis which is having a significant impact on almost all countries.

Therefore, significant changes to the global energy systems are necessary, which calls for long-term planning. There is a pressing need to enhance the ongoing development of new and sustainable energy technologies which can provide a key role for renewable energy resources and lead to the phase-out of fossil fuels in the long term.

New, intelligent energy systems are necessary in order to accommodate fluctuating sustainable energy resources to a much greater extent than is currently the case. In such an intelligent energy system, a close link between end-use and supply must be established to create links between low-energy housing, industry and the transport sector.

It will be necessary to utilise all sustainable energy technologies to meet future global energy needs. No single technology will be able to solve the task. The combination of energy technologies will vary from one region to another, depending on local conditions.

Fossil energy resources will, to a large extent, continue to be used in the coming decade, and for this reason it is important that more efficient and climate-friendly fossil energy applications are developed until renewables can assume a leading role in global energy supplies.

Risø International Energy Conference 2011 highlighted and discussed these topics with the aim of identifying solutions which can fulfil the urgent global need to change energy technologies in a sustainable direction and create the new intelligent energy systems that can accommodate substantial amounts of fluctuating, sustainable energy.

**The conference was sponsored by:**



# SESSIONS OVERVIEW



TUESDAY 10 MAY 2011		
08:00-09:00	COFFEE AND REGISTRATION	
Room	Niels Bohr Auditorium	Main hall
09:00-10:30	<b>OPENING SESSION</b>	
10:30-11:00	BREAK	
11:00-12:30	<b>SESSION 2A</b> SCENARIO AND POLICY ISSUES	
12:30-14:00	LUNCH in H.H. Koch Auditorium	
14:00-15:30	<b>SESSION 3A</b> ENERGY SYSTEMS	<b>POSTER SESSION</b>
15:30-16:00	BREAK	
16:00-17:30	<b>SESSION 4</b> EFFICIENCY IMPROVEMENTS	
17:30-18:30	RECEPTION	

WEDNESDAY 11 MAY 2011		
Room	Niels Bohr Auditorium	H. H. Koch Auditorium
09:00-10:30	<b>SESSION 5A</b> WIND ENERGY I	<b>SESSION 2C</b> PLANNING ENERGY SUPPLY WITHOUT CO <sub>2</sub>
10:30-11:00	BREAK	
11:00-12:30	<b>SESSION 6A</b> BIOENERGY I	<b>SESSION 3B</b> SMART GRIDS
12:30-13:30	LUNCH in Main Hall	
13:30-15:00	<b>SESSION 8</b> FUEL CELLS AND HYDROGEN	<b>SESSION 5B</b> WIND ENERGY II
15:00-15:30	BREAK	
15:30-17:00	<b>SESSION 2B</b> SUSTAINABLE ENERGY PLANNING	<b>SESSION 6B</b> BIO ENERGY II
17:00-18:00	BREAK	
19:00	CONFERENCE DINNER	AT NIMB IN TIVOLI

THURSDAY 12 MAY 2011		
Room	Niels Bohr Auditorium	H. H. Koch Auditorium
09:00-10:30	<b>SESSION 11</b> MECHANISMS AND MARKETS	<b>SESSION 12</b> ENERGY FOR DEVELOPING COUNTRIES
10:30-11:00	BREAK	
11:00-12:30	<b>SESSION 13</b> ENERGY STORAGE	<b>SESSION 2D</b> ECONOMIC PLANNING FOR A LOW-CARBON SOCIETY
12:30-13:00	SUMMARY AND CLOSING REMARKS	
13:00-14:00	LUNCH in Main Hall	

---

## TUESDAY 10 MAY 2011

08:00 – 09:00 COFFEE AND REGISTRATION

09:00 – 10:30 OPENING SESSION

Niels Bohr Auditorium

Chairman: Hans Larsen, Head of Systems Analysis Division, Risø DTU, Denmark

WELCOME AND INTRODUCTION

Anders Bjarklev, acting director, Risø DTU, provost, DTU

KEYNOTE PRESENTATIONS

- **Global challenges and perspectives for the energy sector**, Diana Ürge-Vorsatz, Central European University, Hungary
- **The Industry's role in the development of sustainable energy system**, Dieter Wegener, CTO of Siemens Industry Solutions, Germany

10:30 – 11:00 BREAK

11:00 – 12:30 SESSION 2A – SCENARIO AND POLICY ISSUES

Niels Bohr Auditorium

Chairman: Lars Martiny, Deputy Director, Risø DTU

- **Penetration of new energy technologies: insights from techno-socio-economic factors**, Peter Lund, Aalto University, Finland
- **A 100% renewable power system for Europe**, Martin Greiner, Aarhus University, Denmark
- **Dong Energy's 85/15 strategy for the conversion to 85% renewables**, Charles Nielsen, DONG Energy, Denmark

12:30 – 14:00 LUNCH IN H. H. KOCH AUDITORIUM

14:00 – 18:30 POSTER SESSION IN MAIN HALL

14:00 – 15:30 SESSION 3A – ENERGY SYSTEMS

Niels Bohr Auditorium

Chairman: Diana Ürge-Vorsatz, Central European University, Hungary

- **Development of market design with focus on demand site participation**, Mikael Tøgeby, EA Energi Analyse, Denmark
- **The huge geothermal energy potential in the Danish subsurface – challenges and possibilities**, Lars Henrik Nielsen, GEUS, Geological Survey of Denmark and Greenland, Denmark
- **Integration of fluctuating energy**, Klaus Hilger, DONG Energy, Denmark
- **Performance of Space Heating in a Modern Energy System**, Brian Elmegaard, DTU Mechanical Engineering, Denmark

15:30 – 16:00 BREAK

---

16:00 – 17:30 SESSION 4 – EFFICIENCY IMPROVEMENTS

Niels Bohr Auditorium

Chairman: Kim Dam-Johansen, DTU Chemical Engineering, Denmark

- **Improving energy efficiency in industrial solutions – walk the talk**, Dieter Wegener, Siemens AG, Germany
- **Intelligent Urban Heating**, Anders Dyrelund, Rambøll Energy, Denmark
- **Influence of increased insulation levels on regional air quality**, Ulrik Smith Korsholm, Danish Meteorological Institute, Denmark

17:30 – 18:30 RECEPTION

---

## WEDNESDAY 11 MAY 2011

09:00 – 10:30 SESSION 5A – WIND ENERGY I

Niels Bohr Auditorium

Chairman: Kristine van het Erve Grunnet, Danish Energy Industries Federation, Denmark

- **Status and perspectives for the expansion of Dong Energy's offshore wind power**, Uffe Jørgensen, DONG Energy, Denmark
- **Trends in wind energy technology development**, Flemming Rasmussen, Risø DTU, Denmark
- **A high resolution global wind atlas – improving the estimation of world wind resources**, Hans Ejsing Jørgensen, Risø DTU, Denmark

SESSION 2C – PLANNING ENERGY SUPPLY WITHOUT CO<sub>2</sub>

H. H. Koch Auditorium

Chairman: Stine Grenaa Jensen, Danish Energy Association, Denmark

- **Factors affecting stakeholder perception of carbon capture and storage acceptability**, Laura Kainiemi, Aalto University, School of Science and Technology, Finland
- **The potential for geological storage of CO<sub>2</sub> in Denmark is very promising**, Karen L. Anthonsen, GEUS, Geological Survey of Denmark and Greenland, Denmark
- **Long-term modelling of carbon capture and storage, nuclear fusion and large-scale district heating**, Poul Erik Grohnhøj, Risø DTU, Denmark

10:30 – 11:00 BREAK

11:00 – 12:30 SESSION 6A – BIOENERGY I

Niels Bohr Auditorium

Chairman: Peter Lund, Aalto University School of Science and Technology, Finland

- **Integration of basic biomass conversion processes with communal CHP plant - Influence on energy and environmental performance**, Thomas Kohl, Aalto University, Finland
- **Biomass plans and developments at DONG Energy**, Jeppe Bjerg, DONG Energy, Denmark
- **The role of biomass and CCS in China from a climate mitigation perspective**, Mikael Lüthje, Risø DTU, Denmark
- **The European biofuels policy: from where and where to?** Henrique Pacini, Royal Institute of Technology, Sweden

SESSION 3B – SMART GRIDS

H. H. Koch Auditorium

Chairman: Anders Troi, Risø DTU, Denmark

- **Dynamic power system investment modelling and analysis**, Hans Ravn, RAM-løse, Denmark
- **Scheduling home appliances usage to reduce electricity demand peaks**, Ana Rosselló-Busquet, DTU Fotonik, Denmark
- **Energy-efficient refrigeration and flexible power consumption in a SmartGrid**, Tobias Gybel Hovgaard, Danfoss A/S/DTU Informatics, Denmark
- **The FlexControl concept - a vision, a concept and a product for the future power system**, Per Nørgaard, Risø DTU, Denmark

12:30 – 13:30 LUNCH IN MAIN HALL

13:30 – 15:00 SESSION 8 – FUEL CELLS AND HYDROGEN

Niels Bohr Auditorium

Chairman: Henrik Carlsen, DTU Mechanical Engineering, Denmark

- **Integrated Gasification SOFC Plant with a Steam Plant**, Rokni Masoud, DTU Mechanical Engineering, Denmark
- **Use of Methanation for Optimization of a Hybrid Plant Combining Two-Stage Biomass Gasification, SOFCs and a Micro Gas Turbine**, Christian Bang-Møller, DTU Mechanical Engineering, Denmark
- **Metal-supported SOFCs - development of cost-effective and robust fuel cells for operation at intermediate temperatures**, Trine Klemensø, Risø DTU, Denmark
- **Electrolysis for synthesis gas production**,

SESSION 5B – WIND ENERGY II

H. H. Koch Auditorium

Chairman: Peter Hauge Madsen, Head of Wind Energy Division, Risø DTU

- **Influence of rare earth element supply on future offshore wind turbine generators**, Bogi Jensen, DTU Electrical Engineering, Denmark
- **Improved high temperature superconductor materials for wind turbine generators**, Jørn Bindslev Hansen, DTU Physics, Denmark
- **Offshore wind energy**, Thomas Buhl, Risø DTU, Denmark

15:00 – 15:30 BREAK

15:30 – 17:00 SESSION 2B – SUSTAINABLE ENERGY PLANNING

Niels Bohr Auditorium

Chairman: Poul Erik Morthorst, Risø DTU, Denmark

- **Spurring investments in renewable energy technologies in non-OECD countries. A quantitative analysis on how to design and finance NAMAs**, Tobias Schmidt, ETH Zurich, Switzerland
- **Integrating climate change adaptation in energy planning and decision-making - key challenges and opportunities**, Anne Olhoff, Risø DTU, Denmark
- **Policies for achieving a low-carbon transport sector in India**, Subash Dahr, Risø DTU, Denmark

SESSION 6B – BIO ENERGY II

H. H. Koch Auditorium

Chairman: Kim Pilegaard, Risø DTU, Denmark

- **Algal biofuels: key issues, sustainability and life cycle assessment**, Anoop Singh, DTU Management Engineering, Denmark
- **Greenhouse gas emissions from cultivation of energy crops may affect the sustainability of biofuels**, Mette S. Carter, Risø DTU, Denmark
- **Liquid biofuels from blue biomass**, Zsófia Kádár, Risø DTU, Denmark

19:00

CONFERENCE DINNER AT NIMB IN TIVOLI, COPENHAGEN

---

## THURSDAY 12 MAY 2011

09:00 – 10:30 SESSION 11 – MECHANISMS AND MARKETS

Niels Bohr Auditorium

Chairman: Dieter Wegener, Siemens, Germany

- **On the effectiveness of standards versus taxes for reducing CO<sub>2</sub> emissions in passenger car transport Europe**, Amela Ajanovic, Vienna University of Technology, Austria
- **Dynamic regulatory behaviour in the context of changing policy terrain and market forces: a case of electricity regulation in India**, Gopal Krishna Sarangi, TERI University, India
- **What are customers willing to pay for future technology vehicles**, Jørgen Jordal-Jørgensen, COWI A/S, Denmark
- **The business potential and market opportunities for polymer solar cells**, Torben Damgaard Nielsen, Risø DTU, Denmark

SESSION 12 – ENERGY FOR DEVELOPING COUNTRIES

H. H. Koch Auditorium

Chairman: Mark Radka, UNEP, France

- **Alternative energy for Nepal**, Hari Tiwari, Social Welfare Council, Nepal
- **Identifying technologies for sustainable energy development options in the developing world: the case of providing access to electricity**, Willington Ortiz, Wuppertal Institute, Germany
- **Smart pathways for providing electricity in developing countries**, Brijesh Mainali, Royal Institute of Technology, Sweden
- **Mode of transport to work, car ownership and CO<sub>2</sub> emissions in Mauritius**, Vishal Jaunky, ETH Zürich, Switzerland

10:30 – 11:00 BREAK

11:00 – 12:30 SESSION 13 – ENERGY STORAGE

Niels Bohr Auditorium

Chairman: Søren Linderøth, Head of Fuel Cells and Solid State Chemistry Division, Risø DTU

- **Grid scale energy storage in salt caverns**, Fritz Crotogino, KBB Underground Technologies GmbH, Germany
- **Sensitivity on battery prices versus battery capacity on plug-in hybrid electric vehicles and the effects on the power system configuration**, Nina Juul, Risø DTU, Denmark
- **Wind power impacts and electricity storage - a time scale perspective**, Karsten Hedegaard, Risø DTU, Denmark
- **Compressed air energy storage in offshore grids**, Sascha T. Schröder, Risø DTU, Denmark

---

SESSION 2D – ECONOMIC PLANNING FOR A LOW CO<sub>2</sub> SOCIETY

H. H. Koch Auditorium

Chairman: Knud Pedersen, DONG Energy, Denmark

- **Efficiency and effectiveness of promotion systems for electricity generation from renewable energy sources - an update on lessons learned from EU countries**, Reinhard Hass, Vienna University of Technology, Austria
- **The development and diffusion of renewable energy technologies in Norway and Denmark**, Antje Klitkou, NIFU STEP Norwegian Institute for Studies in Innovation, Research and Education, Norway
- **Trade disputes over clean technology-supporting policies: theories, recent cases, and possible solutions**, Xianli Zhu, Risø DTU, Denmark

12:30 – 13:00 SUMMARY AND CLOSING REMARKS

Anders Bjarklev, acting director, Risø DTU, provost, DTU

Hans Larsen, Head of Systems Analysis Division, Risø DTU

13:00 – 14:00 LUNCH IN MAIN HALL

---

## POSTER SESSION – TUESDAY 10 MAY 2011

12:30 – 18:30 POSTERS ACCEPTED FOR THE POSTER SESSION

Main Hall

**Development of an energy strategy for cities and communities**, Monika Culka, alpS GmbH, Austria

**Application of proton exchange membrane fuel cell for lift trucks**, Elham Hosseinzadeh, DTU Mechanical Engineering, Denmark

**Characterisation of bio-petroleum from hydro-thermal processing of algae**, Chima Amadi, University of Leeds, UK

**An investigation of the application aspects of torrefaction**, Lei Shang, Risø DTU, Denmark

**Statistical analysis for the wind speed in the region of Tetouan in the Kingdom of Morocco**, Redouane Abdelbari, Energy Laboratory, Faculty of Science of Tetouan, Morocco

**Superconductor-ferromagnet composite materials for wind turbine generators**, Jørn Bindeslev Hansen, DTU Physics, Denmark

**Novel catalyst and micro-reactor concept for preferential oxidation of CO**, Oliver Görke, Karlsruhe Institute of Technology, Germany

**The use of local dynamic power prices - example and perspectives**, Per Nørgaard, Risø DTU, Denmark

**Dynamic simulation of a proton exchange membrane fuel cell for automotive systems**, Raja Abid Rabbani, DTU Mechanical Engineering, Denmark

---

## SCIENTIFIC PROGRAMME COMMITTEE

Hans Larsen, Risø DTU (chairman)

Dan Arvizu, NREL, USA

Henrik Carlsen, DTU Mechanical Engineering, Denmark

Kim Dam-Johansen, DTU Chemical Engineering, Denmark

Gijs van Kuik, TU Delft, the Netherlands

Peter Lund, Aalto University School of Science and Technology, Finland

Knud Pedersen, DONG Energy, Denmark

Mark Radka, UNEP, France

Youba Sokona, Coordinator of African Climate Policy Centre, Ethiopia

Anders Stouge, Danish Energy Industries Federation, Denmark

Dieter Wegener, Siemens, Germany

Diana Úrge-Vorsatz, Central European University, Hungary

Nicolai Zarganis, Danish Energy Agency, Denmark

Lars Aagaard, Danish Energy Association, Denmark

---

## LOCAL ORGANISING COMMITTEE

Hans Larsen (chairman)

Peter Hauge Madsen

Jens Juul Rasmussen

Søren Linderoth

Kim Pilegaard

Peter Sommer Larsen

Leif Sønderberg Petersen

Anders Troi

## **Session 2A - Scenario and Policy Issues**

# Penetration of new energy technologies: Insights from techno-socio-economic factors

Peter D. Lund

Aalto University

School of Science

P.O. Box 14100, FI-00076 Aalto (Espoo), Finland

E-mail: peter.lund@tkk.fi

## Abstract

Many studies underline the importance of new renewables such as wind and solar for CO<sub>2</sub> emission mitigation and ensuring access to energy, in particular in the power sector where demand and emissions grow fast. New renewables provide presently < 3% of all electricity, but they grow in two digits per annum explained mostly by demand stimulating public support. Understanding factors that will affect future adoption of new technologies is very relevant as simple extrapolations from present state would be ambiguous. These factors are investigated here in a techno-socio-economic framework including aggregated technology diffusion, private sector investments and integration with energy systems.

High annual growth rates are not exceptional for emerging energy technologies. Based on empirical observations supported by technology diffusion theory, a growth exceeding 20%/yr could be normal when the share of all energy is under 1% but declines to <5%/yr when exceeding a 10% market share. Industries' profitability and capability to generate revenues is the basis for further investments and volume growth. Analyzing top companies, a self-financeable capacity expansion potential of 14-99%/yr (2008) in wind power industry and 60%/yr in average in PV (plunged to 20% in 2009) were found which could facilitate a sustained growth path. However, a decreasing trend was found in all RES which may indicate lowering profit margins explained by harder competition, larger investments in manufacturing lines and R&D needs with raising volumes that may eventually lead to decreasing annual growth.

Under favorable circumstances, i.e. new technologies are given a preferential position in energy and climate policy that accelerates private investments and diffusion, but considering simultaneously the techno-socio-economic boundaries, the share of renewables could grow up to 60% of global electricity in 2050 (19% in 2009), and new renewables >40% (3%), respectively. If going for so-called fast-track strategies, RES-E could in theory grow even close to 100% of all electricity, but would require strong demand side efficiency measures and existing traditional capacity replacement simultaneously.

## 1 Introduction

New energy technologies are perceived to play an increasingly important role in CO<sub>2</sub> emission mitigation and in ensuring access to energy. Some new technologies such as wind power and solar photovoltaics have demonstrated two-digit growth numbers for a longer period of time, which may be explained by a combined effect of increasing subsidy volumes and technology scale and learning effects. For example last year (2010), the PV market almost doubled bringing the production capacity close to 30,000 MW<sub>p</sub> and in the main market Germany solar electricity reaches a 2% share of all electricity. Albeit such skyrocketing market growths, these new technologies still are embryonic in



terms of their overall energy contribution which remains in a few percent range of all energy and electricity demand. The gap between global energy relevance and present situation is still least an order of magnitude wide.

It is important to emphasize that the high annual growth rates are quite typical to new innovations when they enter the market, but we may not conclude from this that strong growth would be a prevailing condition for a new technology. Actually based on empirical observations on energy technology penetration in general over 20%/yr growth could be normal when the share of all energy is under 1% but declines to <5%/yr when exceeding a 10% market share [Lund, 2010]. This is also supported by technology diffusion theory. Understanding factors that will affect future adoption of new energy technologies is therefore highly relevant.

There is a range of factors that will influence the penetration. Most of this fall under a highly sophisticated multidisciplinary techno-socio-economic framework, stretching from consumer related social and behavioral factors to technology characteristics and requirements [Rogers, 1995]. Penetration is strongly linked to decision making processes influenced by above-type factors. A unified analytical model that would include all relevant factors and explain penetration of new energy technologies has not yet been developed and would require a huge effort. Instead partial models that high-light the importance of certain type of factors can be used, for example classical technology diffusion models relate often to user awareness and information excess.

In this paper, we will present a review of different kind of models that could be used for investigating the penetration of new energy technologies in the techno-socio-economic frame. One of the objectives would be to find out how fast these new industries could actually grow taking the different boundary conditions. We will focus here on three major questions and corresponding model categories ranging from micro to macro level, namely:

- 1) Consumer interface: Adoption of a new technology as a social process explained by information dispersion (awareness) and willingness/readiness of consumers to use the new technology (decision);
- 2) Delivery of new technology: Industries' capability to grow and invest in new production capacity which are influenced by their profitability and cash circulation rate;
- 3) Lumped adoption and penetration: Aggregated penetration of energy technologies on a global level in general, emphasizing energy system dynamics influenced by interaction of (non-defined but existing) techno-socio-economic factors and technology integration;

The paper is constructed into three sections: firstly, the methodology and the modelling framework is presented; secondly, key observations and results are shown; and thirdly, a synthesis on how fast could new energy technologies penetrate including some sample scenarios are elaborated.

## 2 Theory and models for penetration

The classical work of Rogers (1995) defines the diffusion of an innovation to the markets as “process by which an innovation is communicated through certain channels over time among the members of a social system”. New technologies will not penetrate on the market if there are not positive decisions to invest in these. The decision-making process, and the factors that affect positive decision, will have a crucial effect on the adoption of the new technology, and hence on its penetration over time (i.e. diffusion). This innovation decision-making process is illustrated in Figure 1 (Rogers, 1995). The rate of adoption, i.e. how fast a new technology will penetrate, depends on a range of factors linked to the characteristics to the technology, type of communication or information,

how decisions are made and by whom (e.g. individual...state), nature of social system, etc.

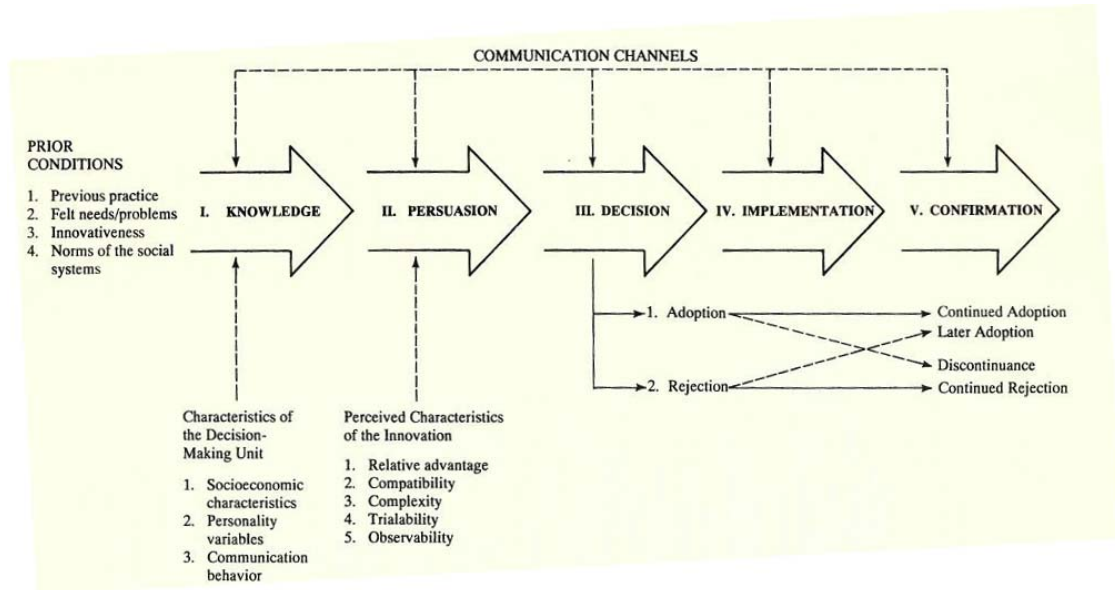

Figure 1. The innovation decision-making process behind technology diffusion (from Rogers, 1995).

The literature of diffusion models that try to describe the kind of process shown above is ample, though most of the models are simplifications of this complex social process (see for example Stoneman, 2004; Geroski, 2000; Mahajan, 1994; Rao 2010; Baretto, 2008). The classical technology diffusion models includes an information and social dimension on decision making and can be presented in simple form as follows:

$$\frac{dP_t}{dt} = \alpha P_t (P^{\max} - P_t) \quad (1)$$

or

$$\dot{f}_t = \alpha f_t (f^{\max} - f_t) \quad (2)$$

$$f_t = \frac{P_t}{\sum_{i=1}^n P_i} = \frac{P_t}{P} \quad (3)$$

where  $P_i$  is the capacity or volume of the new technology of type  $i$ ,  $\alpha$  is the coefficient of diffusion,  $f_t$  is market share or cumulative adoption; superscript max refers to the ultimate potential. Eq (1) leads to a logistic growth and follows a S-curve. Eq(1) gives the well-known Fisher-Pry substitution model with  $f^{\max} = 1$ , i.e. a new technology substitutes another old one (Fisher, 1971).

A more sophisticated form of the diffusion model in Eq(1) is the Bass-model describes the diffusion process and adoption under mixed internal and external/central information sources (Mahajan, 100):

$$\dot{f}_t = (p + q f_t) (f^{\max} - f_t) \quad (4)$$

where  $p$  is called the coefficient of innovation reflecting external information influence or advertising effect (independent adoption);  $q$  is the coefficient of imitation accounting for the internal information influence or word-of-mouth effect (adopters influenced by others). The epidemic model in Eq(1) corresponds to  $p=0$  and  $q=\alpha$ .

In our earlier work, we derived a modified diffusion model for energy technology penetration, a so-called empirical energy technology growth model, which is based on observed penetration rates of different energy technologies over a long time frame [Lund, 2010a; 2010b]. We observed a decreasing year-to-year growth as the share of total market grows which can be put in model form as follows:

$$\frac{dP_t}{P_t} = \Omega(f_t) \quad (5)$$

$$\Omega(f_t) = \frac{1}{\beta_0 + \beta_1 a^{f_t} f_t} \quad (6)$$

where  $\beta_0=0.0519$ ,  $\beta_1= 0.0045$ ,  $\beta_2= 0.02016$ . When  $f_t$  is low, say <1%, the yearly growth rate  $\Omega$  may fluctuate strongly, yield very high values, but eventually settle on a  $d\Omega/df_t < 0$  when  $f_t$  grows. At very high markets shares close to saturation of the technology, the growth  $\Omega$  would approach the organic growth rate of energy demand. Figure 2 shows the growth model accompanied with a modified version at higher market shares which corresponds the observed growth of oil in the past.

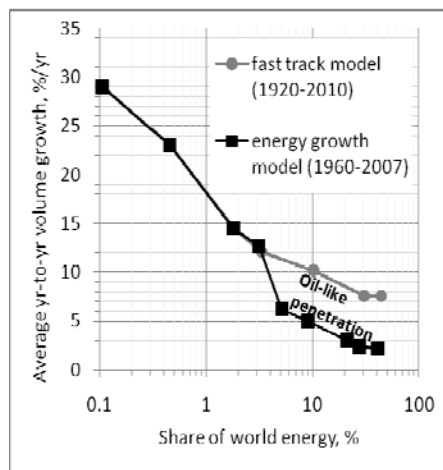

Figure 2. Empirical energy technology growth model.

It is possible to impose different limitation on the growth, e.g. to reflect political, financial or technical constraints, and then we would add to Eq(5) also a condition

$$\frac{dP_t}{dP} < \{limits\} \quad (7)$$

The diffusion can also be viewed from the investment perspective when the companies invest in new production facilities (Peterka, 1977, 1978; Spinrad, 1980). Let's consider a new technology  $i$  (among  $n$  competing technologies  $i=1,2,\dots,n$ ) when its penetration is dominated by the price and cost settings. Assuming that investments in new production facilities are financed by income, then the growth of a can be described as

$$u_i \frac{dP_t}{dt} + a_i P_t = P_t [p - c_i] \quad (8)$$

where  $u_i$  is the specific investment and  $c_i$  is the specific production cost including both direct (e.g., operating costs) and indirect charges (e.g. capital charges), and  $a_i$  is the amortization rate,  $P_t$  is the production volume,  $p$  is the market price. We may also express Eq(8) in terms of the market share  $f_i$ , i.e.

$$\frac{df_i}{dt} = f_i \left[ \frac{p - a_i - c_i}{u_i} + \delta \right]$$

(9)  $\alpha = p^{-1} \frac{dp}{dt}$  is the logarithmic expansion of total market.

The performance of a company can be assessed from Eq(9). A company would gain market share if the commodity price  $p > a_i + c_i + \delta u_i$  and loose share if vice versa. In renewable energy, several of the economic factors are influenced by energy policy measures. For example policies affect factors such as cost of capital, taxation policy or investment subsidies that in turn affect  $c_i$ , feed-in-tariff levels have a direct impact on  $p$ , world market development in general on  $\alpha$  in Eq(1). Policies may thus have a major impact on business profitability, it could influence relocating of industries, and even lead to market distortion. The balance between price and costs may be sometimes a sensitive issue, in particular when markets grow rapidly and benefit of scale and learning effects that in turn may lead to oversubsidization if rigid support schemes were used. The recent turbulence with the FiT levels in many countries is much due to the above balancing need.

Eq(9) may further be refined on a microlevel, where the companies' operational performance and capability to find capital influence their pace of growth. The rate at which a company can sustain growth through the revenues it generate is basically influenced through three factors: operating cash cycle ( $\tau_{OCC}$ ) defined in days, cost of sales ( $C_{sales}$ ) and cash flow from sales ( $R_{sales}$ ) defined per sales dollar for each cycle (Churchill, 2001). The operating cash cycle defines the time that the companies' cash is tied up; the number of OCCs in a year is simply  $N_{OCC} = 365/\tau_{OCC}$ . The shorter the  $\tau_{OCC}$  or the higher the  $N_{OCC}$ , the faster can a company invest from its own resources for growth. Using the OCC, we may then write for the self-financeable growth rate, i.e. revenue sustained growth, for each cycle

$$SGR(\%) = \frac{\text{Sales REVENUES} - \text{Sales COST}}{\text{CASH tied in sales}} \times 100(\%) \quad (10)$$

where the sales costs include cost of sales, operating expenses, depreciation/investments, replacements, financing costs, R&D, etc. The possible different cash tied up durations ( $\neq \tau_{OCC}$ ) in the sales factors in the denominator need to be accounted for. Multiplying above equation with the  $N_{OCC}$ , then we obtain the annual self-financeable growth rate. If we denote normalize the revenues and costs against the revenue, and denote  $\hat{R}_{sales} =$  normalized sales revenue ( $=1\$$ ) and  $\hat{S}_{sales} =$  normalized sales (sales cost per sales dollar), we have for the yearly SGR rate

$$\begin{aligned} SGR(\%) &= \frac{(R_{sales} - S_{sales})}{\sum_j \frac{t_j}{\tau_{OCC}} S_{sales,j}} \times \frac{365}{\tau_{OCC}} \times 100(\%) \\ &= \frac{(R_{sales} - S_{sales})}{\sum_j \frac{t_j}{365} S_{sales,j}} \times 100(\%) \end{aligned} \quad (11)$$

where

$$S_{sales} = \sum_j \frac{t_j}{\tau_{OCC}} S_{sales,j} \quad (12)$$

$\tau_j$  is the duration of cash tied up in cost item  $j$ . The fixed asset wearing e.g. replacements can be included as a fraction of the sales to be directly deducted for the sales number ( $a_1 R_{sales}$ ).

Clearly, the less funds are tied up to the operations and sales cost, the higher is the SFG and the company can invest into growth. The numerator in Eq(11) is the profit and the SFG is directly proportional to it. Assuming that the company has adequate production capacity, growing faster means thus either increasing the profit or lessening the costs. The cost of the investments and the terms for financing have also a major influence on the growth rate as shown in the next.

In case of new energy technologies, growth often required major investments in equipment or R&D to increase future volume. This requires either setting aside funds from the revenue over several OCC cycles or/and lending money, though in both cases the company will finance its growth through making a profit.

The new energy technologies' market grows fast meaning that increasing sales will necessitate new manufacturing capacity, i.e. investments. Let's denote the normalized investments needed for an additional sales dollar with  $\hat{I}_{inv}$  (=investment per sales revenue) and the present value discount factor accounting for amortization and interest with  $d$ , and the part of the profit generated that may be used for growth with  $\theta$ , then the maximum growth rate takes the following form

$$SGR (\%) = \frac{\theta (R_{sales} - a_1 R_{sales} - S_{sales} - d \hat{I}_{inv})}{\sum_j \frac{\tau_j}{365} S_{sales,j}} \times 100 (\%) \quad (13)$$

It should be observed that though both profit and external capital can be used for growth, in the end the profit determines the long-term sustainable growth level through with the external capital will be paid as well.

Eq(13) sets an upper limit for sustainable growth of an industry on a longer term basis. Through influencing the individual terms the growth rate can be enhanced. Public support e.g. on investments or interest rates are important factors affecting  $d \hat{I}_{inv}$  factor. Scaling or learning effects may lower the unit investments  $\hat{I}_{inv}$  as also the other cost factors of sale. Generous feed-in-tariffs would increase the revenues (profit)  $R_{sales}$ . Any sales guarantees could reduce the duration of cash tied up in sales ( $\tau_j$ ). It can be expected that the SGR rates may vary very much within a certain technology field based on company performance and political boundary conditions.

Using an average value for  $\tau_j$  and rearranging Eq(13) we have

$$SGR = \theta \frac{365 (R_{sales} - S_{sales} - a_1 R_{sales} - d \hat{I}_{inv})}{\tau S_{sales}} \\ = \theta \frac{365}{\tau} \left[ \frac{R_{sales} - S_{sales}}{S_{sales}} - \frac{(a_1 R_{sales} + d \hat{I}_{inv})}{S_{sales}} \right] \quad (14)$$

where the first term in brackets represents the self-growth rate without fixed asset burden and the second term the fixed assets costs. Denoting the normalized fixed asset increase (replacements, new investment depreciation) with  $\xi$

$$\xi = a_1 + \frac{d \hat{I}_{inv}}{R_{sales}} \quad (15)$$

and the profit margin as share of revenues generated  $r_{profit}$

$$r_{\text{profits}} = \frac{R_{\text{sales}} - S_{\text{sales}}}{R_{\text{sales}}} \quad (16)$$

we may finally write Eq(14) in parametrized form which is later used in analysing the growth of new technologies:

$$SGR = \theta N_{occ} \times \frac{r_{occ}}{T} \times \frac{r_{\text{profits}}}{1 - r_{\text{profits}}} \times \left( 1 - \frac{\epsilon}{r_{\text{profits}}} \right) \quad (17)$$

Some recent new ways to envision penetration include forecasting by exchange markets and market expectations reflecting investor perceptions (Wolfers, 2004; Polgreen 2007). Malyshkina (2010) used company capitalization to estimate the time of appearance until a substitute appears:

$$T = \frac{M^{old}}{D^{old}} \ln \epsilon \frac{M^{old}}{M^{new}} \quad (18)$$

where  $M^{old}$  and  $M^{new}$  are current aggregate market capitalization of old and new-energy companies,  $D^{old}$  is the annual aggregate dividends paid by the old-energy companies,  $\epsilon$  is the fraction of old energy replace by the new energy at time T.

In the next we employ two major models in Eq (5) and Eq (14).

### 3 Results

Firstly, we demonstrate the technology penetration using the empirical energy growth model in Eq(5) and Fig. 2, i.e. new energy technologies would penetrate in average as the old technologies during their growth phase. The results are shown in Fig. 3 indicating that the renewable electricity technologies could produce slightly over 60% of all electricity in 2050. Wind stands for 25 % and solar electricity for 15% of global electricity. Also is shown the increasing share of new energy technologies of all annual capacity additions (=100%) and we observe from 2040 onwards replacement of existing traditional capacity as well.

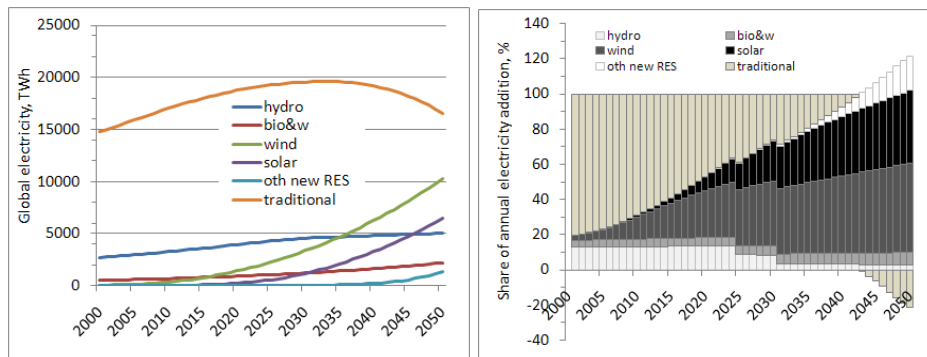

Figure 3. Reference scenario of RES-E penetration.

In next stage, a fast-track penetration case was investigated in which the observed penetration speed of oil was employed (Fig. 2, case oil-like). Three sub-cases with different electricity demand growths were analyzed. The results are shown in Fig. 4 and key numerical data are summarized in Table 1.

One common observation is that if striving for a high renewable electricity share (>80%) in 2050 will necessarily mean replacing existing, but not yet worn-out traditional electric

capacity. Secondly, through energy efficiency measures (high→low), the amount of renewable capacity will remain lower that in case of high demand growth (avg→high) which in turn may have important consequences to system integration and interfacing. Thirdly, RES and energy efficiency together could in theory provide 100% of all global electricity in 2050 in a fast track mode. The average growth of the new technologies over the whole period remains between 6-15%/yr, but in low demand case 6-8%/yr only.

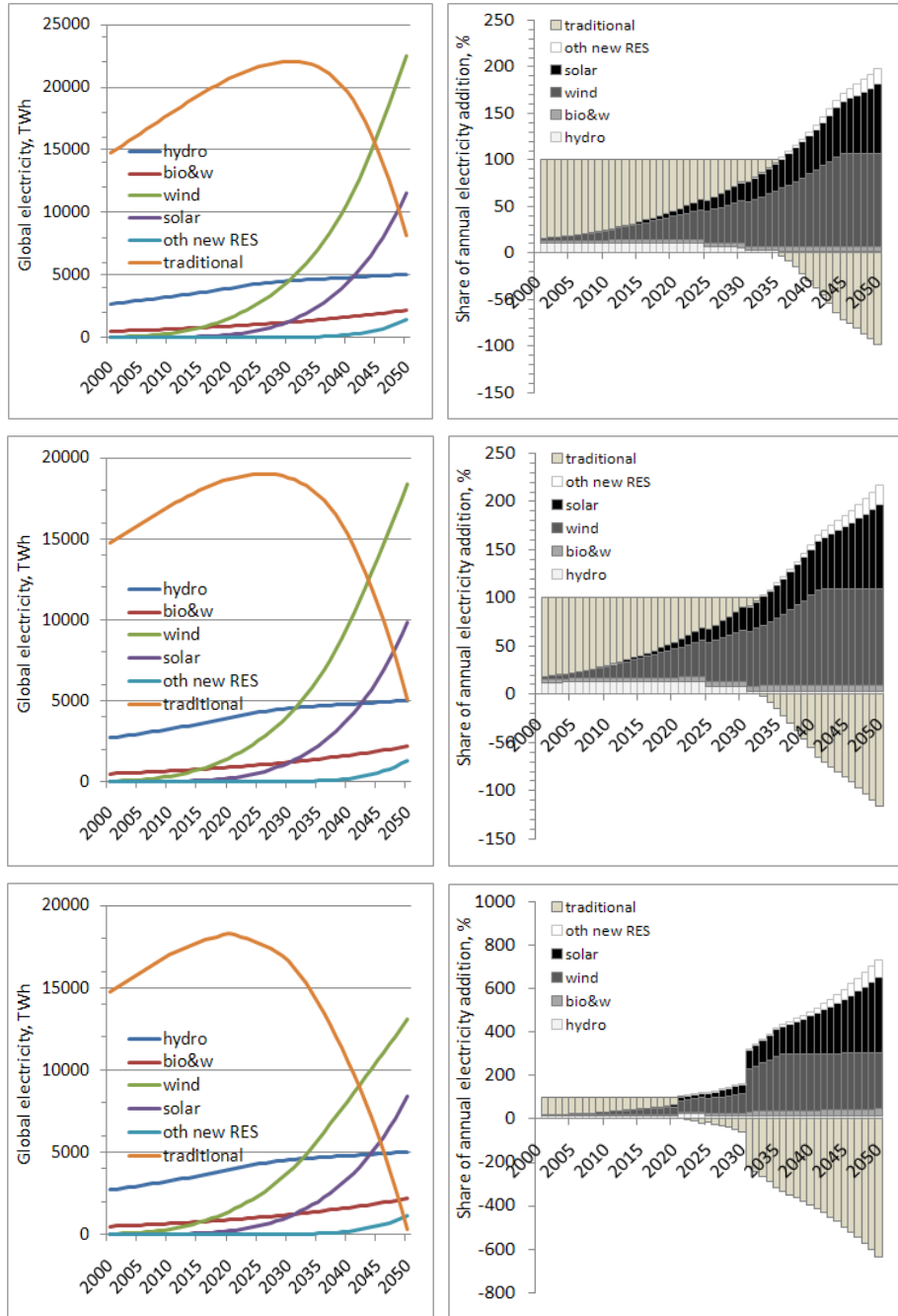

Figure 4. Diffusion dynamics for fast-track renewable electricity by 2050. Left: electricity from different sources, right: share of annual capacity replacement. From top to bottom: high, average and low electricity demand growth

Table 1: Fast track cases for new renewable electricity by 2050.

	low	medium	high	reference (figure 3)
Electricity demand in 2050 (TWh)	30000	420000	51000	42000
Demand growth, %/yr	1.7→0.5	1.7	2.1	1.7
RES of all in 2050	99	88	84	60
New RES of all in 2050	75	71	70	43
Avg. growth of wind, %/yr	8	11	11	9
Avg. growth of solar, %/yr	6	13	14	15

Finally we analyzed major leading companies' ability to grow through their revenue generation (Eq(11)). Table 2 summarizes the findings. We find a large variation in the SGR rate between the companies. Also the effects of the financial crisis can be observed as the SGR drops in all cases in 2009.

Table2: Self-financed growth rate of energy technology industries world-wide (replacements and investments not included)

	2007	2008	2009	Range 2008	Sample size
Photovoltaics	116	63	15	12-237	10
Wind power	-	29	6	14-99	10
Biofuels	60	-2	-161	-565-861	10
Gas and oil	-	73	50	70-241	4

The growth rate was also investigated in Fig. 5 more in terms of the profit margin, investment, and cycle speed. Profit margins will affect strongly the growth. As the profits will most likely decline when market volumes and competition increase, so will the industries' capabilities to invest decrease in relative terms. This in turn means a slowing down of the annual growth as also explained by the empirical energy growth model in Eq(5). To maintain growth in this case emphasizes the speed of the cash cycle (Fig. 5b). How much of the sales revenues need to be devoted to production capacity investments will have also an important effect on the growth as shown below.

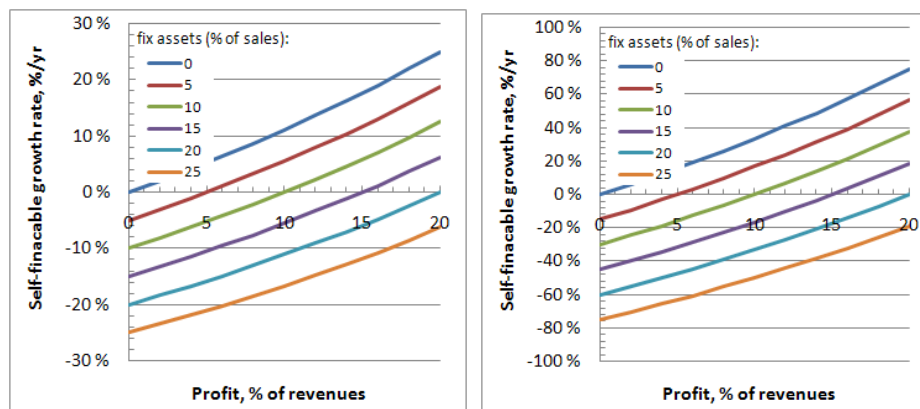

Figure 5. Self-financable growth of new technologies as a function of profit and investments needed.  $\theta N_{occ} \tau_{occ} / \tau = 1$  (a) and 3 (b).



## 4 Summary

The penetration of new energy technologies in the techno-socio-economic frame was investigated. A review of different models was provided. In the analyses, an empirical diffusion type of energy growth model was employed (but subject to imposed limitations contrary to epidemic type of models).

Our results shows that renewable electricity could reach a 60% share of all electricity in 2050 if just assuming the same kind of growth for the new technologies as for the old ones in the past. The new renewables would stand for 43% of all electricity, i.e. a major part of the growth would come from the new technologies indeed.

We also investigated fast-track cases in which the new technologies are allowed to grow as oil did in the past. Now RES-E could reach very high shares, even close to 100%. However, several constraints for such scenario beyond traditional cost or integration issues could be identified: high RES-E shares would require replacement of existing traditional capacity before their end of life-time, and if electricity demand growth is not stabilized, the total amount of RES vis-à-vis existing infrastructures may be in mismatch. Therefore, in case of fast-track strategies energy efficiency and RES need to be linked stronger together.

Finally, industries' capability to generate revenues for further investments and volume growth was studied. Analyzing top companies, a self-financeable capacity expansion potential of 14-99%/yr (2008) in wind power industry and 60% in average in PV (plunged to 20% in 2009) were found which could facilitate a sustained growth path. However, a decreasing trend was found in all RES which may indicate lowering profit margins explained by harder competition, larger investments in manufacturing lines and R&D needs with raising volumes that may eventually lead to decreasing annual growth.

## 5 Literature

Barreto L, Kemp R. Inclusion of technology diffusion in energy-systems models: some gaps and needs. *Journal of Cleaner Production* 2008; 16S1: S95-S104.

Churchill NC, Mullins JW. How fast can your company afford to grow? *Harvard Business Review*, May 2001, 135-142.

Fisher JC, Pry RH. A simple substitution model for technological change. *Technol Forecast Soc Change* 1971; 3: 75-88.

Geroski PA. Models of technology diffusion. *Research Policy* 2000; 29:603-625.

Henderson R, Newell RG. Accelerating innovation in energy: insights from multiple sectors. *Harvard Business School, Working Paper* 10-067, 2010.

Kramer GJ, Haigh M. No quick switch to low-carbon energy. *Nature* 2009; 462; 568-569.

Lund PD. Fast market penetration in retrospect with application to clean energy futures. *Applied Energy* 2010; 87: 3575-3583.

Lund PD. Exploring past energy changes and their implications for the pace of penetration of new energy technologies. *Energy* 2010;35:647-56.

Mahajan V, Muller E, Bass F. New product diffusion models in marketing: a review and directions for research. *J Mark* 1990;54:1-26.

Malyshkina N, Niemeir D. Future of sustainability forecasting by exchange markets: basic theory and an application. *Environ.Sci.Technol.* 2010;44:9134-9142.

Peterka V. Macrodynamics of technological change: market penetration by new technologies. International Institute for Applied System Analysis, IIASA Report RR-77-22, Laxenburg, Austria, 1977.

Peterka V, Fleck F. The dynamics of energy systems and the logistic substitution model. Volume 2: Theoretical part. International Institute for Applied System Analysis, IIASA Report AR-78-1C, Laxenburg, Austria, 1978.

Polgreen PM, Nelson FD, Neumann GR. Use of prediction markets to forecast infectious disease activity. *Healthcare Epidemiology* 2007;44: 272-278.

Rao UK, Kishore VVN. A review of technology diffusion models with special reference to renewable energy technologies. *Renewable and Sustainable Energy Reviews* 2010; 14:1070-1078.

Rogers EM. Diffusion of innovations. Forth Edition. The Free Press, New York, 1995.

Spinrad BI. Market substitution models and economic parameters. International Institute for Applied System Analysis, IIASA Report RR-80-28, Laxenburg, Austria, 1980.

Sterman JD, Henderson R, Beinhocker ED, Newman LI. Getting big too fast: strategic dynamics with increasing returns and bounded rationality. *Management Science* 2007; 53: 683-696.

Stoneman P. Handbook of the economics of innovation and technological change. UK: Blackwell Publishers Ltd; 1995. ediction markets. *Journal of Economic Perspectives* 2004; 18: 107-126.

# Dong Energy's 85/15 strategy for the conversion to 85% renewable

Author: Charles Nielsen, DONG Energy

## Abstract

DONG Energy is one of the leading energy groups in Northern Europe. The company is headquartered in Denmark and the business is based on procuring, producing, distributing and trading in energy and related products in Northern Europe.

DONG Energy has a vision to provide clean and reliable energy and it is expressed as 85/15 strategy because of the ambition to change the share of CO<sub>2</sub> -emitting heat and power production in 2006 from 85% to only 15% and 85% renewable energy in 2040. The basis for realizing this vision is a strong capability in development and establishment of new offshore wind, increased use of biomass and use of gas to secure flexible power production.

It is the clear ambition to continue to generate more energy, while rapidly increasing the green proportion of this energy. And this should be done on a sound commercial basis. The target is thus to double earnings in the period between 2009 and 2015.

## DONG Energy - a dynamic energy company in Northern Europe

Energy is the life blood of modern society, and a reliable supply of energy is essential to keep the wheels of society turning. Energy companies produce different types and forms of energy that is taken to where society and its companies and consumers need it via trading on international markets.

DONG Energy is headquartered in Denmark and the result of a merger between six Danish energy companies in 2006. It is a vertically integrated energy company with activities in upstream oil and gas production in the North Sea, heat and power production at thermal power plants and wind in Northern Europe, energy trade in Northern Europe and gas and electricity distribution network and end-users in Denmark and the Netherlands. The vertical integration creates a robust company for international growth through diversified investments, knowledge of each part of the energy sector and business opportunities along the value chain.

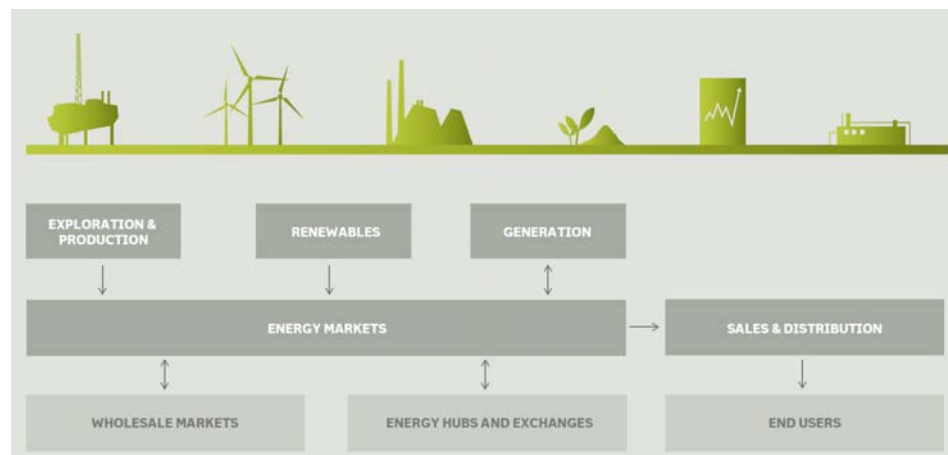

Figur 1 DONG ENERGY's value chain

## Growth in clean and reliable energy production

More global focus on increasing demand for energy and on the use of fossil fuels and the effects of CO<sub>2</sub> on the climate increases the pressure to finding new ways to supply energy on a reliable basis. The EU has introduced the objective to reduce CO<sub>2</sub> emissions by 20% compared to 1990, increase use of renewable energy to 20% and decrease energy consumption by 20% in 2020. In Denmark, the political vision is energy independence of fossil fuels in 2050.

Today, reliable energy is produced at thermal power stations based on fossil fuels such as coal and gas and these fuels emit CO<sub>2</sub> in the conversion process to heat and electricity. With increasing production of electricity from renewable sources as wind, the emission of CO<sub>2</sub> is reduced. But, wind as an energy source is not reliable. As an integrated energy company DONG Energy sees the increasing focus on CO<sub>2</sub> reduction as well as the increase in renewable energy as opportunities to create new business areas.

### DONG Energy's vision is to provide clean and reliable energy.

The vision is to be fulfilled by changing DONG Energy share of CO<sub>2</sub>-emitting heat and power production in 2006 from 85% to only 15% in 2040.

The basis for realizing this vision is a strong capability in development and establishment of new offshore wind, increased use of biomass and use of gas to secure flexible power production. The energy sector is currently in a process of major change to enable it to provide a more sustainable and more reliable energy supply. DONG Energy is taking an active part in this transition through its strategy and an aim to halve its CO<sub>2</sub> emissions per kWh by 2020 compared to 2006. With emissions of 524 g CO<sub>2</sub> per kWh generated in 2010, and with the corresponding figure in 2006 being 638 g CO<sub>2</sub>/kWh, DONG Energy is well on the way to meeting this target.

Wind energy plays a significant role in the transition to clean energy but DONG Energy's strong capabilities in thermal generation will also be instrumental in ensuring that the ambitious targets for the reduction in CO<sub>2</sub> emissions can be met. This will be achieved by converting coal-fired power stations to biomass and reducing the coal-fired power station capacity. Phasing out of coal-fired units from ten to five has already reduced coal consumption from 6 million tonnes in 2006 to 4 million tonnes in 2010. Continued phasing out and the expected conversion of coal-fired units to biomass are expected to reduce coal consumption by a further 2 million tonnes by the end of 2014.

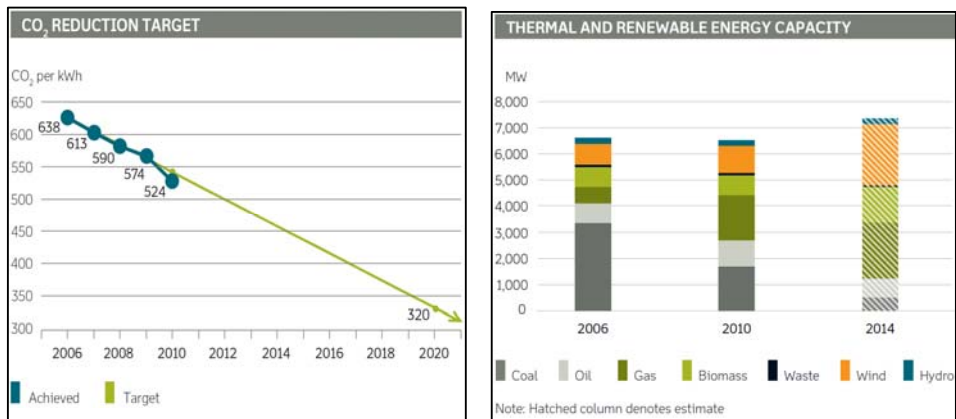

Figure 2 Realization of vision 85/15 and capacity development until 2014

The conversion of thermal generation in the period 2006-2010 has contributed to a reduction of 6 million tonnes in CO<sub>2</sub> emissions, equivalent to 13% of Denmark's total CO<sub>2</sub> emissions (2009) and 44% of the reduction to which Denmark has committed (under the Kyoto Protocol). And with the continued conversion of thermal generation, DONG

Energy expects to be able to reduce its CO<sub>2</sub> emissions in Denmark by a further 4 million tonnes between 2010 and end of 2014.

### The 85/15 strategy implies more focus on renewables and gas

In the coming years, DONG Energy will continue to make major investments in expansion of its renewable energy capacity. These investments will be made in order to convert the power and heat production from being predominantly coal-based to being based, in particular, on green and low-carbon energy sources such as wind, biomass and natural gas.

DONG Energy is currently among the most experienced in the world when it comes to the design, construction and operation of offshore wind farms, and this position is maintained through continued growth in generating capacity. This is currently being achieved by utilizing economies of scale in procurement of wind turbines and components and optimizing and rationalizing the construction process.

Another key element in the realisation of the targets up to 2020 is the establishment of natural gas-fired power stations. DONG Energy is operating two natural gas-fired power stations in Norway and UK and in the process of establishing a new natural gas-fired power stations in the Netherlands. The plant in Norway will deliver a variety of services to Statoil's refinery nearby under a long-term contract. Besides producing significantly lower CO<sub>2</sub> emissions than coal-fired power stations, natural gas-fired power stations provide significantly greater flexibility as a supplement to the uneven generation from renewable energy sources. DONG Energy is consequently focusing on developing its portfolio of natural gas-fired power stations in the coming years.

The use of biomass also contributes significantly to the transition of combined heat and power generation from black to green. In 2010, biomass in the form of straw, wood chips and wood pellets made up 16% of the fuel consumption at the central power stations and small-scale CHP plants in Denmark owned by DONG Energy. The aim is to increase the use of biomass substantially in the coming years, partly by converting existing coal-fired power stations to biomass-firing.

In 2010, New Bio Solutions was established as a new area of activity in DONG Energy. The purpose is to mature and commercialize new technology for pretreatment and utilization of biomass for energy purposes. The technologies were developed at DONG Energy's Innovation Centre and are based on experience from several decades' use of biomass for energy production in Denmark. Biomass today constitutes the largest proportion of renewable energy sources in the global energy supply, and there is a great potential to utilize biomass more efficiently.

Efficient pretreatment of biomass ensures that biomass can become an increasingly important part of the global energy supply. Biomass is a flexible resource and can be combined with unpredictable electricity generation from, for example, wind and solar energy. Biomass can also be used in the transport sector as a substitute for oil-based transport fuels. New Bio Solutions' business model is based on technology sales through license agreements. Efforts to secure the commercial platform and value creation are made through strategic commercial partnerships.



Figur 2 Pre-treatment is a key technology for the utilisation of local biomass and waste

## **Conclusion - an ambitious vision and ambitious growth**

The world is facing two huge challenges. We need to generate enough energy for the increasing numbers of people who want to share in the world's prosperity, and we need to reduce pollution with CO<sub>2</sub>. Many people believe it to be difficult to meet both challenges. However, at DONG Energy, we have made it the core of our business strategy to do just that. It is DONG Energy's 85/15 vision to provide clean and reliable energy.

In this context both wind power and biomass plays an important role in order to reduce corporate CO<sub>2</sub> emissions significantly until 2040. DONG Energy is currently the leading company in the world regarding off-shore wind power installations and very experienced within conversion of biomass to energy.

It is the clear ambition to continue to generate more energy, while rapidly increasing the green proportion of this energy. And this should be done on a sound commercial basis. The target is thus to double earnings in the period between 2009 and 2015.

## **Session 2B – Sustainable Energy Planning**

# **"Spurring investments in renewable energy technologies in non-OECD countries. A quantitative analysis on how to design and finance NAMAs"**

Tobias S. Schmidt, Robin Born and Malte Schneider

Department for Management, Technology, and Economics, ETH Zurich  
Kreuzplatz 5, 8032 Zurich, Switzerland

After the Cancun agreement and in the light of the upcoming negotiations in Durban by the end of this year, the debate on how to proceed with international climate policy after the end of the Kyoto Protocol in 2012 is in full swing (Grubb, 2011). While some parties and scholars suggest a reform of the Kyoto Protocol's project based Clean Development Mechanism (CDM) (Bakker et al., 2011) in order to increase the reduction effects of greenhouse gas (GHG) emissions, others prefer a quick introduction of the so called Nationally Appropriate Mitigation Activities (NAMAs) (Hoehne, 2011). While the CDM has led to the realization of more than 6000 registered projects (Fenhann, 2011) and provided great learning opportunities, it is criticized for the inability to appropriately account for technology and country differences resulting in limited effects (Neuhoff, 2009).

The Cancun agreement highlights the role of technology and country differences and suggests NAMAs as one instrument to overcome many of the shortcomings of the CDM (UNFCCC, 2011). NAMAs are one or a set of policy instruments, which are nationally introduced in order to reduce emissions beyond the business-as-usual baseline. NAMAs of developing countries are to be supported by developed countries (UNFCCC, 2011). The design, implementation and measuring, reporting and verification (MRV) of NAMAs, however, is not straightforward (Okubo et al., 2011). Besides these aspects, the ongoing debate focuses on the height, sources and mechanisms of financing of NAMAs and the role of the Green Climate Fund (GCF) and Technology Executive Committee (TEC), which are to be founded according to the Cancun agreement.

The debate is rather dominated by politicians and economists providing and relying on data from meta-analysis on the overall cost (e.g., Project Catalyst, 2010) but lacks a more detailed understanding of the role of country and technology differences, which are necessary in order to make use of the strength of NAMAs over the CDM. Technology studies providing more fine-grained numbers could serve as additional decision support but are currently insufficient. We want to contribute to bridging this gap and fueling the debate by calculating technology specific numbers based on a bottom-up model for the electricity sector, which we then interpret in order to provide the policy debate with new input.

The electricity sector, being the largest contributor to anthropogenic climate change (IPCC, 2007), is key for any country's mitigation approach and is a good research case for several other reasons. Compared to other sectors, the electricity sector has the advantage that production cost as well as GHG reductions can be calculated and measured relatively easily (Okubo et al., 2011). Due to the high number of CDM projects in this sector, more reliable data exists than for other sectors. Also, effective policy measures for decarbonisation, such as preferential feed-in tariffs for renewables, exist "whose GHG impacts are



relatively easy to evaluate” (Okubo et al., 2011, p.40). Renewable energy technologies (RET) are a means of decoupling the sector from its carbon dependency and hence well suited for drastic emission reductions and other positive side-effects (Sutter and Parreño, 2007).

By bottom-up modelling we calculate the levelised cost of electricity (LCOE) of RET, which are a good indicator for the height of a feed-in tariff needed for an ample diffusion. Above that, we compute the financial gap that needs to be bridged by these tariffs to the technologies which would be installed alternatively, based on the development of a financial and emission baseline. We thereby estimate the financial needs of NAMAs aiming at the large-scale diffusion of RET. We apply the model to Wind and Solar PV<sup>1</sup>, the two RET with the biggest natural potential for which current production capacities for large scale diffusion exist, and to six non-OECD countries, namely Brazil, Egypt, India, Kenya, Nicaragua, and Thailand.

We find that great differences exist between technologies and countries regarding LCOE of both RET (see figure below) and the baseline mix. This heterogeneity highlights the need to address country-technology combinations specifically, a task which could not be served by the CDM. NAMAs have the potential to overcome the CDM’s shortcomings but still an intense baseline discussion is needed. Furthermore, NAMAs and their financing should be designed according to the maturity of a technology and the financing gap of the specific technology-country combination. By providing a detailed understanding of the different financial requirements of different RETs in various countries and interpreting our findings we contribute to the international climate policy debate on NAMAs, financing and the role of the new international institutions (GCF and TEC).

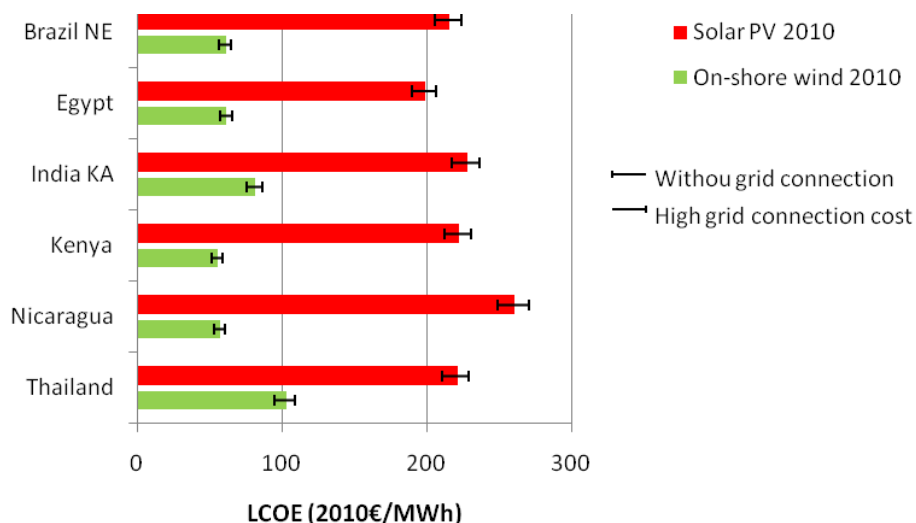

**Figure: The LCOE of solar PV and Wind.** The red bars depict the LCOE in €<sub>2010</sub> of Solar PV; the green ones those of Wind assuming average grid connection cost (state of the art technology). The left end of the black stripes represents the LCOE without grid connection costs; the right end those with very high grid-connection costs.

<sup>1</sup> Solar PV refers to c-Si modules, the currently leading solar technology by market share. Wind refers to on-shore Wind turbines of the 2MW class as they are typically installed in non-OECD countries.

# **Integrating climate change adaptation in energy planning and decision-making – Key challenges and opportunities**

Anne Olhoff and Karen Holm Olsen, UNEP Risø Centre, Risø DTU.

## **Abstract**

Energy systems are significantly vulnerable to current climate variability and extreme events. As climate change becomes more pronounced, the risks and vulnerabilities will be exacerbated.

To date, energy sector adaptation issues have received very limited attention. In this paper, a climate risk management framework is used as the basis for identifying key challenges and opportunities to enhance the integration of climate change adaptation in energy planning and decision-making. Given its importance for raising awareness and for stimulating action by planners and decision-makers, emphasis is placed on reviewing the current knowledge on risks and vulnerabilities of energy systems and on potential adaptation options.

The paper finds that short and longer term action on climate risk management of energy systems strongly depends on: Strengthening the capacity to model and project climate change and its impacts at local and regional scales; improving the geographical coverage of risk, vulnerability and adaptation assessments, and the availability of systematic and integrated assessments; and, providing information and guidance in a form appropriate for planners and decision makers. Another important area concerns establishing improved understanding of potential trade-offs and synergies between energy system adaptation and mitigation options, and adaptation and development prospects in other sectors or areas. Finally, improved knowledge on damage costs, and adaptation costs and benefits is likely to remove barriers to integration of climate risks and adaptive responses in energy planning and decision making. Both detailed assessments of the costs and benefits of integrating adaptation measures and rougher ‘order of magnitude’ estimates would enhance awareness raising and momentum for action.

## **1 Framing the Issue**

The role of energy services for development and economic growth is extensively documented and universally recognized. Energy conversion and end-use is, however, also a major driver of greenhouse gas (GHG) emissions and global warming. The energy sector is consequently a primary target of climate change mitigation efforts. An impressive volume of peer-reviewed literature studies the role and potential of the energy sector for reducing GHG emissions as well as the potential implications of climate change mitigation policies for the energy sector.

The urgency of controlling and reducing GHG emissions cannot be emphasised enough. However, due historic emissions and consequent increased atmospheric concentrations of GHGs, we are already locked-in to a certain degree of climate change. It is, therefore, central not only to avoid the unmanageable, through mitigation, but also to manage the unavoidable, through adaptation.

To date, energy sector adaptation issues have received very limited attention. This is evident in terms of lack of investment and action and through an under-representation of the energy sector in peer-reviewed literature on adaptation (Ebinger and Vergara, 2011). The entire energy supply chain is, nonetheless, vulnerable to current climate variability and extreme events. To illustrate, the World Bank estimates that climate extremes

accounted for a 13 percent variation in energy productivity in developing countries in 2005 (World Bank, 2010a). With projected climate change, both energy sector risks and vulnerabilities will be exacerbated, underlining the need for adaptation.

In this paper, the current knowledge base for integrating energy adaptation in planning and decision-making is explored with the aim of identifying key challenges and opportunities for increasing the climate resilience of energy systems through integrated climate risk management.

Much is at stake if energy projects, planning, and policies continue to disregard the risks imposed by climate change. Investment decisions that do not take climate change implications into account, may lead to inefficient resource use and mal-adaptation<sup>1</sup>, which may ultimately affect the potential for achieving main energy development and security goals. Furthermore, synergies and trade-offs with other sectors and key climate change mitigation issues may be overlooked. Important potential trade-offs with other sectors include competing uses of water and land, where current stresses are likely to be exacerbated by climate change. A significant increase in the share of renewable energy sources is a central component of all emission reduction strategies. Mitigation policies need to take the effects of unavoidable climate change on energy resource endowments and supply into account – in other words, they need to be ‘climate proofed’.

The paper begins by outlining how climate risk management can be used as a framework to guide energy adaptation actions and decision making processes in section 2. Section 3, summarises the current knowledge on key potential climate impacts and vulnerabilities of energy systems, followed by an overview of adaptation options in section 4. In the final section, key opportunities and challenges for increasing the climate resilience of energy systems through integrated climate risk management are put forward.

## 2 Climate Risk Management

Adaptation planning and decision-making takes place under significant risk and uncertainty<sup>2</sup>. An inherent risk of adaptation decisions is that in retrospect they may turn out to have been mistaken or sub-optimal. An important aspect of climate adaptation decision making under risk and uncertainty is therefore to be aware of, and specific about, the potential consequences of erroneous decisions.

Climate risk management provides a framework to guide adaptation decisions and decision-making processes, where the most important risk factors are identified and the uncertainty associated with each is described (Willows and Connell, 2003). Climate risk assessment and management can be undertaken at all relevant levels. This means that it can be used as an integrated framework to guide decisions and actions as well as a framework to guide specific project or sectoral decisions and actions. The main advantage of an integrated assessment, as opposed to project or sector-specific analysis, is that it allows the indirect impacts of adopting a set of adaptation measures to be examined.

Risk assessment and management are already important aspects of planning and decision making in the energy sector as well as in other key sectors including water, agriculture,

---

<sup>1</sup> Mal-adaptation is generally understood as actions taken that (unintentionally) constrain the options available to or ability of other decision makers now or in the future to manage the impacts of climate change, thereby resulting in an increase in exposure and/or vulnerability to climate change.

<sup>2</sup> Risk is the product of the likelihood of an event and its consequences IPCC (2007, p.64). Uncertainty arises when there is a lack of knowledge concerning outcomes. Uncertainty may result from an incomplete knowledge of the risk (probability or consequences). However, even when there is knowledge regarding the risk, there is still uncertainty because outcomes are determined probabilistically. See also Ebinger and Vergara (2011).

transport, and finance. Energy providers and consumers are used to respond to changes in conditions that affect their decisions. The existing familiarity of planners and decision makers with risk management indicates the usefulness of a risk-based approach to facilitate the integration of climate adaptation options and measures in planning and decision making both within and across sectors (ADB, 2005).

Figure 1 below illustrates the main steps of a risk-based framework for adaptation decision making. The figure underlines the iterative nature of the risk management process that captures the dynamics of the decision problem. Uncertain long term impacts are used as a basis for identifying and analysing short-term policy and project objectives, priorities, and options to enable decisions to be based on the best available information at a given point in time (Richels et al., 2008; Ram, 2009). As it becomes available, new information can be incorporated, which may lead to revisiting earlier steps in the decision making process.

**Figure 1: The UKCIP framework to support climate change adaptation decision making under risk and uncertainty**

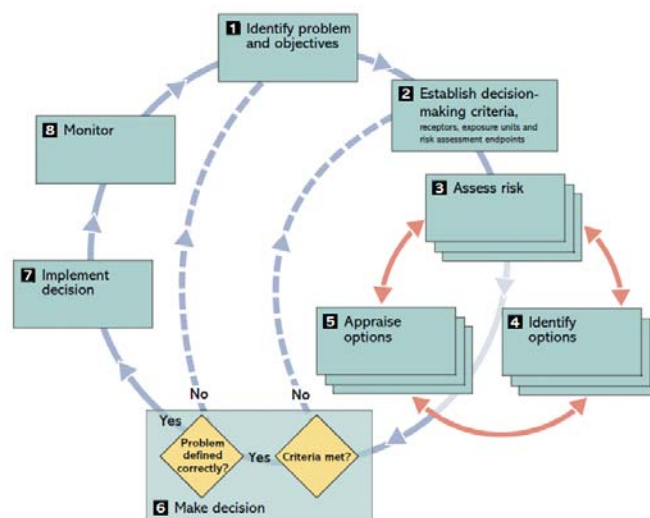

Source: Willows and Connell (2003).

In the following sections, we focus on the current knowledge base related to steps 3, 4, and 5 in Figure 1. Assessing risks and impacts of climate change on the energy system supply chain and on energy demand as well as analysing adaptation options is essential to raise awareness among planners and decision makers on the potential implications of climate risks on their decisions. It is likely one of the key drivers in initiating the process of integrating climate change adaptation in energy planning and decision making as it promotes the inclusion of climate risks in steps 1 and 2 of Figure 1. Central questions that need to be considered by planners and decision makers include: What is the “right” level of adaptation? And: How climate resilient do we want our actions to be?

### 3 Climate Impacts and Energy System Vulnerabilities

In this section, the current knowledge on key potential climate impacts and vulnerabilities of energy systems, including energy resource endowments and supply<sup>3</sup>;

<sup>3</sup> The supply of energy relates to the technologies used to convert primary energy into end-use energy available to consumers. Such technologies typically have a long life-span, which means energy supply decisions need to factor in present and future climate related impacts.

energy demand; and, energy transmission, distribution, and transfer, is summarised. Indirect effects and cross-linkages with other economic sectors are highlighted to the extent possible.

### 3.1 Fossil-fuel and nuclear energy resources and supply

Climate change can have implications for access, production and supply of thermal energy sources. Access to oil and gas resources is impacted by e.g. reduced ice coverage in Greenland and the arctic areas and melting permafrost in Alaska (Casper, 2010). The production of oil and gas is sensitive to extreme weather events that can lead to damages to offshore platforms (Cruz and Krausmann, 2008). Flooding and sea level rise can lead to structural damages and erosion of production equipment. One of the important potential climate change impacts is the effect of increased air and water temperatures on the technical efficiency with which fuels are converted to electricity. Even small variations in temperature can result in a significant change in the efficiency and reliability of energy supply. The demand for water to cool thermal and nuclear power plants is vulnerable to the temperature and fluctuations in water supply and other competing needs for water (Forster and Lilliestam, 2010).

Although there is general knowledge regarding the linkages and potential effects, there is little or no peer reviewed literature on the effects on thermal and nuclear power production of changes in river flows affecting cooling water availability; damages from inundation and from extreme weather events; vulnerability of offshore energy infrastructure and impacts on the potential for exploitation of reserves; and, indirect impacts on countries relying on energy imports through damages to roads, ports, etc., affecting supply channels and end-supply.

### 3.2 Renewable Energy Resources and Supply

Renewable energy including hydropower, wind, solar, and biofuels depend directly on climate parameters and decisions are project and site-specific. Such decisions will generally be subject to additional uncertainty. Indeed, one of the repeated caveats in the available empirical literature on climate change impacts on renewable energy production is that the results obtained are highly sensitive to uncertainties related to modelling the impacts of climate change at regional and local scale (World Bank 2010a; World Bank, 2010b; Mauser and Bach, 2009; Fenger, 2007).

Climate change influences the geographical distribution and the variability of *wind* fields, which determines the availability and reliability of wind energy for electricity production (Pryor and Barthelmie, 2010). Several studies have investigated the impacts of climate change on wind power (Harrison, Cradden et al., 2008; de Lucena, Szklo et al., 2010). However, the geographical coverage of the peer reviewed literature on the impacts of climate change on wind power potential is uneven at present, with no available studies providing detailed analysis of the potential impacts of changes in extreme winds (Mideksa and Kallbekken, 2010). Apart from studies from USA, where a decrease in wind speed is found to be likely with a consequent decline in the potential for wind power, available studies indicate a small to moderate increase in the wind power potential with seasonal variations towards increased wind speed in the winter and decreased wind speed in the summer<sup>4</sup>.

*Hydrological systems* are affected by climate change in a variety of ways. Observed long-term trends in precipitation for the period 1900-2005 indicate an increase in the eastern parts of North and South America, northern Europe and northern and central Asia, while drying is observed in Sahel, the Mediterranean, southern Africa, parts of

---

<sup>4</sup> Available literature mainly covers the North Sea (Sood and Durante, 2006); the Nordic region (Fenger, 2007); Northern Europe (Pryor et al., 2005; Pryor and Barthelmie, 2010); UK (Cradden et al., 2006); Ireland (Lynch et al. 2006); the Eastern Mediterranean (Bloom et al., 2008); and, Continental and Northwest USA (Breslow and Sailor, 2002; Sailor et al., 2008).

northern South America, the Caribbean and parts of southern Asia (Ebinger and Vergara, 2011). Another trend is a substantial increase in heavy precipitation events in many regions, even in areas that have experienced a decrease in overall precipitation.

To assess climate change impacts on *hydropower*, long-term changes in climate variables are translated into run-off (Su and Xie, 2003; Madani and Lund, 2010; Singh, Thompson et al., 2010). The areas most affected include mountainous areas, valleys and rivers fed by melting snow and ice, where run-off and early spring discharge have increased (Dussaillant, Benito et al., 2010). However, as glaciers and snow melt and precipitation patterns change, run-off is likely to decrease. These impacts severely affect the availability of hydropower resources at regional and local levels. The warming of lakes and rivers affect the thermal structure and water quality (Delpla, Baures et al., 2011). An indirect impact is increased competition for water among economic sectors such as agriculture, energy and recreation.

The supply of electricity from hydropower depends partly on the variation in water flows and partly on installed generation capacity. Most systems are designed based on historical records assuming a stable climate, but increasingly analysis try to model projected changes in hydropower generation (Kim and Kaluarachchi, 2009). Two factors are particularly important for the vulnerability of hydropower to climate change impacts: 1) The share of hydropower in the energy mix of the system, and 2) Integration of transmission networks nationally and regionally, as this decides whether plants should be optimized individually or in the context of a larger energy system. Small run-of-river plants offer little flexibility, but are at the same time associated with much lower investment costs, whereas reservoir storage capacity can compensate for seasonal – even annual – variations in water flows (Raje and Mujumdar, 2010).

Peer reviewed literature is larger in volume and available for more regions of the world for hydropower than for wind power, although developing country analysis is under-represented (Mideksa and Kallbekken, 2010)<sup>5</sup>. A study by Harrison et al. (2003) analyses the impacts of climate change on financial risk in hydropower projects using the Zambezi river basin as a case. They find that climate change has the potential to be doubly damaging for hydropower with the alteration of both the expected return from hydroelectric installations and the financial risk that they face. Large parts of Africa rely heavily on hydropower for electricity production and recent droughts have had significant impacts on power supply and economies (Eberhard et al., 2008; Karakezi et al., 2009). Further analyses of financial risk implications would be valuable both for Africa and generally.

In relation to *liquid biofuels*, the crops used as raw material to produce ethanol and biodiesel such as sugarcane, soybeans and maize are vulnerable to the effects of climate change. Climate change affects temperature, precipitation patterns, extreme weather events (droughts, floods, storms, fires and frost) and the level of CO<sub>2</sub> affecting the rate of photosynthesis, which all have significant impacts on crops (Dhakhwa, Campbell et al.,

---

<sup>5</sup> Studies include detailed analyses of impacts caused by the anticipated consequences of climate change on Peru's hydrology and hydropower potential (World Bank 2010c; World Bank, 2010d); hydropower generation vulnerability to climate change and water management practices in Brazil (Freitas and Soito, 2009); linkages between energy, poverty and climate change in Latin America and the Caribbean (Bariloche Foundation, 2009); analysis of climate change implications on hydropower in the Nordic region (Beldring et al. 2006; Fenger, 2007); evaluation of the impacts on hydropower, power plant efficiency, unproductive spills and reservoir reliability due to changes in the hydrological regimes for the Peribonka River water resource system in Quebec (Minville et al., 2009); analysis of the impacts of projected climate change on two Aegean water basins and related issue of water stress for competing uses (Ozkul, 2009); large scale distributed hydrological modelling to study the impact of climate change on the water flows of the mountainous Upper-Danube watershed in Central Europe (Mauser and Bach, 2009); impacts on hydropower production based on the Colorado River (Barnett et al., 2004) and the Central Valley (van Rheenen et al., 2003) in the United States.

1997). Agricultural and crop management practices need to be adapted to reflect the changing conditions for growing energy crops. Studies show that there is an unexplored potential for synergies between mitigation and adaptation strategies for climate change in agriculture (Smith and Olesen, 2010). Traditional biofuels in developing countries for household cooking and small scale industrial purposes will also be affected. Consequences may range from decreased availability as a result of droughts, to problems with drying or storing specific wood or waste resources in case of increased precipitation. Both extremes may, however, lead to the use of poorer quality fuels in household, resulting in increased particle emissions and adverse health effects. Finally, an important issue with respect to particularly liquid biofuels is the potential trade-off between energy and food crop production and associated effects.

*Solar* insulation as a source of energy varies naturally with variations in solar activity (Marsh and Svensmark, 2003). Global warming affects the content of water vapour in the atmosphere, i.e. the cloud cover and its characteristics, with implications for the solar energy available locally and regionally. Solar technologies such as photovoltaic (PV) cells and Concentrated Solar Power (CSP) can also be affected by extreme weather events and are sensitive to changes in temperature that have implications for the efficiency of electricity generation (Wilbanks, Bhatt et al., 2008).

### **3.3 Transmission, Distribution, and Transfer**

There is little research focusing specifically on the potential effects of climate change on energy infrastructure, including energy transmission, distribution and transfer, although there is general knowledge regarding potential impacts.

The transmission, distribution and transfer of energy takes place via transmission lines, oil and gas pipelines extending thousands of kilometres, and land- and sea-based transfer. An increase in extreme weather events due to climate change can impact energy infrastructure in a variety of ways. Transmission lines and pipelines are vulnerable to erosion processes, flooding, landslides, extreme winds, ice loads and the combination of wind-on-ice, which may cause increased damages and collapse (Mideksa and Kallbekken, 2010; Hosek, Musilek et al., 2011). Falling trees due to more frequent and extreme storms are an increasing risk to distribution systems. Higher temperatures, more heavy precipitation and more frequent storms and hurricanes pose increased risks to land-and sea-based transport of energy, though melting of Arctic sea ice also offers opportunities for new shipping routes in Alaska and the through the Bering Strait (Campbell and Mts, 2008).

### **3.4 Energy Demand**

The most significant climate change impact on energy demand is through the effect on heating and cooling needs in buildings in the residential sector. Higher temperatures also impact on energy demand in the industrial and agricultural sectors, for instance in relation to cooling for food processing and storage and electricity use for pumping of water for irrigation. However, the climate impacts on energy demand are less well studied for these sectors. For the residential sector, which accounts for approximately a third of global end-use energy, a global study estimates that aggregate demand for heating will decline by 34 percent by 2100, while aggregate demand for cooling will increase by 72 percent (Isaac and van Vuuren, 2009). While the impacts vary across regions, studies generally find that the increased demand for cooling more than outweighs the decreased demand for heating (Ebinger and Vergara, 2011).

## **4 Adaptation Options**

A broad range of adaptation options are available to manage energy system risks and vulnerabilities arising from climate change, variability, and extreme events. Table 1 below gives an overview of key adaptation actions.

**Table 1: Energy system adaptation strategies, measures and actions**

Adaptation strategies and measures	Examples of actions
<b>Reducing risks/vulnerabilities</b>	
Technological	Physical protection: Retrofitting of existing infrastructure to increase robustness against storms, floods, and drought; building dikes and desilting gates; increasing dam heights; enlarging floodgates. Improved design: Revise structural footings for new pipeline distribution systems in areas where permafrost is unstable through e.g. deeper pilings and use of lighter-weight building materials; application of new weight loads for high voltage transmission towers exposed to increases in the intensity of winter precipitation or winds. New technologies: Development of smart grids to accommodate renewable sources with intermittent generation in existing grids.
Behavioural	Siting decisions that take climate risks into account; use of improved meteorological forecasting tools and strengthen communication with meteorological services to enhance anticipation of hazards; changes in operation and maintenance practices, e.g. manage on-site drainage and runoff of mined resources, change coal-handling processes due to increased moisture content, and adapt plant operations to changes in river flow patterns.
Structural (requiring sector wide changes)	Deployment of sector wide incentives, e.g. adoption of policy frameworks to facilitate the internalization of adaptation concerns in energy systems through economic or fiscal incentives; development and adoption of tools to hedge the costs of protecting energy infrastructure if a disaster occurs.
<b>Sharing responsibility for losses or risks</b>	
Insurance measures	Hedging weather events to limit the financial exposure to disruptive weather events of organizations and/or individuals; weather-index-based insurance schemes; standard and customized insurance solutions for renewable energy projects in developing countries.
Energy system diversification	Broadening the range of power plant types and fuels in the generation mix and using a mix of centralized and decentralized supply patterns to increase the flexibility of the system and its resilience to more variable climatic conditions. Improves energy security in general.
<b>Exploiting opportunities and synergies, and minimising tradeoffs</b>	
Demand side management and energy/water saving	Improvements in vehicle efficiency; building design; codes and standards (e.g. efficiency standards for appliances); changes in consumption patterns (district heating/cooling, flexible working hours); increase cooling efficiency; energy storage technologies. Provides cost-effective, win-win options through mitigation and adaptation synergies in a context of rising demand and supply constraints.
Decentralised energy structures	Build decentralised energy structures based on locally available renewable energy sources situated in secure locations. Can reduce the probability of large-scale outages when centralized power systems are compromised and could prove more flexible and able to cope with the increasing climate variability and unpredictability.
Integrated assessments, planning and management	Integrated resource planning and computable general equilibrium approaches. Integrated energy and water resource management to solve conflicts and optimise the use of water for energy and other uses, in the face of climate change induced and other stresses, such as population growth, land use, and urbanization. Manage competition between land-use for energy and non-energy crops through e.g. more efficient energy and fuel conversion techniques; improving land productivity and pasture efficiency (e.g. irrigation, mechanized harvesting, development of new genetically improved species, and rotating land use between pasture and crops). Urban policy and land-use planning, mainly using energy/water saving and demand-side management (see above) as cities are important and growing consumers of energy.

Source: Based on Ebinger and Vergara (2011, Chapter 4)

Adapting to climate change and climate risk management are ongoing processes (see Figure 1). Building adaptive capacity, defined as “the ability or potential of a system to respond successfully to climate variability and change” (Adger et al., 2007), is a critical step in enhancing the climate resilience of energy systems and a necessary condition for effectively undertaking adaptation actions as exemplified in Table 1. Adaptive capacity hinges on awareness (see also section 2), improved knowledge, e.g. on climate change impacts on energy production and use, on data collection and monitoring, and on the technical capacity to act upon this information. Development of supportive institutional and regulatory structures (governance, partnerships, and institutions) is fundamental in building adaptive capacity (Ebinger and Vergara, 2011). Regulatory and behavioural measures often take time and require strong institutions to put in place, emphasising the need for concerted action now (World Bank, 2010b).

There are very few practical examples to date of systematic efforts targeting the integration of climate change adaptation and risk management into energy planning and decision-making, illustrating that prioritisation of integration of energy sector adaptation options and action is yet to take place. Similarly, project or investment specific identification and appraisal of adaptation options are under-represented in the empirical literature. There are, however, signs of growing awareness. The number of studies that



identify and examine adaptation measures for the energy sector is increasing and so is the frequency with which energy sector vulnerability to climate change impacts are referred to in government papers on climate change; studies by development agencies; and, included on the agenda in international meetings (Ebinger and Vergara, 2011).

The strategies, measures and actions listed in Table 1 target increasing the flexibility and robustness of systems to allow them to function under a wide range of climatic conditions and sustain more severe extreme events. Agrawala and Fankhauser (2008) point out that this may be the best way to account for potential climate change in current investment decisions. As climate change is projected to amplify current variability as well as the frequency and magnitude of extreme events, an important guide to adaptation to climate change is what makes sense in adapting to current climate variability.

The timing of adaptation measures is a key issue<sup>6</sup>. Many energy system investments are large and long-lived. Particularly for these types of investments, integration of adaptation in the design phase is generally assessed to be less costly and more effective than retroactive maintenance and repair costs and inconvenience of expensive retrofitting (IPCC 2007; ADB 2005; Burton, 1996; ECA 2009). Substantial investments in energy infrastructure and supply are under way to support broader economic development strategies and to replace outlived production equipment and transmission infrastructure. More than half of the global energy investment is needed in developing countries, where energy demand and production is projected to have the highest growth rate (IEA, 2009). There is thus an urgent need to guide investment decisions on integration of climate risks.

Delaying adaptation measures can, however, be an appropriate risk management strategy where additional time can reduce uncertainties (Willows and Connell, 2003). For climate risk management of long-lived energy investments, it is therefore relevant to consider whether additional time is likely to improve the informational basis for the investment decision, e.g. through improved forecasting for key climate change variables, availability of more refined modelling and methodologies, and/or improved knowledge regarding integration of appropriate adaptation measures. It is also necessary to consider whether it is possible to postpone the investment decision.

Demand side management is an example of a measure that can 'buy time', i.e. make it possible to avoid or postpone large investment decisions, such as installed capacity and distribution network extensions, through reduced energy consumption and peak demand. It is also an example of an adaptation measure, for which early action is justified, since there are immediate benefits to be gained from its implementation, in the form of no- and low-regret and win-win opportunities<sup>7</sup>. This is the case with respect to climate change mitigation, since the overall consumption of primary energy and thereby greenhouse gas emissions are reduced, but also with respect to broader efficiency and supply priorities including energy security.

The potential for demand side management measures to reduce current inefficiencies in energy production, transmission, and end-use through regulation and incentives, that simultaneously help meet the projected increase in future energy demand in a cost-effective manner, is extensively studied (see e.g. IPCC (2007b)).

---

<sup>6</sup> From an economic perspective, decisions regarding timing will depend on the present value of the relative costs and benefits of undertaking action at different points in time (Agrawala and Fankhauser 2008). The discount factor (if greater than zero) and the prospect of cheaper and more efficient adaptation technologies and techniques becoming available in the future, favour delaying action where possible.

<sup>7</sup> Win-win options are measures that contribute to both climate change mitigation and adaptation and wider development objectives. No-regrets options are climate-related actions that make sense in development terms, whether or not a specific climate threat actually materialises in the future.

More generally, a number of no- or low-regret energy planning and policy options exist. For Africa, for example, a number of options will both promote energy access and reduce the vulnerability of energy systems to climate impacts. Examples include introducing and refining early warning systems, mobilizing energy investments, diversifying energy generation asset types, creating enabling environments for transfer and introduction of new technologies and regulating commercial and industrial energy efficiency implementation (Helio International, 2009).

Economic assessments of potential impacts and available adaptation options are crucial in the prioritisation and selection of adaptive measures. The availability of estimates of economic impacts at energy system level; the economic value of climate change damages at sector and project levels; and, of the benefits and costs of policies, measures and actions to avoid climate change damages through adaptation is low. The World Bank Economics of Adaptation to Climate Change initiative (World Bank, 2010b) is currently the only source of global and regional estimates on adaptation costs related to power generation (for all energy sources) and electricity transmission and distribution infrastructure. Some figures on the climate-related impacts of droughts on hydropower production and GDP for selected countries in Sub-Saharan Africa are available (Eberhard et al., 2008). ECA (2009) includes a case study and cost curve for power adaptation measures in Tanzania, and de Bruin et al. (2009) provide some estimates of costs and benefits of energy related adaptation options for the Netherlands. Apart from these examples and from the literature on changes in energy expenditures for cooling and heating as a result of climate change that mainly covers North America and OECD countries<sup>8</sup>, no comprehensive assessments of costs and benefits of climate change impacts on energy systems or of adaptive responses to alleviate these impacts have been undertaken so far.

## 5 Opportunities and Challenges – Preliminary Conclusions

Climate risk management requires an interdisciplinary effort and participatory approach where the tools and knowledge of scientists, energy analysts, and economists, policy makers and planners, and citizens are combined. So far, key efforts have focused on assessing climate impacts and risks on particularly renewable energy sources and supply and on identifying potential adaptation options. In most cases, these two areas of effort have been undertaken by different communities, with scientists focusing on analysing climate impacts on energy system components and social scientists identifying and discussing potential adaptation measures. Connecting the information on risks and impacts to detailed identification and appraisal of adaptation options provides an immediate opportunity for advancing climate risk management of energy projects, sectors, and systems.

Currently, **gaps in knowledge** pose significant constraints for climate change risk analyses and decision making. Based on the previous sections, opportunities for expanding the scientific and socio-economic knowledge basis for decision making abound in the following areas:

- a. *The capacity to model and project climate change and its impacts at the local and regional scales can be expanded* and target better knowledge on gradual changes at regional and local scales as well as changes in variability and frequency and magnitude of extreme events.
- b. *Providing information and guidance in a form appropriate for planners and decision makers at various levels:* Climate risks are only one of many factors that may influence a decision. Consequently, there is a need for raising

---

<sup>8</sup> See IPCC (2007c), Chapter 17.2 for an overview.

awareness on the potential impacts of climate variability and change on the decision outcomes and for providing information and guidelines that enable decision makers to take such impacts into account. Efforts may centre on translating scientific data and knowledge into information relevant to adaptation decision-making. Examples include the provision of maps (e.g. hydro-meteorological, hazard, coastal, and siting maps) and guidelines and plans (e.g. for siting of new energy assets, for power plant and distribution and transmission infrastructure robustness with regard to storms, floods, and heat waves).

- c. *Improve the geographical coverage of risk, vulnerability and adaptation option analyses and the availability of systematic and integrated assessments:* Impacts in many developing regions of the world are understudied as are many parts of the energy supply chain, including fossil, nuclear, solar, and biomass energy resources and supply, and transmission, distribution, and transfer. Systematic assessments are a pre-requisite for strategic advice and guidelines, and for introducing regulatory adaptation measures. Integrated assessments allow the indirect impacts of adopting a set of adaptation measures to be examined.

Government institutions and international research communities are faced with the important task of filling these knowledge gaps and will have to prioritise research areas given limitations on resources (Ram, 2009).

Another area where there is scope for establishing improved understanding is with respect to potential **trade-offs and synergies between energy system adaptation and mitigation options, and adaptation and development prospects in other sectors or areas**. Notable examples include competing uses of water, where there is an added element of potential conflict arising from the management of transboundary water resources, and specific potential trade-offs between for example biofuel crop production and food security. Integrated risk management is useful for managing cross-sectoral, national and regional issues.

Adaptation measures and mitigation actions have several important overlaps. To date, these have not been studied in detail. Earlier, the potential for exploiting synergies between adaptation, mitigation, and development priorities through demand side management was pinpointed. But other overlaps are equally important to take into consideration. Implementation of mitigation policies hinges on increasing the share of renewable energy sources in the energy mix. Mitigation policies are therefore very likely to affect perceptions and practices related to risk management behaviour in investments by energy institutions and they are almost certain to affect public and private sector energy technology research and development investments and energy resource and technology choices by energy institutions (Wilbanks et al., 2008). Moreover, a failure to integrate climate change impacts on renewable energy sources – and energy sector vulnerability and resilience in general – in climate mitigation policies could impose severe risks of mal-adaptation. Climate mitigation strategies also need to be climate resilient, presenting one of the areas in which further studies seem pertinent.

Information on **damage costs, and adaptation costs and benefits** is currently very scarce. ‘Order of magnitude’ estimates of the likely economic consequences of climate-related impacts on societies and economies in the shorter, medium, and longer term are an effective way of increasing the awareness and catching the attention of central decision makers at international, national and local levels. There is considerable scope for expanding economic assessments at all levels and addressing this gap should a priority, as it is likely to impose a significant barrier to integration of climate risks and adaptive responses in energy planning and decision making. Both detailed assessments of the costs and benefits of integrating adaptation measures in site specific investments and projects and in sectoral and national policies and rougher ‘order of magnitude’ estimates would enhance awareness raising and momentum for action.

## 6 References

- ADB, 2005. *Climate proofing: A risk-based approach to adaptation*. Asian Development Bank, Manila. Available at <http://www.adb.org/Documents/Reports/Climate-Proofing/climate-proofing.pdf>.
- Adger, W. N., S. Agrawala, M. M. Q. Mirza, C. Conde, K. O'Brien, J. Pulhin, R. Pulwarty, B. Smit, and K. Takahashi, 2007. *Assessment of adaptation practices, options, constraints and capacity*. In *Climate Change 2007: Impacts, Adaptation and Vulnerability*. Contribution of Working Group II to the Fourth Assessment Report of the Intergovernmental Panel on Climate Change, eds. M. L. Parry, O. F. Canziani, J. P. Palutikof, P. J. van der Linden, and C. E. Hanson. Cambridge University Press, Cambridge, UK, 717–743.
- Agrawala, S., and S. Fankhauser, 2008. *Economic aspects of adaptation to climate change. Costs, benefits and policy instruments*. OECD Publishing, Paris, France.
- Bariloche Foundation, 2009. *Energy, poverty and climate change in Latin America and the Caribbean: current situation and perspectives*. GNESD (Global Network on Energy for Sustainable Development), Roskilde, Denmark.
- Barnett, T., Malone, R., Pennell, W., Stammer, D., Semtner, B., and Washington, W., 2004. *The effects of climate change on water resources in the West: Introduction and overview*. *Climatic Change* 62, 1–3.
- Beldring, S., Andreasson, J., Bergström, S., Jonsdottir, J.F., Rogozova, S., Rosberg, J., Suomalainen, M., Tønning, T., Vehviläinen, B., and Veijalainen, N., 2006. *Hydrological climate change maps of the Nordic region*. In: European Conference on Impacts of Climate Change on Renewable Energy Sources, Iceland, June.
- Bloom, A., V. Kotroni, and K. Lagouvardos, 2008. *Climate change impact of wind energy availability in the Eastern Mediterranean using the regional climate model PRECIS*. *Natural Hazards and Earth System Sciences* 8: 1249–1257.
- Breslow, P.B., and Sailor, D.J., 2002. *Vulnerability of wind power resources to climate change in the continental United States*. *Renewable Energy* 27(4), 585–598 (14).
- Burton, I., 1996. *The growth of adaptation capacity: practice and policy*. In: Smith, J., Bhatti, N., Menzhulin, G., Benioff, R., Budyko, M. I., Campos, M., Jallow, B. and Rijsberman, F. (eds.): *Adapting to climate change: an international perspective*. Springer-Verlag, New York.
- Campbell, M. L. and I. Mts, 2008. *United States Arctic Ocean Management & the Law of the Sea Convention*. *Oceans 2008*, Vols 1-4. New York, Ieee: 1933-1941.
- Casper, K. N., 2010. *Oil and Gas Development in the Arctic: Softening of Ice Demands Hardening of International Law*. *Natural Resources Journal* 49(3-4): 825-881.
- Cruz, A. M. and E. Krausmann, 2008. *Damage to offshore oil and gas facilities following hurricanes Katrina and Rita: An overview*. *Journal of Loss Prevention in the Process Industries* 21(6): 620-626.
- de Lucena, A. F. P., A. S. Szklo, et al., 2010. *The vulnerability of wind power to climate change in Brazil*. *Renewable Energy* 35(5): 904-912.
- Delpla, I., E. Baures, et al., 2011. *Issues of drinking water quality of small scale water services towards climate change*. *Water Science and Technology* 63(2): 227-232.
- Dhakhwa, G. B., C. L. Campbell, et al., 1997. *Maize growth: assessing the effects of global warming and CO2 fertilization with crop models*. *Agricultural and Forest Meteorology* 87(4): 253-272.
- Dolarin, M., B. Vidrih, et al., 2010. *Predicted changes in energy demands for heating and cooling due to climate change*. *Physics and Chemistry of the Earth* 35(1-2): 100-106.
- Dussailant, A., G. Benito, et al., 2010. *Repeated glacial-lake outburst floods in Patagonia: an increasing hazard?* *Natural Hazards* 54(2): 469-481.
- Eberhard, A., Foster, V., Briceño-Garmendia, C., Ouedraogo, F., Camos, D. and Shkaratan, M., 2008. *Underpowered: The State of the Power Sector in Sub-Saharan Africa*. AICD, Background Paper, Washington, D.C., World Bank.
- Ebinger, J. and W. Vergara, Eds., 2011. *Climate Impacts on Energy Systems. Key issues for energy sector adaptation*. The World Bank, Washington D.C.
- ECA, 2009. *Shaping climate-resilient development. A framework for decision-making. A Report of the Economics of Climate Adaptation Working Group*. Climate Works Foundation, Global Environment Facility, European Commission, McKinsey&Company, The Rockefeller Foundation, Standard Chartered Bank and Swiss Re. Available at [http://www.mckinsey.com/App\\_Media/Images/Page\\_Images/Offices/SocialSector/PDF/ECA\\_Shaping\\_Climate%20Resilient\\_Development.pdf](http://www.mckinsey.com/App_Media/Images/Page_Images/Offices/SocialSector/PDF/ECA_Shaping_Climate%20Resilient_Development.pdf).
- Fenger, J., 2007. *Impacts of Climate Change on Renewable Energy Sources: Their role in the Nordic energy system*. A comprehensive report resulting from a Nordic Energy Research project. Copenhagen, Nordic Council of Ministers, Nordic Energy Research: 183.
- Forster, H. and J. Lilliestam, 2010. *Modeling thermoelectric power generation in view of climate change*. *Regional Environmental Change* 10(4): 327-338.
- Foukal, P., C. Frohlich, et al. 2006. *Variations in solar luminosity and their effect on the Earth's climate*. *Nature* 443(7108): 161-166.

- Freitas, M. A. V. and Soito, J. L. S., 2009. *Vulnerability to climate change and water management: hydropower generation in Brazil*. In: Brebbia, C.A. (Ed.): RIVER BASIN MANAGEMENT V, WIT Transactions on Ecology and the Environment.
- Hadley, S. W., D. J. Erickson, et al., 2006. *Responses of energy use to climate change: A climate modeling study*. Geophysical Research Letters **33**(17).
- Harrison, G. P., L. C. Cradden, et al., 2008. *Preliminary assessment of climate change impacts on the UK onshore wind energy resource*. Energy Sources Part a-Recovery Utilization and Environmental Effects **30**(14-15): 1286-1299.
- Harrison, G.P., Whittington, W., and Wallace, A.R., 2003. *Climate Change Impacts on Financial Risk in Hydropower Projects*. IEEE TRANSACTIONS ON POWER SYSTEMS, VOL. 18, NO. 4, NOVEMBER 2003.
- HELIO International, 2009. *Climate-proofing energy systems*. Unigraphics, Canada. Available at [www.helio-international.org](http://www.helio-international.org).
- Hosek, J., P. Musilek, et al., 2011. *Forecasting severe ice storms using numerical weather prediction: the March 2010 Newfoundland event*. Natural Hazards and Earth System Sciences **11**(2): 587-595.
- IEA (International Energy Agency), 2009. *World Energy Outlook 2009*. IEA, Paris, France.
- IPCC, 2001. *Climate change 2001—the scientific basis*. Contribution of Working Group II to the Third Assessment Report of the Intergovernmental Panel on Climate Change. Cambridge University Press, Oxford.
- IPCC, 2007a. *Climate Change 2007: Synthesis Report*. An Assessment of the Intergovernmental Panel on Climate Change. Cambridge University Press, Oxford. Available online at [http://www.ipcc.ch/pdf/assessment-report/ar4/syr/ar4\\_syr.pdf](http://www.ipcc.ch/pdf/assessment-report/ar4/syr/ar4_syr.pdf).
- IPCC, 2007b. *Climate Change 2007: Mitigation*. Contribution of Working Group III to the Fourth Assessment Report of the Intergovernmental Panel on Climate Change. [B. Metz, O.R. Davidson, P.R. Bosch, R. Dave, L.A. Meyer (eds)], Cambridge University Press, Cambridge, United Kingdom and New York, NY, USA.
- IPCC, 2007c. *Climate Change 2007 – Impacts, Adaptation and Vulnerability*. Contribution of Working Group II to the Fourth Assessment Report of the IPCC. Cambridge University Press, Oxford.
- Isaac, M. and D. P. van Vuuren, 2009. *Modeling global residential sector energy demand for heating and air conditioning in the context of climate change*. Energy Policy **37**(2): 507-521.
- Karakezi, S., J. Kimani, et al., 2009. *Large Scale Hydropower, Renewable Energy and Adaptation to Climate Change: Climate Change and Energy Security in East and Horn of Africa*. Nairobi, AFREPEN/FWD Energy, Environment and Development Network for Africa: 84.
- Kim, U. and J. J. Kaluarachchi, 2009. *Climate Change Impacts on Water Resources in the Upper Blue Nile River Basin, Ethiopia I*. Journal of the American Water Resources Association **45**(6): 1361-1378.
- Lynch, P., R. McGrath, P. Nolan, T. Semmler, and S. Wang, 2006. *Ireland's changing wind resource: An atlas of future Irish wind climatology*. From European Conference on Impacts of Climate Change on Renewable Energy Source, Iceland, June 2006.
- Madani, K. and J. R. Lund, 2010. *Estimated impacts of climate warming on California's high-elevation hydropower*. Climatic Change **102**(3-4): 521-538.
- Mamouda, M. N. A., 2009. *Policy Paper on Energy, Climate Change and Poverty Alleviation*. Roskilde, Global Network on Sustainable Energy (GNESD): 10.
- Marsh, N. and H. Svensmark, 2003. *Solar influence on Earth's climate*. Space Science Reviews **107**(1-2): 317-325.
- Mausser, W., and Bach, H., 2009. *PROMET – Large scale distributed hydrological modelling to study the impact of climate change on the water flows of mountain watersheds*. Journal of Hydrology **376** (2009) 362–377, Elsevier.
- Mideksa, T. K. and S. Kallbekken, 2010. *The impact of climate change on the electricity market: A review*. Energy Policy **38**(7): 3579-3585.
- Minville, M., Brissette, F., Krau, S., and R. Leconte, 2009. *Adaptation to Climate Change in the Management of a Canadian Water-Resources System Exploited for Hydropower*. Water Resource Management (2009), 23:2965–2986
- Ozkul, S., 2009. *Assessment of climate change effects in Aegean river basins: the case of Gediz and Buyuk Menderes Basins*. Climatic Change, Volume: 97, Issue: 1-2, Pages: 253-283
- Pryor, S. C. and R. J. Barthelmie, 2010. *Climate change impacts on wind energy: A review* Renewable & Sustainable Energy Reviews **14**(1): 430-437.
- Pryor, S.C., Barthelmie, R.J., Kjellstrom, E., Mann, J., 2005. *Potential climate change impacts on wind energy resources in northern Europe*. Geophysical Research Abstracts **7**, 01544.
- Raje, D. and P. P. Mujumdar, 2010. *Reservoir performance under uncertainty in hydrologic impacts of climate change* Advances in Water Resources **33**(3): 312-326.
- Ram, B., 2009. *An integrated risk framework for gigawatt-scale deployments of renewable energy: The U.S. wind energy case*. NREL (National Renewable Energy Laboratory), Colorado, USA.
- Richels, R.G., Tol, R.S.J. and Yohe, G.W., 2008. *Future scenarios for emissions need continual adjustment*. Nature, Vol. 453, p. 155

- Sailor, D.J., Smith, M., Hart, M., 2008. *Climate change implications for wind power resources in the Northwest United States*. Renewable Energy; Journal Volume: 33; Journal Issue: 11; Other Information: Elsevier Ltd.
- Singh, C. R., J. R. Thompson, et al., 2010. *Modelling the impact of prescribed global warming on runoff from headwater catchments of the Irrawaddy River and their implications for the water level regime of Loktak Lake, northeast India*. Hydrology and Earth System Sciences **14**(9): 1745-1765.
- Smith, P. and J. E. Olesen, 2010. *Synergies between the mitigation of, and adaptation to, climate change in agriculture*. Journal of Agricultural Science **148**: 543-552.
- Sood, A. and Durante, F., 2006. *The influence of the North Atlantic Oscillation on the wind conditions over the North Sea*. In: European Conference on Impacts of Climate Change on Renewable Energy Sources, Iceland, June.
- Su, F. G. and Z. H. Xie, 2003. *A model for assessing effects of climate change on runoff in China*. Progress in Natural Science **13**(9): 701-707.
- van Rheenen, N.T., Palmer, R.N., and Hahn, M.A., 2003. *Evaluating potential climate change impacts on water resources systems operations: case studies of Portland, Oregon and Central Valley, California*. Water Resources Update 124, 35-50.
- Wang, X. M., D. Chen, et al., 2010. *Assessment of climate change impact on residential building heating and cooling energy requirement in Australia*. Building and Environment **45**(7): 1663-1682.
- Wilbanks, T. J., V. Bhatt, et al., 2008. *Effects of Climate Change on Energy Production and Use in the United States*. U.S. Climate Change Science Program: 96.
- Willows, R. I., and R. K. Connell (Eds.), 2003. *Climate adaptation: Risk, uncertainty and decision-making*. UKCIP Technical Report. United Kingdom Climate Impacts Programme, Oxford. Available at [www.ukcip.org.uk/risk/](http://www.ukcip.org.uk/risk/).
- World Bank, 2010a. *World development report. Development and climate change*. The World Bank, Washington DC.
- World Bank, 2010b. *The costs to developing countries of adapting to climate change. New methods and estimates*. The Global Report of the Economics of Adaptation to Climate Change Study, Consultation Draft. The World Bank, Washington DC.
- World Bank, 2010c. *Assessment of the impacts of climate change on mountain hydrology. Development of a Methodology through a Case Study in Peru*. LCSEG, Sustainable Development Department, Latin America and Caribbean Region, The World Bank, Washington DC.
- World Bank, 2010d. *Peru: Overcoming barriers to hydropower*. Energy Cluster, Sustainable Development Department, Latin America and Caribbean Region, The World Bank, Washington DC.

## **Session 2C - Planning Energy Supply without CO<sub>2</sub>**

# Factors affecting stakeholder perception on Carbon Capture and Storage acceptability

Kainiemi Laura, Eloneva Sanni, Fogelholm, Carl-Johan

Department of energy Technology, Aalto University of Science and Technology

Phone number +358-9-470-23325

[laura.kaniemi@tkk.fi](mailto:laura.kaniemi@tkk.fi)

## Abstract

Carbon Capture and Storage technologies have an important role in climate change mitigation, but it is still a relatively unknown technology and has gained low support. As the implementation of Carbon Capture and Storage requires public acceptance it is important to understand what are the factors that need to be addressed in order to achieve higher acceptance. Looking at existing acceptance studies, three factors were identified, which were shared by all stakeholders; risk- and benefit perceptions and costs. The knowledge stakeholders have regarding these factors varies by group and is low among non- professionals which means their opinions are not always based on facts. Providing people with more information is crucial in increasing their knowledge and acceptance. Successful communication of information was found to require expertise, trust and honest communication. Participatory methods can be used in the implementation of projects as efficient tools for including all stakeholders in the decision making and increasing acceptance through addressing their concerns.

## 1 Introduction

Stakeholder acceptance is crucial to implementation of any technology, also for Carbon Capture and Storage (CCS). For instance, in the Netherlands the government had to withdraw support for a demonstration project in Barendrecht due to resistance from local inhabitants toward the project who considered on- shore storage adjacent to the village to be too dangerous. (Government of the Netherlands, 2010)

In order to increase stakeholder acceptance we need to identify the factors that are most relevant in terms of forming stakeholder's perceptions. Knowledge on these factors will allow those involved in CCS projects to address the issues most important to stakeholders in the process of planning and implementing the technology. This paper looks for common factors in existing acceptance studies in order to establish what influences stakeholder's acceptance to CCS technology and whether these factors vary from one stakeholder group or one country to another. Due to low levels of knowledge among stakeholders (de Best- Waldhober, 2009), providing them with additional information on CCS technologies and other mitigation options is important not only to increase acceptance but also in order to receive reliable information on stakeholder opinions. The identification of factors that are shared by stakeholder groups will enable focusing the communication on the information regarding these factors.

We will first summarize recent studies conducted on stakeholder acceptance in order to illustrate acceptance levels and the factors affecting them. Once the factors that are shared by all stakeholder groups and most studies have been identified, they can be compiled together and analyzed. As the role of information in forming stakeholder



perceptions has been stressed by most acceptance studies, its significance and relations to the factors will be explored. The opinions expressed in acceptance studies can then be combined with the findings on information to provide us with some direction on the issues that need to be addressed if a higher level of acceptance is to be achieved.

## 2 Stakeholder acceptance studies

Although comparative information on public acceptance of CCS on a European level, let alone internationally is scarce, several country specific studies have been conducted, for instance in Japan, Netherlands and the UK (Anderson, 2009) (Reiner, 2006) (Itaoka, 2009). These studies indicate a hesitant, yet positive acceptance. Many of these studies are based on questionnaires designed to test the acceptance of CCS under different assumptions. They provide valuable information on the factors that seem to have effect on increasing or decreasing acceptance for CCS technologies. Below are examples of the studies that have been conducted regarding stakeholder acceptance (Anderson, 2009) (Reiner, 2006) (Itaoka, 2009 and 2004) (Tokushige, 2007) (Van Alphen, 2007) (De Best-Waldhober, 2009) (Sharp, 2006) and some central findings of these studies regarding the factors affecting perceptions.

A study on the acceptance of different methods for greenhouse gas mitigation conducted by Reiner (2009) compiled results from studies conducted in the US, UK, Sweden and Japan. The results indicated strong acceptance (supported by 80-90% of respondents) for solar energy and energy efficient cars and appliances. Other methods, such as wind energy, carbon sequestration through changes in land use (planting trees) and bio energy were also seen as favourable methods by most, while the options of nuclear power and CCS found less support, with 40-50% “not sure” whether these methods should be implemented. Rejection was noted to be higher in the case of nuclear power, and the high level of uncertain respondents was found to be a consequence of low levels of knowledge on the technology. (Reiner, 2006)

A project (ACCSEPT) funded by European union studied stakeholder perceptions in several European countries, including UK, Netherlands, Germany, France, Italy, Belgium, Norway, Denmark, Sweden, Finland and Spain. The results indicated that different groups of stakeholders have different levels of acceptance and differing risk perceptions. It was discovered that highest acceptance levels can be found on stakeholders in the energy sector and among academia, while the most negative perceptions can be found among NGOs with government officials and parliamentarians in between (Anderson, 2009).

Although the numbers of respondents per country in the ACCSEPT project were relatively small, some common factors were drawn. The results indicated that most important factors for determining stakeholder perceptions were the risk perceptions of different groups, along with fossil fuel dependency of the country in question and electricity cost. The significance of cost was more significant for countries with lower GDPs. A combining factor was a consensus that CCS was necessary in order to mitigate climate change, which was regarded as a serious problem. (Anderson, 2007)

The study by Itaoka (2009) used a random sample of ordinary citizens in the cities of Tokyo and Sapporo and identified four main factors that explain acceptance in Japan; (1) risks and leakage, (2) effectiveness of CCS, (3) responsibility, and (4) fossil fuel use. The questionnaire results indicated that understanding the effectiveness of CCS has most weight in determining acceptance levels. Effectiveness was defined as the connection between global warming mitigation and CCS and the effectiveness of CCS in capturing greenhouse gases. Another highly influential factor was risks and leakage. It was noted that the risk factor increased in importance significantly when the respondents were asked questions on the implementation of geological storage specifically, rather than general acceptance. This implies that storage is considered to entail highest risks in the process and uncertainty regarding the risks and safety is likely to have a significant effect on acceptance. (Itaoka, 2009)

Another study conducted in Japan was based on a questionnaire designed to measure the importance of five factors on the level of acceptance among university students. The factors used for the study were risk perception, benefit perception and trust, along with two factors measuring attitudes on human interference to the environment, one of which was related to geological storage and the other to global warming. The study found these five factors to be rather representative in evaluating acceptance, as they explained more than 83% of acceptance levels. The most significant factor was benefit perception followed by risk perception. (Tokushige, 2007)

### **3 Factors of stakeholder perceptions**

Comparison of the results of acceptance studies is difficult due to the facts that the stakeholders and the questionnaires involved in these studies are not directly comparable. Each study used a questionnaire formulated for the specific research conducted and involved different groups of stakeholders and different influential factors. For instance, the study by Itaoka (2009) used a random sample of ordinary citizens, while Anderson (2009) included different groups of stakeholders from the energy industry, local and national governments and academia.

However, most research conducted on public and stakeholder perception finds that the factors of largest significance in forming these perceptions are how the risks and benefits of CCS technology are seen, with the concept of benefits meaning the importance of mitigating climate change and the contribution CCS can provide towards this aim. Another factor that is significant for all stakeholder groups is the cost of electricity following CCS implementation. Additional factors that are important for at least one group but not all are fossil fuel dependency, local impacts, reversibility of technical choices, Europe's role in promoting low- carbon technologies (European stakeholders), attitudes on interfering with nature and a sense of responsibility as mankind to respect the environment. (Anderson, 2007) (Tokushige, 2007) (Itaoka, 2009). Further illustration on the three most important factors; risks, benefits and costs will draw together some of the most significant findings of acceptance studies.

#### **3.1 Risks**

As was demonstrated by the studies discussed in the section above, risk perception is one of the most significant factors determining stakeholder acceptance. It is also a factor which appears to have significant variation among different stakeholder groups. Both the energy industry and governments regard the risks of CCS to be small, and the industry further considers the risks to be well managed and the technology trustworthy, while governments are somewhat more cautious and wish for additional research. Environmental NGOs have expressed most doubt regarding the risks, pointing to uncertainty in the lack of knowledge of possible leakage pathways, the behaviour of carbon dioxide in the underground deposits and the appropriate materials for sealing the injection wells. (Van Alphen, 2007). For the public, the most significant risks are associated with storage, particularly on-shore (Anderson, 2009), despite the fact that approximately 60% report to have very little knowledge regarding storage (Tokushige, 2007).

The public also constructs their risk perceptions differently. While experts base their perceptions on scientific findings, the public tends to form their risk perceptions on intuitive judgments using images of the risks and benefits involved, based on their personal values and experiences. This is particularly the case with new, relatively unknown and complex technologies, such as CCS, and can distort the attitudes of general public in relation to scientific information on the technology. (Slovic, 1985). Nevertheless, there is still evidence that increased knowledge on CCS will increase support not only for CCS in general, but also for different storage options, apart from on-shore storage (Itaoka, 2004). This indicates that providing people with information does

to a certain extent lower the risk CCS is perceived to entail, except for the highest risk storage option.

Stakeholders, such as government representatives, NGOs and industry have expressed wishes for more research on the processes involved in CCS and the development for new monitoring techniques. Experience from successful demonstration projects are likely to lessen fears concerning the risks involved as well as the establishing of rules and standards to ensure continued safety on a longer time- scale. Representatives of governments and NGOs have also suggested the creation of a fund to cover any unanticipated long- term consequences. (Van Alphen, 2007).

### **3.2 Cost**

Research indicates that rises in consumer electricity prices will have a negative effect on stakeholder perceptions (Anderson, 2009). Investments in CCS technology are rather expensive and do not bring direct benefits to the companies investing in CCS projects. The capture of carbon dioxide reduces power plant efficiency, increasing the cost of electricity production, which will push up electricity prices. This makes companies reluctant or at least very cautious when it comes to initiating CCS projects. (Van Alphen, 2007)

A Euro barometer study found that more than 50% of Europeans are not willing to pay more for their electricity in order to use low- carbon energy. Further more 22% of respondents in Britain and 43% in Sweden refuse to pay anything in addition to current electricity prices, compared to 14% of respondents in Japan and 24% in the US, respectively. Willingness to pay in most European countries is very similar; Sweden can be regarded as exceptional in that the cost of electricity is already highest among the countries as a fraction of incomes. However, there may be slight variations depending on whether people are asked on their personal willingness to pay or regarding cost in general. (Eurostat, 2006).

### **3.3 Benefits/Effectiveness**

The benefits of CCS were found to be one of the most significant factors in determining stakeholder perceptions. Benefits include the effectiveness of CCS in climate change mitigation and understanding the importance of mitigation and the links to global warming. Research shows that despite the attention and public discussion on climate change in recent years, there is relatively low awareness among some stakeholder groups even as to what problems carbon dioxide causes (Sharp, 2006).

Furthermore, among low- carbon technologies, CCS is the least familiar option (Reiner, 2006). Awareness of CCS technologies is low or very low and in many instances, those who are aware of the existence of such technologies do not clearly understand what problem it is meant to address. For instance, in the Netherlands, 48% stated to know the greenhouse effect, while 76% of respondents are not aware of CCS, with 50% knowing very little on the greenhouse effect and 20% know very little on CCS. (De Best-Waldhober, 2009) Similarly awareness in Japan has been estimated at 22% and only 4% in the United States (Reiner, 2006) and 15% in Canada (Sharp, 2006). Sharp (2006) found that respondents in Canada seemed to focus on the risks of CCS instead of the benefits, which they had low knowledge of. After they were given information regarding the benefits, their perceptions changed only slightly.

In short, it can be stated that public support for CCS technologies is dependent on peoples understanding for the reasons that CCS is needed (Shackley, 2005). Therefore, information regarding climate change, carbon dioxide and CCS technologies and the links between these is crucial if stakeholder acceptance is to be achieved.

## 4 The effect of information on stakeholder acceptance

Particularly when awareness is low, increasing knowledge through information on the risks and benefits of CCS is likely to increase acceptance. (Anderson, 2009) (Itaoka, 2009). Studies such as Anderson (2009), Itaoka (2009) and Curry (2004) have measured acceptance both before and after providing the respondents information on CCS, or the differences between two groups of respondents, one of which has received information while the other has not.

Information is crucial, first of all, in understanding which the problems CCS is meant to address are. Shackley (2005) found that support for CCS technology was largely dependent on understanding the reasons for carbon dioxide mitigation. On the other hand, information is necessary for understanding the risks involved in using the technology and forming reliable opinions on whether the technologies should be used. Most studies indicate that acceptance of CCS tends to increase when more information is provided. (Anderson, 2009) For instance, in a study by Curry (2004) respondents were asked to choose their preferences from seven options that addressed global warming; business- as- usual (with assumptions there is no global warming or to allow for global warming), increasing nuclear power, increasing renewables, fossil fuel use with CCS, reduced electricity consumption or increased research funding in order to find new solutions. Half the respondents were not given information in advance, while the other half was informed regarding electricity prices and emissions levels that were associated with each option. Of the informed group, 16% considered CCS to be the best option in terms of global warming, while only 6% of the uninformed group selected this option. Furthermore there seems to be some evidence that suggest a correlation between the amounts of information respondent have on CCS and the level of acceptance they express toward it. Itaoka (2004) found that when more information was provided, the more likely respondent were to support CCS. However, a study conducted in Canada by Shackley (2005) found respondents maintaining their negative perceptions or even growing more negative after the provision of additional information. These results seem to conflict the majority of research on this area and it was not specified as to what aspects of the information made the respondents become more negative in their opinions.

In terms of measuring current acceptance levels with the help of questionnaires, low levels of knowledge are somewhat problematic and may lead to distorted results. While part of the respondents who are unfamiliar with CCS technology and its purpose will refrain from giving their opinion, the majority will still respond with “pseudo- opinions” and “non- attitudes” (Converse, 1964), which are not based on factual knowledge. Therefore the provision of information to respondents is also a means to improve the reliability of the results. De Best- Waldhober (2009) reports that out of the respondents that declared never having heard of a given technology, half still gave an evaluation of this technology. Not only are these pseudo- opinions not based on facts, but they are also unpredictable as respondents can easily change their minds in unexpected ways. It has also been stated that the current level of public acceptance, measured with questionnaires, is unstable and can be affected by the type of information given to the respondent. Therefore the resulting answers on acceptance can only be considered as weak indicators on future acceptance and are therefore an uncertainty in terms of decision making. (Daamen, 2006).

Consistency and stability are main factors in determining opinion quality, where stability is the degree that people’s opinions remain consistent over time and consistency depicts on how the opinions are compatible with peoples values and attitudes and the ideologies they express to support. (Price and Neijens, 1997). When the opinions that are expressed in a questionnaire are based on information, the perceptions expressed by the respondents are more likely to remain stable (Petty and Cacioppo, 1986).

Even when people are presented with sufficient information to form informed opinions on CCS, the characteristics of the communicator can influence the acceptance of the

information that has been provided and the quality this information is perceived to have, whether directly or indirectly (Ter Mors, 2006). Ter Mors (2006) describes communicators using two characteristics; expertise and trustworthiness. Expertise is 'the extent to which a speaker is perceived to be capable of making correct assertions', while trustworthiness describes 'the degree of confidence in the communicator's intent to communicate the assertions he considers most valid'. These characteristics can be either congruent or incongruent. When the characteristics are seen as congruent, people will have clearly positive or negative expectations on the quality of the information. If the communicator is seen both as high in expertise and trustworthiness, people will consider the quality of the information to also be high. When the communicator appears low in the level of expertise and untrustworthy, information provided by the communicator is considered low quality. (Ter Mors, 2006)

When these characteristics are incongruent, making judgements on information quality becomes more difficult in the absence of positive/negative expectations and people have to rely more on their own perceptions and knowledge. The effect of one positive characteristic can be overcome if the other characteristic is sufficiently negative. A proponent of CCS, such as a representative of a company that plans to install CCS technology, can be regarded to have high expertise, but not being very trustworthy, whereas another proponent, such as a local government official can be seen as highly trustworthy, but low in expertise when it comes to CSS. Similar estimations are made on the opponents. Therefore the communicator characteristics can affect opinions and deliver different results that would have been achieved through another communicator.

The influence of communicator characteristics becomes more pronounced the less knowledge and ability to process the knowledge people have. (Ter Mors, 2006) Organizations can increase trustworthiness through open and honest communication, fair decision making, emphasizing their competence on the matter being discussed and showing concern with public interests and acting with integrity. It often seems to the public that companies are more concerned with organizational, rather than public issues, which erodes trust toward them. (Terwel, 2009)

There are several channels for people to receive information on complex and new technologies, such as CCS, for example the internet, specialist press and informal networks. However, the most significant source of information is mass media. (Mandel and Gough, 2006). Therefore, media has significant amount of power in influencing public opinions through the way it interprets and presents information to the public, particularly when dealing with a relatively unknown technology such as CCS.

A study conducted by van Alphen (2007) explored the relationship between media coverage and public acceptance of CCS and discovered that not only has the amount of coverage increased since 2005, but the coverage itself has become more positive following the increase in pilot projects and the importance of finding solutions to climate change. The number of arguments included in a single reportage has also increased and it seems that the conversation concerning CCS in the media is becoming rooted into the climate debate. (Van Alphen, 2007)

## **5 Discussion**

If CCS is to be implemented on a scale that has significant effect on greenhouse gas emissions, communication to stakeholders needs to be increased in order to achieve higher awareness. Of the three factors identified in this paper, benefit perceptions can be improved simply by increasing stakeholder awareness on climate change and the need to use CCS in order to mitigate it successfully. In order to reduce risk perceptions and tackle the problems related to increased energy costs, information alone is not sufficient and other, more practical solutions are needed. These solutions should be aimed at the reduction of negative effects of CCS (identified in section 3), such as measures to increase safety during transport and storage, determination of procedure and liabilities in case of accidents and financial support to reduce costs.

Furthermore, communication to stakeholders should be organized in an open way that increases acceptance, through the promotion of high levels of expertise and trustworthiness. This means that risks, as well as benefits should be communicated honestly and in a neutral way, without attempts to direct stakeholders toward a predetermined solution. Allowing people to express their opinions through open communication increases the trustworthiness that is associated with the communicating organization. Further inclusion of stakeholders in the implementation of CCS projects by participatory decision making is likely to increase it even more, in addition to allowing for technical improvements based on the risk perceptions stakeholders have expressed.

Participatory decision making has been utilized for example by Van Alphen (2007). Here stakeholders are not simply the recipients of information, but negotiators in a process of communicating information and opinions and adjusting conclusions following the interactions with other stakeholder groups. This process increases acceptance through broadening the insights of the participants in terms of the needs and opinions of other stakeholders. A group of stakeholders has a better foundation to assess the facts related to the use of CCS technology compared to individuals and it allows the group to process information from different perspectives and to find creative solutions to complex issues. The use of a participatory method is particularly important in terms of the communities adjacent to storage sites, who place stricter criteria on the technology for their acceptance compared to other stakeholders. It is crucial that their concerns are taken into account in the implementation and their fears are addressed through open communication.

When conducting research on stakeholder acceptance it is important to provide the respondents with neutral information regarding the purpose and the risks of CCS, in order to achieve reliable results from questionnaires and avoid “pseudo- opinions”. Of course this itself creates a new problem as information is hardly ever “neutral”. Studies on stakeholder perceptions could also benefit from simulated participatory decision making situations, which would enable stakeholders to gather information concerning the different aspects of CCS implementation from multiple sources as well as gaining an understanding on the factors that are most important to other stakeholders and the compromises that would be necessary in order to achieve optimal solutions.

## Conclusions and recommendations

In order to be able to take measures to increase the acceptability of Carbon Capture and Storage we need to understand which factors determine acceptability for stakeholders. On the basis of the earlier acceptance studies, the most important factors seem to be benefit- and risk perceptions and costs. Having identified them, they can be addressed by taking stakeholders opinions and concerns into account in technical development as well as policy and project implementation. Open communication and participatory decision making involving stakeholders and project developers are important tools for achieving this and also generate higher acceptability levels through increasing trust between stakeholders and the organization involved in CCS projects. In order to increase the reliability of research on stakeholder perceptions, neutral information should be provided to all respondents. Comparability of the variety of studies in the field can be increased through the creation of shared practices, for example in terms of the formation of the questionnaires and the selection of respondents.

## References

Anderson J, Chiavari J, de Coninck H, Shackley S, Sigurthorsson G, Flach T, Reiner D, Upham P, Richardson P, Curnow P (2009): Results from the project ‘Acceptance of CO<sub>2</sub> capture and storage: economics, policy and technology (ACCSEPT)’ Energy Procedia 1 pp.4649–4653

Anderson J, de Coninck H, Curnow P, Flach T, Reiner D, Richardson P, Shackley S, Upham P, Sigurthorsson G (2007): The ACCSEPT project: Summary of the main findings and key recommendations, Final report from ACCSEPT, <http://www.accsept.org/>

Converse P.E, (1964): The nature of belief systems in mass public. In: Apter, D.E. (Ed.), *Ideology and Discontent*. Free Press, New York, pp. 206–261.

Curry T, Reiner D.M, Ansolabehere S, Herzog H.J (2004): How aware is the public of carbon capture and storage? In: Rubin E.S, Keith D.W, Gilboy C.F (Eds.), *Proceedings of the 7th International Conference on Greenhouse Gas Control Technologies*, volume 1: Peer-reviewed Papers and Plenary Presentations, IEA Greenhouse Gas Program, Cheltenham, UK.

Daamen D, de Best-Waldhober M, Damen K, Faaij A (2006): Pseudo-opinions on CCS technologies. Eighth International Conference on Greenhouse Gas Control Technologies (GHGT-8)

De Best- Waldhober M, Daamen D, Faaij A (2009): Informed and uninformed public opinions on CO<sub>2</sub> capture and storage technologies in the Netherlands, *International Journal of Greenhouse Gas Control* 3 pp.322- 332

Eurostat (2006): Attitudes towards energy, Special Eurobarometer 247, European Commission

Government of the Netherlands, 2010: CO<sub>2</sub>- opslagproject in Barendrecht van de baan, <http://www.rijksoverheid.nl/nieuws/2010/11/04/co2-opslagproject-bar>

Gough C, Mander, S (2006): Carbon Dioxide Capture and Storage in the Media. I. G. G. Programme, Tyndall Centre for Climate Change Research.

Hornig S (1993): Reading risk: public response to print media accounts of technological risk. *Public Understanding of Science* 2, 95–109.

Huijts (2003): Public perception of Carbon Dioxide Storage. Eindhoven University of Technology, Eindhoven.

Itaoka K, Saito A, Akai M (2004): Public acceptance of CO<sub>2</sub> capture and storage technology: a survey of public opinion to explore influential factors. In: Rubin E.S, Keith D.W, Gilboy C.F (Eds.), *Proceedings of the 7<sup>th</sup> International Conference on Greenhouse Gas Control Technologies*, volume 1: Peer-reviewed Papers and Plenary Presentations, IEA Greenhouse Gas Program, Cheltenham, UK.

Itaoka K, Okuda Y, Saito A, Akai M (2009): Influential information and factors for social acceptance of CCS: the 2<sup>nd</sup> round survey of public opinion in Japan, GHGT-9, 9th International Conference on Greenhouse Gas Control Technologies, *Energy Procedia* 1, pp 4803- 4810

Mander S, Gough C (2006): Media framing of new technology: the case of carbon capture and storage. Eighth International Conference on Greenhouse Gas Control Technologies (GHGT-8),

Petty R.E, Cacioppo J.T (1986): The elaboration likelihood model of persuasion. In: Berkowitz, L (Ed.), *Advances in Experimental Social Psychology*, vol. 19. Academic Press, New York.

Price V, Neijens PC (1997): Opinion quality in public opinion research. *International Journal of Public Opinion Research* 9 (4), 336–360.

Reiner D, Curry T, de Figueiredo M, Herzog H, Ansolabehere S, Itaoka K, Akai M, Johnsson F, Odenberger M (2006): An International Comparison of Public Attitudes toward carbon capture and storage technologies, *Proceedings of the 8th international conference on greenhouse gas control technologies*

Rijksoverheid, 2010: CO<sub>2</sub>- opslagproject in Barendrecht van de baan, <http://www.rijksoverheid.nl/nieuws/2010/11/04/co2-opslagproject-bar>

- Shackley S, McLachlan C, Gough C (2005): The public perception of carbon capture and storage in the UK: results from focus groups and a survey. *Climate Policy* 4 (4), 377–398.
- Sharp J, Jaccard M, Keith D (2006): Public attitudes toward geological disposal of carbon dioxide in Canada, GHGT8, the 8th International Conference on Greenhouse Gas Control Technologies
- Siegrist M (2000): The influence of trust and perceptions of risk and benefits on the acceptance of gene technology, *Risk analysis* 20, 195-203
- Slovic P, Fischhoff B, Lichtenstein S (1985): Characterizing perceived risk. In: Kates R.W, Hohenemser C, Kasperson, J.X (Eds.), *Perilous Progress: Managing the Hazards of Technology*. Westview, pp. 91–125.
- Ter Mors E, Weenig M, Ellemers N (2006): The influence of (in)congruence of communicator expertise and trustworthiness on acceptance of CCS technologies, GHGT-8, 8th International Conference on Greenhouse Gas Control Technologies
- Terwel B, Harink F, Ellemers N, Daamen D, de Best- Waldhober M (2009): Trust as predictor of public acceptance of CCS, GHGT-9, 9th International Conference on Greenhouse Gas Control Technologies, *Energy Procedia* 2, pp. 4613- 4616
- Tokushige K, Akimoto K, Tomoda T (2007): Public perceptions on the acceptance of geological storage of carbon dioxide and information influencing the acceptance, *International journal of greenhouse gas control* I pp.101-112
- Van Alphen K, Van Voorst Tot Voorst Q, Hekkert M, Smits R (2007): Societal acceptance of carbon capture and storage technologies, *Energy Policy* 35, pp. 4368-4380
- Af Wählberg A, Sjöberg L (2000): Risk perception and the media. *J. Risk Res.* 3 (1), 31–50.



# The potential for geological storage of CO<sub>2</sub> in Denmark is very promising

Karen L. Anthonsen, Peter Frykman & Lars H. Nielsen

Geological Survey of Denmark and Greenland, GEUS, Øster Voldgade 10, DK-1350 Copenhagen K

## Abstract

Geological storage of CO<sub>2</sub> by subsurface injection into porous rocks in deep saline aquifers is one of the options to reduce CO<sub>2</sub> emissions. Several projects concerning estimation of geological storage of CO<sub>2</sub> in Europe has revealed a considerable storage potential, latest the EU GeoCapacity project estimated a total storage capacity of ~360Gt for Europe. Compared to the estimate of 2Gt for the annual CO<sub>2</sub> emission from large stationary CO<sub>2</sub> sources, sufficient capacity seems to be available. The combination of certain point sources with storage facilities might even obtain negative emission budget, when power plants with significant biomass fuelling are incorporated.

Analyses demonstrate that geological storage of CO<sub>2</sub> is a realistic option in the majority of the European countries, with the largest storage potential concentrated in the North Sea region. Widespread geological formations and structures with CO<sub>2</sub> storage potential are found in Norway, United Kingdom and Denmark. In Denmark the subsurface is relatively well known from a large number of exploration wells and various seismic surveys, and the existence of both reservoir layers and sealing units with large areal extension is verified. In addition the occurrence of geological structures with closure makes it very likely that several suitable CO<sub>2</sub> storage sites can be identified, both on- and offshore. The Skagerrak area seems promising as several structures with reservoir rocks are documented with overlying sealing cap rock sections. The Kattegat area may also have potential structures due to block faulting. The combination of burial depth and reservoir properties makes the Triassic – Jurassic Gassum Formation the most attractive storage layer option. The thickness of the Lower Triassic Bunter Sandstone/Skagerrak Formations provides huge storage volumes although probably with low injectivity. Locally the lower Triassic formations may form excellent reservoirs, for example in the Copenhagen-Malmö area.

## 1 CO<sub>2</sub> Storage in a European perspective

Several EU co-funded projects have been dealing with mapping and estimations of the geological storage potential for Europe. The first project estimating the European CO<sub>2</sub> storage potential was the Joule II project in 1996 and the total storage capacity was estimated to approximately 800Gt (Holloway *et al.* 1996). In 2003 the GESTCO project came up with more detailed calculations of storage capacities for 8 North West European countries (Belgium, Denmark, France, Germany, Greece, Netherlands, Norway, UK) (Christensen & Holloway 2004). The Castor project included storage estimations for 8 east and central European countries in 2006 (Bulgaria, Croatia, Czech Rep., Hungary, Poland, Romania, Slovakia, Slovenia). Finally the EU GeoCapacity project covered storage capacity estimations for 21 countries in Europe and the result was a total storage capacity of 357 giga-ton (Gt) CO<sub>2</sub> (Vangkilde-Pedersen *et al.* 2009). If the total storage capacity is compared with the total European CO<sub>2</sub> emission from large stationary sources (>1Mt CO<sub>2</sub>/year) of 2Gt CO<sub>2</sub>, Europe has geological storage capacity for ~180 years. The GeoCapacity project is the most extensive research project to date, including CO<sub>2</sub> storage capacity estimates for saline aquifers, hydrocarbon fields and coal fields (figure 1).

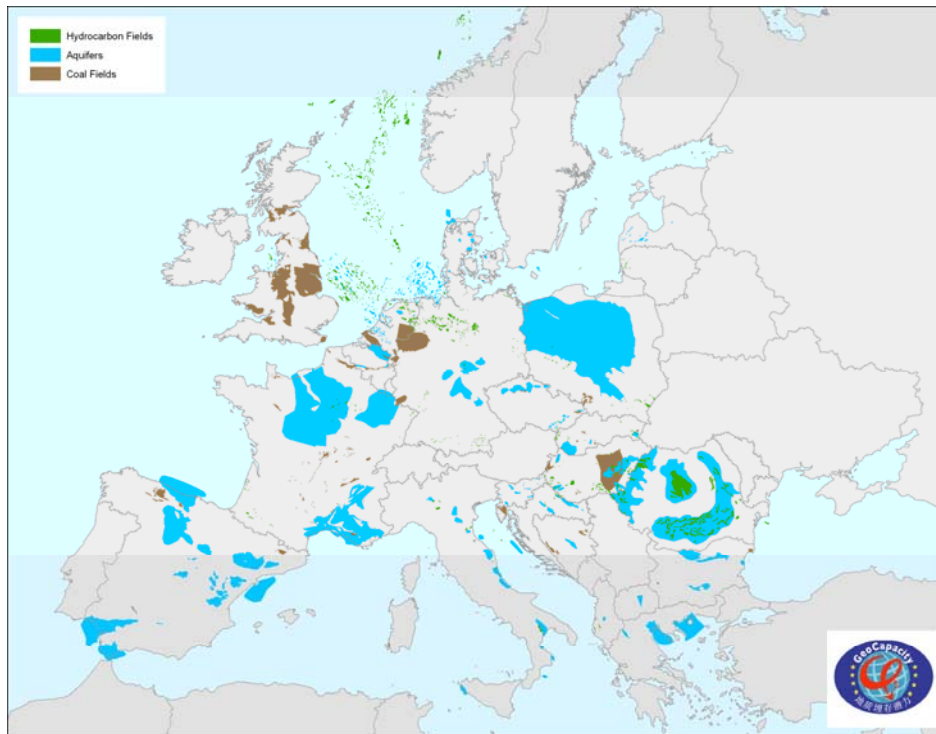

*Figure 1: Potential CO<sub>2</sub> storage sites and large aquifers in Europe. No aquifer data from Norway. Data from the EU GeoCapacity project.*

Results from the GeoCapacity project concludes that coal fields, on a European scale, has a very limited storage capacity (1.5Gt) and low injection rates, but it is possible to use CO<sub>2</sub> for production of methane. For hydrocarbon fields the geology and reservoir conditions are well-known from exploration and production activities and they have proven capability to retain hydrocarbons for millions of years. On industrial scale the storage capacities in hydrocarbon fields is limited (30Gt), but CO<sub>2</sub> injection in a hydrocarbon field offers the possibility to use the CO<sub>2</sub> for enhanced oil/gas recovery (EOR/EGR). Large potential CO<sub>2</sub> storage volumes are found in the saline aquifers (325Gt), but the general lack of detailed data and consequently uncertainties about reservoir integrity and reservoir properties makes aquifers more costly to develop for CO<sub>2</sub> injection.

The CO<sub>2</sub> storage potential in Europe is unequally distributed, reflecting the very variable subsurface geology, but analyses from the GeoCapacity project, also demonstrate geological storage of CO<sub>2</sub> to be a realistic option in the majority of the European countries, with the largest storage potential concentrated in the North Sea region. Widespread geological formations and structures with CO<sub>2</sub> storage potential are found in Norway, United Kingdom and Denmark. Data from GeoCapacity reveal that 65% of the total European aquifer storage potential is located in these three countries, and the majority of the potential aquifers are found offshore Norway.

## 2 CO<sub>2</sub> storage in Denmark

In large parts of the Danish territory the subsurface consist of a thick sedimentary succession of Late Palaeozoic to Cenozoic age overlaying the basement, and reaching a maximum thickness of 9 kilometres in the central parts of the Norwegian-Danish Basin. The sedimentary succession is affected by mainly northwest–southeast striking normal faults and post depositional flow of late Permian Zechstein salt, generating large dome structures. Locally the succession is incomplete due to structural movement and erosion, particularly above the salt domes. Faults often accompany the salt structures. Both the

Skagerrak-Kattegat Platform and the Ringkøbing-Fyn High are characterised by a relatively thin succession of sedimentary cover (figure 2).

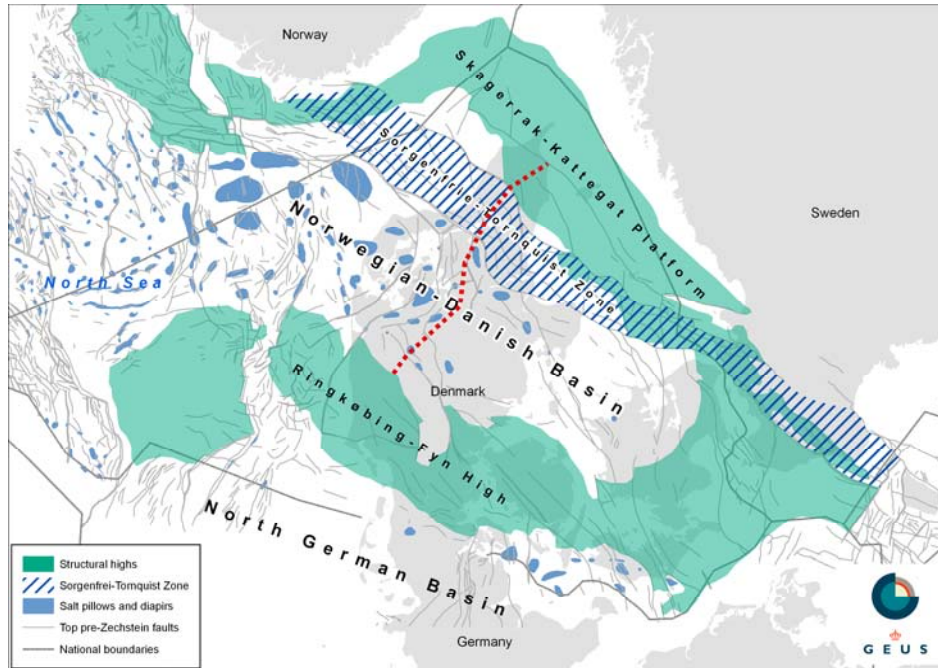

Figure 2: The structural setting of the Danish area. The Mesozoic Norwegian-Danish basin is bordered by the Ringkøbing-Fyn High to the south-west and the Skagerrak-Kattegat platform to the north east. The red broken line shows the position of the cross-section shown in figure 3.

## 2.1 Potential reservoir formations

Research in Denmark has focused on sandstone formations within a depth range of 800 – 2500 m, i.e. between the depth required for CO<sub>2</sub> to become a dense fluid and the depth below which reservoir quality typically deteriorates. To be considered a potential candidate the sediment layer must consist of mainly sandstone with porosity between 15 and 35%. The coarser grained sandstones are preferable since they have higher injectivity. The formations with the most promising potential for CO<sub>2</sub> storage in Denmark are the Bunter Sandstone Formation, the Skagerrak Formation, the Gassum Formation, the Haldager Sand Formation and the Frederikshavn Formation (Figure 3).

The Triassic Bunter Sandstone and Skagerrak Formations are present throughout the Danish area (Figure 4). The succession is thin and locally absent across the Ringkøbing-Fyn High. The large net sand thicknesses of the Bunter Sandstone/Skagerrak Formations, provides huge storage volumes although with large injectivity.

The Upper Triassic–Lower Jurassic Gassum Formation is present in the Norwegian-Danish Basin, on the Ringkøbing-Fyn High and in the south eastern part of Denmark (Figure 4). It demonstrates a remarkable continuity with a thickness between 100 and 150 m throughout most of Denmark, and reaches a maximum thickness of more than 300 m in the Sorgenfrei-Tornquist Zone. The burial depth versus reservoir properties makes the Gassum Formation the most attractive storage option for CO<sub>2</sub> storage (Larsen et al. 2003).

The Middle Jurassic Haldager Sand Formation is present in the central and north eastern part of the Norwegian-Danish Basin, in the Sorgenfrei-Tornquist Zone and on the Skagerrak-Kattegat Platform (Figure 4). The thickness of the formation shows large variations and range between a few metres and up to 200 m. A marked thinning is seen southwest and northeast of the Sorgenfrei-Tornquist Zone related to the Middle Jurassic uplift event (Nielsen 2003).

The Upper Jurassic – Lower Cretaceous Frederikshavn Formation is present in the north eastern part of the Norwegian-Danish Basin and reaches a maximum thickness of more than 230 m in the Sorgenfrei-Tornquist fault zone (Figure 4). Local faults and salt tectonics mainly control thickness variations.

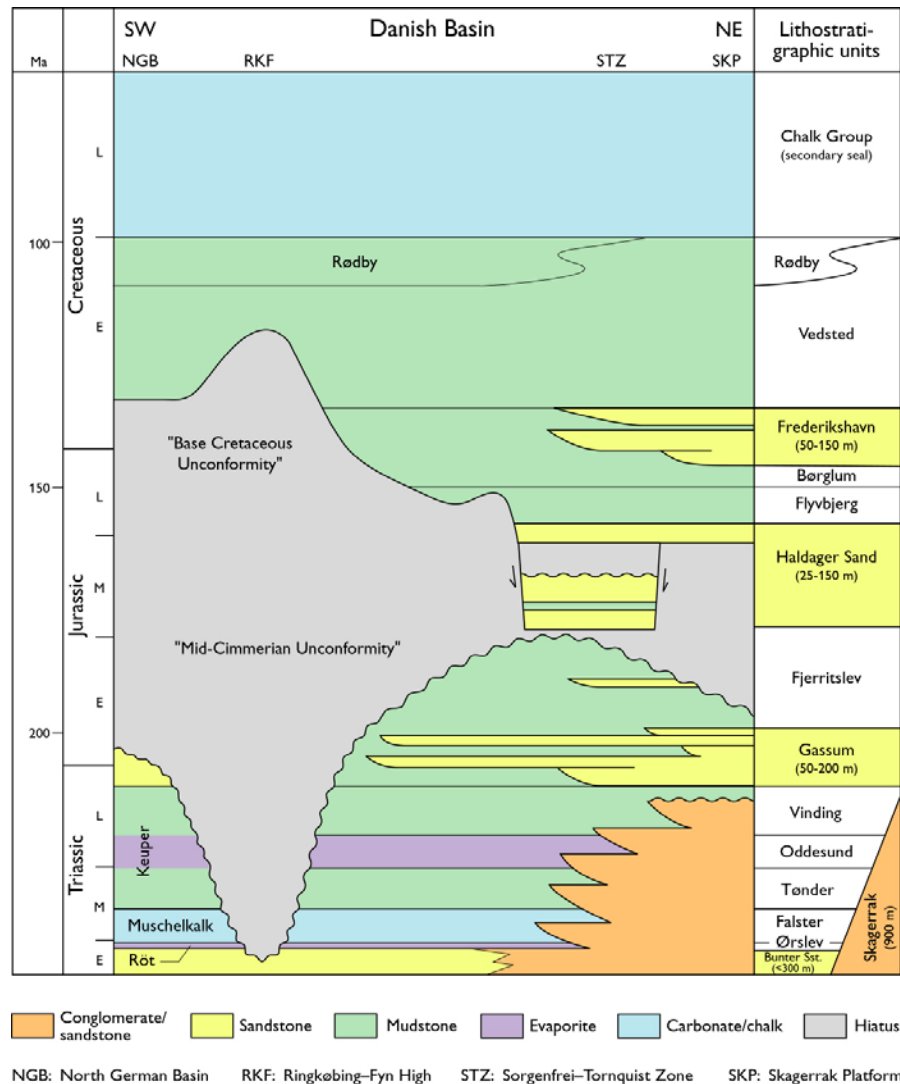

Figure 3: A schematic time-stratigraphic cross-section covering the Triassic–Cretaceous time period and trending SW–NE across the Danish area from the Northern flank of the North German Basin (SW), the Ringkøbing-Fyn High, the Danish Basin, the Sorgenfrei-Tornquist Zone to the Skagerrak-Kattegat Platform (NE). The diagram illustrates the preserved stratigraphy of the area. The colour code illustrates the various lithologies, the right column displays the lithostratigraphic units, and the formations with potential sandstone reservoirs are indicated by yellow colour. Based on Bertelsen 1980, Michelsen et al. 2003 and Nielsen 2003.

## 2.2 Formations with sealing properties

Geological formations in Denmark with sealing properties are lacustrine and marine mudrocks with a large clay content, evaporites and carbonates. The most important

sealing rock type in the Danish area is marine mudstones, which is present at several stratigraphic levels (figure 3).

South of the Ringkøbing-Fyn High the fine-grained Lower Triassic Ørslev Formation forms the primary seal for the Bunter Sandstone Formation in the Rødby and Tønder structures (Bertelsen 1980). The primary seal for the Skagerrak Formation in the Thisted structure is the Upper Triassic Oddesund Formation composed of calcareous, anhydritic claystones and siltstones intercalated with thin beds of dolomitic limestone. The marine mudstones of the Upper Triassic Vinding Formation form a secondary seal for the Bunter Sandstone Formation in the North German Basin and may function as a primary seal for the Skagerrak Formation in some parts of the Norwegian-Danish Basin.

Marine mudstones of the Lower Jurassic Fjerritslev Formation form the primary sealing unit for the Gassum Formation. The formation overlies and locally interfinger with the sandstones of the Gassum Formation. The formation is present in most of the Norwegian-Danish Basin with a thickness of up to 1000 m, although this varies significantly due to mid-Jurassic erosion.

North of the Ringkøbing-Fyn High the marine mudstones of the Børglum Formation makes the primary sealing formation for the Haldager Sand Formation. The marine mudstones of the lower Cretaceous, Vedsted and Rødby Formations, forms the primary sealing formations for the Frederikshavn Formation.

In most of the Norwegian-Danish Basin a 0.5 to 2 kilometres thick succession of mainly low-permeable carbonate rocks of Late Cretaceous – Danian age constitutes a possible secondary seal onshore and in the Kattegat area. The sealing effect is, among others, dependent on chemical reactions between dissolved CO<sub>2</sub> and the carbonate rock.

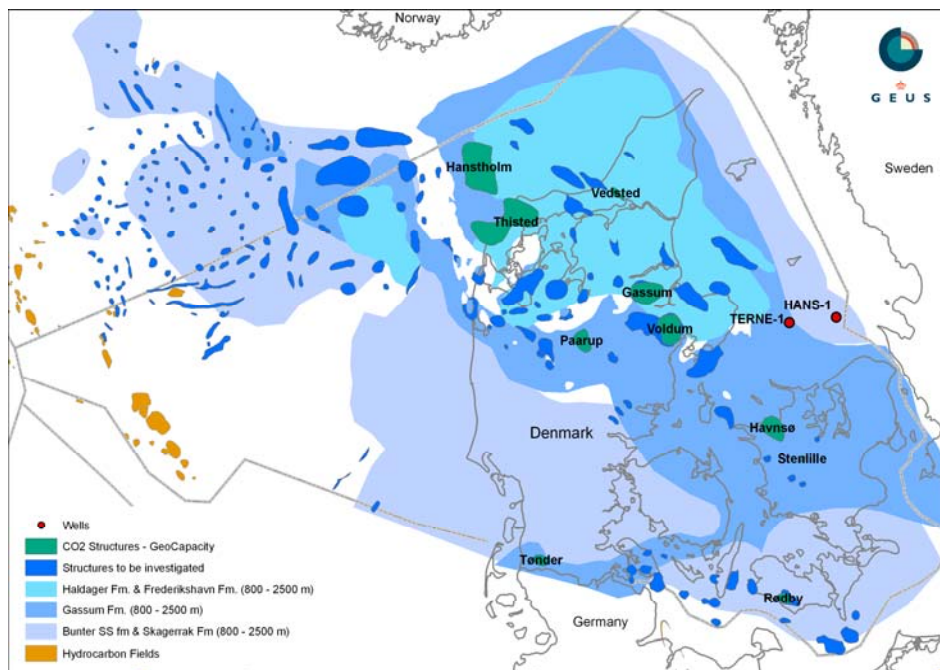

Figure 4: The distribution of Danish geological formations in the depth interval 800 – 2500 meters which is considered the most optimal for CO<sub>2</sub> injection. Geological structures related to salt movement form domes and diapirs.

### 2.3 Areas with promising prospective for CO<sub>2</sub> storage

In order to gain public and political acceptance, structural traps are considered essential, when considering storage in Denmark. Storing CO<sub>2</sub> in defined geological structures in the subsurface allows continuous monitoring of the injected CO<sub>2</sub> and eventually meets the demand for future recovery of all or parts of the injected gas (Larsen *et al.* 2003).



The majority of the individual structures with potential for CO<sub>2</sub> storage are related to movement of the Zechstein salt (figure 5). The salt movement has caused formation of a wide range of structures from gentle domes to diapirs. The dome structures most often form anticlines with 4-way closures and lack of significant faulting. The diapir structures on the contrary breaks through the overlaying deposits and faults accompany the salt structures. It might be possible to find traps with storage potential related to the diapirs and side-sealed by the salt, but investigation and mapping is complicated by disturbance of the seismic signals close to the salt structures. A few structures are related to faulting, for example the Vedsted Structure, these structures may have 2, 3 or 4 way closures (figure 5).

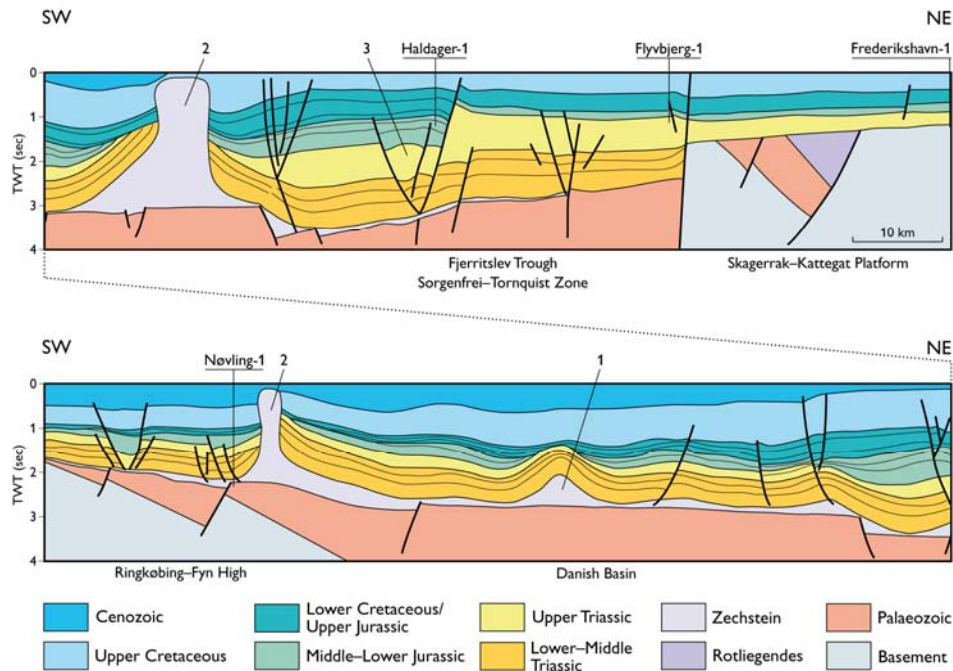

Figure 5: Cross-section trending SW–NE across the Danish area from the Ringkøbing-Fyn High (SW) to the Skagerrak-Kattegat Platform (NE). Position of the cross-section is shown on figure 2. The section illustrates the variation of the salts structures ranging from gentle four-dip dome closures with a fully preserved overlying sedimentary column to salt diapirs penetrating most of the Mesozoic succession. The Danish area has several large dome structures with preserved reservoirs and cap rocks. 1) Soft dome structure, 2) Diapirs, 3) Fault related structure (The Vedsted structure). Modified from Vejrbæk 1990, 1997.

In the GeoCapacity project a number of structures were selected and evaluated with regards to the possibility for CO<sub>2</sub> storage (figure 4). The selected structures are mainly identified on the basis of old seismic data, and in case of future utilization, the structures will need further investigations and qualification based on new seismic data and wells. The data suggest that the structural traps alone may provide storage for at least 16Gt CO<sub>2</sub> assuming that the effective storage capacity is 40% of the total pore volume within the structure. Unfaulted, thick units of claystones or evaporites seal the traps (Larsen *et al.* 2003).

Apart from the ten structures described in the GeoCapacity project many other geological structures within the Danish territory may prove suitable for CO<sub>2</sub> storage (figure 4). Especially in the eastern part of the Norwegian-Danish Basin and close to the Sorgenfrei-Tornquist Zone where the sedimentary succession is extensive, the potential for CO<sub>2</sub> storage seems to be promising.

The potential for CO<sub>2</sub> storage is limited at the Skagerrak-Kattegat platform area because of a thin sedimentary cover. However close to the Sorgenfrei-Tornquist Zone the

Haldager Sand Formation gain an increased thickness and the Gassum Formation reaches a maximum of more than 350 metres in this trend (e.g. Hans-1 and Terne-1 wells). Zechstein salt is not present at the Skagerrak-Kattegat platform area (Michelsen & Nielsen, 1991) and salt induced structures are therefore absent, but the zone is strongly block-faulted and fault blocks with Skagerrak Formation, Gassum Formation or Haldager Sand Formation may form potential structures for CO<sub>2</sub> storage.

The annual emission from large point sources in Denmark roughly corresponds to the volume of natural gas produced from the Danish part of the North Sea, which amounts to 10 billion m<sup>3</sup> (Frykman 2009), which is transported in pipe lines and tankers and processed at plants and refineries. The comparable size of the potential volume of CO<sub>2</sub>, to be moved around at surface and injected into the subsurface (although compressed to smaller volumes at depth), points to the large scale at which a CCS-related processing and transporting industry has to be established.

### **3 CO<sub>2</sub> storage in the near future – possibilities and challenges**

Research projects concerning CCS in Europe have gradually increased in numbers through the last 10 – 15 years. These projects seek to close the gaps in knowledge and reduce costs on capture, transport and storage. One of the obvious possibilities in an initial phase of establishing a CCS infrastructure is to use the limited amounts of available CO<sub>2</sub> for enhanced oil/gas recovery. Many oil and gas fields in Europe experience declining production rate and using CO<sub>2</sub> for EOR/EGR in depleting oil and gas fields has proven successful in e.g. USA and Hungary. One of the research projects addressing the opportunity to use CO<sub>2</sub> being produced from power plants and other industries in Europe for enhanced hydrocarbon production (EOR/EGR) is the ECCO project (European Value Chain for CO<sub>2</sub>), where results will be available in autumn 2011. The results will comprise strategies and recommendations regarding deployment of the CO<sub>2</sub> infrastructure in the near- and mid-term future, liability issues and cross-border regulations, Emission Trading Schemes (ETS), financing schemes, and regime of incentives, and organization of the supply chain.

In a later stage, when an initial infrastructure is established and the amount of CO<sub>2</sub> from increasing numbers of capture facilities has exceeded the amount required for enhanced oil and gas recovery (EOR/EGR), CO<sub>2</sub> storage in aquifers can be the next step. Aquifer storage has large potential although it will take time and economic resources to carry out more detailed surveys of promising geological formations and structures. Geoscience and geo-engineering will play a major role in the analysis of the geological foundation, the assessment of site performance, and will be critical in securing the safety of the operations.

In Denmark the subsurface has ability to store large amounts of CO<sub>2</sub> and almost the whole Danish territory has suitable reservoir formations within the optimal depth interval of 800 – 2500m. So far only 10 geological structures have been evaluated but many structures and formations will possibly reveal increased storage volume if investigated more intensively. Thus, geological storage of CO<sub>2</sub> may contribute considerably to the reduction of the Danish CO<sub>2</sub> emission, if we can be assured about safety issues, and if political and public acceptance can be obtained.

#### **References**

- Bertelsen, F. 1980. Lithostratigraphy and depositional history of the Danish Triassic. Geological Survey of Denmark. Series B 4, 59 pp.
- Christensen, N.P. & Holloway, S. 2004. Geological storage of CO<sub>2</sub> from combustion of fossil fuel. European Union Fifth Framework Programme for Research and

Development. Project no. ENK6-CT-1999-00010. The GESTCO project - Summary report - Second edition. European Union. 17 pp.

- Frykman, P., Nielsen, L.H., Vangkilde-Pedersen, T. & Anthonsen, K.L. 2009. The potential for large-scale, subsurface geological CO<sub>2</sub> storage in Denmark. *Geological Survey of Denmark and Greenland Bulletin* 17, 13–16.
- Holloway, S., Heederik, J.P., van der Meer, L.G.H., Czernichowski-Lauriol, I., Harrison, R., Lindeberg, E., Summerfield, I.R. Rochelle, C., Schwarzkopf, T., Kaarstad, O. & Berger, B. 1996. The underground disposal of Carbon Dioxide. Joule II project No. CT92-0031, summary report.
- Nielsen, L.H. 2003. Late Triassic – Jurassic development of the Danish Basin and the Fennoscandian Border Zone, southern Scandinavia. In: Ineson, J.R. & Surlyk, F. (Eds.) *The Jurassic of Denmark and Greenland. Geology of Denmark Survey Bulletin* 38.
- Michelsen, O. & Nielsen, L.H. 1991. Well records on the Phanerozoic stratigraphy in the Fennoscandian Border Zone, Denmark. Hans-1, Sæby-1, and Terne-1 wells. 37 pp.
- Michelsen, O., Nielsen, L.H., Johannessen, P.N., Andsbjerg, J. & Surlyk, F. 2003. Jurassic lithostratigraphy and stratigraphic development onshore and offshore Denmark. In: Ineson, J.R. & Surlyk, F. (Eds.) *The Jurassic of Denmark and Greenland. Geology of Denmark Survey Bulletin* 38.
- Vangkilde-Pedersen, T., Anthonsen, K.L., Smith, N., Kirk, K., Neele, F., Van der Meer, B., Gallo, Y.L., Bossie-Codreanu, D., Wojcicki, A., Nindre, Y.L.L., Hendriks, C., Dalhoff, F., & Christensen, N.P. 2009. Assessing European capacity for geological storage of carbon dioxide—the EU GeoCapacity project. *Energy Procedia* 1, 2663-2670.
- Vejbæk, O.V. 1990: The Horn Graben, and its relationship to the Oslo Graben and the Danish Basin. *Tectonophysics* 178, 29–49.
- Vejbæk, O.V., 1997. Dybe strukturer i danske sedimentære bassiner. *Geologisk Tidsskrift*, 4: 1-31.



# Long-term modelling of Carbon Capture and Storage, Nuclear Fusion, and large-scale District Heating

Poul Erik Grohnheit, Søren B. Korsholm, Mikael Lüthje,  
Risø National Laboratory for Sustainable Energy, Technical University of Denmark.

## Abstract

Among the technologies for mitigating greenhouse gasses, carbon capture and storage (CCS) and nuclear fusion are interesting in the long term. In several studies with time horizon 2050 CCS has been identified as an important technology, while nuclear fusion cannot become commercially available before 2050. The modelling tools developed by the International Energy Agency (IEA) Implementing Agreement ETSAP include both multi-regional global and long-term energy models till 2100, as well as national or regional models with shorter time horizons. Examples are the EFDA-TIMES model, focusing on nuclear fusion and the Pan European TIMES model, respectively. In the next decades CCS can be a driver for the development and expansion of large-scale district heating systems, which are currently widespread in Europe, Korea and China, and with large potentials in North America. If fusion will replace fossil fuel power plants with CCS in the second half of the century, the same infrastructure for heat distribution can be used which will support the penetration of both technologies. This paper will address the issue of infrastructure development and the use of CCS and fusion technologies using the available models among the ETSAP tools.

## 1 Introduction

The modelling tools developed by the International Energy Agency (IEA) Implementing Agreement ETSAP include both multi-regional global and long-term energy models till 2100, e.g. the EFDA-TIMES model, focusing on nuclear fusion, and national or regional models with shorter time horizons, e.g. the Pan European TIMES model.

*Section 2* describes the modelling issues for heat recovery from carbon capture to compensate for the significant loss of efficiency in fossil fuel plants equipped with facilities for carbon capture. This requires modelling of the infrastructure for large-scale district heating. In addition, the steam parameters for fusion – with temperatures in the range 600-800°C – are similar to those for advanced coal or combined cycle gas turbines. This is suitable for large-scale combined heat and power (CHP), similar to conventional steam turbines that are located for connection to large-scale urban grids for heat distribution.

*Section 3* describes the full range of technologies for carbon capture and storage (CCS). The most critical parameter for modelling of CCS is the loss of thermal efficiency during carbon capture. For example, the electricity efficiency of modern coal-fired steam turbines is reduced from 46 % to 36 %.

*Section 4* summarise the characteristics of fusions power and the stages of the research and development referring to the conceptual studies for assessing the cost and performance for future fusion power plants.

*Section 5* summarises the key issue of this paper: Using the same urban heat distribution infrastructure to support both traditional and emerging technologies.

*Section 6* describes the structure and key input parameters for the selected model and selected illustrative results for Europe.

Finally, *Section 7* summarises the main conclusions for the dynamic development of technologies and infrastructure. The new technologies may benefit from infrastructure, which was developed for other purposes.

The quantitative analysis combines elements from four of the articles in the recent Risø Energy Report issued in November 2009, on CCS (Lüthje, 2010), nuclear energy (Rasmussen et al., 2010), energy scenarios (Karlsson et al, 2010), and system aspects (Wagner et al., 2010).

## **2 Large-scale district heating**

Cogeneration or combined heat and power (CHP) is a very important technology in technology-rich energy flow optimisation models that are used to model the mix of technologies to meet future demands for energy services or materials from energy intensive industrial processes.

The network for transmission and distribution of electricity is a mature infrastructure all over the developed world. The networks are difficult to model without a detailed geographical representation, so the further development of this infrastructure may be neglected in these models. Investments in new electricity transmission network is needed mainly to support large-scale deployment of resource-dependent technologies, e.g. hydro power, solar power located in deserts or wind power. Existing grids for large-scale heat transmission only exist in few city regions supplies by urban waste incineration and fossil fuel CHP plants, so further expansion of large-scale CHP also requires investments in district heating grids, except for industrial CHP.

In some multi-regional TIMES models trade between regions is modelled by transport costs and capacity limits of pipelines or interconnectors, but trade within regions can be made only for grids that are aggregated into a single point, to which costs and capacity limits are assigned.

To model district heating supply from large power stations it is necessary to introduce heat transmission as a technology for endogenous investment assuming a flow efficiency and cost (investment and annual operation) per unit of annual flow. Preliminary model runs show that investment cost in the range €25-50 per GJ annual flow will lead to results that may be used to illustrate the competition among heat supply options.

## **3 Carbon Capture and Storage**

### **3.1 CCS technology**

CCS is a way to reduce the amount of CO<sub>2</sub> released by large industrial plants burning fossil fuels. Most or potentially all of the CO<sub>2</sub> present in the flue gas can be captured, after which it is compressed and pumped into geological reservoirs, onshore or offshore, for long-term storage. The CO<sub>2</sub> storage possibilities worldwide are very large, but current estimates vary significantly.

The main cost of CCS lies in the capture stage, both in the capital cost of the CCS equipment and especially the loss in efficiency of the power plant. The costs of transport and storage, while substantial, are smaller. The overall cost of CCS is estimated at €60–90/t CO<sub>2</sub> during the demonstration phase, falling to € 35-50/t CO<sub>2</sub> during the early commercial phase (2020-2030) and to €30-45/t CO<sub>2</sub> after 2030, once the technology is commercially mature. All prices are per tonne of CO<sub>2</sub> abated. (Metz et al., 2005; McKinsey & Co., 2008). All these costs are on top of the original cost of electricity, and whether CCS is economic depends on the future price of CO<sub>2</sub>. At present, low CO<sub>2</sub> prices make CCS demonstration projects too expensive, so extra funding is required (Figure 1).

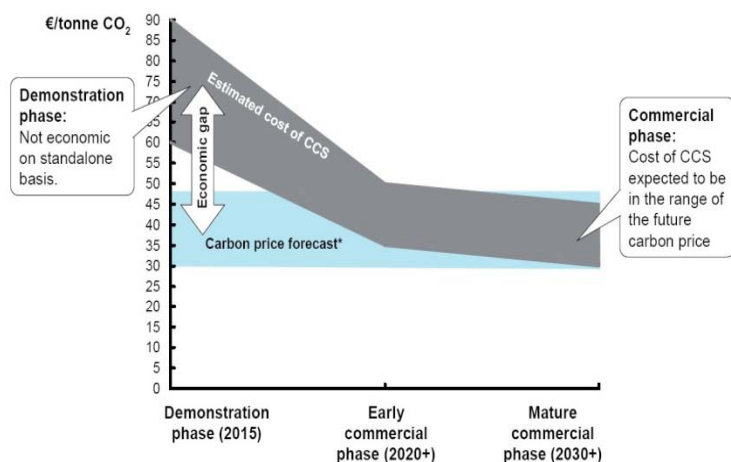

Figure 1. Estimated development of the cost of CCS (McKinsey & Co., 2008)

The technologies for the individual steps in CCS already exist and the geological storage capacity for large-scale implementation exists. The International Energy Agency estimates that CCS could reduce the worldwide emissions by 10 Gt CO<sub>2</sub>/y, and that the cost of achieving climate stability<sup>1</sup> by 2050 would be at least 70% higher without CCS (International Energy Agency, 2008). This number could be even larger as found in Lüthje et al., 2011. In the future, CCS fitted to biomass-fired power and industrial plants could be used to decrease the atmospheric concentration of CO<sub>2</sub>.

### 3.2 CCS modelling in TIMES

The various TIMES models contain techno-economic parameters that quantify expectations on gradually increased efficiencies and lower costs during the next three to four decades. The most critical parameter is the loss of thermal efficiency during carbon capture. For example, the efficiency of modern coal-fired steam turbines (pulverised coal, PC) will be reduced from 46 % to 36 %. Similar reductions apply to Integrated Gasification Combined Cycle (IGCC) and Natural Gas Combined Cycle (NGCC). This will improve in the future for both with and without CCS, and for some of the variants of CCS technologies the difference may be reduced. Table 1 shows the assumptions chosen for quantitative modelling.

<sup>1</sup> 50% reduction in CO<sub>2</sub> emissions, compared to 2005, by 2050.

Table 1. Efficiencies for new large gas and coal fired power plants and the same technologies with CCS (Fidje et al.,2010).

		2010	2020	2030	2040
<i>Reference plants</i>	NGCC	58.0	60.0	63.0	64.0
	PC	46.0	50.0	52.0	52.0
	IGCC	46.0	50.0	54.0	56.0
<i>Post combustion, capture rate 85 %</i>	NGCC	49.0	52.0	56.0	58.0
	PC	36.0	42.5	45.0	46.0
<i>Pre combustion, capture rate 85 %</i>	IGCC	38.0	44.0	48.0	50.0
<i>Oxyfuelling plants, capture rate 94 %</i>	NGCC	48.1	50.1	51.6	52.1
	PC	38.0	40.5	43.0	44.0

Although cogeneration technologies for both district heating and industrial processes has been a key issue for the MARKAL and TIMES models, the use of combined heat and power (CHP) has not been systematically studied together with CCS. A large part of the energy lost in the carbon capture process could be recovered for heat to supply large-scale district heating systems or industrial processes and thereby increase the overall efficiency. Taking into account the infrastructure requirements for CCS with long-distance transport of captured CO<sub>2</sub> there are significant economies of scale when developing this technology. It means that small-scale CHP and distributed electricity, which works well with biomass, is not very interesting together with CCS.

Although the market for space heating may decrease in the future, because of better insulation of buildings and warmer climate, the market for space cooling may increase dramatically all over the world.

## 4 Fusion power

Fusion energy is the energy of the sun and the stars, and it is released when light atoms fuse together. Fusion energy research has been conducted since the mid 20<sup>th</sup> century and is now nearing power plant size experiments. Different concepts to achieve the goal of fusion power plants exist (Rasmussen et al., 2010), while the most coherent and promising concept being that of magnetic confinement as that of ITER.

ITER is the world's largest energy research facility, It is currently under construction in Southern France in a collaboration encompassing China, EU, India, Japan, Korea, Russia, and USA. ITER – “the way” in latin – is closing the gap between fundamental fusion science experiments such as the European JET and an energy producing fusion power plant. The construction of ITER will finish in 2020, and with the scheduled phased approach it will be fulfilling its main target in 2026 producing 500 MW of power while requiring only 50 MW heating power to keep the fuel at operating temperature – i.e. it will demonstrate the practicality of copying the fusion processes of the Sun in a power plant. ITER will be succeeded by DEMO, which will be a prototype power plant producing electricity for the grid. DEMO should be online in the mid to late 2030s, which will allow for the first fusion power plants to commence operation by the middle of the century. Conceptual power plant studies (Maisonnier et al, 2007) predict unit sizes of approx 4 GW thermal and 1.5 GWe.

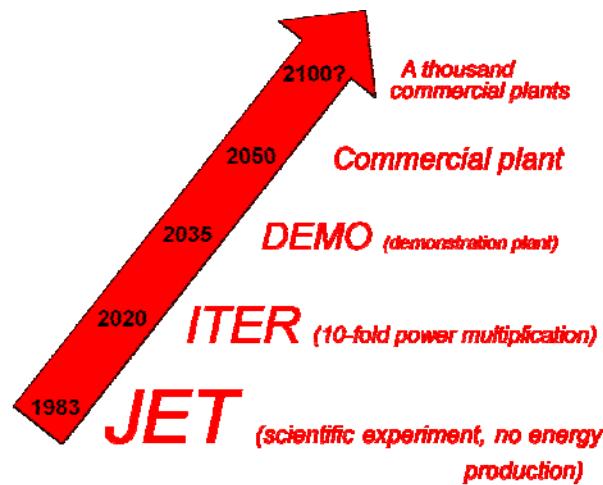

Figure 2 Timeline from the fusion science experiment JET to commercial fusion power plants.

The fuel for fusion power plants is the two hydrogen isotopes, deuterium (D) and tritium (T). D is found abundantly in seawater, and can be extracted from this at a relatively low (energy) cost. The energy of the chemical bonds that is broken when extracting D is approx 1 million times lower than the energy gained by the nuclear fusion reaction. T is radioactive and is thus not found readily in nature. T is produced at the fusion power plant from lithium (Li). Hence the fundamental resources for fusion energy production are D (from sea water) and Li (from mining). The scarcest resource of the two is Li, but could still provide mankind with all required energy for 10,000+ years. The energy density of fusion energy fuel is very high. Merely 10 gram D and 15 gram T would supply a European with energy for a life time. Hence, the cost of electricity is practically not dependent on the fuel price, while it will reflect the write-off of the capital investment of the construction of the power plant. This investment will be significant, and although a power plant could not readily be built, projections predict the energy price to be competitive to most other alternative carbon-free energy technologies. (Maisonnier et al., 2007)

Fusion energy does not leave any long lived radioactive waste, as the waste is the inner parts of the power plant itself. 100 years after a power plant shutdown the components can be handled and recycled. A fusion power plant is inherently safe e.g. because the amount of fuel in the reactor at any instant is in the order of a few grams – enough for only seconds of burn. Fusion power plants could thus be placed close to densely populated areas.

## 5 Heat distribution infrastructure supporting old and new technologies

Fossil fuel plants with CCS and heat recovery may be a driver for the development and expansion of large-scale district heating systems, which are currently widespread in Northern and Eastern Europe, Korea and China, and with large additional potentials in North America. These systems need several decades for development, mainly by interconnection of existing smaller grids. If fusion will replace CCS in the second half of the century, the same infrastructure for heat distribution can be used, which will support the penetration of both technologies.

In addition, district heating systems with CHP and heat storages offer some of the flexibility in electricity generation that is required for wind power and other intermittent electricity generation.

In contrast to current nuclear fission with light water reactors, which operate at relatively low temperatures, the steam parameters for fusion – with temperatures in the range 600-800°C – are similar to advanced coal or combined cycle gas turbines. This is suitable not only for CHP, but also other types of co-generation, e.g. catalytic hydrogen generation.

## 6 Modelling

### 6.1 The EFDA-TIMES model on fusion energy

As a part of the research under the European Fusion Development Agreement (EFDA) there is a small programme on Socio-Economic Research on Fusion (SERF). This includes the EFDA-TIMES model, which was originally developed for EFDA by an external consortium of experts and delivered in 2004. The motivation for this development was that fusion power was not considered in existing long-term energy scenarios, and that the earlier energy scenario studies within EFDA only considered Western Europe or used a basic single-region global model. The structure and data of the EFDA-TIMES model came from the SAGE<sup>2</sup> model, which has been used by the US Department of Energy for their International Energy Outlook from 2002 to 2008.

The current development and use of the EFDA-TIMES model considers a validation and benchmarking phase for EFDA-TIMES and joint contributions to international energy modelling conferences

### 6.2 EFDA-TIMES with large-scale CHP

To understand the cost of electricity and heat from cogeneration and the impact of the recent technical development it is necessary to describe a set of techno-economic parameters, which are derived from the thermodynamics of generation of electricity.

Figure 3 shows the operating area for CHP units. Back-pressure units produce along the back-pressure line. Extraction-condensing unit produces within the maxima and minima for power and heat. The vertical axis represents condensing (electricity-only) capacity.

The iso-fuel line describes the power-loss ratio. A typical value for both traditional and modern units is  $c_v=0.15$ . Typical values for the power-heat ratio are  $c_m=0.5$  for a traditional gas turbine,  $c_m=0.7$  for a large modern extraction-condensing unit, and  $c_m=1.0$  or more for a modern combined-cycle gas turbine for decentralised CHP.

Figure 3 usually describes the operation area for electricity and heat production in individual extraction-condensing units. For decades these units in the capacity range 250-500 MW have been the most important type of electricity generating units in Denmark, which have been systematically located at the heat distribution grids of the larger cities.

---

<sup>2</sup> System to Analyze Global Energy

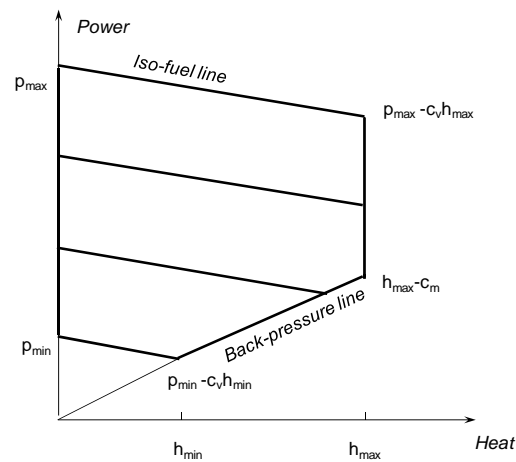

Figure 3. CHP parameters (source: Grohnheit, 1993)

However, for modelling purposes the figure can represent an aggregation of units serving a national electricity system and aggregations of district heating systems, using a set of constraints on heat flows in time-slices (i.e. seasonal and diurnal break-downs of the year). The coupled production of aggregated electricity and heat may be flexible within certain limits, in particular to meet increasing electricity demand or reduced wind production. The reduced heat supply to the district heating system can be met by peak-load boilers or heat storages.

### 6.3 CHP as virtual heat pumps

A further interpretation of the parameters in Figure 3 is to consider heat production by CHP as a virtual heat pump. It means that part electricity generated in condensing mode is converted into heat at an efficiency factor that is the inverse of the power-loss ratio. Instead of operating a physical heat pump by electricity, part of the steam in the turbine is sent to a heat exchanger and the district heating network rather than the low-pressure turbine and the power generator.

Interpreting CHP as virtual heat pumps makes it much easier to integrate CHP and heat supply from power stations with CCS into a heat market, where also individual heat pumps become increasingly important (Orchard, 2010; Grohnheit, 2010). The various heat supply technologies will compete on efficiencies, fuel price and requirement for investment in house installation as well as city-wide infrastructure.

Table 2. CHP as “virtual heat pumps”

Technology	Power-loss-ratio	Efficiency factor
Electricity driven heat pump	n.a	3
Nuclear CHP	0.25	4
Coal/gas CHP; Fission Gen. IV and Fusion.	0.15	7
Low-temperature DH	n.a.	10
Conservative average for heat transmission	n.a.	5
CCS with heat recovery	n.a.	n.a.

## 6.4 Model results from EFDA-TIMES

In the latest work programmes of EFDA-TIMES the work has focused on sensitivity analyses. One of these analyses was aimed at identifying combinations of assumptions that will allow biomass and CCS to play a significant role by 2050 and later (Grohnheit, 2011). Figure 4 shows selected results from this analysis. The presentation is limited to Europe, which is the sum of the EFDA-TIMES regions WEU and EEU. In addition to the Base Scenario, an scenario combining constraints on the share of nuclear fission (maximum 25% of electricity generation in each region) and the global limit of CO<sub>2</sub> emissions to 450 ppm. The latter constraint is applied for numerous scenario analyses.

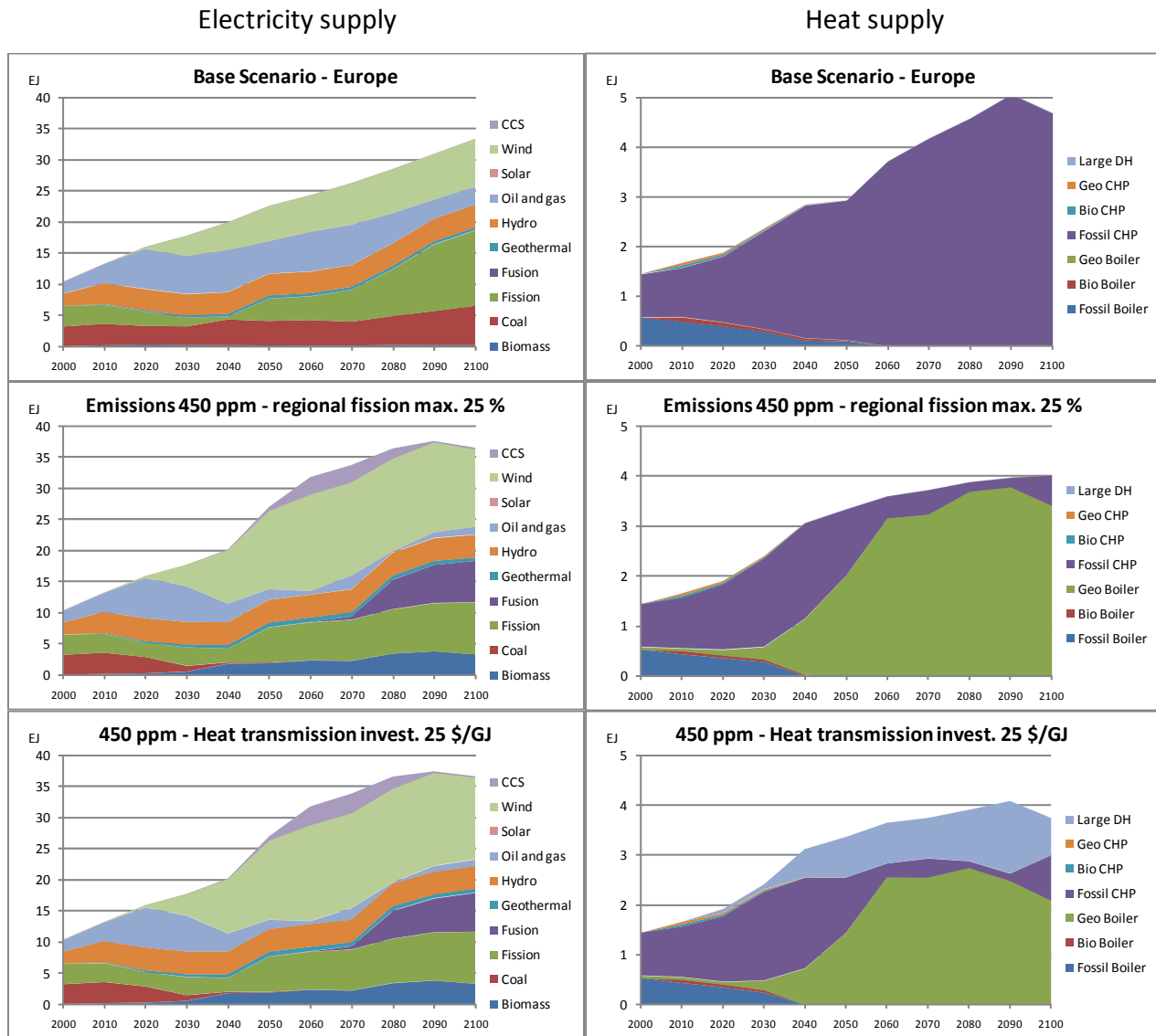

Figure 4. EFDA-TIMES results for electricity and heat supply in Europe 2000-2100. Base Scenario and two scenarios with emission constraints.

An additional scenario is added introducing a technology that represents the heat transmission and distribution infrastructure using a very aggregate parameter for investment costs at 25 \$/GJ annual flow. The choice of investment cost is based on a



parameter study, showing that the infrastructure technology would not enter into the solution at much higher costs.

Without further modification of the model the results for the electricity supply (Figure 4, left) shows the option for large scale heat supply by has little impact on the mix of electricity supply. However, there is a measurable increase in fossil generation with CCS.

In contrast, the impact on the mix of heat supply technologies is more significant (Figure 4, right). Large-scale district heating enters into the solution from about 2020. Geothermal heat becomes the dominant technology for heat supply in the model results when CO<sub>2</sub> is constrained to 450 ppm. However, this technology is very dependent on infrastructure matching geothermal resources and the market for heat at 100-200 °C. So far, this infrastructure has not been considered in the model development.

Globally, the increase in energy demand is much higher than for Europe, which will allow fusion to play a larger role by the end of the century, if left unconstrained. The global results are highly influenced by the huge growth in the large developing regions, China and India. These results show clearly that much more elaborate constraints are needed to reflect the physical structure and possible infrastructure development. This issue also applies for the TIAM model.

## 7 Conclusion

Both CCS and fusion may benefit from infrastructure already developed for other purposes. In the next decades CCS can be a driver for the development and expansion of large-scale district heating systems, which are currently used for distribution of heat from fossil-fuel combined heat and power and urban waste incineration. If fusion will replace CCS in the second half of the century, the same infrastructure for heat distribution can be used, which will support the penetration of both technologies.

## References

- Grohnheit, P. E. (1993), Modelling CHP within a national power system. *Energy Policy*, Vol. 21, No. 4, p. 418-429.
- Grohnheit, Poul Erik (2010), Modelling CCS, Nuclear Fusion, and large-scale District Heating in EFDA-TIMES and TIAM. Regular ETSAP Workshop, 16 November 2010, Cork, Ireland.. [http://www.iea-etsap.org/web/Workshop/Cork\\_11\\_2010/ETSAP\\_Cork\\_Grohnheit\\_v2.pdf](http://www.iea-etsap.org/web/Workshop/Cork_11_2010/ETSAP_Cork_Grohnheit_v2.pdf)
- Grohnheit, Poul Erik (2011), IEA-ETSAP TIMES models in Denmark - Preliminary Edition, Risø-R-1774(EN), <http://130.226.56.153/rispubl/reports/ris-r-1774.pdf>
- IEA (2008),. *Energy Technology Perspectives 2008 – Scenarios and Strategies to 2050*.
- Karlsson, Kenneth; Balyk, Olexandr; Morthorst, Poul Erik; Labriet, Maryse (2010), Energy scenarios for Denmark and Europe. In: Larsen, Hans; Petersen, Leif Sønderberg (Eds.) *Risø Energy Report 9. Non-fossil energy technologies in 2050 and beyond*. Risø-R-1729(EN) pp. 15-21.
- Lüthje, Mikael (2010), Carbon capture and storage. In: In: Larsen, Hans; Petersen, Leif Sønderberg (Eds.) *Risø Energy Report 9. Non-fossil energy technologies in 2050 and beyond*. Risø-R-1729(EN), pp. 67-70.
- Lüthje, M., K. Karlsson, J. Gregg, T. H. Y. Føyn, O. Balyk. The role of biomass and CCS in China in a climate mitigation perspective, accepted for publication in *Risø International Energy Conference 2011*.

- Maisonnier, D., et al. (2007), Power plant conceptual studies in Europe. EFDA CSU Garching, et al.
- McKinsey & Co.(2008),, Carbon Capture & Storage: Assessing the Economics.
- Metz, B., O. Davidson, H. C. de Coninck, M. Loos, and L. A. Meyer (eds.), (2005), IPCC Special Report on Carbon Dioxide Capture and Storage. Cambridge University,
- Orchard, William (2010), Why heat from combined heat and power (chp), vilnius three, is as renewable as heat from electric heat pumps. A marginal analysis for fuel allocation to electricity and heat. 11th IAEE European Conference, "Energy, Economy, Policies and Supply Security: Surviving the Global Economic Crisis", Vilnius 25-28 August 2010.
- Rasmussen, Jens Juul; Lauritzen, Bent; Martiny, Lars Nonbøl, Erik; Hutchinson, Ian; Zohm , Hartmut, (2010), Nuclear energy. In: Larsen, Hans; Petersen, Leif Sønnderberg (Eds.) Risø Energy Report 9. Non-fossil energy technologies in 2050 and beyond. Risø-R-1729(EN) pp. 61-65..
- Fidje, A., K. Espegren, M. Wangen, P. Seljom, A. Ramírez, R. Hoefnagels, Z. Wu, M. van den Broek, N. Strachan, M. Blesl, T. Kober, P. E. Grohnheit, and M. Lüthje. Storage Utsira. Analysis of potentials and costs of storage of CO<sub>2</sub> in the Utsira aquifer in the North Sea. Final Report for the FENCO ERA-NET project, 2010.. [https://www.fenco-era.net/Storage\\_Utsira](https://www.fenco-era.net/Storage_Utsira)
- Wagner, Ulrich; Schock, Robert; Larsen, Hans; Petersen, Leif Sønnderberg (2010), System aspects. In: Risø DTU In: Larsen, Hans; Petersen, Leif Sønnderberg (Eds.) Risø Energy Report 9. Non-fossil energy technologies in 2050 and beyond. Risø-R-1729(EN) pp. 71-76.

## **Session 2D – Economic Planning for a Low-carbon Society**

# Efficiency and effectiveness of promotion systems for electricity generation from renewable energy sources – An update on lessons learned from EU countries

Reinhard HAAS, Gustav RESCH, Christian PANZER, Sebastian BUSCH

Energy Economics Group, Vienna University of Technology, Austria

E-mail: Reinhard.Haas@tuwien.ac.at

Mario RAGWITZ

ISI, Fraunhofer Institut für System und Innovationsforschung, Karlsruhe

## Abstract

Currently, a wide range of strategies is implemented in different countries to increase the share of electricity from renewable energy sources (RES-E). The still most controversial discussion is whether trading-based quotas or technology-specific instruments – like feed-in tariffs (FIT) or the Spanish premium system – lead to preferable solutions for society. The core objective of this paper is to extract the lessons learned from European countries and to discuss the future perspectives of promotion schemes to ensure an efficient and effective further increase of RES-E.

The method of approach applied is based on a formal framework analysing the economic performance of the programmes from societies points-of-view in comparison to the capacities deployed.

The major results of this analysis are:

The most important results and conclusions of this analysis are: (i) The success stories of growth in RES-E in EU member states in recent years has been triggered by FITs. A well-designed (dynamic) FIT provides a certain deployment of electricity generated from Renewable Energy Sources (RES-E) fastest and at lowest costs for society; (ii) yet regarding future prospects for premium systems so far the perception from Spain is that it rather leads to higher costs for society; (iii) certificate-based trading systems in recent years have eroded gradually: they have come closer and closer to FIT (like in UK or Belgium) or lost some of their attractiveness due to continuously lower performance as in Sweden; (iv) one major reason for this is that promotion strategies with low policy risk lead to lower profit requirements by investors and, hence, cause lower costs for society.

## 1 Introduction

In Europe the European Union has set ambitious targets for increasing the share of renewable energy sources for electricity generation (RES-E) since the late 1990s, see e.g. EC [1], EC [2], Resch et al [3] and Johnston et al [4]. To meet these targets the implementation of proper financial support systems is necessary. In this context a still controversial discussion is whether quantity-driven – like Tradable Guarantee-of-Origin Certificates (TGCs) based on quotas – or price-driven (like feed-in tariffs (FIT)) instruments lead to preferable solutions for society. Major pros and cons of support systems have been evaluated e.g. by [7], [8], [9], [10], [11], [12], [13].

The most important issue in the current discussion is the request for a more or less European wide TGC system to promote RES-E, see e.g. EWI [14], or Midtun [15]. This discussion appears to be odd at least because of the following major issues:

- It interprets a quota-based trading system as the best solution simply because it is trading-based. But, the core objective has to be kept in mind which is to achieve an accelerated deployment of RES-E in an effective and efficient manner – and which is not to introduce a level playing field for trade;
- In the current discussion the measure of harmonization is often equated to (technology neutral) quota systems. This ignores the fact that there are other, potentially more favourable options, to form a harmonized support system;
- Moreover, it completely neglects the lessons learned so far which do actually not identify any success story. On contrary, most of the European success stories of promoting RES-E over the past decades in an effective and economically efficient way were driven by feed-in tariffs, which are implemented in a technology-specific manner.

The success of European promotion strategies for RES-E is depicted in Fig. 1 and Fig. 2. An almost exponential growth took place since the beginning of the 1990s. With respect to 'new' RES-E.

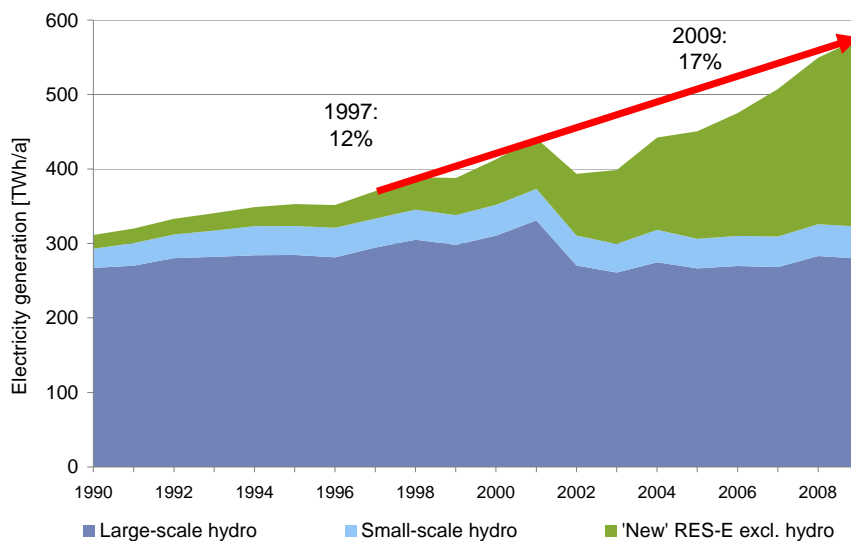

Figure 1. Development of all RES for electricity generation from 1990 to 2009 in EU-27

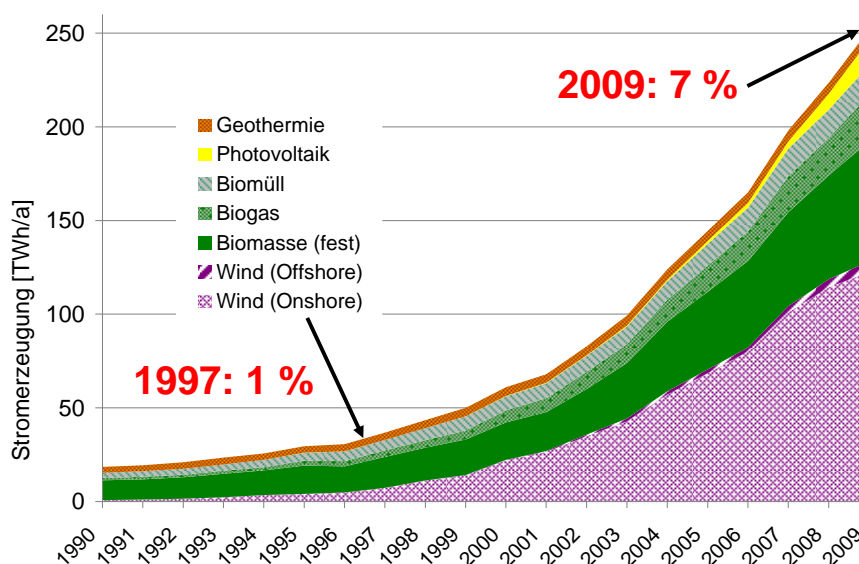

Figure 2. Development of “new” RES-E from 1990 to 2009 in EU-27

The core objective of this paper is to compare the recent lessons learned of quota-based TGC and FIT for an efficient and effective increase of RES-E.

## 2 How promotion schemes work

The following analysis is based on the concept of static (and further-on dynamic) cost resource curves of RES (see e.g. Haas [16], Ragwitz et al [17]). These cost curves are associated with uncertainties. These uncertainties are the higher the more we move to uncertain resources.

Based on this static (and further-on dynamic) cost resource curves a TGC-based quota system works as follows: A quantity (= quota = a certain percentage of electricity to be guaranteed from renewable energy sources) is set by a government. The generators (producers), wholesalers, retailer or consumers (depending who is obligated in the electricity supply chain) are obligated to supply / consume a certain percentage of electricity from renewable energy sources. At the date of settlement, they have to submit the required number of certificates to demonstrate compliance. A FIT works vice versa: the price is set and the quantity finally generated is decided by the market.

Quota-based TGC systems as well as Feed-in tariff systems create an artificial market and cause policy costs (=additional costs to be paid typically by all electricity customers), see Held et al [7]. One of the major criteria for a successful promotion system is the acceptance by the electricity customers (or in exceptional cases the society if reimbursement is done through state budget) who finally have to pay the required expenditures. This acceptance is of course strongly depending on the magnitude of over-all support. So it is important to analyze what are the additional extra costs for the electricity consumers. This is done in the next chapter.

## 3 Major differences between TGC and FIT systems

The major differences between TGC and FIT systems with respect to costs, producer surplus and revenues are depicted in Fig. 3.

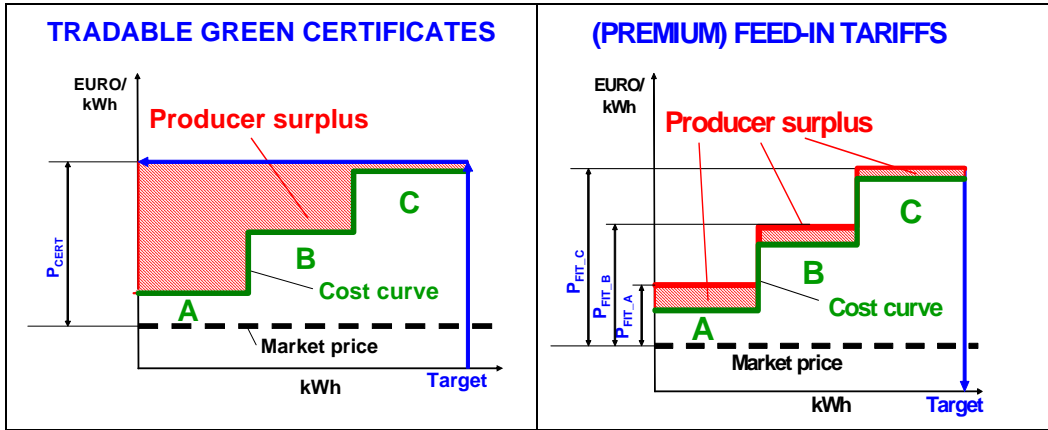

Fig. 3. Differences in transfer costs due to higher Producer surplus of TGC systems in comparison to FIT

Especially, if the cost resource curve is steep – Fig. 3 – Producer surplus in TGC systems is considerable and may even be higher than generation costs! Hence the additional extra costs which finally have to be paid by the electricity consumers/tax payers rise tremendously in comparison with a technology-specific FIT. This case is by far the overwhelming one in EU-27 countries and leads straightforward, to the request for a technology-specific support system e.g. FITs as depicted in Fig. 3, right side.

A uniform European TGC price for all RES-E would be set by the marginal price of the most expensive technology sold (analogous to current quota systems). If the marginal price is set by a medium or high cost technology, this would lead to windfall profits for low cost technologies (this is one reason why the UK government has introduced technology banding for the UK ROCs market).

In addition, it has to be born in mind that in a trading system the risk to recover investments leads to the effect of an additional risk premium, see Fig. 4. This Figure finally explains why the support costs in most trading schemes tend to be higher than in FIT countries.

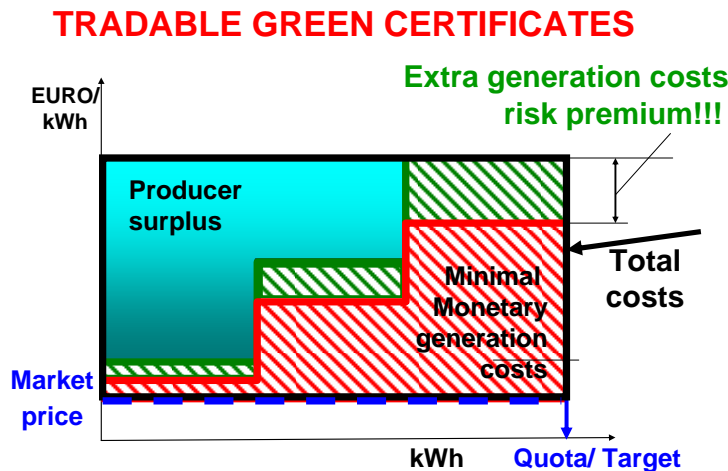

Figure 4. Possible producer surpluses when the cost resource curve is steep

## 4 Country-specific Lessons learned from promoting RES-E

This section summarises the major lessons learned from trading systems implemented in specific countries. Quota-based systems are now in place in the UK, Sweden, Italy, Belgium, and Poland, see Haas [5]. Analyses on the effectiveness of TGC systems have been conducted e.g. by van der Linden [18], Jacobsson et al [19], Ragwitz et al [20], Toke [21]. Fig. 5 shows the premium support level in selected countries. As can be seen the requirement of a noticeable dynamic decrease in the promotion costs is not met for TGCs despite increasing market prices for conventional electricity.

In Sweden, certificate prices are still lowest – see Fig. 5 – although prices have been rising in recent years. In Sweden some old capacity were also allowed to participate in the Swedish quota system. This resulted in the situation that more certificates were produced than redeemed until 2006. In 2007 it was the first time that more certificates were redeemed than issued (see Fig. 7). Moreover, additional investment subsidies for wind power plants were available, improving further the economic incentives for wind power investments, which led to lower marginal costs in the TGC system.

In the UK, the major problem – aside from high certificate prices – is that the quota has never been fulfilled so far. In the accounting period 2007/2008 4.9 % of electricity was generated from “new” RES while the quota was 7.65 % (see Fig. 8) resulting in a quota fulfilment of 64% (see Fig. 9). One main reason for this failure is the intrinsic deficit in the case of ambitious RES targets and a non-mature market environment, where besides policy-driven investor’s uncertainty (e.g. on future certificate prices) several administrative barriers appear to be of relevance. There is a similar situation in Italy. Certificate prices here are high (see Fig. 7) and quota fulfilment is moderate (about 90 % of the quota of 3 % was fulfilled in 2007).

In Belgium there are two parallel TGC systems in Flanders and Wallonia. The TGC prices in Flanders are among the highest in Europe and as reported in Verbruggen [22] and Verbruggen [23] the associated policy effectiveness has been very low until 2008 and appears to be on a rising trend starting in 2009.

Fig. 6 shows the corresponding figure for FIT-countries. It is important to note that support is calculated as the difference between FIT and the wholesale electricity market price. This explains to some extent the volatility. In Fig. 6.

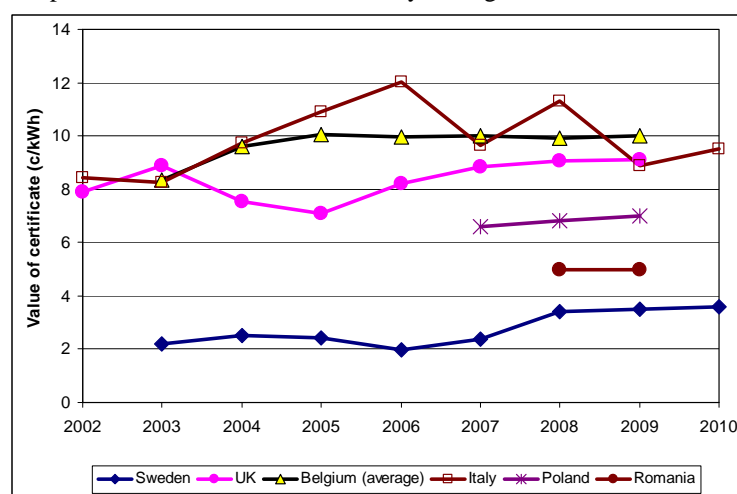

Fig. 5. Value of certificate in different European TGC markets 2002-2010, Figures for 2009 and 2010 preliminary)



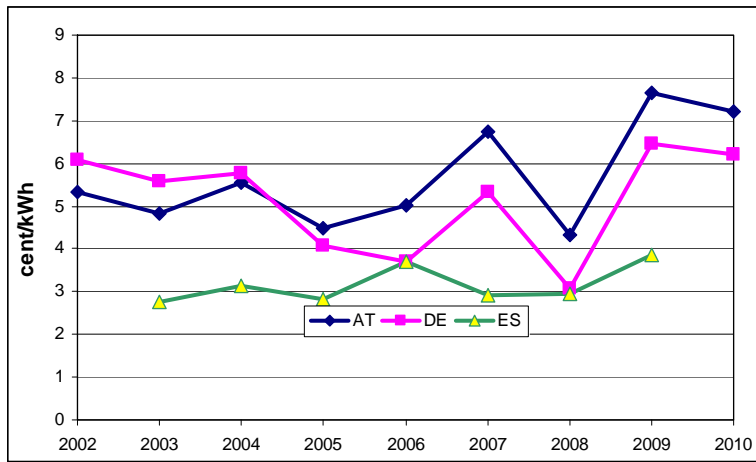

Fig. 6. Magnitude of support in different European countries with FITs 2002-2010, (Figures for 2009 and 2010 preliminary)

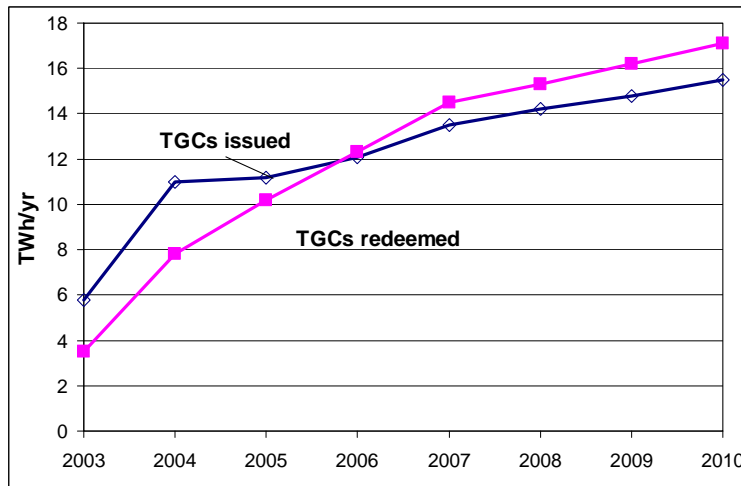

Fig. 7. TGC's in Sweden issued and redeemed (2003-2010, Figures for 2009 and 2010 preliminary)

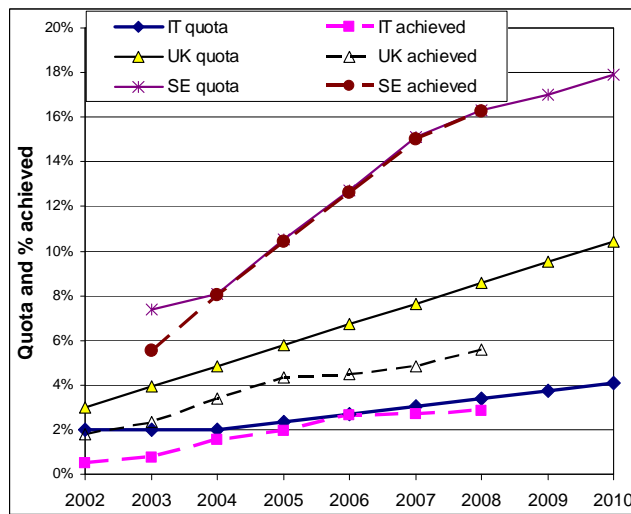

Fig. 8. Quotas and actual shares achieved in different European TGC markets

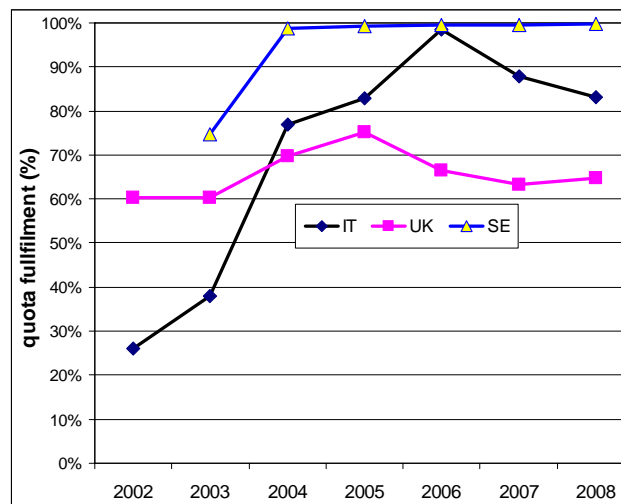

Fig. 9. Quota fulfilments in different European TGC markets

## 5 Effectiveness and efficiency of promotion schemes in EU-countries

A comparison of the different support schemes has been conducted in several projects and investigations see e.g. RWI [24], Sensfuss et al [25], Gomez et al [26].

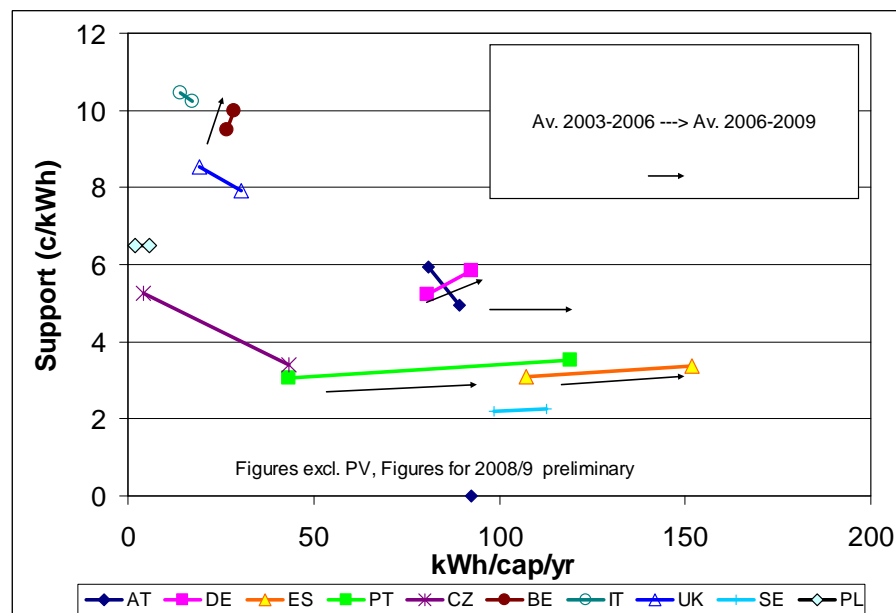

Figure 10. Effectiveness vs costs of promotion programmes for electricity from RES in selected countries 2003-2009 without PV and large hydro power (Source: own investigations)

In this chapter the relation between quantities deployed and the level of support is analysed for some trading and some FIT systems in recent years. It is often argued that the reason for higher capacities installed is a higher support level. Paradoxically, countries with highest support levels – Belgium and Italy for example – are among those with the lowest specific deployment (Figure 10). On the other hand, high FITs especially in Germany and Spain are often named as the main driver for successful investments

especially in the area of wind energy. However, the support level in these countries is not particularly high compared with other countries analysed here.

## 6 Conclusions

The major success stories of this growth in RES-E in EU member states in recent years has been triggered by FIT which are implemented in a technology-specific manner and involve rather modest costs for European citizens. The main reason for this observation is the long term price security of the system combined with technology diversification of support. Compared to short term trading in renewable certificate markets the intrinsic stability of feed-in systems appears to be a key element for success.

Currently a well-designed (dynamic) FIT system provides a certain deployment of RES-E in the shortest time and at rather low costs for society. The experiences made with FIT systems have shown several advantages compared to trading schemes at least for three reasons: (a) a FIT system is easy to implement and can be revised to account for new capacities in a very short time; (b) administration costs are usually lower than for implementing a national trading scheme. This fact is especially important for small countries where a competitive national trading scheme is difficult to implement; (c) The advantage of a technology-specific FIT, which helps to diminish the producer surplus, is the higher the steeper the cost curve is.

In recent years, quota-based TGC systems have shown a lower effectiveness (but with improving tendencies where support is applied technology-specific via banding) although comparatively high profit margins are possible. Firstly, a major problem are the high producer profits for the cheapest options in the market given a steep cost curve as depicted in Fig. 4. This leads to high additional costs for customers. Secondly, market mechanisms seem to fail in TGC-systems. In addition, it is hard to imagine that a European-wide TGC market disconnected from the large incumbent generators will work. The large incumbent utilities tend to favour TGC, since this scheme gives them the chance to earn higher profits.

Summing up a major result of these analyses is that the investigated FIT systems are effective at a relatively low producer profit. A well-designed (dynamic) FIT system provides a certain deployment of RES-E in the shortest time and at reasonable costs for society.

## 7 References

- [1] European Parliament and Council, Directive of the European Parliament and of the Council on the promotion of electricity produced from renewable energy sources in the internal electricity market, Directive 2001/77/EC - 27 September 2001, Brussels, 2001.
- [2] European Commission, Directive on the promotion of the use of energy from renewable sources, Brussels, 2009.
- [3] Resch G, Faber T, Ragwitz M, Held A, Panzer C, Haas R. 20% RES by 2020 – a balanced scenario to meet Europe's renewable energy target. Report compiled by TU Wien / EEG in cooperation with Fraunhofer ISI within the Intelligent Energy for Europe - project futures-e (Contract no. EIE/06/143/SI2.444285), Vienna, Austria, 2008.
- [4] Johnston A, Neuhoff K, Fouquet D, Ragwitz M, Resch G., The proposed new EU renewables directive: interpretation, problems and prospects. *European Energy and Environmental Law Review*, 2008, 17(3), 126–145.

- [5] Haas R., et al: Efficiency and effectiveness of promotion systems for electricity generation from renewable energy sources, In Press, ENERGY – The International journal 2011.
- [6] Haas R, Meyer NI, Held A, Finon D, Lorenzoni A; Wisser R, Nishio K. A review of promotion strategies for electricity from renewable energy sources in F.P.Sioshansi “Competitive Electricity market” Elsevier Publishers, 2008..
- [7] Held A, Haas R, Ragwitz M. On the success of policy strategies for the promotion of electricity from renewable energy sources in the EU. In: Energy & Environment, 2006, 17 (6), 849-868.
- [8] Auer H, Resch G, Haas R, Held A, Ragwitz M. Regulatory instruments to deliver the full potential of renewable energy sources efficiently, in: special issue of the European Review of Energy Markets (EREM) journal, on "Incentives for a low-carbon energy future", Vol 3(2), 2009, 91-124.
- [9] Klessmann C, Nabe Ch, Burges K. Pros and cons of exposing renewables to electricity market risks—a comparison of the market integration approaches in Germany, Spain, and UK. Energy Policy 36, 2008, 3646–3661.
- [10] Komor P. Renewable Energy Policy, Diebold Institute for Public Policy Studies, New York, 2003.
- [11] Menanteau P, Finon D, Lamy ML. Prices versus quantities :environmental policies for promoting the development of renewable energy". In: Energy Policy, 2003, 31 (8), 799-812.
- [12] Meyer NI. European schemes for promoting renewables in liberalised markets. In: Energy Policy, 2003, 31 (7), 665-676.
- [13] Meyer NI. Influence of government policy on the promotion of wind power, Int. J. Global Energy Issues, 2006, 25 (3/4), 204-218.
- [14] Fürsch M, Golling C, Nicolosi M, Wissen R, Lindenberger D. European RES-E Policy Analysis - A model based analysis of RES-E deployment and its impact on the conventional power market. Institute of Energy Economics at the University of Cologne, 2010.
- [15] Midtun A, Gautesen K. Feed in or certificates, competition or complementarity? Combining a static efficiency and a dynamic innovation perspective on the greening of the energy industry. Energy Policy, 2007, 35, 1419–1422.
- [16] Haas R, Eichhammer W, Huber C, Langniss O, Lorenzoni A, Madlener R, Menanteau P, Morthorst PE, Martins, A, Oniszk A. How to promote renewable energy systems successfully and effectively. Energy Policy, 2004, 32 (6), 833-839.
- [17] Ragwitz M, Held A, Resch G, Faber,T, Haas R, Huber C, Morthorst PE, Jensen SG, Coenraads R, Voogt M, Reece G, Konstantinaviciute I, Heyder B. OPTRES. Assessment and optimisation of renewable energy support schemes in the European electricity market. Final report, Karlsruhe, 2007.
- [18] Van der Linden NH, Uytterlinde MA, Vrolijk L, Nilsson J, Khan K, Astrand, K, Ericsson K, Wisser R. Review of international experience with renewable energy obligation support mechanisms. Petten, Netherlands, ECN-C-05-025, 2005.
- [19] Jacobsson S, Bergek A, Finon D, Lauber V, Mitchell C, Toke D, Verbruggen A. EU renewable energy support policy: Faith or facts? Energy Policy, 37, 6,2009, 37(6), 2143-2146
- [20] Ragwitz M, del Rio P, Resch G. Assessing the advantages and drawbacks of government trading of guarantees of origin for renewable electricity in Europe. Energy Policy 37, 2009, 300–307.
- [21] Toke D. The EU renewables directive—what is the fuss about trading? Energy Policy 36, 2008, 3001–3008.

- [22] Verbruggen A, Tradable green certificates in Flanders (Belgium), *Energy Policy*, 2004, 32(2) 165-176
- [23] Verbruggen A, Performance evaluation of renewable energy support policies, applied on Flanders' tradable certificates system, *Energy Policy*, Volume 37(4), 2009, 1385-1394
- [24] RWI. Economic impacts from the promotion of renewable energies: the German experience .Finalreport,RWI,Essen, 2009.
- [25] Sensfuss F, Ragwitz M, Kratzat M, Langniß O, Obersteiner C.,Müller Th, Merten F, Fishedick M. Fortentwicklung des Erneuerbaren Energien Gesetzes (EEG) zur Marktdurchdringung Erneuerbarer Energien im deutschen und europäischen Strommarkt. Karlsruhe, 2007.
- [26] Gómez A, Zubizarreta J, Dopazo C, Fueyo N. Spanish energy roadmap to 2020: Socioeconomic implications of renewable targets, *Energy*, In Press, Corrected Proof, Available online 3 April 2010
- [27] Munoz, M,Oschmann VT, \_Labara JD. Harmonisation of renewable electricity feed-in laws in the European Union, *Energy Policy*, 35, 2007, 3104–3114.
- [28] Klessmann C, Lamers P. Ragwitz M., Resch G. 2010. Design options for cooperation mechanisms under the new European renewable energy directive, *Energy Policy*, 38 2010, 4679-4691
- [29] Klessmann C, The evolution of flexibility mechanisms for achieving European renewable energy targets 2020—ex-ante evaluation of the principle mechanisms. *Energy Policy* 37, 2009, 4966–4979.
- [30] Toke D. Renewable financial support systems and cost-effectiveness, *Journal of Cleaner Production*, 15, 2007, 280-287.

# The development and diffusion of renewable energy technologies in Norway and Denmark

Antje Klitkou\* and Birte Holst Jørgensen\*\*

\* NIFU Nordic Institute for Studies in Innovation, Research and Education,  
Wergelandsveien 7, 0167 Oslo, E-mail: [antje.klitkou@nifu.no](mailto:antje.klitkou@nifu.no)

\*\* Risø-DTU Risø National Laboratory for Sustainable Energy, Wind Energy Division,  
E-mail: [bhjq@risoe.dtu.dk](mailto:bhjq@risoe.dtu.dk)

## Abstract

By applying the technological innovation systems concept this paper compares two case studies on the development and diffusion of renewable energy technologies: the case of solar photovoltaics in Norway and offshore wind in Denmark. Both cases show a high activity level, in terms of RD&D and industrial deployment. Both cases illustrate the contribution to energy security of supply as well as prospects for business opportunities on global markets. The focus of the paper is on what stimulates the development and diffusion of new renewable technologies, asking: Which framework conditions facilitate technology development and the competitiveness of the industry and what are the lessons learned?

## 1. Introduction

The transition to a low carbon energy system requires the emergence and deployment of new renewable energy technologies in a large scale. Many options are open. And they are not confined to national borders. Deployment of renewable energy technology at a global scale can be an important option beside the development of the national energy system. For that purpose innovation policy at the national level is decisive. The paper compares two cases which have high importance for the two Nordic countries in terms of value creation for national energy security of supply and for the worldwide deployment of more efficient renewable energy technologies: offshore wind technology in Denmark and solar photovoltaics in Norway. The presented case studies show some similarities – strong achievements regarding business opportunities of renewable energy technology, but also some differences: The Danish offshore wind case illustrates the importance of a first mover home and North European market for the competitive development of the technology, while this has not been the case for the Norwegian photovoltaic case which shows a strong orientation towards export on the global market. This paper addresses which framework conditions have facilitated the competitive development and diffusion of the technology, and what are the lessons learned.

## 2. The theoretical approach

This paper applies the concept of technological innovation systems. Theories on *technological innovation systems*, introduced and developed by Carlsson and Stankiewicz (Carlsson & Stankiewicz, 1991) define a technological system as:

“a network of agents interacting in the economic/industrial area under a particular institutional infrastructure and involved in the generation,

diffusion and utilization of technology” (Carlsson & Stankiewicz, 1991; p. 94)

This definition acknowledges that a technological innovation system transcends territorial boundaries, and, that a technology cuts across various industrial sectors. The approach has been demonstrated in a number of empirical studies (Bergek et al., 2008; Jacobsson, 2008; Jacobsson et al., 2004; Negro et al., 2008; Borup et al, 2009) and is particularly useful for the purposes of this project as it captures the dynamics taking place within technological innovation systems (TIS). To address these dynamics, key activities in the innovation system can be identified and classified along defined functions of innovation systems. As described by Hekkert et al., the function of innovation systems “focuses on the most important processes that need to take place in the innovation systems to lead successfully to technology development and diffusion” (2007). The seven functions include: entrepreneurial activities, knowledge development (learning processes), knowledge diffusion through networks, guidance of the search, market formation, resource mobilisation, and creation of legitimacy/counteract resistance to change.

Thus, the purpose of the paper is to create insight into how the process of momentum building takes place in the TIS by analysing the dynamic interplay between the system’s actors, institutions and networks and its functional patterns. Likewise, the paper analyses the role of policy targets and mechanisms within and across national boundaries.

### 3. Methodology and data

A comparative case study approach is applied, comprising two different technologies in two countries, both of which are assumed to play a key role for the worldwide transition to a low carbon energy system: offshore wind technology in Denmark and solar photovoltaic technology in Norway. The selection of these cases is motivated not only by the importance in the national energy systems of these technologies, but also because of market opportunities for these energy technologies in a global scope.

The analysis of both cases is structured accordingly in a basic analysis of the technological innovation systems, and a policy outlook.

The basic analysis includes following:

- Review of innovation characteristics,
- Market aspects,
- Actors and networks which are involved in relevant innovation processes,
- Institutional setting (R&D programs, regulations, expectations, norms and values).

The case study on offshore wind technology was made as a desk research developed in various projects. Firstly, an innovation system analysis of the Danish wind energy sector was made as part of the assignment for the Danish Climate Commission on the role of RD&D in accelerating energy technologies (Jørgensen & Münster, 2010). Secondly, back ground work was produced for the Megavind RD&D offshore wind energy strategy, which took place during May – November 2010.

The data used for the basic analysis of the case study on solar photovoltaics was developed in several projects over the last years (Klitkou, 2010; Klitkou & Godø, 2010; Klitkou et al., 2008). This includes an analysis of the technology (patents, bibliometric data), actors and networks of actors, R&D institutions, and market developments. Interviews with R&D programme managers of the RCN and researchers from R&D organisations and industry experts provided important insights.

## a. Offshore wind in Denmark

Denmark was the first country in the world to develop and implement wind power in its energy system. The wind power share of the domestic electricity supply has increased from 1.9% in 1990 to more than 20% in 2010.

Since the end of the 1970s Denmark has built up a strong technological and research competence in wind power and in 1991 Denmark became the first country in the world to install offshore wind with 11 x 450 kW Siemens turbines in the Vindeby offshore wind farm (Danish Energy Agency, 2009). This was followed by smaller demonstration projects until Middelgrunden (20 x 2 MW) paved the way for the first two large offshore wind farms at Horns Rev I (80 x 2 MW) and Rødsand I (72 x 2.3 MW) in 2002 and 2003. Since then UK has passed Denmark in cumulated installed capacity and is today the leading offshore wind country, though relying on offshore technologies and capabilities from the Danish wind energy sector (BTM Consult, 2010).

### Basic analysis

*Innovation characteristics:* The electricity production of a wind turbine depends on wind conditions. Wind speed varies from place to place and over time and generally, wind blows more at sea than on land. The development of offshore wind turbines has since 1991 passed through three phases – the pioneering period up to 2000 consisted of relatively small turbines (450-600 kW) installed near coast. The following three years, mainstream megawatt technology was adapted to offshore. Since 2003 emphasis is to design MW technology for the offshore environment. Upscaling, reliability and quality is needed to develop competitive wind power plants.

Cost of energy is far from being competitive with onshore wind power, not to say electricity produced from coal fired power plants (IEA, 2009; Megavind, 2010). But cost of energy can be halved through dedicated RD&D. The Megavind Offshore RD&D strategy aims at making offshore wind power competitive with newly built coal-fired power plants by 2020 (Megavind, 2010). More specifically, this implies 25% increase of the power production per installed MW, 40% reduction of the installation costs per MW and 50% cost reduction of operation and maintenance per installed MW.

Also, new innovative floating concepts for deep waters may drive down cost of energy in the long run. Also the combination of technology development and installation of near shore wind power farms in shallow waters may drive down cost of energy provided public acceptance.

*Market demand aspects:* The market for wind generation is expected to expand in the future. While land based wind energy will remain dominant in the immediate future, offshore wind will become increasingly important. The actual offshore wind energy is located almost entirely in Northern Europe due to large sea areas with water depth < 50m and good wind resources, while land resources with good wind conditions are scarce. Although the European offshore wind energy is still in its infancy with 2.1 GW in installed capacity, it is expected to increase to 40 GW or 25% of European wind power by 2020 similar to 3.6–4.3% of EU electricity consumption (EWEA, 2009).

While Denmark has the highest proportion of installed wind capacity to population, the future market for offshore wind is abroad, in the waters of Northern Europe. Today, the largest offshore market is UK (894 MW) and Denmark (625.9 MW) (BTM Consult, 2010). Although Denmark has set ambitious target for offshore wind, both Germany and UK have announced indicative targets for offshore wind of 20–30 MW. In the UK the Crown Estate has in its three rounds built up the potential for around 40 GW to be installed by 2025. The national target of Germany is 9 GW but the most likely development indicates 20–25 GW by 2030 (BTM Consult, 2010: 95).

There is some competition around the North Sea to offer attractive shipping ports for offshore turbines, foundations and transformer platforms. Due to the size of these structures, manufacturers and suppliers often prefer to locate manufacturing facilities at or close to the ports of shipping (BTM Consult, 2010: 90).



Outside Europe, the development and deployment of offshore wind is expected to catch up. Although offshore wind development in China is still at an early stage, it is expected to soon have at least 20% of the global project pipeline (BTM Consult, 2010: 46). According to the E&Y Renewable Energy Country Attractiveness Report, China has become the new stand-alone leader not only in the All Renewables Index but also in the Wind Index (E&Y, 2011).

*Technology supply aspects:* Since 1991, the turbine market was dominated by Danish manufacturers (Siemens and Vestas), which still have 91.4% of the market in 2010 (BTM Consult, 2010: 50). But other R&D focused entrants from Europe, US and Asia are expected to catch up (BTM Consult, 2010: 52). Today, Siemens and Vestas have also announced plans for multi-MW technology designed for offshore wind.

A very strong feature of the Danish wind energy industry is the large number of suppliers to the industry, which has grown along with the major wind turbine manufacturers. The suppliers constitute a competitive part of the Danish wind energy industry, and with advanced test facilities the suppliers have the opportunity to set technical standards, codes and norms for the mechanical and electrical components making up the modern offshore wind energy farm and its integration in the grid.

Just like the onshore market, the offshore wind industry keeps the production of key components in house while other parts are outsourced. The world leading blade manufacturer LM Wind Power supplied blades for the turbines at Middelgrunden. Other independent suppliers include Bladt Industries (tower), Per Aarsleff (foundation) and Advanced Offshore Solutions (balance of plant) (BTM Consult, 2010: 71-81). Specialist contractors in offshore wind installation are for example MT Højgaard and A2SEA, the latter being recently acquired by Dong Energy, one of the leading offshore developers in the North Sea.

*Public research organisations:* Risø DTU was a part of the Danish wind energy success story from the very beginning – the industry and Risø so to speak grew up together. Over the years, industry has been consolidated and so has the research community. The Danish Research Consortium for Wind Energy was established in 2002 by Risø, DTU, Aalborg University and the DHI and developed the first national R&D strategy in close dialogue with the industry. This was further complemented by the public-private partnership of Megavind led by industry, which since 2007 has developed RD&D strategies for wind energy in order to maintain Denmark's position on the global market for wind energy. All players are deeply involved and have a leading role in the institutional pillars of the EU Strategic Energy Technology Plan (the so-called SET-Plan) - The European Energy Research Alliance Joint Programme on Wind Energy and the Wind Energy Industrial Initiative.

*Institutional setting:* Denmark's leading position in the global offshore wind energy technology market rests on a unique combination of internationally leading manufacturers, a solid supply chain and a strong and intertwined RD&D environment. A strong political and societal vision to obtain self-sufficiency in terms of energy has since the oil crises in the 70s guided the development of regulatory framework, smart green taxes and support schemes combined with strict environmental, climate and energy conservation policy measures (Mandag Morgen, 2010).

Of particular relevance for the offshore sector is the national target of 33% renewable energy by 2020 and the ambition to be independent of fossil fuel by 2050, where near shore offshore wind is expected to play a key role. Other important framework conditions include the first national offshore wind energy action plan in 2007. Also, the process for project approval is organized as a one-stop shop so that developers only have to deal with one body – Danish Energy Agency – to obtain all necessary approval and licenses.

Economic support mechanisms for offshore wind have varied over time and are low compared to other European countries (Ecofys, 2011: 94). In order to obtain the lowest possible costs, the Danish Energy Agency runs a government tender procedure where

applicants are invited to submit a quotation for the price at which the bidder is willing to produce electricity in the form of fixed in tariff for a number of full-load hours (Danish Energy Agency, 2009: 19-20).

Further, the Danish TSO Energinet.dk has made an ambitious investment plan in grid infrastructure development within and across national boundaries. This is a key element to enable the smooth and economic integration of large scale offshore wind in the electricity system.

The national test centres for large wind turbines play an important role for both industry and research. They provide conditions for manufacturers to test the turbines as well as the necessary facilities for R&D within meteorology, wind turbine technology and grid integration. But due to offshore market growth in the Northern Europe, there is lack of such large test facilities and competitive test facilities are established in neighbouring countries.

Public RD&D programmes for sustainable energy also include offshore wind energy, but expenditure on wind energy remains low compared to the private RD&D expenditure and does not at all match the industry technology development (Jørgensen & Münster, 2010).

### **Policy outlook**

Offshore wind technology started out being onshore wind turbines installed offshore but passing through three phases, manufacturers are now developing turbines specifically for the demanding offshore conditions with high capital and O&M costs. A cost-effective implementation of offshore wind energy in North European waters depends on an intelligent combination of focused RD&D to bring down CoE, an interconnected European transmission grid and well-functioning European electricity markets. Future offshore wind farms have to provide improved cost efficiency at high wind power penetration levels, more specifically increasing the capacity factor and providing system services and functionalities for wind power integration in the power system. It also requires a dedicated offshore electricity system, providing access for the more remote offshore wind farms and also additional interconnection capacity to improve trans-border electricity trading (Megavind, 2010).

In order to match the knowledge requirements of the industry, the Danish research community has strengthened the internal coordination and cooperation on the one hand and on the other hand taken the lead in building up a European Joint Programme on wind energy in order to strengthen the overall research in an effective and efficient way.

Strong political commitment from governments and the EU Commission is needed to provide the necessary financial capital to realize the ambitious RE and offshore wind energy targets. On the technology push side, the EU Strategic Energy Technology Plan (SET-Plan) foresees a development and demonstration programme worth 1.2B€ over ten years for new offshore structures distant from the shore, with lower visual impact and at different water depths (>30m) (SEC (2009) 1295: 16-18). Although the European Research Areas and the internal movement of knowledge have dominated the policy discourse over the years, a robust and intelligent combination of EU, national and private funding is still to be seen. On the market pull side, the liberalisation of the energy markets is being implemented and important mechanisms such as the establishment of the European Network of Transmission System Operators for Electricity (ENTSO-E) is made. The next important question is whether the EU energy policy will move towards some degree of harmonised or supranational support schemes for renewable energy to avoid inappropriate attractiveness for investments.

New public-private partnerships may be established to share risks and provide the necessary investments in the roll out of offshore wind farms in European waters. While national energy systems are primarily confined to the geographical territory and interconnected to its neighbours through transmission cables, the offshore wind industry is

operating on global markets. The leading offshore suppliers are still Siemens and Vestas, followed by newly established suppliers and new entrants especially from China and Korea. Together with dedicated RD&D, grid enforcement and adequate framework conditions, the market uptake and competition will most likely within the next ten years make offshore wind an affordable and reliable energy source.

## **b. Solar photovoltaic in Norway**

Solar photovoltaic (PV) in Norway has been selected because of the importance PV will play in the worldwide transition towards renewable energy technologies and the contribution Norwegian industry and R&D organisations have made to the improvement of this technology over the last fifteen years.

### **Basic analysis**

*Review of innovation characteristics:* Solar PV is a technology that converts light from the sun directly into electricity. The standard technology is production of cells based on refined and purified crystalline silicon. Several specialised companies produce solar-grade silicon for wafers which are used in solar cells. Two types of PV material are most commonly used: poly-crystalline and mono-crystalline silicon. Poly-crystalline silicon is cheaper, but less pure and therefore less effective. The global market of solar PV is still dominated by crystalline silicon; today 85–90% of the global sales are based on crystalline silicon.

In addition to the demand for new technologies for refining silicon with a high degree of purity, new technologies for the recycling of silicon residuals and repair of defect solar cells have also required attention. Frontline automation technology from automobile manufacturing has been applied to the manufacturing of wafers and solar cells combining engineering, sensor technology and clean room technology.

*Market aspects:* Norway has one of the world's largest natural deposits of silicon. Several Norwegian actors are attempting to develop new upstream technologies to exploit this opportunity. The Norwegian producers have access to cheap and renewable hydroelectric power in producing the wafers, which is an energy-intensive industry in itself.

Global solar photovoltaic capacity has been increasing at an average growth rate of more than 40% since 2000 (IEA, 2010b). The European Photovoltaic Industry Association (EPIA, 2010) estimates that there is a cumulative installed capacity of almost 23 GW in 2010, compared to 0.1 GW in 1992 (EPIA, 2010). The highest growth rates achieve on-grid solutions, while off-grid solutions constitute less than 10% of the total PV market. Significant incentives in Japan and Germany triggered a huge growth in demand, quickly followed by production. The largest markets for solar PV have been in Germany, Italy, Spain, Japan and the United States, and recently also China. However, the selling price of modules is still too high to compete with grid electricity.

*Actors and networks which are involved in relevant innovation processes:* There are both larger firms and a number of SMEs involved in solar PV in Norway. Three larger firms are mainly involved in industrial and R&D activities related to manufacturing of solar PV: The REC Group, Elkem Solar and NorSun. The REC Group consists of a several companies working with different steps in the value chain for the production of silicon for wafers, manufacturing of solar cells, modules, etc., both in Norway and abroad. Elkem has traditionally produced silicon products for the construction industry. Elkem Solar has worked for many years with the metallurgical processing of solar-grade silicone for the production of wafers and has developed recently a new and much more efficient process. Elkem was recently bought by China's BlueStar. NorSun is localised both in Norway and abroad and has specialised in the production of wafers and solar cells. In addition to these larger industrial players, there is a growing number of compa-

nies that provide upstream and downstream services, such as recycling, repair of solar cells, PV installation, and engineering services for manufacturers.

*Public research organisations:* the Institute of energy technology and the SINTEF group, and here especially the Sintef institute for Materials and Chemistry. The largest universities in Norway also do PV R&D, the University of Oslo and the Norwegian University of Science and Technology (NTNU). The collaboration between Sintef and the NTNU led in 2006 to the Gemini centre for solar PV. IFE has built its own production line for solar cells and other necessary laboratory equipment and is since 2008 leading the Norwegian Research Centre for Solar Cell Technology, Solar United, which unifies major public and private actors in Norwegian solar PV.

*Institutional setting:* There are more generic innovation policy instruments, such as the Norwegian R&D tax credit scheme SkatteFUNN, the Government Consultative Office for Inventors, and the Public and Industrial Research and Development Contracts administered by Innovation Norway. The RCN is by far the most important public R&D funding organisation. The RCN had and has several R&D programmes which have contributed to funding of solar PV technology development (Klitkou & Godø, 2010). Here is special focus on cooperation between private and public actors.

Traditionally, the Norwegian metallurgical industry has developed with access to cheap hydropower. In recent years, because of liberalisation of energy markets, this has changed; electricity prices have still increased. Energy intensive industries, e. g. aluminium processing, have started to move abroad. Processing of silicone for solar PV has developed as an extension of the traditional metallurgical industry, but has introduced frontline concepts of automation and lean production. However, scarcity of private financial resources endangers further development of technology.

In the wafer industry, there is a pressure to increase efficiency of *first generation PV* within the framework of the existing technology. Beside this there exist also second and third generations of PV. *Second generation PV* is so-called thin-film solar cells (CIGS - copper indium gallium selenium), which are cheaper to produce, but less efficient compared to silicone and based on rare metals. *Third generation PV* try to achieve a higher power efficiency by arranging multi-layer ("tandem") cells made of amorphous silicon or gallium arsenide. Other concepts are photo-electrochemical cells, polymer solar cells, nano-crystal solar cells or dye-sensitized solar cells and they are not commercialised yet.

Improvements of energy efficiency, lifetime extension and recycling of valuable materials address scarcity of resources, raising energy prices and environmental impact. Efforts to improve the performance of silicon based PV will lower the costs per unit. Such efforts include defect engineering of the crystalline silicon material, thinner wafers, and the combination of solar cells with the concentration of light. Further up-scaling of the production of PV material and solar cells – both in Norway and outside – will lower costs. Attempts to take control over the whole PV value chain give improved access to resources and the end-user market, and may allow higher economic growth in the future.

Norwegian industry has to follow the international development of new generations of PV to avoid a lock-in into less efficient technology. The further development of new generations of PV cells applying nano-technology may give a further boost, but are still far from commercial deployment. The use of CIGS is probably less relevant because of a limited access to required materials. "As PV matures into a mainstream technology, grid integration and management and energy storage become key issues. The PV industry, grid operators and utilities will need to develop new technologies and strategies to integrate very large amounts of PV into flexible, efficient and smart grids" (IEA, 2010a).

### **Policy outlook**

Global climate change has put the increased deployment of solar PV on the agenda for many countries. Policy incentives and RD&D support this development. There is a trend

towards use of PV all over the world. According to IEA's solar PV roadmap the competitive parity with the power grid will be achieved by 2020. PV power will provide by 2050 around 11% of global electricity production (IEA, 2010a). The global financial crisis has put a hold to many planned projects which might endanger the fulfilment of the IEA targets. However, some countries are building up an industry to meet the future demands for solar PV and at the same time achieve economic growth. Here China has gained a strong position, further strengthened by the takeover of Norway's Elkem Solar.

Entrepreneurial experiments and demonstrations will help to turn new knowledge into business opportunities and innovations. Policy instruments which support such entrepreneurial activities, under the umbrella of Innovation Norway, have to be strengthened. Further knowledge development and collaboration of important private and public R&D actors across national borders will help creating and diffusing knowledge. Here the cooperation with the Nordic countries (for ex. the Nordic Centre of Excellence in Photovoltaics) and other European countries (activities under the auspice of the Strategic Energy Technology Plan and the European Photovoltaic Industry Association, such as the Solar Europe Industry Initiative and the European Photovoltaic Technology Platform) can turn out to be useful. It is the European industry's vision that by 2020 PV will be a mainstream and competitive energy technology providing up to 12% of the European electricity demand. This is going to increase to 20% in 2030 and 30% in 2050. Priority setting by Norwegian, Nordic and European RD&D funders and governments will improve guidance of the search. Niche markets have to be created and entrepreneurs have to find them also abroad.

Expectations towards the deployment of solar PV are high in most of the countries, but there are several actions needed: the development of standards for PV products, a regulatory framework for large-scale integration of PV into the European grid and of innovative business models for end-users and rural deployment. System integration has to be addressed in cooperation with network operators, producers of electric automobiles and the building sector. As soon as grid competitiveness is achieved, policy should be directed on improving self-sustained markets, phasing-out economic incentives but maintaining access to grids and R&D funding.

Up-scaling of Norwegian industrial actors depend on global market conditions, market incentives, access to financial capital and political framework conditions. Limited access to financial capital was one of the reasons for the takeover of Elkem by China's Bluestar. Not all up-scaling will happen in Norway as some of these developments have already shown (REC's activities in Singapore, Metallkraft's activities in Singapore and China).

Global challenges are not clear enough communicated: the financial crisis has put a hold on further improvements and climate change critics doubt the necessity to rush forward. Several technological solutions still compete: the fossil-based energy sector may choose to invest more on carbon capture and storage than on renewable energy and the atomic industry has huge plans for building nuclear power plants although this may change rapidly because of the atomic energy catastrophe in Japan, after the March 2011 tsunami.

## 4. Discussion

Our case studies show the importance of innovation policy strategies for the successful development of a competitive development and diffusion of renewable energy technologies. Public policies supporting such success stories are an intelligent combination of energy policy and innovation policy strategies. Both countries are small open economies, oriented towards the international markets.

While the Norwegian PV case shows the dependence on the international market conditions, the Danish offshore wind case shows the importance also of the home and neighbouring markets. However, the Danish case also shows the fierce competition and globalisation of the industry, the implications of the liberalised European energy markets

for both technology users and producers and the delicate trade-off between economic interests – national and EU-wide on the one side and societal and business on the other side. Based on the first mover advantage of both the onshore and the offshore technology development and diffusion, the Danish wind energy industry has a relatively strong point of departure for providing competitive and cost efficient technology, system integration, grid enforcement and maintenance and operation of offshore wind energy farms. However, the rapid uptake in emerging markets such as China challenges the overall competitiveness of the industry. In the years to come offshore wind will play an important role in various countries to comply with the European 2020 renewable energy target, but also emerging economies with abundant need for energy set ambitious targets and are willing to invest heavily in RD&D to stimulate ingenious innovation and secure energy of supply.

Both cases illustrate the importance of global markets, but the Danish offshore wind energy case also shows that national and EU policies and framework conditions are increasingly interwoven, that both industry and knowledge communities are constantly challenged to maintain a first mover advantage and that close collaboration between key actors of the TIS is not limited by national boundaries.

The development of the PV industry in Norway is based on a unique combination of technological competencies, raw material and available energy. Niche-markets have developed in some countries both in Europe and elsewhere and innovations developed by Norwegian industry actors have taken advantage of these foreign niche-markets. The efficiency of these niche-market products cannot compete yet with existing fossil-based technology regimes because of too low energy prices in most of the countries. PV technology has not been developed primarily for the Norwegian home market. Therefore the emergence of new entrants further down the value chain has not been in the focus from the beginning, but has received more attention recently, but with a focus on the European and Asian market. New generations of PV may be relevant also for other markets.

We can summarise that both cases illustrate the main challenges for European and global energy production and innovation policy: deployment of a higher share of renewable energy to lower costs for replacing fossil based energy production. A competitive industry operating on global markets, a well functioning supply chain of component industry, new strategic partnerships and close cooperation between users, producers, developers, system operators and public and private investors are all decisive for the successful development and diffusion of these technologies. Ambitious policy targets, grid enforcement, intelligent market pull and technology push support mechanisms at national as well as European level all contribute to reducing costs to a competitive level.

## References

- Bergek, A., Hekkert, M. and Jacobsson, S. (2008) Functions in innovation systems: A framework for analysing energy system dynamics and identifying goals for system-building activities by entrepreneurs and policymakers. In: Foxon, T. J., Köhler, J. and Oughton, C., eds. *Innovation for a low carbon economy: economic, institutional and management approaches*. Cheltenham, UK: Edward Elgar, 79-111.
- BTM Consult (2010) *International Wind Energy Development. Offshore Report 2010*. Ringkøbing: BTM Consult Aps.
- Borup, M.; Dannemand Andersen, P.; Gregersen, B.; Nygaard Tanner, A. (2009) *Ny Energi og innovation i Danmark*. København: DJØF.
- Carlsson, B. and Stankiewicz, R. (1991) On the nature, function, and composition of technological systems. *Journal of Evolutionary Economics*, **1**, 93-118.

- Danish Energy Agency (2009) *Wind Turbines in Denmark*. Copenhagen: Danish Energy Agency. [www.ens.dk](http://www.ens.dk)
- Ecofys (2011) *State of the Offshore Wind Industry in Northern Europe. Lessons Learnt in the First Decade*. Utrecht: Ecofys.
- EPIA. (2010) *Global market outlook for photovoltaics until 2014*. Brussels: European Photovoltaic Industry Association.
- EWEA (2009) EWEA, Oceans of Opportunity. Harnessing Europe's largest domestic energy resource. [http://www.ewea.org/fileadmin/ewea\\_documents/documents/publications/reports/Offshore\\_Report\\_2009.pdf](http://www.ewea.org/fileadmin/ewea_documents/documents/publications/reports/Offshore_Report_2009.pdf)
- E&Y (2011) *Renewable energy country attractiveness indices Issue 28*. EYG Limited. [www.ey.com](http://www.ey.com)
- Hekkert, M., Suurs, R. A. A., Negro, S. O., Kuhlmann, S. and Smits, R. E. H. M. (2007) Functions of innovation systems: A new approach for analysing technological change. *Technological Forecasting and Social Change*, **74**, 413-432.
- Jørgensen, B.H. & Münster, M. (2009) *Nye energiteknologier. Forskning, udvikling og demonstration*. Risø: Rapport til Klimakommissionen. [http://www.klimakommissionen.dk/da-DK/Klimakommissionen\\_report/KK-FUD-rapport-maj-2010.pdf](http://www.klimakommissionen.dk/da-DK/Klimakommissionen_report/KK-FUD-rapport-maj-2010.pdf)
- Mandag Morgen (2010) *Aarhus – Capital of Wind Energy. Industrial hub, technological trendsetter, political frontrunner*. Copenhagen: MM. ([http://www.windpower.org/download/854/Vindm%F8llerapport\\_WEB.pdf](http://www.windpower.org/download/854/Vindm%F8llerapport_WEB.pdf)).
- IEA (2009) *Technology Roadmap Wind energy*. Paris: International Energy Agency.
- IEA. (2010a) *Solar PV roadmap targets*. Paris: International Energy Agency.
- IEA. (2010b) *Technology Roadmap: Solar photovoltaic energy*. Paris: International Energy Agency.
- Jacobsson, S. (2008) The emergence and troubled growth of a 'biopower' innovation system in Sweden *Energy Policy*, **36**, 1491-1508
- Jacobsson, S., Sandén, B. A. and Bångens, L. (2004) Transforming the energy system - The evolution of the German technological system for solar cells. *Technology Analysis & Strategic Management*, **16**, 3-30.
- Klitkou, A. (2010) The emergence of the Norwegian solar photovoltaic industry *International Conference: Which regions benefit from emerging new industries? Evidence from photovoltaic and other high-tech industries*. Halle, Germany.
- Klitkou, A. and Godø, H. (2010) The Norwegian solar photovoltaic industry: a triple helix perspective *VIII. Triple Helix Conference*. Madrid.
- Klitkou, A., Pedersen, T. E., Scordato, L. and Mariussen, Å. (2008) *Competitive policies in the Nordic Energy Research and Innovation Area: Technology reports*. Oslo: NIFU STEP.
- Megavind (2010) *Denmark - Supplier of competitive offshore wind solutions. Megavind's strategy for offshore wind research, development and demonstration*. Copenhagen: Danish Wind Energy Association.
- Negro, S. O., Hekkert, M. and Smits, R. E. H. M. (2008) Stimulating renewable energy technologies by innovation policy. *Science and Research Policy*, **35**, 403-416.

## **Trade Disputes over Renewable Energy Supporting Policies: Recent Cases, WTO Rules, and Possible Solutions**

Xianli Zhu

Risø National Laboratory for Sustainable Energy  
Technical University of Denmark – DTU  
Building 142, P.O. Box 49, 4000 Roskilde, Denmark  
xzhu@risoe.dtu.dk

### **Abstract:**

Increasing concerns about climate change impacts and the high oil prices have made many countries include promoting renewable energy use their national sustainable development strategies. One frequently mentioned barrier to increasing the transition toward renewable energy in many countries is lack of funding – in most cases energy from cleaner sources are also more expensive. And who pays for the GHG emission reductions is the top reason behind the stalemate of the international climate negotiations. Developing countries are requesting large financial support from developed countries for their climate change mitigation actions under the principle of ‘common but differentiated responsibilities’. So it would be logic to assume that if a country helps lower the prices of renewable energy technologies and somehow subsidizes the renewable energy use in other countries, such efforts will be more than welcome, even so when such effort comes from a developing country. But it is not true in real life. The longing for renewable energy sometimes gives way to countries’ competition for leadership in clean technologies or companies’ competition for market shares. In 2010 two trade disputes have arisen under the WTO, for wind energy supporting policies. Recently, Japan has a trade dispute against Canada related to renewable energy equipment in Ontario. The American United Steelworkers are calling for their government to penalise China for grants to Chinese wind turbine and key component manufacturers. This paper will examine the interfaces between various wind energy supporting policies and the WTO trade rules. Some trade disputes will be used as case studies to explain the reasons behind such disputes. Suggestions will be provided on how to avoid such disputes in practice.

**Key words:** wind energy, supporting policies, trade dispute, cases, solutions

### **I. Introduction**

Renewable energy is taken as a new promising area for green growth, which combines the multiple benefits of clean energy supply, zero GHG emissions from energy production, job creation, as well as building national technical capacity for new energy technologies. In the ten years from 2000 to 2010, the global market of solar PV and wind energy increased from 6.5 billion USD to 131.6 billion USD (Clean Edge Inc., 2011). The renewable energy sector has been growing much faster than both the world economy and the energy sector.

Over 80 countries around the world have set targets for renewable energy development. Despite continuing technology progress and declining in costs, renewable energy is still more expensive than fossil fuels. To boost the development of renewable energy and build their competitiveness in this new and promising industry, countries have introduced various supporting policies for the renewable energy sector, from public funding for research and development, to higher tariffs for electricity from renewable sources, mandatory grid connection and preference in



electricity purchase by grid companies, tax credits. While offering subsidies for renewable energy development and persuading consumers and tax payers to pay for the extra costs, creating new jobs, especially in the manufacturing of renewable energy equipment, is often used as one of the strong argument. Therefore, countries with ambitious target for renewable energy development, often combines measures for boosting local manufacturing of renewable energy equipment. In some cases, governments limits the beneficiaries of the supporting policies to local renewable energy equipment manufacturers and enterprises in order to boost local job creation, manufacturing base development, as well as protecting local manufacturers from the competition by international equipment providers.

The majority of countries in the world are members the World Trade Organisation (WTO), the only global international organization dealing with the rules of trade between nations. WTO promotes opening market and minimum government intervention. It demands member countries to make no discrimination among products and services from different countries and no discrimination to imported products and foreign enterprises against domestic ones. Member countries whose interests are hurt by such discrimination can take countervailing measures, demand compensation, or complain to the WTO and request investigation and judgement by the WTO Trade Dispute Settlement Body.

In 2010, two trade disputes arise among WTO member countries regarding domestic fiscal measures for renewable energy development. This is for the first time renewable energy becomes the subject of trade disputes under the WTO. One case is brought by the US against the Chinese grants for local wind power equipment manufacturers, and the other is brought by Japan against the Canadian Province Ontario for its preferential tariff scheme for renewable energy, which stipulates only wind and solar equipment meeting certain local content requirement can benefit from the scheme.

This paper will examine these two cases, various domestic support for investment in renewable energy, the WTO rules on subsidies and incentives and the international trade dispute settlement mechanism, the possible results of the two cases based on the experiences with previous cases, as well as how to design the domestic measures to avoid possible trade disputes.

## **II. The Japan – Canada trade dispute concerning Canada’s Policy Supporting Electricity from Renewable Sources**

The Japan against Canada trade dispute is the first ever WTO trade dispute on renewable energy. Japan filed the case to WTO because it believes Canada violates it WTO obligations and discriminates against imported products. The Canadian Ontario Province introduced the policy of offering 20-40 year long term fixed tariff contract for projects generating electricity from renewable sources, which has a the minimum local content requirements for the wind and solar PV equipments used in such projects. Local content requirement is forbidden in WTO rules and countries that include or plan to introduce such requirements in their renewable energy supporting policies may wonder whether they can continue to do so.

### **2.1 The WTO case of Japan against Canada for Local Content Requirements in Ontario’s Feed-in Tariff program<sup>1</sup>**

On 13 September 2010, Japan requested consultations with Canada regarding Canada's measures relating to domestic content requirements in the feed-in tariff program (the “FIT Program”). Japan claimed that the measures are inconsistent with Canada's obligations under WTO because the FIT Program accord less favourable

---

<sup>1</sup> WTO Case dispute website: **DS412** Canada — Certain Measures Affecting the Renewable Energy Generation Sector (Complainant: Japan)

treatment to imported renewable energy generation equipment than that accorded to like products originating in Ontario. In the same month, the United States and the European Union requested to join the consultations and became third parties in this trade dispute.

### The FIT Program for Under Dispute:

Ontario's feed-in tariff or FIT Program is North America's first comprehensive guaranteed pricing structure for renewable electricity production. It offers stable prices under long-term contracts for energy generated from renewable sources, including: biomass, biogas, landfill gas, on-shore wind, solar PV, and hydropower.

The FIT Program was enabled by the Green Energy and Green Economy Act, 2009 which was passed into law on May 14, 2009. The Ontario Power Authority (OPA) is responsible for implementing the program.

By encouraging the development of renewable energy in Ontario, the FIT Program aims at:

- Help Ontario phase out coal-fired electricity generation by 2014 - the largest climate change initiative in Canada;
- Boost economic activity and the development of renewable energy technologies; and
- Create new green industries and jobs.

Project eligible can enter into a 20-year FIT contract (40 years for qualifying waterpower projects) with the OPA. The detailed feed-in tariffs offered under the FIT is shown in Table 1.

**Table 1.** Feed-in Tariff Prices for Renewable Energy Projects in Ontario (August 13, 2010)

Renewable fuel		Size range	Contract Price ¢/kWh	Escalation Percentage
Biomass		≤10 MW	13.8	20%
		>10 MW	13.0	20%
Biogas	On-farm	≤100kW	19.5	20%
	On-farm	>100kW≤250kW	18.5	20%
	Biogas	≤500kW	16.0	20%
	Biogas	>500kW≤10MW	14.7	20%
	Biogas	>10 MW	10.4	20%
Waterpower		≤10 MW	13.1	20%
		>10MW≤50MW	12.2	20%
Landfill gas		≤10 MW	11.1	20%
		>10 MW	10.3	20%
Solar PV	Rooftop	≤10kW	80.2	0%
	Rooftop	>10≤250kW	71.3	0%
	Rooftop	>250≤500kW	63.5	0%
	Rooftop	>500kW	53.9	0%
	Ground Mounted	≤10kW	64.2	0%
	Ground Mounted	>10kW≤10MW	44.3	0%
Wind	Onshore	Any size	13.5	20%
	Offshore	Any size	19.0	20%

Source: Ontario Power Authority, 2010

To be eligible to benefit from the preferential feed-in tariff from the FIT program, wind projects must use wind turbines that meet certain “made-in-Ontario” requirements. The Ontario province sets minimum local content requirements for wind and solar equipment used in local wind and solar power projects as it strives to create local jobs (see Table 2).

**Table 2.** Local Content Requirement under the FIT Program

	Minimum domestic content level	Milestone date for commercial operation
Wind (>10 kW)	25%	Before 1 Jan 2012
	50%	After Jan 1, 2012
Solar (>10 kW)	50%	Before 1 Jan 2012
	60%	After Jan 1, 2012

Source: Ontario Power Authority, 2010

There are also price adders of up to 1.5 ¢ /kW for aboriginal and community-based projects. Wind and solar projects less than 10kW are subject to the MicroFIT Program, which does not have specific local content requirements.

If Japan wins the trade dispute, Canada needs to withdraw its WTO-rule violating rules, or offer compensation, otherwise Japan can take countervailing measures in the similar sector. It will be a blow to the first ambitious state feed-in tariff program in North America.

To submit a complaint to the WTO and requests for WTO help settle a trade dispute, countries need to demonstrate that another country violating its WTO obligations and the violation causes damages to the important interests of the plaintiff country. In reality, there may be other political and economic considerations.

It may take a long time to solve this trade dispute as according to the WTO rule, Japan will carry out consultation with the federal government of Canada, which has no jurisdiction to regulate the renewable energy supporting policies of one of its provinces.

Even though the results of this trade disputes may not affect the LCR requirements in the renewable energy supporting policies of other countries, this trade dispute may make other countries think it imprudent to include LCR in their new renewable energy policies. Moreover, it may also make investors doubt about the duration and extent they can benefit from such requirements. In a study about the wind supporting policy for the Canadian province British Columbia, Hao et al (2010) recommended that due to the uncertainty caused by the Japanese against Canada trade dispute, LCR should not be included in the wind energy supporting policy packages of British Columbia.<sup>2</sup>

## 2.2 Canada's wind energy supporting policies

Due to its long coastal line and large open area, Canada is a country with abundant wind energy resources. However, it is also rich with other energy resources. It is also the biggest uranium producer in the world and produces 13% of the hydropower worldwide. It has also significant production of coal, oil and natural gas.

<sup>2</sup> Local Content Requirements in British Columbia's Wind Power Industry, May Hao, Matt Mackenzie, Alex Pomerant and Kate Strachran, December 2010

In Canada, the federal government is in charge of inter-provincial and international trade and commerce issues related to renewable energy. The provincial and territorial governments are responsible for making and implementing their own renewable energy supporting policies.

Since 2001, wind energy has been witnessing rapid development. In the first decades of the 21<sup>st</sup> century, Canada's total wind installed capacity grew from 198 MW to 4,009 MW (see Table 3).

Table 3. Total wind installed capacity in Canada

Year	2001	2002	2003	2004	2005	2006	2007	2008	2009	2010
MW	198	236	322	444	684	1,460	1,846	2,372	3,319	4,009

Source: Canada Wind Energy Association

The top three provinces in terms of installed wind capacity are Ontario, Alberta and Quebec (see Figure 1). Together they are home for over two thirds of the installed wind capacity in Canada.

Figure 1. Canadian's installed wind capacity – by April 2011

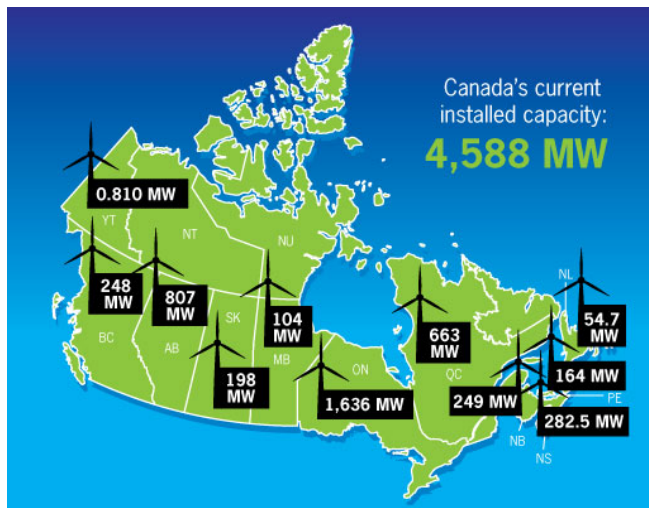

Source: Canadian Wind Energy Association

Ontario's neighbouring province Quebec has had a local-procurement program for years for its energy development, they note, including rules that force power producers to buy equipment from specific regions inside the province. The Quebec started large utility tendering for wind power investment as early in 2003 and its practice of supporting the development of local wind turbine manufacturing capacity in the tendering requirements was once hailed as a good model of combining renewable energy development and local manufacturing capacity building<sup>3</sup>. In fact, LCR requirements have been included in the renewable energy policies of multiple countries. Table 4 illustrates the LCR requirements in the renewable energy policies of selected countries.

<sup>3</sup> Supporting Localization of Wind Technology Manufacturing through Large Utility Tenders in Québec: Lessons for China, Joanna I. Lewis, Ryan H. Wisler Prepared by the Center for Resource Solutions for the Energy Foundation's China Sustainable Energy Program, June 8, 2006.

Table 4. Local Content requirements for renewable energy

Country	
China (2005-2009)	70% domestic content as key criterion for awarding wind farm development projects (this requirements was cancelled in Oct 2009)
Brazil	Brazil's clean energy legislation, Profina program launched in 2005, also has LCR for wind energy. But due to lack of local manufacturing capacity, the LCR is of marginal value. And due to lobbying from its wind energy industry, and LCR threshold has been lowed, but still a condition for receiving local funding
Spain	Several of Spain's provinces have independently employed LCR policies for market access. The Spanish wind turbine manufacturer Gemesa, entered the wind technology market in 1994 and has benefited from the LCR, and now it is a global leader in wind technology
Ontario, Canada	Introduce a 20-year preferential fixed feed-in tariffs program, which includes LCR requirements for wind equipment and solar PV. Japan filed a WTO trade dispute against this policy in Sept 2010.
Québec, Canada	Québec's LCRs, which are a few years older than Ontario's policies, date back to 2003. Québec's regulations stipulate that 60% of the turbine's costs must be incurred in Québec, with a certain percentage to be met in a particular region of the province.

The WTO Agreement on Trade and Investment Measures (TRIM) generally prohibits local content requirements, but such requirements do not necessarily lead to trade disputes. In 2005, China issued a regulation, requesting wind turbines used in wind projects in China should have a minimum of 70% local contents. The foreign wind turbine makers quietly set up factories and built up their local supplying base, and the rule does not lead to any trade dispute. In 2010, China quietly removed the 70% local content requirements. But one difference is that China can justify its action with its developing country status and the preferential treatment to developing countries under the WTO, while Canada can not. (ITCSD, 2010)<sup>4</sup>.

It is puzzling that Japan decided to file the WTO trade dispute with Canada on Ontario's renewable energy feed-in tariff program. Ontario's neighboring province, Quebec, has a local procurement program for years for its energy development. Other experts say they think it is puzzling that Japan has decided to make its move now. Ontario's neighbouring province Quebec has had a local-procurement program for years for its energy development, they note, including rules that force power producers to buy equipment from specific regions inside the province. The Quebec policy has never drawn complaints from the Japanese, the source says.

Shah (2010) pointed out that the real reason behind Japan's filing the WTO trade dispute against the Ontario fixed feed-in tariff program because a consortium led by the Korean company, Samsung, won a 7\$ billion renewable energy contract from the Ontario government to set up 2.5 GW of solar and wind energy capacity and setting up four manufacturing plants between 2013 and 2015 in Ontario. The preferential

---

<sup>4</sup> Bridges Trade BioRes • Volume 10 • Number 17 • 24th September 2010 ICTSD, Japan Challenges Canadian Renewable Energy Incentives at WTO

grid access, subsidies and land offered from this big contract will help Samsung and some of its Korean partners build up their wind and solar power manufacturing capacity and technology. Japan took this as a loss for its renewable energy manufacturers like Sharp, Mitsubishi, and Kyocera. This illustrates that political considerations sometimes is an important factor countries consider whether to file a WTO trade dispute against the WTO-rule violating action of another country or not.

### **III. US complains to the WTO against China's Measures concerning wind power equipment<sup>5</sup>**

Three months after initiation of the Japan – Canada trade dispute concerning LCR in the Ontario Province's renewable energy boosting scheme, the United States filed a WTO case against China for the Chinese scheme which gives grants to Chinese manufacturers of wind turbines and key wind turbine components for their efforts to develop high capacity wind turbine manufacturing technologies. Unlike the Japan-Canada trade dispute, this trade dispute is between the world's largest developed economy and the world's biggest developing economy. Both countries are trying to make renewable energy sector part of their effort for sustainable development and become a global leader in renewable energy technologies.

#### **3.1 The trade dispute by US against China's grants to Chinese wind turbine and key component manufacturers**

On 22 December 2010, the United States requested consultations with China concerning certain Chinese measures of providing grants, funds, or awards to enterprises manufacturing wind power equipment (including the whole unit assembly, and key component manufacturing) in China.

The United States indicated that the measures appear to provide grants, funds, or awards that are contingent on the use of domestic over imported goods and, consequently, they appear to be inconsistent with the WTO Agreement on Subsidies and Countervailing Measures.

In addition, the United States considered that, as China has not notified these measures, China has failed to comply with the transparency requirements under the GATT 1994 and the SCM Agreement. According to the WTO rules, countries should make available their measures into one or more of the 3 WTO official languages, (English, French, and Spanish). In January 2011, the European Union and the Japan requested to join the consultations.

The measure which causes this trade dispute was the "Notice of the Ministry of Finance on Issuing the Provisional Measure on Administration of Special Fund for Industrialization of Wind Power Equipment", issued and taken effect in August 2008. This measure stipulates that a subsidy be granted to any qualified enterprise for its first 50 wind power units by the standard of 600 RMB/kW (equivalent to around 88 US\$/kW). The Chinese Ministry of Finance establishes the Special Fund to offer fiscal subsidies to the manufacturers of wind turbines and main wind turbine components. Only Chinese funded or Chinese-holding enterprises (joint ventures with Chinese having at least 51% of the share) within the territory of China are eligible to receive support from the fund.

Conditions for applying for the subsidy:

The manufacturer owns intellectual property and brand of the products

- The wind turbines should be of generating capacity of 1.5 MW or higher

---

<sup>5</sup> WTO Case Dispute website: DS419 China — Measures concerning wind power equipment (Complainant: United States of America)

- The wind turbines shall pass the certification by Beijing Jianheng Certification Centre
- The turbines, gear box, and generators shall be made by Chinese funded or holding companies, and the manufacturers are encouraged to use current transformer and bearing produced by Chinese funded or Chinese holding companies.
- If an enterprise applies for support for its different product models using the same technologies, the generating capacity between the models shall be 0.5 MW or above.
- The wind power generating units shall be produced, installed, and commissioned in China, operating without problem for over 240 hours, and passed the buyer's inspection
- Size of the subsidy: 600 RMB/kW for the first 50 generating units made by each eligible enterprise. The whole generating unit producers and key component and part manufactures will each get 50% of the subsidies.

The above measure is clearly aimed at supporting Chinese enterprises build up their capacity of manufacturing wind power generating units of 1.5 MW or bigger.

In fact, the US brought WTO trade dispute against China's subsidy to Chinese wind power equipment manufacturers because requests by the US United Steel, Paper and Forestry, Rubber, Manufacturing, Energy, Allied Industrial and Service Workers International Union (United Steelworkers or USW). USW is the largest industrial labor union in North America, with 705,000 members<sup>6</sup>. USW complained about American job losses because of China's WTO violating practices and measures of subsidizing and protection its clean energy technology sector, ranging from wind and solar energy products to advanced batteries and energy-efficient vehicles.

United Steelworkers' Petition Against China WTO-violating Practices of Supporting its Green Technology Sector include five main allegations:

- illegal export subsidies and import-substitution subsidies, such as excessive export financing and grants for Chinese producers of wind turbines, solar panels and advanced batteries;
- laws that discriminate against imports and foreign firms, such as local content requirements for wind and solar plants and exclusion of foreign firms from access to carbon credits arising from Chinese projects;
- requirements that foreign investors transfer technology to Chinese controlled enterprises in order to receive necessary approvals;
- restrictions on foreign access to rare earth materials needed for making solar panels, wind turbines, advanced batteries and energy-efficient lighting; and
- large domestic subsidies to Chinese-controlled green technology industries.

### **3.2 Wind energy development in China and supporting policies**

China's wind energy sector has been experienced fast growth since mid 1990s. In 1996, the country only had 79 MW of installed wind capacity, just around 1% of the world total. A few countries that were leaders in wind power technology, US, Germany, India, Denmark, had far more wind installed capacity than China.<sup>7</sup>

<sup>6</sup> Office of Labor-Management Standards. Employment Standards Administration. U.S. Department of Labor. Form LM-2 labor Organization Annual Report. United Steelworkers of America. File Number: 000-094. Dated March 31, 2009.

<sup>7</sup> United States: Energy Information Administration, Electric Power Annual 1997, Volume II, DOE/EIA-0348(97)/2 (Washington, DC, October 1998) and Rest of the World: Windicator, Wind Power Monthly (January 1998), p. 50.

In 2010, China's total wind installed capacity has risen to be 42.3 GW and China has become the country with biggest installed wind capacity in the world, home to more than one fifth of the worldwide wind energy generating capacity. Moreover, its newly installed capacity in 2010 is more than three times that of US, which is the 2<sup>nd</sup> biggest in terms of newly added wind capacity in the year.

Wind energy investment in China is increasing quickly. In 2010, China saws 12904 new wind generating units installed in the country, with a total installed capacity of 18.9 GW, up 37.1% from the previous year (see Figure 2). And the total wind generating capacity in China is now 44.7 GW (CWEA, 2011).

**Figure 2.** Wind Power Development in China

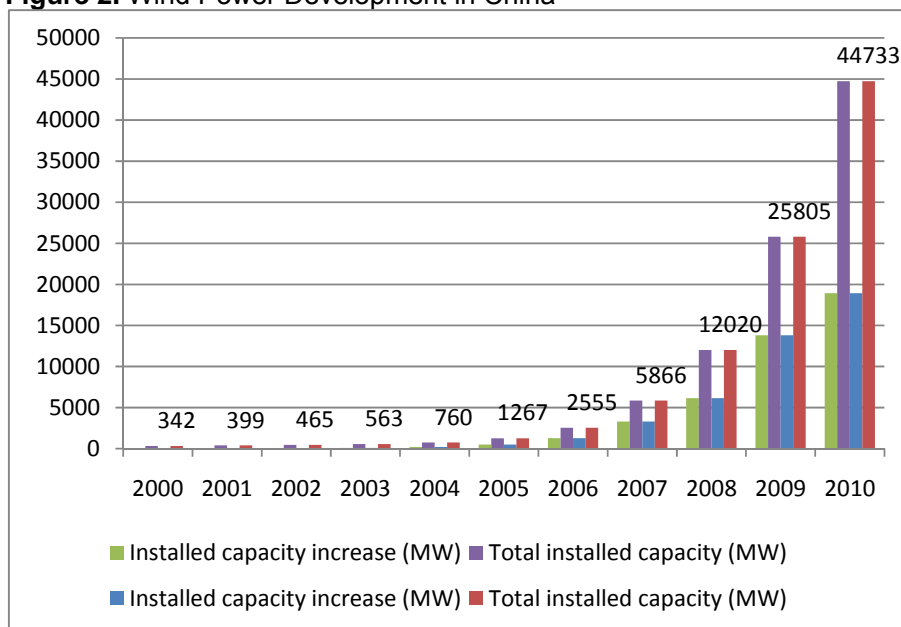

Source: China Wind Energy Association (CWEA, 2011)

Meanwhile, China's wind manufacturing capacity is also improving quickly. Starting from licensing from wind companies in Europe, Chinese enterprises started to enter the wind manufacturing industry in the late 1990s. The country's first big wind turbine manufacture, GoldWind, was established in 1998 and started from purchasing licensing for small wind turbine manufacturing technologies from several German companies (Lewis, 2007)<sup>8</sup>. With the introduction of a series of favourable government policies and measures, foreign companies began to enter the Chinese wind equipment market and set up production bases there, in many cases through establishing joint ventures with Chinese companies and local enterprises start to grow quickly in the wind turbine manufacturing sector. By 2010, there have been over 80 wind turbine producers in China. About 90% of the newly added wind generating capacity in China is from wind turbines made by Chinese enterprises. Famous international wind equipment makers, Suzlon, Gemeasa, GE, Siemens, Vastas, together only have 10% of the market. 3 of the Chinese wind turbine makers, Sinovel, GoldWind, and Dongfang Electronic, are among the top 10 wind turbine makers in terms of market share. Government supporting policies are critical to renewable energy development.

<sup>8</sup> Joanna I. Lewis, 2007. Technology Acquisition and Innovation in the Developing World: Wind Turbine Development in China and India, *Studies in Comparative International Development (SCID)* Volume 42, Numbers 3-4, 208-232.



This is because China has introduced a series of preferential policies for wind energy development. It had already exceeded wind energy development target for 2020, 30 GW of installed capacity by 2020. The faster than expected development of renewable energy makes the country consider about increasing the 2020 renewable energy target from 15% in primary energy supply to 20% in 2020.<sup>9</sup>

Meanwhile, the wind generating unit manufacturing sector is also rising quickly in China, thanks to the booming domestic market and the supportive policies. As shown in Table 5, among the top 20 wind generating unit manufacturers on the Chinese market in 2010, only 4 are foreign companies. Vestas, Gamesa, GE, and Suzlon together only supply 10% of the newly increases in wind generating capacity in China in 2010 (CWMA, 2011).

**Table 5.** Top 20 Wind Power Manufacturers on the Chinese Market in 2010

No.	Manufacturer	Installed capacity(MW)	Market share
1	Sinovel	4386	23.2%
2	GoldWind	3735	19.7%
3	Dongfang Electric	2623.5	13.9%
4	United Power	1643	8.7%
5	Ming Yang	1050	5.5%
6	<b>Vestas</b>	892.1	4.7%
7	Shanghai Electric	597.85	3.2%
8	<b>Gamesa</b>	595.55	3.1%
9	XEMC	507	2.7%
10	China Creative	486	2.6%
11	HZWindPower	383.15	2.0%
12	CSR Times	334.95	1.8%
13	Envision	250.5	1.3%
14	<b>GE</b>	<b>210</b>	<b>1.1%</b>
15	<b>Suzlon</b>	<b>199.85</b>	<b>1.1%</b>
16	Huayi Electronic	161.64	0.9%
17	Yinxing	154	0.8%
18	Windey	129	0.7%
19	Sany	106	0.6%
20	Changxing	100	0.5%
Other		382.9	2.0%
Total		18927.99	100%

Source: China Wind Energy Association (CWEA, 2011)

Already 3 Chinese wind manufacturers are already among the top 10 world wind manufacturers in terms of market share due to their dominant position on the Chinese wind market, the biggest national market in the world (see Figure 3). The Chinese government is encouraging its enterprises to expand their expansion in the international market and Chinese enterprises start to set up offices abroad. For example, Denmark is one of the leading countries in wind technology. Suzlon, the famous wind technology company from India, has its European headquarter based in Århus, Denmark. For example, Ming Yang, one of China's big wind turbine manufacturers, has set up a liaison office at the Risø DTU National Laboratory for Sustainable Energy in Roskilde, Denmark.

**Figure 3.** Market share of the Top 10 wind manufacturers in 2009

<sup>9</sup> China develops 5-trillion-yuan alternative energy plan July 22, 2010 , China Daily

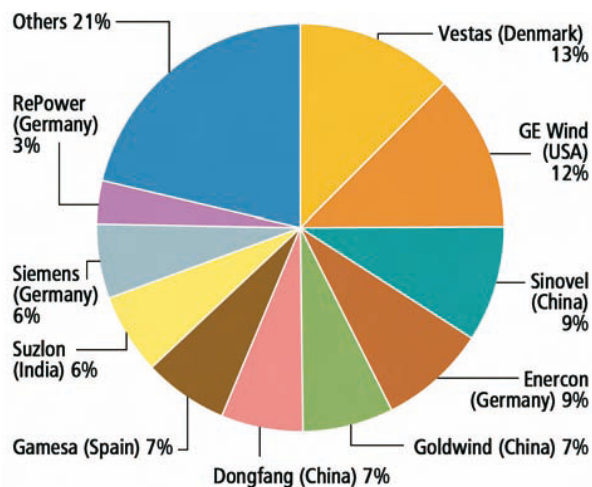

Source: Renewables 2010 Global Status Report, REN21

The fast rising of China's wind energy sector is due to the adaptation of multiple government supporting policies. As indicated in Table 6, the government support covers technology research and development, demonstration projects, tax credits and fiscal subsidies, as well as technology transfer, preferential feed-in tariff, and grid connection. The next five years will continue the high speed growth of the 11th Five-year Plan, by the end of the 12th Five-year Plan total installed capacity has the potential of reaching 130 GW. Wind power equipment manufacturing ability will also improve significantly. Unlike the 11th Five-year Plan's goal which solely focused on installed capacity, the 12th Five-year Plan will focus on both quality and quantity<sup>10</sup>.

**Table 6.** China's wind energy policies

Type	Content
Government support for Wind Technology R&D	Including wind turbine manufacturing technologies in national R&D supporting programs, allowing for pretax deduction of R&D spending
Government subsidy for pilot wind projects	Government tendering, higher tariff to the projects
Tax	preferential financing, VAT rebates, tax incentives, procurement preferences for Chinese-owned and controlled companies
Renewable energy Law enacted in 2006	Guaranteed high tariff for electricity from wind over operation life, mandatory requirements for grid companies to purchase all electricity generation from wind in China, the extra costs of renewable electricity should be shared among all electricity users in China
Five-year and 2020 targets for wind energy development	Medium and Long-Term Development Plan for Renewable Energy in China issued in 2007 first set the targets of increasing installed wind capacity to 30 GW by 2020, which was increased to 100GW, then further to 200 GW by 2020, because the faster than expected development speed
Government concession through tendering	Public bidding, offering subsidies to attract investors, but introducing competition to lower the costs of subsidies.
Government facilitated	Formed two joint ventures, local content requirements

<sup>10</sup> Li Junfeng, Shi Pengfei, Gao Hu et al, 2010, CHINA WIND POWER OUTLOOK 2010, Chinese Renewable Energy Industries Association, Global Wind Energy Council, Greenpeace, October 2010

technology transfer	started from 20% and gradually increased to 80% Government enters into international technology cooperation on wind, and encouraging the set up of joint ventures by multinational wind turbine manufacturers
Customs Duties and Import Tariffs	Import tariff exemption (1990-1995) 1996 onwards: more favourable tariff on component import than whole turbine import, lower duty on high-tech component import
Local content requirements	Especially for large projects tendering by the National Development Commission, min. 40% LCR requirements in 2003, min. 70% LCR 2005 to 2009
Special fund for wind development and special fund for wind technology localisation	Subsidies, grants, and low interest loans for wind energy projects and Chinese wind turbine manufacturers

Source: Howell et al, 2010

In fact, from 2005 to 2009, China has a rule that wind power projects in China have to use wind turbines with a minimum local content of 70%. Some US and European wind power equipment manufacturers find the Chinese market so important that they prefer to quietly follow the Chinese rules than complaining to their governments and resort to trade disputes. Many foreign companies circumvent the rules by setting up factories and joint ventures in China. Gemesa, a leading wind power manufacturer from Spain, helped Chinese enterprises set up wind turbine component producing facilities and its engineers trained the local component suppliers. The 70% local requirements were dropped in 2009, by the time the localisation policy was so successful that the local content rate of some of the foreign wind turbine producers' turbines sold in China had reached 95% and foreign producers began to supply their market outside China with components supplied from China (New York Times, Jan 30, 2010).

#### **IV. Renewable energy development – subsidies, job creation, and manufacturing capacity building and technology competitiveness**

##### **4.1 Renewable energy development**

In the last few years, investments in various renewable energy have been growing at fast speed, especially solar PV, biofuel, and wind capacity have been increasing quickly. In 2010 (World Economic Forum, 2010), the global investments in solar power and wind power grew by 49% and 31% respectively despite the economic difficulties caused by the recent global economic and financial crisis. The world investment in clean energy grew from the 186 billion USD in 2009 to 243 billion USD in 2010, for the first time approaching half of the 500 billion USD per year investment indicated by the IPCC as necessary for peaking the global greenhouse gas emissions by 2020.

**Figure 4.** Average renewable energy growth speed, end-2004 to 2009

**Figure 5.** Global electricity generation from different sources

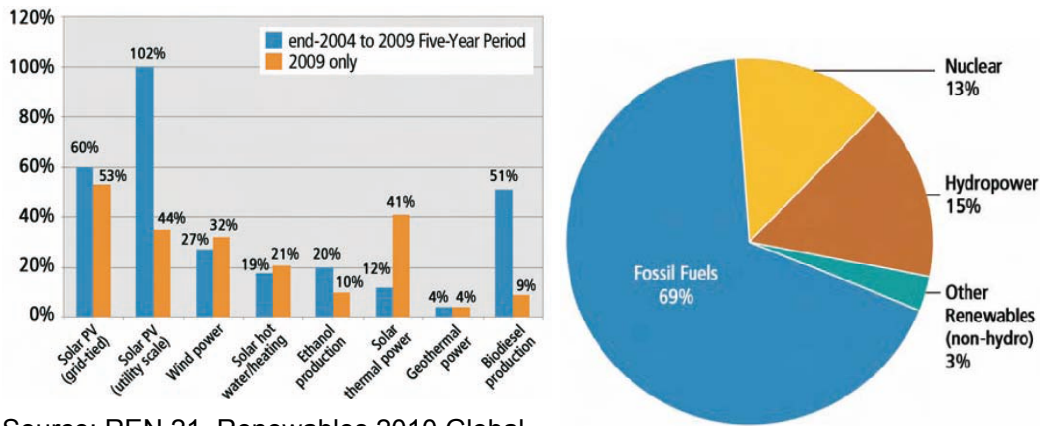

Source: REN 21, Renewables 2010 Global Status Report

According to REN 21 (2010), by early 2010, more than 80 countries had enacted some type of policy target and/or promotion policy related to renewable energy, up from 55 countries in early 2005. Renewable energy is increasingly seen as a green industry that will continue to grow rapidly in the coming decades and can bring about the multiple benefits of climate change mitigation, local pollution reduction, reducing dependence on fossil fuel import, improving national energy security, as well as boosting economic growth and creating new jobs. In 2009, the total installed capacity of renewable energy (including only small hydro) reached 349 GW and electricity generated from renewable sources makes up 3% of the world electricity generation. renewable energy (excluding large hydro) contributes 3% of the global electricity generation,

Despite continual cost decreases due to the fast growth in renewable energy technology deployment and research and development, renewable energy technologies except for large hydro, are still more expensive than fossil fuels. Levelized Cost of Electricity (LCOE) is the indicator for comparing the cost for each kWh generation using different technologies over a power plant's useful life. Table 7 is the IEA estimates of the Levelized Cost of Electricity (LCOE) costs of 6 kinds of electricity generation technologies: nuclear, combined cycle gas turbine (CCGT), supercritical (SC) and ultra-supercritical (USC) coal power plants, coal with 90% carbon capture (and storage) [C with 90% CC(S)], on-shore wind and solar PV. Competitiveness and job creation considerations in countries renewable energy development plans. It can be seen that when the discount rate is 5%, it will cost more to generate each kWh of power from wind and solar PV than the other four major power generation technologies. When the discount rate used is 10%, the gap is even bigger (IEA, 2010).

**Table 7.** Power technology costs

Median Case Specifications	Nuclear	CCGT	SC/USC Coal	Coal w/90% CC(S)	Wind Onshore	Solar PV
Capacity (MW)	1400.0	480.0	750.0	474.4	45.0	1.0
Construction cost (\$/kWe)	3681	1018	1916	3337	2237	5759
O&M /(\$/MWh)	14.74	4.48	6.02	13.61	21.92	29.95
Fuel Cost (\$/MWh)	9.33	61.12	18.21	13.04	0.00	0.00

CO <sub>2</sub> Cost (\$/MWh)		0.00	10.54	23.96	3.22	0.00	0.00
Efficiency (net, LHV <sup>11</sup> )		33%	57%	41%	35%	-	-
Load Factor (%)		85%	85%	85%	85%	26%	13%
Lead time (years)		7	2	4	4	1	1
Expected Lifetime (years)		60	30	40	40	25	25
LCOE (\$/MWh)	5%	58.53	85.77	65.18	62.07	96.74	410.81
	10%	98.75	92.11	80.05	89.95	137.16	616.55

Source: IEA, *Projected Costs of Electricity Generation 2010*

Therefore, in most cases, some government incentives needed to overcome the market failure and stimulate private sector investment in renewable energy. According to REN 21, at least 83 countries—41 developed/transition countries and 42 developing countries—have some policies to promote renewable power generation. The 10 most common policy types are feed-in tariffs, renewable portfolio standards, capital subsidies or grants, investment tax credits, sales tax or VAT exemptions, green certificate trading, direct energy production payments or tax credits, net metering, direct public investment or financing, and public competitive bidding. Table 8 shows the supporting policies for renewable energy by selected countries.

**Table 8.** Supporting policies for electricity generation from renewable sources in selected countries

	Feed-in tariff	Renewable portfolio standard/quota	Capital subsidies, grants, rebates	Investment or other tax credits	Sales tax, energy tax, exercise tax, VAT reduction	Tradable RE certificate	Energy production payments or tax	Net metering	Public investment,	Public competitive
Denmark	X		X	X	X	X		X	X	X
Germany	X		X	X	X			X	X	
Spain	X		X	X	X	X			X	
UK	X	X	X		X	X			X	
United States	(*)	(*)	X	X	(*)	(*)	X	(*)	(*)	(*)
Canada	(*)	(*)	X	X	X			X	X	X
South Korea										
Japan	X	X	X	X		X		X	X	
Brazil				X					X	X
China	X	X	X	X	X		X		X	X
India	(*)	(*)	X	X	X	X	X		X	
Philippines	X	X	X	X	X		X	X	X	X
South Africa	X		X		X				X	X

Note: (\*) means that some states/policies within these countries have state/province-level policies but there is no national-level policy. Only enacted and existing policies are included in the table. Some policies may also apply to renewable energy besides power generation, such as solar hot water and biofuel.

<sup>11</sup> LHV: lower heating value.

Source: adapted from REN21, 2010

It needs to be pointed out that subsidies for renewable energy often lead to higher electricity costs bear by the consumers or tax payers. For example, it is expected that the 7 billion Canadian dollar contract offered by the Ontario provincial government to Samsung, which is identified some expert as the direct cause of Japan's complaint to the WTO. Samsung will receive 437 million in incentives payments over the 25-year duration of the contract if it realises the obligations of creating 16,000 jobs. This incentive will lead to a 1.60 Canadian dollar per year increase in consumers' electricity bills (United Press International, 22 Jan 2010).

Therefore, when persuading public support for subsidy to renewable energy, politicians often point out the benefits of new job creation through local manufacturing, the building up of future competitiveness in renewable technologies, as well as improved energy security, reduced air pollution, as well as greenhouse gases.

The first two benefits are especially emphasized in the aftermath of the recent economic crisis, when countries face the difficult task of having to reducing government spending, while the unemployment remains high. The contributes of renewable energy use to global warming, is more considered as co<sup>12</sup>

For example, the US Congress has been blocking the legislation about accepting any binding commitment for the US. But President Obama signed the American Recovery and Reinvestment Act, which includes more than \$80 billion in clean energy, including the generation of renewable energy sources, expanding manufacturing capacity for clean energy technology, advancing vehicle and fuel technologies, and building a bigger, better, smarter electricity grids and the strong justification is that all these efforts can new, sustainable jobs.<sup>13</sup> During his speech at ZBB Energy Corporation, he clearly announced his commitment to create 800,000 clean energy jobs by 2012 that will not only "create work in the short-term, but lay the foundation for lasting economic growth."

To secure that the subsidies for renewable energy development leads to local job creation and the building up of local competitiveness in renewable energy technologies, countries try to limit the subsidy recipients to local companies, instead of foreign producers. In addition to creating jobs, building up local manufacturing and technology capacity could also serve the purpose of import substitution in the short term, and in some cases, this may reduce the overall costs of relevant renewable energy equipment and services, hence reducing the amount of public subsidy needed. In the long term, countries may hope their suppliers of equipment, renewable-energy related technologi and service could build up international competitiveness and become exporters of such equipment, technologies, and services. This is also known as the needs for protecting 'infant industry', which works in some cases, while fails in other cases. The next section will examine the relevant WTO rules for the various policies and measures used by countries in support of renewable energy development. As indicated in the two WTO trade dispute cases on renewable energy explained in the previous part of this article, local content requirements in the subsidy schemes are the key reason of the complaints by other member countries.

---

<sup>12</sup> <http://www.whitehouse.gov/issues/energy-and-environment>

<sup>13</sup> The White House Blog, New Battery Technology and New Jobs in Wisconsin, Posted by Katelyn Sabochik on August 16, 2010 at 05:27 PM EDT

China successfully builds its wind energy industry within a decade. The Chinese policies play an important role in the process. China's experiences have been much studied by experts<sup>14,15</sup>, international agencies<sup>16</sup>, and other countries.

## V. The WTO, Its dispute settlement procedures, and rules on domestic policies and measures

This

### 5.1 The World Trade Organisation

The World Trade Organization (WTO) was created on 1 January 1995. It is the only global international organization dealing with the rules of trade between nations. Its main function is to ensure that trade flows as smoothly, predictably and freely as possible. Its predecessor is the General Agreement on Tariffs and Trade (GATT) GATT founded in 1947. The WTO agreements are agreed by consensus by the member countries and ratified by the parliaments of the member countries. As of 2008, 153 countries are the members of the WTO, covering 97% of the world trade (see Figure 6). The WTO oversees about 60 different agreements which have the status of international legal texts. Member countries must sign and ratify all WTO agreements on accession.

**Figure 6.** Member countries of the WTO

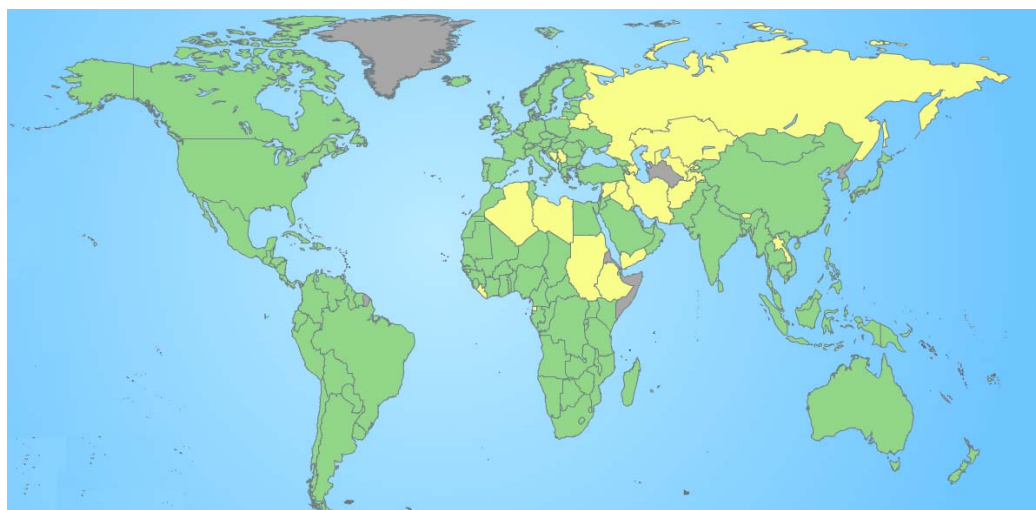

Note: countries in green are WTO members, countries in yellow are observers

**Source:** WTO website

The main activities of WTO includes agreement negotiations, implementing and monitoring of the agreements, trade dispute settlement, trade capacity building for developing country members, as well as outreach about the WTO and ongoing negotiations.

The WTO follows five key principles:

- **Non-Discrimination.** It has two major components: the most favoured nation (MFN) rule, and the national treatment policy. Both are embedded in the main WTO rules on goods, services, and intellectual property, but

<sup>14</sup> A Review of the Potential International Trade Implications of Key Wind Power Industry Policies in China, Joanna I. Lewis, Prepared for the Energy Foundation China Sustainable Energy Program, 2007.

<sup>15</sup> Bloomberg New Energy Finance 2010 Joined at the hip: the US-China clean energy relationship-White Paper. 17 May 2010

<sup>16</sup> World Bank, 2010, China's Envisaged Renewable Energy Target: The Green Leap Forward, Energy Sector Management Assistance Program (ESMAP), the World Bank Group.

their precise scope and nature differ across these areas. The MFN rule requires that a WTO member must apply the same conditions on all trade with other WTO members. National treatment means that imported goods should be treated no less favourably than domestically produced goods and was introduced to tackle non-tariff barriers and discrimination against imported goods.

- Reciprocity. Reduction in tariffs and elimination of trade barriers shall be reciprocal. This makes trade liberalization laws and regulations easier to pass in countries that seek greater access to markets in other countries. Reciprocal concessions intend to ensure that such gains will materialise.
- Binding and enforceable commitments. The tariff commitments made by WTO members in a multilateral trade negotiation and on accession are enumerated in a schedule (list) of concessions. These schedules establish "ceiling bindings": a country can change its bindings, but only after negotiating with its trading partners, which could mean compensating them for loss of trade. If satisfaction is not obtained, the complaining country may invoke the WTO dispute settlement procedures.
- Transparency. The WTO members are required to publish their trade regulations, to maintain institutions allowing for the review of administrative decisions affecting trade, to respond to requests for information by other members, and to notify changes in trade policies to the WTO.
- Safety valves. In specific circumstances, governments are able to restrict trade. There are three types of provisions in this direction: articles allowing for the use of trade measures to attain noneconomic objectives; articles aimed at ensuring "fair competition"; and provisions permitting intervention in trade for economic reasons. Exceptions to the MFN principle also allow for preferential treatment of developed countries, regional free trade areas and customs unions.

WTO is a rule-based system made up over 60 agreements, annexes, decisions, and understandings reached through negotiations among WTO members. These agreements cover the rules and exceptions for international trade on goods, services, and intellectual properties. These agreements can be divided into six main types: umbrella WTO Agreement, goods, services, intellectual property, disputes and trade policy reviews (see Table 9).

Table 9. The Structure of WTO Agreements

Umbrella	Agreement Establishing WTO		
	Goods	Services	Intellectual Property
Basic Principles	GATT	GATS	TRIPS
Additional details	Other goods agreements and annexes	Service annexes	
Market access commitments	Countries' schedules of commitments	Countries' schedules of commitments (and MFN exemptions)	
Dispute settlement	Dispute Settlement		
Transparency	Trade policy reviews		

Source: WTO



## 5.2 The WTO Trade Dispute Settlement Arrangement

Dispute settlement is regarded by the WTO as the central pillar of the multilateral trading system, and as a "unique contribution to the stability of the global economy". WTO members have agreed that, if they believe fellow-members are violating trade rules, they will use the multilateral system of settling disputes instead of taking action unilaterally. [http://en.wikipedia.org/wiki/World\\_Trade\\_Organization\\_-\\_cite\\_note-UnSD-45](http://en.wikipedia.org/wiki/World_Trade_Organization_-_cite_note-UnSD-45)

The operation of the WTO dispute settlement process involves the Dispute Settlement Body (DSB) panels, the Appellate Body, the WTO Secretariat, arbitrators, independent experts and several specialized institutions.

**Figure 7.** Number of WTO Trade Disputes Each Year

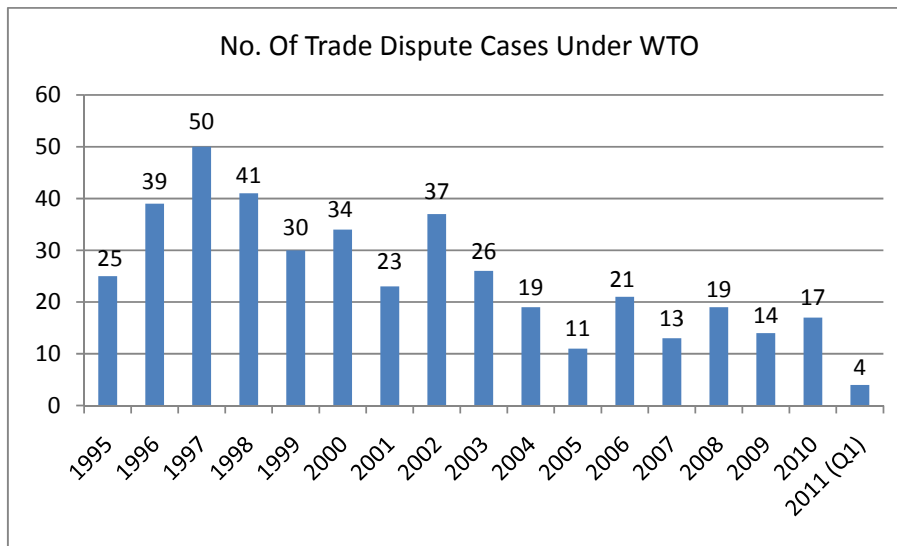

Since establishment of WTO in replace of GATT on 1<sup>st</sup> January 1995, there have been 423 trade dispute cases under the WTO (see Figure 7). According to the WTO rules and practices, the Parties involved can solve the cases at any stage of the process. By January 2008, only 37% of cases had reached the full panel process. Most of the rest have either been notified as settled "out of court" or remain in a prolonged consultation phase — some since 1995.

**Figure 8.** WTO Trade Dispute Settlement Process

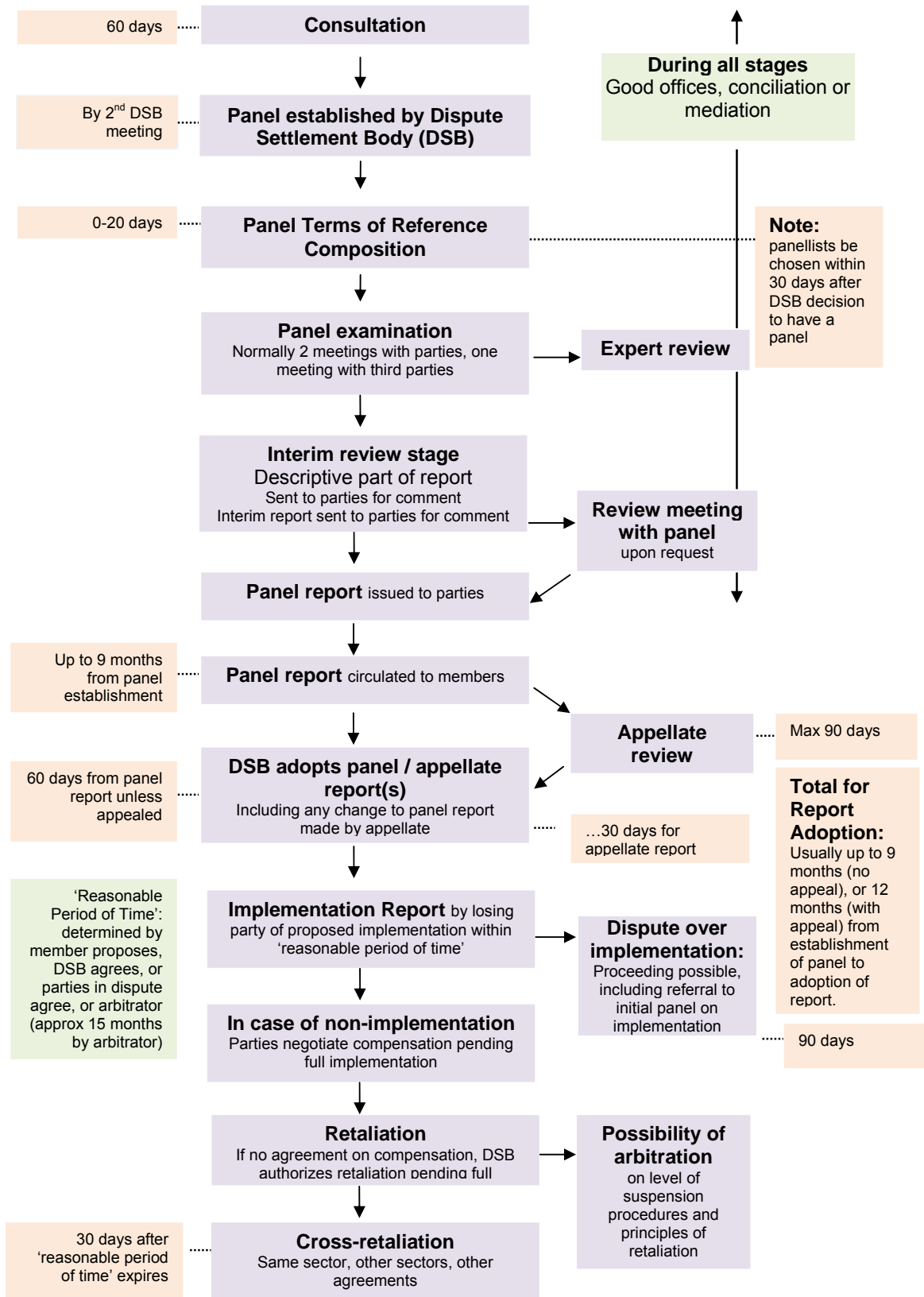

Figure 8 shows the WTO trade dispute settlement process and the duration of each stage. These approximate periods for each stage of a dispute settlement procedure

are target figures — the agreement is flexible. In addition, the countries can settle their dispute themselves at any stage. The dispute settlement involved four steps: consultations, panel process,

If it is decided that a country has done something wrong, it should swiftly correct its fault. And if it continues to break an agreement, it should offer compensation or suffer a suitable penalty from the WTO members whose interests are harmed by the violation.

Even once the case has been decided, there is more to do before trade sanctions (the conventional form of penalty) are imposed. The priority at this stage is for the losing “defendant” to bring its policy into line with the ruling or recommendations. The dispute settlement agreement stresses that “prompt compliance with recommendations or rulings of the DSB is essential in order to ensure effective resolution of disputes to the benefit of all Members”.

If the country that is the target of the complaint loses, it must follow the recommendations of the panel report or the appeals report. It must state its intention to do so at a DSB meeting held within 30 days of the report’s adoption. If complying with the recommendation immediately proves impractical, the member will be given a “reasonable period of time” to do so. If it fails to act within this period, it has to enter into negotiations with the complaining country (or countries) in order to determine mutually-acceptable compensation — for instance, tariff reductions in areas of particular interest to the complaining side.

If after 20 days, no satisfactory compensation is agreed, the complaining side may ask the DSB for permission to impose limited trade sanctions (“suspend concessions or obligations”) against the other side. The DSB must grant this authorization within 30 days of the expiry of the “reasonable period of time” unless there is a consensus against the request.

In principle, the sanctions should be imposed in the same sector as the dispute. If this is not practical or if it would not be effective, the sanctions can be imposed in a different sector of the same agreement. In turn, if this is not effective or practicable and if the circumstances are serious enough, the action can be taken under another agreement. The objective is to minimize the chances of actions spilling over into unrelated sectors while at the same time allowing the actions to be effective.

In any case, the DSB monitors how adopted rulings are implemented. Any outstanding case remains on its agenda until the issue is resolved. The two trade disputes on renewable energy are still at the consultation stage and there is no final decision has been made on them yet.

### **5.3 The WTO rules on subsidies and domestic content requirements**

The case against China offering subsidies to Chinese funded and Chinese holding manufacturers of wind generating units, key components and parts indicates it violates the Agreement on Subsidies and Countervailing Measures.

While the case against Ontario offering higher tariff to renewable and has local content requirements of wind and solar PV projects, Japan claim that the measure violate the Agreement on TRIMs and the Agreement on Subsidies and Countervailing measures. The subsidies are Trade-related investment measures as they affect investment.

#### **The TRIMs Agreement and Regulation of Foreign Investment**

The disciplines of the TRIMs Agreement focus on discriminatory treatment of imported and exported products and do not govern the issue of entry and treatment of foreign investment. For example, a local content requirement imposed in a non-

discriminatory manner on domestic and foreign enterprises is inconsistent with the TRIMs Agreement because it involves discriminatory treatment of imported products in favour of domestic products. The fact that there is no discrimination between domestic and foreign investors in the imposition of the requirement is irrelevant under the TRIMs Agreement. Table 10 shows which policies are allowed and what are forbidden under the WTO TRIM agreements.

**Table 10.** The WTO regulations about Different TRIMs

<b>Examples of TRIMs Explicitly Prohibited by the TRIMs Agreement</b>	
Local content requirement	Measures requiring the purchase or use by an enterprise of domestic products, whether specified in terms of particular products, in terms of volume or value of products, or in terms of a proportion of volume or value of its local production.
Trade balancing requirements	Measures requiring that an enterprise's purchases or use of imported products be limited to an amount related to the volume or value of local products that it exports.  Measures restricting the importation by an enterprise of products used in or related to its local production, generally or to an amount related to the volume or value of local production that it exports.
Foreign exchange restrictions	Measures restricting the importation by an enterprise of products (parts and other goods) used in or related to its local Production by restricting its access to foreign exchange to an amount related to the foreign exchange inflows attributable to the enterprise.
Export restrictions (Domestic sales requirements)	Measures restricting the exportation or sale for export by an enterprise of products, whether specified in terms of particular products, in terms of volume or value of products, or in terms of a proportion of volume or value of its local production
<b>Exceptional Provisions of the TRIMs Agreement</b>	
Transitional period (after entry WTO)	Prohibited measures do not need to be abolished immediately, but they must be notified to the WTO within 90 days after the entry into force of the TRIMs Agreement.  Transition period for abolishing such prohibited measures: 1) Developed countries: 2 years 2) Developing countries: 5 years 3) Least developed countries: 7 years
Exceptions for developing countries	Developing countries are permitted to retain TRIMs that constitute a violation of GATT Article III or XI, provided the measures meet the conditions of GATT Article XVIII which allows specified derogation from the GATT provisions, by virtue of the economic development needs of developing countries.
Equitable provisions	To avoid damaging the competitiveness of companies already subject to TRIMs, governments are allowed to apply the same TRIMs to new foreign direct investment during the transitional period described in (1) above.

Source: WTO TRIM Agreement

### **Subsidies and countervailing measures**

The WTO Agreement on Subsidies and Countervailing Measures disciplines the use of subsidies and regulates actions countries can take to counter the effects of subsidies.

The Agreement is about “specific” subsidy — i.e. a domestic or export subsidy available only to an enterprise, industry, group of enterprises, or group of industries in the country (or state, etc) that gives the subsidy.

Under this agreement, subsidies are classified into two groups:

- **Prohibited subsidies:** subsidies that require recipients to meet certain export targets, or to use domestic goods instead of imported goods. They are prohibited because they are specifically designed to distort international trade, and are therefore likely to hurt other countries’ trade. They can be challenged in the WTO dispute settlement procedure where they are handled under an accelerated timetable. If the dispute settlement procedure confirms that the subsidy is prohibited, it must be withdrawn immediately. Otherwise, the complaining country can take counter measures. If domestic producers are hurt by imports of subsidized products, countervailing duty can be imposed.
- **Actionable subsidies:** in this category the complaining country has to show that the subsidy has an adverse effect on its interests. Otherwise the subsidy is permitted. The agreement defines three types of damage they can cause. One country’s subsidies can hurt a domestic industry in an importing country. They can hurt rival exporters from another country when the two compete in third markets. And domestic subsidies in one country can hurt exporters trying to compete in the subsidizing country’s domestic market. If the Dispute Settlement Body rules that the subsidy does have an adverse effect, the subsidy must be withdrawn or its adverse effect must be removed. Again, if domestic producers are hurt by imports of subsidized products, countervailing duty can be imposed.

Under the agreement, a country can use the WTO’s dispute-settlement procedure to seek the withdrawal of the subsidy or the removal of its adverse effects. Or the country can launch its own investigation and ultimately charge extra duty (“countervailing duty”) on subsidized imports that are found to be hurting domestic producers.

#### **5.4 Exceptions to the MFN clause under the WTO**

There are some exceptions in the WTO rules in terms of non-discrimination to imported products and services from other WTO members and national treatment to imported products. For example, if a country is a member of a regional trade agreement, it can offer imports from other members of the RTA more favourable treatment than to imports outside the RTA. There are also some exceptions due to preferential treatment to developing countries, especially least developed countries.

##### **5.4.1 More favourable trade relations among members of Regional trade Agreements**

By July 2005, among the WTO member countries, only one country, Mongolia, is not member of any regional trade agreements.<sup>17</sup> Since the establishment of WTO in 1995, the number of Regional Trade Agreements (RTAs) has surged. In the 15 years since the establishment of the WTO, the number of RTAs notified to the WTO has exceeded 300, about two and a half times the total notified during the 123 RTAs notified during the period of GATT (1948-1994). The most well-known RTAs include

---

<sup>17</sup> Source: [http://www.wto.org/english/thewto\\_e/whatis\\_e/tif\\_e/bey1\\_e.htm](http://www.wto.org/english/thewto_e/whatis_e/tif_e/bey1_e.htm). Accessed on 18 April 2011.

the European Union, the North American Free Trade Agreement, the Association of Southeast Asian Nations.

When a WTO member enters into a regional integration arrangement through which it grants more favourable conditions to its trade with other parties to that arrangement than to other WTO members' trade, it departs from the guiding principle of non-discrimination under the WTO. Normally, setting up a customs union or free trade area would violate the WTO's principle of equal treatment for all trading partners. But the WTO agreements allow regional trading arrangements to be set up as a special exception, provided certain strict criteria are met.

- RTA arrangements should help trade flow more freely among the countries in the group without barriers being raised on trade with the outside world. In other words, regional integration should complement the multilateral trading system and not threaten it.
- If a free trade area or customs union is created, duties and other trade barriers should be reduced or removed on substantially all sectors of trade in the group. Non-members should not find trade with the group any more restrictive than before the group was set up.
- Developing countries are allowed to enter into regional or global agreements that include the reduction or elimination of tariffs and non-tariff barriers on trade among themselves.

Therefore, within the WTO rule, a RTA member country can in its renewable energy supporting policies offer more favourable treatment to goods and services from other members of the same RTA. For example, an EU member could levy lower tariff on wind turbines imported from another EU member than those from outside EU, without violating the WTO rule.

#### **5.4.2 Preferential treatment for developing countries**

##### **Special and Differential Treatment (SDT) for Developing Countries**

Special and Differential Treatment (SDT) is the term used for the way in which developing countries are treated differently to developed countries within the WTO system. The principle of SDT is that international trade rules should be adapted to the particular economic situation of developing countries. Within the WTO, SDT treatment has taken two main forms:

- With respect to market access commitments, SDT treatment has taken the form of allowing non-reciprocal trade preferences designed to provide preferential access for developing country exports to the markets to developed countries.
- With respect to trade rules and disciplines, SDT treatment means that developing countries can be exempted from the need to implement multilaterally agreed rules or might be asked to accept less onerous obligations. In the Uruguay Round, SDT treatment also meant offering developing countries longer implementation periods and possibly technical assistance to help them meet multilaterally agreed commitments.

This also includes the Generalized System of Preferences (GSP), a preferential tariff system extended by developed countries (also known as preference giving countries) to developing countries (also known as beneficiary countries). It involves reduced MFN Tariffs or duty-free entry of eligible products exported by beneficiary countries to the markets of preference giving countries. The GSP treatment is given by a giving country to the beneficiary country for certain period of time and based on regular

review, the giving country will decide whether to extend the GSP treatment to a beneficiary country further or not. Table 11 shows the GSP some developing countries get from the giving countries.

**Table 11. Selected Receivers of Generalised System of Preferences**

Beneficiaries	Preference-giving countries												
	Australia	Belarus	Canada	EU			Japan	New	Norway	Russia	Switzerland	Turkey	United States
				GSP	GSP-LDCs (EBA)	GSP+							
Chile		X	X	X			X	X		X	X		
China		X	X	X			X	X	X		X	X	
India		X	X	X			X	X	X	X	X	X	
Indonesia		X	X	X			X	X	X	X	X	X	
South Korea			X						X				
Mexico		X	X	X			X	X	X		X		
South Africa		X	X	X			X		X		X	X	X
Malaysia		X	X	X			X	X	X	X	X		

Generalised System of Preferences - List of Beneficiaries, UNITED NATIONS, New York and Geneva, 2009

### 5.5 The possible results of the two Cases on renewable energy – other similar cases

The two cases mentioned previously are both under consultation stage. Trade disputes concerning energy have been rare. So far, both the wind power equipment case and the renewable energy supporting measure case are the first of their kind. Apart from these two cases, there are only two trade disputes cases about discrimination against imported gasoline in the national standards by the United States in 1995. In both cases, the WTO's final decision is that the US's action of discriminating against imported gasoline was against its WTO obligation and US lost the case. After that, the US dropped the special requirements on imported gasoline.

Another case similar to the US vs China dispute on grants to Chinese wind manufacturers is the trade disputes, in which the US<sup>18</sup> and Mexico<sup>19</sup> complained China offering grants, loans and other incentives to Chinese enterprises under the the "China World Top Brand Programme" and the "Chinese Famous Export Brand Programme". These two programs set out criteria for an enterprise to receive a designation by the Ministry of Commerce (MOFCOM) as a "Famous Export Brand" or a designation by the Administration of Quality Supervision, Inspection and Quarantine (AQSIQ) as a "China World Top Brand." Enterprises with these designations are entitled to various government preferences, including, it appears, financial support tied to exports. In December 2009, China agreed to end the various subsidies provided under the two programs and thus the two trade disputes were

<sup>18</sup>WTO DISPUTE DS387 China — Grants, Loans and Other Incentives (Complainant: United States of America), 19 December 2008

<sup>19</sup>WTO DISPUTE DS388 China — Grants, Loans and Other Incentives, (Complainant: Mexico), December 2008

ended. China lost this case because export subsidies on all products are generally prohibited under the WTO Agreement on Subsidies and Countervailing Measures<sup>20</sup>.

## **6 Supporting policies for clean energy technologies and how to avoid trade disputes**

### **6.1. Financial mechanisms to promote the development and deployment of clean energy technologies**

The UNEP-WTO report (2009) on Climate Change and Trade summaries three main types of incentive policies countries often use to promote clean technologies: fiscal measures, price supporting systems, as well as investment supports.

Fiscal measures for clean energy technologies typically take two forms: tax reduction (including tax exemptions, tax deduction and tax rebate) and tax credits (including income tax credits, personal tax credits, corporate tax credits, production tax credits and investment tax credits). These fiscal measures can target at the users for the purchase and use of such technologies or at the equipment or product manufacturers for providing such products and equipment. Another form of fiscal measures widely used in developed countries is allowing for 'accelerated depreciation', which allows for investors in renewable energy projects to depreciate the value of their plant and equipment at a faster rate than what is typically allowed, thereby reducing their state income for the purpose of corporate income taxation. The US, Mexico, India, and the Netherlands have such policies for their renewable energy projects.

With price support measures, governments can guarantee the minimum 'feed-in-tariff' is another widely applied supporting measure for renewable energy generation. With this measure, governments usually offer a higher than average for electricity sales to the grid from renewable energy projects. Preferential feed-in tariff is an effective policy instrument in promoting renewable energy development because of several advantages. It can guarantee the long term income of such renewable energy projects and lower the market risks for such project. It can also offers governments the flexibility of adjusting the tariff level based on local renewable energy resource conditions and technology progress.

'Net metering' is another widely used measure to encourage renewable energy production and supply by energy users. The end users of electricity can supply electricity from their small renewable generating units to the grid and consume electricity from the grid. They only pay for their net electricity consumption from the grid. Most parts of the United States, Canada, Thailand and Mexico have this policy.

Investment support measures are mainly aimed at reducing the capital cost of developing and deployment of clean energy technologies. They can take the form of capital grant and rebate in product costs, low interest loans or guarantees. They can also take the form of low land costs by local government for the project.

When countries select policy instruments for renewable energy development supporting, they need to consider their commitments and obligations under the WTO. If the intended policy violates the WTO rules, then they need to determine whether the exceptions apply so that their violation will not lead to trade disputes or complaints from other WTO members. These policies do not violate the WTO rules as long as it does not lead to discrimination against imported products. The following Table 12 shows which policy instruments are allowed under the WTO and which are forbidden.

---

<sup>20</sup> BBC news, Dec 19, 2009. "China ends brand subsidies behind WTO dispute with US"



**Table 12.** WTO compliance of different policy instruments

	Policy instrument	WTO-Compliant
Goods	Tariff sequencing	
	Import licenses	
	Duty drawbacks	X
Subsidies	Export	
	Production	(actionable)
	R&D	(actionable)
FDI	Local content requirements	
	Tech transfer	X
	Trade balancing	
IPRs	Selective patents	
	Compulsory licensing	X
Other	Skills building	X
	State-run firms	X

Source: DICAPRIO and GALLAGHER, 2006

For example, duty drawbacks are permitted. This means when enterprises components for processing and then export the final products, at the time of export, they get refunding for the import tariff they pay. Export subsidies are prohibited, subsidies for renewable energy generation and R&D are allowed as long as they do not discriminate against imported products and services. In terms of foreign direct investment, local content requirements are forbidden under the WTO rules, however measures stimulating technology transfer are allowed.

## 6.2 The interaction between free trade and environment protection - unsettled issues in WTO<sup>21</sup>

WTO in essence is an organisation promoting free trade and many of its rules and principles were negotiated after the World War II. The energy crisis and global warming, global environmental problems, are all much more recent issues. Compared to the global environmental agreements, the WTO, with its trade dispute settlement arrangement, has a much more powerful compliance system. In the climate negotiations, countries sometimes find it is necessary to use trade as an incentive to stimulate more active contribution by other countries, for example, the Kyoto Protocol, entered into force after 8 years because the EU approved Russia's WTO entry, in return, Russia ratified the Kyoto Protocol. The trading of carbon credits under the Kyoto Protocol has successfully brought about over \_\_\_ billion US dollars of investment in renewable energy, energy efficiency, and other GHG emission reduction projects. During the ongoing post-2012 international climate regime negotiations, border tax is suggested by some experts and officials as an instrument to be used by the US and the EU to force other major GHG emitters take similar actions. There are even suggestions to use WTO to unlock the current stalemate in the climate negotiations.

This suggestion has been opposed by trade negotiators. The WTO negotiations also face the similar problem of lacking progress in the last few years. The Doha Development Round of WTO negotiations started in 2001 and has twice failed to meet its deadline of reaching agreements because developed countries, represented by EU, the US, and Japan, and major developing countries, represented by China,

<sup>21</sup> Bradly J. Condon, Climate Change and Resolved Issues in WTO Law, *Journal of International Economic Law* (2009) 12(4): 895–926.

India, Brazil, South Korea, and South Africa can not agree on such issues as agriculture subsidies, environment and trade, geographic location Intellectual property, and Special and differential treatment to developing countries (WTO)<sup>22</sup>.

Similar to the UNFCCC process, political considerations and economic interests, plus scientific knowledge, are main factors countries consider in their trade relations with other countries. China joined the WTO in 2001, and its rapid economic growth makes it a challenger to the existing world economic and politic order and makes it a target of WTO trade disputes. By March 2011, China has been complained against in 21 WTO trade disputes (Table 13), most of which are from the US and EU. In the last few years, China is fighting back and has so far initiated 8 cases against the US and the EU (Table 14).

Table 13. China joined the WTO in 2001.

	Total	2001	2002	2003	2004	2005	2006	2007	2008	2009	2010	2011 (Q1)
As complainant	8		1					1	1	3	1	1
As respondent	21				1		3	5	5	4	3	

Japan and China are important trade partners, however so far the two countries have had not filed any WTO trade dispute against each other.

Table 14. Trade disputes involving Japan and China

Japan as complainant		Japan as respondent		China as complainant		China as respondent	
Total	14	Total	15	Total	8	Total	21
US	8	US	6	US	6	US	11
Canada	2	EU	6	EU	2	EU	4
EU	2	South Korea	2			Mexico	3
Indonesia	1	Canada	1			Canada	2
Brazil	1					Guatemala	1

Source: WTO, data until end of March 2011

Currently, there are specific WTO agreements on textile and agriculture. Despite the importance of energy in world economy, there is no specific WTO agreement on energy issues. Instead, the various rules on energy issues scatter in various WTO agreements. Some experts (Marceau, 2009; Cottier et al, 2009) suggested introducing a specific energy agreement under the WTO, but this is not formally included in the WTO negotiation agenda yet.

## VII. Conclusions

Renewable energy is a new industry. It can bring about green and sustainable economic growth and contribute to job creation, reducing local air pollution, improving energy security, as well as global climate change mitigation. In recognition of the multiple benefits of renewable energy development, more and more countries are intensifying or introducing measures to support renewable energy development.

<sup>22</sup> Doha Development Agenda - Briefing notes on some of the main issues of the Doha Round, available at [http://www.wto.org/english/tratop\\_e/dda\\_e/status\\_e/brief00\\_e.htm](http://www.wto.org/english/tratop_e/dda_e/status_e/brief00_e.htm), accessed on 15 April 2011

As most countries in the world are also WTO members, their renewable energy supporting policies, need to follow the WTO rules. Otherwise, other WTO members can initiate trade dispute cases against such policies and measures. In 2010, two WTO trade disputes were initiated on the renewable energy supporting policies of China and the Ontario Province of Canada. These two cases are still in the WTO trade dispute settlement process and the final decisions about these cases are not made yet. If it is decided that China and Canada violate their WTO obligations, they have to end these violating policies and measures, or compensate the other WTO members for the harms caused, otherwise the other WTO members have the right for trade sanctions and retaliation actions.

This paper analyzed the two WTO trade dispute cases, the necessity and various types renewable energy supporting policies and actions, as well as the relevant WTO rules on local content requirements and subsidies. Climate change mitigation and renewable energy development promotion will be a long term item on the policy agenda of many countries. With the continuing economic globalisation, the interaction between international trade regime and the global climate regime and countries actions for climate change mitigation will increase. It is necessary to explore new ways to harmonise the rules of the two regimes for global economic prosperity and climate change mitigation, and environment protection.

### References

- Cottier, Thomas; Garba Malumfashi, Sofya Matteotti-Berkutova, Olga Nartova, Joëlle De Sépibus, Sadeq Z. Bigdeli. "Energy in WTO Law and Policy", Working Paper No 2009/25, NCCR Trade Working Papers, May 2009.
- CWEA (China Wind Energy Association), 2011, "China Wind Energy Installed Capacity Statistics 2010". March 18, 2011. Available at: [www.cwea.org.cn](http://www.cwea.org.cn)
- DiCaprio, Alisa, and Kevin P. Gallagher. "The WTO and the Shrinking of Development Space—How Big is the Bite?" *Journal of World Investment and Trade*, Volume 7, no. 5, October 2006
- FratinVergano European Lawyers, "Trade Perspectives", Issue No. 1 of 14 January 2011
- Gowlings, 2010, wind energy law in Canada, Gowling Lafleur Henderson LLP
- Guey-Lee, Louise, 1998, "Wind Energy Developments: Incentives in Selected Countries", Energy Information Administration/ Renewable Energy Annual 1998
- Hao, May; Matt Mackenzie, Alex Pomerant and Kate Strachran, 2010, "Local Content Requirements in British Columbia's Wind Power Industry". December 2010, the Pacific Institute for Climate Solutions
- Howell, Thomas R.; William A. Noellert; Gregory Hume; Alan Wm. Wolff, 2010, "China's Promotion of the Renewable Electric Power Equipment Industry - Hydro, Wind, Solar, Biomass, Dewey & LeBoeuf LLP, For the National Foreign Trade Council March 2010
- Lewis, Joanna 2009, "Can green sunrise industries lead the drive into recovery?"
- Lewis, Joanna; Ryan H. Wiser, 2006, "Supporting Localization of Wind Technology Manufacturing through Large Utility Tenders in Québec: Lessons for China"
- Lewis, Joanna, 2007. "Technology Acquisition and Innovation in the Developing World: Wind Turbine Development in China and India", *Studies in Comparative International Development (SCID)* Volume 42, Numbers 3-4, 208-232.
- Li, Junfeng; Pengfei Shi; Hu Gao, Wind Energy Outlook for 2010. Chinese Renewable Energy Industries Association, the Global Wind Energy Council and Greenpeace. October 2010

- Marceau, Gabrielle, 2009, "The WTO in the emerging energy governance debate".  
Background paper prepared for Panel 1: Setting the Stage: The Landscape of Existing International Cooperation, of the Conference Global Challenges at the Intersection of Trade, Energy and the Environment 22nd and 23rd October 2009, Organised by the Centre for Trade and Economic Integration (CTEI) at the Graduate Institute of International and Development Studies, Geneva, in collaboration with the World Trade Organization.
- Mulholland, Ryan, Increasing the Global Competitiveness of U.S. Clean Energy Companies  
New York Times, Jan 30, 2010. January 31, 2010, China Leading Global Race to Make Clean Energy, By Keith Bradsher.
- OECD/IEA, 2007. Energy Policies of IEA countries – Germany 2007 Review.
- REN21, 2010, Renewables 2010 Global Status Report, September 2010
- Smith, Herbert, "International trade and investment briefing" – November 2008  
(disputes on China local contents requirement about car import. Local content requirements contrary to WTO rules: WTO panel rules against China in auto parts dispute.
- The Pew Charitable Trusts, 2009, "*The Clean Energy Economy: Repowering Jobs, Businesses and Investments Across America*"
- The Pew Charitable Trusts, 2010, "Who's Winning The Clean Energy Race? Competition and Opportunity in the World's Largest Economies, G-20 Clean Energy Factbook.
- UNIDO, 2009, "The case of the wind power industry in China and India", Research and Statistics Branch, Working Paper 2/2009, UNIDO (United Nations RESEARCH AND STATISTICS BRANCH, WORKING PAPER 2 /2009, UNIDO (United Nations
- United Steel, Paper and Forestry, Rubber, Manufacturing, Energy, Allied Industrial and Service Workers International Union (United Steelworkers or USW), 2010, "United Steelworkers' Section 301 Petition Demonstrates China's Green Technology Practices Violate WTO Rules"
- WTO, "WTO Trade Related Investment Measures (TRIMs) Agreement."
- World Wind Energy Association (WWEA), 2010. *World Wind Energy Report 2009*.

## Session 3A - Energy Systems

# Development of market design with focus on demand side participation

Niels Christian Bang, Felicia Fock, and Mikael Togeby (Ea Energy Analyses)

## Abstract

In the current Nordic electricity market, large electricity end-users can adjust their electricity consumption in relation to the day-ahead market. The process is straightforward as the end-user can act on published prices and no communication is needed. The retailer simply buys electricity on behalf of all its customers based on historical data. This uncomplicated process deals with price dependent consumption with a minimum of communication and administration.

In other markets, e.g. the market for regulating power, demand is in practice excluded. Various rules – that have been developed for traditional power plants – hinder electricity consumers in participating. Electricity demand can be a superior resource for regulating power as the demand can be controlled in seconds and is particularly efficient for short term adjustments. Furthermore, the price variations are higher in the regulating power market than in the day-ahead market, so the economic incentive for adjusting the demand is also higher.

This paper will describe the current market for regulating power, the structure of the demand for regulating power, and the obstacles for demand to participate. The FlexPower project involves the design and simulation of a new market for regulating power. One of the core aspects focuses on how a new regulating power market, which can work as a supplement to the existing market, can be designed.

The principle idea is to expose end-users to five-minute prices and that it is voluntary for them to react. As such, the end-user does not have to send in plans or submit bids. In this way the system is easy to use and unbureaucratic for the end-users. This is expected to be essential for the potential end-users. The balance responsible is expected to predict the change in demand based on historical data – as is done today in the spot market.

# 1 Introduction

With the introduction of more intermittent power generation in the Nordic power system it is anticipated that there will be an increased demand for regulating power. In the Danish system regulating power is currently provided primarily by central power plants, in combination with import/export to Norway and Sweden where there is a high share of hydro power. As a greater portion of the electricity provided comes from wind power, less will come from these central plants, thus further increasing the need for regulating power from new sources.

One way of supplying regulating power capacity from new resources is to activate the demand side. This could be resources such as industrial or commercial electricity demand, as well as household electricity demand such as heat pumps, direct electric heating, electrical vehicles and other types of demand that can be controlled with little or no consequences to the end-users. Electricity consumption for heating or air conditioning could for example be converted into thermal energy (heat or cold) during one hour, to provide the service (desired temperature) at another hour; thus involving storage of heat or cold and the shifting of electricity demand from one time to another.

The FlexPower project involves the design and simulation of a new market for regulating power that can work as a supplement to the existing market. The project is supported by Energinet.dk and involves the following partners: Ea Energy Analysis (coordinator), DTU-Technical University of Denmark, Enfor, Actua, Eurisco, EC Power, SEAS-NVE and Nordjysk Elhandel.

This paper will describe one of the core aspects of this project, namely the market design. More information about the project can be found at: [www.flexpower.dk](http://www.flexpower.dk).

## 1.1 Current market for regulating power

The Transmission System Operator (TSO) is responsible for the overall security of supply and to ensure a well-functioning electricity market by maintaining the electrical balance in the power system, and by developing market rules. Electricity production and consumption always has to be in balance, and 45 minutes before the operating hour the task of balancing the two is left to Energinet.dk. It maintains this balance via the regulating power market, and other markets for automatic reserves.

In the hour of operation, Energinet.dk utilises several types of reserves to ensure the stability of the system. The reserves can be grouped into automatic and manual reserves. Generally speaking, the system criteria are initially managed by the automatic reserves, which are activated in accordance with frequency deviations or deviation in the actual compared with the planned exchange with neighbouring areas. These reserves are expensive and have limited capacity.

To anticipate excessive use of automatic reserves and in order to re-establish their availability, regulating power is utilised. Regulating power is a manual reserve and is defined as increased or decreased generation that can be fully activated within 15 minutes. Regulating power can also be demand that is increased or decreased. Activation can start at any time and the duration can vary.

	Generation	Demand
Up-regulation	More	Less
Down-regulation	Less	More

Table 1: Definition of up and down regulation

In the Nordic countries there is a common regulating power market managed by the TSOs with a common merit order bidding list. The balance responsibilities (for load or

production) make bids consisting of amount (MW) and price (DKK/MWh). All bids for delivering regulating power are collected in the common Nordic NOIS-list and are sorted in a list with increasing prices for up-regulation (above spot price), and decreasing prices for down-regulation (below spot price). These bids can be submitted, adjusted, or removed until 45 minutes before the operation hour. In Denmark the minimum bid size is 10 MW, and the maximum is 50 MW. Taking into consideration the potential congestions in the transmission system, the TSO manages the activation of the cheapest regulating power. An example of the NOIS-list is displayed below in Figure 1.

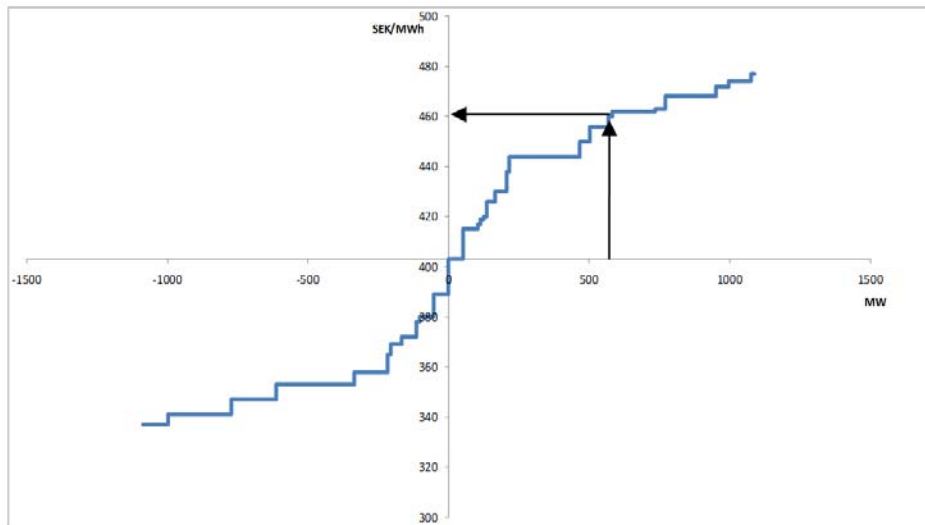

Figure 1: Example of the NOIS list, from 17.6.2009, CET 07-08. 583 MW of up regulating power was activated, corresponding to a price of 460 SEK/MWh (Data provided by SvK).

After the day of operation the costs of activating regulating power are passed on to the balance responsible agents whom were responsible for the imbalances. Both production and demand can cause imbalances, but until now mainly production can benefit from acting in the regulating power market. The only Danish examples for demand used as regulating power are electric boilers. In 2009, 54 MW of electric boilers participated in the regulating power market with down regulation, a figure that is expected to increase to 300 MW in 2011.

## 1.2 Limitations of current regulating market

The current design has some drawbacks that if removed could make the regulating power market more efficient in the future. For example, small-scale demands and small-scale generations are, in practice, excluded from the market. Current requirements that hamper demand side involvement in the regulating power market include:

- A 10 MW minimum bid size
- A plan for the controllable load: The plan must be followed and must exist with 5-minutes values
- Demand must be re-established after activation: In some cases this may be difficult if special staff are needed for re-establishing demand, for example some forms of industrial production (Johansson, 2008).
- Real-time measuring of regulation units: Real-time metering is relevant in relation to consumers in the +10 MW class. However, for small consumers, the cost of such a requirement is prohibitive.
- The bidding process in itself requires several active actions. First a bid must be made, then if chosen the supplier notified, and finally the actual regulation must



occur. This is an undesirably bureaucratic process for smaller resources and a simpler design might attract more participants (Veen et al, 2009).

### 1.3 Aspects of current regulating power market

A central reason behind involving demand response into the regulating market as opposed to in the spot market is that there is a greater need for it, and therefore more potential profit to be made in the regulating market. One way of investigating this hypothesis is to review the historic differences between hourly regulating power and spot prices. For the years 2005 through to the start of August 2010, the absolute hourly difference between the regulating power price and spot price was calculated.

Figure 2 below displays duration curves of the hourly differences between the spot price and regulating power prices for DK1 (West) and DK2 (East) from Jan 1<sup>st</sup>, 2005 till August 10<sup>th</sup> of 2010. The average spot price over the period was 309 DKK/MWh in DK1 and 325 DKK/MWh in DK2.

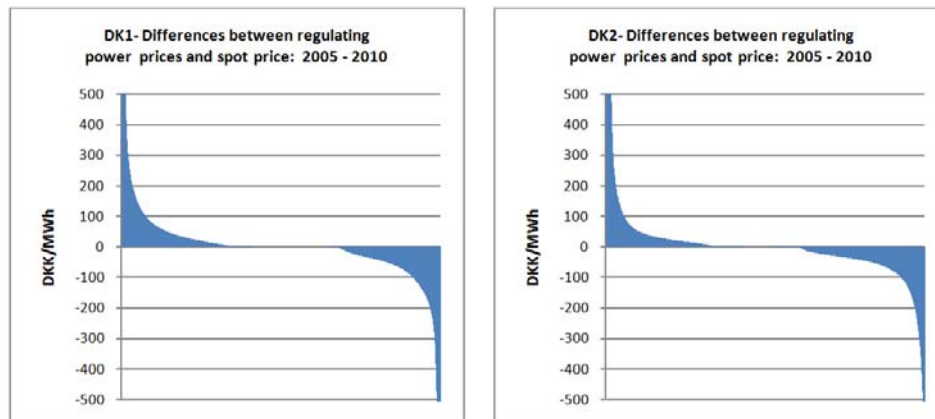

Figure 2: Historical differences between spot and regulating power prices in DK1 (West) and DK2 (East) from Jan 1st 2005 till August 10th 2010. For ease of illustration the vertical axis has been limited to +/- 500 DKK/MWh, thus excluding a total of roughly 2% of hours in both of the graphs (see Table 2 below)

As can be seen from Figure 2 and Table 2, for both DK1 and DK2, on average the absolute difference between the spot price and regulating power price has been 66 DKK/MWh. However, there is a great deal of variation in the data, as more than 1/3 of the hours had an absolute total difference of less than 10 DKK/MWh, and roughly 1/7 of the hours had an absolute value greater than 100 DKK/MWh.

	<u>DK 1</u>	<u>DK 2</u>
Average spot price (DKK/MWh)	309	325
Hours with differences greater than 500 DKK/MWh	1.5%	1.1%
Hours with differences less than - 500 DKK/MWh	0.5%	1.0%
Hours with a difference greater than 100 DKK/MWh	7.5%	5.6%
Hours with a difference less than - 100 DKK/MWh	8.5%	7.3%
Hours with a difference less than +/- 1 DKK/MWh	32.6%	24.8%
Maximum difference (DKK/MWh)	7,034	14,712
Minimum difference (DKK/MWh)	- 6,566	- 10,136
Average absolute difference (DKK/MWh)	65.5	65.5

Table 2: Historical differences between spot and regulating power prices in DK1 (West) and DK2 (East) from Jan 1st 2005 till August 10th 2010.

Lastly, it is interesting to note that the tips at either end of the duration curves are very steep, and as such while rare in number, those hours with large variations (e.g. vary low prices) can be very interesting for the end-user.

## 1.4 Future Development

While the minimum bid size in Denmark is currently 10 MW, Energinet.dk can activate part of a bid after agreement with the bidder (Nordel, 2008). This could be particularly applicable in FlexPower as it is well suited to reacting on smaller bid sizes.

In Nordel's 'Harmonisation of Balance Regulation in the Nordic Countries' report, Nordel also opened the door to smaller bid sizes in the future, something that the report indicates would help to promote demand-side bidding (Nordel, 2008).

Another topic that the report touched on was the potential for other types of bids being included in the NOIS lists. Faster responding bids for example could be earmarked on the bid list and utilised as special regulation. This is something that was also mentioned in an Energinet.dk (2010) report, where it also referenced to potentially incorporating 'self regulating' into the regulating power market, thus signalling a willingness to incorporate other forms of regulating power such as those proposed in FlexPower.

## 2 Design of a new market

The objective of FlexPower is to develop a real time market for regulating power that will attract a large number of small-scale resources (demand and distributed energy resources) to the regulating power market. This can be created by maintaining the current markets as the basis for planning for the system operation, and then expanding the current regulating power market with a new system: *A one-way price-signal for regulating power*. The fundamental idea behind the FlexPower concept is that participating in the market should be voluntary, simple, and straightforward for the end-user.

The primary market design questions to be answered are thus: How could a system with a one-way price be designed, and how can the FlexPower mechanism be integrated into the present electricity market, including the market for regulating power?

### 2.1 Co-existence with current market

The current regulating power market will exist and function as today, and as a starting point larger power plants will still contribute with the main volume in the regulating power market. When the system operator selects a bid from the sorted NOIS list, the marginal price is the most expensive bid selected. The fundamental idea behind FlexPower is that if a load balance responsible (LBR) is activated in the regulating power market to deliver regulating power by increasing/decreasing the consumption from end-users, the marginal price (or a form of it) could then be sent out as a one-way price signal to end-users participating in FlexPower. Every five minutes this signal could be sent out to all participants with controllable loads that decide to subscribe to FlexPower.

Response to the price signal will be voluntary and the price signal acts as the final settlement. Based on past experience the balance responsible creates a curve (see below).

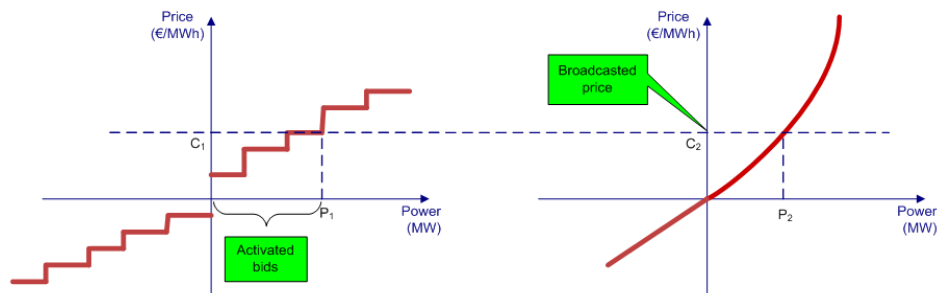

Figure 3: The current market for regulating power (left) and the suggested one-way price signal sent to the end-user from the LBR/retailer (right.)

This curve could be used as a new type of bid, or general bids in the form of stepwise bids representing a price and a volume could be used. The latter will most likely be easier to introduce, largely due to the fact that these kinds of bids are well known in the existing market. However, under the current market structure these bids must have a minimum bid size of 10 MW. In a FlexPower proposal comprised of many small end-users, if the minimum bid size restriction was loosened, to for example 1 MW, this could make a small stepped bidding process more feasible.

The end-users that could be interested in participating in this system would have some electricity uses that are suitable for control. This could be electricity in relation to heating (e.g. heat pumps, direct electric heating, or industrial processes), cooling (e.g. industrial cooling, retail, air condition etc.), pumping (e.g. a water treatment plant) or charging of electric vehicles. In addition, micro generators could also be active in this market. This could be small CHP-units or other controllable generation.

## 2.2 Simple for end-user

In FlexPower no reservation price will be paid to the end-users. Although a reservation price may be attractive for some demand side actors, this would complicate FlexPower unnecessarily, and it is not expected to be essential.

Another aspect that makes it simple for the end user is that they are not required to bid in to the market. The LBR does this on their behalf, and the FlexPower subscribers respond to price signals from the LBR. This price signal will be sent out every 5 minutes, regardless whether regulating power has been activated or not. When regulating power has not been activated, it is assumed that the LBR will simply send out the spot price.

It is anticipated that the reaction from the end-users will be highly predictable, since there will be many end-users, and the majority will have automatic control systems. The aggregated reaction is expected to be influenced by e.g. time of day, out-door temperature and spot prices. This hypothesis will be tested in the FlexPower project.

## 2.3 Time plan and interplay between actors

The figure below is one way of presenting the interplay between the actors in FlexPower. In principle the description of the “loop” can start at any of the points, but since FlexPower is focused on introducing more end-users to the regulating power market, the following description will start with the 5 minute metered data at the end-user.

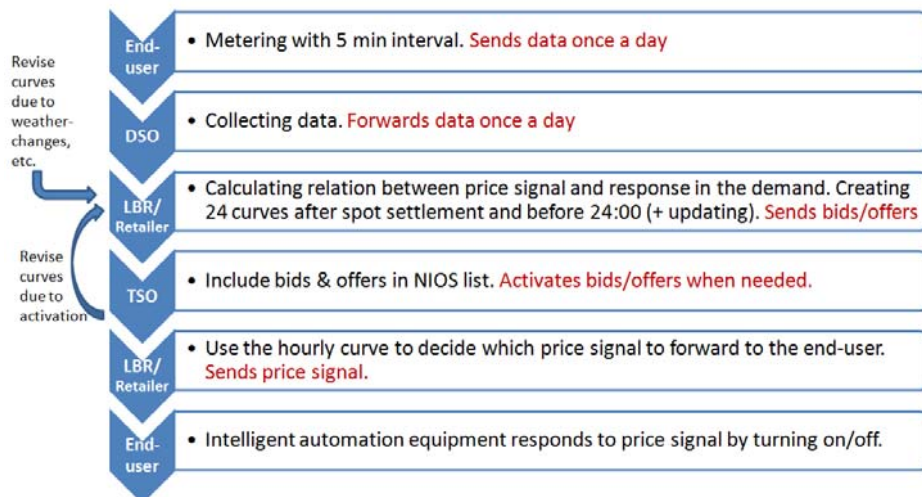

Figure 4: The FlexPower process, starting with the end-user's data being measured and sent daily.

For all customers participating in FlexPower, the end-user's consumption is read in an interval meter each 5 minutes. Once a day these data are sent to the distribution system

operator (DSO), whom forwards this data to the LBR. To improve the LBRs price signal computation process, it is envisioned that a small percentage of the end-users will send unverified 5 minute data directly back to the LBR, thus providing the LBR with immediate feedback, and allowing them to continually update their price signals accordingly.

Based on historical data for consumption, the LBR forms a prognosis for each hour of the next day (hourly values), and this is used to bid on the spot market (before 12:00). The LBR also creates 'relation curves' for each hour showing the relation between the power available for up or down regulation and the price. These curves are based on how the end-users have traditionally responded to changes in prices signals, and are created according to historical 5-minute consumption data. Currently, 5 minute consumption data are not available, however with the FlexPower project requiring the installation or upgrading of meters to make them capable of measuring at 5 minute intervals, this dataset will grow quickly over time.

After the spot market settlement for the following day has been released around 13:00, the LBR incorporates this information into its continuous value curve calculation. These expected demand side reactions to the regulating power price signals (the hourly curves) are converted into a series of stepwise bids and offers for each hour. The LBR sends the series of bids and offers for each hour to the TSO to participate in the regulating power market. The bids and offers are sent on equal terms with other bids (and offers) to the regulating power market, with the FlexPower concept envisioning the possible exception that the LBR may be allowed to send bids and offers with smaller minimum bid sizes than the 10 MW. One hour before each operating hour, an updated final version of these stepwise bids and offers for regulating power (based on the curves) are sent to the TSO. The bids and offers could resemble that depicted in Figure 5 below.

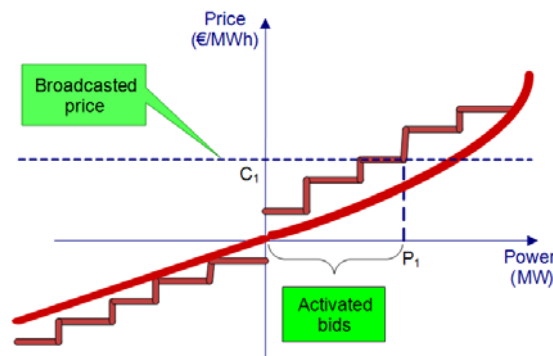

Figure 5: The bids and offers are shown as steps in the graph. The area between the steps and the graphs represents the profit to the balance responsible. It could be argued that the steps will be closer to the graph, or even crossing the graph. This depends on the risk willingness from the balance responsible.

The bids and offers for delivering up or down regulation are collected in the common Nordic NOIS-list. All bids and offers from load balance responsible and generation balance responsible actors are sorted in the list with increasing prices for up-regulation (above spot price), and decreasing prices for down-regulation (below spot price).

When an imbalance in the system occurs, bids or offers from the list are activated by the transmission system operator (TSO) and the corresponding LBR is contacted. Based on the activation price and the relation curves, the LBR then sends a price signal to the end-users participating in the FlexPower system.

At the FlexPower end-user, equipment with automation will include the new price in their internal optimisation. Since each end-user does not make a plan for the consumption and therefore can't detect the change in consumption, the price signal is valid for the total consumption, and not only the change. The equipment will therefore include the new price in their internal optimisation, not only for the up/down regulation,

but for the total consumption, and if it is profitable, change the status (on/off) or load of the various electric devices.

The local computer may compute a prognosis for the regulating power price to reduce risk. If electricity demand can for example only be disconnected for a limited time, the expected future price is important.

## 2.4 Financial Process

For the FlexPower end-user, the real-time price signal sent by the LBR is the settlement price. At times when there is no need for regulating power, the price sent by the LBR will simply be the spot price. Assuming the FlexPower end-user has a meter capable of measuring in 5 minute intervals, for each 5 minute period the end-user simply pays the LBR product of the amount of electricity used and the real-time price signal.

Another way of viewing the financial process is to look at a timeline of interactions from the perspective of the LBR.

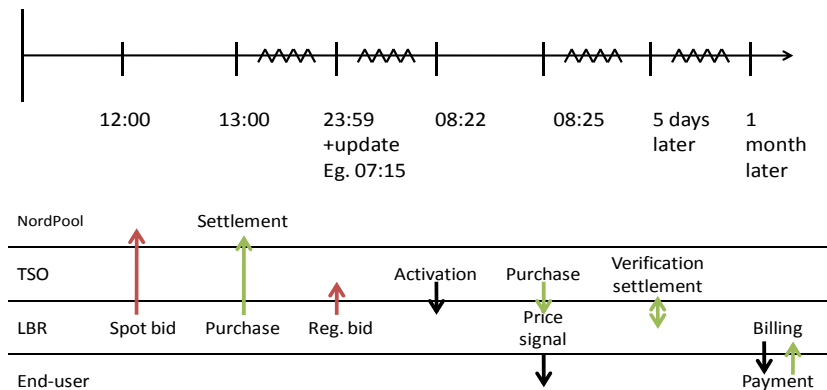

Figure 6: Timeline of events under the FlexPower setup

Assuming that the LBR purchases its electricity on the Nord Pool spot market, the first financial transaction for the LBR occurs when the next day's initial operating plan is finalised at 13:00. At this point in time the LBR knows how much electricity it has purchased, and at what price.

Assuming the LBR does not take part in any bilateral or Elbas transactions, the next financial transaction for the LBR occurs when one of its regulating power bids are activated by the TSO. The activated LBR bid quantity is multiplied by the highest (lowest) price of activated up (down) regulation in that hour, and this value is the amount paid by the TSO to the LBR for up (down) regulation.

After the fact, it's determined whether the amount of electricity that the LBR purchased in the spot market (plus electricity possibly purchased/sold in the regulating power market) equalled the amount of actual demand from its end-users.

## 3 Risks and opportunities

There exist a number of risks and opportunities that must be orientated, primarily where the LBR is concerned.

### 3.1 Risks

The first potential risk occurs because there can be a deviation in settlement between the TSO and the LBR compared to the settlement between the LBR and the end-users. In FlexPower there is only one price (per each five minute interval) for the end-user and there is no distinction between planned and actual demand, since it would be very

administrative and complicated for the end-user to produce a plan for consumption (and thereby be able to distinguish between the plan and a deviation from the plan/actual demand). Put another way, seen from an end-user perspective, all demand is priced equally within the 5 minutes interval. This however creates a risk for the balance responsible as the price signal that the LBR sends out to its FlexPower customers applies to their entire power usage, but the LBR has bought some of this in the spot market, and some in the regulating power market. Therefore the LBR incurs a risk that they will have paid more in the spot market for power they sell to their customers during hours with down regulation. However, in hours with activated up regulation, the LBR can sell electricity purchased in the spot market for a higher price.

The second major risk that must be orientated is that the duration of an activation will affect the price. The longer the activation lasts, the more expensive it will be to deliver the same volume of regulating power. This can be explained by the fact that most of the regulating power delivered by consumers is not a change in total energy consumption, but merely displacement in time. This means that for instance during up regulation, where the cheapest possibilities of reducing (postponing) demand are activated first, then after a while some of this demand will need to start consuming, regardless of the price.

This could for example be a cooling unit that at first is cheap to shut off if the temperature is somewhere in the middle of the accepted interval. After a while the temperature will rise, and when the max temperature is reached the cooling unit will start regardless of price signal. At this point another, and more expensive, unit must be activated to maintain the same volume of regulation. This can be illustrated in the following graph as the curve becoming steeper and steeper as the duration of the regulation lasts.

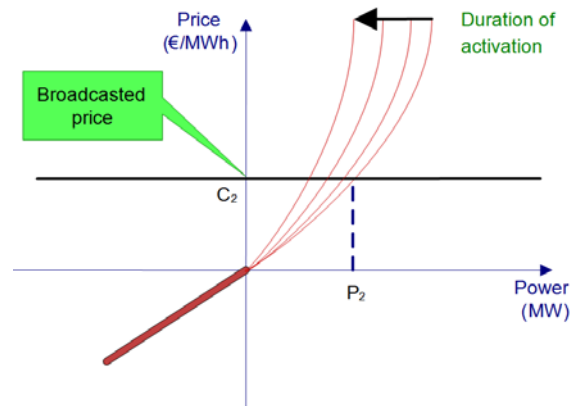

Figure 7: Affect of duration of a regulation on the price signal required to maintain an up regulation

### 3.2 Opportunities

On the other hand, there are also opportunities for the LBR to profit. For example, under the current rules, the hourly settlement price for regulating power is the highest (lowest) bid price for up (down) regulation activated in the hour, and this settlement price is first made public after the hour. However, under the FlexPower proposal as outlined above, the price signal is determined based on the value of the last activated bid, and as such may very well be lower (higher) than the up (down) regulating settlement price for the total hour. The result for the LBR is a potential profit as it will receive the higher regulating price from energinet.dk, but pass on the lower price via the real time price signal to the FlexPower customers.

Another opportunity for the LBR is the different possibilities with respect to the ramping up/down of the regulating power. In the case of down regulation, the LBR can send out price signals motivating the FlexPower consumers to ramp up consumption instantaneously, gradually, or at the last possible moment, as long as the activated bid is 100% effective after 15 minutes and the ramp rate is in accordance with TSO guidelines.

This gives the LBR an opportunity to adjust how fast the end-users should react to an activation with respect to what's most profitable for the LBR.

The above opportunities and risks must all be considered by the LBR when designing its business model, thus ensuring that FlexPower results in a win-win situation for the LBR and end-users alike.

## 4 Next steps

The project will continue until 2013 and will include simulation of the suggested market, and development of prognoses for both the aggregated response and for the expected price. Control strategies and algorithms for distributed energy resources will also be developed, as well as the necessary communication tools. In addition, practical tests will be undertaken in the SysLab at Risø/DTU, and with a group of one hundred real users.

## References

Energinet.dk (2010): Udvilking af rammer for regulerkraft. Energinet.dk

FlexPower (2010): FlexPower project description. Available at:  
[http://www.ea-energianalyse.dk/reports/1027\\_flexpower\\_project\\_description.pdf](http://www.ea-energianalyse.dk/reports/1027_flexpower_project_description.pdf)

Johansson, M. (2008): Statusrapport pr. 31. oktober 2008 for PSO-projektet Priselastisk elforbrug og elproduktion i industrien. Dansk Energi Analyse.

Nordel (2008): Harmonisation of Balance Regulation in the Nordic Countries

Veen, R. A. C. Van der, L. J. de Vries (2009): The impact of microgeneration upon the Dutch balancing market. *Energy Policy* 37 (2009) 2788–2797

# The huge geothermal energy potential in the Danish subsurface – challenges and possibilities

Lars H. Nielsen, Anders Mathiesen, Lars Kristensen, Rikke Weibel, Mette Olivarius, Torben Bidstrup, Carsten M. Nielsen, Troels Laier & Karen L. Anthonsen

## Abstract

The Danish subsurface contains huge geothermal resources that may contribute to a safe, sustainable and reliable supply of energy. Geothermal energy may thus play an important role in the energy strategy in Denmark. The exploitation of the resources is especially attractive in urban areas where it can be combined with district heating systems. The challenge is to find areas where the adequate geological conditions in the subsurface coincide with the presence of essential infrastructure on the surface. The most promising geothermal reservoirs occur within the thick Triassic–Lower Cretaceous successions in the Danish and North German Basins. The potential resource is determined by a number of geological parameters of which the burial depth, thickness, net/gross ratio, continuity (presence of faults or lateral lithological changes) and porosity and permeability of the reservoir sandstones, and the chemistry and temperature of the formation water are the most important. These parameters are all dependent on geological processes and can be investigated by geological and geophysical methods. In most places a preliminary assessment of the geothermal potential can be carried out based on interpretations of data and samples from existing wells, seismic surveys and temperature measurements from the local area. Subsequently the initial assessment, if promising, may be followed by acquisition of new data and further investigations following a stepwise maturation method with a number of decision gates proposed in this paper.

## Introduction

Concerns with respect to the anthropogenic CO<sub>2</sub> emission to the global atmosphere and the predicted climate changes are rising. Use of geothermal energy in district heating systems is a very promising option for reducing the consumption of fossil fuels. It is a well-established technology and direct utilisation of geothermal energy shows an increase of almost 80% from 2005 to 2009 amounting to c. 50,583 MW by the end 2009 (Lund & Freeston 2010). The strong growth is related to increasing public awareness and use of heat pumps. In Denmark exploitation of geothermal energy is related to low-enthalpy resources, i.e. reservoir temperatures of less than 150°C. The Danish subsurface is well-known owing to a long period of hydrocarbon exploration activities. The many data, reports, analytical results, and physical samples such as cores and cuttings samples are kept orderly in the national archives at GEUS. This wealth of information forms an extensive database for the evaluation of the geothermal potential of the subsurface. Research have shown that the subsurface contains sedimentary successions with several thick, porous and highly suitable aquifers that have a great geothermal potential, as they flow saline formation water with temperatures between 25–90°C at the depths of 1–3 km. A newly completed assessment



concludes that the subsurface contains very large geothermal resources (Mathiesen et al 2009). However, despite the good understanding of the subsurface a number of challenges remains for a successful geothermal exploitation owing to the great geological heterogeneity related to faults, lateral and vertical lithology variations, occurrence of pervasive diagenesis reducing porosity and permeability – all factors that decrease the reservoir continuity and performance. Variations in temperature gradient and high salinity of the formation water also impose challenges. This paper reviews the geothermal activities and potential, the geological challenges and presents a stepwise maturation procedure involving a number of decision gates connected to data acquisition and analyses.

## **Geothermal activities in Denmark**

During the late seventies the geothermal potential was investigated by DGU (now GEUS) together with the University at Aarhus (Michelsen 1981). In 1979 and 1982 two wells were drilled by DONG. The wells encountered the Gassum Formation as anticipated but flow rates were not economic. In 1982 the Thisted-2 well successfully tested the Gassum Formation. The EU commission initiated an investigation of the geothermal resources in Europe and the results were presented in a geothermal atlas in 1988, which later was updated (Hurter & Haenel, 2002).

### **Existing and planned geothermal plants**

Two geothermal plants are currently operating in Denmark, the Thisted and Margretheholm plants (Fig. 1). They have demonstrated that it is possible to produce large amounts of heat for district heating purpose using only a minimum of power to extract the heat from the subsurface water. Both plants apply the concept of two wells, a production well pumping warm formation water to the surface and an injection well re-circulating the cooled formation water in a closed system back to the geological reservoir at some distance from the production point to avoid mixing of warm and cold water. The Thisted plant was established in 1984 and has produced water with a temperature of 45°C from the Gassum Formation at a depth of c. 1250 m for more than 25 years without notable production or injection problems. The Margretheholm plant began production in 2006 producing water of c. 73°C from the Bunter Sandstone Formation at a depth of c. 2600 m. For both plants exists plans for further expansion. In Sønderborg initial investigations based on existing data suggested a geothermal potential. After acquisition and interpretation of new seismic data two explorations wells were drilled proving the presence of the Gassum Formation. A geothermal plant is under construction and is expected to begin operations in 2012 utilising 48°C warm water from the Gassum Formation at c. 1200 m of depth.

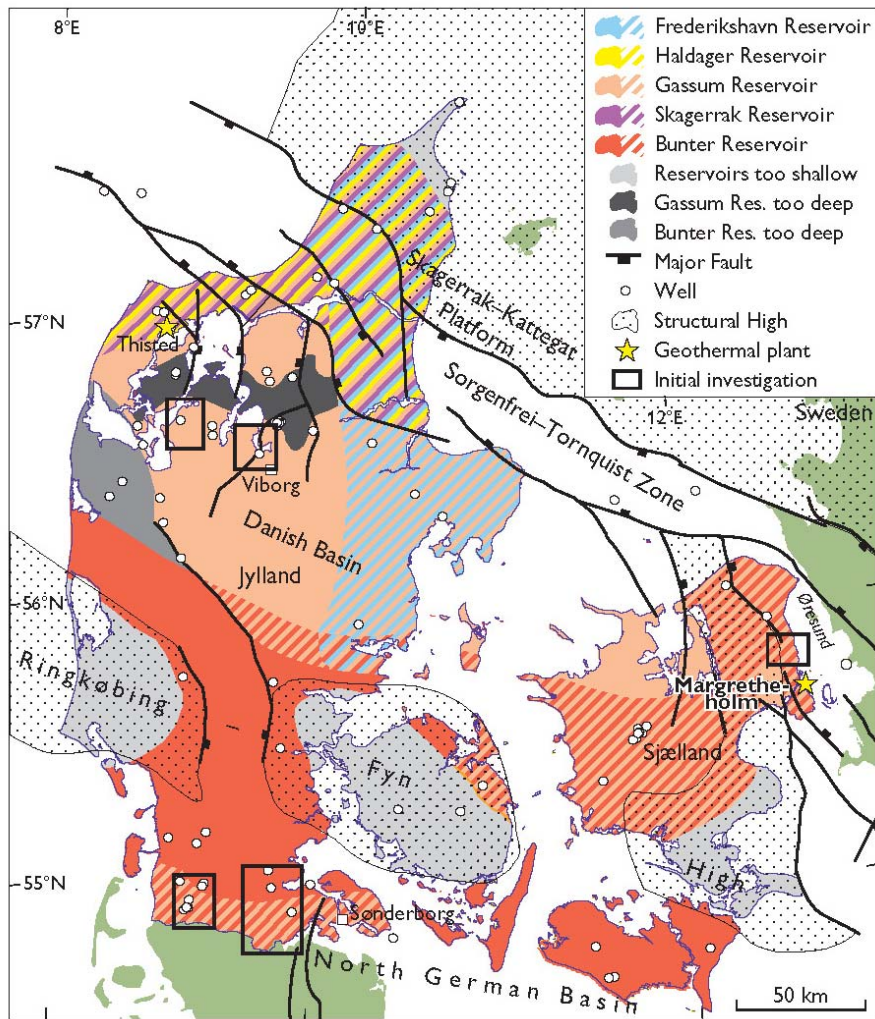

Fig. 1. Map showing the distribution of the potential geothermal reservoirs where they are expected to occur with a thickness of more than 25 m in the 800–3000 m depth-interval. The dark-grey and black areas indicates where the reservoirs are buried too deep; the light-grey areas indicate where no reservoirs are expected to be present (Ringkøbing-Fyn High) or are too shallow buried (< 800 m; northernmost Jutland). The hatched areas indicate two or more reservoirs with a geothermal potential. The existing deep wells, location of the Thisted and Margrethesholm plants, and current areas of interest are shown. Primarily based on Bertelsen (1980), Michelsen (1981), Nielsen & Japsen (1991), Michelsen et al. (2003), Nielsen (2003), Nielsen et al. (2004) and Mathiesen et al. (2009, 2010).

### Future plants

Initial investigations near Lyngby, Skive, Tønder, Viborg and Aabenra suggest a geothermal potential (Fig. 1). At Viborg new seismic data has been acquired and interpreted, and the next step may include the drilling of exploration wells. The investigations at Skive suggest a geothermal potential in the Gassum Formation, and acquisition of seismic data may be carried out

to constrain the evaluation. In addition to these projects, initial investigations are currently underway at a number of places. The great interest is also reflected by the large number of license applications received by the Danish Energy Agency.

## **Geological background**

### **Potential reservoirs**

The Danish subsurface is composed of five major structural units – the Danish Basin, the Sorgenfrei-Tornquist Zone, the Skagerrak-Kattegat Platform, the Ringkøbing-Fyn High and the North German Basin – which exert the overall control on the geothermal prospectivity, as they essentially determine the heat flow, distribution, thickness, facies types and burial depths of the potential reservoirs (Fig. 1). The 1–10 km thick Mesozoic succession has been the target of hydrocarbon exploration for c. 80 years, and is relatively well-known from c. 70 deep onshore wells and seismic data acquired over many years. These data, despite variable quality and coverage, show that the most promising geothermal reservoirs occur within the Triassic–Lower Cretaceous succession in the Danish and North German Basins. The two basins are separated by the elevated basement blocks of the Ringkøbing-Fyn High with a low geothermal potential. Five formations with a regional potential are identified including the Triassic Bunter Sandstone and Skagerrak Formations, the Upper Triassic–Lower Jurassic Gassum Formation, the Middle Jurassic Haldager Sand Formation and the Upper Jurassic–Lower Cretaceous Frederikshavn Formation (Fig. 1). They contain several porous and water bearing sandstone layers/aquifers in the economic interval 800–3000 m below the surface with formation temperatures from 25–90°C, and both basins have a great geothermal potential (Fig.1) (Mathiesen et al., 2009). In addition Rotliegende sandstones may be prospective along the northern rim of the German Basin and lower Jurassic and lower Cretaceous sandstones seems prospective in eastern Sjælland and the Øresund region.

### **The geothermal resource and reserve**

Estimates of the geothermal resource may be based on two principal approaches. The conservative approach calculates the amount of heat present in the reservoir brine and was used in regional assessments to produce comparable values of large areas with very variable and complex geology (Hurter & Haenel 2002; Mathiesen et al. 2009). This approach however, underestimates the amount of heat available for a geothermal plant, as heat stored in the reservoir rock matrix and heat from the adjacent rock units will be supplied to the geothermal water increasing the lifetime of a geothermal reservoir considerably (Magtengaard & Mahler 2010). The geothermal reserve in a given prospect is estimated as the amount of producible heat at the current economic regime.

## **Critical geological parameters**

The principal requirement for successful geothermal exploration is the presence of a warm, thick, continuous, water-bearing, porous and permeable reservoir buried at a suitable depth. Thus burial depth, temperature,

thickness, vertical and lateral variation of lithology, occurrence of faults, formation water chemistry, porosity and permeability are the primary geological factors to evaluate in assessments of the geothermal prospectivity of an area and specific geothermal prospects. By combining 1) the geographic distribution of the formations with known reservoirs, 2) their mapped burial depths, and 3) estimates of the cumulative thickness of the reservoir sandstones a prospectivity map is constructed (Fig. 1). The map shows where the identified reservoirs are expected to occur at depths of 800–3000 m with a thickness exceeding 25 m and provides a first-order indication of the regional geothermal potential.

### **Burial depth and thickness of the reservoirs**

The potential reservoirs show large variations in burial depths which can be mapped in areas with seismic and well data of sufficient density and quality (Fig. 2). In areas with few and poor data or areas with intense deformation in terms of faulting and complicated salt structures, the maps are less reliable. Lateral variations of lithology also impose difficulties as they may complicate the continuity of the seismic reflectors to be mapped. The mapping is carried out in seismic time (two way travel time) and uncertainties regarding the conversion of travel time to depths cause some uncertainty regarding reservoir depths. In some cases it is not possible to resolve both the base and top of a reservoir-bearing formation by seismic data, which typically have a vertical resolution of 20–40 m. The reservoir thickness may then be constructed by combining seismic and well data, which may add uncertainty to the estimate.

### **Lateral and vertical continuity**

Continuity of the reservoir sandstones is mandatory for successful geothermal plants. The lateral and vertical continuity is primarily determined by the depositional environments that formed the sandstones. For instance, the sandstones in the Bunter Sandstone Formation were primarily formed by ephemeral braided rivers and eolian dunes in a warm semi arid climate, whereas intervening mudstones forming hydraulic barriers were formed in playa lakes. On the other hand, the sandstones in Gassum Formation were mainly formed in a humid climate by extensive shoreface progradation interrupted by flooding events forming marine mudstones that constitute vertical barriers (Nielsen 2003). These interpretations of the depositional environments are based well data (well-logs, cores and cuttings) providing information on grain size, sorting, grain shapes, sedimentary structures, fossil content and mineralogy. Large faults with vertical displacement exceeding 100 m are common in many areas destroying the continuity, and are fairly easy to identify although their precise location may be uncertain (Fig. 2). Smaller faults with vertical displacements of less than the thickness of the reservoir units may also reduce the lateral continuity but are more difficult to reveal as the displacement may be smaller or close to the resolution of the seismic data.

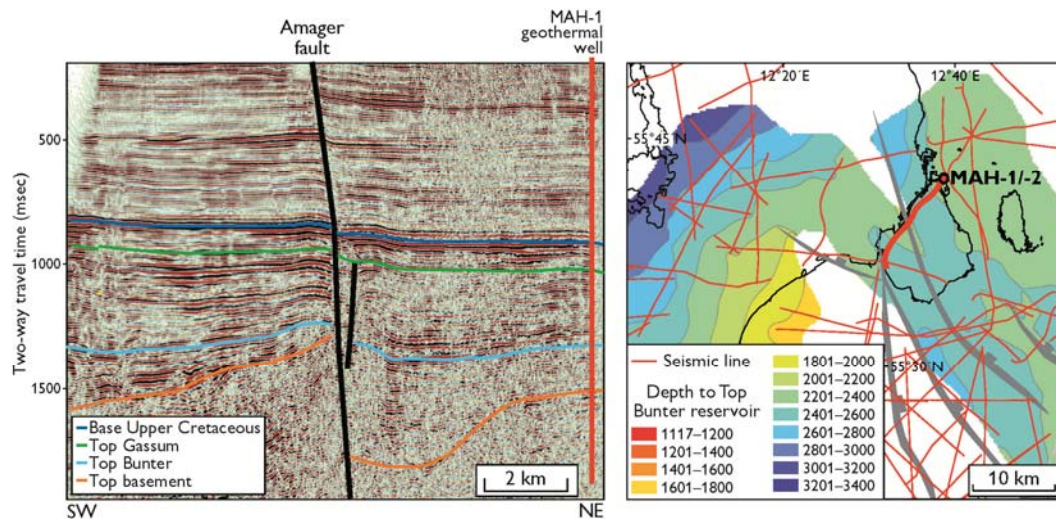

Fig. 2 SW-NE trending seismic profile southwest of Margrethholm (left). The profile illustrates the importance of identifying faults, which reduce the lateral reservoir continuity. The map (right) displaying the depth to the top of the Bunter reservoir shows the location of the seismic lines and illustrates the southwards shallowing of the reservoir top, the disappearance of the reservoir (southern white area) and the faults cutting the reservoir (grey tone). Red dot: Margrethholm and the wells MAH-1 and MAH-2.

### Porosity and permeability

Porosity and permeability decrease with increasing burial depth due to mechanical compaction and formation of diagenetic minerals that reduce pore volume (porosity) and pore connections (permeability) (Figs 3 & 4; 5). The amount of diagenetic alteration is related to petrography of the sediment source areas, sorting and grain sizes of the material supplied to the basins, burial depth and temperature, and chemistry of the formation water. Thus the various depositional processes, mineralogy of the reservoir rocks and their subsequent burial history determine their qualities as geothermal reservoirs.



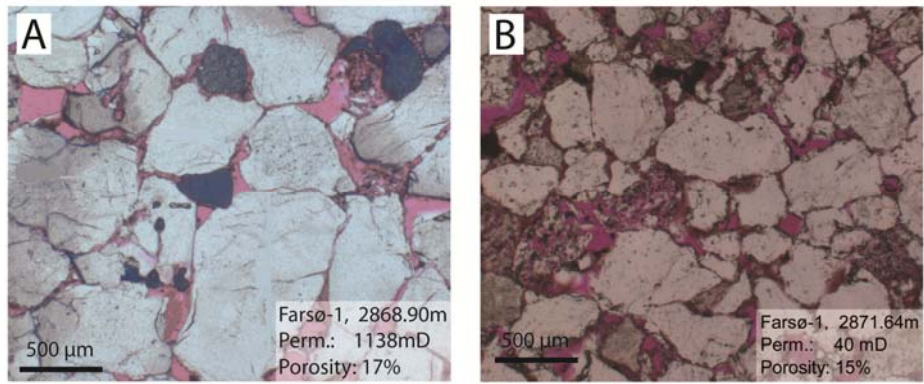

Fig. 3 Gassum Formation. A Coarse grained sandstone of high permeability and moderate porosity, Farsø-1 well, 2868.90 m. B Medium grained sandstone of moderate porosity and permeability reflecting a combination of diagenetic changes. Notable are quartz overgrowth, which reduces the original porosity, and feldspar dissolution, which increases the porosity, Farsø-1, 2871.64 m. (Pores are impregnated with purple material).

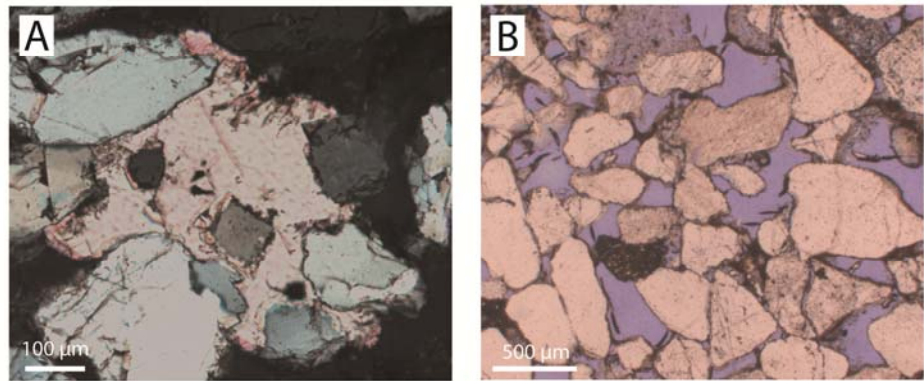

Fig. 4 Gassum Formation. A Low porosity and permeability due to pore filling carbonate cement, photo taken with crossed nicols. Thisted-3, 1225.62 m. B. High porosity and permeability due to minimum of authigenic phases. Stenlille-18, 1672.11 m.

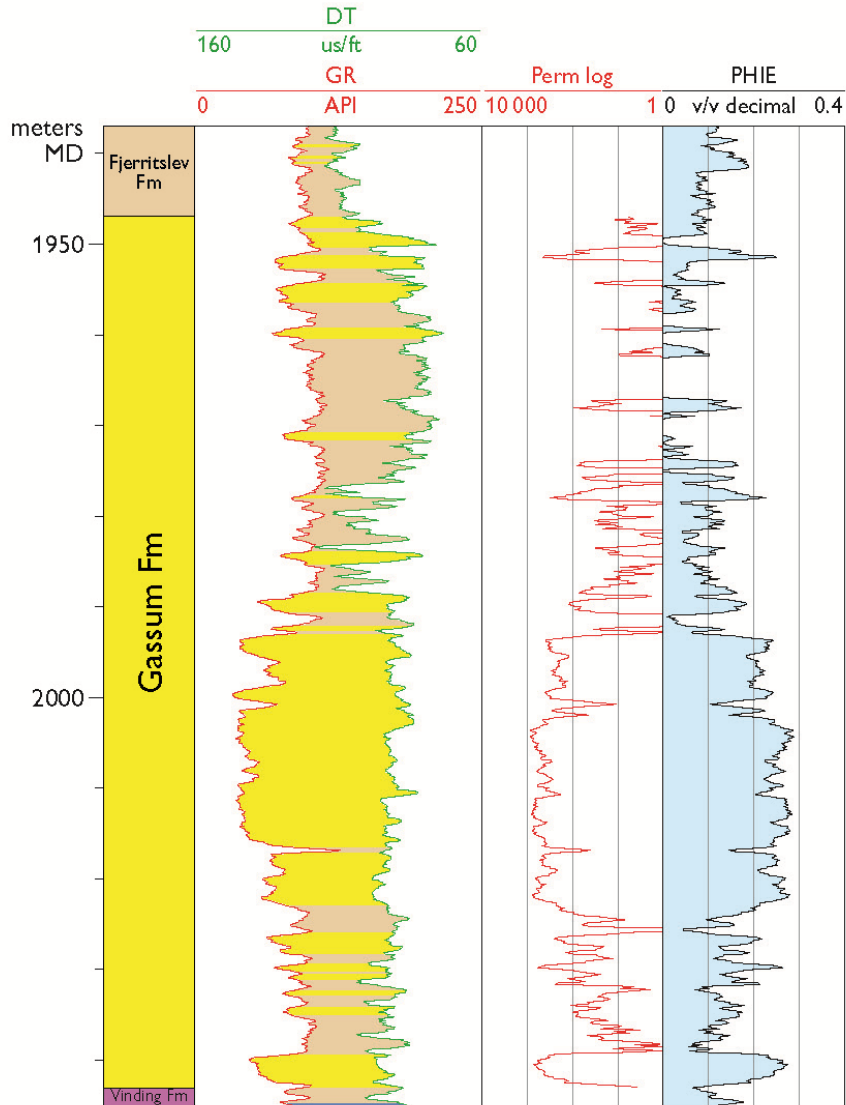

Fig. 5. Petrophysical evaluation of the Gassum Formation in the Rødding-1 well based on interpretation of well-logs. The lithology column (left) encompasses sandstones (yellow) and shales (brown) illustrating the vertical heterogeneity; the column is bounded by the Gamma-ray log (GR) and the Sonic log (DT). The interpreted porosity is highlighted by blue colour fill. The permeability log (PERM\_log) is an estimate curve.

## Temperature and salinity

Temperature and salinity of the reservoir water increase with depth. Based on available data from a number of wells a general temperature-depth relation is established, showing a general gradient of about 25–30°C per km, but local anomalies occur due to variations in thermal conductivity related to lithology variations (Balling et al., 1992). The salinity of the formation water increases almost linearly with depth reaching near-saturation at c. 3000 m, though the salinity gradient may be steeper near evaporates, e.g. the Zechstein halites (Laier 1989).

## Exploration risks and decision tool

Predictions of the quality and performance of subsurface reservoirs at depths of 1-3 km are uncertain. The geological uncertainty reflects the complexity of the subsurface geology and the amount and validity of available data. In areas with intense deformation due to faulting and folding of the geological layers, predictions are uncertain, whereas predictions are more reliable and require less data in areas with weak deformation and high continuity of the layers. In order to evaluate the exploration risks consistently, GEUS is currently developing a systematic approach in which the primary factors such as burial depth, lithological continuity, gross and net thickness, faults, porosity and permeability, temperature, and formation water chemistry are estimated. The investments for establishing a geothermal power plant are high and in order to reduce the risks GEUS has developed a stepwise approach where the available data at every decision point is evaluated before further data acquisition and investments are initiated (Fig.6).

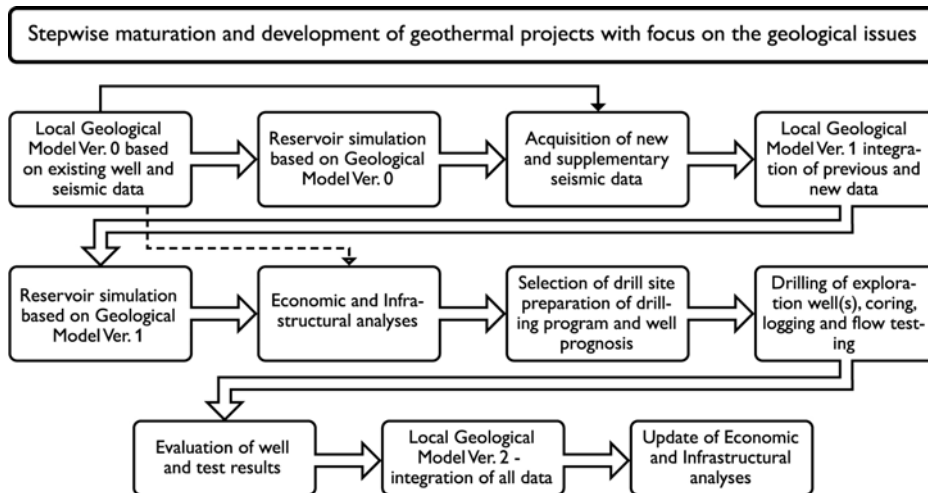

Fig.6. Scheme showing data evaluation steps and decision gates.



## Conclusions

The Danish subsurface contains huge geothermal resources, which are estimated to correspond to several hundred years of the present heat consumption; only a small fraction of this potential is utilised by the present geothermal power plants. Geothermal energy may be utilised in many areas where suitable geological conditions are coinciding with adequate infrastructure on the ground, typically in urban areas with district heating systems. Therefore, geothermal energy has a large potential in Denmark as it provides a safe, sustainable, local and reliable supply of energy that reduces the need for fossil fuels. The major challenge for geothermal prospecting is to find suitable reservoirs with high continuity and sufficient flow capacity of warm water. Permeability is critical, but difficult to predict since large variations occur depending on depositional facies, provenance, mineralogical composition, burial history and temperature. One of the barriers for significant increase in the exploitation of the large geothermal resource is the geological uncertainty in the exploration phase. This uncertainty is related to the difficulties of making reliable predictions of the composition of the subsurface. Precise predictions are dependent not only on existing well and seismic data, but also on a thorough understanding of the various geological processes that formed the geothermal reservoirs. These aspects are addressed in a new 4-years project funded by the Danish Council for Strategic Research (DSF), GEUS and DONG Energy.

## References

- Balling, N., Nielsen, S.B., Christiansen, H.S., Christensen, L.D. & Poulsen S., 1992: The subsurface thermal regime and temperature of geothermal reservoirs in Denmark. Synthesis report to Commission of the European Communities, Contract EN3G-0029-DK.
- Bertelsen, F. 1980: Lithostratigraphy and depositional history of the Danish Triassic. Danm. geol. Unders. Ser. B 4, 59 pp.
- Hurter, S. & Haenel, R.(eds) 2002: Atlas of Geothermal Resources in Europe. Publication No. EUR 17811 of the European Commission. European Communities. Luxembourg, 92 pp.
- Laier T., 1989: Mapping of low enthalpy brines in Denmark for geothermal exploitation. In (Ed. D.L. Miles) *Proceedings of the 6th international symposium on Water-Rock Interaction*, Malvern, England, 3-8 August 1989, 409-412. Balkema, Rotterdam.
- Lund, J. W. & Freeston, D.H. 2010: Direct utilisation of geothermal energy 2010 Worldwide review. Proceedings World Geothermal Congress, 1-23 Conference CD. Bali, Indonesia
- Magtengaard, J. & Mahler, A., 2010: General reserves and sustainability in the Greater Copenhagen Area. Proceedings World Geothermal Conference 2010, Bali Indonesia 25-19 April 2010. 6 pp.

Mathiesen, A., Kristensen, L., Bidstrup, T. & Nielsen, L.H. 2009: Vurdering af det geotermiske potentiale i Danmark. Danmarks og Grønlands Geologiske Undersøgelse rapport 2009/59, 85 pp.

Mathiesen, A., Nielsen, L.H., Bidstrup, T. 2010: Identification of the potential geothermal reservoirs in Denmark. Geological Survey of Denmark and Greenland Bulletin 20, 19-22.

Michelsen, O. 1981: Kortlægning af potentielle geotermiske reservoirer i Danmark. DGU Serie B, Nr. 5, 96 pp.

Nielsen, L.H. & Japsen, P. 1991: Deep wells in Denmark 1935–1990. Lithostratigraphic subdivision. Danmarks Geologiske Undersøgelse Serie A 31, 179 pp.

Nielsen, L.H. 2003: Late Triassic–Jurassic development of the Danish Basin and the Fennoscandian Border Zone, southern Scandinavia. In: Ineson, J.R. & Surlyk, F. (eds): The Jurassic of Denmark and Greenland. Geological Survey of Denmark and Greenland Bulletin 1, 459–526.

Nielsen, L.H., Mathiesen, A. & Bidstrup, T. 2004: Geothermal energy in Denmark. Review of Survey activities 2003. Geological Survey of Denmark and Greenland bulletin, p.17–20.

# Performance of Space Heating in a Modern Energy System

Brian Elmegaard  
DTU Technical University of Denmark  
Department of Mechanical Engineering  
Kgs. Lyngby  
Denmark

## Abstract

In the paper we study the performance of a number of heat supply technologies. The background of the study is the changes in the Danish energy systems over the last three decades which have caused integration of large shares of combined heat and power (CHP), renewable fuels and wind power. These changes mean that there is a significant integration of electricity and heat supply in the system and that several technologies may be beneficial. In particular, heat pumps are under consideration and are often considered to be renewable energy. We study how to distribute fuel and emissions to the heat supply. We find that heat supply is low-efficient seen from an exergy viewpoint, between 1% and 26% utilization. As exergy is a quantification of primary energy, we conclude that far better utilization of primary energy is possible. We also find that combined heat and power and domestic heat pumps are the technologies with best performance, unless we consider solar heating and biomass from the viewpoints of CO<sub>2</sub> emissions and fossil fuel consumption.

## Acronyms

CHP	Combined Heat and Power
COP	Coefficient of Performance
DH	District heating
HP	Heat pump

## 1 Introduction

In the following we introduce the modern energy system to study for understanding of the efficiency of heat supply. We define the Danish energy system to be a modern one as high shares of renewable energy sources are used in both heat and electricity production.

### 1.1 The Danish Energy System

The Danish energy system is in several ways unique and it may be seen as a modern energy system with a significant and increasing share of renewable sources. Some of the main reasons for this characterization are found in the annual energy statistics [1]:

- Denmark has a significant share of cogeneration of heat and power in the energy system. 80% of the district heating is produced in CHP mode. This equals that 55% of the electricity is from CHP.
- 17% of the energy consumption is produced by renewable energy sources, mainly biomass.

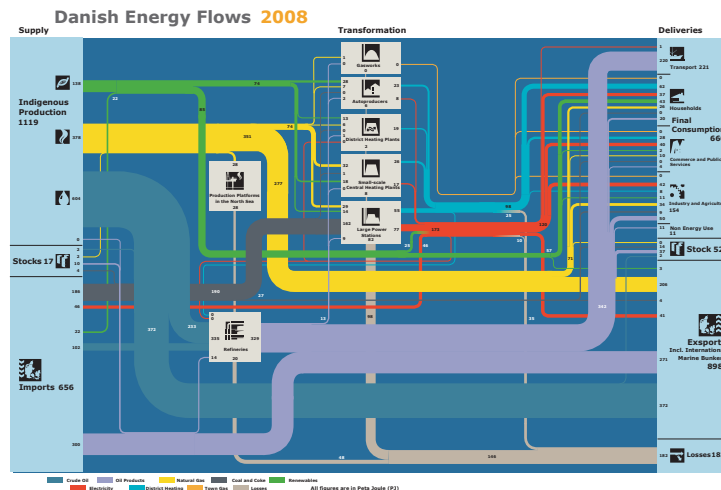

Figure 1: Energy flows in the Danish system 2008, (from <http://www.ens.dk> used with permission)

- Wind power covers 19% of the electricity consumption
- Over the last three decades the energy consumption has been virtually constant, while the gross national product has been steadily increasing.

Key figures of the energy system are found in figure 1. Based on the consumption data we find that the annual consumption of electricity and heat for households and commerce are 76 PJ and 203 PJ, respectively. These figures are used as demand in the calculations below.

The high share of wind power has significant focus from the Danish Energy Agency and the system operator as well as from other players in the energy sector. In particular the intermittent nature of the wind power production and the fluctuations of electricity price, which to some extent are correlated with wind power production, are in focus [10], [16], [19],[20], [26].

Denmark has electrical connections to the neighboring countries which make export and import possible. This is often used, and it is a serious consideration whether wind power produced in Denmark is sold too cheaply to our neighbours, due to surplus situations.

Many ideas for not “giving electricity away”, i.e., export it at no or low cost, are studied. One of the technologies that attracts interest is installation of heat pumps to make use of the wind power in the heat supply. The suggested heat pumps can be divided in two categories: small, domestic heat pumps and large units integrated in district heating systems. In addition electric boilers in the district heating system are considered as flexible consumers. Politically, there has already been taken measures for integration of these technologies, as tax reductions for use of electricity for heat supply in district heating systems have been implemented. From the viewpoint of thermodynamics, direct conversion of electricity to heat for space heating is perhaps the worst imaginable solution. However, if the amount of electricity supply from renewable sources is unlimited, the huge entropy production will not result in any emission of greenhouse gases, and thus may not be seen as a problem. The present study is an effort to understand the implications of different heat supply technologies in the Danish energy system. Denmark is used as case as it due to the significant share of renewable sources is assumed to be a representative, modern energy system.

In addition the results may be seen as an effort to improve on the understanding of exergy as a useful tool in concerns of the society [25]. Political decisions and commercial actions in the market may result in common understanding and solutions that are not necessarily optimal from the viewpoint of thermodynamics, as exergy is not explicitly used as an indicator in these decisions. Exergy is only used to limited extent as performance indicator in overall energy system studies

[5],[10],[11],[16],[18],[20],[26]. Several of these studies are based on assumptions about the performance of technologies, e.g., to large extent the information about technologies found in [2]. Unfortunately, the information in this document is of varying quality, some numbers even violate the second law of thermodynamics, which is inappropriate in the search for optimal solutions. It should be mentioned that the latest edition of the Technology catalogue [4] has been improved concerning performance of technologies.

Several studies in the field of thermodynamics have focused on the construction of energy economics that are based on exergy consumption as the main indicator for price and tax, e.g., [13], [15], [24]. However, the results of these have found little application in practice. In particular, some authors question the exergetic efficiency of the way the economics of the Danish energy system are constructed in the effort to promote CHP [12], [21]. Other authors have studied the exergetic efficiency of heat supply technologies, e.g., [7], [22].

## 2 Methods

The performance of energy conversion technology may be quantified based on different assumptions. In order to utilize the primary energy best possibly, the laws of thermodynamics and thus exergy-based evaluations are required.

We use exergy for quantification of performance and for distribution of fuel between different energy products. This is particularly significant for products that involve electricity because of the conversion of fuel to electricity and cogeneration of heat and power.

Based on the exergetic approach we furthermore determine fossil fuel consumption and greenhouse gas emission from heat supply as well.

### 2.1 Performance of Heat Supply Technologies

The energy supply in the Danish system is used for electricity, for heating and for transportation purposes. As the transport sector is operating separately we limit the study to heat supply and the electricity sector which are closely integrated due to the large share of cogeneration.

The heat supply considered in the paper are:

**Domestic boilers** using oil, gas or biomass (wood or straw). Efficiency of 90% assumed.

**District heating from separate production** based on oil, gas or biomass. Efficiency of 90% assumed. Loss of 30% is assumed for the district heating network[1]

**District heating from combined heat and power (CHP)** based mainly on coal but also natural gas and biomass. Details of efficiency are determined below 3.3.

**Heat pumps** either in households or in district heating plants. Details of efficiency are determined below 3.2.1.

**Electric heating** Efficiency of 100% assumed.

**Solar panels** Annual efficiency of 40% assumed.

**Heat generated from electric appliances** Principally, this cannot be neglected as electricity is about 10% of the energy that enters the heated space. However, in the following we do not account for this for simplicity reasons.

We study how the heating technologies perform with respect to the following criteria:

- CO<sub>2</sub> emission per unit heat supplied

- Share of renewable fuel per unit heat supply
- Primary fuel consumption per unit heat supplied
- Exergetic efficiency of the heat supply (see, however, section 3.1)

## 3 Results

### 3.1 Exergy Consumption of Heat Supply

#### 3.1.1 Energy input

The primary energy supplied to the Danish energy system are:

**Fuels** as

**Coal** Exergy 100% of heating value, CO<sub>2</sub> emission 95 kg/GJ

**Natural Gas** Exergy 100% of heating value, CO<sub>2</sub> emission 57 kg/GJ

**Oil** Exergy 100% of heating value, CO<sub>2</sub> emission 78 kg/GJ

**Biomass, wood and straw** Exergy 100% of heating value, CO<sub>2</sub> emission 0 kg/GJ

**Solar irradiation** Exergy 96% of irradiated energy

**Wind** Exergy 100% of kinetic energy

The exergy content of an energy source has been investigated in several studies, e.g., [14] and [6]. We find from these the very important conclusion that:

*The exergy content of a primary fuel equals its energy content.*

This holds for common energy sources including fuels within an accuracy of about 5%. We thus also conclude that a calculation of primary fuel consumption for heat supply is the same as an exergy analysis. Thus, exergy analysis is implicitly used in any energy system study.

#### 3.1.2 Heat Supply

The basic reason for space heating is to maintain a comfortable temperature indoors, when heat is lost from the space due to the outdoor temperature being lower. The comfort temperature is specified to be  $t_{in} = 20^\circ\text{C} = 293\text{ K}$ . In Danish conditions the average ambient temperature during the heating season is  $t_{ref} = 7^\circ\text{C} = 280\text{ K}$ .

The primary fuel needed for providing this temperature difference is found by calculation of exergy,  $e$ , required to provide the heating energy,  $q$ :

$$\frac{e}{q} = \left(1 - \frac{T_{ref}}{T_{in}}\right) = \left(1 - \frac{280}{293}\right) = 4.4\% \quad (1)$$

Thus, we may provide the energy by using only 4% of the demand as primary fuel, or accordingly, we may theoretically, construct reversibly operating heat pumps with a Coefficient of Performance (COP) of 22.5 for space heating. The annual average COP of modern heat pumps is in order of up to 3-4. As a consequence the demand for primary energy to supply the heat demand of 203 PJ is 10 PJ.

For district heating systems the exergy content per unit energy is found to be 19% for a representative system operating at 90°C/60°C, because the log mean temperature (or entropic temperature) is close to the arithmetic average 75°C. However, when used in the heat supply the exergy demand is still

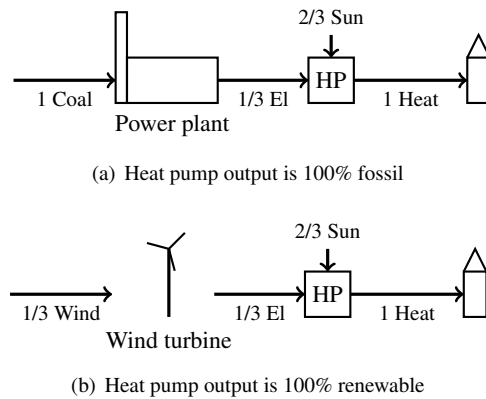

Figure 2: Extremes of fuel consumption of a heat pump. Power coefficient of wind turbine is neglected.

only 4% because the heat is to be used for space heating at 20°C. There is thus a significant exergy loss of about 85% in distribution of district heating. The loss is related to both the heat loss (30%) and the temperature difference between district heating network and indoor space (55%).

## 3.2 Heat Supply Technologies Integrated with Electricity Production

For the domestic boilers it is straightforward to calculate primary fuel consumption and thus CO<sub>2</sub> emissions based on the information in 1. However, for the technologies that are integrated with electricity production it is to a much larger extent a matter of definition to calculate the key figures.

### 3.2.1 Heat Pumps

Heat pumps are often suggested as a renewable energy source as well as a means for integrating fluctuating energy sources in the energy system. It must, however, be kept in mind that heat pumps are operated by electricity that is today produced mainly based on a fossil fuel. This means that the energy supplied by a heat pump actually does emit greenhouse gases. The CO<sub>2</sub> emission from heat pumps is connected to the electricity production, as well. In figure 2 two extremes of the heat supply from a heat pump are illustrated. In one situation (figure 2(a)) a coal-fired power plant produces all the electricity for the heat pump at an electrical efficiency of 33%. With a COP of 3 the heat from the heat pump equals the fuel consumed and the CO<sub>2</sub> emission will be the same as for coal. In the other situation (figure 2(b)) the heat pump is supplied with wind power and thus the heat from it will be Carbon neutral. In the actual system each of these situations may occur at different times of the year. However, the average annual energy supply to the electricity production is significantly more complex, including both fossil fuels and biomass for the thermal power plants and wind power.

The overall characteristics of the energy system are presented in table 1:

Two distinct types of heat pumps are suggested.

**Small-scale heat pumps for domestic use**, mainly intended for floor-heating systems. Measurements [8] show an annual COP of 2.8-4.3. We assume the COP to be 3.3. The energy flows for production of heat for this situation is illustrated in figure 3. We find that the share of fossil fuels required for production of heat is 48%. Out of the produced heat 15% does not come from the heat pump but from the CHP production.

**Large-scale heat pumps for use in district heating system** As the district heating systems oper-

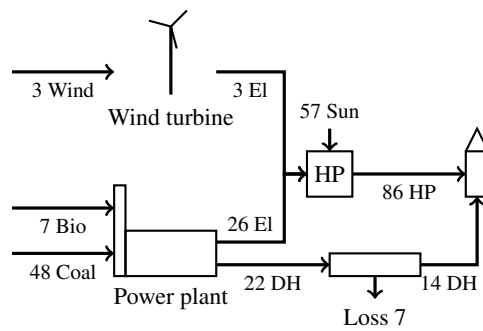

Figure 3: Energy flows in domestic heat pump-based supply

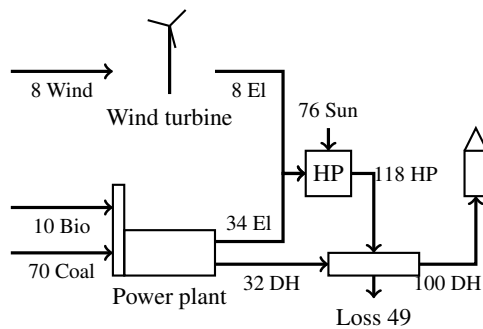

Figure 4: Energy flows in large central heat pump-based supply

	PJ
Total input	273
Renewable share	56
Biomass share	31
Wind share	25
Fossil share	217
Thermal fuel	247
Electricity production	131
Thermal production	106
Efficiency of production	53%
Thermal efficiency	43%
District heat production	124
Non CHP share	25
CHP share	99
Energy Efficiency of DH production	40%

Table 1: Characteristic values of the Danish energy system



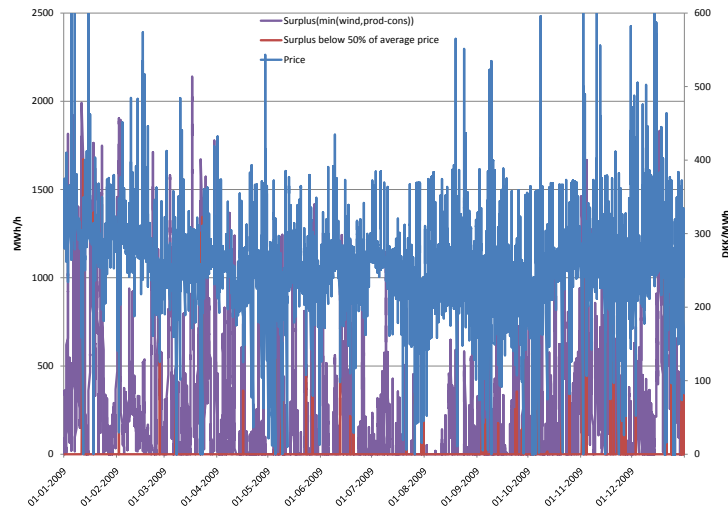

Figure 5: Curves of surplus wind power, surplus wind power below 50% of the average price and electricity price

Method	Fuel for electricity	Fuel for heat	Total fuel	Fuel ratio
100% heat efficiency	152	203	355	1.33
200% heat efficiency	152	102	254	0.67
Lost work	152	22	174	0.14
Exergy-based (DH 75°C)	152	39	191	0.26
Exergy-based (Theoretical)	76	10	86	0.13

Table 2: Fuel demand for supplying electricity and heat

ate at higher delivery temperatures than used in domestic heat pumps, the COP will be lower. An estimate of 2.8 is used for the calculation in figure 4. This performance is based on data for a transcritical CO<sub>2</sub>-based heat pump using high temperature waste water as low temperature heat source [17] and simulation of heat pump cycles for this application. The heat loss from the district heating system is 33%. We find that the share of fossil fuels for this situation is 70%, and that 21% of the consumed heat is from CHP, not from the heat pump itself.

In situations where surplus wind power is available, the production may of course be completely based on renewable fuels. However, the current energy system has low cost surplus wind power in only few hours per year, see figure 5 which shows the electricity price during 2009 as well as the surplus when wind power exceeds demand and the same surplus when the price is less than 50% of the average price. The latter is found to occur rarely. Thus, in order to have a reasonable number of annual operating hours the large-scale heat pumps should in practice operate based on the average mix of fuel for power production.

### 3.3 Combined Heat and Power

As for heat pumps, also heat from cogeneration is produced integrated with electricity and thus we need to distinguish between the fuel for power and for heat. In [23] and [3] different methods are presented.

- **100% efficiency of heat production** The heat is produced at the same efficiency as would be the case in separate production.

- **200% efficiency of heat production** In Danish energy statistics an efficiency of heat production of 200% is used.
- **Fuel for lost work is assigned to heat production** The operation map of a coal-fired large CHP plant is illustrated in [9]. At full load the change of operation point from condensation mode at 250 MW electricity may be changed to full back-pressure mode at 330 MJ/s district heat at the cost of 35 MW. The lost work is 11% of the supplied heat.
- **Exergy-based distribution of fuel** The exergy of the electricity and district heat from the plant may be used for distribution of the fuel for the two products. This approach is the correct one to use based on thermodynamic principles.

Other methods are available, but above represent the range of options.

Assuming that an attainable efficiency with current technology is 50% we find the minimum requirements of fuel to fulfill the supply as calculated by the different methods, see table 2. Quite different values between 86 and 355 PJ are found, meaning that the method for calculating fuel demand is very significant. The last row of the table shows the fuel requirement, 86 PJ, that is actually needed if exergy of the demand is used, i.e., power can be produced at 100% efficiency and heat at COP of 20. This value is the correct minimum demand. We see that it is significantly lower than what is found by the other methods, that take irreversibility of current technology into account.

The ratio between fuel demand for heat and power differs a lot between the different methods. By using other methods than the exergy of the demand we may thus find non-optimal targets for fuel demand.

For a small CHP plant back-pressure steam cycles or engines are used. The lost work approach is not as meaningful because the district heating will be based on waste heat only in these. The electric efficiency is significantly lower than for large plants, e.g., 25%. At an energy utilization of 90%, an exergy-based distribution gives a fuel consumption of 27 units exergy per 100 units heat exergy at the consumer.

### 3.4 Comparison of Heat Supply Technology

Several criteria for comparing technology for heat supply may be used. We compare CO<sub>2</sub> emissions, consumption of non-renewable fuels and exergetic efficiency of each technology. We keep in mind that exergetic efficiency also evaluates primary fuel utilization.

#### 3.4.1 Greenhouse Gas Emissions from Heat Supply

In figure 6 we show the emission of CO<sub>2</sub> from 12 heat supply technologies, and compare these to the emission from combustion of three fossil fuels, coal, oil and natural gas. All emissions are relative to combustion of coal. We find the obvious result that direct use of solar heating or biomass has the lowest emissions, none. Out of the technologies using fossil fuels to some extent we find that domestic heat pumps and, particularly, CHP have lowest emissions. We also find that some technologies result in higher emissions than coal combustion.

#### 3.4.2 Renewable Fuels in Heat Supply

In figure 7 a comparison of the input of fossil fuel required for production of 100 units heat is presented. Again the renewable sources show a value of 0. CHP solutions are in this case better than heat pumps. Central heat pumps are difficult to characterize as renewable energy as they will use 70 units fossil fuel. This technology should thus only be intended for operation when wind power is in

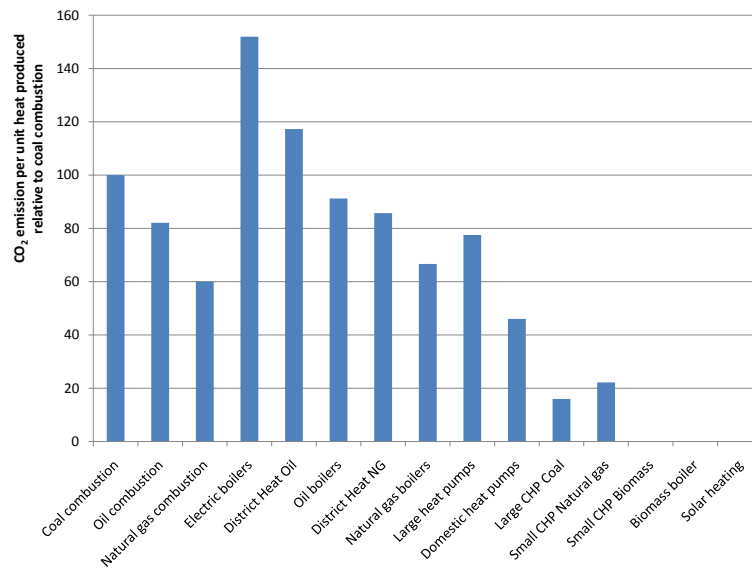

Figure 6: CO<sub>2</sub> emission from heat production

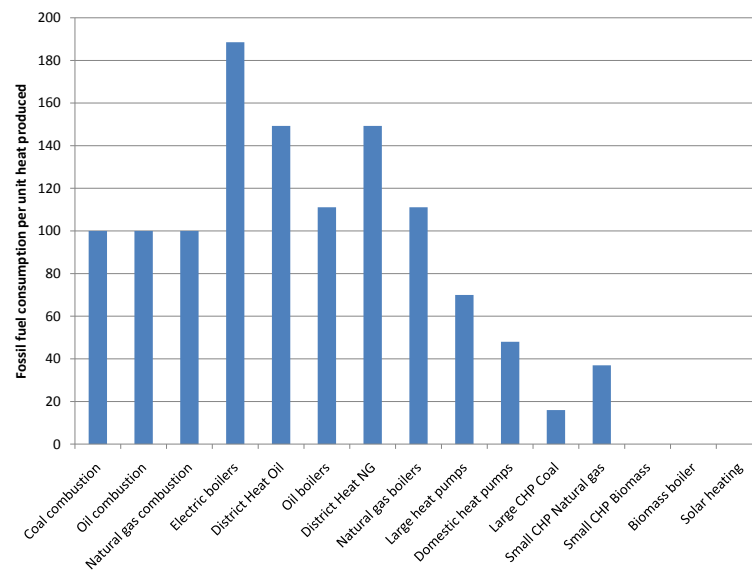

Figure 7: Fossil fuel required for heat production

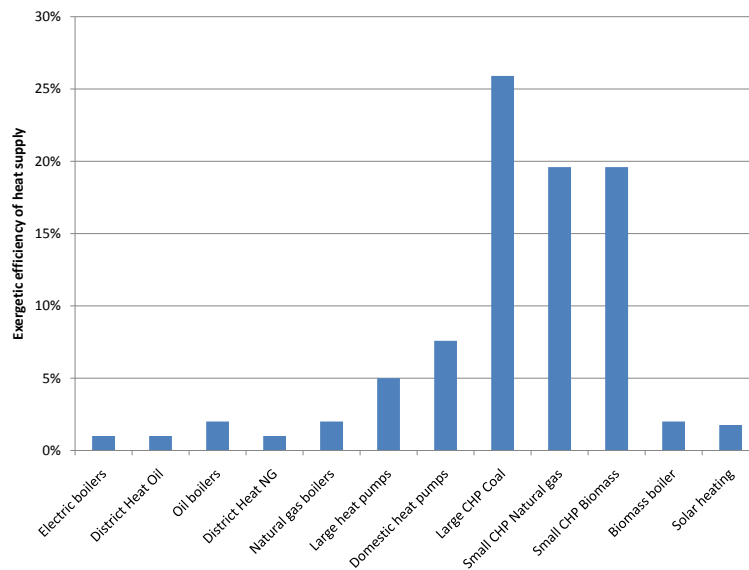

Figure 8: Exergetic efficiency of heat production

surplus. Domestic heat pumps require 48 units fossil fuel. This makes it questionable heat pumps can be characterized as a renewable energy source.

### 3.4.3 Primary Fuel Consumption – Exergy Analysis

In figure 8 we compare the exergetic efficiency of heat supply technologies. We find that all technologies show very low efficiency and thus primary fuel consumption is far higher than needed. In principle we could reach 100% exergy utilization by careful integration of energy supply and consumption. That said, we conclude that large-scale CHP is the best technology and that small-scale CHP and domestic heat pumps show significantly better performance than other technologies.

## 4 Discussion

The obtained results are based on the most reasonable use of thermodynamics of the heat supply technologies for understanding the fuel use in the production. We have, however, made several assumptions of both efficiency and distribution of fuels. For CHP technology other distributions of fuel may give significantly different results. However, exergy is the proper measure.

Concerning heat pumps, the results may also be significantly different if they are operated intelligently, only when wind power is in surplus, not as in this case based on the average electricity production. However, our studies show that wind power surplus does not occur in any magnitude that will make this situation possible. In addition the prognosis for the future energy system only doubles the wind power production in the period until 2030. For a future situation with no fossil fuel consumption other results will of course be found. Another side of the discussion is whether it is not beneficial to export surplus wind to neighboring countries for use as electricity instead of converting it to heat at very low exergetic efficiency even if economics say it is not.

Concerning the renewable fuels the assumptions that wind turbines have an efficiency of unity. This may be questioned as the power coefficient of wind turbines is usually about 30-40%. For heat pumps we have neglected the solar heat input used as low temperature heat source, e.g., for ground source heat pumps. These facts would cause significantly lower performance of heat pumps if included in the exergetic efficiency.

The calculations have been based only on one representative value of performance of the technologies. The results should not be seen only as a representative example, not as exact results.

The electricity demand of 76 PJ is not important for the results. However, the irreversibilities of electrical appliances is significant, and thus the actual demand is lower than this value.

## 5 Conclusion

Based on studies of the modern Danish energy system we have determined the effectiveness of heat supply based on three different criteria: CO<sub>2</sub> emissions, Renewability and Primary Fuel utilization.

In all cases we find that combined heat and power production and domestic heat pumps are the best technologies, out of those that use fossil fuel. We also find that technologies based on renewable sources only are better concerning the two former criteria.

The primary fuel utilization of heat supply is found to be very low, not above 10% in most cases, except for Combined Heat and Power. This may seem very low when boilers of e.g., 95% energy efficiency are available on the market. This suggests that exergy analysis should be used to a larger extent in understanding optimization of energy systems in order to optimize use of primary.

Heat pumps have a significant share of fossil fuel in the current system. Thus it is questionable whether it is reasonable to see this technology as renewable energy.

District heating may be improved significantly by lower temperature in the network. This will lower exergy destruction due to both the heat loss and the temperature differences between network and consumption.

## 6 References

- [1] Danish Energy Agency. Energy statistics 2008. Technical Report ISBN 987-87-7844-805-7, ISBN 978-87-7844-806-4 www, Danish Energy Agency, 2009.
- [2] Anonymous. Technology data for electricity and heat generating plants. Technical Report ISBN: 87-7844-502-7, Danish Energy Authority and Elkraft System and Eltra, March 2005.
- [3] Anonymous. Primære ressourcefaktorer. Technical report, Rambøll, April 2009.
- [4] Anonymous. Technology data for energy plants. Technical Report ISBNwww: 978-87-7844-857-6, Danish Energy Authority, June 2010.
- [5] Lu Aye and W. W. S. Charters. Electrical and engine driven heat pumps for effective utilisation of renewable energy resources. *Applied Thermal Engineering*, 23(10):1295 – 1300, 2003.
- [6] Adrian Bejan, George Tsatsaronis, and Michael Moran. *Thermal Design & Optimization*. Wiley Interscience, 1996.
- [7] P. Cui, H. Yang, and Z. Fang. Energy and exergy analysis of hybrid ground-coupled heat pumps with hot water supply. *International Journal of Exergy*, 6(3):388 – 404, 2009.
- [8] Energistyrelsens liste over energimærkede varmepumper. <http://www.ens.dk/da-DK/ForbrugOgBespareser/IndsatsIBygninger/Varmepumper/Documents/liste\%20over\%20energim\%C3%A6rkede\%20varmepumper.pdf>, December 2009. Downloaded 27-02-2010.
- [9] Brian Elmegaard and Niels Houbak. Simulation of the Avedøreværket unit 1 cogeneration plant with DNA. In *Proceedings of The 16th International Conference on Efficiency, Cost, Optimization, Simulation, and Environmental Impact of Energy Systems (ECOS 2003)*, pages 1659–1666, 2003.

- [10] Energinet.dk. Effektiv anvendelse af vindkraftbaseret el i danmark. Technical Report Dok. 7850/09, Energinet.dk, March 2009.
- [11] Energistyrelsen. Danmarks energifremskrivning frem til 2030 (denmark energy forecast until 2030). Technical Report ISBNwww: 978-87-7844-793-7, Danish Energy Agency, April 2009.
- [12] Ivar S. Ertesvåg. Exergetic comparison of efficiency indicators for combined heat and power (chp). *Energy*, 32(11):2038 – 2050, 2007.
- [13] D. Favrat, F. Marechal, and O. Epelly. The challenge of introducing an exergy indicator in a local law on energy. *Energy*, 33(2):130 – 136, 2008. 19th International Conference on Efficiency, Cost, Optimization, Simulation and Environmental Impact of Energy Systems - ECOS 2006.
- [14] Arif Hepbasli. A key review on exergetic analysis and assessment of renewable energy resources for a sustainable future. *Renewable and Sustainable Energy Reviews*, 12:593–661, 2008.
- [15] Gerard Hirs. Thermodynamics applied. Where? Why? *Energy*, 28:1303–1313, 2003.
- [16] Juha Kiviluoma and Peter Meibom. Influence of wind power, plug-in electric vehicles, and heat storages on power system investments. *Energy*, 35(3):1244 – 1255, 2010.
- [17] Kent Krøyer. Nu kører danmarks første kæmpevarmepumpe på billig møllestrøm (the first danish mega heat pump is now running on cheap wind power). <http://ing.dk09/artikel/102000nukoerererdanmarksfoerstekaempe-varmepumpepaabilligmoellestroem>, September 2009. Downloaded 27-02-10.
- [18] H. Lund and B.V. Mathiesen. Energy system analysis of 100% renewable energy systems—the case of denmark in years 2030 and 2050. *Energy*, 34(5):524 – 531, 2009. 4th Dubrovnik Conference, 4th Dubrovnik conference on Sustainable Development of energy, Water & Environment.
- [19] Henrik Lund and Brian Vad Mathiesen. Baggrundsrapport til Ingeniørforeningens Energiplan 2030 (background report for engineering society energy plan 2030). Technical report, Aalborg Universitet, December 2006.
- [20] Peter Meibom, Juha Kiviluoma, Rüdiger Barth, Heike Brand, Christoph Weber, and Helge V. Larsen. Value of electric heat boilers and heat pumps for wind power integration. *Wind Energy*, 10:321–337, 2007.
- [21] Svein J. Nesheim and Ivar S. Ertesvåg. Efficiencies and indicators defined to promote combined heat and power. *Energy Conversion and Management*, 48(3):1004 – 1015, 2007.
- [22] E. Nieuwlaar and D. Dijk. Exergy evaluation of space-heating options. *Energy*, 18(7):779–790, 1993.
- [23] W. Piller and M. Rudolph. *Kraft-Wärme-Kopplung – zur Theorie und Praxis der Kostenrechnung*. Verlags- und Wirtschaftsgesellschaft der Elektrizitätswerke m.b.H., 1984. ISBN 3-8022-0077-2.
- [24] Alojz Poredos and Andrej Kitanovski. Exergy loss as a basis for the price of thermal energy. *Energy Conversion and Management*, 43(16):2163 – 2173, 2002.
- [25] Marc A. Rosen. Should we educate the public about exergy? *Exergy, An International Journal*, 2(4):211 – 213, 2002.
- [26] Mikael Togeby, Jesper Werling, János Hethey, Lars Bregnbæk, Anders Kofoed-Wiuff, Hans Henrik Lindboe, Kim Mygind, Jonas Ahmt, Alexandros Filippidis, Peter Meibom, and Poul Erik Morthorst. Bedre integration af vind (better integration of wind). Technical report, Ea Energianalyse and Risø DTU, June 2009.

## Session 3B – smart grids

# Dynamic Power System Investment Modeling and Analysis

Hans Ravn, RAM-løse edb, HansRavn@aeblevangen.dk, www.RAM-lose.dk.

## Abstract

In the perspective of the expected large structural changes of the energy system in the present century in relation to ambitious environmental goals it is essential to have a good understanding of investment processes in energy technologies. This encompasses several aspects such as uncertainty, e.g. with relation to technological development, to fuel prices and to future demands, investors' preferences and the timing of investments. Moreover, to properly analyze the possible developments paths of the energy sector, energy system models seem essential.

In the present paper some steps towards development of a suitable energy system model for that task is described and applied. More specifically, the paper describes the enhancement of the existing energy system model, Balmorel, with an investment module that handles endogenous investments in energy transformation technologies with emphasis on the linkage over time. Further, by permitting settings of the investment horizon (varying flexibly between myopic to full technology life-time) it allows the analysis of various actors' different requirements. This enhances and generalizes the present endogenous investments module, which is myopic in the sense that it handles years sequentially.

The investment considerations and logic is documented in the paper, and basic properties of the model are derived and described. Further, it is implemented in the Balmorel model, and development paths for the Nordic electricity and combined heat and power sector are investigated. The emphasis is on variations of assumptions with respect to fuel prices, environmental targets and the attitude of investing companies with respect to pay-back time.

Consequences of the various settings of handling of time linkage and investments horizons are presented and analyzed. The analysis topics include consequences for electricity prices, possibilities and costs of investment timings, and environmental aspects.

## 1 Introduction

The energy sector plays a key role in the environmental policies in the EU and elsewhere. It is expected that large structural changes of the energy sector will take place in the present century in relation to ambitious environmental goals. Due to the large time horizons of the investments to be undertaken the investigation of future – or more appropriately of possible futures- is essential. The changes are governed by a mixture of public planning (using various instruments such as taxes, support, regulation and others) and private decisions on investments and operation.

One way of properly analyzing the possible developments paths of the energy sector is to use energy system models. Many such models exist, here one such model, Balmorel, will be described, in particular in relation to its investment capabilities, including a new feature for providing a more dynamic perspective on investments.



## 2 Myopic Investments

### 2.1 The Balmorel model

Balmorel is a model for analysing the electricity and combined heat and power sectors in an international perspective. It is highly versatile and may be applied for long range planning as well as shorter time operational analysis. The model is developed in a model language GAMS, and the source code is readily available, thus providing complete documentation of the functionalities as well as the possibility for users to adapt the model to specific requirements.

The Balmorel model has been applied in projects in a number of countries around the world, and it has been used for analyses of, i.a., security of electricity supply, the role of flexible electricity demand, hydrogen technologies, wind power development, the role of natural gas, development of international electricity markets, market power, heat transmission and pricing, expansion of electricity transmission, international markets for green certificates and emission trading, electric vehicles in the energy system, environmental policy evaluation. See the description in Ravn et al. (2001) as well as other material available at [www.balmorel.com](http://www.balmorel.com).

In relation to the present investment focus the model may briefly be characterized as follows. The model has an integrated representation of electricity and combined heat and power (chp) in an international framework. The model spans a number of years, each year being sub-divided into time segments, e.g. 10 years each with 300 segments per year.

The investment decisions are made taking into account investment as well as operation costs. Essentially, investments are only made if the resulting prices provide a profit (or at least not a loss).

The basic version of the model is formulated as a linear programming model (versions permitting discrete size investment exist but are not discussed here). The objective function to be maximized is social welfare (sum of consumers' utility minus producers' costs). Taxes and similar may be taken into account. The optimization is constrained by technical and other conditions like physical properties of production and electricity transmission, equality of production and consumption, etc.

### 2.2 Investments in Balmorel

Specifically in relation to investments the following are the main features. Capacities (quantities in MW) of energy conversion technologies are specified exogenously for each geographical area and each year. New capacities may become available by endogenous investments in any year. Any invested MW in a year is available for production during the whole of that year, and will be available also the following years.

In the Balmorel model investments are traditionally made in what is called model (or approach) Balbase2. *Figure 1* illustrates the myopic investment perspective of Balbase12. In this example there are nine years within the horizon to be analyzed, however, they are not consecutive, such that for the first years every year is analyzed (2011, through 2014) while for the most future years only every fifth year is analyzed.

In Balbase2 the nine years within the horizon are investigated sequentially. Investment decisions are taken for each year individually, taking into account both investment and operation costs. The investment costs consist of the annual cost (payment) per MW for each type of technology. This cost is the annuity of the investment, specified by taking into account the invested amount of money, the assumed life time of the technology and the rate of interest. Additionally the operating costs (depending on the production levels) are taken into account.

A total of nine one-year Balbase2- models are solved, cf. *Figure 1*. After solving the model for one year the available existing technology capacity for the next model-year is

updated to consist of the original exogenously specified capacity plus accumulated investments up to immediately before the next model-year.

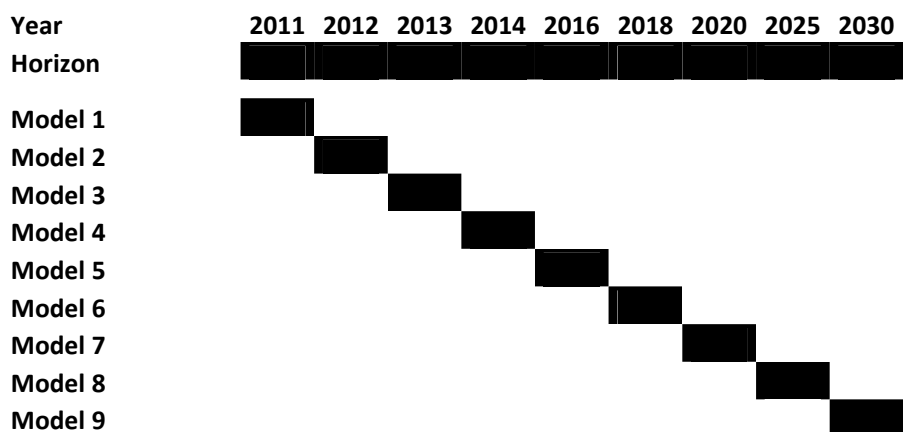

Figure 1: Approach Balbase2 will solve a model Balbase2 for the years in the full horizon (nine years) sequentially one year at a time, updating between solves.

An implicit assumption for justifying the approach of Balbase2 is that in future years the investments made this year will be justified. For instance if demand is increased and/or old technology capacity is removed every year, while all other input data are constant over years, then it seems plausible that more investments of the same kinds of technologies will be relevant next year. More rigorous consideration may be found in e.g. Leahy (1993).

Obviously such assumptions are not realistic in many cases, for example with respect to environmental regulations. A requirement that in a future year, e.g. 2020, the emission from the sector must be reduced by 20% may of course give higher priorities to investments in environmental friendly technologies before 2020 than without such requirement. This is the motivation for development of Balbase4, which will be described next.

### 3 Dynamic Investments in Balmorel

The immediate suggestion for improving the approach of Balbase2 is to make investments simultaneously for all years in one model. Thus, for the example of Figure 1 this has been illustrated in Figure 2, where now one model includes the full horizon of all nine model-years 2011 through 2030. This will permit inclusion of the necessary forward-looking mechanism that can properly provide a consideration of the appropriateness of giving e.g. higher priorities to investments in environmental friendly technologies earlier than 2020, cf. the example mentioned in the previous section.

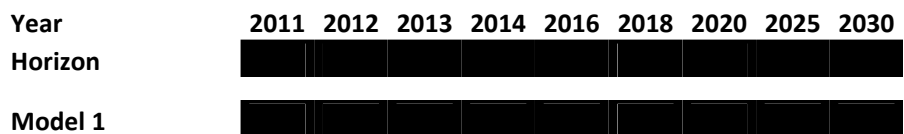
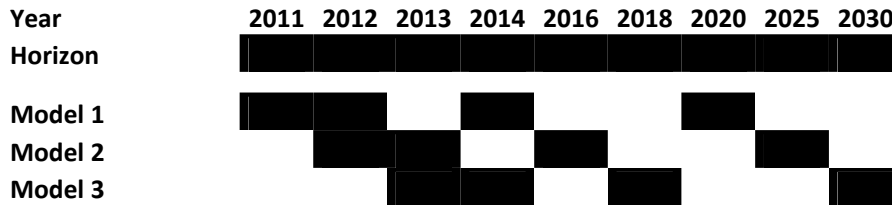

Figure 2: Approach Balbase4 may solve for the years in the full horizon (nine years) integrated in one Balbase4 model.

This is now made possible in the so called Balbase4 model to Balmorel. It is based on Felstedt and Pedersen (2005). That implementation has been adapted, improved and updated for the present version of Balmorel.

Moreover, this model is formulated more flexibly such that a sequence of less-than full horizon may be solved. This is illustrated in *Figure 3*, where each Balbase4 model consists of four years within the full horizon. The spacing between the years within a Balbase4 model is the same as in any other Balbase4 model, in the example two consecutive years (from years within the full horizon) are followed by a slip of one year and the a slip of two years. The number of years and the slips between the years are user defined. This way a quite flexible rolling horizon approach is available.



*Figure 3: Approach Balbase4 sequentially solves Balbase4 models, each consisting of a subset of all years in the full horizon, with updating between solves.*

Thus, in particular Balbase4 may reproduce the approach of Balbase2 which was illustrated in *Figure 1*.

The investment and operations costs are basically taken into account as in model Balbase2. The distinguishing feature is that costs for all the years within a model are included. Thus, for example for the second model in *Figure 3* (years 2012, 2013, 2016 and 2025) annual costs corresponding to that of model Balbase2 are included as follows depending on the year of investment in that model,

- 2012: four times the annual costs plus the four years' operation costs
- 2013: three times the annual costs plus the tree years' operation costs
- 2016: two times the annual costs plus the two years' operation costs
- 2025: one time the annual costs plus the year's operation costs

The other side of the coin is that investments made in year 2012 will have the income from four years of operations to balance the four years of annual costs, etc. for investments the other years. Overall, the objective function in the Balbase4 model is to maximize social welfare over the years included in the model.

### 4 Some observation on the two approaches

Here some general observations with respect to calculation time and prices will be reported.

#### 4.1 Calculation time

Usually model Balbase4 is larger than Balbase2, because it includes several years. On the other hand model Balbase4 may be solved less times. In most application, supposedly, if model Balbase4 includes X times larger than model Balbase2, then model Balbase2 will be solved approximately X times more often than model Balbase4.

A common experience from solution of LP (Linear Programming) models is that the solution time is approximately linear in the size of the problem. If this holds true also here, this would mean that total calculation time would be approximately the same for models Balbase2 and Balbase4. If a constant overhead per solve (model generation, communication between GAMS and solver, output handling) is appreciable, this may tend to favor model Balbase4 in relation to calculation time.

Only if the generated model is large compared to available computer memory and other resources approach Balbase2 (or a sequence of small Balbase4 models in a rolling horizon approach) therefore may be preferable to approach Balbase4 with respect to computation time.

## 4.2 Prices

For a data set that happens to give the same solution for Balbase2 and Balbase4 the objective value will be the same (in case of no discounting in Balbase4). This could imply that marginal costs (some of which are interpreted as electricity prices) would also be identical. However, the situation is more complex, because although all input data are identical, and all optimal (primal) values are identical this does not suffice to make all interpretations (including marginal costs or dual variables) identical. Suffice here to mention that the electricity and/or heat prices will often get higher in model Balbase4 than in model Balbase2 in the time segments that motivate investments, while average prices will often be at the same level.

## 5 Discussion and Conclusions

One would intuitively think that model Balbase4 (without rolling horizon) would be "better" model Balbase2. The reason is that Balbase4 includes all of model Balbase2 and then some more. The additional component is a better look-ahead mechanism for investment decisions.

The only look-ahead mechanism of Balbase2 is the annuity aspect related to investments. If the future is similar to the present, this will probably be a fair representation, but if the future is different (e.g. very different fuel prices or environmental requirements), then there may be Balbase2 investments now that will appear unfavorable in the light of later development. In this respect Balbase4 is "better", since it knows the future.

For these reasons Balbase4 would be preferred to Balbase2, except if the model is very large as commented above. For the Balbase4 model there seems to be no reason to apply a rolling horizon approach (again, except if the model is prohibitively large), since a rolling horizon can not be "better" than one full horizon Balbase4 model.

A main common characteristic for the Balbase2 and Balbase4 approaches is that they are using deterministic models, implying in particular that the future is known with certainty. This is obviously not the case in reality. Usually in such models this situation is handled by calculating solutions under various assumptions concerning the future (i.e., various scenarios). The advantage of such scenario approach is that interpretation of the results are fairly straight forward. – Alternatively a stochastic modeling approach may be taken. It should be noted, though, that it is not necessarily always possible or relevant (due to assumptions of existence of relevant data on probability distributions). When possible, such models provides on the positive side additional information, while on the negative side the interpretations of results are less easy, and the calculation burden is usually heavy.

In balance, the presented approach towards dynamic investment analysis seems attractive. The model has been coded for the Balmorel model, where it will become readily available.

## 6 References

H. Ravn et al., Balmorel: A Model for Analyses of the Electricity and CHP Markets, 2001, available at [www.balmorel.com](http://www.balmorel.com)

John V. Leahy, Investment in Competitive Equilibrium: The Optimality of Myopic Behaviour, *The Quarterly Journal of Economics* (1993) 108 (4): 1105-1133.

Jesper Felstedt and Morten Middelboe Pedersen, Modelling af Investeringer i Elsektoren, Master Thesis at IMM, Technical University of Denmark, 2005.

# Reducing Electricity Demand Peaks by Scheduling Home Appliances Usage

Ana Rosselló-Busquet, Georgios Kardaras, Villy Bæk Iversen José Soler, Lars Dittmann  
Networks Technology & Service Platforms group, Department of Photonics Engineering  
Technical University of Denmark, 2800 Kgs. Lyngby, Denmark  
{aros, geka, vbiv, joss, ladit}@fotonik.dtu.dk

## Abstract

Nowadays there is a tendency to consume electricity during the same period of the day leading to demand peaks. Regular energy consumption habits lead to demand peaks at specific temporal intervals, because users consume power at the same time. In order to avoid demand peaks, users' appliances should consume electricity in a more temporarily distributed way. A new methodology to schedule the usage of home appliances is proposed and analyzed in this paper. The main concept behind this approach is the aggregation of home appliances into priority classes and the definition of a maximum power consumption limit, which is not allowed to be exceeded during peak hours. The scenario simulated describes a modern household, where the electrical devices are classified in low and high priority groups. The high priority devices are always granted power in order to operate without temporal restrictions. On the contrary, the low priority devices have to pause their operation, when the algorithm dictates it, and resume it in the future. This can become beneficial for both energy companies and users. The electricity suppliers companies will be capable of regulating power generation during demand peaks periods. Moreover, users can be granted lower electricity bill rates for accepting delaying the operation of some of their appliances. In order to analyze this scenario, teletraffic engineering theory, which is used in evaluating the performance of telecommunication networks, is used. A reversible fair scheduling (RFS) algorithm, which was originally developed for telecommunication networks, is applied. The purpose is to analyze how a power consumption limit and priorities for home appliances will affect the demand peak and the users' everyday life. Verification of the effectiveness of the RFS algorithm is done by means of simulation and by using real data for power consumption and operation hours. The defined maximum power limit of 750 and 1000 Watt was not exceeded during peak demand hours. The trade-off was an average delay of 36,1 and 12,36 minutes, respectively, for the aggregated low priority class.

## 1 Introduction

It is undisputable that nowadays the number of electrical appliances in modern residences has significantly increased compared to the past. The need for immediate and simultaneous energy consumption has resulted in frequent demand peaks. The problem arising for utility companies is the fact that they are obliged to deploy expensive strategies to succeed generating enough energy to meet the demand. If the demand is not met, this could lead to major black-outs or denial of service. This paper investigates a method which can result in a more distributed consumption of energy over time, in each household. The concept is relatively simple and it is based on the idea of spreading electricity consumption over a finite period of time. The different appliances are scheduled correspondingly based on their priority type. The overall goal of this method is to guarantee that a defined electricity consumption limit will not be exceeded taking into account the specific needs of each household. This technique could result in a more distributed consumption which will lower the demand peaks. As the system presented will ease the task of forecasting consumption, a reduction of greenhouse gasses can be achieved.

## 2 Electricity Management System

The aim of the proposed system is to schedule the consumption of appliances in the users' residence so that the total consumption does not exceed a certain limit. By limiting the consumption of each user, electricity demand peaks could be reduced or even avoided. The purpose of the system is not to reduce the electricity consumption of the household but to spread the consumption over time and avoid having all the appliances turned on at the same time.

To evaluate the system, a household with a television set, a computer, a washing machine, a dryer and a dishwasher is analyzed. In the rest of this paper, these devices will be referred to as household appliances or appliances. Furthermore, these appliances have been divided into two sets: high priority appliances (television set, computer) and low priority appliances (washing machine, dryer and dishwasher). The set of high priority appliances are the household appliances that consume electricity as soon as they are turned on, they cannot be denied electricity and cannot be paused or delayed in any way. On the other hand, for the set of low priority appliances, it is not necessary to provide electricity immediately; it is possible that these appliances wait before being turned on (delayed) and also paused. Therefore their task duration could be prolonged.

### 2.1 System architecture

The system considered in this paper is illustrated in Fig. 1 and consists of the household appliances and a Control System (CS).

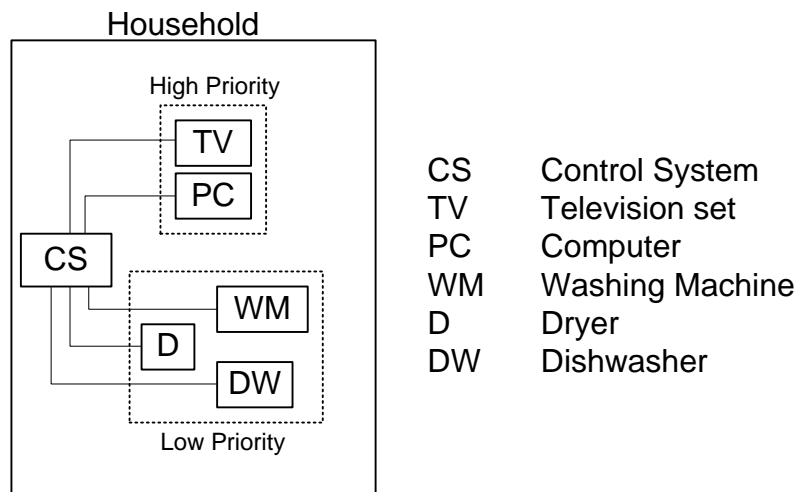

Figure 1: System Architecture

The CS is capable of communicating with the household appliances and monitoring the consumption of each appliance. The main function of the CS is to keep the total electricity consumption under the defined consumption limit. In order to achieve this, the CS is capable of sending basic commands to the household appliances such as *on*, *off*, *pause* and *resume*. The *on* and *off* commands are used to turn on and off the household appliances respectively. The *pause* command is used to force the appliance into stand-by mode, where its consumption is negligible compared to its consumption when it is turned on. On the other hand, the *resume* command is used to turn on the appliance, when it is in stand-by mode. As a result the appliance will then continue its task. For instance, assume that the washing machine has received the *pause* command after the clothes are rinsed and is in stand-by mode. Once it receives the *resume* command, it will continue the washing program from that point by making the drum rotate, instead of starting the washing program from the beginning. The CS will decide which appliances can be paused and when they should continue their task by following the event driven scheduling algorithm illustrated in Fig. 2. This is explained in detail in the next section.

### 3 Event Driven Scheduling Algorithm

In order to keep the total consumption of the household under the determined limit, an event driven scheduling algorithm is used. The flow of the algorithm is determined by two events. Arrival event occurs when an appliance is switched on and requests to use electricity. Departure event occurs when an appliance has finished its task and stops consuming electricity. The algorithm the CS uses is shown in Fig. 2.

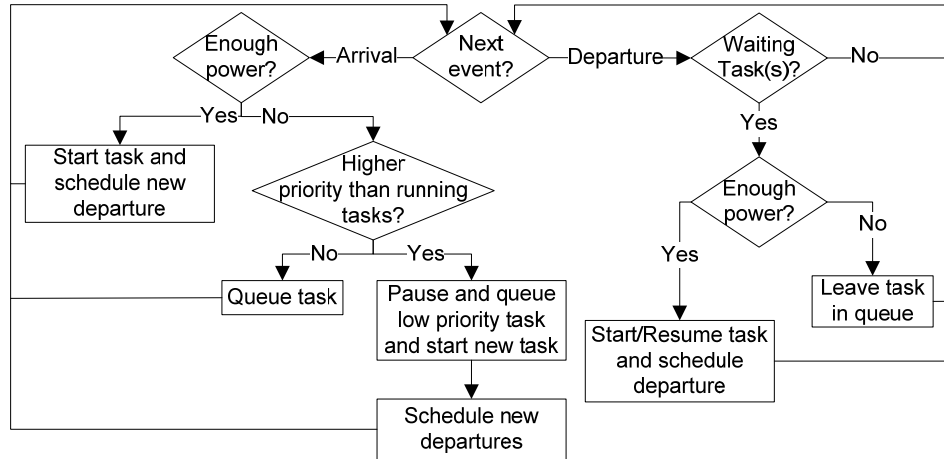

Figure 2: Event Driven Scheduling Algorithm

In order for the appliance to be able to send the request message to the CS, the appliance needs to consume some power. However, this consumption is not considered in this paper as a simplified model is used. In the same way, when an appliance is paused it has to be able to listen for the *resume* message from the CS. This consumption is also not taken into consideration in this simplified model.

When the user turns on an appliance, the CS will receive a request from that appliance to consume power. The CS will then calculate if there is enough power to turn on that appliance without exceeding the maximum consumption:

$$\max\_consumption \leq \sum_{i=1}^{N_1} x_i + x_{new} \quad (1)$$

where  $\max\_consumption$  is the defined maximum electricity consumption,  $N_1$  is the number of appliances turned on,  $x_i$  is the consumption of the appliance  $i$  and  $x_{new}$  is the consumption of the appliance the user just switched on. If equation (1) stands then the appliance requesting to consume electricity is turned on as the total consumption does not exceed the limit. On the other hand, if equation (1) does not stand, the CS proceeds to examine the priorities of the appliances. The CS will try to find a set of  $N_2$  appliances, which are already turned on ( $N_2 \subset N_1$ ), and which have lower priority than the appliance requesting to consume. So the following equation is fulfilled:

$$x_{new} \leq \sum_{j=1}^{N_2} x_j + (\max\_consumption - \sum_{i=1}^{N_1} x_i) \quad (2)$$

where  $x_j$  is the consumption of the appliance  $j$  and the term in between brackets is the available consumption before the limit consumption is reached. If the CS can find a set  $N_2$  that verifies equation (2), these appliances will be paused and added to the *paused appliances list*. The CS will send the command *pause* to the  $N_2$  appliances and it will grant access to the new appliance, as the maximum consumption is not exceeded. On the contrary if the CS cannot find a set of  $N_2$  appliances that fulfill equation (2), the appliances requesting power will be added to the *paused appliances list*.

When an appliance is turned off or it has finished its task, the CS will detect this as a departure event. If the *paused appliances list* is not empty, the CS will evaluate the following equation:

$$\max\_consumption \leq \sum_{i=1}^{N_1} x_i + x_{\text{paused}} \quad (3)$$

where  $x_{\text{paused}}$  is the power consumption of the paused appliance found in the *paused appliances list*. If equation (3) stands, this paused appliance will receive a *resume* command from the CS and will be removed from the *paused appliances list*. Furthermore, if the *paused appliances list* still contains paused appliances, the CS will evaluate equation (3) again until there are no more appliances left in the *paused appliances list* or the maximum consumption is reached. The CS evaluates the appliances in the paused appliances list in input order, FIFO (first-in-first-out), as they will all have the same priority, low priority.

## 4 Teletraffic Theory Revised

Teletraffic engineering is the application of probability theory and stochastic mathematical modeling for solving problems concerning network planning, evaluating network performance and deriving the relationship between grade-of-service and system capacity [1]. The aim is to dimension the network accordingly and establish the appropriate traffic controls. In case of different services, traffic classes are used to aggregate the services according to their grade-of-service requirements. The user flows, or the data to be transmitted by the users, are divided in classes. This division is used as the basis for differentiated processing and service.

The Reversible Fair Scheduling (RFS) algorithm presented and used in this paper has its origin in teletraffic engineering. It is a bandwidth allocation scheduling algorithm and its aim is to allocate resources dynamically to networks supporting multiple services. The resources are allocated depending on the type of user request.

Therefore, the service requiring the highest amount of resources will be served, as long as, the total capacity or defined limit of the system is not exceeded. As shown in Figure 3, a communication link consists of  $n$  channels and  $k$  buffers. The total number of supported services classes is  $N$ , which occupy the resources of the communication link. The system will receive requests from these  $N$  classes to use some of the  $n$  channels in communication link. When a request is received for one of the classes that requires less channels than the available number in the link, it can be served immediately [1, 2].

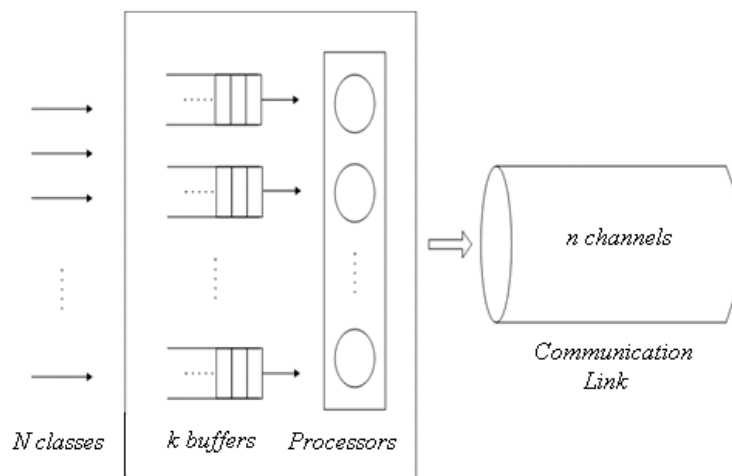

Fig. 1: Resource allocation in a network communication link [3].



## 5 Mapping Teletraffic Theory to Energy Efficient Homes

In this section, the RFS algorithm parameters are mapped to the users' appliances consumption and to the users' consumption habits.

It is assumed that appliances request arrive independently at random times and inter-arrival times of flows are exponentially distributed which results in a Poisson arrival process with specific arrival intensity. The RFS model is insensitive to the distribution of the service time and depends only on the corresponding mean values [2].

### 5.1 Aggregated Classes

As presented in section 2.1, only some appliances have been taken into consideration: television set, computer, washing machine, dryer and dishwasher. For simplicity reasons, the appliances have been aggregated into two traffic classes. Class 1 encloses the high priority appliances: television set and computer, whereas Class 2 encloses the low priority appliances: washing machine, dryer and dishwasher.

### 5.2 RFS Algorithm Parameters

In order to run the RFS algorithm, details about the consumption of appliances and usage are needed. Table I summarizes consumption of each appliance and average usage. This data attempts to model the appliances usage of a typical day of a family (4-6 persons) between 17:00-00:00, when most of electrical consumption takes place.

<i>Appliances</i>	<i>Model</i>	<i>Power Consumption</i>	<i>Average Usage [4]</i>	<i>Usage Duration</i>
<i>Television Set</i>	Television: 42LE4900 LG [5] DVD player: DVX550 LG [6] Home theater: S-HS111US Pioneer [7]	239 Watt	4,3 hours/day	120 min
<i>Computer</i>	PC: HP Pavilion Slimline s5670t series[8] Monitor: BX2340 Samsung [9]	242 Watt	3,5 hours/day	100 min
<i>Washing machine</i>	WM12S32XEE Siemens[10]	733 Watt	3,1 times/week	131 min
<i>Dryer machine</i>	WTW8658XEE Bosch[11]	609 Watt	4,4 times/week	134 min
<i>Dish washer</i>	SMS69T25EU Bosch [12]	720 Watt	4,1 times/week	100 min

*Table I: Home Appliances Characteristics*

As explained in the previous subsection, the different appliances are grouped into two traffic classes. For each class, the arrival rate, the mean service time, the service rate and the channels needed have been calculated, by using the data given in Table I. The arrival rate is defined as the average rate of incoming requests. Those are the parameters needed as input for the RFS algorithm. The RFS algorithm parameters are summarized in Table II. The arrival rate of class 2 has been calculated by adding the average usage for the low priority appliances. On the other hand, to calculate the arrival rate of class 1, the average usage and the duration of the usage of high priority appliances have been used. The mean service time is the approximated average duration of usage of the high priority appliances for class 1, and of the low priority appliances, for class 2. Each of the  $n$  channels has a capacity of 250 watts. Considering the power consumption of the appliances in Table I, it has been assumed that class 1 uses 1 channel (250 watts) and class 2 uses 3 channels (750 watts). The consumption of the appliances used to evaluate the system are higher than the actual values. For this reason, the results obtained in the simulation will be higher than what expected if accurate values were used. This is due to granularity precision within the teletraffic simulator software used.

<i>Classes</i>	<i>Arrival Rate (requests/day)</i>	<i>Mean Service Time</i>	<i>Service Rate</i>	<i>Occupied Channels (channels/request)</i>
<i>Class 1</i>				
<i>High Priority</i>	2,2	1,8 hour	0,5556	1
<i>Class 2</i>				
<i>Low Priority</i>	1,7	2 hour	0,1667	3

*Table II: RFS Algorithm Parameters*

Furthermore, we assume that the resulting blocking probability, after running the RFS algorithm with the above parameters, has to be negligible. The blocking probability refers to the probability that a request is rejected and it is not granted power neither put in queue. This is due to the fact that if the user turns on an appliance, the appliance should eventually proceed with its task, even though the task is delayed or prolonged. In the system described, the request comes from an appliance which expects to consume power. If the request comes from a high priority appliance, the scheduling algorithm will pause the necessary low priority appliances so that the high priority appliance can consume power, without exceeding the maximum consumption. On the other hand, if the request comes from a low priority appliance the request will be granted power if there is enough available power. If there is no available power, the appliance will be put in queue. It is assumed that this queue is long enough so that the blocking probability is negligible. The length of the queue in the RFS algorithm is represented by the number of buffers which has been chosen to be 50.

### 5.3 Device and Users' Assumptions

In order for the system described in this paper to work, it is assumed that home appliances such as washing machine, dryers and dish washers can be paused at any moment and resume after some time. On the other hand, high priority appliances are never paused and power is always granted to them by pausing low priority appliances if necessary.

As mentioned before, when an appliance sends a request message it needs to consume power to make this communication possible. However, this consumption is not considered in this paper as a simplified model is used. In the same way, when an appliance is paused it has to be able to listen for the *resume* message from the CS. This consumption is also not taken into consideration in this simplified model.

Furthermore, it is also assumed that users will accept their low priority appliances to be paused and therefore it will take longer for them to finish their task. In order to get users to accept those terms, utilities could offer the users using this type of system a reduction in their electricity bill. This can be used as a commercial strategy by utilities to face a more homogeneous consumption by using attractive pricing schemes. It has to be taken into consideration that electricity bills are increasing along with the number of electrical appliances and users are interested in reducing their electricity bill. In particular, during the winter of 2007/08, 20% of Americans could not pay on time their electricity bill and 8.7 million American consumers were disconnected from their electricity utility services [13].

## 6 Numerical Analysis

### 6.1 Methodology

Two different scenarios are simulated both using the parameters presented in section 5.2. In the first scenario, the maximum power consumption is set to 750 watts. Considering that each channel is 250 watts the total number of channels is 3. Low priority appliances need therefore 3 channels and high priority appliances need 1 channel. In the second scenario, the maximum power consumption is set to 1000 watts or 4 channels.

## 6.2 Results and Performance Metrics

The scenarios described in the previous subsection are simulated to obtain the mean waiting time for each service class. This is presented in Table III and IV.

The mean waiting time is the time the appliance has to wait before it is granted power. In the system described, high priority appliances are always granted power so their mean waiting time should be zero. However, due to the fact that the RFS algorithm does not pause class 2 appliances when a class 1 appliances request is received the mean waiting time for class 1 is not zero. The CS is responsible for discriminating the classes in priorities, as described in section 3. Nevertheless, after measuring the mean waiting time for each service class, it can be calculated how much time the low priority classes will be delayed. This is the sum of the mean waiting time of class 1 and class 2.

Table III and Table IV present the simulation results for 750 watts maximum consumption and 1000 watts maximum consumption, respectively.

<i>Classes</i>	<i>Mean Waiting Time RFS algorithm</i>	<i>Mean Waiting Time Scheduling algorithm</i>
<i>Class 1 High Priority</i>	6,74 min	0 min
<i>Class 2 Low Priority</i>	29,36 min	36,1 min

Table III: RFS Algorithm Results for 750 watts maximum consumption

<i>Classes</i>	<i>Mean Waiting Time RFS algorithm</i>	<i>Mean Waiting Time Scheduling algorithm</i>
<i>Class 1 High Priority</i>	1,08 min	0 min
<i>Class 2 Low Priority</i>	11,28 min	12,36 min

Table IV: RFS Algorithm Results for 1000 watts maximum consumption

By setting the maximum consumption to 750 watts the low priority appliances will in average take 36,1 minutes longer to finish their tasks than if there was no maximum consumption limit. On the other hand, if the maximum consumption is set to 1000 watts the delay of low priority appliances is only of 12,36 minutes. As stated before, high priority appliances will not be affected by setting a consumption limit and will never have to wait for consuming electricity. Considering that low priority appliances tasks take around 120 minutes to finish, setting a consumption limit to 750 watts will increment their task time a 30,1% and 10,3% when the consumption limit is set to 1000 watts.

## 7 Conclusion

In this paper, an event driven scheduling algorithm for regulating electricity demand peak for home appliances is presented. The objective of the system is to provide a tool for scheduling the operation of daily use home devices, guaranteeing that a maximum limit of power consumption is never exceeded during peak demand hours. The latter can be beneficial for both users and energy companies, as explained throughout this paper. To analyze the proposed event scheduling algorithm, Reversible Fair Scheduling (RFS) is used. RFS is a bandwidth allocation algorithm and originates from teletraffic theory. The parameters of RFS algorithm have been adjusted to the home appliances characteristics and users' appliance usage.

The scenario presented in this paper considers some of the appliances found in a modern household, where the electrical devices are classified in low and high priority groups.

The high priority appliances are always granted power and are never paused. On the contrary, the low priority appliances have to pause their operation, when the scheduling algorithm dictates it, and resume later on. The effectiveness is verified by the RFS algorithm with data obtained from real appliances and studies about users' appliances usage. Two scenarios with different maximum power limits have been simulated, 750 watts and 1000 watt. For a consumption limit of 750 watts, the low priority appliances will have a delay of approximately 36 minutes, which supposes a 30% increment in their task time. However, if the consumption limit is 1000 watts the delay is reduced to approximately 12 minutes, which supposes only an increment of a 10% in their task time.

## 8 References

- [1] Iversen, V.B., "Teletraffic Theory and Network Planning", Technical University of Denmark, 2010 Textbook. Available: <http://oldwww.com.dtu.dk/teletraffic/handbook/telenook.pdf>
- [2] Iversen, V.B., "Reversible Fair Scheduling: the teletraffic revisited", 20th International Teletraffic Congress, Ottawa, Canada 2007.
- [not used] M. Chanbari, C.J. Hughes, M.C. Sinclair, J. P. Eade, "Principles of Performance Engineering for telecommunication and information systems" (IEEE telecommunications Series) 1997.
- [3] Evangelos Iliakis, Georgios Kardaras, "Resource Allocation in Next Generation Internet: Provisioning QoS for Future Networks based on Teletraffic Theory", 2010.
- [4] "*The Smart Grid: An Introduction*", sponsored by DOE's Office of Electricity Delivery and Energy Reliability, U.S Department of Energy, 2008.
- [5] LG 32LE4900, Specifications, ECO, accessed 10 March 2011, <http://www.lg.com/uk/tv-audio-video/televisions/LG-led-tv-42LE4900.jsp>
- [6] LG DVX550, Specifications, POWER, accessed 10 March 2011, <http://www.lg.com/uk/tv-audio-video/video/LG-dvd-player-DVX550.jsp>
- [7] Pioneer S-HS111US, Specifications, accessed 10 March 2011, <http://www.pioneerelectronics.com/PUSA/Home/Home-Theater-Systems/S-HS111US>
- [8] HP Pavilion Slimline s5670t series, Specs, accessed 10 March 2011, [http://www.shopping.hp.com/webapp/shopping/store\\_access.do?template\\_type=series\\_detail&category=desktops&series\\_name=s5670t\\_series&jumpid=in\\_R329\\_prodexp/hhost/p/psg/desktops/promo\\_tile/3/dt\\_promo\\_tile3\\_s5670t\\_113](http://www.shopping.hp.com/webapp/shopping/store_access.do?template_type=series_detail&category=desktops&series_name=s5670t_series&jumpid=in_R329_prodexp/hhost/p/psg/desktops/promo_tile/3/dt_promo_tile3_s5670t_113)
- [9] Samsung BX2340, accessed 10 March 2011, [http://www.samsung.com/uk/consumer/pc-peripherals/monitors/professional/LS23CBUMBV/EN/index.idx?pagetype=prd\\_detail&tab=specification](http://www.samsung.com/uk/consumer/pc-peripherals/monitors/professional/LS23CBUMBV/EN/index.idx?pagetype=prd_detail&tab=specification)
- [10] Siemens WM12S32XEE, Ficha tecnica, accessed 10 March 2011, <http://www.siemens-home.es/WM12S32XEE.html>
- [11] Bosch WTW8658XEE, Ficha tecnica, accessed 10 March 2011, <http://www.bosch-home.es/WTW8658XEE.html>
- [12] Bosch SMS69T25EU, Ficha tecnica, accessed 10 March 2011, <http://www.bosch-home.es/SMS69T25EU.html>
- [13] U.S. Energy Information Administration, Independent Statistics and Analysis. Available: <http://www.eia.doe.gov>

# Energy Efficient Refrigeration and Flexible Power Consumption in a Smart Grid

Tobias Gybel Hovgaard, Rasmus Halvgaard, Lars F. S. Larsen and John Bagterp Jørgensen

## Abstract

Refrigeration and heating systems consume substantial amounts of energy worldwide. However, due to the thermal capacity there is a potential for storing “coldness” or heat in the system. This feature allows for implementation of different load shifting and shedding strategies in order to optimize the operation energywise, but without compromising the original cooling and indoor climate quality. In this work we investigate the potential of such a strategy and its ability to significantly lower the cost related to operating systems such as supermarket refrigeration and heat pumps for residential houses. With modern Economic Model Predictive Control (MPC) methods we make use of weather forecasts and predictions of varying electricity prices to apply more load to the system when the thermodynamic cycle is most efficient, and to consume larger shares of the electricity when the demand and thereby the prices are low. The ability to adjust power consumption according to the demands on the power grid is a highly wanted feature in a future Smart Grid. Efficient utilization of greater amounts of renewable energy calls for solutions to control the power consumption such that it increases when an energy surplus is available and decreases when there is a shortage. This should happen almost instantly to accommodate intermittent energy sources as e.g. wind turbines. We expect our power management solution to render systems with thermal storage capabilities suitable for flexible power consumption. The aggregation of several units will contribute significantly to the shedding of total electricity demand. Using small case studies we demonstrate the potential for utilizing daily variations to deliver a power efficient cooling or heating and for the implementation of Virtual Power Plants in Smart Grid scenarios.

## 1 Introduction

The energy policies in the Nordic countries stipulate that 50% of the energy consumed by 2025 should come from renewable and CO<sub>2</sub>-free energy sources. By 2050 the Nordic countries should be independent of fossil fuels. This transformation of the energy system is needed to reduce CO<sub>2</sub> emissions and global warming as well as to protect the Nordic economies from the consequences of sharply rising prices of fossil fuels due to an increasing world population and depletion of fossil fuel resources [1]. To obtain an increasing amount of electricity from intermittent energy sources such as solar and wind, we must not only control the production of electricity but also the consumption of electricity in an efficient, agile and proactive manner. In contrast to the current rather centralized power generation system, the future electricity grid is going to be a network of a very large number of independent power generators. The Smart Grid is the future intelligent electricity grid and is intended to be the smart electrical infrastructure required to increase the amount of green energy significantly. The Danish transmission system operator (TSO) has the following definition of Smart Grids which we adopt in this work: “Intelligent electrical systems that can integrate the behavior and actions of all connected users - those who produce, those who consume and those who do both - in order to provide a sustainable, economical and reliable electricity supply efficiently” [2]. In this paper we utilize the flexibility of the refrigeration system to offer ancillary demand response to the power grid as regulating power. Different means of utilizing demand response have been investigated in an increasing number of publications e.g. [3]–[6] for plug-in electrical vehicles and heat pumps and in general concerning price elasticity in [7].

In this paper we consider two utilizations of a vapor compression cycle. One for supermarket refrigeration and one for heating residential buildings using heat pumps. Buildings account for approximately 40% of the total energy use in the Nordic countries and in Denmark around 4500 supermarkets consume more than 550 GWh annually. As heat pumps are

T. G. Hovgaard and L. F. S. Larsen are with Danfoss Refrigeration and A/C Controls, DK-6430 Nordborg, Denmark. {tgh, lars.larsen}@danfoss.com

R. Halvgaard and J. B. Jørgensen are with DTU Informatics, Technical University of Denmark, DK-2800 Lyngby, Denmark. {rhal, jbj}@imm.dtu.dk

driven by electricity and connected to house floors with large thermal capacities, they have a large potential to shift the electricity consumption and adapt to the stochastic electricity production from wind turbines. The same holds for refrigeration systems where the thermal capacity in the refrigerated goods can be used to store "coldness" and thereby shift the load in time while keeping the temperatures within certain bounds. These bounds are chosen such that they have no impact on food quality and indoor comfort. We exploit that the dynamics of the temperature in the cold room and residential buildings are rather slow while the power consumption can be changed rapidly.

Simple weather conditions such as outdoor temperature and solar radiation are included in our simulation models. By including forecasts of prices and weather conditions energy consumption is made flexible. It is thus possible to predict where to place the energy consumption and minimize the electricity cost of operating the systems without violating the constraints such as indoor temperature comfort intervals and food storage conditions. The thermal capacities determine how much of the electricity consumption that can be shifted to times with cheap electricity. We investigate different scenarios spanning from a case study with total collaboration between producers and consumers to decoupling through price signals from the NordPool electricity spot market. Utilizing load shifting capabilities to reduce total energy consumption has also been described in e.g. [8], [9].

Our proposed control strategy is an economic optimizing model predictive controller, Economic MPC. Predictive control for constrained systems has emerged during the last 30 years as one of the most successful methodologies for control of industrial processes [10] and is increasingly being considered for both refrigeration and power systems control [11], [12]. MPC based on optimizing economic objectives has only recently emerged as a general methodology with efficient numerical implementations and provable stability properties [13].

This paper is organized as follows. In section 2 we discuss different control architectures for enabling flexible consumption from many distributed units in a Smart Grid. Section 3 describes the models used in our case studies as well as the formulation of our Economic MPC strategy. In section 4 the simulations and results for three cases are illustrated. The first two cases demonstrate direct control and price signal based control with rather simple models while the third case uses more advanced nonlinear models verified with data from real supermarkets and a combination of price and frequency based control. In section 5 means for handling uncertainties in the framework of our proposed strategy are presented. We give conclusions in 6.

## 2 Control Architectures for Virtual Power Plants

A way of creating flexibility in the power grid is Virtual Power Plants (VPP). The concept pools several, otherwise too small, production and consumption units, such as multiple smaller power plants, wind turbines and heat pumps, and make them behave as one unit. The VPP concept enables a huge amount of possibilities for load balancing since it allows active control of the consumer [14].

In this paper we consider individual thermal storage units such as refrigeration systems and houses with heat pumps that are to be aggregated in the VPP framework (see Fig. 1). The control within the aggregated units can rely on different strategies. The following control strategies have been suggested for load balancing and load shifting in electrical grids [15].

- 1) **Direct control.** In this case producers and consumers are assumed to collaborate on a common goal of minimizing the total cost of operation. Given that the communication infrastructure required for sending control signals to the consumers to raise or reduce the demand is established, the producers are allowed a more direct control of the demand. Furthermore, it allows the controller in the consumer to be quite simple as it only sends information and receives commands from the VPP. The drawback of course is that the VPP must solve large-scale optimization problems to coordinate a large number of units. The result might not be optimal for the consumer alone and the VPP decides the consumption schedule entirely.

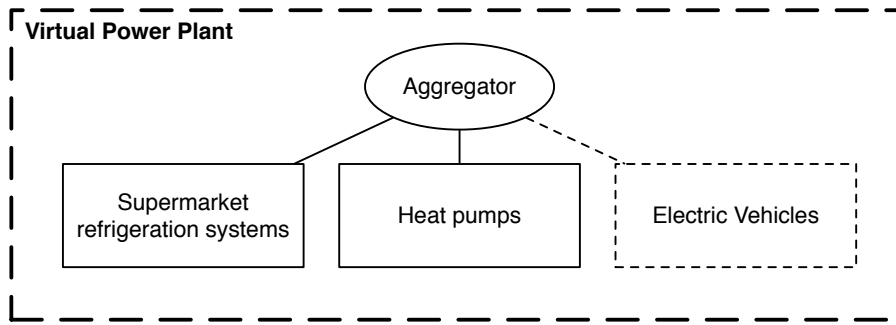

Fig. 1. Sketch illustrating a Virtual Power Plant (VPP).

- 2) **Price based control.** The individual units compute a schedule for the consumption based on dynamic price information given by the VPP. This enables the consumer to shift its load to times with low electricity price. It requires a communication infrastructure between VPP and heat pump/supermarket systems. The drawback of this control strategy is that it is relatively complex and that the VPP does not have any control of the actual load response but merely sends out a guideline in the form of price signals. How to calculate optimal price signals is still an open research issue. In this paper we use the electricity spot price to illustrate such a signal.
- 3) **Frequency based control.** The consumer measures the grid frequency, which in Europe has the nominal value of 50 Hz. When demand exceeds supply, the frequency falls. When supply exceeds demand, the frequency increases. One way of using frequency activation to change demand is demonstrated for residential fridges in [16]. The advantage of this type of control is the low price of the controller, because no communication is necessary. However the consumer does not have any economical incentives to do this unless the enabling of flexible consumption can make the fridge less expensive to buy. Another possibility of frequency activation is to sign a contract where each player participates with a power amount (MW) specified on an hourly basis. The consumer is paid for being at the disposal of the grid (DKK/MW) regardless of the actual activation. Activation is automatic and linearly frequency dependent in the range 50 Hz  $\pm$  200 mHz.

The authors have previously demonstrated some of these strategies in suitable scenarios [17]–[19]. Results and comparisons are provided in this paper.

Note that the two consumers studied in this paper both act as thermal storage to the VPP and the consumed electric energy can not be retrieved as electric energy again. It can only be consumed at the right times. On the contrary electric vehicles are in reality electric batteries able to store electricity when connected to the grid and can thus be used as both a consumer and a producer to the grid.

## 3 Models and Economic MPC formulation

### 3.1 Supermarket Refrigeration Systems

The supermarket refrigeration systems we consider utilize a vapor compression cycle where a refrigerant is circulated in a closed loop consisting of a compressor, an expansion valve and two heat exchangers, an evaporator in the cold storage room and a condenser/gas cooler located in the surroundings. When the refrigerant evaporates it absorbs heat from the cold reservoir which is rejected to the hot reservoir. The setup is sketched in Fig. 2 with one cold storage room and one frost room connected to the system. Usually several cold storage rooms, e.g. display cases, are connected to a common compressor rack and condensing unit.

The dynamics in the cold room can be described by the simple energy balance:

$$mc_p \frac{dT_{cr}}{dt} = \dot{Q}_{load} - \dot{Q}_e \quad , \text{ with: } \begin{cases} \dot{Q}_{load} = (UA)_{amb-cr} \cdot (T_{amb} - T_{cr}) \\ \dot{Q}_e = (UA)_{cr-e} \cdot (T_{cr} - T_e) \end{cases} \quad (1)$$

where  $UA$  is the heat transfer coefficient and  $m$  and  $c_p$  are the mass and the specific heat capacity of the refrigerated goods, respectively.  $T_{amb}$  is the temperature of the ambient air



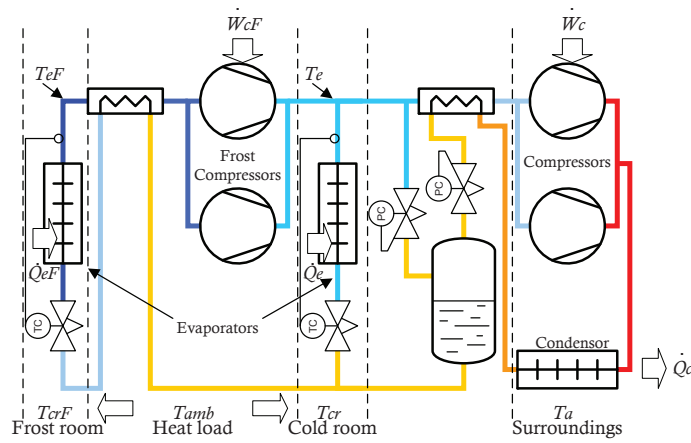

Fig. 2. Schematic layout of basic refrigeration system.

which puts the heat load on the refrigeration system. The states and control variables of the system are limited by the following constraints:

$$T_{cr,min} \leq T_{cr} \leq T_{cr,max} \quad (2a)$$

$$0 \leq T_{cr} - T_e \leq \infty \quad (2b)$$

$$0 \leq \dot{Q}_e \leq (UA)_{cr-e,max} \cdot (T_{cr} - T_e) \quad (2c)$$

The work done by the compressor dominates the power consumption in the system and can be expressed by the mass flow of refrigerant ( $m_{ref}$ ) and the change in energy content of the refrigerant. Energy content is described by enthalpy of the refrigerant at the inlet and at the outlet of the compressor ( $h_{ic}$  and  $h_{oc}$  respectively). Hereby the expression in Eq. (3) is given.

$$\dot{W}_c = \frac{m_{ref} \cdot (h_{oc}(T_e, P_c) - h_{ic}(T_e))}{\eta_{is}(P_c/P_e)} \quad (3)$$

where the enthalpies depend on the evaporation temperature and the condensing pressure as stated. The mass flow can be determined as the ratio between cooling capacity and change of enthalpy over the evaporator:

$$m_{ref} = \frac{\dot{Q}_e}{h_{oe}(T_e) - h_{ie}(P_c)} \quad (4)$$

All the enthalpies given here as functions of ( $T_e$ ,  $P_c$ ) or both are non-linear refrigerant dependent functions which can be calculated e.g. by the software package "RefEqns" [20].

For the studies in section 4.1 we have assumed that the work done in the compressor is directly proportional with the delivered cooling capacity while we in section 4.3 use the real non-linear description of  $\dot{W}_c$  described in [21] where polynomials are fitted for the enthalpy differences. For the latter we have furthermore collected data from several supermarkets in real operation in Denmark. From these data typical parameters such as time constants, heat loads, temperature ranges and capacities in both individual display cases and for the overall system have been estimated. The running compressor capacity have been monitored and from the data sheets the relation to energy consumption has been found.

### 3.2 Building with Heat Pump

#### Heat dynamics of a building

In this section, we develop a model of the heat dynamics of a house floor heating system connected to a geothermal heat pump. The system is illustrated in Fig. 3. The model is based on the energy balances for the air in the room, the floor and the water in the floor heating pipes and condenser water tank. The house is considered to be one big room with the following simplifying assumptions: 1) One uniform air temperature, 2) no ventilation, 3) no influence from humidity of the air, 4) no influence from the heat released from people in the room, 5) no influence from wind. In our model two heat accumulating media are included



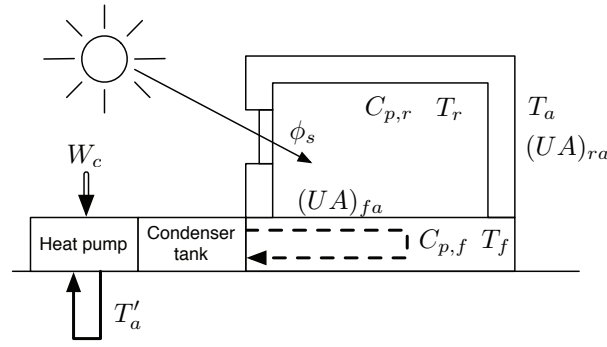

Fig. 3. House and heat pump floor heating system and its thermal properties. The dashed line represents the floor heating pipes that has heat conductivity  $(UA)_{wf}$  and contains water with heat capacity  $C_{p,w}$ .

with heat capacities  $C_{p,r}$  and  $C_{p,f}$ , to capture the short-term and long-term variations of the room air and floor heat dynamics [22]. The resulting energy balances are

$$C_{p,r}\dot{T}_r = Q_{fr} - Q_{ra} + (1-p)\phi_s \quad (5)$$

$$C_{p,f}\dot{T}_f = Q_{wf} - Q_{fr} + p\phi_s \quad (6)$$

The disturbances influencing the room air and floor temperature,  $T_r$  and  $T_f$ , are the ambient temperature,  $T_a$ , and the solar radiation,  $\phi_s$ , through a window with fraction  $p$  of the incident radiation on the floor. The energy balance for the water circulating in the floor heating pipes can be stated as

$$C_{p,w}\dot{T}_w = Q_c - Q_{wf} \quad (7)$$

in which  $Q_c$  is the heat transferred to the water from the condenser in the heat pump.  $Q_{wf}$  is the heat transferred from the water to the floor. The conductive heat transfer rates are

$$Q_{ra} = (UA)_{ra}(T_r - T_a), \quad Q_{fr} = (UA)_{fr}(T_f - T_r), \quad Q_{wf} = (UA)_{wf}(T_w - T_f) \quad (8)$$

$Q_{ra}$  is the heat transferred from the air in the room to the surroundings,  $Q_{fr}$  is the heat transferred from the floor to the air in the room, and  $Q_{wf}$  is the heat transferred from the water in the floor heating pipes to the floor. The term  $U \cdot A$  is a product of the heat conductivity and the surface area of the layer between two heat exchanging media. Its reciprocal value  $R = 1/(UA)$  is often used since it can be interpreted as a resistance against heat flow.

### Heat Pump

A heat pump is a device that transfers heat from a low temperature zone to a higher temperature zone using mechanical work. Heat pumps normally draw heat from the air or from the ground and uses a vapor compression refrigeration cycle. This cycle is also used in the supermarket refrigeration system studied in section 3.1. In order to take advantage of the heat produced in the cycle instead of the cooling, the condenser and evaporator functions are switched such that the condenser is inside the house. As the heat pump dynamics is much faster than the thermodynamics of the building, we can assume a static model for the heat pump. The amount of heat transferred from the condenser to the water,  $Q_{cw}$ , is related to the work of the compressor,  $W_c$ , using the coefficient of performance

$$Q_{cw} = \eta W_c \quad (9)$$

The coefficient of performance  $\eta$  for heat pumps varies with type, outdoor ground temperature, and the condenser temperature. As these two temperatures are approximately constant, we can assume that the coefficient of performance is also constant.

### 3.3 Economic Optimizing MPC

Our systems are influenced by a number of disturbances that can be predicted to some degree of certainty over a time horizon into the future. These must to be handled by the controller that also has to obey certain constraints for the systems while minimizing the cost of operation. Thus, we find it reasonable to aim at formulating our controller as an economic

optimizing MPC problem. Whereas the cost function in MPC traditionally penalizes a deviation from a set-point our proposed economic MPC directly reflects the actual costs of operating the plant. This formulation is tractable for refrigeration and heating systems where we are interested in keeping the outputs (temperatures) within certain ranges while minimizing the cost of doing so.

The models described in the previous sections are converted to their discrete-time state space formulations using zero-order-hold sampling of the input signals

$$x_{k+1} = Ax_k + Bu_k + Ed_k \quad (10a)$$

$$y_k = Cx_k + Du_k + Fd_k \quad (10b)$$

defining  $x$  as the states, the manipulable variable  $u$ , disturbances  $d$  and outputs  $y$ . Using this model to predict the future outputs, we may formulate a linear program that minimizes the electricity cost for operating the system while keeping the temperatures within prespecified intervals

$$\min_{\{x,u,y\}} \phi = \sum_{k \in \mathcal{N}} c_{y,k}^T y_k + c_{u,k}^T u_k + \rho_v^T v_k \quad (11a)$$

$$s.t. \quad x_{k+1} = Ax_k + Bu_k + Ed_k \quad k \in \mathcal{N} \quad (11b)$$

$$y_k = Cx_k + Du_k + Fd_k \quad k \in \mathcal{N} \quad (11c)$$

$$u_{\min} \leq u_k \leq u_{\max} \quad k \in \mathcal{N} \quad (11d)$$

$$\Delta u_{\min} \leq \Delta u_k \leq \Delta u_{\max} \quad k \in \mathcal{N} \quad (11e)$$

$$y_{\min} \leq y_k + v_k \quad k \in \mathcal{N} \quad (11f)$$

$$y_{\max} \geq y_k - v_k \quad k \in \mathcal{N} \quad (11g)$$

$$v_k \geq 0 \quad k \in \mathcal{N} \quad (11h)$$

$\mathcal{N} \in \{0, 1, \dots, N\}$  and  $N$  is the prediction horizon. The electricity prices enter the optimization problem as the cost coefficients  $c_{u,k}$ . The output cost on temperature is zero,  $c_{y,k} = 0$ . It may not always be possible to meet the temperature demand. Therefore, the MPC problem is relaxed by introduction of a slack variable  $v_k$  and the associated penalty cost  $\rho_v$ . The penalties can be set sufficiently large, such that the output constraints are met whenever possible. The Economic MPC also contains bound constraints and rate-of-movement constraints on the control variables. The prediction horizon,  $N$ , is normally selected large to avoid discrepancies between open-loop and closed-loop profiles. At each sampling time, we solve the linear program (11) to obtain  $\{u_k^*\}_{k=0}^{N-1}$ . We implement  $u_0^*$  on the process. As new information becomes available at the next sampling time, we redo the process of solving the linear program using a moving horizon and implementing the first part,  $u_0^*$ , of the solution. The electricity prices,  $\{c_{u,k}\}_{k=0}^{N-1}$ , as well as the disturbances,  $\{d_k\}_{k=0}^{N-1}$ , must be forecasted. In this paper, we assume that the forecasts are perfect.

## 4 Results and Discussions

### 4.1 Direct Control of Cold Room

The Economic MPC has been implemented in Matlab and simulations are presented in this section [17]. We have included two conventional power generators and one large cooling house (or an aggregation of several supermarkets). Direct control, i.e. total collaboration and communication between power producers and consumers is assumed. The production by the power generators,  $y_{1,k} + y_{2,k}$ , must exceed the demand for power by the cooling house and the demand from the external signal  $r_k$

$$y_{1,k} + y_{2,k} \geq y_{3,k} + r_k \quad k \in \mathcal{N} \quad (12)$$

We model farms of wind turbines as instantaneously changing systems and include the effect of their power production together with all non-controllable power consumers in the exogenous net power demand signal,  $r_k$ .

Fig. 4 visualizes a simulation. In this scenario, the power demand from all other consumers than the cold room increases slowly, then stays at a steady level and eventually drops

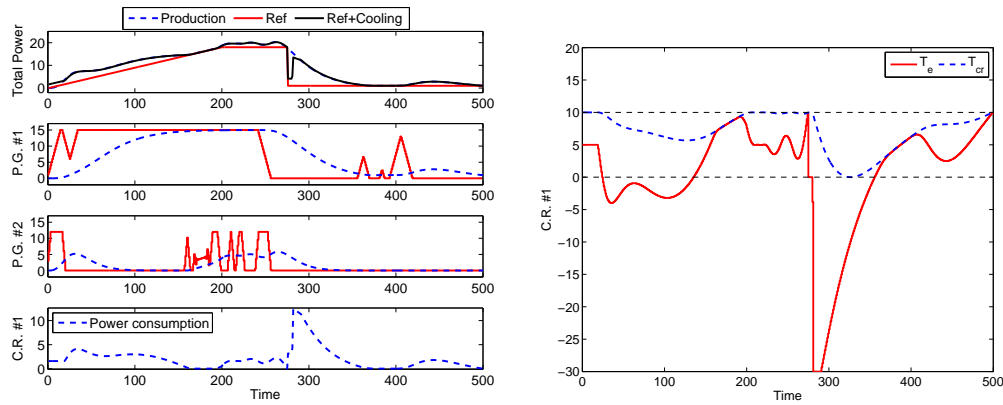

(a) P.G. #1 and 2 show the power productions from the two power plants (dotted blue) and their power set-points (solid red). C.R. #1 is power consumption in the cold room and "Total Power" shows total power production (dotted blue) versus the reference consumption (with (solid black) and without (solid red) the consumption for refrigeration.)

(b) Temperature in the cold room  $T_{cr}$  and the control signal for the refrigeration system  $T_e$ .  $T_{cr,min}$  and  $T_{cr,max}$  are shown with dotted black. The ambient temperature is assumed to be constant in this scenario.

Fig. 4. Simulation of Power Generation problem with two conventional power generators and on cold room with direct control.

significantly. This sudden drop could for instance be seen as an increase in wind speed that changes the demand to the power generators drastically.

If the cold room was a non-controllable load then, intuitively, the evaporation temperature  $T_e$  would stabilize at a level sufficient for keeping the temperature  $T_{cr}$  just below the upper constraint. Thus, with a constant load on the refrigeration system the power demand  $W_C$  that should be added to the reference  $r$  would simply be a constant over the entire scenario. The result is that a great amount of surplus electricity is produced after the sudden drop in demand. However, when the cold room is considered a controllable consumer it is able to absorb the majority of this otherwise redundant energy, as seen in Fig. 4. This causes the temperature in the cold room to decrease from the upper constraint to the lowest feasible level. Due to the thermal capacity in the refrigerated goods this "pre-cooling" makes it possible to entirely shut down the cooling and thereby limit power consumption at a time where the production cost has increased.

## 4.2 Price responsive heat pump

A building with a water based floor heating system connected to a geothermal heat pump was modeled in section 3.2. Parameters for a representative building are provided in [23] and includes values for building heat capacities and thermal conductivities.

To illustrate the potential of the Economic MPC for controlling heat pumps, we simulate scenarios using hourly electricity prices from Nordpool, the Nordic power exchange market [19]. The outdoor temperature,  $T_a$ , is modeled as diurnal cycles with added noise [24]. The sun radiation disturbance  $\phi_s$  is not included in these simulations. We aim to minimize the total electricity cost in a given period while keeping the indoor temperature,  $T_r$ , in predefined intervals. In the case studied, we assume that the forecasts are perfect, i.e. with no uncertainty. We use long horizons ( $N = 6$  days = 144 hours) and assume perfect model predictions.

Fig. 5 illustrates the optimal compressor schedule and the predicted indoor temperature for a six day horizon. The lower plot shows the outdoor temperature,  $T_a$ . The outdoor temperature reflects a cold climate, i.e. the outdoor temperature is lower than the indoor temperature. The middle plot shows the actual electricity prices in Western Denmark. The middle plot also contains the computed optimal heat pump power input,  $W_c$ . The upper plot shows the predicted indoor temperature along with the predefined time varying constraints. The constraints indicate that during night time the temperature is allowed to be lower than at day time. The figure reveals clearly that the power consumption is moved to periods with low electricity prices and that the thermal capacity of the house floor is able to store enough energy such that the heat pump can be left off during day time. This demonstrates that the slow heat dynamics of the floor can be used to shift the energy consumption to periods

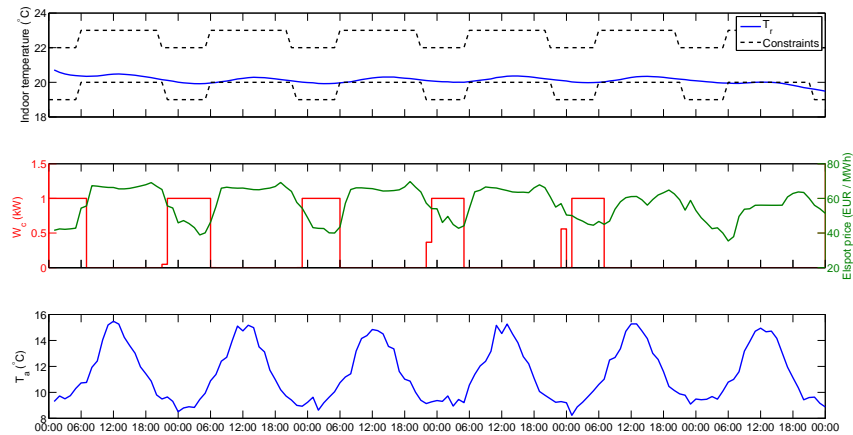

Fig. 5. Temperature in a house with time varying soft constraints, time varying electricity prices, and time varying outdoor temperatures. The time is the time since 18 JAN 2011 00:00. The upper figure shows the indoor temperature, the middle figure contains the electricity spot price and the optimal schedule for the heat pump, and the lower figure contains the ambient temperature. The compressor is on when the electricity spot price is low.

with low electricity prices and still maintain acceptable indoor temperatures. Notice that the constraints on room temperature are soft in this case.

We also conducted a simulation with constant electricity prices. In this case, the heat pump is now turned on just to keep the indoor temperature at its lower limit. This implies that there is no load shifting from the heat pump in this case. By comparing the case with varying electricity price to the case with constant electricity price, we observe economic savings around 33%. Using a simulation study with hard constraints on the temperature limits, the savings by load shifting were 26%.

Using actual electricity prices and weather conditions, we demonstrated that the Economic MPC is able to shift the electrical load to periods with low prices. As the Nordic Electricity spot prices reflect the amount of wind power in the system, the large thermal capacity of the house floor can essentially be used to store cheap electricity from renewable energy sources such as wind turbines. We also observed that the Economic MPC is able to shift the load and reduce the total cost of operating a heat pump to meet certain indoor temperature requirements.

### 4.3 Price and Frequency Controlled Supermarket Refrigeration

In this section we present the simulation of a realistic scenario with the supermarket refrigeration system in a setting where predictions of electricity prices, regulating power prices as well as outdoor temperatures exist. We have chosen a supermarket refrigeration system with three very different units attached. A shelving unit, a chest display case and a frost room. The units have different demands to temperature namely  $[2; 4]^{\circ}\text{C}$  for the shelving unit,  $[1; 5]^{\circ}\text{C}$  for the chest display case and  $[-25; -15]^{\circ}\text{C}$  for the frost room. The models are validated with running supermarkets in Denmark, January 2011. Electricity prices have been downloaded from NordPool's hourly el-spot price for a period of one month. The same is done with the availability payment for regulating power. A sinusoidal approximation is used for a typical diurnal temperature curve.

We divide our simulations into two scenarios. One that illustrates the effect of variations in electricity prices and temperatures and one that shows how regulating power services can be offered. Simulations are performed over at least 24 hours. For the regulating power scenario the frequency dependent primary reserve is accounted for by including the availability payment in the cost function such that the controller is able to deviate from the otherwise optimal trajectory if the payment for the reserve obtained by doing so can counteract the increased cost. Thus, we are not showing the actual activation of the reserve by frequency deviations but merely how the system can prepare for such an activation and benefit from

the availability payment.

## Simulation

Fig. 6 shows the simulated refrigeration system using the predicted outdoor temperature and electricity price to optimize the cost. The amplitude of the electricity price has been multiplied by four to better illustrate the effect. Today the dominating part of the price paid for electricity consist of taxes and connection fees which are all paid as flat rate charges per MWh. Hence, the simulation shown with 4 times amplitude on the el-spot price is an attempt to model a situation where the tax and other fees are charged as a percentage of the actual el-spot price. This would result in a magnification instead of a smoothing of the market signals. In this case the cost savings amount to more than 30%. If the original electricity price is used less change in cold room temperatures can be observed and the cost savings amount to 9%. If we are only exploiting the variations on outdoor temperature the economic MPC control scheme saves around 2% on the energy consumption. From the results illustrated in Fig. 6 we can conclude that the proposed economic MPC scheme has a positive effect on the cost related to operating the supermarket. Variations in outdoor temperature are utilized to minimize power consumption whereas exploiting variations in electricity prices tend to increase overall power consumption but at a lower cost.

In Fig. 7 the effect of participating in the power balancing market is simulated for a selected scenario of availability payments. In this simulation the outdoor temperature is assumed constant in order to illustrate the effect of availability payments for regulation power versus the electricity spot price as clearly as possible. This simulation reveals an additional saving of up to 70% compared to the case where only electricity spot price is used for optimization. Participating in the balancing power market seems to be beneficial for both the power system and the supermarkets if we consider the simulation in Fig. 7. At least at the time of the year/day where extra capacity is available and availability payment is sufficiently high. A large potential saving is found meaning that there is room for deviations from the simulated scenario without ruining the business case of participating with regulating power. Furthermore it is estimated from the simulations that a supermarket can offer at least 20% of its capacity as regulating power (except at the peak load days of the year). Currently in Denmark the peak demand for primary reserves is around 60 MW. With an average supermarket offering about 20% of its capacity approximately 75% of the total needs for primary reserves could be made up by supermarkets. A single supermarket is not able to participate with sufficient capacities to place bids on the balancing market however aggregation of e.g. chains of shops would be an obvious solution.

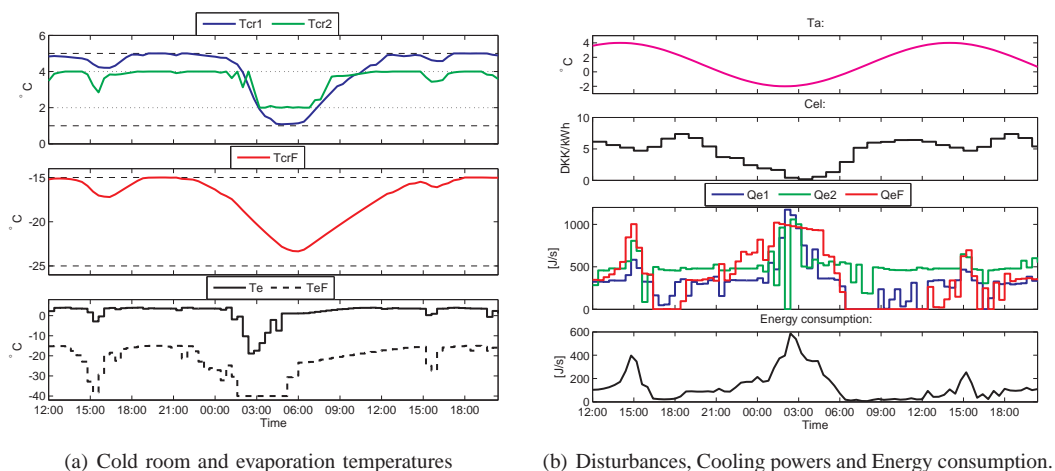

Fig. 6. Simulation showing how variations in outdoor temperature and electricity prices are exploited by utilization of thermal storage.

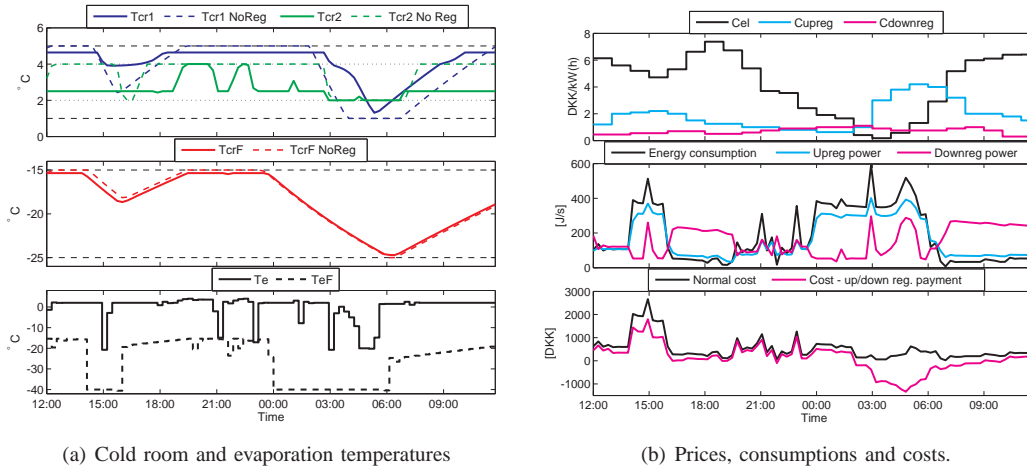

Fig. 7. Simulation showing how the flexible consumption is utilized for offering regulating power to the balancing market. The cold room temperatures for an optimization utilizing only the electricity spot price over the same period are shown to illustrate the difference.

## 5 Handling Uncertainties

So far we have assumed perfect models and deterministic predictions. In this section we illustrate what happens when introducing uncertainties in a more realistic scenario [25]. An optimal solution to a deterministic linear program is not always optimal, nor feasible, in the stochastic case. Therefore we describe means to handle the uncertainties in both forecasts and in the models of the system. We are using assumptions of the uncertainty belonging to certain distribution functions such that the uncertain parameters are normally Gaussian distributed. Furthermore we define the confidence level (probability) at which the constraints are satisfied. The probabilistic constraints are then reformulated as their deterministic counterparts.

First we define the system model on Finite Impulse Response (FIR) form:

$$y_k = b_k + \sum_{i=0}^k H_i u_{k-i}, \quad H_i = \begin{cases} D & \text{for } i = 0 \\ CA^{i-1}B & \text{for } i > 0 \end{cases} \quad (13)$$

where  $b_k$  is a bias term generated by the estimator. Next, the stochastic optimization problem is defined as:

$$\min E \left\{ \sum_{k=0}^N \mathbf{c}_k' u_k \right\} \quad (14a)$$

s.t.

$$u_{min} \leq u_k \leq u_{max} \quad (14b)$$

$$Prob\{\mathbf{y}_k \geq \mathbf{r}_k\} \geq 1 - \alpha, \quad \alpha \in [0, 1] \quad (14c)$$

$$\mathbf{y}_k = b_k + \sum_{i=1}^k \mathbf{H}_i u_{k-i} + \sum_{i=1}^k \mathbf{H}_{D,i} \mathbf{d}_{k-i} \quad (14d)$$

where  $\mathbf{r}$  is a reference trajectory,  $\mathbf{d}$  a disturbance,  $1 - \alpha$  the confidence level for the constraint.

$$\begin{aligned} 1) \quad \mathbf{c}_k &\sim N(\bar{c}_k, \sigma_c^2) & 2) \quad \mathbf{r}_k &\sim N(\bar{r}_k, \sigma_r^2) \\ 3) \quad \mathbf{H}_i &\sim N(\bar{H}_i, \Sigma_H^2) & 4) \quad \mathbf{H}_{D,i} &\sim N(\bar{H}_{D,i}, \Sigma_H^2) \\ 5) \quad \mathbf{d}_k &\sim N(\bar{d}_k, \sigma_d^2) \end{aligned} \quad (15)$$

1) and 2) are forecast uncertainties, 3) and 4) describe model uncertainties while 5) is uncertainty in the disturbances.

As we have shown in [25] we are able to reformulate the probabilistic constraints as deterministic constraints on the form

$$Prob\{\mathbf{y}_k \geq \mathbf{r}_k\} \geq 1 - \alpha \Leftrightarrow \Phi^{-1}(\alpha) \left\| \Sigma_{(\cdot)}^{1/2} \begin{bmatrix} (\cdot)_{past} \\ (\cdot) \end{bmatrix} \right\|_2 + \bar{y}_k \geq \bar{r}_k \quad (16)$$



The constraint in Eq. (16) has the form of a second order cone and the solution to the optimization problem constrained by Eq. (16) can be computed using Second Order Cone Programming (SOCP).

### Simulation

Using Yalmip [26] we have simulated the scenario from section 4.1 but with the addition of uncertainties. The constraints on the cold room temperature and on balancing supply and demand are formulated as probability constraints and implemented with SOCP. A simulation scenario is provided in Fig. 8. From the figure we note the confidence intervals shown as shaded areas around each of the trajectories. The solid lines are the expected outcome while the shaded areas are created by 10,000 simulations with random instances of the noise descriptions. The 95% percentile was used both in the SOCP formulation and for plotting the shaded areas. It is easily seen how the amount of back-off from the boundaries is just enough to account for the 95% confidence interval of the uncertainty descriptions for the system. Particular this can be seen in Fig. 8(b) where the total production is above the total consumption,  $T_{cr}$  stays within the boundaries specified and  $T_e \leq T_{cr}$  is satisfied. All with 95% probability. The solution here is less optimal compared to the one where we are allowed to go strictly to the boundaries but as this solution handles the always present uncertainties it is crucial for real life implementation.

## 6 Conclusion

To enable more use of renewable energy flexible consumption must be established. Using Economic Optimizing MPC schemes for systems with thermal storage capabilities we demonstrated both cost savings and the ability to deliver crucial services to the Smart Grid. Significant savings have been revealed e.g. 33% for heat pumps and around 10% in supermarket refrigeration. For the investigation of regulating power our perspective was seen from the refrigeration system but as it was demonstrated the involvement in the balancing market can be economically beneficial for the system itself while delivering crucial services to the Smart Grid. Different strategies for controlling the loads are available and starting with simplified setups we have demonstrated their ability to efficient control of a VPP setting. The cases have been expanded with realistic scenarios and inclusion of prediction and model uncertainties. The results showed how variations in outdoor temperature are utilized to minimize power consumption whereas exploiting variations in electricity prices tend to increase overall power consumption but at a lower cost. Hence, the goal is not solely to minimize energy consumption but merely to use energy when it is available. Future

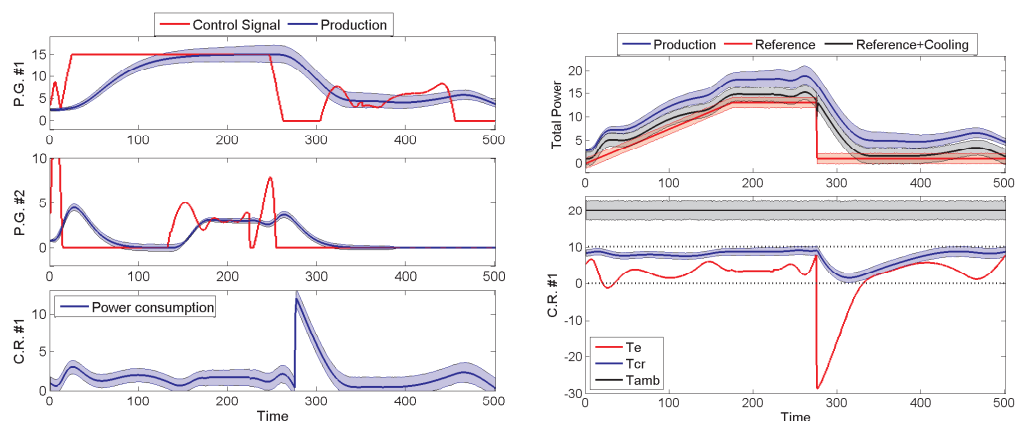

(a) Power productions / consumption. P.G. #1 and 2 show the power productions from the two power plants (blue) and their power set-points (red). C.R. #1 is power consumption in the cold room.

(b) "Total Power" shows total power production (blue) versus the reference consumption (with (black) and without (red) the refrigeration). C.R. #1 shows the temperature in the cold room  $T_{cr}$  and the control signal  $T_e$ .

Fig. 8. Simulation of Power Management scenario.  $\alpha = 0.5$ ,  $H_i \sim N(\bar{H}_i, 0.0055^2)$ ,  $r_k \sim N(\bar{r}_k, 0.7071^2)$ ,  $T_{amb} \sim N(\bar{T}_{amb}, 1.7321^2)$ . The shaded bands show the 95% confidence interval from 10,000 random instances.

work includes simulation of more units with realistic forecasts in a VPP framework and implementation of the methods on real supermarket controllers.

## References

- [1] K. Richardson, D. Dahl-Jensen, J. Elmeskov, C. Hagem, J. Henningsen, J. A. Korstgård, N. B. Kristensen, P. E. Morthorst, J. E. Olesen, and M. Wier, *Green energy - the road to a Danish energy system without fossil fuels*. Danish Commission on Climate Change Policy, 2010.
- [2] Energinet.dk, "Potential and opportunities for flexible electricity consumption with special focus on individual heat pumps (in Danish)," Energinet.dk, The Danish TSO owned by the Danish Climate and Energy Ministry., Tech. Rep., 2011.
- [3] S. L. Andersson, A. K. Elofsson, M. D. Galus, L. Göransson, S. Karlsson, F. Johnsson, and G. Andersson, "Plug-in hybrid electric vehicles as regulating power providers: Case studies of Sweden and Germany," *Energy policy*, vol. 38, no. 6, pp. 2751–2762, 2010.
- [4] H. Saele and O. S. Grande, "Demand response from household customers: Experiences from a pilot study in norway," *IEEE Transactions on Smart Grid*, vol. 2, no. 1, pp. 90–97, 2011.
- [5] S. Han, S. Han, and K. Sezaki, "Development of an optimal vehicle-to-grid aggregator for frequency regulation," *IEEE Transactions on Smart Grid*, vol. 1, no. 1, pp. 65–72, 2010.
- [6] A. Molina-Garcia, M. Kessler, J. A. Fuentes, and E. Gomez-Lazaro, "Probabilistic characterization of thermostatically controlled loads to model the impact of demand response programs," *IEEE Transactions on Power Systems*, vol. 26, no. 1, pp. 241–251, 2011.
- [7] D. S. Kirschen, "Demand-side view of electricity markets," *Power Systems, IEEE Transactions on*, vol. 18, no. 2, pp. 520–527, 2003.
- [8] R. Bush and G. Wolf, "Utilities load shift with thermal storage." *Transmission & Distribution World*, p. 12, 2009.
- [9] F. Oldewurtel, A. Parisio, C. N. Jones, M. Morari, D. Gyalistras, M. Gwerder, V. Stauch, B. Lehmann, and K. Wirth, "Energy Efficient Building Climate Control using Stochastic Model Predictive Control and Weather Predictions," in *Proc. of American Control Conference 2010*, 2010, pp. 5100–5105.
- [10] S. J. Qin and T. A. Badgwell, "A survey of industrial model predictive control technology," *Control engineering practice*, vol. 11, no. 7, pp. 733–764, 2003.
- [11] D. Sarabia, F. Capraro, L. F. S. Larsen, and C. de Prada, "Hybrid nmpc of supermarket display cases," *Control Engineering Practice*, vol. 17, no. 4, pp. 428–441, 2008.
- [12] K. Edlund, J. D. Bendtsen, and J. B. Jørgensen, "Hierarchical model-based predictive control of a power plant portfolio," *Control Engineering Practice*, p. accepted, 2011.
- [13] J. B. Rawlings and R. Amrit, "Optimizing Process Economic Performance Using Model Predictive Control," *Nonlinear Model Predictive Control: Towards New Challenging Applications*, pp. 119–138, 2009.
- [14] K. Edlund, "Dynamic Load Balancing of a Power System Portfolio," Ph.D. dissertation, The Faculty of Engineering and Science, Automation & Control, 2010.
- [15] M. Stadler, W. Krause, M. Sonnenschein, and U. Vogel, "Modelling and evaluation of control schemes for enhancing load shift of electricity demand for cooling devices," *Environmental Modelling & Software*, vol. 24, pp. 285–295, 2009.
- [16] P. Nyeng, "System Integration of Distributed Energy Resources," Ph.D. dissertation, DTU Electrical Engineering, 2010.
- [17] T. G. Hovgaard, K. Edlund, and J. B. Jørgensen, "The Potential of Economic MPC for Power Management," in *49th IEEE Conference on Decision and Control, 2010*, 2010, pp. 7533–7538.
- [18] T. G. Hovgaard, L. F. S. Larsen, and J. B. Jørgensen, "Flexible and Cost Efficient Power Consumption using Economic MPC - A Supermarket Refrigeration Benchmark," in *50th IEEE Conference on Decision and Control, 2011*, 2011, p. submitted.
- [19] R. Halvgaard, N. K. Poulsen, H. Madsen, and J. B. Jørgensen, "Economic Model Predictive Control for Climate Control of Buildings in a Smart Energy System," in *50th IEEE Conference on Decision and Control, 2011*, 2011, p. submitted.
- [20] M. J. Skovrup, "Thermodynamic and thermophysical properties of refrigerants - software package in borland delphi." Department of Energy Engineering, Technical University of Denmark, Tech. Rep., 2000.
- [21] T. G. Hovgaard, L. F. S. Larsen, M. J. Skovrup, and J. B. Jørgensen, "Power Consumption in Refrigeration Systems - Modeling for Optimization," in *4th International Symposium on Advanced Control of Industrial Processes, 2011*, 2011, p. accepted.
- [22] H. Madsen and J. Holst, "Estimation of continuous-time models for the heat dynamics of a building," *Energy and Buildings*, vol. 22, no. 1, pp. 67–79, 1995.
- [23] K. K. Andersen, H. Madsen, and L. H. Hansen, "Modelling the heat dynamics of a building using stochastic differential equations," *Energy and Buildings*, vol. 13, pp. 13–24, 2000.
- [24] F. Oldewurtel, A. Ulbig, A. Parisio, and G. Andersson, "Reducing Peak Electricity Demand in Building Climate Control using Real-Time Pricing and Model Predictive Control," in *Conference on Decision and Control (CDC)*, Atlanta, GA, USA, 2010, pp. 1927–1932.
- [25] T. G. Hovgaard, L. F. S. Larsen, and J. B. Jørgensen, "Robust Economic MPC for a Power Management Scenario with Uncertainties," in *50th IEEE Conference on Decision and Control, 2011*, 2011, p. submitted.
- [26] J. Löfberg, "Modeling and solving uncertain optimization problems in yalmip," *IFAC Proceedings Volumes (IFAC-PapersOnline)*, vol. 17, no. 1, 2008.



# The FlexControl concept – a vision, a concept and a product for the future power system

Per Nørgaard, Risø DTU, Denmark, pern@risoe.dtu.dk

## Abstract

FlexControl is a vision, a concept and a product – a vision for the control of future power systems based on renewable energy and distributed control, a generic concept for smart control of many power units and ‘product’ implementations of the concept in different applications.

The general development trends for power system towards more stochastic power generation from wind and solar, more distributed generation and control, and the introduction of demand responses from a huge number of small, flexible loads, require new architecture, design and means of controlling of the power system in order to maintain the power balances and the high security of supply and power quality in all parts of the grid.

FlexControl is a flexible, modular, scalable and generic control concept designed for smart control of a huge number of distributed, controllable power units (DERs) in the power system. FlexControl is based on aggregated, indirect and rule based communication and control, and open standards. The indirect control is based on responses to the frequency, the voltage and the broadcasting of global or local price signals. The paper presents an overview of the FlexControl concept, with its elements, options and applications.

## 1 Introduction

Power systems, less dependent on fossil fuels (and nuclear power) expect to become more dependent on distributed and stochastic generation (including wind and solar) and on flexible consumption – i.e. more, distributed active units, where also the consumption to a certain degree automatic and dynamically will adapt to the actual, local generation available – the ‘smart grid’ concept. This development requires the development of appropriate power system architectures, components and control mechanisms, including new power markets.

In order to maintain the power quality and power supply in a power system, power balances must be maintained in all nodes of the power system at all time – see Figure 1:

$$P_1 + P_2 + P_3 + P_4 = 0$$

$$Q_1 + Q_2 + Q_3 + Q_4 = 0$$

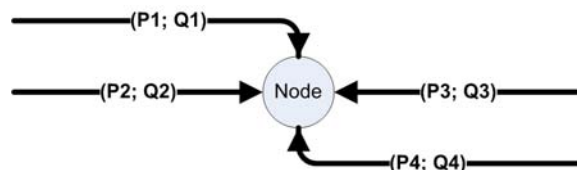

Figure 1: Power balance in a power system node.

In general, in power systems with less controllable, limited predictable, stochastic and intermittent power generation – like wind and solar – power balances can be achieved through combinations of the following means – see Figure 2:

- flexible generations;
- flexible consumptions;
- local storage;
- dynamic import / export;
- conversions to / from other energy carriers.

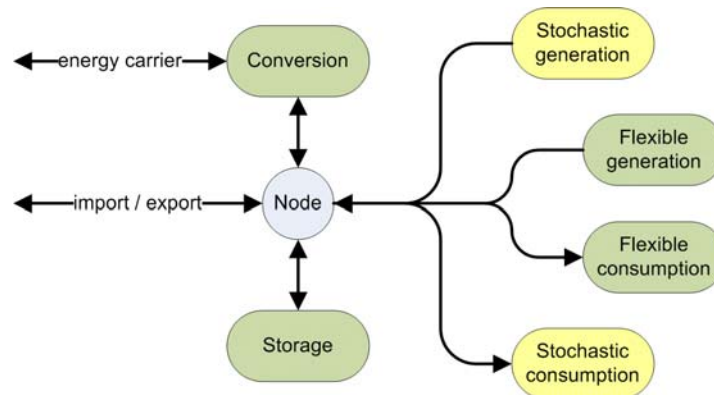

Figure 2: Means of power balancing.

- Flexible generation: The fluctuating power generation from wind and solar may to some extent be compensated by flexible power generation, provided by controllable power generation units.
- Flexible consumption: Some energy services based on electricity may provide flexibility in their consumption, e.g. by shifting part of the load in time – from minutes to days, depending on the actual application. Examples are electrical heating or cooling services with thermal capacities and / or temperature flexibility.
- Storage: Local dedicated electricity storage can act as both (temporary) flexible generation and (temporary) flexible consumption. Requirements to power, energy, efficiency and response time depends on the actual application.
- Import / export: Local power balance may be obtained by exporting or importing power to / from the remaining power system – as far as possible. This option is limited by bottlenecks in the power system and by the extent of the power system. E.g., island systems will not have this option.
- Conversion: Power may be converted to other energy carries – like heat or hydrogen. Conversion to heat may be part of combined power and heat generation (CHP) and as such with an overlap to flexible generation. Conversion to hydrogen may be reversible and as such with an overlap to storage.

All these means could in principle solely be able to provide the full power balances in all power system nodes. However, the most economic solution involves a combination of all available means. The more flexibility and controllability in generation and demand, the better.

Many of the new small-scale distributed power units – providing energy services like heating / cooling, pumping or battery charging – can with minor modifications change status from being passive power units to become active power units that to some extent

can react on requests for power regulation or other power system services. Examples are: freezers, heat pumps and electrical vehicles.

The same is true for the small-scale distributed generation units – like micro CHP. A common term for these small-scale, distributed, active, controllable power units is distributed energy resources (DERs). The contributions to the power regulation from the individual DER units may be modest, but the aggregated contribution from many DER units can be significant.

Most of the present power systems are designed for power flow from the transmission system, through the distribution system to the consumers, and are based on central control, passive consumers and relative few large-scale power generation units, providing the required power regulation. The present power systems – including their architectures and the control mechanisms (and markets) – are not well designed for power systems, based on smart control of a huge number of distributed, small-scale, active power units. Most of the power systems attempt to adapt to the new challenges by adding new functions and actors, but without implementing the necessary radical change of the architecture.

The future power system will differ from the present at least on four characteristics:

- distributed generation, implying two-way power flow in the power distribution system;
- flexible demand based on power system needs expressed through dynamic prices;
- huge number of active units, implying distributed intelligence and control;
- reduced short circuit power, implying new protection schemes.

## 2 FlexControl

FlexControl is a vision, a concept and a product addressing the future power system – a vision for the control of power systems based on renewable energy and distributed control, a generic concept for smart control of many power units and ‘product’ implementations of the concept in different applications.

### 2.1 Vision

FlexControl is a power system architecture, designed for optimised control and operation of a power system based on renewable energy and a huge number of active power units, contributing to the proper operation of the power system. The operation adapts automatically to the components in the system, and new active components can be added as ‘plug & play’.

Power generation based on renewable energy implies reduced controllability and limited predictability – like for wind and solar power. The huge number of distributed, active power units requires distributed, autonomous control. And proper operation must be true in all parts of the power system at any time – even under power failures like short circuits or loss of generation or transmission capacity.

### 2.2 Concept

The FlexControl concept is based on

- a huge number of distributed, active and intelligent power units, providing power system services by automatically responding to the frequency, the voltage and power prices;
- indirect control and simple control schemes, common for all active power units (however with supplementary restrictions for the larger power units);

- division of the power system into appropriate areas with local power prices addressing the local needs for power regulation and the power flow between the areas (for both active and reactive power) – see Figure 3;
- a supervisory control, regulating the power flow between the areas;
- only two level of actors: power system operators and customers;
- no split between producers and consumers – they are all customers;
- no split between transmission and distribution (only between voltage levels) – large power flows are provided by the aggregated effect from many power lines in a meshed grid;
- all power lines are organised in meshed topology with load flow control;
- protection schemes based on voltage dependent current limits designed for variable short circuit power levels.

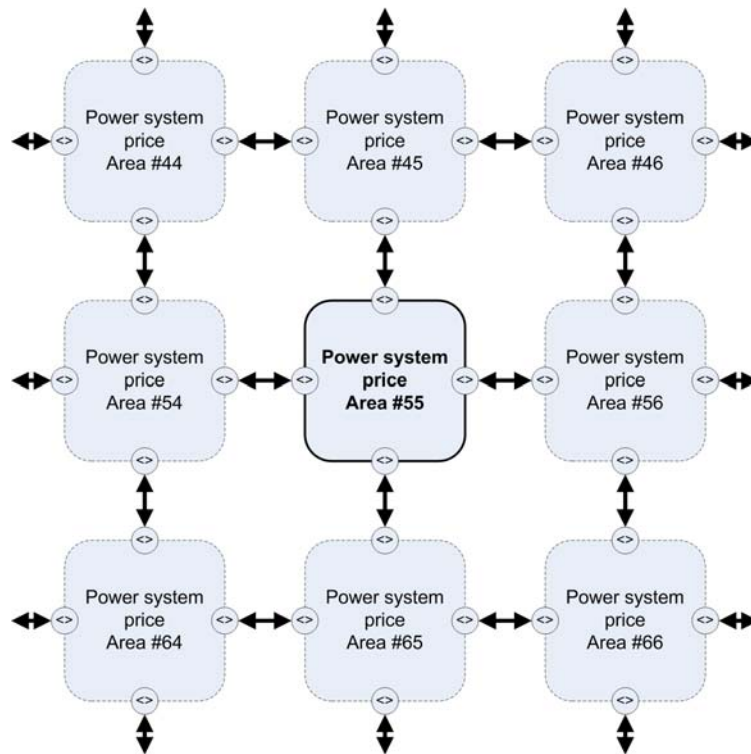

*Figure 3: Illustration of the power system with the mesh topology, the power system price areas and the controlled power exchange between the areas.*

The only types of actors are:

Power system operators: Responsible for the power lines, the power system protection, the supervisory regulation of the power flow and the accounting / billing.

Customers: Produce and / or consume power, and acts according to the defined schemes.

The sign of the power flow for the active power,  $P$ , and the reactive power,  $Q$ , is throughout the paper from the customer to the power system – generation corresponds thus to positive power and consumption corresponds to negative power.

### 3 Control

The concept is based solely on indirect control, based on four control signals, common for all active units:

- the line frequency;
- the local voltage;
- a local, dynamic price for active power; and
- a local, dynamic price for reactive power.

All active power units respond to larger deviations of the line frequency,  $f$ , to larger deviations of the local voltage,  $U$ , and to the local dynamic price signals for the active and the reactive power,  $c_P$  and  $c_Q$ . The individual power unit's responds to the dynamic power prices are voluntary and will depend on the actual application, whereas their automatic responds to the frequency and to the voltage deviations are mandatory.

#### 3.1 Dynamic power prices

The power system is divided into appropriate physical price areas, physically interconnected by a number of power lines, each with individual power exchange capacity – see Figure 3. The distribution of the load flow in the interconnecting lines is partly controllable – through transformer tap changers, phase compensation units or AC/DC/AC connections.

The local dynamic power prices,  $c_P$  and  $c_Q$ , must represent the local power system's needs for active and reactive power, and for regulation of active and reactive power,  $P_\Delta$ , and  $Q_\Delta$ . In addition, the local prices should support the import from areas with relative lower prices and the export to areas with relative higher prices. The new local price,  $c_{t+1}$ , is generated as a correction of the present price,  $c_t$ , relative to the neighbour prices,  $c_t^*$ , and the needs for regulation,  $\Delta$ :

$$\begin{aligned} c_{t+1}^P &= c_t^P + a_X^P \times (c_t^{P*} - c_t^P) + b_\Delta^P \times P_\Delta + c_S^P \\ c_{t+1}^Q &= c_t^Q + a_X^Q \times (c_t^{Q*} - c_t^Q) + b_\Delta^Q \times Q_\Delta + c_S^Q \end{aligned}$$

where  $c_t^{P*}$  and  $c_t^{Q*}$  represent the averages of the prices for the neighbouring areas,  $a_X^P$  and  $a_X^Q$  defines the sensitivity to the neighbour price levels, and  $b_\Delta^P$  and  $b_\Delta^Q$  defines the sensitivity to the needs for regulation.  $c_S^P$  and  $c_S^Q$  are local corrections, forcing an increase or a decrease of the local prices, controlled by the power system operator, and used for the supervisory control. The local prices will to some extent follow the neighbouring price levels, depending on the  $a_X$  factors. If the local prices reduce, the import will increase (or the export decrease), the local generating units will reduce their generation and the consuming units will be motivated to increase their loads. If the local prices increase, the import will decrease (or the export increase), the local generating units will increase their generation, and the consuming units will be motivated to reduce their loads. This will dynamically adjust the local prices, the import / export, the local generation and the local consumption to optimise local the power balances. The dynamic power prices will be updated every second.

When reconnecting an area after black-out or island operation, the local power price will be forced relative high, giving the local generation units an incentive to provide power and the local consuming units an incentive to reduce their demands. This is controlled by the power system operator.

The need for power regulation is determined by the power system area's power import / export. For the active power, the need for regulation is determined by the relative highest loaded interconnecting power line – see Figure 4.

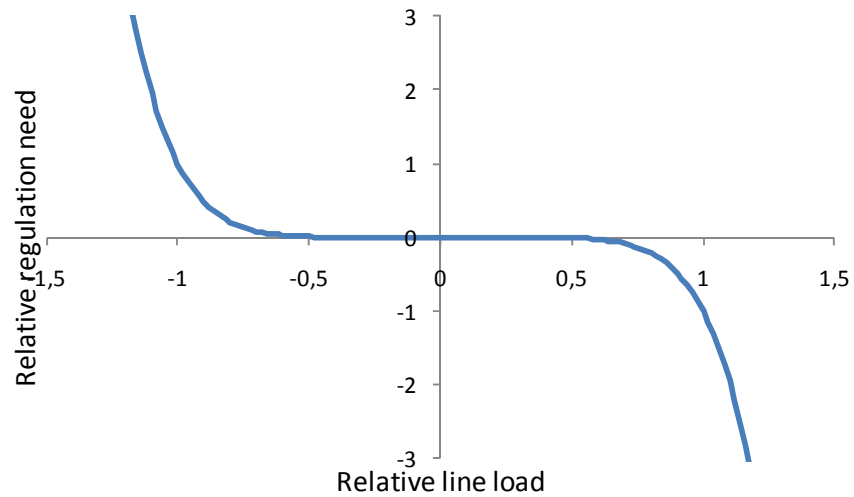

Figure 4: Illustration of the relative need for active power regulation as function of the relative load of the highest loaded interconnecting power line for a specific power system price area.

For the reactive power, the need for regulation is determined by the aggregated import / export of reactive power – see Figure 5.

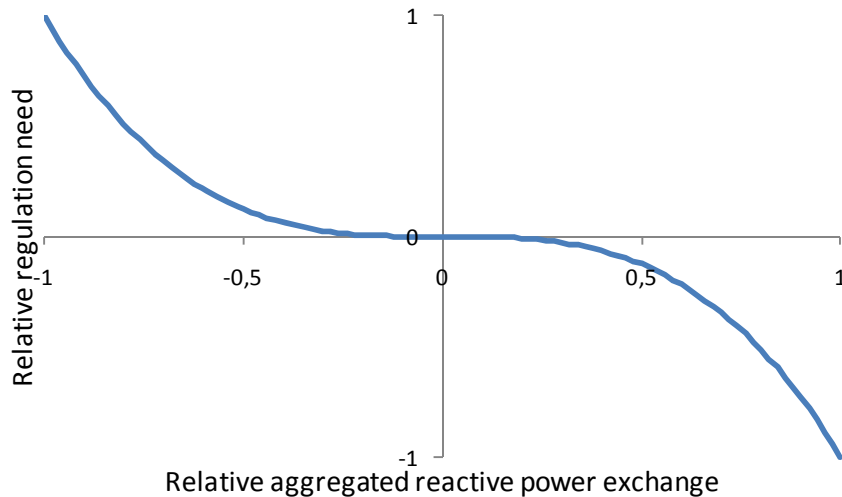

Figure 5: Illustration of the relative need for reactive power regulation as function of the aggregated relative reactive power exchange for a given power system price area.

### 3.2 Price response

The power unit's responds to the power prices are voluntary, but restricted. In order to prevent the larger power units (with nominal power > 1% of the total installed power generation capacity for a specified power system area) to completely switch in or out, resulting in control problems, their power regulations are restricted: their energy exchange on hourly basis,  $E_h$ , must not change more than 30% of nominal power from

one hour to the next – corresponding to that their energy exchange can change from zero to full or from full to zero within 3 hours. They can still regulate their power within the full range for shorter periods.

For larger wind farms this means that the up-regulating of the generation is restricted (this is easy to implement), and the down-regulation of the production must be controlled – either by reacting in due time before larger changes in wind energy are expected or by adding compensating power regulation capabilities, e.g. storage units.

The customer's active and reactive power exchange,  $E_i^P$  and  $E_i^Q$ , will be accounted at the actual prices,  $c_i^P$  and  $c_i^Q$ :

$$C_h^P = \sum_h (E_i^P \times c_i^P)$$

$$C_h^Q = \sum_h (E_i^Q \times c_i^Q)$$

Note, that these amounts can be positive or negative, depending on the direction of the energy flow and if the prices are negative.

In addition, the customer will pay a daily amount,  $C_E^P$  and  $C_E^Q$ , relative to the daily energy flow in both directions,  $E_d^P$  and  $E_d^Q$ :

$$C_E^P = E_d^P \times c_E^P$$

$$C_E^Q = E_d^Q \times c_E^Q$$

where

$$E_d^P = \int_d |P| dt$$

$$E_d^Q = \int_d |Q| dt$$

an amount relative to the maximum power exchange on daily basis:

$$C_p^P = \max_d(P) \times c_d^P$$

$$C_p^Q = \max_d(Q) \times c_d^Q$$

and finally a fixed amount,  $C_S$ , for being connected to the power system, depending on the rated power capacity of the connection. These cost elements,  $C_E$ ,  $C_p$  and  $C_S$ , correspond to the customer's use of the power system.

The total daily amount to be accounted is thus:

$$C_d = \sum_d (C_h^P + C_h^Q) + C_E^P + C_E^Q + C_p^P + C_p^Q + C_S$$

Note, that this amount can become positive or negative – negative means that the customer shall pay the amount to the power system operator and positive means that the power system operator shall pay the amount to the customer – corresponding to the sign of the power flow. All values will be recorded on hourly basis as basis and documentation for the billing.

### 3.3 Frequency response

All power units must be designed to operate properly within a wider frequency range, 45..55 Hz. The active power unit's active power must automatically respond to (larger) deviations (from nominal,  $f_0$ ) of the line frequency,  $f$  – see Figure 6.

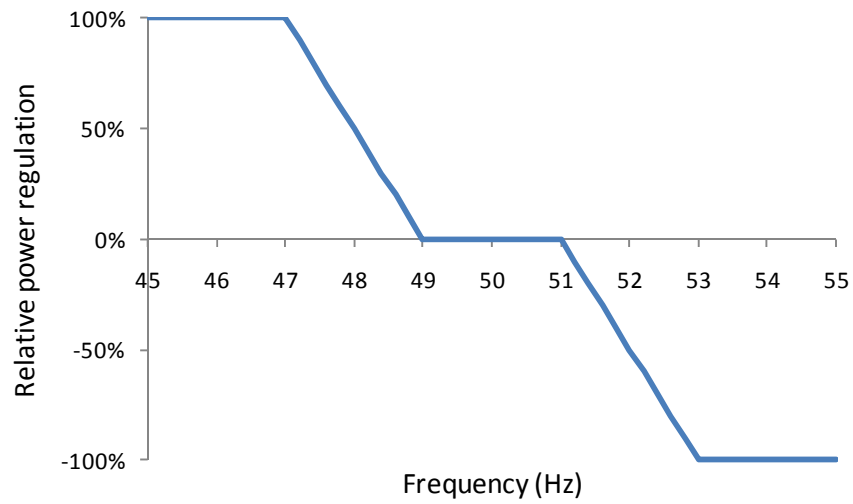

Figure 6: Active power unit's mandatory response to larger frequency deviations.

### 3.4 Voltage response

All active power units must (within their capability) automatically respond with regulation of their reactive power,  $Q$ , to larger deviations of the local line voltage,  $U$ , from the nominal line voltage,  $U_0$  – see Figure 7.

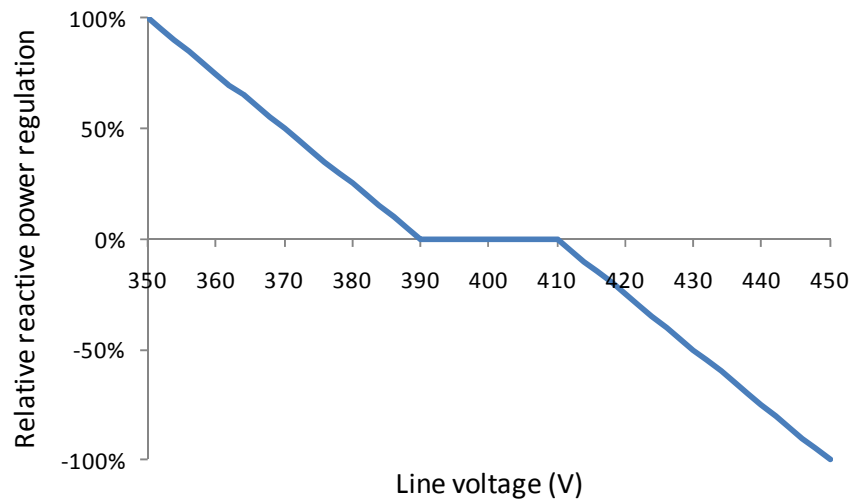

Figure 7: Active power unit's mandatory response to voltage deviations.



## 4 Protection

The protection of the power system must be robust to varying short circuit levels. The protection is therefore based on automatic, voltage sensitive current limiters. The protection units automatically disconnect the power at current levels that depend on the voltage levels – see Figure 8. The disconnection is delayed to prevent from tripping at black-outs.

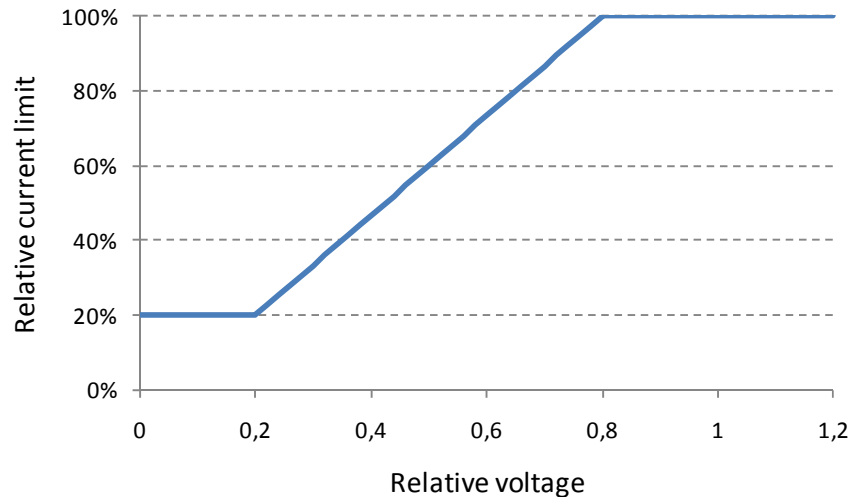

Figure 8: The current limits of the automatic protection relays depend on the voltage level.

## 5 Discussion

The concept has not yet been tested. Part of the concept will be tested through a combination of simulation and experiments as part of the FlexPower project, supported by the Danish research funding ForskEl.

The concept can be introduced gradually in existing power system, gradually introducing dynamic power prices, active and intelligent power units, and isolated AC areas with larger frequency variations.

The determination of the price areas is critical for the proper operation of the power system. They must be large enough to cover many active power units, but small enough to address local power transmission / distribution bottlenecks.

The concept is based solely on indirect control of many units on voluntary basis – there is no direct control and no direct feedback. The feedback is the aggregated response from all the active units. The individual responses will be unknown and different. However, the aggregated response from many units to a given change in the power price expects to be rather predictable.

The concept is critical dependent on the volunteer contribution with regulations from many active power units, including the larger units. As the contribution is voluntary, the contribution must be sufficient attractive through relative large variations of the dynamic power prices.

Local voltage regulations in the low voltage grid with relative high resistive impedances may need to be achieved through a combination of regulation of the active and reactive power.

The dynamic power prices will be adjusted, broadcasted and stored every second, and the costs of the power exchange will be calculated at each customer based on these second values. However, only the cost values on hourly basis will be stored and will be available for billing and documentation. The billing amount can therefore not be fully reconstructed. However, if the customers are smart, the difference relative to a flat load profile will be in the customer's favour, reflecting the payment for his contribution to the regulation.

The concept is fully scalable with 'plug & play' of new active power units. The regulation will automatically adapt to the actual power system and power units.

The development towards less use of fossil fuel can (still) be supported by taxes on the use of fossil fuels.

## References

The European Electricity Grid Initiative. entso-e, 2010.

The FlexPower project 2010 - 2012. Supported by ForskEl, 2010.

EcoGrid.dk Phase I - Summary Report. Energinet.dk, 2009.

Strategic research agenda for Europe's electricity networks of the future. European Commission, 2007.

European SmartGrids Technology Platform – vision and strategy for Europe's electricity networks of the future. European Commission, 2006.

GRID 2030 – a national vision for electricity's second 100 years. US Department of Energy, 2003.

## **Session 4 – Efficiency Improvements**

# Improving Energy Efficiency in Industrial Solutions – Walk the Talk

Dieter Wegener<sup>1\*</sup>, Matthias Finkbeiner<sup>2</sup>, Jens-Christian Holst<sup>3</sup>, Stig Irving Olsen<sup>4</sup>, Frank Walachowicz<sup>3</sup>

1 Siemens AG, Industry Solutions Division, Erlangen, Germany

2 Technische Universität Berlin (TUB), Sustainable Engineering, Berlin, Germany

3 Siemens AG, Corporate Technology, Berlin, Germany

4 Technical University of Denmark (DTU), Management Engineering, Lyngby, Denmark

\* Corresponding Author, E-Mail: [dieter.wegener@siemens.com](mailto:dieter.wegener@siemens.com)

**Keywords:** Eco-Care-Matrix, Energy efficiency, Life Cycle Assessment, Self-declared environmental claim

## Abstract

This paper describes the outline of the energy efficiency and environmental care policy and management at Siemens Industry Solutions Division. This environmental policy coherently embraces strategic planning, eco-design of energy-efficient industrial processes and solutions, design evaluation and finally communication of both environmental and economic performance of solutions to customers. One of the main tools supporting eco-design and evaluation & controlling of derived design solutions is the so called “Eco-Care-Matrix” (ECM).

The ECM simply visualizes the eco-efficiency of solutions compared to a given baseline. In order to prevent from “green washing” criticism and to ensure “walk the talk” attitude the ECM should be scientifically well-founded using appropriate and consistent methodology. The vertical axis of an ECM illustrates the environmental performance and the horizontal axis describes the economical customer benefit of one or more green solutions compared to a defined reference solution. Different scientific approaches for quantifying the environmental performance based on life cycle assessment methodology are discussed especially considering the ISO standards 14040/14044:2006.

Appropriate ECM application is illustrated using the example of the Siemens MEROS<sup>®</sup> technology (Maximized Emission Reduction of Sintering) for the steel industry. MEROS<sup>®</sup> is currently the most modern and powerful system for cleaning off-gas in sinter plants. As an environmental technology MEROS<sup>®</sup> is binding and removing sulfur dioxide and other acidic gas components present in the off-gas stream by using dry absorbents and additional electrical power. Advantage in the impact category of acidification potential (by desulfurization) is a trade-off to disadvantages in global warming and resource depletion potential caused by use of electricity. Representing different impacts, indicator results for impact categories with different tendencies have to be compared category by category and therefore should not be aggregated to a single-score result. Results communicated in the form of a self-declared environmental claim (type II environmental labeling, ISO 14021) for MEROS<sup>®</sup> are presented.

## 1 Introduction

The Eco Care Strategy at Siemens Industry Solutions Division serves to generate and expand its Environmental Portfolio in line with company corporate requirements and regulations. The elements listed in this Environmental Portfolio are designated "Green Solutions" at Siemens Industry Solutions Division. A "Green Solution" is defined in the Eco-Care-Matrix (ECM, see fig. 1 below) and is thereby characterized by a positive environmental impact (y axis), linked to an increased customer benefit (x axis), as shown in the "A" square of figure 1 (ref. to [1]). Products in the "B" and/or "C" areas are, from

the product portfolio point of view, acceptable elements for niche markets, but do not constitute a "Green Solution".

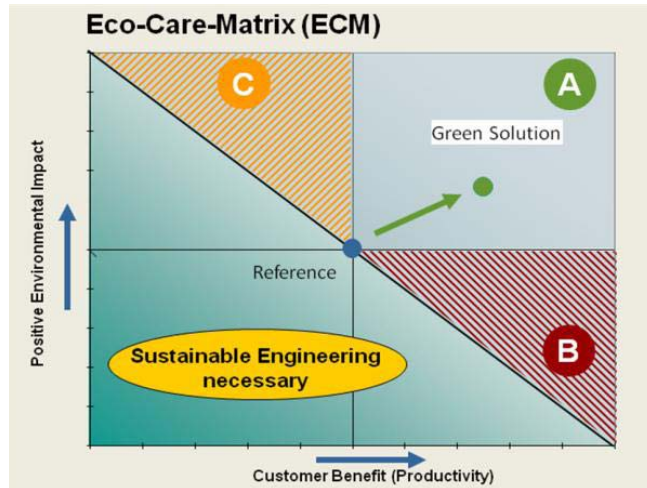

Figure 1: Eco-Care-Matrix (ECM)

The Eco-Care-Matrix has to be applied in the early stages of the product lifecycle especially in product portfolio management process (PPM) as well as in research & development process (R&D) - but only to parts in the Environmental Portfolio. As shown in figure 2 the ECM is used within PPM to support product portfolio decisions (ECM@PPM) and in the R&D process to help with product design selection (ECM@R&D).

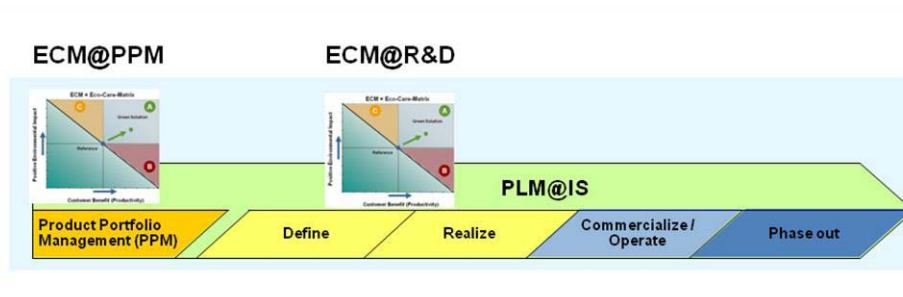

Figure 2: Application of the Eco-Care-Matrix as part of product lifecycle management (PLM)

The maximized emission reduction of sintering (MEROS<sup>®</sup>) is an innovative environmental process characterized by a series of treatment steps in which dust, acidic gases and harmful metallic and organic components still present in the sinter off-gas after the electrostatic precipitator are further reduced.

Figure 3 shows the process flow sheets of two different MEROS<sup>®</sup> applications:

- Figure 3a: MEROS<sup>®</sup> plant with Ca(OH)<sub>2</sub> and lignite as additive
- Figure 3b: MEROS<sup>®</sup> plant with NaHCO<sub>3</sub> and lignite as additive

In the first step, special C-based adsorbents and desulphurization agents (hydrated lime see figure 3a or sodium bicarbonate refer to figure 3b) are injected into the sinter off-gas stream in the countercurrent direction to bind heavy metals and organic compounds. In the second step, the gas stream passes to a conditioning reactor where the gas is moisturized and cooled. This accelerates the chemical reactions required for binding and removing SO<sub>2</sub> and other acidic gas components.

In the third step, the off-gas stream which exits the conditioning reactor passes through a bag filter equipped with special high-performance fabrics where the dust with the

trapped pollutants is removed. In order to enhance the gas cleaning efficiency and to significantly reduce additive costs, a portion of this dust is recycled to the off-gas stream after the conditioning reactor. This also accelerates the formation of a filter cake on the surface of the bag filter which enhances the removal of fine dust in the off-gas stream. The dust removed from the system is conveyed to intermediate storage silos for subsequent disposal or for use in other applications.

Sinter-gas-cleaning efficiency with MEROS<sup>®</sup> process results in emission reduction level previously unachieved applying conventional gas-cleaning technologies. Dust emissions are lowered by more than 99% to less than five milligrams per Nm<sup>3</sup>. Emissions of mercury and lead are reduced by 97% and 99% respectively. Organic compounds such as dioxins and furans (PCDD/F) are eliminated by about 97% and total condensable volatile organic compounds (VOCs) by more than 99%. SO<sub>2</sub> emissions were also considerably reduced.

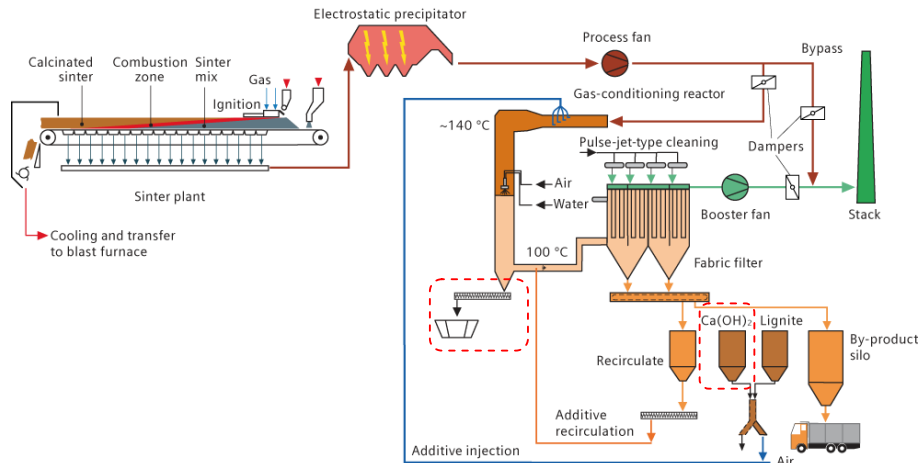

Figure 3a: Process flow sheet of the MEROS<sup>®</sup> plant with Ca(OH)<sub>2</sub> and lignite as additive

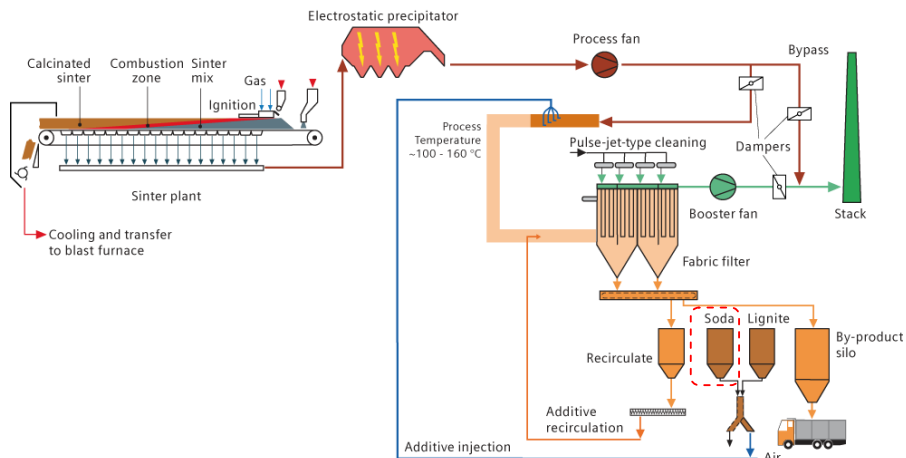

Figure 3b: Process flow sheet of the MEROS<sup>®</sup> plant with NaHCO<sub>3</sub> and lignite as additive

The reference process as the baseline for the comparison to MEROS<sup>®</sup> is chosen to be AIRFINE<sup>®</sup>. The AIRFINE<sup>®</sup> process is a wet-type sinter plant off-gas treatment (refer to figure 4). The heart of this process is the fine scrubber system, where dual flow nozzles eject water and compressed air as high pressurized mist jets into the cooled waste gas stream.

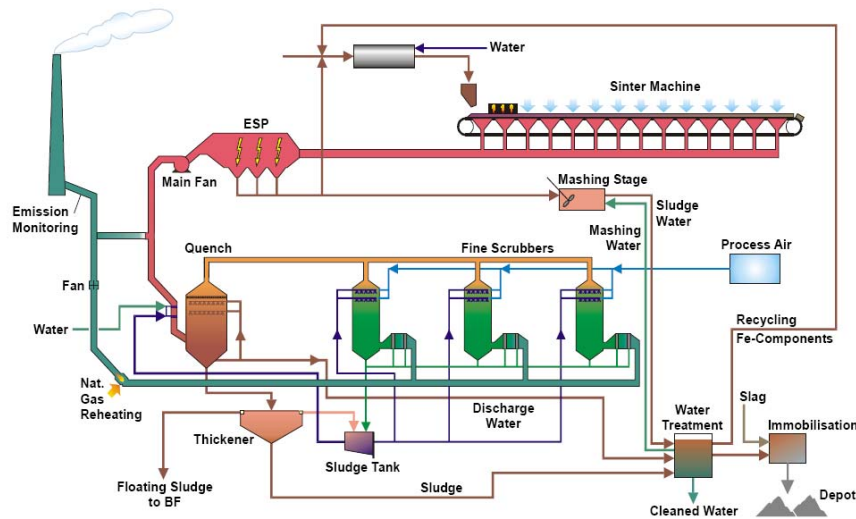

Figure 4: Principle flow sheet of the AIRFINE<sup>®</sup> process at voestalpine Stahl Linz, Austria

The AIRFINE<sup>®</sup> scrubber allows simultaneous removal of the finest dust particles (including alkali and heavy-metal chlorides) and noxious waste gas components. The latter (PCDD/F, heavy metals, polycyclic aromatic hydrocarbons (PAH)) are mainly associated with the fine dust. Compared with dry abatement systems this system can also remove water soluble compounds, such as alkali chlorides and heavy metal chlorides. In case of addition of alkalines to the scrubbing water also acidic components like HF, HCl and SO<sub>2</sub> can be removed significantly. The aqueous solution from the scrubber containing alkali and heavy metal salts is consequently treated by precipitation/ flocculation. The solids are deactivated with slag followed by disposal to secure landfill. The overflow is neutralized and passed through several gravel beds before discharge to the municipal sewage system.

## 2 Methods

The methods employed for the environmental part of the matrix are based on Life Cycle Assessment (LCA) (ref. to [2]) which is standardized in ISO 14040/44 (ISO, 2006). LCA is a tool that considers the environmental impacts of a service or a product throughout its life time, from the extraction of raw materials to the final disposal after end of useful life. LCA encompasses a range of environmental impacts (e.g. global warming, acidification, eutrophication etc.). Since the object of an LCA study is a product or a service, it is a comparative tool useful for comparing the environmental impacts of different solution or products. It can for example be used to identify design guidelines for environmental improvements of the products, solutions or services. It is evidently important to define the goal or purpose of the study including the “product” (used interchangeably with solution, project, system, or technology) that is subject to study. It should be clear what the study is intended to support and how the results are going to be used in the end. In the scoping of the study it is more clearly defined what is to be studied and how. The scope of the study should be defined according to at least the following parameters:

- The functional unit i.e. what is the delivered service of the product is the reference quantity for the study
- System boundaries. How much is included? How to define the system boundaries: Is it necessary to include the whole life cycle? Is it possible to do some simplified LCA? Which technologies are considered and in which geographical area? Etc.

Following the goal and scope definition environmental input and output data for each process within the system boundaries are collected in the inventory.

Life Cycle Impact Assessment (LCIA) transfers the data generated in the inventory into information with environmental relevance. The following section summarizes some key requirements of the international standards with regard to LCIA. According to ISO 14040/44 the LCIA phase shall include the following mandatory elements:

- Selection of impact categories, category indicators and characterization models;
- Assignment of LCI results to the selected impact categories (classification);
- Calculation of category indicator results (characterization).

The selection of impact categories, category indicators and characterization models shall be both justified and consistent with the goal and scope of the LCA. In addition to the mandatory elements of LCIA, there could be optional elements and information as listed below which can be used depending on the goal and scope of the LCA:

- Normalization: calculating the magnitude of category indicator results relative to reference information;
- Grouping: sorting and possibly ranking of the impact categories;
- Weighting: converting and possibly aggregating indicator results across impact categories

Normalization transforms an indicator result by dividing it by a selected reference value. Furthermore normalized indicator results can be weighted to reflect different preferences based on value-choices of involved stakeholders. Finally normalized and weighted indicator results may be aggregated across selected impact categories providing a single score which might be desirable for the sake of simplicity and to deliver results at a glance. However, especially weighting steps are based on value-choices and are not scientifically based. Different individuals, organizations and societies may have different preferences; therefore it is possible that different parties will reach different weighting results based on the same indicator results or normalized indicator results. In an LCA it may be desirable to use several different weighting factors and weighting methods, and to conduct sensitivity analysis to assess the consequences on the LCIA results of different value-choices and weighting methods.

Because of the subjective nature of weighting and the possible consequences on third parties, the standard says that weighting shall not be applied in LCA studies used for comparative assertions intended to be disclosed to the public. It should be recognized that there is no scientific basis for reducing LCA results to a single overall score or number. The standard explicitly states that such LCIAs shall employ a sufficiently comprehensive set of category indicators and the comparison shall be conducted category indicator by category indicator. Nonetheless, in order to illustrate results in the ECM in this case they have been implicitly weighted by the factor of 1, i.e. every impact is weighted equally.

In the Eco-Care-Matrix new technological solutions are compared to a given baseline. The environmental baseline or reference serves as a benchmark for the potential environmental improvements. Comparability is thus the main criterion for choosing the appropriate reference system or technology to perform the comparison of environmental impacts between green solution and baseline. The reference system should deliver nearly the same function or service to the customer as the considered green solution. Only if both product systems under examination have the same function using of course different process technologies and product designs, their environmental impacts can be related to the same functional unit.

The reference must be a realistic alternative to the green solution so it is obvious that the most recent antecedent product is a reasonable reference system for the new next generation product having the same function but different performance and design. Though competitive products might also be an applicable baseline, inventory data and



process information needed are seldom publicly available. Another option for appropriate definition of reference systems is to use description of “best available techniques” (BAT) reported in sector-specific and cross-sector reference documents (e.g. BREFs issued by European IPPC Bureau; <http://eippcb.jrc.es/reference/>).

If a retrofit green solution is to be assessed modernizing an existing solution one could perform a “before - after” comparison considering impacts of the former process technology as baseline. Especially in the case of an assessment of environmental technologies like flue gas treatment the baseline consideration should be based on the actual former situation taking into account legal obligations. For example it would not be realistic and therefore not allowed to compare retrofit flue gas treatment with the former “virtual” situation of flue gas emissions without any treatment. An important aspect of the establishment of an environmental baseline is the consideration of important stakeholder’s interpretation of environmental care. If stakeholders do not agree it is risky to claim environmental care.

Reference technology for the flue gas treatment of sinter off-gas has carefully been chosen to be the Airfine® process. Figure 5 illustrates the reason for justifying Airfine® as an appropriate reference process because both process technologies are having the same function to treat sinter off-gas by removing dust particles and other waste gas components. The Airfine® process also complies with regulations for off-gas. The product of the sinter plant provides the functional unit (1 ton sintered ore).

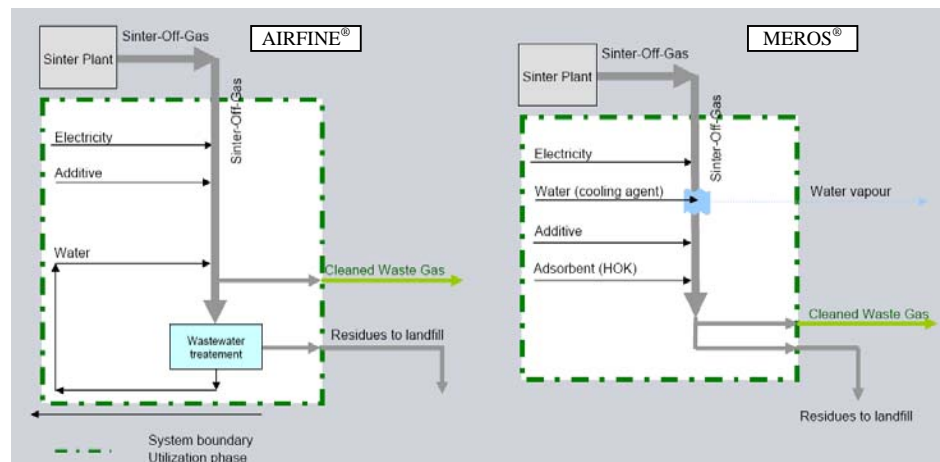

Figure 5: AIRFINE® system and MEROS® system with system boundaries

### 3 Results

The life cycle impact assessment of the different dedusting product systems reveals environmental impacts in five selected impact categories. The following impact categories have been selected:

- Abiotic resource depletion potential (ADP)
- Eutrophication potential (EP)
- Photo-chemical ozone depletion potential (POCP)
- Global warming potential (GWP)
- Acidification potential (AP)

The selection of the impact categories reflects goal and scope of the comparison of product systems dedicated to dedusting and desulfurization of sinter off-gas by applying additives (water, lime and sodium bicarbonate) and electrical power. Figure 6 shows the impact indicator results in each of the selected impact categories. Compared to the

baseline process AIRFINE® the MEROS® process with additive hydrated lime shows the lowest environmental impact with respect to global warming (GWP), resource depletion (ADP) and eutrophication (EP). MEROS® with sodium bicarbonate (NaHCO<sub>3</sub>) as additive leads to higher environmental impacts in these impact categories due to fact that it bears increased upstream environmental burdens compared to lime though it consumes less electrical energy per functional unit (4.83 kWh/ t sinter for additive hydrated lime – 3.63 kWh/ t sinter for additive sodium bicarbonate). Looking at the impact categories of photochemical ozone creation and acidification MEROS® with hydrated lime as additive reveals an increased desulfurization potential due to higher separation process efficiency compared to AIRFINE®. If sodium bicarbonate substitutes hydrated lime as additive the degree of SO<sub>2</sub> separation can further be increased from 55% up to 90% removal. This takes additional resources of about 63% more NaHCO<sub>3</sub> per functional unit compared to the conventional SO<sub>2</sub> separation degree of 55%.

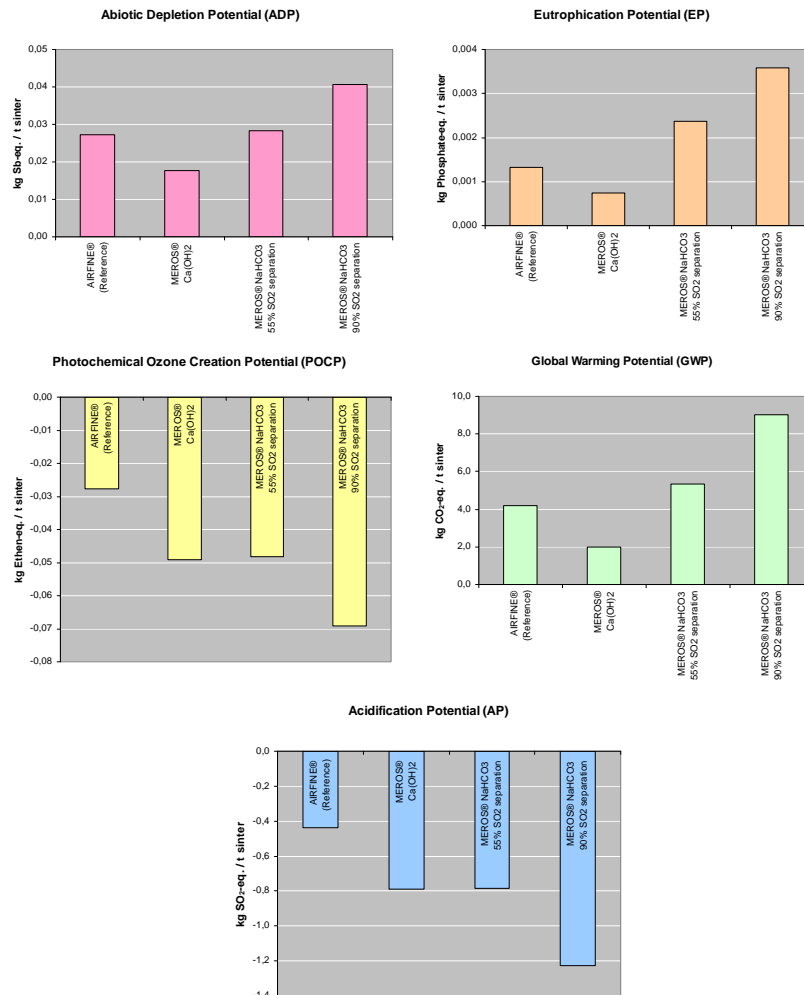

Figure 6: Category indicator results for selected impact categories derived from life cycle impact assessment for the different product systems (characterized acc. to CML 2001, Dec. 2007)

To derive an aggregated value across all selected environmental impact categories the impact indicator results have been normalized using the CML normalization values in the GaBi software tool (GaBi: “Ganzheitliche Bilanzierung”). As mentioned previously it should be kept in mind that weighting and aggregation of indicator results may cover effects of trade-offs between impact categories. Figure 7 illustrates the comparison of normalized indicator results for the test case of dedusting product systems.

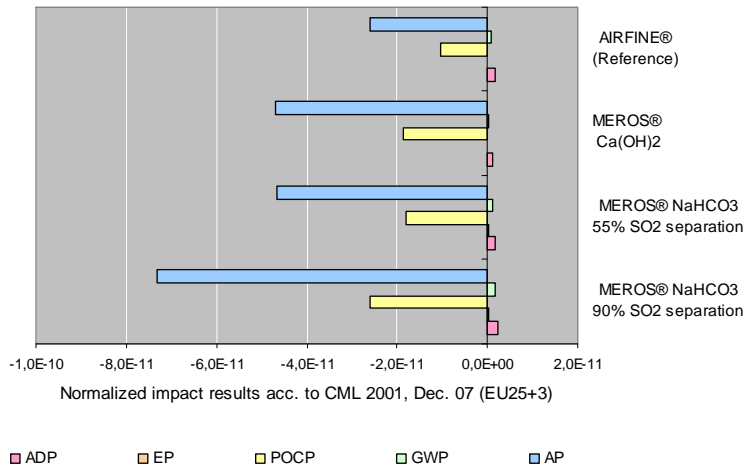

Figure 7: Profile of normalized indicator results for selected impact categories according to CML 2001, Dec. 2007 (spatial normalization to European area (EU25+3))

For presentation and illustrative purposes the normalized indicator results are aggregated across the five selected impact categories by equally weighting in order to derive a single environmental score. In figure 8 the result for such an aggregation is used to place the different product systems on the y-axis. Additionally to the environmental benefit information customer benefits of the product system is reflected by the total cost of ownership on the x-axis.

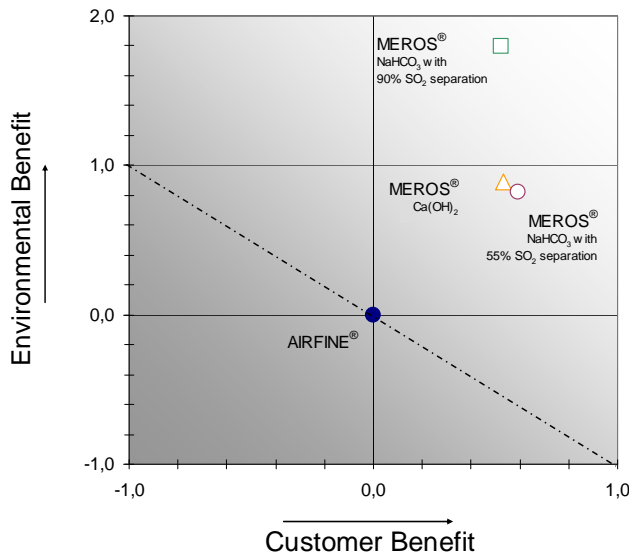

Figure 8: Eco-Care-Matrix representation of aggregated single scores based on five different selected environmental impact categories (aggregated with similar weighting of normalized indicator results)

The Eco-Care-Matrix in figure 8 delivers decision supporting information about the different dedusting product systems at a glance but it may hide the full extent and ramifications of the underlying life cycle impact assessment results because of the aggregation of several impact categories. Trade-off effects between the impact category indicator results as illustrated in figure 6 are not visible anymore in this aggregated view. This could cause incorrect decision-making and also “green washing” criticism by stakeholders. In order to provide the appropriate extent of information it is recommended according to ISO standard 14044:2006 to make data and indicator results or normalized indicator results reached prior to weighting available.

Figure 9 delivers an appropriate ECM representation of multiple environmental indicator results avoiding aggregation to a single score. For each single impact category the relative changes compared to the reference is illustrated. The enlarged detail of the Eco-Care-Matrix comprehensively provides information about the environmental profile of each of the product systems under consideration. For example the MEROS<sup>®</sup> with hydrated lime additive provides environmental benefits in all considered impact categories compared to the baseline AIRFINE<sup>®</sup>. The length of the interval between the lowest and highest indicator result for given product system (indicated with a white arrow in figure 9) represents the potential range of environmental trade-off or shifting effects between different impact categories and thus provides the reader with the entire extent of information needed for decision-making.

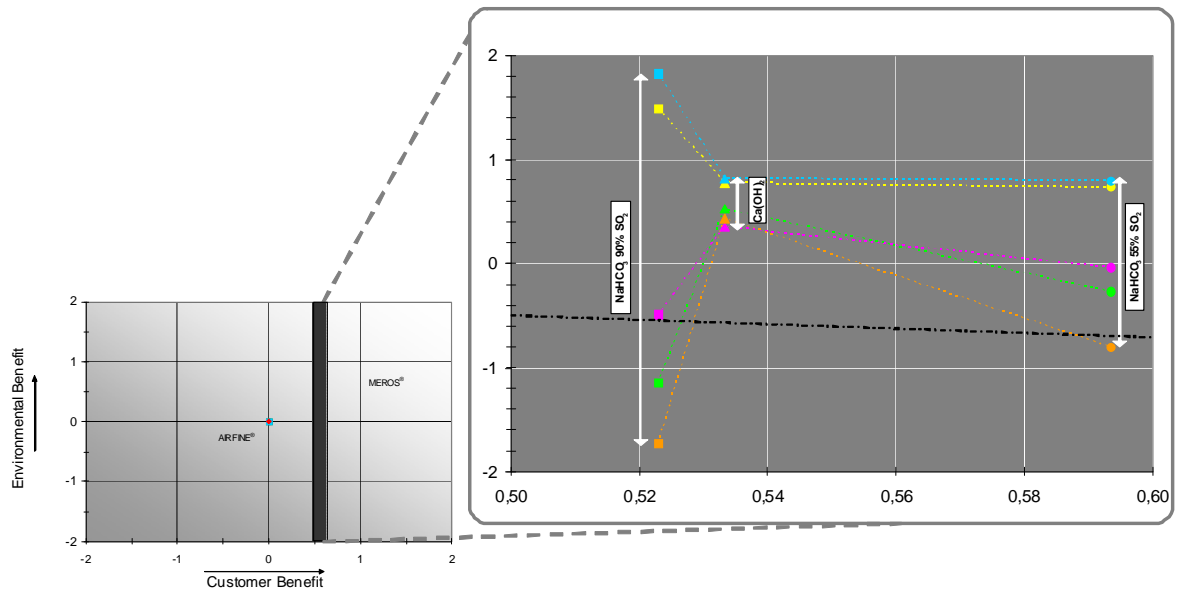

Figure 9: Multiple indicator representation in Eco-Care-Matrix for selected impact categories comparing different MEROS<sup>®</sup> product systems to baseline AIRFINE<sup>®</sup>

ADP = '●'; EP = '●'; POCP = '●'; GWP = '●'; AP = '●'

Used additives Ca(OH)<sub>2</sub> = '△'; NaHCO<sub>3</sub> with 55 % SO<sub>2</sub> separation = '○';

NaHCO<sub>3</sub> with 90% SO<sub>2</sub> separation = '□'

It is clear that the aggregated single score for the environmental impacts presented in figure 8 provides an easy overview of the systems, whereas it may be more difficult to interpret the variation of results between impact categories obtained by the more detailed presentation in figure 9. But it is also clear that the aggregated single score to some extent is misleading in their presentation of the sodium bicarbonate environmental impacts since it does not illustrate the potential problem shifting or trade-off between EP (eutrophication potential) and POCP (photochemical ozone creation potential) for the benefit of global warming (GWP) and acidification (AP). This is much better observed in the multiple impact category presentation in figure 9. Presentation of this type of trade-offs is important in many cases to be aware that the avoided environmental problem is not overshadowed by environmental impacts induced. For example is it generally seen that environmental technologies (cleaning and abatement) helps remediate one environmental problem through the consumption of energy or that providing a higher energy efficiency in the use phase may cause higher environmental impacts during production (e.g. depletion of scarce resources). In order to raise awareness of the consequences of decisions taken it is therefore advocated that presentation of results cannot be solely done by the single score indicator.

## 4 Conclusion & Discussion

The Eco-Care-Matrix (ECM) simply visualizes the eco-efficiency of solutions compared to a given baseline. In order to prevent from “green washing” criticism and to ensure “walk the talk” attitude the ECM should be scientifically well-founded using appropriate and consistent methodology. The vertical axis of an ECM illustrates the environmental performance and the horizontal axis describes the economical customer benefit of one or more green solutions compared to a defined reference solution. Different scientific approaches for quantifying the environmental performance based on life cycle assessment methodology have been discussed especially considering the ISO standards 14040/14044:2006.

Since the assessment of different alternatives only makes sense in a comparative setting it is chosen to let the ECM present results relative to a reference technology. The proper choice of a reference technology is therefore a necessary prerequisite to be able to use the ECM. If the ECM should really represent the potential improvement of the new technologies the reference technology must represent a realistic alternative technology performing the same function, e.g. the current generation of technology being produced by Siemens. The choice of Airfine<sup>®</sup> in the study complies with all requirements to a reference technology.

As illustrated with the single score vs. multiple score presentation there is a strong need for using multiple rather than single scores in order to improve decision making since the single score may hide relevant potential environmental impacts. The use of aggregated single score result may cause intransparency of shifting and trade-off effects between different impact categories and lifecycle phases.

## 5 References

- [1] D. Wegener et al., Comprehensive approach to energy and environment in the Eco Care Program for design, engineering and operation of Siemens Industry Solutions, Paper at Risø Int. Energy Conference 14-16 September 2009
- [2] Standards ISO 14040 / 14044:2006 and ISO 14021
- [3] Siemens Environmental Product Declaration about MEROS<sup>®</sup> available in internet:  
[http://is.industry.siemens.com/broschueren/pdf/metals/simetal/en/Environmental\\_Product\\_Declaration\\_SIMETAL\\_MEROS\\_en.pdf](http://is.industry.siemens.com/broschueren/pdf/metals/simetal/en/Environmental_Product_Declaration_SIMETAL_MEROS_en.pdf) (accessed on 14.02.2011)
- [4] Pressemitteilung von voestalpine 2007 über die erste Inbetriebnahme der MEROS Technologie in Linz (als Ersatz für das seit 1993 eingesetzte Feinabscheidesystem Airfine<sup>®</sup>):  
<http://www.voestalpine.com/group/de/presse/presseaussendungen/MEROS.html>
- [5] K. Hofstadler et al., Solutions for Dioxin Removal from Sinter Plant and EAF Offgas (2003), available in internet:  
[http://www.steelplantequipment.com/pi/518/394\\_VAIDioxinPaperwithfigures.pdf](http://www.steelplantequipment.com/pi/518/394_VAIDioxinPaperwithfigures.pdf) (accessed on 14.02.2011)

# Intelligent Urban Heating

By Anders Dyrelund, Chief Advisor and Market Manager, Rambøll Energy

## Abstract

In smart cities District heating is a precondition for large scale and cost effective integration of CHP and renewable energy for heating in urban areas. In particular, district heating systems combined with CHP, heat pumps, electric boilers and large thermal storages is important for efficient integration of fluctuating wind energy.

In order to develop an intelligent and cost effective urban heating system it is important to integrate and optimize the total urban heating energy system including building envelope, heating installations, district heating networks, heat storages and renewable energy sources. Two examples: 1) the variable long term production cost is a basic parameter for the optimal building envelope. 2) efficient low temperature heating installations increases the efficiency of the district heating distribution network and all the low temperature heat sources.

Besides, in districts with a cooling load, it is important to include the district cooling in the optimized energy system, both for production and end-use.

In EU countries, the Renewable energy directive encourage all local authorities to plan for urban heating and cooling in order to provide the buildings with renewable energy for heating hot tap water and cooling via this infrastructure, whenever it is cost effective compared to individual solutions.

Rambøll has in association with Aalborg University prepared an updated study of Heat Plan Denmark in 2010. The study demonstrates how the Danish Heating sector has reduced the fossil fuel consumption to 40% from 1980 to 2010 and how the sector can be independent of fossil fuels before 2030 in a cost effective way.

The study concludes that it is necessary to optimize investments both at the supply and the demand side. It is estimated that an optimal combination could be 25 % additional heat demand reduction, further reduction of the return temperature in the building installations, expansion of district heating from 50 to 65 %, local heating up to 5% and heat pumps for the remaining 30% heat market.

The heat supply act from 1979 has been the driving force for this development since 1980. It has obviously been a model for the Renewable Energy Directive. In order to continue and develop a CO<sub>2</sub> neutral heating sector in a cost effective way, the study strongly recommends that local authorities shall be responsible for strategic energy planning taking into account all costs of the energy systems including the end-users. Moreover it will be necessary to adjust the building code in such a way that it supports the cost effective solutions taking into account the result of the urban heat planning.

The study demonstrates the concept of smart cities with intelligent grids for electricity, district heating and district cooling.

The intelligent power grid can distribute renewable energy from efficient off shore wind energy farms to the cities, which is much more cost effective than wind turbines and solar cells in the cities. Dynamic tariffs encourage consumers to use electricity when the price is low and not to use it for days when the price is high. Thus, the District Heating and District Cooling grids with storages are among the most intelligent consumers. The district heating grid can distribute heat to any building in the city strategic located CHP plants and renewable sources in and near the city. That includes storage of heat from large scale solar panels and surplus energy via heat pumps from fluctuating wind.

# 1 Energy policy and EU directives

The year 2009 was a mile stone in our efforts to reduce the consumption of fossil fuels in a cost effective way. COP15 in Copenhagen was – although the overall climate agreement failed - a wake-up call for many, as the most dominating countries signed the Copenhagen Accord and started to act.

This counts in particular for the EU member states. In May 2009 EU agreed on a very ambitious directive for Renewable Energy and in 2011 EU submitted Energy Efficiency Plan 2011.

EU has launched the idea of Smart Energy Cities in which energy is used efficiently in intelligent grids for electricity, heating, cooling and natural gas.

As regards urban heating we have two important directives, which are co-ordinated with the overall aim to provide a good indoor climate taking into account the local conditions **at the lowest costs** and at almost zero use of fossil fuels.

The Renewable Energy Directive states for example:

- that member states shall elaborate national actions plans for renewable energy
- that local authorities shall consider district heating and cooling for more efficient use of renewable energy and
- that buildings shall be almost independent on fossil fuels taking into account the more efficient use of renewable energy via district heating and cooling if feasible.

The Building Directive states likewise that the energy consumption in buildings shall be reduced in a cost effective way taking into account possible use of CHP, block heating, district heating and individual sources.

A third important directive is the Directive on Strategic Environmental Assessment. Although this directive is not directly for energy, it can be applied. The directive states that all sectors shall be involved in all Plans, Programs, Projects and Policies to ensure that they are to the benefit for the whole society. In other words: Break Down Barriers between ministries. Once this directive is fully implemented it should not be allowed to invest in condensing power plants as long as there still is a CHP potential.

## 2 Denmark a front runner

In Denmark we got our first wake-up call already in 1973 during the first oil crisis, and we took action passing new legislation:

- The electricity supply act in 1976 giving the power to the Minister to approve all power plants and to refuse approval of plants, which were not located and designed for use of CHP and
- The heat supply in 1979 giving the obligation to all municipalities to plan for heating in order to develop the most cost effective urban heating energy infrastructure, that is to find an optimal zoning between district heating based on CHP and renewable and natural gas boilers.

Therefore the Danish society has a long tradition in energy planning and energy efficiency measures which has reduced the fuel consumption in the heating and electricity sectors significantly. In the past 30 years the Danish energy consumption has been stable although the GDP has doubled. At the same time Denmark has explored oil

and gas in the North Sea. Being net-exporter of energy in the past years we have more than fulfilled our first energy policy objectives. However the strong energy policy continues.

Today there is a general agreement in the Danish Parliament that Denmark shall go one step further and be independent on fossil fuels in 2050. To underline this policy, the Danish Climate Commission announced September 2010 how this can be done at no cost compared to realistic alternatives.

There are three major reasons for this strong energy policy:

- to reduce climate gas emissions
- to reduce the dependency on fossil fuels
- to maintain and strengthen Denmark's position as a front-runner in energy efficiency

According to the Climate Commission, the main measures to be net independent on fossil fuels should be:

- to promote the cost effective solutions and to stimulate market forces
- to increase the share of wind power from to-days 20 % to around 70 %
- to replace fossil fuels by biomass
- to increase the market share of district heating and to install individual heat pumps with some accumulation capacity for the rest of the heat market
- to increase the use of solar heating, geothermal heating and large heat pumps in the district heating sector

A result of the strategy it seems that the role of the natural gas grid will be dramatically changed. In 2050 there will be little or no natural gas for individual heating, as the market will be divided between district heating and heat pumps. Instead the gas grid can be used to transfer biogas and the gas can be stored in seasonal storages to be available for CHP plants to produce electricity and heat when there is lack of wind energy.

### **3 Heat Plan Denmark 2010**

On this background Ramboll and Aalborg University submitted September 2010 an updated version of Heat Plan Denmark from 2008.

The Report, which is financed by the district heating consumers in Denmark through their R&D fund, confirms that the heating sector can be almost independent of fossil already in 2030.

The plan confirms that it is a good idea to increase the market share of district heating from 50% to around 65% in order to implement surplus heat and renewable energy in a cost effective way and that individual heat pumps with some storage capacity is the best solution for the remaining individual heating.

The plan demonstrates that the "intelligent" district heating grid and to some extent also district cooling will play an important role to integrate the very large market share of wind energy into the energy system in a cost effective way. That is by optimizing



biomass CHP, heat pumps, electric boilers and large thermal storages in accordance with the fluctuating wind and the market prices for electricity.

We can say that the district heating system can become – and to some extent already is - an intelligent electricity consumer. It can utilize the existing power grid and offer:

- to consume huge quantities of electricity when the price is very low
- to avoid consumption or even to produce electricity for longer periods (even weeks) when the electricity price is high and
- to regulate the consumption and production of electricity with short notice

The plan also underlines that it is important to promote the cost effective energy saving measures in the building sector and that the long-term optimal measures are basically the same for district heating and individual heat pumps. That is:

- an optimal building envelope
- an integrated low temperature heating system with low return temperature and
- a modest demand for maximal supply temperature

It is in particular important for new individual heat pumps that these investments in the building envelope and the heating installations as well as the capacity of the heat pump are optimized from day 1. For district heating it is more important to connect all consumers from day 1 and then gradually improve the energy performance of the buildings along with building renovations.

We can conclude that district heating and individual heat pumps have major similarities and same response to the building: if the building can accept low temperature heating, this thermal energy can be provided at a rather low variable cost.

Therefore, once there is invested in an efficient urban heating infrastructure in the city and in heat pumps in individual buildings outside the urban areas, the investments in the buildings shall be balanced between optimal modest insulation and a low temperature heating system, e.g. floor heating. One more advantage is that floor heating can be used for cooling in the summer.

Heat Plan Denmark provides specific recommendations to the central administration, local authorities and district heating companies on how to implement the policy, e.g.:

- that the government should establish an inter ministerial task force for implementing the energy policy to ensure coordination between ministries in line with the EU directive on strategic environmental assessment
- that the local authorities should give high priority to strategic energy planning with the aim to minimize the total costs for the society for providing energy services taking into account all sectors and regional aspects
- that the district heating companies should undertake and implement business planning to identify the best strategies to meet the objectives of providing the end-users with thermal comfort at the lowest costs, including to help consumers to improve the energy performance of the buildings

- that the building code should be strengthened with the aim to minimize the (primary) energy consumption in buildings at the lowest costs taking into account the options of district heating and cooling in line with the EU directives, that is both for new buildings and for renovating old buildings

The reason for the last bullet has a special back ground, as the current building code in Denmark is in contradiction with both the Heat Supply Act and all the EU directives. If it is not modified, it will undermine the intelligent energy infrastructure and force building owners to invest in inefficient and too expensive energy production and building envelope.

Finally the plan includes an update of the energy balance of the heating sector from 1980 to 2010 as well as estimates for the development up to 2050, see figure 1-4.

For countries which are in the beginning of the heat planning process the development from 1980 to 2010 could be of special interest as it proves at national scale the importance that local authorities takes responsibility for the urban heating being a natural part of the urban infrastructure. The same can be said about district cooling.

Therefore the Danish Case indeed justifies the requirements in the EU Renewable Energy Directive and Building directive.

Further information:

Anders Dyrelund

+45 51 61 87 66

ad@ramboll.dk

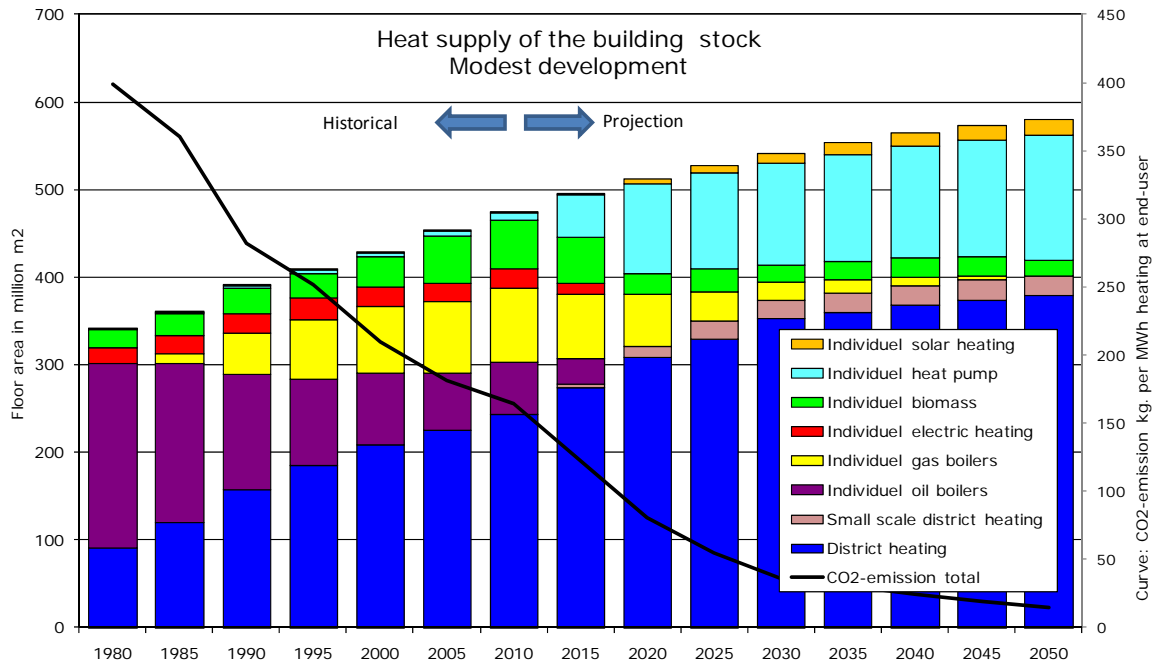

Fig. 1: How to supply a growing heated floor area

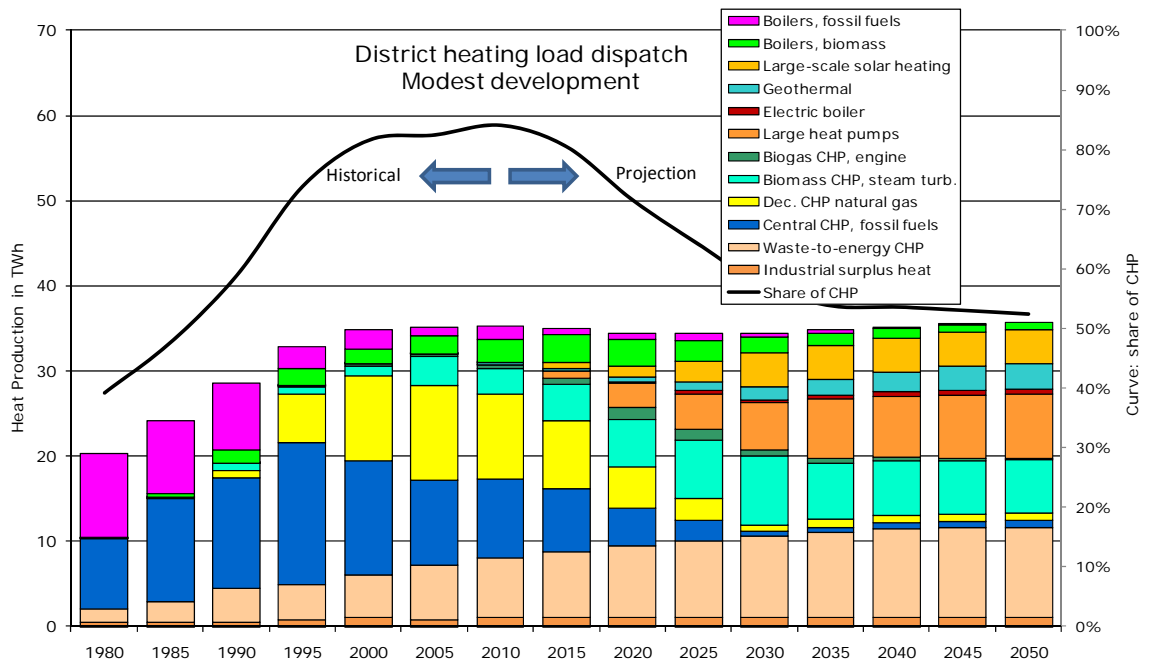

Fig. 2. Taking into account estimated end-user savings and more efficient networks the production demand will be almost constant. The number of heat sources increases and the share of CHP decreases as CHP plants and large heat pumps combined with large storages will integrate the fluctuating wind. Seasonal thermal storages will transfer surplus heat from summer to winter.

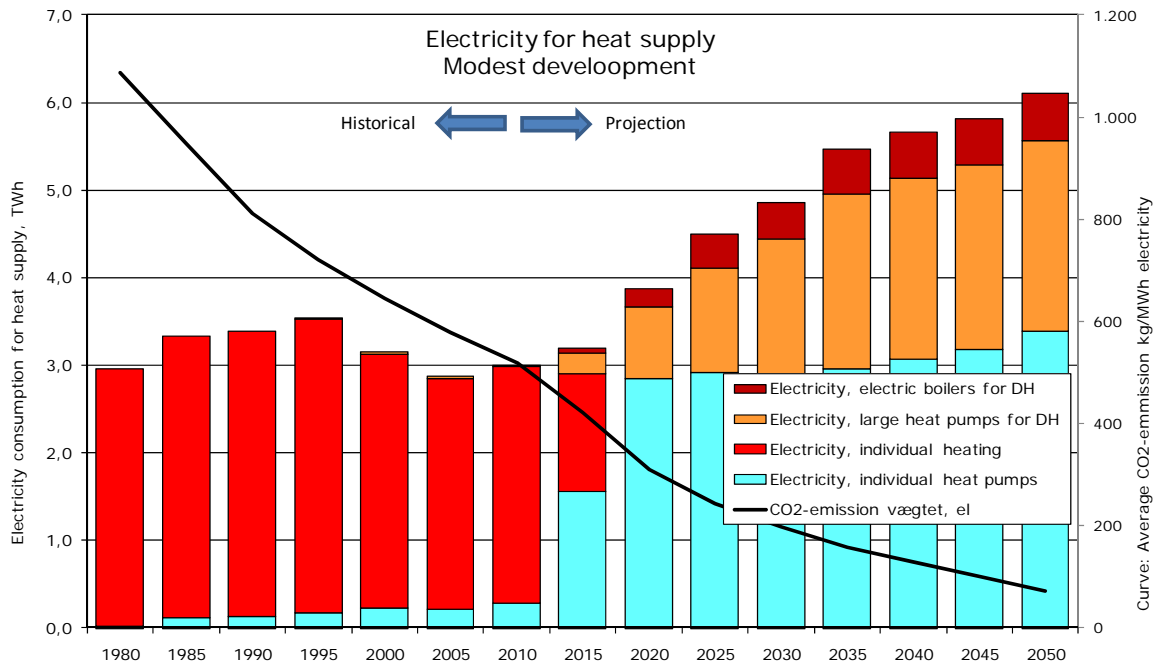

Fig. 3 The consumption of electricity for heating will be doubled according to Heat Plan Denmark. There will be a transformation from electric heating to more intelligent use of electricity for individual heat pumps with small storage capacity and for large district heating heat pumps and electric boilers, which only use surplus electricity at low prices.

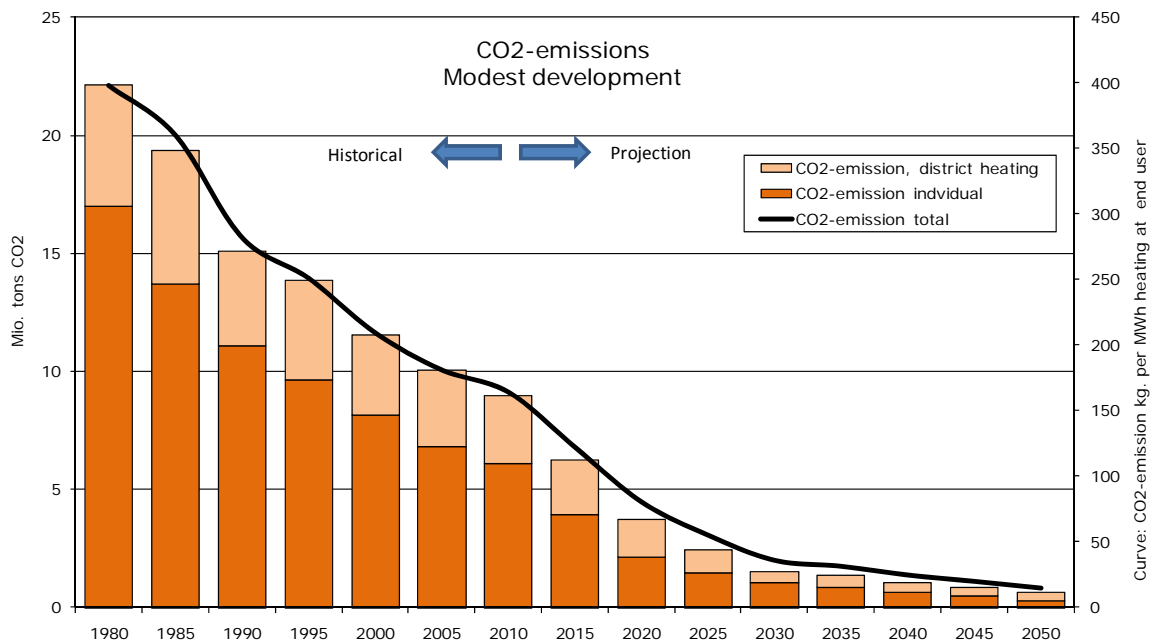

Fig. 4. The total CO<sub>2</sub> emission for heating in Denmark: statics from 1980 to 2010 and Heat Plan Denmark forecast from 2010 to 2050. The diagrams confirm that the district heating and CHP has been the main contributor to the significant reduction of CO<sub>2</sub> emissions from 1980 to 2010

## Session 5A - Wind Energy I

# Trends in Wind Energy Technology Development

Flemming Rasmussen, Peter Hauge Madsen, Risø DTU, Denmark

John O. Tande, Sintef, Norway, Gijs van Kuik, TU Delft, Netherlands

## Abstract

Text Over the past 25 years global wind energy capacity has doubled every three years, corresponding to a tenfold expansion every decade. By the end of 2010 global installed wind capacity was approximately 200 GW and in 2011 is expected to produce about 2% of global electricity consumption.

The huge potential of wind, the rapid development of the technology and the impressive growth of the industry justify the perception that wind energy is changing its role to become the future backbone of a secure global energy supply.

Between the mid-1980s, when the wind industry took off, and 2005 wind turbine technology has seen rapid development, leading to impressive increases in the size of turbines, with corresponding cost reductions.

From 2005 to 2009 the industry's focus seems to have been on increasing manufacturing capacity, meeting market demand and making wind turbines more reliable. The development of new and larger turbines to some extent stagnated, and costs even rose due to high demand and rising materials costs.

We believe, however – and this is supported by recent trends – that the next decade will be a new period of technology development and further scale-up, leading to more cost-effective, reliable and controllable wind turbines and new applications. This is partly due to increased international competition, but also because the industry is increasingly dominated by high-technology international companies. The move to install more capacity offshore also favours larger wind turbines and encourages new ways of thinking.

In this paper we discuss the current status of wind power and its prospects up to 2050, including both existing and emerging technologies.

## 1 Wind 2011

Studies of the exploitable wind resource [1], [2], [4], [5] demonstrate that wind energy is a practically unlimited and emissions-free source of energy, of which only a tiny fraction is currently being exploited.

While the estimates differ by almost an order of magnitude, even the most conservative, such as the 2008 estimate by REN 21 [5], show that the world's expected electricity consumption in 2050 of 31.000 – 46.000 TWh/y could be delivered by wind energy several times over. The potential of onshore wind is thus almost 110.000 Twh/y, even with conservative assumptions about resource and land availability.

The average cumulative growth rate over the last five years has been 27.8%. While in the USA and many other countries the industry was encouraged by stimulus packages, the main growth came from China, which in 2010 installed almost 19 GW. In this light, assumed growth rates of 10–20% for the next 20 years do not seem overly optimistic.

Until the 1990s a great variety of different wind turbine concepts were tested and manufactured. These included turbines with one or two blades, stall-controlled designs, and vertical-axis turbines. In contrast, the typical wind turbine being installed today (2011) is a three-bladed, upwind, pitch-controlled, variable-speed machine connected to the electrical grid, with a capacity of 1.3–1.5 MW in Asia and 1.9–2.6 MW in Europe and the USA [6].

Mainstream technological development for land-based utility-scale wind turbines is now characterised primarily by scale-up (until 2005 the size of turbines doubled every five years), and turbines in the range 7 – 10 MW are being developed at the moment, mainly for offshore application. But though most wind turbines now look similar on the outside, manufacturers have introduced new materials, control principles, generator and converter technologies. Together with the technical challenges associated with scale-up, these developments have called for advanced research in a number of fields.

## 2 Industry trends and costs

Industrial wind turbine technology was originally developed primarily by small companies in Europe and the USA working closely with research organisations. Though this development gradually attracted attention from established industrial manufacturers, the original small companies had made considerable progress in diversification, turbine scale-up and deployment before some of them were taken over by multinational energy companies (GE, Siemens, Alstom), while others (Vestas) grew by merging with competitors of similar size.

In Asia, new players initially licensed technology from Europe, but quickly went on to develop their own wind turbines.

Wind turbines are based on a unique combination of technologies, and are gradually becoming increasingly sophisticated. The amount and diversity of research carried out will determine how far wind turbine technology will develop. Wind turbines are complex machines, and in technical terms there are no limits to how far they can be improved.

However, diminishing returns may cause the industry itself to limit future technological improvements. Whether or not this happens depends very much on the future structure of the industry, and the ability of turbine manufacturers, R&D specialists and legislators to work together to ensure that the industry remains vital, dynamic, innovative and competitive.

Up to 2005 the industry has seen learning rates of 0.09–0.17 (in other words, a doubling of cumulative installed capacity reduces the cost of electricity per kWh by 9–17%) (Figure 1) [3].

From 2005 to 2009 installation was limited by manufacturing capacity, higher material costs and higher margins for manufacturers, with the industry focused on increasing production capacity and improving reliability.

In the future we expect changes in industry structure and increased competition to accelerate technological development, and we see no reason to expect a learning rate of only 10% as assumed in [3] and Figure 1.

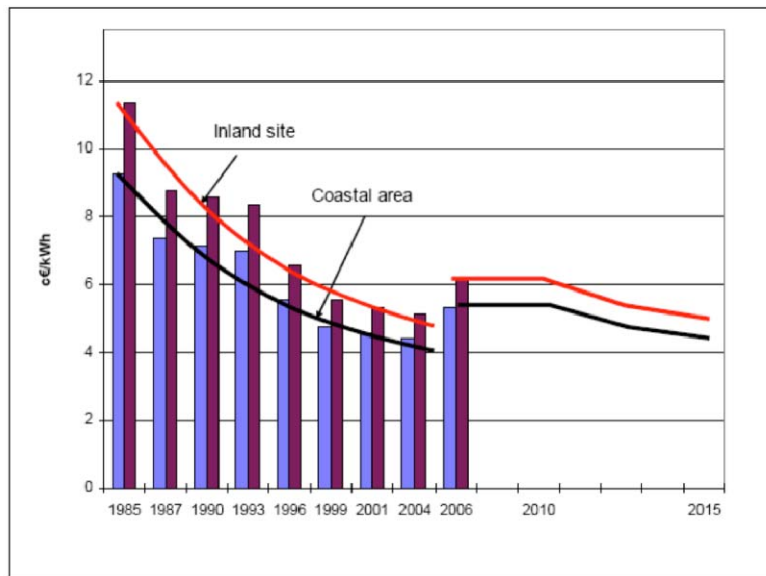

Figure 1: Using experience curves to forecast wind energy economics up to 2015. The costs shown are for an average 2 MW turbine with a present-day production cost of euro €6.1/kWh in a medium wind regime (from [3])

### 3 Technology trends

#### Mainstream technology

The 30-year development of wind energy technology, with its focus on reducing the cost of energy, has seen the size of the largest turbines increase by a factor of 100, from roughly 50 kW to 5 MW.

This is in spite of a theoretical limit to the maximum size of a wind turbine. As a wind turbine increases in size (while keeping the same proportions) its energy output increases as the square of the rotor diameter, but its mass increases roughly as the cube of the rotor diameter (the “square-cube law”). As the mass increases, the mechanical loads imposed by gravity increase even faster, until the point where the materials available are not strong enough to withstand the stresses on the turbine.

So far, engineers have avoided the limits of the square-cube law by avoiding direct geometrical similarity, using materials more efficiently, and using stronger materials. Perhaps most importantly, designers have tailored the responses of turbines ever more carefully to the conditions under which they operate, and this remains one of the main ways to reduce the cost of energy from future turbine designs.

Issues of geometry notwithstanding, several factors favour larger turbines. At some point, however, it seems fair to assume that at some point the cost of building larger turbines will rise faster than the value of the energy gained. At this point scale-up will become a losing economic game.

As a result, it is important also to look at other ways to cut costs. This can be done, for instance, by introducing cheaper technology or by increasing the amount of energy captured by a rotor.

Conventional wind turbines use gears to match the slow speeds of the blades and hub to the higher speeds required to drive a standard induction generator. It has been known for many years that a multi-pole generator, which can run at slower speeds, offer the chance to eliminate the gearbox. Early multi-pole generators were large and heavy, but newer permanent-magnet designs, in which the rotor spins outside the stator, are compact, efficient and relatively lightweight. The next generation of multi-MW gearless wind



turbines is expected to create a step change in the industry, followed by further gradual cost reductions as with previous turbine types.

### Lightweight blades

As described above, geometrical similarity says that as blade length increases, blade weight should increase with an exponent of 3 (a cubic law). In fact, several studies have shown that over recent decades the actual exponent has averaged around 2.3, and for the most recent blade designs it is 2.2 or 2.1 (Figure 2).

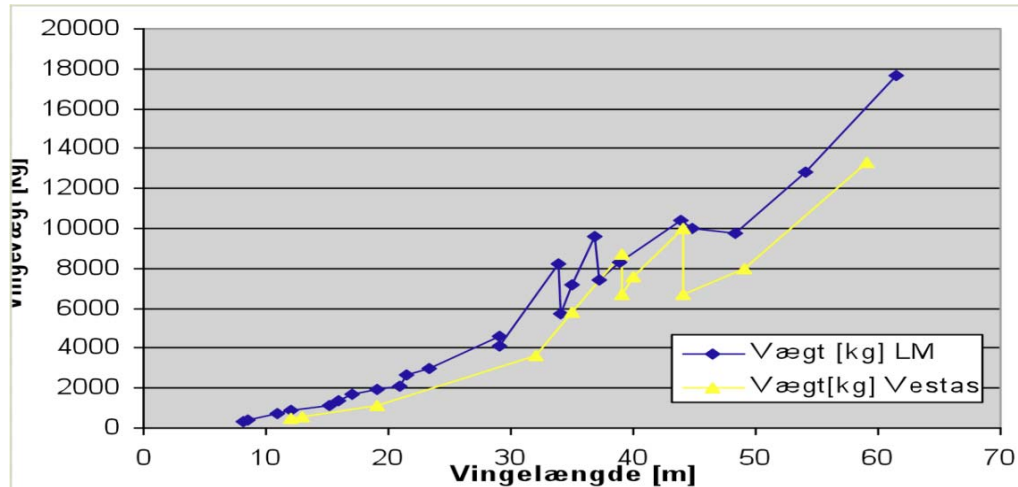

Figure 1: New technology and better design means that new blades are much lighter than simple geometry would predict, based on the weight of older blade designs

Many factors have aided the move to lighter blades, of which the most important has been the development of blades that are much thicker than their predecessors, especially near the hub. Because they are stiffer at the point where the loads are highest, these new blade designs make more efficient use of materials and are lighter overall. This principle can continue to produce even larger blades that beat the square-cube law as long as it is backed by the necessary R&D into better design methods, new materials such as carbon fibre, and advanced manufacturing techniques.

One potential drawback to using thicker airfoil shapes at the blade root is a loss of aerodynamic efficiency. The answer may lie in high-lift designs such as multiple airfoils for use at the blade root (Figure 3), or the newly-developed “flat-back” airfoil, which can maintain lift even when it is very thick.

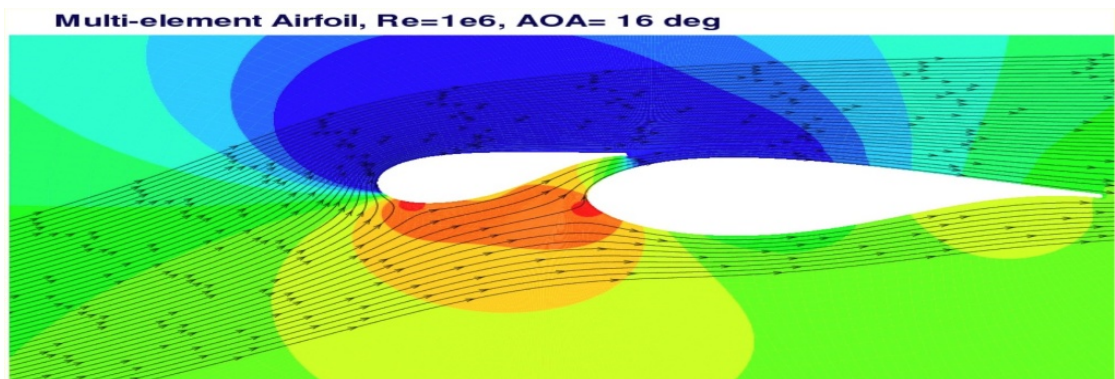

Figure 3: Multi-element airfoil to enhance lift (CFD simulation, Risø DTU)

Another way to cut the cost of wind energy is to increase blade length while reducing the fatigue loading on the blade. There can be a big payoff in this approach because material consumption is approximately proportional to fatigue loading.

Fatigue loads can be reduced by controlling the blade's aerodynamic response to turbulence. This is already done actively via the turbine's pitch control system, which turns the complete blade, and future turbines may also feature movable control surfaces distributed along the blades.

An especially elegant idea is to build passive ways to reduce loads directly into the blade structure. Using the unique attributes of composite materials to tailor its structural properties, for instance, a blade can be built in a way that couples its bending and twisting deformations.

Another way to achieve this "pitch-flap" coupling is to build the blade in a curve so that fluctuations in the aerodynamic load produce a twisting movement which varies the angle of attack [7]. It should also be possible to vary the lift produced by the blade by altering the camber of the airfoil in response to flap-wise deformation, as birds' feathers do. Such complicated blade motion will require a very good understanding of wind turbine aerodynamics and materials science.

Innovative systems of trailing edge control could considerably reduce the fatigue loads on blades. These are now being developed in projects involving European research institutions and industry, including the large EU-funded UpWind project.

As well as reducing loads, such advanced multi-control options could help to improve turbine performance and tune the turbine's operation to the conditions on site. For instance, a laser ranging (LIDAR) system mounted on the turbine could measure upstream wind speed and detect turbulence before it arrives at the turbine, giving an active control system more time to respond.

Indeed, aiming for cost reductions is not only a question of improving the rotor and generator as elaborated on here. The life-cycle cost of energy from an offshore wind farm comprises of the wind turbines, installation and substructures, grid and O&M as the four dominating parts (Figure 4). Hence, for cost reductions, a broad approach must be taken, addressing wind turbine technology, but also sub-structures, grid and O&M.

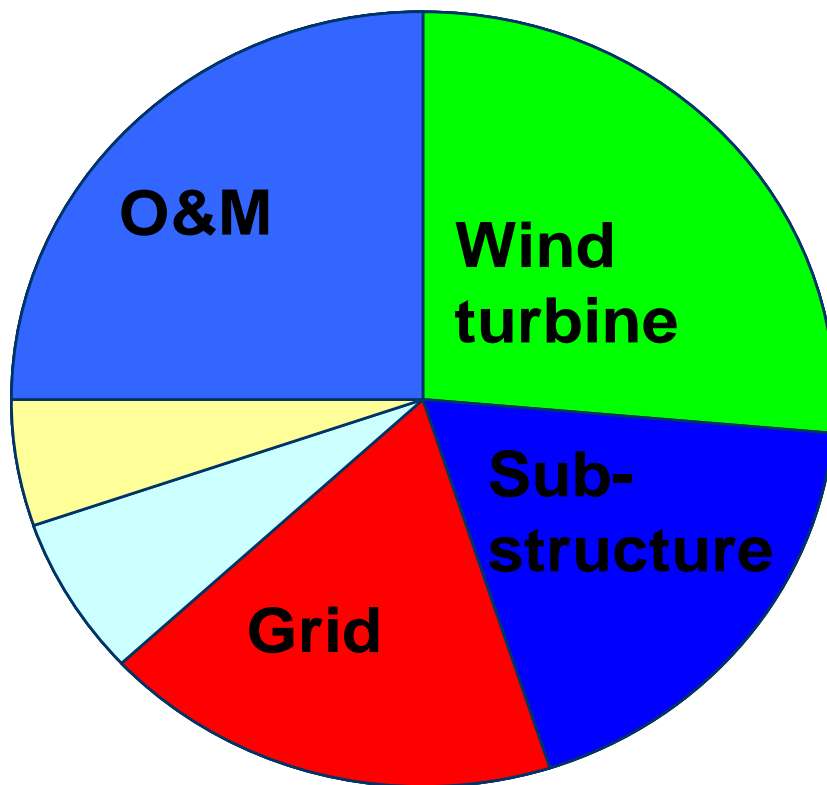

Figure 4: Example life-cycle cost of energy distribution for offshore wind farm (SINTEF Energy Research)

#### Emerging technologies

Most of the development effort so far has been dedicated to an evolutionary process of scaling up and optimising the land-based three-bladed standard wind turbines which first emerged as commercial products at the beginning of the 1980s.

To the original design have since been added individual blade pitch control, variable speed and other refinements to match the increasing size of turbines; increasingly stringent requirements for performance and reliability; and adaptations for use offshore.

One example of a technical development is “negative coning”, in which the blades point slightly forward; this increases the clearance between the blades and the tower, and also improves stability for very flexible blades. Such improvements are only possible when turbine engineering goes hand in hand with the development and application of advanced simulation and design tools. Without such tools, it would not have been possible to increase the size of wind turbines by a factor of 100 in 30 years.

Offshore wind power brings new opportunities, since offshore winds are generally stronger and steadier, but represents an even bigger challenge for turbine development, operation and cost optimisation. Operating conditions offshore are very different, so what is most cost-effective onshore may need a radical re-think for use out at sea. Figure 5 shows how future offshore turbines might diverge from their land-based counterparts.

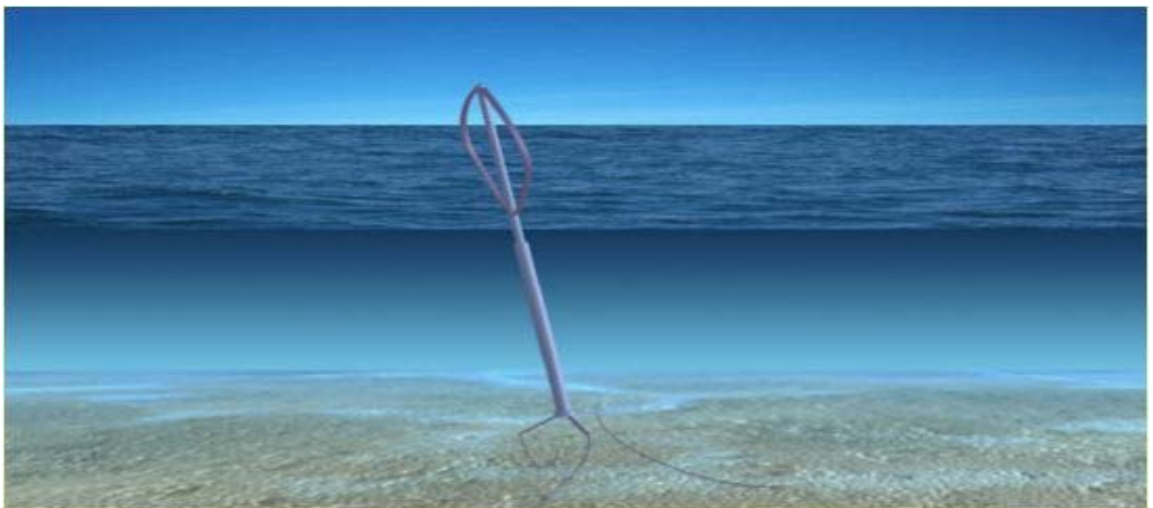

*Figure 5: Ideas for floating wind turbines: SWAY (l) and Hywind (r)*

### **New ideas offshore**

The strength of the offshore market, and the very different conditions found offshore, make it likely that completely new types of offshore turbine may emerge. An example is the vertical-axis floating turbine illustrated in Figure 6.

Vertical-axis turbines have been tried and rejected for onshore use. The logic for using them offshore runs as follows: the need to install turbines in deep water, where foundations are expensive, makes floating turbines an attractive idea. But conventional horizontal-axis turbines carry a large amount of weight at the top of the tower (high “top mass”), and this can cause balance problems for floating turbines. Vertical-axis turbines have lower top mass and do not need to turn into the wind, so large floating versions may become attractive.



*Figure 6: The Risø DTU vertical-axis floating wind turbine*

Another idea is to harvest energy from wind and waves at the same time (Figure 7). The shared supporting structure and infrastructure might create symbiosis that could accelerate the development of reliable and cost-effective wave energy solutions.



*Figure 7: The Poseidon demonstration project is a floating power plant which harvests both wind and wave energy*

## 4 Wind power in context

We have shown above that the opportunities for wind energy are enormous; they expand still further if we take into account the predictability of wind energy when studying the economics of energy investments [9].

The report Wind Force 12 [10] is based on the realistic assumption that wind power will continue to grow in the next ten years as it has over the last ten. If this is so, by 2020 installed wind capacity will be increasing at 151 GW/y, representing an annual investment of €75 billion. In this scenario wind power will produce 12% of the world's electricity requirement by 2020, by which that time is assumed to be 30,000 TWh/y compared to 18,000 TWh/y today. The technological vision of Wind Force 12 is to make wind power 40% cheaper in 2020 than it was in 2000.

In 2000, global electricity production was 15,000 TWh/y. This amount of power could be produced by a fictitious wind farm measuring 1,000 km by 1,000 km. Such an array of turbines would fit into the Great Plains of the USA and still leave 98% of the land available for agricultural use. Supplying the world's total energy needs from wind would need an area around four times bigger, and generating 60,000 TWh/y. For comparison, Wind Force 12 estimates the world's total exploitable onshore wind resource at 53,000 TWh/y, and offshore resources are huge.

Even with the predicted increases in energy demand by 2050, the idea of getting all the world's energy from the wind is still realistic in terms of the geographical area needed. This would, however, require enormous changes in our systems for converting, transporting and storing energy.

Apart from its basic role in getting electricity from wind turbines to consumers, power transmission has an important part to play in balancing local fluctuations in wind power production against fluctuations in consumption. Europe is currently placing much emphasis on strengthening and extending the transmission lines between load centres and producers, including offshore wind power plants.

Other ways to balance demand and production include wide geographical distribution of wind power plants, better forecasting of wind, demand management, and electricity storage.

## 5 Conclusions

We believe that the development of wind energy has only just begun, with respect to both technology and application.

The last 30 years of R&D have established a firm foundation for wind power. While further R&D will certainly be necessary to reduce costs and fully exploit the great potential of wind, much of the earlier uncertainty about the feasibility of wind energy has now been dispelled.

The next decade is thus shaping up as a new period of technology development and further scale-up, leading to more cost-effective, reliable and controllable wind turbines and new applications for wind power.

Increased international competition is helping to reveal the great potential that exists for wind power technology and markets. The increasing dominance of the industry by high-tech global companies and the move towards offshore favours ever-larger wind turbines and opens up new perspectives.

Finally, there is increasing awareness that renewables in general and wind energy in particular will play a major role in global energy supply as oil and gas are phased out in the period towards 2050, and the cost of coal-based energy increases, not least due to the cost of carbon capture and storage.

Wind energy has the potential to supply 30–50% of our electricity, and to do this cost-effectively.

### References

1. Global Wind Energy Outlook 2008, GWEC
2. Nitsch, F. (2007), Technologische und energiewirtschaftliche Perspektiven erneuerbarer Energien, DLR.
3. Lemming, J., Morthorst, P.E., Clausen, N-E., Jensen, P.H., Contribution to the Chapter on Wind Power Energy Technology Perspectives 2008, Risø-report Risø-R-1674(EN), Jan 2008.
4. Archer, C. L., and M. Z. Jacobson (2005), Evaluation of global wind power, *J. Geophys. Res.*, 110, D12110, doi:10.1029/2004JD005462.
5. REN21. 2008. "Renewable Energy Potentials in Large Economies – Summary Report" (Paris: REN21 Secretariat).
6. International Wind Energy Development, World Market Update 2010, Forecast 2011–2015, BTM-Consult, March 2011.
7. Ashwill 2008
8. Archer, C.L. and Caldeira, K., Global assessment of high-altitude wind power, *Energies* 2009, pp. 307–319.

9. Shimon Awerbuch, Determining the real cost – Why renewable is more cost-competitive than previously believed, Renewable Energy World, March- April 2003.
10. Wind Force 12, A blueprint to achieve 12% of the world's electricity from wind power by 2020, European Wind Energy Association & Greenpeace, May 2003.

# A high resolution global wind atlas - improving estimation of world wind resources

Jake Badger and Hans Ejsing Jørgensen

Wind Energy Division, Risø National Laboratory for Sustainable Energy, Technical University of Denmark (DTU), Roskilde, Denmark

## Abstract

Currently, policy makers and energy planners trying to tackling the challenges of climate change and seeking approaches for climate change mitigation, have no global wind resource dataset appropriate for their pressing needs. The current practice of global energy modellers is to use coarse resolution reanalysis datasets. This has the serious shortcoming that the wind energy resource is underestimated, as small scale variability of winds is missing. This missing variability is responsible for a large part of the wind resource not being captured in the analysis. Crucially it is the windiest sites that suffer the largest wind resource errors; in simple terrain the windiest sites may be underestimated by 25% for complex terrain the underestimate can be 100%.

The framework for the methodology, laid out in this paper, is a global method, which is relative fast and economical to complete. The method employs large-scale global meteorological datasets (reanalysis), which are downscaled to high-resolution wind resource datasets via a so-called generalization step, and microscale modelling using WAsP developed at Risø DTU. A new feature of WAsP allows calculation of high resolution resource maps covering extensive areas. For the purpose of downscaling high-resolution datasets surface elevation and roughness lengths need to be derived from global topography and land cover datasets. New and improved meteorological datasets and topographical datasets, in the public domain, are becoming available. All data and the tools necessary are present, so the time is right to link the parts together to create a much needed dataset.

Geospatial information systems (GIS) will be one of the significant applications of the Global Wind Atlas datasets. As location of wind resource, and its relationships to population centres, electrical transmission grids, terrain types, and protected land areas are important parts of the resource assessment downstream of the generation of wind climate statistics. Related to these issues of integration are the temporal characteristics and spatial correlation of the wind resources. These aspects will also be addressed by the Global Wind Atlas.

The Global Wind Atlas, through a transparent methodology, will provide a unified, high resolution, and public domain dataset of wind energy resources for the whole world. The wind atlas data will be the most appropriate wind resource dataset available for the needs of policy makers, energy planners and the Integrated Assessment Modelling (IAM) community.

## 1 Introduction

The current status and coverage of wind resource assessment around the world is a collection of more or less *ad hoc* studies, using a broad range of methods, and in turn providing resource products with different specifications and types. The incomplete coverage is natural enough, as wind resource assessments—usually made on a country-wide scale or smaller—have followed needs and motivations on a country by country basis, and these are very much dependent on each individual case. The broad range of methods and product types is a product of the number of centres and companies that are



engaged in wind energy assessment, and methods develop rapidly. Furthermore the degree to which wind assessment data is open and freely available, as well as the extent to which the methodology is transparent and subject to scrutiny by the wind resource assessment community, is also disparate.

Because of the incomplete assessment of wind resource over the world, policy makers and energy planners have been forced into using coarse resolution global reanalysis data to estimate wind resources. This has a very serious drawback in that the coarse resolution leads to an erroneous negative bias in the wind resource. Consequently the role of wind energy in the future energy mix may be downplayed, with grave implications for modelling approaches to climate mitigation.

Making a complete global wind atlas using a single unified method available in the public domain provides the solution to the needs of the policy makers, energy planners, and Integrated Assessment Modelling (IAM) community. The Global Wind Atlas methodology will be transparent, and presented to wind resource assessment community through conferences and peer reviewed journal publications.

The term wind resource assessment covers a very broad range of methods and many kinds of data. For example, the assessment can be based on *in situ* measurements and as such pertain to the measurement location and height only, unless some kind treatment of the measured winds is carried out. At the other end of the range, the assessment may be based on modelling, giving wind resource in 3 dimensions. However, the value of such model derived assessment is limited without some kind of verification against measurements.

Therefore the most valued wind resource assessment will feature a combination of measurement and modelling. For example the European Wind Atlas (Troen and Petersen, 1989) developed a pioneering method to analyse *in situ* measurements in such a way that the information obtained from the measurements can be applied away from the measurement location. The analysis is done by modelling the effects due to local changes in terrain elevation, local surface roughness changes, and obstacles, each of which impacts the measured winds. The result of the analysis is a generalized wind climate. To predict the wind resource at a new site requires the application of the same aforementioned models (calculating effects due to local changes in terrain elevation, local surface roughness changes, and obstacles) on a generalized wind climate. This method comprises the workings of the WASP ([www.wasp.dk](http://www.wasp.dk)) software developed by Risø DTU and now used by over 10000 users worldwide.

Wind resource assessment of the kind outlined above required a dense network of high quality and long term measurements. This is because a generalized wind climate is only valid for a limited area. Where measurement data is missing, which is more often the case, numerical wind atlas methodologies are used. The conventional numerical wind atlas uses long term, but coarse resolution, atmospheric datasets (e.g. reanalysis from NCEP/NCAR, Kalnay et al, 1996) to force mesoscale models, capable of modelling the atmospheric flow at scales ranging approximately from 100 km to 5 km. This comprises a so-called downscaling technique. From the mesoscale model simulations, maps of wind resource can be created. In the method developed at Risø DTU, post-processing of the simulations results in a grid of generalized wind climates which can be used in WASP. The huge advantage of creating the generalized wind climates is that these can be compared to generalized wind climates derived from measurements in the region of interest. Even if there is a limit to the number of high quality measurements, this comparison of model and measurement derived climate allows for a verification of model results. A proper verification adds tremendous value to a wind resource assessment.

So far the Risø DTU methods outlined above have been used in numerous locations around the world; most recently in India, north-eastern China, and South Africa. However up to this point no single unified wind resource assessment has been performed for the whole world, and it important to note the objective is not to perform a global version of these country-specific studies. A new method is required to generate the

Global Wind Atlas, making it efficient to create, and suitable for the needs of the policy makers and energy planners. This is only now becoming a possibility due to developments in global reanalysis datasets and microscale modelling tools.

## 2 Methodologies

The method to create the high resolution global wind atlas is made up of a chain of processes in which global reanalysis datasets are the input and high resolution wind climate statistics, suitable for analysis and mapping, are the output.

Global reanalysis datasets with a spatial resolution of around 50 km are now available covering a time span of decades. These datasets are at a much higher resolution than previously available, and thus give new possibility for their exploitation for wind resource assessment. A number of reanalysis dataset will be used to investigate the range of wind climates that a set provides. The reanalysis datasets are not wholly independent as the same observational data network is available for assimilation; however the manner in which assimilation is performed is different, as are the models underlying the reanalysis. For example, there will be differences in the physical parameterizations modelling sub-grid scale processes and surface processes, as well as the description of the surfaces.

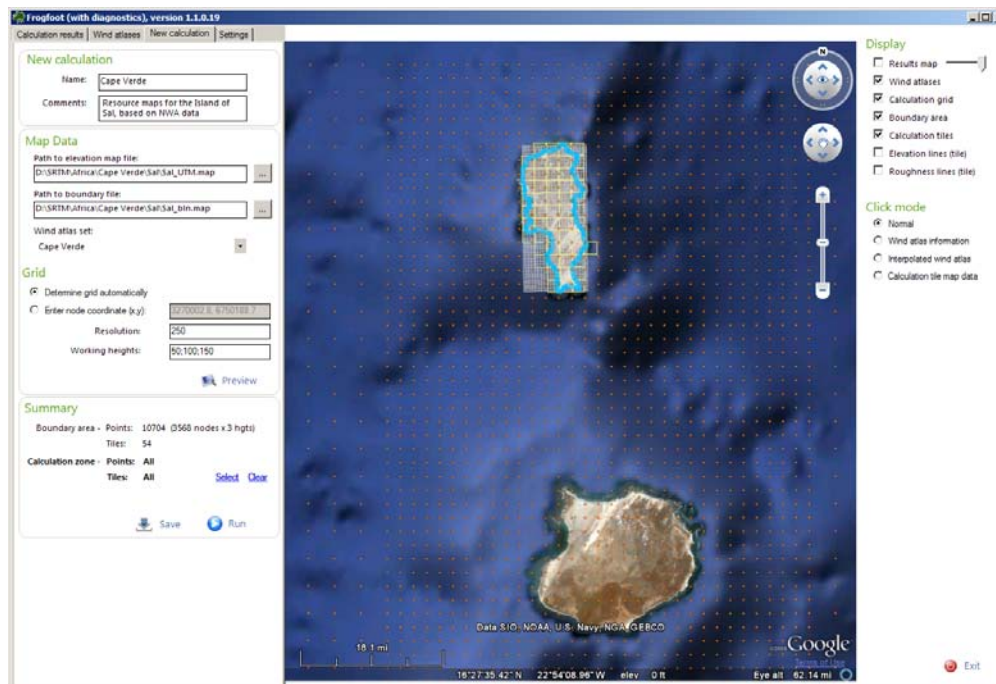

Figure 1: Cape Verde numerical wind atlas (NWA) in FROGFOOT. Each orange dot represents a data point with details sectorwise generalized wind climates statistics. FROGFOOT allows wind resources at high resolution to be calculated in WAsP using the coarser grid of generalized wind climate data points. Only part of Cape Verde is show here

Surface winds given by the reanalysis datasets cannot themselves be used directly to estimate global wind resources because the spatial resolution is still too coarse. Spatial variance of wind climates at scales smaller than that resolved in the reanalysis data will contribute significantly to the wind resource. The small scale spatial variance can be modelled by WAsP. Running WAsP requires that the reanalysis surface winds are

treated in such a way to make them generalized winds. Differences in surface winds given by three reanalysis datasets can in part be explained by differences in the surface roughness lengths used in each reanalysis model. The objective of generalizing the surface winds is to remove the influences of model dependent surface description. Generalized wind climate statistics give the wind conditions for a standard set of heights above the surface and surface roughness lengths. Global generalized wind climate grids will be created, containing sectorwise (directional) frequency distribution and sectorwise (directional) wind speed distributions.

WAsP will be run with the generalized wind climate statistics generated from the reanalysis datasets. A new functionality within the WAsP system, called FROGFOOT, allows resource calculation over a large, high resolution grid to be performed, see Figure 1. Each resource calculation uses generalized wind climate statistics from the nearest reanalysis grid points. For WAsP to calculate the local flow at high resolution, high resolution data of terrain elevation and surface roughness length are also needed.

### 3 Example of importance of resolutions

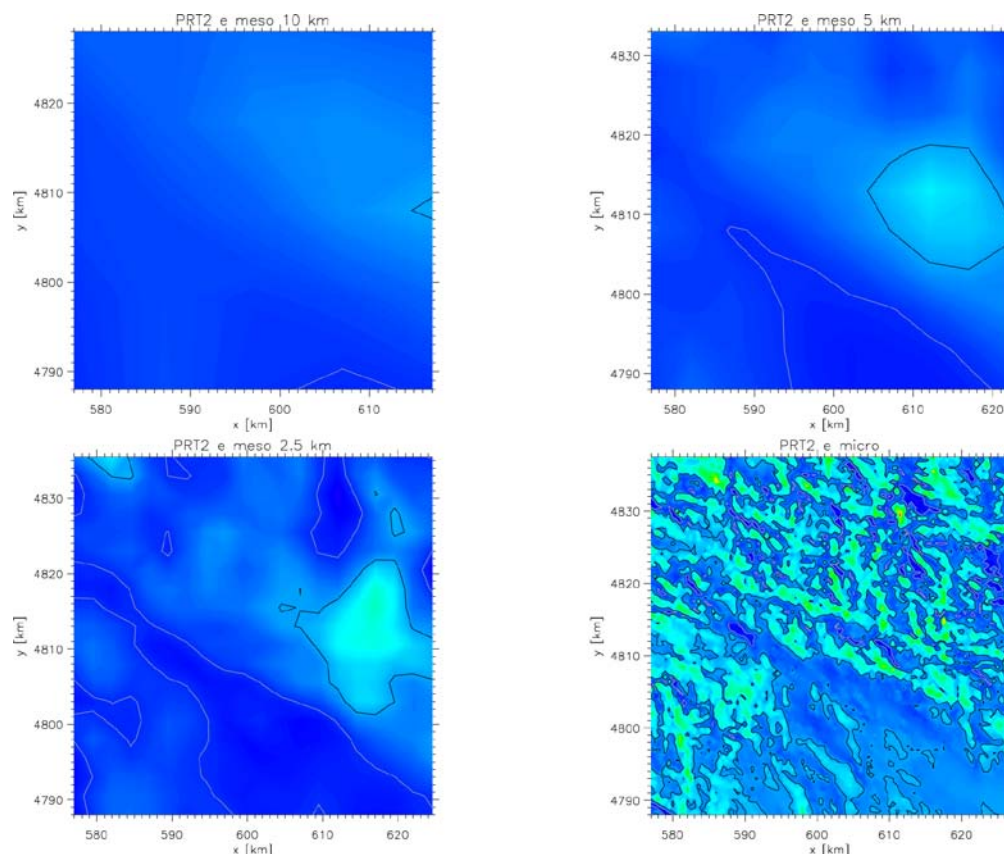

Figure 2: Wind power density calculated at 50m for a 50 x 50 km area at four different resolutions. Top-left 10 km, top-right 5 km, bottom-left 2.5 km mesoscale modelling, and bottom-right microscale modelling at 100 m. The colour scale used in each map is the same.

Figure 2 shows the effect of modelling a wind power density at 50 m for a 50 x 50 km area at four different resolutions, namely 10, 5, 2.5 km and 100 m. As the resolution increases features in the terrain become better resolved. Resolved hills and ridges give

rise to increased wind speeds. As wind power density is a function of wind speed to the power 3 [Eq. 1], the impact of the resolved terrain features is significant.

For the 50 x 50 km area the mean wind power density is estimated to be around 320  $\text{Wm}^{-2}$  for the resolutions of 10, 5, and 2.5 km. For the 100 m resolution the mean power density is around 505  $\text{Wm}^{-2}$ , i.e. an increase of 50% compared to the lower resolution estimates.

The comparison becomes more striking when the distribution of the wind power density is considered. Consider this: we split the 50 x 50 km into two areas, the first area where the wind power density is below the median value and the second area where the wind power density is above the median value. Next we calculate the mean wind power density in the second higher wind area, we get for the 10, 5, 2.5 km resolution estimates 380  $\text{Wm}^{-2}$ , where as for the 100 m resolution we get 640  $\text{Wm}^{-2}$ , an increase of nearly 70%. The impact gets stronger as we look at the even windier areas. As wind turbines will be deployed at the favourable sites, it is important to be able to capture the distribution of wind power density due to terrain features, and this is only possible by consideration of high resolution effects.

Even for rather simple terrain, such as in Denmark, the effect of resolution is important. A similar 50 x 50 km area showed an increase of wind power density of around 25% for the windiest 5-percentile (windiest 1/20th of the area).

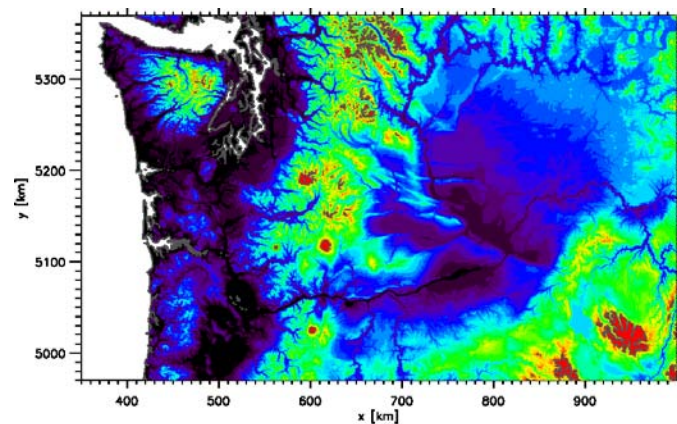

Figure 3: Map showing the orography (elevation) of the 640 x 400 km Columbia Gorge test region located in north-western USA. The elevation ranges from 0 m as the sea to over 2000 m in the mountains.

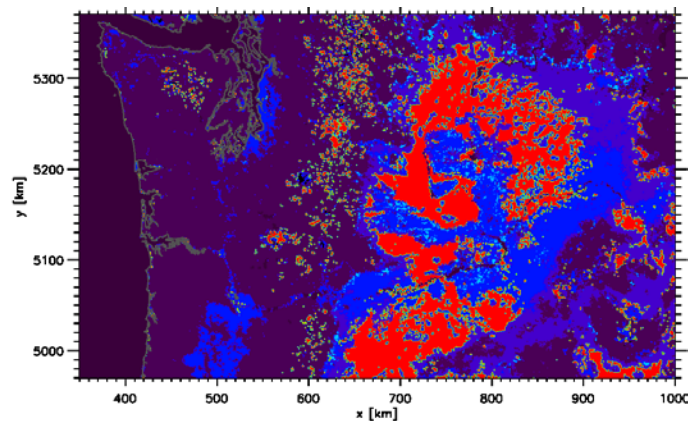

Figure 4: Map showing the variations in the surface roughness length for the 650 x 400 km Columbia Gorge test region.



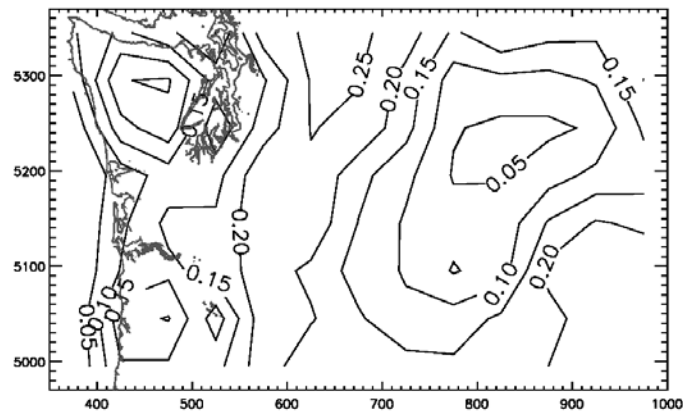

Figure 5: Map showing the estimated variance of wind speed at 500 m resolution due to the orographic speed-up effects.

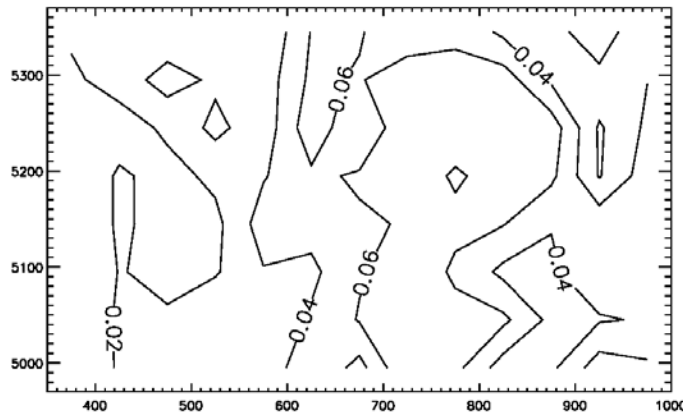

Figure 6: Map showing the estimated variance of wind speed at 500 m resolution due to the variation of surface roughness length.

## 4 Modelling spatial wind speed variance

As part of an exercise test the feasibility of the methodology for the Global Wind Atlas, an area of the northwest United States was selected. This area will also be used in an ongoing collaborative study with the National Renewable Energy Laboratory (NREL), USA. The following section is included to give an impression of the importance of the small scale spatial variation of wind for wind resource assessment

The area is of interest because of the diverse terrain types and coast areas. The area is 650 x 400 km in size. Elevation data at 500 m resolution was derived from the Space Shuttle Topography Mission (SRTM) data with 90m resolution. Surface roughness length data at 1 km resolution was derived from United States Geological Survey (USGS), Global Land Cover Classification (GLCC) data with 1 km resolution. The topography data was projected on to a UTM grid using UTM zone 10, and datum WGS84 and is shown in Figures 3 and 4.

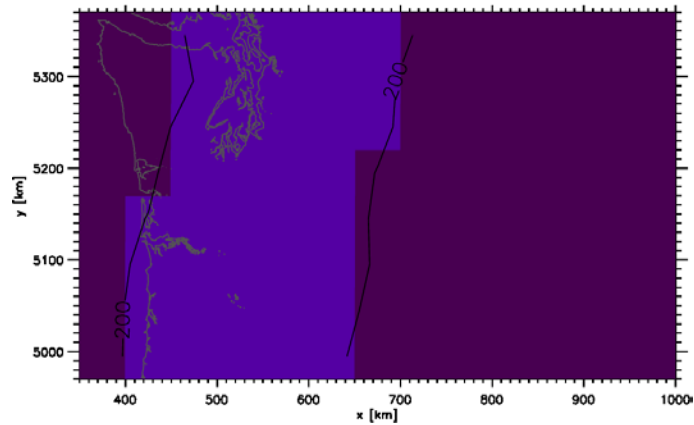

Figure 7: The annual mean power density at 50 m for the Columbia Gorge test region based on annual mean wind-speed, derived from geostrophic winds from CFSR data.

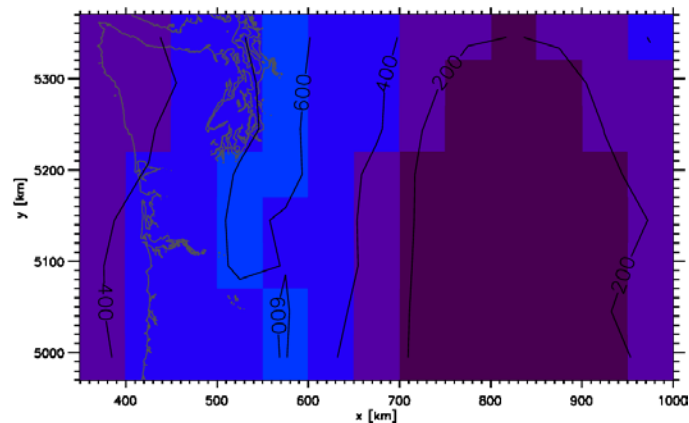

Figure 8: The annual mean power density at 50 m for the Columbia Gorge test region based on annual mean wind-speed-cubed, derived from geostrophic winds from CFSR data.

Figures 3 and 4 illustrate the diversity of elevations and roughness lengths found in the large test area. The 650 x 400 km area was split into 104 blocks, with dimension 50 x 50 km. For each 50 x 50 km block the spatial variance of the wind speed due to variation of elevation and roughness was estimated. The basis for the estimation is given in Badger et al (2010). The simple spectral orography model determines the variance due to speed-up effects on hills and ridges in each 50 x 50 km block, by considering the contributions to elevation variation according horizontal scale, via Fourier transformation of the orography in the block. The simple geostrophic drag model (SGDM) determines variance due to roughness length in each 50 x 50 km block by application of the geostrophic drag law using the distribution of roughness lengths present in the block.

Figures 5 and 6 show the standard deviation (square root of variance) of wind speed due to variation of elevation (orography) and roughness length respectively. The variance due to orography is highest in the 50 x 50 km blocks that contain elevated terrain and is lowest in blocks dominated by river plain and open sea. The variance due to roughness variation is highest in a variety of settings, where heterogeneity of land cover is large. This can occur in mountainous areas, where land cover type follows elevations (i.e. terrain above or below tree line), or where there is a variety of land uses. As in Badger et al (2010), the total spatial variance of wind speed for each 50 x 50 km block is taken as the sum of the variance due to orography and variance due to roughness.

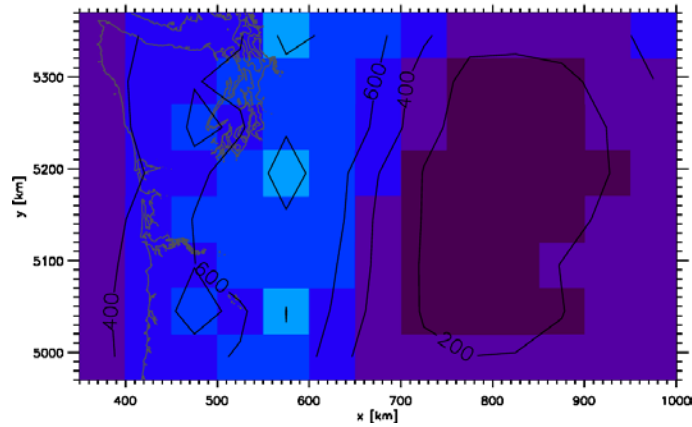

Figure 9: The annual mean power density at 50 m for the Columbia Gorge test region based on annual mean wind-speed and variance modelling. Winds derived from geostrophic winds from CFSR data.

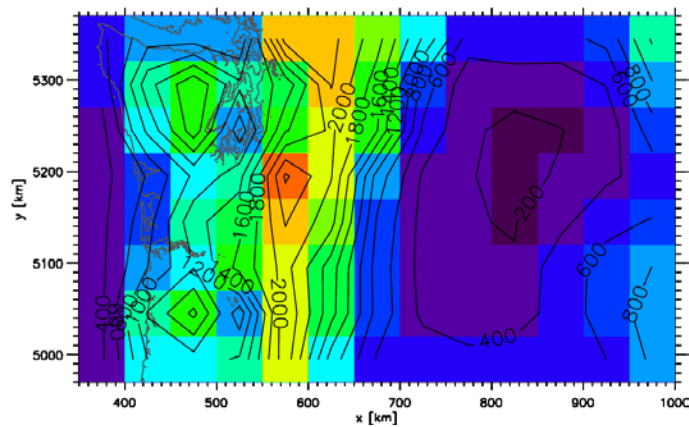

Figure 10: The annual mean power density at 50 m for the top 10-percentile (windiest 1/10<sup>th</sup> of the area) for the Columbia Gorge test region based on annual mean wind-speed and variance modelling. Winds derived from geostrophic winds from CFSR data.

To apply the estimated spatial variance of wind speed, wind data pertaining to the large test areas is required. For this the purpose Climate Forecasting System reanalysis (CFSR) data was used, Saha et al (2010). The data is available at 0.5 degree resolution and hourly. For this exercise geostrophic winds were calculated for year 2000 using 6-hourly data, for each of the 50 x 50 km blocks. The winds were transformed to 50 m above surface level winds, using the geostrophic drag law and mean surface roughness for each 50 x 50 km block.

Wind power density is given by

$$e = \frac{1}{2} \rho u^3 \quad [\text{Eq. 1}]$$

Where  $u$  is wind speed and  $\rho$  is density. Performing Reynold's decomposition for the time and space variation of wind speed, one obtains a time and space mean wind power density given by

$$[\bar{e}] = \frac{1}{2} \rho ([\bar{u}]^3 + 3(\sigma_A^2 [\bar{u}] + [\sigma_T^2] [\bar{u}] + [\sigma_T^{2*} \bar{u}^*])) \quad [\text{Eq. 2}]$$

The  $[\ ]$  represent spatial averaging and the overbar represent temporal averaging, and the prime and \* represent temporal and spatial perturbations respectively. Such that

$$u = \bar{u} + u' \qquad \bar{u} = [\bar{u}] + \bar{u}^* \qquad \text{[Eq. 3]}$$

When the mean wind speed is used (i.e. just the first term in Eq. 2] then the calculated annual mean wind power density for the large test area is given by Figure 7. This is a serious underestimate as time variance contribution and spatial variance contributions are missing.

When the mean of the cube of the 6-hourly wind speed is used then the calculated annual mean wind power density is given by Figure 8. This estimate included the time variance part at the coarse resolution that was missing in Figure 7. However the contribution to wind power density from the spatial variance of wind speed within each 50 x 50 km block is still missing.

Figure 9, shows the calculated wind power density using the mean of the 6-hourly wind speed, plus the contributions temporal and spatial variance of wind speed. The temporal variance comes from a Weibull distribution fitted to the 6-hourly time series of winds; given by a scale factor and a shape factor. The temporal variance can be expressed in term of the shape factor. The spatial variance comes from sum of orography and roughness variance contributions, as described here. This estimate shows somewhat increased wind resources in areas of heterogeneous elevation and roughness length compared to the estimate based on the mean of the cube of wind speed (Figure 8).

Another feature of the method making use of the spatial variance of wind speed over the 50 x 50 km blocks, is that the distribution of wind power density can be estimated, based on an assumed distribution of wind speed distribution. In Badger et al (2010) a Gaussian distribution of wind speed was assumed and found to suitable for most on-land cases, though less appropriate for coastal cases. Figure 10 shows the mean wind power density for the windiest 10-percentile of each 50 x 50 km block. Using this map we can see that the mountainous areas have high wind power density areas, compared to the blocks' mean power density. Whereas in the plain and offshore areas, the wind power density of the windiest sites is not much greater than the blocks' mean wind power density.

Such knowledge of the distribution of the wind power density is of great value, as it gives information about wind resources in a manner suitable for the exploitation of wind. Wind turbines are not randomly distributed. They are sited at the most favourable sites in terms of wind resources and after consideration of relevant constraints. Unlike the method described here, direct application of coarse resolution global wind datasets does not provide the distribution of the wind resource at a spatial scale smaller than the data resolution.

## 5 Application

The datasets comprising the Global Wind Atlas will be created to suit the needs of the policy makers and energy planners. Through dialogue with the Integrated Assessment Model (IAM) community, the required specifications of the Global Wind Atlas datasets will be determined.

The datasets will give both spatial and temporal variation of wind resource. Temporal variation of wind resource can be of particular importance when consideration of energy



mix is required. For example diurnal or annual variation of wind resource may be complimentary to other renewable energy sources.

It is expected that geospatial information system (GIS) applications will be one of the significant destinations of the Global Wind Atlas datasets. As location of wind resource, and its relationships to population centres, electrical transmission grids, terrain types and protected land areas, are likely to be important parts of the resource assessment downstream of the generation of wind climate statistics.

It is not the intention that the result of the Global Wind Atlas will be of interest to wind farm developers, as the accuracy of the resource data and the level of verification will not satisfy the same standards obtained via dedicated wind resource assessment performed for countries individually.

Figure 11 show schematically the expected uncertainty for three methodologies to determine wind resource. The 'coarse climate data' curve represents the current source of global resource estimation used by global energy planners, i.e. the direct application of wind data from global climate models. The 'site specific study' curve represents state of the art resource studies conducted by, among others, commercial companies. These types of study are necessary for accurate wind resource assessment at a specific site before development of a wind farm project. The 'global wind atlas' curve represents the methodology described here, which is designed to optimize appropriateness for global energy planners whilst being economical to produce.

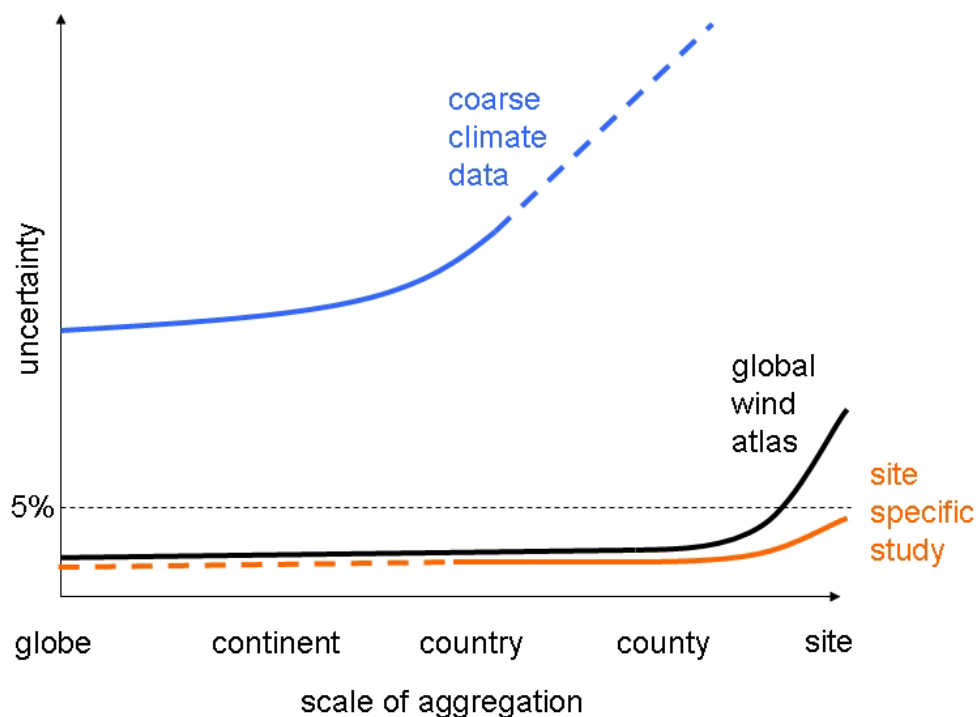

Figure 11: Schematic graph illustrating the uncertainty of wind resource data as a function of different scales of aggregation. The horizontal axis gives scale of aggregation, decreasing from left to right, from global to turbine site scales. The vertical axis gives uncertainty and a value of 5% is given as reference level of uncertainty. See main text for further explanation.

## 6 Conclusions

Currently, policy makers and energy planners trying to tackling the challenges of climate change and seeking approaches for climate change mitigation, have no global wind resource dataset appropriate for their pressing needs. The Global Wind Atlas, outlined in this paper, will provide the datasets that are required. While, it will not substitute the dedicated country specific wind resource assessment, which feature a more in depth verification process, the level of accuracy will be much superior to the current global datasets that are in use.

The current practice of global energy modellers is to use coarse resolution reanalysis datasets. This has the serious shortcoming that the wind energy resource is underestimated, as small scale variability of wind is missing. This missing variability is responsible for a large part of the wind energy resource being missed. Further information about the 'local' spatial distribution of wind resources will be gained, thus knowledge of the resources at windy sites can be obtained, rather than mean wind resource which smear out the best wind resource values.

The Global Wind Atlas will provide data at high resolution for the whole world, using a unified methodology, and will providing an uncertainty estimate based on use of a number of input reanalysis datasets and methodologies.

## 7 Acknowledgements

The work was undertaken in collaboration with the Danish Energy Agency.

## 8 References

- Badger J., M. Kelly, H. E. Jørgensen, 2010. Workshop Climate Change Impacts and Integrated Assessment (CCIIA). July 27-August 4, 2010 <http://emf.stanford.edu/files/docs/259/Jorgensen8-3.pdf>
- Kalnay, E., and Coauthors, 1996: The NCEP/NCAR 40-Year Reanalysis Project. Bull. Amer. Meteor. Soc., 77,437–471.
- Saha, S., and coauthors, 2010: The NCEP Climate Forecast System Reanalysis. Bull. Amer. Meteor. Soc., 91, 1015–1057. doi: 10.1175/2010BAMS3001.1
- Troen I., and E. L. Petersen, 1989. European Wind Atlas. Risø National Laboratory for the Commission of the European Communities, Roskilde, Denmark, 1989. ISBN 87-550-1482-8.

**Session 5B - Wind Energy II**

# Influence of Rare Earth Element Supply on Future Offshore Wind Turbine Generators

Bogi B. Jensen<sup>1\*</sup>, Asger B. Abrahamsen<sup>2</sup>, and Matthew L. Henriksen<sup>1</sup>

<sup>1</sup>Centre for Electric Technology, Department of Electrical Engineering, Technical University of Denmark, 2800 Kongens Lyngby, Denmark.

<sup>2</sup>Materials Research Division, Risø DTU, Frederiksborgvej 399, 4000 Roskilde, Denmark

\*Corresponding author: [bbj@elektro.dtu.dk](mailto:bbj@elektro.dtu.dk)

## Abstract

Rare-earth elements have become very valuable to many industries, including the renewable energy industry. As their usage has spread, their demand has increased dramatically. At present, the vast majority of rare earth elements are mined in China. China is also the world's leading consumer of rare earth material, and there are indications that Chinese rare earth exports will decrease in the near future as China seeks to maintain a sufficient supply of these materials. The magnetic properties of some particular rare-earth elements have made them very useful in producing high power density electrical machines. Such machines are utilized in applications such as electric cars, and wind turbines. This paper will examine the rare earth supply issue, in order to comment on its relevance to the wind turbine industry. The wind turbine topologies which are currently being used are compared, highlighting their advantages and disadvantages in serving as long term solutions for offshore wind farms. Finally, a direct drive induction generator and a high temperature superconducting generator topology, which respectively are not and very little dependent on rare earth elements, are presented as candidates for use in future offshore wind turbines.

## 1 Introduction

One of the most prevalent trends in the wind power industry has, in recent years, been the integration of permanent magnet generators in the latest megawatt class wind turbines. Excitation of the rotor is provided by magnets, rather than by a separate source or by the electrical grid. Some advantages of this are increased efficiency and simpler mechanical design [1]. Table I gives an overview of some of the wind turbines that employ permanent magnet generators.

At the same time, the use of wind power is increasing rapidly. Many countries have instituted policies requiring a percentage of the electricity supply to be generated by wind power. As governments around the world work towards reaching their wind power goals, wind turbine manufacturers will be working hard to produce wind turbines fast enough to keep up with demand. This is illustrated in Figure 1 showing the installed and expected wind power capacity in EU and globally. Given the observed shift towards permanent magnet technology, access to a reliable supply of magnetic material may be critical for the wind power industry in coming years. The latest generation of magnet technology relies heavily on rare earth metals. For several reasons to be discussed in the following section of this paper, rare earth metals present some very interesting economic

TABLE I

SOME OF THE WIND TURBINE MANUFACTURERS USING RARE EARTH PERMANENT MAGNET TECHNOLOGY

MANUFACTURER	Model	Transmission
Vestas	V164-7.0MW	Geared
	V112-3.0MW	Geared
GE	4.0MW-110	Direct drive
	2.5MW-100	Geared
Siemens	SWP-3.0MW-101	Direct drive
	SWP-2.3MW-113	Direct drive
Goldwind	2.5MW PMDD	Direct drive
	1.5MW PMDD	Direct drive
Gamesa	G128-4.5MW	Geared

Goldwind acquired the permanent magnet direct drive manufacturer VENSYS in 2008 and GE acquired permanent magnet direct drive manufacturer ScanWind in 2009.

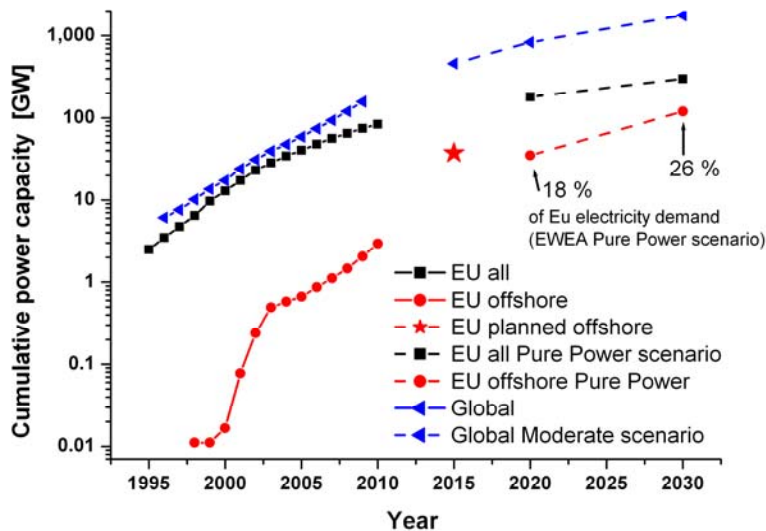

Fig. 1 Installed and expected wind power capacity in EU and globally until 2030 [2]-[4].

and geographic dynamics, which should be well understood by design engineers working in related industries.

## 2 Rare Earth Demand and Supply

The term ‘rare earth’ refers to 17 metallic elements numbered 57 through 71 in the periodic table, also known as the Lanthanide Series, in addition to scandium (number 21) and yttrium (number 39). Today, rare earth metals are vital materials for a wide range of high-tech products, such as mobile phones, x-ray units, and laptop hard drives. Rare earth metals are also drivers of the ‘green’ technology revolution, where they are used in electric vehicles and wind turbines. Figure 2 gives an overview of which rare earth elements are vital for several well-known industries, and which industries use the most rare earths.

Of the 17 rare earth elements, there are several which are considered ‘the magnet metals’ [5]:

- Praseodymium
- Neodymium
- Terbium
- Dysprosium

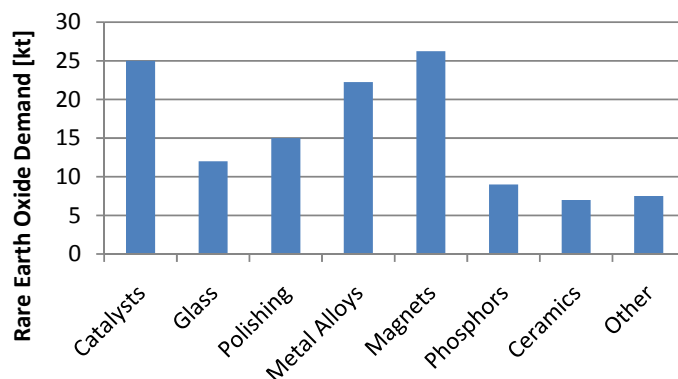

Fig. 2 Estimated demand of rare earth elements by industry in 2008 [6]. It should be noted that the weight fraction of Nd in  $\text{Nd}_2\text{O}_3$  is 0.86, which indicates that the magnets would demand in the order of 22360 tons if it was only based on Nd.

Of particular interest to this industry is neodymium, which is integral to neodymium iron boron  $\text{Nd}_2\text{Fe}_{14}\text{B}$  (NdFeB) magnets. These magnets have become the industry standard for permanent magnet machines. Their use is conducive to motors and generators with high power density and high efficiency. Perhaps the most well-known hybrid car, the Toyota Prius, is estimated to require 1kg of neodymium per unit [7], [8]. A similar trend is taking place in the wind turbine industry. As a rule of thumb, modern wind turbines using permanent magnet generators require approximately 800 kg permanent magnets per rated megawatt [9]. Terbium and dysprosium are also utilized to improve the performance of NdFeB magnets with regards to the Curie temperature and increasing the coercivity. Neodymium is a so-called ‘light’ rare earth element, while dysprosium and terbium are ‘heavy’ rare earth elements, which are currently in shorter supply. Without the addition of these heavy REEs, the performance of NdFeB magnets deteriorates significantly with increasing temperatures.

In nature, mineral deposits containing rare earth elements contain all of them, in some distribution [10]. While they are not actually rare in nature, it is very difficult to separate them, due to their similar chemical structure. This is what makes the individual rare earth metals effectively rare in the marketplace. It is extremely expensive and time consuming to go from a mining operation to production of a useable rare earth material. While the values of most commodities are dictated by supply and demand, the case of rare earth metals is more complicated due to the state of the rare earth mining industry.

## 2.1 Mining and production

Currently, almost all rare earth mining and production takes place in China. This was not the case prior to 2002, before which the USA was self-sufficient in rare earth metals. At that time Chinese rare earths became cheaper, and this made the US rare earth mining operation uneconomical. China has since been the world’s supplier of rare earth metals. Moving from 2010 and onward, Chinese demand for rare earths is expected to approach its supply. This realization, along with the current lack of rare earth production outside of

China, has prompted all parties, including China, to begin thinking hard about security of rare earth supply. As the rare earth supply is a Chinese natural resource, it is China's priority to manage it very carefully and make the most of it. China's export quota for rare earths has indeed dropped in recent years, including a 35% decrease for the first half of 2011 compared to the first half of 2010 [11].

There are plans for worldwide rare earth production to increase significantly in the near future. The USA is targeting 2012 to restart production at the Mountain Pass mine,

TABLE II

RARE EARTH MINING PRODUCTION AND ESTIMATED RESERVES BY COUNTRY.

COUNTRY	Production in 2010	Reserves in 2011
United States	0	13,000,000
Australia	0	1,600,000
Brazil	550	48,000
China	130,000	55,000,000
Commonwealth of Independent States*	Not available	19,000,000
India	2,700	3,100,000
Malaysia	350	30,000
Other countries	Not available	22,000,000

The values are in metric tons of rare-earth oxide (REO) [14].

which is rich in light REE such as neodymium [10], [6]. The Mt. Weld mine in Australia is poised to begin production even sooner (2011) [6], and here the ore is estimated to be rich in neodymium [12]. Although the overwhelming majority of rare earth mine production in 2010 took place in China, the estimated rare earth reserves are in fact much more evenly distributed [13] as seen in Table II.

In the short term, the neodymium supply is a significant issue. There is a possibility that China may soon consume almost all of its annual neodymium production [6]. It's highly likely that during this time additional sources will come on line. Mountain Pass and Mt. Weld, which are very far into the process of beginning production, are especially promising. But, it's an undesirable risk to have a supply chain be dependent on the timely success of any operation with the logistic issues such as those of starting (or restarting) a mine.

In the long term, the supply of dysprosium may be insufficient, worldwide. This is to say that China has expressed concerns that their own domestic supply of dysprosium has between 5-25 years left with current levels of use [14], and China is the only country with history and experience with the mining of these metals. It will therefore be an issue of great importance in the next decade and beyond, to see which mining projects outside of China find significant dysprosium reserves. Furthermore it also must be seen which countries will develop the manufacturing capacity to process them.

## 2.2 Relevance to Wind Power

Most of China's national goals are stated and implemented in the framework of their '5-Year Outlines.' A goal of China's next two 5-Year plans will be to dramatically increase their wind power capacity. The intention has been stated to do so with heavy usage of wind turbines with permanent magnet generators [14].

While knowing the risks associated with the market for rare earth materials, manufacturers have two options. One is to move forward with the current trend towards permanent magnet machines. This in effect means procuring permanent magnets from Chinese manufacturers, or moving in-house permanent magnet manufacturing operations to China. China not only is the only significant source of the required materials, but today it is also the only location with the infrastructure to process the materials and to

produce the magnets. An exception to this is Japan, where there is also a considerable capacity to process rare earth metals into permanent magnets. An additional possibility is investment in a new rare earth mining operation. While this helps the security of supply issue, it is still likely that all produced materials will need to be sent to China for manufacturing.

The alternative is to begin developing wind turbine generators with a reduced, or eliminated, requirement of rare earth metal. While there are several advantages to using permanent magnets, it may be possible to deliver high level solutions with some alternative topologies which will be presented in the following section of this paper.

In either case, the experience of Toyota is interesting for other manufacturers that are becoming reliant on rare earth materials. Toyota has taken multiple actions to mitigate its need to import rare earth material from China. First of all, Toyota has made a significant investment in exploration for rare earth elements in Vietnam. Should this exploration be successful, Toyota will have a secure supply, as well as the liberty of processing rare earth metals in whatever location they deem to be the most advantageous. Additionally, Toyota is developing induction motor technology which would maintain customer expectations for performance, and also eliminate the need for rare earth materials in the motor [7], although lanthanum would still be required if they continue to use NiMH batteries.

### **3 Alternatives to DDPM**

There is no shortage of alternative wind turbine generator topologies. After all, wind turbines have been successfully used for several decades, and only recently have permanent magnet generators become popular. The classic solution is a simple induction generator, connected to the main shaft through a step-up gearbox. This is, however, a topology which operates at a fixed speed. It is possible to operate the wind turbine more efficiently if the rotational speed can change as the wind speed changes and this lead to the development of several additional popular solutions, including the doubly-fed induction generator. Also, the gearboxes used to step-up the generator shaft speed were observed to be a significant source of failure. This led to the industry trend toward direct-drive, or gearless wind turbines. Enercon has been developing direct-drive wind turbines since 1992 [15], the longest of any wind turbine manufacturer. They have used, and continue to use, electrically-excited synchronous generators resulting in very heavy generators, which in large scale are not suitable for offshore applications.

The increased interest in offshore wind power has demanded a strong focus in wind turbine reliability, and this is a big reason that many companies have moved to develop direct-drive wind turbines. With the low shaft speed of a direct-drive generator, the previously-used generators would not be sufficient. Therefore the development of ‘multi-pole’ generators commenced. With the reduced prices of rare-earth materials, as well as the discussed advantages of permanent magnet generators, the direct-drive permanent magnet wind turbine generator has been adopted by many wind turbine manufacturers as the industry standard in modern offshore wind turbines. However, it is worth noticing that one of the major suppliers of offshore wind turbines, namely Vestas, has chosen to retain the gearbox in all their wind turbines in favour of the direct drive solution.

Due to the aforementioned issues associated with the rare-earth market, the time is now to develop a strategy to ensure a dependable supply chain. The decision as to whether or not the supply chain should include permanent magnets needs to be carefully considered. If not, the generator topologies discussed in this section are ready for a closer look in regards to their viability for use in offshore wind turbines.

#### **3.1 Geared Solutions**

While direct-drive generators have been gaining popularity, there is still plenty of interest in continuing to utilize geared wind turbine topologies. One advantage over direct-drive is the generator size, which can be much smaller when a gearbox is used due



to the high shaft speed. Furthermore, this is a technology that most manufacturers have spent considerable time in developing. Thus, the popular argument that removal of the gearbox will lead to a more reliable design can be countered by the argument, for example, that direct-drive permanent magnet technology is in its failure-prone early stage. Despite the potential for gearbox failure, manufacturers can point to years of operational experience and give an empirical estimate of what failures to expect. This reduced uncertainty is a powerful advantage, given the extreme costs of offshore wind farm construction.

Several geared topologies are currently available for offshore operation. Doubly-fed induction generators (DFIG) are perhaps more widely used in geared wind turbines than any other generator. The major benefit of the DFIG is that a range of variable speed is obtained without the need for a fully-rated power converter. A partial-scale power converter, in the range of 30% of the wind turbine rating, is necessary to supply variable frequency current to the rotor. The DFIG gained a large market share via numerous onshore projects, and while it has been used offshore as well, it has some drawbacks for this application. It is necessary to use brushes or slip rings in order to supply currents to the rotor, and these are failure-prone components which are not present in many other wind turbine topologies. Also, the stator is directly-connected to the grid, and this is problematic in the face of new grid codes which require the wind turbine to often remain connected during grid faults. During faults the stator current can reach very high levels, and this in turn induces high rotor currents which can damage the IGBTs in the power converter. Use of a crowbar helps to limit such currents and prevent such damage, however this is yet another component which need not be included in several other topologies.

The other modern options for offshore wind turbines make use of fully-rated power converters. Such converters are obviously heavier and more expensive than the power converters needed for wind turbines using DFIGs. While this is a clear disadvantage, it also must be considered that the full converter decouples the stator from the grid, allowing total variable speed operation. Furthermore, this decoupling of the stator from the grid allows the possibility to stay online during grid faults while maintaining safe levels of current in the stator windings. The usefulness of the full converter will become even more apparent in the future, as grid codes continue to require wind turbines to participate in the power system more like conventional power plants.

Squirrel cage induction generators (SCIG) and permanent magnet synchronous generators (PMSG) are both used in different models of geared wind turbines with full converters. Compared to the direct-drive PMSG (DDPMSG), the geared PMSG can be much smaller. While this reduced generator size is mitigated by the addition of a gearbox, there is a clear benefit in the reduced amount of rare earth metal which is required. As for the topology utilizing the SCIG, a major benefit is that absolutely no rare earth metals are required. Also there is the simple rotor construction of the SCIG, which is ideal for low-maintenance operation. In comparison to PMSG, the need for magnetizing current is a notable disadvantage. It is possible to obtain higher efficiency and a higher power factor with a PMSG.

### **3.2 Induction Generators**

Induction generators for direct drive wind turbines have recently been proposed as an alternative to permanent magnet generators [16]. The induction machine presents several advantages. Most notably:

- Rugged design
- Low part count
- Worldwide experience in manufacturing and use

The experience in manufacturing and use comes from the fact that the majority of motors used around the world are induction motors. This is in large part due to the 'rugged design' which applies to the popular squirrel cage rotor, in which there are no coils on

the rotor. As Figure 3 demonstrates, the rotor conductors are solid, un-insulated bars, typically made of aluminium or copper, and short circuited on both sides by end rings. Compared to the systems used to apply excitation current to the rotor in separately-excited synchronous machines, the squirrel cage rotor is much simpler.

A major downside of the induction machine for this purpose is the fact that it draws magnetizing current from the electrical grid. This is manifested in absorption of reactive power, and furthermore the magnetizing current contributes a portion of electrical loading to the stator. The issue is further accentuated by the fact that the required magnetizing current increases as the number of poles on an induction machine increases.

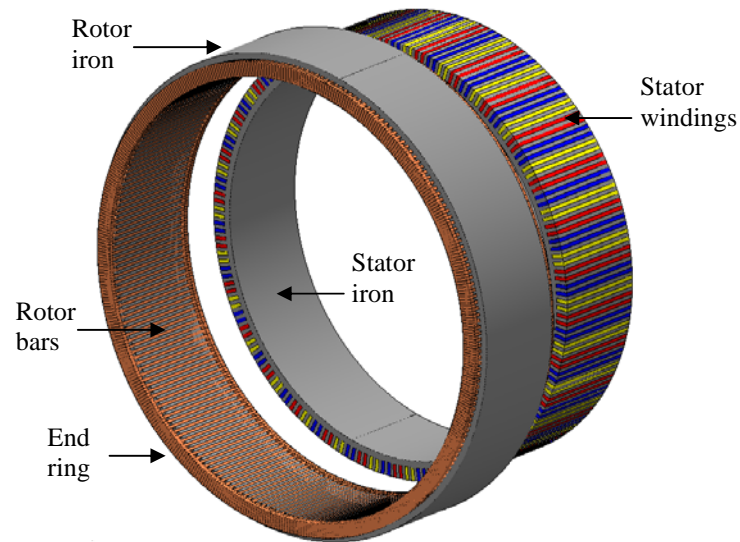

Fig. 3 Simplified diagram of Direct Drive Induction Generator for wind turbines [16]

This is negative in comparison to permanent magnet machines, where the rotor's magnetic field is produced without negatively affecting the loading of the stator, and also where the number of poles does not have any similar detrimental effect on the performance of the machine. An analytical design of a 3MW direct-drive induction generator has been reported, requiring 43 tons of active mass [16]. This is similar to a direct-drive electrically excited synchronous generator of equal rating, but significantly higher than a direct-drive permanent magnet synchronous generator [1]. On the other hand, a portion of this active mass is due to thicker stator and rotor corebacks, resulting from the discussed need to choose a lower pole number. While the coreback has the primary task of containing the flux, it also serves as support for the air gap clearance. A thicker coreback therefore gives an advantage when it comes to the need for structural mass, and the active mass of a direct-drive induction generator will account for a higher proportion of the total mass than for a direct-drive permanent magnet synchronous generator.

### 3.3 High Temperature Superconducting Generators

The usage of superconductors in direct drive generators has been suggested [17], [18], because the almost vanishing resistance of superconducting wires can be used in field windings to create an airgap flux density exceeding the flux density of conventional machines limited by the magnetic saturation of the iron. This opens up the possibility to increase the torque  $T$  of the generator while keeping the volume  $V = D^2l$  of the machine constant, as seen from the simple expression of the torque for a machine with a peak airgap flux density of  $B_r$  and an electric loading of  $A_s$ ,

$$T \propto B_r A_s D^2 l \quad (1)$$

Superconductors must be kept cold below the critical temperature  $T_C$ , because the electron pairs making up the superconducting condensate will be suppressed by thermal fluctuations. This has prevented a large scale usage of superconducting machines, since most used superconducting wire is based on the NbTi alloy, which has a  $T_C$  of 9.8K and liquid helium boiling at  $T = 4.2\text{K}$  is needed as a coolant. The discovery of the High Temperature Superconductors (HTS) with  $T_C = 93\text{K}$  for the  $\text{YBa}_2\text{Cu}_3\text{O}_7$  (YBCO) and  $T_C = 110\text{K}$  for the  $\text{Bi}_2\text{Sr}_2\text{Ca}_2\text{Cu}_3\text{O}_{10}$  (Bi-2223) raised the expectation for the large scale utilization, and direct drive wind turbine generators could be one of the first large scale applications. The first generation Bi2223 superconductor was produced inside flat tapes of silver, but the high price of the silver decreased the expectation for large scale commercial use. A second generation of tapes was invented and based on the YBCO superconductor. This is manufactured by depositing several ceramic layers on top of a metal substrate causing the crystallographic planes in the grains of the final YBCO layer to be aligned, and thereby allowing the supercurrent to pass across the grain boundaries along a tape of up to 1km length. These second generation tapes are typically 4mm wide and 0.1-0.2mm thick, but the YBCO layer is only in the order of  $1\mu\text{m}$  thick. They are often called coated conductors due to the manufacturing process. The voltage drop across a superconductor tape is not given by the simple Ohm's law but from a power law of the form

$$U = U_0 \left( \frac{I}{I_C} \right)^n \quad (2)$$

where a voltage drop of  $U_0 = 1\mu\text{V}/\text{cm}$  is obtained when the current  $I$  in the superconductor is equal to the critical current  $I_C$ , which is a function of the applied field and the temperature. The exponent  $n$  is in the order of 10-40 for the HTS, and is indicating how abrupt the voltage drop will change near  $I_C$ . Typical values of  $I_C$  are in the order of 100-125A when 4mm wide tapes are cooled in liquid nitrogen to  $T = 77\text{K}$ .

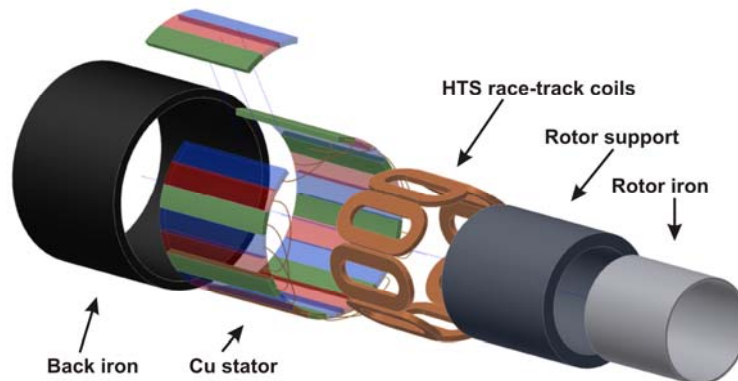

Fig. 4 Illustration of an 8 pole synchronous direct drive superconducting generator [4].

This results in critical engineering current densities in the order of  $J_{C,e} = 60\text{-}180\text{A}/\text{mm}^2$  defined as  $J_e = I_C/A_{\text{tape}}$ , where  $A_{\text{tape}}$  is the cross sectional area of the tape. This  $J_{C,e}$  can be increased by a factor of 7-10 by cooling the superconductor towards  $T = 20\text{-}40\text{K}$ , but it will additionally decrease if the superconductor is in an applied field as in a generator. Thus the knowledge of the  $I_C(B,T)$  is central in the optimization of a superconducting direct drive generator. The large scale generators suggested in [17], [18] are based on race track coils of HTS tapes as field windings and slotless stator windings sitting outside a cryostat separating the cold rotor and the stator at room temperature. The stator is not made of superconducting tape, because the losses of the superconductors will be much larger than dictated by (1), if they are exposed to a time varying magnetic field. Figure 4 illustrates the basic components of an 8 pole superconducting direct drive generator as outlined above.

The optimization of the superconducting direct drive generator involves primarily the parameters weight, size and cost. Generally it can be said that the weight and size can be

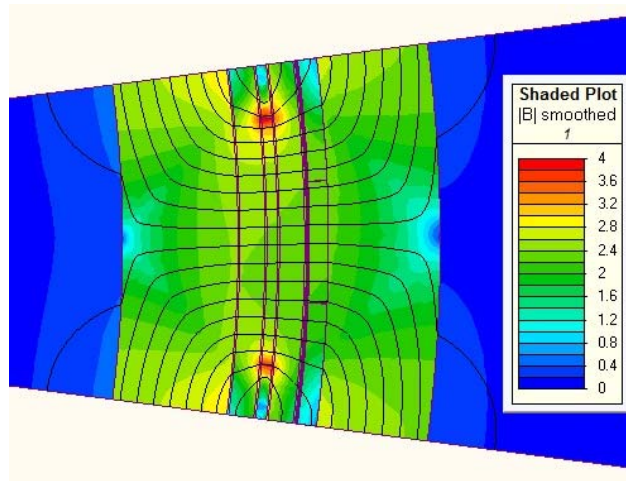

Fig. 5 Magnetic flux distribution of a 24 pole direct drive superconducting generator [20].

reduced by using more superconductor, but since the superconductor is the most expensive active material of the machine, the cost would increase dramatically if the amount of superconductor was increased. We have recently examined the weight as a function of poles of a 5MW direct drive superconducting wind turbine generator with an airgap diameter of 4.5m and an active length of 1.5m [19]. These parameters were chosen in order to fit the generator into the nacelle of a Repower turbine 5M. The peak airgap flux density was targeted at  $B_r \sim 2.5T$ , where figure 5 shows the flux distribution of a 24 pole generator resulting in an active mass of 34 tons by assuming an engineering current density of  $J_e = 300A/mm^2$  in the superconducting tape exposed to 4T. This would require an operational temperature for the superconductor between  $T = 30-40K$ , which is assumed established by cryocoolers and a 40mm thick cryostat on both sides of the superconducting rotor.

In the context of the usage of rare earth materials, it is interesting to determine the mass of rare earth in the 130 km of tape needed to realize the 5MW direct drive turbine. This is determined by the mass density of REBCO which would be approximately  $6.4-7.2 \cdot 10^3 kg/m^3$  (RE = Y-Tm) multiplied by the volume of the superconducting layer being  $1\mu m$  thick and 4mm wide (3).

$$m_{YBCO} = \rho_{YBCO} V_{YBCO} = 3.3-3.8kg \quad (3)$$

An equivalent PM direct drive generator has an estimated usage of  $Nd_2Fe_{14}B$  in the order of 2.3tons [20], which illustrates that the coated conductor technology might be able to both reduce the dependence on the Rare Earth material supply and also spread the dependence across several Rare Earth elements, as nearly any rare earth material can be used in superconductors.

## 4 Discussion

The wind turbine scenario outlined in figure 1 can be used to estimate the increased demand of the magnet rare earths by considering the wind power capacity needed in the period from 2015 and to 2030. In that context the EU offshore, the total EU and the Global expansions correspond to approximately 110GW, 170GW and 1280GW respectively. Table III shows how the demand of NdFeB magnets would increase if the wind power capacity is obtained with the different topologies outlined in this paper. It is clear that the direct drive permanent magnet solution can cause a considerable increase in the world wide demand, because just the EU offshore demand of table III is of the same order of magnitude as the entire world wide demand of the magnet segment shown in figure 2. This would of course be distributed over 15 years and would be equivalent to

an annual increase in demand of 6%, whereas the global case of table III would be equivalent to an increase of the magnet demand by 69%. The latter scenario is not very likely; because such a demand increase will justify considerable new production sites and the price of the RE elements will probably also increase dramatically. Thus what is more likely is that a mixture of drive train topologies outlined in table III will be used. Table III gives an indication of how the usage of hybrid drive trains consisting of a two stage gearbox and a medium speed generator can reduce the dependence of the Nd supplies. Finally, it should be stressed that the direct drive superconducting synchronous generator will reduce this dependence dramatically. However the price of the superconducting tape is still a challenge preventing large scale utilization.

TABLE III

USAGE OF THE RARE EARTH ELEMENTS NEODYMIUM AND YTTRIUM, FOR THE DIFFERENT DRIVE TRAINS. COLUMNS THREE TO FIVE SHOW THE ESTIMATED NEED TO FULFIL THE EU OFFSHORE, THE TOTAL EU AND THE GLOBAL WIND POWER CAPACITY IN THE PERIOD 2015-2030.

TYPE	Nd/Y metal usage [kg/MW]	EU offshore 110GW [ton of metal]	EU total 170GW [ton of metal]	Global 1280GW [ton of metal]
DDPM	200	22,000	34,000	260,000
2GPM	20	2,200	3,400	26,000
DDHTS	0.10	11	17	130
DDIG	0	0	0	0

DDPM: Direct Drive Permanent Magnet Generator; 2GPM: Two Stage Gearbox Permanent Magnet Generator; DDHTS: Direct Drive High Temperature Superconducting Generator; DDIG: Direct Drive Induction Generator. Note: The weight fraction of Nd in  $Nd_2Fe_{14}B$  and of Y in  $YBa_2Cu_3O_{6+x}$  is 0.27 and 0.13 respectively.

## 5 Conclusion

The trend towards offshore wind farms is calling for reliable and efficient wind turbines. Increasing the size of the turbines and focusing on reliability and efficiency results in a lower cost of energy for the user. Commercially, the majority of the large wind turbine manufacturers have chosen to employ permanent magnet generators to meet the demand for reliability and efficiency. Some have chosen the geared version, where the size of the generator is relatively small, whilst others have chosen to omit the gearbox and use a relatively large generator. If the gearbox is omitted there is one less failure component and hence the direct drive promoters argue that the reliability will improve. As the direct drive permanent magnet technology is relatively young, the improved reliability remains to be proven.

The exponential increase in the global demand for rare earth elements (REE) and China's monopoly on supplying REE, has resulted in increased costs and global concerns regarding to security of supply. If the supply of REE should become an issue in the future or if the price continues to rise, the wind turbine manufacturers have to consider how they can minimize the use of REE in their wind turbines. One way of doing this is by employing a gearbox that reduces the size of the generator and hence the amount of permanent magnets needed. This paper has presented two generator topologies, which are not as reliant on REE as the permanent magnet generators.

The first topology is a "low tech" solution, where a direct drive induction generator (DDIG) is used. The DDIG does not require REE and has a very simple structure, which should result in a highly reliable wind turbine.

The second topology is a "high tech" solution, where a direct drive HTS generator (DDHTS) is used. The DDHTS requires REE but only approximately a 1000<sup>th</sup> of what would be required in a direct drive permanent magnet generator. The DDHTS is

however, an unproven technology that requires a rather sophisticated cooling system, and also that the annual production of HTS tapes should be increased by a few orders of magnitude.

It is difficult to predict which technologies will dominate the offshore wind turbine market in the future, but if the supply of REE or the prices of REE restrict the wind turbine manufacturers, then a possible solution might be either the direct drive induction generator or the direct drive HTS generator.

## References

- [1] H. Polinder, F. F. A. van der Pijl, G. J. de Vilder, and P. J. Tavner, "Comparison of direct-drive and geared generator concepts for wind turbines," *IEEE Transactions on Energy Conversion*, Vol. 21, No. 3, pp. 725-733, Sep. 2006.
- [2] EWEA statistics 2009
- [3] EWEA Pure power report 2009
- [4] A.B. Abrahamsen, N. Mijatovic, E. Seiler, T. Zirngibl, C. Træholt, P.B. Nørgård, N. F. Pedersen, N. H. Andersen and J. Østergård, "Superconducting Wind Turbine Generators," *Superconducting Science and Technology* Vol. 23, No. 3, 034019, 2010.
- [5] J. Lifton, "North America doesn't need china's rare earth metals," *The Gold Report*, 21 Jun. 2010, Retrieved 4 Mar. 2011 from <http://www.marketoracle.co.uk/Article20495.html>
- [6] D. J. Kingsnorth, "Rare earths: facing new challenges in the new decade," *SME Annual Meeting 2010*, Phoenix Az. Retrieved 3 Mar. 2011 from [http://www.smenet.org/rareEarthsProject/SME\\_2010\\_Kingsnorth.pdf](http://www.smenet.org/rareEarthsProject/SME_2010_Kingsnorth.pdf)
- [7] M. Ramsey, "Toyota tries to break reliance on china," *Wall Street Journal*, 14 Jan. 2011, Retrieved 1 Mar. 2011, from <http://www.techmetalsresearch.com/2011/01/toyota-tries-to-break-reliance-on-china/>
- [8] J. S. Hsu, C. W. Ayers, C. L. Coomer, "Report on Toyota/Prius Motor Design and Manufacturing Assessment," Oak Ridge National Laboratory, 2004.
- [9] A. Laxson, M. M. Hand, N. Blair, "High wind penetration impact of U.S. wind manufacturing capacity and critical resources, National Renewable Energy Laboratory, Technical report, NREL/TP-500-40482, October 2006.
- [10] C. Zhanheng, "Global rare earth resources and scenarios of future rare earth industry", *Journal of Rare Earths*, Vol. 29, No. 1, Jan. 2011.
- [11] Pui-Kwan Tse, "China's Rare Earth Industry," U.S. Geological Survey Open File Report, 2011
- [12] J. Lifton, "Rare Metals Investment News Updates, Today's Edition (RareMINUTES) 050709 NEODYMIUM," [www.glgroup.com](http://www.glgroup.com), Retrieved 28 Feb. 2011 from <http://www.glgroup.com/News/Rare-Metals-Investment-News-Updates-Todays-Edition-%28RareMINUTES%29-050709-NEODYMIUM-38883.html>
- [13] D. J. Cordier of USGS, "U.S. Geological Survey, Mineral Commodity Summaries, January 2011," retrieved 3Mar. 2011 from [http://minerals.usgs.gov/minerals/pubs/commodity/rare\\_earths/mcs-2011-raree.pdf](http://minerals.usgs.gov/minerals/pubs/commodity/rare_earths/mcs-2011-raree.pdf)
- [14] J. Lifton, "The Effect of Chinese Domestic Growth on Neodymium and Dysprosium Supply," *Technology Metals Research*, 13 March. 2011, Retrieved 13 Mar. 2011 from <http://www.techmetalsresearch.com/2011/03/the-effect-of-chinese-domestic-growth-on-neodymium-and-dysprosium-supply>
- [15] Enercon company website, retrieved 4 Mar. 2011 from <http://www.enercon.de/en-en/82.htm>
- [16] M. L. Henriksen, B. B. Jensen, "Induction Generators for Direct-Drive Wind Turbines," *IEEE International Electric Machines and Drives Conference, IEMDC'11*, Niagara Falls, Canada, Mar. 2011.
- [17] G. Snitchler, "Progress on high temperature superconductor propulsion motors and direct drive wind generators," *International Power Electronics Conference*, Sapporo, Jun. 2010.
- [18] C. Lewis and J. Müller, "A Direct Drive Wind Turbine HTS Generator", *IEEE Power Engineering Society General Meeting*, Tampa, FL, Jun. 2007.
- [19] A.B. Abrahamsen, B.B. Jensen, E. Seiler, N. Mijatovic, V.M.R. Zermeno, N.H. Andersen and J. Østergård, "Feasibility of 5MW superconducting wind turbine generator," Accepted for *Physica C*, 2011.
- [20] Hui Li, Zhe Chen, Henk Polinder, "Optimization of MultiBrid-permanent magnet wind generator system," *IEEE Transactions on Energy Conversion*, Vol. 24, No. 1, Mar. 2009.

# Improved High Temperature Superconductor Materials for Wind Turbine Generators

Peter B. Mozhaev<sup>1,3</sup>, Alexey V. Khoryushin<sup>1,3</sup>, Julia E. Mozhaeva<sup>1,3</sup>, Niels H. Andersen<sup>2</sup>, Jean-Claude Grivel<sup>2</sup>, Jørn Bindslev Hansen<sup>1</sup>, Claus S. Jacobsen<sup>1</sup>

<sup>1</sup> *Physics Department, Technical University of Denmark, DK-2800, Kgs. Lyngby, Denmark,*

<sup>2</sup> *Risø DTU National Laboratory for Sustainable Energy, DK-4000, Roskilde, Denmark*

<sup>3</sup> *Institute of Physics and Technology RAS, 117218, Moscow, Russian Federation*

## Abstract

Effects of yttria addition on the structural and electrical properties of the YBCO thin films are studied. The films were deposited on  $(\text{LaAlO}_3)_{0.3}(\text{Sr}_2\text{AlTaO}_8)_{0.7}$  substrates by pulsed laser ablation from targets with different elemental composition. The contents of elements in the film depend mainly on the yttrium content in the target. An increase of yttrium content leads to formation of a porous film with significant improvement of current-carrying capabilities (critical current density reaches  $35 \text{ kA/cm}^2$  at 77 K, 5 T, and exceeds  $2 \text{ MA/cm}^2$  at 50 K, 5 T). The Y-enriched YBCO film remains *c*-oriented up to 600 nm thickness with no suppression of the critical current density in the film. Yttria decoration of the substrate surface prior to deposition resulted in formation of YBCO films with low strain and high crystal perfection. In contrast to the Y-enriched YBCO films, the films on yttria layers are dense. At temperatures of 77 K and above the YBCO films on yttria-decorated substrates exhibit critical current densities comparable to or better than that of the Y-enriched films.

## 1 Introduction

The implementation of superconducting coated conductors in power applications, like motors or generators, requires high current-carrying capabilities in magnetic fields of 1 to 5 T. Natural pinning centers in high-temperature superconducting (HTSC) thin films can not provide the necessary pinning, thus the introduction of artificial pinning centers (APCs) is needed [1]. The technology of APCs formation should meet the following requirements: (1) the APCs should be dense enough to provide pinning at high magnetic field; (2) the diameter of the APC should correspond to the optimal pinning in the chosen HTSC material; and (3) the APC material should not spoil the adjacent HTSC area. Utilization of “foreign” phases – i.e. elements other than that of HTSC – always results in suppression of superconductivity in the neighboring area, and starting from some certain volume percentage (2-5% for various APC materials, e.g. see [2, 3]), the overall superconducting properties of the composite are compromised. This makes the “native” particulates present in HTSC thin films, consisting of the same elements as the superconductor, more favorable as APCs. Among “native” oxides the  $\text{Y}_2\text{BaCuO}_5$  and  $\text{Y}_2\text{O}_3$  (yttria) have attracted the main attention because they are not expelled from the YBCO matrix and can form nanosize inclusions in the superconductor layer. The  $\text{Y}_2\text{BaCuO}_5$  nanoparticles are relatively big and their introduction may result in cracks in the neighboring superconductor [4].  $\text{Y}_2\text{O}_3$  inclusions are smaller and form a coherent interface with the YBCO matrix due to a good match of lattice constants [5], with minimal reduction of critical temperature of the superconductor. This set of features resulted in extensive studies of yttria nanoparticles as possible APCs [3, 6 - 11].

Two main routes for incorporating yttria into YBCO films have been suggested: decoration of the substrate surface, resulting in seeding of yttria nanoparticles [6, 7], and



addition of yttria to the growing film [7 - 12]. The first technique provides excess yttria only in the very beginning of the growth, and the effect on the critical current density is mainly due to the formation of extended linear defects in the YBCO film overgrowing the yttria nanoparticles. The second method has been implemented by direct addition of yttria into the film by sputtering [8] or ablation [9], or by the use of targets with excess rare-earth element [10], and by sequential deposition of YBCO layers and intermediate quasi-layers of yttria [3, 11, 12]. In [7] the excess yttrium in the film resulted from the features of the deposition technology. In these studies the yttria nanoparticles were formed during the growth of the superconducting layer, and were overgrown by the YBCO matrix resulting in a 3D-net of pinning centers embedded in the superconductor. No suppression of superconductivity, or just a minor effect on  $T_c$  [11] was observed in such composites.

In this paper we present results of our studies of yttria addition into YBCO films deposited by PLD, by direct addition into the growing film by changing the target elemental composition, and by yttria decoration of the substrate before deposition of the superconductor. The goal is to study the differences in the mechanisms of yttria addition on the film properties.

## 2 Experimental methods

All films were deposited by PLD, pulsed laser deposition (KrF excimer laser,  $\lambda = 248$  nm). The details of the deposition technique can be found elsewhere [13]. The deposition of superconducting layers was done in conditions optimized for the formation of high crystal quality and high critical temperature thin YBCO films on perovskite substrates (770 °C, 0.8 mbar total pressure, Ar/O<sub>2</sub> = 8/2 sccm, laser energy density on target 1.5 J/cm<sup>2</sup>, deposition rate 0.165 nm/s, post-deposition oxygenation in 500 mbar O<sub>2</sub> at 450 °C for 1 hour). The films were mainly grown on (100) (LaAlO<sub>3</sub>)<sub>3</sub>-(Sr<sub>2</sub>AlTaO<sub>8</sub>)<sub>7</sub> (LSAT) perovskite substrates, providing fine conditions for YBCO formation.

A short optimization run was carried out to find the conditions for yttria particle deposition on the substrate surface, details will be published elsewhere. In brief, we studied the effect of pressure during ablation and of laser beam energy density on the target on size and density of nanoparticles formed on the substrate surface. The best results were obtained at substrate temperature 800 °C, Ar pressure 0.2 mbar, and energy density of 1.1 J/cm<sup>2</sup>. At these conditions we observed nanoparticles of 40-70 nm in diameter and 20-45 nm in height, with densities up to 1500  $\mu\text{m}^{-2}$  after 4000 pulses.

An important feature of the prepared yttria layers is the presence of both uniform smooth film and nanoparticles embedded into this film. We used this effect to prepare two different types of yttria layers: a uniform “seeding” layer, completely covering the substrate surface, and a “template” layer, consisting of individual nanoparticles with almost no uniform film. The average thickness of both layers was 0.8 nm. All yttria layers showed single (100) orientation. The lattice constant of the yttria layers was 11.609 Å, close to that of bulk yttria (11.605 Å).

The surface morphology of the films was studied by atomic force microscopy (AFM), and by scanning electron microscopy (SEM). The elemental composition of the films was found using EDAX analysis and inductively coupled plasma (ICP) analysis based on quantitative optical emission spectroscopy. The structural parameters were determined by X-ray diffraction (XRD) measurements in Bragg geometry.

## 3 Results and discussion

### 3.1 Transfer of composition from target to YBCO film

In PLD, the transport of material from target to substrate is a rather complicated process with many parameters influencing the resulting composition (e.g. see [14]). We confined



our study to a single set of deposition parameters. The tested changes of the target composition from stoichiometric  $\text{YBa}_2\text{Cu}_3\text{O}_x$  are small ( $\leq 5\%$  of overall cation composition), and the effect of the target composition on the composition of the film is considered to be linear.

Two self-made targets (Ba-excess and Cu-deficient) were used for tests of the transfer of element composition from the target to the growing film, together with a commercially available stoichiometric  $\text{YBa}_2\text{Cu}_3\text{O}_x$  target. The accuracy of the film element composition measurement was 3-4% of the signal, i.e., better than 2% of the overall cation composition.

The nominal compositions of the targets and the results of the measurements are summarized in Table 1. All films contain an excess of Ba, with almost the same relative content of Ba in all films. The heaviest element, Ba, is least scattered by the thin atmosphere in the chamber and, hence, we observe a higher amount of Ba on the substrate surface, compared to Y and, especially, Cu (lightest element). A probable reason for the almost constant Ba contents is re-sputtering or re-evaporation of Ba and BaO (Ba is not incorporated into less volatile oxides).

Another important feature of the transfer of composition to YBCO films is the essential dependence of the composition on the contents of yttrium in the target (Fig. 1). The yttrium content in the film increases almost linearly with an increase of the nominal yttrium content in the target, while the copper content decreases. This is probably a result of the scattering on the way from target to substrate: the higher the concentration of heavy atoms in the plume, the stronger the scattering of the lighter copper atoms.

**Table 1.** Cation compositions of (Y,Ba,Cu) $\text{O}_z$  targets and corresponding films ( $\sim 0.5 \mu\text{m}$  thick). All cation compositions, except target nominal composition, are normalized to 6.

Sample	Target composition		Film composition		Excess material
	nominal	normalized by 6	by ICP	by EDAX*	
HLP09	1/2.3/3	0.952:2.191:2.857	0.897:2.188:2.915	0.947:2.268:2.785	0:0.394:0.224 <sup>#</sup>
HLP08	1/2/3	1.000:2.000:3.000	0.972:2.275:2.753	0.950:2.263:2.787	0.054:0.439:0 <sup>#</sup>
HLP10	1/2/2.85	1.026:2.051:2.923	1.048:2.308:2.644	1.016:2.257:2.727	0.167:0.546:0 <sup>#</sup>
HLP07	1.5/2/3	1.385:1.845:2.770		1.349:1.932:2.719	0.443:0.120:0 <sup>@</sup>

\* calibrated using ICP data

<sup>#</sup> calculated on ICP data

<sup>@</sup> calculated using EDAX data

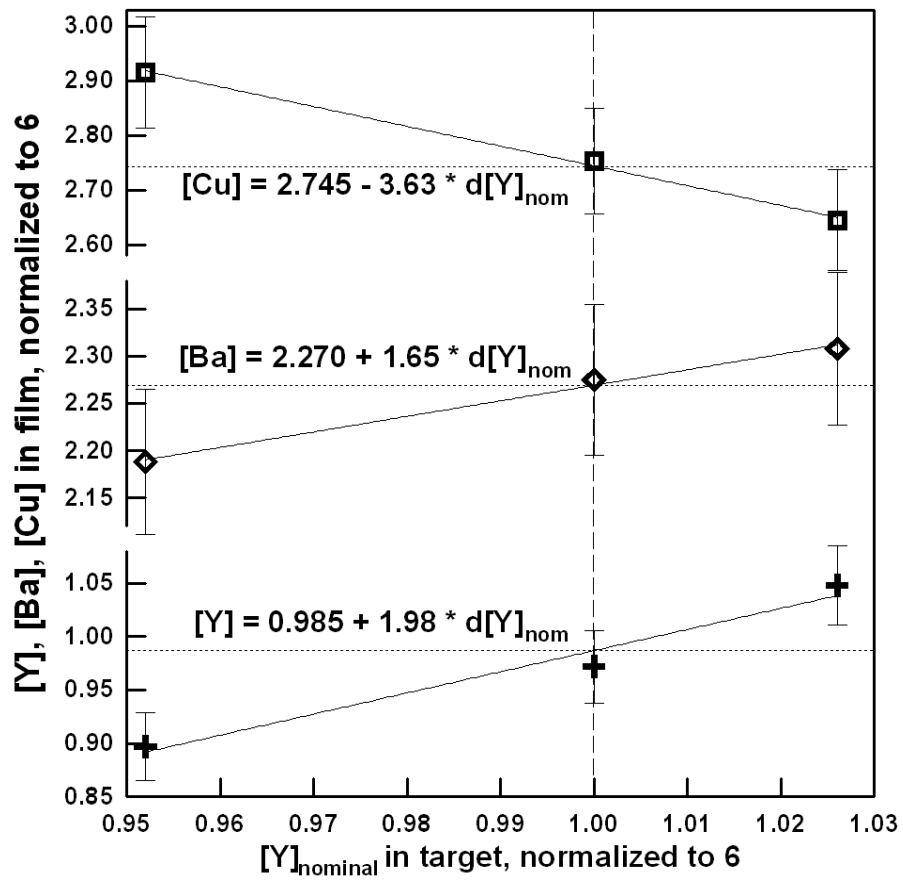

Fig. 1. Contents of cations in the YBCO film measured with ICP technique for varying yttrium contents in target.

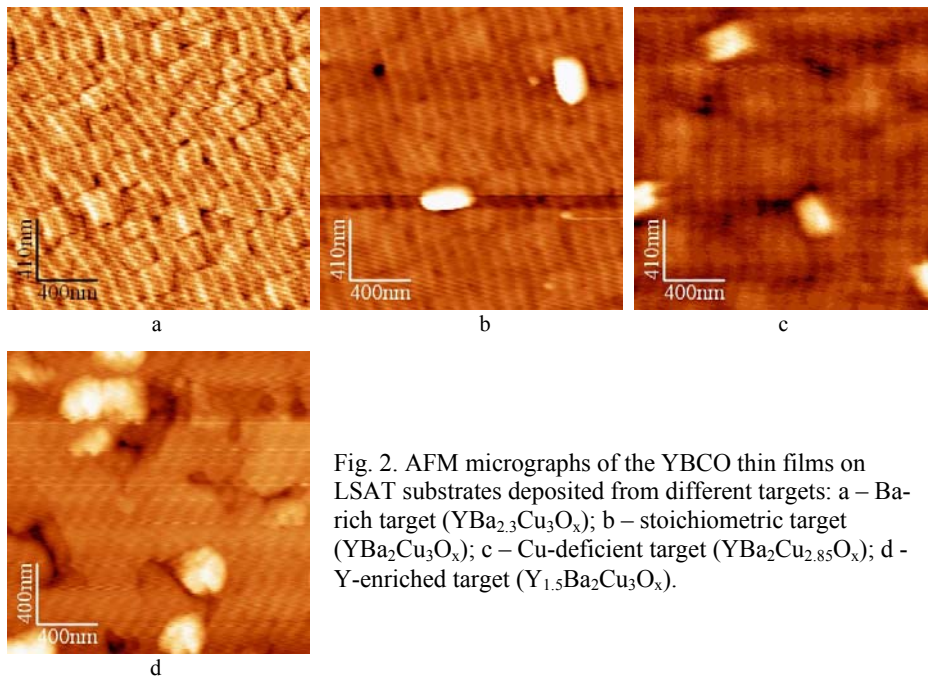

Fig. 2. AFM micrographs of the YBCO thin films on LSAT substrates deposited from different targets: a – Ba-rich target ( $\text{YBa}_{2.3}\text{Cu}_3\text{O}_x$ ); b – stoichiometric target ( $\text{YBa}_2\text{Cu}_3\text{O}_x$ ); c – Cu-deficient target ( $\text{YBa}_2\text{Cu}_{2.85}\text{O}_x$ ); d – Y-enriched target ( $\text{Y}_{1.5}\text{Ba}_2\text{Cu}_3\text{O}_x$ ).

### 3.2 Yttrium-enriched YBCO thin films

The surface morphology of the YBCO films deposited from targets with various compositions is shown in Fig. 2. The films from the Ba-enriched target (Fig. 2a) have smooth surfaces with almost no pores or outgrowths. The gradual increase of nominal yttrium content in the film (Fig. 2b-d, Table 1) results in the formation of deep and wide pores, and growth of particles on the film surface. The pores are present only in the films where excess Y is available (Table 1).

To find the composition of the Y-enriched films, we measured the EDAX spectra of the YBCO films before dissolving them in acid for the ICP measurements. All films had the same thickness of 480 nm, so the obtained calibration (Table 1) made it possible to evaluate the elemental contents of the YBCO films of thickness  $\sim 0.5 \mu\text{m}$ . The EDAX results show much smaller variation of film composition with changing element composition of the target, and the result of the measurement is much closer to stoichiometric YBCO. This discrepancy between the two techniques may be due to concentration of the excess material on the surface of the growing film, so the electrons are passing this layer with highest energy and with the smallest scattering cross-section.

The EDAX measurements with the electron beam positioned on an YBCO grain are close to the results of the area measurements, averaging the elemental composition over the whole film, but usually some excess element can be seen in film grains: Y for the Y-enriched targets, and Ba for stoichiometric and Ba-enriched targets. The amount of excess yttria in the main part of the Y-enriched film is about 6.5 mol% ( $\text{Y}_{1.375}\text{Ba}_2\text{Cu}_3\text{O}_x$ ). Yttria is probably introduced into the YBCO matrix as nanoinclusions, for the solubility limit for yttrium in YBCO is much lower.

To determine the composition of the particles on the surface of the films (Fig. 2b-d) we subtracted the background signal from the YBCO main film [15]. The particles on the surface of Y-enriched films contained mainly Y, but some Cu was also present, on other films the particles consisted of Ba and Y.

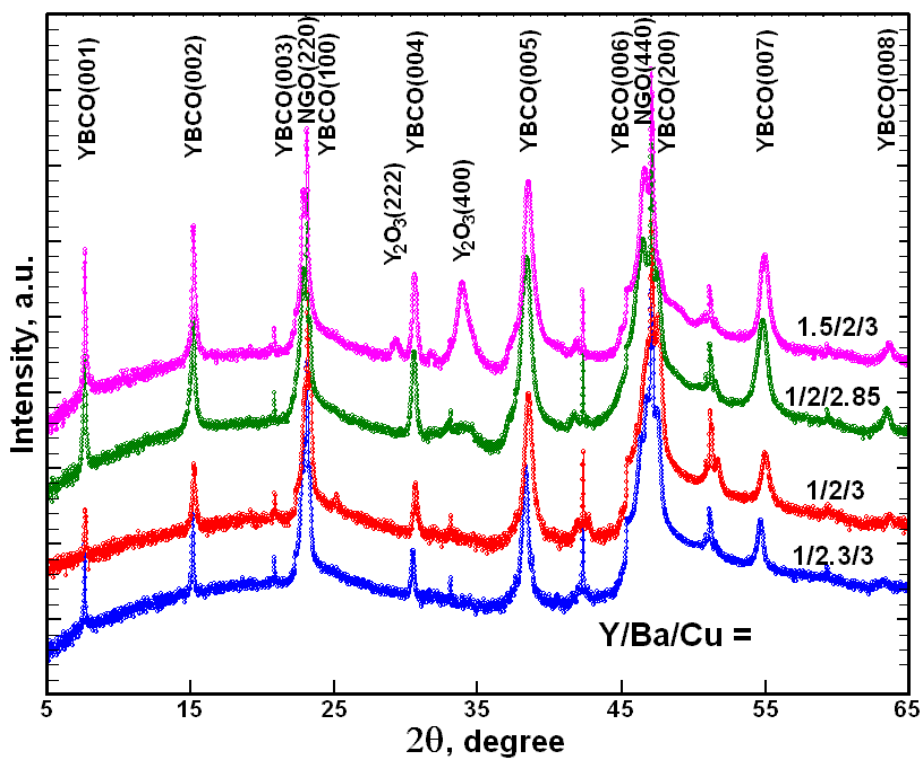

Fig. 3. XRD  $\theta/2\theta$ -scans of YBCO films from different targets (NGO substrates).

The formation of pores in the Y-enriched films implies seeding of some Y-containing particles that are not wetted by the YBCO grains in the very beginning of the film growth. The EDAX spectra for the pores in YBCO films from the stoichiometric target showed almost equal amount of Y and Cu. For the film from the Y-enriched target the composition of the particles inside the film was different, Y:Ba  $\approx$  2:1.

The XRD  $\theta/2\theta$ -scans clearly reveal the presence of yttria in the Y-enriched films, both made from the Cu-deficient target and from the Y-enriched targets (Fig. 3). An increase of the nominal yttrium contents in the target composition results in an increase of the intensity in the yttria peaks. The yttria is present mainly in the (100) orientation, but some minor part grows with the (111) orientation. The lattice constant of the (100)-oriented yttria in the films grown from Y-enriched targets is very close to the bulk value 10.601 Å. The crystallite size evaluation gives values in the range 11-14 nm, implying that the nanoparticles of yttria are incorporated into the YBCO matrix.

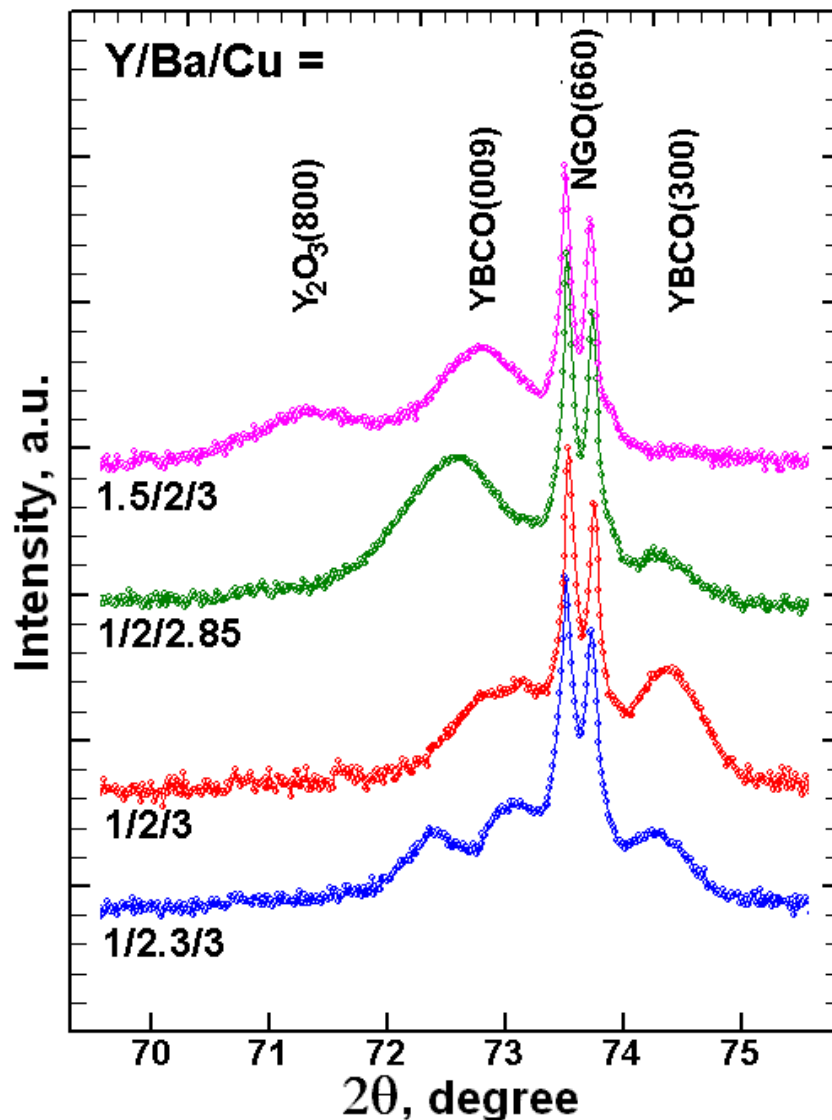

Fig. 4. XRD  $\theta/2\theta$ -scans of YBCO films (made from various targets) in the vicinity of the NGO(660) peak. The films are 480 nm thick.

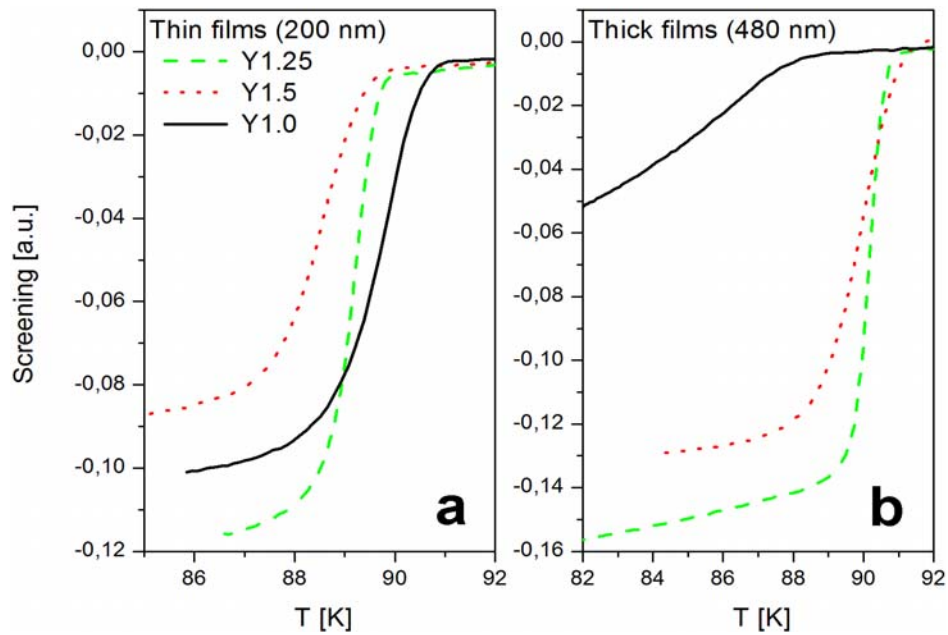

Fig. 5. AC-susceptibility dependences on temperature for YBCO films deposited on LSAT substrates by pulsed laser ablation from targets with varying yttrium contents: solid line – stoichiometric target, dashed line –  $Y_{1.25}Ba_2Cu_3O_x$ , dotted line -  $Y_{1.5}Ba_2Cu_3O_x$ .

Another important feature of the Y-enriched films is the preservation of *c*-orientation even for very thick films (0.4-0.6  $\mu\text{m}$ , see Fig. 4). Due to accumulation of strain in the growing film YBCO films deposited by physical vapor deposition techniques tend to change from *c*- to *a*-orientation when the thickness exceeds 300 to 500 nm. Films both from stoichiometric and from Ba-enriched targets confirmed this rule: the part of *a*-oriented film increased with thickness from almost zero at 180 nm to 70 and 27%, respectively. A high density of pores in the Y-enriched films provides the possibility of strain relaxation, so that seeding of the *a*-oriented grains becomes much less probable. For the  $Y_{1.5}Ba_2Cu_3O_x$  target the part of *a*-oriented film does not exceed 3% on NGO, and is negligible on LSAT even for the films as thick as 600 nm.

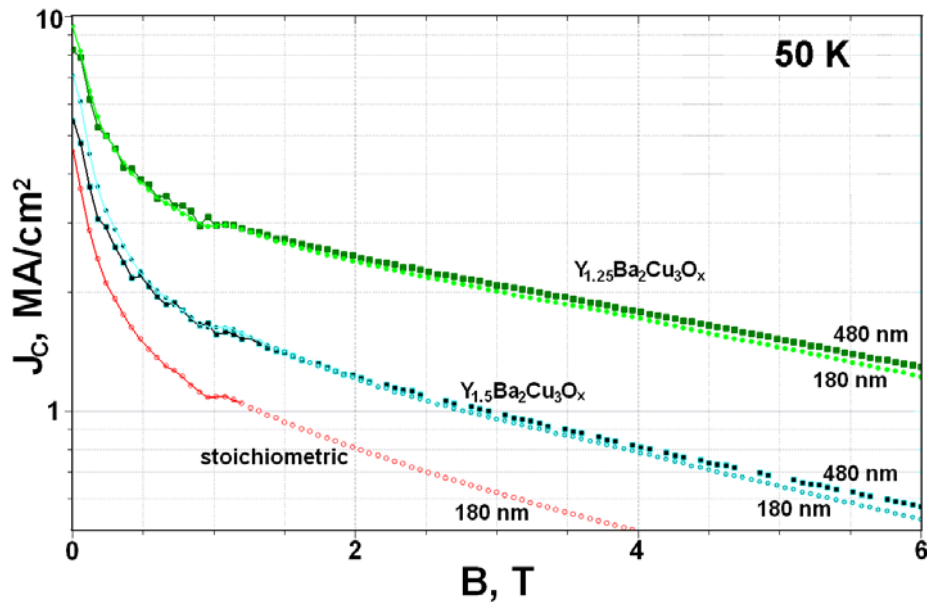

Fig. 6. Critical current density dependences on magnetic field of YBCO films deposited from targets with various compositions.

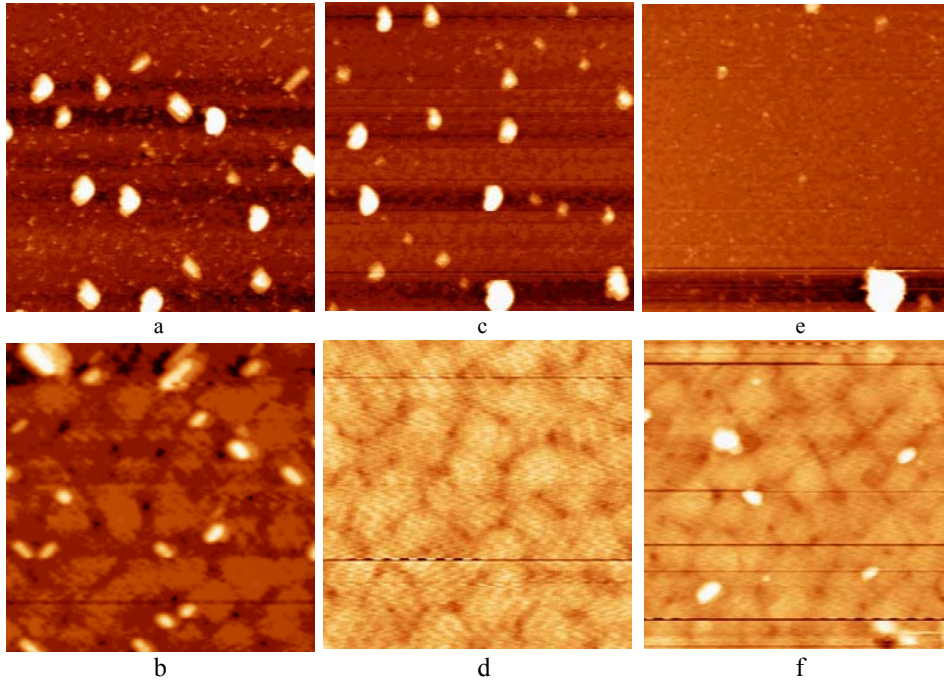

Fig. 7. AFM micrographs of YBCO films from stoichiometric target on different yttria layers. a, b - uniform yttria seeding layer; c, d - template yttria layer of nanoparticles; e, f - bare LSAT substrate. Scan size: a, c, e -  $10 \times 10 \mu\text{m}^2$ , b, d, f -  $2 \times 2 \mu\text{m}^2$ . Vertical scale 100 nm.

For thin films the temperature  $T_c$  of the superconducting transition of the Y-enriched films was  $\sim 1$  K lower than that of a standard film from the stoichiometric target (Fig. 5a), but for the thick films we observed the opposite: the  $T_c$  of the Y-enriched films even increased, while for standard films it decreased, and the superconducting transition became broad (Fig. 5b). Probably, the pores in the Y-enriched films act as routes for the post-deposition oxygenation of the films, while the dense film from the stoichiometric target remains oxygen-deficient.

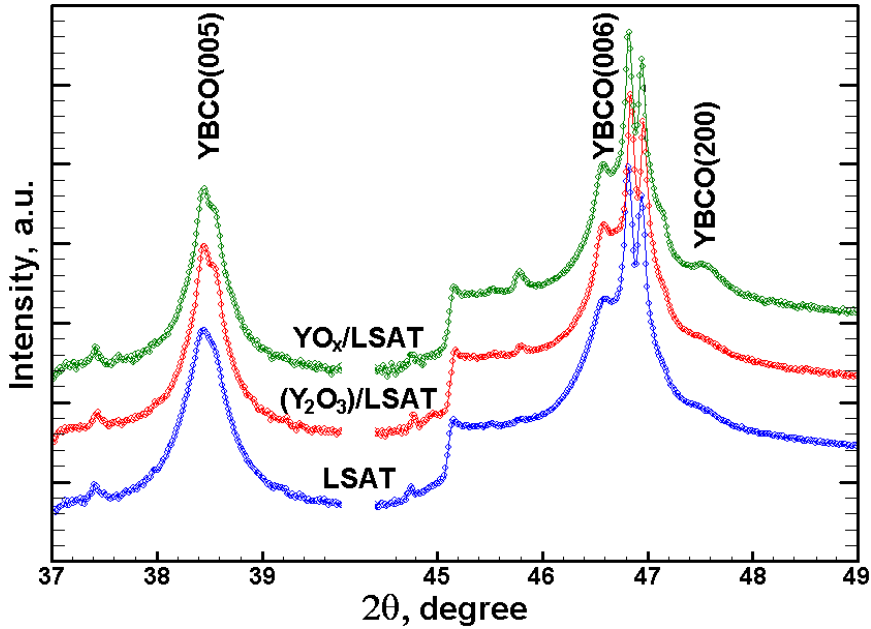

Fig. 8. Fragments of XRD  $\theta/2\theta$ -scans of the YBCO films on LSAT (100) substrates with different yttria decoration.

The  $j_c(B)$  dependence at 50 K for the Y-enriched films and for the standard film from the stoichiometric target are shown in Fig. 6. The standard film has a rather high  $j_c(0\text{ T})$ ,  $4.5 \times 10^6\text{ A/cm}^2$  (about  $2 \times 10^6\text{ A/cm}^2$  at 77 K), but all Y-enriched films show higher  $j_c$ . The  $j_c(B)$  dependence remains almost the same with increasing thickness of the film, proving the preservation of the film structure during film growth.

### 3.3 YBCO thin films on yttria decorated substrates

YBCO thin films (~240 nm) were simultaneously deposited from the stoichiometric target on two LSAT samples with different yttria decoration and on a reference bare LSAT substrate. The morphology of the obtained samples is shown in Fig. 7. Large elongated particles are present on the surfaces of the films on yttria layers (Fig. 7a, c). The particles are oriented along two orthogonal directions on the film surfaces, such behavior is typical for  $a$ -oriented particles. This supposition, though, is not confirmed by the XRD measurements. Peaks of  $a$ -orientation are absent for the YBCO film on a template layer of nanoparticles (Fig. 8). A weak peak from an  $a$ -oriented part of the film is observed only for the film on a uniform yttria layer (top curve, Fig. 8), and, probably, corresponds to the small elongated particles on the film surface (Fig. 7b), that are rare on AFM micrographs of other films.

The crystal structure of the  $c$ -oriented grains seems to be of higher quality for the films on yttria layers: the peaks on the XRD  $\theta/2\theta$ -scans are smeared for the YBCO film on a bare LSAT substrate, while clear  $K_{a1}/K_{a2}$  splitting can be seen on both other curves (Fig. 8, left). The reason is strain, for films on yttria layers  $\delta d/d = 0.3\%$ , while on a bare substrate it increases to 0.5%. The  $c$  lattice constant is the same for all three films and equals to  $11.673 \pm 0.005\text{ \AA}$ . A small  $c$  lattice constant implies a high critical temperature; indeed, all three films showed very high  $T_c$ , 91.4-91.8 K. The YBCO film on a bare substrate showed both the lowest  $T_c$  and the widest superconducting transition (Fig. 9). As the  $c$  lattice constant in the films does not differ, this variation in superconducting transition should be attributed to the difference in lattice perfection.

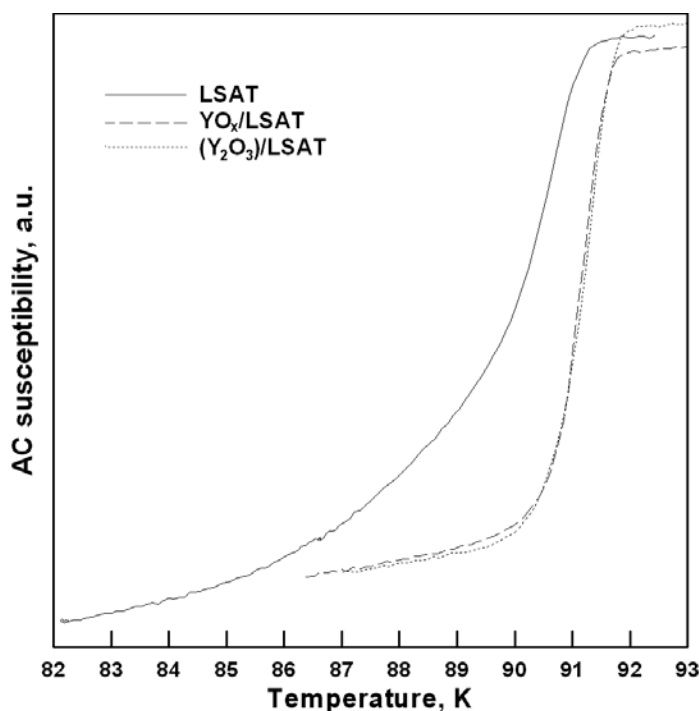

Fig. 9. AC susceptibility curves for YBCO films deposited from a stoichiometric target on LSAT substrates with yttria decoration. Solid line: bare LSAT substrate; dashed line: uniform yttria layer; dotted line: template yttria nanoparticles layer.



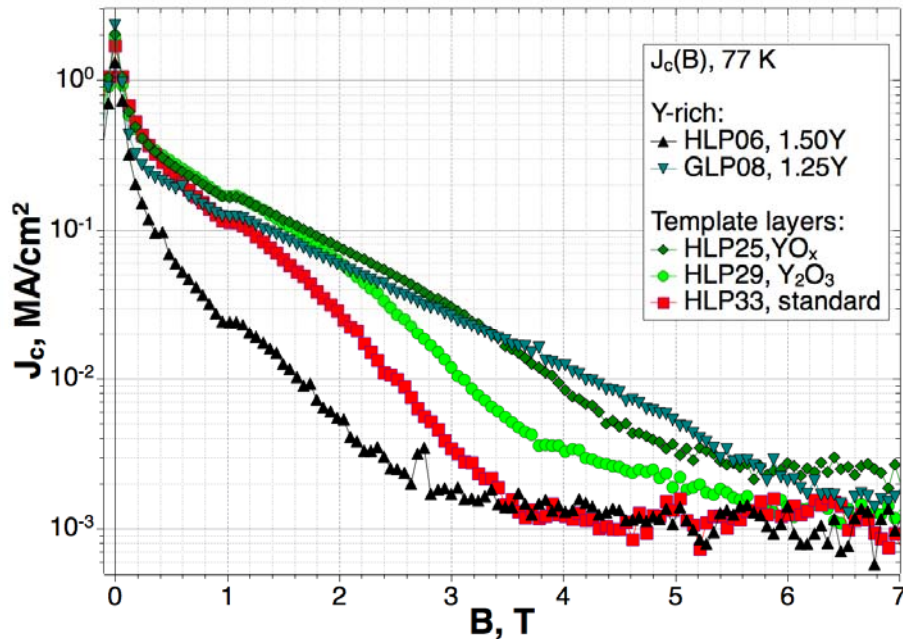

Fig. 10. Critical current density vs. magnetic field for YBCO films deposited from a stoichiometric target on various yttria layers on LSAT substrates. The data for Y-enriched films on bare LSAT substrates with different level of enrichment are added as reference.

The critical current density of the YBCO films on yttria seeding layers also surpass the parameters of the film on a bare substrate (Fig. 10). At 77 K the critical current of YBCO films on yttria layers exceeds that of the standard film for all magnetic fields over 0.5 T.

Comparison with Y-enriched films shows a crossover behaviour: at high temperature ( $> 77$  K) the YBCO films on yttria layers with better lattice perfection have higher values of  $j_C$ , but for lower temperature the high density of APCs in Y-enriched films overcome the advantages of the YBCO films on yttria.

## REFERENCES

- 1 K. Matsumoto and P. Mele, *Supercond. Sci. Technol.*, v. 23 (2010) 014001
- 2 M. Peurla *et al.*, *IEEE Trans Appl. Supercond.*, v. 15, (2005) pp. 3050-3053
- 3 C. Cai *et al.*, *Materials Science Forum*, vols. 546-549 (2007) pp. 1865-1870
- 4 R. Cloots *et al.*, *Supercond. Sci. Technol.*, v. 18 (2005) pp. R9-R23
- 5 T.-Sh. Wang *et al.*, *J. Phys. D: Appl. Phys.*, v. 35 (2002) 2180-2182
- 6 B. Dam *et al.*, *Physica C*, v. 341-348 (2000) pp. 2327-2330
- 7 M. Sparing *et al.*, *Supercond. Sci. Technol.*, v. 20 (2007) pp. S239-S246
- 8 P. R. Broussard, V. C. Cestone and L. H. Allen, *IEEE Trans. Appl. Supercond.*, v. 5 (1995) pp. 1222-1224
- 9 T. Sueyoshi *et al.*, *Physica C*, v. 468 (2008) pp. 1266-1269
- 10 Q. Xie *et al.*, *Journal of Crystal Growth*, v. 318 (2011) pp. 580-585
- 11 T.A. Campbell *et al.*, *Physica C*, v. 423 (2005) pp. 1-8
- 12 A. A. Gapud *et al.*, *Supercond. Sci. Technol.*, v. 18 (2005) pp. 1502-1505
- 13 P.B. Mozhaev *et al.*, *Czechoslovak Journal of Physics*, v. 46 (1996) pp. 1519-1520
- 14 J. Schou, *Applied Surface Science*, v. 255 (2009) pp. 5191-5198
- 15 J.P. Gong *et al.*, *Phys. Rev. B*, v. 50 (1994) pp. 3280-3287



## Session 6A - Bioenergy I

## Biomass in the Future European Energy Market

### Abstract

With Europe's ambitious target in mind to increase its share of renewable energy to 20% (a 34% share of energy for electricity production), this paper discusses the importance and challenges that increased use of biomass will lead to. Biomass comprises a wide range of fuels featuring a variety of properties and qualities, and both usage and import will result in dilemmas in relation to sustainability, area usage and food production. The paper also discusses Eurelectric's reasons why import criteria should be defined. The challenge of establishing the required capacity and the perspectives involved in added use are addressed here based on Danish experience and observations from two decades of development programmes. The development comprises generation of infrastructure, co-firing of straw and coal, gasification, new ways of exploiting the energy in household waste and second-generation bio-ethanol production.

### Introduction

Renewable energy, and this includes biomass, today plays a marginal role in the supply of energy in Europe. In 2009, the share of renewable energy sources (RES) constituted 15,6% of the electricity production and 8% of the energy production. Biomass constituted 3% of the electricity production and 5% of the energy production, respectively.

In view of Europe's ambitious 2020 target according to which RES are to constitute 20% of the energy supply and expectations to continue to pursue an ambitious target in the subsequent period leading up till 2050, the green light has been given to seriously launch the work involved in transforming the energy supply to comprise RES shares of a completely more significant volume.

Biomass has been selected to act the role as the primary source of energy in the future energy mix. A transition in which the costs of producing the resource as well as collecting, storing, transporting, handling and converting it are reduced to a competitive level compared with other resources - while at the same time continuing to expect that this resource can be procured in a sustainable way.

The transition process also means that in several areas biomass changes from being a marginal resource to being a resource of significant importance in the energy supply.

The European politicians are faced with the challenge of closing the financial and legislative gap between the price level of fossil fuels and the platform which the biomass plays on – with all its qualities.

### **What is biomass?**

Basically, biomass comprises a number of different types of waste products and farm-grown biomass. Biomass is generally split up as follows:

- Waste products from farming (straw, livestock manure)
- Wood and waste products from forestry
- Bio-combustible waste from households and industry
- Energy crops (cereals, oil crops and other crops such as willow and miscanthus)
- Blue biomass (microalgae and macroalgae).

This split provides very little information about whether the biomass is in fact suitable for energy purposes – energy density correlated with volume or humidity content and content of undesirable substances. Also the various types of biomass resources require various handling and conversion technologies.

### **Biomass as a resource**

Despite abundant literature about the global potential of bio energy, it is not possible to be specific as to what degree this resource can cover future energy requirements. Today the world consumes at global level about 470 EJ, of which 50 EJ is biomass, by 2050 the world's consumption of energy is expected to reach between 600 EJ and 1040 EJ (twice as much as today). Global models indicate that by 2050 sustainably acquired biomass will reach figures somewhere between today's level of 50 EJ and 250 EJ at global level.

Within the EU the assessment is that it will be possible to produce in the vicinity of 11.7 EJ/year without negative environmental impact. Today the energy supply consumes about 4.3 EJ.

### **The European ambition**

The EU has laid down the target to increase its share of renewable energy in the energy supply from today's level to a level of 20% of the total energy consumption in 2020 – equivalent to 34% of the electricity production. A target which is usually referred to as 20, 20, 20 in 2020.

In the period leading up to the summer vacation in 2010 all member countries developed individual plans which they submitted to the Commission – Renewables Action Plans stating how each country proposes to address this task. These plans are now being scrutinised in the EU and it will be interesting to see how the individual countries expect to procure the resource and establish the capacity.

During 2009 and 2010, the European electricity industry's organisation, Eurelectric, joined forces with VGB to carry out a large-scale study "*Power Choices - Pathways to carbon-neutral electricity in Europe by 2050*". The objective of this study was to document and demonstrate that conversion of the European electricity

supply along the lines of the EU ambition is indeed possible (Figure 1).

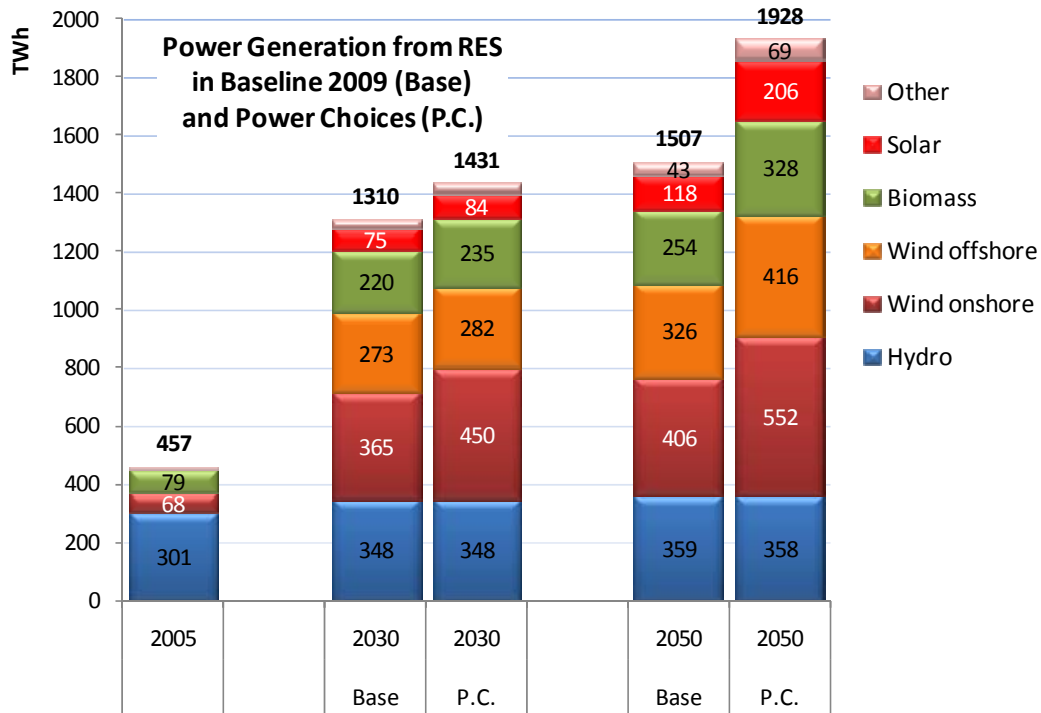

Figure 1: Eurelectric Power Choices: Pathway to Carbon Neutral Electricity in Europe in 2050 - Power Generation from Renewable Energy Sources

In this study Eurelectric and VGB demonstrate that there is indeed a path to a carbon neutral supply of electricity in 2050. Eurelectric is also convinced that this way is feasible and that biomass can play a future role in the transformation process and with this also in the fulfilment of the EU’s 2020 target. According to *Power Choices* the biomass share of European electricity supply grows from about 90 TWh in 2006 to 200 TWh in 2020 – ie, this share more than doubles over the next decade. To this should be added biomass for the production of biofuels, heat and materials.

So far the efforts have resulted in a *Eurelectric Declaration* signed by 61 CEOs - representing over 70% of the generating power in EU. The declaration was handed over to Commissioner Piebalgs on 18 March 2009. The signatories committed themselves to; 1) using all available carbon-free and low-carbon generation options when investing in new plants; 2) operating existing plants and grids in the most efficient way; 3) promoting energy efficiency and use of electricity on the demand side as a way to mitigate climate change; and 4) seeking to deliver power cost-efficiently and reliably through an integrated market.

However, irrespective of the statements computed of the capacity and potential for producing biomass within the EU, the net result will be import of biomass to Europe in view of the present increase and ambitions.

**Sustainability criteria**

The fast growing demand for biomass in these quantities will mean  
that less easily accessible resources will need to be sourced  
that we are looking at a wider range of biofuels  
that the requisite capacity allowing exploitation of the biomass must be established speedily  
that import of biomass to Europe must be envisaged  
that the increasing demand despite advantages of scale can result in increasing biomass prices  
that discussions about the sustainability and demands for recycling of nutrients must be expected  
that the energy industry is likely to compete with other industries about the bio-resources.

The markedly increasing demand may lead to a risk of changes in land use, environmental aspects such as the questions of biodiversity, exhaustion of the soil, erosion, changes to the nutritional balance and degradation of water habitats.

With these consequences in mind for Europe and in view of the expected import of biomass required to reach the ambitious targets laid down by the European countries with the 20/20/20 target, Eurelectric has encouraged the Commission to see to it that a set of European sustainability criteria are defined before the end of 2011. The intention being that a common set of European criteria will ensure sustainable imports and lower the risk of long-term investments in bio-energy while at the same time preventing individual countries from laying down local rules that can add to a non-transparent and inefficient market which would lead to elevated costs.

### Concepts

In specific terms, the highly ambitious biomass plan means that there must be efforts on all fronts. In terms of resources efforts will be invested in taking all conceivable remaining fractions into use and also to a considerable degree in developing new, effective bio-resources. In the terms of application, we are likely to meet demands for speedily establishment of capacity, modest investments and significant flexibility and inventiveness. In parallel with this it will be difficult to make any predictions about prices and reliability of supply for a horizon spanning two or three decades. Consequently, the market will be asking for the lowest possible CAPEX figures.

Now the question is what types of concepts are we looking at? Below is a short list of the trends seen for biomass application based on Danish experience and observations over the past two decades.

There are three immediate scenarios:

**Existing facilities** – co-firing. A scenario which focuses on processing the biomass, in order either to use the biomass alone or together with coal in existing facilities.

**New biomass facilities.** A scenario which tries to make the biomass resemble coal as much as possible – such that the resource can be handled, transported and used in as unsophisticated a manner as possible in new, large, decentralised, dedicated biomass facilities.

**Bio refinery.** A scenario where new concepts are based on the unique properties of the biomass and in view of this deliver fractions of the biomass for energy purposes and other quantities to

other and more valuable purposes.

Common to all three scenarios, in parallel with the development of technologies and concepts for the conversion process, logistics for the collection, storage and transport of the biomass from field to process facilities must be introduced.

### **New facilities**

At several locations in Europe there are targeted efforts to erect a number of new large, dedicated bio-facilities based on a mix of overseas imported biomass in a combination with domestic supplies. These concepts are based on more or less known technologies and a value chain as we know it from coal. Both as regards fuel supply as well as combustion. Technologically the concepts are working with CFB and dust-fired plants.

Similarly, there are various incentives dedicated to using the energy content of slurry at European level. Some countries focus on using this resource at local level whereas other regions focus on upgrading the biogas to a quality at the level of natural gas which would allow “storage” and transport of the gas from source to consumer.

### **Existing facilities**

For more than two decades, the Danish energy producers have been operating co-firing plants adding straw to coal in the central power stations. This has provided these producers with valuable know-how about the logistics involved – collection, transport, processing and the process of co-firing with coal without damage to the boiler. More than two decades of experience with large-scale collection of local biomass has demonstrated that establishing capacity – from logistics to handling of the biomass – is a very time-consuming process. The parties involved are part of a value chain which is outside the power station’s control and most of these come from a completely different world. A challenge not to be underestimated (Figure 2).



*Figure 2: Avedøre Power Plant in Copenhagen. The world's largest straw fired power plant - 25 tonnes per hour capacity. Integrated with coal, pellet and gasfired units in multifuel plant.*

In addition to co-firing, DONG Energy is in the process of converting three specific 350 MW coal-fired power stations from firing 100% coal to firing 100% wood pellets – primarily based on imported biomass.

### **New concepts**

The many years spent working with biomass – mostly straw and household waste – have also resulted in an enormous investment into R&D of this field, and at the moment three new and highly interesting concepts are approaching maturity.

INBICON is a concept which aims to produce 2 G bio-ethanol using straw and other similar types of biomass as raw material. Basically in this concept, the straw is cooked – a process which opens up the structure and makes the cells accessible to enzymes. The enzymes disintegrate part of the biomass to form sugars which can be converted to EtOH. The remainder of the biomass turns into a sugary substance, which contains salts and minerals from the biomass and can be used as animal feed and in the production of biogas, and a solid fuel, which can be co-fired with coal in a power station. The philosophy is that the components of the straw should be used where most appropriate and where they will generate the highest added value. A condition for this concept is that the facility is co-located at the power station premises thus allowing use of the “waste heat” from the power station as a resource in the INBICON facility. The concept is seen as an important step towards introducing a bio refinery which is deemed to play a very important role in the future energy infrastructure. DONG Energy operates a major demo facility in Denmark (by Kalundborg) and has already sold the very first technological licences (Figure 3 and 4).



*Figure 3: INBICON in Kalundborg - the world's largest 2G bioethanol plant. Produces bioethanol, molasse and lignin pellets from straw - capacity to convert 100 tonnes straw per day.*





*Figure 4: Lignin pellets produced on the INBICON 2G bioethanol plant in Kalundborg.*

LT-CFB is another pre-processing concept in which straw and other forms of biomass are gasified at a relatively low temperature (700°C). Thanks to a simple cyclone purification process the gas produced can be used in a power station boiler – either alone or in a combination with coal. The low temperature does not allow for gasification of K<sub>2</sub>CO<sub>3</sub> and other nutrients; instead these substances are discharged with the ash. This minimises corrosion of the power station boilers, and also the nutrients can be recycled in agricultural use. The concept will be scheduled as a demo project in 2011 and is expected to reach full-scale demonstration in 2015 in DONG Energy. Although gasification of coal and wood is not a new process, gasification of biomass with a high content of ash and alkali has always posed difficulties, especially in connection with flue gas cleaning. This process paves the way for exploiting local types of biomass in addition to organic waste products from for example various process industry segments. To begin with the best use of the gas is in dust-tolerant boilers, whereas from a long-term perspective a more sophisticated flue gas cleaning process can lead to a wider scope of applications.

REnascence is a concept which processes household waste. The concept hydrolyses the waste, and after processing with enzymes the organic fraction becomes liquid and forms part of the biogas production. Solid substances, such as metals and glass, can be extracted and recycled, whereas plastic can be co-fired in central plants. This approach departs from conventional waste combustion philosophies and is in line with the principles of making efficient use of our resources and the view point that waste is a resource and not a problem. The concept has been tested successfully over a 12 months period in a demo plant (Figure 5).



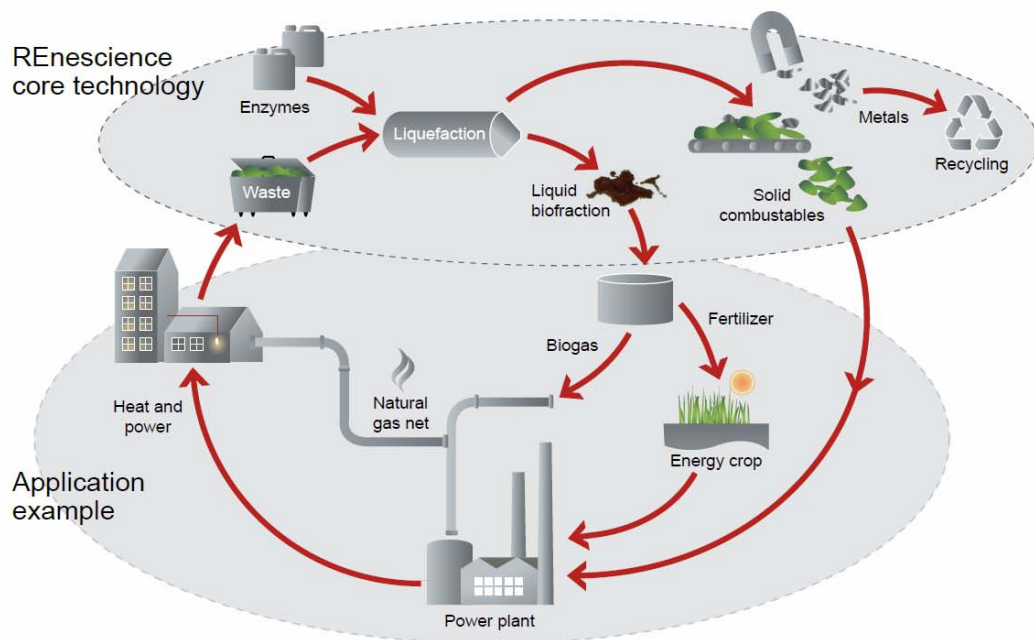

Figure 5: Concept for a sustainable household waste cycle - as demonstrated at the REnescience plant at Amagerforbrændingen waste plant in Copenhagen

### Other observations

While gradually outphasing fossil sources of energy and hastily increasing the volumes of fluctuating energy in the form solar energy and wind energy, storage will become an issue. Initially, the fluctuations can be managed by converting to flexible customer solutions - heat pumps or electric vehicles - and expansion with smart grids. The need for storing the biomass along with the electricity generated by surplus wind or as gas in the natural gas grid in the form of “green electricity” will, however, become a solution. The gas grid could in this way together with the biomass form part of a solution that could take over the role that the storagable and transportable plays today. (Figure 6)

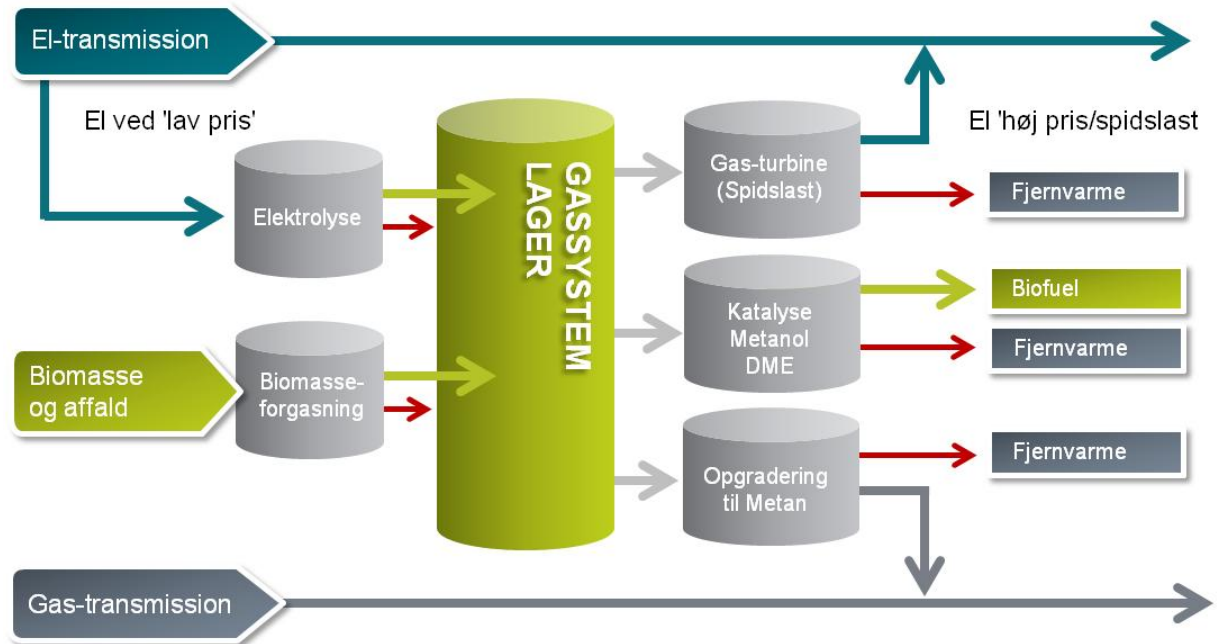

Figure 6: Concept of the possible coupling of the electricity, gas and district heating infrastructure in a future energy system

Finally, bottlenecks are expected to arise both as regards the suppliers of the resource and those that are to build the capacity required to handling and processing the biomass because of the aim to rely heavily on biomass. As a result of this the risk of local or regional price increases cannot be disregarded.

### The future

The future is here. We are well on our way to convert our facilities to using markedly increasing quantities of biomass for energy supply purposes. However, while we consume constantly increasing quantities of biomass for energy purposes, we need to remember that in view of our present knowledge, biomass is the only resource that can substitute oil in the chemical industry and also that biomass for energy purposes compete for the same areas to grow human food and animal feed.

### Conclusion

By way of conclusion, biomass is well on its way into the European energy supply, away from a marginal to a major role, and the pace of many areas must change if the ambitious 2020 targets and the targets for subsequent years are to be fulfilled. Despite of this there are discussions ahead of us that we need to go into on the issues of sustainability and competition for areas for human food and animal feed.

# The role of biomass and CCS in China in a climate mitigation perspective

Mikael Lüthje, Kenneth Karlsson, Jay Gregg, Tullik Helene Ystanes Føyn, and Olexandr Balyk. All authors are affiliated with Risø DTU, Denmark.

## Abstract

As the world's largest emitter of greenhouse gasses (GHGs), China plays a central role in the suite of options for climate change mitigation. To analyze the importance of biomass and carbon capture and storage (CCS) availability in China, varying levels of these parameters are created and then global climate scenarios are simulated using TIAM (TIMES Integrated Assessment Model). TIAM is a 16-region global energy system optimization model that includes a climate module that calculates the global concentrations of GHGs in the atmosphere.

We analyze the potential for using biomass, CCS, and bioenergy CCS (BECCS) in China under the constraint of meeting a climate stabilization target such that dangerous climate change (as defined by the Copenhagen Accord) is avoided. When considering hypothetical scenarios where GHG emissions are constrained, China consumes all available domestic biomass as a relatively inexpensive fuel source. However, while BECCS does have a small role to play, in general it is cheaper to use biomass for the transportation sector and CCS with fossil fuel in order to meet both the energy demand and emissions reduction goals in the cheapest way possible.

Therefore, we find that while both utilization of biomass and CCS are essential options for reducing emissions in China, BECCS is not the most cost effective option in China. CCS is nevertheless an important option for China; in the climate mitigation scenarios modeled, by 2050, China is projected to employ CCS on at least 70% of fossil energy electricity generation. When CCS is excluded, the cost of mitigation is more than doubled compared to the scenarios where CCS is included as a mitigation option.

## 1. Introduction

Reducing the risk of dangerous climate change, defined as an increase in the global mean temperature of 2°C (with the CO<sub>2</sub> concentration not exceeding 443 ppm), will require an ambitious effort to reduce net greenhouse gas (GHG) emissions. Participation from China is crucially important if we are to achieve this goal. First, China accounts for a substantial share of the world's population, economy, and GHG emissions: China has the world's largest population and the second largest economy, and has recently become the world leader in GHG emissions (Gregg et al., 2008). Second, China's Gross Domestic Product (GDP), energy consumption and GHG emissions are expected to continue to increase rapidly in the coming years (Blanford et al. 2008), and this rapid growth in emissions could offset mitigation efforts in other parts of the world, e.g. Annex-I (industrialized) countries (Blanford et al. 2008). Third, because of the speed with which China's energy demand is growing, the country is facing a large challenge in expanding supply rapidly enough. Domestic coal is currently the most used and most readily available energy supply source (BP, 2010 and International Energy Agency, 2008), but it is a carbon-intensive fuel. Therefore, aligning the security of supply requirements with environmental and climate change objectives is a great challenge for China (Zeng et al. 2008). Finally, global mitigation costs increase significantly when action is delayed in non-Annex I countries, including China (Clarke et al. 2009). Current Chinese efforts to combat climate change will therefore be of high importance; avoiding dangerous levels

of planetary warming is likely not possible without substantial GHG emissions reductions from non-Annex I countries, particularly China (Clarke et al. 2009).

This paper examines the role of China in global mitigation efforts, and focuses on biomass, carbon capture and storage (CCS), and bioenergy CCS (BECCS). BECCS has the potential to yield net-negative emissions, yet biomass resources are a limiting factor in the amount this option can be deployed. For the purpose of analyzing China's role in global mitigation efforts, this paper employs a global energy system optimization model (TIAM) with various estimates for future biomass potential and carbon dioxide (CO<sub>2</sub>) storage capacity in China. The model is used to simulate the economically optimal investment path for the global energy system such that atmospheric concentrations of GHGs are stabilized at a point where the increase in global mean temperature remains below or close to 2°C. Different scenarios will be investigated testing different assumptions for biomass potential, available storage volume for CO<sub>2</sub>, and efficiency and costs of CCS technology.

## 2. Methodology

### 2.1 The TIAM model

The TIMES Integrated Assessment Model (TIAM) is a detailed, technology-rich global TIMES<sup>1</sup> model. The structure and data come from the MARKAL-based SAGE model developed by the Energy Information Administration of the US Department of Energy. Detailed information about the development of TIAM, its structure, existing databases and application can be found in Loulou and Labriet (2008), Loulou (2008), and Loulou et al. (2009).

TIAM is a partial equilibrium model, where equilibrium on energy markets is found via minimization of total discounted cost, or equivalently maximization of total surplus (sum of consumer and producer surplus), using linear programming. It is a model of the entire global energy system, i.e. from primary resource extraction to end-use. Fuel prices are endogenous. TIAM has a climate module with climate equations calculating GHG concentration levels in the atmosphere and oceans, consequential change in radiative forcing, and change in global mean temperature. Thus, the model and hence the energy system can be optimized for various climate targets. Given such a target, the model will find a solution where marginal costs of reducing GHG emissions are equal across all of the constrained regions. The TIAM version used for this paper is global, with 16 regions (including, China) and the time horizon is 2100.

### 2.2 Climate scenarios

In a hypothetical climate policy scenario, we assume that the world society has agreed on preventing the increase in global mean temperature from exceeding 2°C. This is reflected in the integrated assessment model by following the GHG emission trajectory from Intergovernmental Panel on Climate Change (IPCC) RCP3-PD emission scenario. RCPs are Representative Concentration Pathways, scenarios developed for the IPCC Fifth Assessment Report (AR5) (Van Vuuren et al., 2007). In the RCP3-PD scenario the CO<sub>2</sub> concentration peaks just after 2050 and decreases then to 421 ppm in the year 2100. Only the CO<sub>2</sub> pathway is included in the following analysis since the majority of CH<sub>4</sub> and N<sub>2</sub>O emissions reductions are handled exogenously in TIAM. The reference scenarios have exogenously defined economic growth rates for the various regions in TIAM and include no climate constraint.

---

<sup>1</sup> TIMES refers to both a model generator and a family of models. Further information is available at <http://www.etsap.org/tools/TIMES.htm>.

## 2.2.1 CCS Potential for China

CCS is becoming an important option for reducing global emissions of GHGs. A large share of the coal consumed in China is used in the power sector, and thus a large share of carbon emissions could be captured and stored in geological formations. CCS could also be coupled with biomass energy production, opening up the possibility for an energy production technology that actually absorbs CO<sub>2</sub> from the atmosphere, or in other words, has negative net emissions. Large scale implementation of biomass energy with CCS allows us to reduce the atmospheric concentration of CO<sub>2</sub>, should we overshoot the stabilization level required to prevent dangerous climate change. In general, it is only possible to capture 85% to 95% of the CO<sub>2</sub> emitted, so power production utilizing CCS on fossil fuels still emit a small amount of CO<sub>2</sub>. In all scenarios, CCS capability is available only to new power plants.

The potential for geological storage of CO<sub>2</sub> is high in China, with a total estimated storage capacity in the order of 3,000 Gt CO<sub>2</sub> (Dahowski et al., 2009), roughly equivalent to 100 years of current global emissions. The vast majority of the storage potential is in saline aquifers, and most large point sources for emissions are in proximity of a storage location. Some storage capacity is found in oil and coal basins where there is a potential to combine it with enhanced coalbed methane recovery and enhanced oil recovery to drive the cost down. The cost of capturing, transporting, and storing the CO<sub>2</sub> are all included in TIAM. Efficiency loss (6-10%) in power generation is the major cost of CCS with the storage capacity being a potential limiting factor. For assessing the importance and possibilities for CCS, three different settings of storage potential are tested together with different levels of efficiency loss for power plants with CCS. In the pessimistic scenario, the storage capacity is halved and the efficiency loss due to capturing CO<sub>2</sub> is increased by 50% over the default values. In the optimistic scenario, the storage capacity is doubled and the efficiency loss due to capturing CO<sub>2</sub> is halved. Finally, we run a scenario that excludes CCS to estimate the increase in cost of reaching a strict climate target when CCS is unavailable as a mitigation option.

## 2.2.2 Biomass Resources

Six categories of biomass resources are modeled: industrial waste, municipal waste, landfill gas, sewage, bioenergy crops, and solid biomass resources (agricultural residues and forestry products). In TIAM the biomass potential is exogenously defined, and it is assumed that biomass is only consumed domestically and is not traded between regions.

Bioenergy crops are assumed to be grown on surplus crop land, and this depends on the amount of cropland available by making projections about future food demand - including diets and trade balances - and future crop yields. Likewise, solid biomass resources, which include agricultural residues and forestry products, are estimated from future crop production and land use. In TIAM, the maximum supply potentials are based on the quickscan model, discussed in Smeets et al. (2004). The quickscan model makes a geographic optimization of land use towards yields that minimizes the cropland, using varying sets of assumptions regarding population, economic growth, diet, and agricultural technological developments. Projections are made to 2050, and from here, the potential is extrapolated until 2100 in TIAM.

The parameters that determine land availability and the total maximum potential supply of biomass are difficult to determine precisely, yet estimates for future potential of biomass resources are highly dependent on these assumptions. For China, the end of century maximum supply is estimated to be 6 EJ yr<sup>-1</sup> for energy crops and another 11.1 EJ yr<sup>-1</sup> from solid biomass. In a literature review of biomass assessments for China, the values for solid biomass potential varied by approximately ±25% from the mean value of a selected group of assessments (Milbrandt and Overend, 2008). Therefore, for this assessment, we vary the default TIAM values by ±25% to determine how sensitive China's fuel portfolio and CCS utilization is to different assumptions about the availability of biomass.

In reality, sources of waste biomass, comprised of industrial waste, municipal waste, landfill gas, and sewage, are a function of industrial output and per capita wealth. However, in TIAM these are exogenously defined assuming a maximum potential availability at different time periods in the next century. Waste biomass contributes only a small part (approximately 15%) of the total biomass potential of China and it also has higher unit energy cost among the various sources of available biomass. Therefore, the amount of waste biomass available is held constant in all scenarios analyzed in this paper.

### 2.2.3 CCS and Biomass scenarios

In this paper, seven scenarios are created representing different combinations of assumptions (Table 1). Scenario one is the default case whereas scenarios two and three have respectively more pessimistic and optimistic assumptions about biomass availability, CO<sub>2</sub> capture efficiency, and CO<sub>2</sub> storage capacity (described in section 2.2.1 and 2.2.2). These three scenarios are run without a climate constraint in “a” (reference) and with a RCP3-PD climate constraint for CO<sub>2</sub> in “b”. Scenario 1c is similar to 1b but with CCS excluded from the list of mitigation options available.

Table 1 Outline of scenarios tested in TIAM.

Scenario	Global Climate Constraint	Biomass Resource in China	Efficiency Loss Due to CO <sub>2</sub> Capture	CO <sub>2</sub> Storage Capacity
<b>1a</b> Reference	Reference (None)	Default (100%)	Default	Default (100%)
<b>1b</b> Mitigation Default	RCP3-PD (CO <sub>2</sub> only)	Default (100%)	Default	Default (100%)
<b>1c</b> Mitigation No CCS	RCP3-PD (CO <sub>2</sub> only)	Default (100%)	NA	0%
<b>2a*</b> Reference Pessimistic	Reference (None)	75%	50% higher	50%
<b>2b</b> Mitigation Pessimistic	RCP3-PD (CO <sub>2</sub> only)	75%	50% higher	50%
<b>3a*</b> Reference Optimistic	Reference (None)	125%	50% lower	200%
<b>3b</b> Mitigation Optimistic	RCP3-PD (CO <sub>2</sub> only)	125%	50% lower	200%

\* Scenarios 2a and 3a are run as reference cases only in order to have starting points for the energy prices and elastic demands for 2b and 3b. The results of 2a and 3a are similar to those of 1a, and these scenarios are thus not displayed in this paper.

## 3. Results and Discussion

This section presents results from model runs of the scenarios and discusses the various scenarios for China concerning biomass and the role of CCS in a CO<sub>2</sub> emissions constrained world. Figure 1 shows China’s share of global emissions and global emission mitigation efforts in the various scenarios. China’s share of global emissions is much higher in the stabilization scenarios than in the reference scenario. China’s share of the global mitigation effort is similar in all scenarios, apart from around 2030-2050, where China takes a slightly larger share of emissions reductions in 1c (Mitigation No CCS) than in the other mitigation scenarios.

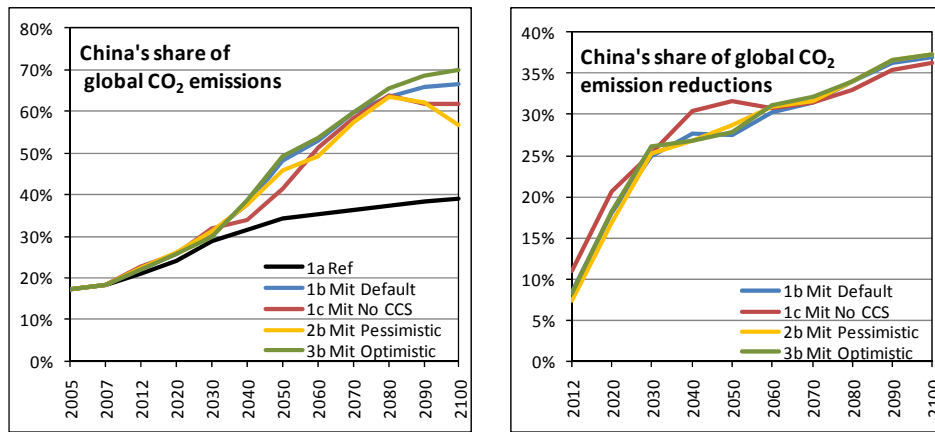

Figure 1 China's share of global CO<sub>2</sub> emissions and reductions

Because the policy scenario is rather stringent, it drives up the price of CO<sub>2</sub> emissions, and increasingly more expensive mitigation options are utilized. Figure 1 plots the CO<sub>2</sub> prices over time in the various policy cases. As can be seen, excluding CCS from the technology portfolio increases the price of CO<sub>2</sub> by a factor of 6 to meet the stabilization target.

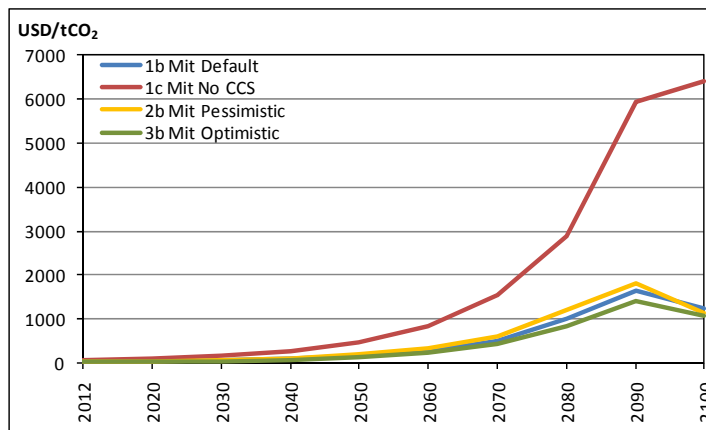

Figure 2 Global CO<sub>2</sub> price

A further indication of the relative difficulty of staying on the stabilization pathway is given by changes in total discounted costs of the energy system in the different mitigation scenarios. In all scenarios, China's share of the total discounted costs of the global energy system is approximately 13%, while its share of the mitigation costs varies between approximately 13% and 17%, with the highest share taking place in scenario 2b (Mitigation Pessimistic), where biomass is more limited and plays a smaller role in mitigation.

Table 2 shows the relative cost increase of different mitigation scenarios, i.e., increases in total discounted costs. In scenario 1b (Mitigation Default) and 3b (Mitigation Optimistic), China's total discounted costs rise at approximately the same rate as the total global costs. With a low biomass potential (2b), or exclusion of CCS (1c), however, China's costs increase relatively more than the global cost. When CCS is excluded as a mitigation option (1b versus 1c), China's mitigation costs rise approximately 171%. In comparison, the corresponding global mitigation costs increase only 118%.

Table 2 Relative cost increase of different mitigation scenarios

	Mitigation Default: 1a vs. 1b	Mitigation No CCS: 1a vs. 1c	Mitigation cost increase 1b vs. 1c	Mitigation Pessimistic: 2a vs. 2b	Mitigation Optimistic: 3a vs. 3b
China	5%	15%	171%	7%	4%
World	5%	10%	118%	5%	4%

When CCS is allowed as a mitigation option, a large share of power generation is projected to come from power plants equipped with CCS, particularly in China. Figure 3 shows the share of the total power production both as world average and for China separately for the three mitigation scenarios that allow investments in power plants with CCS technology. The graphs also distinguish between the shares on fossil CCS and BECCS.

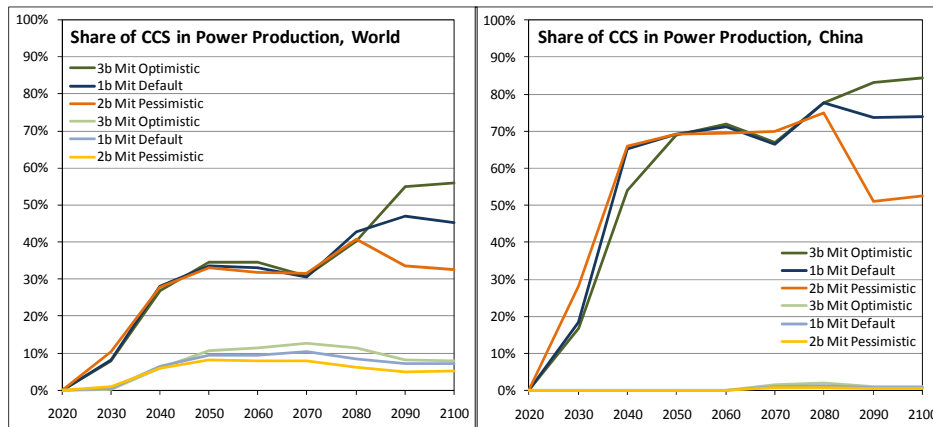

Figure 3 Power plants with CCS share of total power production in the world and in China

Because the emissions constraint is tight and drives up the carbon price, CCS is projected to expand quickly in a cost optimized world. Fossil CCS is utilized on nearly all new non-nuclear thermal power plants beyond 2020 in China, while less so globally. Fossil fuel combustion with CCS is projected to produce around 50% of total global electricity in 2100. However, by mid century, over 70% of the electricity in China is produced from power plants with CCS; and in the optimistic scenario, this increases to over 80% by the end of the century. The electricity demand in China is growing exponentially and therefore the installed power capacity does as well. Under an emissions constraint, CCS is incentivized on new power plants. On the other hand, BECCS power plants only cover 1-2% of electricity production in China while the global average is around 10%. Much of the biomass in China is instead used in the transportation sector, to be discussed below.

In the pessimistic scenario (2b), the CCS share drops from 2080 to 2090, heavily in China, and more moderately for the whole world. Between 2080 and 2090, industry switches from gas to electricity as the main energy carrier and there is a projected increase in electricity and hydrogen powered vehicles. With increased demand for industry electricity, electricity for the transportation fleet, and for hydrogen production (electrolysis), power capacity expands, particularly in China. The increased electricity demand is met by increasing the investment in solar PV at the end of the century in the model, as CCS would emit too much CO<sub>2</sub> to remain within the emission constraint. This gives a large increase in power production and therefore the relative share of CCS power diminishes.



In general, if the CCS technology develops as expected, then it will become an important solution for the global power system, covering around 50% of global power production. In China, CCS will be even more important if the country's economy and industrial production continues to grow throughout the century. All regions in the model utilize CCS to some extent. In scenario 1b (Mitigation Default), more than 2,000 Gt CO<sub>2</sub> is stored worldwide over the next century. About half of this is projected to be stored in China: scenario 1b (Mitigation Default) and 3b (Mitigation Optimistic) 50%; scenario 2b (Mitigation Pessimistic) 46%. The utilization of CCS worldwide and in China is not limited by a lack of storage capacity. In scenario 2b where the expected storage capacity is halved, still only 28% of the world storage capacity and 58% of the capacity in China is utilized (Table 3).

Table 3: Percentage of storage capacity used for the period 2005 to 2100.

CO <sub>2</sub> Storage Capacity Used	Scenario 1b (Mitigation Default)	Scenario 2b (Mitigation Pessimistic)	Scenario 3b (Mitigation Optimistic)
China	35%	58%	18%
World	16%	28%	8%

In scenario 3b (Mitigation Optimistic), the storage capacity is very large and the efficiency loss of the power plants due to the capture process is assumed to be much lower than it is currently. Still, the use of CCS does not increase much and only 2% more CO<sub>2</sub> is stored versus scenario 1b (Mitigation Default) (both for China and worldwide). Compared to scenario 2b (Mitigation Pessimistic) the increase is 25% for China and 16% worldwide. Therefore, the percentage of storage capacity utilized in scenario 3b (Mitigation Optimistic) is low when compared to the two other mitigation scenarios.

Figure 4 shows how much of the biomass potential is utilized. In China, the model's mitigation options are constrained by the available biomass resources already by mid century. Even in the reference scenario (1a), the model uses 90% of the available biomass at the end of the century in China. Taking the world as a whole, mitigation options are not constrained by limited biomass availability. However, a large share of the global potential for biomass is consumed; even without an emissions constraint, more than 70% of the global annual biomass potential is used at the end of the century. Again, it is assumed within TIAM that biomass is consumed domestically and not traded across regions.

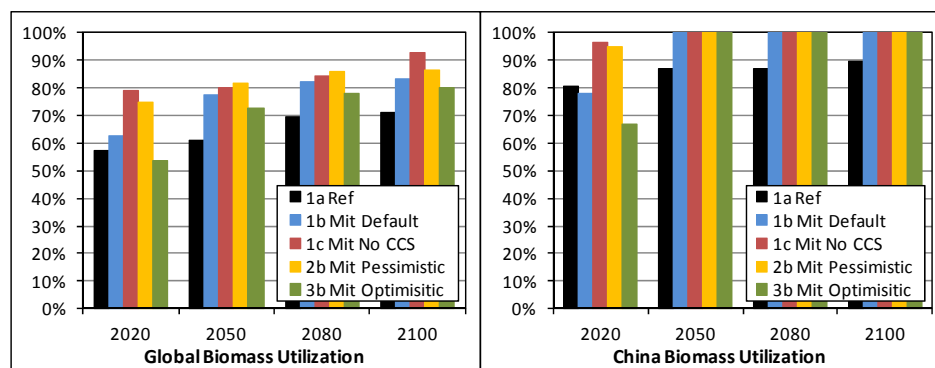

Figure 4 Share of biomass potential utilized. World (left) and China (right).

The share of biomass in primary energy consumption is shown in Figure 5. The fall seen in China is due to the combination of a rapidly increasing energy demand and the exhaustion of the annual biomass potential. Furthermore, in China, biomass plays

virtually no role in the power sector – the share stays below 1.5% in all periods and all scenarios, apart from a short peak towards 2% around 2070-2080 in 3b (Mitigation Optimistic).

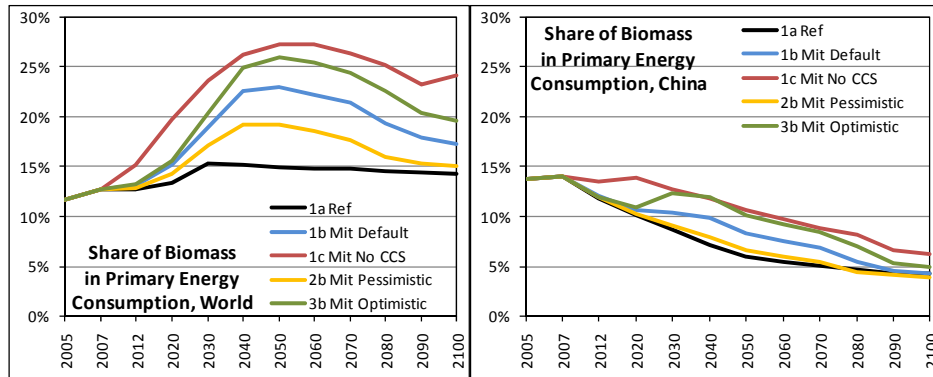

Figure 5 Biomass' share in primary energy consumption. World (left) and China (right).

Throughout the century, biomass plays a substantial role in the transport sector both in China and globally. As Figure 5 shows, this is the case in all scenarios, but in particular in 1c (Mitigation No CCS), where mitigation options are constrained because of an exclusion of CCS.

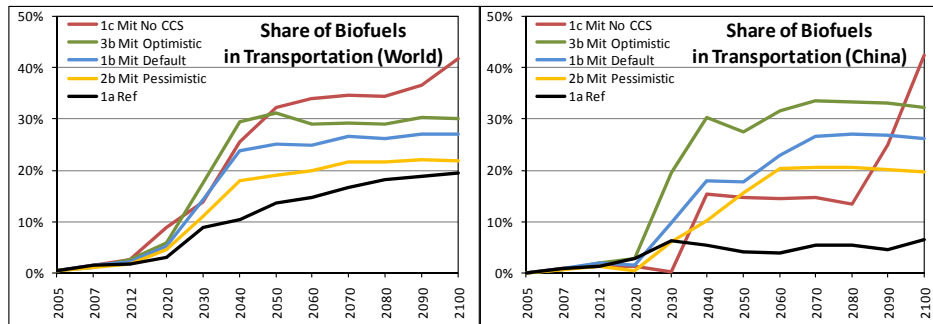

Figure 6 Share of biofuels in transport sector's energy consumption. World (left) and China (right).

## 4. Conclusion

This paper provides some insight into how much China can rely on biomass and CCS technology when taking part in a global effort to mitigate climate change. While all energy technologies and resources are also included in this type of integrated assessment modeling, we have focused on how China could use biomass and CCS optimally to curb emissions.

The underlying economic growth in China causes a dramatic increase in Chinese energy demand until 2100 (final energy demand grows 500-600% from 2010 to 2100). This gives a lot of pressure on domestic renewable resources such as biomass, wind, and solar PV. Even with optimistic assumptions on future biomass availability (scenario 3b), it can only cover around 10% of the Chinese primary energy consumption in 2050 and around 5% in 2100. Most of the available biomass in China is optimally used in the transport sector, thereby favoring fossil CCS over BECCS.

CCS on coal and natural gas based power plants are key technologies for China in an emissions constrained world. The CCS storage potential in China is not a limiting factor. Even with the pessimistic assumptions on the size of storage (2b), our findings show that

with high implementation of CCS China uses less than 60% of the CO<sub>2</sub> storage potential over the next century.

Studies like this are sensitive to specific assumptions: the availability of non-fossil energy resources and CCS availability are essential options to meet mitigation targets. Further research and assessment is therefore needed to help better quantify the future potential for biomass, wind, solar, hydro, geothermal, nuclear power, etc. Moreover, different assumptions for future economic development can also dramatically influence the results.

Nevertheless, this analysis demonstrates the importance and the potential for biomass and CCS (though not BECCS) in meeting emissions reduction targets, particularly in China. Without China on board in a global climate policy, and without the development of biomass resources and penetration of CCS in the power sector, it will be very difficult to prevent dangerous climate change as aimed for under the UN Framework Convention on Climate Change (UNFCCC) and the Copenhagen Accord.

## 5. Acknowledgements

The authors gratefully acknowledge ETSAP and KANLO-KANORS for access to the TIAM model, support and rewarding discussions on modeling issues.

## 6. References

Blanford, G. J., R. G. Richels, and T. F. Rutherford. Revised Emission Growth Projections for China: Why Post-Kyoto Climate Policy Must Look East. The Harvard Project on International Climate Agreements, Discussion Paper 08-06. 2008.

BP Statistical Review of World Energy. 2010

Clarke, L., J. Edmonds, V. Krey, R. Richels, S. Rose, and M. Tavoni. International climate policy architectures: Overview of the EMF 22 International Scenarios. *Energy Economics* 31. 2009.

Dahowski, R. T., L. Xiaochun, C. L. Davidson, N. Wei, and J. J. Dooley. Regional Opportunities for Carbon Dioxide Capture and Storage in China. A Comprehensive CO<sub>2</sub> Storage Cost Curve and Analysis of the Potential for Large Scale Carbon Dioxide Capture and Storage in the People's Republic of China. U.S. Department of Energy. 2009.

Gregg, J.S., R.J. Andres, and G. Marland. China world leader in CO<sub>2</sub> emissions from fossil fuel consumption and cement production. *Geophysical Research Letters* 35: L08806. 2008.

International Energy Agency. Energy Technology Perspectives 2008 – Scenarios and Strategies to 2050. 2008.

Loulou, R. and M. Labriet. ETSAP-TIAM: the TIMES integrated assessment model. Part I: Model Structure. *Computational Management Science* 5: 7-40. 2008.

Loulou, R. ETSAP-TIAM: the TIMES integrated assessment model. Part II: Mathematical formulation. *Computational Management Science* 5: 41-66. 2008.

Loulou, R., M. Labriet, and A. Kanudia. Deterministic and Stochastic Analysis of alternative climate targets under differentiated cooperation regimes. *Energy Economics* 31. 2009.

Milbrandt, A. and R. P. Overend. Survey of Biomass Resource Assessments and Assessment Capabilities in APEC Economies. Report prepared for the APEC Energy Working Group under EWG 01/2007A by: National Renewable Energy Laboratory (NREL) Golden, Colorado, USA. 2008.

Smeets, E., A. Faaij, and I. Lewandowski. A quickscan of global bio-energy potentials to 2050: An analysis of the regional availability of biomass resources for export in relation to the underlying factors. Utrecht, The Netherlands: Report NWS-E-2004-109 (ISBN 90-393-3909-0). 2004.

Van Vuuren, D., M. den Elzen, P. Lucas, B. Eickhout, B. Strengers, B. van Ruijven, S. Wonink, and R. van Houdt. Stabilizing greenhouse gas concentrations at low levels: an assessment of reduction strategies and costs. *Climatic Change*, doi:10.1007/s/10584-006-9172-9. 2007.

Zeng, N., Y. Ding, J. Pan, H. Wang, and J. Gregg. Climate Change - the Chinese Challenge. *Science* 319: 730-731. 2008.

## ***The European Biofuels Policy: from where and where to?***

Summary of paper for presentation for Risø Energy Conference,  
Denmark May 10-12, 2011

Henrique Pacini\*  
Semida Silveira\*

\* Royal Institute of Technology (KTH), Sweden.

E-mail: [pacini@kth.se](mailto:pacini@kth.se)

### **Executive summary**

Biofuels for transport had a long history prior to their formal introduction in the European Union by means of formal directives in 2003 and 2009. Dating back to years before the First World War, busses were already rolling in Paris on a mixture of ethanol and petrol. Between 1920 and 1950 the French continued using sugar-beet-based ethanol as a tool to improve energy independence and reduce trade deficits (Kutas et al, 2007 p. 15). Ethanol utilization as a fuel blend only fell once oil prices achieved record lows in the 1960's, as large reserves started being tapped in the middle-east.

In the 1970s oil price shocks brought concerns about the European dependence on foreign energy, and the following decades saw many actions which started to change the biofuels panorama in Europe. By 1973 biodiesel research was already being conducted in Wieselburg, Austria, and in 1982 the country had its first pilot plant for biodiesel (producing fatty-acid methyl ester - FAME). After successful experiences with ethanol in Brazil, the first European directive which opened potential large markets for biofuels in Europe was the Council Directive 85/536/ECC, which authorized blends of 5% ethanol and 15% Ethyl Tertiary Butyl Ether (ETBE, a bio-ether) on petrol. The usage of bioethanol for blending, however, was hampered by the low prices of oil products which marked the late 1980s and most of the 1990s (the same reasons which dealt a blow to the Brazilian ethanol program during that time).<sup>1</sup>

In tandem with the development of biofuels in Europe, carbon emissions were already consolidated in scholarly literature as the major causal factor behind climate change (Nordhaus, 1983; Daansgaard, 1993). Since the UN's Brundtland commission report from 1987, alternatives to de-carbonize the transport sector were in high demand, but the deployment of alternatives was hampered by a conjuncture of low oil prices. The following years in the 1990s were instrumental for the emergence of the modern environmental policy pursued by the EU, which became rooted in its commitment to the Rio-92 conference and later commitment to the Kyoto protocol. Early in that decade the first attempt at biofuel-promotion legislation at the EU level took place, while at national levels the adoption of technical standards for biofuels gained steam.

---

<sup>1</sup> Calls for air quality control prompted the introduction of oxygenating chemicals into gasoline, producing the so-called reformulated (oxygenated) gasoline which emits less pollutants into the atmosphere. Due to its low price and synergies with oil refineries, methyl tertiary butyl ether (MTBE) was the main gasoline oxygenate since the 1980s, only recently being challenged by bioethanol. See: Linak et al (2009).

## Biofuels at the memberstate level

The 1990s saw intense activity at national levels, with the adoption of technical standards for biofuels, specially biodiesel based on rapeseed oil methyl ester (RME) and FAME. Between 1991 and 1997 Austria, France, Czech Republic, Sweden, Germany and Italy all adopted national biodiesel specifications.<sup>2</sup> The lack of bioethanol standards in the 1990s was partly due to the high demand for diesel in Europe, as the fleet is still mostly based on this fuel. This resulted in more pronounced interest for biodiesel, as Europe then imported diesel to meet its domestic needs (Kutas et al, 2007).<sup>3</sup> Still, ethanol already had some penetration in the EU as Sweden - which ascended to the EU in 1995 - had already adopted ethanol for buses as early as 1989.<sup>4</sup>

At national levels, EU memberstates used tax policy to stimulate the usage of biofuels. According to Kutas *et al* (2007), Italy, France, Sweden, Poland, Slovakia and Germany all applied lower tax rates towards biodiesel in the late 1990s.<sup>5</sup> Support mechanisms also came indirectly via the EU Common Agricultural Policy (CAP), as its 1992 reform included the introduction of a 15% set-aside obligation on farmland, with EU-sponsored payments for the unused fields.<sup>6</sup> While the set-asides could not be used to grow food crops, no restriction was set on growing oily seeds for energy purposes.

Building upon fragmented national initiatives, in 1998 the European Council adopted the first EU-level legislation harmonizing technical standards for transport fuels, in form of the Fuel Quality Directive 98/70/EC, which included specifications for biofuel blending. The United States adopted a nationwide biodiesel standard in the same year.<sup>7</sup> In March 2003 the European Council adopted directive 2003/17/EC, amending the 1998 fuel quality directive by essentially including the blending of biofuels with conventional fuels up to a ceiling of 5% per volume for both ethanol and biodiesel (EC, 2003a; Schnepf, 2006).

## Biofuels at an European level

Early in 1992 a first attempt was made at an EU-wide biofuels policy, as the European Commission (EC) proposed the *Scrivener directive*, which - had it been adopted -

---

<sup>2</sup> Austria (1991 – ON C 1190); France (1993 – by decree and later NF EN 590); Czech Republic (1994 – CSC 65507); Germany (1994 – DIN V 51606); Sweden (1996 – SS 15 54 36) and Italy (UNI 10635).

<sup>3</sup> The regulatory focus on biodiesel during the 1990s is also partly due to the more complex nature of this chemical, which is a composite of many different organic molecules, when compared to ethanol, which is homogenous.

<sup>4</sup> 30 ethanol-powered buses were in service in Stockholm by 1989. Source: SEKAB institutional website. See: <http://www.sekab.com/default.asp?id=1844&refid=1958&l3=1949>

<sup>5</sup> Quotas limited the amount of biodiesel eligible for tax reductions and exemptions, but the scales were already far beyond pilot projects. See Kutas et al (2007, p. 16)

<sup>6</sup> Later reduced to 10% in 1996.

<sup>7</sup> D-6751-02.

aimed to promote agriculture-based biofuels in the European Communities. It was, however, not adopted by the European Council.<sup>8</sup>

While the *Scriveener directive* was the first proposal into a community-level policy for biofuels, the first adopted directive which effectively created a coordinated European effort for biofuels came only 11 years later, in form of the 2003 biofuels directive (2003/30/EC). The new directive promoted an incremental adoption of biofuels towards a reference target of 5.75% of final consumption of the transport sector by 2010. Although non-mandatory, the targets contained in the 2003 directive for the first time pushed for biofuel utilization goals, aiming at 2% (in energy content) for all petrol and diesel for transport in the EU by 2005, to be increased in yearly steps of 0.75% until a reference goal of 5.75% by 2010 (EC, 2003b).

In order to achieve the proposed targets introduced by the biofuels directive, the European Council adopted in November 2003 a directive on energy taxation (2003/96/EC), providing memberstates with regulatory discretion to use tax policy, pending EC approval, to foster the penetration of biofuels in their markets (EC, 2003c). As pointed out by Kutas *et al* (2007 p. 19), by 2007 sixteen EU memberstates applied for permission to introduce tax relief to biofuels, the majority in form of excise tax exemptions proportional to blending levels.

Still in 2003, the EU adopted a reform of the CAP, which decoupled support payments from specific crops, and adopted a special energy crop subsidy of €45/ha up to a limit of 2 million ha, or a maximum subsidy of 90 million Euros.

It became increasingly clear that sourcing large part of the required feedstock for biofuels within the EU borders would be no easy nor cheap task. In late 2005 the Commission adopted a communication on biomass action plans which primarily focused on surveying bioenergy potentials among EU member states for solid and liquid biofuels.<sup>9</sup> This was important, as envisioned second-generation biofuels would be much more dependent on lignocellulosic sources (e.g. wood) than conventional starch, vegetable oil and sugar-based biofuels. Shortly thereafter, in 2006 the European Commission published a communication specifically announcing its strategy for biofuels, which contained a clear emphasis on technological innovation and promoting energy security, complementing the well-known environmental goals of the policy.<sup>10</sup>

Following the communication on a European biofuels strategy, in early 2007 the European Commission attempted to harmonize the multiple fronts of its conventional and renewable energy initiatives. In face of slow progress by memberstates in meeting the indicative targets of directive 2003/30/EC, it became clear that the approach towards biofuels needed to be restructured. The result was a communication entitled *An Energy Policy for Europe*, which was the basis for major regulatory initiatives in the subsequent years.<sup>11</sup>

## **2009 renewable energy directive and future directions**

---

<sup>8</sup> COM(1992) 36

<sup>9</sup> COM (2005) 628 final.

<sup>10</sup> COM (2006) 34 final.

<sup>11</sup> COM (2007) 1 final.

A new chapter of the European biofuels policy started in early 2009 with the introduction of the Renewable Energy Directive, or RES-D (2009/28/EC). The new directive was not only focused on biofuels, but instead a broad legal instrument for the promotion of renewable energy in Europe. Unlike the 2003 biofuels directive, the new law was adopted in a context where biofuels were already used in large scales, although short from the targets set in 2003. The total biofuel consumption in 2009 represented 4% of the transport fuel pool, or 12.1 Mtoe. The size of the European industry was already significant, with 82.450 employees by 2009, according to EurObserv'er (2010).

The RES-D directive incorporated two previous directives, namely 2001/77/EC (on renewable electricity) and 2003/30/EC (on biofuels) into a single, more ambitious instrument. A mandatory target was set specifically for the transport sector, set at 10% renewable energy by 2020. This corresponds to 10% of the total energy consumed in transport, and only petrol, diesel and biofuels consumed in road, rail and electricity are taken into account (RES-D Art. 3, §4).<sup>12</sup> Advanced biofuels (i.e. based on cellulosic or lignocellulosic non-food material), as well as biofuels made from waste and residues count double towards the 10% national renewable energy obligations in the transport sector, on an energy basis (RES-D Art. 21 §2; Hodson et al, 2010, p. 217; GAIN, 2010, p. 6).

The RES-D directive mandated European memberstates to access their renewable energy capacities and strategies to meet requirements laid in Articles 13 to 19 of RES-D via renewable energy action plans (NREAPs). The plans set out national targets for the share of renewables used in a number of sectors (transport, electricity, heating and cooling) and take into account the effects of other policy measures relating to energy efficiency and multi-level cooperation between authorities. These followed a standardized template, which sought to improve information, comparability and reduce heterogeneity in reporting of national renewable energy potentials (ECN, 2011).

Data from the NREAPs suggest a continued dominance of biodiesel as the main renewable energy in transport. There is however an expected trend for ethanol, electricity and other biofuels (including biogas) to achieve a higher contribution in final renewable energy in transport by 2020.

During the development of the RES-D, and in specific for biofuels, a strong debate on sustainability was picking steam, reaching a much politicized tone in Europe by early 2008. As biofuels can be produced in ways which harms the environment more than they protect, the inclusion of a sustainability scheme for the production and usage of biofuels became one of the most debated features to the RES-D.<sup>13</sup> While technicalities of biofuels trade were addressed by a specific Fuel Quality Directive

---

<sup>12</sup> It is important to note that at least three large sectors of energy use in transport are not included in calculating the 10% denominator, as jet fuel, fuel oil (bunker fuel for shipping) and even biofuels used for air and waterway transport are not considered. As pointed by Hodson *et al* (2010), this makes the eligible denominator smaller and the 10% target more attainable.

<sup>13</sup> The RES-D directive was not the only legal instrument to introduce the sustainability criteria for biofuels in the EU. The revised Fuel Quality Directive (2009/30/EC) also included the scheme in its text published on April 23rd, 2009.



(EC, 2009b), and internationally via a tripartite document between the EU, US and Brazil (Brazil, EU and US, 2009), many doubts remained on methodological uncertainties for the calculation of greenhouse gas savings of biofuel usage. Large debate arose on methodological issues of rebound effects of indirect land use change (Pimentel, 2004; Fehrenbach *et al*, 2008).

While far from the first (or the largest) user of biofuel in transport fuel pools, the EU push for regulating biofuel sustainability sent signals throughout the world. The emphasis on GHG lifecycle accounting for different biofuel production pathways produced a level of policy convergence in other important markets. In 2009, the United States Environmental Protection Agency (US EPA) published the Renewable Fuel Standard 2 (RFS2), which introduced GHG thresholds for the classification of biofuels according to their emissions values (REF). At the same time, the Brazilian government launched the agroecological zoning initiative, mapping carbon and biodiversity aspects to identify areas which should not serve for expansion of sugarcane fields.

In an attempt to avoid increasing its dependency on foreign energy, the EU seems to have adopted a technology-focused approach for reducing the need for subsidies on its domestically produced biofuels, contrary to a more short-term option of exposing the domestic market to full international competition (via reduction in prevailing import tariffs). The CAP “health check” from 2009 removed subsidies for energy crops, but the actual effect is limited since the ceiling for energy payments had long been reached and most biofuels are produced from dual-usage crops such as cereals and oil seeds (which still receive payments under the normal scheme). By cross-subsiding biofuels via community support towards cereals and other feedstocks, the market prices of biofuels are artificially low, at the cost of taxpayers (Kutas *et al*, 2007). The RES-D does not promote flexing import duties as a policy tool for biofuels. Instead, the aim to improve competitiveness is focused on the promotion of advanced biofuels, demonstrated by the double-counting incentive on Art. 21 of the directive, biorefinery concepts and incentives for advanced biofuels in the EC 7<sup>th</sup> framework program (FP7) (GAIN, 2010; Silveira *et al*, 2011; Maniatis, 2010).

Concluding, the EU biofuel policy was never the fruit of a single law, but a number of multisectoral initiatives. In addition to the formal directives in 2003 and 2009, the CAP, trade regime (tariffs), fuel standards, sugar subsidies, public opinion and technology progress all played a key role in the shaping of the European biofuels policy. While market growth is expected to be modest in the coming years, unanswered questions on technology development, land rights, and access to affordable food will tell whether current targets for 2020 and beyond will be met or need to be reviewed in light of emerging understanding of the complex interactions between biofuels, socioeconomic and environmental systems.

\*\*\*

The authors would like to thank the Swedish Energy Agency, EUBRANEX and UNCTAD for supporting this research. Additionally, our sincere appreciation goes to Mr. Lorenzo Di Lucia (Lund University) for valuable comments on a previous draft.

## References

- Brazil, EU and US (2007) White paper on internationally compatible biofuel standards. Tripartite task force Brazil, European Union and United States of America. December 2007
- Dansgaard, Willi. et al. (1993). Evidence for general instability of past climate from a 250-kyr ice-core record. *Nature* 364. pp 218–220.
- EC(2003a) Fuel quality directive amendment. 2003/17/EC.
- Fehrenbach, Horst. Fritsche, Uwe R. Giegrich, Juergen. (2008) Greenhouse gas balances for biomass – Issues for further discussion. Öko Institut and IFEU.
- GAIN (2010) EU-27 Annual Biofuels Report. USDA Foreign Agricultural Service – Global Agricultural Information Network.
- Hodson, Jones, Van Steen, Hans, Ladefoegd, Niels. Kottasz, Emese. *et al* (2010) EU Energy Law: Volume III - Book one. Renewable Energy Law and Policy in the European Union. Claeys & Casteels publishing.
- Kutas et al (2007) Biofuels - At what cost? Government support for ethanol and biodiesel in the European Union. Global Subsidies Initiative, IISD.
- Linak, Eric. Janshekar, Hossein. Yoneyama, Masahiro. (2009) Gasoline octane improvers/Oxygenates. SRI consulting.
- Maniatis, Kyriakos. (2010) Biofuels from algae: Results from the 2010 FP7 call. DG Energy. Available at: [http://www.biofuelstp.eu/downloads/presentations/2010\\_KM\\_Algae\\_BTP.pdf](http://www.biofuelstp.eu/downloads/presentations/2010_KM_Algae_BTP.pdf)
- Nordhaus, Willian. Yohe, Gary. (1983) Future Carbon Dioxide Emissions from Fossil. In: National Research Council-National Academy of Sciences, *Changing Climate*, National Academy Press.
- Pimentel, David. (2004) Biomass utilization, limits of. *Encyclopedia of Physical Science and Technology* pp. 159-171.
- Silveira, Semida. Johnson, Francis X. Pacini, Henrique. Mainali, Brijesh. Gomez, Maria. Lönnqvist, Tomas. Morfeldt, Johannes. Khatiwada, Dilip. Sanches Pereira, Alessandro. (2011) The external dimension of the EU Energy policy. Position paper. Available at DG ENER public consultation website: [http://ec.europa.eu/energy/international/consultations/20110221\\_external\\_dimension\\_en.htm](http://ec.europa.eu/energy/international/consultations/20110221_external_dimension_en.htm)
- Schnepf, (2006) European Union Biofuel Policy and Agriculture: An Overview. Congressional Research Service. The Library of Congress.

**Session 6B - Bio Energy II**

# Algal biofuels: key issues, sustainability and life cycle assessment

Anoop Singh\* and Stig Irving Olsen

Quantitative Sustainability Assessment, Department of Management Engineering,  
Technical University of Denmark, Lyngby, Denmark

## Abstract

In recent years research activities are intensively focused on renewable fuels in order to fulfill the increasing energy demand and to reduce the fossil fuels consumption and external oil dependency either in order to provide local energetic resources and or as a means for reducing greenhouse gases (GHG) emissions to reduce the climate change effects. Among the various renewable energy sources algal biofuels is a very promising source of biomass as algae sequester huge quantities of carbon from atmosphere and are very efficient in utilizing the nutrients from the industrial effluent and municipal wastewater. Algae capture CO<sub>2</sub> from atmosphere and industrial flue gases and transform it in to organic biomass that can be used for the production of biofuels. Like other biomass, algal biomass is also a carbon neutral source for the production of bioenergy. Therefore cultivation of algal biomass provides dual benefits; while being able to utilize nutrients in waste water thus reducing impacts on inland waters it produce biomass for the production of biofuels. However, reaching commercial scale production of algal biofuels is difficult. The main drawbacks include the harvesting of dry biomass and higher capital investment. The harvested algal biomass and its extracts can be efficiently converted to different biofuels such as bioethanol, biodiesel, biogas and biohydrogen by implementation of various process technologies. Comprehensive life cycle assessments (LCA) of algal biofuels illustrating environmental benefits and impacts can be a tool for policy decisions and for technology development.

## 1 Introduction

The world has been confronted with the energy crisis due to depletion of finite fossil fuels reserves and also their consumption is not acceptable as sustainable energy source due to greenhouse gases (GHGs) emission and resource depletion (Demirbas, 2010). Energy conversion, utilization and access underlie many of the great challenges associated with sustainability, environmental quality, security and poverty (Korres et al., 2010). The current technological progress, potential reserves, and increased exploitation leads to energy insecurity and climate change by increasing GHGs emissions due to consumption of energy at a higher rate (Singh et al., 2011a). Therefore, it is highly important to develop strong abatement techniques and adopt policies to promote those renewable energy sources which are capable of sequestering the atmospheric CO<sub>2</sub> to minimize the dependency on fossil reserves, and to maintain environmental and economic sustainability (Nigam and Singh, 2011, Singh and Olsen, 2011).

The biomass based fuels can be a possible solution for all the issues related to energy production and consumption. They are renewable by nature, and there are possibilities to use them for heat, electricity and transportation fuel. Biofuels thus have the capabilities to replace fossil fuels, reduce dependency and provide a number of environmental, economical and social benefits (Prasad et al., 2007a,b, Singh et al., 2010). Substantial support programs for biofuels production and utilization launched across the world which lead to significant growth in the production of biofuels.

---

\* Corresponding author email: [apsinghenv@gmail.com](mailto:apsinghenv@gmail.com) Fax: +45 45933435

The commercial scale production of first-generation liquid biofuels has resulted in a series of problems related to food prices, land usage and carbon emissions, while second generation biofuels production suffers with cost effectiveness, technological barriers, feed stock collection networks, etc. (Nigam and Singh, 2011).

The food fuel debate, lead to a negative perception of biofuels, while third generation biofuels i.e. produced from algal biomass are an invoking choice due to its rapid growth, higher lipid content, reduced land usage, limited fresh water consumption and higher carbon absorption rate (Jorquera et al., 2010; Singh et al., 2011a,b).

The present paper aims to highlight key issues in the production of biofuels from algal biomass, their sustainability and life cycle assessment.

## 2 Algal biofuels

Algae range from small, single-celled organisms to multi-cellular organisms and usually found in damp places or bodies of water, thus are common in terrestrial as well as aquatic environments. Algae include seaweeds (macroalgae) and phytoplanktons (microalgae). Algae require primarily three components (sunlight, water and CO<sub>2</sub>) to produce biomass. Using only sunlight and abundant and freely available raw materials (e.g. CO<sub>2</sub> and nutrients from wastewater) algae can synthesize and accumulate large quantities of neutral lipids and carbohydrates along with other valuable co-products (e.g. astaxanthin, omega three fatty acids, etc.). Algae can thus play a major role in the treatment/utilization of wastewater and reduce the environmental impact and disposal problems. The existing large-scale natural sources of algae include bogs, marshes, swamps, etc. (Wagner, 2007, Singh and Olsen, 2011, Singh et al., 2011b).

The algal biomass as an energy feedstock can be utilized with applications being developed for the production of biodiesel, bioethanol, biomethane and biohydrogen (Singh and Olsen, 2011). Algae can be grown on saline/coastal sea water and on non agricultural lands (desert, arid and semi-arid land), reducing the conflicts of energy crops with food crop and fresh water utilization.

Microalgae are single-cell, photosynthetic organisms known for their rapid growth and high energy content. Some algal strains are capable of doubling their mass several times per day. In some cases, more than half of that mass consists of lipids or triacylglycerides. Biomass doubling times during exponential growth are commonly as short as 3.5 h (Chisti, 2007). Oil content in microalgae can be up to 80% of dry biomass depending on species (Singh et al., 2011a).

The wastewater and seawater offers clear advantages for the cultivation of algal biomass over placing increased pressure on freshwater resources. However, wastewater quality varied dramatically from one source to another and also fluctuating over time. Chinnasamy et al. (2010) conducted a study with 85–90% carpet industry effluents along with 10–15% municipal sewage, to evaluate the feasibility of algal biomass and biodiesel production and reported that both fresh water and marine algae showed good growth in wastewaters. Wastewater generated by carpet mills along with sewage from Dalton area in North Central Georgia has potential to generate up to 15,000 tons of algal biomass which can produce about 2.5–4 million L of biodiesel and remove about 1500 tons of nitrogen and 150 tons of phosphorus from the wastewater in one year.

Biogas production is a long-established technology and previous trials have indicated that anaerobic digestion of seaweed (macroalgae) is technically viable. The lack of easily fermented sugar polymers such as starch, glucose or sucrose makes fermentation process difficult as there is little point in pursuing standard sugar fermentation processes. The polysaccharides that are present will require a new commercial process to break down into their constituent monomers prior to fermentation, or a direct fermentation process will have to be developed. Microalgae have the ability to produce lipids that can be used for biodiesel production (Singh et al., 2011b).

## 2.1 Key issues

Different algal strains perform differently, therefore it is essential to select strains capable of growing in variety of wastewaters and producing feedstock for biofuels that can compete with biodiesel, biomethane and bioethanol in terms of land and water use, carbon sequestration and GHG emission savings, etc. Capability of algae to consume large amounts of CO<sub>2</sub> also makes it an attractive option as the process could be carbon neutral (Wang et al., 2008).

Naturally, lipids accumulation increases under specific conditions, thus it is important to maintain those factors that lead to accumulation of lipids in algae, like nutrients, CO<sub>2</sub> concentration and sun light, etc. (Schenk et al., 2008). The best performing micro algae strain can be obtained by screening of a wide range of naturally available isolates and the efficiency of those can be improved by selection, adaptation and genetic engineering (Singh et al., 2011a).

The higher biomass yield with minimal operational cost and energy input is also a challenge to make algal biofuels as a sustainable biofuel. The operational cost and energy input can be reduced by utilizing nutrients from wastewater and CO<sub>2</sub> from industrial flue gases and cultivating at area receiving bright sun shine for longer period.

The quality of oil used for the production of biodiesel has a great impact on the quality of the biodiesel produced. Genetic engineering of key enzymes in specific fatty acid production pathways within lipid biosynthesis is a promising target for the improvement of both quantity and quality of lipids. Algae have excellent potential for the genetic modification of their lipid pathways. Any increase in photosynthetic efficiency will enhance downstream biofuels production as it drives the first stage of all biofuels production processes (Schenk et al., 2008, Singh et al., 2011a).

Bioreactor designs vary widely, but there is room for improvement to make systems simple and cheap enough to be scaled while maintaining the higher productivity and control over the culture than ponds allow. Clearly, an integrative approach where all nutrients are recycled and co-products are generated would be necessary for either ponds or bioreactors to be economic (Chisti, 2008), though this would be easier to achieve for bioreactors because of the greater control over them.

Algal strains required physiological and biochemical adaptations for conditions of low light, including tightly stacked thylakoids and large light-harvesting antenna complexes that allow them to effectively capture light energy. Optimizing stress conditions to obtain the highest possible yields of lipids in the cells is very important to make it economically viable biofuel. Stimulated evolution is one option commonly used for bacteria and stress conditions can induce spontaneous mutation in cultivated strains. Selection of these natural mutants can improve production yields. Another option is to select wild local species that are already adapted to local growth conditions. Genetic modification (GM) is another option to improve production efficiency of algal strain. One current example is the Algenol Company which is developing a strain of GM cyanobacteria capable of producing ethanol. Improved harvesting technologies are also needed. Lipid extraction prior to esterification is an area for further research. It would be an important advance if methods without drying or solvent extraction of the algae slurry could be developed as it would significantly reduce the cost of biomass pre-treatment (Singh et al., 2011b).

## 2.2 Sustainability

World Commission on Environment and Development defined the term ‘sustainability’ as “the development that meets the needs of the present without compromising the ability of future generations to meet their own needs” (UNCED, 1992). Sustainability assessment of products or technologies is normally seen as encompassing impacts in three dimensions i.e. social, environmental, and economic (Elkington, 1998). Sustainability has become an unavoidable issue in all major planning and undertakings that involve future use of energy, water and other natural resources. The sustainability of biofuels production depends on the net energy gain fixed in the biofuels that depends on

the production process parameters, such as land type where the biomass is produced, the amount of energy-intensive inputs and the energy input for harvest, transport and running the processing facilities (Haye and Hardtke, 2009).

Several biofuel candidates were proposed to displace fossil fuels in order to eliminate the vulnerability of energy sector (Korres et al., 2010; Prasad et al., 2007a,b; Singh et al., 2011a,b; Pant et al., 2010). The biofuels produced from crop seeds have come under major controversy as food vs. fuel competition (Nigam and Singh, 2011) as they require land for their production, whereas algae can be grown in the submerged area and also in the sea water (Singh et al., 2011a). The algal cultivation not only provides the biofuel but also provides greenhouse gas (GHG) saving as it utilized large amount of CO<sub>2</sub> during the cultivation.

Microalgae can tolerate and utilize substantially higher levels of CO<sub>2</sub> than terrestrial plants hence they can utilize CO<sub>2</sub> emitted from petroleum-based power stations or other industrial sources which in turn can reduce emission of green house gas (Nigam and Singh, 2011). The whole algal biomass or algal oil extracts can be converted into different fuel forms, such as biogas, liquid and gaseous transportation fuel, kerosene, ethanol, aviation fuel, and biohydrogen through the implementation of processing technologies such as anaerobic digestion, pyrolysis, gasification, catalytic cracking, and enzymatic or chemical transesterification (Subhadra, 2010). Algae can utilize nutrients such as nitrogen and phosphorous from a variety of waste water sources (e.g. agricultural run-off, concentrated animal feed operations, and industrial and municipal wastewater), thus providing a sustainable bioremediation of these wastewater for environmental and economic benefits (Shilton, 2008). The algal biofuels can also couple CO<sub>2</sub> neutral fuel production with CO<sub>2</sub> sequestration from other power industries, in turn generating carbon credits (Dismukes, 2008).

The cost of algal biofuels can be reduced by using cheap sources of CO<sub>2</sub> (flue gas), nutrient-rich wastewaters, inexpensive fertilizers, cheaper design culture systems with automated process control, greenhouses and heated effluents to increase algal yields. These measures will also help to reduce GHG emissions and waste disposal problems.

The major factors that will determine the impacts of biofuels include their contribution to land-use change, the feedstock used, and issues of technology and scale. Biofuels offer economic benefits, and in the right circumstances can reduce emissions and make a small contribution to energy security. The production of different biofuels has their own benefits, uncertainties and risks. In order to ensure net societal benefits of biofuel production, governments, researchers, and companies will need to work together to carry out comprehensive assessments, map suitable and unsuitable areas, and define and apply standards relevant to the different circumstances of each country (Phalan, 2009). Yan and Lin (2009) revealed that the interactions among various sustainability issues make the assessment of biofuel development difficult and complicated. The complexity during the whole biofuel production chain generates significantly different results due to the differences in input data, methodologies applied, and local geographical conditions. A useful tool for addressing environmental sustainability issues is the LCA.

### **2.3 Life cycle assessment (LCA)**

LCA is a tool to assess the environmental impacts and resources used throughout a product's life cycle and consider all attributes or aspects of natural environment, human health, and resources (Korres et al., 2010). LCA has been the method of choice in recent years for various kinds of new technologies for bioenergy and carbon sequestration. LCA is a universally accepted approach of determining the environmental consequences of a particular product over its entire production cycle (Pant et al., 2011). The complete life cycle of the biofuels includes each and every step from raw material production and extraction, processing, transportation, manufacturing, storage, distribution and utilization of the biofuel. In addition, the life cycle stages can have harmful effects or benefits of different environmental, economical and social dimensions, due to these facts; the complete fuel chains from different perspectives is of crucial importance in order to

achieve sustainable biofuels (Markevicius et al., 2010). Thus, LCA is a method to define and reduce the environmental burdens from a product, process or activity by identifying and quantifying energy and materials usage, as well as waste discharges, assessing the impacts of these wastes on the environment and evaluating opportunities for environmental improvements over the whole life cycle (Consoli et al., 1993). For this purpose LCA appears to be a very valuable tool and its use for the assessment of the sustainability of not only fuel products, but also of other commodities has increased dramatically in recent years (Markevicius et al., 2010).

The algal biomass can be utilized for the production of different biofuels, the different life cycle stages are presented in the Fig. 1. Yang et al. (2011) examined the life-cycle water and nutrients usage of microalgae-based biodiesel production. This study quantified the water footprint and nutrients usages during microalgae biodiesel production. 3726 kg water is required to generate 1 kg microalgae biodiesel if freshwater is used without recycling. The results indicated that using seawater or wastewater can reduce the life-cycle freshwater usage by as much as 90%. However, a significant amount of freshwater (about 400 kg kg<sup>-1</sup> biodiesel) must be used for culture no matter whether sea/wastewater serve as the culture medium or how much harvested water is recycled. They also reported the life-cycle usages of nitrogen, phosphorous, potassium, magnesium, and sulfur are 0.33, 0.71, 0.58, 0.27, and 0.15 kg kg<sup>-1</sup> biodiesel without harvest water recycling. However, when the harvest water is 100% recycled, the usage of these nutrients decreases by approximately 55%. Using sea/wastewater for algal culture can reduce nitrogen usage by 94% and eliminate the need of potassium, magnesium, and sulfur. Overall, the water footprint of microalgae-based biodiesel production gradually decreases from north to south as solar radiation and temperature increase.

Clarens et al. (2010) reported in a study on the life cycle model for algae production that only in total land use and eutrophication potential do algae perform favorably. The large environmental footprint of algae cultivation is driven predominantly by upstream impacts, mainly, the CO<sub>2</sub> demand and fertilizer. They also suggested that these impacts can be reduced by using flue gas and wastewater/sea water, to offset most of the environmental burdens associated with cultivation of algal biomass.

Evans and Wilkie (2010) calculated a range of net energy and economic benefits associated with hydrilla harvests and the utilization of biomass for biogas and compost production using a life cycle assessment (LCA) approach. Based on the results, they concluded that energy and economic returns were largely decoupled, with biogas and fertilizer providing the bulk of output energy, while nutrient remediation and herbicide avoidance dominated the economic output calculations, which makes hydrilla harvest a suitable and cost effective management program for many nutrient-impaired waters.

The LCA of third generation biofuels is very important before taking in to consideration for commercial scale and making a policy for that.

### 3 Conclusions

The production of algal biofuels seems very promising, efficient and sustainable as it can be produced from industrial wastewater and flue gases. Additionally, it sequester significant amounts of CO<sub>2</sub> with a lesser land use than terrestrial crops. The residual algal biomass generated in the lipid extraction for biodiesel can be appropriately utilized for the production of bioethanol or biomethane. However, significant improvements in the efficiency, cost structure and ability to scale up algal growth, lipid extraction, and biofuel production must be made to produce commercially viable biofuel. The utilization of organic waste, flue gases and industrial effluent for the production of algal biomass will also reduce the GHG emission and waste disposal problems and will contribute to the sustainability and market competitiveness of the microalgal biofuel industry. An LCA will help in accessing the sustainability of third generation biofuels and adopting the policies for that.



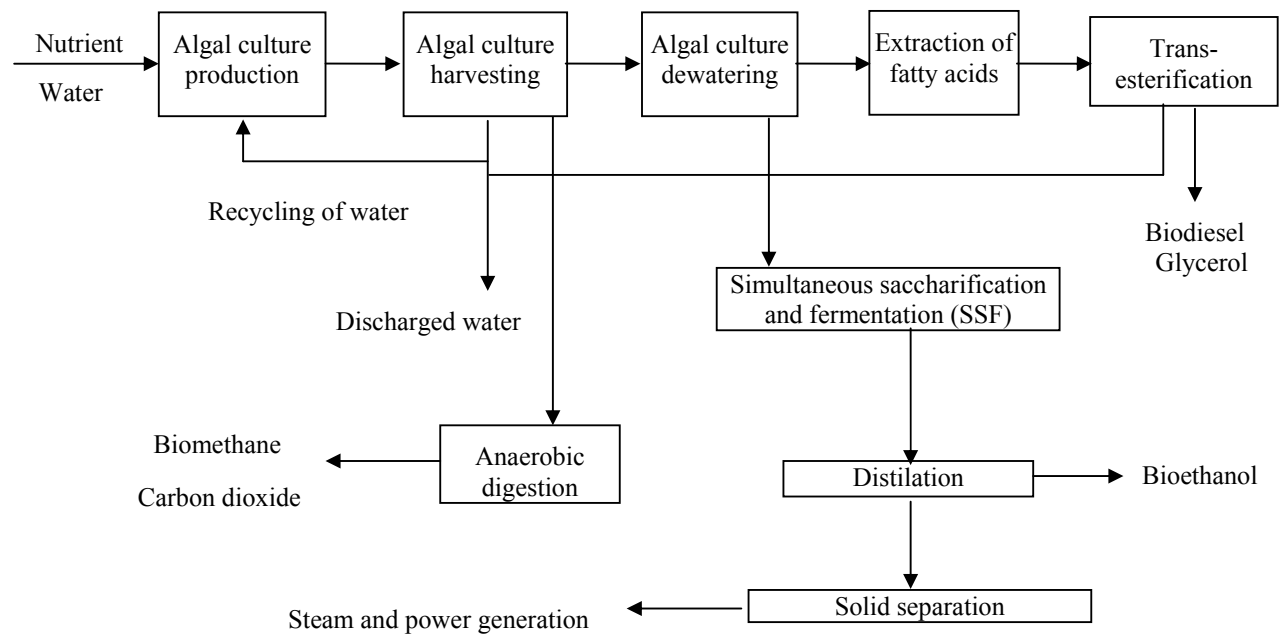

**Figure 1: The life cycle stages of different biofuel production from algal biomass.**

## 4 References

- Chinnasamy, S., Bhatnagar, A., Hunt, R.W., Das, K.C. Microalgae cultivation in a wastewater dominated by carpet mill effluents for biofuel applications. *Bioresour. Technol.* 101, 3097–3105 (2010).
- Chisti, Y. Biodiesel from microalgae. *Biotechnol. Adv.* 25, 294–306 (2007).
- Chisti, Y. Biodiesel from microalgae beats bioethanol. *Trends Biotechnol.* 26, 126–131 (2008).
- Clarens AF, Resurreccion EP, White MA and Colosi LM, Environmental life cycle comparison of algae to other bioenergy feedstocks. *Environmental Sciences and Technology* 44: 1813-1819 (2010).
- Collet P, Hélias A, Lardon L, Ras M, Goy R-A and Steyer J-P, Life-cycle assessment of microalgae culture coupled to biogas production. *Bioresource Technology* doi:10.1016/j.biortech.2010.1006.1154 (2010).
- Consoli, F., Allen, D., Boustead, I., de Oude, N., Fava, J., Franklin, W. and Quay, B. Guidelines for life-cycle assessment: a code of practice, Society of Environmental Toxicology and Chemistry, Brussels, Belgium (1993).
- Demirbas A, Use of algae as biofuel sources. *Energy Convers Manage* 51: 2738–2749 (2010).
- Dismukes GC, Carrieri D, Bennette N, Ananyev GM, Posewitz MC. Aquatic phototrophs: efficient alternatives to land-based crops for biofuels. *Curr Opin Biotechnol* 19:235–40 (2008).
- Elkington J, *Cannibals with Forks - The Triple Bottom Line of 21st Century Business*, New Society Publishers, Canada (1998).
- Evans JM and Wilkie AC, Life cycle assessment of nutrient remediation and bioenergy production potential from the harvest of hydrilla (*Hydrilla verticillata*). *Journal of Environmental Management* 91:2626-2631 (2010).
- Haye S, Hardtke CS, The Roundtable on Sustainable Biofuels: plant scientist input needed. *Trends Plant Sci* 14(8):409-412 (2009).
- Jorquera O, Kiperstok A, Sales EA, Embirucu M, Ghirardi ML. Comparative energy life-cycle analyses of microalgal biomass production in open ponds and photobioreactors. *Bioresour Technol.* 101:1406-13 (2010).
- Korres NE, Singh A, Nizami AS and Murphy JD, Is grass biomethane a sustainable transport biofuel? *Biofuels, Bioproducts and Biorefining* 4: 310-325 (2010).
- Markevičius, A., Katinas, V., Perednis, E., Tamasauskienė, M. Trends and sustainability criteria of the production and use of liquid biofuels. *Renew Sustain Energy Rev* 14:3226–3231 (2010).
- Nigam, PS, Singh A, Production of liquid biofuels from renewable resources. *Progress in Energy and Combustion Science.* 37:52-68 (2011).
- Pant D, Bogaert GV, Diels L, Vanbroekhoven K, A review of the substrates used in microbial fuel cells (MFCs) for sustainable energy production. *Bioresour Technol* 101: 1533–1543 (2010).
- Pant D, Singh A, Bogaert GV, Diels L, Vanbroekhoven K, An introduction to the life cycle assessment (LCA) of bioelectrochemical systems (BES) for sustainable energy and product generation: relevance and key aspects. *Renewable Sustainable Energy Rev* 15, 1305-1313 (2011).
- Phalan B. The social and environmental impacts of biofuels in Asia: an overview. *Appl Energy* 2009;86:S21–9.
- Prasad S, Singh A and Joshi HC, Ethanol as an alternative fuel from agricultural, industrial and urban residues. *Resources, Conservation and Recycling* 50: 1-39 (2007a).
- Prasad S, Singh A, Jain N, Joshi HC, Ethanol production from sweet sorghum syrup for utilization as automotive fuel in India. *Energy Fuels* 21(4):2415-2420 (2007b).

- Schenk, P.M., Thomas-Hall, S.R., Stephens, E., Marx, U.C., Mussnug, J.H., Posten, C., Kruse, O., Hankamer, B. Second generation biofuels: high-efficiency microalgae for biodiesel production. *Bioenergy Res.* 1, 20–43 (2008).
- Shilton AN, Powell N, Mara DD, Craggs R. Solar-powered aeration and disinfection, anaerobic co-digestion, biological CO<sub>2</sub> scrubbing and biofuels production: the energy and carbon management opportunities of waste stabilization ponds. *Water Sci Technol* 58:253–8 (2008).
- Singh A, Nigam PS, Murphy JD. Renewable fuels from algae: An answer to debatable land based fuels. *Bioresource Technology.* 102:10-16 (2011a).
- Singh A, Nigam PS, Murphy JD. Mechanism and challenges in commercialisation of algal biofuels. *Bioresource Technology.* 102:26-34 (2011b).
- Singh A, Olsen SI, Critical analysis of biochemical conversion, sustainability and life cycle assessment of algal biofuels, *Appl. Energy* (doi:10.1016/j.apenergy.2010.12.012) (2011).
- Singh A, Smyth BM, Murphy JD, A biofuel strategy for Ireland with an emphasis on production of biomethane and minimization of land-take. *Renew Sustain Energy Rev* 14(1):277-288 (2010).
- Subhadra BG. Sustainability of algal biofuel production using integrated renewable energy park (IREP) and algal biorefinery approach. *Energy Policy* 38:5892–901 (2010).
- UNCED, Report of The United Nation Conference on Environment and Development, Vol. 1, Chapter 7, June, 1992 (1992).
- Wagner, L. Biodiesel from Algae Oil. Mora Associates Ltd., UK (2007).
- Wang B, Li Y, Wu N, Lan CQ, CO<sub>2</sub> bio-mitigation using microalgae. *Appl Microbiol Biotechnol* 79:707-718 (2008).
- Yan J, Lin T. Bio-fuels in Asia. *Appl Energy* 2009;86:S1–S10
- Yang J, Xu M, Zhang X, Hu Q, Sommerfeld M, Chen Y. Life-cycle analysis on biodiesel production from microalgae: water footprint and nutrients balance. *Bioresour Technol* 102:159–65 (2011).

# Greenhouse gas emissions from cultivation of energy crops may affect the sustainability of biofuels

Mette S. Carter<sup>1</sup>, Henrik Hauggaard-Nielsen<sup>1</sup>, Stefan Heiske<sup>1</sup>, Sune T. Thomsen<sup>1</sup>, Morten Jensen<sup>1</sup>, Jens Ejbye Schmidt<sup>1</sup>, Anders Johansen<sup>2</sup> and Per Ambus<sup>1</sup>

<sup>1</sup> Biosystems Division, Risø National Laboratory for Sustainable Energy, Technical University of Denmark, P.O. box 49, 4000 Roskilde, Denmark

<sup>2</sup> Department of Environmental Chemistry and Microbiology, National Environmental Research Institute, University of Aarhus, P.O. box 358, 4000 Roskilde, Denmark

## Abstract

Agro-biofuels are expected to reduce the emissions of greenhouse gases because CO<sub>2</sub> emitted during the combustion of the biofuels has recently been taken from the atmosphere by the energy crop. Thus, when replacing fossil fuels with biofuels we reduce the emission of fossil fuel-derived CO<sub>2</sub> into the atmosphere. However, cultivation of the soil results in emission of other greenhouse gasses, especially nitrous oxide (N<sub>2</sub>O). Agricultural activity is the dominant source of N<sub>2</sub>O, which is produced by microbes in the soil when the nitrogen availability is high, for instance following fertilization or incorporation of crop residues.

In this study we relate measured field emissions of N<sub>2</sub>O to the reduction in fossil fuel-derived CO<sub>2</sub>, which is obtained when energy crops are used for biofuel production. The analysis includes five organically managed crops (*viz.* maize, rye, rye-vetch, vetch and grass-clover) and three scenarios for conversion of biomass to biofuel. The scenarios are 1) bioethanol production, 2) biogas production and 3) co-production of bioethanol and biogas, where the energy crops are first used for bioethanol fermentation and subsequently the residues from this process are utilized for biogas production. The net reduction in greenhouse gas emissions is calculated as the avoided fossil fuel-derived CO<sub>2</sub>, where the N<sub>2</sub>O emission has been subtracted. This value does not include farm machinery CO<sub>2</sub> emissions and fuel consumption during biofuel production. Thus, the actual net greenhouse gas reduction will be lower than indicated by our data. We obtained the greatest net reduction in greenhouse gas emissions by co-production of bioethanol and biogas or by biogas alone produced from either fresh grass-clover or whole crop maize. Here the net reduction corresponded to about 8 tons CO<sub>2</sub> per hectare per year. The worst result was obtained for bioethanol produced from vetch straw where high N<sub>2</sub>O emissions outweighed the avoided fossil fuel-derived CO<sub>2</sub>.

# Liquid biofuels from blue biomass

Zsófia Kádár, Annette Eva Jensen, Henrik Bangsø Nielsen, Jens Ejbye Schmidt

Risø National Laboratory for Sustainable Energy, Technical University of Denmark (Risø DTU), NRG - Biosystems Division, P.O. Box 49, DK-4000 Roskilde

## 1 Introduction

Marine (blue) biomasses, such as macroalgae, represent a huge unexploited amount of biomass. With their various chemical compositions, macroalgae can be a potential substrate for food, feed, biomaterials, pharmaceuticals, health care products and also for bioenergy. Algae use seawater as a growth medium, light as energy source and they capture CO<sub>2</sub> for the synthesis of new organic material, thus can grow on non-agricultural land, without increasing food prices, or using fresh water. Due to all these advantages in addition to very high biomass yield with high carbohydrate content, macroalgae can be the well suited candidates as feedstock for biofuel production in the future. The aim of our studies is to examine the possibility producing liquid biofuel (ethanol and butanol) from macroalgae.

## 2 Macroalgae

Three different macroalgae (*Chaetomorpha linum*, *Gracilaria longissima* (South Toscana, Italy) and *Ulva lactuca* (Jylland, Denmark)) were involved in our research. Algae were analyzed by means of strong acid hydrolysis for contents of cellulose, hemicellulose, lignin and starch (Table 1).

## 3 Bioethanol production

Raw materials were analyzed and studied for their sugar recovery and bioethanol potentials after thermal pretreatments and enzymatic hydrolysis. Dried and milled samples were treated hydrothermally using a stirred and heated reactor with 6% substrate loading at 195°C for 10 min with and without oxygen. After pre-treatment materials were analysed again for their cellulose, hemicellulose, lignin and starch content (Table 1). Evaluation of pre-treatment was carried out by enzymatic hydrolysis applying commercial enzyme preparations (Celluclast, Novozym 188, Spirizyme Plus Tech) on raw (untreated) and pretreated materials, to test the convertibility of cellulose and starch. Pretreatment of fibres resulted in enriched cellulose content and show very good effect on hemicellulose removal.

Table 1. Chemical composition of untreated and pretreated macroalgae

Name	Cellulose (%)	Hemicellulose (%)	Lignin (%)	Starch (%)
<i>U. lactuca</i> untreated, dried	4.7	2.8	0	1.4
<i>U. lactuca</i> pretreated without oxygen	8.6	1.1	0	0.8
<i>U. lactuca</i> pretreated with oxygen	9.9	0.4	0	0.1

Name	Cellulose (%)	Hemicellulose (%)	Lignin (%)	Starch (%)
<i>G. longissima</i> untreated, dried	12.9	21.2	24.3	7.2
<i>G. longissima</i> pretreated without oxygen	32.2	4.0	29.8	0.5
<i>G. longissima</i> pretreated with oxygen	29.1	9.2	24.8	0.1
<i>C. linum</i> untreated, dried	26.3	3.2	6.0	3.6
<i>C. linum</i> pretreated without oxygen	39.5	0.8	4.2	8
<i>C. linum</i> pretreated with oxygen	67.4	0.5	8.1	0.2

The maximal recovery of carbohydrates is also an important point of an optimal pretreatment. Both cellulose and hemicellulose recovery was low (< 60% and 10% respectively) at *U. lactuca* and *G. longissima*, however the very high cellulose recovery for *C. linum* after pretreatment can be partly explained by its starch content. Enzymatic accessibility of the cellulose of *U. lactuca* and *G. longissima* was not increased by pretreatment.

Based on glucose yields of enzymatic hydrolysis results ethanol potentials were also calculated (Table 2). As a comparison for untreated wheat straw the ethanol yield is 2.7% which can be increased to 15% by hydrothermal pretreatment. Among the studied macroalgae only *C. linum* showed similar yield after pretreatment. Even though final ethanol yields were rather low, algae may be interesting substrates in a biorefinery concept due to their high carbohydrate content.

Table 2. Yield of glucose and ethanol potentials (g/100g dry matter) after pretreatment and enzymatic hydrolysis.

Name	Glucose yield (%)	Ethanol potential (%)
<i>U. lactuca</i> untreated, dried	7.8	4.0
<i>U. lactuca</i> pretreated without oxygen	4.7	2.4
<i>U. lactuca</i> pretreated with oxygen	4.0	2.0
<i>G. longissima</i> untreated, dried	7.9	4.0
<i>G. longissima</i> pretreated without oxygen	8.2	4.2
<i>G. longissima</i> pretreated with oxygen	5.1	2.6
<i>C. linum</i> untreated, dried	15.3	7.8
<i>C. linum</i> pretreated without oxygen	31.2	15.9
<i>C. linum</i> pretreated with oxygen	26.2	13.4

## 4 Butanol production

Butanol will provide greater benefits than ethanol which arise from its gasoline-like properties: it has more than 80% energy density of gasoline, does not absorb water, can be transported through the existing oil and gasoline distribution infrastructure, and used in gasoline-powered vehicles without modification at higher volumes than ethanol. Butanol can be produced from the same feedstocks as ethanol (starch and cellulosic sugars) through Acetone-Butanol-Ethanol (ABE) fermentation by *Clostridia spp.* which is able to ferment different kind of carbohydrates.

Even though final ethanol yields were found to be rather low algae were further studied as a substrate for ABE fermentation by *Clostridium* strains. The advantages of this fermentation process are (i) that all products (acetone, butanol, ethanol) formed during the process are valuable (ii) clostridia are able to use many different carbohydrates (both C6 and C5 sugars) (iii) due to cellulolytic and xylanolytic activities of these clostridia strains, direct production of ABE from the algae polysaccharides might be possible without enzyme addition.

Enzymatic hydrolysis experiments on hydrothermal pretreated (195°C, 10 min, without oxygen) *U. lactuca* and *C. linum* were performed (substrate concentration 5%) by different enzyme mixtures (amylases and cellulases) for 24 hours. The highest final glucose content (7 and 12 g/l, respectively) was achieved when both amylases and cellulases were applied. Liquid fractions of pretreated macroalgae showed inhibitory effect when was fermented by additional glucose, salts, nutrients and fermented in different dilutions. According to our first results of the still ongoing research both *C. linum* and *U. lactuca* can be suitable substrates for ABE fermentation with a total ABE production of 0.35 g/g glucose.

### **Acknowledgement**

The work is financially supported by the PSO Project (Energy Production from Marine Biomass: 2008-1-0050).

## Session 8 – fuel cells and hydrogen



# Integrated Gasification SOFC Plant with a Steam Plant

Masoud Rokni and Leonardo Pierobon

Technical University of Denmark, Dept. Mechanical Engineering,

Thermal Energy System, Building 403, 2800 Kgs, Lyngby, Denmark

E-mail: MR@mek.dtu.dk

## Abstract

A hybrid Solid Oxide Fuel Cell (SOFC) and Steam Turbine (ST) plant is integrated with a gasification plant. Wood chips are fed to the gasification plant to produce biogas and then this gas is fed into the anode side of a SOFC cycle to produce electricity and heat. The gases from the SOFC stacks enter into a burner to burn the rest of the fuel. The off-gases after the burner are now used to generate steam in a Heat Recovery Steam Generator (HRSG). The generated steam is expanded in a ST to produce additional power. Thus a triple hybrid plant based on a gasification plant, a SOFC plant and a steam plant is presented and studied. The plant is called as IGSS (Integrated Gasification SOFC Steam plant). Different systems layouts are presented and investigated. Electrical efficiencies up to 56% are achieved which is considerably higher than the conventional integrated gasification combined cycles (IGCC). Plants characteristics are discussed while the plants sizes are defined from the available steam turbine as well as cultivation area.

## 1 Introduction

The Solid Oxide Fuel Cell (SOFC) is an electrochemical reactor currently under development by several companies for power-heat generation application. Depending on the type of the electrolyte they are operating at temperature levels of more than about 750°C up to 1000°C. The lower temperature alternative is now being developed for market entry probably in current decade. Due to material complication on the balance of plant components companies are trying to find new materials for the SOFC cells to decrease the operating temperature. Risoe-DTU and Topsoe Fuel Cell have mentioned temperatures of about 650°C.

Probably, the biggest advantage of the SOFC in comparison with other types of fuel cells is its flexibility in using different types of fuel. However, one needs to pre-process most kind of fuels in planar SOFCs in order to remove the sulphur content and break down the heavier hydro-carbons which may otherwise damage the stacks. Such fuel pre-processing may be done in two different catalytic reactors operating at different temperature levels.

SOFC-based power plants have been studied for a while and some companies, such as Wärtsilä, are trying to realize such a system for CHP (Combined Heat and Power) applications; see e.g. Fontell et al (2004). The SOFC is also implemented on top of combined cycles (CC) in the literature to achieve ultra high electrical efficiencies, see e.g. Rokni (1993) and Riensche et al. (2000). Due to current operating temperature of the SOFC stacks (more than about 750°C), hybrid SOFC and GT (Gas Turbine) systems has also been studied extensively in the literature, e.g. in Pålson et al (2000) for CHP applications. Other examples could be mentioned as; characterization, quantification and optimization of hybrid SOFC-GT systems, see e.g. Subramanyan et al. (2005). Roberts and Brouwer (2006) compared the modeling results with measured data for a 220 kW hybrid planar SOFC-GT plant. Details on design, dynamics, control and startup of such hybrid power plants are studied in Rokni et al. (2005).

While hybrid SOFC–GT plants have been extensively studied by many researchers, the investigations on combined SOFC and ST (Steam Turbine) are so far very limited; see Dunbar et al. (1991) and Rokni (2010). In addition the SOFC manufactures are trying to decrease the operating temperature of the SOFC stacks, which makes the combination of SOFC–ST hybrid system would be more attractive than the SOFC–GT systems. By decreasing the operating temperature, the material cost for the SOFC stacks will be decreased as well as many problems associating with the BoP components will be diminished.

A gasification plant integrated with a SOFC–ST systems have not been studied in the open literature and therefore, the current study is novel in terms of alternative configurations for future applications.

In this study the Viking two-stage gasifier plant is used. This  $75\text{kW}_{\text{th}}$  biomass gasifier is an autothermal (air blown) fixed bed gasifier situated at the Risoe and is described in detail in Henriksen et al. (2006) and Ahrenfeldt (2006). Hofmann et al. (2007) had operated a SOFC on cleaned syngas from the Viking gasifier for 150 hours without reporting any degradation.

The two-stage gasification plant provides biogas which can directly be fed into the anode side of solid oxide fuel cell plant without any pre-reforming process. A simple single pressure Rankine cycle is as bottoming cycle for the SOFC plant. In addition, a hybrid recuperator (as proposed in Rokni, 2010) was applied to recover more energy of the off-gases. Thus, a non-recuperated Integrated Gasification SOFC–ST (IGSS) plant is compared with a recuperated IGSS plant. Such hybrid recuperator is shown to be very efficient and could increase the plant efficiency significantly.

## 2 Methodology

The results of this paper are obtained using the simulation tool DNA (Dynamic Network Analysis), a simulation tool for energy system analysis which began with a Master's Thesis work in Perstrup, 1989, see also Elmegaard and Houbak (2005). It is the present result of an ongoing development at the Department of Mechanical Engineering, Technical University of Denmark. Since then the program has been developed to be generally applicable covering many features of networks simulations. Some of the important features are:

- Simulation of both algebraic equations (steady state) and differential equations (dynamic models)
- Use of a sparse-matrix-based simultaneous solver for algebraic equations
- Handling of discontinuities in dynamic equations
- Models of thermodynamic states, transport variables and radiative properties for relevant fluids, e.g. steam, ideal gases and refrigerants
- No causality implied on the model input, i.e. no restriction of the choice of inputs and outputs
- Medium compositions can be variables
- Features for modeling solid fuels of arbitrary components

The program library includes various components models such as; of heat exchangers, burners, turbo machinery, dryers, energy storages, engines, valves, controllers as well as more specialized components and utility components.

The mathematical equations include mass and energy conservation for all components, as well as relations for thermodynamic properties of the fluids involved. In addition, the components include a number of constitutive equations representing their physical properties, e.g. heat transfer coefficients for heat exchangers and isentropic efficiencies for compressors and turbines. During the development of DNA the four key terms, portability, robustness, efficiency, and flexibility have been kept in mind as the important features for making a generally applicable tool for energy system studies. The program is written in FORTRAN.

## 2.1 Modelling of SOFC

The SOFC model used in this investigation is based on the model developed in Bang-Møller and Rokni (2010), which were calibrated against experimental for planar SOFC type.

$$E_{FC} = E_{Nernst} - \Delta E_{act} - \Delta E_{ohm} - \Delta E_{conc} - \Delta E_{offset} \quad (1)$$

where  $E_{Nernst}$ ,  $\Delta E_{act}$ ,  $\Delta E_{ohm}$ ,  $\Delta E_{conc}$ ,  $\Delta E_{offset}$  are the Nernst ideal reversible voltage, activation polarization, ohmic polarization, concentration polarization and the offset polarization respectively. The activation polarization can be evaluated from Butler – Volmer equation (see Keegan et al. 2002). This was isolated from other polarization to determine the charge transfer coefficients as well as exchange current density from the experiment data and via curve fitting technique. It followed,

$$\Delta E_{act} = \Delta E_{act,c} + \Delta E_{act,a} = \frac{2RT}{F} \left[ \sinh^{-1} \left( \frac{i + i_n}{2i_{0,a}} \right) + \sinh^{-1} \left( \frac{i + i_n}{2i_{0,c}} \right) \right] \quad (2)$$

where  $R$ ,  $T$ ,  $F$  and  $i_d$  were the universal gas constant, operating temperature, Faradays constant and current density respectively.  $i_n$  was an internal current density added to the actual current density to account for the mixed potential caused by fuel crossover and electrons passing through the electrolyte. This value was adjusted when calibrating the electrochemical model. The anodic and cathodic current densities were calculated from

$$i_{0,a} = \gamma_a \left( \frac{\bar{p}_{H_2,tot}}{\bar{p}_a} \right) \left( \frac{\bar{p}_{H_2O}}{\bar{p}_a} \right) \exp \left( \frac{-E_{act,a}}{RT} \right) \quad (3)$$

$$i_{0,c} = \gamma_c \left( \frac{\bar{p}_{O_2}}{\bar{p}_c} \right)^{0.25} \exp \left( \frac{-E_{act,c}}{RT} \right)$$

where  $E_{act,a} = E_{act,c} = 1.2 \times 10^5$  J/mol. The constants  $\gamma_a$  and  $\gamma_c$  were calibrated against experimental data and found to be  $11 \times 10^9$  mA/cm<sup>2</sup> and  $3.5 \times 10^8$  mA/cm<sup>2</sup>, respectively.

The ohmic polarization depends on the electrical conductivity of the electrodes as well as the ionic conductivity of the electrolyte which could be described as

$$\Delta E_{ohm} = (i + i_n) \frac{t_{el}}{\sigma_e} \quad (4)$$

$$\sigma_e = \frac{\sigma_{e,0}}{T} \exp \left( -\frac{E_{act,e}}{RT} \right) \quad (5)$$

where the electrolyte thickness  $t_{el} = 10$  μm is assumed. The constant  $\sigma_{e0}$  is assumed to be  $3.6 \times 10^5$  S/cm.

The concentration polarization is dominant at high current densities for anode-supported SOFCs, wherein insufficient amounts of reactants are transported to the electrodes and the voltage is then reduced significantly. Neglecting the cathode contribution, it could be modeled as

$$\Delta E_{conc} = \frac{RT}{n_e F} \left( -\ln \left( 1 + \frac{p_{H_2}(i + i_n)}{p_{H_2O} i_{as}} \right) - \ln \left( 1 - \frac{i + i_n}{i_{as}} \right) \right), \quad (6)$$

where  $n_e = 2$ , since it was assumed that all CH<sub>4</sub> and CO are converted to H<sub>2</sub> before the electrochemical reactions take place. In the above equations  $p_{H_2}$  and  $p_{H_2O}$  are the partial

pressures for H<sub>2</sub> and H<sub>2</sub>O respectively. The anode limiting current  $i_{as}$  was assumed to be 1000 mA/cm<sup>2</sup> in the calibration. The Nernst was given by

$$E_{Nernst} = \frac{-\Delta g_f^0}{n_e F} + \frac{RT}{n_e F} \ln \left( \frac{P_{H_2, tot} \sqrt{P_{O_2}}}{P_{H_2O}} \right), \quad (7)$$

$$P_{H_2, tot} = P_{H_2} + P_{CO} + P_{CH_4} \quad (8)$$

where  $\Delta g_f^0$  is the Gibbs free energy (for H<sub>2</sub> reaction) at standard pressure.

The fuel composition leaving the anode is calculated by the Gibbs minimization method as described in Smith et al. (2005). Equilibrium at the anode outlet temperature and pressure is assumed for the following species: H<sub>2</sub>, CO, CO<sub>2</sub>, H<sub>2</sub>O, CH<sub>4</sub> and N<sub>2</sub>. The equilibrium assumption is fair because the methane content in this study is low enough. The power production from the SOFC ( $P_{SOFC}$ ) depends on the amount of chemical energy fed to the anode, the reversible efficiency ( $\eta_{rev}$ ), the voltage efficiency ( $\eta_v$ ) and the fuel utilization factor ( $U_F$ ). It is defined in mathematical form as

$$P_{SOFC} = \left( LHV_{H_2} \dot{n}_{H_2, in} + LHV_{CO} \dot{n}_{CO, in} + LHV_{CH_4} \dot{n}_{CH_4, in} \right) \eta_{rev} \eta_v U_F, \quad (9)$$

where  $U_F$  was a set value and  $\eta_v$  was defined as

$$\eta_v = \frac{\Delta E_{cell}}{E_{Nernst}} \quad (10)$$

The partial pressures were assumed to be the average between the inlet and outlet as

$$\begin{aligned} \bar{p}_j &= \left( \frac{y_{j, out} - y_{j, in}}{2} \right) \bar{p} & j = \{H_2, CO, CH_4, CO_2, H_2O, N_2\} \\ \bar{p}_{O_2} &= \left( \frac{y_{O_2, out} - y_{O_2, in}}{2} \right) \bar{p}_c \end{aligned} \quad (11)$$

## 2.2 Modelling of Gasifier

The two-stage Viking gasifier was used in this investigation. This is a 75 kW<sub>th</sub> gasifier which was demonstrated at Risø–Technical University of Denmark (Henriksen et al., 2006). The process of pyrolysis and gasification were divided into two separate reactors, as shown in Fig. 1. Wet biomass (wood chips) was fuelled into the first reactor where drying and pyrolysis took place before the pyrolysis products (600°C) were fed to a downdraft fixed bed char gasifier which was the second reactor. The exhaust gases from the gasifier were then used to heat the reactor for drying and pyrolysis process, see the steam loop in Fig. 1. Between pyrolysis and char gasification, partial oxidation of the pyrolysis products provided the heat for the endothermic char gasification reactions. Char was gasified in the fixed bed while H<sub>2</sub>O and CO<sub>2</sub> acted as gasifying agents in the char gasification reactions. The Viking gasifier operated near atmospheric pressure.

A simple Gibbs reactor model is used to model the gasifier, see Smith et al (2005). It means that the total Gibbs free energy has its minimum when chemical equilibrium is achieved. Such characteristic is used to calculate the gas composition at a specified temperature and pressure without considering the reaction paths. The procedure is shortly described here. The Gibbs free energy of a gas (assumed to be a mixture of  $k$  perfect gases) is given

$$\dot{G} = \sum_{i=1}^k \dot{n}_i \left[ g_i^0 + RT \ln(n_i p) \right] \quad (12)$$

where  $g^0$ ,  $R$  and  $T$  are the specific Gibbs free energy, universal gas constant and gas temperature respectively. Each atomic element in the inlet gas is balance with the outlet gas composition, which yields the flow of each atom has to be conserved. For  $N$  elements this is expressed as

$$\sum_{i=1}^k \dot{n}_{i,in} \mathbf{A}_{ij} = \sum_{m=1}^w \dot{n}_{m,out} \mathbf{A}_{mj} \quad \text{for } j = 1, N \quad (13)$$

The  $N$  elements correspond to  $H_2$ ,  $CO_2$ ,  $H_2O$  and  $CH_4$  in this pre-reforming process.  $\mathbf{A}_{mj}$  is the number of atoms of element  $j$  (H, C, O, N) in each molecule of entering compound  $i$  ( $H_2$ ,  $CH_4$ ,  $CO$ ,  $CO_2$ ,  $H_2O$ ,  $O_2$ ,  $N_2$  and Ar), while  $\mathbf{A}_{ij}$  is the number of atoms of element  $j$  in each molecule of leaving compound  $m$  ( $H_2$ ,  $CH_4$ ,  $CO$ ,  $CO_2$ ,  $H_2O$ ,  $N_2$  and Ar). The minimization of the Gibbs free energy can be formulated by introducing a Lagrange multiplier,  $\mu$ , for each of the  $N$  constraints obtained in Eq. (15). After adding the constraints, the expression to be minimized is then

$$\phi = \dot{G}_{tot,out} + \sum_{j=1}^N \mu_j \left( \sum_{i=1}^k \dot{n}_{i,out} \mathbf{A}_{ij} - \sum_{m=1}^w \dot{n}_{m,in} \mathbf{A}_{mj} \right) \quad (14)$$

The partial derivation of this equation with respect to  $\dot{n}_{i,out}$  can be writes as

$$\begin{aligned} \frac{\partial \phi}{\partial \dot{n}_{i,out}} &= \frac{\partial \dot{G}_{tot,out}}{\partial \dot{n}_{i,out}} + \sum_{j=1}^N \mu_j \mathbf{A}_{ij} = 0 \quad \text{for } i = 1, k \\ \Rightarrow g_{i,out}^0 + RT \ln(n_{i,out} P_{out}) + \sum_{j=1}^N \mu_j \mathbf{A}_{ij} &= 0 \quad \text{for } i = 1, k \end{aligned} \quad (15)$$

At the minimum each of these is then zero. The additional equation to make the system consistent is the summation of molar fractions of the outlet gas to be

$$\sum_{i=1}^k n_{i,out} = 1 \quad (16)$$

### 3 Suggested Plants Configurations

The suggested plants configurations are presented in Figs. 1. Wood chips are supplied to the two-stage gasification plant for biogas production. The first reactor accounts for drying and pyrolysing processes while the second reactor is the fixed bed gasifier. As reported in Hoffman et al (2006), the product gas is pure enough to be fed to a SOFC cell without any problem. However, in this study a simple hot gas cleaner is used to remove the small amount of sulfur which exists after the gasifier. It is assumed that the desulfurizer is working at about 240°C. The cleaned fuel is preheated and in an anode pre-heater (AP) to 650°C before entering to the anode side of the SOFC stacks. The operating temperature of the SOFC stacks as well as the outlet temperatures is assumed to be 780°C. The burned fuel after the stacks is used to preheat the incoming fuel to AP. On the other side of the fuel cell, air is compressed and preheated in a cathode pre-heater (CP) to 600°C before entering the cathode side of the SOFC stacks. Because some fuel is left after the anode side of the SOFC stacks, the rest of the fuel together with the air coming out of the cathode side are sent to a burner for further combustion. The off-gases from the burner is used to generate steam in a heat recovery steam generator (HRSG) using an economizer (ECO), an evaporator (EVA) and a super-heater (SUP). The generated steam can then be expanded in a steam turbine to produce power. In this study, part of the expanded steam is extracted for a deaerator (feed water tank). The expanded steam after the turbine is then send to a condenser before pumping to deaerator.

In Fig. 1b, the energy of the off-gases from the HRSG was further utilized in a hybrid recuperator (HR in the figure) to preheat the air after the compressor of the SOFC cycle. In other words, heat was recycled back to the SOFC cycle. The study of Rokni (2010) showed that such technique increases the plant efficiency significantly.

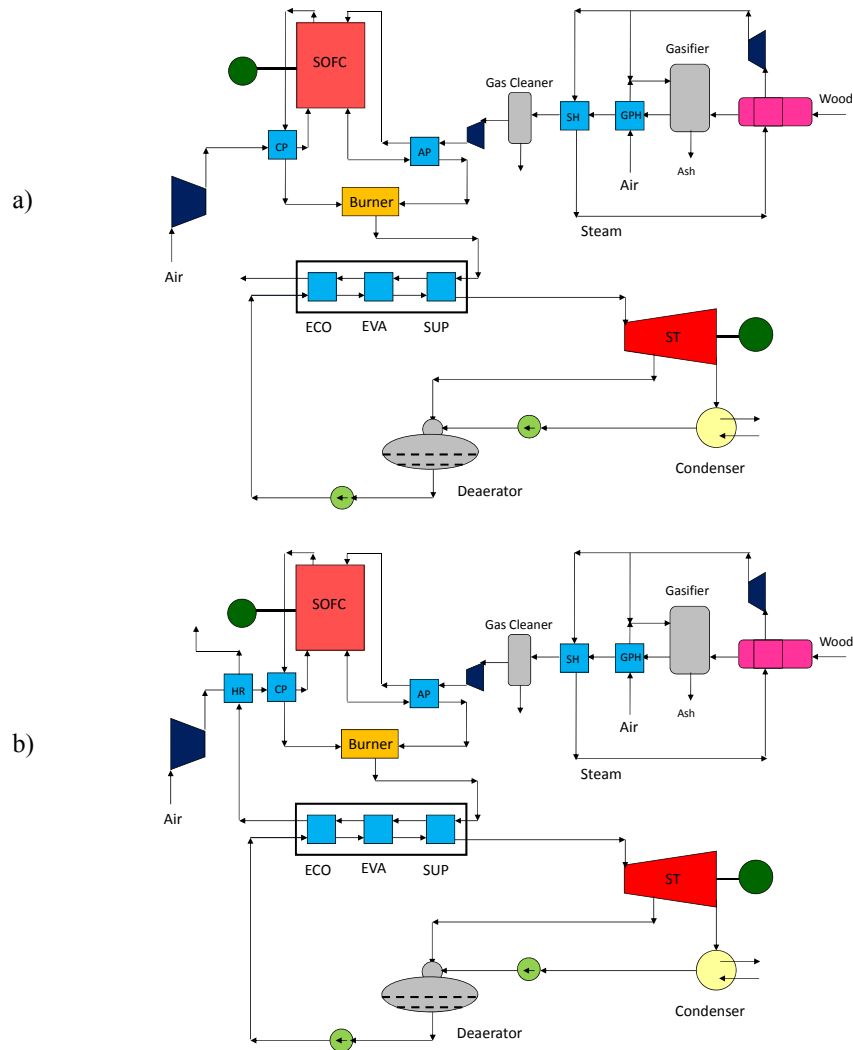

Figure 1. Integrated gasification SOFC-ST plant a) without hybrid recuperator, b) with hybrid recuperator.

The main parameters for the plant are set in table 1. The pressure drops are the setting values for the program, however, pressure drops are a function of channel sizes and mass flows and the channel geometry is not known. Therefore, these values are calculated based on the available data for each channel mass flow and dimensions. In addition, the calculations show that the final values in terms of plant power and efficiency do not change significantly if these values are changed slightly. Several calculations have been carried out to find the optimal extraction pressure as well as the optimum live steam pressure which are not included in this study. The HRSG terminal temperature was assumed to be 30°C while its pinch temperature and approach temperature were set to 15°C and 2°C, respectively.

In order to optimize the systems presented above, significant numbers of simulations have been carried out. Plants efficiencies versus live steam pressures and moisture contents are presented in Fig. 2. The results indicate that, for the plant A had a maximum efficiency at live steam pressure of 8 bar (the solid-line in the figure). Note that the left-

hand side y-axis corresponds to efficiency, while the right-hand side y-axis corresponds to moisture. For Case B, the plant efficiency increases when the live steam pressure is increased. The moisture content at the last stage of the steam turbine is another important issue to be taken into account.

Table 1. Main parameters for design point calculations of Fig. 1.

Parameter	Case A	Case B
Wood chips temperature (°C)	15	15
Wood chips mass flow (kg/s)	1.2	1.2
Dry wood temperature (°C)	150	150
Gasifier temperature (°C)	800	800
Gasifier pressure drop	0.005	0.005
Gasifier carbon conversion factor	1	1
Gasifier non-equilibrium methane	0.01	0.01
Steam blower isentropic efficiency	0.8	0.8
Steam blower mechanical efficiency	0.98	0.98
Steam temperature in the steam loop (°C)	150	150
Wood gas blower isentropic efficiency	0.9	0.9
Wood gas blower mechanical efficiency	0.98	0.98
Gas cleaner pressure drop	0.0049	0.0049
Compressor air inlet temperature (°C)	15	15
Compressor isentropic efficiency	0.85	0.85
Compressor mechanical efficiency	0.95	0.95
SOFC cathode inlet temperature (°C)	600	600
SOFC anode inlet temperature (°C)	650	650
SOFC operating temperature (°C)	780	780
SOFC utilization factor	0.85	0.85
SOFC current density (mA/cm <sup>2</sup> )	300	300
Heat exchangers fuel side pressure drop ratio (bar)	0.005	0.005
Heat exchangers air side pressure drops (bar)	0.01	0.01
Pre-Reformer inlet temperature	400°C	400°C
Pre-Reformer outlet temperature	450°C	450°C
Burner pressure drop	0.98	0.98
Water side pressure drop in super heater	0.02	0.02
Water side pressure drop in evaporator	0.03	0.03
Water side pressure drop in economizer	0.04	0.04
HRSG outlet temperature	–	90°C
High pressure steam turbine isentropic efficiency	0.9	0.9
Low pressure steam turbine isentropic efficiency	0.7	0.7
Extraction pressure	2 bar	2 bar
Condenser pressure	0.05 bar	0.05 bar
Pumps efficiency	0.85	0.85
DC/AC convertor and generators efficiency	0.97	0.97

Case A: without hybrid recuperator

Case B: with hybrid recuperator

Too high level of moisture (more than about 16%) may cause blade corrosion at the last stage; see e.g. Kehlhofer et al. (1999). For Case A the moisture content was well below 16% and the maximum live steam pressure could be selected without any problem for the moisture content. For Case B, the moisture content was above the limit value of 16% when the live steam pressure was more than about 97 bars. The dashed area in the figure represents the area in which moisture content was beyond the limit and was not accepted here. However, the live steam pressure must be selected well below the limit value of 97 bars in order to avoid the moisture when the plant is running on part-load or other parameters are going to be changed. Another reason could be mentioned was due to practical problems associated with designing of such steam turbine which may occur at

such mass flow and power output when the live steam pressure was too high. Therefore, for Case B, 60 bar was selected as the live steam pressure in the steam cycle. Shortly the reasons to select this pressure was basically on two important issues; a) avoiding too high moisture content at the last stage of steam turbine, b) avoiding problems associated with designing and constructing the first row of the steam turbine when pressure is relatively high with relatively low mass flow.

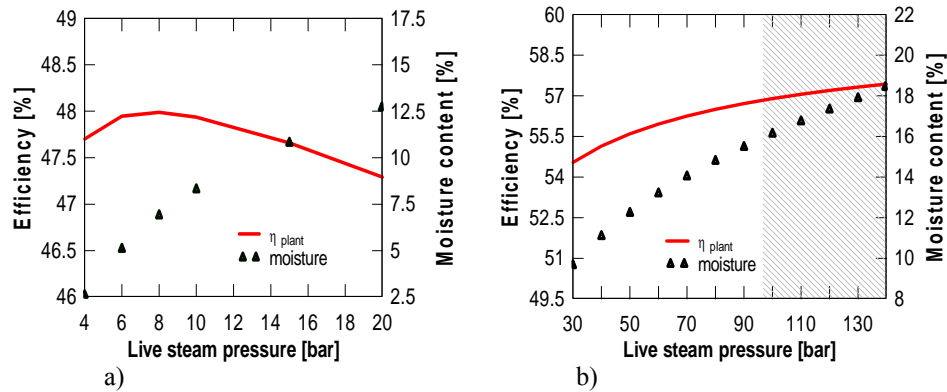

Figure 2. Electrical efficiency and moisture content of the combined SOFC–ST plants as function of live steam pressure, a) case A, and b) Case B.

### 3.1 Effect of Fuel Cell Operating Temperature on Plant Performance

The plant with hybrid recuperator shown in Fig. 1, Case B is now considered for further study but with 0.9 and 100 mA/cm<sup>2</sup> for SOFC utilization factor respective SOFC current density. The calculated results were then shown in Table 2. Along 780°C (current development), the 650°C (possible future generation) was also considered.

As could be seen from Table 2, with current temperature technology (780°C) the plant efficiency of 62.7% was available, while for the future generation (650°C if possible) the plant efficiency could reach to 54.7%. All these values are considerably higher than the traditional combined cycle with integrated gasification. Live steam pressure was set to 60 bar as discussed above. Live steam temperatures were considerably lower than the current technology for steam turbines (about 650°C). For the 780°C case, about 82.8% of the total net power was coming from SOFC plant. This value was 77.5% for the possible future technology.

Table 2. Calculated net powers and efficiencies for the optimized plants.

Parameter / SOFC operating T	780 °C	650 °C
Live steam pressure (bar)	60	60
Live steam temperature (°C)	420.3	405.0
Net power output (kW)	8582	7478
Net power output from SOFC cycle (kW)	7121	5813
Net power output from ST cycle (kW)	1490	1694
Steam blower power consumption (kW)	29	29
SOFC cell voltage (V)	0.884	0.723
Gas temperature before hybrid recuperator (°C)	232.2	236.9
Moisture content after ST (%)	13.9	14.7
HRSG effectiveness (%)	49.4	46.2
Thermal efficiency of steam cycle (LHV %)	29.6	28.8
Thermal efficiency of SOFC cycle (LHV %)	41.7	31.9
Thermal efficiency of plant (LHV %)	62.7	54.7



The moisture content for these three scenarios were less than the limit value of 16%. The HRSG effectiveness were less than 70%, indicating that the size of the HRGS were within acceptable cost. It could also be concluded from the values of HRSG effectiveness that the rather high plant efficiency with the 780°C scenario was not only producing steam at higher temperature but also using the HRSG more effectively. The net power produced from the SOFC cycle was directly related to the operating temperature, meaning that the higher SOFC operating temperature was the higher SOFC net power became.

## 4 Conclusions

A novel IGSS (Integrated Gasification SOFC – Steam turbine) was presented, designed and thermodynamically analyzed for the first time in an open literature. A novel recuperated system configuration versus non-recuperated design was compared in terms of plant efficiency, net power output and other important parameters. Woodchips was supplied to a two-stage gasifier with cold efficiency of 93% to produce wood gas. The produced wood gas was adequately clean to be used in SOFC stacks without any pre-reforming process. However, for the sake of safety a desulfurization reactor was used to remove the small amount of sulfur from the wood gas. The wood gas was then supplied to an SOFC cycle for electricity production. The energy of the waste gases from the SOFC cycle was then recovered in an HRSG to generate steam. The generated steam was then used to produce power in a Rankine cycle which was accounted as a bottoming cycle for the topping SOFC cycle. In addition, the energy of the off-gases after the HRSG was recovered in a hybrid recuperator for further usage. The later recovered energy was sent back to the topping cycle again. Such recovering treatment was shown to increase the plant efficiency significantly. Plant efficiencies of 56% were reported under normal operation which was considerably higher than the tradition IGCC plants. Under certain operating condition plant efficiency could be as high as 63%, with current SOFC technology.

It was thermodynamically shown that the corresponding non-hybrid recuperated plant had an optimal live steam pressure at 8 bar with a plant efficiency of about 48% which was comparable with traditional IGCC plants. Applying a hybrid recuperator and recovering more energy increased the plant efficiency by about 17% (or 8 point percentage from 48% to 56%).

Finally, it was also discussed that if it was possible to increase the operating temperature of the SOFC to 894°C, then the plant efficiency of 65% would be achieved under certain operating condition such as SOFC utilization factor of 90% and SOFC current density of 100 mA/cm<sup>2</sup>.

## 5 References

- [1] Fontell, E., Kivisaari, T., Christiansen, N., Hansen, J.-B. and Pålsson, J. 2004, "Conceptual study of a 250 kW planar SOFC System for CHP Application", *J. Power Sources*, Vol. 131, pp. 49 – 56.
- [2] Rokni, M., 2003, "Introduction of a Fuel Cell into Combined Cycle: A Competitive Choice for Future Cogeneration", *ASME Cogen – Turbo*, IGTI vol. 8, pp. 255 – 261.
- [3] Riensche, E., Achenbach, E., Froning, D., Haines, M. R., Heidug, W. K., Lokurlu, A., and von Andrian, S., 2000, "Clean Combined-cycle SOFC Power Plant – Cell Modeling and Process Analysis", *J. Power Sources*, Vol. 86, pp. 404 – 410.
- [4] Pålsson, J., Selimovic, A. and Sjunnesson, L., 2000 "Combined Solid Oxide Fuel Cell and Gas Turbine System for Efficient Power and Heat Generation", *J. Power Sources*, Vol. 86, pp. 442 – 448.

- [5] Subramanyan, K. and Diwekar, U. M., 2005 “Characterization and Quantification of Uncertainty in Solid Oxide Fuel Cell Hybrid Power Plants”, *J. Power Sources*, Vol. 142, pp. 103 – 116.
- [6] Roberts. R. A. and Brouwer, J. 2006, “Dynamic Simulation of a Pressurized 220 kW Solid Oxide Fuel-Cell – Gas-Turbine Hybrid System: Modeled Performance Compared to measured Results”, *J. Fuel Cell Science and Technology*, Vol. 3, No. 1, pp. 18 – 25.
- [7] Rokni, M., Fontell, E., Ylijoki, Y., Tiihonen, O., Hänninen, M., 2005, ”Dynamic Modeling of Wärtsilä 5kW SOFC System”, Ninth International Symposium on Solid Oxide Fuel cell (SOFC IX), Quebec, Eds. S.C. Singhal and J. Mizusaki, pp. 865 – 875.
- [8] Dunbar, W.R., Lior, N., Gaggioli, R.A., 1991, “Combining Fuel Cells with Fuel – Fired Power Plants for Improved Exergy Efficiency”. *J. of Energy*, Vol. 16, No. 10, pp. 1259 – 1274.
- [9] Elmegaard, B, Houbak, N, 2005, “DNA – A General Energy System Simulation Tool,” Proceeding of SIMS 2005, Trondheim, Norway.
- [10] Perstrup C. Analysis of power plant installation based on network theory (in Danish). M.Sc. thesis, Technical University of Denmark, Laboratory of Energetics, Denmark, 1991.
- [11] Petersen, T.F., Houbak, N. and Elmegaard, B., 2005, “Development of a Zero-Dimensional Model of a 2<sup>ND</sup> Generation Planar SOFC with Empirical Calibration of Electrochemical Parameters”,
- [12] Keegan, K. M., Khaleel M., Chick L. A., Recknagle K., Simner S.P. and Diebler J., 2002, “Analysis of a Planar Solid Oxide Fuel Cell Based Automotive Auxiliary Power Unit”, *SAE Technical Paper Series No. 2002-01-0413*.
- [13] Kim, J.W. and Virkar, A.V., 1999, “The Effect of Anode Thickness on the Performance of Anode – Supported Solid Oxide Fuel Cell”, *Proc. of the Sixth Int. Symp. On SOFCs*, (SOFC – VI), PV99 – 19, The Electrochemical Society, pp. 830 – 839.
- [14] Elmegaard, B, Houbak, N, 1999, “On the implementation of energy simulators with emphasis on chemical equilibrium gasifier models”, Proceedings of ECOS'99 (ISBN: 4-9980762-0-5) , pages: 258-263, 1999, ECOS'99, Tokyo.
- [15] Kehlhofer, R.H., Warner, J., Nielsen, H. and Bachmann, R., 1999, “Combined – Cycle Gas Steam Turbine Power Plants”, PennWell, ISBN: 0-87814-736-5.
- [16] Ahrenfeldt J, Henriksen U, Jensen TK, Gøbel B, Wiese L, Kather A and Egsgaard H, Validation of a continuous combined heat and power (CHP) operation of a two-stage biomass gasifier, *J Energy and Fuels* 2006, Vol. 20, Issue 6, pp. 2672-2680.
- [17] Hofmann PH, Schweiger A, Fryda L, Panopoulos KD, Hohenwarter U, Bentzen JD, Ouweltjes JP, Ahrenfeldt J, Henriksen U, and Kakaras E, High temperature electrolyte supported Ni–GDC/YSZ/LSM SOFC operation on two-stage Viking gasifier product gas, *J Power Sources* 2007, Vol. 173, Issue 1, pp. 357–366.
- [18] Rokni M, Thermodynamic analysis of an integrated solid oxide fuel cell cycle with a rankine cycle, *J Energy Conversion and Management* 2010, Vol. 51, No. 12, pp. 2724 –2732.
- [19] Bang-Møller C and Rokni M, Thermodynamic performance study on biomass gasification, solid oxide fuel cell and micro gas turbine hybrid systems, *Energy Conversion and Management* 2010, Vol. 51, pp 2330–2339.
- [20] Smith JM, Van Ness HC, Abbott MM, Introduction to Chemical Engineering Thermodynamics, 7th ed., Boston:McGraw-Hill; 2005.

# Use of Methanation for Optimization of a Hybrid Plant Combining Two-Stage Biomass Gasification, SOFCs and a Micro Gas Turbine

Christian Bang-Møller\*, Masoud Rokni and Brian Elmegaard

Section of Thermal Energy Systems, Department of Mechanical Engineering,  
Technical University of Denmark, Nils Koppels Allé 403, 2800 Kgs. Lyngby, Denmark

## Abstract

A hybrid plant producing combined heat and power (CHP) from biomass by use of the two-stage gasification concept, solid oxide fuel cells (SOFCs) and a micro gas turbine (MGT) was considered for optimization. The hybrid plant is a sustainable and efficient alternative to conventional decentralized CHP plants. The demonstrated two-stage gasifier produces a clean product gas, thus ensuring the need for only simple gas conditioning prior to the SOFCs. Focus in this optimization study was on SOFC cooling and the investigation was conducted by system-level modelling combining zero-dimensional component models in the simulation tool DNA. By introducing an adiabatic methanation reactor prior to the SOFCs, the excess air flow for SOFC cooling could be reduced due to additional endothermic reforming reactions internally in the SOFCs, thus lowering the air compressor work. Installing an adiabatic methanator reduced the mass flow of cathode air by 27% and increased the turbine inlet temperature by 17% resulting in an electrical efficiency gain from 48.6 to 50.4% based on lower heating value (LHV). Furthermore, the size of several components could be reduced due to the lower air flow. The study also showed that combining alternative product gas preheating and adiabatic methanation made the traditional anode in/out heat exchanger redundant and an electrical efficiency of 52.5% (LHV) was achieved.

*Keywords:* System-level model, optimization, gasification, SOFC, methanation

## 1 Introduction

Development of sustainable power plants has gained focus in the recent years and utilization of biomass resources are seen as a pathway towards a sustainable combined heat and power (CHP) production. Biomass resources are distributed, thus decentralized biomass conversion would avoid extensive cost for biomass transportation. Traditional decentralized CHP plants suffer from low net electrical efficiencies compared to central power stations, though. Modern central coal power plants can obtain net electrical efficiencies of around 50%, while the performances of decentralized and smaller power plants (<30 MW<sub>e</sub>) typically suffer from significantly lower electrical efficiencies. Especially decentralized and dedicated biomass CHP plants producing electricity via a steam turbine suffer from low electrical efficiencies, reaching only 30-34% on dry biomass in the typical size of 5-25 MW<sub>e</sub> [1]. Improving the electrical power yield from small-scale CHP plants based on biomass will improve the competitiveness of decentralized CHP production from biomass as well as move the development towards a more sustainable CHP production.

Fuel cells present an opportunity to achieve significant efficiency improvements of electricity producing plants. Especially the fuel cell type SOFC (Solid Oxide Fuel Cell) has the advantage of efficient power production. Furthermore, SOFCs operate with high

---

\* Corresponding author, email: [cbm@mek.dtu.dk](mailto:cbm@mek.dtu.dk), phone: 0045 45254123

exhaust gas temperature, which can be utilized for additional power generation in heat engines or used for other heating purposes, whether internal in or external to the system. The Danish SOFC developer Topsoe Fuel Cell A/S states that the electrical efficiency of distributed power generation can be increased from average 40% in traditional power plants to 55% when using SOFC technology [2]. SOFCs can electrochemically convert  $H_2$  and CO to electricity and heat as well as internally reform  $CH_4$  into more  $H_2$  and CO due to their high operating temperature and the presence of a nickel catalyst. Compared to other fuel cell types, these conversion pathways make SOFCs very fuel flexible and ideal for conversion of product gas from thermal gasification.

Generally, a major issue of combining gasification and SOFC technology has proved to be gas conditioning, as SOFCs have strict requirements for fuel cleanliness [3]. In typical gasifiers, relatively high levels of contaminants are entrained in the product gas flow, thus advanced gas cleaning is needed. In this study, a novel two-stage gasification concept producing a very clean product gas at high cold gas efficiency is used, thus only simple gas conditioning is necessary. General documentation of the demonstrated two-stage gasification concept has previously been published [4]-[5]. The concept is scalable up to the range of 3-10 MW<sub>th</sub> [6], and it has been demonstrated up to 0.6 MW<sub>th</sub> (based on lower heating value, LHV) at present [7]. Hoffman et al. [8] operated an SOFC on cleaned product gas from a demonstrated two-stage gasifier for 150 hours without any prove of cell degradation.

Previous studies by the authors have shown that combining SOFC and gas turbine technology significantly enhances the power yield from thermally gasified biomass compared to using only one of the two technologies [9]-[11]. A small-scale gasifier-SOFC-MGT hybrid plant can reach an electrical efficiency around 50% (LHV). Furthermore, an exergy analysis study has revealed that optimization of the heat management can increase the electrical efficiency even more [12]-[13].

This work presents thermodynamic assessments of alternative plant layouts of a previously studied novel hybrid CHP plant combining two-stage biomass gasification, simple gas conditioning, an SOFC stack and a MGT. These alternative plant layouts include optimization efforts by introducing a methanation reactor to increase the  $CH_4$  content in the anode feed, thus ensuring more SOFC cooling by the endothermic internal reforming reactions. Hereby, the parasitic loss of the plant can be reduced due to lowering of the excess air flow to the SOFCs. The thermodynamic assessments are conducted by use of mathematical models describing the thermodynamic processes. The models rely on connecting zero-dimensional component models to generate the complete plant-level models. The simulation tool used in this modelling study is DNA (Dynamic Network Analysis), which is made for simulations of mathematical models representing thermodynamic processes [14]-[16].

## 2 Reference Plant Designs

The plant is divided into a gasification plant part and a CHP producing plant part. Wood chips are converted to product gas in the gasification part, and in the CHP producing part, the product gas is converted to electric power and heat by use of an SOFC stack and a MGT.

The gasification plant part is based on the two-stage gasification concept, which comprises a technique where drying and pyrolysis take place prior to an autothermal downdraft gasification reactor, and where partial oxidation creates a high-temperature tar-cracking zone in between the pyrolysis and char gasification steps. By this gasification concept, a very clean product gas can be produced, thus avoiding advanced gas conditioning and easier utilization in an SOFC. The simple gas conditioning performed in this plant includes gas cooling, a bag filter and a condensing gas cooler.

The CHP producing plant part comprises an SOFC stack and a MGT. The SOFC ensures efficient power production from the product gas, while the MGT ensures additional

power production from utilizing the high-temperature SOFC off gases containing residual fuel. Furthermore, the MGT pressurizes the SOFC stack, thus enhancing the SOFC performance.

Heat for district heating purposes is mainly extracted from cooling the plant exhaust gas with minor contributions from cooling the product gas in the gas conditioning step. Some of the produced heat should be applied to the drying and pyrolysis step, though.

Based on the plant concept described above, a system design without integration between the gasification and the CHP producing plant parts were initially studied in a previous publication [11]. A flow sheet of this initial plant design can be found in Figure 1 and it is used as *reference plant 1* in this study. As depicted in Figure 1, wet wood is fed to the steam dryer, producing dry wood and steam, which both are led to the gasifier. For reasons of simplification, the pyrolysis takes place inside the gasification reactor in this modelling study. Heat for the wood drying is provided by the hot product gas from the gasifier (and transferred via superheated (SH) steam), thus ensuring possible independent operation of the gasifier plant part. A bag filter removing particulates is the only gas cleaning device in the considered system. The product gas is cooled to 90°C before it is led through the filter. It is assumed that no alkali compounds leave the gasifier plant entrained in the product gas flow, since all alkalis should be condensed at such low temperatures, thus removed along with particulates in the bag filter. The sulphur content is expected to be very low (cf., [12]-[13]), so no sulphur clean-up step is included. If it was found necessary, a ZnO bed could be located after the gasifier air preheater depending on the preferred operating temperature of such a sulphur removal unit. The condensing gas cooler lowers the water content in the product gas to 12.7 vol-% resulting in a steam to carbon ratio (S/C) of 0.41, which is somewhat low [17] but justified by the very low tar content in the product gas. Hofmann et al. [8] showed that carbon formation did not occur when fuelling an SOFC with product gas from a two-stage gasifier at low fuel utilization and a S/C ratio of 0.5. Higher fuel utilization should enable operation at lower S/C ratios [17].

The conditioned product gas is then converted to electricity and heat in the CHP producing plant part consisting of a pressurized SOFC stack and a recuperated MGT. In addition, the product gas compressor works as a suction blower for the gasifier system. A generator (not illustrated) is situated on the shaft of the gas turbine and it produces the net electric MGT power. A DC/AC inverter (not illustrated) converts the DC power from the SOFC stack to AC power.

The size of the plant is defined by the thermal input of biomass fed to the dryer, and in this study it is approximately 0.5 MW<sub>th</sub> (LHV).

Based on an exergy analysis, some modifications of the heat management can be implemented to enhance the plant performance. For details, the reader is referred to [12] and [13]. The resulting plant layout is depicted in Figure 2 and it is used as *reference plant 2* in this study. In reference plant 2, the exhaust gas downstream the recuperator is delivering heat to the biomass drying process by heating dryer steam in the steam heater. The hot product gas leaving the gasifier air preheater, that previously heated the drying process, preheats the pressurized product gas in a first step preheater, while the anode off gas preheats the pressurized product gas in a second step preheater. The added first step preheater ensures a higher temperature of the anode off gas leaving the second step preheater and entering the burner. Since the first step product gas preheater works as a recuperator, a heat exchanger effectiveness of the same level as the MGT recuperator is applied.

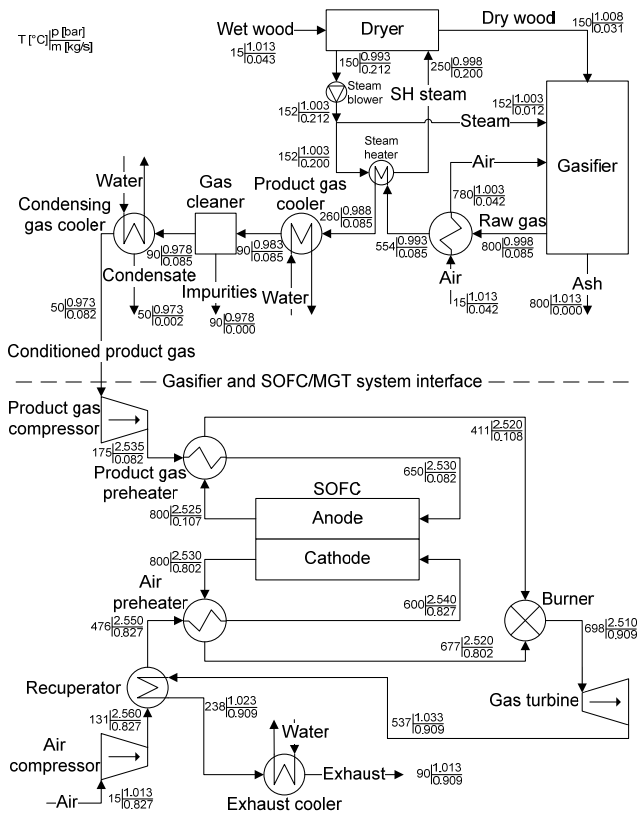

Figure 1: Flow sheet of reference plant 1. The data presented in this figure is results belonging to Section 4.

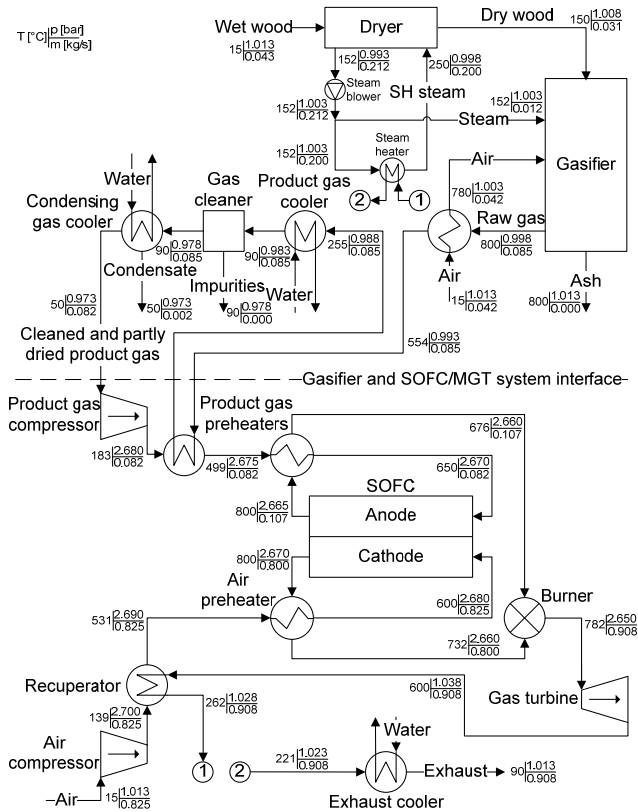

Figure 2: Flow sheet of reference plant 2. The data presented in this figure is results belonging to Section 4.

## 2.1 Model Description

The developed system-level models comprise combined zero-dimensional component models to describe the thermodynamic behaviour of the plants. The modelled systems are assumed to be in a steady state operation and heat losses are neglected (except from the generator, DC/AC inverter and compressors). The system and component models are described in detail in previous publications ([12]-[13]), to which the reader is referred for additional details. The essential operating conditions of the plants are listed in Table 1.

*Table 1: Essential operating conditions.*

<i>Gasifier</i>	
Gasifier operating pressure	0.998 bar
Gasifier operating temperature	800°C
Carbon conversion	99%
<i>SOFC</i>	
SOFC operating temperature	800°C
Anode inlet temperature	650°C
Cathode inlet temperature	600°C
Fuel utilization, $U_F$	85%
Current density	300 mA cm <sup>-2</sup>
DC/AC inverter efficiency	95%
<i>MGT</i>	
Pressure ratio	Optimized <sup>a</sup>
Isentropic efficiency of fuel compressor	75%
Mechanical efficiency of fuel compressor	98%
Isentropic efficiency of air compressor	75%
Mechanical efficiency of air compressor	98%
Isentropic efficiency of expander	84%
Recuperator effectiveness	85%
Generator efficiency	95%
<i>Peripheral equipment and conditions</i>	
Ambient temperature	15°C
Ambient pressure	1.013 bar
Biomass input	0.5 MW <sub>th</sub>
Biomass composition (wt-%)	33.09% C, 4.20% H, 29.76% O, 0.014% S, 0.115% N, 0.617% Ash, 32.20% H <sub>2</sub> O (LHV: 11.61 MJ kg <sup>-1</sup> )
Water content in dried biomass (wt-%)	5%
Temperature of dried biomass	150°C
Temperature of superheated dryer steam	250°C
Isentropic efficiency of steam blower	60%
Mechanical efficiency of steam blower	98%
Pinch temperature of gasifier air preheater	20°C
Gas cleaning temperature	90°C
Temperature of conditioned product gas	50°C
Plant exhaust temperature	90°C

<sup>a</sup> Different optimum in the studied plants (all in the range of 2.5-3.2, see Table 2).

The gasifier component model calculates the product gas composition and produced ashes based on the inlet media compositions and the operating conditions. The ashes originate from a defined content in the inlet biomass. The product gas composition is determined by the Gibbs free energy minimization method [18], thus it is assumed that chemical equilibrium is reached at the gasifier operating temperature and pressure. The product gas composition is calibrated against data from a demonstrated two-stage gasifier [5]. The calibrated product gas composition and cold gas efficiency can be found in [11]. The reason for the relatively high cold gas efficiency (~93%) of the two-stage gasifier design compared to traditional downdraft gasifiers is that the drying process is heated by either an external heat source or by the hot product gas, thus not requiring heat from partial oxidation.

The SOFC component model determines the electric power production depending on the fuel input and the SOFC efficiency. The SOFC efficiency is defined as:

$$\eta_{\text{SOFC}} = \eta_{\text{rev}} \eta_{\text{v}} U_{\text{F}} \quad (1)$$

The fuel utilization factor ( $U_{\text{F}}$ ) is estimated, while the reversible efficiency ( $\eta_{\text{rev}}$ ) is the maximum possible efficiency (defined in [11]). The voltage efficiency ( $\eta_{\text{v}}$ ) is determined from an electrochemical model ensuring dependence on operating conditions such as temperature, pressure, average species concentrations and current density. The electrochemical model predicts the Nernst potential and overpotential at various operating conditions and is based on the assumption that only  $\text{H}_2$  is electrochemically converted in the anode. If CO is present in the fuel feed, remaining CO after chemical equilibrium is reached at the anode inlet is considered inert (cf., [12]). Thus, in case of the presence of substantial amounts of CO in the fuel, the electrochemical model will underestimate the SOFC performance and may be considered a worst case scenario. The electrochemical model has been calibrated to fit the performance of an  $\text{H}_2+\text{N}_2$  fuelled SOFC stack based on 2<sup>nd</sup> generation cells from Topsoe Fuel Cell A/S and Risø DTU National Laboratory for Sustainable Energy [19].

Modelling of gas turbines is well described in the open literature. The reader is referred to Saravanamuttoo et al. [20] for details. Characteristics of the turbomachinery and other components connected to the MGT are listed in Table 1. The performance of the compressors and the MGT expander corresponds to common performance data for an MGT of this scale, e.g., see [21]. The pressure ratio has been optimized in all presented plants in this study.

### 3 Optimization by Methanation

To optimize the presented plant, focus in this study is on exploiting the benefits of increasing the share of  $\text{CH}_4$  in the product gas fed to the SOFCs. By including a methanation reactor prior to the SOFC anodes, the  $\text{CH}_4$  content in the product gas can be increased and internal reforming of the produced  $\text{CH}_4$  will contribute to the SOFC cooling. Hereby, the excess air flow on the cathode side of the SOFCs could be decreased, thus lowering the parasitic loss of the plant (lower air compressor work). Furthermore, the exothermic methanation process produces a higher temperature of the fuel feed. If this temperature is high enough, the need for a product gas preheater (anode in/out heat exchanger) could be eliminated. Nevertheless, the higher temperature will ensure a higher temperature of the anode off gas fed to the burner and a higher turbine inlet temperature (TIT), thus boosting the MGT power output. Potentially, water produced in the methanation process could also increase the S/C ratio, thus lowering the risk of carbon formation in the SOFCs.

The major thermodynamic reactions occurring within the methanation reactor are:



Modelling of the methanation reactor is done by performing a minimization of Gibbs free energy of the product gas components to determine the chemical equilibrium composition at the outlet of the reactor (similar to the gasification reactor). In this study, an adiabatic methanation reactor is used. The outlet temperature of the adiabatic reactor is determined by energy balancing. Isothermal reactors or series of adiabatic reactors with intercooling could also be used and could enhance the  $\text{CH}_4$  production, but the heat generated is not of great value in a plant of this scale and would thus lead to increased exergy losses. Heat from a large scale methanation process could be used to produce steam for additional power generation in a steam cycle.

To investigate the potential of including a methanation step, an adiabatic methanation reactor has been installed in the two reference plants. The new plant designs are illustrated in Figure 3 and Figure 4.



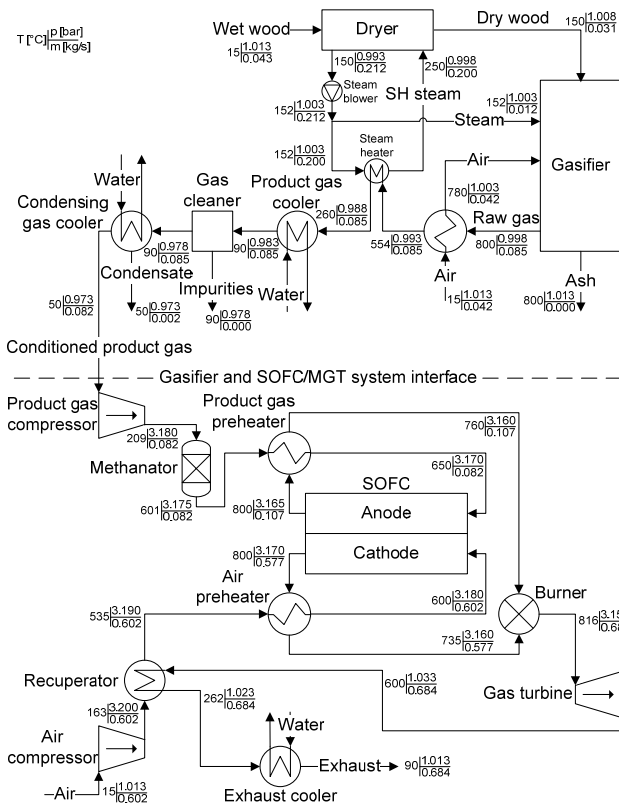

Figure 3: Flow sheet of methanation plant 1 (reference plant 1 with methanator). The data presented in this figure is results belonging to Section 4.

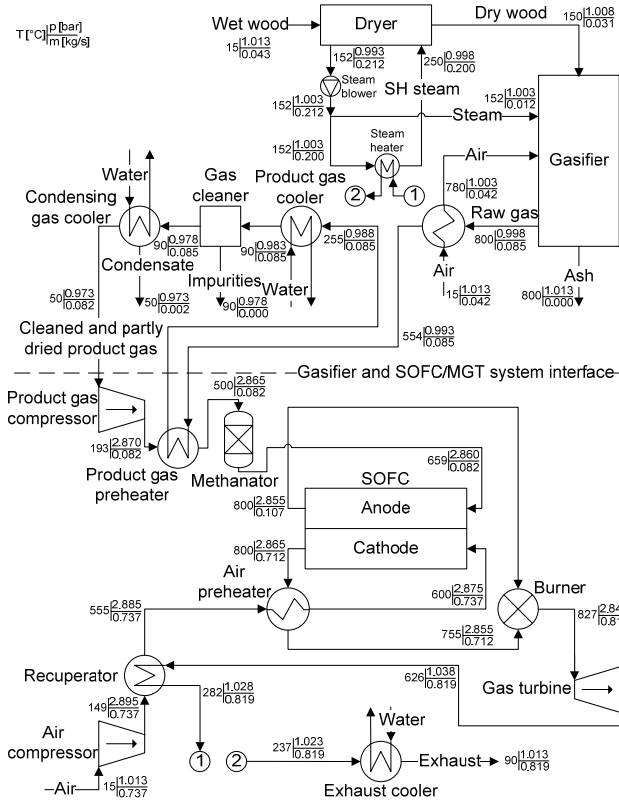

Figure 4: Flow sheet of methanation plant 2 (reference plant 2 with methanator). The data presented in this figure is results belonging to Section 4.

## 4 Results and Discussion

The two reference plants and the two methanation plants have been simulated to be able to compare their performances. Key data from the simulations are listed in Table 2 and temperatures, pressures and mass flows in the plants are available from the previously presented flow sheets.

With the same thermal input in all the studied plants, the electrical power production is a direct measure of the performance of the plants. More specifically, the MGT net power production is the primary plant performance indicator because the SOFC performance only show minor changes due variations in operating pressure.

*Table 2: Key data of studied plants.*

	Reference plant 1	Reference plant 2	Methanation plant 1	Methanation plant 2
Biomass input / kW <sub>th</sub>	499.1	499.1	499.1	499.1
Optimal pressure ratio / -	2.53	2.67	3.16	2.86
Turbine inlet temperature / °C	698	782	816	827
SOFC cell potential / mV	662	663	665	664
MGT net power prod. / kW <sub>e</sub>	53.8	69.6	62.1	72.7
SOFC net power prod. / kW <sub>e</sub>	188.5	188.9	189.7	189.2
Total net power prod. / kW <sub>e</sub>	242.4	258.4	251.7	261.9
District heating prod. / kJ s <sup>-1</sup>	172.9	156.0	158.6	159.0
Electrical efficiency (LHV) / %	48.6	51.8	50.4	52.5
CHP efficiency (LHV) / %	83.2	83.0	82.2	84.3
CH <sub>4</sub> level at anode inlet / vol-%	1.0	1.0	6.8	3.3
S/C ratio at anode inlet / -	0.41	0.41	0.41	0.40
Mass flow of cathode air / kg s <sup>-1</sup>	0.83	0.83	0.60	0.74

Studying the two reference plants, plant 2 achieves the highest electrical efficiency due to a higher MGT net power production. The higher MGT net power output is caused by the additional product gas preheating, thus ensuring a higher turbine inlet temperature.

Comparing reference plant 1 and methanation plant 1, one can conclude that installing an adiabatic methanator improves the electrical efficiency by approximately 2 percentage points or 4%. Primarily the MGT net power output increases (despite the lower mass flow of air) and this is due to a higher turbine inlet temperature caused by; (1) the exothermic methanation step ensures a higher temperature of the anode off gas fed to the burner and (2) a reduced excess air flow for SOFC cooling ensures a higher fuel-to-air ratio in the burner. The higher CH<sub>4</sub> content at the anode inlet (6.8 versus 1.0 vol-%) induce additional cooling of the SOFCs due to the endothermic internal reforming reactions.

Comparing reference plant 2 and methanation plant 2, the adiabatic methanation step also improves the plant performance. Here, the electrical efficiency is increased by less than 1 percentage point or 1-2%. The reason for this improvement is similar to plant 1, though the impact is more moderate due to a lower CH<sub>4</sub> production in the methanator. The lower CH<sub>4</sub> production is caused by the higher inlet temperature to the methanator. With the product gas composition from the gasifier of this study, the theoretical maximum CH<sub>4</sub> level achieved from full methanation is approximately 16 vol-%. In methanation plant 2, the methanator could also be installed before the product gas preheating to lower the inlet temperature to the methanation reactor. In this setup, the product gas preheating by raw product gas would be useless and instead it would require use of an anode in/out product gas preheater to reach the desired anode inlet temperature. The setup would be almost identical to methanation plant 1, the only difference being the heat source for wood drying.

Of the two methanation plants, plant 2 performs better than plant 1 even though a higher degree of methanation is reached in plant 1. This is because of both a higher turbine inlet temperature and a higher mass flow of air achieved in plant 2. The highest electrical

efficiency and turbine inlet temperature of the four plants (52.5% and 827°C, respectively) is found in methanation plant 2 and is reached by combining product gas preheating and adiabatic methanation, thus avoiding an anode in/out heat exchanger. If an anode inlet temperature of 600°C (instead of 650°C) was allowed in methanation plant 1, the anode in/out heat exchanger could also be skipped here and a turbine inlet temperature of 843°C could be reached. The electrical efficiency would increase very little, though (~0.3 percentage points, without taking into account any SOFC performance penalty due to the lower anode inlet temperature).

Studying reference plant 2 and methanation plant 1, it can be seen that installing additional product gas preheating results in a better plant performance than installing an adiabatic methanator. In methanation plant 1, the turbine inlet temperature reaches the highest level of the two plants, but the lower mass flow of air limits the MGT net power output. In reference plant 2, a relatively high turbine inlet temperature is reached without reducing the air flow resulting in a greater performance gain.

From Table 2 it is also evident that the S/C ratio is rather constant in all plant scenarios. In this study, an adiabatic methanator cannot lower the risk of carbon formation in the SOFCs. If the theoretical maximum CH<sub>4</sub> level from full methanation was reached, the S/C ratio would only increase to 0.53.

## 5 Discussion

Making use of an adiabatic methanation step has a positive, though limited, impact on the net electrical efficiency of the plant. Besides affecting the overall plant performance, including a methanation step reduces the size and duty of several components due to reduced SOFC cooling by excess air flow. These are the air compressor, recuperator, SOFC air preheater, burner, MGT expander and exhaust cooler. This is most pronounced in methanation plant 1 with the lowest air mass flow. So from an investment point of view, it is expected that adiabatic methanation is beneficial due to reduced component sizes. Solely from a plant performance point of view, additional product gas preheating (reference plant 2) or combined methanation and product gas preheating (methanation plant 2) is better. In these cases, component sizes are not reduced or not reduced as significantly as in methanation plant 1.

The temperature levels in the methanation reactors in the two methanation plants cover a range from 209°C at the coldest inlet to 659°C at the hottest outlet. Catalysts with high and stable activity in this temperature range are commercially available [22]-[23].

Furthermore, the turbine inlet temperatures reached in this study are all acceptable with regard to material constraints. Commercially available MGTs reach 950°C in turbine inlet temperature [24].

## 6 Conclusion

The present study investigated the benefits of introducing an adiabatic methanation step in a novel hybrid CHP plant combining two-stage biomass gasification, simple gas conditioning, an SOFC stack and a MGT. It was confirmed that by introducing an adiabatic methanation reactor prior to the SOFCs, the excess air flow for SOFC cooling was reduced due to additional endothermic reforming reactions internally in the SOFCs, thus lowering the air compressor work. Regardless of the limited CH<sub>4</sub> levels achieved from adiabatic methanation (between 3.3 and 6.8 vol-%), gain in plant performances were shown due to higher MGT net power production. Installation of an adiabatic methanator in reference plant 1 reduced the mass flow of cathode air by 27% and increased the turbine inlet temperature by 17% resulting in an electrical efficiency increase from 48.6 to 50.4% (LHV) and reduced the size of several components. On the other hand, by introducing additional product gas preheating from the raw product gas instead of an adiabatic methanation step, the plant performance was better (50.4 versus

51.8%). The best plant performance was achieved when combining the alternative product gas preheating and adiabatic methanation. In this setup, the traditional anode in/out heat exchanger was redundant and the plant reached an electrical efficiency of 52.5% (LHV).

## 7 References

- [1] International Energy Agency. IEA Energy Technology Essentials: Biomass for power generation and CHP (No. 3). 2007. Available from: <https://www.iea.org/techno/Essentials.htm> [cited 2011 March 22].
- [2] Topsoe Fuel Cell A/S. Business Areas, Distributed Generation. 2010. Available from: [http://www.topsoefuelcell.com/business\\_areas/dg.aspx](http://www.topsoefuelcell.com/business_areas/dg.aspx) [cited 2011 Mar 22].
- [3] Dayton DC, Ratcliff M, Bain R. Fuel cell integration - A study of the impacts of gas quality and impurities: Milestone completion report. Golden (CO): National Renewable Energy Laboratory; 2001 Jun. Report No.: NREL/MP-510-30298.
- [4] Henriksen U, Ahrenfeldt J, Jensen TK, Gøbel B, Bentzen JD, Hindsgaul C, Sørensen LH. The design, construction and operation of a 75 kW two-stage gasifier. *Energy* 2006;31:1542–1553.
- [5] Ahrenfeldt J, Henriksen U, Jensen TK, Gøbel B, Wiese L, Kather A, Egsgaard H. Validation of a continuous combined heat and power (CHP) operation of a two-stage biomass gasifier. *Energ Fuel* 2006;20:2672–2680.
- [6] Bentzen JD, Hummelshøj RM, Henriksen U, Gøbel B, Ahrenfeldt J, Elmegaard B. Upscale of the two-stage gasification process. In: van Swaaij WPM, Fjällström T, Helm P, Grassi A, editors. Proceedings of 2. World conference and technology exhibition on biomass for energy and industry. Rome: 2004.
- [7] Energinet.dk. Opskalering og demonstration af tottrinsprocessen – Slutrapport [Danish]. 2007. 31 p. Project No.: ForskEL 6529 (FU4202). Available from: <https://selvbetjening.preprod.energinet.dk/www.energinet.dk/da/menu/Forskning/ForskEL-programmet/Projekter/Afsluttede/Projekt+6529+%28FU4202%29.htm> [cited 2011 Mar 11].
- [8] Hofmann Ph, Schweiger A, Fryda L, Panopoulos KD, Hohenwarter U, Bentzen JD et al. High temperature electrolyte supported Ni-GDC/YSZ/LSM SOFC operation on two-stage Viking gasifier product gas. *J Power Sources* 2007;173:357–366.
- [9] Bang-Møller C, Rokni M. Modelling of a biomass gasification plant feeding a hybrid solid oxide fuel cell and micro gas turbine system. In: Sønnderberg PL, Larsen HH, editors. Proceedings of Risø international energy conference 2009: Energy solutions for CO<sub>2</sub> emission peak and subsequent decline. Roskilde, Denmark: 2009, pp. 289-299.
- [10] Bang-Møller C, Rokni M. Modelling a combined heat and power plant based on gasification, micro gas turbine and solid oxide fuel cells. In: Elmegaard B, Veje C, Nielsen MP, Mølbak T, editors. Proceedings of SIMS 50: Modelling of energy technology. Fredericia, Denmark: 2009, pp. 189-196.
- [11] Bang-Møller C, Rokni M. Thermodynamic performance study of biomass gasification, solid oxide fuel cell and micro gas turbine hybrid systems. *Energy Conv and Manag* 2010;51:2330–9.
- [12] Bang-Møller C, Rokni M, Elmegaard B. Exergy analysis and optimization of a biomass gasification, solid oxide fuel cell and micro gas turbine hybrid system, Submitted for Energy 2011.
- [13] Bang-Møller C. Design and optimization of an integrated biomass gasification and solid oxide fuel cell system [PhD thesis]. ISBN: 978-87-89502-98-4. Technical University of Denmark; 2010. Available from: <http://orbit.dtu.dk/query?record=270909> [cited 2011 Mar 24].

- [14] DNA - A Thermal Energy System Simulator. Homepage of the thermodynamic simulation tool DNA. Technical University of Denmark. Available from: <http://orbit.dtu.dk/query?record=231251> [cited 2011 Mar 11].
- [15] Elmegaard B. Simulation of boiler dynamics – Development, evaluation and application of a general energy system simulation tool [PhD thesis]. Report No.: ET-PhD 99-02. ISBN: 87-7475-222-7. The Technical University of Denmark; 1999.
- [16] Elmegaard B, Houbak N. DNA – A general energy system simulation tool. In: Amundsen J et al., editors. Proceedings of SIMS 2005 46<sup>th</sup> Conference on simulation and modelling. Trondheim: Tapir Academic Press; 2005, p. 43–52.
- [17] Mermelstein J, Brandon N, Millan M. Impact of steam on the interaction between biomass gasification tars and nickel-based solid oxide fuel cell anode materials. *Energy Fuel* 2009;23:5042–8.
- [18] Smith JM, Van Ness HC, Abbott MM. Introduction to chemical engineering thermodynamics. 7<sup>th</sup> ed. Boston: McGraw-Hill; 2005.
- [19] Linderoth S, Larsen PH, Mogensen M, Hendriksen PV, Christiansen N, Holm-Larsen H. Solid oxide fuel cell (SOFC) development in Denmark. *Mater Sci Forum* 2007;539-543:1309–1314.
- [20] Saravanamuttoo HIH, Rogers GFC, Cohen H, Straznicky PV. Gas turbine theory. 6<sup>th</sup> ed. Essex: Pearson Education Ltd; 2009. ISBN: 978-0-12-222437-6.
- [21] Fryda L, Panopoulos KD, Kakaras E. Integrated CHP with autothermal biomass gasification and SOFC-MGT. *Energy Conver and Manag* 2008;49:281–290.
- [22] Haldor Topsøe A/S. PK-7R low temperature methanation catalyst. Available from: [http://www.topsoe.com/business\\_areas/ammonia/processes/methanation.aspx](http://www.topsoe.com/business_areas/ammonia/processes/methanation.aspx) [cited 2011 Mar 31].
- [23] Haldor Topsøe A/S. From solid fuels to substitute natural gas (SNG) using TREMP™. Available from: [http://www.topsoe.com/business\\_areas/gasification\\_based/Processes/Substitute\\_Natural\\_Gas.aspx](http://www.topsoe.com/business_areas/gasification_based/Processes/Substitute_Natural_Gas.aspx) [cited 2011 Mar 31].
- [24] Turbec AB. Turbec T100 CHP datasheet international 2005. Available from: [http://www.turbec.com/pdf/Turbec%20brochure%202005%20eng\\_Email%20version.pdf](http://www.turbec.com/pdf/Turbec%20brochure%202005%20eng_Email%20version.pdf) [cited 2011 Apr 6].

## Session 11 - Mechanisms and Markets

# On the effectiveness of standards vs taxes for reducing CO<sub>2</sub> emissions in passenger car transport Europe

Amela AJANOVIC, Reinhard HAAS

Energy Economics Group, Vienna University of Technology, Austria

E-mail: ajanovic@eeg.tuwien.ac.at

## Abstract

The current problems arising from motorized individual transport lead to an urgent need for implementing efficient policy measures. To get a reliable appraisal of the effects of different types of policies it is very important to know the impact of different parameters like prices and fuel intensities. Of special relevance in this context is how consumer behaviour and the rebound affect especially technical measures like standards for fuel intensity.

The core objective of this paper is to analyse the impact of taxes and fuel intensity standards on overall energy demand for car passenger transport in fifteen EU countries.

The method of approach is based on econometric analysis of EU-15 countries over the period 1980 to 2007. We analyse energy consumption (e.g. litre of gasoline and diesel) as well as service demand (vehicle km driven). The effects of irreversible efficiency improvements are considered by means of using fuel intensities explicitly in the econometric analyses.

The major results of this investigation are: The service price elasticity is about -0.3 for the aggregate of the investigated countries. The effect of energy efficiency improvements is about 0.7. This is a very nice result indicating that: (i) price increases e.g. due to taxes (of 1%) lead to energy demand reductions of 0.3% in the short run; (ii) pure efficiency increases (of 1%), e.g. by standards trigger savings of 0.7% (either due to standards or due to lasting price increases).

The major conclusion for energy policy makers is that the most effective set of measures is to introduce a combined system of taxes (to reduce CO<sub>2</sub> emissions due to less driving) and technical standards (to reduce CO<sub>2</sub> emissions due to lower fuel intensities).

## 1 Introduction

The current problems arising from motorized individual transport lead to an urgent need for implementing efficient policy measures. To get a reliable appraisal of the effects of different types of policies it is very important to know the impact of different parameters like prices and fuel intensities. Of special relevance in this context is how consumer behaviour and the rebound affect especially technical measures like standards for fuel intensity.

One of the most heavily discussed policy issues for passenger car transport is what is more effective and more acceptable by people especially car drivers: taxes or standards.

The EU currently puts all its bets on standards, see Section 2.

In this paper we analyse the impact of taxes and fuel intensity standards on overall energy demand for car passenger transport in EU-15 and how a tax vs standard works. We pay special attention to the interactions between price and efficiency changes and investigate the crucial role of service price elasticity.

Finally, we try to identify a best practice policy for EU-15 which combines (national) taxes and (EU-wide) standards.

How does a tax work in comparison to a standard?

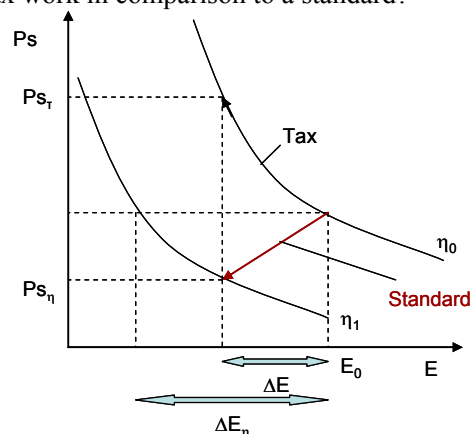

Figure 1. How a tax vs a standard works

Figure 1 depicts the principle of changes in efficiency, energy consumption and service price. For a tax the reduction in energy consumption  $\Delta E$  results from higher service price  $P_{S_t}$  remaining on the same curve  $\eta_0$ . When a standard is implemented we switch from  $\eta_0$  to  $\eta_1$  leading to a reduction  $\Delta E$  of energy consumption. Yet, due to a lower service price  $P_{S_\eta}$  this saving effect is lower than the theoretical effect which is  $\Delta E_\eta$ .

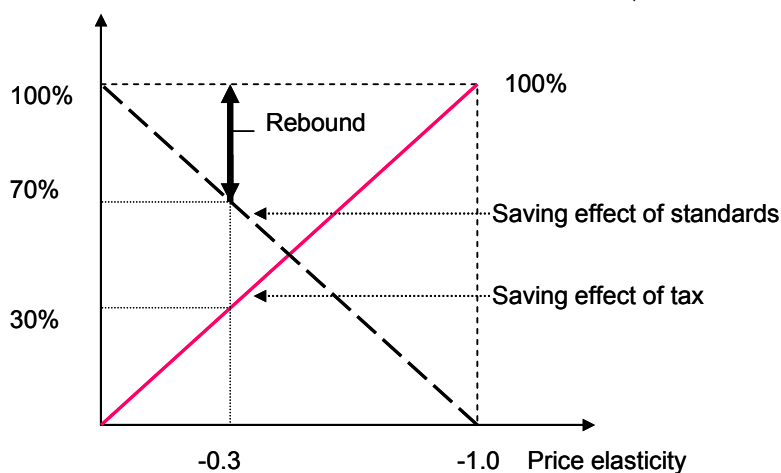

Figure 2. Effect of a tax vs standard depending on service price elasticity

Figure 2 depicts the effect of a tax vs standard depending on service price elasticity. As shown, if a tax in the magnitude of 1% is introduced and the price elasticity is e.g. (-0.3) then the energy saving effect is 0.3%. If standard in the magnitude of 1% is introduced and the price elasticity is e.g. (-0.3) then the energy saving effect is 0.7% and the rebound effect due to more km driven is 0.3%.

## 2 EU policies for standards and nation fuel tax policies

Since road transport contributes about one-fifth of the EU's total emissions of carbon dioxide (CO<sub>2</sub>), which are continuously increasing, the European Commission has designed a comprehensive strategy for reduction of average CO<sub>2</sub> emissions from new cars to 120 grams per km by 2012 - a reduction of around 25% from 2006 levels. This strategy was adopted in 2007. However, already in 2010 can be noticed, that the goal of



reducing new car emissions to 120 g CO<sub>2</sub>/km by 2012, as defined in the strategy, is not likely to be achieved.

Despite a low probability of achieving the 2012 target, the strategy, and the measures it includes, has played an important role in reducing CO<sub>2</sub> emissions from light-duty vehicles.

Evolution of CO<sub>2</sub> emissions from new passenger cars by association are shown in Figure 2 as well as the voluntary commitments undertaken by the European (ACEA), Japanese (JAMA) and Korean (KAMA) car manufacturer associations related to average new car emission targets of 140 g CO<sub>2</sub>/km by 2008/2009 (EU, 2010).

The reduction of average CO<sub>2</sub> emissions from new cars can be achieved by means of improvements in vehicle motor technology (e.g. air-conditioning systems, pressure monitoring systems...) as well as with the increased use of biofuels. The binding targets for Member States is to achieve a 10% share of renewable energy in the transport sector by 2020 (Directive 2009/28/EC18).

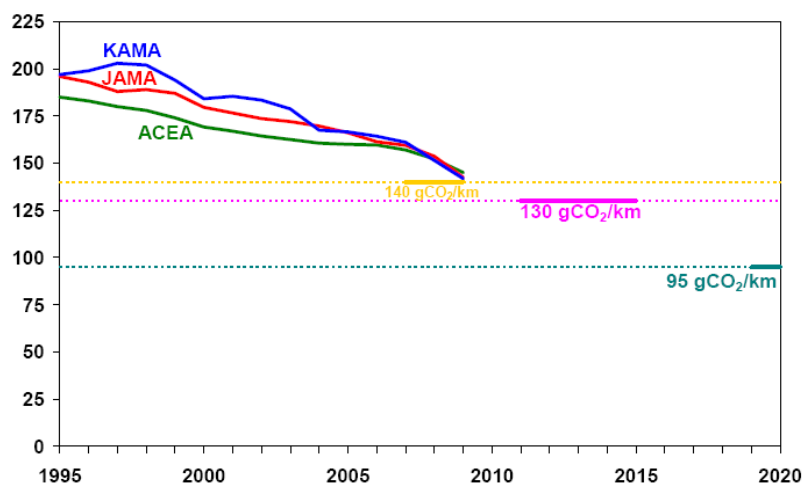

Figure 3. Evolution of CO<sub>2</sub> emissions from new passenger cars by association (adjusted for changes in the test cycle procedure)

Since the achievement of the EU objective of 120 g CO<sub>2</sub>/km in 2012 is not possible, new objective implemented by Regulation (EC) No443/2009 is to achieve 130g CO<sub>2</sub>/km in the period 2012-2015.

A second target of 95 g CO<sub>2</sub>/km announced in the Strategy as a target for further consideration is included for 2020. The modalities of reaching this target are to be defined by 2013.

Beside standards, fuel tax is a widely used policy instrument. However, the primary reason for fuel tax is to increase governmental income and not to reduce CO<sub>2</sub> emissions.

Fossil fuel prices were rather volatile and continuously increasing in the last decades. They may have a significant impact on travel demand and fuel intensity. The range of fuel prices vary wide across analyzed countries mostly due to the different taxes.

Actually, the largest part of fuel price in most of the countries is excise tax.

The share of total tax (VAT and excise taxes) on gasoline is very different across the EU-countries ranging from 40% to 60% of the total gasoline price, see Figure 4. Currently, the highest tax on gasoline is in the Netherlands, Germany and Sweden. The lowest tax on gasoline is in Cyprus.

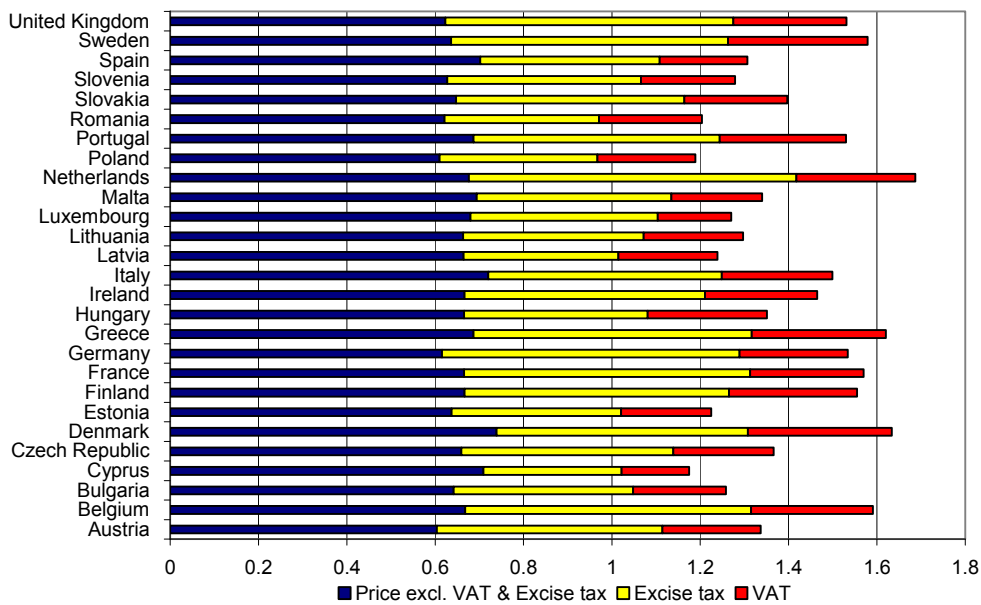

Figure 4. Gasoline prices in 2011 for EU-27 (Data source: Europe's Energy Portal, effective March 2, 2011)

The share of tax in total diesel price in 2011 is shown in Figure 5. Currently, the highest tax on diesel fuel is in United Kingdom, 0.92 EUR per litre of diesel. The share of tax in total diesel price is a little bit lower comparing to tax on gasoline. In EU the share of tax on diesel is in range from 36% to 57% of the total diesel price, see Figure 5.

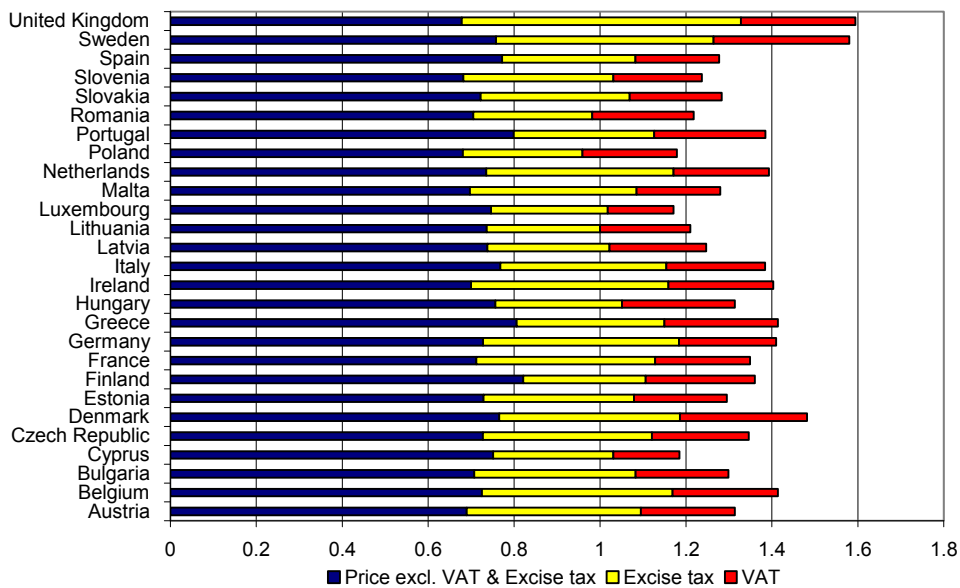

Figure 5. Diesel prices in 2011 for EU-27 (Data source: Europe's Energy Portal, effective March 2, 2011)

### 3 Modeling energy consumption and service demand: Results of econometric analyses

The method of approach applied in this paper is based on the fundamental relationship:

$$E = S \cdot FI \tag{1}$$

In addition energy consumption E and service demand S (vehicle km driven) are analyzed by means of econometric approaches.

To analyze the impact of fuel intensity and prices on energy consumption, we start with a simple estimation of total energy consumption. We apply the conventional approach where energy consumption depends on price and income assuming symmetric price elasticities:

$$\ln E_t = C + \alpha \ln P_t + \beta \ln Y_t \quad \text{- model 1} \quad (2)$$

$$\ln E_t = C + \alpha \ln P_t + \beta \ln Y_t + \gamma \ln FI \quad \text{- model 2} \quad (3)$$

where:

C.....Intercept

Et..... Energy demand in year t

Pt..... Real energy price (calculated by means of weighted fuel prices)

Yt.....Real private final consumption expenditures as a proxy for income

Additionally to estimating energy consumption we conduct an econometric estimate of service S (vkm driven).

The level of service demand S<sup>1</sup> of e.g. a household with respect to km driven depends on available income Y and the price of energy service Ps:

$$S = f(P_s, Y) \quad (4)$$

We estimate the impacts on vkm driven by using a cointegration approach:

$$\ln S_t = C + \alpha \ln P_{S_t} + \beta \ln Y_t \quad \text{- model 3} \quad (5)$$

where:

C.....Intercept

St..... Demand for service, vehicle km driven in year t in a country

PSt..... Weighted average price of service vkm driven (calculated by means of weighted fuel prices)

Yt.....Real private final consumption expenditures

εt .....Residual (error term)

The most interesting numbers of this analysis are the service price elasticities because they contain information for both - price and efficiency impact.

The results of cointegration are shown in Tables 1A and 1B.

---

<sup>1</sup> It is important to note, that "energy service" for cars is not just distance driven. Rather it is kg-km define or even kW-km, and efficiency is energy use/kg-km or energy use/kW-km. By these measures, efficiency increased enormously fed mostly by increasing weight and power and not simply by reducing fuel consumption. Thus, a large part of the increase in energy efficiency is not translated into a decrease of FI.

Table 1A.

Estimates for long-term over-all energy consumption (with and without fuel intensity) and service demand for period 1980-2007 (t-statistics in parentheses)

	Model 1	Model 2		Model 3
C (intercept long-term)	2.95 (11.75)	0.89 (0.43)	C (intercept long-term)	6.71 (13.3)
$\alpha$ (long-term price elasticity)	-0.44 (-11.89)	-0.43 (-15.7)	$\alpha$ (long-term service price elast.)	-0.42 (-8.41)
$\beta$ (long-term income elasticity)	0.63 (22.7)	0.78 (5.31)	$\beta$ (long-term income elasticity)	0.97 (21.1)
$\gamma$ (long-term fuel intensity elasticity)	-	0.33 (0.95)		-

Table 1B.

Estimates of ECM for over-all energy consumption energy consumption (with and without fuel intensity) and service demand for period 1980-2007 (t-statistics in parentheses)

	Model 1	Model 2		Model 3
ARDL* order	(1,0,0)	(1,0,0,1)	ARDL order	(1,0,0)
C (intercept short-term)	0.96 (11.45)	3.33 (0.44)	C (intercept short-term)	2.59 (8.61)
A (short-term price elasticity)	-0.15 (-9.91)	-0.16 (-12.0)	A (short-term service price elast.)	-0.16 (-7.92)
B (short-term income elasticity)	0.21 (6.27)	0.29 (4.12)	B (short-term income elasticity)	0.37 (5.08)
$\Gamma$ (short-term fuel intensity elasticity)	-	0.48 (3.38)		-
ECM*(-1)	-0.32 (-7.99)	-0.37 (-9.83)	ECM(-1)	-0.38 (-6.26)
$\bar{R}^2$	0.85	0.90	$\bar{R}^2$	0.75
RESS	0.000801	0.000506	RESS	0.00187
F-Stat	50.0	57.1	F-Stat	27.65
AIC*	98.4	102.6	AIC	86.9
SBC*	95.8	108.6	SBC	84.3
DW*	1.93	1.80	DW	1.96

\*ARDL (AutoRegressive Distributed Lag); AIC (Akaike Information Criteria); ECM (Error-Correction-Model); DW (Durbin-Watson statistic)

The most important finding of this analysis is that long-term as well as short term price elasticities are virtually the same for energy and service demand. Moreover, the

coefficient  $\gamma$  for the impact of fuel intensity in Model 2 is not significant. These results indicate that there is no long-term – no irreversible – impact of changes in efficiency and virtually all theoretically calculated energy saving due to efficiency improvements are eaten up by a rebound e.g. due to the larger cars and more km driven.

This rebound is analysed in the next section.

## 4 Interaction of taxes and standards

In this section we analyze the impacts of changes in fuel intensity – due to standards vs changes in fuel prices – due to taxes on energy consumption. This is important to derive conclusions with respect to the effect of the implementation of standards for fuel intensity vs the effect of the introduction of fuel taxes increasing fuel prices.

One of the most critically discussed issues with respect to the implementation of standards for fuel intensity or corresponding CO<sub>2</sub> emissions is the rebound effect.

In the following, we conduct an estimation of the following effects: (i) the effect of changes in fuel intensity due to standards including a saving effect and a rebound effect because of increases in vehicle km driven and (ii) the price effect.

The definition of service demand  $S$  in equ. (4) can be extended to:

$$S = f(P \cdot FI, Y) = C(P \cdot FI)^\alpha Y^\beta \quad (6)$$

Using derivations the change in service demand ( $dS$ ) can be split up into the price, the efficiency and the income effects:

$$dS = \frac{\partial f}{\partial P} dP + \frac{\partial f}{\partial FI} dFI + \frac{\partial f}{\partial Y} dY \quad (7)$$

In this paper we are further on interested in the change of service demand due to a change in the fuel price and the fuel intensity. We do not look at the income effect.

We proceed further using equ. (1)<sup>2</sup> and we obtain for the change in energy consumption:

$$dE = SdFI + FIdS \quad (8)$$

The change with respect to price is:

$$\frac{dE}{dP} = \frac{SdFI}{dP} + \frac{FIdS}{dP} \quad (9)$$

The change in energy demand (if  $dFI/dP=0$ )<sup>3</sup> due to the direct price effect is:

$$\frac{dE}{dP} = \frac{FIdS}{dP} \quad (10)$$

The change in service demand vehicle km driven caused by the price effect and using equ. (6) is:

---

2 See also the detailed derivation in Ajanovic/Haas (2011)

3 In the long run, lasting price changes will have an impact see e.g. Walker/Wirl (1993).

$$\frac{dS}{dP} = \frac{\partial f}{\partial P} = \alpha(P FI)^{\alpha-1} FI \frac{P}{P} = \alpha \frac{S}{P} \quad (11)$$

where  $\alpha$  is the elasticity of vehicle kilometres driven with respect to service price  $P_s$ .  
Straightforward, the change in energy demand due to a change in the fuel price is:

$$\frac{dE}{dP} = FI \frac{dS}{dP} = FI \alpha \frac{S}{P} \quad (12)$$

and the total energy change from a price change with  $dP=f(\tau)$  ( $\tau$ ...tax) is:

$$dE(dP) = FI \alpha S \frac{dP}{P} \quad (13)$$

Next we analyse the effect of an exogenous fuel intensity change with  $dFI=f(\eta)$  ( $\eta$ ...standard):

$$\frac{dE}{dFI} = FI \frac{dS}{dFI} + S \frac{dFI}{dFI} = \alpha FI (P FI)^{\alpha-1} P + S = S(\alpha + 1) \quad (14)$$

and the total energy change from a change in FI is:

$$dE(dFI) = S(1 + \alpha)dFI = SdFI + \alpha SdFI \quad (15)$$

Introducing the fuel intensity savings factor  $\gamma$  we can rewrite equ. (15) as:

$$dE(dFI) = \gamma SdFI \quad (16)$$

and we obtain for the relationship between the impact of fuel intensity and price (see also Walker/Wirl (1993) and Greene (1997)):

$$\gamma = 1 + \alpha \quad (17)$$

This relationship can be illustrated by the following simple example. If the short-term price elasticity is (-0.3) resulting elasticity for fuel intensity  $\gamma$  is  $(1+(-0.3))=0.7$ . That is to say, if fuel intensity is decreased by e.g.10% due to a standard, the energy savings are only 7% because of a rebound in service demand due to the price elasticity of -0.3!

Figure 6 shows the two effects due to changes in fuel intensity from equ. (15). The first effect is change in demand from driving more fuel efficient vehicles the same number of miles ( $SdFI$ ). It can be noticed that the total change in FI led to total energy savings  $dE(dFI)$  of about 500 PJ in EU-15. The second effect is the energy change from driving more kilometers, ( $\alpha S dFI$ ) called the rebound effect. The rebound effect led to an additional energy consumption of about 350 PJ.

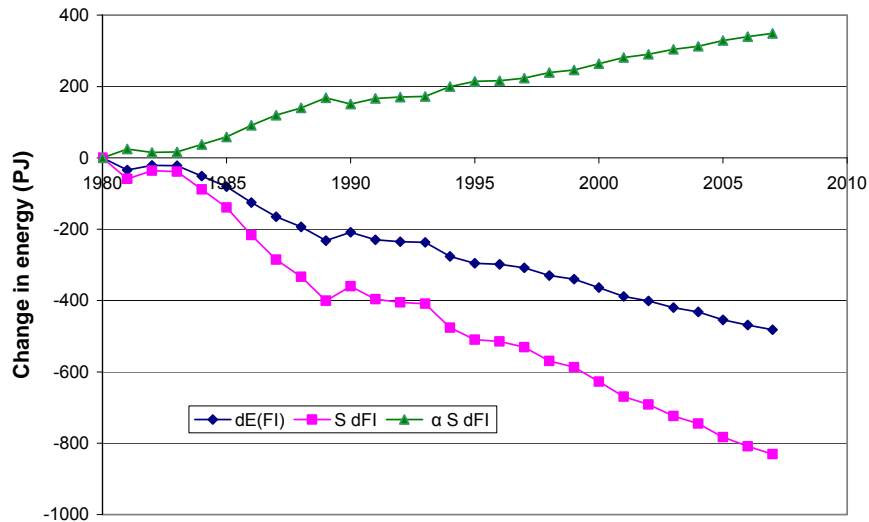

Figure 6. The change of energy consumption due to changes in fuel intensity for EU-15, base 1980

Figure 7 compares the overall effect due to a change in fuel intensity ( $dE(FI)$ ) and the price effect ( $dE(dP)$ ). As shown in Figure 7, due to the volatility of the fuel price, the price effect can lead to higher or lower energy consumption. With respect to the fuel intensity effect savings compared to the base year can be observed starting from 1980.

The saving effect of prices can be noticed between 1980 and 1985. After 1985 the price drop led to an increase in energy consumption. In total the price and the fuel intensity effect brought about energy savings  $dE$  of about 500 PJ.

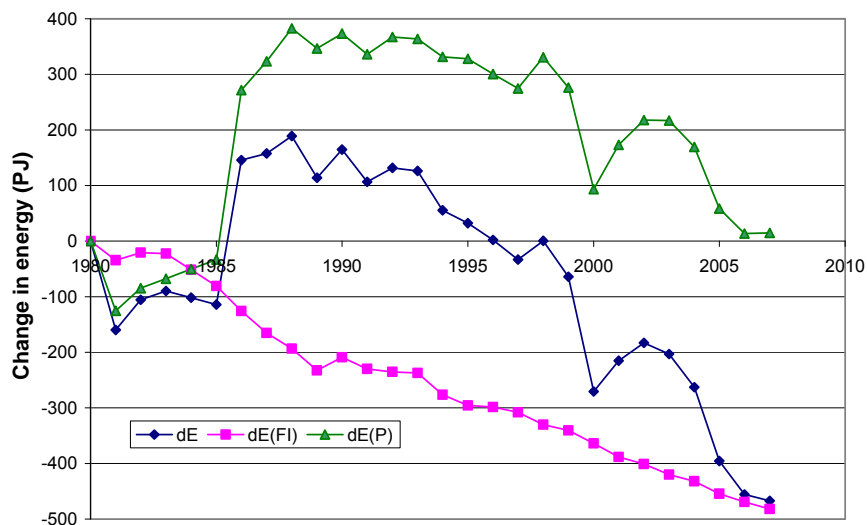

Figure 7. The change of energy consumption due to changes in fuel intensity and fuel price for EU-15, base 1980

Figure 8 depicts the development of total energy consumption in comparison to the impact of fuel intensity and fuel prices. In 2007 the impact of price effect was almost zero and the fuel efficiency effect reduced energy consumption by about 8%.

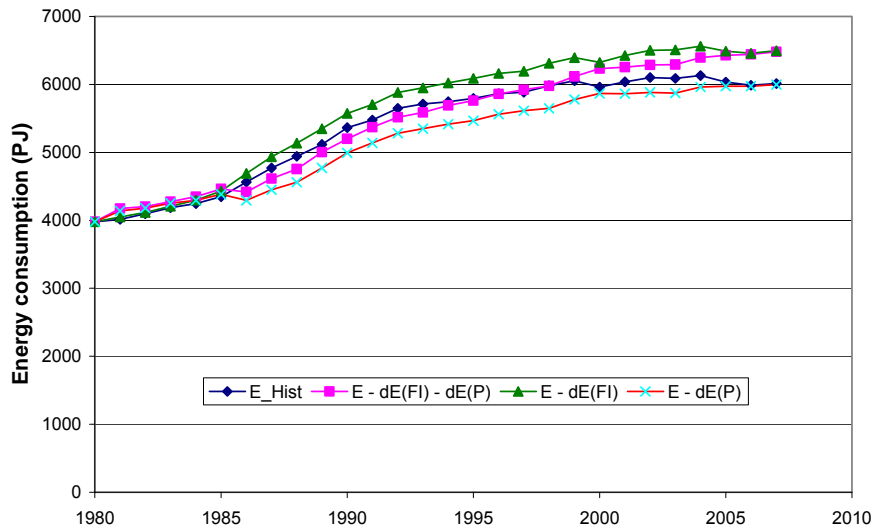

Figure 8. Historic development of total energy consumption in comparison to the impact of fuel intensity and the fuel price for EU-15, base 1980

## 5 Scenarios for EU-15

The core question of interest is, of course, what can be learned from the past for future energy policies. We discuss this aspect in four scenarios using the following assumptions:

In Business as usual scenario (BAU) it is assumed that fuel price is increasing 2.5% per year, and GDP 2.5%. We have also assumed reduction of fuel intensity of 2.6% per year.

In Tax-Scenario we have assumed additionally to the assumptions in the BAU-Scenario an increase of fuel tax of 2.3% per year.

In Standard-Scenario we have assumed additionally to the assumptions in the BAU-Scenario that fuel intensity has to be reduced also due to the standards for additional 1.2% per year.

The Policy Scenario (Tax & Standard Scenario) is a combination of increasing fuel taxes and improving fuel efficiency due to the standards.

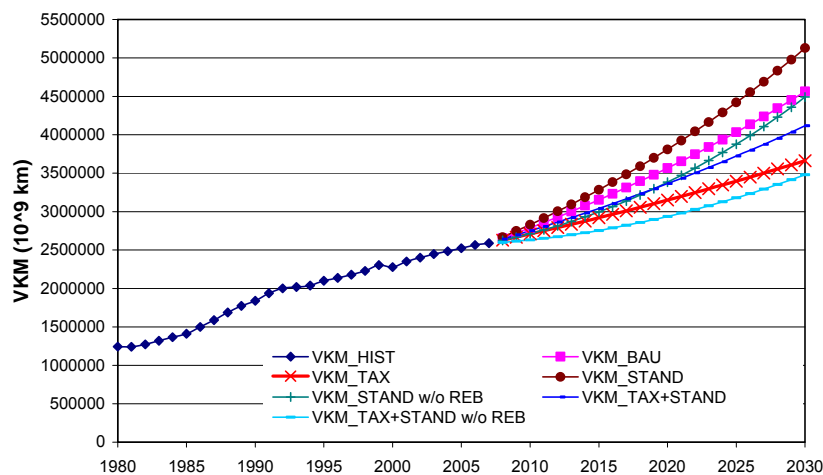

Figure 9. Scenarios for the future development of vkm driven for a BAU-Scenario vs Tax-, Standard- and Policy- Scenario up to 2030



Figure 9 depict scenarios for the future development of vkm driven for above described scenario up to 2030. It can be seen that due to the standards vkm driven are higher than in BAU-Scenario. As shown with the increasing fuel tax, travel activity could be significantly reduced. However, the lower increase in vkm driven could be reached, as shown in Policy Scenario.

The future development of energy consumption in four scenarios described above with and without rebound up to 2030 is shown in Figure 10.

Due to the efficiency improvements increases in energy consumption are not as steep as for service, see Figure 10. The pure Standard-Scenario shows lower energy consumption than BAU-Scenario (on contrary to the effect in Figure 9) and the Policy Scenario leads to lowest energy consumption.

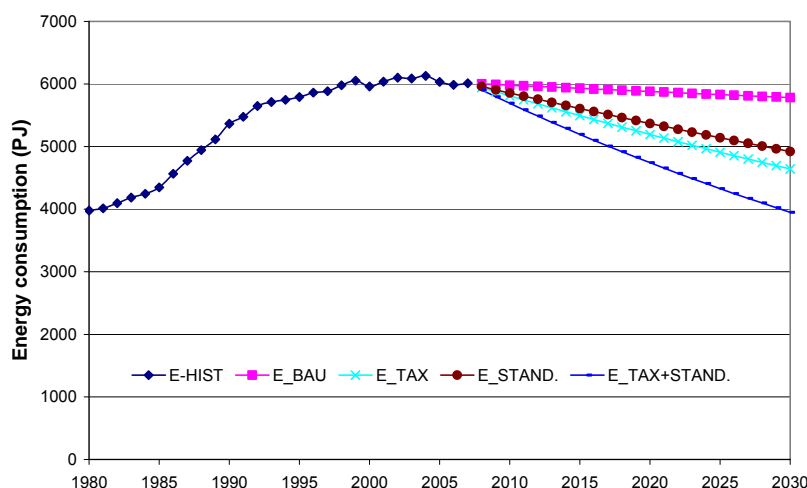

Figure 10. Scenarios for the future development of energy consumption driven for scenarios up to 2030

Figure 11 depicts the development of CO<sub>2</sub> emissions for the BAU and Policy Scenario. We can see that over-all saving effect is about 14% compared to BAU up to 2030. Note that in this figure also fuel switching effects are included, e.g. to biofuels<sup>4</sup>.

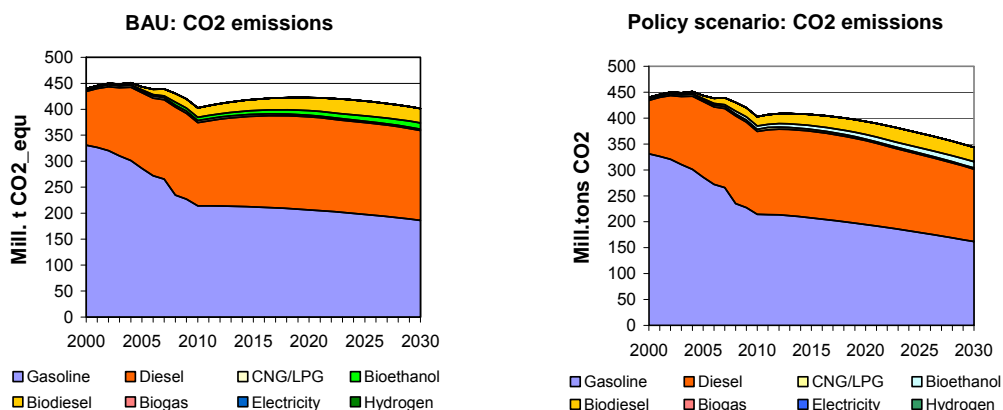

Figure 11a. CO<sub>2</sub> emissions in BAU-Scenario

Figure 11b. CO<sub>2</sub> emissions in Policy-Scenario

<sup>4</sup> This analysis was conducted in the EU-funded project ALTER-MOTIVE. For further details see Ajanovic et al. (2011) and website: [www.alter-motive.org](http://www.alter-motive.org)

## 6 Conclusions

The major conclusions of this analysis are:

The intended introduction of standards as announced by EU (130 gCO<sub>2</sub>/km in the period 2012-2015, and 95 gCO<sub>2</sub>/km by 2020, see Section 2) will not lead to the expected or desired overall energy savings and CO<sub>2</sub>-reduction. The major reason is that the rebound effect due to more km driven and larger cars will eat up most of the theoretically calculated savings. Yet, a simultaneously introduced tax in the magnitude of 30% up to 2020 will compensate this rebound even without hurting car drivers due to service km driven remaining at same service price, see Figure 12. So finally a combined tax-standard policy will lead to a win-win situation from which the environment benefits and car drivers are not hurt.

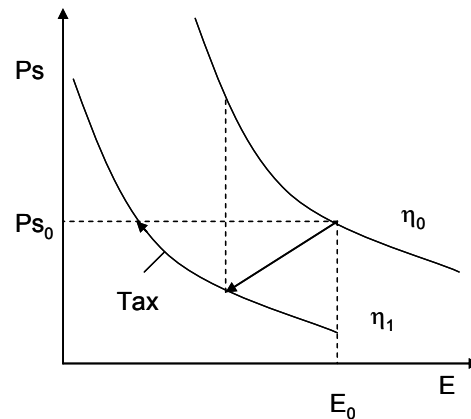

Figure 12. How taxes and standards interact and how a win-win situation is derived for society

## References

Ajanovic A, R. Haas, 2011: The role of efficiency improvements vs price effects for modeling passenger car transport demand and energy demand – Lessons from European countries, Energy Policy, 2011 -forthcoming

Ajanovic et al.,2011: ALTER-MOTIVE Final Report ([www.alter-motive.org](http://www.alter-motive.org)) - forthcoming

DIRECTIVE 2009/28/EC 18: Directive 2009/28/EC of the European Parliament and of the Council of 23 April 2009 on the promotion of the use of energy from renewable sources and amending and subsequently repealing Directives 2001/77/EC and 003/30/EC

EU, 2010: Progres report on implementation of the Community's integrated approach to reduce CO<sub>2</sub> emissions from light-duty vehicles, COM(2010) 656 final

Europe's Energy Portal, <http://www.energy.eu/>, March 2, 2011

Greene, D. L., 1997. Theory and empirical estimates of the Rebound Effect for the U.S. transportation sector. ORNL.

Regulation (EC) No 443/2009: Regulation (EC) No 443/2009 of the European Parliament and of the Council of 23 April 2009 setting emission performance standards for new passenger cars as part of the Community's integrated approach to reduce CO<sub>2</sub> emissions from light-duty vehicles

Walker, I. O., F. Wirl, 1993. Irreversible Price-Induced Efficiency Improvements: Theory and Empirical Application to Road Transportation. The Energy Journal 14(4), 183-205

# What are customers willing to pay for future technology vehicles.

Jørgen Jordal-Jørgensen, COWI

## Abstract

In the energy sector there is a growing need to understand what customers want. Stated preference is the perfect technique for doing so, particularly where there is no historical precedence. It was originally introduced for use in the transportation sector, but is now used across a very wide variety of sectors including, amongst others: energy, finance, communications and health.

Its strengths lie in the fact that it is a particularly robust means of prioritising product or service features, determining the relative values of the different potential attributes of a product or service and showing what people would be willing to pay for different products and services. The reasons for it being more robust than other techniques are because it places respondents in a more “realistic” choice scenario by presenting a package of features for them to choose from (as would be the case for products and services in a real choice environment), rather than asking them to comment on individual features in isolation and because the resultant data much more clearly distinguishes relative priorities than standard questions (such as the use of importance ratings) can do.

In the energy sector the stated preference technique is increasingly used to determine what customers would be willing to pay for investments in infrastructure and service and to provide robust data in response to regulatory requirements. It has also been used to explore the premium that customers would pay for green energy and to look at the likely churn between products and suppliers as prices and product specifications change.

The current paper presents main findings from a Stated Preference survey of Danish car purchasers' preferences for future technology vehicles with alternative (green) fuels.

## 1 Background

The transport sector accounts for 24% of Danish CO<sub>2</sub> emissions. One way to reduce CO<sub>2</sub>-emissions is to increase use of renewable energy like for instance wind energy, in the transport sector. Wind energy may be transformed to hydrogen - or be used to charge batteries for electric vehicles. But the question is, are the consumers willing to purchase the new technologies. This is the issue in the current survey.

In the absence of actual choice observations on new vehicle technologies, known as revealed preferences (RP), researchers resort to innovative methods of data collection using hypothetical options, referred to as stated preferences. In such stated preference surveys, data can be obtained from the implementation of choice experiments, in which attributes of hypothetical vehicles and their values are presented to households/respondents, who are asked to select their most preferred alternative.

The main attributes in this survey are:

- Monetary cost (purchase price, fuel and maintenance cost)
- Fuel availability, the range between refuelling or recharging
- Vehicle performance like acceleration and interior space.
- Environmental attributes.

## 2 Method

### *Car choice games*

The objective of this stage is to obtain household preferences for alternative fuelled vehicles and to identify trade-offs and incentives for households to switch to cleaner vehicle technologies. Vehicle options are labelled based on the fuel-type and class/size of the vehicle. The fuel-type label includes five options:

- Conventional gasoline and conventional diesel
- Hydrogen
- hybrid-electric
- Hydrogen
- Electric

Each respondent gets 3 sets of choice situations. In each of the 3 sets, the choice sets for the respondents were selected randomly.

There are 10 different combinations of technologies.

Choice set 1	Choice set 2	Choice set 3
Conventional vs Hydrogen	Hydrogen vs Hybrid	Bio fuel vs Plug-in
Conventional vs Hybrid	Hydrogen vs Biofuel	Bio fuel vs Hybrid
Conventional vs Biofuel	Hydrogen vs Plug-in	Plug-in vs. Hybrid
Conventional vs Plug-in		

### 2.1 Choice Design

During each choice set, the reference technology and the alternative technology are kept constant. Thus, in game 1 each respondent is asked to choose between the conventional vehicle with unchanged characteristics and an alternative technology with varying characteristics.

As mentioned above, the design consists of three sets of games with four choices in each game for each respondent.

The general idea is that the left-hand vehicle (the reference vehicle) is a vehicle of the same size and price as the vehicle recently purchased by the respondent. The right-hand vehicle (the alternative) has varying characteristics in each game.

The table below shows how the characteristics for the alternative vehicle are varied during the games.

*Table 2-1 Attributes and levels*

Item	Alternatives/Levels	
Purchase price	Randomly, continuous up to $\pm 50\%$	
Annual fuel cost and maintenance	Randomly, continuous up to $\pm 25\%$	
Range, Hydrogen-vehicles randomly	once a month once every three weeks fortnightly Once a week	twice a week every other day every day
Range other	Average (20% from empty of car bought)	

	Randomly, continuous up to $\pm 50\%$
Acceleration	Randomly, continuous up to $\pm 25\%$
Service	No service agreement. Service to cover the servicing and maintenance, and repairs not covered by warranty, is included in the annual operating costs. Including free rental car.
Local air pollution	Like gasoline car Like diesel car 50% of gasoline car (hybrid) No local emissions (electric or Hydrogen)
Green house gas (CO <sub>2</sub> )	Conventional car 50% of conventional (hybrid) No CO <sub>2</sub> emissions, Pure renewable energy

In order to identify protest bids the questionnaire used the following follow up-questions to respondents who replied identically in all four games:

You have chosen XX in all four games. Please indicate the reason for this choice below:

- I believe XX were the most profitable in all four games.
- I do not think that XX is sufficiently reliable.
- I believe XX was too expensive.
- I do not think XX is safe enough.
- I did not know what to choose.
- As I think XX is more environmentally friendly, other characteristics are less important.

## 2.2 SP

The sampling of alternatives is based on a random uniform probability. This may not be the most efficient design. However, since we ask a large number of respondents this is no problem parameter estimates will be estimated with large precision and significance anyway. Furthermore, using this approach we will be able to analyse all parameters and interaction effect.

Each choice exercise includes three generic monetary attributes, which are customized to each respondent individually. Monetary attributes constitute the most important consideration of households willing to purchase a vehicle. This experiment summarizes the monetary costs under three attributes: the purchase price, the annual fuel and maintenance cost. The annual fuel cost is computed as the product between the number of kilometres the vehicle would be driven per year, as specified by the respondent earlier in the survey, and the average fuel cost per kilometre, which is calculated based on the vehicle just purchased by the respondent.

Environmental characteristics are not varied across each technology since it is assumed that it would not be meaningful for the respondent to bring in more detailed differences on top of the five different technologies.

### 2.3 Data collection

The data collection is based on an online internet based questionnaire.

Respondents were recruited by means of an invitation letter sent out by Statistics Denmark to respondents who have purchased a new car in the previous month. Each month Statistics Denmark sends out invitation letters to approx 1500 respondents

### 2.4 Estimation

The standard estimation of the stated preference (SP) data can be described as follows:

We assume that consumers choose alternatives with highest utility. The utility consists of a systematic part related to the characteristics plus an unobserved part  $\varepsilon$ .

$$U_i = V_i + \varepsilon_i$$

The systematic part may be written as

$$V_i = \beta_0 + \beta_1 X_1 + \beta_2 X_2 + \beta_3 X_3$$

Assuming utility maximisation and independence of irrelevant alternatives, we can assume to have a logit density function.

In this case, we can estimate the n'th respondent's probability for an alternative 'i' in question t, by the following formula:

$$P_{nit}(\beta_n) = \frac{\exp(\beta_n x_{nit})}{\sum_j \exp(\beta_n x_{njt})}$$

The above simple fixed effect logit model has been applied in the initial estimations.

Final estimations have been based on a more advanced logit model allowing for unobserved heterogeneity and panel specification.

The probability of the observed sequence of choices conditional of knowing  $\beta^n$  is given by:

$$S_n(\beta_n) = \prod_t L_{ni(n,t)t}(\beta_n)$$

Where  $i(n,t)$  denotes the alternative chosen by individual 'n' on choice occasion t.

The unconditional probability of the observed sequence of choices is the conditional probability integrated over the distribution of  $\beta$ :

$$P_n(\theta) = \int S_n(\beta) f(\beta | \theta) d\beta$$

The unconditional probability is thus a weighted average of a product of logit formulas evaluated at different values of  $\beta$ , with the weights given by the density f.

The mixed logit can be used to estimate a multinomial logit model with unobserved heterogeneity considered by Haan and Uhlenborff (2006).

The likelihood for the model is given by:

$$LL(\theta) = \sum_n \ln(P_n(\theta))$$

The simulated log likelihood is given by:

$$SLL(\theta) = \sum_n \ln \left[ \frac{1}{R} \sum_{r=1}^R S_n(\beta^r) \right]$$

Where R is the number of replications and  $\beta^r$  is the r-th draw from the  $f(\beta|\theta)$ .

The final estimations have been based on the above formulation. Estimations have been made by STATA based on a programme file developed by Arne Rise Hole (Hole (2008)).

### 3 Results

In total 18,863 respondents were invited to participate. Of these 13,525 declined to participate. 5,318 filled in the questionnaire and participated in the games. 20 respondents filled in the questionnaire, but for some reason, missing data make the outcome of the SP games for these respondents unusable.

#### 3.1 Socioeconomics

##### *Family type and sex*

More than two thirds of respondents (and thus car purchasers) are men, and most of whom live as a couple with or without children.

*Table 3-1 Family type and sex*

	No reply	Female	Male	Total
Single without dependent children		278	356	634
Single parents with children		122	52	174
Couples without children living at home	2	636	1861	2499
Couples with dependent children	3	586	1361	1950
Cohabiting relatives		25	38	63
Several families living together		4	14	18
Total	5	1651	3682	5338

It is widely accepted that people have different preferences for cars depending on their age and sex. For instance, young people and especially young men have strong preferences for fast cars.

The chart below shows the age and sex distribution in the car purchase sample.

It appears that only very few young people purchase new cars. On the contrary, middle-aged men account for a very large share of new car purchases.

*Age and sex distribution (for new-car-purchasers)*

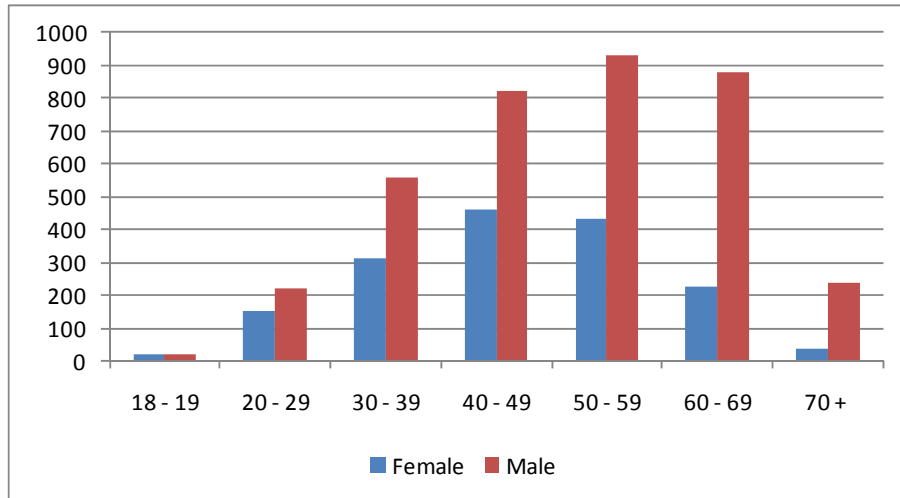

**Important factors when deciding which car to purchase**

In order to get a picture of the parameters that are most important for the car purchasers, respondents were asked about how different vehicle characteristics governed their car purchase decision.

The valuation scale varies from 1 (not important) to 6 (very important).

*Important factors governing the choice of a new car*

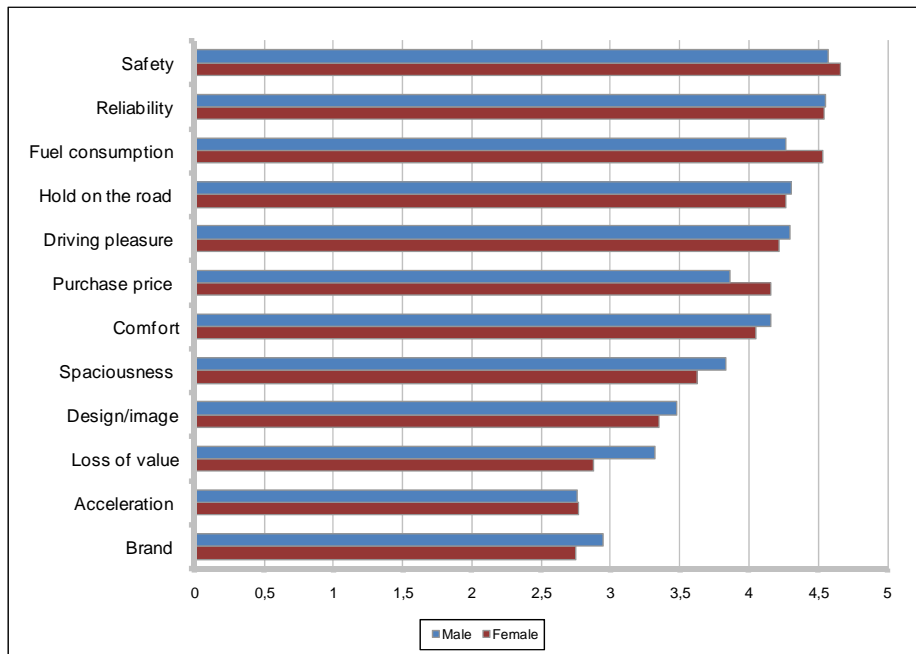

In general, safety has top priority closely followed by reliability. These factors are followed by fuel efficiency, road grip and driving pleasure.

In the low-rated factors are acceleration and brand. Also resale price and design have low importance. It should be noted that there were no restrictions in the questionnaire meaning that respondents were forced to assign a low priority to some characteristics. In principle, all could be given top priority. Thus, assigning low importance to a factor



really means that this factor and not only relative to more important factors is of low importance.

Looking at differences between sexes, there is a tendency that female respondents care more for fuel consumption and purchase price compared to male respondents. On the other hand, male respondents care more for spaciousness, retail price and brand compared to female respondents. It should be noted that in the above table respondents express what they think is important. We have two more data sources that can help analyse in more detail the actual behaviour of respondents. One source which the vehicles respondents actually bought, the other source is the results from the Stated Preference games. It is interesting to see whether actual behaviour corresponds to respondents' replies in this section.

The table below shows the characteristics of the actual car purchases of respondents.

*Table 3-2 Revealed car characteristics*

	Female	Male
Purchase price (DKK)	195,499	255,002
Max weight, kg	1,084	1,210
Kerb weight, kg	1,602	1,765
Acceleration (sec 0 - 100)	13.7	13.0
Liter fuel per 100 km	5.6	5.9

As can be seen, male car purchasers buy heavier, more expensive, faster and more fuel-consuming vehicles compared to female car purchasers. This is in accordance to what is stated above by the male car purchasers.

## 4 Segmentation

The car purchasers were divided into two segments according to their attitudes and behaviour towards environmental issues and car driving. The segmentation is based on a class analysis using SAS Proc Class procedure.

In the following table, it is shown how respondents in the two segments reply to attitude and behavioural questions.

Environmentalists care about the environment. They do not consider driving a pleasure, and they do not want to use the car to express their personality.

Car lovers do not care about the environment. They want a car that expresses their personality, and they like car driving.

Furthermore, respondents were segmented relative to their actual behaviour, measured in terms of how often they purchase organic milk. The table below shows the final segmentation in the survey based on both latent classes and actual environmental behaviour.

Table 4-1 Illustration of car purchaser's attitudes to car driving and environmental problems

	Segment	
	Environ- mentalist	Like cars and car driving
.. I often consider how I do something about it.	<b>Yes</b>	No
It does not matter what car I choose, it disappears in the crowd.	No	<b>Yes</b>
I would like to choose a car that damages the environment less.	<b>Yes</b>	No
I would like to damage the environment less when I am driving.	<b>Yes</b>	No
The topic environmental impact from cars is irrelevant to me.	No	<b>Yes</b>
I like to drive.	No	<b>Yes</b>
For me, the car is only a means of transport.	<b>Yes</b>	No
It is important for me to ride in a car I like.	No	<b>Yes</b>
It does not matter to me what car I drive in.	<b>Yes</b>	No
My car also expresses something about myself.	No	<b>Yes</b>
With my car, I can separate myself from others.	No	<b>Yes</b>
I want a car that not everyone else has.	No	<b>Yes</b>
I noticed which car other people drive.	No	<b>Yes</b>
Number of respondents	4405	933
- Milk	Often	
- Meat	Often	
- Bread	Often	

Note: Classes were identified by SAS proc class. Respondents were asked state to what extent they agreed to the above statements. 'Yes' and 'No' reflect if they agreed more or less compared to the average for all three groups.

Table 4-2 Segmentation applied in final estimations

	Buy organic milk often or regularly	Buy organic milk seldom or never
Environmentalist	2774	1631
Car lover	468	465

## 5 SP estimations

This subsection shows the main results of the estimation of the model.

In order to improve the model fit of the model, respondents were divided into four segments according to attitudes towards environmental issues and actual behaviour. Here measured as the frequency of purchasing organic milk.

Table 5-1 Parameter estimates from main model.

Parameter	All	Environmentalist		Car lover	
		Buy ecological milk often		Buy ecological milk often	
		Yes	No	Yes	No
<b>Mean</b>					
Price (10,000 DKK)	-2.535197 (-62.5)	-2.573390 (-44.8)	-2.679704 (-36.2)	-1.803334 (-26.8)	-1.994993 (-22.5)
Price (incomegrp 3)	0.003724 (8.1)	0.004393 (6.8)	0.003354 (3.6)		
Price (house finansing 3)	-0.297774 (-4.1)	-0.359177 (-3.6)	-0.668258 (-3.8)		
Annual cost (1000 DKK)	-1.040471 (-30.5)	-1.012442 (-20.9)	-1.199259 (-18.7)	-0.810099 (-8.7)	-0.755005 (-8.1)
Price (age 18 - 29)	-0.139732 (-1.5)	-0.542186 (-3.1)	0.017250 (0.1)		
Price (age 30 - 50)	-0.108584 (-2.3)	-0.264346 (-4.0)	-0.130945 (-1.5)		0.306505 (2.6)
Accceleration (0 - 100)	-0.106273 (-11.2)	-0.108187 (-7.9)	-0.077919 (-6.3)	-0.143296 (-5.0)	-0.125640 (-6.1)
Accceleration (age > 50)	0.029631 (2.2)	0.037909 (2.0)		0.086661 (1.9)	
Service included	0.122449 (2.4)	0.114673 (1.6)	0.339714 (8.0)		
Service included, hydrogen	0.187485 (2.6)	0.216059 (2.1)			
Service included, biofuel	0.252180 (3.7)	0.214940 (2.2)			
Service included, hybrid	0.330345 (5.0)	0.335606 (3.6)			
Service included, plug-in	0.404587 (6.2)	0.411854 (4.4)	0.303639 (3.5)		
Operating range level 5	-0.435425 (-9.1)	-0.404689 (-6.0)	-0.467411 (-5.4)	-0.347727 (-2.4)	-0.460110 (-3.2)
Operating range level 6	-0.978907 (-20.1)	-1.036251 (-15.0)	-0.984333 (-11.0)	-0.788350 (-5.5)	-0.723792 (-4.9)
Operating range level 7	-1.415472 (-28.1)	-1.426020 (-20.1)	-1.409805 (-15.2)	-1.149387 (-7.8)	-1.390855 (-8.6)
Range, km	0.002798 (32.3)	0.002546 (21.1)	0.003058 (19.4)	0.002740 (10.5)	0.002589 (10.7)
Central Copenhagen/Aarhus	0.238156 (2.6)	0.380481 (3.0)	0.309100 (1.8)		
Hydrogen (age 18-29)	-0.414333 (-3.3)	-0.609203 (-2.9)			
Hydrogen (age 30-49)	-0.179814 (-2.5)	-0.312809 (-3.1)			
Hybrid (age 18-29)	-0.463037 (-4.0)	-0.777128 (-3.9)			
Hybrid (age 30-49)	-0.162473 (-2.4)	-0.323120 (-3.4)			
Bio-diesel (age 18-29)	-0.156909 (-1.3)	-0.452416 (-2.1)			
Bio-diesel (age 30-49)	-0.136773 (-2.1)	-0.294242 (-3.2)			
Plug-in electric (age 18-29)	-0.502016 (-4.0)	-0.567001 (-2.7)			
Plug-in electric (age 30-49)	-0.222205 (-3.2)	-0.373141 (-3.8)			
Hydrogen	1.430544 (23.3)	1.771497 (20.3)	1.228811 (19.0)	0.608761 (6.6)	0.450023 (5.0)
Hybrid	0.812060 (14.1)	1.124811 (13.7)	0.713930 (12.3)		
Bio-diesel	0.434107 (7.6)	0.674028 (8.4)	0.405449 (6.9)		
Plug-in electric	0.987018 (16.7)	1.369164 (16.5)	0.615402 (8.0)	0.453950 (5.2)	

As can be seen from the table above, parameter estimates are estimated at a high level of significance. This is mainly due to a very large number of respondents in the survey.

Furthermore, respondents seem able to reply meaningfully to questions, which seem reasonable since the choice situation is quite similar to the situation they were in recently when choosing which new car to purchase in real life.

Another interesting finding is that group 1, having an environmentally friendly attitude and behaviour, values more environmentally friendly alternatives such as hydrogen or hybrid significantly higher compared to the other segments. This is what one would expect. What may be more interesting is that respondents who are "car lovers" and who have an environmentally friendly behaviour value environmentally friendly alternatives lower compared to other segments.

## 6 Willingness to pay

### 6.1 Alternative technology

Based on the parameter estimates above it is possible to calculate willingness to pay for the new technologies, both for the total sample and broken down in the four segments.

As can be seen the willingness to pay for a hydrogen car which have the same comfort and reliability as a "normal" car is 42,600 DKK. The corresponding willingness to pay for an Plug-in electric vehicle is 23,500 DKK. These amounts represents an additional willingness to pay of approximately 10% - 15%. It should be noted that the scenarios assume that these vehicles are driven by windmill power.

*Table 6-1 Willingness to pay for new technology vehicles.*

Technology	All	Environmentalist		Car lover	
		Buy ecological milk often		Buy ecological milk often	
		Yes	No	Yes	No
Hydrogen	42,600	44,000	44,900	33,800	24,400
Hybrid	18,800	19,300	26,100		
Bio-diesel	10,800	10,100	14,800		
Plug-in electric	23,500	30,200	22,500	25,200	

The willingness to pay for cleaner technology is significantly higher in the segment of environmentalists. But in this segment the willingness to pay is approx twice as high in the segment that state they not only have environmental concern but also acts ecologically (buy ecological milk often).

It is clear that new technologies with less environmental friendly technologies as for instance Hybrid vehicles and bio-fuel do also have significant WTP, although somewhat lower compared with Plug-in electric and Hydrogen.

### 6.2 Operating range

One of the major problems with plug-in electric vehicles is that the operating range is limited, and in many cases too limited in order to substitute a traditional vehicle. In the above willingness to pay it is assumed that this problem is solved. However, in real world it is not. Plug-in electric vehicles have low operating range. In a recent study by FDM it was found that plug-in electric vehicles have lower operating range relative to what is stated in the manuals, at least in the winter time.

The survey conclude that the operating range is important. Overall, respondents are willing to pay 11,000 DKK extra for a vehicle with 100 km more operating range.

Table 6-2 Willingness to pay for 100 km extra operating range

	All	Environmentalist		Car lover	
		Buy ecological milk often		Buy ecological milk often	
		Yes	No	Yes	No
100 km extra	10,500	8,600	11,200	15,200	14,100

The highest willingness to pay for operating range is seen in the segment "Car lower". "Car lower" obviously think that operating range is more important compared to the "Environmentalist".

### 6.3 Service included

During the survey there has been a concern whether respondents accepted the assumption that the new technology vehicles in the choice situations are just as reliable as traditional vehicles. To eliminate this potential bias, the survey included a service agreement in the choice situations.

The following table shows the willingness to pay for service agreement for vehicles with different technology.

Table 6-3 Willingness to pay for service agreement

Technology	All
Traditional	4,600
Hydrogen	11,700
Hybrid	14,100
Bio-diesel	17,000
Plug-in electric	19,800

As can be seen, the willingness to pay is highest for the plug-in electric vehicles and lowest for the traditional vehicles, indicating that people might not completely accept the assumption that the different technologies have the same reliability. It seems that people consider the plug in electric technology more unreliable compared to a traditional vehicle. It may be that may be the current problems with short operating range for plug in electric vehicles impact the perception of the reliability of plug in electric vehicles. And thus makes the service agreement for the plug-in electric vehicle more important for the respondents.

### 6.4 WTP difference in age groups

Willingness to pay for new and more environmentally friendly technologies is lower in younger age groups.

6-4 Willingness to pay by age groups

	Age		
	18 - 29	30 - 49	50 +
Hydrogen	-38,000	-47,300	-56,400
Hybrid	-13,000	-24,600	-32,000
Bio-diesel	-10,400	-11,200	-17,100
Plug-in ele	-18,100	-28,900	-38,900

This is partly due to higher the fact that younger people are more sensitive to prices (higher elasticity). But even if we disregard this difference, the results from the estimations shows that young people are less likely to choose new environmentally

friendly vehicles compared to older people. They seem to give things like acceleration higher weight when they choose which vehicle to purchase.

## 7 Literature

Hole (2008) Estimating mixed logit models using maximum simulated likelihood. The Stata Journal.

Haan and Uhlenborff (2006), Estimation of Multinomial Logit Models with Unobserved Heterogeneity Using Maximum Simulated Likelihood, Discussion Papers 573, DIW Berlin, German institute for Economic Research.

Ben-Akiva, M., J. Walker, A. Bernardino, D. Gopinath, T. Morikawa, and A. Polydoropoulou (2002): Integration of Choice and Latent Variable Models, in (H. Mahmassani, Ed.) In perpetual Motion: Travel Behaviour Challenges and Opportunities

Denis Bolduc, Moshe Ben-Akiva, Joan Walker and Alain Michaud (2005): Hybrid Choice Models with Logit Kernel: Applicability to Large Scale Models

Train, Kenneth (2003): Discrete choice methods with simulation, Cambridge University press, 2003.

Dirk Temme, Marcel Paulssen, Till Dannewald (2008): Incorporating Latent Variables into Discrete Choice Models – A Simultaneous Estimation Approach Using SEM Software, Business Research, vol 1, issue 2, 2008.

GLAMM manual:

<http://www.bepress.com/context/ucbbiostat/article/1160/type/pdf/viewcontent/>

Skrondal, Anders and Sophia Rabe-Hesketh, (2004), Generalized Latent Variable Modelling, Chapman & Hall/CRC, 2004..

Rabe-Hesketh, S., Skrondal, A. and Pickles, A. (2004a). Generalized multilevel structural equation modelling. *Psychometrika* 69 (2), 167-190.

## **Session 12 - Energy for Developing Countries**

# Alternative Energy in Nepal

**Authors**

**Hari Babu Tiwari**

**Co-Authors**

**Kalika P. Bhandari**

## 1. Background

Renewable energy Technology (RET) becomes the mainstream option for rural Nepal to access modern source of energy. It focuses on the trend of RET applications consisting of biogas technology, solar thermal, micro and Pico hydropower, biomass technology, bio fuel technology, wind power technology etc. The RET's which provide both electricity based as well as non electricity based services, have been shown to most immediately meet the needs of a cleaner indoor environment, better quality lighting for education and income generating activities, alternatives cooking fuels and agro processing as well as rural industries. Improve cooking stove comes much more beneficial side than other technologies. Wind energy utilization is still not popular. Solar thermal to generate thermal energy to cook, warm and dry, biogas for lighting and cooking services. Micro hydropower for electric as well as mechanical use and solar PV mainly for domestic lighting may come in hierarchical choice.

The most important Renewable Energy Technology (RET's) in Nepal are related to Pico hydropower and micro-hydropower, biomass energy (biogas, briquettes, gasifies, improved cooking stoves, bio-fuels etc.) solar photovoltaic energy, solar PV water pumping, solar thermal energy (solar heater, solar dryers, solar cookers etc.) and wind energy (such as wind generators, wind mills etc.)

One of renowned Non- governmental organization has been implemented in the Jhapa and Mornag Bhutanese refuse camp. It has been simplified the problem of fuel scarcity for the refugees, who has been residing in the camps since last 18 years. This has reduced the consumption of firewood and hence conserved the forest. A dispute amongst the locals and the refugees who cut trees from the community forests had led to the death of one of the refugees; this incident has also motivated the organization to continue service for the humanity.

Two families from all the (seven camps are in Nepal) receives one solar cooker, one hay box & two cooking posts to each family. Under this programme, a total of 6,850 solar cookers, 12600 hay boxes and 25,200 cooking pots have been distributed 2009. The number of beneficiaries from this program has reached 85,000.

Before the distribution of the cookers and the utensils, the instruction and orientation training for the maintenance and repair and operation method was improved. The refugees were divided I 315 groups of 40 persons each. With this NGO is going to be the implementer of the largest solar project of world. NGO repair of the damaged cookers form resettled refugees in the third countries in is underway.



## ( Solar Cooker Program)



VFN' s Solar cooker distribution project has been simplifying the fuel problem of Bhutanese Refugees, who have been living in the eastern part of our country since 17 years back. A total of about 1 Lakh eight thousand Refugees are residing in different seven camps. The consequences of the refugee's settlement in that area are the destruction of the environment and the natural resources. A dispute between the local people and the refugees once even turned into a violent clash and resulted in the death of one person. VFN's search for alternative energy got further energized by such consequences and the suffering of the Refugees. VFN extended its solar cooker program from 2062 B.S, by distributing the parabolic cookers, hay-boxes and utensils to the families of all seven camps. The hay-boxes and utensils were distributed to all the families while one cooker was distributed for every two families. Initially, the solar cooker program had been implemented in Beldangi camp only. With this, a total of 6300 parabolic cookers and 1200 Hay Box along with 25,200 utensils have already been distributed. Before the distribution of the cookers, a feasibility

study to find out the houses with the proper sunlight was conducted because the cookers require enough sunlight. The information regarding the proper use, maintenance, repair was provided through trainings before the project implementation. For the effectiveness of the program and efficient supervision, 315 groups each comprising of 40 members was formed. From each camp 3 supervisors were also appointed, who have been facilitating to the users about the proper use and care of cookers. Supervision and evaluation of the program was also performed by Drs. Maarten Olthof, the Chairman of VFH.

The huge fire that caught Goldhap Camp destroyed around 1300 households and 450 solar cookers. Soon, when the reconstruction of those houses was complete, for the fire affected families, 270 cookers were re-distributed. With the completion of this program, Vajra Foundation Nepal feels prouder than ever for knowing that, this program is going to be the biggest solar cooker project in the world. Currently, the repair of the burnt cookers, the collection of the cookers from the refugees settling in the third country and the supervision of the program is underway.





## **SOLAR COOKER PROGRAM**

Since the inception of Vajra Foundation Nepal, solar cooker program has been implemented in the Jhapa and Morang districts of the eastern Nepal. It has simplified the problem of fuel scarcity for the refugees, who have been residing in the camps since last 18 years. This has reduced the consumption of firewood and hence conserved the forests. A dispute amongst the locals and the refugees who cut trees from the community forests had led to the death of one of the refugees; this incident has also motivated the organization to continue service for the humanity.

Two families from all the seven camps receive one solar cooker, one hay box & two cooking pots to each family. Under this program, a total of 6,850 solar cookers, 12,600 hay boxes and 25,200 cooking pots have been distributed till date. The number of beneficiaries from this program has reached 85,000.

Before the distribution of the cookers and the utensils, the instruction and orientation training for the maintenance and repair and operation method was provided. The refugees were divided in 315 groups of 40 persons each. With this, Vajra Foundation Nepal is going to be the implementer of the largest solar cooker project in the world, which not only has made us proud but further energized us. Currently, the repair of the damaged cookers in the fire that engulfed the camps, recollection of the cookers from the resettled refugees in the third countries is underway. This program is going to be run by the assistance of UNHCR from this year.







## (Environment Program)

### Solar Cooker Program

Since 1998, Vajra Foundation has been assisting Bhutanese refugees through the distribution of solar cookers, training, care and maintenance. The project was run in coordination with UNHCR, Government of Nepal and LWF. The project was implemented with the financial support of Stichting Vluchteling (SV), The Netherlands till May 2010. UNHCR has been supporting financially after the SV project completion.

The program is world's largest solar cooker distribution program with 6971 solar cookers already distributed for 13,942 families. The purpose of this project is to supplement the scarce cooking fuel available to Bhutanese Refugees, reduce expenses on fuel, to minimize the environmental degradation due to deforestation and smoke. Solar Cookers have been found to be best alternative energy source for cooking in the refugee camp setting.

During the project period, VFN will continue with regular follow-up to ensure proper use, repair and maintenance and organize training on how to use cookers properly. In addition to this, redistribution of the cookers recovered from the refugees resettling in the third countries is also underway. So far, more than 300 solar cookers have already been distributed to local host community.





Alternative Energy Promotion Centre (AEPC) is a Government of Nepal (GoN) organization that acts as the apex body to promote renewable and other alternative energy technologies in the rural areas of Nepal.

A numbers of donor-supported programmes exist under AEPC. Energy Sector Assistance Programme (ESAP) is one of such program funded by DANIDA and Norway. Besides Danida and Norway, other donors are also expected to participate in the programme. The ESAP Phase I (1999-2007) have reached more than 1.5 million people benefited from improved cooking stoves & electric lights through solar home system and micro hydro. The phase I of the ESAP was positively appraised by the DANIDA and Norway. ESAP II has been signed in March 15, 2007 to be implemented from 2007 till 2012. ESAP Phase II has a) Rural Energy Investment (Rural Energy Fund), b) Institutional Strengthening of Rural Energy Sector c) Technical Support: Mini-Grid Rural electrification, Biomass Energy, Solar energy as main areas to work. Solar Energy Component or Solar energy Support Program (SSP), basically support dissemination of solar photo voltaic systems, SSP co-ordinates the national level solar sector activities in AEPC / ESAP and has been the largely successful components towards meeting its objective.



## 2. PROGRAM DETAILS

### 2.1 Achievements of SSP in ESAP I

SSP in phase I has made a remarkable progress towards fulfillment of the immediate objective, particularly in creation of an enabling framework for dissemination of good quality SHS by establishment of quality assurance mechanisms, capacity building of the private sector and other concerned organizations, and market expansion through subsidy provision as well as other technical support.

Major achievements of SSP in ESAP I are;

- ▶ Prominent growth in number of solar PV companies. Before ESAP there was only 3 registered solar PV companies, however, at present there are around 50 registered solar PV companies. Out of which, 26 solar PV companies have been qualified by AEPC/ESAP to participate in dissemination of SHS. Under these qualified companies hundreds of branches offices, dealers and agents are operating all over Nepal. This is creating a fairly good network of SHS dissemination.
- ▶ Remarkable increase in users' confidence on solar PV technology, SHS and its benefits thereby creating a competitive SHS market in rural areas. The SHS installation has increased by 15 times in ESAP I. At end of ESAP I, about 69,533 SHS have been installed and subsidy approved by REF in about 1,855 Village Development Committees of 73 districts.
- ▶ Systems for promoting product quality and service quality is developed
  - Development and setting of Solar PV component standards, Nepal Interim Photo voltaic Quality Assurance (NIPQA).
  - Establishment of Renewable Energy Test Station (RETS) for Solar PV component testing.
  - Development and implementation of guidelines for company qualification and disqualification mechanisms.
  - Design and implementation of a system for Quality Assurance & Monitoring (QA&M) of SHS in the field, including performance evaluation and grading of the companies, penalty and exit mechanism.



- Development of training manuals and training courses for solar electric technicians and establishment of skill testing system and laboratory at CTEVT.
- Around 860 Solar Electric Level I and 100 Solar Electric Level II technicians are certified that has improved skill of locals and boosted employment opportunity in rural areas.
- ▲ SHS has catalyzed a small revolution all over rural Nepal opening up peoples' minds by providing electricity for better lighting as well as for operating radio, TV, video for information and entertainment. Use of SHS has improved children education, health and sanitation, communication and socialization.

## 2.2 SSP in ESAP II

The Solar energy Support Program (SSP) in ESAP II envisages continuous support on promotion of Solar Home Systems (SHS). In addition, the component also plans to support promotion of 'Solar Tuki' as an alternative lighting option of rural poor.

### 2.2.1 Immediate objectives

- ▲ Reinforced national frameworks for the dissemination of quality solar energy system.
- ▲ Increased and sustainable access and affordability for the rural poor to solar energy systems.

### 2.2.2 Elements

- a) Support to rural electrification through SHS dissemination.
- b) Development and promotion of appropriate credit mechanism to increase affordability of rural poor to purchase SHS and SSHS.
- c) Provide alternative lighting option to poorest rural population by promoting 'Solar Tuki'.
- d) Support to minimize the environment hazard by initiating used battery management system.

### 2.2.3 Expected outcome at the End of ESAP II

- a) Efficient and Effective Service Providers
- b) Improved Quality Assurance Systems
- c) Inputs to Policy Formulation
- d) Credit Delivery Modalities Developed for Easy Access and Wider Availability.
- e) Increased Use of Solar Home Systems and

Small Solar Home System.

- f) Used Battery Management Initiated
- g) Increased Cooperation for Complementarities and Synergies

### 2.2.4 Activities

The Solar energy Support Programme (SSP) works towards building a commercially viable and sustainable solar photovoltaic industry in Nepal that can deliver SHS & SSHS the technology to the needy population with good quality and reasonable price.

The following are the main activities of SSP:

- ▲ Capacity building of partner organizations, including training, skill testing, etc.
- ▲ Promotion of the PV technology among the rural population out of access to electricity.
- ▲ Market priming by providing subsidy to the end users of the solar PV systems.
- ▲ Development and promotion of appropriate credit mechanism to increase affordability of rural poor to purchase SHS.
- ▲ Preparation and updating of the required technical standards and delivery modalities for sustainable dissemination of solar technologies.
- ▲ Establishment of an effective monitoring mechanism to avoid possible abuse of the subsidy facility or to avoid any other unscrupulous activities e.g. use of substandard components, etc.
- ▲ Establishment of an appropriate battery recovery/recycle mechanism to avoid possible environmental hazards.
- ▲ Exposure visits for experience and knowledge sharing.
- ▲ Establishment of Solar Energy MIS and Database (SEMD) system.
- ▲ Preparation of training manuals.
- ▲ Conduct various surveys and other studies required.
- ▲ Provide input to policy formulation of the solar sector.

### 2.2.5 Targets for ESAP II

SSP targets to achieve the following in the Phase II of ESAP:

- ▲ Support for installation of 150,000 Solar Home Systems.
- ▲ Support for installation of 250,000 Small Solar Home Systems (Solar Tuki)





### 3. SOLAR HOME SYSTEM (SHS)

Solar Photo Voltaic (PV) Technology has been proven to be one of the best options for electrifying rural and the remote residing homes where there is no other options for lights, which can instantly produced and used locally. A Solar PV system used for lighting homes and for using of low power consuming electronic goods like radio and TV is named as Solar Home System (SHS).

Solar Home System basically consists of a PV panel, Charge Controller, Deep-cycle Battery, DC lights, wires, switches etc. A PV panel, converts the Sun light energy into electricity. The electricity generated in the daytime is stored in a deep cycle lead-acid battery and consumed for home lighting in the night.

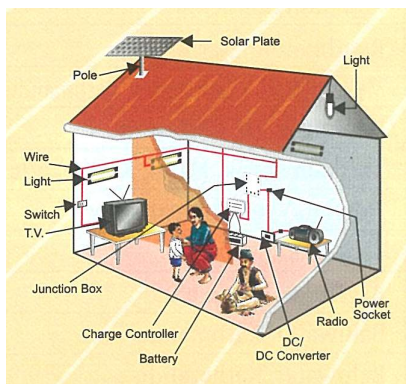

The charge controller controls the charging and discharging process of the battery. Other accessories are switches, sockets, junction boxes and cables etc.

#### 3.1 Quality Assurance of Solar Home System

In order to assured the quality of the components to be used in SHS, AEPC / ESAP has prepared and successfully implemented a standard named, Nepal Interim Photovoltaic Quality Assurance (NIPQA). In order to check and verify technical parameters of SHS components a special laboratory named as Renewable Energy Test Station (RETS) is set up and functional.

Solar PV companies qualified by AEPC/ESAP to participate in the dissemination of SHS, should compulsorily use the NIPQA 2005 complied components, that is verified by RETS. The program also carries out the monitoring of the SHS installed in the field in the random sampling basis though pre qualified Quality Assurance & Monitoring Consultant and technicians from RETS, AEPC/ESAP & Regional Renewable Energy Service Centre (RRESC)

#### 3.2 Where and how can we get Solar Home System?

Where costumer has to contact for SHS? → Costumer has to contact to qualified solar PV companies as listed in page 6 or its branch office/dealer/agents.



How does costumer tell about their need/requirement to technicians? → Costumer has to specify the number and wattage of lamps and its operating hours. Whether to use radio, T.V. or not. If yes, then has to specify the wattage and operating hours.

How does company representative select the size of SHS to meet costumer requirements? → Company representative has to select the system according to system sizing table mentioned in page 4 and components to be used in SHS must be tested in RETS as per NIPQA 2005.

Where can costumer know about the SHS price and subsidy? → Costumer must ask about the price and GoN subsidy for the SHS that wants to purchase to company representative. GoN subsidy is mentioned in page 5.

Who should install the SHS? → CTEVT certified level I technicians has to install SHS and after installation s/he has to take photo with users. Photo must clearly show SHS owner holding poster, technician, house and installed panel.

What are the things SHS owner must take from technicians? → SHS operation and maintenance manual, warranty card, bill/voucher, Booklet and poster provided by SSP

What are the things SHS owner must give to technicians? → Remaining amount of SHS price subtracting subsidy, two copies of subsidy application forms signed by owner, photocopy of citizenship certificate and permission to take photograph.

Qualified Company will do necessary process to get subsidy



### 3.3 Solar Home System component selection table

S N	SHS Capacity			Loads that can be connected			
	Solar Panel capacity (Watt peak)	Battery capacity* (Ampere hour)	Charge controller capacity (Ampere)	Name	Power Watt	Numbers	Maximum use hours
1	10 to 14	26	4	Light	7	1	3
				WLED Light	0.5	2	3
				Radio	1	1	1
				Cassette Player	5	1	1
2	15 to 19	35	4	Light 1	7	1	3
				Light 2	3	2	3
				Radio	1	1	1
				Cassette Player	5	1	1
3	20 to 24	45	4	Light 1	7	1	3
				Light 2	3	2	3
				Radio	1	1	4
				Cassette Player	5	1	2
4	25 to 29	50	4	Light 1	7	2	3
				Light 2	3	1	3
				Radio	1	1	1
				Cassette Player	5	1	2
5	30 to 36	65	5	Light 1	7	1	3
				Light 2	3	2	3
				Radio	1	1	2
				Cassette Player	5	1	3
6	37 to 42	80	5	BW TV	25	1	1
				Light 1	7	2	3
				Light 2	3	1	3
				Radio	1	1	2
7	43 to 50	100	5	Cassette Player	5	1	4
				BW TV	25	1	1
				Light	7	3	3
				Radio	1	1	2
8	51 to 60	120	8	Cassette Player	5	1	4
				BW TV	25	1	2
				Light	7	3	3
				Radio	1	1	2
9	61 to 70	135	8	Cassette Player	5	1	1
				color TV	65	1	1
				Light	10	3	3
				Radio	1	1	1
10	71 to 80	150	10	Cassette Player	5	1	1
				Color TV	65	1	1
				Light 2	7	1	3
				Light 1	10	3	3
11	81 to 90	180	10	Color TV	65	1	1
				Cassette Player	5	1	2
				Radio	1	1	2
				Light 2	7	1	3
12	91 to 100	200	10	Color TV	65	1	1
				Cassette Player	5	1	1
				Radio	1	1	3
				Light 2	7	1	3
13	101 to 110	200	10	Light 1	10	4	3
				Color TV	65	1	2
				Cassette Player	5	1	3
				Radio	1	1	3
14	111 to 120	200	10	Light	10	5	3
				Cassette Player	5	1	2
				Radio	1	1	3
				color TV	65	1	2

\*The above mentioned Battery is designed for Solar Deep Cycle Flat Plate Battery. If You Want Solar Deep Cycle Tubular Plate Battery you can use up to 15% less Battery capacity



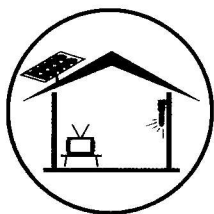

## 5. LIST OF PRE-QUALIFIED COMPANIES FOR DISSEMINATION OF SOLAR HOME SYSTEM (SHS)

S.No.	Name of the Company	Full Address	Phone no.
1	Alternative Energy Resources Nepal Pvt. Ltd.	Gairidhara Chowck, Kathmandu	01-4416701
2	Bio Energy pvt. Ltd.	Balaju Chowk, Kathmandu	01-6225310
3	Bionic Energy Pvt. Ltd.	Goushala, Kathmandu	01-2003356
4	Dhaulagiri Solar and Electronics Company	Balaju, Kathmandu	01-4365376
5	Energy and Construction Company Pvt. Ltd.	Kalanki, Kathmandu	01-6220189
6	Energy International Pvt. Ltd.	Jawal, Lalitpur	01-5543482
7	Everest Solar Energy pvt. Ltd.	Gogabu, Tokha Road, Kathmandu	01-4360086
8	Kathmandu Power Company Pvt. Ltd.	Shanti Nagar, Baneshwar, Kathmandu	01-4107716
9	Krishna Grill and Engineering Works Pvt. Ltd.	Bhumiparsasan Chowk, Biratnagar	021-525492
10	Lasersun Energy Pvt. Ltd.	Pulchowk Lalitpur	01-5536171
11	Lek Bensi Sourya Urja Tatha Gobar Gas Sewa Company	Rupandhei, Butwal	071-540074
12	Lotus Energy Pvt. Ltd.	Bhatbhateni, Kathmandu	01-4418203
13	Nabajyoti Urja Pvt. Ltd.	Maharajgunj, Chakrapath, Kathmandu	01-4721741
14	Nepal Energy Development Company Pvt. Ltd. Company Pvt. Ltd.	Bharatpur 10, Chitawan	056-521563
15	Perennial Energy Nepal Pvt. Ltd.	Thribam sadak, Naxal, Kathmandu	01-4414363
16	Rural and Alternative Energy Pvt. Ltd.	Tanahu, Vyas Municipalaty-11	065-560573
17	Scientific Technology Pvt. Ltd.	Tangal, Kathmandu	01-4423638
18	Solar Electricity Company Pvt. Ltd.	Bagbazar, Kathmandu	01-4225253
19	Sprint International Pvt. Ltd.	Baluwatar, Kathmandu	01-4430417
20	Sun Power Pvt. Ltd.	Baluwatar, Kathmandu	01-4440354
21	Sunshine Energy Pvt. Ltd.	Samakhushi, Kathmandu	01-4353538
22	Suryodaya Urja Pvt. Ltd.	Dhapasi VDC -2, Lilanagar	01-4379000
23	Suryojyoti Company Pvt. Ltd.	Newroad, Guccha tole, Kathmandu	01-4249255
24	Swabhiman Urja Bikash Company Pvt. Ltd.	Mahandrapath, Baglung	068-520818
25	Swogun Energy pvt. Ltd.	Samakhushi, Kathmandu	01-4362505
26	Urja Ghar Pvt. Ltd.	Balaju, Devakota Margh, Kathmandu	01-6911556

### Reference

**Solar energy Support Programme (SSP)  
Alternative Energy Promotion Center (AEPC)/  
Energy Sector Assistance Programme (ESAP)**





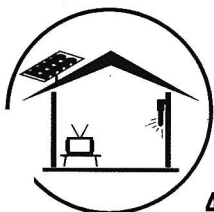

## 4. SUBSIDY ARRANGEMENT FOR SOLAR HOME SYSTEM

### 4.1 Amount of Subsidy

As per GoN "Renewable (Rural) Energy Subsidy Arrangement, 2006" The Solar Home System with capacity equals to 10 Wp or higher will receive subsidy as follows.

Geographical Location	10-18 Wp (NPR)	More than 18 Wp (NPR)
Karnali and adjoining districts* and very remote VDCs# categorized A in other districts	7,000	10,000
Remote VDC # categorized B in other districts	6,000	8,000
Accessible VDCs	5,000	6,000
<p>* Humla, Jumla, Kalikot, Dolpa, Mugu, Rolpa, Rukum, Jajarkot, Bajhang, Bajura, Achham, Dailekh, Darchula            # The very remote and remote VDCs of the remote districts are as per Ministry of Local Development (MOLD)/GON notification in the Nepal Gazette. The category A comprises of very remote VDCs, while category B represents remote VDCs.</p>		
<p>For Solar PV System less than 10 WP, Institutional PV System &amp; Solar PV Water Pumping System, Government has separate subsidy arrangement and delivery mechanism, for further details contact to the programme.</p>		

### 4.2 Criteria to get Subsidy for SHS

In order to be eligible for subsidy, a Solar Home System installed must meet following conditions.

- ▲ Solar energy subsidy will only be available to Nepalese Citizens for specified SHS installed in the rural areas not electrified by other means.
- ▲ SHS subsidy will be available when an area or cluster has at least 10 SHS installed from a qualified company or a group of qualified company provided that a proper ASS arrangements is made. The area or cluster has been defined in general as a VDC or a group of adjoining VDCs within 3 hours' walking distance and closeness has to be certified by one of the involved VDCs or DDC.
- ▲ Installation of SHS or SSHS must be done by qualified companies and its recognized branch/agents/dealers using NIPQA complied components. In order to ensure NIPQA compliance the systems must use components certified by RETS only.
- ▲ Installation of SHS must be done by a technician certified as Solar Electric Technician Level I by the CTEVT.
- ▲ The qualified company must assure that there must be an adequate after sales service (ASS) in the region.
- ▲ Payment due to RETS for certification and inspection of components must be cleared within 6 months as per the rules of RETS.
- ▲ The subsidy request must be made in the REF/SSP prescribed SHS Subsidy Application Form.
- ▲ The SHS application form must be submitted along with a copy of the user's Citizenship Certificate and two photos. The first photo must clearly show the house in full picture with the panel installed with a proper angle to show the front view of the panel. The second photo should clearly show the user or the installer holding a poster provided by SSP standing or sitting together with the house in the background.
- ▲ Household that has received SSHS subsidy may apply for SHS subsidy after one year.

# Identifying technologies for sustainable energy development options in the developing world: The case of providing access to electricity

Willington Ortiz\*, Carmen Dienst, Daniel Vallentin, Steffen Kisseler

Wuppertal Institute for Climate, Environment and Energy;

Doeppersberg 19, D-42103 Wuppertal, Germany;

\*(corresponding author; willington.ortiz@wupperinstorg)

## Abstract

Rapid diffusion of climate friendly technologies is regarded as core element for the transformation of the future energy system in order to achieve effective global climate change mitigation and to meet challenges we currently face, like energy security, global warming and poverty reduction. Providing clear and transparent information on the multiplicity of (available and emerging) technological options to meet specific energy related needs seems to be a determinant factor to trigger replication and to accelerate diffusion.

Recognizing this challenge, the Wuppertal Institute developed a “Technology Radar”, which is a scientifically founded online information tool. Its aim is to give a comprehensive overview of technologies and their possible contribution to meeting basic energy needs by using renewable energy sources. In the first phase, special focus was set on technological options for providing access to electricity to those population currently not covered by a central grid.

Small-scale technologies suitable for community-based solutions represent promising options for the developing world. In this context wind electric power, micro-hydroelectric power, solar photovoltaic power as well as biogas and vegetable oil-based solutions have been analysed in detail.

In order to evaluate the applicability and appropriateness of the technologies, the following set of criteria was defined: Potential contribution to global sustainable development and to achieve the Millennium Development Goals; environmental impacts; socio-economic aspects and regional impacts linked to implementation; the type of set up needed to ensure the economical viability and expected technological developments. Main findings for each technology are summarized along the different sustainability aspects. Lessons learned from case studies can be found in the published online-version and brochure.

## 1 Introduction and Background

The current debates on the future prospects of the energy system, energy security, climate change and the reduction of energy poverty are clearly linked to the urgent need for a broader implementation of sustainable energy technologies (SET). Introducing SET can mitigate environmental damage (like deforestation, indoor pollution, pollution due to fossil fuel exploration and transportation), support the provision of basic needs (cooking, heating, lighting, and so on) and promote productive uses in developing countries.

However, the usual path of gradual diffusion of technologies is not fast enough for the demanding challenges ahead. One of the most important barriers is the lack of knowledge of existing and appropriate options.

The aim of the newly developed Technology Radar (TR) of the Wuppertal Institute under its initiative WISIONS is to give a comprehensive and transparent overview of the

existing renewable energy technologies and their possible contribution to meeting basic energy needs, today and in the future. In the first phase, focus is put on the access to electricity.

The relevance of electrification stems mainly from two challenges: achieving universal access to electricity and the expected growing global demand. Electricity is regarded as a key factor in meeting the Millennium Development Goals (UN 2009), but still about 1.45 billion people have not access (in 2009, IEA 2010). On the other hand the IEA expects an increase of electricity demand by 55% between 2007 and 2030 (from 16,400 TWh by 2007 to 25,400 TWh by 2030; IEA 2009).

Main focus of the study lies on small-scale technologies for community-based implementation approaches in off-grid regions.

## 2 Development of Technology Radar

In order to offer transparent, comprehensive and technology neutral information on technological options, the development of the TR comprises two guiding principles.

Need-orientation: This is an attempt to redirect the focus to the energy related needs to be met. It recognizes that energy technologies are (only) means to enable the realization of daily tasks or the fulfilment of daily needs, be it individual or collective needs.

Multi-criteria: The supply of energy comprises multiple interconnected processes: from the resource extraction up to the provision of end energy to the user. And also the interactions with the ecological and social systems are manifold. Thus, information on these multidimensional interactions may be essential for the design of measures that aim at ensuring the provision of energy based on the use of renewable resources.

### 2.1 Set of evaluation criteria

A set of five criteria has been established to reflect and cover the different issues important for the selection and application of sustainable energy technologies. Each criterion may entail quantitative and/or qualitative data that help to build a more comprehensive understanding on the technology performance today or in the near future.

#### **Potential contribution to global sustainable development**

Data gathered in this set describes how the application of the technologies is expected to contribute to three of the main urgent global challenges of our time:

- a. Shaping low-carbon energy systems: The main parameter used for this topic is the expected share of the technology in the future global energy supply (by year 2030 and 2050). For this purpose, results from scenario analysis have been summarized. Additionally, qualitative descriptions of the global distribution of the energy sources are given and the suitability in decentralized approaches is analysed.
- b. Contribution to climate change mitigation: Description on the technology's potential to contribute to climate change mitigation, like reduction of CO<sub>2</sub>e-emissions.
- c. Contribution to MDG achievement: Indications of the suitability of certain technologies to help meeting the Millennium Development Goals (MDGs) are collected. Main source of information is literature of international organisations working in the field of development cooperation.

#### **Environmental Issues**

The production of energy and delivery of energy services can lead to environmental changes that can pose threat to the ecosystems or to human beings. A large range of

environmental and human health indicators has been developed during the last decades in order to assess the magnitude of impacts deriving from the production of good and services. Technology Radar is focused on searching for impact assessments. Four impact categories are considered: possible impacts on land use, water use, toxic effects to humans, and quantitative data on global warming effects. For the latter the emission of greenhouse gases (measured in CO<sub>2</sub> equivalent) for each unit of energy provided by the technologies is applied. For this end data from life cycle assessments (LCA) were used when available.

### **Social Issues**

The social dimension of sustainability is the less developed construct within the discussion on sustainability (Dillard et al., 2008). However from the rich tradition research on social well-being a set of principles can be extracted: Human well-being, equity, democratic government and democratic civil society. The most direct effects from the application of energy technologies are related with the access to energy services and the opportunities that can be derived from them (e.g. employment, improved health and education services etc.).

On the other hand, social structures are not only “receptors” of impacts, they also play a significant role as “agents” in the implementation of energy projects, thus ensuring sustainability of activities requires enabling social structures. Additionally, the installation and operation of energy technologies is associated with changes in the use and values of local resources. Such changes may result in conflicts or synergy effects with other uses or values of the resources.

The Technology Radar gathered qualitative information on these three main topics: (a) Impacts related with the provision of energy; (b) Impacts related with possible conflicts and/or synergies with other socio-economic values; (c) The role of local social structures in order to guarantee long-term adoption of energy solutions.

### **Development status and technological perspectives**

Three topics are gathered under these criteria: (a) Information regarding the commercial maturity of the technology. (b) The current role of the technology in the global energy system. When available quantitative parameters like installed capacity or market participation is given. (c) Expected technological progress. Significant trends in the future development of the technologies are described. To this end specialized literature is reviewed and diverse information about possibilities for cost reduction, optimization potentials, weakness to be solved or new emerging concepts is collected

### **Economic issues**

For the first version of the Technology Radar data on current capital costs are considered as well as expected development of costs in the middle or long term, if available. Special emphasis is given on describing the systems and their costs, because data available in literature often refer to different system configurations.

## **2.2 Data management system**

In order to storage and manage the information flows during the operation of the Technology Radar a data management system (DMS) has been developed. The structure of the DMS reproduces the general structure of any energy provision system as illustrated in Figure 1. Energy resources must experiment a whole transformation process before the adequate energy form can be provided and applied to meet a specific (energy-related) need. The energy provision system takes primary energy from energy resources and delivers different kind of energy carriers (secondary energy) to consumers. Consumers may make use of technologies that reduce the need of energy (e.g. insulation, day lighting, intelligent controls). The end-application technology provides the actual energy service to meet the target need. The three main (collection of) objects involved in the system are: Needs, Technologies and Energy (i.e. the different energy forms).

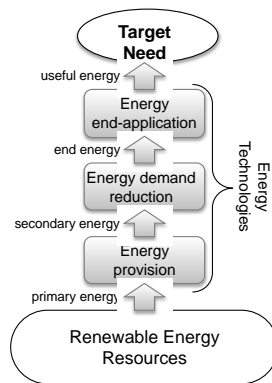

Figure 1 Schematic view of the basic structure guiding the design of the DMS

The concept of “Energy Needs” refers to a collection of standard applications of energy for a wide range of sectors. Energy is a quite transversal issue that touches upon different activities of human life. The first version of the Technology Radar gathers five categories of basic needs related with the provision of energy: Access to electricity; Lighting; Food processing; Space heating and cooling; Water supply and treatment.

The provision of energy can be seen as a chain of interconnected single technologies. Each component of the chain performs a specific energy task (e.g. transformation, storage or transport). Thus at the interface between the components energy is being exchanged in different forms. In order to facilitate the navigation through the DMS and allow an overview of the different technological options, technologies are collected in groups (technology families) according to the function and the basic principles applied. Each family may contain several specific technologies as illustrated in Figure 2. Thus also the information offered is becoming more specific, as the user is going inside the categories.

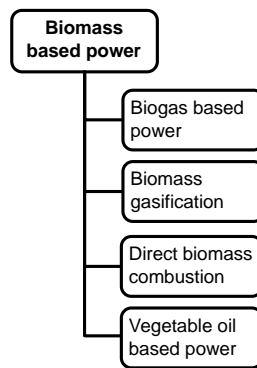

Figure 2 Example of a technology family and the specific technologies contained in it

### 3 Access to Electricity - Screening for renewable energy technologies

Technologies for assuring access to electricity were gathered into ten technology families: Seven power generation technologies, power distribution and electric power regulation and electric power storage. Figure 3 shows a section of the on-line navigation tool of the DMS, with the technology families established “Electricity”.

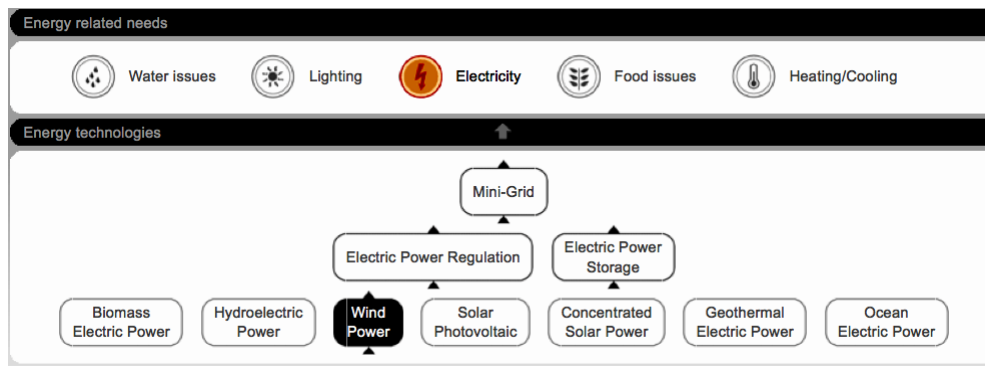

Figure 3: Section of the on-line navigation tool showing the technology families in the case of access to electricity

Relevant data were collected from literature for each specific technology, so that a complete description according to the established criteria has emerged. Each description was reviewed by experts from Wuppertal Institute and in consultation with international experts that have special focus on the corresponding technology. The final draft of textual information of each technology was last reviewed by one of the experts before activating the on-line access. The results are online available since October 2010.

In the framework of the WISIONS initiative, the Technology Radar is intended to help to identify technological options that better fit (today) to the kind of activities supported by the initiative and those that promise to do so in the near and middle term. The initiative is particularly interested in community-based implementation approaches, i.e. projects that consider the needs of the local population and that actively involve the locals in the project implementation, which is crucial for the long-term success and sustainability.

The following technologies on Solar PV, Biomass (especially biogas and vegetable oil)-based power as well as small wind and small hydro power systems have been identified as most suitable for community-based solutions. Table 1 summarizes the result of analysing these technology options according to four of the proposed criteria (social, environmental, economic and technical issues).

### 3.1 Solar PV

Solutions based on PV technology are commercially available to respond to different levels of electricity demand: The smallest solutions (also known as pico PV) mainly address the need for lighting and some basic electrification services (e.g. battery recharging). Integrated systems that allow a basic electrification of single households are known as Solar Home Systems (SHS). PV systems for the electrification of several households are increasingly applied in mini-grid approaches.

Photovoltaic systems already represent an economically feasible solution for many decentralized applications. The necessary equipment and installations to provide electric power are relatively simple. Operation and maintenance can also be achieved at relatively low costs, which make photovoltaic technologies a powerful tool to address energy poverty. The PV industry has been characterized by high learning rates and substantial costs reductions are expected on the short run. But broad dissemination of decentralized solutions requires appropriate financial schemes to bridge the gap between high front up costs and low investment capacity of potential beneficiaries. A combination between subsidizing part of capital cost and direct soft loans for the users seems to be a preferred scheme.

Besides the financial barrier faced by potential users, several experiences in the dissemination of PV solutions have illustrated the importance of establishing sustainable delivery networks (IFC, 2007), i.e. local technical, managerial and marketing capacities. Access to technical advice, maintenance and repair services, the availability of spare

parts or the means of enforcing warranty agreements can all help to ensure the long lasting adoption of the solutions.

### 3.2 Biomass based electric power

There are several technical options to transform the energy content of biomass to electricity. Figure 4 illustrates the most conventional transformation paths, which are the production of fuels through gasification, anaerobic digestion or vegetable oil extraction to run engines-generator sets, fuel cells or (micro) turbines. On a global perspective, biomass resources are available in almost all climates. They already play a key role in many economic and social activities and make part of environmental functions. Therefore, designing sustainable schemes for using biomass for power generation is a complex task that requires very case-specific assessment.

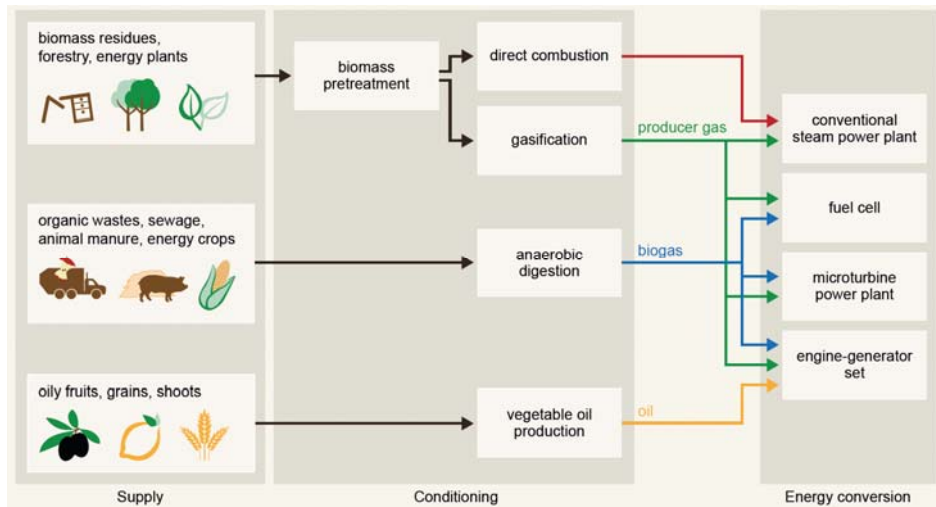

Figure 4. Transformation paths to generate electric power from biomass

Particularities of the biomass supply system have a significant influence on the environmental and social effects of the single measure for power supply and are crucial for the technical and economic feasibility. In general, the use of biomass from waste flows may lead to environmental and social improvements and low operation costs, if the use of waste flows will not threaten already established economic activities (e.g. fuel for cooking) or environmental functions (e.g. soil enhancement). In case woody biomass and/or crops are produced for energy purposes, changes in land use patterns can result in both, improvements or detrimental effects. The demand of (additional) biomass for power may lead, for example, to reforestation of wastelands, the enhancement of soils and additional income generation activities. On the other hand, it can also lead to clearing of pristine forest, reduced production of food crops or intensification of conflicts on land ownership. Therefore, thorough assessments of environmental and social impacts and transparent and participative consultation processes should make part of the early design phases of each measure that seeks to encourage the use of biomass for energy purposes.

The biomass supply system is also a decisive issue for the feasibility of a project. The reliable provision of biomass is crucial as the daily supply of electric power is dependent on the output of the agricultural and/or animal tenure activities. In the case of vegetable oil, the provision of energy is exposed to all traditional risks and uncertainties of seed production (e.g. unstable yields, pests, water scarcity, etc) and requires the allocation of additional labour (e.g. planting, weeding, harvesting, etc) and inputs (e.g. fertilizers, irrigation, etc). Seed harvest is seasonally. Thus, the actual yield of a season will impact the potential energy supply of a whole period between harvest seasons and storage capacities has to be considered as part of the project. In the case of biogas-based power, the potential supply of substrate depends on the number of animals but also on the

animal tenure practices. Additional investment for stables and efforts to adapt the traditional practices are often required in order to facilitate the collection of manure. Free grazing is the simplest breeding system, practiced in many rural areas of developing countries, but it makes the manure collection difficult and costly. The collection and preparation of manure and the feeding of the biogas digester become additional daily tasks that can be seen as part of the whole supply system.

The main hardware components required for the transformation of biomass resources to electric power belong to well-known and mature technologies, but commercial availability of appropriate solutions for community-based approaches is often missing.

### **Biogas-based power**

The main components for small power applications are the biodigester and the engine-generator set. Both are well-known and broadly available technologies. However, the maturity and rate of adoption offer an uneven picture. The most striking case is biogas used for households, where in some regions high acceptance and diffusion rates are reported, yet in others the users have become disappointed and the technology experiences discredit. The availability of local technical and marketing capacities in the field of biogas technologies is region specific. While large and long lasting programs in some Asian nations may have contributed to build strong and widespread innovation capacities (Bajgain et al., 2005; Cheng et al., 2010), the biogas sectors in African and Latin American countries are in an earlier stage of development (Nyagabona et al., 2009; GreenEmpowerment, 2010).

Running engine-generator sets with biogas is already a commercial practice. The use of cogeneration units to utilize biogas from sewage plants and landfills is common practice in many countries, but experiences of biogas-based village electrification are still scarce. For community-based approaches the use of commercial gas engines may become a preferred option. The power generation at household level may be a feasible option for cases where household biodigesters generate considerable surplus of biogas. However, gas engines below 1 kW seem not yet to be commercially available (Energy Forum, 2009). Disregarding the size of the application, the quality of the biogas significantly affects the power generation capacity and the maintenance and overhauls requirements.

### **Vegetable oil-based power**

Oil pressing units and engine-generator represent the main common components for power generation based on pure vegetable oil. Both are commercial technologies. Though, power systems optimized for running on vegetable oils are still not broadly available. Some manufacturers (particularly in Europe and USA) are already offering small cogeneration systems adapted to run on particular kind of vegetable oil (e.g. rapeseed oil). A common practice - where such optimized products are not commercially available - is adapting conventional diesel engines to run on vegetable oil. Modifications of the equipments and appropriate operation strategies are necessary in order to avoid harmful impacts on the equipments. E.g. modifications in the internal fuel supply of the engine and the use of fossil diesel for the starting phase of the engine.

## **3.3 Micro-hydro electric power**

Where hydro potentials are available, micro-hydroelectric power is often the least-cost generation option for off-grid regions. Hydroelectric technologies are available to cover a wide range of needs: from the supply of electricity for single households or workshops (e.g. through pico-hydro plants) to the electrification of whole villages in mini-grids approaches. Most of the used water turbines and generators are commercially available. They are already mature technologies and no significant cost changes are expected.

New concepts of in-stream turbines are gaining increased interest. They are designed to better use the kinetic energy of water flow. The installation of such turbines does not require complex civil works to divert the water, as they are submerged in the river and commonly fixed to a floating platform. These concepts would open additional options for using hydro resources.



The development of micro-hydro projects can lead to synergies or conflicts with other socio-economic issues. A micro-hydropower project can be integrated into programs addressing other local needs such as irrigation, flood prevention, flow regulation for navigation or the fostering of tourism activities. On the other hand, the operation of a micro-hydro plant can also lead to negative effects like floods or insufficient water flow, and therefore result in conflict with other values of water flows (even those that can have potential synergies). Appropriate communication and consultation strategies already included in the design of projects can reduce such conflict risks.

### 3.4 Small wind power systems

In contrast to wind power for normal size on-grid applications, the industry of small wind systems (below 10 kW rated power) seems to be still struggling to establish a robust market. On the other hand, there are already several manufactures that offer commercial product lines. They seem to be serving early niches for off-grid electrification in both, developed and developing countries. Additionally, some initiatives are fostering the development of local technical innovation and production of small wind in developing countries. These initiatives are particularly focusing on the adaptation of free patent designs to materials and skills availability in their target regions. Beyond the wind turbine, an off-grid system comprises many other elements like batteries, charge controller, DC-AC inverter, different electric components as well as structural elements (i.e. tower and wires), as schematic described in Figure 5.

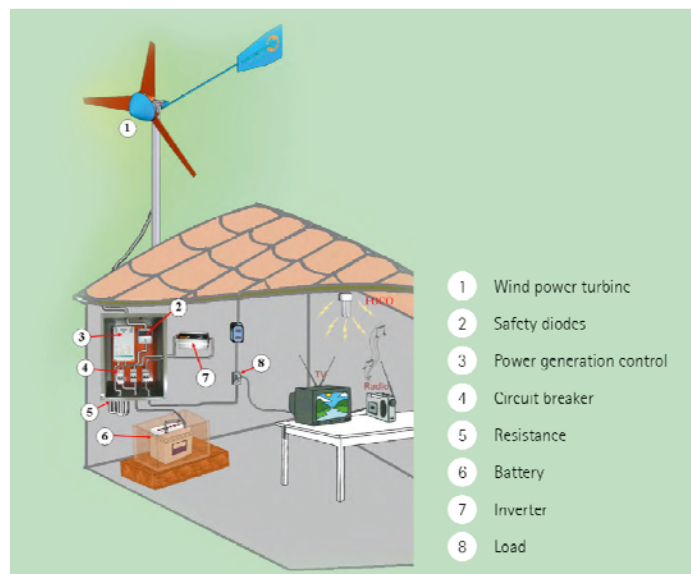

Figure 5. Schematic view of a wind power system for off-grid applications. (*Soluciones Practicas, 2009*)

Disregarding the kind and specialization of the manufacturers, the lack of standardisation seems to be a key factor hindering the broad diffusion of the technology. Already the selection of a turbine requires not only technical knowledge but also access to ‘insider information’ that are not necessarily available in catalogues or handbooks. Additionally, establishing sustainable networks for the supply of equipments and services require important efforts in building and spreading technical know-how, marketing and managerial skills.

## 4 Conclusions

The Technology Radar is proposed as a tool to systematically identify and evaluate renewable energy technologies, which can be applied for tackling specific energy-related

needs. Five criteria covering relevant issues for sustainable development were defined in order to provide multidimensional and technology-natural information. The data available in the TR offer the possibility to compare the ability of technologies to respond to multidimensional challenges coupled with the provision of energy.

In its first operation round the Technology Radar has focused on the need for access to electricity. In this case the collection of technologies was screened by means of the power capacities available and the commercial maturity of devices found under each technology category. The search for technological options to address regions and population without access to a power grid, illustrates the possibilities of the Technology Radar.

Solar photovoltaic, micro hydroelectric, biogas based power, small wind power and vegetable oil based power are technologies that offer good chances for the conception and realisation of solutions adapted to the particular necessities of off-grid communities. Although technology fields like wind and biogas-based power already offer commercial solutions for industrial and on-grid applications, commercial products and integrated solution for some niches of lower power are still lacking. Technical improvements are expected (or rather required) that may enhance the applicability of the screened technologies in community-based approaches. Significant difficulties for the adoption and diffusion of the screened technologies arise from socio-economic factors, which are not directly linked to properties of the devices themselves. Issues like the establishment of appropriate networks delivering technical advice, equipments and services; the building of local technical, managerial and marketing capacities; the need for thorough assessments of available resources and potential impacts to environment and/or other social values indicate that more efforts on understanding the interlinks between technology and the particularities of the socio-economic context of “off-grid population” are needed.

Table 1. Electric power generation technologies for community-based approaches. Main findings on social, environmental, economic and technical issues.

	<b>Social issues</b>	<b>Environmental aspects</b>	<b>Economic issues</b>	<b>Technological challenges</b>
<b>Solar Photovoltaic Systems</b>	<ul style="list-style-type: none"> <li>* Awareness on limits of small PV needed to avoid high expectations/ disappointment of user</li> <li>* Appropriate delivery networks crucial for assuring effectively access to products and services</li> </ul>	<ul style="list-style-type: none"> <li>* Operation free of GHG emissions</li> <li>* Life cycle GHG emissions depend on system (<math>\geq 35</math> gCO<sub>2</sub>eq/kWh<sup>(1)</sup>)</li> <li>* Appropriate disposal/recycling system of components (e.g. batteries, PV cells) crucial for avoiding detrimental effects</li> </ul>	<ul style="list-style-type: none"> <li>* Already economic feasible for many off-grid solutions</li> <li>* Appropriate financial schemes required: Investment costs too high for low-income population <math>\geq 5,000</math> US\$/kW<sup>(4)</sup></li> </ul>	<ul style="list-style-type: none"> <li>* Design of new or adaptation of existing products according to technical, social and economic requirements of low-income population</li> <li>* Further cost reduction</li> </ul>
<b>Biomass based electric power (in general)</b>	<ul style="list-style-type: none"> <li>* Supportive: e.g. additional value to products (or waste) from agricultural/forest activities</li> <li>* Detrimental: concentration of land ownership, competing land uses, increase in food prices, etc.</li> </ul>	<ul style="list-style-type: none"> <li>Impacts depend on supply:</li> <li>* Use of waste is often linked to environmental improvements</li> <li>* Increasing production of biomass may lead to positive (reforestation) or negative effects (clearing of forests)</li> </ul>	<ul style="list-style-type: none"> <li>* Operation costs depends on biomass supply scheme.</li> <li>* Use of wastes often implies only costs for collection and transport.</li> <li>* Increasing biomass production supposes additional allocation of resources (land, water), labour, inputs</li> </ul>	<ul style="list-style-type: none"> <li>* Research on sustainable biomass production needed: increasing the uptake of biomass while avoiding/mitigating detrimental impacts</li> </ul>
<i>Biogas</i>	<ul style="list-style-type: none"> <li>* Changes in traditional practices: e.g. longer corral standing times</li> <li>* Cultural barriers: use of wastes</li> <li>* Establishing managerial structures for collection of feedstock and operation of communal plants can be challenging.</li> </ul>	<ul style="list-style-type: none"> <li>* By substituting the untreated disposal of waste flows, environmental and human health risks can be reduced or avoided.</li> <li>* By using animal manure, net reductions of GHG emissions can be achieved, up to 850 g CO<sub>2</sub>eq/kWh<sup>(2)</sup></li> </ul>	<ul style="list-style-type: none"> <li>* Main investment outlay: Biodigester and engine generator set.</li> <li>* Capital costs of systems &gt; US\$ 2,000 per kW<sup>(4)</sup></li> </ul>	<ul style="list-style-type: none"> <li>* Practical experience on village electrification based on biogas still scarce.</li> <li>* Lack of commercial "robust" gas generator sets of low power rates (&lt;1kW) for household solutions.</li> <li>* Development of small compact trigeneration units (electricity, heat and cold) use more effectively biogas energy content</li> </ul>

<i>Vegetable oil</i>	<ul style="list-style-type: none"> <li>* Cultivation of energy plants may displace/reduce means of livelihood: e.g. changes in land use, (re)allocation of labour and inputs.</li> </ul>	<ul style="list-style-type: none"> <li>* Some oil plants can be used in reforestation measures and/or as live fences.</li> </ul>	<ul style="list-style-type: none"> <li>* Risks of seed production (e.g. unstable yields, pests, water scarcity, etc)</li> <li>* Seasonality of seed harvests. Storage capacities required</li> <li>* Power generation component has low capital costs (US\$ 200 to 500 US\$ per kW) but recurrent operation costs</li> </ul>	<ul style="list-style-type: none"> <li>* Successful experiences on communal approaches still scarce.</li> </ul>
<b>Micro-hydro Power</b>	<ul style="list-style-type: none"> <li>* Synergies or conflicts with other socio-economic issues possible: Irrigation, flood prevention, navigation, recreational activities.</li> <li>* Establishment of local technical and managerial capabilities decisive for sustainable operation</li> </ul>	<ul style="list-style-type: none"> <li>* Overall GHG emissions marginal</li> <li>* Modifications of the natural water flow can have critical impacts on ecosystems. Appropriate flow management strategies</li> </ul>	<ul style="list-style-type: none"> <li>* Capital costs highly depend on site characteristics</li> <li>* Cost of "pico-hydro" solutions around US\$ 1,500 per kW.</li> <li>* Cost generation systems (mini-grids) vary US\$ 2,000 - US\$ 2,800 per kW <sup>(4)</sup></li> </ul>	<ul style="list-style-type: none"> <li>* Development and commercialization of in-stream turbines will enlarge the applicability of micro-hydro power</li> </ul>
<b>Small Wind Power</b>	<ul style="list-style-type: none"> <li>* Establishment of local technical and managerial capabilities decisive for sustainable operation</li> </ul>	<ul style="list-style-type: none"> <li>* Overall (life cycle) GHG emissions depend on system configuration. It can be as lower as 23 g CO<sub>2</sub>eq/kWh <sup>(3)</sup></li> <li>* Appropriate disposal/recycling schemes necessary (e.g. for batteries)</li> </ul>	<ul style="list-style-type: none"> <li>* Capital costs of whole systems (including batteries, controls etc.) still high: &gt; US\$ 4,000 per kW <sup>(4)</sup></li> </ul>	<ul style="list-style-type: none"> <li>* Efforts in standardizing methods for measuring and reporting technical characteristics needed</li> <li>* Data for wind and production prediction in developing countries often scarce</li> <li>* Cost reductions</li> </ul>

(1) Estimations for on-grid PV system in south Europe in Frankl et al., 2006; (2) estimations for biogas based power generation in Germany in Fritsche et al., 2007; (3) estimations for on-shore wind systems in Europe in DONG Energy, 2008; (4) capital costs estimations for different off-grid options in ESMAP, 2007

## 5 References

- Bajgain, S., Shakya, I., (2005): The Nepal biogas support program. Ministry of Foreign Affairs The Netherlands
- Chen, Y., Yang, G., Sweeney, S., Feng, Y. (2010): Household biogas use in rural China: A study of opportunities and constraints. *Renewable and Sustainable Energy Review* 14 (1), 545-549.
- DONG Energy (2008). Final report on offshore wind technology. Report of the project – New Energy Externalities Developments for Sustainability (NEEDS)
- Energy Forum (2009): Final Report to the Project “Mainstreaming biogas power as an off-grid electricity generating source in Sri Lanka” supported by WISIONS, Unpublished manuscript.
- ESMAP (2007): Technical and Economic Assessment of Off-grid, Mini-grid and Grid Electrification Technologies, Energy Sector Management Assistance Program
- Frankl, P., Menichetti & E., Raugei, M., (2006). Final report on technical data, costs and life cycle inventories of PV application. Report of the project – New Energy Externalities Developments for Sustainability (NEEDS)
- Fritsche, U. R., Rausch, L. & Schmidt, K., (2007): Treibhausgasemissionen und Vermeidungskosten der nuklearen, fossilen und erneuerbaren Strombereitstellung
- GreenEmpowerment (2010): Final Report to the Project “Biogas Digester Innovations in Latin America” supported by WISIONS, Unpublished manuscript.
- IEA (2009). World Energy Outlook 2009, International Energy Agency.
- IEA (2010). World Energy Outlook 2010, International Energy Agency
- IFC (2007). Solar Development Capital: Lessons Learned in Financing Solar Home Systems, in: Monitor, Nr.13, April, International Finance Corporation
- Nyagabona, N.T., Olomi, D. R. (2009): Analysis of the value chain for biogas in Tanzania Northern zone. Policy Innovation System for Clean Energy Security (PISCES)
- REN21 (2008): Renewables 2007 - Global Status Report, Renewable Energy Policy Network for the 21st Century.
- Soluciones Practicas (2009): Technical Handbook. Training material prepared during the Project “Small Wind Power Generation Systems to Provide Clean Energy in Poor Rural Areas of Peru” supported by WISIONS, Unpublished manuscript.
- UN (2009): The Millennium Development Goals Report 2009. New York

## Smart pathways for providing electricity in developing countries

Brijesh Mainali<sup>1</sup> and Semida Silveira

Energy and Climate Studies

Royal Institute of Technology, Stockholm, Sweden

[brijesh.mainali@energy.kth.se](mailto:brijesh.mainali@energy.kth.se); [semida.silveira@energy.kth.se](mailto:semida.silveira@energy.kth.se)

### **Abstract**

*A key objective in the energy agenda of many developing nations is to increase the electricity access rate. Often, the discussion on electrification in developing countries tends to oscillate between the merits of centralized electrification versus decentralized off-grid electrification and both the options are often promoted in parallel. However, the basis for choosing pathways in electrification is not often clear or rational. The role of electricity is beyond household lighting and thus the electrification options need to be analyzed based on their capability to meet the demand for commercial and industrial usage. But it is equally important to address the electricity need of the rural poor who have limited uses of electricity. In the context of scarce resources, least cost options should be searched for looking at what the technology can offer and what the real need is. This study analyses scenario for rural electrification using (i) off-grid isolated renewable energy (RE) technologies viz. solar home systems and wind home systems (ii) mini grids with micro hydro and (iii) considering the case when the national grid connection reaches an area previously supplied with off-grid technologies. The comparative analysis has also been made with the different scenarios with the extension of grid line and supply with the conventional fossil based technology. We have also analyzed different scenarios considering various technical and socio-economic parameters in two country cases Afghanistan and Nepal. Levelized cost of electricity (LCOE) has been taken as the main basis to compare various options. Analysis has shown that the micro hydro technology is the most competitive technologies in both the country cases (Afghanistan and Nepal) compared to individual solar home system and wind home system. In Nepal, the chosen pathway for off-grid electrification with the technology choices of micro hydro and solar PV seems relevant. In Afghanistan, the uses of diesel generator are not the least cost option. Thus, Afghanistan needs to prioritize the micro hydro sector to drive rural electrification in the smart pathways.*

Key Word: Levelized cost, off-grid, mini grid, grid connection, smart pathways

---

<sup>1</sup> Corresponding Author

## Introduction

Electricity has become a part of the modern civilization and is the most common form of energy in use because of its cleanliness, simplicity and its versatility in uses. Despite of century long history of the grid electrification, still large population in the developing world are living either in dark or with alternative arrangement for lighting. In most of the developing countries, electricity market is characterized by low access rate and low load factors (Haanyika, 2008; Mainali and Silveira, 2010). Rural areas in many developing countries are thinly populated and geographically isolated, which means difficult accessibility. This increases the unit cost of electricity delivery (Ashok, 2007; Banerjee, 2006). Even the access areas are of poor supply quality with huge gap between supply and demand, followed by load-shedding, frequent blackouts and high transmission losses. The rural electrification in many developing countries has been implemented on political interest and without the real resource assessment (looking at the cost of electricity generation with different alternatives). The off-grid and on-grid options are often promoted in parallel, many times responding to opportunities generated through international action and donors' programs objectives. Thus, the basis for choosing pathways in electrification is not often clear or rational.

Various literatures are available on the discussion about off-grid technologies with system design, policies and programmes, and economic analysis (Martinot et al., 2001; Arun et al., 2007; Chaurey and Kandpal, 2010; Kumar and Banerjee, 2010; Brent and Rogers, 2010). Nguyen (2007) examined the economic feasibility of two off-grid technologies i.e. solar PV and wind power in the context of rural Vietnam, looking at their levelized cost of generation. Thiam. (2010) has analyzed alternative pathways (off-grid technologies versus on-grid) in the context of Senegal by adopting similar methodology as of Nguyen (2007) with additional consideration of environmental externalities. Some other literatures are also available on off-grid technologies with mini grid systems and the grid connection (Wamukonya and Davis, 2001; Oparaku, 2003; Nfah et al., 2008; Kirubi et al., 2009; Kumar et al., 2009).

This paper basically follows the same methodology as followed by Nguyen (2007) and Thiam. (2010) and looks at the various alternative pathways for rural electrification in Afghanistan and Nepal. The paper analyses rural electrification scenarios with (a) various renewable energy (RE) technologies of individual household system, (b) using mini grids with micro hydro, and (c) also the case when the national grid connection reaches in an area which is previously supplied with off-grid technologies. Levelized cost of electricity (LCOE) has been taken as the main basis to compare various options. Three reference technologies Solar PV system, Micro hydro and Wind generators are chosen for the analysis. The study has chosen the two countries Afghanistan and Nepal, due to some similar characteristics such as both of these countries are landlocked, and economically among the poorest countries in the world, and politically both have passed through a long history of conflict and insurgency. Similarly from the resource perspectives, both the countries have similar average solar intensity in the range of  $200 \text{ w/m}^2$ , and both have hilly terrain areas having huge potential for micro and small hydro powers for rural electrification. Wind potential has not been harnessed in both the cases, but could be explored in future. In the case of Nepal, efforts have been made to collect the data on

solar insolation and wind velocity by Solar and Wind Energy Resource Assessment (SWERA), unit supported by UNEP/GEF while Afghanistan is far behind in this regards.

The first section paper highlights the general energy situation in Afghanistan and Nepal. The methodology that has been adopted for the analysis of Levelized cost of electricity (LCOE) of various reference energy technologies has been discussed in the second section and result and analysis have been discussed in the third section. Conclusions from this study have been drawn in the fourth section. This paper will help the policy makers and planners of these countries to understand the cost behind following different technological pathways and decide on the appropriate technology choice depending upon the local need and the resource potentials.

### **1.1 Energy situation in Afghanistan**

Afghanistan is a landlocked country with an area of 647,500 square kilometer, and is bounded by the northern latitude of 29°30'N, and 36°20'N and the eastern longitudes 61°25'E and 71°08'E. The damage in the infrastructure because of decade's long political insurgency, poor maintenance, lack of investment, and poor technical and management capacity had pushed the development of Afghanistan several years back (SARI-Energy, 2010). Before 1978 i.e. before the conflict, the total installed power capacity in the country was 396 MW (the large hydro installation of 259 MW and thermal diesel power plants of 137 MW), and in 2002 i.e. just after the end of insurgency, the country's functional installed capacity was decreased to 243 MW (the large hydro installation of 140 MW, thermal diesel power plants of 16 MW and imported power from neighboring country of 87 MW). Huge international support has been channeled in Afghanistan since 2002 for its rehabilitation and infrastructure development. As a result, the country's electricity generation has been increased to 464 MW (with large hydro installation of 183 MW, thermal power plants of 88 MW, imported power from neighboring country of 96 MW and off-grid micro hydro of 14.84 MW) by 2007 (MOEW, 2007). The electricity access rate in Afghanistan is still very poor with 14.4 % covering 22% in the urban areas and 12% in the rural areas (IEA, 2008). This indicates a huge challenge ahead for Afghanistan for electrifying all its populations. Connecting rural people is crucial, but the process is expensive and complicated. The pace and the pathways that Afghanistan will take in its process of rural electrification are important for the rural poverty alleviation.

### **1.2 Energy situation in Nepal**

Nepal is also a landlocked country having an area of 147,181 square kilometer (4.4 times smaller than Afghanistan) and is circumscribed by the northern latitudes of 26° 22' and 30° 27', and the eastern longitudes of 80° 04' and 88° 12'. Nepal is largely dependent on traditional non-commercial fuels such as fuel wood, agricultural residues and animal dung to fulfill its energy demand. The change in the fuel mix has been marginal since 1975, going from 89.2% to 87.1% in 2009, while most of the increase in energy demand has been met with traditional biomass. The hydroelectricity share of the total energy use in Nepal increased from 1.2 % (1975) to 2.0% (2009) (Shrestha, 1981; WECS, 2010). As



of 2008, 43.6% of the total population of Nepal has access to electricity; with the electrification access rate of 89.7% in the urban areas and 34% in the rural areas (IEA, 2008). Government policies in Nepal promote both on-grid and off-grid solutions for rural electrification. On-grid electrification is developed by Nepal Electricity Authority (NEA), the national utility accountable for generation, transmission and distribution of electricity. Off-grid electrification is promoted by Alternative Energy Promotion Centre (AEPC), the government body formed to promote alternative energy technologies. Micro hydro and solar technologies are the current choice in Nepal, because of the provision government subsidy support under two major programmes: Rural Energy Development Programme (REDP) and Energy Sector Assistance Programme (ESAP).

The contribution of electricity generation from off-grid technologies (solar PV and micro hydro) has been doubled in last eight years i.e. from 0.8% (2000/01) to 1.7% (2008/09) of the total electricity supplied. The contribution of micro hydro and solar PV is shown in the table 1.

Table 1: Contribution of Micro hydro and Solar PV in GWh from 2000/01-2008/09

Fiscal Year → Technology ↓	00/01	01/02	02/03	03/04	04/05	05/06	06/07	07/08	08/09
Micro hydro	10.58	11.42	13.11	14.50	15.81	18.08	25.06	31.30	37.77
Solar PV	0.083	0.250	0.472	0.611	0.750	0.806	0.861	1.139	1.556

(Source: WECS, 2010)

The government of Nepal has given priority for rural electrification with clearly defined subsidies policies, which has helped in the formation of market and promote electrification using renewable technologies (Mainali and Silveira, 2011). In addition, a well-defined quality assurance system has made the technology market reliable and presence of users association, manufacturing/installation companies and their dealers' network, local NGOs and credit institutions have more or less given tangible shape to the market (Mainali and Silveira, 2010).

## 2. Methodology

As mentioned earlier, three reference energy technologies viz. solar PV, micro hydro and wind technologies have been taken for the alternative scenario assessment. The methodology developed in this study is elaborated form of the methodology used by Nguyen (2007). The comparative scenario with fossil based generation is also analyzed and the electrification scenario with central grid extension is also looked at. In addition, the paper has also analyzed the scenario with grid connection of the isolated micro hydro plants, if the grid line reaches the vicinity. Selection of technology, estimation of the energy output from those selected technologies and their economic analysis create a basis for judging the alternative pathways. Levelized cost of electricity (LCOE) for these various scenarios will allow in making comparative analysis. The sensitivity analysis is also carried out to look at the relation of these LCOE from various technologies with variation in the load factors, rise in the fuel price (in case of fossil based technology), distance from the grid lines, load densities and also with the subsidy level. This assessment has been done in the case of Afghanistan and Nepal. The situations have

been further compared with the case study of Vietnam, done by [Nguyen \(2007\)](#). The data for this analysis has been collected from various projects implemented under Alternative Energy Promotion Centre/Ministry of Environment, Rural Energy Development Programme (REDP) supported by United Nation Development Programme (UNDP) and World Bank (WB), Regional Renewable Energy Service Centres (RRESC) of Energy Sector Assistance Programme (ESAP) and the private companies from Nepal. In case of Afghanistan, availability of systematic data was a major constraint noticed during the time of study. Data were collected from National Solidarity Programme (NSP) and National Area Based Development Programme (NABDP) under Ministry of Rural Rehabilitation and Development and supported by UNDP in case of Afghanistan.

## **2.1 Technology selection and energy estimation**

Stand-alone technology like solar home systems (SHS), wind home systems (WHS) and micro hydro are the promising off-grid technologies for remote rural electrification in Nepal. Wind technology is not much explored in Nepal other than wind resource mapping under the support of United Nations Environment Programme (UNEP) and some small wind generators for the demonstration. Diesel generator set is hardly used in few accessible places where there is no grid lines. In this paper we analyze the scenarios with solar home system of 40 Wp, wind generator set of 400 Wp, and micro hydro of 25 kW and 50 kW. The analysis will also look at the alternatives supplying with diesel generator, and also connecting the household with national grid extension. After the huge investment in micro hydro power for the off-grid electrification and rapid expansion of grid electricity under community rural electrification project of NEA, the distance between grid and some of the micro hydro project area is reducing significantly in Nepal. So, we have also looked at the LCOE with micro hydro connected with grid.

In case of Afghanistan, the source of electricity is mainly micro hydro power, private diesel generators and solar PV. No records on the exploitation of wind energy were found. We analyze the levelized cost of solar home system (60 Wp), micro hydro (25 kW and 50 kW) and diesel generator (20 kW).

After the choice of the reference technologies for the analysis, we will estimate the availability of the energy with these various renewable energy technologies. The energy produced by these technologies is location specific and hence differs in case of Afghanistan and Nepal. The amount of energy generated depends on the metrological conditions and it has been estimated based on the yearly average data of the resources.

The annual average solar insolation in Nepal varies from 3.5–8.5 kWh/m<sup>2</sup>/day ([NREL, 2007a](#)) and the estimated days for sun shine in a year is 300 days ([WECS, 2010](#)). Similarly, the average solar insolation intensity is 200 watt/m<sup>2</sup>. The annual average solar insolation in Jhapa, Biratnagar and Chitwan districts are comparatively lower whereas Dolpa, Mugu and Mustang have higher average solar insolation among all the 75 districts. In case of Afghanistan, the annual average solar insolation is varying from 4.5 to 7.0 kWh/m<sup>2</sup>/day ([NREL, 2007b](#)), and the estimated sun shine days in a year is 300 days ([Meisen and Azizy, 2008](#)). Most of areas have good solar insolation. Kandahar and

Hilmand provinces have comparatively higher solar insolation while Badakshan and Takhar provinces have lower solar insolation among the provinces.

The electricity generated by a solar PV system depends upon the surface area, daily solar insolation incident and the time of the exposure to the sun. The annual energy produced by a solar panel can be expressed as equation (1)

$$E_s = \eta_s * (I) A_{\text{surface}} * 365 \dots \dots \dots \text{eq. (1)}$$

Further, the surface area can be expressed in terms of the nominal power of the module and the isolation also depends upon the surface orientation. With an assumption that the surface of the module is tilted at an angle equal to the latitude of the location and further expressed as equation (2).

$$E_s = \eta_s * (I) (W_p / I_0) * 365 \dots \dots \dots \text{eq. (2)}$$

Where,  $\eta_s$  is the system efficiency including battery charging and discharging, charge controller and wirings. “I” is the annual average solar insolation kWh/m<sup>2</sup>/day;  $W_p$  is the peak capacity of the module and “ $I_0$ ” is the standard insolation (1000 watt/m<sup>2</sup>) chosen for defining the watt peak of the solar modules by the manufacturers (Luque and Hegedus, 2003).

Wind energy is one of the potential energy resources and could be good for exploring in case of rural electrification. However, this technology has not been harnessed so far both in Nepal and Afghanistan. In case of Nepal, five wind anemometer stations were installed in 2001 by Water and Energy Commission Secretariat (WECS), especially for analyzing the possibility of wind resource for generating electricity. These stations were later handedover to Alternative Energy Promotion Centre, which has been actively involved in exploring the resource map for wind generation under Solar and Wind Energy Resource Assessment (SWERA) since 2003. So in this study, wind energy alternative has been explored in two places namely Ramechhap and Kagbeni. The average wind speed at the height of 10 m altitude has been taken from SWERA (2006). The annual average wind speed in Ramechhap is 3.4 m/s and in Kagbeni is 6.5 m/s. Ramechhap represents the the place having medium wind speed in the country where as Kagbeni is one of the places having high wind speed.

For the wind turbine, the power output varies with the cube of the average wind speed. So, wind velocity is very sensitive in determining the power. Further, for estimating the quantity of energy produced by a wind turbine, sound knowledge on the wind distribution pattern of the location is necessary. Though the wind distribution varies from site to site, the distribution normally follows a Rayleigh distribution function, which is basically probability density function. If we look at such distribution, the probability of winds occurring at low speeds and at high speeds are minimum and the probability of the middle speed are maximum (Masters, 2004).

The Weibull function further simplified the distribution function and represents the wind speed distribution well enough as shown in the equation 3..

If  $V_a$  is the average wind speed, then the probability function  $f(v)$  to have the wind speed of  $v$  is expressed as

$$f(v) = \pi v / 2 (V_a)^2 * \exp\left[(-\pi/4)(v/V_a)^2\right] \dots \dots \text{eq. 3.}$$

The annual energy production from a wind turbine in a location with an annual average velocity of  $V_a$  using following equation (Nguyen, 2007).

$$E_w = \sum_{v=1 \text{ to } 25} \eta_s * f(v) * P(v) * 8760 \dots \dots \text{eq. 4.}$$

Where,  $P(v)$  is the turbine power at speed  $v$ ;  $f(v)$  is the probability density function.  $\eta_s$  is the system efficiency.

In Nepal, micro hydro and pico-hydro plants are run of river type and are designed with 11 month exceedance flow (i.e. the design discharge should be available at least 11 months of the year), while no fix set criteria was found in the case of Afghanistan. So in case of micro hydropower, we have assumed here that the availability factor is 90%. Mini grid option of supplying the rural areas with these micro hydro power plants has also been analyzed in this paper.

The concept of connecting small generating units to the grid is not new. This is a proven technology and has been in practice in many countries. However, connecting small generating plants operating in the remote location is relatively emerging issues in context of rural electrification in many developing countries. The connection of such plants in the grid needs to look beyond the technology. This has to be judged from various points including technical requirements, economic sense and socio-economic benefits. In this paper, we have looked at the economic significance in connecting such isolated plants in grid. What if a grid line reaches the area which is previously supplied with the off-grid technologies? Is this means a threat to off-grid technologies or this can be seen as a complementary action and a way forward in the direction of creating smartening the rural electrification for future.

## 2.2 Economic Analysis

Resource availability and the economic analysis of selected energy technologies help to select the smart pathway among available alternatives. We have adopted Levelized cost of electricity (LCOE) as a major tool for the comparison, along with the estimated energy output. The financial and economic data are then analyzed to calculate the LCOE of various reference technologies.

### *Calculation of levelized cost of electricity*

The levelized cost of electricity (LCOE) is a means to compare alternative technologies with different scales of operation, investment or operating time periods. Levelized cost is the average cost per kWh of useful electrical energy produced by the system over the life period.

$$LCOE = \frac{\text{Total life time cost of the project}}{\text{Total life time useful electricity produced}} \dots \text{eq. 5}$$

LCOE is the net present value of total life time costs of the project divided by the quantity of energy produced over the system life. The levelized cost model used in this paper has been represented in the figure 1. LCOE provides the information on the relative cost competitiveness of technologies and a transparent method to show the key factors affecting the costs of different technologies (Allan et al., 2010; Gross et al., 2010). Metrological information is important to look at the resource potential of any technology for a particular location. The parameters associated with the system reliability like life spans of the component and system, system degradation rate (not considered in this paper), plant outages are also important input in estimating LCOE. Similarly, the performance indicators such as system losses and efficiency, plant availability factors and load factors, financial parameters such as system capital cost, installation cost, operation and maintenance cost, discount rate, price escalation rates are also important factors in determining the LCOE of any technologies. In this section we will discuss the method of calculating the levelized cost of various different technologies.

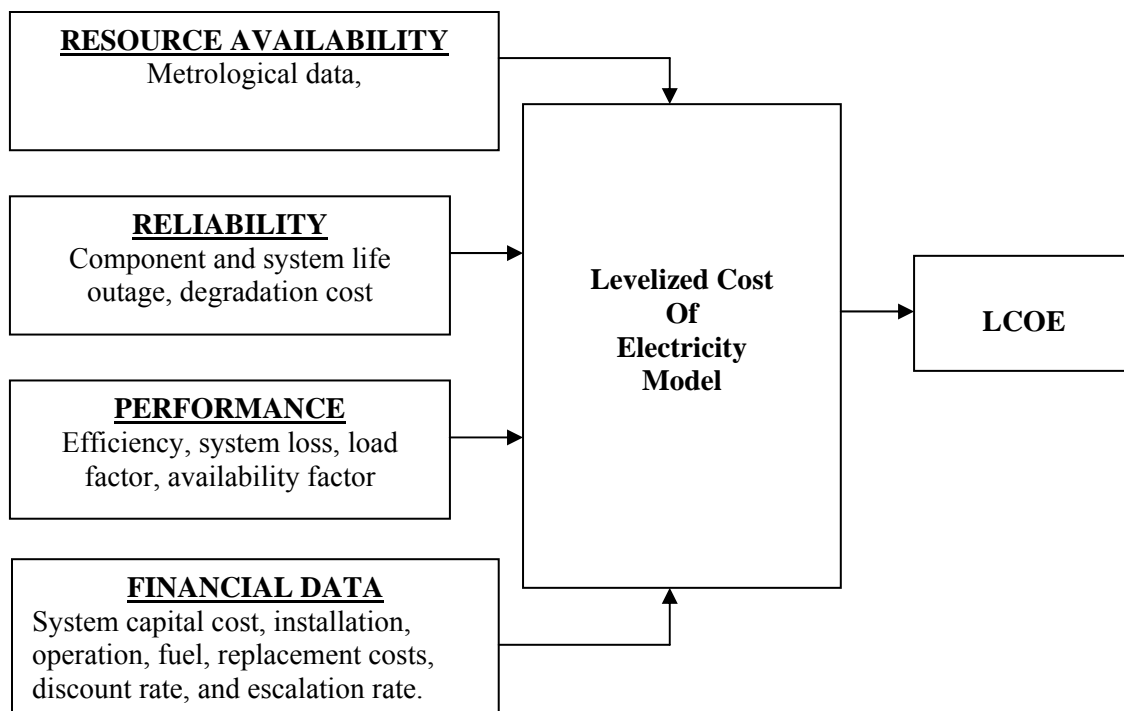

Figure 1: LCOE Model

The total life time cost of the project is the sum of the annualized capital investment ( $C_c$ ) and the annualized production cost which is further divided into fixed and variable operational/maintenance cost ( $C_{om}$ ), fuel cost ( $C_f$ ) if applicable and the replacement cost ( $C_r$ ) of the components those have shorter life span than the total life span of the evaluation period. This annualized cost is basically the discounted costs that incurred each year and summed over the life. The amount of the useful electricity produced over the total life period of the system ( $E_l$ ) is calculated by determining the annual electricity

production, divided by the anticipated load factor over the life period, which is then discounted based on a derived discount rate. Therefore, this can be represented as follows in the equation.

$$LCOE = \frac{C_c + C_{om} + C_r + C_f}{E_l} \dots \dots eq 6$$

*Capital costs* ( $C_c$ ) are the initial investment for purchasing equipment and installing them before the system is placed in operation i.e. in year zero. If the initial investments have been made in several years before the plant comes in operation, then all those investments should be discounted to the year zero (year of plant operation). This can be applicable for the micro hydro installation which might take few years to be installed. The residual value of the plant after its life time and the system degradation factor has not been taken into account for the simplification.

*Operation and maintenance costs* are the cost that incurred during the operation of the system. This includes the recurring cost each year spent for staffing and repairing and maintaining the components as and when required. The operation and maintenance cost are comparatively low for renewable energy in comparison to the fossil based conventional technologies. If “AOMC” represents the annual operation and maintenance cost of the year one,  $e_0$  is the general escalation factor and  $r$  is the discount rate, the annualized operation and maintenance cost ( $C_{om}$ ) can be expressed as:

$$C_{om} = AOMC * \left( \frac{1+e_0}{r-e_0} \right) \left( 1 - \left( \frac{1-e_0}{1+r} \right)^N \right) \dots eq. 7$$

*Replacement Cost* is associated with the investment needed for replacing those equipment or the components in the system that has relatively shorter life span than the project under evaluation. The replacement cost can be expressed as:

$$C_r = \sum_{i=1}^v \left\{ Item Cost_i * \left( \frac{1+e_0}{1+r} \right)^{N_R} \right\} \dots eq. 8$$

Where,  $Item Cost_i$  is the replace cost of the item “I” with the life span of  $N_R$ . “ $v$ ” is the numbers of components to be replaced.

*Fueling Cost* represents the cost invested in the consumption of the fossil fuels, in the case of operation of conventional diesel generators. If “AFC” is the annual fuel cost and  $F_f$  represents the yearly increment in the fossil fuel price, then annualized fuel cost over the project period is represented by:

$$C_f = AFC * \left\{ \left( \frac{1 + F_f}{r - F_f} \right) * \left[ 1 - \left( \frac{1 + F_f}{1 + r} \right)^N \right] \right\} \dots eq. 9$$

In this study, we have taken the general escalation based on the projected inflation rate between 2011 and 2015 using the data of International Monetary Fund (IMF) (For the

case of Nepal, it is 5% (Trading economics, 2011a), and for the case of Afghanistan, it is 4% (Trading economics, 2011b). The bank's nominal interest rate in lending is 16% (Nepal) and 18% (Afghanistan).

#### *Discount Rate*

The role of discount rate is important in estimating levelized cost. This is the real annual interest rate also called the real interest rate, which is used to convert between one-time costs and annualized costs. The annual real interest rate is related to the nominal interest rate of the bank and has relation with the inflation rate. This is represented in the equation as:

$$\text{Discount Rate}(r) = \frac{(\text{Nominal interest rate} - \text{Inflation rate})}{(1 + \text{Inflation rate})} \dots \text{eq. 10}$$

Thus, discount rate adopted for the calculation is 10% (Nepal) and 13% (Afghanistan).

*Life time electricity* is the present worth of the total life time useful electricity ( $E_l$ ) produced over a life span of  $N$  year and discounted at the rate "r". If "E" is the energy produced annually, then:

$$E_l = E * \left[ \frac{1 - (1+r)^{-N}}{r} \right] \dots \text{eq. 11}$$

### **3. Result and Analysis**

#### **3.1 Levelized cost of the Solar Home System (SHS) and Wind Home System (WHS)**

Individual home system for the electricity is increasing popularly in the rural areas to meet their basic electricity needs mainly for lighting. Among them, solar home systems (SHS) have widely been used in the scattered rural areas of developing countries (Chaurey and Kandpal, 2010; Rai, 2004). The dissemination of solar PV systems has been significantly increased in the last decades in the rural electrification of Nepal (Mainali and Silveira, 2010), and this technology is also getting popularity in the remote areas of Afghanistan. Afghanistan is a Sunbelt country with huge potential of solar energy including solar PV Burns (2011). However, as mentioned earlier, wind resources have not been explored in both countries (Afghanistan and Nepal). Wind mapping started in Nepal in 2003 with the support of SWERA, but no wind mapping activities were reported in the case of Afghanistan. SHS basically comprises solar PV modules, a bank of battery, charge controller and supplies the DC output. DC appliances like CFL lamps, TVs and small radios are the most commonly used loads which are served by such kind of system. Wind home system (WHS) also has a wind generator and its mounting accessories and other components are similar as mentioned in the case of SHS. In this section, the levelized cost of isolated home technologies viz.: SHS of 40 watt peak and WHS of 400 watts rated output (for Nepal) and SHS of 60 watt peak (for Afghanistan) have been estimated. The technical and economical parameters of the SHS and WHS with detail breakdown have been presented in table 1.



With the life span of 20 years for solar modules, 3 years for batteries and 10 years for the charge controllers and 0.5% of the total cost of the system as operational and maintenance cost, the LCOE was in the range of 0.61 to 0.90 USD/kWh in case of Nepal and 0.98 to 1.54 USD/kWh in case of Afghanistan. The variable range of LCOE within the country is because of variation in the insolation level available at different places. The lower value of LCOE is for higher insolation. In another study carried out in India, LCOE from a 35 Wp system was estimated to be 0.864 USD/kWh (Chaurey and Kandpal, 2010). The solar insolation used in the case of India was 5.0 kWh/m<sup>2</sup>/day and day of operation of 365 days a year. The other conditions were more or less same. Only the major difference was the chosen discount rate (0.12 in case of India).

Table 1: Technical and economical parameters of SHS and WHS (2010)

Country	Afghanistan		Nepal	
	Description/Specification	SHS <sup>a</sup>	SHS <sup>b</sup>	WHS <sup>c</sup>
Module capacity in watt		60	40	400
System cost in USD		305	132	1889
12 V-Battery AH-capability		100 AH	36 AH	4x100AH
Battery life time in years		3	3	3
Battery cost in USD		135	56	289
Charger controller life in years		10	10	10
Charge controller cost in USD		30	14	125
Lighting and others cost in USD		13	17	50
Installation /transportation		60	25	174
System life time		20	20	20
Annual operational and maintenance cost (0.5% for SHS and 2.5% for WHS)		27	12	39
Solar insolation kWh/m <sup>2</sup> /day		4.5-7.0	3.5-8.5	-
Average wind velocity (m/s)		-	-	3.4-6.5
Levelized cost in USD/kWh		0.98-1.54	0.61 -0.90	0.46-3.2

Data Source: MRRD/UNDP. Afghanistan <sup>a</sup>; Dibya Urja Pvt. Ltd, Nepal <sup>b</sup>; Krishna Grill, Nepal <sup>c</sup>

In case of Vietnam, LCOE was varying from 0.671 USD (in the south) to 0.840 USD (in the north) (Nguyen, 2007). The methodology and the assumed parameters are more or less similar in both of these cases. Besides, the LCOE from solar PV is comparatively less in Nepal than that in case of Afghanistan. The reasons behind are the risk factor associated in the business due to security reasons and also the weakly formed market infrastructure in the case of Afghanistan, where as the solar PV market has well defined structure in the case of Nepal (Mainali and Silveira, 2011). The huge investments in research and development of solar PVs from mid-seventies to mid-eighties helped to



bring down the cost of solar PV modules from \$600/Wp to \$5/Wp while overall efficiency improved three fold (Erickson and Chapman, 1995). The cost of solar PV system has been come down with the technological learning-by-doing and economies of scale (Ferioli et al., 2009). The technological learning rate of solar PV modules over the last 20 years varied from 18% to 23%, which means that there has been a reduction in the cost of the module by 18%–23% per doubling of cumulative installed capacity (Sanden, 2005). So with the increase in the learning rate, the LCOE of solar PV system is also expected to go down. The LCOE for wind home system is varying significantly (0.46-3.2 USD/kWh) depending upon the wind speed. The wind energy market in Nepal is on the very primitive level and there are very few companies that manufacture the wind turbine at the local level. This cost also could go significantly down in case of the expansion of the market in the future. So, some initial support in terms of technical and financial assistance deemed necessary for the wind sector to form the market infrastructure.

### 3.2 Levelized cost for Micro Hydro (MH) Plants

Micro hydro is very site specific technology and the cost may vary a lot depending upon the physical features of the major components namely civil components like water way, electromechanical equipment like turbine, generator, load controller, protection system and electrical transmission distribution system. In general, the study has shown that cost of the MH projects decrease with the size of the plants (Mainali and Silveira, 2011).

The average installation cost of typical 25 kW and 50 kW size micro hydro projects were adopted for the reference for both the case of Nepal and Afghanistan. Operation and maintenance cost (O & M cost) has been assumed 5% of the installation cost. Small and minor replacement may be needed in the power plant during its life span, but small hydro power can be operated its full life span without any major replacement cost (Lako, 2010). These small replacement cost are taken into account in the regular operational and maintenance cost. Normally, construction of micro hydro may take 1.5 to 2.5 years. In this analysis, we have assumed that the construction period is 2 years with equal distribution of the investment for both two years. The other assumptions regarding plant availability factor, load factor for islanded mode and life span of the projects are mentioned in Table 2.

Table 2: Information on cost and other parameters for different size MH projects (2010)

Countries	Nepal		Afghanistan	
Description /Plant Size→	25 kW	50 kW	25 kW	50 kW
Installation cost per kW in 000 USD	2.8-3.5	2.5-3.0	3.0-4.0	2.5-3.5
Yearly O & M cost in terms of total project cost	5%	5%	5%	5%
Availability factor	0.9	0.9	0.9	0.9
Load factor	0.3	0.3	0.2	0.25
Life span	20	20	20	20
Levelized cost in USD/kWh	0.28-0.35	0.25-0.30	0.50-0.67	0.34-0.47

*Data Source: RRESCs, ESAP, Nepal and MRRD/UNDP, Afghanistan.*

The Levelized costs were varying within 0.28-0.35 USD/kWh for the plant of 25 kW and 0.25-0.30 USD/kWh for the plant size of 50 kW in case of Nepal. In other hand, the levelized costs in the case of Afghanistan were higher compared to Nepal. The LCOE were varying from 0.50-0.67 USD/kWh for the plant of 25 kW and 0.34-0.47 USD/kWh for 50 kW plant. This shows that the variation of LCOE with the size of the technology is insignificant rather it varies mainly with the initial capital cost for construction/installation of project, and this can vary significantly in case of MH projects depending upon the site specific conditions. The higher LCOE in case of Afghanistan is due to high installation cost per kW and comparatively low average load factors.

### Sensitivity Analysis

Sensitivity analysis gives the scenario on how the changes in particular parameter impact the cost analysis of different generation technologies. The variation of LCOE with load factor has analyzed in this section. The sensitivity analysis has been done for a 25 kW micro hydro project with higher range of cost per kW.

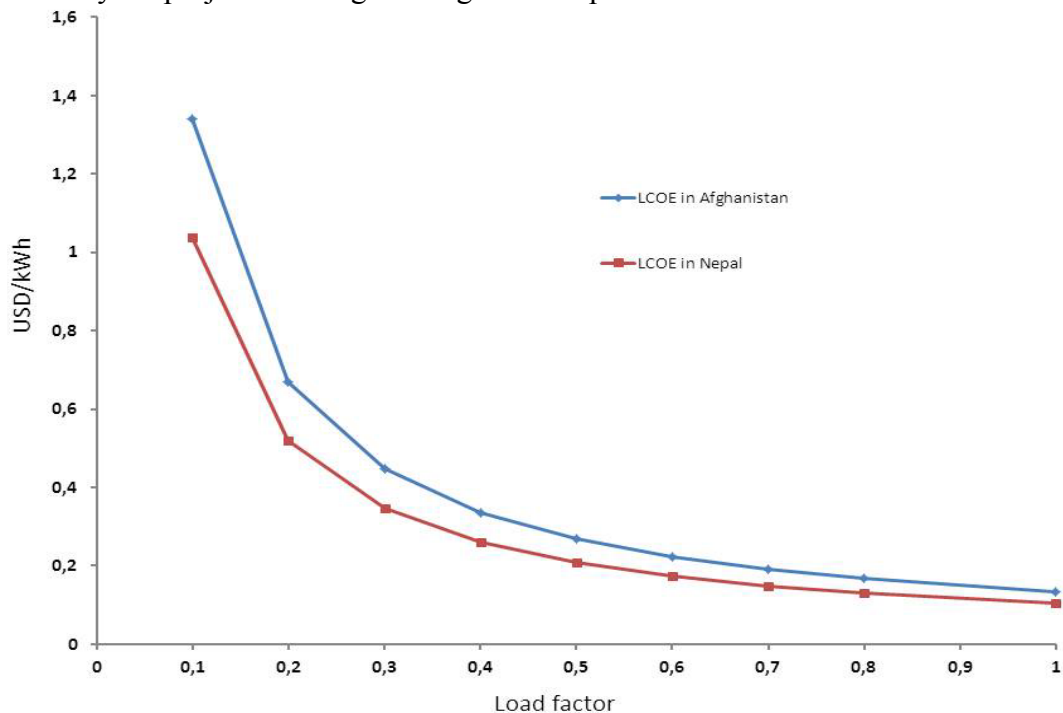

Figure 2: Variation in LCOE from MH project with change in load factor.

Figure 2 shows that LCOE decreases when the load factor increases. The sensitivity of LCOE is high with the load factor below 40%. Once load factor crosses 40%, the variation in LCOE is less significant as that of in the low load factors. Normally, the rural electrification is characterized by low load factor resulting in high LCOE. So, the productive end uses promotion in the rural electrification projects is important for making these projects financially attractive.

### 3.3 Serving the rural areas with national grid

When looking at the scenario serving the rural areas with the grid line, how effective is the cost to serve rural areas with grid is an interesting question. In Nepal, about 185,000 households have been provided with the grid line extension under community rural electrification programme with 1781 Km of transmission lines (Medium voltage), 5792 Km of distribution lines (low voltage) and 2905 numbers of transformers installed by the end of FY 2009/10 (NEA, 2010). Afghanistan has a huge challenge to extend the grid based rural electrification because of difficult terrain and scattered settlements (Hallett, 2009). In Afghanistan, the transmission grid infrastructure has been badly damaged due to war (MoEW, 2007), and it will take several years to recover all these lines in the system. Therefore, extension of grid in rural areas might not be their prior issue at present. We have analyzed here the extension of grid scenario in the case of Nepal.

The cost for extending grid line in rural areas depends on the average energy consumption per household (energy demand), the number of household to be connected in unit square kilometer periphery of service area (load density), number of household to be served and the distance from the gridline. Productive end uses and future load growth also can impact on the levelized cost with the grid connection in the selection of the path, if the rural areas have a high possibility of the rural industries and high load growth rates. For simplicity we have not considered these two factors in our estimation.

In the context of Nepal, 90% of rural customers of the gridline consume less than 20 kWh per month (units fixed for the lifeline tariff) (ADB-NEA, 2004). In this analysis, we have assumed the average household consumption as 18 kWh. The analysis has been done with combinations of the following variable sets, which resembles the rural conditions of Nepal: (i) the load density of 25 household per Km<sup>2</sup> to 150 household per Km<sup>2</sup>, (ii) household to be served from 50 to 1000 and (iii) distance of grid line medium voltage substation between 4 Km and 25 Km.

For the analysis of grid extension cost, the marginal cost of electricity supply to the load centres is also needed. ADB (2004) has used Average Incremental Cost (AIC) as a subset of marginal costing techniques and adopted as a proxy in electricity system analysis in Nepal. This cost has been estimated to be 5.83 cents/kWh for the year 2014 (ADB, 2004). We have also used the same value for this analysis. Besides, transmission and distribution cost per Km has been estimated using unit cost model based on the current market price. The analysis is then done with the technical and economical parameters as given in table 3.

Table 3: Technical and economical parameters for grid extension to rural areas in Nepal

Description/Specification	Value
Discount factor	0.1
Gen escalation factor	0.03
<b>Transmission line</b>	
AIC of electricity supply (USD/kWh)	0.058
11 KV line extension cost (USD/Km)	4608.3
Annual O and M cost of 11 KV transmission line including transformer (USD/Km/yr)	252.1
Transformer 11 KV	3796
<b>Distribution line</b>	
Distribution line length per Km <sup>2</sup> load area (Km/Km <sup>2</sup> )	4
Distribution line extension cost (USD/km)	2403
Annual O and M cost of distribution line (USD/Km/yr)	120.2
Service wire connection and house wiring (USD/HH)	83
Overall transmission/distribution line loss	0.1
Life span	40

Source: NEA, 2011; ADB, 2004 and estimation using unit cost model

Table 4: Levelized cost of electricity from the grid (USD/kWh) in Nepal

Load Density (household/Km <sup>2</sup> )	Households to be connected in grid				
	50	100	200	500	1000
MV substation distance= 6 KM					
25	0.582	0.376	0.274	0.212	0.192
50	0.543	0.338	0.235	0.173	0.153
75	0.530	0.325	0.222	0.161	0.140
100	0.524	0.318	0.216	0.154	0.134
150	0.517	0.312	0.209	0.148	0.127
MV substation distance= 10 KM					
25	0.822	0.497	0.334	0.236	0.204
50	0.784	0.458	0.295	0.198	0.165
75	0.771	0.445	0.282	0.185	0.152
100	0.764	0.439	0.276	0.178	0.146
150	0.758	0.432	0.269	0.172	0.139
MV substation distance= 20 KM					
25	1.424	0.797	0.484	0.296	0.234
50	1.385	0.759	0.446	0.258	0.195
75	1.372	0.746	0.433	0.245	0.182
100	1.366	0.740	0.426	0.238	0.176
150	1.359	0.733	0.420	0.232	0.169
MV substation distance= 25 KM					
25	1,725	0,948	0,559	0,326	0,249
50	1.686	0.909	0.521	0.288	0.210
75	1.673	0.896	0.508	0.275	0.197
100	1.667	0.890	0.502	0.268	0.191
150	1.660	0.883	0.495	0.262	0.184

The levelized costs of electricity (LCOE) in case of grid line extension have been tabulated in table 4 with combinations of multiple scenarios. LCOE from a grid extension is depends largely on the numbers of household to be served, followed by the load density and then the distance from the MV substation of the grid line. The table shows that serving a village with 1000 households with the load density of 150 household/Km<sup>2</sup> and 6 Km from the MV substation has the minimum LCOE (0.127 USD/kWh). Whereas, the LCOE for serving a village of 50 households, with scattered settlement (25 Household/Km<sup>2</sup>) and 25 Km away from the MV substation is very high (1.75USD/kWh). If we compare the LCOE with grid with other renewable energy technology, it is clear that if there are large numbers of clients and load density is high, the grid connection can be competitive. But as most of the rural areas are characterized by scattered settlement, less households to be served which are far away from the grid lines, renewable energy technology are more competitive on such cases.

### **3.4 Connection of micro hydro in National Grid line:**

The off-grid and on-grid options are often promoted in parallel for electrification in many developing countries like Nepal, and basis for the choice is not very clear. In this context, least cost options in face of scarce resources have seldom been searched. However in Nepal, there has been huge investment in off-grid electrification by the two national programmes (REDP and ESAP) as well as rapid expansion of grid electricity under community rural electrification project of Nepal Electricity Authority. This has apparently reduced the distance between national grid line and existing micro hydro project significantly in some of the areas. This has led to a question in the pathways of rural electrification. What if the grid line reaches the location where there exists micro hydro or what if small power developers serving the rural areas in islanding mode (isolated mode) also wants to connect the plant in the remote ends?

Is this scenario a conflict between on-grid path and off-grid path or they can be complement each other's and serve in a better way? This section has analyzed and discussed the issue of connecting micro hydro in grid line.

There are no hard and fast definitions and guidelines for what size of micro hydro can be connected and at what voltage level. Site specific studies need to be performed to look at local network situation and cost of connection to the grid. Literatures ([Spooner and Harbidge, 2001](#); [AEP-ESAP, 2005](#); [Marsh, 2004](#); [Muñoz et al., 2010](#)) are available on the standards of grid connection and review of various issues related with technology and legislation specific. There are various factors which determined the feasibility and cost of connection to the grid. The voltage of the local network and the grid at which the system need to be connected; size and type of generating units to be connected; distance of the existing grid line from the point of interconnection; present fault levels and fault rating of equipment on network; existing local substation arrangements, such as output profile and fault contribution of new generator are the parameters that determines the feasibility. Some of the above issues are of more technical importance while some have financial significance. In this paper we have discussed only the financial aspect and therefore, looked at the levelized cost of micro hydro power plant if connected in the grid, and

serves both the islanded and the off peak loads to the grid. It has been assumed that the energy that are excess from supplying the islanding mode load will be sold to gridline.

The possibility of connecting various sizes of micro/mini hydro plants ranging from 25 kW to 500 kW at the low voltage of 400V grid line has been discussed here considering the entire technical requirement as prevailed by the grid connection standards. The transmission line extension cost which is needed for connection to grid has been based on unit cost model, developed on the basis of the recent market price. The upgrading cost (additional equipment/systems for grid connection) has also been based on the current market price. The analysis has been done with the assumption of point of interconnection (POI) at the grid line at the distance of 4 km from the existing micro hydro system.

**Low voltage 0.4 kV point of interconnection (POI)**

The cost scenario has been analysed for the case of grid at the distance of 4 km from the micro hydro/mini hydro power plant. The point of interconnection has been put in the low voltage side at 0.4 kV. Over voltage, under voltage, over current, earth fault relays and reverse power relay with Contactor switch and Molded Case Circuit Breaker (MCCB's) with synchronization panel has been proposed for the interconnection. The details layout for POI at 0.4 kV has been shown in Figure 3 as an example. The POI can be also in 11 kV, which has not been discussed here in this paper.

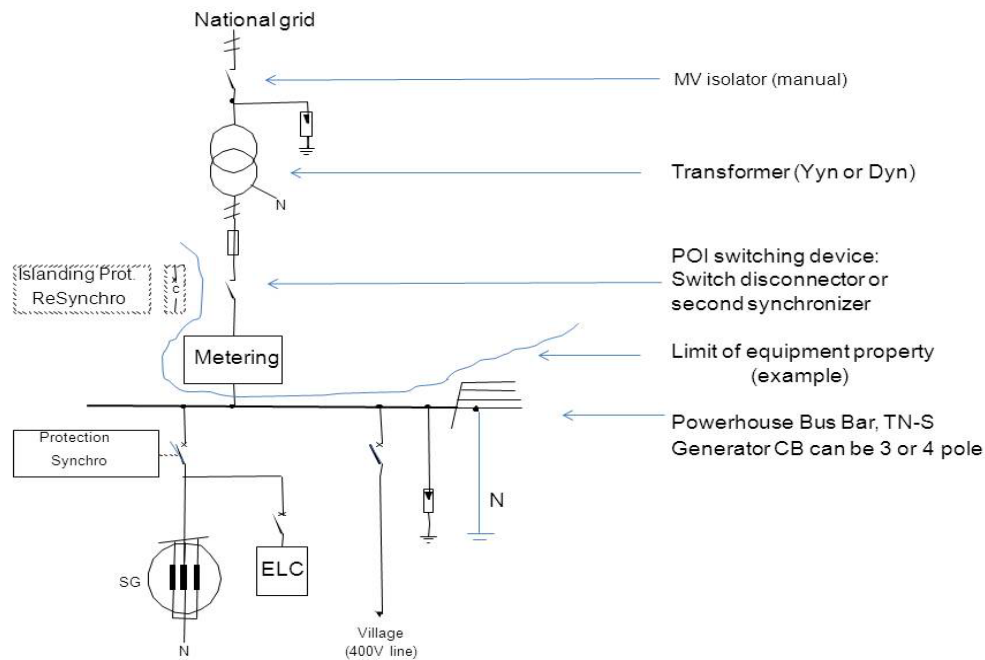

**Figure 3** Connection diagram for MH power plant in the grid with POI at 0.4 KV

The analysis 25 kW micro hydro power plants shows that levelized cost of the electricity production when run in an isolated mode with 30% LF is 0.346 USD /kWh where as if the same plant is connected to the grid; the levelized cost is only 0.137 USD / kWh, which is almost three times less.

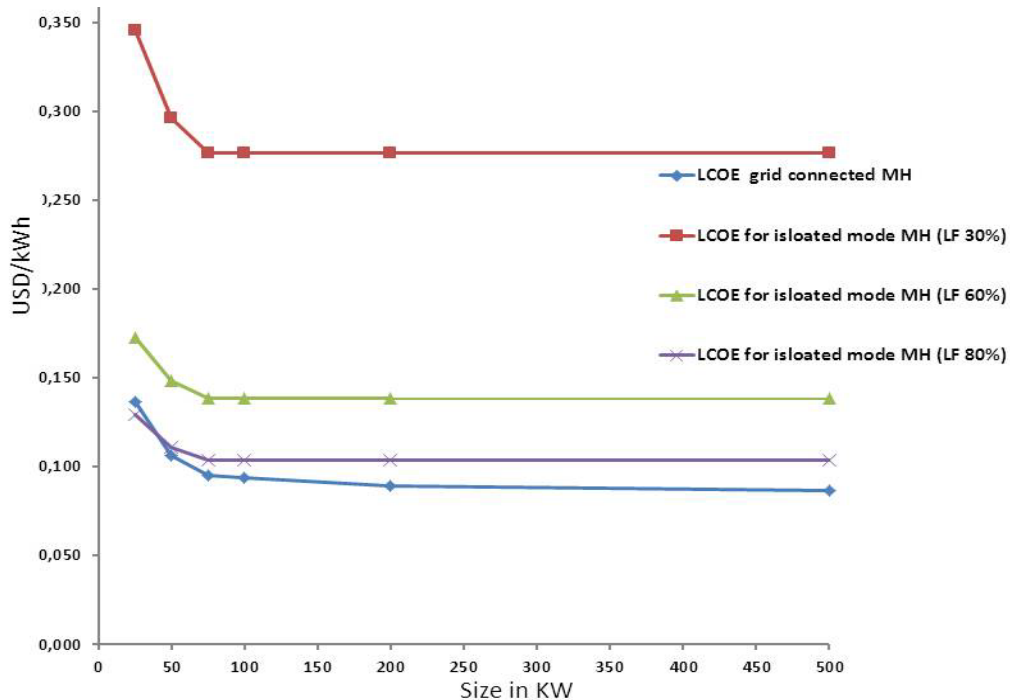

Figure 4. Variation in LCOE with size of the MH plant and POI at 0.4 kV

So, from the perspective of the power plant, there is always an advantage to connect to the nearby grid. The sensitivity analysis has been done with various scenarios of the LCOE from micro hydro considering its system size, at different load factors and if it is connected with the grid line (Figure 4). The sensitivity analysis shows that LCOE significantly decreases with increase in the load factor however change in the LCOE is less significant with the plant size except for small plants less than 75 kW.

### 3.5 Diesel Generator (DG) for the rural electrification

Diesel power plants have been the mostly used in the commercial and industrial sector as back-up power. Diesel generator (DG) is also one of the options used in the rural electrification in the places where there is fairly high population density. The initial installation of such generators is cheap compared to other renewable energy technology. For off-grid electrification, small size diesel gen-sets are quite oftenly used where low load factors prevail (Banerjee, 2006). Diesel generators are extensively used in Afghanistan for the electrification. As per the National Solidarity Programme of Afghanistan, about 1310 diesel schemes has been installed in various provinces with the total install capacity of 47.25 MW each ranging from 4 kW to 280 kW (NSP, 2011). However, diesel generator sets are not common in rural electrification in Nepal. This paper has also looked upon the levelized cost of electricity production by using DG. A diesel generator with revolving field, brushless AC, 3 phase, 400V, power factor 1.0 and directly coupled has been taken as the reference for cost analysis. The technical and cost information of DG sets in case of Afghanistan and in Nepal has been given in table 3. With this information, the estimated levelized costs are USD 0.634/kWh (Afghanistan) and USD 0.512/kWh (Nepal).



Table 5: Information on cost and other parameters of DG Set for Afghanistan and Nepal.

Country	Afghanistan	Nepal
Description/Specification	DG	DG
Diesel generator capacity in kW	20	20
Generator, accessories, housing and installation cost in USD	14100	12500
Cabling, distribution (with 200 HH/Km <sup>2</sup> and 200 HH and 4 Km/Km <sup>2</sup> )	10014	8345
System life time in operational hours	20000	20000
Fuel tank cost in USD	780	700
Fuel tank life in years	3	3
Annual operational and maintenance cost (5% for total cost of DG installation)	1114	1081
Diesel price in USD/lit	1.25	1.0
Diesel price escalation	4%	4%
Levelized cost in USD/kWh	0.634	0.512

Source: NSP, Afghanistan, Kubota Diesel Generator, USA (Technical and price information)

*Sensitivity Analysis:*

In the above analysis, the LCOE has been estimated assuming 4% fuel price escalation factor however, the cost of fossil fuel is volatile in nature and it may keeps on fluctuating between high and low values. Sensitivity analysis has been performed to look the impact on the LCOE with change in the fuel price escalation rate (Figure 5).

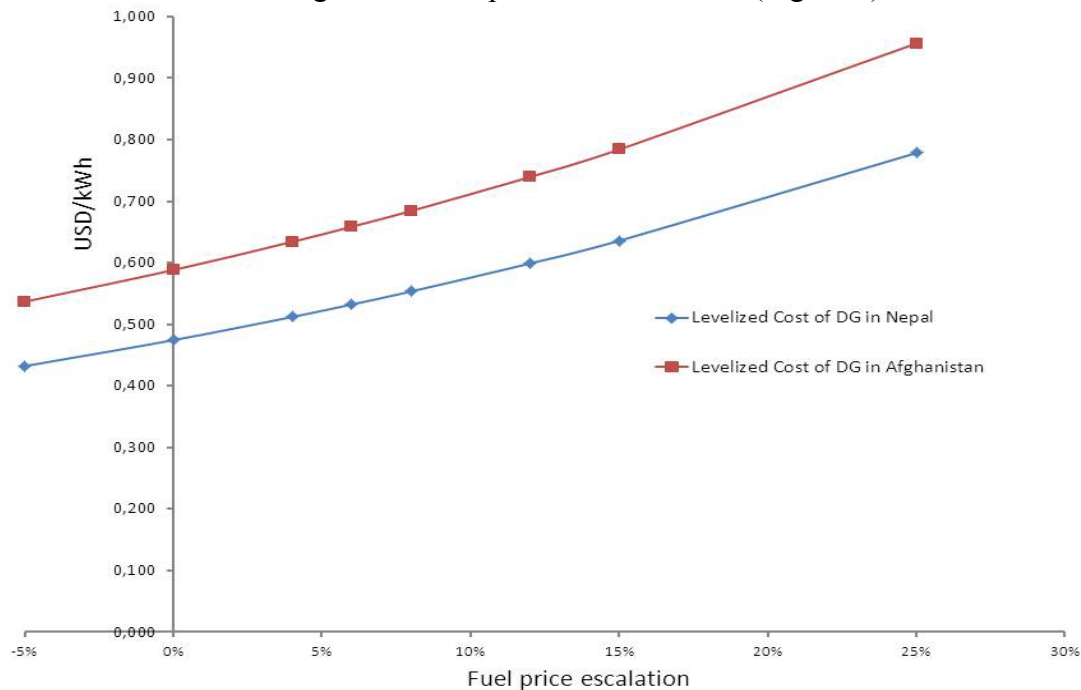

Figure 5: Variation in LCOE with fuel price escalation in a DG



The analysis reveals that fuel cost impact significantly on the LCOE. With the 25% increment in the fuel price, there will be 60% increment in the LCOE. In remote areas, the fuel needs to be transported by porters and mule. The transportation costs in some hilly areas are as significant as the cost of the fuel itself. Therefore, fuel cost can be doubled in the remote areas because of the transportation cost. Also, the reliability of supply of fuel in such place is uncertain. Since remoteness ultimately impact in the fuel price, a separate analysis for remoteness has not been made.

### **3.6. Technologies choices and smart pathways**

The conventional pathways for rural electrification was to provide access through grid extension with the conventional mindset that the electrification is the responsibility of government utility (Ilskog and Kjellström, 2008). Later, it has been realized that extension of grid line alone putting all responsibility on the government utility for electrifying rural areas will not serve the issues of electricity access of billions of rural people. Innovation in the off-grid technologies (especially renewable energy technologies), and encouragement of private investments in the electrification has given new pathways in the rural electrification process and as a result, overall electrification rate has been increased significantly in many countries in the recent years (IEA, 2008). Still the electricity basis for the choice of technologies is not clear and the pathways for reaching the universal access rate is not well defined in many countries cases. Levelized cost of electricity is one of the indications for choosing the cost effective technology to install in a particular location. But, there are various other factors that play an important role in determining the choice of the technology. In this context, the service which the grid line extension, micro/small hydro generation can provide, cannot simply compare with solar home system or wind home system. The quality of electricity and the type of service that one can offer also need to be taken into account and what service is intended from the technology is also important.

The role of electricity is beyond household lighting and thus, the electrification options need to be analyzed based on their capability to meet the demand of commercial/industrial usage. But for a remote village with scattered settlements, where the demand of electricity is mainly for household lighting, our analysis has shown that there is no economic sense to go with extension of national gridlines. Micro hydro could be the first choice. In case of solar and wind technologies, if the resource is available and depending upon the solar insolation and wind availability, these technologies could be second or third choices. In Nepal, out of 6 wind stations' data observed, 4 stations had yearly average wind velocity below 3.5 m/s (SWERA, 2006), where the LCOE for WHS will be more than USD 3.2/ kWh. As the wind generator output is highly depended on the wind speed, the role of small wind turbine is rather limited in Nepal. However, in the locations where there is sufficient wind resources, WHS is more cost competitive than SHS. In case of Afghanistan, even though huge number of the diesel plants has been installed for the rural electrification, the DG itself is not the best option from both the environmental and economic point of view. The micro hydro should be the first choice as long as the resources are available. The LCOE of solar PV are comparatively higher than DG but as mentioned earlier, in a very remote location, where the cost of transportation of fuel can be as high as the cost of fuel, solar PV can be cheaper than DG. The LCOE

from solar PV technology is fairly high in case of Afghanistan, despite of high insolation value. This could be mainly due to high capital cost of the equipment and small economic scale of the current solar PV market. The similar study carried out by [Nguyen \(2007\)](#) has shown that wind technology as the most prominent off-grid technologies for the individual households in Vietnam.

The LCOE of a micro hydro connected to national grid is the lowest among the options considered in this paper. So, this analysis shows that there are no threats for the small power developer to invest in off-grid rural electrification from the on-grid line extensions as long as their projects are technically sound enough to connect in the grid, and grid operator agrees to buy the excess power from the plant. In-fact, connection of small power plants at the remote ends is a win-win situation from technical point of view. It also reduces the line losses that might have occurred due to several kilometers of transmission in meeting the power demand of rural industries. This also helps to maintain the receiving end line voltage.

Furthermore, the prevailing energy policies of the country also have significant influence in the choice of the technologies and formation of the market ([Mainali and Silveira, 2011](#)). Subsidy is one of the policy instruments used in many developing countries in increasing access to electricity. Nepal has a defined subsidy policy and delivery mechanism for the implementation of rural electrification ([AEPC, 2009](#)) whereas, Afghanistan has been promoting off-grid electrification without any commonly defined subsidy policy. Different programmes have set their own level of subsidy and in most of the cases; the subsidy is up to 80% of total project cost. We have also looked upon the scenarios of LCOE from various alternatives discussed above at different capital subsidy level in the terms of percentage of the total initial investment (Figure 6).

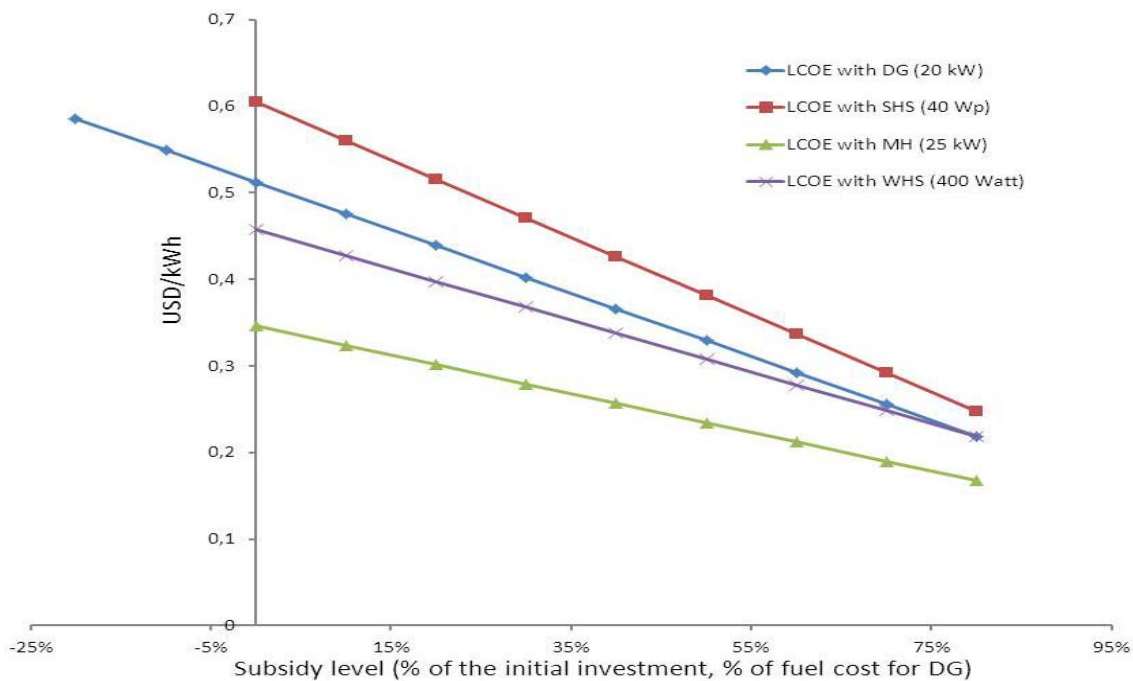

Figure 6: LCOE from different off-grid technologies as a function of capital subsidy

In case of DG, we have looked with the subsidized price of diesel. The negative subsidy in the case of DG represents the externalities added in the diesel price in some form of tax considering its environmental impact in the future. The analysis clearly indicates that the subsidy has strong role in determining the LCOE. Higher the subsidy level, lower is the LCOE. The change in the subsidy level has largest impact on the LCOE from solar PV and least impact on the LCOE from micro hydro. At the higher subsidy level, the LCOE of all technologies try to converse closer indicating the fact that at high subsidy level the competitiveness of technologies are insignificant.

#### **4. Conclusion**

The policy and pathways that is adopted in the process of electrification will determine how fast the access issue of 1.44 billion of the world population can be resolved. The choice of technology is important in determining the least cost option for serving the electricity need of the poor rural people. This study examines the levelized costs of three different renewable energy technologies viz. solar PV, small wind turbines and micro hydro and supplying with conventional fossils technology (diesel generators) and compares with the case of grid line extension in two countries cases (Afghanistan and Nepal). Analysis has shown that the micro hydro technology is the most competitive technologies in both the country cases (Afghanistan and Nepal). The isolated off-grid technologies serving individual household viz. SHS and WHS are comparatively high LCOE and have limited uses in terms of the service that it can offer. Thus, these technologies shall be promoted in the scattered areas where there is low load density and electricity demand is mainly for household lighting. The off-grid electrification pathways that the Nepal has chosen with the technology choices of micro hydro and solar PV seems relevant but exploitation of other technologies shall not be undermine. Wind energy in the some of the potential areas has been found to be least cost solution than solar PV, which need to be exploited. [Mainali and Silveira \(2010\)](#) have shown that the market growth rate of SHS is higher than the micro hydro in terms of connecting number of households. This is one of the areas, the policy makers and planners need to think while deciding on the level of subsidy in these two technologies. The smart pathway to move in the rural electrification is to promote individual household technology only in those places where there is no possibility of micro hydro technology. The LCOE with micro hydro connected to national grid is the most competitive among the options considered in this paper. So, this analysis shows that there are no threats from the grid line extensions for the small power developer to invest in the off- grid rural electrification as far as their projects are technically sound enough to connect in the grid, and grid operator agrees to buy the excess power from the plant. So, connecting such small plants to the grid in the future when the national grid reached those areas is the smart pathways and policy environment should encourage such actions.

In Afghanistan, huge numbers of the diesel generators are in operation for electrifying rural villages. However, the uses of diesel generator for rural electrification are not the least cost option as indicated by our study and this won't lead Afghanistan in the smart pathway. Thus, focus and attention shall be made to promote rural electrification through micro hydro as this is the most competitive technology in Afghanistan context. Solar

home systems are most expensive options at the moment because of lack of local market set up to support and promote this technology.

Subsidy has an important role in making the technology competitive, but as seen from the analysis, the heavy subsidies in all the technologies make the issues of competitiveness irrelevant. Subsidy in one technology should not impact on the competitiveness of the other technologies and should not close the opportunities of other least cost options. Thus, deciding on the appropriate subsidy is also important for the policy makers for choosing the right pathways and maximizing the access rate within the available natural and financial resources and meeting the rural service demand. We believe; this study has been able to give broad pictures where the rural electrification should have priority and which path does it need to follow.

### Reference

- ADB, 2004. Nepal: Power Sector Reforms in Nepal. Technical Assistance Consultant's Report. International Resources Group, Washington D.C, USA
- ADB-NEA, 2004. Project performance audit report on the seventh power project in Nepal. Asian Development Bank.
- AEPC, 2009. Subsidy Policy for Renewable (Rural) Energy-2009. Alternative Energy Promotion Center, Ministry of Environment, Nepal.
- AEPC-ESAP, 2005. Reference Micro-hydropower Standard. Energy Sector Assistance Programme, Kathmandu, Nepal.
- Allan G., Gilmartin M., McGregor, P., Swales, K., 2010. Levelised costs of Wave and Tidal energy in the UK: Cost competitiveness and the importance of "banded" Renewables Obligation Certificates. *Energy Policy*, 39, 23-39.
- Arun, P., Banerjee, R. Bandyopadhyay S., 2007. Sizing curve for design of isolated power systems. *Energy for Sustainable Development* 11 , 21–28
- Ashok, S., 2007. Optimised model for community-based hybrid energy system. *Renewable Energy*, 32, 1155-116.
- Banerjee R., 2006. Comparison of option for distributed generation in India. *Energy Policy*, 34, 101-111
- Brent, A.C., Rogers, D.E., 2010. Renewable rural electrification: Sustainability assessment of mini-hybrid off-grid technological systems in the African context. *Renewable Energy*, 35, 257-265
- Burns, R.K., 2011. Afghanistan: Solar assets, Electricity production, and rural energy factors. *Renewable and Sustainable Energy Reviews*, 15, 2144-2148.
- Chaurey, A., Kandpal, T.C., 2010. A techno-economic comparison of rural electrification based on solar home system and PV micro-grids. *Energy Policy*, 38, 3118-3129.
- Erickson, J., Chapman, D., 1995. Photovoltaic technology: markets, economics, and rural development. *Journal of World Development*, 23, 1129-1141.
- Feroli, F., Schoot, K., Zwaan vander B.C.C., 2009. Use and limitations of learning curves for energy technology policy: A component-learning hypothesis. *Journal of Energy Policy*, 37, 2525-2535.

- Gross, R., Blyth, W., Heptonstall, P., 2010. Risks, revenues and investment in electricity generation: Why policy needs to look beyond costs. *Energy Economics*, 32, 796-804.
- Haanyika, C.M., 2008. Rural electrification in Zambia: A policy and institutional analysis. *Energy Policy*, 36, 1044-1058.
- Hallett, M., 2009. Distributed power in Afghanistan: The Padisaw micro-hydro project. *Renewable Energy*, 34, 2847-2851.
- IEA, 2008. Electricity access database in 2008. International Energy Agency. Available at: [http://www.iea.org/weo/database\\_electricity/electricity\\_access\\_database.htm](http://www.iea.org/weo/database_electricity/electricity_access_database.htm)
- Ilskog E., Kjellström, B., 2008. And then they lived sustainably ever after?—Assessment of rural electrification cases by means of indicators. *Energy Policy*, 36, 2674-2684.
- Kirubi, C., Jacobson, A., Kammen, D.M., Mills, A., 2009. Community-based electric micro-grids can contribute to rural development: evidence from Kenya. *World Development*, 37, 1204–1221.
- Kumar, A., Shankar, R., Momaya, K., Gupte, S., 2010. The market for wireless electricity: The case of India. *Energy Policy*, 38, 1537-1547.
- Kumar, M.V.M., Banerjee, R., 2010. Analysis of isolated power systems for village electrification, *Energy for Sustainable Development*, 14, 213-222
- Lako, P., 2010. Hydropower. IEA-ETSAP. available at <http://www.etsap.org/E-techDS/PDF/E07-hydropower-GS-gct.pdf>
- Luque, A., Hegedus, S., 2003. *Handbook of Photovoltaic Science and Engineering*. John Wiley and Sons. p 295.
- Mainali, B., Silveira, S., 2011. Financing off grid rural electrification: Country Case Nepal. *Energy*, 36, 2194-2201.
- Mainali, B., Silveira, S., 2010. Renewable Energy Market in Rural Electrification: Country Case Nepal. *Energy Policy* (Article under Re-view).
- Marsh, G., 2004. Lowering the barriers to RE: Grid connection of small renewables. *Refocus*, 5, 45-47.
- Martinot, E., Cabraal, A., Mathur, S., 2001. World Bank/GEF solar home system projects experiences and lessons learned 1993–2000. *Renewable and Sustainable Energy Reviews*, 5, 39–57.
- Masters, G. M., 2004. *Renewable and Efficient Electric Power Systems*. Pp 654, John Wiley and Sons Inc., Hoboken, New Jersey.
- MoEW, 2007. *The Afghanistan National Development Strategy: with Focus on prioritization*. Ministry of Energy and Water, Afghanistan.
- Muñoz, A. M., Rosa, J.J.G., López, M.A., Gil de Castro, A.R., 2010. Grid interconnection of renewable energy sources: Spanish legislation. *Energy for Sustainable Development*, 14, 104-109.
- NEA, 2010. *Annual Report of Nepal Electricity Authority. Fiscal year 2009/2010*.
- NEA, 2011. Data provided by Thapa, T., Assistant Manager of Grid Department, Nepal Electricity Authority. Personal communication made on 2011-03-20.
- Nfah, EM., Ngundam, J.M., Vandenberg, M., Schmid, J., 2008. Simulation of off-grid generation options for remote villages in Cameroon. *Renewable Energy*, 33, 1064-1072
- NREL, 2007a. *Afghanistan Resource Maps and Toolkit*. National Renewable energy laboratory.

- NREL, 2007b. Afghanistan Resource Maps and Toolkit. National Renewable energy laboratory. Available at: [http://www.nrel.gov/international/ra\\_afghanistan.html](http://www.nrel.gov/international/ra_afghanistan.html)
- NSP, 2011. Personal communication. National Solidarity Programme, Afghanistan.
- Nyugen, KQ., 2007. Alternatives to grid extension for rural electrification: Decentralized renewable energy technologies in Vietnam, *Energy Policy*, 35, 2579-2589.
- Oparaku, O.U., 2003. Rural area power supply in Nigeria: A cost comparison of the photovoltaic, diesel/gasoline generator and grid utility options, *Renewable Energy*, 28, 2089–2098
- Rai, S., 2004. Sustainable dissemination of solar home systems for rural development: experiences in Nepal. *Energy for Sustainable Development* 8, 47-50.
- Sanden, B.A., 2005. The economic and institutional rationale of PV subsidies. *Solar Energy*, 78, 137-146.
- SARI-Energy. 2010: Afghanistan: Energy sector overview. South Asian Regional Initiatives/ Energy. Available at: [http://www.sari-energy.org/PageFiles/Countries/Afghanistan\\_Energy\\_detail.asp#ruralenergy](http://www.sari-energy.org/PageFiles/Countries/Afghanistan_Energy_detail.asp#ruralenergy)
- Shrestha, K.L., 1981. Nepal's Energy Situation. *Energy*, 6, 817-821.
- Spooner, E. D., Harbidge, G., 2001. Review of international standards for grid connected photovoltaic systems. *Renewable Energy*, 22, 235-239.
- SWERA, 2006. Solar and Wind Energy Resource Assessment (SWERA) in Nepal. Alternative Energy Promotion Centre, Kathmandu, Nepal.
- Thiam, D.R., 2010. Renewable decentralized in developing countries: Appraisal from microgrids project in Senegal. *Renewable Energy*, 35, 1615-1623.
- Trading economics, 2011b. Afghanistan Inflation end-of-period. Available at: <http://www.tradingeconomics.com/afghanistan/inflation-end-of-period-imf-data.html>
- Trading economics, 2011a. Nepal Inflation end-of-period. Available at: <http://www.tradingeconomics.com/nepal/inflation-end-of-period-imf-data.html>
- Wamukonya, N., Davis, M., 2001. Socio-economic impacts of rural electrification in Namibia: comparisons between grid, solar and unelectrified households. *Energy for Sustainable Development*, 5, 5-13.
- WECS, 2006. Energy Synopsis Report: Nepal. Water and Energy Commission Secretariat, Government of Nepal.

### **Acknowledgement:**

We would like to especially thank M. Khadka of National Area Based Development Programme of Ministry of Rural Rehabilitation and Development, Afghanistan for his valuable support in providing the information and data.

## Mode of Transport to Work, Car Ownership and CO<sub>2</sub> Emissions in Mauritius

**Vishal Chandr Jaunky\***

Centre for Energy Policy and Economics

ETH Zürich

Zürichbergstrasse 18

8032 Zürich

Switzerland

Telephone: +41 44 632 06 52

Email: [vjaunky@ethz.ch](mailto:vjaunky@ethz.ch)

**Mohammed Naweed Bundhoo**

Mauritius

Telephone: +230 7036626

Email: [n-26-@hotmail.com](mailto:n-26-@hotmail.com)

**Salehmohamed Yaasin Moco**

Mauritius

Telephone: +230 7867289

Email: [yaasin\\_sm@hotmail.com](mailto:yaasin_sm@hotmail.com)

**March 2011**

### Abstract

Fast economical and demographic revolution in the small island developing state of Mauritius over the last decades has led to an unprecedented rise in private vehicle utilization. In this arena, the cognition of ongoing travel practices and their determinants is sine qua non. This paper examines the determinants of mode of transport, rise in car ownership and its related environmental impacts. We employ cross-section micro-data obtained from our household drop-off survey to estimate a multinomial logistic regression model of transport mode choice coupled with an exhaustive ordinary least squares analysis of carbon emissions. Empirical results indicate that factors such as travel time, expenses and time lost in traffic jam coupled with demographic and socio-economic characteristics such as age of individual and household income have profound upshots on transport mode decisions. On the other hand, fuel type, residential distance from work and age of individual displays statistically significant impacts on carbon dioxide emissions.

**Keywords:** Mode of transport, carbon dioxide emissions, survey data, multinomial logistic.

**JEL Classification:** C25, Q54, R41.

---

\* Corresponding author. We would like to thank Jan Imhof for his comments and suggestions on a previous version of this paper. Errors, if any, are the author's own only.



## 1 Introduction

Located in the Indian Ocean, about 850 kilometers (km) east of Madagascar, the Republic of Mauritius is made up of various small islands which are Rodrigues Island, the Agalega Islands and Cargados Carajos Shoals and covers a total area of 2040 square km. Mauritius is the biggest island of the Republic, with an area of 1,825 square km. It is of volcanic origin and is surrounded by coral reefs, with a coastline of about 16 km (refer to Figure 1 for a map of Mauritius). Since its independence in March 1968 from the British Empire, Mauritius has successfully evolved from a mono-crop sugar-based economy to a modern and diversified service-based one. Together with the traditional sugar and manufacturing (mainly the export processing zone (EPZ)) sectors, information, communication and technology (ICT), financial, and tourism sectors constitute the new economic pillars of the country. In addition, the government has been encouraging the development of the seafood and aquaculture hubs which could be considered as promising pillars.

Mauritius has a population about 1.28 million and is a fairly democratic state<sup>1</sup>. In 2009, about 40% of the population<sup>2</sup> lives in the urban regions such as the capital city of Port Louis (146,319), Beau-Bassin/Rose-Hill (105,377), Vacoas (101,789), Curepipe (82,756) and Quatre-Bornes (77,145). The island state has a population density of 665 inhabitants per square km. On average, Mauritius has experienced a real gross domestic product (GDP) growth rate of 4.35% over the period 2006-2009. On an international purchasing

---

<sup>1</sup> The average political rights and civil liberties scores over the period 2007- 2009 are 1 and 2 respectively. Political rights and civil liberties are measured on a one-to-seven scale, with one representing the highest degree of Freedom and seven the lowest. These democracy scores are computed from the Freedom House website at: **Error! Hyperlink reference not valid.**

<sup>2</sup> More information is available online at: <http://www.state.gov/r/pa/ei/bgn/2833.htm>.



power parity (PPP) basis, GDP per capita<sup>3</sup> in 2009 was \$12,900, which is one of the highest in Africa.

Figure 1: Map of Mauritius



Source: Computed.

Over the years, the Mauritian government has massively invested in human capital, for example, providing free access to health service and education from primary to tertiary

<sup>3</sup> Further details are can be accessed online at: [http://www.indexmundi.com/mauritius/gdp\\_per\\_capita\\_\(ppp\).html](http://www.indexmundi.com/mauritius/gdp_per_capita_(ppp).html).

level<sup>4</sup>. In a view to make the island a knowledge hub and accentuate the move towards the next stage of economic development, the “cyber city” was built at Ebene, about 15 km south of the capital, Port Louis. The city is in line with the policy of making Mauritius an ICT or knowledge hub in the African region. Indeed, it acts as a gateway connection between the African and Asian markets. Links have been established between the cable landing point of the South Africa Far East (SAFE) submarine communications cable between South Africa and Malaysia. The city has attracted various ICT enterprises such as Orange, Infosys, Infinity BPO, Tele-forma and Hua Wei. Its construction started in 2001 and was inaugurated in 2005.

However, at the same time, the problem of traffic congestion has exacerbated. About 5000 people worked at Ebene in 2008 and employment at the cyber city is expected to rise to 20000 in the following years (**Ackberally, 2008**). Figure 1 shows the various regions and road networks across Mauritius. Gridlocks are generally severe along the M2 and A1 motorways<sup>5</sup> leading towards the two main epicenters which are Ebene and Port Louis. It is quite easy to imagine the dense traffic facing the majority of commuters on their way to work. Yet, such problematic situation has been prevailing for decades and this raises urgent need for prompt and efficient transport policies. In 2009, car ownership in Mauritius was around 91 per 1000 population. There are no railways and bus is the main public transport in the island. Taxis are widespread but remain relatively expensive. Over the period 2006-2009, private car ownership has risen rapidly by about 30.4% from

---

<sup>4</sup> Further information about the educational system can be found online at: [http://www.ibe.unesco.org/National\\_Reports/ICE\\_2008/mauritius\\_NR08.pdf](http://www.ibe.unesco.org/National_Reports/ICE_2008/mauritius_NR08.pdf).

<sup>5</sup> Information concerning road safety policies especially along the motorways is available online at: **Error! Hyperlink reference not valid.**

83,385 to 109,108 while the number of registered buses rose by 7.27% from 2,612 to 2,802<sup>6</sup>. This is dismaying since motor vehicles keep on expanding whilst no efficient planning is being made so far to magnify the country's road network<sup>7</sup>. The length of road is 2,066 km as per the year 2009. It has merely increased by 38 km as compared to the previous year. In this day and age, traffic congestion and car emissions<sup>8</sup> are, so far, paramount. The decision confronting the government of Mauritius is how to respond to booming motorization subsequent to an emerging standard of living.

Traffic congestion is costing the Mauritian economy millions while many individuals are finding themselves trapped for hours in the traffic. Moreover, as per Menon (2004), "*cost of traffic congestion in Mauritius is estimated at 1.2 billion Rs<sup>9</sup> (excluding vehicle operating costs) annually. There is anecdotal evidence that motorists spend as much as 600 hrs annually in traffic congestion.*" This problem is exacerbated with car emissions leading to environmental concerns. Exhaust fumes represent the most critical part of the waste generated by a vehicle and can impact adversely on the quality of air, waste and soil (**Himanen et al, 1992**). Road congestion "... *not only imposes high costs in terms of lost time and high stress, but also increases emissions by decreasing the speed of travel* (**Alpizar and Carlsson, 2003**). As per the Kyoto Protocol that took effect on February 16<sup>th</sup>, 2005, many countries have triggered off plans to reduce greenhouse gas emissions and are especially interested in (CO<sub>2</sub>) mitigation. Recently, the government initiated the

---

<sup>6</sup> The data are computed from the 2009 Central Statistical Office report which can be accessed online at: [www.gov.mu/portal/goc/cso/file/anudig09.pdf](http://www.gov.mu/portal/goc/cso/file/anudig09.pdf).

<sup>7</sup> More information about the transport data are available online at: <http://www.gov.mu/portal/goc/cso/ei816/toc.htm>.

<sup>8</sup> Car emissions are the waste products emanating from the exhaust pipe. The emissions consist of CO<sub>2</sub>, nitrogen gas (N<sub>2</sub>), water vapor (H<sub>2</sub>O), carbon monoxide (CO), nitrogen oxides (NO<sub>x</sub>), hydrocarbons, etc.

<sup>9</sup> The exchange rate is \$1=Rs.27.50 in 2004 and by 2009 it is \$1= Rs. 33.60.

“*Maurice Ile Durable*<sup>10</sup> (MID)” project in 2007 with the objective of making Mauritius less dependent on imported fossil fuel i.e. 65% autonomy by the year 2028. In June 2008, the MID Fund was set up to finance programmes which aimed at achieving greater fuel efficiency in the use of energy in residential, corporate and public sectors.

In the perspective of devising proper transport and environmental policies, knowledge of the demand for traveler’s transport is hence vital. The purpose of the study is twofold: first, factors influencing the mode of transport to work in Mauritius are assessed and second determinants of atmospheric emissions especially carbon dioxide (CO<sub>2</sub>) emissions from cars are studied. Income, working place, travel expenses and time to work duration are found to significantly affect the travel choice while age, fuel type and distance affect significantly the level of car emissions produced when commuting to work. The paper is organized as follows: Section 2 overviews the literature. Section 3 describes the data. Section 4 and Section 5 present the empirical results for the choice mode and CO<sub>2</sub> emissions model respectively. Section 6 concludes and provides some policy recommendations.

## **2 Previous Research**

Numerous studies were based on mode of transport and at the same time, acknowledging the acuteness of congestion. Some early research includes that of **McGillivray (1972)** who analyzes the mode of choice for selected urban trips in the San Francisco Bay area. Transit fares are found to be more important in mode choice for the work trip than for

---

<sup>10</sup> More details about the MID are available on the government website at: <http://www.gov.mu/portal/goc/mpu/file/ile.pdf>.

other purposes so that reduced fares for commuters may make economic sense where there is congestion and a choice of mode for the work trip. Income is found to be an unimportant determinant of mode choice. **McCafferty and Hall (1982)** analyze the choice to travel in Hamilton, Ontario. Journey time is shown to be an insignificant factor in the individual's choice of time to travel. **Button *et al.* (1993)** investigate trends in car ownership over the past twenty years in low income countries and discover a rapid increase as their prosperity gradually begins to grow. **Alperovich *et al.* (1999)** provide evidence whereby permanent income is an important determinant on the probability of owning a car as well as the number of household wage earners and city size in Israel. According to **De Palma and Rochat (2000)**, car ownership decision in Geneva is found to be mostly related to income levels of the households, contextual constraints (e.g. congestion) and regional issues.

Moreover, **Asensio (2002)** analyses the determinants of travel mode choice for suburbanized commuters in Barcelona. The incessant suburbanization is found to result in increasing the market share of rail at the expense of the private car use and, mainly, the bus, provided that accessibility to the public transport network is maintained at present levels. **Alpizar and Carlsson (2003)** discuss the significance of travel cost for car and travel time as important determinants of mode choice to work for Costa Rica. **McDonnell *et al.* (2006)** conduct a study in Dublin and observe that given traffic congestion is one of the most disputative urban issues facing policymakers. They find that while the bus is perceived as the fastest mode in peak periods, its advantage diminishes significantly for the off-peak period. **Vega and Reynolds-Feighan (2008)** evaluate the travel to work

mode in the Dublin region. According to them, travel attributes such as travel time and travel cost both have an important effect on the choice of mode of travel highlighting the role of trip destination as a main driver of travel behaviour. **Salon (2009)** studies the determinants of car ownership and car use for commuting in New York City. New Yorkers are found to be more sensitive to changes in travel time than to changes in travel cost. **Commins and Nolan (2011)** investigate the Irish travel patterns and their determinants. Travel and supply-side characteristics such as travel time, costs, work location and public transport availability, as well as demographic and socio-economic characteristics such as age and household composition are found to have significant effects on the mode of transport to work.

The choice of the mode of transport has a direct impact on the environment. For instance, an increase in car ownership can be accounted for the upward trend of CO<sub>2</sub> emissions in the transport sector in Mauritius. This situation is aggravated with the occurrence of chronic bottlenecks (**Van Mierlo et al., 2004**). Almost all existing transport studies have focused on the decomposition of national CO<sub>2</sub> emissions. Decomposition methodological analysis, such as Laspeyres index and Divisia index, have been mainly applied to examine energy consumption, energy saturation and pollution emission. These techniques break down an object into a multiplicative product of various elements to search the primary components impacting its variation. The logarithmic mean Divisia index (LMDI) method is presently considered as among the most approving decomposition techniques (**Ang, 2004**). The LMDI provides a residual-free decomposition and can accommodate the occurrence of zero values in a data set. One common aspect among the vehicle

emissions studies is that they were carried out based upon time series data. The Divisia approach has severe restrictions in some applications with cross-sectional or panel data, there is no apparent way of sequencing the observations (**Good *et al.*, 1999**). **Timilsina and Shrestha (2009)** provide a concise review of this literature. To date no studies have been done to analyze CO<sub>2</sub> emissions at individual levels. This study attempts to add new empirical evidence to both the literature of mode of transport to work and vehicle emissions.

### **3 Data Description**

For the purpose of the study, a questionnaire<sup>11</sup> has been designed to conduct a household drop-off survey. Since survey is targeting only the working population and our channel of data comes mainly from two working zones which are Ebene and Port Louis. Congestions are usually lousy in close proximity to those regions. The survey started in December 2009 and was completed in February 2010. About 87% of the whole 600 questionnaires were received. Due to the incompleteness and bias of some questionnaires, 20 observations were discarded of the 521 received which led us to 501 observations. About 28% and 56% individuals in our sample travel by car and bus respectively. As for the remaining 16%, it portrays individuals who commute to work by motorcycle, on foot, by company van/car and by taxi. However, the big majority in the third group travels to work by motor cycle.

The questionnaire has four parts. Section 1 was meant to gather information about the demographic characteristics of the individuals and their views about the transport

---

<sup>11</sup> The questionnaire is available upon request.

problem in Mauritius. Sections 2 and 3 collect information about the car and bus users respectively such as car fuel type, weekly travel expenses, comfort, among others. Section 4 amasses information about the perceptions of individuals regarding the different projects proposed by the government to curtail congestions in particularly the Bus Rapid Transit System from Port Louis to Curepipe (Bus Lane), development of the Ring Road and Harbour (Dream) Bridge<sup>1</sup> and decentralization. In general about 60% of individuals believe that these policies will have a major impact in decongesting the traffic. Views on a 24/7 economic model were also inquired. 43% of the participants consider it as an effective means to reduce traffic congestion.

#### 4 Modelling Choice of Mode of Transport

When categories (more than two) are unordered, MNL regression is one often-used strategy (McFadden, 1981). The MNL model is designed to handle  $J + 1$  response, for  $J \geq 1$ . According to this model, the probability that any one of them is observed is:

$$\Pr(y_t = l) = \frac{\exp(W_{it}\beta^l)}{\sum_{j=0}^J \exp(W_{ij}\beta^j)} \text{ For } l = 0, \dots, J. \quad \text{----- (1)}$$

Here  $W_{ij}$  is a row vector of dimension  $k_j$  of observations on variables that belong to the information set of interest, and  $\beta^j$  is a  $k_j$ -vector of parameters, usually different for each  $j=0 \dots J$ . Estimation of the MNL model is reasonably straightforward. The loglikelihood function can be written as

$$\sum_{t=1}^n \left( \sum_{j=0}^J I(y_t = j) W_{ij} \beta^j - \log \left( \sum_{j=0}^J \exp(W_{ij} \beta^j) \right) \right) \quad \text{----- (2)}$$



where  $I(\cdot)$  is the indicator function. Each observation contributes two terms to the loglikelihood function. The first is  $W_{ij}\beta^j$ , where  $y_i = j$ , and the second is minus the logarithm of the denominator that appears in equation (1). The above explanation deals with multinomial probability and loglinear models. However our study is based on the nested MNL model (**McFadden, 1981**). There is a range of advantages to employing MNL model instead of a series of regular logistic regressions. First, when applying all the data for the estimation rather than subsets so, the estimates are prompter. Secondly, there follows a logical relationship amidst the choices, for instance, if an individual prefers to travel by car to bus and prefers motorcycle to car, he should prefer a motorcycle to a bus, and his relative orientation should be a definite variety of combination of the individual preferences. The coefficients once generated represent how the logarithmized probability of choosing one alternative instead of the base outcome changes if variable changes from 0 to 1.

Various determinants of the mode to transport to work are considered. Table 1 present a description of variables used in the MNL model. The choice of transport mode is classified under three distinct categories namely: car, bus and others (motorcycle, taxis, company van/car and on foot). Demographic characteristics include age, gender, household size, education and income level. The travel characteristics described so far conceal significant differences between genders. Males travelling by car outweigh female car travelers by more than the double as revealed by the survey. A slightly higher proportion of women are bus passengers. Travelling by motorcycle and other mode tends to be more of a male characteristic. Next, education level which includes secondary,

diploma holders, undergraduates and other qualifications (those possessing mainly professional qualifications from the Association of Chartered Certified Accountants (ACCA), Institute of Chartered Secretaries and Administrators (ICSA), postgraduates and others), is accounted. Various levels of income are also considered together with household size. An extended family is more likely to have a car than a nuclear one. A dummy variable controlling for the working place such as Port Louis and Ebene is incorporated in the model. Travel expenses can as well affect an individual's mode of transport. Likewise, the time lost in congestion can also impact on the transport mode.

Table 2 provides the estimates of the MNL model. An important assumption of this model is independence of the irrelevant alternatives (IIA) which in line with the assumption of independent disturbances. Alternatives, such as choosing a car, bus or other means of transport, should be independent of each other. The baseline category in the model is bus as a mode of transport. If the choice sets are dependent, the MNL estimates will be inconsistent. The IIA property can be tested with a Hausman specification test for the MNL model (**Hausman and McFadden, 1984**). Hausman's specification test failed to reject the null hypothesis that the difference is not systematic. Their associated  $\chi^2$  statistics are 0.00, 0.00 and 0.46 respectively. The IIA conjecture cannot be rejected and hence employing a MNL analysis is not inappropriate.

Age is found to have no impact on the choice of travelling either by car or bus. However, as age increases, the odds of choosing of choosing other means of transport rather than bus increase by about 11.7 times. This can be interpreted as effects of experience. As age

increases, individuals acquire more working experience, leading to a rise in income. Hence, individuals are in a better position to afford other means of transport. This might also reflect to some extent the use of motor cycles, among others, as a means to avoid the routine traffic congestion when travelling to work. Gender has no effect on the choice between car and bus. Conversely, the regression results of gender for other transport means compared to bus reveal that female is less likely to choose other means of traveling. Usually females do not travel by motorcycles to go to work in Mauritius. The variable Female for others compared to bus turns out to be statistically significant at 1% level, reflecting the importance of a gender effect in travel choice process.

Similar to **Commins and Nolan (2011)**, income is also found to be an important predictor of choice between car and bus as a mode of transport to work. With reference to individuals getting a monthly income greater than Rs. 65,000, all income groups are significantly less likely to travel by bus to work than by car. In other words, people with relatively lower income are more likely to use bus rather than car. For the income group Rs.45,000-Rs.65,000 individuals are less likely to choose bus transport relative to other means of transport. Nonetheless, in general, income does not have an impact on the mode of transport between bus and other means. This result is not very surprising given the cost of travelling by motor cycles is almost the same as traveling by bus.

Next, geographical location is found to have no significant impact. As mentioned by a transport study conducted by **Halcrow Fox** in association with MDS Transmodal in 2001, *“Mauritius generally has a well-developed road network, with access to all parts of*

*the island, and the bus network is also extensive.*” Similarly and in general, education does not seem to have a major impact on the choice of mode of transport to work. Apart from individuals possessing a diploma as compared to secondary education, the odds of using other means of transport increase. To some extent, this may reflect a preference for alternative modes of transport which are not subject to congestion for some relatively well-educated individuals. Moreover, as family size grows, this may affect an individual’s attitude in favour of car ownership and eventually choose car as a mode of transport to work. **Ong (2002)** finds evidence in favour of family size which has an impact on type of employment and eventually the mode of transport. However, no evident of an impact of household size is to be found for the Mauritian context.

Working place turns out to be significant for both car and other modes. Ebene is usually much less congested than Port Louis. Cars are about 2.1 times more likely to be chosen as mode of transport when going to Ebene, certainly because of the lean reduction in congestion. Along the same line, other modes of transport are 4.34 times more likely to be called for when heading to Ebene, probably for the same reason. The main roads to reach the door of Ebene are normally more congested during peak hours, such as before and after office hours. It is usually much less congested than Port Louis. Hence, most people find it more convenient to use car rather than bus as a mode of transport to work to go to Ebene.

The effect of spending on the two categories is found be statistically significant. A rise in travel expenses increases slightly the odds of choosing car rather than bus by 1.01 times,

while that of other means of transport decreases by 0.99 times. Car allowances or mileage compensation are a more common practice to cover travel expenses in Mauritius. Travel expenses are usually reimbursed (either partially or fully) by the employers and that any rise in such expenses may only slightly increase the odds of travelling by car relative to bus. In addition, the cost of travelling by bus is usually slightly dearer than by motor cycle. On the other hand, it can be argued that commuters tend to advantage of the generous travelling schemes offered by companies. This may explain the rather one to one relationship between the different transport modes when it comes to travelling expenses.

Travel choice has obviously an impact on the travel time to work. The variable 'time to work' indicates that as the duration of the trip to work rises the odds of traveling by car and other means such as motor cycle, walking, etc. fall. Cars generally take less time compared to bus when tripping to work. Yet, drivers can be subject to stress and aggressive driving<sup>12</sup> by increasingly congested roads (**Shinar, 1998**). Per se, a rise in travel time tends to reduce the odds of choosing car to bus as a mode of transport to work. The same effect also pertains in the case of other means of transport. Congestion usually means more driving tensions, higher cost of wear-and-tear of vehicles and air pollution. As such, using alternatives means such as motor cycles may not be considered the best choice in event of acute traffic jams. Mauritian regulations have been recently very strict and old buses are being quickly renewed with new and modern ones. For

---

<sup>12</sup> **Shinar (1998)** shared the popular view that aggressive driving is mainly caused by increasingly congested roads while **Dollard et al. (1939)** put forward the classic frustration-aggression hypothesis. The frustration-aggression hypothesis contains two claims about the causes of aggression. First, frustration conceptualised as the blocking or thwarting of some form of ongoing, goal-directed behaviour, always leads to some form of aggression. Secondly, aggression always stems from frustration.

instance, “Blue-Line” buses which provided air conditioned service are now accessible to the workers. The MNL model hence provides some insights about the effect of traffic congestion on an individual’s travel choice. The improved bus serviced in Mauritius (**Enoch, 2003**) may have had a positive impact on selecting bus as a mode of transport to work, especially in period of road congestions.

## **5. Modelling Car Emissions**

Having studied the various determinants that influence the travel to work choice of an individual, it would be interesting to look at the trend in car emissions, especially CO<sub>2</sub> emissions. An increase in car possession can instigate both congestion and environmental dilemmas. Indeed, congestions and environment concerns are two sides of the same coin. CO<sub>2</sub> emissions produced during the combustion process are considered a major ecological threat as they contributed to global warming. For instance, during acute traffic congestions, CO<sub>2</sub> emissions have a tendency to rise due to the unrelenting stop-and-go traffic and acceleration and braking. Alarmingly, vehicle emissions from the land transport sector have followed an upward trend over the past decades in Mauritius (**Enoch, 2003**).

Vehicle emissions are a direct consequence of the mode of transport and congestions. In an attempt to study CO<sub>2</sub> emissions ejected by cars, the guidelines<sup>13</sup> provided by The Intergovernmental Panel on Climate Change (IPCC) are employed. The guiding principle for calculating CO<sub>2</sub> emissions inventories necessitates the application of an oxidation factor to the carbon content to account for a small portion of the fuel that is not oxidized

---

<sup>13</sup> More details are available online at: <http://www.epa.gov/otaq/climate/420f05001.pdf>.

into CO<sub>2</sub>. For all oil and oil products, the oxidation factor used is 0.99 (99% of the carbon in the fuel is eventually oxidized, while 1% remains un-oxidized). To estimate the CO<sub>2</sub> emissions from a gallon of fuel, the carbon emissions are multiplied by the ratio of the molecular weight of CO<sub>2</sub> (m.w. 44) to the molecular weight of carbon (m.w.12): 44/12.

The formulations are as follows:

- CO<sub>2</sub> emissions from a gallon of gasoline = 2,421 grams x 0.99 x (44/12) = 8,788 grams = 8.8 kg/gallon = 19.4 pounds/gallon.
- CO<sub>2</sub> emissions from a gallon of diesel = 2,778 grams x 0.99 x (44/12) = 10,084 grams = 10.1 kg/gallon = 22.2 pounds/gallon.

Having constructed the emissions series, a sample of 140 car owners is once more used to study the determinants of CO<sub>2</sub> emissions. A simple ordinary least squares (OLS) regression is employed. A reduced-form cross-section equation can be represented as follows:

$$\ln(CO_2)_i = \beta_0 + \beta_1 \ln(Agec)_i + \beta_2 Income'_i + \beta_3 Diesel_i + \beta_4 \ln(Distance)_i + \varepsilon_i \quad \text{----- (3)}$$

where,  $\beta$ 's are the coefficients to be estimated.

$\ln(CO_2)$  = natural logarithmic of CO<sub>2</sub> emissions per gallons.

$\ln(Agec)$  = natural logarithmic of car owners' age.

$Income'$  = set of dummy variables representing various income levels. The baseline category is income level greater than Rs. 65,000.

$Diesel$  = is a dummy variable denoting 1 if the engine uses diesel fuel and 0 if gasoline is instead used.

$\ln(\text{Distance})$  = natural logarithmic of working distance<sup>14</sup> from residential area in km.

$\varepsilon$  = the error term.

The Ramsey Regression Equation Specification Error Test (RESET) test (**Ramsey, 1969**) which uses the powers of the fitted values of the natural logarithmic of per gallon CO<sub>2</sub> emissions is performed. The test statistic is computed to be  $F(3, 128) = 1.94$  with a p-value of 0.127. The null hypothesis of no omitted variables in the model cannot be rejected. In other words, the model is well specified. Further results are presented in Table 3.

Age has a negative and statistically significant impact on CO<sub>2</sub> emissions. In some ways, this variable can be used as a proxy for driving behavior. So with time, some individuals tend to become more patient and avoid irresponsible maneuver like pressing on the gas and then braking persistently during traffic jams. Besides, fuel type has an impact on the amount of CO<sub>2</sub> discharged in the atmosphere. Referring to Table 3, vehicle running on diesel type of fuel produce more carbon dioxide than gasoline type. Diesel fuel has higher energy content and therefore can propel a vehicle farther on the same amount of fuel. But the use of diesel poses a serious threat to the environment during traffic congestion as it implies more pollution per km. According to **Davis et al. (2002)**, diesel exhaust contains 20 times extra particles than gasoline exhaust does. Finally, distance from work is also assessed and a positive impact on CO<sub>2</sub> emissions is found. **Stohl (2008)** advocates such

---

<sup>14</sup> For computational purpose a distance calculator is used. This is available online at: <http://www.infoplease.com/atlas/calculate-distance.html>.



impact. In general, income is found to have no significant impact on the level of CO<sub>2</sub> emissions.

## **6 Conclusion and Policy Implications**

This paper has attempted to analyze the determinants of transport mode choice to work in Mauritius as well as the resulting carbon emissions emanating from private cars. For this purpose, a household drop-off survey was conducted. A MNL model is utilized to estimate the effect of personal, household, institutional, and economic characteristics on the travel choices, namely car, bus and others (such are motor vehicles, company vans, walking, taxis and company cars). While age, gender, qualification and residential area have no impact on the mode choice between car and bus, factors such as household income, work location, travel expenses and duration of journey to work are found to be of statistically significant influence. Additionally, an OLS regression is run to capture the factors affecting CO<sub>2</sub> emissions. These are age of the individuals, fuel type and distance to work.

With the continuous rise in income and suburbanization development, private car ownership is expected to continue its upward trend. However, due to limited land capacity, bottlenecks are bound to become more acute while at the same time car emissions are expected to rise. More and more people are becoming dependent on car to travel to work. There is therefore a pressing need to reverse this unhealthy state of affairs. With income playing a central role in choice mode, increasing the cost of private transport such increasing car declaration fee can stimulate a modal shift. Car pooling can

turn out to be a viable option. Congestion toll and fuel tax can also be considered<sup>15</sup>. On the air quality control side, individuals may prefer to use low fuel consumption cars. Carbon neutral or hybrid cars which combine an internal combustion and electric engines can be promoted. A stop/start system on diesel vehicles can be encouraged to reduce the amount of CO<sub>2</sub> emissions (**Fonseca et al. (2011)**).

Over the last decade, major road and traffic management policies have been designed and implemented. These include the construction of the Ring Road and Bus Lane. Then again, polices should not merely focus on increasing road capacity. The government did launch the Bus Modernization Programme<sup>16</sup> in 2008. This was intended to enable bus operators to renew their fleet at no extra cost with new generation buses which are more comfortable and release less harmful emissions. So far, no such study was done to assess its impact. Moreover, **Sarkar et al. (2009)** suggest the introduction of flexible hours while the government has recently been promoting a 24/7 working environment. Port Louis is a congested area. Decentralizing and supporting economic activities away from Port Louis, can constitute a good policy option. In terms of alternative mode of transport, the government has also been considering the Light Rail Transit or the métro léger system. This may enable faster travel time and less pollution but it still regarded as costly means. One of the major barriers to develop a sustainable transport system is political. The government has been unwilling to restrict car use as such policy is quite unpopular (**Warren and Enoch, 2010**). Yet, designing effective transport policies remain one crucial means in achieving the objectives of the MID project.

---

<sup>15</sup> About 52.1% of car users in the sample agree to pay a road toll to avoid congestion.

<sup>16</sup> More details are available online at: <http://unpan1.un.org/intradoc/groups/public/documents/cpsi/unpan030901.pdf> and <http://www.gov.mu/portal/sites/nsp/industry/bus.htm>.

## 7 Reference

- Alperovich, G., Deutsch, J., Machnes, Y., 1999, The demand for car ownership: evidence from Israeli data. *International Journal of Transport Economics* 26, 351–375.
- Alpizar, F. and Carlsson, F., 2003, Policy implications and analysis of the determinants of travel mode choice: an application of choice experiments to metropolitan Costa Rica, *Environment and Development Economics*, 8, 603-619.
- Ang, B. W. 2004, Decomposition analysis for policymaking in energy: Which is the preferred method? *Energy Policy* 32, 1131–1139.
- Asensio, J. 2002. Transport mode choice by commuters to Barcelona's CBD, *Urban Studies*, 39, 10, 1881-1895.
- Ackberally, N. 2008, Indian Ocean cyber-city: originally, the creation of the cyber-city at Ebene, 25km south of the capital in the heart of Mauritius, was justified by the vision of developing a cyber-island and creating some 25,000 jobs. Today, the cyber-city is best known for its call-centres and business processing outsourcing, *Africa Business*, at: [http://findarticles.com/p/articles/mi\\_qa5327/is\\_342/ai\\_n29434097/?tag=content:coll](http://findarticles.com/p/articles/mi_qa5327/is_342/ai_n29434097/?tag=content:coll).
- Button, K., Ngoe, N. and Hine, J. 1993, Modelling Vehicle Ownership and Use in Low Income Countries, *Journal of Transport Economics and Policy*, 27, 1, 51-67.
- Commins, N. and Nolan, A. 2011, The Determinants of mode of transport to work in Greater Dublin Area, *Transport Policy*, 18, 259-268.
- De Palma, A. and Rochat, D. 2000, Mode choices for trips to work in Geneva: an empirical analysis, *Journal of Transport Geography*, 8, 43-51.
- Dollard, J., Doob, L. W., Miller, N. P., Mowrer, O. H., and Sears, R. R. 1939, *Frustration and aggression*. New Haven, CN: Yale University Press.
- Enoch, M. P., 2003, Transport practice and policy in Mauritius, *Journal of Transport Geography*, 11, 297–306.
- Fonseca, N., Casanova, J. and Valdes, M. (2011) Influence of the stop/start system on CO2 emissions of a diesel vehicle in urban traffic, *Transportation Research Part D*, 16, 194-200.
- Golob, T. F., 1989, The causal influences of income and car ownership on trip generation by mode, *Journal of Transport Economics and Policy*, 23, 2, 141-162.
- Golob, T. F, and Meurs, H. 1988, Modeling the dynamics of passenger travel demand by using structural equations, *Environment and Planning A*, 20, 9, 1197 – 1218.
- Good, D. H., Nadiri M. I. and Sickles R. 1999, Index Number and Factor Demand Approaches to the Estimation of Productivity, in *Handbook of Applied Econometrics: Microeconometrics*, Vol II, pp. 14-80. H. Pesaran and Peter Schmidt eds, Blackwell Publishers, Oxford, UK.
- Halcrow Fox in Association with MDS Transmodal, 2001. Integrated National Transport Strategy Study, Summery Report (Final), online at: <http://www.gov.mu/portal/goc/mpi/file/summary.pdf>.
- Hausman, J. and McFadden, D. 1984, Specification Tests for the Multinomial Logit Model, *Econometrica*, 52, 1219–1240.
- Himanen, V., Nijkamp, P. and Padjen, J. 1992, Environmental quality and transport policy in Europe, *Transportation Research Part A: Policy and Practice*, 26, 2, 147-157.

- McCafferty, D. and Hall, F. 1982, The Use of Multinomial Logit Analysis to Model the Choice of Time to Travel, *Economic Geography*, 58, 3, 236-246.
- McDonnell, S., Ferreira, S. and Convery, F. 2006, Impact of bus priority attributes on catchment area residents in Dublin, Ireland, *Journal of Public Transportation*, 9, 3, 137-162.
- McGillivray, R. 1972, Binary Choice of Urban Transport Mode in the San Francisco Bay Region, *Econometrica*, 40, 5, 827-848.
- Menon, G. 2004, Report on Congestion Pricing in Port Louis, Ministry of Public Infrastructure & Land Transport, Republic of Mauritius, June, [www.gov.mu/portal/goc/mpi/file/congest.doc](http://www.gov.mu/portal/goc/mpi/file/congest.doc).
- Ong, P. M. 2002, Car Ownership and Welfare-to-Work, *Journal of Policy Analysis and Management*, 21, 2, 239-252.
- Ramsey, J. B. 1969, Tests for Specification Errors in Classical Linear Least Squares Regression Analysis, *Journal of Royal Statistics Society B*, 31, 2, 350–371.
- Salon, D. 2009, Neighborhoods, cars, and commuting in New York City: A discrete choice approach, *Transportation Research Part A*, 43, 180-196.
- Sarkar, P. K., Moonshiram, K. B. and Nowbuth, M. D., 2009, A Critical Appreciation of Road Transport Problems in Mauritius and Possible Approaches to Solutions, *India Journal*, 6, 4, 22-40.
- Shinar, D., 1998, Aggressive driving: the contribution of the drivers and situation. *Transportation Research Part F*, 1, 137–160.
- Stohl, A. 2008, The travel-related carbon dioxide emissions of atmospheric researchers, *Atmospheric Chemistry and Physics*, 8, 6499–6504.
- Timilsina, G. R. and Shrestha, A. 2009, Why have CO<sub>2</sub> emissions increased in the transport sector in Asia? underlying factors and policy options, No 5098, Policy Research Working Paper Series, The World Bank, Available at: <http://econpapers.repec.org/RePEc:wbk:wbrwps:5098>.
- Van Mierlo, J., Maggetto, G., Van de Burgwal, E. and Gense, R. 2004, Driving style and traffic measures-influence on vehicle emissions and fuel consumption. Proceedings of the Institution of Mechanical Engineers, Part D: *Journal of Automobile Engineering*, 218, 1, 43-50.
- Vega, A. and Reynolds-Feighan, A. 2008, Employment Sub-Centres and Travel to Work Mode Choice in the Dublin Region, *Urban Studies*, 45, 9, 1747-1768.
- Warren, J. P. and Enoch, M. P. 2010, Island transport, car ownership and use: A focus on practices in Cuba, Malta, Mauritius and Singapore, *Island Studies Journal*, 5, 2, 193–216.

Table 1: Definitions of Variables and Summary Statistics

<b>Variables</b>	<b>Definition</b>	<b>%</b>
<b><u>Dependent:</u></b>		
<b>Car</b>	Private Cars	27.94
Bus (Ref.)	Bus owned by private and public individuals	56.09
<b>Others</b>	Other means of transport	15.97
Motor Vehicles		12.37
Company Van		1.80
Walking		1.20
Taxis		0.40
Company Car		0.20
<b><u>Independent:</u></b>		
<b>Ln (Age)</b>	Natural logarithmic of an individual's age	100
<b>Female</b>	Gender	38.12
Male (Ref.)		61.88
<b>Income:</b>	Individuals' income group	
Below Rs. 10,000		16.97
Rs. 10,001 – Rs. 15,000		34.13
Rs. 15,001 – Rs. 30,000		38.72
Rs. 30,001 – Rs. 45,000		7.98
Rs. 45,001 – Rs. 65,000		1.20
Above Rs. 65,000 (Ref.)		1.00
<b>Rural</b>	Residential location	24.85
Urban (Ref.)		75.15
<b>Education:</b>	Academic Qualification	
Secondary (Ref.)		39.52
Diploma		17.96
Bachelor Degree		31.94
Other Qualifications		10.58
<b>Ln (Household Size)</b>	Natural logarithmic of household size	100
<b>Ebene</b>	Working place	15.57
Port Louis (Ref.)		84.43
<b>Travel Expenses</b>	Weekly travel expenses	100
<b>Ln (Time To Work)</b>	Duration of trip from house to work	100

Source: Computed

Table 2: MNL Model of Mode of Transport to Work

Variable	Car		Others	
	Coefficient	Standard Error	Coefficient	Standard Error
<b>Constant</b>	13.44756	3.618034*	1.461686	3.088761
<b>Ln(Age)</b>	0.932767	0.7589297	2.456675	0.6800624*
<b>Female</b>	-0.2836241	0.3402351	-2.277146	0.5997164*
Male (Ref.)				
<b>Income:</b>				
Below Rs. 10,000	-14.41533	1.115669*	-1.127713	1.504047
Rs. 10,001 – Rs. 15,000	-13.89378	1.067715*	-1.664311	1.607804
Rs. 15,001 – Rs. 30,000	-13.90392	0.9314132*	-1.739124	1.46648
Rs. 30,001 – Rs. 45,000	-13.27501	1.076855*	-1.152838	1.571939
Rs. 45,001 – Rs. 65,000	-12.63246	1.249028*	-16.70235	1.973758*
Above Rs. 65,000 (Ref.)				
<b>Rural</b>	-0.1431156	0.3721816	-0.4461487	0.6097439
Urban (Ref.)				
<b>Education:</b>				
Secondary (Ref.)				
Diploma	-0.4116315	0.4879279	0.9234647	0.5114895
Bachelor Degree	0.2489088	0.4016172	-0.2331949	0.5979318*
Other Qualifications	0.7774849	0.6553876	0.9237205	0.9911186
<b>Ln (Household Size)</b>	0.0162542	0.4671584	-0.3865739	0.5339064
<b>Ebene</b>	0.7427547	0.343072**	1.4686	0.6037197**
Port Louis (Ref.)				
<b>Travel Expenses</b>	0.0067411	0.0015152*	-0.0092009	0.0028367*
<b>Ln (Time To Work)</b>	-1.887441	0.2677421*	-1.966488	0.4924752*
Number of Observations	501			
Log Pseudolikelihood	-190.6957			
Wald $\chi^2(30)$	1042.93			
Prob > $\chi^2$	0.0000*			
Pseudo R <sup>2</sup>	0.6090			

Source: Computed. Note: The baseline category for the mode of transport is bus. Ref. symbolizes the reference category. \* and \*\* denote 1% and 5% significance level respectively. Standard errors are computed with the Huber/White/sandwich robust variance estimates.

Table 3: OLS Model of natural logarithmic of CO<sub>2</sub> Emissions per Gallon

Variable	Coefficient	Standard Error
<b>Constant</b>	4.969187	0.6234562*
<b>Ln(Age)</b>	-0.2729997	0.1328992**
<b>Income:</b>		
Below Rs. 10,000	-0.1296833	0.3535528
Rs. 10,001 – Rs. 15,000	-0.2654535	0.3440229
Rs. 15,001 – Rs. 30,000	-0.0838857	0.3299615
Rs. 30,001 – Rs. 45,000	-0.012245	0.3312299
Rs. 45,001 – Rs. 65,000	-0.0583566	0.3392438
Above Rs. 65,000 (Ref.)		
<b>Diesel</b>	0.4540671	0.1433961*
Gasoline (Ref.)		
<b>Ln (Distance)</b>	0.2824811	0.0619785*
Number of Observations	140	
F(8, 131)	4.29	
Prob > F	0.0000*	
R <sup>2</sup>	0.2368	

Source: Computed. Note: The baseline category for the mode of transport is bus. Ref. symbolizes the reference category. \*, and \*\* denote 1% and 5% and significance level respectively. Standard errors are computed with the Huber/White/sandwich robust variance estimates.

## Session 13 - Energy Storage

# Grid Scale Energy Storage in Salt Caverns

Fritz Crotagino, Sabine Donadei,  
KBB Underground Technologies GmbH, Hannover, Germany

## Abstract

Fossil energy sources require some 20% of the annual consumption to be stored to secure emergency cover, cold winter supply, peak shaving, seasonal swing, load management and energy trading. Today the electric power industry benefits from the extreme high energy density of fossil and nuclear fuels. This is one important reason why e.g. the German utilities are able to provide highly reliable grid operation at a electric power storage capacity at their pumped hydro power stations of less than 1 hour (40 GWh) related to the total load in the grid – i.e. only 0,06% compared to 20% for natural gas! Along with the changeover to renewable wind-and to a lesser extent PV-based electricity production this “outsourcing” of storage services to fossil and nuclear fuels will decline. One important way out will be grid scale energy storage in geological formations.

The present discussion, research projects und plans for balancing short term wind and solar power fluctuations focus primarily on the installation of Compressed Air Energy Storages (CAES) if the capacity of existing pumped hydro plants cannot be expanded, e.g. because of environmental issues or lack of suitable topography. Because of their small energy density, these storage options are, however, generally less suitable for balancing for longer term fluctuations in case of larger amounts of excess wind power, wind flaws or even seasonal fluctuations. One important way out are large underground hydrogen storages which provide a much higher energy density because of chemical energy bond. Underground hydrogen storage is state of the art since many years in Great Britain and in the USA for the (petro-) chemical industry.

## 1 Introduction

Every energy economy, whether based on fossil fuels, nuclear fuel or renewable primary energy sources, requires extensive energy storages at a grid scale to balance out the time-dependent availability of primary energy sources and actual grid load. Despite the enormous investment already made in renewable energy sources, Germany for instance still only has a storage capacity for electrical energy amounting to less than 1 hour’s consumption. By comparison, the storage capacities for natural gas and crude oil are sufficient for 2 months. This dramatically illustrates the large future storage demand for electrical energy during the transition from a fossil/nuclear to an electrical power-based energy economy.

Only pumped hydro and underground gas storages are capable of providing the storage capacities at the scale that is forecast. This paper describes and compares the options for the large scale storage of electrical energy, especially in underground geological formations via compressed air and hydrogen; key issues are layout, performance data, state-of-the-art technology and costs.

The published information on the future demand for large scale storages is used as the basis for the discussion here of the options available for each of the potential scenarios from a technical and economic point of view. This is followed by an overview of the geological conditions in Europe specific to the possible construction of underground storages. The final part of the paper discusses how this may be associated with limitations to the realisation of an energy economy based purely on renewable energy sources.



## 2 Storage demand and resulting storage solutions – current status of the ongoing discussions in Germany

### 2.1 General

The current discussion about the future demand for energy storages at a grid scale is characterised by major differences in the premises (availability of large or small proportions of conventional energy sources or dispensing with them completely) and the associated large differences in the findings.

The spectrum ranges from a current study by the German transmission grid operators<sup>1</sup>, which considers the need for compressed air storage power plants in the near future to be low on the basis of economic considerations and the assumption that fossil and nuclear power plants will be available in the long term; to the work by Greiner, Aarhus University<sup>2</sup>, which investigates the enormous demand for storage capacities in case of a future 100% renewable power system scenario for Europe. The following sections of this paper sketch out the typical premises and the associated storage demands.

### 2.2 Balancing out short-term discrepancies (balancing power)

Assuming that a significant proportion of fossil fuel power plants and possibly also nuclear power plants will remain available even in the long term, temporary shortages in wind power output and PV output can be largely balanced out by the use of these conventional power plants. In this case, additional storage demand mainly focuses on the provision of balancing power, to balance out short-term divergences in wind forecasts in both directions, and to stabilise conventional generation in order to make best use of both fossil as well as renewable generation resources<sup>3</sup>. The appropriate main storage options are the following, which are characterised by their high levels of flexibility: (i) pumped hydro and water storage power plants, (ii) compressed air energy storage (CAES) power plants and (iii) demand side management. Power in-/output is expected to be up to several Gigawatts for up to several hours. Converting large amounts of excess wind power into hydrogen

In the medium term in North Germany in particular, there it becomes apparent that the planned construction of offshore wind farms will give rise to a considerable excess in the generation of wind power. The current excess already leads to the frequent shut-down of wind turbines because of grid bottlenecks – an expensive option because of the high compensation payments then due to the wind farm operators. Even with the necessary expansion of grid capacities, there will still be periods with a major excess in wind power output because of strong winds at times of low grid loads. This excess wind power cannot be fed into the transmission grid: the German state of Schleswig-Holstein bordering on Denmark is expecting excess wind energy in 2020 totalling 4,000 GWh corresponding to 20 % of the offshore wind power<sup>4</sup> generated per year. There are basically three options for using hydrogen generated by excess wind power:

---

1 Peter Radgen et.al.: *The Economics of Compressed Air Energy Storage under Various Framework Conditions*; PowerGen Europe 2010, Amsterdam

2 Martin Greiner: *A 100% Renewable Power System for Europe*; Risø International Energy Conference 2011, Roskilde, Denmark

3 The Boston Consulting Group (BGC): *Revisiting Energy Storage – There is a Business Case*; 2011

4 U.Albrecht: *Wind hydrogen: A module for the future supply of power in North German*; study prepared by Ludwig-Bölkow-Systemtechnik GmbH, Munich, on behalf of the Hydrogen Society Hamburg, the city of Hamburg and the state of Schleswig-Holstein

(i) FEEDING THE HYDROGEN INTO EXISTING NATURAL GAS PIPELINES COMBINED WITH STORAGE: Natural gas pipelines transport large continuous rates of gas. The German gas industry therefore suggests replacing partially fossil fuel (natural gas) with green fuel (hydrogen) in case of need to absorb excess wind power. Studies have shown that 5 to 10% by-volume hydrogen can be mixed into the natural gas without any problems. E.g. the DEUNA pipeline which links Denmark with Germany is designed for a nominal capacity of 430,000 m<sup>3</sup>/h ( $V_{st}$ ) corresponding to 4,000 MW; the mixing-in of only 5% hydrogen would correspond to a continuous (!) gross power of around 100 MW or a gross amount of energy equivalent to 876 GWh per year. This highlights the enormous potential of the existing natural gas infrastructure to accommodate excess hydrogen. At E-World 2011, the German Technical & Scientific Association for Gas and Water (DVGW) stated unequivocally that they would support the integration of fluctuating wind power by the option of feeding in green hydrogen into the natural gas distribution grid. Feeding the hydrogen into natural gas pipelines will require large scale storage in salt caverns in order to balance *fluctuating* hydrogen production and the demand for *continuous* injection because of the very rigid specifications for the composition of natural gas.

(ii) MATERIAL USE OF GREEN HYDROGEN: In Germany, 1.8 million tonnes of hydrogen with an energy content of 70 GWh are currently produced every year for the chemical industry: around 50% of this is used for the production of ammoniac as a raw material for fertilisers, while 25% is used by the petrochemical industry. This hydrogen is produced from natural gas, and production is forecast to grow by 10% annually. Major hydrogen consumers are present for instance in the greater Hamburg area. In addition to the above, major carmakers such as Daimler, GM and Volkswagen, are looking intensely at the development of fuel cell powered cars consuming hydrogen. The study mentioned above therefore also looked at the extent to which green hydrogen from excess wind power could be used to supply the future fleet of such vehicles in the greater Hamburg area. Preliminary studies indicated a need of several 500,000 m<sup>3</sup> caverns for Northern Germany for the uses stated under (i) and (ii).

(iii) GENERATING ELECTRICITY: This appears actually the most logical option – using the stored hydrogen during demand peaks to generate electricity in combined cycle gas power stations, because with the two options described above, the shortage of renewable power has to be balanced out by conventional fuels. Because of the low overall efficiency achievable today of only 40% (power to power), using hydrogen to generate electricity has so far only played a subordinate role for economic reasons. This option has to compete against the alternative generation of electricity by natural gas, whose proportion has been reduced by mixing in green hydrogen; in this case, generating electricity is no longer restricted to the vicinity of the hydrogen storages or the construction of a hydrogen distribution infrastructure.

### 2.3 Pure regenerative scenario

In a scenario based exclusively on regenerative sources, the power generators are dominated by wind and PV systems whose availability fluctuates stochastically in a strong way because of the daily cycles as well as the seasonal variations. In the paper by Greiner “*A 100% renewable power system for Europe*” mentioned previously, there is also an estimate of the associated storage demand in Europe required by this scenario; the calculations are based a 60 % wind and 40 % PV power and optimal grid expansion. Assuming wind and PV over-capacity of 50% in order to reduce storage demand, there is still an enormous storage demand of 35 TWh for an output of 90 GW. The key factor here is balancing out seasonal fluctuations.

Previewing briefly here the discussions in the following chapters, such huge amounts of energy can only be realised in combination with additional pumped hydro storages in Scandinavia and in other parts of Europe, and particularly by a large number of hydrogen storage facilities in salt caverns; a rough estimate results in 400 large caverns compared to some 200 existing gas caverns in Germany today. Alternative storage methods such as

compressed air storages, demand site management, or even batteries can be ignored as completely inadequate solutions in the face of the enormous scale involved.

### 3 Energy storage in salt caverns

#### 3.1 Large-scale storage options - overview

Only three methods are viable in practise when dealing with storage capacities at scales of GWh to TWh, and power input or output of several 100 MW up to larger GW scales: (i) water reservoirs without pump capacities supplemented by pumped hydro plants, (ii) CAES plants and (iii) hydrogen storage power plants.

PUMPED HYDRO POWER PLANTS are particularly flexible and boast a high efficiency of up to 80%. However, the volumetric storage density is low. In Germany the acceptance of new facilities is limited although there seems to be less resistance in Austria, Switzerland and Scandinavia with the by far largest potential in Europe.

COMPRESSED AIR ENERGY STORAGE POWER PLANTS are much discussed today for future applications because favourable geological conditions exist in the wind-rich areas of the North Sea for the construction of storage caverns in salt formations. The associated environmental impact is low, and investment and operating costs are moderate. The efficiency of future adiabatic facilities could achieve 70%. The volumetric storage density is higher than that of pumped hydro power plants but still low.

HYDROGEN STORAGE POWER PLANTS consist of electrolyzers to convert electrical energy into hydrogen, salt caverns including compressor plant to store the gas, and combined cycle gas turbine power plants to generate electricity again. A disadvantage of this option is the low overall efficiency of today <40%; the crucial advantage, however, is the much higher volumetric energy storage density of which is around two orders of magnitude greater.

Fig. 1 compares the volumetric energy densities of the three storage options mentioned above; Fig.2 illustrates some of the typical areas of application of the three storage options referred to above.

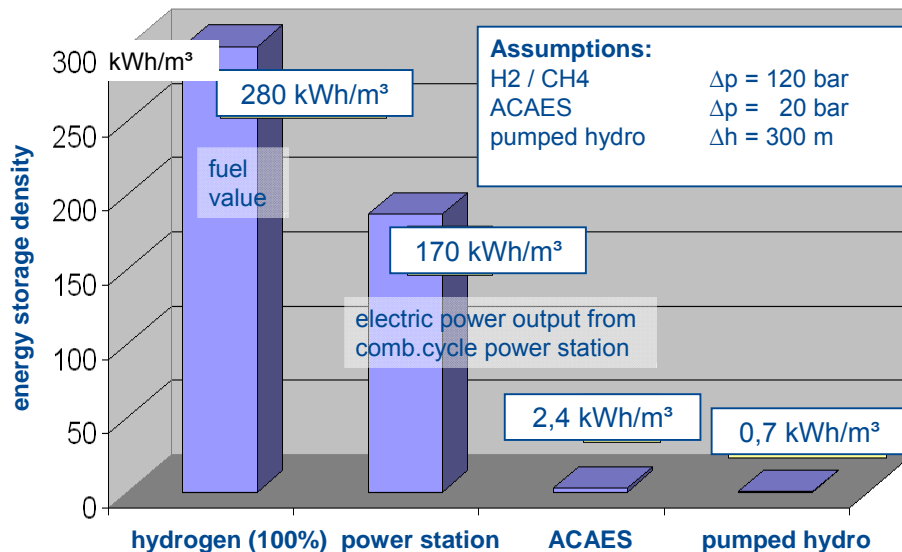
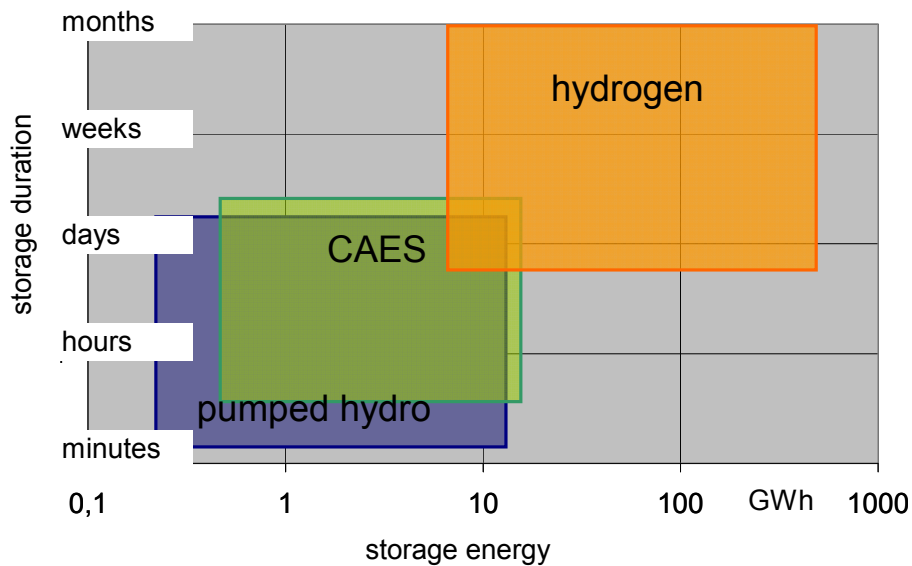

Fig. 1: Volumetric energy storage densities



*Fig. 2: Application ranges for large scale energy storage options*

The below sections focus on the underground storage options.

### 3.2 Underground storage options – why focus on salt caverns?

The storage of natural gas in depleted oil and gas reservoirs, in aquifer formations or in man-made salt caverns, has been standard practise for many decades. In Germany and in France, over 20% of annual consumption is stored underground. And some 100 new caverns are currently being constructed in Northern Germany. Fig. 3 illustrates the gas storage options in underground geological formations including abandoned mines and hard rock caverns. Natural reservoirs dominate in terms of amount of gas stored underground world-wide. However, the current enlargements in storage capacities in Europe are concentrated on salt caverns because these storages are much more flexible: having much higher injection and withdrawal rates, and the flexibility to handle frequent cycles. The installation of caverns is naturally dependent on the availability of suitable salt formations, as well as the ability to dispose of in an environmentally-compatible way the large volumes of brine produced during the solution mining of the caverns – normally an easy problem to solve when caverns are located close to the North Sea.

Another aspect plays an important role in the selection of suitable storage formations for the storage of air and hydrogen looked at in this paper: after injection of the media, the oxygen in the air or the hydrogen can react with the minerals and the microorganisms present in natural reservoirs. This can result in a loss of oxygen or hydrogen, production of hydrogen sulphide as well as the blockage of the fine pores in the reservoir rocks by the reaction products. To avoid this, caverns are exclusively used as energy storages in those regions which have suitable salt formations available. In the USA, because the regions with large wind resources are often in areas with no suitable salt deposits, the use of pore storages for compressed air and hydrogen are also being analysed. If a means is found of using these formations, it would make considerable additional storage potential available.

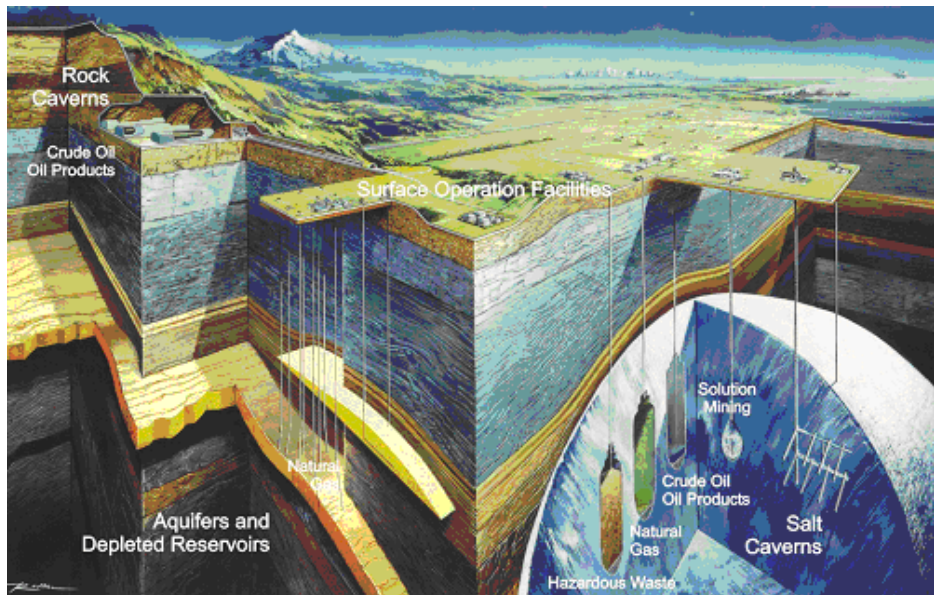

Fig. 3: Options for underground storage of gases

### 3.3 Compressed air energy storage plants

CAES plants have previously been the main focus of discussions when considering the integration of large volumes of wind power into the grid because favourable conditions for the construction of storage caverns exist in the wind-rich areas close to the North Sea. Other reasons include the low environmental impact, moderate investment and operating costs, and the fact that two facilities have already been successfully operated for over 20 years; a 320 MW installation belonging to E.ON KRAFTWERKE in Huntorf, Germany; and a 110 MW facility in McIntosh, Alabama, USA, operated by POWERSOUTH.

The two currently operating *diabatic* facilities do not use the compression heat generated during the compression of the air, which means that natural gas has to be used to heat the air back up during withdrawal from the storage. These CAES power plants are therefore strictly speaking gas turbine power plants with storages rather than a pure storage power plant. The advantage compared to a pure gas turbine power plant is the 40 to 60 % lower consumption of natural gas and the associated emissions of CO<sub>2</sub>. The new facilities currently planned in the USA are largely based on the standard components and are much more flexible compared to the two existing plants because of the mechanical decoupling of the compressor side and the turbine side. The efficiency levels are still 42 to 54% depending on the way the waste heat is used.

Research has been carried out for many years in Germany on the *adiabatic* CAES version which also stores and uses the compression heat boosting efficiency to 70 %. However, the development of the various components is very challenging and it will probably take another 10 years before such systems are ready for the market. RWE and GE plan to start a demonstration project in 2016 with an output of 200 MW and storage capacity of 1,000 MWh.

The low volumetric energy storage density of around 3 kWh/m<sup>3</sup> limits the use of this technology to cover very large storage capacities. Installation is also dependent on the availability of suitable salt formations as well as the need to dispose of in an environmentally-compatible way the brine which is generated during the leaching of the caverns; this is not considered to be a problem in the vicinity of the North Sea. Unlike natural gas and hydrogen caverns, CAES caverns can only be constructed within a depth window of 500 to 1,300 m because the operating pressure is directly dependent on the depth, and the power plant components using today's state-of-the-art technology operate

at pressures between 50 to 100 bar. This places an additional constraint on the selection of suitable salt formations. The investment costs range from 550 to 900 EUR/kW<sup>5</sup>

### 3.4 Hydrogen

The hydrogen option is based on the following components, see Fig. 4: (i) Electrolyser to generate pre-compressed hydrogen and oxygen from water, (ii) storage caverns and (iii) compressor plant to inject the hydrogen into the storage cavern, and later on to withdraw it, reduce the pressure to pipeline pressure.

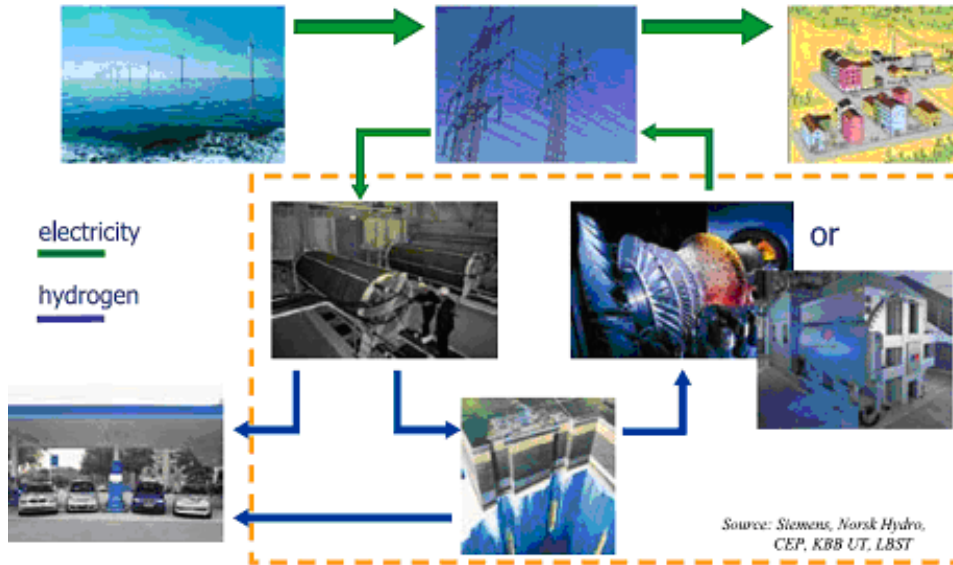

Fig. 4: Block diagram of hydrogen storage power plant

The withdrawn gas may need to be dried because brine residues in the cavern sumps can saturate the gas with water vapour. No other contamination is expected during storage because rock salt does not react with hydrogen.

Practical experience with the storage of hydrogen in caverns has already been gained from an old installation in Teeside, England, and younger facilities in Texas, USA, where a third cavern for the petrochemical industry is currently also being installed. The layout of the caverns largely corresponds to that of modern natural gas caverns, although specific components need to be adapted for future use in Europe in order for them to comply with the latest safety standards such as the installation of special production strings including subsurface safety valves.

Typical dimensions are volumes of 500,000 m<sup>3</sup> with pressure ranges between 60 to 180 bars, which corresponds to a net storage capacity of around 4,200 t or 140 GWh<sup>6</sup>. Practical experience in the USA shows that the losses are negligible at less than 0.1 % p.a.

Because the energy in the hydrogen is chemically bound (just like natural gas), hydrogen caverns can be designed much more flexibly than CAES caverns, and can therefore also adapted better to the local geological conditions. This means that many more salt formations in Europe are potentially suitable for the construction of this type of energy storage than is the case with CAES caverns, as already mentioned above. The CAPEX is according to the *dena Grid Study II* 2,300 to 2,700 EUR/kWh, an estimate with still a major uncertainty.

<sup>5</sup> DENA (German Energy Agency): *dena Grid Study II – Integration of Renewable Energy Sources in the German Power Supply System from 2015 – 2020 with an Outlook to 2025*, 2011.

<sup>6</sup> related to lower heating value



### 3.5 Geological potential in Europe

Fig. 5 gives an overview of the – very irregular – distribution of salt formations in Europe. The symbols for existing and planned salt cavern projects indicate where formations are present with potential suitability for the construction of future energy storages.

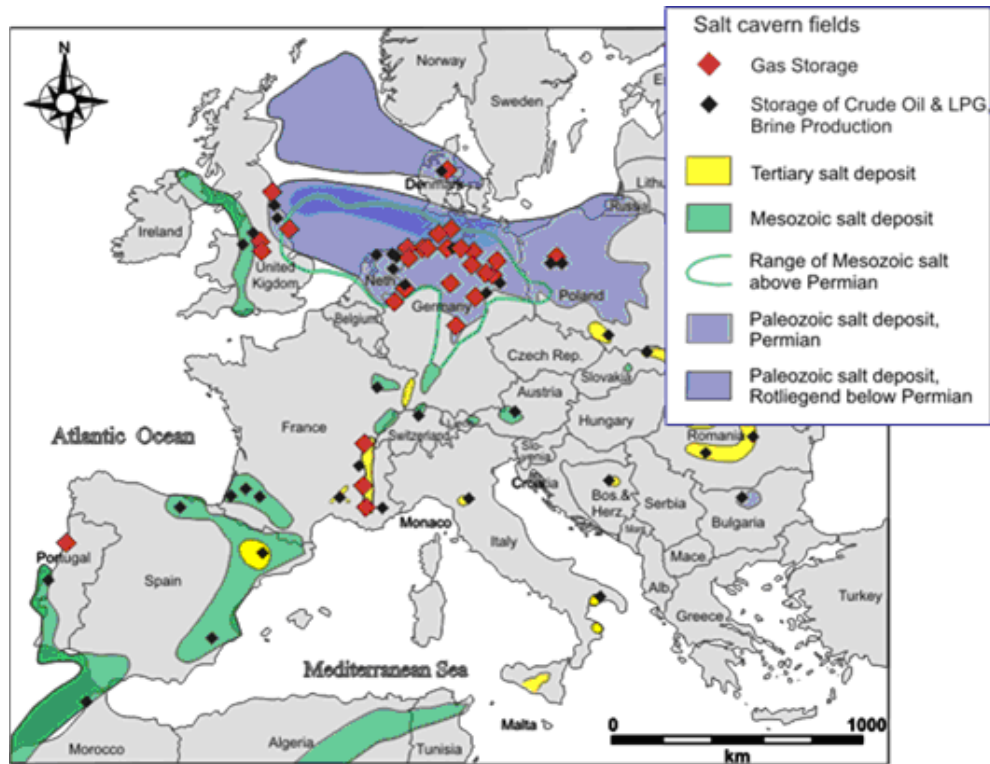

Fig. 5: Salt formation and cavern projects in Europe

The map is dominated by the large *Zechstein deposits* (blue colour) which extend from the east coast of England, across the Netherlands, Germany and Denmark, all the way to Poland. This shows that in these countries, and in Central Europe in particular, very favourable conditions exist for the construction of additional storage caverns. The potential in England, however, is restricted to natural gas and hydrogen caverns because the deposits are too deep for the construction of CAES caverns.

The *other salt deposits* younger than the *Zechstein* have less favourable properties: they are frequently thinner often allowing only smaller cavern volumes, and often have high proportions of insoluble minerals, which means that there are also additional losses in net storage volume. The deposits on the west coast of England are almost completely exploited by natural gas storage caverns – the additional potential is largely only available offshore in the Irish Sea. In France, the salt deposits in question lie at the eastern and the southern edge of the country and are mostly very deep, which will limit construction of CAES caverns. Spain has no gas storage caverns to date even though there is an enormous demand for capacity. This clearly indicates the limited suitability of the salt deposits in this country. Portugal has potential – albeit limited – and one large natural gas storage facility is currently being constructed. According to the information available today, Italy basically has no suitable deposits.

In conclusion, the potential for the construction of energy storages in salt formations is very unevenly distributed and limited. There is a great need to look at the potential in greater detail because otherwise this may give rise to restrictions in the expansion of regenerative energies in Europe; this topic has not attracted a great deal of attention to date.

## 4 Summary

The transition from fossil and nuclear fuels to regenerative energy sources goes hand-in-hand with a decrease in the importance of the previously dominant role played by conventional energy storage in the form of for example natural gas and crude oil caverns, characterized by the very high volumetric energy storage density. This transition is coupled to an increase in the demand for large-scale energy storages, particularly for fluctuating wind power as well as PV energy.

During the transition period, energy storage will primarily be required to make balance energy available to compensate for divergences in wind power forecasts. Possible options here are pumped hydro storage and CAES power plants, although they are dependent on local topography or geology, and public acceptance.

If the proportion of renewable energies then dominates the energy mix, large volumes of excess wind energy will be generated over longer periods of time which can no longer be stored in pumped hydro and CAES plants for technical and economic reasons. This scenario is behind the current considerations in Germany of converting the excess energy into hydrogen and using this hydrogen mainly for the chemical industry, for powering future fuel cell vehicles, and for replacement of natural gas by green hydrogen.

An energy economy based *purely* on regenerative energy sources will have a very high demand for energy storages, mainly to compensate for the seasonal fluctuations in power generation. Even a rough estimate of the storage capacities involved show that this scenario could only be realised by constructing a enormous number of hydrogen storages in underground geological formations, which then leads to the next question of whether there is adequate geological potential to satisfy this demand. A solution might be to maintain a certain natural gas reserve – even in an - almost complete renewable energy based world.



# Sensitivity on Battery Prices and Capacity on board Electric Drive Vehicles and the Effects on the Power System Configuration

Author: Nina Juul, Risø National Laboratory for Sustainable Energy, Technical University of Denmark, Roskilde, Denmark, e-mail: njua@risoe.dtu.dk

## Abstract

The need for reserves is increasing with increasing fluctuating production capacities in the power system. For flexible reserves, either reserves with fast response time are needed, or storage options are to be investigated. In the transport system, the expectation for electric drive vehicles, including both battery electric vehicles and plug-in hybrids, is that they will be taking over parts of the market within the next decade or two. The electric drive vehicles can provide some of the flexibility needed in the power system both in terms of flexible demand and electricity storage. The question is how much reserve capacity in terms of batteries is interesting for the power system? To answer that question, the optimal capacity of the battery in a vehicle is to be found, given the use of the battery for both driving and storage in the power system. Likewise, the prices at which the electric drive vehicles are interesting in a cost minimisation problem are to be found. This article presents an analysis of the integrated power and transport system focusing on the sensitivity in the power system according to battery capacity and price, in a situation where the vehicles use smart charge and are able to deliver power back to the grid (vehicle-to-grid). The analyses show that it is very beneficial to introduce the flexibility of the battery, and the larger the battery, the more benefits are included, although, the marginal benefit decreases. For very high battery prices, large batteries imply that investments in diesel vehicles are preferred.

## 1 Introduction

Electric drive vehicles (EDVs) are of increasing interest in a world with intensified focus on climate and CO<sub>2</sub>-emissions. Integration of the power and transport systems has great potentials in terms of synergies between fluctuating renewable energy and the possibility of storing electricity on board the EDVs. For the configuration of the power system, the value of the batteries depends on the price, whereas, for the operation of the power system, the value of the batteries depends on the capacities.

In this article, the consequences on the power system operation and configuration are analysed given various battery prices and capacities in the EDVs. Based on a model of an integrated power and transport system described in [1], scenarios are analysed for the northern European power system.

The vehicle-to-grid (V2G) concept has been described by Kempton and Tomić [2]. [3] and [4] give an overview of potentials of grid-to-vehicle (G2V) and V2G capabilities. The EDVs providing regulation, operating reserves, etc. to the power system has been analysed by a number of researchers. In [5] the economic details on providing the different services have been analysed.

Integrating the power and transport systems influences the power production. The impact of the integration has, so far, only been quantified by few researchers. Lund and Kempton [6] have looked into the value of V2G with different wind penetrations and how the EDVs can help integrate more wind. Investment analysis and optimal operation of the integrated power and transport system has been introduced in [1] and in [7] in terms of illustrative cases on the Danish and Portuguese energy systems respectively.

Shortt and O'Malley [8] have studied fast charge versus slow charge of the EDVs and the impacts on both the power system and the electricity prices.

[9] has focused on the impacts of different battery charging strategies. Charging control algorithms are studied in [10] and [11]. Lipman and Hwang [12] touch on the technological innovation of batteries and the EDVs. In [13] the characteristics for different EDVs with different battery types, their potentials and requirements are studied. Vehicle efficiency changes depending on battery weight is the focus of [14].

Despite broad research, not many researchers have focused on the benefits or costs of changing battery capacity or price in the EDVs. Valuing a change in battery capacity has been done by Lemoine [15] using real options, capturing the electricity price uncertainty. In this article, a model of the integrated power and transport system [1] is used to analyse the power system consequences of varying battery prices and capacities on board the EDVs.

The model of the integrated power and transport is described in the next section including a touch on relevant assumptions. The base case is described in Section 3.1 while Section 3.2 presents the scenarios. Results are presented in Section 4 and discussed in Section 5. Section 6 concludes.

## 2 Balmorel with road transport

Balmorel is a partial equilibrium model [16] assuming perfect competition. The model minimises operational costs subject to constraints including renewable energy potentials, balancing of electricity and heat production, and technical restrictions. An economically optimal solution is found through investment generation and electricity prices are derived from marginal system operation costs.

Balmorel has three geographical entities; countries, regions, and areas. Balancing of electricity and transport supply and demand is on regional level, whereas balancing of supply and demand for district heating is on area level. The optimisation horizon is one year. The model works with an hourly time resolution that can be aggregated into fewer time steps.

Including passenger road transport in Balmorel requires activation of the transport add-on [1], resulting in an analysis of the integrated power and transport system. The transport model includes electricity balancing in the transport system and the power system - and in the integrated power and transport system. Vehicles that are non-plug-ins are treated in a simplified way, since they do not provide flexibility to the power system.

### 2.1 Assumptions

The model is based on assumptions to be found in [1] and [17]. Two assumptions are particularly relevant for the analyses in this article.

PHEVs are assumed to use the battery until depletion before using the engine. Due to price differences between electricity and diesel, and the differences in efficiency of the electric motor and the diesel engine, the assumption seems reasonable.

The load factor of the battery is fixed for every vehicle group, due to non-linearity in the model otherwise. Thus, all vehicles in each group leave the grid with the same battery state-of-charge (SOC).

## 3 Application

The model is applied to a northern European case, year 2030. The base case is based on scientific data and the scenarios have been developed with offset in the base case. Base case and scenarios are described in the following.

### 3.1 Base case

A northern European energy system including the Scandinavian countries and Germany, is used for the analyses. Each country is modelled as one region except from Denmark and Germany, due to bottlenecks in the system.

Power and transport demand is set according to [18] (Table 1). The source only includes EU-countries. For estimating Norwegian demand, Swedish demand has been scaled according to historical demand.

*Table 1 Demand input data year 2030 (source [18])*

	Denmark East	Denmark West	Sweden	Norway	Finland	Germany (total)
Electricity demand (TWh/yr)	16	24	153	133	104	620
District heat demand (TWh/yr)	12	15	46	3	56	102
Transport demand (bill. persons km/yr)	31	41	148	69	86	1,262

Balancing supply and demand requires investment possibilities in new plants.

Investments are possible in the technologies shown in Table 2. Hydrogen is not included because preliminary analyses show that hydrogen is too expensive and will not be used.

*Table 2 Technology investment options in the simulation. Investment costs for heat storage is given as M€/MWh storage capacity.*

Technology	Source	Fuel	Inv costs (M€/MW)	Var O&M cost (€/MWh)	Fixed O&M cost (k€/MW/yr)	Efficiency*
Onshore wind	[19]	Wind	1.22	11.5		1
Offshore wind	[19]	Wind	2.2	15		1
Coal extr., Steam Turbine	[19]	Coal	1.1		34	0.51
Open cycle gas turbine	[19]	Natural gas	0.57	3	8.6	0.42
Combined cycle gas turbine, cond.	[20]	Natural gas	0.56	3.4	21.4	0.58
Combined cycle gas turbine, extr.	[19]	Natural gas	0.47	4.2		0.61
CHP plant, biomass (med)	[19]	Wood	1.6	3.2	23	0.485
CHP plant, biomass (small)	[19]	Wood- waste	4		140	0.25
Nuclear	[20]	Uranium	2.81	7.7	55.5	0.37

The focus is on diesel vehicles, diesel PHEVs, and BEVs, the latter two with varying battery sizes. The electric efficiency today is approx. 5 km/kWh [21], [22], [23]. Based on these efficiencies and assumed evolution, the efficiency is believed to reach approx. 7 km/kWh by 2030. Based on [24], the battery size by 2030 will provide a driving range of 50 km for PHEVs and 200 km for BEVs.

The vehicles are assumed to be plugged-in when parked, making the batteries available to the transmission system operator. Driving patterns are derived from the investigation of transport habits in Denmark [25]. Driving habits are assumed to be the same for all the Nordic countries. Grid capacity is set to 6.9 kW (3 phase 10 Amp with a 230V cable).

## 3.2 Scenarios

The battery evolution is uncertain, both in terms of capacities (density) and battery prices. Expectations used in this article are based on the technology roadmap from IEA [24] (Table 3). For the PHEVs, the battery capacity is expected to support a driving range from 20km to 100km, corresponding to a battery capacity from 3kWh to 15kWh. For the BEVs the driving range is from 100km to 500km, a battery capacity from 15kWh to 72kWh.

*Table 3 Vehicle battery range options (based on [24] and [14])*

Type of vehicle	Battery max costs (€/kWh)	Battery min costs (€/kWh)	Electric storage cap. max (km)	Electric storage cap. min (km)
BEV	400	100	500	100
PHEV	600	150	100	20

Depending on the size of the battery, one could argue that the weight is increasing with increasing power capacity. Considerations on varying the battery weight and vehicle efficiencies have been made based on [14]. It is decided not to include the battery weight both because of the high uncertainty and because of the belief that the size of the battery will be negatively correlated with the weight. That is, the lighter the battery per kWh, the larger the capacity is incorporated in the EDV – approx. reaching the same driving efficiency. Thus, the final weight of the vehicle is believed to end up more or less the same.

Two analyses are made:

1. Analysis of the influence of the battery capacity. In this analysis it is assumed that 25 % of the vehicle fleet is BEVs and 75% PHEVs. These assumptions are based on data from DST where the share of 2nd, 3rd, etc. vehicle in the household sums up to 25%.
2. Analysis of the influence of battery pricing. This is done by changing the price for different battery capacities. The model invests in the most optimal vehicle fleet as well as the optimal heat and power system.

An overview of the scenarios tested for analysis 1 is shown in Table 4. The table leaves out unrealistic combinations, i.e., small batteries in the BEVs and large batteries in the PHEVs.

*Table 4 Scenarios run for analysing the influence of the battery capacity*

Type	BEV					
	kWh	15	29	43	58	72
PHEV	3	x				
PHEV	4.5	x	x			
PHEV	6	x	x			
PHEV	7.5	x	x	x	x	
PHEV	9		x	x	x	x
PHEV	11.5		x	x	x	x
PHEV	15			x	x	x

In order to analyse the influence of the battery prices many scenarios are run as shown in Table 5.

*Table 5 Annual vehicle price depending on the battery price (€/year)*

Battery Price	kWh	€150/kWh	€250/kWh	€300/kWh	€500/kWh	€600/kWh
PHEV	3	1122	1150	1177	1219	1247
PHEV	4.5	1143	1184	1226	1288	1330
PHEV	6	1164	1219	1274	1357	1413
PHEV	7.5	1184	1253	1323	1426	1496
PHEV	9	1205	1288	1371	1496	1579
PHEV	11.5	1240	1346	1452	1611	1717
PHEV	15	1288	1426	1496	1772	1911

## 4 Results

The model is run on a computer with 7.8 GB RAM and a 2.99 GHz processor. Computation time is approx. 35 hours for each model run.

### 4.1 Battery capacity change

Changing the capacity of the battery in a vehicle fleet of 75% PHEVs and 25% BEVs changes different factors in the power system. In general, costs are decreasing with increasing battery sizes due to the decrease in use of diesel.

#### Investments and electricity generation

Focusing on Denmark, wind power investments are increasing with increasing battery capacities whereas a slight decrease in combined cycle gas turbine (CCGT) and heat pumps is experienced. Figure 1 shows a decrease in electricity generation on coal with increasing battery capacity for PHEVs up until 7.5 kWh. After that, the usage of coal is almost the same with a slight increase except for BEVs with 29kWh batteries that experience a larger increase than the others. The increases are not due to increases in investment, but rather an indication that increased use of existing plants are more beneficial than investment in other plants.

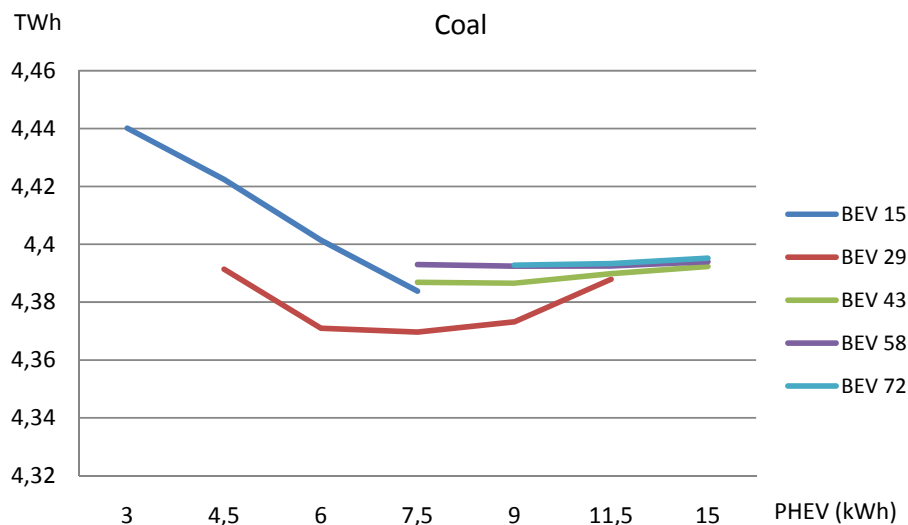

Figure 1 Electricity generation on coal in Denmark, 2030 (TWh)

For natural gas, an increase in consumption is experienced with increasing battery capacity in the PHEVs when batteries are small (Figure 2). However, with battery capacities larger than 7.5 kWh the usage is decreasing. For BEVs the electricity generation on natural gas is decreasing with increasing battery capacity except for the situation with extremely large batteries in both PHEVs and BEVs, where the change is almost invisible. Thus, for the largest benefits are found reaching a level of 43-58 kWh for the BEV and 9-15 for the PHEVs.

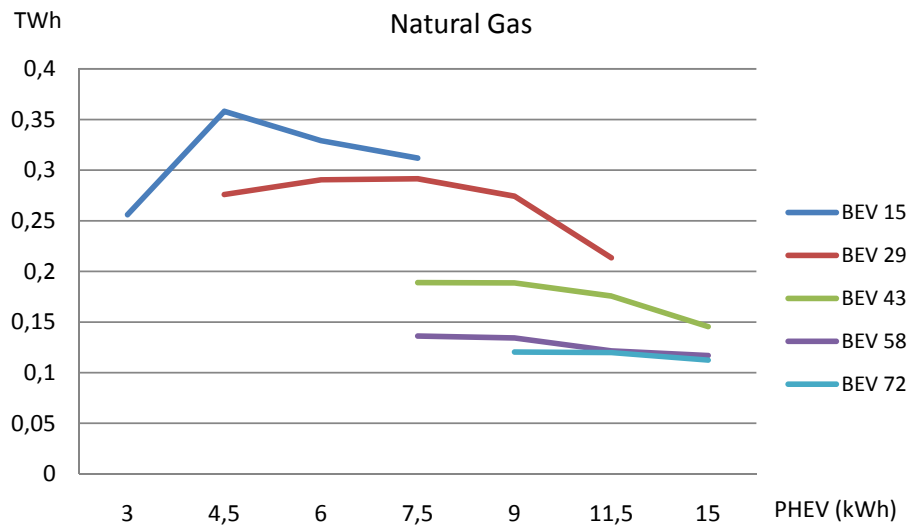

Figure 2 Electricity generation on natural gas in Denmark, 2030 (TWh)

The large increase when increasing the battery capacity from 3kWh to 4.5kWh for PHEVs (15kWh for BEVs), can be due to increased shares of renewable energy incorporated in the system. With small battery sizes in the EDVs more reserve capacities than can be provided with these are needed. Investments in CCGT have decreased, indicating that the increased use is spread over time.

The increase in electricity on wind power is large and continuous with increasing battery capacities (Figure 3). Although, increasing the battery capacities for the BEVs do not change much in the wind power generation.

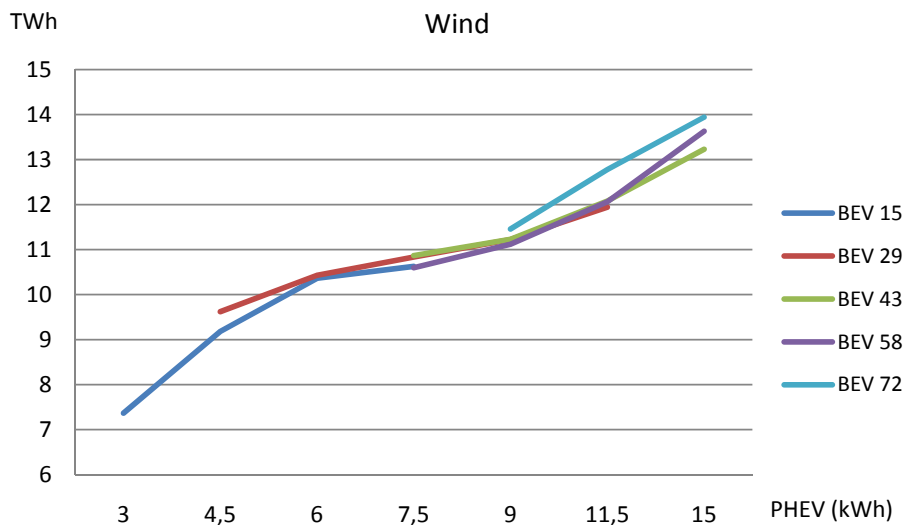

Figure 3 Electricity generation on Wind in Denmark, 2030 (TWh)

For Finland, investments in wind power has reached the limit even with the smallest batteries, leaving changes in investments to be on fossil fuelled power plants. Both investments in and generation from coal power plants increases with increasing battery capacities (Figure 4) and the share of renewable energy is decreasing. Investments in Finland include a maximum investment in wind power of 25,000 MW in all scenarios.

Furthermore, a slight decrease in the use of natural gas and heat pumps with increasing battery capacity is experienced.

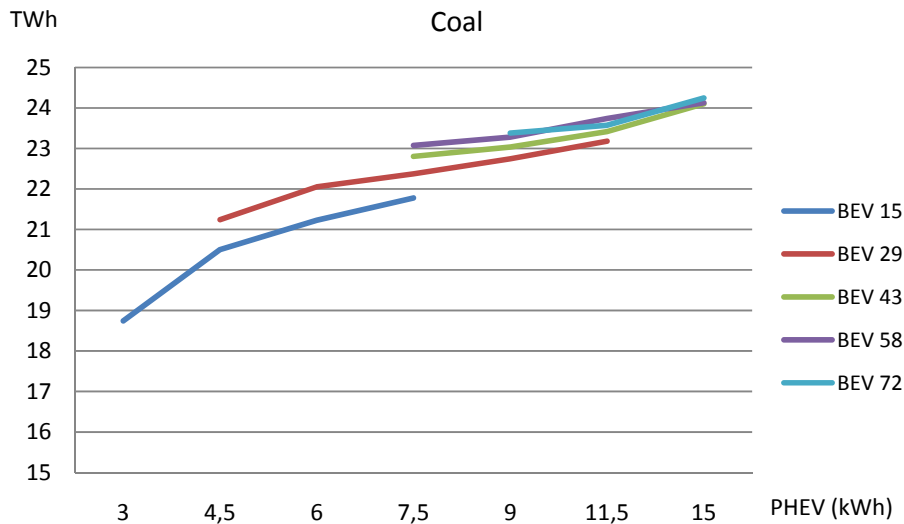

Figure 4 Electricity generation on coal in Finland, 2030 (TWh)

In Germany investments are in coal plants only. The majority of the generation is on nuclear, coal, and lignite. Both coal and lignite is increasing with increasing battery capacities. It is interesting though, that with an increase in the BEVs battery capacity, the electricity generation on coal is decreasing as can be seen from Figure 5. Furthermore, the largest increase is experienced with the increase from 3 to 6 kWh batteries in the PHEVs.

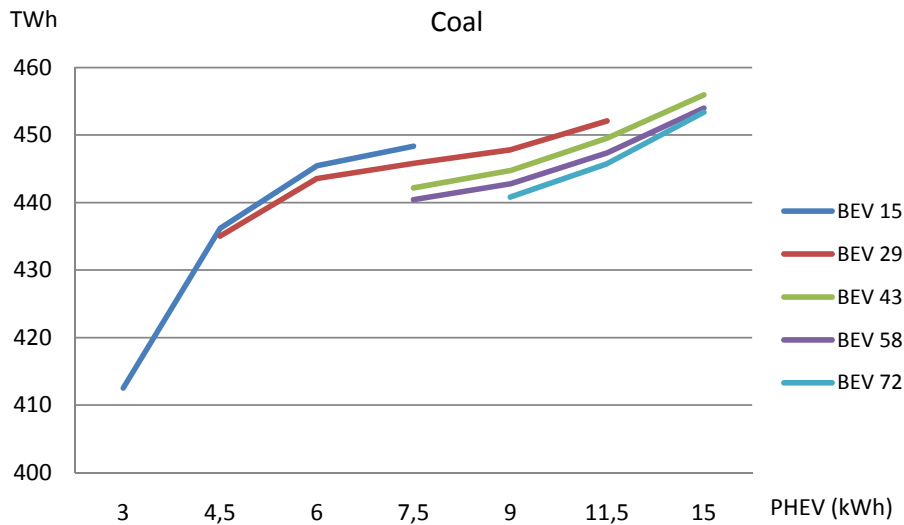

Figure 5 Electricity generation on coal in Germany, 2030 (TWh)

Usage of lignite decreases up to a battery level of 4.5 kWh for the PHEVs and increases otherwise (Figure 6). The level of renewable energy is 0%, due to resources and maybe also Germany only being allowed transmissions with the other Nordic countries.

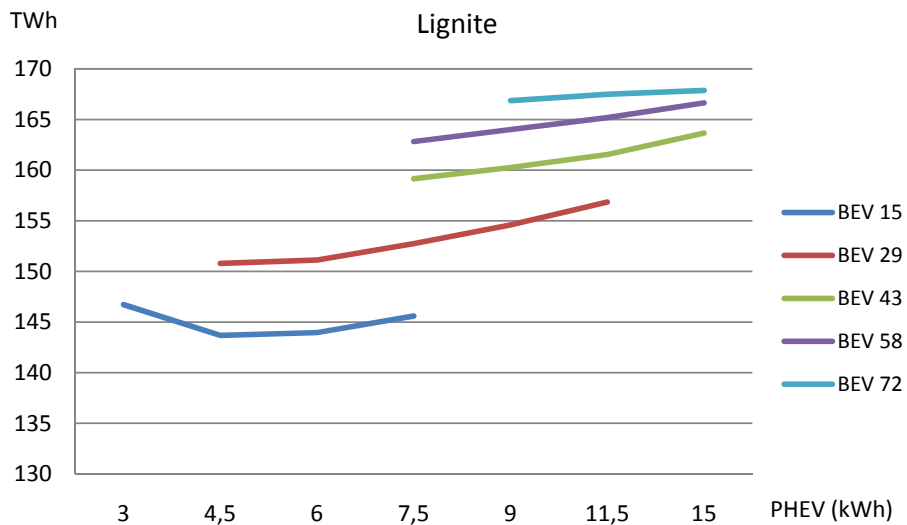

Figure 6 Electricity generation on lignite in Germany, 2030 (TWh)

Norway is atypical with a rather stable electricity production on water and an increasing investment and production on wind power with increasing battery capacities.

In Sweden power production is primarily on wind, water, and nuclear. Investments are almost non-changing. Changes in the use of natural gas are experienced (Figure 7). A small increase is seen up to 6 kWh in the PHEVs and after that, the use of natural gas is generally decreasing. Furthermore, the use is decreasing with increasing battery capacities in the BEVs. All of this is resulting in a level of approx. 71% of renewable energy in Sweden in all scenarios.

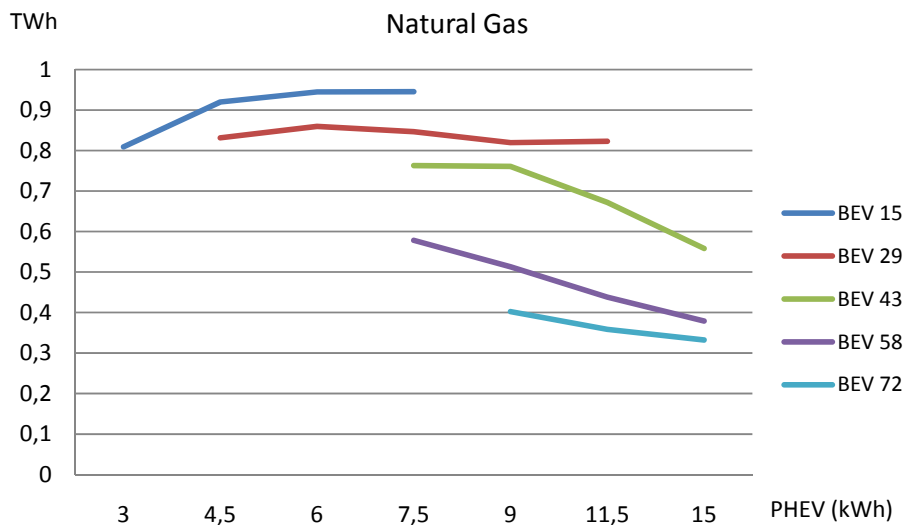

Figure 7 Electricity generation on natural gas in Sweden, 2030 (TWh)

#### **CO<sub>2</sub>-emissions from electricity generation**

CO<sub>2</sub>-emissions increase for Germany and Finland with increasing battery capacity and decrease in Denmark and Sweden. In Norway, CO<sub>2</sub>-emissions are stable.

#### **Charging and discharging of the vehicles (net from grid)**



Night time charging increases with increasing battery capacity for both BEVs and PHEVs. Slight trend of less charge during the day for the BEVs, the larger the battery.

Discharging – or V2G – is used very differently from country to country. In Norway the V2G is not used at all – probably due to the availability of hydro storage and flexibility enabling large integrations of wind power. For Denmark the BEVs are used for V2G around 6 p.m. for large batteries and with 72kWh batteries V2G is widely used during the day (btw 8 a.m. and 3p.m.). The PHEVs are used for V2G to some extent. For Sweden and Finland, V2G is widely used for the BEVs with the large battery capacities (58kWh and 72kWh) between 8a.m. and 7p.m., whereas, V2G is rarely used for the PHEVs. In Germany, however, V2G is heavily used for all battery sizes and for both PHEVs and BEVs all times of day. This is due to the batteries enabling a more stable production on the remaining fossil power plants.

### **Electricity prices**

In Denmark, Norway, and Germany, electricity prices are more even the larger the batteries. Thus, lower peaks and higher downs in the prices are experienced. In Finland, electricity prices are increasing slightly with larger battery capacities, although, still with less distinct peaks and downs. Finally, Sweden experiences increasing prices with increasing battery capacities. The stable production makes the power prices increase.

## **4.2 Battery price change**

Investments are in either PHEVs or diesel vehicles when optimising investments in vehicles. Interestingly, battery prices as well as battery capacity have to be very high for EDVs not to be beneficial for the integrated power and transport system. Diesel vehicles are optimal only in situations with battery capacity of 11.5kWh and a battery price of 600€/kWh or battery capacity of 15 kWh and a battery price of either 500€/kWh or 600€/kWh. Note that this counts both for countries with primary investments in coal and countries with primary investments in wind.

## **5 Discussion**

The analyses presented are based on an optimisation model assuming rational behaviour. As for the heat and power system this assumption does to a large extent seem reasonable with all players minimising costs. For investments in private vehicles, however, people act less rational and choices are often based on both preferences and wealth. Although the results shown are optimal, investments in vehicles will most likely differ from this, yet, incentives could still be considered in order to move towards a beneficial solution for the integrated power and transport system.

Optimising the load factor is of interest for future analyses. This could be done in situations where investments are not included. Optimising the load, when leaving the grid, is expected to increase the value of the EDVs and might result in EDVs being beneficial in all the scenarios investigated in this paper.

## **6 Concluding remarks**

As has been showed in this paper, optimal investments are in most cases in EDVs. Only with very large batteries and high battery costs, optimum changes to investments in diesel vehicles. Thus, optimum is not as sensitive to the battery prices as expected.

Configuring the power system and generating electricity is sensitive to the battery capacity. The largest changes happen from the 3kWh to 6kWh batteries in the PHEVs, with large increases in coal use in Germany and Finland and decrease in coal in Denmark. The use of wind power increases most significantly with the small batteries in both Denmark and Norway. The need for natural gas is increasing in scenarios with

small batteries, whereas, larger batteries seem to be able to eliminate some of the need for natural gas.

As for the BEVs the greatest benefits are experienced up to the 43kWh battery capacity. Afterwards, the marginal benefits are decreasing. As for the CO<sub>2</sub>-emissions, the BEVs reach a level of 58kWh before the marginal benefits approaches a level of almost zero.

In an environmental perspective, a choice of 58kWh battery for the BEVs and 7.5kWh for the PHEVs is a beneficial choice for both the investment and electricity generation perspective.

## REFERENCES

- [1]. Juul, N., Meibom, P., Optimal configuration of an integrated power and transport system, *Energy*, 2011
- [2]. Kempton, W., Tomic, J., Vehicle-to-grid power fundamentals: Calculating capacity and net revenue, *Journal of Power Sources*, Vol. 144, pp 268-279, 2005
- [3]. Lipman, T., Integration of Motor Vehicle and Distributed Energy Systems, *Encyclopedia of Energy*, Vol. 3, pp 475-486, 2004
- [4]. Turton, H., Moura, F., Vehicle-to-grid systems for sustainable development: An integrated energy analysis, *Technological Forecasting and Social Change*, 2008, doi:10.1016/j.techfore.2007.11.013
- [5]. Kempton, W., Tomic, J., Letendre, S., Brooks, A., Lipman, T., Vehicle-to-Grid Power: Battery, Hybrid, and Fuel Cell Vehicles as Resources for Distributed Electric Power in California, UCD-ITS-RR-01-03, 2001
- [6]. Lund, H., Kempton, W., Integration of renewable energy into the transport and electricity sectors through V2G, *Energy Policy* 36, pp. 3578-3587, 2008
- [7]. Ibáñez, E., McCalley, J., Aliprantis, D., Brown, R., Gkritza, K., Somani, A., Wang, L., National Energy and Transportation Systems: Interdependencies within a Long Term Planning Model, *IEEE Energy2030*, 2008
- [8]. Shortt, A., O'Malley, M., Impact of optimal charging of electric vehicles on future generation portfolios, in *IEEE PES/IAS Sustainable Alternative Energy Conference*, Spain, 2009
- [9]. Hadley, S., Tsvetkova, A., Potential Impacts of Plug-in Hybrid Electric Vehicles on Regional Power Generation, *The Electricity Journal*, 2009
- [10]. Hutson, C., Venayagamoorthy, G.K., Corzine, K.A., Intelligent Scheduling of Hybrid and Electric Vehicle Storage Capacity in a Parking Lot for Profit Maximization in Grid Power Transactions, *IEEE Energy2030*, 2008
- [11]. Markel, T., Kuss, M., Denholm, P., Communication and Control of Electric Vehicles Supporting Renewables, *IEEE Vehicle Power and Propulsion Systems Conference*, September 2009
- [12]. Lipman, T., Hwang, R., Hybrid Electric And Fuel Cell Vehicle Technological Innovation: Hybrid and Zero-Emission Vehicle Technology Links, 20th International Electric Vehicle Symposium and Exposition, 2003
- [13]. Kempton, W., Letendre, S., Electric vehicles as a new power source for electric utilities, *Transportation Research*, Vol. 2 (3), pp 157-175, 1997
- [14]. Shiau, C.-S.N., Samaras, C., Hauffe, R., Michalek, J.J., Impact of battery weight and charging patterns on the economic and environmental benefits of plug-in hybrid vehicles, *Energy Policy*, vol. 37 (7), pp. 2653-2663, 2009
- [15]. Lemoine, D., Valuing Plug-in Hybrid Electric Vehicles' Battery Capacity Using Real Option Framework, *The Energy Journal*, Vol. 31, No.2, pp 113-143, 2010
- [16]. Ravn H, et al., Balmorel: A Model for Analyses of the Electricity and CHP Markets in the Baltic Sea Region, 2001
- [17]. Elkraft System, Risø National Laboratory, AKF, Institute of Local Government Studies, Stockholm Environment Institute, Institute of Physical Energetics,

- Lithuanian Energy Institute, PSE International, and Kaliningrad State University, Balmorel: A Model for Analyses of the Electricity and CHP Markets in the Baltic Sea Region, Balmorel Project, 2001
- [18]. European Commission, Directorate of Energy and Transport, European energy and Transport Trends to 2030 – Update 2007, 2007
  - [19]. Danish Energy Authority, Technology Data for Energy Plants, 2010
  - [20]. IEA International Energy Agency, Tackling Investment Challenges in Power Generation, IEA 2007
  - [21]. Short, W., Denholm, P., A Preliminary Assessment of Plug-In Hybrid Electric Vehicles on Wind Energy Markets, Technical Report, NREL/TP-620-39729, 2006
  - [22]. Denholm, P., Short, W., Evaluation of Utility System Impacts and Benefits of Optimally Dispatched Plug-In Hybrid Electric Vehicles, technical report, NREL/TP-620-40293, 2006
  - [23]. Delucchi, M. A., Burke, A., Lipman, T., Miller, M., Electric and Gasoline Vehicle Lifecycle Cost and Energy-Use Model, report, UCD-ITS-RR-99-04, 2000
  - [24]. IEA International Energy Agency, Technology Roadmap – Electric and plug-in hybrid electric vehicles, 2009
  - [25]. Transport, DTU, "Transportvaneundersøgelsen" (*Investigation of transport habits in Denmark*), 2006

# Wind power impacts, electricity storage and heat measures – a time scale perspective

Karsten Hedegaard<sup>a</sup>, Peter Meibom<sup>b</sup>

<sup>a</sup>Systems Analysis Division, Risø DTU, Technical University of Denmark, 4000 Roskilde, Denmark

<sup>b</sup>Intelligent Energy Systems Programme, Risø DTU, Technical University of Denmark, 4000 Roskilde, Denmark

## Abstract

Integrating large amounts of wind power in energy systems poses balancing challenges due to the variable and only partly predictable nature of wind. In this paper, using the case of West Denmark in 2025 with an expected 57 % wind power penetration, wind power impacts are analyzed, indicating the physical potential for power balancing on different time scales. This is done by analysing the length of high and low net load periods; expressing the two overall challenging operational situations. The results indicate a potential for flexible technologies capable of charging/activating demand and discharging/inactivating demand in periods of one hour to around half a day, providing intra-day balancing. More interestingly, the occurrence of consecutive negative net load periods with lengths of 0.5-3 days, consecutive high net load periods of 0.5-0.75 day and of average negative/high net load periods with lengths of one to several days also indicate a potential for flexible technologies capable of balancing *intra-week*. Finally, the results also indicate a potential for seasonal balancing.

## 1 Introduction

Several countries expect large wind power penetrations in the future and this will pose system balancing challenges due to the variable and only partly predictable nature of wind. The Danish energy system forms an interesting case for analysing these challenges. This is firstly due to a high amount of wind power, corresponding to almost 20 % of annual electricity consumption. Secondly, around 50 % of the power production is based on combined heat and power (CHP), resulting in a large amount of heat bound power production [1]. As a result, in periods with high wind power production, high heat demand and low electricity demand, forced electricity export occurs. Furthermore, in order to ensure stable system operation and meeting electricity demand over the year, there is a significant need for regulating power and ancillary services. The target of 50 % wind power in Denmark in 2025 points to significantly increasing challenges of wind power integration in the near future [2]. Moreover, considering the long term goal of the Danish Government of phasing out the use of fossil fuels, an efficient utilisation of the wind power is important.

In addition to enhancing and expanding the existing power grid and interconnections with neighbouring countries, studies suggest that use of large heat pumps and electric boilers in combination with heat storages in CHP systems are economically feasible in increasing system flexibility and integrating wind power [3-6]. Individual heat pumps can also contribute with system benefits and are considered to have high feasibility in areas outside district heating [7] [8]. When operated intelligently, battery electric vehicles also offer high potentials in facilitating the integration of wind power [1, 9]. In addition, dedicated electricity storage technologies such as large batteries, flow

batteries, Compressed Air Energy Storage (CAES) and electrolysis combined with fuel cells could play a role in the future energy system.

The challenges of balancing power production and demand cover different time scales from e.g. intra-hour and intra-day to seasonal level. Due to differences in technology characteristics such as response time, storage possibilities and cost considerations, electricity storage technologies and heat measures will differ with regard to the time scales at which they are suited to support wind power integration. The above calls for a time scale perspective on the system impacts of wind power and the potentials of the various flexibility measures.

A number of studies, e.g. [10-12], analyse wind variations and their impacts on the Nordic electricity system and Jónsson et al. [13] analyse how day-ahead wind forecasts affect electricity spot prices at the day-ahead spot market. Another study [14] evaluates the current occurrence of low and high wind power shares (as pct. of electricity demand) in West Denmark on an overall level as well as the impact on electricity prices. In this paper, using the case of West Denmark in 2025 with an expected 57 % wind power penetration, wind power impacts on different time scales are analysed. The power system of West Denmark is in focus as this will continue to comprise the majority of the Danish wind power production, around 75 % in 2025 (the remaining in East Denmark forming the second part of the power system).

The system impacts of wind power are analysed based on hourly data on net load, defined as gross load (electricity demand) minus wind power<sup>1</sup>. Net loads provide a better indication of wind power impacts than do wind power shares. The reason is that net loads capture variations in wind power as well as in electricity demand expressing what have to be covered by other units in the power system. Overall, there are two possible challenging operational situations, namely high net load and low net load, and these are both treated in this study. By analysing the length of high and low net load periods, the expected demand for power system balancing at different time scales is investigated. This approach has not been found in previous studies and brings interesting perspectives to discussing wind power integration. In line with this approach, further work will categorise different heat measures and electricity storage technologies with respect to the time scales at which they are suited to support wind power integration.

## 2 System impacts of wind power

### 2.1 The system today and in 2025

A certain minimum power production is needed to maintain voltage and frequency stability of the grid, today normally supplied from the large power plants. In West Denmark, this minimum power production is currently considered to be in the neighbourhood of 400 MW [15]. This constraints the system's ability to respond to wind power variations and is therefore taken into consideration. Thus, the net loads used in this study are defined as gross load minus wind power and minus the minimum power production provided by the centralised thermal power plants.

In 2006-2008, in West Denmark, wind power and minimum power production together exceeded electricity demand, resulting in negative net load, in relatively few hours corresponding to around 2 % of the year on average (see Fig. 1). Furthermore, as shown there is currently plenty of dispatchable thermal power capacity and import capacity to

---

<sup>1</sup> Danish power generation from other variable renewable energy sources such as photo voltaic and wave power is negligible.

backup periods with high net loads, i.e. low wind power and high electricity demand.

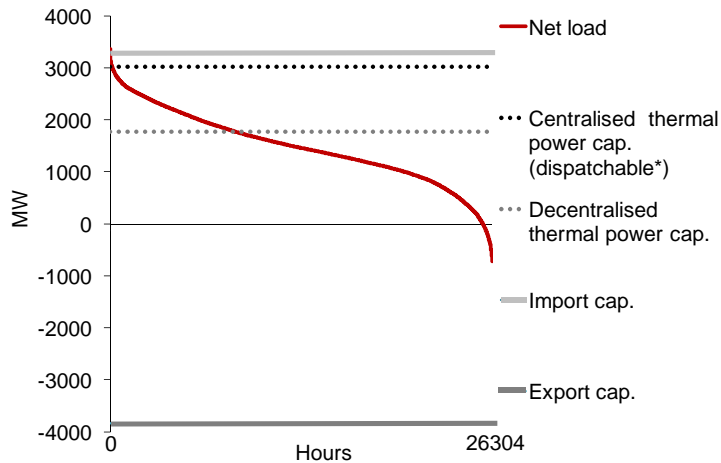

Fig. 1. Net load duration curve for 2006-2008 vs. thermal power capacities and import/export capacities in 2009 for West Denmark (Net load [16], Capacities [17]).

Based on data from the Danish TSO regarding expected wind power production, electricity demand and thermal power capacities, a corresponding figure has been set up for 2025 (see Fig. 2). The estimated wind power production for West Denmark in 2025 is based on expected on-shore and off-shore wind power capacities at different locations and wind power production variations based on wind speed measurements at different locations. In total, 2800 MW wind power on-shore and 1760 MW off-shore is assumed in 2025 covering 57 % of the electricity demand on annual basis. The estimates are made to represent a normal wind year.

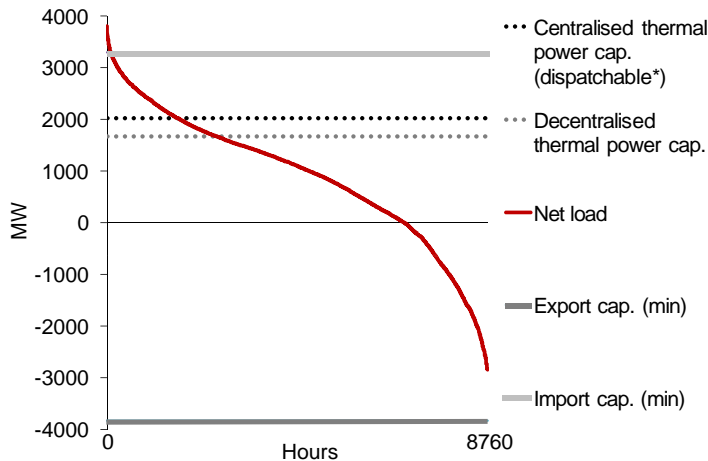

Fig. 2. Estimated net load duration curve and expected thermal power capacities and minimum import/export capacities in 2025 for West Denmark (Capacities [18]).

An interconnection between the power system of West and East Denmark being established during 2010 (600 MW) will reduce the need for minimum power production in thermal plants in West Denmark. Moreover, in a future energy system with wind power penetrations approaching 50 % or more, wind turbines may be able to contribute to grid stabilising system services [19]. Overall, some-what less, around 300 MW of minimum centralised power capacity for grid stabilisation is therefore assumed in West Denmark in 2025. As shown in Fig. 2, the number of hours with surplus wind power, i.e.

negative net load, can be expected to be considerable in 2025; corresponding to around 22 % of the year.

In addition, the dispatchable centralised thermal power capacity will be lower; around 2000 MW in 2025 compared to around 3000 MW currently. As a result, compared to the present situation less abundant thermal capacity will be available to cover electricity demand in high net load periods. Part of the high/low net load periods in West Denmark can be balanced through the interconnection with East Denmark. When also including interconnections with neighbouring countries, sufficient import and export capacity, 3300-6000 MW and 3800-6000 MW, respectively, is expected to be available in 2025 for handling high and negative net load periods [18]. However, considerable wind power penetration is expected in East Denmark and neighbouring countries in 2025, and wind power variations in these areas typically show similar patterns. As a consequence, future electricity prices in neighbouring areas can often be expected to be low when domestic electricity prices are low leading to low value of exported wind power [20]. Correspondingly, electricity import in high net load periods could be costly. The higher the ability to obtain balance in the energy system without having to rely on electricity import/export, the better possibilities will be for using external electricity trade only when it is profitable. In this regard, flexible technologies providing power balancing can play an important role.

Setting a general threshold level for what should be considered high net loads in West Denmark in 2025 is very difficult as the power production activated to cover the net load is based on an economic market optimisation and as the situation will vary from hour to hour. Acknowledging the difficulties in setting such a threshold limit, high net loads above 2000 MW, 2500 MW and 3000 MW, respectively, are investigated. Correspondingly, different degrees of negative net loads are analysed, i.e. net loads below 0 MW, -500 MW, -1000 MW, -1500 MW and -2000 MW, respectively. Considering that the power production at centralised and decentralised CHP plants will have a certain level due to heat bound power production, excess electricity production can be expected to be some-what higher than indicated by the negative net loads in the study.

## 2.2 Categorisation of system impacts

On an aggregated regional level, i.e. for West Denmark in the present case, the system impacts of wind power can be categorised into the following time scales:

- *Intra-hour*: Impacts due to the imperfect predictability of wind power requiring intra-hour balancing at the regulating market and at the reserve market. A subdivision can be made into impacts requiring activation of frequency controlled primary reserves with an activation time of a few to 30 seconds and impacts requiring regulating power and activation of secondary reserves within 15 minutes [21].
- *Intra-day*: Wind power variations creating high/low net periods of one hour to around half a day (12 hours), corresponding to a time scale typically relevant for intra-day balancing technologies, i.e. flexible electricity demand/electricity storage of a few hours or e.g. shifting of demand from day to night
- *Intra-week*: Wind power variations creating high/low net load periods approaching one day to several days, corresponding to a time scale relevant for balancing intra-week
- *Seasonal*: Impacts due to seasonal wind variations creating high/low net loads variations across months

Data for Danish wind power production and electricity demand on second or minute level have not been available and hence, *intra-hour* impacts cannot be evaluated. However, wind power variations on second to a few minutes basis are smoothed by

different gusts for the individual turbines, inertia of the large rotors as well as the variable speed turbines absorbing the variations and there is no correlation between the variations of geographically dispersed wind farms. As a result, wind power variations within seconds or few minutes, in the order of the activation notice of primary reserves, have very small effects on system operation even at considerable penetration [10, 11]. For regulating power and secondary reserves with an activation time of maximum 15 minutes, the impact of wind power forecast errors is significant but nevertheless lower than the impact of hourly wind power variations [22].

The remaining wind power impacts are in the following analysed using projected hourly net load variations for West Denmark in 2025. The length of negative and high net load periods<sup>2</sup> is investigated based on two different approaches:

- 1) Length of consecutive negative/high net periods and
- 2) Rolling averages indicating periods with negative/high net loads on average.

### 2.3 Negative and high net load periods

The results suggest that negative net load periods in 2025 will be rather pronounced, occurring in 22 %, 15 % and 10 %, of the year for consecutive net load periods below 0 MW, -500 MW, -1000 MW, respectively (see Fig. 3). A significant part will cover periods with a length of up to half a day, i.e. 34 %, 40 %, 54 %, 82 % and 100 % of the periods with net loads below 0 MW, -500 MW, -1000 MW, -1500 MW and -2000 MW, respectively. However, periods of 0.5-3 days will comprise the majority of the consecutive negative net load periods below 0 MW and -500 MW and hereof, a significant part of the periods have lengths above one day.

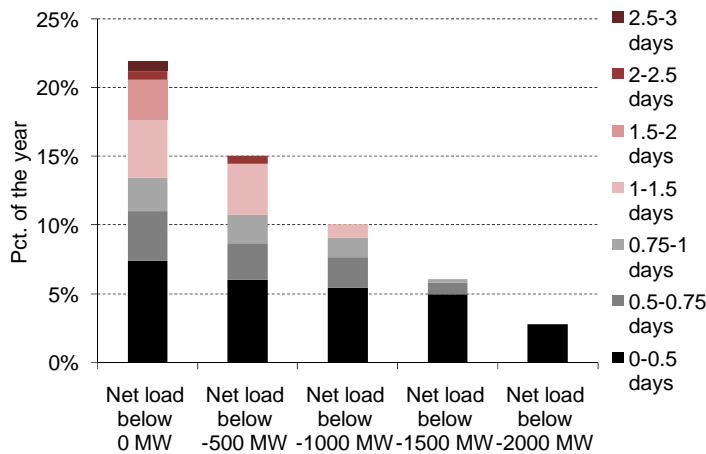

Fig. 3. Consecutive negative net load periods expected for West Denmark in 2025.

As illustrated in Fig. 4, consecutive high net load periods will not exceed a length of one day. Hereof, periods of lengths below and above half a day, respectively, will both be significant.

<sup>2</sup> After subtracting of 300 MW minimum power productions on large thermal plants.



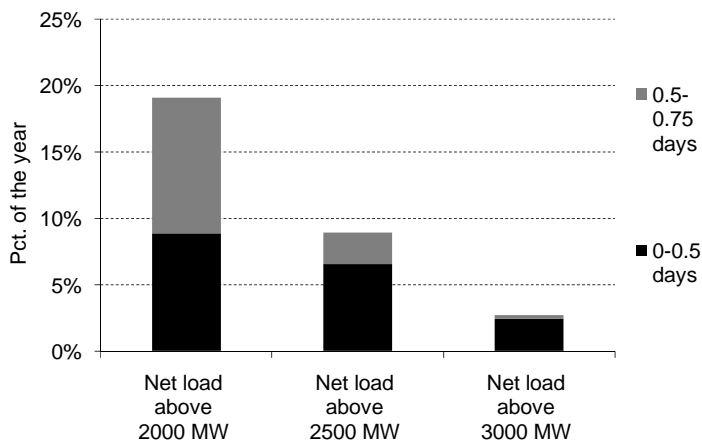

Fig. 4. Consecutive high net load periods expected for West Denmark in 2025.

The use of rolling averages indicates that periods with net loads below 0 MW on average, when seen over 1-7 days have a rather high frequency, i.e. 9-21 % (see Fig. 5). More critical excess electricity periods, i.e. with negative net loads below -500 MW on average, have more modest frequencies, i.e. around 4-12 % when seen over 1-4 days.

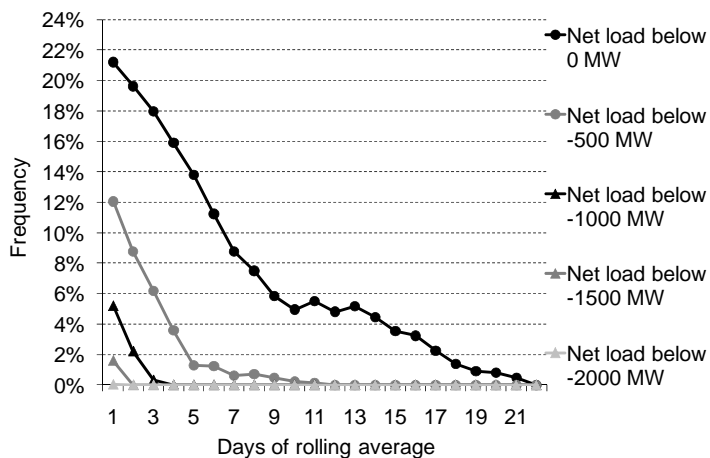

Fig. 5. Periods in West Denmark 2025 with average negative net load indicated by rolling averages.

Periods with high net loads on average when seen over one to several days are less pronounced compared to average negative net loads periods but are also significant. As such, high net load periods on average when seen over 1-3 days have a frequency around 5-13 % (see Fig. 6).

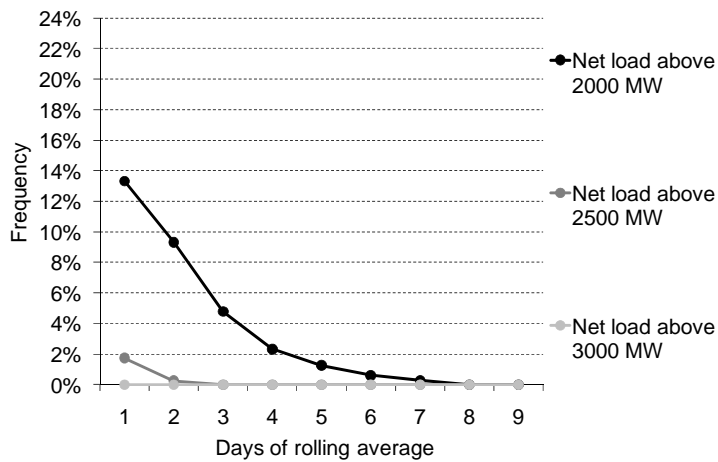

Fig. 6. Periods in West Denmark 2025 with average high net loads indicated by rolling averages.

The estimated length of consecutive negative and high net load periods in West Denmark 2025 indicate a physical potential for flexible technologies being able to charge/activate demand and discharge/inactivate demand in periods from one hour to around half a day, corresponding to a typical time scale for intra-day balancing. The need for intra-day balancing is also illustrated in Fig. 7, revealing large net loads variations intra-day for a given week.

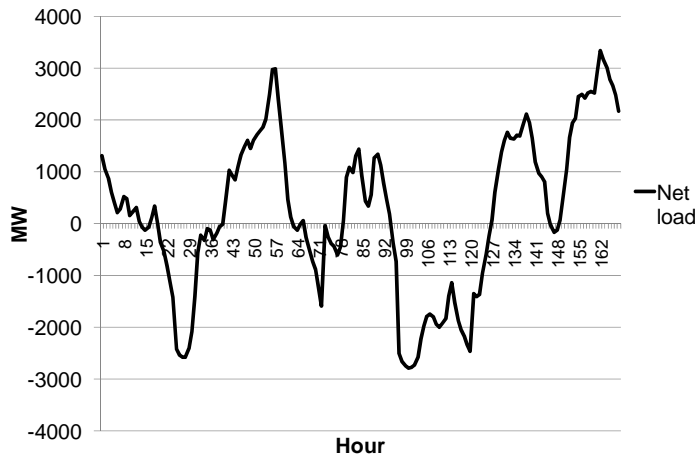

Fig. 7. Net load variations for West Denmark in 2025 for a selected week (9-15 Dec.)

The occurrence of consecutive negative net load periods with lengths of 0.5-3 days, consecutive high net load periods of 0.5-0.75 day and of average negative/high net load periods with lengths of one to several days further indicate a potential for flexibility measures capable of balancing intra-week. This potential is also illustrated in Fig. 8, showing large variations in total net loads from day to day.

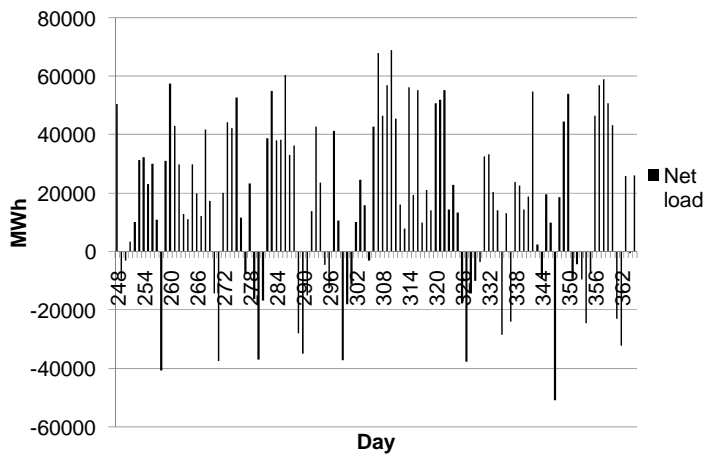

Fig. 8. Net load per day for a longer period expected for West Denmark in 2025 (day 248 to 365).

## 2.4 Seasonal variations

Wind power production in West Denmark expresses significant seasonal variations with typically highest wind power production in the cold months of the year (October to February) and lowest production in the warmer months (April to August). Electricity demand in the region also expresses variations across months; presumably due to the influence of electricity based heating and seasonal holidays (see Fig. 9). As shown, the projected net load variations for 2025 also show significant seasonal variations.

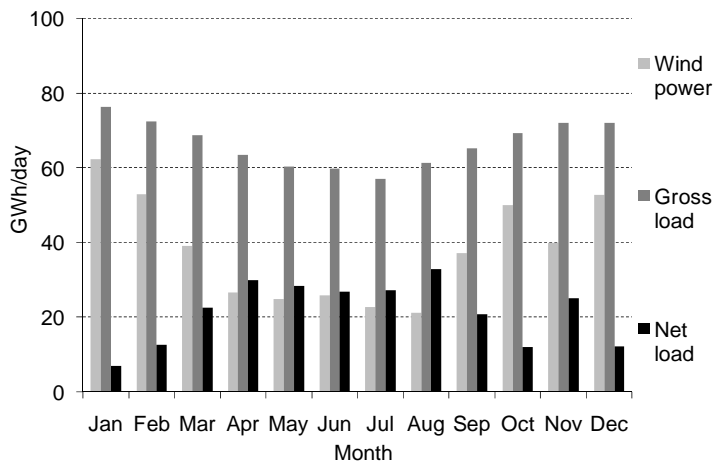

Fig. 9. Average wind power production, gross load and net load per day in each month estimated for West Denmark in 2025.

Fig. 10 illustrates that the amount of surplus wind power (net loads below 0 MW) exceeds the amount of high net loads (above 2000 MW) in some months, while in other months; the amount of high net loads exceeds surplus wind power. This indicates a physical potential for power balancing across months.

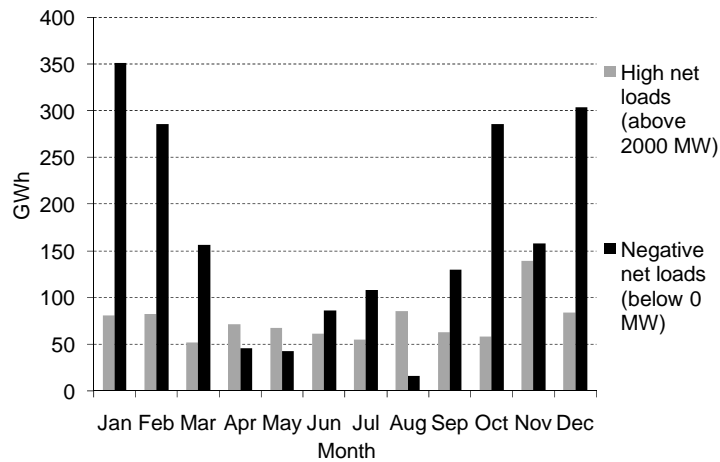

Fig. 10. Monthly distribution of negative net loads and high net loads (above 2500 MW) for West Denmark in 2025.

### 3 Conclusion

In this study, using the case of West Denmark in 2025 with an expected 57 % wind power penetration, wind power impacts are analyzed in a time scale perspective. By analysing the expected length of high and low net load periods, the physical potential for power system balancing on different time scales is investigated. The expected length of consecutive negative and high net load periods indicate a physical potential for flexible technologies being able to charge/activate demand and discharge/inactivate demand in periods from one hour to around half a day, providing intra-day balancing. The occurrence of consecutive negative net load periods with lengths of 0.5-3 days, consecutive high net load periods of 0.5-0.75 day and of average negative/high net load periods with lengths of one to several days also indicate a potential for flexible technologies capable of balancing *intra-week*. Finally, the estimates indicate a potential for *seasonal* balancing. *Intra-hour* impacts could not be evaluated since only hourly data where available. As will be shown in further work, flexible technologies such as electricity storage technologies and heat measures will differ with regard to the time scales at which they are suited to support wind power integration.

### Acknowledgements

The study is financed by Risø DTU as part of a PhD study on flexibility measures facilitating wind power integration. Thanks are given to the Danish TSO, Energinet.dk, for contributing with data for the analysis.

### References

- [1] H. Lund and W. Kempton, "Integration of renewable energy into the transport and electricity sectors through V2G," *Energy Policy*, vol. 36, pp. 3578-3587, 2008.
- [2] Energinet.dk. 2007, System plan 2007. Energinet.dk. Fredericia, Denmark. Available: [www.energinet.dk](http://www.energinet.dk).
- [3] P. Meibom, J. Kiviluoma, R. Barth, H. Brand, C. Weber and H. V. Larsen, "Value of electric heat boilers and heat pumps for wind power integration," *Wind Energy*, vol. 10, pp. 321-337, JUL-AUG, 2007.

- [4] B. V. Mathiesen and H. Lund, "Comparative analyses of seven technologies to facilitate the integration of fluctuating renewable energy sources," *IET Renewable Power Generation*, vol. 3, pp. 190-204, JUN, 2009.
- [5] J. Kiviluoma and P. Meibom, "Influence of wind power, plug-in electric vehicles, and heat storages on power system investments," *Energy*, vol. 35, pp. 1244-1255, 3, 2010.
- [6] H. Lund, "Large-scale integration of wind power into different energy systems," *Energy*, vol. 30, pp. 2402-2412, 10, 2005.
- [7] H. Lund, B. Möller, B. V. Mathiesen and A. Dyrelund, "The role of district heating in future renewable energy systems," *Energy*, vol. 35, pp. 1381-1390, 3, 2010.
- [8] Ea Energy Analyses, Risø DTU and RAM-løse edb, "Effektiv fjernvarme i fremtidens energisystem," Ea Energy Analyses, Denmark, 2009.
- [9] H. Lund and E. Münster, "Integrated transportation and energy sector CO2 emission control strategies," *Transp. Policy*, vol. 13, pp. 426-433, 9, 2006.
- [10] H. Holtinen, "Hourly wind power variations in the Nordic countries," *Wind Energy*, vol. 8, pp. 173-195, APR-JUN, 2005.
- [11] H. Holtinen, "Impact of hourly wind power variations on the system operation in the Nordic countries," *Wind Energy*, vol. 8, pp. 197-218, APR-JUN, 2005.
- [12] H. Holtinen, Ed., *The Impact of Large Scale Wind Power Production on the Nordic Electricity System, PhD Thesis*. Finland: Dept. of Engineering Physics and Mathematics, Helsinki University of Technology, 2004.
- [13] T. Jónsson, P. Pinson and H. Madsen, "On the market impact of wind energy forecasts," *Energy Econ*, vol. 32, pp. 313-320, 3, 2010.
- [14] P. E. Grohneit and F. M. Andersen. Is more than 25 % wind power feasible in a regional electricity market. Presented at 10th IAEE European Conference, "Energy, Policies and Technologies for Sustainable Economies".
- [15] H. Lund, F. Hvelpelund, P. A. Østergaard, B. Möller, B. V. Mathiesen, A. N. Andersen, P. E. Morthorst, K. Karlsson, P. Meibom, M. Münster, J. Munksgaard, P. Karnøe, H. Wenzel and H. H. Lindboe, "Danish wind power export and cost," Department of Development and Planning, Aalborg University, Denmark, 2010.
- [16] Energinet.dk. Download of market data. December 2009, Available: <http://www.energinet.dk/en/menu/Frontpage.htm>.
- [17] Energinet.dk. 2009, Miljørapport 2009 - baggrundsrapport. Energinet.dk;. Available: [www.energinet.dk](http://www.energinet.dk).
- [18] Energinet.dk. 2007, Forudsætninger for analyser af regeringens energistrategi - en visionær dansk energipolitik 2025 - til systemplan 2007. Energinet.dk;. Available: [www.energinet.dk](http://www.energinet.dk).
- [19] P. A. Østergaard, "Ancillary services and the integration of substantial quantities of wind power," *Appl. Energy*, vol. 83, pp. 451-463, 5, 2006.

[20] Energinet.dk. 2009, Effektiv anvendelse af vindkraftbaseret el i Danmark. Energinet.dk. Available: [www.energinet.dk](http://www.energinet.dk).

[21] Energinet.dk. 2009, Systemydelser til levering i Danmark - udbudsbetingelser. Energinet.dk. Available: [www.energinet.dk](http://www.energinet.dk).

[22] H. Holttinen, P. Meibom, A. Orths, F. van Hulle, B. Lange, M. O'Malley, J. Pierik, B. Ummels, J. O. Tande, A. Estanqueiro, M. Matos, E. Gomez, L. Söder, G. Strbac, A. Shakoor, J. Ricardo, J. C. Smith, M. Milligan and E. Ela, "IEA wind task 25 - design and operation of power systems with large amounts of wind power," VTT Technical Research Centre of Finland, Finland, 2009.

# Compressed Air Energy Storage in Offshore Grids

Sascha T. Schröder<sup>1</sup>, Fritz Crotogino<sup>2</sup>, Sabine Donadei<sup>2</sup>, Peter Meibom<sup>3</sup>

## Abstract

Fluctuating renewable energy sources can be rendered more reliable by massive international grid extensions and by energy storages. The latter ones are partially discussed as offshore grids to combine the grid connection of offshore wind parks with international power trading. This paper gives a first assessment of offshore energy storage possibilities.

Compressed air energy storage (CAES) is a technology that has been used successfully onshore for decades and is the most economic large-scale storage option after pumped hydro. More efficient adiabatic CAES is under development. At the same time, the oil&gas offshore industry provides enough experience to state that a CAES power plant could be installed and operated offshore even though at considerable higher costs. Suitable salt formations for the salt caverns exist in and around the North Sea and to a lower extent the Baltic Sea.

Offshore energy storage can facilitate several issues in an offshore grid: firstly, it can delay or even replace the necessity for building interconnectors due to additional wind or wave power. Secondly, it can balance generation deviations due to forecast errors. Depending on market design, these have a negative effect on offshore generation or interconnector operation. Balancing forecast errors could allow operating the interconnectors in a more reliable and thus, more profitable way. If the offshore grid is considered a single price zone between countries, a storage has a lowering effect on electricity price volatility. The WILMAR planning tool is used to estimate these effects. Comparing onshore and offshore CAES, it is concluded that an offshore adiabatic CAES can participate in several markets, but that this advantage is outweighed by an onshore unit's ability to provide spinning reserves.

## 1 Introduction

Achieving EU policy goals for renewable energy requires both a massive installation of renewable generation capacity as well as adjustments of the remaining infrastructure. The bulk of renewable generation such as wind and solar is fluctuating, so possible remedies comprise very flexible dispatchable units, flexible demand, large-scale extension of the transmission system and energy storage options. The focus of this analysis evolves around offshore wind energy in the North Sea. A strong meshed offshore grid would be able to balance power fluctuations partially. The largest share of power balancing could be either provided by strong interconnectors to the Norwegian-Swedish hydro-dominated system that could be operated as a pumped storage system. Alternatively, storage could take place closer to the Southern shore of the North Sea,

---

1 Corresponding author (sasc@risoe.dtu.dk, (+45) 4677 5113). Risø National Laboratory for Sustainable Energy, Technical University of Denmark, Systems Analysis Division.

2 KBB Underground Technologies GmbH, Hanover/Germany.

3 Risø National Laboratory for Sustainable Energy, Technical University of Denmark, Intelligent Energy Systems Programme.

where large amounts of offshore wind energy are to be installed – namely in Germany, Denmark and the Netherlands. These countries share the common characteristics that their coastal regions are flat, i.e. that pumped hydro cannot be realised regionally. Building new pumped hydro storages in Southern Germany faces environmental concerns as a central obstacle and requires new transmission capacity over several hundred kilometres. The only large-scale storage option that is currently operational in Northern Germany is a diabatic Cavern Air Energy Storage (CAES) plant. When electricity prices are low, air is compressed into an underground salt cavern. For generation, this pressurized air is injected into a gas turbine and thus, raises the turbine's efficiency. Adiabatic CAES, which is independent of gas supply and achieves a higher efficiency through a heat storage, has lately been the subject of a research project and is generally considered feasible (see also Crotogino/Donadei, 2011 or Gatzen, 2008). In several scenarios of a 100% renewable energy study for Germany, CAES plays a major role (German Advisory Council on the Environment, 2011). As technical feasibility is in principle also given for offshore locations, this paper analyses possible offshore applications. It is structured as following: first, technological issues are addressed. Second, economic effects in offshore grids are presented qualitatively before turning towards the model and data description. Onshore storage, offshore storage and an increased interconnector capacity between Germany and Norway are compared before moving to the discussion and conclusion of this first estimation on the subject.

## 2 Technology

### 2.1 Caverns

Natural gas has been stored successfully in large quantities in underground salt caverns for many years worldwide in facilities like the Ll. Torup Energinet Storage Facility in North Jutland, Denmark, see Fig. 1.

Salt caverns are artificially constructed cavities in salt deposits created by solution mining. Typical dimensions of salt caverns are a geometrical volume of 500 000 m<sup>3</sup> at depths of over 1 000 m, and pressure ranges of 60 to 180 bar.

Unlike surface storages, salt caverns enable extremely large amounts to be stored at low specific costs. The storages are almost maintenance-free and they boast negligible leakage rates. This is why salt caverns are also highly suitable for the storage of compressed air and hydrogen.

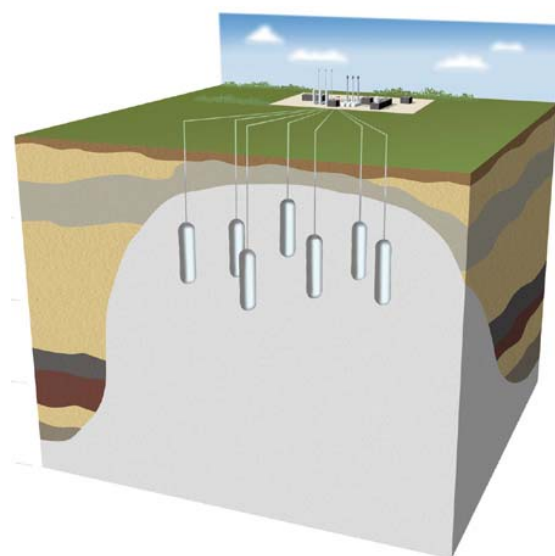

Figure 1: Figure 1: The 7 gas caverns in Ll. Torup (Energinet)

A precondition for the installation of salt caverns to store compressed air is the availability of suitable salt formations with the necessary thickness and the appropriate depth range of around 700 to 1 300 m. There also have to be adequate quantities of fresh water available for solution mining the caverns, as well as environmentally-compatible options for disposing of the large volumes of brine produced during the solution mining process.

A borehole with a cemented casing gives access to the cavern – an additional production string that can be pulled out of the cavern is also installed for safety reasons. In the special case of



compressed air caverns, corrosion-resistance plays a major role because moist, salty compressed air is extremely corrosive.

The minimum and maximum pressures increase with the depth of the caverns. For instance, at the depth to the cavern roof of 1 000 m, pressures will be around 60 to 180 bar. This pressure range must match the operating pressures of the compressed air energy storage power plant. In the case of the CAES plant in Huntorf, Germany (the only CAES power plant in Europe) the air entering the turbine is at a pressure of 46 bar. This means that the depth of the cavern has to have matching specifications to enable the operating pressures of the storage and the turbine/compressors to be compatible.

The investment costs for salt caverns comprise a relatively high proportion for volume-independent costs for the solution mining equipment, infrastructure, pipelines, boreholes, and a volume-dependent share. Because the storage costs for a CAES power plant are typically only around 20% or less of the total costs, the actual storage volume which is realised plays only a minor role.

The interest in offshore caverns has risen in recent years for several reasons: a shortage of suitable onshore salt structures for natural gas caverns, and the ability of locating CAES-caverns next to offshore wind farms (Dena, 2011).

An example is the Gateway project involving the construction of around 30 caverns for natural gas storage in the Irish Sea off the coast of England. Figure 2 shows the whole facility in which each cavern is connected to a shared pipeline with an onshore compressor station. It also shows a monopod – a standpipe rammed into the seafloor – which acts as the platform for the equipment used to construct the cavern.

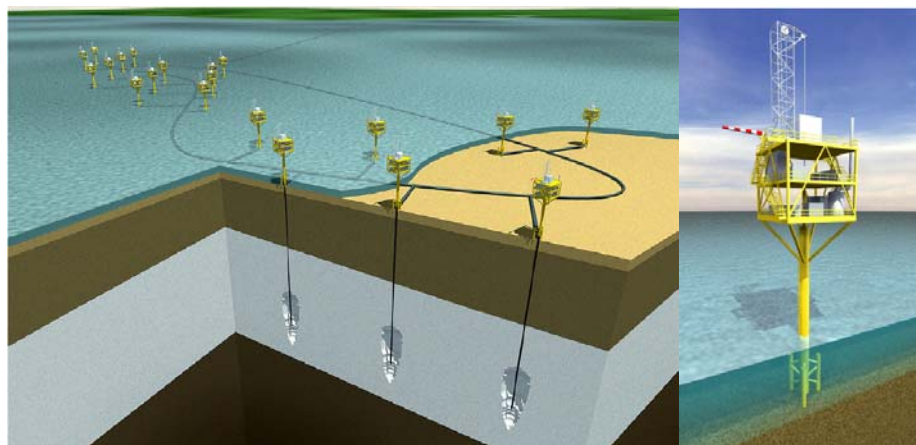

Figure 2: Planned offshore gas caverns in the Irish Sea (left), monopod for an offshore gas cavern (right). Stacey, 2008.

On the positive side is the easy access to adequate volumes of fresh water, and no problems with brine disposal. On the negative side are the much higher costs for well installations and maintenance work. The installation of power plants on offshore oil and gas platforms is state-of-the-art technology: the power plants are built in the port, pre-tested, and then towed out to their offshore locations. The feasibility of constructing an offshore CAES power plant is therefore less a question of the technology, and more a question of the considerable additional costs for installation, corrosion protection in the offshore climate, and maintenance.

## 2.2 Distribution of salt formations beneath the surface of North Germany and Denmark, and in nearshore parts of the North Sea

Rock salt is widely distributed beneath the surface of North Germany, Denmark, and the North Sea. It is found in beds ranging in thickness from several tens of metres to several hundred metres. The bedding of the salt formations ranges from nearly horizontal or

slightly dipping packages, to undulating sequences, usually lying at depths of between two to five kilometres. They are overlain by younger sediments consisting of limestones, claystones and sandstones. The rock salt formed approx. 250 million years ago within the Zechstein Sea that covered large areas, including the Netherlands, the whole of North Germany, large parts of Denmark and of Poland and the area presently covered by the North Sea.

Because rock salt has a low specific gravity, geological changes over the course of geological time (including the development of faults) caused the salt to rise up towards the surface: this salt movement lifted up the overlying sediments as it formed a salt pillow. This process can proceed so far that the salt breaks through the overlying beds and pushes them to the side, giving rise to a salt diapir. These commonly have a mushroom-like shape, extending upwards for several kilometres in some cases. They have moved upwards to within a few hundred metres of the ground surface.

Up to 200 separate salt diapirs are known to exist in Northwest Germany. However, there are only a few isolated salt diapirs in Northeast Germany. Salt diapirs often have circular to oval horizontal cross sections with diameters of 5 to 10 km on average. The situation in the approx. 100 \* 130 km large area between Wilhelmshaven and W-Hamburg, as well as Flensburg and Kiel, is for three to five salt domes to be joined up to form several elongated salt walls with lengths of 50 to 100 km. Salt walls and numerous salt domes are also present in the southern, western and northern parts of the German sector of the North Sea.

The tops of the salt formations in the diapir salt structures in North Germany usually lie at depths below ground level of 400 to 1,200 m. The top salt in some salt domes or parts of salt walls can be deeper (>1,200 m) – especially in the central part of the German sector of the North Sea. On the other hand, there are salt structures with top salt at depths as shallow as 200 – 400 m along the North Sea coast of Schleswig-Holstein in particular, as well as near Bremen and Hamburg.

With the exception of North Jutland, the island of Fyn, and the area to the east of Sjælland, as well as a zone between Ringkøbing, Grindsted, Gram and Esbjerg, there are also salt deposits beneath Denmark. Salt formations have been confirmed underground beneath large parts of the Danish sector of the North Sea and the Baltic Sea. 14 salt diapirs have been located in an area covering around 90 \* 120 km between Aalborg, Århus and Nissum Fjord. The maximum diameter of these salt diapirs is between approx. 4 and 11 km. Top salt in these structures usually lies at depths from approx. 200 to 500 m. To the north of Ringkøbing, there are 5 offshore salt diapirs at distances of 1 to 25 km from the coast, with depths to top salt of <500 m. Over 20 more salt domes have been identified beneath the Danish sector of the North Sea.

The uppermost parts of salt domes usually consist of anhydrite, gypsum and claystones forming the cap rock – with thicknesses of a few metres to >100 m. Experience has shown that the rock salt zones most suitable for the construction of underground salt caverns, i.e. those parts of the salt formation with the lowest concentrations of foreign lithologies (anhydrite, clay), lie in the central parts of salt domes.

Figure 3 and Figure 4 display the prevalence of salt structures in Denmark and Germany. For Germany, the offshore wind farms and their connection corridors illustrate that cavern storage would be possible in their proximity.

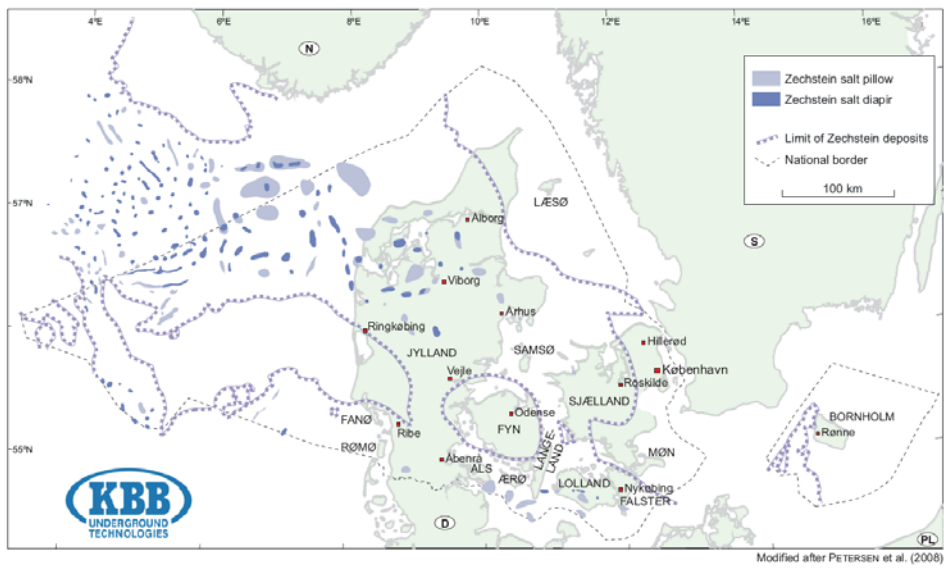

Figure 3: Distribution of salt deposits and salt structures in Denmark

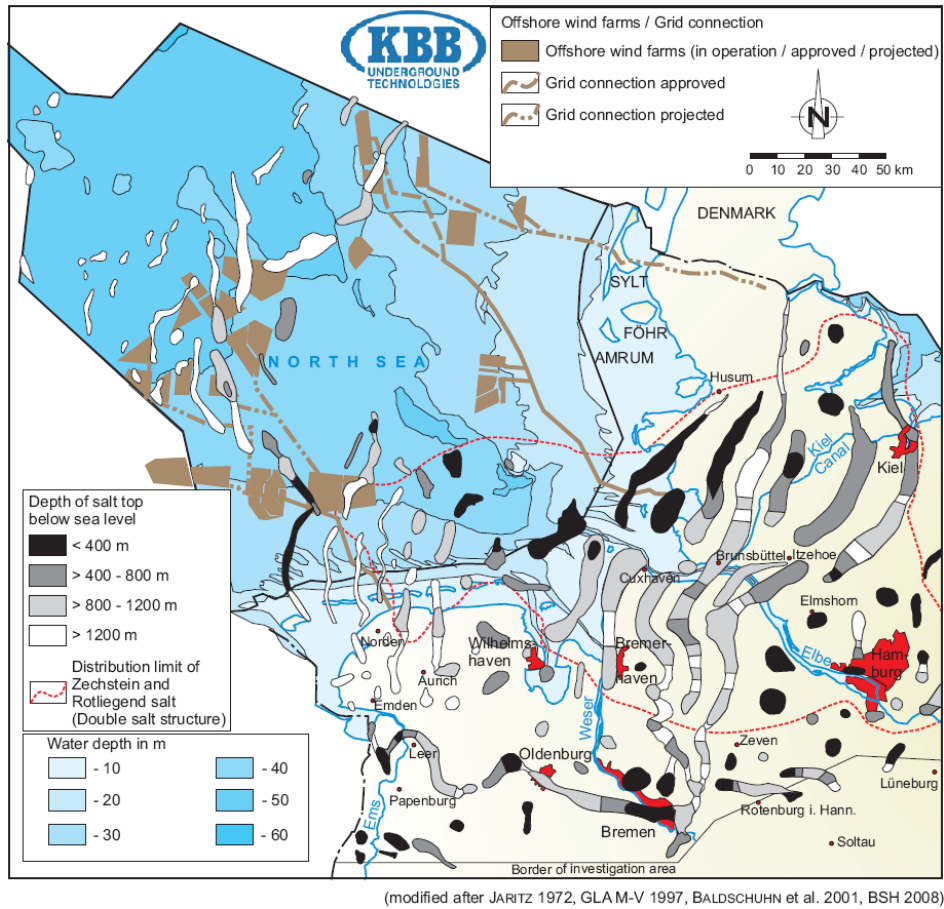

Figure 4: Salt diapirs in Northwest Germany and in the German exclusive economic zone of the North Sea

### 2.3 CAES and AA-CAES power plants

The two existing CAES power plants in McIntosh, Ohio, and Huntorf, Germany, have several decades of operational experience. As the adiabatic CAES (AA-CAES) technology is expected to reach a higher efficiency of 70% and does not rely on natural gas as an additional fuel, it is in the focus of this analysis.

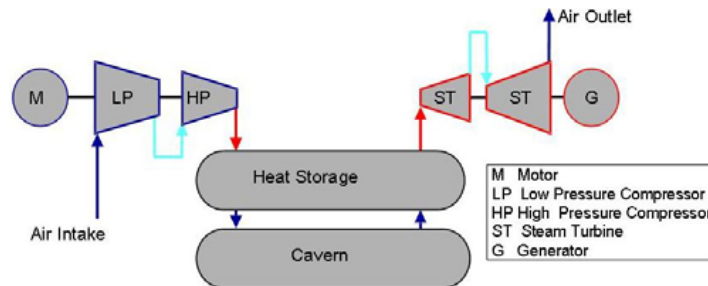

Figure 5: Function diagram of an adiabatic compressed air energy storage power plant in single-stage configuration (Zunft et al., 2006)

Figure 5 displays a diagram of the main components of an AA-CAES facility. The air is compressed and injected into the underground cavern while the heat is stored in the surface heat storage. When later producing power, the air passes through the heat storage again into an expander. Losses of the heat storage are estimated at 2% per day (Radgen et al., 2010). Note that a heat storage corresponding to 1,000 MWh has approximately a diameter of 20 m and a height of 30-40 m. This suits water depths in the North Sea of ca. 40 m, so that the heat storage could be used as a gravity foundation for the compressor and expander.

Radgen et al. (2010) assume that an onshore AA-CAES facility with a compressor of 150MW, 250MW, a storage capacity of 1,000MWh and a round trip efficiency of 70% requires an investment of approx. 180 Mill. Euro.

## 3 Offshore grids and economic considerations for storage

Offshore wind is a cornerstone of all North Sea riparian countries energy strategies. First offshore wind farms are mainly erected close to shore, but a large number will be built at large distances from shore. This requires HVDC connections and involves considerable connection costs. Several offshore wind farms can be connected via a single HVDC line, as is done e.g. for the German SylWin1 connection. For the future, a meshed offshore grid might provide a least-cost possibility of combining the connection of offshore wind farms to their countries and building interconnectors for international power trading. Figure 6 gives an illustrative example of a possible topology.

Economic considerations for investing in offshore storage technologies can be categorized as following. First, a storage can replace or deter the need for additional transmission lines. In the context of offshore wind energy, this seems most probably if changes to the original design of an offshore wind farm / cable combination take place – e.g. through the addition or upgrade of wind turbines leading to a larger installed capacity, or through the addition of wave power.

Second, a storage can increase reliability in the operation of a meshed offshore grid. Wind power generation is inherently associated with prediction errors, leading to the effect that power flows for international trading are scheduled suboptimally on day-ahead electricity markets. Local offshore energy storage could outbalance these prediction errors and thus, ensure a more reliable day-ahead scheduling of cables. The value of this option, however, depends largely on assumed rescheduling procedures.



Figure 6: EWEA's 20 year Offshore Network Development Master Plan and Europe's offshore wind power development and concession zones [extract, EWEA (2009)]

The third point is of a more general nature: providing system reserves could be provided in a cheaper way by storages than by having additional fast-reacting thermal capacity installed. In a meshed offshore grid, however, these reserves can only be provided to a neighbouring country if the line towards the country is not fully utilised. In other words, an offshore storage will never be able to provide up-regulating reserves for the neighbouring country where demand is most scarce (reflected by high power prices and power import at the full capacity of the interconnector).

## 4 Model and data

The WILMAR planning tool (Wind Power Integration in Liberalised Electricity Markets) optimizes the operation of a power system with a focus on fluctuating wind energy. The time resolution is hourly, and the calculation period is up to a year. For wind power production forecasts, a perfect forecast without forecast error, a single forecast or several forecasts per region can be part of the optimization. The latter cases are based on the Scenario Tree Tool of the model, which calculates wind power production forecasts, load forecasts and demand for positive minute reserves as scenario trees. The Joint Market Model uses these data as input for the power system optimization. The geographical extension can be Europe-wide; for further details, see e.g. Barth et al. (2006), Tuohy et al. (2009) or Meibom et al. (2011). In this paper the model is run with a geographical scope covering the North Sea countries, namely Norway, Sweden, Denmark, Germany, the Netherlands, Belgium and the United Kingdom. Sweden is subdivided into 2 zones, whereas Germany is divided into 3 zones (Northwest, Northeast, Central-South) to represent bottlenecks due to transmission network constraints (Dena, 2011). The offshore hub in the North Sea is defined as a single country. Forecast errors are reflected deterministically, which is estimated to reflect current practice most appropriately. The assumptions for electricity demand, interconnector capacities etc. are largely in line with EWIS study assumptions for 2015, installed wind power is according to best estimate. Fuel prices are set at the comparatively high World Energy Outlook 2008 levels, with slight regional differences for transportation costs. An AA-CAES unit has in principle the same characteristics as



pumped hydro, as Swider (2007) correctly points out. A major difference is that the compressor and generator could also be operated simultaneously.

Wind production at the offshore node in the North Sea is set at a nominal capacity of 1000MW with 5% unavailability. The wind power production has been generated from measurements at the FINO1 research platform at a height of 100m, following the multi-turbine power curve approach suggested by Nørgaard and Holttinen (2004). The annual course of data, which is used as input to the stochastic data model of WILMAR, is displayed in the following figure.

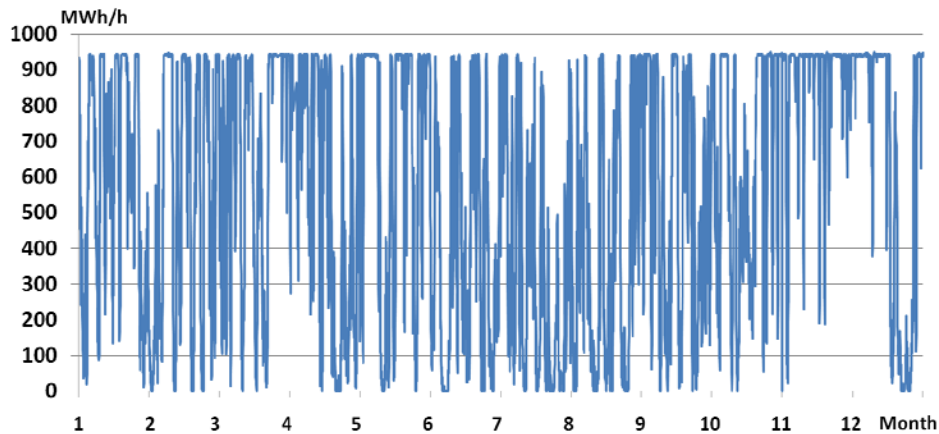

Figure 7: Wind power generation at the offshore site

## 5 Case descriptions

The underlying idea is to compare an onshore AA-CAES power plant e.g. in the Netherlands, Germany or Denmark with the option of placing it offshore. Alternatively, interconnector capacity to Norway could be increased. Three main exemplary cases are distinguished:

1. An AA-CAES storage (70% round-cycle efficiency) with a 150MW compressor, 250MW generator and a storage volume of 2,000 MWh is inserted in the Northwestern German electricity market region. Furthermore, an offshore hub with 1,000 MW wind power capacity and connected to the United Kingdom, the Netherlands and Northwestern Germany with an interconnector capacity of 1,000 MW each is added.
2. Everything else unchanged, the AA-CAES storage is placed in the offshore hub (instead of Germany).
3. The AA-CAES storage is replaced by an equivalently increased interconnector capacity (250 MW) between Germany and Norway.

## 6 Results

Figure 8 illustrates an example of storage operation at the offshore site. The value is indicated as net generation because these modes never occur simultaneously. It can clearly be seen that charging and production periods follow a diurnal pattern provoked by power prices.

Figure 9 shows the analogous example if the AA-CAES facility is placed onshore. Production does not reach the maximum capacity of 250 MW, and the compressor and generator always operate simultaneously. This is due to the fact that this operation mode allows the AA-CAES unit to provide least-cost spinning reserves to the overall electricity system. Spinning reserves are determined on a daily basis, which is why a daily spinning reserve level and hourly spikes caused by standard operation on day-ahead and intraday markets can be distinguished. It should be noted that positive

spinning reserves can be provided by down-regulating the compressor as well as by up-regulating the generator (and vice versa). This leads to the effect that a least-cost solution is a case where the generator is permanently producing power with at least 30 MW. In conclusion, a large benefit of having the unit onshore is its ability to provide spinning reserves.

The storage capacity is only rarely used above 50% of its capacity (2,000 MWh). Thus, it seems reasonable that limiting the storage to 1,000 MWh capacity, equivalent to a single cavern, is beneficial.

As Figure 7 illustrates, there is a large number of successive hours when the wind power generation is close to its maximum. Therefore, dimensioning the cavern in a way that it would be able to absorb these long-lasting peaks and allow a smaller cable is not profitable.

Table 1 states the costs of offshore storage and additional interconnector capacity relative to the benchmark case (onshore storage). System costs are higher in case of an offshore location, which is partly due to the fact that spinning reserves need to be provided locally in Northern Germany. This is a competitive advantage for placing an AA-CAES facility onshore, though additional are possible by choosing an interconnector to the Nordic power system. This, however, cannot support covering the local demand for spinning reserves. In contrast to total system cost, CO<sub>2</sub> emissions are reduced by 0.01% if the storage is placed offshore or by 0.03% by an interconnection to Norway. With regard to AA-CAES, this is caused by the losses associated with operating the compressor and generator simultaneously for spinning reserves.

*Table 1: Additional costs of different cases relative to onshore AA-CAES*

		Offshore storage	Interconnector Germany-Norway
System cost	Mio. Euro	33.8	-73.0
CO <sub>2</sub> cost	Mio. Euro	-2.4	-5.1
System cost	%	0.0464	-0.1003
CO <sub>2</sub> cost	%	-0.0141	-0.0306

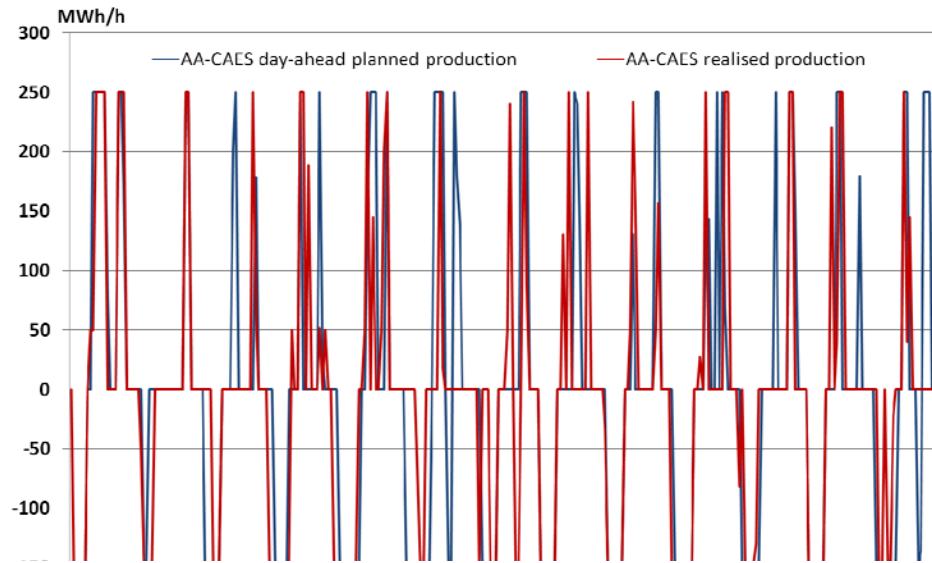

Figure 8: Storage generation at the offshore site (example covering days 2 to 14 of the year)

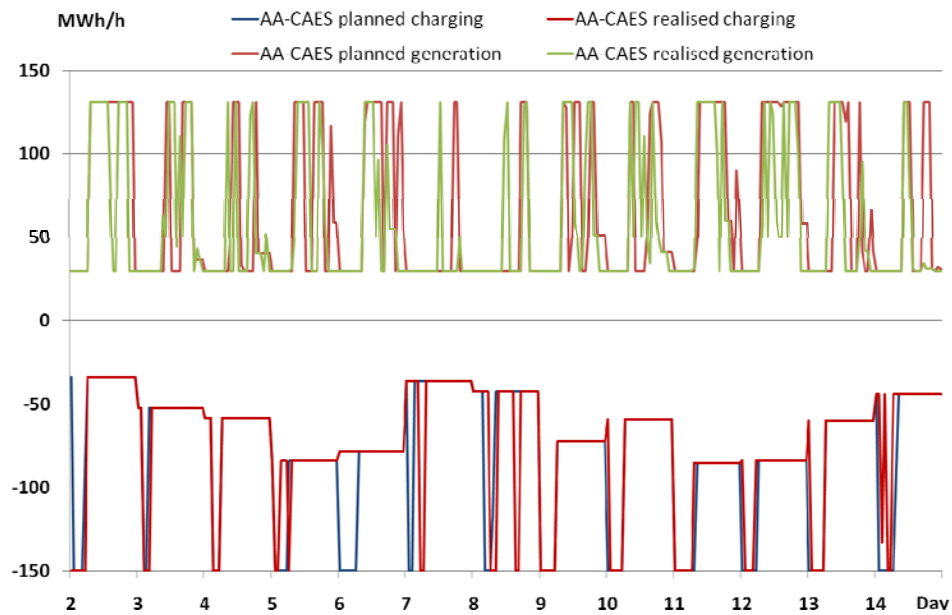

Figure 9: Storage generation at the onshore site (example covering days 2 to 14 of the year). Charging is indicated by negative numbers.



## 7 Discussion and conclusions

This paper compares an onshore AA-CAES with placing it offshore or an interconnector increase to a hydropower-dominated system. It concludes that placing an AA-CAES unit offshore is technically feasible, though at higher cost. The selected power price assumptions are comparatively high, which is generally beneficial for storage units. While the storage can interact with several intraday markets when it is placed offshore, this advantage is outweighed by the fact that it can provide spinning reserves onshore. The provision of spinning reserves through HVDC cables is a subject of ongoing discussions and therefore, the results might overestimate the benefit of the onshore siting. In every case, the onshore operation mode dominated by spinning reserves is remarkable and to the authors' knowledge the first time that this has been shown explicitly for an AA-CAES facility. Another aspect of having a storage unit onshore is that in scarce supply, both the import cable and the storage can contribute to covering local demand. If the storage is placed offshore, the total contribution is the import cable capacity (including storage generation). This is also an important conclusion for the idea of building integrated generation/hydro-storage units (PowerIslands) offshore.

For the future, it seems that AA-CAES is a promising technology that requires further research. Especially the round-trip efficiency of 70% needs to be validated. AA-CAES may prove valuable if international interconnections of several dozen gigawatts, as e.g. suggested by the German Advisory Council on the Environment (2011), cannot be built. However, onshore or nearshore locations in Germany, the Netherlands, the United Kingdom or Denmark seem more promising than far-offshore locations.

Public acceptance, locally scarce availability of geologic structures as well as environmental concerns and permission issues may be reasons for placing AA-CAES units nearshore, but in a way that they are not separated from their home country's electricity market by interconnector constraints.

## 8 Acknowledgements

The authors would like to thank the German Federal Maritime and Hydrographic Agency (BSH), the Federal Ministry for the Environment, Nature Conservation and Nuclear Safety (BMU) and Projektträger Jülich for their coordinated effort on publishing wind data from the FINO1 platform in the North Sea.

## 9 References

Barth, R.; Brand, H.; Meibom, P.; Weber, C. A stochastic unit commitment model for the evaluation of the impacts of the integration of large amounts of wind power, 9th International Conference on Probabilistic Methods Applied to Power Systems, Stockholm, 2006.

Crotogino, F., Donadei, S. Grid scale energy storage in salt caverns. Conference presentation at the Risø International Energy Conference 2011.

Dena (German Energy Agency): dena Grid Study II – Integration of Renewable Energy Sources in the German Power Supply System from 2015 – 2020 with an Outlook to 2025, 2011.

EWEA, 2009. Oceans of Opportunity – Harnessing Europe's largest domestic energy resource. Report by the European Wind Energy Association (EWEA).

Gatzen, C. The Economics of Power Storage – Theory and Empirical Analysis for Central Europe. PhD thesis, University of Cologne, 2008.

German Advisory Council on the Environment, 2011. Pathways towards a 100% renewable electricity system. Special report, January 2011.

Meibom, P.; Barth, R.; Hasche, B.; Brand, H.; O'Malley, M. Stochastic optimisation model to study the operational impacts of high wind penetrations in Ireland, IEEE Transactions of Power Systems, 2011, epublished, DOI: 10.1109/TPWRS.2010.2070848.

Nørgaard, P., Holttinen, H. A Multi-Turbine Power Curve Approach. Nordic Wind Power Conference, 1-2 March 2004, Chalmers University of Technology.

Radgen, P.; Calaminus, B.; Marquardt, R.; Nekrassov, A. The Economics of Compressed Air Energy Storage under various Framework Conditions. Power Gen Europe, Amsterdam 8.-10. June 2010.

Stacey, A. UK Offshore Salt Cavern Gas Storage Development. Solution Mining Research Institute Spring 2008 Technical Conference, 28-29 April 2008, Porto, Portugal.

Swider, D.J. Compressed Air Energy Storage in an Electricity System With Significant Wind Power Generation. IEEE Transactions on Energy Conversion, (22)2007.

Tuohy, A; Meibom, P.; Denny, E.; O'Malley, M. Unit commitment for systems with significant wind penetration, IEEE Transactions of Power Systems, (24) 2009, 592-601.

Zunft, S; Jakiel, C.; Koller, M.; Bullough, C. Adiabatic Compressed Air Energy Storage for the Grid Integration of Wind Power. Sixth International Workshop on Large-Scale Integration of Wind Power and Transmission Networks for Offshore Windfarms, 26-28 October 2006, Delft, the Netherlands.

Risø DTU is the National Laboratory for Sustainable Energy. Our research focuses on development of energy technologies and systems with minimal effect on climate, and contributes to innovation, education and policy. Risø DTU has large experimental facilities and interdisciplinary research environments, and includes the national centre for nuclear technologies.

---

**Risø DTU**  
**National Laboratory for Sustainable Energy**  
**Technical University of Denmark**

Frederiksborgvej 399  
PO Box 49  
DK-4000 Roskilde  
Denmark  
Phone +45 4677 4677  
Fax +45 4677 5688

[www.risoe.dtu.dk](http://www.risoe.dtu.dk)