

Technical University of Denmark



## A novel approach for navigational guidance of ships using onboard monitoring systems

Nielsen, Ulrik Dam; Jensen, Jørgen Juncher

*Published in:*  
Ocean Engineering

*Link to article, DOI:*  
[10.1016/j.oceaneng.2010.11.024](https://doi.org/10.1016/j.oceaneng.2010.11.024)

*Publication date:*  
2011

[Link back to DTU Orbit](#)

*Citation (APA):*  
Nielsen, U. D., & Jensen, J. J. (2011). A novel approach for navigational guidance of ships using onboard monitoring systems. *Ocean Engineering*, 38, 444-455. DOI: 10.1016/j.oceaneng.2010.11.024

## DTU Library

Technical Information Center of Denmark

---

### General rights

Copyright and moral rights for the publications made accessible in the public portal are retained by the authors and/or other copyright owners and it is a condition of accessing publications that users recognise and abide by the legal requirements associated with these rights.

- Users may download and print one copy of any publication from the public portal for the purpose of private study or research.
- You may not further distribute the material or use it for any profit-making activity or commercial gain
- You may freely distribute the URL identifying the publication in the public portal

If you believe that this document breaches copyright please contact us providing details, and we will remove access to the work immediately and investigate your claim.

A NOVEL APPROACH FOR NAVIGATIONAL GUIDANCE OF SHIPS USING ONBOARD  
MONITORING SYSTEMS

ULRIK DAM NIELSEN\* AND JØRGEN JUNCHER JENSEN

Department of Mechanical Engineering,  
Technical University of Denmark, DK-2800 Kgs. Lyngby, Denmark

ABSTRACT. A novel approach and conceptual ideas are outlined for risk-based navigational guidance of ships using decision support systems in combination with onboard, in-service monitoring systems. The guidance has as the main objective to advise on speed and/or course changes; in particular with focus on ship operations in rough weather. It is strived for to make use of a probabilistic framework considering the mathematical procedures that the guidance relies upon. The paper presents a novel concept which has the possibility to increase the reliability of the provided guidance, although information about on-site sea state parameters not necessarily is in complete agreement with the unknown and true wave parameters, nor may the hydrodynamical models of the vessel give a perfect quantitatively description of the vessel in waves. The paper includes an analysis of full-scale motion measurements and the proposed concept for navigational guidance gives promising results.

*Key words:* Navigational guidance of ships; Decision support systems for safety; Wave estimation; Risk-based approaches; Gaussian and Non-Gaussian processes; Uncertainty modelling.

## 1. INTRODUCTION

In recent years there has been increasing focus on the application of onboard, real-time guidance for ships as well as offshore structures in terms of decision support systems. Decision support systems (DSS) are studied, developed and applied in a wide range of contexts; e.g. to increase the operational and navigational safety of ships, for improved safety with regards to ship-to-ship operations, and within dynamic modelling of risk-based ship traffic prioritisation, see Huss and Olander [15], Colwell and Stredulinsky [6], Chen et al. [5], Payer and Rathje [47], Tellkamp et al. [56], Nielsen et al. [34], Pedersen et al. [48], Eide et al. [10], to mention but a few. It is often the case that the DSS is an integrated part of an onboard, in-service system that monitors and records

---

\*Corresponding author. E-mail: udn@mek.dtu.dk      Ph: +45 45251970

the data/responses which are of concern. With the increasing focus on energy consumption by and gas emissions from ships it is also foreseen that DSS, in the future, are aimed at facilitating more efficient ship operations with a resulting decrease in fuel consumption.

This paper deals exclusively with concepts and fundamentals of online (real-time) navigational guidance to the master of a ship, where the overall goal is to supply advice with respect to, first and foremost, course and/or speed changes relative to the waves. The support concerns decisions, which should be made during navigation at open sea (in severe weather), to reduce critical response levels of, say, the wave-induced acceleration(s) and the wave-induced hull girder bending moment. The guidance does not concern manoeuvring aspects for collision avoidance of, say, other ships. In this context, it is by guidance understood to provide the ship's master with statistical predictions of future response levels to be expected in a time horizon of 30-90 minutes from the moment of action, in the event that a given combination of speed and heading is chosen. To make the guidance as reliable as possible it is strived for to make use of probabilistic and risk-based approaches, where uncertainties are kept track of during all processes/procedures, and so that risk acceptance criteria can be established and introduced. Concepts and procedures of risk-based DSS have recently been studied by e.g. Bitner-Gregersen and Skjong [4], Nielsen et al. [42] and Nielsen [41]. The idea of risk-based DSS goes hand in hand with the general trend within the maritime transportation sector, where focus is turned towards goal-based standards that are based on probabilistic and risk-based methods, e.g. Skjong and Guedes Soares [51], Papanikolaou (Ed.) [52], and the FSA Guidelines [7].

In decision support systems used for navigational guidance, there is a continuous need for reliable estimates of the sea state parameters or the wave energy spectrum at the exact position of the advancing vessel. However, on-site estimation of sea state parameters forms a crucial and fundamental problem to which there has not been found any perfect solution yet. In the literature there are reports on the estimation of sea state parameters using measured ship responses (e.g. motion data) where the ship, to make an analogy, acts as a wave rider buoy; e.g. Iseki and Ohtsu [17], Tannuri et al. [55], Nielsen [36], Pascoal et al. [46], and Pascoal and Guedes Soares [45]. Compared to the alternative approach that exists in terms of a wave radar system (leaving out the use of satellite data for on-site, real-time wave estimation), the wave buoy analogy offers an estimation concept which is not influenced by meteorological conditions. Moreover, the concept is comprised by a system with a low initial cost due to a simple instrumentation of sensor arrangements that (usually) require little maintenance and are often installed on today's ships anyway for monitoring reasons. Although inherent problems of the wave buoy analogy with regard to filtering have been

reported (e.g. Simos et al., [49]; Nielsen, [37]; Pascoal and Guedes Soares, [44]), the wave buoy analogy is, in theory, capable of estimating exactly those waves which are of importance to the ship, in the operational and navigational sense. That is, the wave buoy analogy estimates the waves to which the ship responds (Nielsen, [39], [40]). In the end, it should, however, be remembered that no matter what means - the wave buoy analogy or a wave radar system - is used to make estimation of wave parameters from, it will be only a qualified guess of the true wave parameters. Experiences with shipboard wave estimation by wave radar systems have, e.g., been presented in Stredulinsky and Thornhill [54].

Typically, the underlying approach for navigational guidance builds on a pure mathematical model only, where seakeeping characteristics of the ship, often given in terms of response amplitude operators (RAOs), are combined with information about the on-site sea state using linear spectral analysis to make statistical predictions of future responses to be expected (e.g. [15],[47],[34]). The shortcoming of this approach is that it relies completely on a correct estimation of the on-site sea state at the location of the ship. This means that the guidance might be useless/incorrect if the estimated wave parameters are in poor agreement with the *true* and *unknown* parameters. At best, this leads to conservative guidance but, at worst, it could have catastrophic consequences jeopardising cargo and crew. The problem is that it is very difficult to say whether the guidance is the one or the other, since the true wave parameters are indeed unknown for what reason the accuracy of the estimated sea state is unknown.

This paper outlines conceptual ideas that can be used in the development of risk-based decision support systems used for navigational guidance of ships. Furthermore, the paper presents a novel procedure which has the possibility to increase the reliability of the given navigational guidance, although the on-site sea state parameters may not, necessarily, have been determined/estimated in complete agreement with the true parameters. Thus, predictions of future response levels will be based on an integrated model using a mathematical model that has as input the estimated sea state parameters, and using also the until-now-measured response data recorded by an onboard monitoring system. The potential of the novel approach is investigated by analysing full-scale motion measurements where information about the on-site sea state parameters is obtained by use of the wave buoy analogy.

## 2. ONBOARD MONITORING SYSTEMS AND GUIDANCE

**2.1. Development of and interest in guidance systems.** The development of in-service monitoring systems for ship safety started in the 1970's and some of the first papers published, Lindemann and Nordenstrøm [28] and Lindemann et al. [29], were based on an inquiry among Norwegian navigators. Thus, the inquiry revealed that there was a large demand for more exact knowledge of how ships respond to changes in speed and course. Today, this knowledge is still paramount for the safe navigation of ships; however, as mentioned by Huss and Olander [15] already in the mid-nineties, in recent days the commercial competition and the general technical development have lead to more and more optimised ships. Consequently, such optimisations may imply a slow drift towards the physical limits of a ship's capability and survivability. The main issue is therefore how to match safety with operationally optimised ships, and, in a paper on safety consequences of optimised ships, Francescutto [11] concluded "that the only way to overcome the many difficulties lies in the development of a system for the time domain simulation of ship motions in a seaway, including a detailed description of the environment...".

The need for guidance and decision support with regards to navigation in a seaway is basically due to a concern for non-desired effects which include among others (depending on ship type):

- Seasickness of passengers
- Damage to cargo due to large accelerations
- Local structural damage to forward structure due to slamming, wave impacts and green water on deck

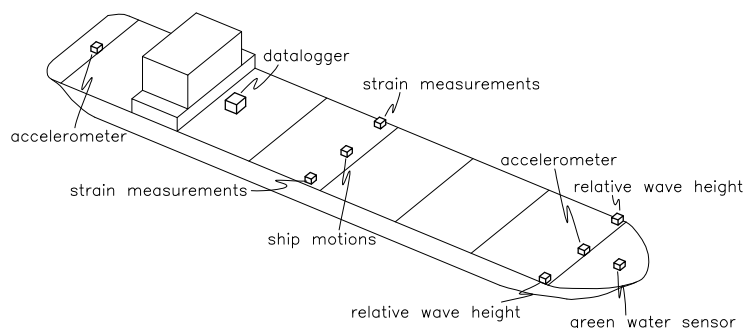

FIGURE 1. A ship mounted with a set of sensors used for response monitoring.

- Shift or loss of cargo due to a combination of roll and accelerations
- Excitation of large roll motions (e.g. due to parametric roll)
- Loss of stability in following waves
- Hull girder damage due to extreme wave-induced loads
- Fatigue damage accumulation in critical structural details

Very often the non-desired effects can be associated to specific ship responses (or combinations of these) and therefore it is typical to monitor and record these responses; an example of responses/sensors is sketched in Figure 1. Therefore, there is normally a close link between onboard monitoring systems and decision support systems for ships.

**2.2. Guidance by use of polar diagrams.** One way to provide guidance is in terms of polar diagrams, where estimates of response levels for specific responses are shown as function of, say, speed and heading with colours used to indicate the different response levels. It is understood that the diagrams apply to the very situation (for the actual sea state and operational conditions) in which the ship is operating. Examples of polar diagrams can be found in, e.g., Colwell and Stredulinsky [6], Tellkamp et al. [56] and Krüger et al. [25]; Figure 2 is from Nielsen et al. [34].



FIGURE 2. Examples of guidance plots from the SeaSense system. Nielsen et al. [34]

There are several statistical measures that can be used as a response level indicator. One measure is obtained from the standard deviation, as it is a good measure for detecting changes in trends of the measured response(s). Thus, the standard deviation can be used as a means which alarms can be built upon. In this way, the ship's master is informed about increasing standard deviations in a given (severe) situation and therefore indications are that course and/or speed changes relative to the incoming waves might be necessary. Guidance may then be provided from calculations of standard deviations for alternative combinations of speed and course, so that, say, a green colour in a polar diagram indicates that the standard deviation for the alternative combination is reduced, whereas a red colour would indicate the opposite. The standard deviation can be used to provide the ship's master with a qualitative picture of a given operational and navigational situation; both in terms of trends and guidance. However, it is not easy to "quantify" the danger - or the risk - experienced in a severe situation from the number of the standard deviation. Therefore, by defining risk as the expected loss  $L$  (FSA guideline [7]), an additional response level indicator may be based on

$$L = \nu\mu T \quad (1)$$

which is the expected loss associated to an event within time period  $T$ , if the event happens at a mean outcrossing rate  $\nu$  relative to some threshold value with an associated consequence (or cost)  $\mu$  in case of exceedance. The engineering task is here related to the calculation of the outcrossing rate, whereas the consequence might be obtained from regulatory works. Based on risk acceptance criteria it is possible to associate limits, or colours, to the expected loss.

In the next section the focus is on the estimation of future - expected - statistical values that can be used to make guidance from. The consequences as well as the risk acceptance criteria that might be associated to losses, cf. Eq. (1), or the actual presentation of guidance in terms of, e.g., polar diagrams will not be dealt with any further.

### 3. A NOVEL CONCEPT FOR RISK-BASED DSS

In general, the fundamental tool in decision support systems is a mathematical model that describes the physical behaviour of the system that needs decision support. In the present context, the interest concerns navigational guidance of ships for increased safety which means that the mathematical model must be able to describe how the ship behaves in a seaway. As a vital part of the mathematical model it is therefore important to have a tool that can be used to evaluate the seakeeping performance of the ship.

This section outlines a novel concept for risk-based guidance of ships, where the ship responses can be both of Gaussian and non-Gaussian nature. The presented details of the mathematical model concerns the calculation of (expected) statistics on which guidance can be based. However, the parts of the model concerning evaluation of seakeeping performance are only mentioned briefly since, in general, it suffices to say that the actual seakeeping model should rely on state-of-the-art hydrodynamics software, as also reported by Bitner-Gregersen and Skjong [4].

**3.1. Statistics of Gaussian ship responses.** On the assumption of linearity between wave excitations and ship motions/responses, response amplitude operators (RAOs) in terms of complex-valued frequency response functions  $\Phi(\omega_e, \chi)$  can be used, as a reasonable approximation, to evaluate seakeeping characteristics of a ship. In a stochastic seaway, the electric filter analogy (St. Denis and Pierson [8]) yields the relationship between the response spectrum  $S_R(\omega_e)$  and the directional wave spectrum  $E(\omega_e, \chi)$

$$S_R(\omega_e) = \int_{-\pi}^{\pi} |\Phi_R(\omega_e, \chi)|^2 E(\omega_e, \chi) d\chi \quad (2)$$

where  $\omega_e$  and  $\chi$  are the encounter wave frequency and the relative wave heading, respectively. The  $n$ -th order spectral moments are given by

$$m_{Rn} = \int_0^{\infty} \omega_e^n S_R(\omega_e) d\omega_e \quad (3)$$

and, from the combined use of the spectral moments, statistics can easily be obtained for the considered response, e.g. Jensen [19]; this include standard deviations, outcrossing rates and peak distributions. For future reference, the standard deviation  $\sigma_R$  is given by

$$\sigma_R^2 = \int_0^{\infty} S_R(\omega_e) d\omega_e \quad (4)$$

It is important to underline that Eqs. (2)-(4) apply only to ship responses that belong to the subset of Gaussian processes.

**3.2. Statistics of non-Gaussian ship responses.** If the ship response does not belong to the category of Gaussian processes, the evaluation of statistics cannot be obtained from linear spectral analysis. Instead, more elaborate time domain procedures must be applied, where use can be made of, e.g., Monte Carlo simulation (MCS) and the first order reliability method (FORM) known from structural reliability theory (Madsen et al. [30] and Melchers [31]). Often, it is the case that the relevant response can be described by a second-order, coupled differential equation as, for example, the rolling motion of a ship. Specifically, the following simplified formulation, Jensen and Pedersen



[23] and Jensen [20], can be used to study the time-domain behaviour of roll motions of a ship:

$$\ddot{\varphi} + 2\beta_1\omega_\varphi\dot{\varphi} + \beta_2\dot{\varphi}|\dot{\varphi}| + \frac{\beta_3\dot{\varphi}^3}{\omega_\varphi} + \frac{(g - \ddot{w})GZ(\varphi)}{r_x^2} = \frac{M_\varphi}{I_{xx}} \quad (5)$$

where  $\varphi$  is the roll angle,  $\beta_1$ ,  $\beta_2$  and  $\beta_3$  are damping terms,  $\omega_\varphi$  is the natural roll frequency of the ship,  $g$  is the acceleration of gravity,  $w$  is the heave motion,  $GZ(\varphi)$  is the GZ-value depending on  $\varphi$ ,  $r_x$  is the radius of gyration about the longitudinal axis,  $M_\varphi$  is the wave-induced roll moment, and  $I_{xx}$  is the mass moment of inertia about the longitudinal axis of the ship.

The excitation of a ship in a seaway is controlled by the wave elevation  $H(X, t)$  and, assuming normally distributed waves, the variation with time  $t$  and space  $X$  in the direction of vessel propagation is given by the sum

$$H(X, t) = \sum_{n=1}^N \sum_{m=1}^M [V_{mn}c_{mn}(X, t) + W_{mn}d_{mn}(X, t)] \quad (6)$$

where the variables  $(V_{mn}, W_{mn})$  are uncorrelated, standard normal distributed, while the deterministic coefficients are determined as

$$\begin{aligned} c_{mn}(X, t) &= \sigma_{mn} \cos(\omega_n t - k_n X) \\ d_{mn}(X, t) &= -\sigma_{mn} \sin(\omega_n t - k_n X) \\ \sigma_{mn}^2 &= S(\omega_n, \chi_m) \Delta\omega \Delta\chi \end{aligned} \quad (7)$$

Here  $S(\omega_n, \chi_m)$  is the discretised wave energy spectrum,  $\chi_m$  is the relative wave heading, and the wave frequency  $\omega_n$  and the wave number  $k_n$  are related through the (deep water) dispersion relation.  $\Delta\omega$  and  $\Delta\chi$  are increments of the discretised range of wave frequencies and directions, respectively.

In the probabilistic assessment of Eq. (5) it can be a specific task to calculate/estimate the mean outcrossing rate relative to a given threshold. The straightforward approach includes brute force time series simulations applying e.g. Monte Carlo simulation. Thus, realisations similar to that in Figure 3 can be used to count the number of outcrossings. In practice, the mean outcrossing

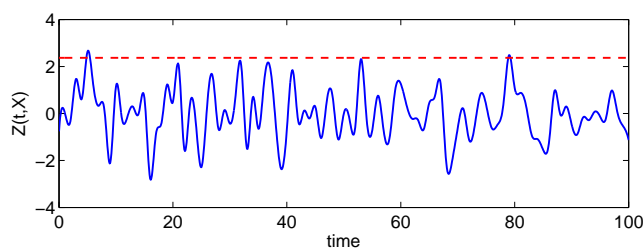

FIGURE 3. Level crossings relative to a threshold of an arbitrary process  $Z(t; \mathbf{X})$ .

rate can be estimated from an ensemble of  $k$  simulations of length  $[0; T_0]$  in which the number of outcrossings is counted. However, the counting should not start before stationary conditions (in a statistical sense) are attained, so that the influence of initial conditions is avoided. In the actual calculations, this means that only the last  $\Delta t_{simul}$  seconds in each realisation should be used to count the number of outcrossings; implying that the initial period  $\Delta t_{initial}$  ( $T_0 = \Delta t_{initial} + \Delta t_{simul}$ ) is neglected. The mean value estimate of the outcrossing rate is then

$$\bar{\nu}(\varphi_{cr}) = \frac{1}{k\Delta t_{simul}} \sum_{j=1}^k n_j(\varphi_{cr}; \Delta t_{simul}) \quad (8)$$

where  $n_j(\varphi_{cr}; \Delta t_{simul})$  denotes the number of outcrossings of the level  $\varphi_{cr}$  by time history no.  $j$ .

A fundamental problem of brute force simulations is that of exhaustive computational times for small probability levels. Means to (partly) accommodate this inherent type of problem have been studied in the literature for Monte Carlo simulation applied to extreme value predictions of offshore structures; e.g. Naess et al. [32], Naess and Karlsen [33] and Gaidai and Naess [12]. In the future, it will be of interest to investigate these means applied in the context of decision support systems for ships. There are, however, other procedures which can be used to calculate the expected value of the mean outcrossing rate. One of the procedures is based on FORM, as first suggested by Der Kiureghian [24] and later specialised to wave induced loads by Jensen and Capul [22] (see also e.g. Jensen [21], Jensen and Pedersen [23] and Nielsen and Jensen [43]). The main problem is the finding of a so-called critical wave episode, specified by the design point  $(V_{mn}, W_{mn}) = (V_{mn}^*, W_{mn}^*)$ , for which the response value (e.g. the roll angle) exceeds a threshold value  $\varphi_{cr}$  at exactly time  $t = T_0$ . The details can be found in the literature mentioned above, but basically the problem is defined through the limit state problem,

$$\varphi_{cr} - \varphi(t = T_0 | V_{11}, W_{11}, V_{21}, W_{21}, \dots, V_{MN}, W_{MN}) < 0 \quad (9)$$

which is well-known within time-invariant reliability theory. As shown by Jensen and Capul [22], with application to processes of wave induced loads, the mean outcrossing rate can be estimated by use of the design point, so that, within a FORM approximation, the mean outcrossing rate of level  $\varphi_{cr}$  can be written

$$\bar{\nu}(\varphi_{cr}) = \frac{1}{2\pi} \exp\left(-\frac{1}{2}\beta^2\right) \sqrt{\sum_{n=1}^N \sum_{m=1}^M (\alpha_{mn}^{*2} + \bar{\alpha}_{mn}^{*2}) \omega_n^2} \quad (10)$$

$$\{\alpha_{mn}^*, \bar{\alpha}_{mn}^*\} = \frac{\{V_{mn}^*, W_{mn}^*\}}{\beta}$$

where  $\beta$  - the reliability index - is the distance from the design point to the origin in the hyperspace of the variables  $(V_{mn}, W_{mn})$ .

**3.3. Uncertainty modelling of stochastic parameters.** In what has been outlined above for the statistics of Gaussian and non-Gaussian ship responses, the processes (and associated limit states) depend explicitly on the wave excitation in terms of the stochastic seaway. Implicitly, the responses and limit states depend, in general, on a number of (input) parameters such as significant wave height, wave direction, loading condition, speed of vessel, material properties, to mention but a few. Under real operational conditions many of these governing parameters are not known exactly (e.g. Bitner-Gregersen and Hagen [2] and Bitner-Gregersen et al. [3]). Instead, the parameters may be specified with uncertainty, so that the specific parameter is described by a random variable with a given probability density function. This fact calls for probabilistic and risk-based methods when evaluating the statistics of the ship responses. General concepts of risk-based decision support systems have been given by, e.g., Bitner-Gregersen and Skjong [4] and Tellkamp et al. [56], and specific means to be applied in the computational procedures of Gaussian and non-Gaussian processes have been studied by, among others, Jensen [21], Krüger et al. [25], Spanos et al. [53], Nielsen [38], Nielsen et al. [42], and Nielsen [41]. It is important to stress that the uncertainty modelling should both seek to describe the kind of uncertainties - aleatory (natural and physical) and/or epistemic (knowledge) - and to quantify the uncertainties in question (Bitner-Gregersen and Hagen [2] and Skjong et al. [50]). The details of the computational procedures to evaluate, say, mean outcrossing rates of Gaussian and non-Gaussian processes, including uncertainty modelling, will not be outlined here. Instead, the mentioned literature should be consulted, where particularly [41] and [42] deal with calculation algorithms for processes with stochastic input parameters.

**3.4. Making the guidance more reliable.** From the preceding sections it appears that statistical predictions of future responses of a ship operating at open sea can be estimated if the directional wave spectrum is known, and assuming that the hydrodynamic behaviour and seakeeping characteristics are described reasonable well by mathematical model(s). Focussing on the wave spectrum, it is thus crucial with an accurate wave estimation at the location of the advancing vessel, since otherwise the guidance is most likely unreliable. However, as discussed in the Introduction, there exists no perfect/complete means to estimate wave parameters from an operating ship. In other words, as reported by Colwell and Stredulinsky [6]: "An accurate definition of the wave height, frequency and directional parameters is critical for providing reliable tactical operator guidance; however, this is not easy to accomplish with existing shipboard sensors".

In order to make the navigational guidance more reliable it is therefore suggested, in addition to the mathematical model(s), to use statistics of the already-measured response data, recorded by an onboard monitoring system. The idea is sketched in the diagram of Figure 4 where, traditionally, there is no direct connection between the past measurements and the provided guidance (for what reason the arrow between the 'past measurements' and the 'mathematical model' is dashed).

In this novel approach it is suggested to make use of calculations of the ratio of, say, the standard deviation of a given response, where the ratio is obtained from standard deviations calculated for either two different vessel speeds or two different wave headings; with both calculations being based on the mathematical model using the estimated wave parameters at the current location of the ship. It is here understood that the one, say, wave heading is the current (estimated) wave heading whereas the other heading is the alternative choice that the ship's master needs guidance about. Now, if the mathematical model describes the seakeeping characteristics of the ship reasonably well, and assuming that the estimated wave parameters are not significantly wrong from the "true" parameters, the calculated ratio of standard deviations can be used to approximate the same ratio of measured standard deviations. That is, for a current wave heading  $\chi_1$  and an alternative wave heading  $\chi_2$ , the following expression is assumed to hold:

$$\frac{\sigma_{\chi_1}^{\text{calculated}}}{\sigma_{\chi_2}^{\text{calculated}}} = \frac{\sigma_{\chi_1}^{\text{measured}}}{\sigma_{\chi_2}^{\text{estimated}}} \quad (11)$$

where  $\sigma_{\chi_1}^{\text{measured}}$  represents the standard deviation of the past measured data of the given response, whereas  $\sigma_{\chi_2}^{\text{estimated}}$  is the future expected/estimated standard deviation if the course is changed to a relative wave heading  $\chi_2$ . This means that, e.g., polar diagrams for guidance on speed and/or

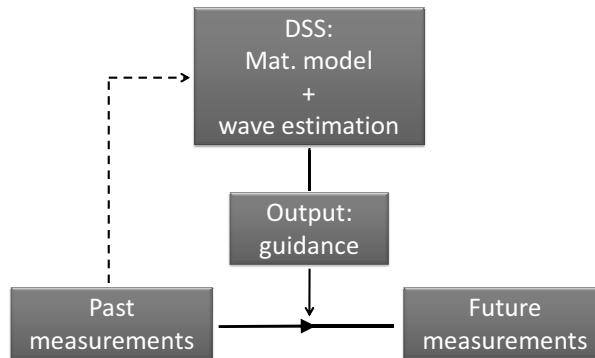

FIGURE 4. *Guidance is provided from a mathematical model and statistics of past measurements are used to supplement shipboard wave estimations in the mathematical model.*

course may be established by calculating

$$\sigma_{\{\chi_2; U_2\}}^{\text{estimated}} = \frac{\sigma_{\{\chi_2; U_2\}}^{\text{calculated}}}{\sigma_{\{\chi_1; U_1\}}^{\text{calculated}}} \cdot \sigma_{\{\chi_1; U_1\}}^{\text{measured}} \quad (12)$$

for relevant combinations of wave heading and vessel speed  $\{\chi; U\}$ , where index 1 designates the current value whereas index 2 designates an alternative choice.

It is important to note that the calculated values of the standard deviations,  $\sigma^{\text{calculated}}$ , are conducted according to the risk-based approaches outlined in the preceding subsections. This means that uncertainties in the actual estimation of wave parameters as well as uncertainties in the mathematical model(s) are taken into account.

**3.5. Human factor disciplines and fault tolerant decision support systems.** The outlined conceptual ideas, including the novel approach for giving navigational guidance, have focussed on calculation procedures for expected future values of statistical measures as well as focussed on onboard estimation procedures of sea state parameters. Little attention has been given to the development of the presentation of the actual guidance to a ship's master. However, this issue is very important for DSS to be useful in practice and therefore it is necessary also to include human factor disciplines and issues of man-machine interfaces in the development of DSS, e.g. Wittkuhn et al. [57]. Moreover, for DSS and the combined use of onboard monitoring systems there is also a (foreseen) great potential in looking at ideas developed within control engineering with regard to (automatic) fault monitoring and detection, so that the decision support system can be developed as a fault tolerant system; studies in this area have begun, see Lajic et al. [26] and Lajic and Nielsen [27].

#### 4. ANALYSIS OF FULL-SCALE MOTION MEASUREMENTS

This section is devoted to the analysis of motion measurements obtained from full-scale trials. The objective is to study and investigate the potential of the proposed - improved - method, Eq. (11), in terms of its ability to deduce guidance from.

**4.1. Motion measurements from full-scale experiments.** The motion measurements have been obtained from a set-up of full-scale experiments using the research vessel Shioji-Maru of Tokyo University of Marine Science and Technology. The main dimensions of Shioji-Maru are given in Table 1. The experiments were conducted in the sea outside Tokyo Bay, where specifically motion measurements were recorded during three runs, A, B, and C, within the same confined area of sea

TABLE 1. *Main dimensions of the Shioji-Marui; research vessel of Tokyo University of Marine Science and Technology.*

Length, $L_{pp}$	46.0 m
Breadth, $B_{mld}$	10.0 m
Draught, $T$	2.65 m
Displacement	659 t

but with different speeds and courses. The individual runs lasted for six minutes and the time in between the runs was in the order of 15 minutes. Table 2 presents the vessel’s speed and course for each run, and the table shows also the recorded mean wind measurements as well as information about the waves obtained from an onboard wave height meter and visual observations. The course as well as the wind and wave directions are given relative to the compass directions, where North is 000 deg., East is 090 deg., South is 180 deg., and West is 270 deg.

In the analysis, attention is given to three motion responses: roll, pitch and vertical acceleration at the forward perpendicular (FP). All three responses are assumed to be linear with respect to the incident waves, which means that the behaviour of the ship in waves can be approximated by the use of RAOs, calculated by, e.g., strip theory. Specifically, the roll motion of a ship may exhibit a strong non-linearly behaviour if large roll angles occur, as can happen in severe conditions, whereas the heaving and pitching motions, in general, show less non-linearly behaviour. However, the motion measurements of Shioji-Marui were carried out during relatively calm sea conditions, so the use of RAOs is assumed to be valid and will not be discussed any further.

**4.2. Estimation of on-site wave spectrum and modelling .** The wave buoy analogy has been mentioned in the Introduction as a means to estimate sea state parameters from measured ship responses at the exact location of the operating ship. It is not the intention to favour the wave buoy analogy to other estimation techniques; however, as Shioji-Marui was not fitted with a wave

TABLE 2. *Measurement conditions. Vessel course as well as wind and wave directions are given relative to North (000 deg.).*

Run	Vessel		Wind		Waves		
	Speed	Course	Speed	Dir.	Height	Period	Dir.
A	8.5 kt	260 deg.	16 m/s	235 deg.	1.3 m	7.0 s	250 deg.
B	8.5 kt	270 deg.	17 m/s	230 deg.	1.6 m	7.0 s	235 deg.
C	7.0 kt	220 deg.	14 m/s	230 deg.	1.8 m	7.0 s	220 deg.

radar system, the on-site wave spectrum estimation will be carried out by use of the wave buoy analogy only. The details of the concept behind wave estimation using measured ship responses can be found in the literature ([17],[18],[16],[55],[36],[39],[46],[45],[49]) where a lot of comparisons with numerical and model-scale as well as full-scale data also can be found. However, Appendix A outlines briefly the fundamentals of the concept and presents selected results too.

In the studied data, the wave estimation is based on recordings of the motions of pitch, roll and vertical acceleration at FP. The justification for choosing these responses is purely subjective and, in general, it is worth to consult the mentioned literature for a discussion about the selection of specific/relevant responses used for wave estimation. In the literature, there is also a thorough discussion about the cross spectral analysis that must be carried out as an initial task of the wave buoy analogy; the discussion includes, among others, details about appropriate tools such as Fast Fourier Transform (FFT) and multivariate autoregressive (MVAR) modelling ([36],[44]).

In the present analysis, the on-site wave spectrum is obtained by parametric modelling which means that the complete frequency-directional spectrum is estimated through an optimisation problem. The solution to, or the outcome of, the problem is a set of (optimised) wave parameters that, in combination with a parameterised wave spectrum, characterise the sea state. The parameterised directional wave spectrum is chosen to be a fifteen-parameter trimodal spectrum that allows for mixed sea such as, say, wind and swell, since it is a summation of three spectra. Basically, the spectrum is similar to the ten-parameter spectrum suggested by, e.g., Hogben and Cobb [14], which is a summation of two parameterised five-parameter spectra. The applied parametric expression reads

$$E(\omega, \theta) = \frac{1}{4} \sum_{i=1}^3 \frac{\left(\frac{4\lambda_i+1}{4}\omega_{p,i}^4\right)^{\lambda_i}}{\Gamma(\lambda_i)} \frac{H_{s,i}^2}{\omega^{4\lambda_i+1}} A(s_i) \cdot \cos^{2s_i} \left( \frac{\theta - \theta_{mean,i}}{2} \right) \exp \left[ -\frac{4\lambda_i+1}{4} \left( \frac{\omega_{p,i}}{\omega} \right)^4 \right] \quad (13)$$

with  $H_s$  being the significant wave height,  $\lambda$  is the shape parameter of the spectrum,  $\theta_{mean}$  is the mean wave direction,  $\omega_p$  is the angular peak frequency, and  $s$  represents the spreading parameter.

$$A(s) = \frac{2^{2s-1}\Gamma^2(s+1)}{\pi\Gamma(2s+1)} \quad (14)$$

is a constant introduced to normalise the area under the  $\cos^{2s}$  curve and  $\Gamma$  denotes the Gamma function. It should be noted that the spreading parameter(s)  $s$  is not included in the optimisation, which means that a total of twelve parameters is to be optimised. The spreading parameter is modelled as a function of wave frequency and as function of the principal parameter  $s_{max}$ , cf. Goda

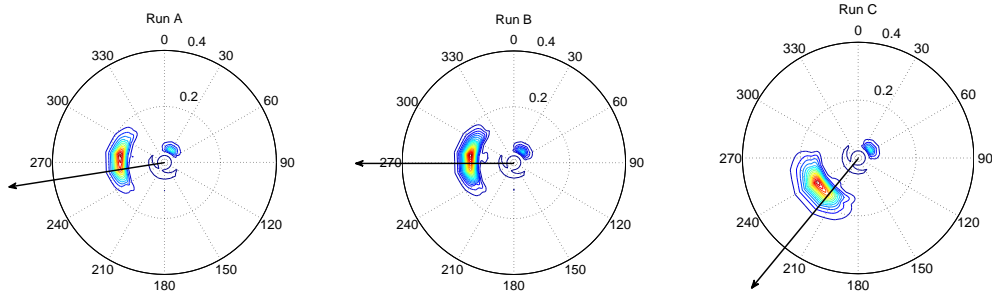

FIGURE 5. Polar diagrams of estimated directional wave spectra in runs A, B, and C; the vessel course - shown by the arrow - is 260 deg. (A), 270 deg. (B) and 220 deg. (C), respectively.

[13]

$$s = \begin{cases} \text{ceil} \left[ (\omega/\omega_p)^5 s_{max} \right], & \omega \leq \omega_p \\ \text{ceil} \left[ (\omega/\omega_p)^{-2.5} s_{max} \right], & \omega > \omega_p \end{cases} \quad (15)$$

where  $s_{max} = 25$  in all runs is chosen. This value characterises wind waves and/or swells with a short decay distance, cf. Goda [13], which is assumed to be applicable for the given environmental conditions and geographical area. In Eq. (15), 'ceil' rounds towards plus infinity and is a numerical technique utilised to stabilise the optimisation.

Based on the motion measurements of runs A, B, and C, the wave buoy analogy produces frequency-directional wave spectra as presented in Figure 5. In the polar diagrams, the wave energy is shown as 'approaching' and relative to true North (000 deg.). The associated frequency spectra are seen in Figure 6, and the estimated wave parameters are given in Table 3. It should be noted that the wave period is given in terms of the zero-upcrossing period  $T_z$ , and notice also that the mean wave

TABLE 3. Estimated sea state parameters of the individual parameterised wave spectra (1st, 2nd, 3rd) and the total significant wave height and zero-upcrossing period as calculated from the spectral moments of the total spectrum. Units:  $H_s$  [m];  $T_z$  [s];  $\theta$  [deg.];  $\lambda$  [-]

Run	1st				2nd				3rd				Total	
	$H_s$	$T_z$	$\theta$	$\lambda$	$H_s$	$T_z$	$\theta$	$\lambda$	$H_s$	$T_z$	$\theta$	$\lambda$	$H_s$	$T_z$
A	0.9	5.9	285	5.0	0.3	6.5	270	1.0	0.5	15.2	030	1.2	1.1	6.6
B	1.1	6.0	285	5.0	0.3	7.0	275	1.0	0.6	15.4	040	1.2	1.3	6.6
C	1.2	5.4	240	2.3	0.3	6.7	230	1.0	0.5	14.8	055	1.1	1.3	6.3



direction  $\theta$  is given relative to true North. It is difficult to comment on the values of the estimated wave parameters, since no other spectral estimation technique has been applied. However, it is seen that the estimated parameters deviate only slightly from each other in the three runs, which were carried out in the same confined area of sea and within a relatively short time separation. Most noteworthy is the deviation in wave direction which is observed when studying runs A and B versus run C with a focus on the main energy peak, comprised by waves with a zero-upcrossing period of about 6-7 s and coming from West (runs A and B) and West-South West (run C). In general, it can be said that the estimated parameters agree fairly well with the reports from the onboard wave height meter and the visual observations, cf. Table 2, although there is a slight discrepancy in the wave energy as judged by the significant wave height. As a final word on the differences between the estimated wave parameters of the individual runs, it should be remembered that each run lasts (only) 6 minutes. This relatively short length of time might associate to some uncertainty in the statistics.

**4.3. Uncertainty modelling of random variables.** For a ship operating at sea, all operational and environmental parameters are, in principle, to be considered as random variables. In the response calculations, which navigational guidance relies upon, the estimated wave spectrum is

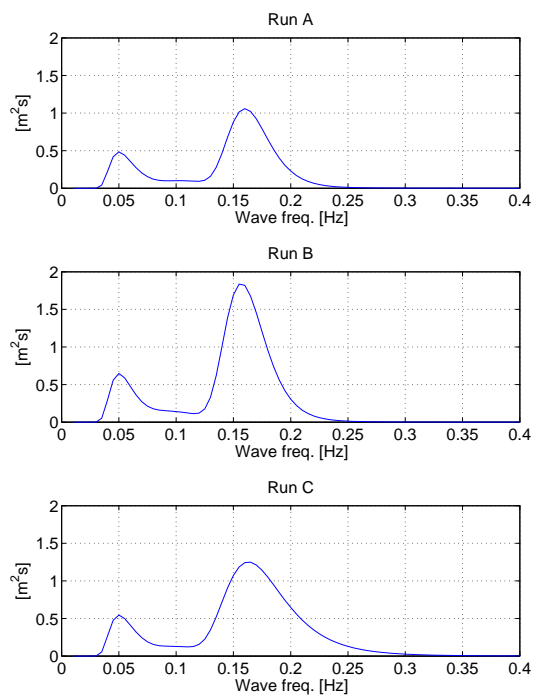

FIGURE 6. *Estimated frequency wave spectra.*

TABLE 4. *Uncertainty modelling of random variables. Mean: mean value; CoV: coefficient of variation; Low: lower limit; Lim: lower and upper limits.*

Parameter		Unit	Distribution	Parameter values
$H_s$	Significant wave height	[m]	Log-Normal	Mean-CoV-Low
$T_z$	Zero-crossing period	[s]	Log-Normal	Mean-CoV-Low
$\chi$	Relative wave heading	[deg.]	Trunc-Normal	Mean-CoV-Lim
$\lambda$	Shape parameter	[-]	Log-Normal	Mean-CoV-Low
$U$	Speed of vessel	[m/s]	Log-Normal	Mean-CoV-Low

combined with the hydrodynamic model of the ship, and the response statistics is thus carried out as outlined in Section 3 with all parameters being random variables. In the present analysis, uncertainty modelling will, however, be associated to only the estimated wave parameters of Eq. (13) and to the speed of the vessel. The reason for including the vessel speed as a random variable is due to the lack of knowledge about the speed made through water compared to the speed over ground.

The actual modelling of uncertainties is introduced by means of given distributions for the individual parameters, and Table 4 describes the distributions that are assumed to be applicable. The parameter values that need to be specified in the probabilistic analysis using Proban (software for general probabilistic analyses), DNV [9], are also given in the table. From the table, it is noted that the relative wave heading  $\chi$  has been introduced instead of the absolute wave direction, since it is the former which is of interest in response calculations.

In the risk-based calculations, which follow in the next subsection, the distributions shown in Table 4 are applied to the corresponding parameters of Table 3, where each of the estimated values of Table 3 enter into Table 4 as the mean value. With respect to the values of the coefficient of variation (CoV) and the limit(s), these will be set completely subjective and no sensitivity analysis will be conducted. The selected values of the CoVs, in particular, will have a (potentially) large influence on results; however, the main idea of this paper does not concentrate on actual results, but on a methodology for improved prediction of future expected response values. In the calculations, the coefficient of variation is for all parameters, and in all runs, chosen to be  $\text{CoV} = 0.20$  (which may be regarded as a large CoV for the vessel speed). As lower limit for all parameters, except the relative wave heading, is chosen a value taken to be 10% of the mean value of the given parameter in question. With respect to the relative wave heading, the lower and upper limits are based on the mean value minus/plus 30 degrees, respectively.

It should be pointed out that the specific distributions in Table 4 are all based on rather intuitive presumptions and do not reflect any data as for justification. It also is important to realise that the uncertainty modelling of the variables does not associate to the aleatory uncertainties (e.g. the long-term statistics) of the variables. Instead, the modelling relates to the epistemic uncertainties which are associated to observation of the variables in a short-term sense, since this is of interest when focus is on navigational guidance of ships. Moreover, it is noteworthy that no correlation are assumed between the parameters.

**4.4. Prediction of response values.** The central idea of the following analysis is to combine the wave estimate from a given run, say, A with the RAOs of the ship to see how well the response statistics of the subsequent run B can be reproduced; with the objective to compare with what was actually measured. The focus is on the *standard deviation* and, initially, it is therefore of interest to report about the measured standard deviations of the responses in each of the runs. Thus, Table 5 lists the measured standard deviation of the pitch, the roll, and the vertical acceleration at FP in the individual runs. In the table, the calculated values of the standard deviation of the responses are also given, using Eq. (4) with input from Table 3 and assuming no uncertainty in the estimated wave parameters. The relative deviation between the two has been included in the table. Ideally, the relative deviation should be zero for all responses in the single runs, since the governing equations of the wave buoy analogy, indeed, seek to equalise the (distribution of) energy of measured and calculated responses (cf. Eq. (16), Appendix A). However, it is important to realise that the wave buoy analogy yields estimates of wave parameters, i.e. optimised wave parameters, which, when applied to Eq. (2), on average secures the equivalence of energy for the three considered responses. Therefore, in practice, the wave buoy analogy comes up with a wave spectrum that - in the best overall sense - fulfills the governing equations, which means that the differences, as reported in Table

TABLE 5. *Measured and calculated standard deviation, including relative deviation, of responses. The calculated values have been obtained with wave parameters as estimated in the respective runs.*

Run	Pitch [deg.]			Roll [deg.]			Vert. Acc. [m/s <sup>2</sup> ]		
	Meas.	Calc.	Dev.	Meas.	Calc.	Dev.	Meas.	Calc.	Dev.
A	0.79	1.14	45%	0.61	0.75	24%	1.37	1.14	-17%
B	1.10	1.48	35%	0.79	0.95	21%	1.89	1.45	-23%
C	1.17	1.38	18%	0.95	1.05	10%	1.88	1.31	-30%

5, are to be expected (see also Nielsen [35]). The bottom line is that, although wave estimates of the specific run are used, it is difficult to completely match measured and calculated response statistics in the individual run, for what reason the improved methodology, Eq. (11), is suggested for making response predictions of the future. As a final remark, it is important to mention that similar comparisons - and agreements - of measured and calculated standard deviations are found with wave parameters estimated by a wave radar system. A report is given by, e.g., Nielsen [35], although for another set of full-scale measurements.

From subsection 4.2 it is clear that the estimated wave spectra are not (completely) identical in the individual runs. In terms of operational decision support for navigational guidance, the situation is therefore quite realistic. Tables 6, 7, and 8 present the estimated/predicted standard deviations of the pitch, the roll and the vertical acceleration at FP, respectively. For each response comparisons are made for all the runs using the different ways of calculating the standard deviation; namely, by Eqs. (4) and (11) directly, and also by Eq. (11) where uncertainty modelling is applied according

TABLE 6. *Comparison of predicted and measured standard deviation (Std) of pitch. Predicted values calculated with Eq. (4) and Eq. (11).*

Run	Prediction using wave spectrum of	Std [deg.]			Measured
		Eq. (4)	Eq. (11)	Eq. (11)*	
A	run B	1.49	1.11	1.10	0.79
A	run C	1.17	0.99	0.98	0.79
B	run A	1.12	0.77	0.77	1.10
B	run C	1.03	0.87	0.89	1.10
C	run A	1.10	0.76	0.76	1.17
C	run B	1.36	1.00	1.01	1.17

\* Calculations including uncertainty modelling.

TABLE 7. *Comparison of predicted and measured standard deviation (Std) of roll. Predicted values calculated with Eq. (4) and Eq. (11).*

Run	Prediction using wave spectrum of	Std [deg.]			Measured
		Eq. (4)	Eq. (11)	Eq. (11)*	
A	run B	0.77	0.63	0.69	0.61
A	run C	2.55	2.31	2.24	0.61
B	run A	0.98	0.79	0.73	0.79
B	run C	3.28	2.98	2.68	0.79
C	run A	1.15	0.92	0.75	0.95
C	run B	2.03	1.68	1.19	0.95

\* Calculations including uncertainty modelling.

TABLE 8. *Comparison of predicted and measured standard deviation (Std) of vertical acceleration at FP. Predicted values calculated with Eq. (4) and Eq. (11).*

Run	Prediction using wave spectrum of	Std [deg.]			Measured
		Eq. (4)	Eq. (11)	Eq. (11)*	
A	run B	1.37	1.78	1.80	1.37
A	run C	0.82	1.19	1.32	1.37
B	run A	1.13	1.35	1.36	1.89
B	run C	0.61	0.87	1.11	1.89
C	run A	0.54	0.65	0.89	1.88
C	run B	0.56	0.73	1.07	1.88

\* Calculations including uncertainty modelling.

to Table 4. The tables (6, 7, 8) should be read line-wise, and considering, say, Table 6 it is seen that by use of the estimated wave spectrum of run C, the predicted standard deviation of run A is  $\text{Std} = 0.98$  deg., if Eq. (10) is applied probabilistically, where uncertainty modelling is included. This number should be compared to what was actually measured in run A for the pitch motion, and with a measured value of  $\text{Std} = 0.79$  deg., the relative deviation is 24%.

All the predictions, as presented in Tables 6-8, have also been compared graphically in Figures 7-9. Figure 7 presents a situation where predictions are made of run A using the estimated wave spectrum obtained from runs B and C, respectively. In Figure 8, predictions are made of run B, using runs A and C, respectively, whereas Figure 9 presents the predictions of run C. In the individual plots, normalised standard deviations are presented for the three responses, where a comparison can be made between the predictions of each response using the outlined computational procedures; i.e. Eq. (4) and Eq. (11) with and without uncertainty modelling. The normalisation has been made with the actual measured standard deviations of the very run which is being predicted about. In the optimal - and hypothetical - situation, all columns in the plots would therefore be of a height equal to 1. As it appears from Tables 6-8, Figures 7-9 also reveal that in many cases, the prediction of future response values are improved using Eq. (11) - the novel approach - compared to Eq. (4) - the "traditional" approach. There are, however, cases where Eq. (4) gives a better prediction of what was actually measured.

In order to evaluate the different calculation/prediction procedures in an overall sense points are assigned to the individual equation according to the agreement of the respective predicted values with the actual measured values of the standard deviations, as they appear from Tables 6-8. One way to do this, is to assign 2 points to the equation which has the best (absolute) agreement

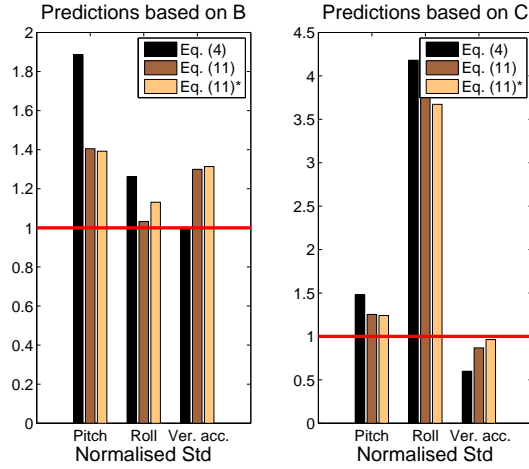

FIGURE 7. Predictions of standard deviations of responses in **run A** using the estimated wave spectrum of runs **B** and **C**, respectively. The predicted standard deviations are normalised with the measured standard deviations of run **A**.

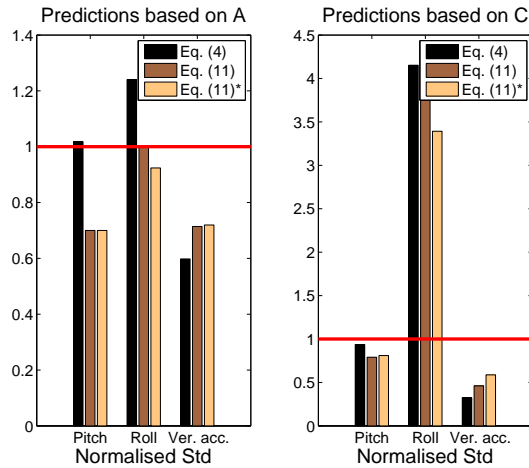

FIGURE 8. Predictions of standard deviations of responses in **run B** using the estimated wave spectrum of runs **A** and **C**, respectively. The predicted standard deviations are normalised with the measured standard deviations of run **B**.

with the measured value, and 1 point to the equation with the second best agreement, whereas zero point is given for the worst agreement. In this way, it is found that Eq. (11), including uncertainty modelling, scores the highest number of points with a total of 28 points. The second highest score is obtained by Eq. (11), without uncertainty modelling, where the score is 18 points. The lowest score is given to Eq. (4), which obtains 8 points. Although this comparison cannot be used to quantitatively assess the prediction procedures' ability to yield correct guidance, the

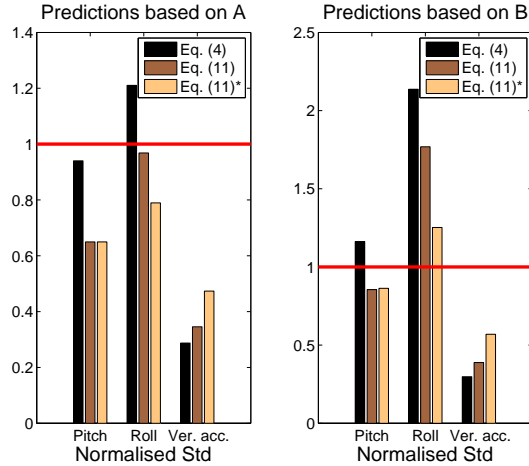

FIGURE 9. Predictions of standard deviations of responses in *run C* using the estimated wave spectrum of runs *A* and *B*, respectively. The predicted standard deviations are normalised with the measured standard deviations of *run C*.

comparison gives a good qualitative picture of the specific procedures/methodologies for predicting future responses. As judged by the studied data, runs *A*, *B*, and *C*, it is, indeed, evident that the novel procedure for making guidance, i.e. Eq. (11), has the potential to improve navigational guidance of operational decision support systems. In the same time, the guidance can be given in a probabilistic framework, which should make the guidance more reliable in the average sense.

Although Eq. (11) (including uncertainty modelling) seems as the best calculation procedure to make guidance from, it is important to note that in a few cases the predictions of response values are in poor agreement with what was actually measured, irrespectively of the calculation procedure. This is seen when the estimated wave spectrum of *run C* is used to predict about the roll motion of runs *A* and *B*; cf. the right-hand side plots of Figures 7 and 8. The explanation for the poor agreement in these cases is (presumably) the difference in the peak energy wave direction, which is observed when the estimated wave spectra of runs *A* and *B* are compared to the estimated wave spectrum of *run C*, cf. Figure 5 and Table 3. A similar difference in wave direction is reported by the visual observations, cf. Table 2, and indications are therefore that the peak energy wave direction, indeed, has changed during the runs. Therefore, it is to be expected that the roll standard deviation is overpredicted in runs *A* and *B*, respectively, using the estimated wave spectrum of *run C*. The reason is that using wave spectrum *C*, and choosing a course equal to 260 deg. (*run A*) or 270 deg. (*run B*), the vessel experiences quite some beam seas, while in reality - in runs *A* and *B* - the vessel was going straight head sea, relative to the peak wave energy. Obviously, it

is not good when predictions of future - expected - response values are too far from what will be actually measured. However, the considered situation is very difficult to deal with, since it is not the calculation procedures that are to be blamed but instead the relative quickly changing sea conditions; a phenomenon which is difficult to handle in the models of decision support systems. It should be realised that there is only little disagreement for the predicted pitch motion and the predicted vertical acceleration at FP in the considered cases, cf. the right-hand side plots of Figures 7 and 8. This is explained due to the fact that these motions are not as sensitive to deviations in course changes as is the roll motion.

It has previously been noted that each run lasts (only) 6 minutes, which might associate to uncertainties in the estimated wave parameters, due to the relatively short length of time that the estimation is based upon. Similarly, considering Eq. (11), the uncertainty in the measured standard deviations, due to consideration of only 6 minutes of data, will (negatively) influence the prediction of future expected standard deviations. It is therefore expected that the performance by Eq. (11) will be further improved by taking into account longer measurement periods of the data.

## 5. SUMMARY AND FINAL REMARKS

In decision support systems for navigational safety of ships there is a fundamental need of the on-site sea state parameters at the location of the advancing vessel. However, it is not easy to obtain this information with existing shipboard sensors, as mentioned by Colwell and Stredulinsky [6]. A novel concept has therefore been proposed to make decision support more reliable. In this concept, it is suggested to include statistics of the already-measured response data, recorded by an onboard monitoring system, with the objective to improve the accuracy as well as the overall reliability of the predicted response calculations. In the paper, an example of full-scale experiments has been presented to study (and verify) the outlined novel approach. From the studied data, the potential of the approach is promising, and comparisons with "traditional" predictions (calculated directly from spectral moments) reveal a better agreement with actual measured data applying the novel approach. However, it is important to note that in the analysis a rather limited set of full-scale data is studied, and therefore there is a need for further verifications of the novel approach. In the near future the analysis of an extended full-scale measurement campaign will be initiated.



## ACKNOWLEDGEMENT

The authors would like to express their sincere thanks to Professor Toshio Iseki, Tokyo University of Marine Science and Technology, for providing the full-scale data as well as the complex-valued transfer functions of Shioji-Maru.

## REFERENCES

1. M. Aschehoug, *Scientific Paper on The Sea State Estimation Methodology*, Tech. report, SIREHNA, France, 2003, Paper prepared in the HullMon+ project.
2. E.M. Bitner-Gregersen and Ø. Hagen, *Uncertainties in data for the offshore environment*, Structural Safety **7** (1990), 11–34.
3. E.M. Bitner-Gregersen, L. Hovem, and R. Skjong, *Implicit Reliability of Ship Structures*, Proc. of OMAE'02 (Oslo, Norway), 2002.
4. E.M. Bitner-Gregersen and R. Skjong, *Concept for a risk based Navigation Decision Assistant*, Marine Structures **22** (2009), 275–286.
5. H. Chen, V. Cardone, and P. Lacey, *Use of Operation Support Information Technology to Increase Ship Safety and Efficiency*, Trans. of SNAME **106** (1998), 105–127.
6. J.L. Colwell and D. Stredulinsky, *Seakeeping Operator Guidance*, Proc. of Pacific'08 (Sydney, Australia), 2008.
7. Maritime Safety Committee, *Guidelines for formal safety assessment (FSA) for use in the IMO rule-making process*, IMO Circular MSC/Circ.1023-MEPC/Circ.392, International Maritime Organization, London, UK, 2002.
8. M. St. Denis and W.J. Pierson, *On the Motion of Ships in Confused Seas*, Trans. of SNAME **61** (1953), 280–332.
9. DNV, *Proban Theory, General Purpose Probabilistic Analysis Program*, Det Norske Veritas, 2002.
10. M.S. Eide, Ø. Endresen, P.O. Brett, J.L. Ervik, and K. Rang, *Intelligent ship traffic monitoring for oil spill prevention: Risk based decision support building on AIS*, Marine Pollution Bulletin **54** (2007), 145–148.
11. A. Francescutto, *Is It Really Impossible to Design Safe Ships?*, Trans. of RINA **135** (1993), 163–168.
12. O. Gaidai and A. Naess, *Extreme response statistics for drag dominated offshore structures*, Probabilistic Engineering Mechanics **23** (2008), 180–187.
13. Y. Goda, *Random Seas and Design of Maritime Structures*, Advanced Series on Ocean Engineering, vol. 15, World Scientific, 2000.
14. N. Hogben and F.C. Cobb, *Parametric Modelling of Directional Wave Spectra*, Proceedings of 18th Offshore Technology Conference (Houston, Texas), 1986, pp. 489–498.
15. M. Huss and A. Olander, *Theoretical Seakeeping Predictions On Board Ships - A System for Operational Guidance and Real Time Surveillance*, Tech. report, Naval Architecture, Department of Vehicle Engineering, Royal Institute of Technology, 1994.
16. T. Iseki, *Real-time Estimation of Directional Wave Spectra using Non-stationary Ship Motion Data*, Proc. of OMAE'09 (Honolulu, HI, USA), 2009.
17. T. Iseki and K. Ohtsu, *Bayesian estimation of directional wave spectra based on ship motions*, Control Engineering Practice **8** (2000), 215–219.

18. T. Iseki and D. Terada, *Bayesian Estimation of Directional Wave Spectra for Ship Guidance Systems*, International Journal of Offshore and Polar Engineering **12** (2002), 25–30.
19. J.J. Jensen, *Load and Global Response of Ships*, Elsevier Ocean Engineering Book Series, vol. 4, Elsevier, 2001.
20. ———, *Efficient Estimation of Extreme Non-linear Roll Motions using the First-order Reliability Method (FORM)*, Journal of Marine Science and Technology **12** (2007), 191–202.
21. ———, *Stochastic procedures for extreme wave load predictions - wave bending moment in ships*, Marine Structures **22** (2009), 194–208.
22. J.J. Jensen and J. Capul, *Extreme response predictions for jack-up units in second order stochastic waves by FORM*, Probabilistic Engineering Mechanics **21** (2006), 330–338.
23. J.J. Jensen and P.T. Pedersen, *Critical wave episodes for assesment of parametric roll*, Proc. of IMDC'06 (Ann Arbor, MI, USA), 2006, pp. 399–411.
24. A. Der Kiureghian, *The geometry of random vibrations and solutions by FORM and SORM*, Probabilistic Engineering Mechanics **15** (2000), 81–90.
25. S. Krüger, F. Kluwe, and H. Vorhölter, *Decision Support for Large Amplitude Roll Motions based on Nonlinear Time-Domain Simulations*, Proc. of COMPIT'08 (Liege, Belgium), 2008.
26. Z. Lajic, M. Blanke, and U.D. Nielsen, *Fault Detection for Shipboard Monitoring - Volterra Kernel and Hammerstein Model Approaches*, Proc. of 7th IFAC Symposium on Fault Detection, Supervision and Safety of Technical Processes (Barcelona, Spain), 2009.
27. Z. Lajic and U.D. Nielsen, *Fault Detection for Shipboard Monitoring and Decision Support Systems*, Proc. of OMAE'09 (Honolulu, HI, USA), 2009.
28. K. Lindemann and N. Nordenstrøm, *A System for Ship Handling in Rough Weather*, Proc. of Fourth Ship Control System Symposium (Royal Netherlands Naval College), vol. 7, 1975, pp. 45–68.
29. K. Lindemann, J. Odland, and J. Strengehagen, *On the Application of Hull Surveillance Systems for Increased Safety and Improved Structural Utilization in Rough Weather*, Trans. of SNAME **85** (1977), 131–166.
30. H.O. Madsen, S. Krenk, and N. Lind, *Methods of Structural Safety*, Prentice Hall, New Jersey, USA, 1986.
31. R.E. Melchers, *Structural Reliabilty Analysis and Prediction*, 2nd ed., John Wiley & Sons, 1999.
32. A. Naess, O. Gaidai, and P.S. Teigen, *Extreme response prediction for nonlinear floating offshore structures by Monte Carlo simulation*, Applied Ocean Research **29** (2007), 221–230.
33. A. Naess and H.C. Karlsen, *Numerical calculation of the level crossing rate of second order stochastic Volterra systems*, Probabilistic Engineering Mechanics **19** (2004), 155–160.
34. J.K. Nielsen, N.H. Pedersen, J. Michelsen, U.D. Nielsen, J. Baatrup, J.J. Jensen, and E.S. Petersen, *SeaSense - Real-time Onboard Decision Support*, Proc. of WMTC2006 (London, UK), 2006.
35. U.D. Nielsen, *Estimation of Directional Wave Spectra from Measured Ship Responses*, Ph.D. thesis, Section of Coastal, Maritime and Structural Engineering, Department of Mechanical Engineering, Technical University of Denmark, May 2005.
36. ———, *Estimations of on-site directional wave spectra from measured ship responses*, Marine Structures **19** (2006), 33–69.
37. ———, *Response-based estimation of sea state parameters - influence of filtering*, Ocean Engineering **34** (2007), 1797–1810.

38. ———, *Calculating Outcrossing Rates used in Decision Support Systems for Ships*, Proc. of Intl. Mech. Eng. Congress and Exposition (Boston, MA, USA), 2008.
39. ———, *Introducing two hyperparameters in Bayesian estimation of wave spectra*, Probabilistic Engineering Mechanics **23** (2008), 84–94.
40. ———, *The wave buoy analogy - estimating high-frequency wave excitations*, Applied Ocean Research **30** (2008), 100–106.
41. ———, *Calculation of mean outcrossing rates of non-Gaussian processes with stochastic input parameters - reliability of containers stowed on ship in severe sea*, Submitted for possible publication in Probabilistic Engineering Mechanics (2009).
42. U.D. Nielsen, P. Friis-Hansen, and J.J. Jensen, *A Step towards risk-based decision support for ships - Evaluation of limit states using parallel system analysis*, Marine Structures **22** (2009), 209–224.
43. U.D. Nielsen and J.J. Jensen, *Numerical Simulations of the Rolling of a Ship in a Stochastic Sea -Evaluations by use of MCS and FORM*, Proc. of OMAE'09 (Honolulu, HI, USA), 2009.
44. R. Pascoal and C. Guedes Soares, *Non-parametric wave spectral estimation using vessel motions*, Applied Ocean Research **30** (2008), 46–53.
45. ———, *Kalman filtering of vessel motions for ocean wave directional spectrum estimation*, Ocean Engineering **36** (2009), 477–488.
46. R. Pascoal, C. Guedes Soares, and A.J. Sørensen, *Ocean Wave Spectral Estimation Using Vessel Wave Frequency Motions*, Journal of Offshore Mechanics and Arctic Engineering **129** (2007), 90–96.
47. H.G. Payer and H. Rathje, *Shipboard Routing Assistance Decision Making Support for Operation of Container Ships in Heavy Seas*, Trans. of SNAME **112** (2004), 1–12.
48. E. Pedersen, E. Shimizu, T. Haugen, and T.E. Berg, *On the development of guidance system design for ships operating in close proximity*, Proc. of IEEE-PLANS 2008 Symposium (Monterey, CA, USA), 2008.
49. A.N. Simos, J.V. Sparano, E.A. Tannuri, and V.L.F. Matos, *Directional Wave Spectrum Estimation Based on a Vessel 1st Order Motions: Field Results*, Proc. of 17th International Offshore and Polar Engineering Conference (Lisbon, Portugal), 2007.
50. R. Skjong, E. Bitner-Gregersen, E. Cramer, A. Croker, Ø. Hagen, G. Korneliussen, S. Lacasse, I. Lotsberg, F. Nadim, and K.O. Ronold, *Guidelines for Offshore Structural Reliability Analysis - General*, DNV Report 95 - 2018, Det Norske Veritas, Høvik, Norway, 1995.
51. R. Skjong and C. Guedes Soares, *Editorial: Safety of maritime transportation*, Reliability Engineering and System Safety **93** (2008), 1289–1291.
52. C. Guedes Soares, A. Jasionowski, J.J. Jensen, D. McGeorge, A. Papanikolaou, E. Pöyliö, P.C. Sames, R. Skjong, J. S. Juhl, and D. Vassalos, , Risk-Based Ship Design - Methods, Tools and Applications (A. Papanikolaou, ed.), Springer, 2009.
53. D. Spanos, A. Papanikolaou, and G. Papatzanakis, *Risk-based Onboard Guidance to the Master for Avoiding Dangerous Seaways*, Proc. of 6th Osaka Colloquium on Seakeeping and Stability of Ships (Osaka, Japan), 2008.
54. D. Stredulinsky and E. Thornhill, *DRDC Experiences with Shipboard Measurement of Seaway Wave Characteristics*, Proc. of 8th Canadian Marine Hydromechanics and Structures Conference (St. John's, Canada), 2007.

55. E.A. Tannuri, J.V. Sparano, A.N. Simos, and J.J. Da Cruz, *Estimating directional wave spectrum based on stationary ship motion measurements*, Applied Ocean Research **25** (2003), 243–261.
56. J. Tellkamp, H. Günther, A. Papanikolaou, S. Krüger, K.-C. Ehrke, and J.K. Nielsen, *ADOPT - Advanced Decision Support System for Ship Design, Operation and Training - An Overview*, Proc. of COMPIT'08 (Liege, Belgium), 2008.
57. D. Wittkuhn, K.-C. Ehrke, and J.K. Nielsen, *Man-Machine Interface and Training*, Proc. of COMPIT'08 (Liege, Belgium), 2008.

## APPENDIX A. FUNDAMENTALS AND RESULTS OF THE WAVE BUOY ANALOGY

**A.1. Physical equations and modelling procedures.** The very principle of the wave buoy analogy is sketched in Figure 10: Measured response spectra are compared with calculated response spectra and based on an error calculation (some) action is taken to minimise the error. Iteratively, this procedure is repeated until convergence has been reached.

The physical equation, on which the error calculation is based, is derived from the assumption of linearity between waves and ship responses,

$$S_{ij}(\omega_e) = \int_{-\pi}^{\pi} \Phi_i(\omega_e, \chi) \overline{\Phi_j(\omega_e, \chi)} E(\omega_e, \chi) d\chi \quad (16)$$

similar to the electric filter analogy, cf. Eq. (2), but written here in complex numbers. In Eq. (16), the left-hand side  $S_{ij}(\omega_e)$  is the measured cross (response) spectrum of the  $i$ th and  $j$ th responses, whereas the right-hand side is the calculated cross spectrum using the estimated wave spectrum  $E(\omega_e, \chi)$ . The bar denotes the complex conjugate.

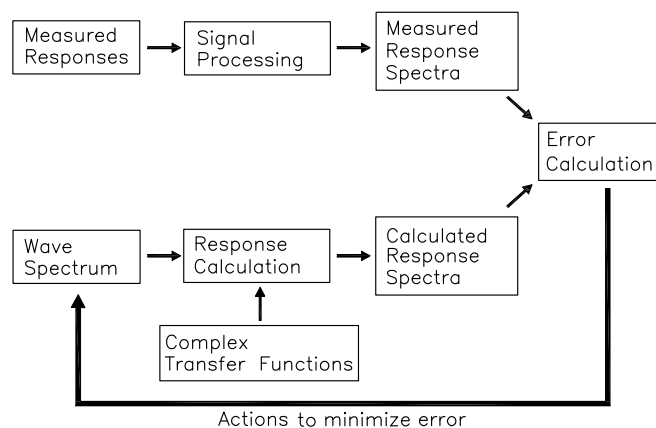

FIGURE 10. *The fundamental idea in the estimation of wave spectra based on measured ship responses.* Aschehoug [1]

The speed-of-advance problem for a moving ship can be taken into account by imposing the requirement

$$\omega_e = \omega - \omega^2 A \quad , \quad A = \frac{U}{g} \cos \chi \quad (17)$$

where  $\omega$  is the true wave frequency,  $U$  is the speed of the ship, and  $g$  is the acceleration of gravity.

In terms of matrix notation, Eq. (16) can be written

$$\mathbf{b} = \mathbf{A}\mathbf{f}(\mathbf{x}) \quad (18)$$

where the vector function  $\mathbf{f}(\mathbf{x})$  expresses the unknown wave spectrum  $E(\omega, \chi)$  that, by some modelling, can be estimated from the minimisation of  $g^2(\mathbf{x})$

$$g^2(\mathbf{x}) \equiv \|\mathbf{A}\mathbf{f}(\mathbf{x}) - \mathbf{b}\|^2 \quad (19)$$

where  $\|\cdot\|$  represents the  $L_2$  norm. Traditionally, either parametric modelling or non-parametric (Bayesian) modelling is employed, where the former assumes a parameterised wave spectrum (e.g. JONSWAP) while the latter modelling solves for the complete discretised wave spectrum by imposing prior constraints.

**A.2. Examples based on numerical data and full-scale measurements.** The potential of the wave buoy analogy has been studied extensively by use of numerical simulations, where the underlying - true - wave spectrum is known. In particular, Nielsen [37], [40] has made thorough studies, where motion responses for a moving ship have been numerically simulated, to investigate the interesting phenomenon of filtering. Thus, a ship is, in general, only sensitive to wave excitations characterised by wave lengths in a certain interval due to the finite vessel size and due to the equivalent mass-spring-damper behaviour of a ship. From the studies ([37],[40]) it was seen that wave estimations can be improved by considering a set of three responses which are not all sensitive to the same frequency band of wave energy. For example, the relative motion (measured to the sea surface) at a given position of a ship responds to high-frequency excitations of a seaway, which is not the case of, say, the pitch motion.

The wave buoy analogy has also been applied to full-scale measurements, e.g. Iseki and Terada [18], Iseki [16], and Nielsen [39]. Figure 11 shows the estimated frequency wave spectrum as obtained from the wave radar system Wavex (legend: wavex) and from the wave buoy analogy (legend: bay), respectively. The results are from [39], where measurements from an operating container ship have been analysed. As it is seen from Figure 11, four spectra are shown and estimations have been made under the conditions of beam sea (Data A), head sea (Data E), following sea (Data F), and

bow quartering sea (Data H); where there is good agreement of the wave directions as estimated from both Wavex and the wave buoy analogy. In the shown spectra the agreement between Wavex and the wave buoy analogy is fairly good but there are also other cases where the agreement is less good; not to say which one is the correct one.

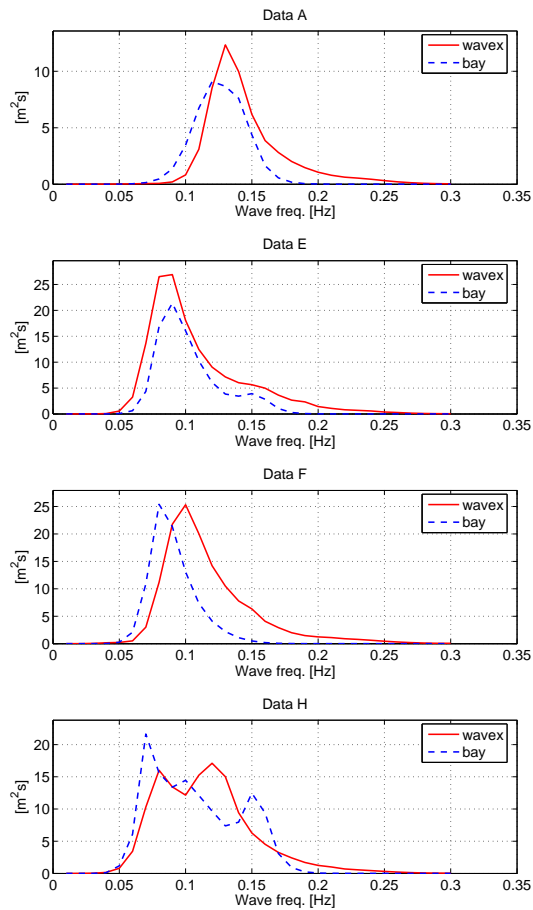

FIGURE 11. *Wave estimation from full-scale measurements. (Note the difference in scales.)* Nielsen [39]