



Optimization of buildings with respect to energy and indoor environment

Nielsen, Toke Rammer; Svendsen, Svend

Publication date:
2003

Document Version
Publisher's PDF, also known as Version of record

[Link back to DTU Orbit](#)

Citation (APA):
Nielsen, T. R., & Svendsen, S. (2003). Optimization of buildings with respect to energy and indoor environment. Kgs. Lyngby, Denmark: Technical University of Denmark (DTU). (BYG Rapport; No. R-036).

DTU Library

Technical Information Center of Denmark

General rights

Copyright and moral rights for the publications made accessible in the public portal are retained by the authors and/or other copyright owners and it is a condition of accessing publications that users recognise and abide by the legal requirements associated with these rights.

- Users may download and print one copy of any publication from the public portal for the purpose of private study or research.
- You may not further distribute the material or use it for any profit-making activity or commercial gain
- You may freely distribute the URL identifying the publication in the public portal

If you believe that this document breaches copyright please contact us providing details, and we will remove access to the work immediately and investigate your claim.

BYG • DTU

DANMARKS
TEKNISKE
UNIVERSITET



Toke Rammer Nielsen

Optimization of buildings with
respect to energy and indoor
environment

Rapport
BYG • DTU R-036
2002
ISSN 1601-2917
ISBN 87-7877-094-7

Optimization of buildings with respect to energy and indoor environment

Toke Rammer Nielsen

Department of Civil Engineering
DTU-building 118
2800 Kgs. Lyngby
<http://www.byg.dtu.dk>

2002

Preface

This thesis concludes the Ph.D. work entitled *Optimization of Buildings with respect to Energy and Indoor Environment*. The work was carried out between February 1999 and June 2002 at the Department of Civil Engineering, Technical University of Denmark and was financed by a scholarship from the Technical University of Denmark. The project concerns optimization of whole building designs.

I would like to use this opportunity to thank my supervisor professor Svend Svendsen and my colleagues for rewarding discussions and exchange of ideas.

Toke Rammer Nielsen
Lyngby, September 2002

Summary

The purpose of this project is to develop a building design methodology that supports optimization of building designs in the early stages of the design process. The purpose of building design optimization is to reach a cost effective building design with good performance. This means that the optimal building design in a given case must fulfill requirements expressed by the society and the user of the building at minimal cost. The evaluation of cost is based on life cycle cost calculations and the optimization is performed with respect to other performance aspects such as energy use, indoor environment and daylight conditions.

The design methodology is developed based on a discussion of the building design process, performance assessment methodologies, modeling and simulation of buildings, economic theory and optimization approaches.

Many aspects of the overall building performance depend on decisions in the early stage of the design process. To improve the performance of buildings it is necessary to be able to assess the performance and monitor cost during the design process. This is possible if the consultants and the building user cooperate with the contractors, manufacturers and suppliers from the early stage of the design process.

The desired performance of the building is based on an early identification of the needs expressed by the user and the society. Many aspects related to the physical, energetical and environmental performance of a building design influence the life cycle cost. Therefore, the life cycle cost may be used as an objective measure of the overall building performance. Still aspects such as thermal indoor environment and daylight conditions are difficult to associate directly with cost. These aspects must be handled individually by imposing additional performance requirements.

Performance assessment of different building designs requires the use of computer simulation. With few exceptions, existing design tools may be used to evaluate the consequences of a particular building design but are generally unable to suggest a particular design solution. Using design tools, problem definition and parameter variations can be very time consuming. Also analyzing many parameter variations may not result in the optimal solution, as the influence of different design parameters on the performance can be difficult to understand. Automatic optimization can replace manual variation of different design variables and save the building designer a lot of work and at the same time guide the building designer towards a cost effective building design with good performance.

In this thesis a building design methodology is suggested that support optimization of building designs in the early stage of the design process. The design methodology is implemented in a design tool that utilizes an optimization method to perform automatic parameter variations of the design variables to find the geometry and mix

of building components that minimizes the life cycle cost with respect to energy use, thermal indoor environment and daylight conditions. The building designer defines the geometric parameters, selects alternative building components from a building component database and defines performance constraints that constitute the solution space for the design problem using a graphical user interface.

The design methodology implemented in the prototype tool is tested on two case studies. The case studies consider optimization of a room in a one-family house and optimization of office rooms in a multi storey office building.

Based on the work presented in this thesis it is concluded that is possible to develop design tools that are useful in the early stage of the design process and helps the building designer minimize the life cycle cost of the building design with respect to energy and indoor environment.

Resume (in Danish)

Formålet med dette projekt er at udvikle en metode til optimering af bygninger der kan bruges i den tidlige fase af projekteringen. Målet er at optimere bygningerne med hensyn til ydeevne og totaløkonomi. Dette betyder, at de krav der stilles til bygningen af myndighederne og bygherren skal tilfredsstilles med den laveste totaløkonomi. Optimeringen udføres med hensyn til energi forbrug, termisk indeklima og dagslysforhold.

Metoden udvikles ud fra en diskussion af design processen, metoder til evaluering af bygningers ydeevne, modellering og simulering af bygninger, økonomisk teori og optimeringsmetoder.

Mange aspekter af en bygnings ydeevne afhænger af beslutninger der træffes i den tidlige fase af projekteringen. For at forbedre bygningers ydeevne er det nødvendigt at kunne evaluere ydeevnen og føre kontrol med udgifterne igennem hele projekteringsforløbet. Dette er kun muligt hvis de rådgivende og bygherren samarbejder med entreprenører, udførende, producenter og leverandører gennem hele projekteringsforløbet.

Den ønskede ydeevne baseres på en tidlig identifikation af myndighedskrav og bygherrens ønsker. Mange aspekter vedrørende bygningens fysiske, energi- og miljømæssige egenskaber har betydning for bygningens totaløkonomi. Totaløkonomien kan derfor benyttes som et objektive mål for bygningens overordnede ydeevne. Visse aspekter af bygningens ydeevne er svære at tillægge en økonomisk værdi. Disse aspekter må håndteres individuelt ved at formulere ekstra krav til bygningens ydeevne.

Design værktøjer benytter computerbaserede beregninger til at evaluere ydeevnen af forskellige design løsninger. Eksisterende design værktøjer kan benyttes til at evaluere konsekvenserne af en bestemt design løsning men kan med få undtagelser ikke foreslå løsningsmuligheder der forbedrer bygningens ydeevne. Brugen af design værktøjer er meget tidskrævende hvad angår opbygning af modeller og kørsel af parametervariationer. Ved at udføre og analysere mange parameter variationer er det ikke sikkert at den optimale løsning bliver fundet. Dette skyldes at det kan være svært at se sammenhængen mellem de parametre der beskriver bygningen og bygningens ydeevne. Ved at erstatte manuelle parametervariationer med en automatisk optimeringsmetode kan der spares tid og opnås designløsninger med en bedre ydeevne.

Dette projekt foreslår en metode til optimering af bygninger der kan bruges i den tidlige fase af projekteringen. Metoden implementeres i et design værktøj. Værktøjet benytter en optimeringsmetode til at udføre automatiske parametervariationer af bygningens design for at finde den geometri og de valg af bygningskomponenter, der minimerer bygningens totaløkonomi med hensyn til energiforbrug, termisk indeklima og dagslysforhold. Ved hjælp af en grafisk brugergrænseflade defineres de valg der kan foretages blandt alternative bygningskomponenter, geometriske parametre og krav til ydeevne, der indgår i optimeringen af bygningens udformning. De bygningskompo-

ninger, der indgår i optimeringen vælges fra en database med bygningskomponenter.

Design værktøjet benyttes til at teste optimeringsmetoden i forbindelse med optimering af et rum i et enfamilie hus og optimering af kontorlokaler i en fleretagers kontorbygning.

Baseret på det arbejde der er udført i dette projekt konkluderes det, at det er muligt at udvikle design værktøjer, der minimerer totaløkonomien for bygninger med hensyn til energi og indeklima i den tidlige fase af projekteringen.

Contents

Preface	i
Summary	iii
Resume (in Danish)	v
1 Introduction	1
1.1 Background	1
1.2 Purpose and demarcation	2
1.3 Scientific method	3
1.4 Publications	4
2 Design process	7
2.1 Phases in the design process	7
2.2 Organization	7
2.3 Discussion	9
3 Building performance	11
3.1 Performance requirements	11
3.2 Integral building envelope performance assessment	11
3.3 Reducing performance into one measure	13
3.4 Life cycle cost	13
3.4.1 Net present value calculation	14
3.4.2 Investment cost	14
3.4.3 Operational cost	14
3.4.4 Service life	14
3.4.5 Maintenance cost	16
3.4.6 Replacement cost	16
3.4.7 Scrap value	16
3.5 Energy performance	17
3.6 Indoor environment performance	17
3.7 Daylight performance	19
4 Performance assessment	21
4.1 Design tools	21

5	Simple tool for performance assessment	25
5.1	Model considerations	25
5.2	Calculation procedures	26
5.2.1	Energy analysis and thermal simulation	26
5.2.2	Daylight evaluation	29
5.2.3	Energy consumption	30
5.2.4	Life cycle cost	30
5.3	Validation of energy analysis and thermal simulation	32
5.3.1	Test case	32
5.3.2	Weather data	34
5.3.3	Results	34
6	Description of buildings and building components	39
6.1	Product models	39
6.1.1	Standard for exchange of product model data	39
6.1.2	Industry Foundation Classes	40
6.2	Characterization of building components	40
6.2.1	Building envelope components	40
6.2.2	Windows	41
6.2.3	Systems	42
7	Optimization approaches	47
7.1	Optimization	47
7.2	Building design optimization	48
7.3	Optimization methods	49
7.4	Systematic optimization methods	51
7.4.1	Local optimization	51
7.4.2	Global optimization	53
7.5	Heuristic methods	53
7.5.1	Global optimization	53
7.6	Hybrids	55
7.7	Multi criteria optimization	55
7.8	Handling constraints	55
7.8.1	Constraints on design variables	55
7.8.2	Constraints on dependent variables	56
7.9	Applications of optimization to energy related building design problems	57
8	Choosing optimization algorithm	59
8.1	Direct	59
8.2	Hooke-Jeeves and Simulated Annealing	59
8.3	Direct Search Simulated Annealing	62
8.4	Handling constraints	63
8.5	Test case	63
8.6	Chosen approach	64

9	Design methodology	67
9.1	Assumptions	67
9.2	Requirements for design tools	67
9.3	Design optimization process	68
9.4	Hypothesis	69
10	Prototype tool	71
10.1	Objective	71
10.2	Software environment	71
10.3	Program structure	72
10.3.1	Data model	72
10.3.2	Optimization loop	74
10.4	Using the prototype tool	77
10.4.1	Building component database	79
10.4.2	Energy prices and economic constants	79
10.4.3	Location and weather data	79
10.4.4	Schematic geometric design	80
10.4.5	Component lists of constructions and systems	80
10.4.6	Define component lists, boundary conditions and geometric constraints for surfaces and subsurfaces	82
10.4.7	Define system lists, schedules and controls for thermal zones	83
10.4.8	Geometric boundaries for building	84
10.4.9	Performance requirements	84
10.5	Optimizing the design	85
11	Case study	89
11.1	Objectives	89
11.2	Building components used in the case studies	89
11.2.1	Outer wall constructions	90
11.2.2	Internal constructions	92
11.2.3	Deck constructions	92
11.2.4	Roof constructions	93
11.2.5	Window constructions	93
11.2.6	Heating systems	95
11.2.7	Ventilation and cooling systems	96
11.2.8	Solar shading devices	97
11.2.9	Lighting system	97
11.3	Economic assumptions	98
11.4	Case 1: Room in one-family house	98
11.4.1	Geometry	98
11.4.2	Loads and HVAC systems	98
11.4.3	Design options	99
11.4.4	Performance requirements	99
11.4.5	Optimized result	100
11.4.6	Parametric runs	100
11.5	Case 2: Office building	103
11.5.1	Geometry	104

CONTENTS

11.5.2	Loads and HVAC systems	104
11.5.3	Design options	106
11.5.4	Performance requirements	107
11.5.5	Optimized result	107
11.5.6	Parametric runs	108
12	Evaluation of prototype tool	113
12.1	Claims	113
12.2	Discussion	113
13	Conclusion	115
	Bibliography	118
	Appendices	I
A	Article in LEAS	III

Chapter 1

Introduction

1.1 Background

Many aspects of the overall building performance depend on decisions in the early stage of the design process. These decisions are often made with only little consideration to important performance aspects such as energy use, indoor environment and life cycle cost. These performance aspects are often not assessed before the detailed building design has been decided. At this stage of the design process only small changes to the building design are possible and the changes often result in high extra expenses. In many cases, problems with poor indoor environment are not realized before the building is taken in use. Changing the building design at this stage is very expensive and it may not be possible to solve the problems without a major redesign. Often the actions taken to improve the indoor environment after the building is taken in use increase the energy use and thereby increase operational expenses. To improve the performance of buildings it is important to develop design tools that may be used to assess performance aspects of building designs in the early stages of the design process where the building designer still has the freedom to choose between almost unlimited numbers of different possible design solutions.

Buildings are constructed to solve the needs of a user and should be designed to fulfill these needs. Additional needs are expressed by the society in building codes, standards and other legislation. When new buildings are designed these needs must be considered.

The energy performance of buildings is often regulated in building codes. According to the Danish building regulations, the requirement for heating demand can be fulfilled in several ways (BR, 1995). The requirement for heating demand is fulfilled if the thermal transmittances of different building constructions are below stated limits or if the heating demand is below the energy frame of the building. The energy frame expresses the maximum yearly heating demand allowed in a building and depend on the size of the building. The energy frame gives the building designer a larger degree of freedom in the design process. This makes it possible to combine and vary many different design solutions, which result in a large number of alternative solutions to the building design. Therefore, methods are needed that helps the building designers choose solutions that fulfill the demands in the building regulation in an optimal way.

Cost is often considered to be the single most important design parameter. Today

evaluation of cost mainly focus on the investment costs with only little regard to future costs. For the building user the expense of using a building is a result of the accumulated costs during the buildings lifetime. Initiatives that reduce the future costs (e.g. energy savings, improved durability of building components) often result in larger investment costs, e.g. because of addition of thermal insulation, more durable building materials etc. If future costs are not included in the evaluation, these initiatives will not be implemented. Therefore, the total cost of different building designs should be evaluated based on the life cycle cost (LCC), which includes all expenses and incomes during the lifetime of the building. The LCC may be evaluated using net present value calculations where all future expenses and incomes are discounted to the present to obtain a common reference for a comparison. By this approach, it is possible to compare the economical performance of several alternatives even though the distribution of associated costs and incomes through time may be different. Many aspects of the building performance such as initial cost, maintenance cost, durability, scrap value and energy demand are included in the LCC. But not all performance aspects can be evaluated as part of the LCC. It is difficult to give an economical value to performance aspects such as fire safety, thermal comfort, visual comfort, air quality and environmental aspects. Therefore multiple performance aspects must be considered in the design process.

Designing a building that fit the needs is the task of the building designer. The needs are often expressed as basic functional needs and must be translated into measurable performance requirements that make evaluation and comparison of different building designs possible. The performance requirements define the design domain within which the building designer can operate. In the early stages of the design process the building designer has a large degree of freedom but is bounded by requirements that must be fulfilled in a cost effective way. Many design parameters exist, which results in a complicated design problem. Proper performance assessment of different designs may require the use of computer simulation where problem definition and parameter variations can be very time consuming. Also analyzing many parameter variations may not result in the optimal solution, as the influence of different design parameters on the performance can be difficult to understand. Automatic optimization can replace manual variation of different design parameters and save the building designer a lot of work and at the same time guide the building designer towards a cost effective building design with good performance.

1.2 Purpose and demarcation

The purpose of this project is to develop a building design methodology that supports optimization of building designs in the early stages of the design process. The purpose of building design optimization is to reach a cost effective building design with good performance. This means that the optimal building design in a given case must fulfill requirements expressed by the society and the user of the building at minimal cost. The evaluation of cost is based on life cycle cost calculations and the optimization is performed with respect to other performance aspects such as energy use and indoor environment.

The first part concerns development of a design methodology to optimize the life

cycle cost of buildings in situations with many design variables. In this part relevant approaches are extracted from the building design process, performance assessment methodologies, modeling and simulation of buildings, economic theory and optimization approaches. The design methodology is developed from a whole building point of view but with emphasis on the building envelope. The second part concerns development of a prototype tool that implements the design methodology and helps the designers choose among different alternatives in the early phases of the design process.

The topic of optimization of buildings is investigated from a building physics point of view and concentrates on performance aspects related to cost, energy and indoor environment.

1.3 Scientific method

The general scientific method starts with the formulation of a hypothesis describing a phenomenon. Predictions based on the hypothesis are deduced from the hypothesis and tested against observations to either falsify or prove the hypothesis. The hypothesis may be falsified if predictions deduced from the hypothesis are refused by the tests. On the other hand the hypothesis can never be proven based on deduction. This is the problem of induction. A number of tests may confirm our confidence in a hypothesis but never prove the hypothesis (Føllesdal et al., 1999; Kragh and Pedersen, 1991). The majority of scientific work faces the problem of induction.

Engineering science is occupied with producing knowledge aiming at the solution of technical problems having a practical impact (Hendricks et al., 2002). The objective may not be to find the “truth” but to find a solution to the problem that is useable and reasonably correct. Solving technical problems, the scientist often uses theories from many scientific fields and well-defined scientific objects. The scientific object is a simplified representation of the real object and may be described using mathematical models. The models are used to predict the behavior of the real object. Constructing a scientific object involves delimitation of the object, abstraction from irrelevant properties and idealization. It is important to evaluate the correctness of the scientific object to ensure an adequate representation of the reality.

In this thesis the scientific process is adapted to a problem-solving project where the objective is to solve a problem by developing a solution. Generally the scientific process is based on the following steps described below:

1. Formulation of a problem based on observations.
2. New and earlier observations, models and theories are used to collect data on the problem.
3. The problem is analyzed based the collected data and a solution to the problem is proposed. The proposed solution is improved through further investigations and finally a testable solution to the problem is formulated (Hypothesis).
4. The solution is used to derive predictions describing consequences of the solution.

5. Comparing predictions and observations during tests implementing the proposed solution are used to validate the solution.

The scientific method described above has been applied in the following way to develop a solution to the problem that is investigated in this thesis:

1. Existing research is investigated. Relevant approaches are extracted from the building design process, performance assessment methodologies, modeling and simulation of buildings, economic theory and optimization approaches.
2. Based on the investigation, a design methodology is proposed that optimizes the design of buildings based on life cycle cost calculations.
3. A prototype computer tool that implements the proposed methodology is developed to test the proposed solution. The computer tool uses a simplified representation of the building to evaluate the performance of the building. The building is thus treated as a scientific object and the mathematical models representing the scientific object are investigated.

1.4 Publications

The contributions to journals and conferences written as part of this ph.d.-study are listed below.

Articles in journals.

Nielsen, T. R. and Svendsen, S. (2002) Life cycle cost optimization of buildings with regard to energy use, thermal indoor environment and daylight. *International Journal of Low Energy and Sustainable Buildings*. Electronic journal available at: <http://bim.ce.kth.se/byte/leas/>. Accepted for publication.

The article is reproduced in appendix A.

Contributions to conferences.

Presented by Claus Rudbeck at ASHRAE Buildings VIII conference:

Rudbeck, C., Nielsen, T. R. and Svendsen, S. (2001) Optimal design of building envelopes. *ASHRAE Buildings VIII*. ASHRAE, 1791 Tullie Circle, NE, Atlanta, GA 30329 U.S.A.

Presented by Claus Rudbeck at International Building Physics conference in Eindhoven:

Rudbeck, C., Nielsen, T. R. and Svendsen, S. (2000) Optimisation of building envelope performances. A methodology developed within International Energy Agency: Annex 32 Integral Building Envelope Performance Assessment, *International Building Physics Conference*. Eindhoven, The Netherlands.

Presented by Toke Rammer Nielsen at the 6th Symposium on Building Physics in the Nordic Countries in Trondheim:

Nielsen, T. R. and Svendsen, S. (2002) Performance optimization of buildings. *Proceedings of the 6th Symposium on Building Physics in the Nordic Countries*. (Gustavsen, A. and Thue, J. V. editors). Norwegian University of Science and Technology, Trondheim, Norway. pp. 563-570.

Chapter 2

Design process

The performance of a building design depends on decisions made in the design process. The design process is divided into several phases involving many professionals. Their involvement in each phase depends on the organization of the design process. To improve the performance of buildings it is necessary to involve all professionals in the early stages of the design process.

2.1 Phases in the design process

In building projects the design process is divided into phases that form a sequence of activities. The following phases are included in the typical design process:

1. Programming
2. Proposal
3. Project

The design process is initiated by the programming phase. In this phase the needs and ideas of the building owner are analyzed to identify the demands and wishes. Based on this a draft of the building design is drawn up and a written program is made that contains schematic reports and drawings dealing with all issues important for carrying out the construction. The proposal adapts the detailed design of the building to the agreements in the written program. The proposal is detailed to a degree so all decisions decisive for the building are made and part of the solution. Based on the proposal the project lays out the details of the building unambiguously.

2.2 Organization

Many professionals take part in the building project and are traditionally involved in different phases of the project. The professionals involved include consultants (architects, engineers), contractors, manufacturers, suppliers and authorities. The building design is a result of the cooperation between the building owner and the professionals. Each phase in the design process includes many considerations and the organization determines the involvement of the different professionals in the different phases. The

traditional project organization is a result of many years practice where the different professionals take care of different aspects of the design. In the later years more interest has been focused on the project organization in order to improve the efficiency in the building sector. A Danish project concerning the use of information technology (IT) in the building process finds that the traditional organization doesn't support the use of IT. One of the outcomes of the project is a proposal for a new organization that involves all professionals in the design process (Høgsted et al., 1999). The traditional and proposed organizations are shown in Table 2.1.

Table 2.1: Traditional and proposed organization of building projects (Høgsted et al., 1999)

Traditional	Proposed
<p>1. Programming building owner, consultants, authorities</p> <p>2. Proposal building owner, consultants, authorities</p> <p>3. Project consultants, authorities</p> <p style="text-align: center;"><i>Invite tenders</i> <i>Negotiation - Changes</i> <i>Contract</i></p> <p style="text-align: center;">Construction</p>	<p>1. Programming building owner, consultants, contractor, manufacturers, suppliers, authorities</p> <p>2. Proposal building owner, consultants, contractor, manufacturers, suppliers, authorities</p> <p style="text-align: center;"><i>Contract</i></p> <p>3. Project consultants, contractor, manufacturers, suppliers</p> <p style="text-align: center;">Construction</p>

The traditional organization doesn't involve contractors, manufacturers and suppliers in the design stages. This makes it difficult to monitor costs and choose specific design solutions during the design process and often results in an extra phase in the project where the building design is changed during the negotiation to keep the cost within the budget. At this stage, the room for changes is limited, as the details of the design have already been decided. There is no time to perform a thorough investigation of the effects of the last minute changes, which may have a large influence on the building performance.

The proposed organization involves all professionals from the early design phase. This makes it possible to choose specific building components and monitor costs during the design. Involving the contractors, manufacturers and suppliers in the design decisions increase their influence, which lead to increased responsibility and interest in the project.

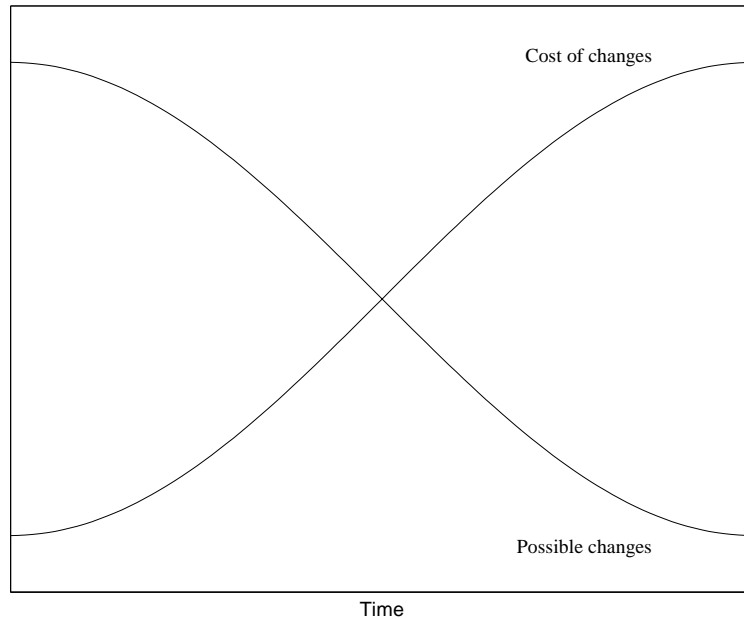

Figure 2.1: Empiric relation describing how the possible changes to the building design decrease during the design process at increasing cost.

2.3 Discussion

Decisions concerning the shape and architecture of the building are made during the programming phase based on the demands and wishes of the building owner and other factors such as building site and district plan. These decisions have a large influence on the following phases in the design process and the performance of the building, but are often made with only little consideration to important aspects such as energy use, indoor environment and life cycle cost. Figure 2.1 shows the empiric relation that the possibilities for changes in the building design decreases during the design process at an increasing cost. The largest degree of freedom for the designer exists in the early phases of the design process and the performance of the building can be improved and costly changes later in the design process can be avoided by if some extra time at this point is used to evaluate performance aspects such as energy use, indoor environment and life cycle cost. To evaluate the performance in the early stages of the design process it is necessary to have a design tool that evaluates the performance of the building based on simple input describing the building design and to have information from contractors, manufacturers and suppliers on their products. The proposed project organization where contractors, manufacturers and suppliers are involved in the programming phase of the design process supports an early assessment of the building performance.

Chapter 3

Building performance

This chapter discusses the performance of buildings. Buildings are constructed to fulfill needs expressed by the user and the society. Before design is started, the needs are identified and formulated in general terms. To assess the performance of different designs during the design process, the needs must be translated into measurable performance requirements. This work considers performance aspects related to building physics mainly including life cycle cost, energy use, thermal indoor environment and daylight performance.

3.1 Performance requirements

A building is constructed to solve a users need for accommodation and the design solution must be related to the need of the user. In addition the society expresses needs in building codes and standards. The initial phase in the design process is concerned with identification and description of the needs in general terms. The identification and description of the needs is followed by a translation into exact and measurable performance requirements that may be tested and verified during the design process. The performance requirements agreed upon by the user and the designer defines the minimum performance of the building. The task of the designer is to find the best solution that fulfills the performance requirements.

To meet the performance requirements, the performance of different design solutions must be assessed and compared during the design process. Performance is often assessed using computer models that evaluate different performance aspects. Some aspects cannot be modeled during the design and here the experience of the designer or general guidelines in standards are important.

Each performance requirement can be tested individually. But improving some performance aspects may deteriorate other aspects. Therefore it is necessary to evaluate the performance at the whole building level.

3.2 Integral building envelope performance assessment

An assessment methodology for evaluation of building envelopes is developed in Annex 32 of the International Energy Agency (IEA) with the title Integral Building Envelope Performance Assessment (IBEPA). The objective of the annex is *to develop a*

comprehensive performance assessment methodology leading to rational strategies for evaluation and optimization of building envelopes with respect to their physical, energetical and environmental qualities, based on a fitness for purpose approach (Hendriks and Hens, 2000).

The annex focuses on the building envelope, but the general methodology may be expanded to cover whole buildings and stock of buildings. The method formulates requirements for aspects related to the building performance such as costs, space requirements, safety, thermal and hygric comfort and acoustics. A comprehensive list of performance aspects are given in Hendriks and Hens (2000).

To test the identified performance requirements during the design process, tools for performance assessment are needed. Typically performance requirements may be expressed in terms of reference values. These references define the minimum quality that should be guaranteed.

The annex suggests using quality scores to assess the performance of different design aspects. A quality score, SPP , is assigned to each of the performance aspects with a score of 1 when the reference value is obtained and a score of 5 when the highest quality is reached. A mean score, MS , is obtained as the sum of all scores divided by the number, n , of performance requirements imposed. When comparing different design alternatives the costs are divided by the received mean score. This result allows classification of the design alternatives according to their quality.

The different performance aspects may not be perceived as equally important. This is solved by assigning a weighting factor, f , to each performance aspect expressing the importance in relation to the other performance aspects. The overall score is then obtained by a weighted mean score, WMS ,

$$WMS = \frac{\sum_{j=1}^n f_j \cdot SPP_j}{\sum_{j=1}^n f_j} \quad (3.1)$$

The quality score allows ranking of different design solutions and facilitates decision-making. To use quality scores it is necessary to decide on reference values, optimum values and weighting factors for each performance aspect.

The assessment methodology developed in IBEPa makes it possible to assess the overall performance using the weighted mean score. The disadvantage is that both the individual scores and the weights are open for interpretation. It would be difficult to argue for fixed weights and reference and optimum values for each performance requirement. This makes it difficult to use the approach for optimization purposes.

Example of whole wall U-value score

A linear quality score is assigned to the whole wall U-value. The reference value and optimum value are assigned a quality score of 1 respectively 5.

$$SPP = 1 \text{ when } U_{ww} = U_{ref}$$

$$SPP = 5 \text{ when } U_{ww} = U_{opt}$$

The quality score for a given U-value, U_{ww} , is obtained by

$$SPP = \frac{4}{U_{opt} - U_{ref}} \cdot U_{ww} + \frac{U_{opt} - 5 \cdot U_{ref}}{U_{opt} - U_{ref}}$$

with reference U-value imposed by the building code U_{ref} , optimum U-value U_{opt} and U-value of the wall construction U_{ww} .

3.3 Reducing performance into one measure

Many performance aspects of a design directly influence the life cycle cost of the building. At the same time, cost is perceived as one of the most important factors when designing buildings. Relating the performance aspects to costs facilitates a direct comparison of different building designs through the life cycle cost. Having one value by which the overall performance is measured facilitates optimization where the optimal design would be the design with the lowest life cycle cost.

Many aspects related to the physical, energetical and environmental performance of a building design directly or indirectly influence the life cycle cost. Aspects such as cost and durability of building components, energy use for heating, cooling, ventilation, lighting, and equipment, and shape and orientation of the building directly influence the life cycle cost. Other aspects may influence the life cycle cost indirectly through the prices. Environmental aspects are to some degree included in the life cycle cost by taxes on energy and polluting materials. The taxes are imposed by the society to account for expected expenses or to stimulate a development using environmental friendly technology. For instance in Denmark the energy prices are influenced by a CO₂-tax to reduce the CO₂ emissions. Still aspects such as indoor environment, daylight and environmental issues may be difficult to associate directly with cost. These performance aspects that cannot be translated into cost must be handled individually. In addition, functional requirements for structural strength, fire safety and energy use stated in building codes must be satisfied. Buildings also have to fulfill architectural and aesthetic wishes and it is important that the performance is evaluated with this in mind.

3.4 Life cycle cost

Traditionally cost is evaluated as the initial investment cost, which is the amount of money the builder has to raise to build the building. Often the builder is not the future user of the building and has low interest in the costs associated with maintenance and operation of the building. The interest of the builder is to keep the initial investment cost low. Often measures taken to lower maintenance and operational cost using more durable and energy efficient building components result in a higher initial investment cost. Not taking the future costs into consideration when the building is designed may result in more expensive buildings for the users. Therefore, comparison of different building designs should be based on life cycle cost calculations where all expenses during the lifetime of the building are taken into account.

3.4.1 Net present value calculation

The life cycle cost is calculated as the net present value. The advantage of net present value calculations is the possibility to compare different investments where the expenses differ during the calculation period. To calculate the present value, all expenses during the calculation period are discounted to the present. It is assumed that all future expenses could have been invested at a given discount rate in an alternative investment. The discount rate used in the net present value calculations compensate for inflation and the difference in revenue compared to the alternative investment. Methods describing life cycle cost calculations on buildings are described e.g. in ASTM (1993).

The net present value, NPV , of the expenses C_t at times t , is calculated by the following formula

$$NPV = \sum_{t=0}^N \frac{C_t}{(1+i)^t} \quad (3.2)$$

with discount rate i , time t and length of study period N .

3.4.2 Investment cost

The investment costs include costs of labor and materials associated with the design and construction of the building.

3.4.3 Operational cost

The operational costs are the costs associated with the operation of the building and include payment for heating, cooling and electric energy that is used to control temperature, air quality, lighting and other parameters that influence the occupants in the building. The operational costs are influenced by the energy demands, energy prices and efficiencies of the energy consuming systems in the building. They occur periodically and may often be viewed as a yearly recurring cost.

3.4.4 Service life

The life cycle cost of a building depends on the lifetime of its components. Many building components have shorter lifetimes than the building and are replaced several times during the lifetime of the building. The lifetime of a building component may be defined in many ways depending on the point of view of the examiner and the objective of the examination. Six different definitions of the lifetime of buildings components are given in Table 3.1 (Rudbeck, 1999). In the following, the service life is defined as the expected time a building component is used in a building before it is replaced.

Several different approaches to estimate the service life of building components exist. In some approaches a reference service life is evaluated based on experience, results from measurements on components in use or results from accelerated aging tests. The reference service life is estimated for reference conditions. The estimated service life of a building component under specified conditions is calculated from the reference service life depending on many aspects such as location, how the component is used in the building etc. The estimated service life may be found using a factors

Table 3.1: Definitions of lifetimes of building components (Rudbeck, 1999).

Design life	Period of use intended by the design, e.g. as established by agreement between the client and the designer to support specific decisions.
Economic life	Actual period during which no excessive expenditure is required on operation, maintenance or repair of a building component. All relevant aspects (including but not limited to cost of design, construction and use, cost of inspection, maintenance, care, repair, disposal and environmental aspects) are taken into account.
Functional life	Period of time after construction in which the building component can be used for its intended purpose without changing the properties of it.
Social and legal life	Period of time after construction until human desire or legal requirements dictate replacement for reasons other than economic considerations.
Technical life	Period of time after construction until such large portion of the building component is changed that it no longer can be said to be the same building component.
Technological life	Period of time after construction until the building is no longer technologically superior to alternatives.

Table 3.2: Description of factors used in eq. 3.3 (ISO, 1998)

Inherent quality characteristics	A	Quality of components
	B	Design level
	C	Work execution level
Environment	D	Indoor environment
	E	Outdoor environment
Operation	F	In-use conditions
	G	Maintenance level

approach where the reference service life is modified by applying several factors. The factor approach suggested by ISO (ISO, 1998) calculates the estimated service life, ESLC, using the following formula

$$ESLC = RSLC \cdot A \cdot B \cdot C \cdot D \cdot E \cdot F \cdot G \quad (3.3)$$

with reference service life RSLC and factors as described in Table 3.2. The factors depend on quality characteristics of the component, influences from environment and the conditions of operation.

Other approaches use probabilistic methods based on Markov chains and probabilistic distribution functions to estimate the service life. These methods will not be discussed in this thesis but a thorough discussion is given by Rudbeck (1999).

3.4.5 Maintenance cost

The building components need maintenance in order to remain functional during the service life. The service life depends on the level of maintenance. Therefore, the maintenance cost must be calculated based on the level of maintenance used to estimate the service life. Often the yearly maintenance cost is simply evaluated as a percentage of the investment cost.

3.4.6 Replacement cost

Many building components have a shorter service life than the building and are replaced during the service life of the building. The replacement cost of a component may simply be evaluated by an extra expense equal to the initial investment cost for the component occurring when the service life of the component is depleted.

3.4.7 Scrap value

The lifetime of buildings often exceed 100 years. Estimating prices and interest rates for a hundred year period is very uncertain and the calculation period for life cycle cost calculations is normally shorter than 30 years. Therefore, the value of the building is not depleted at the end of the calculation period.

The value of the building at the end of the calculation period, referred to as the scrap or resale value, depend on the durability of the building components. Neglecting the scrap value in the life cycle cost calculations means that the durability aspects of the building components are neglected. Therefore, an estimate of the scrap value is necessary. A possible way to estimate the scrap value is to linearly depreciate the value of the building components as a function of their service life. For components that are replaced during the calculation period, the latest investment is used to evaluate the scrap value. The following an example illustrates the influence of the scrap value on the life cycle cost.

Example of product comparison

The life cycle costs of two products are compared. The only differences between the products are the investment cost, IC , and the service life, SL . One product costs 100,000 DKK and has a 30 year service life. The other product uses more durable materials and costs 110,000 DKK and has a 100 year service life. The life cycle costs are calculated for a calculation period, t , of 30 years with a discount rate, i , at 5%. The scrap value is evaluated based on a linear depreciation of the investment cost as

$$SV = IC * \frac{SL - t}{SL}$$

The life cycle cost including the scrap value is calculated by

$$LCC = IC - \frac{SV}{(1 + i)^t}$$

The results in Table 3.3 show the life cycle cost of the two products both inclusive and exclusive the scrap value. If the scrap value is neglected the life cycle costs are

Table 3.3: Life cycle cost (LCC) of the two products

	Product 1	Product 2
Investment	100,000 DKK	110,000 DKK
Service life	30 y	100 y
Scrap value	0 DKK	77,000 DKK
LCC including scrap value	100,000 DKK	92,184 DKK
LCC excluding scrap value	100,000 DKK	110,000 DKK

equal to the investment costs and the first product is the best investment. When the scrap value is included, the durabilities of the products influence the results, making the second product the best investment. The example shows that by neglecting the scrap value, the durability of the building components may be overlooked in the life cycle cost calculations.

3.5 Energy performance

The main purpose of buildings is to provide occupants with a comfortable indoor environment. Different systems in the building are used to control temperatures, air quality, lighting and other aspects of the indoor environment. The energy consumption of these systems depends on the building design, the climate and the activities in the building.

The expenses related to the operation of systems directly influence the operational costs and the energy performance is therefore included in the life cycle cost. The life cycle cost of energy consumed in systems depends on estimation of future energy prices.

A large amount of the total energy consumption is used for operation of buildings. In Denmark approximately 30% of the total energy consumption is used for space heating (Danish Energy Agency, 2000). To decrease the energy consumption the society often have extra taxes on energy and regulate the energy performance of buildings in building codes and standards. The heating demand is often regulated by limits on the heat transfer coefficients of the building components or a limitation on the energy consumption. The Danish building regulations (BR, 1995) states a maximum yearly heating demand for space heating and ventilation depending on the number of stories and the floor area of the building ranging from 280 MJ to 110 MJ pr. m² floor area. The yearly electricity consumption for ventilation must not exceed 2500 J pr. m³ outdoor air moved through the ventilation system.

3.6 Indoor environment performance

The indoor environment influences the well-being and the health of the occupants and significantly influences rates of respiratory diseases, sick building symptoms and productivity. Worker salaries exceed building energy, maintenance and construction costs by a large factor and the cost-effectiveness of improvements in indoor environment will be high even for small improvements in health and productivity. With existing technology it is possible to improve the indoor environment and increase health and

productivity. In the United States it is estimated that the potential annual savings and productivity gains range from \$30 billion to \$150 billion from reducing health problems and improvements in worker performance (Fisk and Rosenfeld, 1998). It has been claimed that productivity may increase 5% to 15% due to improved indoor environments while others claim that measured changes in productivity are too small and too random to be caused by indoor environment (Lorsch and Abdou, 1994a; Lorsch and Abdou, 1994b). Measuring the productivity and linking it to the indoor environment is very difficult. Different studies use different definitions of productivity and of the factors in the indoor environment that influence productivity (Sensharma, 1998).

Although the investigations show a link between indoor environment and productivity there is still no correlations associating factors of the indoor environment to changes in productivity and cost. Including productivity in the life cycle cost calculations would be very uncertain and would have a huge impact on the life cycle cost because the energy, maintenance and construction costs for buildings are much lower than the worker salaries.

A number of recommendations exist that may be used to identify aspects of the building design that influences the indoor environment. Thermal comfort may be evaluated under different conditions (ISO, 1994; ASHRAE, 1992) and quality classes for indoor environment have been suggested (CEN, 1998a). Factors within the control of building designers and facility managers that contribute to productivity have been identified (McKenzie and McKenzie, 1996; Leaman and Bordass, 1999). Factors that might be controlled during the building design process to improve productivity are listed in Table 3.4. Using these guidelines, performance requirements for the indoor environment can be established.

Table 3.4: Factors controlled in the building design phase that improves productivity

<p>Correct temperature and humidity levels. High ventilation efficiency. No condensation or leakage of water. Non-contaminating building materials. Opportunities for personal control. Services fitting to the activities. Design occupancy fitting or higher than expected building occupancy.</p>
--

A simple performance requirement on the thermal indoor environment is suggested in the Danish standard DS 474 (DS, 1993). The standard suggests a limit on the number of hours during the year where discomfort as a result of the thermal indoor environment is allowed. For a normal office building, indoor temperatures above 26°C lead to thermal discomfort and the suggested performance requirement states that the indoor temperatures should not exceed 26°C for more than 100 hours and 27°C for more than 25 hours during the year.

3.7 Daylight performance

The daylight performance is composed of several aspects. Building components that transmit sunlight provide buildings with daylight. A reasonable daylight level is desired by the building occupants and saves energy for artificial lighting. The transmitted sunlight may also cause problem with glare from surfaces with high illumination levels. Building components providing buildings with daylight also often provide visual contact with the outdoor environment.

Daylight in buildings influence the energy use for artificial lighting and thereby influences the operational cost. Part of the daylight performance can therefore be included in the life cycle cost. Other aspects of the daylight performance associated with the distribution of daylight in the room and glare influences the comfort of the occupants. The discomfort from daylight influence the productivity, which as discussed in the previous section, is difficult to include in the life cycle cost.

Daylight levels are often evaluated based on daylight factors. The daylight factor is the fraction of the illuminance on a surface in the room and the horizontal illuminance outside the building. Occupants in a building wish a certain level of daylight and it is recommended that the daylight factor averaged over the floor area in the work plane is above 2% to assure a reasonable level of daylight (Christoffersen et al., 1999).

Discomfort glare may be evaluated by several approaches. The British Glare Index is based on a glare sensation function that describes the glare sensation produced by a single glare source. The glare index is found combining the glare sensation from a number of glare sources. The American Visual Comfort Probability (VCP) is the probability that an observer considers a visual environment comfortable for performing a task. The VCP also use a glare sensation function for a single source. The glare sensation from a number of glare sources may be combined into a value for the discomfort glare rating (DGR).

Chapter 4

Performance assessment

In the design process it is essential to assess the performance of a building design before the building is constructed. In this way the performance requirements can be checked and changes to the design that improves the performance can be investigated. The assessment is often based on experience with similar designs and design tools developed for performance assessment. Many tools use computer simulations to assess different performance aspects.

4.1 Design tools

A large number of design tools have been developed to assess aspects of building performance at different stages of the design process. Many design tools are based on calculation procedures. The development of computers have replaced time-consuming hand calculation procedures by computer calculations and make it possible to investigate physical phenomena that are too complex to examine by hand. Other design tools such as handbooks are not based on calculation procedures and are useful to quickly locate information.

Design tools may be split into specialized tools that evaluate only a few performance issues and integrated tools that evaluate a wide range of performance issues. To simulate reality a wide range of simplified and detailed calculation procedures exist. For instance a simplified method to evaluate the heating demand of a building is the degree-day method where the heating demand of a building is evaluated as the product of the total thermal transmittance and the degree hours for the specific climate. Detailed simulation of the heating demand uses a mathematical model of the constructions and HVAC systems in the building with detailed information on the climate to perform sub-hourly simulations of loads and temperatures.

Table 4.1 shows an overview of commonly used building design tools. The table includes detailed tools for building energy analysis, integrated design tools and specialized design tools.

Table 4.1: Specialized and integrated design tools to evaluate building performance using (D)etailed and (S)implified calculation procedures.

	Energy	Thermal	Daylight	Environment	Moisture	Cost
Bsim2000	D	D	D		D	
tsbi3	D	D	S			
EnergyPlus	D	D	D	D	D	
ESP-r	D	D	D	D	D	
DOE-2	D	D	D			
BLAST	D	D	D			
BDA	D	D	D			
eQUEST	D					
Optibuild	S					D
Radiance			D			
BV98	S					

The building energy analysis tools Bsim2000¹, tsbi3¹, EnergyPlus², ESP-r³, DOE-2⁴ and BLAST⁵ use detailed calculation procedures to evaluate a wide range of issues regarding energy use and indoor environment. They all require a large amount of input that gives a detailed description of the building geometry, constructions and HVAC systems. The detailed level of information required by these programs requires that the user have a high level of knowledge and training. Many of the energy analysis tools use text based input and output. The input may be prepared by other design tools that analyze the output within the context of their need of the detailed calculation procedures of these tools. This is for instance the case with the Building Design Advisor and eQuest programs described below.

The Building Design Advisor⁶ (BDA) is an integrated design tool developed to addresses the needs of building decision-makers from the initial phases of building design through the detailed specification of building components and systems. The BDA is linked to multiple simulation tools and databases and is built around an object-oriented representation of the building. Input to simulation tools is automatically prepared and their output is integrated in ways that support multi-criterion decision-making. A Schematic Graphic Editor allows designers to quickly and easily specify basic building geometric parameters. Through a Default Value Selector default values are assigned to all non-geometric parameters required by the analysis tools from a Pro-

¹Danish Building and Urban research, Hørsholm, Denmark.
URL: <http://www.byogbyg.dk>

²U.S. Department of Energy, Washington DC, USA.
URL: http://www.eren.doe.gov/buildings/energy_tools/energyplus

³University of Strathclyde, Energy Systems Research Unit, Glasgow, Scotland.
URL: <http://www.esru.strath.ac.uk/Programs/ESP-r.htm>

⁴Lawrence Berkeley National Laboratory, Simulation Research Group, Berkeley, USA.
URL: <http://gundog.lbl.gov/dirsoft/d2whatis.html>

⁵University of Illinois, Building Systems Laboratory, Urbana, USA.
URL: <http://www.bso.uiuc.edu/BLAST/index.html>

⁶Lawrence Berkeley National Laboratory, Building Technologies Department, Berkeley, USA.
URL: <http://gaia.lbl.gov/bda>

totypes Database. These default values can be easily reviewed and changed through the Building Browser. In this way the BDA supports the use of sophisticated tools from the initial, schematic phases of building design. The current version of the BDA is linked to DCM (daylighting computation module), ECM (Electric lighting computation module) and DOE-2 (energy analysis module). Future versions will be linked to additional analysis and visualization tools, such as Radiance (day/lighting and rendering) and ATHENA (lifecycle cost of materials). Plans for the future also include links to cost estimating modules, building rating systems, CAD software and electronic product catalogues.

eQUEST⁷ is an easy to use building energy analysis tool. It is designed to perform detailed analysis of today's state-of-the-art building design technologies using today's most sophisticated building energy simulation techniques without requiring extensive experience in the "art" of building performance modeling. This is accomplished by combining a building creation wizard, an energy efficiency measure wizard and a graphical results display module with an enhanced DOE-2-derived building energy simulation program.

The computer program Optibuild⁸ can be used to optimize life cycle cost for buildings. The energy use is calculated based on the simplified method in the European Standard EN832 (CEN, 1998c) and the life cycle cost is calculated as the net present value of the building cost, maintenance cost and operational cost. The program considers energy savings from improved insulation of the building envelope, improved windows, heat recovery on ventilation air, solar heating for domestic hot water, solar heating system of the ventilation air, water savings and improved distribution system and furnace. All possible energy saving measures are calculated and listed in the most profitable order.

BV98⁸ is a simplified computer tool used to calculate the energy demand for heating according to the European Standard EN832 (CEN, 1998c).

Radiance⁹ can be used for detailed analysis and evaluation of lighting in design. The calculation procedure is based on ray tracing and require detailed input on geometry, materials, luminaries, time, date and sky conditions (for daylight calculations). Calculated values include spectral radiance, irradiance and glare indices.

With the exception of Optibuild, the design tools considered here may be used to evaluate the consequences of a particular building design but are generally unable to suggest a particular design solution. The design tools are therefore of limited value to designers who are unable to compare alternative approaches because they lack time for manual parameter variations or in complex cases where it is not straight forward for the designer to locate the possible improvements. Generally, the calculation procedures of the presented design tools are accessible from other programs. This has been utilized in the BDA and eQuest software that form user friendly environments that utilizes detailed calculation tools.

In the same way as the BDA, a design tool for optimization the building design could utilize detailed calculation procedures of existing design tools. Through a user

⁷URL: <http://www.energydesignresources.com/tools/equest.html>

⁸Cenergia Energy Consultants, Ballerup, Denmark.

URL: <http://www.ecobuilding.dk/download.php3>

⁹Lawrence Berkeley National Laboratory, Building Technologies Department, Berkeley, USA.

URL: <http://radsite.lbl.gov/radiance/HOME.html>

friendly environment the design problem is defined and an optimization approach is used to perform automatic evaluation to obtain the optimal design solution.

Chapter 5

Simple tool for performance assessment

This chapter describes calculation procedures to assess the life cycle cost, energy demand, indoor air temperatures and daylight conditions of buildings in the early design stage. Energy demand, indoor temperatures and daylight conditions are based on calculations using hourly weather data. A simplified thermal model of the building is developed that require only few input values. The life cycle cost is calculated from information on the investment costs, replacement costs, maintenance costs and scrap values of the building components and the energy costs based on the energy analysis of the building.

5.1 Model considerations

This study considers optimization of buildings with regard to energy demand, thermal indoor environment and daylight conditions. Evaluation of the thermal indoor environment is based on hourly values of the indoor air temperature. This requires a dynamic thermal model of the building that calculates temperatures and energy flows. The optimization is performed in the early design stage where the building design is described by a limited amount of information. During the optimization of the building design the life cycle cost, energy demand, indoor air temperatures and daylight conditions are evaluated many times. Each evaluation requires a yearly simulation of the thermal performance and the computational time of each simulation run influences the overall time used on the optimization. To limit the computational time, a simple thermal model of the building is developed. The model must be able to calculate the indoor air temperature and energy demands based on a simple description of the building and take into account the outdoor environment, the thermal properties of the constructions and control strategies for HVAC systems. The

5.2 Calculation procedures

5.2.1 Energy analysis and thermal simulation

The thermal performance is evaluated on an hourly basis based on a simple thermal room model. The thermal mass in the room is represented by one effective heat capacity calculated as the sum of the effective heat capacities of the internal surfaces. The effective heat capacities of the internal surfaces are calculated in accordance with the international standard EN ISO 13786 (CEN, 1999). No heat loss from the thermal mass to the outdoor environment is assumed. The outdoor temperature and solar radiation are based on hourly values from a reference year. The differential equation that governs the temperature in the effective heat capacity and the equation stating the heat balance of the room air are given below. This system of coupled equations defines the thermal room model and is solved analytically to get hourly values for indoor air temperature, heating load and cooling load during the year

$$\begin{aligned} C_w \cdot \frac{dT_w}{dt} &= K_i \cdot (T_a - T_w) + S \cdot w_w \cdot Q_{solar} \\ 0 &= K_i \cdot (T_w - T_a) + UA \cdot (T_o - T_a) + S \cdot w_a \cdot Q_{solar} + L + H - C \end{aligned} \quad (5.1)$$

with heat capacity of the room C_w , temperature in thermal mass T_w , time t , outdoor air temperature T_o , indoor air temperature T_a , heat transfer coefficient to outdoor air (transmission and ventilation) UA , heat transfer coefficient to heat capacity K_i , shading factor for variable shading S , part of transmitted solar energy absorbed in the constructions w_w , part of transmitted solar energy absorbed in the air w_a , solar energy transmitted through windows Q_{solar} , thermal load L , heating load H and cooling load C .

The heat transfer coefficient to the outdoor air is calculated based on the constructions facing the outdoor environment and the air change rates in the room

$$UA = \sum_{i=1}^f (U_i \cdot A_i) + \sum_{j=1}^g (\Psi_j \cdot l_j) + \rho \cdot c_p \cdot (q_n + q_v + q_m \cdot (1 - \epsilon)) \quad (5.2)$$

with number of constructions facing the outdoor environment f , heat transfer coefficient of construction U , area of construction A , number of linear losses g , linear loss coefficient Ψ , length of linear loss l , density of air ρ , specific heat capacity of air c_p , volume flow from natural ventilation q_n , volume flow from venting q_v , volume flow from mechanical ventilation q_m and efficiency of heat exchanger ϵ . The density and specific heat capacity for air are assumed to be constant with values of $\rho = 1.205 \text{ kg/m}^3$ and $c_p = 1007 \text{ J/kgK}$.

The heat capacity of the room is calculated based on the effective heat capacity of the internal constructions according to the international standard EN ISO 13786 (CEN, 1999)

$$C_w = \sum_{i=1}^s c_i \cdot A_i \quad (5.3)$$

with number of constructions facing the room s , effective heat capacity of construction c and area of construction A .

The solar energy transmitted through the windows depends on the size, orientation, tilt and total solar energy transmittance of the windows and the incidence angle of the solar radiation. To calculate the transmitted solar energy in each time step, the position of the sun and the incident solar radiation on the window are calculated based on the time of the year and weather data from a reference year. The solar position and the incident solar radiation on sloped surfaces are calculated based on formulas in Scharmer and Greif (2000) and Perez et al. (1990).

The temperatures and the heating and cooling loads to keep the room temperature within the set points are obtained by solving eq. 5.1. Assuming constant values of the heat capacity of the room C_w , outdoor air temperature T_o , heat transfer coefficient to outdoor air (transmission and ventilation) UA , heat transfer coefficient to heat capacity K_i , shading factor for variable shading S , part of transmitted solar energy absorbed in the constructions w_w , part of transmitted solar energy absorbed in the air w_a , solar energy transmitted through windows Q_{solar} , thermal load L , heating load H and cooling load C within the time step dt , the temperature in the thermal mass at time $t + dt$, T_w^{t+dt} , is calculated from the temperature at time t , T_w^t , by

$$T_w^{t+dt} = c \cdot \exp(A \cdot dt) - B/A \quad (5.4)$$

with

$$\begin{aligned} A &= \frac{K_i}{C_w} \cdot \left(\frac{K_i}{K_i + UA} - 1 \right) \\ B &= \frac{K_i}{C_w} \cdot \frac{p + L + H - C}{K_i + UA} + \frac{S \cdot w_w \cdot Q_{solar}}{C_w} \\ c &= T_w^t + \frac{B}{A} \\ p &= UA \cdot T_o + S \cdot w_a \cdot Q_{solar} \end{aligned} \quad (5.5)$$

The room air temperature, T_a , is calculated from the temperature in the thermal mass, T_w , by

$$T_a = \frac{K_i \cdot T_w + p + L + H - C}{K_i + UA} \quad (5.6)$$

The room air temperature may be controlled by heating, cooling, shading, venting, and variable air volume (VAV) ventilation. The calculation procedure in the simplified tool is shown in Figure 5.1. The calculation is initialized with a starting temperature in the thermal mass, T_{start} , at time $t=0$. For each time step, the initial temperature in the thermal mass, $T_{w,0}$, is assigned the temperature in the thermal mass, T_w , calculated at the end of the previous time step. The first step in the calculation procedure calculates the temperatures in the thermal mass and the air when none of the systems to control the air temperature are active. If the calculated air temperature exceeds the heating set point by more than 1 °C the heat exchanger is bypassed linearly to lower the air temperature and new temperatures in the thermal mass and air are calculated. Otherwise the bypass is not activated. The next step activates the heating system if the air temperature is below the set point for heating. If heating is needed, the heating power to obtain the heating set point is calculated and new temperatures in the thermal mass and air are calculated as input for the next iteration. Otherwise it is checked if

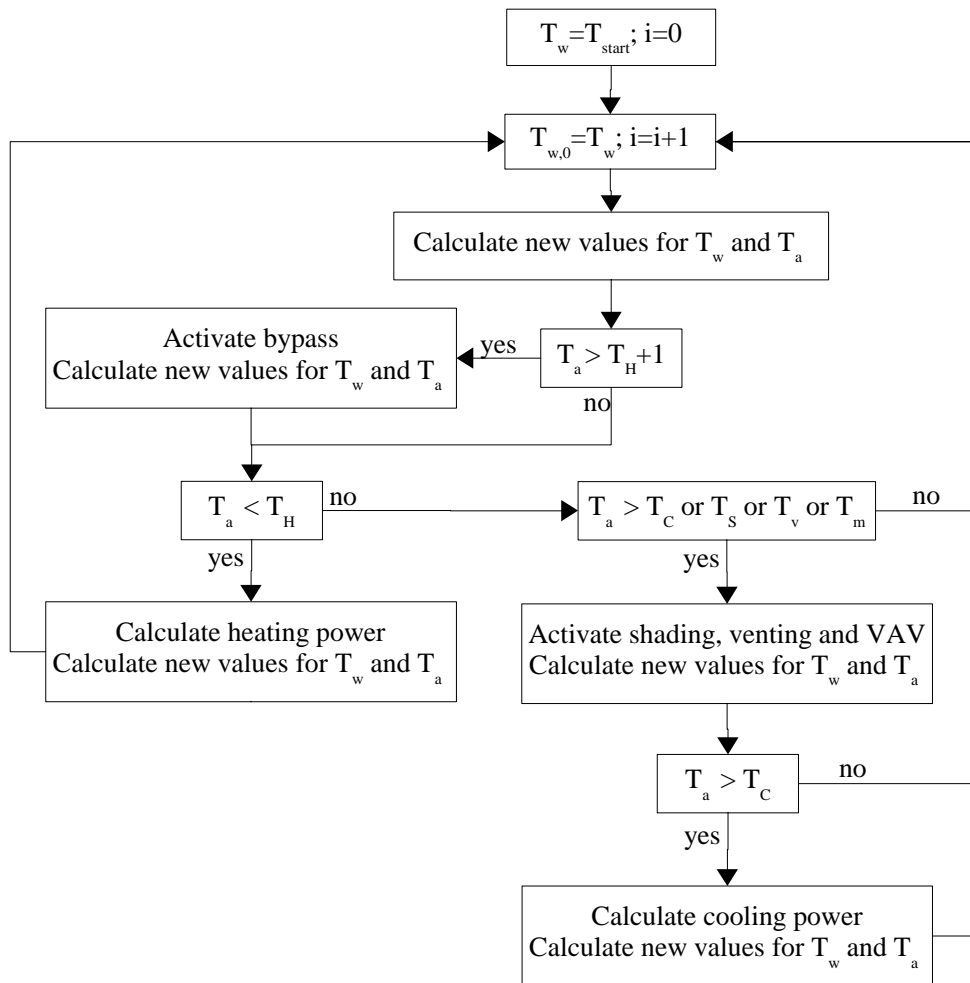

Figure 5.1: Calculation procedure in simple calculation tool.

the air temperature exceeds any of the set points for systems used to lower the air temperature. If none of the set points are exceeded the calculated temperature in the thermal mass is used as input for the next iteration. If the air temperature exceeds any of the set points for shading, venting or variable air volume (VAV) these systems are activated in the given order within their lower and upper limits to reduce the air temperature to the set point for the system. After each system has been activated new temperatures in the thermal mass and air are calculated to check whether the following system needs to be activated. If the air temperature still exceeds the set point for cooling after activating the shading, venting and VAV ventilation systems, the cooling power to obtain the cooling set point is calculated and new temperatures in the thermal mass and air are calculated as input for the next iteration. The simple tool operates with a time step of one hour.

The bypass, solar shading, venting and VAV ventilation are controlled in a simple manner based only on the heat balance of the air in the given time step. This simplification has been chosen because an analytical solution for these controls cannot be

obtained.

The heating and cooling power needed to reach the set point temperatures can be calculated analytically for each time step. The total power, P_T , needed to reach the set point temperature, T_{set} , is obtained by solving eq. 5.6 with an air temperature equal to the set point and is calculated by the following formula

$$P_T = \frac{(t_1 - T_{set})}{t_2} \quad (5.7)$$

with

$$\begin{aligned} t_1 &= \frac{K_i \cdot ((T_w^t + z) \cdot \exp(A \cdot dt) - z) + p}{K_i + UA} \\ t_2 &= \frac{\frac{K_i^2}{C_w \cdot (K_i + UA) \cdot A} \cdot (1 - \exp(A \cdot dt)) - 1}{(K_i + UA)} \\ z &= \frac{K_i \cdot p}{C_w \cdot (K_i + UA) \cdot A} + \frac{S \cdot w_w \cdot Q_{solar}}{C_w \cdot A} \end{aligned} \quad (5.8)$$

In cases where heating is needed the heating power is found as

$$H = P_T - L \quad (5.9)$$

In cases where cooling is needed the cooling power is found as

$$C = -(P_T - L) \quad (5.10)$$

Before the heating or cooling power is calculated, the values of UA , A , B and p must be updated with respect to the other control systems.

5.2.2 Daylight evaluation

The evaluation of daylight in the building is based on a daylight factor averaged for the floor area in the work. The daylight factor is defined as the illuminance on a plane inside the building divided by the global illuminance outside the building. The average daylight factor is used to evaluate the daylight performance and to determine average illuminance from daylight to control the artificial lighting systems. According to the British Standards on Daylighting the average daylight factor is evaluated as (Christoffersen et al., 1999)

$$DF_{avg} = \frac{W \cdot M \cdot \tau \cdot \theta}{A \cdot (1 - R^2)} \quad (5.11)$$

with average daylight factor DF_{avg} , total glazing area in the room W , correction factor for dirt on the glazing M , light transmittance of the glazing τ , angle to the visible part of the sky θ , total internal surface area of the room A and mean reflectance of the room surfaces R .

The average illuminance level on the work plane in the room is evaluated based on hourly values of the outdoor global illuminance from the reference year and the average daylight factor. The power used for artificial lighting is estimated based on the hourly values of the average illuminance level. The artificial lighting system is controlled by an on/off-switch and is switched on when the average illuminance level from daylight is below the set point. The average illuminance level in the room from daylight is found as

$$I_{avg} = DF_{avg} \cdot I_h \quad (5.12)$$

with average illuminance level in the room I_{avg} and outdoor global illuminance I_h .

5.2.3 Energy consumption

The hourly heating loads are calculated as a result of the thermal simulation. The energy consumed by the heating system to provide the desired heating loads depends on the efficiency of the heating system. The yearly energy demand for heating is calculated as

$$E_{heat} = \frac{\int H \cdot dt}{\eta} \quad (5.13)$$

with yearly energy consumption for heating E_{heat} and efficiency of heating system η .

The electrical energy consumed for cooling depend on the hourly cooling loads from the thermal simulation and the coefficient of performance of the cooling system. Hourly values of the airflow in the ventilation system are calculated during the thermal simulation. The electrical power used for air movement in the ventilation system is calculated based on the hourly airflow rates and the pressure drop in the ventilation system. The electric energy for artificial lighting is based on the hourly lighting loads. The sum of electrical energy used in the cooling, ventilation and lighting systems gives the total consumption of electric energy as

$$E_{electricity} = \frac{\int C \cdot dt}{COP} + \frac{\int \Delta p \cdot q_v \cdot dt}{\epsilon} + \int P \cdot dt \quad (5.14)$$

with yearly electric energy consumption $E_{electricity}$, coefficient of performance COP , pressure drop in ventilation system Δp , volume air flow rate q_v , electric efficiency of fans in ventilation system ϵ and power of artificial lighting P .

5.2.4 Life cycle cost

The life cycle cost is calculated as the net present value of investment costs, maintenance costs, energy cost, replacement costs and scrap values based on the described by ASTM (1993). The net present value is calculated for a period of time discounting the future expenses to the present. If the service life of a building component is lower than the calculation period replacements occur at intervals equal to the service life. The scrap value at the end of the calculation period is based on a linear depreciation of the investment or the last replacement cost.

The discount rate, r , used to discount replacement costs, maintenance costs and scrap values to the present is calculated based on the interest rate of an alternative investment, d , corrected with regard to the inflation rate, i , as

$$r = \frac{1 + d}{1 + i} - 1 \quad (5.15)$$

The energy price may not follow the rate of inflation. The discount rate, r_e , used to discount energy cost to the present is calculated based on the discount rate, r , corrected with regard to the energy price rise rate, i_e , as

$$r_e = \frac{1+r}{1+i_e} - 1 \quad (5.16)$$

The net present values in a case with N building components for a calculation period of T years are described in the following. The investment takes place in the present and the net present value of the investment cost, NPV_I , is equal to the sum of the investment costs, IC , for each building component

$$NPV_I = \sum_{j=1}^N IC_j \quad (5.17)$$

The building components are replaced at time steps equal to their service life, SL , at the same price as the initial investment, IC . The net present value of the replacement costs, NPV_R , is

$$NPV_R = \sum_{j=1}^N \left(\sum_{n=1}^{trunc(T/SL_j)} IC_j \cdot (1+r)^{-n \cdot SL_j} \right) \quad (5.18)$$

The yearly maintenance cost, MC , for each building component are paid at the end of each year. The net present value of the maintenance costs, NPV_M , is

$$NPV_M = \sum_{j=1}^N MC_j \cdot \frac{1 - (1+r)^{-T}}{r} \quad (5.19)$$

The scrap value at the end of the calculation period of each building component is based on a linear depreciation of the last investment. The net present value of the scrap value, NPV_S , is

$$NPV_S = \sum_{j=1}^N IC_j \cdot (1 - (T/SL_j - trunc(T/SL_j))) \cdot (1+r)^{-T} \quad (5.20)$$

the expressions uses the function $trunc()$ that truncates the expression within the brackets e.g. $trunc(2.2) = 2$ and $trunc(2.9) = 2$. The expression $trunc(T/SL_j)$ calculates the number of reinvestments during the calculation period for building component j .

The yearly energy cost, EC , are paid at the end of each year and the net present value of the energy cost, NPV_E , is

$$NPV_E = EC \cdot \frac{1 - (1+r_e)^{-T}}{r_e} \quad (5.21)$$

The life cycle cost, LCC , of the building is the sum of the net present values of the expenses subtracted the net present value of the scrap value

$$LCC = NPV_I + NPV_R + NPV_M - NPV_S + NPV_E \quad (5.22)$$

5.3 Validation of energy analysis and thermal simulation

The simple thermal model has been developed to perform fast yearly energy analysis and thermal simulations on buildings using a limited amount of input data describing the building constructions and systems. It is expected that the simple thermal model give a reasonable evaluation of the energy demands and indoor air temperature. To validate this assumption, the results from the simplified thermal model and a detailed energy analysis and thermal simulation tool are compared.

The detailed energy analysis and thermal simulation tool tsbi3 developed at the Danish Building Research Institute is used for the comparison (SBI, 1994). tsbi3 is a computer program for calculation and analysis of indoor environment and energy demand in buildings. It uses a detailed mathematical model of the building to simulate complex buildings with advanced HVAC systems and various operational strategies. The program calculates all power outputs and energy flows through structural parts, between rooms and between the building and the surroundings, based on the physical properties of the material layers using a time dependent finite difference model. For all rooms, the program calculates the heat loss by transmission, infiltration and ventilation and the thermal gains from solar energy, internal loads and components in the HVAC systems. For each room the indoor air temperatures, surface temperatures, air exchange, heat loads etc. are calculated based on an energy balance in the room. The calculations are performed in time steps of half an hour or less using hourly weather data. The program requires detailed input describing geometry, material layers in constructions, windows, HVAC systems and operational strategies.

5.3.1 Test case

A room in an office building is used as test case. The office room measures $5\text{m} \times 3\text{m} \times 3\text{m}$ ($w \times d \times h$). All surfaces except the south-facing surface are internal walls. The south facing surface has an area of 15m^2 and contains two windows measuring 2.7m^2 each. The properties of the outer wall, internal walls and windows are listed in Tables 5.1, 5.2 and 5.3.

Table 5.1: Outer wall from inside

	Thickness [m]	Density [kg/m ³]	Specific heat capacity [J/kgK]	Conductivity [W/mK]
Concrete	0.15	2400	800	2.1
Insulation	0.15	50	1000	0.039
Brick	0.108	1800	880	0.68

Table 5.2: Inner walls

	Thickness [m]	Density [kg/m ³]	Specific heat capacity [J/kgK]	Conductivity [W/mK]
Light concrete	0.1	800	1000	0.35

Table 5.3: Window properties

Window height [m]	1.8
Window width [m]	1.5
Frame width [m]	0.1
Window U-value [W/(m ² K)]	1.53
Glazing g-value [-]	0.66

The simplified model lumps the heat capacity of the room in one node based on the internal effective heat capacities of the building components according to the European standard EN 13786 (CEN, 1999) and uses the U-values of the building components to calculate the transmitted heat. Windows are not included in the calculation of the effective heat capacity and the internal walls are adiabatic. Table 5.4 states the effective heat capacities and U-values of the building components. Detailed models of the building components are used in tsbi3 and the temperature profiles in the constructions are calculated at each time step.

Table 5.4: Effective heat capacities and U-values of building components

	U-value [W/m ² K]	Effective heat capacity [J/m ² K]
Outer wall	0.24	$2.8 \cdot 10^5$
Inner wall	0	$0.4 \cdot 10^5$
Window	1.7	0

In both the simplified model and tsbi3 it is assumed that 20% of the transmitted solar energy is absorbed directly by the air and that the rest is distributed evenly and absorbed on the internal surfaces. The heating and cooling systems in both models are assumed to be purely convective.

In the reference case the room is heated to 20 °C and cooled to 26 °C. An ideal controller controls the heating and cooling systems and the power needed to heat or cool the building to the set point temperature at a given time is assumed to be available. The room is ventilated by a balanced mechanical ventilation system with heat recovery. The heat exchanger has a maximum efficiency of 80% and a bypass is used to lower the airflow through the heat exchanger to avoid high indoor temperatures during warm periods. The bypass is activated at an air temperature of 21 °C. The airflow in the ventilation system may be increased and venting may be applied by opening windows to further increase the air change rate. The extra ventilation and venting are activated at an air temperature of 25 °C. In addition to the reference case several other cases are investigated. In all cases the same room is considered but different systems are present. The cases are given in Table 5.5. In case 4 active solar shading is applied. The transmitted solar energy is given as the shading factor multiplied by the transmitted solar energy with no solar shading. The solar shading is controlled continuously and is activated at an air temperature of 25 °C.

Table 5.5: Test cases

	Shading factor (25 °C) [-]	Internal load [W]	Cooling (26 °C)	Venting (25 °C) [h-1]	Ventilation (25 °C) [h ⁻¹]	
					Min	Max
Reference	1	100	On	2	2	4
Case 1	1	100	Off	2	2	4
Case 2	1	100	Off	0	2	4
Case 3	1	0	Off	0	0.5	0.5
Case 4	0.1	100	On	2	2	4

5.3.2 Weather data

Weather data from the Danish Design Reference Year (Jensen and Lund, 1995) is used for the comparison. As input, the simplified model uses hourly values for the outdoor temperature and transmitted solar energy. To ensure that the same data is used in both tsbi3 and the simplified model hourly values of outdoor temperature and transmitted solar energy are exported from tsbi3. Table 5.6 show the mean outdoor temperature and the yearly transmitted solar energy for the weather data.

Table 5.6: Weather data

Month	Mean outdoor temperature [°C]	Transmitted solar radiation [kWh]
January	-0.5	86
February	-1.0	144
March	1.7	195
April	5.6	235
May	11.3	255
June	15.0	227
July	16.4	228
August	16.2	252
September	12.5	212
October	9.1	163
November	4.8	100
December	1.5	59
Total	7.7	2156

5.3.3 Results

The calculated yearly heating and cooling demands, hours with indoor air temperature above 26°C and maximum indoor air temperature during the year are shown in Table 5.7 for the different cases. The differences in the calculated heating demands are below 10%. The simplified model calculates a considerable lower cooling demand.

The calculated maximum indoor air temperatures during the year are comparable with the largest deviation in case 3.

Table 5.7: Results of simulations with tsbi3 and the simplified model

	tsbi3				Simplified model			
	Heating [kWh]	Cooling [kWh]	Temp. >26°C [h]	Max. temp. [°C]	Heating [kWh]	Cooling [kWh]	Temp. >26°C [h]	Max. temp. [°C]
Reference	445	141	352	26.14	479	108	0	26.00
Case 1	445	0	449	32.69	479	0	332	31.10
Case 2	446	0	714	32.90	479	0	527	31.24
Case 3	426	0	2778	39.17	429	0	3864	43.28
Case 4	450	6	22	26.01	479	1	0	26.00

The indoor thermal environment is evaluated by the yearly number of hours the air temperature exceeds 26°C. This evaluation is quite sensitive to the daily temperature profiles calculated by the two models because temperature levels of 26.1°C and 25.9°C are counted differently. In the reference case tsbi3 calculates a large number of hours with indoor air temperature above 26°C even though a cooling system is active and the yearly maximum temperature is 26.14°C. Evaluating the thermal indoor environment based on the number of hours the temperature exceeds 26°C clearly does not give a reasonable picture of the thermal indoor environment in this case. The simple tool uses ideal controls of heating and cooling systems, which means that the temperature never exceed the cooling set point when a cooling system is active. The controls in tsbi3 are not ideal but simulate real control systems. In real control systems the set point is not always reached and small fluctuations around the set point can be expected. This may explain the large number of hours with indoor air temperature above 26°C calculated by tsbi3 in the reference case. In Figure 5.2 the daily temperature profiles the 1. of August are shown for the reference case and case 1. In the reference case a cooling system is operating with a set point of 26°C. The temperature profile calculated by tsbi3 slightly exceed 26°C for one hour before the cooling system is able to control the temperature. In case 1 no cooling system is active and the daily temperature profile calculated by tsbi3 reaches a higher daily maximum temperature and rises and falls more quickly than the temperature profile calculated by the simplified model. Even though the daily temperature profiles show a similar behavior of the two models, it is clear that the dynamics of the two models are different.

The results show that the simplified model gives reasonable results for the heating and cooling demands compared to a detailed model. Also the daily temperature profiles show a similar behavior. In the cases with no active cooling system, the two models give comparable results of hours with indoor air temperature above 26°C. In cases with an active cooling system tsbi3 may give misleading results if the indoor thermal environment is only evaluated based on the hours with indoor air temperature above 26°C. To avoid misleading results from tsbi3 it is necessary to check that the maximum cooling power of the cooling system is sufficient at all times. Still fluctuations around the cooling set point cannot be avoided. To account for the fluctuations the set point for cooling could be set slightly lower than 26°C. Another approach is to

accept a fluctuation by e.g. 0.5°C caused by the control system where in cases with a limit of 26°C the check is performed for hours above 26.5°C.

European standards describing simplified methods to calculate heating demand (CEN, 1997a), cooling demand (CEN, 1997b) and indoor temperatures (CEN, 2000b; CEN, 2000c) in buildings are under development. When available, the simplified model may be improved by applying the calculation procedures in the standards.

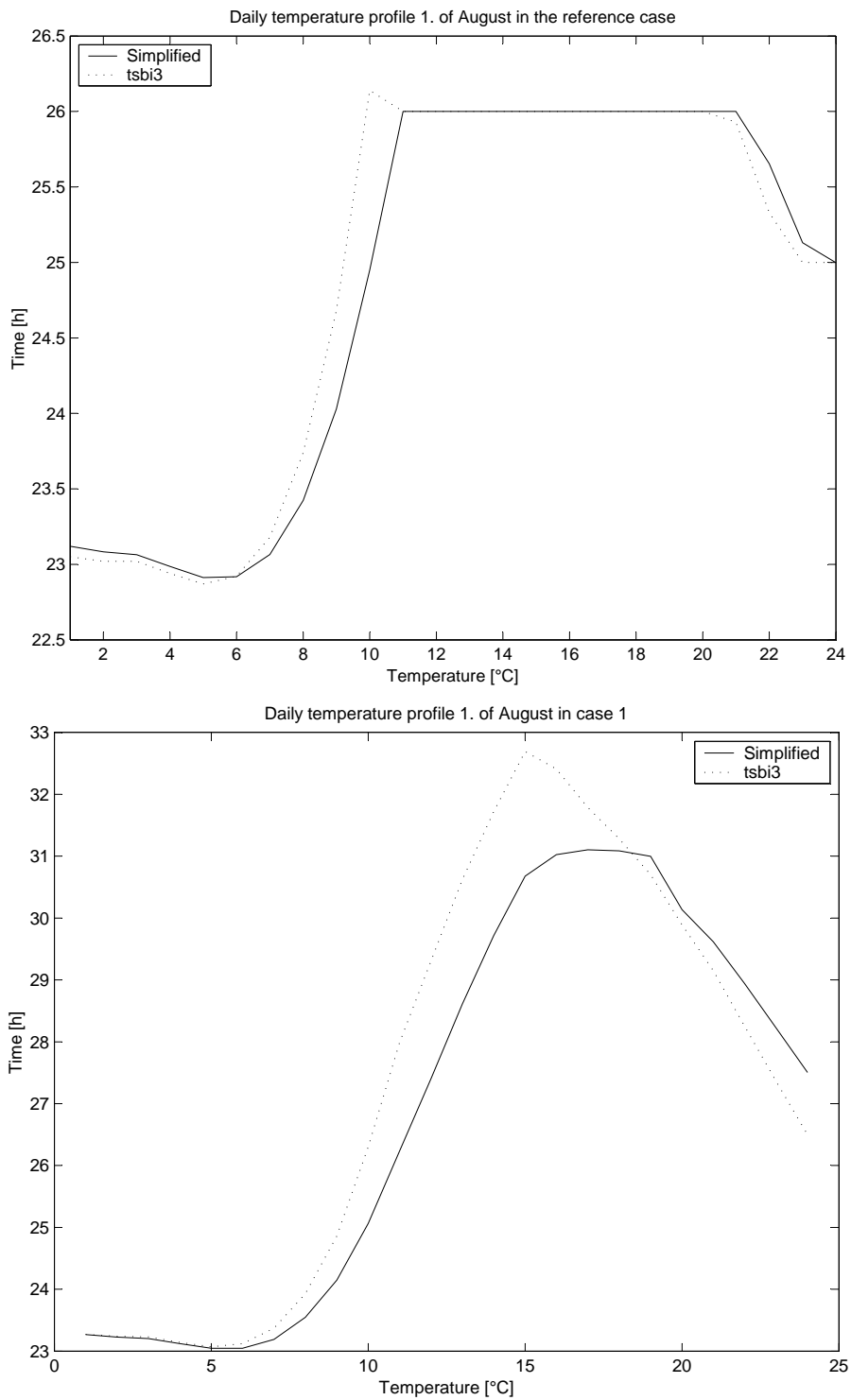

Figure 5.2: Daily temperature profiles 1. of August in the reference case and case 1.

Chapter 6

Description of buildings and building components

This chapter discusses product models of buildings and building components. Product models of buildings deal with all aspects of information and data representing the building and may be used directly in design tools or as a common language when data is transferred or shared between different design tools. Buildings are composed of different building components that may be characterized in a standardized way. A database with description of different building components may be directly used in performance evaluation tools.

6.1 Product models

Product models are information models of products that deal with all aspects of information and data representing a product e.g. a building. Standard product models are developed within the International Organization for Standardization (ISO) and the International Alliance for Interoperability (IAI).

6.1.1 Standard for exchange of product model data

The International Organization for Standardization (ISO) develops the Standard for Exchange of Product model data (STEP) for computer-interpretable representation and exchange of product data (ISO, 1993). The objective is to provide a model that describes product data throughout the life cycle of a product, independent from any particular system. The model is suitable for neutral file exchange and serves as basis for implementing and sharing product databases. The product models are described using the EXPRESS data definition language in terms of entities with attributes, relations and rules and are organized into schemas.

ISO develops product models in general terms and is not concerned with development of product models for specific products.

6.1.2 Industry Foundation Classes

A common product model to enable interoperability between architectural, engineering, construction and facilities management software applications is developed by the International Alliance for Interoperability (IAI) (IAI, 2002). The product model is described by the Industry Foundation Classes (IFC) object model that specifies how elements of a constructed facility (including elements such as doors, walls, fans, etc. and abstract concepts such as space, organization, process etc.) should be represented electronically. The specifications represent a data structure supporting an electronic project model useful for sharing data across applications.

In the IFC object model a 'class' specifies elements and abstract concepts. A 'class' describes things that have common characteristics. Examples of classes are 'window' and 'wall' that describe the common characteristics of respectively windows and walls.

IFC-based objects allow designers to share a project model. Each profession is allowed to define its own view of the objects contained in the model. For instance other designers can later use an object designed by an engineer. This leads to improved efficiency in cost estimating, building services design, construction, and facility management.

6.2 Characterization of building components

A uniform description characterizing different types of building components makes it easier to compare building components and building designs. Standardized descriptions of building components are being initiated in Europe with CE-labeling of building products. The description format should include information that facilitates evaluation of relevant performance aspects. The format of the descriptions should be compatible with a common product model. Descriptions of building components may then be stored in a database and used directly in tools using the product model. Within the IFC, data structures for different building components have been developed. Using this data structure in a building component database makes it possible for the building designer to use components from the database directly in different design tool that use the IFC classes.

6.2.1 Building envelope components

To characterize building envelope components, a uniform description format for all types of building envelope components excluding windows and doors has been suggested (Rudbeck and Rose, 1999; Svendsen et al., 2000). The description includes the following aspects: description of materials and typical design, thermal properties of the clear wall component, effects of thermal bridges in assemblies with wall, roof, deck, foundation, windows and doors, effective heat capacity, static properties, service life, investment and maintenance cost and life cycle analysis of the component. The energy performance is characterized by the thermal transmittance, U , of the clear wall component and the effective heat capacity, C , according to the standard EN ISO 13786 (CEN, 1999). The effects of thermal bridges are characterized by the linear thermal transmittances, Ψ , for assemblies with walls, roofs, decks, foundations, windows and

Table 6.1: Values characterizing the performance of envelope constructions.

Materials	Description of materials
Thermal properties	U $\Psi_{wall}, \Psi_{roof}, \Psi_{deck}, \Psi_{foundation}, \Psi_{window}, \Psi_{door}$ C
Durability	Service life
Cost	Investment Maintenance

doors. It is not possible to characterize linear thermal bridges for a building envelope component without considering the details of the assembly and the building components that are assembled. To make a detailed characterization of the linear thermal bridges it is necessary to include the linear thermal transmittances for a number of possible assemblies. This requires a lot of detailed calculations. A simplified characterization of the linear thermal bridges can be based on expected standard values. Table 6.1 summarizes the parameters characterizing envelope constructions.

Based on the characterization, the heat transfer coefficient for a building component including losses in thermal bridges may be calculated by

$$UA = U \cdot A + \sum_{i=1}^n (\Psi_i \cdot l_i) \quad (6.1)$$

with heat loss coefficient of the clear wall component U , area of the component A , number of linear thermal bridges n , linear thermal transmittance of i 'th thermal bridge Ψ_i and length of i 'th thermal bridge l_i .

6.2.2 Windows

Windows typically consist of a frame profile and a glazing. These products may be supplied by different producers and can be characterized individually. The properties characterizing the window may then be derived from the products of which it consists.

The glazing often has two or three glass layers sealed by an edge construction. The edge construction influences the linear thermal losses in the connection between the frame and the glazing. The energy performance of glazings are characterized by the thermal transmittance, U_g , the total solar energy transmittance, g_g , and the light transmittance, τ_v , at the center of the glazing (CEN, 1997c; CEN, 1998b). The total solar transmittance and the light transmittance are given for radiation at normal incidence but the transmitted solar energy and light depend on the incidence angle of the solar radiation. This dependency may be characterized by the number of glass layers, p , and a category parameter, q , according to the model by Karlsson and Roos (2000). The edge construction may be characterized by a thermal coupling coefficient, L (Kragh et al., 2002). The durability and cost are characterized by the service life, investment and maintenance cost.

The energy performance of frame profiles are characterized by the thermal transmittance, U_f , and the linear thermal transmittance, Ψ (CEN, 2000a). The linear ther-

Table 6.2: Values characterizing the performance of glazings, frames and windows.

	Glazing	Frame	Window
Geometry		b	b
Thermal properties	U_g L	U_f $\Psi(L)$	U_g U_f Ψ
Solar properties	g_g τ_v p q		g_g τ_v p q
Durability	Service life		
Cost	Investment Maintenance		

mal transmittance may be expressed as a function of the thermal coupling coefficient of the edge construction in the glazing, $\Psi(L)$ (Kragh et al., 2002). To evaluate the frame area of a window the width of the frame, b , must be known. The durability and cost are characterized by the service life, investment and maintenance cost.

The energy performance of windows is characterized by properties of the frame and glazing. The linear thermal transmittance, Ψ , depends on both the frame and the glazing. The durability and cost are characterized by the service life, investment and maintenance cost. The parameters characterizing the performance of glazings, frames and windows are summarized in Table 6.2.

For a window of a given size the thermal transmittance, U_t , the total solar energy transmittance, g_t , and the light transmittance, τ_t , are calculated based on the characterized properties as follows (CEN, 1997d; ISO, 1999)

$$\begin{aligned}
 U_t &= \frac{U_g \cdot A_g + U_f \cdot A_f + \Psi \cdot l}{A_g + A_f} \\
 g_t &= \frac{g_g \cdot A_g}{A_g + A_f} \\
 \tau_t &= \frac{\tau_v \cdot A_g}{A_g + A_f}
 \end{aligned} \tag{6.2}$$

with area of glazing A_g , area of frame A_f and perimeter of glazing l .

The total solar energy transmittance, g , for incidence angle, θ , in degrees may be found from the number of glass layers, p , and a category parameter, q , as (Karlsson and Roos, 2000)

$$g = g_t \cdot (1 - az^\alpha - bz^\beta - cz^\gamma) \tag{6.3}$$

with $z = \theta/90$, $a = 8$, $b = 0.25/q$, $c = 1 - a - b$, $\alpha = 5.2 + 0.7q$, $\beta = 2$ and $\gamma = (5.26 + 0.06p) + (0.73 + 0.04p)q$.

6.2.3 Systems

A building contains a number of different systems to provide a comfortable indoor environment. The systems are used to control a number of aspects including the indoor

temperature, the air quality and the lighting level. Systems are more difficult to characterize than envelope constructions and windows because they can be designed in many different ways and may be controlled by a number of different control strategies. For instance the heating of a building may be based on a hot water circuit with radiators connected to a central boiler, electric heating panels or air based heating placed in the ventilation systems.

Heating

A typical heating system in Danish buildings use a hot water circuit with radiators connected to a central boiler. The boiler is supplied with energy from natural gas, oil or district heating.

The investment cost of a heating system depends on the actual layout of the system and the maximum heating power that the system must be able to supply. The maximum heating power that the system must be able to supply depends mostly on the overall heat loss coefficient of the building but also to a lesser degree on the use of the building. For the purpose of this study, the investment cost of heating systems are evaluated based only on the floor area of the building.

The operational cost depends on the energy consumption and the price of the energy used by the heating system. The energy consumption is calculated from the heating demand and the efficiency of the heating system.

The parameters used to characterize heating systems are: the investment cost as a function of the floor area, the yearly maintenance cost as a percentage of the investment cost, the service life, the efficiency and the energy type used by the system.

Cooling

Typically cooling of buildings is supplied in the ventilation system by cooling the inlet air. This type of cooling requires a mechanical ventilation system. Other types of cooling systems include cooling ceilings where a cold medium supplied from a central cooling unit is used to lower the temperature of the ceiling to give radiant cooling in the building.

The investment cost of a cooling system depends on the actual layout of the system and the maximum cooling power that the system must be able to supply. The maximum cooling power that the system must be able to supply depends to a lesser degree on the overall heat loss coefficient of the building. For cooling systems the internal loads from people, equipment and solar gains are the main factors that influence the cooling load but also the presence of other systems that are used to control the indoor temperature such as solar shading devices influence the cooling load. For the purpose of this study, the investment costs of cooling systems are evaluated based only on the floor area of the building. It is assumed that the cooling system is placed in an already existing mechanical ventilation system. Therefore, the cost for cooling only includes the extra cost associated with adding a cooling system to the ventilation system.

The cooling system uses electric energy. The operational cost depends on the price of electricity, the cooling demand and the coefficient of performance of the cooling system.

The parameters used to characterize cooling systems are: the investment cost as a function of the floor area, the yearly maintenance cost as a percentage of the investment cost, the service life and the coefficient of performance.

Ventilation

The air change in buildings is typically provided by natural or mechanical ventilation. Mechanical ventilation systems may have heat exchangers to recover energy from the outlet air and heating and cooling units to control the temperature of the inlet air.

The investment cost of a mechanical ventilation system depends on the building geometry and the airflows in the system. The airflow depends on the use of the building and may be evaluated based on the number of people and polluting equipment in the building. It is assumed that for a given type of building, the investment cost of ventilation systems may be evaluated based only on the floor area of the building.

A mechanical ventilation system uses electric energy in fans to provide the required airflow in the system. The energy consumption depends on the airflow, the head loss in the system and the electric efficiency of the fans. The head loss depends on the layout of the ventilation ducts and the air flows in the system. To simplify the characterization of ventilation systems it is assumed that the head loss is independent of the airflow and may be characterized by constant head loss pr. floor area.

The parameters used to characterize ventilation systems are: the investment cost as a function of the floor area, the yearly maintenance cost as a percentage of the investment cost, the service life, the electric efficiency of fans, the efficiency of the heat exchanger and the head loss as a function of the floor area.

Lighting

Lighting systems use electric energy to provide artificial lighting in the building.

For the purpose of this study, the investment cost of lighting systems are evaluated based only on the floor area of the building.

The operational cost of lighting systems depends on the level of lighting needed in the building and the availability of daylight. The level of light on a surface is evaluated by the intensity. The electric energy consumption depends on the needed intensity and the amount of light delivered by the lighting system as a function of the electric power. Therefore, the energy consumption of lighting systems is characterized by the electric efficiency in Lumen/W.

The parameters used to characterize lighting systems are: the investment cost as a function of the floor area, the yearly maintenance cost as a percentage of the investment cost, the service life and the electric efficiency expressed as Lumen/W.

Solar shading

Solar shading is used to control the transmitted solar energy to avoid high indoor temperatures. Solar shading may be supplied by fixed constructions or as variable shading devices. The following only considers variable shading devices attached to windows.

The prices of shading devices depend on the size of the windows they are attached to and the type of shading device. The ability of the shading device to block solar

CHAPTER 6. DESCRIPTION OF BUILDINGS AND BUILDING COMPONENTS

energy may be expressed by a minimum shading factor. It is assumed that the shading devices may be controlled between a shading factor of 1 (no solar radiation is blocked) and the minimum shading factor.

The parameters used to characterize solar shading devices are: the investment cost as a function of the window area, the yearly maintenance cost as a percentage of the investment cost, the service life and the minimum shading factor.

Chapter 7

Optimization approaches

This chapter presents different optimization methods that may be applied to building design problems. The presentation of optimization methods is not exhaustive and focus on methods that may be applied to optimization problems within the context of this thesis. Previous applications of optimization to energy related building design problems are presented.

7.1 Optimization

Optimization is the process of finding the best solution and can be applied to all problems that are quantifiable. The general optimization problem consist of finding minimum or maximum values of a quantified parameter, objective function, by varying design variables under given design constraints. Optimization can be considered as minimizing a quantified parameter since maximization can always be translated into minimization by changing the sign of the objective function. Therefore, the following only considers minimization. The general optimization problem may be expressed as:

$$\begin{array}{llll} \text{Minimize} & f(x) & & \text{objective function} \\ \text{Subject to} & h_j(x) = 0, & j = 1, 2, \dots, n_h & \text{equality constraints} \\ & g_k(x) < 0, & k = 1, 2, \dots, n_k & \text{inequality constraints} \\ & x_i^l \leq x_i \leq x_i^u, & i = 1, 2, \dots, n & \text{bounds} \end{array} \quad (7.1)$$

where $f(x)$ is the objective function; $x = x_1, x_2, \dots, x_n$ are design variables; n_h is the number of equality constraints; n_k is the number of inequality constraints; n is the number of design variables; x_i^l and x_i^u are lower and upper bounds on a design variable, x_i .

Typically, a large number of constraints and design variables exist in a design problem, leading to a large number of iterations until all criteria are satisfied. Numerical techniques offer a logical approach to such problems and once a problem is defined, an objective function can be formulated using the design variables, and the optimum solutions can be determined using an appropriate optimization method. Selecting an optimization method for a given problem depends on the following considerations (Wetter, 2000):

- structure of the objective function (linear, non-linear, convex, continuous, number of local minima, etc.)
- availability of analytic first and second order derivatives
- number of design variables
- design constraints

Engineering design problems are often multidisciplinary and ill defined. There are numerous design objectives and constraints, which are not necessarily quantifiable such as legal and aesthetic requirements. Furthermore, many of the constraints are inconsistent and in conflict. In practical engineering design problems first and second order derivatives of the objective function cannot be estimated analytically. The objective function is often non-linear, non-convex and has numerous local minima. Furthermore the size of the problem is large and many design constraints exist. Also both continuous and discrete design variables exist.

7.2 Building design optimization

In this work building simulation is used to evaluate energy use, thermal indoor environment and daylight in buildings. Most applications in building simulation cannot be expressed analytically and may be viewed as “black box” functions. “Black box” functions supply output for a given input but the optimization method cannot benefit from any analytic information or derivatives of the function. Both the objective function and the constraint functions use information from the building simulation and are non-linear “black box” functions. Depending on the level of detail in the building simulation the time of one simulation run may vary from seconds to hours. The building simulation may be very expensive and to limit the time used for optimization the optimization method should use as few simulation runs as possible in the optimization process.

Both continuous and discrete design variables describe the building design. The continuous design variables are real numbers e.g. representing size and orientation that may be varied continuously between the lower and upper bounds. Building design involve the selection of components that are included in the design. Choosing between different building components is a discrete process. Therefore, design variables specifying the selection of building components may be represented by integer values. For instance the type of window is a design variable. The window types that may be chosen are given in a list and each integer value of the design variable refers to a window type on the list. Each number represents a window type with unique thermal, solar and cost characteristics.

In Figure 7.1 two different situations of discrete design variables are shown. In one case the design variable is ordered and the objective function behaves “nicely” as a function of the design variable. The other case shows an unordered design variable, which results in an unsmooth objective function with many local minima. The discrete design variables are used to choose between different alternative building components. The building components are characterized by a number of parameters and influence several aspects of the building performance. The objective function is a “black box”

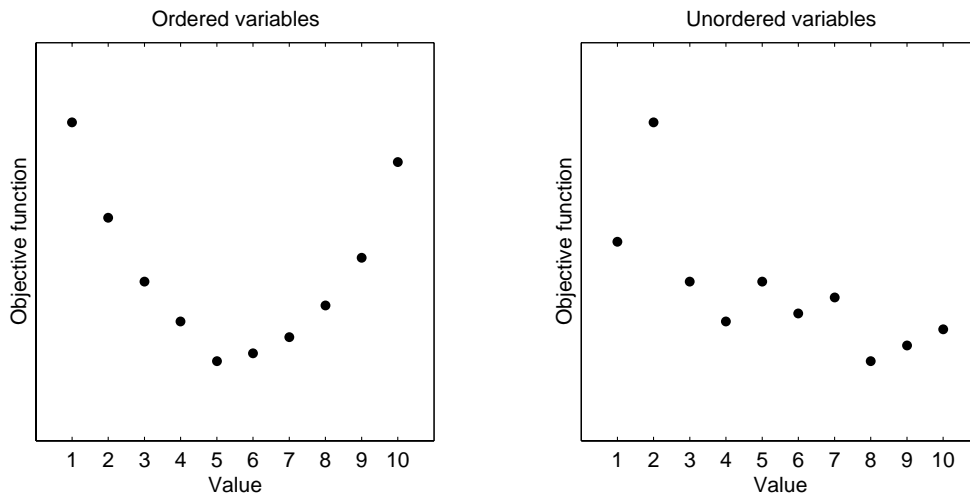

Figure 7.1: Ordered and unordered discrete design variables

function and gives no useful information on how individual design variables influence the performance of the building in isolation from the other design parameters. Therefore, the discrete design variables cannot be ordered to give a “nice” behavior of the objective function. The applied optimization method must therefore be able to handle unordered discrete design variables.

The identified requirements for the optimization method are summed up in the following:

- “Black-box” non-linear objective function (No analytic expression for objective function or derivatives)
- Non-linear inequality constraints
- Expensive simulation runs.
- Continuous and discrete (integer) design variables
- Discrete design variables are unordered

This type of optimization problem is often referred to as a mixed integer non-linear optimization problem and may be solved by methods that can optimize nonlinear objective functions with both continuous and discrete (integer) design variables and nonlinear constraints.

7.3 Optimization methods

During the years many different optimization methods have been developed and in the last decades optimization has been a growing field due to improvement in computer speed. The existing optimization methods range from very general to problem specific formulations and from the strict mathematical to more intuitive formulations.

Optimization problems are often divided into local and global problems. The task of local optimization is to find the smallest value, the local minimum, of the objective function in some local neighborhood of the solution set. For a continuous function $f(x)$ a necessary but not sufficient condition for $f(x)$ to have a local minimum at $x = x^*$ is that $f(x)$ is either not differentiable at x^* or that $\nabla f(x^*) = 0$. A sufficient condition for local a minimum at x^* is that $\nabla f(x^*) = 0$ and $\nabla^2 f(x^*) > 0$. The task of global optimization is to find the smallest value, the global minimum, of the objective function in the solution set. The aim of global optimization is to determine not just “a local minimum” but “the smallest local minimum”. Global optimization problems are typically difficult to solve. In general, global optimization problems are unsolvable. No guarantee exist that a solution to a global optimization problem is the global minimum and not just a local minimum.

Local optimization algorithms are efficient in cases where the objective function has only one minimum. In situations with several local minima global optimization methods should be used. Several global optimization methods have been developed. Heuristic methods cover methods that cannot be proven to find the global minimum and are often based on stochastic approaches. Approximation methods transform the original problem by means of approximations into a simpler global optimization problem. Solving the approximate problem gives an approximate solution for the original problem from where local optimization gives the minimum of the original problem. Systematic methods guaranties to find to global minimum with a predictable amount of work. The guarantee is weak and does not ensure that the method is efficient, but it guarantees the absence of systematic deficiencies that prevent finding a global minimum. In general global optimization methods does not guarantee that the global optimum is obtained.

Several classes of global optimization problems exist for which specific optimization methods have been developed. In addition, general optimization methods have been developed that may be applied to a wide range of problems. The global optimization problems may be divided into:

- Combinatorial problems have a linear or nonlinear objective function defined over a finite set of solutions that is very large.
- General unconstrained problems have a nonlinear objective function with unconstrained continuous design variables.
- General constrained problems have a nonlinear function with constrained continuous design variables.
- Combinations of the above problems

Based on the requirements identified in the previous section some optimization methods that may be applied to building design problems have been investigated. A very large amount of different optimization approaches exist and the following only presents a few of them.

7.4 Systematic optimization methods

Systematic methods guarantee to find the global minimum with a predictable amount of work. The guarantee is weak and does not ensure that the method is efficient, but it guarantees the absence of systematic deficiencies that prevent finding a global minimum. The COCONUT project funded by the European Union provides an in depth discussion of systematic optimization methods (Bliet et al., 2001). The goal of the COCONUT project is to integrate the currently available techniques from mathematical programming, constraint programming, and interval analysis into a single discipline, to get algorithms for global optimization that outperform the current generation of algorithms. In this thesis the discussion of global systematic methods is limited to branching methods.

7.4.1 Local optimization

Gradient based methods

Gradient based methods use the gradient of the objective function, $\nabla f(x)$, at the current iteration point to gather information about the structure of the function and to determine the direction of the next step in the iteration. For analytic differentiable objective functions the gradient is an analytic expression. In other cases the gradient must be approximated numerically. The numerical approximation is not an easy task and costs several extra function evaluations in each iteration. Furthermore, the methods may be sensitive to errors in the gradient approximation.

The gradient based methods are efficient for local optimization of differentiable functions but easily fail in cases where the objective function is not differentiable or has discontinuities.

The gradient based methods form the basis for a large range of different optimization techniques and are often used as part of other optimization methods.

Pattern search

Pattern search methods try to overcome the problem with numerical approximation of the derivatives by formulating methods that do not use the gradient. Examples of pattern search methods are the Simplex method and Hooke-Jeeves method (Wetter, 2000).

The Simplex method is based on a direct comparison of function values without using derivatives. The algorithm superimposes a simplex in the solution space with $n+1$ points. The value of the objective function is evaluated in each point of the simplex. In each iteration step, the point with the highest value of the objective function is replaced by another point. The algorithm consists of three main operations: reflection, contraction and expansion of the simplex. These operations are used to replace points in the simplex by moving around in the solution set. If the search is successful the points in the simplex move towards a minimum of the objective function. Figure 7.2 shows the first steps in a simplex optimization run for a two-dimensional optimization problem.

The Hooke-Jeeves method generates steps along the valley of the objective function. It assumes it is worthwhile to make further exploration in a direction that was

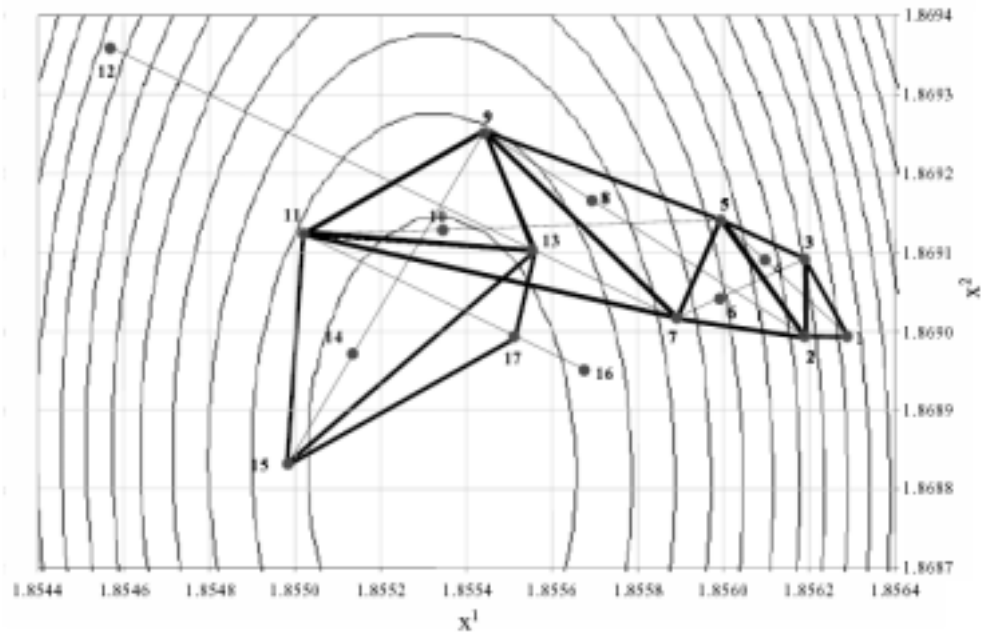

Figure 7.2: Illustration of sequence followed by the simplex method during optimization in two dimensions (Wetter, 2000). The initial simplex consists of the points x_1 , x_2 and x_3 . x_1 has the highest function value and is therefore reflected to x_4 . x_4 has the lowest function value in the set $[x_1, x_2, x_3, x_4]$ and the simplex is further expanded to x_5 . The new simplex is now consists of x_2 , x_3 and x_5 . Now x_3 has the highest function value and the simplex is expanded to x_6 and further to x_7 . This process continues until the simplex consists of x_7 , x_9 and x_{11} . With this simplex, x_7 is moved to x_{12} which is now the point with the highest function value. Therefore, a contraction of the simplex is made, which gives the point x_{13} . It turns out that x_{13} is better than x_7 and the new simplex consists of x_9 , x_{11} and x_{13} . The simplex algorithm continues from here with further reflections, contractions and expansions of the simplex.

successfully in previous steps. The method starts with an exploratory move with small orthogonal steps in each direction from the starting point. After exploring each direction, it assumes that it is likely to get a further improvement in the direction that results from previous successful explorations and makes a further step in this direction. This results in a new point from where a new exploratory move in each direction is performed. This ensures that the search stays in the valley of the objective function. If no further improvement can be achieved, the algorithm restarts from the last successful base with smaller exploratory steps. Otherwise, it takes another step in the resulting direction, followed by exploratory steps.

7.4.2 Global optimization

Branching methods

Branching methods may be used to solve problems where no global information of the problem is available. The information is made available through “black box” functions that provide only local information, i.e. function values at single points. Branching methods use a branching scheme that generates a sequence of boxes that covers the search space. In each box at least one point is evaluated. The first box covers the entire search space and in each iteration step the boxes are divided by appropriate splitting rules. The splitting rules define how and when a box is split. The DIRECT method is an example of a branching method (Jones et al., 1998). The splitting rule in DIRECT uses the volume, v , and the midpoint function value, f , of the boxes. In each iteration boxes that are not dominated by other boxes are split. A box with (v, f) is dominated by another box with (v', f') if both $v' < v$ and $f' > f$. In particular the box with the largest volume and the box with the best function value are never dominated and always split.

7.5 Heuristic methods

The systematic methods are mathematical rigorous and not always easy to apply to real design problems. These difficulties have lead to more intuitive approaches. The methods are often stochastic, lack formal mathematical foundation and a solution cannot always be guaranteed. The methods have often been developed by analogies to other phenomena. Compared to the more mathematical rigorous methods heuristic methods are often easier to implement and are able to handle a wide range of problems often associated with design optimization problems such as discrete and unordered design variables, non-differentiable and non-continuous objective functions and situations with many constraints.

7.5.1 Global optimization

Genetic methods

Genetic methods are search methods inspired by natural selection and survival of the fittest. The method use a “population” of solutions and each iteration involves a competitive selection to remove poor solutions. The solutions with high “fitness” are “recombined” with other solutions by swapping parts of a solution with another. Solutions are also “mutated” by making a small change to a single element of the solution. Recombination and mutation are used to generate new solutions that move towards regions of the solution space where good solutions have already been observed. The genetic methods are well suited for a wide range of combinatorial and continuous problems and perform well on functions with many local minima and tend not to get “stuck” on a local minimum.

Simulated annealing

Simulated annealing is a random search method for global optimization and can be compared to the physical annealing process where a molten material with a high temperature is slowly cooled and form crystals (Horst and Pardalos, 1995). More regular crystals will be formed when the molten material is cooled slowly, and given sufficient time the molecules will end up having minimum internal energy. In simulated annealing the objective function can be compared to the internal energy and the cooling process can be compared to the way the solution is updated. The general simulated annealing method starts from a random starting point. A new random solution is generated and the new solution is accepted if the objective function value is decreased or is accepted with some probability if the objective function value is increased. In the process of the minimization the probability of accepting solutions with increasing objective function value is decreased towards zero. In the beginning almost all new solutions are accepted which leads to an exploration of the entire solution set. In the optimization process fewer and fewer new solution are accepted and the solution converges towards (hopefully) the global minimum. Initially simulated annealing was used for discrete optimization, but later implementations exist also for continuous optimization and mixed integer nonlinear optimization (Ali et al., 2002; Gonzalez-Monroy and Cordoba, 2000).

Tabu search

Tabu Search uses a memory of past moves to diversify the search and avoid becoming trapped in local minima. Each time a move is made, it is placed on a list called the tabu-list. When considering a move, it is deemed unchooseable, or tabu, if it is on the tabu-list. Old moves are typically removed from the tabu-list after some number of iterations. The overall approach is to avoid trapping the solution in a local minimum by forbidding or penalizing moves, which take the solution to points in the solution space previously visited.

Clustering methods

Clustering methods perform a local search from several starting points distributed over the entire solution set. When many starting points are used the same local minimum may identified several times, which leads to an inefficient global search. Clustering methods attempt to avoid this inefficiency by carefully selecting the starting points. The three main steps of clustering methods are: (1) sample points in the search domain, (2) transform the sampled point to group them around the local minima, and (3) apply a clustering technique to identify groups that (hopefully) represent neighborhoods of local minima. If this procedure successfully identifies groups that represent neighborhoods of local minima, then redundant local searches can be avoided by simply starting a local search for some point within each cluster. Clustering methods assume that the objective function is relatively inexpensive since many points are randomly sampled to identify the clusters.

7.6 Hybrids

Different optimization methods may be combined to improve their efficiency. Global and local optimization methods are often used together. The global optimization methods that are inefficient for finding local minima are used to find feasible regions where the local methods are used for a more in depth search.

7.7 Multi criteria optimization

The optimization approaches described so far are all discussed in the context of finding minimum or maximum of a single objective function (single criteria optimization). Another approach to optimization is multi criteria optimization where a number of objective functions are optimized at the same time. The general multicriteria optimization problem is very similar to the problem defined in equation 7.1. The only change is that $f(x)$ is an array of several objective functions. Often the different objective functions to be optimized are in conflict, which means that an ideal solution where every objective function reaches optimum independently of the remaining objective functions does not exist. The optimization is often performed in the Pareto sense. The Pareto solution is not unique, but is a set of non-dominated solutions. The solution in which none of the objective functions can be improved without simultaneous deterioration of at least one of the remaining objective functions is a non-dominated solution. The Pareto optimal solution usually forms an effective curve of design variables in the solution space. A great number of non-dominated solutions exist and it is necessary to select the best solution on the basis of some additional criteria.

7.8 Handling constraints

In most optimization problems constraints are imposed on the design variables (bounds) and on dependent variables (equality and inequality constraints). Constraints on design variables are used to define the search space within which the optimization method operates. Constraints on dependent variables define the solution set within the search space. Figure 7.3 shows an example of a constrained optimization problem in two dimensions. The design variables are constrained by upper and lower bounds, which results in a rectangular search space. Two inequality constraints imposed on dependent variables are shown as a straight and parabolic line. The search space and the inequality constraints define the solution set. The example shows a simple problem with analytic dependent variables. In design problems the dependent functions are often “black box” functions and the solution set within the search space can only be found by numerical techniques.

7.8.1 Constraints on design variables

Constraints on design variables are often given as box constraints where each design variable has a lower and upper bound. Methods for unconstrained optimization operate with unconstrained design variables. Using such methods to solve a constrained optimization problem requires that constraints are handled outside the optimization

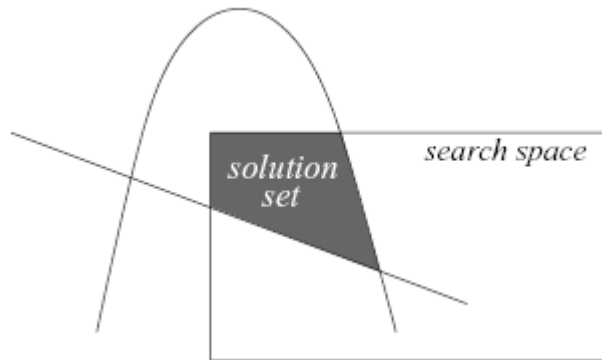

Figure 7.3: Constrained two dimensional optimization problem. The constraints are given by $x \in [-1, 6]$; $y \in [-4, 1]$; $y + 0.5x^2 - 2 \leq 0$ and $2y + x + 2 \geq 0$.

method. Optimization methods developed for constrained optimization handles the constraints within the method.

Box constraints are defined as:

$$x_i^l \leq x_i \leq x_i^u, \quad i = 1, 2, \dots, n \quad (7.2)$$

The simplest way to handle box constraints is to reset the design variable to either the lower or upper boundary value when the optimization method tries to move outside the bounds. However, this may give numerical problems.

A better approach is to transform the constrained optimization problem into an unconstrained problem. This may be done by transforming the bounded design variables, x_i , into a new space, y_i , where no boundaries are imposed.

$$x_i \leftrightarrow y_i, \quad x_i^l \leq x_i \leq x_i^u, \quad -\infty \leq y_i \leq \infty \quad (7.3)$$

The optimization problem is now solved for the new variable, y_i , which is unconstrained.

7.8.2 Constraints on dependent variables

Constraints on dependent function values can be handled by adding barrier or penalty functions to the objective function. Barrier functions add a positive value to the objective function when a dependent variable gets close to its bounds. The closer the dependent variable is to the boundary the higher the value of the barrier function becomes. A disadvantage of the barrier function is that the boundary of the solution set and its close neighborhood can never be reached. Penalty functions add a positive value to the objective function when the dependent variable crosses its bounds. The penalty function may be a large constant value or a function of the dependent variable. If the penalty function is not chosen appropriately, solutions violating the bounds of the dependent variables may still be seen as feasible.

7.9 Applications of optimization to energy related building design problems

Optimization has been applied to many areas within building design problems. In this thesis the focus is on life cycle cost optimization of buildings with regard to energy and indoor environment. Therefore this section presents different applications of optimization to various building design problems related to energy use in buildings.

Analytical approaches have been applied to optimize the insulation thickness of building envelope components. Expressing the cost of construction and operation as a function of the insulation thickness, the insulation thickness giving the lowest cost may be found where the derivative of the cost equals zero (Svendsen, 1997; Bagatin et al., 1984). The OPTIX program optimizes the insulation thickness in floor, wall and ceiling with regard to minimal life cycle cost. The life cycle cost is formulated by an analytical expression including investment costs for insulation, windows, heating and ventilation systems, yearly operational costs and cost for repair (Kalema, 1998).

In more complicated situations where the objective function is not an analytical function numerical optimization approaches must be applied. Several numerical optimization approaches have been applied to optimization of building design problems.

Mixed integer linear programming have been applied to optimization of life cycle cost in connection with building retrofits. The investigation emphasizes on insulation measures but also include other retrofits such as changing the heating system (Gustafsson, 1998a; Gustafsson, 1998b).

In warmer climates where both heating and cooling is needed optimization has been applied to minimize the total cost for heating and cooling (Jurovics, 1978; Al-Homoud, 1997).

A multivariate optimization method has been applied to find the economic optimum for solar low energy buildings. The approach integrates non-linear optimization with building modeling whereby the physical, technical and economic interactions between the building design options and energy flows are accounted for. The optimum is found given the project specific boundaries and energy consumption target (Peippo et al., 1999).

Direct search optimization coupled to an hourly thermal simulation is used to minimize the energy consumption for heating and cooling in residential buildings (Al-Homoud, 1997).

Multi criteria optimization has been applied to optimize the shape of energy-saving buildings. The criteria considered in the optimization is (1) minimize thermal load, (2) minimize capital cost, and (3) maximize net usable area (Marks, 1997).

Chapter 8

Choosing optimization algorithm

Based on the identified requirements for the optimization method, three optimization algorithms are selected. The methods are tested and compared to select the method to implement in the prototype tool. The first method is a systematic optimization method based on the Direct algorithm. The second method is a hybrid method using a systematic approach to handle continuous design variables and a heuristic method to handle discrete design variables. The third method is a heuristic method based on Simulated annealing.

8.1 Direct

A variant of the Direct algorithm has been implemented in Matlab by the Applied Optimization and Modeling group at Mälardalen University in Sweden (Björkman and Holmström, 1999). This algorithm is chosen as a possible systematic optimization approach to the building design problem. The algorithm is part of the Matlab toolbox NLPLIB TB that is distributed with the TOMLAB v1.0 optimization environment (Holmström et al., 1999). A modified version of the direct algorithm is implemented in the Matlab function *gclSolve* for mixed-integer non-linear optimization problems.

The algorithm has no stopping criterion. Therefore, the optimization algorithm runs for a predefined number of function evaluations. The best function value found is considered to be the optimal solution. After a number of function evaluations it is possible to continue with additional function evaluations by starting the algorithm with the final status of all parameters from the previous run. The algorithm is systematic which means that the search path for a given problem is always the same and after a given number of function evaluations the algorithm will always end up in the same solution.

8.2 Hooke-Jeeves and Simulated Annealing

A hybrid optimization approach has been implemented that uses the Hooke-Jeeves method (Wetter, 2000) to optimize the continuous design variables and simulated annealing (Horst and Pardalos, 1995) to optimize the discrete design variables. This is referred to as the Hooke-Jeeves and Simulated annealing (HJ-SA) approach.

The steps in the the algorithm are:

1. Initialize starting point, x_0 , and starting “temperature” for simulated annealing, T_0 .
2. Apply Hooke-Jeeves to continuous design parameters and update solution.
3. Apply simulated annealing to discrete design parameters and update solution.
4. Reduce “temperature”.
5. For each 200 iterations the current solution is reset to the best solution so far.
6. Check for stop criterion.
7. Stop if stop criterion is true else goto step 2.

The first step is to choose a starting “temperature”, T_0 , and a starting point, x_0 . The “temperature”, T , control the probability of choosing a solution with a higher function value in the Simulated annealing algorithm. The possibility of choosing a solution with a higher function value makes it possible for the simulated annealing algorithm to move away from a local minimum. The starting “temperature” greatly influences the effectiveness of the simulated annealing algorithm and should therefore be chosen carefully.

The starting “temperature” is chosen according to (Gonzalez-Monroy and Cordoba, 2000)

$$T_0 = -\mu \cdot f(x_0) / \ln(\psi) \quad (8.1)$$

where $\mu = 0.25$ and $\psi = 1/10$ are suggested as appropriate values and x_0 is the starting point.

The Hooke-Jeeves method can be divided into 1) an initial exploration, 2) a basic iteration and 3) a step size reduction. The initial exploration and the basic iteration use exploratory moves to find the search direction in which the function value decreases.

The exploratory moves use orthogonal searches in each direction from the resulting base point, x_r with the function value $f_p = f(x_r)$. If Δx_i is the step size of the i -th continuous design parameter and e_i is the unit vector in the direction of the x_i axis the first move is done in the first direction ($i = 1$) by setting the new point

$$x_r \leftarrow x_r + \Delta x_i \cdot e_i \quad (8.2)$$

If x_r is within the lower and upper bounds on x the objective function is evaluated in x_r . If $f(x_r) < f_p$ the new base point is x_r and $f_p = f(x_r)$. Otherwise the search is performed in the other direction of x_i and the new point is set to

$$\Delta x_i \leftarrow -\Delta x_i \quad (8.3)$$

$$x_r \leftarrow x_r + 2 \cdot \Delta x_i \cdot e_i \quad (8.4)$$

Again it is checked whether $f(x_r) < f_p$. If this is the case the new base point is x_r and $f_p = f(x_r)$. If both moves for x_i fails, the base point has not been altered by the exploration move in the directions along e_i . The procedure is now repeated along the next direction e_{i+1} from the new base point until all base vectors e_i have been

used. At the end of the n exploration moves, a new base point x_r is found only if the exploratory moves led to a reduction of the objective function.

In the initial exploration the current base point, x_c , is assigned to x_r and exploration moves are made around x_r . If the exploration moves lead to a reduction of the objective function a basic iteration is performed otherwise a step size reduction is performed.

In basic iteration the solution is updated by assigning $f_c = f_p$. The previous base point is assigned the value of the current base point $x_p = x_c$ and the current base point is assigned the value of the resulting base point $x_r = x_c$. Then a pattern move is performed by

$$x_r \leftarrow x_r + (x_r - x_p) \quad (8.5)$$

Regardless of whether the pattern move leads to a reduction of the objective function exploratory moves are performed around x_r with $f_p = f(x_r)$. In any of the exploratory moves are successful then x_r and $f_p = f(x_r)$ are altered. If $f_p \geq f_c$ the pattern move might no longer be appropriate and a new initial step is performed. Otherwise, the pattern move leads to an improvement and a basic iteration is performed again.

The step size reduction reduces the step size for the exploratory moves by

$$\Delta x \leftarrow \Delta x \cdot c \quad (8.6)$$

where $0 < c < 1$. x_c is considered to be the minimum point if the step size has been reduced a given number of times.

The Simulated annealing algorithm randomly changes the discrete design parameters. The starting point of the Simulated annealing is set to the current solution, $x = x_c$. A new point x is generated by assigning a random value for the j -th design parameter x_j between the lower and upper bounds beginning with the first discrete design parameter

$$x_j = \text{random}(x_j^l, x_j^u) \quad (8.7)$$

For the current “temperature”, T , the new point is chosen as the current solution, $x_c = x$, with the probability of $\min[1, \exp((f(x_c) - f(x))/T)]$. This means that the new point is always chosen if $f(x) \leq f(x_c)$ or with a probability that decrease with decreasing “temperature”, T . This is performed a number of times depending on $x_j^u - x_j^l$ for each design variable. When all discrete design variables have been used the “temperature” is reduced by the factor γ according to $T_{new} = \gamma \cdot T_{old}$ where γ is close to 1. When this procedure has been performed for each discrete design parameter the “temperature” is reduced. For each 200 iterations the current solution is reset to the best solution so far, $x_c = x_{min}$. If the stop criterion is not fulfilled, a new optimization run starting with Hooke-Jeeves is performed. The optimization is stopped if the number of iterations exceed the maximum stated number of iterations or if the “temperature”, T , is below the minimum “temperature”, T_{min} .

8.3 Direct Search Simulated Annealing

As discussed heuristic optimization algorithms can be used to perform optimization in situations with many both discrete and continuous design variables, non-linear and non-continuous objective function and many design constraints. A direct search variant of the simulated annealing algorithm (DSA) is described by Ali et al. (2002).

The algorithm avoids gradient calculation by using a subset of N ($N > n$ where n is the number of design variables) points stored in an array A . In each iteration new values of the design variables can be generated in one of two ways: either a new values of the design variables y are generated randomly with probability q ($q \leq 1$) or they are generated using the configuration of $n + 1$ points in A referred to as controlled generation (CG) with probability $1 - q$. The controlled Generation (CG) randomly selects n points, p_2, p_3, \dots, p_{n+1} from A . From the points p_1, p_2, \dots, p_n , where p_1 is the best point in A , the center point G is calculated. A trial point x_p is then given by

$$x_p = 2G - p_{n+1} \quad (8.8)$$

The highest and lowest function values of the points in A are called respectively f_h and f_l . The acceptance criterion is

$$A_{xy}(T) = \min[1, \exp(-(f_y - f_h)/T)] \quad (8.9)$$

where the trial function value, f_y , is only compared with f_h , the worst point in A . If f_y is accepted then y and f_y replace the worst point and its corresponding function value f_h in A and the new f_h and f_l are found in A before the process continues again. If during the execution of the t 'th Markov chain with length L_t^d , a point is generated whose function value is lower than f_l , the best value in A , this ends the current chain, and a new Markov chain begins.

In any implementation of Simulated annealing a cooling schedule must be applied. The "temperature" parameter, T , is set to an initial value T_0 . The initial value is generally relatively high, so that most trials are accepted and there is little chance that the algorithm zooms in on a local minimum in the early stages. A scheme is used to reduce T and for deciding the number of trials to be attempted at each value of T . Finally a stopping criterion is required to terminate the algorithm. These issues are described in detail in the article (Ali et al., 2002). The stopping criterion used is based on two conditions. First the current "temperature" has to be small and secondly the points in A have to form a dense cluster. Therefore the following criterions are chosen

$$T_t \leq \epsilon_1 \cdot f_l \text{ and } |1 - f_l/f_h| \leq \epsilon_2 \quad (8.10)$$

The following describe the DSA-algorithm in pseudo code:

begin

```

initialize ( $T_0, x$ )
initialize an array  $A$  of  $N$  points with function values
stopcriterion = false;  $t = 0$ 
while not stopcriterion do
    check = false
     $i = 0$ 

```

```

while not check and  $i < L_t^d$ 
    generate new solution  $y$  from  $x$ 
    if  $f_y - f_h \leq 0$  or  $\exp(-(f_y - f_h)/T_t) > \text{random}[0, 1]$  then  $x=y$ 
    if  $f_y < f_t$  then  $\text{check}=\text{true}$ 
    replace the worst point in  $A$  and find new worst and best points
     $i = i + 1$ 
end
 $t = t + 1$ 
compute  $T_t$ 
end
end

```

The algorithm described in Ali et al. (2002) has been slightly modified to include discrete design variables.

8.4 Handling constraints

The building design is optimized with regard to minimum life cycle cost. Other performance requirements such as energy demand, indoor thermal environment and daylight level are handled as inequality constraints.

The implementation of the Direct algorithm in the `gclSolve` program handles non-linear constraints on dependent variables as part of the algorithm. In the two other cases the non-linear constraints are handled using a penalty function. If the limits of the constrained expression are exceeded, the objective function (the life cycle cost) is penalized. This penalty function increases the life cycle cost if the requirements are not fulfilled resulting in a large function value of the objective function.

The penalty for performance criterion, c , number k is calculated as

$$p_k = \max[0, (c_{k,l} - c_k)/|c_{k,l}|, (c_k - c_{k,u})/|c_{k,u}|] \quad (8.11)$$

with upper and lower bounds $c_{k,l}$ and $c_{k,u}$ on performance criterion c_k .

The penalized life cycle cost is calculated as

$$LCC_{pen} = LCC \cdot \left(1 + \sum_{k=1}^{n_k} p_k\right) \quad (8.12)$$

with number of constraints n_k

8.5 Test case

A test case has been defined to test the selected optimization methods. The test case uses 7 discrete design variables to choose among alternative building components. Two continuous design variables are used to include the size of the window and the size of an overhang in the optimization. Two tests are performed. The first doesn't include the overhang and only considers one continuous design variable. In the second test both continuous design variables are included.

The test case considers an office room that is occupied during the working hours from 6-18 hr 5 days a week (Monday to Friday). A box represents the room with one window in the south facing facade. The facade, the ceiling and the floor face the outdoor environment whereas the three other walls are treated as internal walls. The geometry, internal heat gain, air change rates and set points for heating and cooling are given in Table 8.1. The window area may vary between 10% and 80% of the facade area. The length of the overhang may vary between 0 m and 1 m. The energy prices are 0.65 DKK/kWh for heating and 1.24 DKK/kWh for electricity. The life cycle cost is calculated for a period of 30 years with a 2% discount rate. The building design is constrained by a maximum energy demand of 180 MJ/m², maximum 100 hours with indoor air temperature above 26 °C within the working hours and a minimum average daylight factor of 2%.

Table 8.1: Design parameters defining the test cases. Air change rates, internal heat gain and set points depend on whether the office room is in use or not.

Design parameter	Value	
	In use	Not in use
Length	5 m	
Width	5 m	
Height	2.5 m	
Infiltration rate	0.1 h ⁻¹	
Specific energy for ventilation	1000 W/(m ³ /s)	
Mechanical air change rate	2 h ⁻¹	0 h ⁻¹
Internal heat gain	15 W/m ²	0 W/m ²
Heating set point	20 °C	17 °C
Cooling set point	26 °C	-

8.6 Chosen approach

The results of the two tests are shown in Tables 8.2 and 8.3. The tables show the time used for an optimization run and the life cycle cost, energy demand, number of hours with indoor air temperature above 26 °C and the average daylight factor of the optimized design for the three optimization algorithms.

In both cases the Direct method gives an optimum value of the life cycle cost that is much higher than the optimum value found by the two other algorithms and uses considerable more time on an optimization run. The Direct algorithm lacks a stopping criterion and therefore runs for a predefined number of function evaluations. Increasing the number of function evaluations will increase the time used on a simulation run and may not guarantee that the global optimum is found. It must be concluded that the Direct method is not efficient in this case where the design variables are mainly discrete variables.

The Hooke-Jeeves and Simulated Annealing (HJ-SA) method and the Direct Search Simulated Annealing (DSA) method give very similar results. Because of the heuristic nature of these methods, the time used on an optimization run depends on the actions

taken during the optimization process. Therefore, the times used on an optimization run have been evaluated running the same design problem several times and the mean values of the times used in the different runs are reported in the results. In both tests the DSA method is slightly faster than the HJ-SA method.

From these tests it is difficult to decide whether the HJ-SA method or the DSA method should be chosen. Two things are in favor of the DSA method. Firstly this method seems to be slightly faster than the HJ-SA method and secondly the algorithm is simpler. Therefore, the DSA method is implemented in the prototype design tool.

Table 8.2: Results test 1

	Direct	HJ-SA	DSA
Time [s]	7314	3302	3080
LCC [DKK/m^2]	5828	5495	5494
Energy demand [MJ/m^2]	132	110	110
Indoor environment [h]	78	82	80
Daylight	2.4%	2.0%	2.0%

Table 8.3: Results test 2

	Direct	HJ-SA	DSA
Time [s]	9927	6008	5055
LCC [DKK/m^2]	5818	5495	5517
Energy demand [MJ/m^2]	120	110	104
Indoor environment [h]	82	82	86
Daylight	2.1%	2.0%	2.1%

Chapter 9

Design methodology

This chapter discusses a general design methodology that may be implemented in design tools to support optimization of building designs in the early stages of the design process.

9.1 Assumptions

The design methodology is based on the discussions in the previous chapters. It is assumed that the design process is organized in a way that gives the building designer access to reliable properties of building components in the early stages of the design process. The properties are supplied by contractors, suppliers and manufacturers and describe specific products. For each building component, the properties are characterized according to a common format and are available in a building component database. The designer may choose the building components to be included in the analysis from the database and does not have to specify the detailed properties manually.

9.2 Requirements for design tools

The building industry need design tools to improve the performance of the building designs and the following needs for a good design tool have been identified (Holm, 1993):

- The design tool should be a user friendly computer program
- It should be of a general nature to facilitate “what if” alternatives readily
- Calculation speed is of higher priority than accuracy
- Input formats should be user oriented - in terms of building materials and components rather than scientific parameters like heat transfer coefficients, densities etc. - and the input process should take less than an hour.

To fulfill the need of a user-friendly computer program, the design tool should use a graphical user interface where the geometry is visualized in a CAD like environment and the input process falls naturally for the designer.

Investigations of “what if” alternatives require that the design tool is able to perform parameter variations. The results of different parameter variations should be stored within the data structure of the design tool to facilitate comparison.

High calculation speeds can be achieved at the cost of lower accuracy by assessing the performance aspects of the building design using simple mathematical models. The design tool would benefit from a possibility to use mathematical models of different detail during the design process. Using simple mathematical models in the early stages of the design process supports a general optimization where many alternative design solutions are investigated. At later stages in the design process, a detailed investigation and documentation of the building performance may be achieved using detailed mathematical models on a few alternative design solutions.

A user oriented input format is supported if the design tool supports access to databases where relevant properties of building components are characterized according to standard descriptions. The designer will be able to view the properties and choose building components from the databases and does not have to specify material properties, material layers in constructions etc. This would also simplify the input process and reduce the number of possible mistakes made in the input process.

9.3 Design optimization process

It is proposed that the following steps in the design optimization process are needed:

1. Identify demands and wishes
2. Translate demands and wishes into measurable performance requirements
3. Schematic design of building geometry
4. Create lists of alternative constructions and systems from a building component database
5. Assign lists of constructions and boundary conditions to surfaces
6. Assign lists of systems to rooms and specify schedules and controls.
7. Formulate possible geometric design options
8. Specify conditions regarding the use of the building
9. Optimize design
10. Present results and perform parameter variations

The process starts with the identification of demands and wishes expressed by the user. This forms the basis for the choices in the following phases. Requirements for the performance aspects considered in the design tool are formulated based on the demands and wishes. The requirements may be based on recommendations in building codes, standards and other legislation. Chapter 3 describes performance requirements for energy, thermal indoor environment and daylight.

The following steps are performed within the context of a computer based design tool. The design tool is used to define the schematic design of the building in terms of rooms, surfaces and sub surfaces. The schematic design defines the floor area and volume of the rooms in the building and later geometric variation only change the shape of the building and sizes of sub surfaces. The schematic design is visualized in the graphical user interface. The designer creates lists of alternative constructions and systems that may be considered during the optimization. The constructions and systems are chosen from the component database. The lists of alternative constructions are assigned to surfaces and sub surfaces and the boundary conditions are defined. In the same way lists of alternative systems are assigned to the rooms and the schedules and controls are specified. The possible geometric variations are defined by limits on the size of sub surfaces and shape and orientation of the building.

The input given by the designer in the previous steps define the search space and an automatic optimization algorithm is applied to search for the optimal solution. The design tool performs the optimization step and the result of the optimization is presented to the designer. Based on the optimized solution, the designer may perform a limited number of parameter variations to investigate effects of changes to the design.

9.4 Hypothesis

This study claims that following the design optimization process described in the previous section it is possible to develop a design optimization tool that

- is useful in the early phases of the design process
- uses descriptions of building components from a building component database
- uses an automatic optimization algorithm
- saves time for manual parameter variations during the design process
- is based on a common product model of the building
- handles complex design problems
- improves the overall performance of the building design

In the following the presented methodology is implemented in a prototype design tool. The claims in the hypothesis are tested by applying the prototype tool to design problems in form of case studies.

Chapter 10

Prototype tool

This chapter describes a prototype design optimization tool. The life cycle cost is minimized constrained by energy use, thermal indoor environment and daylight level. A simplified dynamic thermal model of the building calculates hourly heating and cooling power, ventilation rates and indoor air temperature based on hourly weather data. The results are used in the life cycle cost calculation and evaluation of performance constraints. The optimal building design is found using an optimization algorithm that performs automatic parameter variations of geometric properties and building components used in the building.

10.1 Objective

Based on the design methodology a computer tool is developed that helps the designers optimize the building design in the early phases of the design process. The designer and the building owner identify the initial demands and wishes. Based on this the designer set up the geometric parameters, sets of alternative building components and performance constraints that constitute the solution space for the design problem. An automatic optimization algorithm is applied to find the geometry and mix of building components that form the optimal solution.

10.2 Software environment

The prototype tool has been implemented in Matlab (MathWorks, 2000). Matlab is a software environment for technical computing with many built-in math and graphics functions. The environment supports some degree of object-oriented programming and includes tools for development of graphic user interfaces. Matlab programs execute within the Matlab environment on any platform supporting Matlab. Matlab is available for Microsoft Windows, UNIX, Linux and Macintosh systems that makes Matlab programs practically platform independent. Other software environments such as Delphi, C/C++, Pascal, Basic could have been chosen and the choice of Matlab is mainly based on the authors previous experience and familiarity with this software environment.

10.3 Program structure

The prototype tool uses a graphic user interface to collect input data from the user and to present results. The input is stored in a data structure containing a representation of the building, economic constants, a building component database and specifications of location and weather data. The representation of the building includes geometric information that defines surfaces, sub surfaces and thermal zones. The surfaces, sub surfaces and thermal zones are linked to sets of alternative envelope and system components in the building component database. Schedules and controls are defined for the systems in each thermal zone. The form and orientation of the building and sizes of sub surfaces are linked to geometric constraints. The building representation is passed on to the optimization loop. The first step in the optimization loop is to process the building representation to identify the design variables and the upper and lower limits on each design variable. The number of design variables depends on the actual design problem described in the building representation. The output from the optimization loop is the optimal values of the design variables. Figure 10.1 gives an overview of the structure.

10.3.1 Data model

Ideally the prototype tool uses a common product model to store all data related to the building design and building components as discussed in chapter 6. The preferred choice of object model would be the IFC object model that is already implemented in other computer tools. This would make it possible e.g. to import geometry from CAD tools and use IFC compliant tools to assess different performance aspects. The IFC object model is large and complex and implementing it in the prototype tool is too time consuming for this project. Therefore, the prototype tool uses its own data model to store all data related to the building design and building components.

In the data model classes define different building components. Each class representing a building component contains the properties that characterize the component. An instance of a class creates an object of that class. For each class methods exist that may be invoked to perform operations on objects of the class. All classes have methods to create new and edit existing objects of the class. For instance the class *construction* contains properties characterizing a construction consisting of several material layers. The properties include information on type of material in each layer, prices for investment and maintenance, service life etc. The class *construction* also have methods to calculate thermal transmittance, effective heat capacity and life cycle cost.

Objects may inherit properties and methods from other objects. When one object (the child) inherits from another (the parent), the child object includes all the properties of the parent object and can call the parent's methods. For instance the class *construction* is the parent class for the children classes *wall*, *deck*, etc. This means that an object of the class *wall* contains all properties and methods of the class *construction*, but in addition has its own properties and methods that distinguish walls from decks and ceilings. For instance the class *wall* in addition to the information in the *construction* object include information on price of foundation and linear losses in the foundation. Objects may also contain other objects in the data structure. For instance the class *construction* include a property defining the material layers in the

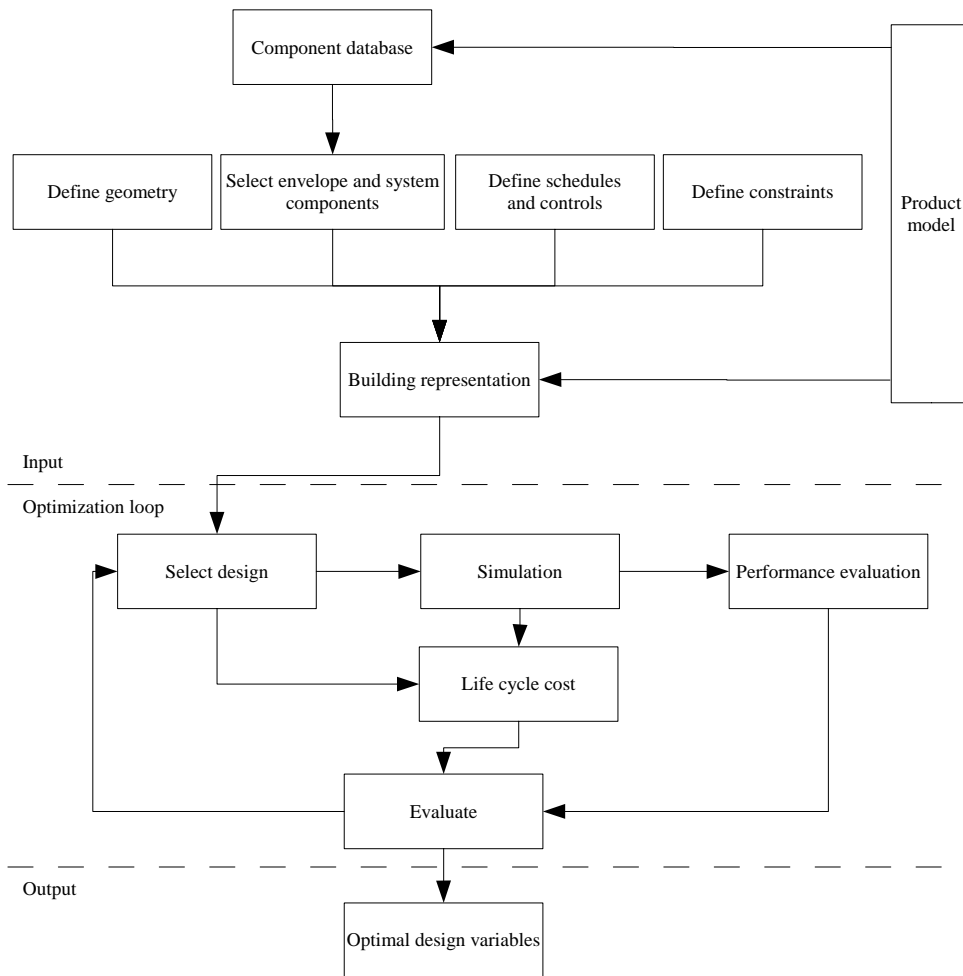

Figure 10.1: Overview of the structure of the prototype tool. In the input part the user describes the design problem using a graphic user interface. The design problem is stored in a data structure based on the product model and is passed on to the optimization loop. In the optimization loop the life cycle cost and performance aspects are evaluated for design solutions selected by an automatic optimization algorithm. The optimal values of the design variables obtained in the optimization loop are passed on to the output part where the user is presented with the optimal solution.

construction as an array of objects of the class *material*.

The choice of component classes is influenced by the fact that Matlab only supports object oriented programming to some degree. Classes exist for each building component considered in the prototype tool. Ceilings, roofs, decks, walls and internal walls are defined as opaque constructions with homogeneous layers of different building materials. The common structure of the classes for these constructions is contained in their parent class *construction* and the class *material* defines the materials. Glazings, frames and dividers may be produced different places and assembled

to a window in different ways by different window producers. Glazings, frames and dividers are therefore described as individual building components. The type of glazing, frame and divider defines a window. The thermal transmittance, total solar energy transmittance and light transmittance of a window are calculated based on the selected glazing, frame and divider, the size of the window and the number of dividers in the window. The systems cooling, venting, ventilation, infiltration, solar shading, lighting and heating are all defined by separate classes. The building component classes used in the prototype tool are shown in Figure 10.2.

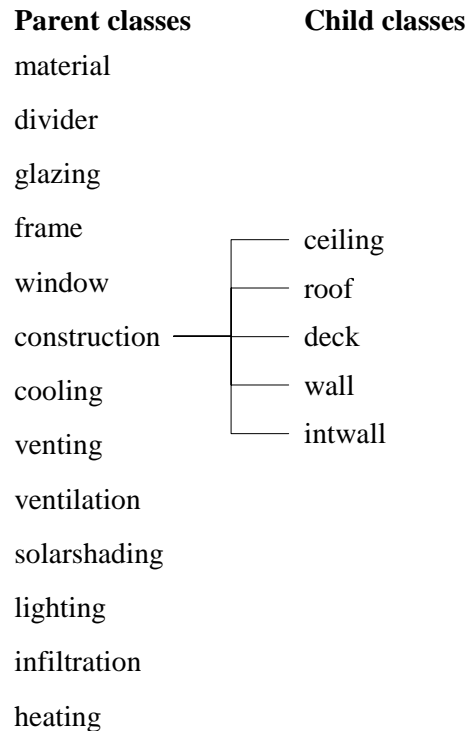

Figure 10.2: Classes in data model

A building component characterized by properties fitting to an existing class may be defined as an object of that class. The building component database contains objects of different building component classes. The building component database is stored in a Matlab structure where each field contains an array of objects of the class specified by the field name.

The project data structure contains a representation of the building, economic constants, a building component database and specifications of location and weather data.

10.3.2 Optimization loop

The calculations in the prototype tool are carried out in the optimization loop. The project data structure defines the design problem and is passed to the optimization loop. The project data structure is stored on the Matlab variable **project**. In the following Matlab variables that refer to data in the project data structure appear in bold.

Input processing

The first step in the optimization loop processes the project data structure to identify the design variables, the lower and upper limits on the design variables and the lower and upper limits on the constraints.

For each object list containing alternative choices of construction and system components and each geometric constraint defined for sub surfaces a design variable is created. The lower and upper limits on the design variables are found based on the number of building components in each object list and the limits specified in the geometric constraints. The design variables used to choose building components are discrete variables and the design variables specifying the size of sub surfaces are continuous variables. After processing the object lists and the geometric constraints defined for sub surfaces, the continuous design variables representing the aspect ratio and the orientation of the building are created and the lower and upper limits are found in the project data structure. The aspect ratio is defined as the width of the building divided by the length of the building and is used to vary the floor plan of the building. The lower and upper limits constraining the energy use, thermal indoor environment and daylight conditions are likewise found in the data structure. Table 10.1 shows limits on the design variables and constraints for a given design problems.

The lower and upper limits on the design variables are stored in the arrays x^l and x^u and the lower and upper limits on the constraints are stores in the arrays c^l and c^u . The lower and upper limits identified during the input processing are used as input for the optimization algorithm.

Optimization

The Direct Search Simulated Annealing algorithm described in section 8.3 is used in the optimization loop to find the geometry and mix of building components that gives the optimal solution. The optimization algorithm require the project data structure, the lower and upper limits on the design variables and the lower and upper limits on the constraints as input and performs automatic parameter variations within the limits on the design variables. For each iteration in the optimization loop the function that calculates the life cycle cost and performance aspects is executed. This function takes the values of the design variables and the project data structure as input. Based on the values of the design variables, the building components and geometry of the selected design solution are used in the calculations. If the performance of the building is not within the limits on the constraints the life cycle cost is penalized as described in Section 8.4. The building design is evaluated and if the stopping criterion is not fulfilled a new iteration in the optimization loop is performed. At the end of the optimization loop the solution with the lowest life cycle cost that fulfills the performance requirements is stored in the project data structure.

Table 10.1: The project data structure is processed to identify the design variables, the lower and upper limits on the design variables and the lower and upper limits on the constraints. The design variables are either (D)iscrete or (C)ontinuous variables. The number of object lists containing construction objects are given by $n=length(\mathbf{project.building.objectlist})$, the number of object lists containing system objects are given by $m=length(\mathbf{project.building.systemlist})$ and the number of geometric constraints for subsurfaces are given by $p=length(\mathbf{project.building.constraint.subsurface})$. The following abbreviations are used in the Table to specify where the data is found in the project data structure: $\mathbf{objectlist=project.building.objectlist}$, $\mathbf{systemlist=project.building.systemlist}$, $\mathbf{constraint=project.building.constraint}$. The function *length* gives the number of elements in the array within the brackets.

Design variable	Description	Limits		Type
		Lower	Upper	
x_1	Construction list nr. 1	1	$length(\mathbf{objectlist}(1).objects)$	D
\vdots				
x_n	Construction list nr. n	1	$length(\mathbf{objectlist}(n).objects)$	D
x_{n+1}	System list nr. 1	1	$length(\mathbf{systemlist}(1).objects)$	D
\vdots				
x_{n+m}	System list nr. m	1	$length(\mathbf{systemlist}(m).objects)$	D
x_{n+m+1}	Geom. constraint nr. 1	$\mathbf{constraint.subsurface}(1).minpart$	$\mathbf{constraint.subsurface}(1).maxpart$	C
\vdots				
x_{n+m+p}	Geom. constraint nr. p	$\mathbf{constraint.subsurface}(m).minpart$	$\mathbf{constraint.subsurface}(m).maxpart$	C
$x_{n+m+p+1}$	Aspect ratio	$\mathbf{constraint.building.aspect.min}$	$\mathbf{constraint.building.aspect.max}$	C
$x_{n+m+p+2}$	Orientation	$\mathbf{constraint.building.orientation.min}$	$\mathbf{constraint.building.orientation.max}$	C
Constraint				
c_1	Energy demand	0	$\mathbf{constraint.performance.energyframe}$	-
c_2	Thermal env.	0	$\mathbf{constraint.performance.thermalenv.hours}$	-
c_3	Daylight	$\mathbf{constraint.performance.daylight}$	1	-

10.4 Using the prototype tool

The prototype tool is designed with a graphical user interface as shown in Figure 10.3 where the user through a system of menus define the design problem to be optimized.

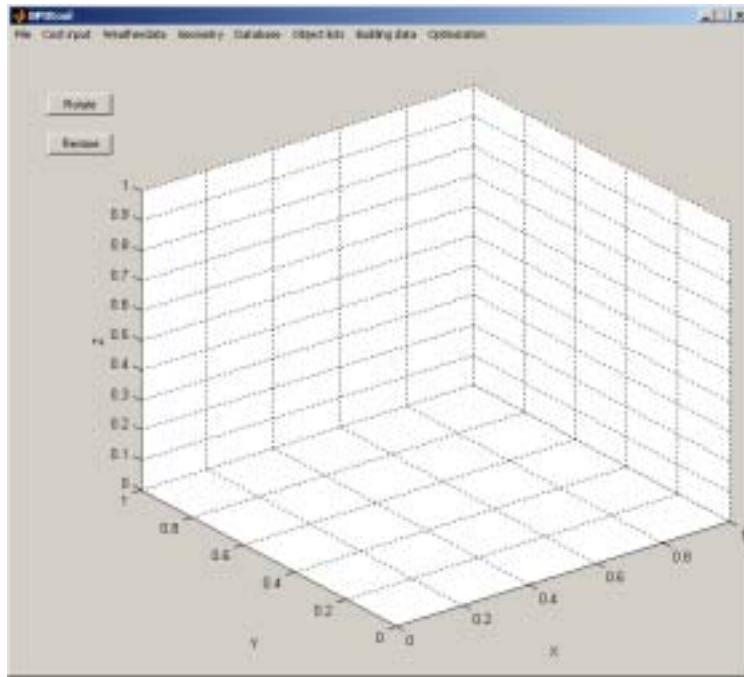

Figure 10.3: The user interface

The following input is needed to specify the design problem:

- Database with building components
- Economic constants
- Location and weather data
- Schematic geometric design
- Component lists of constructions and systems
- Define construction lists, boundary conditions and geometric constraints for surfaces and subsurfaces
- Define system lists, schedules and controls for thermal zones
- Geometric boundaries for the building
- Performance requirements

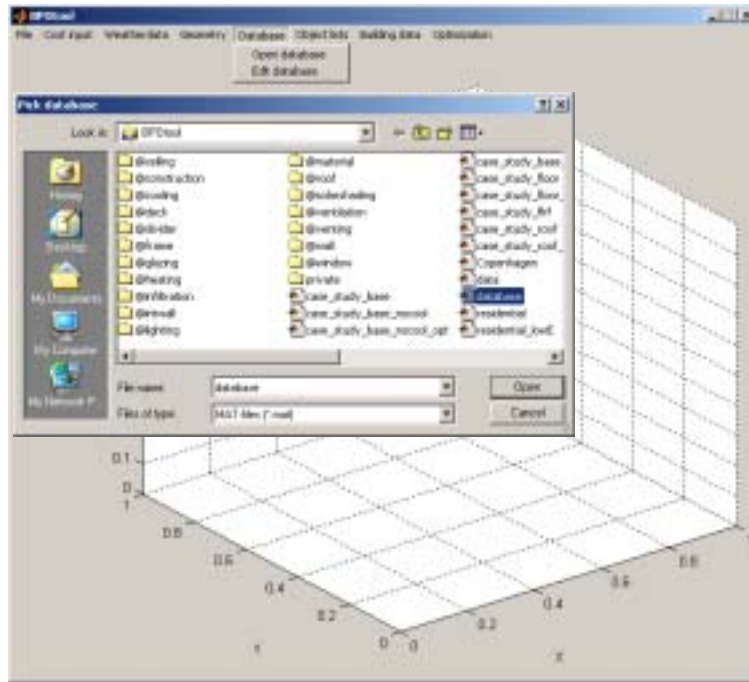

Figure 10.4: The Matlab file containing the existing data base is selected and loaded.



Figure 10.5: Viewing contents of database

10.4.1 Building component database

The building component database is loaded, viewed and modified using the options in the “Database” menu. Selecting the option “Open database” brings up the dialog shown in Figure 10.4 where the Matlab file containing the database is chosen.

The database may be viewed and modified by selecting the “Edit database” option which brings up the window shown in Figure 10.5. The listbox on the left hand side shows the types of building components in the database. Selecting a component type brings up the components in the database of the selected type in the listbox on the right hand side. Existing components can be modified and new components of the selected type can be added. The data characterizing the selected component is shown below the listbox.

10.4.2 Energy prices and economic constants

Economic constants used in the life cycle cost calculations are defined from the “Cost input” menu. Figure 10.6 show the input dialogs for energy prices and economic constants.

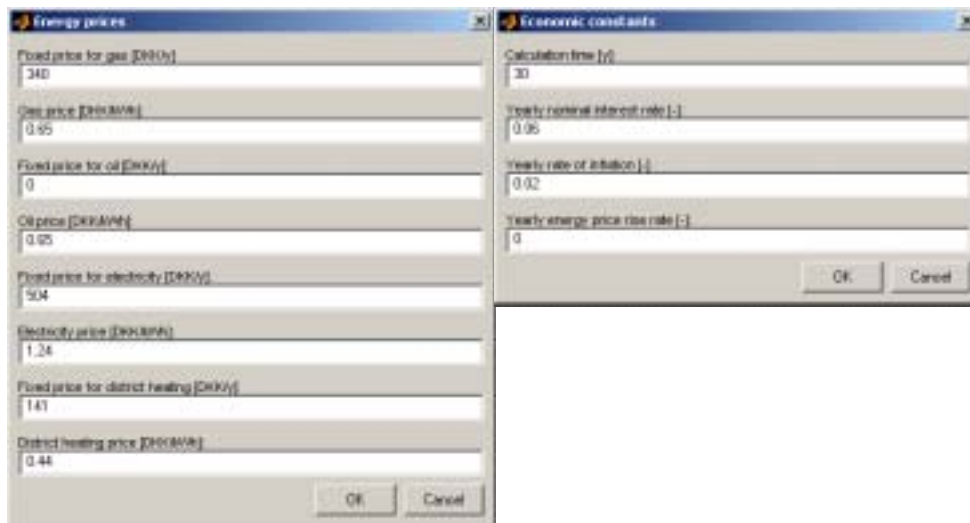

Figure 10.6: Dialogs used to specify energy prices, interest rates and calculation period.

10.4.3 Location and weather data

The weather data file and location is specified in the dialogs shown in Figure 10.7 opened from the “Weather data” menu. The latitude is positive on the northern hemisphere and the longitude and time meridian are positive east of Greenwich.

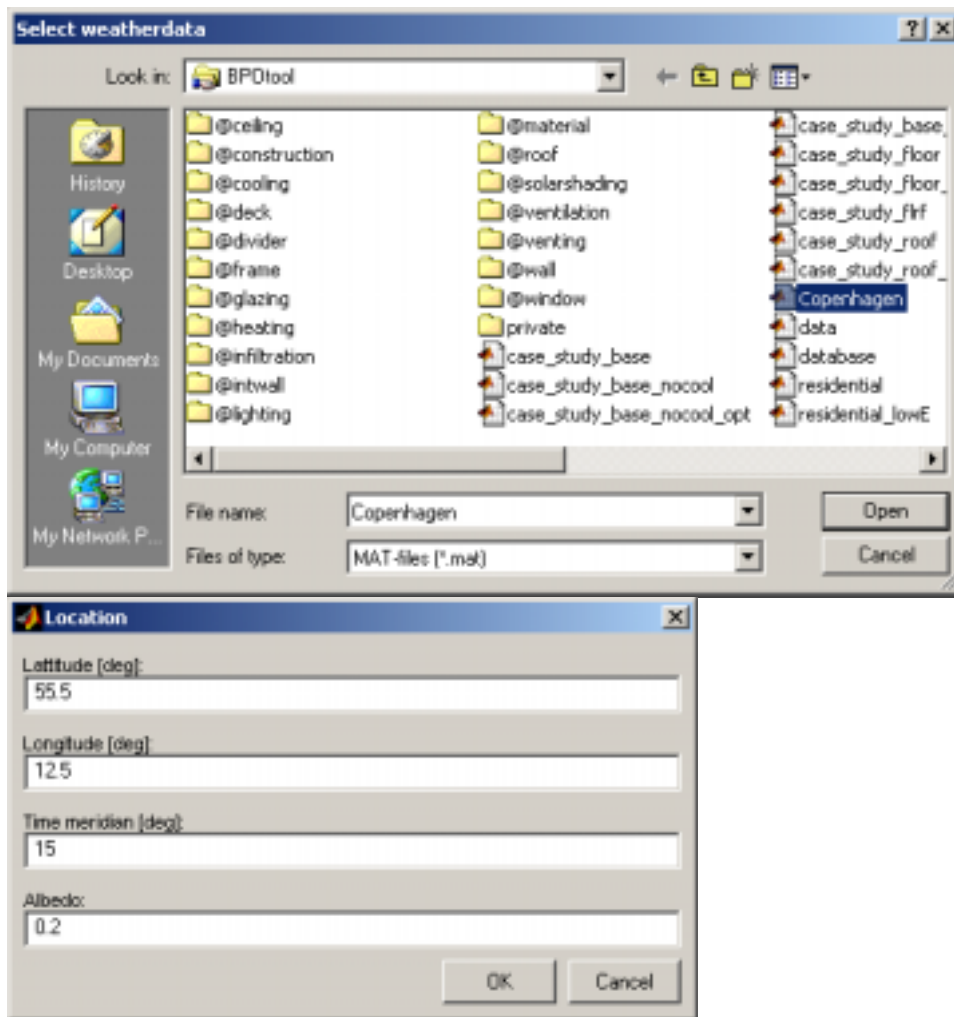

Figure 10.7: Specifying weather data file and location.

10.4.4 Schematic geometric design

The “Geometry” menu is used to specify the schematic geometric design of the building. If no geometry is defined, the “Add zone” option adds a cubic thermal zone by specifying height, width and length of the zone. When one thermal zone is defined, the geometry is shown in the user interface. The surfaces are selected using the mouse. If one zone is already defined, the “Add zone” option adds a new thermal zone in continuation of the existing zone. The “Add subsurface” option defines a subsurface in the selected surface. In Figure 10.8 a new thermal zone is added to the existing thermal zone and a subsurface is defined in a selected surface.

10.4.5 Component lists of constructions and systems

The “Object list” menu is used to create component lists of constructions and systems. Figure 10.9 shows the dialog used to edit the component lists containing building con-

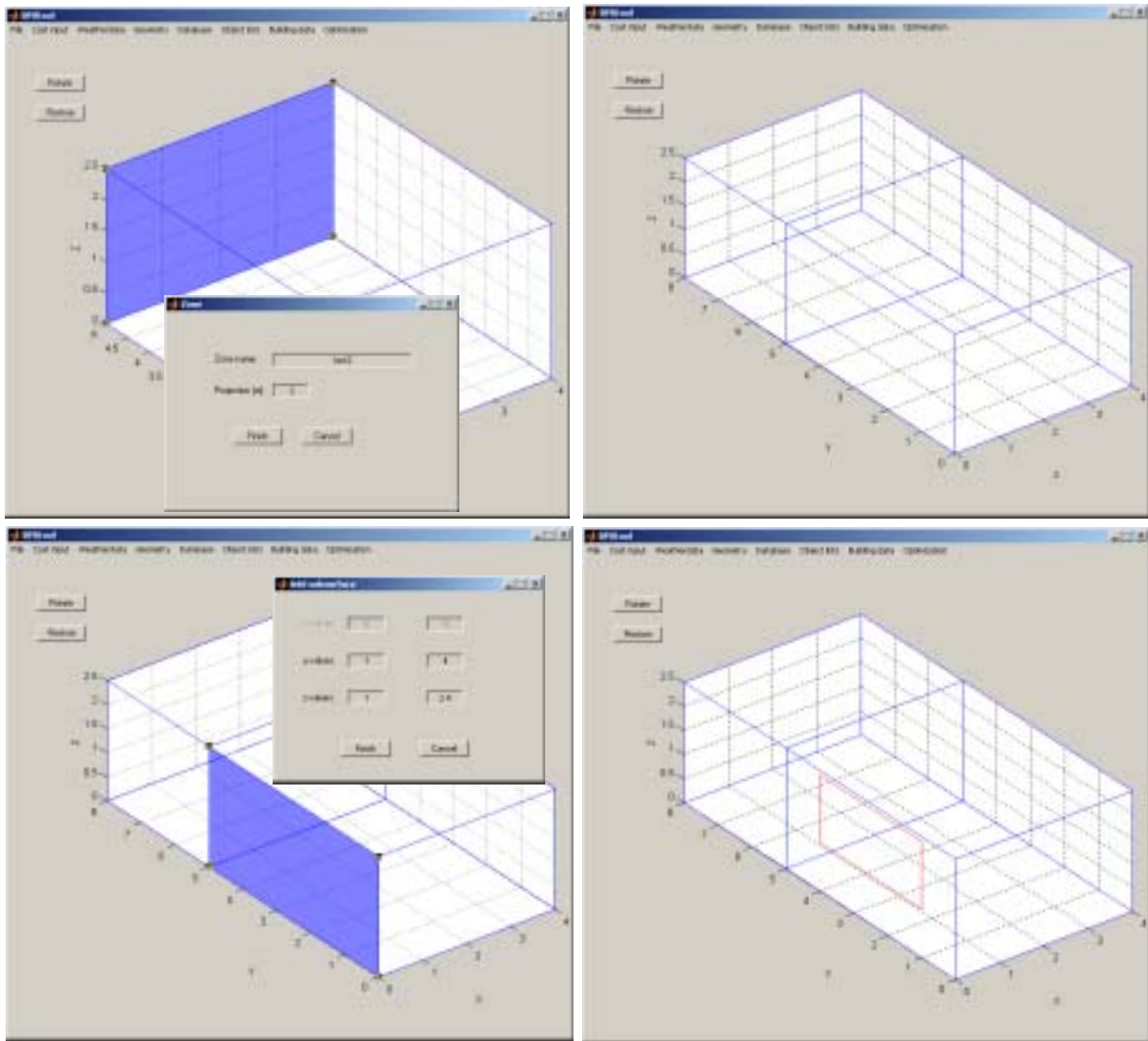

Figure 10.8: Dialogs used to add a new thermal zone in continuation of an existing thermal zone and to add a subsurface in a selected surface.

structions. The dialog used to edit component lists containing systems is similar. The left side shows the contents of the building component database. The component type is selected in the top listbox and all components of the type are listed in the lower listbox. The right side shows the component lists defined by the user. The top listbox shows the names of existing component lists and the lower listbox shows the building components in the selected component list. Lists may be added, edited and removed. The “Add object” button adds the selected database component to the selected component list. The “Remove object” button removes the selected component from the component list. The properties of the selected building components are shown below the listboxes. In Figure 10.9 five component lists with construction components have been defined. As seen, all wall objects in the building component database have been added to the component list “Outerwall”.

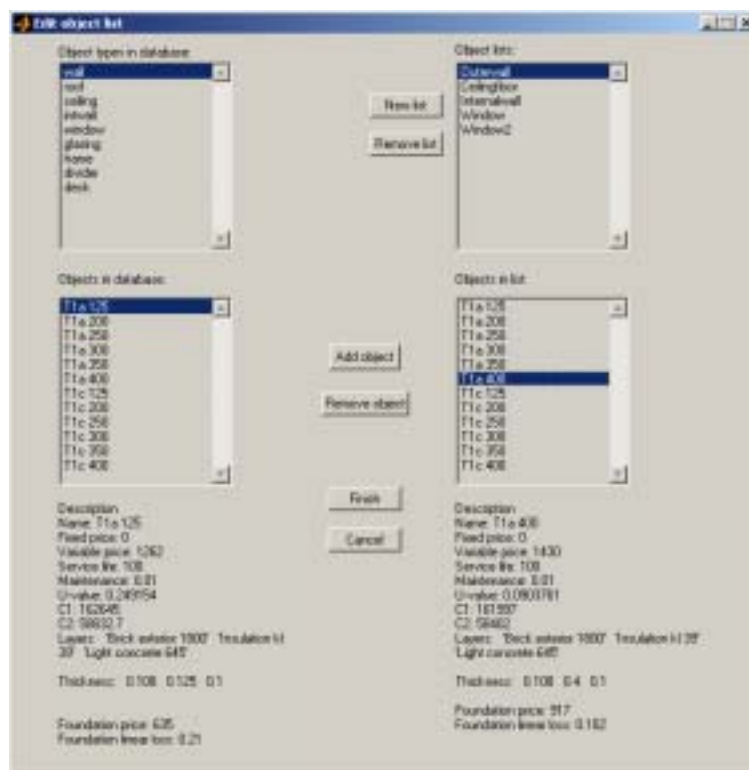

Figure 10.9: Dialog to edit lists of construction components.

10.4.6 Define component lists, boundary conditions and geometric constraints for surfaces and subsurfaces

The “Define surfaces” option in the “Building data” menu is used to define component list, boundary conditions and geometric constraints for the selected surface or subsurface. Each surface and subsurface is associated with a component list selected among the component lists containing constructions. The boundary conditions on the faces of the surfaces and sub surfaces are used to specify internal constructions, construc-

tions towards the outdoor air and constructions towards the ground. For sub surfaces the properties constraining their size must be stated by selecting an existing or defining a new constraint. The constraint defines the minimum and maximum size of the subsurface. It is also possible to specify minimum distances of window walls below and above the subsurface and the maximum size of each window aperture in the surface. Figure 10.10 shows how a component list, boundary conditions and geometric constraint are defined for a subsurface representing a window.

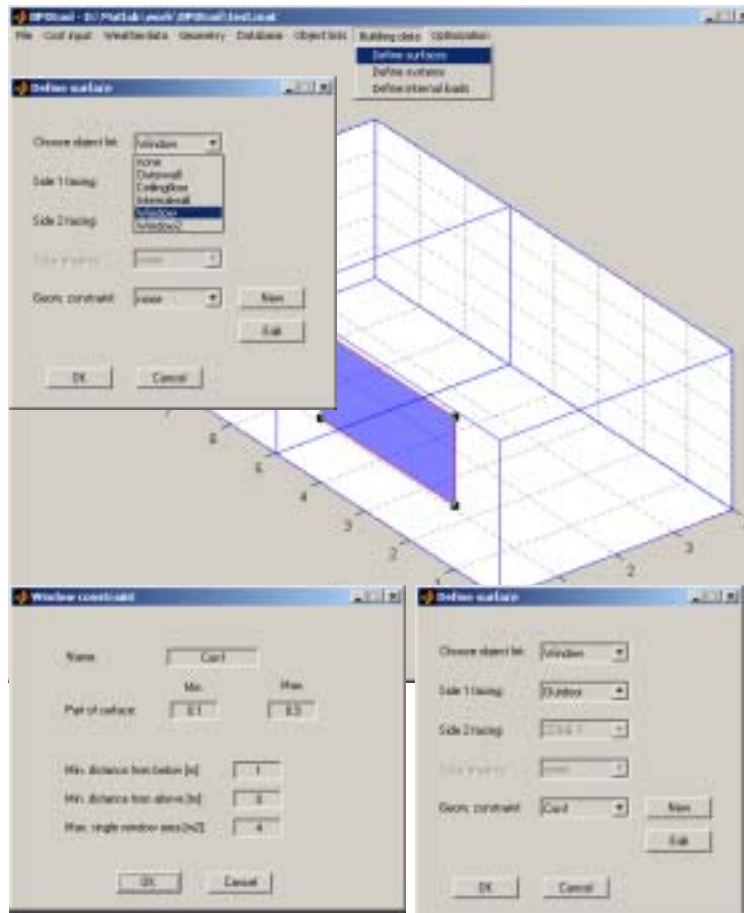

Figure 10.10: Associate component list to surface, define boundary condition and constraints.

10.4.7 Define system lists, schedules and controls for thermal zones

Selecting the “Define systems” option in the “Building data” menu brings up the dialog shown in Figure 10.11. This dialog shows the systems defined for the selected zone. The selected zone is highlighted in the drawing of the building. Systems may be added, modified and removed from the thermal zones. Figure 10.12 shows the dialogs used to define a new heating system. Selecting the “Add system” button brings up a dialog from where the system type is chosen. The system is associated with a component

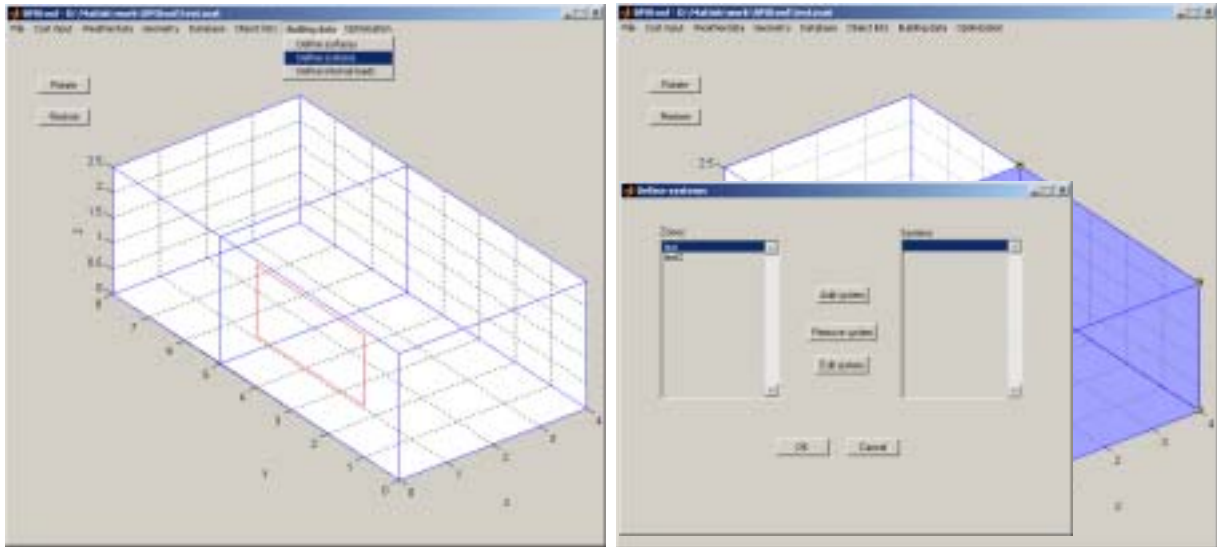

Figure 10.11: Add, edit and remove systems.

list with system components of the selected type. To activate the system a control is needed. The heating system control is defined by a heating set point and a time period where the control is active. The control parameters are different for different system types. The time period is set to a previously defined or new time period. The time period is specified by setting the hours, days and weeks the control is active. Several controls for each system may be defined to reflect the use of the building.

10.4.8 Geometric boundaries for building

The “Geometric constraints” option in the “Optimization” menu is used to define upper and lower limits on the aspect ratio and orientation of the building as shown in Figure 10.13. The shape of the building is defined by the aspect ratio given as $\frac{x_{max} - x_{min}}{y_{max} - y_{min}}$. The building is oriented in the negative direction of the y-axis. The values specifying the orientation on the northern and southern hemisphere are given in Table 10.2.

Table 10.2: Orientation of main directions on northern and southern hemisphere.

	Northern hemisphere	Southern hemisphere
North	180°	0°
South	0°	180°
East	-90°	-90°
West	90°	90°

10.4.9 Performance requirements

The “Performance criteria” option in the “Optimization” menu is used to define the constraints on the building performance. The constraints are a minimum level of

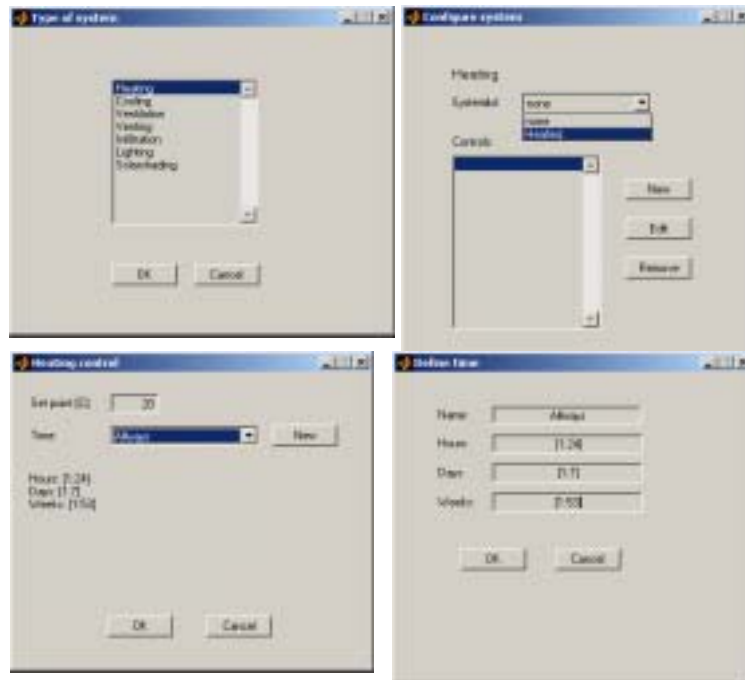

Figure 10.12: Adding new system, defining list of systems, control and schedule.

the average daylight factor, a maximum level of heating and cooling demand and a maximum number of hours with over heating. Over heating occur when the indoor air temperature exceeds the stated temperature within the specified time period. Figure 10.14 shows the input dialog.

10.5 Optimizing the design

The “Optimize” option in the “Optimization” menu starts the optimization. During the optimization process the progress is shown in the optimization dialog shown in Figure 10.15. For each iteration the current minimum value of the objective function is displayed. At the end of the optimization the drawing of the building is updated to show the optimized geometry. Selecting the “Optimized result” option in the “Optimization” menu displays the detailed results as shown in Figure 10.16. The effect of design changes can be investigated using the option “Parameter variation” to manually change the values of the design variables.

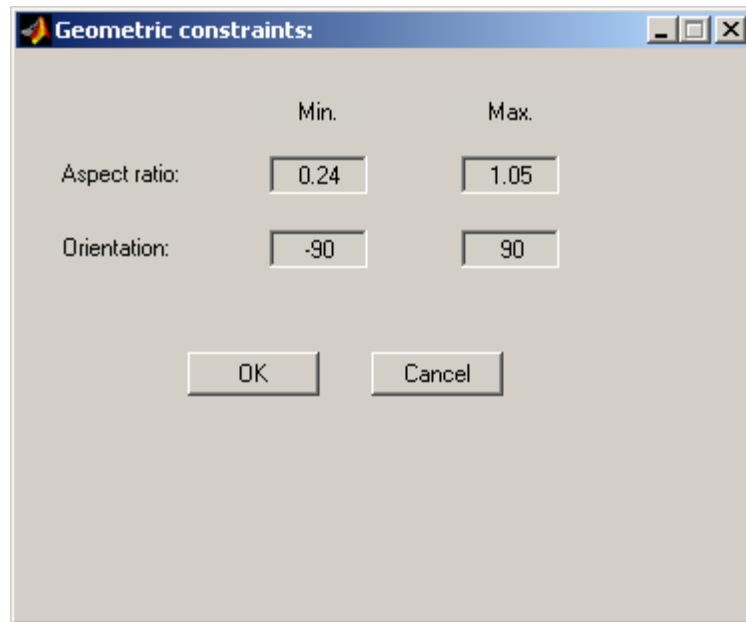

Figure 10.13: Input geometric constraints.

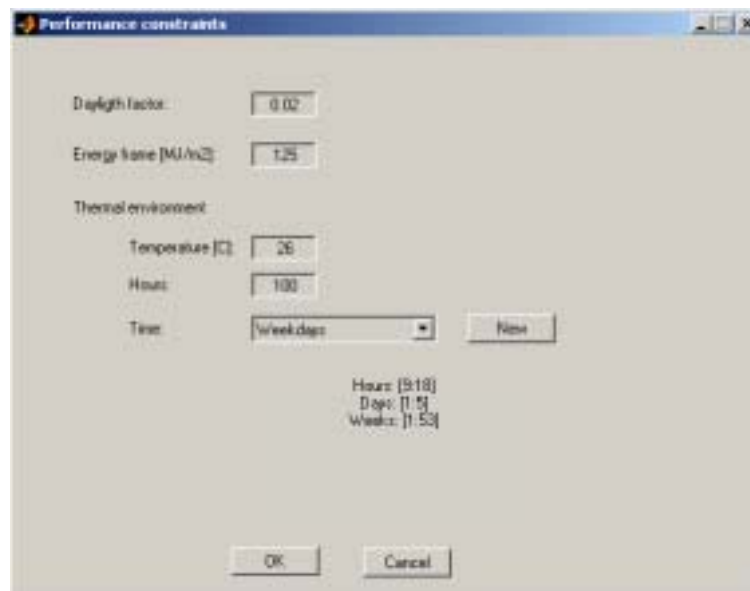

Figure 10.14: Dialog used to specify the performance constraints.

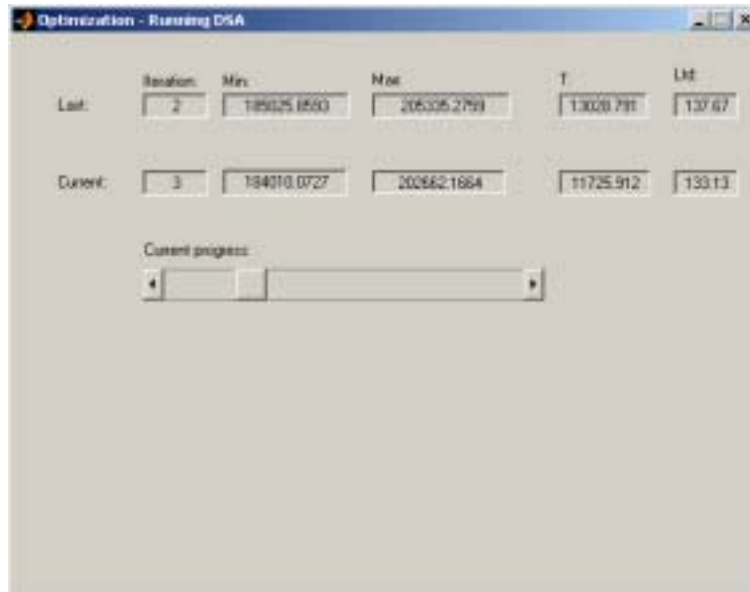

Figure 10.15: Dialog showing the progress of the optimization.

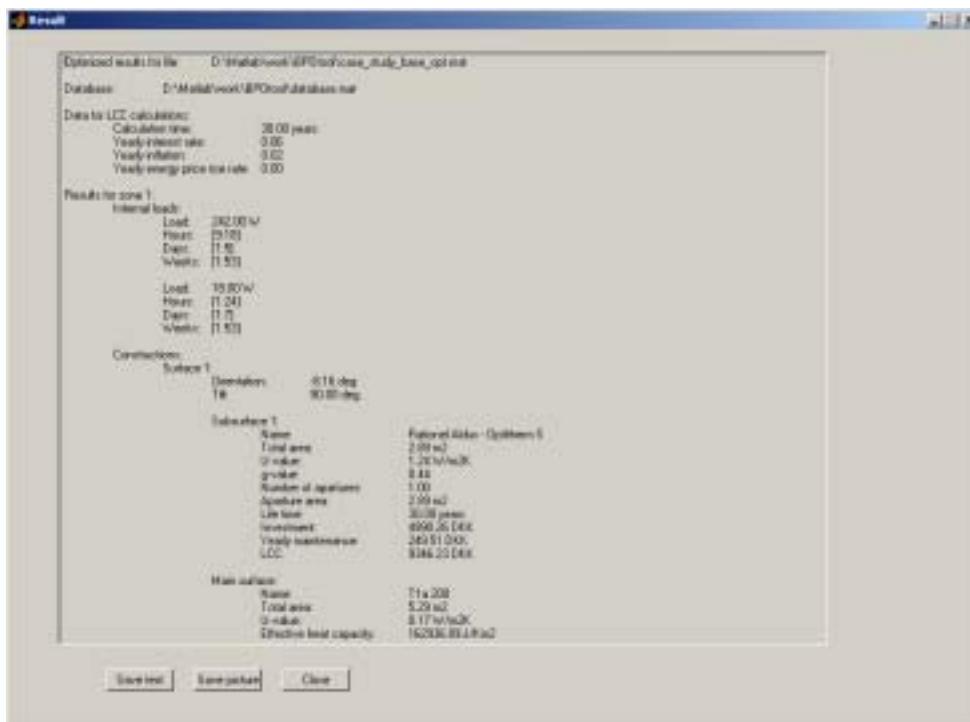

Figure 10.16: The results are presented in a scrollable window.

Chapter 11

Case study

The design methodology implemented in the prototype tool is tested on two case studies. The first case study considers a room in a one-family house with a fixed geometry to simplify the design problem. The second case considers a section in a multi storey office building. Several alternatives of different building components are described and stored in the building components database used by the prototype tool. In the two cases the building design are optimized for different situations to show how the life cycle cost and constraints influence the optimized solution.

11.1 Objectives

The design methodology is based on investigations of the building design process, data models of buildings and building components, building simulation, performance assessment and optimization methods and has been implemented in a prototype tool. To test the design methodology, the prototype tool is applied to design problems defined by two cases. The two cases concern optimization of: 1) a room in a one-family house and 2) a multi storey office building. The one-family house has a low internal load and is dominated by a heating demand. The focus in the first case is mainly on the building constructions, window size and ventilation system for a fixed room geometry and orientation. The office building on the other hand has a high internal load that require building components that control the indoor temperature to avoid over heating problems during the summer period. In this case more design options like the geometry and orientation of the building and cooling and shading systems are included in design options.

The case studies have several purposes. One purpose is to show how design problems are defined and optimized using the design methodology that is implemented in the prototype tool. Secondly, the results and performance of the design methodology are compared to the expectations. This is used to identify weaknesses and strengths that may be used to propose changes that improve the design methodology.

11.2 Building components used in the case studies

The following describes the characteristics of the building components that are used in the case studies. The components are stored in a building component database that is

used in the prototype tool to define the design options. All prices have been evaluated for the year 2000.

In the following description of the building components in the database, a name and a number is assigned to each component. The names and numbers are used to identify the building component that is included in the building design. Design variables representing building components are used to select the building components in the design from a list of alternative building components. The number assigned to each building component refers to the value of the design variable that selects the component. For instance, if the design variable, $x(1)$, represents the outer wall construction then $x(1)=4$ means that the outer wall with number 4 has been selected from the component database.

11.2.1 Outer wall constructions

Two different types of outer wall constructions are defined in the building component database: types T1a and T1c. The constructions are sketched in Figure 11.1.

In both cases the foundation is made of two lightweight clincher blocks separated by insulation material. The thicknesses of the exterior and interior blocks are respectively 100 mm and 150 mm. The total thickness of the foundation is equal to the width of the outer wall.

The U-value, effective heat capacity and linear losses in the foundation are calculated using one- and two-dimensional tools. The investment costs, maintenance costs and service lives are calculated based on standard price catalogues (V&S, 2000). The investment price includes material and labor costs.

Outer wall type T1a

From the outside wall type T1a is made of 108 mm brick, 125-400 mm insulation material and 100 mm lightweight concrete elements. The properties are given in Table 11.1.

Table 11.1: Properties of outer wall construction type T1a.

Name	T1a-125	T1a-200	T1a-250	T1a-300	T1a-350	T1a-400
Number	1	2	3	4	5	6
Insulation [mm]	125	200	250	300	350	400
Investment [DKK/m ²]	1262	1310	1340	1370	1400	1430
Foundation price [DKK/m]	635	693	749	805	861	917
U-value [W/m ² K]	0.249	0.168	0.138	0.118	0.102	0.090
Linear loss to foundation [W/mK]	0.21	0.138	0.121	0.112	0.106	0.102
Effective internal heat capacity [kJ/m ² K]	59	59	59	59	59	58
Yearly maintenance cost	1%					
Service life [years]	100					

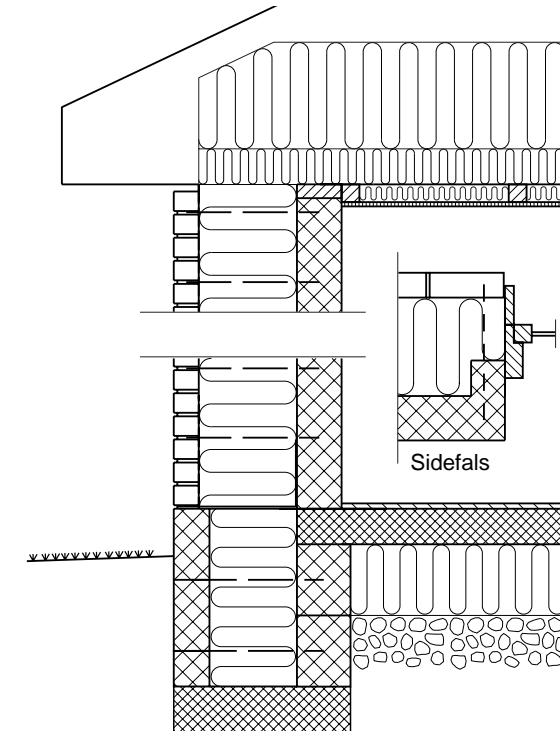

Figure 11.1: Wall construction (Tommerup et al., 2000)

Type T1c

From the outside wall type T1c is made of 108 mm brick, 125-400 mm insulation material and 108 mm brick. The properties are given in Table 11.2.

Table 11.2: Properties of outer wall construction type T1c.

Name	T1c-125	T1c-200	T1c-250	T1c-300	T1c-350	T1c-400
Number	7	8	9	10	11	12
Insulation [mm]	125	200	250	300	350	400
Investment [DKK/m ²]	1307	1470	1574	1679	1784	1889
Foundation price [DKK/m]	635	693	749	805	861	917
U-value [W/m ² K]	0.273	0.179	0.145	0.123	0.106	0.093
Linear loss to foundation [W/mK]	0.224	0.143	0.125	0.115	0.108	0.103
Effective internal heat capacity [kJ/m ² K]	160	160	160	160	160	160
Yearly maintenance cost	1%					
Service life [years]	100					

11.2.2 Internal constructions

The building component database includes internal constructions. The U-values and effective heat capacities are calculated using one-dimensional tools. The investment costs are calculated based on standard price catalogues (V&S, 2000).

Internal walls

Three different types of internal walls are defined in the building component database. The thicknesses of the inner walls are 100 mm and they are made of either brick, concrete or lightweight concrete. The properties are given in Table 11.3.

Table 11.3: Properties of internal wall constructions.

Name	Brick	Concrete	Light concrete
Number	1	2	3
Investment [DKK/m ²]	500	550	364
Effective internal heat capacity [kJ/m ² K]	85	92	45
Yearly maintenance cost	1%		
Service life [years]	100		

Internal floor separations

One type of construction separating different floors is defined and is made of 180 mm concrete. The properties are given in Table 11.4.

Table 11.4: Properties of floor separation construction.

Name	Concrete
Number	1
Investment [DKK/m ²]	483
Effective internal heat capacity [kJ/m ² K]	164
Yearly maintenance cost	1%
Service life [years]	100

11.2.3 Deck constructions

The deck construction shown in Figure 11.2 is build-up on the ground and is from the inside made of tiles, 100 mm concrete, 100 - 300 mm insulation material and 150 mm loose aerated concrete. The properties are given in Table 11.5.

The U-value and effective heat capacity are calculated using one- and two-dimensional tools. The investment costs are calculated based on standard price catalogues (V&S, 2000).

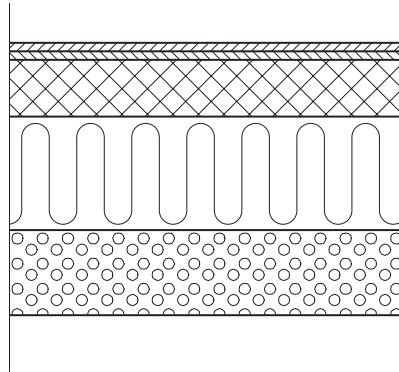

Figure 11.2: Deck construction (Tommerup et al., 2000)

Table 11.5: Properties of deck constructions.

Number	D-70	D-100	D-150	D-200	D-250	D-300
Number	1	2	3	4	5	6
Insulation [mm]	70	100	150	200	250	300
Investment [DKK/m ²]	370	397	450	497	544	591
U-value [W/m ² K]	0.193	0.168	0.138	0.117	0.102	0.101
Effective internal heat capacity [kJ/m ² K]	182	182	183	183	183	183
Yearly maintenance cost	1%					
Service life [years]	100					

11.2.4 Roof constructions

The roof construction is shown in Figure 11.3 and is from the inside made of 13 mm gypsum boards, 45 × 45 mm laths with insulation material, 50 x 100 mm rafters with 100 mm insulation material between rafters, additional insulation above rafters, ventilated roof space and roofing material. The properties are given in Table 11.6.

The U-value and effective heat capacity are calculated using one- and two-dimensional tools. The investment costs are calculated based on standard price catalogues (V&S, 2000).

11.2.5 Window constructions

Windows are composed of a frame and a glazing from the building component database. At this time only one frame is defined. Several glazings from Pilkington with energy and solar control coatings are defined in the database. The prices for the window products been estimated using price catalogues from Pilkington and cost for labor has been estimated using standard price catalogues (V&S, 2000).

Frame construction

The frame construction is a made of wood and the properties are given in Table 11.7.

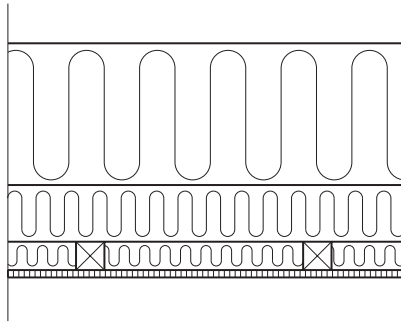

Figure 11.3: Roof construction (Tommerup et al., 2000)

Table 11.6: Properties of roof constructions.

Number	R-250	R-300	R-350	R-400	R-450	R-500	R-550	R-60
Number	1	2	3	4	5	6	7	8
Insulation [mm]	250	300	350	400	450	500	550	600
Investment [DKK/m ²]	565	603	641	678	716	753	791	828
U-value [W/m ² K]	0.147	0.124	0.107	0.094	0.084	0.076	0.069	0.063
Effective internal heat capacity [kJ/m ² K]	18	19	19	19	18	18	18	18
Yearly maintenance cost	1%							
Service life [years]	100							

Table 11.7: Properties of frame constructions. (* A is the area of the window)

Name	F1
Number	1
Investment* [DKK/m ²]	342·A+2204
U-value [W/m ² K]	1.0
Frame width [m]	0.114
Yearly maintenance cost	5%
Service life [years]	30

Glazing

The glazing data is from Pilkington and cover a range of glazings with and without coatings for managing solar and thermal energy. The properties are given in Table 11.8.

Table 11.8: Properties of glazings. (A is the area of the glazing)

Name	G1	G2	G3
Number	1	2	3
U-value [$\text{W}/\text{m}^2\text{K}$]	2.8	1.3	1.1
g-value	0.76	0.66	0.59
τ	0.82	0.77	0.75
Investment* [DKK]	$73+404 \cdot A$	$131+727 \cdot A$	$138+768 \cdot A$
Yearly maintenance cost	5%		
Service life [years]	20		

Name	G4	G5	G6
Number	4	5	6
U-value [$\text{W}/\text{m}^2\text{K}$]	1.4	1.1	1.1
g-value	0.44	0.40	0.37
τ	0.65	0.62	0.60
Investment* [DKK]	$200+1111 \cdot A$	$258+1434 \cdot A$	$266+1474 \cdot A$
Yearly maintenance cost	5%		
Service life [years]	20		

Windows

The windows are made of a frame construction and a glazing. The properties are given in Table 11.9.

Table 11.9: Properties of windows. A is the area of the window and Ψ is the linear thermal transmittance

Name	W1	W2	W3	W4	W5	W6
Number	1	2	3	4	5	6
Window frame type	1					
Glazing type	1	2	3	4	5	6
Ψ [W/mK]	0.082					
Yearly maintenance cost	5%					
Service life [years]	30					

11.2.6 Heating systems

For heating a radiator system is used. The heat is produced in a natural gas boiler. The investment costs are calculated based on standard price catalogues (V&S, 2000). The properties are given in Table 11.10.

Table 11.10: Properties of heating system.

Name	H1
Investment [DKK/m ²]	463
Efficiency	90%
Yearly maintenance cost	2%
Service life [years]	20

11.2.7 Ventilation and cooling systems

The mechanical ventilation system provides the basic air change in the building and can include a heat exchanger. The cost for the mechanical ventilation system depends on the size of the building. Therefore, the cost is different for a one-family house and a multi storey office building. The ventilation system can be coupled with a cooling system to control indoor air temperature. The investment costs are calculated based on standard price catalogues (V&S, 2000).

Ventilation system in office building

The properties of ventilation systems in office buildings are given in Table 11.11.

Table 11.11: Properties of ventilation system in office building.

Name	MO1	MO2
Number	1	2
Investment [DKK/m ²]	475	478
Yearly maintenance cost	5%	5%
Service life [years]	20	20
Heat exchanger efficiency	0%	70%
Electric efficiency of fans	30%	30%
Head loss [Pa/m ²]	2	2

Ventilation system in one-family house

The properties of ventilation systems in a one-family house are given in Table 11.12.

Table 11.12: Properties of ventilation system in one-family house.

Name	MR1	MR2
Number	1	2
Investment [DKK/m ²]	206	273
Yearly maintenance cost	5%	5%
Service life [years]	20	20
Heat exchanger efficiency	0%	70%
Electric efficiency of fans	30%	30%
Head loss [Pa/m ²]	2	5

Cooling

The cost for the cooling system only applies to large buildings. The properties are given in Table 11.13.

Table 11.13: Properties of cooling system in ventilation system.

Name	Cooling in ventilation
Investment [DKK/m ²]	57
Yearly maintenance cost	5 %
Service life [years]	20
COP	2.5

11.2.8 Solar shading devices

Solar shading devices may be applied to reduce the transmitted solar energy. In the building component database an external aluminum lamella system that blocks up to 80% of the solar radiation is defined. The properties are given in Table 11.14. The investment costs are calculated based on standard price catalogues (V&S, 2000).

Table 11.14: Properties of solar shading device.

Name	SH1
Investment [DKK/m ²]	2264
Yearly maintenance cost	2%
Service life [years]	20
Min. shading factor	0.2

11.2.9 Lighting system

Two different lighting systems are defined with properties as given in Table 11.15. The electric efficiencies are based on values from (SBI, 1995) and the investment costs are calculated based on standard price catalogues (V&S, 2000)

Table 11.15: Properties of lighting systems.

Name	Fluorescent lamp	Glow lamp
Number	1	2
Investment [DKK/m ²]	200	200
Yearly maintenance cost	2%	4%
Service life [years]	30	30
Electric efficiency [Lumen/W]	25	5

Table 11.16: Economy

Calculation period	30 years
Interest rate	6%
Inflation	2%
Yearly energy price rise rate	0%
Natural gas price	0.65 DKK/kWh
Electricity price	1.24 DKK/kWh

11.3 Economic assumptions

The life cycle cost calculations are based on the economic constants in Table 11.16. The energy prices have been obtained from energy suppliers in November 2000.

11.4 Case 1: Room in one-family house

The first case considers design of a room in a one-family house. The optimization is performed in two situations: 1) a normal building where the energy demand is within the normal energy frame and 2) a low energy building where the energy demand is within half the normal energy frame.

11.4.1 Geometry

The floor area of the room is 5 m×4 m and the room height is 2.5 m. The north and west facades, roof and deck faces the outdoor environment. All other surfaces are internal walls and it is assumed that no heat is transported to the neighboring rooms. Windows are placed in the north and west facades. The schematic geometry defined in the prototype tool is shown in Figure 11.4.

11.4.2 Loads and HVAC systems

The load from people, lighting and other electric equipment is averaged over the day. In residential buildings the average internal load from people is approximately 5 W/m² in average during the year (SBI, 1995).

The heating system is a radiator system with a natural gas boiler and operates with a set point for the room air temperature at 20°C.

The building has a mechanical ventilation system with a basic mechanical air change rate at 0.5 h⁻¹. When the room air temperature exceeds 25 °C the mechanical air change rate is increased to use outdoor air to cool the building. The mechanical ventilation rate may be increased to a maximum air change rate at 2 h⁻¹.

Venting may be applied to cool the building by opening windows and doors. Venting is activated before the mechanical ventilation rate is increased when the indoor air temperature exceeds 25 °C. The maximum venting rate gives an air change rate at 2 h⁻¹.

The air infiltration is assumed to be constant and is based on a good quality of tightness. The air change rate from infiltration is 0.1 h⁻¹.

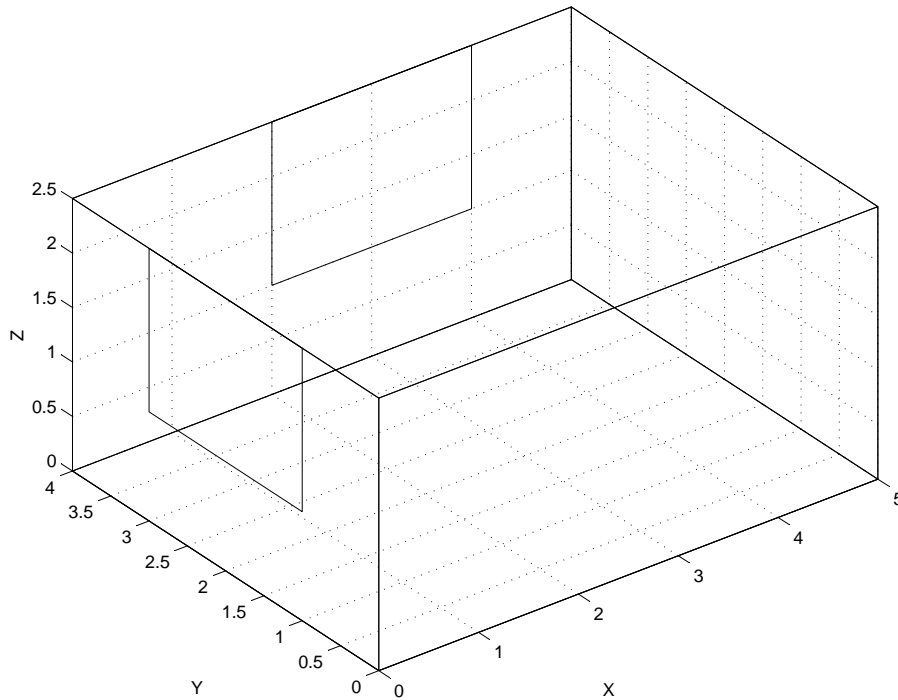

Figure 11.4: Schematic geometry of the investigated room in the one-family house

11.4.3 Design options

The floor layout and the orientation of the building are fixed. The window areas may vary between 0% and 75% of the total area of the facade wherein they are placed and the height of window wall is at least 1 m. The total window area may be divided into several window apertures with a maximum aperture area of 4 m². E.g. if the total window area is 6 m² this is divided on two window apertures each with the area 3 m².

The building components that are varied in the optimization are the outer walls, inner walls, decks, roofs, windows and ventilation systems for one-family houses as defined in the building component database. These design variables are all described by discrete values. The window areas in the north and west facades are continuous design variables in the optimization. Table 11.17 summarize the design variables in the optimization problem, the limits on each variable and the type.

11.4.4 Performance requirements

The building design must fulfill performance requirements regarding energy demand, thermal indoor environment and daylight utilization.

The energy performance is evaluated based on the total energy demand for heating and cooling that should be within the energy frame. According to the Danish building regulations the energy frame of the building is approximately 250 MJ pr. m² floor area. In the low energy case the energy frame is halved to 125 MJ pr. m² floor area.

The requirements for thermal indoor environment in residential buildings are not

Table 11.17: Design variables that are considered in the optimization of a room in the one-family house. The type of each design variable is indicated as either (D)iscrete or (C)ontinuous. (*Fraction of respective facade area)

Design variable	Values	Type
Outer wall	1-12	D
Inner wall	1-3	D
Window	1-6	D
Deck	1-6	D
Roof	1-8	D
Ventilation system	1-2	D
Window area in north facade	0-0.75*	C
Window area in west facade	0-0.75*	C

as strict as in office buildings. In this case the indoor air temperature may not exceed 26 °C for more than 200 hours pr. year during the working hours.

A high daylight utilization is demanded. The average daylight factor in the room should be above 4%.

11.4.5 Optimized result

The building design is optimized for both a normal energy demand and a low energy demand. The results are shown in Table 11.18. The table shows the building components and window areas, the life cycle cost and performance aspects of the optimized building design. The geometry of the optimized room is very similar in both cases and is shown for the normal case in Figure 11.5. In both cases the window area is largest in the west facade, which results in a better utilization of solar energy. The chosen window type and window areas result in a daylight factor equal to the requirement of a minimum daylight factor at 4%. The mechanical ventilation system with heat recovery is used in both cases. The low energy case compared to the normal case lowers the energy demand by 30% with a 3% increase in the life cycle cost. The low energy level is reached by increasing the insulation levels in the constructions and choosing a better insulating glazing. The better insulating glazing lowers the solar transmittance of the windows, which results in a slight increase in the window areas to fulfill the requirement for daylight. In both cases the requirement for the thermal indoor environment is fulfilled.

11.4.6 Parametric runs

Based on the optimized solutions parametric runs are performed where a single design parameter is varied while keeping all other design variables constant. The purpose of the parametric runs is to show the effects of design changes and how the constraints influence the solution.

The outer wall construction is in both solutions chosen to be of type T1a with respectively 200 mm and 350 mm insulation. In the building component database 12 different outer wall constructions are defined. Figures 11.6 and 11.7 show the influ-

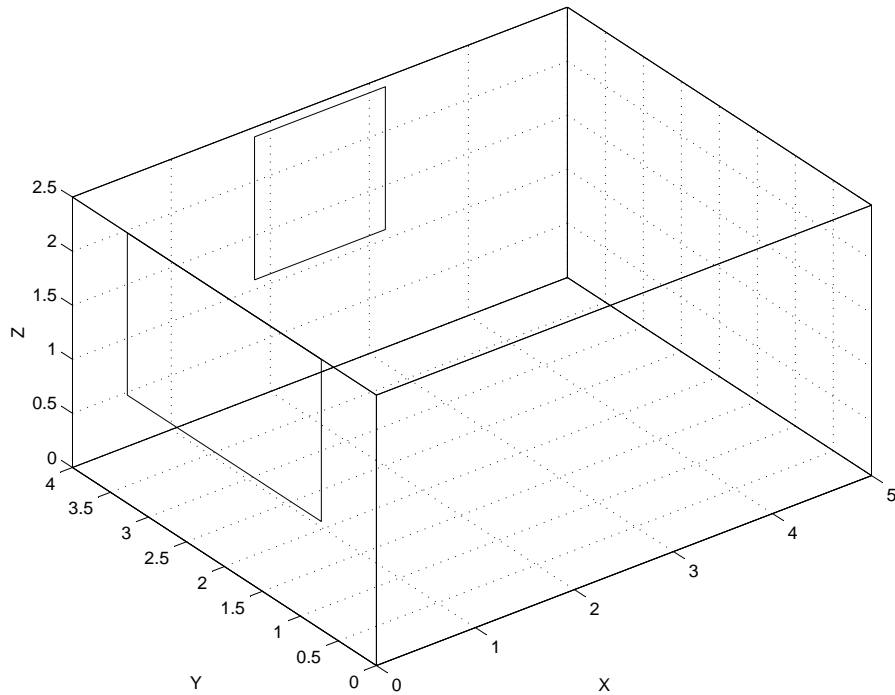

Figure 11.5: Geometry of optimized room

Table 11.18: Optimization results for room in one-family house.* Window area as percentage of the facade area.

	Normal	Low energy
Outer wall type	T1a-200	T1a-350
Roof type	R-250	R-450
Deck type	D-70	D-150
Inner wall type	Light concrete	Light concrete
Frame type	F1	F1
Glazing type (U/g/ τ)	G2 (1.3/0.66/0.77)	G3 (1.1/0.59/0.75)
Window area north	1.75 m ² (14%*)	1.71 m ² (14%*)
Window area west	3.83 m ² (38%*)	3.96 m ² (40%*)
Ventilation (exch.)	MR2 (yes)	MR2 (yes)
LCC [DKK]	115881	119509
Energy demand [MJ/m ²]	179 (\leq 250)	124 (\leq 125)
Thermal env. [h]	172 (\leq 200)	165 (\leq 200)
Daylight	4.0% (\geq 4.0%)	4.0% (\geq 4.0%)

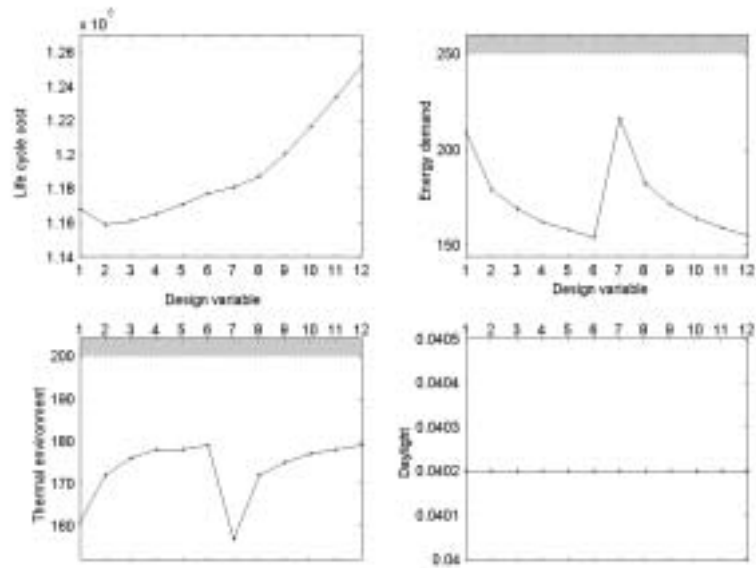

Figure 11.6: Parameter variation of the outer wall construction based on optimized solution in the normal situation. The design variable refers to the wall constructions in the building component database. $x=1-6$: T1a-125, T1a-200, T1a-250, T1a-300, T1a-350, T1a-400; $x=7-12$: T1c-125, T1c-200, T1c-250, T1c-300, T1c-350, T1c-400.

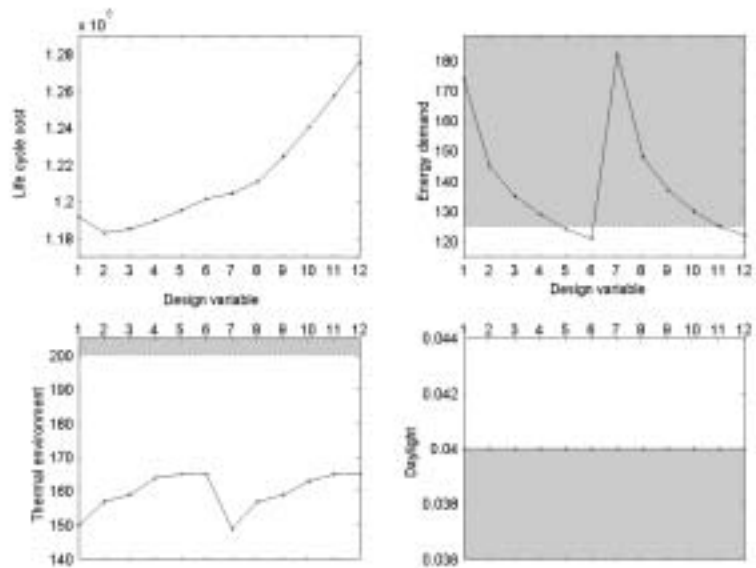

Figure 11.7: Parameter variation of the outer wall construction based on optimized solution in the low energy situation. The design variable refers to the wall constructions in the building component database. $x=1-6$: T1a-125, T1a-200, T1a-250, T1a-300, T1a-350, T1a-400; $x=7-12$: T1c-125, T1c-200, T1c-250, T1c-300, T1c-350, T1c-400.

ence on the life cycle cost, energy demand, thermal indoor environment and daylight factor when the outer wall construction is varied for the normal and low energy case. Solutions within the gray areas violate the given performance requirement. In both cases it is clear that the outer wall construction doesn't influence the daylight factor and that energy demand decrease and the indoor temperature increase slightly with increasing insulation thickness. In both cases the outer wall of type T1a with 200 mm insulation gives the minimum life cycle cost. The low energy case shows that the insulation thickness must be above 300 mm to fulfill the requirement on the energy demand. Therefore, the solution with 200 mm insulation is not a valid solution. A solution to the design problem can only be accepted among the valid solutions. This force an increase in the insulation thickness and the life cycle cost.

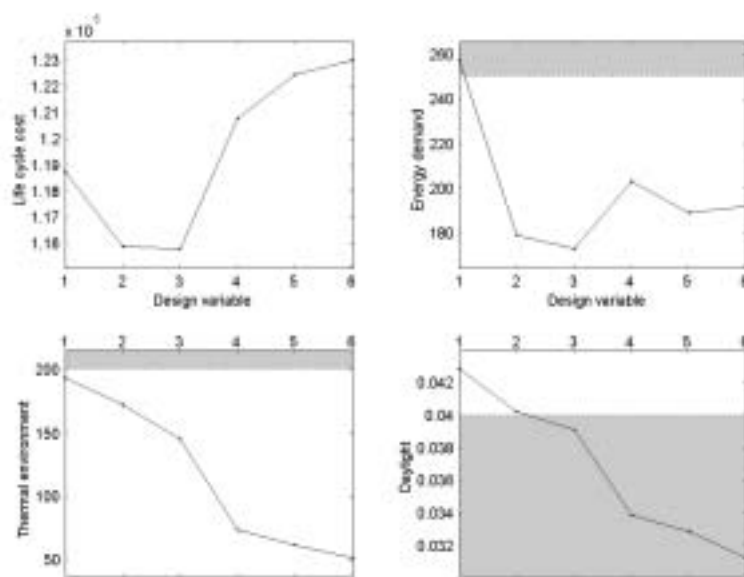

Figure 11.8: Parameter variation of window type based on optimized solution in the normal situation. x=1-6: W1, W2, W3, W4, W5, W6

The window type influences all performance aspects included in the design problem. Figure 11.8 shows the results of varying the window type in the normal case. The optimized solution use windows of type number 2. The life cycle cost is almost the same for windows of type 2 and 3. In this case the window of type 3 violates the requirements for daylight making this choice invalid. The optimized solution in the low energy case uses windows of type 3 and fulfills the requirement for daylight by a slight increase in the window area.

These parametric runs show that the performance requirements have a large influence on the optimized solution.

11.5 Case 2: Office building

The second case considers the design of an office building. The office building is in its base case identical to the reference office used within the IEA Task 27 (van Dijk, 2001).

11.5.1 Geometry

The front view and floor plan is sketched in Figures 11.9 and 11.10. The base geometry of the office rooms are given in Figure 11.11 and listed in Table 11.19.

Table 11.19: Base geometry of office rooms

Width	3.5 m
Depth	5.4 m
Height	2.7 m
Floor area	18.9 m ²

The prototype tool is limited to model a maximum of two thermal zones. It is assumed that the indoor air temperature is equal in all neighboring office rooms and that no heat and air is exchanged between the corridor, service space and office rooms. The corridor and service space are neglected in the calculations. To be able to account for the orientation of the building a section consisting of two opposite facing office rooms is modeled and the schematic geometry is shown in Figure 11.12. The constructions in the office rooms vary depending on the floor number. Three different sections of office rooms exist in the building: 1) Office rooms on the ground floor, 2) office rooms in the middle section and 3) office rooms on the top floor. As a result of the limitations in the prototype tool each section is optimized separately.

11.5.2 Loads and HVAC systems

The office rooms are occupied during the working hours 10 hours a day 5 days a week (Monday to Friday) from 8-18 hr. The heat dissipated from people in the office rooms is based on 1.5 people pr. office room doing office type of work occupying the room 85% of the working day and is based on 8 working hours. The mean internal load from people is estimated to be 70 W pr. office room within the working hours. Equipment that is always switched on give an internal load of 18 W pr. office room. During the working hours there is an additional internal load of 172 W pr. office room. The internal load from lighting depend on the lighting system in the office rooms. The lighting system is on/off controlled by the average illuminance from daylight in the room. The control is active during the working hours and switches the light on when the average illuminance is below 100 lux. The fixed internal loads pr. office room are summed in Table 11.20.

Table 11.20: Internal loads from people and equipment in each office room

	Load [W]	Hours	Days
People	70	8-18 hr	mon-fri
Equipment	18	0-24	mon-sun
Equipment	172	8-18	mon-fri

Mechanical ventilation provide an air change of 1.5 h⁻¹ during the working hours. If the indoor air temperature exceeds 25°C the mechanical ventilation rate is increased

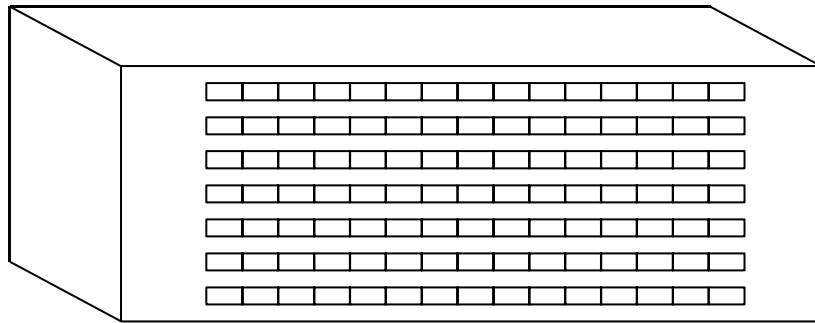

Figure 11.9: Front view of office building

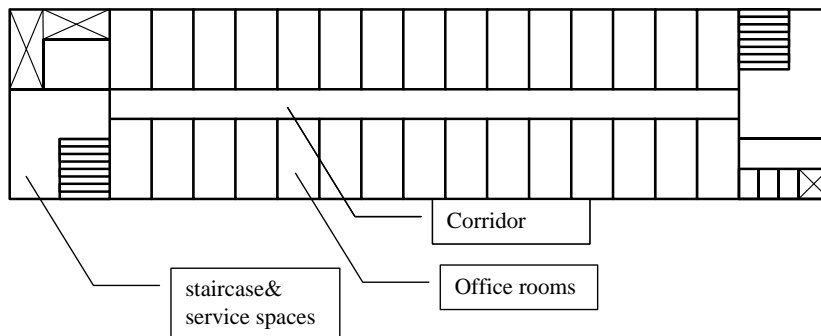

Figure 11.10: Floor plan of office building

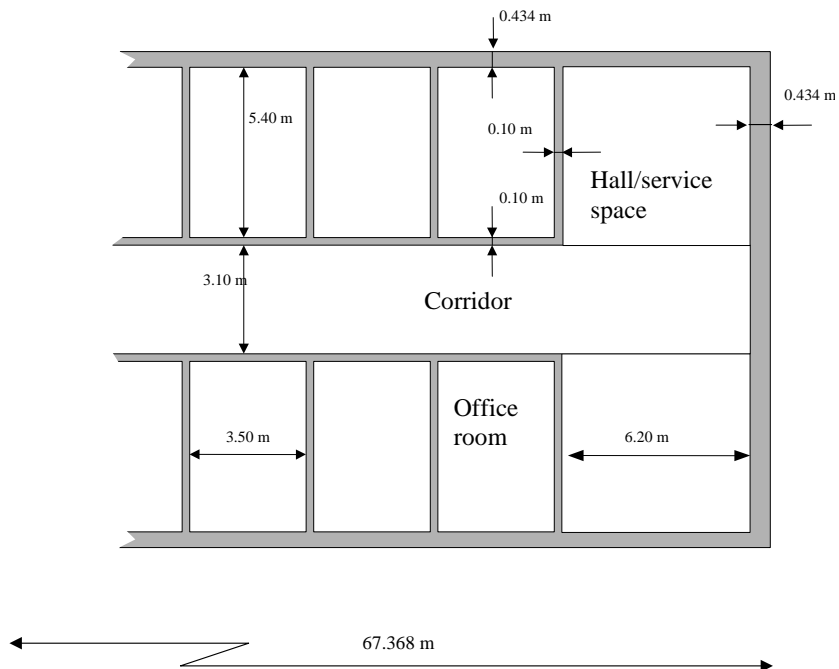

Figure 11.11: Base geometry of office building

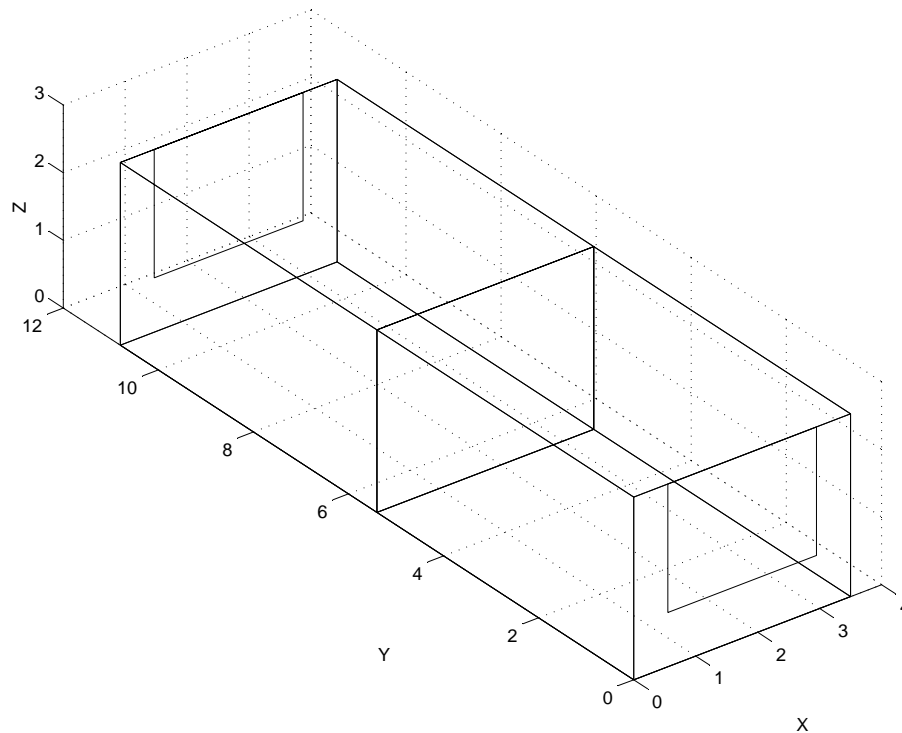

Figure 11.12: Schematic geometry of the section in the office building with two opposite facing office rooms.

to lower the indoor air temperature. The maximum mechanical air change rate is 3 h^{-1} . Outside working hours the mechanical ventilation is switched off.

The heating system operates with a set point at 20°C within working hours. Outside working hours the heating set point is 16°C .

The cooling system operates with a set point at 26°C within working hours and is switched off outside working hours.

Venting may be applied within the working hours and is activated when the indoor air temperature exceeds 25°C . The maximum venting rate gives an air change of 2 h^{-1} .

The air infiltration is assumed to be constant and is based on a good quality of tightness. The air change from infiltration is 0.23 h^{-1} .

11.5.3 Design options

The length or depth of the office rooms should not be less than 3m. The aspect ratio of the modeled geometry given as $\frac{x_{\max} - x_{\min}}{y_{\max} - y_{\min}}$ can vary between 0.24 and 1.05.

The minimum height of the window wall is 0.8m and the window area can vary between 20% and 70% of the facade area. The total window area may be divided into several window apertures with a maximum aperture area of 4 m^2 . E.g. if the total window area is 6 m^2 this is divided on two window apertures each with the area 3 m^2 . The window area is the same in all office rooms regardless that windows in opposite facing office rooms have different orientation.

Table 11.21 summarizes the design variables in the optimization problem, the limits on each variable and the type.

Table 11.21: Design variables that are considered in the optimization of the office rooms. The type of each design variable is indicated as either (D)iscrete or (C)ontinuous. [‡]Fraction of respective facade area. ^{**}The design variable is zero if the system is not used. [†]This design variable is only used when optimizing the ground floor. [‡]This design variable is only used when optimizing the top floor.)

Design variable	Values	Type
Outer wall	1-12	D
Inner wall	1-3	D
Window	1-6	D
Deck [†]	1-6	D
Roof [‡]	1-8	D
Ventilation system	1-2	D
Cooling system	0-1 ^{**}	D
Shading system in office 1	0-1 ^{**}	D
Shading system in office 2	0-1 ^{**}	D
Window area	0.1-0.7 [*]	C
Orientation	-90° - 90°	C
Aspect ratio	0.24 - 1.05	C

11.5.4 Performance requirements

The building design must fulfill performance requirements regarding energy demand, thermal indoor environment and daylight utilization.

The energy performance is evaluated based on the total energy demand for heating and cooling that should be below the energy frame. According to the Danish building regulations the energy frame of the building is approximately 125 MJ pr. m² floor area.

To avoid poor working conditions the indoor air temperature may not exceed 26 °C for more than 100 hours pr. year during the working hours.

A reasonable level of daylight utilization is needed and the average daylight factor in the offices should be above 2%.

11.5.5 Optimized result

The designs of offices on the ground floor, middle section, and top floor of the building have been optimized separately. The results are shown in Table 11.22. In all cases optimized solution resulted in a similar geometry of the office section. The optimized geometry is shown in Figure 11.13. The aspect ratio defines the floor plan of the office section and is close to the lower bounds, which results in minimum facade area. In all cases windows of type 2 or 3 is chosen. The cases where one of the windows is of type 3; the window area is slightly increased to fulfill the requirements for daylight. The orientation is close to 0° which means that the office rooms have north and south facing windows. To avoid over heating problems a cooling system is chosen rather than solar

shading devices and solar control glazings to control the indoor air temperature. This means that the requirement for the thermal indoor environment is fulfilled. The chosen insulation thicknesses are similar to those chosen in the one-family house optimized for normal energy demand. The fluorescent lighting system is chosen. It is seen that the window areas are chosen to fulfill the daylight requirement. From this we must conclude increasing the window area to utilize more daylight is not competitive with an artificial lighting system in this case.

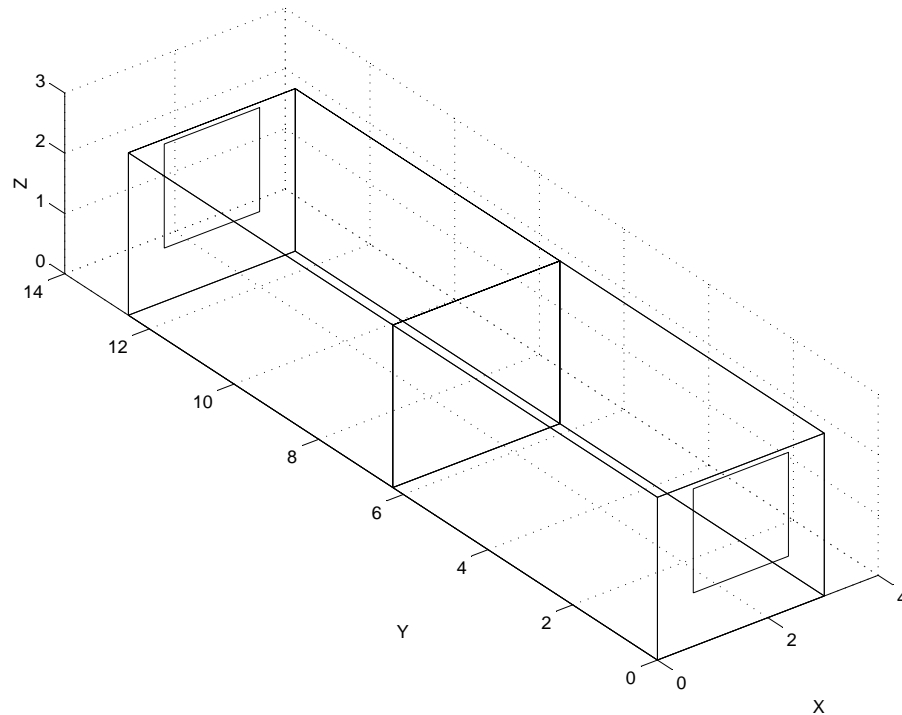

Figure 11.13: Geometry of optimized office rooms in the middle section of the building

The building design for an office room in the middle section has been optimized in a situation with no cooling system in the building to investigate the consequences for the solution. The solution is shown in Table 11.23. Fulfilling the performance requirements with no cooling system increase the life cycle cost by 6%. To avoid over heating solar control glazings are chosen and a solar control device is used in the south facing office rooms. The choice of solar control glazings results in an increased window area to fulfill the requirement for daylight.

11.5.6 Parametric runs

Based on the optimized solution for the office rooms in the middle section of the building parametric runs are performed where a single design parameter is varied while keeping all other design variables constant. The purpose of the parametric runs is to show the effects of design changes and how the constraints influence the solution.

Table 11.22: Optimization results for office rooms.*Window area as percentage of the facade area.

	Ground floor	Middle section	Top floor
Outer wall type	T1a-200	T1a-200	T1a-200
Roof type	-	-	R-250
Deck type	D-70	-	-
Inner wall type	Light concrete	Light concrete	Light concrete
Frame type	F1	F1	F1
Glazing type O1 (U/g/ τ)	G2 (1.3/0.66/0.77)	G3 (1.1/0.59/0.75)	G2 (1.3/0.66/0.77)
Glazing type O2 (U/g/ τ)	G2 (1.3/0.66/0.77)	G3 (1.1/0.59/0.75)	G3 (1.1/0.59/0.75)
Window area	2.77m ² (34%*)	2.89m ² (35%*)	2.88m ² (35%*)
Ventilation (exch.)	MO2 (yes)	MO2 (yes)	MO2 (yes)
Cooling	yes	yes	yes
Solar shading O1	no	no	no
Solar shading O2	no	no	no
Lighting	Fluorescent	Fluorescent	Fluorescent
Orientation O1	-5°	-8°	-19°
Aspect ratio (0.24-1.05)	0.24	0.24	0.24
LCC [DKK]	181296	173696	189592
Energy demand [MJ/m ²]	80 (\leq 125)	54 (\leq 125)	88 (\leq 125)
Thermal env. [h]	0 (\leq 100)	0 (\leq 100)	0 (\leq 100)
Daylight	2.0% (\geq 2.0%)	2.0% (\geq 2.0%)	2.0% (\geq 2.0%)

Table 11.23: Optimization results for office rooms in the middle section with out the option of cooling in the ventilation system.*Window area as percentage of the facade area.

	Middle section
Outer wall type	T1a-200
Inner wall type	Light concrete
Frame type	F1
Glazing type O1 (U/g/ τ)	G4 (1.4/0.44/0.65)
Glazing type O2 (U/g/ τ)	G4 (1.4/0.44/0.65)
Window area	3.2m ² (40%*)
Ventilation (exch.)	MO2 (yes)
Solar shading O1	yes
Solar shading O2	no
Lighting	Fluorescent
Orientation O1	2°
Aspect ratio (0.24-1.05)	0.24
LCC [DKK]	184584
Energy demand [MJ/m ²]	60 (\leq 125)
Thermal env. [h]	80 (\leq 100)
Daylight	2.0% (\geq 2.0%)

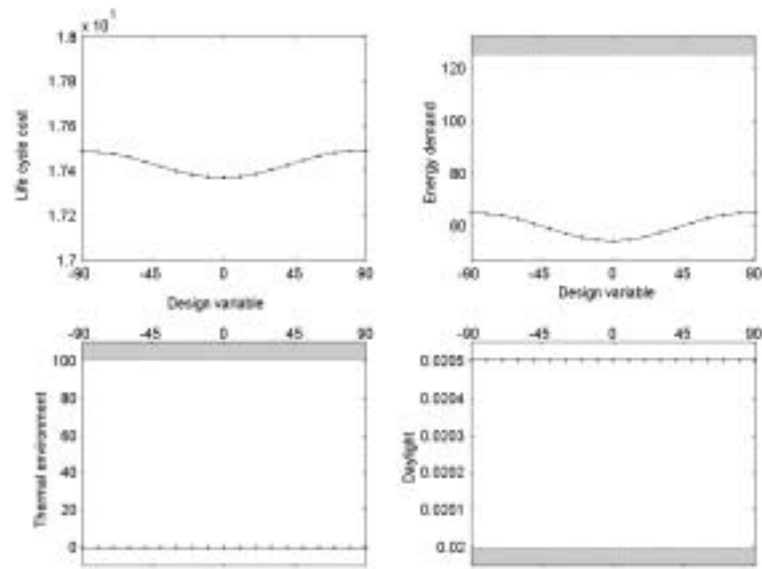

Figure 11.14: Parameter variation of orientation

The influence of the orientation of the office rooms is shown in Figure 11.14. The orientation has a very slight influence in the life cycle cost and both the life cycle cost and the energy demand has minimum values around an orientation of 0° . The orientation of the optimized results in the previous section where all close to 0° but varied slightly. The parameter variation shows that a very flat minimum exist around an orientation of 0° and this explains why the iterative optimization process has difficulties iterating very close to the optimum.

The window area should be within 20% - 70% of the facade area. The result of varying the window area is shown in Figure 11.15. The life cycle cost, energy demand and daylight level all increase with increasing window area. When the total window area exceeds 4 m^2 the window area is divided on several apertures. This is seen as a drastic increase in the life cycle cost. Window areas below 35% of the facade area cannot fulfill the requirements for daylight and the valid solution with minimum life cycle cost is found at the point where the daylight factor is 2%.

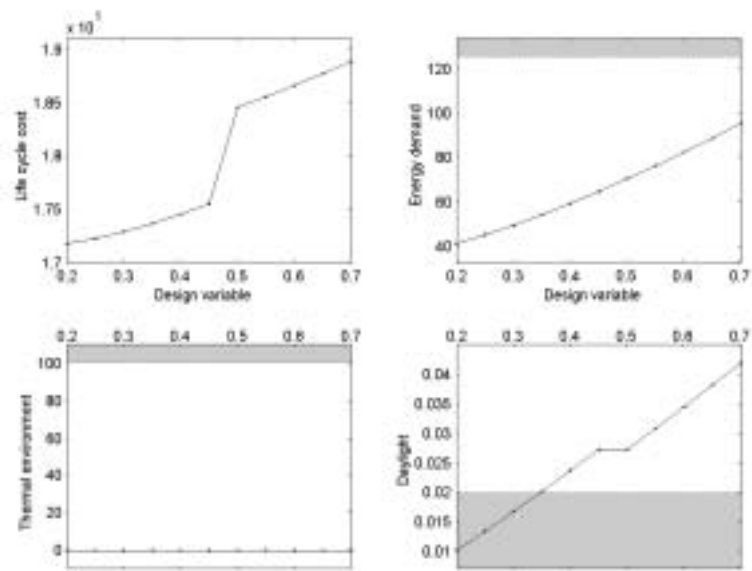

Figure 11.15: Variation of window area

Chapter 12

Evaluation of prototype tool

This chapter evaluates the prototype tool based on the claims in the hypothesis.

12.1 Claims

The hypothesis claims that following the design methodology described in Chapter 9 it is possible to develop a design optimization tool that

- is useful in the early phases of the design process
- uses descriptions of building components from a building component database
- uses an automatic optimization algorithm
- saves time for manual parameter variations during the design process
- is based on a common product model of the building
- handles complex design problems
- improves the overall performance of the building design

12.2 Discussion

The use of the design tool in the early stages of the design process depends on access to a building component database with reliable properties of building components. If this is not the case the designer has to collect data from contractors, suppliers and manufacturers to create a building component database. This would be too time consuming to be included in the early stages of the design process. It could be argued that the data used to develop the building component database only has to be collected once to get a database that could be used in several building projects. But considering the large amount of products on the market, this would be a huge task for the designer and the database would have to be updated as the prices change and new products are put on the market.

Building components are described in a building component database. This makes it easy for the designer to choose the different alternative constructions and systems

that are included in the design optimization. Defining the alternatives by selecting sets of possible components means that building components can only be varied in discrete steps. The outcome of this is that the optimization method has to handle many discrete design variables, which influence the choice of optimization algorithm.

The case studies show that it is possible to apply an automatic optimization algorithm to design problems. The time used to optimize the design depends on the complexity of the design problem. With the current optimization algorithm the optimization process takes several hours. The current optimization algorithm is developed for general optimization purposes. This means that it does not benefit from knowledge regarding how different design choices influence the building performance. For instance as expected, the case studies show that the insulation thickness in the constructions only has a small influence on the thermal indoor environment and no influence at all on the daylight conditions in the room. The optimization algorithm does not know this and may try to change the insulation thicknesses to improve the thermal indoor environment and daylight conditions. Not knowing these relations between the design variables and the building performance reduce the effectiveness of the optimization algorithm. On the other hand, a general optimization algorithm is independent of the problem formulation. Using an automatic optimization algorithm, the designer avoids time-consuming manual parameter variations trying to locate the optimal solution. This would give the designer more time for other tasks in the design process

The prototype tool does not use a common product model (e.g. the Industry Foundation Classes) to represent the building data electronically. The common product models are very comprehensive and could not be implemented within the time frame of this project. A simpler product model has been developed for the purpose of the prototype tool where the data representing the building is stored in an object like data structure much similar to the common product models. Therefore, there is no reason why a common product model would not be suitable.

The case studies show that the performance requirements in many cases have a large influence on the optimal solution. This shows that the prototype tool is able to handle quite complex design problems where it is not obvious how the choices in the design process influence the performance of the building.

Chapter 13

Conclusion

The purpose of this project is to develop a building design methodology that supports optimization of building designs in the early stages of the design process. The purpose of building design optimization is to reach a cost effective building design with good performance. This means that the optimal building design in a given case must fulfill requirements expressed by the society and the user of the building at minimal cost. The evaluation of cost is based on life cycle cost calculations and the optimization is performed with respect to other performance aspects such as energy use, indoor environment and daylight conditions.

Many aspects of the overall building performance depend on decisions in the early stage of the design process. These decisions are often made with only little consideration to important performance aspects such as energy use, indoor environment and life cycle cost. This is a result of the traditional organization of building projects where the building design is decided by the consultants and the building owner before the costs and detailed solutions are negotiated with the contractors, manufacturers and suppliers. To be able to assess the performance and monitor cost during the design process it is necessary for the consultants and the building owner to cooperate with the contractors, manufacturers and suppliers from the early stage of the design process.

The desired performance of the building is based on an early identification of the needs expressed by the user and the society. The needs are often expressed as basic functional needs and must be translated into measurable performance requirements that make evaluation and comparison of different building designs possible. The building owner and the building designer formulate the performance requirements and the task of the building designer is to design a building that fulfills the performance requirements. Many aspects related to the physical, energetical and environmental performance of a building design such as cost and durability of building components, energy use for heating, cooling, ventilation, lighting, and equipment, and shape and orientation of the building influence the life cycle cost. Therefore, the life cycle cost may be used as an objective measure of the overall building performance. Still aspects such as thermal indoor environment and daylight conditions are difficult to associate directly with cost. These aspects must be handled individually by imposing additional performance requirements. E.g. the requirement for thermal indoor environment may be given as a limit on the number of hours during the year where thermal discomfort is acceptable and the requirement for daylight may be based on a minimum daylight

utilization.

Performance assessment of different building designs requires the use of computer simulation. A large number of design tools that use computer simulation have been developed to assess aspects of building performance at different stages in the design process. With few exceptions, the existing design tools are used to evaluate the consequences of a particular building design but are generally unable to suggest a particular design solution. The design tools are therefore of limited value to designers who are unable to compare alternative approaches because they lack time for manual parameter variations or in complex cases where it is not straight forward for the designer to locate the possible improvements. Using design tools, problem definition and parameter variations can be very time consuming. Also analyzing many parameter variations may not result in the optimal solution, as the influence of different design parameters on the performance can be difficult to understand. Automatic optimization can replace manual variation of different design variables and save the building designer a lot of work and at the same time guide the building designer towards a cost effective building design with good performance.

Evaluation of the thermal indoor environment is based on hourly values of the indoor air temperature. This requires a dynamic thermal model of the building that calculates temperatures and energy flows. The calculations are performed in the early stage of the design process where the building design is described by a limited amount of information. To optimize the building design, the life cycle cost, energy demand, indoor air temperatures and daylight conditions are evaluated for many possible design solutions. Each evaluation requires a yearly simulation of the thermal performance and the computational time of each simulation run influences the overall time used on the optimization. To limit the computational time, a simple thermal model of the building has been developed that calculates the indoor air temperature and energy demands based on a simple description of the building and takes into account the outdoor environment, the thermal properties of the constructions and control strategies for HVAC systems. Compared to a detailed design tool for building energy analysis the simplified model gives reasonable results for the heating and cooling demands. The daily temperature profiles show a similar behavior but the calculated temperature levels differ. This results in different assessment of the thermal indoor environment using the detailed and simplified models. European standards are being developed to evaluate the thermal performance of buildings and the simplified model may be improved in the future by applying the calculation procedures in the standards.

To optimize the building design an automatic optimization method is needed. The optimization is performed based on assessment of life cycle cost, energy use, thermal indoor environment and daylight conditions. The function evaluating these values use hourly simulations of energy demand and indoor air temperature. Therefore, the optimization method cannot benefit from any analytic information or derivatives of the function. Both continuous and discrete design variables describe the building design. This type of optimization problem is often referred to as a mixed integer non-linear optimization problem and several optimization methods have been developed to handle this type of optimization problems.

Systematic optimization methods are mathematical rigorous and guaranties to find the optimum with a predictable amount of work. The guarantee is weak and does not ensure that the method is efficient, but it guarantees the absence of systematic de-

iciencies that prevent finding an optimum. The systematic methods are not always easy to apply to real design problems. The difficulties have led to heuristic methods that are more intuitive. These methods are often stochastic, lack formal mathematical foundation and a solution cannot always be guaranteed. Compared to the systematic methods heuristic methods are often easier to implement and are able to handle a wide range of problems often associated with design optimization problems such as discrete design variables, non-differentiable and non-continuous objective functions and situations with many constraints.

A building design methodology is suggested that support optimization of building designs in the early stage of the design process. Based on the design methodology a computer tool is developed that helps the designers optimize the building design in the early stage of the design process. The designer and the building owner identify the initial demands and wishes. Based on this the designer defines the geometric parameters, sets of alternative building components and performance constraints that constitute the solution space for the design problem. A heuristic optimization algorithm is applied to find the geometry and mix of building components that gives the optimal solution.

The design methodology implemented in the prototype tool is tested on two case studies. The case studies consider optimization of a room in a one-family house and optimization of office rooms in a multi storey office building. Several alternatives of different building components are described and may be selected from a building components database.

The case studies show that the performance requirements have a large influence on the optimal solution. This shows that the prototype tool is able to handle quite complex design problems where it is not obvious how the choices in the design process influence the performance of the building.

Building components are described in a building component database. This makes it easy for the designer to choose the different alternative constructions and systems that are included in the design optimization.

The use of the design tool in the early stages of the design process depends on access to a building component database with reliable properties of building components. If this is not the case the designer has to collect data from contractors, suppliers and manufacturers to create a building component database. This would be too time consuming to be included in the early stages of the design process. It could be argued that the data used to develop the building component database only has to be collected once to get a database that could be used in several building projects. But considering the large amount of products on the market, this would be a huge task for the designer and the database would have to be updated as the prices change and new products are put on the market.

Based on this work it can be concluded that it is possible to develop design tools that are useful in the early stage of the design process and helps the building designer minimize the life cycle cost of the building design with respect to energy and indoor environment.

Bibliography

- Al-Homoud, M. S. (1997). Optimum thermal design of air-conditioned residential buildings, *Building and environment* **32**(3): 203–210.
- Ali, M. M., Törn, A. and Viitanen, S. (2002). A direct search variant of the simulated annealing algorithm for optimization involving continuous variables, *Computers & Operations Research* **29**: 87–102.
- ASHRAE (1992). ASHRAE 55-1992 Thermal environment conditions for human occupancy, *ASHRAE Standard*, American Society of Heating, Refrigeration and Air-Conditioning Engineers, Atlanta, USA.
- ASTM (1993). E917-93 Standard Practice for Measuring Life-Cycle Costs of Buildings and Building Systems, *ASTM Standard*, American Society for Testing and Materials, PA, USA.
- Bagatin, M., Caldon, R. and Gottardi, G. (1984). Economic optimization and sensitivity analysis of energy requirements in residential space heating, *Energy research* **8**: 127–138.
- Björkman, M. and Holmström, K. (1999). Global optimization using the direct algorithm in matlab, *AMO - Advanced Modeling and Optimization* **1**(2): 17–37.
- Bliek, C., Spellucci, P., Vicente, L. N., Neumaier, A., Granvilliers, L., Monfroy, E., Benhamou, F., Huens, E., van Hentenryck, P., Sam-Haroud, D. and Faltings, B. (2001). COCONUT Deliverable D1 Algorithms for Solving Nonlinear Constrained and Optimization Problems: The State of the Art.
URL: <http://www.mat.univie.ac.at/neum/glopt/coconut/StArt.html>
- BR (1995). *Building regulations 1995*, Danish Ministry of Housing, Danish Building and Housing Agency, Copenhagen, Denmark.
URL: <http://www.boligministeriet.dk/uk/pub/bygregl/bygregl2.pdf>
- CEN (1997a). CEN/TC 89 WI 37 Thermal performance of buildings - Calculation of energy use for heating, *EN ISO Work item*, European Committee for Standardization, Brussels.
- CEN (1997b). CEN/TC 89 WI 40.1 Thermal performance of buildings - Room cooling load calculation - General criteria for a simplified calculation method, *EN ISO Work item*, International Standards Organization, Brussels.

BIBLIOGRAPHY

- CEN (1997c). EN 673 Glass in buildings - Determination of thermal transmittance (U value) - Calculation method, *EN Standard*, European Committee for Standardization, Brussels.
- CEN (1997d). prEN ISO 10077-1 Thermal performance of windows, doors and shutters - Calculation of thermal transmittance - Part 1: Simplified method, *EN ISO pre-Standard*, European Committee for Standardization, Brussels.
- CEN (1998a). CR 1752 Ventilation for buildings - Design criteria for the indoor environment, *CEN Report*, European Committee for Standardization, Brussels.
- CEN (1998b). EN 410 Glass in buildings - Determination of luminous and solar characteristics of glazing, *EN Standard*, European Committee for Standardization, Brussels.
- CEN (1998c). EN 832 Thermal performance of buildings - Calculation of energy use for heating - Residential buildings, *EN ISO Standard*, European Committee for Standardization, Brussels.
- CEN (1999). EN ISO 13786 Thermal performance of building components - Dynamical thermal characteristics - Calculation methods, *EN ISO Standard*, European Committee for Standardization, Brussels.
- CEN (2000a). prEN ISO 10077-2 Thermal performance of windows, doors and shutters - Calculation of thermal transmittance - Part 2: Numerical methods for frames, *EN ISO pre-Standard*, European Committee for Standardization, Brussels.
- CEN (2000b). prEN ISO 13791 Thermal performance of buildings - Calculation of internal temperatures of a room in summer without mechanical cooling - General criteria and validation procedures, *EN ISO pre-Standard*, European Committee for Standardization, Brussels.
- CEN (2000c). prEN ISO 13792 Thermal performance of buildings - Calculation of internal temperatures of a room in summer without mechanical cooling - Simplified calculation methods, *EN ISO pre-Standard*, European Committee for Standardization, Brussels.
- Christoffersen, J., Petersen, E. and Johnsen, K. (1999). Tools for analysis of daylight in buildings (danish title: Beregningsværktøj til analyse af dagslysforhold i bygninger), *SBI Rapport 277*, Danish Building and Urban Research, Hørsholm, Denmark. In Danish.
- Danish Energy Agency (2000). *Energy Statistics 2000 (Danish title: Energistatistik 2000)*, Danish Energy Agency, Copenhagen, Denmark. In Danish.
URL: <http://www.ens.dk/uk/statis.htm>
- DS (1993). DS 474 Specification of thermal indoor environment (Danish title: Norm for specifikation af termisk indeklima, *Technical report*, Dansk Standard, Copenhagen, Denmark. In Danish.

- Fisk, W. and Rosenfeld, R. (1998). The indoor environment... Productivity and health... and \$\$\$, *Strategic Planning for Energy and the Environment* **17**(4): 53–59.
- Føllesdal, D., Walløw, L. and Elster, J. (1999). *Politikens book on modern theory of science (Danish title: Politikens bog om moderne videnskabsteori)*, Politikens forlag, Copenhagen, Denmark. In Danish.
- Gonzalez-Monroy, L. and Cordoba, A. (2000). Optimization of energy supply systems with simulated annealing: continuous and discrete descriptions, *Physica A* **284**: 433–447.
- Gustafsson, S.-I. (1998a). Mixed integer linear programming and building retrofits, *Energy and Buildings* **28**: 191–196.
- Gustafsson, S.-I. (1998b). Sensitivity analysis of building energy retrofits, *Applied Energy* **61**: 13–23.
- Hendricks, V. F., Jakobsen, A. and Pedersen, S. A. (2002). Identification of matrices in science and engineering, *Journal of general philosophy of science* **31**: 277–305.
- Hendriks, L. and Hens, H. (2000). Building Envelopes in a Holistic Perspective - Methodology, *Technical report*, Laboratorium Bouwfysica, K.U. Leuven, Leuven, Belgium.
- Høgsted, M., Dalum, B., Bang, H., Clausen, L., Brandt, E. and Østergaard, P. H. (1999). *Process and product development in the building industry: Experiences and results (Danish title: Process- og produktudvikling i byggeriet: Erfaringer og resultater)*, Erhvervsfremme Styrelsen, Copenhagen, Denmark. In Danish.
- Holm, D. (1993). Building thermal analysis: What the industry needs: The architect's perspective, *Building and Environment* **28**(4): 405–407.
- Holmström, K., Björkman, M. and Dotzauer, E. (1999). Tomlab v1.0 user's guide, *Technical Report IMA-TOM-1999-01*, Center for Mathematical Modeling, Department of Mathematics and Physics, Mälardalen University, P.O. Box 883, SE-721 21 Västerås, Sweden.
URL: <http://www.tomlab.biz/>
- Horst, R. and Pardalos, P. M. (eds) (1995). *Handbook of Global Optimization*, Kluwer Academic Publishers, Netherlands.
- IAI (2002).
URL: <http://iaiweb.lbl.gov>
- ISO (1993). ISO 10303 Standards for the Exchange of Product Model Data, *ISO Standard*, International Standards Organization, Geneva, Switzerland.
- ISO (1994). ISO EN 7730 Moderate thermal environments - Determination of the PMV and PPD indices and specification of conditions for thermal comfort, *ISO EN Standard*, International Standards Organization, Geneva, Switzerland.

BIBLIOGRAPHY

- ISO (1998). ISO/DIS 15686-1 Buildings - Service life planning - General principles, *ISO/DIS Standard*, International Standards Organization, Geneva, Switzerland.
- ISO (1999). ISO/FDIS 15099 Thermal performance of windows, doors and shading devices - Detailed calculations, *ISO/FDIS Standard*, European Committee for Standardization, Geneva, Switzerland.
- Jensen, J. M. and Lund, H. (1995). Design reference year, DRY - A new Danish reference year (Danish title: Design reference year, DRY - Et nyt dansk referenceår, *Meddelelse 281*, LfV, Technical University of Denmark, Lyngby, Denmark. In Danish.
- Jones, D. R., Schonlau, M. and Welch, W. J. (1998). Efficient global optimization of expensive black-box functions, *Journal of Global Optimization* **13**: 455–492.
- Jurovics, S. A. (1978). Optimization applied to the design of an energy-efficient building, *IBM Journal of Research and Development* **22**(4): 378–385.
- Kalema, T. (1998). Optimisation of the thermal insulation of a building envelope - the optix program, *Technical report*, Institute of Energy Engineering, Tampere University of Technology.
- Karlsson, J. and Roos, A. (2000). Modelling the angular behaviour of the total solar energy transmittance of windows, *Solar Energy* **69**(4): 321–329.
- Kragh, H. and Pedersen, S. A. (1991). *Theory of natural science (Danish title: Naturvidenskabens teori)*, Nyt nordisk forlag Arnold Busck, Copenhagen, Denmark. In Danish.
- Kragh, J., Eriksen, S. and Svendsen, S. (2002). Thermal characterisation of edge construction in glazings, in A. Gustavsen and J. V. Thue (eds), *Proceedings of the 6th Symposium on Building Physics in the Nordic Countries*, Norwegian University of Science and Technology, Trondheim, Norway, pp. 127–134.
- Leaman, A. and Bordass, B. (1999). Productivity in buildings: the killer variables, *Building Research & Information* **27**(1): 4–19.
- Lorsch, H. G. and Abdou, O. A. (1994a). The impact of the building indoor environment on occupant productivity – part 1: Recent studies, measures, and costs, *ASHRAE Transactions* **100**(2): 741–749.
- Lorsch, H. G. and Abdou, O. A. (1994b). Impact of the building indoor environment on occupant productivity - part 2: effects of temperature, *ASHRAE Transactions* **100**: 895–901.
- Marks, W. (1997). Multicriteria optimisation of shape of energy-saving buildings, *Building and Environment* **32**(4): 331–339.
- MathWorks (2000). *Matlab 6*, The MathWorks Inc., 3 Apple Hill Drive, Natick, MA 01760-2098, USA.
URL: <http://www.mathworks.com>

- McKenzie, K. E. and McKenzie, C. J. (1996). Can we engineer a more productive built environment?, *Mechanical Incorporated Engineer* **8**: 45–48.
- Peippo, K., Lund, P. D. and Vartiainen, E. (1999). Multivariate optimization of design trade-offs for solar low energy buildings, *Energy and Buildings* **29**: 189–205.
- Perez, R., Ineichen, P., Seals, R., Michalsky, J. and Stewart, R. (1990). Modeling daylight availability and irradiance components from direct and global irradiance, *Solar Energy* **44**: 271–289.
- Rudbeck, C. (1999). *Methods for Designing Building Envelope Components Prepared for Repair and Maintenance*, PhD thesis, Technical University of Denmark, Lyngby, Denmark.
URL: <http://www.ibe.dtu.dk/publikationer/publikationer.htm>
- Rudbeck, C. and Rose, J. (1999). Characterization of systems for external insulation and retrofitting with emphasis on the thermal performance, *Proceedings of the 5th Symposium on Building Physics in the Nordic Countries*, Chalmers University of Technology, Göteborg, Sweden, pp. 441–448.
- SBI (1994). *tsbi3. Computer program for thermal simulation of buildings. User's Guide.*, Danish Building and Urban Research, Hørsholm, Denmark.
- SBI (1995). *Energy demands in buildings (Danish title: Bygningers energibehov)*, Danish Building and Urban Research, Copenhagen, Denmark.
- Scharmer, K. and Greif, J. (2000). *The European Solar Radiation Atlas. Vol. 2*, Ecole des Mines, Paris, France.
- Sensharma, N. P. (1998). Relationships between the indoor environment and productivity: A literature review, *ASHRAE Transactions* **104**: 686–701.
- Svendsen, S. (1997). Optimal insulation of building envelope constructions (Danish title: Optimal isolering af klimaskærmskonstruktioner, *Internal Report SR-9709*, Department of Buildings and Energy, Technical University of Denmark, Building 118, DK-2800 Kgs. Lyngby, Denmark. In Danish.
- Svendsen, S., Rudbeck, C., Stopp, H. and Mäkelä, H. (2000). *Development and Optimisation of Building Envelopes for Existing and New Buildings*, Laboratorium Bouwfysica, K.U. Leuven, Leuven, Belgium.
- Tommerup, H. M., Munch-Andersen, J. and Esbensen, P. K. (2000). Development of Building Envelope Constructions. (Danish title: Udvikling af klimaskærmskonstruktioner), *Report R-042*, Department of Buildings and Energy, Technical University of Denmark, Building 118, DK-2800 Kgs. Lyngby, Denmark. In Danish.
- van Dijk, D. (2001). Reference office for thermal, solar and lighting calculations, *Draft*, TNO Building and Construction research, Delft, The Netherlands.
- V&S (2000). *Price catalogues (Danish title: Prisbøger)*, V&S Byggedata, Brønshøj, Denmark. In Danish.

BIBLIOGRAPHY

- Wetter, M. (2000). GenOpt. Generic optimization Program, *Technical report*, Lawrence Berkeley National Laboratory, Berkeley, CA 94720, USA.
URL: <http://gundog.lbl.gov/GO/index.html>

Appendices

Appendix A

Article in LEAS

The article "Optimization of buildings with respect to energy use, thermal indoor environment and daylight" accepted for publication in the electronic journal International Journal of Low Energy and Sustainable Buildings ¹ is reproduced on the following pages.

¹<http://bim.ce.kth.se/byte/leas/>

Life cycle cost optimization of buildings with regard to energy use, thermal indoor environment and daylight

SUBMITTED: Jun 2001

REVISED: Jul 2002

ACCEPTED:

Toke R Nielsen

*Department of Civil Engineering, Technical University of Denmark, Lyngby, Denmark
trn@byg.dtu.dk*

Svend Svendsen

*Department of Civil Engineering, Technical University of Denmark, Lyngby, Denmark
ss@byg.dtu.dk*

KEYWORDS: *optimization, life cycle cost, building performance, building design, cost functions*

SUMMARY:

Buildings represent a large economical investment and have long service lives through which expenses for heating, cooling, maintenance and replacement depends on the chosen building design. Therefore, the building cost should not only be evaluated by the initial investment cost but rather by the life cycle cost taking all expenses in the buildings service life into consideration. Also the performance of buildings is important as the performance influences the comfort of the occupants, heating demand etc. Different performance requirements are stated in building codes, standards and by the customer. The influence of different design variables on life cycle cost and building performance is very complicated and the design variables can be combined in an almost unlimited number of ways. Optimization can be applied to achieve a building design with low life cycle cost and good performance. This paper discusses performance optimization and outlines an optimization method based on minimization of the life cycle cost constrained by performance requirements. Many different performance requirements can be included in the optimization. The performance requirements discussed in this paper are heating demand, thermal indoor environment and daylight. To illustrate the optimization method it is applied to performance optimization of an office room. The example shows that optimization is a valuable tool in the building design process.

1 Introduction

Buildings represent a large economical investment and consume a large amount of energy. People spend much time indoors and are therefore influenced by the indoor environment of the buildings they occupy. Poor indoor environment has a negative influence productivity and health. Therefore, society regulates many aspects concerning buildings through building codes, standards and other legislation to ensure that certain requirements are fulfilled. The requirements in the building codes, standards and the wishes of the customer must be considered when designing buildings. The building designer has a large degree of freedom but is bounded by demands that must be fulfilled in a cost effective way. In a building design an almost unlimited number of design variables can be varied. Proper performance evaluation of different designs may require the use of computer simulation where problem definition and parameter variations can be very time consuming. Analyzing many parameter variations manually may not result in the optimal solution, as the influence of different design variables on the performance can be difficult to understand. Optimization can replace manual variation of different design variables and save the building designer a lot of work and at the same time guide the building designer towards a cost effective building design with good performance.

Both analytical and numerical approaches have been applied to solve problems concerning building design optimization. Analytical approaches express the function to optimize as a differentiable function of the design

variables and find the minimum or maximum by differentiation. These approaches have been applied to optimize construction parameters to achieve minimal thermal loads (Jurovics, 1978) and to optimize insulation thickness to minimize costs (Bagatin et. al., 1984). Numerical optimization techniques use algorithms of different kinds to find the optimal solution. The OPTIX model is developed in Microsoft Excel to optimize the energy economy of buildings and uses its Solver for optimization (Kalema, 2001). Multivariate optimization has been applied to minimize cost for of solar low energy buildings (Peippo et. al., 1999), mixed integer linear programming has been applied to optimize costs for building retrofits (Gustafsson, 1998a; Gustafsson, 1998b), direct search algorithms have been applied to minimize the annual energy consumption for heating and cooling (Al-Homoud, 1997), genetic algorithms have been applied to optimize building heating systems (Dickinson and Bradshaw, 1995) and to optimize general building systems (Loomans and Visser, 2000) and simulated annealing has been applied to select the best way to fulfill different energy demands using different transformations and storage devices (Gonzalez-Monroy and Cordoba, 2000).

The previous work only optimizes the building with respect to one aspect of the building performance for instance the life cycle cost. This does not guarantee an acceptable performance regarding other aspects such as thermal indoor environment and daylight conditions. The objective of the work presented in this paper is to minimize the life cycle cost of buildings taking into account other performance aspects. Performance aspects other than the life cycle cost must fulfill minimum requirements. The requirements are based on building codes, standards and recommendations. Minimum requirements for energy use, thermal indoor environment and daylight conditions are considered. Evaluation of the building performance is based on computer simulation and properties of building components are given in a database.

In this article the performance requirements and mathematical models used for performance evaluation are described. Furthermore an optimization method is presented and applied to performance optimization of a room in an office building.

2 Performance requirements

Building activities can normally be divided into the following phases (Hendriks and Hens, 2000).

- Customer's signaling of need.
- Identification and description of requirements
- Functional requirements translation. Design and performance optimization.
- Construction/retrofitting of building.
- Assessment of performance.
- Transfer of building to customer.
- Building use.

This work concentrates on performance optimization and therefore considers the first three phases. To aid the functional requirements translation Hendriks and Hens (2000) compiled a list containing a substantial amount of design considerations.

The performance requirements considered in this work are heating demand for space heating and ventilation, thermal comfort, daylight level and life cycle cost. Many other performance requirements such as fire safety, stability, indoor air quality and environmental issues must also be addressed, but are left out in this work. Based on building codes, standards and wishes of the customer the functional requirements are described.

2.1 Heating demand for space heating and ventilation

To limit the energy used for space heating and ventilation many building codes include limitations concerning the heating demand. The heating demand is often regulated by limits on the heat transfer coefficients of the building components or a heating demand limit. In this work the heating demand for space heating and ventilation must fulfill the requirements in the Danish building code (Danish Ministry of Housing, 1995), which states a limit on the heating demand.

2.2 Thermal comfort

The thermal indoor environment influences the thermal comfort of the occupants in the building and discomfort has a negative influence on productivity and health. Many investigations of the link between thermal indoor environment and productivity have been made, but it is difficult to quantify the influence in order to translate thermal indoor environment into a change in productivity (Leaman and Bordass, 1999;Lorsch, 1994).

Different working conditions require different thermal indoor environments to avoid thermal discomfort. A way to evaluate a thermal indoor environment is to calculate for how many hours the indoor temperature exceeds a given limit. In a Danish standard it is recommended that the indoor temperature does not exceed 26 °C for more than 100 hours during the year in a normal office building (Dansk Standard, 1993).

2.3 Daylight level

To obtain visual comfort in a room a sufficient lighting level is necessary, glare should be avoided and visual contact with the outdoor environment should be possible. Daylight and artificial light can be applied to achieve a sufficient lighting level. Occupants in a building wish a certain level of daylight and it is recommended that the average daylight factor is above 2% to assure a reasonable daylight level (Christoffersen et. al., 1999).

2.4 Life cycle cost

The single most important factor in building design is cost. Often the cost of a building is only evaluated based on the investment cost without taking into account running costs. Initiatives that reduce the running costs often result in higher investment costs e.g. because of extra insulation or more durable building components. To evaluate different building designs the running costs should be included in the evaluation, and the cost evaluation of the building design should be based on the life cycle cost. The life cycle cost can be evaluated using net present value calculations where future costs are discounted to the present. Life cycle cost includes investment costs, running costs, replacement costs and scrap value.

Many aspects of the building performance can be included in the life cycle cost calculation. Energy consumption for heating, ventilation and artificial lighting and maintenance costs are included in the running cost. The service life depends on durability aspects and influence replacement and scrap value of building components.

3 Performance evaluation

To evaluate the performance of a building the thermal environment, daylight level, heating demand, electrical energy consumption and life cycle cost must be evaluated. In a situation with many design variables the number of automatic design variations evaluated by the optimization algorithm is large. To keep the computational time of an optimization run at a minimum simple mathematical models are used to evaluate the performance.

3.1 Thermal simulation

The thermal performance is evaluated on an hourly basis based on a simple thermal room model. The thermal mass in the room is represented by one heat capacity calculated as the sum of the effective heat capacities of the internal surfaces. The heat capacities of the internal surfaces are calculated in accordance with EN 13786 (European committee for standardization, 1999). No heat loss from the thermal mass to the outdoor environment is assumed. The outdoor temperature and solar radiation are based on hourly values from a reference year. The network diagram in Fig. 1 show an electric analogy to the thermal room model.

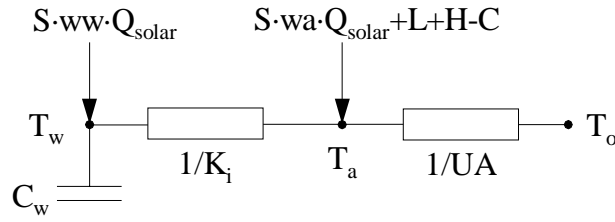

FIG. 1: Network analogy of thermal model. The thermal mass of the room is represented by one heat capacity. The temperature in the thermal mass depends on the solar energy absorbed on internal surfaces and the indoor air temperature. The indoor air temperature is calculated based on a heat balance of the loads in the room and the heat transfer to the thermal mass and the outdoor environment.

The equations given below define the problem and are solved analytically to get hourly values for indoor air temperature, heating load and cooling load.

$$C_w \cdot \frac{dT_w}{dt} = K_i \cdot (T_a - T_w) + S \cdot ww \cdot Q_{solar} \quad (1)$$

$$0 = K_i \cdot (T_w - T_a) + UA \cdot (T_o - T_a) + S \cdot wa \cdot Q_{solar} + L + H - C$$

with heat capacity of the room C_w , temperature in thermal mass T_w , outdoor air temperature T_o , indoor air temperature T_a , heat transfer coefficient to heat capacity K_i , shading factor for variable shading S , fraction of transmitted solar energy absorbed in the air wa , fraction of transmitted solar energy absorbed in the thermal mass ww , solar radiation transmitted through windows Q_{solar} , total heat transfer coefficient to outdoor air (transmission and ventilation) UA , thermal load in room L , heating load H and cooling load C .

The solar radiation transmitted through the windows is calculated based on the incident direct, diffuse and reflected solar radiation on the window surface. The total solar energy transmittance for direct radiation is corrected with regard to the incidence angle and shades from near and far fixed objects. The total solar energy transmittance for diffuse and reflected radiation is multiplied by a diffuse transmittance correction factor but is not corrected for shades. The transmitted solar energy, Q_{solar} , is found as

$$Q_{solar} = g \cdot (f_s \cdot E_{dir} \cdot (1 - \tan^p(i/2)) + f_d \cdot (E_{dif} + E_{ref})) \quad (2)$$

with total solar energy transmittance at normal incidence g , shading correction factor f_s , factor adjusting the total solar energy transmittance for diffuse solar radiation f_d , diffuse solar radiation on surface E_{dif} , direct solar radiation on surface E_{dir} , reflected solar radiation on surface E_{ref} , incidence angle of solar radiation i (in deg) and factor on the dependency of the incidence angle p .

To control the indoor air temperature different possibilities exist. The heating load in a time step is calculated so the indoor air temperature never is below the set point temperature for heating. To avoid high indoor air temperatures different control strategies can be applied. Solar shading, venting and cooling can be applied in order to control the indoor temperature. If all three controls are active they will be applied in the following order: solar shading, venting and cooling.

3.2 Daylight calculation

The daylight level in the room is evaluated using an average daylight factor, DF_{avg} (Christoffersen et. al., 1999)

$$DF_{avg} = \frac{W \cdot M \cdot \tau \cdot \theta}{A \cdot (1 - R^2)} \quad (3)$$

with total glazing area in the room W , correction factor for dirt on the glazing M , visual transmittance of the glazing τ , angle to the visible part of the sky (in deg) θ , total internal surface area of the room A and mean reflectance of the room surfaces R .

The illuminance in the room is evaluated by hourly values of the outdoor global illuminance, I_h , from the reference year. The average illuminance in the room, I_{avg} , is found as

$$I_{avg} = DF_{avg} \cdot I_h \quad (4)$$

3.3 Energy demand

The energy demand for heating, E_{heat} , is found by the hourly heating loads from the thermal simulation divided by the efficiency of the heating system

$$E_{heat} = \frac{\sum H \cdot I_h}{\eta} \quad (5)$$

with heating load H and efficiency of heating system η .

The electric energy consumption, $E_{electricity}$, is the hourly sums of energy for cooling, mechanical ventilation and lighting

$$E_{electricity} = \frac{\sum C \cdot I_h}{COP} + \frac{\sum V \cdot q_v \cdot I_h}{\varepsilon} + \sum P \cdot I_h \quad (6)$$

with cooling load C , coefficient of performance of cooling system COP , specific energy for mechanical ventilation V , volume flow of ventilation air q_v , electric efficiency of ventilation system ε and power for artificial lighting P .

The electricity for artificial lighting is evaluated by the average illuminance, I_{avg} . Within the hours the building is in use the artificial lighting consumes 2 W/m^2 when the illuminance in the room falls below 500 lux and an additional artificial lighting consumption of 5 W/m^2 is added when the illuminance in the room falls below 100 lux .

3.4 Life cycle cost

The life cycle cost is calculated based on investment cost, running cost, replacement cost and scrap value. If the service life of a building component is lower than the calculation period replacements occur at intervals equal to the service life. The scrap value at the end of the calculation time is based on a linear depreciation of the investment or the last replacement cost.

$$lcc = \left(\sum_{n=0}^{N/SL} I_c \cdot (1+r)^{-n \cdot SL} \right) + (Mc + Ec) \cdot \frac{1 - (1+r)^{-N}}{r} - Sv \cdot (1+r)^{-N} \quad (7)$$

with life cycle cost lcc , yearly energy cost Ec , investment cost Ic , yearly maintenance cost Mc , scrap value Sv , service life SL , real interest rate r and calculation period N .

4 Optimization method

A performance assessment methodology has been developed and proposes an overall quality score, which allows comparison of different designs using a single value (Hendriks and Hens, 2000). But it is still unresolved how a set of performance requirements leads to an overall quality score. Therefore, the overall building performance cannot as yet be evaluated using a single value in a reliable way and must therefore rely on an evaluation of a number of different performance requirements.

Optimization is used to find minima or maxima of an objective function. Because the performance cannot be assessed by a single value, the optimization must take into account multiple criterions. In this work the life cycle cost is used as the objective function to be minimized whereas the other performance requirements are used as constraints that must fulfill certain limits. The design variables are all bounded by upper and lower limits. Further more, many of the design variables are represented by integer values. This gives a global mixed-integer non-linear optimization problem.

The optimization problem may be expressed as follows:

$$\begin{array}{llll}
 \text{Minimize} & f(\mathbf{x}) & & \text{objective function} \\
 \text{Subject to} & g_k(\mathbf{x}) \leq 0, & k=1,2,\dots, n_k & \text{constraints} \\
 & x_i^l \leq x_i \leq x_i^u, & i=1,2,\dots, n & \text{bounds}
 \end{array} \quad (8)$$

where $\mathbf{x} = x_1, x_2, \dots, x_n$ are design variables, n_k is the number of constraints, n is the number of design variables; and x_i^l, x_i^u are lower and upper bounds on a design variable, x_i .

The design variables are a mixture of continuous and discrete variables, and the objective function and the functions evaluating the performance are non-linear functions of the design variables. Furthermore, the discrete design variables describe both ordered and categorical quantities. Ordered discrete quantities represent parameters where a discrete increase in the parameter is represented by increasing an integer value thus giving a smooth translation between the discrete quantity and the parameter it represents. Categorical discrete quantities represent parameters where different integer values e.g. represents different types of constructions. Especially the categorical quantities make the optimization difficult. To perform the optimization different algorithms are used to find the optimal values for the discrete and continuous design variables. Simulated annealing (Gonzalez-Monroy and Cordoba, 2000) is used for optimization of the discrete design variables. Simulated annealing is a stochastic method for global optimization and can be compared to the process when a molten material is cooled and form crystals, hence the term annealing. More regular crystals will be formed when the molten material is cooled slowly, and given sufficient time the molecules will end up having minimum internal energy. In simulated annealing the objective function can be compared to the internal energy and the cooling process can be compared to the way the solution is updated. To optimize the continuous design variables a Hooke-Jeeves pattern search is used (Wetter, 2000). The Hooke-Jeeves method generates steps along the valley of the objective function by assuming it is worthwhile to make further exploration in a direction that was successful in previous steps. The method starts with an exploratory move with small orthogonal steps in each direction from the starting point. After exploring each direction, it assumes that it is likely to get a further improvement in the direction that results from previous successful explorations and makes a further step in this direction. This results in a new point from where a new exploratory move in each direction is performed. This ensures that the search stays in the valley of the objective function. If no further improvement can be achieved, the algorithm restarts from the last successful base with smaller exploratory steps. Otherwise, it takes another step in the resulting direction, followed by exploratory steps.

5 Case study of office room

In office buildings the internal heat gain is often high due to a high density of people and equipment per floor area. Furthermore, a reasonable lighting level at the workplaces is needed. The high internal heat gains often make solar energy gain unwanted, whereas a high transmittance of sunlight is wanted to utilize daylight and save electrical energy for artificial lighting. Often a change in design that limits solar energy gain also limits the transmitted sunlight. Therefore, obtaining both a good thermal and visual indoor environment is a complicated problem. To address this problem performance optimization is performed on a room in an office building. Different building designs can be obtained by combining different types of building components and variations thereof. The design variables considered in this example are given below.

- Outer wall insulation thickness
- Ceiling insulation thickness
- Floor insulation thickness
- Type of window frame
- Type of glazing
- Window fraction of the facade area
- Ventilation system
- Variable shading
- Cooling

All design variables except the window fraction of the facade area are discrete parameters representing different building components, and the data describing the different building components are taken from a database. Appendix A shows the contents of the database used in this example.

A box represents the room with one window in the facade. One wall, the ceiling and the floor face the outdoor environment whereas the three other walls are inner walls. The room is located in an office building that is used 5 days a week from 6 o'clock in the morning till 7 o'clock in the evening. Geometry, internal heat gain, air change rates and set points for heating and cooling are listed in Table. 1. The energy prices are given in Table. 2. The life cycle cost is calculated for a period of 30 years and the real interest rate is assumed to be 2%.

TABLE. 1 Design parameters defining geometry, internal heat gain, air change rates and set points for heating and cooling of the office room considered in the case study. Ventilation rates, internal heat gain and set points depend on whether the building is in use or not.

Design parameter	Value	
	In use	Not in use
Length		5 m
Width		5 m
Height		2.5 m
Minimal infiltration rate		0.1 h ⁻¹
Maximal venting rate		4 h ⁻¹
Air change rate	2 h ⁻¹	0 h ⁻¹
Internal heat gain	10 W/m ²	0 W/m ²
Heating set point	20 °C	17 °C
Cooling set point	26 °C	-

TABLE. 2 Energy prices for heating and electricity

Energy type	Price [DKK/kWh]
Heating (gas)	0.65
Electricity	1.24

The building design is optimized in three different cases where the orientation of the facade is respectively north, south and west. Variable shading and cooling is not considered at first to isolate the influence of the windows. In all cases the performance requirements in Table. 3 must be fulfilled at the lowest life cycle cost. The results of the optimization are shown in Table. 4. For all three orientations the optimal window fraction is at the lower limit, which gives a window area of 5m². In the office room facing north a glazing with low energy coating is chosen, whereas in the office rooms facing west or south a glazing with solar protection coating is chosen. In all cases the number of hours the temperature exceeds 26 °C is close to the acceptable limit of 100 hours.

TABLE. 3 Performance requirements. Evaluation of heating demand and thermal comfort are based on yearly simulations with hourly values

Parameter	Requirement
Cost	Minimize the life cycle cost
Heating demand	Must be below 250 MJ/m ²
Thermal comfort	Indoor temperature must not exceed 26°C for more than 100 hours
Daylight Level	Average daylight factor must be above 2%

TABLE. 4 Optimized results for the office room in case of north, south or west facing facade. The results show the optimal value of each design variable, the evaluated performance and life cycle cost for each case. The upper and lower limits on the design variables are shown in the right column. *N: Natural ventilation; M1,M2,M3: Mechanical ventilation with heat recovery (Numbers refer to table in section A.8). **The window fraction refer to the facade area

Orientation	North	South	West	Limits
Outer wall insulation [mm]	250	200	200	125-400
Ceiling insulation [mm]	250	250	250	250-600
Floor insulation [mm]	70	70	100	70-300
Frame type	2	2	2	1-2
Glazing type	3	12	12	1-15
(U/g/τ)	(1.1/0.59/0.75)	(1.0/0.30/0.62)	(1.0/0.30/0.62)	
Window fraction ** [%]	40	40	40	40-90
Ventilation	M3	M3	M3	N/M1/M2/M3
Heating demand [MJ/m ²]	163	147	156	≤250
Hours above 26°C	100	97	100	≤100
Average daylight factor [%]	3.6	3.0	3.0	≥2
Life cycle cost [DKK/m ²]	5469	5639	5704	-

In the case where the office room faces north the window area can be increased without the use of shading devices or cooling. For the office rooms facing west or south the number of hours the temperature exceeds 26 °C is close to the acceptable limit of 100 hours even though the minimal allowed window area, the window type with the lowest glazing area and the glazing with the lowest solar energy transmittance are chosen. This means that if a larger window area is wanted it will be necessary to use glazings with lower solar energy transmittance or some other means e.g. cooling or shading to avoid high indoor temperatures. To see the effect of shading and cooling, optimization is performed on an office room facing south where shading and cooling can be applied. The optimization is performed for three different window areas. The results are shown in Table. 5. Compared to the solution in Table. 4 it is seen that the insulation levels are unchanged and that a glazing with low energy coating, the window frame with the highest glazing area and cooling are chosen. These changes in the solution result in a lower life cycle cost mainly because a less expensive window frame and a less expensive glazing with higher solar energy transmittance and higher solar light transmittance are used. This results in a better utilization of solar energy and a higher daylight factor, which saves energy for heating and artificial lighting. The window fraction is varied from 40% to 60% of the facade area. It is seen that cooling is chosen instead of variable shading and that the life cycle cost and heating demand decrease with increasing window area. The optimized

solution where the window fraction can vary freely is shown in Table 7 for scenario 1. It can be seen that the optimal window fraction of the facade is 75% and the minimal life cycle cost is 5187 DKK/m².

TABLE. 5 Optimal building design for different window areas in south facing office room when shading and cooling can be applied. *N: Natural ventilation; M1,M2,M3: Mechanical ventilation with heat recovery (Numbers refer to table in section A.8). **The window fraction refer to the facade area

Window fraction ** [%]	40	50	60	Limits
Outer wall insulation [mm]	200	200	200	125-400
Ceiling insulation [mm]	250	250	250	250-600
Floor insulation [mm]	70	70	100	70-300
Frame type	1	1	1	1-2
Glazing type	2	2	2	1-15
(U/g/τ)	(1.3/0.66/0.77)	(1.3/0.66/0.77)	(1.3/0.66/0.77)	
Ventilation	M3	M3	M3	N/M1/M2/M3
Cooling	On	On	On	On/off
Shading	Off	Off	Off	On/off
Heating demand [MJ/m ²]	115	111	110	≤250
Hours above 26°C	0	0	0	≤100
Average daylight factor [%]	4.1	5.2	6.3	≥2
Life cycle cost [DKK/m ²]	5250	5219	5203	-

6 Discussion of case study

The case study shows that optimization can be used to minimize the life cycle cost constrained by performance requirements for energy, thermal indoor environment and daylight. The constraints based on the performance requirements must be fulfilled for the solution to be valid, which may result in situations where no solution to the problem exist within the limits on the design variables. In these cases the designer must change the limits on the design variables to get a larger solution space or the performance requirements must be less strict. Still cases may exist where no solution can be found within the limitations. Also, the result of the optimization depends on the problem definitions. Therefore, some parameter variations in the neighborhood of the optimal solution may be valuable to the building designer. Using the optimized solution as a basis for further parameter variations limits the number of parameter variations the designer performs manually opposed to the situation where the building designer starts with no prior knowledge.

In this study the optimal solution is found based on minimizing a single objective function, which in this case is the life cycle cost. The optimization is performed with respect to certain performance requirements that must be fulfilled for the solution to be valid. The optimization procedure does not take into account in what degree the performance requirements are violated. Therefore, solutions that only slightly violate the requirements are ignored and no extra value is given to solutions with better performance than required. This sometimes result in unexpected solutions where e.g. the insulation levels are decreased to avoid to high indoor temperatures. Another optimization approach is to treat the problem as a multicriteria problem where several objective functions are optimized at the same time. In the presence of several objective functions there is generally no solution that simultaneously optimizes all of them, but there is instead a set of efficient solutions where non can be said to be better than another. Formulated as a multicriteria problem the objective could be to minimize life cycle cost, minimize energy consumption, minimize hours with to high indoor temperatures and maximize daylight level.

7 Uncertainty and risk

The calculation of the life cycle cost and evaluation of the performance requirements is subject to uncertainties. The mathematical models described in section 3 are simplified and the differences between the modelled behavior and the real behavior give rise to uncertainties. The life cycle cost is based on information concerning real interest rate, energy prices, and investment cost, maintenance cost and service life of building components.

Investment cost, maintenance cost and service life of building components are very difficult to obtain and therefore uncertain. The future developments of the real interest rate and energy prices are unknown.

To minimize uncertainties caused by the mathematical models they must be validated against measured data. The uncertainties concerning investment cost, maintenance cost and service life of building components can for many well known building components be evaluated by collecting data from the large number of buildings in existence. For newly developed building components an assessment must be used and data must be collected as the designs are implemented in buildings.

The influence from uncertainties can be evaluated using scenarios (Tommerup et. al., 2000). To illustrate the use of scenarios the influence of the energy price is investigated. Table. 6 show the energy prices and economic constants in the two scenarios. The optimized building designs for the two scenarios are found within the same limits on the design variables and with the same performance requirements, so that only the energy price differs. An office room facing south is optimized and the results are shown in Table. 7. Design 1 is the optimized building design for scenario 1 and design 2 is the optimized building design for scenario 2. For each of the building designs the life cycle cost is calculated for each scenario. The life cycle costs for the two building designs are shown in Table. 8. In scenario 1 the extra life cycle cost of choosing design 2 instead of design 1 is 17 DKK/m², whereas in scenario 2 the extra life cycle cost of choosing design 1 instead of design 2 is 29 DKK/m². It is seen that it is possible to be insured against a possible loss of 29 DKK/m² by accepting an extra life cycle cost of 17 DKK/m². This illustrates that the use of scenarios can be used for risk assessment by evaluating different building designs under different future developments. This case shows only a small economical risk, but in other cases the difference might be greater.

TABLE. 6 Energy prices and economic constants in the two scenarios

	Gas price [DKK/kWh]	Electricity price [DKK/kWh]	Calculation period [y]	Real interest rate [%]
Scenario 1	0.65	1.24	30	2
Scenario 2	1.30	2.48	30	2

TABLE. 7 Optimal building design in south facing office room when shading and cooling can be applied. *N: Natural ventilation; M1,M2,M3: Mechanical ventilation with heat recovery (Numbers refer to table in section A.8). **The window fraction refer to the facade area

	Scenario 1	Scenario 2	Limits
Outer wall insulation [mm]	200	250	125-400
Ceiling insulation [mm]	250	250	250-600
Floor insulation [mm]	70	100	70-300
Frame type	1	1	1-2
Glazing type	2	3	1-15
(U/g/τ)	(1.3/0.66/0.77)	(1.1/0.59/0.75)	
Window fraction ** [%]	75	90	40-90
Ventilation	M3	M3	N/M1/M2/M3
Cooling	On	On	On/off
Shading	Off	Off	On/off
Heating demand [MJ/m ²]	108	100	≤250
Hours above 26°C	0	0	≤100
Average daylight factor [%]	7.9	9.3	≥2
Life cycle cost [DKK/m ²]	5187	6023	-

TABLE. 8 The effect of uncertainty regarding the future energy price. Design 1 and 2 are the optimized building designs for scenario 1 and 2 respectively. The life cycle cost in bold face is the minimized life cycle cost for the given scenario

	Scenario 1	Scenario 2
Design 1	5187 DKK/m²	6052 DKK/m ²
Design 2	5204 DKK/M ²	6023 DKK/m²

8 Conclusion

The purpose of the work presented in this paper is to develop a method to optimize buildings that takes into account the overall performance of the building. The goal is to obtain buildings with good performance and low cost. Reaching this goal by manual parameter variations is time consuming and an optimal solution may not be reached, as the interactions between many design variables can be difficult to understand. An optimization procedure that performs automatic parameter variations can replace manual parameter variations. This will lead to better building designs with less work.

An optimization method based on Simulated annealing and a Hooke-Jeeves pattern search is applied to minimize the life cycle cost of buildings taking into account other performance aspects. Minimum requirements for energy use, thermal indoor environment and daylight conditions are identified based on building codes, standards and recommendations and are used as constraints in the optimization. A simplified dynamic model of the building evaluates the thermal performance and properties of building components are given in a database.

A case study is performed to demonstrate the optimization method on a realistic design problem. The case study shows that the minimum requirements for energy use, thermal indoor environment and daylight conditions have a large influence on the optimal solution. Especially the size and type of windows are influenced by the requirements for thermal indoor environment and daylight conditions. This shows that the optimization method is able to handle quite complex design problems where it is not obvious how the choices in the design process influence the performance of the building. The optimal building design depends on the problem definition and must therefore not be used uncritically. The optimized building design should rather be used as a starting point for a few relevant parameter variations that help the building designer obtain the final solution.

The optimization is subject to many different kinds of uncertainties. Much of the uncertainty lies in evaluation of future energy prices and real interest rates, and in obtaining reliable investment costs, maintenance costs and service lives for building components. Uncertainties can be addressed by the use of scenarios. It is shown that scenarios describing different future developments are valuable when evaluating economic risks and can be used for decision-making in the design process.

9 References

- Al-Homoud M.S. (1997). Optimum thermal design of air-conditioned residential buildings, *Building and Environment*, Vol. 32, No. 3, 203-210.
- Bagatin M., Caldon R. and Gottardi G. (1984). Economic optimization and sensitivity analysis of energy requirements in residential space heating, *Energy Research*, Vol. 8, 127-138.
- Danish Ministry of Housing (1995). Building regulations 95, Danish housing and building agency, Copenhagen, Denmark.
- Christoffersen S.J., Petersen E. and Johnsen K. (1999). Tool for analysis of daylight in buildings (in danish: Beregningsværktøj til analyse af dagslysforhold i bygninger), Report 277, Danish Building and Urban Research, Hørsholm, Denmark.(in Danish).
- Dickinson S.J. and Bradshaw A. (1995). Genetic algorithm optimisation and scheduling for building heating systems, *First international conference on 'Genetic algorithms in engineering systems: Innovations and applications'*, GALESIA (Conf. Publ. No. 414), IEE, 106-111.

- Dansk Standard (1993). Specification of thermal indoor environment (in Danish: Norm for specifikation af termisk indeklima), DS 474, Copenhagen, Denmark. (in Danish).
- European committee for standardization (1999). Thermal performance of building components – Dynamic thermal characteristics – Calculation methods, EN ISO 13786, Brussels, Belgium.
- Gonzalez-Monroy L. and Cordoba A. (2000). Optimization of energy supply systems with simulated annealing: continuous and discrete descriptions, *Physica A*, Vol. 284, 433-447.
- Gustafsson S.I. (1998a). Mixed integer linear programming and building retrofits, *Energy and Buildings*, Vol. 28, 191-196.
- Gustafsson S.I. (1998b). Sensitivity analysis of building energy retrofits, *Applied Energy*, Vol. 61, 13-23.
- Hendriks L. and Hens H. (2000). Building envelopes in a holistic perspective: Methodology, International energy agency, Annex 32, Integral building envelope performance, Acco Leuven, Belgium.
- Jurovics S.A. (1978). Optimization applied to the design of an energy-efficient building, *IBM Journal of Research and Development*, Vol. 22, No. 4, 378-385.
- Kalema T. (2001). Optimisation of the thermal performance of buildings – the Optix program, *International Journal of Low Energy and Sustainable Buildings*, Vol. 2, URL: <http://www.ce.kth.se/byte/leas/>.
- Leaman A. and Bordass B. (1999). Productivity in buildings: the 'killer' variables, *Building Research and Information*, Vol. 27, No. 1, 4-19.
- Loomans M. and Visser H. (2000). Application of the genetic algorithm for building system optimisation, International building physics conference – Tools for design and engineering of buildings (Wisse J., Hendriks N., Schellen H. and van der Spool W., editors), FAGO, Department of Building and Architecture, Eindhoven University of Technology, Eindhoven, The Netherlands, 107-114.
- Lorsch H.G. (1994). The impact of the building indoor environment on occupant productivity, *ASHRAE Transactions*, Vol. 100, No. 2, 741-749.
- Peippo K., Lund P.D. and Vartiainen E. (1999). Multivariate optimization of design tradeoffs for solar low energy buildings, *Energy and Buildings*, Vol. 29, 189-205.
- Tommerup H.M., Munch-Andersen J. and Esbensen P.K. (2000). Development of building envelopes (in Danish: Udvikling af klimaskærmskonstruktioner), R-042, Department of Buildings and Energy, Technical University of Denmark, Kgs. Lyngby, Denmark. (in Danish).
- V&S Byggedata (1999). Price catalogues, Brønshøj, Denmark. (in Danish).
- Wetter M. (2000). GenOpt generic optimization program, Lawrence Berkeley National Laboratory, Berkeley, CA, USA.

© International Journal of Low Energy and Sustainable Buildings. 2002.

Available at <http://bim.ce.kth.se/byte/leas/>

Appendix A Input data for optimization

The input for the optimization contain thermal properties and cost information for the different types of building components considered in the optimization. Information concerning prices and thermal properties are taken from a large Danish building envelope project (Tommerup et. al., 2000) and price catalogues (V&S Byggedata, 1999). The tables below show the thermal properties and costs. The yearly maintenance cost is given as a percentage of the investment cost.

A.1 Outer wall

Insulation [mm]	125	200	250	300	350	400
Investment [DKK/m ²]	1262	1310	1340	1370	1400	1430
Foundation price [DKK/m]	635	693	749	805	861	917
U-value [W/m ² K]	0.249	0.168	0.138	0.118	0.102	0.090
Linear loss to foundation [W/mK]	0.210	0.138	0.121	0.112	0.106	0.102
Linear loss to window [W/mK]	0.059	0.036	0.034	0.032	0.031	0.030
Linear loss to ceiling [W/mK]	0.039	0.036	0.034	0.032	0.031	0.030
Effective internal heat capacity [J/m ² K]	58800					
Yearly maintenance cost [%]	1					
Service life [y]	100					

A.2 Ceiling

Insulation [mm]	250	300	350	400	450	500	550	600
Investment [DKK/m ²]	565	603	641	678	716	753	791	828
U-value [W/m ² K]	0.153	0.128	0.110	0.097	0.086	0.077	0.070	0.065
Effective internal heat capacity [J/m ² K]	15200							
Yearly maintenance cost [%]	2							
Service life [y]	50							

A.3 Floor

Insulation [mm]	70	100	150	200	250	300
Investment [DKK/m ²]	370	397	450	497	544	591
U-value [W/m ² K]	0.199	0.173	0.142	0.120	0.104	0.092
Effective internal heat capacity [J/m ² K]	183000					
Yearly maintenance cost [%]	1					
Service life [y]	100					

A.4 Internal walls

Investment [DKK/m ²]	309
Effective internal heat capacity [J/m ² K]	64500
Yearly maintenance cost [%]	1
Service life [y]	80

A.5 Window frame

Two types of window frames. A narrow frame made of plastic, wood and aluminium and a more traditional wooden frame.

A	Area of window
U	Thermal transmittance
ψ	Linear Thermal transmittance

Name	1	2
U [W/m ² K]	2.73	1.40
ψ [W/mK]	0.05	0.08
Frame width [m]	0.064	0.114
Investment [DKK/m ²]	116·A+1632	342·A+2204
Yearly maintenance cost [%]	3	3
Service life [y]	40	30

A.6 Glazings

The selected glazings cover a range of glazing with and without coatings for managing solar and thermal energy.

A	Area of glazing
U	The thermal transmittance
g	The total solar energy transmittance
τ	Light transmittance

Name	U [W/m ² K]	g [-]	τ [-]	Investment [DKK]	Maintenance [%]	Service life [y]
1	2.8	0.76	0.82	73+404·A	2	30
2	1.3	0.66	0.77	131+727·A	2	30
3	1.1	0.59	0.75	138+768·A	2	30
4	1.4	0.44	0.65	200+1111·A	2	30
5	1.1	0.40	0.62	258+1434·A	2	30
6	1.1	0.37	0.60	266+1474·A	2	30
7	1.6	0.46	0.56	200+1111·A	2	30
8	1.2	0.41	0.53	258+1434·A	2	30
9	1.1	0.37	0.52	266+1474·A	2	30
10	1.4	0.35	0.68	251+1394·A	2	30
11	1.1	0.32	0.64	309+1717·A	2	30
12	1.0	0.30	0.62	317+1757·A	2	30
13	2.8	0.55	0.55	120+666·A	2	30
14	1.3	0.47	0.52	178+990·A	2	30
15	1.1	0.41	0.51	186+1030·A	2	30

A.7 Heating system

The heating system is assumed to be fueled by natural gas.

Investment [DKK/m ²]	326
Efficiency [%]	85
Yearly maintenance cost [%]	2
Service life [y]	20

A.8 Ventilation system

The specific energy for ventilation is assumed to be $V=1000 \text{ W}/(\text{m}^3/\text{s})$ for all types of mechanical ventilation systems.

Name	Natural	Mechanical 1	Mechanical 2	Mechanical 3
Investment [DKK/(m ³ /h)]	0	93	93	95
Yearly maintenance cost [%]	0	2	2	2
Service life [y]	-	30	30	30
Heat exchanger efficiency [%]	-	66	63	83
Electric efficiency [%]	-	42	21	26
Extra cost for cooling [DKK/(m ³ /h)]	-	21	21	21
Cooling COP	-	4	4	4

A.9 Variable shading

A variable shading can be applied by an external venetian blind with the capability of blocking 90% of the solar radiation.

Investment [DKK/m ²]	2264
Yearly maintenance cost [%]	2
Service life [y]	30
Min. shading factor [-]	0.1