

Technical University of Denmark



Predictive tools for designing new insulins and treatment regimens

Klim, Søren; Madsen, Henrik; Kristensen, Niels Rode

Publication date:
2009

Document Version
Publisher's PDF, also known as Version of record

[Link back to DTU Orbit](#)

Citation (APA):
Klim, S., Madsen, H., & Kristensen, N. R. (2009). Predictive tools for designing new insulins and treatment regimens. Kgs. Lyngby: Technical University of Denmark, DTU Informatics, Building 321. (IMM-PHD-2009-216).

DTU Library

Technical Information Center of Denmark

General rights

Copyright and moral rights for the publications made accessible in the public portal are retained by the authors and/or other copyright owners and it is a condition of accessing publications that users recognise and abide by the legal requirements associated with these rights.

- Users may download and print one copy of any publication from the public portal for the purpose of private study or research.
- You may not further distribute the material or use it for any profit-making activity or commercial gain
- You may freely distribute the URL identifying the publication in the public portal

If you believe that this document breaches copyright please contact us providing details, and we will remove access to the work immediately and investigate your claim.

PhD Thesis

Predictive tools for designing new insulins and treatment regimens

Søren Klim
Novo Nordisk A/S and DTU
IMM-PHD-2009-216
Kgs. Lyngby, 2009



Technical University of Denmark
Informatics and Mathematical Modelling
Building 321, DK-2800 Kongens Lyngby, Denmark
Phone +45 45253351, Fax +45 45882673
reception@imm.dtu.dk
www.imm.dtu.dk

IMM-PHD-2009-216

Abstract

The thesis deals with the development of "Predictive tools for designing new insulins and treatments regimens" and consists of two parts: A model based approach for bridging properties of new insulin analogues from glucose clamp experiments to meal tolerance tests (MTT) and a second part that describes an implemented software program able to handle stochastic differential equations (SDEs) with mixed effects. The thesis is supplemented with scientific papers published during the PhD.

Developing an insulin analogue from candidate molecule to a clinical drug consists of a development programme including different phases targeting safety and efficacy. The focus of this thesis is the shift from Phase I, targeting safety, to Phase II, targeting efficacy. An insulin analogue is typically tested for safety in glucose clamp experiments in Phase I clinical trials and progresses into Phase II where dose and efficacy are investigated. Numerous methods are used to quantify dose and efficacy in Phase II - especially of interest is the 24-hour meal tolerance test as it tries to portray near normal living conditions.

Part I describes an integrated model for insulin and glucose which is aimed at simulating 24-hour glucose profiles from a MTT with treatments based on the new insulin analogue that previously only has been tested in clamps. The bridge between insulin analogue properties determined in clamp experiments to meal tolerance test outcomes in Phase II trials is not simple and is complicated by shifts in experimental setup, time horizon and treatment regimen.

A bridging strategy was introduced where an integrated model simulating MTTs was extended with models developed on clamp data that described PK and PD for the new insulin analogue. The bridging strategy was tested by building an integrated model based on human insulin trials which was then evaluated using insulin Aspart (IAsp).

The integrated model was estimated in two separate sub models due to computational complexity. Insulin model challenges were faced at the estimation step regarding separability of insulin input pathways (exogenous/secretion) which resulted in several fixed parameters but also an insulin delivery model as opposed to a prehepatic insulin secretion model coupled with hepatic extraction. The glucose model was an extended version of the oral glucose minimal

model [Man et al., 2002] which had a meal function incorporated.

The two sub models were combined into an integrated model which was evaluated in different scenarios: An iso-glucaemic glucose clamp, an insulin tolerance test and comparing derived measures of glucose effectiveness. The model evaluation pinpointed insulin sensitivity issues which were accommodated with a change in model building towards a more insulin sensitive model type. Conclusively, the integrated model fitted estimation data well both for insulin and glucose. Furthermore, the evaluation scenarios showed overall correspondence with literature with only minor discrepancies.

The evaluation on insulin Aspart required a PK model for IAsp and a model describing IAsp action in MTTs. The IAsp PK model was available from a different Novo Nordisk project and the action transfer function was estimated on cross-over clamp data with human insulin and insulin Aspart. The two components were then embedded into the integrated model.

The extended integrated model was used to simulate 24-hour profiles of insulin and glucose from meal tolerance tests including treatments with biphasic insulin Aspart. The evaluation showed that the extended integrated model was able to predict insulin levels reasonably both mean profile and variation whereas glucose profiles were not predicted accurately.

Post modelling analysis targeting both insulin and glucose components showed that preconditions for the bridging strategy which implied the use of a mean IAsp PK model, could be the cause for the mis-predictions. Future research should look into ways for individualising the insulin treatment when no information on individual level is present.

The model building process could have benefitted from the use of SDEs. Unfortunately, availability of a software program able to handle mixed effects and SDEs resulted in a modelling approach based on ordinary differential equations. The absence of such a program motivated the development of new a tool with PK/PD features, SDEs and mixed effects.

Part II presents a software package which was developed in order to be able to handle SDEs with mixed effects. The package was implemented in R which allowed for a single environment for data preparation, model building and results handling but also provided accessibility for users and ease of installation.

The R-package implements the (Extended) Kalman Filter for handling SDEs and uses the FOCE approximation to calculate the marginal likelihood for parameters used in maximum likelihood estimation.

A number of applications of PSM are presented in which deconvolution is the topic for most. Deconvolution based on SDEs was used to determine pre-hepatic insulin secretion rates; hepatic insulin extraction rates using both insulin and C-peptide measurements, and glucose appearance rates constrained to be in the positive range in a simulated minimal model setting. More applications included an insulin secretion model based on an intervention model type and an analysis of influence from input error propagation as estimated with ODEs and SDEs.

KEY WORDS: Insulin, Glucose, Meal Tolerance Test (MTT), Compartment Models, PK/PD modelling, Stochastic Differential Equations (SDEs), Mixed Effects, NLME, FOCE, Extended Kalman Filter

Resumé

Denne PhD afhandling beskriver opbygning af en matematisk model til forudsigelse af 24 timers glukose profiler fra måltidstests. Derudover vil implementeringen af et program, som er i stand til at håndtere stokastiske differential ligninger også blive beskrevet. Afhandlingen er delt op i to tilsvarende dele og derudover kan videnskabelige publikationer, som er tilvejebragt under PhD projektet, findes i appendiks.

Udviklingen af insulin analoger, fra kandidat molekyle til anvendeligt medicin, sker gennem et udviklingsforløb inddelt i faser. Af særlig interesse for dette projekt, er overgangen mellem fase I og fase II.

Fase I indeholder typisk clamp forsøg, hvori sikkerheden af insulin analogen undersøges. Disse forsøg udgør en sikker platform men tilvejebringer kun lidt information om virkningen af insulin analogen under normalt brug. Fase II er målrettet til at bestemme virkningen af insulin analogen og derigennem den nødvendige dosering. Til dette anvendes ofte forsøg, hvori langtidseffekterne kortlægges. I særlige tilfælde kan 24 timers måltidstests bruges til at give en præcis beskrivelse af insulin/glukose forløbet over en hel dag for en patient.

Overgangen fra fase I til II udgøres altså af et spring i tidshorisont, antallet af doser, og måske vigtigst selve testsetuppet. En matematisk model, som er i stand til at hjælpe i beskrivelsen af en insulin analogs egenskaber vil være til stor hjælp i fastlæggelsen af fase II forsøg.

Del I i afhandlingen præsenterer en matematiske model, som skal hjælpe med at bygge bro mellem egenskaber, som kan fastlægges i clamp-forsøg til ultimativt at forudsige resultaterne af 24 timers måltidstests udført med denne nye insulin analog. Modellen skal baseres på tidligere udførte måltidstests samt indeholde en metode, hvorved insulin analogens egenskaber kan indarbejdes.

Kompleksiteten af modellen for insulin og glukose gjorde, at modellen blev delt i to separate modeller, som skulle estimeres adskilt.

Estimeringen af insulin modellen blev i første omgang simplificeret ved at benytte deconvolution til at bestemme præ-hepatisk sekretions rater for insulin, som derved kunne kobles med hepatisk ekstraktion. Denne model opbygning skulle sammenkobles med en absorptionsmodel for administreret insulin, som ikke kan adskilles i målingerne. Absorptionsmodellen består af

en sekventiel struktur, som indeholder et delay kompartment for at opnå overensstemmelse med målingerne. Denne model konstruktion blev evalueret i en række test scenarier, hvor forskellige dele af modellen kunne sammenlignes med resultater fra litteraturen.

Disse scenarier afdækkede en lav insulin følsomhed, som resulterede i en række ændringer i modellen. En del af estimations datasættet blev ekskluderet, og model strukturen blev ændret til en insulin model, som ignorerede hepatisk ekstraktion. Den nye model udnyttede ikke C-peptide målingerne, men var simple og var i god overensstemmelse med målingerne.

En tilsvarende glukose model blev opbygget, som baserede sig på den oral minimal model [Man et al., 2002], som er en videreudvikling af Bergmans minimal model. Modellen inkluderede en måltidsfunktion, som beskrev glukose optræden i plasma efter indtagelse af måltider.

Flere parameter blev fastsat jævnfør litteraturen i stedet for at blive estimeret for at stabiliserer parameter estimationen. Dette gjaldt både for insulin og glukose modellen.

De to modeller blev sat sammen og brugt til at forudsige selv samme data, som de var blevet estimeret på. Dette for at verificere, at den adskilte estimation ikke havde nogen indvirkning. Derudover blev de testet i de tidligere nævnte test scenarierne (clamp og insulin tolerance test) for at bedømme overensstemmelse med uafhængige resultater fra litteraturen.

For at teste anvendeligheden af modellen i klinisk udvikling af insulin analoger, blev modellen brugt til at forudsige 24 timer profiler af insulin Aspart. Den integrerede model for insulin og glukose blev udvidet med en PK model for insulin Aspart samt en model, som oversatte insulin Asparts virkning til tilsvarende virkning for human insulin.

De forudsagte glukose profiler, baseret på modellen udvidet med nye moduler for insulin Aspart, var ikke i overensstemmelse med de målte profiler. De målte profiler havde en stigning i glukose niveauerne henover natten, som ikke blev matchet af forudsigelserne.

En række analyser undersøgte potentielle fejlkilder i modellen. I første omgang blev det forsøgt at erstatte insulin modellen for insulin Aspart med de målte koncentrationer. Derefter blev det undersøgt om parametriseringen af måltidsfunktionen kunne have haft en indvirkning. Til sidst blev fleksibiliteten i minimal modellen undersøgt. Ingen af undersøgelserne var i stand til at afdække præcist, hvor problemet lå.

En afsluttende analyse, som blev udført undervejs i selve sammenfatningen af afhandlingen, benyttede de individuelt målte total koncentrationer til at erstatte hele insulin modellen i simulations modellen. Profilerne fra denne model var gode og viste at problemet meget vel kunne være brugen af gennemsnitsprofiler. Gennemsnitsprofiler blev benyttet for at holde informationer fra clamp til måltidstests adskilte.

Konklusionen på den matematiske model var, at den ikke var i stand til at danne bro mellem clamp egenskaber og resultater i måltidstests, men at enkeltmodellerne kunne beskrive data ganske godt og var i overensstemmelse med litteratur resultater.

Del II af afhandlingen omhandler udviklingen af PSM - en R-pakke, som kan håndtere stokastiske differential ligninger i kombination med mixed effects. Andre tilgængelige programmer kan ikke håndtere denne kombination med undtagelse af en eksplicit implementering af Kalman Filteret i NONMEM.

Programmet benytter Kalman filteret til state estimering i de stokastiske differential ligninger og FOCE approksimationen til at udregne likelihood funktionen for mixed effects delen.

Programmet henvender sig til nye brugere, idet det er nemt tilgængeligt i R, samt at der er skrevet brugermanualer og givet eksempler på normal brug. Implementeringen i R hindrer muligvis anvendelsen på stor-skala problemer, men gør til gengæld programmet vidt tilgængeligt. Dermed sigter programmet mere på en nemmere indgangsvinkel til modellering med stokastiske differential ligninger og mixed effects.

Til sidst præsenteres en række anvendelser af PSM herunder bestemmelse af præ-hepatiske sekretionsrater for insulin og bestemmelse af glukose appearance rater efter et måltid begrænset til det positive domæne. Et eksempel på en analyse af fejl udbredning fra input analyseret med ordinære og stokastiske differential ligninger er også præsenteret.

PhD projektet har spændt vidt og afdækket både matematisk modellering samt udviklingen af et software program. Det endelige mål med den matematiske modellering blev ikke nået, men mange nyttige delmål blev nået og problemstillinger afdækket.

PSM er endnu et nyt program, så udbredelsen af pakken kan endnu ikke kortlægges. Programmet har potentialet til at blive brugt i undervisnings- og forsknings-øjemed, hvorved formålet med programmet vil være opfyldt.

List of Publications

Three scientific papers have been published during the PhD and can be found in the Appendix of the thesis.

Paper A

Klim, S., Mortensen, S. B., Kristensen, N. R., Overgaard, R. V. and Madsen, H.

Population stochastic modelling (PSM)–an R package for mixed-effects models based on stochastic differential equations.

Published in *Computer Methods and Programs in Biomedicin*, 2009, 94, 279-289

Paper B

Mortensen, S. B., Klim, S., Dammann, B., Kristensen, N. R., Madsen, H. and Overgaard, R. V.

A matlab framework for estimation of NLME models using stochastic differential equations: applications for estimation of insulin secretion rates.

Published in *Journal of Pharmacokinetics and Pharmacodynamics*, 2007, 34, 623-642

Paper C

Mortensen, S. B., Jónsdóttir, A. H., Klim, S. and Madsen, H.

Introduction to PK/PD modelling - with focus on PK and stochastic differential equations.

Published as *IMM-Technical Report-2008-16*

Other publications were prepared or the result of collaborations during the PhD but will not be described in the thesis.

- Mortensen, S. and Klim S.
User manual: Population Stochastic Modelling (PSM): Model definition, description and examples. R-Package vignette
- Jónsdóttir, A. H. ,Klim, S., Mortensen, S.B., and Madsen, H.
PK/PD modelling chapter in a mathematics book published by DTU entitled "Matematiske Horisonter", ISBN: 978-87-643-0453-4, p. 114-131
- Strathe A. B., Nielsen B., Klim S., Danfær A. and Sørensen H.
Population based growth curve analysis - a comparison between models based on ordinary and stochastic differential equations implemented in a nonlinear mixed effect framework, Conference Paper, Modelling Nutrient Digestion and Utilization in Farm Animals, ModNut 2009, Paris
- B. Bodvarsson, S. Klim, M. Mørkebjerg, S. Mortensen, C.H. Yoon, J. Chen, J.R. Maclaren, P.K. Luther, J.M. Squire, P.J. Bones, R.P. Millane
A morphological image processing method for locating myosin filaments in muscle electron micrographs. Image and Vision Computing 26, 2008, p. 1073-1080
- Yoon, C.H., Bødvarsson, B., Klim, S., Mørkebjerg, M., Mortensen, S., Chen, J., Maclaren, J.R., Luther, P.K., Squire, J.M., Bones, P.J. and Millane, R.P.
Determination of myosin filament orientations in electron micrographs of muscle cross sections. IEEE Transactions on Image Processing, Volume 18, Issue 4, 2009, p. 831 - 839

Symbols and Abbreviations

Symbols

ϵ_k	Residuals at time t_k , page 104
η	Individual Random Effects, page 11
F	Bioavailability, page 32
G_b	Glucose Baseline, page 46
I_b	Insulin Baseline, page 46
K_{af}	Rate constant, fast absorption, page 32
K_{as}	Rate constant, slow absorption, page 32
K_e	Rate constant, elimination, page 37
$LVPT$	Liver Passthrough, page 37
N	Number of subjects, page 107
n	Number of observations, page 105
Ω	Inter-Individual Variation, page 11
ω	Wiener process, page 104
ϕ_i	Individual parameter vector, page 104
Ψ	Hyper parameter for θ , S and σ , page 106
$R(\cdot)$	Residual conditional covariance, page 105
$S(\cdot)$	Measurement error covariance, page 104
$\sigma(\cdot)$	Scaling diffusion term, page 104
θ	Population parameters, page 11
u_t	Input, page 104
V_{cpep}	C-peptide volume of distribution, page 37
V_I	Insulin volume of distribution, page 37
x_t	States, page 104
\mathcal{Y}	All observations, page 105
y_k	Observation at time t_k , page 104
$\hat{y}_{k k-1}$	One step prediction at time t_k , page 104

Z_i Covariates for individual i , page 106

Abbreviations

AUC Area Under Curve, page 46

BHI30 Biphasic Human Insulin premix with 30% normal insulin, page 16

BHI Biphasic Human Insulin, page 16

BIAsp Biphasic Insulin Aspart, page 17

EGP Endogenous Glucose Production, page 45

GE Glucose Effectiveness, page 50

GEZI Glucose Effectiveness at Zero Insulin, page 78

GIR Glucose Infusion Rate, page 56

HE Hepatic Extraction, page 34

HI Human Insulin, page 16

IAsp Insulin Aspart, page 16

IIV Inter-Individual Variation, page 11

IOV Inter-Occasion Variation, page 11

ISR Insulin Secretion Rate, page 38

IVGTT Intravenous Glucose Tolerance Test, page 19

IV Intravenous, page 7

LR-test Likelihood Ratio test, page 29

MTT Meal Tolerance Test, page 25

NM30 NovoMix30; Biphasic insulin Aspart; 30% normal IAsp, page 17

NM NovoMix, page 17

NPH Neutral Protamine Hagedorn insulin, page 16

ODE Ordinary Differential Equation, page 24

OFV Objective Function Value, page 49

OGTT Oral Glucose Tolerance Test, page 19

PD Pharmacodynamics, page 9

PID Proportional, Integral, Derivative, page 21

PK Pharmacokinetics, page 9

PSM Population Stochastic Modelling, page 110

RA Rate of Appearance, page 78

SDE Stochastic Differential Equation, page 99

T1DM Type 1 Diabetes Mellitus, page 7

T2DM Type 2 Diabetes Mellitus, page 5

Contents

Preface	iii
Abstract	v
Resumé	ix
List of Publications	xiii
Symbols and Abbreviations	xv
Contents	xvii
I Modelling Insulin and Glucose	3
1 Introduction	5
2 PK/PD Modelling	9
2.1 Compartmental Models	10
2.2 Population Model	11
3 Glucose, Insulin, and Diabetes	13
3.1 Glucose and Insulin	13
3.2 Diabetes	15
3.3 Insulin Treatments	15
4 Integrated Model Setup	19
4.1 Bridging Strategy	20
4.2 High Level Model Description	22
4.3 Data	25
4.4 Statistical methods	29
5 Insulin Model	31
5.1 Model Setup	31
5.2 Model Building	36
5.3 Insulin Delivery	42
6 Glucose Models	45
6.1 Meal Function	46
6.2 Model Building	47

7	Integrated Model Evaluation	53
7.1	Model Description	54
7.2	Human Insulin Evaluation Round-Up	61
8	Bridging Strategy Evaluation	63
8.1	Aspart Pharmacokinetic Model	64
8.2	Transfer Function - Insulin Aspart	66
8.3	Prediction of MTT with Insulin Aspart	69
8.4	Aspart Evaluation	74
9	Post Modelling Analysis	75
9.1	Insulin Forcing Function	76
9.2	Meal Function Parameterisation	78
9.3	Flexibility of the Minimal Model	82
9.4	Post Modelling Round-Up	85
10	Discussion and Conclusion	89
10.1	Discussion	89
10.2	Conclusion	94
II	PSM: Population Stochastic Modelling	97
11	Introduction and Motivation	99
12	Methodology	103
12.1	SDE Models for a Single Subject	103
12.2	Mixed Effects	105
12.3	Summary	108
13	PSM - An R-package	109
13.1	Platform	109
13.2	User Interface	110
13.3	Package Components	111
13.4	Accessibility and User Guide	113
14	Applications	115
14.1	Deconvolution	115
14.2	Nonlinear Deconvolution with Non Negativity Constraint	118
14.3	Input Error Propagation	120
14.4	Organic Growth	123
15	Discussion and Conclusion	125
15.1	Discussion	125
15.2	Conclusion	127
	Bibliography	129
III	Appendices	137
A	Paper A	139

B Paper B	151
C Paper C	173
D Data Plots	211
E Glucose Models Runlog	215
F Meal Parameterisation	217
Index	219

Thesis Introduction

The title of the PhD thesis is: "Predictive tools for designing new insulins and treatment regimens" and covers a description of a 24-hour model for insulin and glucose and an implementation of an R package able to handle stochastic differential equations in a mixed effects setting. The two distinct parts are described in separate parts in this PhD thesis.

Part I

The first part covers a project, where PK/PD modelling techniques were used to bridge insulin properties from glucose clamp experiments into 24-hour profiles of glucose from a 24-hour meal tolerance test. The main topics of this part are: Insulin and glucose model building based on ordinary differential equations, utilising insulin analogue properties established in glucose clamp experiments in simulations of a 24-hour meal tolerance test, external evaluation of insulin and glucose models with literature results.

Part II

The second part describes an R package that was developed in collaboration with Stig Bousgaard Mortensen. The package contains functionality for model building with stochastic differential equations extended with mixed effects. The package implements the Kalman filter and uses the FOCE approximation to evaluate the marginal likelihood for the parameters. The motivation and methodology for the package is described along with the different components of the package.

A series of applications of the PSM package is presented that illustrates the strengths of modelling with stochastic differential equations extended with mixed effects such as deconvolution and handling of model misspecification.

Part I

**Modelling Insulin and
Glucose**

Introduction

The main goal of the current PhD thesis is a development of "Predictive tools for designing new insulins and treatment regimens". This part of the PhD thesis will describe the model building - leading to a mathematical model that ultimately can be used to predict outcomes of new insulin treatments.

Problem

The development of new insulin analogues is a vital component for a continued optimisation of treatments for diabetes. Various development paths are being explored but relevant for this thesis is the development of new insulin analogues with improved properties such as faster absorption or slower elimination allowing a more convenient treatment for the patient and/or an insulin profile closer to the insulin profile of a healthy person. The heterogeneous facets of diabetes with multiple causes and symptoms are in this thesis limited to patients with type two diabetes mellitus (T2DM).

The development of insulin analogues starts by investigating insulin candidates in cell cultures and progresses in animals until eventually being tested in humans. The drug development in humans is referred to as clinical development and is divided into different phases. Relevant for this thesis are phase I and II where safety and then efficacy are investigated. Phase I trials aim at establishing safety for the insulin candidate and are often performed in glucose clamp experiments in which the insulin analogue can be tested in a safe environment for the test subject. Phase II targets the efficacy of the insulin candidate in near-normal conditions.

In parallel with the safety assessment in glucose clamp experiments, the pharmacokinetic (PK) and pharmacodynamic (PD) properties of the new insulin analogue are also explored. A glucose clamp consists of an adjustable continuous intravenous infusion of glucose used to maintain a predefined glu-

cose concentration. The infused glucose profile reflects the glucose utilisation at the predefined glucose level. The surplus in infused glucose needed to maintain the glucose level after an insulin injection reflects the action of the injected insulin [Heinemann, 2004]. Concentration measurements of the insulin analogue during the clamp hold important pharmacokinetic information that will be used in the bridging.

After a successful safety evaluation, phase II trials can be initiated. The efficacy and safety of the insulin analogue is typically being assessed by measures of the surrogate marker glycated haemoglobin (HbA1c) which quantifies glucose concentrations for last couple of months and records of adverse events caused by hypoglycaemia. A comprehensive method used to investigate insulin and glucose excursions over 24 hours is the 24-hour meal tolerance test (MTT) which is a scenario mimicking near-normal conditions for a patient over 24 hours with inclusion of meals. Glucose and insulin profiles are measured and used to evaluate the treatment regimen - potentially compared to a cross-over treatment in order to determine an optimal treatment regimen.

The design of a 24-hour meal tolerance test in phase II trials should be based on information from phase I but it is not simple how to translate and incorporate acquired information. A quantitative integrated model for insulin and glucose that bridges clamp determined properties into 24-hour glucose profiles could be a useful tool for designing better trials and ultimately used to predict HbA1c endpoints for an insulin analogue treatment regimen.

Hypothesis

The project hypothesis is that a mathematical model can be determined that is able to characterise insulin and glucose dynamics for a T2DM population in a 24-hour meal tolerance test where insulin treatment is based on injections of the new insulin analogue.

The integrated model should include facilities to embed new insulin analogues in order to simulate new treatments. The inclusion of a new insulin analogue requires a PK model for the new analogue but also a link for the new insulin analogue such that insulin analogue action can be included into the model.

Project Goal

The project goal is to develop a functional model which can be used in clinical development to bridge information from clamp experiments to 24-hour meal tolerance tests. An integrated model of insulin and glucose will aid in designing and optimising treatment regimens: no. of doses, dose level, ratios of insulin mixtures, measurement timing.

The primary outcome from a model prediction is the 24-hour mean glucose profile with corresponding variation. The variation will be based on the

differences between the individuals in the simulation population.

However, the specific glucose profile for a treatment can be difficult to predict as baseline values can drift. A secondary objective is the prediction of difference in glucose profiles between two different treatments. By predicting differences in glucose levels, the glucose baseline value should be circumvented.

The goal is optimistic as traditional insulin/glucose models only cover shorter time periods and usually only a single glucose tolerance tests (IV, oral or meal). Furthermore, the target population of T2DM patients adds complexity to the model as residual insulin secretion is still present as opposed to T1DM patients.

Collaboration

The modelling project was carried out in collaboration with DTU-IMM and Novo Nordisk A/S. The project group and collaborators consisted of: Niels Rode Kristensen, René Normann Hansen, Rune Viig Overgaard, Steen Hvass Ingwersen, Morten Colding-Jørgensen, Henrik Madsen and Roman Hovorka.

Andreas Velsing Groth and Lene Alifrangis provided a PK model for insulin Aspart. Claudio Cobelli and Chiara Dalla Man contributed to an analysis of glucose appearance rates.

The modelling task lasted from July 2006 and onwards and is a pivotal piece in the puzzle that should constitute a PhD thesis.

PK/PD Modelling

A brief introduction to pharmacokinetic (PK) and pharmacodynamic (PD) modelling and related concepts is presented here to form a knowledge base for the modelling performed in this thesis. A more detailed PK/PD introduction was written during the PhD and can be found in Paper C.

The class of PK/PD models described here are semi-mechanistic mathematical/statistical models aimed at descriptive/predictive purposes with parameters driven by data i.e. a model with internal processes in alignment with a priori physiological knowledge and with a physiological interpretation of parameters. Overall a definition close to the definition proposed by Aarons et al. [2001] but loosened as drugs are extended to included endogenous substances as well.

Pharmacokinetics describes the relationship between drug inflow and resulting concentration. The concentrations can be blood concentrations but the point of interest could also be related to the site of action e.g. bone marrow or cerebrospinal fluid. The processes included in PK modelling are characterised by absorption, distribution, metabolism and elimination. Absorption describes the movement from dosing site to systemic circulation. Intravenous dosing as opposed to oral dosing gives a different absorption pattern and should be modelled accordingly. The distribution of drug into other tissues such as fat or muscle is crucial to link dose to concentrations. Metabolism describes the conversion of drug into active or in-active metabolites typically by the liver. Finally, elimination describes the irreversible removal of drug from the body e.g. via the kidneys. The hierarchy of processes can be used as a framework to approach modelling systematically.

Pharmacodynamics describes drug effects over time and relates the drug concentrations to drug effects. Whereas concentrations are often measured on a continuous scale, this is not the case for pharmacological response which may also be binary, categorical and frequently measured on subjective scales.

PK/PD modelling aims at linking dose-exposure-effect into a single model that can be used for exploratory/confirmatory purposes. PK/PD modelling is a versatile and important tool in the learn-confirm cycle in clinical development [Sheiner, 1997; Sheiner and Steimer, 2000], especially for acquiring information and planning trials.

2.1 Compartmental Models

The mathematical models used in PK/PD modelling are often in the form of compartmental models also denoted state space models. Each compartment represents a specific state for the drug being that chemical, physical, or spatial state. The drug within a compartment is assumed to be homogeneous leading to a common set of properties for that specific state. Often states can be joined if properties are nearly identical or inseparable.

The transformation from one state to another is modelled with fluxes between compartments. The outgoing flux is often modelled as being proportional to the amount in the compartment but both simpler and more advanced fluxes can also be used. A compartment model can be specified using differential equations describing the changes in states using the fluxes.

This compartment specification enables statistical tests to determine the functional form of the processes. The test can focus on the number of compartments or complexity of fluxes. The modelling can thus be used to determine influential factors or provide information on the involved processes.

The internal drug states are often non-observable and insight into the system is solely based on noisy observations. The estimation challenge lies in determining system parameters when only partial insight is possible further complicated by measurement error.

The observation link in the model describes the assumed behaviour of the noise. This is often referred to as the error model. The simplest used error models are the additive or proportional but much more complex structures utilising input and correlation could also be used.

The compartmental approach often enables a physiological interpretation of the parameters in relation to described processes. The ability to link parameters to physiology is a powerful feature of compartmental modelling.

2.2 Population Model

The term population model denotes a hierarchical division of the variation observed in trials. The division of variation can be described from population to individual as:

Inter-individual variation (IIV) is described using an individual effect on parameter resulting in a distribution for the parameter.

Within Individual variation is quantified using a mathematical model that describes the PK/PD profile for the specific individual.

Residual variation is the remainder of variation that the within individual model cannot explain. A characterisation of the residual structure is required.

The population model approach allows for simultaneous estimation across individuals. This joint estimation enables a more robust parameter estimation but also serves useful in the case of sparse sampling where the within individual model is unidentifiable.

The hierarchy can be replaced and/or extended with inter-occasion (IOV) or inter-trial variation to accommodate multiple visits or data originating from different trials.

The theory of population modelling comes from the statistical mixed effects theory where responses, typically of repeated measurements, are modelled using fixed and random effects. In the population modelling scheme the fixed effects are denoted population parameters and random effects are used to account for the population's variation on parameters. As many physiological parameters are bound to be in the positive range, the distributions of the parameters are often assumed to be log-normal. The implementation of inter-individual variation on a parameter is thus often modelled as:

$$\phi = \theta \cdot \exp(\eta) \quad (2.1)$$

where ϕ represent the individual parameter and θ is the population value of the parameter. η is assumed to be Gaussian with variance Ω .

The formulation in Equation (2.1) allows for the inclusion of covariates (e.g. weight, BMI, creatinin clearance) to describe parameter variation.

The PK/PD modelling framework based on semi-mechanistic, data driven models combined with the population approach provides a versatile platform for descriptive and predictive analysis in clinical drug development. An increased popularity can also be observed in the range of programs supporting the methodology (NONMEM, Monolix, SPK) and also in the FDA guideline for population pharmacokinetics [FDA, 1999].

Glucose, Insulin, and Diabetes

This chapter will cover a short introduction to insulin and glucose - namely their roles in healthy subjects but also the disorders arising in diabetes. Focus is devoted to processes and concepts in order to form a basis for the model building.

3.1 Glucose and Insulin

Glucose is the main source of energy in the human body and is either ingested via meals or synthesised in the liver. The main role of glucose is to function as fuel for muscle, adipose tissues and most importantly the brain. The brain has a constant consumption of glucose regardless of availability whereas other tissues can adjust to low levels of glucose and even switch to lipids. The lack of glucose supply to the brain can cause unconsciousness or in extreme cases death. This condition is called hypoglycaemia and is feared by diabetic patients.

Hyperglycemia is the opposite condition where glucose concentrations are too high. Severe hyperglycemia can lead to ketoacidosis resulting in coma whereas moderate hyperglycemia has no immediate consequences but have a wide range of long term complications related to micro- and macro-vascular degradation. The most frequent complications are: cardiovascular diseases, renal failure, retinal damages, and nerve damages.

In healthy subjects, glucose is regulated within tight boundaries such that these complications do not occur. The two most important hormones used for the control are insulin and glucagon. In short, the control mechanism can be explained as: insulin decreases glucose concentrations whereas glucagon increases glucose concentrations.

The main pathway for glucose in the human body originates from oral intake i.e. meals. The shifts between intake of meals and fasting periods imply

a constant regulation of glucose. When a meal is ingested, it passes through the gastro-intestinal tract where nutrients such as carbohydrates are degraded and pass through membranes into systemic circulation. The incoming glucose needs to be stored for fasting periods or utilised as energy immediately. Insulin facilitates/accelerates processes that eliminate glucose from blood either for storage purposes or immediate use. These processes occur in both muscle and adipose tissues but the main storage for glucose is the liver. The liver stores glucose by converting it into glycogen that at a later stage can be converted back into glucose. In short, insulin both promotes an increased storage of glucose and an increased utilisation of glucose.

Glucagon increases glucose levels by initiating processes that breakdown glycogen to glucose, decrease the storage of glucose and decrease the utilisation of glucose. The combination of increased input and lowered elimination results in increasing levels of glucose.

Both glucagon and insulin are produced in the pancreas, in the α - and β -cells respectively. These cells reside in regions that in a microscope resemble islands - hence the name "The islets of Langerhans". The main driver for secretion is the glucose concentration such that for a low glucose level glucagon is secreted and for a high glucose level insulin is secreted.

Insulin is secreted in a biphasic pattern denoted first and second phase. The first phase is a pulse of insulin from the pre-packaged vesicles with insulin ready for secretion in the β cells. The second phase secretion comes from an increased production of insulin which is a delayed process compared to the first phase secretion.

The appearance of food in the intestines triggers a class of hormones known as incretin hormones to be secreted. The incretin hormones have a boosting effect on the insulin secretion that can best be observed by comparing an IV infusion of glucose mimicking glucose concentrations seen after an ingestion of a meal. The insulin response from the oral intake is much larger than the IV insulin concentration.

A by-product from the insulin secretion is a peptide that comes from the precursor to the insulin molecule. This peptide originates from the precursor to insulin named proinsulin which is split into insulin and C-peptide in equimolar amounts at secretion. Insulin suffers from a large first pass effect in the liver i.e. large amounts of secreted insulin do not reach systemic circulation. Conversely, C-peptide is eliminated via kidneys and with longer half-life than insulin thereby making it a reliable marker for insulin secretion. The effects of C-peptide have long been assumed to be non-existent but recently a preventive effect of complications have been observed [Marques et al., 2004].

The glucose regulation for healthy subjects result in tightly controlled glucose concentrations that guaranties glucose supply to the brain and avoids long term complications. Several diseases can affect the glucose homeostasis but relevant for this thesis is diabetes which is the topic of the next section.

3.2 Diabetes

Diabetes is the commonly used name for the disease: *diabetes mellitus* which is characterised as a metabolic disorder. Diabetes spans a mixed group of disorders that all are manifested by hyperglycemia as a result of insulin resistance and/or decreased insulin secretion.

The focus on diabetes has increased over the last years partly due to the epidemic development in diagnosed subjects. The world health organisation has estimated the prevalence of diabetes to double from 2000 to 2030.

$$\begin{array}{ccc} \text{year 2000} & \longrightarrow & \text{year 2030} \\ 171,000,000 & & 366,000,000 \end{array}$$

WHO has also estimated that 2.9 million people died in 2005 as a consequence of diabetes or related diseases [WHO, 2008].

The most common types of diabetes are: Type I and Type II which share complications but due to different causes.

Type I Diabetes Mellitus (T1DM) is an auto immune disease where the immune system attacks β cells in the pancreas. The result is a complete halt in insulin production. The patients' cells will starve unless insulin is administered making the patient completely dependent on insulin injections.

Type II Diabetes Mellitus (T2DM) is caused by insulin resistance which causes a lowered effect of insulin. Typically, this lowered effect can be compensated by an increased insulin secretion. T2DM was previously predominately seen in elderly but recently diagnosis in children has become more frequent.

T1DM patients rely on injections of insulin to survive as a replacement for the endogenous production of insulin. T2DM patients are initially treated with diet and exercise, potentially supported by medication that enhances insulin sensitivity or secretion. However, β cells gradually deplete leaving T2DM patients dependent on injections of insulin.

3.3 Insulin Treatments

The goal of the insulin therapies is to replace/supplement the secretion of insulin. The target for the insulin treatment is to obtain an insulin profile as close to a healthy secretion profile as possible. The healthy profile can be described as a basal overall coverage with prandial peaks. A treatment that mimics this pattern is named basal+bolus as a set of injections accounts for basal coverage and bolus injections at meal times accounts for prandial

insulin responses. The insulin injections are usually subcutaneous which are relatively simple for the patient to self-administer.

Synthetic insulin is produced by recombinant DNA technology during which the properties of the insulin can be slightly altered. These analogues are typically focussed on new properties such as faster absorption or slower elimination.

The thesis includes data from many different trials where different insulin treatments are used. The next sections will describe different insulin types and treatments.

Human Insulin

Synthetic human insulin is a common insulin type used in treatments. It is identical to endogenously secreted insulin and will in this thesis simply be denoted as human insulin (HI).

Human insulin is administered via subcutaneous injection and starts working within 30 minutes. The delay requires certain timing in relation to meal injections where a healthy insulin response is almost immediate.

An often used insulin complex based on human insulin is called NPH¹ and has a slower absorption into systemic circulation. The complex is formed by combining human insulin, protamine and zinc which creates a crystal that is poorly absorbed and needs to dissolve before human insulin can pass into circulation. The crystallised version of human insulin is also called protaminated human insulin and is classified as intermediate-acting insulin.

A premix combination of normal human insulin and NPH provides a compound for a single injection with a component for fast absorption and a component for slower absorption. The premix compound is also known as biphasic human insulin (BHI) and is available in different mix ratios e.g. 30% human insulin and 70% NPH which is denoted BHI30. Biphasic human insulin is marketed Mixtard from Novo Nordisk A/S but other companies have similar products.

Insulin Aspart

Insulin analogues are as already mentioned synthetic insulin where alterations/replacements have been made to the amino acid sequence. By replacing amino acid(s) in the insulin molecule, the analogue acquires new properties.

Insulin Aspart is such an insulin analogue where absorption properties have been improved but in plasma the properties are identical to human insulin. This makes insulin Aspart a rapid-acting insulin analogue that starts working within 5-15 minutes. The fast absorption makes insulin Aspart ideal for prandial injections where a rapid increase in insulin is desired. The Novo Nordisk product name for insulin Aspart is NovoRapid.

¹Neutral Protamine Hagedorn named after the inventor Christian Hagedorn (1888-1971)

Similar to human insulin, is Insulin Aspart combined with protamine in order to create a slower release from injection depot. Insulin Aspart and protaminated insulin Aspart is combined into a premix of biphasic insulin Aspart (BIAsp). The mixture ratios are similar to BHI and with same syntax. BIAsp30 consists of 30% insulin Aspart and 70% protaminated insulin Aspart and is marketed from Novo Nordisk as NovoMix30. NovoMix is in this thesis often abbreviated to NM such that NovoMix30 is denoted NM30.

New Analogues

Current research aims at properties which provide faster absorption into circulation but also at obtaining slower elimination from plasma.

The new properties will enable insulin that has reduced delay which would be advantageous for bolus doses at meals or long acting analogues which could cover basal levels over longer time periods.

Insulin Treatments

In this thesis a range of treatment regimens are encountered in trials and simulations which are listed here:

BHI30

A single injection of human insulin premix 30% normal and 70% slow acting.

BIAsp30

A single injection of insulin Aspart premix 30% normal and 70% slow acting.

BHI30 (2xdaily)

Two daily injections of a human insulin premix of 30% normal and 70% slow acting. The injections are given at breakfast and dinner.

BIAsp30 (2xdaily)

Two daily injections of a insulin Aspart premix of 30% normal and 70% slow acting. The injections are given at breakfast and dinner.

BIAsp707050

is a compact notation for three daily injections with insulin Aspart premix. The breakfast and lunch injection is BIAsp70 (70% fast) and a dinner injection with BIAsp50.

BIAsp707070

is a compact notation for three daily injections with insulin Aspart premix. Injections at breakfast, lunch and dinner all with BIAsp70.

With a basic understanding of insulin, glucose and insulin treatments; the focus is now turned towards building an integrated for insulin and glucose.

Integrated Model Setup

The main objective of the PhD project has been to develop a mathematical model able to predict insulin and glucose profiles for T2DM patients examined in 24-hour meal tolerance tests (MTT). The simulated insulin treatments are based on properties of new insulin analogues that have only been evaluated in glucose clamps experiments. The properties of the analogue should be bridged from clamp into a 24-hour MTT model.

The insulin part of the model should thus be interchangeable such that new insulin analogues can be embedded in the integrated insulin/glucose model. The final outcome of the model simulation should be 24-hour profiles of glucose and insulin.

An integrated model of insulin and glucose can provide valuable information in trial design optimisation by quantifying "what if"-scenarios such as "How much would an additional insulin injection improve glucose control?"

Mathematical modelling of insulin/glucose experiments has mainly been used to describe experiments such as intravenous glucose tolerance tests (IVGTT) or oral glucose tolerance tests (OGTT). The experiments constitute a safe setup and procure important information on tested insulins. The scenarios are unfortunately relatively unphysiological and little is learned on how the insulins will perform under normal patient conditions. 24-hour meal tolerance tests are occasionally included in phase II programmes in order to comprehensively investigate treatments in near realistic conditions.

Multiple mathematical models have been published that describe IVGTT and OGTT with different goals and substantially varying assumptions - see review by Landersdorfer and Jusko [2008]. The modelling of 24-hour data is more complicated as meals and diurnal variation needs to be accounted for. During the PhD programme two models for insulin and glucose were published by other groups that targeted 24-hour modelling of insulin and glucose. One

by Silber et al. [2007]; Jauslin-Stetina [2008] and another by Man et al. [2007b]. The two models will be discussed in Chapter 10.

4.1 Bridging Strategy

The notion of bridging characterises the integration of insulin properties mapped in clamp experiments into a model able to simulate 24-hour glucose concentration profiles from meal tolerance tests. The new insulin analogue will potentially have different properties in relation to absorption, disposition and/or action compared to the human insulin.

Preconditions

In order for such a model to be applicable in the development process of new insulin analogues, it needs to adhere to a specific flow of information.

The dynamics and variation seen in historic 24-hour glucose profiles should form the basis for the model predictions and used as foundation. The aim of the model is to predict the population mean response i.e. glucose profile and implicitly insulin profiles but also corresponding variation. The model should allow for inputs on treatment regimen or trial setting e.g. dose sizes, insulin mixture, injection times, and meal sizes in order to be sufficiently flexible to simulate different MTT setups.

A link needs to be established for insulin analogue action between clamp and MTT as the insulin action occurs in a previously untested setting. The only knowledge on the insulin analogue action originates from clamp profiles and should be translated into insulin action during an MTT. The common ground is via human insulin which is often used as comparator treatment in cross-over design in clamps and inevitably also present in T2DM patients during an MTT due to residual insulin secretion. The reference insulin in the model will thus be human insulin. The insulin analogue action needs to be translated into insulin action in the model which was measured with human insulin concentrations.

The prediction of the variation in the meal tolerance test should originate from simulation with an entire population. The model should include a population of individuals that correspond to the typical population recruited for a 24-hour MTT trial. A typical trial simulation would randomly create the population from variation patterns estimated in the historic data but a drawback of sampling a population is the potential range of unphysiological test subjects. In order to guarantee a physiological plausible population, the model population should be generated by "cloning" test subjects. The model population should thus consist of a plausible population of T2DM patients where knowledge on the new insulin analogue needs to be mean population parameters.

The clamp experiment should thus be used for a derivation of a insulin analogue PK model and a transfer function that translates the insulin analogue action into action in a human insulin model.

PK Model

The PK model for the insulin analogue should be estimated on the PK data from the clamp experiments. The absorption and disposition model should be able to extrapolate to new treatment regimens with changed doses, insulin mixture ratios and dosing time points. However, the PK model is constrained to a mean population model as no knowledge is available for the estimated subjects in integrated model based on human insulin.

Transfer Function

The action of the insulin analogue has not been tested in meal tolerance tests and also not in the subjects that the integrated model was estimated on. The action of the insulin analogue should thus be converted into a useful measure in the integrated model - human insulin concentrations. The action of the insulin analogue have been compared to human insulin action in a cross-over design which enables a mapping of the analogue effect relatively to human insulin.

The transfer function simply calculates the action equivalent concentration of human insulin for the new insulin analogue. The transfer function will be unique for each insulin analogue and requires a cross-over comparator with human insulin. As with the PK model the transfer function can only be population model as no individual information can be bridged.

The general setup for the transfer function should include capabilities to accommodate faster absorption and slower elimination for new insulin analogues. The transfer function is pivotal for a correct simulation of the effects of a new insulin analogue as an erroneous translation of effect invalidates the simulation.

Modelling methodology for the transfer function is a PID approach namely a function of a proportional, a delayed and a derivative signal from the insulin analogue profile. The abbreviation PID denotes proportional, integral and derivative and is a well known technique in signal processing and time series analysis.

The bridging strategy ultimately requires the components: an integrated model for insulin/glucose, an insulin analogue PK model, and an insulin analogue transfer function. The next section will describe the general setup for an integrated model for insulin and glucose.

4.2 High Level Model Description

The integrated model is aimed at simulations beyond its estimation basis. An empirical modelling approach would only serve a descriptive purpose but is not useful in an extrapolation setting. The simulation with new insulin analogues requires that model dynamics resemble actual occurring processes in meal tolerance tests.

A schematic model formed the basis for a description of individual components that spanned relevant processes from a PK/PD framework viewpoint.

Several modelling approaches exist with specific focus areas: Mechanism-based [Mosekilde et al., 2005], empirical/black-box, grey-box [Tornøe et al., 2004] and parsimonious modelling [Feng, 2008] etc.

The important point was that the model should be “as simple as possible - but not simpler”¹ - preferably with parameters driven by data, and with model dynamics that were in correspondence with prior physiological knowledge.

Ideally, the parameters in the model should be estimated from data but in cases where a parameter is unidentifiable, a literature value will be used instead.

The relationships between insulin and glucose and corresponding input pathways are shown in Figure 4.1. The figure shows the basic relationship where insulin promotes glucose elimination and glucose triggers insulin secretion. Three different insulin treatments are shown in gray boxes which represents the interchangeable property. The influx of glucose from meals is also shown.

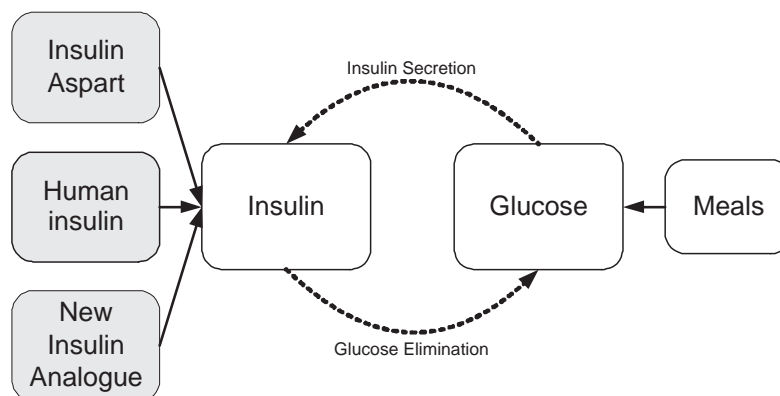

Figure 4.1: Model with an interchangeable insulin component

Identifiability issues are inevitable to arise when working with large state space models especially with multiple input/output pathways. Identifiability issues will not be analysed with analytical or numerical methods [Cobelli and DiStefano, 1980] but primarily be assessed subjectively.

¹Quote from Albert Einstein: Everything should be as simple as possible - but no simpler

Components

The main components in the model are insulin, glucose, their relationship and appearance of injected insulin and ingested glucose. The model will focus on meals and insulin as main factors for glucose excursions - other hormones and lipids are not included in the model but their effects will inherently be lumped into the estimated model dynamics.

Current state of the art models will be used to form an initial integrated model. The models will be found in literature and attention should be on ensuring similarity in population and scenario between the modelling target and literature. In short, preferably only results based on 24-hour MTTs and T2DM patients should be used.

A more detailed overview of the integrated model displayed according to PK/PD concepts is shown in Figure 4.2 where arrows represent both fluxes and influences.

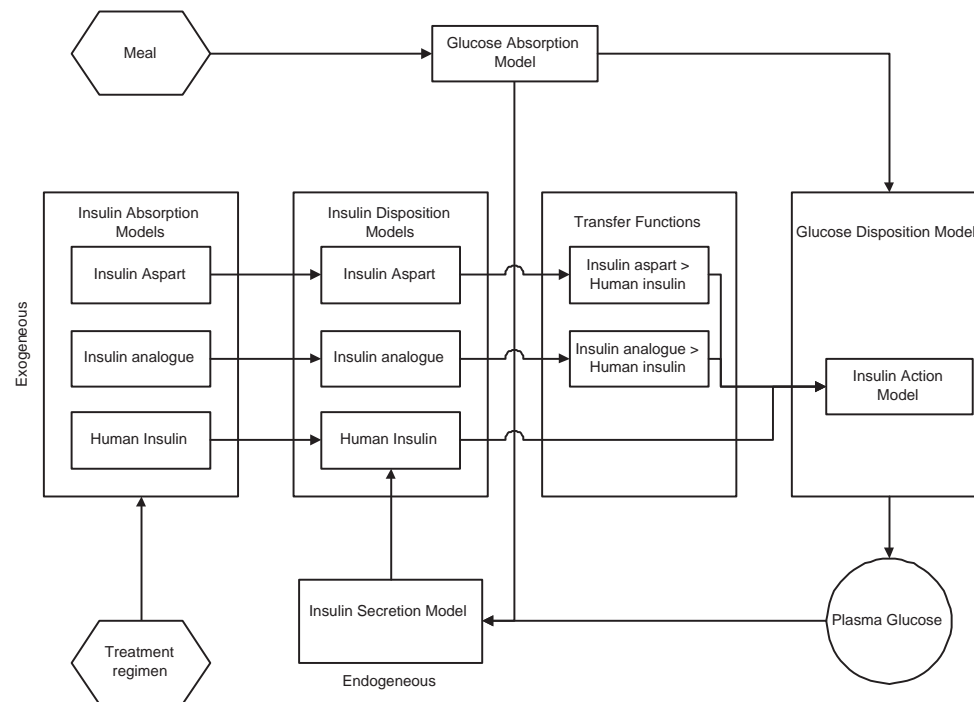

Figure 4.2: Schematic model

Insulin Model

The administered insulin treatment is shown in the lower left corner which gives rise to an inflow of insulin. The regimen covers: choice of insulin (analogue), injection time points, biphasic mixture ratios and insulin doses. The

set of predefined insulin covariates naturally affects the insulin concentration and needs to be included. The insulin absorption component contains three boxes representing different insulin (analogues) to illustrate that the different insulin analogues can have different properties and consequently different models.

The PK model for injected human insulin was estimated simultaneous with the integrated model but models for a new insulin analogue (insulin Aspart) was plugged in - in order to adhere to the bridging strategy.

The population of T2DM subjects requires the inclusion of insulin secretion as opposed to modelling T1DM populations where no secretion is present. The varying degrees of residual insulin secretion and/or changes in insulin sensitivity should be allowed for in the model setup i.e. in the insulin secretion model and the insulin action model.

The insulin secretion model was assumed to be glucocentric, omitting other effects such as nerve signals and free fatty acids. The model for insulin secretion can be approached in two different ways which will be elaborated in the chapter on insulin model building (page 31).

Glucose Model

The glucose part of the model consists of glucose absorption from meals and glucose disposition which includes insulin dependent elimination. The glucose absorption model translates the ingested meal into a glucose appearance profile that enters the disposition model. The covariates characterising a meal are: serving time, energy content and meal composition. The volume of distribution for the disposition of glucose should reflect relevant tissues and fluids.

The elimination of glucose should mimic the processes present during a MTT. Typically, glucose elimination is divided into two parts: insulin independent and insulin dependent elimination.

The relation between insulin and glucose is included as insulin action model in the glucose model and as glucose influence on insulin secretion in the insulin model.

Integrated Model

The general modelling methodology was based on the population model where the dynamical system is specified using ordinary differential equations (ODEs) extended with mixed effects. The setup is widely used within PK/PD modelling and holds the features of being semi-mechanism based and allowing for inter-individual variation. NONMEM V [Sheiner and Beal, 1994] was used for parameter estimation and simulation.

The multivariate complexity of the integrated model resulted in a substantial computational load additionally complicated by limitations in the NONMEM installation. The problems finally led to a decision to separate

the parameter estimation into two sub models: an insulin sub model and a glucose sub model. The insulin sub model was estimated using the observed glucose concentrations as input and vice versa with the glucose sub model. A simultaneous estimation of the integrated model would be preferable but was technically not feasible. The deviation between observations and model predictions should be minimal but a potential bias could arise which should be evaluated at a later stage.

4.3 Data

The estimation of the model components required different data. Human insulin (HI) was, as previously mentioned, chosen as reference insulin with a planned evaluation of the bridging strategy based on insulin Aspart.

The integrated model should be based on data from previously conducted 24-hour MTTs. In order to test the bridging from clamp to MTT, a cross-over HI/IAsp clamp was needed to construct a PK model and transfer function. Furthermore, meal tolerance tests including insulin Aspart in order evaluate the performance of the simulation.

Two Novo Nordisk trials were included that covered T2DM patients, 24-hour MTT and treatment arms with HI and IAsp. An additional trial was included with only a placebo arm investigating newly diagnosed T2DM patients who underwent a 24-hour MTT. The trials are described with in Table 4.1.

The resemblance between the short name for the trial BIASP and the abbreviation for biphasic insulin Aspart (BIAsp) was unfortunate but names were kept to maintain notation from literature. The difference in capitalised letters should be noticed in order to distinguish trial from insulin analogue.

Meal Tolerance Tests

A total of three trials with meal tolerance tests were included for the modelling. Two trials were cross-over trials between BHI and BIAsp treatments enabling an evaluation of the bridging strategy within the same subjects. The third trial was a placebo arm in a Liraglutide study i.e. no insulin treatments were administered.

The subjects were initiated on insulin treatment until steady-state in order to ensure that effects from previous treatments had vanished. Three standardised meals were served to subjects during the 24 hours. The meals varied in size but typically consisted of 2000 calories, which corresponds to ~ 350 mmol of glucose. Subjects were instructed to remain physical inactive as physical activity substantially affects the insulin/glucose homeostasis which would invalidate a comparison between treatments.

In all trials, measurements of glucose, insulin and C-peptide were recorded and profiles can be seen in Appendix D.1, D.2 and D.3 but also insulin doses,

Name	Trialname	Description	Subj.
ANA	ANA-046	Biphasic Insulin Aspart 30 vs. Biphasic Human Insulin 30 both twice daily. A double-blind crossover study in T2DM adults. The trial is described in an article by McSorley et al. [2002]	13
BIASP	BIASP-1074	<p>Treatments: BHI30 2xdaily (2 weeks) BIAsp30 2xdaily (2 weeks)</p> <p>Comparison of thrice daily "high" vs. "medium" premixed insulin Aspart with respect to evening and overnight glycaemic control in T2DM patients. The trial is described in an article by Ejlskjær et al. [2003]</p> <p>Treatments: BHI30 2xdaily (1 weeks) BIAsp70 2xdaily+BIAsp50 (4 weeks) BIAsp70 3xdaily (4 weeks)</p>	16
NN2211	NN2211-1332	<p>Effect of Liraglutide on 24 hour glucose and hormonal levels on T2DM patients. The trial is described in an article by Degn et al. [2004]</p> <p>Treatments: Placebo</p>	13

Table 4.1: Trial description

Trial	Subj	Age	Weight	Height	BMI	Dia.Duration
ANA	13	64.2 (4.8)	79.3 (15.7)	1.68 (0.1)	28.0 (4.0)	13.1 (7.2)
BIASP	16	59.3 (8.1)	82.1 (8.4)	1.73 (0.1)	27.7 (2.8)	12.3 (4.9)
NN2211	13	56.4 (9.2)	91.4 (14.0)	1.71 (0.1)	31.2 (3.6)	3.0 (2.6)

Table 4.2: Summary of covariates in trials: mean (std.dev)

premix and other covariates were recorded.

The subject specific covariates measured in all three trials were: age, height, sex, race, weight, diabetes duration, and BMI - a summary of the covariates can be found in Table 4.2. It can be seen that the two trials ANA and BIASP can be regarded as similar populations based on the covariates. NN2211 has lower diabetes duration compared to the other trial populations. At the initial stage in the modelling this was not regarded as a major issue.

The insulin and glucose profiles from the MTTs were sampled more frequently around meals with ANA and BIASP having 46 observations in a profile and NN2211 35 observations. The shortest time interval between observations was 15 minutes and the longest time interval was one hour.

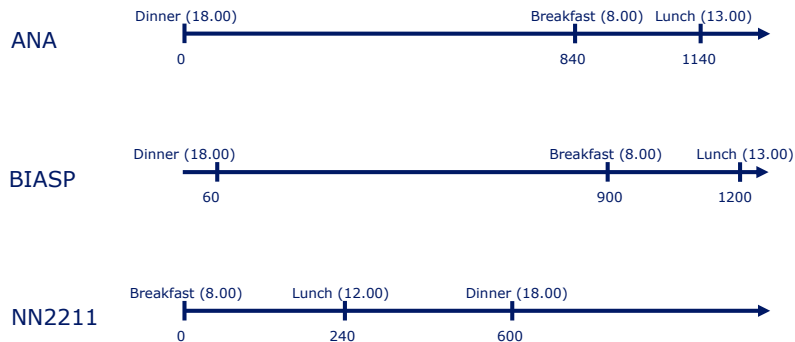

Figure 4.3: Mealtimes in the trials

The three trials covered a period of 24 hours but were not started at the same times during the day as shown in Figure 4.3. The displacement in time was not a problem but simply added complexity to modelling and should be remembered when observing plots.

The complete data basis for the meal tolerance test model was based on 42 subjects on 4 different insulin treatments and a placebo group. Three study arms - two BHI and one placebo arm was used for estimation and three BIAsp arms was used for evaluation. The evaluation part only covered two of the trials but NN2211 was included to provide information on the insulin secretion process.

Clamp

The bridging framework relies on incorporating information from a clamp study into a simulation of a MTT. The clamp study should be used both for a derivation of a PK model for the new analogue but also in the determination of a transfer function.

The Novo Nordisk trial ANA-033 with results reported in Weyer et al. [1997] is a cross-over clamp study comparing BHI30 with BIAsp30 (NM30). The trial population consisted of 26 healthy male volunteers who received 0.3 IU/kg subcutaneous injection of premixed insulin. The mean profiles of insulin and glucose infusion rates can be seen in Figure 4.4.

Insulin Aspart - PK Model

A pharmacokinetic model for insulin Aspart was determined as a part of a different project whereby the PK modelling task was redundant. The data

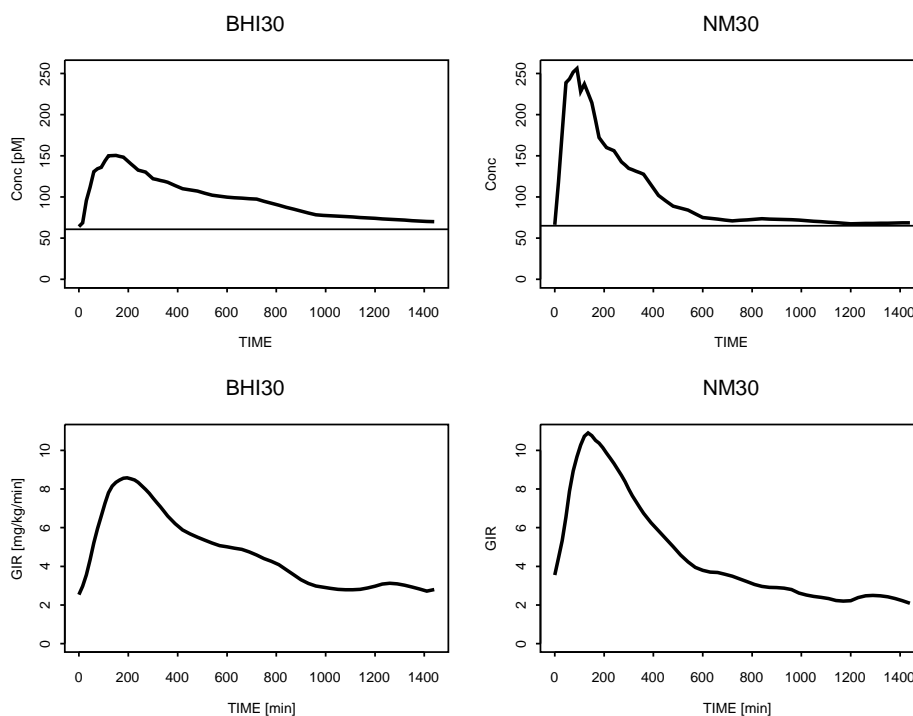

Figure 4.4: Mean profiles for GIR data used for transfer function

and model will be presented in the thesis but should be accredited to Andreas Velsing Groth and Lene Alifrangis, Biomodelling, Novo Nordisk.

The estimation data were trials, using IAsp in different premix ratios. The trials included in the PK modelling are listed in Table 4.3.

Trial	Population	Ratio	#Subjects
ANA-046	T2	NM30	13
ANA-1199	T2	Aspart	36
BIAsp-1086	HV	NM30, NM50, NM70	32
BIAsp-1318	T1	NM30, NM70	26
BIAsp-1526	T2	NM50, NM70	72
BIAsp-1746	T1	NM30, NM50, NM70	32

Table 4.3: Trials included in the Insulin Aspart PK Model

The PK model is presented in Chapter 8 where the bridging strategy is evaluated on insulin Aspart treatment arms.

4.4 Statistical methods

The modelling task described in this report deals with differences in structural models, different parameterisations and inclusions of additional measurements. Non-linear mixed effects are used to divide the variation into inter- and intra-subject variation according to the population model.

In this thesis the statistical model building is based on likelihood theory which can be utilised to test nested models with likelihood ratio tests (LR-tests). The likelihood ratio is defined as:

$$\lambda(\mathcal{Y}) = \frac{\sup_{\theta \in \Omega_0} L(\theta; \mathcal{Y})}{\sup_{\theta \in \Omega} L(\theta; \mathcal{Y})} \quad (4.1)$$

where $L(\theta, \mathcal{Y})$ is the likelihood for the model with parameter vector θ given all data \mathcal{Y} and the parameter space Ω_0 being a subset of Ω .

The statistical setup examines whether a smaller model with parameters as a subset of a full model describes the data equally well. The null hypothesis is that the smaller model cannot be distinguished from the alternative - the full model. The likelihood ratio will for equally performing models approach 1 as the likelihood of the smaller model cannot exceed the full model. When the smaller model performs worse than the full model the likelihood ratio will approach 0. Within the range from 0 to 1 exists a critical value c that defines if the null hypothesis should be rejected.

A convenient asymptotic property for the statistic $(-2\log\lambda)$ is that the distribution as the number of observations tend to ∞ is a χ^2 -distribution with degrees of freedom equal to the difference in dimensions between Ω_0 and Ω [Pawitan, 2001; Madsen, 2007]. The asymptotic properties of the statistical test is based on the Wilk's λ distribution.

Due to the statistic $-2\log\lambda$, the objective function for an optimisation is often defined as $-2\log$ likelihood. The Wilk's test statistic then becomes the difference in objective function values for the models. The critical value for the rejection of the null hypothesis at a 5% significance level for a single parameter is a difference greater than 3.84. The significance level of 5% was used throughout the thesis.

The statistical model building based on the likelihood ratio test will be used to differentiate models with different structure, processes, error models and inter-individual effects.

Furthermore, model building will focus on physiological interpretation to aid a simulation of unknown treatment regimens. The selection of models will also be guided by graphical fits and comparisons with literature.

With a high level model description, estimation data, and statistical methodology in place, the model building could begin for the two separate models: insulin and glucose.

Insulin Model

The integrated model estimation was separated into sub models and this chapter will focus on the insulin sub model.

The human insulin model covers absorption of synthetic human insulin, endogenous secretion, distribution and elimination. The assay used for the measurement of the insulin concentrations was unable to distinguish between endogenous secreted human insulin and synthetic human insulin from injections. The origin of a single insulin molecule could thus not be traced which complicated model building with regards to the split between secretion and absorption.

The measured glucose concentrations were used as input into the model to compensate for the separation into sub models. In practice, linear interpolation of the glucose concentrations was used.

Frequently used covariates in model building with insulin and glucose are baseline values. The baseline values for human insulin and glucose were extracted from the treatment arms with human insulin. The observation prior to breakfast was used as baseline resembling regular measurement of fasting plasma glucose.

5.1 Model Setup

The model setup was divided into absorption, secretion and disposition which will be described in detail in the following sections.

Insulin Absorption

PK models including a description of the absorption process of injected insulin has been modelled by Novo Nordisk but also examined and reviewed by many others [Nucci and Cobelli, 2000].

Typically, the initial model structure is based on the properties of the injected insulin e.g. physical or chemical. The chemical structure of biphasic insulin naturally leads to a model structure for normal insulin and another for protaminated insulin. The dissolution of protaminated insulin results in insulin molecules identical to the normal component. It is often assumed due to the size of the protaminated crystals that they remain in the injection depot and do not enter systemic circulation. The transfer from depot to circulation covers both the physical distance to veins and arteries but also passage of membranes and tissue. The sequential absorption model structure progresses from: protaminated insulin \rightarrow normal insulin \rightarrow insulin in blood; and can be seen in Figure 5.1(a).

A different model structure assumes that the injected insulin consists of two different components with separate pathways into circulation. The parallel model structure potentially results in additional parameters to describe both paths in circulation. The parallel model structure can be seen in Figure 5.1(b).

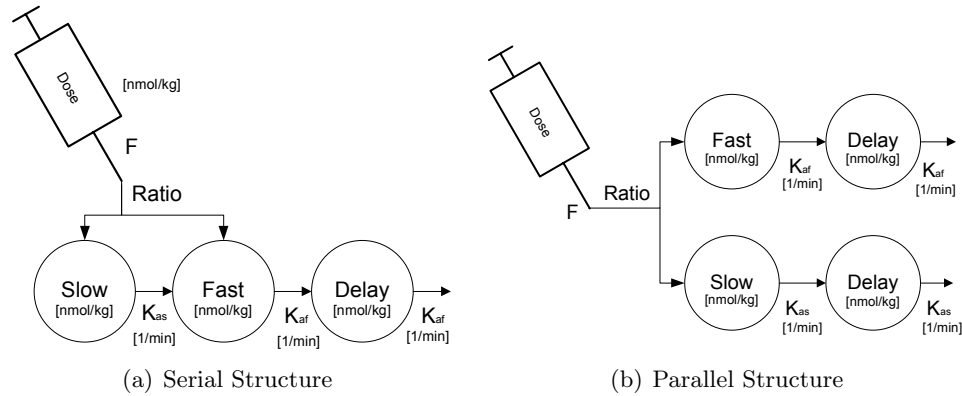

Figure 5.1: Insulin Absorption Models

Both model structures can be extended with the inclusion of a delay compartment describing the transition phase between depot and plasma. A robust estimation of a specific delay parameter requires frequent sampling during the absorption phase which is often not the case. This challenge is often solved by reusing absorption rate constants as delay parameters. Both versions of the delay extension were tested either via visually inspecting profile fits, comparing objective function values or by using likelihood ratio test when appropriate.

The intercompartmental flow is frequently modelled as first order flows, i.e. proportional to the amount in the compartment. However, saturable or constant flows were also tested as candidates for flow complexity.

The bioavailability of insulin was another problematic issue as no cross-over information from intravenous to subcutaneous was available. The bioavailability was confounded with elimination rates and volume of distribution whereby estimation was problematic. The biphasic structure could potentially also lead

to different bioavailabilities for the two different components. The problem of identifiability is discussed in a later section but it was decided to assume an overall bioavailability for human insulin and protaminated human insulin.

With regards to insulin injection, several factors add to the variability: injection volume, injection site/depth and blood perfusion at the injection site has all been shown as important factors [Nucci and Cobelli, 2000; Søbørg et al., 2009]. If factors influenced the insulin absorption then an inter-individual variation model would be insufficient to describe variations, but an inter-occasion (inter-injection) variation model would be needed.

The important points in relation to the development of the insulin absorption model are:

- **Serial vs. parallel absorption structural model?**
Which model would best characterise the absorption profile from an injection of biphasic insulin?
- **Inclusion of delay compartment?**
Should the absorption model include a delay compartment in order to describe the transport from depot to circulation?
- **Flow constants e.g. nonlinear relationships**
Are first order rate constants sufficiently to describe inter-compartment fluxes?
- **Bioavailability confounded in volume and elimination?** Can bioavailability, distribution volume, and elimination be estimated robustly without too much correlation?
- **Inter-occasion variability?** Should the variability model be extended to include inter-occasion variability in order to capture differences in absorption between injections?

The different issues cannot be tested separately from the remaining human insulin model due to inseparability of injection and secretion pathway. The absorption model thus needs to be estimated simultaneously with insulin secretion and insulin disposition.

Insulin Secretion

Insulin secretion occurs in the pancreas specifically in the beta cells as a feedback mechanism to decrease glucose concentrations. The insulin secretion model was assumed to be glyco-centric which is also a common model assumption where effects of neuronal signalling and free fatty acids are disregarded [Mari, 2002]. The secretion model should accommodate for the varying degree of insulin secretion in T2DM patients where often first phase secretion has disappeared where as others have no secretion left.

As previously mentioned, meal ingestion will trigger insulin secretion enhanced by the incretin effect from intestinal hormones. In a meal tolerance test, the incretin effect is confounded within the regular secretion and cannot be modelled independently. This should be remembered if the integrated model is used to simulate scenarios where no incretin effect is present.

Models able to describe insulin secretion following a glucose provocation have been proposed and analysed in multiple articles based on different assumptions and availability of data. A well known secretion model by Mari et al. [2001, 2002a,b] is based on three components: a static, a dynamic and a potentiation factor accounting for incretin and neuronal effects. The potentiation factor has been the focus of a number of articles arguing that it is unrelated to incretin effects [Bock et al., 2007; Cobelli et al., 2007]. A reduced incretin effect for T2DM patients was shown in Knop et al. [2007] adding to the arguments for a secretion model able to handle different disease progression states.

Recent publications include free fatty acids and other non-glucose nutrients to explain the insulin secretion [Roy and Parker, 2006; Periwal et al., 2008] or describes the secretion via provisioning of new insulin [Overgaard et al., 2006]. Conclusively, most approaches used to describe insulin secretion are glyco-centric i.e. glucose is used as input signal to describe insulin secretion.

The pancreas secretes insulin directly into the portal vein which passes through the liver before reaching systemic circulation. The liver has a substantial extraction of insulin which varies over time and is often described as non-linear. Furthermore, it is not well established which dependent variable that best describes the hepatic extraction (HE).

Hepatic extraction of insulin has been examined in several papers. Meier et al. [2005] states that insulin traversing the liver is the predominant determinant for clearance and finds that fractional hepatic extraction is $\sim 80\%$. Toffolo et al. [2006b] has determined hepatic extraction to be 70% in basal state and 54% during a glucose load. Caumo et al. [2007] and Bonora et al. [1983] both agree on a HE of $\sim 50\%$.

Pre-hepatic insulin secretion is practically immeasurable in-vivo and can usually only be quantified via C-peptide. The modelling of insulin secretion should either describe pre-hepatic secretion and account for HE or focus on describing the post-hepatic insulin delivery into systemic circulation.

- **Insulin Secretion**

Insulin secretion is modelled and coupled with hepatic extraction to determine the insulin delivery. The model setup allows for inclusion of C-peptide measurements to quantify pre-hepatic secretion rates. The drawback is that a model for HE is required and it isn't well described. Furthermore, the model relies on PK parameters extrapolated from Van Cauter [Cauter et al., 1992] to describe C-peptide kinetics.

- **Insulin Delivery**

Insulin Delivery to systemic circulation is modelled directly in an empirical manner bypassing the effect of the hepatic extraction. The first pass effect is thus lumped into the feedback parameters from the glucose influence.

The advantage of the insulin secretion model is that C-peptide concentrations can be included into the model. C-peptide is a by-product from the secretion of insulin that comes from the split of proinsulin into insulin and C-peptide. Insulin is thus secreted in equimolar amounts as C-peptide. C-peptide has a longer half life than insulin, does not suffer from first pass effect, and well behaved kinetics, all in all making it a reliable marker for pre-hepatic secretion rates. The inclusion of C-peptide measurements implies the inclusion of a PK model for C-peptide. A population model with covariates: gender and age was published by Cauter et al. [1992] and constitutes the golden standard for C-peptide modelling.

The alternative approach is an empirical focus on insulin concentrations. From a simplistic point of view only post-hepatic insulin delivery rate in plasma is required to describe insulin changes in plasma. The insulin delivery model aims at directly linking glucose observations with insulin plasma appearance. The insulin delivery model thus lumps secretion and hepatic extraction into a single model. The physiological interpretation of the parameters is diminished but a simpler model is achieved.

Both model types were tested during model building simultaneously with the insulin disposition which is the focus for the next section. To recap the important points on insulin secretion modelling

- **Glycocentric secretion model**

Insulin secretion was assumed to be driven by glucose signals in a PID setting (Proportional, Integral and Derivative).

- **Insulin secretion / Insulin delivery**

How should the insulin secretion be included in the model either via a model for pre-hepatic secretion coupled with hepatic extraction or via an empirical description of post-hepatic insulin delivery into plasma?

- **Hepatic extraction - functional form, dependent variable**

If insulin secretion is modelled via pre-hepatic secretion - What functional relationship that best describes HE and based on which dependent variables?

Insulin Disposition

The disposition model for insulin has influx from injected insulin and endogenous insulin secretion which in the case of human insulin have identical disposition.

In literature a range of different insulin kinetic models have been suggested, structurally ranging from one to three compartments. Castillo et al. [1994] analysed both IVGTT- and OGTT-experiments with a three compartment structure and two elimination pathways and found half lives for insulin of 2.4 min and 130 min. A three compartment structure is supported by Sherwin et al. [1974] whereas a two compartment structure was used to mimic liver and periphery by Man et al. [2007b].

A review article by Nucci and Cobelli [2000] compares several models for subcutaneous injected insulin, several of them having a one compartment structure for distribution. The one compartment structure is also supported by Silber et al. [2007] in a 24-hour integrated model.

The basis for the insulin distribution model was a one compartment structure with first order elimination.

The focus on simplicity originates in identifiability problems for parameters. The process setup with multiple inseparable input pathways, distribution and elimination unfortunately results in identifiability issues. The inseparability of insulin origins spills into estimated parameters causing parameters to become highly correlated. Especially, parameters influencing the scaling of insulin concentrations such as bioavailability, volume of distribution, elimination rate constant, and endogenous secretion. Solutions stabilising the estimation could be introduction of priors which could be used in a Bayesian estimation scheme or by fixing parameter values. The Bayesian estimation would have been preferable but not easy achievable in NONMEM V which resulted in a fixation approach being applied.

5.2 Model Building

This section will present the insulin modelling results and highlight important choices that were made during the modelling process. The modelling was not a linear sequence of models being tested. Challenges and ideas induced a parallel working environment where different models were tested simultaneously. The run times for parameter estimation in NONMEM lasted from minutes to hours which also contributed significantly to parallel tracks of model classes.

Insulin Disposition

Initially, the model building was simplified by determining the pre-hepatic secretion rate via deconvolution based on C-peptide measurements and the Van Cauter model [Cauter et al., 1992]. The deconvolved pre-hepatic secretion

rates were used directly as inflow into the insulin disposition model reducing the computational complexity. A similar approach was also used by Mari et al. [2001] however their approach was refined by replacing the classic deconvolution of C-peptide with deconvolution based on stochastic differential equations as shown in Paper B.

The deconvolved pre-hepatic insulin secretion rates were adjusted for changes in distribution volume between C-peptide and insulin. The different structural setups for absorption (sequential and parallel) were combined with the one compartment disposition model and different HE models. One structural model can be seen in Figure 5.2. The initial models had severe identifiability problems with unphysiological estimates of distribution volume and elimination.

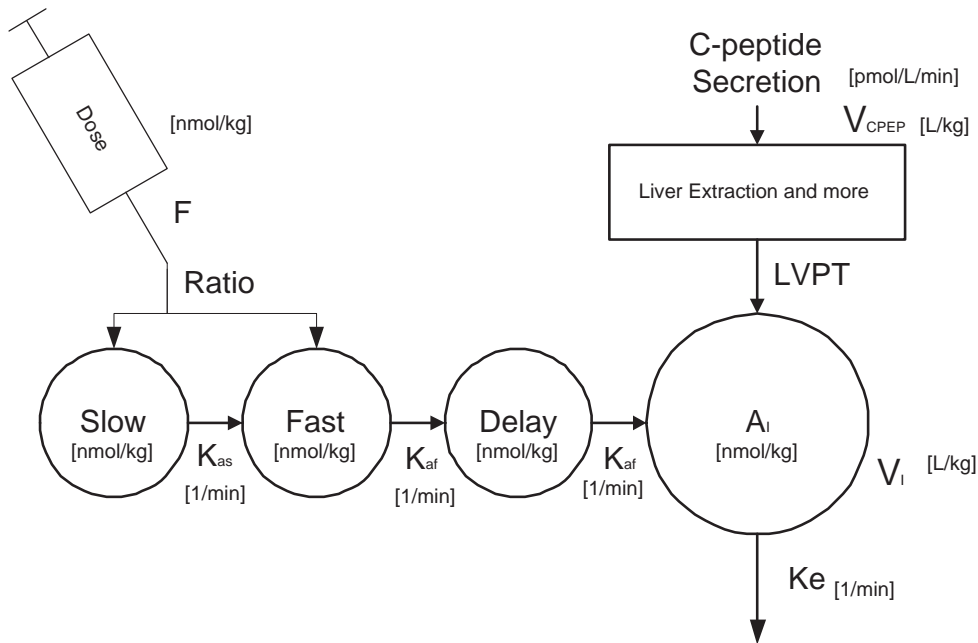

Figure 5.2: Insulin disposition model

The model type found in Figure 5.2 is in correspondence with the model structure previously determined at Novo Nordisk but the inseparability of inputs resulted in correlated parameters due to counteracting effects. Literature values were used as the next step in order to fix parameters.

The next generation of models had a fixed volume for insulin of 0.12 L/kg which is supported by Hovorka et al. [2004]. The distribution volume for C-peptide was determined using body surface area as described in Cauter et al. [1992]. The insulin absorption model was still sequential.

The model for hepatic extraction was tested in different functional forms: constant, linear or saturable with different dependent variables: insulin secre-

tion rate or insulin concentration - both variables were also tested in log scale. The hepatic extraction models were tested in the model shown in Figure 5.2. The shown model was found to be the optimal insulin model. It reused the fast absorption constant for a delay compartment and had a linear hepatic extraction with insulin secretion rate as dependent variable. The inter-subject variability was explained with random effects on parameters K_e , K_{af} and F - furthermore extended with inter-occasion variability on the K_{as} parameter. The hepatic extraction was parameterised as:

$$HE = 0.55 + \alpha(ISR - 100) \quad HE \in [0; 1] \quad (5.1)$$

where $LVPT = 1 - HE$. The values 0.55 and 100 were selected as a baseline hepatic extraction of 55% at 100 pM/min . α was estimated but constrained to be negative such that HE decreases as ISR increases.

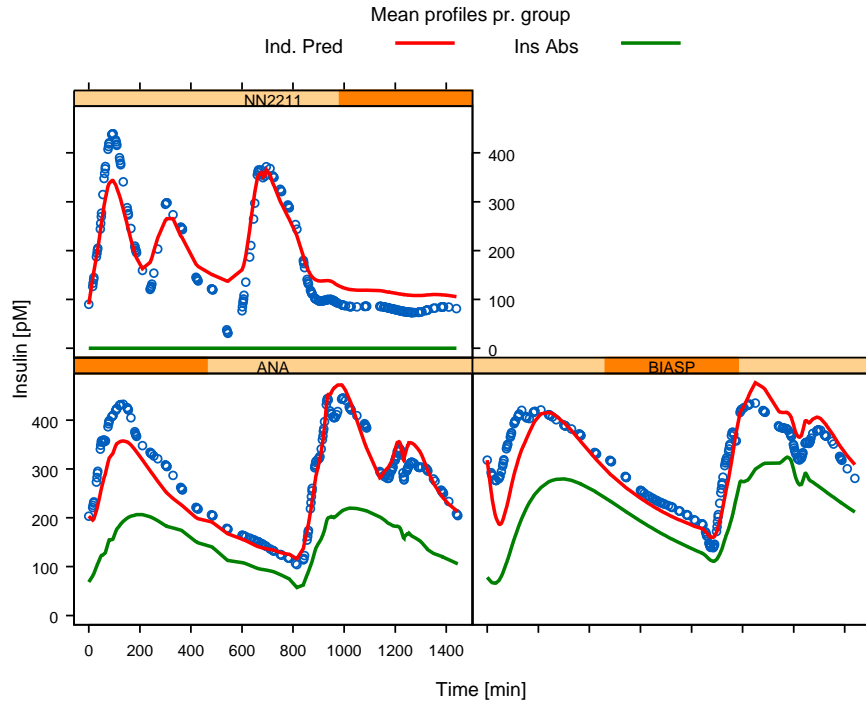

Figure 5.3: Mean insulin fits pr. group

In Figure 5.3 the mean profiles of insulin observations and individual predictions are plotted per trial. The contribution from injected insulin is shown with the green line.

The general fit to observations for ANA looked good but dinner peak was under predicted. The fit for BIASP was worse with problems relating to initial conditions and a slight overestimation of the breakfast and lunch peak. For NN2211, peaks and troughs are both correspondingly under- and over-estimated resembling an average fit for the level.

The seemingly non-smooth contribution from injected insulin was due to the modelling using actual time points for observations as opposed to nominal time points. The initial condition was a steady state condition for based on a replica of the last two insulin doses inserted the day prior to the MTT in order to account for accumulation.

Insulin Secretion

With insulin absorption, disposition and hepatic extraction in place, the modelling of insulin secretion was initiated to replace the deconvolved pre-hepatic secretion rates with a model able to describe pre-hepatic secretion and thereby C-peptide measurements.

The C-peptide model by Cauter et al. [1992] was used as a dynamic model with an input driven by glucose concentrations. The rate parameters in the model were determined using the covariate age according to the article. The Van Cauter subject population was younger with larger BMI compared to the trial populations. This could potentially bias the results as the Van Cauter parameter relationship is beyond its original scope.

The insulin secretion rate model was tested with different dependent variables: glucose, delayed glucose and a signal from the derivative of the glucose concentrations. The derivative of the glucose signal had to be derived from data pre-modelling whereas the delay parameter in the integral glucose signal was estimated simultaneously. Besides the glucose dependent terms the secretion rate model also included a baseline secretion.

The statistical model building showed that only the proportional term was significant. The delay parameter was estimated very low, which indicated a collapse of the delayed part towards the proportional part. The individual plots showed that the high secretion peaks were not captured, which intuitively would be improved by including a derivative term but the improvement was not statistically significant. The sampling period of minimum 15 minutes could conceal the effect of the derivative in the proportional term as the glucose concentration increases within 15 minutes of meal ingestion.

The fit for the insulin secretion model to C-peptide concentrations can be seen in Figure 5.4. The mean fits were good for both ANA and BIASP whereas the fit for NN2211 was poor for both lunch and dinner.

The C-peptide concentrations added information on the pre-hepatic insulin secretion rates based on the Van Cauter model at the cost of the introduction of hepatic extraction in the insulin model. The model was combined with a glucose model for an evaluation of the integrated model for human insulin.

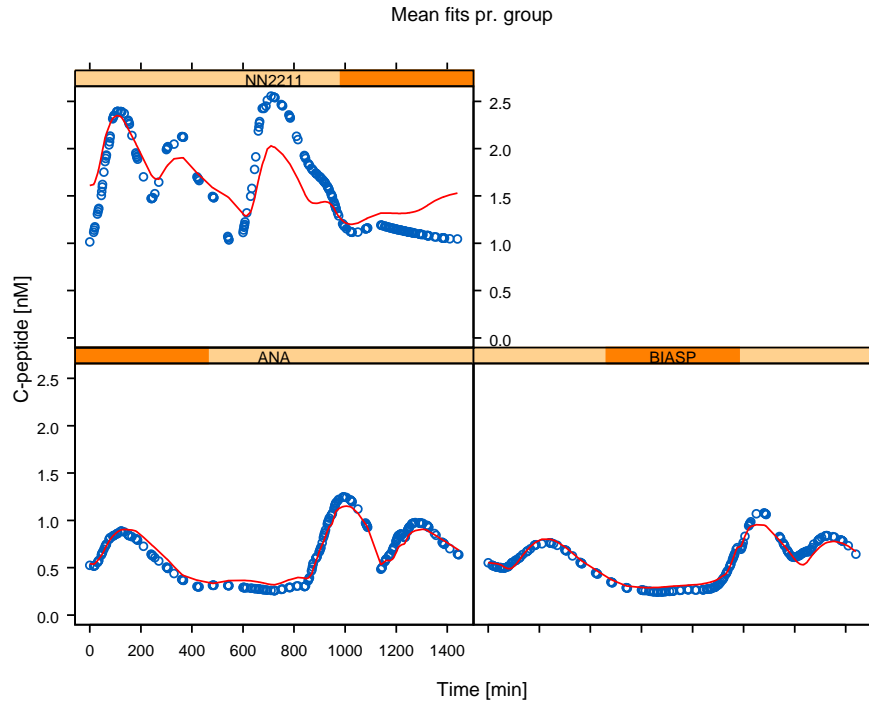

Figure 5.4: Mean C-peptide fits pr. trial

Model Evaluation

The insulin model and a glucose model (described in Chapter 6) were combined and used to simulate different scenarios in order to evaluate performance. The integrated model was used to simulate an insulin tolerance test and a clamp experiment.

A concern was that insulin secretion included incretin effects that would not occur in clamp scenarios. As a result, the scenarios were simulated knowing that the insulin secretion potentially could be too large with subsequently enlarged glucose elimination.

The comparison for the insulin tolerance test was made with the article by Inchiostro [2005] where 247 T2DM patients were studied. Glucose concentrations were measured at -15 and -1 min and 3, 6, 9, 12, and 15 min after an intravenous bolus injection of insulin (0.1 IU/kg). K_{ITT} was calculated as the half life of glucose. The result of the simulations can be seen in Table 5.5(a).

The clamp evaluation was a comparison with a Novo Nordisk conducted trial (NN304-1439) where an iso-glycemic clamp with three dose levels of subcutaneous injected NPH insulin (0.3, 0.6 and 1.2 IU/kg) had been conducted in T2DM patients. The AUCs of the glucose infusion rates were compared to

trial results which can be seen in Figure 5.5(b).

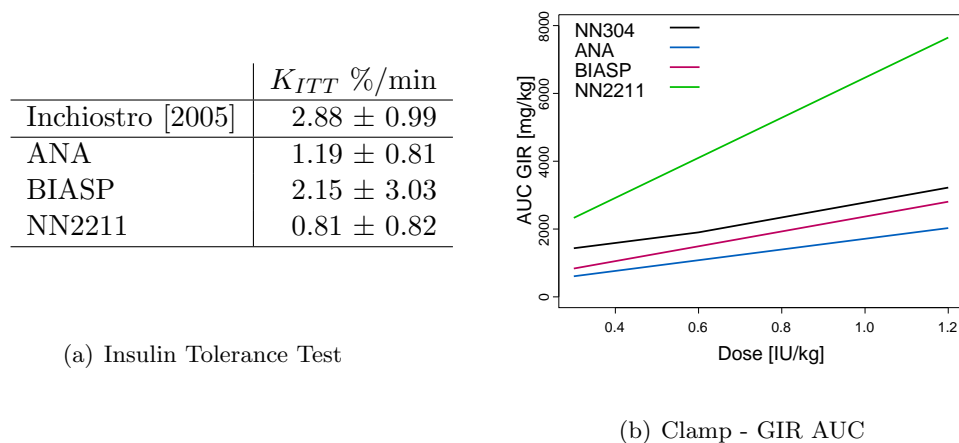

Figure 5.5: Model Evaluation

The insulin tolerance test (Table 5.5(a)) shows that the simulated decrease in glucose for all three groups are lower than reported in literature.

For the clamp simulation, both ANA and BIASP have a lower GIR AUC compared to the reference trial, however NN2211 had a larger response to insulin compared to both ANA and BIASP but also the reference trial.

The result of the model evaluation as seen in Figure 5.5 was that the model was not sufficiently insulin sensitive in the insulin tolerance test and the clamp experiment. With regards to insulin secretion, it should be remembered that incretin effect was confounded within the estimation such that the secretion during a clamp experiment should be too high leading to a higher insulin action. The conclusion was to change the glucose/insulin action model into a more insulin sensitive version which will be described in Section 6.2.

With regards to the insulin model it was decided to switch to an insulin delivery model. The decision was based on insulin fits, uncertainty regarding extrapolations in the C-peptide model coupled with uncertainty in hepatic extraction. A switch to insulin delivery type model would simplify the model structure.

Furthermore, NN2211 had at this point also caused several problems in the glucose model estimation and the result in Figure 5.5(b) added to the belief that the NN2211 population was too different compared to other T2DM patients. The differences in demographics as described in Table 4.2 page 26 were more influential than initially anticipated. Consequently, it was decided to exclude NN2211 as a population group from the modelling.

5.3 Insulin Delivery

The parameters in the insulin model were re-estimated with the insulin delivery rate (IDR) component and the corresponding model structure that can be seen in Figure 5.6.

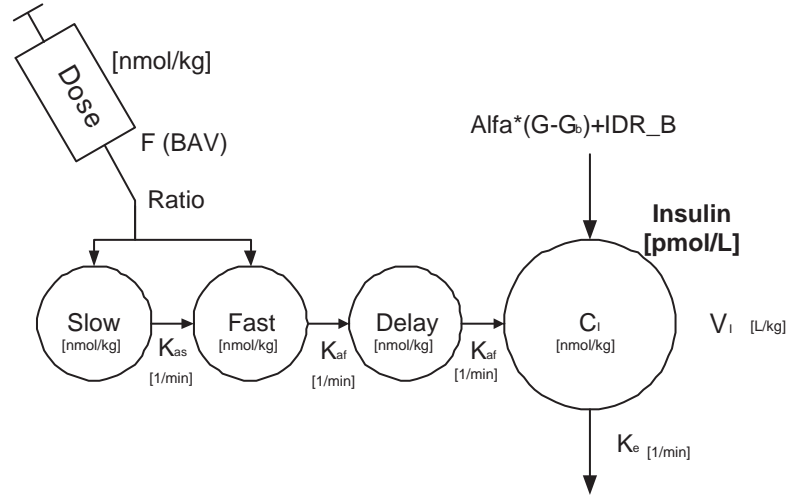

Figure 5.6: Insulin Model structure with Insulin Delivery Rate

The glucose effects were tested in the IDR model and only the proportional effect of glucose concentration and a basal delivery rate were statistically significant. The direct effect of glucose was modelled as the glucose concentration above baseline as the insulin delivery at basal glucose is the basal delivery rate. The parameters describing the insulin delivery rates were determined with inter-subject variation, which was tested significant.

The updated insulin model was simpler with glucose observations linked into insulin delivery rate, which unfortunately rendered C-peptide observations redundant. An interesting challenge would be how to include C-peptide observations in an insulin delivery type of model, but this analysis was not pursued.

The full range of models that could be combined with different structures, included processes and inter-individual variations were not all tested. The tested models were selected based on prior knowledge and experience gained through the modelling.

The final model was a compromise of identifiability obtained by use of literature values for volume of distribution V_I but also insulin elimination (K_e) which was fixed to 0.075 min^{-1} . The model included both inter-individual variation on secretion parameters ($Alfa$ and IDR_B) and bioavailability (F). Inter-occasion variation was added to absorption parameters (K_{as} and K_{af}).

The model structure can be interpreted from a physiological viewpoint and resembled previous models within insulin modelling. The model fits are seen in Figure 5.7. The mean profiles fitted observations quite well with the insulin delivery model. The BIASP pre-breakfast level was overestimated but remaining peaks and troughs was fitted nicely.

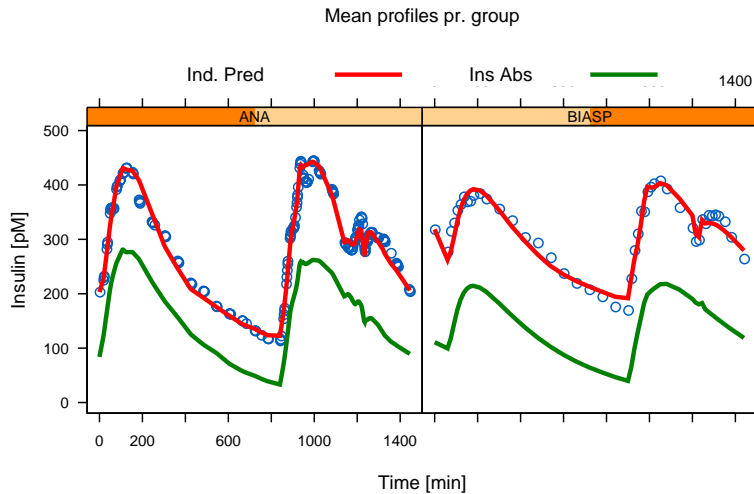

Figure 5.7: Mean fits with Insulin Delivery Rate

The plot clearly shows that the insulin fits are much better compared to the previous insulin secretion model type (Figure 5.3) but there was a concern that the insulin basal delivery rate was estimated too high as the glucose dependent insulin response was low. However, due to inseparability of input pathways this could not be investigated nor rejected on the current fit.

The next step was to construct a glucose model that could be combined with the human insulin model in order to create an integrated model for human insulin. The glucose model is the topic for the next chapter where both model building and selection is covered.

Glucose Models

The separate estimation of the human insulin model was covered in the last chapter. This chapter will describe the model building of the glucose model using insulin concentrations as input.

Glucose absorption, disposition and elimination have been modelled in a range of different models. The most well known model is the Bergman minimal model [Bergman et al., 1979] which is often described as a balance between data availability, physiological knowledge and mathematical flexibility [Bergman and Lovejoy, 1997]. Reservations with regards to the minimal model concerns that it was originally based on IVGTT data, but has since been adapted to MTT and OGTT [Man et al., 2004, 2002], the later denoted as the oral minimal model.

An alternative model was proposed by Hovorka et al. [2002]. It includes three insulin actions on respectively inter-compartmental distribution, glucose disposal and endogenous glucose production (EGP).

In the period of the PhD programme several articles on models for insulin and glucose have been published by other groups. An IVGTT model was proposed by Silber et al. [2007]. This model is based on labelled glucose, which enables more detailed processes to be identified. A 24-hour model also based on labelled glucose data was presented by Man et al. [2007b,a]. It was estimated on single meal data, and subsequently extended into a 24-hour model, which was validated on 24-hour MTT data. Hovorka et al. [2007] used a two compartment structure to analyse tracer studies. The use of labelled glucose facilitates quantification of processes normally in-observable using cold¹ data. Specifically, a separation of glucose gut absorption and endogenous glucose production (EGP) is possible when tracer techniques are used.

¹The expression cold data refers to standard observations of glucose whereas hot data refers to the use of radioactive tracers or stable isotopes of glucose

The oral minimal model [Man et al., 2002] will be used as a basis for the model building. The current model includes a meal function that describes glucose appearance following ingestion of meals.

$$\frac{dG}{dt} = U_p - S_G \cdot (G - G_b) - S_I \cdot X \cdot G \quad (6.1)$$

$$\frac{dX}{dt} = p_2 \cdot ((I - I_b) - X) \quad (6.2)$$

where U_p is the meal function and S_G is the glucose effectiveness, which describes glucose effects on its own disposal. S_I is the insulin sensitivity that describes insulin's effect on glucose disposal. X is the insulin action, which physiologically is often interpreted as interstitial insulin concentrations with a delay parameter p_2 .

In periods with high glucose concentrations, the liver converts glucose into glycogen for storage and in periods with low glucose concentrations, glycogen is converted back into glucose. This dual role of the liver can usually be neglected in shorter trials as such experiments do not impose both roles. In a MTT covering 24-hours the liver will assume both roles, but often the model assumption is that EGP is constant.

6.1 Meal Function

The expression "meal function" refers to a mathematical function that describes the glucose rate of appearance following a meal. The rate absorption profile is influenced by many factors e.g. meal composition, previous meals and amount of liquid.

Lehmann and Deutsch [1992] published a physiological model of insulin and glucose that incorporated glucose absorption. The model is based on an empirical description of the gastric emptying rate. Recently, a mixed meal model was proposed by Man et al. [2006a,c,b] which divides the meal into a solid and a liquid state in the stomach followed by an intestine state. The model includes a non-linearity in the gastric emptying rate dependent on total amount of glucose in the stomach. A model including the mixed meal function was published in [Man et al., 2007b,a] after the current modelling work and is mentioned for a more complete overview.

The different approaches to glucose rate of appearance seem different in form and physiological interpretation but the resulting glucose absorption profiles are similar in shape.

The meal function parameterisation used in this thesis is described in [Hansen, 2004]. It is a sum of two exponentials where an upper limit for the area under curve (AUC) in the meal function is ingested glucose as either recorded during the trial or specified in the protocol. The meal function can be simplified by assuming identical time constants.

$$U_p = 2 \cdot MA_p \cdot MK_p \cdot e^{-MK_p \cdot t} (1 - e^{-MK_p \cdot t}) \quad (6.3)$$

The product ($2 \cdot MA_p \cdot MK_p$) is used to normalise the AUC based on an upper bound of ingested glucose (MA_p). MK_p is a rate parameter and U_p is the rate of appearance of glucose from meals. p denotes the different meals during 24 hours ($p = 1, 2, 3$).

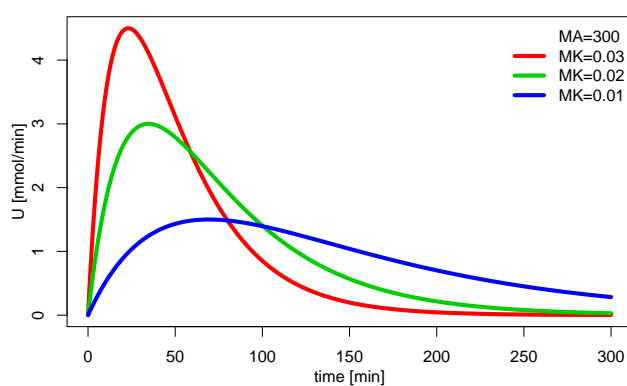

Figure 6.1: Schematic Meal Function

The glucose model with meal function suffered from identifiability issues. The contribution in plasma glucose from meal could not be separated from EGP. Furthermore, glucose elimination and meal function have opposing effects. The process of selecting candidates for parameters that could stabilise estimation and the model building in general is the focus point for the next section.

6.2 Model Building

The model building had parallel tracks and choices were influenced from different tracks but also the insulin model building. Combined parameter estimation for trials proved to be unstable and was quickly split into pr. trial estimation, which increased stability.

The glucose models were tested in two structural versions: one or two compartments. The possibility to fix parameters to literature values was also explored. Random effects were included for inter-individual variation describing the glucose kinetics.

Regarding the meal function, different parameterisations were tested with random effects on rate constants and/or meal sizes. The most robust solution was a trial specific meal function which fitted nicely into the bridging strategy.

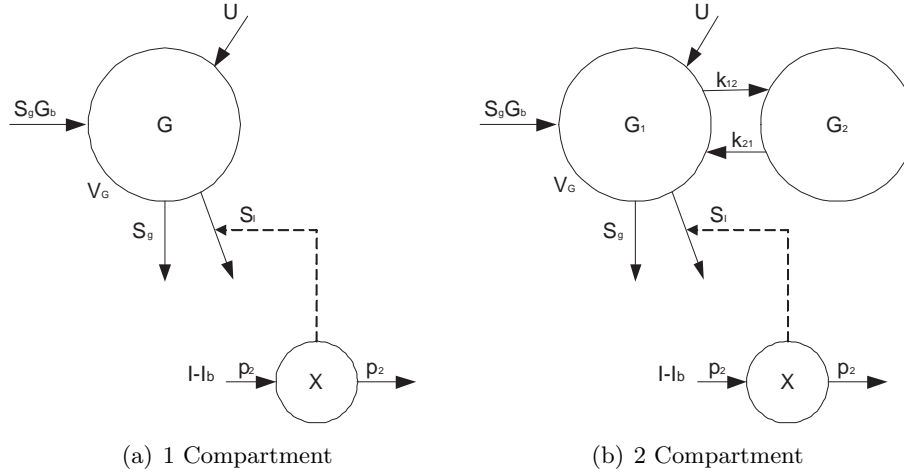

Figure 6.2: Glucose Models

As a starting point for the modelling, the glucose volume of distribution was fixed to 17 litres advised from Morten Colding-Jørgensen and Roman Hovorka. The distribution volume for glucose was an object for investigation. In Table 6.1, glucose volumes from different publications are listed. The table shows that often the volume of distribution is weight normalised. A volume of 17 litres will for an 80 kg individual correspond to 2.13 dl/kg, which is in agreement with reported values from cold data and T2DM.

Publication	Glucose Vol	Comment
Steele et al. [1956]	1.69 dl/kg	Dilution, Dogs, see [Finegood and Tzur, 1996]
Radziuk and Pye [2002]	18% of weight	Tracer, T2DM
Finegood and Tzur [1996]	2.50 dl/kg	Mean literature value, T1DM
Man et al. [2002]	1.7 dl/kg	Prior for healthy
Sunehag et al. [2009]	2.40 dl/kg	Prior for T2DM
Hovorka et al. [2002]	1.60 dl/kg	* Healthy males, hot IVGTT
Man et al. [2007b]	1.49 dl/kg	* Healthy+T2DM, hot MTT
Silber et al. [2007]	9.33 liter	* Healthy+T2DM, hot IVGTT

* Estimate for central compartment in two compartment models

Table 6.1: Glucose volume of distribution

Parameter estimation in two compartment structures had inter-compartmental rate constants fixed, as they could not be estimated from cold data. The rate

parameters were fixed to $k_{12} = 0.05$ and $k_{21} = 0.07$. This is in accordance with literature values shown in Table 6.2 and also used in Hovorka et al. [2007]. The delay for insulin action p_2 was fixed to 0.03 min^{-1} in some models candidates.

Article	Population	#Subj	k_{12}	k_{21}	Reference
Silber	Healthy+T2D	72	0.047	0.052	[Silber et al., 2007, p.1166]
Krudys	Healthy	10	0.068	0.110	[Krudys et al., 2005, p.1043]
Hovorka	Healthy	6		0.065	[Hovorka et al., 2002, p.998]
Hovorka	Healthy	6	0.079	0.121	[Hovorka et al., 2002, p.1001]
Vicini	Healthy	14	0.070	0.080	[Vicini et al., 1997, p.1028]

Table 6.2: Literature values for glucose inter-compartmental rate constants

In literature different values for p_2 and S_G have been published and fixed parameters are in range with reported values in Hovorka et al. [2002] and Man et al. [2004]. Many articles have discussed the overestimation of the S_G parameter in the minimal model [Cobelli et al., 1998; Caumo et al., 1999; Vicini et al., 1999] as a result of modelling. The S_G parameter was set to 0.0055 min^{-1} , which was determined as a representative value from the publications using labelled glucose to determine S_G (see Table 6.3).

Article	Population	#Subj	Comp	S_G
Avogaro et al. [1996]	T2D	7	1	0.0053
Hovorka et al. [1998]	Healthy	10	1	0.0089
Vicini et al. [1997]	Healthy	14	2	0.0038

Table 6.3: Literature values for S_G

The performance of the glucose models were evaluated on fit to observations, objective function values (OFV) but also evaluated on their correspondence with results from literature.

Model Selection

The initial models included random effects on p_2 , S_I and S_G but also tested random effects on the trial specific meal parameters.

Similar to the insulin model building, the range of potential models was substantial and the full combinational tree of structural models, random effects and parameterisations was not traversed, but relevant groups were investigated. The models were compared on general fit to observations, OFV, physiological interpretation and correspondence with literature.

The initial models were mainly evaluated on their ability to capture meal sizes in correspondence with protocols. The main problem was increased flexibility of the meal function obtained with random effects decreased the effect of insulin (S_I). It was hypothesised that the meal function captured all the

variation in the observations which motivated a shift to a trial specific meal function.

The first version of the glucose model was a one compartment structure with random effects on p_2 , S_I and S_G and a trial specific meal function. The model was combined with the insulin model (pre-hepatic insulin secretion) and used to simulate scenarios (euglycemic clamp and insulin tolerance test, see Chapter 5.2 page 36). As previously mentioned in the insulin chapter, the analysis led to a series of conclusions. The main conclusion was that the combined model was not insulin sensitive enough and led to a changed insulin appearance model, which disregarded C-peptide measurements, an exclusion of the NN2211 population from estimation data and a new glucose model building with the focus on a more insulin sensitive model.

A range of potential models were re-investigated, specifically analysing the fraction between insulin dependent elimination (IDE) and total elimination². The models were compared to the model in the evaluation to investigate if the elimination fraction had increased towards a more insulin sensitive model.

According to literature, glucose elimination via non-insulin mediated pathways should be $\sim 50\%$ for normal subjects and $\sim 83\%$ in obese insulin resistant individuals [Best et al., 1996]. Baron et al. [1985] state that the fraction should be 71% for T2DM and 75% for normal subjects.

The fractions of insulin mediated glucose elimination for different model candidates can be seen in Table E.1. The articles just mentioned report the non-insulin mediated elimination but the model derived fractions reported in the table are insulin dependent elimination fractions. Furthermore, literature values are based on clamp experiments and described as being representative for a post-absorptive state, which differs from a MTT model setup that includes all phases over 24 hours. Despite an increased divergence compared to literature values, it was decided to opt for a more insulin sensitive model.

The model selection was also based on estimates for glucose effectiveness (GE) found in literature. GE is the effect of glucose per se to stimulate its own uptake and inhibit hepatic glucose production. A number of publications were selected [Best et al., 1981, 1996; Prato et al., 1997; Hawkins et al., 2002], all described hyperglycaemic clamp experiments from which GE indexes could be derived. The glucose effectiveness is defined as shown in Equation (6.4). The S_G parameter is often denoted glucose effectiveness as it describes the glucose effectiveness in the minimal model but the parameter only explains a part of the physiological effect.

$$GE = \left. \frac{\delta R_D}{\delta G} \right|_{SS} = \left. \frac{\delta(R_U - EGP)}{\delta G} \right|_{SS} \quad (6.4)$$

where R_D is the total glucose disposal. R_U is glucose uptake and EGP is endogenous glucose production.

²Total elimination = IDE + IIE (Insulin In-dependent Elimination)

The GE indexes from literature cannot be directly compared to model estimates due to differences in insulin baselines. The literature indexes originate from different physiological scenarios, typically clamp experiments with different insulin levels and had to be adjusted accordingly using Equation (6.5).

$$GE = (SG + SI * (I_{Pub} - I_b)) * V_G \quad (6.5)$$

where I_{Pub} is the mean insulin level in the publication and I_b is the individual basal insulin level.

Table E.1 page 216 summarises the GE for model candidates, which should be compared to the three publications in the bottom of the table. The comparison shows that the models for ANA and BIASP have GE in the same range as the publications.

The glucose model selection resulted in a glucose model with a fixed S_G as a compromise of OFV, GE estimates and insulin dependent elimination. The parameterisation included random effects on S_I and p_2 and a meal function that was trial specific.

Different error models have been tested and initially proportional was used, but due to stability a switch was made to an additive error model. The model fits can be seen in Figure 6.3. The fits can be seen to be close to observations but with some artefacts from the calculation of the mean profile.

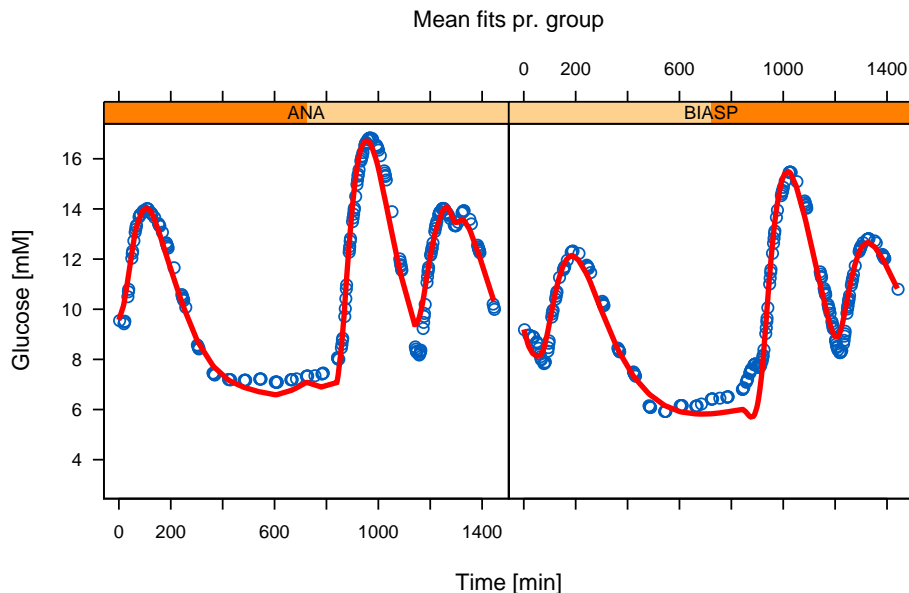

Figure 6.3: Fits from Glucose Model

The next step was to combine the final models for insulin and glucose into an integrated model and verify that the data used for estimation could still be predicted. Furthermore, a series of evaluation scenarios was simulated and compared to literature. The overall qualification of the integrated model will be the subject of the next chapter.

Integrated Model Evaluation

The integrated model for insulin and glucose was created by combining the two sub models that were previously described. Both models were estimated using measured concentrations as input to model either glucose driven insulin secretion or insulin driven glucose elimination. This chapter will evaluate the integrated model both on estimation data but also in a series of scenarios which can be compared to literature.

The scenarios were also used during model building and consist of a euglycemic clamp and an insulin tolerance test simulation. A sensitivity analysis on the insulin doses was performed as an additional scenario that should be evaluated subjectively.

The scenarios that were used to evaluate the performance of the integrated model were:

- **Prediction of estimation data**

The integrated model was used to predict estimation data to investigate potential bias from the separate estimation.

- **Euglycemic Clamp**

A clamp scenario was simulated with three different dose levels and resulting AUCs were compared to a similar trial.

- **Insulin Tolerance Test**

An ITT was simulated and results were compared to results from a reported study.

- **Sensitivity Analysis on insulin doses**

Insulin doses were altered (doubled and halved) and the corresponding glucose profiles were analysed. The analysis was subjective as no reference was available.

7.1 Model Description

Prior to evaluating the integrated model in different scenarios, the model will first be described in detail and estimated parameters be presented.

The model consisted of a system of ordinary differential equations that described both insulin and glucose dynamics. The model can be seen in schematic form in Figure 7.1 and equations can be seen in the following equations (7.3)-(7.11). The estimated parameters are shown in tables 7.1 - 7.3.

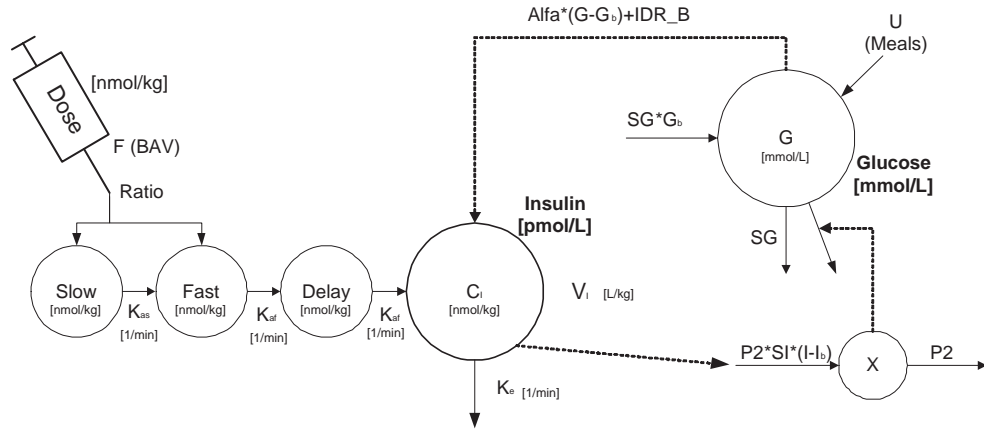

Figure 7.1: Simulation Model

Some parameters were not estimated directly due to constraints. F was estimated using a logit transform to ensure values within $[0; 1]$. Parameters K_{as} and K_{af} were estimated using a relationship that guaranteed that K_{af} was faster than K_{as} also at the individual level shown in equations (7.1)-(7.1).

$$K_{as,breakfast} = K_{as} \cdot e^{\eta_{as,breakfast}} \quad (7.1)$$

$$K_{af,breakfast} = K_{as,breakfast} + K_{af} \cdot e^{\eta_{af,breakfast}} \quad (7.2)$$

Insulin Model

$$\frac{dI_{Slow}}{dt} = (1 - Ratio) \cdot F \cdot Dose - K_{as} \cdot I_{Slow} \quad (7.3)$$

$$\frac{dI_{Fast}}{dt} = Ratio \cdot F \cdot Dose + K_{as} \cdot I_{Slow} - K_{af} \cdot I_{Fast} \quad (7.4)$$

$$\frac{dI_{Delay}}{dt} = K_{af} \cdot (I_{Fast} - I_{Delay}) \quad (7.5)$$

$$\frac{dI_{Central}}{dt} = (\alpha(Glu_{conc} - G_b) + IDR_B) + K_{af} \cdot I_{Delay} - K_e \cdot I_{Central} \quad (7.6)$$

$$Ins_{conc} = \frac{I_{Central}}{V_{Ins}} \cdot (1 + \epsilon_I) \quad (7.7)$$

Glucose Model

$$\frac{dX}{dt} = p_2 \cdot (Ins_{conc} - I_b) - p_2 \cdot X \quad (7.8)$$

$$U_p = 2 \cdot MA_p \cdot MK_p \cdot e^{-MK_p \cdot t_p} (1 - e^{-MK_p \cdot t_p}) \quad p = 1, 2, 3 \quad (7.9)$$

$$\frac{dG}{dt} = U/V_G + S_G \cdot G_b - S_G \cdot G - SI \cdot X \cdot G \quad (7.10)$$

$$Glu_{conc} = G + \epsilon_G \quad (7.11)$$

Name	Var Type	ANA		BIASP	
		Value	Variance	Value	Variance
F^*	IIV,IOV	0.476	2.83	0.412	1.94
K_{as}	IIV,IOV	3.27E-03	0.171	2.47E-03	0.139
K_{af}	IIV,IOV	9.15E-03	0.473	1.03E-02	0.301
α	IIV	7.09E-05	0.658	1.73E-05	3.17
IDR_B	IIV	5.74E-04	0.454	7.29E-04	1.56
K_e	FIX	7.50E-02	-	7.50E-02	-
V_I	FIX	0.12	-	0.12	-
ϵ_I	-	-	2.42E-02	-	2.15E-02

* logit transformed [0;1]

Table 7.1: Estimated Insulin Model Parameters

Name	Var Type	ANA		BIASP	
		Value	Variance	Value	Variance
P_2	IIV	3.60E-02	1.06	1.61E-02	1.45
S_I	IIV	1.29E-05	0.78	1.92E-05	1.13
S_G	FIX	5.50E-03	-	5.50E-03	-
V_G	FIX	17	-	17	-
ϵ_G	-	-	2.61	-	3.64

Table 7.2: Estimated Glucose Model Parameters

	ANA			BIASP		
	Breakfast	Lunch	Dinner	Breakfast	Lunch	Dinner
MA	385	304	261	346	266	263
MK	1.55E-02	1.23E-02	1.39E-02	1.59E-02	1.24E-02	1.18E-02

Table 7.3: Estimated Meal function parameters

Prediction of Estimation Data

The potential bias from the separate estimation was assessed by predicting the estimation data with the integrated model.

The simulation with the integrated model used insulin doses and weight covariates from data and a parameter set for each subject that described the insulin and glucose models. The trial MTT was as a steady state treatment experiment i.e. after several days of treatment. The simulation replicated this by simulating several days of treatment in order to obtain a steady state situation but also to eliminate artefacts from initial conditions.

In Figure 7.2, the simulated insulin and glucose are compared for groups ANA and BIASP. The full line is the mean simulation and the points are mean observations. For ANA both insulin and glucose fits are generally good with the largest misfit at dinner peak in the insulin profile. The largest misfit for BIASP is seen in the overnight period in the insulin concentrations.

The increasing insulin prediction around lunch time indicates that insulin secretion is present as the exogenous insulin is decreasing in this period. However, the contribution from the basal delivery still seemed high compared to the glucose driven delivery.

The conclusion for the prediction of the estimation data was that both insulin and glucose were well described by the integrated model i.e. that no bias had been introduced by the separate estimation.

Isoglycemic Clamps

Glucose clamps are used in clinical trials to assess safety and provides valuable information on the insulin delay and action [Heinemann, 2004]. This evalu-

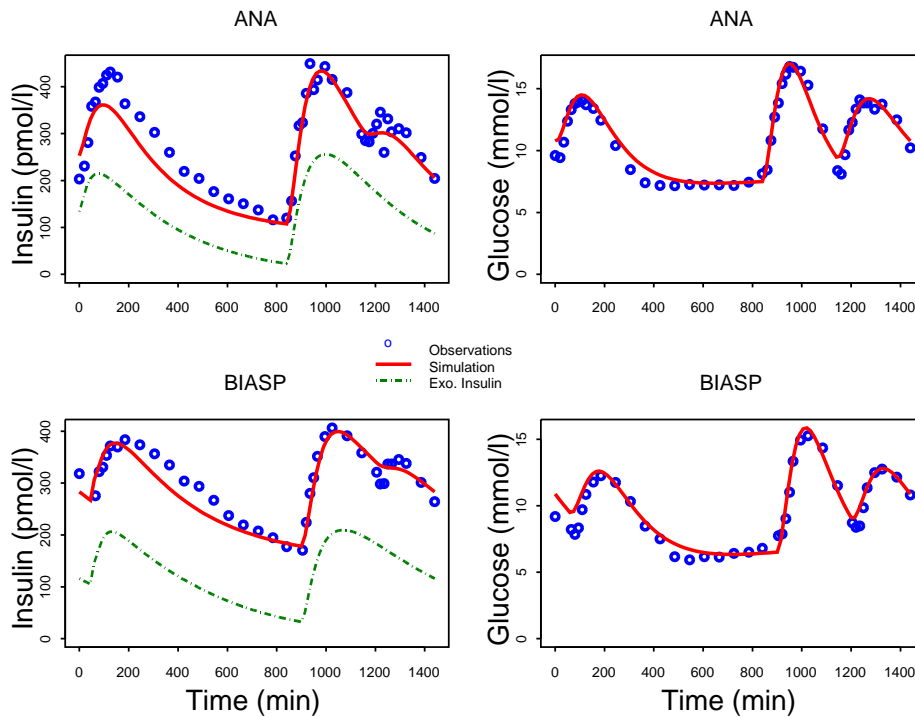

Figure 7.2: Prediction of Estimation Data

ation scenario was also used during the model building and it simulated a glucose clamp identical to a study conducted at Novo Nordisk (NN304-1439). Patients were clamped at 7.2 mmol/l glucose and had three different insulin dose levels (NPH 0.3, 0.6 and 1.2 IU/kg). The glucose infusion rate (GIR) profiles from NN304 are shown stratified by ethnicity (Blacks, Hispanics and Whites) in Figure 7.3.

The simulations are compared to the trial results by GIR_{AUC} , GIR_{Tmax} and GIR_{max} . The measured GIR profiles have a flat plateau in the insulin action profile where an estimate of GIR_{Tmax} is uncertain for which reason the comparison was only visual. The GIR_{AUC} was calculated from [0; 16] hours after injection for all dose levels. The GIR_{AUC} s from simulations were then subsequently compared to trial reported values.

The simulated GIR profiles are shown in Figure 7.4. The individual profiles have been adjusted to an intercept identical to the mean NN304 starting point (0.5 mg/kg/min). The adjustment was needed as the simulated GIR profiles could become negative due to a model artefact from glucose baseline values.

The GIR increase, needed to counteract the effect of injected insulin, can be seen to differ in shape for simulations and trial groups. The GIR_{max} was in the correct range but the peak is more pronounced in the simulations than

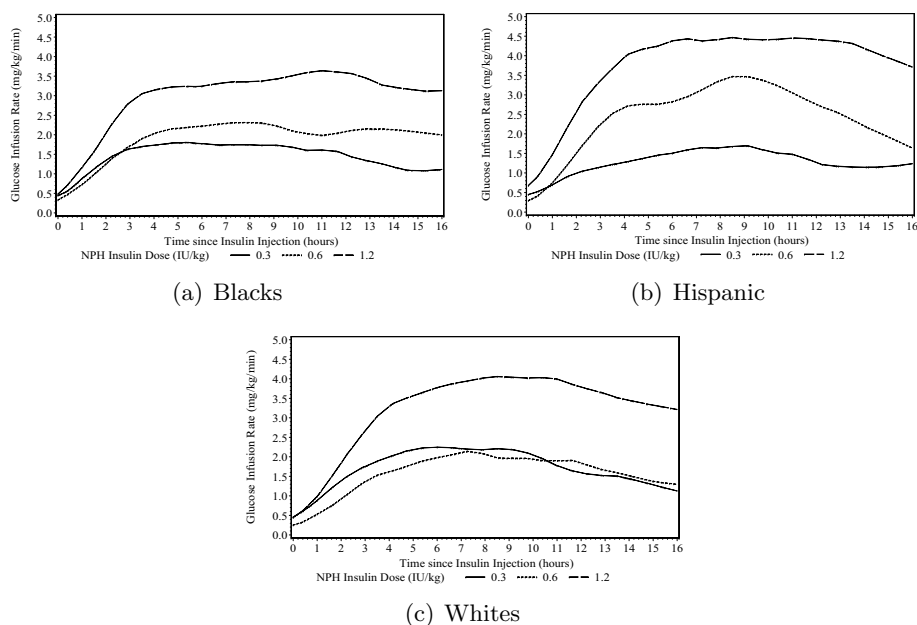

Figure 7.3: GIR profiles from NN304-1439 (ICTR p. 50)

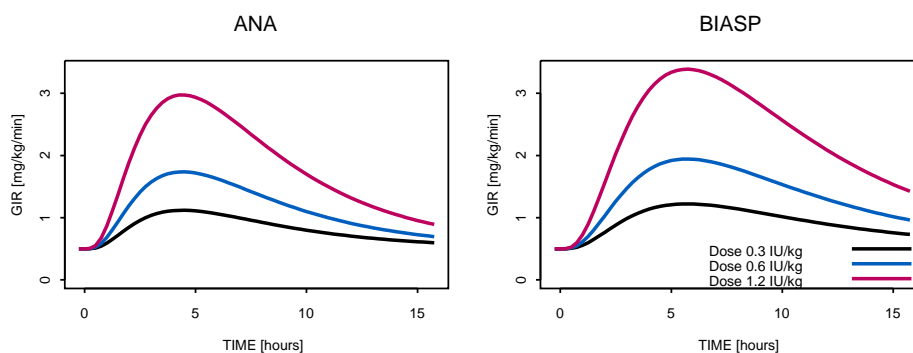

Figure 7.4: Simulated GIR profiles

compared to NN304 trial profiles.

A comparison of $GIR_{T_{max}}$ was difficult but it can be seen that the delay before plateau compares to $GIR_{T_{max}}$ for the simulations. The tails of the simulated profiles can be seen to return to a near baseline value whereas the reported profiles remain on the plateau.

The GIR_{AUCs} were calculated and compared to trial AUCs in Figure 7.5. The slope of the lines indicated that the increases in GIR response for increasing dose were equal for simulations and reported AUCs. The absolute response is lower for the simulated values which indicated low insulin sensi-

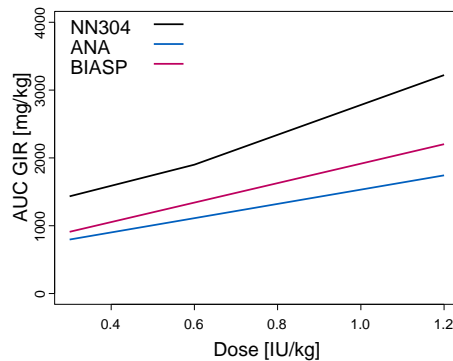

Figure 7.5: AUC of the GIR Profiles

tivity. However, the scaling mentioned to remedy the artefacts from glucose baselines have a great influence on calculated AUC.

The conclusion was that the clamp scenario revealed discrepancies in relation to shape of GIR profiles and also the comparison of GIR_{AUC} was not on par.

Insulin Tolerance Test

Another scenario used in the evaluation was an insulin tolerance test (ITT). It was also used during model building (Section 5.2) and was repeated here for the evaluation of the integrated model.

The ITT measures the rate of decrease in glucose after an IV insulin bolus dose. Inchiostro [2005] reports the results of an ITT conducted where patients after an overnight fast were dosed IV with 0.1 IU/kg insulin. Venous blood samples were collected at -15, -1, 3, 6, 9, 12 and 15 min and the glucose concentrations were determined. The index K_{ITT} is the elimination rate constant from a first order decline in the time period [3, 15]. The ITT setup is illustrated in Figure 7.6 where the red line is the first order decline.

The article by Inchiostro [2005] analyses a group of newly diagnosed T2DM patients. The comparison between the groups should be weighted with the fact that ANA and BIASP consist of patients who were not characterised as newly diagnosed. The reported K_{ITT} for the ANA and BIASP groups are seen in Figure 7.7. It can be seen that the calculated K_{ITT} are closer to the reported values than during model building.

Physiologically, it means that insulin driven glucose disposal in the model is not as fast as reported in literature i.e. the glucose disposal is not as sensitive to insulin. Furthermore, the uncertainty (standard deviation) is large indicating a very inhomogeneous group of parameter values. A hypothesis for the large variation could be the influence of glucose baselines which complicated the analysis.

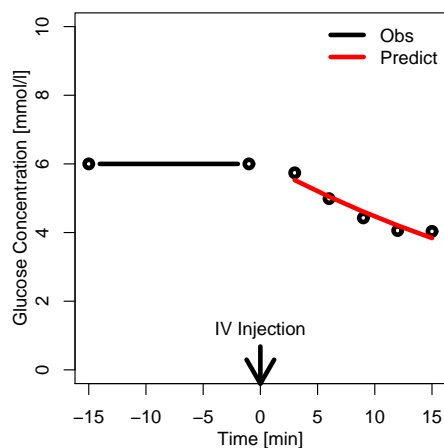

Figure 7.6: Insulin Tolerance Test Illustration

Group	$K_{ITT}\%/min$
ANA	1.85 ± 1.65
BIASP	2.17 ± 3.36
T2D	2.88 ± 0.99
Males	2.74 ± 0.94
Females	3.15 ± 1.02

Estimates from Inchiostro [2005]

Figure 7.7: Group mean \pm sd of K_{ITT}

The conclusion was that the ITT did not falsify the integrated model but were also not in complete correspondence.

Sensitivity Analysis

The evaluation also included a "what-if" scenario where insulin doses were altered. The insulin doses were halved and doubled in order to evaluate how the integrated model responded to a substantial change in dosed insulin. The subjects in ANA and BIASP received ~ 50 IU/day, which from a titration viewpoint confirms that the populations were insulin resistant [Hirsch et al., 2005].

The results of the sensitivity analysis could not be compared to literature but only be evaluated on a subjective basis. Intuitively, the glucose concentrations should drop dramatically if dose was doubled. Normally, hypoglycaemic episodes could be expected but as the model was not estimated in the low glucose range or had processes included that describes hypoglycaemia, it was unclear how the model would perform.

Figure 7.8 shows the profiles with changed insulin doses. Both alterations of dose induced a change to the glucose profile but none of them was as pronounced as expected. This subjective measure also supports the belief that the integrated model was insulin insensitive.

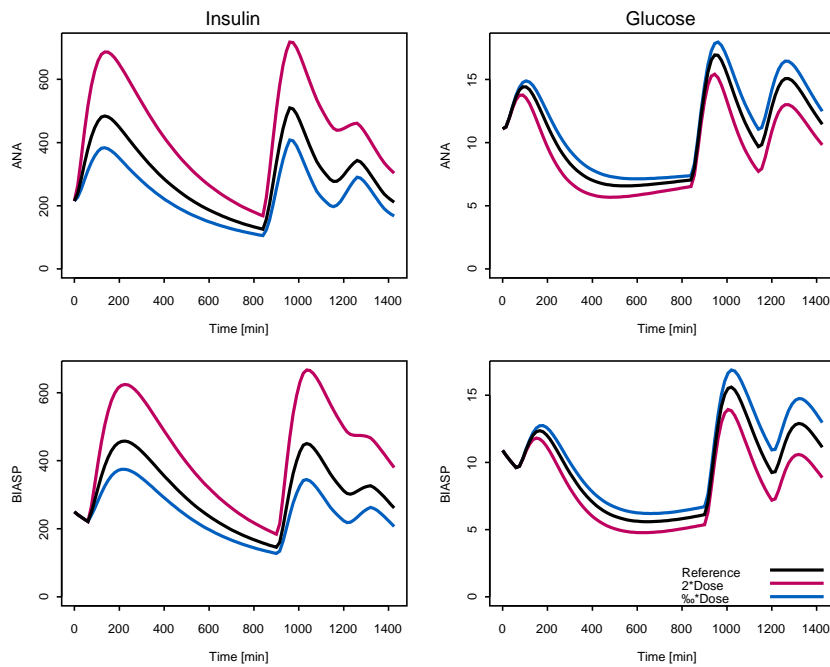

Figure 7.8: Insulin dose sensitivity analysis with the integrated model

7.2 Human Insulin Evaluation Round-Up

The integrated model was evaluated in scenarios which aimed at different aspects of the insulin/glucose system.

The prediction of estimation data evaluated the separate estimation scheme and assessed overall performance. The clamp scenario targeted the insulin absorption and action part of the integrated model. The insulin action was also the focus of the insulin tolerance test scenario whereas the sensitivity analysis of insulin doses was a subjective scenario, which evaluated the entire integrated model.

The evaluation scenarios were not exclusively confirmatory due to simulation outcomes that were not completely on par with literature. In general, the deviations were considered minor in comparison to the variation in profiles/study population etc. A model insulin sensitivity issue was identified during model development and triggered a shift in model structure and estimation data. The lack of insulin sensitivity was unfortunately still present in the evaluation scenarios which were also supported by the sensitivity analysis.

Additionally, glucose effectiveness was used to evaluate/compare potential models during glucose model building in which model derived GEs were in range with reported values.

The integrated model was able to predict the estimation data nicely, so for descriptive purposes the integrated model performs adequately. In relation to external evaluation scenarios, the integrated model had issues, but was still reasonably similar to literature. It was decided to proceed in the project to an integration of insulin Aspart in a bridging setup.

Bridging Strategy Evaluation

The overall goal with the project is a bridging of a new insulin analogue only investigated in clamps into an integrated model in order to simulate 24-hour glucose profiles from meal tolerance tests. The integrated model for human insulin will form the basis which in this chapter will be used for a bridging of insulin Aspart (IAsp) by which the bridging strategy performance can be assessed.

The premises of the bridging strategy imply that information on insulin Aspart should originate from clamp experiments. This requirement was fulfilled with only minor deviations.

The original estimation data for the integrated model was based on human insulin treatment arms with corresponding cross-over treatment arms with insulin Aspart. The cross-over meal tolerance tests with insulin Aspart from the estimation data enable a comparison to the simulated IAsp MTTs.

Bridging Strategy

The bridging concept links the mapped properties of a new insulin analogue into the integrated model enabling a simulation of meal tolerance tests. The simulation uses "cloned" subjects for the integrated model that is not replaced by the new insulin. A cloned subject consists of individual parameters estimated in the integrated model and a set of mean parameters describing the new parts of the model.

It would have been optimal to sample from parameter distributions in order to create new subjects in a MTT, but the separate model estimation did not establish a parameter correlation structure. A sampling from two separate parameter distributions (insulin and glucose) would potentially result in parameter sets that were physiologically infeasible and not representative for a

T2DM population. In order to retain inter-individual variation in simulations the cloning approach was used.

The bridging strategy requires two insulin Aspart components to be developed:

- a population PK model for insulin Aspart
- a transfer function converting insulin Aspart concentration into action-equivalent concentration of human insulin

The estimation of a PK model for IAsp and a transfer function should be completely decoupled from the integrated model estimation data. The PK model and transfer function are the topics for the next sections.

8.1 Aspart Pharmacokinetic Model

The development of the pharmacokinetic model for insulin Aspart was a part of a different Novo Nordisk project and was carried out by Andreas Velsing Groth and Lene Alifrangis, BioModelling, Novo Nordisk A/S.

A PK model for insulin Aspart had previously been published by Clausen et al. [2006]. This model was based on the chemical dissolution process for the protaminated crystals and a one compartment structure for the insulin disposition with first order elimination. The parameter estimate for distribution volume is unphysiologically high, however clearance is comparable to literature values. Furthermore, the rate constants for the dissolution process are slow which introduces a large degree of accumulation which seems unrealistic in a multiple dose setting.

The estimation data were Novo Nordisk conducted trials using IAsp in different premix ratios and initially both single-dose and steady-state data were included for the estimation. The trials selected in the analysis are listed in Table 8.1. The trials were not exclusively clamp trials which deviate from the bridging strategy but only PK data was used so the deviation was minor.

Trial	Population	Ratio	#Subjects
ANA-046	T2	NM30	13
ANA-1199	T2	Aspart	36
BIAsp-1086	HV	NM30, NM50, NM70	32
BIAsp-1318	T1	NM30, NM70	26
BIAsp-1526	T2	NM50, NM70	72
BIAsp-1746	T1	NM30, NM50, NM70	32

Table 8.1: Trials included in the Insulin Aspart PK Model

The structural model previously reported and also used as basis for the modelling is a two compartment model for absorption and a single compart-

ment model for distribution. The model can include a reverse dissolution process as also shown in Figure 8.1.

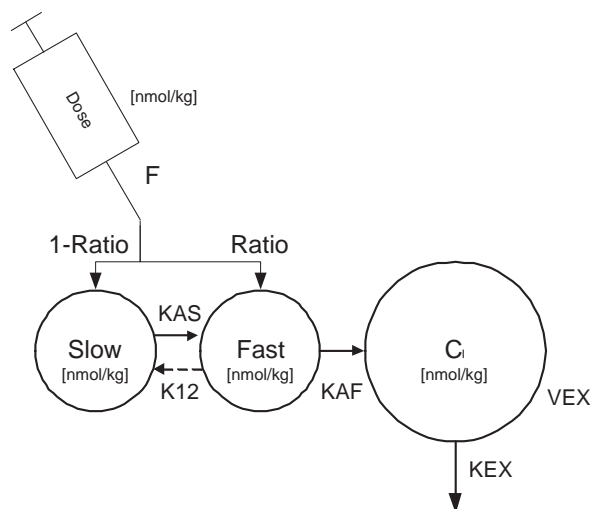

Figure 8.1: Structural model for biphasic insulin Aspart

The modelling analysis encountered several issues, which are also encountered in other PK models for biphasic insulin. The sampling focuses on the peak after an injection which primarily provides information on the fast component. Some trials also used pure insulin Aspart which adds reliable information on the fast component.

The choice of error model also highly affects the estimation of the slow absorption process. By using a proportional error model increased weight is put on low concentrations. The sparse sampling, the choice of premisses, and error model all complicate estimation of the slow component in the model.

The use of steady state data in the estimation requires a calculation of the amount of accumulation. An explicit calculation was not possible and the steady-state data had to be discarded due to numerical problems with the calculation of the accumulation. The consequence was that only single dose data was used for the parameter estimation.

Parameter	F	KAS [/min]	KAF [/min]	KEX [/min]	VEX [liter/kg]
Value	1	0.000783	0.0253	0.00997	1.36

Table 8.2: Estimated parameters in the insulin Aspart PK Model

The estimated parameters for the PK model are shown in Table 8.2. A high volume of distribution and a low elimination rate constant renders the model unphysiological. However, the model is able to fit data from several trials

and it was decided to regard the model as an empirical population absorption model for insulin Aspart. The model was based on mixture ratios 30, 50 and 70 and the empirical structure should discourage ratios beyond this range.

8.2 Transfer Function - Insulin Aspart

The simulation with IAsp treatments based on the integrated model requires a function able to translate the action of insulin Aspart into corresponding concentrations of human insulin. This section deals with the estimation of this function.

Clamp experiments are used to quantify the effect of a new insulin analogue and typically these trials include comparator insulin. The clamp experiment thus provides four profiles used in the estimation of the transfer function: insulin/glucose profile for human insulin treatment and insulin/glucose profile for insulin Aspart treatment. This enables a translation of the insulin analogue action into the action of the reference insulin in the integrated model. The clamp data is presented in Section 4.3 and profiles are shown in Figure 4.4.

The dependent variable in the transfer function is an insulin Aspart concentration profile and the output is a concentration profile of human insulin that would result in an identical action. The modelling approach to the transfer function was PID based where the outcome concentration profile is a linear combination of a proportional, a delayed and a derivative part of the insulin Aspart profile. The derivative component can be derived from the profile whereas the delayed component depends on a delay parameter which was also a part of the estimation of the transfer function.

The transfer function for insulin Aspart should be relatively simple as the molecule is nearly identical to human insulin - the only difference being a faster absorption leading to a faster onset of action [Mudaliar et al., 1999]. The insulin concentrations are measured in plasma so a difference in absorption has been accounted for once the measurement is taken. The insulin equivalence in plasma suggests a transfer function that should directly translate the insulin Aspart concentration to an identical concentration of human insulin.

In order to determine the transfer function, the structural GIR-response model should also be estimated. A GIR-response model translates an insulin concentration into a GIR-response. The GIR-response is typically modelled with a delayed effect from insulin, but structural form and delay needs to be inferred statistically.

The GIR-response is based on a insulin action assumption, which was modelled similar to the minimal model.

$$\frac{dX}{dt} = p_2(S_I \cdot I - X) \quad (8.1)$$

where X is the insulin action, p_2 is a delay parameter and S_I is insulin sensitivity.

Three candidates for GIR models are shown in Equations (8.2)-(8.4)

$$\text{M1: } \quad GIR = X \quad (8.2)$$

$$\text{M2: } \quad GIR = \frac{E_{max}X}{1 + X} \quad (8.3)$$

$$\text{M3: } \quad GIR = \frac{E_{max}X^\gamma}{1 + X^\gamma} \quad (8.4)$$

The first candidate (M1) is a direct translation from insulin action to glucose infusion rates. The second and third candidate models assumes a saturable model structure with a max GIR response of E_{max} moreover the third (M3) uses a hill coefficient to alter the slope.

Another factor in the GIR model building was whether to include baselines for insulin and glucose infusion rates. The GIR baseline can be thought of as a product of non-insulin dependent elimination and the contribution from insulin dependent elimination from insulin baseline.

Insulin action as used in the GIR models was determined using the following equations that also include the transfer function $Tr(\cdot)$.

Human Insulin:

$$\frac{dX}{dt} = p_2(S_I \cdot I_{HI} - X) \quad (8.5)$$

Insulin Aspart:

$$I_{HI}^* = Tr(I_{IAsp}) \quad (8.6)$$

$$\frac{dX}{dt} = p_2(S_I \cdot I_{HI}^* - X) \quad (8.7)$$

The equations (8.2-8.7) represent the models that will be used to analyse the cross-over clamp experiment with simultaneous estimation of the transfer function. The parameterisation of the transfer function will be as shown in Equation (8.8).

$$Tr(I_{IAsp}) = \overbrace{C_1 \cdot I_{IAsp}}^{\text{Proportional}} + \overbrace{C_2 \cdot I_{IAsp}^D}^{\text{Delayed}} + \overbrace{C_3 \cdot \frac{dI_{IAsp}}{dt}}^{\text{Derivative}} \quad (8.8)$$

$$\frac{dI_{IAsp}^D}{dt} = I_{IAsp} - \tau \cdot I_{IAsp}^D \quad (8.9)$$

The transfer function consists of three scaling constants (C_x) and a delay parameter (τ) needed to create the integral part. The derivative component ($\frac{dI_{IAsp}}{dt}$) is determined with a smoothing algorithm a priori. The determination of the derivative was performed using the `loess` algorithm in S-Plus, which implicitly relies on a choice of smoothing factor.

Differences in potency and/or delay between the insulin analogue and human insulin should be encompassed by the structure of the transfer function. If the two insulins have different potency, a simple scaling factor in the transfer function will correct the difference in S_I .

If the two insulins have different delayed effects, the relationship is difficult to derive from equations. It is clear that a true difference in p_2 between the insulins is not a simple delay or acceleration in I_{HI}^* as it should account for changed elimination in the effect compartment ($\Delta p_2 X$).

The model building investigated combinations of different parameterisations of the GIR response (M1-M3), different versions of the transfer function and inclusion of baselines. The GIR observation used in the modelling was weight normalised glucose infusion rate which seemed to be physiologically reasonable.

The final model for the insulin Aspart clamp data did not include a derivative or integral component of insulin Aspart. The structural model was of the form M1 seen in Equation (8.2) with baseline values for GIR and insulin included. The expected unit transfer function was nearly confirmed with a proportional constant (C_1 in Equation (8.8)) estimated to a value of 1.06. The model included random effects on parameters p_2 , S_I and also on GIR baseline.

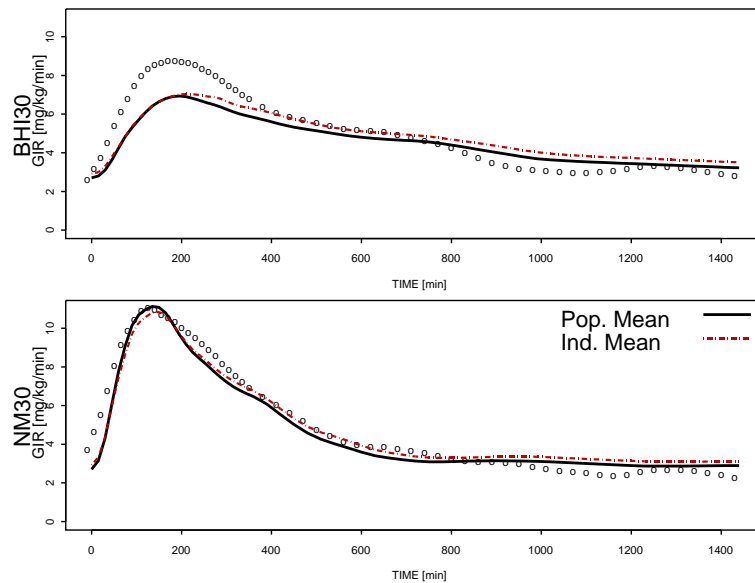

Figure 8.2: Simultaneous fits to BHI30 and NM30 using the transfer function

The mean fits can be seen in Figure 8.2. The model fit to human insulin (BHI30) does not capture the peak whereas the general trend in the tail is

fitted well. The fit for Aspart GIR is quite good. The simultaneous estimation using both profiles resulted in a transfer function consisting only of a proportional term of 1.06 which is very close to the physiologically expected value.

The transfer function and the PK model were now ready to be embedded in the integrated model.

8.3 Prediction of MTT with Insulin Aspart

An extended version of the integrated model was created by embedding the mean IAsp population pharmacokinetic model and the transfer function for insulin Aspart into the integrated model. Individual parameter estimates were used for the glucose and insulin delivery part of the integrated model but the IAsp components of the model were driven by mean population parameters.

The trial specific meal functions were kept in the integrated model as identical meals were served in the cross-over treatments. A simulation of a completely new trial would require a derivation of meal sizes from the protocol.

The extended integrated model can be seen in Figure 8.3, where the new parts are shown in grey boxes.

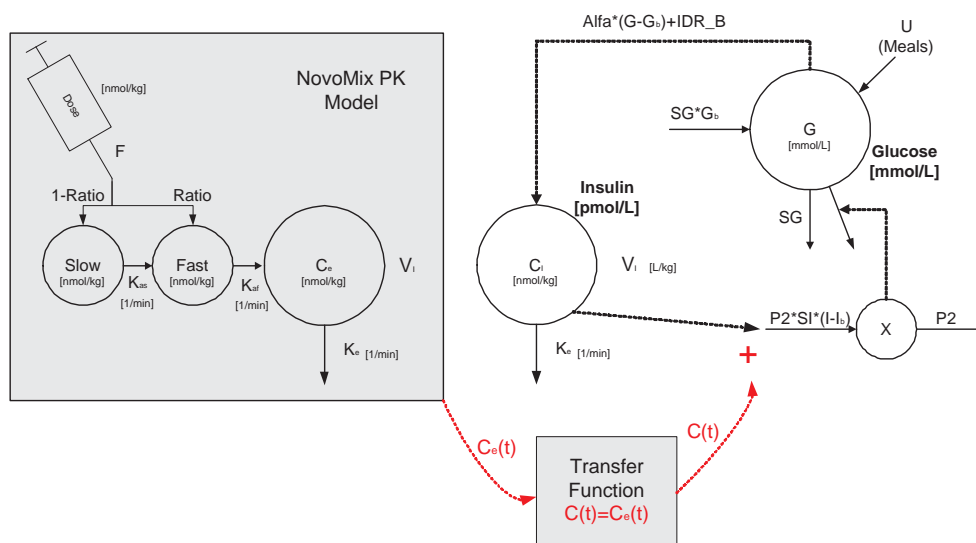

Figure 8.3: Aspart Simulation Model

The individual covariates (weight and baselines) from the human insulin arms were reused. The insulin doses were mean doses in order to adhere to the bridging premises. The cloning approach of parameters combined with covariates and insulin doses formed the population used in the simulations.

The MTT experiment assumes a steady-state condition for the subjects, which was replicated in the simulation with a run-in period of several days of identical treatments. This should ensure that accumulation has been accounted for and that effects of initial conditions have vanished.

The bridging strategy is evaluated by comparing cross-over treatment arms with simulations. The treatment regimens that were simulated were:

- 2 daily injections with Novomix30 (ANA)
- 2 daily injections with Novomix70 and a dinner injection with Novomix50 (NM707050 - BIASP)
- 3 daily injections with Novomix70 (NM707070 - BIASP)

The simulated predictions of insulin Aspart, total insulin and glucose are shown in Figure 8.4. The mean insulin/glucose profiles that were measured in the MTTs are overlaid with the simulations. Both observations and simulation are plotted with the standard error of the mean in order to visualise mean variation.

The assay used in the IAsp MTTs is able to distinguish human insulin from insulin Aspart, which enables a more specific evaluation of the model components.

Figure 8.4 is divided into rows according to the three analysed treatment arms and columns according to measured variable. The first column shows the concentration of insulin Aspart, the second column shows the total concentration of insulin and finally the last column shows the glucose concentrations.

NM30

The bidaily NM30 treatment (first row) fits the measured insulin Aspart concentrations reasonably well. A misfit is seen at the dinner peak for insulin Aspart. Total insulin¹ concentrations fits peak values nicely but the overnight level of total insulin is too high. The overnight profile for insulin Aspart fitted so the discrepancy is believed to originate from an overestimated insulin delivery baseline. The glucose fit show a discrepancy in the same overnight period but also the lunch peak is under-predicted. The general fit in glucose is reasonable and variation is within the observed range.

NM707050 & NM707070

For the NM707050 and NM707070 treatment arms, the predicted insulin Aspart profiles are very similar to the measured insulin Aspart levels. The peaks and trough values for insulin Aspart are captured and only the overnight period is a little off. The variation pattern for insulin Aspart seems to be a little low at peaks.

¹Total insulin = endogenous secreted insulin + translated insulin Aspart

The fits to total insulin shows that the morning levels of insulin are over-predicted contrary to peak values that are nicely captured.

The corresponding glucose concentrations for the treatments show that the overnight periods are not predicted adequately. The measured glucose concentrations show an overnight increase whereas the predictions are flat until breakfast is served. These mis-predictions propagate into the breakfast peak which is also under-predicted. The conclusion was that the extended integrated model was unable to predict the glucose profiles for NM707050 and NM707070.

The overnight rise in glucose can be caused by poor glycemic control as a result of low insulin doses or potentially due to the dawn phenomenon that is linked to growth hormones. Regardless of cause, the measured concentrations are not captured by the predictions.

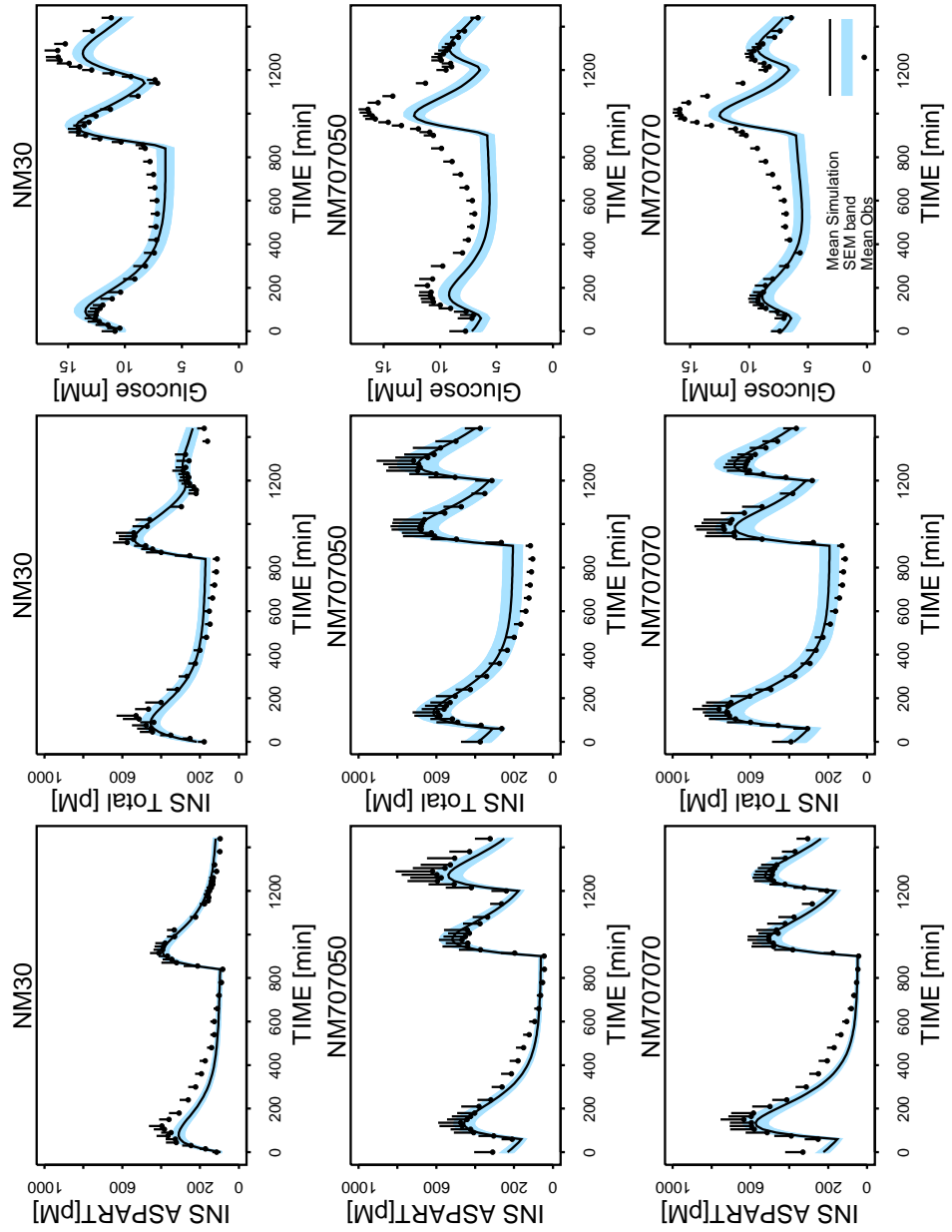

Figure 8.4: Simulation of the MTTs treated with NovoMix

Treatment Differences

A secondary goal with the bridging strategy was a prediction of the differences between treatments. A comparison between treatments should partially eliminate the influence of baseline values which have a substantial impact in the current model.

The BIASP trial included a comparison of treatments NM707070 versus NM707050. Figure 8.5(a) and 8.5(b) show the glucose profiles for simulated treatments and the measured. The difference between the profiles should thus be the prediction of the simulation.

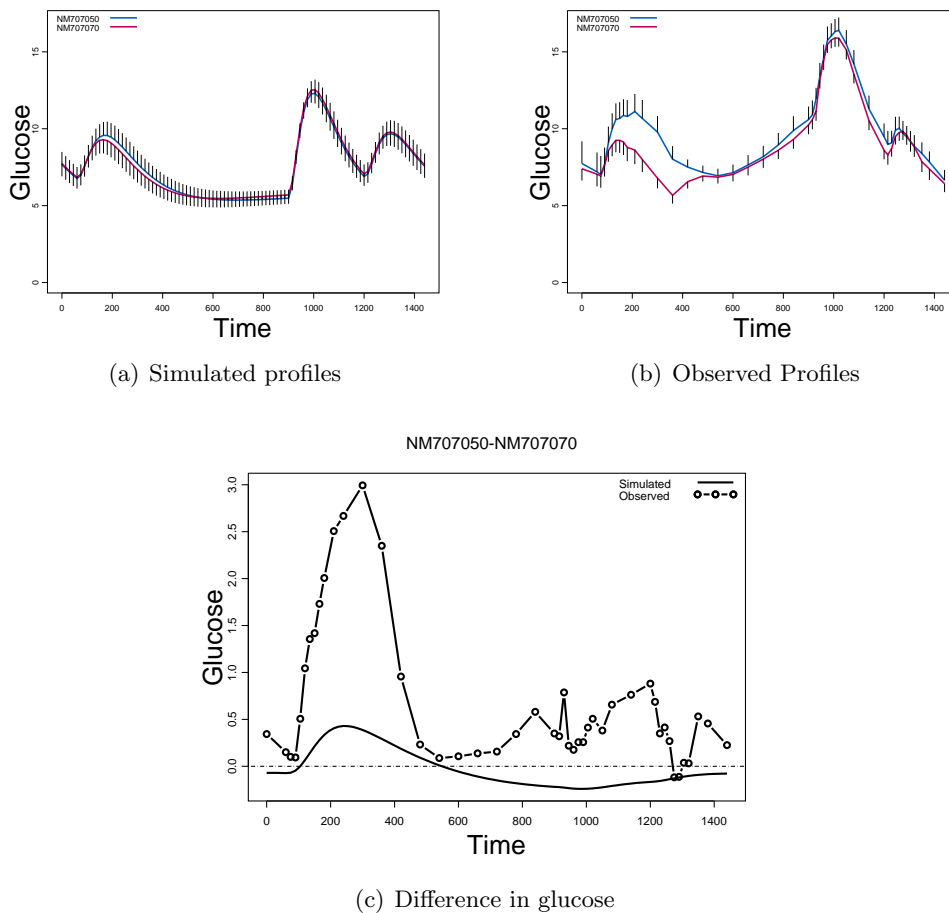

Figure 8.5: Difference in treatments NM707070/NM707050

The plot in Figure 8.5(c) shows that the difference between measured profiles cannot be predicted using the difference between simulated profiles.

The measured difference between treatments show that the treatment with a higher fraction of fast acting insulin is more glucose lowering at dinner time i.e. the difference NM707050-NM707070 is positive. An interesting point is

that the treatment with the better overnight coverage NM707050 counter-intuitively does not provide better overnight glycemic control as expected.

8.4 Aspart Evaluation

In this chapter, the bridging strategy was evaluated using insulin Aspart as a insulin analogue case. The integrated model was extended with a PK model and a transfer function for insulin Aspart, which was then used to simulate cross-over treatments arms from the estimation data. The meal tolerance test treatments were based on biphasic insulin Aspart in different treatment regimens.

The result of the simulation was that the prediction for the NM30 treatment in ANA was good with only minor deviations, whereas the predictions of NM707070 & NM707050 was poor and did not capture the glucose dynamics. The insulin profiles showed that the baseline insulin delivery was too high and the overnight drift in glucose was not fitted.

Unfortunately, the conclusion was that the bridging strategy was not successful on insulin Aspart when compared to cross-over MTTs from estimation data. A series of questions naturally arose: What caused these mis-predictions? Could the integrated model be corrected by simple adjustments? The next section will cover the analysis that was performed in order to map the cause(s).

Post Modelling Analysis

The evaluation of the bridging approach with insulin Aspart showed that the glucose profiles in a MTT could not be predicted accurately. This chapter describes the analyses that were performed to determine any remedies that could aid in a better model prediction.

A range of analysis was conducted to examine the bridging strategy with insulin Aspart.

- **Insulin Aspart as forcing function**

An analysis was conducted where the insulin Aspart PK model was replaced with the measured insulin Aspart concentrations to avoid any error to spill over into the predictions. The use of measured profiles in the model is sometimes denoted as using the observations as a forcing function.

- **Meal function parameterisation**

It was raised during the modelling that the estimation of the meal function potentially would absorb variation from other glucose pathways, e.g. variations in elimination. In order to evaluate the meal function, a comparison with a different parameterisation was performed to pinpoint differences and to detect potential gains by a shift in parameterisation. The comparator meal function was proposed by Chiara Dalla Man from the University of Padova, Italy [Man et al., 2002].

- **Flexibility**

The structural model setup was investigated to determine if the minimal model structure had sufficient flexibility to fit an overnight increase in glucose concentrations as observed in the BIASP data. This analysis was focused on the mean structural model setup and therefore examined on mean data.

The analyses were carried out subsequently to the evaluation with insulin Aspart in order to find remedies for the bridging strategy.

During the preparation of the PhD thesis, a retrospect analysis was conducted that could pinpoint the cause of the mis-predictions to reside either within the insulin model or the glucose model. The analysis was devised after the post-modelling analysis had been concluded and solely performed out of curiosity.

9.1 Insulin Forcing Function

The influence of the insulin Aspart PK model was investigated by repeating the simulation, but replacing the insulin Aspart PK model with the actual measured IAsp concentrations. Any error introduced by the insulin Aspart model was circumvented and the remaining extended integrated model was kept including insulin/glucose baselines. In order to fulfil the preconditions of the bridging strategy, the mean of the measured IAsp profile was used as forcing function.

The results of the simulation can be seen in Figure 9.1. The concentrations of total insulin in the different treatments are still overestimated in the night period and the corresponding glucose predictions do not capture the overnight increase. The simulations are better than the original simulations with the extended integrated model but far from a successful bridging.

The new simulation with mean insulin Aspart profile as input indicated that the problem causing the mis-predictions did not reside in the Aspart PK model as it was still present even though the IAsp PK model had been replaced.

The outcome of the analysis was that the attention was moved to the glucose model - specifically the meal function.

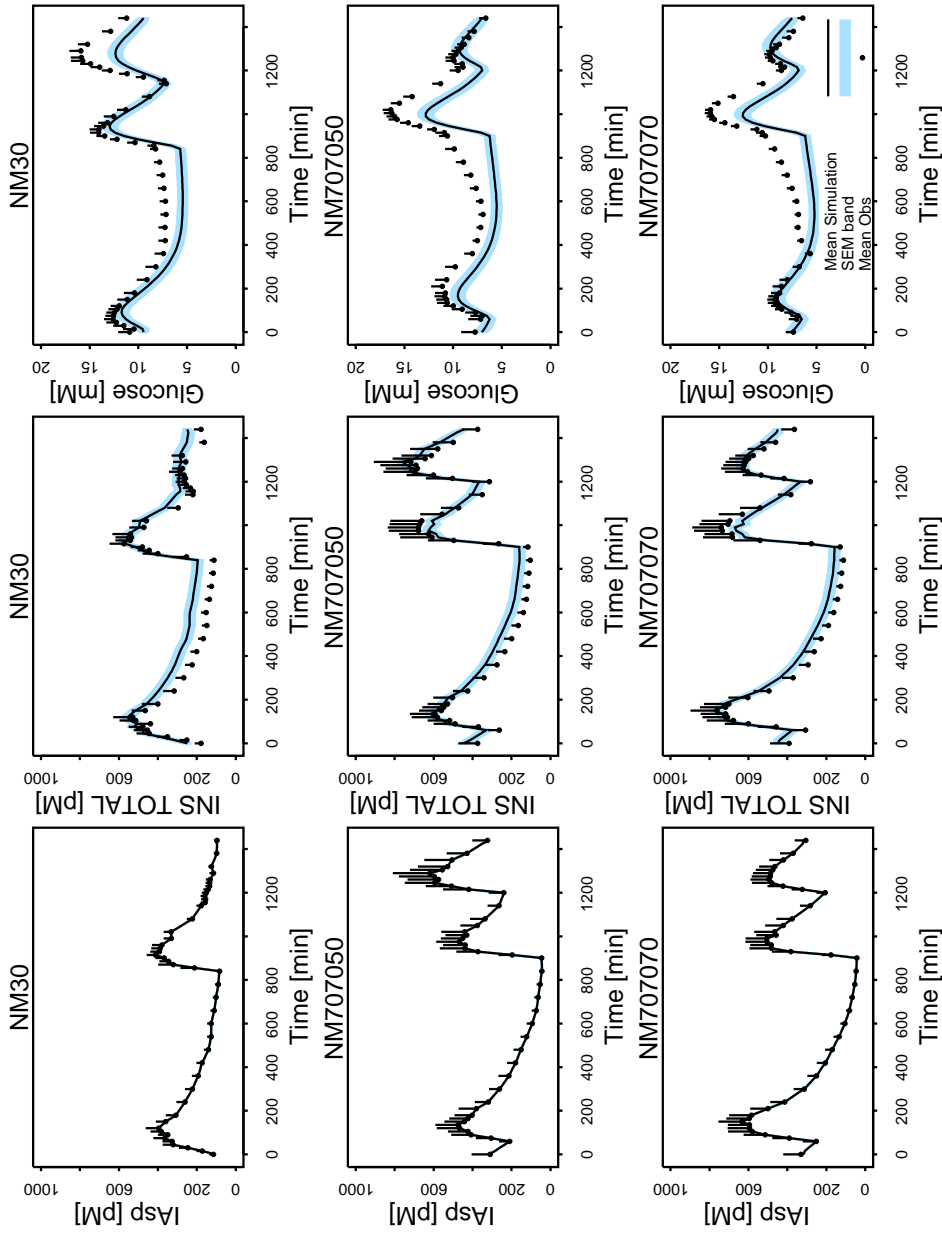

Figure 9.1: Aspart Simulations with Mean Aspart Profile as input

9.2 Meal Function Parameterisation

The meal function was suspected to play an important role in the mis-predictions. The glucose appearance and glucose elimination counteract each other and remain inseparable in cold glucose experiments, causing the estimation of the meal function to compensate for elimination, or vice-versa. This section will cover an analysis that includes a comparison with a different parameterisation that potentially could have provided a different prediction.

The comparison of parameterisations was initiated after a visit to Padova University where a different parameterisation of glucose rate of appearance (RA) was used. The parameterisation was developed on tracer data which enables determination of unobservable glucose fluxes, e.g. glucose appearance.

The original estimation data was not used for the analysis instead estimation data originated from a meal tolerance test in T1DM patients treated with Insulin Aspart. The trial compared two different mixture ratios of insulin Aspart (NM30/NM70) and is briefly described in Appendix F.

Only the breakfast meal was examined to simplify the analysis. The breakfast meal was selected as it starts from a fasting state and meal accumulation should be minimal. Both treatment arms were included for all 22 subjects resulting in a total of 44 glucose profiles being analysed. The glucose profiles can be seen in Appendix F.1. A disregarded but still interesting analysis would be to examine if the three meals from the same day would have equal absorption properties or if some trend could be determined.

The parameter estimation was performed using the software SAAMII, which enables Bayesian parameter estimation, but is limited to single subject modelling.

Model Setup

The model setup was the oral minimal model [Man et al., 2002], also described below in equations (9.1)-(9.2).

$$\dot{G}(t) = -(p_1 + X(t)) \cdot G(t) + p_1 \cdot G_b + \frac{RA}{V} \quad G(0) = G_b \quad (9.1)$$

$$\dot{X}(t) = -p_2 \cdot (X(t) + S_I \cdot (I(t) - I_b)) \quad X(0) = 0 \quad (9.2)$$

where $I(t)$ is a linear interpolation of the measured insulin concentrations during the MTT.

The parameter estimation included Bayesian priors in combination with the GEZI index. Priors were used for $GEZI$ and pp_2 whereas bioavailability and glucose distribution volume were fixed ($f=0.9$ and $V=1.45$ dl/kg).

GEZI was used to determine p_1 based on S_I .

$$p_1 = (GEZI + S_I \cdot V \cdot I_b)/V \quad (9.3)$$

$$GEZI \in N(0.025, 0.0025^2) \quad (9.4)$$

pp_2 was used as prior for the delay parameter p_2 .

$$p_2 = (pp_2)^2 \quad (9.5)$$

$$pp_2 \in N(0.11, 0.011^2) \quad (9.6)$$

In order to ensure a common frame of reference, the comparisons were performed with identical prior information and parameter boundaries, whenever possible. The only difference between the models lies within the parameterisation of glucose rate of appearance (RA).

Parameterisations

The two parameterisations for RA are in this thesis named according to their origin i.e. Padova and Novo Nordisk. An illustration of the two parameterisations can be seen in Figure 9.2.

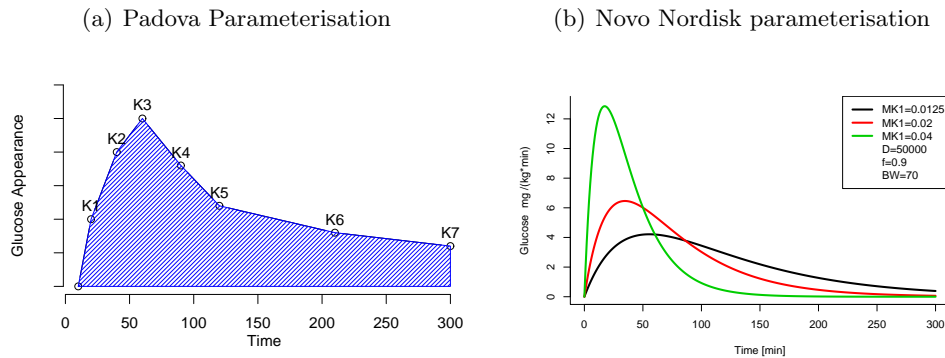

Figure 9.2: Illustrations of the different parameterisations

Padova Meal Function

The Padova approach is a flexible piece-wise linear function consisting of seven knots at specific time points. The time points are pre-defined and are thus not a part of the estimation process.

The Padova parameterisation can be written mathematically as shown in Equation (9.7).

$$RA(t) = \begin{cases} k_{i-1} + \frac{k_i - k_{i-1}}{t_i - t_{i-1}} & \text{for } t_{i-1} \leq t \leq t_i \quad i = 1 \dots 7 \\ 0 & \text{otherwise} \end{cases} \quad (9.7)$$

where a pseudo parameter $k_0 = 0$ is used to simplify notation.

The amount of absorbed glucose should be corrected for the body weight and the bioavailability of the meal and cannot exceed the amount of ingested glucose. This simple limitation was implemented through an AUC limit. The knot K_3 was not estimated but instead it was a function of the other knots ensuring that AUC corresponds to ingested meal. The remaining knots were estimated under the constraint that they must be positive.

The Padova parameterisation allows for a very flexible fit to the glucose absorption at the cost of many parameters (knots). The definition of the time points is based on an assumption of the profile and thus affects the estimation.

Novo Nordisk Meal Function

The Novo Nordisk approach to glucose appearance from meals have previously been modelled in this thesis with the "meal function" as a double exponential function as shown in Equations (9.8)- (9.9).

$$MS_1 = MA_1 \cdot (MK_1 + MK_2) \cdot \left(\frac{MK_1}{MK_2} \right) \quad (9.8)$$

$$RA(t) = MS_1 \cdot e^{-MK_1 \cdot t} (1 - e^{-MK_2 \cdot t}) \quad (9.9)$$

where MA_1 is the glucose amount in the meal and the parameters MK_1 and MK_2 are rate constants.

For the integrated model, the meal function was assumed to have identical rate constants which were also used in this analysis.

$$MS_1^* = 2 \cdot MA_1 \cdot MK_1 \quad (9.10)$$

$$RA(t) = MS_1^* \cdot e^{-MK_1 \cdot t} (1 - e^{-MK_1 \cdot t}) \quad (9.11)$$

To make the comparison fair, the meal function needed to be revised. The Padova approach relies on that the entire meal is digested within five hours. In order to use the identical constraint for the Novo Nordisk parameterisation, the normalisation constant was altered.

A new normalisation constant MS_2 was calculated that ensured that the glucose from available weight normalised meal corresponded to the AUC of the meal function.

$$\frac{f \cdot Dose}{BW} = MS_2 \cdot \int_{t=0}^{5 \cdot 60} MealFunction dt \quad (9.12)$$

$$= MS_2 \cdot \int_{t=0}^{300} e^{-MK_1 \cdot t} (1 - e^{-MK_1 \cdot t}) dt \quad (9.13)$$

$$MS_2 = \frac{f \cdot Dose}{BW} / \left(\frac{1}{MK_1} \left(\frac{1}{2} - e^{-MK_1 \cdot 300} + \frac{1}{2} e^{-2 \cdot MK_1 \cdot 300} \right) \right) \quad (9.14)$$

$$RA(t) = MS_2 \cdot e^{-MK_1 \cdot t} (1 - e^{-MK_1 \cdot t}) \quad (9.15)$$

Using the normalisation in Equation (9.14) the AUCs for the Padova parameterisation and the Novo Nordisk parameterisation were identical.

Table 9.1 contains a summary of the two models. The main interest should be that the two models have identical insulin/glucose model with identical constraints and priors and only differ in parameterisations of the glucose appearance rate.

Model	Parameter	Bayesian	Fixed	RA	Covariates
Padova	S_I	$GEZI, pp2$	V, f	$k_1 \dots k_7$	Dose, I(t), BW, I_b
Novo Nordisk	S_I	$GEZI, pp2$	V, f	$MK1$	Dose, I(t), BW, I_b

Table 9.1: Parameter comparison between the two methods.

Parameterisations Results

The mean estimated profiles for the Padova and Novo Nordisk parameterisation are shown in Figures 9.3(a) and 9.3(b).

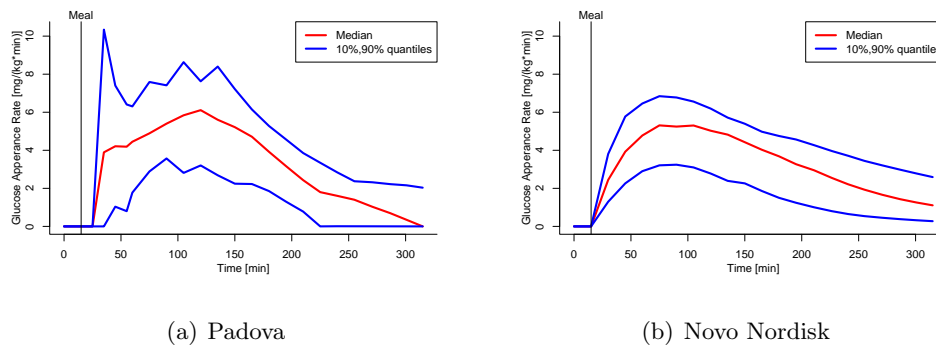

Figure 9.3: Median Rate of Appearance with 10% and 90% quantiles

Visually, it can be seen that the estimated glucose appearances after a meal are similar with the two parameterisations. Both estimate maximum glucose

appearance to be approx $6 \text{ mg}/(\text{kg} \cdot \text{min})$ at around time=100 min. The more flexible Padova RA shows a slightly more rapid incline but otherwise the RA profiles seem similar. It was concluded that it was highly unlikely that the Padova approach would have resulted in a better prediction with the integrated model.

The verification that the meal function parameterisation on cold data was on par with current parameterisation led to a continued analysis of the integrated model - specifically the structural glucose model.

9.3 Flexibility of the Minimal Model

The analysis of the glucose component of the integrated model continued with an analysis of the flexibility of the minimal model. It was of interest to determine if the structure of the minimal model had sufficient flexibility to fit the glucose profiles seen in the BIASP trial.

The analysis was conducted on mean data instead of individual profiles to focus on the structural dynamics for glucose and to facilitate faster computation. It was visually evaluated that the mean profiles were representative for the glucose dynamics in each treatment arm. The mean profiles can be seen in the data profiles in Appendix D.

The minimal model used in the modelling is shown in Equations (9.16)-(9.17):

$$\dot{G}(t) = U + S_G(G_b - G) - S_I \cdot G \cdot (X(t) - I_b) \quad (9.16)$$

$$\dot{X}(t) = p_2 \cdot (I(t) - X) \quad (9.17)$$

The integrated model used a literature value for the S_G of 0.0055 min^{-1} whereas the remaining parameters were estimated. The flexibility of the minimal model was examined by altering the set of parameters being estimated. Glucose baseline was also included into parameters that could be estimated, but not insulin baseline as insulin was regarded as input. The fits should be used to evaluate the flexibility of the estimated parameters. Four different model types were constructed by changing which parameters were estimated. The four model types are summarised in Table 9.2

The models were estimated on each treatment arm, but also tested in a bridging setup. The bridging setup tested whether a set of parameters estimated on human insulin profiles could be used to predict the glucose profile for IAsp treatment arms.

Figure 9.4 shows the fits from the four different model types to each of the treatment arms. The fits to observations are good but a closer inspection reveals differences during the night period. The two model types that estimate G_b are clearly better at fitting the increasing glucose whereas the models with G_b extracted from data are not capturing the increase.

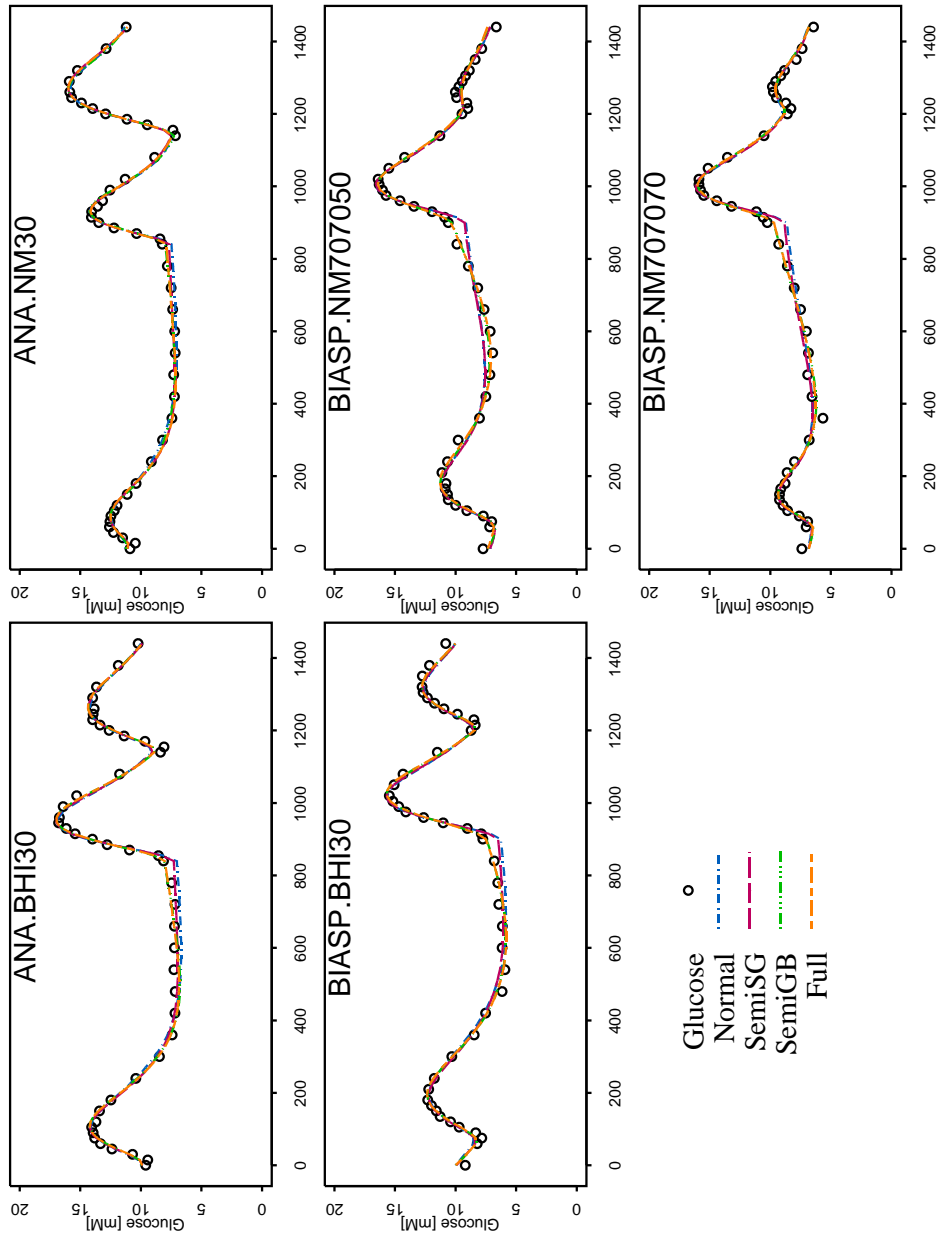

Figure 9.4: Fits pr. arm with different model types

Model	Estimated	Fixed
Normal	S_I, p_2, U	S_G, G_b^*, I_b^*
SemiSG	S_I, p_2, U, S_G	G_b^*, I_b^*
SemiGB	S_I, p_2, U, G_b	S_G, I_b^*
Full	S_I, p_2, U, S_G, G_b	I_b^*

U includes all meal related parameters MA_p, MK_p

* denotes extracted from data

Table 9.2: Models tested for flexibility and bridging performance

The bridging setup was investigated by estimating the model types on human insulin treatment arms and reusing the parameters to predict the glucose profile for IAsp. The bridged glucose profiles can be seen for treatments NM30, NM707050 and NM707070 in Figure 9.5 where model types are denoted as in Figure 9.4.

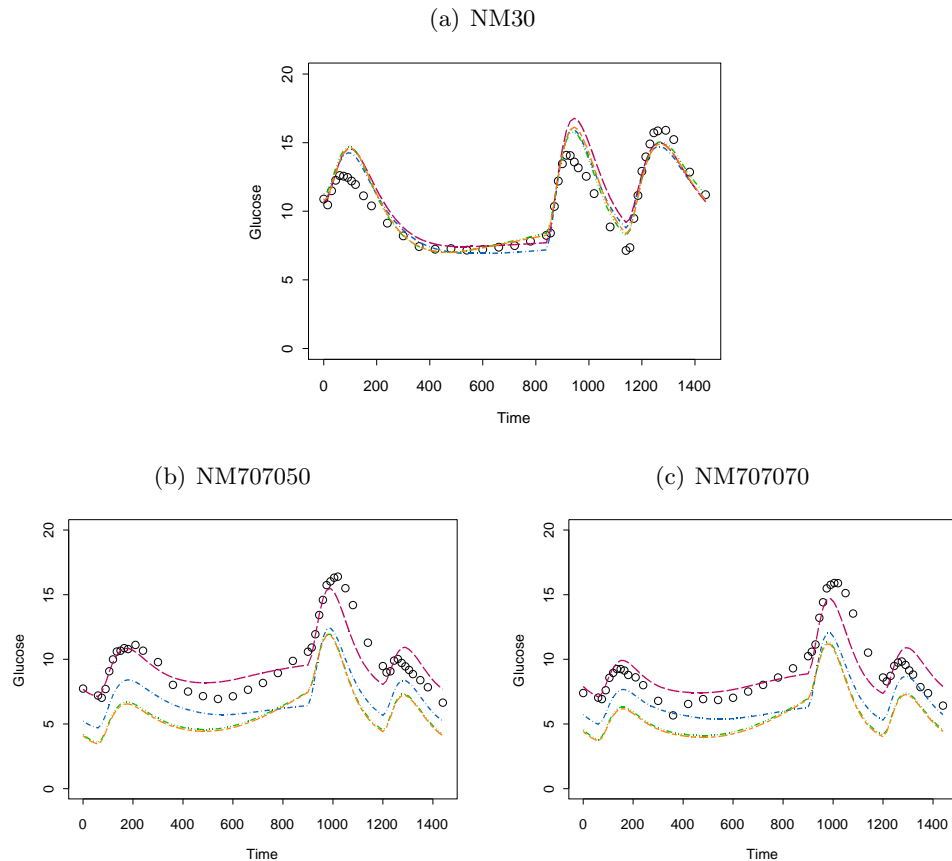

Figure 9.5: Bridging Mean Profiles from Human Insulin to insulin Aspart

The profile for NM30 (see Figure 9.5(a)) has problems with peaks that could be linked to the estimated meal function but the overnight period is actually captured.

The predicted glucose profiles for NM707050 and NM707070 are out of scale. The only model type that nearly predicts in the correct range is the SemiSG model. The dynamics for the models that estimate G_b display correct dynamics compared to observations for the overnight period but are 2-3 mM low.

The challenging overnight increase in glucose was best fitted with model types that estimated G_b but these models performed inferior in the bridging setup.

The conclusion for the analysis of the structural model was that the minimal model has sufficient flexibility to fit the glucose profiles. However, it was also concluded that the same set of parameters cannot be used to bridge from human insulin profiles to IAsp profiles.

9.4 Post Modelling Round-Up

The post modelling analysis aimed at pinpointing the cause(s) for the misprediction of the extended integrated model. The analysis included replacing the insulin Aspart PK model with the mean IAsp observations, a comparison of two different glucose appearance parameterisations, and investigating the flexibility of the minimal model.

The use of mean insulin Aspart observations as input showed that a potential error in the Aspart PK model was not the cause of the mis-predictions. The insulin predictions were marginally better but no improvement was seen in glucose predictions.

The second analysis targeted the glucose appearance from a meal and was a comparison between two different parameterisations. The comparison did not reveal relevant differences in the estimated glucose rate of appearance. The conclusion was that the prediction from the integrated model would not change by replacing the meal function.

The final analysis examined the structural model for the glucose dynamics. Mean profiles of glucose and insulin were modelled and tested in a bridging setup in order to verify that the minimal model was sufficiently flexible to fit the increasing glucose overnight. The result was that the minimal model was able to fit the mean glucose profiles adequately when G_b was also estimated. However, the bridging setup was not successful for NM707050/NM707070 IAsp treatment arms but nearly accurately predicted the NM30 treatment arm.

The post-modelling analysis was not successful in establishing a remedy for the bridging strategy. Conclusions acquitted some components but a clarification of the problem was not obtained.

During the preparation of the PhD thesis, a new analysis was conceived that potentially could identify the problem area.

Retrospect

The condensation of the results from the insulin/glucose modelling, initiated new ideas and analyses that could pinpoint functional components of the extended integrated model.

Despite warnings against initiating modelling work in the final part of the PhD programme, an analysis was started where the insulin part was completely bypassed. The analysis focused on treatments NM707050 and NM707070 which were simulated using the individually measured total insulin profiles as input. The preconditions of the bridging strategy are thus not adhered.

The remaining components in the model were meal function, glucose dynamics, and insulin action.

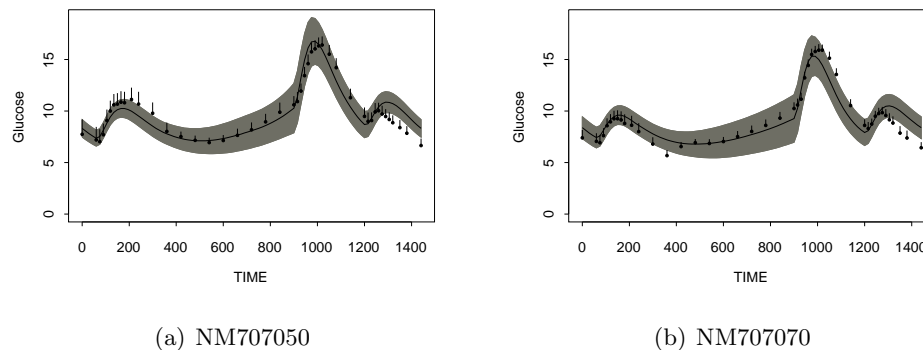

Figure 9.6: Simulation of NM707050 and NM707070 using individual total insulin as input

The simulation profiles in Figure 9.6 clearly show that the simulation captures the overnight increase in glucose. The dinner and breakfast glucose peaks are also nicely predicted whereas the lunch peak is slightly over-predicted.

The new simulation revealed an important point that has not previously been determined. The cause of the mis-predictions was initially believed to reside in the glucose part of the integrated model but the retrospect simulation showed that the insulin model coupled with the bridging strategy was the likely problem. Especially, the use of the mean insulin profiles was a candidate.

The estimation of the integrated model was performed on human insulin with individual insulin profiles but the bridging setup does not include an individualisation of insulin (IASp) profiles. The inherent correlation between

insulin sensitivity, insulin dose/titration and insulin baseline was estimated on human insulin and this relationship was broken when the mean insulin Aspart PK model was embedded in the integrated model as a part of the bridging strategy.

The minimal model is centred around baselines (insulin/glucose) which implicitly means that the term $(X - I_b)$ in the insulin dependent glucose elimination can become negative, which interpreted physiologically, means an appearance of glucose. The mean IAsp profile used in simulations could imply that this artefact scenario does not happen and no glucose increase will occur in periods of insulin levels lower than insulin baseline.

Perspectives from this knowledge are that insulin profiles need to be individualised, which could be obtained through a scaling using AUCs from human insulin profiles or insulin doses. A challenge lies in combining this individual scaling with the new treatment regimen specified in the protocol. The correlation between dose and insulin sensitivity etc. determined on human insulin should be maintained while still adhering to a new titration scheme specified in the protocol.

Discussion and Conclusion

The framework for the modelling was aimed at predicting 24-hour glucose profiles for a new insulin analogue. The integrated model for insulin and glucose was to be estimated on human insulin and the properties of the new insulin analogue were to be embedded using insulin properties determined from clamp experiments including PK studies.

10.1 Discussion

The data selected for the model building was trials with 24-hour meal tolerance tests performed in T2DM patients treated with human insulin and insulin Aspart in a cross-over design. The meal tolerance tests setting included three meals, insulin injections and measurements of insulin, glucose and C-peptide concentrations. Initially, three trials were selected: ANA, BIASP and NN2211 which meant a total of 42 T2DM subjects.

The NN2211 trial population was discarded during the model building due to discrepancies between the population of the NN2211 trial and the other trial populations. The exclusion was based on results from a range of evaluation scenarios that were compared to literature values. The results from the simulations were in accordance with the difference in populations also seen in the demographics summary. A valid exclusion should have been based on the demographics prior to modelling and not on evaluations performed during model development.

The integrated model for insulin and glucose was estimated by NONMEM V based on system dynamics described by ordinary differential equations and non-linear mixed effects to capture inter-individual and inter-occasion variability. The multivariate structure with insulin and glucose, the dimension of the parameter space, and the numerical solution of differential equations led

to a decision of separate estimation of two sub models: An insulin sub model and a glucose sub model.

Insulin Model

The insulin sub model was estimated using measured glucose concentrations as input for the insulin secretion. Pre-hepatic insulin secretion was initially modelled using C-peptide concentrations which aided in the determination of pre-hepatic insulin secretion but also required a model for hepatic insulin extraction. The model building established that it was more robust to link glucose observations to systemic insulin delivery rates than to pre-hepatic insulin secretion. Consequently, the information in the C-peptide profiles was disregarded in the current model setup but it could be interesting to explore methods of including C-peptide information in an insulin delivery model.

The insulin model had several parameters fixed to literature values due to identifiability issues. The fixation approach restricts the mixed effects estimation and also enforces a structure from a potentially different population into the model. Alternative solutions could be to perform a Bayesian parameter estimation with a prior instead to allow for more flexibility or even better to obtain tracer data enabling accurate estimation of internal processes.

The choice of human insulin as reference insulin in the bridging strategy implied that estimation of indistinguishable pathways was required. This was due to the fact that administered insulin and endogenously secreted insulin are identical. An estimation of the secretion/delivery component on insulin Aspart data would allow for a separation and a better estimation of the basal level. However, this solution violates the preconditions of the bridging strategy for insulin Aspart.

The insulin model building showed the strength of deconvolution based on stochastic differential equations in a population setting when the insulin model was simplified using deconvolved pre-hepatic insulin secretion rates as input. The deconvolved insulin secretion rates were replaced with an insulin secretion model at a later stage.

The insulin model was able to fit the human insulin profiles in estimation data. Several model candidates were tested during model development including variations within: insulin secretion/delivery, absorption structures, non-linear hepatic insulin extraction, and inter-injection variability.

Glucose Model

The glucose sub model structure was inspired from the oral minimal model and included a meal function to describe glucose appearance after ingestion of meals. The trial specific meal function in the final model was a compromise between robustness in parameter estimation but also in accordance with the experimental setting where identical meals were served to all patients.

The model structure was tested for a two compartment extension but this was found not be statistically significant. Furthermore, the model had volume of distribution volume fixed to 17 litres and S_G fixed to 0.0055 min^{-1} . Both values were selected from a range of literature values from T2DM patients.

The fixation of S_G was a result of the evaluation scenarios (clamp and ITT) that guided the model building towards a more insulin sensitive model. The comparisons with literature values for insulin driven elimination fractions were complicated by the different experimental setups used in literature. The glucose model selection was primarily based on properties in correspondence with literature, increased insulin driven elimination fraction motivated by the evaluation scenarios and naturally the model fit to estimation data. The final glucose model was in accordance with reported glucose effectiveness, was more insulin sensitive than previous models evaluated in simulation scenarios and fitted estimation data well.

Integrated Model

An integrated model for insulin and glucose was created by combining the two sub models that had been estimated on human insulin. The integrated model was evaluated in the glucose clamp and ITT scenarios previously described but also in a insulin dose sensitivity analysis.

The evaluation scenarios motivated a shift in the model structure during model development and also raised important points. A critical issue with the evaluation scenarios based on external sources is the assumption of identical populations and negligible influence from uncontrollable factors in the experiments. For these reasons, the scenarios were selected to specifically match the T2DM population and with relatively simple experimental setups.

The estimation data was predicted nicely with the integrated model which led to the conclusion that the separate estimation had not caused biased predictions.

The clamp simulation showed that the insulin action peaked in the correct time period and the GIR_{max} value indicated a correct estimation of insulin absorption and insulin action. The glucose clamp simulation also showed that the tail of the simulated GIR profiles were under-predicted. A comparison with a NPH insulin action profile as illustrated in Heinemann [2004, p.39] supported decreasing insulin action after a peak at around 4 hours as seen in the simulated profiles.

An additional evaluation was a subjective sensitivity analysis on insulin doses where it was concluded that the integrated did not show as low glucose concentrations as intuitively expected. A potential cause could be that the physiology behaves differently in the lower ranges and these are not well extrapolated by the integrated model or as previously indicated that the integrated model has issues with insulin sensitivity.

The evaluation scenarios targeted different components of the integrated

model: insulin absorption, insulin sensitivity, glucose effectiveness, and glucose elimination. The scenarios were essential in evaluating the integrated model for an overall qualification.

The integrated model was able to predict estimation data and the results from evaluation scenarios pinpointed issues but none with crucial impact.

Bridging

The bridging setup was evaluated on insulin Aspart from cross-over trial arms and required a PK model for IAsp and a transfer function for the analogue action. The PK model was supplied by a different project and the transfer function was developed based on clamp data.

The transfer function setup using a PID approach proved reliable in relation to estimating a scaling parameter in accordance with physiology. However, the simultaneous fit for GIR profiles showed an underestimated peak value for GIR_{HI} . The insulin Aspart transfer function should be simple and less complex than the expected transfer functions for future analogues. The transfer function setup was analysed with focus on embedding long acting insulin analogues. The setup provided good interchangeability for insulin analogues with altered potency but accelerated/delayed action was more complex to accommodate. This is unfortunate as the bridging strategy specifically targets new insulin analogues with prolonged action. Further research should focus on testing the PID approach to assess performance or investigate other methods.

An extended integrated model was created by embedding the PK model and a transfer function for insulin Aspart. The "cloning" approach was used for parameters in the extended integrated model where parameters were either reused from the HI integrated model or mean population parameters for IAsp components. The cloning approach ensured that the simulation was not based on subjects that had unphysiological parameters. Preferably, a simulation should consist of a sampling from the parameter distributions in order to create synthetic subjects representative for the estimation inter-individual variation. However, the sampling approach was not used due to parameter correlation structures that could not be determined in the separate sub model estimation. The cloning approach restricts the simulation to the estimation foundation i.e. 29 subjects but a small plausible subject population was weighted over a large potentially unrealistic synthetic population.

The evaluation of the extended integrated model showed that the insulin components fitted the evaluation data well. The fits for insulin Aspart profiles showed good fits for breakfast and lunch but slightly under-predicted in the overnight period. The profiles for total insulin had problems with the basal level of total insulin prior to breakfast that was over-predicted in all three profiles. The remaining parts of the profiles were captured nicely.

The glucose observations showed an overnight drift that was not captured

in any of the simulations. A corresponding drift was not observed in the estimation data and potential causes could be lack of overnight insulin coverage or dawn phenomenon which is driven by growth hormone. The discrepancy in glucose dynamics between estimation and evaluation data tests the model dynamics in an extrapolation setting which is always cumbersome. The conclusion was that the ultimate goal of a bridging for insulin Aspart from clamp to 24-hour glucose profiles was not successful.

The modelling objective included both the prediction of absolute glucose profiles but also a secondary objective with the simulation of differences between treatments. Simulation of differences should hopefully eliminate the influence of insulin and glucose baselines. The evaluation of the simulated difference in treatments (NM707050 and NM707070) showed that the model predictions for treatment differences were not comparable to the observed data. The excursions of the observed differences were of higher amplitude than the simulated. Furthermore, the simulated and observed difference did not have the same sign in periods. This means that there was a discrepancy between which treatment was the most glucose lowering in the observed and simulated profiles.

Post Modelling Analysis

The post modelling analyses aimed at pinpointing the cause(s) for the mispredictions from the extended integrated model. The analyses included replacing the insulin Aspart PK model, investigating the meal function, and evaluating sufficient flexibility of the minimal model setup.

The influence from the IAsp PK model was investigated by replacing the PK model with the observed mean IAsp concentration profiles. This had no substantial effect on the glucose predictions and it was concluded that the cause was not in the mean IAsp PK model.

The post modelling analysis of meal glucose appearances indicated that a shift in parameterisation would not have changed the predictions but a literature evaluation of the glucose appearance e.g. from a tracer experiment Basu et al. [2003]; Toffolo et al. [2006a] would add further certainty about this model component.

The flexibility of the minimal model structure was also investigated and it was found that sufficient flexibility was available for predicting the overnight increase in glucose. The crucial point was the split between parameters being estimated and parameters being directly extracted from data. By estimating G_b , the overnight glucose increase was fitted but the ability to bridge from HI profiles to IAsp profiles was lost. The analysis was initiated based on the hypothesis that the cause of poor predictive power resided in the glucose model but no specific issues were found.

The analysis performed in retrospect in which the entire insulin part of the extended integrated model was replaced by observed individual profiles

indicated that the problem was the mean insulin profiles used in the simulations. The model was estimated using individual human insulin profiles and was simulated using a mean PK model with mean doses (pr. weight). The simulated profiles from the retrospect analysis clearly show that using individualised insulin profiles then the glucose part of the integrated model is able to accurately predict the overnight increase in glucose.

Future work could be to bridge information on individual insulin requirements coupled with the protocol specifications for the new meal tolerance test into a simulation.

Another interesting challenge lies in investigating the model proposed by Silber et al. [2007]. The model structure has been showed in publications to be able to fit IVGTT and OGTT experiments and a MTT model version was mentioned in the PhD thesis of Petra Jauslin-Stetina [Jauslin-Stetina, 2008]. Similar has an insulin-glucose model been published from the Padova group by Man et al. [2007b] that was approved by the FDA as an "In Silico" platform for testing of closed loop systems [Kovatchev et al., 2009].

Both models have high potential but are un-identifiable on current data. So an analysis should be conducted into which parameters to reuse and which to fix from the publications, in order to adjust the models to current goals.

10.2 Conclusion

The development of a mathematical model for insulin and glucose aiming at predicting 24-hour glucose profiles from meal tolerance tests with a new insulin analogue has proven to contain many challenges: identifiability issues, availability/validity of evaluation scenarios, limitations in software, endless combinations of model candidates, adherence to preconditions stemming from drug development, and finally a complex biological system that was estimated based on limited insight from noisy observations.

The modelling approach has shown a method for the model building with interim evaluation for determining the performance of a model. The cloning of subjects enables a generic population that can be used in simulation as a substitute for a full sampling of inter-individual and inter-occasion variability.

The extended integrated model for simulation of insulin Aspart treatments did not perform adequately. Specifically, did the model predictions not capture a substantial increase in overnight glucose concentrations. The PK model for insulin Aspart predicted mean and variance in the correct range but a retrospect analysis showed that the use of a mean insulin model could be an important factor in the mis-predictions.

Future work should focus on including tracer data or other detailed data for obtaining a more accurate integrated model. Also, a method to bridge individual insulin requirements in the clamp experiment into the MTT simulation in order to individualise new insulin analogue treatments could form an

interesting path forward in the bridging strategy. With regards to modelling techniques, the emerging use of stochastic differential equations (SDEs) also provides a modelling framework with appealing properties. Potentially, the diurnal variations could be tracked with SDEs and consequently modelled.

The main experiences from the thesis are that abundant information was available with the challenge to dissect into relevant and useful information. The modelling and simulation of insulin/glucose required insight into multiple academic fields spanning from statistics, engineering, human physiology, and computer science - A combination that have been both challenging and rewarding.

We have not succeeded in answering all our problems. The answers we have found only serve to raise a whole set of new questions. In some ways we feel we are as confused as ever, but we believe we are confused on a higher level and about more important things.

Posted outside the mathematics reading room, Tromsø University. Personally, I discovered the quote in Bernt Øksendals book [Øksendal, 1998].

Part II

PSM: Population Stochastic Modelling

Introduction and Motivation

The goal of the PhD project was the development of predictive tools for designing new insulins and treatment regimens and the first part of the PhD thesis focussed on the formulation of an integrated model based on ordinary differential equations for the prediction of 24-hour glucose profiles.

In parallel to the model building, a different part of the thesis aimed at methodology - specifically the development of a software package able to handle mixed effects models based on stochastic differential equations (SDEs). The package should be aimed at PK/PD modelling with features for bolus dosing and infusion but should also be applicable to other modelling fields.

Statistical mixed effects models are widely used within drug development both within classic statistical analysis of dose-response models but also as random coefficients models in PK/PD modelling. The strength of mixed effects models is typically formulated as the ability to separate sources of variability into: Random variation within a class and variation between classes. In PK/PD modelling, a class is typically an individual but methodology is not limited to individuals other classes could be occasions, trials or centres etc. [Davidian and Giltinan, 1995; Pinheiro and Bates, 2002].

PK/PD modelling is an emerging field within industry and academia and also motivated by the FDA in both guidance papers [FDA, 1999] but also implicitly in the critical path initiative that endorses a modernising of scientific tools used in drug development.

The increased use of mixed effects in PK/PD modelling has been facilitated by NONMEM [Sheiner and Beal, 1994]. NONMEM is the golden standard of today for analysis of ODE based models using mixed effects in parameters. It is widely used due to its flexibility and capabilities for dosing and infusion. Other programs exists (Monolix, S-Adapt, SPK, etc. [Bauer et al., 2007; Dartois et al., 2007]) which provide different capabilities such as optimisation methods or user interfaces.

The modelling approach used in PK/PD is typically based on models using ODEs to describe the system dynamics. These models can be both non-linear and/or include random effects to account for inter-individual variation. An ODE based model is deterministic in system dynamics which is in contrast to the variation present in many experiments. A deterministic description is characterised by the fact that such a model is able to predict future concentrations without any error provided that the initial conditions are known. However, PK/PD models are often aimed at complex systems where a complete description is beyond current knowledge. The inevitable model misspecification and natural variation within the experiment calls for a more flexible model type.

The motivation to combine mixed effects and SDEs is not new. The articles by Overgaard et al. [2005] and Tornøe et al. [2005] both target the combination of SDEs and mixed effects, with a proposed estimation scheme and an implementation based on an explicit description of the Kalman Filter in NONMEM. A drawback of the NONMEM implementation is that it requires a detailed level of understanding to specify the required filtering equations however the implementation benefits from the PK/PD features already present in NONMEM and its computational speed. Markov Chain Monte Carlo (MCMC) methods are often used as an alternative to the Kalman Filter approach but comes at the cost of increased computational requirements [Ditlevsen and Gaetano, 2005].

The extension to SDEs from ODEs enables a split of the prediction error into system error and observation error [Tornøe et al., 2004]. The use of SDEs is still being explored and investigated but the perspectives within PK/PD modelling are promising. SDEs are in particular useful for systems with natural occurring variation or model misspecification. A strong motivation point for SDEs is the capability to correctly handle correlated residuals which are often disregarded even though traditional statistical tests are invalidated due to wrong assumptions on residuals. Furthermore, SDEs provides a systematic framework for pinpointing model deficiencies [Kristensen et al., 2005].

The desired features for a program include model specification using SDEs, dosing/infusion capabilities, multivariate observations, and inclusion of mixed effects to handle inter-individual variation.

CTSM [Kristensen et al., 2004] is a software program aimed at models based on SDEs and was developed at DTU-IMM by Niels Rode Kristensen as an extension of programs developed by Henrik Melgaard and Henrik Madsen [Melgaard and Madsen, 1993]. CTSM uses the Kalman Filter approach to handle SDEs but does not include capabilities for mixed effects or doses. CTSM was used as the basis for the development and Niels Rode Kristensen also provided highly valuable input for the development, which was greatly appreciated.

A prototype package for Matlab was built in 2006 and formed the basis for the article found in Paper B. The article describes the estimation methodology and provides an application of the prototype where pre-hepatic insulin secretion rates were determined via deconvolution.

The next chapters will describe the mathematical methodology and the R-package that was the result of the development process. The applications of the package are then presented and discussed.

Methodology

The mathematical methodology used in the development of the PSM package is described in this chapter. The methodology will focus on parameter estimation and not on simulation and smoothing. For a detailed description of simulation with SDE models - see [Kloeden and Platen, 2000; Iacus, 2008], and for smoothing - see the CTSM Mathematics Guide [Kristensen, 2003] or Gelb et al. [1982].

The parameter estimation for models based on SDEs extended with mixed effects has previously been described in detail and the current description will focus on the highlights of the method [Overgaard et al., 2005; Overgaard, 2006; Tornøe, 2005]. Furthermore, a full description of stochastic differential equations is beyond the scope of the thesis which only focuses on a subset of SDEs handled through the Itô interpretation [Øksendal, 1998; Madsen and Holst, 2000].

12.1 SDE Models for a Single Subject

Solutions for single subject ODE based models can in simple cases be derived analytically but often numerical integrators are needed to determine an approximate solution. The solution for SDE based models cannot be derived via deterministic solution of system dynamics but a more complicated method is needed to handle the separation of measurement and system error.

The single subject model for observations is typically described by a set of differential equations that describe system dynamics and a link from internal states to observations. The SDE state space model can in general form be written as follows:

$$\frac{d\mathbf{x}_t}{dt} = \mathbf{f}(\mathbf{x}_t, \boldsymbol{\phi}, \mathbf{u}_t, t)dt + \boldsymbol{\sigma}(\mathbf{u}_t, t, \boldsymbol{\phi})d\boldsymbol{\omega}_t \quad (12.1)$$

$$\mathbf{y}_k = \mathbf{g}(\mathbf{x}_k, \boldsymbol{\phi}, \mathbf{u}_k, t_k) + \mathbf{e}_k \quad (12.2)$$

where $k = 1 \dots n$, $t \in \mathbb{R}$ is time, $\mathbf{x}_t \in \mathbb{R}^s$ is a vector of state variables, $\mathbf{u}_t \in \mathbb{R}^m$ is a vector of input variables, $\mathbf{y}_k = \mathbf{y}_{t_k} \in \mathbb{R}^l$ is a vector of output variables. $\mathbf{f}(\cdot)$ and $\mathbf{g}(\cdot)$ are functions (potentially non-linear). The measurement error is assumed to be normal distributed as $\mathbf{e}_k \in \mathbf{N}(\mathbf{0}, \mathbf{S}(\mathbf{u}_k, t_k, \boldsymbol{\theta}))$. $\boldsymbol{\omega}$ is a standard Wiener with $\boldsymbol{\omega}_t - \boldsymbol{\omega}_s \in \mathbf{N}(\mathbf{0}, |t - s|)$. $\boldsymbol{\phi}$ is the parameter vector for individual i .

This SDE model specification can be seen to collapse into an ODE system when the scaling diffusion term $\boldsymbol{\sigma}(\cdot)$ tends to zero. This property enables parameter interpretation/comparison between ODE and SDE models and also enables the use of statistical methods to test the extension to SDE.

The notation for SDEs shown here are for the non-linear case with further simplifications being possible for the linear case. The SDEs used in this thesis are continuous-discrete as shown in Equations (12.1)-(12.2) which only constitutes a small subset of the complete class of SDEs.

The main assumptions in the current class of SDEs are: Gaussian measurement error and state independent diffusion term. The main difference to many other applications of SDEs is the measurement error that is often discarded to enable other estimation methods e.g. [Picchini et al., 2008].

The calculation of residuals in an ODE based model can be performed by a numerical solution of the deterministic ODE system resulting in a set of predictions which subsequently can be compared to the actual observations.

$$\mathbf{e}_k = \mathbf{y}_k - \hat{\mathbf{y}}_{k|k0} \quad (12.3)$$

In an SDE model, the residual is a result of measurement error and accumulated system error since last observation. The residual for an SDE one-step prediction is shown in Equation (12.4).

$$\boldsymbol{\epsilon}_k = \mathbf{y}_k - \hat{\mathbf{y}}_{k|k-1} \quad (12.4)$$

The prediction for the internal states should be updated accordingly to the observed system error in order to predict the next observation. The problem now consists of how to divide the residual in measurement and system error such that the states can be updated accordingly.

This problem can be solved by using the Kalman Filter [Kalman, 1960] which provides a minimum-variance estimator for the internal states. The Kalman Filter is a filtering method that recursively predicts and updates estimates of internal states by weighting the measurement error $\mathbf{S}(\cdot)$ and system error $\boldsymbol{\sigma}(\cdot)$.

The Kalman Filter is based on a propagation of first and second order moments for the estimates of the internal states. For linear models, the Kalman Filter provides the exact solution but for non-linear models the Extended Kalman Filter uses a linearization by which the solution becomes approximate.

The likelihood for the parameters in the SDE based model can be formulated using the conditional densities for the residuals [Kristensen, 2003].

$$L(\phi|\mathcal{Y}_n) = p(\mathcal{Y}_n|\phi, \mathbf{S}, \boldsymbol{\sigma}) = \left(\prod_{j=2}^n p(\mathbf{y}_j|\mathcal{Y}_{j-1}, \phi, \cdot) \right) p(\mathbf{y}_1|\phi, \cdot) \quad (12.5)$$

where \mathcal{Y}_j denotes all observations up to time t_j and n denotes the total number of observations.

The residuals are can be assumed to follow a multivariate Gaussian distribution given a set of conditions stemming from linear state space model, Gaussian measurement error and Wiener noise.

$$\boldsymbol{\epsilon}_k \in \mathcal{N}(\mathbf{0}, \mathbf{R}_{k|k-1}) \quad (12.6)$$

The Kalman filter is used to calculate the conditional mean and conditional covariance for the residuals which is then used to calculate the likelihood via the multivariate Gaussian distribution.

$$L(\phi|\mathcal{Y}_n) = \left(\prod_{j=2}^n \frac{\exp\left(-\frac{1}{2}\boldsymbol{\epsilon}_j^T \mathbf{R}_{j|j-1}^{-1} \boldsymbol{\epsilon}_j\right)}{\sqrt{|2\pi \mathbf{R}_{j|j-1}|}} \right) p(\mathbf{y}_1|\phi) \quad (12.7)$$

The likelihood for parameters ϕ given observations can for the single subject case be specified as in Equation (12.7). The residuals and conditional covariances are determined using the Kalman Filter and form the basis for the maximum likelihood parameter estimation.

The likelihood for a given parameter vector given the observation profile for a single individual can now be determined and parameter estimation facilitated through maximum likelihood estimation. The extension to mixed effects models is described in the next section.

12.2 Mixed Effects

Non-linear mixed effects modelling is an appealing alternative to the classic two-stage method for PK/PD modelling. The ability to handle multiple sparse data profiles or unbalanced designs provides a robust method - especially useful for PK/PD modelling [FDA, 1999]. Data analysed in clinical trials

often originates from multiple individuals that have been exposed to one or more treatments. The non-linear mixed effects model provides a framework to characterise variation within individuals and between individuals.

The term mixed effects refers to two kinds of effects being estimated: fixed effects that describe the mean parameters and random effects that describe variation between individuals forming a distribution around the mean parameter. Furthermore, the framework facilitates the use of covariates in order to explain inter-individual variation e.g. the parameter describing volume of distribution can often be partially explained using weight or BMI. The individual parameter vector is a function of fixed effects, random effects and covariates as shown in general notation below:

$$\phi_i = \mathbf{h}(\boldsymbol{\theta}, \boldsymbol{\eta}_i, \mathbf{Z}_i) \quad (12.8)$$

where the parameter ϕ_i denotes the parameter vector for individual i . $\boldsymbol{\theta}$ are the fixed effects, \mathbf{Z}_i are the covariates for individual i , and $\boldsymbol{\eta}_i$ are the random effects. It is generally assumed that $\boldsymbol{\eta}_i \in \mathbf{N}(\mathbf{0}, \boldsymbol{\Omega})$ to simplify derivation of the likelihood.

The distribution of individual parameters e.g. estimates for volume are often found to be log-normal distributed. This leads to a common parameterisation as shown in Equation (12.9) which also guarantees that sign shift do not occur from the influence of random effects.

$$\phi = \boldsymbol{\theta} \cdot \exp(\boldsymbol{\eta}) \quad (12.9)$$

The estimation methods for non-linear mixed effects methods are numerous and hold different properties. Pinheiro and Bates [Pinheiro and Bates, 2002] describe a number of approaches for parameter estimation in nlme-models.

The parameter estimation is based on maximum likelihood optimisation of the marginal likelihood. A simpler notation is obtained by introducing a hyper parameter $\boldsymbol{\Psi}$ which contains parameters relevant for $\boldsymbol{\theta}$, \mathbf{S} and $\boldsymbol{\sigma}$. First the marginal likelihood for $\boldsymbol{\Psi}$ and $\boldsymbol{\Omega}$ is formulated based on the distribution functions for the first and second stage models denoted p_1 and p_2 , respectively. The first stage model describes the intra-individual variation i.e. the single subject model and the second stage model describes the inter-individual variation from the random effects.

$$\begin{aligned} L_i(\boldsymbol{\Psi}, \boldsymbol{\Omega} | \mathcal{Y}_i) &= p(\mathcal{Y}_i | \boldsymbol{\Psi}, \boldsymbol{\Omega}) = \int p(\mathcal{Y}_i, \boldsymbol{\eta}_i | \boldsymbol{\Psi}, \boldsymbol{\Omega}) d\boldsymbol{\eta}_i \\ &= \int p_1(\mathcal{Y}_i | \boldsymbol{\eta}_i, \boldsymbol{\Psi}) p_2(\boldsymbol{\eta}_i | \boldsymbol{\Omega}) d\boldsymbol{\eta}_i \end{aligned} \quad (12.10)$$

where \mathcal{Y}_i is the observations for individual i .

The likelihood function for the entire population can be formulated as shown in Equation (12.11).

$$L(\Psi, \Omega | \mathcal{Y}) = \prod_{i=1}^N \int p_1(\mathcal{Y}_i | \Psi, \boldsymbol{\eta}_i) p_2(\boldsymbol{\eta}_i | \Omega) d\boldsymbol{\eta}_i \quad (12.11)$$

By introducing l_i as the a posteriori log-likelihood function for individual i the likelihood can be formulated. It relies on Gaussian conditional densities for the residuals and a Gaussian distribution of the random effects.

$$l_i(\Psi, \boldsymbol{\eta}_i) = -\frac{1}{2} \sum_{j=1}^{n_i} \left(\boldsymbol{\epsilon}_{ij}^T \mathbf{R}_{i(j|j-1)}^{-1} \boldsymbol{\epsilon}_{ij} + \log |2\pi \mathbf{R}_{i(j|j-1)}| \right) - \frac{1}{2} \boldsymbol{\eta}_i^T \boldsymbol{\Omega}^{-1} \boldsymbol{\eta}_i - \frac{1}{2} l \log |2\pi \boldsymbol{\Omega}| \quad (12.12)$$

$$L(\Psi, \Omega | \mathcal{Y}) = \prod_{i=1}^N \int \exp(l_i(\Psi, \boldsymbol{\eta}_i)) d\boldsymbol{\eta}_i \quad (12.13)$$

A closed-form solution to Equation (12.13) is rarely available and one solution method is to approximate the integral. A detailed derivation of different approximations are found in Wang [2007] and in the NONMEM User guide part VII [Beal and Sheiner, 1998].

The FOCE approximation was chosen for this development project as it was the standard in PK/PD development at the time. The FOCE approximation is based on the Laplace approximation which can be used to approximate complex integrals. It is based on a second order Taylor expansion of the integrand around maximum ($q'(x_0) = 0$) and can in a general notation be written as below.

$$\int p(x) dx = \int \exp(q(x)) dx \approx p(x_0) \cdot \sqrt{\frac{2\pi}{-q''(x_0)}} \quad (12.14)$$

For a detailed description and derivation of the Laplace approximation see Wang [2007].

The Laplace approximation requires the Hessian of the log-integrand ($q(x)$), which is not easy to calculate precisely due to computational issues.

The marginal likelihood function in (12.13) is solved by approximating l_i with a second-order Taylor expansion, where the expansion is made around the value $\boldsymbol{\eta}_i^*$ that maximizes $l_i(\boldsymbol{\eta}_i)$ in the value l_i^* . At this optimum the first derivative $\nabla l_i |_{\boldsymbol{\eta}_i^*} = 0$ and the population likelihood function can be reduced to:

$$L(\boldsymbol{\theta}, \mathbf{S}, \boldsymbol{\sigma}, \Omega | \mathcal{Y}) \approx \prod_{i=1}^N \left| \frac{-\Delta l_i^*}{2\pi} \right|^{-\frac{1}{2}} \exp(l_i^*) \quad (12.15)$$

as shown in Appendix of Paper B. The approximation of the Hessian at the optimum Δl_i^* is obtained using the First-Order Conditional Estimation (FOCE) method, which results in the Hessian approximation seen in Equation (12.16).

$$\Delta l_i^* \approx - \sum_{j=1}^{n_i} \left(\nabla \epsilon_{ij}^T \mathbf{R}_{i(j|j-1)}^{-1} \nabla \epsilon_{ij} \right) - \mathbf{\Omega}^{-1} \quad , \quad \nabla \epsilon_{ij} = \frac{\partial}{\partial \boldsymbol{\eta}_i} \epsilon_{ij} \Big|_{\boldsymbol{\eta}_i^*} \quad (12.16)$$

The first order derivative of the one-step prediction with relation to random effects needs to be derived numerically through the single subject estimation.

12.3 Summary

The methodology for combining stochastic differential equations with mixed effects has been described covering both a single subject estimation handled using the Kalman Filter and a mixed effects part where the marginal likelihood was approximated with FOCE.

The intra-individual variation is handled using the (extended) Kalman Filter that recursively updates/predicts states according to model specification and incoming observations. The Kalman filter is based on a series of assumptions on Gaussian distributions: Measurement error and increments in the diffusion term (Wiener Process). Other preconditions are state independent diffusion term and additive measurement error. The Kalman filter can be derived as first and second order moments of the estimated states facilitated by a first-order Markov property of the system [Madsen, 2007].

These assumptions can be extended via a log transform of the observations to obtain a log-normal error model or including input in the diffusion term to describe the state evolution. The Kalman Filter provides an attractive solution in relation to computational load balanced with restrictions to model specification. The a posteriori individual likelihood is based on one-step prediction errors from the first stage model with covariances determined in the Kalman Filter.

The population part of the modelling is achieved with a second stage model using mixed effects. The mixed effects allow for a description of the inter-individual variation explained through distributions in parameters. The random effects are assumed Gaussian and are often used to model log-normal distributions of parameters which correspond to a physiological interpretation.

Parameter estimation is based on maximum likelihood estimation of the marginal likelihood which is approximated using a first order Laplace approximation aided by an optimisation of the a posteriori individual likelihood. The evaluation of the population likelihood thus relies on individual optimisations to obtain $\boldsymbol{\eta}_i^*$. The parameter estimation consequently consists of a nested optimisations leading to a substantial computational load.

PSM - An R-package

This chapter will describe and introduce PSM i.e. the development of an R-package. A description of the package was published (Paper A) which also contained an application where insulin secretion rates were determined using deconvolution based on stochastic differential equations (SDEs).

The combination of SDEs and mixed effects has already illustrated via an explicit implementation of the Kalman Filter in NONMEM [Tornøe et al., 2005] but also as a Matlab Framework (Paper B). However, it was still believed there was a need for an accessible, simple to use software with PK/PD features.

The NONMEM approach to SDEs is non-trivial to new users, but provides a flexible and fast framework. In Paper B, a Matlab prototype was presented which procured valuable experiences and knowledge. Inspiration was also found in other software programs such as CTSM, WinNonlin, NONMEM, SAAM, Berkeley Madonna etc. which all features different strengths.

The aim with the program was an accessible software program which could provide a better start to modelling with SDEs. Several aspects were considered during the software implementation as for instance:

- Availability to users
- Computational Speed
- Data preparation
- Results handling

13.1 Platform

R was chosen as programming platform due to its open source availability and its widespread applications in statistical and numerical groups [R Development

Core Team, 2009]. R is available on most operating systems and its package system makes it easy for the user to add new functionality to the installation. Furthermore, R holds functionality for many statistical/mathematical operations that allowed the development process to focus on implementing new functionality and not re-implementing basic operations.

The shortcoming of R concerns computational speed - the original aspiration with a software program was a multicore implementation to accommodate large scale models. Multicore facilities are available in R but a general platform-independent framework hidden from the novice user was not available. The available multicore options would thus require configuring and setup according to the specific setup. The multicore facilities could have been implemented at several different levels such as numerical gradient calculations but also in individual contribution to the marginal likelihood. The compromise between a widely and easily available program and a multicore implementation tipped in favour of availability.

The software implementation in R consists of a set of functions that can perform tasks on models based on SDEs extended with mixed effects. The main functionality consists of simulation, parameter estimation and smoothing supplemented with utilities that aid in general model building. The functions and utilities were compiled in an R-package named PSM - an abbreviation for "Population Stochastic Modelling". The R package system makes it easy for the user to access the package which also contains documentation and introductory examples.

A main strength of R comes with capabilities in pre- and post-modelling process. The pre-processing of data with the compilation of data-file(s) can be performed within R and likewise for the post-processing of modelling results. The statistical analysis and visual presentation of results can be handled with R - overall enabling a single environment for the entire modelling process.

The package aimed at a separation of the dosing information and the observations as opposed to NONMEM where dosing and observations are contained in the same data file. This enables an easy change of dosing regimen or observations without having to regenerate a data file.

13.2 User Interface

The model specification is done through user defined functions for the individual parts of the model definition. The model functions/elements are collected in a list. The functions rely on component names to extract model components from the list which can be the cause for problems with misspelling. A more compact and user friendly notation like the notation in the `nlme` package Pinheiro et al. [2009] could be beneficial but it does not allow for the desired flexibility.

Linear and non-linear models are specified differently as the linear case can

use simpler estimation techniques. For a linear system, the system matrices suffice but for non-linear models, the full model specification and derivatives needs to be specified. The program doesn't utilise automatic differentiation but numerical versions of the gradient/jacobian can be implemented which is slower but often a more accessible solution for new users.

In Table 13.1 a general model specification for a non-linear model is shown. The component `Functions` is a list containing system dynamics, observation link and corresponding derivatives. The remaining components are all R functions that return a specific component.

Components	Arguments	Output
<code>Functions</code>	$\mathbf{x}, \mathbf{u}, t, \phi$	List with $\mathbf{f}(\cdot)$, $\mathbf{g}(\cdot)$, $d\mathbf{f}(\cdot)$, and $d\mathbf{g}(\cdot)$
<code>X0</code>	t, ϕ, \mathbf{u}	Matrix with initial state condition(s)
<code>SIG</code>	ϕ	Matrix with diffusion scaling term σ
<code>S</code>	ϕ	Matrix with residual covariance
<code>h</code>	$\eta, \theta, \text{covar}$	Vector with individualised parameters ϕ
<code>ModelPar</code>	Θ	List with fixed effects θ and inter individual variation Ω

Table 13.1: Non-linear Model Elements in PSM

A large part of the methodology relies on matrix operations whereby it is only natural that the model is specified using matrix syntax. The matrix syntax can often induce dimension problems which the software program tries to prevent by thoroughly checking dimension validity prior to any calculations are started.

13.3 Package Components

The package provides functionality for simulation, parameter estimation and smoothing. The simulation algorithm is a simple Euler scheme but has been shown to perform similar to other discretization schemes in SDE simulation [Iacus, 2008].

Smoothing is the optimal reconstruction of estimated states based on all available data and thus constitutes a post-processing functionality which can be highly useful.

The internal calculations in the package are formed by components such as optimisation algorithms, gradient calculations and low-level implementations for faster computations. These components are described for a complete understanding of the package which could be used to extend functionality or better understand results.

Optimisation and Gradients

The parameter estimation relies on a optimisation of the objective function which is:

$$-\log L(\Theta) \approx \sum_{i=1}^N \left(\frac{1}{2} \log \left| \frac{-\Delta l_i}{2\pi} \right| - l_i \right) \quad (13.1)$$

where Θ denotes the combined set of parameters i.e. both fixed effects and variance parameters.

The nested optimisations required in FOCE are performed per individual to determine the optimal random effects (η_i^*) for a given set of population parameters (θ). Consequently, a single evaluation of the objective function value induces N individual optimisations of random effects.

The estimation of population parameters is performed using a quasi-Newton based optimisation based on function values and gradients. The default optimiser in the package is `optim` but hands-on experience has shown that the `ucminf` [Nielsen and Mortensen, 2009] optimiser performs better. The optimisation per individual is restricted according to the specified covariance matrix Ω decrease computational load.

Gradients are determined numerically with finite differences. Typically, a simple forward difference is used but for the ϵ -gradient in Equation (12.16) central differencing is used.

Physiological parameter boundaries are not uncommon and constrained optimisation has been implemented to ensure robust parameter estimation. Parameter boundaries are implemented for the population parameters using the logit transformation extended with a penalty function to avoid flat gradients near parameter boundaries. [Kristensen, 2003, p.25].

Parameter Uncertainty

The parameter uncertainty for the estimated parameters is based on the observed Fischer Information Matrix originating from the Hessian of the negative log likelihood defined as [Pawitan, 2001; Madsen, 2007]:

$$j(\Theta) = -\frac{\partial^2}{\partial \Theta \partial \Theta^T} \log L(\Theta) = -\nabla^2 \log L(\Theta) \quad (13.2)$$

If the parameters maximizing the likelihood function are called $\hat{\Theta}$ they will asymptotically have the distribution

$$\hat{\Theta} \sim N(\Theta, j(\hat{\Theta})^{-1}). \quad (13.3)$$

This is used in PSM to provide a 95% Wald confidence interval, standard error and correlation matrix for the estimates. The Hessian is evaluated numerically using `hessian` in the `numDeriv` package.

Low-level

The package implementation in R is supplemented with an implementation of core elements in low-level languages for faster computation. The Kalman Filter for linear models was implemented in FORTRAN and linked with R which increased performance substantially.

The Extended Kalman Filter was also considered but not straight forward and not implemented as it required system calls from FORTRAN back to R to evaluate model components in each time step.

13.4 Accessibility and User Guide

The package was named PSM and was published via R's package system (CRAN). The users now easily add PSM to their installation via R-package system and start exploring SDEs combined with mixed effects through user guides and examples.

The user guide can be accessed via R by executing the command:
> vignette("PSM")

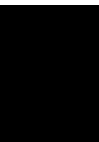

Applications

PSM is still a new package and applications mostly originate from personal work. External applications are still to be published but it is the hope that these will come.

14.1 Deconvolution

Deconvolution is used within signal processing to determine the original signal from a noisy and convolved signal for linear systems. The term deconvolution used here in this thesis only refers to the concept of determining an underlying signal from noisy observations.

Deconvolution in this thesis is based on an approach using stochastic differential equations to quantify the original signal. The deconvolution of a signal is obtained by including an additional state in the model specification. The new state represents the unknown signal e.g. an incoming flow or a time-varying parameter. The dynamic of the new state is modelled solely with a stochastic component i.e. the state is modelled as a random walk or more advanced as an integrated random walk.

Parallel to the parameter estimation, the most likely trajectory for the state is determined by the Kalman Filter. The unknown state can now be assessed by examining the filtered or smoothed estimate of the state.

The determination of the pre-hepatic insulin secretion rates (ISRs) given the C-peptide measurements is presented in Paper B and was also presented at the PAGE conference in 2008 [Klim et al., 2008]. The deconvolution of pre-hepatic insulin secretion rates were also utilised in the insulin/glucose model building that is described in this thesis.

The deconvolution approach for the insulin secretion can briefly be described as: An additional state modelled with a random walk was included

into the C-peptide dynamical system. The model setup is the standard Van Cauter C-peptide model [Cauter et al., 1992] extended into a SDE system with ISR modelled as a separate state.

A strong feature of the deconvolution method is that the Kalman Filter determines both the most likely outcome of the random walk but also the corresponding uncertainty. The uncertainties can be used to evaluate the deconvolved profile and aid in a mathematical description.

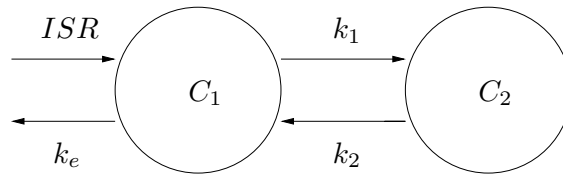

Figure 14.1: ISR Deconvolution Model

The standard two compartment C-peptide model can be seen in Figure 14.1 with ISR shown as input rate into the central compartment. The rate parameters were based on covariates but variance components (\mathbf{S} , σ and $\mathbf{\Omega}$) and initial C-peptide concentration were estimated.

In Figure 14.2, the deconvolved insulin secretion rates for two subjects are shown. The estimated state uncertainty is also presented as the grey shadow on the profile. It can be seen how the top profile exhibits clear peaks at meal times whereas the bottom profile displays a more flat secretion profile.

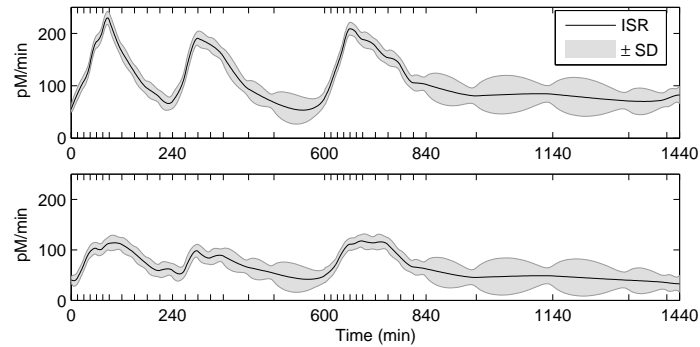

Figure 14.2: Deconvolved ISR

Hepatic Extraction

By extending the C-peptide model into a multidimensional model for C-peptide and insulin, a quantification of the hepatic extraction rates for insulin becomes feasible [Vølund et al., 1987; Bergman and Lovejoy, 1997]. The model

can be seen in Figure 14.3(a) and the deconvolved profiles for hepatic extraction rates over time can be seen in Figure 14.3(b).

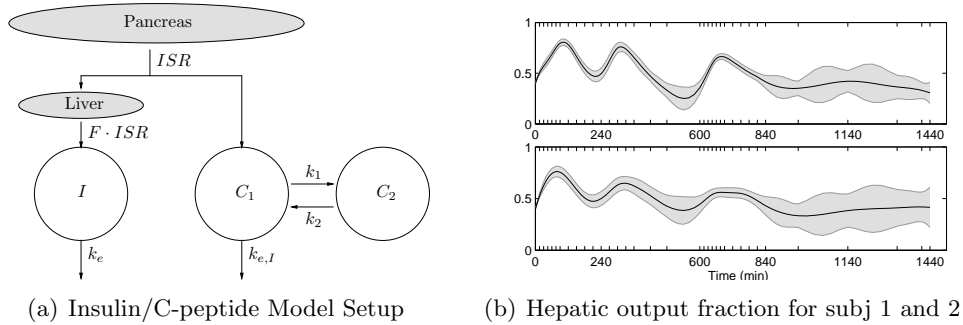

Figure 14.3: Deconvolution of hepatic extraction rate

In this application, the multivariate capability of PSM is illustrated and it is shown how the population approach can support estimation of parameters e.g. k_e .

The quantification of hepatic extraction could be used to determine factors controlling hepatic extraction which could have been useful in combination with the insulin secretion model building (Chapter 5).

Intervention Model

The deconvolution example of insulin secretion rates was extended further in Paper A with an intervention model. A common trait for the physiologically anticipated insulin secretion rate and also the deconvolved ISR is that the profiles do not have mean zero which contradicts assumptions for Wiener noise. An intervention model was tested for the ISR case by including an impulse signal for every meal lasting 30 min. The signal amplification and delay was estimated to build a base model for insulin secretion.

The model structure used here uses the stochastic differential equations to compensate for unmodelled variation in insulin secretion rates.

In Figure 14.4, the C-peptide fits and deconvolved ISR can be seen. The red dashed line represents the deterministic model fit. The deconvolved random walk is in much better correspondence with the Wiener assumption than the original ISR deconvolution.

The model assumes identical responses for the insulin secretion response for all three meals. The intervention model could easily be extended such that each meal had its own insulin response. The deconvolved insulin secretion profiles are not different from previously determined but the estimated model can now be used in simulation scenarios as opposed to the previous deconvolution model where insulin secretion rates were pure random walks.

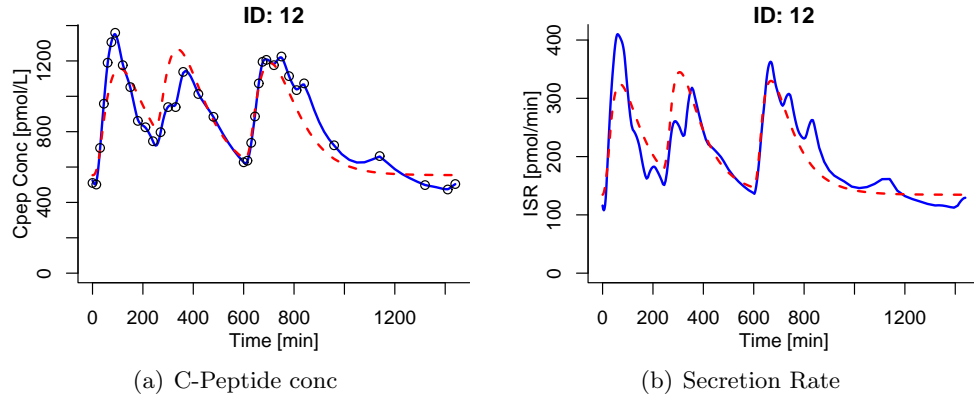

Figure 14.4: Intervention Model

The intervention model shows an application where SDEs are used to compensate for model mis-specification and/or natural variation.

14.2 Nonlinear Deconvolution with Non Negativity Constraint

The deconvolution technique was presented in articles and at conferences and main arguments against the approach was the loose assumption with the random walk. However, some constraints from physiological knowledge are not guaranteed with the random walk but the approach gives maximum flexibility.

A simulation study of the glucose minimal model was used to illustrate that deconvolution can also be applied for non-linear models and a non-negativity constraint was added for the deconvolved glucose appearances.

Glucose profiles were simulated using predefined model structures for the insulin and glucose appearance. The analysis aimed at a deconvolution of the glucose appearance based on simulated glucose observations and insulin profile.

The glucose appearance was modelled as an additional state but introduced in the glucose dynamics using an exponential function to ensure a positive glucose appearance.

Three different deconvolution scenarios were tested where noise levels and sampling times were varied. The parameter estimation only included variance components whereas system parameters were reused from the simulation.

The non-negativity constraint implemented using the exponential function led to an unstable model. As a solution the parameter estimation was revised such that tight parameter boundaries were gradually loosened and estimation re-started in last optimum until optimum no longer resided on parameter boundaries.

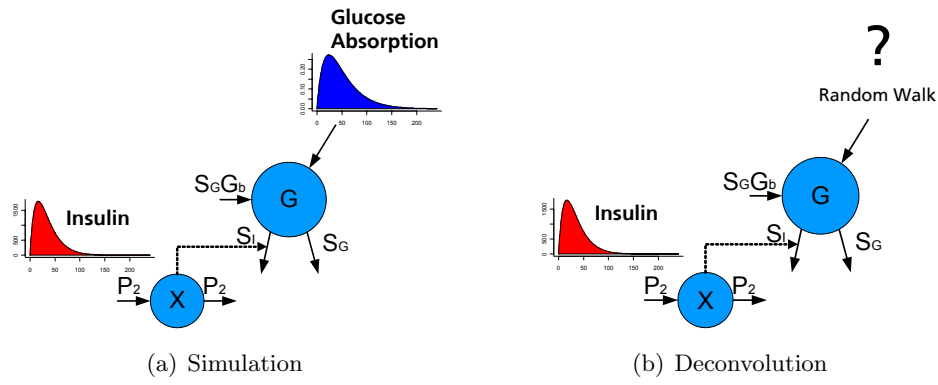

Figure 14.5: Non-linear deconvolution with the Minimal Model

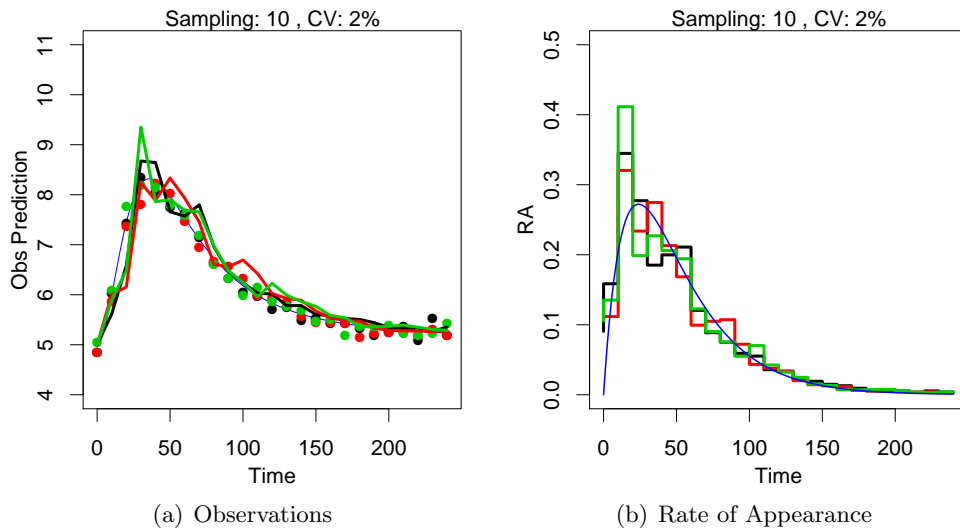

Figure 14.6: Results from non-linear deconvolution in a scenario with sampling every 10th min and a 2% coefficient of variation

The predicted observations and glucose appearance rates are shown in Figure 14.6. Three profiles are shown to illustrate the variation from measurement noise. The smoothed profiles would have been preferred but due to the unstable model, this was not feasible. The correspondence between the simulated glucose appearance and the filtered estimate is reasonable. However, the performance decreases rapidly with lower sampling rates and/or increasing noise levels which have not been shown here.

The glucose appearance example shows that deconvolution can also be applied in non-linear cases which is not possible in classic signal processing and time series analysis. Furthermore, it shows an implementation of a physiological constraint implemented via the exponential function.

14.3 Input Error Propagation

Dynamic models do frequently include inputs e.g. temperature or insulin concentrations. The measured input often enters into the model dynamics without means to account for measurement error. The input measurement error should be distinguished from the observations measurement error as the later is accounted for in the observation link. The input measurement error will propagate through the model dynamics and potentially influence predictions.

The hypothesis is that an SDE model should be better at handling the input error propagating through the model via the system noise component than an ODE model.

An analysis was conducted in order to assess the influence of input error in two different scenarios: a linear and a non-linear model. The model setups were tested with different combinations of measurement error on observations and input. The analysis was not an analytical derivation of the influence but two different scenarios were the effects were analysed.

Linear Model

The linear model was a one-compartment model with a known drug infusion. The simulations were performed without any noise components. Afterwards, measurement noise was added to both input and observation profiles. The model parameters (V and K) were estimated from noisy profiles with both an ODE model and an SDE model. The sampling of input and observations noise followed by an ODE and SDE estimation that were repeated multiple times after which the distributions of estimated parameters were compared to the parameter values from the simulation.

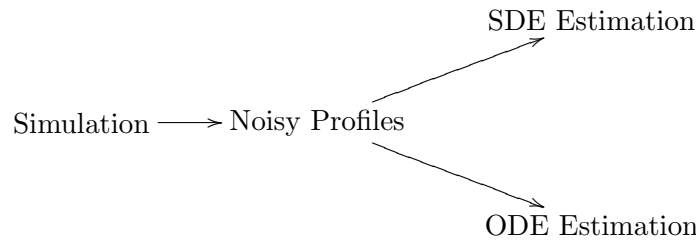

The parameter distributions for V and K can be seen in Figure 14.7. The simulation parameter value is indicated with a red vertical line and the mean of the estimated parameters is shown with a blue vertical line. The histograms show very little difference between estimation methods which does not favour SDE model parameter estimation.

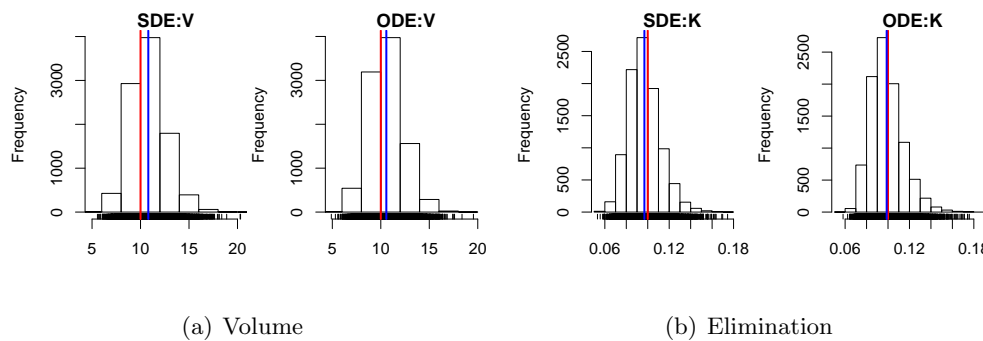

Figure 14.7: Parameter histograms for the linear model

Nonlinear Model

The non-linear model was the glucose minimal model depicted in Figure 14.5(a). The glucose appearance was assumed to be known both during simulation and estimation. The main interest was in parameters S_G , S_I , and p_2 . The measurements noise levels were 20% for the input and 1% for the observations. The levels were chosen such that input error was much larger than measurement error. Samples of the glucose and insulin profiles from the estimation are shown in Figure 14.8.

The sampling of noise followed by parameter estimation was repeated 500 times for the non-linear model using both an ODE and a SDE model type.

The results can be seen in Table 14.1 that shows nearly identical parameter estimates from the SDE and ODE estimation. S_G and S_I are correspondingly over- and under-estimated which is in agreement with a simulation analysis by Cobelli et al. [1999]. The standard deviations for the parameters do not differ substantially but the residual variation is lower for the SDE estimation and corresponds with the used variation in the simulation.

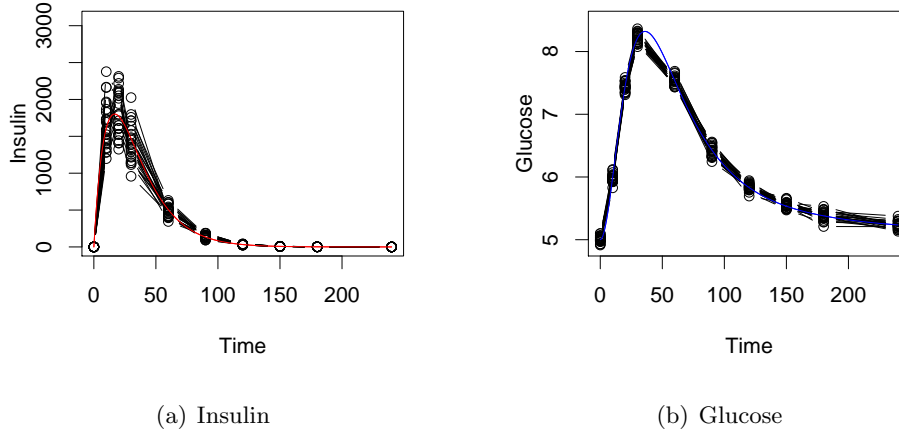

Figure 14.8: Sample profiles from estimation with the non-linear model

	SIM	SDE.Par	SDE.SD	SDE.Rel	ODE.Par	ODE.SD	ODE.Rel
S_G	5.50E-03	1.06E-02	3.41E-03	191.84	1.06E-02	3.62E-03	191.90
S_I	2.82E-05	2.62E-05	1.59E-06	92.84	2.58E-05	1.66E-06	91.61
p_2	3.00E-02	3.33E-02	9.69E-04	111.16	3.33E-02	1.03E-03	111.12
S	1.00E-04	1.01E-04	5.04E-05	100.57	1.14E-04	5.31E-05	114.21

Table 14.1: Parameter estimates from the non-linear model

The analysis of the influence of input error with regards to estimation with ODE and SDE based models showed that dynamic parameter estimates were alike but the residual variation was estimated correctly with SDEs. A hypothesis on why the parameters did not show a difference could be that Gaussian noise with mean zero was used on input and measurements profiles which in combination with the sampling scheme resulted in a cancelation of effects such that the estimates from ODE and SDE did not differ significantly.

14.4 Organic Growth

The applications presented so far have all been personal but PSM is also used by others. Unfortunately have the results not been published yet. PSM is being used by PhD student Anders Strathe, Copenhagen University for the modelling of animal growth in order to determine optimal time for slaughter.

The growth in pigs is usually modelled with ordinary differential equations which are unable to capture the natural variation present especially during disease periods. The growth of a pig that becomes ill will pause or even result in a decrease. The ODE setup is not able to handle disease situations. The SDE model provides a framework where the variations in slaughter time due to diseases are handled correctly and not just as measurement error. Furthermore, does the population approach suits the problem nicely with the population of pigs being analysed.

Another interesting field is the analysis of bacterial growth. Analysis of bacterial growth is used for determining effects of anti-bacterial treatments [Philipsen et al., 2008]. The bacterial growth is analysed in multiple of identical populations with identical initial conditions whereby the growth is established as a mean growth. The population approach provides an attractive method to determine growth patterns for each bacterial population and an estimate for the variation present between bacterial populations.

Discussion and Conclusion

The development of PSM was motivated by a need for a program able to handle stochastic differential equations (SDEs) combined with mixed effects. A further aim was the inclusion of features for PK/PD modelling. An aspiration was a program that would constitute a softer introduction to modelling with SDEs.

15.1 Discussion

The combination of SDEs and mixed was shown to be possible by explicit implementation of the Kalman Filter in NONMEM by Tornøe et al. [2005]. The lack of software providing an easy platform for modelling with SDEs and mixed effects motivated the development of the R-package PSM.

The package implements the combination of SDEs and mixed effects with focus on PK/PD modelling but the aspiration was that the package should also be used in areas such as energy, financial or biological. The motivation to use SDEs in modelling includes the ability to decompose the error into system and measurement noise whereby correlated residuals are handled correctly. Furthermore, the SDEs enable a modelling framework that can be used for pinpointing model deficiencies.

The package was implemented in R which makes it widely and easily accessible to users. The accessibility is an important point in relation to teaching or other research groups where PSM makes SDE models easier to approach and to use as a modelling alternative to standard ODE models.

The PSM package includes functionality for model building, utilities, documentation and tutorials. The model specification is syntax sensitive with regards to types or dimension mismatch. In order to help users, a validation check has been implemented in the package which captures the most common

mistakes and returns meaningful error messages. However, a simpler notation would have been preferable but model flexibility was weighted over notation.

The choice of R comes at a compromise in computational time compared to other programming languages and will potentially hinder applications on large scale problems. A multicore implementation was not implemented as a general platform independent implementation was not possible. Thereby, the scope of the package becomes more of an introductory program to SDEs and mixed effects than aimed at large scale problems. A benefit of using R as platform comes with the integration in an existing data and statistics environment that allows the user to perform most modelling tasks within the same program.

The methodology implemented is the Kalman Filter used to handle stochastic differential equations supplemented with the FOCE approximation to enable maximum likelihood estimation in combination with the mixed effects. The Kalman Filter and the FOCE approximation both can be exchanged with other methods but form a good balance between numerical performance and assumptions.

The current open source implementation also allows users to experiment with the code. New optimisers or gradient methods can be tested by replacing the relevant modules. The intention was a modular program that can be used as a framework to test new ideas.

A range of applications have been presented that illustrates the potential of PSM. Deconvolution based on stochastic differential equations has been an application for insulin secretion rates or glucose appearance rates using the non-negativity constraint.

The intervention model showed the strength of SDEs to account for misspecification in a secretion model where natural variation was present. The example resembles deconvolution but the result is an estimated model also useful in a simulation setting.

The application on input error propagation showed the benefit of modelling with SDEs in models using inputs. The result showed that the parameter estimates were nearly identical but only in the SDE estimation was the residual variation estimated correctly. A hypothesis for the only slightly differing parameters estimates could be that the noise structure had mean zero and was sampled too frequently whereby potential propagation was cancelled out.

15.2 Conclusion

A useful, documented program able to handle stochastic differential equations extended with mixed effects was developed and is freely available in R.

The implementation enables a wide range of models which holds benefits for PK/PD models where inter-individual variation is handled but natural variation or model misspecification are often inevitable.

The current applications are nearly all from authors of the PSM package but it is believed that the program will facilitate the emerging use of SDEs both in PK/PD model development as well as in other scientific fields.

Bibliography

- L. Aarons, M. O. Karlsson, F. Mentré, F. Rombout, J. L. Steimer, A. van Peer, and C. O. S. T. B15 Experts. Role of modelling and simulation in phase i drug development. *Eur J Pharm Sci*, 13(2):115–122, May 2001.
- A. Avogaro, P. Vicini, A. Valerio, A. Caumo, and C. Cobelli. The hot but not the cold minimal model allows precise assessment of insulin sensitivity in niddm subjects. *Am J Physiol*, 270(3 Pt 1):E532–E540, Mar 1996.
- A. D. Baron, O. G. Kolterman, J. Bell, L. J. Mandarino, and J. M. Olefsky. Rates of noninsulin-mediated glucose uptake are elevated in type ii diabetic subjects. *J Clin Invest*, 76(5):1782–1788, Nov 1985. doi: 10.1172/JCI112169. URL <http://dx.doi.org/10.1172/JCI112169>.
- Rita Basu, Barbara Di Camillo, Gianna Toffolo, Ananda Basu, Pankaj Shah, Adrian Vella, Robert Rizza, and Claudio Cobelli. Use of a novel triple-tracer approach to assess postprandial glucose metabolism. *Am J Physiol Endocrinol Metab*, 284(1):E55–E69, Jan 2003. doi: 10.1152/ajpendo.00190.2001. URL <http://dx.doi.org/10.1152/ajpendo.00190.2001>.
- Robert J Bauer, Serge Guzy, and Chee Ng. A survey of population analysis methods and software for complex pharmacokinetic and pharmacodynamic models with examples. *AAPS J*, 9(1):E60–E83, 2007. doi: 10.1208/aapsj0901007. URL <http://dx.doi.org/10.1208/aapsj0901007>.
- Stuart L. Beal and Lewis B. Sheiner. Nonmem users guide - part vii: Conditional estimation methods. March 1998.
- R. N. Bergman, Y. Z. Ider, C. R. Bowden, and C. Cobelli. Quantitative estimation of insulin sensitivity. *Am J Physiol*, 236(6):E667–E677, Jun 1979.
- Richard Bergman and Jennifer C. Lovejoy, editors. *The Minimal Model Approach and Determinants of Glucose Tolerance*, volume 7. Pennington Center, 1997.
- J. D. Best, G. J. Taborsky, J. B. Halter, and D. Porte. Glucose disposal is not proportional to plasma glucose level in man. *Diabetes*, 30(10):847–850, Oct 1981.
- J. D. Best, S. E. Kahn, M. Ader, R. M. Watanabe, T. C. Ni, and R. N. Bergman. Role of glucose effectiveness in the determination of glucose tolerance. *Diabetes Care*, 19(9):1018–1030, Sep 1996.
- Gerlies Bock, Chiara Dalla Man, Marco Campioni, Elizabeth Chittilapilly, Rita Basu, Gianna Toffolo, Claudio Cobelli, and Robert Rizza. Effects of nonglucose nutrients on insulin secretion and action in people with pre-diabetes. *Diabetes*, 56(4):1113–1119, Apr 2007. doi: 10.2337/db06-1272. URL <http://dx.doi.org/10.2337/db06-1272>.
- E. Bonora, I. Zavaroni, C. Coscelli, and U. Butturini. Decreased hepatic insulin extraction in subjects with mild glucose intolerance. *Metabolism*, 32(5):438–446, May 1983.
- M. J. Castillo, A. J. Scheen, M. R. Letiexhe, and P. J. Lefèbvre. How to measure insulin clearance. *Diabetes Metab Rev*, 10(2):119–150, Jul 1994.
- A. Caumo, P. Vicini, J. J. Zachwieja, A. Avogaro, K. Yarasheski, D. M. Bier, and C. Cobelli. Undermodeling affects minimal model indexes: insights from a two-compartment model. *Am J Physiol*, 276(6 Pt 1):E1171–E1193, Jun 1999.

- A. Caumo, I. Florea, and L. Luzi. Effect of a variable hepatic insulin clearance on the postprandial insulin profile: insights from a model simulation study. *Acta Diabetol*, 44(1):23–29, Mar 2007. doi: 10.1007/s00592-007-0237-7. URL <http://dx.doi.org/10.1007/s00592-007-0237-7>.
- E Van Cauter, F Mestrez, J Sturis, and KS Polonsky. Estimation of insulin secretion rates from c-peptide levels. comparison of individual and standard kinetic parameters for c-peptide clearance. *Diabetes*, 41(3):368–77, Mar 1992.
- W. H O Clausen, A. De Gaetano, and A. Vølund. Within-patient variation of the pharmacokinetics of subcutaneously injected biphasic insulin aspart as assessed by compartmental modelling. *Diabetologia*, 49(9):2030–2038, Sep 2006. doi: 10.1007/s00125-006-0327-z. URL <http://dx.doi.org/10.1007/s00125-006-0327-z>.
- C. Cobelli and J. J. DiStefano. Parameter and structural identifiability concepts and ambiguities: a critical review and analysis. *Am J Physiol*, 239(1):R7–24, Jul 1980.
- C. Cobelli, F. Bettini, A. Caumo, and M. J. Quon. Overestimation of minimal model glucose effectiveness in presence of insulin response is due to undermodeling. *Am J Physiol*, 275(6 Pt 1):E1031–E1036, Dec 1998.
- C. Cobelli, A. Caumo, and M. Omenetto. Minimal model sg overestimation and si underestimation: improved accuracy by a bayesian two-compartment model. *Am J Physiol*, 277(3 Pt 1):E481–E488, Sep 1999.
- Claudio Cobelli, Gianna Maria Toffolo, Chiara Dalla Man, Marco Campioni, Paolo Denti, Andrea Caumo, Peter Butler, and Robert Rizza. Assessment of beta-cell function in humans, simultaneously with insulin sensitivity and hepatic extraction, from intravenous and oral glucose tests. *Am J Physiol Endocrinol Metab*, 293(1):E1–E15, Jul 2007. doi: 10.1152/ajpendo.00421.2006. URL <http://dx.doi.org/10.1152/ajpendo.00421.2006>.
- Céline Dartois, Annabelle Lemenuel-Diot, Christian Laveille, Brigitte Tranchand, Michel Tod, and Pascal Girard. Evaluation of uncertainty parameters estimated by different population pk software and methods. *J Pharmacokinetic Pharmacodyn*, 34(3):289–311, Jun 2007. doi: 10.1007/s10928-006-9046-9. URL <http://dx.doi.org/10.1007/s10928-006-9046-9>.
- Marie Davidian and David M. Giltinan. *Nonlinear Models for Repeated Measurement Data*. Chapman and Hall, 1995.
- Kristine B Degn, Claus B Juhl, Jeppe Sturis, Grethe Jakobsen, Birgitte Brock, Visvanathan Chandramouli, Joergen Rungby, Bernard R Landau, and Ole Schmitz. One week’s treatment with the long-acting glucagon-like peptide 1 derivative liraglutide (nn2211) markedly improves 24-h glycemia and alpha- and beta-cell function and reduces endogenous glucose release in patients with type 2 diabetes. *Diabetes*, 53(5):1187–1194, May 2004.
- Susanne Ditlevsen and Andrea De Gaetano. Mixed effects in stochastic differential equation models. *REVSTAT Statistical Journal*, 3:137–153, 2005.
- N. Ejskjaer, M. Rasmussen, N. Kamp, A. Lindholm, and J. S. Christiansen. Comparison of thrice daily ‘high’ vs. ‘medium’ premixed insulin aspart with respect to evening and overnight glycaemic control in patients with type 2 diabetes. *Diabetes Obes Metab*, 5(6):438–445, Nov 2003.
- FDA. Guidance for industry population pharmacokinetics, February 1999. URL <http://www.fda.gov/cder/guidance/index.htm>.
- David Dagan Feng. *Biomedical Information Technology*. Academic Press, 2008.
- D. T. Finegood and D. Tzur. Reduced glucose effectiveness associated with reduced insulin release: an artifact of the minimal-model method. *Am J Physiol*, 271(3 Pt 1):E485–E495, Sep 1996.
- Arthur Gelb, Jr. Joseph F. Kasper, Jr. Raymond A. Nash, Charles F. Price, and Jr. Arthur A. Sutherland. *Applied Optimal Estimation*. The MIT Press, seventh edition, 1982. ISBN 0 262 70008-5.
- Rene Normann Hansen. *Glucose Homeostasis A Biosimulation Approach*. PhD thesis, Technical University of Denmark, 2004.

- Meredith Hawkins, Ilan Gabriely, Robert Wozniak, Kalpana Reddy, Luciano Rossetti, and Harry Shamoon. Glycemic control determines hepatic and peripheral glucose effectiveness in type 2 diabetic subjects. *Diabetes*, 51(7):2179–2189, Jul 2002.
- Lutz Heinemann. *Time-Action Profiles of Insulin Preparations*. Verlag Kirchheim + Co, 2004. ISBN: 3-87409-364-6.
- Irl B. Hirsch, Richard M. Bergenstal, Christopher G. Parkin, Jr. Wright, Eugene, and John B. Buse. A real-world approach to insulin therapy in primary care practice. *Clin Diabetes*, 23(2):78–86, 2005. doi: 10.2337/diaclin.23.2.78. URL <http://clinical.diabetesjournals.org>.
- R. Hovorka, P. Bannister, D. J. Eckland, D. Halliday, D. N. Murley, S. E. Rees, and M. A. Young. Reproducibility and comparability of insulin sensitivity indices measured by stable-label intravenous glucose tolerance test. *Diabet Med*, 15(3):234–246, Mar 1998. doi: 3.0.CO;2-9. URL <http://dx.doi.org/3.0.CO;2-9>.
- Roman Hovorka, Fariba Shojaee-Moradie, Paul V Carroll, Ludovic J Chassin, Ian J Gowrie, Nicola C Jackson, Romulus S Tudor, A. Margot Umpleby, and Richard H Jones. Partitioning glucose distribution/transport, disposal, and endogenous production during ivgtt. *Am J Physiol Endocrinol Metab*, 282(5):E992–1007, May 2002. doi: 10.1152/ajpendo.00304.2001. URL <http://dx.doi.org/10.1152/ajpendo.00304.2001>.
- Roman Hovorka, Valentina Canonico, Ludovic J Chassin, Ulrich Haueter, Massimo Massi-Benedetti, Marco Orsini Federici, Thomas R Pieber, Helga C Schaller, Lukas Schaupp, Thomas Vering, and Malgorzata E Wilinska. Nonlinear model predictive control of glucose concentration in subjects with type 1 diabetes. *Physiol Meas*, 25(4):905–920, Aug 2004.
- Roman Hovorka, Harsha Jayatillake, Eduard Rogatsky, Vlad Tomuta, Tomas Hovorka, and Daniel T Stein. Calculating glucose fluxes during meal tolerance test: a new computational approach. *Am J Physiol Endocrinol Metab*, 293(2):E610–E619, Aug 2007. doi: 10.1152/ajpendo.00546.2006. URL <http://dx.doi.org/10.1152/ajpendo.00546.2006>.
- Stefano M. Iacus. *Simulation and Inference for Stochastic Differential Equations With R Examples*. Springer, 2008. doi: 10.1007/978-0-387-75839-8.
- S. Inchiostro. Measurement of insulin sensitivity in type 2 diabetes mellitus: comparison between kitt and homa-relationship with the components of the insulin resistance syndrome. *Diabet Med*, 22(1):39–44, Jan 2005. doi: 10.1111/j.1464-5491.2004.01354.x. URL <http://dx.doi.org/10.1111/j.1464-5491.2004.01354.x>.
- Petra Jauslin-Stetina. *Mechanism-Based Modeling of the Glucose-Insulin Regulation during Clinical Provocation Experiments*. PhD thesis, Uppsala University, Department of Pharmaceutical Biosciences, 2008. ISSN 1651-6192, ISBN: 978-91-554-7195-8.
- R.E. Kalman. New approach to linear filtering and prediction problems. *American Society of Mechanical Engineers – Transactions – Journal of Basic Engineering Series D*, 82(1):35–45, 1960.
- Søren Klim, Stig Bousgaard Mortensen, and Henrik Madsen. Deconvolution of insulin secretion rates. In *Population Approach Group Europe*. PAGE, 2008. URL <http://www.page-meeting.org/?abstract=1254>. Abstr. 1254.
- Peter E. Kloeden and Eckhard Platen. *Numerical Solution of Stochastic Differential Equations*. Springer, 2000.
- Filip K Knop, Tina Vilsbøll, Patricia V Højberg, Steen Larsen, Sten Madsbad, Aage Vølund, Jens J Holst, and Thure Krarup. Reduced incretin effect in type 2 diabetes: cause or consequence of the diabetic state? *Diabetes*, 56(8):1951–1959, Aug 2007. doi: 10.2337/db07-0100. URL <http://dx.doi.org/10.2337/db07-0100>.
- Boris P Kovatchev, Marc Breton, Chiara Dalla Man, and Claudio Cobelli. In silico preclinical trials: A proof of concept in closed-loop control of type 1 diabetes. *J Diabetes Sci Technol*, 3(1):44–55, 2009.

- Niels Rode Kristensen. Ctsm mathematics guide. Technical report, Technical University of Denmark, December 2003. URL <http://www.imm.dtu.dk/~ctsm/>.
- Niels Rode Kristensen, Henrik Madsen, and Sten Bay Jørgensen. Parameter estimation in stochastic grey-box models. *Automatica*, 40(2):225–237, 2004. ISSN 0005-1098. doi: DOI:10.1016/j.automatica.2003.10.001. URL <http://dx.doi.org/10.1016/j.automatica.2003.10.001>.
- Niels Rode Kristensen, Henrik Madsen, and Steen Hvass Ingwersen. Using stochastic differential equations for pk/pd model development. *J Pharmacokinet Pharmacodyn*, 32(1):109–141, Feb 2005. doi: 10.1007/s10928-005-2105-9. URL <http://dx.doi.org/10.1007/s10928-005-2105-9>.
- Kevin M Krudys, Michael G Dodds, Stephanie M Nissen, and Paolo Vicini. Integrated model of hepatic and peripheral glucose regulation for estimation of endogenous glucose production during the hot ivgtt. *Am J Physiol Endocrinol Metab*, 288(5):E1038–E1046, May 2005. doi: 10.1152/ajpendo.00058.2004. URL <http://dx.doi.org/10.1152/ajpendo.00058.2004>.
- Bernt Øksendal. *Stochastic Differential Equations - An introduction with applications*. Springer, fifth edition, 1998.
- Cornelia B Landersdorfer and William J Jusko. Pharmacokinetic/pharmacodynamic modelling in diabetes mellitus. *Clin Pharmacokinet*, 47(7):417–448, 2008.
- E. D. Lehmann and T. Deutsch. A physiological model of glucose-insulin interaction in type 1 diabetes mellitus. *J Biomed Eng*, 14(3):235–242, May 1992.
- Henrik Madsen. *Time Series Analysis*. Chapman and Hall, 2007.
- Henrik Madsen and Jan Holst. *Modelling Non-Linear an Non-Stationary Time Series*. IMM, December 2000.
- Chiara Dalla Man, Andrea Caumo, and Claudio Cobelli. The oral glucose minimal model: estimation of insulin sensitivity from a meal test. *IEEE Trans Biomed Eng*, 49(5):419–429, May 2002. doi: 10.1109/10.995680. URL <http://dx.doi.org/10.1109/10.995680>.
- Chiara Dalla Man, Andrea Caumo, Rita Basu, Robert Rizza, Gianna Toffolo, and Claudio Cobelli. Minimal model estimation of glucose absorption and insulin sensitivity from oral test: validation with a tracer method. *Am J Physiol Endocrinol Metab*, 287(4):E637–E643, Oct 2004. doi: 10.1152/ajpendo.00319.2003. URL <http://dx.doi.org/10.1152/ajpendo.00319.2003>.
- Chiara Dalla Man, Michael Camilleri, and Claudio Cobelli. A system model of oral glucose absorption: validation on gold standard data. *IEEE Trans Biomed Eng*, 53(12 Pt 1):2472–2478, Dec 2006a. doi: 10.1109/TBME.2006.883792. URL <http://dx.doi.org/10.1109/TBME.2006.883792>.
- Chiara Dalla Man, Robert A Rizza, and Claudio Cobelli. Mixed meal simulation model of glucose-insulin system. *Conf Proc IEEE Eng Med Biol Soc*, 1:307–310, 2006b. doi: 10.1109/IEMBS.2006.260810. URL <http://dx.doi.org/10.1109/IEMBS.2006.260810>.
- Chiara Dalla Man, Gianna Toffolo, Rita Basu, Robert A Rizza, and Claudio Cobelli. A model of glucose production during a meal. *Conf Proc IEEE Eng Med Biol Soc*, 1:5647–5650, 2006c. doi: 10.1109/IEMBS.2006.260809. URL <http://dx.doi.org/10.1109/IEMBS.2006.260809>.
- Chiara Dalla Man, Davide M. Raimondo, Robert A. Rizza, and Claudio Cobelli. Gim, simulation software of meal glucose – insulin model. *Journal of Diabetes Science and Technology*, 1(3):323–330, May 2007a. URL <http://www.journalofdst.org/May2007/pdf/VOL-1-3-SYM2-DALLAMAN.pdf>.
- Chiara Dalla Man, Robert A Rizza, and Claudio Cobelli. Meal simulation model of the glucose-insulin system. *IEEE Trans Biomed Eng*, 54(10):1740–1749, Oct 2007b. doi: 10.1109/TBME.2007.893506. URL <http://dx.doi.org/10.1109/TBME.2007.893506>.
- A. Mari, S. Camastra, E. Toschi, A. Giancaterini, A. Gastaldelli, G. Mingrone, and E. Ferrannini. A model for glucose control of insulin secretion during 24 h of free living. *Diabetes*, 50 Suppl 1: S164–S168, Feb 2001.

- Andrea Mari. Mathematical modeling in glucose metabolism and insulin secretion. *Curr Opin Clin Nutr Metab Care*, 5(5):495–501, Sep 2002.
- Andrea Mari, Ole Schmitz, Amalia Gastaldelli, Torben Oestergaard, Birgit Nyholm, and Ele Ferrannini. Meal and oral glucose tests for assessment of beta -cell function: modeling analysis in normal subjects. *Am J Physiol Endocrinol Metab*, 283(6):E1159–E1166, Dec 2002a. doi: 10.1152/ajpendo.00093.2002. URL <http://dx.doi.org/10.1152/ajpendo.00093.2002>.
- Andrea Mari, Andrea Tura, Amalia Gastaldelli, and Ele Ferrannini. Assessing insulin secretion by modeling in multiple-meal tests: role of potentiation. *Diabetes*, 51 Suppl 1:S221–S226, Feb 2002b.
- Ruy G Marques, Magali J Fontaine, and Jeffrey Rogers. C-peptide: much more than a byproduct of insulin biosynthesis. *Pancreas*, 29(3):231–238, Oct 2004.
- Paul T McSorley, Patrick M Bell, Lisbeth Vestergård Jacobsen, Allan Kristensen, and Anders Lindholm. Twice-daily biphasic insulin aspart 30 versus biphasic human insulin 30: a double-blind crossover study in adults with type 2 diabetes mellitus. *Clin Ther*, 24(4):530–539, Apr 2002.
- Juris J Meier, Johannes D Veldhuis, and Peter C Butler. Pulsatile insulin secretion dictates systemic insulin delivery by regulating hepatic insulin extraction in humans. *Diabetes*, 54(6):1649–1656, Jun 2005.
- Henrik Melgaard and Henrik Madsen. Ctism - continous time linear stochastic modelling. Technical Report 1, IMSOR, Technical University of Denmark, DK-2800 Lyngby, Denmark, January 1993.
- Erik Mosekilde, Olga V Sosnovtseva, and Niels-Henrik Holstein-Rathlou. Mechanism-based modeling of complex biomedical systems. *Basic Clin Pharmacol Toxicol*, 96(3):212–224, Mar 2005. doi: 10.1111/j.1742-7843.2005.pto960311.x. URL <http://dx.doi.org/10.1111/j.1742-7843.2005.pto960311.x>.
- S. R. Mudaliar, F. A. Lindberg, M. Joyce, P. Beerdsen, P. Strange, A. Lin, and R. R. Henry. Insulin aspart (b28 asp-insulin): a fast-acting analog of human insulin: absorption kinetics and action profile compared with regular human insulin in healthy nondiabetic subjects. *Diabetes Care*, 22(9):1501–1506, Sep 1999.
- Hans Bruun Nielsen and Stig Bousgaard Mortensen. *ucminf: General-purpose unconstrained non-linear optimization*. Informatics and Mathematical Modelling, DTU, Denmark, 1.0-5 edition, March 2009.
- G. Nucci and C. Cobelli. Models of subcutaneous insulin kinetics. a critical review. *Comput Methods Programs Biomed*, 62(3):249–257, Jul 2000.
- Rune V Overgaard, Niclas Jonsson, Christoffer W Tornøe, and Henrik Madsen. Non-linear mixed-effects models with stochastic differential equations: implementation of an estimation algorithm. *J Pharmacokinetic Pharmacodyn*, 32(1):85–107, Feb 2005. doi: 10.1007/s10928-005-2104-x. URL <http://dx.doi.org/10.1007/s10928-005-2104-x>.
- Rune V Overgaard, Katarina Jelic, Mats Karlsson, Jan Erik Henriksen, and Henrik Madsen. Mathematical beta cell model for insulin secretion following ivgtt and ogtt. *Ann Biomed Eng*, 34(8):1343–1354, Aug 2006. doi: 10.1007/s10439-006-9154-0. URL <http://dx.doi.org/10.1007/s10439-006-9154-0>.
- Rune Viig Overgaard. *Pharmacokinetic/Pharmacodynamic modeling with a stochastic perspective. Insulin secretion and interleukin-21 development as case studies*. PhD thesis, Technical University of Denmark, Informatics and Mathematical Modelling, 2006.
- Yudi Pawitan. *In All Likelihood: Statistical Modelling and Inference Using Likelihood*. Oxford Science Publications, 2001.
- Vipul Periwal, Carson C Chow, Richard N Bergman, Madia Ricks, Gloria Lena Vega, and Anne E Sumner. Evaluation of quantitative models of the effect of insulin on lipolysis and glucose disposal. *Am J Physiol Regul Integr Comp Physiol*, Aug 2008. doi: 10.1152/ajpregu.90426.2008. URL <http://dx.doi.org/10.1152/ajpregu.90426.2008>.

- K. R. Philipsen, L. E. Christiansen, L. F. Mandsberg, O. Ciofu, and H. Madsen. Maximum likelihood based comparison of the specific growth rates for *p. aeruginosa* and four mutator strains. *J Microbiol Methods*, 75(3):551–557, Dec 2008. doi: 10.1016/j.mimet.2008.08.009. URL <http://dx.doi.org/10.1016/j.mimet.2008.08.009>.
- Umberto Picchini, Susanne Ditlevsen, and Andrea De Gaetano. Maximum likelihood estimation of a time-inhomogeneous stochastic differential model of glucose dynamics. *Mathematical Medicine and Biology*, 25(2):141–155, 2008. URL <http://dx.doi.org/10.1093/imamb/dqn011>.
- Jose Pinheiro, Douglas Bates, Saikat DebRoy, Deepayan Sarkar, and the R Core team. *nlme: Linear and Nonlinear Mixed Effects Models*, 2009. R package version 3.1-92.
- Jose C. Pinheiro and Douglas M. Bates. *Mixed Effects Models in S and S-Plus*. Springer, 2002.
- S. Del Prato, M. Matsuda, D. C. Simonson, L. C. Groop, P. Sheehan, F. Leonetti, R. C. Bonadonna, and R. A. DeFronzo. Studies on the mass action effect of glucose in niddm and iddm: evidence for glucose resistance. *Diabetologia*, 40(6):687–697, Jun 1997.
- R Development Core Team. *R: A Language and Environment for Statistical Computing*. R Foundation for Statistical Computing, Vienna, Austria, 2009. URL <http://www.R-project.org>. ISBN 3-900051-07-0.
- J. Radziuk and S. Pye. Quantitation of basal endogenous glucose production in type ii diabetes: importance of the volume of distribution. *Diabetologia*, 45(8):1053–1084, Aug 2002. doi: 10.1007/s00125-002-0841-6. URL <http://dx.doi.org/10.1007/s00125-002-0841-6>.
- Anirban Roy and Robert S. Parker. Dynamic modeling of free fatty acid, glucose, and insulin: An extended minimal model. *DIABETES TECHNOLOGY & THERAPEUTICS*, 8(6):617–626, 2006.
- Tue Søbørg, Christian Hove Rasmussen, Erik Mosekilde, and Morten Colding-Jørgensen. Absorption kinetics of insulin after subcutaneous administration. *Eur J Pharm Sci*, 36(1):78–90, Jan 2009. doi: 10.1016/j.ejps.2008.10.018. URL <http://dx.doi.org/10.1016/j.ejps.2008.10.018>.
- L. B. Sheiner. Learning versus confirming in clinical drug development. *Clin Pharmacol Ther*, 61(3):275–291, Mar 1997. doi: 10.1016/S0009-9236(97)90160-0. URL [http://dx.doi.org/10.1016/S0009-9236\(97\)90160-0](http://dx.doi.org/10.1016/S0009-9236(97)90160-0).
- L. B. Sheiner and S. L. Beal. *NONMEM User's Guide*. NONMEM Project Group, University of California, San Francisco, 1994.
- L. B. Sheiner and J. L. Steimer. Pharmacokinetic/pharmacodynamic modeling in drug development. *Annu Rev Pharmacol Toxicol*, 40:67–95, 2000. doi: 10.1146/annurev.pharmtox.40.1.67. URL <http://dx.doi.org/10.1146/annurev.pharmtox.40.1.67>.
- R. S. Sherwin, K. J. Kramer, J. D. Tobin, P. A. Insel, J. E. Liljenquist, M. Berman, and R. Andres. A model of the kinetics of insulin in man. *J Clin Invest*, 53(5):1481–1492, May 1974. doi: 10.1172/JCI107697. URL <http://dx.doi.org/10.1172/JCI107697>.
- Hanna E Silber, Petra M Jauslin, Nicolas Frey, Ronald Gieschke, Ulrika S H Simonsson, and Mats O Karlsson. An integrated model for glucose and insulin regulation in healthy volunteers and type 2 diabetic patients following intravenous glucose provocations. *J Clin Pharmacol*, 47(9):1159–1171, Sep 2007. doi: 10.1177/0091270007304457. URL <http://dx.doi.org/10.1177/0091270007304457>.
- R. Steele, J. S. Wall, R. C. Debodo, and N. Altszuler. Measurement of size and turnover rate of body glucose pool by the isotope dilution method. *Am J Physiol*, 187(1):15–24, Sep 1956.
- Agneta L Sunehag, Chiara Dalla Man, Gianna Toffolo, Morey W Haymond, Dennis M Bier, and Claudio Cobelli. beta-cell function and insulin sensitivity in adolescents from an ogtt. *Obesity (Silver Spring)*, 17(2):233–239, Feb 2009. doi: 10.1038/oby.2008.496. URL <http://dx.doi.org/10.1038/oby.2008.496>.

- Gianna Toffolo, Rita Basu, Chiara Dalla Man, Robert Rizza, and Claudio Cobelli. Assessment of postprandial glucose metabolism: conventional dual- vs. triple-tracer method. *Am J Physiol Endocrinol Metab*, 291(4):E800–E806, Oct 2006a. doi: 10.1152/ajpendo.00461.2005. URL <http://dx.doi.org/10.1152/ajpendo.00461.2005>.
- Gianna Toffolo, Marco Campioni, Rita Basu, Robert A Rizza, and Claudio Cobelli. A minimal model of insulin secretion and kinetics to assess hepatic insulin extraction. *Am J Physiol Endocrinol Metab*, 290(1):E169–E176, Jan 2006b. doi: .2004. URL <http://dx.doi.org/.2004>.
- Christoffer W Tornøe, Judith L Jacobsen, Oluf Pedersen, Torben Hansen, and Henrik Madsen. Grey-box modelling of pharmacokinetic/pharmacodynamic systems. *J Pharmacokinet Pharmacodyn*, 31(5):401–417, Oct 2004.
- Christoffer W Tornøe, Rune V Overgaard, Henrik Agersø, Henrik A Nielsen, Henrik Madsen, and E. Niclas Jonsson. Stochastic differential equations in nonmem: implementation, application, and comparison with ordinary differential equations. *Pharm Res*, 22(8):1247–1258, Aug 2005. doi: 10.1007/s11095-005-5269-5. URL <http://dx.doi.org/10.1007/s11095-005-5269-5>.
- Christoffer Wenzel Tornøe. *Population pharmacokinetic/pharmacodynamic modelling of the hypothalamic-pituitary-gonadal axis*. PhD thesis, Technical University of Denmark, July 2005. URL http://www2.imm.dtu.dk/pubdb/views/publication_details.php?id=3926.
- P. Vicini, A. Caumo, and C. Cobelli. The hot ivggt two-compartment minimal model: indexes of glucose effectiveness and insulin sensitivity. *Am J Physiol*, 273(5 Pt 1):E1024–E1032, Nov 1997.
- P. Vicini, A. Caumo, and C. Cobelli. Glucose effectiveness and insulin sensitivity from the minimal models: consequences of undermodeling assessed by monte carlo simulation. *IEEE Trans Biomed Eng*, 46(2):130–137, Feb 1999.
- A. Vølund, K. S. Polonsky, and R. N. Bergman. Calculated pattern of intraportal insulin appearance without independent assessment of c-peptide kinetics. *Diabetes*, 36(10):1195–1202, Oct 1987.
- Yaning Wang. Derivation of various nonmem estimation methods. *J Pharmacokinet Pharmacodyn*, 34(5):575–593, Oct 2007. doi: 10.1007/s10928-007-9060-6. URL <http://dx.doi.org/10.1007/s10928-007-9060-6>.
- C. Weyer, T. Heise, and L. Heinemann. Insulin aspart in a 30/70 premixed formulation. pharmacodynamic properties of a rapid-acting insulin analog in stable mixture. *Diabetes Care*, 20(10):1612–1614, Oct 1997.
- WHO. Diabetes fact sheet 312. Online, November 2008. URL <http://www.who.int/mediacentre/factsheets/fs312/en/>.

Part III
Appendices

Index

- Bridging, 20
 - Preconditions, 20
- Collaborators, 7
- Data, 25
 - Clamp, 27
 - Meal Tolerance Tests, 25
- Deconvolution
 - Hepatic Extraction, 116
 - Insulin Secretion Rates, 115
 - Intervention Model, 117
- Evaluation
 - Insulin Tolerance Test, 59
 - Isoglycemic Clamps, 56
- Glucose, 13
 - Meal Function, 46
 - Meal Function Parameterisations, 78
 - Model Building, 47
 - Model Selection, 49
 - Models, 45
- Input Error Propagation, 120
- Insulin, 13
 - Absorption, 31
 - Analogues, 17
 - Aspart, 16
 - BHI30, 16
 - Delivery, 42
 - Disposition, 36
 - Forcing Function, 76
 - Human, 16
 - Model, 31
 - NPH, 16
 - Secretion, 33, 39
- Insulin Aspart, 63
 - Pharmacokinetic Model, 64
- Integrated Model
 - Description, 22
 - Evaluation, 53
- Integrated Model Setup, 19
- MTT
 - Prediction, Insulin Aspart, 69
- Non Negativity Constraint, 118
- Post Modelling Analysis, 75
- PSM
 - R-Package, 109
 - Methodology, 103
- Transfer function
 - Insulin Aspart, 66