

Rapid and Simultaneous Determination of Neptunium and Plutonium in Environmental Samples Using Anion Exchange Chromatographic and Sequential Injection Setup Combined with Inductively Coupled Plasma Mass Spectrometry

Qiao, Jixin; Hou, Xiaolin; Roos, Per; Miro, Manuel

Published in:

Workshop on Radioanalytical Chemistry for Radioecology and Waste Management: Report, evaluation, abstracts and full papers of presentations

Publication date:

2010

Document Version

Publisher's PDF, also known as Version of record

[Link back to DTU Orbit](#)

Citation (APA):

Qiao, J., Hou, X., Roos, P., & Miro, M. (2010). Rapid and Simultaneous Determination of Neptunium and Plutonium in Environmental Samples Using Anion Exchange Chromatographic and Sequential Injection Setup Combined with Inductively Coupled Plasma Mass Spectrometry. In X. Hou (Ed.), Workshop on Radioanalytical Chemistry for Radioecology and Waste Management: Report, evaluation, abstracts and full papers of presentations (pp. 45-45). Roskilde: NKS. (NKS-218).

DTU Library

Technical Information Center of Denmark

General rights

Copyright and moral rights for the publications made accessible in the public portal are retained by the authors and/or other copyright owners and it is a condition of accessing publications that users recognise and abide by the legal requirements associated with these rights.

- Users may download and print one copy of any publication from the public portal for the purpose of private study or research.
- You may not further distribute the material or use it for any profit-making activity or commercial gain
- You may freely distribute the URL identifying the publication in the public portal

If you believe that this document breaches copyright please contact us providing details, and we will remove access to the work immediately and investigate your claim.



Nordisk kernesikkerhedsforskning
Norrænar kjarnöryggisrannsóknir
Pohjoismainen ydinturvallisuustutkimus
Nordisk kjernesikkerhedsforskning
Nordisk kärnsäkerhetsforskning
Nordic nuclear safety research

NKS-218
ISBN 978-87-7893-288-4

Workshop on Radioanalytical Chemistry for Radioecology and Waste Management: Report, evaluation, abstracts and full papers of presentations

Xiaolin Hou

Risø National Laboratory for Sustainable Energy,
Technical university of Denmark, Denmark

March 2010

Abstract

A NKS-B workshop on radioanalytical chemistry for radioecology and waste management was held at Risø, Roskilde, Denmark in 16-20th November 2009. The workshop was organized as 3 days lectures and presentations and two days laboratory practice. 48 peoples participated the workshop, including 32 young participants from Denmark, Finland, Norway, Sweden, Lithuania and Ireland. This report gives a brief description of the workshop and an evaluation of the workshop by statistic analysis of questionnaires feed back from the participants. The book of abstracts and proceedings presented in the workshop is enclosed

Key words

Workshop, Radioanalysis, radiometric techniques, radiochemical separation, environmental radioactivity

NKS-218
ISBN 978-87-7893-288-4

Electronic report, March 2010

NKS Secretariat
NKS-776
P.O. Box 49
DK - 4000 Roskilde, Denmark

Phone +45 4677 4045
Fax +45 4677 4046
www.nks.org
e-mail nks@nks.org

Workshop on Radioanalytical Chemistry for Radioecology and
Waste Management: — report, evaluation, abstracts and full
papers of the presentations

Xiaolin Hou

Risø National Laboratory for Sustainable Energy,

Technical university of Denmark, Denmark

March 2010

Project partners and workshop organizer:

Xiaolin Hou (Risø-DTU, Denmark, Coordinator, Chairperson of the workshop)

Jukka Letho (University of Helsinki, Finland)

Mats Jonsson (Royal Institute of Technology, Sweden)

Lindis Skipperud (University of Life Science, Norway)

Ylva Ranebo (Lund University, Sweden)

Workshop report

The NKS-B workshop on radioanalytical chemistry for radioecology and waste management was organized by Risø National Laboratory for Sustainable Energy, Technical University of Denmark, by collaboration with University of Helsinki, Finland, Royal Institute of Technology, Sweden, University of Life Science, Norway, and Lund University, Sweden, and supported of NKS-B Program. The workshop was held at Risø, Roskilde, Denmark in 16-20th November 2009. There were total 48 persons participating in the workshop; 15 lecturers, one secretary and 32 young participants. About half of the participants were master and PhD students. Among the 32 young participants, 8 were from Denmark, 7 from Norway, 9 from Sweden, 4 from Finland, 3 from Lithuania, and 1 from Ireland. A list of the participants is enclosed in the end of this report. The workshop consisted of two parts, three days lectures/presentations in 16-18th November, and two days laboratory practice in 19th-20th November 2009. The lectures/presentations were organized in 6 sessions; general aspects in radioanalytical chemistry, sampling and measurement techniques, rapid analytical methods, radioanalytical methods, separation procedures for radionuclides, and presentations from young scientists/students in oral and poster presentations. 19 lectures covering all aspects in the radioanalytical chemistry were presented by 15 invited lecturers for 40 min each with discussion. 8 oral presentations of 20 minutes each and 5 posters were presented by young participants. The lab practice was organized in three parallel groups: (1) Radiochemical separation of ²¹⁰Po, ²²⁶Ra and γ - and α -spectrometry measurement; (2) Radiochemical separation of ⁹⁹Tc, Pu isotopes and ICP-MS measurement; (3) Radiochemical separation of ³H, ¹⁴C, ⁵⁵Fe, ⁶³Ni, and LSC measurement, which were carried out in Risø's laboratories. The programme of the workshop is attached.

A book of proceedings/abstracts for the workshop (68 pages) was printed and distributed to the participants during registration of the workshop in the morning on 16th November, a copy of the book is enclosed in this report. The slides of the 26 lectures and oral presentations were published as PDF files in NKS website immediately after the workshop, These slides are free accessible from NKS website: (http://www.nks.org/dk/seminarier/praesentationer/nks-b_radworkshop_16-20_november_2009.htm).

Objectives of the workshop and performance

The objectives of this workshop include:

1. Providing the participants with an overview of the radioanalytical methods developed and applied in Nordic laboratories.
2. Providing an opportunity to the participants to get knowledge and practical (hands-on) experience of state-of-the-art measurement techniques used for the determination of different radionuclides by participating in practical training in the laboratory (experimental demonstration and analysis of real samples).
3. Providing a forum for knowledge exchange of n radioanalysis of various radionuclides and discussion of present radiochemical procedures for the individual radionuclides applied in the different Nordic labs.

Which all lead to education of MSc and PhD student and increased competence of staff involved in radiochemical separation and determination of radionuclides.

Evaluation of the workshop

Questionnaires were distributed to all participants during the workshop to get feedback and evaluate the workshop. Total 22 out of 32 questionnaires were collected. A statistic analysis of these questionnaires is presented for each question.

Question 1 : Do you think the workshop is useful for your work?

21 of 22 participants gave a positive answer, and one did not answer this question.

Question 2: What do you think was the best thing in this workshop?

The answers are various, 8 participants put the lab practice as the best thing among others; 4 took the combination of lectures and lab practice as the best thing; the others mentioned include meeting the young colleagues from other Nordic countries, radionuclides chemistry and separation procedure, opening discussion, broad topics etc.

Question 3. What do you think was the worst thing in this workshop?

11/22 participants choose nothing, and others include: short time lab practice, breaks are too long, too heavy schedule, early start at 8:30am, bad weather, and too long distance walking to lab.

Question 4. How useful did you find the topics of the lectures in the workshop?

21/22 participants give positive answer, of them 8 gave a very positive answer. One did not answer this question.

Question 5. How useful did you think the lab practice in the workshop?

All 22/22 participants gave a positive answer, of them, 13 gave very positive answer.

Question 6. Are there other topics that you would like to be covered in the lecture sessions? If yes, please list it.

12/22 did not give any suggestions, 10 gave their suggestions, which includes more ICP-MS, hot particles, colloid, surface characterization, pollution, more sampling techniques, alpha and gamma spectrometries, radioisotopes tracer application, basic radiochemistry, radical chemistry and analysis. All these suggestions are much more specific interest, which mainly reflected the personal interests.

Question 7. How do you rate the quality of the lectures (both positive and negative comments welcome)?

3/22 rate as very high quality, 17/22 rates high quality, 1/22 rates ok, and one did not answer the question.

Question 8. Can you suggest any improvements to the workshop?

17/22 participants gave their suggestions and comments, these include: lab practice first of lectures, mix the lecture and practice each day or one after another, more lab practice, and focusing on a few topic each time. These suggestions are useful for improving the quality of the workshop in the future and should be considered.

Question 9. Do you think should we continue to organize this workshop? If yes, how often and how to organize?

22/22 supported to continue this workshop in the future, workshop frequency of every 2-3 year are the common suggestion, some suggested to have it every year but focus on 1-2 topic each year.

Question 10. Should the workshop be at one place or should it rotate among Nordic labs?

6/22 participants suggested to have workshop at Risø-DTU, and 15/22 supported to rotate the place among Nordic Labs, but all of them agreed that the organizer should have good facilities for the workshop, especially laboratories and equipments. One did not care the place.

Question 11. Will you recommend this workshop to your colleagues/friends if we organize it again?

21/22 gave a very positive answer to this question; one did not answer the questions.

Table 1: Statistic analysis of the questionnaires

Question No.	Yes	No	Comments
1	21/22		One did not answer
2	22/22		More lab practice and combination of lectures and lab practice are top two best things in the workshop
3		11/22	Short time lab practice, long breaks, heavy schedule, start too early, weather and long distance walking to lab.
4	21/22		One did not answer
5	22/22		
6		12/22	Personal interest such as: more ICP-MS, hot particles, colloid, surface characterization, pollution, more sampling, alpha and gamma spectrometry, radioisotopes tracer application, basic radiochemistry, radical chemistry and analysis.
7	21/22		One did not answer
8	17/22		lab practice first of lectures, mix the lecture and practice each day or one after another, more lab practice, and focus on a few topic each time
9	22/22		workshop frequency of every 2-3 year are the common suggestion for this workshop, but some also suggested to have it every year but focus on 1-2 topic each year.
10	6/22	15/16	6/22 participants suggested to have workshop at Risø-DTU, and 15/22 support to rotate the place among Nordic Labs, but most of them agree that facilities for the workshop, especially laboratories and equipments is more important. One does not care about the place.
11	21/22		One did not answer the question

Conclusions:

From the above analysis of the questionnaires, the following conclusion can be drawn:

- 1) The workshop was very successful, and exceeded the expectation of many participants. All objectives were reached; this is confirmed by questionnaire investigation and communication with participants.
- 2) Almost all participants were satisfied with the workshop and thought the workshop is useful for their works.

- 2) All participants supported continuation of such workshop, and will recommend this workshop to their colleagues/friends if it is organized again. Most of them suggested organizing the workshop every 2-3 years, while some suggested organizing it each year but focusing on 1-2 topics at a time.
- 3) All participants agreed that the laboratory practice is the best part of the workshop. Some of them suggested extending the lab practice, and put the lab practice before the lecture, or mix the practice with lectures each day.
- 4) Almost all participants were satisfied with the quality of the invited lectures, the presentation of some participants might not be of high quality, but it gave the young scientists/student opportunity to show their work. This should be a positive issue for the future workshops.
- 5) The organization of the workshop could be improved. For the organization of the lab practice, smaller groups (5-6 persons per group) will be better, lab practice before the lecture or lecture in the morning and lecture in the afternoon may have a better effect. Improving two ways communication during lectures is needed. However, during the lab practice, questions and discussions were better. This might indicate that the atmosphere during the lectures session is still too formal, which makes the young participants more hesitate to ask question. Changing the order of the lab practice and lecture, may be helpful to establish friendlier atmosphere among participants and lecturers, and to stimulate a good communication and discussion.

From the questionnaires, it indicates that most of the participants have limited knowledge on the radioanalytical chemistry, especially limited lab practice, although they are working in this field. This supports that the workshop is very useful and necessary not only for education of young scientists, but also for improving and keeping the expertise of Nordic laboratories in radioecology and waste management.

Suggestion:

This workshop should be continued, because it will very benefit to the Nordic society of radioecology, radioanalytical chemistry and nuclear emergency preparedness by educating the students and young scientist and improving the expertise of Nordic labs in these fields.

Copy of the book of proceedings/abstracts is enclosed below.

NKS-B Workshop on Radioanalytical Chemistry for Radioecology and Waste Management



Programme and Abstracts

Risø, Roskilde, Denmark
16th – 20th November 2009

NKS-B Workshop on Radioanalytical Chemistry for Radioecology and Waste Management (RadWorkshop)

16th – 20th Nov. 2009, Risø, Roskilde, Denmark

The workshop sponsor:

Nordic Nuclear Safety Research (NKS), Program B (Manager: Justin Gwynn)

The workshop organizers:

Risø National Laboratory for Sustainable Energy, Risø-DTU, Technical University of Denmark, Denmark

University of Helsinki, Finland

Royal Institute of Technology, Sweden

Norwegian University of Life Sciences, Norway

Lund University, Sweden

Organizing Committee:

Xiaolin Hou, Risø-DTU, Technical University of Denmark (Chair person)

Sven P. Nielsen, Risø-DTU, Technical University of Denmark

Jukka Letho, University of Helsinki, Finland

Mats Jonsson, Royal Institute of Technology, Sweden

Lindis Skipperud, Norwegian University of Life Sciences, Norway

Ylva Ranebo, Lund University, Sweden

Editor of the Program and Abstracts:

Xiaolin Hou

Risø-DTU, Technical University of Denmark (Chair person)

The workshop Secretary:

Majbritt E. Nielsen, Risø-DTU, Technical University of Denmark

Tel. +45 4677 5300, E-mail: majb@risoe.dtu.dk

Printing:

Risø-DTU, Technical University of Denmark, November 2009

Workshop Programme

Time	Speaker	Title of Presentation
Monday, 16th Nov. 2009		
8.30-10:00	Registration	
10:00-10.20	Xiaolin Hou Justin Gwynn, Sven, P. Nielsen,	Opening address of the workshop
Session 1	General aspects on Radioanalytical Chemistry (Chair by: Sven P. Nielsen & Justin Gwynn)	
10.20-11:00	Jukka Lehto , Univ. Helsinki, Finland	Use of precipitation, ion exchange, solvent extraction and extraction chromatography in radiochemical separations
11:00:11:40	Mats Jonsson , KTH, Sweden	Dynamics of spent nuclear fuel dissolution and radionuclide migration
11:40-13:00	Lunch	
Session 1	General aspects on Radioanalytical chemistry –Continue (Chair by: Sven P. Nielsen & Justin Gwynn)	
13:00-13:40	Brit Salbu , UMB, Norway	Speciation analysis of radionuclides
13:40-14:20	Wangsuo Wu , Lanzhou Univer. China	Determination of radionuclides for decommissioning of nuclear facility and its environment
14:20-14.40	Kasper G. Andersson , Risø-DTU, Denmark	Emerging needs for physicochemical analyses in connection with radiological terror preparedness'
14.40-15.10	Break	
Session 2	Sampling and measurement techniques (Chair by: Jukka Lehto & Mats Jonsson)	
15:10-15:50	Per Roos , Risø-DTU, Denmark	Sampling and pre-concentration techniques for environmental radioactivity analysis
15:50-16:30	Sven P. Nielsen , Risø-DTU, Denmark	Gamma spectrometry and beta counting used for monitoring of environmental radioactivity at Risø
17:30-19:00	Guide tour to Viking ship museum	
19:00-21:00	Workshop Dinner (Restaurant Snekken, Roskilde)	
Tuesday, 17th Nov. 2009		
Session 2	Sampling and measurement techniques -Continue (Chair by: Jukka Lehto & Mats Jonsson)	
8:30-9:10	Xiaolin , Risø-DTU, Denmark	Liquid scintillation counting , principle and applications
9:10-9:50	Vasily Alfimov , ETH, Switzerland	AMS analysis for long-lived radionuclides

9:50-10:30	Per Roos , Risø-DTU, Denmark	ICP-MS analysis for long-lived radionuclides
10:30-10:50	Break	
10:50-11:30	Lindis Skipperud , UMB, Norway	Application of ICP-MS and AMS for determination of Pu- and U-isotope ratios for source identification
11:30-12:10	Mats Eriksson , IAEA-MEL, Monaco	Hot particle measurement techniques and application
12:10-13:30	Lunch	
13:30-13:50	Ylva Ranebo Lund Univ., Sweden	SIMS technique and its application for hot particle characterisation
Session 3	Rapid methods for radionuclide analysis (Chair by: Brit Salbu & Xiaolin Hou)	
13:50-14:30	C.K. Kim , IAEA, Seibersdorf, Austria	Application of off-line and on-line sequential injection system with high resolution ICP-MS to measurement of low level radionuclides in environmental samples
14:30-15:10	Xiongxin Dai , Chalk River, Canada	Rapid analytical methods for determination of actinides
15:10-15:30	Jixin Qiao , Risø-DTU, Denmark	Rapid and Simultaneous Determination of Np and Pu in Environmental Samples Using Sequential Injection Setup
15:30-16:00	Break	
Session 4	Radioanalytical method (Chair by: Brit Salbu & Xiaolin Hou)	
16:00-16:40	Justin Gwynn , NKS, NRPA, Norway	The use of $^{99}\text{Mo}/^{99\text{m}}\text{Tc}$ generators in the analysis of low levels of ^{99}Tc in environmental samples by radiochemical methods
16:40-17:20	Jussi Jernström Risø-DTU, Denmark	Radiochemistry analysis of ^{99}Tc in environmental samples
Wednesday, 18th Nov. 2009		
Session 5	Radioanalytical methods and procedures (Chair by: Wangsuo Wu & Per Roos)	
8:30-9:10	Aude Bombard , TRISKEM, France	Absorption study of Am and Cm to TEVA, TRU and DGA Resins
9:10-9:50	Xiaolin Hou Risø-DTU, Denmark	Radiochemical analysis of ^{90}Sr , ^{41}Ca , ^{129}I and ^{36}Cl in waste samples
9:50-10:30	Per Roos , Risø-DTU, Denmark	Radiochemical analysis of Ra, ^{210}Po , ^{210}Pb , U and Th
10:30-10:50	Break	
10:50-11:30	Xiaolin Hou , Risø-DTU, Denmark	Radiochemical analysis of ^3H , ^{14}C , ^{55}Fe , ^{63}Ni in waste samples

11:30-11.50	Rajdeep Singh Sidhu, IFE, Norway	Radiochemistry at the Environmental Monitoring Section at Institute for Energy Technology (IFE), Kjeller, Norway
11:50-12:10	Anna Ljungfalk Ringhals NPP, Sweden	Advances in Isotopic Separation by Ion Chromatography and External Scintillation Analysis
12.10-13:30	Lunch	
Session 6	Poster	
13:30-14:30	Poster session (Coffee, tea, and fruits are supplied)	
Session 7	Presentations and discussion (Chair by: Xiongxin Dai & Jussi Jernström)	
14:30-14:50	Peng Yi Uppsala Univ., Sweden	Distribution of ^{129}I in the Baltic Sea using a model approach
14:50-15:10	Sara Nordén, SKB, Sweden	Multi-element analyses for estimation of concentration ratios with site specific chemistry data from two sites in southern Sweden
15:10-15:30	Suvi Lamminmäki Helsinki Univ. Finland	Hot particles from atmospheric nuclear explosions
15:30-16:00	Break	
16.00-16.30	Discussion (Chair by: Xiongxin Dai & Jussi Jernström)	
16.30-16:50	Close the lecture part of the workshop (Justin Gwynn & Xiaolin Hou)	
Thursday, 19th Nov. 2009		
8:30-17:00	Lab practice Group 1: Radiochemical separation of ^{210}Po , ^{226}Ra and γ - and α -spectrometry measurement (Tutor: Per Roos) Group 2: Radiochemical separation of ^{99}Tc , Pu isotopes and ICP-MS measurement (Tutor: Jussi Jernström) Group 3: Radiochemical separation of ^3H , ^{14}C , ^{55}Fe , ^{63}Ni , and LSC measurement. (Tutor: Xiaolin Hou)	
Friday, 20th Nov. 2009		
8:30-15:30	Lab practice Group 1: Radiochemical separation of ^{210}Po , ^{226}Ra and γ - and α -spectrometry measurement (Tutor: Per Roos) Group 2: Radiochemical separation of ^{99}Tc , Pu isotopes and ICP-MS measurement (Tutor: Jussi Jernström) Group 3: Radiochemical separation of ^3H , ^{14}C , ^{55}Fe , ^{63}Ni , and LSC measurement. (Tutor: Xiaolin Hou)	

RADIOCHEMICAL SEPARATION METHODS

Jukka Lehto

Laboratory of Radiochemistry, University of Helsinki, Finland

Radiochemical separations make use of the traditional methods of separating elements: precipitation, ion exchange and solvent extraction, of which precipitation has been employed from the very beginning. A new method, accepted into wide use in the 1990s, is extraction chromatography, which combines solvent extraction as the separation method with column chromatography technology earlier used in ion exchange. These four methods are discussed in the following.

Precipitation

Precipitation is a traditional method for radiochemical separations. Marie Curie used precipitation methods in the late 1890s to separate the new radioactive elements, radium and polonium, from ore minerals. Figure IV.I shows Curie's separation scheme for polonium, which is marked with an "X" since the element was unknown at the time. Although the separation scheme used in the analysis was a familiar one, a new feature was that the route of the radiating component (X) could be followed, and conclusions about its chemical properties were drawn on the basis of the elements that it accompanied. This was the very first radiochemical separation procedure.

As new radionuclides, first natural and then artificial ones, became known, separation methods, most of them based on precipitation, were developed for them. In the context of nuclear weapons development projects in the 1940s, separation methods based on precipitation were developed for most of the fission products, and some of these methods remain in use. Precipitation has nevertheless lost its favored status as the most essential step in a radiochemical separation, yielding place to ion exchange and liquid extraction, and beginning in the 1990s, also to extraction chromatography.

Solubility product

For radionuclides forming sparingly soluble compounds precipitations are used in radiochemical separation procedures. For precipitation of a compound to occur, its solubility product (K_s) must be exceeded. The solubility product of a compound A_xM_y is expressed as

$$K_s = [A]^x \cdot [M]^y,$$

where $[A]$ and $[M]$ are the concentrations of the anion and cation in the solution and x and y are their charges. The smaller the solubility product, the lower is the solubility of the compound, though direct comparison of solubility products is possible only for compounds whose anion and cation charges are the same.

Because the concentrations of radionuclides in solution are generally very low, their solubility products are seldom exceeded without the addition of a carrier. Even if the solubility product were exceeded, the amount of precipitate can be too small to be practically handled and also in this case carrier addition is necessary. When an isotopic carrier is added to exceed the solubility product or to increase the amount of precipitate, it must be added to the solution in the same chemical form as the target radionuclide. The chemical form of a radionuclide in solution is not often known, and, after the addition of the carrier, the chemical form of the nuclide and the carrier must be made the same, for example by treating the solution with strong acids and with oxidizing or reducing agents.

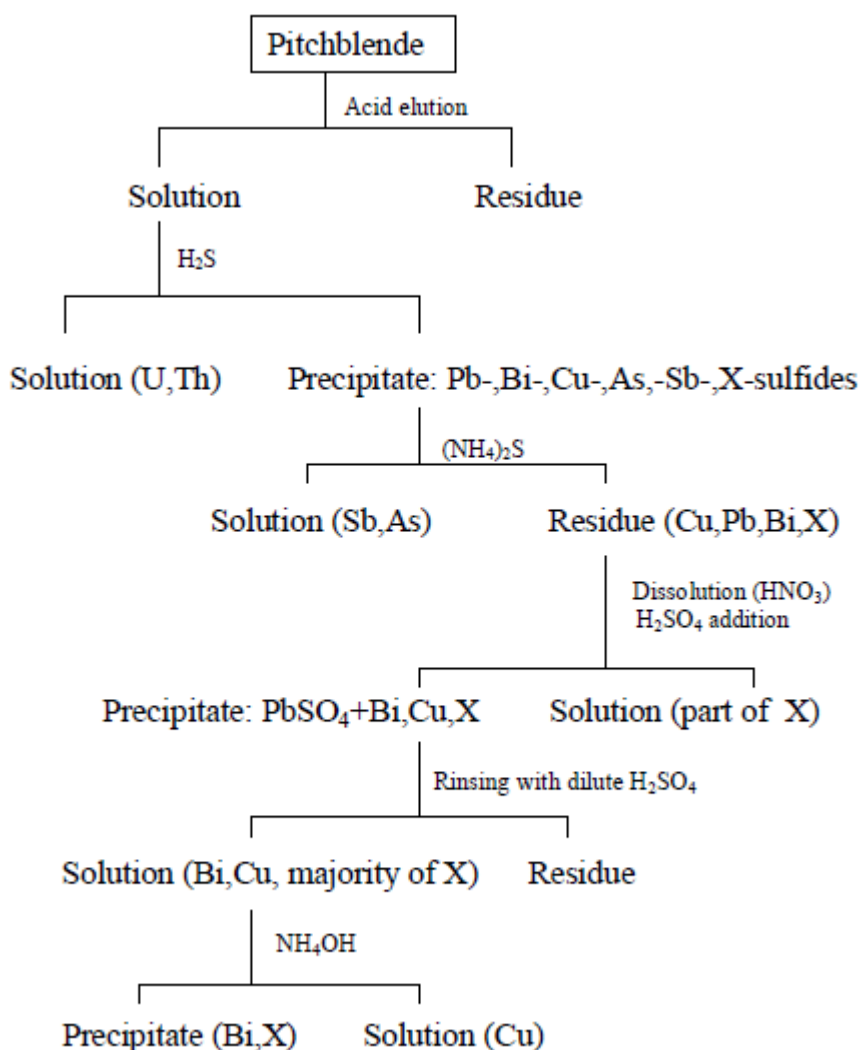

Figure IV.I Separation scheme used in Marie Curie's separation of polonium (X) from pitchblende.

Coprecipitation

For those radionuclides for which a suitable isotopic carrier is not available, a non-isotopic carrier must be used for the precipitation. In that case the precipitation is called coprecipitation. Coprecipitation relies on one of the following mechanisms:

- The precipitate consists of normal mixed crystals, in which the trace radionuclide is uniformly distributed in the crystal lattice and replaces the carrier atoms without causing lattice defects; that is, it replaces the carrier atoms in the lattice isomorphically. For this to occur, the carrier and the target radionuclide must be chemically similar. For example, ^{226}Ra can be coprecipitated with sparingly soluble BaSO_4 , because both Ra and Ba are alkaline earth metals with a charge of +2 and their ionic sizes are not very different. If the trace component forms a less soluble compound than the carrier does with the oppositely charged precipitating ion (in the above case, sulfate), it will enrich into the precipitated compound. In other words, the ratio of the trace component to the carrier component will be larger in the precipitate than in solution. Isomorphic replacement does not necessarily mean that the concentration of the trace component is homogeneous in the whole crystal. Precipitation conditions (temperature, rate of precipitation, concentrations, aging) affect the homogeneity. In general, high precipitation temperature, slow precipitation, and aging promote homogeneity. Strong

enrichment of a radionuclide promotes heterogeneity, so that the concentration is greater in the crystal core than on the surface region.

- The precipitation process gives rise to anomalous mixed crystals, in which the radionuclide may be uniformly distributed in the compound formed with the carrier but the replacement is not isomorphic. The charges of the carrier atoms and the radionuclide to be precipitated are not necessarily identical in anomalous mixed crystals. For example, lanthanide fluorides (CeF_3 , NdF_3 , etc.) coprecipitate from hydrofluoric acid both tri- and quadrivalent actinides (e.g., both Pu^{3+} and Pu^{4+}). Although the precipitation is efficient, Pu does not substitute in the crystals isomorphically, at least not in valence state four.
- During precipitation of the carrier compound the radionuclide adsorbs onto the surface of the precipitating substance, for example, by ion exchange adsorption. Hydroxides of multivalent metals, e.g., iron hydroxide $\text{Fe}(\text{OH})_3$, or hydrous oxides, e.g., $\text{MnO}_2 \cdot x\text{H}_2\text{O}$, coprecipitate metals effectively, especially metals with high charge. These hydroxides and oxides have $-\text{OH}$ groups on their surfaces, and the hydrogen dissociates in neutral and basic solutions and the generated $-\text{O}^-$ group binds cations. Because this is a surface reaction, the adsorption is greater the greater the surface area of the absorbing substance. The adsorbing precipitate is exploited for the separation of radionuclides in two ways. Most often the adsorbing precipitate is formed by adding appropriate chemicals to the solution containing the radionuclides. For example, several transition elements adsorb onto $\text{Fe}(\text{OH})_3$ precipitate, which is formed by adding trivalent iron to the acidic solution (pH about 2) and then precipitating $\text{Fe}(\text{OH})_3$ by adding NaOH or NH_4OH to the solution. The other, less common approach is to add to the solution containing the radionuclide a preprepared adsorbing precipitate and to mix the mixture so that the radionuclides sorb on the precipitate.

Objectives of precipitation

Precipitation processes can be divided into three categories according to the objective.

1. Precipitations specific for the investigated radionuclide. There are only a few such precipitations: e.g., nickel (^{63}Ni) is precipitated from solution with dimethylglyoxime, which is highly specific for nickel (Figure IV.2).

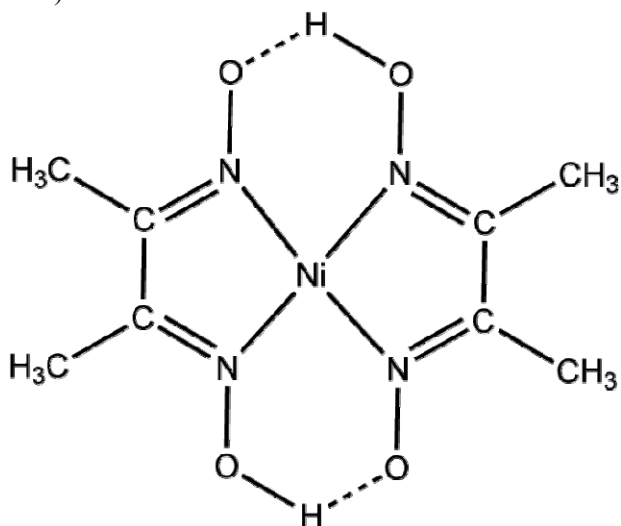

Figure IV.2. Binding of nickel to dimethylglyoxime, which is a highly specific precipitant for nickel.

2. Group precipitations, used to preconcentrate the target radionuclide. Preconcentration involves separating the target radionuclide with materials behaving in the same way, in order to achieve smaller volume. For example, iron hydroxide precipitation is used to concentrate actinides and other hydrolyzing metals present

in very large sample volumes, as much as 100 to 200 liters. The obtained precipitate is dissolved in a much smaller amount of acid for further separation and purification.

3. Group precipitations, used to remove interfering radionuclides and stable elements. Most of these processes rely on hydroxide, carbonate, and oxalate precipitation. Precipitation as hydroxide, usually as iron hydroxide, at pH 8–9, leaves all alkali and alkaline earth metals in solution since the alkali metals do not form hydroxides at all and the alkaline earth metals do not precipitate as hydroxides at such low pH. Moreover, radionuclides appearing in anionic form remain in solution in hydroxide precipitation. Lanthanides, actinides and most d-transition elements precipitate as hydroxides. The primary objective in many radiochemical analyses is to remove iron, which interferes with several of the stages in radiochemical separations. Iron is abundant in soil and sediment samples, and also the iron added to the sample in iron hydroxide precipitations must be separated before following stages. In the separation of actinides, iron can be removed by coprecipitation of the actinides with calcium oxalate. Prior to oxalate precipitation the iron in the solution is totally oxidized to trivalent Fe^{3+} ion, which does not form an oxalate precipitate. Since the precipitation is done at pH under 2, the iron does not precipitate as hydroxide either. When interfering nuclides are removed from the solution by precipitation, the process can be described as scavenging. In the determination of ^{90}Sr in milk, for example, the coexisting ^{140}Ba can be separated by precipitating it with BaCrO_4 as scavenger. Carbonate precipitations are the usual choice when alkali and alkaline earth metals are to be separated from each other. When hydroxide precipitation is carried out first, the metals that form hydroxides are removed from the solution, while alkali and alkaline earth metals and anionic radionuclides remain in the solution.

Table IV.I The major precipitations used for radionuclide separations

<i>Radionuclide</i>	<i>Precipitation</i>	<i>Purpose of the precipitation</i>
^{14}C	<ul style="list-style-type: none"> • CaCO_3 precipitation of $^{14}\text{CO}_2$ formed in sample combustion and trapped in NaOH solution 	<ul style="list-style-type: none"> • precipitate $^{14}\text{CO}_3^-$ as CaCO_3
^{36}Cl	<ul style="list-style-type: none"> • AgCl precipitation 	<ul style="list-style-type: none"> • ^{36}Cl separation/purification
^{41}Ca	<ul style="list-style-type: none"> • $\text{Fe}(\text{OH})_3$ coprecipitation • carbonate precipitation 	<ul style="list-style-type: none"> • removal of transition metals • Ca separation from alkali metals
^{55}Fe	<ul style="list-style-type: none"> • $\text{Fe}(\text{OH})_3$ precipitations 	<ul style="list-style-type: none"> • concentration, separation of interfering components
^{63}Ni	<ul style="list-style-type: none"> • carbonate or hydroxide coprecipitation • dimethylglyoxime precipitation 	<ul style="list-style-type: none"> • separation of interfering component • selective separation of ^{63}Ni
^{90}Sr	<ul style="list-style-type: none"> • nitrate precipitation in 70% HNO_3 • BaCrO_4 precipitation • carbonate precipitations • $\text{Y}(\text{C}_2\text{O}_3)_3$ precipitation 	<ul style="list-style-type: none"> • separation of strontium from calcium • separation of strontium from barium • concentration, separation of interfering components • separation of ^{90}Y from ^{90}Sr
^{99}Tc	<ul style="list-style-type: none"> • $\text{Fe}(\text{OH})_3$ and $\text{Fe}(\text{OH})_2$ coprecipitations 	<ul style="list-style-type: none"> • preconcentration of Tc from natural waters
^{129}I	<ul style="list-style-type: none"> • AgI precipitation 	<ul style="list-style-type: none"> • ^{129}I separation/purification
^{210}Pb	<ul style="list-style-type: none"> • PbSO_4 and PbS coprecipitations 	<ul style="list-style-type: none"> • ^{210}Pb separation/purification
^{226}Ra	<ul style="list-style-type: none"> • BaSO_4 coprecipitation 	<ul style="list-style-type: none"> • separation of ^{226}Ra
Th nuclides	<ul style="list-style-type: none"> • $\text{Fe}(\text{OH})_3$ coprecipitation 	<ul style="list-style-type: none"> • concentration, separation of interfering components
$^{234,235,238}\text{U}$		
^{237}Np	<ul style="list-style-type: none"> • oxalate coprecipitation 	<ul style="list-style-type: none"> • concentration, separation of interfering components
$^{238,239,240,241}\text{Pu}$		
^{241}Am	<ul style="list-style-type: none"> • CeF_3 or NdF_3 coprecipitation 	<ul style="list-style-type: none"> • source preparations for activity measurement, determination of oxidation states
^{242}Cm		

Summary of the most important precipitations used in radiochemistry:

- carbonate precipitations used for preconcentration of the target radionuclide and for removal of alkali metals and anionic radionuclides from samples; these remain in solution
- iron hydroxide precipitations used for preconcentration of the target radionuclide and for removal of alkali metals, alkaline earth metals, and anionic radionuclides from samples; these remain in solution
- oxalate precipitations used for concentrating the target radionuclide and for the removal of alkali metals, alkaline earth metals, iron and anionic radionuclides from samples; these remain in solution
- lanthanide fluorides used for the precipitation of tri- and quadrivalent actinides
- a specific dimethylglyoxime precipitation used to separate nickel

Ion exchange

Ion exchange resins

Almost all the ion exchangers employed in radiochemical analyses are common organic cation and anion exchange resins. Resins are prepared from polystyrene cross-linked with divinylbenzene (DVB) (Figure IV.3). A functional group is attached to the benzene rings of the porous polymer: either the sulfonic acid group $-\text{SO}_3\text{H}$ is added, so that the resin works as a cation exchanger upon dissociation of the hydrogen ion of the sulfonic acid group, or the quaternary ammonium ion $-\text{N}(\text{CH}_3)_3\text{OH}$, which acts as an anion exchanger upon dissociation of the hydroxide group. Both are strong ionexchangers: that is, they dissociate easily and function therefore as ion exchangers over the whole pH range, including in strong acids.

Ion exchangers are available in powdered and granular form, but only granules are used in radiochemical separations for analytical purpose to allow packing in columns. Typical grain sizes are 0.30–0.85 mm (20–50 mesh), 0.15–0.30 mm (50–100 mesh), and 0.07–0.15 mm (100–200 mesh). The smaller the grain size, the more favorable is the ion exchange kinetics. Another factor affecting the kinetics is the degree of cross-linking in the resin, which is a reflection of the percentage of divinylbenzene in the resin reaction mixture. The degree of cross-linking typically varies between 2 and 20%. Resins with low degree of cross-linking offer faster ion exchange reactions but are less durable than resins with high degree of cross-linking, whose kinetics are slower. Ion exchange resins also contain other functional groups than sulfonic acid or quaternary ammonium. If the functional group is a carboxylic group, the resin is a weakly acidic cation exchanger, which functions as a cation exchanger only in neutral and basic solutions. If it is a tertiary ammonium group, the resin is a weak anion exchanger and functions as an anion exchanger only in neutral and acidic solutions. There are also ion exchange resins in which the functional group is a chelating group, such as iminodiacetic acid. Types of organic ion exchange resins are listed in Table IV.2. In addition to organic resins, some highly selective inorganic exchangers, such as titanates and hexacyanoferrates, have been developed for the treatment of nuclear waste, but they are not typically used in radioanalytical separations.

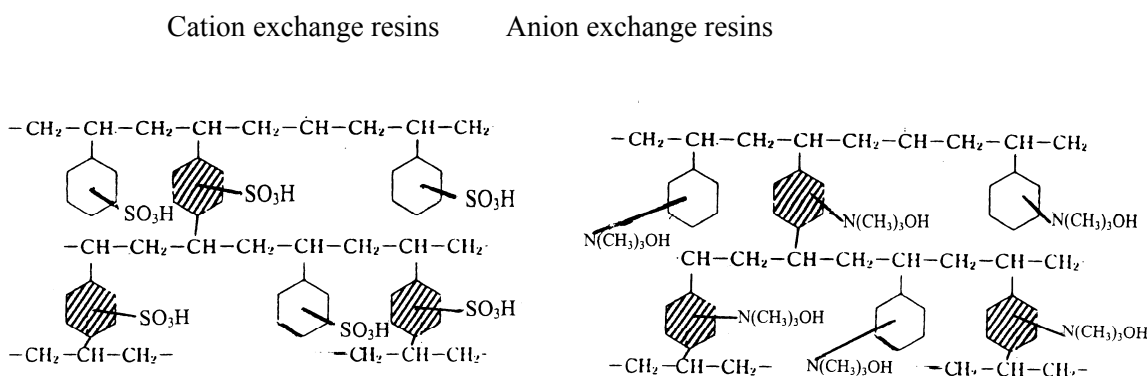

Figure IV.3 Structure of common ion exchange resins

Table IV.II. Types of organic ion exchange resins.

Resin type	Matrix	Functional group
Strongly acidic cation resin	DVB- PS	Sulphonate $-\text{SO}_3^-$
Weakly acidic cation resin	PMM A	Carboxylate $-\text{CO}_2^-$
Strongly basic anion resin	DVB- PS	Quaternary ammonium ion $-\text{N}(\text{CH}_3)_3^+$
Weakly basic anion resin	DVB- PS	Tertiary amino $-\text{N}(\text{CH}_3)_2$
Chelating resin (an example)	DVB- PS	Aminophosphonate $-\text{CH}_2-\text{NH}-\text{PO}_2^{2-}$

PMMA = polymethylmetacrylate

DVB-PS = divinylbenzene crosslinked polystyrene

Distribution coefficient and selectivity

Typical way to present the selectivity of an ion exchanger to bind ions is to calculate the distribution coefficient. This is written variously as K_D , K_d or D . The distribution coefficient is the concentration of an ion in the exchanger divided by its concentration in solution at the equilibrium state. D is a coefficient, not a constant and its value depends on several factors. First of all, it is dependent on the concentration of the ion to be separated. This does not, however, in practice apply to trace concentrations. Radionuclides are almost always present in trace concentration, and their distribution coefficients are constant with respect to their concentrations. This simplifies the use of the distribution coefficient as a separation parameter, or as a measure of the selectivity of the ion exchanger for a certain ion. Second, D is dependent on the concentration of other ions with the same charge present in the solution; namely, the presence of other competing ions decreases the binding of the target ion to the exchanger. A third important factor affecting ion exchange is the H^+/OH^- concentration, that is pH. As the pH decreases, i.e., as the concentration of H^+ ions increases, the sorption of cations on a cation exchanger decreases due to competing hydrogen ions with metal ions on ion exchange site. The reverse is true for anion and an anion exchanger: increasing pH, i.e. OH^- concentration, decreases sorption of anions on anion exchangers.

Cation exchange or anion exchange?

Cation exchangers retain metal cations more effectively the higher their charge and the smaller their size because Coulombic interaction with the functional groups of the exchanger is then increased. Cation exchangers generally allow the separation of metals with valence states +1, +2, and +3. Separations are based on pH adjustment since the higher the charge on the cation the lower is the pH at which it is retained on the exchanger (Figure IV.4). The separation of cations according to size is not very strong, which means that cation exchangers cannot be effectively used for the separation of metals, for example alkali metals, of the same valence state. Cation exchangers are thus not widely used in radiochemical separations. Anion exchangers are much more commonly used than cation exchangers in radiochemical analyses. Their widest use is in the separation of actinides. They form anionic complexes in strong acids and these complexes are retained on the anion exchanger according to their charge: that is, the higher the charge the more effectively they are bound. The most widely used acids are HCl and HNO_3 , and the complexes are thus chloride and nitrate complexes. Figures 14.5 and 14.6 show the distribution coefficients for the elements on an anion exchanger as a function of the concentrations of HNO_3 and HCl: the x-axis shows the concentration of the acid between 0 and 14 M and the y-axis the distribution coefficient as a logarithm between 0 and 1,000,000.

Ion exchange chromatography

The normal way in which an ion exchanger is used in the separation of radionuclides is in ion exchange chromatography. A granular ion exchanger is packed into a glass, or more often a plastic column, and is pretreated with a suitable solution. Anion exchangers are pretreated with acid at the same concentration as

the sample solution. A small volume of the sample solution is poured into the column, and the column is rinsed with the same acid so that nonretained radionuclides are flushed from the column. Any radionuclides that have sorbed to the column are then eluted out, usually with dilute acids or with complexing agents. The concentration, or composition, of the eluant can be adjusted during the elution step so that radionuclides sorbed with different strengths are separated from one another. The advantage of ion exchange chromatography over precipitation is that no carrier is required and separation performance is typically better than in precipitation.

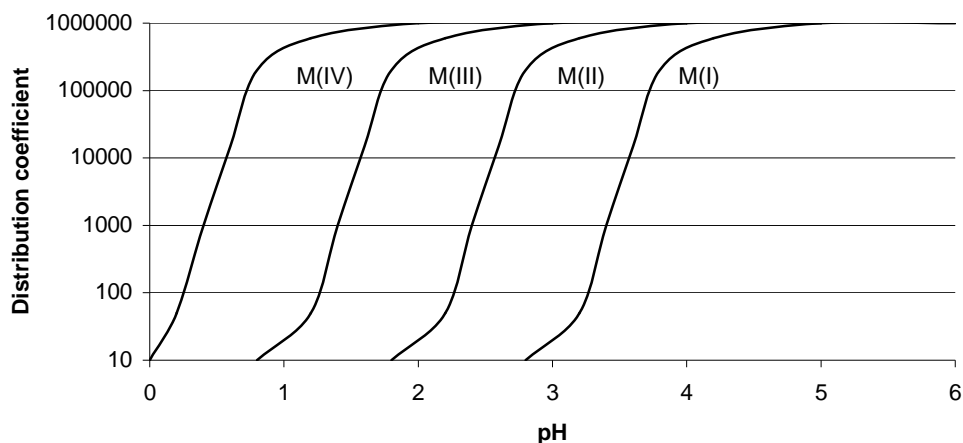

Figure IV.4 Distribution coefficients of metals in oxidation states +1, +2, +3, and +4 as a function of pH for a cation exchanger. The values of the distribution coefficients are suggestive only and do not depict a real case.

Ion exchange in actinide separations

A most important field of ion exchange applications in radiochemistry is actinide separations. In these separations the following features are most relevant:

- uranium is retained efficiently in anion exchange resin in 9M HCl
- thorium is retained in anion exchange resin in 8M HNO₃ – in HCl medium no thorium uptake takes place
- trivalent actinides are usually not taken up by anion exchange resins
- separation of plutonium from other is accomplished by the adjustment of its oxidation state
- separation of americium from lanthanides takes advantage of their different complexation behavior with thiocyanate

An example of actinide separation by ion exchange is shown in Figure IV.7, in which uranium, thorium and radium are separated from each other in the acid that was used in leaching rock samples. The ion exchange column is pretreated with 9 M HCl and the sample solution is added to the column in 9 M HCl. Uranium is retained on the exchanger as negative uranium chloride complex, while thorium and radium, which do not form chloride complexes, pass through the column. Uranium is eluted from the column with dilute HCl, which causes the uranium chloride complexes to break down, and the uranium elutes in cationic form. The solution containing the thorium and radium is evaporated to dryness, dissolved into 8 M HNO₃, and poured into another anion exchange column which has been pretreated with 8 M HNO₃. Thorium is retained on the column as negative nitrate complex while the radium passes through. It is eluted from the column with dilute HNO₃. The radium-containing solution is further purified on a cation exchange resin.

Solution containing Th and Ra in 9 M HCl

- evaporate to dryness
- dissolve in 8 M HNO₃
- load to a strongly basic anion exchange column
- elute the retained thorium with dilute HNO₃; determine activity

Solution containing Ra in 9 M HCl

- evaporate to dryness
- dissolve in 0.1 M HCl
- load to a strongly acidic cation exchange resin; interfering substances are retained
- measure activity of the Ra in the effluent

Figure IV.7 Separation of uranium, thorium, and radium by ion exchange chromatography from the acid used in extracting rock samples.

The various oxidation states of the actinides can be effectively exploited, especially in the case of Pu, U, and Np. Figure IV.7 shows that uranium will be retained on an anion exchanger in different ways depending on its oxidation state. The method used in the separation of Pu involves its capture on the anion exchanger in 8 M HNO₃. Under these conditions plutonium forms a negatively charged nitrate complex in oxidation state four, and its oxidation state must be adjusted for the ion exchange separation. Pu can be eluted from the column by reducing it, for example with NH₄I, to Pu(III), which does not form nitrate complexes and so does not bind to the anion exchanger.

An important ion exchange application is the separation of the lanthanides from trivalent actinides (Am, Cm). Trivalent lanthanides behave much the same as Am and Cm and must be separated so that they do not add mass to the alpha measurement source and so weaken the counting efficiency and resolution of the spectrum. In a widely used anion exchange method, Am, Cm, and lanthanides are bound to the anion exchanger as nitrate complexes from 1 M HNO₃ which is 93% relative to methanol. The lanthanides are eluted from the column with a solution of 0.1 M HCl–80% MeOH–0.5 M NH₄SCN. Under these conditions, the lanthanides do not form thiocyanide complexes and elute from the column, leaving americium and curium bound to the exchanger as anionic thiocyanide complex. Am and Cm are then eluted from the column with 1.5 M HCl–86% MeOH solution. Am and Cm do not form negatively charged chloride complexes under these conditions and elute from the column as cations.

Solvent extraction

Solvent extraction involves the movement of the investigated component, usually a metal, from one to the other of two immiscible phases. In the analysis of radionuclides, typically the metal is in aqueous phase and is extracted into an organic phase, while the interfering component remains in the aqueous phase. Not all interfering components are removed through solvent extraction; rather, solvent extraction is one step in a chain of several analytical steps. After the extraction, the radionuclide is back-extracted to the aqueous phase and the analysis continues.

Extractable complexes

A metal ion in the aqueous phase cannot be extracted to the organic phase as such because its electroneutrality must be preserved in both phases. As well, the metal ions form hydroxy complexes (M(H₂O)_x) in the aqueous phases, and these are hydrophilic and thus not soluble in organic solvents. Before it can be extracted from the aqueous phase to the organic solution, the metal ion must form a neutral molecule that is soluble in the organic phase. Such neutral molecules are

- Simple molecules and compounds, such as I₂ or RuO₄.
- Simple coordination complexes with anionic unidentate ligands (halide ions, CN⁻, SCN⁻, NO₃⁻). For example, in hydrochloric acid, trivalent metal M³⁺ forms a coordination complex MCl₃. Conditions, in this case the acid concentration, must be carefully chosen so that cationic or anionic coordination compounds, such as MCl²⁺ or MCl⁴⁻ are not formed.

- Simple coordination complexes with neutral unidentate ligands. Typical ligands are R_3N , R_3P , R_3S , in which R is an organic group. These ligands have a free electron pair on nitrogen, phosphorus, or sulfur, which forms a coordination bond with the metal. Because the ligand is neutral, before the complex can transfer to the organic phase anions must be added to neutralize the charge. An ion associate is formed, for example $(MR_3N)^{3+}(Cl_3)^{3-}$, in which trivalent metal M^{3+} forms a complex with R_3N , and three chloride ions balance the charge.
- Chelates, ring-structured complexes, which form with multidentate ligands. Chelates, penta- and hexagonal chelates in particular, are considerably stronger than simple complexes. Figure IV.8. a) shows the bidentate ligand 2,2',bipyridine, which forms a five-membered chelate with metal. Because the arms of bipyridine do not carry a charge, a neutral ion associate must be formed with anions in order for the chelate to transfer to the organic phase. Besides having free electron pairs, and through them atoms forming coordination bonds (S, N, P, O), the arms may also have weakly acidic groups which, upon dissociation, form anionic groups, which bind metal cations with ionic bonds. An example is EDTA (Figure IV.7. b), which includes both coordinating nitrogen atoms and anionic carboxyl groups.

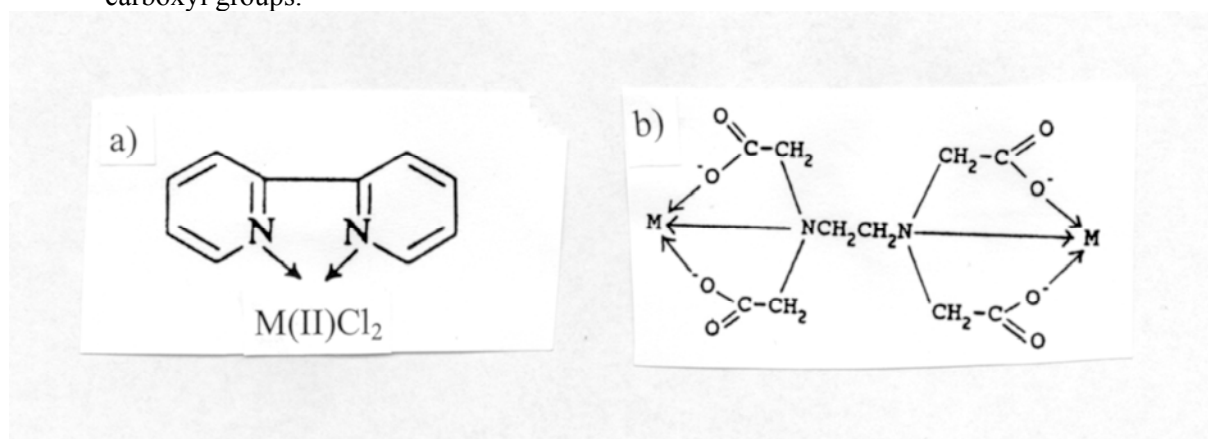

Figure

e IV.8.a) 2,2'-Bipyridine chelate and b) EDTA chelate with metal.

The binding of metals with both neutral and dissociated acid ligands is pH dependent. Acid ligands, such as the carboxyl group, are weak acids, which dissociate in weakly acidic or neutral solutions in degree depending on their acid strength. Thus, acid ligands are not able to bind metals in acidic solutions, where their acid groups are protonated. The same applies to neutral ligands; for example, in weakly acidic and neutral solutions, nitrogen atoms have a free electron pair with which they can form a coordination bond with metal. In acidic solution, on the other hand, nitrogen atoms protonate, forming $-NH^+$ ions, which, as cations themselves, are unable to bind metal cations. The binding of metals to ligands is not only dependent on pH but also on the nature of the metal. Metal ions with larger positive charge and smaller size sorb more strongly because of the larger Coulombic interaction. Also steric factors are of importance: some cations more readily than others fit into the ligand space. Neutral ligands (O,S,P,N) only bind transition elements, which have partially filled d- or f-shells, allowing the formation of a coordination bond with the free electron pair of a ligand. Alkali and alkaline earth metals are not typically extracted by solvent extraction because they do not form complexes; they do not have unfilled outer shells allowing the formation of a coordination bond. They are also large in size and have a small charge. Crown ethers are exceptional: they can be used to extract strontium.

Distribution constant and distribution ratio

The distribution constant k_D is used as an exact measure of the effectiveness of extraction. k_D is the concentration of the metal complex to be extracted in the organic phase divided by its concentration in the aqueous phase at the equilibrium distribution. The distribution constant is not, however, a useful practical measure because metals appear in solution in many different forms and the relative proportions are seldom known. Moreover, the analytical methods rely on the determination of total concentration. Thus, when the aforementioned complex MCl_3 is extracted, the metal forms MCl_2^+ or MCl_4^- , which are not extracted, may be

present in the original solution. If, then, the total metal concentrations in the aqueous and organic phases are determined at the equilibrium distribution, the calculated value for the distribution constant will be erroneous because the concentration in the aqueous phase includes components that do not participate in the extraction process. In place of the distribution constant, wide use is made of the distribution ratio d , which measures the total concentration of the metal in the organic phase divided by its total concentration in the water phase. Yet another measure is the percentage distribution, or extraction percentage. Neither measure is a constant like k_D . The distribution of metals between the two phases in solvent extraction is not dependent on the original concentration of the metal, which means that the method is suitable for the separation of both trace and macro amounts. The extraction efficiency is improved when the organic solution is divided into several small portions, the extraction is carried out several times, and finally the organic fractions are combined.

Examples of the use of solvent extraction in radiochemical separations

The primary purpose of most separations of radionuclides by solvent extraction is to remove alkali and alkaline earth metals and interfering anions which are usually not extractable. Metals can also be separated from one another through appropriate choice of a specific complexing extraction reagent and adjusting the pH to a value such that the complexing agent binds as much as possible the target metal, and only the target metal.

Solvent extraction is widely used in radiochemical separations. It is used in industrial scale in the reprocessing of spent nuclear fuel, where, in the PUREX process, the fuel is dissolved in nitric acid and uranium and plutonium are extracted as nitrate complexes with tributyl phosphate (TBP), while fission products and other actinides remain in the acid phase. TBP is also used in radioanalytical separations, for example in the separation of ^{99}Tc from nuclear waste solutions: most of the interfering substances are removed first by scavenging with $\text{Fe}(\text{OH})_3$, and $^{110\text{m}}\text{Ag}$ is precipitated as AgCl , whereafter technetium, which forms the pertechnetate ion TcO_4^- in solution, is extracted into TBP as neutral dimeric Tc_2O_7 molecule in 3 M H_2SO_4 .

Another example of solvent extraction is the separation of ^{55}Fe from nuclear waste solution and fallout samples. The iron is first concentrated through precipitation as $\text{Fe}(\text{OH})_3$. The precipitate is dissolved in 8 M HCl , where the $\text{Fe}(\text{III})$ ion forms FeCl_3 complex. This is then extracted fairly specifically into di-isopropyl ether, being followed only by ^{125}Sb . Iron is back-extracted into the aqueous phase, and ^{125}Sb is removed with a cation exchanger where the Fe^{3+} ion is retained while SbO_3^- passes through the column.

A third example is the separation of the iodine isotopes $^{131-135}\text{I}$ from a fission product mixture. KI and KIO_3 are added as carriers. Iodine is extracted, as I_2 , from 2M HNO_3 into carbon tetrachloride (CCl_4). Iodine is reduced with NaHSO_3 to iodide ion I^- and back-extracted into the aqueous phase.

A fourth example is the use of HDEHP (bis(2-ethylhexyl) hydrogen phosphate) or TIOA (triisooctylamine) in ^{241}Am determinations. These are used as extraction reagents used to isolate americium from naturally occurring radionuclides (Th, Po, Pb, Ra).

Extraction chromatography

Extraction chromatography or solid phase extraction was developed for radiochemical separations only twenty to thirty years ago and is now widely applied. The underlying separation process is solvent extraction, which is carried out in a chromatographic column. The reagents for solvent extraction functioning as the stationary phase are impregnated into a porous inert support, either silica gel or an organic polymer. The space between the beads provide passage for the mobile phase, normally nitric or hydrochloric acid, which contains the radionuclides to be separated. In extraction chromatography, as in ion exchange chromatography, a small amount of the sample solution is poured into the column. Those nuclides that do not transfer to the stationary phase are flushed out of the column. The radionuclides that were retained in the stationary phase are then eluted by adjustment of the composition of the eluant: change in the acid concentration, addition of a complexing agent or adjusting the oxidation state within the resin. Extraction

chromatography resins are particularly useful in the separation of actinides and lanthanides. Besides these there are commercially available resins designed for specific radionuclides: Ni Resin for ^{63}Ni , Sr Resin for ^{90}Sr , and Pb Resin for ^{210}Pb . Table IV.III lists some of the extraction chromatography resins and resins designed for specific radionuclides that are available from Eichrom Technologies and Triskem International.

Table IV.III. Extraction chromatography resins and resins designed for the separation of specific radionuclides.

RESIN	USE	EXTRACTION REAGENT
Nickel Resin	Ni	dimethylglyoxime (DMG)
Pb Resin	Pb	crown ether (18-crown-6)
Sr Resin	Sr, Pb	crown ether (18-crown-6)
MnO ₂ Resin	Ra	MnO ₂
Diphonix® Resin	Actinides and transition metals	diphosphonic and sulfonic acid
Ln Resin	Lanthanides, Ra-228	di(2-ethylhexyl) orthophosphoric acid (HDEHP).
Actinide Resin	Group actinide separations/gross alpha measurements	DIPEX
DGA Resin	Actinides, lanthanides, Y, Ra	N,N,N',N'-tetra-n-octyldiglycolamide
TEVA® Resin	Tc, Th, Np, Pu, Am/lanthanides	aliphatic quaternary amine
TRU Resin	Fe, Th, Pa, U, Np, Pu, Am, Cm	octylphenyl-N,N-diisobutyl carbamoylphosphine oxide (CMPO)
UTEVA® Resin	Th, U, Np, Pu	diamyl, amylphosphonate (DAAP)

Not all resins listed in the table above are extraction chromatography resins. The separation mechanism in Ni Resin is not solvent extraction occurring in the resin pores, but rather nickel forms a very sparingly soluble solid compound with the dimethylglyoxime solution that is present in the resin pores. Before precipitation will occur, a nickel carrier must be added to the sample solution. Diphonix Resin is an organic ion exchanger, which contains two functional groups: diphosphate and sulfonic acid groups. MnO₂ Resin is an inorganic ion exchanger, the uptake of metals on which takes place by adsorption on its surface hydroxyl sites.

As can be seen from the Table IV.III, Pb Resin and Sr Resin are very similar: both contain crown ether (18-crown-6) as extraction reagent. The differences are that Pb Resin has a lower concentration crown ether and the solvent is longer chain alcohol isocedanol instead of 1-octanol in Sr Resin. The purpose of these differences is to facilitate the elution of lead from the column. Both resins can be used strontium separations.

The main application field of extraction chromatography is actinide separations. For this purpose the three last products in Table IV.III are used: TEVA, TRU and UTEVA. They are mainly utilized in nitric acid solutions, where their special characteristics are:

- TEVA resin binds only tetravalent actinides Th^{4+} , U^{4+} , Np^{4+} , Pu^{4+}
- TRU resin binds both tri and tetravalent actinides Th^{4+} , U^{4+} , Np^{4+} , Pu^{4+} , Pu^{3+} , Am^{3+} and hexavalent uranium UO_2^{2+}
- UTEVA resin binds tetravalent actinides Th^{4+} , U^{4+} , Np^{4+} , Pu^{4+} and hexavalent uranium UO_2^{2+}

These essential differences make it possible to separate most actinides from each other. Americium can be effectively separated from other actinides by using TEVA and UTEVA resins, in which americium does not retain. The oxidation state of plutonium can be adjusted to +3 and it can be removed along with americium from other actinides. Plutonium and americium are, in turn, separated from each other by adjusting the oxidation state of plutonium back to +4.

Separations are usually carried out in nitric and hydrochloric acid solutions, in which the elements to be separated form nitrate and chloride complexes. In extraction chromatography, as in normal solvent extraction, a neutral hydrophobic complex should form, which can move to the organic stationary phase. In the organic phase it forms coordination bonds with the extraction reagent; in TRU Resin, for example, in which the extraction reagent is CMPO (Figure IV.9), a chelate forms through the free electron pairs of nitrogen and oxygen.

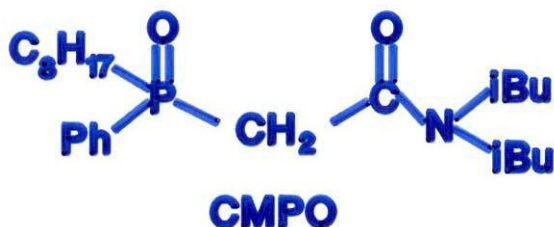

Figure IV.9. Structure of the extraction reagent CMPO in TRU Resin. CMPO is dissolved in tributyl phosphate (TBP).

In nitric acid, the actinides form neutral nitrate complexes as follows:



The complexes transfer to the organic stationary phase, which in the case of TRU is CMPO/TBP. The formation of nitrate complexes is dependent on the acid concentration: when the concentration of the acid (nitrate) increases, the percentage of actinide forming a complex with the nitrate increases. This is reflected as better retention on the resin. Figure IV.10 shows the k' values of TRU Resin for several metals as a function of the nitric acid concentration. The k' value is the number of column volumes used to elute the target element from the column measured when the element reaches maximum concentration in the eluate. The more selective the resin for the element, the higher is the k' value, which is proportional to the distribution ratio in solvent extraction.

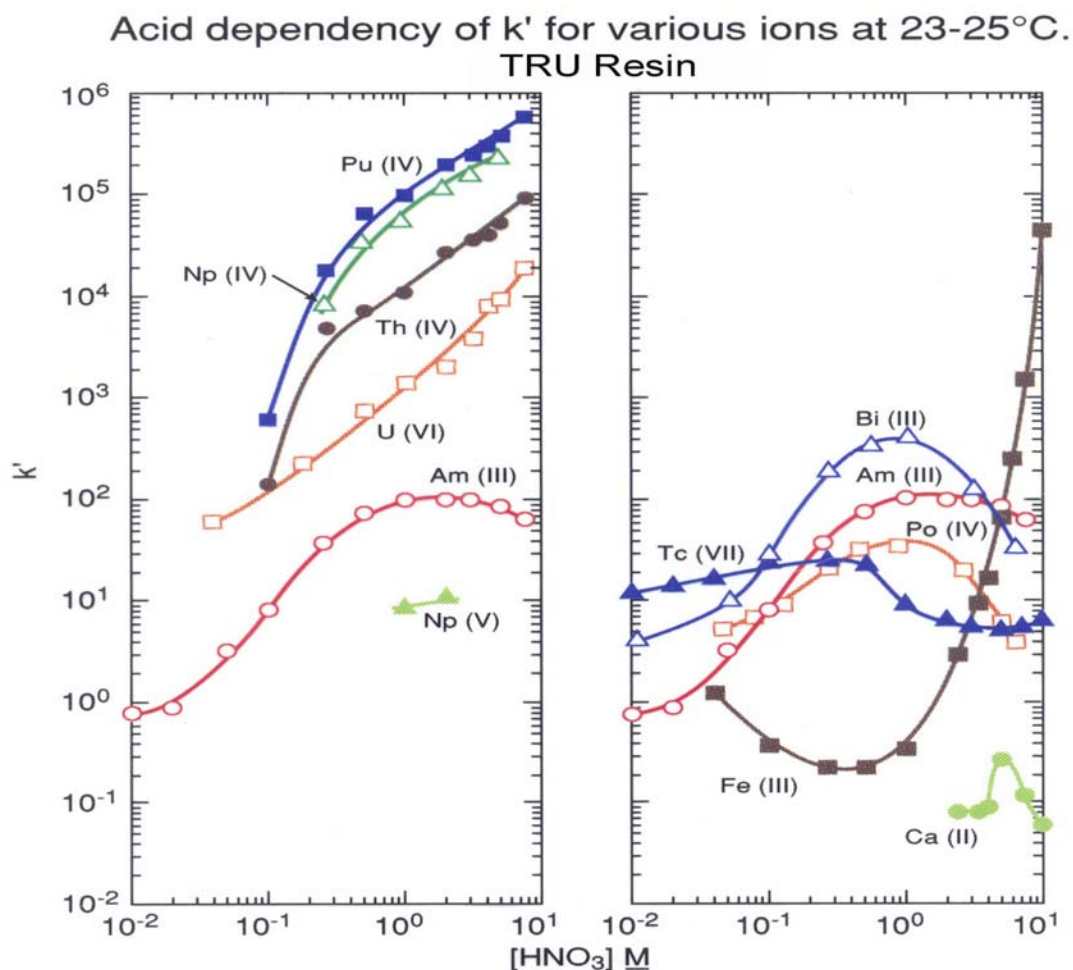

Figure IV.10. k' values for different metals for TRU column as a function of the nitrate concentration. k' value is the number of column volumes at maximum metal concentration in the eluate when eluting the column with the acid of specified concentration. (Horwitz, E.P, Chiarizia, R., Dietz, M.L., Diamond, H., Separation and Preconcentration of Actinides from Acidic Media by Extraction Chromatography, *Analytica Chimica Acta* 281(1993)361).

In comparison with earlier methods, anion exchange for example, extraction chromatography offers two notable advantages:

- the amounts of strong acid are less and reduce waste disposal problems
- times required for the analysis are sometimes noticeably shortened.

As an example of the application of extraction chromatography, we may consider the use of UTEVA and TRU resins in the determination of U, Pu, and Am in air filters (Figure IV.11). The filter is first ashed in an oven and then leached in strong nitric acid. Plutonium is reduced with $Fe(NH_2SO_3)_2$ to Pu^{3+} and the solution, in 3 M HNO_3 , is poured into a UTEVA column. Because UTEVA does not bind actinides in oxidation states three, Pu^{3+} and Am^{3+} pass through, while U(VI) is retained. Uranium is eluted from the resin with dilute hydrochloric acid and its activity is determined. The solution containing americium and plutonium is poured into the TRU column and plutonium is oxidized to oxidation state four with $NaNO_2$, so that it binds more strongly to the column and is not eluted from the column along with americium in 4 M HCl, after which the plutonium is reduced to oxidation state three with $TiCl_3$ and eluted with 4 M HCl.

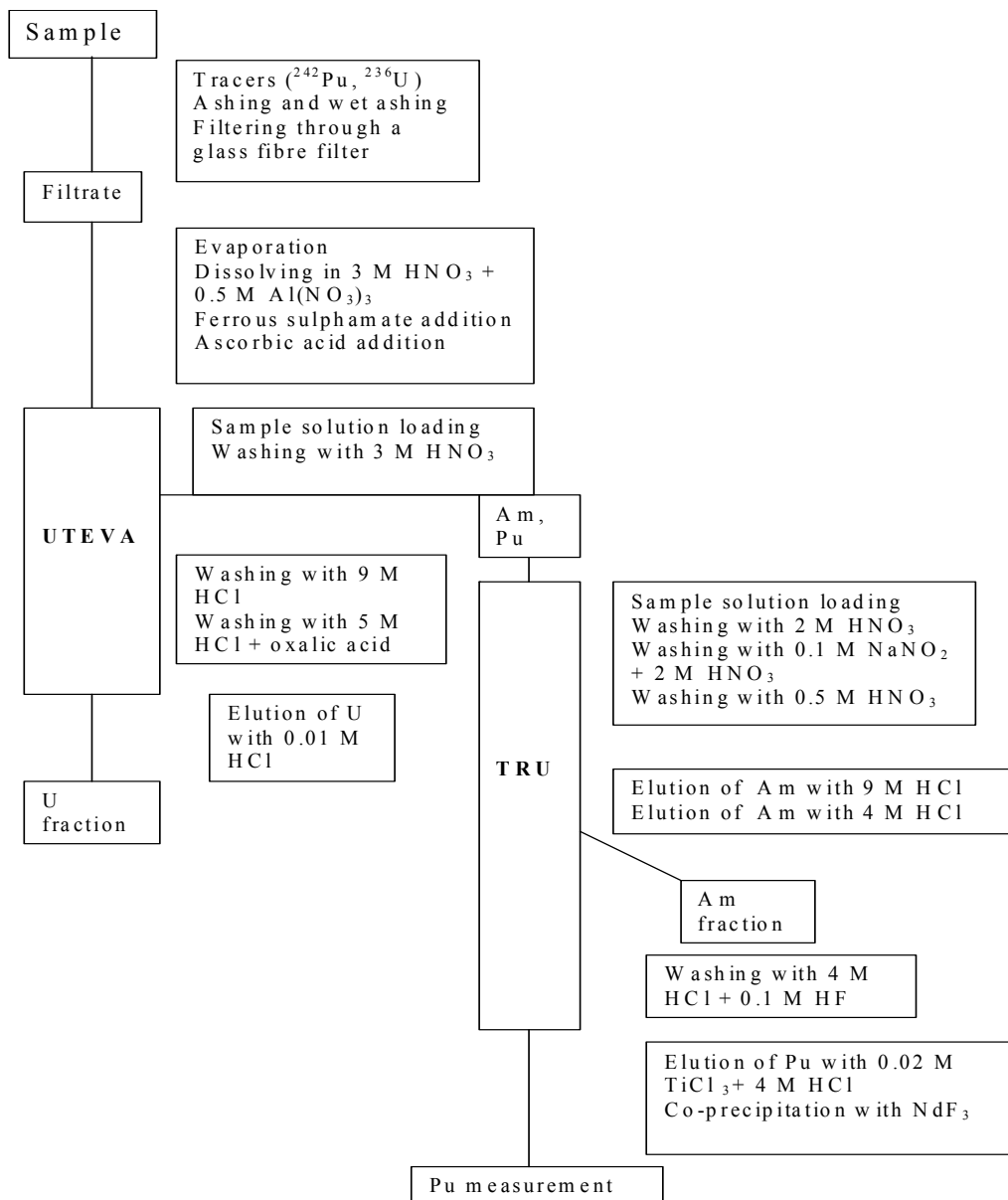

Figure IV.11. Separation of uranium, plutonium and americium from air filters by extraction chromatography resins UTEVA and TRU.

Dynamics of spent nuclear fuel dissolution and radionuclide migration

Mats Jonsson,

*KTH Chemical Science and Engineering, Nuclear Chemistry, Royal Institute of Technology, SE –
100 44 Stockholm, Sweden*

A political decision to build and take into use a deep geological repository for long term storage of spent nuclear fuel will largely depend on the outcome of thorough scientifically based safety assessments. Given the very long operational time span for the repository, the safety assessments must be performed on the basis of extreme extrapolations of a number of fairly complicated processes. Consequently, the quality demands on the experimental results as well as the models underlying these extrapolations must be very high.

One of the key processes here is the dissolution of the spent nuclear fuel matrix in groundwater, liberating radioactive fission products and actinides. In this presentation, the fundamental aspects of processes contributing to the release of radionuclides will be discussed with particular focus on radiation induced dissolution and inhibition of this process. A simple approach for simulation of spent nuclear fuel dissolution will be presented. The characteristics of the barriers used to prevent spreading of radionuclides will also be discussed in connection to the processes responsible for radionuclide retention.

Speciation analysis of radionuclides

Brit Salbu

Norwegian University of Life Sciences, N-1432 Ås, Norway

Naturally occurring and artificially produced radionuclides in the environment can be present in different physico-chemical forms (i. e. radionuclide species) varying in size (nominal molecular mass), charge properties and valence, oxidation state, structure and morphology, density, complexing ability etc. Low molecular mass (LMM) species are believed to be mobile and potentially bioavailable, while high molecular mass (HMM) species such as colloids, polymers, pseudocolloids and particles are considered inert. Due to time dependent transformation processes such as mobilization of radionuclide species from solid phases or interactions of mobile and reactive radionuclide species with components in soils and sediments, however, the original distribution of radionuclides deposited in ecosystems will change over time and influence the ecosystem behaviour.

To assess the environmental impact from radionuclide contamination, information on radionuclide species deposited, interactions within affected ecosystems and the time-dependent distribution of radionuclide species influencing mobility and biological uptake is essential. The development of speciation techniques to characterize radionuclide species in waters, soils and sediments should therefore be essential for improving the prediction power of impact and risk assessment models. The present paper reviews fractionation techniques which should be utilised for radionuclide speciation purposes.

Emerging needs for physicochemical analyses in connection with radiological terror preparedness

Kasper G. Andersson

Risø National Laboratory for Sustainable Energy, Technical University of Denmark, DK-4000 Roskilde, Denmark

In recent years, the threat of a radiological terror attack leading to airborne contamination of large inhabited areas has attracted increasing attention. The radioactive sources that would be involved in such an attack would be likely to be selected on the basis of a combination of factors like availability, portability, source strength, half-life, type of emitted radiation and suitability for aerosolisation. Although it would in this context be prudent to expect the unexpected, a limited number of types of strong sources would be of primary concern. These include radionuclides that have not traditionally been considered important in connection with preparedness, and whose behaviour after dispersion in the environment is not well understood. Moreover, the initial physicochemical matrix of the sources as well as the dispersion process (e.g., explosion, nebulisation) can imply a variety of different dispersed physicochemical contaminant forms with very different particle sizes, solubility and environmental mobility. This means that parameters currently used by default in emergency decision support systems are inapplicable, and here physicochemical contaminant characterisation is a key to future reliable long term dose prognoses, enabling optimised intervention.

Sampling and pre-concentration techniques for environmental radioactivity analysis.

Per Roos

Risø National Laboratory for Sustainable Energy, Technical University of Denmark, DK-4000 Roskilde, Denmark

Sampling and pre-concentration techniques are important both in the field and at the laboratory. Sampling should be done so that results are representative for the material being studied and the tools for sampling designed not to introduce artefacts. Part of the sampling may involve different pre-concentration techniques designed to both reduce the mass of the sample and to separate the radioactive elements from other interfering radioisotopes. The presentation will give an overview of sampling and pre-concentration techniques used for various samples in the field but also employed in the laboratory.

Gamma spectrometry and beta counting used for monitoring of environmental radioactivity at Risø

Sven Nielsen

Risø National Laboratory for Sustainable Energy, Technical University of Denmark, DK-4000 Roskilde, Denmark

Monitoring of environmental radioactivity started at Risø in 1956 and detection of radioactivity in samples was first based on commercial GM counters. These were later replaced by low-level GM counters produced at Risø and supplemented with NaI and Ge(Li) detectors. The present version of the Risø low-level multicounter system is a gas-flow unit incorporating five individual GM sample counter elements and a common guard counter. The guard counter reduces the cosmic-ray background using anti-coincidence technique. A sample slide allows five samples to be inserted into the multicounter where they are counted simultaneously. The counter is placed in a 10-cm lead shield to reduce the ambient background.

NaI well detectors are used in connection with analysis of ^{90}Sr and ^{99}Tc in environmental samples for the purpose of determining chemical yields of the radiotracers, ^{85}Sr and $^{99\text{m}}\text{Tc}$. Determination of ^{90}Sr and ^{99}Tc is carried out by beta counting in multicounters.

Gamma-emitting radionuclides in environmental samples are determined by gamma spectrometry using Ge detectors. The Ge detectors used for monitoring purposes are placed in 10-cm lead shields, cover efficiencies in the range 25-39% and include low gamma energies. Samples range by size and geometry from sub-gram amounts in well geometries to kilogram amounts in Marinelli beakers. Software for analysis of gamma spectra was developed in-house and calibration is based on measurement of mixed nuclide solutions. The gamma analysis includes corrections for true coincidence summing effects and sample density.

Liquid Scintillation Counting — Principle and applications

Xiaolin Hou

National Laboratory for Sustainable Energy, NUK-202, Technical University of Denmark,
DK-4000 Roskilde, Denmark,

1. Principle

Radioactive decay is the process by which a nucleus moves towards a stable state. In beta decay two particles are emitted: an antineutrino (ν) and an electron, beta particle (β), $n \rightarrow p + \beta + \nu$, for instance $^{14}_6\text{C} \rightarrow ^{14}_7\text{N} + \beta + \nu$. The antineutrino shares with the beta particle the energy accompanying a radioactive decay. A slow moving beta particle would therefore be associated with a fast antineutrino and vice versa. The resulting beta radiation has a distribution of energies that gives rise to a continuous beta spectrum (Fig.1). Antineutrinos do not interact significantly with matter and thus do not feature in beta counting. However, beta particles can be detected by its reaction with matter. Normally, beta particles are detected by gas flow detector.

Due to the low penetrative power of beta radiation, the detection efficiency of beta emitter, especially the low energy beta emitters, are quite low, the quantification of beta emitting isotopes is quite difficult without LSC. The best possible contact is achieved when the sample is dissolved in the scintillation solution. By the counting the photons produced in the reaction of beta particles with the scintillator, the quantification of beta emitting isotopes can be easily carried out. Comparing with gas flow counter, LSC has many advantages, such as:

- (1) High counting Efficiency, for hard beta emitter 80-90% and for alpha \sim 100%.
- (2) Easily check the purity of separated nuclides.
- (3) No self-absorption, homogeneous distribution of sample in cocktail.
- (4) Simple sample preparation procedure.
- (5) Easy standardization using internal or external standard.
- (6) Easy for determination of low energy beta emitter and also nuclides decay by internal electron conversion or electron capture.

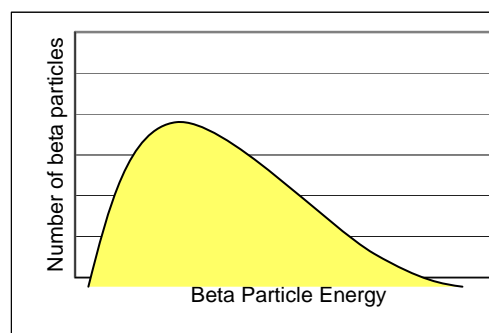

Fig.1 Energy distribution of beta spectrum

1.1 Basic Scintillation Process

In LSC, the radionuclide is mixed with a cocktail, which consists of solvent and scintillator (fluor), the decay energy will be transferred to the cocktail, and converted to photons, by counting the photons using a PMT (photomultiplier tube), the activity of radionuclides is measured. Aromatic compounds are usually used as LSC solvent because a high density of electrons is associated with these solvents. When they react with beta particles, a large amount of fluorescence can be produced. The traditional aromatic solvents are toluene, xylene, and pseudocumene. Although they are still popular, but due to high toxicity, vapor pressure, low flammability and easy permeation through

plastics, they have generally been replaced by the newer generation of “safer” solvents, such as diisopropylnaphthalene (DIN), phenylxylethane (PIXE), and dodecylbenzene (LAB).

PM tubes are not sensitive to the fluorescence wavelength of the aromatic solvents. A fluor is therefore used to capture the solvent energy and emit light at a wavelength more easily detected. Unfortunately the PM tubes were also not sensitive in the region of fluorescence emission of the primary scintillators. To solve this problem a wavelength shifter (secondary scintillator) was introduced. This absorbs energy from the primary scintillator and emits light at a wavelength more suitable to the PM tubes. There are many organic compounds, such as 2,5-diphenyloxazole (PPO), 2,5-diphenyl-1,3,4-oxadiazole (PPD), PBO, PBD, BBD etc. were used as primary fluor, and the most popular and widely used is PPO. There are also many secondary fluors, the important and widely used is bis-MSB (p-bis-(o-methylstyryl)benzene), and POPOP (1,4-bis-2-(5-phenyloxazolyl)benzene). Fig.2 shows the energy transfer process in LSC.

To manually count these many flashes of light (scintillations) would be an impossible task, therefore, photomultiplier (PM) tubes have been developed which can convert the minute flashes of light into measurable electrical pulses. Each individual radioactive decay event produces a pulse of photons. In general from five to seven photons are generated for every 1 keV of decay energy and these are distributed uniformly in space. The photons of light are collected by the optical reflector system of the scintillation counter to the light sensitive photocathode of the PM tubes and multiplied. The electrical charge pulse obtained is proportional to the original beta particle energy.

A single photon striking the photocathode has at most a 30% probability of producing an electrical pulse. It is thus of prime importance that the energy transfer process is as effective as possible in order to maximise the counting efficiency, as there are energy losses associated with the full light generation process (quench). The electronic pulse produced in the MPT is recorded by a multichannel analyser (MCA). Each individual decay event is stored at a location in the MCA depending upon its pulse height (decay energy). A digital picture of the energy distribution of the isotope is formed as more events are accumulated. In LSC the count rate of a sample is dependent on how efficiency the nuclear decay events are converted to light flashes that are detected and quantified by liquid scintillation analyzer. Because the sample solution is always present, it can absorb nuclear decay energy or photons of light that are produced in the scintillation cocktail. This causes the phenomenon called quench.

1.2 Quench in Liquid Scintillation Counting

There are three types of quenching: Physical, Chemical, and Colour quench. Physical quenching occurs when a barrier impairs contact between the radioactive particle and the scintillator solution, or when the photons of light generated are absorbed by some solid within the vial. Radioactivity adsorbed onto active surfaces or filter disks, and two phase aqueous organic solutions are some of the most common sources of physical quenching. Colour quenching occurs after the fluorescence stage when light absorbing compounds interpose and lessen the number of photons

Fig.2

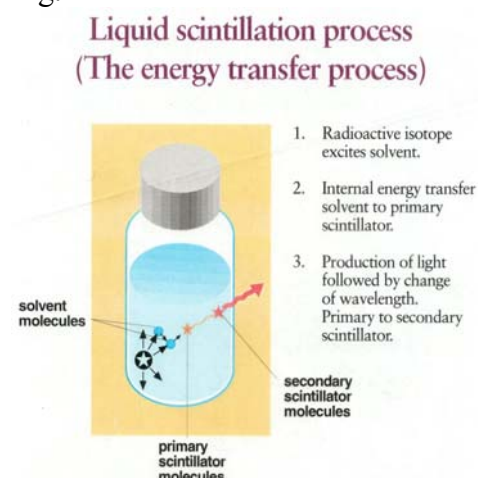

leaving the scintillation vial. Fluorescence emission takes place in the blue region of the spectrum, therefore the order of severity of colour quenching is: Red > orange > yellow > green > blue. Any compound that does not have an aromatic structure will produce some quenching effect, called chemical quench. Quenching causes a reduction in the photon yield from each radioactive decay event, results that the whole energy distribution is shifted down and counts (CPM) is reduced. The higher energy β emitter has a less effect on the reduction of counts than that of low energy emitter. The quench level can be measured using quench indices, such as SIS (spectral index of the sample), SQP(I) (Spectral Quench Parameter of the Isotope Spectrum), IC# (average energy of the sample spectrum expressed as a number), SQP(E) (Spectral Quench Parameter of the external standard), tSIE (transformed spectral index of the external standard) and H# (Horrock's number). The popular used quench indices are SIS, SQP(I) and SQP(E). SIS is a measure of the average energy of the sample calculated to represent endpoint energy of the sample spectrum. From the digital picture we can deduce a parameter, SPQ (I), that reflects the position of the spectrum in the MCA. One of the most widely used algorithms utilises the MCA channel number at the centre of gravity of the spectrum. SQP(E) is the endpoint of the net external standard, i.e. a channel below which reside 99% of the counts generated by the gamma radiation from the external standard.

There are mainly two methods are used to correct for quench, internal standard method and Quench indicating parameter (QIP) method. The internal standard method is the oldest and most accurate method. In this method, the first step is to counts the sample, then a known activity of radionuclides standard is added to the sample and counts again, then the counting efficiency can be calculated as:

$$E = \frac{C_{s+i} - C_s}{D_i}$$

where E is counting efficiency of the sample; C_{s+i} is the count rate after the addition of internal standard; C_s is the count rate before the addition of internal standard; D_i is The disintegration rate of the added internal standard; and D_s , the disintegration rate of the sample. The disintegration rate of the sample D_s can be calculated as: $D_s = C_s/E$. In QIP method, some QIP, such as SIS, QSP(I) or QSP(E) are measured for the standard at different quench level, then a curve of the counting efficiency vs. quench level can be obtained. By measuring the quench level of sample and counting rate, the disintegration rate can be calculated. Fig. 3 shows the the curves of QIP vs. counting efficiency.

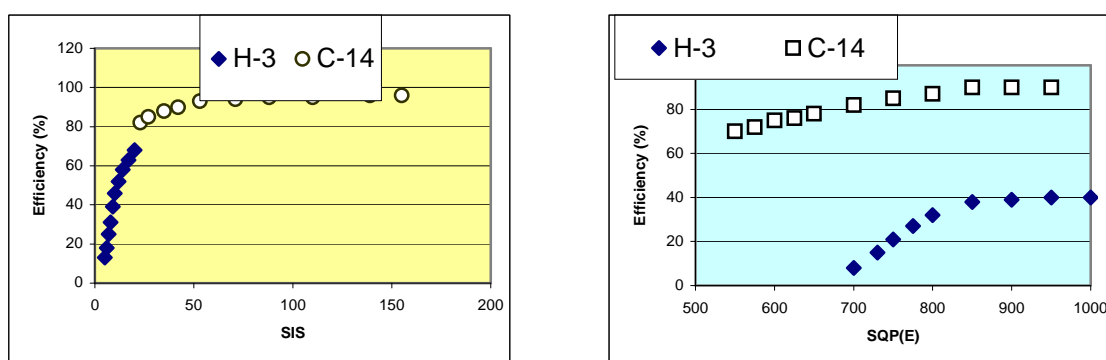

Fig. 3 Curve of QIP vs. counting efficiency

1.3 Interferences in Liquid Scintillation Counting

There are many interferences in the liquid scintillation counting, the main interferences include background, static, wall effect, radionuclide mixtures, and luminescence.

Background Interference comes from instrument noise, PMT cross talk, and external radiation, such as cosmic and environmental radiation. The Method used for reduction or eliminating of background interference includes coincidence circuitry, passive shield using lead and copper, active shield using guard detector to remove the effect from external radiation, pulse amplitude comparison, low background vial, underground lab, temperature control etc. In LSC, Two PMTs are usually be used for the measurement of the light intensity, and a coincidence circuit is used to distinguish instrumental background from true nuclear event, which reduce the background from 10,000CPM to about 30 CPM. It is based on the fact that when nuclear decay event occurs, light produced is emitted equally in all directions and the decay process and resultant scintillation are very rapid. The summation circuit is also be used, which helps to optimize the signal-to-noise ration and to compensate for the light intensity variation due to the position of the nuclear decay in vial when sample containing color are counted. The coincidence pulse from background produced by fluorescence and Cerenkov in PMT comprises a relatively large amplitude component from the affected tube and a small amplitude from other tube, while sample scintillation produce coincidence with a much smaller difference between the component amplitude from two PMT. By adjust the ratio of of two coindidence pulse amplitudes from two PMT, PAC, this interference can be reduced. For further reduce the background, passive shield was used in LSC. A diagraphme of passive shield used in Quantulus is shown in Fig. 4. the outer layer is asymmetric lead shield, then a layer of copper of the active liquid scintillation guard container. The lead X-rays induced by cosmic radiation are partly absorbed by the copper wall of the container.

In addition, an active shielding is also used in LSC. In Quantulus, an asymmetric liquid scintillation guard with two PMT is used as an active shield. Cosmic which moves through material leaves a trace behind, this is in the form of excited atoms and molecules. In the active guard the excitation creates scintillations. Which are detected by the PMT of the guard detector. The pulse in the guard detector activates a logical signal. If this signal is coincident with a pulse in the beta detector, it can be used to inhibit the analogue to digital conversion of the pulse.

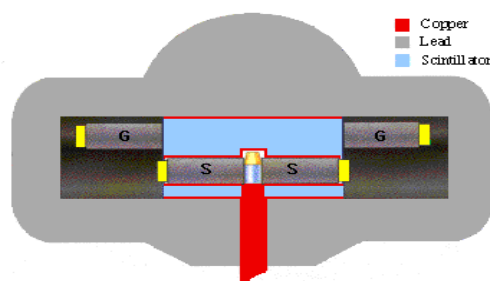

Fig. 4 Passive shield used in Quantulus

Static electricity may be generated on the scintillation vial in the sample preparation. Electrostatic discharge occurs randomly and produce photo, which interfering LSC. Many methods can be used to reduce or eliminate static, such as Use of electrostatic controller, metal vial holder, selection of suitable vial type, antistatic wipes, and humidification of sample preparation and counting area. In which, the electrostatic controller used by Parkard LSC can generate a 3600 field of electrically produced ions, when counting vial pass through it enters the field of electrically produced counterions, which neutralize all static electricity on the vial surface.

Some organic scintillator from the cocktail can penetrate the wall of the plastic vial. Plastic vial with solvent penetration can scintillate, and casing a distortion of the external standard pulse height spectrum. This will results in an inaccurate quench correction. The wall effect can be

reduced by using of new environmentally safer cocktail solvent, using of glass vial or low diffusion PE vial.

Multiple radionuclide in sample can present an sum spectrum. When the energy spectra of two radionuclides overlap, they interfere each other. In LSC, the radionuclides normally need to be separated before the measurement, but in the present equipment some special method such as dual or triple label counting method can be used to measure more than one radionuclides in the sample. There are three kind of luminescences, bioluminescence, Photoluminescence and chemiluminescence. The bioluminescence is caused by the photons produced from biochemical reaction. Photoluminescence is the result of the exposure of the sample-fluor cocktail mixture to ultraviolet light. Photoluminescence is normally single photon and decay in minutes. So, it can be eliminated by keep in dark for 10-15 minutes. Chemiluminescence is the production of light in the scintillation cocktail due to a chemical reaction. When cocktail is mixed with sample solution, the pH effect and chemical interaction among the components cause molecular excitation and light emission. A radioactive decay is characterised by the production of multiple photons of light. While a luminescence event produces only a single photon of light, and the luminescence spectrum occurs at the very low energy portion, generally in 0-6 keV region. So, single photons produced in the luminescence can be rejected by coincidence circuitry. However, if a large number of luminescence events occur, the time between two luminescence singles photon events will be less than the time span of the coincidence gate the pulses appear to come from a multiple photon event they may bypass the coincidence circuit and be registered as counts together with counts produced by the radionuclides in the sample. In this case, a Delayed coincidence method can be used to separate the luminescence signals from the radioactive decay. Other method can be also used to reduce the luminescence, such as Chemical method, Temperature Control, and Counting Region Setting. Neutralization of sample solution before mixing with cocktail can partly eliminate the chemiluminescence, using special cocktail designed to reduce luminescence, such as Insta/Fluor, Hionic/Fluor can also reduce the chemiluminescence. Heating the sample to 40°C before measurement helps drive the chemiluminescence reaction to its endpoint, cooling during measurement can also reduces counts from chemiluminescence. By setting the counting region to over 10 keV, the luminescence will also be eliminated.

1.4 Counting by Cherenkov radiation

Charged particles, e.g. β , that possess sufficient energy can travel at a velocity exceeding the speed of light in the media such as water, organic solution. When this occur, the charged particle produces Cherenkov photons, which extend from the ultraviolet into the visible wavelengths. Beta particles with energy excess of 263 keV in water can produce Cherenkov effect and can be detected by Cherenkov photons without cocktail. The Cherenkov photon is normally detected in the low energy counting region (0-50 keV). The Cherenkov counting efficiency is in the range of 35-50%. Fig. 5 shows the Cherenkov spectrum of Y-90 and beta spectrum of $^{90}\text{Sr}/^{90}\text{Y}$.

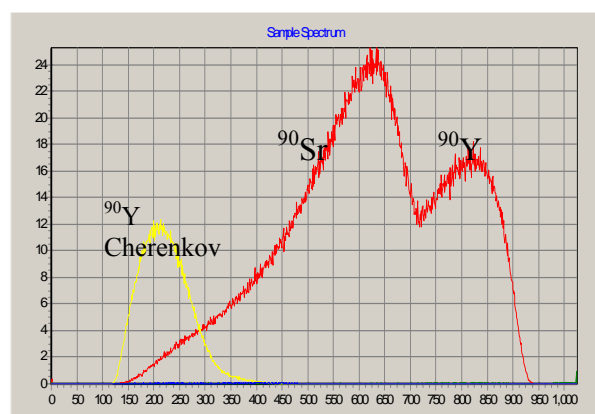

Fig.5 Cherenkov spectrum of Y-90 and beta spectrum of $^{90}\text{Sr}/^{90}\text{Y}$

1.5 Measurement of nuclides decayed by alpha, internal conversion electrons and electron capture

Besides beta emitter, LSC can be also used to measure the radionuclides decayed by alpha, internal conversion electron and electron capture.

As beta particles, alpha particles can also react with the cocktail, and transfer the decay energy to the cocktail to produce photons. But, the higher charge and mass of a particle make the transfer of excitation energy of alpha particles to solvent and fluor less efficient. It results that a particles produce light in the liquid scintillation cocktail at about 1/10 of light intensity per unite of particle energy of β particles, and its pulse height is equivalent to approximate 1/10 of its original decay energy. The alpha particle is monoenergetic, so a single pulse height peak is seen for each a decay.

Internal conversion is a deexcitation process of unstable nuclei, which accompanies and even compete with gamma ray emission. Decay by internal conversion results in the emission of an atomic electron, called internal conversion electron (ICE). The energy of ICE is the energy of transition of the excited nucleus to its ground or low energy state minus the binding energy of the atomic electron $E_{IC}=(E_i-E_f)-E_b$. Internal conversion electrons are identical in their properties to beta particles, so can be also detected by LSC. A characteristic difference between ICE and β particle is their energy spectra. β particle produces a broad spectrum or energy ranges from 0 to E_{max} . However internal conversion electron with certain energy produce a monoenergy peak in LSC, Fig. 6 shows the internal conversion electron spectrum of ^{137}Cs .

Electron Capture decay is a decay process that an unstable nucleus capture a atomic electron, the absorbed electron combines with a proton to yield a neutron within the nucleus. The capture of atomic electron by the nucleus leaves a vacancy in the electron shell, and this is usually filled by an electron from an outer shell, resulting in the x radiation. This x radiation may collide with an atomic electron, resulting in the emission of the electron referred as an Auger electron. The energy of Auger electron is low, normally less than 10 keV. The characterization of Auger electron like low energy beta. So electron capture decay can be measured by counting Auger electrons using LSC. The liquid scintillation spectrum of Fe-55 which decayed by electron capture is shown in Fig. 7

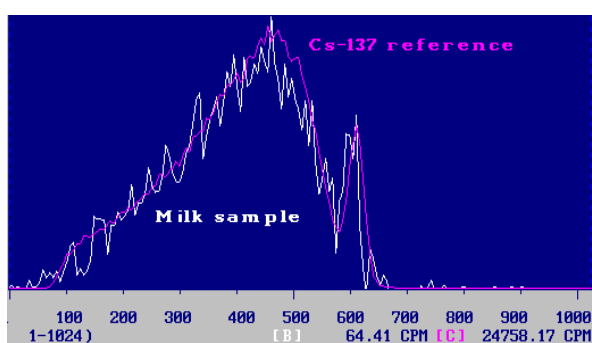

Fig.6 Internal conversion electron spectrum of Cs-137

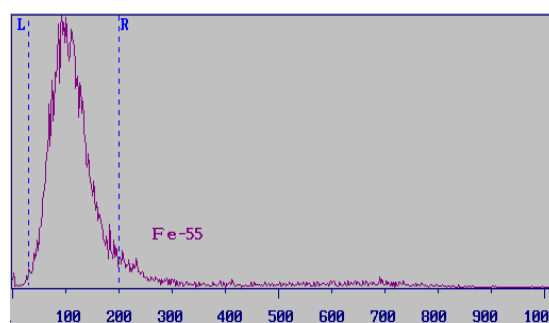

Fig. 7 LS spectrum of Fe-55

1.6 Discrimination of α/β spectra

Since α particle produces about 1/10 as much light intensity as β particles per unit of radiation energy, α and β pulse height spectra often overlap. α particles emit 5 MeV or more energy which is able to create triple state in solvent which de-excite to ground state slower than single state

produced by β particles. The pulse decay time of a particle is 30-40 ns longer than β particles interaction with cocktail (Fig.8). Measurement of the pulse decay time and length allows identification of particle which cause it and enable simultaneous recording of pure α and β spectra, respectively, So called pulse shape analysis (PSA). In Quantulus, the α/β pulse amplitude spectrum is transformed in the process to a three dimensional counts vs. pulse amplitude and pulse spectrum. Electronic division of pulse into α and β spectra is carried out by dividing the pulse amplitude/length plane in two parts by a straight, user adjustable line (PSA level, Fig. 9).

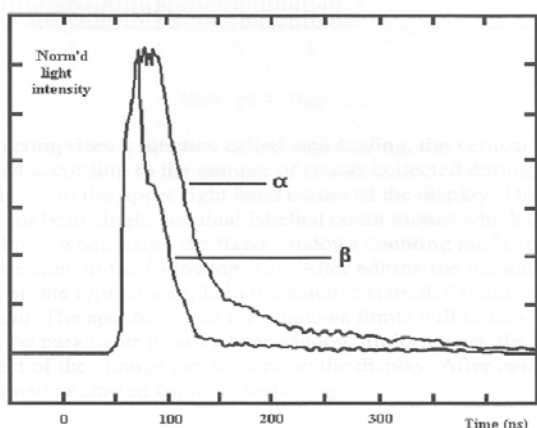

Fig.8 Pulse shape for event caused by α and β particles

Pulse length vs. pulse height for Ra-226 by Quantulus

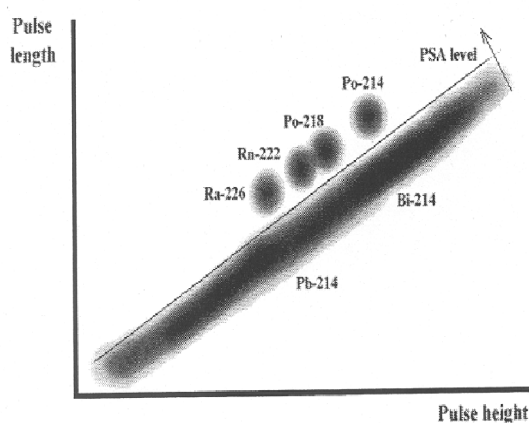

Fig. 9 3-D spectrum of Ra-226 vs. Pulse amplitude and Pulse length

2. Application of Liquid Scintillation Counting for the Determination of Beta and Alpha Emitter in Environmental samples

In our lab, liquid scintillation counting has been used for the determination of many beta emitter and some alpha emitter, such as radium and radon in environmental samples. For this purpose, the radionuclides is normally need to be separated, then mixed with the suitable cocktail. Here, some preparation procedures for the determination of some radionuclides, such as ^3H , ^{14}C , ^{89}Sr and ^{90}Sr , ^{222}Rn , ^{226}Ra etc. are highlighted. In addition, a guide for choice the cocktail are also be given.

Preparation of sample for LSC

2.1.1 *Tritium in environmental water*

The environmental water is usually distilled to separate the ^3H from other most of interference radionuclides. For normal environmental water, the tritium concentration is quite low to be measured, so need to be enriched for measurement. Due to the slightly higher binding energies, mmolecules of THO are not decomposed to form H_2 and O_2 as readily as H_2O during electrolysis. When electrolysis is carried out, H_2O will be first decomposed, while ^3H as THO is left. Thus, tritium can be enriched by electrolysis. The procedure of electrolytical enrichment used in our lab is as follow: (1) Na_2O_2 or NaOH is added to water to make it slightly alkaline, the water is transferred

to an electrolysis cell. (2) A constant current (10 A) is applied to the cell, which is cooled to 0-2 °C. The water volume is reduced to 5-10% by electrolysis decomposition. (3) The enriched water is transfer to the counting vial by evaporation. (4) Cocktail is added to the vial and mixed for the LSC. Fig.10 shows a beta spectrum of tritium in environmental water, and Fig. 11 shows the variation of tritium concentration in rainwater collected at Risø in Denmark.

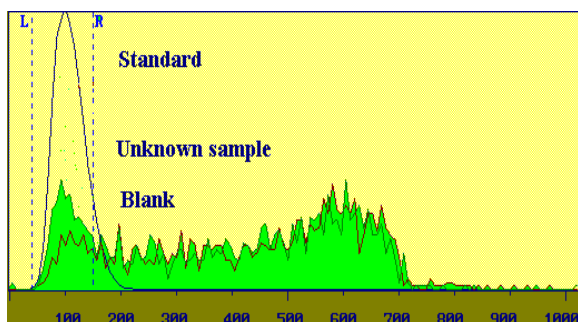

Fig. 10 Beta spectrum of tritium in rain

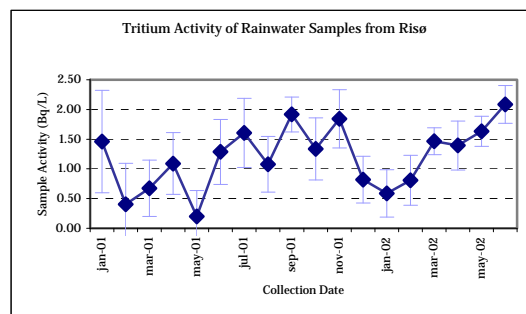

Fig. 11 Variation of tritium concentration in rain water collected at Risø

2.1.2 Tritium in Urine

Urine tritium is good index for the tritium exposure of people who works in the nuclear facilities. Because the concentration of organic compounds in urine, such as protein, is higher, direct mixture of urine with cocktail will produce an unclear solution. In addition, distillation is also difficult to be directly used. Thus, the organic compounds needs to be separated first, then to distillate to separate tritium from other interference radionuclides. In this case only free tritium is obtained, but normally, it is equilibrium with organic tritium. If organic tritium is also needed to be analyzed, sample can be evaporated to dry, then to separate organic tritium by combustion method. The following procedure is used at Risø for the monitoring the tritium exposure of Risø staff who worked in nuclear facilities.

- (1) An aliquot of urine is mixed with active charcoal, which absorbs most of organic matters in urine.
- (2) The mixture is filtered through a filter paper, the charcoal is removed.
- (3) The filtrate is then distilled to remove any other radionuclides and organics.
- (4) The distilled water can be further electrolytically enriched, if the concentration of ^3H is not higher enough for measurement.
- (5) 3-10 ml of water sample is taken for LSC.

2.1.3 Separation of ^3H and ^{14}C in environmental and waste samples by combustion

The tritium and C-14 in the environmental and waste samples can be separated from other radionuclides and each other by a combustion method. Packard Oxidizer is a good equipment for this purpose. The principle of the oxidizer is that the sample is burn at 1100-1200 °C in an oxygen atmosphere. During the combustion process, the all isotopes of hydrogen including tritium are oxidized to HTO, and carbon in graphite or carbonate is oxidized to CO_2 . Due to the high combustion temperatures, the HTO exists as vapor and pass to an air cooler with nitrogen flow and condensed to liquid water, then be collected in a tritium vial. Any uncondensed water is collected in the tritium exchange column. In the end of the combustion, the water in the exchange column is flushed down into the tritium vial with the tritium cocktail.

While, ^{14}C as CO_2 pass through the air cooler and tritium exchange column, and trapped in a column filled with a CO_2 absorbent (amine) and forms a carbamate. In the end of combustion, CO_2 absorbed in the absorbent is collected in the C-14 vial; the column is flushed with C-14 cocktail to the vial. Fig.12 show the working principle of sample oxidizer.

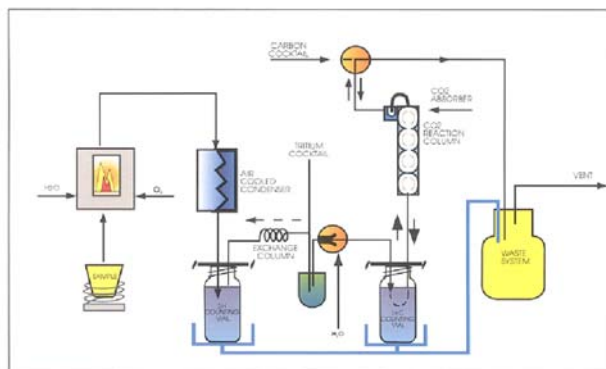
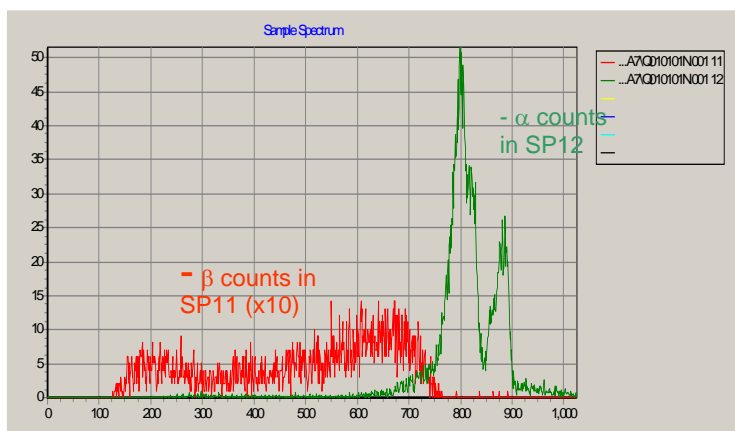

Fig. 12 diagram of Packard oxidizer

2.1.4 ^{222}Rn in water

^{222}Rn is a daughter of ^{226}Rd in ^{235}U decay series, it normally exists as gas, so can be released from the soil or sediment to the surround water. In some ground water, the ^{222}Rn concentration is quite higher, so need to be monitored to estimate the exposure dose to the people who drink this water. Due to the solubility of Rn in water is much lower than the organic solvents, so it can be easily separated from other radionuclides and Ra by using an organic cocktail. The analytical procedure for ^{222}Rn in water is given below.

(1) 10 ml aqueous-immiscible extraction cocktail (such as ultima Gold F) is added to a 20 ml low diffusion PE vial. (2) At sampling site, 10 ml water is added to the vial with cocktail, the vial is immediately capped tightly. (3) By shaking, radon will be extracted to the cocktail, because the solubility of radon is much higher in the organic cocktail than in the water. (4) Measurement of ^{222}Rn and its daughter using LSC. Fig. 12 is beta and alpha spectrum of ^{222}Rn and its daughters.



2.2.5 ^{226}Ra in biological samples

^{226}Rn in soil and sediment is usually measured by gamma spectrum. But for biological samples, it is difficult to be measured by gamma spectrum due to its low concentration. In this case chemical separation and alpha spectrum can be used. However, not suitable yield tracer and difficult to be electrodeposit on the disc, it is not easy to be measured by alpha spectrometry. While LSC is a good method because ^{133}Ba can be used as a tracer and no electrodeposition is needed. A LSC analytical procedure is shown below.

(1) 0.5-1.0 kg biological samples is taken, Ba carrier and ^{133}Ba tracer is added. (2) Ashing at 500-600 °C for 5-10 hours. (3) Dissolving the ashed samples with concentrated HNO_3 . For some vegetation samples with high Si content, addition of HF is needed. (4) Ra in the dissolved samples

is separated from the matrix and other radionuclides by co-precipitation with Ba as Ba(Ra)SO₄ under acidic condition (pH < 5). (5) Dissolving Ba(Ra)SO₄ with alkaline EDTA solution at hot water bath. Transfer the dissolved Ra solution to a counting vial, added cocktail and capped tightly, keep 2 weeks for ingrowth of ²²²Rn.

2.1.5 ⁸⁹Sr and ⁹⁰Sr in environmental sample

Radiostrotium is normally measured by GM detector, but if both ⁸⁹Sr and ⁹⁰Sr exist in the sample, it will be difficult to identify and measure them. The maximum energy of beta particles of ⁸⁹Sr is 1.5 MeV, while only 0.55 MeV for ⁹⁰Sr, thus only ⁸⁹Sr can be measured by Cherenkov radiation in the sample solution. By measure the total activity of both ⁹⁰Sr and ⁸⁹Sr by LSC and subtract the contribution of ⁸⁹Sr which measured by Cherenkov radioation, both these two isotopes of strontium can be measured. Fig. 13 is the LSC spectrum of ⁹⁰Sr and ⁸⁹Sr and the Cherenkov spectrum of ⁸⁹Sr.

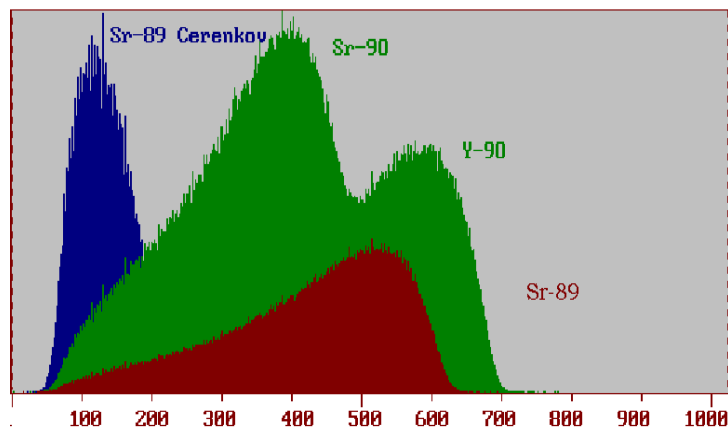

Fig.13 LSC spectrum of ⁹⁰Sr and ⁸⁹Sr and the Cherenkov spectrum of ⁸⁹Sr

AMS analysis for long-lived radionuclides

Vasily Alfimov

Ion Beam Physics, ETH, HPK G24, Schafmattstrasse 20, CH-8093 Zurich, SWITZERLAND

Accelerator Mass Spectrometry (AMS) is a unique single-atom counting technique that is capable of measuring a ratio of long-lived radionuclide to a stable isotope of the same element in the range of 10^{-10} - 10^{-15} . Many cosmogenic and artificial long-lived radionuclides, such as ^{14}C , ^{10}Be , ^{26}Al , ^{36}Cl , ^{41}Ca , ^{129}I , and $^{240}\text{Pu}/^{239}\text{Pu}$, are normally measured by AMS. This talk will present the introduction to the AMS technique and describe the applications of ^{129}I , ^{36}Cl and $^{240}\text{Pu}/^{239}\text{Pu}$ in radioecology and nuclear waste management. These long-lived radionuclides have the following major applications: (A) ^{129}I --retrospective ^{131}I dosimetry, determination of marine transport of the reprocessed low-level nuclear waste, (B) ^{36}Cl -- investigation of underground water transport, determination of site suitability for nuclear waste storage, thermal neutron flux recovery, and (C) $^{240}\text{Pu}/^{239}\text{Pu}$ -- Pu source determination (weapon-grade or reactor-grade).

ICP-MS analysis for long-lived radionuclides

Per Roos

*Risø National Laboratory for Sustainable Energy, Technical University of Denmark, DK-4000
Roskilde, Denmark*

Inductively coupled plasma mass spectrometry (ICP-MS) is an attractive alternative for the analysis of radioisotopes having a half-life in the order of several hundred years and above. The technique should not be considered a replacement for radiometric measurements of these isotopes but merely an alternative. Similarly to radiometric techniques like alpha and beta spectrometry most analysis of 'low-level' concentrations by ICP-MS requires chemical isolation of the element in question. For 'ultra-low-level' concentrations this clean-up of the sample is usually even more necessary than for the alternative radiometric techniques. The presentation gives an overview of advantages and disadvantages in using ICP-MS and compares it to relevant radiometric alternatives.

Application of ICP-MS and AMS for determination of Pu- and U-isotope ratios for source identification

LINDIS SKIPPERUD

Isotope Laboratory, Department of Plant and Environmental Sciences, Norwegian University of Life Sciences, P.O. Box 5003, N-1432 Ås

Anthropogenic plutonium has been introduced into the environment over the past 50 years as the result of the detonation of nuclear weapons and operational releases from the nuclear industry. In the Arctic environment, the main source of plutonium is from atmospheric weapons testing, which have resulted in a relatively uniform, underlying global distribution of plutonium.

Plutonium isotope ratios are known to vary with reactor type, nuclear fuel-burn up time, neutron flux, and energy, and for fallout from nuclear detonations, weapon type and yield. Weapons-grade plutonium is characterized by a low content of the ^{240}Pu isotope, with $^{240}\text{Pu}/^{239}\text{Pu}$ isotope ratio less than 0.05. In contrast, both global weapons fallout and spent nuclear fuel from civil reactors have higher $^{240}\text{Pu}/^{239}\text{Pu}$ isotope ratios (civil nuclear power reactors have $^{240}\text{Pu}/^{239}\text{Pu}$ atom ratios of between about 0.2-1). Thus, different sources often exhibit characteristic plutonium isotope ratios and these ratios can be used to identify the origin of contamination, calculate inventories, or follow the migration of contaminated sediments and waters.

The measurement of the plutonium-isotope ratios in these studies offers both a means of identifying the origin of radionuclide contamination and the influence of the various nuclear installations on inputs to the Arctic, as well as a potential method for following the movement of water and sediment loads in the rivers. The present paper presents results from determination of plutonium concentrations and isotope ratios in sediment samples collected during various expeditions to the Kara Sea, the Ob and Yenisey estuaries and their river systems and also Pu isotope ratios in the near area of Mayak PA.

Weapons-grade plutonium is characterized by a low content of the Pu-240 isotope, with Pu-240/Pu-239 isotope ratio less than 0.05. In contrast, both global weapons fallout and spent nuclear fuel from civil reactors have higher Pu-240/Pu-239 isotope ratios, and the Pu-240/Pu-239 ratio offers a reliable way of distinguishing weapon's grade sources from global fallout. Since these two isotopes are not separated easily by conventional alpha spectrometry techniques, mass spectrometry is required for an assessment of the isotope ratios. Because of the low levels of plutonium in the Arctic area, plutonium concentrations and 240/239 ratios have been determined using accelerator mass spectrometry (AMS), which has proved a useful and reliable method for analysis of plutonium. ICP-MS has proven to be a good tool together with traditional alpha spectrometry when it comes to analysing plutonium and its isotope ratios in more contaminated areas.¹⁻⁶

1. Oughton, D. H.; Skipperud, L.; Fifield, L. K.; Cresswell, R. G.; Salbu, B.; Day, P. Accelerator mass spectrometry measurement of Pu-240/Pu-239 isotope ratios in Novaya Zemlya and Kara Sea sediments. *Applied Radiation and Isotopes* 2004, 61 (2-3), 249-253.
2. Oughton, D. H.; Fifield, L. K.; Day, J. P.; Cresswell, R. C.; Skipperud, L.; Di Tada, M. L.; Salbu, B.; Strand, P.; Drozcho, E.; Mokrov, Y. Plutonium from Mayak: Measurement of isotope ratios and activities using accelerator mass spectrometry. *Environmental Science & Technology* 2000, 34 (10), 1938-1945.
3. Skipperud, L.; Oughton, D. H. Use of AMS in the marine environment. *Environment International* 2004, 30 (6), 815-825.
4. Skipperud, L.; Oughton, D. H.; Fifield, L. K.; Lind, O. C.; Tims, S.; Brown, J.; Sickel, M. Plutonium isotope ratios in the Yenisey and Ob estuaries. *Applied Radiation and Isotopes* 2004, 60 (2-4), 589-593.
5. Skipperud, L.; Oughton, D. H.; Salbu, B.; Strand, P.; Drozcho, E.; Mokrov, Y. Plutonium contamination in soils and sediments at Mayak PA, Russia. *Health Physics* 2005.
6. Skipperud, L. Plutonium in the Environment: Sources and Mobility. PhD. thesis, Norwegian University of Life Sciences, 2005.

Hot particle measurement techniques and applications

Mats Eriksson

IAEA-MEL, 4 Quai Antoine 1er, MC 98000 Monaco

This talk will focus on hot particles. These particles have been demonstrated to be very important in special cases where the release scenarios involve explosions. This as, in such events the contaminating material usually is distributed as particles into the environment. A special characteristic for these particles are that the size distribution will be log-normal. A log-normal particle distribution means that very few particles will carry the majority of the mass/activity released in the event causing a heterogeneous contamination pattern. This fact must be considered when designing the sampling strategy, especially when inventory studies should be conducted. Many radiological studies investigate the translocation and dissolution properties of the contaminated material and long term behaviour. The talk will give an overview of hot particle studies from sampling/identification and separation techniques to the analysis of particles in different analytical instruments. Results from scanning electron microscopy coupled with energy dispersive X-ray analyser and synchrotron radiation based X-ray techniques like: X-ray absorption and combined X-ray fluorescence and absorption micro tomography will be presented. A discussion how these analytical tools can be used in radiological studies will be given.

SIMS technique and its application for hot particle characterisation

Ylva Ranebo

Department of Medical Radiation Physics, Lund University Hospital, Lund, Sweden

Secondary ion mass spectrometry (SIMS) is a versatile analytical technique providing the isotopic composition of a solid surface. In fact, SIMS is one of only few methods that produce ions from a solid sample without any vaporization of the specimen. The fact that the samples do not need any special sample preparation prior analysis is a strong advantage for the technique because the risk of cross-contamination of natural elements present in the laboratory environment is minimized. Basically, the technique is a mass filtered ion microscope that analyses the isotopic surface distribution of the species. SIMS can either be operated to provide information on the most superficial layers of the sample (with negligible damage to the sample), or in a more destructive mode, giving information sequentially through atomic layers reflecting the interior of the sample, so-called depth profiling. By far the largest application of SIMS is in semiconductor analysis, but it is also useful in the area of *hot particles* studies. This presentation will cover a description of the technique and its benefits for hot particle studies and in addition, some analytical difficulties will briefly be summarized. Finally, some examples of results on the analysis of hot particles will be given.

Application of off/on Line Sequential Injection System with High Resolution ICP-MS to Measurement Radionuclides in Environmental Samples

Chang-Kyu Kim

*IAEA, Physics, Chemistry and Instrumentation Laboratory,
Agency's Laboratories, Seibersdorf, A-2444, Austria*

ABSTRACT

A sequential injection system was developed, which can be widely used for the separation and preconcentration of analytes from diverse environmental samples. The system enables the separation time to be shortened by maintaining a constant flow rate of solution and by avoiding clogging or bubbling in a chromatographic column. The SI system was successfully applied to the separation of ^{237}Np and Pu isotopes in IAEA reference materials and environmental samples, and to the sequential separation of ^{210}Po and ^{210}Pb in a phosphogypsum candidate reference material. The replicate analysis results of ^{237}Np , $^{239+240}\text{Pu}$, ^{210}Po and ^{210}Pb in some IAEA reference materials using the SI system associated with HR-ICP-MS, alpha-spectrometry and LSC are in good agreement with the recommended value within 5% of standard deviation. The SI system enabled a halving of the separation time required for radionuclides.

1. INTRODUCTION

Recently, extraction chromatographic resins like TEVA, UTEVA, TRU-Spec and Sr-Spec which are highly specific for actinide extraction have been used in on-line or off-line SI (sequential injection) system coupled with ICP-MS for the separation of Pu (Schaumlöffel 2005; Epov 2005). In particular, the on-line SI system coupled with high resolution ICP-MS (SI-HR-ICP-MS) has enabled the analysis time to be shortened effectively compared to conventional methods (Kim 2004). However, commercial flow/sequential injection systems have a limitation in the number of samples to be treated simultaneously. Furthermore, no sequential injection system coupled with a large column size has been applied to the determination of radionuclides by alpha spectrometry and LSC, despite the fact that the ion chromatographic separation for alpha spectrometry and LSC is tedious and still a time consuming process.

For this reason, in this work a sequential injection system which can simultaneously treat 8 samples has been developed and applied to the measurement of ^{99}Tc , ^{237}Np , ^{239}Pu and ^{240}Pu by high resolution ICP-MS (HR-ICP-MS), to separate Pu isotopes from IAEA Soil-6 reference material, and to the sequential separation of ^{210}Po and ^{210}Pb from phosphogypsum. The results from the SI system were compared with those from the conventional method.

2. EXPERIMENT AND MATERIALS

2.1 Configuration of SI system for HR-ICP-MS

The SI system for sequential separation of Pu and Np, shown schematically in Fig.1, was configured using a 6-port solvent selection valve, 7 channels peristaltic pump, a solvent distributor and two-way valve which was used to change the final pathway of eluent and extraction chromatographic column.

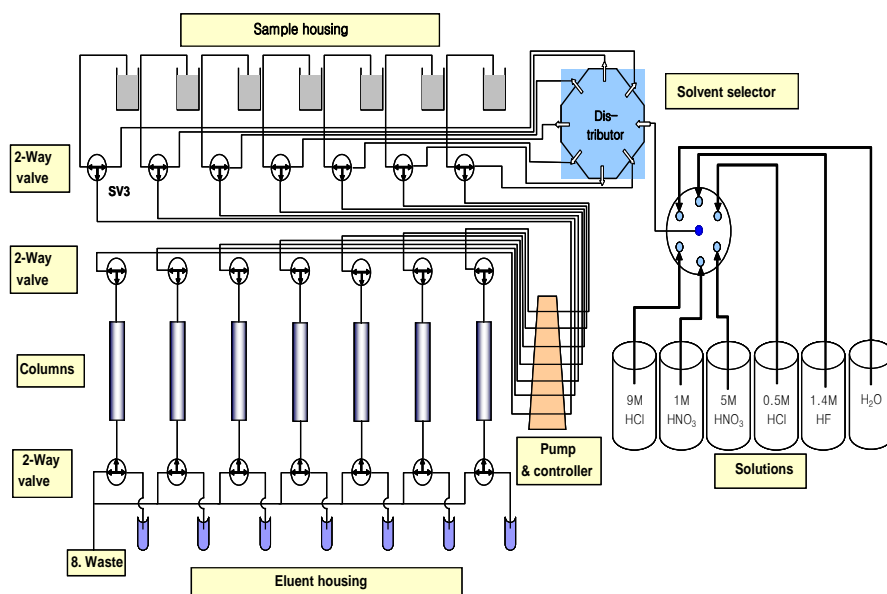

Fig. 1 Schematic diagram of new SI system

2.2 Configuration of SI system for alpha-spectrometry and LSC

The SI system for alpha-spectrometry and LSC, which was made by laboratory-order, is composed of a 6-port solvent selection valve (CHEMINERT™ 25Z-3186D, Valco Instrument, TX, USA), a solvent distributor (Omnifit, Cambridge, England) which can divert solution to 7 directions, six 2-way isolation valves (NResearch P/N 161 K032, NJ, USA), a two channel peristaltic pump (REGLO Digital MS-2/12, ISMATEC, Switzerland) and a chromatographic column (8 mm i.d. x 200 mm long, FLON Tech, Japan) connected to the end of the peristaltic pump. The SI system was applied to the measurement of ^{210}Po and ^{210}Pb in phosphogypsum.

3. Results and discussion

3.1 Application of the SI system to the simultaneous separation of Pu and Np for simultaneous determination of ^{239}Pu , ^{240}Pu and ^{237}Np by HR-ICP-MS

To validate the simultaneous determination of ^{239}Pu , ^{240}Pu and ^{237}Np by SI-HR-ICP-MS, IAEA reference materials and NIST's standard reference material (NIST-4350B) were analyzed. All results for $^{239+240}\text{Pu}$ fell within the 95% confidential interval suggested by the IAEA document (Ballestra 1993; Veglia 1989). The ^{237}Np activity and $^{240}\text{Pu}/^{239}\text{Pu}$ atom ratio in reference materials were comparable with the reported values in other papers (Lee 2001; Kenna 2002; Chen 2002). The relative standard deviation for Np was around 10 %, which is higher than the 3 % for total Pu because of the low concentration of Np.

3.2 Applications of the SI system to the determination of ^{210}Po and ^{210}Pb in phosphogypsum by alpha-spectrometry and LSC

The SI system was applied to the sequential separation of ^{210}Po and ^{210}Pb in phosphogypsum. The phosphogypsum used in this work is a candidate IAEA reference material which is under the proficiency testing. Therefore, the activity concentrations of ^{210}Po and ^{210}Pb in this phosphogypsum

can not be published at this time. For this reason, the applicability of the SI system to the separation of both nuclides was studied by comparing the results obtained by the SI system with the average value taken from 50 samples analyzed by the conventional method. The analytical results of ^{210}Pb and ^{210}Po obtained with the SI system were in good agreement with the average value taken from 50 samples by the conventional method within a standard deviation of 5%.

4. Conclusion

A sequential injection (SI) system, which can automatically separate analytes from sample bulk matrices, was developed in order to shorten the separation time for radionuclides. This was achieved by keeping the flow rate of solution constant and by avoiding clogging or bubbling in the chromatographic column. The SI system was successfully applied to the simultaneous determination of Np and Pu in several IAEA reference materials and a NIST sample using HR-ICP-MS. The SI system associated with a large ion exchange column and extraction chromatography resin was also successfully applied to separate Pu from large amount of soil sample (10 g) and to the sequential separation of ^{210}Po and ^{210}Pb from phosphogypsum. The results for Pu in IAEA reference material (Soil-6) obtained with the SI system are in good agreement with the recommended value. The analytical results for ^{210}Pb and ^{210}Po obtained using the SI system are in good agreement with the average value taken from 50 samples by the conventional method within a standard deviation of 5%. The SI system enabled the shortening of separation time for radionuclides by a factor of two, as the system could be operated overnight. It is expected that the SI system can be widely used for separation and preconcentration of analytes in diverse samples.

5. REFERENCES

- Ballestra, S.; Gastaud, J.; Lopez, J.J.; Parsi, P.; Vas, D. Intercomparison of radionuclide measurements in marine sediment sample IAEA-135, IAEA/AL/63; 1993
- Chen, Q.; Dahlgaard, H.; Nielsen, S.P.; Aarkrog, A. ^{242}Pu as tracer for simultaneous determination of ^{237}Np and $^{239,240}\text{Pu}$ in environmental samples, *J. Radioanal. Nucl. Chem. Articles* 253: 451-458; 2002
- Epov, V. N.; Benkhedda, K.; Cornett, R. J.; Evans, R. D. Rapid determination of plutonium in urine using flow injection on-line preconcentration and inductively coupled plasma mass spectrometry. *J. Anal. At. Spectrom.* 20: 424-430; 2005
- Kenna, T. C. Determination of plutonium isotopes and neptunium-237 in environmental samples by inductively coupled plasma mass spectrometry with total sample dissolution. *J. Anal. At. Spectrom.* 17: 1471-1479; 2002
- Kim, C. S.; Kim, C. K.; Lee, K. J. Simultaneous analysis of ^{237}Np and Pu isotopes in environmental samples by ICP-SF-MS coupled with automated sequential injection system. 19: 743-750; 2004
- Lee, S. H.; Gastaud, J.; La Rosa, J. J.; Liang, L.; Kwong, W.; Povince, P. P.; Wyse, F. F.; Hausladen, P. A.; Di Tada, L. M.; Santos, G. M. *J. Radioanal. Nucl. Chem.* 248: 757-764; 2001
- Schaumlöffel, D.; Giusti, P.; Zoriy, M. V.; Pickhardt, C.; Szpunar, J.; Łobiński, R.; Becker, J. S. Ultratrace determination of uranium and plutonium by nano-volume flow injection double-focusing sector field inductively coupled plasma mass spectrometry (nFI-ICP-SFMS). *J. Anal. At. Spectrom.* 20: 17-21; 2005
- Veglia, A.; Ballestra, S.; Lopez, J.J.; Gastaud, J.; Vas, D.; Noshikin, V. Report on the Intercomparison of IAEA-307 radionuclides in a sea plant, IAEA/AL/14; 1989
- Workshop on Radioanalytical Chemistry for Radioecology and Waste Management
November 16-20, 2009, Roskilde, Denmark

Rapid Analytical Methods for Determination of Actinides

Xiongxin Dai

AECL Chalk River Laboratories, Chalk River, Canada

The presence of radionuclides in the environment as results of nuclear weapon tests, reactor accidents, and reprocessing of nuclear fuels has led to growing public concerns about potential radioactive contamination on the health of individuals and on the environment. Actinides are considered most hazardous radionuclides due to their high radiological and chemical toxicities, and long radioactive half-lives. Accurate, reliable and rapid analyses of low level actinides in biological and environmental samples (e.g., urine, feces, water, soil and sediment samples) are in great demand not only for occupational health monitoring but also in response to radiological and nuclear emergency situation, to provide adequate information for fast population screening and environmental assessment for radioactive contamination.

This presentation will review state-of-the-art techniques for rapid actinide separation and analysis. Recently, new rapid and sensitive actinide urinalysis methods have been developed at the Chalk River Laboratories, AECL. In these methods, actinides (including U, Th, Pu, Am and Cm isotopes) are co-precipitated with hydrous titanium oxide from urine samples, separated using anion exchange and extraction chromatographic columns, and finally measured by alpha spectrometry, inductively coupled plasma mass spectrometry (ICP-MS) and thermal ionization mass spectrometry (TIMS). Details on development of these rapid actinide bioassay methods will be presented and discussed.

Rapid and Simultaneous Determination of Neptunium and Plutonium in Environmental Samples Using Anion Exchange Chromatographic and Sequential Injection Setup Combined with Inductively Coupled Plasma Mass Spectrometry

Jixin Qiao^a, Xiaolin Hou^a, Per Roos^a, Manuel Miro^b

^a Radiation Research Division, Risø National Laboratory for Sustainable Energy, Technical University of Denmark, DK-4000 Roskilde, Denmark

^b Department of Chemistry, Faculty of Sciences, University of the Balearic Islands, Palma de Mallorca, Spain

This paper presents an automated analytical method for the rapid and simultaneous determination of Pu and Np in the environmental samples. Anion exchange chromatographic column was incorporated in a sequential injection system to actualize the automated separation of Pu isotopes along with ²³⁷Np from the matrix elements and interfering radionuclides. K₂S₂O₅-conc. HNO₃ was applied as redox reagents for the valence adjustment and stabilization of Pu(IV) and Np(IV). ²⁴²Pu preformed well as a tracer for both Pu isotopes and ²³⁷Np. It was observed that the cross-link and particle size of the resins had significant influence on the separation efficiency and anion exchange resin Bio-Rad AG 1 × 4 with the particle size of 100-200 mesh was chosen as the optimum. The investigation on the capacity showed small-sized column packed with 2mL resin sufficed up to 50g of soil sample, which provides an advantage of low consumption of the resin and low generation of acid waste after the column washing. The analytical results for Pu and Np in three reference materials showed good agreement with the certified or reference values at the 0.05 significance level. Chemical yields of Pu and Np equally range from 80% to 100%, and the decontamination factors for uranium, thorium and lead were in the range of 10³ to 10⁴. The total time of separation for a single sample was < 2.5 hours, which extremely improve the analysis efficiency and reduces the labor intensity, as well as enables a rapid determination of Pu and Np in emergency situations.

The use of $^{99}\text{Mo}/^{99\text{m}}\text{Tc}$ generators in the analysis of low levels of ^{99}Tc in environmental samples by radiochemical methods

Dowdall M.¹, Gwynn J.P.², Selnæs Ø.G.¹ and Lind B.¹

1 - Norwegian Radiation Protection Authority, PO Box 55, 1332, Østerås, Norway

2 - Norwegian Radiation Protection Authority, Polar Environmental Centre, 9296, Tromsø, Norway

In recent years much attention has been devoted to the presence of the long-lived fission product ^{99}Tc in the Norwegian marine environment, the main source of this contamination being activities conducted at European nuclear reprocessing facilities. The discovery of ^{99}Tc in the Norwegian Arctic marine environment precipitated the initiation of monitoring activities by the Norwegian Radiation Protection Authority, within the framework of the national programme for monitoring of Radioactivity in the Marine Environment (RAME), to assess and elucidate the levels and behaviour of this contaminant in the Norwegian Arctic marine environment.

The analysis of low levels of ^{99}Tc in environmental samples presents special challenges, particularly with respect to the selection of an appropriate and practicable chemical yield tracer. Of all the tracers available, $^{99\text{m}}\text{Tc}$ eluted from $^{99}\text{Mo}/^{99\text{m}}\text{Tc}$ generators appears to be the most practicable in terms of availability, ease of use and cost. These factors have led to an increase in the use of such generators for the provision of $^{99\text{m}}\text{Tc}$ as yield tracer for ^{99}Tc . For the analysis of low levels (<1 Bq/m³ or kg) of ^{99}Tc in environmental samples, consideration must be given to the radiochemical purity of the tracer solution with respect to contamination with both ^{99}Tc and other radionuclides (Vesely and Cifka, 1970; Dowdall et al., 2004). The possible contaminants that may occur may be conveniently divided into two groups; isotopes of elements other than Tc and isotopes of Tc other than $^{99\text{m}}\text{Tc}$ (Table 1).

Isotope	$t^{1/2}$	γ Energies (keV)	β_{max} Energy (MeV)
^{99}Mo	65.9 hours	140.5 (4.5%) 739.5 (12.2%) 777.9 (4.2%)	1.350
^{99}Tc	211100 years		0.294
$^{99\text{m}}\text{Tc}$	6.01 hours	140.5 (89.6%)	0.437
^{131}I	8.02 days	364.4 (81.7%)	0.971
^{132}I	2.95 days	522.6 (16.0%)	3.577
^{106}Ru	373.59 days		0.039
^{90}Sr	28.74 years		0.546
^{90}Y	64.1 hours		2.282
^{89}Sr	50.53 days		1.495
^{103}Ru	39.26 days	497.1 (91%)	0.763

Table 1. Potential isotopic impurities in tracer solutions from $^{99}\text{Mo}/^{99\text{m}}\text{Tc}$ generators

Of the possible contaminants, the presence of ^{99}Mo is of potential concern as it will constitute a source of $^{99\text{m}}\text{Tc}$ within the tracer solution. Chemical yield calculations in ^{99}Tc analysis rely on the comparison of the signal produced in a gamma detector by an unadulterated mass of tracer and a

mass of tracer that has gone through the analytical sequence. Of even more significance is the potential presence ^{99}Tc itself in the tracer solution.

Holland et al. (1986) assessed commercial $^{99}\text{Mo}/^{99\text{m}}\text{Tc}$ generators in the United States and reached a number of important conclusions;

1. That the amount of ^{99}Tc produced by generators is often underestimated by up to 300%
2. The amount of ^{99}Tc produced is extremely variable between generators from different manufacturers
3. That theoretical calculations are not sufficient to calculate the ratio of $^{99\text{m}}\text{Tc}/^{99}\text{Tc}$ in tracer solutions from generators.

Correcting for contaminating ^{99}Tc by electrodepositing an aliquot of the unadulterated tracer solution on a planchette followed by beta counting is not an option due to the additional presence of the beta emitting ^{103}Ru in the tracer solution. The presence of ^{103}Ru on the planchettes containing unadulterated tracer solution has been confirmed by high resolution gamma spectrometry (Figure 1).

High resolution gamma spectrum of generator eluate
(4-5 weeks old)

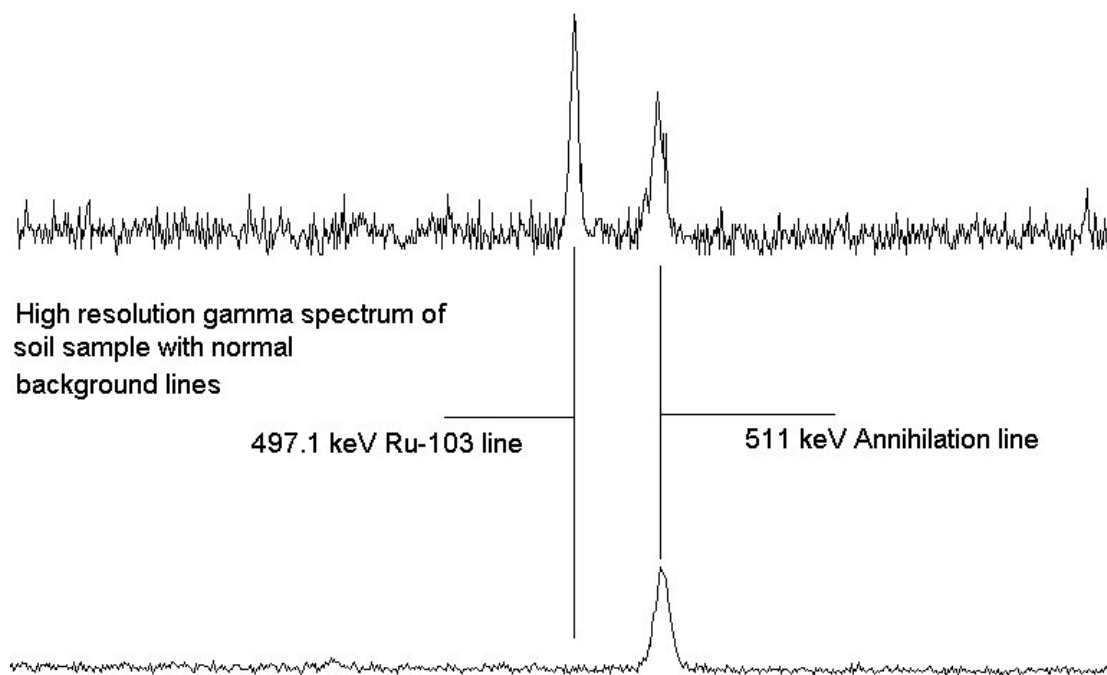

Figure 1. Gamma ray spectrum (400 – 600 keV) of tracer solutions exhibiting evidence of ^{103}Ru contamination. A soil sample exhibiting normal background lines is shown for comparative purposes.

Although it would appear that the chemical separation procedure employed by the NRPA is sufficient to remove at least some of the non-Tc contaminants, the presence of ^{99}Tc in the tracer solution presents a continuing problem for measurement of low level samples. The impact of ^{99}Tc contamination in tracer solutions on samples with varying levels of ^{99}Tc can be seen in Figure 2.

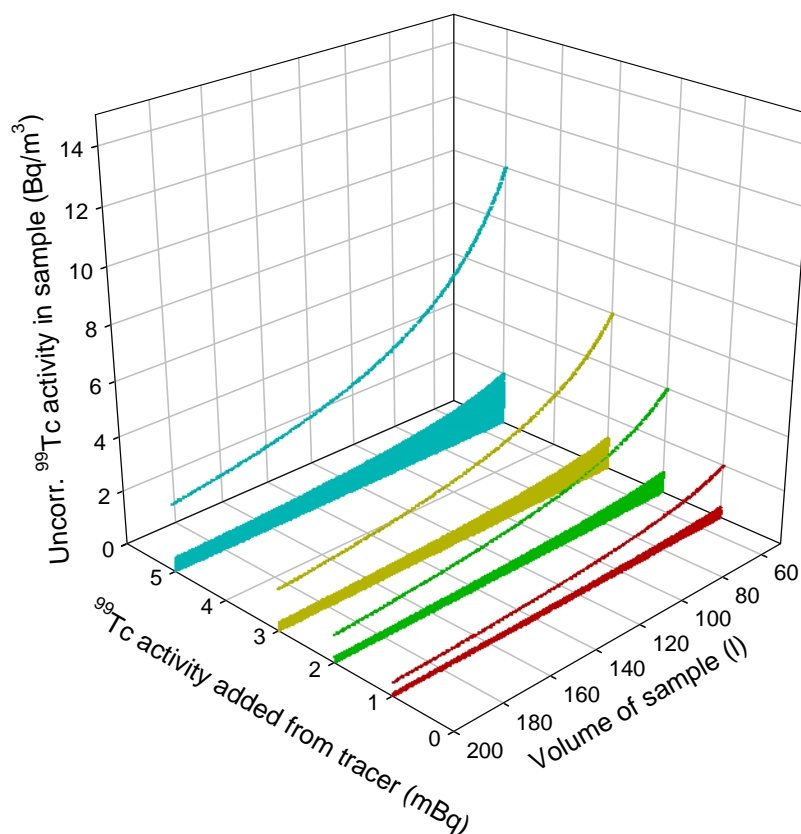

Figure 2. Contribution of tracer ^{99}Tc to sample ^{99}Tc for varying sample volumes and tracer ^{99}Tc activity. Solid line: 5% or more, dashed line: 1%

Correction for contaminating ^{99}Tc is possible but is not as straightforward as first seems. Simply depositing known masses of the tracer on a planchette to determine levels of ^{99}Tc in the tracer is not practicable, due to the presence of ^{103}Ru , as is trying to predict any amount of ^{99}Tc present in tracer solutions using mathematical methods. Due to the variable nature of the extent of the interference from tracer solution to tracer solution, it is unwise to try and establish a correction factor for any single generator. The only practical solution to the problem therefore is to run a “blank” sample with each batch of samples drawn from a single tracer solution.

- Dowdall, M., Selnaes, Ø, Gwynn, J. and Lind, B. (2004). On the use of $^{99}\text{Mo}/^{99\text{m}}\text{Tc}$ generators in the analysis of low levels of ^{99}Tc in environmental samples by radiochemical methods. *Water, Air, and Soil Pollution*, 156: 287-297.
- Holland, M.E., Deutsch, E. and Heineman, W.R. (1986). Studies on commercially available $^{99}\text{Mo}/^{99\text{m}}\text{Tc}$ radionuclide generators – II. Operating characteristics and behaviour of $^{99}\text{Mo}/^{99\text{m}}\text{Tc}$ generators. *Applied Radiation and Isotopes*, 37(2):173-180.
- Vesely, P and Cifka, J. (1970). Some chemical and technical problems connected with technetium- $^{99\text{m}}$ generators. Nuclear Research Institute, Pez, Czechoslovakia. UJC 2414-Ch. 21pp.

Radiochemistry analysis of ^{99}Tc in environmental samples

Jussi Jernström

National Laboratory for Sustainable Energy, NUK-202, Technical University of Denmark, DK-4000 Roskilde, Denmark

Measurement of ^{99}Tc with ICP-MS is feasible due to low determination limit. When compared to classical method beta counting the modern ICP-MS instruments reach even three orders of magnitude lower determination limits. However, for efficient analysis the sample needs to be free of interfering agents such as isotopes of other elements and polyatomics. The main interferences in the mass spectra of ^{99}Tc are ^{99}Ru and, to some extent, ^{98}MoH , $^{59}\text{Co}^{40}\text{Ar}$, $^{87}\text{Sr}^{12}\text{C}$, $^{87}\text{Rb}^{12}\text{C}$, $^{43}\text{Ca}^{16}\text{O}^{40}\text{Ar}$, $^{40}\text{Ar}_2^{18}\text{OH}$ and $^{40}\text{Ca}^{18}\text{OH}^{40}\text{Ar}$. These can be removed in the chemical separation procedure, for example, by using TEVA resin, but when working with large samples and using large amounts of reagents, absolute clean up can be difficult. The amount of Ru in the sample can be calculated from its relatively undisturbed isotope ^{101}Ru , however, this decreases the determination limit of ^{99}Tc which is problematic with samples of low ^{99}Tc concentration. Large amounts of Mo in samples create a problem for measurement of Tc via the interference of ^{98}Mo -hydride. Another issue with Mo is the interference of ^{97}Mo isotope when ^{99}Tc is used as yield tracer.

In this work HPLC pump and ion chromatography column has been applied in the separation chain for aiming to separate Tc from Mo and Ru and thus yield a pure Tc fraction for measurement with ICP-MS. Different complexing agents have been applied to study the separation efficiency of Tc in the column both in reduced and oxidized form.

This talk will give an overview of radioanalytical methods used in our laboratory for Tc as well as the results obtained with the applied chromatographical experiments.

Absorption Study of Am and Cm to TEVA, TRU and DGA Resins

A. Bombard³, A. Crable¹, A. Capote², N. Gharibyan¹, S. Happel³, G. Maddigan⁴, R. Sudowe⁵

¹ Radiochemistry PhD Program, University of Nevada, Las Vegas - USA

² IAEA, Vienna – AUSTRIA

³ TrisKem International, Bruz - FRANCE

⁴ Ortec/AMETEK, Oak Ridge – USA

⁵ Department of Health Physics, University of Nevada, Las Vegas - USA

It has been generally assumed that Am and Cm retention behaviour on extraction chromatographic resins like TRU and DGA are sufficiently similar in order to allow the use of Am-243 as internal standard for Cm without additional yield correction. However recent results from intercomparison exercises (PROCORAD, NPL) showed that, depending on the separation method used, biases of up to 50% for the Cm results can be found. Unfortunately there is a distinct lack of data on the extraction behavior of Cm on TRU and DGA that might help identifying conditions under which Cm extraction behaviour significantly deviates from the behavior of Am.

The aim of this study is the determination of the k' values of Am and Cm under varying conditions frequently found in separation methods used for the determination of Am and Cm. The evaluated conditions included, amongst others, various HCl and HNO₃ concentrations, the presence of anions such as phosphate and cations like Al, Fe(II) and Fe(III). The results obtained will allow identifying conditions under which Am and Cm do not behave similarly and that are thus most probable to cause the bias between Am and Cm yields. This information will allow laboratories performing Am and Cm analysis to evaluate if their currently used protocol risks to result in biased Cm results and to indicate which step of the method might need to be changed in order to avoid these.

Radiochemical analysis of ^{90}Sr , ^{41}Ca , ^{129}I and ^{36}Cl in waste samples

Xiaolin Hou

National Laboratory for Sustainable Energy, NUK-202, Technical University of Denmark, DK-4000 Roskilde, Denmark

The decommissioning of a nuclear facility requires estimating the total inventory of radioactivity in various materials and its variation with time, which has to be carried out by the determination of the radioactivity of various radionuclides presented in the materials. Of all materials in the nuclear facilities, graphite, concrete, and steel are the main low-medium radioactive waste due to their large volume. Besides the neutron activation products of components and impurity in the materials including ^{36}Cl and ^{41}Ca , some fission products, such as ^{90}Sr , ^{99}Tc , ^{129}I , and ^{137}Cs , also exist in the materials due to the contamination of the leaked nuclear fuel. Of these radionuclides, the determination of gamma emitters is easier and can be directly carried out by gamma spectroscopy without any radiochemical separation. But the beta and alpha emitters including ^3H , ^{14}C , ^{36}Cl , ^{41}Ca , ^{55}Fe , ^{63}Ni , ^{90}Sr , ^{99}Tc and ^{129}I and some transuranics, have to be determined by radiochemical analysis including a completely separation of individual radionuclides from matrix and other radionuclides before measurement by beta counting, alpha spectrometry or mass spectrometry. This work presents radiochemical analytical methods developed in our laboratory in the recent years for the determination of ^{36}Cl , ^{41}Ca , ^{90}Sr and ^{129}I in bio-shielding concrete, graphite and metals. for the decommissioning of nuclear facilities. Besides individual procedure for the purification of various radionuclides, a combined procedure is also developed and presented for the simultaneous determination of all four radionuclides from one sample.

Radiochemical analysis of Ra, ²¹⁰Po, ²¹⁰Pb, U and Th

Per Roos

National Laboratory for Sustainable Energy, NUK-202, Technical University of Denmark, DK-4000 Roskilde, Denmark

The analysis of isotopes of uranium, thorium, radium, ²¹⁰Po and ²¹⁰Pb is of great importance in fields where these isotopes are used as tracers or where dosimetric aspects are considered. Because of the emission of alpha, beta and gamma radiation from several of the isotopes a combined measurement strategy is often preferred (eg beta counting of ²³⁴Th followed by alpha spectrometry of ^{228, 230, 232}Th). Also, due to their position in the natural decay chains it is sometimes an advantage to measure the concentration of the daughter products than the mother isotope itself (eg. ²²²Rn+daughters instead of analysing ²²⁶Ra directly). The presentation gives an overview of analytical techniques useful for separating the isotopes in a sequential manner from each other.

Radiochemical analysis of ^3H , ^{14}C , ^{55}Fe , ^{63}Ni in waste samples

Xiaolin Hou

National Laboratory for Sustainable Energy, NUK-202, Technical University of Denmark, DK-4000 Roskilde, Denmark

In the nuclear waste from decommissioning of a nuclear facility, most of the beta activity is contributed from ^{14}C , ^3H , ^{55}Fe , and ^{63}Ni , especially in the first 10 years after the close of reactor. The determination of these radionuclides in radioactive waste is important for decommissioning and disposal of the waste. ^{14}C , ^3H , and ^{63}Ni are pure beta emitter; and ^{55}Fe decay by electron capture. It is therefore necessary to decompose sample and separate individual radionuclide from matrix element and other interfering nuclides before measurement of their radioactivity. In our laboratory, analytical methods have been developed for the determination of these radionuclides in various nuclear wastes for the decommissioning of nuclear facilities.

An oxidizing combustion method has been developed to decompose graphite, concrete, metals, and other solid samples. ^{14}C and ^3H released from the sample are separated trapped and measured by liquid scintillation counter (LSC). By this method the sample preparation time can be shortened to only 2-3 minutes. The detection limit of this method for ^{14}C and tritium are 0.96 and 0.58 Bq/g graphite and 0.11 and 0.06 Bq/g concrete respectively. The interference of other radionuclides in samples is insignificant.

A radiochemical separation procedure based on precipitation, ion exchange and extraction chromatography have been developed for the determination of ^{55}Fe and ^{63}Ni . The decontamination factors of the developed method are higher than 10^4 for the interfering radionuclides. The chemical recoveries for both Fe and Ni are higher than 80%. The detection limits of this method are 0.018 Bq for ^{55}Fe and 0.014 Bq for ^{63}Ni .

The developed method has been successfully applied for the analysis of heavy concrete, graphite, steel, aluminium, and lead from nuclear reactor and the estimation of inventories of these radionuclides in nuclear waste have been carried out. In addition, the methods were also applied for the analysis of sediment, water and vegetation samples for and investigation of the environmental chemical behaviour of these radionuclides.

Radiochemistry at the Environmental Monitoring Section at Institute for Energy Technology (IFE), Kjeller, Norway

Rajdeep Sidhu,

Environmental Monitoring Section, Health and Safety Department, Institute for Energy Technology, Kjeller, Norway

The Environmental Monitoring Section monitors radioactive pollutions and studies the mechanisms influencing the dispersion and transfer of radioactive materials in nature. The section is responsible for control of radioactive discharges from IFE's nuclear activities at Kjeller and for monitoring of radioactive contamination in the local environment. The Environmental Monitoring Section runs one of Norway's leading laboratories for analyses of radioactivity in environmental samples.

The section performs analysis of anthropogenic and natural radionuclides in a variety of sample materials in connection with discharge control, environmental monitoring, research projects, and on assignment from external customers. In many cases a chemical separation of the element of concern must be performed before activity measurement. The measurements may often be performed directly on the sample, or following a simple pre-treatment. When measuring pure alpha or beta emitters or nuclides with very weak gamma lines, the nuclide of concern must be separated chemically before measuring by alpha spectrometry or gross beta counting respectively.

Some of the radiochemical procedures in use, and procedures in development will be presented.

Advances in Isotopic Separation by Ion Chromatography and External Scintillation Analysis

Anna Ljungfalk

Radiochemical engineer, Ringhals AB, Sweden

A nuclear power plant is an artificial radiation source that daily gives a small contribution of radioactivity to our environment. There are several different release pathways from a plant to the surroundings including e.g. atmospheric discharges from stacks to the air and liquid discharges from water pipes to the ocean.

The regulatory Authorities put strict limitations on the amount of released activity, and continuous nuclide specific analysis of radioactive nuclides is therefore performed on the emissions. However, some of the radioactive nuclides to be analyzed in complex water samples may have a too weak signal to be detected, which may be due to interference by other nuclides in the sample. Therefore a chemical separation must first be performed prior to the activity determination. These nuclides are usually termed as "difficult to measure nuclides" and include e.g. ^{90}Sr , ^{63}Ni and transuranic elements.

Today, nuclear power plants usually perform the separation of "difficult to measure nuclides" by conventional ion exchange techniques. Because of a complex matrix, these techniques require a time demanding pre-concentration step to get a detectable concentration of the nuclide of interest. Another problem related to these methods is that they involve a lot of work with unhealthy chemicals.

In order to decrease the amount of work, a less time demanding method for separation of "difficult to measure nuclides" is presently under development at Ringhals NPP. Here, a conventional ion chromatographic technique is used to concentrate and separate the radioactive elements. The elements are detected through conductivity and collected as fractions eluted from a separation column, and hereafter counted on a liquid scintillation counter. This will also exclude most of the work with unhealthy chemicals.

In this presentation, the isotopic separation by ion chromatography at Ringhals NPP will be described in detail.

Distribution of ^{129}I in the Baltic Sea using a model approach

Peng Yi

Department of Earth Sciences, Uppsala University, SE-752 36 Uppsala, Sweden

Anthropogenic input of ^{129}I has provided a number of applications in the marine and terrestrial environments. The discharged quantities into the atmosphere and the oceans have not been of particular health concern for regions at considerable distance from the discharge sources, as the Baltic Sea. Marine currents and wind patterns affect the migration and distribution of ^{129}I to and in the Baltic Sea, but there are no sufficient measured data to predict present day and future distribution of the isotope. Modeling may, in some cases, become an excellent alternative of prediction and later comparison with measured data, when they become available, can improve and correct the model results. Here we present a mass-balance model (SPM) originally established for phosphorus by Håkanson (2007), but slightly modified in this work to accommodate to calculation of ^{129}I concentration the Baltic Sea from different depths. The model is based on conventional equations and the processes governing elemental dynamic in the Baltic Sea such as mixing and diffusion. The calculated values were assessed with the average empirical data and reasonably matched in most areas of Baltic Sea. Moreover, ^{129}I fluxes corresponding to different parts of Baltic Sea are estimated which are, to our best knowledge, never done before but are the indispensable task for further research. Due to the semi-close characteristics of Baltic Sea, ^{129}I has a relatively long residence time and model prediction failed to run as they largely rely on meteorological data (temperature, precipitation and winds) which are difficult to prognoses and thus doubtful on a long time span. Despite this difficulty, the model presented here seems successful for prediction on a long timescale as all derived variables are accessed from GIS maps.

Håkanson, L. and Eklund, J.M., 2007. A dynamic mass-balance model for phosphorus fluxes and concentrations in coastal areas. -Ecol Res., 22: 296-320.

Multi-element analyses for estimation of concentration ratios with site specific chemistry data from two sites in southern Sweden

Sara Nordén

Svensk Kärnbränslehantering AB, Box 250, 101 24 Stockholm

The Swedish Nuclear Fuel and Waste Management Co. (SKB) has investigated two sites as potential locations for a geological repository of spent nuclear fuel. During the site investigations, samples from water, deposits and biota representing different parts of the terrestrial, limnic and marine ecosystems were analysed chemically for approximately 70 elements. The dataset represents two well investigated sites (Forsmark and Oskarshamn) in the temperate boreal region of Sweden. A common and consistent sampling strategy facilitates relative comparisons between organisms, ecosystems and the sites. The wide range of elements analysed also facilitates studies revealing the correlation structure among elements. The distribution patterns of naturally occurring radionuclides or stable isotopes may be used to study the long-term behaviour of radionuclides in the environment. One of the reasons for the extensive sampling program was the need to estimate site specific concentration ratios (CR) for different elements. These parameters are used in the models for dose calculations, which are part of the safety assessment. Literature values for such CR can often vary several orders of magnitude and it is therefore of large importance to use site specific information when assigning values for use in the safety assessment. Compared with literature data the site specific CR are in most cases within the reported ranges.

Hot particles from atmospheric nuclear explosions

Suvi Lamminmäki¹⁾, Marja Siitari-Kauppi¹⁾, Jukka Lehto¹⁾, Jussi Ikonen¹⁾, Jussi Paatero²⁾, Riitta Zilliacus³⁾

1) Laboratory of Radiochemistry, University of Helsinki; 2) Finnish Meteorological Institute; 3) Maija Lipponen, VTT Technical Research Centre of Finland

Hot particles were often observed with autoradiography in the 1960s and 1970s as a result of the atmospheric nuclear tests. These particles were formed by condensing material, both radioactive and inactive, from the exploding nuclear device, underlying soil etc.

The Finnish Meteorological Institute (FMI) has monitored atmospheric radioactivity since the early 1960's at several monitoring stations in Finland by collecting aerosol particles onto paper or glass-fibre filters. After the measurement of total beta activity the collected filter samples have been archived. Since the mid 1960s some of the filters were also examined with autoradiography. Hot particles were frequently observed after atmospheric nuclear tests in Lop Nor, People's Republic of China.

In this work the archived filters were analysed by digital autoradiography for screening the radioactive particles from them. Further analyses were done by scanning electron microscopy and energy dispersive X-ray spectrometer to study morphology, size and surface elemental composition of the localized radioactive particles. Based on electron microscopy results gamma and alpha measurements were performed. After this the samples were analysed by fission track technique to find out if fissile material is present in the particles. ICP-MS analyses were performed to determine plutonium and uranium content of the particles. $^{239}\text{Pu}/^{240}\text{Pu}$ ratios were determined with a sector mass spectrometer and $^{235}\text{U}/^{238}\text{U}$ ratios with a quadrupole mass spectrometer.

The objective was to utilise modern instrumentation in the detection and analyses of hot particles in order to get new information on their physical and chemical characteristics. Contrary to particles found in e.g. lake or sea sediments or ice cores, the particles can be connected to individual nuclear tests. According to the preliminary results, uranium and plutonium were found in particles with a diameter of about 10 microns.

Deposition of Caesium and Strontium Substances on Growing Crops: Effects and Countermeasures

Bengtsson, Stefan

Swedish University of Agricultural Sciences, Department of Soil and Environment, SWEDEN

To investigate how the two radionuclides caesium (^{134}Cs) and strontium (^{85}Sr) are taken up and transported to the harvested parts (the seeds) by fallout in a growing crop. Further on how this is related to the size and time of the fallout. From the information collected recommendation of suitable countermeasures at different scenarios to prevent further spreading to food stuff can be suggested.

In the project a number of field trials where artificial deposited by the two radionuclides ^{134}Cs and ^{85}Sr in a contaminated rainfall, on the two agricultural crops *Brássica napus* L. (spring rape) and *Tríticum aestívum* L. (spring wheat). The trial contained different treatments where the radionuclides where deposited by a rainfall simulator at different growing stages of the crops. The field trial continues for two more years and the reason for that is due to the variation of the climate for the different years. The radionuclides were applied in the form of a wet deposition and the rainfall was about 1 mm m^{-1} with a concentration of 20 kBq m^{-1} for each radionuclide. Samples were taken from the plots at the day(s) after the treatment of contaminated rainfall, both from the latest treated plots and from the earlier treated plots.

The hypotheses are: 1. That the size of the deposition and the time in relation to the development stages of the crop will steer how much caesium and strontium that are coughed, detained and transferred to the harvested parts. 2. That the levels of caesium and strontium in the harvested parts of the crops are related to the insensitivity of the rainfall after a deposition and also how long time the first intensive rain will occur. 3. That the size of caesium and strontium in harvested plant parts are related to the size of uptake throw the leaves. 4. If the deposition of caesium and strontium will be the same, the levels of caesium will be much higher than strontium in the harvested parts.

Collection, pre-treatment and analyses of Cs-137 and Tc-99 in marine samples at the Institute of Marine Research (IMR), Norway

Hilde Elise Heldal

Institute of Marine Research, P. B. 1870 Nordnes, N-5817 Bergen, Norway

The Institute of Marine Research (IMR) is an important contributor to the Norwegian marine monitoring programme RAME (Radioactivity in the Marine Environment). RAME is funded by the Ministry of the Environment and coordinated by the Norwegian Radiation Protection Authority (NRPA).

Sample collection is performed from IMR's research vessels in the open sea areas of the North-, Norwegian- and Barents Seas and in Norwegian fjords. The samples consist of biota (fish and other marine organisms), sediments and seawater.

Biota samples are frozen onboard the ship and transported to IMR where the samples are subsequently ground up, freeze dried, homogenized and aliquoted into polyethylene counting boxes of appropriate size prior to analysis. Attempts are made to collect filets from 25 fish for each sample of large fish such as cod, haddock, saithe, red-fish and Greenland halibut. For smaller fish (e.g. blue whiting, polar cod, capelin and Atlantic herring) and other organisms such as amphipods, krill, and deep-sea shrimps, a sample of 2-3 kg of each species is taken. These samples are ground up whole.

Sediment samples are collected using a Smøgen boxcorer, from where both surface samples and cores are taken. The samples are frozen onboard the ship. While half-frozen, the cores are cut into slices of 1 or 2 cm thickness on board the ship, then frozen again and transported to IMR where they are treated as described above for the biota samples.

Large volumes (typically 50-200 L) of seawater are needed in order to get enough material for analysis. Pre-treatment of the samples in the field is therefore an advantage. Surface samples (5 m) of seawater are collected from a shipboard pump, while a CTD-rosette multi-bottle sampler with 12 10 L samplers is used to collect seawater from depths below 5 meters.

For the analysis of Cs-137, $\text{Cu}_2[\text{Fe}(\text{CN})_6]$ -impregnated cotton filters are used for the pre-concentration. One pre-filter without impregnation, two $\text{Cu}_2[\text{Fe}(\text{CN})_6]$ -impregnated filters and a flow-meter are mounted in a series directly on the ship's water intake. About 200 L seawater are passed through the filters at a flow rate of 5 L/min. The filters are then dried at 60 °C for about 24 h and brought back to IMR where they are ashed at 450 °C and filled into 60 ml polyethylene counting boxes prior to analysis. Samples from the CTD-rosette multi-bottle sampler are shipped back to the laboratory and analysed using the ammonium molybdophosphate (AMP)-method.

Biota, seawater and sediment samples are gamma-counted on Ortec HPGe-detectors with efficiencies ranging from 30 to 60 %, electric cryostat cooling systems, and 10 cm lead shieldings.

For the analysis of Tc-99, 50-100 L of seawater is collected from the shipboard pump (surface samples) or CTD-rosette multi-bottle sampler (samples from the water column) and filled into 25 L polyethylene carboys. A known amount of rhenium (Re) is added to each sample as a carrier and yield monitor on board the ship. Further, the samples are passed through anion exchange resins made of BioRad AGx8 (100-200 mesh) packed into 60 ml disposable polystyrene syringes. The syringes containing the anion exchange resin are brought back to IMR for further radiochemical treatment. A RISØ beta-counter is used for beta-counting for Tc-99.

Information about salinity and temperature of the seawater is normally available from the stations we collect samples. This information is important while interpreting the results. Samples of biota and sediments are collected for analysis of different hydrocarbons and persistent organic pollutants (POPs) from the same stations as the radionuclide samples. Combining these results gives us a more overall picture of the pollution load.

Radioactivity monitoring of Irish Dairy Produce

Kevin Kelleher

Radiation Monitoring, Radiological Protection Institute of Ireland, Dublin 14, Ireland

The RPII has been carrying out monitoring of milk and dairy produce since 1986. Milk samples are routinely analysed for radiocaesium and strontium-90 as part of the RPII's environmental monitoring programme to determine the doses received to the Irish population from milk consumption.

The method the RPII utilises for determining the Sr-90 activity in milk is by measuring the Cerenkov radiation produced by its daughter ^{90}Y isolated from interfering nuclides such as uranium, thorium, radium and their decay products as well as isotopes of caesium, potassium and strontium by extraction with 10% di-(2-ethylhexyl)phosphate (HDEHP) in toluene. The chemical yield of ^{90}Y is determined by the acidmetric titration of yttrium nitrate carrier with titriplex III.

The levels of Sr-90 and dose to the Irish population from milk consumption have been negligible when compared to other radioactive sources in the Irish environment.

Other dairy products are analysed for radiocaesium on a routine basis for commercial customers to ensure the levels of radioactivity in the dairy products fall within EC regulations governing the export/import of dairy produce. The export of milk and milk produce from Ireland is a very important industry, 80% of dairy products produced in Ireland are exported and these exports are worth €2.2 billion annually to the Irish economy.

The dairy products are analysed by gamma spectroscopy and include full and skim milk powders, butter, casein, cheese, cream, whey and lactose. The levels of radioceasium in these products are typically below 5 Bk/kg and fall well within the limit of 370 Bq/kg laid down by the European Community in Council Regulation 737/90.

Although the levels of these radionuclides are relatively low the RPII recognises the importance of analysing these samples for radioactivity to inform the public, ensure consumer confidence and, more importantly, to maintain a level of expertise in the RPII in these analytical techniques so that, in the event of a nuclear emergency or incident, prompt action can be taken.

Analysis of Colloids Released from Bentonite and Crushed Rock

Mari Lahtinen

Radiochemistry laboratory, Helsinki University, Finland

Inorganic colloids are present in natural groundwater but colloids can also be produced from degraded Engineered Barrier System (EBS) materials. The potential relevance of colloids for radionuclide transport is highly dependent on the release and stability of colloids in different chemical environments and their interaction with radionuclides. In this work release and stability of inorganic colloids were determined from bentonite and crushed rock which will be used as backfill materials in the deposition tunnels. In the batch dispersion experiments, MX-80 bentonite powder or crushed rock samples of unaltered, moderately altered and strongly altered tonalite and mica gneiss were added to saline OLSO and low salinity Allard artificial groundwater with adjusted pH values 7–9. After four months pH, particle size distribution, zeta potential, colloid concentration, elemental composition and morphology of colloids were analyzed. The release and stability of colloids depended significantly on the salinity and pH of groundwater and the degree of alteration of the rock. In saline OLSO zeta potential values near zero, wide distribution of particle sizes and low colloid concentrations indicated particle aggregation and instable colloidal dispersion. In low salinity Allard high or moderate zeta potential values, smaller particle sizes and higher colloid concentrations than in OLSO indicated the existence of stable colloids. The found elements correspond to the mineral compositions of the rocks and bentonite.

COMPARISON OF CHEMILUMINESCENCE METHODS FOR ANALYSIS OF HYDROGEN PEROXIDE AND HYDROXYL RADICALS

R. Pehrman^{1,2}, C. Cachoir³ M. Amme¹

¹ *European Commission, Joint Research Centre, Institute for Transuranium Elements, Postfach 2340, D-76125 Karlsruhe, Germany*

² *Laboratory of Radiochemistry, University of Helsinki, P.O.Box 55, 00014 Helsinki, Finland*

³ *SCK•CEN, Waste and Disposal Unit;*

Boeretang 200, B-2400 Mol, Belgium

Disposal of spent nuclear fuel in underground repositories is being considered in many countries and for this purpose understanding of behaviour of radiolysis products is required. To study the effects of alpha radiolysis products of water on oxidation and dissolution of actinides, a method to analyse those products is needed. Chemiluminescence is generally considered a simple, sensitive and reasonably selective method to detect reactive oxygen species on low concentrations. Concentrations of interest for both hydrogen peroxide and hydroxyl radicals are 10^{-6} to 10^{-9} M. The aim of this study is to compare various chemiluminescence methods for detecting hydrogen peroxide and hydroxyl radicals.

Four methods to analyse hydrogen peroxide were chosen based on the estimated suitability for radiolysis experiments. Two of these use luminol, catalyzed by either μ -peroxidase or hemin, one uses 10-methyl-9-(p-formylphenyl) acridinium carboxylate trifluoromethanesulfonate and one potassium periodate. All methods were tested as batch systems in basic conditions.

For hydroxyl radical detection luminophores tested were 3-hydroxyphthalic hydrazide (product of phthalic hydrazide and hydroxyl radical) and rutin. Both methods were tested as batch systems.

The results are compared and the applicability of the methods for near-field dissolution studies is discussed.

^{129}I in Finnish waters

Tero Rätty¹, Jukka Lehto¹, Xiaolin Hou², Ala Aldahan³, Göran Possnert⁴, Jussi Paatero⁵, Juha Flinkman⁶, Harri Kankaanpää⁶,

1 University of Helsinki, Laboratory of Radiochemistry, Helsinki, Finland, 2 Technical University of Denmark, Risø, Denmark, 3 Department of Earth Science, Uppsala University, Sweden 4 Tandem Laboratory, University of Uppsala, Uppsala, Sweden, 5 Finnish Meteorological Institute, Helsinki, Finland, 6 Finnish Environment Institute, Helsinki, Finland

^{129}I is long-lived beta emitting (E_{max} 154,4 keV) radioisotope of iodine. Half-life is 15,7 million years. ^{129}I is produced mainly by human nuclear activities and especially it has been released to the environment from the spent nuclear fuel reprocessing plants. In the pre-nuclear era $^{129}\text{I}/^{127}\text{I}$ ratios in the environment were approximately 10^{-12} . Nowadays $^{129}\text{I}/^{127}\text{I}$ ratios have reached values from

10^{-10} to 10^{-4} .

In this study activity concentrations of ^{129}I and its distribution into various chemical species (iodide I^- , iodate IO_3^- and bound in organics) were analyzed from four different lakes in Finland (Pyhäselkä, Lappajärvi, Oulujärvi and Muddusjärvi) and from four different sea locations, Gulf of Finland, Bothnian Sea and Bothnian Bay. ^{129}I was also analyzed from four rainwater samples (Virolahti, Ähtäri, Hailuoto and Kevo). Samples were taken in the summer of 2009.

Water samples (approx. 300 ml) were first filtrated through $0,45\mu\text{m}$ filter. After that, separation of various iodine species was done by anion exchange chromatography. $^{129}\text{IO}_3^-$ passes through an anion exchange resin bed in NO_3^- form while $^{129}\text{I}^-$ absorbs into the bed. $^{129}\text{I}^-$ is eluted from resin with NaClO . Finally samples were precipitated by AgNO_3 to AgI and ^{129}I was measured by accelerator mass spectrometry (AMS) Stable iodine (^{127}I) was analyzed by inductively coupled plasma mass spectrometry (ICP-MS).

First results from a lake in the southern Finland and from water taken from the Finnish Bay in front of Helsinki show that levels of ^{129}I in lake water are around 1×10^9 atoms per litre while in sea water the levels are 4-5 times higher. ^{129}I occurs both in lake and sea water mainly in iodide form and the fraction of iodate form is only about 5%. The $^{129}\text{I}/^{127}\text{I}$ ratio is clearly elevated compared to natural levels and are approximately the same in sea and in lake, 14×10^{-8} and 8×10^{-8} . These results are only preliminary and a better picture of the situation will be obtained after finalizing the project. The results obtained so far are however, at the same level as obtained in Swedish studies at the same latitudes.

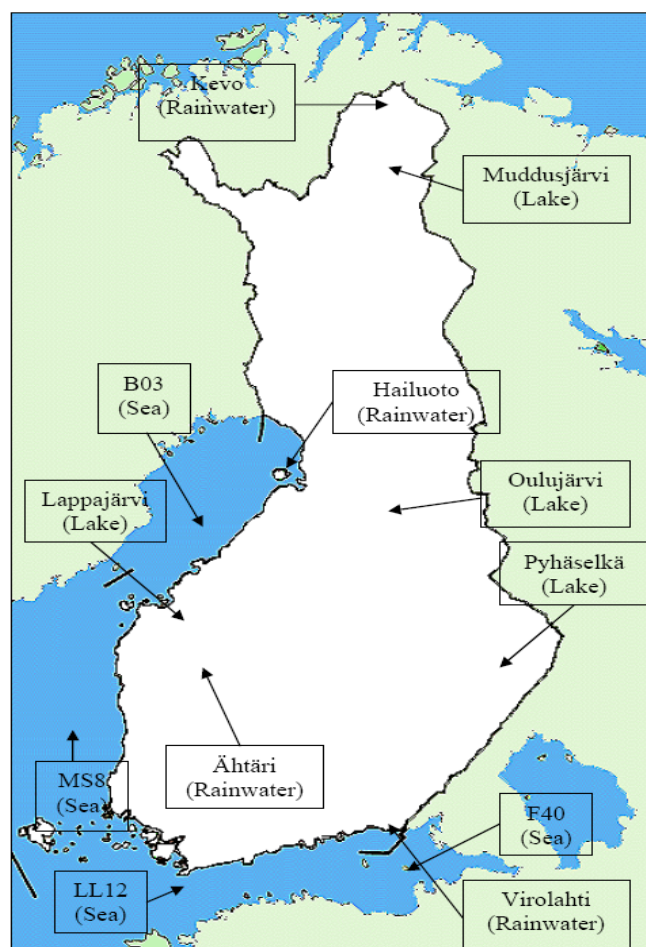

Application of inorganic sorbents for removal of Cs, Sr, Pu and Am from contaminated solutions

Kristina Ribokaite

Institute of Physics, Nuclear and Environmental Radioactivity Research Laboratory, Savanoriu 231, LT-0230 Vilnius, Lithuania

Titanium silicates (TiSi) and iron oxides were synthesised and their structural characteristics were studied using X-ray, Mössbauer, and sorption ability towards a number of long-lived radionuclides was tested using gamma and alpha spectroscopy.

The laboratory batch method was applied to determine the distribution coefficient values of Cs, Sr, Pu and Am radionuclides (background electrolyte – $0.1 \text{ mol}\cdot\text{L}^{-1} \text{ Na}^+$) at the 1:100 and 1:1,000 $\text{g}\cdot\text{mL}^{-1}$ liquid : solid . The total concentrations of caesium in solutions were $2.30\cdot 10^{-10} \text{ mol}\cdot\text{L}^{-1}$ and $6.80\cdot 10^{-5} \text{ mol}\cdot\text{L}^{-1}$ (the solutions were labelled by ^{134}Cs). A mixture of Pu (IV) isotopes ($^{238,239,240,241}\text{Pu}$ prepared from highly contaminated Chernobyl soil) was used in sorption experiments. Starting concentrations of Pu(IV) and ^{241}Am were $1.10\cdot 10^{-9}$ and $3.20\cdot 10^{-11} \text{ mol}\cdot\text{L}^{-1}$, respectively. ^{134}Cs activities were measured with an intrinsic germanium detector (resolution 1.9 keV @ 1.33 MeV, and efficiency 42 %). Plutonium and americium in the solution and the solid-phase were determined after radiochemical separation using UTEVA and TRU (Eichrom Industries) resins, and their activities were measured by alpha spectrometry. ^{242}Pu and ^{243}Am were used as tracers in the separation procedures. Precision of radionuclide measurements by gamma- alpha-spectrometry was for Cs $\leq 2\%$, Pu $\leq 5\%$, Am $\leq 7\%$. Sr concentrations in the liquid-phase were measured with a Perkin Elmer Zeeman/3030 AAS-GF.

TiSi produced using TiOSO_4 revealed better sorption ability towards all studied radionuclides in comparison with TiSi synthesised on the basis of TiCl_4 one. The highest Pu K_d values and better kinetics were found for synthetic iron oxides. An increase in the Pu K_d value by a factor of 7 found for magnetite/hematite composite in comparison with the pure magnetite suggests that this sorbent is efficient for plutonium removal and it is promising for its separation from contaminated solutions. Distribution coefficient (K_d) values obtained using the laboratory batch method ranged from 390 to 163000 ml/g for Sr, from 6 to 40470 ml/g for Cs, from 220 to 257000 ml/g for Pu and from 50 to 16260 ml/g for Am.

List of workshop Participants

Name	Institution	Country	E-mail
Andrius Puzas	Insitute of Physics	Lithuania	andriusp@ar.fi.lt
Anna Ljungfalk	Ringhals AB	Sweden	anna.ljungfalk@vattenfall.com
Anna Nalbandyan	NRPA, Statens strålevern	Norway	Anna.Nalbandyan@nrpa.no
Anne Sørensen	Danish Decommissioning	Denmark	anne.soerensen@dekom.dk
Aude Bombard	TRISKEM International	France	abombard@triskem.fr
Britt Salbu	Norwegian University of Life Sciences	Norway	brit.salbu@umb.no
C.K. Kim	IAEA-Seibersdorf	Austria	C.K.Kim@iaea.org
Cato Christian Wendel	University of Life Sciences	Norway	cato.wendel@umb.no
Claudio Lousada	Institutionen för kemi, KTH,	Sweden	claudio.lousada@hotmail.com
Dan Bohr	Danish Decommissioning	Denmark	dab@dekom.dk
Fredrik Henricsson	Lund Univeristy	Sweden	Fredrik.Henricsson@med.lu.se
Gjermund Strømman	University of Life Sciences	Norway	gjermund.stromman@umb.no
He Peng	Uppsala University	Sweden	peng.he@geo.uu.se
Heidi Sjølin Thomsen	Danish Decommissioning	Denmark	hst@dekom.dk
Hilde Elise Heldal	Institute of Marine Research	Norway	hilde.elise.heldal@imr.no
Jelena M. Popic	University of Life Sciences	Norway	jelena.mrdakovic.popic@umb.no
Jens Hassingboe	Danish Decommissioning	Denmark	jha@dekom.dk
Jixin Qiao	Risø-DTU	Denmark	jixin.qiao@risoe.dk
Jukka Lehto	University of Helsinki	Finland	jukka.lehto@helsinki.fi
Jussi Jernstroem	Risø-DTU	Denmark	jusj@risoe.dtu.dk
Justin Gwynn	NKS-B Programme, Norwegian Radiation Protection Authority	Norway	Justin.Gwynn@nrpa.no
Kasper G. Andersson	Risø-DTU	Denmark	Rajdeep.Singh.Sidhu@ife.no
Keliang Shi	Risø-DTU	Denmark	keliang.shi@risoe.dk
Kevin Kelleher	Radiological Protection Institute of Ireland	Ireland	kkelleher@rpii.ie
Kristina Ribokaite	Insitute of Physics	Lithuania	kristina_ribokaite@yahoo.com
Lindis Skipperud	Norwegian University of Life Sciences	Norway	Lindis.Skipperud@umb.no
Majbritt E. Nielsen	Risø-DTU	Denmark	majb@risoe.dtu.dk
Mari Lahtinen	Helsinki Univeristy,	Finland	mari.lahtinen@helsinki.fi
Mats Eriksson	IAEA-MEL	Monaco	Mats.Eriksson@iaea.org
Mats Jonsson	Institutionen för kemi, KTH,	Sweden	matsj@kth.se
Parvine Naqhchbandi	NRPA, Statens strålevern.	Norway	Parvine.Naghchbandi@nrpa.no
Per Roos	Risø-DTU	Denmark	roos@risoe.dtu.dk
Rajdeep Singh Sidhu	IFE	Norway	kgan@risoe.dtu.dk
Rasa Gvozdaite	Insitute of Physics	Lithuania	Rasa.Gvozdaite@ar.fi.lt
Reijo Pehrman	Helsinki Univeristy,	Finland	reijo.pehrman@helsinki.fi

List of workshop Participants

Name	Institution	Country	E-mail
Sara Nilsson	Institutionen för kemi, KTH,	Sweden	sara@nuchem.kth.se
Sara Nordén	Svensk Kärnbränslehantering AB	Sweden	sara.norden@skb.se
Stefan Bengtsson	Swedish University of Agricultural Sciences	Sweden	stefan.bengtsson@mark.slu.se
Suvi Lamminmäki	Helsinki University,	Finland	suvi.lamminmaki@helsinki.fi
Sven P. Nielsen	Risø-DTU	Denmark	spni@risoe.dtu.dk
Wangsu Wu	School of Nuclear Science, Lanzhou University	China	wuws@lzu.edu.cn
Xiaolin Hou	Risø-DTU	Denmark	xiho@risoe.dtu.dk
Xiongxin Dai	AECL Chalk River Laboratories	Canada	daix@aecl.ca
Yi Peng	Uppsala University	Sweden	peng.yi@geo.uu.se
Ylva Ranebo	Lund Universityhospital	Sweden	ylva.ranebo@med.lu.se

Transportation in Denmark

From Airport to Roskilde:

There is train connection from Copenhagen Airport to Roskilde station (Railway) through Copenhagen Central Station (need to change train), it takes about 50 min. The train departs from the airport 3-4 times per hour. You can find your time schedule from the website: <http://www.rejseplanen.dk/bin/query.exe/en>

The cost of a taxi from Copenhagen Airport to Roskilde is approx. DKK 500.

From Roskilde Station to your Hotel:

Hotel Prindsen is very close to Roskilde station, about 10 min. walk (see the map, you can also find a big map from Google map).

Danhostel Roskilde is about 1.5 km from Roskilde station; you can take Bus No. 216 from Roskilde station.

From Hotel to Risø

Bus No. 216 and 600S stop at the main gate of Risø, it takes about 15 min. from Roskilde to Risø. Those who stay in the Hotel Prindsen, can take the Bus 600S or 216 from Roskilde Station. Those staying at the Danhostel Roskilde, can take Bus 216 from the bus stop nearby (see map above). Below are the time tables for the buses 600S and 216.

The cost of a taxi from Roskilde to Risø is approx. DKK 150.

Meeting place at Risø

The workshop on 16th and 18th will hold in Niels Bohr auditorium at Risø-DTU, about 5 min walk from the gate of Risø.

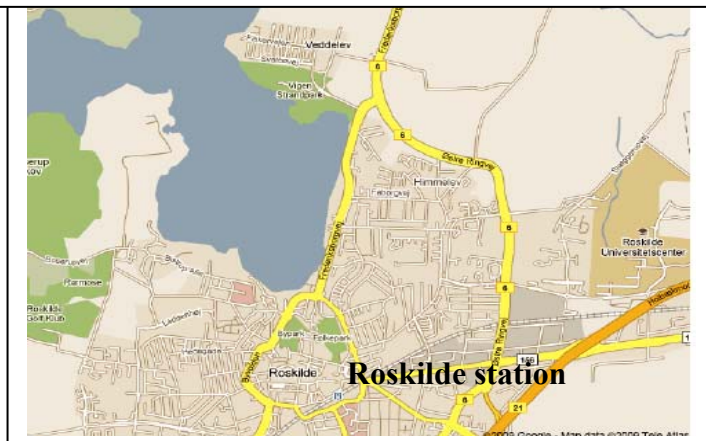
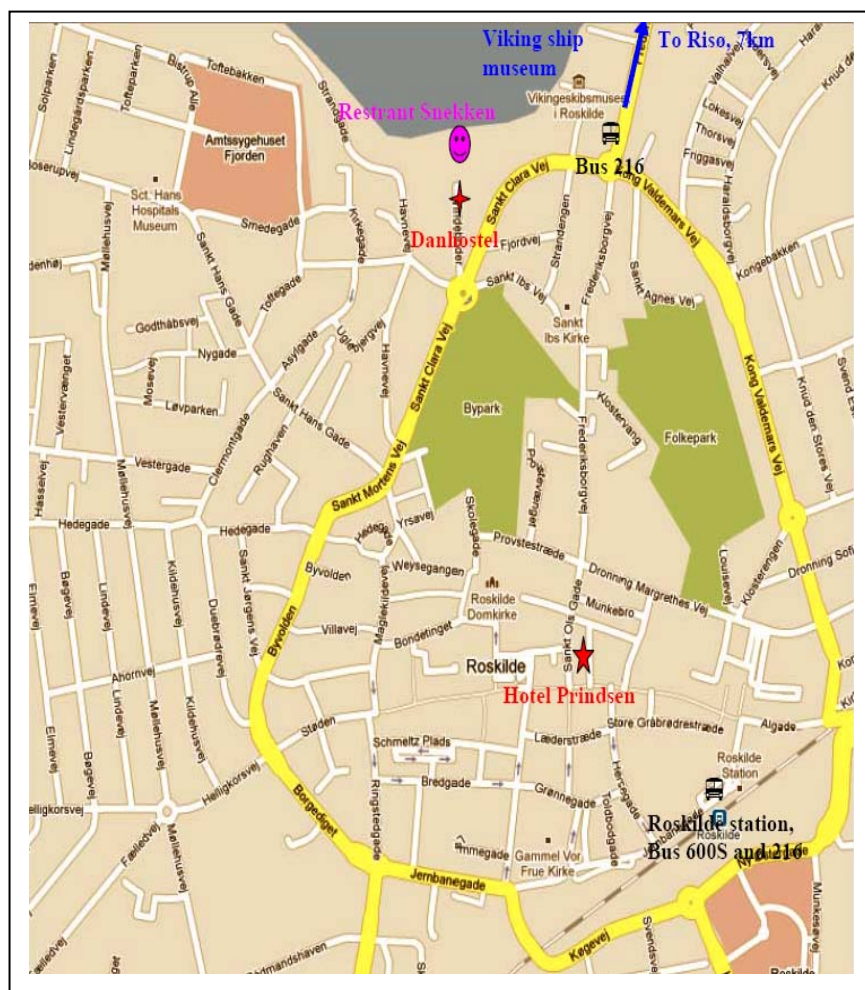

Title	Workshop on Radioanalytical Chemistry for Radioecology and Waste Management: Report, evaluation, abstracts and full papers of presentations
Author(s)	Xiaolin Hou
Affiliation(s)	Risø National Laboratory for Sustainable Energy, Technical university of Denmark, Denmark
ISBN	978-87-7893-288-4
Date	March 2010
Project	NKS-B / RadWorkshop 2009
No. of pages	74
No. of tables	4
No. of illustrations	26
No. of references	0
Abstract	A NKS-B workshop on radioanalytical chemistry for radioecology and waste management was hold at Risø, Roskilde, Denmark in 16-20th November 2009. The workshop was organized as 3 days lectures and presentations and two days laboratory practice. 48 peoples participated the workshop, including 32 young participants from Denmark, Finland, Norway, Sweden, Lithuania and Ireland. This report gives a brief description of the workshop and an evaluation of the workshop by statistic analysis of questionnaires feed back from the participants. The book of abstracts and proceedings presented in the workshop is enclosed
Key words	Workshop, Radioanalysis, radiometric techniques, radiochemical separation, environmental radioactivity