

## **Risø energy report 8**

The intelligent energy system infrastructure for the future

**Larsen, Hans Hvidtfeldt; Sønderberg Petersen, Leif**

*Publication date:*  
2009

*Document Version*  
Publisher's PDF, also known as Version of record

[Link back to DTU Orbit](#)

*Citation (APA):*

Larsen, H. H. (Ed.), & Sønderberg Petersen, L. (2009). Risø energy report 8: The intelligent energy system infrastructure for the future. Roskilde: Danmarks Tekniske Universitet, Risø Nationallaboratoriet for Bæredygtig Energi. (Denmark. Forskningscenter Risoe. Risoe-R; No. 1695(EN)).

## **DTU Library**

Technical Information Center of Denmark

---

### **General rights**

Copyright and moral rights for the publications made accessible in the public portal are retained by the authors and/or other copyright owners and it is a condition of accessing publications that users recognise and abide by the legal requirements associated with these rights.

- Users may download and print one copy of any publication from the public portal for the purpose of private study or research.
- You may not further distribute the material or use it for any profit-making activity or commercial gain
- You may freely distribute the URL identifying the publication in the public portal

If you believe that this document breaches copyright please contact us providing details, and we will remove access to the work immediately and investigate your claim.

# Risø Energy Report 8



## The intelligent energy system infrastructure for the future

Risø-R-1695(EN) September 2009

Edited by Hans Larsen and Leif Sønderberg Petersen



## **Risø Energy Report 8**

Edited by Hans Larsen and Leif Sønderberg Petersen,  
Risø National Laboratory for Sustainable Energy  
Technical University of Denmark

### Reviewed by

Professor Olav Hohmeyer, Flensburg University, Germany  
Professor Mark O'Malley, University College Dublin, Ireland  
Dr. Jayant A. Sathaye, Lawrence Berkeley National Laboratory, University of California, USA

### Editorial consultant

Charles Butcher, science journalist

### Secretary

Birthe Andersen

Design by IdentityPeople | PeopleGroup

Cover photo by Pasieka/spl - Getty Images

Printed by Schultz Grafisk

Copyright: Risø DTU 2009

National Laboratory for Sustainable Energy

Risø-R-1695 (EN)

ISSN 0106-2840

ISBN 978-87-550-3754-0

ISBN 978-87-550-3755-7(Internet)

# Risø Energy Report 8

## **The intelligent energy system infrastructure for the future**

### EDITED BY

Hans Larsen and Leif Sønderberg Petersen

### REVIEWED BY

Professor Olav Hohmeyer, Flensburg University, Germany

Professor Mark O'Malley, University College Dublin, Ireland

Dr. Jayant A. Sathaye, Lawrence Berkeley National Laboratory, University of California, USA

### EDITORIAL CONSULTANT

Charles Butcher, Science Journalist, UK

### SECRETARY

Birthe Andersen

Copyright: Risø National Laboratory for Sustainable Energy, Technical University of Denmark, 2009

Risø-R-1695(EN)

ISBN 978-87-550-3754-0

ISBN 978-87-550-3755-7 (internet)

ISSN 0106-2840

1. Preface	3
2. Conclusions and recommendations	5
3. The changing global energy scene	9
4. Challenges for a future Danish intelligent energy system	15
5. Market and grid challenges: planning for large-scale renewables	21
6. Flexibility, stability and security of energy supply	25
7. Flexibility in the distribution system	31
8. System control and communication	39
9. Energy storage	43
10. Links between energy carriers	47
11. End-user behaviour, incentives and measures	51
12. Synthesis	61
13. References	65
14. Index	69
15. Risø Energy Report Series	71

This report is volume 8 in a series started in 2002, and will take its point of reference in the need for the development of a highly flexible and intelligent energy system infrastructure which facilitates substantial higher amounts of renewable energy than today's energy systems. This intelligent and flexible infrastructure is a prerequisite in achieving the goals set up by IPCC in 2007 on CO<sub>2</sub> reductions as well as ensuring the future security of energy supply in all regions of the world.

The report presents a generic approach for future infrastructure issues on local, regional and global scale with focus on the energy system.

The report is based on chapters and updates from Risø Energy Report 1 – 7, as well as input from contributors to the DTU Climate Change Technology workshops and available international literature and reports.

*Hans Larsen and Leif Sønderberg Petersen*

*Risø National Laboratory for Sustainable Energy,*

*Technical University of Denmark*





*Hans Larsen and Leif Søndberg Petersen, Risø DTU*

Within the energy sector energy security and climate change are the two overriding priorities. This is especially true for industrialized countries and the more rapidly developing economies. Many other developing countries, on the other hand, still face basic energy development constraints which give quite a different meaning to the concept of energy security.

Renewable energy resources (RES), which at one time occupied an almost insignificant niche, are gradually expanding their role in global energy supply. Today the largest contributor is traditional biomass, followed by large hydro-power, leaving only a tiny fraction to “new renewables” such as photovoltaics, wind power, small-scale hydro, biogas and new biomass. But the contribution of new renewable sources has expanded rapidly in recent years. This is especially true for wind power and photovoltaics, though the latter started from an extremely low level.

Today’s energy system is the result of decisions taken over more than a century. This long-term development is reflected in the structure of the energy system, which in most cases was developed according to basic engineering requirements: energy is produced to meet the needs of consumers. However, a new supply structure based on variable energy resources such as wind power will require a much more flexible energy system, also including the flexibility of the energy consumers.

The power system is currently undergoing fundamental structural changes. The causes of this include not only the rapidly increasing amount of fluctuating renewable energy that is being connected to the system, but also the use of new types of production and end-use technologies.

One such change is a general increase in distributed production units that are smaller than traditional thermal power plants; in the future this may include low-voltage connections from microCHP plants in individual households. Another is the increasing use of Information and Communications Technology (ICT). The rapidly increasing capabilities, and falling costs, of ICT open the way to two-way communication with end-users, making this one of the most important enabling technologies for the future power system.

The need for energy storage in a future energy system dominated by fluctuating renewable energy depends on many factors, including the mix of energy sources, the ability to shift demand, the links between different energy vectors, and the specific use of the energy. Since energy storage always introduces extra costs and energy losses, it will be used only when it sufficiently increases the value of energy between produc-

tion and use. Modern transport depends heavily on fossil fuels. Ways to reduce emissions from transport are to shift to renewable or at least CO<sub>2</sub>-neutral energy sources, and to link the transport sector to the power system. Achieving this will require new fuels and traction technologies, and new ways to store energy in vehicles.

A future electricity system with a considerable amount of fluctuating supply implies quite volatile hourly prices at the power exchange. Economists argue that exposing customers to these varying prices will create flexible demand that matches the fluctuations in supply. Persuading customers to react to hourly prices would improve market efficiency, reduce price volatility, and increase welfare.

Customers show some reluctance to react to hourly pricing, partly because their average gain is less than 0.5% of the electricity bill. Gains vary considerable between years, however, and depend crucially on the variation in prices, which in turn depends on the amount of fluctuating supply. Increasing the proportion of wind power in the system increases the benefits to consumers of acting flexible.

## Recommendations

The global economy has in recent years faced a number of changes and challenges.

Globalization and free market economics have dominated the last decade, but the current financial crisis is rapidly changing the political landscape.

In the energy sector, energy security and climate change mitigation are the two overriding priorities. This is especially true for industrialized countries and the more rapidly developing economies; whereas many developing countries still face basic energy development constraints that give quite a different meaning to the concept of energy security.

We have several options in addressing climate change and energy security issues, but all of them will require strong global and national policy action focusing on low-carbon energy sources and gradual changes in the way the overall energy systems are designed:

- More flexible and intelligent energy system infrastructures are required to facilitate substantially higher amounts of renewable energy compared to today’s energy systems. Flexible and intelligent infrastructures are a prerequisite to achieving the necessary CO<sub>2</sub> reductions and secure energy supplies in every region of the world.

During the transition to the flexible and intelligent energy



systems of the future, short-term policy actions need to be combined with longer-term research on new energy supply technologies, end-use technologies, and the broader system interaction aspects.

Prerequisites to the development of flexible and intelligent energy system infrastructures are the ability to:

- effectively accommodate large amounts of varying renewable energy;
- integrate the transport sector through the use of plug-in hybrids and electric vehicles;
- maximise the gains from a transition to intelligent, low-energy buildings; and
- introduce advanced energy storage facilities in the system.

It is important that flexible and intelligent energy systems are economically efficient and can be build up at affordable cost.

To allow high proportions of fluctuating renewable power production in the future energy system it is necessary to have:

- Long-term targets for renewable energy deployment and stable energy policies are needed in order to reduce uncertainty for investors. A mix of distributed energy resources is needed to allow system balancing and provide flexibility in the electricity system. Electric vehicles, electric heating, heat pumps and small-scale distributed generation, such as fuel-cell-based microCHP, are promising options.

For the electrical power system, the following Issues should also be addressed in the planning of the intelligent power grid:

- energy shifting – the movement in time of bulk electricity through pumped hydro and compressed air storage;
- “smart” electricity meters in houses, businesses and factories, providing two-way communication between suppliers and users, and allowing power-using devices to be turned on and off automatically depending on the supply situation;
- communication standards to ensure that the devices connected to the intelligent power system are compatible, and the ability of the system to provide both scalability (large numbers of units) and flexibility (new types of units);

- optimal use of large cooling and heating systems, whose demand may be quite time-flexible;
- large-scale use of electric vehicles is highly advantageous from the point of view of the power system as well as the transport system.

The integration of a larger share of fluctuating wind power is expected to increase the volatility of power prices; demand response facilitates integration by counteracting fluctuations in supply.

Finally, there is a strong need to pursue long-term research and demonstration projects on new energy supply technologies, end-use technologies, and overall systems design. Existing research programmes in these areas should be redefined and coordinated so that they provide the best contribution to the goal of a future intelligent energy system.

Figure 1

Highly flexible and intelligent energy system infrastructures are required to facilitate substantially higher amounts of renewable energy than today's energy systems and thereby lead to the necessary CO<sub>2</sub> reductions as well as ensuring the future security of energy supply in all regions of the world.

**Information and communication technologies**

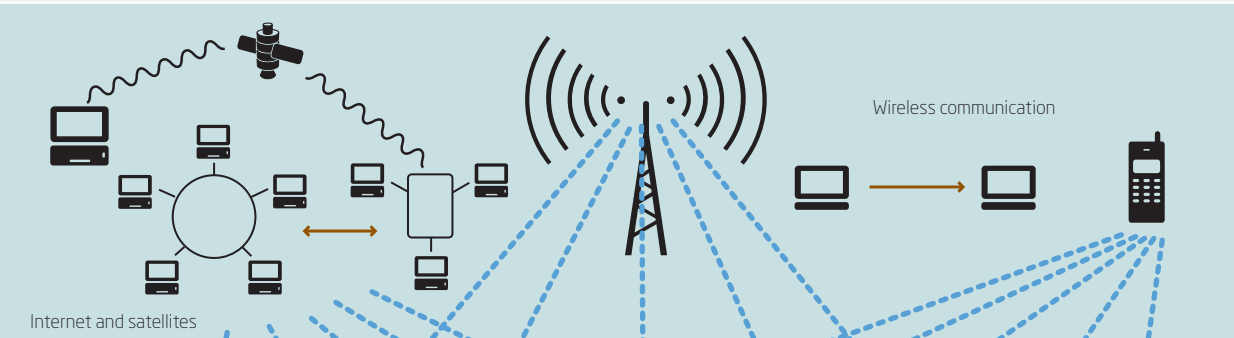

**Traditional power system structure**

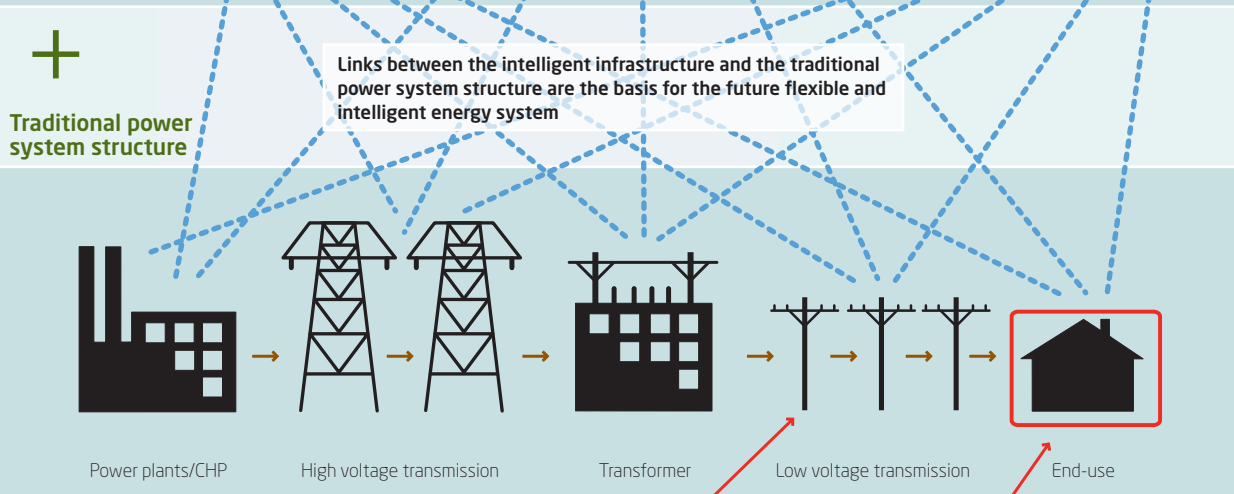

Links between the intelligent infrastructure and the traditional power system structure are the basis for the future flexible and intelligent energy system

**Intelligent energy system**

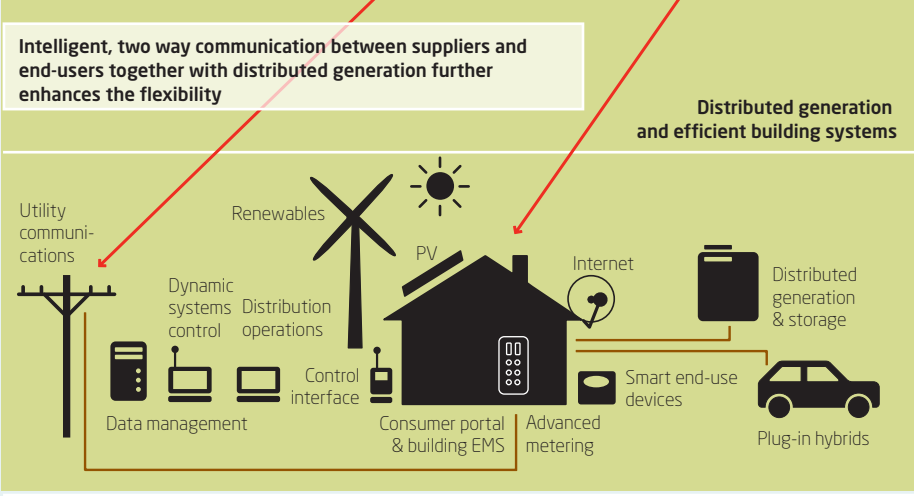

Combine with intelligent houses, smart meters, distributed generation, plug-in vehicles, energy storage etc. Then we are well underway to the future's flexible and intelligent energy systems.



John M. Christensen, Hans Larsen, Risø DTU; Robert Schock, World Energy Council

## The global financial crisis and energy priorities

The global economy has over the last year faced a number of changes and challenges with the so-called financial crisis, which have significant impacts on almost all countries. At the time of writing this report it is still too early to analyze the full consequences of this crisis and fully grasp the potential impacts, but the attendant issues and their possible solutions are emerging.

The crisis comes after a decade of unprecedented economic growth in many countries including most of the major economies. Globalization and free market economy have been dominant and the crisis now seems to bring back focus on the role of government and policy in almost all countries and economic sectors.

The decade of economic growth has meant increasing energy consumption with above average annual growth rates in the order of 2 – 3% [1]. This put increasing pressure on oil and gas markets and was one of the causes leading to a three or four fold price increase from 25 – 30 USD per barrel of oil to over 140 USD per barrel at its peak. International projections started assuming oil prices would remain over 100 USD in the long term. The immediate consequence of the financial crisis has, however, been a rapid decline in economic activity and related demand for energy resulting in prices plummeting very rapidly to around 30 to 40 USD per barrel. This is expected by many to be a short term phenomenon and mid-2009 prices have moved up to around 60 USD per barrel and with gradual economic recovery most international projections expect over the next years that fossil fuel prices will increase again.

While these dramatic short term changes affect the current situation significantly, the basic concerns that have been driving energy policy makers for the last decade have not changed fundamentally. Energy security and climate change are the two overriding priorities. This is especially true for industrialized countries and the more rapidly developing economies while it must be noted that many less-rapidly developing countries still face basic energy constraints giving a very different meaning to the concept of energy security and climate change concern.

The economic recession may be seen as short term relief for many countries, but does not change any of the fundamental concerns. The statement by the World Energy Council [2] is a clear example of how the energy industries share this view.

WEC members feel that the energy sector short and longer term challenges centre on:

- The security of supply and predictable energy demand,
- The sustainability of current energy policies,
- Alleviating the energy poverty experienced by more than two billion inhabitants of our planet.

“These challenges remain while the world is in recession, in fact the recession in many ways exacerbates the issues in the long term; but in other ways it also provides new opportunities for us to reconsider our energy policies.”

WEC Statement 2009 [2]

## Climate change

On the climate side recent scientific findings show that due to the growth in the last decade, GHG concentrations in the atmosphere have been building up faster than even the most pessimistic scenario predicted by the Intergovernmental Panel on Climate Change (IPCC) and consequently the climate change impacts are occurring faster and more significant than was predicted, see information from the Global Carbon Project [3] in boxes below.

### Atmospheric CO<sub>2</sub> growth

Annual mean growth rate of atmospheric CO<sub>2</sub> was 2.2 ppm per year in 2007 (up from 1.8 ppm in 2006), and above the 2.0 ppm average for the period 2000-2007. The average annual mean growth rate for the previous 20 years was about 1.5 ppm per year. This increase brought the atmospheric CO<sub>2</sub> concentration to 383 ppm in 2007, 37% above the concentration at the start of the industrial revolution (about 280 ppm in 1750)

### Emissions from fossil fuel and cement

Emissions increased from 6.2 PgC per year in 1990 to 8.5 PgC in 2007, a 38% increase from the Kyoto reference year 1990. The growth rate of emissions was 3.5% per year for the period of 2000-2007, an almost four fold increase from 0.9% per year in 1990-1999. The actual emissions growth rate for 2000-2007 exceeded the highest forecast growth rates for the decade 2000-2010 in the emissions scenarios of the Intergovernmental Panel on Climate Change, Special Report on Emissions Scenarios (IPCC-SRES). This makes current trends in emissions higher than the worst case IPCC-SRES scenario.

The United Nations Climate Change Conference in Copenhagen (COP15) is targeted to deliver a new global agreement to expand and enhance the actions initiated with the Kyoto Protocol in 1997. A new agreement has to deliver on four fronts. First as stated above there is an urgent need for ambitious emission reductions by industrialized countries. This must be combined with involvement of developing countries – especially major ones – to limit their emissions growth. The historic responsibility for the greenhouse effect is recognized by industrialized countries and reflected in the UNFCCC, as the basic principle of “common but differentiated responsibilities”, but it is equally clear that size matters reflecting the fact that China has become the largest emitter and the developing countries' emissions as a group will overtake the OECD countries, if current emissions growth is not limited. Therefore the industrialized countries will have to face significant net reductions in emissions while developing economies need to take a cleaner development path and limit their projected growth in GHG emissions. These trends are illustrated in Figures 3 and 4 (see p. 13) from the IEA World Energy Outlook 2008.

From the negotiations under the UN Framework Convention on Climate Change (UNFCCC) it is evident that for developing countries to engage in limiting future emissions growth there will be a need for a new agreement on financing that results in new additional, sustainable and predictable funding and technological support provided by the industrialized countries. To be implemented in an effective manner a new agreement will require a new international governance structure to manage the funds for adaptation and mitigation, as the required action will make dramatic

changes in current north – south resource flows. For this to happen unprecedented levels of cooperation and integration will have to be established between national governments as well as between governments and the private sector in general. The current finance crisis may with the strong role of governments on interventions and cooperation offer a unique opportunity, but so far it is mainly the US interventions that have had strong emphasis on climate and energy.

### Energy security

The concept of *energy security* is traditionally directly linked with energy supply. Securing stable supply is a major political concern and a challenge facing both developed and developing economies since prolonged disruptions would create serious economic and basic functionality problems for most societies. Stability of energy demand is evidently a concern seen from the energy supplier side and will affect investment decisions at that level, but in this section the focus is mainly on the supply side of energy security.

On a more detailed level the issue of energy supply security can be disaggregated into a number of more detailed concerns:

- Changes in global distribution of demand and supply
- Increasing import of fossil resources in most OECD countries but also for example in China and India
- Political focus on national control of supply and production
- Affordability of energy import for low income countries
- Micro-level access to affordable and reliable supply

Traditionally the concerns about energy security have been driven by worries about oil supply disruptions and this still remains vitally important, but the issue of gas security has emerged with the increasing share of natural gas in the energy matrix in many countries.

Realizing that there is an increasing global interconnectedness as regards energy issues, there is growing focus on enhancing both global and regional dialogue to address this interconnectedness. One example of this dialogue is between producing and consuming countries by the creation of the International Energy Forum, IEF, which brings together countries accounting for more than 90% of global oil and gas supply and demand. Through the Forum and its associated events ministers and energy industry executives participate in a dialogue, which is of increasing importance to overall global energy security.

The new US administration is very focused on both energy security and climate change issues and seems to be taking a more dialogue oriented approach on energy security than the previous administration. The EU concerns on energy security are very much oriented towards increasing reliance on supplies coming from Russia. Experiences from the last couple of years illustrate the vulnerability of energy supply dependency at the political level. For the large developing economies like China and India there has, especially for China, been a marked shift in the interest in securing stable foreign supply and China has been strengthening links with a large number of fossil fuel producing countries around the world with a special focus on Africa. On the energy demand security side Russia and other fossil energy resource suppliers are increasingly raising concerns about the need for stability of demand reflecting the importance the fuel exports constitute for their economies.

**Policy opportunities**

Governments around the world are currently striving to overcome the financial crisis through more or less direct and active involvement of the state in the finance sector and implementing different types of economic stimulus initiatives.

In this process there is a unique opportunity to direct the economic stimulus packages towards the energy industry. If done with a clear climate or energy security objective it could foster the deployment of existing technologies, including energy efficiency and carbon free energy resources, encourage research, development and demonstration, assist in the early commercialization of new technologies and reducing the risk for investors in climate-friendly energy projects. Such action has the potential to stimulate economic growth, increase energy security and provide significant benefits for the climate, however, early indications show that most of the national stimulus packages may include elements in this direction but do not have it as clear objective

As presented in Fig. 2 from the IPCC Fourth Assessment [5] it is clear that for the electricity sector the business as usual (BaU) projection is going to be strong growth mainly based on fossil fuels. But with wide scale application of energy efficiency measures both on the supply and demand sides combined with increased utilization of esp. renewable energy sources it is technical feasible to reduce emissions in 2030 by almost 50% compared to the present situation instead of a projected BaU increase of more than 50% although at increased cost.

This will evidently require strong political will and support

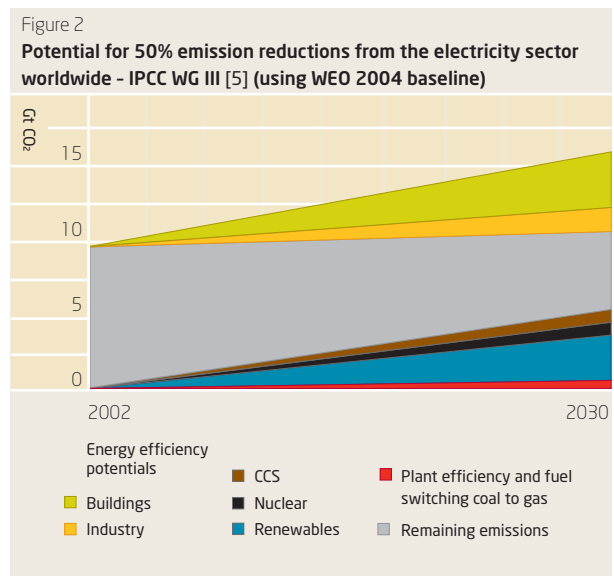

from both private consumers and industries around the world, as well as stringent and permanent regulation. But as stated by both the IPCC [5] and the Stern Report [6] the cost of this action is manageable in comparison to the cost of inaction.

Comparing with the magnitude of current financial losses and associated reduction in global GDP in a very short time, the cost of global mitigation, as assessed by the IPCC [5], is not significant, but will require consistent action over several decades. With a focus on efficiency, renewables and other low carbon solutions, the actions will however benefit both national and global energy security with lower consumption and reliance on more diverse resources.

Mitigation action at the required scale will risk leading to both national and elements of global redistribution of production and income, depending on what approach is used. It is therefore necessary to ensure that the UNFCCC process addresses the global concerns while governments at the national level ensure that benefits from emerging industries reach those that may be affected by closure of old and polluting facilities.

Although coming from a small share of the global energy supply the renewable energy industry has been growing rapidly the last 5 years. This has partly been policy driven but it also reflects that there is an increasing private sector interest in investing in renewables as a future profitable business area. The Annual Status Report by the Renewable Energy Policy Network for the 21st Century - REN21 [7] has selected a number of indicators that show the increasing financial flows and the resulting capacity expansion in

Table 1

## Selected indicators

	2006 >	2007 >	2008
Investment in new renewable capacity (annual)	63 >	104 >	120 billion USD
Renewables power capacity (existing, excl. large hydro)	207 >	240 >	280 GW
Renewables power capacity (existing, incl. large hydro)	1,020 >	1,070 >	1,140 GW
Wind power capacity (existing)	74 >	94 >	121 GW
Grid-connected solar PV capacity (existing)	5.1 >	7.5 >	13 GW
Solar PV production (annual)	2.5 >	3.7 >	6.9 GW
Solar hot water capacity (existing)	105 >	126 >	145 GWth
Ethanol production (annual)	39 >	50 >	67 billion liters
Biodiesel production (annual)	6 >	9 >	12 billion liters
Countries with policy targets		66 >	73
States/provinces/countries with feed-in policies		49 >	63
States/provinces/countries with RPS policies		44 >	49
States/provinces/countries with biofuels mandates		53 >	55

installed capacity. Wind remains the dominant sources, but both solar PV and water heating are expanding rapidly and production facilities are emerging in a number of developing countries to facilitate continued expansion in the rapidly growing economies.

### REN21 - Global Status Report - 2009 Update

There is still an evident gap between the positive developments in renewable energy and the needed expansion illustrated by the IPCC [5] and it is clearly urgent to take major policy action by both OECD countries and the large emitting developing countries to accelerate the already positive trends.

The EU has as part of its action on climate change agreed on an initial reduction of emissions by 20% in 2020 with an option to go for a 30% reduction if other major economies join the efforts. This was specifically combined with a parallel target for renewable energy also at 20% by 2020, including a specific provision for a minimum of 10% biofuels in transport to ensure that targets are not only addressed in electricity and heating.

China has similarly set a target of increasing renewable energy use from the present 10% to 20% of the total energy consumption by 2030 to meet the increasing demand and reduce the greenhouse effect. Indicative targets for the following decades show ambitions towards a steady increased share from RE. The new US administration is similarly moving on both energy efficiency and renewables, and during the election President Obama in his "New Energy plan for America" indicated ambitions for the US to have 25% renewable energy electricity in 2025. The recent bill passed by the House of Representatives has a target of reducing greenhouse gases in the United States to 17% below 2005 levels by

2020, and 83% by midcentury. The bill will likely undergo changes in the Congress approval process, but it does provide indications of the new proactive US position.

### Energy system challenges

While many international studies IPCC [5], IEA's WEO [4] and others indicate that the technical and policy options exist to address the emission reductions required for the first decades and enhanced research and development in already known areas are likely to provide a span of options for the full transition to a low carbon world, there has been little attention given to what this will require in terms of what could broadly be termed the *energy systems*.

Large scale application of renewable sources in the electricity supply will represent a marked shift for current transmission and distribution systems. Although renewable energy technologies cannot be discussed en bloc e.g., hydro has a completely different supply profile than wind, it is clear that the level of variability will increase and introduce some degrees of uncertainty compared with fossil systems, which will require more flexible systems. In order to deal with the increased variability it will be required to ensure flexible back-up and increase the general robustness of existing systems with e.g., gas turbines representing a flexible back up option, while on longer time scales it is the expectation that storage technologies will improve enough to become an integral part of the electricity supply set-up.

One storage or flexibility option is to increase the interaction between supply and demand in what is often termed *intelligent systems*. This can take many forms but typically involves advanced metering coupled with end-use devices that can be turned on and off electronically depending on the supply situation in a two way communication with the sup-



pliers. This approach lends itself well to larger cooling and heating systems where demand may be quite time flexible. It may gradually be extended to other areas and appliances as the technologies develop. Large fleets of electrical cars could also be seen as a future storage and/or charging option being able to provide flexibility. This will clearly require major and challenging restructuring of the transport sector.

In future energy systems with high emphasis on efficiency improvements in both industry and private households changing demand patterns are going to generate new challenges to system operators and utilities. The customers are becoming increasingly independent as they in long periods of time are expecting the system to supply all their needs e.g., during cold winter nights or during peak periods in industrial production. As an example future low energy houses or even *plusenergy houses* could be taken as examples. These houses are built with high insulation standards and equipped with appliances with best efficiency standards. Furthermore, such a house may be producing some of its limited need for electricity and heat by solar collectors, fuel cells etc. Hence, the need for buying external supply of energy is limited to selected periods of time.

The issue of variability in supply can partially be addressed if it is possible to increase predictability of the resource availability. If the availability of RE capacity is better predicted the value of the supply will increase, especially in the wind sector significant resources are invested in enhancing predictability. This is seen from a technical point of view. In systems where you have a major part of electricity and heat produced on CHP plants the variability of renewable energy technologies in the system affect the economic performance in a negative way as the plants due to obligations to supply

Figure 3  
World energy-related CO<sub>2</sub> emissions in 2030 by scenario. OECD countries alone cannot put the world onto a 450-ppm trajectory, even if they were to reduce their emissions to zero.

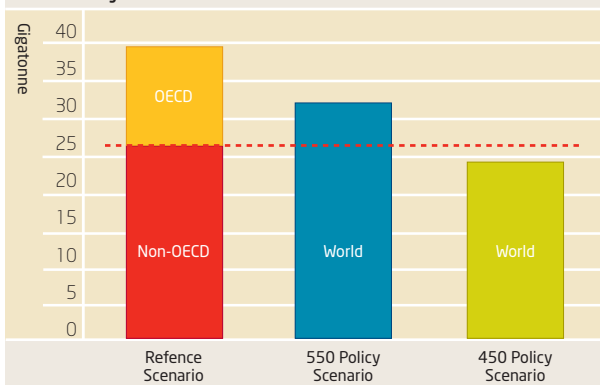
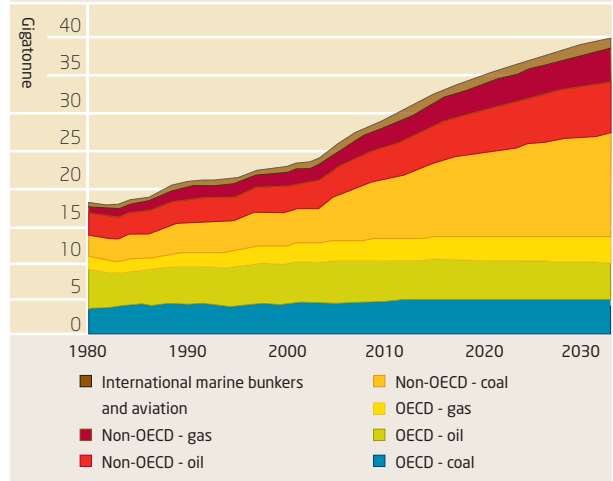

Figure 4  
Energy-related CO<sub>2</sub> emissions in the Reference Scenario - WEO 2008. 97% of the projected increase in emissions between now and 2030 comes from non-OECD countries - three-quarters from China, India and the Middle East alone.



heat on demand might have to sell surplus electricity to unfavourable prices.

With uneven distribution of the renewable resources both within countries and regionally an increased share of renewables will require better interconnections and stronger regional transmission grids. Furthermore, there are great differences from country to country across the world with regard to base load energy supply systems, giving further rise to challenges but at the same time also opportunities for optimizing the total supply system. Plans for major PV based production in North Africa illustrate this challenge, but it already exists on small scale in for example Denmark where the western part of the country on a windy day runs 100% on wind power and on occasion cannot consume all the power produced. Here interconnections are available but the unpredictability of the wind based supply means that export prices are very low valued on the spot markets. This indicates that integration is not only relevant for the infrastructure but also for the national or sub-regional markets. In addition it will be determined by the more technical constraints related to the overall power supply and stability and grid management and operation.

The overall short-term challenge related to addressing both climate change concerns and energy security will be to establish a more diverse low-carbon energy supply infrastructure where especially the power system would become gradually more decentralized in terms of having an increasing number of smaller renewable energy based production units. Such a development direction will if not require then at least ben-

efit from stronger regional interconnections and collaborations, which can be seen emerging in many regions of the world. Regional power pools are in place or emerging in sub-regions in Africa, as part of Mercosur in Latin America, between Central American countries, in US at state level, in South-East Asia and in China and India between local states and regions. In the long term, where many countries have low emission targets or even carbon neutrality objectives for 2050, renewable energy technologies should play a major role together with new advanced supply technologies. At the R&D level today there will be a strong need for advanced bulk storage facilities and cost-effective long distance electricity transmission capacity.

### Concluding remarks

The global economy has over the past years faced a number of changes and challenges.

Globalization and free market economy have been dominant for the last decade but the current financial crisis is rapidly changing the political landscape.

In the energy sector energy security and climate change mitigation are the two overriding priorities. This is especially true for industrialized countries and the more rapidly developing economies while it must be noted that many developing countries still face basic energy development constraints giving quite a different meaning to the concept of energy security.

Several options to address both climate change and energy security concerns exist, but will require strong global and national policy action focusing on low carbon energy sources in combination with a gradual change of the way the overall energy systems are designed:

- More flexible and intelligent energy system infrastructures are required to facilitate substantially higher amounts of renewable energy than today's energy systems. Such *intelligent and flexible* infrastructures will in fact be a prerequisite for achieving the necessary CO<sub>2</sub> reductions as well as ensuring the future security of energy supply in all regions of the world. In order to make such a transition of the current energy systems the shorter term policy actions must be combined with longer term research on new energy supply technologies, end-use technologies as well as the broader system interaction aspects.

# Challenges for a future Danish intelligent energy system

Poul Erik Morthorst, Risø DTU; Dorte Vinther, Energinet.dk, Denmark

## The major challenges for future energy systems

Once an insignificant fraction of the world's energy supply, renewable energy sources (RESs) are now gradually expanding their contribution. Today the dominant sources are large hydro, which supplies around 2% of global energy, and biomass, which amounts to a little more than 10%. Only around 1.5% of our energy comes from "new" renewable sources such as wind, photovoltaics (PV), small-scale hydro, biogas and non-traditional biomass. Nevertheless, while large hydro and traditional biomass are growing slowly or not at all, new renewable sources are expanding rapidly. Today the fastest-growing energy technology is PV, which over the last five years has increased by 35% annually. Wind power has grown by 28% annually over the same period – in absolute terms much more than PVs - and other new renewables are expanding too.

In Europe this growth is driven by both national and EU policies. By 2008 the EU member states had adopted long-term targets in three different areas of energy policy:

- a binding reduction in greenhouse gas emissions of 20% by 2020 compared to 1990; this target can be raised to 30% subject to the conclusion of binding international climate change agreements;
- a mandatory target for renewable energy sources such as wind, solar and biomass, which by 2020 must supply 20% of the EU's final energy demand; and
- a voluntary agreement to cut EU energy consumption by 20% by 2020, compared to a reference projection.

The EU has also set a target of 10% renewable energy, including biofuels, in transport by 2020.

This new policy, with its increasing reliance on renewable sources, will change European energy systems radically within the next decade. Energy technologies based on variable sources, especially wind power but to a lesser extent also wave power and PV, are expected to play a large role in the future energy supply. For example, by 2020 wind power is expected to supply 50% of the Danish electricity consumption – implying that from time to time significantly more wind power will be available than Denmark can consume<sup>1</sup>. This challenge will require not only significant changes in energy system structure, but also the development of intelligence within the system.

<sup>1</sup> Already today we have an excess supply of electricity in periods with strong wind.

Figure 5  
National renewable energy targets as a percentage of final energy consumption.

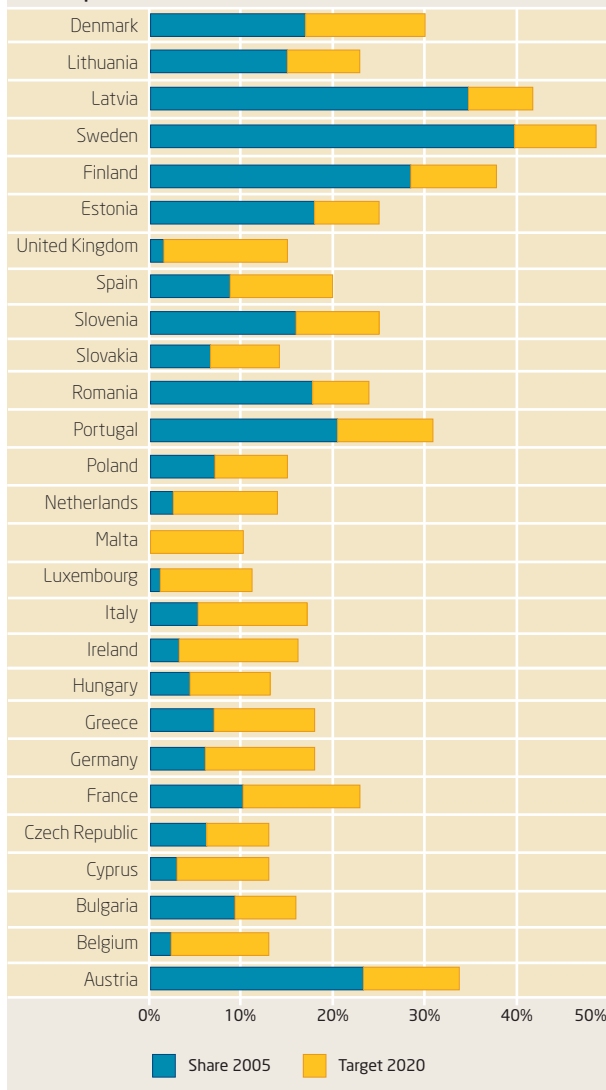

## What do we want to achieve?

The Danish energy system is characterized by an intensive use of combined heat and power (CHP) and renewable energy sources, especially wind power, which were developed in close relation to the development of the three national grids: power, district heating, and natural gas. Denmark is geographically located at the border between the Nordic countries and the continent and we have an extensive exchange of power and natural gas with neighboring countries.

Today's energy system is the result of decisions taken over more than a century; this is as true in Denmark as in the rest of Europe. This gradual development is reflected in the structure of the energy system, which in most cases is designed to meet basic engineering requirements: energy is produced to fulfill the needs of energy consumers, and made available according to these needs.

However, a new supply structure based on variable energy resources such as wind power will require a much more flexible energy system, and one which includes flexibility among energy consumers as well as suppliers. Thus the core of an intelligent system should include fast communication between energy producers and energy consumers.

Such communication might well be based on real-time pricing. Under such a system, the cost of energy is signaled to consumers who then respond by demanding more or less energy, according to whether the price is low or high. This would allow consumers to make productive use of a surplus of low-cost wind power, and restrict demand when supplies are scarce.

Figure 6

**Dialogue between energy producers and consumers can match demand to supply by adjusting prices.**

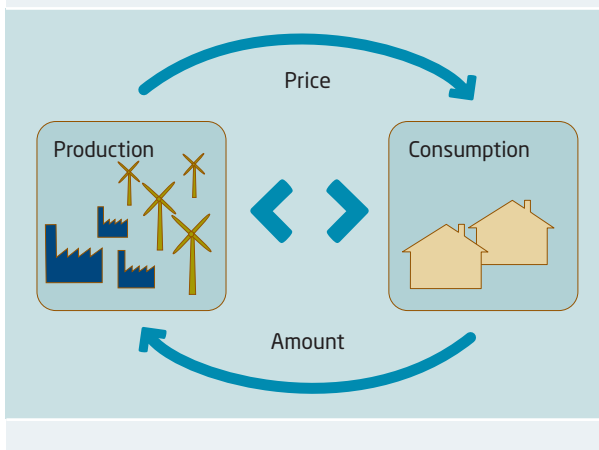

The Danish energy system is today characterized by a high degree of diversification and distribution based on the above-mentioned three national grids for power, district heating, and natural gas. This combination implies a highly efficient energy supply system incorporating a large fraction of combined heat and power.

Increased production of renewable energy in the future, primarily as wind power, must interact with these grids effectively if it is to displace as much fossil fuel as possible in the electricity, heat and transport sectors. In this respect, flexibility will be a key concern.

Thus an intelligent energy system has to:

- efficiently integrate large amounts of variable renewable energy sources
  - in power, heating, and not least in transport
- ensure that energy demand is met efficiently and appropriately
  - without compromising security of supply or consumer comfort
- facilitate energy conservation and efficiency improvement
- ensure reasonable energy costs for consumers
  - by implementing an intelligent system that is economically efficient.

### The role of the power system

As mentioned above, the predominant renewable energy resources in Denmark and northern Europe in the near future will be wind power and, perhaps in the longer term, PVs and wave power. In general, solutions based on electricity are characterized by high energy efficiency and flexibility in the use of renewable energy. As it is precisely these two factors that will be key to the energy systems of tomorrow, electricity will play a pivotal role.

Integrating markedly larger amounts of fluctuating electricity generation requires a re-think of the power system to accommodate more distributed production on land, plus a number of central fluctuating units in the form of offshore wind farms.

Within the power system, generation and consumption must always balance. It is therefore necessary always to have reserve capacity available to provide extra regulating power at short notice. The larger the proportion of fluctuating electricity generation, the greater the need for reserves to cover periods when there is no wind and the need to handle excess electricity production when the wind is strong.

Lack of wind power is not a problem in Denmark today; wind supplies only 20% of the country's electricity on average, and renewable energy has not yet displaced large power stations. At the moment, regulating power is supplied from central and local generation facilities and from abroad. In the future, extra regulating power can be provided by new thermal plants designed for rapid regulation and by new flexible technologies such as electric vehicles.

Surplus electricity during periods of strong wind, on the

other hand, is already a problem for about 100 hours a year, and is expected to become three to five times worse in a few years if appropriate measures are not taken.

An internationally connected, well-developed infrastructure and well-functioning international energy markets are essential to the effective integration of wind power. The expansion of interconnections will ensure that surplus electricity can be sold, and will also give Denmark access to areas with higher electricity prices, thus increasing the value of wind power.

Increasing the amount of electricity generated by fluctuating sources implies a need to tailor demand so that it is highest when plenty of wind power is available and prices are low. Technologies such as heat pumps and electric vehicles, which use significant amounts of electricity and can interact intelligently with the power system, will be useful here. Such technologies can increase the value of wind power, absorb surplus generation, and put wind power to use in sectors with the best potential for displacing fossil fuels and reducing CO<sub>2</sub> emissions.

In the long term, technologies aimed at ensuring flexibility over longer periods of time (weeks and months), including hydrogen, pump storage, large batteries and compressed air energy storage (CAES), can also help to balance the power system.

The energy system of tomorrow must therefore be able to handle complex interactions between grid interconnections, central and distributed generating equipment, fluctuations in generating capacity and certain types of controllable demand, while maintaining security of supply. This interaction must rely on market-based instruments.

All this means that the power system of tomorrow must be intelligent: it must be able to control, regulate and monitor itself to a greater extent than is the case today. Key components in the intelligent power system of the future will thus be systems for metering, controlling, regulating and monitoring power, allowing the resources of the power system to be used effectively in terms of both economics and operability.

Key to the development of an intelligent power system in Europe is the SmartGrids European Technology Platform. The vision of SmartGrids is to develop a power system that will create an optimum balance between environmental issues, market service and security of supply – in other words, to integrate renewable energy into the power system using demand response and new technologies.

To achieve this vision, the future power system must include communications and IT. Efforts are therefore directed at developing intelligent control, regulation and monitoring to enable optimum integration of renewable energy. The idea is that as much as possible of the equipment used to generate, transport and use electricity should contribute actively to solving operational tasks. The scales on which this will take place range from second-to-second control of generating and transmission equipment, right up to active participation in energy markets through intelligent price management.

Continuous development of metering, communications, market frameworks and regulatory frameworks for generation and consumption is a precondition for an intelligent power system:

- Extended use of intelligent electricity meters is needed to enable demand response. Intelligent meters will support tomorrow's electricity markets by enabling future producers and consumers to sell and buy on the spot market, and even within the current hour, to provide regulating power and ancillary services.
- Intelligent communications for tomorrow's producers and consumers will be crucial in converting metered data into an effective market. It is particularly important to develop communication standards for the new power system elements, including electric vehicles, so that they gain good access to the electricity market. Lack of an intelligent connection to the electricity grid will be expensive from a socioeconomic point of view and may require significant extra investment in grid capacity.
- The market framework must be developed on a rolling basis to ensure that the resources (flexibility and ancillary services) provided by tomorrow's players have free and equal access to the market. Flexible electricity consumption and generation must be translated into economic value for the provider via the market and communication standards. In practice, this means that the value offered by a flexible generator or consumer, be it a wind farm, a local CHP plant, an electric vehicle, a microCHP plant or a heat pump, must be able to participate in the spot market and the regulating power market. In the slightly longer term, it may be advantageous to shorten the time scale of the spot market, so that it operates closer to real time.
- As regards the regulatory framework, it is important that price signals to the market reflect real costs. If demand flexibility is valuable in managing local bottlenecks in the electricity distribution network, the consumers who

Figure 7

**Intelligent charging involves interaction between electric vehicles and the power system. Electric vehicle batteries should be charged when electricity is cheapest - typically between midnight and 7 a.m. - and when large amounts of wind power are available.**

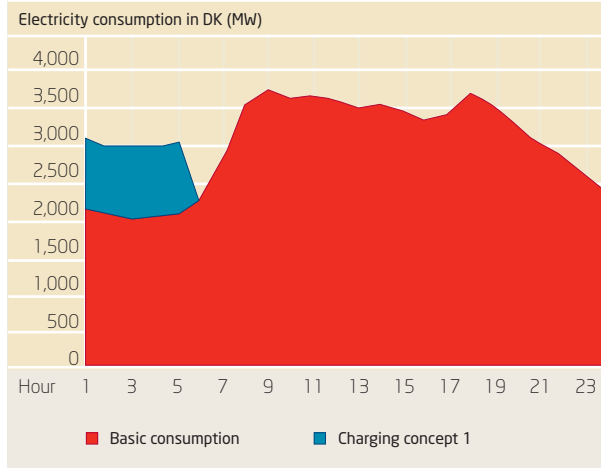

provide this flexibility should benefit. Thus, in the longer term, it may be necessary to adjust the tariff structure for distribution so that it continues to reflect real-cost payments in proportion to the consumer profile.

If these key elements are developed, the intelligent power system – interacting with other energy systems – will be able to contribute significantly to meeting future challenges.

## Electric vehicles

Electric vehicles can become a major asset to the Danish energy system and to the vision of integrating larger amounts of renewable energy. The combination of large-scale wind power expansion and increased use of electric vehicles holds a significant potential for social synergy. On the one hand, electric vehicles can add balancing and reserve capacity to the power system; this is valuable in the day-to-day operation of the power system and aids the integration of fluctuating electricity generation. On the other hand, electric vehicles will reduce oil dependence, pollution and noise nuisance, and may lower motoring costs for consumers. If electricity is produced by wind power, significant CO<sub>2</sub>-reductions in the transport sector will be achieved as well.

But electric vehicles must be intelligently connected to the power system (Figure 7). The design of the infrastructure and electricity market must ensure easy and inexpensive driving and exploit the possibilities of intelligent interaction with the power system. It is crucial to control the time of day when vehicles are charged, and especially the resulting pow-

Figure 8

**Simple charging means no intelligent interaction between electric vehicles and the power system. Instead, consumers charge their batteries whenever they wish, regardless of the current electricity price. In this model, most charging is expected to take place when people return from work, from 5 p.m. to 9 p.m.**

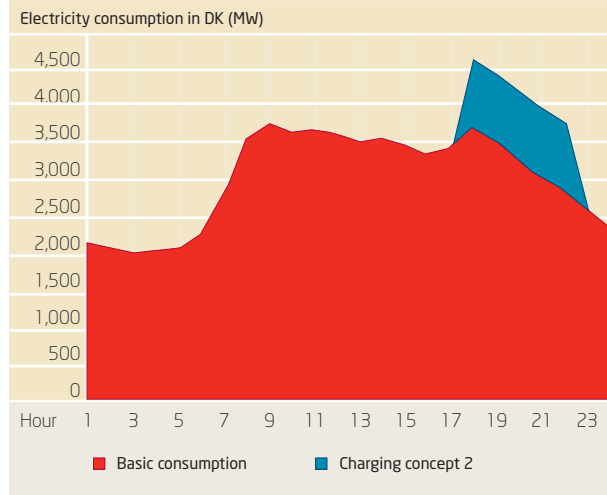

er demand, since power consumption must be matched to the available supply. Without intelligent interaction, electric vehicles will never reach their full potential (Figure 8), and may even become an expensive load on the power system.

One ambitious scenario assumes that by 2025, electricity will provide 15% of the energy used by road vehicles in Denmark. Such an expansion of electric vehicles would reduce CO<sub>2</sub> emissions in the Danish transport sector by 2 million tonnes a year and cut the amount of gasoline and diesel consumed for transport by 32 PJ a year. In comparison, Denmark's present total energy consumption for road transport is about 170 PJ a year, with CO<sub>2</sub> emissions of about 13 million tonnes a year. This study shows that intelligent interaction between electric vehicles and the power system yields a considerable socioeconomic profit.

However the socioeconomic advantages of electric vehicles, and their specific advantages to the power system, will only materialize if electric vehicles are charged intelligently – when the electricity price is low. If they are charged whenever consumers wish, regardless of the current electricity price, we will need to make comparatively large investments in generating capacity and distribution infrastructure. The lack of intelligent interaction will be expensive, and will stress the power system significantly. Consequently, it is crucial to ensure intelligent interaction between the power system and electric vehicles.



### Interactions with other sectors

Though the power system has a vital role to play in the intelligent energy system, district heating and natural gas are important as well. Also of interest are a number of new technologies, either available now or in the development pipeline, that may serve to link the three systems.

To link the heating system and the power system, heat pumps are promising. In this case, heat pumps would take energy from the air or the ground, and use this energy to produce hot water that could be stored before being used to heat individual houses or in district heating systems. With intelligent control and real-time market information, systems like this could use low-cost electricity to good effect.

A link between the power sector and the transport sector could be created through technology such as the IBUS biorefinery developed by Danish company Inbicon A/S, a subsidiary of DONG Energy. These flexible plants use wind power and biomass to produce heat, liquid transport fuels (methanol and ethanol) and electricity, in proportions depending on demand and relative prices (see figure 9). A demonstration facility is currently planned in Denmark.

Finally, various kinds of storage facilities will help to make the energy system more flexible. An example is compressed air energy storage (CAES), in which excess power from wind turbines is used to compress air, which is then stored in large underground chambers or aquifers. When more power is needed, the compressed air can be mixed with natural gas, which is then burned to power gas turbines. A CAES plant in Germany (Huntorf) is used mainly for balancing wind power.

### Recommendations

It will not be possible to integrate large amounts of new renewable energy sources – wind power, wave power and PV – into the Danish energy system without intelligent control and regulation systems. However, the intelligent energy system will also facilitate far-reaching energy conservation and efficiency measures by adding significantly to their profitability.

Prerequisites for an intelligent system include:

- Intelligent electricity meters and communication standards to enable flexible matching of demand and supply. It is highly recommended that intelligent meters should be installed in homes and businesses as quickly as possible, and communication standards introduced to ensure compatibility between the components of the intelligent system.
- A market framework must be developed to ensure that future flexible supply and demand, plus ancillary services, have free and equal access to the market. In practice, this means that flexible generators and consumers must be able to trade on the spot market and the regulating power market. In the slightly longer term, it may prove advantageous to move the spot market closer to real time.
- Intelligent electric vehicles could be highly advantageous to the power system as well as the transport network, facilitating the integration of variable renewable energy sources. This requires standards for intelligent communication between electric vehicles and the power system, thus providing electric vehicles with open and equal access to the electricity market.

Figure 9  
Linking the power, heat and transport sectors: the IBUS biorefinery developed by Inbicon A/S.

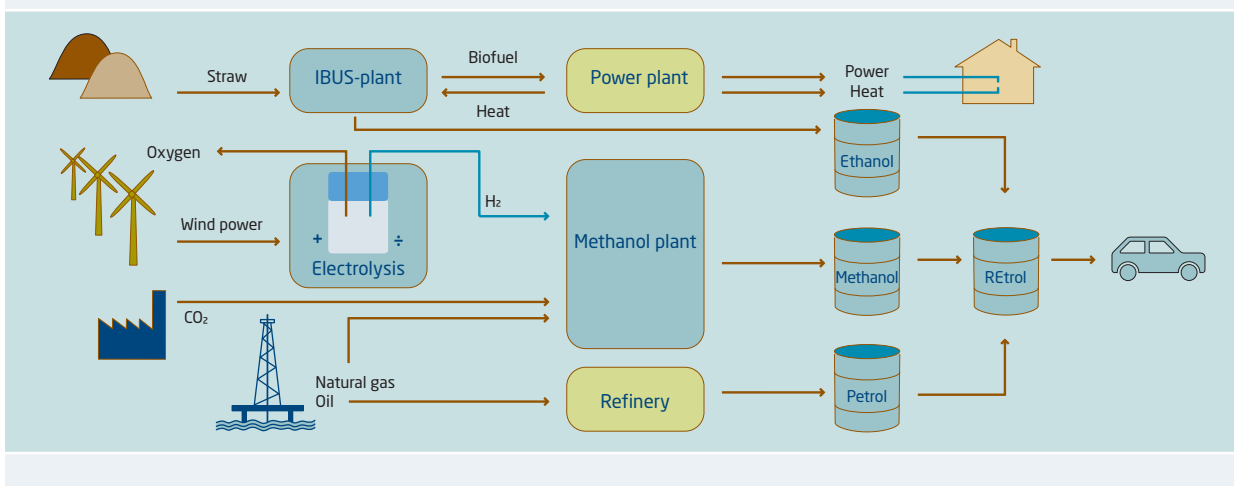



- Heat pumps could provide an important link between the power and heating sectors. Heat pumps differ widely, however, so it is important to install designs with the right technical and economic characteristics to interact with variable energy sources such as wind power. Unsuitable types of heat pump could hinder the overall energy system instead of improving it.
- As a supplement to electric vehicles the Danish IBUS concept, which includes integrated production of power, heat and transport fuel, looks interesting from a systems viewpoint. It is important to prove the flexibility under real conditions, and the first results from the demonstration facility are awaited impatiently.

# Market and grid challenges: planning for large-scale renewables

Peter Meibom, Poul Sørensen, Jens Carsten Hansen, Risø DTU

The planning and operation of large interconnected power systems take place over a broad range of time scales (Table 2). This chapter outlines the planning issues facing the greatest challenges from the large-scale introduction of renewables, and discusses ways to deal with these challenges.

The main difficulties are caused by the variability and limited predictability of power from renewable sources such as wind, photovoltaics (PV) and waves. Uncertainties over future prices of biomass are important, but no different in principle from the well-known uncertainties over trends in the prices of fossil fuels, wheat, rice and corn.

The following sections present and discuss the planning issues influenced by large-scale renewables starting with the longest planning horizons.

## Investment decisions: years to decades

The lifetimes of power system components such as generating plants and transmission lines are in the range 20–60 years. Construction takes 2–10 years, including planning procedures, which especially in the case of transmission lines can be very prolonged.

The decision to build a power plant or transmission line therefore requires cash flow and socioeconomic benefits to be estimated many years ahead. These estimations involve scenarios for the future development of key parameters such as CO<sub>2</sub> permit prices and fossil fuel prices. In turn, it is important to estimate the future capacities and locations of renewable energy generating plants with fluctuating outputs, because they will influence power prices.

## Power plants

Taking wind power as an example, expected production is bid into day-ahead power markets. Bidding prices for wind power are low because the short-term marginal production costs of wind turbines are very low. In areas with large amounts of wind power, such as western Denmark [3], this lowers the day-ahead power prices to the point where wind displaces conventional production from the day-ahead market.

Due to the limited predictability of wind power, however, demands for rescheduling and regulating power on the intra-day and minute reserve markets increase. This raises prices on these markets for flexible production and consumption.

Table 2  
Overview of market and grid issues divided according to time scale.

Time scale	Market and grid issues
Decades	Lifetime of power plants and transmission lines
Years	Financial and fuel contracts; new generating capacity; new transmission lines
Year	Financial and fuel contracts; procurement and auxiliary services; explicit auction
Month	Financial and fuel contracts; procurement and auxiliary services; explicit auction
Day	Day-ahead markets for power, reserves and auxiliary services; implicit or explicit auction; estimating transmission capacity available for power markets
Hour	Intra-day markets; implicit or explicit auction
Minute	Activation and exchange of minute reserves; grid monitoring and protection
Second	Activation and exchange of spinning reserves; grid monitoring and protection
Millisecond	Inertia; grid monitoring and protection

“Spinning reserve” refers to spare capacity that is only available from units that are actually generating. It corresponds to the sum of primary and secondary control reserves in the UCTE definition [1], and the sum of frequency-controlled normal operating reserve and frequency-controlled disturbance reserve in Nordel terminology [2].

“Minute reserves” provide regulating capacity within 5–15 minutes of being called upon. They are known as tertiary reserves in the UCTE grid code and secondary reserves in the Nordel grid code.

“Explicit auction” allocates transmission capacity to market participants in a sequence of auctions that often take place yearly, monthly and daily. Generating companies therefore have to estimate their demand for transmission capacity long before the actual operating hour, and somewhat independently of planned power production and consumption.

“Implicit auction” is a market clearing process that simultaneously distributes power production and consumption on producers and consumers, and determines the use of transmission lines to carry power between pricing areas. It is used for example in the day-ahead market of the Nordic power pool.

The large-scale introduction of fluctuating renewable energy will therefore produce market conditions which favor flexible power plants with lower investment costs than traditional base-load plants such as nuclear power. This does not imply that we will not still see investment in base-load power plants, because their competitive advantage due to lower fuel prices – coal versus natural gas, for instance – may outweigh the benefits of flexibility and low capital cost.

Large-scale introduction of variable and partly predictable renewable energy complicates the investment decisions for power generation and energy storage plants. Firstly, as explained above, because renewables influence power market prices, and secondly because of uncertainty over the future of political schemes supporting renewable energy projects that would otherwise not be economic. As most renewable energy investments still depend on public funding, it is important to set long-term targets for renewable energy capacity or CO<sub>2</sub> emissions with wide support across political parties, so as to encourage consensus on the future of renewable energy.

### Transmission lines

Investment in transmission lines is different from investment in generating units, since the former depends more on geographical price differences than on the prices themselves. A large price difference, lasting for many hours, between two neighboring pricing areas suggests that increasing the transmission capacity between these areas might have socioeconomic benefits.

Transmission line investment is measured according to its socioeconomic benefits because it is typically carried out by monopoly companies – transmission system operators (TSOs) – whose profits are regulated by society. The location of renewable energy sources is a compromise between the distribution of wind or wave resources and the ability of the existing grid to transfer the resulting power to places where it can be used. However, aggregating production over large geographical areas will help to mitigate the variability and limited predictability of power from sources such as wind (Figure 10).

Investment in transmission lines is therefore important to the successful integration of fluctuating renewable energy.

Reinforcing the transmission grid does not greatly increase the cost of converting power systems to larger shares of renewable energy. A study of how the Irish power system could be transformed to use a large proportion of wind

Table 3  
Ways to expand the transmission grid and increase the capacity of existing lines.

Measure	Problem	Solution
Build new lines	Local opposition towards overhead lines	– Underground AC cables
		– Offshore subsea HVDC cables
		– High-temperature overhead lines, which carry more power than their conventional equivalents
Use existing lines better	Explicit auctions	Implicit auctions, which optimize power production and power exchange at the same time
	Rigid capacity limits	– Line-temperature monitoring – Wide area monitoring and protection systems

Figure 10  
Increasing the geographical area over which wind power is aggregated significantly reduces its variability. The data is taken from operating wind power plants, except for Sweden, where simulations representing 4,000 MW of capacity at 56 sites were used. The figure is a reproduction of Figure 7 in Chapter 4.

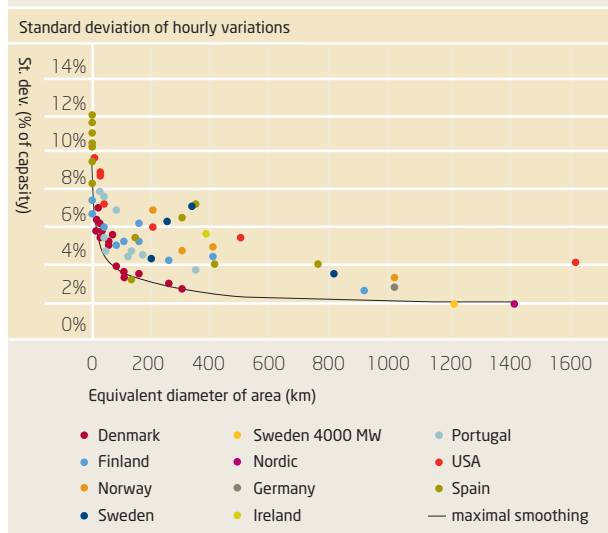

power [5] shows that the annualized investment cost of network reinforcements would be only 1–2% of the total yearly investment and operational costs. Grid reinforcement is still a major obstacle, however, as many communities are reluctant to accept new overhead lines. Table 3 summarizes ways to increase transmission capacity by expanding the grid and improving the utilization of existing lines. In expanding the transmission grid there are three alternatives to new overhead lines:

- Denmark has decided to gradually replace its existing 132–150 kV overhead lines with underground AC cables [6] and also selected parts of the 400 kV overhead lines. Investment costs for underground cables are higher than for overhead lines, but the gap is narrowing [7]. As the

electrical properties of underground cables are different from those of overhead lines, careful engineering analysis will be needed. As well as not spoiling the view, underground cables suffer fewer weather-related problems than overhead lines, but fault location and repair are probably more difficult.

- Countries like Denmark, Germany, Great Britain, Norway and Sweden have ambitious plans to expand offshore wind power. Offshore wind turbines have so far been connected by high-voltage direct current (HVDC) subsea cables running only as far as the nearest landfall. A new suggestion is to build offshore grids that would link several offshore wind farms to several onshore connection points.

Such offshore grids would allow wind power from an individual offshore wind farm to be sold in any one of several different countries or power markets, depending on the relative prices at the time. The variability of offshore wind would also make some of the transmission capacity of the offshore grid available for exchanging power between the countries concerned.

Offshore grids could also avoid the need for grid reinforcement on land by allowing wind power to be fed into the onshore transmission grid closer to centers of consumption. Research on the topology, costs and operability of offshore grids in the North Sea is underway [8].

- Resistive power losses in AC overhead lines cause heating and thermal expansion, which in turn allows the cable to sag. Because of the need to maintain a safe distance between the cable and objects beneath it, the allowable sag normally limits the maximum current the cable can carry. Replacing conventional copper or aluminum cables by

materials with lower thermal expansivity could increase overhead line capacity by up to 50% [7], at the expense of higher transmission losses.

Apart from building new transmission lines, existing lines should be used as efficiently as possible. Wide area monitoring and protection systems, and line-temperature monitoring, provide detailed information that allows operational conditions to be taken into account when setting capacity. For example, high wind speeds keep overhead lines cooler and so allow them to carry more current without sagging dangerously. Explicit auction, another way to increase utilization of existing lines, is discussed below.

### Procurement and ancillary services: months to days

Several important functions in energy supply are planned over time scales of up to a year. These include fuel price contracts, financial products relating to future power prices that are used for hedging and speculation, and ancillary services. Another example is the explicit auction of transmission capacity, which takes the form of a sequence of yearly, monthly and daily contracts.

Some auxiliary services, for example reactive power, can be provided from fluctuating renewable energy sources such as wind power. The involvement of fluctuating renewable energy in the delivery of auxiliary services will benefit from shifting the procurement time scale closer to the actual hours of operation, creating day-ahead or intra-day markets for auxiliary services.

Table 4 gives an overview of operational actions and decisions in the time scale of minutes to day.

Table 4

**Operations on a time scale of minutes to days. Implicit auction of transmission capacity is assumed.**

Operational actions	Responsible	Time scale
Forecast electricity demand and production from fluctuating renewable energy	Producers, consumers, TSOs	Morning of day before
Determine transmission capacity available for day-ahead power market	TSOs	Morning of day before
Determine next day's demand for minute reserves	TSOs	Morning of day before
Procure minute reserves	TSOs	Day before
Bid on day-ahead power market	Traders, producers, large consumers	Day before
Clear day-ahead power market	Operator of power market	Day before
Create production plans based on day-ahead power sold	Power producers	Day before
Reschedule power plants and transmission line usage in light of new information on loads, fluctuating renewable energy forecasts, and plant and line outages. Can be organized as intra-day markets or initiated by TSO	Producers, consumers, TSO	Within operating day
Bid minute reserves on regulating power market	Flexible producers and consumers	Up to one hour before operation hour
Activate minute reserves, including changes to planned exchanges via transmission lines	TSOs	Within operating hour

### Operation: days to seconds

Operations on a time scale of milliseconds to seconds involve issues such as inertia (Chapter 6) and grid protection (Chapter 8). Spinning reserve handles fast changes in production and consumption. The variability of large scale wind power from minute to minute is low. Demand for spinning reserve is therefore only weakly influenced by the introduction of wind power [4], and will not be discussed further in this chapter.

A study known as Tradewind analyzed the importance of market designs for wind power integration [9]. One of its main conclusions was that the limited reliability of day-ahead wind forecasting means that power systems with high proportions of wind power need good mechanisms for the dispatch and rescheduling of generating units and power exchange via transmission lines. This implies that when allocating transmission capacity, implicit auction is preferred over explicit auction.

Intra-day rescheduling can either take place through intra-day markets or be organized by the TSOs. It is important to create incentives for traders to take part in intra-day rescheduling, because if they do not, the entire difference between the day-ahead production and consumption plans will have to be regulated within the operating hour – and the system may not have enough flexibility to achieve this.

Power injected at one grid node flows to neighboring nodes along the paths of lowest impedance, as determined by Kirchoff's circuit laws. Unfortunately, neither implicit auction nor explicit auction as used in most of Europe take the physics of meshed power grids fully into account. For example, wind power produced in northern Germany flows not only down to central Germany but also to Belgium and Poland, so actual power flows can be very different from those estimated on the day-ahead market.

Market models that take into account the physics of meshed power grids are described as using locational marginal pricing. Such models are used by, for example, the regional transmission organisation PJM in the US. They might be useful in continental Europe to avoid the large differences between contractual and realized power flows that sometimes occur [10].

New trans-national intra-day markets and markets for minute reserves would be beneficial, because they would provide geographical smoothing of deviations from day-ahead production and consumption plans, and increase flexibility by providing access to a larger pool of low-cost resources.

### Main observations and recommendations

Observations regarding future power systems with high proportions of variable and partly predictable renewable power are:

- Large-scale introduction of fluctuating renewable energy will produce market conditions which favor flexible power plants with lower investment costs than traditional base-load plants such as nuclear power.
- Although network reinforcement costs are low relatively to the total costs of transforming power systems into having high shares of renewable energy, they constitute a major obstacle due to many communities being reluctant to accept new overhead lines.

Recommendations are:

- Implementing national long-term targets for renewable energy will reduce uncertainty for investors in conventional power plants and storage technologies.
- Power market designs supporting intra-day rescheduling of operation of power plants and storage units, and intra-day rescheduling of power exchange will reduce the costs related to the partly unpredictability of wind power and other fluctuating power production.
- Introduction of locational marginal pricing or a similar mechanism to the power markets, to reduce differences between contractual and realized power flows in meshed power grids.
- Creation of trans-national intra-day markets and markets for minute reserves, in order to share low-cost flexibility resources.
- Closer monitoring using wide area monitoring and protection systems, and the use of this information to allow system limits, such as transmission capacity, to vary according to actual operating conditions.

# Flexibility, stability and security of energy supply

*Poul Sørensen, Risø DTU*

## Introduction

Stability is essential to any energy system that is to operate satisfactorily and serve its customers adequately. Stability is a particular concern in electric power systems, which are very vulnerable if they are not properly prepared for system disturbances. Stability is essential if we are to maintain the existing high standard of electricity supply in modern power systems, with the minimum number and duration of blackouts and disturbances.

There are several reasons why power systems are particularly vulnerable. First of all, they require voltages and frequencies to remain within narrow margins, and units will trip if the limits are exceeded. Furthermore, the transmission and distribution grids suffer frequent disturbances because their huge areas create a high risk of lightning strikes and damage to overhead lines.

The stability of the power system traditionally depends on ancillary services provided by conventional thermal or hydro power plants. However, a future intelligent power system operated in such a way as to minimize costs and emissions will often have less conventional generating capacity online, especially when production from renewables is high. We therefore need to find other ways to ensure system stability.

The ability to do this economically will be a key performance indicator for a future intelligent energy system. Such a system should be able to monitor itself in real time, assess the need for ancillary services to provide stability, and call on these when necessary. For example, when a storm front is approaching and sudden shutdowns of a large capacity of wind power plants are expected, the system should call on reserves elsewhere.

Different types of ancillary service differ noticeably in the geographical areas they cover. Automatic frequency dependent reserves, for instance, are shared between TSOs in large interconnected systems such as the Europe-wide UCTE and NORDEL synchronous systems, whereas reactive power and voltage control support are needed more locally. These differences influence the design of the infrastructure used to provide the various ancillary services required for grid stability.

## Power system inertia

Power system inertia is a service which is crucial to system stability, and which is provided implicitly by large central power plants. The inertia of the spinning turbines and generators in these plants ensures that the frequency of the AC power generated does not change too fast when power generation is out of balance with consumption.

In an interconnected power system, the synchronous generators used in large power plants all rotate at the same speed, as determined by the nominal system frequency. Dynamic effects will produce some speed differences between generating units sited far apart, but in general, speed is tied very closely to frequency.

When a power plant trips out, i.e. stops generating because of a fault, the total amount of power being generated drops instantaneously, but the amount of power being used by consumers remains the same. As a result, the total electric power supplied by all the synchronous generators in the system is higher than the total mechanical power (from steam turbines and gas turbines) that is driving the generators. This unbalance causes the synchronous generators to slow down, with the result that the frequency starts to fall.

If the frequency does not fall too quickly, there will be time for the remaining power plants to increase production and thus re-establish the power balance. If this does not happen, the frequency will drop to a critical value at which other generators trip out due to critical underspeed, creating a domino effect, which can cause widespread blackouts.

The rate of change of frequency is essentially governed by two physical factors: the size of the imbalance, and the total rotating inertia in the power system, i.e. power plants and consumption (motor loads, e.g., pumps). For design purposes the imbalance is normally given by the loss of the largest generating unit in the system. Maintaining the frequency at an acceptable interval therefore requires a certain minimum inertia.

When renewable energy sources replace large central power plants, the inertia of the power system often falls as explained below. Fixed speed wind turbines with directly connected generators do contribute inertia, but the inertia is typically less than in conventional power plants of the same capacity. Standard variable speed wind turbines do not contribute to the power system inertia, because their rotational speeds are independent of frequency, neither does solar power (PV), simply because there is no rotating mass to provide the inertia. Due to the relatively low share of installed PV capacity this is not likely to be an issue in near future.

The net effect depends on the technology used to connect wind turbines to the grid, and the number of conventional power plants that are switched off as a result. In good wind conditions, wind turbines will replace more conventional power plants, and total inertia is likely to fall.

The lack of power system inertia provided by variable speed



wind turbines is particularly relevant for the stability of island power systems with large amounts of wind power. But large scale wind power in areas of large interconnected systems has also been shown to influence frequency and power oscillations [1].

Holdsworth et al [2] in 2004 proposed *virtual inertia* control of variable-speed wind turbines. The idea is to modify the control of the power conversion system so that it responds to the rate of change of frequency in the same way as a real synchronized generator with inertia.

In principle, the amount of virtual inertia can be adjusted simply by changing a control parameter. If the inertia is set too high, however, there is a risk that the wind turbine generator will lose too much speed, making the turbine unstable and unable to supply the required power. Figure 11 shows simulations of how virtual inertia can improve the simulated response of a power system containing wind turbines when faced with a loss of 5% of generating capacity. The frequency drops faster and deeper in a system where ordinary variable-speed wind power replaces conventional generation. Thus, simulations indicate that adding virtual inertia mitigates the problem, although there is not yet any experimental proof of this.

Several TSOs are now considering adding to their grid codes a requirement for virtual inertia control in variable-speed wind turbines.

Figure 11

**Simulated frequency response to loss of 5% of generation, with (a) no wind power, (b) 50% wind power without virtual inertia, and (c) 50% wind power with virtual inertia. The simulations are done with a simple pu. power system model, including governor and prime mover (turbine) dynamics of conventional generation, and dynamic wind turbine models.**

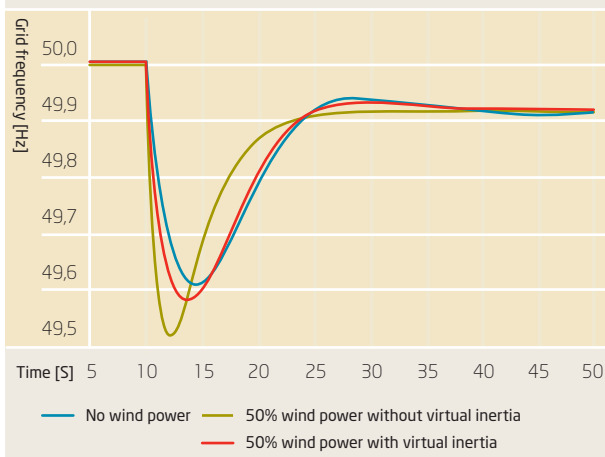

## Governor response

Inertia can only prevent the frequency from falling too fast immediately after the loss of a generating unit. As the frequency changes, the speed governors in the power plants are needed to reestablish the rotor speed and consequently the frequency. Figure 11 shows this recovery process graphically: the frequency begins to drop because a power plant trips out at time  $t=10$ s. In the beginning, this is almost a linear drop, with a slope that is determined by the inertia, but as the frequency decreases, the governors respond and increase it again at  $t=12-15$ s. At  $t=40$ s, the governors have stabilized the frequency again, though still below its nominal value.

When renewable generation supplants conventional central generation units with speed governors, the associated automatic frequency dependent reserves also need to be replaced. In interconnected systems, this is often not a big task, because the frequency dependent reserves are shared between the interconnected areas. Thus Denmark must provide primary reserves (i.e. automatic frequency dependent reserves) of  $\pm 26$  MW to UCTE and  $\pm 23$  MW to the Nordic system under normal operating conditions, plus a further 171 MW to the Nordic system when the frequency gets below 49.9 Hz.

Negative reserves are generation that can be downregulated when the frequency is too high. Negative reserves can be provided by wind turbines that downregulate temporarily when the frequency increases. This may be a good solution, because the wind power is only downregulated temporarily while the frequency is too high, and therefore the associated amount of lost wind power is fairly small.

Wind turbines can also provide positive reserves if they run continuously in downregulated mode. This is a much more costly solution, however, because downregulation continuously wastes power that could otherwise be sold. Still, in systems with very large amounts of wind power, it may be economic to provide positive reserves from wind power when wind speeds are high and electricity prices low or negative.

A more promising source of positive primary reserves is demand response, (Chapter 7). Since the frequency will normally only be low for periods of 15 minutes or so, until new fast accessible capacity (regulating power) can be brought on line, equipment such as refrigerators, freezers and air conditioners can generally be switched off without harm.



## Regulating power

As indicated, regulating power is needed to bring the frequency back to its nominal value (50.0 Hz or 60.0 Hz depending on the system) after it has stabilized at a lower level. A frequency below the nominal value signals that the automatic frequency dependent reserves have been activated, so they will not be available if another generator trips out. The system is therefore in an alert state whenever the frequency is low, and needs to be quickly brought back to normal. Once regulating power comes online, the frequency dependent reserves are released, and the system returns to a less vulnerable state.

Figure 12 shows an example of a response to a power plant trip, with a primary response like that of Figure 11, but followed by a secondary response that re-establishes the nominal frequency by allocation of regulating power. When the regulating power comes online, it releases the (primary) automatic frequency dependent reserves. The secondary response time here is 30 minutes, but many systems will recover quicker.

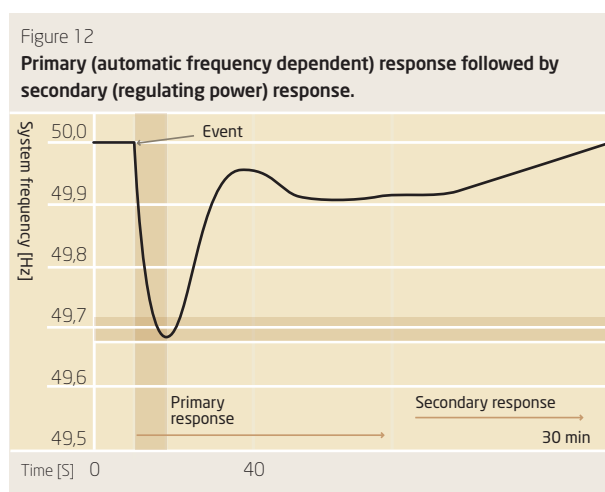

As with automatic, frequency dependent reserves, regulating power can be provided by downregulating wind turbines, which may be economic when the wind speed is high and power prices low, or by demand response. But regulating power must be able to operate for much longer periods than frequency dependent reserves do, and this may cause problems when demand response is used. For example, refrigerators can provide regulating power, but only as long as their temperatures remain at acceptable values. It is thus a challenge for an intelligent system to make sure that it does not run out of regulating power.

## Response to grid faults

The ability to tolerate grid faults (fault ride-through capability) has become a key issue in the large-scale use of wind power. This is reflected in the grid codes – the rules that govern the behavior of generating equipment connected to the grid. Every country planning to develop large-scale wind power now has grid codes dealing specifically with wind turbines.

The purpose of fault ride-through is to ensure that wind turbines are able to stay connected to the grid during and after a grid fault such as a short circuit. If this does not happen, the resulting sudden loss of wind generation can turn a minor grid fault into a more serious incident. Fault ride-through is not unique to wind turbines. Similar capabilities are required of conventional generators to ensure that the system will continue to operate after a short circuit. It will also be necessary for other renewable resources when they are used on a large scale within a power system.

The TSOs require that the mathematical simulation models used to design wind power plants take grid faults into account. The wind power industry provides these models today, and in several countries the TSOs are working with generic models for the main types of wind turbines. The International Electrotechnical Commission (IEC) has just agreed to start work on a new international standard for such models [3].

## Geographical spread and storm control

The planned development of offshore wind power in northern Europe is very ambitious. Experience with large offshore wind farms in Denmark has shown that concentrating wind turbines in relatively small areas causes power fluctuations to increase significantly [4]. Another consequence is that the need to shut down wind farms when a storm passes through can be expected to have more severe effects as offshore wind power grows in scale, and as a consequence, the shut down must be controlled in an intelligent way, based on forecasts and coordinated with operation of other units in the power system. Such a control, based on forecasts, implies intelligence.

The Danish TSO Energinet.dk issues a system plan every year. The 2007 system plan [5] included for the first time a description of how Energinet aims to meet the challenges of the national plan, A Visionary Danish Energy Policy 2025 [6], which involves a large expansion of wind power. Energinet's plan suggests that future offshore wind farms should be

spread out over a wide geographical area so as to reduce the overall effect of storms.

Still, the number of sites suitable for offshore wind power is limited, and according to the Danish Energy Authority more than about 2,000 MW of wind farms may need to be concentrated along the Danish west coast [7] if the country is to reach its ambitious targets for 50% of electricity supplied by wind power. On top of that, wind farms will be built in Germany and the Netherlands on sites that may well be affected by a single storm front at about the same time.

With such geographical concentration of wind power, it is important to be able to shut down these large wind farms in a controlled way as a storm approaches, rather than waiting for individual wind turbines to shut themselves down when the storm strikes. The shutdown must be done intelligently

to ensure that system security is maintained, the wind turbines are not overloaded mechanically, and at the same time a minimum of power is lost. Accurate storm predictions will help to minimize power losses and ensure that the system has enough time to shut down the affected wind farms and ramp up other generating sources in a coordinated way.

The importance of geographical spread is illustrated below by a simulation of wind power variability over a four-day period with two different scenarios for wind power development. Figure 13 shows the first scenario assuming four wind farms concentrated around Horns Rev on Denmark's west coast, while the Figure 14 scenario assumes two wind farms at Horns Rev and two at Djursland-Anholt, i.e. distributed over a larger area. A storm passes Horns Rev 29 January at night, which causes the wind power to drop dramatically

Figure 13

**When large offshore wind farms are concentrated in a small geographical area, the passage of a storm can cause production to drop to zero. This is here illustrated with simulation of power generated by 4 wind farms located at Horns Rev (HR1, HR2, HRA and HRB).**

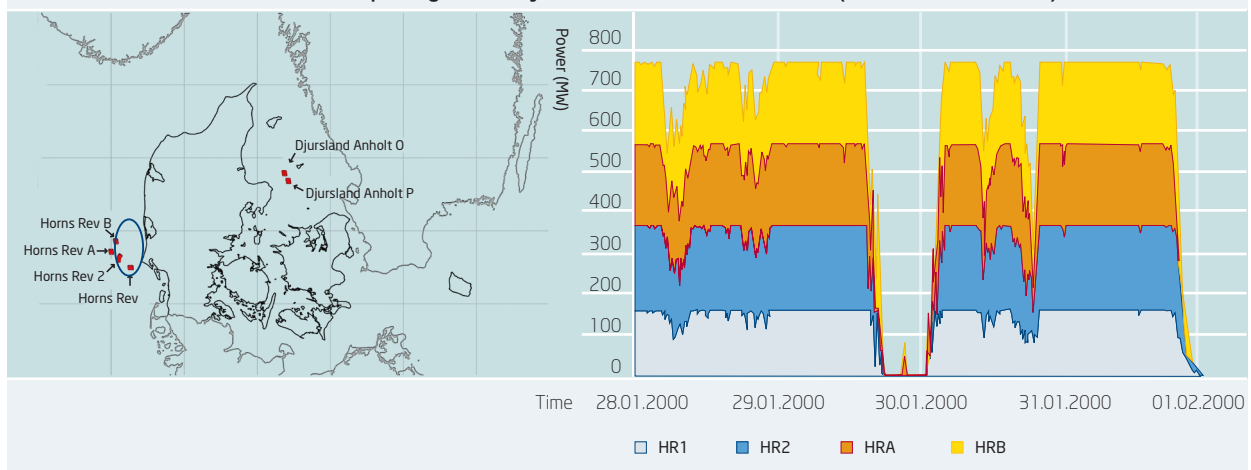
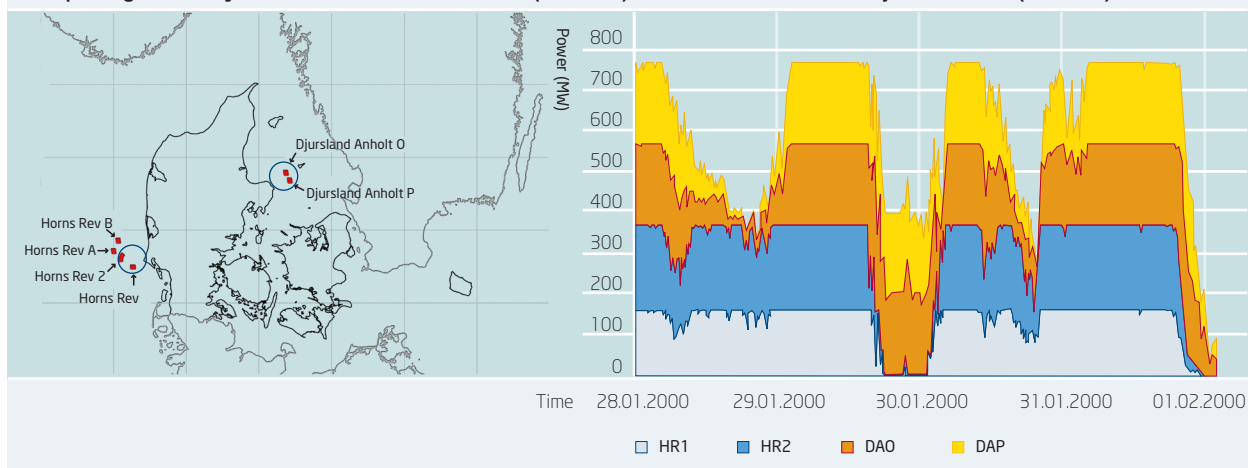

Figure 14

**With the same wind farms spread over two different parts of the country, the storm reduces but does not halt production. This is here illustrated with power generated by 2 wind farms located at Horns Rev (HR1, HR2) and 2 wind farms located at Djursland-Anholt (DAO, DAP).**



with the first scenario, but less dramatic in the second scenario. Also, when the wind speed decreases on the following day (30 January), then the summed wind power drops much faster in the first scenario than in the second.

### Reactive power and voltage control

Reactive power is needed to keep the voltage on the grid within an acceptable range: the maximum allowable deviation from the nominal voltage is typically  $\pm 10\%$  or less. Reactive power is also needed to enable power to be transmitted over longer distances. In a conventional power system, reactive power is typically provided by central power plants, supplemented by compensation units such as capacitors, static VAR compensators (SVCs) and synchronous condensers.

Reactive power can in principle be transmitted over large distances, but this is detrimental to voltage stability and decreases transmission capacities and increases transmission losses. Reactive power is therefore a local issue, where the location of the sources is much more important than is the case with frequency dependent reserves and regulating power.

The growth of renewable energy promises to offer new sources to the control of reactive power and voltage. Modern wind turbines with power converters can control reactive power quickly and continuously, as can grid-connected PV systems. Most local CHP (cogeneration) plants, as widely used in Denmark, can also control reactive power. To date, these options have not been used to their full potential, so this is an important task for a future intelligent energy system.

### Short-circuit power and system protection

Conventional methods of fault protection in power systems rely on the fact that the synchronous generators of large central power plants will produce very high currents under short-circuit conditions. Traditional HVDC lines, which operate using a principle known as line commutation, also rely on sufficient short-circuit power being available.

Power systems containing large amounts of distributed generation, including renewable sources, lack sufficient short-circuit power unless measures are taken to correct this.

One option is to install synchronous compensators, which provide controllable reactive power (see above) as well as short-circuit power. Alternatively, new intelligent methods of system protection such as wide area measurement systems (WAMS) may provide a solution.

### Conclusions and recommendations

The infrastructure of the future intelligent energy system should support the provision of ancillary services from sources other than the central power plants. This is because the economic operation of future power systems will reduce the capacity of central power plants to remain online especially in periods with high wind speeds and low electricity consumption.

Ancillary services provided by wind power plants and other renewable resources will become increasingly important as the penetration of renewable energy increases.

More specific, the following issues should be mentioned:

- Virtual inertia can be provided from wind power to replace the lost power system inertia when conventional power plants are shut down. This can be done without loss of wind power production.
- Wind power can provide reserves, but this will typically reduce the amount of wind power generated, so it is only useful when the value of the reserves is higher than that of the lost wind power.
- Since reactive power and voltage control is a local issue, it is particularly obvious to look for solutions to activate the not fully used reactive power resources in distributed generation units.
- There should be special focus on intelligent solutions to the problems that storms cause for wind power. This is especially the case for the North Sea, where storms are relatively frequent and where wind power is expected to increase dramatically in the next 10–20 years.



*Jacob Østergaard, Chresten Træholt, DTU Electrical Engineering; Mikael Tøgeby, Ea Energy Analyses, Denmark*

The electricity system of the future will require increased flexibility to ensure that it can continuously balance fluctuating renewable energy sources such as wind, solar or wave power. The EU's goal is that renewables will make up 20% of all energy consumption by 2020 [1]. Since the various EU member states have different prospects for renewable energy, some areas will end up with more than 20% renewables. Denmark, for instance, expects to have 30% renewable energy by 2025, which in turn is expected to imply that 50% of all the country's electricity will come from wind [2].

With such a high proportion of renewable energy, power balancing becomes a huge challenge that will require all means at our disposal. This includes not only new transmission lines between regions and new flexible generating plants, but also the use of existing resources distributed across the power system.

End-users too can help to balance the system. Several types of demand, such as heating and cooling equipment controlled by thermostats, can operate in a flexible way. So too can small-scale distributed generating units, and future storage technologies such as electric vehicle batteries.

Up to now, end-users have played only a limited role in system balancing. More active participation of distributed energy resources (DERs) in the balancing process requires the development of suitable technologies for appliances and electric vehicles.

## Demand response

Electricity is traditionally billed at standard rates for each customer, with little effort to adapt consumption to suit varying conditions in the supply system. However, a combination of liberalization of electricity markets, an increase in wind power and new communications technologies have made it possible – and attractive – to develop active demand response.

In many cases, electrical systems can be balanced through delaying the demand for power by minutes or hours, instead of adding extra high-cost generation. Demand response is a voluntary reaction to dynamic electricity prices based on wholesale day-ahead prices or dynamic tariffs, which may include the cost of ancillary services.

Demand response has been demonstrated in practice at full scale [3]. Denmark, however, has only a few examples of demand response apart from demonstration projects.

Developments in high-speed communications and new

computing power have made it possible to calculate, communicate and manage prices dynamically. Typically, spot prices are published at 14:00 every day for each hour of the next day. End-users with interval meters can choose to buy electricity at spot prices. The spot price contract can also be combined with a financial contract, which sets the average electricity price before it is weighted with a demand profile.

Companies who can control the timing of their power demand, e.g., by delaying their usage by two or three hours, can reduce their electricity costs in this way. Examples of electricity use that can be timed to benefit from low power prices are processes involving heating and cooling, batch processes, and pumping in water treatment plants.

Also, some small electricity users – households and small businesses – have meters that can log hourly electricity consumption, allowing these consumers to buy electricity at spot prices. Advanced metering schemes are being developed in European countries like Italy, Sweden, the Netherlands, the UK, France, Germany, Spain, Portugal, Ireland, Finland and Norway [4] as well as in many other countries around the world. Denmark has no mandatory plan to roll out advanced meters, but individual grid companies have decided to do this for nearly half the country's electricity users. Within a few years, all these users will be able to take advantage of dynamic power pricing.

In households, direct electric heating and heat pumps are well-suited to provide demand response, because of the thermal inertia of buildings. In demonstration projects, switching off electric heating for up to three hours has been shown to cause few comfort problems [5].

Figure 15 shows results from one demand response project. When price is low (green) the demand was increased with 0.2 kW per household, while the demand was reduced with up to 0.25 kW in high priced hours (red). When several high priced hours came in a row, the impact was weakened. The pattern of consumption changed to reflect variations in electricity price, though the response was smaller than expected. In this case only one thermostat was installed per house, and this apparently reduced the impact [6].

Figure 15

**Demand response in action:**

46 electrically-heated houses were equipped with control systems to adjust temperature setpoints automatically in response to electricity price changes. For simplicity, prices were colour-coded: green for prices (including taxes and tariffs) more than 5% below the daily average, and red for prices more than 5% above the average. The information shown here is based on a regression analysis of 19 months of hourly data, and is adjusted to indicate the response at an outdoor temperature of 0°C. The graph illustrates the impact of the nine types of prices that are modelled in the regression analysis.

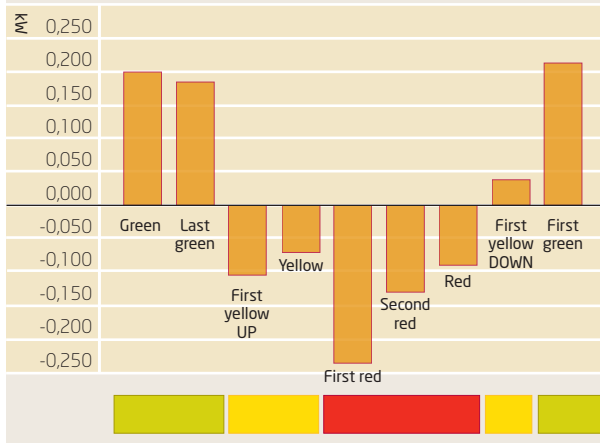

Dynamic price elements are not limited to spot prices. At the moment in Denmark, losses in the transmission and distribution systems are charged as simple fixed tariffs independent of the actual amount of losses and the value of electricity. In markets with nodal pricing, like in New England, USA, the costs of losses are calculated hour by hour for a large number of locations. In this way the price reflects the true costs – and the incentive for demand response is increased.

Several studies have analyzed the value of demand response [7, 8]. The fact that hydro power accounts for half of all

electricity in the Nordic system means that prices in Norway and Sweden remain quite stable over days and weeks and this reduces the incentive for demand response. Price variation is much larger in Germany, while in Denmark the situation is somewhere in the middle. More wind power is likely to increase the price variation, signaling the need for an active demand side.

## Electric vehicles

Electric vehicles (EVs) can be considered as a specific type of demand response. They provide an opportunity to reduce CO<sub>2</sub> emissions from the transport sector, and can by proper design also help the economic and reliable balancing of electricity systems containing high proportions of fluctuating renewable energy.

Electricity demand will be substantially affected by the large-scale deployment of EVs. In Denmark, demand would increase by around one-third (10–14 TWh/year) if EVs were to provide all road transport.

EVs can act as storage devices for smoothing power fluctuations from renewable resources, and can provide other services valuable to the reliable operation of the power system. EVs that can discharge to the grid, as well as charging from the grid, are said to have vehicle-to-grid (V2G) capability, otherwise known as intelligent bidirectional charging. By helping to make up shortfalls in conventional generating capacity, V2G could add a great deal of flexibility to the power system.

Figure 16

**Vehicle-to-grid (V2G) power transfer allows electric vehicle batteries to supplement conventional generation when power demand is high.**

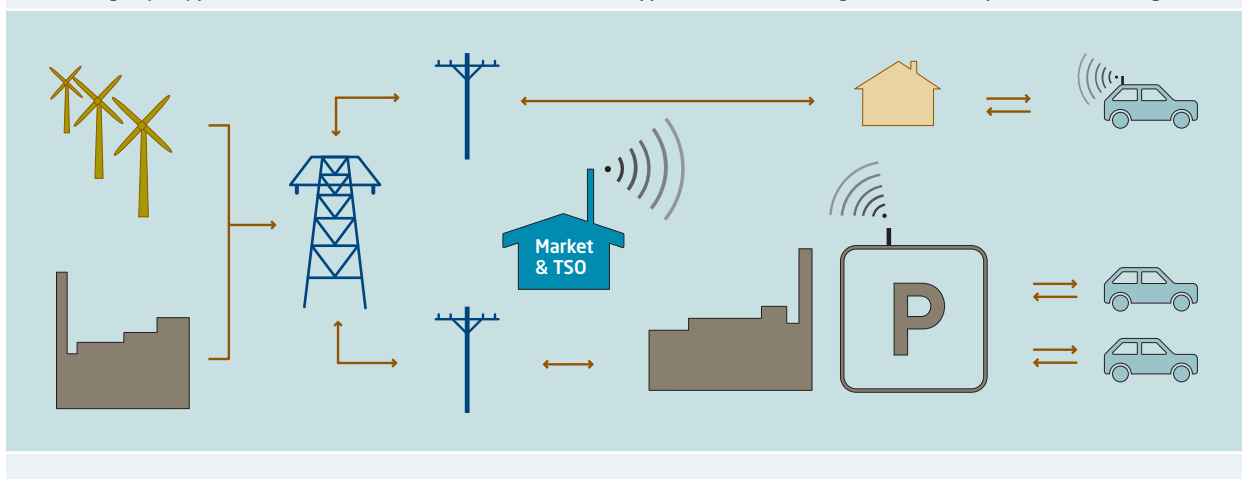



Cost-benefit analysis of the Danish electricity system shows that V2G could provide a socioeconomic benefit of €150 million/year by 2025, assuming 50% wind power penetration and that electricity powers 15% of the country's road transport [9, 10]. This calculation used the SIVAEL model described in Eriksen (2001) [11]. Other assumptions include:

- by 2020 EVs cover 10% of road transport, and heat pumps cover 10% of district heating needs and 33% of individual heating needs;
- trends in new generating capacity, cross-border cables and fuel costs follow standard projections by the Danish system operator Energinet.dk;
- all energy taxes reflect the socioeconomic value of energy costs.

The study also showed that introduction of EVs together with heat pumps could meet approximately 40% of Denmark's obligations towards the EU's targets for 2020 on:

1. renewable energy penetration (5 percentage points increase);
2. CO<sub>2</sub> emissions from sectors not subject to quotas (3 million tonnes per year reduction);
3. proportion of renewable energy in the transport sector (4 percentage points increase); and
4. energy efficiency (7 percentage points improvement).

The calculated benefit of approximately €150 million/year takes into account investment in EVs and the energy system, as well as the cost of emissions; the cost of control systems for charging and V2G functionality are not included.

If simple charging based on time of day is assumed instead of V2G, the cost of the energy system – including system services – would increase by €190 million/year and the resulting socioeconomic benefit would be negative [9, 10].

The attention given to electric vehicles and V2G is increasing rapidly. Most of the major car manufactures have EV development programmes, and many countries have started their own research and development. Table 5 lists recent activities in Denmark.

Table 5  
EV integration projects started in Denmark in 2008-09.

Project	Leader	Budget (€ million)
Better Place Denmark: full-scale commercial implementation of EV infrastructure	Better Place Denmark (backed by DONG Energy)	104
EDISON : R&D project on intelligent integration of EV and optimal interaction with wind power	See www.edison-net.dk	5.6
National test program for EVs	Danish energy authorities	4.0 + co-funding

## Electric heating and heat pumps

Uses of electricity that involve thermal inertia form another attractive opportunity to introduce demand response. Such uses include direct electric heating and heat pumps, both of which are used to some extent in Denmark today.

Direct electric heating is used in 118,000 houses and 233,000 weekend cottages, for instance, as well as in some factories, offices and shops. Danish electricity is heavily taxed and there are campaigns to convert all-electric households to district heating or natural gas. Partly as a result, between 1990 and 2007 power consumption for direct electric heating in single-family houses fell by 44% (corrected for degree days).

Direct electric heating loads are easy to predict from outdoor temperatures. The potential for demand response via direct electric heating is estimated at up to 500 MW.

7,000 houses in Denmark use heat pumps as their main source of heating, and the government is trying to increase this figure. If 100,000 houses were heated by heat pumps, this would add another 200 MW to the potential for demand response.

Heat pumps used to heat concrete floors have a large amount of thermal inertia and can be switched off for more than three hours without causing discomfort. For all types of electric heating, the acceptable time for which the heating can be switched off will typically be longer in well-insulated buildings.

## MicroCHP

CHP stands for *combined heat and power, co-generation of heat and power* or, sometimes in the US, *cold, heat and power*. From an electric viewpoint, a CHP plant is a generating unit whose waste heat is exploited for useful purposes such as hot water or space heating.



MicroCHP (MCHP or mCHP) refers to a unit sized for applications ranging from a single house up to an institution, say up to 25 kWe (kWe is used to measure electricity, while kWt refers to heating).

Because they are coupled to the grid at low voltage (typically 400 V) and have small power ratings, microCHP units are often dealt with indirectly by electricity system operators through grid codes or legislation. Thus microCHP units, like other small-scale generators and individual consumers, are not directly visible to the system operator. Today's power systems are not designed to integrate and control such large numbers of generating units.

The basic principle of microCHP is the conversion of primary energy into both heat and electric power. MicroCHP can be implemented using many different technologies, including Stirling engines, internal combustion engines (ICEs), steam engines, fuel cells, and microturbines.

The overall efficiency of microCHP can reach more than 90% when heat is recovered from the engine's exhaust. The electrical efficiency, that is the fraction of the input energy converted into electric power, is 20–25% for ICEs and Stirling engines [12], and up to 50–60% for combined-cycle turbines and fuel cells. MicroCHP based on fuel cells is promising because, unlike heat engines, fuel cells are not limited by Carnot efficiency.

MicroCHP units are typically driven by heat demand. As a consequence, microCHP units make full use of all the heat they produce. Combined with their low losses in the distribution of electricity ( $\sim <5\%$ ) and hot water (15–20%), this provides very high total efficiencies, even though their electrical efficiency is typically lower than for larger generating plants of the same type.

Further advantages of the small units are their versatility with respect to fuel – Stirling engines especially are noted for their ability to run on almost any kind of fuel – and their flexibility in terms of starting and stopping. The use of a hot water tank as a heat store also increases the system's flexibility in meeting electric power demands.

Due to the relatively high up-front investment, the profitability of microCHP is sensitive to local factors such as grid codes and legislation. Compared to boilers, microCHP is more versatile but also more complex, and boilers do not need to meet grid codes. This explains why microCHP is typically more costly.

Many recent tests have proved the beneficial contributions microCHP can make to the power system [8]. This is es-

pecially true for microCHP units equipped with hot water reservoirs, which boost electrical flexibility while acting as an energy buffer. By increasing the overall efficiency of the energy system and helping to absorb fluctuating electricity production from wind, wave and solar power, microCHP may contribute to or even accelerate the development of sustainable energy systems.

One Danish project ([www.dmkv.dk](http://www.dmkv.dk)) aims to install 100 microCHP units based on fuel cells in homes, to demonstrate the technical and economic feasibility of fuel cells for microCHP. The project will also show the advantages of microCHP in terms of fuel versatility and rapid electrical response even in a system controlled by heat demand.

### Virtual power plants and other clustering options

*Distributed energy resources* (DERs) are the generic terms for small generating units and loads such as microCHPs, heat pumps, demand response devices, some EVs and other appliances with power ratings in the range 1–25 kW. EVs designed for rapid charging or discharging do not qualify as DERs, since they can be rated at up to 500 kW.

To the system operator, DERs are non-controllable and invisible. However, their collective impact is becoming increasingly noticeable. In the context of balancing power or even active reserve, DERs are currently ignored by system operators, yet their aggregate effect is predictable and cannot be ignored.

Various clustering arrangements have been suggested as responses to the increasing penetration of DERs. One of these is the virtual power plant (VPP) [13], which aggregates a large number – up to 1,000 – individual DERs and manages them in such a way that they appear to the system operator as a single, reliable and integrated resource. In some areas aggregation is already practiced with larger units (above 400 kW) [14].

VPPs could be useful in several ways. In the short term they could act as an enabling technology for small and innovative generating units, allowing these to enter electricity markets which in some countries are restricted to large power plants. In the long term, it may be better for system operators to continue to deal with a small number of generating plants; as DERs become more common, the alternative will be to negotiate production plans, prices and contracts with thousands of small generators. And for small consumers or producers it may be advantageous to be a member of a larger entity with the resources to handle negotiations and

stay abreast of changing regulations. Other aspects which may become issues in the future include complex services, forecasting, islanding and security, control and management strategies, and market interaction.

Figure 17 shows the minimum requirements for a VPP: a number of small participants (consumers or DERs); a communications network (the internet or dedicated lines); a communication platform with a common information model and a consensus on the communication architecture; a primary energy supply network; and a link to the energy market. The primary energy supply is the foundation of the

VPP, the communication system forms the glue holding the VPP together, and the market link is the incentive which drives the system to service the needs of its owners and customers.

A VPP may be dispersed over a large area, though in the case of islands and other microgrids it may equally well have tight geographical limits.

Figure 17  
**Topology of a generic VPP showing the integration of energy, electrical and information system.**

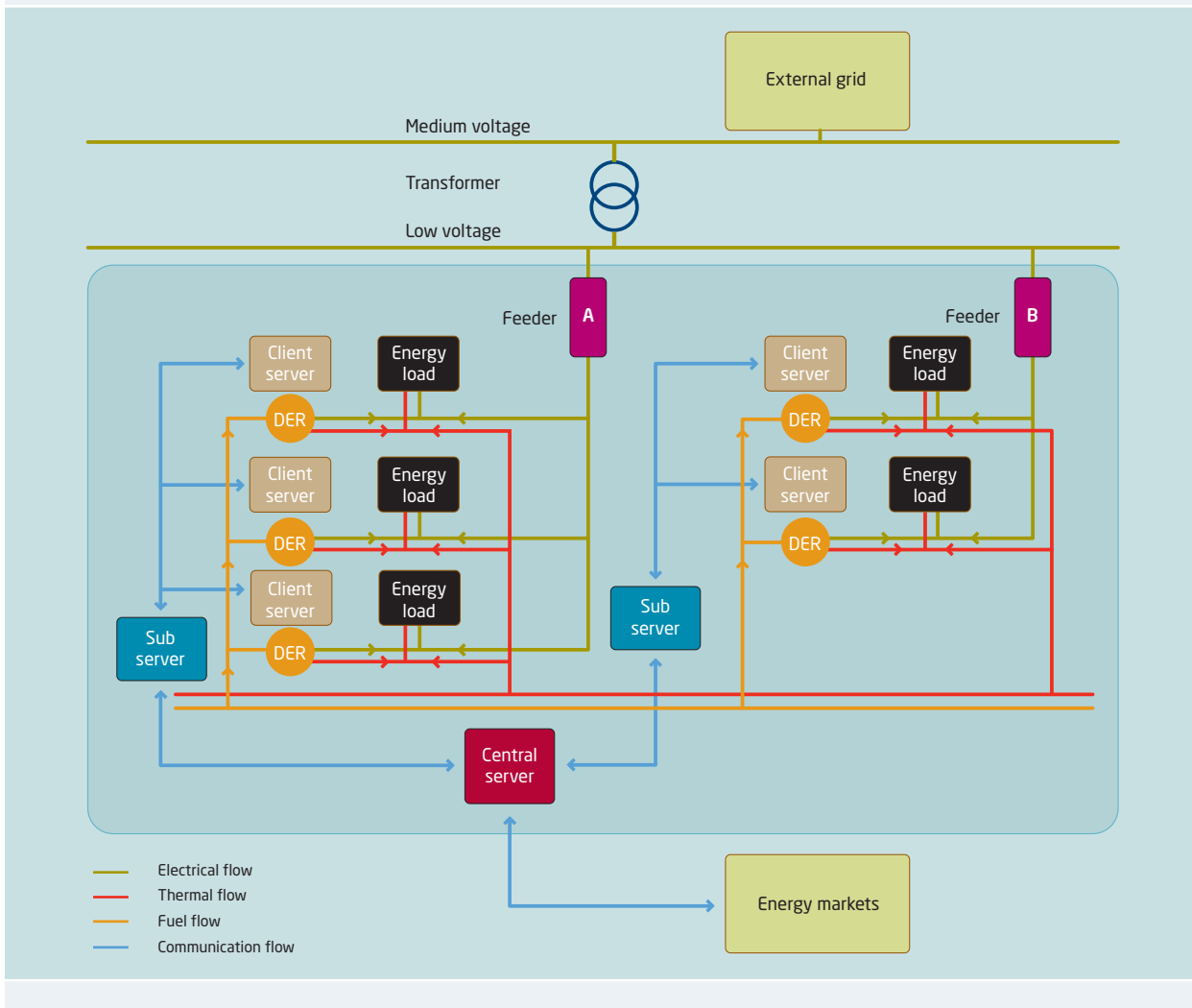

There are several strategies for controlling or managing a VPP, from a fully centralized approach to an almost decentralized system [15], and from a purely technological driver (power balance) to a market-based system:

- The conventional approach is to have a central operator who knows everything and controls all the details. The resulting organizational structure may be rather flat.
- A hierarchy in which a number of local, decentralized controllers manage the bottom level, referring important decisions upwards to a centralized control system. Such a structure will have three or more levels.
- Fully decentralized control in which local controllers exchange information to enable autonomous control at the level of individual units. The organizational structure is flat, but with optional aggregation that can create local hierarchies.

Is it possible to identify a minimum information flow needed to maintain a VPP and a stable grid? First of all the relevant interest groups need to be identified. These are the consumers, the producers, and the customers, or in general the DERs. The information flows between authorized power service providers (large units and business entities) and the system operators are already defined, so the present focus is on the information flow necessary to maintain coherence in a clustered resource such as a VPP. The information flow between an aggregator (or a local controller) and the system operator needs to follow the conventional authorized format, but the information flow that glues the smaller units into an orchestrated entity may be different. This information flow must include certain basic components:

1. registration of the unique identity of each participant;
2. a transaction in which goods or services are exchanged;
3. a measurement of the amounts of goods or services exchanged; and
4. a settlement which closes one transaction and opens the way for the next.

The identity of each participant is conventionally static and associated with a static grid connection point, but EVs bring a need for dynamic connection points (roaming) and potentially also dynamic identities. The transaction may be a simple *instruct and execute*, but it could also contain a complete market reaction pattern, including broadcast price signals, local and limited bidding and negotiation, and submission

and execution of generating schedules. Metering of the services exchanged needs to be through standardized and validated measuring equipment and, at a higher level, a neutral third party. The settlement may contain data ranging from agreement on the metering to a final payment.

Onto this platform can be added other services such as weather forecasting, information on grid maintenance plans, price and production forecasting, and future services that have not yet been thought of.

The ultimate scenario is a power grid that is fully coupled to the power market through an integrated communication system. This would create a platform for new market opportunities and provide plug-and-play functionality for individual consumers and producers. It would, in fact, be a sort of internet version of the power grid. Developing such a system requires that important challenges regarding reliability and data security are addressed and proper solutions are developed.

### Market design

Regulating power is used to balance the system during events that have not been foreseen on the day-ahead market. By definition, up-regulation (more generation or less demand) is more expensive than the spot price for the same hour, and down-regulation (less generation or higher demand) is cheaper than the spot price. Regulating power prices therefore see more variation than those on the spot market; negative prices will be allowed in the spot market from October 2009, but have long been common in regulating power. Figure 18 shows how regulating power prices can differ significantly from spot prices. In hour 11 the regulating power price of nearly 2,000 DKK/MWh indicated the marginal cost of electricity.

The regulating power market is attractive for demand response because of its larger price variation and the fact that regulating power is about increasing as well as reducing demand. Regulating power may be activated at any time, not just during peak demand periods.

However, the current administrative system makes it difficult for demand response to form part of the regulating power market. Since regulating power must be traded in minimum increments of 10 MW, for instance, sources of demand response need to agree on the price and timing of each bid. Furthermore, requirements about real-time metering make it too costly to use demand as regulating power. The current set-up was developed for large power plants, though

Figure 18  
**Spot price and price for regulating power on 15 January 2009 [www.energinet.dk].**

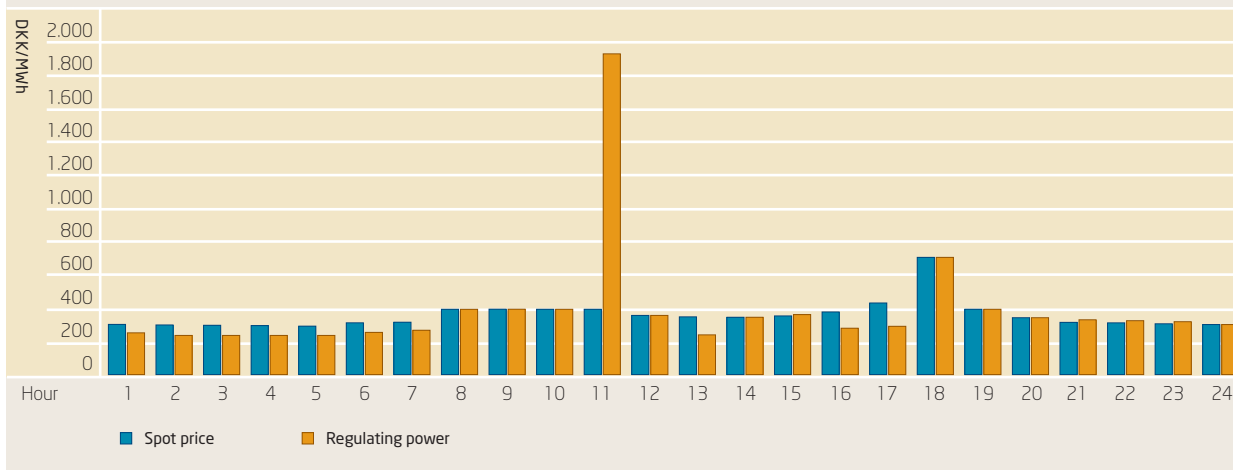

there is no reason why it could not be extended to include small players such as DERs and sources of demand response.

This could be done by allowing small players to react to real-time price signals. These signals could be quoted as adjustments to the spot price, and updated every five minutes. Adjustment of demand (or generation) could be voluntary, but the overheads involved mean that the scheme would only be attractive if at least some of the control were automatic. This would require less administration, and fewer contracts and sanctions, but also testing, so that the consequences of a given price signal could be predicted.

Opening the attractive regulating power market for electricity demand could activate new resources, which may be vital in an intelligent energy system with a high share of wind power. Such a system may have fewer conventional power plants, and must put all available resources to the best use.

**Conclusion**

Distributed energy resources can help to balance the power system and provide flexibility in operation. Promising options include electric vehicles, electric heating, heat pumps, and small-scale distributed generation such as microCHP based on fuel cells.

Effective use of these resources requires new technical solutions. Ideas to be developed include:

- Aggregation technologies in the form of virtual power plants (VPPs). Such systems act as brokers between distributed energy resources and the main markets and central control systems.

- New market systems, based for instance on near-real-time broadcast price signals. Embedded in VPPs, such solutions can help small players to take part by keeping transaction costs low.
- Interval meters will be needed to enable financial settlement; these are now being rolled out in many countries. It is important that the meters meet future technical requirements such as settlement in near-real-time markets.

Research and development is needed to release the potential of distributed energy resources. Especially important are aggregation technologies and market designs, and the way these systems will interact under abnormal conditions. The economic viability of the resources as well as the integration technologies should be an integrated part of the research.

Reliability and data security of the involved information technology are major issues still to be addressed. Tests at both demonstration and full scales will be needed; Danish facilities for these include the Syslab facility at Risø DTU and the Bornholm distribution system, with its 27,000 customers, 32% wind power penetration and ability to operate in parallel with the main power system as well as in island mode.



Henrik Bindner, Oliver Gehrke, Risø DTU

## A changing environment

This chapter deals with the structure of the control system and communication between the entities in the power system. The structure of the control system includes issues such as control hierarchies and decision-making strategies.

The power system is currently undergoing fundamental changes in its structure. These changes are associated not just with the rapidly increasing amounts of renewable energy connecting to the system, but also to the use of new types of production and consumption technologies. These changes imply a requirement for a new control structure of the entire system.

One such change is a general increase in distributed production units that are smaller than traditional thermal power plants. In the future, this will include low-voltage connections from microCHP plants in individual households. Another important trend on the low-voltage side is active control of demand, which creates new and flexible ways to control power balance and voltage.

In parallel with these developments is the increased use of information and communications technologies (ICT). Communications capabilities are rapidly increasing in power and scope, while at the same time becoming cheaper. This opens the way to systems incorporating bidirectional communication with end-users, and is thus one of the most important enabling technologies for the future. Advanced computational methods for predicting prices, consumption and weather, and improved measuring technologies, are opening up new ways of controlling the entire power system.

Progress in reducing the use of fossil fuels for transport and space heating can result in much higher electricity consumption. To keep costs down, this must be handled in a smart way, making use of the flexibility offered by electric transport and heating thanks to their ability to store energy.

The change from few large power plants to a much higher number of smaller plants implies a need to change the control system paradigm of the power system. Increased use of electric vehicles and electric space heating will require control of the demand side, but the very high number of units that must be handled simultaneously requires a change of the control concept. A similar conclusion springs from the need to control increasing amounts of renewable energy, with its stochastic nature.

The continued development and deployment of communication technology makes it possible to access units in the system that so far have been out of reach and activate them in the control of the system which can change the control

concept of the power system. This is also the case with the increased use of computer science such as distributed computing, security and communication and information processing in the power system.

## Developments in system control

Initially, it is difficult to separate system control and communications. The two concepts are tightly interlinked: a particular control system will require specific information to be communicated between the different parts of the system, while developments in communications can open up new possibilities for control.

The objective of controlling the power system is to maintain the voltage and frequency at specified values, handle emergency situations, and to some extent ensure – or in a market-based system, enable – economic operation. In the present system this is done through a number of defined services, which include:

Power balance:

- primary control/automatic frequency control;
- secondary control/manually-activated reserves;

Voltage control:

- automatic voltage control;
- supply of reactive power;

Special services:

- black start.

How these services are implemented differs significantly from one power system to another, and as a particular power system evolves, so too may the implementation of its services.

The main challenge for future power systems is to ensure that distributed and decentralized generators provide the services for which we currently rely on large central power stations. The three key issues for emerging power systems are:

- handling large proportions of renewable power;
- increased electricity consumption by electric vehicles and electric heating/cooling; and
- managing many small units connected to the low-voltage distribution grid.

The focus in this section will be on the activation of small energy resources connected to the distribution grid, since this offers great potential and yet requires a completely new



control structure for the entire system due to the high number of units that has to be handled. The requirements to the control and communication infrastructure for integrating small energy resources are very different from the existing system but it has to be part of the total control concept of the power system that includes large central thermal power plants and large wind farms..

The use of electric energy for transport will naturally increase the load on the power system. Even worse is the fact that, if nothing is done to prevent it, much of this extra consumption will be synchronized – for instance, as people charge their electric cars after driving home at the same time every evening. The result will be an overloaded power system.

Increased use of electricity for heating will also increase the risk of overload; demand will probably be less synchronized in terms of daily peaks, but will of course rise in the winter.

Both transport and heating loads possess inherent energy storage that allows them to be scheduled with some flexibility if the control systems allows this. Loads could therefore be staggered so as to reduce their impact at peak periods. Such control could even actively benefit the operation of the power system, for instance at times when production from renewable energy is high and consumption is low.

Another major trend is the move towards active control of domestic loads. This is a result of pressure from the transmission and distribution system operators, who want to use their assets (both generating units and networks) effectively. The increasing popularity of home automation systems with advanced capabilities will make this easier.

However, the flexibility introduced through the ability to control part of household power consumption is difficult to exploit, for several reasons. One is that the control architecture of the power system does not support the direct management of such small units connected to the low-voltage distribution grid.

As mentioned above, small generating units based on renewable energy and in households have great potential in contributing to the control of the system. The challenge is to coordinate their actions so that they can provide the necessary services. Another open question is how much information about their capabilities and schedules they should exchange with the central control system.

Increases in distributed generation and active control of consumption open the way to new control strategies with a more distributed approach and a more dynamic control hierarchy. In recent years this has been the focus of several large proj-

ects such as SmartGrids in Europe [1], and Intelligrid [2] and Gridwise [3] in the US. Their aim has been to take advantage of the possibilities created by combining ICT and distributed energy resources in the power system. ICT developments have included communication with end-users; self-healing and self-organizing control structures, including the use of agents; and wide-area measurement and control. Many of these efforts are still in the laboratory phase.

Many current research programmes focus on intelligent power systems and especially the integration of EVs. Among the main issues addressed are:

- scalable solutions to handle millions of participants;
- aggregation and disaggregation of units with different features and capabilities. This is of course linked to scalability, but is a problem in itself;
- security and robustness;
- use of distributed capabilities to create a more resilient power system; and
- determinism, in other words how well the state of the system should be known and to what extent it is acceptable to rely on statistical approximations.

There are several ways to aggregate millions of low-voltage units aggregated to the power system (Figure 19). One is to coordinate the behaviour of all the low-voltage units connected to each substation at the lowest distribution level – an approach often termed a microgrid (red balloons in Figure 19) [4].

Figure 19

**Different ways of aggregating units connected to distribution grid.**

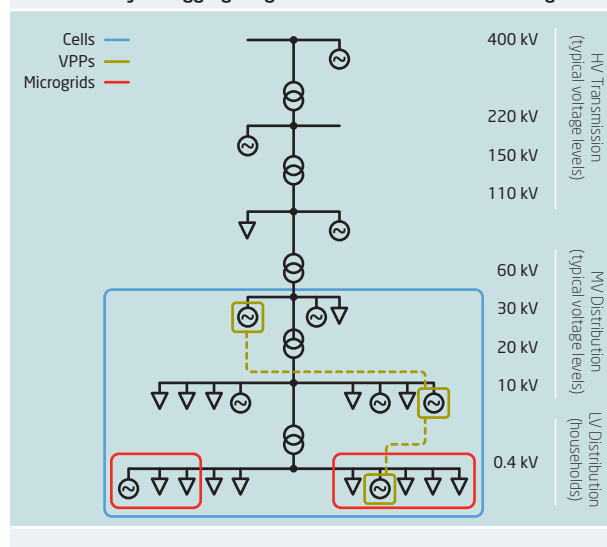

Another option is to include the distribution network below a substation connecting the distribution system to the transmission grid (blue balloon in Figure 19). Energinet.dk has worked with this type of system in its Cell Project [5], creating *subgrids* that can be self-sustaining and thus able to survive a collapse of the transmission system.

A third aggregation technique is to create *virtual power plants* (VPPs) (green balloons in Figure 19) [6]. Here the aggregation is not based on the topology of the network; instead, any unit can participate in a VPP, regardless of its location. The main service available from VPPs therefore relates to power balance, which is a global characteristic. The two first-mentioned methods of aggregation, can also provide services related to local grid conditions, such as voltage control because they are linked to grid topology.

Many different options are still being studied in research and demonstration projects. A key aspect is how to handle changes in topology caused by switching in the network or by EVs travelling from one point to another. Another important issue is how to make the system robust and able to take advantage of the potential flexibility of DERs. This can be done by autonomous handling of dynamic hierarchies of aggregation, making it possible to establish a new aggregator if the existing one fails. This is one of the key principles of self-healing networks.

## System communication

In many ways system communications can be seen as an enabling technology for control. The issues raised above also apply to communications, but there are some additional issues to take into account:

- cost;
- security;
- reliability/bandwidth/latency;
- compatibility between and extensibility of various protocols; and
- flexibility with respect to the control system.

The cost of communications has dropped significantly in recent years, and every household connected to the power system can now be assumed to have some kind of communications link: power line communication, broadband using cables, xDSL or cable tv, wireless or mobile phone.

There is, however, a tradeoff between bandwidth and reliability. The control of the current power system is often as-

sumed to have fast and reliable communications with low known latency. This is reasonable in a system comprising only a few tens or hundreds of large power plants and control centers, but it is too expensive for millions of small units.

xDSL and wireless communications are not reliable enough for tight closed-loop control, quite apart from the fact that millions of units cannot be controlled individually from one control room. Power line communication, in addition, has so far not been able to provide the high bandwidth required.

A mix of technologies could be a viable solution. A high-bandwidth channel with low reliability would be used to exchange large volumes of information that is not time-critical, such as communicating the current state of the unit and setting up control actions that can be triggered by subsequent events. Another channel with low bandwidth and low known latency would then be used to trigger control actions that had already been set up.

Security must be integral to communication and control in such a distributed system. The power network is one of the most important infrastructure elements of a modern society, and physical access to the communication system will be available from every connected device. Security measures must therefore be designed in from the beginning. This area is very much in its infancy.

In many parts of the world, modern communications are already being installed in power systems. Substations at both transmission and distribution level are being equipped with modern measurement and protection devices as well as new SCADA systems for supervision and control. Communication between control rooms is also being modernized as is the communication between several subsystem of the high level control at large power producers at the energy management system (EMS) level. These are often based on open protocols, notably the IEC61850 family for SCADA-level communication with substations and distributed generating units [7], and the IEC61968/61970 CIM family for EMS-level communication between control centers [8].

Such standards are a big step forward, since they provide vendor interoperability and to some extent extensibility, they do have significant limitations however. One issue is that the two families of standards describe the same units in the power system, but in different ways. This makes vertical integration a challenge, since the necessary translation is not straightforward. There is considerable international effort to solve this problem including joint working groups in IEC.

Issues of flexibility and extensibility are also significant.

Figure 20

**Methods of providing services from components based on component type (left side) or on component function (right side).**

When aggregation is based on component type the aggregator has to know the type of the components that are being aggregated, thus if a new type of component is connected the aggregator has to be modified. If the aggregation is based on the function the component can provide, the aggregator only has to know the functions and new types of components that can provide the function can readily be integrated.

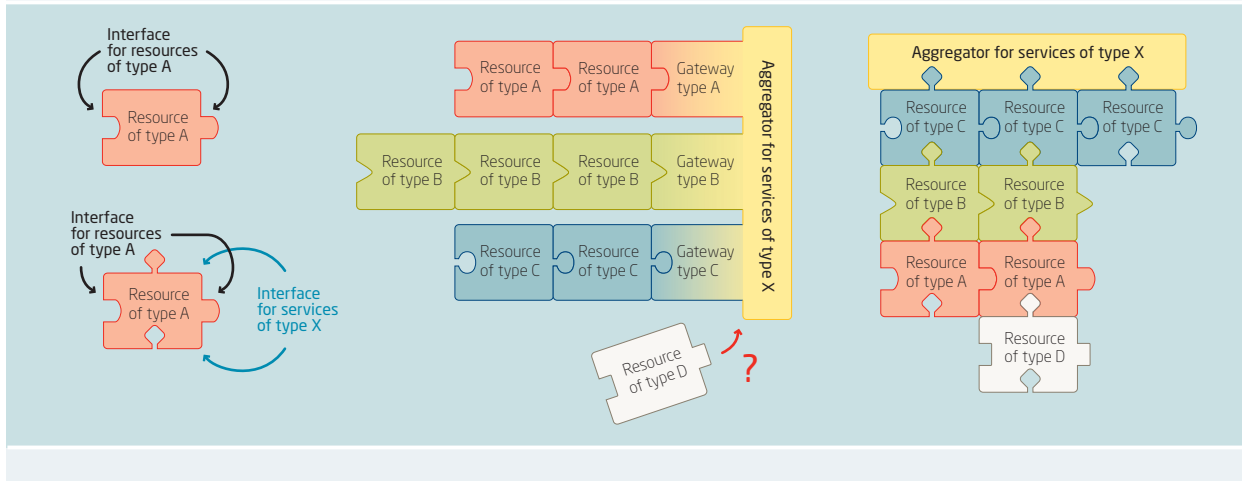

The present standards focus on technologies or component structures – for wind turbines, for instance, they address blades, hubs, gearboxes and generators – rather than power system functions such as power production, reactive power and frequency control. The view of the components based on its subcomponents is very useful for condition monitoring and maintenance whereas a view that is based on the functions it can provide to the power is very useful from a control point of view.

In the current versions of the standards, each component has an interface that is particular to the technology. Wind turbines and microCHP plants, for instance, each have their own specific interfaces, even though much of the information – such as current power production, setpoint for maximum production, and terminal voltage – is common to both types of equipment. As the lower left-hand part of Figure 20 shows, this means that when services from a group of components are being aggregated, the aggregator has to know what types of components are in the group.

This is a big disadvantage for new technologies: they cannot be part of aggregated services because the aggregator will not know how to communicate with them. New technologies can only be included once a standard has been agreed on, which can take several years, even though many of their basic functions are the same as those of existing technologies as far as the power system is concerned.

The right-hand part of Figure 20 shows that if a service or functional view is combined with the technology or structural view, new technologies can be integrated much more easily. Work is currently underway to develop and test a functional interface that will make this possible. A function-

al interface to system components could be a way to build flexibility into the communication system, enabling the development of control structures that are not too limited by the capabilities of the communication system.

## Conclusion

A future power system with many intelligent components capable of participating in the control of the system could provide a robust power system supporting a high proportion of renewable energy. However, some barriers have to be overcome if this is to be achieved. In a system control and communications context, two of these are:

- scalability: how to handle a very large number of active units; and
- flexibility: how to integrate new technologies as they are developed and introduced.

Scalability is a key limiting factor, and so far no single technology has shown itself to be the obvious choice. As a result, many different approaches are still being investigated. Since many of the problems of power system control are related to the physical grid, methods based on topology may have an advantage since they can provide services that are local to the part of the grid where they are connected.

In the area of flexibility, one issue is the ability to handle new types of components in the system. New function-based communications protocols to supplement the existing structure-based methods provide a promising route to seamless integration of new technologies.

Claus Krog Ekman, Allan Schrøder Pedersen, Tom Cronin, Risø DTU; Brian Elmegaard, DTU Mechanical Engineering

## Energy storage

Energy can be stored in six different forms: chemical, thermal, kinetic, potential, electromagnetic and nuclear. All the energy we consume has, until the time of use, occupied one or another of these forms. One example is electromagnetic energy radiated from the sun which is converted and stored as chemical energy in biomass and later burned to yield thermal energy and possibly converted into electricity which is electromagnetic.

This chapter considers a narrower notion of energy storage: artificial energy storage mechanisms that can facilitate a higher proportion of renewable energy in future energy systems. For our purposes, biomass and biofuels are considered to be harvested energy stores rather than deliberate storage mechanisms, so they are not included here. Bioenergy for transport is, however, dealt with in Chapter 10.

Since both energy consumption and renewable energy supplies fluctuate over time, energy management is needed to ensure that energy supply balances demand at all times – this is true for heat, electricity, and energy for transport. Energy storage can facilitate this management and has the technical potential to be a key system component as the proportion of renewable energy increases. Transport applications also require high-density mobile energy storage independently of the balancing issue.

Here we describe various storage technologies for thermal energy, grid power and transport.

### Thermal energy storage technologies

The possible uses of stored thermal energy depend a lot on the temperature level of the storage. The lower the temperature, the lower the quality of the heat and the more restricted its applications. However, low-temperature heat is abundantly available as waste heat from many processes. In addition, solar radiation may be collected as heat much more efficiently than by converting it to electricity. As a result, heat storage is of great interest.

Compared to energy storage technologies such as liquid fuels and electric batteries, heat storage materials have low energy densities and long response times (typically minutes), mainly because their rate of energy transfer is limited by slow heat transport mechanisms. In addition, the economics of insulation dictate that the round-trip efficiency of heat storage depends not only on the quality of the thermal insulation but also on the length of time for which the heat needs to be stored. Despite these rather poor properties of heat

storage technologies, the topic is important because heat is necessary for comfort in a large part of the world.

*Sensible heat storage* relies on the capacity of matter to absorb heat when its temperature is raised. This principle has a long history of use in domestic hot water tanks and district heating systems, but has caught new interest thanks to research into new materials and other technological developments.

An example from the US is the use of concentrated solar energy to heat liquids to temperatures high enough to generate steam to drive turbines, which then generate electricity. A number of commercial plants are operating with multi-megawatt capacities and capacity factors up to 20% [1]. On the downside, the solar concentrators take up significant areas of land and are only economic in sunbelt regions. There are many types of designs and research is focusing on the development of the heat transfer to energy-storing fluids.

Smaller-scale sensible heat storage is also attractive to households as a means to increase the efficiency and effectiveness of small solar power installations. These systems are in full commercial production, and so benefit from the associated cost reduction.

*Phase change materials* (PCMs) store and release energy in the form of latent heat as they change from one phase to another. Typical systems store heat by melting a solid material (latent heat of fusion), and recovering the energy by allowing the liquid to solidify.

Compared to sensible heat storage, PCMs have the advantage that – in principle – heat is stored and released at a constant temperature. Conventionally, PCMs have been used to absorb unwanted heat in order to prevent a temperature rise, but attention is increasingly turning to storing heat for later use.

At present, PCM systems have relatively small capacities and are tailored for specific applications, but many new materials and combinations have been developed, and new applications considered. For households and larger entities in the future, PCMs may provide an attractive way to store heat. New ways of integrating PCMs in building materials, for instance, may extend the applications of solar heating [2].

### Electrical energy storage technologies

Balancing electricity supply and demand becomes increasingly difficult with the introduction of more renewable (fluctuating) electricity sources. There are challenges on both

long time scales (hours, days or longer), where both electricity demand and renewable energy supply fluctuate independently (energy management), and on short time scales (minutes to hours) where uncertainty in the prediction of renewable energy supplies leads to imbalance (power regulation and reserve).

Large-scale electricity storage would be able to shift demand and supply, helping to provide balance over all time scales, and may therefore play an important role in the future power system.

### Pumped hydro

Pumped hydro has been in commercial service as an energy storage technique for a long time in many countries where the topography is suitable. However, new techniques such as underground water storage [3] are opening up the possibility of pumped hydro in areas without mountains, like Denmark. Pumped storage can have high efficiencies – up to 75% round-trip on average [4] – with start-up times of a few seconds. Pumped hydro power stations may have power capacities of up to several hundred MW, with the amount of energy storage naturally depending on the volume of water and the height difference. Installations can be designed together with conventional hydro plants, and thus provide a relatively cost-efficient bulk storage mechanism. The technology is mature and the costs are well-known.

### Compressed air

Compressed air energy storage (CAES) [5] is not yet used to a large extent, but a few CAES plants have operated on a test basis for decades. The best-known is operated by German energy supplier E.ON in Huntorf, northern Germany.

A CAES plant is, in principle, a gas turbine plant split into separate compressor and expander sections, and extended by a large underground chamber capable of storing air at pressures from around 50 bar (empty) to 100 bar (full).

Despite the name, a conventional CAES plant is not simply a way to store electricity; it also shares many characteristics with a conventional gas turbine generating plant. When the compressed air is re-expanded, it must be heated in order to keep the turbine exhaust temperature at a practical level (the original heat of compression generally having been lost). The simplest way to do this is to burn natural gas in the compressed air stream, recovering the energy with a high-temperature gas turbine rather than a simple turboexpander.

As a result, the amount of energy supplied by the natural

gas is usually greater than that stored in the compressed air. This makes the economics of CAES sensitive to fuel prices, as well as to the leakage rate from the storage chamber and the efficiencies of compression and expansion.

For Danish conditions recent studies show that conventional CAES is not economically viable [6]. Development of CAES with lower fuel consumption by better use of the heat generated during compression is ongoing and may produce significant improvements. At present, however, there is too little experience, and suitable sites are too varied to establish reasonable costs for energy storage using this technology.

### Batteries and flow batteries

Several MW-scale battery systems have been developed, and there are a number of demonstration and commercial installations around the world. Most common are lead-acid, nickel-cadmium and sodium-sulphur batteries [7].

Halfway between conventional batteries and fuel cells are devices known as flow batteries. These convert electrical energy to chemical energy in a liquid electrolyte which can be stored in tanks that are independent of the electrical part of the battery. To produce power, charged electrolyte is pumped back through the electrochemical cells. The advantage over conventional batteries is that flow batteries decouple power (MW) from energy storage capacity (MWh). This should reduce costs, and also allow flow batteries to provide power for many hours or even days – something that is difficult with conventional batteries on a scale suitable for power systems.

Flow battery chemistries include vanadium, polysulfide-bromine and zinc-bromine. These do not suffer from memory effects or self-discharge, and can achieve high round-trip efficiencies above 80% (not including AC-DC-AC conversion).

The drawbacks of all large-scale batteries are their large footprints and relatively high prices in terms of both power and storage capacity. However, their very fast response times make them suitable for system services such as frequency support (primary reserves). Unlike pumped hydro and CAES, batteries can be located almost anywhere and can thus be placed in a system where losses are lower and the need for storage greater.

For these reasons there is a growing interest in the potential for large batteries to aid the integration of renewable energy [8]. Parallel research is taking place on the various chemistries to improve efficiency and increase suitability for bulk manufacture, which would lead to cost reductions.



### Hydrogen and fuel cells

Using hydrogen as a storage of electrical energy requires firstly the conversion from electrical to chemical energy (electrolysis, i.e. electrochemical splitting of water), secondly the storage of hydrogen, and thirdly conversion back to electricity (by fuel cells or combustion generators). There are several technologies for electrolysis as well as for fuel cells (a detailed description can be found in the Risø Energy Report 3 [9]). Due to its low volumetric energy density (in gaseous form at atmospheric pressure) hydrogen is typically stored as a high-pressure gas, a low-temperature liquid, or in chemically bound form. None of these storage options, however, is easily applied in practice, and partly for this reason there is considerable skepticism about hydrogen as a future energy carrier. The round-trip efficiency for electricity storage via hydrogen is typically well below 50% and the costs of electrolyzers and fuel cells are still high. However, research efforts are concentrating on improving the reliability of fuel cells and reducing their costs.

### Other storage methods

Other technologies for storing electrical energy include flywheels, superconducting magnets and supercapacitors. These are mainly for special applications, however, and are not likely to play a substantial role in the future energy system.

The concept of using the batteries in electric vehicles (EVs) to store power from the grid (vehicle-to-grid or V2G) is also widely discussed. A large number of grid-connected electric (or hybrid) vehicles could provide energy storage if a certain fraction of their total battery capacity were reserved for grid services. The availability and reserved fraction of the battery capacity could depend on the hour of the day and be restricted by the vehicle owner. Such a system will promote a large battery-powered vehicle fleet and encourage large investments in advanced communication and control.

### Transport

Energy storage for transport requires relatively high volumetric and gravimetric energy densities as well as rapid energy flows. Lower efficiency in the overall conversion process (from chemical to kinetic energy) can be tolerated providing the volume and weight of the fuel and power train are acceptable.

### Batteries

There are high expectations for the battery technologies aimed at EVs and hybrids. Several projects are being carried out, for instance in Denmark, to assess the technology and develop the market for electric vehicles.

Supplying energy for transport via the power grid has several advantages, including increased flexibility through closer links between the power and transport sectors, increased energy efficiency, and the chance to include transport-related greenhouse gas emissions in carbon trading schemes. However, a serious drawback to the use of batteries in transport is their low energy density.

Even advanced batteries show energy densities (kWh/kg) one or two orders of magnitude below those of gasoline and diesel. This is the reason why battery vehicles have relatively short operating ranges between charges – typically up to 150 km according to the manufacturers. Longer ranges require large, heavy and expensive battery packs. Despite this, most major car manufacturers have electric vehicle R&D programmes and much attention is being paid to battery technology. Car manufacturers are under pressure to deliver electric cars with similar characteristics to today's conventional vehicles.

The current front runner in electric vehicle applications is the lithium ion battery, mainly due to its superior energy density. Problems associated with traditional lithium ion batteries include a short cycle life and performance degradation with age. However, research has yielded adaptations that promise to avoid these restrictions.

Cost is of course a major issue, as indicated by the fact that the few available performing electric cars are very expensive. The car industry has a history of reducing costs through mass production, however, and if the right battery technology is found, costs can be greatly reduced.

### Hydrogen and synthetic fuels

The challenge for hydrogen as a transport fuel is in finding a method to store enough of it safely on board a vehicle. So far, designing a hydrogen vehicle with a range similar to that of a conventional vehicle has proved difficult, whether the hydrogen is stored in gaseous, liquid or solid form.

As well as providing a source of hydrogen, high-temperature electrolysis has also shown the potential to split CO<sub>2</sub>, allowing synthesis gas (mixtures of carbon monoxide (CO) and hydrogen) to be created directly from electricity [10]. This is of interest because it could be used to create synthetic liquid



fuels similar to those we are already used to and for which we already have an infrastructure. Chapter 10 covers this in more detail.

### Outlook and recommendations

The need for energy storage in a future energy system dominated by renewable energy depends on many factors, including the mix of energy sources, the ability to shift demand, links between the different energy carriers (see Chapter 10), and the end-use of the energy. Since energy storage always brings extra costs and energy losses, it should be used only when it increases the value of the energy sufficiently from the time of storage to the time of use.

In the personal transport sector, the necessary increase in value comes from fulfilling the need for mobility and high energy output. It is likely that a large fraction of energy for transport in the near future will come from biofuels (not considered a form of artificial energy storage in this context), but batteries and perhaps hydrogen and synthetic fuels will also play an increasing role.

In the heat and power sectors value is represented by changes in the prices of heat and power, so the feasibility of energy storage depends on fluctuations in these prices. District heating systems, as used in Denmark, already incorporate substantial thermal energy storage. This is feasible due to the low cost of excess heat associated with power production, and the relatively low cost of thermal energy storage in the form of hot water. As wind power penetration increases, there will be more hours of low or even negative power prices. Conversion of electricity to heat (by heat pumps or direct electric heaters) will therefore become more common, leading to an increase in heat storage capacity.

In a power system which generates electricity only from thermal and fluctuating sources, system stability and security of supply are only possible either if the thermal plants can meet the entire peak demand, or if the system incorporates large-scale energy storage. In a future power system that is independent of fossil fuels, it may not be realistic to have enough production capacity in thermal biomass power plants to meet peak demand. Large-scale electricity storage will therefore be needed to ensure that power from fluctuating sources will always be available during the hours of peak demand.

In electric power systems, the role of storage can be divided into two tasks:

1. Energy shifting: the movement of bulk electricity in time, either as consumption (charging) or supply (discharging). The amount of energy stored needs to be large and the storage method relatively cheap. Suitable technologies are pumped hydro and compressed air storage.
2. Power balancing and quality issues: rapid response covering smaller amounts of energy. This is suited to batteries and fuel cells, whose comparatively high costs can be justified by the higher value of the electricity stored.

If energy storage is to become widespread then its direct environmental impact also must be considered. The most obvious concern is the safe and cost-effective recycling or disposal of batteries and their electrolytes. This must be accounted for in the life-cycle costs. However, the indirect and positive environmental impact of storage systems should also be included if they allow the use of a higher proportion of renewable energy, with consequent environmental benefits. Storage can also indirectly increase security of supply by increasing the use of renewable energy and reducing reliance on imported fossil fuels.

In a brief survey of energy storage it is not possible to pick out a clear technology leader, not least because much depends on the application. However, recent advances in storage for transport, based on both batteries and fuel cells, are exciting. It appears that lithium ion technology may allow battery-powered cars at last to throw off the slow, short-range and dowdy image that has plagued electric vehicles to date. Society's need for transport, and the car industry's desire to fulfill this need profitably, should not be underestimated as drivers for the development of mobile energy storage. Much more work is needed, of course, and technology research and development looks set to increase. We should not forget, however, that alongside research into the technologies themselves, work is needed on finding out how best to use storage devices of all kinds. Given the inevitable losses from energy conversion and storage, it is important to try to use primary energy as it is produced and not store it.

If we have to store energy, we should store excess renewable energy rather than energy produced by conventional means. The losses involved in storage are not insignificant, but since the marginal production cost from wind and solar sources is insignificant, we may need to change our traditional view, formed from the use of fossil fuels, that energy efficiency is the ultimate goal. Until recently, energy experts have agreed overwhelmingly that energy storage is costly, inefficient and something to avoid if at all possible. As we have seen, this may be set to change: the prospects for large energy storage devices have never been better.

Allan Schrøder Pedersen, Risø DTU; Jesper Schramm, DTU Mechanical Engineering

## New primary energy sources

The future energy supply will rely on new, sustainable sources. For applications such as the energy used by industry and households this will not be a major technical problem, although higher costs may be an issue. For transport the situation is different, as this sector will require new fuels and traction technologies.

Modern means of transport depend heavily on fossil fuels. Transport accounts for approximately 20% of total worldwide energy consumption [1], and in countries like Denmark transport consumes around 65% of all oil products [2]. It is thus evident that transport will have to contribute significantly to our efforts to cut CO<sub>2</sub> emissions. As CO<sub>2</sub> capture from moving vehicles and subsequent safe storage appears difficult – and certainly very expensive – it seems that the only way to reduce emissions from transport is a shift to energy sources that are renewable or at least CO<sub>2</sub>-neutral.

## Renewable and nuclear electricity

With the outstanding exception of bioenergy, renewable energy is largely harvested as electricity, and the same is true of nuclear energy. Using low-carbon electricity to provide energy for transport therefore requires economic and efficient storage technologies.

Direct storage of electricity is practically impossible in large quantities, as shown by the limitations of capacitors. Batteries store energy in chemical form, but their ability to absorb electricity directly and re-deliver it with high efficiency makes them attractive for transport applications. Electricity is also well-suited to propulsion.

Electricity has a high value because it is more versatile than other forms of energy such as heat. It can easily be converted into other forms of energy, including chemical fuels to drive engines.

## Bioenergy

Bioenergy in the form of biomass is a direct and natural form of solar energy storage. The traditional way of utilizing bioenergy is via combustion, producing heat that can be used directly or to generate electricity. However, biomass may also be converted biochemically (fermentation) or chemically (gasification and Fischer-Tropsch) into liquid fuels like ethanol and higher carbon compounds.

## Transport

### Batteries

As discussed above, electricity is an attractive energy source for vehicles. Drive systems based on electric motors are fairly simple and very mature. They do not require gearboxes, and can incorporate regenerative braking, in which energy is collected and returned to the battery. Electricity can be supplied either by wires (as in trains or trolley buses), by batteries charged from the grid, or by fuel cells fed with liquid or gaseous fuels.

Unfortunately, the energy density of presently available batteries is low – one or two orders of magnitude below that of gasoline (Table 6). This is a serious limitation for battery electric vehicles (BEVs), which often have short ranges: below 100-150 km is typical when the battery has been used for a while.

Table 6  
Volumetric and weight based energy densities of different energy storage systems. The data are based on higher temperatures of combustion and do not include the weight or volume of fuel containers and other system components. For ammonia the values refer to the hydrogen content.

System	kJ/ml	kJ/g
Hydrogen, gaseous at 200 bar	2.4	141.0
Hydrogen, liquid	10.0	141.0
Complex hydride	16.9	17.0
Methanol	18.0	22.7
Gasoline	33.4	47.6
Advanced battery	0.5	0.7
Liquid ammonia	17.9	25.2
Flywheel	0.25	0.5

The attractive features of BEVs, which have created great expectations, are their simplicity and electrical efficiency. With appropriate control, vehicle batteries may also be able to act as a resource for the power system, absorbing electricity when it is freely available and returning it to the grid during periods of high demand. This idea is being discussed intensively, and tested at a preliminary level, since it may be very useful in a future power system characterized by fluctuating production from wind and solar sources.

### Fuel cells

Fuel cells (FCs) generate electricity by the electrochemical combustion of fuels. The fuel cells used by most car manufacturers in demonstration projects until now are based on low-temperature polymer electrolyte membranes (LT PEM-FCs), which require pure hydrogen as fuel.

Hydrogen can be made from renewable electricity by electrolysis, and in this way fuel cells may aid the transition of transport from fossil to renewable energy sources. Hydrogen can be stored as a compressed gas with a relatively high energy density (Table 6), giving a driving range of several hundred kilometers.

However, LT PEMFCs operate at temperatures of approximately 80°C, making it difficult to start the vehicle rapidly from cold. To address this, most car manufacturers are planning electric cars powered by a combination of advanced batteries and fuel cells.

### Internal combustion engines

Internal combustion engines (ICEs) burning fuels derived from oil are still the dominant power source for most vehicles worldwide. Though this will probably remain true for many years to come, we are starting to prepare for a future without an adequate supply of oil.

Though electric vehicles powered by fuel cells and batteries are some of the most promising replacements in the long term, the transition to all-electric transport may be smoothed by hybrid vehicles featuring both ICEs and electric motors. Here the ICE serves both to drive the wheels directly and to charge the vehicle's battery. The next promising development is the plug-in hybrid, which can also be charged directly from the grid.

ICEs can run on many types of fuel, both liquid and gaseous, as well as the conventional gasoline and diesel. Gaseous fuels would require a new infrastructure and introduce new safety issues, so the best bet seems to be liquid fuels with their high energy densities. These include alcohols and biodiesel produced from biomass, and synthetic hydrocarbons, alcohols and ethers made from natural gas and coal.

In the long term, growing demand means that energy for transport will have to be based on many sources. There is no doubt that we will continue to use liquid hydrocarbons, as well as quasi-liquid fuels like liquefied natural gas (LNG) and dimethyl ether (DME). Alternatives such as hydrogen and electricity will gain market share at rates determined by technical and economic issues.

### Future fuels

#### *Hydrogen and synthetic fuels from renewable sources*

Hydrogen is chemically the simplest fuel and can easily be produced from electricity by the electrolysis of water. Although hydrogen has the highest mass energy density (kJ/

kg) of any known substance (ignoring nuclear fuels), it has low volumetric energy density (kJ/m<sup>3</sup>) because it takes up a lot of space even at high pressures. Hydrogen may be stored in liquid form at low temperatures (approximately 20 K at ambient pressure), but the liquefaction process is costly and results in energy losses of up to 40% [3]. For this reason liquid hydrogen does not have extended interest as fuel among car manufacturers.

In general it has proved difficult to store hydrogen in ways appropriate for use in vehicles. Intensive efforts are being made to develop solid-state storage technologies, but compressed hydrogen still seems to be the car manufacturer's preferred technology.

Synthetic fuels from renewables are hydrocarbons (or partly oxidized hydrocarbons) prepared from renewably-sourced hydrogen and carbon. The hydrogen typically comes from wind or solar power via electrolysis, while the carbon source can be CO<sub>2</sub> from the fermentation or combustion of biomass.

Once manufactured, liquid synthetic hydrocarbons have the enormous advantage that they can be distributed via the infrastructure already used for gasoline, diesel, biodiesel and bioethanol.

Synthetic hydrocarbons are currently made by a route known as Fischer-Tropsch synthesis. This is proven technology, which was developed in Germany during the Second World War, and later in South Africa.

A promising future possibility is the use of high-temperature electrolysis in combination with Fischer-Tropsch synthesis of liquid fuels. Experiments have shown that high-temperature solid oxide electrolysis of CO<sub>2</sub> and water can produce mixtures of carbon monoxide (CO) and hydrogen [4]. Such mixtures can easily be used to produce liquid hydrocarbons.

Synthetic hydrocarbons may be chemically identical to gasoline or diesel, but they may also differ, potentially giving them properties that are better than those of conventional gasoline and diesel.

*Synthetic fuels from fossil fuels* include hydrocarbons and hydrogen produced from fossil fuels by the process known as steam reforming, followed in the case of liquid fuels by Fischer-Tropsch synthesis. This has the advantage of allowing liquid fuels to be produced from coal and natural gas, and of providing hydrogen that could smooth the transition to a transport system based on hydrogen from renewable sources.

Figure 21

**Links between energy carriers and energy converters in the future sustainable energy system. The sun is the primary energy source. Electricity and various forms of synthetically prepared chemical fuels are predominating energy carriers and a variety of conversion technologies will be required. The figure is not exhaustive.**

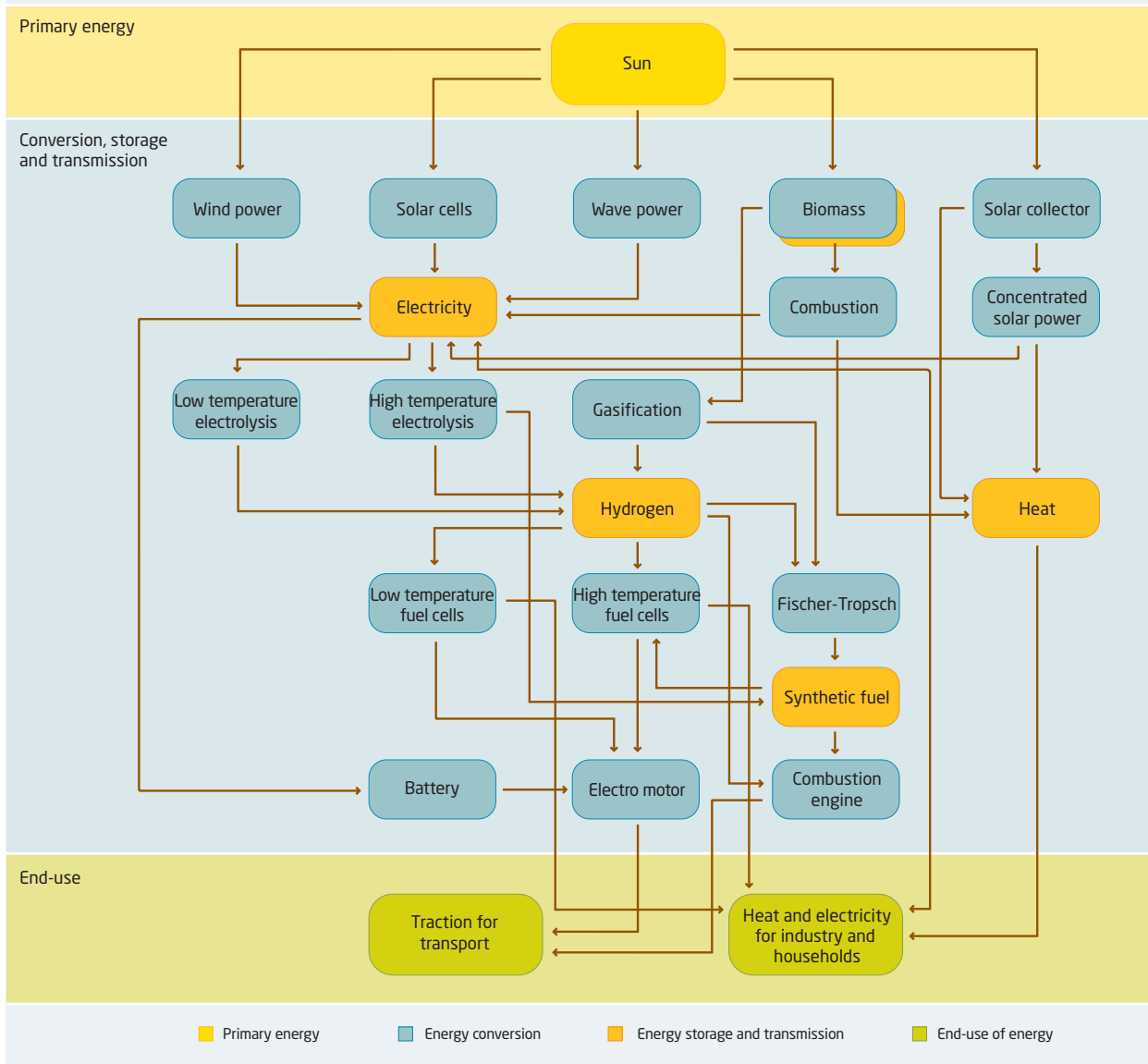

As when fossil fuels are burned directly, the process of manufacturing synthetic fuels from fossils yields CO<sub>2</sub>, which will have to be captured and stored if we wish to be CO<sub>2</sub>-neutral. The storage technology would be identical to that used for coal-burning power plants, and relies on the existence of suitable underground cavities. Public acceptance of the idea remains to be properly tested.

**Biofuels** can be produced from biomaterial such as crops and crop wastes, including wood. In some cases the fuel is created directly by biological processes driven by sunlight; an example is rapeseed oil, which can be used directly in diesel

engines. Other biofuels are manufactured via more complex chemical or thermochemical processes. Most biofuels are liquids, and therefore fit well into the existing infrastructure for fossil transport fuels.

#### Links between electricity and future fuels

As described above, electricity will undoubtedly be a core constituent of the future energy supply. Luckily, electricity is also a versatile energy source for transport, whether stored directly in batteries or indirectly as a synthetic chemical fuel.

When electricity from renewables reaches 50% of our total

energy supply, the well-known problem of mismatches between supply and consumption will cause prices to fluctuate strongly. Both technically and economically, a need will arise for electrical loads that can be activated during periods of excess power production (see also Chapter 9) [5]. Such loads could well include car batteries and electrolysers producing transport fuels.

Even with 100% renewables, the spare power available as a result of mismatches between supply and demand could not produce enough energy to power the existing transport sector [5]. We therefore need to envisage plants more or less dedicated to producing transport fuels.

The uncertainties in this scenario relate less to the necessary production technology than to the infrastructure. To make plug-in electric vehicles practical, for instance, we would need a profound change in infrastructure to create a widespread network of charging points; a similar argument applies to hydrogen. The alternative approach of making piecemeal changes is not feasible in these cases.

How much can we afford to invest in a new infrastructure? Would it be cheaper to start building plants for synthetic fuels, which could gradually replace fossil fuels in transport over a period of many years?

## Recommendations

In our opinion it is not possible at this stage to predict a long-term winner among the available energy carriers. We therefore need to provide enough support to allow every likely technology a chance to compete on equal terms.

We tend to agree with David Friedman, who wrote [6]: “For example, the darling of the moment, the plug-in-hybrid, is still too expensive, and there are still concerns about the longevity of its batteries. Instead of picking winners, the government must place bets on all of the above contenders and give them enough of a chance to prove themselves. We keep jumping from silver bullet to silver bullet. It takes longer than that to revolutionize the auto industry.”

Frits Møller Andersen, Henrik Klinge Jacobsen, Helge V. Larsen, Risø DTU; Stine Grenaa Jensen, Dansk Energi

## Introduction

High targets for renewable energy in the energy system, related to EU's climate and energy package, are expected to increase the share of renewable energy in the electricity system up to 50% in Denmark. The dominating source of renewable energy in Denmark is wind power, whose fluctuations imply volatile hourly prices in future power markets. Economists argue for exposing customers to these varying prices, and hence, create a flexible demand that will help to balance the power system, improve market efficiency, reduce price volatility, and create a welfare gain.

Using a simulation model for the Californian electricity market Borenstein (2005) calculates a significant long-term efficiency gain from hourly electricity pricing, mainly related to a reduced need for peak capacity.

Real customers, however, show some reluctance to observe and react to hourly prices. Explanations for this could include the extra costs of metering and billing, information costs and costs of changing consumption, wealth transfers among customers, and volatility of bills. In addition, short-term gains seen in the market so far have been quite small, while long-term gains are not very transparent for the customer.

Holland and Mansur (2006) developed a simulation model for the Mid-Atlantic electricity market PJM and calculated very small short-term gains. Using Nord Pool data for the period 2001-2008 the analysis in this paper evaluate average welfare gains to be less than 0.5% of the electricity bill paid by customers.

However, gains vary considerable between years and depend crucially on the variation in prices. Larger proportions of wind power will increase the consumer benefits of flexible consumption. In addition, in the future enabling technologies may make it easier for customer to respond to varying prices.

## The market for electricity

A fundamental characteristic of the electricity market is that demand varies over time due to consumer behaviour, and costs of producing electricity vary with the unit generating electricity.

Figure 22 (top) shows hourly average electricity consumption in Denmark for working days and weekends. Representing the hourly variation in a standard microeconomic scheme Figure 23 (top) shows that demand variations (shifting the demand curve) imply a systematic positive correlation between the price and quantity consumed.

Figure 22  
Average hourly consumption curves for Denmark 2007, and the variation of wind power production in the second half of January 2007.

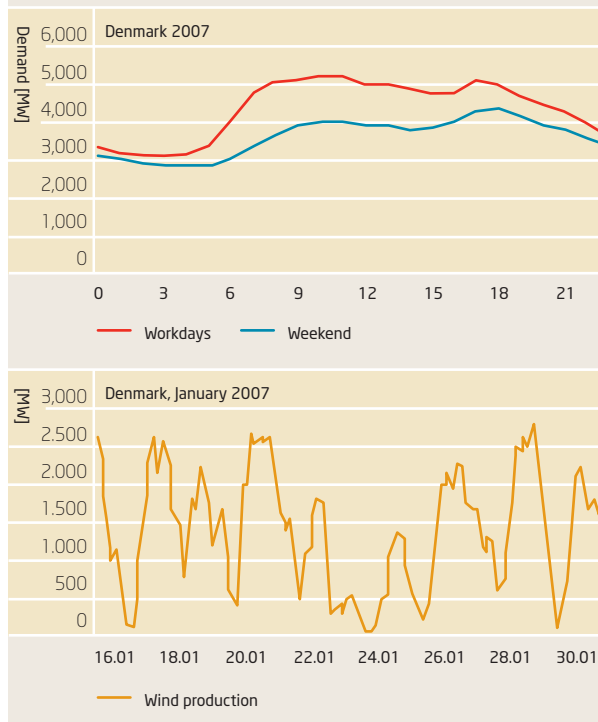
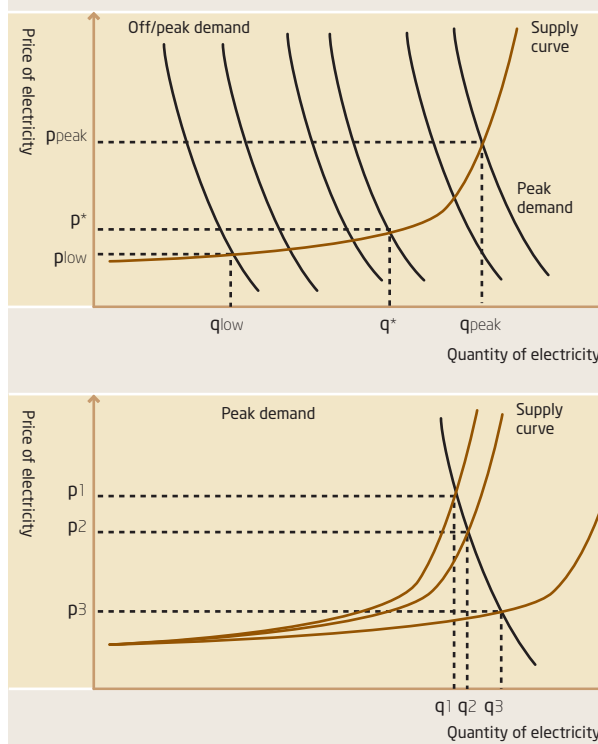

Figure 23  
Effects of changes in the demand and supply of electricity.





Turning to supply, Figure 22 (bottom) shows an extreme example of the stochastic nature of the hourly wind production in Denmark, and Figure 23 (bottom) illustrates that this implies a negative correlation between the unsystematic variation in wind power production and the market price.

Combining effects, Figure 24 shows hourly consumption, Nord Pool area price, and relative wind power production for western Denmark during the second half of January 2007. It illustrates a systematic positive correlation between daily and weekly electricity consumption and the area price, and a negative correlation between an unsystematic variation in wind power production and the price. (The bottom part of Figure 24 shows the hourly wind power production relative to hourly consumption in western Denmark.) January 2007 was an extreme case, but one which may arise quite often in the future as the proportion of wind power in the system increases.

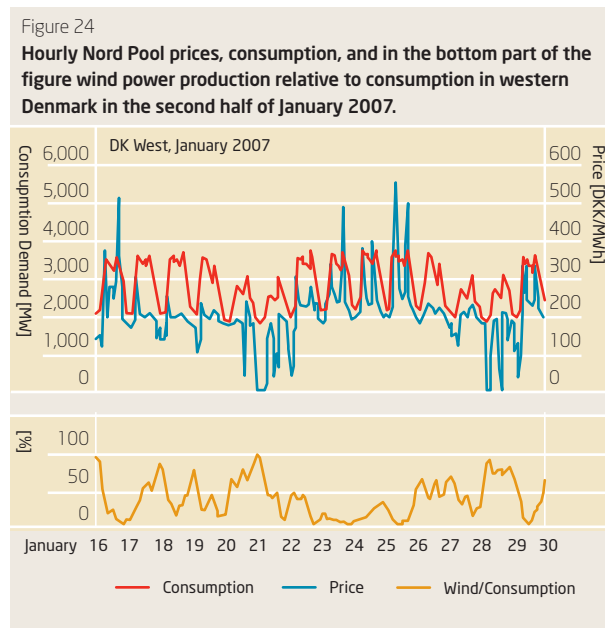

In terms of descriptive statistics for hourly prices and quantities traded at the Nord Pool market, Table 7 shows average, standard deviation and skewness coefficient<sup>2</sup> for the two Danish price areas. Looking at quantities consumed, western Denmark is approximately 45% larger than eastern Denmark. Looking at different years, average hourly con-

sumption and standard deviation in consumption is almost constant over the years, and the relative standard deviation is almost the same for western and eastern Denmark. The distribution of hourly consumption is almost symmetrical, giving a skewness coefficient close to zero.

Prices, on the other hand, are much more volatile; looking at years and comparing western and eastern Denmark shows that the average hourly price, the standard deviation of prices and the skewness coefficient all vary considerably.

In summary, the distribution of hourly consumption is relatively stable, but the distribution of prices changes significantly over the years and differs for the two Danish price areas at Nord Pool. In general the distribution of hourly prices has a positive skewness coefficient, indicating a “long tail” of high prices.

### Microeconomic analysis of short-term demand response

Looking at one supply curve, a peak, and an off-peak demand curve, short-term effects of changing from a fixed average price to hourly prices are illustrated in Figure 25. If customers are charged an average price ( $P_{avg}$ ) they demand electricity according to the intersection of the horizontal price curve and their demand curves at points A or  $\bar{A}$ . This implies marginal production costs at points B and  $\bar{B}$  and market prices of  $P_B$  and  $P_{\bar{B}}$ . Assuming that consumers are charged hourly prices an efficient clearing of the market is obtained in points C and  $\bar{C}$  implying lower price and quantity variations in the market and a short-term welfare gain equal to the shaded areas ABC and  $\bar{A}\bar{B}\bar{C}$ . In off-peak periods, electricity that has a value to the customer when priced according to its marginal costs is now consumed, and in peak periods an excess demand not valued the costs is foregone. The size of these effects depends on the shape of the supply and demand curves. Looking specifically at demand, the more flexible demand is (a less steep demand curve), the larger is the effect on the price, quantity, and welfare gain.

<sup>2</sup> The skewness coefficient is calculated as:  $E[(x-m)^3]/s^3$ . For a symmetric distribution the skewness coefficient is zero and for asymmetric distributions the skewness coefficient is positive if the long tail is in the positive direction. For a further description of the skewness coefficient see Greene, W.H. (1997) p. 66.

Table 7  
**Descriptive statistics for observed prices [€/MWh] and quantities [MW] traded at Nord Pool 2001-2008.**

		Average		Standard deviation		Skewness coefficient	
		Price	Quantity	Price	Quantity	Price	Quantity
2001	DK West	24	2353	10	554	8.69	0.28
	DK East	24	1662	10	382	7.71	0.20
2002	DK West	25	2343	16	547	5.20	0.26
	DK East	29	1636	18	386	2.73	0.23
2003	DK West	34	2358	22	539	9.62	0.28
	DK East	37	1617	16	377	3.06	0.24
2004	DK West	29	2375	7	537	-0.37	0.25
	DK East	28	1623	6	375	0.37	0.22
2005	DK West	37	2398	17	549	4.85	0.23
	DK East	34	1642	30	372	34.52	0.18
2006	DK West	44	2443	13	542	0.09	0.26
	DK East	49	1664	18	374	2.24	0.20
2007	DK West	32	2465	24	545	11.92	0.23
	DK East	33	1657	22	364	13.42	0.19
2008	DK West	56	2461	20	538	0.72	0.20
	DK East	57	1649	22	357	1.08	0.15

Figure 25  
**Effects of going from average pricing to hourly prices at the market.**

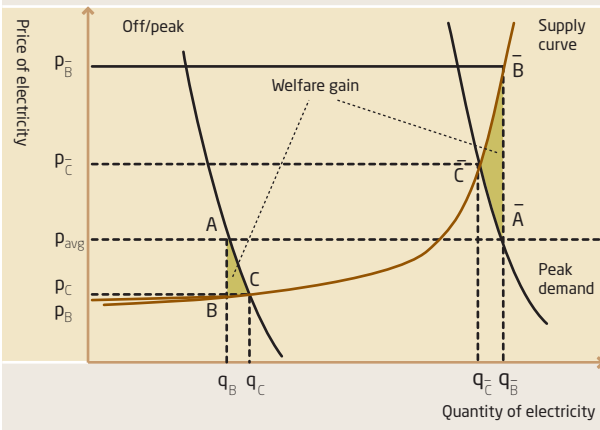

Interpreting Figure 25 in the Nord Pool day-ahead market, point  $\bar{B}$  represents the hourly prices and quantities traded in the market, point  $\bar{A}$  represents the average annual price paid by customers facing annual pricing. To calculate point  $\bar{C}$  and the welfare gain the marginal properties of the demand and supply curves are required. In the calculations presented in the next section the curves are described by constant elasticity functions.<sup>3</sup> Finally, adding welfare gains for each hour of a year gives the annual welfare gain reported in the next section.

<sup>3</sup>Assuming that the marginal properties of the demand and supply curves are represented by constant elasticity functions, we have:

$$\begin{aligned}
 \text{Demand:} & \quad \Delta \log(q) = \alpha \cdot \Delta \log(p) \\
 \text{Supply:} & \quad \Delta \log(q) = \beta \cdot \Delta \log(p)
 \end{aligned} \tag{1}$$

where, the price elasticity of demand, is a negative constant and, the price elasticity of supply, is a positive constant.

Inserting prices and quantities from Figure 25 into eq. [1] the equilibrium price and quantity at point C may be calculated as:

$$p_C = \frac{p_B^{\beta/(\beta-\alpha)}}{p_{avg}^{\alpha/(\beta-\alpha)}} \quad \text{and} \quad q_C = q_B \cdot \left( \frac{p_B}{p_{avg}} \right)^{\alpha\beta/(\beta-\alpha)} \tag{2}$$

Finally, integrating over the constant elasticity equations, the welfare gain is calculated as:

$$w = \left( \frac{p_C \cdot q_C}{1 + 1/\beta} \right) \cdot \left[ \left( \frac{q_B}{q_C} \right)^{1+1/\beta} - 1 \right] - \left( \frac{p_C \cdot q_C}{1 + 1/\alpha} \right) \cdot \left[ \left( \frac{q_B}{q_C} \right)^{1+1/\alpha} - 1 \right] \tag{3}$$

where the first part of the equation is the area under the supply curve going from  $q_B$  to  $q_C$ , and the second part is the corresponding area under the demand curve.

### Short-term welfare gains from increased demand response in Denmark

Supply elasticities for the two Danish price areas at Nord Pool are calculated from the Balmorel model<sup>4</sup>, and as a sensitivity analysis demand elasticities ranging from -0.05 to supply elasticities for the two Danish price areas at Nord Pool are calculated from the Balmorel model, and as a sensitivity analysis demand elasticities ranging from -0.05 to -0.5 are analysed.

Two additional assumptions related to demand are:

- The retail price paid by customers is calculated from the Nord Pool wholesale price plus average additions for subscription, grid-payment, and taxes. Three categories of customers are identified: households, small companies, and large customers. For households the additive is 196.4 €/MWh, for small companies 50.3 €/MWh, and for large customers 27.7 €/MWh. Price additives act as a scaling factor on the price. Assuming constant elasticities, fixed price additives reduce the relative price change and therefore the corresponding quantity change.
- At each hour, each of the customer categories consumes one-third of the total power sold. On average, this is a reasonable approximation, but for individual hours it is somewhat dubious. Figure 26 shows actual hourly consumption by the three categories for the period 5-10 January

ary 2008. This shows that households consume a smaller share of total consumption during normal working hours and a larger share at other times. However, this information is not used in the calculations presented here.

Looking at prices and the relation between the descriptive statistics of Table 7 and changes in the demand elasticity, for 2007 the relation is illustrated in Figure 27.

The main effect of introducing demand response is a considerable reduction in price volatility, especially the tail of high prices is reduced (that is, as the demand elasticity increases the standard deviation and skewness coefficient are reduced considerably). Changes in quantities and the distribution of hourly quantities consumed are much smaller than for prices.

Combining price and quantity changes, short-term welfare gains for 2001 to 2008 are given in Table 8. In general, welfare gain increases with the numerical size of the demand elasticity, but the steepness of the curve decreases with increasing elasticity. The size of the short-term welfare gain is, however, quite small; assuming a large demand elasticity of -0.5, on average over the years 2001 to 2008 the total welfare gain is 12.9 M€ per year or less than 1% of the trade in the market. Due to grid payment, taxes etc. welfare gains are less than 0.5% of what customers pay for electricity. Assuming a more realistic elasticity of -0.05, on average over the years analysed 2.1 M€ per year is gained.<sup>5</sup> This conclusion,

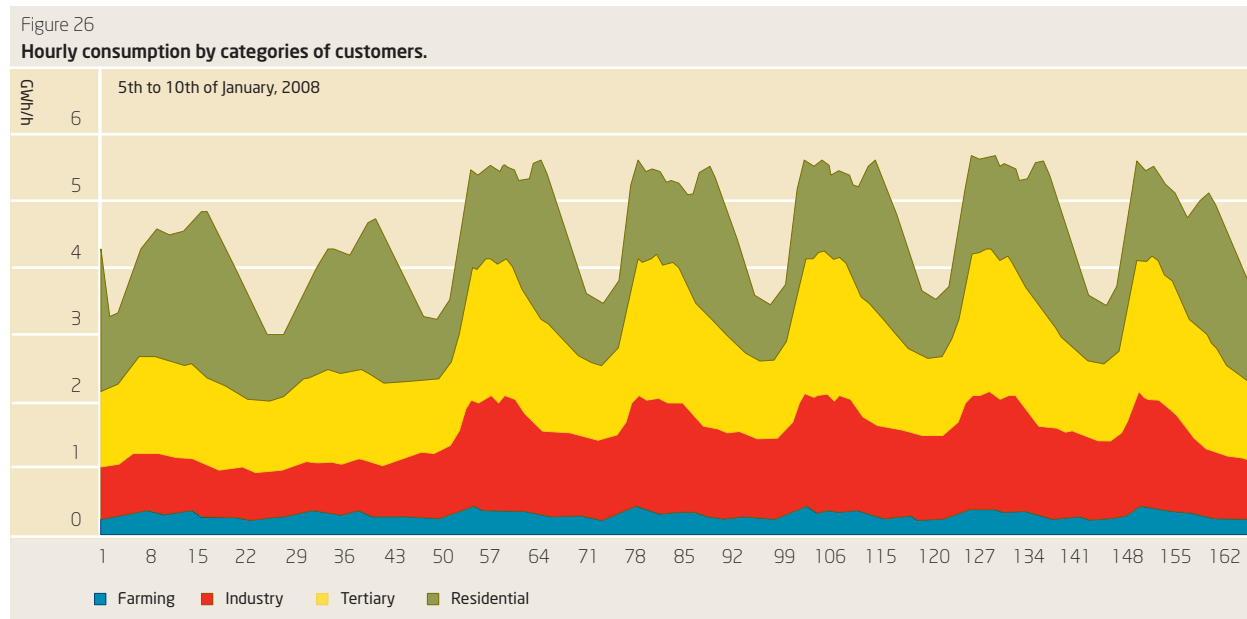

<sup>4</sup> A detailed description of the Balmorel model can be found in [www.Balmorel.com](http://www.Balmorel.com)



related to the average welfare gain over the years analysed, is in line with conclusions in Holland and Mansur (2006). However, looking at individual years, Table 8 shows quite large differences in the annual welfare gain from one year to another. Annual differences are actually larger than the effect of a doubling of the demand elasticity. Doubling the

demand elasticity from -0.15 to -0.3 increases the average gain by app. 70%, but annual gains vary a factor 6 to 7 from one year to another. To explain differences in annual welfare gains the distribution of hourly prices is important.

Plotting the annual welfare gain against the standard deviation of hourly prices, Figure 28 shows that in general the welfare gain increases with increasing volatility of prices. However, welfare gains are not related to standard deviation of price only, also the structure of the price variation is important. Looking at eastern Denmark, the welfare gain for 2005, which have the largest standard deviation in prices, is lower than for 2007. Concerning 2005, November 28 the price peaked at 60 times the normal price. If we repeat the calculation leaving out these critical hours, the welfare gain for eastern Denmark in 2005 falls by about 30% and the standard deviation falls by about 40%. That is, a few very high prices contribute significantly to both the welfare gain

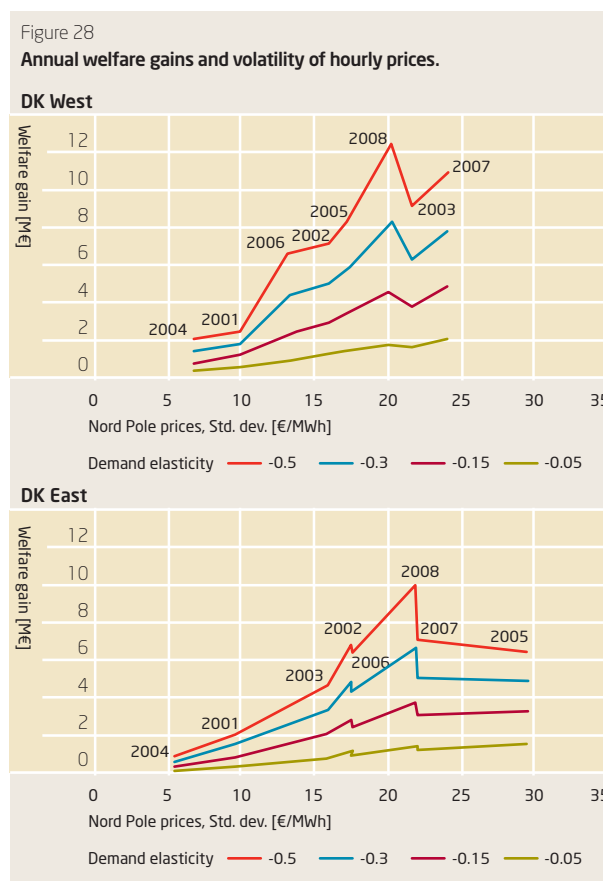

<sup>5</sup> An elasticity of -0.05 implies that in an hour where the consumer price is twice the average, consumption is reduced by 5%. An average customer pays app. 90 €/MWh in grid payment, taxes etc. plus an average Nord Pool price of app. 40 €/MWh; in total app. 130 €/MWh. A doubling of the consumer price gives a price of 260 €/MWh equivalent to app. a 5 doubling of the NordPool price.

Table 8  
Short-term welfare gain [M€/year] assuming different price elasticities as well as standard deviation [€/MWh] and skewness in Nord Pool prices, 2001 to 2008.

	Demand price elasticity												Standard deviation in Nord Pole prices			Skewness in Nord Pole prices	
	-0.05			-0.15			-0.3			-0.5							
	West	East	Total	West	East	Total	West	East	Total	West	East	Total	West	East			
2001	0.5	0.4	0.8	1.1	0.9	2.0	1.8	1.5	3.3	2.5	2.1	4.5	10	10	10	9	8
2002	1.2	1.1	2.3	3.0	2.8	5.8	5.0	4.8	9.7	7.1	6.8	13.9	16	18	17	5	3
2003	1.6	0.8	2.4	3.8	2.0	5.8	6.3	3.3	9.6	9.0	4.7	13.7	22	16	19	10	3
2004	0.3	0.1	0.4	0.7	0.3	1.0	1.3	0.6	2.0	2.1	0.9	3.0	7	6	6	0	0
2005	1.3	1.5	2.8	3.3	3.3	6.6	5.6	4.9	10.5	8.1	6.4	14.6	17	30	22	5	35
2006	0.8	0.9	1.8	2.4	2.5	4.8	4.3	4.4	8.7	6.7	6.4	13.1	13	18	15	0	2
2007	2.1	1.3	3.4	4.8	3.1	7.9	7.7	5.1	12.8	10.9	7.1	18.0	24	22	23	12	13
2008	1.7	1.4	3.0	4.5	3.7	8.2	8.2	6.6	14.8	12.3	9.9	22.2	20	22	21	1	1
Average	1.2	0.9	2.1	3.0	2.3	5.3	5.0	3.9	8.9	7.3	5.6	12.9					

Table 9  
Contribution to welfare gain in 2004 and 2007.

	M€/year	Demand price elasticity											
		-0.05			-0.15			-0.3			-0.5		
		West	East	Total	West	East	Total	West	East	Total	West	East	Total
2004	Below average price	0.1	0.1	0.2	0.4	0.2	0.6	0.9	0.4	1.2	1.4	0.6	2.0
	Average to two times average price	0.1	0.0	0.1	0.3	0.1	0.4	0.4	0.2	0.6	0.6	0.3	0.9
	Above two times average price	0.0	0.0	0.0	0.0	0.0	0.1	0.0	0.1	0.1	0.0	0.1	0.1
	<b>Total</b>	<b>0.3</b>	<b>0.1</b>	<b>0.4</b>	<b>0.7</b>	<b>0.3</b>	<b>1.0</b>	<b>1.3</b>	<b>0.6</b>	<b>2.0</b>	<b>2.1</b>	<b>0.9</b>	<b>3.0</b>
2007	Below average price	0.6	0.3	0.9	1.8	1.0	2.8	3.5	2.0	5.5	5.7	3.2	8.9
	Average to two times average price	0.3	0.2	0.5	0.7	0.5	1.2	1.2	0.9	2.0	1.6	1.2	2.9
	Above two times average price	1.2	0.8	2.0	2.3	1.6	3.9	3.0	2.2	5.3	3.5	2.7	6.2
	<b>Total</b>	<b>2.1</b>	<b>1.3</b>	<b>3.4</b>	<b>4.8</b>	<b>3.1</b>	<b>7.9</b>	<b>7.7</b>	<b>5.1</b>	<b>12.8</b>	<b>10.9</b>	<b>7.1</b>	<b>18.0</b>

and standard deviation of prices. Finally comparing years with a low (2004) and a high (2007) welfare gain, the former is characterized by a symmetric price distribution with a low standard deviation; in 2007, on the other hand, prices were fairly volatile and the distribution has a considerable tail of high prices. Looking at which parts of the price scale that contribute to the total welfare gain in 2004 and 2007, Table 9 shows the welfare gain attributed to prices in three bands: below the Nord Pool average; between the average and twice the average; and above twice the average.

In 2004, with its symmetric distribution of prices and a low standard deviation, most of the welfare gain stems from prices below the average price. For 2007, where prices are more volatile and the distribution has a tail of high prices, assuming a low demand elasticity most of the welfare gain comes from prices above two times the average price.

With an increase in the demand elasticity, however, the contribution from below-average price increases faster than the total, and for very large demand elasticities more than 50% of the total gain is related to prices below the average.

This suggests that when the demand price elasticity in the market is low, welfare gains are mainly related to reducing

consumption in periods with high prices, while periods with zero - or close to zero prices contribute less to the short-term welfare gain. However, as the demand price elasticity increases an increasing share of the welfare gain is related to increased consumption in periods with low prices.

Finally, we look at the implication of fixed additives to the market price such as grid payment and taxes. Table 10 shows the effects on the contribution from customers in the three different categories. This assumes that each hour, each category of customer uses one-third of the total power sold, and that the only difference between the three categories is the size of the fixed price additive.

A large fixed price additive for households (app. six times the average wholesale price) implies a low relative price variation, and therefore, a limited welfare gain from exposing households to varying prices. For large customers, paying a much lower price additive (app. 100% of the wholesale price), relative price variations are larger and the welfare gain is higher. Put in another way, the welfare gain for households in Denmark is less than half of the corresponding figure for large customers.

If in addition, it is evaluated that large customers have

Table 10  
Welfare gain and consumer categories (effects of fixed price additives).

	M€/year	Price-addition €/MWh	Demand price elasticity											
			-0.05			-0.15			-0.3			-0.5		
			West	East	Total	West	East	Total	West	East	Total	West	East	Total
2004	Large customers	28	0.1	0.1	0.2	0.4	0.2	0.5	0.7	0.3	1.0	1.0	0.5	1.5
	Small customers	50	0.1	0.0	0.1	0.3	0.1	0.4	0.5	0.2	0.7	0.8	0.3	1.1
	Households	196	0.0	0.0	0.0	0.1	0.0	0.1	0.2	0.1	0.3	0.3	0.1	0.4
	<b>Total</b>		<b>0.3</b>	<b>0.1</b>	<b>0.4</b>	<b>0.7</b>	<b>0.3</b>	<b>1.0</b>	<b>1.3</b>	<b>0.6</b>	<b>2.0</b>	<b>2.1</b>	<b>0.9</b>	<b>3.0</b>
2007	Large customers	28	1.0	0.6	1.6	2.2	1.4	3.6	3.5	2.3	5.8	4.9	3.2	8.1
	Small customers	50	0.8	0.5	1.3	1.8	1.1	2.9	2.8	1.8	4.7	3.9	2.6	6.5
	Households	196	0.4	0.2	0.6	0.9	0.6	1.5	1.4	0.9	2.4	2.0	1.3	3.4
	<b>Total</b>		<b>2.1</b>	<b>1.3</b>	<b>3.4</b>	<b>4.8</b>	<b>3.1</b>	<b>7.9</b>	<b>7.7</b>	<b>5.1</b>	<b>12.8</b>	<b>10.9</b>	<b>7.1</b>	<b>18.0</b>

Table 11  
Price differences in the Western Denmark price area from 2 to 12 hours.

Hours with >10 €/MWh deviation	Hours with deviation (2 hours difference)			Hours with deviation (4 hours difference)			Hours with deviation (12 hours difference)		
	Negative	Positive	Total	Negative	Positive	Total	Negative	Positive	Total
2006	712	773	1485	1298	1332	2630	2045	2030	4075
2007	376	495	871	763	898	1661	1307	1317	2624
2008	1493	1525	3018	2509	2225	4734	3184	3132	6316

higher price elasticities than households, to obtain demand response exposing large customers to varying prices seems a reasonable starting point. As Figure 26 shows, however, the evening demand peak comes mainly from households, so some flexibility in household consumption is needed to reduce peak loads.

### Incentives and measures for demand response

For electricity customers in general, the value of demand response increases with the amount of price fluctuation. For an individual customer, the value depends on the price paid each hour, not on the average price or price variations. That is, average incentives for all customers may be small, but customer demand profiles vary considerably, and incentives for some customers might be quite high.

With high volatility of prices the profitability of certain new technologies increases. Low hourly prices occurring frequently facilitate substitution from other fuels to electricity, e.g., switching from other heating technologies/fuels or from transport fuels to electric vehicles. The profitability of this switching stems from switching a major part of the consumption in time. In the average calculations presented in the previous section only a minor share of each customer's consumption is switched, and therefore, incentives for these technologies are not adequately represented by the average calculations referred to above.

The profitability of the new technologies depends on the

actual fluctuation in prices and a major part of price variation has to be short time variation. Long periods with lower prices and long periods with high prices are not beneficial to technologies that have to be reloaded regularly (daily), e.g., car batteries and heat storage.

On an annual basis, prices vary less than in the extreme example of January 2007. When examining the incentives to engage in different demand response options, it is interesting to consider price changes from one hour to the next. Table 11 shows the frequency of price differentials of different durations for western Denmark over three years. To create a significant amount of demand shifting, the time horizon should not be more than 2-4 hours.

A similar argument applies to switching of demand from natural gas or oil to electric heating or heat pumps without larger storage facilities. For this to be attractive, the price differential has to be large. Even more importantly, periods of low prices must occur frequently.

Price swings lasting more than 12 hours are useful only for applications that need to operate just a few times a week. This applies to large heat storage facilities, and possibly electric vehicles.

Table 11 compares actual price differentials in €, not the relative differentials. The large variation from year to year is caused not by differences in wind capacity or conditions, but by the fact that average prices or price levels are varying.

As expected, the number of occasions on which the price



changes by more than 10 €/MWh over two hours is less than that over four hours, and the 12-hour difference is the largest. 4075 hours in 2006 and 6316 hours in 2008 showed a price difference of more than 10 €/MWh relative to 12 hours earlier.

The crucial issue is whether these price differences are sufficient to induce demand response (demand shifting). For households facing an electricity bill of more than 225 €/MWh (as in Denmark), a saving of 10 €/MWh for shifting is scarcely worthwhile unless a large proportion of consumption is shifted.

For an industry paying 100 € per MWh for power and large short-term loads that can conveniently be shifted, the situation is more promising. The same is true if the factory uses electric heating: on 4734 occasions in 2008 the price changed by more than 10 € difference over four-hour period. This is a big enough saving to induce demand shifting of heating, and even investments in additional heat storage.

Table 11 also shows that price differentials measured over 12 hours reach 10 €/MWh on 6316 occasions in 2008. For half of these hourly periods, demand shifting would have produced lower demand; during the remaining hours, demand would be higher. The total saving from demand shifting thus equals the amount of demand shifted multiplied by half of the hours. Demand response would of course also reduce the variation in prices, but here we only consider the marginal incentive.

For the 12-hour time horizon the frequency of significant price changes is high, so it is worthwhile looking at a price difference of 20 €/MWh. Table 12 shows that in 2008, prices changed by 20 €/MWh or more over 12 hours during 3656 hourly periods.

Even more important is that the average deviation for these hours was close to 40 € per MWh revealing that the average incentive is much higher than just the 20 €. However, this can not be interpreted as if it is possible to shift for all hours because a lot of these occurrences are correlated in time and large differences normally occurs in hours close to each other.

2008 is not necessarily a representative year; for a large part of the year electricity prices were very high, as a consequence of high fossil fuel and carbon prices. This situation has already been reversed, and with a lot of new intermittent generation coming on stream, prices will probably remain below 2008 levels for at least two or three years. However, price variability relative to the average price will not fall.

In the longer term it is likely that conventional generation

capacity will shrink, or at least not increase to match the growth in demand. When this happens, both average prices and especially price volatility will increase, and incentives for demand response will be at least as high as those of 2008.

## Conclusions

From an international perspective, Denmark is located between the hydropower of the Nordic system and the thermal generation of continental Europe. Denmark itself is characterized by a thermal system with a large share of wind power. In a thermal system with wind, hourly costs and prices are very volatile, while in a hydro-based system with large storage facilities to balance fluctuating wind generation, hourly prices are more stable. Introducing a large proportion of wind in the continental European system is therefore expected to require an increased demand flexibility, additional regulation and storage capacity, or both.

Demand response, even at relatively low demand price elasticities, considerably reduces the volatility of prices, and especially the tail of high prices. Average prices and quantities consumed, and the hourly distribution of consumption, change only marginally.

In terms of short-term welfare gains from demand response, on average over the period 2001 to 2008 the potential gain for domestic users in Denmark was less than 0.5 % of the electricity bill paid by customers including grid payment and taxes. However, the incentive for customers is somewhat larger as the average wholesale price is reduced. In addition, welfare gains vary considerably over the years, and gains increase with increasing volatility of prices and long tails of high prices.

Integration of a larger share of fluctuating wind power is expected to increase price volatility. This will encourage demand response, which also facilitates the integration of wind by counteracting fluctuations in supply. Zero prices in periods with excess wind power have been an argument for increasing demand response, and the decision to use negative power prices in the Nordic area will encourage this.

However, looking at welfare effects, the important effect of demand response is a reduction of demand at high prices. Assuming realistic demand elasticities, welfare gains relate mainly to periods with high prices; to obtain substantial welfare gains from low-price periods, demand elasticities have to be very large. In the future, demand elasticities may become larger thanks to the introduction of enabling technologies, such as automatic disconnection of appliances

Table 12

**Price differences over 12 hours in the western Denmark price area.**

Hours with >20 €/MWh deviation over 12 h	Average price €/MWh	Hours with lower price	Average deviation €/MWh	Hours with higher price	Average deviation €/MWh	Hours total	Average deviation €/MWh
2006	45.8	989	-29.7	985	29.6	1974	29.6
2007	34.8	542	-29.4	529	30.1	1071	29.8
2008	58.3	1827	-39.5	1829	40.0	3656	39.7

when the price becomes high. Even so, elasticities in the near future are likely to remain fairly low.

The incentives for customers to shift demand in time depend on the price differential over a suitable time interval. Price differentials over two, four and 12 hours are substantial in Denmark, mainly due to demand variation and, to a limited extent, to fluctuations in wind power. In the future, electric vehicles will be able to take advantage of price differentials when charging their batteries.

Given that long-term welfare gains are evaluated to be substantial, yet short-term gains seen in the market so far have been small, new incentives are needed to increase demand response. Looking at fixed price-additives, for an efficient market fixed additives should be minimized and replaced by a percent-type of additives. This is important especially looking at the very high fixed price-additives (mainly taxes) placed on household consumption in Denmark.

Given hourly metering, another recommendation is that customers should be billed according to hourly consumption and prices. Customers with a high consumption in expensive hours should pay the cost and should not be allowed to choose an average rate.

Finally, enabling technologies making it easier for customers to react to changing prices should be introduced.



*Hans Larsen and Leif Søndberg Petersen, Risø DTU*

This chapter gives an overview of the findings of the report.

### **Trends in European and international energy development**

Within the energy sector energy security and climate change are the two overriding priorities, as described in Chapter 3. This is especially true for industrialized countries and the more rapidly developing economies. Many other developing countries still face basic energy development constraints that give quite a different meaning to the concept of energy security.

Chapter 4 outlines how renewable energy resources (RES), once insignificant, are gradually expanding their role in global energy supply. Today the dominant contributions are from large hydropower, which supplies approximately 2% of the world's energy, and traditional biomass, which amounts to a little more than 10%. Only around 1.5% of global energy comes from new renewable sources such as photovoltaics (PV), wind power, small-scale hydro, biogas and new biomass.

Nevertheless, while hydropower and traditional biomass are increasing only slowly or even staying constant in absolute terms, the contributions from new renewable sources are expanding rapidly. Today the fastest growing energy technology is PV, which from a previously insignificant level has grown at 35% a year for the last five years. Other fast-growing new renewables include wind power, which has increased by 28% a year over the same period.

In Europe this development is driven by both national and EU policies. By 2008 the EU member states had adopted long-term energy targets, setting a path to a radical change in European energy systems within the next decade. Energy technologies based on variable sources, especially wind and PV but also smaller amounts of wave power, are expected to contribute significantly to future energy supply. In Denmark, for instance, the target is to double the existing share of renewable energy by 2025.

Today's energy systems, in Denmark as in the rest of Europe, are the result of decisions taken over more than a century. Of course this long-term development is reflected in the structure of the energy systems, which in most cases follow basic engineering requirements: energy is produced to fulfil the needs of consumers and should be made available according to these needs. A new supply structure based on variable energy resources such as wind power, however, will require a much more flexible energy system, including flexibility on the part of energy consumers.

### **Planning and operation of power systems with a high share of renewable energy**

Planning and operating large interconnected power systems involves a range of time scales from milliseconds to decades, Chapter 5 notes. Planning and operation will be strongly influenced by the introduction of large amounts of renewable energy; the main challenges arise from the variable and only partly predictable nature of renewable energy sources such as wind, PV and wave power. Uncertainties over future prices of biomass are important, but resemble existing well-known uncertainties about the prices of oil, gas, wheat, rice and corn.

Stability, according to Chapter 6, is essential to ensure that any energy system operates satisfactory and provides its customers with energy of sufficient quality. The stability concern is particularly important for electric power systems, because they are very vulnerable if not properly prepared for possible disturbances. Power system stability is essential if we are to maintain the high standard we have today, with a minimum frequency and duration of black-outs and other disturbances.

There are several reasons why power systems are particularly vulnerable. First of all, power systems require voltages and frequencies to remain within relatively narrow margins, and units will trip if these limits are not kept. The transmission and distribution systems also suffer frequent disturbances because they are very extensive and very exposed to problems such as lightning strikes and short circuits on overhead lines.

Power system stability is traditionally maintained through ancillary services provided by central power plants. Optimal operation of the future intelligent power system, with lowest costs and lowest emissions, will often require less central generating capacity to be online, notes Chapter 6, especially when production from wind and other renewables is high.

There is therefore a need to look at other ways of ensuring system stability, and the ability to ensure stability at affordable cost will be a key performance indicator for a future intelligent energy system. An intelligent power system should also be able to monitor itself and assess the varying need for ancillary services. An example of this could be need for extra reserves when a storm front is passing and wind power plants can be expected to shut down suddenly.

With a very high share of fluctuating renewable energy sources, power balancing becomes a huge challenge, as Chapter 7 describes. Such a scenario would require the use

of all potential balancing measures, including new transmission lines between regions, new flexible generating plants, and the use of existing distributed resources within the system.

End-users have the potential to contribute to system balancing. Several types of demand, notably electric heating and cooling systems, can be operated in a flexible manner that responds to signals from the power company. As the use of small-scale distributed generating units increases, many of these can also be used in ways that help to balance the system. Future storage technologies such as electric vehicle batteries also have the potential to act as flexible balancing measures.

### **Interaction between central and local energy production and end-users**

The power system is currently undergoing some fundamental changes in its structure, Chapter 8 explains. These changes are associated not just with the rapidly increasing amounts of renewable energy being connected to the system, but also to the development of new types of production and end-use technologies.

One such change is a general increase in the number of distributed production units that are smaller in scale than traditional thermal power plants. This development will in the future include low-voltage connections from microCHP plants in individual households. On the low-voltage side, another important trend is the active control of demand, which introduces a new way to provide some of the necessary flexibility in power balancing.

In parallel with this development is the increased use of Information and Communications Technologies (ICT). The communications capabilities of electric devices are expanding rapidly, while also becoming cheaper. This opens the door to a power system incorporating two-way communication with end-users, and is therefore one of the most important enabling technologies for the future power system. Advances in measuring technology and advanced computational methods, e.g., for predicting weather, energy consumption and prices creates new ways to control the entire power system.

### **Energy storage is essential to a more flexible energy system**

The need for energy storage in a future energy system dominated by renewable energy depends on many factors, includ-

ing the mix of energy sources, the ability to shift demand, the links between different energy vectors and the specific use of the energy. Since energy storage is always associated with additional capital costs and energy losses, it will be used only when it increases the value of the stored energy sufficiently from the time of generation to the time of use. Storage can also help, indirectly, with security of supply, by allowing the proportion of renewable energy to increase and so reducing reliance on imported fossil fuels.

If energy storage is to play a significant role, its direct environmental impact needs to be considered. The obvious area for attention is the safe and cost-effective recycling or disposal of batteries and their electrolyte.

As Chapter 9 says, the inevitable energy losses during the storage process mean that it is important to avoid storing conventionally produced energy, and to limit storage to excess renewable energy. As a result, the prospects for energy storage have never been better.

### **Transport must be linked to the power system**

Modern methods of transport depend heavily on fossil fuels. Transport accounts for around 20% of total energy consumption worldwide, and in countries like Denmark consumes approximately 65% of all the oil used. Transport will therefore have to provide significant contributions to our efforts to cut CO<sub>2</sub> emissions. Chapter 10 explains that doing this will require a shift to renewable, or at least CO<sub>2</sub>-neutral, energy sources, and links between the transport sector and the power system. This in turn will require new fuels and traction technologies, together with new options for energy storage in vehicles.

### **Reluctance in customer behaviour reduces flexibility**

A future electricity system with a considerable amount of fluctuating supply implies quite volatile hourly prices at the power exchange, according to Chapter 11. Getting customers to react to hourly prices improves market efficiency, reduces price volatility, and creates a welfare gain.

However, customers show some reluctance to react to hourly prices. Various explanations for this have been offered including the costs of metering and billing, information costs, the costs of changing consumption, wealth transfers among customers, and volatility of bills. In addition, the short-term gains seen in the market are quite small and the long-term gains are not very transparent to customers.

According to Chapter 11, the average welfare gain is less than 0.5% of the customer's electricity bill. However, gains vary considerably from one year to another; they depend crucially on the variation in prices and hence on the amount of fluctuating supply. This means that increasing proportions of wind power will increase the consumer benefits of flexibility in consumption. In addition, developments in technology may make it easier for customers to react to varying prices.





### 3. The changing global energy scene

1. BP. (2009). *Statistical review of world energy 2009*. London.
2. World Energy Council. (2009). *WEC annual statement 2009*. London.
3. Global Carbon Project. (2008). *Carbon budget and trends 2007*. [www.globalcarbonproject.org] (26 September 2008)
4. International Energy Agency. (2008). *World energy outlook 2008*. Paris: OECD/IEA.
5. Intergovernmental Panel on Climate Change. (2007). *Mitigation. Contribution of Working Group III to the 4th Assessment Report of the Intergovernmental Panel on Climate Change*. New York, NY; Cambridge: Cambridge University Press.
6. Stern, N. (2006). *Stern review report on the economics of climate change*. Cambridge: Cambridge University Press.
7. REN21. (2009). *Renewables. Global status report 2009 update (review draft)*. Paris: REN21 Secretariat. [www.ren21.net/pdf/RE\_GSR\_2009\_Update.pdf] (23 July 2009)

### 4. Challenges for a future Danish intelligent energy system

- European Commission. (2007). *Communication from the Commission to the Council and the European Parliament – Green paper follow-up action. Report on progress in renewable electricity*. Brussels. (COM(2006) 849 final).
- Energinet.dk. (2007). *System plan 2007*. Fredericia: Energinet.dk. [www.energinet.dk/NR/rdonlyres/55E4CE52-8412-4FB1-A62D-5BC321E3C792/0/Systemplan2007GB.pdf] (24 July 2009)
- Transport- og Energiministeriet. (2007). *En visionær dansk energipolitik. 2025*. Copenhagen: Danish Energy Authority. [www.ens.dk/sw68153.asp] (24 July 2009)

### 5. Market and grid challenges: planning for large-scale renewables

1. UCTE. (2004). *Policy 1: Load-frequency control and performance, final policy 2.2 E*. [www.entsoe.eu] (24 July 2009)
2. Nordel. (2007). *Nordic grid code 2007*. Oslo: Nordel. [www.nordel.org] (24 July 2009)
3. Jonsson, T.; Pinson, P.; Madsen, H. (2008). The effects of wind power forecasts on electricity spot prices in Denmark. *Proceedings of the European Wind Energy Conference 2008*.
4. Holttinen, H.; Meibom, P.; Orths, A.; van Hulle, F.; Lange, B.; Tiedemann, A.; O'Malley, M.; Pierik, J.; Ummels, B.; Tande, J.O.; Estanqueiro, A.; Matos, M.; Gomez, E.; Söder, L.; Strbac, G.; Shakoob, A.; Smith, J.C.; Milligan, M.; Ela, E. (2009). *Design and operation of power systems with large amounts of wind power - Final report, IEA Wind annex 25, Phase one 2006-2008*. Finland: VTT. [www.vtt.fi/inf/pdf/tiedotteet/2009/T2493.pdf] (24 July 2009)
5. Department of Communication, Energy and Natural Resources. (2008). *All island grid study. Work stream 4. Analysis of impacts and benefits*. Belfast: Department of Trade, Enterprise and Investment. [www.detini.gov.uk] (24 July 2009)

6. Energinet.dk. (2009). *Kabelhandlingsplan – 132-150 kV – Marts 2009*. Fredericia: Energinet.dk
7. International Energy Agency. (2008). *Empowering variable renewables – Options for flexible electricity systems*. Paris: OECD/IEA [www.iea.org] (24 July 2009)
8. SINTEF (2009). *Norwegian research center for offshore wind technology*. [www.sintef.no/Projectweb/Nowitech/] (16 August 2009)
9. Van Hulle, F. et al. (2009). *Integrating wind: Developing Europe's power market for the large-scale integration of wind power*. Brussels: TradeWind. [http://www.trade-wind.eu/index.php?id=13] (24 July 2009)
10. European Academies Science Advisory Council. (2009). *Transforming Europe's electricity supply – A renewable and secure power system*. [www.easac.eu] (16 August 2009)

### 6. Flexibility, stability and security of energy supply

1. Fernández, R.D.; Mantz, R.J.; Battaiotto, P.E. (2007). Impact of wind farms on a power system. An eigenvalue approach. *Renewable Energy*, 32, 1676-1688.
2. Holdsworth L., Ekanayake J.B., Jenkins N. (2004). Power system frequency response from fixed speed and doubly fed induction generator-based wind turbines. *Wind Energy*, 7, 21-35.
3. IEC TC 88 WG 27. *Wind turbines: Electrical simulation models for wind power generation. IEC Dashboard C -27*. [www.iec.ch/dyn/www/?p=102:14:0:::FSP\_ORG\_ID:5613] (24 July 2009)
4. Akhmatov, V.; Abildgaard, H.; Pedersen, J.; Eriksen, P.B. (2005). Integration of offshore wind power into the western Danish power system. *Proceedings of the Copenhagen offshore wind conference 2005, Copenhagen, 25-28 Sep 2005*.
5. Energinet.dk. (2007). *System plan 2007*. Fredericia: Energinet.dk. [www.energinet.dk/NR/rdonlyres/55E4CE52-8412-4FB1-A62D-5BC321E3C792/0/Systemplan2007GB.pdf] (24 July 2009)
6. Transport- og Energiministeriet. (2007). *En visionær dansk energipolitik. 2025*. Copenhagen: Danish Energy Authority. [www.ens.dk/sw68153.asp] (24 July 2009)
7. Nielsen, S. (ed.). (2007). *Fremtidens havmølleplaceringer – 2025*. Copenhagen: Danish Energy Authority. [www.ens.dk/Graphics/Publikationer/Havvindmoeller/Fremtidens\_Havvind\_Final\_240407.pdf] (24 July 2009)

## 7. Flexibility in the distribution system

1. Commission of the European Communities. (2007). *An energy policy for Europe*. Brussels: Commission of the European Communities. [europa.eu/legislation\_summaries/energy/european\_energy\_policy/127067\_en.htm] (24 July 2009)
2. Transport- og Energiministeriet. (2007). *En visionær dansk energipolitik. 2025*. Copenhagen: Danish Energy Authority. [www.ens.dk/sw68153.asp] (24 July 2009)
3. Chardon, A.; Almén, O.; Lewis, P.E.; Stromback, J.; Château, B. (2008). *Demand response: a decisive breakthrough for Europe. How Europe could save gigawatts, billions of Euros and millions of tons of CO<sub>2</sub>*. CapGemini.
4. Kester, J.C.P.; Burgos, M.J.G.; Parsons, J. (eds.). (2009). *European smart metering guide energy saving and the customer. Edition 2009*.
5. Kofod, C.; Togeby, M. (2004). Demand response offered by households with direct electric heating. *Demand response in energy markets, Conference proceedings, Nordic Energy Research, 26. November, 2004*. Oslo: Nordic Energy Research.
6. Windolf, M. (2009). *Flexible electricity demand in the consumer market*.
7. Andersen, F.M.; Jensen, S.G.; Larsen, H.V.; Meibom, P.; Ravn, H.; Skytte, K.; Togeby, M. (2006). *Analyses of demand response in Denmark*. (Risø-R-1565(EN)). Roskilde: Risø National Laboratory.
8. U.S. DoE. (2006). *Benefits of demand response in electricity markets and recommendations for achieving them. A report to the United States Congress pursuant to section 1252 of the Energy Policy Act of 2005*. U.S. Washington, DC: Department of Energy. [http://eetd.lbl.gov/ea/EMP/reports/congress-1252d.pdf] (26 July 2009)
9. Østergaard, J. et al. (2009). *Electric vehicles in power systems with 50% wind power penetration: the Danish case and the EDISON programme*. Presented at the European Conference SmartGrids and Mobility, Germany, 16-17 June 2009.
10. Energinet.dk. (2009). *Effektiv anvendelse af vindkraftbaseret el i Danmark. Samspil mellem vindkraft, varmepumper og elbiler*. Fredericia: Energinet.dk.
11. Eriksen, P.B. (2001). Economic and environmental dispatch of power/CHP production systems. *Electric Power Systems Research, 57*, 33-39.
12. Carbon Trust. (2007). *Micro-CHP. Interim report*. London: Carbon Trust. [www.warwickshire.gov.uk/Web/corporate/pages.nsf/Links/AF861E015721F387802572FB004AADF6/\$file/CTC726+Micro-CHP+Interim+Report+FINAL+(26+Nov+07).pdf] (26 July 2009)
13. Awerbuch, S.; Preston, A. (eds.). (1997). *The virtual utility: Accounting, technology & competitive aspects of the emerging industry*. Dordrecht: Kluwer Academic Publishers Group.
14. Nordjysk Elhandel. [www.neas.dk]
15. Shi, Y. et al. (2009). *A market-based virtual power plant*. Accepted for publication at ICCEP09, June 2009, Capri, Italy.

## 8. System control and communication

1. SmartGrids [www.smartgrids.eu] (8 June 2009)
2. IntelliGrid architecture [www.intelligrid.info/IntelliGrid\_Architecture/Overview\_Guidelines/index.htm] (26 July 2009)
3. Gridwise Alliance [www.gridwise.org/] (26 July 2009)
4. Microgrids [www.microgrids.eu/default.php] (8 June 2009)
5. The Cell Project [www.energinet.dk/en/menu/R+and+D/The+Cell+Project/The+Cell+Project.htm] (26 July 2009)
6. fenix. Flexible electricity network to integrate the expected energy evolution'. [www.fenix-project.org/] (26 July 2009)
7. International Electrotechnical Commission. IEC 61850-SER Ed. 1.0 English.
8. International Electrotechnical Commission. IEC 61970-301 Ed. 2.0 English.

## 9. Energy storage

1. Next Era Energy. *Solar energy generating systems*. [www.nexteraenergyresources.com/content/where/portfolio/pdf/segs.pdf] (26 July 2009)
2. PCM Phase Change Material Products Limited. FlatICE TM - *Solar house thermal energy storage system*. [www.pcmproducts.net/files/solar\_house\_1\_1\_.pdf] (26 July 2009)
3. Uddin N.; Asce M. (2003). Preliminary design of an underground reservoir for pumped storage. *Geotechnical and Geological Engineering, 21*, 331-355.
4. First Hydro Company. *Dinorwig Power Station*. [www.fhc.co.uk/dinorwig.htm] (26 July 2009)
5. Succar S.; Williams R. (2008). *Compressed air energy storage: theory, resources, and applications for wind power*. Princeton, NJ: Princeton University. [www.princeton.edu/~cmi/research/Capture/Papers/SuccarWilliams\_PEL\_CAES\_2008April8.pdf] (26 July 2009)
6. Elmegaard, B. et al. (2009). *Possibilities for applications of compressed air energy storage in the future energy system. Final report*. Elforsk project no. 2005-1-6567.
7. EPRI-DOE. (2003). *Handbook of energy storage for transmission and distribution applications*. Palo Alto, CA: EPRI; Washington, DC: U.S. Department of Energy.
8. Divya K.C.; Østergaard, J. (2008). Battery energy storage technology for power systems – An overview. *Electric Power Systems Research, 79*, 511-520.
9. Risø Energy Report 3. (2004). *Hydrogen and its competitors*. (Risø-R-1469 (EN)). Roskilde: Risø National Laboratory. [www.risoe.dk/rispubl/energy\_report3/ris-r-1469.pdf] (26 July 2009)
10. Jensen, S.; Larsen, P.; Mogensen, M. (2007). Hydrogen and synthetic fuel production from renewable energy sources. *International Journal of Hydrogen Energy, 32*, 3253-3258.

## 10. Links between energy carriers

1. International Energy Agency. (2004). *World Energy Outlook*. Paris: OEC/IEA. (p. 68)
2. Danish Energy Authority. (2008). *Energistatistik 2007*. København: Danish Energy Authority.
3. Jones, S. (2000). *Hydrogen distribution and transmission*. [www.h2net.org.uk/PDFs/Stor2000/Nov\_00\_Hydrogen\_Energy\_Network.pdf] (26 July 2009)
4. Jensen, S.H.; Larsen, P.H.; Mogensen, M. (2007). Hydrogen and synthetic fuel production from renewable energy sources. *Int. J. Hydrogen Energy*, 32, 3253-3257.
5. Jørgensen, C.; Ropenus, S. (2008). Production price of hydrogen from grid connected electrolysis in a power market with high wind penetration. *Int. J. Hydrogen Energy*, 33, 5335-5344.
6. Campoy, A. (2009). Just add water: Hydrogen car backers defend the dream. *Wall Street Journal*, May 8. [blogs.wsj.com/environmentalcapital/2009/05/08/just-add-water-hydrogen-car-backers-defend] (26 July 2009)

## 11. End-user behaviour, incentives and measures

- Andersen, F.M.; Jensen, S.G.; Larsen, H.V.; Meibom, P.; Ravn, H.; Skytte, K.; Tøgeby, M. (2006). *Analyses of demand response in Denmark*. (Risø-R-1565(EN)). Roskilde: Risø National Laboratory.
- Borenstein, S. (2005). The long-run efficiency of real-time electricity pricing. *The Energy Journal*, 26( 3), 93-116.
- Borenstein, S. (2007a). Customer risk from real-time retail electricity pricing: Bill volatility and hedgability. *The Energy Journal*, 28(2), 111-130.
- Borenstein, S. (2007b). Wealth transfers among large customers from implementing real-time retail electricity pricing. *The Energy Journal*, 28(2), 131-149.
- Danish Energy Authority. (2005). *Basisfremskrivning af el- og fjernvarmeproduktionen 2005-2025. Teknisk baggrundsrapport til energistrategi 2025. Bilag A*. København: Danish Energy Authority. [www.ens.dk/da-DK/Info/TalOgKort/Fremskrivninger/Fremskrivninger/Documents/Basisfremskrivning\_el\_og\_varmeproduktion.pdf] (26 July 2009)
- Holland, S.P.; Mansur, E.T. (2006). The short-run effects of time-varying prices in competitive electricity markets. *The Energy Journal*, 27(4), 127-155.
- Nord Pool. Data used can be found at the Nord Pool FTP server <http://www.nordpool.com> or at the server of the Danish TSO Energinet.dk <http://www.energinet.dk/en/menu/Market/Download+of+Market+Data/Download+of+Market+Data.htm>



- A** Africa 11, 13, 14, 48  
aggregation technologies 57  
artificial energy storage 43, 46  
Austria 15
- B** Batteries 17, 18, 31, 32, 44, 45, 46, 47, 48, 49, 50, 57, 59, 62  
Belgium 15, 24  
Better Place Denmark 33  
BEVs 47  
bidirectional charging 32  
biodiesel 12, 48  
biofuels 12, 15, 19, 43, 46, 49  
biogas 5, 15, 61  
Bulgaria 15
- C** CAES 17, 19, 44  
carbon free energy resources 11  
CCS 11  
Cell Project 40  
Central America 14  
China 10, 11, 12, 13, 14  
CHP 5, 13, 15, 17, 29, 33, 34, 37  
climate change 5, 9, 10, 11, 12, 13, 14, 15, 61  
CO<sub>2</sub> capture 47, 49  
communication 5, 6, 7, 13, 16, 17, 31, 35, 36, 39, 40, 41, 42, 45, 61  
compressed air storage 6, 17, 19, 44, 46  
COP15 10  
Cyprus 15  
Czech Republic 15
- D** day-ahead markets 21, 23, 24, 36, 53  
demand response 6, 17, 26, 27, 31, 33, 34, 36, 37, 52, 54, 56, 57, 58, 59  
Denmark 13, 15, 16, 17, 18, 19, 21, 22, 23, 26, 27, 28, 29, 31, 32, 33, 44, 45, 46, 47, 51, 52, 54, 55, 56, 57, 58, 59, 61, 62  
developing countries 5, 9, 10, 12, 14, 61  
diesel 12, 18, 45, 48, 49  
dimethyl ether 48  
distributed generation 6, 7, 29, 37, 40  
distributed production 5, 16, 39, 62  
distribution system 12, 31, 32, 37, 40, 61  
district heating 15, 16, 19, 33, 43, 45  
DME 48
- E** EDISON 33  
electric vehicles 6, 16, 17, 18, 19, 20, 31, 32, 33, 37, 39, 45, 46, 47, 48, 50, 57, 59, 62  
electrical energy storage 43  
EMS 41  
Energinet.dk 27, 33, 40  
energy management system 41  
energy poverty 9  
energy shifting 6, 46  
energy storage 5, 6, 7, 17, 19, 22, 40, 43, 44, 45, 46, 47, 49, 52, 62  
energy supply 5, 6, 7, 10, 11, 13, 14, 15, 16, 23, 25, 35, 43, 45, 49, 50, 61  
Estonia 15  
ethanol 12, 19, 47
- EU 11, 12, 15, 31, 32, 55, 61  
Europe 15, 16, 17, 24, 26, 27, 40, 58, 61  
EVs 32, 33, 34, 36, 40, 41, 45  
explicit auction 21, 22, 23, 24
- F** financial crisis 5, 9, 14  
Finland 15, 22, 31  
Fischer-Tropsch synthesis 47, 48  
flexible back-up 12  
flexible demand 5, 51, 52  
flexible infrastructure 5, 14  
flow batteries 44  
fluctuating renewable energy 5, 21, 22, 23, 24, 31, 32, 62  
fossil fuel 5, 9, 10, 11, 16, 17, 21, 39, 46, 47, 48, 49, 50, 58, 61, 62  
France 15, 31  
fuel cells 6, 13, 34, 37, 44, 45, 46, 47, 48, 49
- G** Germany 15, 19, 22, 23, 24, 28, 31, 32, 44, 48  
GHG 9, 10  
Global Carbon Project 9  
Great Britain 23  
Greece 15  
greenhouse effect 10, 12  
Gridwise 40
- H** heat pumps 6, 17, 19, 20, 31, 33, 34, 37, 46, 57  
heat storage 43, 46, 57, 58  
home automation systems 40  
Horns Rev 28  
hourly electricity pricing 51  
Hungary 15  
Huntorf 19, 44  
hybrids 6, 7, 45  
hydro 5, 6, 12, 15, 32, 44, 58, 61  
hydrogen 17, 45, 46, 47, 48, 49, 50
- I** IBUS 19, 20  
ICT 5, 39, 40, 62  
IEA 12  
implicit auction 21, 23, 24  
India 10, 11, 13, 14  
industrialized countries 5, 9, 10, 14, 61  
inertia 21, 23, 25, 26, 29, 31, 33  
information and communication technologies 5  
intelligence infrastructure 7  
intelligent power system 17, 18, 25, 40, 61  
Intelligrid 40  
interconnected power system 21, 25, 26, 61  
Intergovernmental Panel on Climate Change 5, 10  
International Electrochemical Commission 27  
International Energy Forum 10  
intra-day markets 21, 23, 24  
IPCC 5, 10, 11, 12  
Ireland 15, 22, 31  
IT 16  
Italy 15, 31
- K** Kyoto 10



- L** Latin America 14
  - Latvia 15
  - liquefied natural gas 48
  - lithium ion batteries 45, 46
  - Lithuania 15
  - LNG 48
  - low carbon solutions 11
  - low-energy houses 12
  - low-temperature polymer electrolyte membranes 47
  - LT PEMFCs 47
  - Luxembourg 15
- M** Malta 15
  - MCHP 34
  - Mercosur 14
  - Metering 6, 7, 12, 17, 31, 36, 50, 59, 62
  - Methanol 19, 47
  - microchip 6, 17, 33, 34, 37, 39, 42, 62
  - Middle East 13
  - mobile energy storage 43, 46
- N** Netherlands, the 15, 28, 31
  - New England 32
  - Nord Pool 51, 52, 53, 54, 55, 56
  - Nordel 21, 25
  - North Africa 13
  - North Sea 23, 29
  - Norway 22, 23, 31, 32
  - Nuclear 11, 21, 24, 43, 47, 48
- O** OECD 10, 12, 13
  - offshore wind 16, 23, 27, 28
- P** PCMs 43
  - phase change materials 43
  - photovoltaics 5, 15, 21, 61
  - PJM 24, 51
  - plug-in electrical vehicles 50
  - plug-in hybrid 6, 7, 48, 50
  - Poland 15, 24
  - Portugal 15, 22, 31
  - power balancing 31, 46, 62
  - power infrastructure 7
  - power market 17, 19, 21, 22, 23, 24, 36, 37, 51
  - price volatility 5, 51, 54, 58, 62
  - pumped hydro 44, 46
  - pumped storage 44
  - PV 7, 12, 13, 15, 16, 19, 25, 29, 61
- R** RE 12
  - reactive power 23, 25, 29, 39, 42
  - real-time pricing 16
  - recession 9
  - regulatory frameworks 17
  - REN21 11, 12
  - Renewable Energy Policy Network for the 21st Century 11
  - RES 5, 15, 61
  - Romania 15
  - Russia 11
- S** SCADA systems 41
  - Slovenia 15
  - Slovakia 15
  - smart meters 6, 7
  - SmartGrids 17, 40
  - solar 12, 13, 15, 25, 31, 34, 41, 43, 46, 47, 48, 49
  - spot market 13, 17, 19, 36
  - South Africa 48
  - South-East Asia 14
  - Spain 15
  - steam engines 34
  - Stirling engines 34
  - supply technologies 6, 14
  - surplus electricity 13, 16, 17
  - Sweden 15, 22, 23, 31, 32
  - synthetic fuels 45, 46, 48, 49, 50
  - SYSLAB 37
- T** thermal 5, 16, 23, 31, 33, 35, 39, 43, 46, 58, 62
  - traction technologies 5, 47, 49, 52
  - Tradewind 24, 26
  - transmission grid 13, 22, 23, 40
  - transmission system operators 22
  - transport 5, 6, 12, 13, 15, 16, 17, 18, 19, 20, 32, 33, 39, 40, 43, 45, 46, 47, 48, 49, 50, 57, 62
  - TSOs 22, 23, 24, 25, 26, 27
- U** UCTE 21, 25, 26
  - UK 31
  - UNFCCC 10, 11
  - UN Framework Convention on Climate Change 10
  - United Kingdom 15
  - United Nations Climate Change Conference 10
  - US 10, 11, 12, 14, 24, 33, 40, 43
  - USA 22, 32
- V** V2G 32, 33, 45
  - vehicle-to-grid 32, 45
  - vehicles 5, 6, 7, 16, 17, 18, 19, 20, 31, 32, 33, 37, 39, 45, 46, 47, 48, 50, 57, 59, 62
  - virtual inertia 26, 29
  - virtual power plants 34, 37
  - VPP 34, 35, 36, 37, 40, 41
- W** WAMS 29
  - wave power 15, 16, 19, 31, 49, 61
  - WEC 4
  - welfare gain 5, 51, 52, 53, 54, 55, 56, 57, 58, 63
  - WEO 11, 12, 13
  - wide area monitoring 23, 24
  - wind power 5, 6, 12, 13, 15, 16, 17, 18, 19, 20, 21, 22, 23, 24, 25, 26, 27, 28, 29, 31, 32, 33, 37, 46, 49, 51, 52, 58, 59, 61, 63
  - World Energy Council 9

## Risø Energy Report 1

---

### **New and emerging technologies: options for the future**

All over the world, increasing energy consumption, liberalisation of energy markets and the need to take action on climate change are producing new challenges for the energy sector. At the same time there is increasing pressure for research, new technology and industrial products to be socially acceptable and to generate prosperity. The result is a complex and dynamic set of conditions affecting decisions on investment in research and new energy technology.

Edited by Hans Larsen and Leif Sønderberg Petersen

Risø National Laboratory, October 2002, 64 p., ISBN 87-550-3082-3, Risø-R-1351(EN)

---

## Risø Energy Report 2

---

### **New and emerging bioenergy technologies**

Three growing concerns - sustainability (particularly in the transport sector), security of energy supply and climate change - have combined to increase interest in bioenergy. This trend has been further encouraged by technological advances in biomass conversion and significant changes in energy markets. We even have a new term, "modern bioenergy", to cover those areas of bioenergy technology - traditional as well as emerging - which could expand the role of bioenergy.

Edited by Hans Larsen , Jens Kossmann and Leif Sønderberg Petersen

Risø National Laboratory, November 2003, 48 p., ISBN 87-550-3262-1, Risø-R-1430(EN)

---

## Risø Energy Report 3

---

### **Hydrogen and its competitors**

Interest in the hydrogen economy has grown rapidly in recent years. Countries with long traditions of activity in hydrogen research and development have now been joined by a large number of newcomers. The main reason for this surge of interest is that the hydrogen economy may be an answer to the two main challenges facing the world in the years to come: climate change and the need for security of energy supplies. Both these challenges require the development of new, highly-efficient energy technologies that are either carbon neutral or low-carbon.

Edited by Hans Larsen , Robert Feidenhans'l and Leif Sønderberg Petersen

Risø National Laboratory, October 2004, 76 p., ISBN 87-550-3350-4, Risø-R-1469(EN)

---

## Risø Energy Report 4

---

### **The future energy system: distributed production and use**

The coming decades will bring big changes in energy systems throughout the world. These systems are expected to change from central power plants producing electricity and sometimes heat for customers, to a combination of central units and a variety of distributed units such as renewable energy systems and fuel cells.

Edited by Hans Larsen and Leif Sønderberg Petersen

Risø National Laboratory, October 2005, 62 p., ISBN 87-550-3474-8, Risø-R-1534(EN)

---

## Risø Energy Report 5

---

### **Renewable energy for power and transport**

Global energy policy today is dominated by three concerns: security of supply, climate change, and energy for development and poverty alleviation. This is the starting point for Risø Energy Report 5, which addresses trends in renewable energy and gives an overview of the global forces that will transform our energy systems in the light of security of supply, climate change and economic growth. The report discusses the status of, and trends in, renewable energy technologies for broader applications in off-grid power production (and heat).

Edited by Hans Larsen and Leif Sønderberg Petersen

Risø National Laboratory, November 2006, 72 p., ISBN 87-550-3515-9, Risø-R-1557(EN)

---

## Risø Energy Report 6

---

### **Future options for energy technologies**

Fossil fuels provide about 80% of global energy demand, and this will continue to be the situation for decades to come. In the European Community we are facing two major energy challenges. The first is sustainability, and the second is security of supply, since Europe is becoming more dependent on imported fuels. These challenges are the starting point for the present Risø Energy Report 6.

Edited by Hans Larsen and Leif Sønderberg Petersen

Risø National Laboratory, November 2007, 84 p., ISBN 978-87-550-3611-6, Risø-R-1621(EN)

---

## Risø Energy Report 7

---

### **Future low carbon energy systems**

The report presents state-of-the-art and development perspectives for energy supply technologies, new energy systems, end-use energy efficiency improvements and new policy measures. It also includes estimates of the CO<sub>2</sub> reduction potentials for different technologies. The technologies are characterized with regard to their ability to contribute either to ensuring a peak in CO<sub>2</sub> emissions within 10 - 15 years, or to long-term CO<sub>2</sub> reductions. The report outlines the current and likely future composition of energy systems in Denmark, and examines three groups of countries: i) Europe and the other OECD member nations; ii) large and rapidly growing developing economies, notably India and China; iii) typical least developed countries, such as many African nations. The report emphasises how future energy developments and systems might be composed in these three country groupings, and to what extent the different technologies might contribute.

Edited by Hans Larsen and Leif Sønderberg Petersen

Risø DTU, October 2008, 86 p., ISBN 978-87-550-3690-1, Risø-R-1651(EN)

---

