

**Proceedings of the 8th symposium on building physics in the nordic countries**  
Copenhagen, June 16-18, 2008

**Rode, Carsten**

*Publication date:*  
2008

*Document Version*  
Publisher's PDF, also known as Version of record

[Link back to DTU Orbit](#)

*Citation (APA):*  
Rode, C. (Ed.) (2008). Proceedings of the 8th symposium on building physics in the nordic countries: Copenhagen, June 16-18, 2008. Danish Society of Engineers, IDA. (BYG Rapport; No. R-189).

**DTU Library**  
Technical Information Center of Denmark

---

**General rights**

Copyright and moral rights for the publications made accessible in the public portal are retained by the authors and/or other copyright owners and it is a condition of accessing publications that users recognise and abide by the legal requirements associated with these rights.

- Users may download and print one copy of any publication from the public portal for the purpose of private study or research.
- You may not further distribute the material or use it for any profit-making activity or commercial gain
- You may freely distribute the URL identifying the publication in the public portal

If you believe that this document breaches copyright please contact us providing details, and we will remove access to the work immediately and investigate your claim.

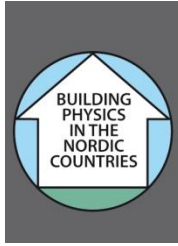

# **NSB2008**

Nordic Symposium on Building Physics 2008

## **Proceedings of the 8<sup>th</sup> Symposium on Building Physics in the Nordic Countries**

**Volume 3  
Wednesday, June 18**

**Copenhagen, June 16-18, 2008**

**Carsten Rode, editor**

Department of Civil Engineering  
Technical University of Denmark

The Danish Society of Engineers  
Society for Building Physics

Danish Building Research Institute  
Aalborg University

## **The Organizing Committee**

Carsten Rode, Technical University of Denmark (chairman)  
Svend Svendsen, Technical University of Denmark  
Eva B. Møller, The Danish Society of Engineers, IDA, Society for Building Physics  
Torben V. Rasmussen, Danish Building Research Institute, Aalborg University (since Dec. 2007)  
Morten H. Hansen, Danish Building Research Institute, Aalborg University (until Dec. 2007)  
Dan Kallehave, Technical University of Denmark (student help, secretary to the Committee)

## **Contact Address**

Nordic Symposium on Building Physics 2008  
Department of Civil Engineering  
Brovej, Building 118  
Technical University of Denmark  
DK-2800 Kgs. Lyngby, Denmark

Phone: +45 45 25 17 00  
Fax: +45 45 88 32 82  
E-mail: [byg@byg.dtu.dk](mailto:byg@byg.dtu.dk)  
Web: [www.byg.dtu.dk](http://www.byg.dtu.dk)  
[www.nsb2008.org](http://www.nsb2008.org)

## **Reference to papers**

Author. Title. Proceedings of the 8<sup>th</sup> Symposium on Building Physics in the Nordic Countries (C. Rode, editor) , Report R-189, Dept. of Civil Engineering, Technical University of Denmark, Kgs. Lyngby, Denmark, 2008

DTU Byg Report R-189  
ISBN 978-87-7877-265-7

Number of copies printed: 280  
Printed by the Danish Society of Engineers, IDA  
Copenhagen, Denmark, June, 2008

## Foreword

The 8th Symposium on Building Physics in the Nordic Countries was held June 16-18, 2008 in Copenhagen, Denmark. The Symposium has been organized jointly by The Technical University of Denmark; The Danish Society of Engineers' Society for Building Physics; and the Danish Building Research Institute, Aalborg University.

The Symposium in Copenhagen invited contributions regarding:

*Research results on*

- *Energy performance*
- *Hygrothermal performance/moisture*
- *Air transport*

*Covering building physical heat, air and moisture transfer in*

- *Building materials*
- *Building envelopes*
- *Whole buildings*

*With special emphasis on*

- *Models*
- *Experiments*
- *Practice*

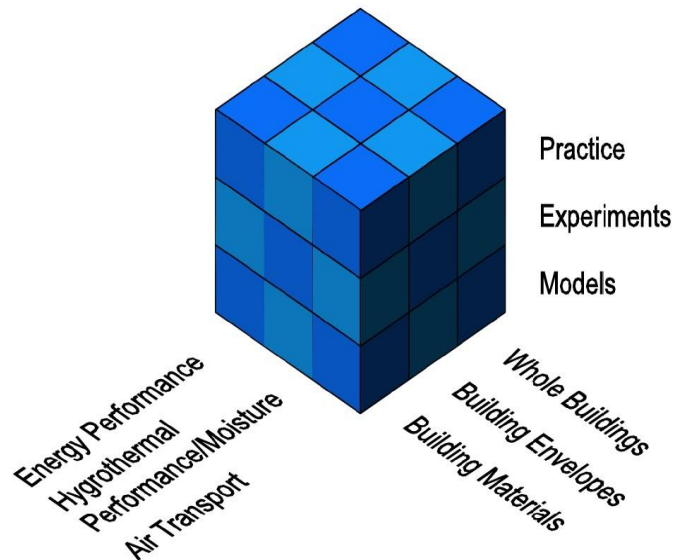

The Symposium was held in the format of two days as a traditional conference with oral presentations followed by brief discussions. The third day was devoted to the practical use of research results, and the programme on this day was laid such as to allow for more discussion of the presented results, not least with a scope to debate the practical implications.

The Symposium follows previous symposia held in Lund 1987, Trondheim 1990, Copenhagen 1993, Helsinki 1996, Gothenburg 1999, Trondheim 2002 and Reykjavik 2005. While the symposia are always arranged in one of the Nordic countries, they are increasingly attracting participants from other countries. Out of more than 250 abstracts, some 182 papers were eventually prepared for the 2008 Symposium in Copenhagen, half of them by researchers from other than the Nordic countries.

The venue of the Symposium was the meeting centre of the Danish Society of Engineers, IDA, on the harbour front of central Copenhagen. By providing this facility, IDA constituted the main sponsor of the Symposium, and their cooperation is gratefully acknowledged!

The organizers also would like to thank the participants of the scientific committee and people who have assisted in reviewing papers. Their contributions have been very important to ensure the quality of the Symposium.

Personally, I would like to thank my colleagues in the organizing committee for their true dedication to the project.

*Copenhagen, June 2008*

*Carsten Rode  
Chairman of the organizing committee*

## Scientific Committee

Prof. Anker Nielsen, Chalmers University of Technology  
Dr. Berit Time, SINTEF Byggeforsk  
Prof. Carl-Eric Hagendoft, Chalmers University of Technology  
Sen.Res.Fel. Chris Sanders, Glasgow Caledonian University  
Prof. Georg-Wilhelm Mainka, University of Rostock  
Prof. Gerd Hauser, Fraunhofer Institute for Building Physics  
Prof. Gudni Johannesson, Royal Institute of Technology in Stockholm  
Dr. Gulten Manioglu, Istanbul Technical University  
Prof. Hugo Hens, Katholieke Universiteit Leuven  
Prof. Ingemar Samuelson, SP Technical Research Institute of Sweden  
Prof. Jan Carmeliet, Technische Universiteit Eindhoven  
Prof. Jan Vincent Thue, Norwegian University of Science and Technology  
Prof. Jesper Arfvidsson, Lund University  
Prof. John Grunewald, Technische Universität Dresden  
Prof. Kalema Timo, Tampere University of Technology  
Prof. Klaus Sedlbauer, Fraunhofer Institute for Building Physics  
Prof. Lars-Olof Nilsson, Lund University  
Assoc. Prof. Maria Wall, Lund University  
Dr. Miimu Airaksinen, Technical Research Centre of Finland  
Dr. Monika Woloszyn, University of Science and Technology - INSA Lyon  
Prof. Paul Fazio, Concordia University  
Prof. Per Heiselberg, Aalborg University  
Dr. Phalguni Mukhopadhyaya, National Research Council Canada  
Prof. Shuichi Hokoi, Kyoto University  
Sen.Res. Targo Kalamees, Tallinn University of Technology  
Assoc. Prof. Dr. Thomas Bednar, Vienna University of Technology  
Prof. Dr. Holger Wallbaum, Swiss Federal Institute of Technology - ETH Zürich  
Prof. Arild Gustavsen, Norwegian University of Science and Technology  
Dr. Juha Vinha, Tampere University of Technology  
Dr. Morten Hjørnslev Hansen, DUKO · Dansk Undertagsklassifikationsordning

## Reviewers

The following experts have contributed to the review of papers. Their important contribution is gratefully acknowledged!

*Hashem Akbari ; Steve Cornick; Andre Desjarlais; Heiko Fechner; Diana Fisler; Hua Ge; Stig Geving; William Healy; Bengt Hellström; Jonas Holme; Ronald Krpan; Mark Lawton; Qinru Li; Yang Li; Uwe Meinhold; Qian Mao; Wahid Maref; Andreas Nicolai; Mostafa Nofal ; Vildan Ok; Seyhan Onbaşıoğlu; Gul Koclar Oral; Anil Parekh; İsmail Cem Parmaksızoğlu; Hans Petzold; Jiwu Rao; Cynthia Howard Reed; Ian Ridley; Patrick Roppel; Madeleine Rousseau; Uli Ruisinger; Prabal Talukdar; Sergio Vera; Xiangjin Yang; Alpin Yener & Zerrin Yilmaz*

# Table of Contents

Foreword .....	iii
Scientific Committee and Reviewers.....	iv
Table of Contents.....	v
Monday, June 16.....	v
Tuesday, June 17.....	x
Wednesday, June 18.....	xv
List of Authors.....	xix

## Monday, June 16

### **Session M1A – Energy Performance of Materials**

Thermal insulation performance of reflective insulation in well-insulated timber frame structures UVSLØKK, Sivert and ARNESEN, Heidi.....	1
Analytical Model for Computing Thermal Bridge Effects in Thermally High Performance Building Panels TENPIERIK, Martin J.; van der SPOEL, Wim H. and CAUBERG, Johannes J. M.....	9
Prediction of the long-term insulating capacity of cyclopentane-blown polyurethane foam PERSSON, Camilla and CLAESSON, Johan.....	17
A transient method to determine the temperature-dependent thermal conductivity of polyurethane foam in district heating pipes REIDHAV, Charlotte and CLAESSON, Johan.....	25
Determination of thermal conductivity by a combination of monotonic heating and surface heat transfer measuring MATIASOVSKY, Peter; MIHALKA, Peter and DRZIK, Milan.....	33

### **Session M2A – Energy Performance of Constructions**

Evaluation of thermal bridges by means of numerical simulation GUDUM, Charlotte.....	41
Key issues in energy-efficient building envelopes of Norwegian office buildings HAASE, Matthias and ANDRESEN, Inger.....	49
Using Controlled Active Mass (CAM) to decrease energy demand for cooling NIK, Vahid Moussavi and NIELSEN, Anker.....	57
Influence of Active Heat Capacity on Indoor Climate and Energy Demand of a Building VALANCIUS, Kestutis and STANKEVICIUS, Vytautas.....	65
The cooling capacity of the Thermo Active Building System combined with acoustic ceiling WEITZMANN, Peter; PITTARELLO, Emanuele and OLESEN, Bjarne W. ....	71
Ground Storage Heat Transfer with Non-linear Features Modeled in the Frequency Domain JÓHANNESSON, Gudni and LAZZAROTTO, Alberto.....	79

### **Session M3A – Energy Performance of Windows**

Applications of the Calculus Program "Spatial Glazing" for Windows MOGA, Ligia and MOGA, Ioan.....	87
Tool for selection of windows in dwellings SVENDSEN, Svend; SANTOS, Inês P.; LAUSTSEN, Jacob B. and KRAGH, Jesper .....	95
Characterization and performance evaluation of solar shading devices SANTOS, Inês P.; LAUSTSEN, Jacob B. and SVENDSEN, Svend.....	103
Solar shading system based on daylight directing glass lamellas LAUSTSEN, Jacob B.; SANTOS, Inês P.; SVENDSEN, Svend; TRABERG-BORUP, Steen and JOHNSEN, Kjeld.....	111
Simple tool to evaluate the impact of daylight on building energy consumption HVIID, Christian, Anker; NIELSEN, Toke Rammer and SVENDSEN, Svend.....	119
The development of a climate facade for a hot humid climate van den ENGEL, Peter and MIXOUDIS, Georgios.....	127

### **Session M4A – Air Flow in Windows**

CFD modelling of 2-D heat transfer in a window construction including glazing and frame VENDELBOE, Morten V.; SVENDSEN, Svend and NIELSEN, Toke Rammer.....	135
Modeling a Naturally Ventilated Double Skin Façade with a Building Thermal Simulation program JENSEN, Rasmus Lund; KALYANOVA, Olena and HEISELBERG, Per.....	143
Data Set for Empirical Validation of Double Skin Façade Model KALYANOVA, Olena; JENSEN, Rasmus Lund and HEISELBERG, Per.....	151
Analysis of the exterior convective heat transfer coefficients of a cubic building with CFD DEFRAEYE, Thijs; BLOCKEN, Bert and CARMELIET, Jan.....	159

### **Session M1B – HVAC System Interaction**

A 1D stationary model for assessing the performance of indirect evaporative cooling STEEMAN, Marijke; JANSSENS, Arnold and De PAEPE, Michel.....	167
Evaluation of the cooling potential of a desiccant evaporative cooling system using the SimSPARK environment MAALOUF, Chadi; WURTZ, Etienne and ALLARD, Francis.....	175
Comparison of a novel ventilation system with a system controlled by relative humidity – influence on comfort, hygiene and energy demand - KRUS, Martin; RÖSLER, Doris and LENGSELD, Kristin.....	183
Comparison of a Constant Air Volumen (CAV) and a Demand Controlled Ventilation (DCV) System in a Residential Building MORTENSEN, Dorthe Kragtig; NIELSEN, Toke Rammer and TOPP, Claus.....	191

Under-balancing mechanical supply and exhaust ventilation systems with heat recovery - effects on energy use JOHANSSON, Dennis.....	199
--	-----

### **Session M2B – Exterior climate interaction**

Radiation Effects On Exterior Surfaces KEHRER, Manfred and SCHMIDT, Thomas.....	207
Surface Temperatures on Flat Roofs and Hygrothermal Consequences BLUDAU, Christian; ZIRKELBACH, Daniel and KÜNZEL, Hartwig M.....	213
Spectator comfort in sports stadiums: on the impact of roof geometry on wind-driven rain shelter van HOOFF, Twan; PERSOON, Jan; BLOCKEN, Bert; CARMELIET, Jan and de WIT, Martin.....	221
Snow and ice on roofs - icicles and climate change NIELSEN, Anker.....	229

### **Session M3B – Exterior Climate Interaction / Durability of Surfaces**

Wind-driven rain distribution and its hygrothermal effect on two different types of building geometry KUMARAPERUMAL, Ayyapan N.; SANDERS, Chris H.; BAKER, Paul; GALBRAITH, Graham H. and ESSAH, Emmanuel Adu.....	237
Wind-Driven Rain Impact on Historical Brick Wall Buildings ABUKU, Masaru; JANSSEN, Hans and ROELS, Staf.....	245
Influence of rain water leakage on the hygrothermal performance of exterior insulation systems KÜNZEL, Hartwig M. and ZIRKELBACH, Daniel.....	253
High-resolution CFD simulations of forced convective heat transfer coefficients at exterior building surfaces BLOCKEN, Bert; DEFRAEYE, Thijs; NEALE, Adam; DEROME, Dominique and CARMELIET, Jan...	261
Destructive Factors Causing Deterioration of Paints on Buildings Walls MINIOTAITE, Ruta.....	269
Algal defacement of facade materials - results of long-term natural weathering tests obtained by new diagnostic tools VENZMER, Helmuth; von WERDER, Julia; LESNYCH, Natalia and KOSS, Lev.....	277

### **Session M4B – Thermal Conductivity / HM Salt**

Analysis and modelling of effective thermal conductivity of dry porous building materials MATIASOVSKY, Peter and KORONTHALYOVA, Olga.....	285
Ion binding isotherms of building materials PAVLÍKOVÁ, Milena; FIALA, Lukáš and ČERNÝ, Robert.....	293
Parametric Study of Salt Transport and Phase Transition Parameters in Simulations of Porous Materials Saturated with Salt Solutions under Drying Conditions NICOLAI, Andreas and GRUNEWALD, John.....	299



Simultaneous Heat, Moisture and Salt Transfer in Clothing ABUKU, Masaru; HOKOI, Shuichi and TAKADA, Satoru.....	307
Coupled water and sulfate transport parameters of materials of historical buildings PAVLÍK, Zbyšek; FIALA, Lukáš; PAVLÍKOVÁ, Milena and ČERNÝ, Robert.....	315

### **Session M1C – Air Flow Assessment**

Impact of furnishing on room airflows MORTENSEN, Lone H.; RODE, Carsten and PEUHKURI, Ruut.....	323
Experimental Confirmation on the Theoretical Model for the Velocity Profile in a Rectangular Wind Tunnel TALEV, Goce; GUSTAVSEN, Arild and THUE, Jan Vincent.....	331
Measurements and simulations of airflow in a mechanically ventilated active facade PEGGE, Evelien; BLOCKEN, Bert; de WIT, Martin; CARMELIET, Jan and BOSSCHAERTS, Walter...	339
Thermal transfer through membrane cushions analyzed by Computational Fluid Dynamics ANTRETTNER, Florian; HAUPT, Wolfram and HOLM, Andreas.....	347
Numerical Studies of Heat and Air Flow in Ventilated Insulated Slanting Roofs GUSTAVSEN, Arild and UVSLØKK, Sivert.....	355

### **Session M2C – Air in Rooms**

Estimation of air flow rates in large buildings based on measurements KONDER, Hannes and BEDNAR, Thomas.....	363
Measurement of air temperature using infrared thermography in rooms equipped with UFAD systems in cold climate DUFOUR, Marianne Bérubé; DEROME, Dominique; TARDIF, Michel and ZMEUREANU, Radu.....	369
Distribution of carbon dioxide in a naturally ventilated room with high internal heat load STEIGER, Simone; HELLWIG, Runa Tabea and JUNKER, Elmar.....	377
Sensing and detoxification devices in public building spaces TRABERG-BORUP, Steen; GUNNARSEN, Lars B. and AFSHARI, Alireza.....	385
Experimental Setup and Initial Results of Moisture Transport through Horizontal Openings VERA, Sergio; FAZIO, Paul and RAO, Jiwu.....	393
Stochastic versus deterministic approach to threshold criteria for building/environment system performance PIETRZYK, Krystyna.....	401

### **Session M3C – Air Flow in The Building Envelope / Air Flow Assessment**

Measuring and modelling transport of microbes from crawl space to indoors AIRAKSINEN, Miimu and PASANEN, Pertti.....	409
Air tightness performance of different sealing methods for windows in wood-frame buildings RELANDER, Thor-Oskar; THUE, Jan Vincent and GUSTAVSEN, Arild.....	417

Wind induced induced airflow through lightweight pitched roof constructions: Test roof element - measurements and validation DESEYVE, Christoph and BEDNAR, Thomas.....	425
Measurements and CFD simulations for the analysis of wind flow in a semi-enclosed stadium MAAS,Reinier; DIEPENS, Jan and BLOCKEN, Bert.....	433
<b><u>Session M4C – Insulation Materials</u></b>	
Results of measured and simulated hygrothermal loads acting on mineral fiber insulation suggest a revision of durability tests ZIRKELBACH, Daniel; KÜNZEL, Hartwig M. and BLUDAU, Christian.....	441
Computational modeling of heat and moisture transport in a building envelope with hydrophilic mineral wool insulation JERMAN, Miloš, MADĚRA, Jiří and ČERNÝ, Robert.....	449
Experimental Testing of the Wick-Concept Insulation KOVERDYNSKY, Vit.....	457
Condensation and drainage of condensate in train enclosure systems exposed to high moisture loads BJÖRK, Folke and ENOCHSSON, Tomas.....	465
Frost formation and condensation in stone-wool insulations VRÁNA, Tomas and BJÖRK, Folke.....	473
Hygrothermal Properties and Performance of Sea Grass Insulation ERIKSEN, Marlene Stenberg Hagen; LAURSEN, Theresa Back; RODE, Carsten and HANSEN, Kurt Kielsgaard.....	481

**Tuesday, June 17**

**Session T1A – Ventilation and Heating of Buildings**

Saving energy for ventilation by careful selection of building materials WARGOCKI, Pawel and KNUDSEN, Henrik N.....	489
The influence of different sealing methods of window and door joints on the total air leakage of wood-frame buildings RELANDER, Thor-Oskar; THUE, Jan Vincent and GUSTAVSEN, Arild.....	497
Manual for Improving the Energy Performance of Existing Buildings using Timber and Derived Timber Products HOPPE, Michaela.....	505
Evaluation of a dynamic model for a cold climate counter flow air to air heat exchanger NIELSEN, Toke Rammer; KRAGH, Jesper and SVENDSEN, Svend.....	511
Self-regulating Floor Heating Systems in Low Energy Buildings KARLSSON, Henrik.....	519
Experimental Study on Crawl-Space Heating with Thermal Storage using Heat Pump FUJITA, Koji; IWAMAE, Atsushi and MATSUSHITA, Takayuki.....	527

**Session T2A – Calculation of Thermal Performance of Buildings**

Accuracy of the calculation of heating and cooling energy needs in Nordic conditions KALEMA, Timo and PYLSY, Petri.....	535
An Analysis of Stochastic Properties of Room Air Temperature and Heating/Cooling Load - Analytical Method of Non-Gaussian Noise - HOKOI, Shuichi.....	543
A Method for more specific Simulation of Operative Temperature in Thermal Analysis Programmes CHRISTENSEN, Jørgen E.....	551
Feasibility of mechanically driven night ventilation in a high profile office building LAVERGE, Jelle; JANSSENS, Arnold; VANLONDERSEELE, Els and DIELS, Stef.....	559
Energy-saving concepts for supermarkets OSTERMEYER, York; WALLBAUM, Holger and BRAND, Christian.....	567

**Session T3A – Design and Optimization of Low Energy Buildings**

Cost-efficient lowest-energy multifamily houses in Vienna - Part 1: Design strategies BEDNAR, Thomas; HÖFER, Tanja and DREYER, Jürgen.....	573
Strategic optimization of non-residential buildings MARIO, Sofic and BEDNAR, Thomas.....	581
Numerical methods for optimizing the performance of buildings PEDERSEN, Frank.....	589

Method for integrated design of low energy buildings with high quality indoor environment PETERSEN, Steffen and SVENDSEN, Svend.....	597
---	-----

Combining building thermal simulation methods and LCA methods PEDERSEN, Frank; HANSEN, Klaus; WITTCHEM, Kim B.; GRAU, Karl E. and JOHNSEN, Kjeld....	605
---	-----

### **Session T4A – Low Exergy Buildings**

An Exergetic Analysis and Potential for Improving the Rational Energy Use in Dwellings MOLINARI, Marco and JÓHANNESSON, Gudni.....	613
---	-----

Benchmarking of Low "Exergy" Buildings SCHMIDT, Dietrich.....	621
--	-----

Concept for exergy balancing on community level for enhanced sustainable energy performance in a residential development in Kassel SAGER, Christina.....	629
---	-----

Exergy Consumption for Heating in Retrofitted Detached Houses KALMÁR, F. and KALMÁR, T.....	637
--	-----

Exergetic assessment and contribution of solar energy systems to energy performance of buildings TORÍO, Herena and SCHMIDT, Dietrich.....	645
--	-----

### **Session T1B – Mass Exchange 1**

Influences of the Indoor Environment on Heat, Air and Moisture Conditions in the Component: Boundary conditions modelling STESKENS, Paul W.M.H.; RODE, Carsten and JANSSEN, Hans.....	653
---	-----

The influence of surface treatment on mass transfer between air and building material KWIATKOWSKI, Jerzy; RODE, Carsten; HANSEN, Kurt Kielsgaard; WOLOSZYN, Monika and ROUX, Jean-Jacques.....	661
--	-----

The dependable characterisation of the moisture buffer potential of interior elements JANSSEN, Hans and ROELS, Staf.....	669
---	-----

Characterisation of the hygric inertia of a room for a reliable prediction of interior humidity variations ROELS, Staf and JANSSEN, Hans.....	677
--	-----

Simulation of dynamic moisture response of autoclaved aerated concrete KORONTHALYOVA, Olga; MATIASOVSKY, Peter; VESELSKY, Juraj; SZABO, Daniel and PUSKAR, Anton.....	685
---	-----

Moisture accumulation within porous bodies - simplified calculation method for indoor air humidity balance MIJAKOWSKI, Maciej.....	693
--	-----

### **Session T2B – Mass Exchange 2 / Tools and Protocols**

Design of a test chamber for investigation of moisture transport in air flows and porous materials van BELLEGHEM, Marnix; STEEMAN, Hendrik-Jan; De PAEPE, Michel; STEEMAN, Marijke and JANSSENS, Arnold.....	699
--	-----

Experimental and numerical determination of convective vapour transfer coefficients NEALE, Adam; DEROME, Dominique; BLOCKEN, Bert and CARMELIET, Jan.....	707
Coupling moisture transport in air flows and porous materials using CFD STEEMAN, Hendrik-Jan; JANSSENS, Arnold and De PAEPE, Michel.....	715
Measurements of the Convective Mass Transfer Coefficient between the Water Surface and Still Air TALEV, Goce; THUE, Jan Vincent and GUSTAVSEN, Arild.....	723
Numerical Simulation Aided Design of an experimental protocol PIOT, Amandine; ABELÉ, Charlotte; WOLOSZYN, Monika and BRAU, Jean.....	731
Laboratory Testing Protocols for Exterior Walls in Canadian Arctic Homes CORNIC, Steve; ROUSSEAU, Madeleine and MANNING, Marianne.....	739

### **Session T3B – Building Envelope Issues**

Durability of Crawl Space Based on Damage due to Wood Rot IWAMAE, Atsushi and SUZUKI, Hirotaka.....	747
Moisture content in insulated basement walls BLUM, Peter and HOLØS, Sverre B.....	755
Tightening against rain and wind for facades - experience from practice BØHLERENGEN, Trond; ROLSTAD, Anna Næss; GUSTAVSEN, Arild; EINSTABLAND, Håkon and MELØYSUND, Vivian.....	761
Pressure equalisation as design strategy for watertight windows van den BOSSCHE, Nathan; JANSSENS, Arnold and MOENS, Jan.....	769
Moisture convection performance of wall and attic floor joint KALAMEES, Targo and KURNITSKI, Jarek.....	777
Measurement of Moisture Transport through Perforated Vapour Barriers SLANINA, Petr and SILAROVA, Sarka.....	785
Simulating the Energy Benefits and Reduction in Condensation Formation that is obtained from Houses with Cold Pitched Roofs ESSAH, Emmanuel Adu; SANDERS, Chris, H.; BAKER, Paul; GALBRAITH, Graham H. and KALAGASIDIS, Angela Sasic.....	793

### **Session T4B – Indoor Humidity and Buffering**

Indoor air humidity in Norwegian houses GEVING, Stig; HOLME, Jonas and JENSSEN, Jon A.....	801
Laboratory Testing for Daily Hygroscopic Inertia Assessment RAMOS, Nuno and de FREITAS, Vasco Peixoto .....	809
Accuracy of simplified indoor humidity simulation KORONTHALYOVA, Olga and MIHALKA, Peter.....	817

Object-oriented hygrothermal building physics library as a tool to predict and to ensure a thermal and hygric indoor comfort in building construction by using a Predicted-Mean-Vote (PMV) control ventilation system NOUIDUI, Thierry; NYTSCH-GEUSEN, Christoph; HOLM, Andreas and SEDLBAUER, Klaus.....	825
Stochastic analysis of moisture buffering in rooms CARMELIET, Jan; DEROME, Dominique and GUYER, Robert.....	833
The King's House on the Schachen - Indoor Climate Analysis of a Cultural Heritage Building KILIAN, Ralf; HOLM, Andreas and RADON, Jan.....	841
Surface Condensation at the Roof of Ice Sports Arenas MARQUARDT, Helmut and MAINKA, Georg-Wilhelm.....	849

### **Session T1C – Silicate Materials and Structures 1**

Water absorption in two-layer masonry systems Moisture fixation measured over the complete moisture range JOHANSSON, Peter S. and NILSSON, Lars-Olof.....	857
Moisture transfer across the interface between brick and mortar joint DERLUYN, Hannelore; JANSSEN, Hans; MOONEN, Peter and CARMELIET, Jan.....	865
Quantitative model of moisture redistribution in dual layer concrete slabs with regards to hysteresis ÅHS, Magnus.....	873
Evidence on dynamic effects in the water content - water potential relation of building materials SCHEFFLER, Gregor A. and PLAGGE, Rudolf.....	881
Humidity Migration and Condensation Risk in Autoclaved Aerated Concrete Walls BORODINECS, Anatolij; KRELSINS,Andris; VILNITIS,Martins and NOVIKS, Juris.....	889
Mechanical, hygric and thermal properties of gypsum produced from different raw materials TESÁREK, Pavel and ČERNÝ, Robert.....	895

### **Session T2C – Silicate Materials and Structures 2 / Mould**

Hygric and thermal properties of materials of historical masonry PAVLÍKOVÁ, Milena; PAVLÍK, Zbyšek and ČERNÝ, Robert.....	903
Characterization of a hygro-regulated Wall Base Ventilation System for Treatment of Rising Damp in Historical Buildings de FREITAS, Vasco Peixoto and GUIMARÃES, Ana Sofia.....	911
Why do we often get biological growth on thin rendering on thermal insulation constructions? JOHANSSON, Sanne; WADSÖ, Lars and SANDIN, Kenneth.....	919
Development of an improved model for mould growth: Modelling VIITANEN, Hannu; VINHA, Juha; PEUHKURI, Ruut; OJANEN, Tuomo; LÄHDESMÄKI, Kimmo and SALMINEN, Kati.....	927
Development of an improved model for mould growth: Laboratory and field experiments LÄHDESMÄKI, Kimmo; VINHA, Juha; VIITANEN, Hannu; SALMINEN, Kati; PEUHKURI, Ruut; OJANEN, Tuomo; PAAJANEN, Leena; IITTI, Hanna and STRANDER, Tomi.....	935

Investigation of Microbial Volatile Organic Compounds and their Transport through the Building Envelope HACHEM, Caroline; FAZIO, Paul; RAO, Jiwu; BARTLETT, Karen and CHAUBEY, Yogendra P.....	943
---	-----

### **Session T3C – Measuring Techniques / Wood Materials**

Accelerated Climate Ageing of Building Materials and Application of the Attenuated Total Reflectance (ATR) Fourier Transform Infrared (FTIR) Radiation Experimental Method JELLE, Bjørn Petter; NILSEN, Tom-Nils; HOVDE, Per Jostein and GUSTAVSEN, Arild.....	951
Model for hysteretic moisture behaviour of wood DEROME, Dominique; DERLUYN, Hannelore; ZILLIG, Wolfgang and CARMELIET, Jan.....	959
Sampling and Analysis of Natural Isotopes in Moisture Transport from Porous Materials. Applications to Capillary Suction KONIORCZYK, Marcin; GUDMUNDSSON, Kjartan and JOHANNESSEN, Gudni.....	967
A New Method of Determining Moisture Flow Coefficients for both Isothermal and Non-isothermal Conditions BURKE, Stephan; CLAEISSON, Johan and ARFVIDSSON, Jesper.....	975
Influence of the microstructure on the vapor transport in wood ZILLIG, Wolfgang; CARMELIET, Jan and DEROME, Dominique.....	983
Evaluation of Moisture Pins in Wooden Claddings NORE, Kristine and THUE, Jan Vincent.....	991
Measurement and modeling of drying for pellet production BENGTSSON, Peter and CLAEISSON, Johan.....	999

### **Session T4C – Wood Constructions**

Behaviour and optimization of environmental sensitive layered systems BRAUNS, Janis and ROCENS, Karlis.....	1007
Comparison of small- and large-scale wall assembly specimens exposed to similar experimental conditions DEROME, Dominique; SANEINEJAD, Saba; CARMELIET, Jan and KARAGIOZIS, Achilles.....	1015
Simulation of drying of wood-frame walls submitted to water infiltration THIVIERGE, Constance; DEROME, Dominique and CARMELIET, Jan.....	1023
Determining moisture evacuation profiles and drying capacity of building envelope panels of various configurations ALTURKISTANI, Arslan; FAZIO, Paul and RAO, Jiwu.....	1031
Investigations on the Durability of Load-Bearing, Directly Rendered, External Sheathings of Wood-Framed Houses ROSENAU, Britta and MAINKA, Georg-Wilhelm.....	1039
A Comparative Analysis of Hygrothermal Behavior in Wood Construction Walls from Two Different Geographical Perspectives in the USA LARSON, Kennard G.; RIESNER, Katrin; MAINKA, Georg-Wilhelm and ERIKSON, Robert.....	1047
Moisture Performance Assessment of Wood-frame Exterior Building Envelope Construction in China MUKHOPADHYAYA, Phalguni; van REENEN, David; KUMARAN, Kumar; COPELAND, Curt; NEWMAN, Paul J.; EL KHANAGRY, Ramez and ZALOK, Ehab.....	1055

## Wednesday, June 18

### **Session W1A – Design and Development of Energy Efficient Buildings**

Life-cycle optimised housing NIEMINEN, Jyri and LYLYKANGAS, Kimmo.....	1063
Low energy class 1 typehouses according to the Danish building regulations ROSE, Jørgen; KRAGH, Jesper and SVENDSEN, Svend.....	1071
Prefabricated EPS Elements used as Strip Foundation of a Single-family House with a Double Brick Wall RASMUSSEN, Torben Valdbjørn.....	1079

### **Session W2A – Measured Energy Performance of Buildings**

An Analysis of the Difference between Measured and Predicted Energy Savings when Houses are Insulated SANDERS, Chris H. and PHILLIPSON, Mark.....	1087
The distribution of the air leakage places and thermal bridges in Finnish detached houses and apartment buildings KALAMEES, Targo; KORPI, Minna; ESKOLA, Lari; KURNITSKI, Jarek and VINHA, Juha.....	1095
Cost-efficient lowest-energy multifamily houses in Vienna - Part 2: Measurement results and feedback of occupants BEDNAR, Thomas; DREYER, Jürgen and SCHÖBERL, Helmut.....	1103
Measurement results and experiences from an energy renovation of a typical Danish single-family house TOMMERUP, Henrik.....	1111

### **Session W3A – Energy Savings in Existing Buildings**

Energy renovation saving potentials of typical Finnish buildings HOLOPAINEN, Riikka and HEKKANEN, M.....	1119
Retrofitting of a school with an integral aspect HOLM, Andreas; HELLWIG, Runa Tabea and SEDLBAUER, Klaus.....	1127
Energy efficiency and saving on lighting: the case study of a modern art museum FRATTARI, Antonio and CHIOGNA, Michela.....	1135
Heat pumps for conservation heating BROSTRÖM, Tor and LEIJONHUFVUD, Gustaf.....	1143

### **Session W4A – Windows and Facades**

Controlling ventilated facades HAASE, Matthias and AMATO, Alex.....	1151
Method for including detailed evaluation of daylight levels in BE06 PETERSEN, Steffen.....	1159



Where to use vacuum insulation ... and where not!	
WILLEMS, Wolfgang and SCHILD, Kai.....	1165
Energy Gaining Windows for Residential Buildings	
KRAGH, Jesper; LAUSTSEN, Jacob B. and SVENDSEN, Svend.....	1173

### **Session W1B – Moisture Safety**

ByggaF A Method for Including Moisture Safety in the Building Process - Experience from Pilot Projects	
MJÖRNELL, Kristina and ARFVIDSSON, Jesper.....	1181
When the safest solution is unacceptable	
MØLLER, Eva B.....	1189
Insufficient Moisture Control in the Building Process - Recommendations for a Multi-disciplinary Management Tool	
ØYEN, Cecilie Flyen; KVANDE, Tore and NORENG, Knut.....	1197
Moisture Performance Criteria to Control Mould Growth in UK Dwellings	
ALTAMIRANO-MEDINA, Hector; DAVIES Mike; RIDLEY, Ian; MUMOVIC, Dejan and ORESZCZYN, Tadj.....	1205

### **Session W2B – Moisture Sensitive Construction**

Moisture and Mould Damage in Norwegian Houses	
HOLME, Jonas; GEVING, Stig and JENSSEN, Jon A.....	1213
Moisture and mould growth in compact roofs - Results from a three-stage field survey	
HOLME, Jonas; NORENG, Knut and KVANDE, Tore.....	1221
Massive timber elements in roofs - moisture performance	
TIME, Berit; GEVING, Stig and SANDLAND, Knut Magnar.....	1229
Mould growth control in cold attics through adaptive ventilation	
HAGENTOFT, Carl-Eric; KALAGASIDIS, Angela Sasic; NILSSON, Stefan F. and THORIN, Marcus...	1237
Analysis method for determining sufficient water vapour retarder for timber-framed walls	
VINHA, Juha.....	1245
Moisture damage in rendered, undrained, well insulated stud walls	
SAMUELSON, Ingemar; MJÖRNELL, Kristina and JANSSON, Anders.....	1253

### **Session W3B – Building Envelope Issues and Innovation**

Multiple-skin facades: high tech blessing or not?	
HENS, Hugo; SAELENS, Dirk; De MEULENAER, Veerle and ELSSEN, Patricia.....	1261
Investigation of a Novel Ceiling Panel for Heat and Moisture Control in Buildings	
FAUCHOUX, Melanie T; SIMONSON, Carey J and TORVI, David A.....	1269
Possibilities for redevelopment of slope roof constuctions	
NÖSKE, Florian; HOLM, Andreas and SEDLBAUER, Klaus.....	1277

Inverted compact sloped turfed roofs SKOGSTAD, Hans Boye and UVSLØKK, Sivert.....	1285
--	------

### **Session W4B – Innovative Products**

The use of finite-element software to solve hygrothermal building physical problems related to insulating high rise building facades SCHELLEN, Henk; van SCHIJNDEL, Jos and NEUHAUS, Edgar.....	1293
Drop shape analysis - innovative implement in renovation area REINTHALER, Petra and HECHT, Clemens.....	1301
Innovative and adaptable textile shaping systems for ETICS SAUR, Alexandra; BERINGER, Jan and SEDLBAUER, Klaus.....	1309
New type of "Moisture adaptive vapour barrier" KLOCH, Niels Peter; CHRISTENSEN, Georg and JENSEN, Eirik Sandberg.....	1317

### **Session W1C – Energy Performance in Cold Climate**

Passive houses for a cold climate NIEMINEN, Jyri; HOLOPAINEN, Riikka and LYLYKANGAS, Kimmo.....	1325
Integrated Design and Passive Houses for Arctic Climates VLADYKOVA, Petra and RODE, Carsten.....	1333
The assessment of freezing risk in apartment buildings after heat supply break KARBAUSKAITE, Jurate; STANKEVICIUS, Vytautas; BURLINGIS, Arunas and MORKVENAS, Romaldas.....	1341

### **Session W2C – Heat Capacity and Energy Performance**

Heat capacity in relation to the Danish Building regulations OLSEN, Lars.....	1349
A Comparative Evaluation of the Importance of Thermal Mass of Traditional Architecture in Hot and Dry Region in Turkey MANIOGLU, Gulden and YILMAZ, Zerrin.....	1357
Effect of climate change on energy consumption in buildings KALAGASIDIS, Angela Sasic; NIK, Vahid Moussavi and NIELSEN, Anker.....	1365
Proposal for a Building Energy Efficiency Certificate LEIMER, Hans-Peter.....	1373

### **Session W3C – Air Tightness and Building Envelope**

The effect of micro air movement on the heat and moisture characteristics of building constructions van SCHIJNDEL, Jos.....	1381
Air transport in Building Envelope and Construction Process, R&D Programme BANKVALL, Claes and SIKANDER, Eva.....	1389

Airtightness of single-family houses and apartments KORPI, Minna; VINHA, Juha and KURNITSKI, Jarek.....	1397
Implementation of Airtight Constructions and Joints in Residential Buildings AHO, Hanna; VINHA, Juha and KORPI, Minna.....	1405

### **Session W4C – Indoor Humidity in Practice**

The influence of exterior walls on the level and stability of indoor relative humidity and temperature in detached houses KORPI, Minna; KALAMEES, Targo; VINHA, Juha and KURNITSKI, Jarek.....	1413
Crawl Space heat and moisture behaviour AIRAKSINEN, Miimu.....	1421
Simple climate control in archives is hindered by too strict standards PADFIELD, Tim.....	1429

## LIST OF AUTHORS

<u>NAME</u>	<u>VOLUME 1</u>	<u>VOLUME 2</u>	<u>VOLUME 3</u>
ABELÉ, Charlotte		731	
ABUKU, Masaru	245		
ABUKU, Masaru	307		
AFSHARI, Alireza	385		
AHO, Hanna			1405
AIRAKSINEN, Miimu	409		1421
ALLARD, Francis	175		
ALTAMIRANO-MEDINA, Hector			1205
ALTURKISTANI, Arslan		1031	
AMATO, Alex			1151
ANDRESEN, Inger	49		
ANTRETTTER, Florian	347		
ARFVIDSSON, Jesper		975	1181
ARNESEN, Heidi	1		
BAKER, Paul	237	793	
BANKVALL, Claes			1389
BARTLETT, Karen		943	
BEDNAR, Thomas	363, 425	573, 581	1103
BENGTSSON, Peter		999	
BERINGER, Jan			1309
BJÖRK, Folke	465, 473		
BLOCKEN, Bert	159, 221, 261, 339, 433	707	
BLOM, Peter		755	
BLUDAU, Christian	213, 441		
BORODINECS, Anatolijs		889	
BOSSCHAERTS, Walter	339		
BRAND, Christian		567	
BRAU, Jean		731	
BRAUNS, Janis		1007	
BROSTRÖM, Tor			1143
BURKE, Stephan		975	
BURLINGIS, Arunas			1341
BØHLERENGEN, Trond		761	
CARMELIET, Jan	159, 221, 261, 339	707, 833, 865, 959, 983, 1015, 1023	
CAUBERG, Johannes J. M.	9		
ČERNÝ, Robert	293, 315, 449	895, 903	
CHAUBEY, Yogendra P.		943	
CHIOGNA, Michela			1135

<u>NAME</u>	<u>VOLUME 1</u>	<u>VOLUME 2</u>	<u>VOLUME 3</u>
CHRISTENSEN, Georg			1317
CHRISTENSEN, Jørgen E.		551	
CLAESSON, Johan	17, 25	975, 999	
COPELAND, Curt		1055	
CORNICK, Steve		739	
DAVIES, Mike			1205
de FREITAS, Vasco Peixoto		809, 911	
De MEULENAER, Veerle			1261
De PAEPE, Michel	167	699, 715	
de WIT, Martin	221, 339		
DEFRAEYE, Thijs	159, 261		
DERLUYN, Hannelore		865, 959	
DEROME, Dominique	261, 369	707, 833, 959, 983, 1015, 1023	
DESEYVE, Christoph	425		
DIELS, Stef		559	
DIEPENS, Jan	433		
DREYER, Jürgen		573	1103
DRZIK, Milan	33		
DUFOUR, Marianne Bérubé	369		
EINSTABLAND, Håkon		761	
EL KHANAGRY, Ramez		1055	
ELSEN, Patricia			1261
ENOCHSSON, Tomas	465		
ERIKSEN, Marlene Stenberg Hagen	481		
ERIKSON, Robert		1047	
ESKOLA, Lari			1095
ESSAH, Emmanuel Adu	237	793	
FAUCHOUX, Melanie T			1269
FAZIO, Paul	393	943, 1031	
FIALA, Lukáš	293, 315		
FRATTARI, Antonio			1135
FUJITA, Koji		527	
GALBRAITH, Graham H.	237	793	
GEVING, Stig		801	1213, 1229
GRAU, Karl E.		605	
GRUNEWALD, John	299		
GUDMUNDSSON, Kjartan		967	
GUDUM, Charlotte	41		
GUIMARÃES, Ana Sofia		911	

<b><u>NAME</u></b>	<b><u>VOLUME 1</u></b>	<b><u>VOLUME 2</u></b>	<b><u>VOLUME 3</u></b>
GUNNARSEN, Lars B.	385		
GUSTAVSEN, Arild	331, 355, 417	497, 723, 761, 951	
GUYER, Robert		833	
HACHEM, Caroline		943	
HAGENTOFT, Carl-Eric			1237
HANSEN, Klaus		605	
HANSEN, Kurt Kielsgaard	481	661	
HAUPT, Wolfram	347		
HECHT, Clemens			1301
HEISELBERG, Per	143, 151		
HEKKANEN, M.			1119
HELLWIG, Runa Tabea	377		1127
HENS, Hugo			1261
HOKOI, Shuichi	307	543	
HOLM, Andreas	347	825, 841	1127, 1277
HOLME, Jonas		801	1213, 1221
HOLOPAINEN, Riikka			1119, 1325
HOLOPAINEN, Riikka			1119, 1325
HOLØS, Sverre B		755	
HOPPE, Michaela		505	
HOVDE, Per Jostein		951	
HVIID, Christian, Anker	119		
HÖFER, Tanja		573	
HAASE, Matthias	49		1151
IITTI, Hanna		935	
IWAMAE, Atsushi		527, 747	
JANSSEN, Hans	245	653, 669, 677, 865	
JANSSENS, Arnold	167	559, 699, 715, 769	
JANSSON, Anders			1253
JELLE, Bjørn Petter		951	
JENSEN, Eirik Sandberg			1317
JENSEN, Rasmus Lund	143, 151		
JENSSEN, Jon A		801	1213
JERMAN, Miloš	449		
JÓHANNESSON, Gudni	79	613, 967	
JOHANSSON, Dennis	199		
JOHANSSON, Peter S.		857	
JOHANSSON, Sanne		919	
JOHNSEN, Kjeld	111	605	
JUNKER, Elmar	377		

<b><u>NAME</u></b>	<b><u>VOLUME 1</u></b>	<b><u>VOLUME 2</u></b>	<b><u>VOLUME 3</u></b>
KALAGASIDIS, Angela Sasic		793	1237, 1365
KALAMEES, Targo		777	1095, 1413
KALEMA, Timo		535	
KALMÁR, F.		637	
KALMÁR, T.		637	
KALYANOVA, Olena	143, 151		
KARAGIOZIS, Achilles		1015	
KARBAUSKAITE, Jurate			1341
KARLSSON, Henrik		519	
KEHRER, Manfred	207		
KILIAN, Ralf		841	
KJELLSTRÖM, Erik			1349
KLOCH, Niels Peter			1317
KNUDSEN, Henrik N.		489	
KONDER, Hannes	363		
KONIORCZYK, Marcin		967	
KORONTHALYOVA, Olga	285	685, 817	
KORPI, Minna			1095, 1397, 1405, 1413
KOSS, Lev	277		
KOVERDYNSKY, Vit	457		
KRAGH, Jesper	95	511	1071, 1173
KRELSINS, Andris		889	
KRUS, Martin	183		
KUMARAN, Kumar		1055	
KUMARAPERUMAL, Ayyapan N	237		
KURNITSKI, Jarek		777	1095, 1397, 1413
KVANDE, Tore			1197, 1221
KWIATKOWSKI, Jerzy		661	
KÜNZEL, Hartwig M.	213, 253, 441		
LARSON, Kennard G.		1047	
LAURSEN, Theresa Back	481		
LAUSTSEN, Jacob B.	95, 103, 111		1173
LAVERGE, Jelle		559	
LAZZAROTTO, Alberto	79		
LEIJONHUFVUD, Gustaf			1143
LEIMER, Hans-Peter			1373
LENGSFELD, Kristin	183		
LESNYCH, Natalia	277		
LYLYKANGAS, Kimmo			1063, 1325

<b><u>NAME</u></b>	<b><u>VOLUME 1</u></b>	<b><u>VOLUME 2</u></b>	<b><u>VOLUME 3</u></b>
LÄHDESMÄKI, Kimmo		927, 935	
MADĚRA, Jiří	449		
MAINKA, Georg-Wilhelm		849, 1039, 1047	
MANIOGLU, Gulten			1357
MANNING, Marianne		739	
MARIO, Sofie		581	
MARQUARDT, Helmut		849	
MATIASOVSKY, Peter	33, 285	685	
MATSUSHITA, Takayuki		527	
MELØYSUND, Vivian		761	
MIHALKA, Peter	33	817	
MIJAKOWSKI, Maciej		693	
MINIOTAITE, Ruta	269		
MIXOUDIS, Georgios	127		
MJÖRNELL, Kristina			1181, 1253
MOENS, Jan		769	
MOGA, Ioan	87		
MOGA, Ligia	87		
MOLINARI, Marco		613	
MOONEN, Peter		865	
MORKVENAS, Romaldas			1341
MORTENSEN, Dorthe Kragtig	191		
MORTENSEN, Lone H.	323		
MUKHOPADHYAYA, Phalguni		1055	
MUMOVIC, Dejan			1205
MØLLER, Eva B.			1189
MAALOUF, Chadi	175		
MAAS, Reinier	433		
NEALE, Adam	261	707	
NEUHAUS, Edgar			1293
NEWMAN, Paul J.		1055	
NICOLAI, Andreas	299		
NIELSEN, Anker	57, 229		1365
NIELSEN, Toke Rammer	119, 135, 191	511	
NIEMINEN, Jyri			1063, 1325
NIK, Vahid Moussavi	57		1365
NILSEN, Tom-Nils		951	
NILSSON, Lars-Olof		857	
NILSSON, Stefan F.			1237
NORE, Kristine		991	



<u>NAME</u>	<u>VOLUME 1</u>	<u>VOLUME 2</u>	<u>VOLUME 3</u>
NORENG, Knut			1197, 1221
NOUIDUI, Thierry		825	
NOVIKS, Juris		889	
NYTSCH-GEUSEN, Christoph		825	
NÖSKE, Florian			1277
OJANEN, Tuomo		927, 935	
OLESEN, Bjarne W.	71		
OLSEN, Lars			1349
ORESzcZYN, Tadj			1205
OSTERMEYER, York		567	
PADFIELD, Tim			1429
PASANEN, Pertti	409		
PAVLÍK, Zbyšek	315	903	
PAVLÍKOVÁ, Milena	293, 315	903	
PEDERSEN, Frank		589, 605	
PEGGE, Evelien	339		
PERSOON, Jan	221		
PERSSON, Camilla	17		
PETERSEN, Steffen		597	1159
PEUHKURI, Ruut	323	927, 935	
PHILLIPSON, Mark			1087
PIETRZYK, Krystyna	401		
PIOT, Amandine		731	
PITTARELLO, Emanuele	71		
PLAGGE, Rudolf		881	
PUSKAR, Anton		685	
PYLSY, Petri		535	
PAAJANEN, Leena		935	
RADON, Jan		841	
RAMOS, Nuno		809	
RAO, Jiwu	393	943, 1031	
RASMUSSEN, T. Valdbjørn			1079
REIDHAV, Charlotte	25		
REINTHALER, Petra			1301
RELANDER, Thor-Oskar	417	497	
RIDLEY, Ian			1205
RIESNER, Katrin		1047	
ROCENS, Karlis		1007	
RODE, Carsten	323, 481	653, 661	1333
ROELS, Staf	245	669, 677	

<u>NAME</u>	<u>VOLUME 1</u>	<u>VOLUME 2</u>	<u>VOLUME 3</u>
ROLSTAD, Anna Næss		761	
ROSE, Jørgen			1071
ROSENAU, Britta		1039	
ROUSSEAU, Madeleine		739	
ROUX, Jean-Jacques		661	
RÖSLER, Doris	183		
SAELEN, Dirk			1261
SAGER, Christina		629	
SALMINEN, Kati		927, 935	
SAMUELSON, Ingemar			1253
SANDERS, Chris			
SANDERS, Chris H.	237	793	1087
SANDIN, Kenneth		919	
SANDLAND, Knut Magnar			1229
SANEINEJAD, Saba		1015	
SANTOS, Inês P.	95, 103, 111		
SAUR, Alexandra			1309
SCHEFFLER, Gregor A.		881	
SCHELLEN, Henk			1293
SCHILD, Kai			1165
SCHMIDT, Dietrich		621, 645	
SCHMIDT, Thomas	207		
SCHÖBERL, Helmut			1103
SEDLBAUER, Klaus		825	1127, 1277, 1309
SIKANDER, Eva			1389
SILAROVA, Sarka		785	
SIMONSON, Carey J			1269
SKOGSTAD, Hans Boye			1285
SLANINA, Petr		785	
STANKEVICIUS, Vytautas	65		1341
STEEMAN, Hendrik-Jan		699, 715	
STEEMAN, Marijke	167	699	
STEIGER, Simone	377		
STESKENS, Paul W.M.H.		653	
STRANDER, Tomi		935	
SUZUKI, Hirotaka		747	
SVENDSEN, Svend	95, 103, 111, 119, 135	511, 597	1071, 1173
SZABO, Daniel		685	
TAKADA, Satoru	307		
TALEV, Goce	331	723	

<b><u>NAME</u></b>	<b><u>VOLUME 1</u></b>	<b><u>VOLUME 2</u></b>	<b><u>VOLUME 3</u></b>
TARDIF, Michel	369		
TENPIERIK, Martin J.	9		
TESÁREK, Pavel		895	
THIVIERGE, Constance		1023	
THORIN, Marcus			1237
THUE, Jan Vincent	331, 417	497, 723, 991	
TIME, Berit			1229
TOMMERUP, Henrik			1111
TOPP, Claus	191		
TORÍO, Herena		645	
TORVI, David A			1269
TRABERG-BORUP, Steen	111, 385		
UVSLØKK, Sivert	1, 355		1285
VALANCIUS, Kestutis	65		
van BELLEGHEM, Marnix		699	
van den BOSSCHE, Nathan		769	
van den ENGEL, Peter	127		
van der SPOEL, Wim H.	9		
van HOOFF, Twan	221		
van REENEN, David		1055	
van SCHIJNDEL, Jos			1293, 1381
VANLONDERSEELE, Els		559	
VENDELBOE, Morten V.	135		
VENZMER, Helmuth	277		
VERA, Sergio	393		
VESELSKY, Juraj		685	
VIITANEN, Hannu		927, 935	
VILNITIS, Martins		889	
VINHA, Juha		927, 935	1095, 1245, 1397, 1405, 1413
VLADYKOVA, Petra			1333
von WERDER, Julia	277		
VRÁNA, Tomas	473		
WADSÖ, Lars		919	
WALLBAUM, Holger		567	
WARGOCKI, Pawel		489	
WEITZMANN, Peter	71		
WILLEMS, Wolfgang			1165
WITTCHEN, Kim B.		605	
WOLOSZYN, Monika		661, 731	

<b><u>NAME</u></b>	<b><u>VOLUME 1</u></b>	<b><u>VOLUME 2</u></b>	<b><u>VOLUME 3</u></b>
WURTZ, Etienne	175		
YILMAZ, Zerrin			1357
ZALOK, Ehab		1055	
ZILLIG, Wolfgang		959, 983	
ZIRKELBACH, Daniel	213, 253, 441		
ZMEUREANU, Radu	369		
ØYEN, Cecilie Flyen			1197
ÅHS, Magnus		873	



## Life-cycle optimised housing

*Jyri Nieminen*

*VTT*

*jyri.nieminen@vtt.fi, <http://www.vtt.fi/>*

*Kimmo Lylykangas*

*Helsinki University of Technology*

*kimmo.lylykangas@hut.fi, <http://www.hut.fi/>*

**KEYWORDS:** *life-cycle, eco-efficiency, energy efficiency, buildings.*

### **SUMMARY:**

*Performance approach aims at management of a product's life cycle properties, and benefit for the users. In eco-efficient construction, performance is an output value achieved with certain input by environmental impacts and life cycle costs. Market driven life-cycle optimised construction has to fulfil three major requirements. A performance that fulfils the user requirements for extended periods should be the output from the design and construction process. Low environmental pressure and low life cycle costs are the input needed to fulfil the requirements. As decision-making is often based on first costs, the building's technical solutions need to be cost-effective.*

*Based on performance requirements set for indoor climate, comfort and adaptability to user's varying needs on one hand and requirements on first costs, life cycle costs and environmental impacts on the other, a model house introducing a new wooden structural system was designed. The architectural challenge of the model house comes from the high adaptability of interior and exterior spaces including a possibility to expand the house according to future needs*

*The analysis of the model house shows 60% reduction of heating energy consumption and 30% reduction of life cycle costs compared to a typical house. According to call for tenders, the investment costs are on the level of a typical house*

*The building introduces a new open wood-framed building system Nordic Platform allowing for shorter delivery cycle than with typical site-construction. The system aims at site-construction from pre-fabricated products for building envelope. The open construction system with published structural details is free to be copied by other network actors. As the basic principle of the construction process is to utilise local enterprise networks, resources and labour, education for both producers of building products and site-workers is needed. Special features of the system are 250 mm single-frame wooden structure with integrated thermal break for exterior walls and trussed construction for internal floors. The house has a mechanical ventilation system with heat recovery. Two heating systems are introduced: floor heating and ventilation heating system. The house is also designed for regional construction and distributed energy supply. Trussed floors include a possibility for easy and flexible installation and maintenance of building services systems.*

## 1. Introduction

Sustainable construction strives to minimize the consumption of energy and resources for all phases of the life cycle of buildings. This includes the whole process from land use strategies, design issues and decision making in planning and construction to use, renovation and disposal and demolition of buildings. The concept of eco-efficient construction is well known, but the concept of network operations based new regional building is still under-developed. As the models for both eco-efficient buildings and neighbourhoods and operations models are implemented, the technology and process develop in the company networks.

The model house was designed according to the desired performance characteristics describing the user requirements and environmental targets of the house. VTT's requirement's management tool EcoProp (2003) was used in setting the requirements. Requirements for the technical design were derived from the performance requirements:

- The house is adaptable with regard to both size and floor plan
- The wooden house serves for short delivery cycle at site and simple thermal insulation system. The load-bearing wooden frame is single-framed allowing for high levels of insulation. Comfort is taken into account in all dimensioning of structures.
- The house is energy-efficient. The heating energy demand of the house is less than 50% compared to a house according to national building code of 2003, and less than 35% compared to typical buildings before 2003. Heating energy consumption can be decreased further by building service systems. Appliances and heating and ventilation equipments are energy labelled.
- The house has a long-service life. The durability of the wooden envelope structures is improved by environmentally friendly wood preservatives. The colouring of the house is based on tinctures traditionally used in wooden houses. The house has a tilted roof for facade protection.
- The house has a good and healthy indoor climate. The adaptability of the house is taken into account in the design of building services. The materials and solutions support good and healthy indoor environment.

## 2. Model house design

### 2.1 Architecture

The designed housing areas are quite different in nature. This was also anticipated in the design of the model house. The house should fit for both rural areas and dense town areas.

A full adaptability is a difficult task to achieve for a common model house design. The solution was to allow different floor plans within the structural modules, and to make it possible to build different apartment sizes from 73 to 195 m<sup>2</sup> with the same basic foot print of the house. As the house has either 1½ or 1¾ story the upper floor can be finished later-on depending on the needs of the family, Figure 1. Building services systems are designed for the maximum size of the building. Routing of building service's systems can be placed in the internal floor. The bathroom, sauna and room for technical equipment is a prefabricated module. Kitchen is directly connected to the module, and upper floor bathroom locates directly above the module. This enables short routing of ductwork, electricity and water and sewage systems. Design features of the model house given in Table 1.

Special features of the building envelope systems are 250 mm single-frame wooden structure with integrated thermal break for exterior walls and trussed construction for internal floors, Figure 2. The single frame system allows for 25 cm insulation between the frames, and an exterior insulation to improve the insulation level. The house has a mechanical ventilation system with heat recovery. Two heating systems are introduced: floor heating and ventilation heating system based on ground heat pumps. The house is also designed for regional construction and distributed energy supply. Trussed internal floors include a possibility for easy and flexible installation and maintenance of building services systems. The building introduces a new application of open wood-framed building system Nordic Platform allowing for shorter delivery cycle than with typical site-construction. The system aims at site-construction from pre-fabricated products for building envelope. The open construction

system with published structural details is free to be copied by other network actors. The Nordic Platform system will be the first nationally standardized frame system.

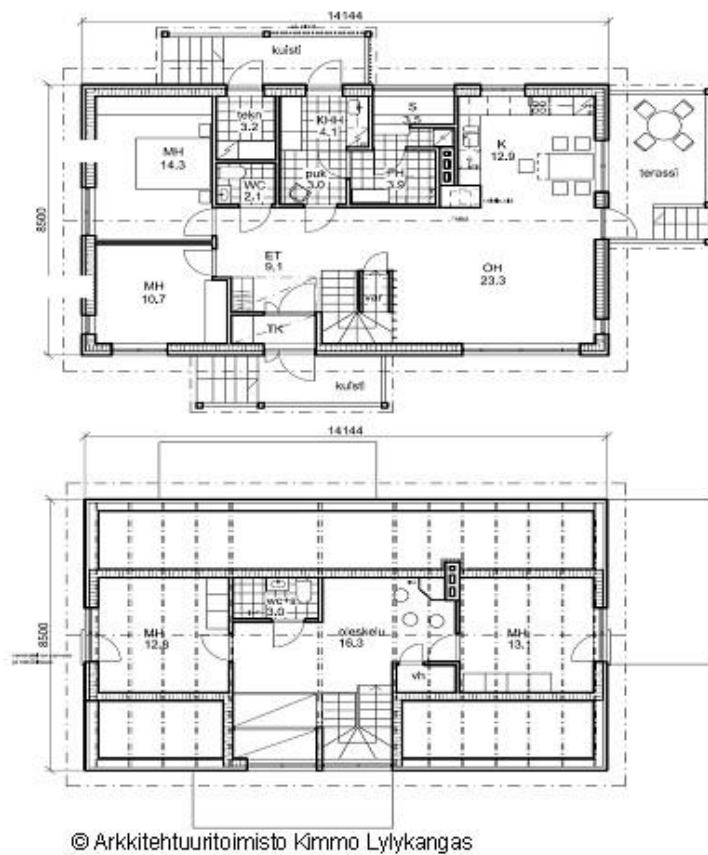

FIG. 1. Floor plans of the two-storey model house. All installations using water are inside the wet modules. Routing of ventilation duct work locates in the internal floor or ceiling of the first floor.

Table 1. Design Features of the model house.

<b>A. Good indoor climate</b>	
<b>Indoor air classification</b>	S1 or S2 [1]
<b>Emission Classification of Surface Materials</b>	M1
<b>Purity Classification of Construction Work</b>	P1
<b>B. Ventilation</b>	
<b>Air flows</b>	The lowest air flow in winter = $0,33 \text{ dm}^3/\text{s}/\text{m}^2$ The largest air flow in summer = $1,5 \text{ dm}^3/\text{s}/\text{m}^2$
<b>Air tightness of ductwork</b>	Air tightness rate at 50 Pa < $0,04 \text{ dm}^3/\text{s}/\text{m}^2$
<b>Heat recovery</b>	Yearly efficiency of heat recovery from exhaust air $\geq 60 \%$
<b>Electrical efficiency</b>	Specific power of ventilation system < $1,5 \text{ W}/(\text{dm}^3/\text{s})$
<b>Noise level of ventilation equipment</b>	Bed rooms and living room < 22 dB(A), other < 25 dB(A)
<b>C. Thermal insulation</b>	
<b>Exterior wall</b>	$U < 0,15 \text{ W}/\text{m}^2\text{K}$
<b>Floor</b>	$U < 0,14 \text{ W}/\text{m}^2\text{K}$ (crawl space foundation)
<b>Roof</b>	$U < 0,12 \text{ W}/\text{m}^2\text{K}$
<b>Window</b>	$U < 0,9 \text{ W}/\text{m}^2\text{K}$ , Window energy classification Class A [2]
<b>Door</b>	$U < 0,7 \text{ W}/\text{m}^2\text{K}$

[1] Classification of Indoor climate (2000)

[2] Window energy classification



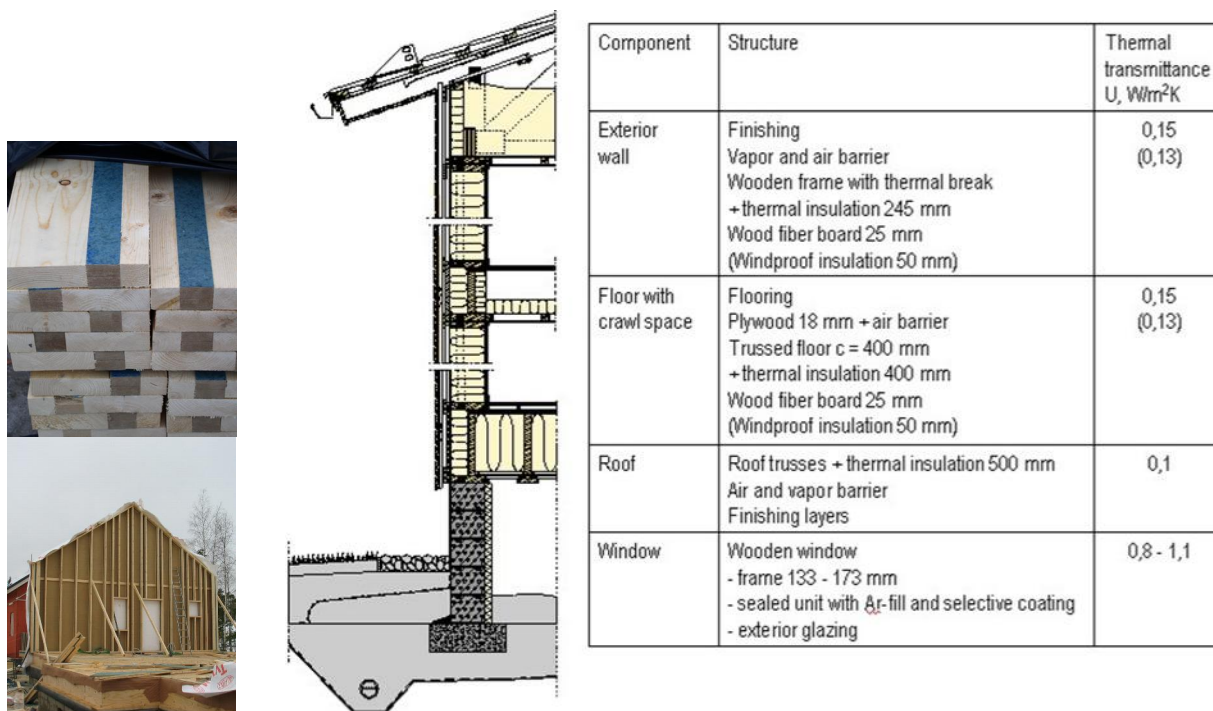

FIG 2. Structures of the building envelope, Nieminen et al. 2008.

## 2.2 Energy efficiency

The houses are designed so that the larger is the house the less energy by m<sup>2</sup> it consumes. The maximum heating energy demand can vary between 70 - 50 kWh/m<sup>2</sup>, which includes energy produced for heating and hot water, and fire wood used in the fire places, Table 2. Company-built houses are required to have lower consumption than houses built by home builders. The peak auxiliary heating energy power is restricted to 35 W/m<sup>2</sup>.

Table 2. Energy performance of the model house (150 m<sup>2</sup>). Heating energy consumption with ground source heat pump system.

Consumption, kWh/m <sup>2</sup>	Existing buildings	Model house
Heating energy	140 - 170	25 - 30
HVAC electricity	20 - 30	10 - 20
Household	30 - 40	25 - 35
Total	190 - 240	60 - 85

## 3. Distributed energy systems

Two case studies were carried out, Tuusniemi and Tampere. In the municipality of Tuusniemi (3000 inhabitants), a new housing area was designed. A possibility to join a distributed heating energy system was analysed. The system based on the following principles:

- The municipality offers the connection to the network
- Builders have a possibility to join the network with their own heating systems
- A service provider would be responsible on the network and heat generation.

Three alternatives were considered for a distributed heating energy network:

- High temperature biomass plant (T = 80/43 °C) using local energy sources.

- Centralized ground heat distribution system ( $T = 50/40\text{ }^{\circ}\text{C}$ ) with separate hot water system
- Distributed low temperature ground heat system ( $T = 2/-1\text{ }^{\circ}\text{C}$ ) with individual heat pumps.

A cost analysis showed that the low temperature distributed ground heat system (Figure 3) is cost efficient for both the municipality with regard the construction costs and the builders with regard the life-cycle costs. The investment cost for the ground collector systems is roughly  $35 - 45\text{ €/floor-m}^2$  of houses. The costs are dependent on the plot ratio of the area. As the plot ratio for the Tuusniemi housing area is extremely low, the costs for a total network is high. If the network can be divided into sub networks, the costs will be reduced down to  $25 - 35\text{ €/floor-m}^2$ . The ground system uses water soluble and environmentally safe heat carrier.

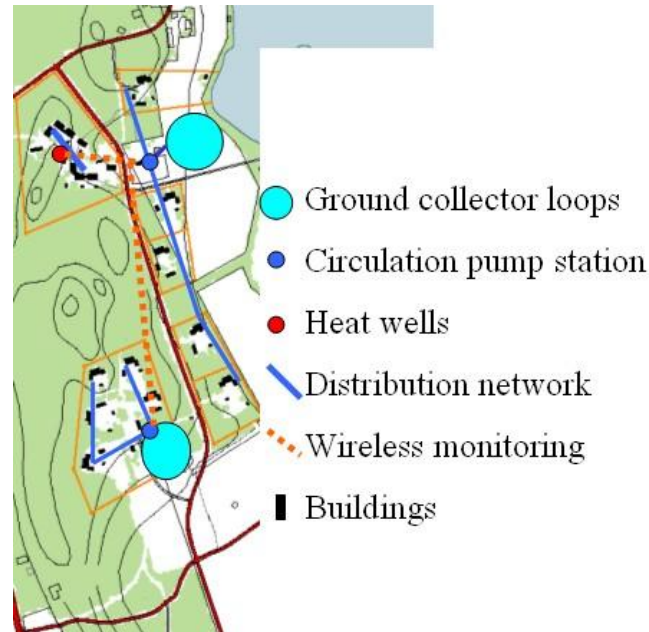

FIG. 3. The suggested ground heat system in Tuusniemi. The ground pipe work for heat collection depends on ground conditions. Horizontal pipe work is used in soil with clay, and heat wells in rock.

In Tampere, a new housing area of 13500 inhabitants is under development. The major part of the area will be covered by co-generated heat and power produced with natural gas, peat and biomass as primary energy sources. Distributed heat pump systems can be utilized in areas where district heat is not economical. The possibilities are to use lake water or heat wells as ground heat sources. The system costs range from  $7$  to  $9\text{ €/floor-m}^2$  (cost level 2004) for the heat collector systems only, as an average cost level for distribution network for district heating varies roughly between  $10$  and  $15\text{ €/floor-m}^2$ .

The importance of the efficiency of the design area was also analysed. The price of the supplied heat was calculated using the following parameters:

- Electricity price
- Investment costs (heaters, heat pumps, network)
- Interest rate, service life
- Maintenance and running costs, replacements
- Heating equipment in houses
- Density of the area
  - Rural density
  - Old low density housing areas
  - Typical new housing areas
  - Low and dense housing areas

Single family houses use direct electric or accumulating electrical heating system. During the last few years heat pump heating has gained market share in single-family houses' heating systems. Figure 4 shows the dependence of the life-cycle cost of supplied heat on the price electricity in different types of housing areas. In life-cycle

perspective, the ground heat network is cost-efficient in dense housing areas, whereas the direct electric heating is more cost-efficient in low density areas and present electricity prices.

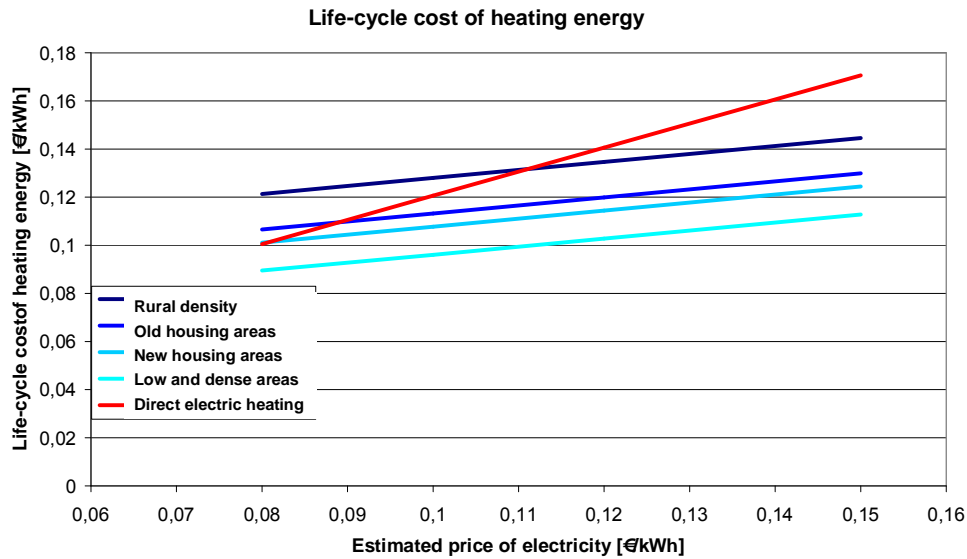

FIG. 4. Life-cycle cost of heating energy according to different types of housing areas.

It is clear that improving energy-efficiency of a building requires more effort in design of the building, and also in construction of the building envelope. If the energy-efficiency is improved by simple, low-cost, and small-sized measures, it brings along important consequences. Power demand for heating and electrical energy, service power demand, basic rates, heat exchangers and heating equipment can be reduced. In dense housing areas a group of buildings can use, e.g., the same ground heat pump system.

The need for renovation of a house comes from two sources: reduced technical condition of the building components, and the spaces and appearance of the house becoming old-fashioned. The need and extend for such renovation measures depends largely on the target setting in the early design phase. The need for future renovations can be reduced by taking the future needs into account in the design. Therefore it is important that the builder and the design team work together to find out the needs of the first user of the house, and try to settle these needs with a view to the future performance of the house. Systems serving as a platform for decision-making have been developed in a number of international frameworks. An example of such a system is described in the Table 3.

Table 3. VTT ProP Property classification

A CONFORMITY	B PERFORMANCE	C COST AND ENVIRONMENTAL PROPERTIES	D PROCESS
A1 Location A2 Services	B1 Indoor conditions B2 Service life B3 Adaptability B4 Safety B5 Comfort B6 Accessibility B7 Usability	C1 Life-cycle costs C2 Environmental pressure	D1 Briefing/Programming D2 Procurement D3 Commissioning D4 Operation
$\text{Eco-efficiency} = \frac{\text{conformity} + \text{performance}}{\text{environmental pressure}}$		$\text{Cost efficiency} = \frac{\text{conformity} + \text{performance}}{\text{life cycle costs}}$	

The direct benefits of eco-efficiency are given in the Table 4. For a housing provider eco-efficiency serves for improved return and running costs. In general the importance of eco-efficiency can be given as:

- Acquisition costs: 0 ... 5% higher than with typical construction
- Life-cycle costs: 10 ... 30% lower than with typical construction
- Life-cycle profit: 30 ... 50% better than with typical construction
- After market value: 10 ... 30% better compared to typical construction.

Table 4. The direct benefits of eco-efficiency for a home builder, Nieminen et al. (2008).

Location: Tuusniemi	Typical house	Eco-efficient house
Reference period 20 years	150 m <sup>2</sup>	150 m <sup>2</sup>
Real interest rate: 2%		
<b>Cost properties</b>	€/m <sup>2</sup>	€/m <sup>2</sup>
Acquisition cost <b>A<sub>q</sub></b>	<b>1 370</b>	<b>1 405</b>
Financing cost: loan for 60% of acquisition cost/15 years	140	145
Maintenance cost (actions defined in house manual)	100	90
Operating cost		
- Heating energy	110	35
- Electrical energy	40	35
- Other operating cost	80	40
- Adaptability cost (changes in floor plan)	35	20
- Risk cost (damages that can not be anticipated)	40	30
- Development cost (for adaptability)	50	20
Life-cycle cost <b>LCC</b>	<b>1 965</b>	<b>1 765</b>
Life-cycle income <b>LCI</b>	2 040	2 040
Life-cycle economy <b>LCE = LCI - LCC</b>	+75	+275
Resale value <b>RV</b>	1 000	1 200
Life-cycle profit <b>LCP = (LCE + RV)/(A<sub>q</sub> x t)</b>	3,9 %/a	5,2 %/a

#### 4. Market situation

VTT's market study on potential home builders that are willing to build an energy-efficient home showed that the demand does not meet the supply. Roughly 50% of the builders considered building energy-efficiently, but only 10% built an energy efficient home, Mikkola & Riihimäki (2003). The main reason for building typical was the lack of appealing possibilities.

However, business opportunities for energy efficient single-family houses do exist. The demand for energy-efficient housing is increasing. There are forerunning companies that have already opened the market for passive houses. Energy directive and energy labelling of houses also tend to change the market situation

The segments of the Finnish housing market have not been defined. It has been anticipated that the demand for eco-efficient housing grows from academic families with children, but there is no clear evidence on that. It is also quite uncertain that market orientation based on market segments would change the processes and market situation to enable rapid and wide market penetration.

The development of the both case housing area is carried out as a network operation. In Tuusniemi, the wide publicity the project gained immediately increased interest on the housing area. Before any single building was erected, the population of the municipality turned growing, thus helping the municipality with its main problem of depopulation. The project also supported local building products' industry. Manufacturing of new timber products and low-energy windows grew from the development carried out. If these are weak signals of increased interest on eco-efficient housing, the concept itself can be expected to benefit from the growing interest.

## 5. Conclusions

In the last 15 - 20 years, a number of projects have been carried out aiming at energy-efficient and environmentally friendly housing. There is a wide range of technologies and concepts that have been tested in monitoring projects. The technological possibilities to reduce a building's energy consumption have been available for a long time. Also, the costs of energy efficiency have been proved to be almost negligible. Despite of the existing vast amount of information, no clear market change has happened.

The major demand for housing and primary market area for eco-efficient construction is single-family housing. The basic assumption is that in future only eco-efficient solutions will be acceptable in the aftermarket. This will bring improvements to the value thinking in construction through the following operational impacts:

- Market conditions of products and services improve through better user/owner requirement management
- Improvement in life-cycle properties of new single-family houses are qualified according to commonly accepted criteria (e.g., energy classification, labelling procedures).
- Life-cycle costs, investment costs and value thinking are evenly important factors in decision making.

Sustainable development and development of knowledge society will affect on the production, supply chains and delivery modes of buildings, as well as in-use services. Information services offer a platform for more accurate user (owner) participation, and thus also a media for verification of user benefits. Internet is already the primary information source in pre-construction phase.

Performance based building is placing user and owner needs in the focus. The methodology provides practical means for assessing benefits of new technologies. Performance approach requires an integrated and transparent procurement process and is therefore closely connected to the development of knowledge society. The process of change can be supported by the following measures:

- Increased independent and impartial information on sustainable building: Overcoming contradicting information produced by companies who have their own interest in the market.
- Objective information for builders: Objective, builder oriented information on user benefits and cost effects of eco-efficiency.
- Social acceptance: Evaluation of demand on eco-efficient housing and living and social acceptance of model buildings.
- New eco-efficient housing concepts (e.g., model houses): Open concepts especially for SME's to be utilised in network operation.
- New procurement procedures: Integrated design process, performance based tendering, commissioning.

## References

- Classification of Indoor Climate 2000. Finnish Society of Indoor Air Quality and Climate (FiSIAQ),  
Window energy classification. <http://www.motiva.fi/>
- EcoProP - Requirements Management, 2003. [http://cic.vtt.fi/eco/ecoprop/english/EcoProp\\_brochure.pdf](http://cic.vtt.fi/eco/ecoprop/english/EcoProp_brochure.pdf)
- Nieminen, J. et al. 2008. Models of eco-efficient housing and housing areas. VTT Research Notes. (to be published 2008)
- Mikkola, K., Riihimäki, M. 2002. The readiness of one-family house constructors to environmentally friendly construction methods. (in Finnish). VTT Research Notes.
- Imperial College (1999). Natural Resins as a Potential Wood Processing Agent. EU FAIR research program 1999. The life cycle analysis by Imperial College of Science, Technology and Medicine, UK..

## Low energy class 1 typehouses according to the Danish building regulations

*Jørgen Rose, Senior Researcher,  
Department of Energy and Environment, Danish Building Research Institute, Aalborg University;  
[jro@sbi.dk](mailto:jro@sbi.dk), [www.en.sbi.dk](http://www.en.sbi.dk)*

*Jesper Kragh, Assistant Professor,  
Department of Civil Engineering, Technical University of Denmark;  
[jek@byg.dtu.dk](mailto:jek@byg.dtu.dk), [www.byg.dtu.dk/english.aspx](http://www.byg.dtu.dk/english.aspx)*

*Svend Svendsen, Professor,  
Department of Civil Engineering, Technical University of Denmark;  
[ss@byg.dtu.dk](mailto:ss@byg.dtu.dk), [www.byg.dtu.dk/english.aspx](http://www.byg.dtu.dk/english.aspx)*

*KEYWORDS: Building Regulations, total energy use for heating, cooling, ventilation and domestic hot water, optimization, DseeC, low energy classification, typehouses, BE06, building simulations, BSIM 2002.*

### *SUMMARY:*

*In 2005 the Danish Building regulations introduced two low energy classes for buildings in addition to tightened minimum requirements. The low energy class 1 and low energy class 2 correspond to total energy use, i.e. energy use for heating, ventilation, cooling and domestic hot water, as 50% and 75% of the minimum requirement respectively. The main purpose of introducing the low energy classes were to further support and encourage the development of low energy buildings in Denmark.*

*In 2010 it is expected that demands of the Building Regulations are tightened by 25-30% and in 2015 it is expected that the minimum demand will correspond to the low energy class 1 demands of today. In order to secure this development in the building regulations, it is essential to support the development of low energy solutions and demonstrate that the goal is well within reach of the Danish building industry.*

*This paper describes the development of a low energy class 1 typehouse. The house is based on a standard typehouse, and through an optimization process of the building constructions and heating and ventilation systems, the total energy use for the typehouse has been reduced in order to meet the low energy class 1 demands. The paper describes the original typehouse solution, optimization process and detailed simulations of the energy use and indoor climate of the optimized solution.*

## 1. Introduction

The EU Directive on Energy Performance of Buildings (EU Directive, 2002) was implemented in Denmark in 2006, and in order to comply with the directive, Denmark introduced new energy performance requirements in 2005 (Danish Building Regulations, 2005). In addition to a general tightening of the minimum requirements, the new building regulations also introduced a classification system for low energy buildings, i.e. low energy class 1 and low energy class 2 buildings corresponding to 50% and 75% of the minimum requirement respectively.

In order to stimulate the use of the new classification system and hereby induce further energy savings in new buildings, it is necessary to demonstrate how total solutions that fulfill the low energy classes can be developed without major impact on basic building techniques and economy. This is especially important in order to visualize the possibilities for the building industry and hereby start a process creating a market for low energy houses. This will pave the way for the development of new building components and system solutions that can form a basis for new low energy buildings so that the present low energy class 1 can be made a minimum demand in 2015 for standard houses.

The purpose of the project described in this paper was to develop typical typehouse solutions that fulfill the demands on low energy class 1 buildings. The development was performed in co-operation with typehouse contractors. Based on the standard typehouses chosen by the contractor, a list of energy saving measures were

suggested and for each measure the reduction in total energy use was calculated using a calculation program, *BE06* (Aggerholm and Grau, 2006) described in detail in (Aggerholm and Grau, 2007). This program has been developed to fulfill the requirements in the European Standard EN ISO 13790 (EN ISO 13790, 2005) and is used in Denmark for demonstrating that new houses fulfill the energy requirements according to the Building Regulations. Using detailed calculations/simulations of the total energy use along with economic optimization procedures, new typehouse solutions that fulfill the low energy class 1 requirements were proposed and in cooperation with the contractors a final solution was chosen.

This paper describes one of two developed typehouse solutions. (Rose, 2007) describes both in detail.

## 2. Existing typehouse solution

The existing solution was a traditional Danish typehouse solution from Eurodan Huse A/S, see figure 1.



FIG. 1: Picture of the original typehouse. The total heated area is 157 m<sup>2</sup>.

### 2.1 Constructions for the original typehouse

In figure 2 a cross-section of the house is shown. In the following the constructions are described.

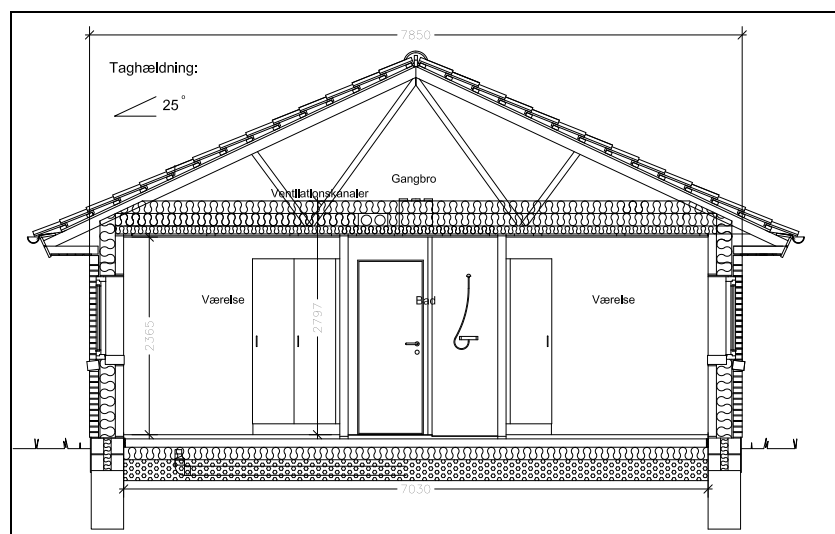

FIG. 2: Cross-section of the original typehouse.

Exterior walls are based on brick and lightweight aggregate clinker whole-wall elements with 190 mm insulation. The mean U-value of the exterior wall is 0.196 W/m<sup>2</sup>K.

The floor construction consists of a 100 mm concrete slab, 150 mm polystyrene and 250 mm lightweight aggregate clinker. The U-value for the floor construction is 0.119 W/m<sup>2</sup>K. The house is heated by both floor heating and radiators. Floor heating covers approximately 1/3 of the total floor area.

The roof construction has 385 mm insulation and a U-value of 0.092 W/m<sup>2</sup>K.

Windows and doors have 92 mm wide wooden frames with a mean U-value of 1.50 W/m<sup>2</sup>K. The panes have 2 layers of 4 mm glass with a 90/10 argon/air gas between, resulting in a U-value of 1.13 W/m<sup>2</sup>K and a solar

transmittance of 59%. The spacer profile is aluminum, resulting in a large thermal bridge. The overall mean U-value for windows and doors is 1.42 W/m<sup>2</sup>K.

The most important thermal bridges (foundation and window/wall joint) have also been evaluated. The linear thermal transmittance of the foundation constructions below the exterior wall and below windows/doors are 0.103 W/mK and 0.210 W/mK respectively (calculations performed according to Danish calculation standard (DS418, 2005). The window/wall joint has a linear thermal transmittance of 0.044 W/mK for the vertical cross-section and 0.026 W/mK for the horizontal cross-section.

## 2.2 Heating and ventilation system for the original typehouse

The house is fitted with a ventilation system with heat recovery. Exhausts are placed in the kitchen (20 l/s), utility room (10 l/s) and two bathrooms (15 l/s), i.e. a total of 60 l/s (0.38 l/s per m<sup>2</sup>) corresponding to a ventilation rate of 216 m<sup>3</sup>/h. Inlets are placed in bedrooms, kitchen and living room. The temperature efficiency of the unit is approximately 87% (at 20 °C indoor temperature, 50% relative humidity and 5 °C outdoor temperature). The SEL-value (specific electricity use for air transport) is 0.8 kJ/m<sup>3</sup>. The mean infiltration for this type of house is 0.05 h<sup>-1</sup> (typical result obtained by contractor in blower door test).

The heating system is a condensing gas furnace with a nominal effect of 14.7 kW and a maximum efficiency of 109%. The blower has a rated output of 96 W and automatic control of 0.9 W. The pump is a three step pump with power draws of 46 W, 63 W and 78 W respectively. The total standby power draw is 10 W. The reduction factor for the pump is 0.8. The supply pipe temperature is 70 °C and the return temperature is 40 °C. Heating is provided through a 2-string system.

The domestic hot water system has a hot water tank with a capacity of 65 l and a specific heat loss of 1.30 W/K (measured by manufacturer).

## 2.3 Total energy use for the original typehouse.

The total energy use for the original typehouse is calculated using the program *BE06*, and the result is 60.8 kWh/m<sup>2</sup> per year. This covers the energy used for heating, ventilation, cooling and domestic hot water and all electricity use is multiplied by a factor 2.5 in order to take into account the difference in CO<sub>2</sub>-emission associated with the production of this energy type. In *BE06* cooling is automatically initiated if indoor temperatures rise above 26 °C and cooling energy is assumed to be electric, i.e. the energy is multiplied by a factor 2.5. The energy frame for this particular typehouse according to Danish Building Regulations is 84.0 kWh/m<sup>2</sup> per year, so the original solution easily fulfils the minimum requirements.

## 3. Optimization of the energy performance

Optimization of the energy performance for the typehouse is achieved using a method developed at the Department of Civil Engineering at the Technical University of Denmark (Christensen, J. H., 2006-I). The main principle of the method is to determine a so-called solution space represented by the energy frame minus the energy use for domestic hot water and electricity use (typically pumps in the heating system and fans in the ventilation system). Domestic hot water use is specified as 250 l/m<sup>2</sup> for houses and electricity use for the heating and ventilation system will typically be independent of the building layout, and therefore these two elements can be withdrawn from the optimization process.

After this the remaining energy use (the solution space) is reduced by the energy use for space heating under the assumption of there being no windows in the building. The remaining part of the solution space can be used for installing windows in the house, taking into account any extra reduction in the solution space if overtemperatures are introduced when installing windows.

The method is implemented in a Pc-program, *DseeC* (Christensen, J. H., 2006-II) which represents the solution space graphically. Below is a short description of the results obtained with *DseeC* for the original typehouse.

The insulation thickness in the roof construction should be as large as possible because it is inexpensive to insulate this part of the building envelope compared to other areas.

The exterior wall should be insulated with 300 mm insulation or more – depending on which type of exterior wall is used. If the heavy wall (brick and lightweight aggregate clinker) is maintained, insulation thicknesses



beyond 300 mm will be quite expensive, as the width of the foundation will need to be increased also. If a lighter wall-type is used the insulation thickness can be increased without problems, however this will also reduce the overall heat capacity of the typehouse.

Statically and economically it can be difficult to operate with insulation thicknesses (expanded polystyrene) beyond 300 mm in floor constructions. However, combinations of expanded polystyrene and lightweight aggregate clinker, as in the original solution, can be used, and this type of solution with increased insulation thicknesses is an obvious choice.

For the windows and doors it is concluded, that it is possible to reduce the total energy use for the typehouse significantly, by using the best windows/doors on the market. However, the price for using the best that the market has to offer is too high for it to be economically viable and therefore it is concluded that focus should be on increasing individual window size and orientating the windows to increase solar gains. In addition choosing a pane with a lower U-value and a "warm edge" should be considered.

With respect to the heating and ventilation system the original house already has good solutions, and therefore only slight adjustments are performed on these. The pump in the heating system could be exchanged for a more energy efficient one and by increasing focus on air-tightness of the building envelope, it is expected that the infiltration can be minimized also. Instead of having a combination of floor heating and radiators, floor heating could be used throughout the house, meaning that the temperature in the system can be reduced significantly.

## 4. Optimized typehouse solution

The optimized typehouse is shown in figure 3.



FIG. 3: Low energy class 1 typehouse.

### 4.1 Constructions for the optimized typehouse

In figure 4 a cross-section for the optimized typehouse is shown.

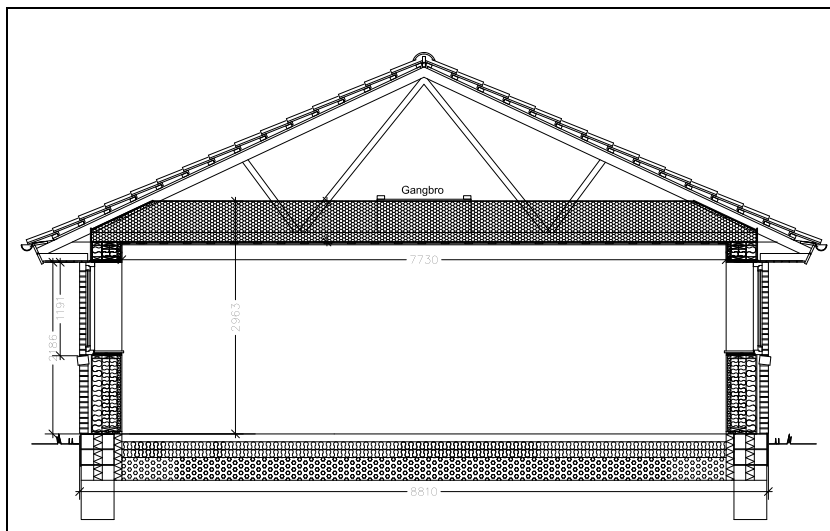

FIG. 4: Cross-section of the low energy class 1 typehouse.

In the optimized house the exterior walls are based on a load bearing wooden construction with a brick outer leaf. The construction has 365 mm of insulation and a mean U-value of 0.105 W/m<sup>2</sup>K.

The insulation thickness of the floor construction has also been increased, so that the optimized house has 200 mm polystyrene and 290 mm lightweight aggregate clinker. This decreases the U-value for the floor construction to 0.098 W/m<sup>2</sup>K.

The roof construction now has 520 mm of loose-fill stone wool resulting in a U-value of 0.081 W/m<sup>2</sup>K. The loose-fill insulation thermal conductivity is somewhat higher than the batts used in the original solution, however when the insulation thickness reaches this level it is practically impossible to insulate the roof with batts.

The linear thermal transmittance of the foundation constructions below the exterior wall and below windows/doors are 0.063 W/mK and 0.093 W/mK respectively. The window/wall joint has a linear thermal transmittance of 0.059 W/mK for both the vertical cross-section and the horizontal cross-section.

Window and door frames are the same type in the optimized house as in the original house. However, the glazing has been improved as a 3-layer pane with argon has been chosen. This reduces the total mean U-value from 1.42 W/m<sup>2</sup>K to 1.11 W/m<sup>2</sup>K but also decreases the solar-transmission from 0.59 to 0.45. The window sizes have been increased and generally the largest areas have been orientated towards south, east and west, i.e. minimizing the area towards north. In table 1 the construction U-values and building joint  $\psi$ -values are shown for both typehouses. In table 2, the window areas and orientations are shown for both typehouses.

TABLE. 1: Comparison of construction U-values and building joint  $\psi$ -values.

	U-values [W/m <sup>2</sup> K]				$\psi$ -values [W/mK]	
	Exterior wall	Slab on ground	Roof	Windows	Foundation	Window reveal
Original typehouse	0.196	0.119	0.092	1,42	0.103/0.210	0.044/0.026
Optimized typehouse	0.105	0.098	0.081	1,11	0.063/0.093	0.059/0.059

TABLE. 2: Comparison of window areas in m<sup>2</sup> and orientations.

	North	East	South	West	Total
Original typehouse	10.80	5.20	7.60	2.00	25.60
Optimized typehouse	9.50	5.30	16.30	10.30	41.40

## 4.2 Heating and ventilation system for the optimized typehouse

The pump used in the heating system has been exchanged for a Grundfos Alpha Pro with a nominal wattage of 25 W and a reduction factor of 0.4. In the optimized house there is floor heating throughout the house, which means that the temperature in the heating system can be reduced significantly (from 70 °C to 35 °C).

The air-tightness of the typehouse is expected to be lower than in the original solution, and therefore the infiltration is reduced from 0.05 h<sup>-1</sup> to 0.03 h<sup>-1</sup>. Previous experiences with low energy buildings have shown that this level and even better can be reached through careful design, especially of the construction joints in the planning phase, and meticulous craftsmanship in the building phase.

The floor plan has also been changed, but this has merely been a token of the contractors wish, and does not have any significant influence on the energy use for the typehouse.

## 4.3 Total energy use for the original typehouse.

The total energy use for the optimized typehouse is calculated as 40.4 kWh/m<sup>2</sup> per year. The requirement for low energy class 1 is 40.6 kWh/m<sup>2</sup> per year, so the requirement has just been fulfilled.

## 5. Simulation of indoor climate and heating demand

In addition to the simplified calculation of the total energy use for the low energy class 1 typehouse, a simulation of the indoor climate and heat balance has also been made on an hourly basis. Detailed simulation of the indoor climate in a low energy house is necessary in order to estimate the risk of overtemperatures during summer.

The simulation was carried out using the program *BSIM* (Danish Building Research Institute, 2002). In figure 5 the *BSIM* model is shown. The model is defined with constructions and systems as described above. With the present version of *BSIM* (4, 7, 1, 18) it is not possible to simulate waterborne floor heating systems. As the floor heating system increases the heat loss to the ground, due to a higher temperature (approx. 30 °C) in the floor construction, an alternative method has been used to compensate for this extra transmission heat loss. The floor heating is simulated by lowering the ground temperature by 10 °C, corresponding to the difference between room temperature, 20 °C, and typical floor heating temperature in a low energy house, 30 °C. This will also influence the line loss for the foundation construction.

To document the heating demand according to the building code the set point temperature for the heating system was simulated to be 20 °C in all rooms (Aggerholm, S. and Grau, K., 2007).

In a low energy house the internal heat gains are a significant part of the heat balance. The internal heat gains from equipment and people have been simulated to be 5 W/m<sup>2</sup> according to (Aggerholm, S. and Grau, K., 2007).

The ventilation and infiltration have been simulated as described in chapter 2.2. If the room temperature gets above 23 °C venting is activated by opening the windows.

Figure 5 shows the simulation model from *BSIM*. Each room has been simulated as a thermal zone and the air distribution between the rooms (mixing) has been set to equalize the in- and outlets from the ventilation system.

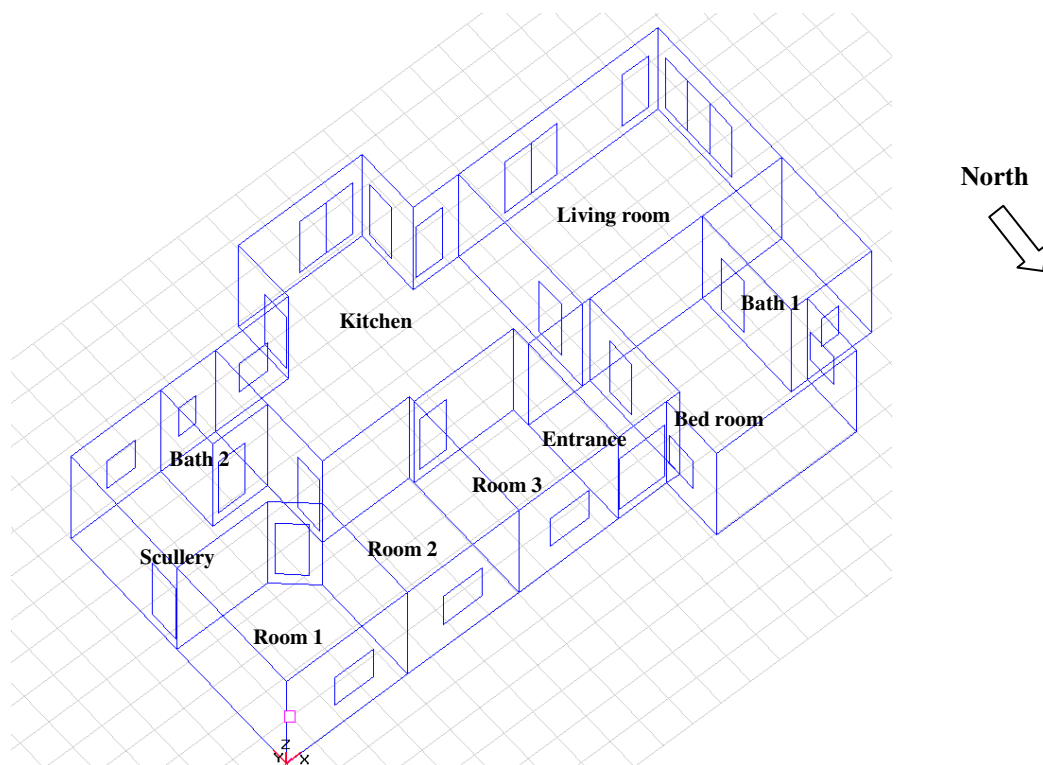

FIG. 5: *BSIM* model of the low energy class 1 typehouse. The house is orientated so that the large windows of the kitchen and living room are facing south. The overhang from the roof is 0.75 m (not shown).

The windows have a relatively large overhang from the roof, which is included in the simulation but not shown in figure 5. The overhang plays an important role when calculating the solar heat gains during the summer. To maximize the heat load from solar gains through the window it is also assumed that the house is located in an open flat country (simulated horizon angle 10°).

In figure 6 the simulation result from *BSIM* is presented. The figure shows the energy balance of the typehouse. As *BSIM* only calculates the net heat loss from the building the figure is supplemented with the results previously found by the *BE06* program regarding energy use for domestic hot water (15.4 kWh/m<sup>2</sup>), electricity use for fans and heating system (7.1 kWh/m<sup>2</sup>) and heat losses from the heating system (3.9 kWh/m<sup>2</sup>).

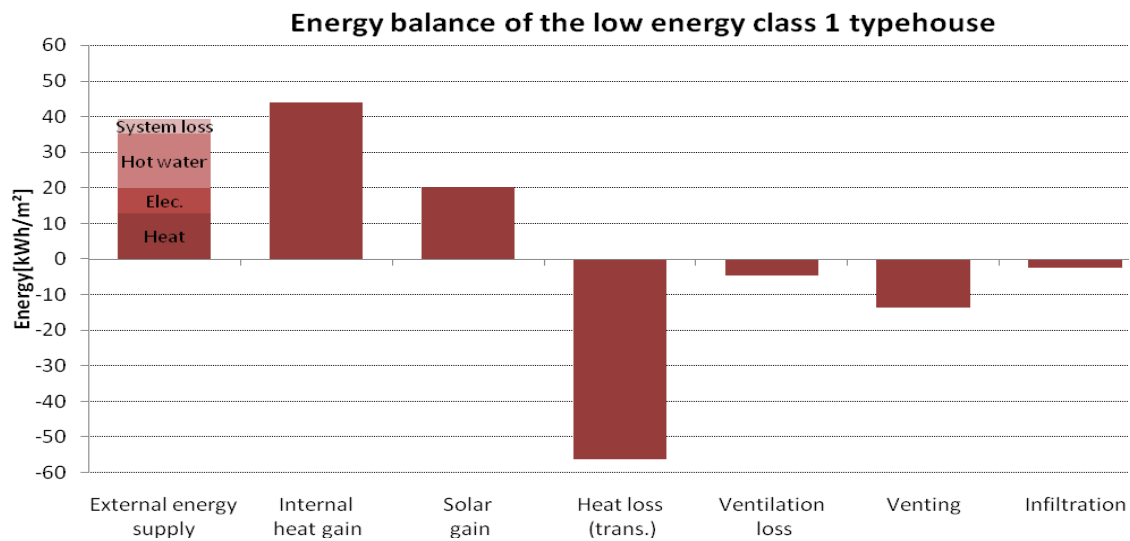

FIG. 6: Results from the *BSIM* simulation showing the energy balance of the typehouse. The electricity is multiplied by 2.5 as described in chapter 2.3. Energy consumption for domestic hot water, electricity and system loss is calculated by the *BE06* program.

It is seen that the simulated total energy consumption for heating including electricity is 39.2 kWh/m<sup>2</sup> which can be compared with the results found by the *BE06* program (40.5 kWh/m<sup>2</sup>).

The simulation results from *BSIM* also give the room temperatures for each hour. Figure 7 shows an analysis of number of hours above different temperature limits to give an indication of possible problems with overheating.

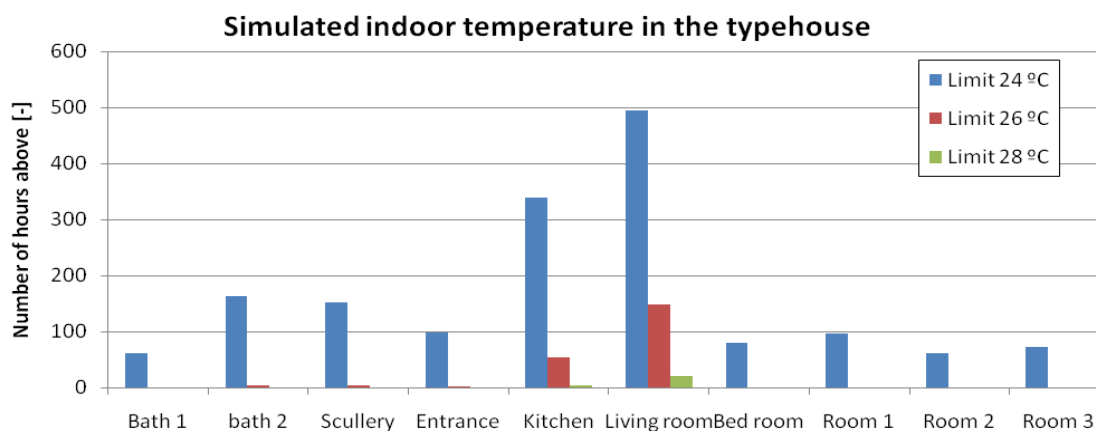

FIG. 7: Analysis of possible overheating problem. The figure shows the number of hours when the operative room temperature was above 24 °C, 26 °C and 28 °C.

From figure 7 it can be seen that the living room is the room with the highest temperatures. The recommendation in Denmark for achieving a good indoor climate (Valbjørn et al, 2000) is that the indoor temperature in any room does not exceed 26 °C for more than 100 hours per year. From figure 7 it is evident that this recommendation is almost fulfilled, and therefore the room temperature in the typehouse is assessed to be acceptable in all rooms.

## 6. Conclusions

The Danish Building Regulations have introduced two low energy classes for new buildings in order to stimulate and support the development of low energy solutions. Low energy class 1, i.e. 50% of the minimum requirement, is expected to be made the minimum requirement in 2015. In order to ensure the continued development of low energy solutions that can form the basis for meeting the future demands, it is necessary to demonstrate how low energy class 1 buildings can be developed without significant influence on basic building techniques and economy. The purpose of this project was to demonstrate how low energy class 1 typehouses can be developed from existing typehouse solutions.

This paper has described the development of a low energy class 1 typehouse. The typehouse was developed from a typical existing solution and through detailed calculations and optimization. Calculations were performed using the Pc-program *BE06*, and the total energy use was reduced from 60.8 kWh/m<sup>2</sup> per year to 40.5 kWh/m<sup>2</sup> per year hereby meeting the demand on low energy class 1, i.e. 40.6 kWh/m<sup>2</sup> per year.

Detailed simulations using *BSIM* have shown that the indoor climate of the typehouse is more or less within the typical recommendations used in Denmark, and it is concluded that this is acceptable.

At the completion of the first phase of this project, two low energy class 1 typehouses have been developed. Hereby, it has been demonstrated how the classification can be achieved for typical typehouses through adapting building constructions and systems.

## 7. Acknowledgements

This work was financed by the Danish Energy Authority, Energy Research Programme (ERP).

## 8. Future work

At present the developed typehouse is being built and it is the objective of the project to follow up the detailed calculations/simulations with detailed measurements of the indoor climate and energy use of the finished house.

## 9. References

- European Directive on the Energy Use from Buildings. (2002). Directive 2002/91/EC of the European Parliament and of the Council of 16. December 2002 on the Energy Performance of Buildings.
- Building Regulations. (2005). Danish Ministry for Housing and Urban Affairs.
- Aggerholm, S. and Grau, K. (2006). *BE06* (version 2.0), Bygningers Energibehov – Pc-program og beregningsvejledning – Pc-program, Danish Building Research Institute.
- Aggerholm, S. and Grau, K. (2007). *Bygningers Energibehov – Pc-program og Beregningsvejledning – Beregningsvejledning*, SBI-Anvisning 213. Danish Building Research Institute.
- EN ISO 13790 – Thermal performance of buildings – Calculation of energy use for space heating and cooling (2005), European Committee for Standardization. (ISO/DIS 13790:2005).
- Rose, J. (2007). *Udvikling af typehuse i lavenergiklasse 1*, Rapport SR 07-01, Department of Civil Engineering, Technical University of Denmark.
- Beregning af bygningers varmetab, DS418 - 6. Udgave, 2002-04-03, Dansk Standard.
- Christensen J. H. (2006-I). *Metode til design af lavenergibyggeri baseret på et energimæssigt løsningsrum*. Polytechnic Exam project, Department of Civil Engineering, Technical University of Denmark.
- Christensen J. H. (2006-II). *DseeC – Pc-program "Metode til design af lavenergibyggeri baseret på et energimæssigt løsningsrum"*. Department of Civil Engineering, Technical University of Denmark.
- Danish Building Research Institute. (2002). *BSIM*: Computer program for calculating and analyzing indoor climate conditions, energy demands and energy consumption in buildings.
- Valbjørn, O., Laustsen, S. Høwisch, J., Nielsen, O. and Nielsen, P. A. (2000). *Indeklimahåndbogen*. SBI-anvisning 196. Danish Building Research Institute.

# Prefabricated EPS Elements used as Strip Foundation of a Single-family House with a Double Brick Wall

*T. Valdbjørn Rasmussen, MSc (Eng), PhD*  
*Danish Building Research Institute, Aalborg University*  
*Department of Building Design and Technology*  
*Denmark*  
*[tvr@sbi.dk](mailto:tvr@sbi.dk), <http://www.sbi.dk>*

**KEYWORDS:** *Building envelope; EPS; Prefabricated elements; Strip foundation, Double brick wall, Single-family house, non-freezing ground*

## **SUMMARY:**

*A new prefabricated lightweight element was designed for a strip foundation that was demonstrated on site as the base of a single-family house with a double brick wall. The element was placed on a stable surface underneath the top soil layer, just 0.25 m underneath the finished ground surface. The prefabricated element was designed to fulfil the requirements of low energy consumption required by the new Danish Building Regulations. The base of the house was cast in one working operation and completed within two working days. The element, made of expanded polystyrene, was designed to be handled on site by one man. A non-freezing ground was established by using outer insulation located at the outer plinth. Temperatures were measured at measurement points located at the outer plinth and onwards from these points underneath the building. In addition the soil temperature, the temperature within the concrete floor slab and indoor and outdoor temperatures and relative humidity were measured.*

## **1. Introduction**

In 2005 the Danish Government presented an action plan that aimed to promote significant results in the energy field. This action plan will have an impact on Danish energy-saving initiatives in the years to come (Ministry of Transport 2005). The action plan includes a description of the Danish energy sector in the years up to 2025. One subject in the strategy is the climate policy related to the Kyoto Protocol, United Nations (1998), which entered into force on 16 February 2005. As part of the internal distribution of obligations within the EU, Denmark must reduce its emissions of greenhouse gases by 21% compared with 1990 emissions (Olesen, *et al.* 2004).

The draft plan in particular focuses on energy consumption in buildings, where the largest and most cost-effective potential for energy savings lies. The most important initiative is a tightening of energy provisions in the Danish Building Regulations (Danish Enterprise and Construction Authority 1995).

The tightening of energy provisions in the Danish Building Regulations will apply both to new and existing buildings. Besides strengthening the current regulations in 2006, the plan paves the way for a further strengthening in 2010 and in 2015. The tightened energy provisions were entered in the Danish Building Regulations on 1 January 2006 and came into force on 1 April 2006, and they are expected to result in an energy reduction of 25 % for new buildings compared with the former building regulations. The new energy provisions incorporated in the Danish Building Regulations (Danish Enterprise and Construction Authority 2008) have had an impact on energy consumption in buildings, in that the regulations focus on the building envelope as well as individual building components. One focus area has been heat loss through the strip foundation of a building. In order to meet the new energy consumption requirements and the need to improve innovation and efficiency in the building environment, an alternative solution to the strip foundation traditionally used in Denmark and built 0.9 m below the finished ground surface was tested on site.

The alternative solution was a prefabricated element made of expanded polystyrene that was demonstrated used as strip foundation and the base of a single-family house with a double brick wall. The prefabricated element was to meet the same performance requirements as traditional solutions.

Methods for establishing stable non-freezing ground underneath the building, taking advantage of natural geothermal energy, (Steiner 2004), were described and instructions were drafted of how to handle the element on site.

## 2. Temperature Measurements

The temperature was measured using type T thermocouples and a datalogger, type 605. The junction of the thermocouples was covered with epoxy. Data from the datalogger were transferred to a PC and a computer program processed the results. The datalogger was placed outdoors in a waterproof plastic container located over and above the finished ground surface. The plastic container was sealed to ensure a dry clean location for the datalogger. The plastic container included an electrical supply for the datalogger as well as a 10 W heating element. Measurement points were located on site underneath the strip foundation, at the outer plinth and underneath the insulation layer in the ground deck, and cast in the concrete floor slab of a building. In addition one measurement point was located in the soil, approximately 0.4 m underneath the ground level. Measurement points were not exposed to direct sunlight and were well away from any heat producing appliances. The temperature was recorded every hour.

## 3. Meters for Measurement of Indoor and Outdoor Climate

The indoor and outdoor climate was measured by means of small dataloggers. Data from the individual dataloggers were transferred to a PC and a computer program processed the results. Dataloggers were placed at locations approximately 2.5 m above the ground level, not exposed to direct sunlight and away from any heat or moisture producing appliances. The climate was recorded every hour. The indoor and the outdoor climate was determined by the indoor and the outdoor temperature, together with the indoor and the outdoor relative humidity.

## 4. Materials Used for the Strip Foundation

The prefabricated elements were made of expanded polystyrene to form an element that could be used as strip foundation of a house of up to two storeys. Elements were produced as one coherently shaped element through a production including an injection molding process. The expanded polystyrene is produced from a mixture of about 5-10% gaseous blowing agent (most commonly pentane or carbon dioxide) and 90-95% polystyrene by weight. The solid plastic is expanded into a foam through the use of heat, usually steam. The polystyrene is filled with trapped air, which gives it low thermal conductivity. This makes it ideal as a construction material used as insulation in building systems, (Petersen 1986). In the following the expanded polystyrene will be referred to as EPS. The calculated thermal conductance is 0.034 W/mK.

The EPS element was specially designed to form the strip foundation that together with the ground deck represents the base of a traditional double brick wall with insulation, see FIG. 1a). However, the EPS element is unique in its design though it can also be used for a traditional wood-stud wall, or combinations of lightweight concrete, brick and wood-stud walls with insulation (Valdbjørn Rasmussen 2007). The prefabricated element was produced as units of 1.2 m in length and 0.6 m in width. The prefabricated element has a density of 33.0 kg/m<sup>3</sup>.

## 5. Performance-based Criteria for the Design of Strip-foundation Element

The prefabricated element of EPS has been designed to comply with the new Danish Building Regulations (Danish Enterprise and Construction Authority 2008), which allow very little heat to be lost through the strip foundation between the ground deck and the exterior wall. In the following the heat loss through the strip foundation will be referred to as the surplus heat loss, [W/mK]. The surplus heat loss is defined as the heat loss that can be attributed neither to the one-dimensional heat loss through the ground deck nor to the exterior wall. Surplus heat loss through the joint between the ground deck and the exterior wall is to a great extent related to the design of the strip foundation (Janssens A. *et al.* 2007).

Buildings that meet the new energy provisions of 1 January 2006, which came into force on 1 April 2006 and are incorporated in the Danish Building Regulations (Danish Enterprise and Construction Authority 2008), must in practice, when using heating in the concrete floor slab, normally not exceed a surplus heat loss of 0.12 W/mK. When using conventional heating in the building, the surplus heat loss must not exceed 0.15 W/mK. Danish Building

Regulations require the overall coefficient of heat transmission of the ground deck and the exterior wall to be equal to or less than  $0.12 \text{ W/m}^2\text{K}$  and  $0.2 \text{ W/m}^2\text{K}$  respectively.

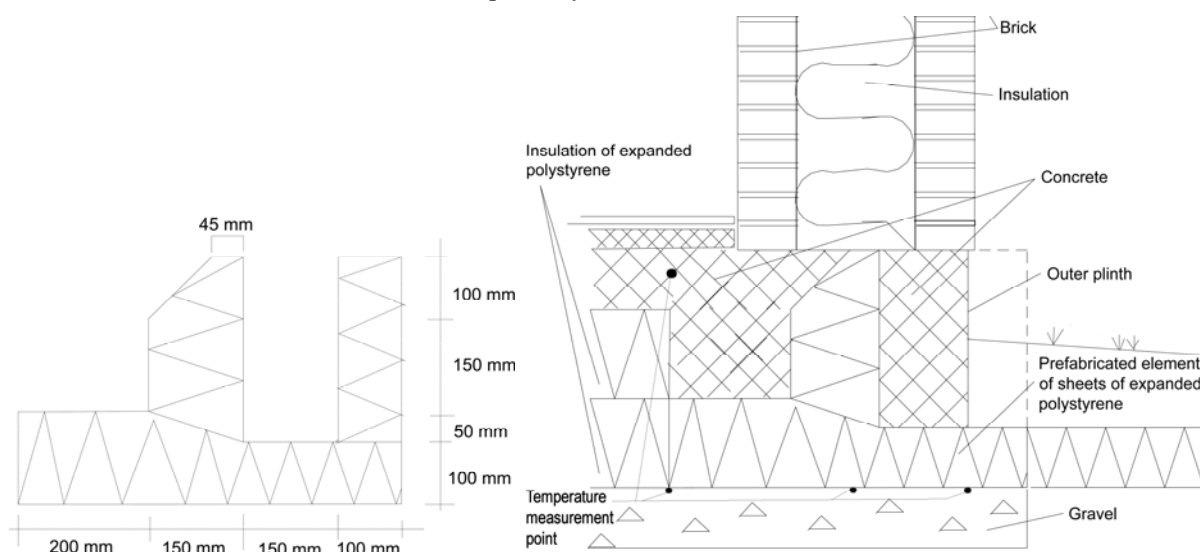

FIG. 1 a): left, the prefabricated element made of EPS, b):right, the EPS element used as the strip foundation of a traditional double brick wall separated by mineral-based insulation.

Calculations of the surplus heat loss through the prefabricated element were carried out by using a PC and the finite difference program HEAT2 version 5.0 in accordance with the method described in Danish Standards 2002. Calculations are dynamic with the outdoor temperature changing throughout the year, see FIG. 2.

FIG. 1b) shows the prefabricated element of EPS used as the strip foundation of a traditional double brick wall, separated by mineral fiber insulation, with an interim insulation of  $0.17 \text{ m}^2\text{K/W}$ . Stainless steel rods of 5 mm in diameter were put through the EPS, every 0.6 m, forming the mechanical fastening point of the concrete for the outer plinth and the concrete floor slab. The contribution of the mechanical fastening to the surplus heat loss through the strip-foundation element is  $0.002 \text{ W/mK}$  (Danish Standards 2002, Table A.3.2).

The overall coefficient of heat transmission of the exterior wall was  $0.2 \text{ W/m}^2\text{K}$ . The surplus heat loss was calculated to be  $0.14 \text{ W/mK}$  for a building with heating in the concrete floor slab. Calculations were carried out with a temperature of the concrete floor slab of  $30 \text{ }^\circ\text{C}$  and with an interim insulation to the soil of  $1.5 \text{ m}^2\text{K/W}$ , which allows the overall coefficient of heat transmission of the ground deck to be  $0.1 \text{ W/m}^2\text{K}$ . Using conventional heating in the building, the surplus heat loss was calculated to be  $0.13 \text{ W/mK}$ . For the calculations, the temperature towards the concrete floor slab was  $20 \text{ }^\circ\text{C}$  with an interim insulation to the ground deck and soil of  $1.67 \text{ m}^2\text{K/W}$ , which allows the overall coefficient of heat transmission of the ground deck to be  $0.09 \text{ W/m}^2\text{K}$ .

Calculations were carried out with the specific heat capacity of the soil and the thermal conductivity of the soil set to  $2.0 \text{ MJ/m}^3\text{K}$  and  $2.0 \text{ W/mK}$ , respectively.

## 6. Ensuring Stable Non-freezing Ground Underneath the EPS Element

Ensuring stable non-freezing ground underneath the building is necessary for maintaining the stability of the structure and avoids settling cracks. To ensure stability of the strip foundation, it is important that temperatures lower than  $-1 \text{ }^\circ\text{C}$  do not occur in any layer susceptible to frost underneath the building during a cold winter (Danish Standards 2001). Temperatures below  $-1 \text{ }^\circ\text{C}$  underneath the capillary breaking layer during a cold winter could cause frost deformations of the soil underneath, and this would increase the risk of the strip foundation settling. Boards of EPS from the outer plinth of the strip foundation were used to form the part of the prefabricated element called the outer insulation. At the vicinity of a corner of a building, the necessary outer insulation was designed on the basis of the experience using the PC finite difference program HEAT2 for 2D and 3D calculations. Calculations showed that if the temperature was determined to be  $+1.6^\circ\text{C}$  along the facade of the building this was equal to  $-1^\circ\text{C}$  at the vicinity



of a corner of the building. Experience was gained from calculations on different types of foundation all dug at lower depth. Temperature characteristics for a cold winter were fed into the model using a design value of 100 years, based on the descriptions given in the Danish Standards 2001. The lowest average temperature of a month was decreased from  $-0.5\text{ }^{\circ}\text{C}$  in a normal year to  $-7.3\text{ }^{\circ}\text{C}$  in a cold year (Rose 2006), see FIG. 2.

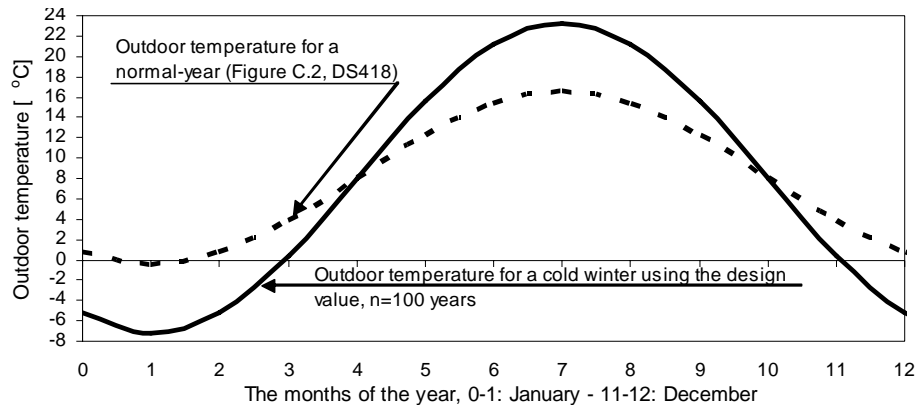

FIG. 2 Variation of the outdoor mean month temperature for a normal year and for a cold year in Denmark.

Outer insulation was designed for three different cases describing the indoor temperatures, 1) an indoor temperature of  $20\text{ }^{\circ}\text{C}$ , 2) an indoor temperature equalling the outdoor temperature but not lower than  $5\text{ }^{\circ}\text{C}$  and 3) an indoor temperature equalling the outdoor temperature.

Along the facade of a building, calculations showed that an outer insulation of EPS (0.1 m in thickness and extending 0.4 m in front of the outer plinth of a building facade just 0.15 m under the finished ground surface) was sufficient to keep the soil just underneath the gravel layer from freezing during a cold winter, while keeping an indoor temperature equal to the outdoor temperature.

At the vicinity of a corner of a building there was a need for extending the outer insulation if the indoor temperature was not kept at  $20\text{ }^{\circ}\text{C}$ . Keeping an indoor temperature at  $20\text{ }^{\circ}\text{C}$  in the building, it was calculated that it was adequate with an outer insulation of EPS, 0.1 m thick and extending 0.4 m in front of the outer plinth just 0.15 m under the finished ground surface in order to keep the soil just underneath the gravel layer at the vicinity of a corner of a building from freezing during a cold winter. If the indoor temperature was kept equal to the outdoor temperature but not lower than  $5\text{ }^{\circ}\text{C}$ , it was sufficient with an outer insulation of EPS, 0.1 m thick and extending 0.7 m in front of the outer plinth just 0.15 m under the finished ground surface, in order to keep the soil just underneath the gravel layer at the vicinity of a corner of a building from freezing during a cold winter. However, maintain an indoor temperature equal to the outdoor temperature, an outer insulation of EPS (0.1 m thick and extending 0.9 m in front of the outer plinth and just 0.15 m under the finished ground surface) was able to keep the soil just underneath the gravel layer at the vicinity of a corner of a building from freezing during a cold winter. It was recommended that the vicinity of the corner includes the area in the ground in front of the corner and the area along the facade of a building, at least covering the extra length of outer insulation along the outer plinth around the corner.

## 7. Performance on Site and Location of Temperature Measurement Points

In most locations in Denmark a stable ground of glacial deposits (moraine) is found underneath a top soil layer of approximately 0.2 to 0.4 m in thickness. The top soil layer was removed in an area covering the ground of the building. Material at least up to a depth 0.35 m underneath the top soil surface had to be dug up. The excavated area was then covered with a 0.1 m capillary breaking layer of gravel, which was stamped in order to form the stable base for the building. Temperature measurement points were mounted and the prefabricated elements were mounted as the strip foundation. The strip foundation elements were held together with large stable-shaped pieces of plastic, 0.3 m of EPS in two layers was mounted inside the strip foundation serving as insulation underneath the concrete floor slab. Before casting the concrete, iron was mounted preventing shrinkage crack development, as a net in the concrete floor slab and as wires performing circular reinforcement in the concrete forming the outer plinth. Wires were located in the moat formed by the two vertical boards of EPS in the prefabricated elements. Wires of stainless steel

rods, 5 mm in diameter were put through the inner vertical boards of the prefabricated elements of EPS every 0.6 m, in order to attach the concrete at the outer plinth cast in the moat to the concrete floor slab. Concrete was cast and levelled. After a few hours, when the concrete was stable in shape, the outer vertical boards of the prefabricated elements of EPS were removed exposing the outer surface of the concrete moat as the outer plinth. The removed outer vertical boards of EPS were used as the outer insulation on the ground around the outer plinth, see FIG 1. The base of the house was cast in one working operation and completed within two working days. The strip foundation was handled on site by one man.

On site, temperatures were observed at locations in the zone between the capillary break layer of gravel and the layer of EPS. Temperature measurements were made at measurement points located along two lines. Firstly, along a line taking its starting point at the north/eastern corner, under the strip foundation at the outer plinth and onwards from this point at a 45° angle horizontally, underneath the building. Temperature measurement points were located along the straight line  $\sqrt{2} \cdot (0, 0.2, 0.5, 1 \text{ and } 2)$  m from the outer plinth corner. Secondly, along a line taking its starting point 3 m from the north/eastern corner along the side of the building facing east, under the strip foundation at the outer plinth and onwards from this point along a straight line at a 90° angle horizontally, underneath the building. Temperature measurement points were located along the straight line 0, 0.2, 0.5, 1 and 2 m from the outer plinth, see FIG. 1b). In addition the temperature of the concrete floor slab of the building was observed at four points along the two straight lines, where temperatures were measured, just above the measurement point located  $\sqrt{2} \cdot 0.5$  m and  $\sqrt{2} \cdot 2$  m from the outer plinth on the first line and above the measurement point located 0.5 and 2 m from the outer plinth on the second line, see FIG. 1b). Temperature measurements along the two lines located horizontally and temperature measurements within the concrete floor slab were carried out underneath the same room of the building. Furthermore the soil temperature was measured 2 m from the north/eastern corner along the side of the building facing east in front of the strip foundation 0.2 m from the outer plinth 0.4 m below the ground level.

## 8. Indoor and Outdoor Climate

The indoor and the outdoor climate was measured at locations in the shadow. The first winter the building was under construction. The second winter the building was ready for occupation and not heated. Results from the temperature and relative humidity measurements indoors and outdoors are shown in FIG. 3. Measurements are shown as mean values of measurements made over a 6-hour period.

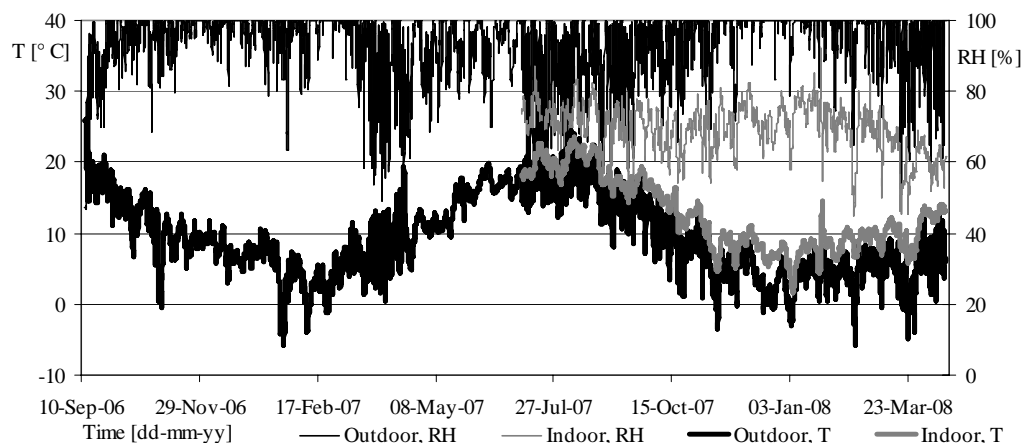

FIG. 3: Temperature and relative humidity measured indoors and outdoors at shady locations. Measurements are shown as mean values of measurements made over a 6-hour period.

## 9. Temperatures Calculated at Measurement Points

The outdoor temperature has an impact on the temperature at the measurement points in between the capillary break layer of gravel and the layer of EPS underneath the building. Table 1 shows the lowest temperatures calculated at the

measurements points facing the east-facing facade for the strip foundation shown in FIG. 1b). Calculations were carried out for the three different cases describing the indoor temperature, denoted 1), 2) and 3) for a normal year and for a cold year.

TABLE. 1: Lowest temperatures calculated at measurement points facing the east-facing facade. Measurement points were located under the strip foundation from under the outer plinth and onwards from this point along a straight line 0, 0.2, 0.5, 1 and 2 m underneath the house referred to as Facade #1, Facade #2, Facade #3, Facade #4, Facade #5, respectively.

Measurement points	Facade #1	Facade #2	Facade #3	Facade #4	Facade #5	Inside
Normal year	5.0 °C	6.0 °C	7.2 °C	8.4 °C	9.9 °C	20 °C
Normal year	4.0 °C	4.7 °C	5.5 °C	6.4 °C	7.5 °C	≥5 °C
Normal year	3.8 °C	4.4 °C	5.1 °C	5.9 °C	6.9 °C	Outdoor
Cold year	1.7 °C	3.2 °C	5.0 °C	6.9 °C	9.3 °C	20 °C
Cold year	0.7 °C	1.9 °C	3.4 °C	5.1 °C	7.0 °C	≥5 °C
Cold year	0.2 °C	1.2 °C	2.4 °C	3.9 °C	5.7 °C	Outdoor

## 10. Results

Results from temperature measurements on site between the capillary break layer of gravel and the layer of EPS underneath the building are shown in FIG. 4 and FIG. 5. FIG 4 shows temperature measurements at 5 locations along the line that starts at the north/eastern corner, from under the strip foundation at the outer plinth and onwards from this point at a 45° angle, in the following referred to as Corner #1, Corner #2, Corner #3, Corner #4 and Corner #5 respectively, located along the straight line  $\sqrt{2} * (0, 0.2, 0.5, 1 \text{ and } 2)$  m from the outer plinth. FIG. 5 shows temperature measurements at 5 locations along a line that starts 3 m from the north/eastern corner along the side of the building facing the east-facing facade, from under the strip foundation at the outer plinth and onwards from this point at a 90° angle, also referred to as Facade #1, Facade #2, Facade #3, Facade #4, Facade #5 respectively, located along the straight line 0, 0.2, 0.5, 1 and 2 m from the outer plinth. Measurements are shown as mean values of measurements made over a 6-hour period.

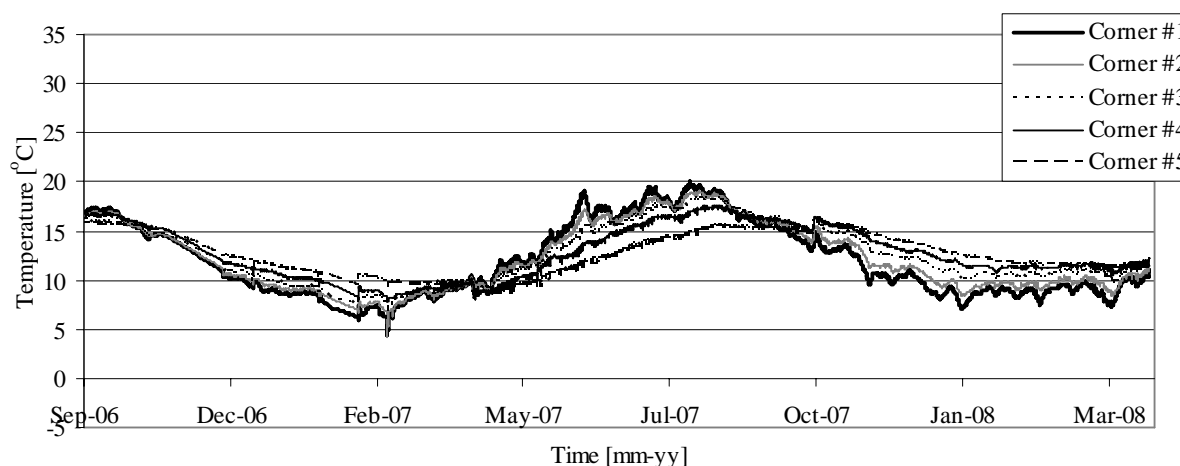

FIG. 4. Temperature measurements at 5 locations along the line that starts at the north/eastern corner, from under the strip foundation at the outer plinth and onwards from this point at a 45° angle.

Results from temperature measurements on site within the concrete floor slab of the building and within the soil are shown in FIG. 6. The measurements at the 4 locations within the concrete floor slab vertically above the locations Corner #2, Corner #5, Facade #2 and Facade #5, are referred to in the following as Corner #1 concrete, Corner #2 concrete, Facade #1 concrete and Facade #2 concrete. In the following, measurement of the soil temperature is referred to as Soil. Measurements are shown as mean values of measurements made over a 6-hour period.

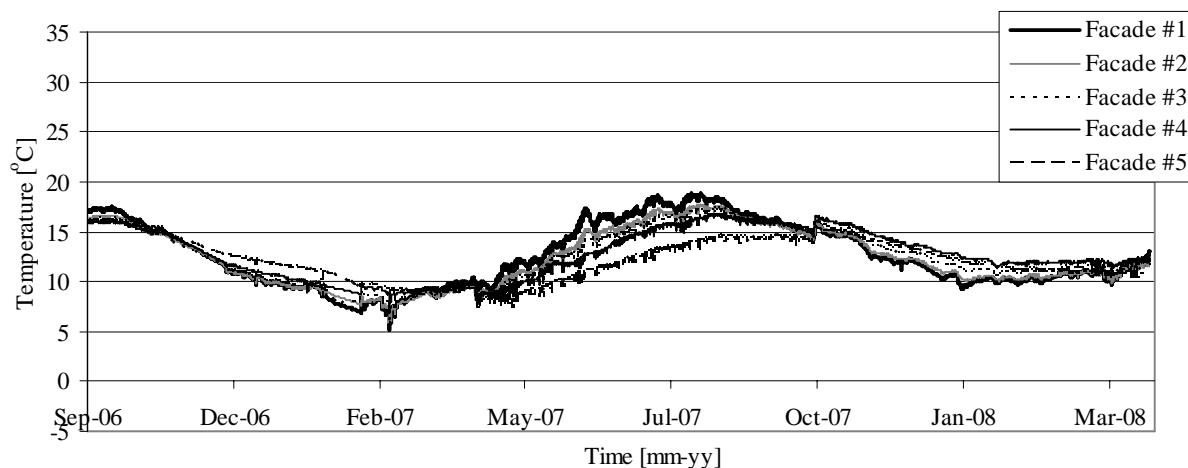

FIG. 5. Temperature measurements at 5 locations along a line that starts 3 m from the north/eastern corner along the side of the building facing the east-facing facade, from under the strip foundation at the outer plinth and onwards from this point at a 90° angle.

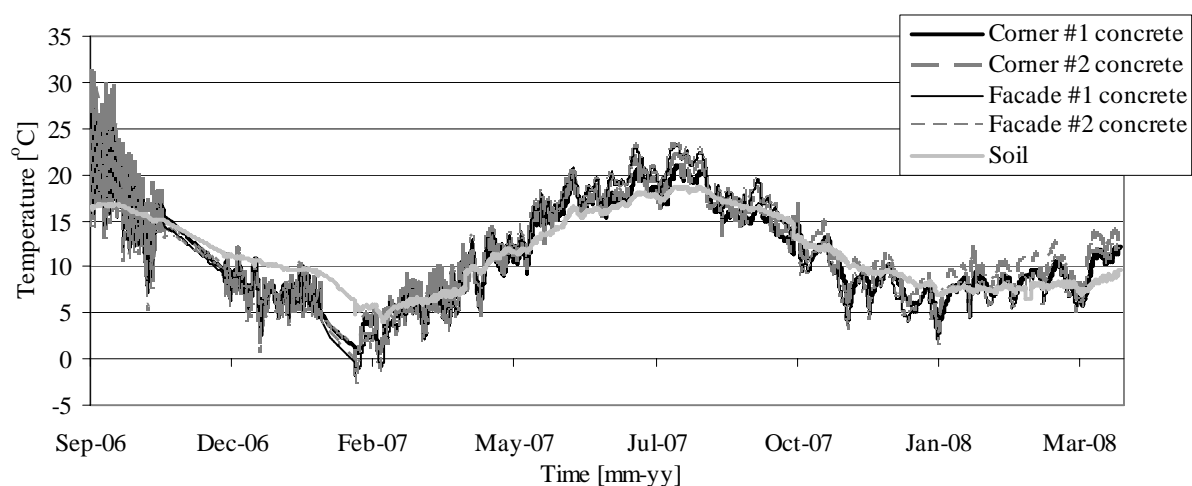

FIG. 6. Temperature measurements within the concrete floor slab of the building and in the soil.

## 11. Summary and Conclusion

The study investigated the performance of a new prefabricated lightweight element used as strip foundation of a single-family house with a double brick wall. The element meets the requirements for low energy consumption outlined in the new Danish Building Regulations (Danish Enterprise and Construction Authority 2008) for a single-family house with a double brick wall using conventional heating. It was shown that the element could be built on stable ground of a capillary breaking layer of gravel underneath the top soil layer, just 0.25 m underneath the finished ground surface. For a real-life situation the base of the house was cast in one working operation and completed within two working days. The strip foundation was handled on site by one man. The house was open and under construction during the first winter of investigation and ready for occupation but not heated the second winter, see FIG. 3 to FIG. 6.

Stable non-freezing ground underneath the building was ensured by using insulation located at the outer plinth. Temperature measurements on site, FIG. 3 to FIG. 6 indicate case 2), a house with an indoor temperature equalling

the outdoor temperature but not lower than 5 °C exposed to outdoor temperature for a normal-year. As listed in TABLE 1, case 2) normal-year shows that the method for calculating the temperatures under the strip foundation, outlined by Danish Standards (Danish Standards 2001 & 2002), was calculated to be comparable with the measurements on site. However, using the PC finite difference program HEAT2 for 2D and 3D, calculations were shown to provide conservative results determining the need of outer insulation that would ensure stable non-freezing ground underneath a building. Furthermore, it was demonstrated that outer insulation is needed to ensure stable non-freezing ground underneath the house, which is necessary for maintaining the stability of the structure and preventing settling cracks during a cold winter by taking advantage of natural geothermal energy.

Designing a strip foundation element to meet the requirements of low energy consumption, this study has demonstrated that the strip foundation must provide full and continuous cover of insulation of the heated part of a building.

## 12. Acknowledgement

Sundolitt A/S, Denmark, has supported this field study.

## 13. References

- Danish Standards. 2002. DS 418, 6th ed. Beregning af bygningers varmetab, Calculation of heat loss from buildings. Copenhagen.
- Danish Standards. 2001. DS/EN ISO 13793, version 1. Bygningers termiske ydeevne – Konstruktion af fundamenter til forebyggelse af frostforskydning. Thermal performance of buildings – Thermal design of foundations to avoid frost heave. Copenhagen.
- Danish Enterprise and Construction Authority. 2008. Bygningsreglement 2008. Danish building regulations 2008. Copenhagen. [with amendments] <http://www.ebst.dk/br08.dk/BR07/0/54/0> [In Danish]
- Danish Enterprise and Construction Authority. 1995. Bygningsreglement 1995. Danish building regulations 1995. Copenhagen. [with amendments] [http://www.ebst.dk/BR95\\_12/0/54/0](http://www.ebst.dk/BR95_12/0/54/0) [In Danish]
- Janssens A. et al. 2007. Development of Limits for the Linear Thermal Transmittance of Thermal Bridges in Buildings. In R. Karney (Ed.), Buildings X Conference, Thermal performance of the exterior envelopes of the whole building X, December 2-7, 2007.
- Ministry of Transport. 2005. Transport- og Energiministeriet. 2005. Handlingsplan for en fornyet energispareindsats. Energibesparelser og marked. [http://www.ens.dk/graphics/Publikationer/Energipolitik/TRM\\_handlingsplan\\_web.pdf](http://www.ens.dk/graphics/Publikationer/Energipolitik/TRM_handlingsplan_web.pdf) [In Danish]
- Olesen, J.E., et al. 2004. Jordbrug og klimaændringer - samspil til vandmiljøplaner. Tjele: Danmarks JordbrugsForskning (DJF rapport. Markbrug ; nr.109-2004). [http://www.vmp3.dk/Files/Filer/Rap\\_fra\\_t\\_grupper/Jordbrug-og-Klimaraendringer-13-09-2004.pdf](http://www.vmp3.dk/Files/Filer/Rap_fra_t_grupper/Jordbrug-og-Klimaraendringer-13-09-2004.pdf)
- Petersen, W. 1986. Understanding polystyrene insulation. (Dow Chemical Co, Midland, MI, USA) Source: Construction Specifier, v 39, n 11, Nov, 1986, p 110-114
- Rose, J. 2006. Konstruktioners frostsikkerhed, BYG-DTU. Lyngby: Danish Technical University. [In Danish]
- Steiner, Elizabeth M. 2004. Frost-protected shallow foundations. (Expanded Polystyrene Molders Assoc.) Source: Construction Specifier, v 57, n SUPPL., November, 2004, p 24-28
- United Nations. 1998. Kyoto protocol to the United Nations framework convention on climate change. <http://unfccc.int/resource/docs/convkp/kpeng.pdf>
- Valdbjørn Rasmussen, T. 2007. Prefabricated elements used as strip foundation of single-family housing. In R. Karney (Ed.), Buildings X Conference, Thermal performance of the exterior envelopes of the whole building X, December 2-7, 2007

# An Analysis of the Difference between Measured and Predicted Energy Savings when Houses are Insulated

*Chris Sanders, Director,  
Centre for Research on Indoor Climate and Health, Glasgow Caledonian University;  
C.H.Sanders@gcal.ac.uk*

*Mark Phillipson, Research Fellow,  
Centre for Research on Indoor Climate and Health, Glasgow Caledonian University  
Mark.Phillipson@gcal.ac.uk*

**KEYWORDS:** *Energy saving, reduction factor, comfort factor*

## **SUMMARY:**

*When houses are retrofitted with cavity wall and loft insulation, the actual energy savings derived from measurements of before and after fuel consumptions are commonly found to be considerably less than expected from model predictions. This discrepancy, termed a 'reduction factor' is caused in part by changed internal temperatures, a 'comfort factor', with the remainder due to other causes, such as insulation performance, occupancy and ventilation.*

*This study reviewed 13 papers relating to the relationship between the predicted and the actual energy saving that occurs when houses are insulated. These papers can be divided into a) 'strategic' studies using simplified data from large groups of dwellings, b) detailed analyses of specific monitoring exercises with information from smaller groups of dwellings, and c) specific studies of individual measures including cavity wall insulation, loft insulation and ventilation. It was possible to quantify either a reduction factor or a comfort factor from five of the reports. These figures suggest that the best estimate for the reduction factor was 50% of the theoretical expected energy savings, with the comfort factor contributing 15%.*

*Various issues were identified as relevant to the difference between the predicted and measured energy saving; these include:*

- *The performance of thermal insulation;*
- *Ventilation, which is a significant energy burden and is largely under occupant control, is difficult to represent theoretical models;*
- *Separation of energy use for hot water, cooking, lighting and other appliances from space heating consumption;*
- *The correction of energy use for different outside temperatures before and after insulation;*
- *The use of appropriate energy models to model specific houses.*

## **1. Introduction**

It has been recognised for many years that the maximum theoretical improvement in thermal performance due to insulation refurbishment is not achieved in practice (Cornish, 1985). The difference between the maximum theoretical and the achieved energy savings has been referred to by a variety of terms, most commonly the overall 'comfort factor', which includes 'true comfort' taken in the form of higher internal household temperatures, together with all other factors that can affect the achievement of theoretical energy savings. As some confusion has arisen as to the meaning of comfort factor, we shall refer to the difference between the theoretical and actual energy saving as the 'reduction factor'; that part of the reduction factor due to increased internal temperatures as the 'comfort factor' and the remaining part as the 'other factor'.

Assessment of the theoretical energy savings in UK housing arising from the installation of energy saving measures relies primarily on calculations from models, such as the BRE Domestic Energy Model (BREDEM) (Anderson et al, 1985), which are based on well established physical principles governing heat transfer in dwellings supported by physical measurements. Because these models have been developed and validated from large scale trends of energy use in the housing stock and assume a “typical” pattern of occupant behaviour, they may not be representative of conditions in specific houses.

This paper details a study, undertaken on behalf of the UK Energy Savings Trust, into the findings from 13 monitoring studies to provide the best available estimate of the reduction and comfort factors to help guide future decisions about the refurbishment of UK buildings with insulation.

## 2. Studies Analysed

Current knowledge of the way energy consumption and temperatures are affected by insulation refurbishment has been derived from a series of monitoring projects which have attempted to quantify a number of key parameters.

The reports that have been reviewed for this project can be divided into three categories:

- ‘Strategic’ studies using simplified data from large groups of dwellings (Oreszczyn et al, 2006), (Summerfield et al, 2006), (DEFRA, 2004), (Milne & Boardman, 2000). These set the background and give the context of the concepts of comfort factor and reduction factor.
- Detailed analyses of specific monitoring exercises with information from smaller groups of dwellings (Energy Saving Trust, 2004), (BRE, 2004), (EMC, 2006), (BRE 2003), (Hong et al, 2006). These allow quantitative values of the comfort factor and reduction factor to be derived.
- Specific studies of individual measures including cavity wall insulation, loft insulation and ventilation (BRE, 2006a) (AEAT, 2004) (BRE, 2006b) (Hong et al, 2004). These provide information which serves to explain the size of the reduction factor.

## 3. Definitions

One feature of many of these studies is the varied, and sometimes confusing terminology adopted. The discrepancy between the two energy saving figures has been referred to by a range of terms including ‘comfort factor’, ‘foregone savings’, ‘take back’ or ‘rebound’. For clarity, in this report we are using the following terminology, and have interpreted the published reports to be consistent with this.

- Reduction Factor (RF) – the amount by which the measured energy saving following refurbishment is less than the saving predicted from theory.
- Comfort Factor (CF) – the part of the reduction factor which can be identified as being caused through improved internal temperatures.
- Other Factor (OF) – the part of the reduction factor which is not explained by the comfort factor but include other benefits taken by the householders

These terms can be defined with equation (1):

$$\frac{(E1_B - E2_B) - (E1_M - E2_M)}{(E1_B - E2_B)} = RF = CF + OF \quad (1)$$

Where:  $E1_B$  and  $E2_B$  are the energy consumptions predicted by a theoretical model before and after the installation of insulation  
 $E1_M$  and  $E2_M$  are the measured before and after energy consumptions.

The reduction and comfort factors are commonly expressed as percentages.

In many of the published papers “comfort factor” can be used interchangeably with reduction factor, which can lead to confusion. This appears to be because a number of the papers do not consider the existence of a significant other factor, and equate improved comfort with the reduction factor (Milne & Boardman, 2000), this has led to the results being misinterpreted and the factors being applied inappropriately. A number of the studies

have identified that the reduction factor and the comfort factor are actually different, and therefore imply that there is an observable additional reduction factor (EMC, 2006), (BRE, 2003), (Hong et al, 2006).

## 4. Reduction Factor

A number of studies have measured the reduction factor by monitoring energy consumptions (Energy Saving Trust, 2004) (EMC, 2006), (BRE, 2003) and (Hong et al, 2006). Typically this is achieved by recording electricity and gas meter readings over a given period of time before and after refurbishment and modelling the theoretical consumptions, commonly using BREDEM. For modelling, a good survey of each property is required to identify details of the building fabric, occupancy, appliances and heating. In addition calibration of the model with actual measured internal and external temperatures throughout the period is desirable to achieve good accurate results, and identify important occupant behaviour patterns.

Specific measured values of the comfort factor are given in Table 1. Findings from the individual studies have identified the following features as being important to the reduction factor.

- The reduction factor increases with the passage of time after refurbishment (BRE 2003), (DEFRA, 2004). This may be explained in part by the change of the comfort component of the reduction factor, with occupants increasing their internal temperatures as they get used to the potential of the installed energy saving measures. The reduction factor is therefore not a steady state value.
- The reduction factor has been found to be statistically linked to the level of fuel use before refurbishment, with lower users showing a high reduction factor (Energy Saving Trust, 2004), (BRE, 2003). This may be because consumption before insulation was limited by heating cost rather than by the internal conditions that can be achieved.

It is notable that the reduction factor is not found to be directly related to the household income, as had been previously thought (Energy Saving Trust, 2004). It is however related to the level of heating observed before refurbishment (Energy Saving Trust, 2004), (BRE, 2003). This highlights the fact that household income is only part of the reason for fuel poverty, and that the link between level of heating and income is complex.

## 5. Comfort Factor

All studies of the comfort factor require measurement of the internal temperature of the dwellings under consideration; this is usually measured in only 2 or 3 locations and the results extended to the rest of the house using algorithms developed many years ago, when UK houses were used very differently from today. The distribution of internal temperatures before and after insulation was explored in detail in only one of the papers (Oreszczyn et al, 2006). One study (BRE, 2004) measured the internal temperatures and related this to the observed building fabric insulation to determine a relationship between the level of insulation and the temperatures within the dwelling, this was then compared to a theoretical relationship predicted by BREDEM to establish a level of comfort taken with increasing insulation levels. Other studies take an alternative approach of measuring the mean internal temperatures before and after refurbishment, and, by applying BREDEM with the measured temperature conditions included, to calculate a consumption and thereby a comfort factor associated with the refurbishment (EMC, 2006), (BRE, 2003).

Specific measured values of the comfort factor are given in Table 1. The following issues were identified as being significant for the comfort factor:

- Cavity wall insulation was found to be significantly different from other refurbishment measures (BRE, 2003). It has been suggested (Milne and Boardman, 2000) that cavity wall insulation will lead to a different comfort response because it leads to an increase in the radiant temperature within the dwelling.
- Time after refurbishment (BRE, 2003), (DEFRA, 2004). Some evidence suggests that the comfort factor increase with time after refurbishment, which would be consistent with the idea that the comfort factor represents a dynamic process of changing behaviour.
- As with the reduction factor, the comfort factor appears to be significantly affected by the level of fuel use before refurbishment.



An examination of internal temperatures within dwellings (Oreszczyn et al, 2006) identified significant differences as a function of property age, property construction, age of head of household, and property thermal efficiency. These factors may be significant to the thermal improvement by association with the assessment of comfort factor. No published monitoring has analysed and demonstrated that these additional factors are significant, however, the possibility remains that they could be.

TABLE. 1: Reduction and Comfort Factors identified from Studies.

Reduction Factor	Comfort Factor
50% (Energy Saving Trust, 2004)	14% (BRE, 2004)
40% (EMC, 2006)	16% (EMC, 2006)
53% (BRE, 2003)	17% (BRE, 2003)
60% (Hong et al, 2006)	

## 6. Other Factor

A number of plausible explanations for the other factor have been suggested. In reality a combination of these explanations is likely to be present for any dwelling that has had its fabric insulation upgraded. These potential causes of the other factor are discussed below.

### 6.1 Effectiveness of insulation in practice

An important component of the BREDEM predictions of before and after energy consumption is the fabric heat loss, which is determined by the areas and U-values of the various elements. The relevant wall, roof and areas should be determined reasonably accurately by surveys of the house, however the actual areas covered by insulation may be more uncertain. The procedure for calculating U-values specified in BS EN ISO 6946 (ref), is well defined.

BRE has carried out a review (BRE, 2006a) of the possible effect on the roof U-value of a variety of defects in installed loft insulation. This has enabled a correction to the U-value, 'Delta U-value', to be specified in a variety of defined circumstances to account for insulation defects.

Methods for measuring wall U-values in situ have been developed, based on ISO 9869 (ref), however these are difficult to carry out successfully in occupied homes and the measured U-values so far have tended to be somewhat higher than those calculated by the BS6946 method. There is also a suggestion that typically 10 – 15% of the area of cavity walls are not fillable in practice. A major project is currently in progress to carry out a series of measurements in houses before and after insulation; this will help further inform this issue.

### 6.2 Ventilation

The way in which BREDEM describes ventilation is a possible weakness, and a methodology for testing this has been developed (BRE, 2006b). The results of a study of the air tightness of dwellings show that different refurbishment measures lead to different levels of air tightness (Hong et al, 2004). With the exception of cavity wall insulation, BREDEM assumes that changing insulation levels does not have any effect on airtightness.

A number of studies have suggested that the other factor could be partly explained by an increase in window opening following refurbishment (BRE, 2003), (Hong et al, 2006), (Summerfield, 2006). The idea is that as typical internal conditions during the heating season become comfortable for occupants, further insulation measures may lead to increased ventilation through increased opening of windows to 'dump heat'. This change in behaviour would not be measured in many comfort studies, and would appear as a discrepancy between the reduction factor and true comfort factor.

BREDEM takes account of various features of the building fabric and installed fans etc. to find the ventilation rate for the house, which is used in the calculation of the energy load. The fabric airtightness is affected by various features of the building, some of which may be obvious to a surveyor (e.g. extract fans) and other features which may be less obvious.

### 6.3 Unmetered fuels

The presence of unmetered fuels (solid fuel and paraffin heaters) has been identified in a number of the monitoring studies (BRE, 2003), (Hong et al, 2006). Where significant quantities of these fuels are used it is impossible to estimate the actual heating consumption, and in these 2 studies these properties were removed from the analysis. However, even limited use of unmetered fuels will lead to the measured fuel consumption data being underestimated, and the reduction factor being inaccurately assessed. This may explain some of the other factor.

### 6.4 Use of Energy Models in Studies

The definition of reduction factor in equation (1) assumes the use some form of theoretical model to predict the energy use before and after the installation of energy saving measures. This prediction is therefore based on the quality of the model, not on some essentially unknowable 'right answer' and it is important to note that any discrepancies between the measured and predicted savings may be due to inadequacies in the model rather than 'faults' in the way the occupants are using the house.

The model used by almost all the studies was BREDEM (Anderson et al, 1985), which, for almost two decades, has been the leading domestic energy model in the UK and is the basis for the SAP rating and Carbon Index used in regulations. BREDEM uses a mixture of analytical and empirical techniques. An analytical approach, involving balancing heat losses against gains, is used to calculate the space heating energy requirements. This incorporates empirical functions to estimate quantities such as the utilisation of gains. Predictions of energy consumption for water heating, cooking, lights and appliances are based on measurements of actual consumption, and are determined by algorithms based on the house type and number of occupants.

The relation between the calculated mean temperatures (where 'mean' refers to averages both over all rooms in a house and over all the monitoring period) and energy demand is complex. If a poorly insulated house that is heated intermittently in the living room alone is insulated with cavity wall and loft insulation, the mean internal temperatures will rise, even if the living room demand temperature is unchanged. This is because a) the living room will warm up faster when the heating comes on and cool down slower when it goes off, and b) the remainder of the house will warm up as it retains the heat from the living room. Should this rise in mean temperature which does not require an energy input, be regarded as a comfort factor and used to explain the difference between predicted and actual savings? This has implications for the internal temperatures that used in the studies; is the mean living room temperature in the evening more appropriate than the whole house overall mean?

### 6.5 Hot water and appliance use

It is assumed that the installation of energy saving measures will not affect the occupants use of energy for hot water, cooking, lights and appliances. For comparison with BREDEM consumption it is therefore necessary to separate the space heating consumption from the remainder. In a very detailed (and expensive) monitoring programme it would be possible to record the energy used by every appliance; given current advances in controlling and monitoring house performance this may be possible in the not too distant future, however it was not possible in any of the present studies.

Various methods have been applied in the studies to account for appliance use, however there is no method for determining which, if any, gives a reasonably accurate result.

### 6.6 Correction for outside temperatures

As it is highly unlikely that the external temperatures were the same during the monitoring periods before and after insulation, it is necessary to correct using some measure of climate such as degree days. Various methods were used in the different studies; there is no commonly accepted robust methodology. The most sophisticated method used (EST, 2004) normalised space heating consumption to the number of degree days in an average year using equation (2).

$$E_{\text{shn}} = E_{\text{sh}} \left( 1 + \alpha \frac{D_{\text{ay}} - D_{\text{p}}}{D_{\text{p}}} \right) \quad (2)$$

Where

- $E_{\text{shn}}$  is the normalised space heating consumption
- $E_{\text{sh}}$  is the observed space heating consumption
- $D_{\text{ay}}$  is the number of degree days in a average year
- $D_{\text{p}}$  is the number of degree days in the monitoring period
- $\alpha$  is a constant determined to be about 0.55 – 0.6 from other studies.

A simpler method (Hong et al, 2006) divided the measured energy consumption by the number of degree days during the monitoring period. Some of the studies fail to make clear what correction, if any, was applied to the data.

## 6.7 Analysis of Internal Conditions

To estimate the comfort factor separately from the other factor, it is necessary to measure the change in internal temperatures. This should be done in as many rooms as the resources of the survey will allow, however measurement in at least three rooms: living room, kitchen and a bedroom, seems to be essential to characterize the overall temperature within a house. There is evidence in one paper (Hong et al, 2006) that temperatures in bedroom 2 may be more representative of zone 2 temperatures than those measured in the main bedroom. It is probable that questionnaire data gathered on occupancy patterns within the house could be used to provide a better estimate of the whole house conditions from measurements in a limited number of rooms. Spot temperatures taken in all rooms when instruments were installed and removed could also provide useful information.

Some energy saving measures such as draught stripping of doors and windows will affect ventilation in the house, others, such as cavity fill and loft insulation will not. Few measurements of ventilation were made in any of the studies, only the Warm Front project carried out pressurization tests in a proportion of their studies. In other cases, information about the house was used to estimate the ventilation using the BREDEM algorithms.

## 7. The effect of different insulation measures

The issue of whether or not different refurbishment measures have different characteristic reduction factors and different levels of true comfort taking associated with them is of interest. Analysis of reduction factors [7, 8] has shown that the reduction factor varies with the refurbishment measure.

It has been suggested (Milne and Boardman, 2000) that there will be lower levels of true comfort taking with refurbishment measures that act to increase the radiant temperature within the dwelling, such as with double glazing or cavity wall insulation. This is consistent with steady state thermal comfort theory (Fanger, 1970) which identifies that mean radiant temperature is one of the key drivers of human perception of thermal comfort, alongside air temperature, relative air velocity and relative humidity. Measurements of thermal comfort in dwellings support this (BRE, 2003) where it has been found that the true comfort taken with cavity wall insulation alone (7%) is significantly lower than that observed with loft insulation alone (29%). Unfortunately none of the papers examined have a sufficiently large sample of dwellings of all different refurbishment combinations to rigorously calculate the associated true comfort factor. This may be further complicated by the finding that the true comfort factor evolves over time, which reflects the way in which occupants adapt their behaviour, this may be different for measures which impact on the radiant temperature. This makes comparison of different monitoring projects difficult.

In summary there are both arguments for, and evidence of, the reduction factor and the true comfort factor being dependent on the refurbishment measure. Cavity wall insulation has been shown to lead to significantly lower comfort factors than found in properties receiving other refurbishment measures.

## 8. Discussion of the derived reduction and comfort factors

The values of the reduction factor derived from the four papers summarized in Table 1, lie between 40% and 70%, with two close to 50%.

One of the studies (EMC, 2006) undertook the monitoring before insulation between November and January, while the monitoring after insulation extended into May. The warmer external temperatures after insulation should have been taken into account in the analysis and derivation of the comfort factor, however the very much higher solar gains during May compared to the winter may not have been. It is also probable that occupancy patterns in early summer may be significantly different from those earlier in the year with less use of the heating system. This can explain the low value of the reduction factor derived from this study, 40%.

Another study (Hong et al, 2006) gives a reduction factor of 60%. A different analysis method was used to derive the results in this study making comparison of the results more difficult. In addition, this study examined results from a refurbishment programme aimed at providing insulation to particularly poor households, who would be expected to have difficulties affording fuel before insulation. They will then take much of the benefit from insulation as improved temperatures, leading to a large reduction factor, with the comfort factor making the largest contribution.

The remaining two reports (EST, 2004) (BRE, 2003) both derived reduction factors close to 50%, and included large samples monitored for long periods before and after insulation and covered a range of house and occupancy types. We feel, therefore, that the best available reduction factor that comes from these studies is 50%.

The three values of comfort factor that it was possible to derive from the studies are all close to 15%, we feel therefore that this is the best available value.

## 9. Conclusions

When the thermal insulation of houses is improved by measures such as cavity wall or loft insulation, the actual energy savings derived from measurements of before and after consumptions are commonly found to be less than expected from the predictions of energy models such as BREDEM. This discrepancy, termed a 'reduction factor' is caused in part by changed internal temperatures, a 'comfort factor', with the remainder due to other causes such as insulation performance and ventilation.

This study has reviewed papers relating to the relationship between the predicted and the actual energy saving that occurs when houses are insulated. These papers can be divided into a) 'strategic' studies using simplified data from large groups of dwellings, b) detailed analyses of specific monitoring exercises with information from smaller groups of dwellings, and c) specific studies of individual measures including cavity wall insulation, loft insulation and ventilation.

The best estimates for the reduction factor and comfort factor to come from the surveys reviewed are:

**Reduction factor: 50% Comfort factor: 15%**

It was possible to separate the effects of cavity wall insulation and loft insulation in only one of the studies (BRE, 2003). This found that the comfort factor taken with cavity wall insulation alone is significantly lower than that observed with loft insulation alone and with cavity wall insulation combined with loft insulation. This is consistent with steady state thermal comfort theory (Fanger, 1970) which identifies that mean radiant temperature is one of the key drivers of human perception of thermal comfort. There may be lower levels of comfort taking with refurbishment measures such as double glazing or cavity wall insulation that act to increase the radiant temperature within the dwelling, compared to loft insulation which does not.

Various issues could contribute to the difference between the predicted and measured energy saving; these include:

- The performance of thermal insulation;
- Ventilation, which is a significant energy burden and is largely under occupant control is difficult to represent in energy models;
- Separation of energy use for hot water, cooking, lighting and other appliances from space heating consumption;
- The correction of energy use for different outside temperatures before and after insulation;
- The use of energy models which are designed and validated for analysis of large scale energy use trends across the stock, to model specific houses;

Various techniques have been used to deal with these points in the different studies, however there is no evidence as to the relative validity or accuracy of them and no commonly accepted methodology for this type of study.

## 10. References

- AEAT (2004) Measurement of the Performance of Cavity Wall Insulation Installed in Domestic Dwellings; AEA Technology, London.
- Anderson B.R., Clark A.J., Baldwin R., Millbank, N.O. (1985) BREDEM – BRE Domestic Energy Model. BRE report BR 66, Building Research Establishment, Watford.
- Building Research Establishment. (2003) Standards of Performance 2: Findings from Monitoring; BRE Client Report 16099, Building Research Establishment, Watford.
- Building Research Establishment. (2004) Using historical monitoring data to examine the relationship between mean internal temperatures and dwelling heat losses. Building Research Establishment, Watford.
- Building Research Establishment. (2006a) Research into the effectiveness of loft insulation. BRE Client Reports 227479 and 227480. Building Research Establishment, Watford.
- Building Research Establishment. (2006b) Monitoring Ventilation in Homes Built Before 1995: A pilot study; BRE Client Report 229615. Building Research Establishment, Watford.
- Cornish J.P. (1985) Insulation. The Journal of the Chartered Institution of Building Services, Vol. 7, No. 3, pp 45-47.
- DEFRA (2004). Comfort Taking in Housing – a Background Note. DEFRA Note, Department for Environment, Food, Rural Affairs, UK Government.
- Energy Monitoring Company (2006) Measurement of energy Savings and Comfort Levels in Houses Receiving Insulation Measures. EMC, UK.  
<http://www.defra.gov.uk/environment/climatechange/uk/energy/research/pdf/comfort-measurement.pdf>
- Energy Saving Trust (2004) Monitoring Energy Savings achieved from Insulation Measures installed in Gas heated homes in SoP3 and EEC Schemes. Energy Saving Trust, London.
- Fanger P.O. (1970) Thermal Comfort – Analysis and Applications in Environmental Engineering. McGraw Hill.
- Hong S.H., Ridley I., & Oreszczyn T. (2004) The impact of energy efficient refurbishment on the airtightness in English dwellings. 25th AIVC (Air Infiltration and Ventilation Centre) Conference, 15-17 September 2004, Prague, Czech Republic.
- Hong S.H., Oreszczyn T., Ridley I. (2006) The Impact of energy efficient refurbishment on the space heating fuel consumption in English dwellings. Energy and Buildings 38, 1171-1181.
- Miln, G., Boardman B. (2000) Making cold homes warmer: the effect of energy efficiency improvements in low-income homes. Energy Policy, 18, 411-24.
- Oreszczyn T., Hong S.H., Ridley I., Wilkinson P. (2006) Determinants of winter indoor temperatures in low income households in England. Energy and Buildings 38, 245 – 252.
- Summerfield A.J., Bruhns H.R., Caeiro J.A., Lowe R.J., Steadman J.P., Oreszczyn T. (2006) Milton Keynes Park revisited: changes in internal temperatures. NCEUB International Conference.  
<http://en.scientificcommons.org/17043503> .

## 11. Acknowledgements

The authors would like to thank the support from the UK Energy Saving Trust in this work.

<http://www.energysavingtrust.org.uk/>.

# The distribution of the air leakage places and thermal bridges in Finnish detached houses and apartment buildings

*Targo Kalamees, PhD,  
HVAC-Laboratory, Helsinki University of Technology, Finland;  
targo.kalamees@ttu.ee*

*Minna Korpi, M.Sc,  
Department of Civil Engineering, Tampere University of Technology, Finland;  
minna.korpi@tut.fi*

*Lari Eskola, M.Sc,  
HVAC-Laboratory, Helsinki University of Technology, Finland;  
lari.eskola@tkk.fi*

*Jarek Kurnitski, Dr.Tech,  
HVAC-Laboratory, Helsinki University of Technology, Finland;  
jarek.kurnitski@tkk.fi*

*Juha Vinha, Dr. Tech,  
Department of Civil Engineering, Tampere University of Technology, Finland;  
juha.vinha@tut.fi*

**KEYWORDS:** *air leakages, air tightness, thermal bridges, thermography*

## **SUMMARY:**

*Air leakage path affect infiltration and air pressure conditions in building. The main objectives of this study were to analyse the distribution of the air leakage places and thermal bridges in detached houses and apartment buildings. Field measurements have been carried out in 21 detached houses and 16 apartments during the years 2005-2007. To determine typical air leakages and thermal bridges and their distribution, an infrared image camera and a smoke detector were used during winter period. Temperature factor was used to determine and to classify thermal bridges. Relative decrease of the surface temperature was used to determine and to classify air leakage places. Typical thermal bridges in the studied detached houses were around the doors and windows. Low temperatures were determined also in the junction of the base floor with the external wall. Typical air leakages were in the junction of roof and external wall, penetrations through the air barrier systems, and around and through windows and doors. Typical thermal bridges in the studied apartments were around the doors and windows. Typical air leakages were around and through windows and doors, in the junction of ceiling/floor and external wall, penetrations through the air barrier systems, and walls and floors between apartments.*

## **1. Introduction**

The uncontrolled air infiltration is an important factor in a building's energy consumption (Jokisalo et al. 2007) and energy efficiency of a ventilation system (Binamu and Lindberg 2000), especially in cold climate. In well insulated buildings, the infiltration energy loss is a relatively more important factor than in a poorly insulated building. Local moisture convection through the building envelope may cause severe moisture loads imposed on the structure (Ojanen and Kumaran 1992, Hagentoft and Harderup 1996, Kilpelainen et al. 2000, Karagiozis 2002, Janssens and Hens 2003, Derome 2005). Indoor air exfiltration in cold climates may cause moisture accumulation or condensation, leading to the microbial growth on materials, change of the properties of the material or even to structural deterioration. This moisture load due to air leakage may cause moisture accumulation that can be many times more important than the moisture accumulation due to diffusion transport. Air leakage through a building envelope could introduce outdoor or crawl space airborne pollutants (Mattson et al. 2002, Airaksinen et al. 2004) as well radon gas into the indoor air (Nazaroff and Doyle 1985, Kokotti et al. 1994, Ljungquist and Lagerqvist 2005).

Almost all building envelopes have thermal bridges - locations where the thermal resistance of the assembly is locally lower. Thermal bridges are caused mainly by geometrical or structural reasons. In cold climates, the assessment of thermal bridges is important for many reasons. Thermal bridges may lead to surface condensation, mould growth, and staining of surfaces. Due to lower temperatures on the thermal bridge, higher RH occurs. While surface condensation starts at the RH 100%, the limit value for RH in respect of mould growth is above RH 75% to 90% depending on the material (Johansson 2005). Thermal bridges lead to an increase of heat losses. An increase in the thermal insulation level will increase the relative significance of the thermal bridges in the energy consumption of buildings. If large poorly insulated or uninsulated envelope areas exist, the surfaces will be cold in the winter and may cause thermal comfort problems due to cold draughts or radiation (in particular, asymmetric radiation).

The distribution of the air leakage places affects infiltration and air pressure conditions in building. The main objectives of this study were to analyse the distribution of the air leakage places and thermal bridges in detached houses and apartment buildings. Field measurements of the air tightness and thermography measurements have been carried out in 21 detached houses and 16 apartments in Finland.

## 2. Methods

### 2.1 Studied dwellings

Analysis of the distribution of the air leakage places and thermal bridges were carried out in 21 detached houses and in 16 apartments in different buildings. Studied dwellings were selected from the databases of national research projects: “Air tightness, indoor climate and energy efficiency of residential buildings” (2005-2008) and “Moisture-proof healthy detached house” (2002-2005). Dwellings in research projects had different structures: 170 detached houses with timber-frame (TF), log (L), light expanded clay aggregate concrete (LECA), autoclaved aerated concrete (AAC), brick, concrete sandwich element (CSE), and concrete block (CB) external walls structures and 56 apartments in buildings with concrete and timber-frame wall structures. Typical base floor was slab on ground (SG) or floor with crawl space (CS). Roof, attic floor or intermediate floors were made with concrete slab (CS) or with timber-frame structure. Dwellings were randomly selected from the databases of the companies manufacturing and building houses. Air leakage and thermal bridge distribution investigations were carried out during winters 2005-2007, allowing the analysis in all representative types of houses in Finland.

Main data of the studied dwellings are shown in tables 1 and 2. In the case of timber-frame envelope, the vapour barrier that controlled water vapour diffusion through the envelope was designed to function also as an air barrier. Brick and block walls were plastered from inside or from both sides.

TABLE 1 The main characteristics of the studied apartments

Code	Constr. year	No. of floors	$n_{50}$ , ach	Vent. air change rate	External wall		Base floor		Roof/ceiling	
					TF	CB	SG	CS	CS	TF
5201	2000	5/7	1.9	0.6		X	X		X	
5202	2000	4/7	4.5	0.61		X	X		X	
5203	2000	1/7	1	0.68		X	X		X	
6601	2006	4/4	0.8	0.5		X	X		X	
6602	2006	2/4	0.4	0.5		X	X		X	
6603	2006	1/4	1.1	0.49		X	X		X	
7101	2006	4/4	3.2	0.45	X					X
7102	2006	4/4	2.9	0.63	X					X
7103	2006	3/4	2.9	0.48	X					X
7104	2006	3/4	3.2	0.28	X					X
7105	2006	2/4	2.2	0.45	X					X
7301	1996	5/5	4.8		X					X
7302	1996	4/5	3.3		X					X
7303	1996	3/5	3.8		X					X
7304	1996	2/5	2.9		X					X
7305	1996	1/5	5.5			X			X	

TABLE 2 The main characteristics of the studied detached houses

Code	Constr. year	No. of floors	n <sub>50</sub> , ach	Vent. air change rate	External wall							Base floor		Roof/ceiling		
					TF	L	AAC	LECA	B	CB	CSE	SG	CS	CS	AAC	TF
1042	1994	2	3.4	0.32	X							X				X
1047	2002	2	3.5	0.37	X							X				X
2014	2000	2	3.9	0.31	X							X				X
3106	1997	1	8.1			X						X				X
3110	2006	2	3.7	0.19		X						X				X
3114	2005	2	6.9	0.31		X						X				X
3202	2001	2	2.1	0.38			X					X		X		
3204	2000	1	1.5	0.47			X					X		X		
3205	1999	2	1.2	0.29			X					X		X		
3302	2004	4	3	0.35				X				X				X
3303	2005	1	3.5	0.29				X				X				X
3305	2004	2	4.2	0.46				X				X				X
3402	1997	2	2.3	0.3					X			X				X
3405	1997	1	2.4	0.19					X			X				X
3406	2005	2	3.5	0.45					X			X				X
3503	2003	2	1.9	0.5						X		X				X
3505	2004	1	1.6	0.46						X		X				X
3508	2003	1	0.7	0.47						X		X		X		
3602	2004	1	4.1	0.24						X		X				X
3603	2003	1	2.5	0.73						X		X				X
3609	1999	2	2.7	0.48						X		X				X

## 2.2 Measurement methods

The air tightness of each house and apartment was measured with the standardized fan pressurization method, using ‘‘Minneapolis Blower Door Model 4’’ equipment with an automated performance testing system (flow range at 50 Pa 25–7.800m<sup>3</sup>/h). All the exterior openings: windows and doors were closed; ventilation ducts and chimneys were sealed. To determine typical thermal bridge and air leakage places and their distribution, an infrared image camera FLIR ThermaCam P65 (thermal sensitivity of 0.08 °C, measurement range -40 °C to +500 °C) and a smoke detector were used. The difference between the indoor and the outdoor air temperature was at least 20 °C. Thermography investigations were done twice. First, to determine the thermal bridges, the surface temperature measurements were performed without any additional pressure difference. Next, to determine the air leakage places, the 50 Pa negative pressure under the envelope was set with fan pressurization equipment. After (~30...45 min) the infiltration airflow had cooled the inner surface of the envelope, the surface temperatures were measured with the infrared image camera from the inside of the building.

## 2.3 Assessment of thermal bridges and air leakages

Temperature factor was used to assess and to classify thermal bridges. The temperature factor at the internal surface ( $f_{R_{si}}$ , -) shows the relation of the total thermal resistance of the building envelope ( $R_T$ , (m<sup>2</sup>·K)/W) to the thermal resistance of the building envelope without the internal surface resistance ( $R_{si}$ , (m<sup>2</sup>·K)/W) and it depends on the indoor ( $T_i$ , °C) and the outdoor ( $T_e$ , °C) air temperature and on the temperature on the internal surface of the building envelope ( $T_{si}$ , °C), see Eq. 1.

$$\frac{R_T - R_{si}}{R_T} = f_{R_{si}} = \frac{T_{si} - T_e}{T_i - T_e} \quad (1)$$

Many countries have set limit values or guidelines for the temperature factor. According to Finnish instructions regarding housing health (Asumisterveysohje 2003) temperature factor for floors  $f_{R_{si}} \geq 0.97$  and for walls  $f_{R_{si}} \geq 0.87$  reflect good level and temperature factor for floors  $f_{R_{si}} \geq 0.87$  and for walls  $f_{R_{si}} \geq 0.81$  reflect tolerable level. Temperature factor values for the thermal bridge are  $f_{R_{si}} \geq 0.65$  on good level and  $f_{R_{si}} \geq 0.61$  on tolerable level (on the basis of an indoor temperature  $T_{in} +21$  °C and relative humidity  $RH_{in}$  45 %, an outdoor temperature  $T_{out} -10$  °C, and the highest relative humidity at the surface of the building envelope  $RH_{si}$  100 %). According to mould growth



criterion in cold climate the temperature factor on the thermal bridge should be  $f_{Rsi} \geq 0.80$  in dwellings with high occupancy and/or low ventilation (moisture excess  $\Delta v=6\text{g/m}^3$  during cold period  $T_{out}<5^\circ\text{C}$ ) and  $f_{Rsi} \geq 0.65$  in dwellings with low occupancy and normal ventilation (moisture excess  $\Delta v=4\text{g/m}^3$  during cold period) (Kalamees 2006). In this study, temperature factor values were classified into five groups (characterisation of these groups is received also from the Finnish guide of thermography investigations of building, RT 14-10850 2005):

- $f_{Rsi} < 0.61$  (includes healthy risks or hazards and should be repaired);
- $f_{Rsi} 0.61 \dots 0.65$  (possibility for healthy hazards or structure risks, the details/structure must be checked and repairing necessity should be clarified);
- $f_{Rsi} 0.65 \dots 0.69$  (includes obvious hygrothermal defects or faults but fulfils the requirements of the housing health)
- $f_{Rsi} 0.70 \dots 0.74$  (fulfils of the requirements of the good level, no risks in dwellings with low occupancy)
- $f_{Rsi} 0.75 \dots 0.80$  (includes some risk in dwellings with high occupancy and low occupancy)

Relative decrease of the surface temperature was used to determine and to classify air leakage places. Relative decrease of the surface temperature shows the relation of the difference between indoor ( $T_{in}$ , °C) and the outdoor ( $T_e$ , °C) air temperature to the temperature difference between internal surface of the building envelope measured before ( $T_{s,i1}$ , °C) and after ( $T_{s,i2}$ , °C) the depressurization, see Eq. 2.

$$\Delta T_s = \frac{T_{s,i1} - T_{s,i2}}{T_{in} - T_{out}} \times 100\% \quad (2)$$

The values of the relative decrease of the surface temperature were classified into five groups: 5-9%, 10-14%, 20-24%, 25-30%, and >30%.

Air leakage and thermal bridge places were classified according to location:

- penetrations through the air barrier system;
- junction of external wall with the base floor;
- junction of external wall with the intermediate floor;
- junction of external wall with the attic floor of roof;
- junction of external wall with the external or separating wall;
- doors and windows;

and according to the shape:

- linear;
- spot.

### 3. Results

In statistical analysis, measurement data from 21 detach house and 13 apartment building was used. Figure 1 shows the example of measurement procedure of a junction of external wall and attic floor.

#### 3.1 Thermal bridges

Typical thermal bridges in the studied dwellings were around the doors and windows, Figure 2 left. These thermal bridges include both thermal bridges of windows and doors in themselves and in connections of windows and doors with building envelope. In addition, at normal conditions, low surface temperatures were determined also in the junction of external wall with base floor, intermediate floor, attic floor or roof and with external or separating walls. One fourth of the determined thermal bridges were severe ( $f_{Rsi} < 0.65$ ). Figure 2 right shows the distribution of severe thermal bridges in detached houses. In apartments, all the severe thermal bridges were around the doors and windows.

Picture



Thermal image 1.  $\Delta P$  -4Pa

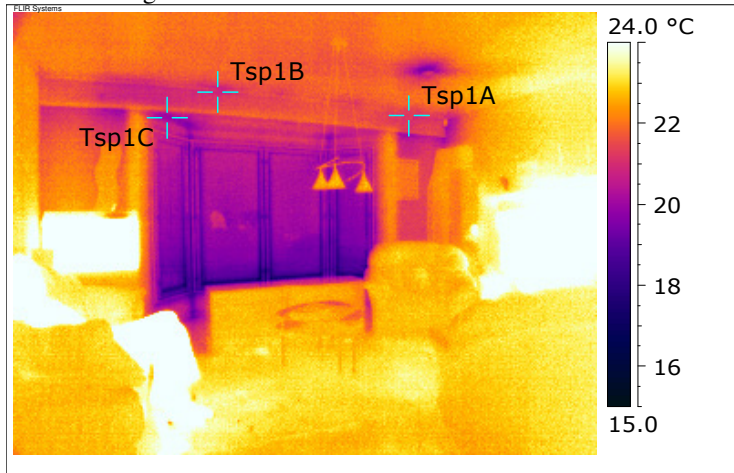

Thermal image 2.  $\Delta P$  -50Pa

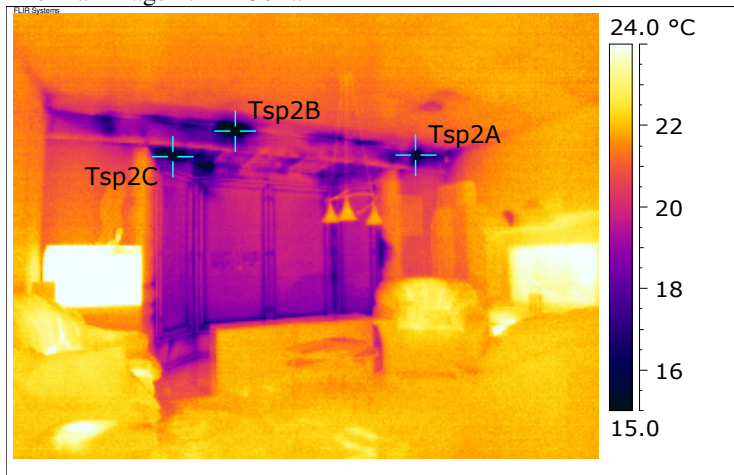

FIG 1. Air leakage on the junction of the wall and attic floor

Detached house:

Attic floor: timber frame structure, plastic air/vapour barrier (joints taped);  
 External wall: concrete sandwich element;  
 Base floor: insulated concrete panel with crawl space;  
 Air leakage rate of the building envelope:  
 $n_{50}$ : 2.5 1/h  
 Ventilation system: mechanical supply and exhaust with heat recovery ( $CO_2$  controlled)  
 Air change rate on using level: 0.73 1/h  
 Heating system: floor heating with water  
 Year of construction: 2003

Environmental conditions

Outdoor temperature -1.7 °C  
 Indoor temperature +21.5 °C

Measurement results

$T_{sp1A}$  +21.2 °C  
 $T_{sp1B}$  +20.8 °C  
 $T_{sp1C}$  +19.9 °C

Temperature factor

$f_{Rsi\ sp2A}$  0.99  
 $f_{Rsi\ sp2B}$  0.97  
 $f_{Rsi\ sp2C}$  0.93

Environmental conditions

Outdoor temperature -1.7 °C  
 Indoor temperature +21.5 °C

Measurement results

$T_{sp2A}$  +14.3 °C  
 $T_{sp2B}$  +12.8 °C  
 $T_{sp2C}$  +13.5 °C

Temperature factor

$f_{Rsi\ sp2A}$  0.69  
 $f_{Rsi\ sp2B}$  0.62  
 $f_{Rsi\ sp2C}$  0.65

Relative decrease of surface temperature

$\Delta T_{SA}$  30%  
 $\Delta T_{SB}$  34%  
 $\Delta T_{SC}$  28%

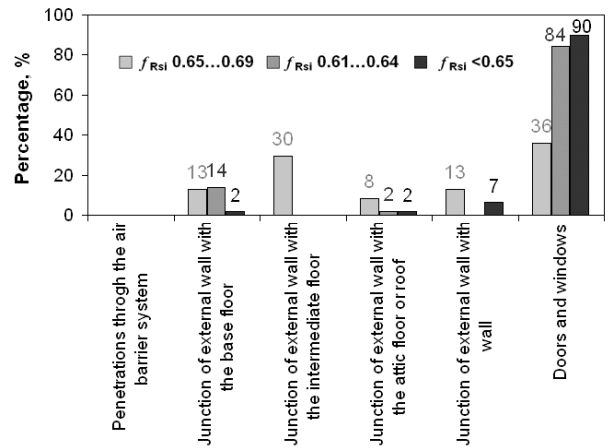
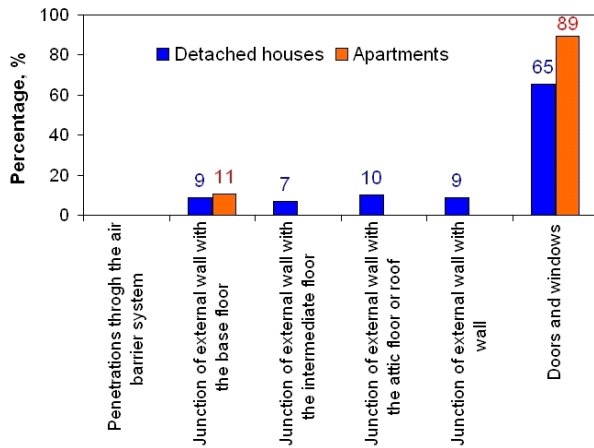

FIG 2. Location (left) of the thermal bridges  $f_{Rsi} < 0.8$  and severity of the thermal bridges in detached houses (right)

76% on houses had no thermal bridges in junction of overall building envelope and 48% on houses had no thermal bridges around the doors and windows, Figure 3 left. 77% on apartments had no thermal bridges around the doors and windows, Figure 3 right.

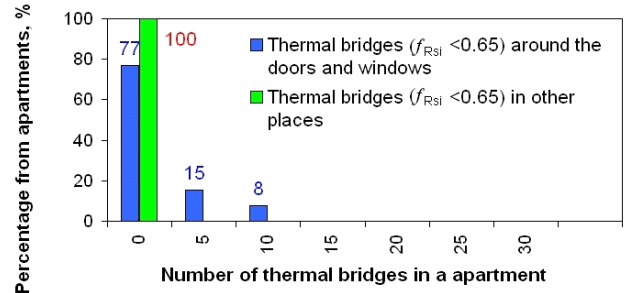
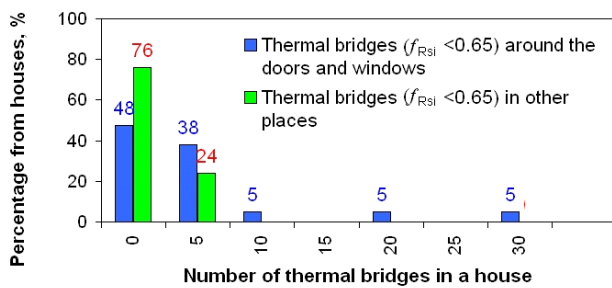

FIG 3. Number of severe thermal bridges  $f_{Rsi} < 0.65$  in detached houses (left) and in apartments (right)

### 3.2 Air leakages

Typical air leakage places were around and through windows and doors, in the junction of ceiling/floor with the external wall, penetrations through the air barrier systems, and walls and floors between apartments, Figure 4 left. The main typical air leakage place was in detached houses in the junction of the roof and the external wall (Figure 4 right). In apartments most typical air leakage was around the doors and windows.

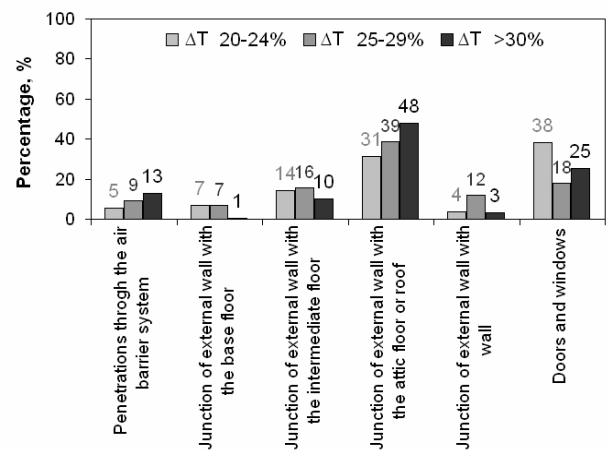
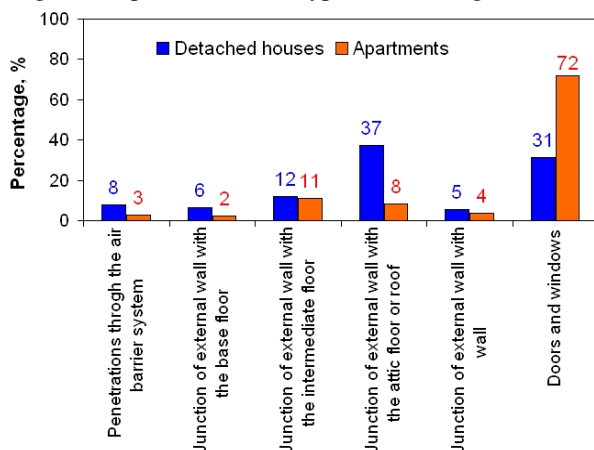

FIG 4. Location of the air leakage places (left) and severity of the air leakage places in detached houses (right)

## 4. Discussion

In this study, the distributions of the air leakage places and thermal bridges were analysed in detached houses and apartment buildings. Field measurements of the airtightness and thermography measurements have been carried out in 21 detached houses with different structures and in 16 apartments during the years 2005–2007 in Finland.

In the current study, one of the main typical air leakage places in detached houses was in the junction of roof with external wall. Another study (Kalamees 2007) has shown that one of the main critical junctions is also the junction between intermediate floor and external wall. The distributions of thermal bridges and air leakage places are influenced by their representation. For example, there is no junction of intermediate floor and external wall in one-storey detached house and not all apartments have a junction of roof and external wall. Therefore, measured data from one-storey houses and multi-storey houses, as well as data from apartments in the first, last and intermediate floor were analysed separately. Figure 5 shows the influence of the number of floors to the distribution of air leakage places. Especially the junction of external wall and intermediate floor, attic floor or roof are compared.

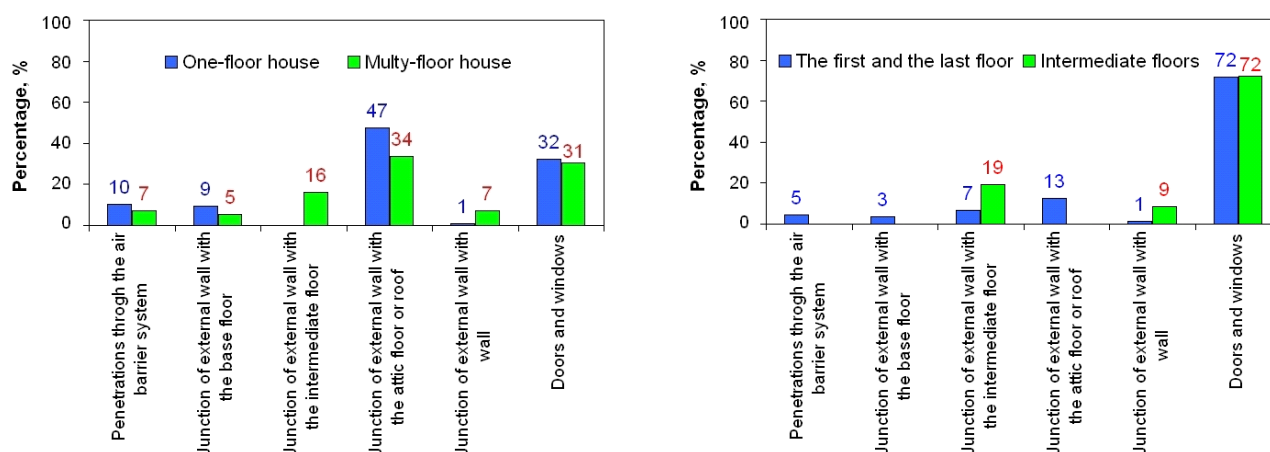

FIG 5. The distribution of air leakage places in detached houses with different number of floors (left) and in apartments on different floors (right)

Relative decrease of the surface temperature was used to determine and to classify air leakage places. If the junction has also a thermal bridge, this factor shows lower criticality than a junction without thermal bridge does. Different air leakage paths affect the temperature profile and two air leakages with the same airflow may show different surface temperature. Therefore, the relative decrease of the surface temperature is not direct and absolute characteristic of air leakage.

## 5. Conclusions

In this study, typical air leakages and thermal bridges and their distribution were statistically analysed based on field measurements in 21 detached houses and 16 apartments. Temperature factor was used to determine and to classify thermal bridges. Relative decrease of the surface temperature was used to determine and to classify air leakage places.

Severe thermal bridges are not typical failure in new Finnish dwellings. Typical thermal bridges in the studied detached houses were around the doors and windows. Low temperatures were determined also in the junction of the base floor with the external wall. Typical air leakages in detached houses were in the junction of roof with the external wall, penetrations through the air barrier systems, and around and through windows and doors.

Typical thermal bridges in the studied apartments were around the doors and windows. Typical air leakages in apartments were around and through windows and doors, in the junction of ceiling/floor with the external wall, penetrations through the air barrier systems, and walls and floors between apartments.

## 6. Acknowledgements

This study has been financed by National Technology Agency of Finland and Finnish companies and associations and was carried out by the HVAC Laboratory at Helsinki University of Technology and Laboratory of Structural

Engineering at Tampere University of Technology. The authors are grateful to researchers Juha Jokisalo, Kai Jokiranta, Hanna Aho, Mikko Salminen, Kati Salminen and Kimmo Lähdesmäki who have helped carrying out the measurements.

## 7. References

- Airaksinen M, Pasanen P, Kurnitski J, Seppänen O. (2004). Microbial contamination of indoor due leakages from crawl space. *Indoor Air* 2004;14(1):55–64.
- Asumisterveysohje (2003). Instructions regarding housing health. Ministry of Social Affairs and Health Handbooks 2003:1 Helsinki, 2003 (in Finnish).
- Binamu A H, Lindberg R. (2000). Efficiency of ventilation systems with heat recovery as a function of the air tightness of the building envelope. Proceedings of Roomvent 2000, "Air Distribution in Rooms: Ventilation for Health and Sustainable Environment", 9-12 July 2000, Reading, UK, Volume 2, pp 1061-1066
- Derome D. (2005). Moisture accumulation in cellulose insulation caused by air leakage in flat wood frame roofs, *Journal of Thermal Insulation and Building Envelope*, 2005;28(1): 269-287.
- Hagentoft C E. and Harderup E. (1996). Moisture conditions in a north-facing wall with cellulose loose-fill insulation: construction with and without a vapor retarder and air leakage, *ASHRAE Transactions*, v1, 639-646.
- Janssens A, Hens H. (2003). Interstitial condensation due to air leakage: a sensitivity analysis. *Journal of Thermal Envelope and Building Science*, 2003;27(1):15–29.
- Johansson P, Samuelson I, Ekstrand-Tobin A, Mjörnell K, Sandberg P.I, Sikander E. (2005). Kritiskt fuktillstånd för mikrobiell tillväxt på byggmaterial – kunskapssammanfattning (Microbiological growth on building materials – critical moisture levels. State of the art). SP Swedish National Testing and Research Institute SP Report 2005:11 (in Swedish).
- Jokisalo J, Kurnitski J, Vinha J. (2007). Building leakage, infiltration and energy performance analyses for Finnish detached houses. Proceedings CLIMA 2007 - Wellbeing Indoors, 10-14 June Helsinki, pp 8.
- Kalamees T. (2007). Air tightness and air leakages of new lightweight single-family detached houses in Estonia . *Building and Environment*, 42(6):2369-2377.
- Kalamees T. (2006). Critical values for the temperature factor to assess thermal bridges. Proceedings of the Estonian Academy of Sciences. *Engineering* 2006;12(3-1):218-229.
- Karagiozis A, (2002). Building enclosure hygrothermal performance study phase I., ORNL/TM-2002/89, Oak Ridge National Laboratory.
- Kilpelainen M, Luukkonen I, Vinha J, Käkelä P. (2000). Heat and moisture distribution at the connection of floor and external wall in multi-storey timber frame houses. World Conference on Timber Engineering Whistler Resort, British Columbia, Canada July 31 - August 3, 2000.
- Kokotti H, Kesikuru T, Kalliokoski P. (1994). Radon mitigation with pressure-controlled mechanical ventilation. *Building and Environment* 1994;29(3):387-392.
- Ljungquist K, Lagerqvist O. (2005). A Probabilistic Approach for Evaluation of Radon Concentration in the Indoor Environment. *Indoor and Built Environment* 2005;14(1): 17-27.
- Mattson J, Carlson OE, Engh IB. (2002). Negative influence on IAQ by air movement from mould contaminated constructions into buildings. Proceedings of Indoor Air 2002, vol. 1. Monterey, USA, 2002. p. 764–9.
- Nazaroff WW, Doyle SM. (1985). Radon entry into houses having a crawl space. *Health Physics* 1985;48(3):265–81.
- Ojanen T, Kumaran M.K. (1992). Air exfiltration and moisture accumulation in residential wall cavities, Thermal Performance of Exterior Envelopes of Buildings V, Proceedings of ASHRAE/ DOE/ BTECC Conference, pp. 491-500, 1992.
- RT 14-10850 (2005). Rakennuksen lämpökuvaus. Rakenteiden lämpötekninen toimivuus (Thermography of buildings. Thermal performance of structures). Helsinki, 2005. Rakennustieto Oy, 8p (in Finnish).

# Cost-efficient lowest-energy multifamily houses in Vienna

## Part 2: Measurement results and feedback of occupants

*Thomas Bednar Assoc.Prof. Dr.  
University of Technology Vienna  
thomas.bednar@tuwien.ac.at*

*Jürgen Dreyer Em.Prof. DDr.  
University of Technology Vienna*

*Helmut Schöberl  
Schöberl&Pöll GmbH*

*KEYWORDS: cost-efficient, lowest energy houses, energy performance, indoor comfort, energy balance, build-in moisture*

### *SUMMARY:*

*During the last years research on the design of cost-efficient lowest energy houses had been finalized and in September 2006 the occupation of the first multifamily house started.*

*The buildings are made out of steel-concrete with an EIFS-system, having a very high air-tightness and triple glazed windows. The ventilation system is equipped with a central heat recovery unit and is used to heat the flats. No radiators are installed in the rooms. Occupants can control the heat input to the flat and the ventilation rate between 0 and 0.7 ach. The thermal performance of the building is designed that the normal operation of the ventilation system with 0.4 ach is enough to keep the temperature even during cold periods on a comfortable level.*

*From the construction phase on a lot of measurements have been made to assess the indoor climate. The energy consumption for heating and hot water is measured since the start of occupation. After the first heating period occupants have been asked for the feedback on design and indoor comfort.*

*The paper summarizes the impact of build-in moisture on the indoor climate, the measured and calculated energy consumption and the indoor comfort during heating season and hot summer periods.*

## 1. Multifamily houses in Vienna

The first multifamily houses in the west of Vienna are social tenements. There are 39 flats with 2.778m<sup>2</sup> useable living area in the complex of three houses over a basement garage.

### **Construction**

The buildings are made of reinforced concrete with 30cm heat insulation on the exterior wall, 45cm heat insulation on the roof and 35cm heat insulation on the ceiling between basement garage and heated rooms. The thermal uncoupling of the base point from the supporting walls is made of aerated concrete with punctual steel or reinforced concrete supports. For the windows were used 3 pane glasses.

### **Energy**

The heat production for heating and hot water occur from a gas-fired condensing boiler with a domestic hot water accumulator with circulation pipe.

The design ratings are:

heating load: 9,1W/m<sup>2</sup>

heating demand: 14,5kWh/m<sup>2</sup>a

primary energy demand: 118kWh/m<sup>2</sup>



FIG. 1: Complex of the three lowest energy houses in Vienna

## 2. Room climate during the drying process of the building shell

The room climate during the drying process of the building shell was determined by a measurement system. The measuring system was installed in the building with the following equipment:

Wireless communication data logger (wireless thermo recorder RTR-53) for temperature and humidity.

In Figure 2 the graph the blue curve is the outside temperature and the black curve is the inside temperature. Until the time the insulation of the outer walls was finished the inside and the outside climate is similar at the most of the time. The big vertices of the outside temperature are not the same as inside the building. Without finished insulation of outer walls the thermal inertia of the building avoided the intensity of the vertices in temperature. After the finishing of insulation of the outer walls the difference between outside and inside is demonstrated.

In the next graph the blue curve is the outdoor humidity and the black curve is the inside humidity. It shows that the drying process of the screed enhances the absolute humidity indoor over the outdoor humidity.

Room temperature and daily mean outdoor temperature in °C

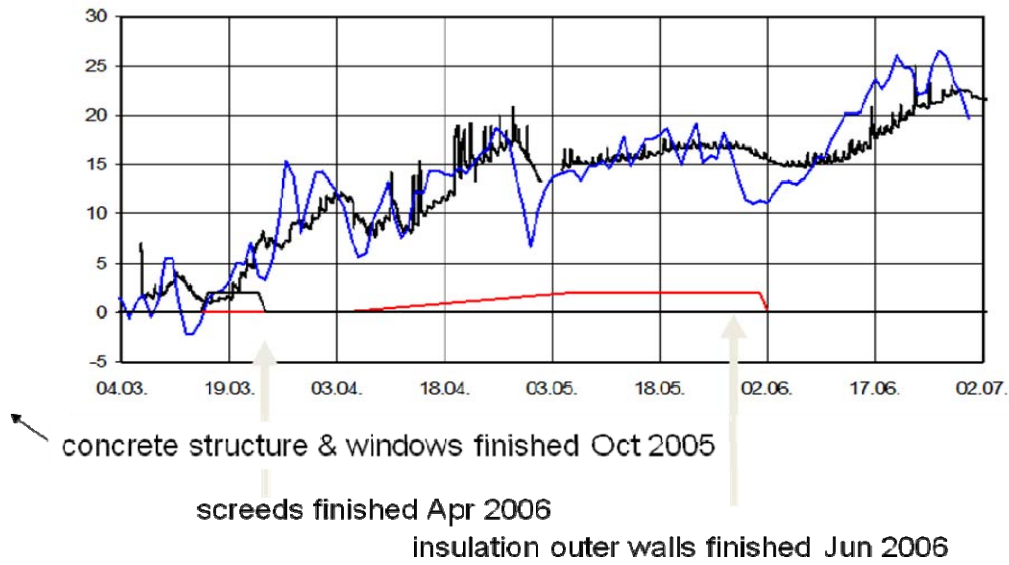

FIG. 2: Measurement results of indoor temperature and outdoor temperature during the construction phase

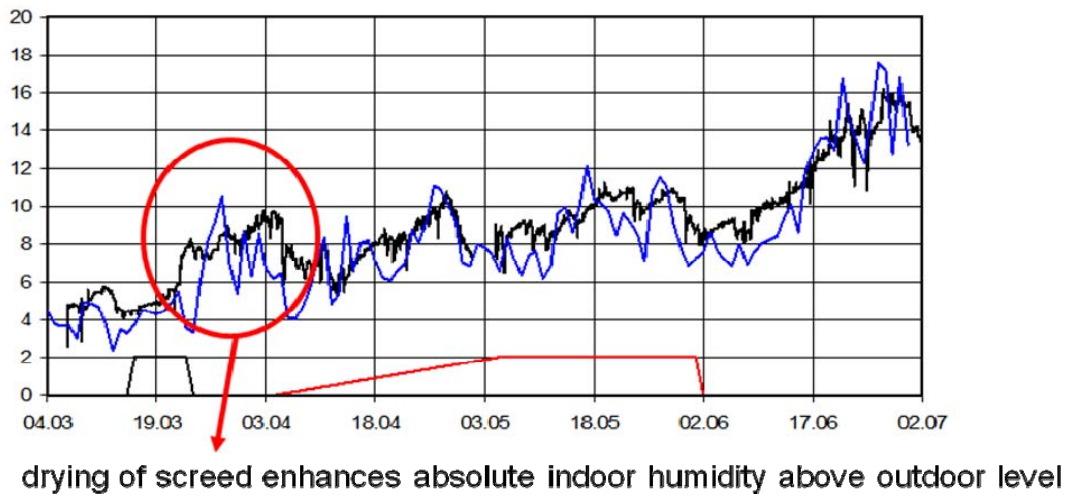

FIG. 3: Measurement results of indoor and weekly average outdoor absolute humidity during the construction phase. The circle marks the time where the windows were closed to avoid rapid drying of the screed.



### 3. Start of occupation

Two weeks before occupation started the ventilation system was turned on. As one can see in figure 4 there was no difference between the absolute humidity of the supply and the return air. As the ventilation rate is 0.4 l/h the drying of the concrete structure does not enhance the humidity inside the rooms. As one can see in the figure 5 looking at the temperatures one can see some owners started to “experiment” with the heating system. The occupants of TopC wanted to know how high the temperatures could be and turned the heating system on until the reached 27°C after 20 days. The mean temperature during the first winter season was around 22°C

Absolute humidity in g/m<sup>3</sup>

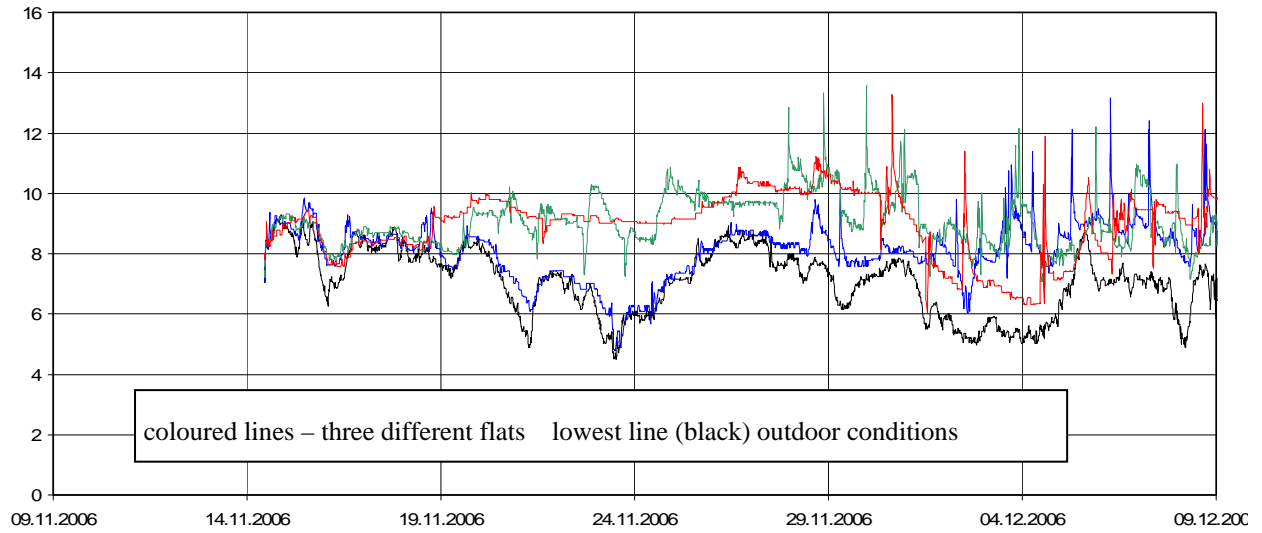

FIG. 4: Measurement results of supply and return air moisture content for three different flats over the first days of occupations.

air temperature in °C

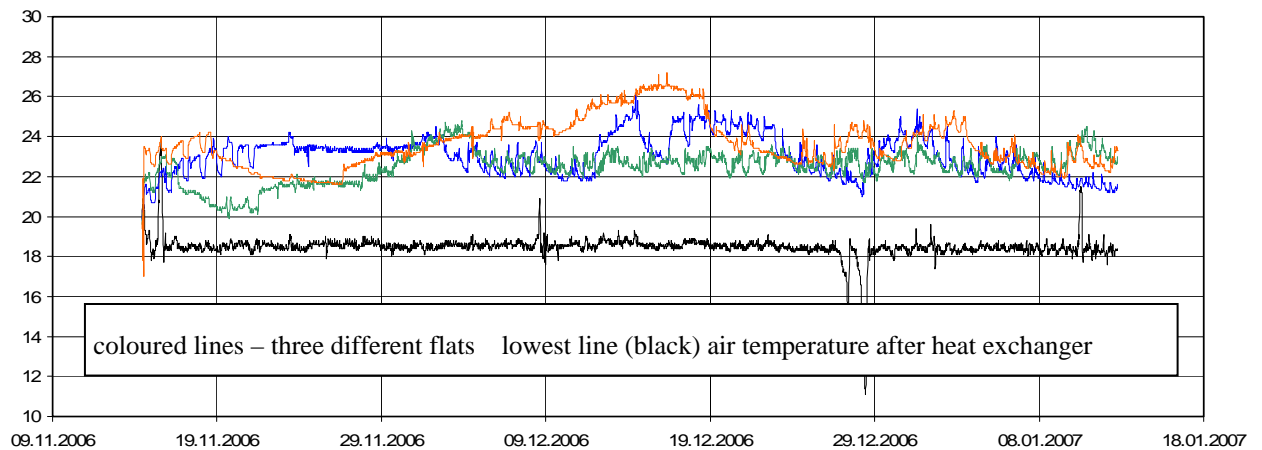

FIG. 5: Measurement results air temperature of supply and return air conditions for three different flats over the first months of occupations. The occupants of one flat experimented with the possibility to heat up the flat. After the first weeks of “experiments” by the occupants the temperatures were around 22°C.

## 4. Feedback from occupants

During summer semester 2007 students from the faculty of architecture did a post-occupancy evaluation by questioning the occupants about their satisfaction with the building and the heating system. 80% of the occupants answered the question. 87% were very satisfied and 10% answered satisfied only 3% answered less satisfied. 58% of the occupants would very much recommend the building system to a friend 39% would recommend it and 3% would not recommend the building system to a friend. 50% did not report any problem with the heating system. 25% report too cold or too hot and 14% reported low indoor relative humidities.

Overall after the first winter the occupants gave a very good feedback on the building and the heating system.

## 5. Climate during summertime (thermal protection against overheating)

The gray line in the background of Figure 6 is the outdoor temperature. During the last summer there was a very hot period with 7 days with a mean temperature of 30°C and the maximum temperature of 37°C. The ground floor flat was not used by the occupants in this period and one can see that the temperature was less than 27°C at the end of the period. The top floor flat was used and the rooms with the tilted windows (south facing sleeping room, north facing nursery) had temperatures less than 27°C only the living room with the exit to the balcony had less than 27°C and only if the balcony had been used the temperature increased for a short period because of the hot air ventilated into the room.

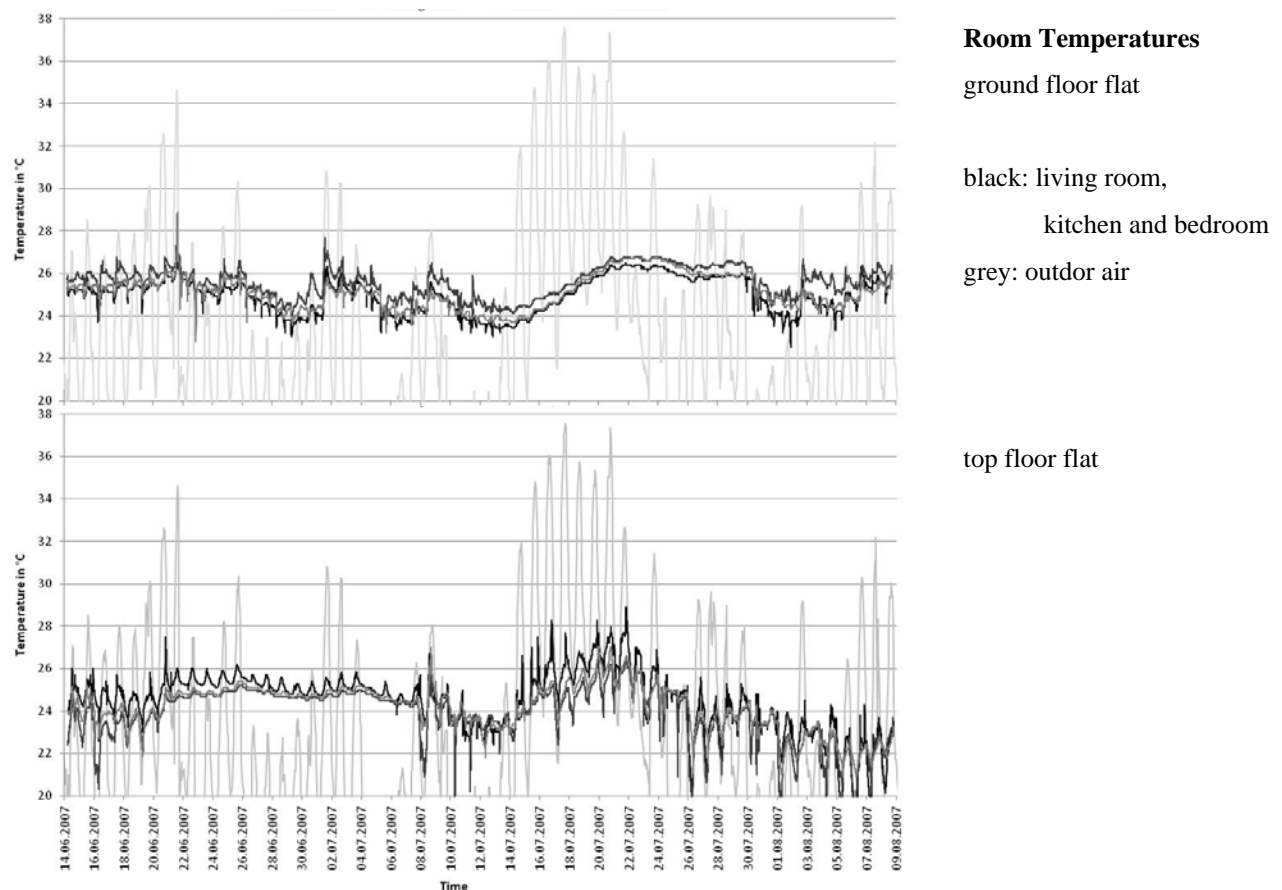

FIG. 6: Measurement results of air temperature in different rooms in one flat of the ground and the top floor

## 6. Energy consumption

The energy consumption had been measured over the year 2007 by reading the gas consumption and the electricity meters. The measured total ventilation rate of the building was 1200 m<sup>3</sup>/h (flats and staircase) resulting in an overall ventilation rate of 0.5 1/h.

Table 1: Parameters important for energy consumption measured in 2007 and the standardized values for energy calculations

	Measurement 2007	Standardized values
Room temperature	22 °C	20 °C
ventilation rate	0.5 1/h	0.4 1/h
outdoor climate	2007	Standardized Vienna
hot water consumption	377 m <sup>3</sup>	285 m <sup>3</sup>
internal loads	3,74 W/m <sup>2</sup> 60% electricity	3,0 W/m <sup>2</sup> gross area

The ventilation system had an overall electricity consumption of 6 kWh/m<sup>2</sup> gross area.

The next graph shows the measured gas consumption and the calculated gas consumption. The gas consumption has been calculated according to the Austrian calculation rules for the energy certificate (Pech et al. 2007) using the parameters from table 1. The standardized values for outdoor climate, indoor temperature, hot water consumption and internal loads result in a little less gas consumption.

### Gas consumption

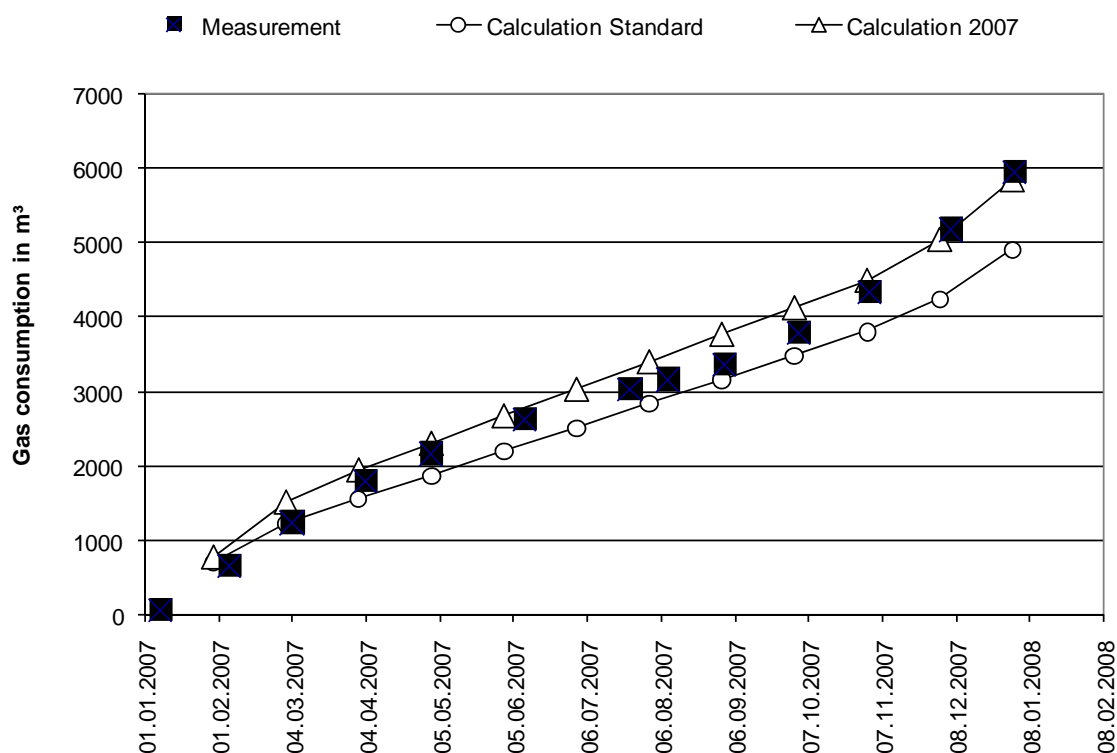

FIG. 7: Measured and calculated gas consumption.

The overall energyconsumption in 2007 can be seen in Table 2. The splitting into demand and system losses has been done with the calculation rules for the Austrian energy certificate.

Table 2: Energy consumption 2007 of Vienna-Utendorfgasse (13flats, 900m<sup>2</sup> usable area, 1300m<sup>2</sup> gross area)

	without system losses	with system losses
	kWh/m <sup>2</sup> gross area	kWh/m <sup>2</sup> gross area
heating	8	19 (gas)
ventilation		6 (electricity)
hot water	13	31 (gas)
lighting of cellar, staircase auxiliary electricity for heating system, pumps etc.		6 (electricity)
household electricity		18 (electricity)

A comparable multifamily house with the same building service system and the same number of flats had during the same time a gas consumption of 15000 m<sup>3</sup>.

## 7. Conclusions

The first year of occupancy of the multifamily house Utendorfgasse in Vienna gave very satisfying results on the indoor climate during winter and summer and the predicted energy consumption. A post-occupancy evaluation showed that the occupants are very satisfied with the building and the heating system. Only minor problems had been reported on indoor relative humidity and the usability of the heating system. The biggest problem with the heating and ventilation system was the correct set up of volume flow rates for the different rooms. Regarding the overall energy consumption the system losses were higher than the energy demand. Future research should focus on reduction of system losses.

## 8. References

- Keul A. (2007) Post occupancy evaluation of three Passiv houses in Vienna, Vienna University of Technology  
 A. Pech, C. Pöhn, T. Bednar, W. Streicher (Hrg.): (2007), "*Bauphysik, Erweiterung 1: Energieeinsparung und wärmeschutz, Energieausweis - Gesamtenergieeffizienz*"; Springer Verlag, Wien, ISBN: 978-3-211-25722-7



# Measurement results and experiences from an energy renovation of a typical Danish single-family house

*Henrik Tommerup, M.Sc. Civ. Eng.  
Technical University of Denmark, Department of Civil Engineering  
[hmt@byg.dtu.dk](mailto:hmt@byg.dtu.dk), [www.byg.dtu.dk](http://www.byg.dtu.dk)*

*KEYWORDS: EPBD, single-family house, energy renovation, measurements, cost effectiveness, experiences.*

## *SUMMARY:*

*Energy renovation of existing buildings has a large potential for cost effective energy savings. However, it is a major challenge to develop and implement the technologies for reducing the energy use in existing buildings to a very low level in combination with renovation of the buildings. To demonstrate how it could be done in small residential buildings a thorough retrofitting of a single-family house from 1972 was carried out. The house was brought up to the energy performance level of a new house. The energy renovation has reduced the net room heating consumption from 27.8 to 12.7 MWh/year corresponding to a 54 % reduction. The energy renovation project has proven that it is possible to renovate a typical Danish single-family house from the 1960/70's in a cost efficient manner to roughly the energy performance standard of a new Danish single-family house. As a positive side effect the living conditions have been greatly improved. In the paper the author also describes the lessons learned during the process of renovating the house.*

## **1. Introduction**

In 2006, new tighter energy performance requirements were introduced in Denmark for both new buildings and renovation. These requirements are based on the directive on Energy Performance of Buildings, the EPBD (2002/91/EC), but the Danish government has decided to implement renovation requirements to all building and not only buildings larger than 1000 m<sup>2</sup> as required in the EPBD directive. In general the effect of the new requirements for renovation is that existing buildings should be brought up to the energy performance level of new buildings in connection with larger renovations and other substantial changes in the buildings.

Studies (Tommerup 2004, Tommerup 2008) have documented that energy optimization has to be done in connection with traditional maintenance and other improvements/changes of the building in order to be cost-effective. Furthermore it has been pointed out that such opportunities for thorough improvements of the building envelope and technical installations occur with a long interval so it is of outmost importance not to miss these opportunities by making a renovation without upgrading the energy performance of the specific building component; i.e. for instance bringing the insulation standard of the roof up to and preferably beyond the current requirements in the building code.

The overall purpose of the demo-project has been to demonstrate that it is technically possible to bring a single-family house up to current energy standard of new buildings. In most cases this would imply a step by step approach. The components would be upgraded in accordance with the need for renovation or maintenance. This might be over the next 10-15 years. For a demonstration purpose this is not suitable. Thus the renovation tasks and following energy optimization have been forced. Due to this the costs of this project should not be taken as guidance for costs in general for energy upgrade of existing buildings.

To demonstrate how it could be done in single family residential buildings, a thorough energy efficient renovation of a typical Danish single-family house from the 1960/70's with need of renovation was initiated by Rockwool International in 2005. The house is typical as about 500,000 of a total of 1.1 million Danish detached single-family houses were erected in the 1960/70's.

The project is a follow-up on an energy renovation project regarding an old poorly insulated single-family house built in 1927 that was carried out a few years ago. This project showed that large profitable energy savings are possible (Overgaard 2005). Preliminary results (Tommerup 2007) have indicated that it is achievable to renovate the typical Danish single-family house from the 1960/70's to roughly the energy performance standard of a new Danish single-family house and that living conditions are expected to be greatly improved. The present paper presents results from a whole year of measurements before and after the renovation, which generally verify the

preliminary conclusions. The lessons learned during the process of renovating the house are described, taking into account to some extent the twofold benefit of renovation, i.e. the energy savings and the rehabilitation of the physical condition of the building elements.

## 2. House before the renovation

The selected house was built in 1972 and is occupied by a small family of three (two adults and their teenage son plus three dogs), and has a heated floor area of 155 m<sup>2</sup> and a volume of 400 m<sup>3</sup>. It should be noted that the Danish way of calculating the heated floor area is to use external dimensions, which is different from most other European countries who use internal dimensions. To convert e.g. energy consumption per external squaremeters into internal dimensions an approximate multiplying factor of 1.25 could be used.

The one storey house consists of a large living and dining room area with a ceiling to the ridge, three small living rooms, a kitchen, bathroom, toilet, entrance hall and utility room. Some illustrations showing the house before the renovation are shown in Fig. 1 below.

Exterior wall structures of the house consisted partly of 300 mm insulated cavity walls (around 75 mm of insulation) with steel ties and with an outer leaf of 110 mm masonry and an inner leaf of 100 mm light-weight concrete or 110 mm masonry. Parts of the external walls were originally framed walls with studs of timber and with an insulation thickness of 75 mm, which was later increased by 125 mm. The fairly large areas of windows were traditional old wooden windows with double-pane glazing.

The roof with one half of it having a ceiling to the ridge and the other half with a normal flat ceiling was insulated with 100 mm and 300 mm of mineral wool, respectively. The slab on ground construction had an insulation thickness of only 30-50 mm.



Fig. 1. North and south facing façades and the ceiling to the ridge in the living room

Room heating was provided by iron heaters with old thermostatic valves. The room heating system was water-based, pump-driven, and two-stringed. The heating was produced by a 15-year-old traditional open gas boiler placed in the utility room (supplemented by a wood burning stove). Domestic Hot Water (DHW) was stored in a 90 l integrated hot water tank. The heating pipes were placed in the insulation layer of the slab on ground construction.

The necessary ventilation (i.e. fresh air supply) in the house was provided by means of manual opening and closing of windows combined with use of air shafts in external walls and roof (i.e. natural ventilation). Besides this intended and somewhat controllable ventilation, a significant and uncontrolled infiltration took place through various air leakages in the building envelope.

## 3. House after the renovation - energy saving measures carried out

Specific solutions were designed for renovation of roof, external walls, foundation, windows, heating system and ventilation system. The implemented energy saving measures carried out on site were:

- External insulation of walls (100-150 mm)
- External insulation of foundations, 45 cm below ground (100-225 mm)
- External insulation of the ceiling to the ridge (345 mm) (no extra insulation of the flat part)
- New slim framed wooden windows and external doors with double-pane low-e-glazing

- New triple-pane low-e-glazing with krypton in the large glazing facades
- Air tightness measures regarding building envelope
- New high-efficiency condensing gas boiler (Viessmann Vitodens 300), insulated hot-water tank and new thermostatic valves.
- Installation of a mechanical ventilation system with high-efficiency heat recovery (Nilan Comfort 300T EC)

Fig. 2 shows a cross section of the house and the external envelope related improvements. The external insulation of the exterior walls increases the heated floor area from 155 to 161 m<sup>2</sup>. Insulation of the poorly insulated slab on ground construction was, due to the economic implications, not prioritized as one of the measures carried out.

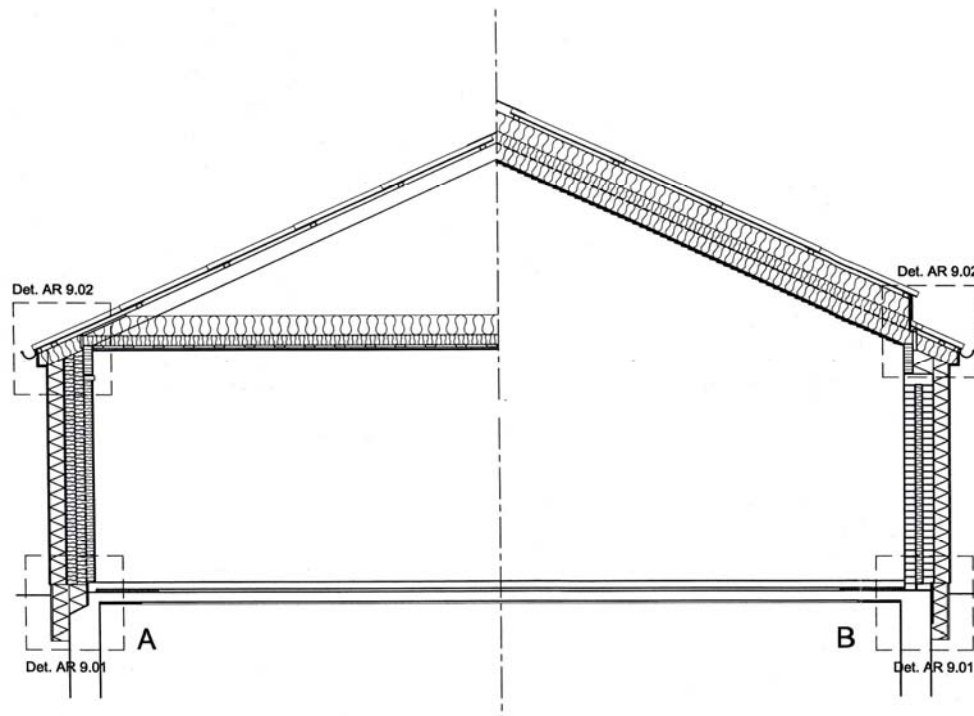

Fig. 2. Cross section of the energy renovated house

Fig. 3 shows the façade of the house. Note the new rain screen, the new slim framed wooden windows, new doors, the external insulation of the ceiling to the ridge (left side), and the outlet from the condensing gas boiler. The appearance of the façades after the energy renovation must be rated as a considerable so-called non energy benefit.



Fig. 3. House façade to the south after the renovation.



## 4. Measured energy consumption and indoor environment before and after the renovation

A detailed monitoring program was implemented in order to document the energy performance and indoor climate before and after the renovation, which included measurements of energy consumptions, air change rates using blower door and tracer gas methods, indoor climate conditions and solar radiation. The measurements started in June 2005. This paper is based on measurements carried out from September 1<sup>st</sup> 2005 to January 31<sup>st</sup> 2008. The renovation took place in November and December 2006.

### 4.1 Temperatures

The measured indoor temperature level was approximately 2°C higher after the renovation (21.9°C compared to 20.1°C), which is based on measurements in the heating season and at the same time of the year, i.e. the month of January and February, see Fig. 4.

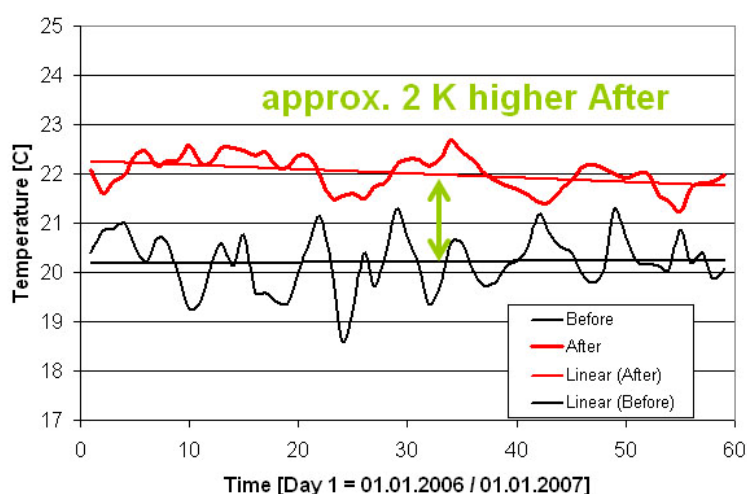

Fig. 4. Average indoor temperatures during January and February 2006 (Before) and 2007 (After).

Fig. 4 clearly shows that the energy renovation has greatly improved the thermal indoor comfort. The average indoor temperature rose from about 20 to 22°C. Before the renovation the temperature fluctuated between 18.5 and 21.5°C (3 K) and after the renovation the variation was only 1 K. Before the renovation the resident had problems with heating up the house during cold winter days, and that is certainly not the case after the renovation. The higher temperature level after the renovation has its drawbacks as it results in higher energy consumption for space heating compared with a situation with unchanged temperature conditions.

### 4.2 Air change rates

The air leakage of the building before and after the renovation was measured by means of a *blower door test* at 50 Pa pressure difference between inside and outside. Before the energy renovation the house was characterised by having no mechanical ventilation and a rather leaky building envelope corresponding to an air leakage rate of 12 ach at 50 Pa (ach is an abbreviation for air change per hour). The blower door test result was reduced significantly to 2.1 ach after the renovation. This level of air leakage corresponds roughly to the level of air tightness required for new Danish buildings at 50 Pa, which is 1.5 l/s/m<sup>2</sup> or 2.2 ach.

The air change rates *at normal use* of the house were measured during the month of November 2005 by means of tracer gas measurements. The PFT-method (Bergsøe 2007) and also CO<sub>2</sub>-measurements (Baránková 2007) were used. The average ventilation rate at normal use was measured at 0.39 ach by means of the PFT-method and the CO<sub>2</sub> measurements showed a variable air change in the different rooms of 0.19 - 0.46 ach corresponding to an average of 0.3 ach. The measured level of air change rate of 0.3 - 0.4 ach before the renovation is slightly lower than the typical design value of 0.5 ach.

The energy renovation included the installation of a mechanical ventilation system with heat recovery. The air change rate at normal use after the renovation was measured early 2007 but only by means of the PFT-method, and it showed a total air change rate of 0.51 ach including infiltration. The pre-adjusted ventilation air flow rate was 0.45 ach, so the small difference (0.06 ach) is an indication of the post renovation infiltration air change rate at normal use.

### 4.3 Gross energy consumption for heating before and after

In Denmark all legislation and standards are based on requirements to the gross energy performance of the building as mentioned before. Results in this chapter are therefore based on this.

The total energy consumption for heating (m<sup>3</sup> per year) has been continuously measured from June 2005 and until now. The yearly consumption is compared before and after the renovation. The consumption in the renovation period is influenced by the renovation and is left out of the comparison.

In the table below the preliminary results of the measurements are shown. In the coming month the results will be further investigated and a final report of the project can be expected by the end of the year.

*Table 1 Preliminary results of the project. These results show a reduction of the heating consumption of 54% due to the energy renovation of the house.*

	Before 1. September 05 – 31. August 06	After 1. February 07 - 31. January 08
Gas consumption, m <sup>3</sup>	2717	1610
Fire wood (estimate), m <sup>3</sup>	4 m <sup>3</sup> ≈ 455 m <sup>3</sup> gas	0 (not used in the heating season)
Total equivalent gas consumption, m <sup>3</sup>	3172	1610
Yearly boiler efficiency	85 % (estimated)	98 % (energy labelling)
Gross energy consumption for heating, m <sup>3</sup>	2696	1578
Gross energy consumption for heating, MWh/year	29.7	17.7
Estimate of gross domestic hot water consumption based on consumption in the month of may, MWh/year	12 · 0.25 = 3.0	12 · 0.45 = 5.4
Net room heating consumption, MWh/year	26.7	12.3
Number of degree days in the measurement period	3126	2632
Number of degree days in a standard year	3258	3258
Net room heating consumption adjusted for degree days, MWh/year	27.8	15.2
Ajustment for higher indoor temperatures, MWh/year	0	- 2.5
Adjusted net room heating consumption, MWh/year	27.8	12.7
Result		Reduction 54 %

Comments to the table:

- The house owners were asked not to use the fire stove in the measurement period after the renovation
- The energy consumption for hot water production is estimated to 12 times the consumption in the month of May which is assumed to be a relatively normal working month with no consumption for heating. It is assumed that the hot water consumption is the same all year. The estimate of hot water

consumption including heat losses included estimation of the summer efficiency of the boiler. The final documentation of the project will include more detailed investigations of the variations in the boiler efficiency during a year.

- The use of degree days is a relatively simple way of adjustment of the data. In connection with the further investigations it will be judged whether this is sufficient or if more advanced methods (including adjustment for solar gains) should be used in the final documentation of the project.
- The temperatures (January and February) in the house have increased 2 degrees. This indicates that the family has achieved an increase in indoor comfort but it also means that the energy consumption is higher in the situation after the renovation than before. To compare the achievements the results in the “after” situation has been adjusted. The adjustment is based on a simulation carried out using the Danish building simulation tool BSIM (BSIM 2000-2008).
- Electricity consumption has been measured but not yet been evaluated. This will be discussed in the final report.
- The energy consumption for hot water production has increased since there has been installed a circulation pump for hot water for comfort reasons. Since the hot water pipes run in the insulation layer under the concrete slab under the house only a very small part of the heat loss from the pipes actually add to the heating of the house. In the calculation above it is assumed that none of the heat loss add to the heating of the building.

## 5. Economy

The total installed costs of the renovation have been approximately kr. 900,000 (Euro 120,000). As mentioned in the introduction the aim of the project has been to demonstrate the technical possibilities for upgrading the energy standard of such buildings to current standard in the building code. Thus several tasks of maintenance have been forced. It should also be noted that the refurbishing was done in a period with rather high activity in the building sector resulting in higher costs. This would probably be lower today. The cost should be split into costs for maintenance and other building improvements done without energy optimization, and the costs for bringing the energy standard up to current level. A correct image of this requires two cases to compare. This has not been possible in this project so the only indication is the subjective estimate of the contractors who have made the estimate that approximately ½ of the costs can be referred to energy improvements. This subject will be further investigated before the final report is issued. At this point it has to be stressed that the implementation of the requirements to energy renovation in the building codes should lead to a bigger market for energy optimization thus lowering the prices as it becomes more common and due to development of new solutions which can also lower the costs.

The energy savings are expected to lower the family’s energy bill by about 20,000 DKK/year (2,700 €/year) using an energy price of 850 DKK/MWh (115 €/MWh). That equals a pay back time of 25 years.

With a conservative estimate of a rise in energy prices of about 2% per year, the running yearly energy savings of the energy measures will be equal to the yearly interest and capital repayments for the house owner. In case of increasing energy prices the economy of the house owner will be positive. The same is assumed for the value of the house. The aesthetics have been modernized and increasing energy prices should also improve the value of the house on the market as the energy performance of the house and hereby the energy expenses now and in the years to come are better than for similar houses.

## 6. General experiences during the renovation process

The general impression of the project is that it is possible to reduce the energy consumption and at the same time improve the indoor comfort and the architecture of the house. The best solution for insulation of the house is to insulate the outside, since this prevents moisture problems and more effectively eliminate thermal bridges. This house was therefore insulated from outside. The lessons learned during the process of renovating the house were:

- The premise for refurbishing the house was that the aesthetic value of the house was retained or even improved. In this case this could easily be done since the roof had a large overhang. In other cases with less overhang this could have caused severe aesthetical and practical problems.
- It was the goal to insulate with the most economic thickness of insulation – in praxis the thickness was governed by practical reasons as you were working on an existing house. It is important when only

parts of buildings are changed/renovated to take the further step into account – i.e. to think about the wall insulation when the roof is changed.

- Local restrictions on facades can cause exemptions to change the outlook of the facades. (e.g. demands of the appearance of facades, demands for material used). To get such exemptions depends usually of the local homeowners' association and/or the building authority. The new Danish building code from 2008 includes the possibility to install insulation externally on building facades without any further permission.
- Using a ventilation system with heat recovery requires a very air tight house, which again requires a very good workmanship placing and taping the vapour retarder especially under wet weather conditions. Furthermore the loft in half of the house had to be sealed which was done by adding a plasterboard ceiling.
- It was difficult to get the right data for the ventilation system, and it seems that there is a need for more systematic and reliable information of the efficiency of these small systems.
- The airtightness of the building has been improved dramatically and the building now full fills the same requirements as to new buildings. Generally this is very good news since energy losses through ventilation becomes a great factor when other parts of the building are improved.
- Doing perimeter insulation was only possible to a depth of 250 – 300 mm, as the trench footing from this level was poured without scaffolding.
- Insulation of slab on ground construction was not feasible or reasonable for economic reasons. Existing concrete floor would have to be removed and excavation for new insulation to be done including a new floor construction and placement of new heating pipes on the warm side of the building envelope.
- Even though drawings exist for the house a lot of investigations have to be done to verify these drawings. The experience from the refurbishing was that drawings did not always correspond to existing conditions.

## 7. Conclusions

1. The project has documented that it is possible to lower the energy consumption in a house typical for the 500,000 one family houses from the 60-70'ies to a level corresponding to new buildings.
2. The energy renovation has reduced the net room heating consumption from 27.8 to 12.7 MWh/year (a 54 % reduction). The energy savings are expected to lower the family's energy bill by about 20,000 DKK/year (2.700 €/year) using an energy price of 850 DKK/MWh (115 €/MWh).
3. Total installed costs of the renovation (including both upgrading/refurbishment and energy saving measures) were approximately 900,000 DKK (120,000 €). It has to be taken into consideration that the project due to demonstration purposes has forced a number of investments and that the project was done in a period with very high activity in the building sector and thus considerable increases in prices. It is not easy to split the price of the energy upgrade from the general upgrade of the building. This topic has not yet been investigated.
4. With a conservative estimate of a rise in energyprices of about 2% per year, the running yearly energy savings of the energy measures will be equal to the yearly interest and capital repayments for the house owner.
5. As a positive side effect the living conditions have been greatly improved: much better thermal indoor climate, more uniform ventilation air change rate and no cold draught, and acoustic improvements, especially reduced noise from outside.
6. To further improve the energy performance of the house the most obvious measure is to remove the floor concrete slab and carry out a highly insulated floor heated construction with a suitable weather controlled supply-pipe temperature. Use of solar energy for DHW and supplement for room heating is

another obvious measure that could be considered in the future development of low energy solutions for renovation of existing single-family house.

## 8. Acknowledgements

The work on which this paper is based was initiated and funded by Rockwool International A/S. The author would like to give thanks to all people involved in the project and special thanks to the house owners.

## 9. References

- Baránková P. (2007). Ventilation Measurements in Næstved by the CO<sub>2</sub> Method. (internal report). Czech Technical University in Prague – International Centre for Indoor Environment and Energy, DTU.
- Bergsøe N.C. (2007). Retrofit – PFT-målinger i villa i Næstved. Notat med jour. nr. 732-014. Afdelingen for Energi & Miljø, SBI.
- Grau K.E, Wittchen K.B., Johnsen K. (2000-2008). BSIM - Integrated software for thermal analysis of buildings and installations. Danish Building Research Institute. See [www.bsim.dk](http://www.bsim.dk) and [www.sbi.dk/download/bsim/bsimbrochure.pdf](http://www.sbi.dk/download/bsim/bsimbrochure.pdf)
- Jensen J.M. and Lund H. (1995). Design Reference Year, Technical University of Denmark, Meddelelse 281.
- Overgaard L.L. et al. (2005). Energy renovation of an old single-family House, Nordic Building Physics Symposium, Reykjavik, 2005, proceeding vol. 1, p. 260-266.
- Tommerup H, Svendsen S. (2007). Energy Renovation of a Typical Danish Single-family House, In conference proceedings of the 11<sup>th</sup> International Conference on Passive Houses 2007, Bregenz, Austria. p. 197-202.
- Tommerup H (2004). Technical University of Denmark. Energibesparelser i eksisterende og nye boliger. BYG.DTU rapport R-080
- Tommerup H (2008), Laustsen J.B. Technical University of Denmark. Energibesparelser i bygninger i den offentlige sektor. BYG.DTU rapport R-184.

# Energy renovation saving potentials of typical Finnish buildings

**R. Holopainen, Research scientist,**  
**Technical Research Centre of Finland VTT;**  
[riikka.holopainen@vtt.fi](mailto:riikka.holopainen@vtt.fi) [www.vtt.fi](http://www.vtt.fi)

**M. Hekkanen, Lecturer,**  
**Oulu University of Applied Sciences**  
[martti.hekkanen@oamk.fi](mailto:martti.hekkanen@oamk.fi) [www.oamk.fi](http://www.oamk.fi)

**KEYWORDS:** energy use, costs, renovation, Finland.

## **SUMMARY:**

VTT's Energy renovation technologies-project (2006) studied the profitability of energy renovation measures for buildings. Different energy renovation technologies for structural improvements (retrofit insulation, air tightening), heat supply systems, ventilation systems, lighting, electrical appliances, solar shading and cooling were evaluated. The effects of different energy renovation measures to reduce heating or cooling energy were simulated for two single-family houses, three apartment houses and one office building. The energy consumption of the example buildings was simulated before and after the renovation, and payback times of the renovation procedures were calculated. The total energy renovations reduced the annual heating and ventilation electricity consumption of the electrically heated single-family house by 67 % and the annual heating energy consumption of the oil-heated single-family house by 65 %. The specific heat consumptions of the studied apartment houses were reduced between 46 % - 56 %. The annual cooling energy use of the office building was reduced between 44 % - 71 %. With current energy prices, the calculated payback times of these energy renovations were in most cases too long for repairing the building only to reduce its energy use.

## **1. Introduction**

The heating energy and electrical energy use of Finnish residential and public buildings is responsible for about 30 % of the Finnish CO<sub>2</sub> emissions. Energy renovations, such as supplementary insulation and heat recovery from outlet air, can be performed to reduce the buildings energy use and CO<sub>2</sub> emissions.

Following energy saving potential calculations for single-family houses are made with WinEtana, a building energy use calculation tool developed at VTT. The calculations for the apartment houses are made with VTTenergiასeniorei, also developed at VTT. The dynamical simulations for the office building are made with IDAIce.

In payback time calculations the oil price is 0.6 €/dm<sup>3</sup> (0.06 €/kWh), electricity price 0.11 €/kWh and district heating price 0.05 €/kWh.

## **2. Single-family houses**

The studied house is a typical in 1960 built one-storey single-family house. It is inhabited by a four-person family, 2 adults and 2 children. The building volume is 466 m<sup>3</sup>, the floor area is 147 m<sup>2</sup>, the brutto area is 163 m<sup>2</sup> and the room height is 2.5 m. The original U-values of the envelope are based on the 1969 building regulations: outer walls 0.81 W/m<sup>2</sup>K, roof and base floor 0.47 W/m<sup>2</sup>K and windows 3.14 W/m<sup>2</sup>K. The energy calculations are made for Helsinki (South Finland) and Jyväskylä (Central Finland). The original space heating demand of the brutto area is 252 kWh/m<sup>2</sup> in Helsinki and 275 kWh/m<sup>2</sup> in Jyväskylä.

Two similar houses with different heating systems are studied: 1) direct electrical heating and 2) water central heating with an oil-fired boiler. Common energy renovation technologies for the both houses are:

- supplementary insulation to fulfil the present heat insulation regulations, U-values: outer walls 0.25 W/m<sup>2</sup>K, roof 0.16 W/m<sup>2</sup>K, base floor 0.2 W/m<sup>2</sup>K;
- new windows, U-value 1,1 W/m<sup>2</sup>K;
- air tightening the envelope and thus reducing the air leakage rate ( $n_{50}$ ) from 7 l/h to 3 l/h;
- changing the existing mechanical exhaust ventilation system to a mechanical supply and exhaust ventilation system with heat recovery. The energy efficiency of the new fan is 1.60 kW/(m<sup>3</sup>/s) (energy class A), air inlet temperature 20 °C, annual heat recovery efficiency 60 %. The increase of the electricity use of the ventilation system is 280 kWh/a.

The calculated annual heating and ventilation electricity use of the single-family house with a direct electrical heating is 46 500 kWh in Helsinki and 50 300 kWh in Jyväskylä, and the respective annual costs are 5 120 € and 5 540 €. Besides the common energy renovations, the effect of an outdoor air heat pump is evaluated. The outdoor heat pump is assumed to produce 17 % of the space heating energy use.

After the energy renovations the space heating demand of the brutto area is 76 kWh/m<sup>2</sup> in Helsinki and 84 kWh/m<sup>2</sup> in Jyväskylä. The total electricity consumption for heating and ventilation is 15 500 kWh/a in Helsinki and 16 900 kWh/a in Jyväskylä, the costs respectively 1 700 €/a and 1 860 €/a. Figure 2 shows the gradual decrease of the annual electricity use for heating and ventilation.

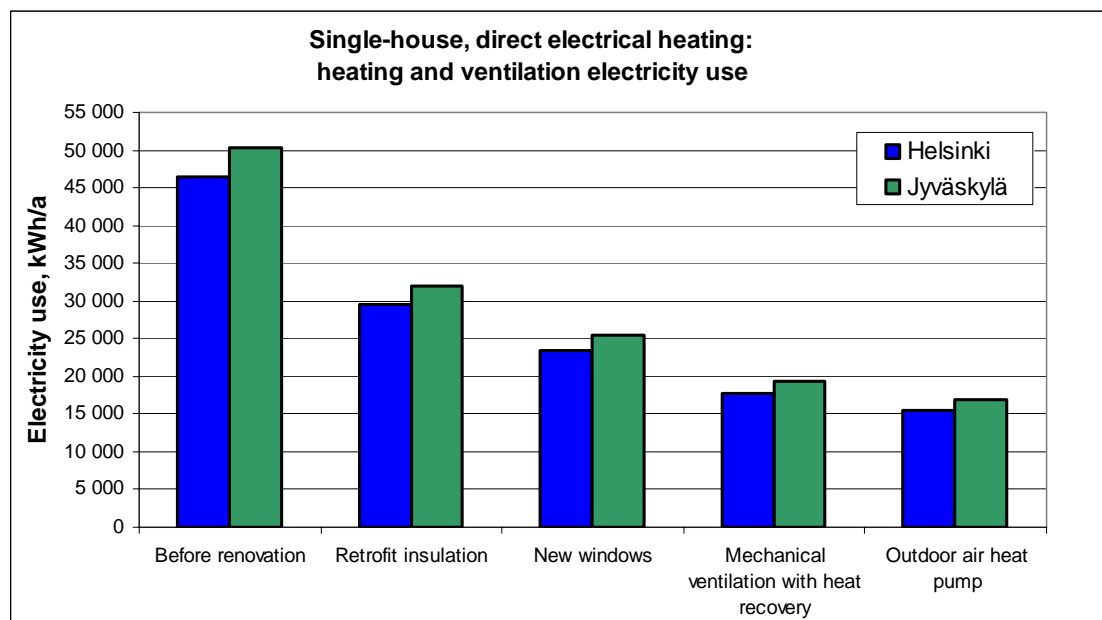

FIG. 1: Single-house with direct electrical heating: decrease of the annual electricity use (space heating, domestic hot water and ventilation) by energy renovation procedures.

The estimated total renovation costs are 34 770 € with state funding as 15 % of the investment price of the heat pump. The construction costs are not included. The payback times of the total energy renovation are 13 years in Helsinki and 12 years in Jyväskylä with the state funding as 15 % from the cost of the outdoor heat pump included. The energy escalation (yearly price increase) is 1.5 % and interest rate 5 %.

The annual savings and payback times are also calculated for separate energy renovation procedures (Table 1).

TABLE. 1: Payback times for separate energy renovation procedures in Helsinki and Jyväskylä

	Total investment cost, €	Annual saving in Helsinki, €	Payback time in Helsinki, a	Annual saving in Jyväskylä, €	Payback time in Jyväskylä, a
Retrofit insulation	17 800	1 870	8.1	2 009	7.6
New windows	11 200	670	12.9	726	12.1
Mechanical ventilation with heat recovery	3 500	697	4.5	758	4.2
Outdoor air heat pump	1 870	783	2.5	854	2.1

The heating system of the oil-heated single-family house is a water central floor heating with an oil-fired boiler. The annual heating oil use is 5 750 dm<sup>3</sup> in Helsinki and 6 160 dm<sup>3</sup> in Jyväskylä, with respective costs as 3 450 € and 3 700 €. Besides the common energy renovation procedures, the effect of installing a new oil-heating system equipped with a solar heating system is studied. The new oil heating system has a yearly efficiency of 93 % (87 % for the old system), and the solar-heating equipment is assumed to heat up 50 % of the domestic hot water in annual level.

After the energy renovations the annual oil use is 2 030 dm<sup>3</sup> in Helsinki and 2 180 dm<sup>3</sup> in Jyväskylä, with respective costs as 1 220 € and 1 310 €. Property electricity use has increased 300 kWh/a (33 €/a). Figure 2 shows the gradual decrease of the annual oil use.

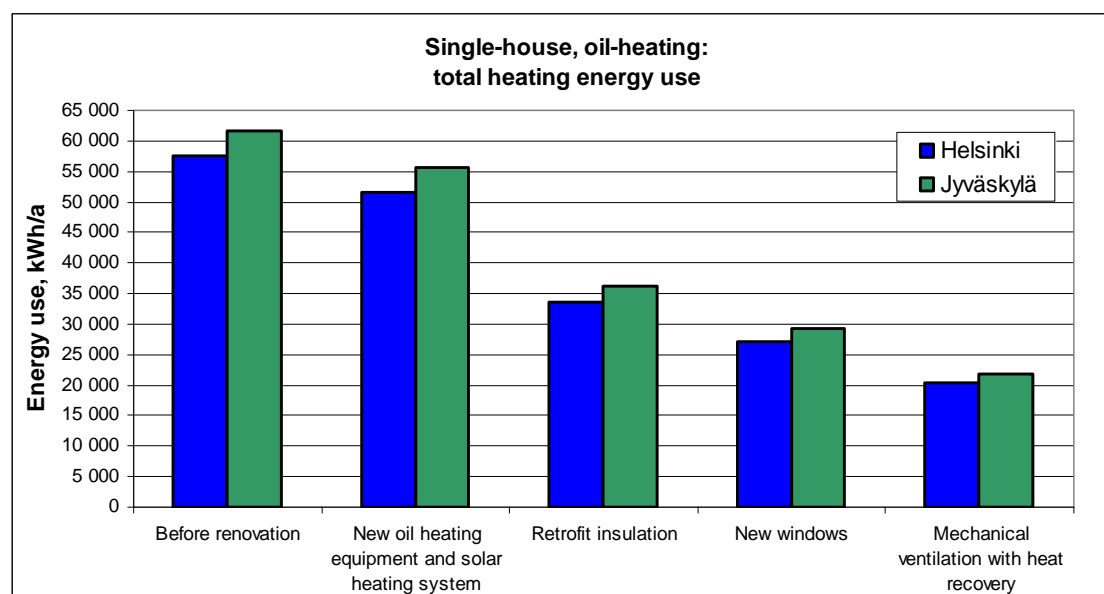

FIG. 2: Oil-heated single-house: decrease of the annual heating energy use by energy renovation procedures. .

The total renovation cost with the state funding included (15 % of the investment costs of a new oil-heating system equipped with a solar heating system) is 41 100 €. The payback time of the total renovation is 31 years in Helsinki and 27 years in Jyväskylä with the energy escalation 1.5 % and interest rate 5 %.

The payback times for separate renovation procedures are presented in Table 2.



TABLE 2: Payback times for separate energy renovation procedures, oil-heated single-house in Helsinki and Jyväskylä.

	Total investment cost, €(State funding included)	Annual net saving in Helsinki, €	Payback time in Helsinki, a	Annual net saving in Jyväskylä, €	Payback time in Jyväskylä, a
New oil-heating system	8585	346	17.5	363	16.9
Retrofit insulation	17800	1155	12.1	1238	11.4
New windows	11200	416	18.6	450	17.6
Mechanical ventilation with heat recovery	3500	429	7.1	466	6.6

The total energy renovations reduce the annual heating and ventilation electricity consumption of the electrically heated house by 67 % and the annual heating energy consumption of the oil-heated house by 65 %. The payback times for the total energy renovations for the both single-houses as a function of the energy escalation rate are presented in Figure 3.

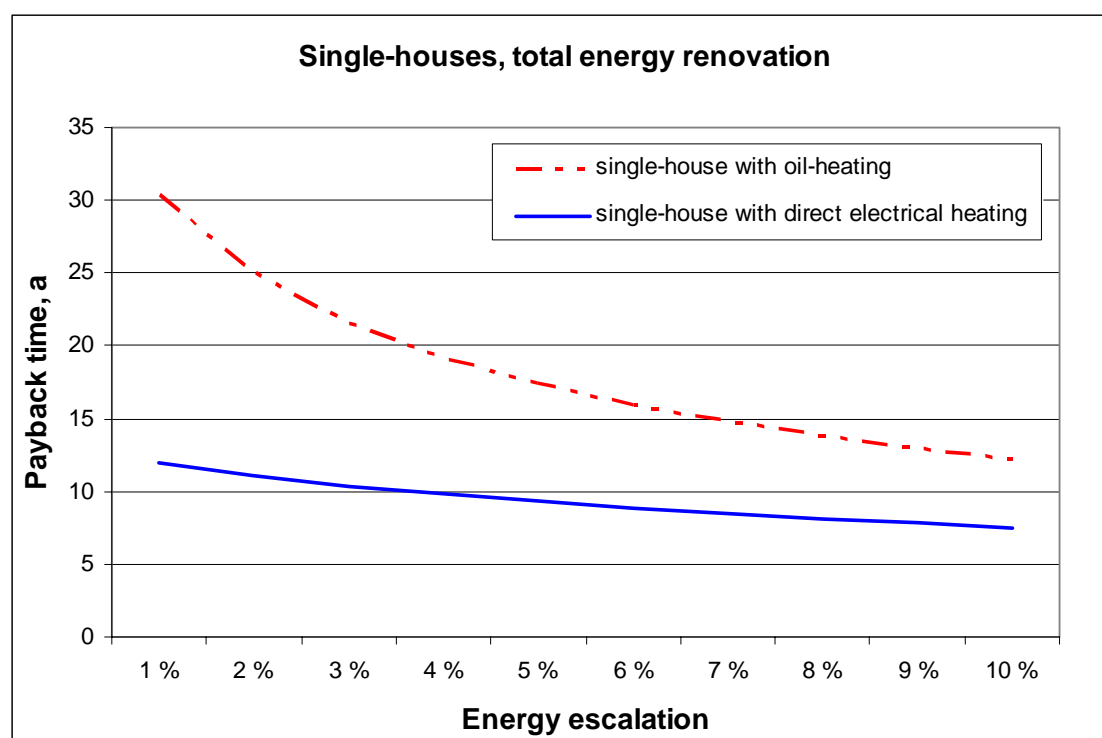

FIG. 3: Single-houses: payback times as a function of the annual energy price increase rate (Location: Jyväskylä)

### 3. Apartment houses

The three simulated houses represent typical Finnish apartment houses built in years 1950, 1960 or 1970. The apartment areas are 1613 m<sup>2</sup> (1950), 3390 m<sup>2</sup> (1960) and 3863 m<sup>2</sup> (1970). The houses are heated by district heating and the original annual specific heat consumptions are 255 kWh/m<sup>2</sup> (1950), 213 kWh/m<sup>2</sup> (1960) and 188 kWh/m<sup>2</sup> (1970).

The apartment houses are renovated with exterior retrofit insulation and new surface structure for the outside walls. The windows, balcony doors and front doors are renewed. The district heating centre and the heat supply system are modernized. Mechanical supply and exhaust ventilation systems with heat recovery (annual efficiency 30 %) are installed in all apartments.

After the renovation the specific heat consumptions are 138 kWh/m<sup>2</sup> (1950), 116 kWh/m<sup>2</sup> (1960) and 82 kWh/m<sup>2</sup> (1970). The specific heat consumption was thus reduced between 46 % -56 %.

Energy renovation procedures for apartment buildings are nearly always done in connection with other renovations; an energy renovation also increases the indoor air quality and the energy efficiency of the house. For these reasons, in following payback time calculations (Figure 4) the interest rate is 0 % and the investment costs are taken as the price difference between a “traditional” repair method and an energy saving repair method, e.g. installing windows with lower U-values instead of standard windows.

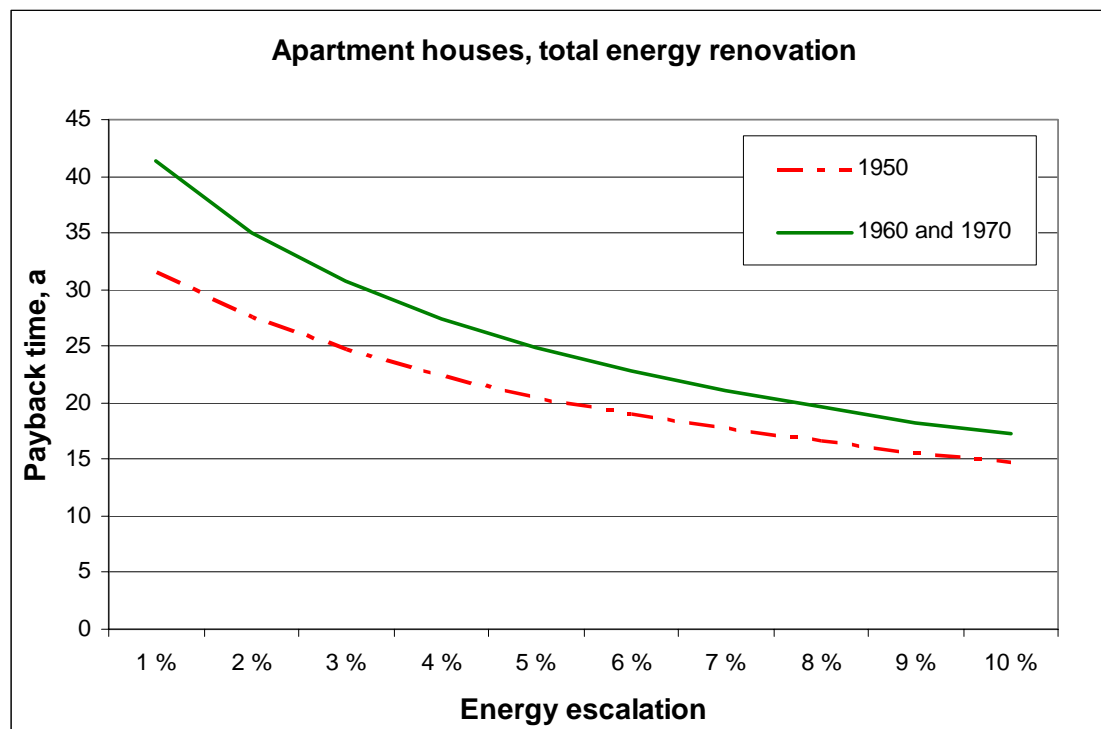

FIG. 4: Apartment houses: payback times as a function of the annual energy price increase rate (Location: Jyväskylä)

## 4. Office building

The simulated office building is built in 1980, the brutto area is 916 brm<sup>2</sup>, and the annual cooling energy demand is 31.5 MWh.

The cooling energy reduction potential of the office building is calculated by dynamic simulation. The power level of the lighting is reduced from 17.5 W/m<sup>2</sup> to 10 W/m<sup>2</sup> by means of energy-efficient lamps. The effects of four different solar shading technologies are studied: two different solar control glass windows (total transmittance factor  $g = 0.21$  or  $0.44$ ), blinds and awning (between April and September). Combined with the reduction of the lighting power level, the annual cooling energy use is reduced from 44 % to 69 % with solar control glass windows, 56 % with blinds and 71 % with awning.

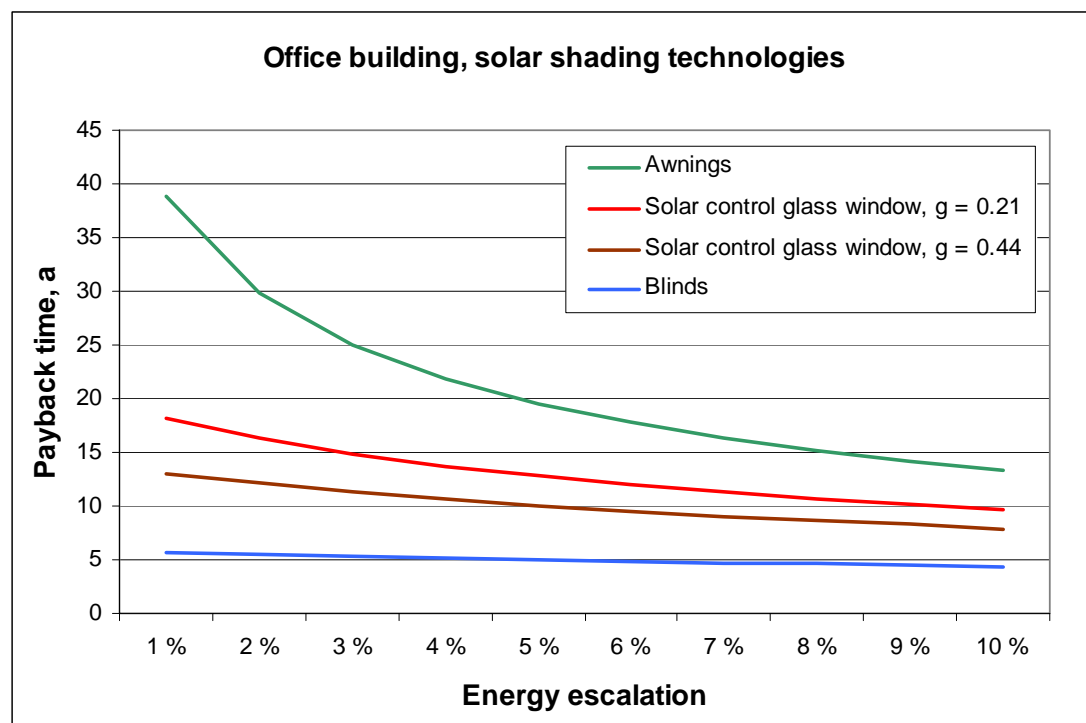

FIG. 5: Office building: payback times of different solar shading technologies (combined with the reduction of lighting power level) as a function of the annual energy price increase rate (Location: Helsinki)

## 5. Conclusions

The theoretical energy saving potential of the existing building stock is large. The energy renovations procedures calculated in this study reduced the annual heating and ventilation electricity consumption of the electrically heated single-family house by 67 % and the annual heating energy consumption of the oil-heated single-family house by 65 %. The specific heat consumptions of the studied apartment houses were reduced between 46 % - 56 %. The annual cooling energy use of the office building was reduced between 44 % - 71 %.

With current energy prices, the payback times of energy renovations are often too long for repairing the building only to reduce its energy use. Energy renovation actions can be cost-effectively carried out in connection with another renovation procedures (e.g. building façade renovation, renovation of the ventilation system). Renewable energy sources should be utilized, when possible.

The technological solutions of energy renovations are already available; the essential development need lies in the implementation process. Thermal comfort issues should be emphasized in marketing: controlled mechanical ventilation improves the indoor air quality, and with increased insulation levels the inner surface temperatures are higher, which decreases the draught experienced by the radiation of cold surfaces. New business service models are needed to offer attractive and cost-effective energy renovations for customers.

## References

WinEtana simulation program is developed at VTT for estimating building energy consumption. The program is described in following publications: 1) R. Kosonen, J. Shemeikka, The use of simple simulation tool for energy analysis, in: Proceedings of Building Simulation '97, 5th International IBPSA Conference, Prague, September 8–10, 1997, pp. 369–376. and 2) J. Shemeikka, WinEtana 1.0 LT Building Energy Calculation Program Manual, Technical Research Centre of Finland, Espoo, 1997, p. 29 (in Finnish).

VTTenergiaseeni calculation tool for estimating building energy consumption is developed at VTT. The program is described in: Hekkanen, Martti, Hienonen, Markku, Ilmarinen, Juhani, Kilpeläinen, Mikko, Klemetilä, Tapio, Mäkikyrö, Tapani, Riippa, Tommi, Seppälä, Pekka & Tulla, Kauko. Pientalon ekomititit [Key methods for energy efficiency and ecological impacts in private housing]. Espoo 2006. VTT Tiedotteita . Research Notes 2354. 43 p. + app. 9 p. (in Finnish)

IDA ICE, A tool for simulation of thermal comfort, indoor air quality and energy consumption in buildings  
[http://www.eere.energy.gov/buildings/tools\\_directory/software.cfm/ID=243/pagename=alpha\\_list](http://www.eere.energy.gov/buildings/tools_directory/software.cfm/ID=243/pagename=alpha_list)

Suomalaisten rakennusten energiakorjausmenetelmät ja säästöpotentiaalit [Energy renovation technologies and saving potentials of Finnish buildings]. Holopainen, Riikka; Hekkanen, Martti; Hemmilä, Kari; Norvasuo, Markku. 2007. VTT, Espoo. 104 s. + liitt. 2 s. VTT Tiedotteita - Research Notes : 2377  
<http://www.vtt.fi/inf/pdf/tiedotteet/2007/T2377.pdf> (in Finnish)



## Retrofitting of a school with an integral aspect

*Andreas Holm, Dr.-Ing.  
Fraunhofer Institute for Building Physics  
andreas.holm@ibp.fhg.de*

*Runa Hellwig, Dr.-Ing.  
Fraunhofer Institute for Building Physics  
hellwig@hoki.ibp.fhg.de*

*Klaus Sedlbauer, Prof.  
Fraunhofer Institute for Building Physics  
sedlbauer@hoki.ibp.fhg.de*

**KEYWORDS:** *schools, IAQ, moisture, thermal comfort, WUFI Plus, CO<sub>2</sub>*

### **SUMMARY:**

*International studies, like the PISA study [PISA 2006], detect the performance of pupils. Besides the teaching method, other influences are also relevant for their performance. The environment in the classrooms is supposed to play an important role. Caused by sinking numbers of pupils, new school buildings are very rare, and available school buildings will be increasingly retrofitted. A great reduction potential and a not insignificant environmental protection could be achieved by specific measures in this field. But what are the adequate measures?*

*Yet school buildings are different from residential buildings. Therefore, airtight and well insulated building envelopes are not sufficient, because this one-sided approach forces a false user behaviour and counterproductive as concerns targeted energy savings and environmental protection. During the school year 2006/2007 environment measurements (energy consumption, IAQ, acoustics, etc) were carried out in a school in the Munich region and an integral retrofitting strategy was developed. For the first time all relevant factors, not only energy saving, were taken into account. A special focus was laid on the future performance of the pupils.*

## 1. The Problem

There are more than 40.000 school buildings in Germany. Due to decreasing numbers of pupils, already existing school buildings will rather be further operated than new ones are built. After a substandard retrofitting rate in the last few years, a multitude of school buildings is awaiting retrofitting throughout Germany. [BINE 2006].

The societal significance of an optimal education is emphasized everywhere. Besides the quality of teaching, the conditions of teaching and learning in educational institutions are increasingly gaining in importance. Retrofitting is not only intended to improve the energetic standards, but first of all to optimize learning and teaching conditions for pupils and teachers. Building physics can contribute to create a comfortable indoor environment. Comfortable indoor climatic conditions are composed of thermal, acoustic, visual and olfactory room climate. The integral approach of retrofitting school buildings shows, how other factors than energetic ones contribute to clearly upgrade the quality of a building to achieve optimal working conditions for the users. Both, pupils as well as teacher benefit.

Specific characteristics must be taken into consideration in retrofitting school buildings [BINE 2006]:

- Due to the high occupation by persons, the internal heat gain is high.
- Due to the high occupation by persons, air requirements in classrooms are high.
- To guarantee an equal illumination of the classrooms, facades are generally glazed from the breast area resulting in a high share of window surfaces of more than 50 %.
- Shading is therefore a very important topic due to high internal loads and high shares of glazing.
- The periods are relatively short, when the classrooms are used (generally in the mornings).

- The building structure of school buildings frequently dates back to various years of construction.

Targeted measures will result in energy savings potential and the improvement of indoor climatic conditions. But which measures are adequate? According to a literature analysis of assessment parameters for a comfortable indoor environment, the analysis of the indoor climatic conditions in the actual state and the resulting measures of retrofiting are presented by the example of the grammar school in Miesbach, Bavaria.

## 2. Indoor Climatic Conditions in Classrooms

Various recent studies documented the CO<sub>2</sub> contents in classrooms in cross-section images. [Fromme et al. 2006] investigated among other indoor air parameters the carbon dioxide content in Bavarian classrooms in two measurement periods. Measurements in winter in 92 classrooms at 46 schools provided the daily medians of 0.06 to 0.42 Vol. %, whereby 92% of the daily medians exceeded the Pettenkofer value of 0.1 Vol. % and further 60% of the daily medians the value of 0.15 Vol. %. During the measurements in summer in 76 classrooms at 38 schools only 28 % of the measured medians (0.05 to 0.19 Vol. %) exceeded the Pettenkofer value, but only 9% the value of 0.15 Vol. %.

Investigations of the local health authorities in Lower Saxon [Grams et al. 2004] showed a similar frequency of exceeding of carbon dioxide contents. Measurements in Berlin showed averaged carbon dioxide concentrations for one school day from 0.05 to 0.42 Vol. %. The median for the total of measurement values amounts to 0.16 Vol. %. The Pettenkofer value of 0.1 Vol. % was exceeded in approx. 90% of the classrooms [ILAT].

The existing indoor climatic conditions in the grammar school in Miesbach are demonstrated by the example of several classrooms, which were investigated within the framework of the project financed by the DBU (German foundation to promote innovative and exemplary environmental projects) and the Kreissparkasse Miesbach-Tegernsee (local savings bank). Measurements were carried out during one week respectively in summer and in winter. FIG. 1 shows classroom 205 in the south-west part of the building. An inspection of the room showed serious acoustic problems. The thermal insulation of external building components is low with u-values between 0.6 and 1.8 W/m<sup>2</sup>K for the external walls and 2.7 W/m<sup>2</sup>K for the windows. The windows are equipped with swinging sashes. The external blinds mounted in front of the windows are ventilated by an adequate distance to the façade, but the blinds fabric was assessed as insufficient concerning efficiency. Any energetic assessment will not be given at this stage of investigations but in the final report [GyMB 2007].



FIG. 1: Panoramic view into an investigated classroom [photo IBP].

To measure thermal comfort, sensors were installed at the heights of 0.1 m, 0.6 m, 1.1 m and 1.7 m above ground to measure air temperature, relative air humidity and relative indoor air humidity. A carbon dioxide sensor was installed at a height of 1.7 m. The measurement axis was positioned directly at a seat in the middle of the classroom, if possible. A room utilisation protocol recorded data on the number of persons present and the duration, when the windows were opened.

FIG. 2. shows the example of temperature profile of Tuesday, January 9, 2007. At the beginning of lessons at 8:00 a.m. room temperature was around 17 °C. Due to the presence of the pupils, the room temperature rises to 20°C until the end of the first lesson. Due to the opening of the windows for air change after the first lesson and no occupation until the third lesson, temperature falls to almost 17°C. During the third lesson, persons are again present in the room. The temperature rises to a little more than 20°C. After the break, the room is occupied from the fourth until the seventh lesson resulting in temperatures between 20 and 22 °C. The vertical temperature gradient is between 0 and 1.6 K, as average value at 0.6 K. This is clearly below the maximum value of up to

3 K between head and foot. The relative indoor air humidity amounts to values between 38 and 64% in the classrooms, or a mean value of 47%.

The carbon dioxide concentrations reach a maximum value of 0.41 Vol. % during the lessons and have a mean value of 0.18 Vol. %. Thus 75% of the values are lower than 0.22 Vol. % and only 10% of the measured values are lower than 0.1 Vol. %.

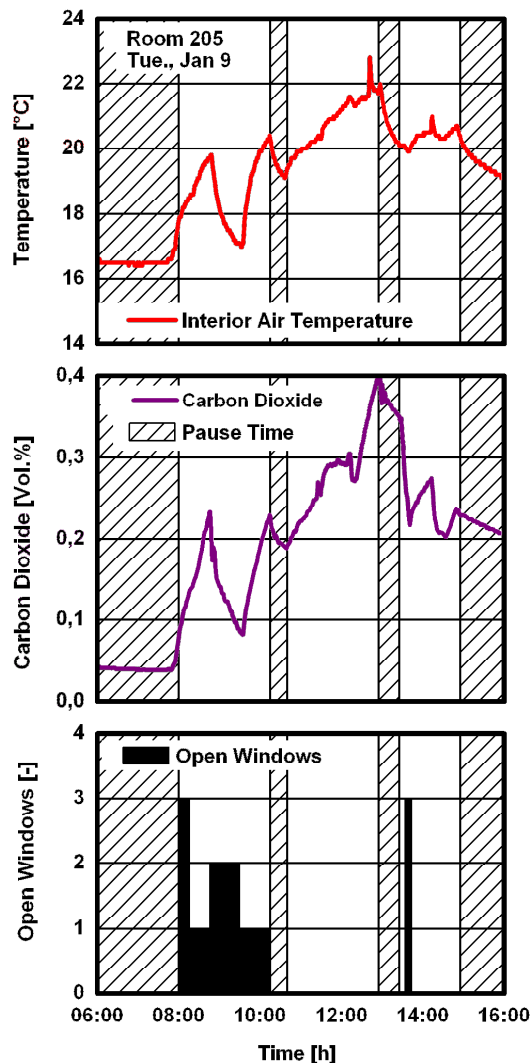

FIG. 2: Classroom 205: gradient of air temperature and CO<sub>2</sub> concentrations in the investigated classroom on January 9, 2007. The periods of opening the windows for air change recorded in the room utilisation protocol are also shown.

FIG. 3 shows the measurement values in summer recorded during one week. The constantly high temperatures in the classroom can be clearly identified. The rising internal temperature during the week can also be clearly recognized, which is closely linked to the rise of the external temperature. At the beginning of the lessons on July 19, 2006 at 8:45 a.m. (the room is not occupied in the first lesson) the room temperature already amounts to 23.5°C. This is approximately equivalent to the external air temperature at that time. Due to the presence of 31 pupils the room temperature amounts to 26°C at the end of the third lesson. At the end of lessons, after the fifth lesson in this case, the room temperature rises to 27.5 °C. The rise in room temperature in the afternoon indicates that the solar protection devices were not shut after leaving the room. The relative indoor air humidity during the lessons is between 35 and 54%, the average value is 44%.

Carbon dioxide concentrations reach a maximum value of 0.30 Vol. % during the lessons and have a mean value of 0.07 Vol. %. Thus 75% of the values are lower than 0.09 Vol. %.



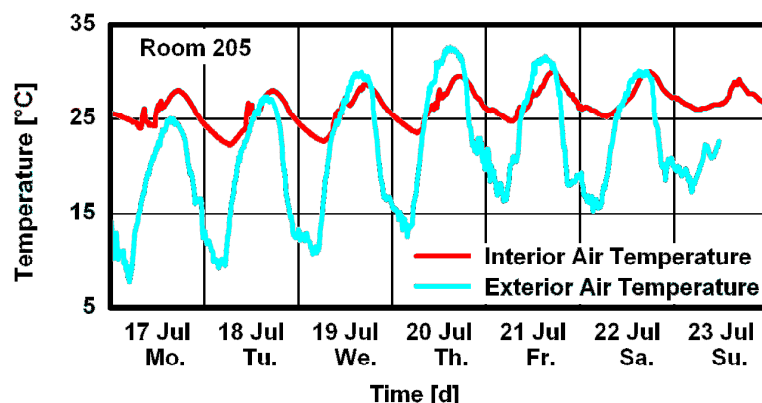

FIG. 3: Classroom 205: gradient of air temperature in the room and external air temperature in the investigated classroom in the period from July 17 to July 23, 2006.

The approximation of the measured mean value of illumination strength is 500 lx and thus clearly exceeds the required 300 lx. The daylight quotient  $D_{Rb}$  of the room is 3.5 %. The daylight supply is low due to the shading roof overhang. The background noise level was 28.6 dB (A) during the measurement period and thus it was slightly lower than the required value. The resulting sound insulation towards the adjacent classroom is only 36 dB and must be assessed as inadequate. The double door in the partition (escape route) was identified as dominating sound transmission path by listening. The classroom door leading to the corridor also has inadequate sound insulation with  $R_w = 21$  dB. The reverberation time is obviously too long in the entire frequency range. Even in case of full occupation of the room no significant improvement of the situation will be achieved. Inadequate audibility is to be expected in this room. An indicator is the level of clearness of below 50 % at all locations with the exception close to the sound source.

### 3. New integral room quality indicator

It is intended to consider the room quality integrally by means of a simple classification system in radar charts FIG. 4. Each of the investigated characteristics can be attributed to one of the following categories:

- 1 = good to very good
- 2 = acceptable
- 3 = bad

The structural parameters are assessed such as thermal insulation, sun protection, sound insulation, possibilities for ventilation, thermal comfort in summer and winter, air quality, daylight situation and room acoustics. The room needs to be retrofitted from the energetic point of view. As is evident, this representation offers a simple possibility to describe various problems of rooms and to identify the focus of retrofitting.

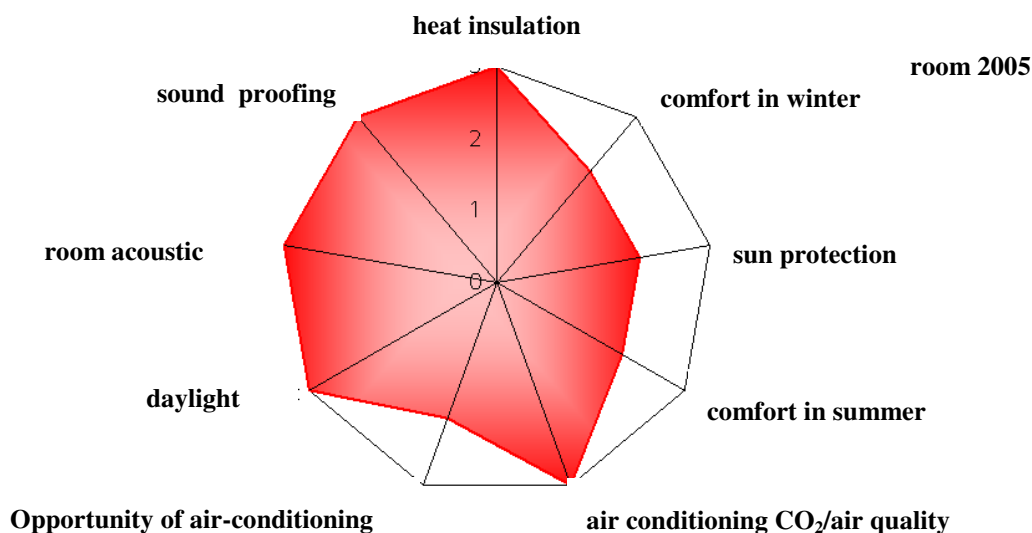

FIG. 4: Assessment of the actual state or room quality

*Legend:*

0 = the criterion was assessed with:

1 = good to very good

2 = sufficient

3 = bad

## 4. Solutions and Perspective

The present ventilation behaviour results in too high carbon dioxide concentrations in the investigated classrooms, as was to be expected primarily in winter, causing bad indoor air quality. Particularly in summer, temperatures are too high in the classrooms for thermal comfort. This is not only true of rooms in south-east or south-west direction. Even the rooms with north-west direction have too high temperatures due to the lacking solar protection.

It must, however, be taken into consideration that besides the appropriate ranges of temperature, high temperatures occur only for a short time and in connection with a rise of the external air temperature. Consequently, an additional heating-up of classrooms particularly in summer and after the end of the lessons must be efficiently avoided and even during extreme summer periods the cooling of classrooms during the night must be achieved. Compared to the minimum temperature expected at the beginning of the lessons, classrooms should have a relatively low temperature in summer after lessons started in the morning.

The actual condition is compared to 6 different retrofit variations. Hourly data of the Holzkirchen weather station were chosen as climatic boundary conditions.

Concerning the internal thermal loads, moisture loads, and CO<sub>2</sub>-loads the classroom is assumed to be continuously occupied by 30 individuals (Monday through Friday between 8 am and 1 pm, except for a 30-minute break from 10:15 am to 10:45 am).

TABLE. 1: Variations of Wufi @plus calculations

Case	Infiltration [h <sup>-1</sup> ]	Ventilation	Duration	controlled by	HRS*	Heating Demand [kWh] 1.Dec. → 31.Mar.
Base	0.3	5 h <sup>-1</sup>	during breaks	-	-	1924
C1	0.1	5 h <sup>-1</sup>	during breaks	-	-	590
C2	0.1	15 m <sup>3</sup> /(hm <sup>2</sup> )	7am → 2pm	-	-	2360
C3	0.1	15 m <sup>3</sup> /(hm <sup>2</sup> )	7am → 2pm	-	80%	314
C4	0.1	max. 15 m <sup>3</sup> /(hm <sup>2</sup> )		RH > 55%	-	381
C5	0.1	max. 15 m <sup>3</sup> /(hm <sup>2</sup> )		CO <sub>2</sub> > 1500 ppm	-	443
C6	0.1	8 m <sup>3</sup> /(hm <sup>2</sup> ) plus 5 h <sup>-1</sup>	7am → 2pm during breaks		-	237

HRS=Heat Recovering System

TABLE. 1 presents the classroom ventilation strategies that were investigated for the six variations of retrofitting, compared to the current situation. For all variations (except for the actual condition), calculations considered an improved level of thermal insulation (external walls: U = 0.2 W/m<sup>2</sup>K) and new windows (U = 1.3 W/m<sup>2</sup>K). This causes a substantial improvement in the heating energy demand. If the air change set according to the required 5 m<sup>3</sup>/h m<sup>2</sup> (approx. 30 m<sup>3</sup>/h pers), the heating energy demand rises sharply, in spite of the clearly improved level of thermal insulation (compared to the current situation). How important it is to use a heat recovery system becomes quite clear on directly comparing Case #2 and Case #3. This is why any further considerations are based on a heat recovery system with an efficiency of 80 %. The predicted profiles of indoor air humidity and indoor air temperatures are represented in FIG 5.

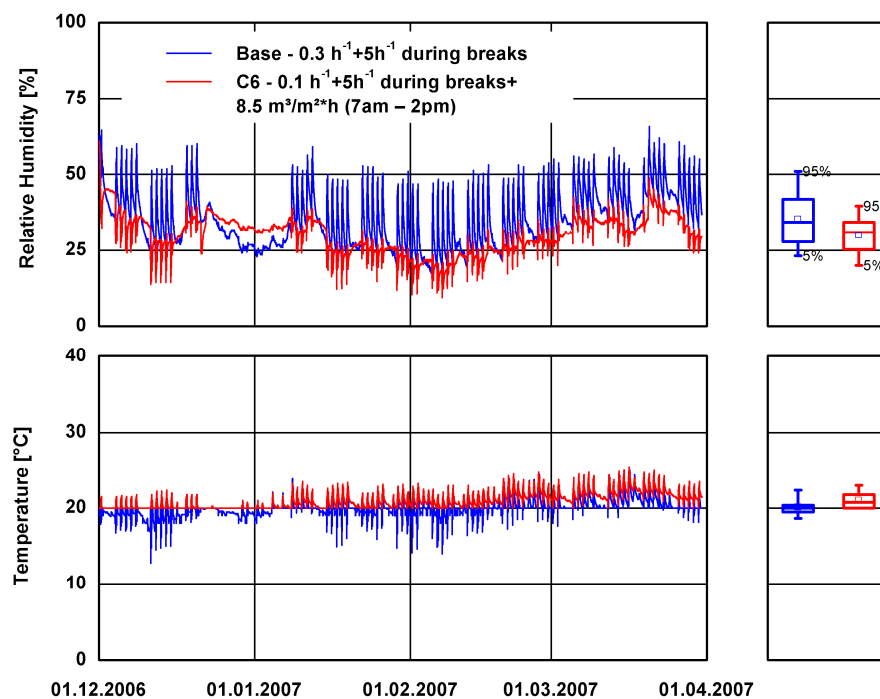

FIG. 5: Calculated profiles of relative humidity and temperature inside the classroom for the original classroom and the suggested retrofitting (case 6).

In FIG 6 the resulting concentrations of CO<sub>2</sub> are compiled for an exemplary day. In the upper part of the diagram the corresponding air change rate is plotted, the calculated indoor-air concentration of CO<sub>2</sub> is indicated in the lower part. Limiting the maximum permissible relative humidity to 55 % achieves the most favourable situation regarding the heating energy demand - but the concentration of CO<sub>2</sub> is hardly improved at all. If the

maximum permissible concentration of  $\text{CO}_2$  is limited to 1,500 ppm (0.15 vol%) the total heating energy demand amounts to almost 450 kWh. Under aspects of energy use, this is the least favourable solution at all. This is why case 6 was computed for a variation assuming the classroom to be vented at a reduced air change rate of  $8.5 \text{ m}^3/(\text{h m}^2)$  between 7 am and 2 pm, with additional thorough window ventilation during the breaks. This variation also produces clearly improved  $\text{CO}_2$  concentrations. Temporarily, 0.15 vol% are slightly exceeded after three hours of teaching lessons. However, this situation can be improved by additional thorough venting after every lesson (i.e. after 45 min the classroom will be thoroughly vented). The calculations presented in this context are intended to facilitate the assessment of different ventilation concepts by way of nonsteady-state computation. However, it is not possible to assess the demand of final and/or primary energy on the basis of these calculations.

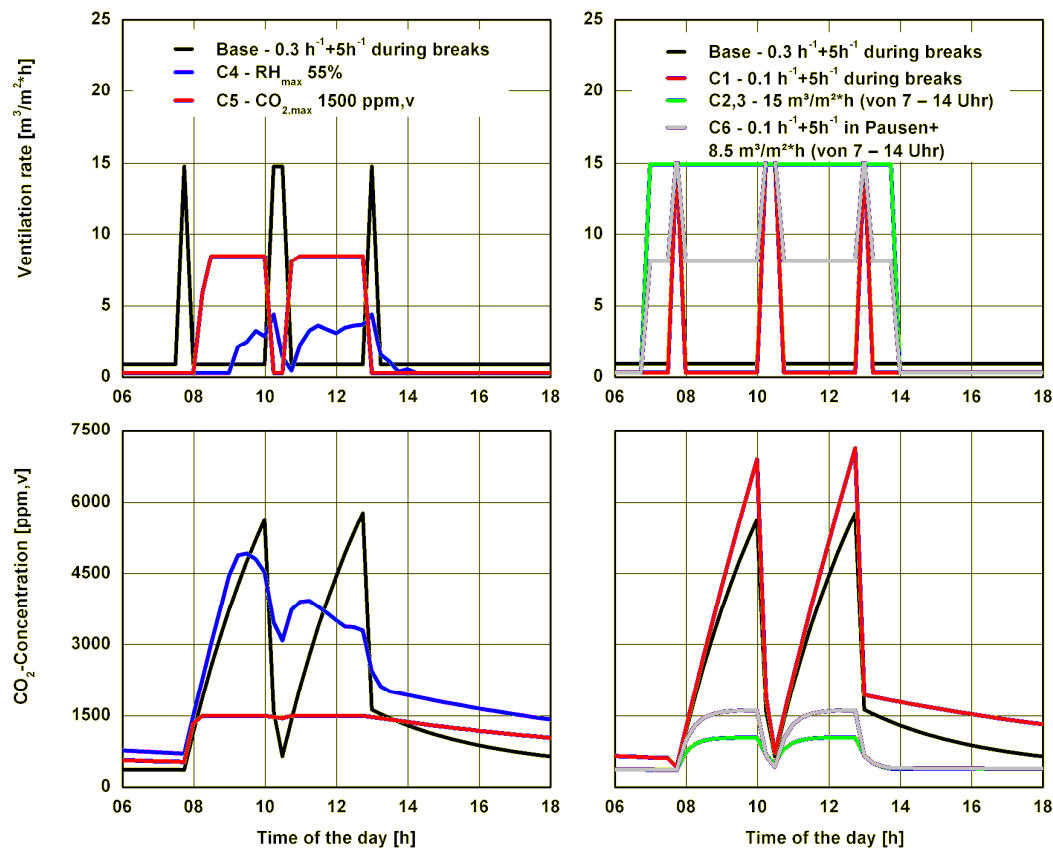

FIG. 6: Assumed outdoor air change and calculated  $\text{CO}_2$ -concentration profile resulting inside the class room

## 5. Conclusions

Approaches are given for solutions for the classroom 205 described above. Besides the thermal improvement of the external wall and the upper floor for energetic retrofitting measures to improve thermal comfort are to be described primarily. To improve air quality, an air quality measuring instrument with red, yellow and green light indication similar to traffic lights is most suited. This instrument is used in combination with window ventilation, supported by an actuator for the individual window sashes so that opening the window is easy to dose. To support adequate ventilation to achieve good air quality in the classroom, pupils must cooperate (energy foxes). It is planned to entrust as many pupils as possible with the „job of an energy fox“ in the class, i.e. being responsible for adequate ventilation. It is also planned to support the users of a building by designing façades in combination with actuators to offer more variability in opening the windows during lessons and to allow nevertheless short-term ventilation by air passage and total air change during the breaks. Manual operation during lessons should also be possible. To use the cooling potential in the foothills of the Alps during the night (or cooling during the early hours of the morning before lessons begin) in summer, a control system dependent on external temperature and time can be arranged.

Old windows should be replaced by new ones with improved thermal insulation. Selecting glazing it must be taken into consideration that the light transmittance of the glass must not be essentially reduced in order to avoid any further deterioration of the low supply of daylight of the room. The total energy transmission coefficient of the glazing should be lower (approx. 50%) in comparison to the old windows.

To improve thermal comfort in summer and solar protection, it is important to install new and efficient solar protection systems or more efficient (solar and glare protection) sun blind fabrics. Moreover and besides a weather-dependent control system, an automatic control system of the solar protection must be integrated to avoid the heating-up of classrooms after the lessons are over in the afternoon during intensive solar radiation. Manual operation by the users must still be also possible.

To improve room acoustics it is necessary to install sound-absorbing suspended ceilings and sound-absorbing wall panels with the dimensions of approx. 5 m x 1.2 m on the back wall. The double door towards room 204 is to be replaced by a door with a weighted sound reduction index of  $R_{w,P} = 42$  dB (i.e.  $R_{w,P} = 47$  dB). The door leading to the corridor is to be replaced by a door with the weighted sound reduction index of  $R_{w,P} = 32$  dB (i.e.  $R_{w,P} = 37$  dB).

Measures to improve ventilation and thermal comfort as well as lighting can be assessed together with energetic considerations. Acoustic measures, however, are generally independent of energy savings. Measures, which improve indoor climatic conditions, but are irrelevant for the retrofitting of schools either from the environmental point of view or as concerns reduced operating expenses, risk remaining unconsidered, as they are not favoured by any monetary argumentation. The conclusion therefore is that a comfortable indoor environment, including adequate acoustic conditions of the classroom, are prerequisites for good learning. Schools are primarily meant to provide the education of our children!

## 6. Acknowledgement

The investigations in the grammar school of Miesbach were performed within the framework of the project „Integral further development of school buildings with the focus and under the aspect of utilisation-optimized preservation of resources – conception phase of model project at the grammar school in Miesbach/Bavaria”, financed by the Deutschen Bundesstiftung Umwelt (German foundation to promote innovative and exemplary environmental projects) and the Kreissparkasse Miesbach-Tegernsee (local savings bank).

## 7. References

The OECD Programme for International Student Assessment (PISA), <http://www.pisa.oecd.org/>

Informationsdienst BINE: Gebäude sanieren – Schulen. Themeninfo I/06, FIZ-Karlsruhe 2006.

Grams, H.; Hehl, O.; Dreesman, J.: Niedersächsisches Schulmessprogramm: Untersuchung von Einflussfaktoren auf die Raumluftqualität in Klassenräumen sowie Modellierung von Kohlendioxid-Verläufen. Niedersächsisches Landesgesundheitsamt. Projektbericht Dezember 2002 und Ergänzungen November 2004.

Fromme, H.; Dietrich, S.; Kiranoglu, M.; Twardella, D.; Schierl, R.; Nowak, D.; Heitmann, D.; Körner, W.: Frische Luft an bayerischen Schulen. Untersuchungen zur Verbesserung der Luftqualität. Vorläufige Zusammenfassung. Bayerisches Landesamt für Gesundheit und Lebensmittelsicherheit, September 2006

Institut für Lebensmittel, Arzneimittel und Tierseuchen Berlin (ILAT) und Landesamt für Arbeitsschutz, Gesundheitsschutz und technischer Sicherheit Berlin: Dicke Luft im Klassenzimmer? Innenraumluftqualität in Berliner Schulen. Untersuchungen im Berliner Stadtgebiet 2002/2003. Ohne Jahresangabe.  
[http://www.bbges.de/content/fileadmin/res\\_bbges/dicke-luft.pdf](http://www.bbges.de/content/fileadmin/res_bbges/dicke-luft.pdf)

Integrale Weiterentwicklung von Schulgebäuden mit Schwerpunktsetzung auf nutzungsoptimierte Ressourcenschonung – Konzeptionsphase Modellvorhaben am Gymnasium Miesbach/ Obb. – Gemeinsamer Abschlussbericht der Projektpartner. In Print

A. Holm, H. Kunzel, K. Seldbauer. 2003. The hygrothermal behaviour of rooms: combining thermal building simulation and hygrothermal envelope calculation. Eighth International IBPSA Conference, Eindhoven, The Netherlands, August 11-14, 2003, 499-505.

# Energy efficiency and saving on lighting: the case study of a modern art museum.

*Antonio Frattari, Full Professor;  
University of Trento, Trento, Italy;  
antonio.frattari@unitn.it*

*Michela Chiogna, Phd student  
University of Trento, Trento, Italy;  
michela.chiogna@ing.unitn.it*

**KEYWORDS:** *automation system, lighting, energy saving, supervision system.*

## **SUMMARY:**

*Given new and emerging standards and requirements in Europe regarding energy performance of buildings (see, for example, EPBD 2002/91), it has become increasingly important to improve the energy effectiveness of building operation. Toward this end, efficient daylight-responsive systems for illumination of buildings (including installation of automatic lighting control systems) can provide a significant contribution (EN 15193). At the CUnEdI (University Centre for Intelligent Building) of the University of Trento, study and research activities have been carried out in order to define a new methodology for the design of lighting systems, using automation technology to optimize the energy demand.*

*In this paper, we present the application of this design method and the final results of the yearly energy saving amount for a specific case study: the MART (Modern and Contemporary art Museum of Trento and Rovereto - Italy).*

*The lighting control system of the museum was operated in a conventional manner: luminaires was switched on and off manually by the staff in a central station control. In order to improve the energy efficiency of the lighting system, different automated control regimes were implemented and monitored over the first year of installation: occupancy detectors, illuminance sensors and dimming actuators, have been installed and programmed specifically for each scenario, defined on a temporal and by event definition.*

*We compared the lighting energy use in the museum operated in the traditional manner and implemented with the automated scenarios: a considerable amount of lighting energy has been saved, covering in almost one year the installation cost.*

## **1. Introduction: state of the art analysis**

### **1.1 Sustainability and lighting control system**

Climate changes are one of the main challenges that our society will face in the incoming years.

Given concerns regarding global warming, the urgency of reducing CO<sub>2</sub> emissions is growing. In this context the built environment plays an important role: the residential and commercial sectors account for more than 40% of end energy consumption in the European Community and are thus responsible for an important part of carbon dioxide emissions systems [UNEP, 2007]. Thereby the fulfilment of the Kyoto commitment for the reduction of Green House Gas emissions results to be a main goal of our society. Lighting has a substantial impact on the environmental [ECCP, 2001]: the commercial sector account more than 25% of energy consumption in EU for the lighting sector. Considerable savings could be achieved even by application of intelligent control technologies in existing buildings, with acceptable economical parameters [Zalesak M., 2006]. New European Regulations refer specifically to the use of occupancy and light sensors to control the artificial light and to improve the systems efficiency [prEN 15193-2006]. The referred standard also gives advice on techniques for separate metering of the energy used for lighting that will give regular feedback on the effectiveness of the lighting controls and thereby recommends the use of supervision system. In the commercial sector the management of the museums could play an important role, as building typology that usually requires a considerable amount of electricity use for the exposition halls mounting.

## 1.2 Case study layout and project issues

The MART is one of the building consumers in the Trento Province that has the highest energy consumption. It is a very complex and spread building with considerable visitors flux.

The museums appurtenances are developed in three floors and outside spaces, including terraces, panoramic ways and a square partially covered by a couple, that is the museum symbol.

All the museum complex occupies a surface of 80.000 square meters ca., of which more than 4.300 are exhibition halls. The subdivision of the functional areas, included in the referred study, are the following: at the underground floor (-5.25 m) many caveau (depending on the different work of art typology guarded), book archive and library; at the ground floor foyer, book shop, bath rooms and conference hall; at the first floor exhibition halls, offices and class rooms; at the second floor the main exposition area [FIG. 1]. The natural light, available in the exposition area only on the second floor from roof-lights, is not used in this zone because it is uneven and changeable during the day, depending on weather and seasonal conditions. For this reason the dimming regulation of the light in relation with the solar light contribution does not play a crucial strategy for this specific case study. The visitors' amount of the museum complex is included between 2.200 and 2.500 pro day.

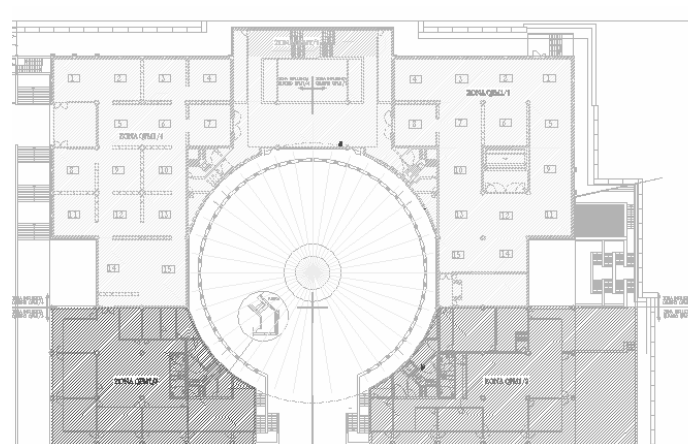

FIG. 1: Distribution of the functional spaces on the first floor: exhibition halls (light grey), didactic area and offices (dark grey).

In the 2006 its energy consumption amount has been about 2.300.000 kWh for both lighting and heating/cooling system. Almost one half of this value is related to the lighting electricity use.

In order to improve the energy demand of the museum, the APE (Provincial Agency for the Energy of the Autonomous Province of Trento) and the technical and management committee of the MART its self declared the imperative requirement to individuate new strategies to use the building systems. For this reason the CUnEdI has been charged with defining the technical and functional characteristics of an additional automation system that could be an integration of the existent electrical system, improving it in terms of energy saving.

In this paper the design of the lighting automation system will be presented. This intervention has been realized during November and December 2006; afterthat the energy saving has been monitored for all the year 2007.

At the state of the art the lighting system was controlled in one single place, located by the ticket booth, where only the complete switching on of the whole museum was permitted. In this room the switching of the light was controlled by authorized personnel two times per day: the first time around 6.00 AM, at the beginning of the cleaning shift, when all the luminaires were switch on as in the opening museum configuration (this situation remained the same during the whole occupancy period of the museum); the second time at 22.00 PM, after the evening cleaning shift, even if the opening period of the expositions is from 10.00 AM to 18.00 PM [FIG. 2]. The complete switching on of the indoor and outdoor lighting system of the building was activated without a direct relation with the activity typology, the effectiveness required for a specific action, the occupancy level of the museum's rooms and of its outdoor places.

Sometimes the light could be forgotten on during all the night, because of a human error. Otherwise the lights were turned on purpose continuously, day and night, because the light designer set a specific light configuration that could be modified by the system turning off. This use of the inside and outside museum lighting system could make increase fast and unreasonable the energy demand, so to reach the energy consumption amount cited above.



FIG. 2: Glass couple on the museum square (left side); electric cabinet for the manual centralized control of the previous system.

## 2. Method

The research presented in this paper aims to reduce the lighting energy demand of the MART, through the use of an automation system, defining functional scenarios in relation with the different activities operated in the building.

The designed scenarios are based on three parameters:

1. Illuminance level setting: definition of the luminous flux intensity as function of the role operated in a specific space
2. Timing setting: individuation of a specific chronology for event/activities
3. Spatial setting: subdivision of the museum spaces in homogeneous sub-area, characterized by the same lighting control strategy.

The method adopted for the automation system design is structured in the following steps:

### 1. Analytical and programmatic phase

This step includes an accurate check of the existing wirings and their functionalities, verifying both technical documentation and electrical drawings. As completion of this phase, the precise confirmation of the installed system has been carried out during survey actions in the building. For this scope, specific sheets have been developed for each functional space, containing the luminaires typologies, the related electric panels and the use of each control channel.

### 2. Propositional phase: system solution

This action involves the preparation of drawing boards and technical reports for the adopted solutions, with particular attention to the activation mode of the automatic control system (concerning both the position and the technical characteristics of the automation system devices).

A synoptic table containing the **functional cycles** of the new installation has been developed. In order to preview the potential energy saving of the news installation, the previous energy demand (with the traditional electric system) has been calculated as theoretical value, considering the lighting power installed and its utilisation period. It is not easy to achieve this probabilistic prevision by the conventional lighting software tool, because the daynamic simulation of the use for a so complex building involves too many parameters.



The regulation in force for the indoor spaces requires the verification of the photometric parameter standard for the working and public places (offices, classrooms, and so on) but there is any specification with reference to the exposition halls, where the illumination typology and intensity is strictly related to each single art exhibit [EN 1264-1, 2004; table 5.5].

### *3. Evaluation phase: evaluation and verification*

Checking the electricity bills concerning 2 years with the previous lighting system (2005-2006) and the one related to the first utilize year of the new automation system (2007), the comparison between the energy demand with or without the intelligent devices has been carried out. In addition the user's satisfaction with the new control system has been evaluated.

## **3. Automation system design**

The technology used to realize the lecture halls is a comprehensive, integrated system for home and building automation for the implementation of upwardly compatible and flexible systems: the Konnex solution.

KNX is a standardised [EN 50090, ISO/IEC 14543], OSI-based network communications protocol for intelligent buildings. It is the successor to, and convergence of, three previous standards: the European Home Systems Protocol (EHS), BatiBUS, and the European Installation Bus (EIB).

This standard allows all electrical components to be interconnected through an electrical bus so that every component is able to send commands to other components, no matter where they are [EIB Konnex Association, 1999].

KNX standard allows a remarkable flexibility for the electric system, not only regarding the bus wiring but also the quantity of devices available on the market that are possible to interface using this protocol. There are about 120 companies of electrical supplies using this communication protocol.

From the point of view of the location of the intelligence of the domotic system resides, there are three different architectures:

- **Centralized Architecture:** a centralized controller receives information of multiple sensors and, once processed, generates the opportune orders for the actuators.
- **Distributed Architecture:** all the intelligence of the system is distributed by all the modules that are sensors or actuators. Usually it is typical of the systems of wiring in bus.
- **Mixed Architecture:** systems with decentralized architecture as far as they have several small devices able to acquire and to process the information of multiple sensors and to transmit them to the rest of devices distributed by the house.

KNX is a decentralized open system that fulfils the requirements of project design, installation, commissioning and operation of the bus system. For these operations a software tool is needed: ETS3. For the referred case study the KNX system has been connected with a supervision system in order to have the global overview and control of the lighting state and regulation. In the following paragraphs both devices installed technical details and supervision system functionalities have been analyzed.

### **3.1 Bus devices installed in the case study system: technical detail**

A functioning bus device principally consists of three parts: bus coupling unit (BCU), application module (AM), and application program (AP). BCU are currently available for connection to two different media: Twisted Pair (Safe Extra Low Voltage 32V) or Powerline (mains power). The system installed in the referred case study uses a TP connection.

Bus devices can principally be divided into three classes: input devices or sensors, in the case study design switches, light sensors, occupancy sensors, weather station and timer switch; output devices or actuator, in the case study design on/off actuators and dimming actuators; controller.

The control of light system in outdoor spaces depends on the presence detections, the outside illuminance level and the activities program (public event or usual use). Only on/off activations have been select for all the outside wirings, in relation with the luminaires installed (unequipped with dimming ballasts).

During the cleaning time the lighting system will be operated sector by sector, as function of the effective occupation of the cleaning worker on each floors.

In the museum opening time the pre-selected lighting configuration will be automatically operated, in compliance with the light designer setting. In this operation the dimming and on/off actuators will be used by the visualization supervision interface.

The **dimming/switching actuator** is a DIN rail mounted device for insertion in a distribution board. The connection to the EIB is established via a bus connecting terminal. It has more independent channels, to select for the specific requirements. They can dim different luminaires (load types). Using automatic load detection, the device is able to set its output to various loads. The automation system design for the referred case study includes around 300 wirings on/off (27 on-off actuator with 12 channels) and 200 wirings dim (63 dimming actuator 0-10V with 4 channels) for the lighting configuration of the exhibition halls), for a global luminaires amount of 3.078 units inside and 358 units outside.

The **presence sensors** chosen for the specific case study is assembled on solid ceilings or walls in outside conditions and could have a detection zone of 360°, 220° or 180°. The movement detector has a photo-electric sensor function too. This function triggers telegrams when the brightness level exceeds or falls below set values. The recovery time and the sensitivity of the integrated photo-electric switch can be set using the two potentiometers at the back of the movement detector or via the parameters in ETS. It is also available with a multi-lens and modified detection range.

The **weather station** is used primarily for detection of brightness (1,000...99,000 lux), rain (upper sensor and lower surfaces are permanently heated), temperature (– 30 ... + 50 °C), day/night (under 10 lux is night at more than 10 lux it is day -one minute and 15 seconds after the brightness value has exceeded 10 lux) and wind speeds (0...24.0 m/s). This device has over 41 communication objects. Moreover in the case study application mainly the measured values function has been used, in order to send the current actual values and to control the light under the covered square.

The **time switch** can send switching or value telegrams to EIB actuators at the specified times. There are 324 memory locations available with free weekday block formations. Using a program for use during holidays, the execution of the programming can be interrupted for up to 45 days. The time switch has a priority switching operation (single operation) for special days databank. In the specific case study this device activates the sequence of the defined functional cycles as reported in [Tab.1].

FUNCTIONAL CICLES	PERIOD
Usual night: library open	from 18,00 to 22,00 selected day
Usual night: library closed	From 22,00 to 7,00 selected day
Night with special event	From 18,00 to 1.00 selected day
Museum opening time	from 10,00 to 18,00 (Friday until 21,00)
Museum cleaning time	from 7,00 to 10,00 and from 18.00 to 20.00
Maintenance	Monday all the day

TABLE 1: Functional cycle definition

### 3.2 Supervision system

The supervision system selected for the case study (eVision) is a software tool with a graphical interface for execution of a system based on bus with KNX communication protocol. It allows a total personalization of graphical interface and it keeps under control the following devices: emergency lamps, on/off actuators, dimmer, on/off and numerical indicators, thermostat, roll up shutter actuators. In the referred design only the lighting system is included in the supervision system.

The software allows the insertion of an unlimited number of objects to control and it is provided with functions for dynamic scenarios realization and logical operations.

By means of the visualisation program it is possible to check, floor by floor and room by room, the state of the lights. The five functional cycles have been included in the control panel, so that the automatic activation of each scenario could be controlled or manually forced for specific event directly by the supervision software. The

lighting design can use this software by a laptop directly during the commissioning in the exhibition halls. It is possible to define the performance of specific lighting configuration and memorized it in order to re-use it for future applications.

## 4. Results

Comparing the data of the monthly energy consumption in 2006 and the one monitored in 2007<sup>i</sup> it is possible to note a remarkable reduction of the global electricity use, equal to 28.5% calculating the yearly overage. This energy use is related not only to the lighting system, but also to the heating/cooling system.

This result corresponds to a reduction of energy use pro month included between 38.847 kWh and 63.357 kWh, for a global yearly amount equal to 607.656 kWh [Fig. 3 and 4].

The only one system improvement operated on the referred building between 2006 and 2007 is the one described in this paper concerning the introduction of the automation system for the lighting control, in addition it is possible assert that the same operation trend has been maintained (opening hours and exhibition time) during the year 2007. Comparing the energy demand between 2004 and 2006 it is possible to note that there is a quite similar energy demand trend, so that it is reasonable to affirm that the museum energy demand is not strictly related to the weather outside conditions, considering the building location and climate zone too.<sup>ii</sup> Depending on these observations, the improvement of the lighting system by the automation system application is the main cause of the energy saving amount in 2007.

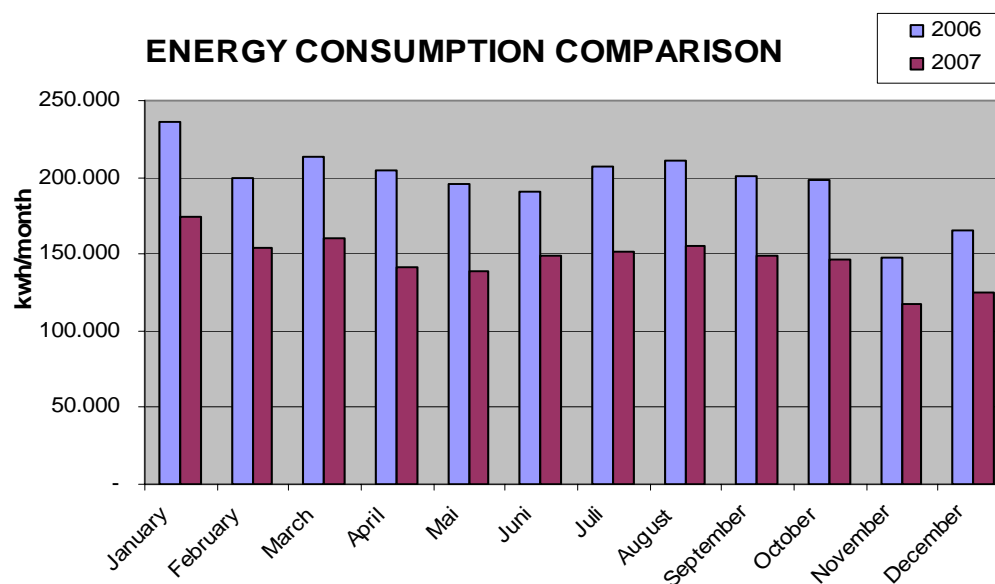

FIG. 3: Monthly energy demand during 2006 and 2007: monthly values.

<sup>i</sup> The official electric bill is not yet available for the last three months of 2007. For this reason a personal check of the energy consumption on the museum electricity counter has been done. These data have been compared with the mean energy demand in 2004 and 2005 so that it was possible to estimate the energy consumption trend for the last months too.

<sup>ii</sup> Any significant climate change has been recorded comparing the solar year 2006 and 2007, neither in the summer or in the winter temperatures, so that it is possible to affirm that the recorded energy saving is not caused by a different use of the heating/cooling system.

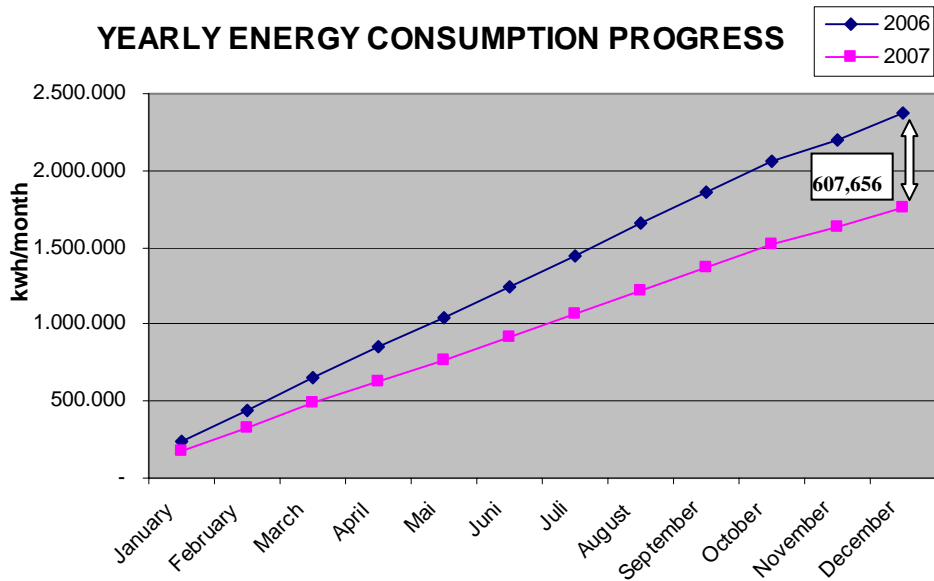

FIG.4: Pprogressive amount of energy saving.

These data can be more significant if they are converted in equivalent kilogram of CO<sub>2</sub> or in Euro saved [Fig. 5 and 6]. In particular the emissions of 354 ton of CO<sub>2</sub> has been avoided, that are equivalent to the emission caused by over 100 cars pro year<sup>iii</sup>. In other terms, this value is comparable to the CO<sub>2</sub> consumption for the total management of over 200 flat of mean dimension (80 square meters).

The economic valuation of the automation system installation is very profitable as well: indeed the automation system cost has been 80.000 € against the 90.000 € saved only in the first year of the new system utilisation.

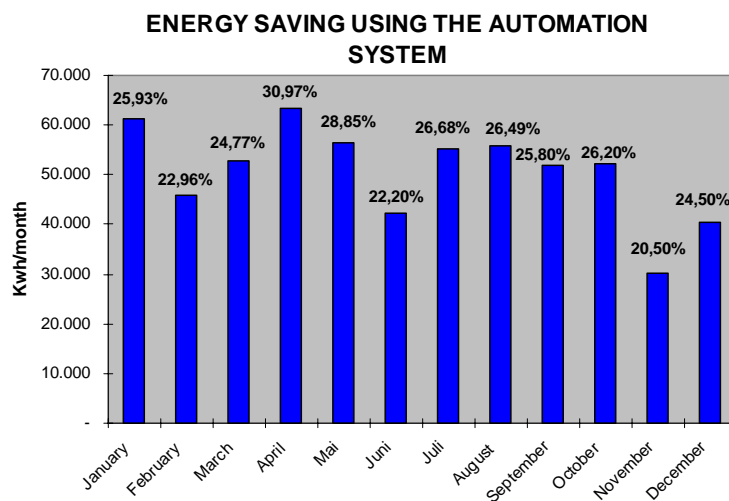

FIG. 5: Monthly energy saving in kWh and percentage.

<sup>iii</sup> For this estimation has been considered a mean distance covered equal to 20.000 km pro year and a mean fuel consumption of 162 gr. CO<sub>2</sub>/km in 2004 (European report 08/02/2007 about the CO<sub>2</sub> emissions of the cars: [www.europarl.europa.eu](http://www.europarl.europa.eu)).

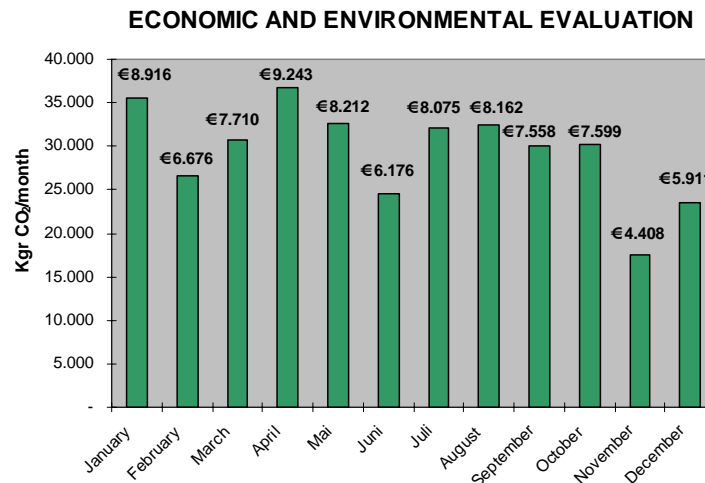

FIG. 6: Environmental and economical sustainability evaluation (respectively in terms of Kg of CO<sub>2</sub> and Euro).

## 5. Conclusions

At the present time it is becoming increasingly important to control and improve the energy consumption in the buildings. For this issue, it is strategic to explore and quantify the benefits of typical energy saving design measures (automated systems) compared with traditional operation systems (manual system), establishing a realistic baseline of the actual lighting energy consumption for the different scenarios nowadays used. The features of lighting simulation tools nowadays available underline the importance of defining suitable reference cases for benchmarking the performance of automated lighting control. The control strategy of the lighting system of the MART, using the referred automation techniques, demonstrates to can generate an improvement in the energy efficiency that produces not only an economic profit, but also a substantial reduction of the consumption of un-renewable resources. The analysis of the energy saving potential of automated lighting scenarios have been monitored in real use conditions and not in controlled laboratory environment, in order to prove the automation systems efficiency in operating time. The reduction of the CO<sub>2</sub> emissions produced by the new system installed, measured in the first commissioning year and previewed with the same trend for the next operating period, is a good result for the specific case study presented. In addition the application of the new design tools could be applied in different building typologies: the methodological approach defined in this research could be a general praxis to be used in other case studies.

## 6. References

- EN 1264-1 (2004). *Light and lighting - Lighting of work places - Part 1: Indoor work places*
- UNEP (2007). *Report on Building and Climate Change*
- European Climate Change Program (2001) *Final Report*
- PrEN 15193 (2006) *Energy performance of buildings — Energy requirements for lighting*
- CENELEC EN50090 (2002) *Home and Building Electronic Systems (HBES)*
- Zalesak M. (2006) *Possible impacts of intelligent technologies application in residential buildings on energy efficiency*, proceeding of KNX scientific Conference 2006, 9-10 November 2006, Vienna
- [www.europarl.europa.eu](http://www.europarl.europa.eu): UE report 08/02/2007
- IESNA (2000) *The IESNA Lighting Handbook, 9th ed. New York:IESNA*

## Acknowledge

The authors would like to thank the technical staff of MART and APE, that proposed and financing the project and Ernesto Patti toward the support in the automation device selection.

# Heat pumps for conservation heating

*Tor Broström, PhD, Assistant Professor,  
Gustaf Leijonhufvud, Research Assistant*

*Gotland University, Department of Building Conservation;  
tor.brostrom@hgo.se, www.hgo.se*

**KEYWORDS:** *conservation heating, climate control, heat pumps*

## **SUMMARY:**

*Conservation heating is used to control relative humidity in order to better preserve historic buildings and their interiors. The heating load for conservation heating when applied in a Nordic climate was characterized in order to investigate if and how air-to-air heat pumps can be used for conservation heating. Heating for conservation results in indoor temperatures that follow the seasonal variation of the outdoor temperature. Depending on the season and moisture load on the building, the indoor temperature will be 0-10 °C higher than the ambient temperature. The heating load is much smaller and more stable over the year as compared to heating for comfort. In the south of Sweden conservation heating is motivated mainly by preservation aspects, whereas in northern Sweden the potential for energy saving is considerable. Heat pumps in general and air-to-air heat pumps in particular, have properties that match the requirements of conservation heating and can provide a cost effective solution. Heat pumps specially designed for conservation heating could improve the performance radically in relation to standard heat pumps.*

## **1. Introduction**

### **1.1 Background**

Climate induced degradation is one of the major threats to historic buildings and their interiors. The best conservation strategy is to act in order to prevent damages. Climate control, when properly used, is an efficient and cost-effective method for preventive conservation. The present paper deals with historic buildings, such as churches, castles and manor buildings where preservation is a primary consideration in determining the proper indoor climate. Climate control in this type of buildings should ideally be a combination of passive control and active measures such as heating, ventilation, humidification, and dehumidification. In practice, heating is often the only kind of active climate control available.

Heating used to control relative humidity (RH) for preservation purposes is called *conservation heating*. Conservation heating is used mostly in temperate climates in buildings that are heated for comfort intermittently or not at all. The effects of conservation heating on the preservation of buildings, interiors and objects has been the subject of a number of investigations, (Staniforth et al 1994, Padfield 2007, Maekawa 2003 and Neuhaus et al 2006)

In Scandinavia a limited number of churches use conservation heating in combination with intermittent heating for services. Background heating, i.e. heating the building to a constant temperature, is used in a wide range of building types even though the objective is seldom clear. Many historic buildings are unheated, but would require some kind of climate control to reduce relative humidity. Other old buildings, for example churches, can no longer be heated due to increasing energy costs. Global warming may increase the need for conservation heating in some regions. A number of warm and humid summers and autumns during the last ten years have caused mould in buildings that have been without problems for hundreds of years.

Conservation heating is becoming more common in Scandinavia and national policies for conservation heating have been discussed. There is a growing pressure from building owners to use relatively cheap air-to-air heat pumps for conservation or background heating. It has become clear that the consequences of and requirements for conservation heating in a Nordic climate are not well understood. Engineers, conservators and policy makers need scientific facts, methods and verified solutions in order to use conservation heating in a responsible manner.

## 1.2 Objectives

The primary objective of this paper is to investigate, from an engineering point of view, if and how air-to-air heat pumps can be used for conservation heating. In order to do this, the heating load for conservation heating when applied in a Nordic climate must be characterized in a general way, not only for individual objects. This analysis will also add new and relevant information about conservation heating in general when applied in a Nordic climate.

## 2. Indoor climate criteria for preservation

One major problem in controlling the indoor climate in historic buildings is to specify the appropriate climate. For museums, the research and development on climate specifications is summarised in ASHRAE handbook (2007). There is a continuous development and discussion about climate specifications which is well reflected by the contributions to the conference on Museum Microclimate in Copenhagen 2007. Often the museum requirements are too strict for historic buildings; this is due to the use of the building or to economic limitations. The present paper does not intend to extend the knowledge or discussion about climate requirements. The following is a description of the general requirements for conservation heating.

An upper limit for RH is needed in order to prevent biodeterioration; mould, insects etc. Mould and other fungi depend on a combination of relative humidity and temperature (Krus et al 2007). At normal room temperatures the limiting RH is around 80%, the colder it gets, the higher RH can be allowed without any risk for mould growth. In Scandinavian historic buildings mould growth occurs mostly in late summer and early autumn when it is both warm and humid. Insects have optimal conditions between 20 and 35°C and RH above 70% (Child 2007). In defining the upper limit for RH one should take into account microclimates that may occur in parts of the building; in corners behind furniture etc.

The moisture content in wood and other hygroscopic materials depends on the surrounding relative humidity. As the moisture content varies, the materials will shrink and swell. In order to avoid damages, such as cracking, flaking and peeling, variations in relative humidity must be limited.

Salt damages are due to the crystallization of salt on the surface or inside porous materials. Repeated cycles of varying RH can be detrimental if crystals are formed and dissolved. The critical levels depend on the types of salt involved.

All organic materials degrade with time, the rate of degradation increases with temperature and RH. This means that, if we have a choice, cool and dry is generally better than warm and humid. Conservation heating increases temperature and reduces RH. The effects on degradation would tend to offset each other, but in some cases conservation heating could accelerate degradation (Padfield 2007).

In the following calculations, a set value for relative humidity of 70% has been used. This represents a minimum requirement for conservation heating that would give a stable indoor climate and a margin with respect to biodeterioration.

## 3. Conservation heating

The basic principle of conservation heating is to control the temperature in a building in order to keep relative humidity within given limits. Hygrostats are used to control the heat input, this is a reliable solution based on commercially available technology. The result is that the indoor temperature will follow the seasonal variations of the outdoor temperature throughout the year as shown in fig 1.

There are some limitations to the use of conservation heating. When the RH is too low, the temperature can only be reduced to the level set by the ambient temperature and/or the temperature of the interior surfaces. In the winter, conservation heating may result in uncomfortably low temperatures, even below 0°C. In the summer time conservation heating may result in uncomfortably high temperatures.

Assuming that the humidity by volume inside the building is the same as on the outside, the temperature required to maintain a specified relative humidity can easily be determined. In most buildings however, the humidity by volume is higher inside than outside. For buildings in general this can be related to the use of the building, but in many historic masonry constructions moisture is continuously added from the walls, (Broström 1996, Klens Larsen 2007). The evaporation from the walls increases with indoor temperature.

$$v_i = v_a + \Delta v \quad (1)$$

$v_i$  Indoor humidity by volume ( $\text{g}/\text{m}^3$ )

$v_a$  Ambient humidity by volume ( $\text{g}/\text{m}^3$ )

$\Delta v$  Humidity added from the building structure ( $\text{g}/\text{m}^3$ )

The indoor temperature required to maintain a given relative humidity depends on the specified relative humidity, the ambient humidity by volume and the vapour added from the building

$$T_i = f(\phi_{is}, v_a, \Delta v) \quad (2)$$

$T_i$  Indoor temperature ( $^{\circ}\text{C}$ )

$\phi_{is}$  Set value for the indoor relative humidity

A set value or range for RH should be defined by a conservation specialist, in this case 70% is used. The ambient vapour concentration depends on time and location. The humidity added to the indoor air depends on the building construction and the weather. A typical range of  $\Delta v$  from 0 to  $2 \text{ g}/\text{m}^3$  was used in the following calculations.

## 4. The heat load for conservation heating

The indoor temperature resulting from conservation heating was calculated based on climate data for two different locations in Sweden. Malmö in the south of Sweden has a mild coastal climate with a high RH most of the year. Östersund, located in the middle of Sweden has an inland climate, colder and drier than Malmö. Weather data for 2007 were used, provided by the Swedish Meteorological and Hydrological Institute.

### 4.1 Temperatures resulting from conservation heating

The indoor temperature required to maintain 70% relative humidity was calculated for a range of  $\Delta v$  based on monthly average values for the ambient climate in Malmö and Östersund, fig 1.

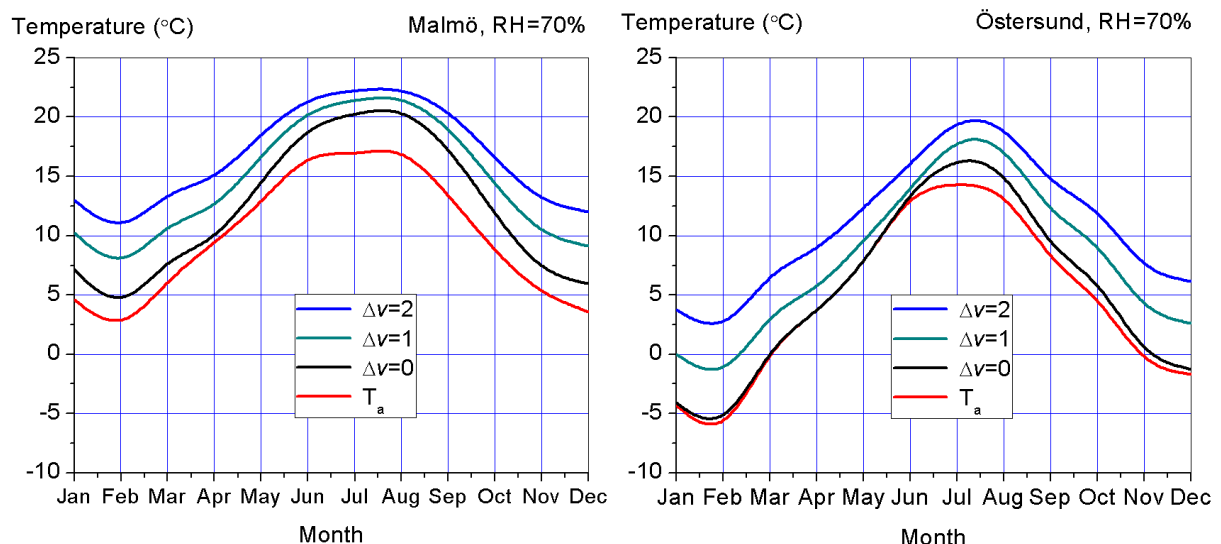

FIG. 1: Indoor temperatures resulting from conservation heating at 70% RH for Malmö (left) and Östersund (right) at varying values of  $\Delta v$ . The outdoor temperature is included for reference.



The calculated indoor temperature follows the variation of the outdoor temperature. In Malmö the indoor temperature is in the range of 3–23°C and in Östersund -6–20°C. Sub zero temperatures indoors are not necessarily a problem from preservation point of view, many castles and churches are left unheated in the winter without any problems.

Comfort in the buildings using conservation heating would be low in the winter, limiting the use of the building and increasing demands on intermittent heating systems for comfort. In the summer time the monthly average for the preservation temperature in Malmö reaches 22°C, which indicates that at times it will be too warm for comfort. In Östersund, summer heating would generally not be a comfort problem.

The amount of moisture added from the building has a significant influence on the temperature levels required.

## 4.2 Energy demand

To design heating systems in general, we need to determine energy demand and heating load variation over the year. For heat pumps in particular, this is crucial both for technical and economic reasons which will be explained in the following chapter. Rules of thumb and know how related to heating for comfort are not applicable, other design criteria must be used.

The heating power for conservation is indicated by the difference between the indoor temperature and the ambient temperature. By multiplying the temperature difference with the heat loss coefficient for a building, we get the heating power. Thus the monthly averages would give a relative indication of the monthly energy demand of a building.

The temperature difference,  $(T_i - T_a)$  required to maintain 70% RH was calculated for a range of  $\Delta v$  and compared to the temperature difference resulting from background heating with a constant indoor temperature 10 °C, fig 2.

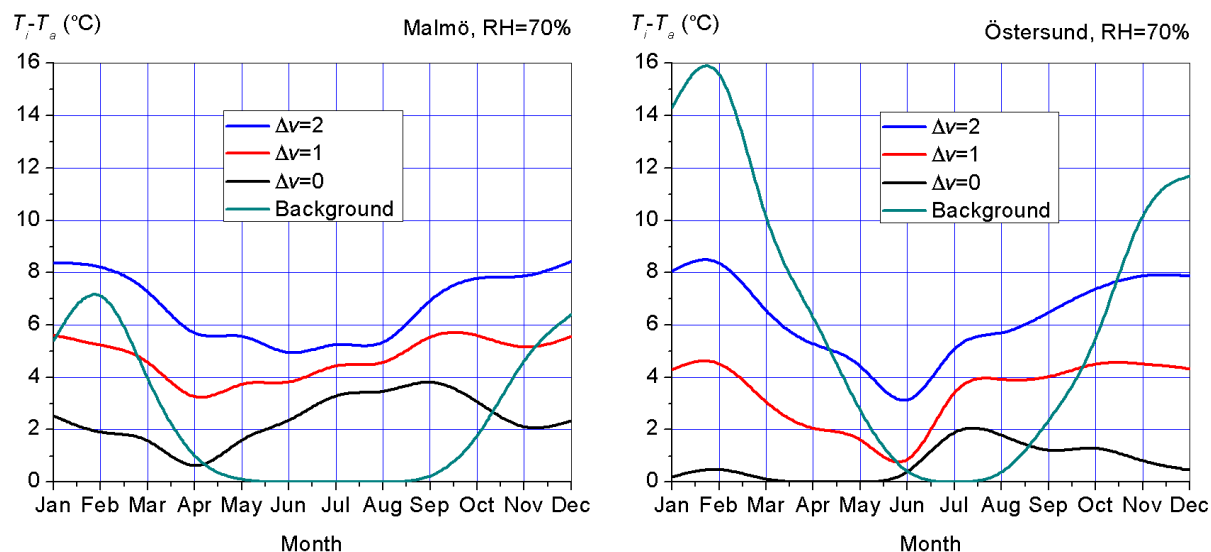

FIG. 2: The temperature difference  $(T_i - T_a)$  for conservation heating compared to background heating with a constant indoor temperature 10 °C.

It can be seen that the heating load for conservation heating is much more stable over the year as compared to low temperature background heating. The winter heating loads for both locations are remarkably similar. In Malmö, conservation heating would be needed throughout the year for all ranges of  $\Delta v$ . In Östersund, a dry building with  $\Delta v = 0$  would need conservation heating only a few months.

Table 1 shows the annual energy consumption, expressed as an annual average temperature difference, for conservation heating and background heating. It can be seen that conservation heating in southern Sweden does not necessarily lower the energy consumption as compared to background heating. In northern Sweden, conservation heating can give significant energy savings as compared to background heating. The moisture added to the indoor air from the walls is a very important parameter from an energy point of view.

TABLE. 1: The average annual temperature difference  $\overline{(T_i - T_a)}$  for conservation heating and background heating. The annual energy demand is proportional to this temperature difference.

	$\overline{(T_i - T_a)}$ for conservation heating			$\overline{(T_i - T_a)}$ for background heating		
	$\Delta v=0$	$\Delta v=1$	$\Delta v=2$	$T_i=8$	$T_i=10$	$T_i=12$
Malmö	2.4	4.7	6.8	1,6	2,6	3,7
Östersund	0,73	3,4	6,4	5,2	6,7	8,2

### 4.3 Heating power

To determine the optimal heating power of the system in relation to the heating load, a higher resolution than monthly averages is required. Since most historic building have a relatively high inertia with regard to temperature and humidity variations it was assumed that daily averages would be relevant in this case. The preservation temperature was calculated in the same way as in the previous cases, but based on daily average climate data. For design purposes the results are presented as load duration graphs, fig 3.

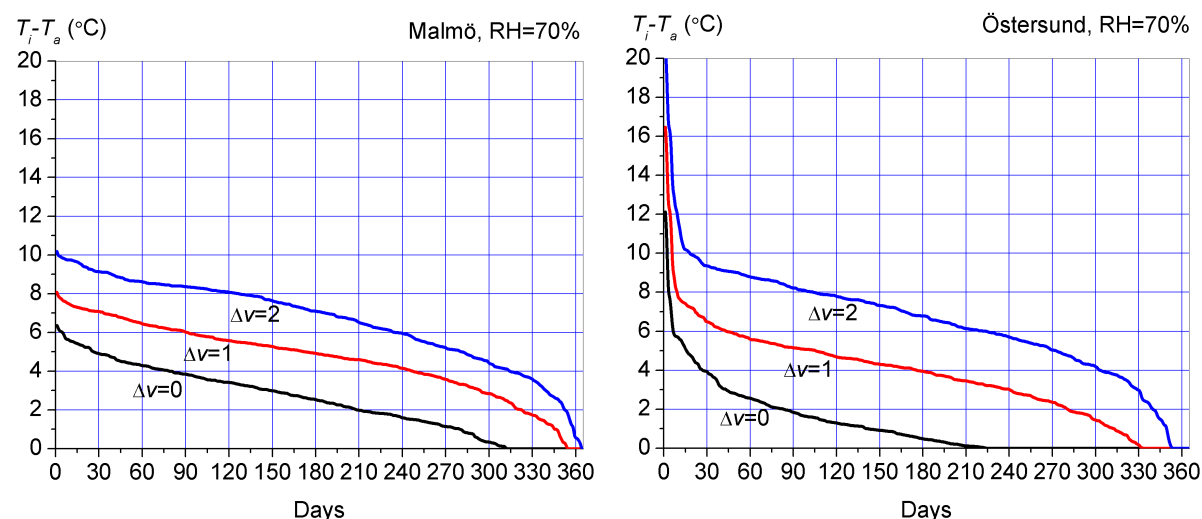

FIG. 3: Load duration graphs based on the temperature difference  $(T_i - T_a)$  required to maintain RH at 70%.

The load duration graph shows the maximum heating load, the time variation of the load and the energy demand over the year (as the surface under the curve). The load duration graph is a tool to find the optimal design of a heat pump, which will be explained in the next section.

The extreme values on the high end for Östersund are associated with a few very cold days. Since risk for mould is nonexistent, they could be disregarded in determining the maximum heating power.

The utilization factor is the ratio between actual energy produced over the year and the amount of energy produced if the system was running at full power the whole year. For Malmö and Östersund, the utilization factor would be 20-25% for comfort heating. For conservation heating it is in the range of 40-60%.

## 5. Air-to-air heat pumps for conservation heating

In the last years, air-to-air heat pumps have increased their performance to cost ratio dramatically. In combination with a relatively simple and unobtrusive installation, this makes them an interesting option for conservation heating. An additional benefit is that some air-to-air heat pumps can be used for dehumidification in the summer.

As shown above, the heating load for conservation heating is quite stable over the whole year. The ideal working conditions for a heat pump is a continuous and stable heat load. From a technical point of view this will enhance efficiency and makes the heat pump last longer. From an economic point of view, the heat pumps need a stable load to pay off a relatively high investment. For this reason, heat pumps in Scandinavia are generally not designed to cover the maximum load, as this leads to high investment costs and low utilization. The heat pump is designed for a base load, the top load is provided by an auxiliary heat source with lower cost per kW, typically direct electric heating. Consider the top curve in the left graph of fig 3. If a heat pump is designed to cover 80% the maximum load, it would cover around 95% of the energy demand.

The optimal combination of heat pump and auxiliary heating is determined by comparing the power cost and the energy cost for both heat sources:

$$C = C_F + C_E \tau \quad (3)$$

$C$  Annual cost per kW

$C_F$  Annual fixed cost per kW

$C_E$  Cost per kWh

$\tau$  Utilization time

The intersection of the cost lines for the heat pump and the auxiliary heat source define the optimal relation between the two heat sources, fig 4. By superimposing the lines on the load duration graph, we can determine the right heating power for the heat pump and the electric heaters to minimise the total heating cost.

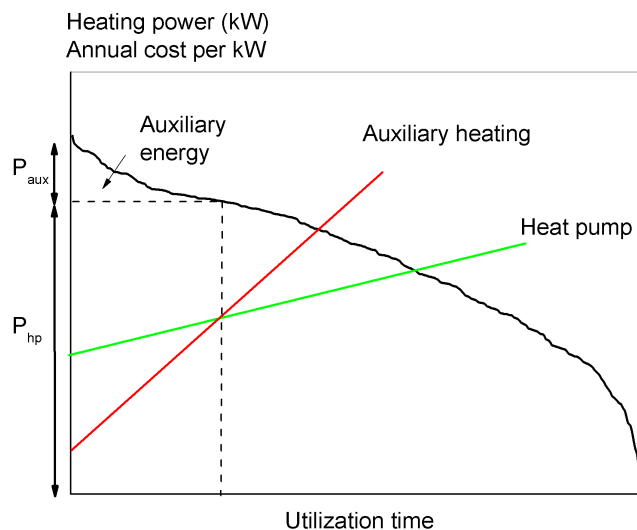

FIG. 4: By superimposing the cost lines for a heat pump and direct electric heating on a load duration graph, the optimal heating power for the heat pump  $P_{hp}$  and auxiliary power  $P_{aux}$  can be determined.

Thermodynamically conservation heating is a good match for heat pumps because their efficiency increases as the indoor temperature decreases. The coefficient of performance (COP) for a heat pump is defined as

$$COP = \frac{Q}{W} \quad (4)$$

Where

Q is heat produced (J)

W is work added (J)

For the ideal Carnot process the COP depends only on the temperature levels on the hot and cold side of the heat pump:

$$COP = \frac{T_1}{T_1 - T_2} \quad (5)$$

T<sub>1</sub> temperature of the heat sink (indoor air) (K)

T<sub>2</sub> temperature of the heat source (outdoor air) (K)

The performance of the ideal heat pump will improve radically as the difference between the heat source and the heat sink decreases. Even though this is an ideal process, the Carnot process sets the ultimate limit and potential for heat pumps. In practice COP may reach 60-70% of the Carnot value. Theoretically a heat pump designed and optimised for conservation heating could reach COP values around 10; this is yet to be investigated in practice.

Commercially available air-to-air heat pumps typically have COP-values in the range of 1,5 – 4,0 depending on the outdoor temperature and the load. These heat pumps are optimised for normal room temperatures, and can be operated at room temperatures down to 8-10°C. At lower indoor temperatures, defrosting becomes a problem.

Two pilot studies have been started with the objective to investigate if and how commercially available air-to-air heat pumps can be used for conservation heating. The objects are the church in Ludgo south of Stockholm and a vernacular 18<sup>th</sup> century dwelling house on Gotland. In the church, the main incentive was to save energy. The second building has severe moisture problems; mainly algae and insects. The results so far can be summarised as follows:

- The heat pumps provide a cost effective alternative to other heat sources. They are reliable and there have been no technical complications.
- The heat pumps are controlled by thermostats with a lowest temperature of 10 C. This is because defrosting cannot be guaranteed at lower temperatures. One company has introduced a hygrostatic control module which will be added on one of the heat pumps.
- It is not possible to see if the COP is higher due to lower indoor temperatures. Laboratory testing is on the way.
- Dehumidification was used in the dwelling house. Technically it works fine, but the control algorithms are not adjusted to conservation heating.
- With air-to-air heat pumps the heat is supplied by convection from a limited number of point sources. Investigations of resulting temperature distribution and air movements will be presented in the near future.

## 6. Conclusions

The present paper has related the heating load for conservation heating in a Nordic climate to the properties of heat pumps. The heating load is characterised by a low temperature difference ( $T_i - T_a$ ) and a relatively stable heating load over the whole year. The results provide rudimentary tools for engineers to design conservation heating systems. This is a first step, further studies should take into account transient effects, dynamic indoor climate requirements, more representative data for the ambient climate and a wider geographical distribution. Simulations and detailed field studies are needed to better understand conservation heating.

Depending on the use of the building, conservation heating may have to be limited for comfort reasons. It gets cold in the winter and warm in the summer. In southern Sweden, conservation heating would mainly be motivated by preservation, whereas in the northern part energy conservation would also be a factor.

Heat pumps in general, and air-to-air heat pumps in particular, have properties that match the requirements of conservation heating. They can provide a cost effective solution for conservation heating. Heat pumps designed and optimised for conservation heating could significantly increase the performance in relation to standard heat pumps. Air-to-air heat pumps may not be the ideal long term solutions for historic buildings, but in many cases, they could enable the use and preservation of the buildings until more appropriate solutions have been developed.

The results also show that there is an economic potential in controlling the moisture transport into the building by improving the structure and controlling ventilation and/or infiltration. Clearly there is a need for integrated solutions based on a combination of passive and active measures for climate control

Another application for conservation heating, which is becoming more common, is winter heating of summer houses. There is a huge potential for energy saving by using heat pumps and replacing thermostats by hygostats.

## References

- ASHRAE Handbook (2007) HVAC Applications, chapter 21: Museums, Galleries, Archives, and Libraries
- Bratasz L., Camuffo D. and Kozłowski R. (2007). Target microclimate for preservation derived from past indoor conditions. *Contributions to the conference Museum Microclimates*, The National Museum of Denmark, Copenhagen.
- Broström, T. (1996). Uppvärmning i kyrkor – Fukt- och värmetekniska beräkningar för dimensionering och klimatstyrning. Royal Institute of Technology, Stockholm.
- Child, R. (2007). Insect damage as a function of climate. *Contributions to the conference Museum Microclimates*, The National Museum of Denmark, Copenhagen.
- Klenz Larsen P. (2007). Climate Control in Danish Churches. *Contributions to the conference Museum Microclimates*, The National Museum of Denmark, Copenhagen.
- Krus M., Kilian R. and Sedlbauer K. (2007). Mould growth prediction by computational simulation on historic buildings. *Contributions to the conference Museum Microclimates*, The National Museum of Denmark, Copenhagen.
- Maekawa S., and Franciza T. (2003) Sustainable Climate Control for Historic Buildings in Hot and Humid Regions, *Management of Environmental Quality: An International Journal* Vol. 14, No. 3.
- Neuhaus E., Schellen H.L. (2006). Conservation Heating to Control Relative Humidity and Create Museum Indoor Conditions in a Monumental Building. *Proceedings of the 27th AIVC conference - (EPIC2006AIVC) . Technologies & sustainable policies for a radical decrease of the energy consumption in buildings*, Lyon, France, 45-50.
- Padfield T. (2007) *Conservation Physics*. <http://www.padfield.org/tim/cfys/>
- Staniforth S., Hayes B. and Bullock L. (1994). Appropriate Technologies for Relative Humidity Control for Museum Collections Housed in Historic Buildings. *Preventive Conservation: Practice, Theory, and Research*. Preprints of the Contributions to the Ottawa Congress. London: The International Institute for Conservation of Historic and Artistic Works (IIC), 123-128.

## Controlling ventilated façades

**Matthias Haase, Research Scientist,**  
**SINTEF Building and Infrastructure, 7465 Trondheim, Norway;**  
[matthias.haase@sintef.no](mailto:matthias.haase@sintef.no) and [www.sintef.no/byggforsk](http://www.sintef.no/byggforsk)

**Alex Amato, Dr., Associate,**  
**Davis Langdon Management Consulting, MidCity Place, 71 High Holborn, London WC1V 6QS;**  
[alex.amato@davislangdon.com](mailto:alex.amato@davislangdon.com)

**KEYWORDS:** double skin facade, hot-and humid climate, building simulation.

### SUMMARY:

There is a need for sustainable building design in Hong Kong. The Hong Kong climate is sub-tropical with hot and humid weather from May to September and temperate climate for the remaining 7 months period. A mechanical ventilation and air conditioning (MVAC) system is usually operated to get rid of the high peak cooling loads. One of the most significant technologies for energy savings in an office building is the façade. This work evaluates different ventilated façade designs in respect to energy consumption savings. An important factor was the development of a climate sensitive regulator that helps to take advantage of the hot and humid climate. It could be demonstrated that this façade design can play an important role in highly glazed buildings.

## 1. Introduction

There is a world-wide need for a sustainable development (Behling 1996). 52% of the total energy in Hong Kong is used by buildings, office and commercial buildings being responsible for 37% of the total energy (EMSD 2003). Thus it is important to develop buildings that consume less operational energy during its life cycle. Consequently, several ways of reducing energy consumption by applying energy efficient technology in the built environment have been identified (Baker 2002; CEC 2002; Goulding et al. 1992; Krishan 2001; Lee et al. 1998). New building concepts incorporating climate responsive elements have mainly been developed and tested in moderate to cold climates in Europe. They took into account the outdoor conditions and tried to create a climatic responsive building (Givoni 1992; Szokolay 1980; Wigginton 1996). Advanced façade technologies were developed (Wigginton and Harris 2002), especially for the top-end market sector of office buildings, trying to integrate more and more building services into the façade system. One promising development of advanced façade systems is the double-skin façade (DSF). This has the advantage of reducing the space needed inside the building and reducing initial overall costs. However, little work has been done on the behaviour of double-skin façades (DSF) in hot and humid climates (Haase and Amato 2005b). One of the reasons might be that building types and climate are different in Hong Kong (Lam 1995; Lam 1999; Li and Lam 2000) with an urban environment that is dense and high-rise with usually 40 floors and above (Close 1996).

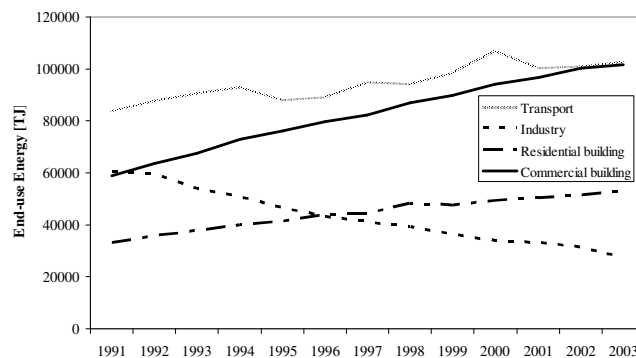

FIG. 1: Energy consumption in Hong Kong (EMSD 2003)

The seasonal and daily climate in respect to mean temperature, humidity and wind speed distribution in Hong Kong is different to the moderate climate in Europe (Lam and Li 1996; Li and Lam 2000; Li et al. 2004). A new approach for DSF design has to take the climatic factors into account to reduce the energy consumption in office buildings in a hot and humid climate.

## 1.1 Advanced facades

In a DSF, conduction through the window system can be significantly reduced by making use of the air gap. The complexity of the new concept and technology requires a careful and responsible planning. Heat transfer due to convection is the most complex one depending on the temperature distribution in the gap, the air velocity and pressure field. To predict the performance of a DSF is thus not trivial. The temperatures and airflows result from many simultaneous thermal, optical and fluid flow processes which interact and are highly dynamic (Chen and Van Der Kooi 1990; Garde-Bentaleb et al. 2002; Prianto and Depecker 2002; Qingyan and Weiran 1998; Xu and Chen 2001; Zhang and Chen 2000). These processes depend on geometric, thermophysical, optical, and aerodynamic properties of the various components of the double-skin façade structure and of the building itself (Hensen et al. 2002). The temperature inside the offices, the ambient temperature, wind speed, wind direction, transmitted and absorbed solar radiation and angles of incidence govern the main driving forces (Manz 2003; Reichrath and Davies 2002; Zhai et al. 2002). Many types of DSFs have been developed since the first double layer was used in the building envelope (Parkin 2004). Figure 2 gives a classification of the main characteristics often used when describing the various features of DSFs.

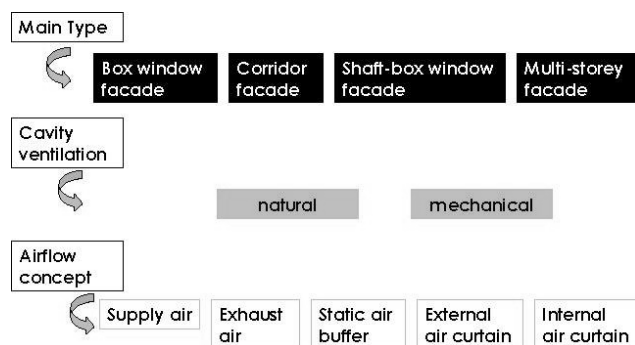

FIG. 2: Classification of DSFs

## 1.2 Double-skin façade concept

When looking at the various airflow concepts it is important to note that all main types of DSFs can be combined with both types of ventilation and all types of airflow concepts. This produces a great variety of DSFs. More recently, DSF have been developed that act as climate responsive elements with hybrid ventilation (natural and mechanical) concepts with a possibility to change the airflow concept due to different weather conditions in different seasons (Heiselberg et al. 2001).

## 1.3 DSF performance

The development of DSF technology involves several advantages by improving the thermal, visual and acoustic comfort (Oesterle et al. 2001). In moderate climates the air layer helps to insulate the building and thus reduce the energy consumption for heating. This is more significant in cool climates with strong winter periods (Balocco 2002; Park 2003). Furthermore the buoyancy flow in the cavity itself may reduce solar heat gain and additionally it can support the HVAC-system (heating, ventilation and air-conditioning) and it can help to minimize the size of the system and consequently the energy consumption of the building (Allocca et al. 2003; Andersen 2003; Gratia and De Herde 2004a; Gratia and De Herde 2004b; Gratia and De Herde 2004c; Gratia and De Herde 2004d; Saelens et al. 2003; Stec and Paassen 2001; Stec and Paassen 2004).

Then, it creates a space for advanced sunshading devices. Positioned into the cavity of the DSF it seems to reduce heat gain (von Grabe 2002). In addition, natural daylight filtered into a building for lighting appears to reduce the heat load for artificial lighting on air conditioning (Garcia-Hansen et al. 2002; Grimme 1999). Thus, it is important to enhance the use of natural daylighting in office buildings (Bodart and De Herde 2002; Lam and

Li 1998; Lam and Li 1999). This provides not only energy saving potential but also acknowledges the growing awareness for natural daylight and its effects on a healthy environment (Li and Lam 2001).

## 2. Objectives

The concentration of heat gain in the cavity might result in an increase of thermal comfort next to the window area. Since a part of the cooling ventilation is directed through the airflow window cavity a detailed analysis is needed that will help to improve airflow rates and ventilation efficiency (Haase and Amato 2005a). Finally, DSFs provide an additional layer that helps to reduce the acoustic impact into the building (Oesterle et al. 2001).

This study tried to find out if it is possible to design an energy efficient DSF system for warm and humid climate. First, the amount of heat gain through the buildings envelope should be reduced by designing a ventilated DSF. Then, several control strategies in respect to DSFs have been tested. The first is to control the shading system. The second strategy is to control the airflow direction. The third strategy is to control the HVAC system. Thus, the DSF should be optimised in respect to its energy performance by applying different control strategies.

## 3. Methodology

The heat transfer through the buildings envelope depends on solar radiation, conduction and convection on the airflow through the double-skin gap. The convection in the cavity depends on the airflow. Several possible calculation models have been developed to simulate the thermal behaviour of DSF (Manz 2003; Saelens et al. 2003; Stec and Paassen 2004). One problem is to use dynamic building simulation with hourly weather data on the one hand but also to take the effects of airflow in the cavity into account. The airflow affects the heat transfer but is also influenced by external wind conditions (and the pressure it creates on the building envelope).

Three models were used to compare their performance. The first model is a curtain wall system which acts as a base case for comparison. The second model is a natural ventilated external air curtain. A cavity depth of 600mm was chosen. Both glass layers were selected as single clear glass (8mm). An internal shading device was positioned in the cavity. The third model is a mechanical ventilated internal air curtain with a cavity depth of 240mm.

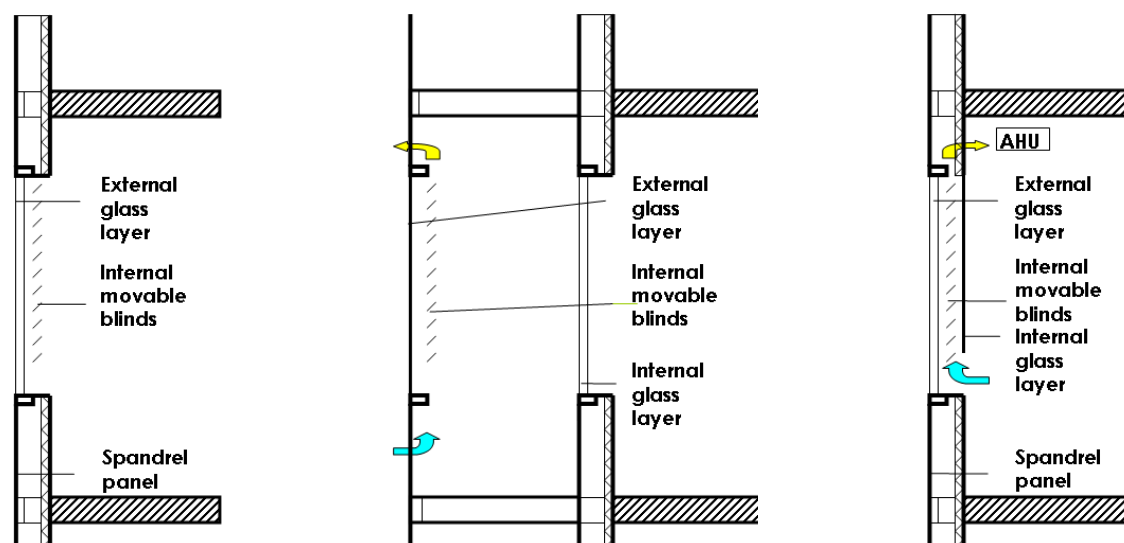

FIG. 3: Three facade systems (BC model on the left; EAC model in the middle; IAC model on the right)

### 3.1 Base Case Model

The model room was simulated with 6.6m width and 8m deep. The façade was facing south and a schedule was used to simulate the office use (working hours from 8am to 8pm). The model consists of a single glazed curtain wall (CW) system. The window to wall ratio is WWR=44%. A section is shown in Figure 3 (left).



For this study a combined thermal and airflow simulation was chosen. TRNSYS and TRNFLOW (coupled with COMIS) were used to model an office room with DSF. A simple DSF can be described as naturally ventilated external (EAC) which does not require a control strategy for solar control and HVAC. The other possibility which is used in HK is a mechanically ventilated internal air curtains (IAC). For simulation purposes the two DSF were simulated and then a switch has been tested by opening windows to allow for supply air and exhaust air. The switch is controlled by measuring enthalpy in the cavity which allows controlling the exhaust airflow. The aim of both control strategies was together with the optimisation of the shading device to reduce solar heat gain and thus reducing the peak cooling load of the building.

### 3.2 External Air Curtain

The design proposal includes a double-skin façade with 600mm cavity with one-storey double-skin façade. The double-skin façade is open on bottom and top to the outside allowing a naturally ventilated cavity as shown in Figure 3 (middle). A shading device is positioned in the cavity and solar controlled (DSF1). The internal window is closed. The second case is with an open able internal window and controlled by enthalpy difference between room and cavity. A regulator indicates the times of the year when the enthalpy of the air in the room is exceeding the enthalpy of the air in the cavity (DSF2) and the window opened.

### 3.3 Internal Air Curtain

The windows are connected to an additional second layer of glazing placed on the inside of the window to create a DSF. A section is shown in Figure 3 (right). The mullion's depth of around 240mm is needed for structural purposes and leaves space for the shading device which can be opened and closed automatically. At the same time the mullion can be used to introduce a second glass layer on the inside. It is open to the room at the bottom and has a ventilation slot on the top of the window. Air is vented through the airflow window from the room back to the MVAC system (AFW1). The cavity of the double-skin is connected to the interior, air handling unit respectively allowing used air from the room to be forced through the gap and back to the air handling unit. Solar heat gain through the external glass layer is counting towards the total cooling load of the room. A regulator indicates the times of the year when the enthalpy of the air in the window gap is exceeding the enthalpy of the outside air (AFW2). The regulator will then exhaust the air which is expected to result in reduction of cooling load.

### 3.4 Control Strategy

Several control strategies have been simulated in respect to DSFs which are summarized in Table 1. The first is to control the airflow direction (from internal to external or vice versa). The second strategy is to control the shading system. Both strategies involve climatic indicators. The third is to control the HVAC system.

In the first case a sensor is used to detect the amount of solar radiation on the façade and to shade the window accordingly. It was switched down when the amount of incident solar radiation on the vertical façade exceeded  $200\text{W/m}^2$  (switched up below  $150\text{W/m}^2$ ).

The second strategy is more complex. In temperate climates where natural ventilation is a cooling strategy the internal façade consists of open able windows. This allows the occupant to control airflow according to individual comfort (Saelens et al. 2003).

For the third strategy the set point temperature determines the room temperature at which the HVAC system starts cooling and is very sensitive to changes (Lam and Hui 1996). Here, different set point temperatures were chosen with infinite cooling power. A heating system was not used. In hot and humid climates natural ventilation can be applied to increase thermal comfort throughout the year. But especially in sub-tropical climates this effect is rather small. For Hong Kong thermal comfort improvements of natural ventilation are 20% for the whole year and during the three hottest months (June, July, and August) 10% (Haase and Amato 2005c). For the DSF with EAC a comparison between room enthalpy and cavity enthalpy was done. The window was opened when the room enthalpy was higher than in the cavity. For the DSF with IAC the window was opened when the cavity enthalpy was higher than outside in order to exhaust the air.

TABLE 1: List of control strategies.

case	Airflow		Solar		HVAC	
	control	Strategy	Control	Strategy	Control	Strategy
BC0	no	-	no	-	yes	cooling above 24°C
BC1	no	-	yes	200 – 150	yes	cooling above 24°C
BC2	no	-	yes	200 – 150	yes	cooling above 26°C
BC3	no	-	yes	150 – 100	yes	cooling above 24°C
BC4	no	-	yes	100 – 50	yes	cooling above 24°C
BC5	no	-	yes	50 – 0	yes	cooling above 24°C
DSF0	no	-	no	-	yes	cooling above 24°C
DSF1	no	-	yes	200 – 150	yes	cooling above 24°C
DSF2	no	-	yes	200 – 150	yes	cooling above 26°C
DSF3	no	-	yes	150 – 100	yes	cooling above 24°C
DSF4	no	-	yes	100 – 50	yes	cooling above 24°C
DSF5	no	-	yes	50 – 0	yes	cooling above 24°C
DSF6	yes	hr > hc	no	-	yes	cooling above 24°C
DSF7	yes	hr > hc	yes	200 – 150	yes	cooling above 24°C
DSF8	yes	hr > hc	yes	200 – 150	yes	cooling above 26°C
DSF9	yes	hr > hc	yes	150 – 100	yes	cooling above 24°C
DSF10	yes	hr > hc	yes	100 – 50	yes	cooling above 24°C
DSF11	yes	hr > hc	yes	50 – 0	yes	cooling above 24°C
AFW1	no	-	yes	200 – 150	yes	cooling above 24°C
AFW2	yes	hc > he	yes	200 – 150	yes	cooling above 24°C

## 4. Results

Simulations of the room cooling loads were done for the whole year. The results shown in Figure 4 give the annual cooling load per floor area for the different façade options with different control strategies.

It can be seen from Figure 4 that the base cases (BC1-BC5) result in a simulated cooling load between 128 and 155 kWh/m<sup>2</sup>. This is an improvement of 18% between BC2 and BC0 due to the increase in set point temperature (from 24 to 26°C) and the introduction of a solar control that lowers the shading device when the solar radiation is more than 200 W/m<sup>2</sup> and lifts it when solar radiation is falling below 150 W/m<sup>2</sup>. Further reductions in cooling load are possible by further reducing the amount of solar radiation on the façade before the shading device is lowered (BC3, BC4). Interestingly, a further reduction to 50 W/m<sup>2</sup> (BC5) increases the cooling load slightly (from 145 kWh/m<sup>2</sup> for BC4 to 146 kWh/m<sup>2</sup> for BC5, or 0.53%).

The EAC uses between 81 and 120 kWh/m<sup>2</sup> cooling load which is less than all base cases. Again, there is an improvement between DSF0 and DSF2 of 30% due to the increase in set point temperature (from 24 to 26°C) and the introduction of that solar control. Further reductions in cooling load are possible by further reducing the amount of solar radiation on the façade to 100 W/m<sup>2</sup> (DSF3, DSF4). Interestingly, a further reduction to 50 W/m<sup>2</sup> (DSF5) increases the cooling load slightly (from 114 kWh/m<sup>2</sup> for DSF4 to 115 kWh/m<sup>2</sup> for DSF5, or 0.92%).

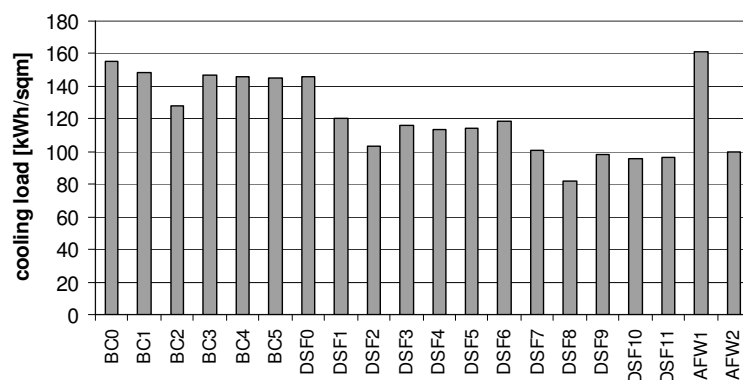

FIG. 4: Cooling energy for different facade systems and different control strategies (as described in Table 1)

The DSF with additional airflow control (DSF6 to DSF11) are significantly reducing cooling load compared to DSF without this control. There is an improvement between DSF6 and DSF8 of 31% due to the increase in set point temperature (from 24 to 26°C) and the introduction of that solar control. Further reductions in cooling load are possible by further reducing the amount of solar radiation on the façade to 100W/m<sup>2</sup> (DSF9, DSF10). Interestingly, a further reduction to 50W/m<sup>2</sup> (DSF11) increases the cooling load slightly (from 95.7kWh/m<sup>2</sup> for DSF10 to 96.8kWh/m<sup>2</sup> for DSF11, or 1.17%).

The IAC without airflow control increases the cooling load to 161kWh/m<sup>2</sup> (AFW1). Only the introduction of an airflow control ensures that cooling load can be reduced to 99.5kWh/m<sup>2</sup> (AFW2) which is 38% compared to AFW1.

## 5. Conclusions

It is possible to design an energy efficient DSF system. The amount of heat gain through the buildings envelope can be reduced by designing a ventilated DSF that is optimised in respect to its control strategy.

For the base case curtain wall system solar control and HVAC control can be applied. The results for BC0, BC1 and BC3 show the effectiveness of the applied control strategy.

The DSF uses natural ventilation in the cavity to reject heat gain. The system provides a possibility to reduce annual cooling loads of an office room. The performance of the EAC can further be optimized by using the appropriate control strategy.

The IAC does not reduce the cooling load of the office room unless an enthalpy based control is used that extracts air in order to reduce the cooling load of an office room. This system is giving the best results for the solar control strategy of lowering the shading device at 200W/m<sup>2</sup> and lifting it at 150W/m<sup>2</sup>. Further reductions are possible if the solar control strategy is more stringent and uses 100W/m<sup>2</sup> for lowering the shading device. Further reducing the amount of solar radiation to control the shading device does not reduce cooling load.

While a reduction of radiation is met by using controlled solar shading devices, there are constraints from maximizing the use of daylight. Further research is planned to optimize the amount of daylight and thus reduce internal heat gain.

An EAC system has the potential of reducing cooling load even without applying control strategies (comparing DSF0 with BC0 provides 6% reduction in annual cooling load). For IAC the importance of an airflow control based on enthalpy of the air was demonstrated.

## 6. References

- Allocca, C., Chen, Q. Y., and Glicksman, L. R. (2003). Design analysis of single-sided natural ventilation. *Energy and Buildings*, 35 (8), pp. 785-795.
- Andersen, K. T. (2003). Theory for natural ventilation by thermal buoyancy in one zone with uniform temperature. *Building and Environment*, 38 (11), pp. 1281-1289.
- Baker, N. (2002). *Daylight design of buildings*, James & James, London.
- Balocco, C. (2002). A simple model to study ventilated facades energy performance. *Energy and Buildings*, 34 (5), pp. 469-475.
- Behling, S. (1996). *Sol power : the evolution of solar architecture*, Prestel, Munich.
- Bodart, M., and De Herde, A. (2002). Global energy savings in offices buildings by the use of daylighting. *Energy and Buildings*, 34 (5), pp. 421-429.
- CEC. (2002). COMMUNICATION FROM THE COMMISSION ON IMPACT ASSESSMENT. [http://europa.eu.int/eur-lex/en/com/cnc/2002/com2002\\_0276en01.pdf](http://europa.eu.int/eur-lex/en/com/cnc/2002/com2002_0276en01.pdf), access date: 10. Oct 2006
- Chen, Q., and Van Der Kooi, J. (1990). A methodology for indoor airflow computations and energy analysis for a displacement ventilation system. *Energy and Buildings*, 14 (4), pp. 259-271.
- Close, J. (1996). Optimising daylighting in high-rise commercial developments in SE Asia and the use of computer programmes as a design tool. *Renewable Energy*, 8 (1-5), pp. 206-209.

- EMSD (2003). "Hong Kong Energy End-use data (1991-2001)." Electrical and Mechanical Service Department, Hong Kong. Access date: 10. Oct 2006
- Garcia-Hansen, V., Esteves, A., and Pattini, A. (2002). Passive solar systems for heating, daylighting and ventilation for rooms without an equator-facing facade. *Renewable Energy*, 26 (1), pp. 91-111.
- Garde-Bentaleb, F., Miranville, F., Boyer, H., and Depecker, P. (2002). Bringing scientific knowledge from research to the professional fields: the case of the thermal and airflow design of buildings in tropical climates. *Energy and Buildings*, 34 (5), pp. 511-521.
- Givoni, B. (1992). Comfort, Climate Analysis and Building Design Guidelines. *Energy and Buildings*, 18(1), pp. 11-23.
- Goulding, J. R., Lewis, J. O., and Steemers, T. C. (1992). *Energy conscious design : a primer for architects*, Commission of the European Communities, London.
- Gratia, E., and De Herde, A. (2004a). Is day natural ventilation still possible in office buildings with a double-skin facade? *Building and Environment*, 39 (4), pp. 399-409.
- Gratia, E., and De Herde, A. (2004b). Natural cooling strategies efficiency in an office building with a double-skin facade. *Energy and Buildings*, 36 (11), pp. 1139-1152.
- Gratia, E., and De Herde, A. (2004c). Natural ventilation in a double-skin facade. *Energy and Buildings*, 36 (2), pp. 137-146.
- Gratia, E., and De Herde, A. (2004d). Optimal operation of a south double-skin facade. *Energy and Buildings*, 36 (1), pp. 41-60.
- Grimme, F.-W. and Laar., M. (1999). Energy Efficiency in Tropical Office Buildings. Latest Developments in Daylight Guidance Systems. Modern Glazings - Efficient for Cooling and Daylighting. Development of Energy Efficiency Policy for Buildings and Research Activities after 1970 in the field of Low Energy. Conferencia Internacional de Energía Renovable y Educación Energética, Havana, Cuba.
- Haase, M., and Amato, A. (2005a). DEVELOPMENT OF A DOUBLE-SKIN FACADE SYSTEM THAT COMBINES AIRFLOW WINDOWS WITH SOLAR CHIMNEYS. Sustainable Building Conference 2005 (SB05), Tokyo, Japan.
- Haase, M., and Amato, A. (2005b). Double-skin facades in Hong Kong. 5th International Postgraduate Research Conference, Salford, U.K.
- Haase, M., and Amato, A. (2005c). Fundamentals for climate responsive envelopes. Glass in Buildings 2 Conference, Bath, UK.
- Heiselberg, P., Svidt, K., and Nielsen, P. V. (2001). Characteristics of airflow from open windows. *Building and Environment*, 36 (7), pp. 859-869.
- Hensen, J., Bartak, M., and Drkal, F. (2002). Modeling and simulation of a double-skin facade system / Discussion. *ASHRAE Transactions*, 108, pp. 1251.
- Krishan, A. E. (2001). *Climate responsive architecture : a design handbook for energy efficient buildings*, Tata McGraw-Hill, New Delhi.
- Lam, J. C. (1995). Building envelope loads and commercial sector electricity use in Hong Kong. *Energy*, 20 (3), pp. 189-194.
- Lam, J. C. (1999). Climatic influences on the energy performance of air-conditioned buildings. *Energy Conversion and Management*, 40 (1), pp. 39-49.
- Lam, J. C., and Hui, S. C. M. (1996). Sensitivity analysis of energy performance of office buildings. *Building and Environment*, 31 (1), pp. 27-39.
- Lam, J. C., and Li, D. H. W. (1998). Daylighting and energy analysis for air-conditioned office buildings. *Energy*, 23 (2), pp. 79-89.
- Lam, J. C., and Li, D. H. W. (1999). An analysis of daylighting and solar heat for cooling-dominated office buildings. *Solar Energy*, 65 (4), pp. 251-262.

- Lee, E. S., DiBartolomeo, D. L., and Selkowitz, S. (1998). Thermal and Daylighting performance of an automated venetian blind and lighting system in a full-scale private office. *Energy and Buildings*, 29 (1), pp. 47-63.
- Li, D. H. W., and Lam, J. C. (2000). An analysis of climatic parameters and sky condition classification. *Building and Environment*, 36 (4), pp. 435-445.
- Li, D. H. W., and Lam, J. C. (2001). Evaluation of lighting performance in office buildings with daylighting controls. *Energy and Buildings*, 33 (8), pp. 793-803.
- Manz, H. (2003). Numerical simulation of heat transfer by natural convection in cavities of facade elements. *Energy and Buildings*, 35 (3), pp. 305-311.
- Oesterle, E., Lieb, R.-D., Lutz, G., and Heusler, B. (2001). *Double-skin facades : integrated planning : building physics, construction, aerophysics, air-conditioning, economic viability*, Prestel, Munich.
- Park, C.-S. (2003). Occupant-Responsive optimal control of smart facade systems, PhD thesis, Georgia Institute of Technology.
- Parkin, S. (2004). A description of a ventilated double-skin façade classification. International Conference on Building Envelope Systems & Technology, Sydney, Australia.
- Prianto, E., and Depecker, P. (2002). Characteristic of airflow as the effect of balcony, opening design and internal division on indoor velocity - A case study of traditional dwelling in urban living quarter in tropical humid region. *Energy and Buildings*, 34 (4), pp. 401-409.
- Qingyan, C., and Weiran, X. (1998). A zero-equation turbulence model for indoor airflow simulation. *Energy and Buildings*, 28 (2), pp. 137-144.
- Reichrath, S., and Davies, T. W. (2002). Using CFD to model the internal climate of greenhouses: past, present and future. *Agronomie*, 22 (1), pp. 3-19.
- Saelens, D., Carmeliet, J., and Hens, H. (2003). Energy performance assessment of multiple skin facades. *International Journal of HVAC&Research*, 9 (2), pp. 167-186.
- Stec, W., van Paassen, A. H. C. (2001). Controlled double facades and HVAC. 7th Clima 2000 World Congress, Napoli, Italy.
- Stec, W. J., and Paassen, A. H. C. v. (2004). Symbiosis of the double skin facade with the HVAC system. *Energy and Buildings*, 37 (5), pp. 461-469
- Szokolay, S.V. (1980). *Environmental science handbook for architects and builders*, Construction Press, Lancaster.
- von Grabe, J. (2002). A prediction tool for the temperature field of double facades. *Energy and Buildings*, 34 (9), pp. 891-899.
- Wigginton, M. (1996). *Glass in architecture*, Phaidon Press, London.
- Wigginton, M., and Harris, J. (2002). *Intelligent skins*. Butterworth-Heinemann, Oxford.
- Xu, W., and Chen, Q. (2001). A two-layer turbulence model for simulating indoor airflow: Part II. Applications. *Energy and Buildings*, 33 (6), pp. 627-639.
- Zhai, Z., Chen, Q., Haves, P., and Klems, J. H. (2002). On approaches to couple energy simulation and computational fluid dynamics programs. *Building and Environment*, 37 (8-9), pp. 857-864.
- Zhang, W., and Chen, Q. (2000). Large eddy simulation of indoor airflow with a filtered dynamic subgrid scale model. *International Journal of Heat and Mass Transfer*, 43 (17), pp. 3219-3231.

# Method for including detailed evaluation of daylight levels in Be06

*Steffen Petersen, PhD student,  
ALECTIA A/S and Department of Civil Engineering, Technical University of Denmark;  
stp@byg.dtu.dk*

**KEYWORDS:** *Daylight simulation, Energy performance, Electrical lighting, Danish national calculation method*

## **SUMMARY:**

*Good daylight conditions in office buildings have become an important issue due to new European regulatory demands which include energy consumption for electrical lighting in the building energy frame. Good daylight conditions in offices are thus in increased focus as an energy conserving measure. In order to evaluate whether a certain design is good daylight design or not building designers must perform detailed evaluation of daylight levels, including the daylight performance of dynamic solar shadings, and include these in the energy performance evaluation. However, the mandatory national calculation tool in Denmark (Be06) for evaluating the energy performance of buildings is currently using a simple representation of available daylight in a room and simple assumptions regarding the control of shading devices. In a case example, this is leading to an overestimation of the energy consumption for electrical lighting by 30% compared to the method suggested in this paper, which is based on hourly calculated illuminance levels in a representative point in the workspace. Implementing the suggested method in Be06 would be a better representation of the reality compared to the current method. Furthermore it will reward the efforts of building designers who are designing buildings with good daylight conditions, which also include the use of dynamic controlled external solar shadings, and encourage the design of low energy buildings.*

## **1. Introduction**

The energy performance building directive (EPBD, 2002) from the European commission states, amongst other issues, that the energy for electrical lighting has to be included the evaluation of the energy performance of non-domestic buildings. This is affecting the way that building designers and practitioners throughout Europe work. According to EPBD all energy consumptions in a building, being mechanical, electrical or thermal energy, shall be evaluated with respect to the primary fuel used for production of the respective types of energy. This means that mechanical, electrical and thermal energy should be multiplied with primary energy factors converting the different energy consumptions in to the same primary fuel. In practice this conversion is a question of converting electricity in to primary fuel through a primary energy factor. This primary energy factor is different throughout Europe depending on the source of the primary fuel. In Denmark, where EPBD has been implemented in the building code since April 2006, the primary energy factor for electricity is 2.5 because the primary fuel is fossil fuels and district heating (Aggerholm S. and Grau K. 2005). Reducing the use of electricity in the design of buildings is therefore important in order to reach the national energy frame of 95 kWh/m<sup>2</sup> (Danish Building Code 2006) and even more important when designing low energy buildings.

The primary electricity consumptions in an office building are cooling and lighting. The amount of primary energy for cooling can be divided with the efficiency factor of the cooling unit (>1). Electrical lighting units, however, does not have an efficiency factor. This means that 1 kWh of electrical energy for lighting is worse than for 1 kWh of electrical energy for cooling in terms of energy performance. Good design in terms of daylight is therefore of great importance to minimise the energy consumption for electrical lighting. External solar shadings for minimising the energy consumption for cooling is also an important energy conserving measure especially in the design of low energy buildings. However, external solar shadings may affect the daylight level in the office thus the energy consumption for electrical lighting. Detailed evaluation of daylight performance, including daylight performance of solar shadings, is therefore important in terms of the calculation of the energy performance of a building.

In the current Danish national calculation method for calculation of energy performance, Be06 (Aggerholm S. and Grau K. 2005), the amount of daylight in offices is represented by one single daylight factor in a representative point in the office. The illuminance caused by this daylight factor is assumed available throughout the year – even when solar shadings are down. This is a very simple representation of daylight conditions in an

office, especially when dynamically controlled solar shadings is a part of the design. In this paper a method for including detailed evaluation of daylight levels in Be06 is suggested in order to improve the accuracy of the Danish national calculation method thus rewarding efforts of good daylight design in the mandatory demonstration of compliance with the Danish Building Code. The method is used in a case to illustrate the impact on the energy consumption for electrical lighting in an office when a detailed evaluation of daylight levels is applied compared to the current simple method in Be06.

## 2. Method

In the Danish national calculation method, manifested as the computer program Be06, the properties of a given solar shading device is stated by a single solar shading factor,  $F_c$ . This factor is activated whenever there is direct sunlight on a window surface no matter whether there is a heat demand or a cooling demand. This control is based on the assumption that whenever there is direct sunlight on the window surface the solar shading will be activated due to glare problems. In general, the introduction of a solar shading device based on above described control may also affect the level of daylight in the building. In Be06 the light system is controlled based on the needed amount of illuminance on an external surface in order to reach a certain desired illuminance in a representative reference point. The external illuminance needed,  $I_d$ , is expressed as in eq. 1.

$$I_d = (I_p + I_c) \cdot \frac{100}{DF} \quad (1)$$

where  $I_p$  is the desired illuminance in a representative reference point [lux],  $I_c$  is an amount of illuminance representing the selected control of the system [lux] and  $DF$  is the daylight factor in same point as  $I_p$  [-].

Be06 is comparing  $I_p$  with the monthly average illuminance for each hour of the day on an outside surface,  $I_{e,n}$ , as expressed in eq. 2.

$$I_{e,n} = \frac{\sum_{d=1}^b I_{d,n}}{b} \quad (2)$$

where  $b$  is the number of days in a the particular month of the year and  $I_{d,n}$  is the illuminance in the  $n$ 'th hour of the day  $d$  on an external surface [lux],  $n=[1,24]$ .

If  $n$  is a working hour and  $I_e < I_d$ , the electrical lighting is turned on. Be06 uses the part of working hours in the month where  $I_e < I_d$ , in this paper called  $h_m$ , to calculate the average wattage for general lighting per month hence the energy consumption for electrical lighting. This ratio can be expressed in general terms as in eq. 3.

$$h_m = \frac{\sum_{n=s}^k \min[1, \max(I_d - I_{e,n}, 0)]_{n,m}}{k - s} \quad (3)$$

where  $s$  is the start hour of the working time,  $k$  is the end hour of working time and  $m$  is the particular month of the year  $m=[1,12]$ .

The simple approach to daylight conditions in rooms in Be06, where the available daylight is expressed as a stationary daylight factor converted in to illuminance with respect to a diffuse sky with 10.000 lux, is overestimating the amount of available daylight in the room if the external sky has a an illuminance lower than 10.000 lux thus underestimating the need for electrical lighting. Furthermore it is provided in Be06 that the part of the illuminance coming from daylight is the same when the solar shading is activated. This is based on the assumption that even though the solar shading device is active the amount of daylight in the area would at least correspond to the stated daylight factor. The method used in Be06 linking  $I_e$  to  $I_p$  through  $DF$  and leaving out the daylight performance of solar shadings might be a reasonable assumption when  $DF$  correspond to an illuminance above  $I_p + I_c$ . But in building designs where the corresponding illuminance of  $DF$  is lower than  $I_p + I_c$  this assumption is leading to underestimation of the illuminance in the reference point, thus overestimating the need for electrical lighting, because the daylight illuminance level when solar shading is needed is easily much higher than illuminance level stated as the stationary daylight factor,  $DF$ .

In order to do better estimations of the daylight conditions in the workspace, thus better estimations of energy consumption for electrical lighting, we need to change the method based on  $DF$  to a method based on hourly calculated illuminances where daylight performance of solar shadings also are taken in to account. Providing that the shading control strategy implemented in Be06 (lowering the solar shading whenever there is direct sunlight on the window surface) is retained, we need to identify whether there is direct solar beam radiation or not in each hour of the year. This information can be found in the weather data file of the Danish reference year. Whenever there is direct solar beam radiation the defined solar shading is activated and the illuminance in a reference point in the working space is calculated. Whenever there is no direct solar beam radiation the defined solar shading is deactivated and the illuminance in the reference point in the working space is calculated. The output data of this calculation is hourly illuminances,  $L_n$ , in a reference point in the working space for each hour the entire year. The electrical lighting is turned on when  $n$  is a working hour and  $L_n < I_p + I_c$ . Based on this comparison,  $h_m$  (the part of a month where  $L_n < I_p + I_c$ ) can be calculated as in eq. 4.

$$h_m = \frac{\sum_{d=1}^b \left( \sum_{n=s}^k \min \left[ 1, \max \left( (I_p + I_c) - L_{n,d}, 0 \right) \right] \right) \cdot \frac{1}{k-s}}{b} \quad (4)$$

where  $b$  is the number of days in a the particular month of the year,  $s$  is the start hour of the working time,  $k$  is the end hour of working time and  $L_{n,d}$  is the illuminance in the  $n$ 'th hour of the day  $d$  on in the reference point.

The suggested method for calculating  $h_m$  based on illuminance in a reference point in the working space demands a daylight simulation program which is capable of evaluating the hourly illuminances in a reference point of a representative work space in the case of a clear glazing and when the solar shading is activated. A suggestion for such a program is LightCalc (Hviid C.A., Nielsen T.R. and Svendsen S. 2008). Besides calculating illuminance levels for clear glazings, LightCalc is capable of calculating illuminance levels of window systems with external blinds in a fixed slat angle position or in cut off slat angle position (cut off slat angle is the slat angle position of the external blind in which all direct sunlight is blocked out from the underlying room) and for fully activated solar screens. Using LightCalc for illuminance calculations has an additional advantage: the same input data for LightCalc can be used to calculate monthly average values for the solar shading factor,  $F_c$ . Using monthly average values instead of using a single user defined  $F_c$  for the entire year would improve the accuracy of the thermal calculation in Be06.

### 3. Example

The design of a landscape office with the dimensions of the office seen in FIG. 1 is used as a case for comparison of the suggested method for including detailed evaluation of daylight levels in Be06 and the current method in Be06. The office is designed with external blinds which are lowered whenever there is direct sunlight. The slat angle of the blinds is adjustable: the angle is always set to the cut off slat angle whenever there is direct sun. Working hours are 8-17, Monday to Friday. A point placed in the middle of the room is selected as the representative point for daylight in the workspace.

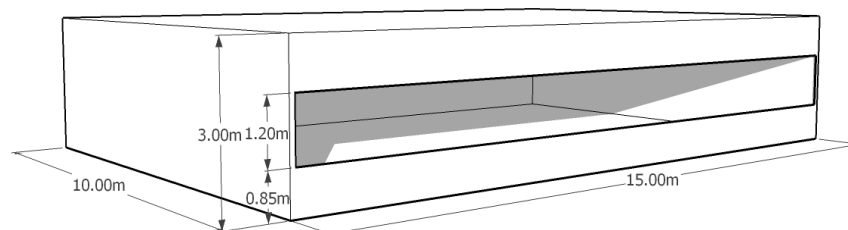

FIG. 1: Geometry of room for comparison of methods.

In order to use the Be06 method for calculation of  $h_m$ ,  $DF$  in the representative point is calculated in LightCalc to be 2%. If  $I_p = 200$  lux and  $I_c = 100$  lux (automatic control in Be06) then  $I_d$  is 15.000 lux according to eq. 1. Be06 is using the Perez algorithm (Perez R., Ineichen P., Seals R., Michalsky J. and Stewart R. 1990) to convert irradiation data to illuminance data and  $I_e$  is generated as in eq. (2). The part of the month where the electrical



lighting is turned on based on the Be06 method (eq. 3) and the suggested method (eq. 4), respectively, is seen in table 1 for all months in the year.

TABLE. 1: List of  $h_m$  based on the Be06 method and the suggested method for each month of the year.

Month	$h_m$ (Be06)	$h_m$ (Suggested method)	Difference
Jan	1.00	0.76	0.24
Feb	1.00	0.67	0.33
Mar	0.56	0.34	0.22
Apr	0.11	0.22	-0.11
May	0.00	0.25	-0.25
Jun	0.00	0.20	-0.20
Jul	0.00	0.09	-0.09
Aug	0.00	0.12	-0.12
Sep	0.33	0.23	0.10
Oct	1.00	0.43	0.57
Nov	1.00	0.80	0.20
Dec	1.00	0.90	0.10
<b>Total average</b>	<b>0.50</b>	<b>0.35</b>	<b>0.15</b>

Table 1 show that the simplified method of Be06 is overestimating the need for electrical lighting in the autumn/winter months and underestimates the need for electrical lighting in the spring/summer months. Overall the lighting system is turned on 50% of the time in the working hours in the current method in Be06. In the suggested method the lighting is turned on in 35% of the time in the working hours. Using the suggested method with detailed evaluation of hourly illuminances reveals that the simplified method of Be06 is overestimating the energy consumption for electrical lighting significantly. In practice this means that if 25% of the energy frame (95 kWh/m<sup>2</sup> per year) is electrical lighting, then Be06 is overestimating the total energy performance by approximately 7 kWh/m<sup>2</sup> per year.

## 4. Conclusion

The Danish national calculation method, Be06, for evaluation of the energy performance of an office is underestimating daylight performance as an energy conserving measure thus overestimating the energy consumption for electrical lighting.

This conclusion is drawn based on a comparison of the simple representation of available daylight in a room based on a daylight factor, which is used in Be06, and the method suggested in this paper. The suggested method is based on the hourly illuminances in a representative point in the workspace. A case featuring the detailed evaluation of daylight levels in an office with dynamically controlled external blinds is used for comparison of the two methods. The case shows that Be06 is overestimating the energy consumption for electrical lighting by 30%. Implementing the suggested method in Be06 would be a better representation of the reality compared to the current method. The suggested simulation program for generating illuminance for building designs with or without external solar shading, LightCalc, is capable of generating the data needed. However, in case of external solar shading it needs input information regarding the incident angle-dependent light transmittances of the external solar blinds. This information is currently provided by very few manufacturers which is a main barrier for the full implementation of the suggested method as the standard method in Be06. If the full implementation of the method as the standard method for some reason is found inexpedient, building designers should at least be given the possibility of providing the Be06 calculation with detailed daylight data generated with the suggested method instead of the data generated by the simple standard method. An additional advantage of implementing

the suggested method is that the same input data for LightCalc can be used to calculate monthly average values for the solar shading factor,  $F_c$ . Using monthly average values instead of using a single user defined  $F_c$  for the entire year would improve the accuracy of the thermal calculation in Be06.

In the current method implemented in Be06, no credit is given to the designer who is doing an effort to design good daylight solutions for buildings because all solar shading solutions are treated the same way in terms of daylight. The implementation of the suggested method will reward the efforts of building designers who are designing buildings with good daylight conditions, which also include the use of dynamic controlled external solar shadings, with a better energy performance and therefore encourage the design of low energy buildings.

## 5. References

- Aggerholm S. and Grau K. (2005). SBI-anvisning 213. Bygningers energibehov. PC-program og beregningsvejledning. Danish Building Research Institute, Hørsholm, Denmark.
- Danish Building Code. (2006). Bygningsreglement for erhvervs- og etagebyggeri. National Agency for enterprise and construction, Copenhagen, Denmark
- EPBD. (2002). Directive 2002/91/EC of the European parliament and of the council of 16 December 2002 on the energy consumption of buildings. Webpage: [http://europa.eu.int/eur-lex/pri/en/oj/dat/2003/l\\_001/l\\_00120030104en00650071.pdf](http://europa.eu.int/eur-lex/pri/en/oj/dat/2003/l_001/l_00120030104en00650071.pdf)
- Hviid C.A., Nielsen T.R. and Svendsen S. (2008). Simple tool to evaluate the impact of daylight on building energy consumption, *Proceeding of the 8th Nordic symposium on building physics*, (accepted)
- Perez R., Ineichen P., Seals R., Michalsky J. and Stewart R. (1990). Modeling daylight availability and irradiance components from direct and global irradiance, *Solar Energy*, Vol. 44, No. 5, 271-289.



## Where to use vacuum insulation ... and where not!

**Wolfgang M. Willems, Univ.-Prof. Dr.-Ing. habil.**  
*Technical University Dortmund, Building physics and building services*  
*Wolfgang.Willems@uni-dortmund.de*  
*<http://www.tga.bauwesen.uni-dortmund.de>*

**Kai Schild, Dr.-Ing.**  
*Technical University Dortmund, Building physics and building services*  
*Kai.Schild@uni-dortmund.de*  
*<http://www.tga.bauwesen.uni-dortmund.de>*

**KEYWORDS:** *vacuum insulation, vacuum insulation panel, thermal bridge.*

### **SUMMARY:**

*The classical - film covered - vacuum insulation panel (VIP) has made its way from the research state to an accepted building material that is used in different fields of application. Some manufacturers of VIP have even mastered the testing procedures necessary for getting a national technical approval from the german Deutsches Institut für Bautechnik (DIBt). Other types of vacuum insulation are subject of an ongoing research process but not available on the market by now.*

*Due to economical aspects, in general the use of vacuum insulation is limited to applications where the reduced heat loss and/or the financial consequences of creating slim building structures equalize the higher material prices. But accompanying the growing market relevance some application fields and building products have occurred, where the use of vacuum insulation misses the self-chosen aims. Unconsidered thermal bridges, high conductive coverings, misinterpreted calculation standards and an obsessive endeavour to use innovative solutions whether it is useful or not, result in underestimated heat losses or costs for construction and maintenance.*

*By using examples, this paper shows some cases that should set the alarm bells ringing - in other words: Where to use vacuum insulation ... and where not.*

## **1. Where to use vacuum insulation**

Vacuum insulation is a high efficient but also expensive material for the thermal insulation of the building envelope. Therefore, vacuum insulation is an alternative to conventional insulation materials only in such cases, where the thinness of the elements leads to:

- much lower heat losses, because a thermally equivalent layer of conventional insulation cannot be applied;
- the possibility to do some renovation measures without any additional necessary worksteps (e.g. to low parapet or door heights as well as unacceptable bottom step heights);
- thinner envelope structures accompanied by an enlargement of the rentable or saleable net floor area.

For that reasons, the main application fields of vacuum insulation are loggias and roof terraces, floor constructions and facade systems.

## 2. Applications where it doesn't work out

### 2.1 Problems occurring in stick facades

Figure 1 shows a part of a stick facade of a school building. It consists of window areas (not seen in the picture because of the lowered blinds) and opaque areas located behind steel grilles. The panels the opaque areas are build of are vacuum panels with aluminium claddings.

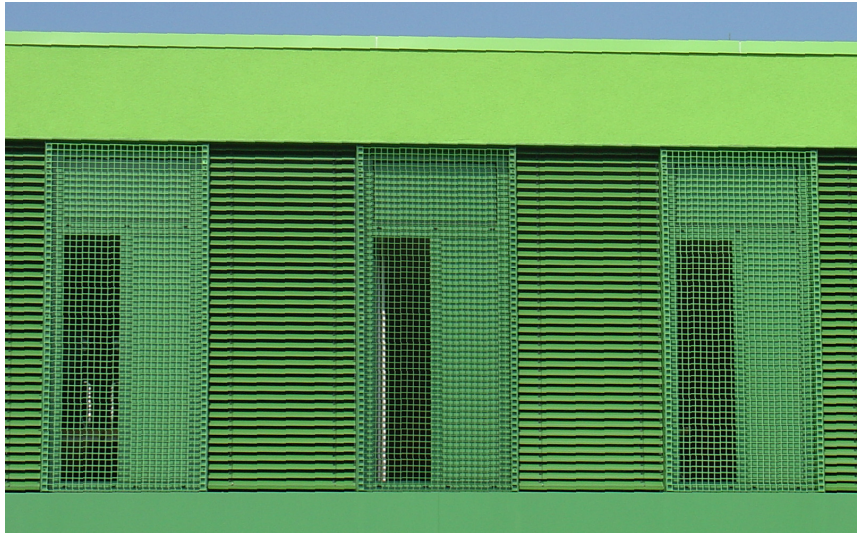

FIG. 1: Part of a stick facade with window elements (areas with closed blinds) and opaque vacuum insulated panels (one panel door open for ventilation).

The manufacturer of the stick facade used the well known following equation (1) from EN ISO 10077-1 [1] to calculate the mean U-Value of the different facade elements.

$$U_w = \frac{U_p \cdot A_p + U_f \cdot A_f + \psi_p \cdot \ell_p}{A_p + A_f} \quad (1)$$

While the U-values and areas had been calculated correctly, the linear thermal transmittance of the assembly of the glazing and the frame was assumed to 0.06 W/(mK). This is the value for a combination of a standard double or triple glazing, wood or PVC frame and steel or aluminium spacer. Therefore the manufacture-side calculated U-Value was 0.89 W/(m<sup>2</sup>K) for the element shown in Fig. 1. Obviously, the real linear thermal transmittance of the assembly of the vacuum panel and the aluminium frame is of a complete different order.

For a more accurate calculation, cross sections of the construction had been simulated according to EN ISO 10077-2 [2] in a FEM environment. The linear thermal transmittance for the cross section in Fig. 2a has been calculated to 0.166 W/(mK). Taken this calculation as a starting point, a case study had been carried out to show the influence of the thermal conductivity of the covering panels and the type of the spacer used in the vacuum panel on the linear thermal transmittance of the joint. The results of these calculations are shown in Fig. 3. With the linear thermal transmittances from Fig. 3, U-Values for the sample facade element from Fig. 1 had been calculated using equation (1). The complete results are pictured in Fig. 4.

As a result of the calculations, the – vacuum insulated – facade element in Fig. 1 shows a U-value of 1.23 W/(m<sup>2</sup>K) which is about 40% above the manufacture-side calculated value of 0.89 W/(m<sup>2</sup>K).

Another comparative calculation with a polyurethane sandwich without spacer bar instead of the vacuum panel led to  $\psi = 0.062 \text{ W/(mK)}$  and because of that low additional edge loss to  $U = 1.32 \text{ W/(m}^2\text{K)}$ . Hence the difference in heat loss between the conventional and the vacuum insulated solution is only about  $0.1 \text{ W/(m}^2\text{K)}$  which is far below one litre oil per year and squaremeter (assuming a heating period of 185 d/a and 2900 degree days). It is obvious that for this example the additional costs for the vacuum panels will never pay off in a sensible period.

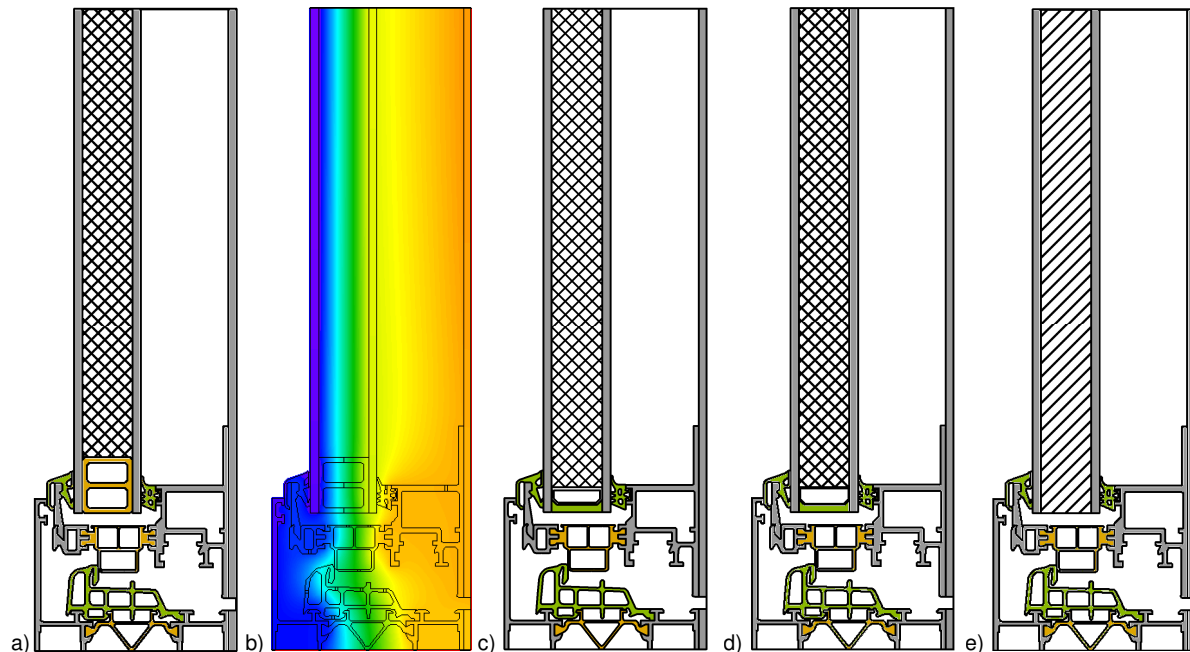

FIG. 2: Cross section of the connection of the panel to the frame.

**a)** spacer bar 1 - polyamid **b)** temperature distribution corresponding to a) **c)** spacer bar 2 - stainless steel **d)** spacer bar 3 - polypropylene with stainless steel seal **e)** conventional sandwich element with polyurethane core

If one compares the U-value of the vacuum insulated facade panel itself which is  $U_{\text{cop}}=0.26 \text{ W/(m}^2\text{K)}$  and the resulting U-value for the sample facade element in Fig. 4 (between  $1.1 \text{ W/(m}^2\text{K)}$  and  $1.7 \text{ W/(m}^2\text{K)}$  depending on the type of spacer bar and the thermal conductivity of the covering material), one quickly realizes the massive influence of the frame and the thermal bridge at the connection between panel and frame. This shows two things:

- The center-of-panel thermal conductivity  $\lambda_{\text{cop}}$  for a vacuum panel and its corresponding U-value are far from being useful to characterize the thermal quality of a stick facade.
- Even for the best combination of materials the achievable U-value of a conventional insulated facade element for this example is only about  $0.2 \text{ W/(m}^2\text{K)}$  below the corresponding value for the vacuum insulated element and because of that a conventional insulated panel is to be preferred for such small panel sizes.

The vacuum panels of the sample facade element shown in Fig. 4 show U/A-values between 3.5 and 4. Acceptable U/A-values are well below 2.5. The results of the carried out calculations show, that such small facade elements with vacuum panels and high conductive covering materials show only slightly lower heat losses than conventional solutions but are much more expensive, not to mention the durability of vacuum panels exposed to high summerly temperatures with just an aluminium "protection" layer. An effective vacuum insulated facade panel has to have low conductive covering materials, an optimized spacer bar and a thin additional layer of conventional insulation or at least a ventilated air layer on the outside to keep temperature peak away from the vacuum panel. Furthermore a vacuum panel is most effective with large dimensions.

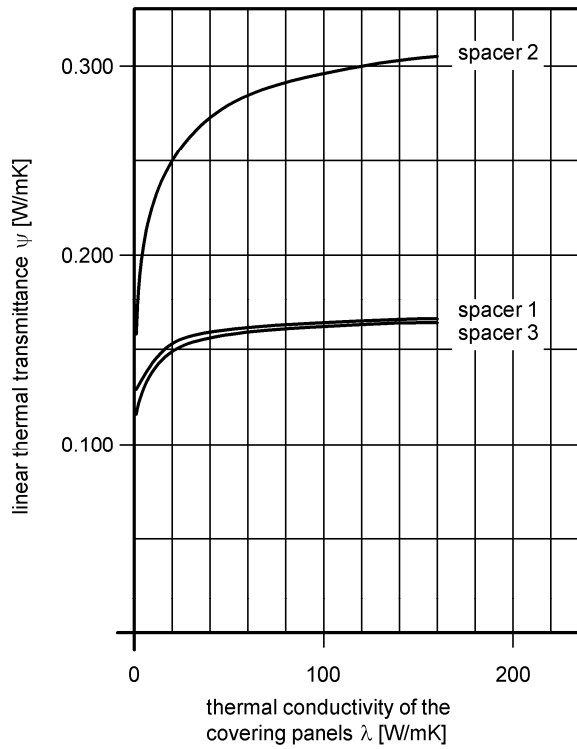

FIG. 3: Linear thermal transmittances of the Cross section shown in Fig. 2 for different thermal conductivities of the covering panels and different types of spacer bars.

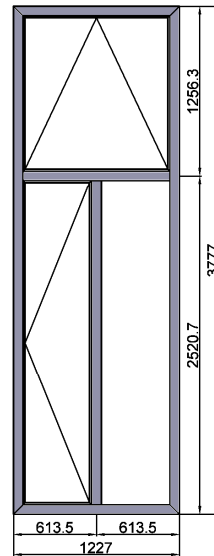
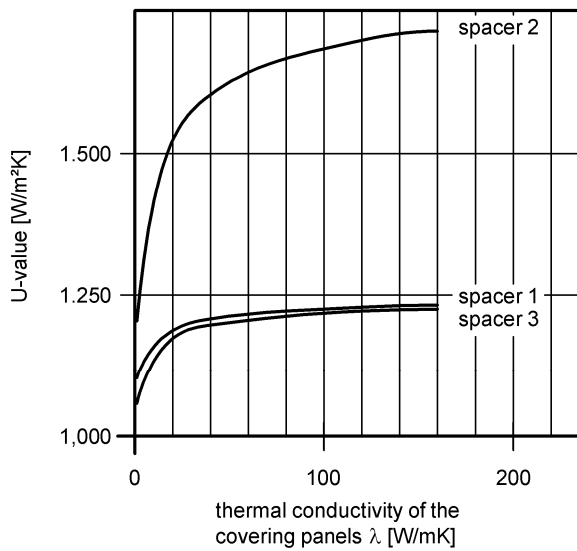

FIG. 4: Heat transfer coefficients for a sample facade element calculated with the linear thermal transmittances from Fig. 3.

## 2.2 Vacuum insulation as a thermal bridge insulation

### 2.2.1 Window details

The following Figures 5 to 7 show typical thermal bridges occurring with window details. Each case shows a solution using conventional insulation materials and another one using a vacuum panel. For every detail it has to be considered that the vacuum panel needs an outer covering layer that is usable as a plaster base and an inner covering layer that is suitable for fixing the panel to the wall structure.

Figure 5 shows different solutions for thermal insulated window reveals. Because of the relative thin concrete wall in Fig. 5a and 5b, the influence of the vacuum panel is relatively small. The difference of the linear thermal transmittances increases slightly from about  $\Delta\psi=0.04$  W/(mK) to about  $\Delta\psi=0.06$  W/(mK) for deeper reveals with masonry walls (Fig. 5c and 5d).

In Figure 6, the insulation situation at the window lintel is pictured. The use of vacuum insulation for the undersight compared to the conventional alternative again leads to differences  $\Delta\psi=0.04$  W/(mK). Only if the vertical insulation is made of vacuum insulation too, the  $\psi$ -value is reduced to  $\psi=0.04$  W/(mK) giving a difference of about  $\Delta\psi=0.15$  W/(mK).

The parapet example from Figure 7 in fact gives a difference in linear thermal transmittances of only  $\Delta\psi=0.03$  W/(mK) between conventional and vacuum insulation which is even lower than the values for the other examples described above.

For each example the lowest interior surface temperature had been calculated in addition to the heat loss. It arose that neither with the conventional insulation nor with the vacuum panel there is a risk of mould growth with a usual indoor climate (20 °C, 50 % RH). The difference between the compared alternatives is always only a few tenths degrees Celsius.

In nearly every shown case, the difference in linear thermal transmittances is about 0.04 W/(mK). That equals about one quarter litre Oil per year and per meter thermal bridge which is about 0.15 EUR. Comparing the prices for conventional insulation and vacuum panels, those savings lead to an amortization period of about 100 years. The only worthwhile application is the complete insulation of the window lintel as described above. In this case, the additional costs pay off after about 20 years.

Again one has to remember that vacuum insulation is useful primarily in large scale elements and not in small bits around a window.

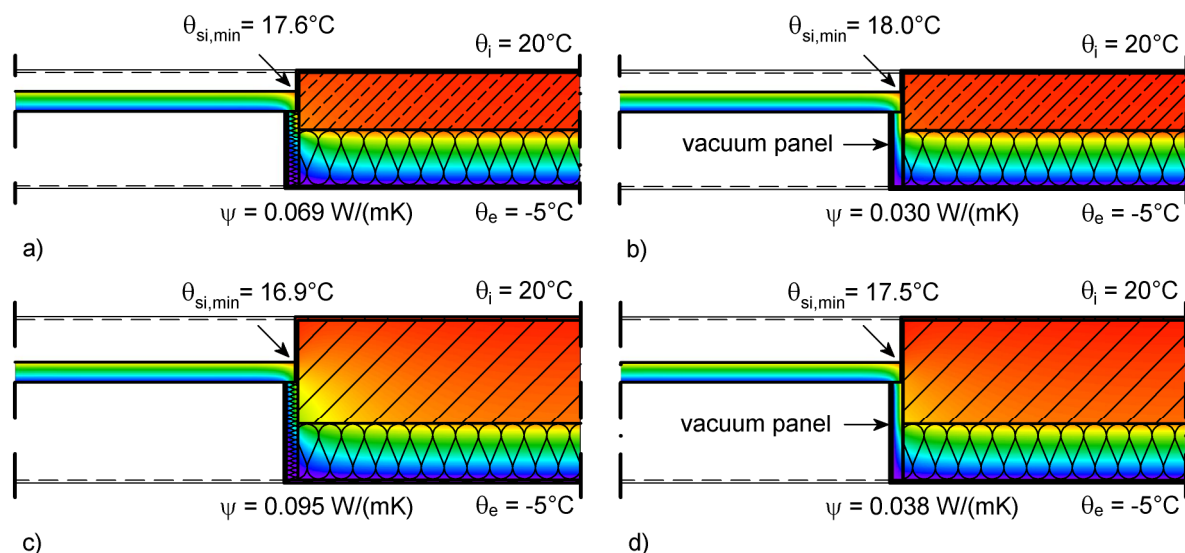

FIG. 5: Linear thermal transmittances for different window reveals **a)** concrete wall, reveal insulated with a conventional insulation panel **b)** concrete wall, reveal insulated with a vacuum panel **c)** masonry, reveal insulated with a conventional insulation panel **d)** masonry, reveal insulated with a vacuum panel



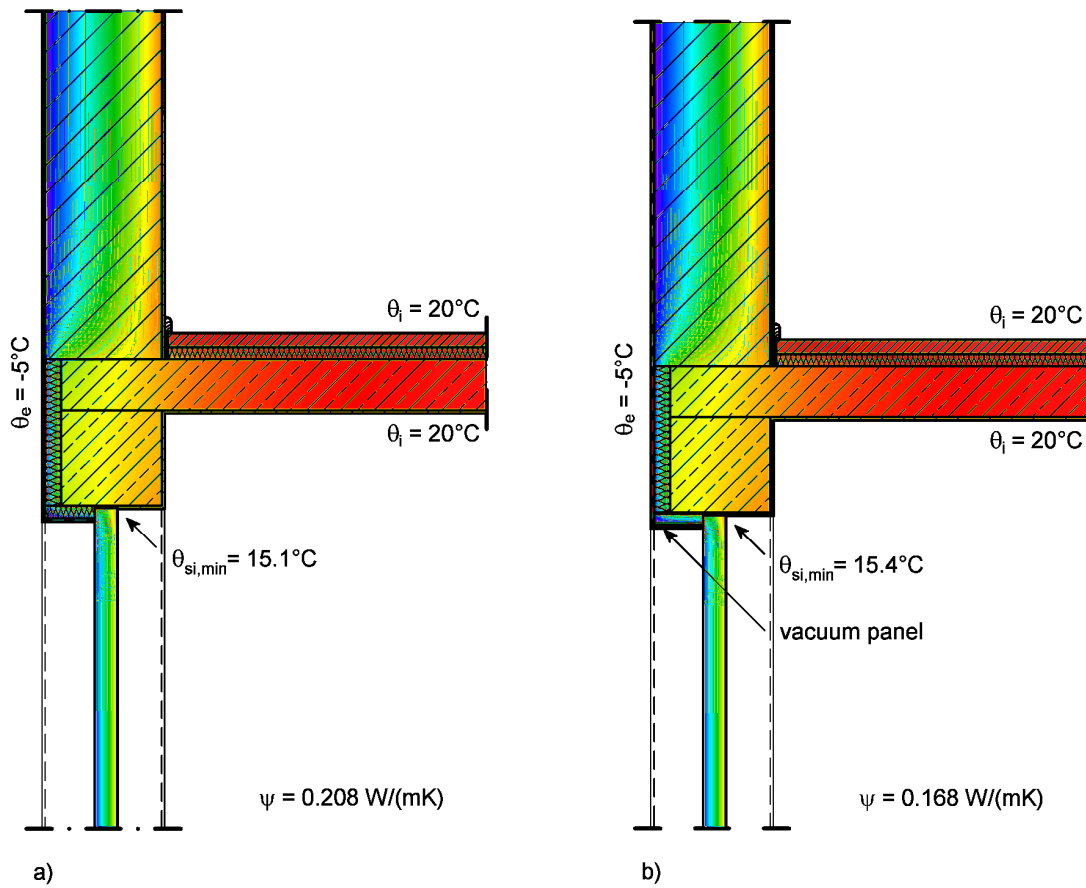

FIG. 6: Linear thermal transmittances for a window lintel insulated **a)** with a conventional insulation panel and **b)** with a vacuum panel

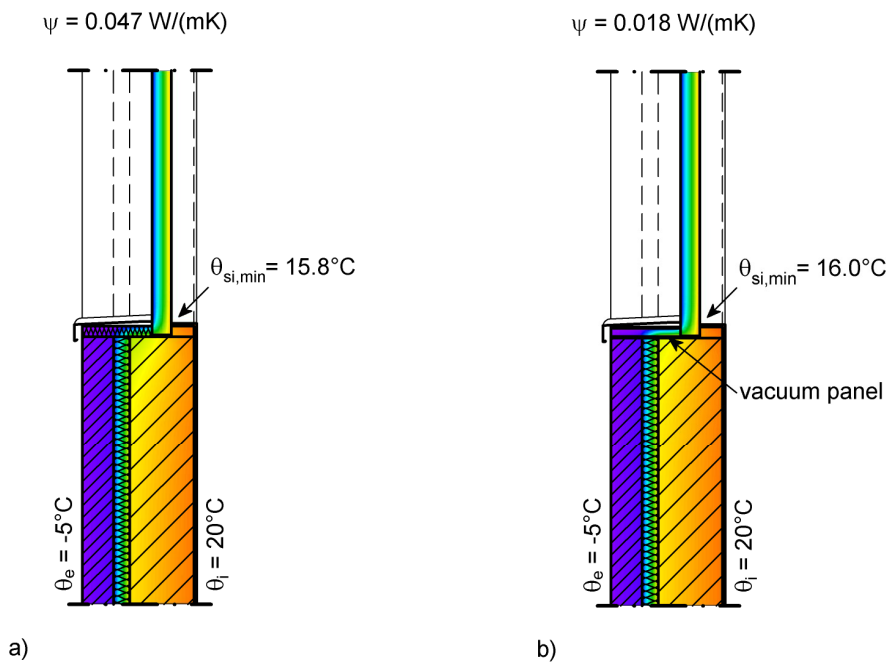

FIG. 7: Linear thermal transmittances for a parapet top insulated **a)** with a conventional insulation panel and **b)** with a vacuum panel

### 2.2.2 Exterior blind

The use of vacuum panels as an insulation behind an exterior blind is obvious. But even in this application, the annual savings are only about four times higher than in the cases shown above. That deduces amortization periods about 25 years which is only just acceptable. So if there is really few space behind the blinds, vacuum insulation can be a suitable alternative. In all other cases, a conventional insulation behind the blinds is the more economical solution.

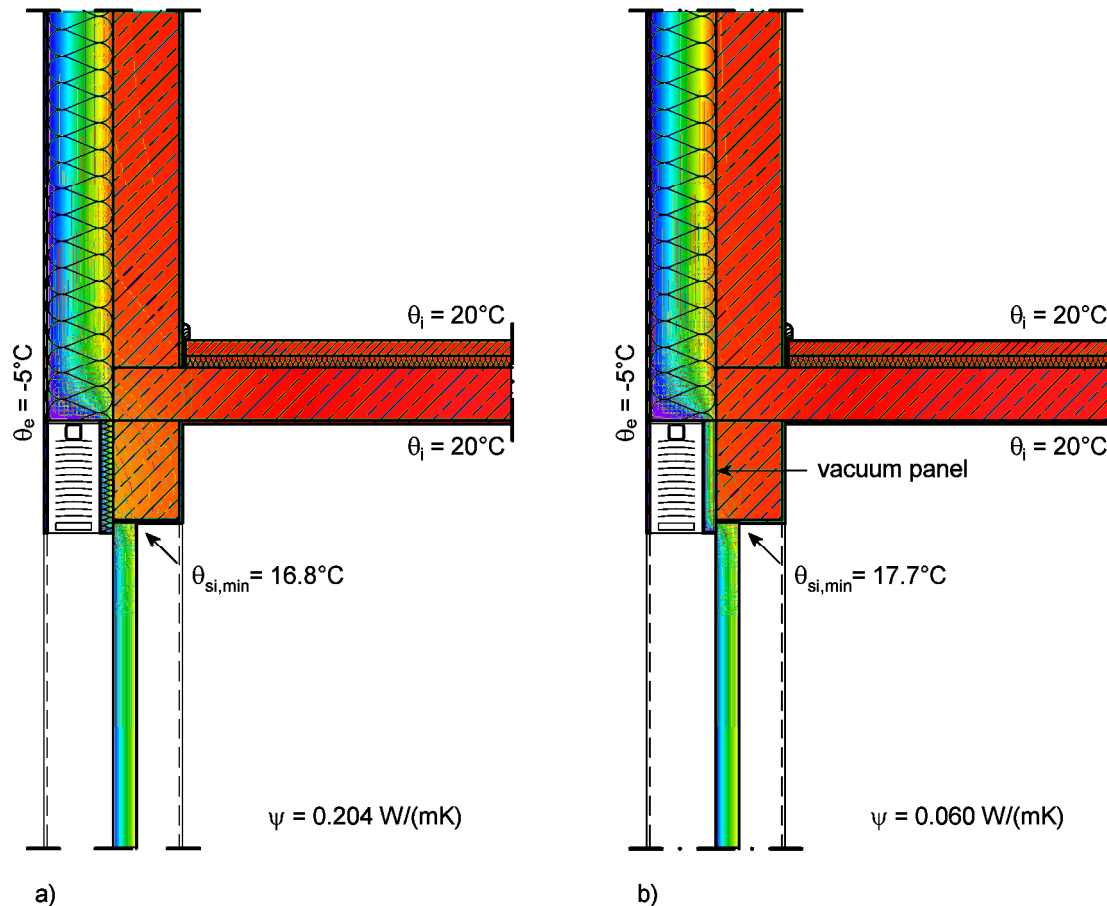

FIG. 8: Linear thermal transmittances for a window lintel with exterior blinds insulated **a)** with a conventional insulation panel and **b)** with a vacuum panel

## 3. Conclusion

Vacuum insulation is an alternative to conventional insulation in cases where large scale elements can be used in a building construction as thermal insulation and if additional worksteps can be reduced or completely avoided. If the element sizes get too small or if the covering materials or the build-up of the element do not suit to the particular application situation, the usability of vacuum insulation is questionable. The achievable reduction of heat loss never justifies the considerable extra costs of vacuum panels if they are used in inappropriate applications as described in this paper.

## 4. References

- [1] EN ISO 10077-1:2006 Thermal performance of windows, doors and shutters -- Calculation of thermal transmittance -- Part 1: General
- [2] EN ISO 10077-2:2003 Thermal performance of windows, doors and shutters -- Calculation of thermal transmittance -- Part 2: Numerical method for frames



# Energy Gaining Windows for Residential Buildings

*Jesper Kragh, Assistant Professor,  
Department of Civil Engineering, Technical University of Denmark;  
[jek@byg.dtu.dk](mailto:jek@byg.dtu.dk), [www.byg.dtu.dk/english.aspx](http://www.byg.dtu.dk/english.aspx)*

*Jacob B. Laustsen, Assistant Professor,  
Department of Civil Engineering, Technical University of Denmark;  
[jbl@byg.dtu.dk](mailto:jbl@byg.dtu.dk), [www.byg.dtu.dk/english.aspx](http://www.byg.dtu.dk/english.aspx)*

*Svend Svendsen, Professor,  
Department of Civil Engineering, Technical University of Denmark;  
[ss@byg.dtu.dk](mailto:ss@byg.dtu.dk), [www.byg.dtu.dk/english.aspx](http://www.byg.dtu.dk/english.aspx)*

*KEYWORDS: Low- energy windows, slim frame profiles, solar gain, net energy gain, low energy houses*

## *SUMMARY:*

*This paper presents some of the research done during the last 8 years at the Technical University of Denmark developing improved low-energy window solutions. The focus has been on maximizing the net energy gain of windows for residential buildings. The net energy gain of windows is the solar gain minus the heat loss integrated over the heating season. It is assumed that in northern cold climates all of the solar gain during the heating season can be utilized for space heating. Problems with overheating in the summer period must be solved with overhang or moveable solar shading devices.*

*Two windows have already been developed and prototypes constructed for laboratory test and a third generation of the window design is now in the developing and designing phase in a new project.*

*The first window constructed was made of wood profiles and a low-energy double glazing unit. The second and third windows are made of fiber-reinforced plastic (plastic reinforced by fine fibers made of glass). This composite material is a weatherproof material with very low thermal conductivity and high mechanical strength. These properties make the material very suitable for frame profiles due to lower heat loss and longer durability of the window. The glazing in these fiber reinforced polyester windows is both unsealed and sealed triple glazing units.*

*To increase the net energy gain slim frame profiles have been developed to increase the glazing area and thereby the solar gain. The challenge when developing slim frame profiles is to make enough space for hinges and fasteners and still maintaining the functionality and strength of the window. Proposals for new hinges and handles are also given in this paper.*

## **1. Introduction**

The energy consumption for the space heating of buildings was in 2007 about 40 % of Denmark's total energy consumption, of which approximately 25 % are assumed to be heat loss through windows. There is therefore a considerably energy saving potential in developing new and better low-energy windows both for use in renovation of the existing building mass and for use in new buildings. The EU Directive on Energy Performance of Buildings (EU Directive, 2002) was implemented in Denmark in 2006, and in order to comply with the directive, Denmark introduced new energy performance requirements in 2005 (Danish Building Regulations, 2005). The key to fulfill these new requirements is often the selection of the best available window components. On the Danish window market only a few products have been developed during the last couple of years and there is therefore a great need to help the entire window line to start this developing process. The development of improved frame constructions has not kept up with the development in the glazing area. Therefore, windows are not nearly as good as the glazing in these.

One of the main objects of the research done during the last 8 years at The Technical University of Denmark has been to form the basis of the development of Danish windows with a positive net energy gain to the house still maintaining a long lifetime and an architectural attractive form. The general goal of the project is to make the window an energy gaining component of a house and not as today an energy consuming component.

This development will support both the present and the future (2010 and 2015) tightened energy requirements in the building regulations.

The window designs presented in this paper differ from the traditional high insulated passive house windows by focusing on the energy balance of the window. By using slim frames, the solar radiation through the glazing is maximized, which is an advantage in cold climates where all the solar radiation can be utilized for space heating in the heating season. To avoid overheating problems during the summer, large overhangs from the roof or solar shading devices are probably necessary, especially in low-energy houses.

## 1.1 Definition of the Net Energy Gain

It is difficult to evaluate the performance of a window based on the heat loss coefficient ( $U$ -value) and the solar energy transmittance ( $g_w$ ) separately. It is therefore obvious to use the Net Energy Gain illustrated in figure 1 as this value takes into account both the  $U_w$ -value and  $g_w$ -value (Nielsen, T. R. et al, 2000). The net energy gain is defined in eq. (1) and fitted for the Danish climate based on the test reference year (DRY) in eq. (3). The  $g_w$ -value of the window is defined in eq. (2).

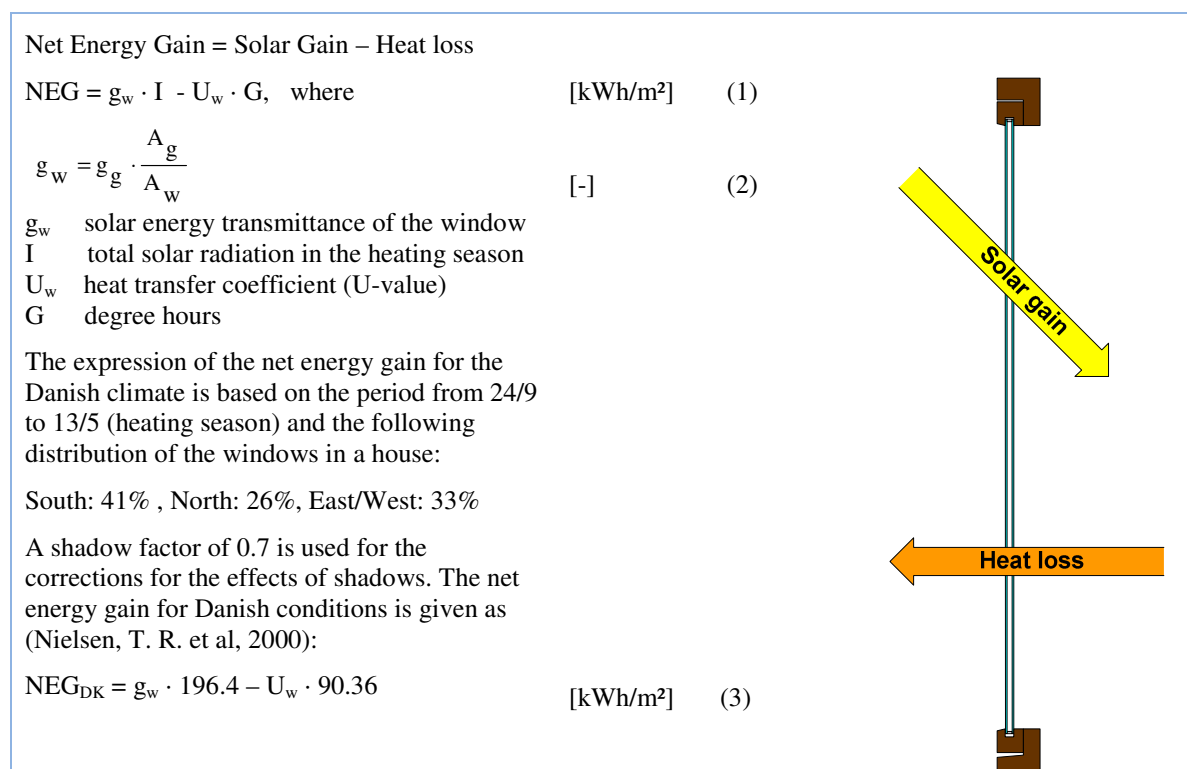

FIG. 1 Definition of the net energy gain of a window in a reference house in Denmark.

Other definition assumed in this paper:

- Standard size of a window is defined as 1230 x 1480 mm
- The type of the window is a single-light (window without mullions, transom or glazing bars)
- Frame width: The visible projected width of the frame section (seen from the front)

## 1.2 Previously developed frame profiles at DTU

Two windows were developed in previously finished project at The Technical University of Denmark. Both windows were designed with slim frame profiles produced in the projects “Projekt Vindue“ and “Energirigtige vinduessystemer“ financed by the Danish Energy Authority and VILLUM KANN RASMUSSEN FONDEN, respectively. The profile designs and pictures of the prototypes are presented in figures 2 and 3.

### The first window

The first window was constructed with frame profiles made of wood and covered with aluminium. The used glazing was a double layer low-energy glazing 4-15-4 mm with 90/10% argon filling in the gap and a low-emittance coating on the inner pane on the surface facing the gap. To get a high g-value the outer pane was made of float glass with low iron content. Moving the sash out in front of the outer frame reduces its width to approximately 5 cm. Hereby the glazing area is increased by 15% (for the standard window dimensions: 1480 x 1230 mm) compared to a corresponding window of wood with a frame width of 10 cm.

In the bottom between the aluminium and the wood a weather strip of flexible elastomeric foam is mounted to prevent ventilation of the cavity between the aluminium and the wood. (Laustsen, J. B et al, 2005).

#### The performance of this window is:

$$U_f = 1.33 \text{ W/m}^2\text{K}$$

$$U_w = 1.23 \text{ W/m}^2\text{K}$$

$$g_w = 0.57$$

$$\text{NEG}_{\text{DK}} = -3 \text{ kWh/m}^2$$

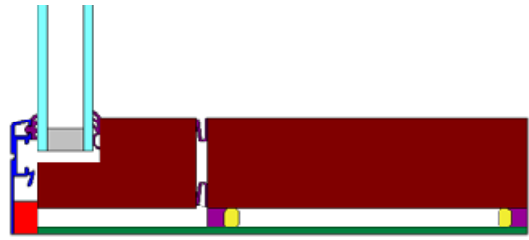

FIG. 2 The first prototype constructed at DTU

### The second window

The frame was made of fibre glass reinforced polyester, which is a weatherproof material that in combination with a non-sealed glazing unit with two hard low-emittance coatings results in a considerably better durability than traditional windows. It has often been asserted that the hard low-emittance coating can distort the colour reproduction more than the soft low-emittance coating and thus give a poorer daylight quality in the room. A questionnaire investigation was carried out, in which 36 test persons were asked to estimate the daylight conditions in four identical offices with different glazing solutions. The investigation showed, among other things, that no marked difference was observed in the daylight quality of rooms with a triple-glazing with soft or hard low-emittance coatings. It could therefore be justified to use the hard low-emittance.

#### The performance of this window is:

$$U_f = 1.40 \text{ W/m}^2\text{K}$$

$$U_w = 1.03 \text{ W/m}^2\text{K}$$

$$g_w = 0.54$$

$$\text{NEG}_{\text{DK}} = 13 \text{ kWh/m}^2$$

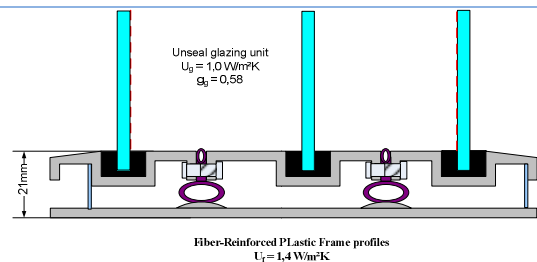

FIG. 3 The second prototype constructed at DTU

### 1.3 The performance of today's window products

In figure 4 the performance of different products on the window market 2007/2008 is shown. The net energy gain is presented as a function of the frame width as this is mentioned to be the key for further improvement of the windows performance. This is also indicated by a random selection of certified passive house windows from Germany (<http://www.passiv.de>). The glazing and frame profiles of the passive house windows have almost the same U-value (0.6 – 0.8 W/m<sup>2</sup>K). The aim of the project is to improve the performance of the window to a net energy gain above 20 kWh/m<sup>2</sup> per year (In Denmark).

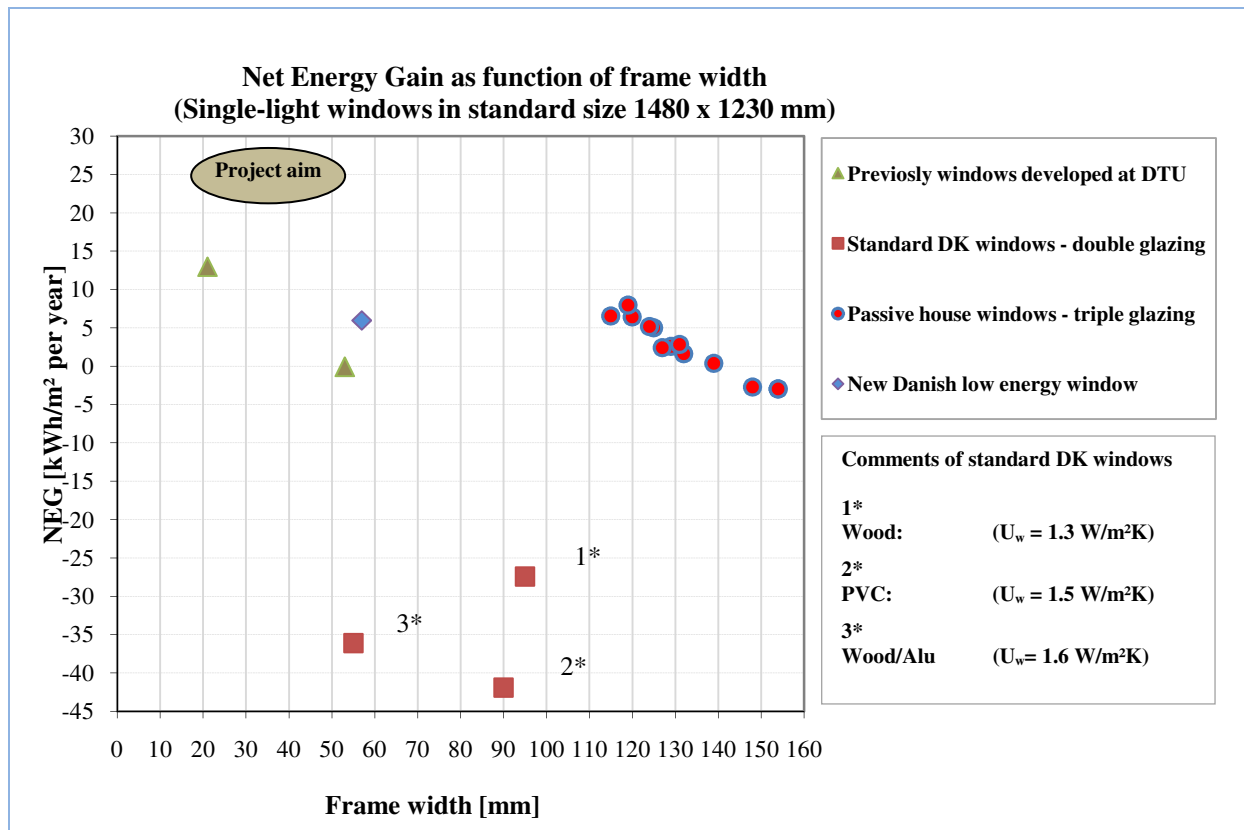

FIG. 4: Examples of the net energy gain for typical Danish windows of wood, pvc and wood/alu, certified passive house windows from Germany and two windows previously developed at the Technical University of Denmark.

From figure 4 it is evident that the passive house windows with slim frame profiles perform best regarding the net energy gain. Comparing the Danish standard products of wood, pvc or alu/wood shows a significant difference in the net energy gain.

It also has to be mentioned that in the end of 2007 a new low-energy window was introduced on the market from the Danish company PRO TEC Vinduer A/S. The window's performance is impressive, as shown in figure 4, due to a triple glazing unit with gaps filled with krypton (U<sub>g</sub> = 0.52 W/m<sup>2</sup>K). This is however a little worrying as krypton is more expensive (compared to argon) and thus the price of the window is expected to be relatively high.

## 2. Design proposals for Energy Gaining Windows

In this paper only two of the frame-proposals developed in the project are presented. The main difference to the other proposals of the frame designs is the opening function of the windows. The first presented frame profile is designed for a reversible window and the second is designed for a top or side-hung window.

## 2.1 The optimization method

As the main target is to develop a window that reduces the total consumption for heating of the house the optimization process is divided into separate key points as shown in figure 5.

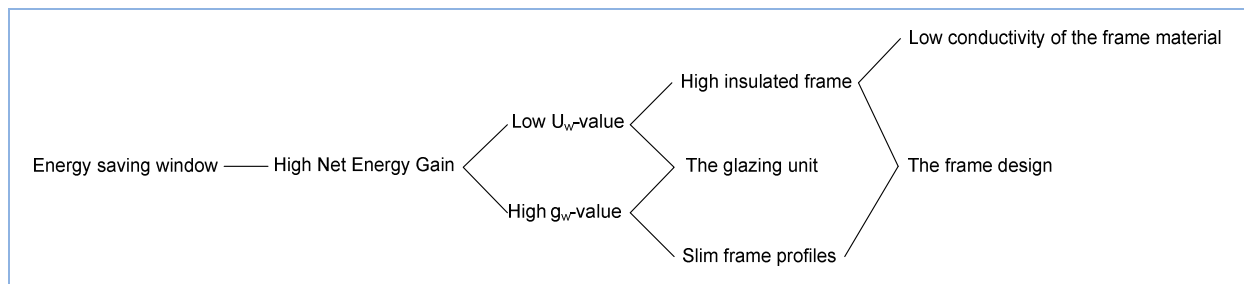

FIG. 5 The method for optimization of the net energy gain of a window

## 2.2 Other demands of the window design

In the design phase of the window other aspects also have been considered. These are listed below.

- Fulfilling the different window standards requirements
- Flexible profile system
- Same profile design for top, bottom, and side
- Architectural
- Opening function
- Materials
- Production cost
- Lifetime
- Maintenance

The most influencing and limiting demands when designing slim frame profiles are perhaps the mounting instructions of the glazing unit as shown in figure 6.

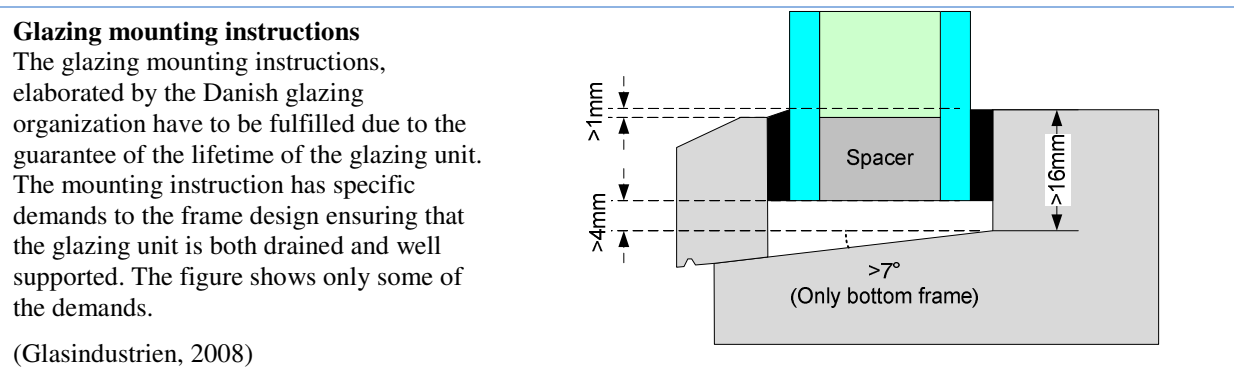

FIG. 6 The mounting instruction for glazing units elaborated by the Danish glazing organization

## 2.3 The glazing solution

As mention in the introduction the heat loss from the glazing unit has been reduced significantly during the last 10 years. The standard glazing product on the Danish market 2007/2008 is a double glazing unit with a soft low e-coating and argon fill (4/16Ar/E4). The U-value is 1.1 W/m<sup>2</sup>K and the g-value is 0.61. The next generation of low-energy glazing in Denmark is probably a triple glazing unit with argon (4E/16/4/16/E4). The U-value of this is 0.62 and the g-value is 0.55 (<http://www.passiv.de>). This is also the most applied glazing in German passive house windows. For this project the priority of the glazing unit has also been to use a standard product to keep the extra cost of the low-energy window at a minimum. This glazing unit has therefore been selected as the best solution for the design of the low-energy window.



## 2.4 The frame design proposals

Several research projects have concluded that the method to maximize the Net Energy Gain is a slim frame construction. The project has therefore focused on developing these frame constructions in composite materials. The composite material, fiber glass reinforced polyester, is a complex material that is light, strong and resistant to corrosion, with low thermal conductivity, which makes it extremely suitable for window profiles.

Another issue that also has been a key objective in the developing process was to design a profile system that only consists of one or two different profiles to minimize the production cost.

In figures 7 and 8 the two most promising profile systems developed in the project are presented.

### Design proposal 1

One of the large challenges making slim frame profiles is to make a reversible window as the hinges for this window type requires relatively large space in the frame. This problem is solved by using a detachable attack list. The idea is that the attack list should be easy to remove and mount without using any kinds of tools. If the owner wants' to reverse the window the attack list is removed in the top and the bottom. Two stainless steel bars supports the frame from the top. The function of the window is also shown in figure 7.

It was also decided to make an alternative assembly of the frame and glazing unit. The standard solution is a detachable glazing bead which makes it possible to replace the glazing unit. This is not possible with the shown proposal as the frame is closed around the glazing unit. If e.g. damages of the glazing occur the idea is that the producer delivers a complete new frame with glazing unit as this is not easily replaced.

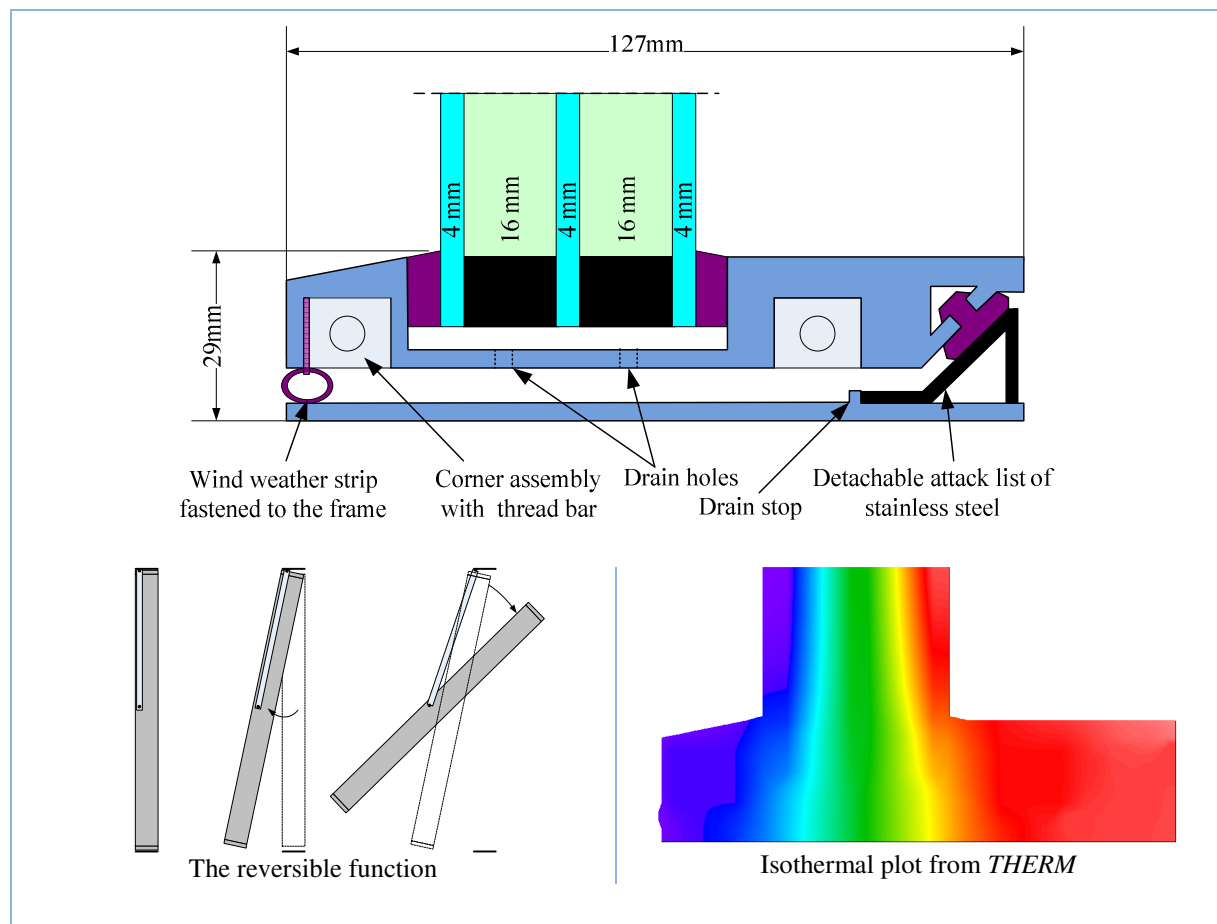

FIG. 7 Design proposal 1: Slim frame profile for a reversible window using a detachable attack list. In the bottom the turning functions and an isothermal plot of the profile are shown.

As shown in figure 7 the angle of the bottom cavity below the glazing unit does not fulfil the requirement of an angle of  $7^\circ$  to drain the profile. Instead small draining holes should be made along the profile.

**Design proposal 2**

The second frame proposal is a top or side-hung window. It is with this profile system possible to change the glazing unit by removing the glazing bead.

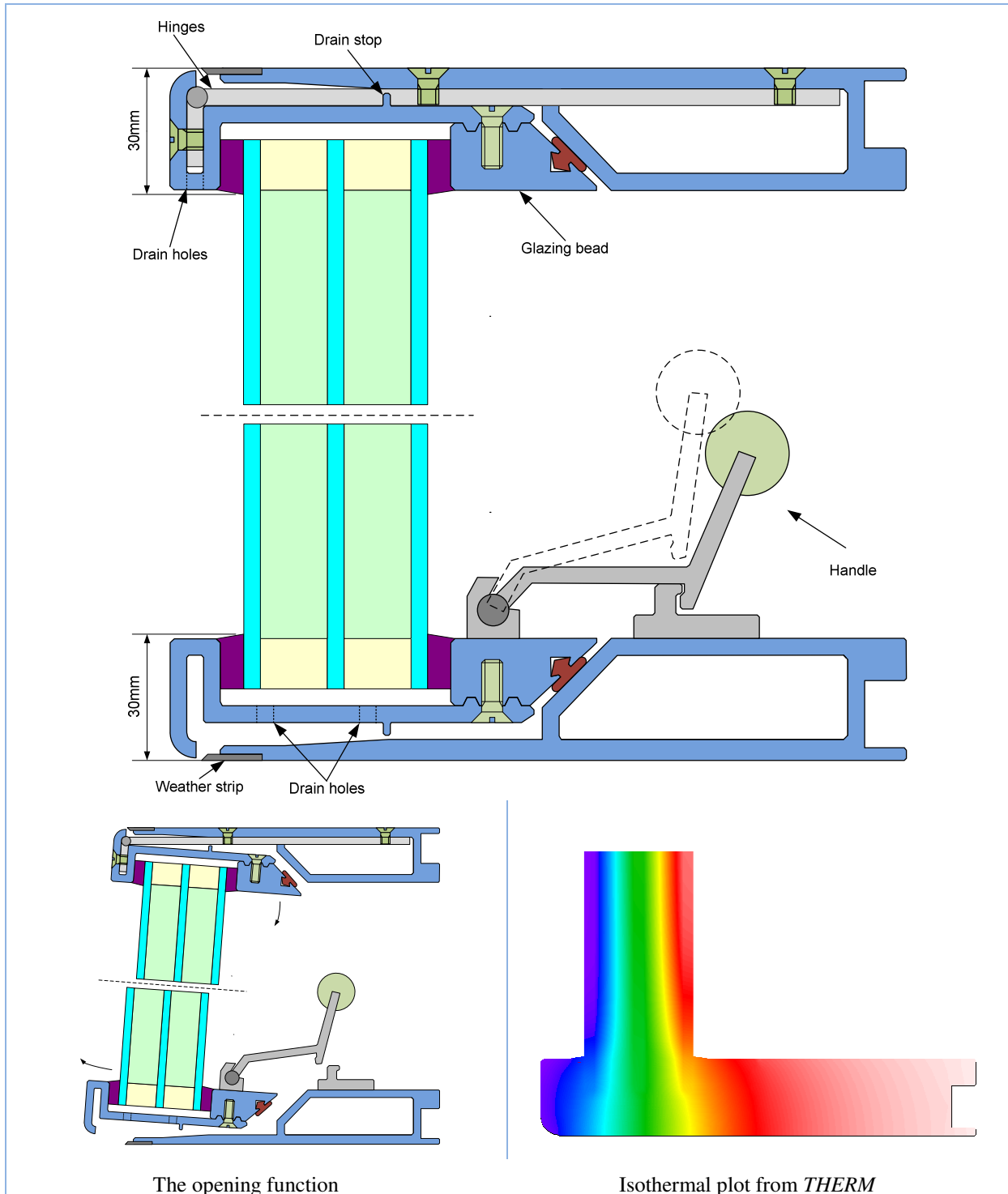

FIG. 8 Design proposal 2: A top or side-hung window. In the bottom the opening functions and an isothermal plot of the profile are shown.

Just as proposal 1 the angle of the bottom cavity below the glazing unit does not fulfil the requirement of an angle of 7° to drain the profile. Instead small draining holes should be made along the profile.

## 2.5 The performance of the two design proposals

The U-value and  $\Psi$ -value of the two proposals were calculated according to the standards EN ISO 10077-1 (CEN, 2000) and EN ISO 10077-2 (CEN, 2003). The calculation program *THERM* (LBNL, 2005) was used to simulate the 2-dimensional heat transfer. The performances of the two windows are shown in table 1.

TABLE. 1: The performance of the presented proposals for improved window with slim frame profiles

Proposal	Frame width	$U_f$	$\Psi_g$	$U_w$	$g_w$	Net Energy Gain
	[mm]	[W/m <sup>2</sup> K]	[W/mK]	[W/m <sup>2</sup> K]	[-]	[kWh/m <sup>2</sup> ]
Proposal 1 – reversible	29	1.79	0.037	0.82	0.50	24
Proposal 2 - top/side-hung	30	1.52	0.031	0.79	0.50	28

Compared to Danish standard windows the energy saved for a house with 20 m<sup>2</sup> of windows could easily larger than 1.000 kWh per year.

## 3. Conclusions

Two proposals for slim frame profiles have been developed and designed at the Technical University of Denmark in a new project. The proposals have improved the Net Energy Gain of the windows significantly even compared with certified passive house windows. The net energy gains of the windows are positive and the windows are hereby not an energy consuming construction of a house but an energy gaining construction.

Both proposals use a triple glazing unit (4E/16Ar/4/16ArE4) as this is expected to be the standard solution of a low-energy glazing in the future.

The first proposal is a reversible window type with a detachable attached list, which must be removed before turning the window. The width of the frame was reduced to only 29 mm. The  $U_f$ -value and  $\Psi$ -value of the frame profile are calculated to be 1.79 W/m<sup>2</sup>K and 0.037 W/mK, respectively, and the net energy gain is then calculated to be 24 kWh/m<sup>2</sup>. The second proposal is a top or side-hung window. The width of the frame was reduced to only 30 mm. The  $U_f$ -value and  $\Psi$ -value of the frame profile are calculated to be 1.52 W/m<sup>2</sup>K and 0.031 W/mK, respectively, and the net energy gain is calculated to be 28 kWh/m<sup>2</sup>. The aim of the projects is thereby fulfilled.

## 4. Acknowledgements

This work was financed by the Danish Energy Authority, Energy Research Programme (ERP).

## 5. Future work

The presented proposals have to be described and analyzed in details. Also the strength and possible weaknesses should be analyzed further. The best suitable hinges and handles should be found by investigating the market. Finally, prototypes of the most promising windows should be constructed for test in the laboratory.

## 6. References

- European Directive on the Energy Use from Buildings (2002). Directive 2002/91/EC of the European Parliament and of the Council of 16 December 2002 on the Energy Performance of Buildings. Building Regulations. (2005). Danish Ministry for Housing and Urban Affairs.
- CEN (2000). EN ISO 10077-1. 2000. European Standard. Thermal performance of windows, doors and shutters – calculation of thermal transmittance – Part 1: Simplified method.
- CEN (2003). EN ISO 10077-2. 2003. European Standard. Thermal performance of windows, doors and shutters – calculation of thermal transmittance – Part 2: Numerical method for frames.
- Lausten, J. B., Svendsen, S. (2005). Improved windows for cold climate, 7th Symposium on Building Physics in Nordic Countries, Technical University of Denmark.
- LBNL (2005). Therm ver. 6.0, Finite element simulator, (2005), Lawrence Berkley National Laboratory, USA
- Nielsen, T. R., Duer, K., Svendsen, S (2000). Energy Performance of Glazings and Windows. Solar Energy Vol. 69(Suppl.), Nos. 1–6, pp. 137–143, 2000.
- Glasindustrien (2000), Monteringsanvisning, Grundlag for garantiordningen

# ByggaF A Method for Including Moisture Safety in the Building Process – Experience from Pilot Projects

*Kristina Mjörnell, PhD,  
Senior researcher;  
[kristina.mjornell@sp.se](mailto:kristina.mjornell@sp.se), [www.sp.se](http://www.sp.se)*

*Jesper Arfvidsson, Professor,  
Professor;  
[jesper.arfvidsson@byggtek.lth.se](mailto:jesper.arfvidsson@byggtek.lth.se), [www.lth.se](http://www.lth.se)*

**KEYWORDS:** *moisture safety, building process, pilot project*

## **SUMMARY:**

*Many buildings, both new and old, suffer from moisture-related problems, with negative consequences on health, costs for rebuilding and lost confidence in the building trade. These problems could have been avoided if moisture issues had been focused on and dealt with throughout the building process. A method for including moisture safety in the building process has therefore been developed. In Sweden, the method is called ByggaF. The purpose of the method is to help all those involved to work with moisture safety activities and to document them in a structured way. The method includes a number of tools and aids for developers to specify requirements for moisture safety early on in the project, and to follow up and document the measures employed by different participants. There are also tools for architects and design engineers, such as lists of references to literature, check lists and design examples to use for dry building design. For contractors, a number of routines have been developed for moisture control during construction. The method has been applied to a number of building projects, covering residential buildings and commercial buildings. Based on experience from these projects, the method and the tools have been evaluated and revised. This method is now ready to be used by all parties in the building process. There are also plans to make this method into a Swedish standard.*

## **1. Introduction**

### **1.1 Background**

A large number of moisture-related building problems, such as mould growth and chemical emissions from decomposed material exposed to high moisture levels, have occurred during the last few years, with adverse effects on health, building costs and confidence in the building industry. These problems could have been avoided if moisture safety issues, such as design of structures and choice of material with respect to moisture exposure, weather protection at the building site, drying out of concrete structures, moisture measurements etc. had been included in the building process. Knowledge of how to avoid moisture damage in buildings exists today. However, one of the important tasks of the building sector is to formulate this knowledge so that it can be applied in all stages of, and by everyone involved in, the design, construction and operational phases of a building's lifetime.

### **1.2 Former studies**

In 2005, Sikander and Grantén worked out a method and tools for the developer to control and monitor moisture in the building process in the project "The building developer's requirements, management and verification to ensure dry buildings", (Sikander E., Grantén J., 2003, 2004 and Sikander E, 2005). This method was tested in four pilot projects, (Sikander E., Mjörnell K., 2006). The experience from these projects was that follow-up of the measures to ensure moisture safety is significant in obtaining a moisture-safe building. There was also a need for new routines and more tools for parties other than the developer. The method was further developed to include all parties and all stages in the building process, (Mjörnell K., 2005). The new extended method (called ByggaF) was applied in three pilot projects, and the experience from them used further to improve the method and tools (Mjörnell et al, 2007, Mjörnell K., 2007). This paper presents some experience from using the ByggaF method in these pilot projects.

## 2. Description of the method

### 2.1 Outlines of the method

The outlines of the new method, for including moisture safety in the building process, are presented in *FIG. 1*, with the different stages in the building process along the horizontal axis and the different parties along the vertical axis. The method starts at an early stage of planning, when the client decides on the location, type of building etc. The first step in the method includes the client's decision on the requirements concerning moisture levels etc. in contract documents. The second stage is the design stage, when the consultants design the building to meet the requirements. The consultants apply dry building design and produce documentation of their work. In the third stage, construction, the contractor appoints a person responsible for moisture inspection at the building site. He/she identifies the critical parts of the structure and draws up a plan for handling and storage of materials, use of weather protection, moisture inspection and moisture measurements. The contractor makes regular inspection rounds (once a week or more, depending on the rate of work on the building site) to check that the plan is being followed. At the end of the construction stage, the moisture safety documentation is put together and presented to the administrator. In the fourth stage, administration of the building, there are also routines to adopt such as routines for moisture inspection, dealing with leaks, moisture damage and complaints of indoor environment problems caused by moisture damage. The method refers to a number of routines, templates and checklists helping the participants design and construct moisture-safe buildings.

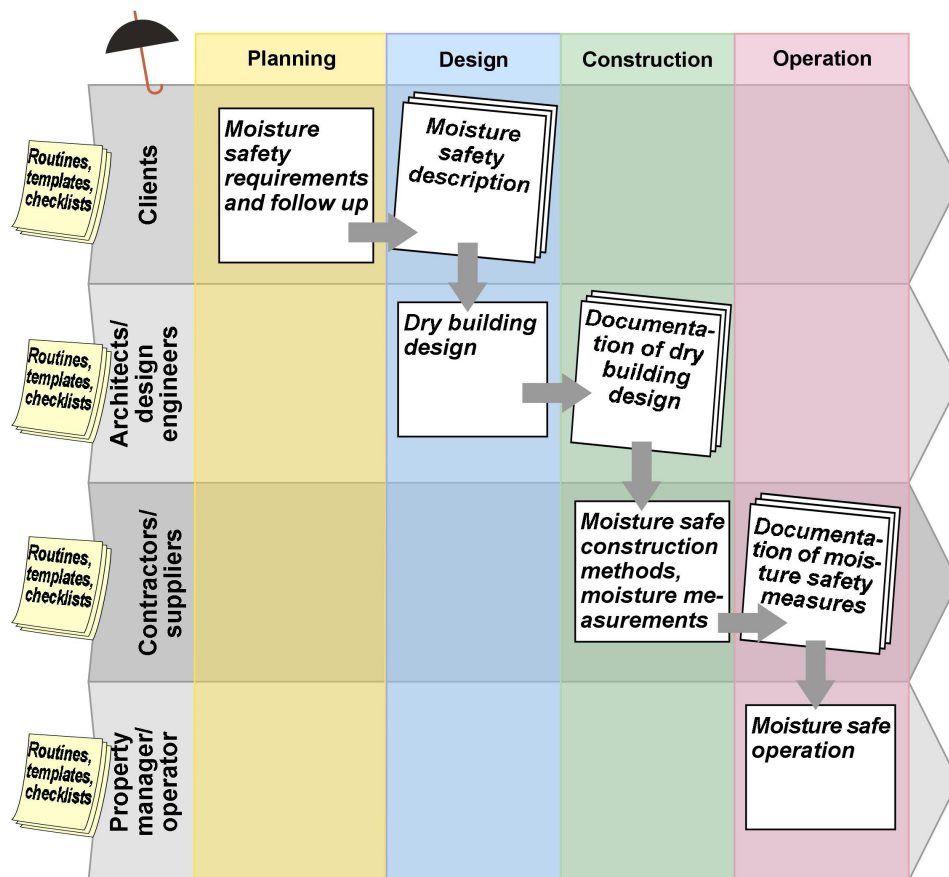

FIG. 1: A schematic description of the method.

## 2.2 Activities, routines, templates and checklists included in the ByggaF method

The method consists of a number of activities for the different parties in the building process, described briefly in *TABLE 1* below. Most of the activities, routines, templates or checklists have been developed to help the parties dealing with moisture safety. The intention has been to present a complete set of works of reference, including routines, templates and checklists, from which the participants could choose the documents suited for their work. The complete description of the method and all documents belonging to the method are presented in a report (Mjörnell K, 2007), but they can also be downloaded from the web site of FuktCentrum, [www.fuktcentrum.se](http://www.fuktcentrum.se). Some of the most commonly used checklists have been translated into English.

*TABLE 1. Description of activities for the different parties concerned, routines, templates and checklists that are included in the method. ME stands for moisture expert.*

Phase	Activities	Responsible parties	Routines, templates, checklists
<b>Planning</b>	Decision of moisture requirements	Client	Suggestion of moisture requirements
	Formulation of moisture requirements in building programme and administrative requirements.	Client	Moisture requirements in administrative requirements
	Appoint a person responsible for moisture safety issues or engage a moisture expert with documented training and experience. (ME)	Client	Job description for a moisture expert
	Draw up a moisture safety description for the project.	Client and ME	Template for moisture safety description
<b>Beginning of design</b>	Information to architects and design engineers about the client's requirements and methods of follow-up.	Client and ME	
<b>Design</b>	Holding moisture meetings with architects and design engineers during the design stage.	Client and ME	Meeting agenda
	Working with, and documentation of, moisture safety design.	Architects and design engineers	Checklist and template for documentation of the moisture safety design
<b>End of design</b>	Carry out inspection with respect to moisture safety of building documents such as drawings and specification of works.	Responsible architect and design engineer	Checklist for inspection of building documents
	Client's final inspection of building documents with respect to moisture safety.	Client and ME	Checklist for final inspection of building documents
	Update and complete the moisture safety description.	Client and ME	
	Information to contractors about the results from the dry building design.	Client and ME	
<b>Beginning of construction</b>	Information to contractors about the client's requirements and methods of follow-up.	Client and ME	Information meeting
	Pass on requirements and information from design stage to construction stage.	Architects and design engineers	Information meeting
	Identification of moisture-critical work, operations and construction.	Contractors	Checklist for identification of moisture-critical work operations and construction.
	Draw up a moisture control plan.	Contractors	Template for moisture control plan
<b>Construction</b>	Follow-up meetings with contractors	Client and ME	Agenda for moisture meetings
	Moisture reviews at the building site	Contractors	Checklist and template for documentation of moisture review at the building site.
	Documentation of moisture safety measures during construction.	Contractors	

Phase	Activities	Responsible parties	Routines, templates, checklists
<b>End of construction</b>	Collect all documents dealing with moisture issues, such as drawings, descriptions, minutes of moisture meetings, results from measurements, and documentation from moisture rounds etc.	Contractors	Checklist for table of contents of moisture safety documentation
	Put together the moisture safety documentation.	Client and ME	
	Information to operator and property manager about moisture safety measures made during the construction stage and moisture-critical designs.	Contractors, Client and ME	Information meeting
<b>Before operation of the building</b>	Put together basic data for operation and management instructions concerning building services, building envelope, building materials and construction with respect to moisture safety.	Client, Contractors, suppliers	
	Draw up routines for recurrent moisture control/checks and measurements in case of moisture damage.	Property manager	
<b>Operation</b>	Carry out regular control/checks of structures sensitive to moisture during maintenance rounds.	Property manager Operations technician	Checklist for recurring check for effects of moisture
<b>In case of moisture damage</b>	Perform remedial measures according to agreed routines	Operations technician	Routine for handling moisture damage, leakage

### 3. Application of the method in pilot projects

#### 3.1 Description of pilot projects and how they used the ByggaF method

The ByggaF method, routines, templates and checklists have been tested in a number of projects in different parts of Sweden to find out if and how they work with regard to moisture safety in the building process. Three of the projects have been followed up in more detail. Among them there is one public building, one condominium building and one apartment building complex. The clients were one public manager, one private housing company and one municipal housing company. The different types of contracts have been: design and construct contract, divided contract and general contract, see FIG 2.

#### 3.2 Following up application of the method in pilot projects

One of the authors has been involved in all pilot projects to some extent, in the capacity of moisture expert, with the aim of introducing the method at the beginning of the project and following up the work during the design and construction stage. The author has, for example, visited the pilot projects a number of times to follow up the moisture safety design and to carry out moisture reviews at the building site. This support may have been an advantage for these projects compared to other projects starting to use the method and tools on their own initiative and by themselves. It should also be mentioned that the method has been used to different extents in the pilot projects. Parts of the reference works have been further developed during the project, so changes and completion of the routines, templates and checklists have been made to meet demands as they arise. Different groups of those involved have also used different tools. The evaluation of the tools should therefore be seen as guidance for their future development.

#### 3.3 Experience from using the ByggaF method

A field survey was carried out at the end of the project. Ten persons representing different parties in the pilot projects were interviewed to obtain feedback on the method. The interviewees were asked to present their own experience from using the method, tools, routines and templates, and also to suggest changes and improvements. The interviews are reported verbatim in the report, (Mjörnell K, 2007). The following is a summary of the interviews. The answers from the interviewees are listed below each question.

FIG 2. Description of the pilot projects.

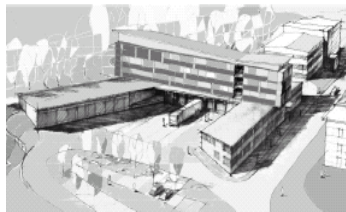

Type of Building: Supply building, Sahlgrenska Hospital

Developer: Public

Type of contract: Design and construct contract



Type of Buildings: Condominiums

Developer: Private estate owner

Type of contract: Divided contract



Type of Buildings: Apartment building complex

Developer: Municipal housing company

Type of contract: General contract

### 3.3.1 Question at issue: The method from a general point of view

**Clients:** Most parts of the method have been used, but there is some resistance among those involved, and it takes time before all have learnt. All interviewees agree that the method has led to improved quality, and intend to use it in the next project. Several companies have included the method in their procedures.

**Architects:** The architects have used the method and will use it in future projects. All interviewees agree that using the method has led to an increased quality. A suggestion is that moisture issues should be included in the companies' own checklists. One adverse experience from the projects has been poor co-ordination between the consultants.

**Design engineers:** Moisture safety design is carried out only if there is a demand from the client. The design engineers are often pressed for time during design. The interviewees think a common checklist would be helpful.

**Contractors:** In principle, the method has been used in its entirety, and one company has included it in its quality and environmental plan. One contractor followed his own routines, and did not apply the new method.

### 3.3.2 Question at issue: Responsibility for moisture safety in your part of the project

**Clients:** Ultimately, it is the client who is responsible, but the person responsible for production is responsible at the building site. The client engaged a moisture expert. The client should have taken more responsibility for the moisture issues.

**Architects:** The person who is responsible for the commission (project) is also responsible for the moisture issues. One of the companies engaged an internal environmental expert to be responsible for the moisture safety design. In another company, no one had overall responsibility for moisture safety design.

**Design engineers:** It is the design engineers who are responsible for the moisture safety issues, but the companies are too small to be able to employ a moisture expert.

**Contractors:** The site engineer has the overall responsibility. A consultant was engaged for making predictions of drying times and moisture measurements in concrete. Another person was responsible for putting together the moisture documentation.



### 3.3.3 Question at issue: Communication of moisture safety issues

**Clients:** Moisture requirements have been communicated at special meetings during tendering, in administrative requirements at design meetings, site meetings, and in connection with start-up meetings. Communication has not worked completely, since not all of the parties have listened.

**Architects:** Moisture requirements have been communicated at meetings, sometimes at special moisture meetings, in documents such as moisture PM, moisture safety descriptions and in administrative descriptions. More time would have been needed to report experience.

**Design engineers:** Some special issues have been discussed, but there has not been much of a dialogue, and the interviewees did not think that they received enough feedback on the work they carried out.

**Contractors:** Moisture safety issues have been communicated at sub-contractors' meetings, production meetings, internal meetings, foremen's meetings, special moisture meetings and at moisture reviews at the building site. Communication between consultants and contractors has been insufficient, and co-ordination between consultants has been poor.

### 3.3.4 Question at issue: Were the moisture safety requirements relevant, and where were they stated?

**Clients:** Moisture requirements are relevant and distinct, but not all parties know what they involve. The interviewees emphasise the importance of understanding the meaning of requirements. For example, was the requirement of 85% RH for concrete too low? The moisture safety requirements have been stated in the environmental programme. The interviewees realise that they should also have required weather protection.

**Architects:** The requirements have been relevant, but weather protection should also have been required.

**Design engineers:** Many requirements compared to previous projects. The interviewees thought that the requirements were relevant, but they should not be too general but must be broken down into concrete requirements in order to be clear. Weather protection should have been a requirement.

**Contractors:** Moisture requirements are to be found in the moisture safety description. Some interviewees consider the requirements as exaggerated (85% RH in concrete and 17% MR in wood), while others consider the requirements as good. The clients had specified the requirements in the contract documents, such as in the moisture safety description, the environmental programme and in the administrative requirements.

### 3.3.5 Question at issue: Moisture safety work

**Clients:** Moisture reviews at the building site and moisture measurements are not considered extra work. The interviewees intend to continue to work in this way in the projects. The moisture safety work has involved more focus on the moisture issues. Moisture reviews with checklists were a new thing.

**Architects:** The interviewees have been working with the moisture design checklist, and presented their work using the documentation template. They have spent more time on details with respect to moisture. They have engaged an environmental specialist to work with the moisture issues.

**Design engineers:** It was fairly new for the consultants to work with moisture safety descriptions and moisture safety design, but they have always been aware of moisture issues. They have learnt how to use TorkaS to predict drying times of concrete.

**Contractors:** The interviewees have had moisture safety on the agenda at meetings, and there have been in-depth discussions at the meetings. Moisture reviews at the building site were new to most of them. The moisture safety work has been documented in the form of the moisture safety documentation.

### 3.3.6 Question at issue: Follow up on moisture safety work

**Clients:** The moisture safety work has been followed up at moisture meetings, at moisture reviews at the building site, and with checklists from the design phase. Moisture requirements have been followed up and departures have been noted and followed up.

**Architects:** The requirements have been followed up. The moisture expert reviewed the designers' quality plans and checklists. The interviewees require feedback from the construction phase.

**Design engineers:** The checklist for moisture safety design was gone through when it was ready, but they lack a meeting for follow-up of the checklist. The requirements have been included in the system documents.

**Contractors:** The moisture expert engaged by the client has followed up the requirements at moisture meetings and reviews at the building site. One interviewee experienced the meetings as a form of policing, and did not feel as if he was taking part.

### 3.3.7 Question at issue: Incentives and consequences if the requirements were not fulfilled

**Clients:** There have been no incentives, and no pronounced consequences.

**Architects:** There have been no incentives, and no pronounced consequences. Usually the price is fixed and there is no extra compensation for the work with moisture safety issues. If there had been more time, the work would probably have been even better.

**Design engineers:** There have been no incentives, no pronounced consequences.

**Contractors:** There have been no incentives and no pronounced consequences. One interviewee felt that there have been “sticks, but no carrots”. If the designs were not approved, we had to rebuild. We had to demolish a great deal of damaged material. Another comment was that a consequence of not fulfilling requirements may be leakage and dissatisfied clients.

### 3.3.8 Question at issue: Competence in the field of moisture safety among those involved

**Client:** The interviewees felt that they have sufficient competence, but are interested in taking more moisture courses.

**Architects:** The interviewees did not feel that they had enough expertise, and there are no moisture specialists in the company. They think that they have acquired new knowledge by working with the proposed method, but many aspects are simply common sense.

**Design engineers:** The interviewees did not feel that they had enough expertise, but are interested in working with moisture issues and will send a colleague to attend a moisture course.

**Contractors:** Some of the interviewees did not feel that they had enough expertise, but they learn all the time and they have acquired new knowledge in the course of the discussions held in the projects. One respondent felt that he had enough knowledge, and had learnt nothing new.

### 3.3.9 Question at issue: Usefulness of tools included in the ByggaF method

**Clients:** The tools are good but can always be improved. The checklist for moisture reviews may be shortened. Some checkpoints recur.

**Architects:** Tools are used only if they are included in the quality assurance system. The interviewees want a continuous update of the checklist with new material and types of designs as well as more reference material, such as literature and good examples.

**Design engineers:** The interviewees think that checklists are a good help to remember important aspects, but they prefer to use them for review rather than fill them in continuously. They think that the proposed checklist is too detailed, and would like to see a checklist for moisture-critical structures.

**Contractors:** The checklist for moisture reviews at site is easy to fill in, but too detailed. Some questions recur. Other good tools are TorkaS and the “Moisture in Buildings” information booklet.

## 4. Conclusions

The ByggaF method, routines, templates and checklists have been tested in a number of projects at different locations in Sweden to find out if and how they work in regards to moisture safety in the building process. The following conclusions can be drawn from implementation of the method in pilot projects.

- Most of the participants have adopted the method into their own routines in the company.
- The method has been used and is considered to give improved quality of the building project.
- Meetings where moisture is discussed have been established.
- Most participants find the requirements are relevant and good. Only a few parties felt that the requirements were unreasonably high.
- According to results from the interviews and questionnaires, most participants are quite satisfied with their competence, but they are in favour of training in the field of knowledge of moisture.
- Many participants ask for further development of the routines, templates and checklists to make them simpler to use and understand, as well as clearer.
- There were observations of insufficient follow-up and feedback from all participants, so an important remaining task is to increase understanding of the importance of follow-up and feedback.
- Our experience is that working according to the new method increases interest in discussion and putting more effort into the work of increase moisture safety. However, motivation needs to be further increased. Not all participants have actively participated in the work.

To sum up, the proposed new method presented in this paper has been used successfully in a number of building projects. Those involved agreed that working with moisture safety has lead to improved quality of the building projects. Many companies have adopted the method and included the routines and templates in their work programmes. However, there are still a few ways in which the method can be further improved. They include, for example: increasing interest in the procedure and improving methods of follow-up and feedback. Increase motivation by appropriate incentives. Offer training and information suitable for the different parties. Further develop routines, templates and checklists to make them simpler and more distinct. This year, seminars will be held, presenting the method and its tools. In parallel with that, moisture courses for moisture experts, clients, architects, design engineers and contractors will be held. In the future, we also hope to be able to go back to the pilot projects and evaluate the effects of the moisture safety work carried out. There are also plans to make this method into a Swedish standard for including moisture safety in the building process.

## 5. References

- Sikander E. and Grantén J. 2003. Byggherrens krav, styrning och verifiering för fuktsäker byggnad, (SP rapport 2003:9 (The Building Developer's Requirements, Management and Verification to Ensure Dry Buildings by Moisture Control) (in Swedish).
- Sikander, E et al. 2004. The Building Developer's Requirements, Management and Verification to Ensure Dry Buildings by Moisture Control. Proceedings, IX International Conference, 2004 Performance of Exterior Envelopes of Whole Buildings. Clearwater. USA.
- Sikander, E. 2005. The Developer's Part to Ensure Dry Buildings. Requirements, Monitoring, Aids and Experience. SP Report 2005:13. Available at [www.sp.se](http://www.sp.se).
- Mjörnell, K., 2005. A Method for Moisture Management in the Building Process, Proceedings of NBPS 2005 in Reykjavik.
- Sikander, E. and Mjörnell, K., 2006, Moisture Management in the Building Process – Experience from Four Projects, Proceedings of the 3rd International Building Physics Conference, Montreal, 2006.
- Mjörnell, K et al. 2007 A Method for Including moisture safety in the buiding process. Proceedings of Performance of the Exterior Envelopes of Whole Buildings X International Conference, Clearwater Beach 2007.
- Mjörnell, K., 2007. Fuktsäkerhet i byggprocessen med ByggaF metoden, (Moisture safety in the building process using the ByggaF-method), SBUF report 2007-02. (In Swedish)

# When the safest solution is unacceptable

*Eva B. Møller, Ph.D.*

*ALECTIA;*

*ebm@alectia.com*

**KEYWORDS:** *Robustness diagram, renovation, practitioners, user behaviour, risk analysis, pilot project.*

## **SUMMARY:**

*Practitioners, who work with renovation based on building physical problems, recommend the building owner to renovate according to the given guidelines. However, this is often too expensive for the building owner, and the consultant is therefore often asked to find cheaper ways to renovate the houses. The risk in less thorough renovations is often that the building will not have the same robustness towards unexpected but not unrealistic events as if the recommended solution had been chosen. The paper shows how the robustness can be illustrated in a diagram showing what parameters will be influenced when different solutions are compared. The method implies a risk analysis of each solution to determine the relevant parameters, and although it is preferable to quantify all parameters objectively, this is not always possible, which makes the method somewhat unscientific. But as an illustration of robustness it is effective. Some of the difficulties in the method are that computer simulations often have difficulties in handling irregularities and defects, i.e. the essence of robustness, and that humans not always act rational, and therefore not can be expected to act as recommended. The risk in using a less thorough renovation can be reduced by the use of pilot projects, with relevant measurements for at least a year. The paper also describe how relevant flats or houses for pilot projects are chosen.*

## **1. Introduction**

Building physical problems are often the reason for renovations of dwellings. Although methods to rectify the problems are available, the building owners are often unwilling to accept the safest solutions for economical reasons. Practitioners are therefore forced to develop alternative solutions, which are less thorough and therefore cheaper but only lessens the problem or are less robust in more extreme situations.

The aim of this paper is to illustrate some of the problems practitioners are facing when the building owner cannot afford the safest solution and is pressing for something cheaper. There is always the possibility to refuse working on other solutions than the correct one, but it is the consultants aim to help the client, and other solutions might be sufficient in this particular case or if the client is willing to take a risk. Therefore the consultant often tries to find different ways, which are less expensive but involve some risks. This can be an acceptable solution if all involved i.e. building owners as well as building users are aware that a less safe solution has been chosen, and are informed what this means to them in terms of user behaviour and extended maintenance.

## **2. Safety versus economy**

The expected life span of non-interim buildings in Denmark is about 50 years, although 70-100 years are not uncommon (Erhvervs- og Byggestyrelse, 2008). It is often seen as a quality of a building that it has a long expected lifetime, despite the fact that the users expectations of the buildings performance often increases over time. As a consequence the buildings may be renovated during its lifetime, either because the building has been damaged or because it does not live up to modern demands, e.g. regarding room sizes, energy performance, indoor climate etc. Sometimes new demands cause damage to the building. A classic example is the installation of individual calorimeters in flats; the aim was to save energy by making the users aware of their energy use and urge a decrease as those who saved energy would be rewarded directly by lower heating costs. The users did save energy by changing their heating and ventilation patterns, in many cases to an extent where moisture problems occurred.

Many dwellings, typically social housings build between 1950 and 1980, have reached an age where renovations are necessary, although size and situation of the dwellings make them attractive. In some cases mainly moisture related problems have slowly increased, and have reached a point where it cannot be treated as individual problems any longer but general measures are needed. The reasons for the problems are often:

- Cheap or sometimes experimental use of materials or solutions when the houses were build
- Increased focus on energy savings i.e. decrease in room temperature and ventilation
- Increased moisture production by more frequent bathing

The increase in moisture production is in some cases outweighed by less people per m<sup>2</sup>. The drying of laundry in the flats is still a problem; outdoor facilities for drying are increasingly unpopular, where as dryers are becoming more common.

Combinations of the reasons listed above can result in problems that are difficult to repair and expensive to prevent from happening again, as they often require radical changes in the building envelope.

Thorough renovations are expensive, although some renovations might be subsidized to some extent, the rent will have to be raised. If the renovation costs are too high the current tenants may not be able to stay in their flats after the renovation. In some cases the rent increase will make it difficult to find new tenants for the renovated flats. The renovation cost should therefore be compared to the costs of demolition and new buildings. However, new buildings will due to new regulations and architectural trends generally be different from the old ones, in more than rectifying the original problem.

The building owners and users might therefore be interested in finding a cheaper way to renovate their houses, although it is not the safe way, recommended by authorities or in guidelines. The price would be a higher risk for not having rectified the problem, and the costs can therefore be a total loss. Another possibility is emphasis on user behaviour or maintenance.

The consultant will have no interest in taking any risks, and will empathise that the solution is *not* according to general recommendations and is to be seen as an experiment. In this way the consultant cannot be held responsible for any shortcomings of the solution, except maybe ethically. The building owner thereby loses the insurance he normally would have by engaging a professional consultant.

Despite these problems, consultants are often asked to find cheaper ways to renovate buildings than the general recommended solutions. As a professional the consultant will try to help, and only suggest solution that under given conditions have a chance of succeeding. The consultants work is therefore to make it clear to the client what these conditions are, and how the client can reduce the risk.

### 3. Robustness

In Denmark different guidelines are given for specific solutions concerning the building envelope. The guidelines are given based on a combination of experience and knowledge. If these guidelines are followed, the building envelope will perform satisfactorily under non-extreme conditions, i.e. ordinary conditions with some margin. Or as described in (DS/INST 146, 2003): "A construction is robust, if important parts of it only are little sensitive to undesigned effects and defects" (Authors translation).

The safety level has been chosen to protect the building owner from speedy deterioration of the building, if the building is not misused. But the level is not too much on the safe side as the cost become too high compared to the gain in safety. A very high safety level means high costs for the society.

If the costs for a general recommended solution are unacceptable, solutions which have a lower safety level might be considered. The safety level can also be described by how robust the solution is i.e. how sensible is the solution to minor discrepancies from optimal conditions.

An unscientific but useful way to help illustrate how some solutions are more robust than others is to draw a robustness diagram, where the boundary conditions are illustrated by some simple parameters.

#### 3.1 Illustrating robustness

The robustness of different solutions can be illustrated as in FIG. 1, where the robustness of different solutions, measured on six different parameters, are shown. What parameters are to be chosen depends on what risks can be detected for the different solutions (e.g. workmanship) and what is important for the building owner (e.g. architecture). The value of the parameters should be quantified objectively if possible, but for instance the parameter materials, where the scale illustrates the risk of using unknown materials, known materials in new ways or using materials with known risks, in all cases the solution will be placed closer to the centre than if

known robust materials are used as always. By connecting the dots from the different parameters a polygon is created. From the figure, the following can be seen:

- The area of the polygon illustrates the robustness of the solution, the larger area, the more robust
- Parameters which needs special attention are very visible

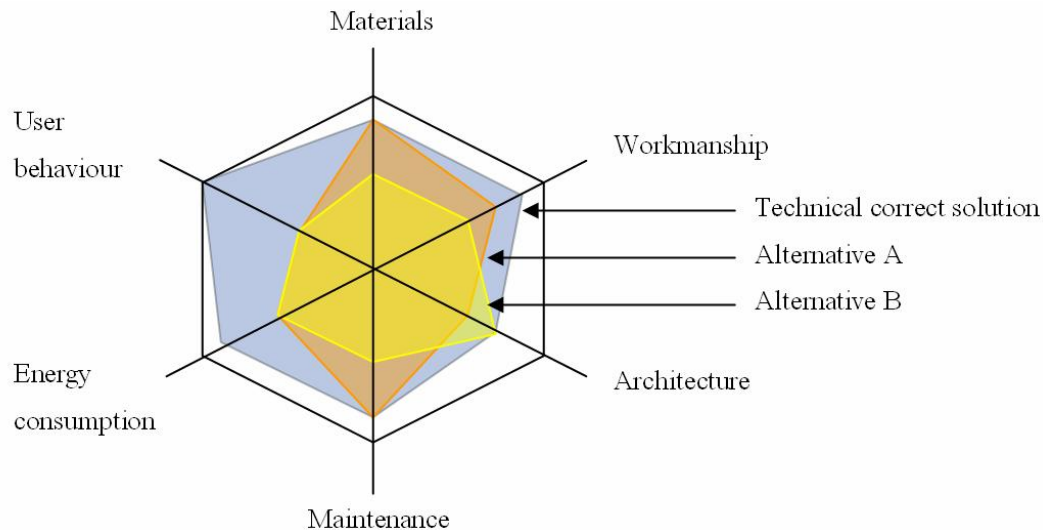

FIG. 1: Illustrating robustness. The technical correct solution has a larger area as the alternatives, and is therefore the most robust solution.

The method is not very scientific as the scales of some of parameters may be based on individual estimates, and the area depends on in which order the different parameters are placed. However the method helps the consultant illustrating to the building owner where the risks are, and therefore on what parameters there should be focused.

If actual conditions for a building are plotted into the robustness diagram, the method can also explain why this building has problems. E.g. if a solution with little robustness towards user behaviour is chosen, as in Alternative B in FIG. 1, and the user is behaving far from optimal, the plot will be outside the area of solution B, therefore the building fails. In a similar building, the user behaviour is more optimal, and the plot is inside the area, and there are no problems. In this way it is simple to explain why two similar buildings seem to behave differently.

To be able to draw a believable robustness diagram different steps are necessary:

1. Risk analysis for all solutions in question
2. Choose all parameters that are relevant for one or more solutions based on the risk analysis
3. Define scales for the parameters, preferably based on objective measurable quantities
4. Estimate the values of the parameters for the different solutions

### 3.2 Choosing robustness parameters and scales

The robustness diagram is only useful and believable if the relevant parameters for a specific problem are treated. For every solution a risk analysis must be made to find the relevant parameters. To compare solutions all the parameters must be treated, even when some of the parameters may not be relevant to all the solutions.

This means, that the number of parameters is not always six as in the example in FIG. 1. The number of parameters depends on the complexity of the problem. If only a part of the building envelope e.g. the roof is to be evaluated, the number of parameters will be smaller than if the whole building is to be treated.

The scale of the parameters can be defined more or less precise. While some scales are relatively easy to define with specific numbers, e.g. energy consumption and maintenance costs, it can difficult to find a simple scale for e.g. materials as stated above. The parameter architecture is another parameter which is difficult to measure. E.g.

in Denmark naked brickwork is often seen as an architectural advantage, the arguments are, that it is traditional, has been used with good results for centuries and patinates gracefully. If a building is to be fitted with an exterior insulation, the original brickwork would be hidden. Some would see this as an advantage, as it makes it possible to change the whole architecture, others would prefer new brickwork as facing. It is not possible to put a number on taste. Some of the parameters in the robustness diagram may therefore be less scientific than others.

However, the aim should be to make the scales as objective as possible, and therefore try to make the parameters as measurable as possible.

The next step is to determine the value for the parameters of each solution. Here more traditional scientific tools like calculations and simulations are useful. However, knowledge of what is realistic is important, otherwise solutions that may be unethical to suggest, as the conditions are impossible to secure, can be chosen because the building owner has no knowledge of what is to be expected.

## 4. Believable computer simulations

Although computer simulations can be helpful, they often mimic a perfect world which is exactly what robustness is *not* about, actually the robustness only becomes effective when minor failures or unexpected but not unrealistic effects occur. Many computer simulations are based on optimal functioning solutions, and failures have to be simulated separately; you often have to “trick” the program to simulate failure, although some programs have “standard failures”. E.g. the program MATCH for calculating heat and moisture transport in building constructions has different standard vapour barriers, two of them are defect, which is an often occurring defect and easy to simulate by decreasing the water vapour resistance. In reality the effect may be that convection occurs, a form of moisture transport the program does not treat (Pedersen, 1990).

Computer simulations that disregard minor failures in workmanship, material properties etc. can be misleading, as it is difficult if not impossible to build flawless. In fact, in a guideline to the Danish building regulations (SBI, 2008) it is stated: “Construction parts and materials should have a surplus to withstand minor failures. Minimizing to the limits of the performance is for ordinary buildings not advisable, as it demands flawless execution in all elements, which experience shows, is difficult to achieve” (Authors translation).

When evaluating the degree of robustness computer simulations should therefore be used even more sceptically than in other simulations.

## 5. Reducing the risk

As calculations and simulations can be misleading, there is a considerably risk of making mistakes when the robustness is estimated. The building owner knows there is a risk, and needs ways to reduce the risk.

### 5.1 Pilot projects

If a project is extensive e.g. with many repetitions, a pilot project can be very useful if it is followed by relevant measurements. A pilot project will reveal many of the unforeseen problems represent a believable simulation of the whole project. However, pilot projects can only give the results of one single project. In the next project different failures may occur, the users may behave differently or something else will be different. The pilot project can only show a probable outcome of a renovation. To get the most use of a pilot project, some simple advice can be useful:

- Do not try to make it easier for yourself, by cutting corners because it is a small project
- Choose a pilot project where there is a high risk of failure, e.g. in a flat where there are serious problems already; if the problem is mould related, chose a flat with mould problems. Do not choose a flat just because the users are cooperative or because it is conveniently vacant.
- After the renovation the renovated area should be used as it is intended to be used after the main renovation is completed.
- Measure relevant parameters e.g. humidity and temperature, preferably for a year. Data loggers are often useful but check your instruments regularly. Loosing measurements for half a year is bitter.
- More than one pilot project reduces the risk of having a not-representative case.

## 5.2 Educating the users

Many parameters can be influenced by the user; using FIG. 1 as an example not only the user behaviour but also maintenance, energy consumption can be influenced by the user. If the user knows more about what can cause damage, chances are that he in the future will act responsible to prevent new damages or act sooner to rectify a situation before it becomes a serious problem.

In housing most users are aware of a general recommendation to make a draught in the residence two to three times a day for 10-15 minutes. If a moisture related problem is reported from a residence, the resident will often empathise that the flat or house is ventilated the recommended way, sometimes even before the question has been asked. However, there is very little understanding for the extra costs for energy consumption or briefly low temperatures caused by ventilation. When the ventilation habits are checked by logging temperature and humidity, it is not seldom seen, that the windows in reality are opened only for a few minutes and no draught has been created. Drying laundry in the residence is another example; most users report, that they only dry very little laundry in the residence, but when asked directly how they dry their laundry, they tell that a clothes rack in the residence is not uncommon, because they have very little alternatives.

This means that although the user knows how to act and directly feels the consequences of not acting the recommend way, he does not change his behaviour, probably because he does not understand or believe in the recommendations or finds them unacceptable or as an interference in his personal liberty.

Educating the users is therefore not just to hand out some simple rules or to ban some undesired behaviour, which cannot be controlled anyway. During a pilot project, it is often easier to teach the users how to use the renovated house, because the users feel singled out and are susceptible to recommendations, but this is not useful for a large number of users. An effective way to educate general users is a task for sociologists not engineers.

Except for leaking roofs and pipes, moisture related problems in residences are often problems that evolve slowly, and the user cannot feel the effect of his behaviour directly; he feels the cold when he opens the window but not the reduced humidity. One way to make the user more aware of his behaviour is to install sensors, displaying the humidity. If the user has been told in what range the humidity should be, he might react sooner if sees the humidity is above 75% RH for a longer time than if the first sign is mould growth behind the bookcases.

## 6. Examples

The situation where a client cannot afford the safe and generally recommended solution is not uncommon and examples where cheaper solutions have been used are numerous. In some cases the result has been a success, in other cases the opposite. The chosen examples illustrate the robustness diagram and some of the results.

### 6.1 Interior insulation

The first example is concerning the gable walls in three 14 storey houses build in the 1960'ties for housing. The exterior walls are of concrete sandwich panels. In the gables the sandwich panels are relatively uninterrupted, see FIG. 2. As the insulation is 50-70 mm in the panels, the residents were complaining about cold gable walls.

It was decided to install prefab interior insulation walls of mineral wool and gypsum board, the adhesive between the mineral wool and the gypsum board is the vapour barrier. In the work description, it was empathised that an acrylic joint sealant should secure the tightness of the vapour barrier where the prefab walls met the adjoining walls, ceiling and floor. Detailed drawings were made of this. Everything was made as describe in the official guidelines of that time (2000). The current guidelines on that field (BYG-ERFA, 2004) only differs from this as it prescribes, that the existing wall paper must be removed before the insulation is installed. In the actual case, the wall paper was ripped open with a wire brush to prevent a double vapour barrier.

After a few years some of the inhabitants were complaining about headaches and other typical Sick Building Syndromes. The conditions behind the interior insulation were checked in some of the flats. In too many cases significant mould growth was found. As a result it was decided to remove the interior insulation and clean the walls. Three possible solutions for the gable walls were now discussed:

1. Another attempt with interior insulation
2. Exterior insulation of the gables
3. Status quo i.e. no extra insulation





FIG. 2: The gables of the 14 storey houses consist of relatively uninterrupted concrete sandwich panels.

Beside an economical estimate the building owners needed to know the consequences of the three different solutions. One way to illustrate the consequences is the robustness diagram, as shown in FIG. 3

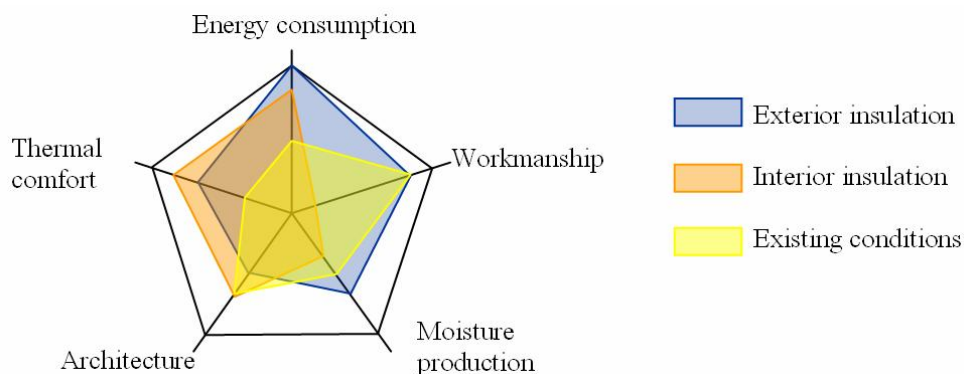

FIG. 3. Robustness diagram for insulation of gable walls

FIG. 3 shows that the original problem with cold walls is best solved with interior insulation, as the thermal comfort close to the walls would be best with interior insulation. However, it also shows very little tolerance or robustness towards workmanship, i.e. tightness of the vapour barrier or the moisture production in the flats.

Although the residents first had decided to reinstall interior insulation, a thorough explanation of the risk of interior insulation changed the general opinion. In the end it was decided to do nothing, but in the future maybe try to find the money for an exterior insulation.

## 6.2 Terraced house

The next example is more complex as it concerns not only a few walls but the entire building. The example is of 34 terraced houses of 80 m<sup>2</sup>, which were built in the 1950'ties as social housing. The roof is fibre cement board, the exterior wall 290 mm aerated concrete with rendering and paint. The floor consists of parquet floor, wood fibre board, concrete and crushed slag as capillary barrier, see FIG. 4. The houses are electrically heated.

With very poor insulation in as well exterior walls as floors, combined with an expensive heating system, the residents were complaining of the thermal comfort of the houses, heating costs and mould growth.

The houses were investigated and as the houses cannot live up to today's standards it was suggested to renovate them thoroughly, by applying exterior insulation to the walls, increase the insulation in the attic, replace the whole floor inclusive crushed slag, with a modern ground floor. A perimeter drain was also suggested.

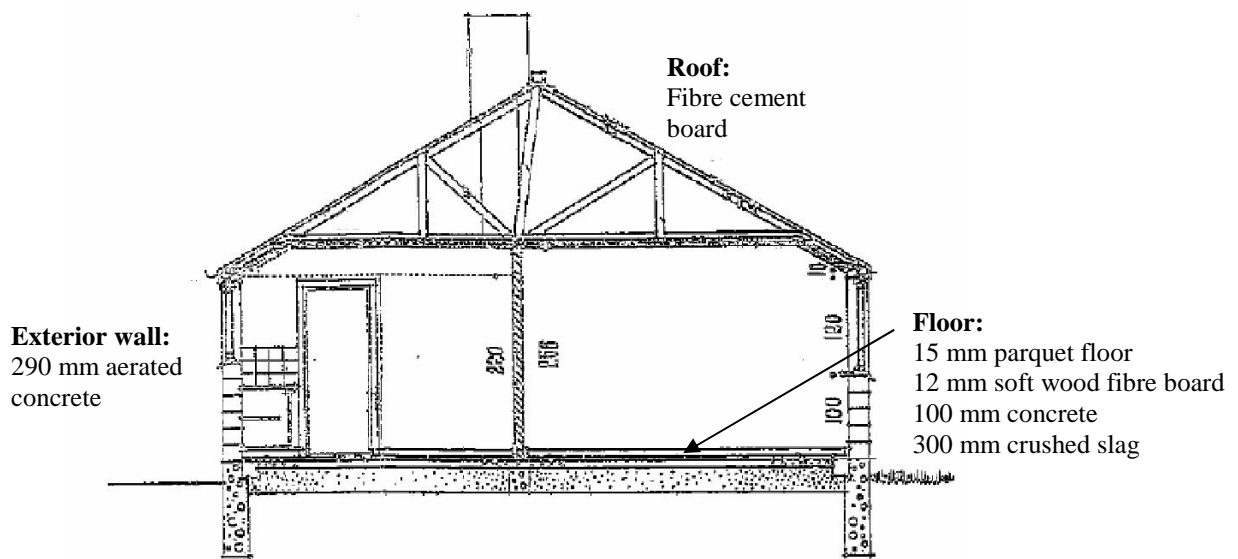

FIG. 4. Cross section of terraced house.

However, this would be too expensive, and suggestions of demolishing the houses were made, although there is a tradition of *not* demolishing social housing in Denmark. A cheaper alternative to the thorough renovation was needed.

An alternative could be to install a ventilation system with heat recovery, and replace the flooring above the concrete with 25 mm insulation and new parquet floor.

A robustness diagram (see FIG. 5) shows the different solutions, and the numbers of parameters illustrate the complexity of the problem. The crushed slag is a problem in it self, as slag now is known to lose its ability to function as a capillary barrier and instead promote capillary suction. In some cases the crushed slag swell up to 10 % and lift the floor.

Although the improved ventilation makes the houses more robust towards moisture production, as the ventilation removes the moisture, the cheap solution does not reduce many of the other problems in the houses, and the houses will still be cold and the heating costs high.

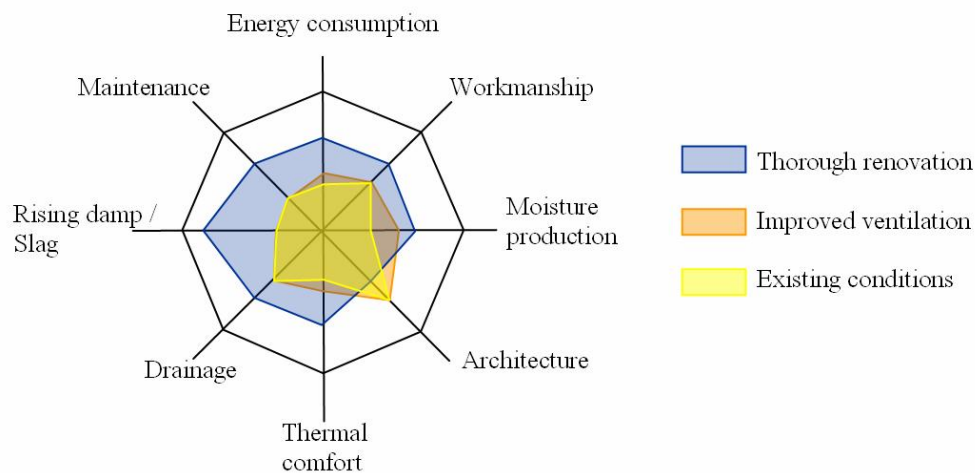

FIG. 5. Robustness diagram for the renovation of terraced house.

In this case a pilot project of two houses was chosen, in both houses mould growth was found on walls and in the floor. The houses differ in the number of occupants (see TABLE 1) and in one of the houses the electrical

heating is supplemented with a wood stove. The residents have been very positive about the pilot project and seem to have understood the limitations of the cheap solution. E.g. the residents who had removed the electrical radiator in their bedroom to gain more room, accepted to reinstall the radiator, as it is not to be expected that a bedroom, occupied by two, and with two exterior walls can remain mould free, when the exterior walls consist of 290 mm aerated concrete.

Measurements in the floor (between insulation and parquet) from September 2007 to January 2008 show differences in the two houses as can be seen in TABLE 1. Until now there is no risk of mould growth in house 1, while there is some risk in house 2. The measurements will continue until September 2008, then it will be decided how and if the houses are to be renovated.

TABLE 1: Measurements in the two houses in the pilot project with improved ventilation in terraced houses.

	# occupants	Temperature (°C)	Relative humidity (%RH)
House 1	2-3	13-20	68-75
House 2 (with wood stove)	4-5	15-20	75-80

## 7. Conclusions

When working with renovation it is not uncommon as a consultant to be asked to create a cheaper and less thorough solution than the safe and generally recommended solution. If one accept to try this, it is important, that the building owner is explained where the risks are and where to focus if the cheaper less robust solution is to be chosen. The term robustness describes how sensitive a construction is to undesigned effects and defects, i.e. events that are unexpected but not unrealistic.

A robustness diagram can help explaining the building owner the difference between different solutions. The parameters of the robustness diagram can be determined by risk analysis of the suggested solutions. The method is somewhat unscientific as not all parameters can be measured objectively. However, an attempt to quantify all parameters should be made.

Computer simulations can be deceiving when predicting robustness, as most simulations have difficulties in simulating defects or irregularities.

Assuming that it is possible to educate all users and therefore accept less tolerance toward user behaviour is unrealistic. Experience show that even when users theoretically know how to act and they know they will feel the annoyance themselves if they act differently, they still might choose not to act as recommended.

Therefore the robustness diagram is a tool, which should be used with cautiousness. The risk of a less thorough solution can be reduced by the use of pilot projects with measurements for at least a year. But sometimes the consultant has an ethical responsibility to tell the building owner when the robustness is too small.

## 8. References

- Christensen G. and Bunch-Nielsen T. (2004). Indvendig isolering – ældre ydermure over terræn, BYG-ERFA 04 07 29, Ballerup, Denmark.
- Erhvervs- og Byggestyrelsen. (2008). Bygningsreglement 2008, www.br08.dk
- Pedersen C.R. (1990). Combined heat and moisture transfer in building constructions, Thermal insulation Laboratory, Technical University of Denmark., Lyngby, Denmark
- SBi (2008). SBi-anvisning om Bygningsreglementet, SBi-anvisning 216, www.sbi.dk

# Insufficient Moisture Control in the Building Process – Recommendations for a Multi-disciplinary Management Tool

*Cecilie Flyen Øyen, M. Arch., Senior scientist, PhD fellow,  
SINTEF Building and Infrastructure/Norwegian University of Science and Technology (NTNU), Norway;  
cecilie.oyen@sintef.no and www.sintef.no/byggforsk and www.ntnu.no*

*Tore Kvande, Dr.ing, Senior Scientist, Professor II,  
SINTEF Building and Infrastructure/Norwegian University of Science and Technology (NTNU), Norway;  
tore.kvande@sintef.no and www.sintef.no/byggforsk and www.ntnu.no*

*Knut Noreng, M. Sc, Senior Scientist,  
SINTEF Building and Infrastructure, Norway;  
knut.noreng@sintef.no and www.sintef.no/byggforsk*

**KEYWORDS:** *architectural management, building defects, building performance, building process, civil engineering management, climatic impact, climate adaptation, design process, management tools, moisture*

## SUMMARY:

*Insufficient moisture control and climate adaptation in the building process is partially due to an increased centralisation and standardisation in the construction sector. Climate challenges and developments are not afforded sufficient attention in the building process. A fresh report from the SINTEF Building and Infrastructure programme “Climate 2000” concludes that the participants in the construction sector need and expect the development of multi-disciplinary guidelines in order to properly address process-related moisture problems. This paper discusses the development of multi-disciplinary guidelines and management tools in dealing with moisture challenges at the various stages of the building process. The principal basis of the paper is a qualitative survey in an ongoing PhD study by one of the authors. A large number of building defects occur in the early stages of the building process, often caused by incomplete or non-existent requirements, omissions, errors in the design phase or ignorance in the field of building physics. Other issues are related to management and organisation, participant interfaces, risk-assessment analysis, technical and functional requirements, material use, drying methods, micro-biological growth and indoor climate, related to the complexity of the construction process as a whole. The paper concludes with an outline of structure and content of a practical multi-disciplinary management tool for a moisture-resistant construction process.*

## 1. Introduction

A large number of process-related building defects originate in the early planning and design stages of the building process. This applies in particular to moisture, where the impact of climate loads during the construction period is substantially greater than desired. The anticipated changes due to the impact of global warming will serve to enhance such loads on the building environment. In the case of Norway, predictions indicate that climate change will involve a rise in temperatures, increased amounts of precipitation, stronger winds, higher sea levels, etc., and thus a varied range of consequences.

At the same time, investigations made by SINTEF Building and Infrastructure have established that similar building defects are often repeat occurrences. It would appear that the construction industry is incapable of learning from past experience. Poor information flow and an inability to communicate experience in the construction sector appear to be crucial factors in achieving a design suitable for local climate loads. The legal planning and building framework for the handling of moisture and climate challenges is not particularly efficient. The handling of planning and building applications by local authorities does not necessarily ensure that moisture problems and local climate conditions are addressed and solved throughout the building process. Thus the legislation itself and the implementation of the local authorities' practice, does not in itself necessarily ensure that sufficient attention is paid to these issues during the building process.

Most participants in the building process have computer-based systems for attending to planning, design and project administration details. SINTEF Building and Infrastructure's investigations (Eriksen et al. 2007)

demonstrate that a number of construction-industry companies organised as chains collaborate internally in subscribing to and disseminating relevant net-based information, legislation and e.g. building information sheet systems. However the empiricism available shows that the issues of climate adaptation and moisture problems are not sufficiently covered by existing computer-based systems in the industry (Eriksen et al. 2007). Altogether, factors related to ambiguity caused by impacts and insufficient attention to climate loads and moisture problems in the building process are numerous. This is closely linked to the complexity of planning, designing and construction of the building environment. The present number of building defects and the increasing strain on the building environment caused by a deteriorating climate indicates a clear need for the implementation of effective counter-measures. Furthermore, the demand for guidelines as well as administration and management tools in the construction sector is increasing.

The main objectives of this paper are

- to identify the main driving forces behind building defects
- to identify at what stage in the building process defects emerge, and pinpoint the participant responsible
- to develop a framework model ensuring interaction between the main driving forces, identify the stage of the building process at which defects emerge as well as the participant responsible for any preventive measure needed to decelerate the generation of defects.

The purpose of forming the model as described above is to develop a tool enabling participants to make early adaptations and decisions at any stage of the building process. Thus, implementation and use of such a tool will, to a large extent, prevent defects caused by climate and moisture loads in line with the above identified settings.

## 2. Theoretical and practical framework

### 2.1 The challenge posed by extreme climatic variations

Norway's climate is extremely varied; the rugged topography being one of the main reasons for large local differences in temperatures, precipitation and wind velocities over short distances. The seasonal variations are also extreme. The country's long coastline and steep topography make it particularly vulnerable to frequent and extreme events such as coastal storms, avalanches and landslides. From its southernmost point to its northernmost extremity there is a span of 13 degrees of latitude. See Fig. 1 for an illustration of the Norwegian climate according to the Köppen climate classification system.

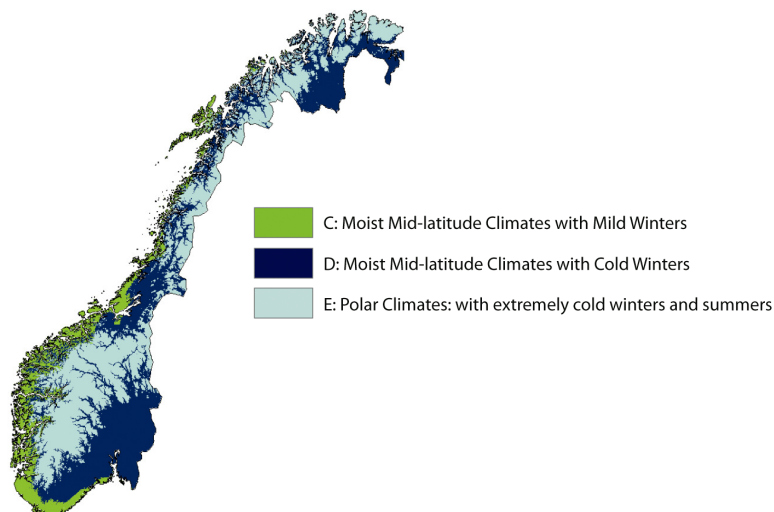

*FIG. 1: The climate of Norway based on the Köppen Climate Classification System (developed by Wladimir Peter Köppen around 1900, with several later modifications). The map is prepared by the Norwegian Meteorological Institute ([www.met.no](http://www.met.no)), using weather data (annual and monthly averages of temperature and precipitation) from the reference 30-year period 1961–1990 (Lisø 2006).*

Thanks to a long coastline facing the northern extension of the Gulf Stream, Norway has a much milder climate than the latitude indicates. The highest annual temperatures can be found in the coastal areas of the southern and western part of the country. The coldest area throughout the year is the Finnmark Plateau (when excluding uninhabited mountain areas). There are also large differences in the normal annual precipitation in Norway. The largest normal annual precipitation is found some miles from the coast of Western Norway. These amounts are also among the highest in Europe, with an annual normal precipitation of more than 3.5 m. The inner part of Eastern Norway, the Finnmark Plateau, and some smaller areas near the Swedish border, are all lee areas in relation to the large weather systems mainly coming from the west. Common for these areas is the low annual precipitation with showery precipitation during summer as the main contributor. Norwegian climate data and indices for building physics design are given by Lisø and Kvande (2007).

## 2.2 Typical building defects

The volume of building defects in Norway is tremendous. Ingvaldsen (1994) estimates that the cost of repairing process-induced building defects amounts to 5% of the annual capital invested in new buildings. Correcting faults and repairing defects in buildings during the construction process is estimated to cost roughly the same amount as repairing buildings in use, e.g. another 5% (Ingvaldsen 1994). With an annual investment in refurbishment and new construction of 16.5 billion euro (as in 2003), it is reasonable to assume that approximately 1.65 billion euro is being spent on repairing defects or damage to buildings every year (provided that Ingvaldsen (1994)-estimate is still valid). According to Ingvaldsen (1994), 20% of the process-induced building defects could be directly linked to the owners' decisions to lower cost, 20% to planning or design omissions, 20% to planning or design errors, 30% to workmanship mistakes and 10% to material defects.

Analyses based on process-induced building defect assignments carried out by SINTEF Building and Infrastructure (Lisø et al. 2006) indicate that moisture is the dominant source of building defects in Norway, accounting for as much as 76% of all cases (Fig. 2). Defects related to the building envelope (Fig. 3) constitute 66% of the investigated cases. The categorisation of defect sources in Fig. 2 is chosen to allow for a simple classification of the main impact responsible for the defect. Precipitation, often in combination with wind, is a self-explanatory climatic impact. Indoor activity (humans, animals and plants) produces indoor moisture. Built-in moisture is moisture in both materials and constructions. Defects related to water in soil are due to insufficient draining and circumstances related to the outside terrain. 9% of the cases are related to moisture in combination with other sources. These other sources are often reinforcement corrosion and sulphate attack. 24% of the investigated cases are not moisture related at all.

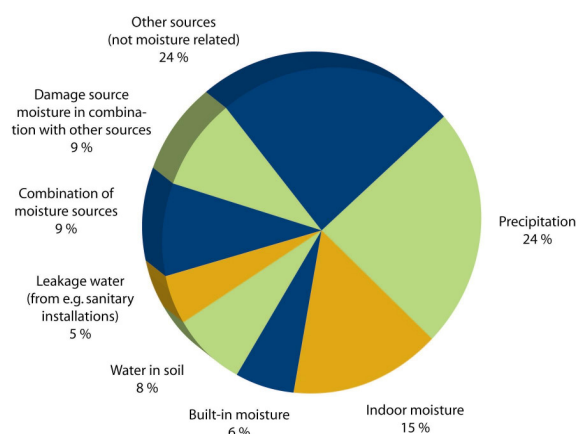

FIG. 2: Process induced building defect cases distributed by source of defects (Lisø et al. 2006). The term “process induced building defects” is defined by Ingvaldsen (2001).

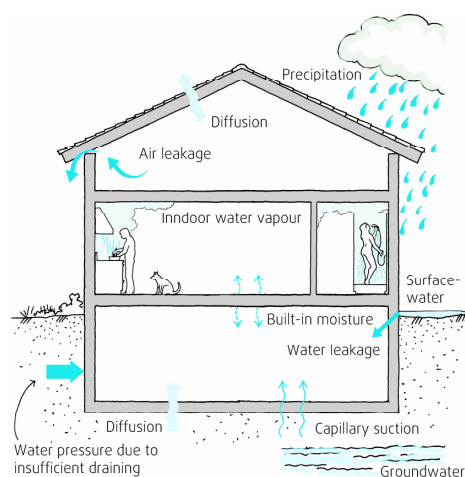

FIG. 3: The term building envelope includes roofs, terraces, external walls above terrain, external walls under terrain and slab-on-ground floors.

According to Lisø et al. (2006), lack of knowledge on fundamental principles of building physics is a common problem in building projects in Norway. Many types of building defect cases are recurring items. A wide range of classical problems has been recorded. Lisø et al. conclude that the construction industry is not able to learn

from past experience and that the exchange of knowledge in construction projects is unsatisfactory. These findings are also supported by earlier investigations (Ingvaldsen, 1994 and 2001). Recent trends are pushing towards the use of untested solutions and details in the construction industry, possibly resulting in a series of future building defects. The traditional use of tested solutions assures secure, tested documented techniques based on well-incorporated knowledge and experiences. Thus, the architects' creativity may in fact be a threat to good building quality, without fundamental expertise covering the project. When considering the use of earlier non-tested solutions, it is of great importance to compensate for the lack of incorporated knowledge by using extended competence in the specific field of knowledge. Another possible preventive measure is to evaluate and reduce to a minimum the number of variations of different solutions used on similar details (e.g. different types of external walls) (Øyen, 2007).

### **2.3 Moisture and climate issues within Norwegian legislation**

The professional participants in the building process are responsible for addressing moisture-related issues in buildings; on a level with other important aspects, relative to their particular area of liability. Yet the issues of moisture and moisture problems are not comprehensively dealt with in the Planning and Building Act. However, the focus in legislation, building codes/regulations and guidelines should in principle be sufficiently thorough to ensure sufficient attention in practice.

Moisture is an issue of great importance at all stages of the building process, not least in the early stages of planning and design. Yet other aspects than moisture appear to be dealt with in a far more thorough way within the legal framework. As one such aspect, aesthetics is a topic of broader consideration, anchored in the planning and building act, the building codes/regulations and the guidelines, as well as at central, regional and local authorities' levels. Legislation clearly instructs the regional and local authorities to consider aesthetics as an important topic when developing plans and other means such as e.g. local statutes, directions for the handling of building permits and guidelines for participants involved in planning and design. There are no corresponding instructions pertaining to moisture in planning and development of guidelines or statutes. Hence the pressure on the local authorities is more clear-cut in the case of e.g. aesthetics than of moisture, where the requirements principally are directed towards the participants involved.

Local authorities are responsible for the implementation of legislative requirements through the local planning and building approval system. They are instructed to incorporate important legislative issues in municipal plans at strategic and local levels, local requirements, statutes and guidelines. It is of vital importance to place climate challenges and moisture problems on the local political agenda and in the various tools of the local authorities. The aspects of moisture and climate will thereby be introduced early in the building process and thus boost the participants' awareness in the field.

As a result of a comprehensive reform of the Norwegian planning and building legislation in 1997, responsibility for the technical contents of planning, design and construction was formally transferred to the participants. Thus the local authorities are no longer instructed to perform a substantial technical examination of the mandatory drawings following the building permit application. Yet, aesthetics is the only remainder of such technical review by the local authorities. At the same time the building inspection formerly performed by the local authorities, was terminated, leading to a withdrawal of the local authorities' technical and experience-based competence. The revised legislation imposed a new supervisory function on the local authorities, in order to control the participants' area of liability and own inspection. The supervision task has however not been implemented to the intended extent. Altogether these factors have resulted in the builder/owner assuming responsibility for compliance with the legal framework, through the assistance of his privately assigned consultants and constructors.

### **2.4 Survey of participant requirements**

The majority of moisture-related building defects reveal a need for immediate highlighting and focused actions in the building industry. The participants in the building process have a clear need for improved knowledge and information regarding the driving forces and preventive measures necessary to reduce the extent and negative impact of building defects. Another important aspect is to visualise the potentials of improvement, and the extent of actual expenditure cuts such improvements represent. It is of vital importance to enhance the focus attention on moisture-related problems at the earliest possible stage in the building process. This applies to the choice of materials, techniques and solutions, implementation of weather protective measures, management tools and the

attention of local authorities on the issue of moisture and climate through planning and building approval implementation.

A study of climate adaptation in the Norwegian pre-fabricated housing industry (Eriksen et al., 2007) shows that climate adaptation does, to a certain extent, take place in Norway, but that several development features weaken the process of adaptation. It has often been assumed that the process of adaptation appears as a linear relationship to legislative changes through municipal implementation in the construction industry and practice. The actual adaptation process departs from this to a far greater degree, by being linked to changes in marked demand, knowledge exchange in networks and the competence of the trade. Due to large variations in local climate conditions, solutions that are suitable for one location may not suit another. This implies a need for expertise regarding local climate variations and pertinent building adaptations. A weakened adaptation process within the construction sector is reflected in several aspects of how climate adaptation is handled in local building practice:

- Use of more robust and thus more expensive solutions than necessary;
- Use of unsuitable solutions, due to the fact that one solution may not fit at all locations;
- Informal adjustments that have not been designed in advance, with deficient quality control and thus deviations from the approved building application. Such adjustments may lead to faults or defects that are undetectable due to lack of documentation of completion.

Lack of flexibility and focus on local adaptation does occasionally result in solutions that are locally adapted yet are contrary to the approved plans and solutions. Although this may result in solutions better suited to the local climate loads, they will still be incorrect due to non-compliance with the legal requirements. Such practice may also complicate the tracing of the actual cause of defects. In order to secure adequate climate adaptation, it is important that the knowledge of local craftsmen is taken into account and documented. This implies increased exchange of information between the participants in the building process and, if possible, the presence of local craftsmen earlier in the building process and in the planning and design stages. In order to meet the problems of solutions that may not fit all locations, the development of climate-zone differentiated solutions is another possible alternative. A well-defined, vertical flow of information and well-developed knowledge networks are important measures in order to further generate competence on appropriate, locally-adapted solutions.

The practice of local enterprises is influenced by several conditions. Some of these, like competitive factors, local knowledge and centralisation of production, seem to be more important to climate adaptation than the legal framework. Changes in central and local government administration have led to a down-scaling of competence in local planning and building administrations. The local authorities' formal role has altered from being an active controller to that of a passive organiser. As a result of this change climate adaptation has, relatively speaking, become more dependent on knowledge networks in order to take place. This development towards a clearer dependence on networks implies that the adaptation process has become more vulnerable. At the same time, governmental changes have reinforced the market changes towards centralisation of both the pre-fabricated housing companies' organisational structures and of the use of equal detail solutions undermining local knowledge.

## 2.5 Main driving forces behind building defects

The following list gives a summary of credible causal connections behind building defects. Such driving forces have to be viewed against this background, and in recognition of the fact that 3/4 of defects are due to some kind of moisture and that 2/3 of the defects occur within, or in connection with, the building envelope:

- Insufficient attention to moisture and climate issues within the legal framework:* A more holistic attention within the legal framework and implementation in local municipalities' plans and tools would raise awareness and ensure a wider approach in the building process;
- Reduced competence at local planning and building authorities:* As a result of the major reform of the planning and building legislation in 1997, the technical aspect of the handling of building applications was radically diminished. Gradually the competence has been transferred to private consultants and other occupations in the industry. Thus the local planning and building authorities are in need of considerably enhanced competence in order to provide efficient service;
- Lack of focus on moisture and climate issue within local authorities' plans, statutes, guidelines and general information:* This comes in addition, to or as a result of, the decline in competence at local



authorities, and is thus closely linked to the preceding paragraph. These shortcomings result in a further reduction of focus on moisture problems and climate loads in the building process;

- *Lack of implementation and effectuation of supervision at the local building authorities (insufficient or absent):* The supervision should scrutinise the participants' systems of own-inspection and control of projects, and thus initiate a demand for such control. Due to lacking implementation of the statutory, systematic supervision in a great number of municipalities, control of the participants is not demanded;
- *Lack of control by responsible participants (insufficient or ineffective):* Many participants in the building process do perform an efficient control or own-inspection. However, due to the lack of municipal supervision of this control, a good deal of the motivation for performing the control is lacking. This has led to an untenable situation that has to be dealt with in order if the quality of the building environment is to be improved;
- *Lack of knowledge regarding fundamental principles of building physics among the participants:* The area of liability regarding building physics is often not covered by the design team, or covered by the architect. This is however often not sufficient, and may cause impending defects and have a great impact on the construction.
- *Recurring defects:* Lack of experience-based learning and lack of information flow is a probable cause, due to the fact that the same mistakes or defects often appear repeatedly. This indicates a need for systematic evaluation and documentation of mistakes or defects, in order to prevent repeated similar mistakes;
- *Use of non-tested solutions leading to a number of unnecessary defects:* This is often induced in the planning and design stages, and reveals the fine line existing between encouraging creativeness and assessing the challenges posed by the elements. This is also a question of assessing possibilities and of covering all the necessary areas of liability in a project with sufficient competence;
- *Similar solutions being utilised despite varying climatic loads and locations:* This reveals an obvious need for climate-zone differentiated solutions;
- *Too many alternative detail solutions in use:* The more alternative solutions, the greater the chance of defects occurring. By narrowing the selection of solutions, and by a closer relationship to climate zones, the chances of success will increase correspondingly.

There seems to be a low degree of consciousness and a clear lack of focus on the issues of climate adaptation and moisture safety at a general level. As the list of driving forces behind building defects shows, legislation has a low focus, local authorities have a low focus, buyers have a low degree of demands on the issues and the participants in the building process tend to focus on other areas rather than consolidating a higher quality in respect of a reduction in the number of defects and an increase in climate adaptation.

## 2.6 Moment when building defects emerge

A rough overview of how defects originate at participant/building process phase level, points overwhelmingly to origins in the early stages of the building process. As much as 20 % of defects are due to owners' decisions to reduce costs. This reveals a clear need of information aimed at builders/owners. A possible and somewhat paradoxical consequence is that the intended cost-reduction measures may lead to unforeseen expenditure due to climate/moisture originated defects. Another 20 % of the defects originate due to omissions in planning or design, and further 20 % in planning- or design errors. Thus 60 % of the defects may be traced to early planning and design stages of the building process. Combined with the knowledge that  $\frac{3}{4}$  of the defects are due to some kind of moisture, this bears witness to a complete absence of necessary focus and approach to the issues of climate adaptation and moisture protection. Approximately 30 % of defects are caused by workmanship errors, and roughly 10 % are due to material defects. This may seem negligible compared to the obvious obstacles in the early stages of the building process. Nevertheless, when almost  $\frac{1}{3}$  of the defects arise in the construction stages, measures are requisite also later in the building process.

## 3. Proposal for multi-disciplinary guidelines and management tools

A common tool for all the participants in the building process will increase the possibilities of exchange of experiences and ease the flow of information within projects. Further, it will consolidate the attention of

interfaces between the participants. The local authorities are not intended as a partner or user of such a tool. When in use, the system may however be utilized for production of documentation of e.g. the regime of control attaching the building application of a project (paper based or digital). The development of a building process management tool of this kind will precede the introduction of the aspects of climate adaptation and moisture safety to digital building models for interaction in the building industry (www.buildingsmart.com). Further, the attributes of the tool may easily be transferred to the municipal digital planning and building approval systems.

As shown, there is a huge need for systematic work methods to handle moisture technical topics. One objective in the ongoing SINTEF strategic institute project Climate 2000 is to develop an electronic tool/aid for a moisture-resistant building process. The intension of the tool/aid is to signal demands to each participant in the building process, so that the current requirements to moisture resistance can be given adequate attention at any given moment throughout the building process. The upper part of fig. 4 gives an overview of when in the building process the particular participant is involved. The lower part of fig. 4 indicates the different choices proposed to be made available in the tool.

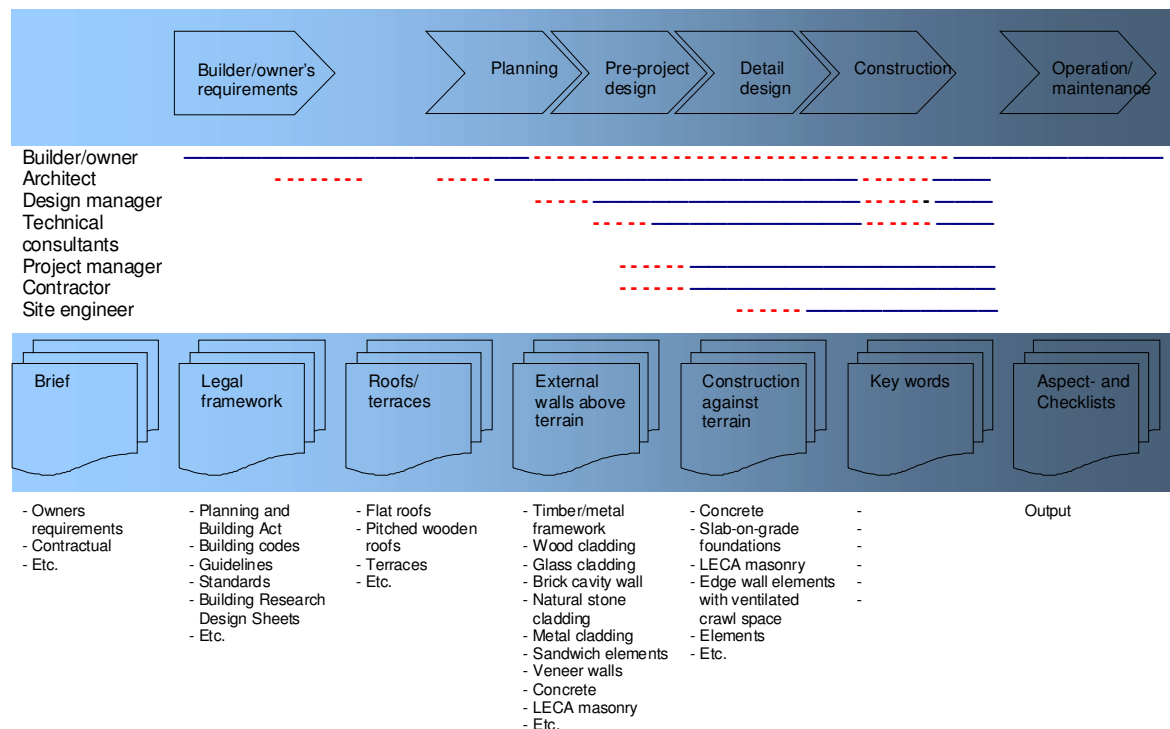

FIG. 4: Outline of structure and content of a multi-disciplinary management tool/aid for a moisture-resistant construction process practice. A continuous line indicates complete involvement; a dotted line indicates partial involvement of the particular participant. The participants' tasks end at the time of acquisition, although their liability continues for several years.

The requirements can be formulated as checklists adjusted to any particular stage or participant, part of building, project or technical function related to the building process (see Table 1). Such a tool/aid can successfully provide decision makers in the building process with vital basic information thus enabling them to make pertinent and relevant decisions. The tool may, at any given moment, display requested information on implemented measures, stage or time of implementation, executer/liable participant in charge. Any necessary or possibly remaining or lacking actions will also appear. In order to provide support and suggest possible solutions for the participants, the basic technical information of the tool will be closely linked to the relevant Building Research Design Sheets. Systematic evaluation of moisture resistance has traditionally been afforded little or no attention in the building sector. During the building process, moisture-technical questions are merely handled as one of several problematic elements that are often underestimated or even omitted. Increasingly stricter demands on economy, progress and quality push the performance abilities to the limits. Simultaneous, extreme weather events and varying climate loads challenge the progress of the building process. These challenges appear to be difficult to combine with the requirements of adequate moisture resistance in the building process.

TABLE 1: Example of a checklist formulated according to the principles shown in Fig. 4.

Check	Checkpoint	Requirement of the Norwegian law *)	Information (**)
	<b>Situation</b>	- Construction process stage: Pre-project design	
	- Participant:	Architect	
	- Building component:	Flat roof	
<input type="checkbox"/>	Aesthetics: In order to promote a good architectural style, it is necessary to adapt the new building or extension to the surrounding environment (natural and man-made)	PBL §74.2	312.008 321.010/011 525.002 725.012
<input type="checkbox"/>	Flat roof need sufficient slope (minimum 1:40) to avoid water pools forming on the roof	PBL §77 TEK §8-22 and §8-37 REN §8-37	525.002 525.207
<input type="checkbox"/>	Compact, warm roofs need internal downpipes to ensure water from freezing before it's drained	PBL §77 TEK §8-22 and §8-37 REN §8-37	525.002 525.207
<input type="checkbox"/>	Gullies need to have an ice-free design	-	-

\*) Norwegian Planning and building Act (PBL), Technical requirements (TEK), Guidelines (REN)

\*\*\*) SINTEF Building and Infrastructure's Building Research Design Sheet

The fundamental idea behind the multi-disciplinary management tool/aid is thus to attain an overview of possible solutions suitable for specific cases of climate and moisture loads; involve participants and decision makers at different stages of the building process and ensure a flow of information between them by allowing all parties to operate using one common, open, digital tool. ByggaF is a similar tool for high quality developed in Sweden (Mjörnell 2007). However, it is not yet a digital tool.

## 4. Acknowledgements

This paper has been written within the ongoing SINTEF strategic institute project "Climate 2000 – Weather Protection in the Construction Process". The authors gratefully acknowledge funding by the Research Council of Norway. A special thanks to Kim Robert Lisø for important contributions and to David H. Lovett MSTF for English language improvements.

## 5. References

- Ingvaldsen T. (1994). Byggskaedemfanget i Norge (Building defects in Norway, in Norwegian), Project Report 163, Norwegian Building Research Institute, Oslo.
- Ingvaldsen T. (2001). Skader på bygg: grunnlag for systematisk måling (Building defects: A basis for systematic evaluation, in Norwegian), Project Report 308, Norwegian Building Research Institute, Oslo.
- Lisø K.R. (2006). Building envelope performance assessments in harsh climates: Methods for geographically dependent design. Doctoral theses at NTNU 2006:185, Norwegian University of Science and Technology (NTNU), Trondheim.
- Lisø K.R. and Kvande T. (2007). Klimatilpasning av bygninger (Climate Adapted Buildings, in Norwegian), SINTEF Byggeforsk, Oslo.
- Lisø K.R., Kvande T. and Thue J.V. (2006). Learning from experience – an analysis of process induced building defects in Norway, *Research in Building Physics and Building Engineering – Proceedings of the 3<sup>rd</sup> International Building Physics Conference*, Taylor & Francis Group, London, 425-432.
- Mjörnell K. (2007). ByggaF Metod för fuktsäker byggprocess, FoU Väst rapport 0702, Sveriges Bygginstrument, Göteborg.
- Øyen C.F. (2007). Design process challenges – Simple obstacles or complex building defects. Project report 1, SINTEF Building and Infrastructure, Oslo.

# Moisture Performance Criteria to Control Mould Growth in UK Dwellings

*Hector Altamirano-Medina, PhD Student*  
*Bartlett School of Graduate Studies, University College London*  
*h.altamirano-medina@ucl.ac.uk*

*Mike Davies, Professor*  
*Bartlett School of Graduate Studies, University College London*  
*michael.davies@ucl.ac.uk*

*Ian Ridley, Dr*  
*Bartlett School of Graduate Studies, University College London*  
*i.ridley@ucl.ac.uk*

*Dejan Mumovic, Dr*  
*Bartlett School of Graduate Studies, University College London*  
*d.mumovic@ucl.ac.uk*

*Tadj Oreszczyn, Professor*  
*Bartlett School of Graduate Studies, University College London*  
*t.oreszczyn@ucl.ac.uk*

**KEYWORDS:** *mould growth, criteria, building regulations, relative humidity*

## **SUMMARY:**

*In 2006, ventilation regulations in England and Wales introduced new performance criteria for the control of mould. The UK Government's Building Regulations Research Programme subsequently funded University College London (UCL) to investigate the extent to which these are the most appropriate criteria for the control of mould in UK dwellings. This paper details work which included the growth of mould in an environmental chamber. Field data from two studies was also analysed – the Milton Keynes Energy Park (MKEP) and a national study of England's Home Energy Efficiency scheme (Warm Front). The conclusion from the laboratory and field work was that the current 'Approved Document F' (ADF) guidelines would benefit from clarification and amendment. The paper also reports on further work that has been undertaken to begin the move to a modified set of guidelines. The laboratory work reported here supports the assumption that - for the purposes of the suggested revisions - mould reacts in the same way to the average of transient surface RH conditions as it does to the equivalent steady state conditions. The recommendations for the next revision of the regulations are described.*

## **1. Introduction**

Recent ventilation regulations in England and Wales (HMSO, 2006a) introduced new performance criteria for the control of mould. The UK Government's Building Regulations Research Programme subsequently funded University College London (UCL) to investigate the extent to which these are the most appropriate criteria for the control of mould in UK dwellings. The current (2006) moisture criterion as stated in 'Approved Document F' (ADF) is that there should be no visible mould growth on external walls. The guidance also states:

*“For the purpose of this Approved Document, the moisture criterion will be met if the relative humidity (RH) in a room does not exceed 70% for more than 2 hours in any 12 hour period, and does not exceed 90% for more than 1 hour in any 12 hour period during the heating season”*

A number of interpretations of this key paragraph are possible. The *literal* interpretation is that if these specific criteria are exceeded once in a heating season then the system has failed to demonstrate compliance. This may not have been the original intention when the guidelines were drawn up but no other interpretation is offered – for example, no indication of the period (i.e. number of repeating days) over which such conditions may be tolerated is given. The following sections summarise the key work that has been undertaken for the project. The

work was essentially split into two parts – the testing of the existing guidelines and developmental work for the suggested revision.

## 2. Testing of the existing (2006) guidelines

### 2.1 Chamber testing

Work was undertaken with an environmental chamber at UCL that allowed transient profiles of temperature and RH to be programmed for the tests. The work was performed using a variety of representative moulds (Rowan et al 1996) with an appropriate range of moisture requirements:

- *Aspergillus repens*
- *Aspergillus versicolor*
- *Penicillium chrysogenum*
- *Cladosporium sphaerospermum*
- *Ulocladium consortiale*

In order to test the current ADF guidelines an attempt was made to grow the mould species in the environmental chamber under typical conditions which an external wall may be exposed to if the air conditions specified by ADF for mould growth are met.

In order to determine an appropriate temperature and RH profile that the environmental chamber should be controlled to, a computer model was used of a typical construction detail to calculate the relationship between the wall surface and air RH and temperature. A 12 hour air RH and temperature profile was constructed – see figure 1. This profile involved the room air RH exceeding 70% for more than two hours in a period of 12 hours - mould growth would therefore be 'expected' by ADF. It was then required to convert this profile to the surface conditions that would be tested in the environmental chamber.

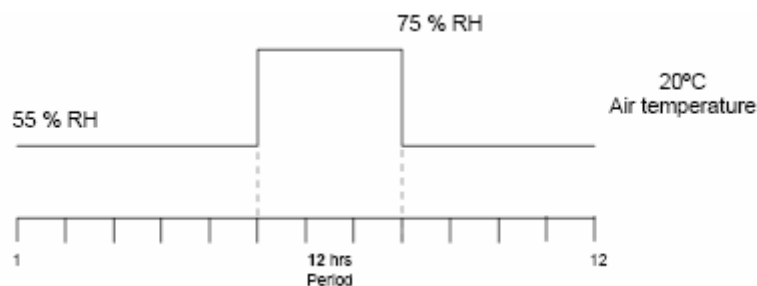

FIG. 1: Room air condition profile (this profile corresponds to the surface conditions tested in the environmental chamber shown in figure 2).

The surface temperature was calculated by a multi-dimensional steady state computer thermal model (TRISCO) at a wall/ceiling junction. The internal surface conditions were calculated for the internal room air temperature of 20 °C and a representative external air temperature of 5 °C. The calculated temperature at the coldest location on the internal surface of the construction was found to be 17 °C. The surface relative humidity was then calculated using both the surface temperature already calculated (17 °C) and the air RH profile (an RH of 55% for a period of 9 hours and RH of 75% for a period of 3 hours) shown in figure 1. The RHs at the surface for air RHs of 55% and 75% at 20 °C were then calculated using standard psychrometrics. The resulting surface RH was found to be 67% when the air RH was 55% and 91% when the air RH was 75%. With regards to the control of mould, a figure of 10% has conventionally been added e.g. BS5250 (BSI, 2005) to the *air* RH to arrive at an estimate of the RH at the internal *surface* of the external walls of a dwelling. The elevations of the RH from the air to the surface that have resulted from the above analysis are *higher* than the 10% elevation suggested by BS5250 and

hence (appropriately) provide conditions more likely to result in mould growth. Figure 2 thus shows the profile that the environmental chamber worked to.

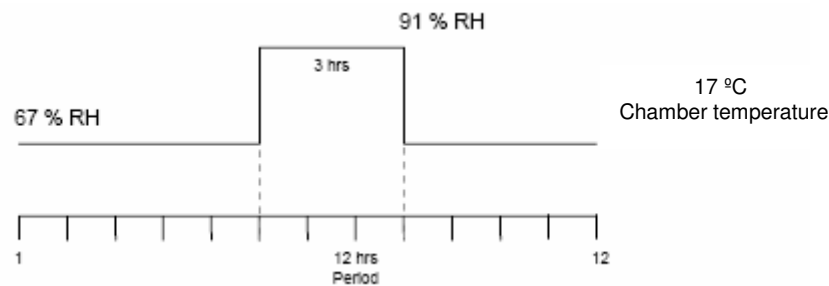

FIG. 2: Conditions tested in environmental chamber.

No mould germination was observed on agar samples when the environmental chamber was run using the RH profile in figure 2 over a period of almost a month. These results suggested that the ADF guidelines - as interpreted literally - are too severe.

## 2.2 Correlations with field data -Warm Front and Milton Keynes Energy Park

An analysis of the Warm Front and Milton Keynes Energy Park (MKEP) datasets was undertaken to determine the number of dwellings not complying with the current ADF guidelines

### 2.2.1 Warm Front Study

The 'Warm Front' project was undertaken to evaluate one of the UK Government's programmes to help eradicate fuel poverty. Funded by the Department of the Environment, Food and Rural Affairs, and managed by the Energy Saving Trust, Warm Front is one of the most comprehensive health and building environment studies ever conducted in the UK. The study included 3,099 dwellings undergoing Warm Front improvements over the winters of 2001-02 and 2002-03 in five urban areas of England: Birmingham, Liverpool, Manchester, Newcastle and Southampton. In 2,917 households, a computer assisted personal interview was undertaken with a household member. The scheme provides a comprehensive study of occupant behaviour, energy use, moisture production and the occurrence of mould and damp in dwellings occupied by families on low income and pensioners. In 1600 dwellings, temperature and RH was monitored in living rooms and bedrooms for approximately 3 weeks during the heating season. Measurements of external temperatures and RH were also recorded in central locations in each of the survey areas. Subsets of 222 cases were also pressure tested to evaluate the dwellings' air tightness. Although the occupant profile of the dwellings is heavily skewed towards the over 60's and those on low income, the properties they occupied are fairly typical of UK dwellings and were located in five areas across England. The applicability of the Warm Front study to the building stock in general has been explored (Davies et al 2007). The differences between the 2001 English House Condition Survey (EHCS) and the Warm Front datasets in terms of their impact on relative humidity in dwellings and mould occurrence can be summarised as follows:

- **Moisture Generation:** The total dwelling floor area per person of the Warm Front and EHCS data sets are similar. There is no reason therefore to suggest that the Warm Front dwellings are either less or more overcrowded than the norm. A greater proportion of the Warm Front occupants are from the over 60 age group than in the EHCS dataset. However, analysis of the Warm Front dataset suggest that the standardised vapour pressure excess at 5 °C in houses with an occupant below the age of 60 is 305 Pa (Confidence Interval (CI) 21.9) compared to 315 Pa (CI 21.8) in houses with an occupant above the age of 60, suggesting that the skewing of the Warm Front compared to EHCS in terms of age should not be significant.

- **Wall Surface Temperatures:** It was concluded that the energy efficiency of the Warm Front and EHCS datasets is similar. The Warm Front dataset included more terraced and semi-detached dwellings, which would be expected to have fewer external walls than other built forms. A greater percentage of the Warm Front external walls are insulated compared to the EHCS sample, although the Warm Front sample has a smaller proportion of dwellings with central heating.

It was thus concluded that the Warm Front dataset does appear to have value in terms of its representativeness of the current housing stock and it thus formed a useful input into this particular project. Overall, 19.5% of the surveyed dwellings had a Mould Severity Index (MSI) greater than 0 (i.e. mould in at least one room). Table 1 shows that 35% of Warm Front dwellings do not meet the ADF criterion for a RH of 70% (more than 2 hours in a 12 hour period) whilst 3% of Warm Front dwellings do not meet the ADF criterion for a RH of 90% (more than 1 hour in a 12 hour period).

*TABLE 1: Performance of Warm Front dwellings with respect to existing ADF criteria*

	70% RH for more than 2 hours in 12		90% RH for more than 1 hour in 12	
	Number of properties	% of properties	Number of properties	% of properties
Meet existing ADF criteria	975	65	1454	97
Do not meet existing ADF criteria (hence mould growth would be 'expected')	523	35	44	3

Note that the period of monitoring in all cases is 3 or 4 weeks. It is very likely that if data was available for the full season the number of failures would be significantly higher.

### 2.2.2 MKEP Study

In 1989, National Energy Foundation conducted a detailed energy monitoring study of 160 low energy homes in the Milton Keynes Energy Park (MKEP). The majority of these dwellings essentially followed conventional housing design for the UK but were built to higher standards than required by the building regulations at that time. They incorporated energy efficiency features, such as increased floor and wall insulation, frequent use of double glazing, and condensing boilers. A sub sample of 29 dwellings also had temperatures and RH monitored hourly in the living rooms, bedrooms and (usually) hallways. An occupant behaviour survey was conducted at the same time. UCL has now revisited a sub-set of these 29 dwellings – a detailed physical survey has been carried out to record relative humidities any mould growth in these houses. 18 dwellings were evaluated considering the data available for two consecutive heating seasons: from February to March 2005 and from mid October 2005 to mid April 2006. Data on mould occurrence was available for 12 of the properties. Mould was observed in 4 out of 12 of the properties (33%). Table 2 indicates that 78% of the dwellings do not meet the ADF criterion for a RH of 70% (more than 2 hours in a 12 hour period) and 11% of the dwellings do not meet the ADF criterion for a RH of 90% (more than 1 hour in a 12 hour period).

*TABLE 2: Performance of MKEP dwellings with respect to existing ADF criteria*

	70% RH for more than 2 hours in 12		90% RH for more than 1 hour in 12	
	Number of properties	% of properties	Number of properties	% of properties
Meet existing ADF criteria	4	22	16	89
Do not meet existing ADF criteria (hence mould growth would be 'expected')	14	78	2	11

### 2.2.3 Summary of fieldwork results

It can be seen then that a significantly higher percentage of the Warm Front and MKEP dwellings appear to fail the current ADF criteria than actually have mould. Of course, one would expect some discrepancy but the scale of the difference supports the view that the ADF guidelines – as interpreted literally - are too severe.

## 2.3 Conclusions from the evaluation of the current criteria

As previously noted, a number of interpretations of the key ADF paragraph are possible. The literal interpretation is that if these criteria are exceeded once in a heating season then the system has failed to demonstrate compliance. The literature (Davies et al 2007) and the laboratory work undertaken in this project do not support this interpretation. In addition, a significant proportion of buildings from the field studies fail this interpretation even though many do not have mould growth.

This reading of the guidelines may not have been the original intention when the words were drawn up but no other interpretation is offered – for example, no indication of the period (i.e. number of repeating days) over which such conditions may be tolerated is given. The conclusion of the initial stage of the project was that this guidance would benefit from clarification and amendment.

## 3. Suggestions for change to ADF moisture criteria

Given the conclusion that some modification of the guidance was required, two options were considered: (1) adapt the existing guidelines (2) consider an alternative approach. It was concluded that a ‘fundamental’ change (rather than minor changes to the exact number of hours allowable per day above a certain %RH) was preferable. An alternative approach was thus sought. A key consideration was that any guidance must be practical and capable of being easily implemented. This ‘ventilation related’ guidance must sit alongside guidance for the thermal quality (i.e. minimum temperature factors) of the building envelope as set down in other parts of the Regulations (HMSO, 2006b).

### 3.1 Consideration of existing alternative approaches

An exhaustive review of the literature (Davies et al 2007) revealed the surface RH guidelines suggested by IEA Annex 14 (IEA Annex 14, 1990) as potentially the most suitable basis for changes to ADF. IEA Annex 14 incorporated an extensive body of detailed research into mould growth in buildings. IEA Annex 14 notes that hygroscopic inertia dampens short period oscillations in RH on and in the surface layer and gives the following criteria necessary for mould growth to occur in dwellings (Table 3):

TABLE 3: IEA Annex 14 criteria – surface water activity required for mould growth.

Period	f (a correction factor to acknowledge that different maximum average surface water activities are appropriate for different timescales)	Surface water activity
1 month	1	0.8
1 week	1.11	0.89
1 day	1.25	1.00

Note that the surface water activity is simply the surface RH divided by a factor of 100. An assumption is that, over these averaging periods, the average surface RH (divided by a factor of 100) and the average surface water activity are equal. This supposes that the water activity is a result only of interactions with the moisture in the room air. If instead, water is introduced via rain penetration or flooding this assumption is less likely to hold. The criteria thus state that average surface humidities below values corresponding to the water activities noted in Table 3 (for each averaging period) should result in no mould growth in dwellings. The criteria acknowledge the water activity of any substrate as being of fundamental importance in determining whether mould growth will occur. The authors suggest that any criteria stated in ADF should be ‘traceable’ back to this parameter. The



basic tenet then of the Annex 14 criteria is that mould reacts in the same way to average of transient surface RH conditions as it does to the equivalent steady state.

It is likely that the greatest uncertainty with the Annex 14 criteria lies with the weekly and daily values – the monthly value is now well established as a useful figure e.g. BS5250 (BSI, 2005). We have compared the IEA Annex 14 criteria against other data published in the literature regarding the conditions required for mould growth - for example, the ‘isopleths’ published by Sedlbauer (2002) that detail the (laboratory) conditions required for mould to grow. Sedlbauer (2002) notes that mould will germinate and grow differently on different substrates and provides a useful classification - a set of idealised isopleths for the different substrates is given. The Annex 14 criteria are not as strict as the Sedlbauer isopleths e.g. for a ‘class 1’ material (i.e. most building surfaces) and a temperature of 15 deg. C, Sedlbauer suggests mould will grow if the RH is kept at 93% RH for a period of a day. In contrast, the Annex 14 criterion is 100% RH for a day. However, to create the substrate specific isopleth systems, Sedlbauer used the least demanding conditions for mould to grow that could be found in literature. For example, if there were different spore germination times for the same material with the boundary conditions being the same, the shorter times were taken. Classification of the different building materials was also done in a way that they were always assigned to the more unfavourable substrate group. The combined effect of all these assumptions results in the worst case scenario. If one compares the isopleths with similar data produced by other researchers then one can see that they are indeed more conservative than other workers (Sedlbauer, 2002).

### 3.2 Chamber testing

This section provides a brief summary of some of the work that has been undertaken to test the basic assumption behind the Annex 14 criteria (i.e. that mould reacts in the same way to the average of transient surface RH conditions as it does to the equivalent steady state conditions). Examples of the relevant experiments undertaken are described in the following sections.

#### 3.2.1 Transient conditions

Inoculated agar samples were exposed to a transient 12 hours profile with an average RH of 90% (83-89-98) (25 deg. C) – see Figure 3. All six species germinated on the agar samples within 3 or 4 days.

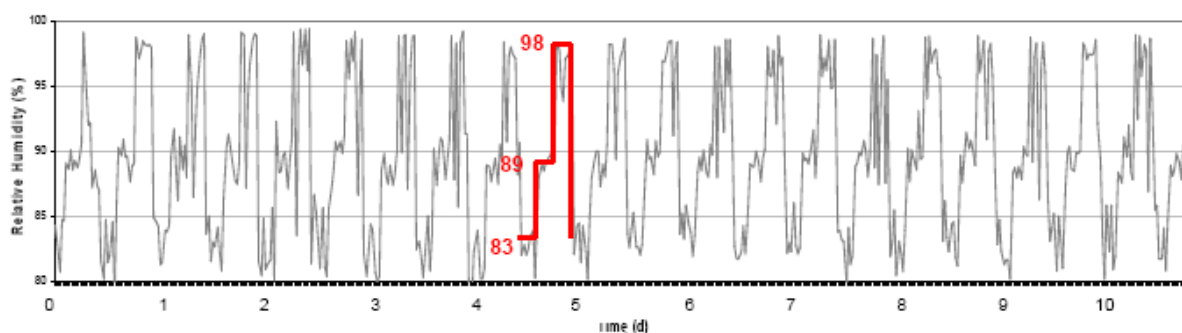

FIG. 3: Monitored RH in Environmental Chamber during mould growth tests.

#### 3.2.2 ‘Equivalent’ steady state conditions

In this case, inoculated Agar samples were exposed to a steady state profile with a constant RH of 90% (25 deg. C). The results were the same as the results from the transient experiment thus supporting the assumption that mould reacts in the same way to the average of transient surface RH conditions as it does to the equivalent steady state conditions. Whilst much more work is required in order to provide definitive evidence (indeed this work forms part of an ongoing study at UCL), these results support the basic approach of the Annex 14 criteria.

### 3.3 Issues relating to the conversion from air RH to surface RH

The Annex 14 criteria relate to surface RH levels. This would not form a particularly convenient basis for the ADF guidelines - air RH levels would be preferable as this is what is more normally measured and modelled in buildings. For a given air RH value, there will be a spread of surface RH values in a space dependent on the local surface temperature (due to thermal bridging, furniture placement etc.). With regards to the control of mould, a figure of 10% has conventionally been added e.g. BS5250 (BSI, 2005) to the air RH to arrive at a reasonable RH at the surface of the external walls of a dwelling. Modelling work undertaken for the project indicated that for the averaging periods of day, week, month, the addition of 10% to each of these averages was appropriate for temperature factors as low as 0.6. Indeed this 10% factor is also utilised implicitly in the 2006 ADF criteria – it is noted that the current guidelines are related to the surface RH work of Adan (1994) with a reduction of 10%RH applied to account for the difference between the colder external wall and the room air. Giving consideration, for example, to the findings of a related project at UCL (Oreszczyn et al 2005) regarding the consequences of inadequate build quality in new dwellings, we suggest that this value represents a reasonable limit whilst not being too extreme. The value may need to be reassessed as thermal insulation standards for new dwellings improve.

### 3.4 Possible correlations with field data - discussion

The size of the Warm Front dataset makes it potentially attractive to use to test the Annex 14 criteria. However, generally only 3 or 4 weeks of data from each dwelling is available. This was not an issue when testing the 'one-off' failure mode of the existing criteria but here a full heating season is required to test the Annex 14 criteria because of the averages required at monthly and weekly intervals. The 3 or 4 weeks may have been unrepresentative of the rest of the season. Note also that the primary function of the ADF criteria is not to predict the occurrence of mould in one particular property but rather to provide a reasonable representation of the behaviour of the building stock. Therefore, the small sample size of the MKEP dataset is not ideal. It would be possible in future to attempt to 'optimise' the Annex 14 criteria via testing with these data sets but we believe that this would have little value as a result of the small sample size. Certainly, the proposed criteria *will* be tested against field data when an appropriate set is available – relevant work is currently underway at UCL.

## 4. Conclusions

It was concluded that the current (2006) ADF guidelines would benefit from clarification and amendment. The current ADF document as a whole is planned to be revised in 2010 and this will present an opportunity to change the criteria relevant to mould growth. UCL will continue to attempt to optimise the proposed amendment to ADF with a view to this date. However, the initial laboratory work reported here supports the assumption that - for the purposes of the suggested revisions - mould reacts in the same way to the average of transient surface RH conditions as it does to the equivalent steady state conditions. The provisional suggestions (based on the recommendations of IEA Annex 14) for the revised ADF moisture criteria then are:

*“There should be no visible mould growth on external walls. For the purpose of this Approved Document, the moisture criterion will be met if the average relative humidity (RH) in a room is less than the following during the heating season:*

<i>Daily average</i>	<i>90%</i>
<i>Weekly average</i>	<i>79%</i>
<i>Monthly average</i>	<i>70%”</i>

The proposed new criteria have the following advantages with specific regards to the Building Regulations for England and Wales:

- They are consistent with BS5250 because they imply a 'long-term' (monthly) limit for the average air RH of 70%.
- They are presented in an easy to interpret 'useable' format.

It is the contention of this paper that these new criteria are soundly based and have less potential for misinterpretation than the current criteria. Other approaches for the construction of the guidelines are certainly possible but the suggested modifications to ADF represent what the work has assessed as being the most suitable compromise between a reasonable representation of the physical processes involved and the need for understandable and applicable criteria. However, it should be clearly stated that there is still some uncertainty with regards to the exact, optimal Annex 14 criteria and associated 10% modifying factor. Indeed this is the subject of further work at UCL.

## 5. Acknowledgments

This research is funded by the UK Government's Building Regulations Research Programme. The views expressed in this paper however, are those of the authors only.

## 6. References

- Adan O.C.G. (1994). On the fungal defacement of interior finishes, *PhD Dissertation*, Technical University of Eindhoven.
- BSI (2005) BS5250:2002 (as amended 2005). Code of practice for the control of condensation in buildings, BSI, London.
- Davies M., Ridley I., Altamirano-Medina H., Mumovic D., Oreszczyn T, Sung H. and Ucci M. (2007). Relative Humidity in Dwellings, *Final Report*, DCLG, Building Regulations Division Under the Building Operational Performance Framework.
- HMSO (2006a). The Building Regulations, Approved Document F - Ventilation (2006 edition), The Stationary Office.
- HMSO (2006b). The Building Regulations Approved Document L1A: Conservation of fuel and power (New dwellings) (2006 edition) The Stationary Office.
- IEA Annex 14 (1990). Condensation and Energy: Guidelines and Practice, Belgium, KU Leuven, Laboratory for Building Physics, 55pp.
- Oreszczyn T., Mumovic M., Davies M., Ridley I., Bell M., Smith M. and Miles-Shenton D. (2005). Condensation Risk – Impact of Improvements to Part L and Robust Details on Part C, *Final Report*, Office of Deputy Prime Minister Building Regulations Division under the Building Operational Performance Framework.
- Rowan N. J., Anderson J. G., Smith J. E., Clarke J. A., Johnstone C., Kelly N. J. and McLean R. C. (1996). Development of a technique for the prediction/alleviation of conditions leading to mould growth in houses, *Final Report No. 68017*, Scottish Homes, Edinburgh.
- Sedlbauer K. (2002). Unwanted Biological Growth in and around buildings, Rosenheimer Fenstertage 2002, Germany.

# Moisture and Mould Damage in Norwegian Houses

*Jonas Holme, Cand Scient, Research Scientist, PhD-fellow,  
SINTEF Building and Infrastructure, Norway;  
jonas.holme@sintef.no and www.sintef.no/byggforsk*

*Stig Geving, Dr.ing., Senior Scientist,  
SINTEF Building and Infrastructure, Norway;  
stig.geving@sintef.no and www.sintef.no/byggforsk*

*Jon A. Jenssen, M. Sc,  
Trondheim Municipality, Norway  
jon-andreas.jenssen@trondheim.kommune.no*

**KEYWORDS:** *Moisture indicators, moisture supply, mould growth, building characteristics*

## **SUMMARY:**

*Several studies have demonstrated associations between living in “damp” buildings and health effects such as respiratory symptoms, asthma and allergy. There is only limited knowledge about which agents in indoor air and what levels of exposure that causes the health effects. One possible agent is mould. Because of this there is a strong need for understanding the associations between building characteristics and mould growth.*

*The survey “Prevention of atopy among children in Trondheim” includes both self-reported information about housing, and inspections and measurements from 205 homes. The study includes registered building characteristics such as construction, installations systems and moisture problems. Measurements include temperature, relative humidity and mould spores in the indoor air. The measurements were made in bedrooms, living rooms, bathrooms, basements/cellars and outdoor air.*

*50 percent of the houses had one or more indicator of a visible mould problem. In 42 % of the houses with no reported moisture problem, the inspector found an indicator of a problem. Looking at the moisture supply there were some higher values in rooms with a visible moisture indicator and in rooms with registered mould growth compared to rooms with no indications or mould. Type of ventilation, foundation and building period, have an influence on the present share of houses with one or more indicator of a visible moisture problem or registered mould growth.*

## **1. Introduction**

Dampness and other excessive moisture accumulation in buildings are closely connected to observations of mould, mildew, or other microbial growth. The behaviour of moisture and air movements can be characterized by physical parameters, but the biological processes take place according to a complicated network of regulating factors. Several phenomena make up the microbial ecology of an indoor environment (IOM 2004).

Several studies have examined the aspects of moisture that are associated with biological contamination; these include exhausts in kitchens and bathrooms; below grade moisture seepage; bulk water (plumbing leaks, roof drainage, and envelope penetration); condensation on inadequately insulated outside walls; and inappropriately sized cooling coils (i.e. incorrect latent heat ratio) (Spengler et al. 1994, Trechsel 1994, Dales et al. 1997). In many of the epidemiologic studies showing an association between moisture and adverse respiratory health effects or lung disease, exposure is often defined with both qualitative and quantitative methods (Bornehag et al. 2001, Bornehag et al. 2004). Exposure assessment methods used to characterize moisture and mould include the following: (1) physical measurements (e.g., humidity, temperature); (2) sampling and analysis to detect moisture related microbes and/or chemicals in air and dust; (3) visual inspections for moisture and mould (observations); or (4) self reports from inhabitants and workers in questionnaires or interviews (reports).

Reports of damp spots, water leakage or water damage, and mould or mildew from self-report questionnaires, are used as surrogate measures for the number of fungi in several published epidemiologic studies (Kilpelainen et al. 2001, Pirhonen et al. 1996, Dales et al. 1991, Platt et al. 1989, Strachan 1988). Several studies have relied on home inspections by professionals (observations) for verifying self reported moisture and mould in the home (Haverinen et al. 2001, Platt et al. 1989, Dharmage et al. 1999a, Verhoeff et al. 1994). Dharmage et al. 1999b and Garrett et al. 1998 measured the presence of fungal propagules in air and demonstrated that observed house characteristics, such as visible mould or dampness patches, have validity as measures of mould concentrations and dampness in homes. Dharmage et al. 1999b showed that higher total airborne fungal concentrations were associated with reported visible mould.

Fungal exposure and its association with moisture damage in a building are complex and multifaceted. Many types of fungal species are reported to grow in the indoor home environment (IOM 2004). One way to provide a better understanding of the influence of residential characteristics (and behaviour) on fungal levels is to clarify the definitions of “fungal levels.” Most studies use total airborne fungi concentrations or report a dominant type of fungi species, such as *Cladosporium* or *Aspergillus*, in their exposure assessment analyses. Li and Kendrick 1995 found significantly higher airborne fungal spore counts of specific species (*Aspergillus/Penicillium*, *Cladosporium*, unidentified basidiospores, etc.) in damp residences (defined as homes with visible mould, water damage, or water in the basement). Fungi can grow only on a surface or in a substrate. Many conditions of the surrounding environment (e.g., relative humidity and temperature) affect fungal growth by increasing or decreasing the drying potential of the substrate. In general, water requirements for fungi are species specific. Exposure assessments may prove more useful if a broad group of fungal species is selected according to their nutrient requirements and substrate characteristics, including water availability.

As studies increasingly support the presence of health risks associated with moisture related agents (microbes and/or chemicals), there is a strong need for understanding fungal concentrations and physical measurements as they relate to the microenvironment (associations between building characteristics and mould growth).

Such knowledge is important to make future prevention of mould growth in new and already existing houses possible. Since 20-30% of the existing buildings are affected by moisture problems (IOM 2004) we need knowledge for measures in such buildings, i.e. what should we do in a problem building, how much of the affected material should be taken away, etc. It may also be a tribute to improve the characterization of commonly used moisture/mould indicators, such as observation of mould, odours, ventilation and reports of moisture and water sources in the house.

The aim of this study has been the following;

- Describe indicators of visible moisture problem in buildings observed by inspectors and compare these to self reported moisture problem.
- Compare the air humidity in bedroom, living room, bathroom and basement with or without one or more indicator on a visible moisture problem and with or without registered mould growth.
- Compare the influence of some building characteristics on the number of houses with one or more indicator on a visible moisture problem or registered mould growth compared to those without any registered indications or mould growth.

## 2. Method

The work presented in this paper is part of the study “Prevention of atopy among children in Trondheim” (Jenssen et al., 2001). Parents of the children that were included in the “Prevention of atopy”-study were asked for permission to perform inspection of their houses until enough participants had accepted. The survey includes both self-reported information about housing and inspections from 205 homes in Trondheim, Norway. Indoor air humidity levels and viable mould spores in the indoor air have been measured in a selection of the houses. The houses were randomly selected for each of the four following building types; detached one family houses, semidetached two family houses, undetached (chained) houses and apartment buildings. In each house measurements were made in the children bedroom, the living room, the most used bathroom and basement/cellar.

Six professional inspectors performed visual inspections and assessments of air humidity levels and viable mould spores in the indoor air. The inspectors were blinded to case-control status of the children living in the

homes. During these investigations, a checklist was followed regarding factors such as the type of building, building construction, type of ventilation, and mould and moisture problems. The inspectors observed possible moisture problem and sources, and finally graded each room and the house according to the following “moisture condition”; “no sign of moisture”, “few” (1 or 2, small and spread symptoms on moisture), “more” (> 2 symptoms, clear signs of moisture) and “unambiguous sign of moisture” (breakdown and function failure).

Questions in the baseline questionnaire (reported) regarding signs of moisture problems in the house could be answered by “yes” or “no”. If the answer was “yes” there was a follow up question regarding whether or not the problem had been fixed. Also this question could be answered by “yes” or “no”.

Relative humidity (RH) and temperature of the indoor air were measured in 86 houses. The temperature and RH were measured at 15 minutes interval over a period of seven days. Small logging units were used (Tiny tag, TGU 1500, Intab). The loggers were positioned away from windows, heating units, direct sunlight or outer door. The loggers were placed between 1,5 – 2,0 m above floor level. The accuracy of the loggers were  $\pm 5\%$  RH and  $\pm 0,5\text{ }^{\circ}\text{C}$ . The loggers were controlled in a climate chamber at 50% RH and 23  $^{\circ}\text{C}$  before being used. Hourly data for outdoor RH were retrieved from an automatic weather station located in Trondheim operated by the Norwegian Meteorological Institute. The moisture supply ( $\Delta v$ ) was calculated on an hourly basis. The moisture supply is defined as the difference between indoor and outdoor air water vapour content (in  $\text{g}/\text{m}^3$ ). Mean weekly values for the moisture supply were calculated from these hourly values.

In selected buildings, samples of viable micro organisms (fungi and bacteria) were taken in the child's bedroom, living room, bathroom and basement. The samples were taken approximately one meter above the floor, under normal conditions regarding use, heating and ventilation in the house. Reference samples were taken outdoors. The sampler used was a Biotest Standard RCS Sentrifugal Air Sampler (Biotest AG, Dreieich, Germany), which is a handheld, battery operated instrument that collects bioaerosols on a nutrient agar to allow direct culturing techniques to be used to enumerate airborne micro organisms. A fan draws air through the sieve plate causing airborne particles to impact on the agar plate and air is exhausted through the side of the sampler. All sampling equipment was calibrated before use. The samples were taken on both Tryptic Soy Agar (TSA) and Rose Bengal Agar (RBA). Sampling volume was set at 40 litres/minute in 8 minutes for each media.

Microscopical analyses at 400x and 1000x magnification in light microscope were conducted after cultivation at 22  $^{\circ}\text{C}$  for 5-7 days. Identification of fungi was in general done to the level of specie. Amount and type of mould specie detected in the respective room, was compared to the sample taken outdoor. If the sample from the indoor air differed either in concentration, mould specie or both, compared to the sample taken from the outside, the room had registered mould growth.

### 3. Results

Table 1 shows the percent share of different indicators of a moisture problem in the houses, the child's bedrooms, living rooms, bathrooms and basements. 50 % of the buildings had one or more visible indicator of a moisture problem. The most common indicator was spots of moisture, swelling or capillary attraction of water in wood which appeared in 18 % of the houses. 15 percent had a leak from the ground, and 15 % showed condensation on surface other than windows. In the child's bedroom 11 % of the rooms inspected had one or more visible indicator on a moisture problem. The most dominant indicator was condensation on window (3%) and on surface (6%). Living rooms had fewer indicators compared to the other rooms. Only 5 % of the rooms had one or more indicators of a moisture problem. 21 % of the bathrooms had one or more indicator of a visible moisture problem. The dominating indicators were spots of moisture, swelling and capillary attraction of water (5 %) and condensation on window (5%) and surface (9%). 65 % of the basements had one or more indicator of a visible moisture problem. The most common indicator was not surprisingly, leakages from the ground (52 %).

The inspectors found that in the houses with no reported moisture problem ever, 42 % had one or more indicator on a visible moisture problem (Table 2). In the houses where a reported moisture problem had been repaired, the inspectors found an indication in 53 % of them. In the houses where a moisture problem never had been repaired, the percent share with one or more indicator on a visible moisture problem was 62 %. The percent share varies between the different types of rooms. The basements had a high percent share observed moisture indicator in each of the reported categories, all over 63 %.

Table 3 shows the mean moisture supply in child's bedroom, living room, bathroom and basement, with or without indicators of a visible moisture problem and with or without registered mould growth. Bathrooms had

the highest moisture supply with a mean on  $3.16 \text{ g/m}^3$ . Living rooms had a mean on  $1.9 \text{ g/m}^3$ . Child's bedrooms and basements had a mean around  $1.5 \text{ g/m}^3$ . There was a higher moisture supply in child's bedrooms, living rooms and bathrooms with one or more indicator on a visible moist problem compared to those with no observed indicator. In the basement however the moisture supply was higher in those with no indicator. Child's bedrooms and bathrooms had a higher moisture supply compared to those with no registered mould growth. In living rooms and basements the rooms with no registered growth had a higher moisture supply compared to those with a registered growth

Table 4 gives the percent share of houses and rooms with (yes) or without (no) mould growth in each category of the categorized (by inspectors) moisture condition in all houses, child's bedrooms, living rooms, bathrooms and basements. The percent share houses with registered mould growth in one or more rooms are higher in the two worse categories ("more" and "unambiguous") regarding the inspector's classification of the moisture condition of the whole house. The situation is the same for bathrooms.

Table 5 gives an impression on how different building characteristics influence on the percent share of houses with or without one or more indicator on a moisture problem, and with or without registered mould growth.

The percent share with "no ventilation" and "natural ventilation" is higher in the groups of houses with one or more moisture indicator and the houses with registered mould growth, compared to the houses with no indicator or no registered mould growth. The difference is significant ( $p < 0.05$ ).

The houses with one or more indicator on a moisture problem have a higher percent share of "basement" compared to those with no indicator. The houses with no indicator have a higher percent share of "other apartment". The difference in type of foundation is significant between houses with or without a moisture indicator. In houses with registered mould growth there were 13 % more houses with a basement/cellar compared to the houses with no registered growth. The houses with no registered growth had more slab on ground compared to the houses with mould growth.

43.9% of the houses with one or more indicator of a moisture problem were built before 1960. Less was built after 1984 (25.6%). In houses with no indicator fewer was built before 1960 (30.2%), and the distribution was quite like for the tree construction periods. Houses with registered mould growth were built before 1960 (47.2 %) and less after 1984 (19.4%). The houses with no registered mould growth were more even spread throughout the tree construction periods.

Looking at type of building there were no large differences between houses with or without indicators of a moisture problem and houses with or without a registered mould growth.

TABLE 1: The percent share of each visible indicator on a moisture problem in the houses, the child's bedrooms, living rooms, bathrooms and basements/cellars.

Moisture Indicator	Whole building (205)	Child's bedroom (205)	Living room (205)	Bathroom (205)	Basement/cellar (46)
<i>Spots of moisture, swelling, capillary attraction of water in wood</i>	18	2	2	5	13
<i>Blathers</i>	7	0	0	0	11
<i>Leakage from the ground</i>	15	0	0	0	52
<i>Condensation on windows</i>	10	3	1	5	9
<i>Condensation on surfaces other than windows</i>	15	6	1	9	2
<i>Leakage from sanitary installations</i>	6	0	0	1	0
<i>Other leakages</i>	4	0	0	1	2
<i>At least one indicator</i>	50	11	5	21	65

TABLE 2: The percent share with one or more observed indicator of a visible moisture problem in houses and different type of rooms in each category of reported moisture problem

	Whole building (205)	Child's bedroom (205)	Living room (205)	Bathroom (205)	Basement (46)
Never reported a moisture problem (n =107)	42	8	5	18	67
Reported moisture problem are repaired (n = 32)	53	16	6	25	63
Reported moisture problem are not repaired (n =66)	62	14	6	24	65

TABLE 3: Moisture supply in child's bedroom, living room, bathroom and basement with or without indicators of a visible moisture problem, and with or without mould growth.

		Valid N	Mean	SD	Percentile 75
Child's bedroom		87	1.5	1	1.97
Living room		87	1.9	0.95	2.54
Bathroom		86	3.16	1.32	3.94
Basement		85	1.37	1.08	1.98
<b>One or more indicator on a visible moisture problem</b>					
Child's bedroom	No	79	1.47	1.0	1.97
	Yes	8	1.82	1.05	2.37
Living room	No	78	1.87	0.97	2.51
	Yes	9	2.20	0.75	3.0
Bathroom	No	69	3.12	1.3	3.94
	Yes	17	3.31	1.45	4.39
Basement	No	67	1.44	1.13	2.17
	Yes	18	1.13	0.87	1.83
<b>Registered mould growth</b>					
Child's bedroom	No	44	1.39	1.06	1.95
	Yes	6	1.55	0.91	2.40
Living room	No	40	1.87	1.05	2.53
	Yes	10	1.42	0.67	1.72
Bathroom	No	42	3.07	1.49	3.93
	Yes	7	3.17	0.74	3.63
Basement	No	10	1.2	0.74	1.8
	Yes	2	0.87	2.02	-



TABLE 4: The percent share of houses and rooms with (yes) or without (no) mould growth in each category of the “Moisture condition” in all houses, child’s bedrooms, livingrooms, bathrooms and basements / cellars.

	All houses*		Child’s bedroom		Livingroom		Bathroom*		Basement / cellar	
	Yes (43)	No (96)	Yes (18)	No (121)	Yes (27)	No (112)	Yes (19)	No (120)	Yes (9)	No (21)
No symptom	25.6	43.8	77.8	90.9	92.6	94.6	52.6	63.3	22.2	19.0
Few (1 or 2) small and spread symptoms	27.9	32.3	22.2	7.4	7.4	4.5	21.1	24.2		33.3
More (>2) and good visible signs	41.9	24.0		1.7	0.9		21.1	12.5	66.7	47.6
Unambiguous sign	4.7						5.3		11.1	

\* Significant difference between the two groups (“yes” and “no”) ( $p < 0.05$ )

TABLE 5: Different building characteristics influence on the percent share of houses with or without one or more indicator on a moisture problem, and with or without registered mould growth.

	One or more indicator on a visible moisture problem		Registered mould growth	
	No	Yes	No	Yes
<i>Ownership</i>				
Owner	64.3	60.6	59.1	64.3
Owner, housing cooperative	31.6	28.3	32.3	31.0
Tenant	4.1	11.1	8.6	4.8
<i>Ventilation</i>				
No ventilation	2.9	11.8	5.3	11.6
Natural ventilation	39.2	52.9	44.2	58.1
Mechanical ventilation	49.0	29.4	41.1	27.9
Balanced ventilation	8.8	5.9	9.5	2.3
<i>Basement/cellar</i>				
Basement/cellar	13.7	36.3	21.9	34.9
Crawl space	2.0	3.9	2.1	2.3
Slab on ground	40.2	42.2	41.7	30.2
Other apartment	43.1	16.7	33.3	30.2
Other	1.0	1.0	1.0	2.3
<i>Year of construction</i>				
→ 1960	30.2	43.9	34.1	47.2
1961 to 1983	34.9	30.5	32.9	33.3
1984 →	34.9	25.6	32.9	19.4
<i>House type</i>				
Detached one family houses	26.5	36.3	34.4	26.2
Semidetached family houses	28.4	23.5	25.0	26.2
Undetached (chained) houses	9.8	17.6	12.5	19.0
Apartment buildings	32.4	20.6	27.1	23.8
Other house	2.9	2.0	1.0	4.8

## 4. Discussion

In this study 50 % of the houses had one or more indicator of a visible moisture problem. The prevalence is a bit high compared to other studies. The damp indoor space and health report (IOM 2004) have summarized published data on the prevalence of signs of moisture in buildings. The reported prevalence of signs of moisture ranged from 1 % to 85 %. In most datasets, at least 20 % of the buildings have one or more sign of a moisture problem.

In this study child's bedroom and living room have a relatively low share of indicators of a moisture problem. This is not surprisingly because these two rooms have few elements that can cause a water damage compared to i.e. bathroom and basements.

In 42 % of the houses with no reported sign of a moisture problem ever, the inspectors found one or more indicator of a moisture problem. Nevalainen et al. (1998) reported similar results, suggesting that the explanation was a result of a trained eye and of knowledge of what represents a critical problem. There is a tendency in our study in a higher percent share of houses with one or more indicator of a moisture problem among the houses where the inhabitants themselves once have reported a moisture problem compared to those who never have reported a problem.

Rooms with one or more indicator on a visible moist problem have a higher moisture supply compared to those with no indicators (this does not include basement/cellars). These findings are not surprisingly, taken into account that the moisture indicators often brings water into the environment. Regarding rooms with or without registered growth we should expect the same result, but in this study the differences is even smaller and appears only in child's bedroom and bathroom. This is strange because water is the most important limiting factor for mould growth (IOM 2004).

Indoor moisture is linked to some building characteristics. In this study there is an association between a higher percent share of houses with one or more moisture indicators and type of ventilation, type of foundation and building period. Reported dampness has been associated with age of the building, lack of central heating, humidifiers and pets (Sprengler et al., 1994; Tariq et al., 1996). Older buildings tend to be colder and (Hunt and Gidman, 1982), and therefore to have higher RH. Microbiological has also been associated with building characteristics. Measures of microbial contamination have been found to be positively correlated with indoor temperature and humidity, age and size of buildings, use of wood stoves and fireplaces, absence of mechanical ventilation (IOM 2004). In this study there were more houses with registered mould growth in houses with no or natural ventilation compared to houses with mechanical ventilation, and in houses with basement cellar compared to those with slab on ground. There was also an association in more registered mould in older houses compared to newer ones.

## 5. Acknowledgements

This paper has been written within the ongoing SINTEF strategic institute projects "Climate 2000 – Weather Protection in the Construction Process". The authors gratefully acknowledge the Research Council of Norway.

## 6. References

- Bornehag, C.G. et al. (2001) Dampness in buildings and health. Nordic interdisciplinary review of the scientific evidence on associations between exposure to "dampness" in buildings and health effects (NORDDAMP), *Indoor Air*, 11, 72-86.
- Bornehag, C.G. et al. (2004) "Dampness in buildings as a risk factor for health effects, EUROEXPO: a multidisciplinary review of the literature (1998-2000) on dampness and mite exposure in buildings and health effects", *Indoor Air*, 14, 243-257.
- Dales R.E., Burnett R. and Zwanenburg H. (1991). Adverse health effects among adults exposed to home dampness and molds, *American Review Of Respiratory Disease*, Vol 143.3, p.505-09.
- Dales R.E., Miller D. and McMullen E. (1997). Indoor air quality and health: validity and determinants of reported home dampness and moulds, *International Journal of Epidemiology*, Vol 26.1, p.120-25.
- Dharmage S. et al. (1999a). A reliable and valid home visit report for studies of asthma in young adults, *Indoor Air*, Vol 9.3, p.188-92.
- Dharmage S. et al. (1999b). Prevalence and residential determinants of fungi within homes in Melbourne, Australia, *Clinical and Experimental Allergy*, Vol 29.11, p.1481-89.
- Garrett M.H. et al. (1998). Indoor airborne fungal spores, house dampness and associations with environmental factors and respiratory health in children, *Clinical and Experimental Allergy*, Vol 28.4, p.459-67.
- Haverinen U. et al. (2001). Comparison of two-level and three-level classifications of moisture-damaged dwellings in relation to health effects, *Indoor Air*, Vol 11.3, p.192-99.
- Hunt D.R.G and Gidman A.M.I.A. (1982). A national field survey of house temperatures. *Building and Environment* 17(2):102-124
- IOM. (2004). *Damp Indoor Spaces and Health*, Institute of Medicine of the National Academies.
- Jenssen J.A. et.al. (2001). Barneallergistudien i Trondheim (Children allergy study in Trondheim: In Norwegian), *Allergi i praksis*, Vol 4, p.34-38.
- Kilpelainen M. et al. (2001). Home dampness, current allergic diseases, and respiratory infections among young adults, *Thorax*, Vol 56.6, p.462-67.
- Li D.W. and Kendrick B. (1995). Indoor aeromycota in relation to residential characteristics and allergic symptoms, *Mycopathologia*, Vol 131.3, p.149-57.
- Nevalainen A. et al. (1998). Prevalence of moisture problems in Finish houses. *Indoor Air (Supplement 4)*:45-49
- Pirhonen I. et al. (1996). Home dampness, moulds and their influence on respiratory infections and symptoms in adults in Finland, *European Respiratory Journal*, Vol 9.12, p.2618-22.
- Platt S.D. et al. (1989). Damp housing, mould growth, and symptomatic health state, *British Medical Journal*, Vol 298.6689, p.1673-78.
- Spengler J. et al. (1994). Respiratory Symptoms and Housing Characteristics, *Indoor Air*, Vol 4.2 , p.72-82.
- Strachan D.P. (1988). Damp housing and childhood asthma: validation of reporting of symptoms, *British Medical Journal*, Vol 297.6658, p.1223-26.
- Tariq S.M et al. (1996). Sensitization to *Alternaria* and *Cladosporium* by the age of 4 years. *Clinical and Experimental Allergy* 26:794-798
- Trechsel H.R. (1994). *Moisture Control in Buildings*, American Society for Testing and Materials, Philadelphia.
- Verhoeff A. P. et al. (1994). Fungal Propagules In-House Dust .2. Relation with Residential Characteristics and Respiratory Symptoms, *Allergy*, Vol 49.7, p.540-47.

## Moisture and Mould Growth in Compact Roofs – Results from a Three-Stage Field Survey

*Jonas Holme, Cand Scient, Research Scientist, PhD-fellow,  
SINTEF Building and Infrastructure, Norway;  
jonas.holme@sintef.no and www.sintef.no/byggforsk*

*Knut Noreng, M. Sc, Senior Scientist,  
SINTEF Building and Infrastructure, Norway;  
knut.noreng@sintef.no and www.sintef.no/byggforsk*

*Tore Kvande, Dr.ing, Senior Scientist, Professor II,  
SINTEF Building and Infrastructure/Norwegian University of Science and Technology (NTNU), Norway;  
tore.kvande@sintef.no and www.sintef.no/byggforsk and www.ntnu.no*

**KEYWORDS:** *building performance, building defects, climatic impact, field investigation, driving rain, moisture, micro-biological growth, roofs, weather protection, self-drying (dehydration) potential climate*

### **SUMMARY:**

*Compact roof systems that are done right, using materials that are not mould-prone between a correctly installed vapour barrier and the roof waterproofing membrane, have typically been considered to be not very moisture sensitive. Moisture in compact roofs has therefore perhaps not received sufficient attention. With large precipitation amounts in southern Norway in the fall of 2000, the theme of built-in moisture in compact roofs again became relevant. Both in connection with roof work during periods with heavy precipitation and for example, from leakage, relatively large amounts of moisture can get trapped in the roof. This paper summarize some of the results from a field study was performed in order to investigate how flat, compact roof behave over time when moisture has been trapped in the construction. The investigation includes 12 roofs. 10 of the 12 roofs were chosen among roofs we knew had considerable problems with built-in moisture during the building period (fall 2000). Two of the roofs did not have any previously known moisture problems, and were therefore to act as reference roofs. Nine of the roofs were inspected in 2002, 2004 and 2007.*

*Even though the majority of compact roofs covered by this field investigation had moisture problems during manufacturing, the extent of moisture problems are decreasing. Compared to what was assumed beforehand, measurements in several of the roofs showed that dehydration was so extensive that mechanisms other than pure diffusion through the roofing or inward diffusion had possibly been a dominant factor in several instances. Other mechanisms contributing towards drying out may be convection currents in the roof and outward diffusion via the parapet, as well as lesser incidental air currents through all or portions of the roofs surface.*

*Microbiological growth observed inside the compact roofs are limited, confirming a small potential for growth in such constructions. This is due to the general robustness of the thermal insulation regarding growth and unfavourable maximum temperature amplitude ( $> 60^{\circ}\text{C}$ ). We assess a limited or negligible impact of indoor air quality caused by the observed microorganisms inside the investigated compact roofs.*

## **1. Introduction**

With the high levels of precipitation in southern Norway during the autumn of 2000, built-in moisture in compact roofs again became an important issue. Exacting building schedules and heavy precipitation during construction increase the risk of moisture entrapment in the roof structure. Similarly leakages are known to occur during the actual building process, as this is a period often characterised by much movement, traffic and other building activity, even after completion of the roof. In addition, there are many other reasons why roof leakages develop during the building's service life. Sometimes considerable quantities of water can penetrate into a roof.

A "compact roof" is a roof where the various material layers have been laid close together without ventilation. Compact roofs can be executed both as flat roofs (gradient  $< 6^{\circ}$ ) and sloping roofs (gradient  $> 6^{\circ}$ ) (Building

Research Design Sheet 525.207). This is the predominant type of roof construction used for large buildings in Norway. When correctly executed, with non-perishable materials between a correctly dimensioned/ installed moisture barrier (Noreng 1996) and well-executed waterproof roofing, compact roofs are not considered to be highly susceptible to moisture ingress. As a consequence, insufficient attention has been paid to moisture in compact roofs.

The most frequent questions have generally been along the lines: What happens in the long and short term in cases where moisture has been allowed to penetrate the construction? What kind of problems can we expect? Will moisture result in dripping from the roof, corrosion of fastenings, reduced insulating capabilities, rotting of roof woodwork and/or mould formation in the future? Will moisture in the roof construction create problems of such a nature that all moist materials must be replaced, or will there be sufficient natural dehydration through the roofing, parapets, etc. whereby these problems would be avoided?

## **2. Principal objective and scope**

The purpose of the field investigation is to establish the extent of moisture in compact roofs, ascertain how roofs with moisture will develop over time, determine whether they will dry out of their own accord or if prolonged moisture creates problems such as condensation droplets, corrosion, reduced insulation capabilities, mould formation or fungal growth. The investigation was intended to give increased knowledge about a roof's dehydrating (self-drying) capability, and the problems we can expect from moisture in compact roofs.

This paper presents some of the results from a field investigation concentrating on moisture condition in the roofs, a roof's dehydrating (self-drying) capability and microbiological growth.

## **3. The field investigation**

### **3.1 Extent of the field investigation**

The field investigation comprises surveys of twelve compact-roof constructions carried out in three separate stages. Eleven of the twelve roofs are located in Eastern Norway and were examined in June 2002. The twelfth roof was located in Trondheim and was examined in October 2002. 2004 comprises eight of the eleven roofs in Eastern Norway (examined in June 2004) and the roof in Trondheim (examined in October 2004) (Noreng et al. 2005). The nine roofs were examined again in 2007 in the same month as in 2004. The 2004 and 2007 investigations were intended to be a follow-up and continuation of the 2002 investigation by re-examining a selection of the same roofs after a two-year (2004) and five-year (2007) period.

For reasons of economy the number of roof constructions that were examined was restricted to twelve in 2002 and nine of the same twelve roofs in 2004 and 2007. Nevertheless the investigation provides some clear advance indications that can be considered representative for the types of roof construction examined.

### **3.2 The roofs – localisation and composition**

The roofs were chosen so that a majority of the constructions should have encountered actual moisture problems during the build period. On request, a number of key figures in the building trade put forward suggestions regarding buildings where they had experienced moisture problems during construction. As it rained a lot in the autumn of 2000, causing many problems in Eastern Norway, nine roofs were intentionally picked from among this selection. On Roof Nos. 3, 7, 8 and 9 the moisture problems during the build period were reported as being "serious," and on Roof Nos. 4, 5, 6, 10 and 11 the moisture problems during the build period were reported as being "very serious." Even though attempts were made to prevent or limit the source of the precipitated moisture by various means, such as covering with tarpaulins, this had only a limited effect. For Roof Nos. 4 and 6, ventilation louvres were installed afterwards in an attempt to dry out the building moisture. No other special means of covering, nor subsequent drying-out measures were implemented.

Roof Nos. 1 and 2 did not have any known moisture problems and were therefore chosen to act as reference roofs. When uncovering the reference roofs it was discovered that the moisture barrier over the DT-elements was missing, something that gave an opportunity for some moisture ingress from the inner side for most of the year (and drying-out inside the building during other parts of the year).

Finally a portion of the roof above an office wing at SINTEF Building and Infrastructure's premises in Trondheim was examined (Roof No. 12). This proved to be of great interest because five years previously this particular roof had been executed as an experimental roof and had been pre-fitted with instruments enabling measurements to be taken of moisture/ humidity and temperature after a given amount of water (1 litre per m<sup>2</sup>) had been applied to the roof construction (Time et al. 2002). Table 1 indicates the roofs covered by the investigation.

*TABLE 1: Examined roofs, with indications of presumed extent of building moisture and composition of the roof structure.*

No.	Usage Area [m <sup>2</sup> ]	Roofing year	Presumed extent of building moisture	Composition of roof structure	Examined year
1	Warehouse 2400 m <sup>2</sup>	2000/ 2001	Normal	Single-layer bitumen roofing, 50 mm mineral wool insulation, DT-concrete elements w/ open joints (no moisture barrier)	2002 2004 2007
2	Warehouse 800 m <sup>2</sup>	1989	Normal	Dual-layer bitumen roofing, 50 + 30 mm mineral wool, DT-concrete elements w/ open joints (no moisture barrier)	2002 2004 2007
3	Office block 750 m <sup>2</sup>	Autumn 2000	Serious	Dual-layer bitumen roofing, 50 mm mineral wool, + 200 mm EPS, PE-foil moisture barrier, concrete	2002
4	Office wing 1200 m <sup>2</sup>	2000/ 2001	Serious	Bitumen roofing, 200-300 mm mineral wool, PE-foil moisture barrier, steel supporting plates	2002 2004 2007
5	Offices 500 m <sup>2</sup>	2000/ 2001	Very serious	PVC roofing foil, 100 mm mineral wool, PE-foil moisture barrier, 50 mm mineral wool, steel supporting plates	2002 2004 2007
6	Packing house 3000 m <sup>2</sup>	2000/ 2001	Very serious	Bitumen roofing, 100 mm mineral wool, PE-foil moisture barrier, 50 mm mineral wool, perforated steel supporting plates	2002 2004 2007
7	Office wing 150 m <sup>2</sup>	Autumn 2000	Serious	Single-layer bitumen roofing, 50 mm EPS insulation, wooden under-roof (no moisture barrier)	2002
8	Material store 900 m <sup>2</sup>	Autumn 2000	Serious	Dual-layer bitumen roofing, 200 mm mineral wool, bituminous moisture barrier w/loose overlaps, steel supporting plates	2002
9	Residential and day-care centre 450 m <sup>2</sup>	2000/ 2001	Serious	PVC roofing foil, matted glass-fibre migration barrier, 200-250 mm EPS, PE-foil moisture barrier, concrete	2002 2004 2007
10	Sports hall 800 m <sup>2</sup>	Autumn 2000	Very serious	PVC roofing foil, 200-250 mm mineral wool, PE-foil moisture barrier, concrete	2002 2004 2007
11	Shopping mall 5000 m <sup>2</sup>	2000/ 2001	Very serious	PVC roofing foil, 200-250 mm mineral wool, old roofing foil, 150 mm old mineral wool PE-foil moisture barrier, steel supporting plates	2002 2004 2007
12	Office wing 600 m <sup>2</sup>	1997	Serious	FPO roofing foil, 30 mm mineral wool, + 0-100 mm EPS, old PVC roofing foil, 50 mm old insulation, Dina elements filled with insulation	2002 2004 2007

### 3.3 Field investigation – observations and measurements

A survey report was made for each of the roofs giving details of the participants, building, roof geometry and design/construction, as well as date of the roofing work. The actual examinations were made by taking measurements and observations at three to five points along an imaginary line drawn across the roof. The constructions were uncovered in order to make more detailed observations, take measurements of moisture content such as RH/temperature measurements, as well as take samples of roof insulation materials for more accurate evaluation back in our own laboratory. The measurement and observation points in 2004 and 2007 were positioned adjacent to those chosen in 2002 and simply moved approx. 0.5 m so that new samples could be taken from an undisturbed area. The survey reports contain pictures and sketches showing the measuring point locations as well as detailed observations and measurements.

Sample taking and analyses with a view to possible microbiological growth formed an important part of the investigation. Mycoteam AS and SINTEF Energy Research assisted us with these examinations. The salient points from the analyses are included in this paper.

### 3.4 Concerning moulds/fungi and investigation of micro-biological activity

In this paper we have differentiated between moulds, blue-stain fungus, wood-decaying fungus, yeasts and bacteria. Dispersal of the fungi species mentioned is by means of microscopic spores which are spread by air currents and which are found in the air everywhere. Both viable and dead spores are to be found. It is difficult to give simple general rules for the criteria that determine growth. Access to nutrients, moisture, oxygen, temperature and time are important factors affecting growth. For mould  $RH \geq 85\%$  and  $t \geq 0^\circ\text{C}$  is a normal, but simplified criterion for growth on surfaces (Grant et. al., 1989).

In connection with the investigation into fungal growth and other possible biological activity, material samples were taken of roofing, insulation and moisture barriers. In addition, samples of outside air and of air from within the roof construction were collected for cultivation in the laboratory.

## 4. Some results from the investigation

### 4.1 Moisture content of insulation samples

An overview of the moisture content in samples of insulation materials from the roofs is given in Table 2. Only results from the nine roofs followed during the whole five-year periode are included. Roof No. 5 differs from the other due to a moisture content in the rock wool exceeding 1.0 weight percentage. Except Roof No. 11 all roofs undergo drying during the periode 2002-2004. In 2004 only Roof Nos. 5 and 11 contain rock wool exceeding 1 weight percentage water. During the periode 2004-2007 further drying of the roofs are measured. The exception is Roof No. 11, which now contains 16.8 weight percentage water. The other roofs contain less than 0.35 weight percentage water.

### 4.2 Micro-biological activity

Table 2 includes observation of microbiological growth in 2002, 2004 and 2007. Only results from the nine roofs followed during the whole five-year periode are included. Microbiological growths were observed in seven of the nine roofs already in 2002, see Table 2. The growths were mainly blue-stain fungus observed at the back of the roofing, at the surface of the thermal insulation or inside the insulation. In addition minor or moderate growth of mould (cladosporium, aspergillus and penicillium) were observed. Bacteria were observed in one roof. Roof No. 11 and 12 differ from the other because of conspicuous microbiological growth.

In 2004 microbiological growths were observed in all of the nine roofs (see Table 2). Blue-stain fungus is still the most common growth, however, the amount of mould is increasing. Observations indicate growth in Roof Nos. 2, 4, 6, 9, 10, 11 and 12 during the periode 2002-2004.

The microbiological activity decreased during the periode 2004-2007. Growths were observed in six of the nine roofs in 2007, see Table 3. Blue-stain fungus is still the most common growth and mould is still growing in some of the roofs. No growths were observed in Roof No. 5, 6 and 10.

TABLE 2: Moisture content in insulation samples taken from Roofs Nos. 1 to 12 in 2002, 2004 and 2007.  
 N.B: Moisture content of 1 volume-% in 100 mm thick insulation yields 1 litre of water per m<sup>2</sup>.

No.	Sample point	Thermal insulation	Summer 2002		Summer 2004		Summer 2007	
			[weight-%]	[volume-%]	[weight-%]	[volume-%]	[weight-%]	[volume-%]
1	P1-Ø	Rock wool	0.41	0.07	0.29	0.05	0.27	0.04
	P2-Ø	Rock wool	0.41	0.07	0.28	0.04	0.21	0.03
	P3-Ø	Rock wool	0.43	0.07	0.29	0.05	0.21	0.04
	P4-Ø	Rock wool	-	-	0.25	0.04	-	-
2	P1-Ø	Rock wool	0.31	0.03	0.22	0.03	0.13	0.02
	P1-N	Rock wool	0.34	0.07	0.12	0.01	-	-
	P5-Ø	Rock wool	-	-	0.15	0.03	0.22	0.04
	P5-N	Rock wool	-	-	0.55	0.06	0.20	0.02
4	P1-Ø	Rock wool	-	-	0.38	0.08	0.15	0.02
	P1-N	Rock wool	-	-	0.22	0.03	0.25	0.03
	P2-Ø	Rock wool	-	-	0.31	0.06	0.22	0.03
	P2-N	Rock wool	-	-	0.40	0.05	0.05	0.01
	P3-Ø	Rock wool	3.31	0.40	0.24	0.03	0.15	0.02
	P3-N	Rock wool	-	-	0.36	0.03	0.20	0.03
	P6-Ø	Rock wool	-	-	-	-	0.21	0.03
	P6-N	Rock wool	-	-	-	-	0.13	0.01
5	P1-Ø	Rock wool	150.00	17.80	93.70	13.13	0.11	0.02
	P1-oD	Rock wool	225.00	17.60	-	-	0.13	0.01
	P1-du	Rock wool	0.60	0.07	0.31	0.04	1.12	0.13
	P2-Ø	Rock wool	-	-	0.47	0.08	0.31	0.05
	P2-oD	Rock wool	-	-	-	-	0.28	0.03
	P2-uD	Rock wool	-	-	0.28	0.03	0.17	0.02
6	P1-oD	Rock wool	11.00	1.00	0.42	0.06	0.24	0.02
	P1-du	Rock wool	-	-	0.22	0.03	0.19	0.03
	P2-oD	Rock wool	-	-	-	-	0.23	0.02
	P2-uD	Rock wool	-	-	-	-	0.19	0.02
9	P1-Ø	EPS	0.87	0.02	0.72	0.01	26.32	0.48
	P1-N	EPS	-	-	0.44	0.01	0.08	0.00
	P2-Ø	EPS	34.00	0.55	0.70	0.17	0.26	0.00
	P2-N	EPS	-	-	0.09	0.06	0.46	0.01
	P3-Ø	Rock wool	-	-	0.37	0.01	0.24	0.00
	P3-N	Rock wool	-	-	0.97	0.01	-	-
	P3-N'	EPS	-	-	0.60	0.00	0.37	0.01
10	P1-Ø	Rock wool	0.33	0.05	0.33	0.06	0.11	0.02
	P1-N	Rock wool	-	-	0.25	0.02	0.09	0.01
	P2-Ø	EPS	-	-	0.79	0.02	0.50	0.01
	P2-N	EPS	-	-	0.48	0.01	0.59	0.01
	P3-Ø	Rock wool	0.36	0.06	0.36	0.04	0.13	0.02
	P3-N	Rock wool	-	-	0.40	0.04	0.14	0.02
11	P1-Ø	Rock wool	-	-	0.24	0.04	0.11	0.02
	P1-ugt	Rock wool	0.41	0.06	-	-	6.35	0.63
	P2-Ø	Rock wool	-	-	0.37	0.06	95.92	14.11
	P2-ugt	Rock wool	14.32	1.20	13.10	1.29	8.71	1.24
		Rock wool	-	-	-	-	6.11	0.70
	P3-Ø	Rock wool	-	-	1.70	0.23	0.23	0.03
	P3-ugt	Rock wool	1.40	0.20	38.80	5.52	-	-
	P3-N	Rock wool	-	-	13.40	1.42	0.24	0.02
12	P1-ø	Rock wool	0.34	0.03	0.31	0.06	0.24	0.05
	P1-m	Rock wool	0.41	0.07	-	-	-	-
	P1-n	Rock wool	0.37	0.08	0.33	0.04	0.42	0.05
	P6-ø	Rock wool	0.62	0.14	0.33	0.06	0.33	0.06
	P6-m	EPS	1.18	0.02	-	-	-	-
	P6-n	EPS	1.65	0.03	1.88	0.03	1.10	0.02
	P7-ø	Rock wool	1.35	0.21	0.55	0.10	0.29	0.06
	P7-n	EPS	1.66	0.03	2.18	0.04	0.91	0.02
	P9-ø	Rock wool	7.93	1.43	0.50	0.09	0.27	0.06
	P9-ugt	EPS	-	-	-	-	1.33	0.03



TABLE 3: Microbiological activity observed in 2002, 2004 and 2007.

No.	Registered growth in 2002	Registered growth in 2004	Registered growth in 2007	Comments
1	Yes	Yes	Yes	Sparse growth
2	No	Yes	Yes	Sparse growth
4	No	Yes	Yes	Sparse growth
5	Yes	Yes	No	Decreasing growth
6	Yes	Yes	No	Decreasing growth
9	Yes	Yes	Yes	Decreasing growth
10	Yes	Yes	No	Decreasing growth
11	Yes	Yes	Yes	Sparse growth
12	Yes	Yes	Yes	Sparse growth

## 5. Discussion

### 5.1 Moisture content and drying potential

Reports received from the roof entrepreneurs at the beginning (concerning the building-in of considerable amounts of moisture from precipitation into the roofs) seem to be confirmed by 2002 of the investigation. Nevertheless, in several places we could see that even though moisture had quite clearly penetrated into the roofs, there was less evidence of moisture in the roofs 1½ years after the roofing period than the reports from the roofing period would suggest. In 2004 and 2007, after a further two and five years, this impression was reinforced.

There are several mechanisms contributing towards drying out of possible moisture in compact roofs over a period of time: outward diffusion through the roofing, inward diffusion, convection currents in the roof and outward diffusion via the parapet, as well as lesser incidental air currents through all or portions of the roof surface.

Drying out (dehydration) via outward diffusion through the roofing is minimal and varies according to the type of roofing and also e.g. with the outside temperature. In the field investigation eleven of twelve roofs were located in the southeastern part of the country. Compared to what was assumed beforehand, measurements in several of the roofs showed that dehydration was so extensive that mechanisms other than pure diffusion had possibly been a dominant factor in several instances.

In order to assist with the drying out of building moisture, ventilation louvres were installed on two of the roofs (Roof Nos. 4 and 6) after the building was completed but prior to the examinations in 2002. The sizes, quantity and locations were different on the two roofs. When we returned to implement 2004, the ventilation louvres had been removed from both roofs. We were told that this was because the roofs in the meantime were considered to be dry and that ventilation louvres were therefore no longer necessary. As an example we would mention Roof No. 6: A large number (64) of ventilation louvres were retrofitted in the bituminous roof covering. The moisture content of the mineral wool in 2002 was measured as being 1.0 % (volume). This is a fairly high moisture content. The position of the sampling point was approx. 2 m away from four of the ventilation louvres. As we do not know how much moisture was present in the roof from the start, it is difficult to judge the effect of the ventilation louvres up to the examination in 2002. The drying out that was registered between 2002 and 2004 (measured value in 2004 was 0.06 % by volume) is however so large that dehydration mechanism other than pure diffusion must have had a significant effect. It therefore looks as if the ventilation louvres have made a positive contribution.

## 5.2 Microbiological growth potential

Microbiological growth may appear on almost every material exposed by moisture. The humidity exposure may be caused by water supply/leakage or by high air humidity. Microbiological growth may appear both on organic materials (wood, textile, cardboard etc.) (Nielsen, Holm et. al. 2004) and on inorganic materials (concrete, clay brick, natural stone etc.) settled by organic compounds (Viitanen 2004). E. g. component in compact roofs such as roofing, thermal insulation, vapour barrier etc, are polluted by organic compounds from the manufacturing and from the everyday use of the building. Hence, the contents of organic compounds in compact roofs may be sufficient nutrition for growth of mould, yeast and bacteria. Such growths are normally harmless for the substratum itself, but it may decompose emollients and adhesives in vapour barriers and roofings, increasing the stiffness and brittleness of the material and then the risk for fracture and leakages.

Trace of mould and/or bacteria was observed in seven of the nine roofs in 2002, none of them with strong growth. Neither was a gradient of growth according to the thickness of the roofs observed. In 2004 trace of mould and/or bacteria was observed in all the nine roofs, none of them with strong growth. It is now observed a trend of less blue-stain fungus in the roofing and/or in the thermal insulation close upon the roofing. However, the amount of growth was small, making it difficult to carry out a secure determination of species. Theoretically limited growth was supposed beneath roofing due to the temperature amplitude reaching maximum summer temperature exceeding 60°C. Such high temperature expect to restrain/kill mould growth (IOM 2004). Limited growth observed in 2002 and 2004 correspond with this theory.

Bacteria were in 2004 observed on the vapour barrier and partly on the thermal insulation against the vapour barrier in several of the roofs. Some places mould and blue-stain fungus are also found at the same places. The analysis of growth did not distinguish upper and under side of the vapour barrier. However, the observation indicates more bacteria on the upper side (i.e. inside the compact roofs). Approximately no microbiological growth was found inside the thermal insulation with exception of sparse growth inside the insulation in Roof Nos. 9 and 11.

In 2007 microbiological activity was found in Roof Nos. 1, 2, 4, 9, 11 and 12. No activity was found in Roof Nos. 5, 6 and 10 even though microbiological growth has been observed earlier. Lack of growth in these roofs may be due to decomposition of the former growth and no new growth, or due to circumstances attached to sparse growth in the roof. In addition to the roofs without microbiological activity, the growth in Roof No. 9 was less than in 2004.

The microbiological growth in Roof No. 11 and maybe also in No. 4 increased in the periode 2004-2007. However, the increasing is small and it may be due to variations of growth in the construction.

The moisture content in the roofs, except of Roof No. 1, 2 and 10, was from the beginning very high, varying between 225.00 and 0.31 weightpercent in the rock wool. The first inspection of the roofs (2002) was carried out during the first one and half year after manufacturing. Expecting some drying during that periode, it is likely to expect the initial moisture content to be even higher than determined in 2002.

A moisture content of 0.8 weightpercent in rock wool correspond to 95% RH. Test of mould growth in thermal insulation indicate growth at 95% RH (Konsumverket 2002, Foarde et. al. 1996). Condensation in the outer part of compact roofs appears during the winter season dependent of the moisture content. The possibility for condensation supports the trend towards more mould at the underside of the roofing and/or the insulation against the roofing. However, the amount of microbiological growth in the compact roofs was limited indicating unfavourable growing conditions in this type of construction.

## 5.3 Indoor air impact of micro-biological growth in compact roofs

Even growing inside a closed construction element e.g. compact roof, microorganism may at least theoretically influence the indoor climate. That occurs because spores and particles (mycotoxins) as well as volatile matters they produce (MVOC), may be transferred to the indoor air by airflow through the construction element. MVOC may also partly diffuse the vapour barrier influencing the indoor air.

Compact roofs don't normally have any intended ventilation. Correctly manufactured the vapour barrier will avoid downward airflow through the roof into indoor living room. Indoor overpressure beneath the roof construction prevent inward airflow from the compact roof. Hence, spores or mycotoxins from microbiological growth inside a compact roof likely intrude the indoor air quality beneath the roof. The risk potential may be larger due to the growths production of MVOC and diffusion through the vapour barrier. However, the potential risk is decreasing

dependent of the growths distance above the vapour barrier. The microbiological growths were mainly observed in the outer part of the compact roofs. Due to indoor overpressure, airflow likely goes upward against the roof. Ventilation of the living room is also an important measure to reduce the potential impact of MVOC-migration.

It is a vital risk for microbiological impact of indoor air quality if water is leaking from the roof down to the ceiling, wooden cornice or the upper part of walls. This point of view is not included in this paper, but empirically the indoor air quality is more vulnerable to microbiological growth at those places because of growth inside the vapour barrier.

## 6. Conclusions

Even though the majority of compact roofs covered by this field investigation had moisture problems during manufacturing, the extent of moisture problems are decreasing. Compared to what was assumed beforehand, measurements in several of the roofs showed that dehydration was so extensive that mechanisms other than pure diffusion through the roofing or inward diffusion had possibly been a dominant factor in several instances. Other mechanisms contributing towards drying out may be convection currents in the roof and outward diffusion via the parapet, as well as lesser incidental air currents through all or portions of the roofs surface.

Microbiological growth observed inside the compact roofs are limited, confirming a small potential for growth in such constructions. This is due to the general robustness of the thermal insulation regarding growth and unfavourable maximum temperature amplitude ( $> 60^{\circ}\text{C}$ ). We assess a limited or negligible impact of indoor air quality caused by the observed microorganisms inside the investigated compact roofs.

## 7. Acknowledgements

This field investigation has been performed in cooperation with The Norwegian Roofing Research Group, and the paper has been written within the ongoing SINTEF strategic institute projects “Climate 2000 – Weather Protection in the Construction Process”. The authors gratefully acknowledge the Research Council of Norway and The Norwegian Roofing Research Group. Thanks to Cathrine M. Whist, Mycoteam, and Elisabeth N. Haugen, SINTEF Energy Research, analysing the samples to possible microbiological growth.

## 8. References

- Building Research Design Sheet 525.207 (2000). Kompakte tak (Compact roof). Norwegian Building Research Institute, Oslo (in Norwegian).
- Foarde K.K. et al. (1996). Evaluation of Fungal Growth on fibreglass Duct Materials for Various Moisture, Soil, Use and Temperature Conditions. *Indoor Air* p. 83-92.
- Grant C., Hunter C.A., Flanningan B., Bravery A.F. (1989). The moisture requirements of moulds isolated from domestic dwellings. *International Biodeterioration & Biodegradation*, Vol 25, p.259-284.
- Institute of Medicine (IOM) (2004). *Damp Indoor Spaces and Health*, The National Academies, Washington DC.
- Konsumetverket (2002). Lösull - Enkelt och effektiv isolering, Råd & Rön 8.
- Nielsen K.F., G. H., Uttrup L.P, Nielsen P.A. (2004). Mouldgrowth on building materials under low water activities. Influence of humidity and temperature on fungal growth and secondary metabolism. *International Biodeterioration and Biodegradation*, Vol 54, p.325-336.
- Noreng K. (1996). Dampspærre i tak (Vapour barrier in roof), Project Report 190, Norwegian Building Research Institute, Oslo (in Norwegian).
- Noreng K., Time, B., Kvande, T. and Uvsløkk, S. (2005) Moisture in compact roofs – Results of a two-stage field survey, Proceedings of the 7<sup>th</sup> Symposium on Building Physics in the Nordic Countries, the Icelandic Building Research Institute, Reykjavik.
- Time B., Noreng K., Hernæs J. and Geving S. (2002). Drying-out potential of a retro-fitted compact roof, *Building Physics in the Nordic Countries*, Proceedings of the 6<sup>th</sup> Symposium Trondheim, p.247-254.
- Viiitanen, H. (2004). Critical conditions for the mould growth in concrete and in other materials contacted with concrete - durability of concrete against mould growth. VTT-Work-6.

## Massive timber elements in roofs – moisture performance

*Berit Time, Research Manager, Dr.ing  
SINTEF Building and Infrastructure  
berit.time@sintef.no*

*Stig Geving, Senior Researcher, Dr.ing  
SINTEF Building and Infrastructure  
stig.Geving@sintef.no*

*Knut Magnar Sandland, Research Manager, Dr.scient.  
Norsk Treteknisk Institutt (NTI)  
knut.sandland@treteknisk.no*

**KEYWORDS:** *roof, massive timber elements, moisture transport, vapour barrier*

**SUMMARY:** *This paper presents an evaluation of the hygrothermal performance of massive timber roof constructions. An ongoing project “Massive timber – properties and use” is aiming towards giving recommendations for how to build sustainable massive timber roofs. Activities like water vapour permeability measurements of wood, hygrothermal simulations, field measurements and following up several ongoing building projects is being done in the project in order to fulfil the aim*

### 1. Introduction

In Norway there are long traditions for using wood in building constructions. Most houses in Norway except for apartment buildings are for instance lightweight timber frame houses and an increasing amount of smaller apartment buildings are built in wood.

In Norway the Building Regulations, which are based on European Union’s Construction Product Directive, are performance based and has been so since 1997. This means that there are opportunities to build multi-storey buildings in wood as long as the requirements in the Construction Product Directive (Council Directive 89/106/EEC) on building and civil engineering works are judged to be fulfilled. The timber industry is important for Norway and forest raw materials represent a considerable renewable resource, with a large unexploited potential for a wide range of applications. The Norwegian government, through different research and development programmes, support initiatives that leads to development in the use of timber. The wood sector of Norway has as it’s most important aim to increase the use of wood in order to increase the growth of value in the wood industry and in the forest sector.

Wooden buildings have become more popular lately also because of its environmental feature and sustainability.

Massive wood constructions are made of massive wood elements. These elements are in principal multi-layer cross-laminated timber panels (fig. 3). The panels can be tied together mechanically or by use of glue. Massive wood constructions are more often used in central Europe and in Austria in particular. In Norway there are a couple of factories producing these kinds of elements and the building sector also imports elements from the neighbouring countries. The manufacturers report about high activity and a huge interest in this building technique.

## 2. Modern architecture and roof performance

### 2.1 New architectural trends

Many Norwegian architects these days see a great potential in applications for massive timber in an urban context and for environmental friendly design in general. There is a great focus on renewing/developing the wood based architecture in Norway and many bigger cities name themselves “wooden cities” (e.g Bergen, Stavanger, Trondheim and Elverum). The timber-built-village at Siriskjær in Stavanger (approximately 18 500 m<sup>2</sup> of dwellings), fig. 2 and the Preikestolen Mountain Lodge (high standard lodge with 29 bedrooms), fig. 1, are examples of modern high-lighted projects. The architecture of these new projects are claimed to be innovative and creative, future-oriented, environmentally friendly and universal



Fig. 1  
Sketch of the Preikestolen Mountain Lodge  
([www.preikestolhytta.no](http://www.preikestolhytta.no)). Architect: Helen & Hart



Fig. 2  
Illustration of the timber-built-village at Siriskjær in Stavanger (Architect: Studio Ludo + A.A.R.T)



Fig. 3  
Examples of mounting of massive timber elements,  
roof on walls.



Fig. 4  
It is recommended to raise massive timber  
constructions using Weather Protection Systems



Fig. 5  
Modern dwellings built of massive timber element



Fig. 6  
Part of a new school being built in massive timber

As have been experienced in for instance Sweden (Vessby 2007) Norwegian architects and engineers have a great focus on keeping the massive timber visually exposed to at least parts of the indoor surroundings. Their reason for this is often aesthetical and/or related to a wish of profiting on the woods ability to be a moisture buffer (see e.g Hameurey 2006) and also related to environmental and indoor reasons. Buildings built in massive timber can be competitive compared to e.g concrete slabs and steel roofing elements, and in addition there are several advantages (renewable raw material, possibilities for solutions of high flexibility, low weight) and builders/craftsmen report that it is very easy to work with.

When using massive timber elements in floors and walls there are however, some challenges, e.g. sound transmission in the construction and exposure for bad weather in the building period.

Roofs made of massive timber elements can be regarded having a great potential for use, and therefore it is of interest to increase the knowledge to attain optimal building solutions for this purpose.

## 2.2 Sharing of knowledge

It has been claimed/questioned among practitioners and experienced by SINTEF that there is a need for more knowledge in terms of climate adaption, constructive timber detailing and building physics for these kinds of constructions. New building regulations that imply 300 – 350 mm of thermal insulation have also risen a question about moisture performance.

In a development project running these days on “*Massive timber – properties and use*” one of the project goals is to study and make guidelines and recommendations on how to build sustainable and well performing roofs by use of massive timber. SINTEF Building and Infrastructure give to the Norwegian building sector on planning and building through the Building Design Sheet. Advices and recommendations given in the Building Design Sheets are typically well documented recommendations. It is a goal for the project to implement recommendations for this kind of roof constructions in a Building Design Sheet (In Norwegian : Byggforskserien).

## 2.3 Type of roofs

In Norway roofs are being built according to one of two main principles in order to meet overall performance criteria mentioned

- Compact roofs (warm roofs)
- Ventilated roofs (cold roofs)

Compact roofs are roofs with no airspace between the material layers and shall as a main rule according to SINTEF recommendations have water downlets inside the building (Norwegian climate zones). The roofs can be either flat or sloped and they must be covered with a roofing material that can resist water pressure.

Ventilated roofs are roofs that need to be ventilated beneath the roof coverings so that the roof should be kept cold, snow should not melt and the excess of moisture should be ventilated. The roof water downlets should be outside the building envelope and the roof should preferably have a slope of at least 10–15 degrees (Building Design Sheet 525.002).

Massive timber roofs can be built according to both these principles though the most common way of doing it up to now has been to make compact flat roofs.

## 2.4 Challenges and often raised questions

Challenges and questions often asked among architects and engineers for massive timber roofs in relation to building physics are connected to

- Wooden compact roofs and moisture issues/-problems
- Should there be a vapour barrier in this kind of roofs ?
- Temperature levels around the downlets/-pipes in compact roofs and minimum requirements for thermal insulation thickness by roof drain (pipes)

- The air tightness of massive timber element roofs
- Moisture protection during the construction process

### **3. Activities in the project**

In order to be able to give good answers to the questions raised it was decided to work with the following activities in the ongoing project:

- Measurement of water vapour permeability through wood and glued wood at different relative humidity levels
- Hygrothermal simulations of relevant massive timber roof constructions
- Measurements of hygrothermal properties in a compact flat roof in an apartment building
- Cooperation and communication with contractors and assessments of constructions being built
- Development of recommendations and general drawings for massive timber roof detailing

#### **3.1 Water vapour permeability of wood with and without glue**

It is a well known fact that water vapour transport in wood is dependent on moisture level and temperature. Literature show great variations in water vapour permeability in wood (Time 1998). The water vapour permeability is often said to be approximately 4 times higher for wood in equilibrium with 100 % relative humidity than for dry wood. Since the internal variations in wood properties vary considerably, more consistent values on vapour permeability for same quality of wood (used as massive timber elements) with and without glue depending on relative humidity levels should be available. A modification of the cup test method has been done in order to measure water vapour properties for wood and glued wood at different relative humidity and hysteresis levels. The test samples have been made so that same samples in a lid can easily be moved from one cup (i.e one specific RH – saltsolution) to another. For further description of the test method, see NS-EN ISO 12572 (2001). The measurements are in process and the results from these measurements will be presented at the symposium.

#### **3.2 Hygrothermal simulations of relevant massive timber constructions**

In wooden architecture and engineering there is and has always been a certain focus on the necessity of using a vapour barrier in massive timber constructions. This is the case for walls as well as for roofs. Roofs built with massive timber can be compact roofs or ventilated roofs. The main function of a vapour barrier is to maintain the airtightness of the building element and to reduce the transport of water vapour from the interior. Moisture transported through air leakages normally represents a greater risk for moisture problems and building damages than vapour transport by diffusion. Both these mechanisms have to be considered when assessing and recommending built up of roofs.

Initial hygrothermal calculations of compact roof elements have been performed and more calculations are in process. The main objective of the present work is to document how different roof solutions (i.e mainly with a vapour barrier, without a vapour barrier or with a vapour retarder) in relation to

- thickness of thermal insulation and wooden timber element
- type of materials in the construction
- built-in-moisture (level) for the massive timber element
- exterior climate
- indoor air humidity level.

Based on previous experience and hygrothermal simulations, the project aims to present a practical tool for assessing the necessity of using a vapour barrier for different kinds of roof constructions, for different built in moisture levels and for different climate zones.

### 3.2.1 Initial calculations

Initial calculations have been performed for a compact roof. For description of the roof construction and the different cases simulated see table 1.

Table 1

The roof construction is consisting of (seen from the cold side/outdoor climate side) for 4 different calculation cases:

	Case			
	1	2	3	4
One-layer bitumen roofing	x	x	x	x
250 mm mineralwool	x	x		
80 mm mineralwool			x	x
0,15 mm PE-foil (vapour barrier)		x		x
150 mm massive timber element	x	x	x	x

The purpose of the initial calculations was to consider the need for a vapour barrier in a specific roof being built in Trondheim. The building was one of the buildings studied in this project and the contractors were worried about the hygrothermal performance in relation to the area of the roof around the roof drain where the thickness of the thermal insulation is at a minimum. In that particular area the thermal resistance of the massive timber element might be at the same level or even higher than the thermal insulation. With a vapour barrier on top of the timber element the RH below the vapour barrier might get to high, and giving an increased risk for mould growth. The calculated cases with an insulation thickness of 80 mm should simulate the situation by the drainage down lets.

The calculations have been performed with WUFI 1D Pro 4. The transport mechanisms considered in the calculation tool are water vapour diffusion and capillary transport. The tool includes the moisture capacity of the material layers. Air leakages are not considered. The climatic data used are the so called Moisture Design Reference Year (MDRY) for Trondheim. The calculation period has been selected to 5 years. The indoor air humidity level have been defined by the moisture supply, which is the difference between indoor and outdoor air water vapour content. The moisture supply was chosen to 4 g/m<sup>3</sup> for outdoor temperatures below 0°C, and decreasing linearly to 1 g/m<sup>3</sup> at an outdoor temperature of 20°C. The built in moisture level has been set in equilibrium with 80 % RH. This is considered to be fairly conservative as we experience that the contractors have become more aware of moisture problems in the building process and precautions are taken especially in relation to wood and wooden elements. For the particular project a WPS-system (tent) were used during construction. Material parameters from WUFI material database have been used. A  $\mu$ -value for the bitumen roofing membrane of 600 has been used and 108 (at 0 % RH) and decreasing linearly to 27 (at 100 % RH) has been used for wood. The glue layers in the massive timber elements have not been accounted for since our measurements are still not reported. Some results for these initial calculations are given in the two example diagrams in figure 7 and 8.

### 3.2.2 Discussion

The calculations show (fig.7) that the cases without a vapour barrier obtain the lowest RH in the outer parts of the constructon (i.e in the mineralwool just below the membrane) during the summer months. The results show that for the cases with a vapour barrier the moisture transport will be stopped before it reaches/is absorbed by the massive timber elements. It is to be seen that the inward drying is particularly large especially for case 3 (with 80 mm of insulation and no vapour barrier) and that it starts early in the spring. For case 1 (with 250 mm of insulation and no vapour barrier) the calculations show that the drying process starts later than for case 2 and 4 (with vapour barriers). Fig. 8 shows that the RH in the outer parts of the timber elements (close to the mineralwool and the vapour barrier) is very much dependent on material layers (vapour barrier/no vapour barrier) and the insulation thickness. For the cases with 80 mm thickness of the mineralwool it is seen that the RH in the outer parts of the wood is lower for the case with no vapour barrier. This is because the thermal resistance of the wooden layer is approximately on the same level as the thermal resistance of the insulation layer and the vapour barrier is placed in a position more than (the recommended by SINTEF) 25 % inside the thermal resistance of the roof. However it is to be considered that for both cases the RH and temperature levels will be below the critical limit for mould growth (i.e below 80 % RH while the outdoor temperature is below 0 °C).



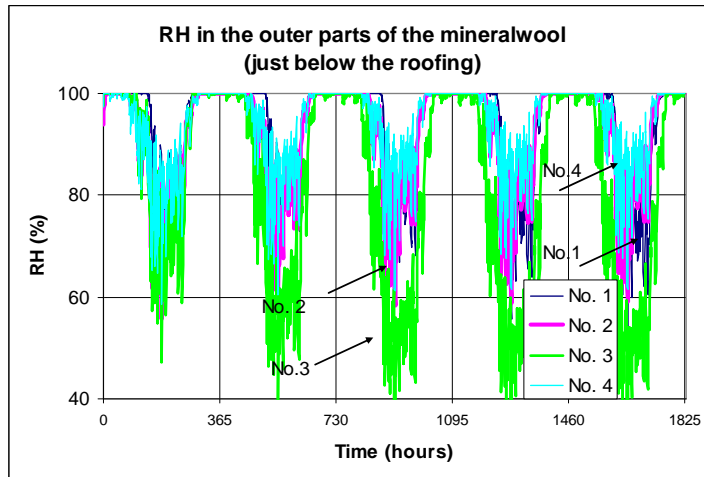

Fig. 7  
 RH in the outer mm of the mineralwool (just below the roofing membrane). The 5 years calculation period starts on the 1 of January the first year.

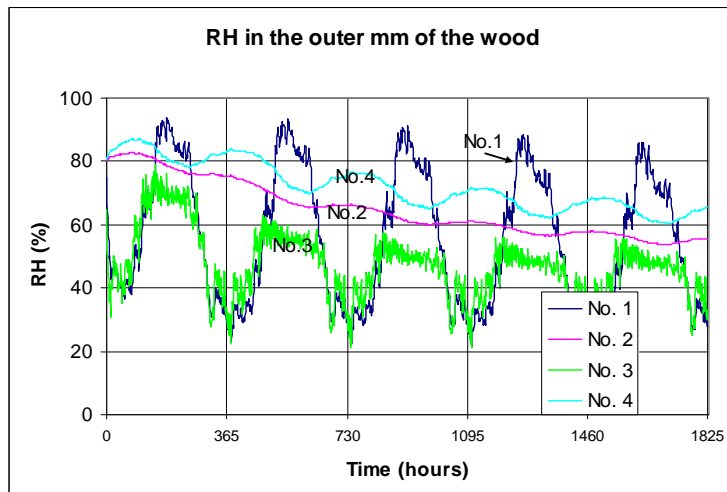

Fig. 8  
 RH in the outer parts of the massive timber elements (close to the mineralwool and the vapour barrier). The 5 years calculation period starts on the 1 of January the first year.

For the cases with 250 mm of mineralwool we can see a greater risk for mould growth for the construction without a vapour barrier likely due to summer condensation and also because a greater amount of built in moisture is transported outwards compared to the case with 80 mm thickness of thermal insulation . The inward vapour transport during the summer will be stopped by the vapour barrier if it is there, if not the moisture will be absorbed by the massive timber element and give an increased RH. If it is considered that mould growth on the wooden parts near the insulation is the potential risk of this construction, it is judged, according to these initial calculations, to be safe to use a vapour barrier between the mineralwool and the timber element. This material layer/the barrier can also serve as a contribution to the airtightness of the roof. The calculations also show that in the areas around the roof drain the need for a vapour barrier is less important if the airtightness can be dealt with. Anyway for the assumptions/considerations used in these calculations the use of a vapour barrier should not be any problem.

The airtightness of massive timber element constructions are very much dependent on how the separate elements are connected to each other. The authors are not aware of any documentation of the airtightness of massive timber elements.

Further calculations will be done in order to be able to give more detailed advices related to indoor moisture level, initial moisture level (e.g for “built under-roof” constructions), other insulation thicknesses, different climate zones and for recommended minimum levels for insulation thicknesses by the water down lets.

### 3.3 Field measurements of hygrothermal properties in a roof

Norsk Treteknisk Institutt (NTI) has set up moisture measurements in two separate massive timber roofs in a newly built apartment building in Hokksund in the southern part of Norway. The built up of the roof can be seen in fig. 9. There is a vapour barrier in one roof and no vapour barrier in the other. Apart from that they are equal. It has been focus on reducing the weather exposure of the massive timber elements during construction by the aid of not permanent covers. RH levels have been recorded for approximately one year and concerning differences in moisture levels within the two roofs, only minor difference can be seen at this stage between the roof, having and not having a vapour barrier (fig. 10 and fig.11). A small difference can be seen in the reduction of the RH level just below the roofing throughout the winter and spring. The measurements will carry on some more years in order to record first, second and third year results.

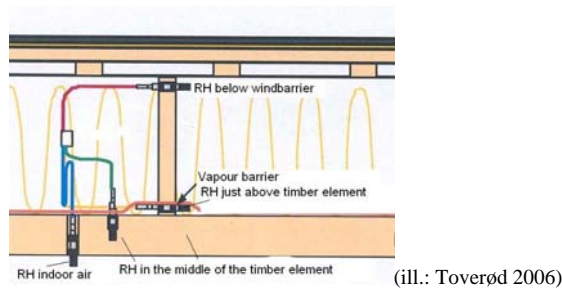

Fig. 9  
A sketch showing the roof in which RH levels are recorded. It is an almost flat roof (6°), 12 meter wide, with a ventilated roof construction. The roofing is 3 mm PVC-membrane on a 16 mm OSB-board, 100 mm ventilated air gap, wind barrier, 270 mm mineral wool, vapour barrier alt. no vapour barrier, 80 mm massive timber elements.

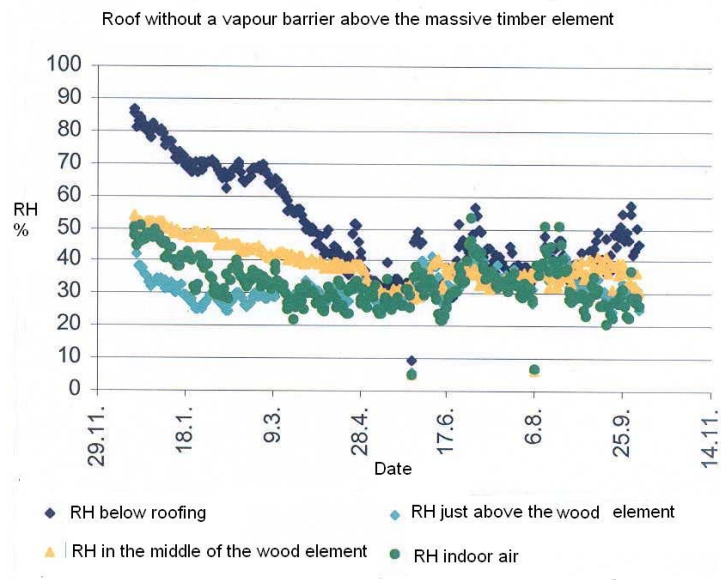

Fig. 10  
RH level measurements at 4 different positions in a roof without a vapour barrier above the massive timber element

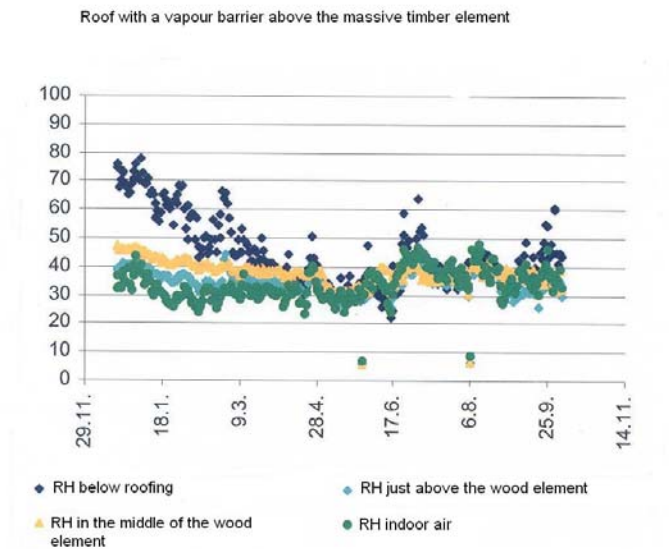

Fig. 11

RH level measurements at 4 different positions in a roof with a vapour barrier above the massive timber element

#### 4. Concluding remarks

The paper presents some building physic challenges experienced in connection with massive timber roof constructions. An ongoing project “*Massiv timber – properties and use*” is aiming towards giving recommendations for how to build massive timber roofs. Activities like water vapour transport measurements, hygrothermal simulations, field measurements and following up several ongoing building projects are being done in the project in order to fulfil the aim.

#### 5. Acknowledgements

The content of this paper is a part of the ongoing project “*Massive timber – properties and use*” financed by the Research Council of Norway, The Forest Owner Association, Moelven Massivtre AS, Holz100 Norge AS, Dynea ASA, Moelven Limtre AS, Heimdal Gruppen and Norsk Treteknisk Institutt, The paper has also been supported by the project “*Climate Adapted Buildings*” (CAB) funded by The Research Council of Norway. The authors gratefully acknowledge the supporters of the project.

#### 6. References

Byggdetaljer 525.002 (2007) Valg av taktype og konstruksjonsprinsipp, Byggforskserien, SINTEF Byggforsk, Oslo 2007 (In Norwegian).

Vessby (2007), Sveriges högsta moderna bostadshus i trä: Limnologen i Växjö, Bygg & teknik 2/07 (In Swedish)

Time, B., (1998) Hygroscopic Moisture Transport in Wood, Doktor Ingeniør thesis, Norwegian Univ. of Science and Technology, Dept. of Building and Construction Engineering, February 1998.

Hameurey S. (2006), The Hygrothermal Inertia of Massive Timber Constructions, Dr. Thesis, KTH, Sweden.

NS-EN ISO 12572 (2001). Hygrothermal performance of building materials and products -- Determination of water vapour transmission properties, CEN European Committee for Standardization.

# Mould growth control in cold attics through adaptive ventilation

*C.-E. Hagendoft, A. Sasic Kalagasidis*

*Chalmers University of Technology, Department of Civil and Environmental Engineering*  
[carl-eric.hagendoft@chalmers.se](mailto:carl-eric.hagendoft@chalmers.se), [angela.sasic@chalmers.se](mailto:angela.sasic@chalmers.se)

*S. F. Nilsson, M. Thorin*

*Ventotech AB*  
[stefan.nilsson@ventotech.com](mailto:stefan.nilsson@ventotech.com), [marcus.thorin@ventotech.com](mailto:marcus.thorin@ventotech.com)

**KEYWORDS:** *Adaptive ventilation, mould growth, moisture problems.*

## **SUMMARY:**

*This paper presents results from numerical simulations and field measurements which indicate a significant potential to reduce mould growth in cold attic spaces by sealing the attic and fitting it with a system for adaptive ventilation.*

## **1. Introduction**

Problems with high humidity levels and mould growth in cold attics have been increasing over the last few years. A recent Swedish study showed that as many as up to 60 – 80 % of the single-family houses in Västra Götaland (largely, the Gothenburg region) are showing significant mould growth and thereby risk developing serious moisture problems. The high humidity levels are to a large extent a consequence of the increasing demand on energy efficiency. Houses are frequently retrofitted with additional attic insulation, which leads to a colder attic space and hence a higher humidity. Furthermore, furnace heating is often replaced in favour of heat pumps or district heat. This may alter the air-pressure balance of the house, resulting in an increased thermal pressure on the ceiling with subsequent air-leakage up to the attic.

Current theories and models for the growth rate of mould fungi at different climate conditions indicate a potential for significantly reducing the risk for mould problems by lowering the relative humidity by moderate amounts during critical seasons. For cold attics, the humidity reduction necessary is not greater than what should be possible to obtain with optimised ventilation.



*FIG. 1: Example of moisture damaged attics.*

### **1.1 Ventilation and air infiltration**

An important moisture source influencing the attic hygrothermal condition is the water vapour in the surrounding air. The air is carrying both moisture from the indoor environment through air leakages of the attic floor and from the ventilation of the attic itself. High relative humidity during long periods is very often found in cold attics. This can lead to mould growth on the roof underlay often made of plywood or wood.

Leaks of indoor air up to the attic through the attic floor, and the under cooling of the roof due to sky radiation, increase the problem. The moist air might condensate at the underlay and small droplets of liquid water can build up. The water will then be absorbed and accumulated in the surface area. High moisture content can even lead to rot.

The advice given to the building sector in Sweden is to have a not too high or not too low ventilation rate of the attic. A too high ventilation rate, in combination with under cooling, results in high relative humidity. Too low ventilation is also risky in case of construction damp or leaky attic floor. The optimal air exchange rate varies with the outdoor climate, and fixed ventilation through open eaves and/or gable and ridge vents are not always the best choice.

## 1.2 Controlled and adaptive ventilation

To get optimised ventilation, whatever type of external climate, attic insulation, airtightness etc. ventilation must be controlled and adapted to the present situation. By using sensor technology, mechanical ventilation and making the attic as air tight as possible, this can be achieved, cf. FIG. 2. A basic system would comprise mechanical fans and dampers controlled by attic and outdoor climate sensors installed in a sealed attic without vents. The ventilation system runs only when the outdoor air has a potential to dry out the attic.

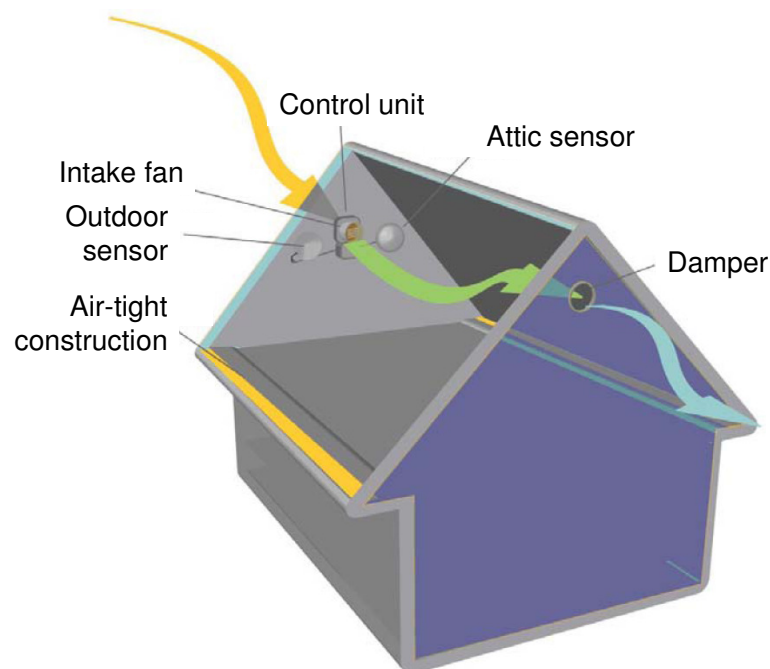

FIG. 2: Controlled ventilation of a cold attic.

## 2. Simulations

### 2.1 HAM-Simulation

The state-of-the-art simulation model HAM-Tools has been used in the calculation of the hygrothermal conditions of the attic. The model has been validated for attics (Sasic, 2004) and (Samuelsson 1995). It has also been validated in the EU-project, HAMSTAD, (Hagentoft et.al. 2004).

It is quite complicated to model a real building and a real attic. There are many variables coupled to climate, materials, and geometry etc. that must be known. To handle this, a number of assumptions must be made. Parameter variations in the simulation can give us an idea of the performance of a building or a component.

The presented simulation results do not account for the positive pressure created by the ventilation fan. If this is accounted for we can expect an improved moisture situation since the leakage of indoor air through the attic floor will be lowered.

## 2.2 Modelled building and parameter cases

The slope of the roof is 28°. The thickness of the mineral wool insulation on the attic floor is 0.4 m. A vapour barrier, 0.2 mm polyethylene sheet, is placed below the insulation. The roof structure consists of, from the inside, 22 mm of wood, a bitumen felt and concrete tiles. The building is located in the Göteborg region. The indoor relative humidity is 30% for an average outdoor temperature of -10 °C and it is linearly increasing to RH=60% at the outdoor temperature of 20 °C. On an average this will correspond to an indoor moisture supply of 3 g/m<sup>3</sup>.

The interior volume of the living space in the building is 396 m<sup>3</sup>, and the part of the building envelope exposed to the exterior is 338 m<sup>2</sup>. The air leakage characteristics for the base case building envelope is correlated to a pressure test at 50 Pa, and it gives an air exchange rate of 3 1/h. The air tightness of the attic floor is denoted: Leaky, Medium tight and Tight, corresponding to an air leakage of 75, 24 or 0 m<sup>3</sup>/h at 50 Pa. For the Leaky case, the air tightness of the building envelope is equal distributed, while for the Medium tight case the attic floor is four times tighter than the other envelope parts.

The air volume of the attic is approx. 80 m<sup>3</sup> and the roof area exposed outwards is 189 m<sup>2</sup>. The area of the attic floor is 74.8 m<sup>2</sup>.

TABLE. 1: Parameter cases for the modelling. The air exchange rates refer to pressure test at 50 Pa.

Ventilation system	Attic floor tightness	Airtightness of the attic	Attic ventilation
<b>Exhaust (E)</b>	<b>Leaky</b> 0.85 1/h Vol. building	<b>Regular</b> 130 1/h Vol. attic	<b>Normal</b>
<b>Balanced (B)</b>	<b>Medium tight</b> 0.27 1/h Vol. building	<b>Sealed</b> 7 1/h Vol. attic	<b>Controlled</b>
	<b>Tight</b> 0 1/h Vol. building	<b>Well sealed</b> 11/h Vol. attic	
		<b>Tight</b> 0 1/h Vol. attic	

The air tightness for the base case attic corresponds to 130 air exchanges per hour at 50 Pa. This corresponds to an effective leakage area of 0,55 m<sup>2</sup> (=0,74x0,74m), assuming that Dicks law is valid.

In the case of controlled ventilation there are no intentional ventilation gaps or ducts, and the construction is tightened. Three levels of air tightness are studied, corresponding to 7, 1 and 0 air exchanges per hour at 50 Pa. The case with 7 1/h corresponds to an effective leakage area of 0,03 m<sup>2</sup> (=0,17x0,17m), or a 1 mm wide gap along both eaves of the attic.

The air pressure inside the building is calculated from a mass balance where the air flow rates are based on stack effects, wind pressure, and the working curves for the mechanical ventilation components. The ventilation inside the house is 0,6 air exchanges per hour both for the case with exhaust ventilation system and the balanced ventilation system. The installation of the balanced ventilation system gives an under pressure inside the building of 1 Pa. For the exhaust ventilation system the corresponding number lies in the range 4-5 Pa. These numbers do not account for temperature or wind effects. The modelled air flows in the case of balance ventilation show that 75% of the supply air comes from intentional openings and 25% from air leakages of the building envelope.

The controlled ventilation of the attic results in 1 air exchanges per hour. For perfectly tight attic (excluding the intentional air outlet) the over pressure inside the attic is 10 Pa.

For the case with an air leakage through the attic floor of 75 m<sup>3</sup>/h and the air tightness case corresponding to 7 1/h at 50 Pa, a slight overpressure of 1-2 Pa will be generated between the attic and the inside of the building.

Table 1 shows the parameter cases that are studied. However, all possible combinations are not considered.

For a few cases, and extra air tight building has been modelled as well, corresponding to 1 air exchanges per hour at 50 Pa. Some cases with an increased controlled attic ventilation of 5 1/h have also been added to the parameter cases.

## 2.3 Air flow through the attic floor

Table 2 shows the calculated annual average air flow rates through the attic floor.

TABLE. 2: Calculated air flow through the attic floor as annual average flow rates ( $m^3/h$ ). For the case of controlled attic ventilation the attic is sealed.

Attic ventilation	Exhaust ventilation	Balanced ventilation
Normal/Leaky attic	3,1	47,0
Normal/Medium tight attic	2,7	17,5
Controlled/Leaky attic floor	2,8	40,6
Controlled /Medium tight att	2,6	16,7

## 2.4 Calculated temperature and relative humidity

Table 3 and 4 below give the number of weeks in three different hygrothermal intervals for a house with a balanced and exhaust ventilation system.

## 2.5 Mould risk

A fundamental uncertainty lies in how to evaluate the calculations results for the temperature and the relative humidity. What we really want to do is to estimate the probability or risk for mould growth in the attic. There are several studies on this subject, for instance (Adan, 1994). However, there is no standardised or widely accepted method for the evaluation of the mould growth risk. Here, we will base the risk on the method developed by Viitanen (2001) and Hukka & Viitanen (1999):. He introduces mould index, in a scale from 0 to 6, where 0 means no growth of mould and 6 means very heavy and tight growth.

As a measure of the mould risk, a mould growth potential  $m$  has been used in this paper for the field measurements, which is simply the relative humidity divided by the critical relative humidity for mould growth to start according to Hukka & Viitanen (1999):

$$m = \frac{RH}{RH_{crit}} \quad RH_{crit} = \begin{cases} -0.00267T^3 + 0.160T^2 - 3.13T + 100.0, & T \leq 20^\circ C \\ 80\%, & T > 20^\circ C \end{cases} \quad (1) \quad (2)$$

Theoretically, mould growth is possible only when  $m > 1$ . Hence, the development over time of  $m$  may be used illustrate the development of the mould risk. By comparing this parameter for the tests attics with corresponding results from reference cases, the effect of the adaptive ventilation may be estimated.

## 2.6 Mould index simulations

A theoretical model for mould index calculations has been suggested by (Hukka, Viitanen 1999), and it will be used below.

TABLE. 3: Number of weeks in given RH and temperature intervals and the maximum mould index during one simulated year. The building has a balanced ventilation system.

Building	Ceiling floor	Attic	Attic ventilation/controlled	No of weeks		Mould index
				0-5 °C above 90% RH	5-15 °C above 80% RH Above 15 °C and 70% RH	
Normal	Medium tight	Regular	No	12/6/3	3.24	
Normal	Tight	Regular	No	11/5/3	1.35	
Normal	Medium tight	Sealed	Yes	12/4/0	3.02	
Normal	Medium tight	Sealed	Yes/extra strong fan	4/0/0	0.06	
Normal	Medium tight	Well sealed	Yes	8/2/0	1.03	
Normal	Medium tight	Well sealed	Yes/extra strong fan	1/0/0	0.02	
Normal	Tight	Sealed	Yes	0/0/0	0	

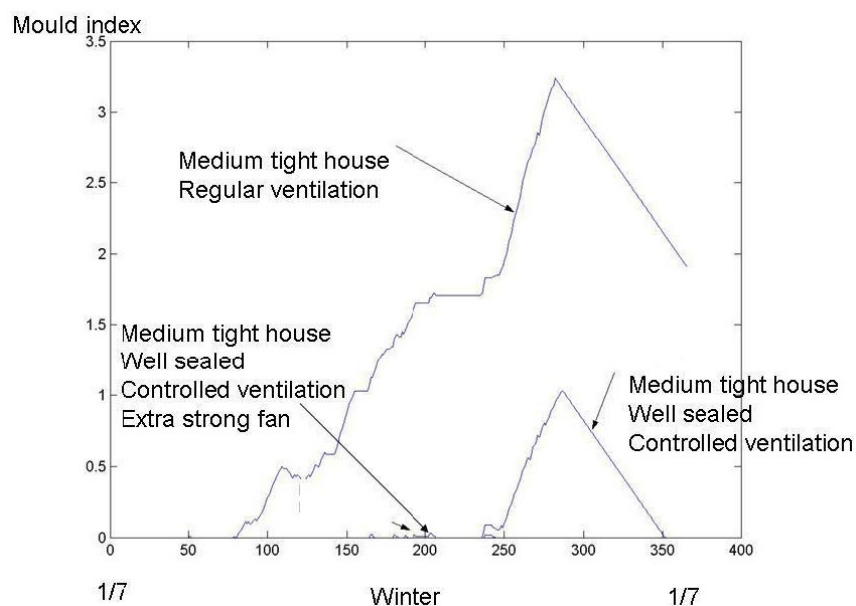

FIG. 3: Variation of the mould index in time (from summer to next summer). The base case with a medium tight attic floor is considered. The building has a balanced ventilation system.

TABLE 4: Number of weeks in given RH and temperature interval for the roof underlay, and the maximum mould index during one simulated year. The building has an exhaust ventilation system.

Building	Ceiling floor	Attic	Attic ventilation/controlled	No of weeks			Mould index
				0-5 °C above 90% RH	5-15 °C above 80% RH	Above 15 °C and 70% RH	
Normal	Leaky	Regular	No	11/5/1			2.63
Normal	Medium tight	Regular	No	12/5/3			2.81
Normal	Leaky	Sealed	Yes	5/1/0			0.05
Normal	Medium tight	Sealed	Yes	1/1/0			0.04
Normal	Medium tight	Sealed	Yes/extra strong fan	1/0/0			0.02
Extra tight	Medium tight	Well sealed	Yes	0/0/0			0

### 3. Field tests

Adaptive ventilation systems in accordance with fig. 2 were installed in the cold attics of two houses in December 2006 and January 2007, respectively. Temperature and relative humidity of attic and outside air have been recorded since. The indoor sensors for temperature and relative humidity were placed approximately halfway up the inside roof at the centre of the attic. The external sensors were placed on the northern gables, below the roof overhang, protected from rain and direct sunlight.

TABLE 5: Field test cases.

House	Location	Test object	Reference
1	Gothenburg	Ridge attic	Previous measurements since 2005.
2	Stockholm	North side attic	Previous measurements since 2006 and simultaneous measurements on naturally ventilated south side attic.





FIG. 4: Test houses in Gothenburg (left) and Stockholm (the house in the centre).

### 3.1 Case 1 – Gothenburg

The adaptive ventilation system was installed on Dec. 21, 2006. Prior to this, the owner of the house had been recording the climate on the attic since the beginning of 2005. These old measurements were used as a reference for evaluating the effect of the adaptive ventilation, fig. 5.

It is seen that the mould risk with natural ventilation during 2005 – 2006 is more or less the same, and that the mould risk during 2007 is slightly smaller. One exception, though, is the period centred around day 70. This represents the end of March 2007, when the weather was extraordinarily beautiful for a number of weeks resulting in a significant heating of the roof. On the whole, though, a positive effect from the adaptive ventilation is seen.

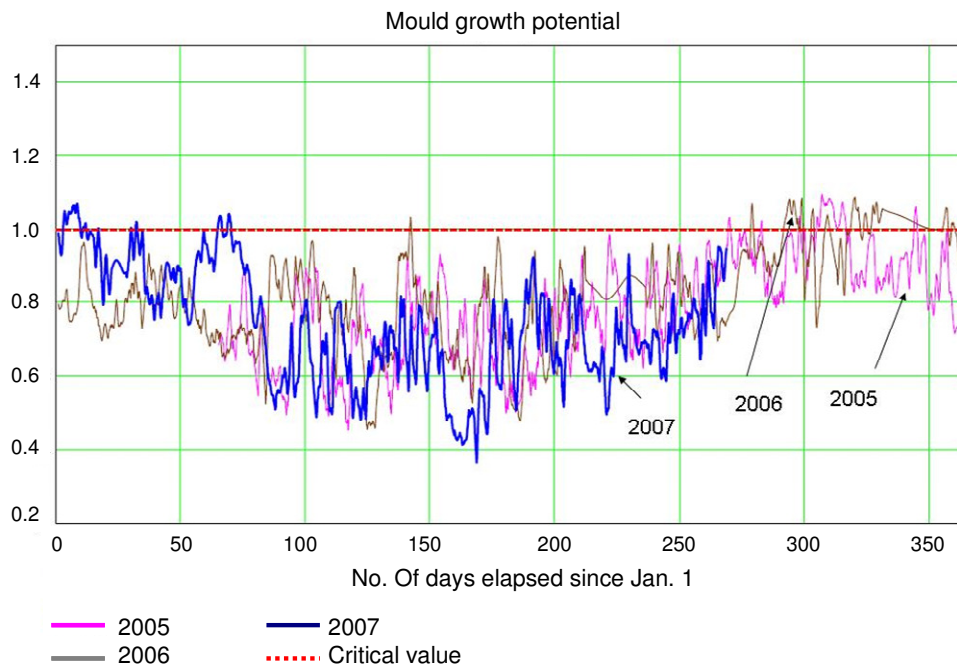

FIG. 5: Comparison of mould growth potential with natural ventilation (2005 – 2006) and adaptive ventilation (2007).

### 3.2 Case 2 – Stockholm

The adaptive ventilation was installed on the north side attic on Jan. 4, 2007. Prior to this, the owner of the house had been recording the climate since 2006—on the north attic as well as on the south attic. The measurements on the naturally ventilated south attic continued also during 2007. Hence, it was possible to compare the results both with the same attic from previous year, fig. 6, and with the simultaneous measurements on the south attic, fig. 7.

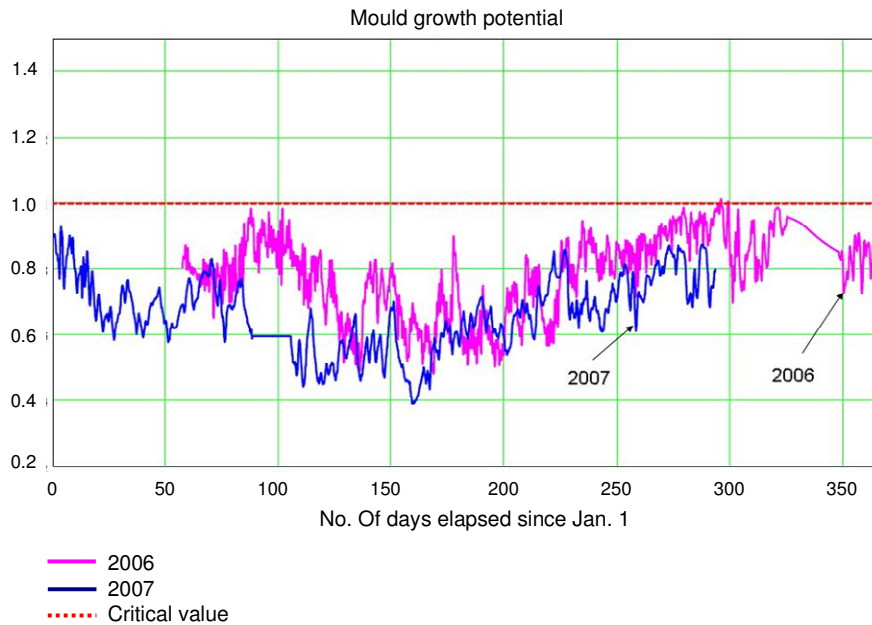

FIG. 6: Comparison of mould growth potential with natural ventilation (2006) and adaptive ventilation (2007)

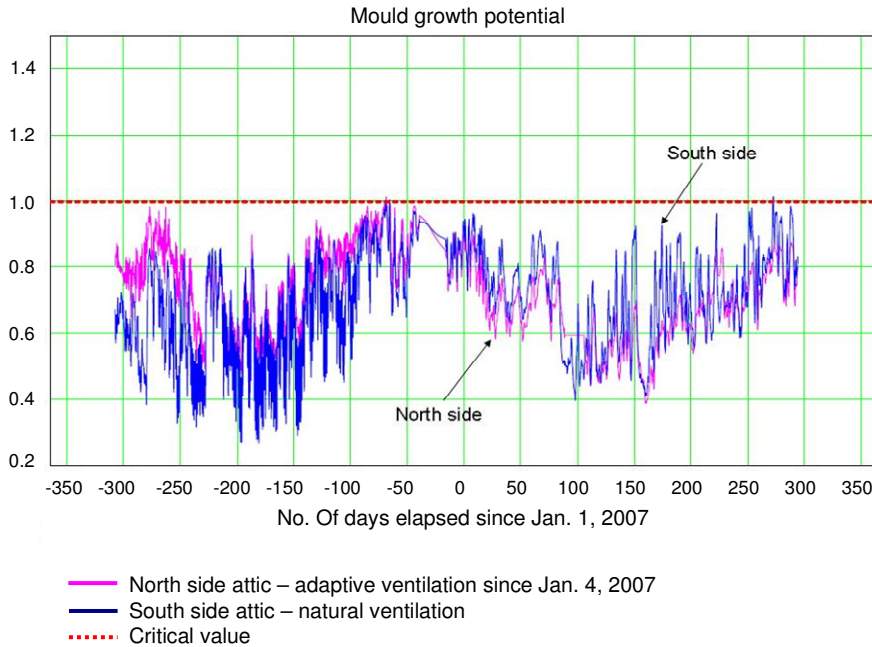

FIG.7: Comparison of mould growth potential between north and south side attics. Adaptive ventilation was installed on the north attics on Jan. 4, 2007. The south attic is naturally ventilated the whole period.

It is obvious that the mould growth potential on the north attic is smaller with adaptive ventilation than with natural ventilation, fig 6. It is also interesting to note that, with natural ventilation, the mould risk was higher in the north attic than in the south, cf. the year 2006 in fig. 7. In fact, this was the reason for the house owner to install the measurement equipment: mould growth was observed in the north attic but not in the south. After installation of the adaptive installation system, however, the situation is turned around (cf. year 2007 in fig. 7). The mould risk is now lower in the north attic.

## 4. Discussion

Advanced numerical simulations have shown that the risk for mould growth can be substantially reduced, and even eliminated, if the cold attic is sealed and fitted with adaptive ventilation. Ideally, the construction is well built and air-tight, but leaks can to some extent be compensated with an increased ventilation rate. Field tests and extensive measurements over complete annual cycles confirm the simulations.

## 5. References

- Sasic A. HAM-Tools. An integrated simulation tool for heat, air and moisture transfer analyses in building physics. Doktorsavhandling, Byggnadsfysik, Chalmers P-04:1.
- Ahrnens C & Borglund E (2007). Fukt på kallvindar – En kartläggning av småhus i Västra Götalands län, Examensarbete 2007:11, Institutionen för bygg- och miljöteknik, Chalmers tekniska högskola. (In Swedish) Link: <http://www.chalmers.se/cee/SV/avdelningar/byggnadsteknologi/forskargrupper/tillampat-varme-och2125/kallvindar>
- Adan O.C.G 1994 On the fungal defacement of interior finishes. ph.d thesis, Technical University of Eindhoven.
- Hagentoft C-E, Sasic Kalagasidis A., Adl-Zarrabi B., Roesl S., Carmeliet J., Hens H., Grunewald J., Funk M., Becker R., Shamir D., Adan O., Brocken H., Kumaran K., Djebbar R. Assessment Method of Numerical Prediction Models for Combined Heat, Air and Moisture Transfer in Building Components. Benchmarks for One-dimensional Cases. Journal of Thermal Envelope and Building Science, Vol. 27, No. 4/ April 2004.
- Hukka E., Viitanen H.A., 1999. A mathematical model of mould growth on wooden material. Wood Science and Technology 33, Springer-Verlag.
- Viitanen H.A., 2001. Factors affecting mould growth on kiln dried wood. VTT Finland.
- Engman L., Samuelson I, 2006. Redovisning av fältundersökning och forskningsprojekt: Kalla vindar – problem och förbättringar. Bygg & Teknik 4/2006. (In Swedish)
- Samuelson I., 1995. Fuktbalans i kalla vindsutrymmen. SP-Rapport 1995:68. (In Swedish)

# Analysis method to determine sufficient water vapour retarder for timber-framed walls

*Juha Vinha, Dr.Tech.,  
Department of Civil Engineering, Tampere University of Technology;  
juha.vinha@tut.fi, www.tut.fi*

**KEYWORDS:** *cold climate, timber-framed external walls, water vapour resistance ratio, analysis method, performance criteria, limit values, indoor and outdoor conditions, condensation, mould growth.*

## **SUMMARY:**

*This article is a brief summary of a doctoral thesis on the hygrothermal performance of timber-framed external walls in Finnish climatic conditions. The performance of wall assemblies has been studied at Tampere University of Technology (TUT) for 10 years by laboratory and field tests and numerical analyses. The timber-framed external wall assemblies were examined by laboratory and field tests and numerical analyses. Building physical research equipment was also developed and constructed for the laboratory tests on wall assemblies. A new method was developed as a result of the research that can be used to evaluate the acceptability of the hygrothermal performance of wall assemblies by numerical analyses.*

## **1. Introduction**

The research was inspired by the decades-long discussion about the need of a vapour retarder in the interior lining of walls. Many studies related to that topic have been conducted worldwide in the last 70 years. They have found that the interior lining must always have sufficient water vapour resistance to prevent diffusion of water vapour from the inside out. A diffusion flow occurs when the excess moisture in indoor air produced by the occupants diffuses into outdoor air through external walls. In the absence of sufficient water vapour resistance, a detrimental amount of moisture may condense on the interior surface of the sheathing or conditions conducive to mould growth may exist there for too long.

On the other hand, studies have shown that in Nordic climatic conditions the external wall assembly does not necessarily require a plastic vapour barrier in the interior lining. Furthermore, in more southern climatic conditions the interior wall lining may in some instances have to be highly permeable to water vapour since the direction of the diffusion flow is from the outside in for much of the time.

Despite numerous studies, no agreement has been reached on the minimum water vapour resistance that should be required of the interior lining of timber-framed external wall assemblies under different conditions. Consequently, different guidelines and regulations regarding the magnitude of the resistance exist even in countries located in quite similar climatic regions.

The basic reason for the differences between the research results is that the behaviour of wall assemblies has not been studied holistically by considering all the factors contributing essentially to their performance. In order to be able to evaluate comprehensively the hygrothermal performance of assemblies, the performance criteria and limit values that an assembly is to meet, the outdoor and indoor conditions to be used, and the structural solution and used materials and their building physical properties are to be established. The acceptability of the moisture behaviour of external wall assemblies depends essentially on all these factors.

## **2. Implementation of the research**

The research examined the moisture behaviour of timber-framed external wall assemblies through laboratory and field studies and numerical analyses (Vinha 2007). A new method was created in connection with the research which allows evaluating the moisture behaviour of timber-framed external wall assemblies in different situations by numerical analyses. The performance criteria, limit values and dimensioning conditions necessary for evaluating wall assemblies in Finnish climatic conditions were established for the analyses. Minimum water vapour resistance ratios for different types of walls were determined on the basis of the selected criteria and study conditions.

### 3. Selection of performance criteria, limit values and design conditions

#### 3.1 Selection of performance criteria and limit values

On the basis of a literature review and the moisture damage observed in wall assemblies, moisture condensation and mould growth were selected as the moisture performance criteria of the wall assemblies of this research. They also established that if the assemblies perform acceptably in terms of these factors, they will generally function acceptably also in terms of the other performance criteria like material deformations, peeling of paint, rotting, loss of glue adhesion, amount of material emissions and corrosion of metal parts and fasteners.

The most ideal situation from the viewpoint of the performance of an assembly exists when no moisture condensation and mould growth occur. However, climatic conditions leading to moisture condensation and conducive to mould growth do occur occasionally in Finland. An impermeable vapour and air barrier in the interior wall lining cannot prevent that.

Another problem is that no generally accepted standard limit values can be set for moisture condensation and mould growth since climatic conditions between countries differ so much. Mould growth is naturally much stronger in a warmer climate, while the further up north we go, the more moisture condenses in assemblies in winter. Therefore, the limit values for moisture condensation and mould growth were set according to the following principle in this research:

*The temperature and moisture conditions for the exterior wall lining must not be more critical with respect to moisture condensation and mould growth than with the most critical acceptable wall assembly (so-called reference wall) where said conditions are solely the result of outdoor air conditions. The same principle applies also in the examination of the conditions of the interior wall lining. In the middle section of the wall the limit value is assumed to change linearly from the limit value set for the exterior lining to that of the interior lining of the wall (Fig. 1).*

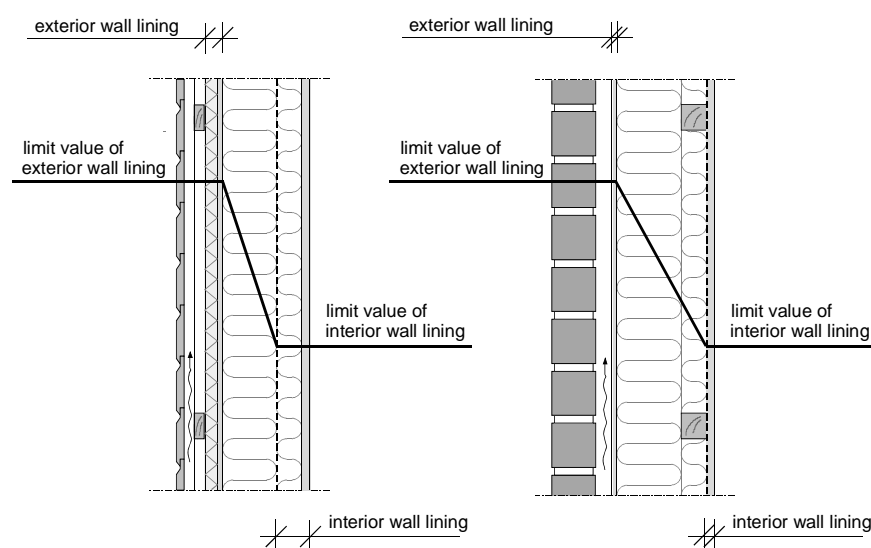

*FIG. 1: Principle drawing of change in limit value of performance criterion set for an external wall across the assembly. Exterior wall lining of wall consists of one or more sheathing materials and interior wall lining consists of inner board and vapor retarder and material layers between them. Cladding does not include to the exterior wall lining because ventilation gap is always assumed to be between cladding and sheathing.*

The described setting of limit values allows them to change as climatic conditions change. This allows having similar conditions in the interior and exterior wall linings as would be caused by outdoor and indoor air in any case, even if no diffusion of water vapour through the assembly were to occur. Moreover, this method improves the accuracy of numerical analysis as the moisture behaviour of assemblies is compared to that of the reference wall, which has been calculated by the same principles and software.

A membrane was selected as sheathing for the reference wall since laboratory tests and numerical analyses showed that a non-insulating sheathing is the most critical alternative in examining the moisture behaviour of a

wall. The reference wall was used for numerical analyses in outdoor air conditions critical for condensation by varying the water vapour resistance of the sheathing and thermal insulation materials. Calculations showed that as the water vapour resistance of the sheathing exceeds  $5 \times 10^3$  s/m, the length of the continuous condensation period of the interior surface of the sheathing increases rapidly. On that basis, an assembly with a plastic vapour barrier in the interior lining and a sheathing membrane with a water vapour resistance of  $5 \times 10^3$  s/m was selected as the reference wall.

### 3.2 Selection of outdoor and indoor conditions

Since two performance criteria were selected for the research, two reference years were needed for numerical analyses: one for moisture condensation and another for mould growth. The critical period for condensation was winter when outdoor air temperature is low and its RH is high. The most critical periods for mould growth, again, are the warm and humid conditions prevailing in late summer and autumn.

The outdoor air temperatures and relative humidities of four Finnish localities (Vantaa, Lahti, Jyväskylä and Sodankylä) measured by the Finnish Meteorological Institute over a 30-year period were acquired for selecting the reference years. The values had been measured at 3-hour intervals in 1971–2001. The localities were chosen so that their temperature and moisture conditions would represent adequately the outdoor air conditions in different parts of the country (see Fig 2).

Sanders (1996) recommends selecting as the reference year conditions that the assembly is subject to once in every ten years. Then, 90 % of the conditions are less critical with respect to the examined issue. This criterion was also applied in this research.

The critical reference year for condensation was determined by comparing the average outdoor air saturation deficit over a period of one month in different years. The average saturation deficit was calculated as follows:

$$\Delta v_{\text{sat,def}} = \overline{v_{\text{sat}} - v_e} \quad (1)$$

where  $v_{\text{sat}}$  = humidity by volume at saturation at certain outdoor air temperature ( $\text{kg/m}^3$ )  
 $v_e$  = humidity by volume of outdoor air at said temperature ( $\text{kg/m}^3$ )

The smaller the outdoor air saturation deficit, the more critical the year for moisture condensation.

The moisture reference year critical for mould growth, again, was determined by calculating the maximum mould index value of outdoor air by the method described by Hukka & Viitanen (1999). The mould index value varies between 0 and 6, where 1 indicates microscopically detectable incipient mould growth and 6 mould growth across the entire surface.

In both cases the 13th most critical year from a group of 120 examined years was selected as the reference year by the calculation method described by Vinha (2007). Each one-year survey period commenced at the beginning of July and ended at the end of June the following year. The most critical reference year from the viewpoint of condensation proved to be *Sodankylä 1985–86* and for mould growth *Lahti 2000–2001*. Figure 2 gives an example of mould index calculation results for different years in the various locations.

Limit values for moisture condensation and mould growth in Finnish climatic conditions were also determined in connection with the selection of the reference years according to the principle presented in Section 3.1. The length of the continuous condensation period of the interior surface of the sheathing of the reference wall (or alternately, the length of time the moisture content of its materials stayed continuously in the capillary range) chosen for numerical analyses was *34 days* in the *Sodankylä 1985–86* conditions when indoor temperature was  $21^\circ\text{C}$ . This value was made the limit value for condensation. The mould index value of *1.96* calculated in the *Lahti 2000–2001* outdoor air conditions was used as the limit value for mould growth (see Fig. 2). Limit values for the interior wall lining were set so as to allow no condensation of moisture or mould growth in the assembly. Then, the continuous condensation period became *0 days* and the mould index  $< 1.0$ .

The limit values for the interior wall lining were necessary for examining the moisture condensation and moulding risk of the interior and exterior surfaces of the plastic vapour barrier in critical conditions. Mould growth was the more critical performance criterion in these studies. Two types of studies were done. In the first type, the interior was cooled in summertime (temperature  $21^\circ\text{C}$ ) and the average humidity by volume of outdoor air during the three summer months was as high as possible (90 % criticality level). In the second type, a plastic vapour barrier installed at a depth of 50 mm from the interior surface of the thermal insulation was studied when

indoor air temperature was 19°C and the average outdoor air temperature during the three winter months was as low as possible (90 % criticality level). In these cases, the reference years turned out to be Lahti 1988 (first case) and Sodankylä 1977–78 (second case).

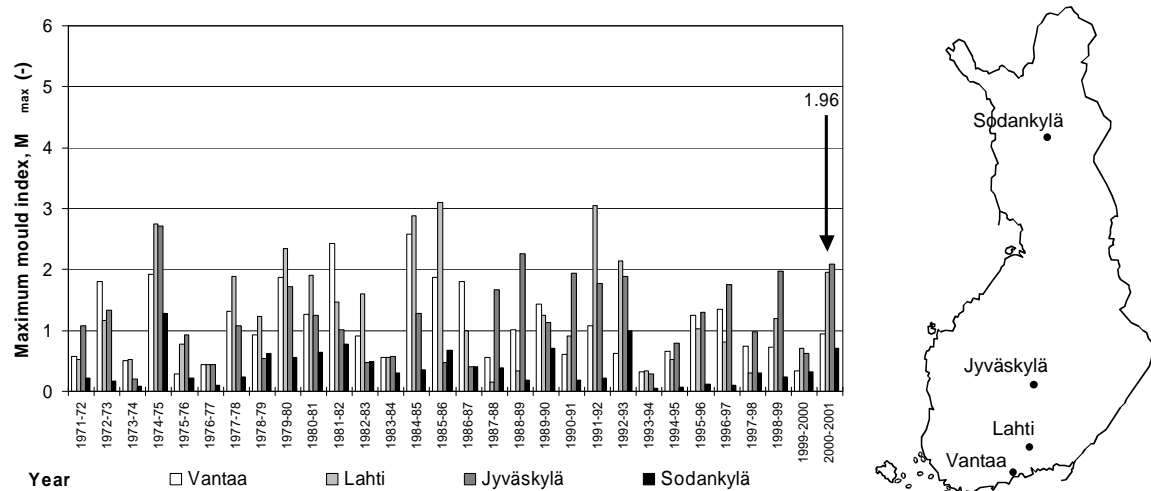

FIG. 2: Maximum mould index values for the surface of pine sawn goods in four Finnish localities in 1971–2001 calculated on the basis of outdoor air temperature and relative humidity conditions.

Indoor air temperature was generally set at 21°C in numerical analyses. Based on a comprehensive field test on Finnish timber-framed one-family houses, 4–5 g/m<sup>3</sup> can be used as the design value for indoor air excess moisture depending on occupancy rate and whether air is humidified in winter (Vinha et al. 2005a). The excess moisture value used in calculations also considered changes in outdoor temperature as described by Vinha et al. 2005a.

## 4. Laboratory tests on external wall assemblies and materials

The laboratory tests conducted as part of the research can be divided into tests on assemblies and materials. The aim of assembly tests was to verify in practice the functional differences between different types of assemblies to provide reference material for numerical analyses from controlled conditions. Material tests, again, determined the building physical properties of building materials as a function of temperature and relative humidity. Their aim was to discover how the properties of various materials change as temperature and moisture conditions vary as well as to provide more comprehensive material properties for numerical analyses of assemblies.

### 4.1 Tests on external wall assemblies

The behaviour of external walls was studied in a laboratory using building physical research equipment which was also developed and constructed during the research (Fig. 3). The research equipment allows monitoring the behaviour of wall assemblies under controlled indoor and outdoor air conditions corresponding to actual conditions. The research equipment consists of two chambers. The warm chamber duplicates indoor air conditions and the protective chamber outdoor air conditions. The studied test element is inserted in the test opening measuring 1200×1200 mm<sup>2</sup> between the chambers. The operation and features of the equipment are described in more detail by Vinha & Käkelä (1999).

The used test elements were generally divided into four assembly types so that the area of each wall was 542×542 mm<sup>2</sup>. Assemblies were studied in average Finnish autumn, winter and spring conditions. The indoor air temperature of tests was 20°C and excess moisture 4 or 6 g/m<sup>3</sup>. Altogether 64 different walls were studied in two test series during research.

During the tests temperature and relative humidity were always measured inside the assembly at the interior surfaces of sheathing and thermal insulation. Other sensor positions within the wall were varied by tests. The most important monitoring point was on the interior surface of the sheathing which was most critical for moisture condensation and mould growth. Figure 4 gives an example of the RH values measured at the interior surface of the sheathing of various test walls in autumn conditions with excess moisture of 4 g/m<sup>3</sup>.

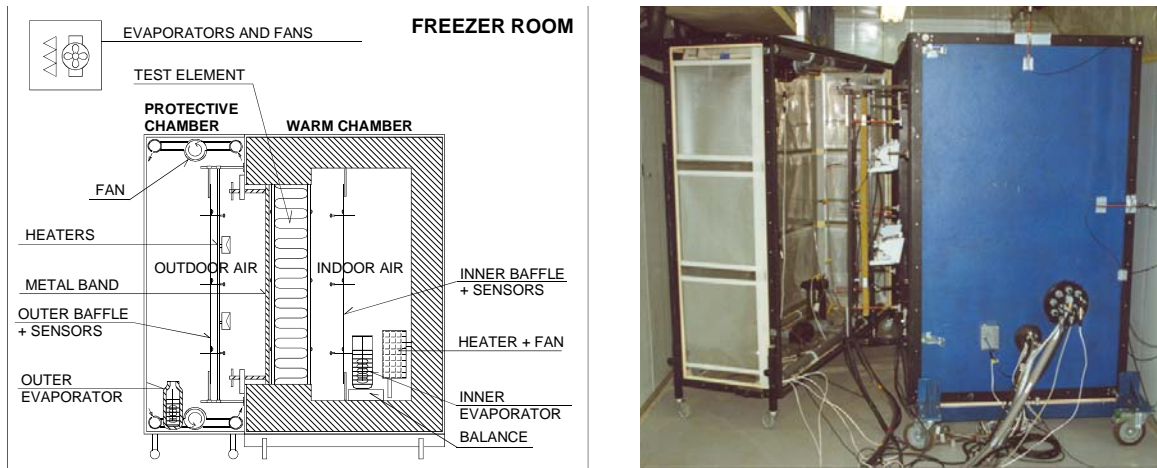

FIG. 3: The building physical research equipment of TUT.

Figure 4 shows that as the water vapour resistance ratio diminished, relative humidity generally increased at the interior surface of the sheathing. Conditions conducive to mould growth started occurring in many assemblies when the ratio was smaller than 10:1. However, the relative humidity of all assemblies did not reach the critical range although the water vapour resistance ratio was small. The key reason for that is that these assemblies had a thermally insulating sheathing. This shows that other properties of wall assemblies besides the water vapour resistance ratio between the interior and exterior wall linings also have a significant impact on their moisture behaviour.

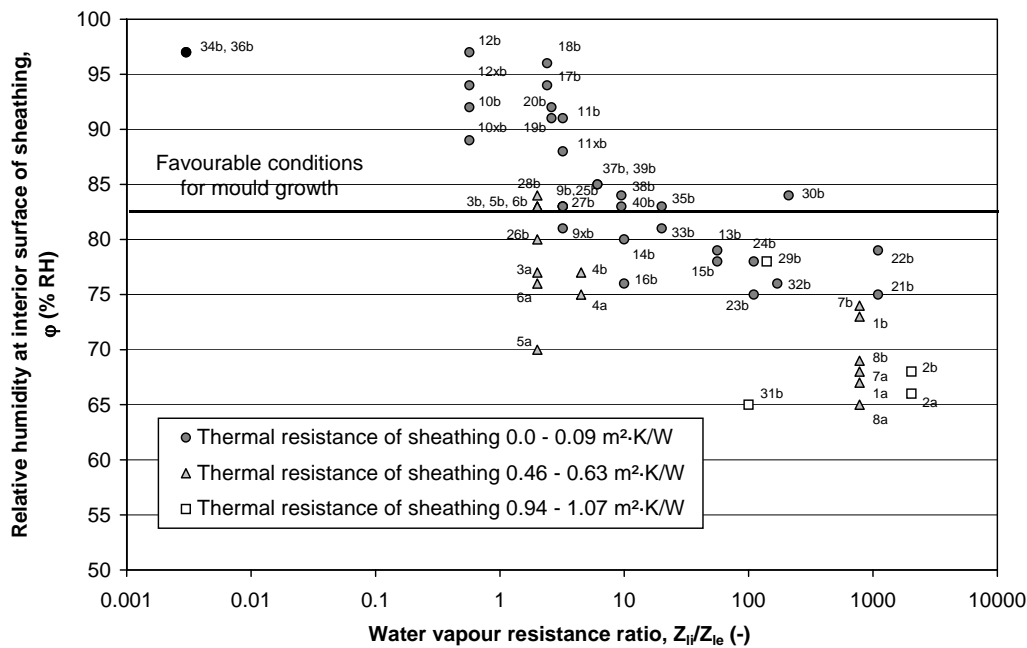

FIG. 4: Relative humidity at the interior surface of sheathing in autumn conditions as a function of the water vapour resistance ratio ( $Z_i/Z_{ie}$ ) between the interior and exterior wall linings. The excess moisture of the tests was  $4 \text{ g/m}^3$ . The assemblies (numbered in figure) were divided into three groups on the basis of the thermal resistance of used sheathing. The black color of test walls 34b and 36b indicates moisture condensing on the interior surface of the sheathing within these walls.

### 4.2 Material tests

Material tests were conducted to define the most important building physical properties of used materials (Vinha et al. 2005b). Altogether 42 materials were tested. The thermal conductivity and water vapour permeability/



resistance of materials was determined at different temperature and RH conditions. The equilibrium moisture content curves, water absorption coefficient and capillary saturation moisture content of materials were also determined. Measured material properties were fed into the calculation programs for numerical analyses of assemblies.

## 5. Field tests on external walls

Field tests on external walls looked into the behaviour of walls permeable and impermeable to water vapour in a one-family house as well as the temperature and moisture conditions of TUT test houses.

### 5.1 Field tests on one-family house

Tests on the one-family house showed that a moisture permeable interior wall lining increases relative humidity at the interior surface of the sheathing also in actual conditions. However, these tests did not reveal any condensation of moisture or frequent occurrences of temperature and RH conditions conducive to mould growth at the interior surface of the sheathing. This was due to, for instance, the fact that 25 mm wood fibreboard of high thermal resistance was used for sheathing. Moreover, the examined wall faced south and was exposed to direct sunlight.

### 5.2 Field tests on TUT test houses

Numerical analysis of the moisture behaviour of the external wall assembly required knowing with sufficient accuracy the air temperature and RH conditions in the ventilation gap behind the cladding. Therefore, the field tests were done in the ventilation gaps of brick- and wood-clad test houses in all cardinal directions.

Measurement results showed that the humidity by volumes of the ventilation gap and outdoor air are quite similar regardless of outdoor air temperature or used cladding. Thus, flowing air was capable of transporting any extra moisture out of the ventilation gap although the airflow rate was often quite low. Consequently, there was no need to change the outdoor air RH used in calculations. The results also proved that there was no need to consider the impact of driving rain separately in numerical analyses since both the board and brick cladding protected the assembly sufficiently well.

As to temperatures, it was found that, especially in the case of southern and western walls, the average ventilation gap temperature was clearly higher due to solar radiation than that of outdoor air. On the other hand, the difference in temperature between a northern wall and outdoor air was small, especially in the wood-clad test house. This indicated that the conditions of a northern wall are clearly the most critical for the moisture behaviour of an assembly. The thermal insulation effect of the ventilation gap and cladding could be taken into account in calculations by means of a rface resistance whose value based on test results was  $0.04 \text{ m}^2\cdot\text{K}/\text{W}$ .

## 6. Verification of calculation programs

In the first stage of numerical analyses, the results from laboratory and field tests were compared by three calculation programs (1D-HAM 2.0, MATCH 1.5 and WUFI-2D 2.1) to calculated results. In the case of temperatures, calculated and test results corresponded closely. A typical difference between them was that the relative humidity of pore air changed more quickly within assemblies in tests than in calculations (Kalamees & Vinha 2003). With some assemblies, factoring capillary moisture transfer into calculations improved the correlation between calculated and test results. Generally speaking, differences in relative humidity were quite small with the exception of a few assemblies where they were significant (Vinha 2007).

On the whole, the results yielded by the programs correlated sufficiently closely with test results to allow using the programs in numerical analyses of wall assemblies. WUFI-2D was selected, for instance, because it enables taking into account the capillary transfer of moisture and it supports two-dimensional calculation.

## 7. Numerical analyses of external walls

The water vapour resistance required of the interior lining of external wall assemblies at different excess moisture values in the temperature and moisture conditions of the reference years was determined through numerical analyses. Diffusion, capillary flow and surface diffusion were the moisture transfer mechanisms considered in calculations. The significance of the selection of limit values, reference years and surface

resistance of the exterior surface in determining the acceptability of the moisture behaviour of wall assemblies was also looked into. Finally, the moisture conditions at the interior and surface of the plastic vapour barrier were examined based on selected reference year conditions (see Section 3.2).

The water vapour resistance ratio between the interior and exterior linings of wall assemblies was set so that the continuous condensation period of the interior surface of the sheathing did not exceed 34 days and the maximum mould index value stayed under 1.96 (see Section 3.2). Indoor air temperature was 21°C in all calculations, and excess moisture was varied between 0 and 8.0 g/m<sup>3</sup>. Table 1 gives an example of the calculated results with different open pore thermal insulation and sheathing materials when excess moisture is 5 g/m<sup>3</sup> under winter conditions. Non-hygroscopic thermal insulations include glass wool, rock wool and polyester fibre. Hygroscopic thermal insulations include cellulose, flax and hemp while sawdust and cutter chips are high hygroscopic.

TABLE 1: Minimum values of the water vapour resistance ratio ( $Z_i/Z_e$ ) between the interior and exterior wall linings, and the water vapour resistance ( $Z_{v,i}$ ) of the interior lining, of timber-framed external walls with different sheathing and thermal insulation materials when air excess moisture is 5 g/m<sup>3</sup> in winter conditions.

Sheathing	Thermal insulation					
	Non-hygroscopic		Hygroscopic		High hygroscopic	
	$Z_i/Z_e$	$Z_{v,i}$ ×10 <sup>3</sup> s/m	$Z_i/Z_e$	$Z_{v,i}$ ×10 <sup>3</sup> s/m	$Z_i/Z_e$	$Z_{v,i}$ ×10 <sup>3</sup> s/m
Glass wool board 30 mm	4:1	6.2	2:1	3.1	2:1	3.1
Wood fibreboard 25 mm	9:1	38	8:1	34	2:1	8.5
Wood fibreboard 12 mm	18:1	44	15:1	37	3:1	7.3
Gypsum board 9 mm	20:1*	53	21:1	55	10:1	26
Wood hardboard 4.8 mm	14:1	200	28:1	390	Unacceptable	
Oriented strand board (OSB) 12 mm	11:1	790	Unacceptable		Unacceptable	
Spruce plywood 9 mm	26:1	220	78:1	650	Unacceptable	
Plywood 9 mm + Glass wool board 30 mm	6:1	93	7:1	110	5:1	78
Sheathing membrane, $Z_v = 300$ s/m	40:1*	12	10:1*	3.0	2:1	0.6
Sheathing membrane, $Z_v = 1000$ s/m	41:1	41	31:1	31	2:1	2.0
Sheathing membrane, $Z_v = 3000$ s/m	73:1	220	76:1	230	74:1	220
Sheathing membrane, $Z_v = 5000$ s/m	110:1	550	Plastic vapour barrier		Unacceptable	

In cases indicated by (\*) the mould risk analysis yielded a higher resistance ratio than the condensation time analysis.

Table 1 shows that the minimum water vapour resistance ratio between the interior and exterior linings of wall assemblies varies considerably depending on the selected sheathing material and thermal insulation. The required water vapour resistance of the interior lining is lower if thermally insulating and water vapour permeable sheathing and high hygroscopic thermal insulation are used. On the other hand, the differences between non-hygroscopic and hygroscopic insulation are quite small. The water vapour resistance ratio required of hygroscopic insulations when using sheathing highly permeable to water vapour is slightly smaller, but with less permeable sheathing materials the opposite is true. Sawdust and cutter chips are not suitable insulation at all if the water vapour resistance of the sheathing is high since the insulation cannot dry fast enough. In general, a thermally insulating and water vapour permeable sheathing improves the moisture behaviour of a timber-framed external wall independent of the water vapour resistance of the interior wall lining (see Fig. 4). Table 1 also shows that, with the chosen limit values, moisture condensation usually was the most important criterion for the performance of assemblies.

Examination of the risk of mould growth on the interior and exterior surfaces of plastic vapour barrier showed that a plastic membrane can also be installed at a depth of 50 mm from the interior surface of thermal insulation. However, temperature and moisture conditions at the interior surface of the vapour barrier at the vertical studs may change so as to be conducive to mould growth if thermal insulation exists on the interior side of the vapour barrier and indoor air excess moisture is > 3 g/m<sup>3</sup>. This can be avoided by installing vertical battens on the interior side of the vapour barrier at the studs behind the vapour barrier. The alternative is to use a sheathing of high thermal resistance outside the wood frame. Moreover, it is recommended that at least 3/4 of the thermal insulation is installed outside the plastic vapour barrier.

## 8. Acknowledgements

Many people have taken part in this research project. Timo Niemelä, Pasi Käkälä, Pekka Viitala, Antero Miettinen, Kauko Sahi, Kari Häyrinen, Minna Teikari, Antti, Mikkilä, Ilkka Valovirta, Minna Korpi, Heli Toukonieni and Hanna Aho from Tampere University of Technology/ Department of Civil Engineering assisted in the implementation of various parts of this research. Lari Eskola, Juha Jokisalo and Kai Jokiranta from Helsinki University of Technology/ HVAC-laboratory worked on the field test project of timber-framed one-family houses and Targo Kalamees participated in measurements and compilation of research results at both universities. I thank all those involved in this research effort for their contribution.

The researches have been funded by the National Technology Agency of Finland (TEKES) and 18 Finnish companies and associations to whom I express my gratitude. I am also indebted to the Finnish Meteorological Institute for providing weather data from various localities for the research for a reasonable compensation.

## 9. Conclusions

The performance of timber-framed external wall assemblies was examined by laboratory and field tests and numerical analyses. The research produced a new method that can be used to evaluate the acceptability of the hygrothermal performance of wall assemblies by numerical analyses.

The acceptability of the moisture behaviour of external wall assemblies depends on the performance criteria and limit values set for an assembly, outdoor and indoor air conditions, and the structural solution and related materials. In this study the selected performance criteria for an external wall assembly were moisture condensation and mould growth in the assembly. Moisture condensation was evaluated on the basis of a continuous condensation period and mould growth by the maximum mould index.

The research proved, for instance, that a plastic vapour barrier functions flawlessly in the interior lining of timber-framed external walls in Finnish climatic conditions. It is, however, also possible to use retarder materials more permeable to water vapour in many assemblies. Nevertheless, the guideline of the Finnish Building Code (RakMK C2 1998) that the water vapour resistance of a vapour retarder should be at least fivefold compared to that of the sheathing is inadequate for most assemblies. The best way to improve the hygrothermal performance of a timber-framed wall assembly, besides installing a sufficiently tight vapour retarder, is to have a thermally insulating and highly water vapour permeable sheathing. On the other hand, the difference between using non-hygroscopic and hygroscopic thermal insulation is quite small as regards the performance of a wall. Hygroscopic thermal insulation differs from non-hygroscopic thermal insulation mainly in that it wets more slowly in autumn conditions and dries more slowly in spring conditions.

## 10. References

- Hukka A. & Viitanen H. (1999). A Mathematical Model of Mould Growth on Wooden Material. *Wood Science and Technology*, Vol. 33, 475-485.
- Kalamees T. & Vinha J. (2003). Hygrothermal calculations and laboratory tests on timber-framed wall structures. *Building and Environment*, Vol. 38, 689-697.
- RakMK C2. (1998). Kosteus, määräykset ja ohjeet 1998. Suomen Rakentamismääräyskokoelma, Helsinki, Ympäristöministeriö. 11 p. (in Finnish)
- Sanders C. (1996). IEA Annex 24: Task 2: Environmental Conditions. Leuven, Acco, International Energy Agency, Energy Conservation in Buildings and Community Systems, HAMTIE, Final Report, Vol. 2. 96 p.
- Vinha J. (2007). Hygrothermal Performance of Timber-Framed External Walls in Finnish Climatic Conditions: A Method for Determining the Sufficient Water Vapour Resistance of the Interior Lining of a Wall Assembly. Tampere, Doctoral thesis, TUT, Department of Civil Engineering. 338 p. + app. 10 p.
- Vinha J., Korpi M., Kalamees T., Eskola L., Palonen J., Kurnitski J., Valovirta I., Mikkilä A. & Jokisalo J. (2005a). Puurunkoisten pientalojen kosteus- ja lämpötilaolosuhteet, ilmanvaihto ja ilmatiiviys. Tutkimusraportti 131, Tampere, TTY, Talonrakennustekniikan laboratorio. 102 p. + app. 10 p. (in Finnish)
- Vinha J. & Käkälä P. (1999). Water Vapour Transmission in Wall Structures Due to Diffusion and Convection. Tampere, Tampere University of Technology, Laboratory of Structural Engineering, Publication 103. 110 p.
- Vinha J., Valovirta I., Korpi M., Mikkilä A. & Käkälä P. (2005b). Rakennusmateriaalien rakennusfysikaaliset ominaisuudet lämpötilan ja suhteellisen kosteuden funktiona. Tutkimusraportti 129, Tampere, TTY, Talonrakennustekniikan laboratorio. 101 p. + app. 211 p. (in Finnish)

# Moisture damage in rendered, undrained, well insulated stud walls

*Ingemar Samuelson, Professor,  
Senior researcher, Professor;  
[ingemar.samuelson@sp.se](mailto:ingemar.samuelson@sp.se), [www.sp.se](http://www.sp.se)*

*Kristina Mjörnell, PhD,  
Senior researcher;  
[kristina.mjornell@sp.se](mailto:kristina.mjornell@sp.se), [www.sp.se](http://www.sp.se)*

*Anders Jansson, MSc,  
Technical investigator;  
[anders.jansson@sp.se](mailto:anders.jansson@sp.se), [www.sp.se](http://www.sp.se)*

**KEYWORDS:** *moisture damage, stud wall, rendering, stucco, cellular plastic.*

## SUMMARY:

*During the last few decades well-insulated, rendered, unventilated and undrained stud walls have been very popular in Sweden. Unfortunately, this structure has shown itself to be vulnerable to moisture. Experience from surveys of more than a hundred buildings shows that the problem is that moisture enters the structure - for example, at joints, poor connections to windows and doors, or at fixing studs - wetting the materials inside the stud wall and causing mould growth. The damage is never visible on the surface of the wall, but is hidden within the wall. The only way to detect the damage is to measure the moisture conditions inside the wall.*

*A national survey is being carried out this year in order to determine the extent of the problem and any connection to local climates, orientation (i.e. points of the compass), frequency and direction of driving rain, design of connections, type of plaster (thin or thick), and insulation material (mineral wool or cellular plastic) etc. At the same time, a number of mock-ups of rendered stud walls of existing and new designs are being tested in the laboratory, complemented by theoretical investigations of heat and moisture conditions in the walls. Finally, guidelines for protection of existing walls, remediation of damaged walls, and suggestions for alternative designs in new walls have been drawn up.*

## 1. Introduction

### 1.1 Background

Moisture problems in walls with external plaster rendering and a non-drained internal structure have been encountered in relatively newly built buildings. Damage has occurred in walls consisting of a wooden stud wall, with external thermal insulation in the form of foamed polystyrene plastic or rigid mineral wool bats applied directly to an external sheet of gypsum board, chipboard or plywood. A thin or thick layer of plaster is applied to the outside of the insulation. This type of exterior wall construction has been found to be vulnerable to moisture damage, as moisture which manages to get into the structure in some way or other takes a long time to dry out. Rain during the building period is not the entire explanation for moisture damage in walls of this type. A lot of damage in detached houses and apartment buildings having this type of wall construction cannot be explained simply by the ingress of additional moisture during the construction period. In these cases, the damage has been caused by water finding its way in through defects in joints between the facade and parts such as balconies, windows etc, and has arisen after completion of the building.

### 1.2 Originally developed for masonry walls

The particular system of rendering on the outside of thermal insulation was developed to insulate existing brick-walled buildings. Experience of the method has been very good, and so it started to be used in Sweden for buildings having wooden stud walls as well. However, what was not considered in connection with the new

system was the risk of moisture damage in an unventilated, non-homogeneous, lightweight wall with a relatively impermeable exterior. Although the system has worked well for retro-fitting of insulation on stone and brick buildings, it presents a risk of moisture damage when used on wooden stud walls.

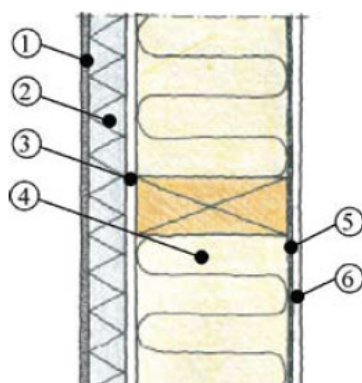

- 1 - Thick or thin plaster rendering.  
 2 - 'Rigid' insulation of foamed plastic or mineral wool secured to the sheet (3).  
 3 - Gypsum board, plywood, chipboard, mineral fibre board or similar.  
 4 - Studs with additional insulation between them.  
 5 - Vapour barrier, often 0,2 mm polyethene film.  
 6 - Internal board, often gypsum.

FIG 1. A cross-section of the structure, as used in Sweden.

### 1.3 Description of the damage

In many cases, very high moisture ratios and growth of mildew and bacteria have been discovered in/on the external gypsum board or plywood sheet in the wall structure. The gypsum board may have been damp when it was fitted to the wall, or it could have been fitted at a time when it was raining, which could have resulted in the growth, as it takes a long time for the structure to dry out. However, it is not likely that damp gypsum board would have been applied to so many different buildings, or that the moisture ratios should still be so high, unless this moisture had found its way into the structure on more than one occasion. The other explanation is that the gypsum board has become damp, and the growth has occurred, after the rendering was secured. This moisture can have reached the wind barrier either by the transport of moist indoor air out through the wall, or it could have found its way into the wall through defects in joints between the facade and other fittings at times of driving rain.

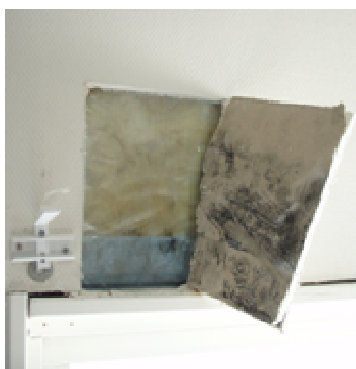

FIG 2. Microbial growth on the internal gypsum board, caused by inward-leaking water.



FIG 3. Microbial growth on the outer gypsum board, caused by water leaking in through a defective connection. Picture from the inside.



FIG 4. Microbial growth on sole plate and studs, caused by inward leakage of water. Picture from the outside.

The overall picture of the damage, i.e. the extent and location of high moisture ratios and growth of bacteria on gypsum board and wooden stud structures, indicates that the damage has probably not been caused by moisture from the inside of the building, but more probably by inwardly leaking rainwater.

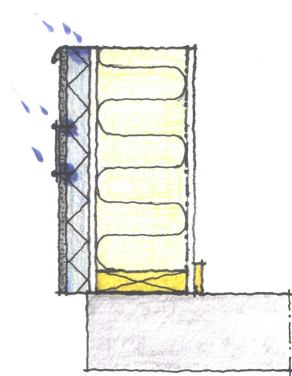

FIG 5. Water finds its way through poor connections or fasteners.

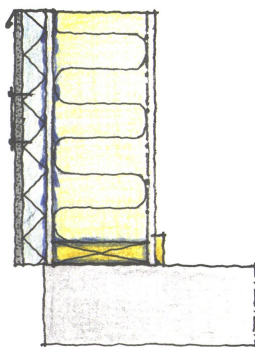

FIG 6. The water runs down the gypsum board, and dampens the gypsum board, the sole plate and studs.

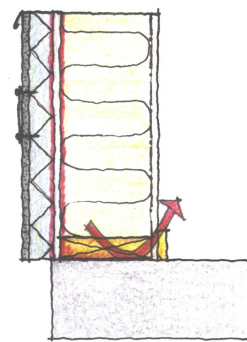

FIG 7. If left damp, microbial growth is likely to occur, with associated unpleasant smell.

## 2. The purpose of the project

The first cases of damage to undrained, unventilated wooden stud walls that SP Technical Research Institute of Sweden investigated occurred at the beginning of the 2000s. Extensive damage occurred when, in connection with the construction of residential buildings in Stockholm, rainwater found its way into the walls (*see Samuelson and Wånggren, 2002*). This has been followed by an increasing number of investigations, all of which have shown that damage is occurring on a large scale. In 2006, in conjunction with its clients, SP decided to write an article for the technical press with information on the damage that had occurred and on the risks associated with this type of wall construction, and this was published as an article (*Jansson, Samuelson, Mjörnell, 2007*). In addition, three theme days were held in the spring in order to inform the construction sector of this type of damage. In June SP, together with a number of contractors, applied to SBUF for research funding in order to carry out a project on rendered undrained wooden stud walls. The central point of the project has been to investigate whether it is possible at all to produce a moisture-proof multilayer wall of this type (*Samuelson, Mjörnell, Jansson, 2007*). The purpose of the project is therefore to:

1. Prepare an inventory of the extent of moisture damage in rendered, undrained walls. How many buildings have this form of construction, how many have been damaged, what is the cause of the damage and what do they look like?
2. Evaluate the performance of this type of construction in respect of their moisture resistance. This will be carried out both by calculations and by measurements of mock-up wall elements in the laboratory.
3. Develop appropriate measures for dealing with walls that have already been damaged.
4. Provide proposals for better design solutions, both for existing walls which are to be renovated, and for new walls that are yet to be built.

## 3. Ascertaining the extent of the damage

### 3.1 Instructions for field surveys

SP has prepared a guide for investigating the extent of the damage, based on experience from SP's own field investigations and laboratory tests over the last years. Work in the field is carried out as follows:

- Examination of drawings. The drawings show the type of materials and construction details.
- Visual inspection. (Checking the quality of workmanship around connections and penetrations, and looking for the possible presence of cracks)
- Check measurements. (Measurements in the gypsum board as follows.)

### 3.2 Method of measurement

Moisture measurements are made as follows.

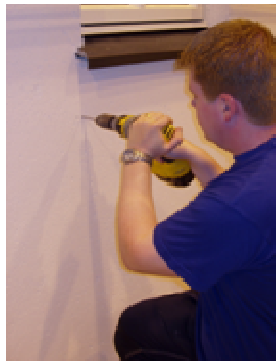

FIG 8. Two small holes are drilled through the plaster, about 20 mm apart.



FIG 9. Inserting insulated probes in an upward direction through the holes and through the external insulation.

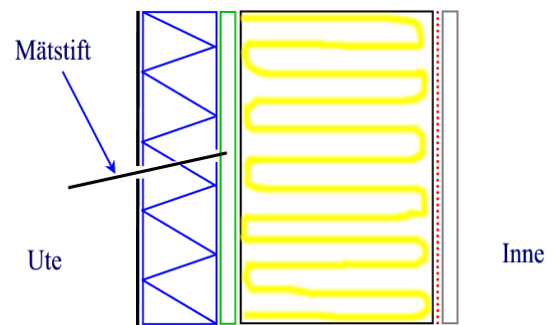

FIG 10. Inserting insulated probes in an upward direction through the holes and through the external insulation into the gypsum board.

### 3.3 Typical details with potential for leaks and a high frequency of damage

In a number of inspections of rendered façades that SP has carried out, it has been found that the detailing of fittings and connections to/in the facade has been carried out in an unsatisfactory manner, allowing rainwater to find its way into the wall. These weaknesses have occurred particularly in end connections to balconies, windows, patios and overhanging roofs (see Figures 11-13). Moisture measurements in the gypsum board beneath these poor connections have often found high moisture ratios (>0,28 kg/kg), particularly on facades that are most exposed to wind and rain.



FIG 11. A poor connection to a patio door.



FIG 12. A poor connection around a window



FIG 13. Leaks around the edge of a balcony.

### 3.4 Results from field measurements

The project has included identification of how common these, or similar structures, are, and how common it is for damage to occur. Where were these walls built, when were they built, are they damaged, what is the extent of the damage, what have been the consequences of the damage, what was the cause of the damage and where is it most frequent (i.e. in what part of the country, facing in what direction, at what height above ground, with what age of building etc.), and how have the cases of damage been discovered? This information complements the results from the surveys (carried out as described above), which are reported to SP.

TABLE 1: The number of damaged buildings reported to SP April 2008.

Number of buildings	Southern Sweden	Western Sweden	Eastern Sweden	Northern Sweden
315	52	168	92	3

TABLE. 2: Frequency of damage, by areas of Sweden, among buildings reported to SP.

Number of damaged buildings	Southern Sweden	Western Sweden	Eastern Sweden	Northern Sweden
236 (74,9%)	36 (69,2%)	149 (88,7%)	51 (55,4%)	0 (0%)

TABLE. 3: Frequency of damage, by types of insulation, among buildings reported to SP.

Number of buildings with external EPS insulation	Number of buildings with external mineral wool insulation	Number of damaged buildings with external EPS insulation	Number of damaged buildings with external mineral wool insulation
298 (94,6%)	17 (5,4 %)	226 (75,8%)	10 (58,8%)

The results that have hitherto been recorded indicate that damage is occurring in all parts of the country, although it is most frequent in west Sweden. There does not seem to be any relationship between the frequency of damage and the type of external insulation material. However, it should be pointed out that the number of facades having mineral wool as the external insulation that have been investigated is considerably lower than those having foamed plastic insulation.

#### 4. Laboratory measurements on wall elements (mock-ups)

Mock-ups of walls regarded as providing doubtful protection, and of those regarded as being moisture-resistant, have been built in the laboratory and used for practical tests of their moisture resistance. The objective of the tests has been both to find sustainable solutions for existing damaged structures, and also to arrive at good designs for new buildings. The work includes evaluation not only of the structures as such, but also of details, parts, penetrations and connections. Wall elements, 3 x 3 m in size, have been built in the laboratory, each containing a number of fastening parts and connections, including two windows, a light fitting, an electric meter cubicle, a ventilator and a through beam, as shown in Figure 14. The elements have not been insulated, but have been covered with an internal plastic film vapour barrier, as shown in Figure 15. They were erected in a rig, in which they have been exposed to rain, followed by a pulsating wind pressure from 0 up to 600 Pa. The moisture ratio in the studs was measured during the tests, and inward water leakage monitored by eye and documented by camera.



FIG 14. A mock-up wall panel, seen from the outside. FIG 15. The panel seen from the inside.

As not all of the mock-up panels have yet been tested, no results can yet be given.

### 5. Calculations of moisture conditions

#### 5.1 Calculations with WUFI

A theoretical investigation of the moisture resistance of the designs has been carried out, using the WUFI program for one-dimensional and two-dimensional temperature and moisture conditions. The program can calculate non-steady-state moisture and temperature conditions under varying external conditions. It is also possible to add moisture and temperature sources and sinks inside the structure. A moisture source inside the



structure can simulate inward leakage of rainwater through a penetration, thus making (for example) a gypsum board damp. A moisture sink, on the other hand, represents a drain.

The calculations have used the following conditions:

Outdoor climate:	Oslo
Indoor climate:	20 °C, medium moisture load
Calculation time:	Three years, starting from 1 October.

The calculations have been made for the following two wall sections, as seen from the outside:

Thick plaster	Thin plaster
Mineral wool 80 mm	EPS foamed plastic 80 mm
Gypsum board 13 mm	Gypsum board 13 mm
Mineral wool 200 mm	Mineral wool 200 mm
Plastic film	Plastic film
Gypsum board 13 mm	Gypsum board 13 mm

The calculations have been based on application of a moisture source to the gypsum board.

## 5.2 Results

Relative humidity %

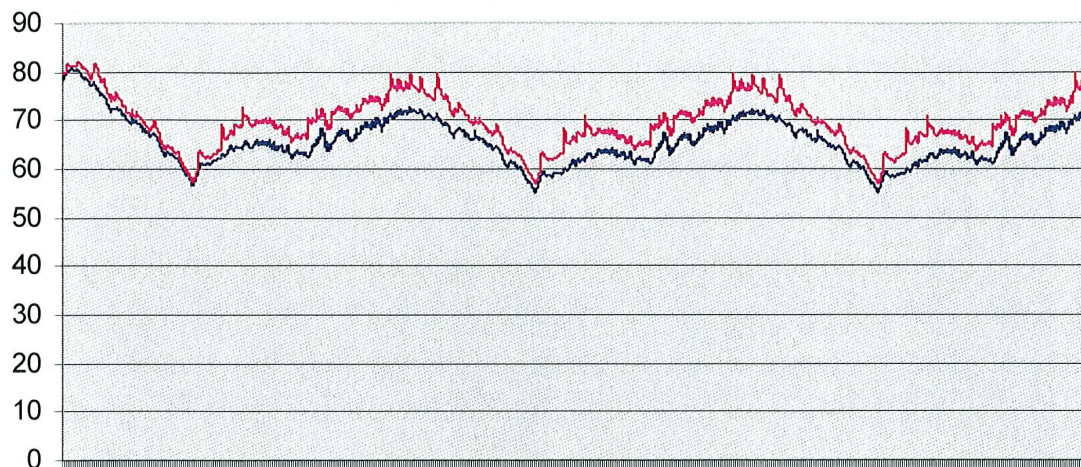

*FIG 16 shows the calculated relative humidity of the gypsum board in a wall having external thick plaster rendering on mineral wool during three years. The two curves show the respective effects of 0,1 % and 1,0 % of inwardly leaking driving rain. It can be seen that the moisture will dry out between inputs*

Relative humidity %

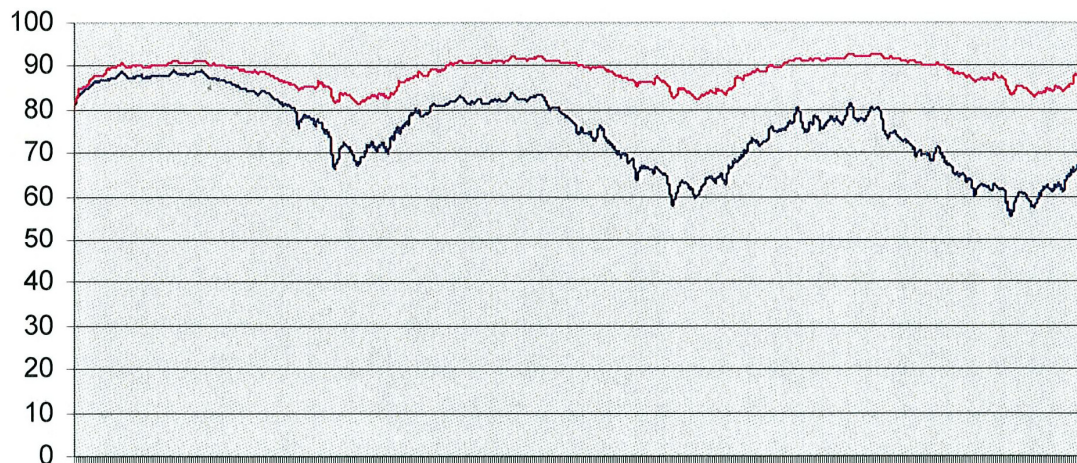

FIG 17 shows the calculated relative humidity of the gypsum board in a wall having external thin plaster rendering on foamed plastic during three years. The two curves show the respective effects of 0,1 % and 1,0 % of inwardly leaking driving rain. It can be seen that the moisture does not manage to dry out between inputs, thus introducing a steadily increasing moisture concentration in the gypsum board.

## 6. How serious is the damage?

The question is how important this type of moisture problem is for the integrity of stud walls if damage of this type occurs. Except in extreme cases, it is not likely that the load-bearing capacity of the wall would be at risk. However, there is a risk that the damage can affect the quality of the indoor environment. If organic materials in the wall become damp, they can provide a basis for the growth of mildew and bacteria and, in certain cases, also for rotting of the wood. There is usually a slight negative air pressure in most buildings, which can mean that volatile substances, odour and particles from the microbiological growth can find their way in through gaps in the wall, to reach the interior. It is still not clear why we experience discomfort or various symptoms in damp buildings, but there are many factors that indicate that microbial growth is an important element.

Until more is known about the link between moisture damage and ill-health, it is reasonable to apply a general principle of care. Moisture damage and the growth of mildew inside parts of a building that can affect indoor environmental conditions cannot be accepted. In addition, the National Board of Housing, Building and Planning's 2006 Building Regulations clearly state that the growth of mildew must not occur.

## 7. Recommendations

### 7.1 Dealing with existing walls

In the case of existing walls, it is essential to ensure that moisture cannot find its way in. Such damage can be caused by extensions or other work, such as when the house owner mounts a television aerial on the wall, or fits outside lighting. Awareness of the risks, and great care in the quality of such work, are essential. At present, the following recommendations and advice are applicable.

- Carry out an investigation as above.
- Decide on the necessary remedial measures as follows:
  - Remove visible growth by replacing material or by planing or grinding
  - Replace any materials having an unpleasant odour
  - Allow damp materials to dry to acceptable values, and check that there is no continued or further growth of micro-organisms
- Be prepared to deal, not just with local areas of damage, but with the entire wall or façade.
- Apply the following principles if it is necessary to rebuild the wall:
  - Change to a two-stage barrier construction

- Incorporate drainage in the structure
- Replace sensitive materials by more moisture-resistant materials
- If the wall is rebuilt with the same design, it will need to be regularly checked for possible new or recurring damage.

## 7.2 New walls

Our conclusion is that this form of construction, with plaster rendering on a wooden stud frame, especially in the way that it is often built, without drainage gaps, is at risk of moisture damage, and should not be used. There is no way in which such walls can dry out. Water that finds its way in through connections or fastenings results in high moisture concentrations in the wall over a long period of time, presenting a risk of microbial growth. The immediate risk of damage can be reduced by replacing moisture-sensitive materials by materials that are more resistant to moisture. Nevertheless, the single-barrier design is still sensitive to moisture.

From this, it can be seen that it is of vital importance that detailing of fastenings and connections is carefully designed in order to prevent the ingress of moisture, and that the work is carried out with high quality and quality assurance. Details should be tested and evaluated before being used. Finally, the wall must be regularly maintained, and inspected for any signs of moisture penetration.

The risk of damage can be reduced by incorporating an air gap in the wall. A double-barrier wall of this type should look much the same as a rendered single-leaf undrained wall, while providing the same good moisture resistance performance of a traditional ventilated wall. Wind barriers and rain barriers should be separated. Proper care must be taken when designing connections and fittings. The underlying principle must be that any water that does find its way in must also be able to dry out. Detail designs of double-barrier walls should be tested and evaluated before they are used on a large scale.

## 8. Conclusions

The single-barrier wall is a wall that is sensitive to moisture. The investigations have so far shown many serious damaged buildings with damages not only being a risk for a bad indoor climate but also a problem for the durability.

## 9. References

Samuelson, I, Wångren, B., (2002), Moisture and moisture damage at Hammarby Sjöstad. SP RAPPORT 2002:15. *[In Swedish.]*

Jansson, A, Samuelson, I, Mjörnell, K. (2007). Damage in rendered wooden stud walls, Bygg&Teknik no. 1/2007. *[In Swedish.]*

Samuelson, I, Mjörnell, K., Jansson, A, (2007). Moisture damage in rendered, undrained wooden stud walls – Status report, October 2007. SP Report 2007-36. *[In Swedish.]* Available from [www.sp.se](http://www.sp.se).

Künzel, H Zirkelbach, D (2007) Feuchteverhalten von Holzständerkonstruktionen mit WDVS – Sind die Erfahrungen aus amerikanischen Schadensfällen auf Europa übertragbar? Zeitschrift für Wärmeschutz, Kälteschutz, Schallschutz, Brandschutz Heft 58 Juni 2007 *(In German)*.

## Multiple-skin facades: high tech blessing or not?

*Hugo Hens, dr. ir. Professor*

*K.U.Leuven, Department of Civil Engineering, Laboratory of Building Physics  
hugo.hens@bwk.kuleuven.be/ <http://www.kuleuven.be/bwf/eng/index.htm>*

*Dirk Saelens, dr. ir. VK Engineering*

*Veerle De Meulenaer, ir*

*K.U.Leuven, Department of Civil Engineering, Laboratory of Building Physics  
veerle.demeulenaer@bwk.kuleuven.be/ <http://www.kuleuven.be/bwf/eng/index.htm>*

*Patricia Elsen, ing.*

*K.U.Leuven, Department of Civil Engineering, Laboratory of Building Physics  
Patricia.elsen@bwk.kuleuven.be/ <http://www.kuleuven.be/bwf/eng/index.htm>*

**KEYWORDS:** *Double skin facades, condensation, thermal comfort*

### **SUMMARY:**

*Multiple-skin facades have been hype now for more than two decenniums. Those pushing the technology claim the solution has a bundle of advantages: energy conserving, better thermal comfort, excellent sound insulation, solar shading device protected from the weather, etc.*

*The paper starts with reviewing some relevant literature. Then two cases of prestigious buildings with multiple-skin façade (MSF) are discussed. The first, where the MSF acted as return duct for the exhaust air, suffered from surface condensation in the façade and comfort complaints during winter. The second, a recently constructed high rise with MSF, cool ceilings, IDA2 ventilation and the façade acting as return duct, was problematic from the start. Employees in fact complained about thermal comfort soon after the building was inaugurated. Measurement of the temperature profile in a south oriented façade bay gave surface temperatures on the inside single glass panel of 35°C and more on sunny days with the shading device closed. That turned the façade into a heating surface and switched the employees between that and a cold radiating horizontal surface above their head. The resulting consequences for thermal comfort during warm weather were devastating.*

## 1. Introduction

Multiple-skin facades (MSF's) have been hype now for more than two decenniums. The name refers to façade assemblies which consist of two glass panes separated by an air cavity with a solar shading device in it and air drawn through it. The type of air flow is the main parameter typifying the solution, see table 1 (Baker et al, 2000) (Saelens, 2002).

TABLE 1: Global classification of multiple-skin facades

Type	Description
Air curtain	Air leaves the cavity at the same side it came in. Could be inside (AFWi) or outside air (AFWo)
Supply	Air from the outside flows through the cavity to the inside (SUPe)
Exhaust	Air from the inside flows through the cavity to the outside (EXHo)

With inside air flowing along, the outside glass pane should be well insulating while the inside pane can be single glass. Outside air, instead, demands an insulating inside pane and a single glazed outside pane. In case buoyancy activates the flow, wind pressure and temperature differences are the driving forces. Forced convection is fan-activated. In that case, inside air curtain facades typically become part of the HVAC-system.

Another parameter intervening in the classification is the horizontal and vertical granularity. If the airflow extends over several floors and bays, the name 'active façade' is used. If, instead, the façade consists of floor high and bay-wide elements, the name active window' is more appropriate.

From the eighties on, numerous papers have been published on double skin facades. In 1999, K. Gertis critically evaluated a large number of them, mainly published in Germany between 1980 and 1998 (Gertis, 1999). Many could be classified as non-scientific. Some included measured data. But even then, it was difficult to get an overall picture of the field performance of MSF's. Gertis therefore added a discussion on energy efficiency, summer comfort, moisture tolerance, acoustical performance, day lighting, fire safety, maintenance and first costs, that in comparison with well insulated single skin facades with highly performing windows (SSF's). His conclusions were quite negative for MSF's, the only positive score being a better sound insulation against outside noise, as was proven later on by Blasco et al, 2006. All other performances were either equal or worse. The International Energy Agency's Implementing Agreement on Energy Conservation in Buildings and Community Systems Annex 32 did the same exercise in 1996-2000. The report 'Advanced Envelopes' pictures MSF's as being more critical in terms of performances than highly performing SSF's (Baker et al, 2000). Important in their conclusions was that, because of the combination of a dynamic thermal transmittance with enthalpy flow, evaluating MSF's on energy efficiency is only possible at whole building level. Saelens et al 2008, calculated the net energy demand of an office floor with MSF's and well performing SSF's. He concluded that smart MSF's with alternating operation mode and variable air flow may do better than SSF's with outside shading device, although the difference is easily bridged when using heat recovery and free cooling techniques. A paper by Lehar et al, 2003 confirmed these findings.

Hraska et al, 2003 looked to buoyancy induced air flow in AFWo MSF's, used in medium rise buildings. They showed that outside air enters the cavity at the lower floors and leaves it at the higher floors. With small windows at each floor in the outer skin open, air temperature in the MSF hardly passes the outside value. If, instead, leakage is the only supply route, temperature increases rapidly from the bottom up to reach values beyond 40°C at the highest floor in windless, sunny weather. Ziller et al, 2003, analysed wind-induced airflow. Not only the average wind velocity but also the wave length of wind gusts should be accounted for. Wave lengths shorter than the height of the cavity give pressure waves between in- and outlet rather than air flow. Temperatures in an AFWi MSF, designed to minimize solar gains, were measured by Manz et al, 2003. The assembly had an argon-filled low-e outside double glass with solar transmissivity 0.31, a metallized solar screen with solar transmissivity 0.09 and an inside single glass with solar transmissivity 0.68 and a long wave emissivity of 0.22 at the cavity side. That resulted in a solar transmittance of 0.07 of which 0.03 were direct gains and 0.04 indirect gains. Anyhow, on a warm, sunny day, temperatures measured in the AFWi still passed 40°C close to the exhaust.

Temperature and air flow measurements on different field exposed DSF mock-ups were conducted by Saelens 2002 and Micono et al 2006. The last paper compared an AFWi MSF with clear double glazing outside, an aluminium Venetian blind inbetween and clear single glass inside with a double glass with outside reflective pane, solar reflectivity unknown, but without additional solar shading. Although the authors claimed that the AFWi MSF did much better, quite some air was needed ( $52 \text{ m}^3/(\text{m}\cdot\text{h})$ ) to get surface temperatures inside lower than those on the double glazing. The same hold when looking to the dynamic efficiency, i.e. the heat removed by the inside air flow compared to the energy entering the system. Again, high efficiencies demanded quite some air flow. Modelling of the set-up of Micono et al, 2006, by Jiru et al, 2006, gave excellent agreement with the experimental data. This was also true for the model Saelens 2002 developed for his set-up with forced inside air flow.

All in all, one should be very carefull when forwarding good performance of MSF's. The reference used is of paramount importance. Correct claims demand a SSF with a comparable static response, not a SSF which performs much worse than the sealed MSF without air flow. If comparisons are done correctly, Gertis' overall judgement remains true.

## 2. Problem cases analysed

### 2.1 Office building 1

#### 2.1.1 Multiple-skin facade

The first case concerned an office building with groundfloor and four upper floors that form an extension of an existing building. The five floors are arranged around a central atrium. The building has air curtain type active windows as MSF at the two corners (Figure 1), with air flowing top down between the two skins (AFWi). The air enters the office spaces through VAC-boxes at floor level, leaves them at ceiling level, is conducted to the top of the active windows, flows down the cavity and returns from the bottom back to the air handling units. The

outside pane of the active windows consists of clear double glass, the inside pane of clear single glass, the cavity inbetween is 24 cm wide and contains a roller blind as solar shading device. During working hours, the air flow along the cavity varies between 100 and 140 m<sup>3</sup>/(h.m). The dynamic thermal transmittance of the MSF, calculated with a simplified tool, is as low as 1.26 W/(m<sup>2</sup>.K).



FIG. 1: building 1: outside view, view from inside on the MSF, schematic section of the MSF

### 2.1.2 Problems and diagnosis

Once the building was in use, two problems arose: (1) people complaining about bad thermal comfort during winter and (2) surface condensation deposited in the MSF against the aluminium jambs and the double glazing of the outer skin.

The diagnosis was based on comfort measurements and infrared pictures of the DSF. Thermal comfort was evaluated by installing a Brüel & Kjaer comfort meter in an employee's position close to the MSF. For a metabolism of 1.2 Met and winter clothing (Clo=1.2), overall comfort during working hours oscillated around a PMV of -1.04 and a PPD of 28.5% (Fanger, 1972). The draft rate noted however reached 61.2%. A comparison with ASHRAE standard 55-2004 (ASHRAE, 2004) underlined that these conditions are unacceptable. The reason was found to be lack of airtightness of the façade's inside skin. In fact, each alternate single glass panel was an operable one. Near the rebates in the jambs, air velocities up to 0.5 m/s where measured, which was an indication of wind-induced leakage of cool air from the MSF back into the office space.

The outer skin should not have suffered from surface condensation. In fact, aluminium jambs with thermal break are used having an equivalent U-value close to the central value for double glass. However, the spacers at the glass perimeter induce some thermal bridging, resulting in lower surface temperature ratios along the glass edges than in its central part. At the same time, a detailed inspection revealed that the joints between the horizontal and vertical jambs in the outer skin were not sealed. That allowed outside air to enter the voids in the aluminium profiles, annihilating bottom up the effect of the thermal break over a limited distance. An important fact also was that, as logging showed, the inside relative humidity in winter was kept around 50%.

Figure 2, which relates the dewpoint ratio at several relative humidities to the outside temperature, pictures the consequences. Each time the outside temperature drops below 6°C for an inside relative humidity around 50%, surface condensation starts. The fact that outside temperatures below 6°C are common during the colder months in Belgium explains why surface condensation was long-lasting, provoking complaints that way.

To complete the evaluation, we logged the temperatures in the MSF during summer. Figure 3 gives the results for a warm spell. Looking to the temperature in the cavity outside the solar screen (14), one is forced to conclude that MSF's behaves like a greenhouse. Happily, the air flow exhausted top-down was high, 100 to 140 m<sup>3</sup>/(m.h) and mainly washed the cavity at the inner side of the screen. That resulted in much lower temperatures there, the largest difference noted with the outer cavity touching 19°C on august, 11, 1998 (55.5°C in the outside cavity, 35.5 °C in the inside cavity). Anyhow, plastic solar screens suffer from temperatures that high. As was noted in an MSF, used in a lecture room building, they expand, buckle, get stuck and stop functioning! The air washing the DSF also dumps quite some solar heat back into the building and the HVAC-system, where it has to be

cooled away. The increase in primary energy consumption for cooling that way completely overwhelmed the avoided primary energy for heating (Saelens et al, 2008).

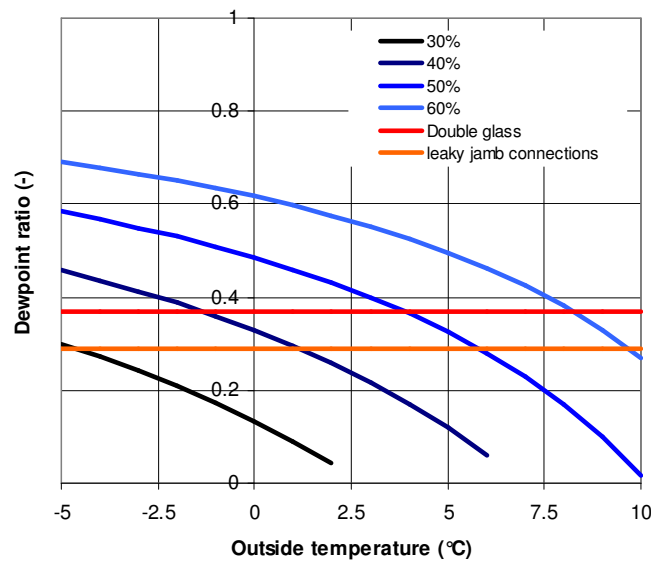

FIG. 2: dewpoint ratio for a given inside relative humidity compared to the surface temperature ratio at the double glass edge and the aluminium jamba

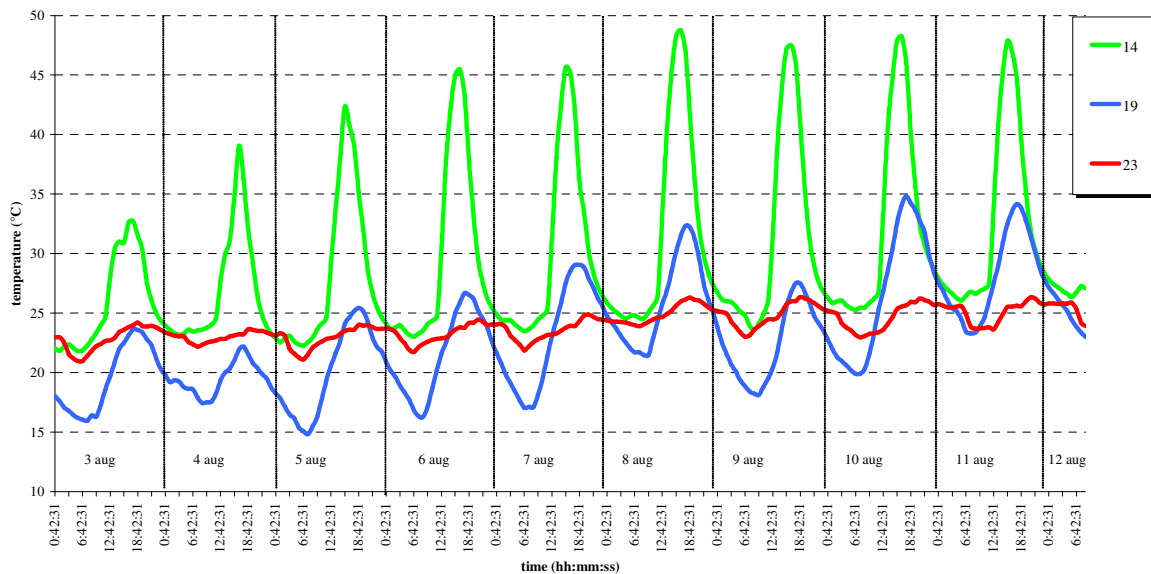

FIG. 3: building 1, MSF, summer time. Inside temperature (23), outside temperature (19) and temperature in the cavity at the outside of the solar screen (14)

## 2.2 Office building 2

### 2.2.1 Multiple-skin facade

The second case concerned a new high-rise office building with 34 floors. The envelope consists of air curtain type active window MSF's (Figure 4), with air flowing bottom-up between the two skins (AFWi). The building is conditioned using cool ceilings in combination with slightly cooled ventilation air. The air enters the offices through ceiling slots, washes the room and then passes to the DSF at floor level where it flows upward the cavity to be exhausted at ceiling level for returning to the central air handling units. That way some 30 m<sup>3</sup>/(m.h) moves up through the active window MSF during working hours. The outside pane of the MSF consists of double glass,

the inside pane of 6 mm thick clear single glass, the cavity inbetween is 15.4 cm wide and contains a solar shading device, composed of vertical white lamellas, which turn around a central axis. For the properties of the double glazing, see table 2. The dynamic thermal transmittance of the MSF touched  $1.3 \text{ W}/(\text{m}^2\cdot\text{K})$

TABLE 2: Properties of the double glazing used as outside skin the the MSF of office building 2

LTA	$\tau_s$	$\rho_s$	$\alpha_s$	U W/(m <sup>2</sup> .K)
0.62	0.38	0.29	0.33	1.6

## 2.2.2 Problems and diagnosis

Since the building is in use, employees working in offices with the MSF facing east over south to west complain about very warm conditions during sunny weather. Apparently, the inside surface of the single glass panel, forming the second skin, heats up to quite high temperatures, creating a situation where the body gains radiant heat from the façade, while loosing radiant heat to the cool ceiling.

To diagnose the situation, two MSF-bays, one facing south at the 32<sup>d</sup> floor and one facing north at the 30<sup>st</sup> floor, were equipped with thermocouples on three heights (30 cm, 132 cm and 234 cm) at the cavity side of the double glass, at the inside surface of the dingle glas, in the middle of the cavity outside of the solar screen and in the middle of the cavity at the inside of the solar screen (Figure 5). Logging spanned the whole summer of 2007, which was neither warm nor very sunny. At the same time a Brüel & Kjaer comfort meter moved over the office at the 32<sup>d</sup> floor, while a second comfort measurement was done in a landscape office at the 25<sup>th</sup> floor with a MSF-facade facing east and south.



FIG. 4: building 2: outside view, MSF-bay

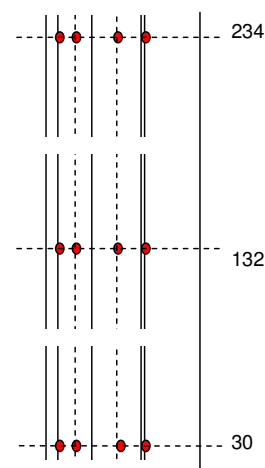

FIG. 5: MSF, thermocouples

Figure 6 shows the temperatures measured on the inside surface of the single glass inside skin in the south oriented bay during the warmest week of the cool summer 2007. Peak values up to  $35^\circ\text{C}$  are logged during working hours for an air temperature in the office close to  $30^\circ\text{C}$ . The highest temperature noted on the single glass outside working hours was even  $47^\circ\text{C}$ . At that moment, temperatures in the MSF looked as shown in figure 7.

Why such high temperatures? There are three main reasons for that: the outside skin is too transparent for solar heat, its low U-value restrains heat conduction to the outside and the air flow washing the MSF is too limited.

As figure 8 illustrates for one location, all comfort measurements revealed a complete unacceptable situation in both the office on the 32<sup>th</sup> floor and the landscape office on the 25<sup>th</sup> floor. The predicted mean vote for a metabolism of 1.2 Met and summer clothing could go up from cold in the morning (below -1) to 3 in the afternoon, much too warm, ending with 100% dissatisfied. Hence, the complaints of the employees were clearly justified.



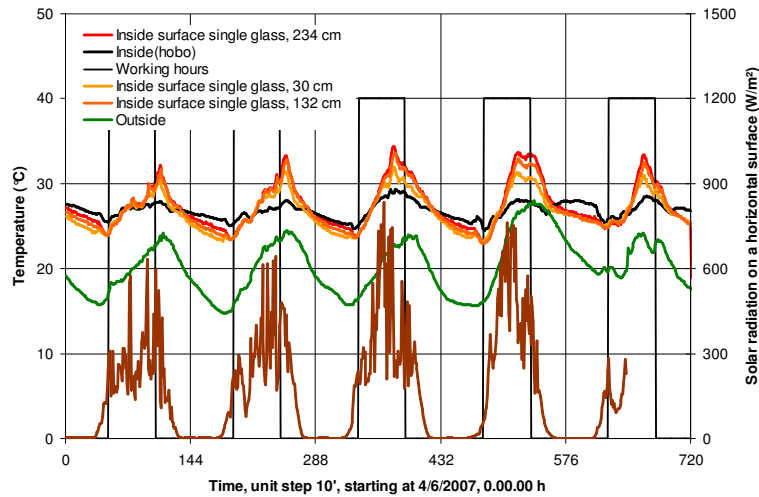

FIG. 6: building 2, MSF, summer time. Temperatures on the inside surface of the single glass inside skin, air temperature in the office, outside climatic data

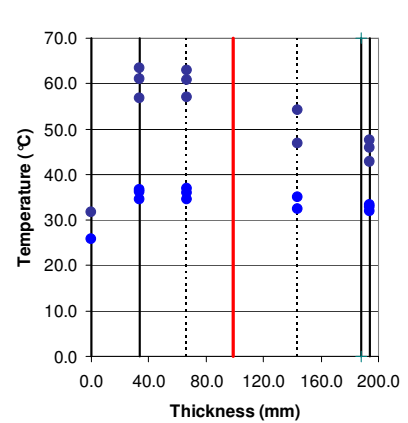
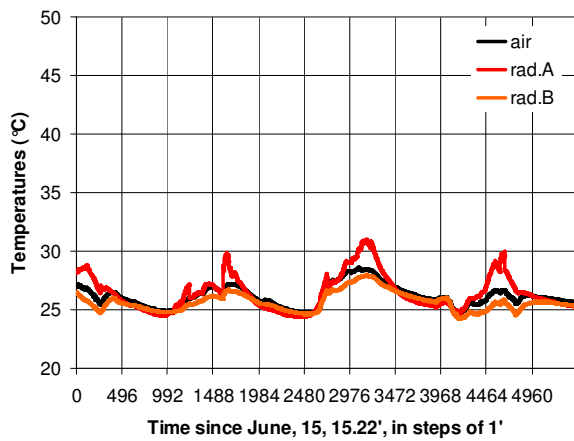
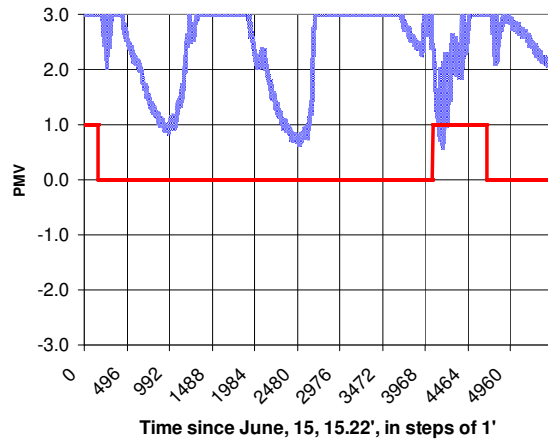

FIG 7: temperatures in the MSF (lowest points are the daily mean, highest points the peaks)



(a)



(b)

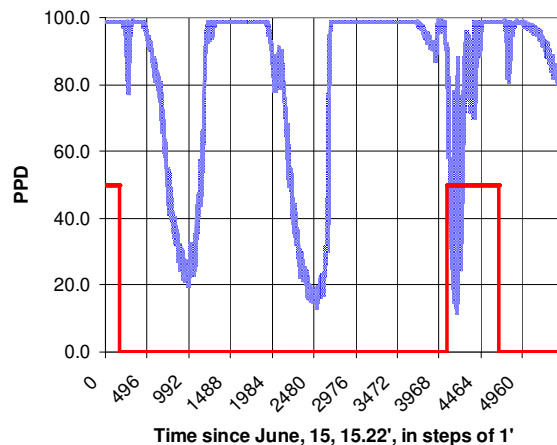

(c)

FIG. 8: building 2, office at the 32th floor with east and south MSF, summer time. Comfort conditions. (a) gives the air and the vertical half spherical radiant temperature, (b) shows the predicted mean vote and (c) the number of dissatisfied. The blocks curve give the working hours

## 2.3 Solutions

### 2.3.1 Office building 1

The solution was quite simple and payable. First of all, the inside relative humidity during winter was lowered to 30-35%. Then the rebates between the operable single glass panels and the fixed jambs in the inner skin got expansion strips, which upgraded air tightness. Finally the jamb junctions in the outside skin were sealed as to avoid outside air from penetrating into the voids within the aluminium profiles. The deficient energy performance of the MSF, however, could not be corrected that way.

### 2.3.2 Office building 2

A simple solution could not be presented. A combination of two measures, a double glass with very low solar transmissivity for the outer skin and a higher return flow through the cavity, resulted in much better performances, but, to arrive there, the whole outside skin was to remove and better glazing to be mounted instead, while more return air demanded a complete upgrade of the HVAC-system in the new high-rise. Both costed a fortune in investment and should cause huge annoyances for the building users during the retrofitting activities.

A possible upgrade analysed was to leave more space between the MSF and the employee's desks. In fact, moving away from the inside leaf diminishes the view factor between the body and the façade and increases the view factor between the body and the ceiling. That causes a decrease in resulting temperature, as figure 9 illustrates for a rather warm, sunny day. Anyhow, for the upgrade to work, air temperature should not pass 26°C. For that to realise, the cool ceiling is to be chilled to a temperature as low as 15.8°C. Although this will not give radiant asymmetry complaints, the resulting temperatures may drop to 24°C farther away from the DSF. In summer, that may be perceived as quite cool by female employees wearing a typical summer dress.

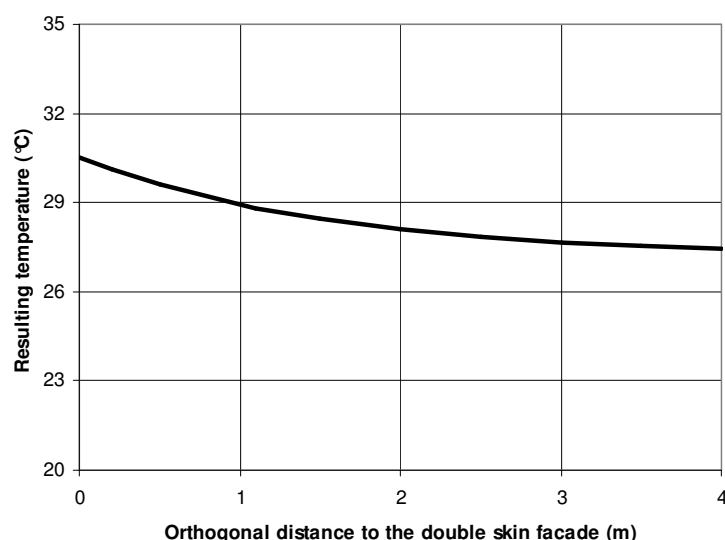

FIG. 9: building 2: resulting temperature depending on the distance to the DSF

Such upgrade anyhow also costs money as an argument in favour of DSF's runs out: the fact that the whole floor surface is usable. By moving away from the DSF quite some square meters at the perimeter are lost for further use, resulting in less usable space in the high-rise.

## 3. Conclusions

Are double skin facades worthwhile to be a hype? When going through the literature, the answer seems negative. For one performance only they do better than well insulated single skin facades with outside solar shading: sound insulation between the inside and outside. All other performances that are praised as being superior than for a highly performing SSF with outside shading do not withstand an in depth evaluation. Air tightening is more problematic. Energy efficiency may be worse. For a same glazed surface, daylighting is not as good as far an

SSF with the same glass surface although designers try to correct this by using MSF's that are glazed from floor to ceiling. Investment is higher. Maintenance turns out to be more expensive as four glass surfaces have to be cleaned. Fire safety is a problem. Papers that claim better performances for MSF's typically use a SSF reference which performs poorly. This of course ends in comparing apples with pears.

The two cases forwarded in the paper strengthen the statement that double skin facades are not the high-tech blessing expected by many, but may act as expensive trouble makers. Neither of the two conserves energy. In both cases thermal comfort during winter and/or summer is at least problematic or bad. The measurements done all underline the green house equivalency, which is not advantageous. In fact, only a few architects, who call themselves energy conscious even when lacking basic physical knowledge, still think that putting a building in a green house solves energy and environmental problem.

## 4. References

- ASHRAE, 2004, Standard 55-2004, Thermal Environmental Conditions for Human Occupancy
- Blasco M., Crispin C., Ingelaere B. (2006), Acoustical performances of Ventilated Double Glass Facades, Research in Building Physics and Building Engineering-Fazio, Ge, Rao & Desmarais (eds), Taylor & Francis Group, London, p 287-291
- Baker P., Saelens D., Grace M., Takashi I. (2000). Advanced Envelopes. Methodology, Evaluation and Design Tools, Final Report IEA-EXCO ECBDS, Annex 32, ACCO, Leuven, 64 p. + appendices.
- Fanger P.O., 1972, Thermal Comfort, Mc Graw-Hill Book Company, New York
- Gertis K. (1999), Sind neuere Fassadenentwicklungen bauphysikalisch sinnvoll? Teil 2: Glas-Doppelfassaden (GDF), Bauphysik 21, heft 2, p 54-66
- Hraska J., Janak M., Rabenseifer R., Strigner R. (2003), Double-skin facades: two case studies, Research in Building Physics -Carmeliet, Hens & Vermeir (eds), Swets & Zeitlinger, Lisse, p 497-502
- Jiru T., Haghihat F., Perino M., Zhanhirella F. (2006), Zonal Modeling of Double-Skin Facades, Proceedings of the EPIC 2006 AIVC Conference, Lyon, pp 129-134
- Lehar M., Glicksman L. (2003), A simulation tool for predicting the energy implications of advanced facades, Research in Building Physics -Carmeliet, Hens & Vermeir (eds), Swets & Zeitlinger, Lisse, p 513-518
- Manz H., Simmler H. (2003), Experimental and numerical study of a mechanical ventilated glass double façade with integrated shading device, Research in Building Physics -Carmeliet, Hens & Vermeir (eds), Swets & Zeitlinger, Lisse, p 519-526
- Micono C., Perino M., Zanghirella F., Filippi M. (2006), Performance assessment of innovative transparent active envelopes through measurements in test cells, Research in Building Physics and Building Engineering-Fazio, Ge, Rao & Desmarais (eds), Taylor & Francis Group, London, p 293-300
- Saelens D. (2002), Energy performance assessment of single storey multiple-skin facades, PhD-thesis: K.U.Leuven; 2002.
- Saelens D., Roels S., Hens H. (2008), Strategies to improve the energy performance of multiple-skin facades, Building and Environment 43, p 638-650
- Ziller C., Döring B. (2003), Influence of the external dynamic wind pressure on the ventilation of double facades, Research in Building Physics -Carmeliet, Hens & Vermeir (eds), Swets & Zeitlinger, Lisse, p 527-533

# Investigation of a Novel Ceiling Panel for Heat and Moisture Control in Buildings

*Melanie T. Fauchoux, PhD Student*  
University of Saskatchewan  
<http://www.engr.usask.ca/dept/mee>  
[melanie.fauchoux@usask.ca](mailto:melanie.fauchoux@usask.ca)

*Carey J. Simonson, PhD, PEng*  
University of Saskatchewan  
<http://www.engr.usask.ca/dept/mee>  
[carey.simonson@usask.ca](mailto:carey.simonson@usask.ca)

*David A. Torvi, PhD, PEng*  
University of Saskatchewan  
<http://www.engr.usask.ca/dept/mee>  
[david.torvi@usask.ca](mailto:david.torvi@usask.ca)

**KEYWORDS:** HVAC, heat and moisture transfer, experimental testing, radiant ceiling panel, porous membrane, indoor relative humidity, test facility design.

## **SUMMARY:**

*Radiant ceiling panels have been shown to be an effective alternative to all-air systems to maintain the operative temperature in a space. Radiant panels use water flowing through pipes to transfer heat by convection and radiation to maintain the indoor temperature. When radiant panels are used the flow rate of supply air can be drastically reduced as the flow rate only needs to meet ventilation and latent load requirements. This saves energy, capital costs and space as the size of fans and ductwork can be reduced. A disadvantage of using current radiant ceiling panel technology is the lack of control of the latent load in the space.*

*The aim of this research is to create a new ceiling panel that can transfer both heat and moisture to maintain temperature and relative humidity (RH) in a space. The newly designed heat and moisture transfer panel (HAMP) will be constructed from a porous membrane and contain a flowing aqueous salt solution. This will allow for moisture transfer between the panel and the space air, helping to maintain the RH levels in the space.*

*This paper focuses on the design of the new experimental test facility and preliminary results obtained from the experiments. The test facility delivers air at a desired RH past the HAMP. The temperature and RH of the air before and after the HAMP are measured, as well as the temperature of the liquid in the HAMP. Initial tests are performed with stationary water, with and without a porous membrane. The preliminary data presented in this paper show that the test facility is functioning properly and can be used to measure heat and moisture transfer between flowing air and the HAMP.*

## **1. Introduction**

When designing heating, ventilating and air conditioning (HVAC) equipment for buildings, it is important to consider the comfort of the occupants in the building. Occupant comfort is mainly affected by the operative temperature of the space, but can also be affected by other aspects, such as RH of the air and air velocity. All-air systems supply air that has been heated or cooled, to control the temperature of the space. To meet the ventilation requirements of ASHRAE Standard 62 (2007), a portion of this supply air must come from outdoor air. In some cases, the supply air may consist of only 10-20% outdoor air, while the rest is return air from the building. This mixed air is then heated or cooled to the desired temperature before being supplied to the space by large fans. Heat and moisture are transferred to the space air from the conditioned supply air. These systems can consume large amounts of energy through heating, cooling and fan power. One alternative to an all-air system is radiant panels.

Radiant ceiling panels respond quickly to load changes and are used for both heating and cooling, which makes them ideal for large commercial spaces. The lightweight metal panel is attached to a series of pipes through which heated or chilled water is pumped. The temperature in the space is maintained through heat transfer by a combination of radiation and convection as opposed to convection only, as in all-air systems.

Since space heating and cooling is accomplished by transporting water through pipes in the radiant ceiling panel, the amount of air supplied to the space can be reduced to meet ventilation and dehumidification requirements. With a smaller amount of supply air necessary, the size of the ducts and fan used to supply the air can be scaled down. In new constructions, the smaller ducts allow smaller plenums and overall building cost savings. Smaller fans reduce the total fan power, as well as the noise associated with the fan. The use of radiant ceiling panels also reduces drafts in the space because of the lower airflow rates (ASHRAE, 2004).

Many researchers have studied the applications of radiant cooling panels. Vangtook and Chirarattananon (2006) performed experiments on a test room equipped with a radiant cooling panel on the ceiling and one on the western wall, located below a window. The results from the experiments were compared with a computer simulation program that was used to calculate comfort levels of the occupants. The results show that a radiant panel can be used to achieve thermal comfort in hot and humid climates.

Kim et al. (2005) performed field measurements on an office in Japan. They used a Computational Fluid Dynamics model to analyze the indoor environment of the office for three cases: cooling panel with all-air system for ventilation, all-air cooling system and cooling panel with natural ventilation. In all cases, the latent load was ignored. The results of this research show that more radiant heat is transferred between a cooling panel and a human than an all-air system. They also found that the cooling panel system kept the mean radiant and operative temperatures lower than the all-air system.

Imanari et al. (1999) performed experiments to determine the effect of radiant ceiling panels on thermal comfort, compared to an all-air system, in a meeting room. An air-handling unit was used to meet the latent load and provide ventilation during the tests with the ceiling panels. The experiments were performed with human subjects who were present in the room for at least one hour and given a questionnaire to fill out about their comfort. They found that the radiant panels created a more comfortable work place than an all-air system for both genders. They also found that the mean radiant temperature of the space was lower, there was a smaller vertical temperature gradient in the space and the mean air velocity was lower. All of these factors improved the comfort of the occupants and resulted in a smaller percent dissatisfied with the radiant panels. They also performed numerical simulations to determine the energy consumption of the radiant panels. From these simulations, they found that the air transport energy was reduced by 20% and the total energy consumption was reduced by 10%.

Brunk (1993) also found that total energy consumption was reduced with the use of radiant ceiling panels, as compared to a variable volume system. It was found that electrical power requirements for fans and pumps decreased by 36%. The total energy cost was reduced by 22% when using radiant panels with displacement ventilation and by 30% when using radiant panels with ceiling-mounted air outlets. The results also showed that cooling ceilings with high radiation effects and low temperature differences between the cooling medium and the cooling surface could provide high indoor comfort levels.

Although there are many advantages to using radiant ceiling panels, one major disadvantage is that they only handle the sensible heating and cooling loads. This means that the dehumidification of the space still needs to be controlled with the supply air. This work focuses on the development of a ceiling panel that can transfer latent energy as well as sensible energy. The work presented in this paper is the first phase of this research: the design of a new test facility to measure the heat and moisture transfer across such a panel.

The second phase of this project will be to create a numerical model of the panel. This model will then be validated using the experimental results obtained from this testing facility. The final stage of the project is to integrate this model with the commercial building energy software package TRNSYS. TRNSYS will be used to model an office building in order to determine the effect of this panel on the indoor RH, occupant comfort and overall energy consumption. The simulations will be run using weather data for different locations to compare the performance of the panel in different climates.

The new heat and moisture transfer panel (HAMP) is similar to existing radiant panels, except that the panel surface will be made of a porous membrane that is permeable to water vapour but impermeable to liquids. The liquid media that will flow over the membrane will be a salt solution. Salt solutions have lower surface RH and

vapour pressure than water at the same temperature. If the vapour pressure of the salt solution is higher than that of the air, moisture will be transferred to the air, and if the vapour pressure of the salt solution is lower, moisture will be removed from the air. This will allow the HAMP to humidify or dehumidify the air. As with the existing panel, temperature of the liquid entering the HAMP can also be controlled. By creating the panel in this manner, both heat and moisture transfer will occur, thus conditioning the air in the space to acceptable temperature and RH levels.

## 2. Test Facility

The test facility that is described here was created to test the HAMP. The main part of the facility is the test section, which consists of an acrylic tray that is 0.23 m by 0.23 m and 0.03 m deep. It can be used with open water (Fig 1a) or with a porous membrane (Fig 1b). There are four baffles attached to the bottom of the tray. The baffles are 0.006 m wide and are the same height as the tray. The baffles ensure that the liquid media flows well through the tray during tests with moving water. They also help with securing the membrane to the tray as the membrane is glued to the top of the tray, as well as the top of the baffles.

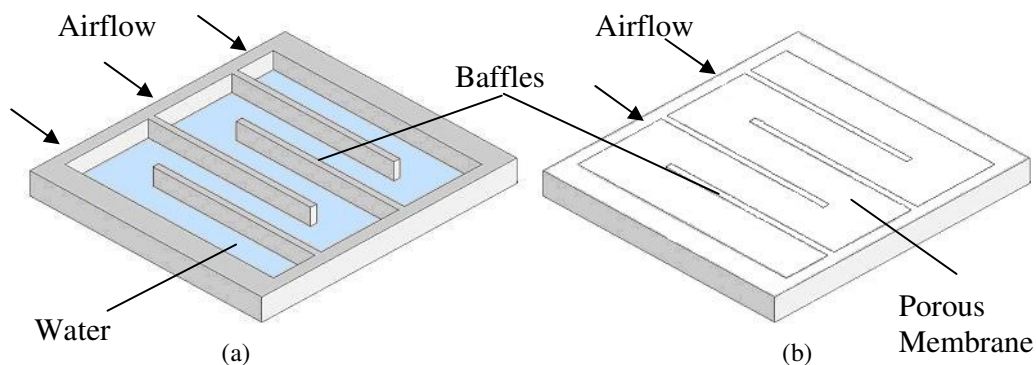

Figure 1. Schematic of the acrylic tray (a) with open water and (b) with a porous membrane.

In order to test the HAMP upside down, an acrylic top was created for the tray. Figure 2 shows the tray and top as they will be oriented for (a) flow over the HAMP and (b) flow under the HAMP. The top has the same dimensions as the tray so that the whole section may be turned upside down with ease. This is necessary so that no alterations have to be made to the ductwork between tests. The section is simply turned upside down to test in the other orientation. The tray and the top are fitted together with pins and taped with aluminum tape to ensure that no air or water passes through the seam. The porous membrane is glued to the top of the tray and is pinched between the tray and the top when in use. This ensures the membrane is affixed tightly to the tray and minimizes the deformation of the membrane due to the weight of the water when the HAMP is turned upside down. The test section was insulated with 0.025 m thick insulation.

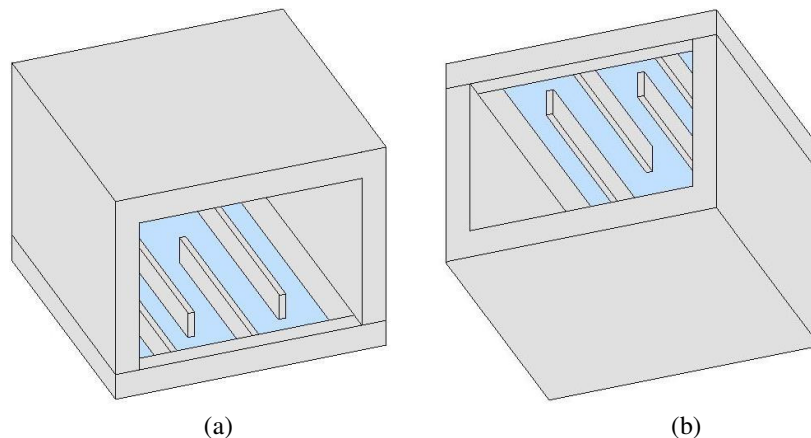

Figure 2. Schematic of the acrylic tray and top with airflow (a) over the tray and (b) under the tray.

The air that passes over/under the HAMP is compressed air, which is initially dried to approximately 4% RH. The flow rate of the air is controlled by a mass flow controller. The desired flow rate is set by the user on the computer. The compressed air is humidified by passing some of the air through water tanks. By controlling how much air goes through the tanks, and how much is bypassed around the tanks, the RH of the mixed air can be set to the desired level. For the experiments presented here, the entering air was not humidified.

Once the air has been conditioned to the desired RH and temperature, it enters the entrance chamber, seen in Figure 3. The entrance chamber is comprised of several parts, all made of galvanized steel. The dimensions of each part are shown in the schematic. The air enters through a hose with a diameter of 0.05 m and then goes through an expansion into a 0.1 m diameter pipe. The pipe is connected to a diffuser with an area ratio of 27.0 and an included angle ( $2\theta$ ) of approximately  $10^\circ$ . The diffuser contains three screens located as shown in Figure 3. The placement of each screen was calculated based on equations found in Mehta (1979). The screens have an open area ratio of 0.45. After the diffuser, the air passes into a settling chamber. The settling chamber is filled with coroplast, a corrugated plastic. When several sheets are stacked together, they resemble a honeycomb. Both the screens and the settling chamber are used to help straighten the flow and ensure there is no flow separation in the tunnel.

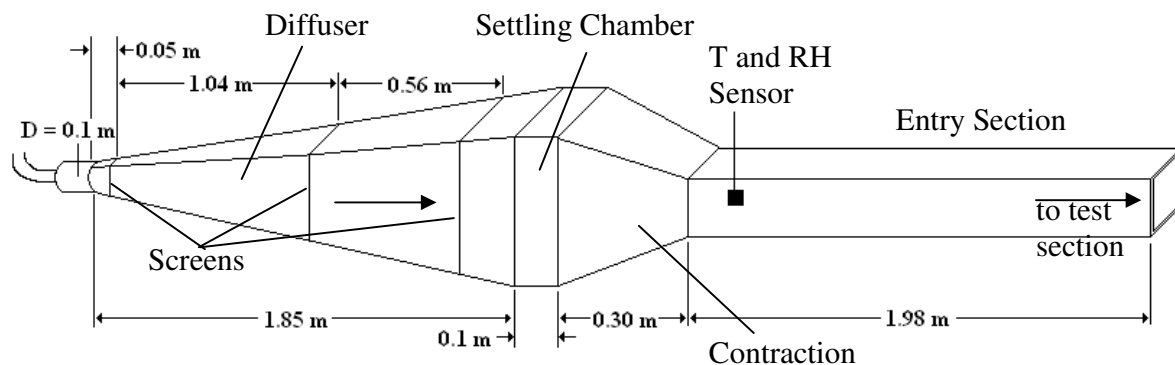

Figure 3. Schematic of the entrance chamber, prior to the test section.

After leaving the settling chamber, the air enters a contraction to bring the air down to the desired cross-sectional area of 0.15 m high by 0.23 m wide. This height was chosen so that the height of the airflow in the test section would be large enough to resemble the actual situation in the field (a ceiling panel in a room), but small enough so that the temperature and RH gradients across the height are small. This enables the user to take one measurement of the bulk air temperature or RH. The geometry of the entrance chamber was chosen based on guidelines provided by Mehta (1979). After passing through the contraction, the air enters a long straight section, with a hydraulic diameter of 0.18 m. This entry section is used to ensure the flow is fully developed. Based on flat plate boundary layer theory the entry section should be 0.70 m long for laminar flow and 2.4 m long for turbulent flow, to ensure the boundary layers in each direction have merged. This is taken as an approximate value as the boundary layers will develop faster in a rectangular duct than on a flat plate, due to

interference from the other sides and corners. A generally used rule of thumb to ensure fully developed flow in a long straight section is that the length is greater than ten times the hydraulic diameter (Idelchik, 1986). After considering this, the chosen length was deemed adequate. After leaving the entrance chamber, the air enters into the test section, which was described above.

Once the air has passed over/under the HAMP it passes into the exit section, shown in Figure 4. This consists of a straight section and a nozzle. The purpose of this section is to mix the air exiting the test section and allow the measurement of the bulk temperature and RH at the end of this section. The nozzle funnels the flow into a jet as it leaves the exit section to prevent any re-circulation of the air. These pieces are also made of galvanized steel.

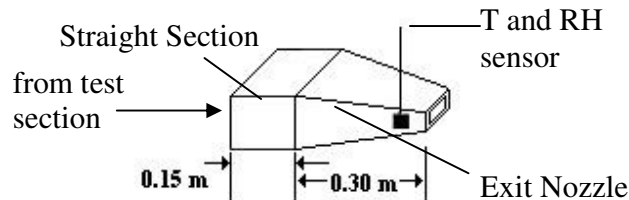

Figure 4. Schematic of the exit section of the test facility.

The airflow rate is controlled using a Type 1559A Mass-Flo<sup>®</sup> Controller (MKS, Massachusetts, USA), with a range of 23.6 L/s. The controller has an accuracy of  $\pm 1.0\%$  of the full scale measurement. The temperature and RH of the air are measured upstream (1.73 m before the test section) and downstream (0.41 m after the test section) using HMP233 sensors (Vaisala, Helsinki, Finland). The sensors use a HUMICAP<sup>®</sup> sensor, which contains a thin polymer film that absorbs water molecules. As water molecules are absorbed, the capacitance changes and the RH is determined. The sensors have a measuring range of  $-40^{\circ}\text{C}$  to  $80^{\circ}\text{C}$  and 0 - 100% RH and an accuracy of  $\pm 0.1^{\circ}\text{C}$  and  $\pm 1\%$  RH (for the range 0-90% RH). The RH sensors are calibrated using a humidity generator (Thunder Scientific Corporation, New Mexico, USA) which has an accuracy of  $\pm 1\%$  RH. The temperature of the water is measured using five T-type thermocouples. The thermocouples are calibrated using a 9107 dry cell (Hart Scientific, Utah, USA) which has an accuracy of  $\pm 0.1^{\circ}\text{C}$ . All information is collected using a SCXI 1000 chassis (National Instruments, Texas, USA) connected to a 16-bit data acquisition card. The experimental data is recorded using LabView<sup>®</sup> 7.1 (National Instruments), which is a graphical development software package. This program continuously displays measurements and records them to a text file every 10 s.

### 3. Data Analysis

Preliminary experiments were conducted during the commissioning of the test facility. To determine if the facility is functioning properly mass and energy balances will be performed on the test results. If the mass and energy balance within an acceptable margin of error, the facility is working properly. If they do not balance it is possible that the facility contains some leaks. The test section was first tested using a tray full of water, but no membrane. Tests were performed at two different Reynolds numbers ( $Re$ , based on hydraulic diameter), 940 and 5240, which result in airflow rates of 2.8 L/s and 13.9 L/s, respectively. Three tests were performed at a  $Re$  of 940 and four at a  $Re$  of 5240. Two tests were also run with a membrane at a  $Re$  of 940. Table 1 shows the time average inlet and outlet air temperature and RH for each of the tests. Figure 5 shows the upstream temperature and RH of the air throughout the experiment, for both  $Re$ . The inlet conditions remained relatively constant throughout the tests, with the temperature varying  $0.5^{\circ}\text{C}$  and the RH varying 1% RH.



Table 1. Average temperature and RH Measurements Made During Tests With and Without Membrane.

Reynolds Number	Test Number	Inlet Temp (°C)	Inlet RH (% RH)	Outlet Temp (°C)	Outlet RH (% RH)
<b>Without Membrane</b>					
940	1	21.0	5.7	20.3	40.1
940	2	21.1	7.2	20.6	41.7
940	3	20.9	5.1	20.6	40.1
5240	1	21.2	5.1	20.4	16.7
5240	2	21.4	4.7	21.0	10.6
5240	3	21.5	4.5	21.0	13.2
5240	4	20.9	5.2	20.6	13.1
<b>With Membrane</b>					
940	1	20.0	7.7	19.7	34.4
940	2	19.7	6.9	19.5	32.4

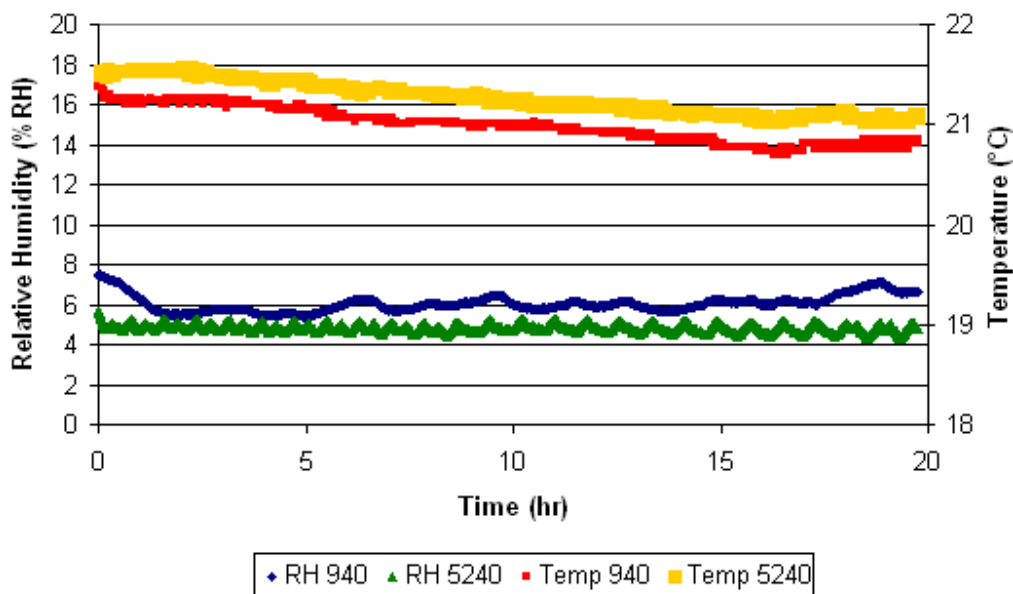

Figure 5. Upstream air temperature and RH for test 1 with Reynolds number of 940 and 5240.

The initial temperature of the water in the different channels ranged from 18.4°C to 19.0°C, for a Re of 940 and from 20.3°C to 21.1°C for a Re of 5240. Figure 6 shows the temperature of each thermocouple through the first test, for a Re of 940. The initial temperature difference between the thermocouples decreases as the time increases. Eventually, the temperature of each thermocouple reaches a steady state value of approximately 17.9°C. In the higher Re test, the water reaches a steady state value of 17.3°C. In the test with the membrane, the water reaches a steady state value of 17.0°C. The time that the experiment takes to reach steady state is determined by the temperature of the water. When this temperature stops changing, steady state has been achieved. From these tests it appears that steady state is achieved after approximately 12 hours for the Re, 17 hours for the higher Re and 13 hours for the test with the membrane.

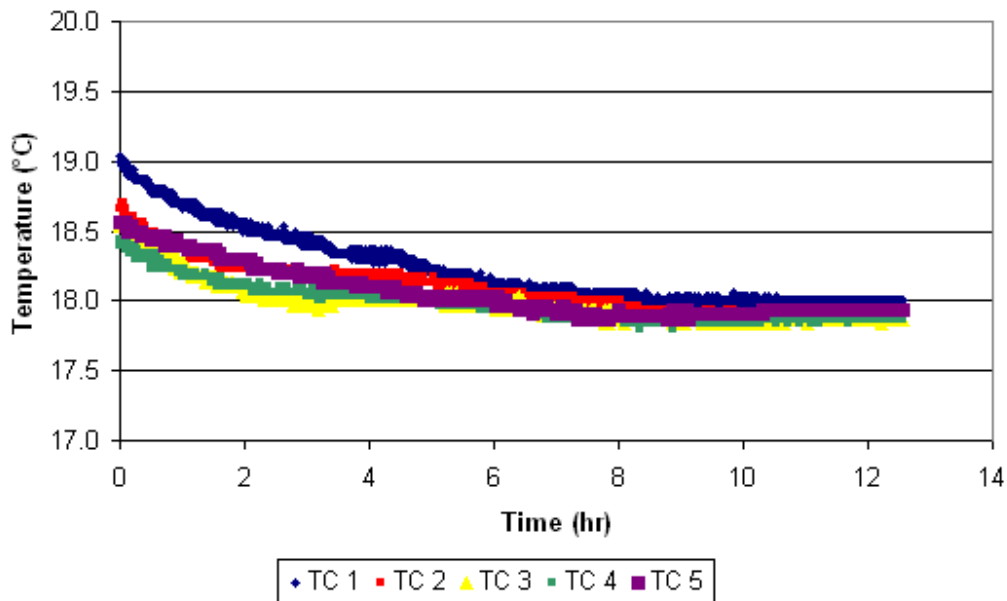

Figure 6. Temperature of the water measured by the five thermocouples, for a Reynolds number of 940.

The change in RH across the test section can be seen in Figure 7, for each of the three conditions. The average change in RH throughout the low Re tests is an increase of 34% RH. The high Re tests have a lot of scatter at the beginning, but the average change in RH throughout most of the tests is 7% RH. The average change in RH for the test with the membrane is about 26% RH. The tests with open water resulted in a decrease in the water level of approximately 2mm. When the membrane was attached it was not possible to tell the height of the water, but to fill the tray back up to the level of the membrane required 70 mL of water to be added. It can be seen from the graph that with a low Re the air is able to pick up more moisture than with a high Re. The air picks up less moisture when the membrane is used, then when it is not used, for the same Re.

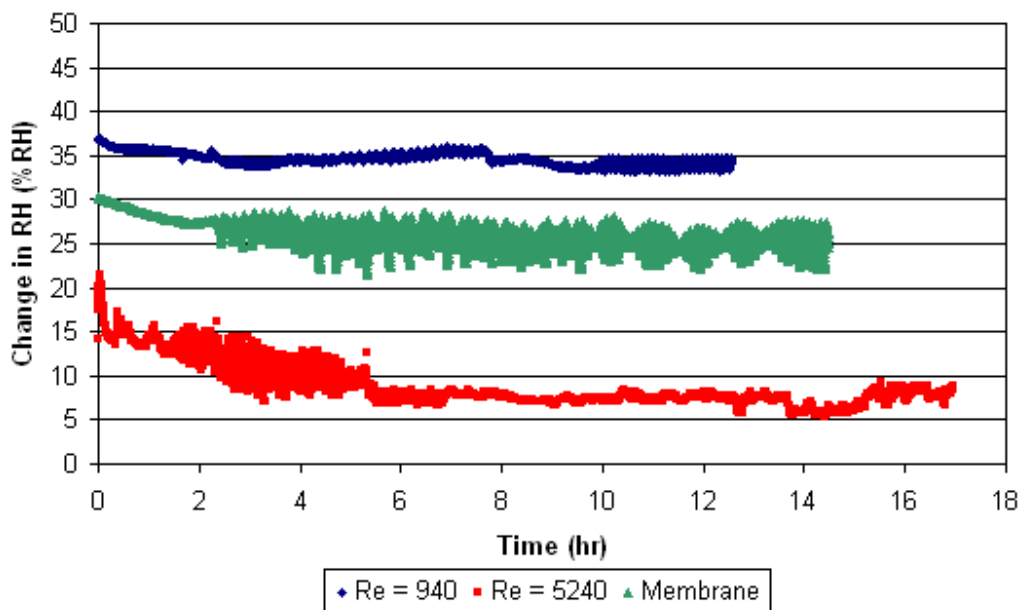

Figure 7. Difference in Relative Humidity across the HAMP for all three test conditions.

To ensure that the facility is working properly mass and energy balances are performed. For the mass to balance, the mass of water removed from the tank (determined by measuring the change in volume) should be equal to the amount of moisture added to the air. The mass balance agrees to within 5% for the tests with Re of 940 and 5240. The mass balance for the membrane tests agrees to within 15%. This is good agreement for the open water tests. The tests with the porous membrane do not agree so well. More work needs to be put into securing the membrane to the tray to ensure no leakage occurs. The energy balance shows that the change in temperature of the airflow corresponds with the phase change energy required to evaporate the water. The energy balance agreed within 5% for all tests. Since the mass and energy balances agree within reasonable error, it can be concluded that the test facility is operating correctly.

#### 4. Conclusions and Future Work

This paper outlines the design of a new test facility used to measure the heat and moisture transfer between flowing air and the newly proposed heat and moisture transfer panel. In the facility, air at a known temperature and RH passes over/under the panel. Moisture and heat are transferred between the liquid in the panel and the air stream to change the RH and temperature of the air downstream of the test section. Preliminary tests have been performed in the commissioning of this facility. Air at room temperature and low RH is passed over a tray full of water. As the air passes over the water, moisture is removed and humidifies the air. The temperature of the water drops approximately 2°C throughout the test. When the water reaches a constant temperature, the test has reached steady state conditions. This occurs after 12 hours for Re of 940, after 17 hours for a Re of 5240 and after 13 hours for a Re of 940 when a porous membrane is used. The RH of the air increased an average of 34% RH for the lower Re, an average of 7% RH for the higher Re and an average of 26% RH when a membrane was used. Mass and energy balances were performed and all agreed within reasonable error. This means that the facility is functioning as expected and can be used to further test the HAMP.

To determine the heat and moisture transfer coefficients of the HAMP further tests will be run, with a flowing salt solution instead of stationary water. The salt solution will be heated or cooled to simulate both heating and cooling conditions. In these cases more heat transfer is expected than was found in the tests reported here. To date all of the current tests have been run with the HAMP on the bottom of the test section, but future tests will place the HAMP upside down, on the top of the test section, as a ceiling panel would be used. Tests may also be possible in the vertical position to represent a wall panel. After testing is completed, a numerical model of a HAMP will be created and verified with the experimental results obtained. Simulations will be created in TRNSYS to determine the effect of the panel on indoor air RH, occupant comfort and energy consumption.

#### 5. References

- ASHRAE (2004). ASHRAE Handbook – HVAC Systems and Equipment, SI ed., American Society of Heating, Refrigerating and Air-Conditioning Engineers, Inc., Atlanta, Georgia, USA, Chapter 6.
- ASHRAE standard 62.1-2007. Ventilation for Acceptable Indoor Air Quality, American Society of Heating, Refrigerating and Air-Conditioning Engineers, Inc., Atlanta, Georgia, USA.
- Brunk M.F. (1993). Cooling ceilings - an opportunity to reduce energy costs by way of radiant cooling, *ASHRAE Trans.*, Vol. 99, No. 2, 479-487.
- Idelchik I.E. (1986). Handbook of Hydraulic Resistance, 2<sup>nd</sup> ed., Hemisphere Publishing Corporations, New York, New York, USA, Chapter 4.
- Imanari T., T. Omori and K. Bogaki (1999). Thermal comfort and energy consumption of the radiant ceiling panel system. Comparison with the conventional all-air system, *Energy and Buildings*, Vol. 30, 167-175.
- Kim T., S. Kato, S. Murakami and J. Rho (2005). Study on indoor thermal environment of office space controlled by cooling panel system using field measurement and the numerical simulation, *Building and Environment*, Vol. 40, 301-310.
- Mehta R.D. (1979). The aerodynamic design of blower tunnels with wide-angle diffusers, *Progress in Aerospace Sciences*, Vol. 18, 59-120.
- Vangtook P. and S. Chirattananon (2006). An experimental investigation of application of radiant cooling in hot humid climate, *Energy and Buildings*, Vol. 38, 273-285.

# Possibilities for redevelopment of slope roof constructions

*Florian Nöske, M.Eng.*  
*Fraunhofer-Institute for Building Physics;*  
[florian.noeske@ibp.fraunhofer.de](mailto:florian.noeske@ibp.fraunhofer.de)

*Andreas Holm, Dr.-Ing.*  
*Fraunhofer-Institute for Building Physics;*  
[andreas.holm@ibp.fraunhofer.de](mailto:andreas.holm@ibp.fraunhofer.de)

*Klaus Sedlbauer, Dr.-Ing., Professor*  
*Fraunhofer-Institute for Building Physics;*  
[klaus.sedlbauer@ibp.fraunhofer.de](mailto:klaus.sedlbauer@ibp.fraunhofer.de)

*KEYWORDS: technology, redevelopment, slope roof, demonstration center*

## *SUMMARY:*

*The restoration of an old building is a challenge for building-owners, planers and any firm involved in the realization of renovation. A variety of constructional solutions is offered in the field of slope roofs. The Fraunhofer-Institute for Building Physics makes the broad public to understand hygrothermal processes by means of 6 different slope roof constructions. A demonstration center was established for this purpose, where this complex topic is explained to visitors in various ways. Knowledge transfer avoids constructional defects already in the phase of placing orders and working out the design.*

## **1. Introduction**

Demand for living room is growing continuously. Increased wealth is expressed by higher living space per person. The statement of higher prices for estate and a great amount of old buildings forces builders to think about the loft. Meanwhile there is a great variety of possibilities to redevelop the loft. Insulation under rafter, between rafter, on top of rafter, diffusion, moisture barriers, ecological and conventional materials of insulation are important factors for builders, architects, carpenters and the building industry. The Fraunhofer-Institute for Building Physics in collaboration with associations of carpenters realized these topics in a new research and demonstration center for roof construction. The demonstration center stands for knowledge transfer. It is intended to sensitize all groups participating in loft construction for the accurate application of materials and to promote communication.

## **2. Objectives of the demonstration center**

The center is an institution to obtain information, addressing a great number of visitors and offering a variety of topics. The center gives explanations of all terms relevant in building physics. The actual discussion on energy savings is only a section of the total field of construction. The demonstration center shows all possible roof structures, various materials and their accurate application. The exhibition encourages builder-owners to carry out energetic redevelopment of roofs as well as supports companies in charge to avoid characteristic constructional defects. Moreover, the center offers opportunity for mutual contact, the exchange of desires and opinions and further proceeding and realization. In the best possible way, the exhibition brings together builder-owners and the respective specialized firms resulting in cooperation.

### 3. The object as demonstration center

A roof structure of 1907 was selected as object for redevelopment for the demonstration center. With a roof slope of 48° it was especially appropriate to demonstrate the redevelopment of the loft as living space.

TABLE. 1: Further characteristics of the roof structure in old buildings in regions of Central Europe

used wood	spruce
type of roof	hipped roof
roof construction	purlin roof structure
rafters	12 x 10 cm
offset of rafters	64 – 76 cm (irregular)
interior purlin	15 x 18 cm
roofing	plain roof tiling
boarding	20 mm
2. water-bearing layer	bituminised felt
lathing / counter lathing	48 x 28 mm
battens offset	16 cm

The object was an undeveloped and unheated roof, used as store room, as is often the case concerning old buildings. The existing bitumen sheet may be assessed as accurate vapour barrier (Künzel 2003), similar to sheet or slate roof coverings. The demonstration center is conveniently situated for public transport, close to the suburban railway station in the south east of Munich/Bavaria.



(1)



(2)

Fig. 1: view of the roof structure (1) – outside view of slope roof (2)

### 4. Variations for redevelopment

Six variations are represented in the demonstration center as examples for possible redevelopment or renovation of the roof structure. The respective building physical effect is measured and investigated by means of measurement probes. The selection of the variations is performed according to the state-of-the art as well as to the markable constructions of tested renovations. Besides the conventional roof systems, innovations are also presented. The materials are restricted to the products and desires of sponsors.

#### 4.1 Variation 1: Inter-rafter insulation

This variation of roof structure is supposed to be the most traditional. But it has only low thermal insulation. It is easy to handle and frequently represents the do-it-yourself variation for builder-owners. The German Energy Conservation Regulations (Deutsches Institut für Normung 2007 = German National Standardisation Organisation) supports this variation very much by special provision. Even if it does not fulfil the requirement of a minimum value of  $u = 0,3 \text{ W/m}^2\text{K}$  due to inadequate thickness of the thermal insulation, it is allowed to be applied. The already existing roof structure remains the same and is only completed.

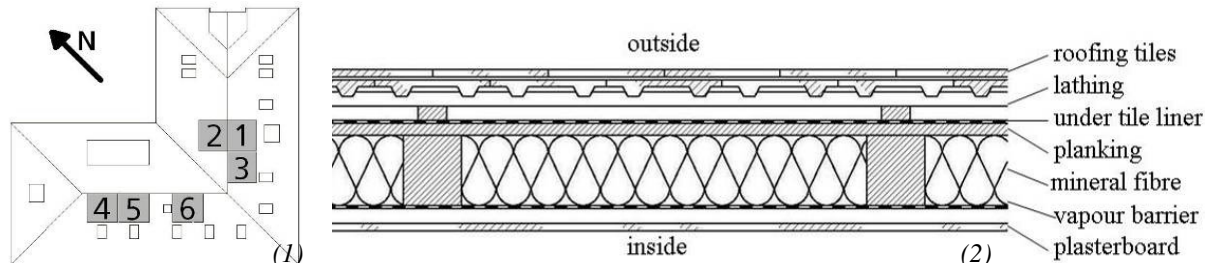

Fig. 2: top view of the position of the variations (1) and example for roof structure of variation 1 cross section (2)

Mineral fiber insulation was installed in the interior between the rafters. Then, the moisture-adaptive vapour retarder was installed over all rafters. It does not only guarantee moisture protection, but it is the simultaneous air-tight internal wall insulation. Interior lining was performed as lower construction with installation level and internal insulation with spring rails and plasterboard.

#### 4.2 Variation 2: Inter-rafter insulation with insulating suspended ceiling

External renovation was selected as the second variation: inter-rafter insulation with insulating suspended ceiling. In former years, roof structures in Germany frequently consisted of plastered wood-wool lightweight building board and sometimes thin thermal insulation behind. As the interior is already used and does not show any defects, external renovation by new roofing with tiles seems to be reasonable.

After removal of the tiles, of the substructure and the boarding with bitumen sheet the rafters became visible. It was reasonable to install a thin levelling insulation layer of mineral wool, to avoid that the next level consisting of the vapour barrier was damaged by nails or screws from inside thus causing defects. The moisture-adaptive foil was installed on the rafters. Then, the rafter fields were filled by hemp. The second water-bearing layer and the additional insulation consisted of a suspended ceiling board in form of a diffusion-open wooden board.



Fig. 3: Variation 2 under construction – open roof with boarding (1), vapour barrier over rafters (2), installation of hemp insulation (3)

#### 4.3 Variation 3: Inter-rafter insulation and insulation below the rafters

To optimize variation 1, an additional insulation layer was installed as insulation below the rafters (PUR insulation), thus complying with the actual thermal insulation standards (German Energy Conservation Regulations). This is the only way to achieve a  $u$ -value of below  $0.3 \text{ W/m}^2\text{K}$ . This variation shows a roof structure according to thermal insulation standards.

#### 4.4 Variation 4: Traditional insulation over the rafters

This variation shows an external insulation of the roof: traditional insulation over the rafters. This redevelopment solution demonstrates how precious living space may be preserved and decorative roof structures are completely visible. An additional building physical advantage is the fact that it is possible to achieve a thermal envelope almost free of any thermal bridges. Flexibility also remains due to the thickness of the insulation material and the resulting improvement of the u-value. Wood fiber insulation boards were selected as thermal insulation system. They were mounted on air-tight diffusion-open foils. Another foil was mounted beneath the roof tiles as second water-bearing layer.

#### 4.5 Variation 5: Innovative insulation over the rafters

In comparison to variation 4 only the thermal insulation system was modified. For the first time ever in the field of slope roof redevelopment and as an example to be stated, a vacuum thermal insulation panel system was installed. These panels are available in the standardized dimensions of 100x50x2cm. As the vacuum insulation panel (VIP) must not be damaged, it is impossible to mount the load-bearing lathing for roofing directly on them. Therefore, the panels (20mm) are mounted at the distance of the lathing. In the process, considerable thermal bridges occur, which can, however, be compensated by cross-wise covering by a second panel layer. The only thermal weak points are the knots of the battens construction (30x30mm).



*Fig. 4: insulation over the rafters – open roof structure (1), wood fiber insulation boards and vacuum insulation panels (2), completed roof structure (3, on the left: fields of insulation over the rafters)*

#### 4.6 Variation 6

Further energy savings and a reduction of the u-value require increasing costs. The thickness of the necessary thermal insulation material to keep thermal conductivity  $\lambda$  constant increases exponentially. To achieve the defined passive house standard ( $U < 0.15 \text{ W/m}^2\text{K}$ ), the thermal insulation structure must be designed to be at least 23 cm. But this variation requires enormous space. In this case, flax was used as natural fiber insulation material. Installation is similar to variation 1 and 3.

Three variations demonstrate renewable thermal insulation materials: wood fibres, hemp and flax in contrast to mineral fibres, PUR insulation and the application of innovative vacuum panels.

## 5. Measurements

Measurements were carried out for all variations. The parameters of temperature, air humidity, heat flow and wood humidity were measured. All in all, 120 measurement points are recorded in the demonstration center. The temperature is measured in the individual layers for any redevelopment variation. These measurements clearly show the energy transmission of the roof surface, allow the direct comparison of the variations.

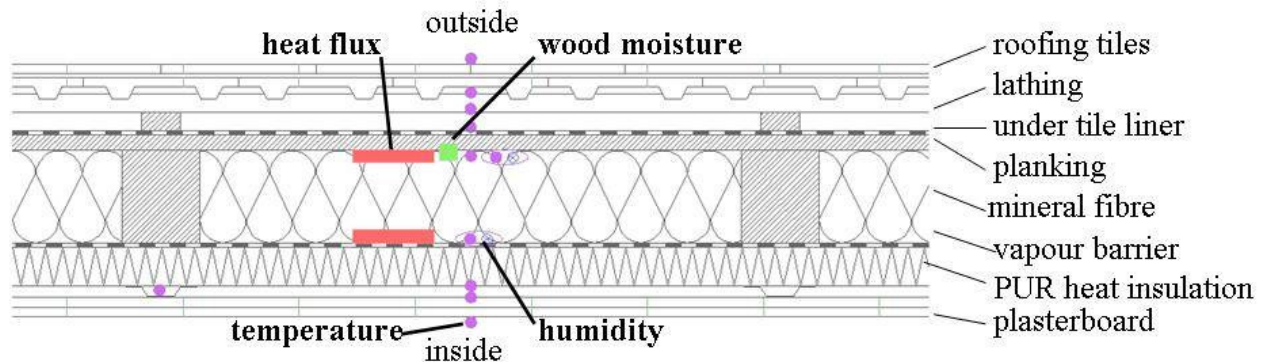

Fig. 5: example of the measurement plan of variation 3 in cross section

Sensors were installed between the individual working steps during construction, requiring mutual agreement and coordination of the trades involved in the realisation. The sensor cables were led to the interior in a bundle for acquisition of measurement data.

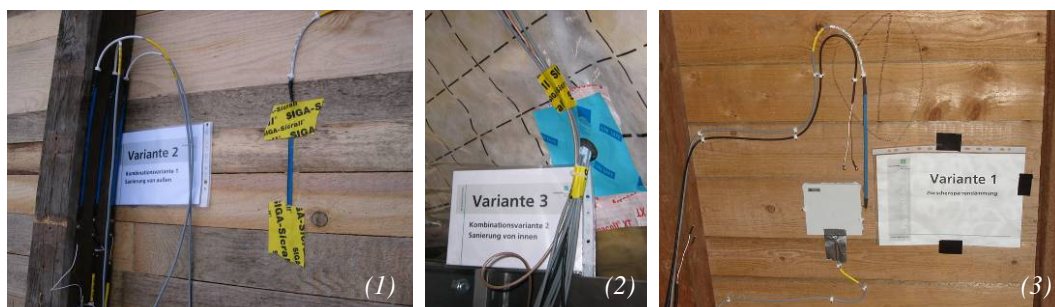

Fig.6: example of sensor installation – temperature sensors (1), penetration of vapour barrier (2), heat flow board and wood humidity sensors (3)

## 6. Technology transfer

The new premises allow the public an insight into the practice and research of construction, whereby the carpenter association delivers the state-of-the-art technology of this trade. As an umbrella organisation of carpentry it is well informed on procedures, backgrounds and desires of the craftsmen involved in realisation. The Fraunhofer-Institute for Building Physics is an ideal partner to contribute and impart the expertise of research.

### 6.1 Target audience

The demonstration center for the redevelopment of slope roof constructions was designed for the following target groups:

- handcraft enterprises of different guilds;
- apprentice in vocational training (carpenters, drywallers, roofers, joiners, plumbers and the like);



- student of a master class of craftsmanship;
- students of civil engineering (civil engineers, architects, technicians of building services, student of building physics and the like);
- private customers interested in construction, to be convinced that the redevelopment of a loft is reasonable and, if carried out by experts, of high quality.

## 6.2 Motivation of the visitors

To succeed in transferring expertise and achieving targets, it is important to know the motivation factors of the visitors. Expert information, building physical expertise and processes are significant for further education. Companies are seeking contact to potential customers. Builder-owners want to be informed on the possibilities of redevelopment, costs, procedures, risks and benefits. The demonstration center helps to reduce inhibitions and concern towards renovation. New methods of redevelopment are demonstrated.

## 6.3 Didactic means

In general, the showrooms are designed to be intelligible, close to practise and comprehensible. Experts are always present to answer detailed questions.

The demonstration center appears in public by the designation „FFZ-Dach“ as branding, standing for research and training center for the redevelopment of roof structures. The logo gives the concept a professional impression and is perceived in a uniform way.

Information flyers, press releases, media events and the website provide publicity and the acquisition of interested target groups.

The total construction phase is accurately documented in pictures and can be easily tracked by visitors. The individual renovation levels for each variation are recorded step by step. The installation of the measurement sensors is also documented. All in all, this documentation simplifies the understanding of the tasks and problems of redeveloping roof structures.

Abstract data from measurement value acquisition of all building physical parameters clearly explain processes of the correlations of humidity and temperature. They are represented by digital visualisation on monitors. The visitors can directly compare and assess several variations in this way. Actual measurement values, but also daily, weekly or monthly reviews are available. The advantages of a more intensive insulation, for example, are clearly visible concerning great temperature differences. This is also available via the Internet, yet in a restricted way. The Internet website, however, is intended to call attention to visit the demonstration center.

Posters and models on a 1:1 scale point out the critical points and connection details. Visitors are sensitized to potential constructional defects and the building physical understanding is trained. Standard cross-sections do not cause any problems, but connections and breakthroughs in the roofing.

The showrooms give a survey on any kind of insulation material, covering renewables as well as conventional materials. The whole spectrum of systems, already available on the market or under development, is considered. It is important in the process to consider the entire subsequent construction, the position of the vapour barrier as well as the water drainage.

The demonstration center offers various trainings on building physical topics, e.g. BlowerDoor, energetic considerations, thermal insulation in summer and winter, hygrothermal behaviour of building components. Specific questions on individual problems may be managed best in this way.

Visitors of the exhibition are offered audioguides, which guide them through the demonstration center within 30 minutes, explain each of the six variations, their specialties and structure, as well as critically discuss the material selection.

The visitors receive a 40-page catalogue of exhibition for sustainable information.

The demonstration center for the redevelopment of slope roof structures sees itself as partner in a network of demonstration centers in the field of construction. This allows the integrated knowledge transfer between slope roof and flat roof, renovation and new building, massive and wood construction, research and practice, university and craftsmanship, customer and industry, ecology and economy.

## 7. References

Construction phases of the demonstration center [Online] Available from: <<http://www.bauphase.blogger.de/>> [15.February 2008]

Deutsches Institut für Normung, D. Verordnung über energiesparenden Wärmeschutz und energiesparende Anlagentechnik bei Gebäuden (Energieeinsparverordnung - EnEV) \*. EnEV. 26-11-2007.

European Union. Directive 2002/91/EC of the European Parliament and of the Council (2002). Directive on the energy performance of buildings. 16-12-2002.

European Association of Insulation Manufacturers (EURIMA). The critical importance of building insulation for the environment. Avenue Louise 375, Box 4, B-1050 Brussels.

Forschungs- und Fortbildungszentrum Dach (FFZ Dach): Website of the demonstration center in the future <<http://www.ffz-dach.de>>

Künzel, H.M.(2003). Richtiger Einsatz von Dampfbremsen bei der Altbausanierung, WTA-Journal, Vol 1, München, Germany, p. 6-25.

Byggeskadefonden vedrørende Bygningsfornyelse (BvB): Another project in Denmark for redevelopment <[http://www.godetage.dk/asp/sadeltag\\_oversigt.asp?k=11&d=0](http://www.godetage.dk/asp/sadeltag_oversigt.asp?k=11&d=0)> [10.April 2008]



## Inverted compact sloped turfed roofs

*Hans Boye Skogstad, M. Sc.*  
*SINTEF Building and Infrastructure*  
[hans.boy.skogstad@sintef.no](mailto:hans.boy.skogstad@sintef.no)  
[www.sintef.no/byggforsk](http://www.sintef.no/byggforsk)

*Sivert Uvsløkk, M. Sc.*  
*SINTEF Building and Infrastructure*  
[sivert.uvsløkk@sintef.no](mailto:sivert.uvsløkk@sintef.no)  
[www.sintef.no/byggforsk](http://www.sintef.no/byggforsk)

**KEYWORDS:** *Turf, roof, mineral wool, thermal insulation, moisture, ice building, snow.*

### **SUMMARY:**

*Traditional sloped turfed roofs are recommended to be ventilated to avoid moisture damage and ice building on roof eaves.*

*The moisture content has been measured in the thermal insulation on three different holiday cottages with inverted compact sloped turfed roofs. The ice building and icicles on the roof on a continuous heated holiday cottage is studied through one winter.*

*The design thermal conductivity of the insulation board used in inverted compact turfed roofs is determined. The risk of ice building on compact sloped turfed roofs is calculated. The calculation is done for continuous heated buildings with different outdoor temperatures and different snow depth through one winter season.*

*The field study from Otta shows that conditions with stable low outdoor temperature results in a frozen turf layer through the winter season, even with a snow depth close to one meter on the roof. During such conditions the risk of ice building is very low.*

*For inland regions with stable cold climate during the winter, like Karasjok, Røros and Lillehammer, the calculations show that the snow depth has to be higher than approximately 0.5 m to give noticeably ice building, even though the thermal insulation has a thickness of just 150 mm. With 300 mm thermal insulation, the risk of ice building is eliminated according to the calculations.*

*In regions with average monthly mean temperatures a few degrees below zero, and a turf layer that is saturated with water and unfrozen when the snow starts falling, the calculations show that the risk of ice building is considerably higher. Such conditions combined with large snow falls will increase the risk of ice building. In such regions however mild weather might occur several times during the winter. Snow and ice will then melt and partly or fully disappear from the roof without any damaging ice building.*

## **1. Introduction**

Traditional sloped roofs are recommended to be ventilated both to avoid moisture damage and to keep the roof surface cold to avoid snow melting and ice building and icicles along the roof eaves. Snow melting and ice building along the roof eaves may dam up melt water and increase the risk of leakages through the roof covering. Ice building and icicles along the roof eaves may also damage the roof construction and ice can fall down and hurt people staying near the building.

A/S Rockwool has during the last ten years good experience with inverted compact sloped turfed roofs in Norway, called Rockwool Turfed Roof. Such roof design with outside rain gutter and drainpipe has in general not been recommended by SINTEF. A/S Rockwool engaged SINTEF to do laboratory testing, field studies and calculations to document their good experience with this special way of designing the roof.

## 2. Design of Rockwool Turfed Roof

Rockwool Turfed Roof is built up from top with turf, Rockwool RockTorv® insulation board of mineral wool, sheets for roofing of bitumen, plastic or rubber and in the bottom wooden board as ceiling as shown in FIG. 1. The RockTorv insulation board has high compressive strength, higher density in the upper layer and is special designed for the use in compact turfed roofs. The thermal insulation thickness in the roof on the cottages included in the field studies is 150 mm. In houses for living and in bigger cottages that are continuous heated, the roof thermal insulation thickness normally will be approximately 300 mm according to requirements in the building regulations.

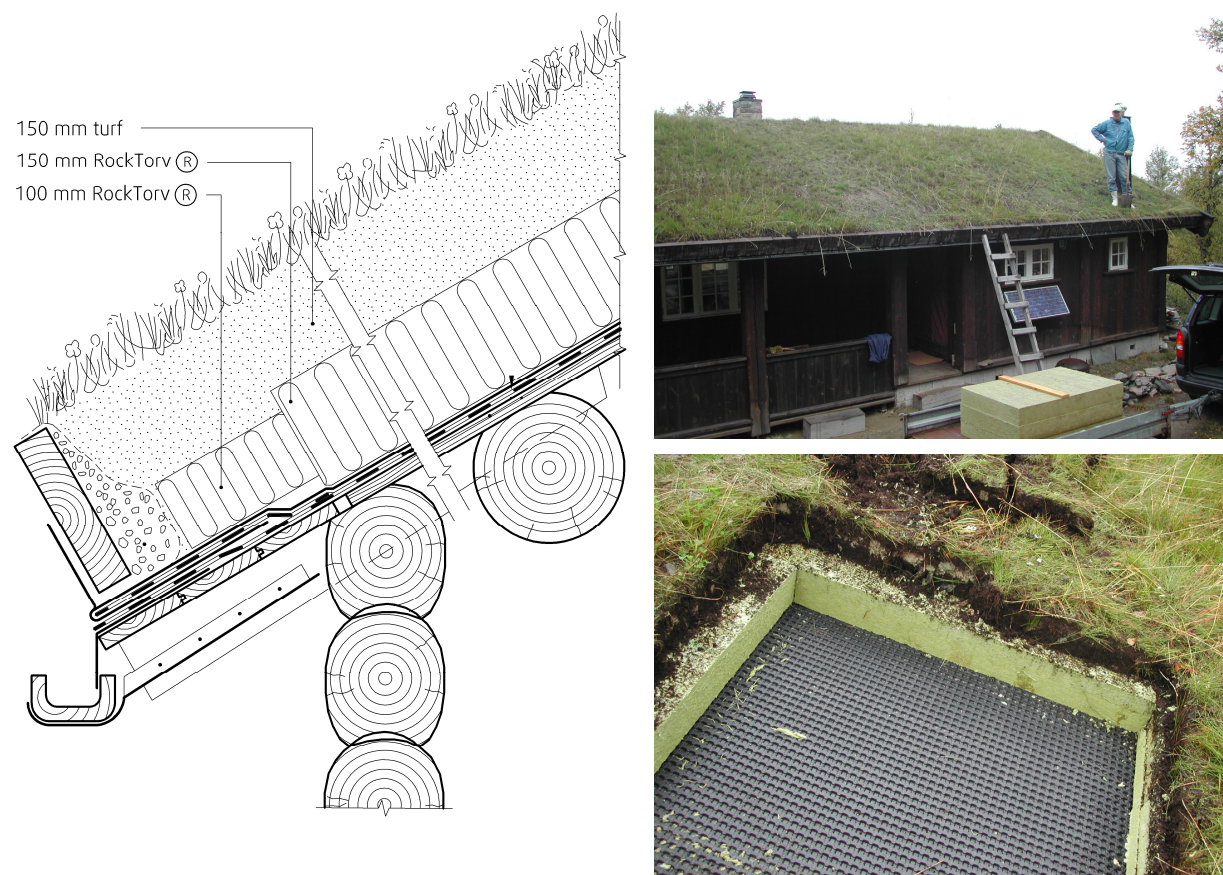

FIG. 1: Rockwool Turfed Roof.

## 3. Field studies

### 3.1 Moisture content in RockTorv insulation board

The moisture content in the RockTorv insulation board used in Rockwool Turfed Roof was measured on cottages with three different locations as shown in TABLE. 1. The moisture content was measured in thin layers of 10 to 40 mm thickness. The water absorption could be seen in a thin layer of approximately 1 to 5 mm in from the surface of the insulation board. The highest moisture content was measured on the upper side, directly under the turf, but also a thin layer along the underside had some higher moisture content than inside the insulation board.

TABLE. 1: Moisture content measured in the thermal insulation in three different Rockwool Turfed Roofs

Location weather conditions	Tolga, inland light rain last month	Otta, inland light rain last month	Grong, costal area heavy rain last 2 months
Roof slope	22	27	22
Year of construction	August 2002	October 2001	August 2002
Sampling date	August 2003	October 2003	October 2003
Average moisture content, m <sup>3</sup> /m <sup>3</sup>	0.002	0.001	0.014

### 3.2 Snow melting and ice building on roof eaves

The snow conditions and ice building on the roof of a continuous heated cottage is followed through one winter. The cottage is located in Otta with typical inland climate 860 meters above sea level. The roof was insulated with 150 mm RockTov insulation board, and the turf layer had a thickness of 150 mm.

The temperature and relative humidity were measured with Tinytag data loggers at several places both inside and outside the cottage. Indoor temperature near the ceiling and outdoor temperatures one meter above the turf and on the turf under the snow layer are shown in FIG. 2.

The snow depth was registered through weekly photos of the roof with rule sticks through the winter. FIG. 3 shows the roof with snow and the rule stics. The snow depth through the winter is shown in FIG. 4. The roof had a snow depth between approximately 0.6 and 1.0 meter most of the time during the winter.

The temperature on the turf under the snow layer was beneath the freezing point from the measurements started in December to approximately the 1<sup>st</sup> of April. In April and the first days of May, the temperature was zero degrees Celsius which indicates the period with snow melting. No ice building or icicles were observed on the roof eaves during the winter. This corresponds well with the calculations presented in 4.2 from Lillehammer when it is assumed that the turf is frozen before the snow starts covering the roof.

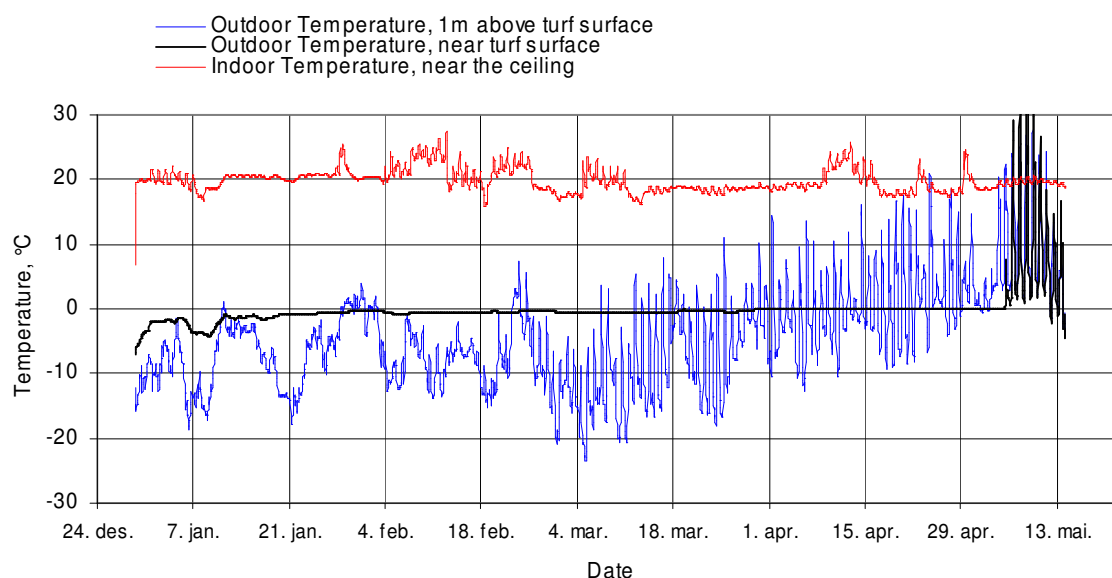

FIG. 2: Indoor and outdoor temperatures measured through the winter on the cottage in Otta. Outdoor temperatures are measured both near the turf surface and one meter above the turf surface.



FIG. 3: Rule sticks for measurement of the snow depth on the roof of the cottage in Otta. Picture is taken the 21<sup>st</sup> of January. Temperature sensor can be seen in top of the rule stick to the left.

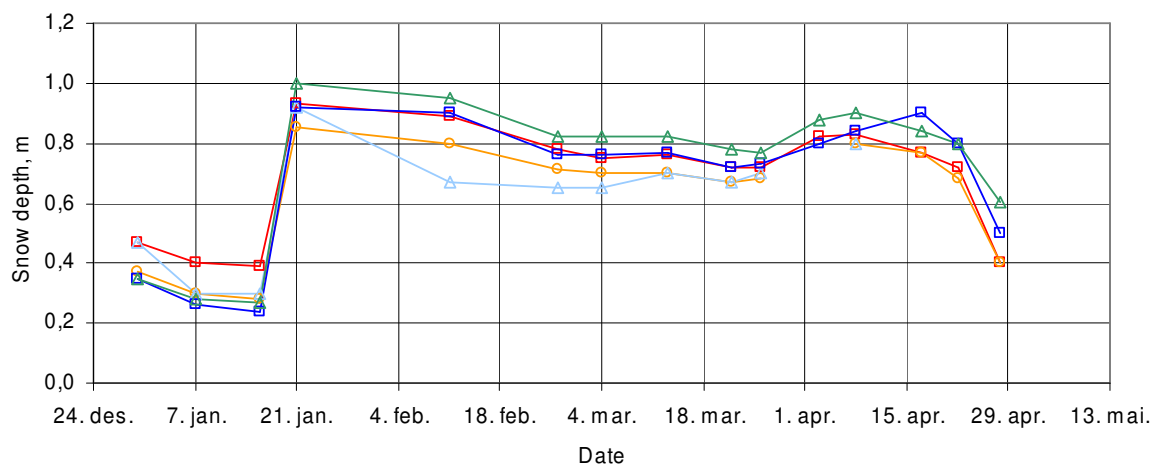

FIG. 4: Snow depth measured through the winter at five measuring points on the roof of the cottage in Otta.

## 4. Calculations

### 4.1 Design value of thermal conductivity

The declared thermal conductivity of RockTorv insulation board is  $\lambda_D = 0.037 \text{ W/(mK)}$ . The water vapour diffusion resistance factor is  $\mu = 1$ . Thermal conductivity as function of moisture content is calculated in accordance with EN ISO 10456:1999. Based on the moisture content measured in 3.2, the design value of thermal conductivity is assumed to be  $\lambda_d = 0.040 \text{ W/(mK)}$ .

## 4.2 Ice building on compact sloped turfed roofs

### 4.2.1 Calculation method

The calculation program used is a spread sheet based program developed for this project. It calculates steady state mass and heat transfer in insulated, non ventilated turf roofs including latent heat due to melting or freezing of ice and snow on the roof. Calculations have been performed for a heating season using monthly mean values of outdoor air temperature and constant indoor temperatures of twenty degrees Celsius. Calculated accumulated content of ice and water in the turf and ice on the roof eave for a month has been used as input values for the successive month.

The program calculates the thermal conductivity of the turf depending on both on the water content and the amount of ice in the turf. To simplify the study both the thickness and the density, and thus the thermal conductivity, of the snow layer on the roof has been kept constant during the months with monthly mean outdoor temperature beyond zero degrees Celsius.

The total capacity of water absorption in the turf layer will vary particularly with the type of turf used. Based on laboratory tests and information in "Frost i Jord" and from different turf producers, the total water absorption capacity in the turf layer is assumed to be 100 kg/m<sup>2</sup>. In the calculations presented in this paper, the free water absorption capacity in the unsaturated turf is set to 20 kg/m<sup>2</sup> when the snow starts covering the roof. 20 kg/m<sup>2</sup> is 20 % of the assumed total water absorption capacity. The calculations are done for a house with rectangular form with a length of twelve and a half meter and a width of ten meter. The roof slope is set to be thirty. The thermal conductivity of the materials in the roof construction is shown in TABLE. 2. Average monthly mean temperatures for the actual locations are given in TABLE. 3.

### 4.2.2 Calculation results

FIG. 5 shows maximum possible ice building on the roof eaves according to the calculation model. The calculation of possible ice building is done for monthly mean values of outdoor temperatures for the locations Karasjok, Lillehammer, Oslo and Kristiansand S. Calculations from Lillehammer and Kristiansand S is presented in the diagrams shown in FIG. 6 to FIG. 9. For each location the diagrams show possible ice building when the turf layer is unsaturated with a water absorption capacity of 20 kg/m<sup>2</sup> and for the two situations were the turf layer is frozen or unfrozen. As we can see of the diagrams, the risk of ice building is low when the turf layer is frozen before the snow starts covering the roof. The diagrams also show that the risk of ice building is particularly higher in Kristiansand S with a monthly mean temperature near zero degrees Celsius compared with Lillehammer were we have more stable cold winter climate.

In regions with stable low outdoor temperature during the winter, like Karasjok, Røros and Lillehammer, the calculations show that the snow depth has to be higher than approximately 0.5 m to give noticeably ice building, even though the thermal insulation has a thickness of just 150 mm. With 300 mm thermal insulation, the risk of ice building is eliminated according to the calculations.

The thermal insulation thickness, in real the thermal resistance of the roof construction, has great consequence for the risk of ice building. If the thermal insulation thickness is increased from 150 mm to 300 mm the calculated ice building is halved. If it at the same time is assumed that the turf is frozen before the roof is covered with snow, none of the calculations show ice building on the roof eaves.

TABLE. 2: Values for thermal conductivity used in the calculations. The thermal conductivity for the turf and snow is collected from "Frost i Jord".

Material	Thermal conductivity, W/(mK)
RockTorv insulation board	0.04
Turf, dry - unfrozen / water saturated - unfrozen / water saturated - frozen	0.06 / 1.6 / 1.9
Snow, density 200 kg/m <sup>3</sup>	0.15



TABLE. 3: Average monthly mean temperature in degrees Celsius for actual locations in Norway

Location	Average monthly mean temperature, °C							
	Oct	Nov	Dec	Jan	Feb	Mar	Apr	May
Karasjok	-1.3	-9.4	-15.3	-17.1	-15.4	-10.3	-3.1	3.8
Røros	1.7	-5.2	-9.1	-11.2	-9.7	-5.6	-0.7	5.6
Lillehammer	3.6	-2.7	-7.3	-9.3	-8	-3	2.2	8.8
Oslo	6.3	0.7	-3.1	-4.3	-4	-0.2	4.5	10.8
Kristiansand S	8.1	1.9	0.5	-0.9	-1.2	1.6	5.2	10.3

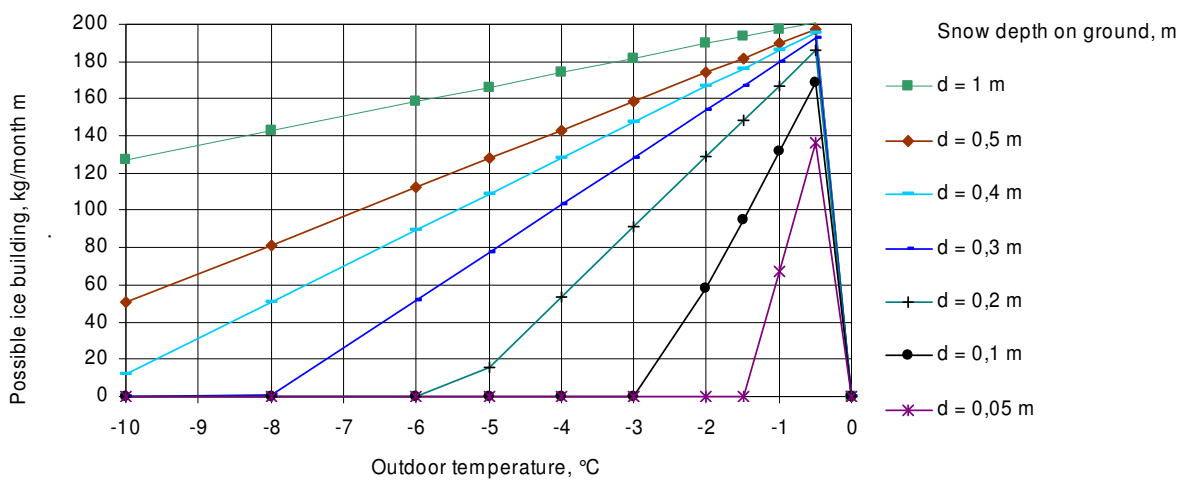

FIG. 5: Calculated maximum possible ice building on roof eaves dependent on snow depth and outdoor temperature. Insulation thickness is 150 mm. The turf's possibility to absorb melt water and the heat capacity in a frozen turf layer is not taken into consideration in the calculation.

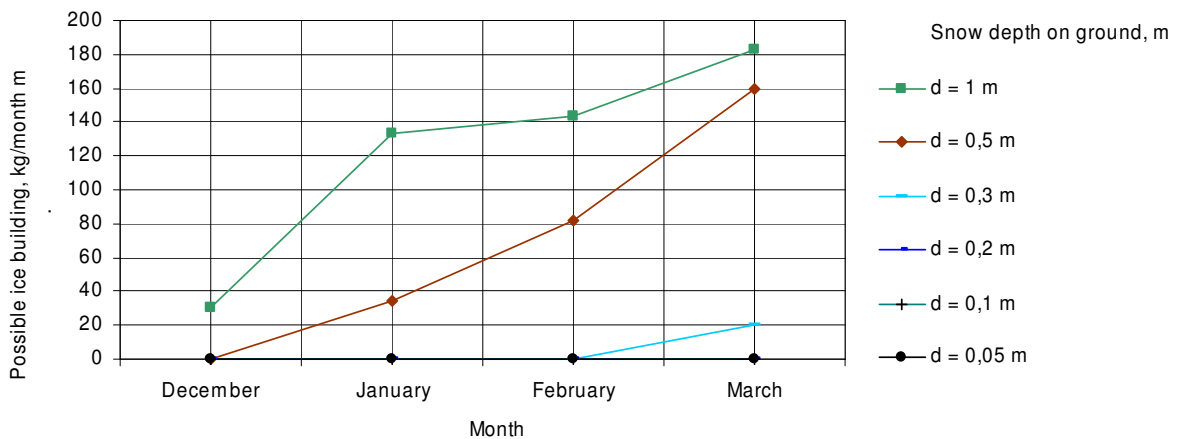

FIG. 6: Calculated possible ice building on roof eaves. Insulation thickness is 150 mm. Location in Lillehammer. Unsaturated turf with absorption capacity 20 kg/m<sup>2</sup>. Turf unfrozen when the snow starts falling.

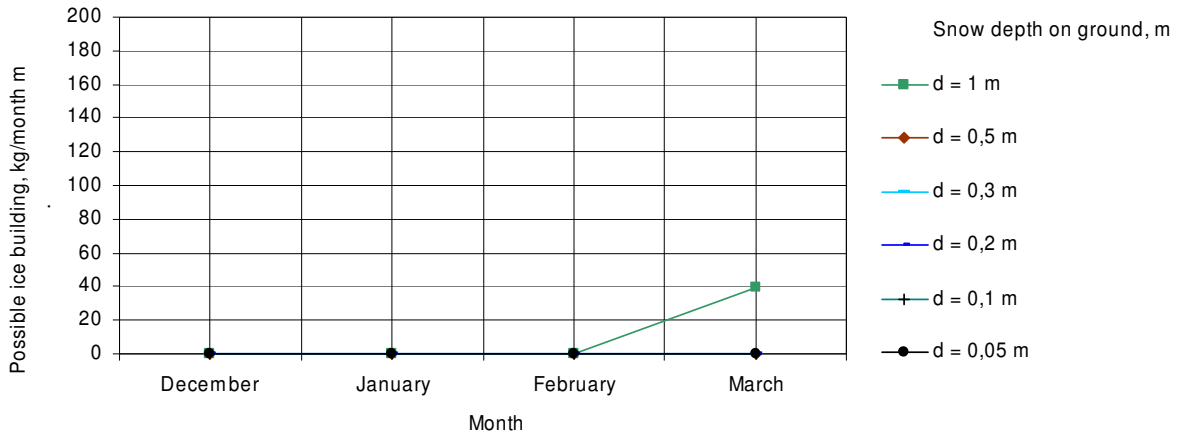

FIG. 7: Calculated possible ice building on roof eaves. Insulation thickness is 150 mm. Location in Lillehammer. Unsaturated turf with absorption capacity 20 kg/m<sup>2</sup>. Turf frozen when the snow starts falling.

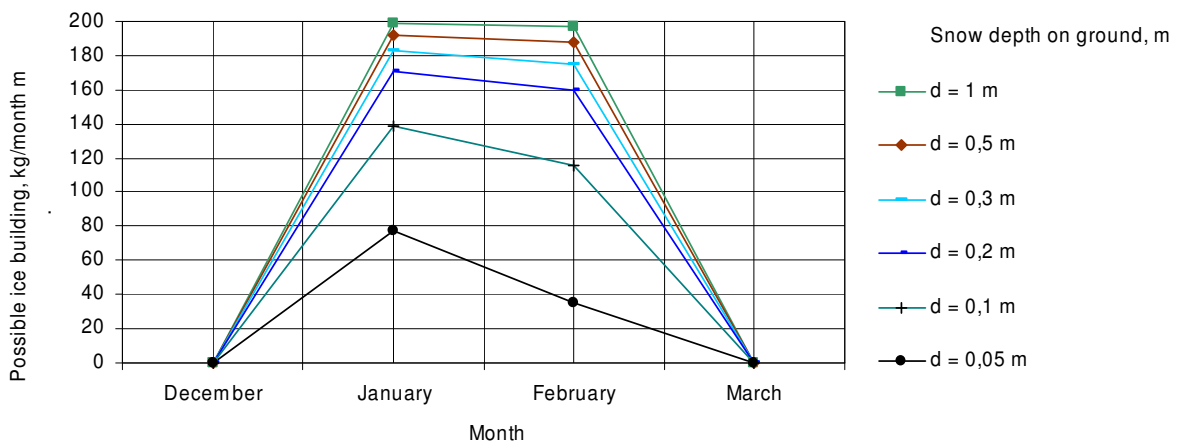

FIG. 8: Calculated possible ice building on roof eaves. Insulation thickness is 150 mm. Location in Kristiansand. Unsaturated turf with absorption capacity 20 kg/m<sup>2</sup>. Turf unfrozen when the snow starts falling.

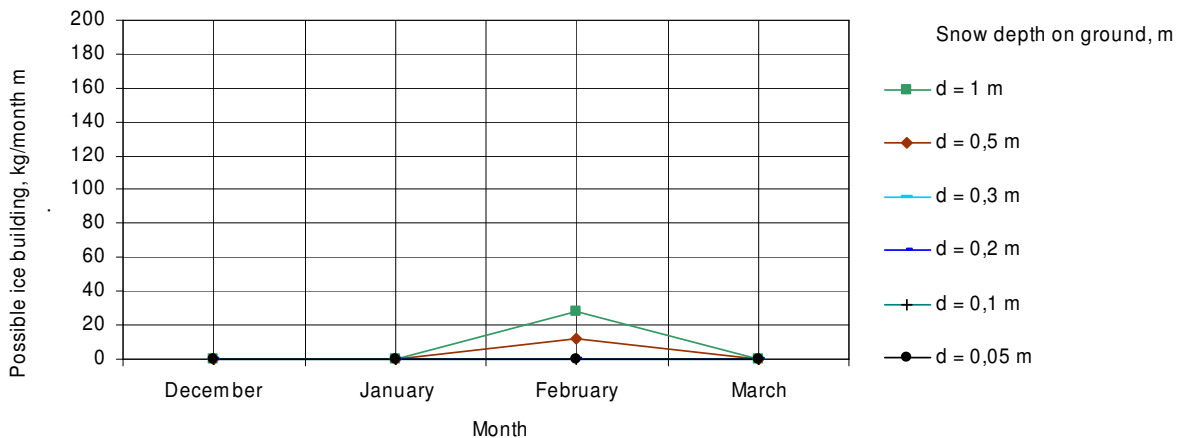

FIG. 9: Calculated possible ice building on roof eaves. Insulation thickness is 150 mm. Location in Kristiansand. Unsaturated turf with absorption capacity 20 kg/m<sup>2</sup>. Turf frozen when the snow starts falling.

## 5. Discussion

The moisture content in the thermal insulation was some lower than expected. The moisture content in the insulation in Rockwool Turfed Roof will be followed up through measurements in the field the coming years.

The calculations are considered to be conservative and the calculated ice building is probably higher than we can expect in practise. Ice building is a complicated process and will first of all depend on the local weather conditions, the roof design and the indoor temperature. The calculated results can be considered with a substantial part of uncertainty because of the choices taken to simplify the calculations. For example the snow conditions like snow depth, density and thermal conductivity is assumed to be constant. In addition the snow will melt and partly or fully disappear from the roof when mild weather occurs several times during the winter. Some of the melt water will be absorbed in the lowest snow layer and therefore not flow out on the roof eaves.

Turf has special qualities that reduce and delay the risk of ice building and growth of icicle along the roof eaves compared with other roof coverings on compact sloped roofs.

Unsaturated turf will absorb some melt water and reduce and delay the flow of water out on the roof eaves. The turf's ability to store water will reduce the ice building, but this is not of great importance. If the turf has a capacity to absorb 20 kg/m<sup>2</sup> of the melt water, the ice building is reduced the first month. In regions where the mean temperature is near zero degrees Celsius, the melt water will saturate the turf during the first month.

The turf layer can partly or fully freeze before the snow starts covering the roof. Depending on wind and cloud cover the radiation will cause that the turf layer might freeze even though the air temperature is some above zero degrees Celsius. A frozen turf layer has to be totally unfrozen before the snow starts melting. This thawing requires a substantial part of time and heat input. These conditions taken into account, the calculations show that the risk of ice building on roof eaves is considerably reduced for a turfed roof compared to other compact roofs without this possibility to store heat and water.

## 6. Conclusion

A/S Rockwool in Norway has ten years of good experience with compact sloped turfed roofs, called Rockwool Turfed Roof. Field studies and calculations support this good experience.

The field study from Otta shows that conditions with stable low outdoor temperature results in a frozen turf layer through the winter season, even with a snow depth close to one meter on the roof. During such conditions the risk of ice building is very low.

For inland regions with stable cold climate during the winter, like Karasjok, Røros and Lillehammer, the calculations show that the snow depth has to be higher than approximately 0.5 m to give noticeably ice building, even though the thermal insulation has a thickness of just 150 mm. With 300 mm thermal insulation, the risk of ice building is eliminated according to the calculations.

In regions with average monthly mean temperatures a few degrees below zero, and a turf layer that is saturated with water and unfrozen when the snow starts falling, the calculations show that the risk of ice building is considerably higher. Such conditions combined with large snow falls will increase the risk of ice building. In such regions however mild weather might occur several times during the winter. Snow and ice will then melt and partly or fully disappear from the roof without any damaging ice building.

## 7. References

- EN ISO 10456:1999. Building materials and products. Procedures for determining declared and design thermal values
- Sætersdal R. (1976). Frost i Jord. Vegdirektoratet/NTNF, Oslo, Norway, ISBN 82-7207-007-3.
- Skogstad H. B. (2003). Rapport O14306 fra Norges byggforskningsinstitutt, Rockwool Torvtakplate, fuktinnhold og isolasjonsevne
- Skogstad H. B. (2007). Rapport O20916-1-2-3 fra SINTEF Byggforsk, Rockwool Torvtakplate. Ising ved raft, feltundersøkelse. Ising på kompakte torvtak, teoretisk beregning. Vannopptak i taktorv
- Ramstad T. (2007). SINTEF Byggforsk Teknisk Godkjenning nr. 2488 av Rockwool Torvtak

# The use of finite-element software to solve hygrothermal building physical problems related to insulating high rise building facades

*Henk Schellen, Associate Professor,  
Eindhoven University of Technology, Department of Building and Architecture  
[h.l.schellen@tue.nl](mailto:h.l.schellen@tue.nl)*

*Jos van Schijndel, Assistant Professor,  
Eindhoven University of Technology, Department of Building and Architecture  
[a.w.m.v.schijndel@tue.nl](mailto:a.w.m.v.schijndel@tue.nl)*

*Edgar Neuhaus, research engineer,  
Physitec, The Netherlands,  
[e.neuhaus@physitec.nl](mailto:e.neuhaus@physitec.nl)*

**KEYWORDS:** *Envelope retrofit, moisture design, thermal bridges, insulation, air flow, hygrothermal modeling.*

## **SUMMARY:**

*In The Netherlands high rise buildings from 1960 and before were hardly insulated. To improve the thermal performance of the buildings the facades may be insulated afterwards. The energy loss will be reduced and thermal comfort will be improved by higher indoor surface temperatures.*

*Problems however may be introduced by thermal bridge effects of anchors, floors and indoor walls. Further more the outer facade surface will be colder during winter time. Frost damage and internal condensation may be the deleterious building physical effects. The purpose of the work is to prevent damages which may result from insulating retrofitting of building facades.*

*For this kind of building physical problems specific software has been developed and is in use all over the world. The coupling of heat, air and moisture (HAM) transport, however, has not been solved most of the times. An attempt has been made to solve this kind of coupled problems by the use of COMSOL (Comsol 2006).*

*As an example of this kind of coupled problems the thermal bridge effect of an anchor in an uninsulated and afterwards insulated facade of a high rise building has been examined. The air flow calculation in the cavity was coupled to the thermal and hygric diffusion process. The results of the separately uncoupled COMSOL simulations (like thermal bridge calculations) were compared with results from third party software and the coupled simulation results were compared with infrared thermographs.*

*The conclusion of the paper is that the use of COMSOL in this kind of problems may solve the problem of coupled building physical effects in building constructions.*

## **1. Introduction**

The building case introduced here is an office building in Eindhoven, The Netherlands (Pernot et al. 2007). The building is a high rise building, counting 10 floors and dating from the 1960's (figure 1). The construction of the building consists of concrete floors and breastwork of concrete and masonry (figure 2).

The outer facade is finished with natural stone slabs with a thickness of 40 mm. An air gap of about 60 mm is in between. The reduction of energy consumption related to this building is of great importance. Therefore the thermal resistance of the facade should be improved. The higher indoor surface temperatures will also improve thermal comfort and decrease the mould and condensation risk. To retrofit the construction by insulation, a choice has to be made for the type of insulating material and the position in relation to the facade materials. For the type of insulation material a choice can be made out of a number of materials: mineral wool, expanded or extruded polystyrene, polyurethane. For a decision on the location of the insulation material it can be situated at the inside or in the gap in between the facade slab and the concrete or masonry breastwork.



FIG. 1: Building façade

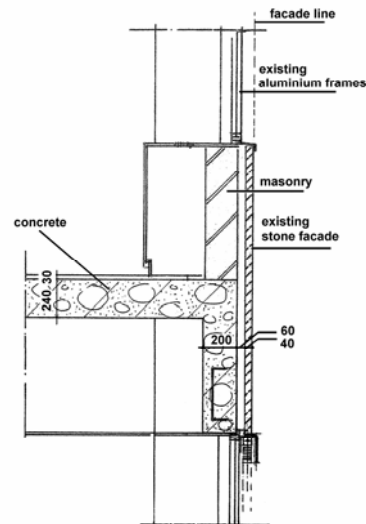

FIG. 2: Vertical section of the façade (dimensions in mm)

A building physical analysis should be made of the thermal and hygric effects of these choices. Until now third party software has been developed to calculate energy losses, thermal bridge effects and moisture effects of this kind of constructions. The coupling however of the thermal, hygric and air flow effects in this type of constructions has not been solved in this software. In this article an attempt has been made to solve this type of coupled problems by the use of COMSOL.

## 2. Method

The method of research was the following: First, an impression of the thermal performance of the facade construction was made by infrared thermal imaging. Second, modeling of the 2D thermal bridge effect of the original and afterwards insulated facade construction was compared, using third party software and COMSOL. Third, moisture effects were introduced using a coupled 2D heat and moisture transport model in COMSOL. Finally the effect of air flow in the construction was modeled with COMSOL.

## 3. Measurements

To get an impression of the thermal quality and thermal performance of the building infrared thermal images of the exterior and interior of the facade have been made during a relatively cold winter period. In these thermal images a relatively large heat loss at the outside surface is visible as an increase in surface temperature. From the inside the larger heat loss is seen in a reduction of the surface temperature, leading to a reduced thermal comfort experience, an increased risk of mould growth and sometimes even condensation.

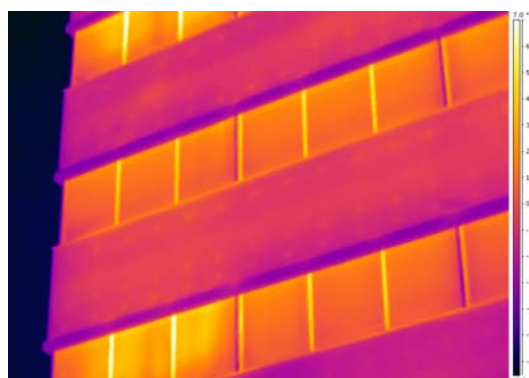

FIG. 3: Infrared thermal image of the façade (scale -6 to 6 °C)

The infrared thermo graphic measurements took place during a cold winter period on February 7th 2007 in the morning. The sky was clouded and the air temperature was about 1 °C. Conclusions from the infrared images are the following: The facade is hardly thermal insulated. A well insulated facade would appear with a temperature in the order of the outdoor temperature. The thermal quality of the facade is in the order of its simple double glazing. The U-value of the aluminum frame is larger (i.e. worse) than the U-value of the double glazing.

## 4. Calculations

### 4.1 Thermal bridge calculations

To evaluate the retrofitting effects of insulating a construction afterwards it is quite usual to use so-called thermal bridge calculations. Since the 1980's specific software has been developed to calculate the 2- and 3D thermal bridge effects in building constructions. The computer program BISCO (Physibel 2002) e.g. is a well known computer code to calculate the 2D effects of a thermal bridge. Its calculations are based on 2D stationary heat conduction, mathematically described by the Laplace equation:

$$\nabla(-\lambda \nabla \theta) = 0 \quad (1)$$

$\theta$  = Temperature [°C]

$\lambda$  = Thermal conductivity [W/m.K]

The BISCO and COMSOL software have been used to calculate the thermal bridge effect when insulating the cavity between the facade slab and the construction behind, or insulating the construction from the inside. The material properties, as they were used in the calculations, are taken from literature and are summarized in table 1.

TABLE 1: Thermal and hygric properties of building materials

Material	Thermal conductivity	Density	Diffusion resistance
	$\lambda$ [W/(m·K)]	$\rho$ [kg/m <sup>3</sup> ]	$\mu$ [-]
Brick	0.6	1900	10
Natural stone	2.3	2440	140
PUR	0.035	33	50
Concrete	1.6	2300	180
Mineral wool	0.040	60	1.3
XPS	0.034	30	100

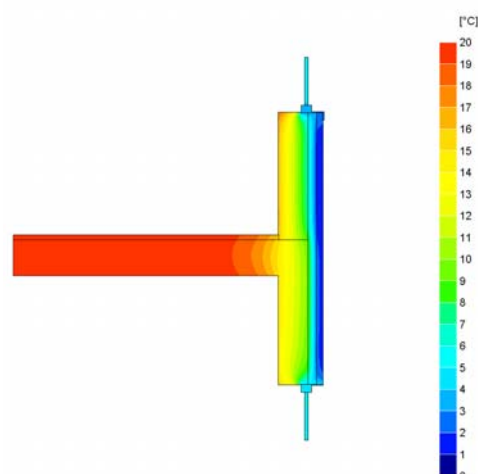

FIG. 4: Thermal bridge calculations in BISCO of the insulated construction

From the results it is clear that the interior construction will become warmer after insulating the cavity. The outer natural stone slab, however, will decrease in temperature. The results from the BISCO and COMSOL calculations were nearly identical within a range of less than 0.1 % difference.

#### 4.1.1 Temperature factor

To reduce the risk on surface condensation and mould growth Dutch standards demand a calculation of the so called temperature factor. This factor is a dimensionless number, representing the lowest temperature of the thermal bridge. It is defined by

$$f = \frac{\theta_{s_{i,\min}} - \theta_e}{\theta_i - \theta_e} \quad (2)$$

Indices:

s<sub>i,min</sub>: interior surface, minimum; i: interior; e: exterior

For office buildings in The Netherlands an f-factor is required of at least 0.50.

The table below gives the results of the calculated inside surface temperatures and the resulting temperature factor as they were calculated using BISCO (or COMSOL).

TABLE 2: Temperature factor at the connection upper surface floor-facade

Insulation variant	$\theta_{s_{i,\min}}$	f	Ok?
1. Original non insulated facade	12	0.60	yes
2. PUR insulation in cavity	18	0.90	yes
3. XPS at the inside surface	13	0.65	yes
4. XPS as 3 with additional material	16	0.80	yes

#### 4.1.2 Linear U-value

Due to thermal bridge effects there is an increased heat loss through the building construction, compared with the 1-dimensional heat loss without thermal bridges. The extra heat loss can be defined by a linear U-value  $\Psi$ . The linear U-value is the extra heat loss for a 2D thermal bridge with a length of 1 meter exposed to a temperature difference across the construction of 1 K.

Making use of the heat loss as it was calculated by BISCO (or COMSOL) the linear U-value can be calculated from:

$$\psi = \frac{\phi}{\theta_i - \theta_e} - U_1 l_1 - U_2 l_2 \quad (3)$$

$\psi$	=	Extra heat loss compared to 1D heat loss per mK	[W/mK]
$\phi$	=	Total heat loss through construction per m	[W/m]
$U_{1,2,..n}$	=	1D overall heat transfer coefficient of construction	[W/m <sup>2</sup> K]
$l_{1,2,..n}$	=	Length of constructions	[m]

The table below summarizes the linear U-values as they were calculated using BISCO (or COMSOL).

TABLE 3: Linear U-values

Insulation variant	Linear U-value [W/m·K]
1. Original non insulated facade	0.56
2. Insulation in gap	0.15
3. XPS with additional material	0.57

#### 4.1.3 Conclusions from thermal bridge calculations

Conclusion from the thermal bridge calculations is that the thermal bridge effect is minimal for variant 2 with gap insulation. The results from the thermal bridge calculations show that insulating the gap between external slab and interior building construction results in higher interior surface temperatures. Thermal comfort therefore will be improved and the risks on mould growth will be reduced. The slab temperatures however will be lower. Furthermore, due to the insulation material in the gap the ventilation will be reduced and the slab material will get wetter. Together with lower slab temperature effects the deterioration risk by freezing of the slab will increase. That is why a combination of thermal and hygric effects should be included in the calculations.

## 4.2 Hygrothermal calculations

For the calculation of the coupled thermal and hygric transport throughout a facade section the Fraunhofer Institute in Germany e.g. developed a computer code WUFI (Künzel 2006). The drying effects in the ventilated gap, however, were not included in older versions of this kind of model. That is why COMSOL was used to calculate the coupled thermal, hygric and air flow effects.

The COMSOL model is based on the following equations for steady state conditions:

Thermal transport by conduction and convection:

$$\nabla \cdot (-\lambda \nabla \theta) = -\rho c_p \bar{u} \nabla \theta \quad (4)$$

$\rho$	=	Density	[kg/m <sup>3</sup> ]
$c_p$	=	Constant pressure specific heat	[J/kg.K]
$\bar{u}$	=	Air velocity	[m/s]

Vapour transport by diffusion and convection:

$$\nabla \cdot \left( -\frac{\delta}{\mu} \nabla c \right) = -\frac{\bar{u}}{RT} \nabla c \quad (5)$$

$c$	=	Vapour concentration	[kg/m <sup>3</sup> ]
$\delta$	=	Water vapour permeability	[s]
$\mu$	=	Vapour diffusion resistance number	[-]
$R$	=	Specific gas constant for water vapor	[J/kg.K]
	=	462	J/kgK

Incompressible air flow:

$$\rho \bar{u} \nabla \bar{u} = \nabla \cdot \left[ -pI + \eta (\nabla \bar{u} + (\nabla \bar{u})^T) \right] \quad (6)$$

$$\nabla \cdot \bar{u} = 0 \quad (7)$$

$I$	=	Identity matrix	[-]
-----	---	-----------------	-----



p	=	Pressure	[Pa]
$\eta$	=	Dynamic viscosity air	[Pa.s]
	=	1.7E-5	Pa.s

The stationary boundary conditions were:

Thermal:

$$q = h_o \cdot (\theta_o - \theta_s) \quad (8)$$

q	=	Heat flux at surface	[W/m <sup>2</sup> ]
h	=	Heat transfer coefficient	[W/m <sup>2</sup> .K]
h <sub>i</sub>	=	7.7	W/m <sup>2</sup> .K
$\theta_i$	=	20	°C
h <sub>e</sub>	=	25	W/m <sup>2</sup> .K
T <sub>e</sub>	=	0	°C

Hygric:

$$g = \frac{\beta_o}{\rho} \cdot (c_o - c_s) \quad (9)$$

g	=	Vapor flux at surface	[kg/m <sup>2</sup> s]
$\beta$	=	Vapor transfer coefficient	[kg/m <sup>2</sup> s]
$\beta_i$	=	7.1E-3	kg/m <sup>2</sup> s
c <sub>i</sub>	=	0.5*csat( $\theta_i$ )=0.0088	kg/m <sup>3</sup>
$\beta_e$	=	22.9E-3	kg/m <sup>2</sup> s
c <sub>e</sub>	=	csat( $\theta_e$ )=0.0035	kg/m <sup>3</sup>
csat	=	Saturation concentration	[kg/m <sup>3</sup> ]

Air flow:

u <sub>o</sub>	=	inlet velocity	[m/s]
u <sub>o</sub>	=	0 (no ventilation)	
u <sub>o</sub>	=	0.1 (no insulation in gap, assumed on basis of earlier cavity measurements)	
u <sub>o</sub>	=	0.01 (mineral wool in gap, assumed)	

Indices:

o,i,e	:	environmental
s	:	surface

#### 4.2.1 Variant study

The coupled thermal and hygric calculations were evaluated for a number of 4 relative simple variants. Until now, the calculations are stationary and wind-driven rain, solar radiation and long-wave radiation are not included in the model.

Variants: 1: the original non insulated façade; 2: mineral wool in gap; 3: Polyurethane (PUR) in gap; 4: inside surface insulation with extruded polystyrene (XPS);

4.2.2 Results

Temperature [°C]

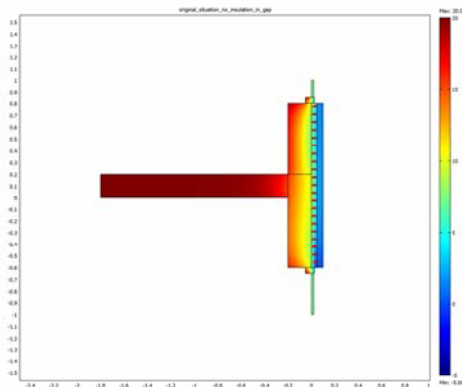

Relative Humidity [-]

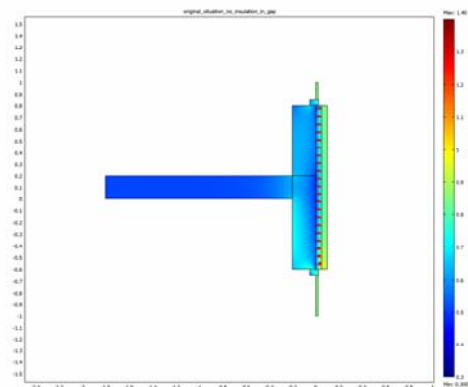
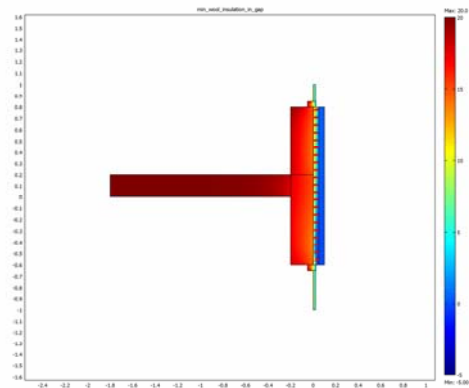

FIG. 5: variant 1, the original non insulated facade

Variante 1: The non insulated construction shows indoor construction surface temperatures which are rather low ( $\theta_{min} < 16$ ). Due to the vapor flux from indoor to outdoor condensation will occur in the gap at the cold outdoor slab. Drying of this slab will take place by ventilation of the cavity ( $RH < 0.95$ ).

Temperature [°C]



Relative Humidity [-]

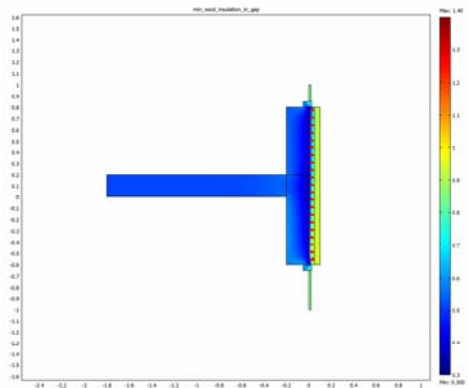
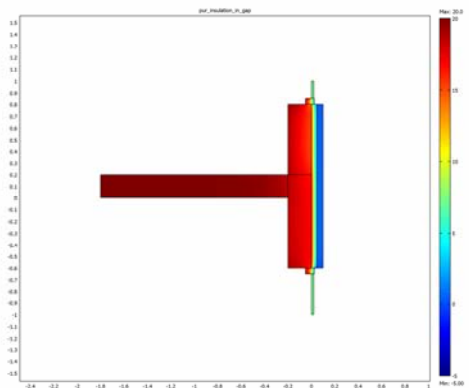

FIG. 6: variant 2, mineral wool in gap

Variante 2: Due to the insulation material in the gap the construction surface temperatures at the inside will remain rather high ( $\theta_{min} > 18$ ). The outside slab however will get colder and higher relative humidities will occur at the slab surface in the gap. The density of the mineral wool is low and some air flow by ventilation will still remain ( $RH < 0.95$ ).

Variante 3: Polyurethane in the cavity will give construction temperatures which are likewise as variant 2 ( $\theta_{min} > 18$ ). The ventilation of the gap, however, is not possible anymore. The intrinsic vapor resistance is much larger than in the mineral wool case. The result will be a rather high vapor resistance and low relative humidity at the cross section of the concrete breastwork ( $RH < 0.6$ ).

Temperature [°C]



Relative Humidity [-]

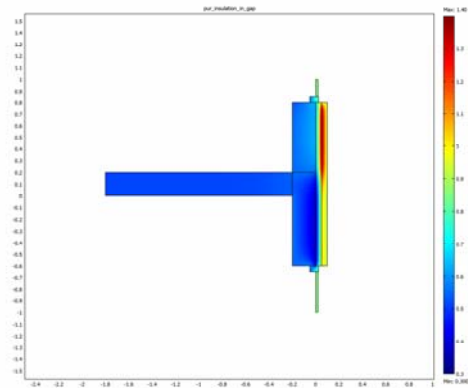

FIG. 7: variant 3, polyurethane in the cavity

Variant 4: Insulation at the inside surface with a rather vapor resistant material like extruded polystyrene will lead to rather low construction temperatures behind the insulation material ( $\theta < 10$ ). The vapor flow into the material, however, will be low. The natural ventilation of the cavity will remain intact and the relative humidity in the gap will remain low ( $RH < 0.9$ ). The ventilation with cold air will cool down the construction at the inlet. This is the reason for an increasing relative humidity at the inner construction part ( $RH > 0.9$ ).

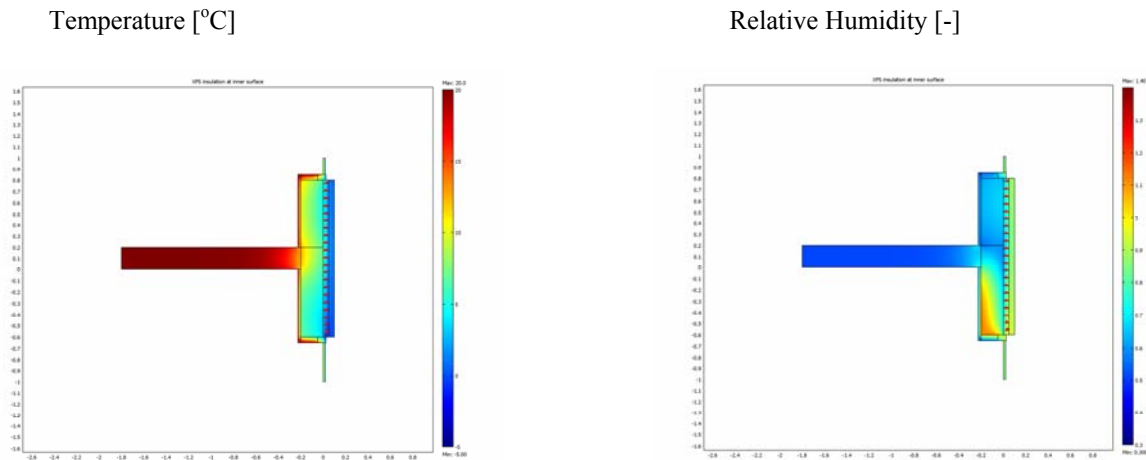

FIG. 8: variant 4, inside surface insulation with XPS

## 5. Conclusion

Cavity insulation, either fully-filled or partially-filled, belongs to a special class of envelope design. It has its advantages and disadvantages, some of the latter may lead to severe adverse consequences to the performance and durability of the envelope (Straube et al. 1997). Hygrothermal numerical modelling has been done to optimize retrofitting options (Djebbar 2002). Thermal and hygric simulations in this paper show that the occurrence of condensing moisture at the slab surface in the gap depends on the choice of insulation material and the place it is installed. The drying of the natural stone exterior cladding construction depends on the ventilation of the gap. Therefore it is important to make use of coupled thermal, hygric and air flow calculations in the simulation study. Most of the known building physical simulation tools do not include this coupling. Therefore the use of general finite-element software like COMSOL for these situations may be important in future. Validation of the results on the moisture aspects and a time dependant transient analysis, however, is important for future work.

## 6. References

- Physibel (2002), BISCO, computer program to calculate two-dimensional steady state heat transfer in free-form shaped objects using the energy balance technique, BISCO 6.0W manual
- Künzel H.M., Schmidt T. & Holm A. (2006), WUFI Pro 4.1: Programm zur instationären berechnung des ein-dimensionalen Wärme und Feuchtetransports in Bauteilen, Fraunhofer Institut für Bauphysik, Holzkirchen
- Künzel H.M. (1995), Simultaneous Heat and Moisture Transport in Building Components. - One- and two-dimensional calculation using simple parameters. Fraunhofer IRB Verlag
- Pernot C., Neuhaus E. & Schellen H.L. (2007), GGD-toren Stadhuisplein 2 te Eindhoven: adviesrapport inzake de gevelrenovatie, Technische Universiteit Eindhoven, BPS-rapport 07.04
- Comsol (2006), COMSOL 3.3 Multiphysics User's Guide, COMSOL Inc, Los Angeles USA
- Straube, J.F., and Burnett, E.F.P., (1997), Field testing of filled-cavity wall systems, ICBEST, Int. Conf. Building Envelope, Science and Tech. '97, Bath, UK, April 15-17, pp. 429-434.
- Djebbar, R.; Kumaran, M.K.; Van Reenen, D.; Tariku, F. 2002. Use of hygrothermal numerical modeling to identify optimal retrofit options for high-rise buildings. 12th International Heat Transfer Conference. Grenoble, France, pp. 165-170, August 2002.

## 7. Acknowledgements

The authors like to thank the municipality of Eindhoven, The Netherlands, for their involvement and support.

# Innovative and adaptable shaping systems for ETICS

*Alexandra Saur, Dipl.-Ing.,  
Fraunhofer Institute for Building Physics;  
alexandra.saur@ibp.fraunhofer.de*

*Jan Beringer, Dr.,  
Research Institute Hohenstein;  
j.beringer@hohenstein.de*

*Klaus Sedlbauer, Prof.,  
Fraunhofer Institute for Building Physics;  
Klaus.sedlbauer@ibp.fraunhofer.de*

**KEYWORDS:** ETICS, mineral plaster, textile coating, nanotechnology

## **SUMMARY:**

*For certain building applications textile industry offers many high-performance products which can outclass conventional systems. Examples are well known outdoor products which combine rain protection/water-repellence with high water vapour permeability by use of membranes or special fabric finishings. Innovative and adaptable textiles and functional membranes from the textile area are introduced and transformed to the building sector. New façade elements with functional multi layers and optical flexible textile outer skin are developed. This system may replace traditional plaster walls by a lightweight solution employing minimum materials, production steps and effort while providing superior performance, innovative and adaptable shaping and aesthetic potential in building design. Experiments and determinations of characteristic parameters are performed in the lab. Investigations on functionality and outdoor suitability are carried out in open field tests under real climatic conditions.*

## **1. Introduction**

The demand on energy efficient buildings has dramatically increased during the last years. According to agreed targets of the Kyoto Protocol total emissions of greenhouse gases in industrial countries during the first commitment period (2008-2012) must be reduced. Therefore, buildings constitute an important sector in the effort to reduce environmental emissions. In the last decade the application of External Thermal Insulation Composite Systems (ETICS) became a popular measure to improve the energy performance and the weather resistance of facades in the building stock. The concept of ETICS is to cut down the heat bridges and losses to a minimum and to protect the building reliable and durable against environmental and climatic factors (i.e. wind, frost, IR etc).

The Fraunhofer Institute for Building Physics carried out investigations at completed buildings at different times to prove the performance of the ETICS in practice [Künzel 1976], [Mayer 1984], [Künzel 1991], [Künzel 1997]. In former decades, the pollution of façades was the main cause for refurbishment by applying new coatings. The pollution of the façades was mainly visible at wall areas with differing exposure to rain: Areas with a high exposure to rain were explicitly cleaner than protected areas, e.g. below projecting roofs or window sills. By filtering the exhaust air of industrial plants, air pollution was reduced as well as the concentration of gaseous pollutants in the air, especially the concentration of sulphur dioxide SO<sub>2</sub>. Because SO<sub>2</sub> is a strong biocide the consequence of its disappearance was that the growth of microorganisms on façades, such as algae, fungi and bacteria, was stimulated. This is the reason why those areas of the façades which are frequently exposed to rain might be infested with algae growth, because moisture is a prerequisite for the development of algae. With respect to External Wall Insulation Systems condensation on façades during the night may be a further reason for additional moisture, stimulating again the growth of algae [Künzel 2001]. Changes on the surfaces of façades, caused by dirt or microbial growth, are generally accepted as “patina“ as long as they are evenly spread, whereas local concentrations of pollution or algae are frequently assessed as being a “visually adverse effect.”

Frequently a thin exterior plaster and a smooth insulation material as substrate are supposed to ease possible damage from mechanical impact. Cracks in the wall below windows and along insulation sheets or mechanical

“decoupling” of the finishing plaster from the structural masonry joints must be assessed as system specific. Exterior plasters must not be applied below 5°C or if there is a risk of frost within 24 hours. Protection from rain must be provided until decorative coats have dried. Drying of the finishes is dependent on temperature and relative humidity. Under average conditions this will be in less than 24 hours, but in winter it may be longer.

A new innovative textile shaping system may replace traditional plaster walls by a lightweight solution employing minimum materials, production steps and effort while providing superior performance, innovative and adaptable shaping and aesthetic potential in building design. The system offers a choice of options in insulation thickness and fixing methods to meet different substrate conditions. Textile shaping system decorative coats are available in a variety of textures and a wide range of colours, colour prints and patterns so that a finish appropriate to the building character, context and type may be achieved. The new system can be used for both new-build and refurbishment purposes on a wide range of building types. Different textures and finishes can be used to change monotonous appearance of buildings. For reconstructions ETICS can provide a new optical attractive façade. It can be classified as a thin coat system which has a high degree of flexibility and which is not subject to the temperature stress put on conventional renders. The intermediate reinforcing coat has high expansion capability, therefore reduced susceptibility to cracking, high reliability against impact stress, high resistance against driving rain, high weather resistance and also high water vapour permeability. It should show good adhesion performance, be easy and fast to apply with low economical effort.

## 2. Investigations

Due to the novel idea of using textiles as multifunctional facades, both laboratory and field tests were carried out to verify constructability and performance of the new coating system. Laboratory tests can provide useful information on properties and application prospects of new building materials or compounds. For prediction of their behaviour under real life conditions comparative field tests as close as possible to the building reality are necessary. This is particularly true with regard to verification of structural performance, as well as air and water penetration resistance and the thermal efficiency of the building enclosure.

## 3. Performance requirements

The coated material is selected on the basis of specific requirements. The material for this innovative and adaptable shaping system is a flexible composite material of three layers. On the back side there is a non-woven material for fixing. The front side consists of a synthetic fibre fabric as textile-based material with miscellaneous chemical modifications. With the corresponding chemical additives the following properties are achieved: resistant against fungal and algae attacks, weather proofing, soil proofing and extension of service life. The textile finishes combine excellent vapour diffusion with a high degree of water repellence. The system also includes glass fibre reinforcing mesh for additional strength. For areas which are likely subject to high levels of impact, an additional high impact coat can be applied to the system. In principal the synthetic fibre fabric can be manufactured from a wide range of synthetics such as polyester, glass fibre or polyamide. Proven in practice for decades, the dimensionally stable polyester fabric has been generally accepted as coating base material.

### Base coat options with nanotechnology surface coating and photocatalytic coating

Nanotechnology is one of the key technologies of the 21st century from which fresh stimuli can be expected in particular for the textile industry. Every day fascinating new active agents on the basis of microscopically small particles of nanometre (= one billionth of a metre) size are created displaying completely new surface properties due to their specific material mix. The multiplicity of the nanoparticles is so great that it is often difficult to gain an overview of the various nano-materials used, their properties and possibilities for textile applications [Beringer 2004]. With a nanotechnology surface coating, an innovative composite finishing material, emulates nature by keeping dirt and water away. Water droplets just roll off the surface, taking dirt particles along with them. Learning from nature's example, science has recognized that it is not the smoothest possible surfaces but those with nanostructures that repel dirt and water most effectively. The nano façade coatings also contain preservatives to protect the coating against algae and fungal growth.

The principle of photocatalytic reaction was to accelerate the nature's cleaning and purifying process using light as energy. The majority of the work in surface technologies has been carried out mainly on UV initiated processes. In addition to its photocatalytic oxidation effect, titanium dioxide coating also exhibited hydrophilic property (or high water-affinity) which attracts moisture in air to form an invisible film of water. This thin film of water allows the substrate to be anti-static so the coated surface can easily be cleaned by rinsing off with

water. Industrial utilisation of this effect is already been used for various applications, especially for self-cleaning and anti-fogging purposes like self-cleaning tiles, self-cleaning windows or self-cleaning textiles. The anti-microbial effect has also been demonstrated. A building's exterior surface can benefit from this special coating (Sustainable Coating) by eliminating any contaminants that cause buildings to become dirty e.g. from the oil content from car exhaust and any mould or mildew stain.

## 4. Investigations

### 4.1 Experimental set-up

The following field test was carried out in Holzkirchen, a location 680 m above sea level close to the Bavarian Alps, and was selected because of its rather severe outdoor temperature fluctuations and driving rain incidents compared to most other locations in Germany. In a test hall which is conditioned during wintertime at 20 °C and 50 % R.H., masonry bonds of an autoclaved aerated concrete (AAC) with a surface of 60x60 cm<sup>2</sup> and a thickness of 24 cm have been exposed with one side facing to the wet. The west side of the hall with wall elements between wooden frames is shown in Figure 1.

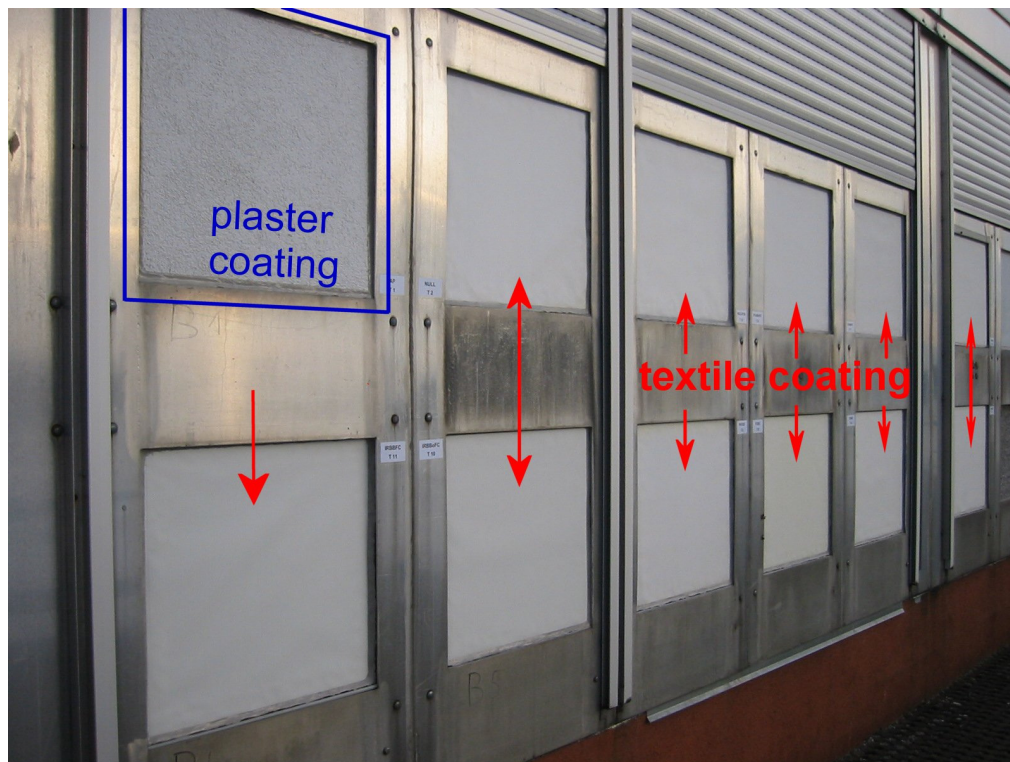

FIG. 1: West façade of the test hall with removable wall elements.

All twelve ETIC elements are composed of multiple layers: the insulation material consisting of mineral wool boards (10 cm) and the adhesive fixing on the substrate. On the reference outside surface of one test specimen a reinforcing intermediate coating, reinforcement mesh and a finish mineral plaster was applied. For this system there are many factors that impact the drying rate and the application steps of the plaster finish, e.g. temperature, humidity, sunlight, wind and coating thickness. Each of these variables has a distinct effect on the time it takes for the water to evaporate from the finish. Until this evaporation occurs, the wall must be protected from rain to avoid wash-off damage to the finish. Under ideal conditions (24°C, 50% relative humidity), drying time should be less than 48 hours. Different conditions could extend the drying time up to a week. No rendering should be carried out when the temperature is below 5°C if or there is a danger of frost, or above 30°C.

The other wall elements were sealed with different innovative and adaptable textile coating systems. The fixing was quite simple. The textile layers were fixed with a hook-and-pile fastener. There is no distinct effect of above mentioned variables on the time it takes for the water to evaporate from the finish.

## 4.2 Results

The role of the textile finisher has become increasingly demanding, and now requires a careful balance between the compatibility of different finishing products and treatments and the application processes used to provide textiles with desirable properties. Surface properties can be described for example by the chemical composition of a surface, or by its porosity, hydrophobicity or hydrophilicity.

The contact angle characterizes the hydrophobic properties of surfaces and can be used to define surface energies, surface heterogeneity and surface roughness [Lam 2001]. It is defined geometrically as the angle formed by a liquid at the three phase boundaries liquid, gas and surface. By the contact angle, physical properties of interaction between surface and liquid like wettability, affinity, adhesiveness and repellence can be explained. Figure 2 shows the connection between contact angle and wettability. Suitable control and modification of the contact angle are essential and a wide range of technologies is available to influence it. In this case we have used a special nanotechnology surface coating and fluor-based brushes. Both are suitable options for increasing contact angle. The contact angle is an important characteristic of this coating system and can be a decisive factor and a quantitative measure for the wetting of a surface by a liquid. It is an appraisal criterion for soil-resisting surface.

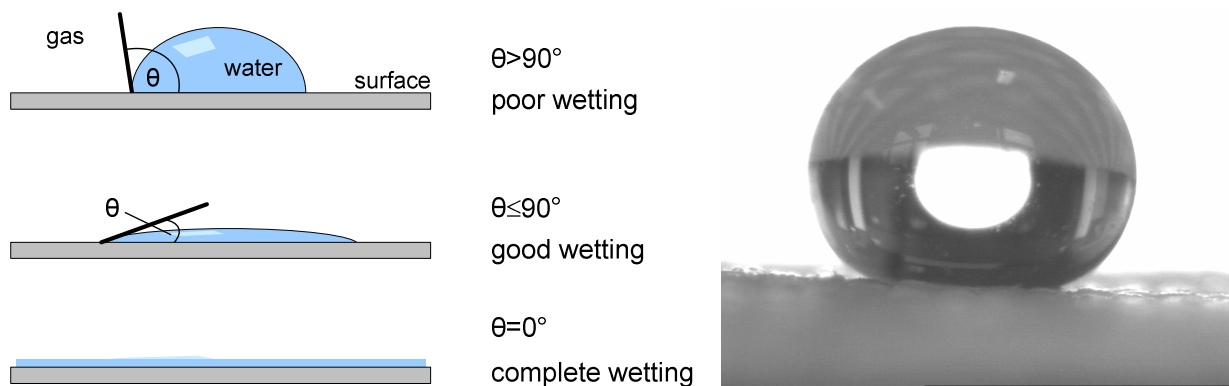

FIG. 2: Contact angle and wettability of different surfaces. Example for water droplet on material No. 6 showing a contact angle  $\theta=143^\circ$ .

Low values of  $\theta$  indicate that the liquid spreads, or wets well, while high values indicate poor wetting. If the angle  $\theta$  is less than  $90^\circ$  the liquid wets the surface. Or if  $\theta$  is greater than  $90^\circ$  it is non-wetting and both the wettability and the adhesiveness of the surface coating is worse. This means that our coating is soil-resistant. A contact angle zero represents complete wetting. When a surface has a regular and well-controlled surface roughness, it is possible to create “super” hydrophobic or hydrophilic surfaces (Table 1). Laboratory tests have shown that with the right coating and topology, contact angles close to  $145^\circ$  can be reached. The water contact angle of all materials varies between  $0^\circ$  and  $143^\circ$ .

By using titanium dioxide ( $\text{TiO}_2$ ) coating, easy-to-clean or self-cleaning surface functionality of the textile coating can be introduced.  $\text{TiO}_2$  shows two separate photo-induced phenomena: a photocatalytic phenomenon and a super hydrophilic phenomenon. The  $\text{TiO}_2$ -coated surface has the lowest contact angles and could not be measured. Textile prototype No.9 with  $\text{TiO}_2$  coating exhibited a hydrophilic property or high water-affinity surface. Surface properties were measured in order to identify explanatory factors of soiling and cleaning phenomena. The results show the correlation of cleanability and contact angle.

TABLE 1: Prototype description and measured contact angle.

Prototype No.	Prototype description	contact angle [ ° ]
1	Conventional plaster system	circa 50
2	Textile without modification	70
6	Outer skin with nanoparticles type 1	143
8	Outer skin with nanoparticles type 2	135
9	Photocatalytic coating	no measured angle

One elemental method for characterising nano-scale surface modifications is surface electron microscopy with element analysis (SEM/EDX). This makes it possible to display the specific distribution of individual elements, depending on nanoparticle type, broken down for a specific location. In a SEM scan, Figure 3 shows an even application of nanoparticles type 1 and TiO<sub>2</sub> particles (left and middle) in comparison to the untreated fibres (right). This procedure allows optimisation of nanoparticle applications [Beringer 2007].

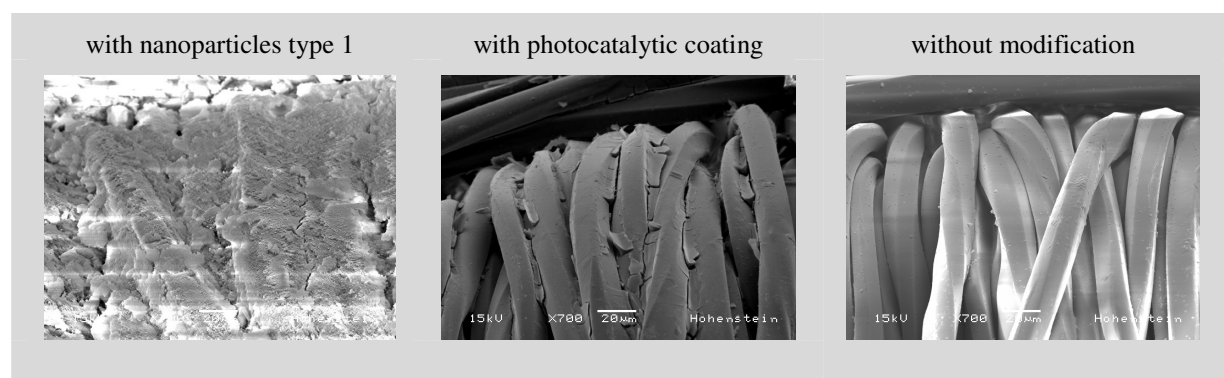

FIG. 3: This scanning electron micrograph shows a textile coating surface with and without chemical modification, magnified 700 times.

left: Outer skin with nanoparticles type 1

middle: Photocatalytic coating

right: Textile without modification.

In order to examine a wide range of coatings the test hall was erected containing removable façade elements with driving rain exposure. After exposing the wall elements to the natural climate, at certain intervals they were removed from the façade and the water content of the wall elements was recorded gravimetrically indirectly by weighing the wall sections. The variation in water content of wall elements with different types of coating is shown in Figure 4. The drying of the wall element with traditional plaster is similar to the ones with textile shaping layers. The west-facing elements were clearly affected by driving rain events. In all wall elements the water content increased after a rainy period in May (heavy rainfall: 09.05.07 and 29.05.07 with 66 and 98 l/m<sup>2</sup>). All curves show that the water content variation is determined by the balance between rainwater absorption and the subsequent water release in dry weather. From the slopes of the curves it may be concluded that the wall with water-repellent coating with nanoparticles type 1 (curve No. 6) quickly absorbs water but also dries out faster. This means the capillary transport capacity of these systems is very small and the initial moisture of AAC masonry dries out faster by vapour diffusion through the layer. The water absorption of the wall element with traditional mineral plaster is similar to the one with textile coating.



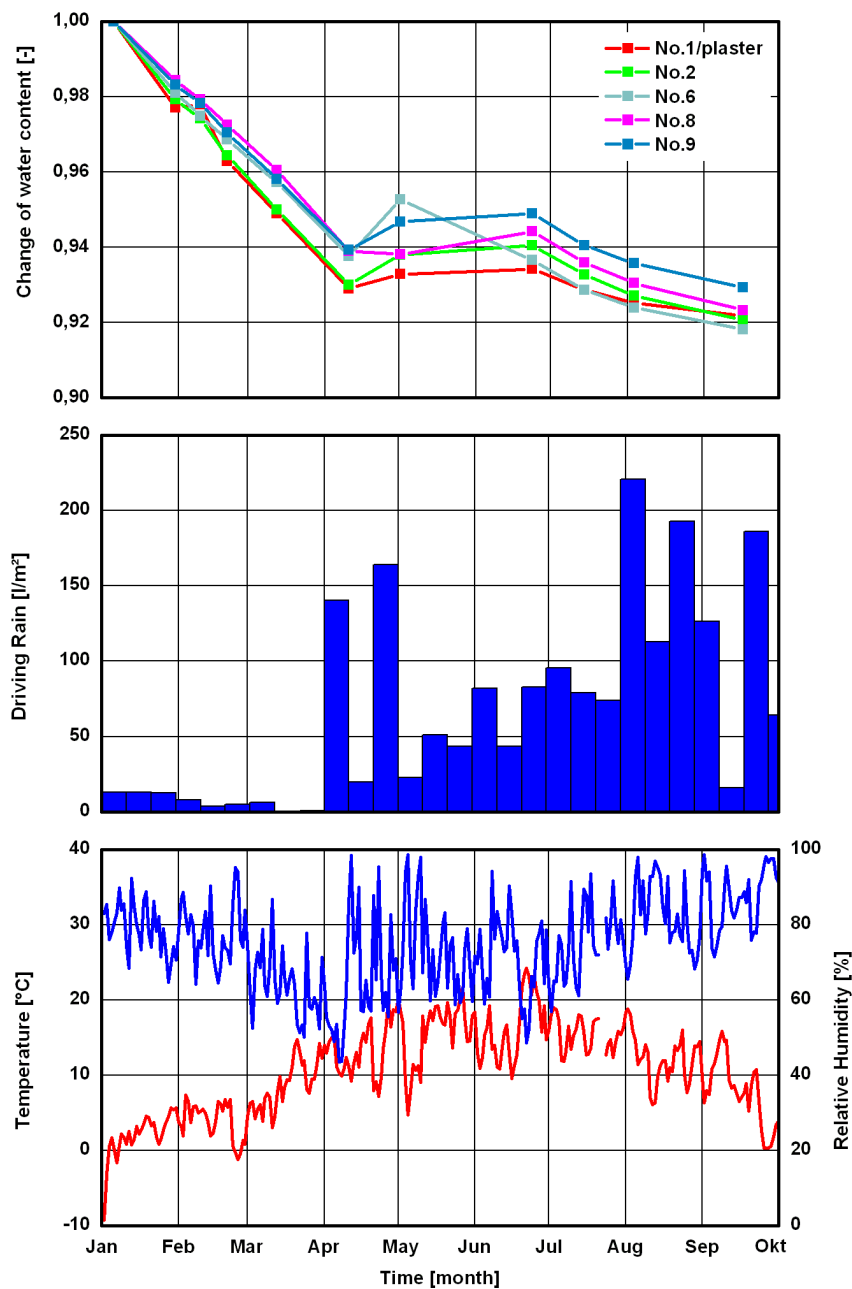

FIG. 4: Measured water content variation of exposed wall elements with different coating, monthly driving rain load and climatic conditions at Holzkirchen in 2007.

## 5. Conclusions

New innovative textile shaping system may replace traditional plaster walls by a lightweight solution employing minimum materials, production steps and effort while providing superior performance, innovative and adaptable shaping and aesthetic potential in building design. ETICS with an optical flexible outer textile skin opens up huge potentials for façade design, optical attractive facades on old and new buildings. Due to its optical flexibility the design can be conservative, not distinguishable from regular plaster façades or eye-catching to allow architectural creativity. The variability of functional multi layers, the low weight of the insulation material

permits to shape forms while insulating. The textile finishes combine excellent vapour diffusion with a high degree of water repellence. The new system is dimensionally stable. This makes it an ideal insulation for external walls as expansion and contraction put considerable stress on conventional plaster.

According to the multifunctionality of multilayerd textiles it is depicted that e.g. nanotechnology and photocatalysis show the possibilities of innovative textile surface coating for practical application with new kinds of surface properties. Further applications are pictured in Figure 5.

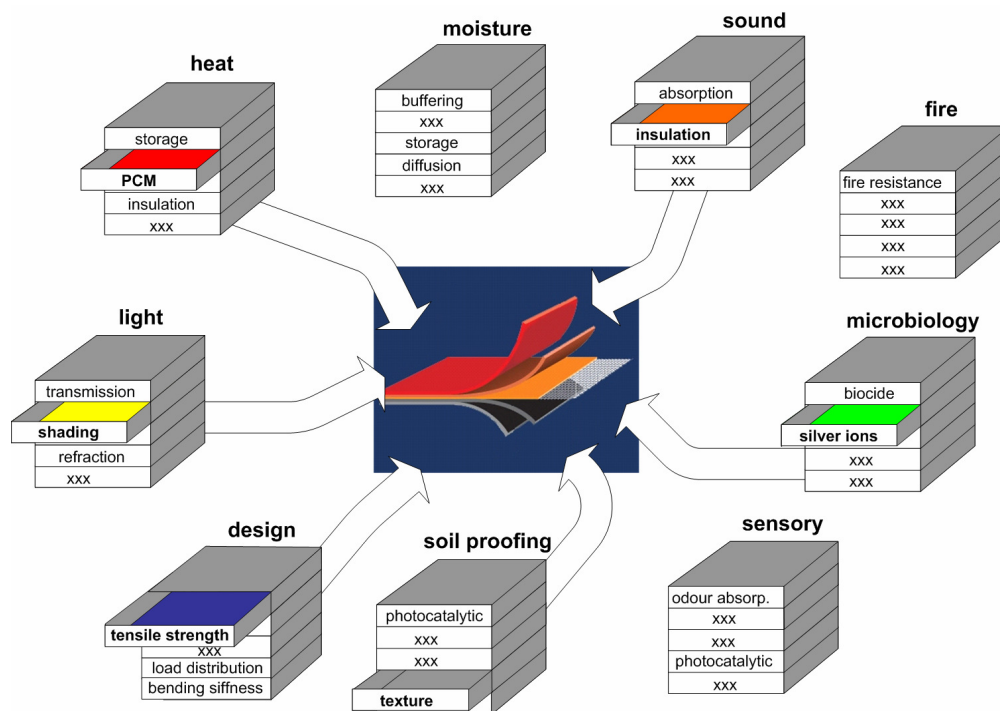

FIG. 5: Application set-up for further textile coating systems.

## 6. References

- Künzel, H., Mayer, E. (1976). Überprüfung von Außendämmsystemen mit Styropor-Hartschaumplatten. DBZ, H.6, S. 763-764.
- Mayer, E., Künzel, H. (1984). Bewährung von Wärmedämmverbundsystemen mit Kunstharzputzen in der Praxis. Der Architekt, H. 6.
- Künzel, H., Leonhardt, H. (1991). Praxisbewährung von mineralischen Wärmedämmverbundsystemen. Die Mappe, H. 7, S. 20-22.
- Künzel, H., Riedl, G., Kießl, K. (1997). Praxisbewährung von Wärmedämmverbundsystemen. Deutsche Bauzeitung 131, H. 9, S. 97-100.
- Künzel, H.M., Sedlbauer K., (2001). Biological Growth on Stucco. Buildings VIII-Proceedings Clearwater Beach, ASHRAE Publication.
- Beringer, J., Höfer D. (2004). Nanotechnology and its application – From the molecule to application. Melliand Textilberichte, T5, S. 295-296.
- Lam, C.N.C., Lu, J.J. & Neumann, A.W., (2001). Measuring contact angle. In: Holmberg, K. (ed) Handbook of Applied Surface and Colloid Chemistry.
- Beringer, J., Schubert M., Gündel, J., (2007). Effektiver permanenter UV-Schutz mit Nanoschichten. Melliand Textilberichte, T1, S. 57-61.



## Drop shape analysis – innovative implement in renovation area

**Petra Reinthaler**  
Vienna University of Technology,  
Center for Building Physics and Building Acoustics;  
petra.reinthaler@tuwien.ac.at and www.bph.tuwien.ac.at

**Clemens Hecht, Dr.**  
Vienna University of Technology,  
Center for Building Physics and Building Acoustics;  
clemens.hecht@tuwien.ac.at and www.bph.tuwien.ac.at

**KEYWORDS:** drop shape analysis, contact angle, wettability, hydrophobic, water absorption.

### **SUMMARY:**

*The destructive impact of water and solutes (mostly salt solutions) to prevent in building sector are often used injection materials for refurbishments. These materials are based on raw substances whose dilution will be applied. Refurbishments can be carried out with an additional horizontal moisture barrier, hydrophobic treatments and coatings.*

*The resistance against water load is evaluated by material properties like moisture content, water absorption, diffusion resistance, deliquescence and so forth. Additional to the common evaluation methods in this work drop shape analysis is used to assess water resistance of building material. The obtained values are contact angle, decrease of contact angle by time, surface tension and wettability. The aim of this work is to evaluate the significance, practicability, possibilities and meaning of drop shape analysis in building sector.*

## **1. Introduction**

After a refurbishment with injection materials and/or coatings the question of the effectiveness always arises after the time. This to answer is often connected with a complex sampling. There is no guarantee for a non destruction of the renewed building volume. A goal of this work is to present a method which sometimes supplies even more precise results with low expenditure and low sample amount than generally expected. Same applies to the evaluation of cases of damage.

## **2. Contact angle measurements on solid materials**

Due to the used measurement instrument and the analysed material respectively material character are the following methods known:

- € Sessile Drop Method  
is an optical contact angle measurement method to evaluate the punctual wettability on solid surfaces. The angle in the three-phase point between solid body, liquid and air is identified with goniometer or with optical software analyse.
- € Powder Contact Angle Method  
enables the measurement of contact angle and adsorption character of powders and other porous materials. The put on weight is measured by time out of it the wettability of powders, pigments, papers and textiles is calculated.

- € Dynamic Wilhelmy Method  
evaluates the advancing and the receding angle on solid bodies with defined geometry. The contact angle is evaluated due to the wetting force, wetting length and surface tension.
- € Single Fibre Method  
works with the same principle as Dynamic Wilhelmy Method. The advancing and the receding angle are evaluated on single fibres.

### 3. Drop shape analysis – feasibilities and limits

The used system is based on optical drop shape analysis (Sessile Drop Method) and evaluates punctual the wettability. Changes of measurement method, material and ambience have significant influence on results because of the punctual application.

#### 3.1 Influence of the measurement method and analysing method

The results of drop shape analysis are sensitive to changes of boundary conditions and changes of measurement procedure. The measurement instrument has to be positioned horizontal and the optical settings like focus, magnification, illumination, contrast, reflection and perspective should harmonise with the particular measurement. An essential influence has the evaluation of the three-phase point between solid body, liquid and air where the contact angle is measured. This is automatic or manual.

The drop profile is optically detected and characterised by curves which are analysed with following methods for sessile drops:

- € Ellipse  
The whole profile of a sessile drop is fitted to a general conic section equation. The derivative of this equation at the baseline gives the slope at the three-phase point of contact and therefore the contact angle.
- € Tangent  
The profile of the sessile drop in the region of the baseline is fitted to a polynomial function. From the obtained parameters the slope at the tree-phase point of contact at the baseline from which the contact angle is calculated.
- € Height-Width  
It is granted that the contact angle is not affected by the absolute drop size. The relation between maximum height and width of sessile drop let specify the contact angle.
- € Circle Fitting  
This method is used for small contact angles preferably. The drop shape is fitted to a circle segment equation. With this method, the whole drop shape is fitted and not only the base line region. Therefore, the needle must not remain in the drop.
- € Young-Laplace Fitting  
The drop shape is described mathematically using the Young-Laplace equation for curved interfaces.

The comparison of one measurement analysed with the different methods show value variations of 5 degrees.

#### 3.2 Influence of material and ambience

Geometry and surface character of solid samples, for example unevenness, surface finish, pores, inhomogeneity of composition have a significant influence to the measurement result. It is advantageous to know the water absorption and actual moisture content at point of measure time. The gravitation affects the drop profile until a drop volume of 10 µl insignificant. As bigger the sessile drop as more sensitive is it to conditions of ambience. Temperature and air move affect respectively change the surface characters of the liquid and therefore the drop shape.

## 4. Application in building sector

### 4.1 Correlation between contact angle and water absorption

The measuring of contact angle and water absorption of building materials leads to different results. With two examples the correlation between contact angle and water absorption will be constituted. Due to the measurement of contact angle on wooden probes the different water transport properties will be revealed. For several facade systems the contact angle and its decrease by time will be compared with measured water absorption.

#### 4.1.1 Wood

The wood sorts beech, spruce and pine with different age from felling are used for analysing. Used ages are: newly lumbered, 10 years, 30 years, 50 years and 200 years after felling. Due to the dosing of very small drops ( $2\mu\text{l}$ ) the differentiation of annual rings like spring wood and summer wood is possible. Dependent on form and design of samples the contact angle will be measured in direction of fibre and cross to it.

Water transport in wood is essential lower across the fibre direction than along direction of fibre. This behaviour is investigated by measuring contact angle by the time. Observation over a period is important to evaluate water absorption properties by results of contact angle measurement. On parts of spring wood and summer wood small dosed drops of water are deposited and values of contact angle are measured by time. Due to the dense structure of the summer wood a lower water absorption compared to spring wood is expected. This assuming means that the contact angle is smaller and the slope (contact angle over period) plunges down. The results of summer wood show a higher contact angle than results of spring wood except results of newly lumbered wood, where contact angle of summer wood is lower than that of spring wood. Due to the fact that this result appears exclusively on newly lumbered wood the reason is maybe based on balance moisture. In FIG. 1 are the results of newly lumbered pine wood shown. The results differed in fibres direction deliver comparable results, so slopes in fibres direction and slopes cross fibres direction show similar decrease. Drops which are deposited in fibres direction are absorbed fast, the contact angle plunge down. Values of contact angle are in the same range but curves differ in gradient.

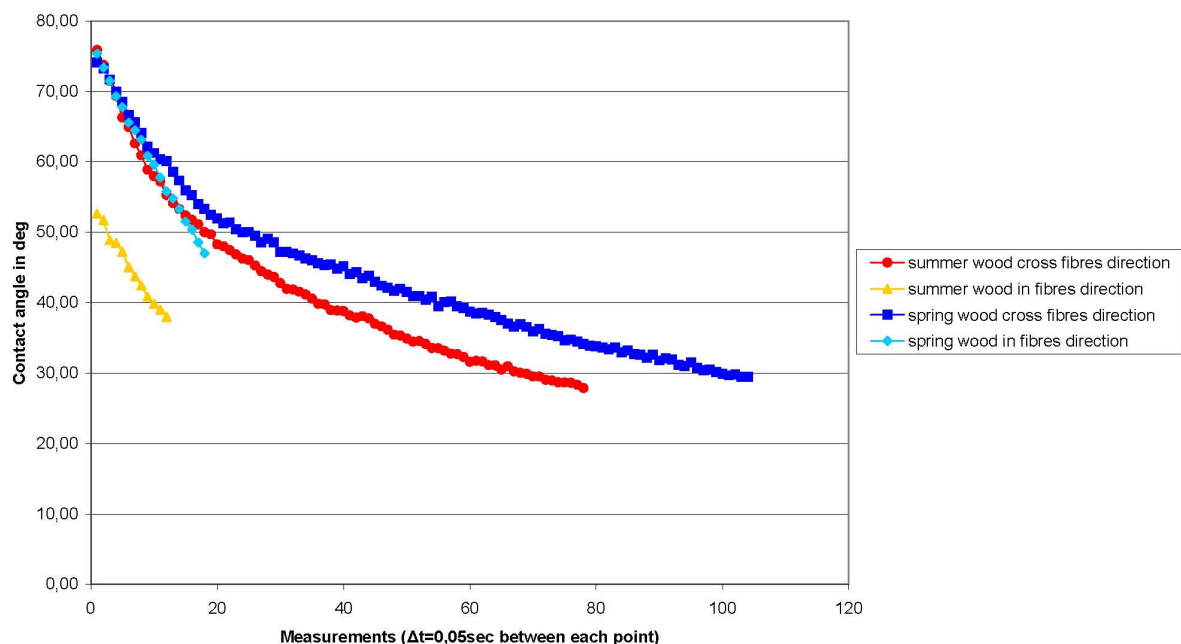

FIG. 1: Contact angle water on pine sapwood

#### 4.1.2 Facade coating

The water absorption of several facade coatings is measured by two different processes (see FIG. 2):

- € Direct water absorption  
The sample is vertical with the thin side deposed in water. This kind of water absorption is comparable with ascending water absorption from soil moisture.
- € Water absorption by fleece  
Samples are deposed with the broadside on wet fleece. Water absorption in this way is similar to water load by driving rain.

The gain of weight because of water absorption is measured over period and the water absorption coefficient in  $\text{kg}/(\text{m}^2\text{h})$  is calculated.



FIG. 2: Direct water absorption



Water absorption by fleece

Drops of  $5\mu\text{l}$  volume are deposed on the broadside of the facade samples to measure the contact angle over period. The results are plotted against time and the decrease of contact angle is evaluated by the gradient of the curve. The values of the contact angle are summed up over whole measuring period and the arithmetic mean is calculated. In FIG. 3 are values of contact angle, contact angle decrease, water absorption direct and by fleece compared. The samples are ordered due to its position on completed facade in situ, from porous to tight coating. The increasing water-repellent effect to the surface of the facade is visible on the values of contact angle (magenta columns). With increasing contact angle the value of contact angle decrease is more level that means low water absorption. The lines and the scale on the right side show the water absorption coefficient defined by tests (direct water absorption – turquoise line; water absorption by fleece – green line). An overall consideration of the chart shows that samples with low contact angle and high contact angle decrease have high water absorption. Except the sample SA2 the relation between contact angle and water absorption is visible well in figure FIG. 3. According to the results the contact angle is better differentiable than values of water absorption coefficient, especially in the range of low water absorption respectively high contact angle.

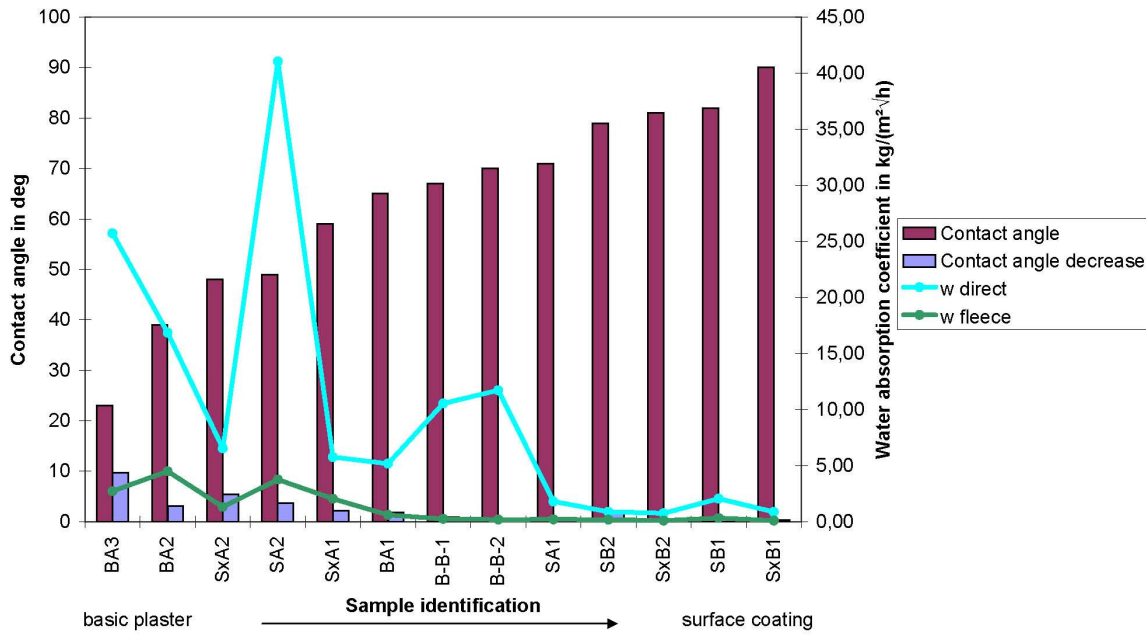

FIG. 3: Comparison contact angle - water absorption

### 4.2 Verification of hydrophobic effect

For testing and evaluation of hydrophobic effects of materials the contact angle of water is measured. A material is called hydrophobic when the contact angle of water on the specific material is higher than 90 degrees.

The aim of this analysing is to evaluate the effect and the existence of hydrophobic agents on different materials and different states. The contact angle is measured on solid state, several fractions and drilling chips respectively powder (see FIG. 4 to FIG. 6). Results will be compared and the applicability of the measurement method on powder will be evaluated. Due to the possibility to measure contact angle on powder there is no need to retain samples of drilling cores, so the amount of sample material can be minimized. Drilling step by step enables to analyse the hydrophobic effect proportional to depth from surface. With this method sample material will be minimized and can be used in renovation sector like preservation of monuments and historic buildings.

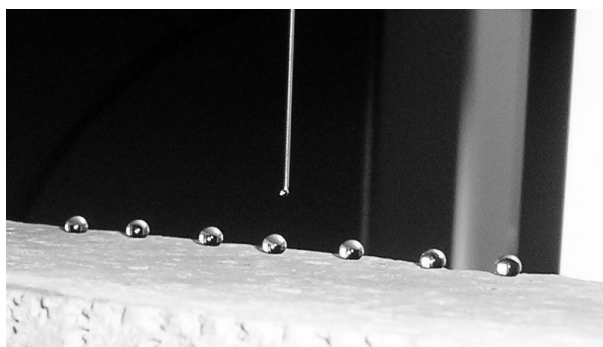

FIG. 4: drops on solid body

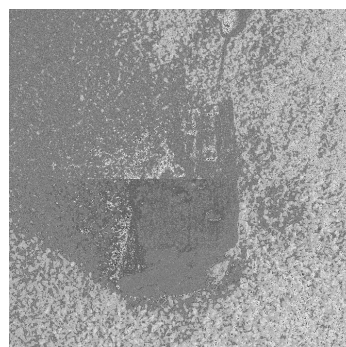

FIG. 5: drops on fraction



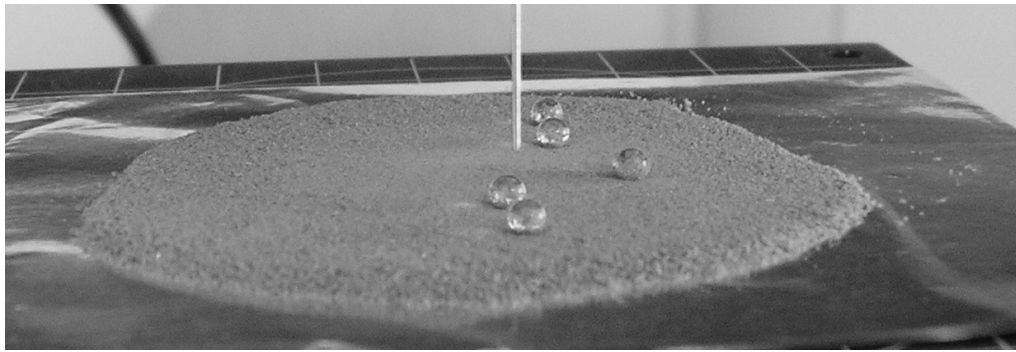

FIG. 6: drops on drilling powder

Brick samples are used for analysing which took several hydrophobic agents by capillary force. Variations in application conditions like temperature and concentration of solution are carried out to evaluate consequences of failures in application. Each variation is done triple and on each sample are minimum five drops deposited.

In FIG. 7 are the results of contact angle on brick compared to contact angle on drilling powder of the same material. The empty rings show each separate measurement and the fulfilled dots show the arithmetic means of the single measurements. The hydrophobic effect that means a higher contact angle than 90 degrees is in both cases demonstrated. The results of the two charts are in the same range and the values are considerably above 90 degrees. The variations between 120 and 150 degrees follow from the ball form of the water drop where it is hard to find the significant tangent.

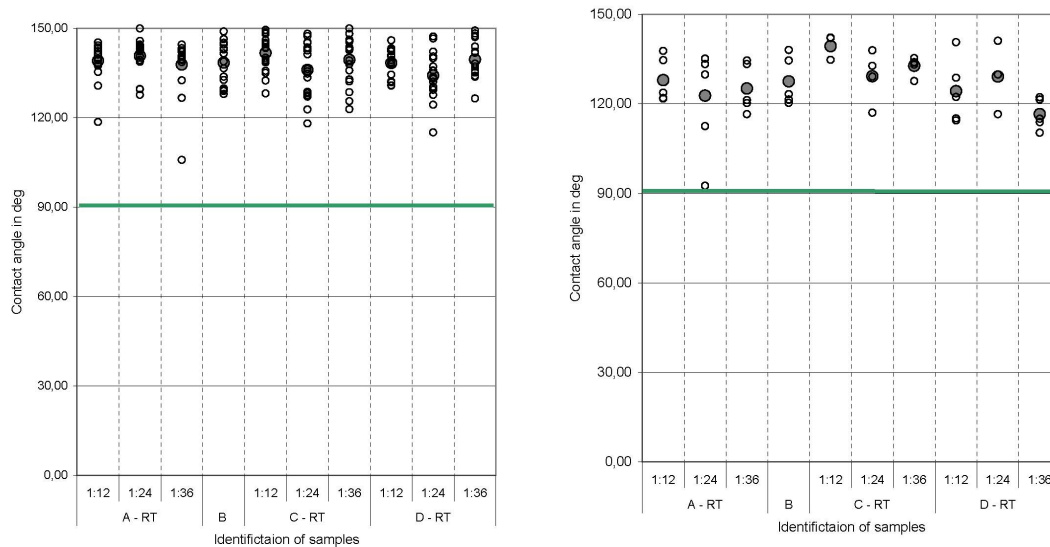

FIG. 7: Contact angle on brick

Contact angle on drilling powder

Gypsum plaster boards for application in damp locations (bath rooms for example) are during fabrication treated with water repellent agents for impregnation. To evaluate the effect the drop shape analysis is used. Therefore the cardboard is removed and a drop of water is deposited directly on gypsum material where it is observed by period. An example of results is visible in FIG. 8. The pure lines picture samples which are treated with hydrophic agents and the lines with the dots mark untreated gypsum material. The gradient of the pure lines demonstrates a considerably improvement of the water repellent effect but the criteria of hydrophobic identification (contact angle higher than 90 degrees) is not met. Even when criterion is not met the contact angle stays constant in comparison to the untreated material (line with dots).

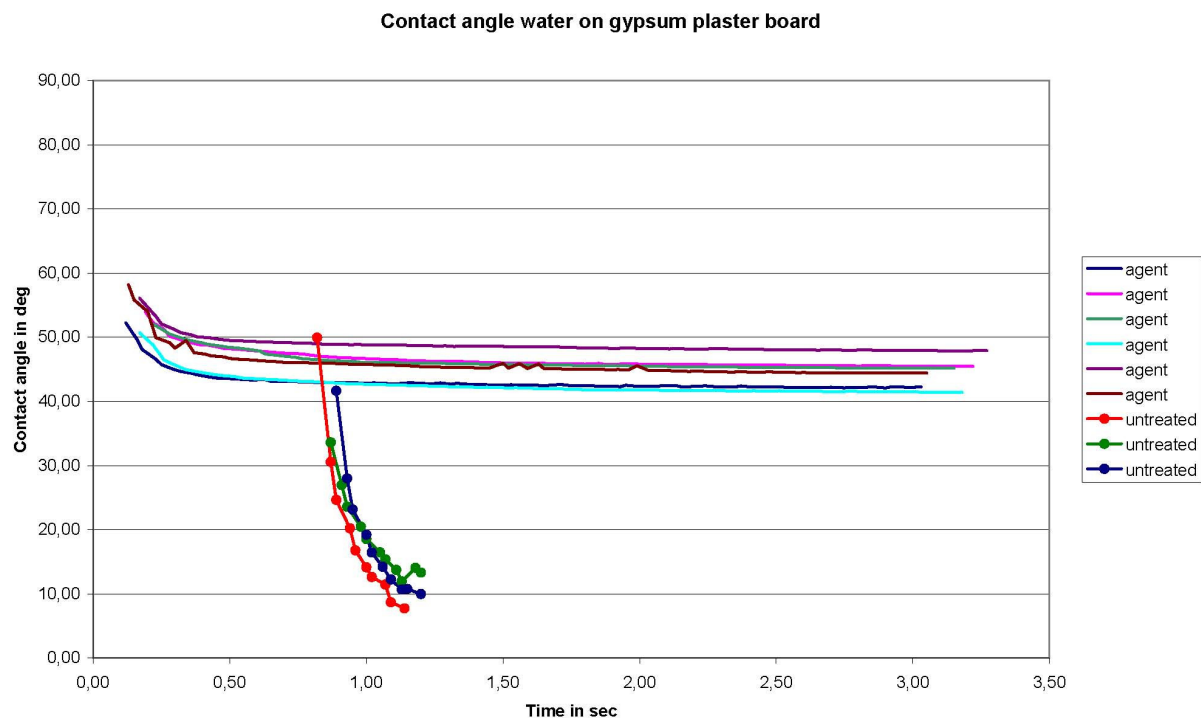

FIG. 8: Contact angle water on gypsum plaster board

## 5. Conclusion

With the measurements on the wooden samples and facade coatings the coherence between water absorption and contact angle is visible. But at contact angle measurement there exist multitude of influencing factors to consider and include in evaluation. It is not assured to deduce material properties from only value of contact angle in fact the observation of the drop by period is significant (compare results of gypsum plaster board).

The results for evaluation of renovation actions show that the water repellent effect of agents is measurably with drop shape analysis. Too thin solutions and too cold application temperatures don't have a clearly impact to the value of contact angle so it is not possible to conclude to the quality of the renovation action.

Reconfirming that the observation of the drop by period is required; the material is hydrophobic or has water repellent properties if the contact angle stays constant for some length of time. The consequence is to evaluate the water absorption with the change of contact angle by period not with the limit value of 90 degrees. Explicit texts are running at the Center for Building Physics, Vienna University of Technology.

The successful measurement on drilling powder shows that drop shape analysis has high potential to be used in renovation sector like preservation of monuments and historic buildings. At this time the specific definition of the minimum required amount is missed yet, tests are running.

## 6. References (complete)

- De Clercq H., De Witte E. (2002). Effectiveness of Commercial Silicon Based Water Repellents Applied under Different Conditions, *International Journal for Restoration of Buildings and Monuments*, Vol 8, No 2/3, p.149-165.
- Carmeliet J., Houvenaghel G., Van Schijndel J., Roels S. (2002). Moisture phenomena in hydrophobic porous building material, Part 1: Measurements and physical interpretations; *International Journal for Restoration of Building and Monuments*, Vol 8, No 2/3, p.165-185.
- Carmeliet J., Houvenaghel G., Van Schijndel J., Roels S. (2002). Moisture phenomena in hydrophobic porous building material, Part 2: Measurements and Modelling; *International Journal for Restoration of Building and Monuments*, Vol 8, No 2/3, p.185-205.
- Ficenc J., Hecht C. (2007). Hygrothermische Analyse der Außenbeschichtung von Wärmedämmverbundsystemen; Paper 12th Symposium for Building Physics / Dresden, in „Proceedings Vol. 2.

# New type of “Moisture adaptive vapour barrier”

*Niels Peter Kloch, Civil Engineer  
AleKri ApS  
np@kloch.eu*

*Georg Christensen, Civil Engineer  
Bygge- og Miljøteknik A/S  
gc@byggeteknik.com*

*Eirik Sandberg Jensen Civil Engineer  
Icopal A/S  
dkesj@icopal.com*

**KEYWORDS:** *Moisture transport, vapour barriers, laboratory tests in small and large scale.*

## **SUMMARY:**

*This paper describes a new moisture adaptive vapour barrier based on lamination of two foils with different properties regarding water vapour diffusion.*

## **1. Introduction**

During the last two decades a number of so called “Moisture Adaptive Vapour Barriers” have been developed and later used in the building industry to a great extent.

The overall objective behind the development of these vapour barriers (foils) has been to produce a vapour control layer which has a high vapour permeability in a moist environment and a lower permeability in a dry environment.

The desired effect has often been achieved in a combination of properties related to diffusion and capillary effect or diffusion alone.

In this paper a new type of moisture adaptive vapour barrier based on diffusion will be presented. The Vapour control layer differs from earlier types in two ways; 1) by having almost as high a vapour diffusion resistance as traditional vapour barriers in dry condition but still being able to function under moist conditions and second; 2) by having different diffusion resistances dependent on the direction of the diffusion. This has been achieved by laminating materials with different properties and geometry (e.g. Perforations).

Results dealing with vapour permeability will be presented from standard cup tests and from full scale tests on a roof component.

## **2. Background**

Moisture adaptive vapour barriers (MAVB) have been used in the building industry in a relative short period of time, approximately 20 years. The technology has been known and used for decades within other industries; especially different polymeric membranes have been used in the food packaging industry for long.

The first product<sup>1</sup> in this area was not based upon a variable water vapour transmission. The functionality of this membrane was based upon physical measures of capillarity and condensing of water on the cold side of the vapour barrier combined with physical diffusion and capillary action transporting water through spacings in an intermediate felt. The first MAVB<sup>2</sup> entirely based on diffusion and used in the construction industry was a polyamide 6 or other types of polyamides which are known for their hygroscopic behaviour.

The idea behind the development of a new MAVB is, to create a membrane which is diffusion tight in the winter period, with a low relative humidity, to prevent moisture from the warm indoor climate to penetrate into the structure. Under summer conditions, the temperature difference over the structure is often reversed having the warmest side outside thus reversing the direction of the diffusion. If moisture is trapped inside the structure, a vapour control layer VCL with a low diffusion resistance will allow the moisture to escape by means of diffusion from the structure to the indoor environment.

Above being the reason for designing a TVB, which has a higher diffusion resistance in the winter period with lower relative humidity, and a lower diffusion resistance in the summer period, with higher relative humidity.

In figure 1 is shown an example on how the diffusion resistance could vary with the relative humidity. Please note that the values displayed are not actually values, but only used for illustration of the function.

However, it is often seen that there is a high relative humidity in the indoor climate, during the construction period, and during refurbishment. The ideal MAVB would therefore not only change the diffusion resistance with the humidity, but also have different diffusion resistances dependent on the direction of the diffusion, to reduce the water vapour transport into the structure. The diffusion resistance of the MAVB under moist conditions must be balanced between being low enough to secure the drying out of the structure under summer conditions, but also high enough to reduce the water vapour diffusion into the structure, during high humidity conditions in the indoor environment.

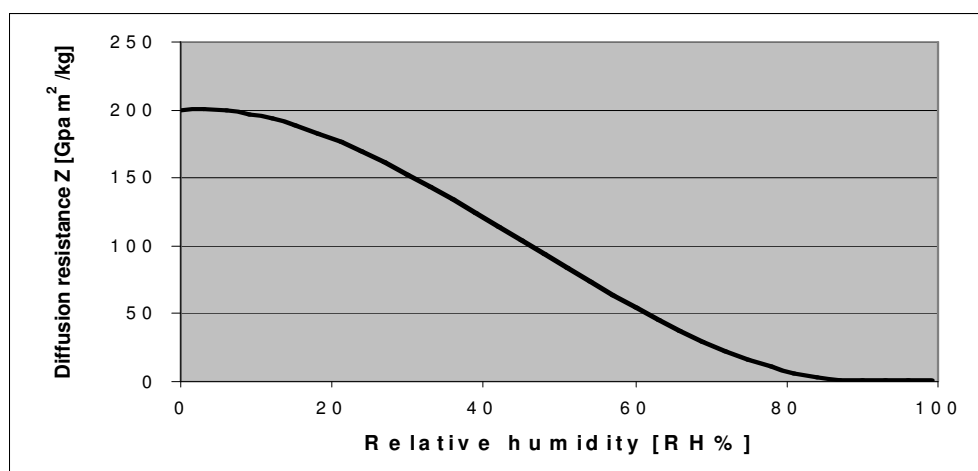

FIG. 1: The diffusion resistance as a function of the relative humidity.

### 3. Product parameters

A membrane with different diffusion resistances dependent on the direction of the diffusion would be an improvement to the above-mentioned MAVB. A new foil is developed by laminating a traditional vapour barrier (TVB) having a fixed diffusion resistance, with a MAVB. The diffusion resistance will then not only vary with the humidity, but the diffusion resistance will also depend on which side of the membrane lies on the moist side.

In figure 2 is shown the principle behind the development of the new foil. Although the membrane is laminated into one membrane the calculation for the membrane is divided into three different layers, MAVB, TVB layer, and a fictive air layer between the two materials.

Moisture resistance depending on direction (relative values)					
Moist condition in room	Room	New membrane			Structure
		TVB		MAVB	
Relative humidity	80%	70%	60%	50%	40%
Diffusion resistance Z		100		95	Total Z= 195
<hr/>					
Moist condition within structure					
Relative humidity	40%	50%	60%	70%	80%
Diffusion resistance Z		100		25	Total Z= 125

FIG. 2: Schematic calculation of diode effect of the new foil.

This first calculation demonstrates that there is a difference in the diffusion resistance for the new foil dependent on the direction the diffusion. By iterating a few times, it can be demonstrated, that the difference in diffusion resistance (Z-value) is even larger than shown here.

By applying a TVB the combined diffusion resistance cannot be lower than the diffusion resistance of the TVB. By perforating the TVB, a larger dynamic effect can be achieved for the new foil. This does, however, reduce the “diode effect” of the membrane.

A simple method of calculating the now combined diffusion resistance of a perforated TVB laminated to a MAVB is to calculate the values for the two different cross sections and use the area weighted average value. This method will be valid if the diffusion resistances of the two cross sections are close, but the diffusion will always be perpendicular to the isobars for the partial water vapour pressure, giving a proportional bigger diffusion through the areas with a lower diffusion resistance, than for the other areas. A method of calculating the resulting diffusion through perforations is given by Wim van der Spoel<sup>3</sup>.

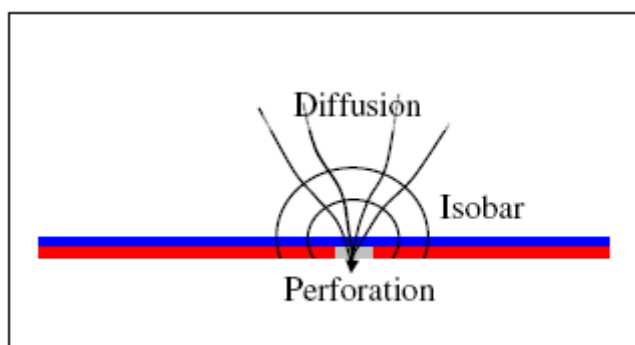

FIG. 3: The diffusion will always be perpendicular to the isobars for the partial water vapour pressure.

Table 1 gives the results of measurements of the water vapour diffusion resistance with respect to %RH from the side of the hygroscopic film respectively the perforated polyethylene side. The results show a difference in the diffusion resistance depending upon which side of the new film is towards the high %-RH. The perforation is a grid of 1,5mm pinholes with a distance of 4,5mm.

RH [%] Perforated TVB	RH [%] MAVB	Z-value
0	80	23,4
80	0	32,2
30	80	16,9
80	30	21,1
50	100	9,5
100	50	10,3
80	100	4,4
100	80	5,1

TABLE. 1: Z-values for the new foil.

## 4. Two full scale tests

In order to compare a traditional MAVB and the new foil where a moisture adaptive vapour barrier is laminated to a perforated foil (not moisture adaptive) two full scale laboratory test were carried out.

In the first case it was studied how moisture accumulated in the top of the roof components under simulated winter conditions.

In the second test it was studied how moisture escaped from the bottom of the components during simulated solar radiation on the roof covering.

In both cases identical roof components were used – except for the two different vapour barriers.

### 4.1 Moisture transport into the roof components

Two roof components shown in figure 4 were placed side by side as separations between a cold room and a warm room. The temperature in the cold room was app 3 degrees and 90% RH. The temperature in the warm room was app 22 degrees and 50% RH.

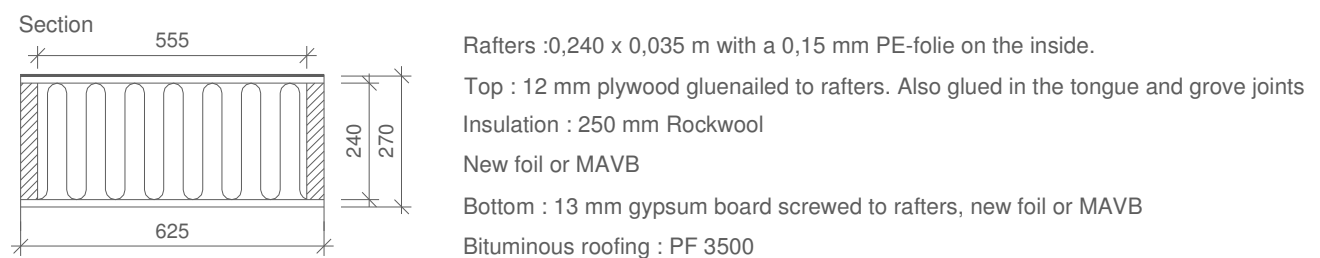

FIG. 4: Components used for the two full scale tests

These conditions were simulating winter conditions and were maintained for about four months.

Six moisture meters were placed in the 12mm plywood used as substrate for the roof covering. These were 12mm plywood discs (d= 50mm) equipped with calibrated electrodes for measuring moisture content by means of the electrical resistance between the two electrodes. Further a thermocouple was placed in the discs to make the necessary corrections due to the influence of the temperature on the measured electrical resistance.

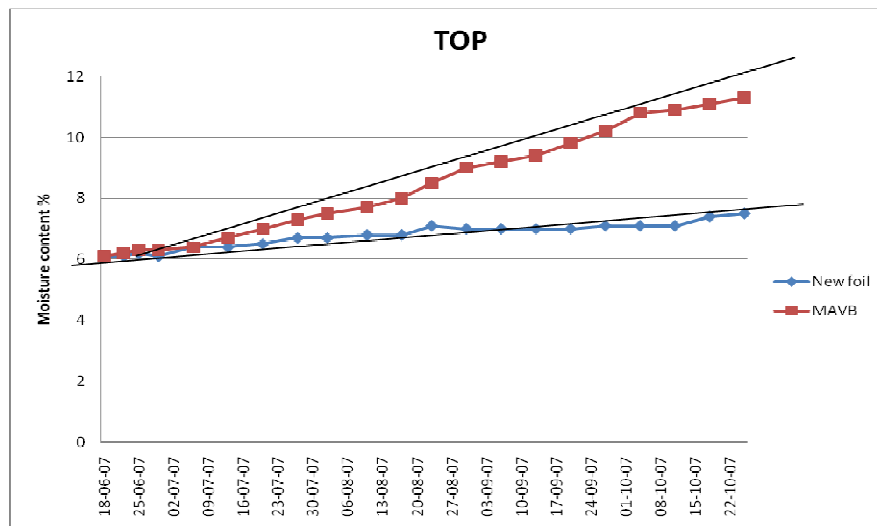

FIG. 5: Moisture accumulation in the plywood beneath the roof covering under simulated winter conditions

In figure 5 is shown the moisture content in the plywood underlay during a four month period. Each graph is the average of measurements from the six moisture meters. From the slope of the two graphs it can be seen that the accumulation of moisture in the plywood takes place app 3 times as fast in the component with the traditional MAVB compared with the new foil. It is then reasonable to assume that the Z-value ( $s_d$  value) in this case is also differing with a ratio of app 3 since the vapour barriers are the only real resistances to the moisture flow in the components. The new foil having the greatest diffusion resistance.

This feature is important not only under winter conditions but also in situations where it is considered important to avoid moisture accumulation during the construction period.

#### 4.2 Moisture transport out of the roof components

In the second test figure 6 shows how drying through the bottom takes place when sunshine is simulated on top of the roof one hour a day (app. 55 degrees on the roof surface) and app 12 degrees on the roof surface the remaining period. In the warm room temperature and humidity conditions are approximately as during the first test. The testing period was approximately two months.

The plywood beneath the roof felt has on beforehand in both components been moistened in the same way by means of diffusion to a level above 30% moisture content. It should be noticed that the moisture meters cannot measure moisture contents correctly above app 30%.



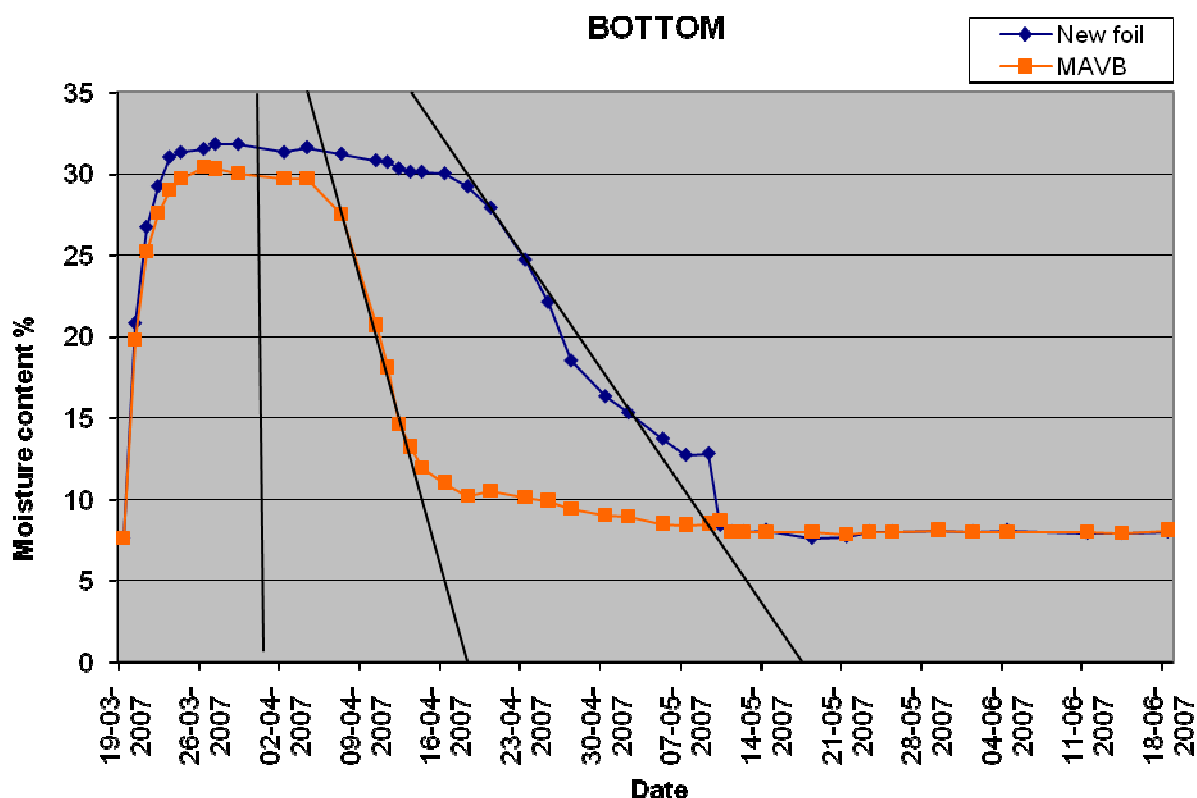

FIG. 6: Drying of moisture in the bottom of the components under simulated solar radiation

Measurements in the bottom are made with six wood dowels placed between the mineral wool and the vapour barriers. Electrical resistance and correction for temperature is made in the same way as for the plywood discs. It can be seen that drying takes place faster with the traditional MAVB than with the new foil. Due to the non linear graphs it is not possible to state any rather exact ratio between the two rates as it was the case in the first test. However by looking at the development in the moisture content when drying goes from 25% to 15% it is reasonable to assume that the relationship between diffusion resistances of the two foils is again app 3 with the diffusion resistance of the new foil being the greater.

### 4.3 Conclusion from the two full scale tests

When simulating winter conditions the first full scale test has shown that moisture accumulates in the top at a slower rate app 3 with the new foil compared to the traditional MAVB thus indicating a corresponding higher Z-value of the new foil.

The second full scale test has shown that the moisture accumulated in the bottom caused by solar radiation on the roof surface dries out slower with the new foil compared with the MAVB. Due to the non-linear drying process it is not possible to give a similar accurate ratio between the two diffusion resistances as in the first situation. However it is reasonable to assume that the ratio is approximately the same in the drying situation with the new foil having the highest diffusion resistance.

Further it should be noticed that when the ratio between the diffusion resistances are approximately the same in the two directions for moisture transport it is reasonable to assume that the maximum moisture content and the amplitude of the moisture content both over the years will be smaller in a roof component with the new foil than in a roof component with a traditional MAVB.

## 5. Conclusion

A new type of moisture adaptive vapour barrier having different diffusion resistances dependent on direction of the diffusion has been design and tested. The “diode effect” of the membrane has been found by measuring the diffusion resistances of the new foil under different climate conditions.

Full scale laboratory tests demonstrates, that even though the new foil has a higher diffusion resistance than earlier types of MAVB, the drying out potential is sufficient. The high diffusion resistance during winter conditions gives a slower diffusion of water vapour into the structure under winter conditions. Compared to known MAVB the amplitude and maximum content of water in the structure is reduced using the new foil as vapour control layer.

---

<sup>1</sup> V. Korsgaard, EP 0.148.870, „Vapour Barrier“.

<sup>2</sup> H.M. Künzel, DE 195 14 420, ”Dampfbremse für den einsatz zur Wärmedämmung von Gebäuden“.

<sup>3</sup> Win van der Spoel, “Water vapour transport through perforated foils”, Research in building Physics 2003. ISBN 90 5809 565 7



## Passive House for a cold climate

**Jyri Nieminen**

VTT

*jyri.nieminen@vtt.fi, <http://www.vtt.fi/>*

**Riikka Holopainen**

VTT

*riikka.holopainen@vtt.fi, <http://www.vtt.fi/>*

**Kimmo Lylykangas**

*Helsinki University of Technology*

*kimmo.lylykangas@hut.fi, <http://www.hut.fi/>*

**KEYWORDS:** *energy efficiency, buildings ,passive housed, energy demand.*

### **SUMMARY:**

*Passive house refers to a specific construction standard for residential buildings with good comfort conditions during winter and summer, without traditional heating systems and without active cooling. Typically this includes very good insulation levels, very good airtightness of the building, whilst a good indoor air quality is guaranteed by a mechanical ventilation system with highly efficient heat recovery. The properties of the Finnish passive house were defined by VTT in the European research project Promotion of European Passive Houses (PEP) funded by Intelligent Energy Europe program in FP6:*

- *The total primary energy use for appliances, domestic hot water and space heating and cooling is limited to 130 – 140 kWh/m<sup>2</sup>,*
- *The total energy demand for space heating and cooling is limited to 20 - 30 kWh/m<sup>2</sup> floor area;*
- *The airtightness of the building envelope  $n_{50} \leq 0,6$  l/h*

*Pilot projects fulfilling the cold climate requirements for a passive house are being built in Vantaa and Valkeakoski. Preliminary results show that the suggested definition is applicable in the climate of Southern and Central Finland.*

## **1. Introduction**

The energy demand is defined to be higher than the corresponding demand in Central Europe. Energy simulations [1] have shown that a Passive house in the climate of Central Finland would require insulation (thermal conductivity  $\lambda = 0,035$  W/mK) thicknesses of 50 - 60 cm in exterior walls, 70 - 80 cm in the roof, and roughly 40 cm in the floor to fulfil the Central European requirement. At the same time window area should be minimized, and the total window U-value should be less than 0,5 W/m<sup>2</sup>K. The economic viability of such a building is rather low, and thus the Central European definition is not justified.

The heating energy-saving potential of passive house is at least 75% of the current standard of construction in all climates in Europe. The experiences gained in Central Europe are not directly applicable in the Nordic or Baltic cold climate zones. There are several issues that restrict the use of existing passive house systems in cold climates, e.g.:

- The demonstrated concepts do not fulfil the energy demand requirement in a cold climate
- The hygrothermal performance of typical passive house building systems may not be appropriate
- The frost conditions in cold climate require foundation thermal insulation measures that have not been tested or provided with appropriate instructions
- The ventilation heat recovery efficiency is affected by defrosting that reduces the yearly efficiency of that of the best practice in milder climates
- The traditional Nordic heat supply systems are not applicable to passive houses due to high heat release power, and thus the user sensed thermal comfort differs of that typical, e.g., in Finland

If the passive house concept can be widely adapted to new construction the concept offers an important possibility to reduce the overall CO<sub>2</sub> emissions in Europe.

The definition of a passive houses bases on the energy demand. The aim of a passive house is also the use of renewable and low-emission energy sources. The total energy demand of a passive house refers to total primary energy demand. The problem with the primary energy approach is the use of conversion factors, as requested. Consumers can order, e.g., wind electricity via the grid. If the conversion factor refers to all electricity from the grid, the method does not promote the development of renewable energy supply. As such the conversion to primary energy is not applicable.

Thick insulation layers necessitate special attention to be paid to the performance of the structures. Frost protection of foundations, drying capacity of insulated structures, avoidance of thermal bridge effects, and long term performance of the airtight layers need to be considered. The concept development and construction of the first Finnish Passive houses tackled these challenges.

Experiences on ventilation heating systems show that simple heating systems are viable also in the cold climates. The increased heating power demand compared to climates in Central Europe does not reduce the indoor air quality. Room based control enables varying room temperatures according to specific needs of the users.

## 2. Passive house design

### 2.1 Building envelope

A passive house for a cold climate requires a high thermal insulation level. A passive house can be built of different building systems, and there is no special material dependence. The importance of thermal mass is also quite low in a cold climate. As the heating season is short, only 4 – 6 months, passive solar heating has also a low importance – there is only few sun shine hours in the midwinter months from November to January.

Passive house design requires accurate knowledge over the properties of building component. The effects of thermal bridges need to be included into the thermal transmittance of the building envelope. Therefore the design bases on more accurate U-value calculations than, e.g., required by the building code. The following indicative proper-ties for thermal insulation of the building envelope help for structural and energy design of the house:

- Wall 0,07 – 0,1 W/m<sup>2</sup>K
- Floor 0,08 – 0,1 W/m<sup>2</sup>K
- Roof 0,06 – 0,09 W/m<sup>2</sup>K
- Window 0,7 – 0,9 W/m<sup>2</sup>K
- Fixed window 0,6 – 0,8 W/m<sup>2</sup>K
- Door 0,4 – 0,7 W/m<sup>2</sup>K

Ground conditions vary in different parts of the country. During a cold winter the ground may freeze down to 1,5 meters in Southern areas, and even down to 2,5 meters in Lapland. These conditions require special attention to foundation system design. Basically, depth of the foundation bed in the ground, heavy foundation insulation , or change of ground mass to non-frosting soil removes the risk. In a typical building the floor heat loss is used for reducing the frost heave risk. As the thermal transmittance of the floor is very low, the heat loss is not applicable any more. Therefore the risk need to be analysed carefully, as the guidelines for foundation design do not cover floor structures with U-values below 0,15 W/m<sup>2</sup>K.

### 2.2 Heating demand

Internal heat loads cover a large part of a passive house's heating demand. Table 1 and Figure 1 show the dependence of the heating demand on the various properties in the climate of Helsinki. The risk of freezing of heat recovery unit is a problem connected to cold climate solutions. The energy performance requires an average heat recovery efficiency of more than 75% in the climate of Helsinki at the same time as defrosting is needed.

Defrosting by heat or cyclic use of heat recovery for reduces the efficiency of heat recovery. Thus other ways and means should be applied as far as possible.

Subsoil heat exchanger for preheating of supply air may reduce or eliminate the defrosting demand. Ståhl (2002) and Thevenard (2007) give the following guidelines on the performance and possible problems with solutions for a subsoil heat exchangers for a cold climate:

- Performance
  - 30 - 100% of the cooling demand in summer
  - Prevent freezing in the heat exchanger unit
  - Energy gain 1200 kWh with minor increase of intake fan power
  - Tube length 10 - 100 m
- Potential problems
  - Moisture control: mould and bacteria growth
    - § pipes with a 2-3% slope, water collects at the lowest point, pumped out;
    - § intake filters to prevent the entry of spores, insects, etc into the system;
    - § access to the pipes for easy cleaning;
    - § anti-microbial coating on the pipes.
  - Radon seepage from the soil: Airtight tube with connections

In the light of possible problems, subsoil heat exchanger can not be recommended to be used in a cold climate. However, ground heat is a possibility by using a heat well of ground loop system integrated with a heat exchanger to pre-heat the fresh air. This system will be used in the first passive house to be build and certified in Finland.

Table 1. Properties of a passive house for heating energy demand calculations for a passive house in Helsinki

<b>Building envelope</b>					
Component	m <sup>2</sup>	a) W/m <sup>2</sup> K	b) W/m <sup>2</sup> K	c) W/m <sup>2</sup> K	d) W/m <sup>2</sup> K
Wall	343	0,12	0,1	0,09	0,09
Basement wall	110	0,12	0,1	0,08	0,08
Roof	235	0,1	0,07	0,07	0,07
Floor	235	0,15	0,15	0,1	0,1
Window		0,8	0,8	0,7	0,7
- South	6				
- East	8				
- West	30				
- North	6				
Doors	16	0,4	0,4	0,4	0,4
<b>Air tightness</b>					
n <sub>50</sub> value	1/h	0,6	0,6	0,6	0,6
<b>Ventilation</b>					
Rate	l/s	2 x 76			
Heat recovery	%	70	75	75	80
<b>Spaces</b>					
Gross floor area	2 x 235 m <sup>2</sup> According to external dimensions				
Treated area	2 x 187 m <sup>2</sup> According to internal dimensions				
Gross volume	2 x 844 m <sup>3</sup> According to external dimensions				
Volume	2 x 540 m <sup>3</sup> , room height: downstairs 2,6 m, upstairs 3,2 m				

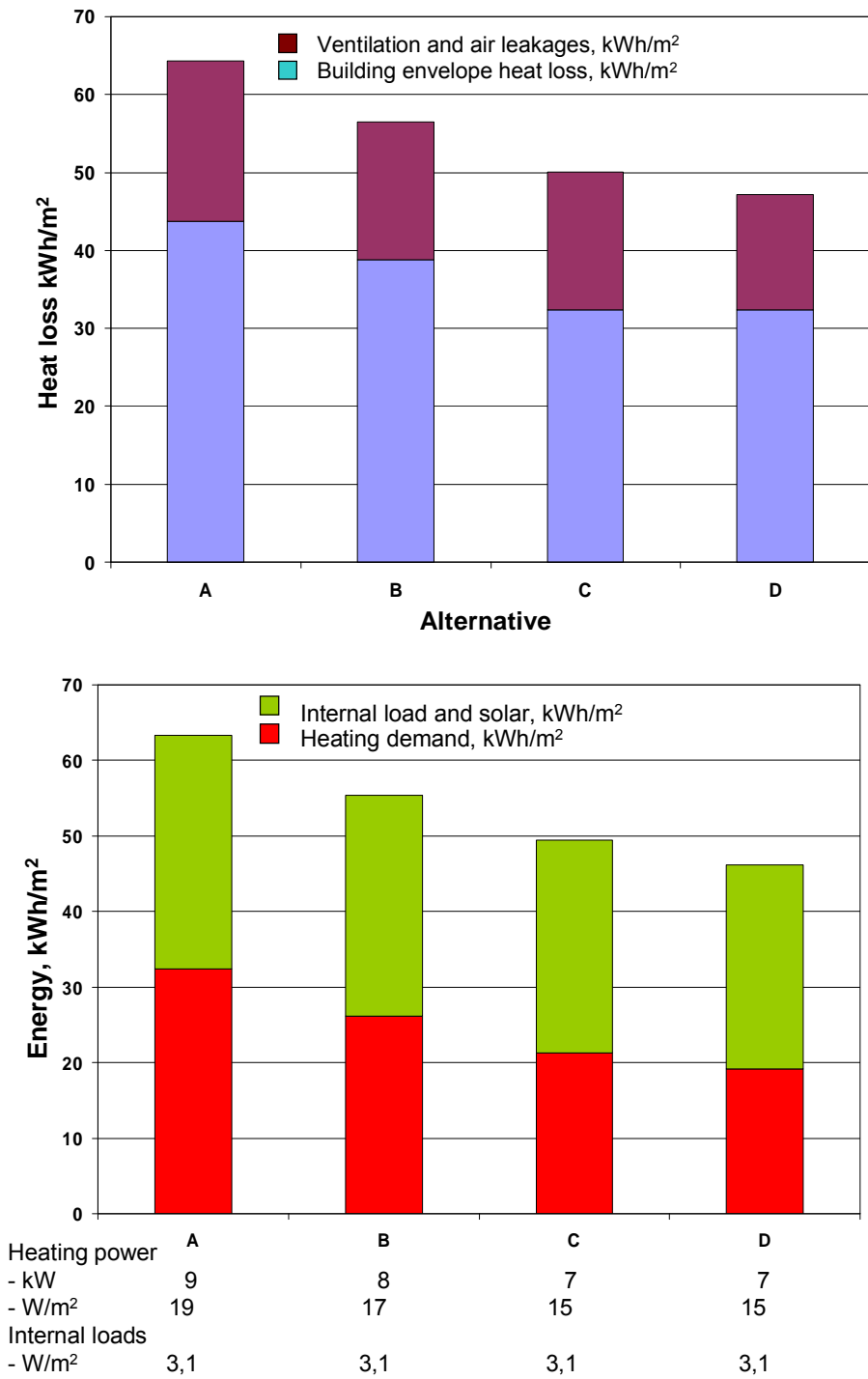

FIG. 1. Passive house's heating demand according to different properties of the house (Nieminen, J. et al. 2008)

### 3. Pilot projects

Interest in passive houses has increased in Finland. Several projects started in 2007. Two passive house projects under construction serve as pilots where different technologies and parameters are being tested. The Vantaa passive house is a two storey two family house, Figure 2. Building is a massive building with exterior insulation composite system as thermal insulation.

The Valkeakoski passive house is a wooden single family house, Figure 3. The load-bearing structural system is a modified Nordic Platform with I-beam wall structure and internal floor. Basic structural details of the system are at <http://www.puuinfo.fi/>.

Both buildings have a trussed roof. The properties of these buildings are given in table 2.



FIG. 2. Passive house Vantaa.



FIG. 3. Passive house Valkeakoski



Table 2. Properties of a passive house for heating energy demand calculations for a passive house in Helsinki

<b>Building envelope</b>			
House		Vantaa	Valkeakoski
Wall	W/m <sup>2</sup> K	0,1	0,08
Basement wall	W/m <sup>2</sup> K	0,1	-
Roof	W/m <sup>2</sup> K	0,07	0,07
Floor	W/m <sup>2</sup> K	0,10	0,10
Window	W/m <sup>2</sup> K	0,8	0,75
- South	m <sup>2</sup>	6	30
- East	m <sup>2</sup>	8	2
- West	m <sup>2</sup>	30	1
- North	m <sup>2</sup>	6	42
Doors	W/m <sup>2</sup> K	0,7	0,7
<b>Air tightness</b>			
n <sub>50</sub> value	1/h	0,6	0,6
<b>Ventilation</b>			
Rate	l/s	2 x 76	
Heat recovery	%	80	80
<b>Spaces</b>			
Gross floor area	m <sup>2</sup>	2 x 235	290
Gross volume	m <sup>3</sup>	2 x 844	1200

### 3.1 Energy demand

The pilot buildings' energy demands were simulated using VTT House simulation program. VTT House is a non-commercial building simulation application with integrated calculation of heat transfer and fluid flow processes. Calculation basics are

- Free nodal approach with discrete definition of mass balance, momentum, and heat balance equations
- True modelling on thermal conduction, convection, and radiation
- SIMPLE Algorithm
- Sparse matrix solver (Preconditioned Conjugate Gradient Method)
- A graphical interface for building material, HVAC system, and other necessary input data definitions.

Both the Vantaa and Valkeakoski passive houses have a ground preheating system for the ventilation fresh air. In the Vantaa house, two 100 m loops locate at 2 m depth in the ground. In the Valkeakoski passive house, a heat well will be utilized.

Figure 4 and 5 shows the hourly heating power demand and heating energy demand of the Vantaa passive house. The total heating power demand is 6,6 kW or 14 W/m<sup>2</sup> without ground source preheating of ventilation fresh air, or 5,6 kW or 12 W/m<sup>2</sup> with ground heat. The total heating energy demand is 18 kWh/m<sup>2</sup>, however, the expected heat recovery efficiency requires reduction in the defrosting energy loss.

The heating system in the Vantaa passive house is ventilation heating. The room based heating power demand varies from 2 kWh/m<sup>2</sup> up to 36 W/m<sup>2</sup> in the in the different spaces of the house.

The estimated energy gain from the ground loop system net energy gain from the ground is roughly 1000 kWh.

The Valkeakoski passive house is now under design phase. The calculated heating energy consumption is 30 kWh/m<sup>2</sup> according to specifications in the table 2. The required demand level is 25 kWh/m<sup>2</sup>. To meet the demand, e.g., widow area needs to be limited by 20 m<sup>2</sup>.

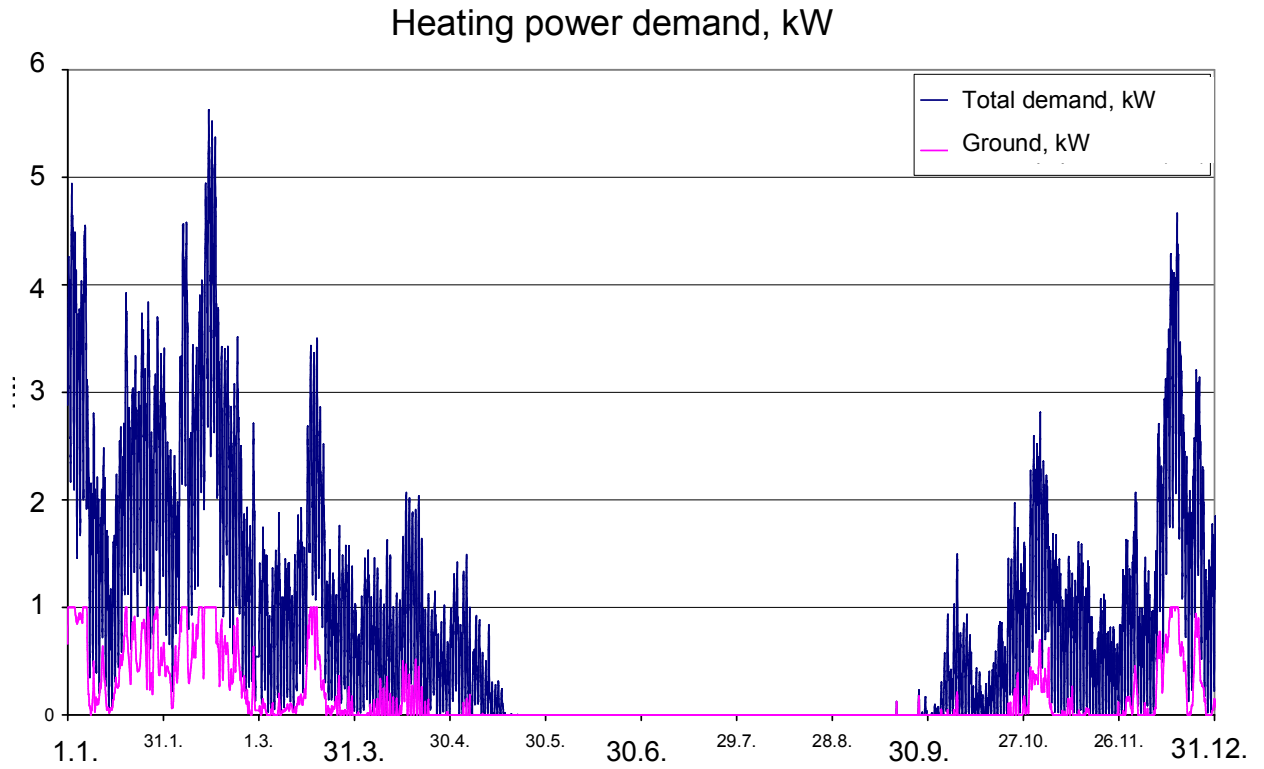

FIG. 4. Hourly heating power demand of the Vantaa passive house (Nieminen et al. 2008)

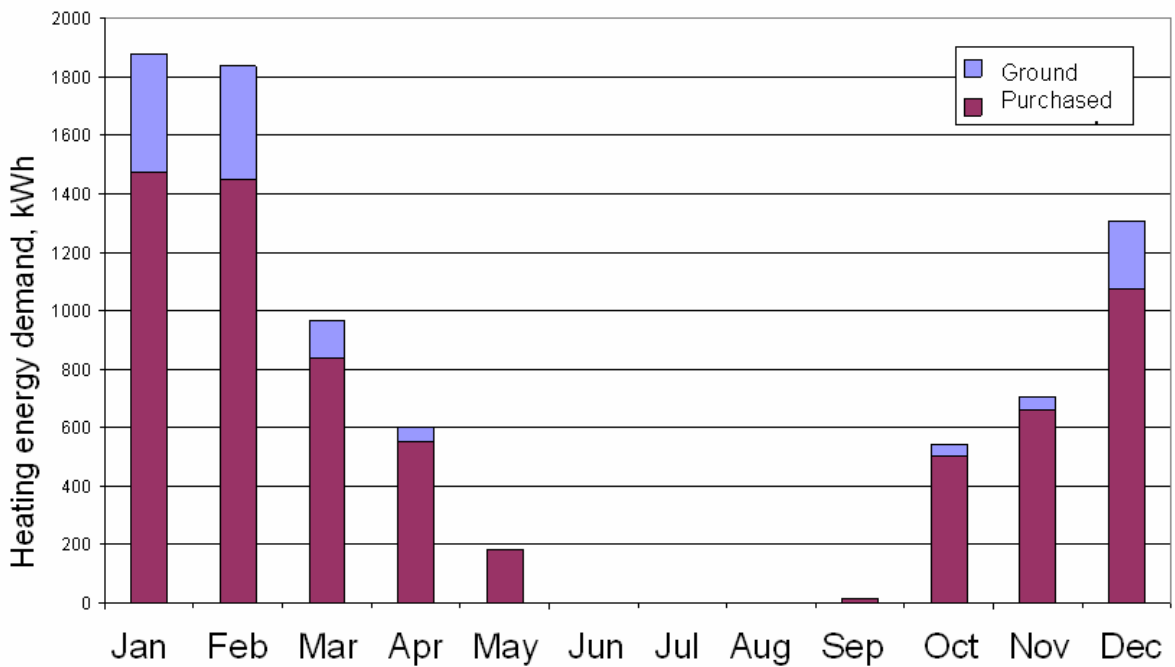

FIG. 5. Space heating demand of the Vantaa passive house (Nieminen et al. 2008). The total space heating demand is 18 kWh/m<sup>2</sup>. The estimated utilizable ground heat supply is 1200 kWh.

## 4. Conclusions

The pilot projects show that the suggested specifications for the Finnish climate can met. However, The research results show that there are specific problems initiating from the thick insulation layers especially in the floor structures and floor external wall connections. In the phase of this study, also the building physical performance of the building systems of the pilot houses will be studied.

## Acknowledgements

The paper bases on Intelligent Energy Europe project Promotion of European Passive Houses and Paroc Oy Ab's project Passive Houses for the Nordic and Baltic housing markets.

## References

Ståhl, F. (2002). Pre-heating of ventilation air through an earth tube system. Nordic Symposium on Building Physics 2002 .

Thevenard, D. (2007).Bibliographic Search on the Potential of Earth Tubes. Numerical Logics Inc

Nieminen, J., Holopainen, R., Kouhia, I., . (2008). Passive house. VTT Research Notes (to be published in May, 2008).

# Integrated Design and Passive Houses for Arctic Climates

*Petra Vladykova, Ph.D. student,  
Department of Civil Engineering, Technical University of Denmark;  
[pev@byg.dtu.dk](mailto:pev@byg.dtu.dk)*

*Carsten Rode, Associate Professor,  
Department of Civil Engineering, Technical University of Denmark;  
[car@byg.dtu.dk](mailto:car@byg.dtu.dk)*

**KEYWORDS:** *integrated design, passive house, energy performance, heating.*

## **SUMMARY:**

*Integrated design is important for Passive buildings and it has to be implemented in the early stage of the design process. The article deals with proposal of a new dormitory building in Sisimiut, Greenland, where the shape of building, indoor climate and energy needs are crucial factors to be considered in the early design stage of the project. The software simulation in iDbuild outlines the functional requirements for the dormitory building on the room level and points out an alternative space of solutions of a room with respect to indoor environment (e.g. design of the room, insulation thickness and window design). The aim of the work is to simulate the initial design of the dormitory on room level and point out the possibility of saving energy for heating and ventilation by factor variations. The work focuses on geometrical variations of the room and window, and on the orientation, and outlines the importance of factors and their variations. The most influencing parameter variation could be called the start of the sensitivity parameter analysis and will help later for the designing and evaluating of the future Arctic Passive House.*

## **1. Introduction**

**Integrated design** is a process of sustainable building design which focuses on producing buildings with a high level of environmental performance where the building design starts from the first very moment of the building project. The integrated design process requires multidisciplinary collaboration, including key stakeholders and design professionals (architects, engineers), from conception to completion. Energy performance and indoor environment have become important factors and performance decisive design parameters. Greenland is an extreme place to build a good energy performing building, but there is still the need for saving energy which can be done by implementing the integrated design process from the early stage of building design. From Integrated design point of view the article deals only with the potential energy performance in heating and ventilation demand on the room level; the aspects are not included in simulations such daylight, costs, humidity, etc.

**The software iDbuild** (Petersen, 2007) has been developed for the integrated design purposes as a tool for parameter variations of performance-decisive parameters. The variations give the building engineers an overview of how different parameters affect the energy consumption and indoor environment on room level. The integrated design method with the computational analysis in iDbuild establishes the space of solutions, which depends on the boundary conditions, energy performance and indoor environment. The iDbuild simulations give an overview of the consequences of changing a performance-decisive parameter for alternative design proposals, altogether on room level.

**The methodology of iDbuild:** The software iDbuild is based on the reference value of a performance-decisive parameter and two variations (lower and higher). The lower/higher parameter variations indicate the possible variation of input data (e.g. room width, window height, U-value of wall, etc.). The designer can decide which parameters to vary and perform it in two ways: 1. set up the conditions as a variation of the single performance-decisive parameters to vary (default alias reference room); or 2. as a bundles of performance-decisive parameters (elective alias reference value, variation1 and variation2). The simulation allows making not only three variations at the time but also provides a comparative output (var1, ref, var2) for each performance-decisive parameter (such as energy performance, thermal indoor environment, indoor air quality and daylight factor in point). The limitation of the software is that it is developed for analyses of offices and class rooms only with single sided windows (one window). Furthermore, only rectangular shapes of rooms/buildings only can be evaluated.

Once the room decision and design is created in iDbuild with good energy performance and indoor climate, then the number of final building design proposals can be established according to owner's functional requirements and needs (number of rooms, shape of building and orientation, number of storeys, etc).

Possible performance-decisive parameters of the single room in software iDbuild: 1.geometry (room depth, width, height, overhang); 2.building components (window, orientation and size; U-value of opaque constructions; thermal mass of construction, thermal capacity of interior); 3.systems (internal loads, lighting, ventilation, controls); 4.energy data (coefficient of performance of the heating and cooling system, solar water heating, photovoltaic, specific fan power for mechanical ventilation system, pumps, hot water consumption).

The evaluation of energy performance of rooms is based on **Greenland's new Building Code** (Bygningsreglement, 2006). Although the software iDbuild is based on the Danish Building Code (Petersen, 2007) and the indoor performance of rooms in the program are evaluated according to European Standard (prEN 15 271, 2007). The Greenland's Building Code evaluates the dwellings using two energy frames for two zones: where the building South of the polar circle (Zone 1) and one for North of the polar circle (Zone 2). This zone split takes into account the climate variations from South to North.

Zone 1:  $420 + 280/e$  [MJ/m<sup>2</sup>] per year,

Zone 2:  $510 + 325/e$  [MJ/m<sup>2</sup>] per year, where e is the number of storeys.

Sisimiut is located North of the Arctic Circle (latitude 66.96°, longitude 53.68°; heating season the whole year), and therefore the Zone 2 applies and the number of storeys is two: energy frame for the dormitory is 650 MJ/m<sup>2</sup> per year or approximately 181 kWh/m<sup>2</sup> per year. The energy frame is determined from climate data measured through a long period, with building components with U-values (standard values) according to Building Code, and has mechanical ventilation. Energy contributions from solar gains through windows are taken into account.

## 2. Architectural proposal of dormitory

The new dormitory proposal was designed by TNT Nuuk, Greenland, and the building will be funded by the "Villum Kann Rasmussen Foundation" and by "A.P. Møller og Hustru Chastine Mc-Kinney Møllers Fond til almene Formaal". The requirements were to accommodate a number of students coming to study in Sisimiut and to make a building which complies with good low energy standards (e.g. regarding building envelope, solar collectors, and indoor climate).

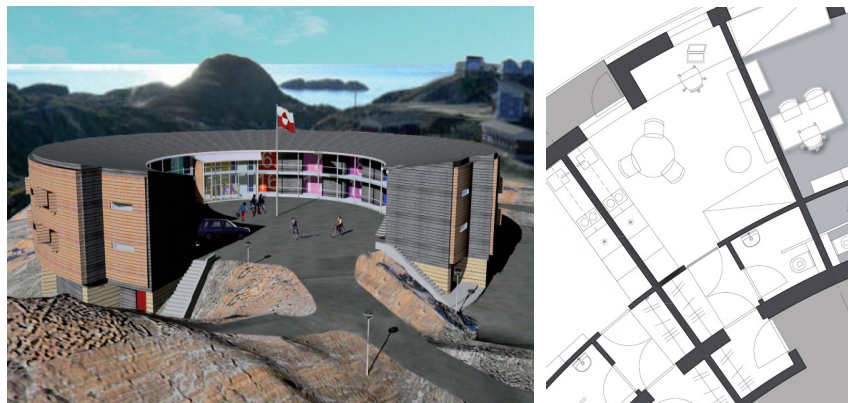

FIG 1: Proposal of shape of new dormitory in Sisimiut and typical single room (view, floor plan)

The dormitory building has two types of accommodation: single room (porch, entre/wardrobe, bathroom and room with kitchen area); and two bedrooms accommodation. The building accommodates a total of 44 students and total area is 1 271.9 m<sup>2</sup>. The building has a cylindrical shape which gives the advantage of closed space inside the circle, especially from the West side (wind from sea). The rooms are very open to daylight due their shape and window area. The building will serve as an accommodation and a case study (measuring indoor climate, solar collectors, etc). With its thermal properties (thermal resistance) the dormitory could become a good energy performing building with good indoor environment. The calculated dormitory energy consumption is annually for space heating approximately 160 000 kWh which corresponds to 125 kWh/m<sup>2</sup> per year (Ingeniørkollegium i Sisimiut, 2007).

### 3. Optimization within the iDbuild software

The space of solutions is generated on the room level where the reference room is established based on the design of a cylindrical shape of dormitory building. Since iDbuild is able to calculate only quadrangular shape of rooms, the designed room (single room type1, without bathroom and entrance) is simplified into a simple rectangular shape with one window.

**Strategy of simulations:** As the parameter analysis on room level offers a very large number of variations, the strategy was as follows: three types of room (with different dimension ratio) and one system for the initial calculation. The setting of only one system should be an objective start of parameter variation. The system for heating was set to always run at the same condition (set point temperatures for heating 21°C) in order to compare the results in the analysis when dimensions and orientations were varied. The room is connected to the building's mechanical ventilation which has a heat exchanger efficiency of 0.8.

The calculations focus on geometry (width, depth, height) of the room and its influence on energy performance (heating demand, ventilation energy), on window (width, height, orientation), on U-value (of window and walls). Furthermore, the focus was put on variation of designed room dimensions  $\pm 10\%$  and orientation of windows for every single simulation. A calculation model has been set up to analyse the energy performance of a single room. A reference (alias designed) room was defined being identical with the room as designed for dormitory proposal.

TABLE 1: List of simulations for parameter variations – reference, variation 1 and variation 2

Simulation	Conditions	Variation 1	Reference (as designed)	Variation 2
I. Dimension ratio (depth vs width) – larger rectangular room, rectangular room and square room (with designed window <sup>(2)</sup> )	Depth of room [m] <sup>(1)</sup>	6.00	4.90	4.00
	Facade width [m] <sup>(1)</sup>	2.70	3.30	4.00
II. Dimension modification $\pm 10\%$ (depth of room, facade width)	Depth of room [m] <sup>(1)</sup>	4.41	4.90	5.39
	Facade width [m] <sup>(1)</sup>	2.97	3.30	3.63
III. Reference room (depth 4.90 m, width 3.30 m) vs. height of room 2.50 m	Height of room [m]	2.20	2.50	2.80
IV. Designed room <sup>(2)</sup> vs. window dimensions ratio, area of window 2.90 m <sup>2</sup> , window shape: larger rectangular, rectangular and square	Window width [m]	2.00	2.50	1.70
	Window height [m]	1.45	1.16	1.70
V. Designed room <sup>(2)</sup> vs. designed window size ( $\pm 25\%$ of window size in m <sup>2</sup> )	Window width [m]	1.88	2.50	3.13
	Window height [m]	0.87	1.16	1.45
VI. Designed room <sup>(2)</sup> vs. $U_{\text{frame}}$ and $U_{\text{glazing}}$	Window $U_{\text{glass}}$ [W/m <sup>2</sup> K]	1.18	0.76	0.65
	Window $U_{\text{frame}}$ [W/m <sup>2</sup> K]	1.50	1.10	0.70
VII. Designed room <sup>(2)</sup> vs. $U_{\text{wall}}$ ( $\pm 25\%$ of $U_{\text{wall}}$ )	Walls $U_{\text{A}}$ [W/K]	0.82	1.10	1.37
	$U_{\text{walls}}$ [W/m <sup>2</sup> K]	0.11	1.14	0.18

<sup>1</sup>optimization of designed room area into a simple rectangular shape (FIG 1)

<sup>2</sup> designed room is reference room (depth 4.90 m, width 3.30 m, height 2.50 m); designed window (width 2.50 m, height 1.16 m)

Note: thickness of wall insulation:  $d_{\text{wall}} = 250$  mm:  $U_{\text{wall}} = 0.14$  W/m<sup>2</sup>K; triple pane window  $U_{\text{glass}} = 0.76$  W/m<sup>2</sup>K for glass and  $U_{\text{frame}} = 1.10$  W/m<sup>2</sup>K; internal load 300 W. All dimensions are taken as internal measurements. Air change is 1.3 h<sup>-1</sup>. The ventilation rate is taken from dormitory proposal for single room because of the exhaust from kitchen part of the room, although the requirements for the energy efficient buildings have smaller demands (Ingeniørkollegium i Sisimiut, 2007). Orientation: South, East, West, and North: 0, -90, 90, and 180.

#### 3.1 Example of reference room – room & window variations

The iDbuild software offers a large number of possible variations and consequently also a large number of results (FIG 2) show the total energy performance of the reference room and results of two possible variations on

both side (var1 and var2). Furthermore the thermal indoor environment represented by hours outside the ranges, indoor air quality and daylight factor can be evaluated according prEN (prEN 15 251, 2007).

Furth more the energy use can be divided into nine columns where the energy needed for heating, cooling, artificial lighting, ventilation, hot water, installation, solar hot water and photo voltaic. The article deals only with heating consumption and ventilation energy (the electricity needed for running fans) therefore there are only two columns (heating, ventilation) represented (see ).

More specific and detailed results (images and data files) can be achieved such as outdoor & indoor temperature, heating & cooling power, transmitted solar energy, ventilation air flow, shading factor, daylight factor, eye illuminance, electrical lighting, wind velocity & direction, predicted mean vote & percentage of dissatisfied. The results can be represented for the whole year or for selected days/months.

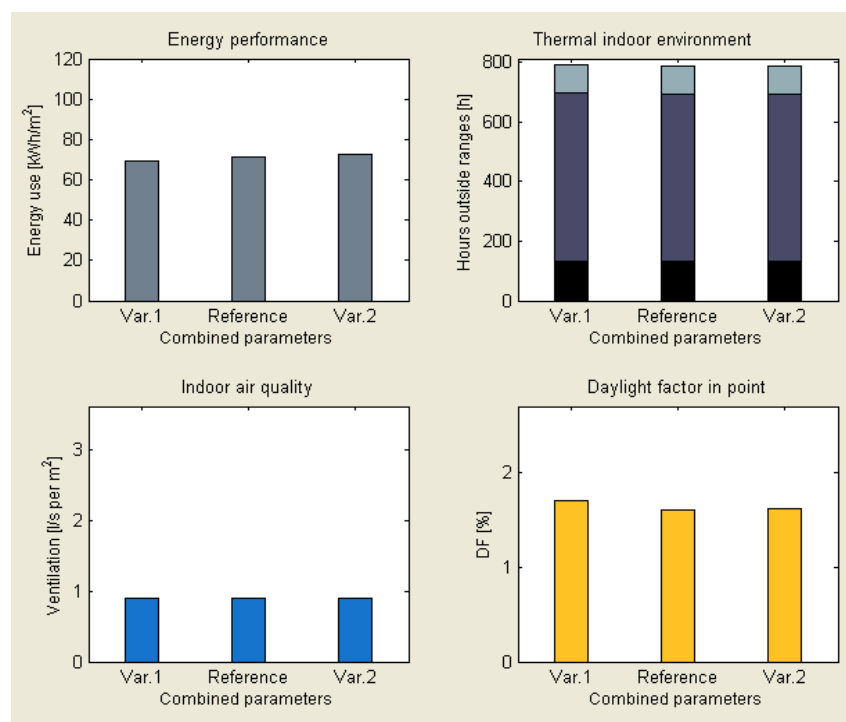

FIG 2: Example of results from iDbuild – parameter variations

### 3.2 Space of solutions for a single room – room & window & orientation variations

The results in the following chapter are simulations which focus on energy use for  $m^2$  of a building. The images state approximately how much energy is needed to heat the room area and how much electricity is needed for running the fans to ventilate the room. Therefore only two columns are represented in figures named “Combined parameters”. The total energy use of the building based on calculation of energy use for  $m^2$  is evaluated according to Greenland Building Code (Bygningsreglement, 2006), where the zone 2 requires app.  $181 \text{ kWh/m}^2$ .

**I. Variation of dimension ratio (length vs. width)** indicates that if the area of the room is still  $16.10 \text{ m}^2$ , then the length and width ratio of the room dimensions does not have a large impact (with designed window  $2.50 \times 1.16 \text{ m}$ ). For results see from to FIG 4. The var1 (larger rectangular room: facade width  $2.70 \times$  length  $6.00 \text{ m}$ ) has the performance for heating around  $45 \text{ kWh/m}^2$ , the ref (designed rectangular room:  $3.30 \times 4.90 \text{ m}$ ) needs  $47 \text{ kWh/m}^2$  for heating, and var2 (square room:  $4.00 \times 4.00 \text{ m}$ ) requires  $48 \text{ kWh/m}^2$ . All rooms need  $\sim 24 \text{ kWh/m}^2$  for ventilation as the designer states in dormitory proposal (Ingeniørkollegium i Sisimiut, 2007) air change 1.3 per hour for single room. But the room serves as a living room, kitchen and working area at the same time. The total energy consumption is then between  $70$  and  $75 \text{ kWh/m}^2$  (). When orientating the room to other directions, some similar results appear for North and East facing windows, and similar results for South and West. The South and West facing windows requires  $\sim 6 \text{ kWh/m}^2$  less for heating than rooms with window facing East and North (FIG 4).

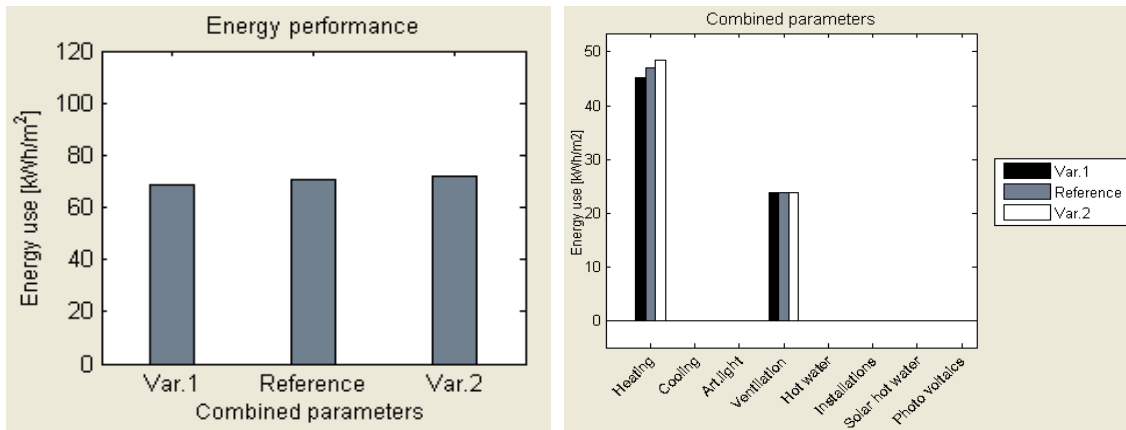

FIG 3: Variation of dimension ratio (length vs. width) – orientation South (0°); var1: facade width 2.70 x length 6.00m; ref: 3.30 x 4.90 m, var2: 4.00 x 4.00 m

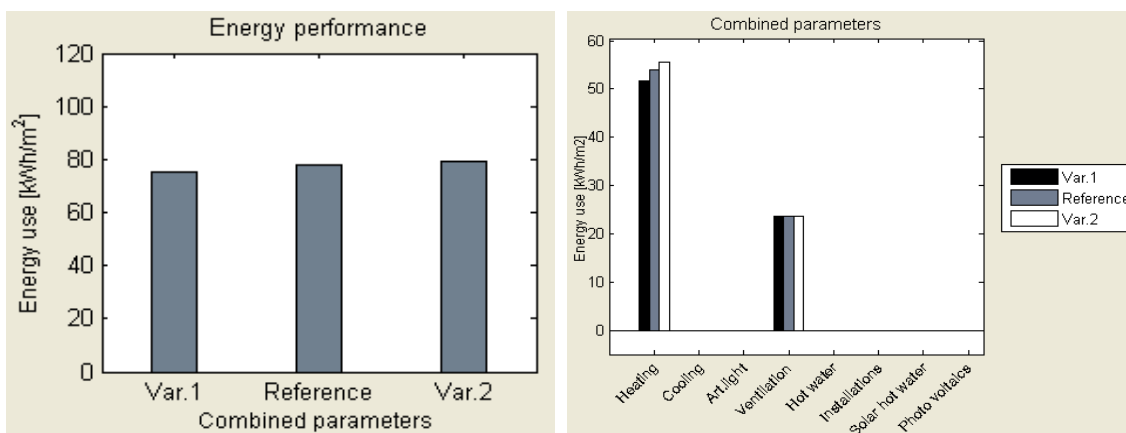

FIG 4: Variation of dimension ratio (length vs. width) – orientation East (-90°); var1: facade width 2.70 x length 6.00m; ref: 3.30 x 4.90 m, var2: 4.00 x 4.00 m

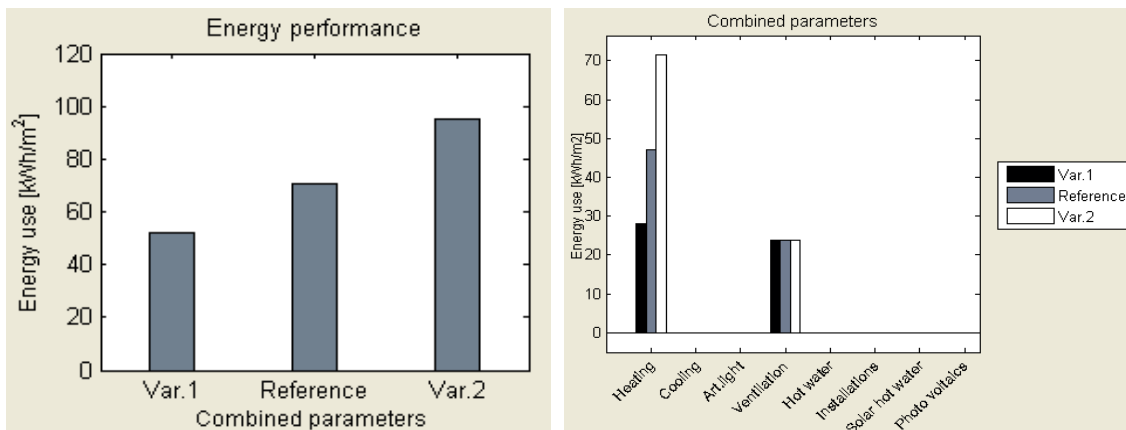

FIG 5: Variation of dimensions (width, depth) ± 10 % - orientation South (0°); var1: dimensions (width, depth of room ) 4.41 x 2.97 m; ref: 4.90 x 3.30 m; var2: 5.39 x 3.63 m



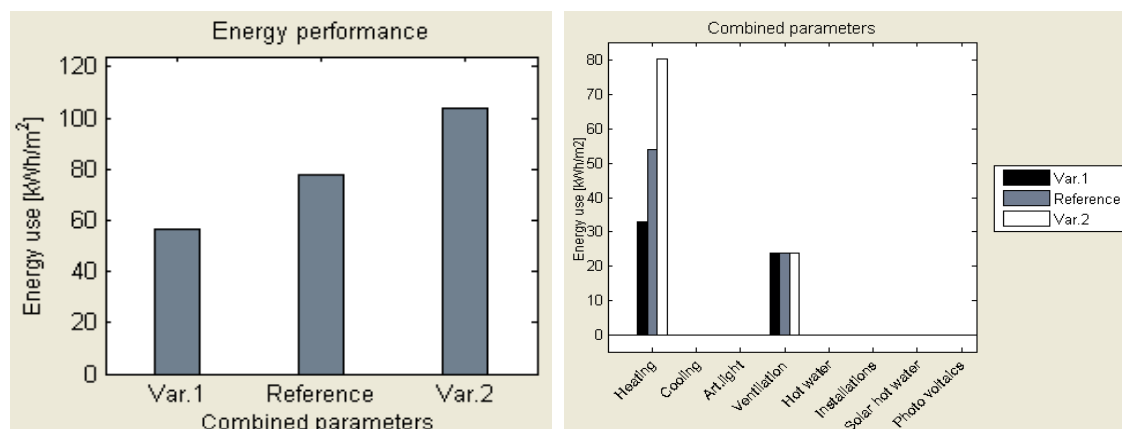

FIG 6: Variation of dimensions (width, depth)  $\pm 10\%$  - orientation East ( $-90^\circ$ ); var1: dimensions (width, depth of room) 4.41 x 2.97 m; ref: 4.90 x 3.30 m; var2: 5.39 x 3.63 m

## II. Variation of dimensions (width, depth) $\pm 10\%$

The increase or decrease of the room's dimensions for  $\pm 10\%$  has an influence on total energy use. When decreasing the width and depth of the room by  $10\%$  the difference can result saving  $20 \text{ kWh/m}^2$  in such an extreme climate as the Greenlandic. Also increasing the dimensions by  $10\%$  saves  $23 \text{ kWh/m}^2$  in total energy use. Those results are valid for window orientated to South and West (see FIG 5), with window facing East and North the total energy use is  $4 \text{ kWh/m}^2$  higher (see FIG 6).

## III. Variation of room dimensions (designed room versus height of the room)

Variation of room dimensions if the height of the room varies from 2.20 – 2.80 m, the total energy performance of the room can be significantly different. For the height of 2.50 m the reference designed room the heating energy is  $48 \text{ kWh/m}^2$ , the room with height of 2.20 m has  $34 \text{ kWh/m}^2$  for heating and the room with the height of 2.80 m needs  $61 \text{ kWh/m}^2$ . Those stated numbers are valid for window orientated to South and West which has very similar performance. The rooms with windows orientated to East and North are performing also in a similar way, but the heating energy for every room is  $\sim 8 - 10 \text{ kWh/m}^2$  more (e.g. 2.20 m height =  $40 \text{ kWh/m}^2$ ; 2.50 m height =  $53 \text{ kWh/m}^2$ ; 2.80 m height =  $70 \text{ kWh/m}^2$ ).

## IV. Variation of designed room vs. window dimensions ratio

Variation of window dimension ratio (the same window area  $2.90 \text{ m}^2$ ), but different window shape (var1: 2.00 x 1.45, ref: 2.50 x 1.16, var2: 1.70 x 1.70) for designed reference room (ratio 1:1.5), and different orientation to East, South, West and North. The results for South and West are very alike, where the heating energy is  $47 \text{ kWh/m}^2$ . Windows orientated to East and North require more heating ( $\sim 6 \text{ kWh/m}^2$ ), than windows orientated to South and West. For this variation would be the optimal to explore the daylight factor based on window shape.

## V. Variation of designed room vs. different window size ( $\pm 25\%$ of window size in $\text{m}^2$ )

Variation of window size ( $\text{m}^2$ ) for the reference room where the window differs from the designed window (ref:  $2.90 \text{ m}^2$  with 2.50 x 1.16 m) to  $-25\%$  for var1 ( $1.63 \text{ m}^2$  with 1.88 x 0.87 m) and  $+25\%$  for var2 ( $4.53 \text{ m}^2$  with 3.13 x 1.45 m) indicates that the larger window ( $+25\%$  of area) influences the heating and larger window needs more heating. The small window facing South or West requires  $43 \text{ kWh/m}^2$ , designed window  $48 \text{ kWh/m}^2$  and the largest window requires  $52 \text{ kWh/m}^2$ . This consumption is increased by orienting the window to East or North, whereby  $\sim 5 - 8 \text{ kWh/m}^2$  will be saved for each increase/decrease of window area.

## VI. Variation of designed room vs. $U_{\text{frame}}$ and $U_{\text{glazing}}$

Variation of  $U_{\text{frame}} + U_{\text{glazing}}$  versus site orientation for designed room and window size where var1 ( $U_{\text{frame}} = 1.50 \text{ W/m}^2\text{K} + U_{\text{glazing}} = 1.18 \text{ W/m}^2\text{K}$ ), ref ( $U_{\text{frame}} = 1.10 \text{ W/m}^2\text{K} + U_{\text{glazing}} = 0.76 \text{ W/m}^2\text{K}$ ), and var2 ( $U_{\text{frame}} = 0.70 \text{ W/m}^2\text{K} + U_{\text{glazing}} = 0.65 \text{ W/m}^2\text{K}$ ) proves that the better U-value the less heating needs. But the difference between var2 and ref is only  $1-2 \text{ kWh/m}^2$  (difference from ref to var1 is  $5 \text{ kWh/m}^2$ ) which leads to the assumption that the designed window has good thermal characteristics and the designer should use the windows

with thermal characteristic less than  $1.0 \text{ W/m}^2\text{K}$ . The heating use for var1 is  $53 \text{ kWh/m}^2$ , ref  $48 \text{ kWh/m}^2$  and var2  $45 \text{ kWh/m}^2$  for windows orientated to South and West. For orientation to East and North the heating demand is larger  $\sim 5 - 9 \text{ kWh/m}^2$  in each case.

### VII. Variation of designed room vs. $U_{\text{wall}} (\pm 25 \% \text{ of } U_{\text{wall}})$

Variation of  $U_{\text{walls}}$  for designed room var1 ( $U_{\text{wall}} = 0.11 \text{ W/m}^2\text{K}$ ), ref ( $U_{\text{wall}} = 0.14 \text{ W/m}^2\text{K}$ ) and var2 ( $U_{\text{wall}} = 0.18 \text{ W/m}^2\text{K}$ ). As the room has already been designed with the thermal characteristics fulfilling the Greenlandic Building Code and increasing the thermal properties for  $0.03 \text{ W/m}^2\text{K}$  (energy difference for  $U_{\text{wall}} = 0.11 - 0.14 \text{ W/m}^2\text{K} \Rightarrow 2 \text{ kWh/m}^2$ ) does not have a larger impact than  $2 \text{ kWh/m}^2$ . Rooms with windows orientated to South and West have the heating demand for var1  $45 \text{ kWh/m}^2$ , ref  $47 \text{ kWh/m}^2$  and var2  $49 \text{ kWh/m}^2$ . For rooms with windows orientated to East and North the heating demand is bigger by  $\sim 4 - 9 \text{ kWh/m}^2$ .

**System variations:** as the proposal of the dormitory in Greenland has showed a quite large number for ventilation of room type1, some calculations were made for the optimization of systems for the designed room and window, where the var1 has min&max air change  $0.6 \text{ h}^{-1}$ , ref min&max air change  $1.3 \text{ h}^{-1}$ , and var2 min&max air change  $0.5 \text{ h}^{-1}$ . The results show significant saving of energy use for heating where decreasing the air change from  $1.3$  to  $0.6 \text{ h}^{-1}$  will save  $\sim 18 \text{ kWh/m}^2$  (see FIG 7).

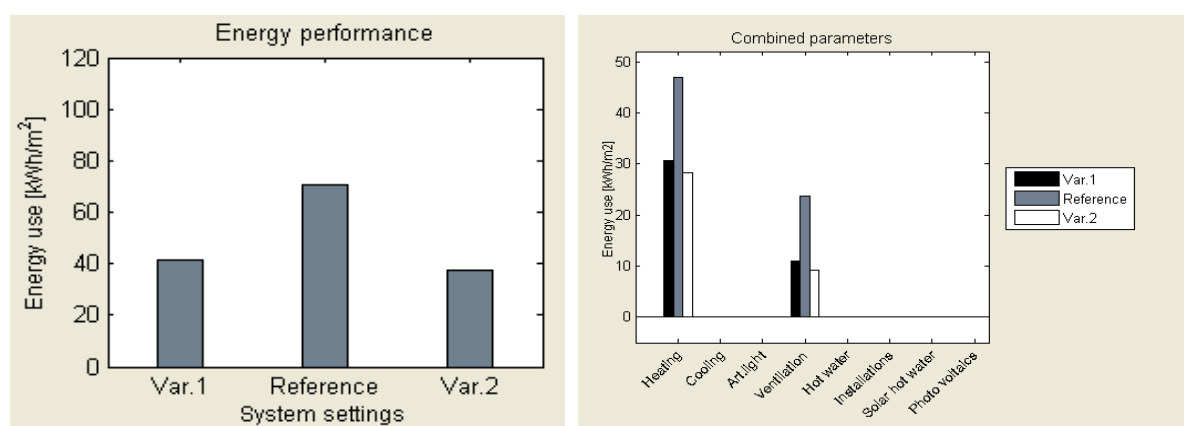

FIG 7: Variation of systems (air change) for designed room – orientation South; var1: air change  $0.6 \text{ h}^{-1}$ ; ref  $1.3 \text{ h}^{-1}$ ; var2:  $0.5 \text{ h}^{-1}$

## 4. Evaluation of results

The calculation strategy was applied on the important factors in the already designed dormitory in Sisimiut, Greenland, where the shape is cylindrical and every room is rotated by  $\sim 22^\circ$  degrees. Therefore the room and window dimensions were more deeply investigated together with the orientation factor. Some variations of the thermal characteristic of window, wall and system variations have been done to show the possible scale of improvement. The variations of room and window dimensions have been investigated with the following results:

- **Room dimensions – width versus depth of room:** if the floor area and window area are kept the same, than the larger rectangular room and designed rectangular room have slightly better performance than the square room. The rooms with windows orientated South and West have better energy performance which is caused by slightly lower heating demand. But the variations  $\pm 10 \%$  of dimensions have a larger impact on energy use for heating and ventilation.
- **Variation of the height of the room:** the designed height  $2.5 \text{ m}$  is optimal height which also fulfils the Greenlandic Building Code (Bygningsreglement, 2006).
- **Variation of window orientation:** the rooms with windows orientated to South and West have better energy performance which is caused by a lower heating. The difference for windows orientated to South and West is between  $5 - 9 \text{ kWh/m}^2$  for all variations made with different factors.
- **Variation of window dimension ratio** (the same window area  $2.90 \text{ m}^2$ ), but different window shape for designed reference room (ratio  $1:1.5$ ), and different orientation. The difference in energy performance of window shape is not very significant.

- **Variation of window size (m<sup>2</sup>)** where the window differs between the designed window 2.90 m<sup>2</sup> to -25% (1.63 m<sup>2</sup>) and +25% (4.53 m<sup>2</sup>) indicates that the larger window (+25% of area) influences the heating and larger window needs more heating. The energy use can be decreased by orientating the window towards South or West.
- **Variation of U<sub>frame</sub> + U<sub>glazing</sub>** for the designed room and window size leads to the conclusion that U<sub>frame</sub> = 1.10 W/m<sup>2</sup>K + U<sub>glazing</sub> = 0.76 W/m<sup>2</sup>K has a good energy performance and may be beneficial if using at least triple-pane glass window with U-value < 0.8 W/m<sup>2</sup>K for houses in the Arctic.
- **Variation of U<sub>wall</sub>** proves that the thermal properties of the wall are good and to vary them in such a low scale brings only small energy savings.
- **Variation of building services** proves that the largest energy saving could be made by changing the air change rate from 1.3 h<sup>-1</sup> to 0.6 h<sup>-1</sup> as it would be almost impossible to make a good energy performing building with such a high air change.

## 5. Conclusions

The aim of the article is to bring to attention more closely the connection of the Integrated design optimization method using iDbuild, where the decisive parameters are closely connected to energy performance and indoor environment. The iDbuild software is a tool for parameter analysis and in the case of new dormitory building should have been used in the early stage of the design process as a decisive-parameter evaluation tool. Although the cylindrical shape has a large quality in architectural expression, the extreme climate in Arctic regions should more focus on low energy performance and consumption. Since the shape of the dormitory is crucial, the calculations are focused on the use of iDbuild as a tool for factor variations connected to dimensions (room, window) and site orientation. The energy load for heating and ventilation is calculated and presented. For such an extreme weather conditions the heating season is necessary for the whole year, so only one heating system (heating set point temperature is for 21 °C) is considered in calculations.

**Optimization:** the distribution of rooms with the window orientation has shown the best possible option would be to place as much rooms as possible orientated to South and West, where the total energy performance on room level is the best. In the designer's proposal the approximation distribution of rooms is: West 7 rooms + South 8 rooms + North 5 rooms + East 2 room. The designer has chosen the best possible placement for window orientation, although by making a more simple shape (rectangular) of building and orienting the rooms only to South and West, he could decrease the heating energy. The main optimization step is the window not facing North and East.

**Neglectation:** as the great emphasis in analysis was put on dimensions (room and window) and window orientation, the system for heating was neglected therefore there exist rather more energy savings as is stated above. The energy for lightning and hot water consumption was not considered, and the daylight factor was not evaluated. **Further investigation** should be put in investigation of lightning energy and solar gain as the daylight is crucial in Greenland, where the half of the year, and also where the total solar gains are greater than in European regions. More analysis should be made with two or more systems for heating season in such an extreme location as Sisimiut and compare to the climate in Denmark and to Germany where the Passive Houses origins, and the climate challenges are different. As the dormitory is not build yet, the calculations (for reference room) made in iDbuild can not be validated.

## 6. References

- Petersen S. (2007), Software iDbuild and iDbuild user guide, Technical University of Denmark, [www.byg.dtu.dk](http://www.byg.dtu.dk)
- Bygningsreglement (2006), Ineqarnermut Attaveqarnermullu Pisortaqaarfik, Namminersornerullutik Oqartussat, Grønland, ISBN 87-991296-0-4, [www.nanoq.gl](http://www.nanoq.gl)
- prEN 15 251– Criteria for the Indoor Environment incl. thermal, indoor air quality, light and noise (2007), CEN.
- Ingeniørkollegium i Sisimiut 22077 (2007), TNT Nuuk, Illussanik Titartaasarfik a/s, Greenland. [www.tntnuuk.gl](http://www.tntnuuk.gl)
- Strub H. (1996), Bare Poles, Building design for high latitudes, Carleton University Press, ISBN 0-88629-278-6
- PEP Promotion of European Passive House, [www.europeanpassivehouses.org](http://www.europeanpassivehouses.org)

# The assessment of freezing risk in apartment buildings after heat supply break

*Jurate Karbauskaitė, dr., assoc. Professor,  
Kaunas Technology University, Institute of Architecture and Construction,  
[jukarb@asi.lt](mailto:jukarb@asi.lt), [www.asi.lt](http://www.asi.lt)*

*Vytautas Stankevicius, hab. dr., Professor,  
Kaunas Technology University, Institute of Architecture and Construction,  
[Vytautas.stankevicius@personalas.ktu.lt](mailto:Vytautas.stankevicius@personalas.ktu.lt), [www.asi.lt](http://www.asi.lt)*

*Arunas Burlingis, dr.,  
Kaunas Technology University, Institute of Architecture and Construction,  
[arunas.burlingis@asi.lt](mailto:arunas.burlingis@asi.lt), [www.asi.lt](http://www.asi.lt)*

*Romaldas Morkvenas, M.Sc.  
Kaunas Technology University, Faculty of Construction and Architecture,  
[morkvenas@ldha.lt](mailto:morkvenas@ldha.lt), [www.dlha.lt](http://www.dlha.lt)*

**KEYWORDS:** *air tightness, thermal resistance, indoor/outdoor air temperature, time period, freezing risk*

## SUMMARY

*The economical casualties could be of tremendous value with the restoration of the pipelines themselves, tenant relocation, refurbishing of apartments and other additional works if the heat supply break in the district heating pipelines happens because of the severe outdoor temperature. The feasibilities of the freezing in heating system of existing apartment buildings at various duration of the heat supply break in regard to building envelope characteristics and outdoor temperature, as well as the danger of freezing in main heat supply pipes in the building are analyzed with the purpose to avoid or decrease the level of possible losses. The special calculation method is composed for the assessment according to outdoor infiltration level, thermal resistance and heat capacity of the envelope and heat supply pipelines in the building. In regard to the removal experience at accomplished heat supply breaks and with purpose to decrease risk of the future casualties, the limit period of chilling down to 0 °C in the spaces of apartment buildings and in the main pipelines of the heating system is assessed due to thermal capacity level, thermal resistance of the building envelope elements, outdoor air infiltration level, insulation type of the pipelines at calculated outdoor temperature (-15, -20, -25, -30 °C) during the heat supply break. Temperature descent to 0 °C in corner rooms of apartment buildings at average quality of building structures is reliable to be 15 – 18 h at outdoor air temperature -20..-25 °C, for leaky rooms 12-15 h, in basement premises the water in pipelines of heating system could freeze in even shorter period. The basic recommendations for safety measures implementation are suggested.*

## 1. Introduction

The economical casualties could be of tremendous value with the restoration of the pipelines themselves, tenant relocation and other additional works if the heat supply break in the district heating pipelines happens because of the severe outdoor temperature. The rough evaluation of indoor temperature change after the heat supply break in a big apartment building of mass construction type showed more than 3 days term of freezing period down to 0 °C, which could be estimated enough satisfactorily for heat supply restoration. The sequence analysis of the real big accident in district heating heat supply pipelines in Lithuania indicated quite low time periods, during which water in building heating system was frozen. It took in from 12 to 18 hours in typical buildings. The investigation of the reasons has been carried out with the purpose to highlight the effect of the building quality on the heat storage. The feasibilities of the freezing in heating system of existing apartment buildings at the heat supply break in regard to building envelope thermal characteristics, air tightness and outdoor temperature, as

well as the danger of freezing in main heat supply pipes in the building are analyzed. The estimation of sequences at such heat supply break in new buildings and buildings after additional insulation is included into research volume.

## 2. Method of assessment and the main simulation schemes

The corner rooms in side apartments of ground and topmost floor are recognized to be mostly dangerous places for freezing according to the initial consideration. Thus values of indoor temperature, temperature on inside surface of the external wall and in the middle of heating radiator have been calculated for a corner room located in the ground floor, topmost floor and in the middle floor. Room space of 3x5 m, at height 2,5 m with two external walls and two internal partitions has been selected. Window area is estimated to be 18 % of floor area. Radiator size is selected according to the heat loss calculation. The following heat flows have been estimated at the simulation of the freezing process: heat flow through the external building envelope elements (wall, roof and window and ceiling over basement respectively), heat amount accumulated in the external envelope elements and internal partitions, heat amount accumulated in the furniture and internal equipment, heat flow due to outdoor air infiltration, heat flow due to internal heat gains and heat gained from heating device (radiator) and heating system pipeline. The heat gained from insulated heating system pipeline was included at the simulation of the thermal behaviour in the premise located in basement as well as the heat flows through the walls and floor in contact with ground.

The heat flow has been calculated for the least time period  $\Delta z$  of the structure layers in accordance with the essential requirement obtained from equation in detail discussed by [2],[3],[11]:

$$a \cdot \Delta z < 0,5 \cdot d_i^2, \quad (1)$$

where:  $d_i$  – thickness of material layer, m;  $a$  – temperature conductance of a material,  $m^2/h$ , determined:

$$a = 3,6 \cdot \lambda_i / (\rho_i \cdot c_i) \quad (2)$$

and:  $\lambda_i$  - thermal conductivity of a material layer, W/(mK),  $\rho_i$  - density of material layer,  $kg/m^3$ ;  $c_i$  – specific heat of material layer, kJ/(kgK).

The building element materials are divided into smaller imaginary layers according to limit indicated by (1) equation at the selected time period. Temperature on the border of layer at the certain time is calculated according to equation (3) in dependence if the both calculated layers are of the same material, if not, the equation (4) is used:

$$\theta_{ij} = \theta_{i,j-1} + [(\theta_{i-1,j} - \theta_{i,j-1}) / \Delta R_i - (\theta_{i,j-1} - \theta_{i+1,j-1}) / \Delta R_i] \cdot 3600 \cdot \Delta z / (d_i \cdot \rho_i \cdot c_i); \quad (3)$$

$$\theta_{ij} = \theta_{i,j-1} + [(\theta_{i-1,j} - \theta_{i,j-1}) / \Delta R_i - (\theta_{i,j-1} - \theta_{i+1,j-1}) / \Delta R_i] \cdot 2 \cdot 3600 \cdot \Delta z / (d_i \cdot \rho_i \cdot c_i + d_{i-1} \cdot \rho_{i-1} \cdot c_{i-1}); \quad (4)$$

$\theta_{i,j}$  - temperature of  $i$ -th layer at time moment  $j$ ;

$\theta_{i,j-1}$  – temperature of  $i$ -th layer at the time moment  $(j-1)$ , that means time step before;

$\theta_{i-1,j}$  – temperature of  $(i-1)$ -th layer at time moment  $j$ ;

$\theta_{i+1,j-1}$  – temperature of  $(i+1)$ -th layer at time moment  $(j-1)$  that means temperature of next layer time step before;

$\Delta R_i$  – thermal resistance of calculated layer  $i$ ;

$c_i$  – heat capacity of calculated layer  $i$ ;

$\rho_i$  – density of calculated layer  $i$ .

Initial temperatures of the layers at the beginning of calculation are determined according to constant condition terms – indoor and outdoor air temperature and standard surface thermal resistance values.

Heat amount which is transferred through a building element during time period  $\Delta z$  is determined according the equation [2],[3],[5]:

$$Q_j = A_{at} \cdot (\theta_{air,j} - \theta_{si,j}) \cdot \Delta z / R'_{vp}; \quad (5)$$

where:  $A_{el}$  – area of a considered building element,  $m^2$ ;  $\theta_{air,j}$  – indoor air temperature at the time moment  $i$ ;  $\theta_{si,j}$  – temperature on internal surface of building element at the time moment  $i$ ;  $R'_{vp}$  – corrected value of inner surface thermal resistance, in dependence to the temperature difference of air and surface.

The heat accumulation by furniture and indoor equipment is presumed to have the same shape as in inner partition of a certain area. It is assumed, that equivalent area is equal to  $5 m^2$ . Heat flow due to internal heat sources is estimated as a linear dependence due to floor area. The value could be assumed to be  $0 - 15 W/m^2$  in regard to the space destination. The value of  $5 W/m^2$  is taken as default. The total heat amount is calculated from the heat flow balance in the simulated room at the considered time moment. The equations system for calculation has been laid down in the spreadsheets MS „Excell“. The relations between the quantities included into calculation of building element with thermal mass are described in the Fig.1. Similar system is applied for every building element of the simulated room model.

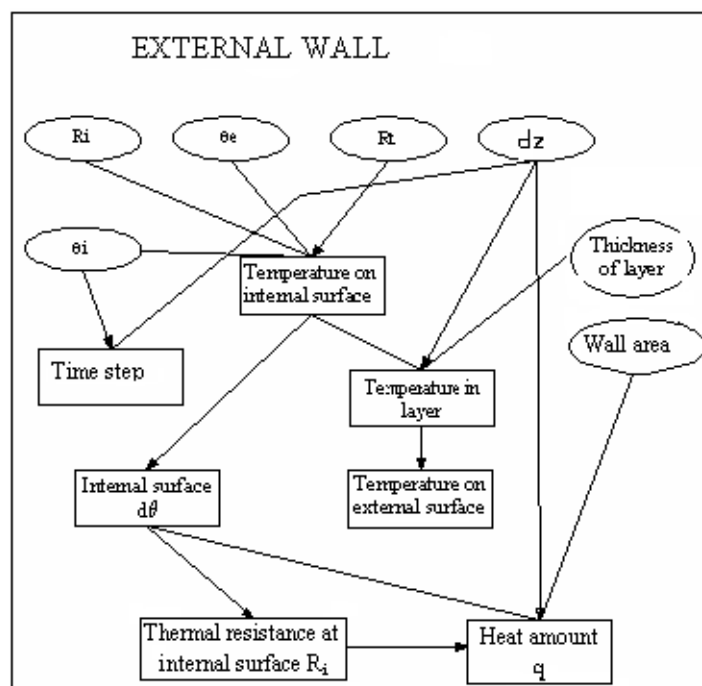

FIG. 1: The calculation graph for determination of heat transfer through the external wall

The freezing period is determined according to the time period when pursued indoor air temperature value should be equal to  $0\text{ }^{\circ}\text{C}$ . The freezing period estimated by internal surface temperature value is determined also, as well as water temperature drop period in the middle of radiator and pipeline.

Outdoor air temperature during calculation was assumed to be constant. The values have been selected under following consideration:  $-30\text{ }^{\circ}\text{C}$  – average temperature of coldest day during the recent 30 years,  $-25\text{ }^{\circ}\text{C}$  – average temperature of coldest 3 days during the recent 30 years, probability 0,98,  $-20\text{ }^{\circ}\text{C}$  – average temperature of coldest 5 days during the recent 30 years, probability 0,92,  $-15\text{ }^{\circ}\text{C}$  – average temperature of coldest 10 days during the recent 30 years,  $-10\text{ }^{\circ}\text{C}$  – average temperature of coldest month during the recent 30 years.

Time step in the calculation then is assumed 0,03 h as the least value along the modeled room building elements. The thermal parameters of apartment building elements used in the calculations are indicated in Table 1. The data obtained during long-time experience by Institute of Architecture and Construction has been used for estimation of average thermal resistance values of building elements in dependence to the type of apartment building for old apartment buildings [1, 7, 9, 10]. The value of a considered building element thermal resistance for new buildings is derived according to the requirements of recent National Building Code [8] for the heat transfer coefficient of building elements. Most popular modern structure types are selected. Airtightness in accordance with the investigations of [4, 6, 9] expressed by air change rate was assumed to be estimated from 0,2 changes per hour as minimal value for new modern windows, 0,5 1/h – as normal rate for new windows

including ventilation, 0,7 1/h – as average rate for old windows of good quality, up to 0,9 1/h – as characteristic for bad old shape windows.

The calculation was provided for a corner room in the top floor, the middle and ground floor with the set of building elements appropriate to the certain type of apartment building. The building elements included in calculation for every variant are indicated in Table 2, with the step-by step spread of calculation volume.

TABLE. 1: Thermal parameters of mass construction apartment building elements

Description of building element	Thickness, mm	Material		Thermal resistance, m <sup>2</sup> K/W
		Name	Density, kg/m <sup>3</sup> Specific heat, kJ/(kg·K)	
External walls	450			1,02
External walls of expanded clay concrete boards	400	expanded clay concrete	1250	0,84
	350			
	300			
External walls of ceramic brick masonry	510	ceramic brick masonry	1600	0,88
	510 +	ceramic brick masonry	1600	0,88
External walls with additional insulation	100	+ mineral wool layer	35	0,84
	250 +	ceramic brick masonry +	1600	0,88
New construction, three layered	150 +	mineral wool +	35	0,84
	120	ceramic brick masonry	1800	0,88
Roofs				
Old shape, bad quality	200 +	Concrete board with cavities	1000	0,88
	200	+ cellular concrete + hydro coating	600	0,84
Old shape, satisfactorily quality	200 +	Concrete board with cavities	1000	0,88
	200	+ cellular concrete + hydro coating	600	0,84
Renewed with additional insulation	200 +	Concrete board with cavities	1000	0,88
	200 +	+ cellular concrete	600	0,84
	100	+ mineral wool layer+ + hydro coating	300	0,84
New	200 +	Concrete board with cavities	1000	0,88
	200	+ mineral wool layer+ + hydro coating	300	0,84
Ceilings				
Old shape, over basement	200	Concrete board with cavities + linoleum	1000	0,88
New, three layered over basement	200 +	Concrete board with cavities	1000	0,88
	100 +	+ expanded polystyrene	25	1,34
	50	foam + equalizing layer	1600	0,88
Windows				
Old shape, bad quality			-	-
Old shape, satisfactorily quality				2,7
New				2,4
			-	-
				1,6

### 3. Results and discussion

The least time period of temperature descent down to 0 °C could be observed on the internal surface of the external wall, it is 1 -2 h less than the time period of indoor air temperature descent for the almost all simulated variants. The time period for water temperature descent in heating pipeline is insignificantly less (0,1–0,2 h) than in radiator itself. The time period of indoor air temperature descent is in all cases less than for water in radiator

by 1 -1,5 h. In apartment buildings with external walls of the expanded clay concrete boards indoor air temperature is falling down to the 0 °C throughout 23–33 h at the outdoor air temperature of -25 °C in dependence to the outdoor air infiltration rate and room location when thermal resistance value external wall is near 1,0 m<sup>2</sup>K/W. The effect of internal heat gains of default value is about 4–6 h. If the thermal resistance value of the external wall is near 0,75 m<sup>2</sup>K/W (4 row in Table 1, met in buildings of mass construction of 1975- 1980 year), the time period of indoor air temperature descent is decreased up to 17–20 h, and the time period of temperature descent temperature on internal surface of the external wall is 13–17 h, the time for restoration of heat supply is decreased approximately by 30 %. The time period could be expected near 6 h, according to the calculation results if the outdoor temperature level is about -30 °C. The emergency heating must be provided in buildings of this type without considerations, if heat supply break happens at outdoor temperatures lower -20 °C.

TABLE. 2: Calculation elements for estimation of freezing danger in apartment buildings

Model location	Calculation elements included								
	Building elements	Heating device	Internal gains, W/m <sup>2</sup>			Outdoor air infiltration rate			
Top floor	External wall, internal partitions, roof, window	Radiator and heating system pipeline	5	10	15	0,2	0,5	0,7	0,9
Middle floor	External wall, internal partitions, window	Radiator and heating system pipeline	5	10	15	0,2	0,5	0,7	0,9
Ground floor	External wall, internal partitions, ceiling over basement, window	Radiator and heating system pipeline	5	10	15	0,2	0,5	0,7	0,9
Basement	External wall, internal partitions, ceiling over basement, window, wall in contact with ground	Heating system pipeline	5	10	15	0,2	0,5	0,7	0,9

The time period of indoor air temperature descent to the 0 °C in brick masonry buildings in dependence to the air infiltration rate is 24–31 h, and for temperature on internal wall surface is 23–28 h at the outdoor air temperature of -25 °C. In comparison with the values for apartment buildings of expanded clay concrete walls the values are 10–15 % better.

The time period of temperature descent to 0 °C in the radiator estimated according to the simulation terms is close to assumption of radiator location in the middle of the room space. In reality, the cold air flow coming through the window and falling down would additionally chill the radiator which is located underneath the window. Thus it seems to be more correct to assess the danger of freezing according to the temperature descent on the internal surface of the external wall.

Analysis of the results in relation to the floor location of the considered room has revealed the following dependence: at the outdoor temperature level of -20..-30 °C, the least temperature descent is found in the room at the top floor, and at the outdoor temperature of -10..-15 °C - at the ground floor. The generalized results according to least values are presented in the Fig. 2.

In the summary the danger of freezing could arise after 12 h in the apartment building with walls of expanded clay concrete boards, when the thermal quality of structures is good ( $R \approx 1,0$  m<sup>2</sup>K/W, air change < 0,7 ) at outdoor temperature -30 °C. If thermal quality is bad ( $R \approx 0,7$  m<sup>2</sup>K/W, air change  $\geq 0,9$  ), danger of freezing could arise approximately in 6 h from the heat supply break. The apartment in the middle floor of building when quality is recognized to be bad could be estimated in same range as the apartment in ground floor at good quality due to danger of freezing. So, this type of buildings could be assumed as very unsafe for heat supply breaks.

The danger of freezing could arise after 13 h in the masonry apartment building when the thermal quality of structures is good ( $R \approx 1,0$  m<sup>2</sup>K/W, air change < 0,7 ) at outdoor temperature -30 °C, and accordingly in buildings of bad quality it could arise in 11 h.

In the renewed buildings with additional wall insulation at the auspicious circumstances the danger of freeze could arise in 19 h, at outdoor temperature -30 °C. The temperature descent is less than expected because of un-insulated ceiling over basement (additional insulation here is very complicated to be installed and expensive). Danger value of freezing in new buildings under recent requirements for thermal protection could be estimated near 38 h, that is, time for heat supply restoration is 3 times longer, than for the buildings of old shape.



The increase of outdoor air infiltration air rate from 0,5 up to 0,9 times per hour could reduce the temperature descent period by 15 -20 %, and the influence is bigger if thermal resistance of the building enclosure is better.

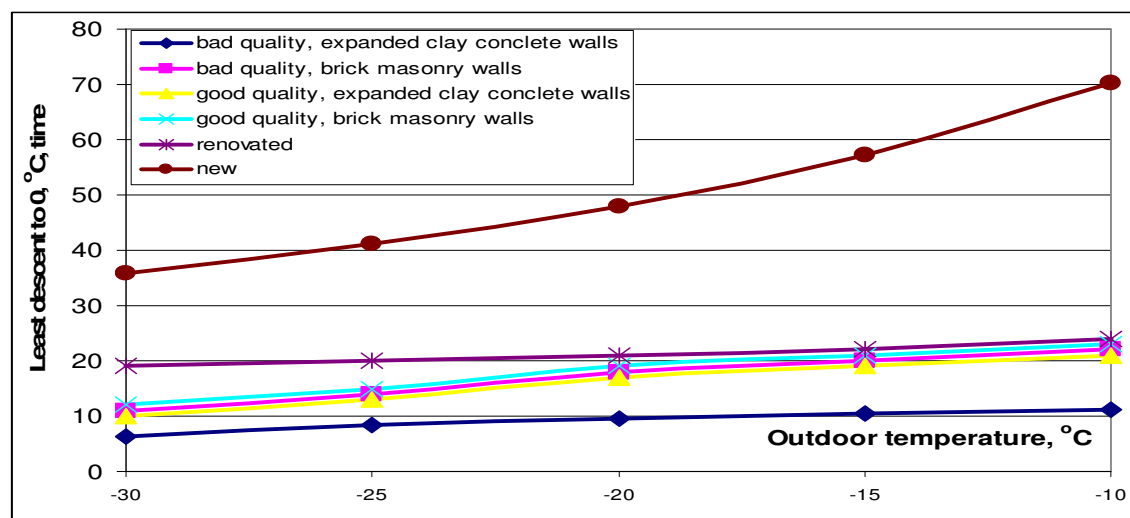

FIG.2: Dependence of temperature descent time to 0 °C due to outdoor temperature at different quality of apartment building structure

(bad quality, expanded clay concrete walls:  $R_{wall} \approx 0,75 \text{ m}^2 \text{K/W}$ ,  $R_{rof} \approx 1,2 \text{ m}^2 \text{K/W}$ ,  $R_{ceiling \text{ over basement}} \approx 0,44 \text{ m}^2 \text{K/W}$ , air change 0,9 times per hour,

good quality, expanded clay concrete walls:  $R_{wall} \approx 1,0 \text{ m}^2 \text{K/W}$ ,  $R_{rof} \approx 1,8 \text{ m}^2 \text{K/W}$ ,  $R_{ceiling \text{ over basement}} \approx 0,44 \text{ m}^2 \text{K/W}$ , air change 0,5 times per hour,

bad quality, brick masonry walls:  $R_{wall} \approx 1,0 \text{ m}^2 \text{K/W}$ ,  $R_{rof} \approx 1,2 \text{ m}^2 \text{K/W}$ ,  $R_{ceiling \text{ over basement}} \approx 0,44 \text{ m}^2 \text{K/W}$ , air change 0,9 times per hour,

good quality, brick masonry walls:  $R_{wall} \approx 1,0 \text{ m}^2 \text{K/W}$ ,  $R_{rof} \approx 1,8 \text{ m}^2 \text{K/W}$ ,  $R_{ceiling \text{ over basement}} \approx 0,44 \text{ m}^2 \text{K/W}$ , air change 0,5 times per hour,

renovated:  $R_{wall} \approx 3,5 \text{ m}^2 \text{K/W}$ ,  $R_{rof} \approx 6,0 \text{ m}^2 \text{K/W}$ ,  $R_{ceiling \text{ over basement}} \approx 0,5 \text{ m}^2 \text{K/W}$ , air change 0,5 times per hour,

new:  $R_{wall} \approx 4,6 \text{ m}^2 \text{K/W}$ ,  $R_{rof} \approx 6,0 \text{ m}^2 \text{K/W}$ ,  $R_{ceiling \text{ over basement}} \approx 2,66 \text{ m}^2 \text{K/W}$ , air change 0,5 times per hour)

The danger assessment of freezing could be determined according to the temperature descent on internal surface of the wall. Calculation of any other element could be omitted.

The change of outdoor air infiltration rate and heat capacity of the building elements have the biggest influence on the temperature descent in a heated space at the same thermal protection level.

The temperature descent of water down to 0 °C in the main pipeline of heating system located in the basement depend upon the outdoor air infiltration rate and pipeline insulation level. The least value is obtained for wall above the ground level because of the low thermal resistance of this building element. The thermal parameters of the space in the ground floor do not show significant effect on the thermal behavior in the basement premises because of big thermal capacity here. And, in opposite, the conditions in the basement premises shall have influence on thermal behavior in heated space of ground floor.

The least value of indoor air temperature descent down to 0 °C is 10 hours, for internal surface of wall above the ground is 3 hours, for wall surface in contact with ground is 30 hours at the outdoor air temperature -25 °C. The value for water temperature descent in insulated pipeline is 10 hours. The results are close with the freezing time values presented in the report of the real accident check-up.

Usually the pipelines are laid along the side wall above the window top within the building envelope. Taking into consideration this detail, the water freezing in the pipelines could occur even faster in separate places, where the windows are leaky.

In basements of renovated apartment buildings the danger of freezing is delayed by 3 hours approximately in comparison to the buildings without renovation, as the basements usually are not refurbished at all. New buildings: the temperature descent to 0 °C for the indoor air is close to 28 hours, on internal surface of external wall above the ground – 18 h approximately, on the internal surface of wall in contact with ground – 39 h at outdoor air temperature of -25 °C. The danger of freezing in pipelines is assessed as 30 h.

The temperature descent is more deliberated if the heating from other heat source is provided. The possible heat flow value has been estimated to be near  $20 \text{ W/m}^2$ , if the local electric heating devices are applied. The capacity of such heating is restricted by the power of old electricity supply net. Then time period could be prolonged from 3 to 6 hours in respect to external air infiltration rate and outdoor air temperature for the apartment buildings with expanded clay concrete walls when the thermal resistance value  $0,9 \text{ m}^2\text{K/W}$ , and 2-4 hours when the thermal resistance value  $0,75 \text{ m}^2\text{K/W}$ . The same measure could delay this period by 4 to 8 hours in dependence to outdoor air temperature and infiltration rate.

If the heat supply from independent source is begun after the 6 hours break, the considered impact is not significant. In apartment buildings with walls of expanded clay concrete the time period is almost the same as in case of  $5 \text{ W/m}^2$  default value of internal heat gains. In brick masonry apartment buildings the increase is assessed by 2 up to 6 h in regard to outdoor air temperature and infiltration rate.

The windows and doors are recommended close carefully and all the air leak sources seal immediately after sudden heat supply break. The all possible heat sources shall be switched on. If the additional heating is not provided immediately in the apartment buildings with the walls of expanded clay concrete, the danger of freezing shall occur in really short time period, otherwise the additional heat flow in apartments should be increased up to  $30 - 50 \text{ W/m}^2$ . Then electricity supply power could be insufficient.

## 4. Conclusions

1. Temperature descent to  $0^\circ\text{C}$  in corner rooms of apartment buildings at average quality of building structures is reliable to be 15 – 18 h at outdoor air temperature  $-20..-25^\circ\text{C}$ , for leaky rooms 12-15 h, in basement premises the water in pipelines of heating system could freeze in even shorter period.
2. The least temperature descent is obtained for rooms in the top floor when flat roof is of old shape, a little larger time period is determined for rooms in the ground floor, the largest value is determined for middle floor.
3. Temperature descent in basement premises is not significantly dependent on the thermal behavior in the ground floor, the outdoor air infiltration has the biggest impact. The danger of freezing in pipelines could occur in shorter period than in 12 h, if the outdoor temperature will be lower than the design outdoor level.
4. The thermal characteristics of windows and doors in staircases, basements or other premises of common use are dependent on the maintenance level especially. The danger of freezing at heat supply break is increased when the maintenance is insufficient and the windows and doors are untight.
5. The municipal authorities should pay especial attention to the development of measures to be fulfilled at the heat supply breaks for the reduction of the possible damages.

## 5. References

- Bliūdžius R and Stankevičius V. (2001). Guide of building thermal physics, Technologija, Kaunas, Lithuania, p.90. (in Lithuanian)
- Bogoslovsky V. (1970). Building thermal physics, Strojizdat, Moscow, Russia, p. 375 (in Russian)
- Fokin K.(1973), Building thermal physics, Strojizdat, Moscow, Russia, p. 288 (in Russian)
- Juodis E. (2000). Energy Saving and Airtightness of Blocks of Flat in Lithuania, *Indoor + Built Environment*, 9/3-4/00, Basel, May – August 2000, 143–148.
- Juodvalkis J., Blaževičius E. and Vipartas R. A. (2005). The possibilities of the heat loss minimization in buildings, *Proceedings of 8-th REHVA World Congress*, 9-12 Oct., Lausanne, Switzerland.
- Jurelionis A and Karbauskaitė J. (2005). The indoor air quality in renovated Lithuanian school buildings *Energetika*, Vilnius, Lithuania, ISSN 0235-7208, No 4, 54-59.
- National Building Code 1986. SNIP II-3-79\*\* Building thermal physics, Gosstroj SSSR, Moscow, Russia, p.32
- National Building Code STR 2.05.01:2005. Thermal technique of building envelope, Ministry of environment, Vilnius, Lithuania, p.133 (in Lithuanian)
- Stankevičius V., Karbauskaitė J. and Bliūdžius R. (2002). Analysis of heat consumption in apartment buildings *Energetika*, Vilnius, Lithuania, ISSN 0235-7208, No 2, 57-61.
- Stankevičius V. and Karbauskaitė J. (2000). The conformance of real heat consumption in apartment buildings to the designed heat supply demand, *Journal of civil engineering and management*, Vilnius, Lithuania, ISSN 1392-1525, vol.6, NO. 5, 366-370.
- Ulgen K.(2002). Experimental and theoretical investigation of effects of wall's thermophysical properties on time lag and decrement factor, *Energy and Buildings*, vol.34, 273–278.



# Heat capacity in relation to the Danish building regulations

*Lars Olsen, MSc, PhD,  
Danish Technological Institute, Department of Building Technology;  
lars.olsen@teknologisk.dk*

**KEYWORDS:** *Storage of heat, heat capacity, overheating, calculations.*

## **SUMMARY:**

*To fulfil the requirements in the Danish building regulations for new buildings it is necessary to have a limited heating demand. The heating demand is calculated on the basis of a number of energy related parameters. One of these is the heat capacity of the building. In the present study three different methods for determination of the heat capacity of the building have been assessed: Tabulated values in connection with the Danish calculation method, a simplified CEN method and the active heat capacity. To estimate the active heat capacity an analysis has been made where surfaces with different materials are exposed to a diurnal variation of the room temperature. The heat which is transmitted into the surface during a 12 hour period with positive heat flux, and stored in the material, is called the ability to store heat.*

*Examples are shown of how it is possible to calculate the heat capacity for different materials. It is demonstrated how the heat capacity for the single surfaces can be added in order to calculate the heat capacity of a whole building. The result expressed as the heat capacity per m<sup>2</sup> heated floor area, is used as one of the input values in the Danish calculation programme for assessment of the energy demand of buildings. This study indicates that it can normally not be expected that a detailed calculation will provide a larger heat capacity than when the Danish tabulated values are used. This is the case for both lightweight and solid buildings. There might be a need for assessment of the Danish tabulated values to check whether the level the heat capacity is appropriate.*

## **1. Introduction**

In the Danish building regulations, which were introduced in 2006, a calculation of the heating and cooling demand is required (Aggerholm S. and Grau K. (2005)).

It is possible to utilize the thermal mass in solid constructions to reduce the variation of the room temperatures and thereby create a more uniform indoor climate and to reduce the requirements for heating and cooling.

Previously only demands on heating in the cold period were required. Today there are requirements on both heating and cooling. In few years it is expected that new requirements will be introduced which will reduce the energy consumption. This will further encourage to the utilisation of thermal mass for reduction of the heating and cooling demand and for reductions of the temperature variations in buildings. A study (Olsen L. and Hansen M. (2007)) on some examples with different thermal capacities of buildings shows that this parameter can provide an influence on the heating demand of the size of 4% to 13%.

### **1.1 Objective**

On this background it is the objective of this paper to:

- Perform calculations, which make it possible to quantify the effect of the utilisation of the thermal mass for accumulation of heat in the surfaces of buildings.
- Analyse the energy and comfort related performance of the different choices of building materials. The calculation principle which corresponds to the new building regulations is applied.
- Show examples on how the material data can be used in connection with the new building regulations.
- Show how it is possible to calculate the heat accumulation in an actual construction.

## 2. Calculations

In order to investigate the effect of different materials' influence on the thermal indoor climate, calculations are performed of the heat accumulation achieved when heat is supplied or dissipated at the interior building surfaces (Olsen L. and Hansen M. (2007)).

Below in table 1 a number of typical data for different materials is shown (Dansk Standard (2005), Dansk Standard. (2001)). The material lightweight concrete is used for concrete with aggregate of expanded clay.

TABLE 1: Material characteristics used in the calculations.

No.	Material	Density	Thermal conductivity	Thermal capacity	Thermal capacity per volume	Thermal effusivity
		$\rho$	$\lambda$	$c_p$	$c_p \cdot \rho$	D
		kg/m <sup>3</sup>	W/mK	J/(kg·K)	MJ/(m <sup>3</sup> ·K)	J/(m <sup>2</sup> ·K·s <sup>1/2</sup> )
1	Concrete	2400	2.1	1000	2.40	2245
2	Lightweight concrete	1800	0.8	1000	1.80	1200
3	Masonry	1800	0.62	840	1.51	968
4	Lightweight concrete	1200	0.4	1000	1.20	693
5	Gypsum plasterboard with paper liners	900	0.25	1000	0.90	474
6	Autoclaved aerated concrete	700	0.19	1000	0.70	365
7	Lightweight concrete	600	0.17	1000	0.60	319
8	Wood	500	0.13	1600	0.80	322

The calculations of the accumulation of heat are done with the programme Heat2 (Bloomberg T. and Claesson J. (2003)). The heat accumulation is calculated with the influence of a sinusoidal fluctuation of the air temperature with an amplitude of  $\pm 1$  K. The materials are assumed to be applied in the following thicknesses: 2.5 cm, 5 cm and 10 cm. The exposure is assumed to be from one side while the other surface is adiabatic. This adiabatic surface corresponds to an insulated side of a well insulated wall or that the wall has an equal two-sided exposure, and the thickness corresponds to the half of the wall thickness.

### 2.1 Calculation of the heat accumulation

Below in FIG. 1 and 2 examples on the calculated temperatures and heat flows in the materials are shown (positive heat flow, when the heat flow is supplied to the material).

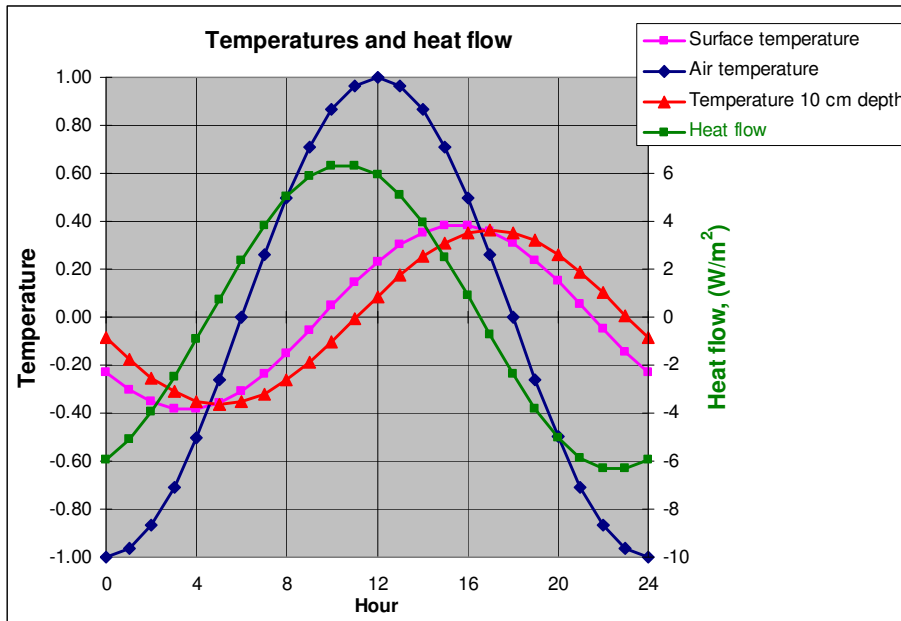

FIG. 1: Example of surface temperature, air temperature, temperature in the depth of 10 cm and the heat flow at the surface for a concrete wall (material no. 1), thickness of the wall 10 cm.

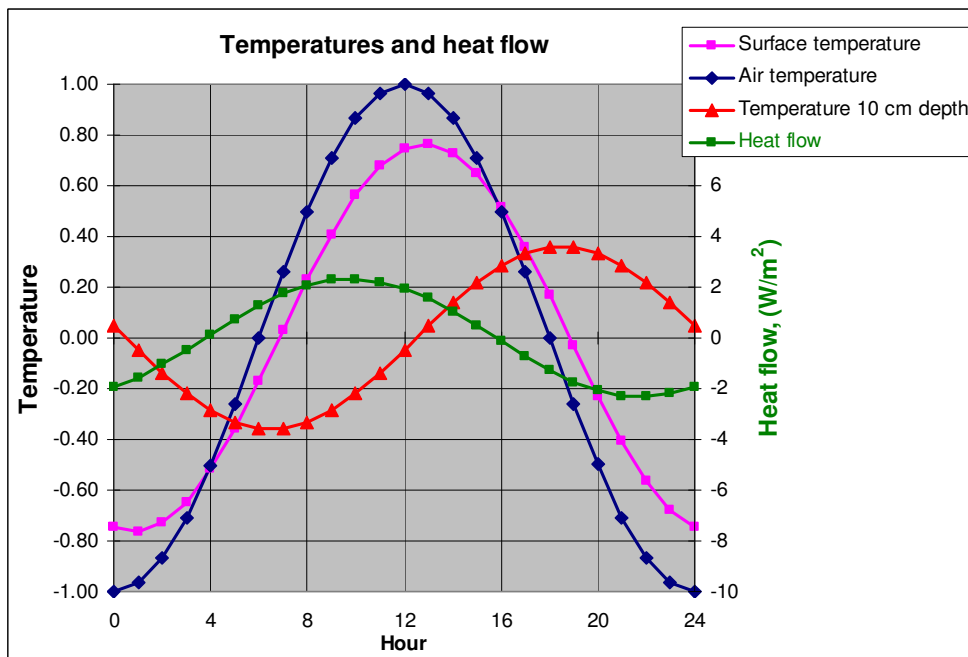

FIG. 2: Example of surface temperature, air temperature, temperature in the depth of 10 cm and the heat flow at the surface of a solid wood wall (material no. 8), thickness of the wall 10 cm.

In FIG. 1 an example with a 10 cm thick *concrete* wall is shown. The curves show the temperature and heat flow, when the air temperature (blue curve) varies  $\pm 1$  K. The calculations show that this results in a surface temperature (purple curve), which varies  $\pm 0.4$  K. The maximum of the air temperature is assumed to be at hour 12. The maximum of the surface temperature is calculated to be 3-4 hours later. The temperature in the depth of

10 cm from the surface (**red curve**) varies with nearly the same size of temperature fluctuations as at the surface. The maximum temperature occurs with a delay of approx. 5-6 hours compared to the maximum of the air temperature.

The heat flow at the surface (**green curve**) varies proportionally with the temperature difference between the air temperature and the surface temperature. The size of the heat flow can be seen at the right side scale in FIG. 1. The maximum value of the heat flow occurs 1-2 hours after the maximum of the air temperature is obtained.

These results are compared with the conditions of a wall of *wood* (FIG. 2). In this case the maximum surface temperature fluctuation is  $\pm 0.75$  K. The temperature in a depth of 10 cm thickness varies with a fluctuation of approx.  $\pm 0.35$  K. The heat flow is less than the flow obtained with the other walls due to the lower thermal conductivity and the smaller heat capacity per volume.

In TABLE 2 below a summation of the flow during the 12 hours, where the air temperature is larger than the surface temperature (positive heat flow), is shown. The sum is shown in the table as the calculated heat accumulation per surface area exposed to a sinusoidal temperature variation. It corresponds to the amount of heat transferred into the material in the period with positive heat flow.

In the table the thermal capacity per surface area with the different thicknesses of the material is also shown. This size is calculated as:  $c_p \cdot \rho \cdot t$  [Wh/(m<sup>2</sup>·K)], where t is the thickness of the material.

The calculated heat accumulation depends on the amplitude (temperature variation). It is assumed that the difference between the maximum and minimum air temperature is 2 K. If the temperature of the material follows this temperature variation exactly, there will be a 100% utilization of the thermal capacity. In practice the temperature in the material will fluctuate less due to the surface resistances and the thermal conductivity of the material. The temperature variation in the material corresponds to the amount of heat accumulated in the material. The size of the accumulated heat is shown in TABLE 2.

The accumulated heat can be related to the maximum possible amount of heat at a certain temperature fluctuation of the whole material. The relation between these sizes can be defined as a *utilization of the thermal capacity*. It is also possible to use the term *active thermal capacity*, which is the actual thermal capacity multiplied by the utilisation of the thermal capacity.

The temperature variation which corresponds to the sinusoidal fluctuation of  $\pm 1$  K is therefore 2 K.

The utilisation of the thermal capacity is shown in TABLE 2. The table shows that at a thickness of the materials of 2.5 cm the utilisation is between 86 and 96% of the thermal capacity for all the materials. Correspondingly between 64 and 89% of the thermal capacity is utilized with a thickness of the materials of 5 cm and with a thickness of the materials of 10 cm is between 37 and 56% of the thermal heat capacity utilized.

The utilisation of the thermal capacity is less for concrete than for materials with a smaller density. The reason can be explained by the reduction of the amount of heat transferred due to the surface resistance and the thermal conductivity of the material.

In practice it is not of great importance that the utilisation of the thermal capacity is less for concrete than for other materials with lower density. It is the size of the heat accumulation per surface area which is the most important parameter.

The unutilized thermal capacity can in principle be utilized if the temperature variations have a longer time period than assumed in the present calculations, e.g. weekly variations. That means, if periods of days with a large internal gain of heat are followed by periods with smaller internal gains, a larger part of the thermal capacity will be able to participate in the heat accumulation.

Alternatively the unutilized heat capacity can be utilized if there is an active storage of heat in the constructions, e.g. due to embedded pipes and the like.

The utilization of the thermal capacity must from an overall point of view be considered to be more dependent on the thickness of the material than the characteristics of the material. Therefore the heat accumulation per surface area must be regarded as the most important parameter to consider, when the performance in relation to heat accumulation of a construction is evaluated.

In FIG. 3 the heat accumulation is shown in dependence of the effusivity and thickness of the materials. It appears that the heat accumulation is increased as a function of the effusivity and the thickness of the material.

For a certain thickness it appears that the slope of the curves is largest for small values of the effusivity and smallest for large values of the effusivity. The only exception is wood which in the thickness of 5–10 cm gives a minor deviation in comparison with the other materials.

The curves in FIG. 3 can be utilized to estimate the heat accumulation for other materials than the investigated, if the effusivity has been calculated.

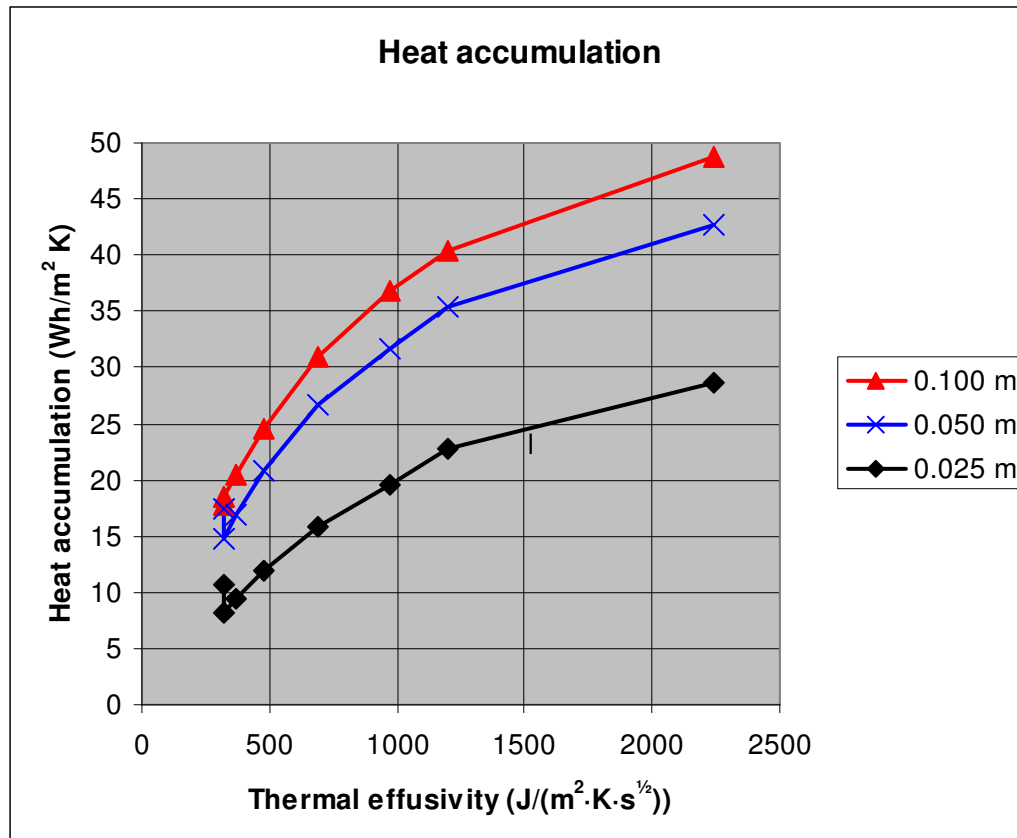

FIG. 3: Calculated heat accumulation in relation to effusivity and thickness of the material.



TABLE 2: Thermal capacity per surface area, calculated heat accumulation per surface area and utilisation of the thermal capacity.

The calculated heat accumulation is estimated with a variation of the air temperature with a period length of 24 hours and an amplitude of  $\pm 1K$ .

No.	Material	Density	Thermal capacity per surface area [Wh/(K·m <sup>2</sup> )]				Calculated heat accumulation per surface area [Wh/m <sup>2</sup> K] with sinusoidal variation ( $\pm 1 K$ )				Utilisation of the thermal capacity [%]			
			0.025 m	0.050 m	0.100 m	0.100 m	0.025 m	0.050 m	0.100 m	0.100 m	0.025 m	0.050 m	0.100 m	0.100 m
		$\rho$	Thickness of the material				Thickness of the material				Thickness of the material			
		kg/m <sup>3</sup>	0.025 m	0.050 m	0.100 m	0.025 m	0.050 m	0.100 m	0.100 m	0.025 m	0.050 m	0.100 m	0.100 m	
1	Concrete	2400	16.7	33.3	66.7	28.6	42.7	48.8	48.8	86	64	37		
2	Lightweight concrete	1800	12.5	25.0	50.0	22.8	35.3	40.4	40.4	91	71	40		
3	Masonry	1800	10.5	21.0	42.0	19.6	31.7	36.8	36.8	93	76	44		
4	Lightweight concrete	1200	8.3	16.7	33.3	15.8	26.6	30.9	30.9	95	80	46		
5	Gypsum plasterboard with paper liners	900	6.3	12.5	25.0	12.0	20.9	24.5	24.5	96	83	49		
	Autoclaved aerated concrete	700	4.9	9.7	19.4	9.5	16.8	20.5	20.5	98	87	53		
7	Lightweight concrete	600	4.2	8.3	16.7	8.2	14.8	18.6	18.6	98	89	56		
8	Wood	500	5.6	11.1	22.2	10.6	17.5	17.8	17.8	96	79	40		

### 3. Thermal capacity of a building

In calculations according to the Danish building regulations it is recommended to specify the building in one of four categories of thermal capacity for a building (Aggerholm S. and Grau K. (2005)). The categories are ranging from an extra light weight building to an extra heavy weight building. The thermal capacity of the building per floor area ranges from values of 40 Wh/(K·m<sup>2</sup>) to 160 Wh/(K·m<sup>2</sup>).

In the European standards (Dansk Standard (2004)) a simplified method is given for the estimation of the thermal capacity of surfaces and buildings. This method is not described in details here, but provides an approximate method to obtain the thermal capacity for each single surface.

An example is calculated where the internal surface area is estimated for of the different constructions. The surface area of the different constructions is correlated to the gross floor area. In TABLE 3 an example of how it is possible to calculate the total heat capacity and the total active heat capacity is shown.

TABLE 3: Example of calculation of total heat capacity and total active heat capacity for a building.

Construction	Surface-area in relation to the floor area	Material thickness	Heat capacity per surface area	Heat capacity per floor area	Active heat capacity per surface area	Active heat capacity per floor area
		m	Wh/(K·m <sup>2</sup> )	Wh/(K·m <sup>2</sup> )	Wh/(K·m <sup>2</sup> )	Wh/(K·m <sup>2</sup> )
Roof, concrete	0.90	0.10	66.7	60.0	24.4	22.0
Floor, tiles/concrete	0.90	0.10	66.7	60.0	24.4	22.0
Partition walls concrete	0.90	0.09	60.0	54.0	22.2	20.0
External walls, concrete	0.29	0.10	66.7	19.3	24.4	7.1
Sum	2.99			193.4		71.0

In this example the total heat capacity per floor area is estimated to be 193 Wh/(K·m<sup>2</sup>). The active heat capacity per floor area is estimated to be 71 Wh/(K·m<sup>2</sup>). This value can be compared with the tabulated value applied in the Danish calculation rules of 160 Wh/(K·m<sup>2</sup>).

Calculations with other materials demonstrate a similar difference between the calculated total active heat capacity for a building and the values obtained using the Danish tabular values. (Olsen L. and Hansen M. (2007)).

### 4. Conclusions

Following conclusions can be drawn from this study:

- A large part of the heat capacity of heavy weight solid constructions can be utilized for heat accumulation.
- The part of the material closest to the surfaces takes more active part in the accumulation than the parts of the constructions with a larger distance to the interior surfaces.
- The heat capacity of the building has a major influence on the thermal performance of a building for both heating and cooling.

- It is demonstrated, how it is possible to calculate the heat capacity of a certain building.
- It can not be expected to obtain a larger heat capacity of a building by doing detailed calculations instead of using the Danish tabulated values.
- It seems that there is a need of revising the Danish tabulated values for heat capacities in buildings.

## 5. References

Aggerholm S. and Grau K. (2005). By og Byg Anvisning 213, Bygningers energibehov. Beregningsvejledning. (ver. 1.06.03), Statens Byggeforskningsinstitut 2005.

Bloomberg T. and Claesson J. (2003). Heat 2. version 6.0, T, [www.buildingphysics.com](http://www.buildingphysics.com)

Dansk Standard (2001). Byggematerialer og produkter - Hygrotermiske egenskaber - Tabeller med designværdier, DS/EN 12524:2001.

Dansk Standard (2004). Termisk ydeevne for bygninger - Beregning af energiforbrug til rumopvarmning. DS/EN ISO 13790:2004.

Dansk Standard (2005). Beregning af bygningers varmetab, DS 418, 6. udgave 2002-04-03, inkl. DS 418/Till. 1 2005-12-21.

Olsen L. and Hansen M. (2007). Varmeakkumulering i beton, Arbejdsrapport fra Miljøstyrelsen, Nr. 19, 2007.

# A Comparative Evaluation of the Importance of Thermal Mass of Traditional Architecture in Hot and Dry Region in Turkey

*Gulten Manioglu, Assist. Professor,  
Istanbul Technical University, Faculty of Architecture;  
[manioglugu@itu.edu.tr](mailto:manioglugu@itu.edu.tr)*

*Zerrin Yilmaz, Professor,  
Istanbul Technical University, Faculty of Architecture;  
[yilmazzer@itu.edu.tr](mailto:yilmazzer@itu.edu.tr)*

**KEYWORDS:** *traditional architecture, climate responsive design, thermal performance, building envelope, design strategies in hot dry zone.*

## **SUMMARY:**

*This paper is a brief review of a more detailed field and theoretical survey to understand the role of climate in formation of the building envelope in hot and dry zone of Turkey. A detailed critical discussion of traditional patterns of architecture will be discussed in relation to the thermal comfort conditions in traditional houses in hot and dry regions. The potential for heat storage capacity of building envelope has been known and used in hot and dry regions for several thousand years. This study is based on evaluating the importance of thermal masse on different traditional architecture examples in hot and dry climate of Turkey. In hot and dry climatic zone in Turkey, in traditional architecture examples, to benefit the time lag of the building envelope, materials with greater thermal mass have been chosen. The high heat capacity of the opaque component provides a high time lag for the transmission of the outside temperature to the internal area. It is well known that, thermal mass of the envelope becomes more important issue than heat insulation, especially in the regions where the difference of day and night temperature is very high. Moreover, heat storage capacity of building envelope affects significantly heating energy demand of building especially when the heating system is working intermittently.*

*In this study the importance of thermal mass of traditional architecture in hot and dry region in Turkey has been explained. Thermal behavior of different wall details was compared by measurements and calculations. The conclusion will guide to examine the traditional design opportunities in order to review and improve today's bioclimatic design strategies.*

## **1. Introduction**

Traditional architecture is a real living environment created by indigenous people for themselves. To evaluate traditional architecture, primarily natural and social environment and local resources then construction materials and techniques should be examined. In other words, traditional architecture can be founded on main bases such as climate, socio cultural base and local technology and materials.

Design strategies affecting indoor thermal comfort conditions are significantly different for all climatic zones as it can be easily seen in the traditional design. Climate is a determining factor key in design parameters such as distance between buildings, building form, orientation and building envelope (walls, windows, roof). Local technology and materials are also important factors affecting indoor thermal comfort.

The use of characteristics of local climate in housing is not a new innovation. As Vitruvius pointed out, “we must at the outset take note of the countries and climates in which buildings are built”. Many problems can be avoided if careful work is done at the design level to reduce the effects of the most annoying climatic factors. Types of undesirable weather conditions vary considerably from area to area and country to country. Each region has its own climatic conditions which must be the basis for the design strategies in each individual case. Protection from sun and heat plays an important role in the areas with a great temperature difference between day and night. Focusing on several architectural examples in hot and dry regions in Turkey, numerous precautions taking against the hot climate can be displayed:

- High density settlement which reduce the overall exposure to intensive solar radiation,
- High walls which provide usually shady areas in courtyards,
- Suitably oriented narrow streets which support passive cooling potential via resulting air flow patterns and shading functionality of buildings ,
- Water usage which allows the utilization of the evaporative cooling effect via pools and wetted surfaces
- Semi-open elements used to create shady and cool living space during the day ,
- Utilizing the greater thermal stratification range in room with greater heights, cooler air is provided to the lower zone of the room, where people are,
- Rooms partly constructed into ground which provides always cooler ambient than the outer temperature in summer,
- Benefit from large day-night temperature differences by choosing materials with a high heat capacity in the construction of building envelope.

Among these design parameters, building envelope, as it separates the outdoor and indoor environment, is the most important parameter. Considering a space as the built environment, the most important parameter affecting indoor climate is the building envelope which separates the indoor space from the external environment and in this way, modifies or prevents the direct effect of climatic variables. Therefore according to its storage capacity and its insulation resistance, the building envelope modifies also the effect of the heating system in the space.

When passive heating or air conditioning is used, indoor air and surface temperatures change with the rate of heat flow through the building envelope, which consists of opaque and transparent components. The rate of heat flow through the building envelope is a function of the thermophysical and optical properties of the opaque and transparent parts. Therefore, the thermophysical and solar radiation properties of the building envelope are the main determinants of the indoor climate, and also of the demand for supplementary mechanical energy.

## 2. The Effect of Thermal Mass of Building Envelope

Due to the effects of solar radiation and outdoor air temperature, the amount of heat flow through the building envelope varies with the optical and thermo-physical properties of the envelope. The most important heat transfer properties of the building envelope are;

- Overall heat transfer coefficient
- Transparency ratio
- Thermal conductivity
- Decrement factor and time lag
- Optical properties, such as absorptivity, transmissivity and reflectivity

Optical properties are absorptivity, transmissivity (not valid for the opaque component) and reflectivity. Thermo-physical properties of the opaque component of the building envelope are represented by the transparency ratio (the ratio of window area to total façade area) heat capacity of the layers constituting the opaque component and the overall heat transfer coefficient of the component which includes also the thermal conductivity and thickness. The overall heat transfer coefficient of an existing or proposed opaque component detail can be determined by the following formula.

$$U_o = \frac{1}{\frac{1}{\alpha_i} + \frac{d_1}{\lambda_1} + \frac{d_2}{\lambda_2} + \dots + \frac{d_n}{\lambda_n} + \frac{1}{\alpha_e}} \quad (1)$$

$U_o$  : The overall heat transfer coefficient of the opaque component  $W/m^2K$ .

$\alpha_i, \alpha_e$  : Internal and external surface heat transfer coefficients,  $W/m^2C$ .

$d_1, d_2, \dots, d_n$  : Thickness of the layers constituting the opaque component , m.

$\lambda_1, \lambda_2, \dots, \lambda_n$  : Thermal conductivities of the layers constituting the opaque component  $W/m^2K$ .

The decrement factor and time lag are valid for the opaque component which can store heat within the structure. The time it takes for the heat wave to propagate from the outer surface to the inner surface is named as “time lag” and the decreasing ratio of its amplitude during is named as “decrement factor”.

All of these parameters are related to each other and the optimum values of each parameter should be determined depending on the values of each other. The heat loss through the building envelope is the function of the heat transfer coefficient and the heat storage capacity of the building envelope. The heat loss can be determined according to overall heat transfer coefficients of differently oriented façades, decrement factor and time lag depending on thermal diffusivity of the opaque materials. Heat storage capacity can be defined by the thermal diffusivity of the material. The thermal diffusivity is calculated by the formula below:

$$a = \frac{\lambda}{\rho \cdot c} \quad (2)$$

a: Thermal diffusivity, m<sup>2</sup>/s

λ: Thermal conductivities, W/mK

ρ: density, kg/m<sup>3</sup>

c: specific heat, J/kg K

Thermal mass is a very important parameter especially in hot and dry regions where temperature fluctuations during a 24 hour period are very significant. It helps avoid the daytime heat and keep the night-time coolness inside the building for a longer period. The thermal capacity of the building's elements delays the heat transfer to the interior of the building, by soaking up excessive heat for several hours. During the night, when the external temperature is lower, the stored heat is slowly expelled to the environment by radiation and by convection. The thermal mass of the building envelope has also a direct effect on the intermittently heated spaces. If a building is intermittently heated, the time lag needed to obtain the comfort value of the surface temperature of the envelope is very important from the energy conscious design point of view.

In this study thermal performance of different building envelope alternatives were evaluated for a school building in Diyarbakir by means of finite difference method which is numerical solution of dynamic heat transfer equations.

## 2.1. The Effect of Thermal Mass of Building Envelope in Hot and Dry Regions

The hot and dry climatic region of Turkey is mostly represented by the South Eastern Anatolian Plateau of the country with a great temperature difference between day and night. The climate of South Eastern part of Turkey is relatively similar to desert climate. In hot and dry climatic zone in Turkey where the continental climate is effective, in traditional architecture examples, to benefit the time lag of the building envelope, materials like ALKER with greater thermal mass have been chosen. These kinds of thermally massed envelope details are very convenient for continental climates, where the summers are very severe with high swings in daily temperature variations. This big thermal mass will slow down the heat transfer through the envelope and thus higher day-time temperatures will be reached indoors when outdoor air temperature is much lower and consequently more stable indoor thermal conditions will be provided. On the other hand this thermal mass, which has higher surface temperature on outer side will rapidly lose heating energy to the atmosphere via thermal radiation at night to start the next day from a cooler level.

As it is known opaque building materials have a certain amount heat storage capacity and therefore, thermal behavior of these materials should be analyzed by means of dynamic heat transfer models. In this study thermal performance of gypsum stabilized adobe (ALKER) were evaluated for a school building in Diyarbakir in comparison with the other external wall materials by means of finite difference method which is numerical solution of dynamic heat transfer equations. For this evaluation a school building has been considered and thermal behavior of this building, which external walls are formed with ALKER and other external wall materials, has been analyzed with dynamic heat transfer equations.

### 3. Evaluation of Thermal Mass of the Building Envelope in Hot and Dry Region

The building envelope detail, which provides the minimum heat loss with the comfort value of inner surface temperature by means of the certain operation period of the heating system, is qualified as the most convenient opaque component for the building envelope for that heating period. The evaluation has been applied to Diyarbakır, which is a representative city of Turkey for temperate-hot zone. A primary school building, which is heated intermittently, was chosen for the evaluation. For this analysis a simulation model, which is simulating the finite difference heat transfer solutions has been used. The following works and assumptions have been made for the evaluation.

- Since the purpose of this study is to analysis the thermal performance of the building envelope according to the mechanical heating system, January, which is the representative month of underheated period, has been selected for the evaluation. Outside air temperature and solar radiation data for January was provided by the Turkish State Meteorological Service.
- In order to emphasize the importance of the U value and thermal mass of the building envelope on heat loss amount, the infiltration rate has been considered at a constant amount and the ventilation has been neglected.
- The primary school building was supposed in a region in Diyarbakır, without any slope and not to be shaded by the other buildings. The building has four external walls oriented to the main four directions as N, E, S and W. The building has two storeys with the height of 6.80m and floor area is 2395 m<sup>2</sup>.
- Permissible limit value for the difference between inner surface temperature and comfort value of indoor air temperature is accepted as 3°C, comfort value indoor air temperature ( $t_i = 19^\circ\text{C}$ ) by means of Turkish Standards. Thus the comfort limit of the inner surface temperature ( $t_{is} = t_i - 3 = 16^\circ\text{C}$ ).
- The external surfaces of the opaque components are painted in dark colors, with the solar radiation absorptivity of  $a_o=0.70$ .
- Window type is double glazed with wooden sash. Overall heat transfer coefficient of the transparent component is  $U_w= 3.25 \text{ W/m}^2\text{K}$ . The variation of the transparency ratios of the building envelope is as follows. North: 0.35, East: 0.37, South: 0.42, West: 0. 37.
- Overall heat transfer coefficient for the opaque component is  $U_o= 0.78 \text{ W/m}^2\text{K}$ . Opaque component alternatives were derived from the building materials which are produced and commonly used in Turkey including ALKER which is traditional wall type in hot and dry area to provide this overall heat transfer coefficient. Those alternatives are given in Table 1.
- In this study various external wall alternatives were evaluated but all calculations are carried out for the same floor and ceiling details. The other design parameters such as orientation, window size and window type were not changed for the different wall materials in order to compare the thermal performance of external wall materials
- The primary school building is used at least 8 hours in a day. The heating system is operated to supply the comfort value of indoor air temperature ( $t_i =19^\circ\text{C}$ ) from 05:00am to 15:00 pm.

Since the variation of the outdoor air temperature and solar radiation intensity is time-dependent and heat storage capacity of the building materials constituting the opaque components is usually not negligible, the temperature distribution within the component and the amount of heat transmission is also time dependent. Time dependent heat flow calculations to determine indoor air temperature and inner surface temperatures are based on the Finite Difference Method. Heat flow variability according to the time and hourly values of the inner surface temperatures were calculated by using a computer simulation model. Thermal properties of ALKER were obtained from the results of an experimental study for this material. Building envelope alternatives (no:3 and 4) with ALKER were evaluated both with and without insulation layer. Calculations were made for the opaque component alternatives given in Table 1, for the determined operation period.

The inner surface temperature determines the indoor air temperature with respect to heat flow trough the building envelope and it can be different from the indoor air temperature even if the indoor air temperature is controlled by the heating system. Therefore, the time dependent values of the inner surface temperatures are the most important indicator of thermal performance of a building from thermal comfort and energy conservation point of view. In this study all the building envelope alternatives were first evaluated through their inner surface temperatures and the variation of the internal and external surface temperatures for building envelope alternatives were expressed with graphs in FIG.1. Heat flows through the selected building envelope have been

calculated to see the thermal behavior of different wall details having same U-value but different thermal mass. Especially for the 4th alternative only ALKER was used to evaluate the thermal mass effect of this material.

TABLE. 1: Alternatives for the opaque façade components (Uo: 0.78 W/m<sup>2</sup>K)

Build. env.no	Materials	Thermal conductivity $\lambda$ W/mK	Thickness of the material d m	Weight of unit volume $\rho$ kg/m <sup>3</sup>	Specific heat c kJ/kg°C
<b>1</b>	Cement mortar	1.4	0.02	2000	1.05
	Insulation board made of PVC	0.04	0.02	50	1.26
	<b>Porous light brick</b>	0.33	0.19	<b>800</b>	0.92
	Lime mortar	0.87	0.02	1800	1
<b>2</b>	Cement mortar	1.4	0.02	2000	1.05
	Insulation board made of PVC	0.04	0.02	50	1.26
	<b>Vertically perforated standart bricks</b>	0.45	0.26	<b>1000</b>	0.92
	Lime mortar	0.87	0.02	1800	1
<b>3</b>	Cement mortar	1.4	0.02	2000	1.05
	Insulation board made of PVC	0.04	0.02	50	1.26
	<b>Alcer</b>	0.46	0.26	<b>1400</b>	1.254
	Lime mortar	0.87	0.02	1800	1
<b>4</b>	Cement mortar	1.4	0.02	2000	1.05
	<b>Alcer</b>	0.46	0.5	<b>1400</b>	1.254
	Lime mortar	0.87	0.02	1800	1

As the result, the opaque component, which provides the minimum heat loss with the proposed operation period of heating system, is qualified as the most convenient opaque component from thermal comfort and energy conservation point of view.

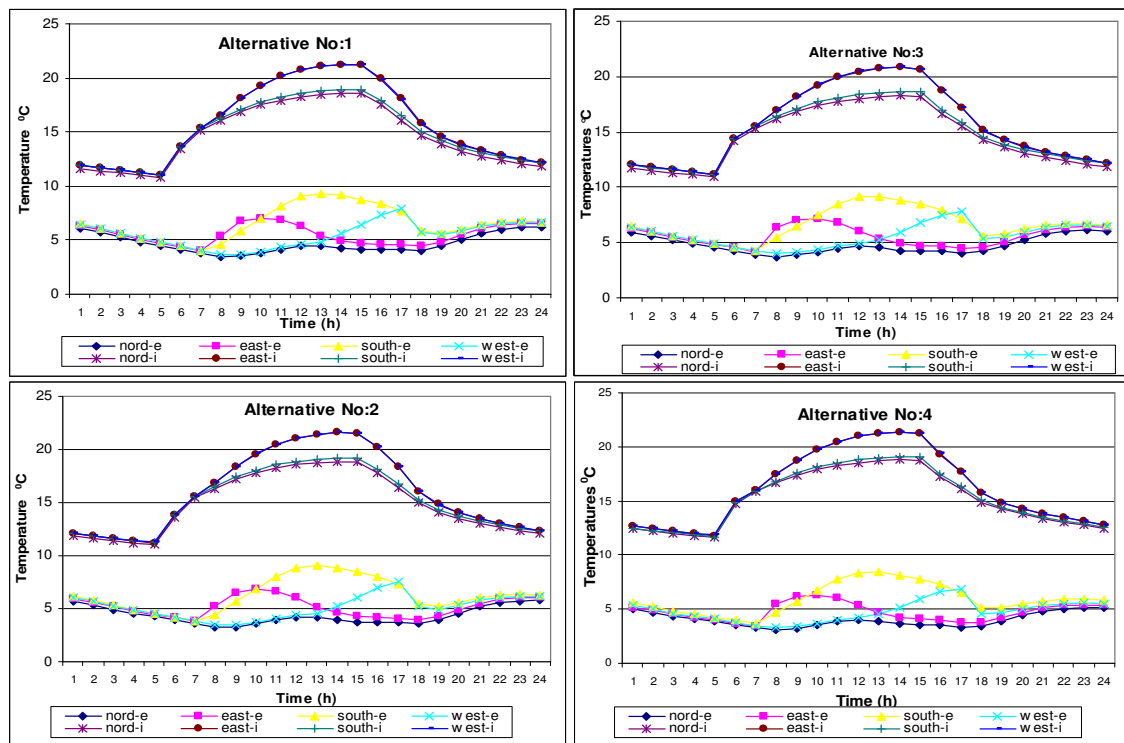

FIG. 1: Variation of internal and external surface temperature for different building envelope alternative with the heating period 05:00-15:00



As it can be seen in FIG.1, all of the alternatives provide 10 hours comfort value of the inner surface temperature during the occupation period. The amount of heat loss and consequently the heating energy consumptions will be significantly different for different walls in the same city however all of them have the same U-value. From FIG.2, it can be seen that the thermal performance of the building envelope alternative 1, 2 and 3 is the result of the combined effect of the insulation layer together with the main wall material. But the building envelope alternative 4, constructed with only ALKER provides the minimum heat loss without any insulation layer. Therefore the effect of thermal mass of the building envelope alternative 4 on the heat loss amount can be realized easily when comparing all proposed alternatives. That means that the U value is not sufficient to determine the real thermal performance of the building envelope. Building envelopes which have the same U value perform differently depending on different thermal mass, thus thermal mass is as important as the U value and it should certainly be taken into consideration especially in hot and dry climatic zone where the continental climatic effects are dominant.

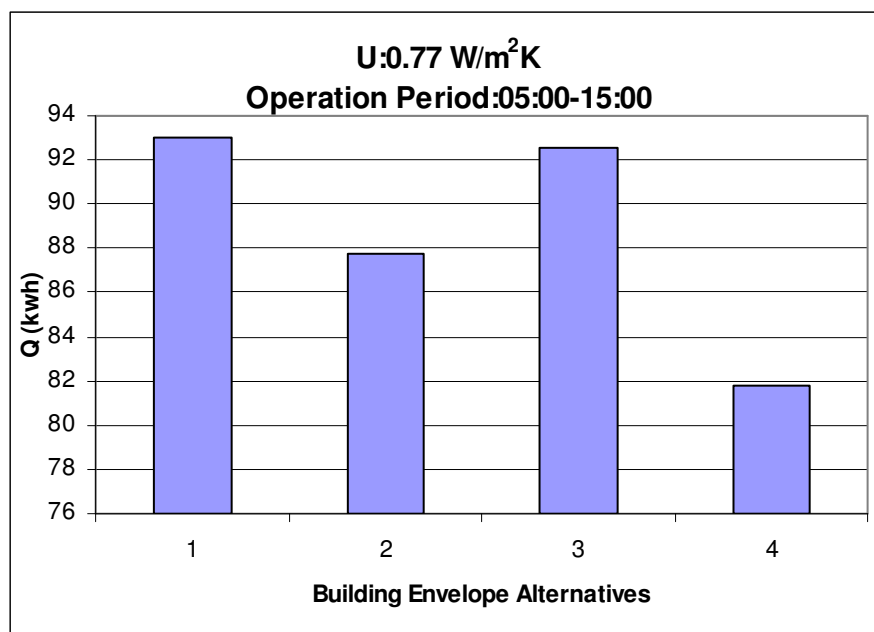

FIG. 2: Total monthly heat loss through the building envelope alternatives with the heating period 05:00-15:00

## 4. Conclusion

In this paper an evaluation methodology is proposed for the determination of the most convenient building envelope detail, which provides the minimum heat loss for the comfort value of the inner surface temperatures with a certain operation period of the heating system. Thermal performance of ALKER has been compared with those of other building materials by means of this dynamic thermal evaluation model.

Theoretical study has been carried out for a primary school building constructed with different wall details providing the same U-value ( $0.77 \text{ W/m}^2\text{K}$ ). When we compare the thermal performance of ALKER with porous light brick, vertically perforated brick and ALKER with an insulation layer, considering the inner surface temperatures and heat losses for January, ALKER has the same thermal performance with other building envelope details by providing 10 hours the comfort values of the inner surface temperature for the considered school building walls.

The most important conclusion of this study is; the ALKER wall (alternative no:4) is providing the least energy consumption for heating; however it has the same U-value (without any insulation layer) with other walls. Thus, different building envelope details may show different thermal behavior according to their thermal mass; even if their heat transfer coefficients are same.

As it can be concluded from the results of the theoretical studies, the heat transfer coefficient of the building envelope calculated in steady state conditions are not sufficient to determine the real thermal performance of buildings. Moreover, we can say that the modern buildings in hot and dry regions, which are constructed with

contemporary design strategies, cannot correctly respond to the climate of the region. Thermal mass of the materials should be taken into account and local materials as ALKER should be integrated into modern construction design strategies. It is possible to say that, especially on the regions, where the continental climate is experienced thermal performance of buildings should be evaluated by a dynamic model of heat transfer calculations during the design stage, taking into account also the thermal mass of the building envelope to provide energy conservation in buildings in these regions.

Another conclusion from this study, same building envelope alternatives should be reanalysed in order to provide the comfort values of the inner surface temperature in the most economical manner for the summer period. Moreover, the evaluation can be repeated by choosing different operation period for different climatic zones, by this way it is possible to determine the optimum combination of building envelope detail and operation period to provide minimum energy consumption. So it is recommended to select the type of operation period not only according the building function but also to the envelope detail. An other traditional materials, a masonry wall example should be added to the evaluation to see the thermal mass effect of the building envelope from the energy conservation point of view to enforce the result of the study, Furthermore, lifecycle cost studies should have been done in order to see the economical results of local and contemporary building envelope details by comparing them with an without insulation layer.

The application of the proposed method to a school building in Diyarbakır is given as an example. In order to determine the thermal behavior in the most economical manner in the hot and dry regions, the proposed method can be applied for different wall types and operation periods. Repeating the calculation, which is covered by the proposed method, for all possible combinations of the design parameters, the most convenient architectural solutions for energy conscious design in hot and dry regions can be obtained. Furthermore, since the effect of building envelope is not independent from the operation period, the analysis to evaluate the energy consciousness of different building envelope alternatives of different building type can be done by means of this methodology considering the operation period of the heating system.

## References

- Berköz E. and Yılmaz Z. (1987) Determination of the Overall Heat Transfer Coefficient of the Building Envelope from the Bio-climatic Comfort Point of View, *Architectural Science Review*, Vol. 30, pp.117-121.
- Holman J.P.(1976). Heat Transfer, 4. Ed., New York, Mc Graw Hill Book Co.
- Mahdavi A. (2007). Learning from traditional architecture through building diagnostics and performance modeling, *12<sup>th</sup> Symposium for Building Physics*, Vol. 1, Dresden, pp.11-22
- Manioğlu G. and Yılmaz Z. (2006) Evaluation of Thermal Performance of Traditional and Modern Residential Buildings in the Hot Dry Climatic Zone of Turkey”, *3<sup>rd</sup> International Conference on Building Physics, “Research in Building Physics and Building Engineering”*, Montreal, pp. 683,
- Manioğlu G. and Yılmaz Z. (2005) Evaluation of Thermal Performance of Gypsum Stabilized Adobe (Alker) for a School Building in ISTANBUL, *First International Conference, Living in Earthen Cities-Kerpic’05*, Istanbul, pp. 182.
- Oktay D. (2001). Design with Climate in housing environments: an analysis in Northern Cyprus, *Building and Environment*, Vol. 37, 2002, pp.1003-1012
- Turkish Standars TS 825 (1998), Rules of Heat Insulation in Building
- Vitivius (1960). The Ten Books on Architecture, *Dover Publication*, New York.
- Yıldız E. (1990). A Method to Determine Orientation of Rooms According to Activities and Thermo-physical Properties of Building Envelope, *PhD Thesis, Istanbul Technical University*, Istanbul, pp.17-27
- Yılmaz Z. (2006) Evaluation of Energy Efficient Design Startegies for Different Climatic Zones: Comparison of thermal performance of buildings in temperate humid and hot dry climate, *Building and Environment*, Vol. 39, 2007, pp.306-316
- Yılmaz Z. (2005). Thermal Mass Effect on Energy Concious Design, *TESKON* , Istanbul.
- Yılmaz Z. (2004). Studies on Energy Efficient Design in ITU Sustainable Energy Research Group, *Energy Conservation and Insulation Congress and Exhibition for Sustainable Environment*, Istanbul pp.5-9.
- Yılmaz Z. (2004). The Effect of Thermal Mass on Energy Efficient Design, *VI. International HVAC+R Technology Symposium*, Istanbul pp. 511-520 .
- Yılmaz Z.(1987). Evaluation of Built Environment from the Thermal Comfort Viewpoint, *ASHRAE Transactions*, Vol.93, Part 1, pp.549-563.



# Effect of climate change on energy consumption in buildings

*Angela Sasic Kalgasidis, Assistant professor  
Chalmers University of Technology, Dep. of Civil and Environmental Engineering, Sweden;  
[Angela.Sasic@chalmers.se](mailto:Angela.Sasic@chalmers.se); [www.chalmers.se](http://www.chalmers.se)*

*Vahid Moussavi Nik, PhD student  
Chalmers University of Technology, Dep. of Civil and Environmental Engineering, Sweden;  
[Vahid.Nik@chalmers.se](mailto:Vahid.Nik@chalmers.se); [www.chalmers.se](http://www.chalmers.se)*

*Erik Kjellström, PhD researcher  
Swedish Hydrological and Meteorological Institute, Norrköping, Sweden;  
[Erik.Kjellstrom@smhi.se](mailto:Erik.Kjellstrom@smhi.se); [www.smhi.se](http://www.smhi.se)*

*Anker Nielsen, Professor  
Chalmers University of Technology, Dep. of Civil and Environmental Engineering, Sweden;  
[Anker.Nielsen@chalmers.se](mailto:Anker.Nielsen@chalmers.se); [www.chalmers.se](http://www.chalmers.se)*

**KEYWORDS:** *Climate change, climate scenarios, future energy consumption, climate load in buildings*

## **SUMMARY**

*Scenarios for predicting future climate changes build on emission scenarios and climate model simulations. The uncertainties regarding future growth in population and economic development make it impossible to rely on any simplified forecasts for the future. Universal in most climate change scenarios for the 21<sup>st</sup> century is the increase of the global mean temperature. By the end of the century the increase may be 1-4 °C depending on the chosen emission scenario. This paper demonstrates one future climate scenario for Sweden and discusses: firstly, weather design conditions in terms of deviations from presently used climatic loads for buildings' energy design and, secondly, possible results on energy consumption in buildings in relation to climate change scenarios. Evaluation of the method is performed by testing it on a hindcast simulation covering the last decades. The results presented here originate from the recently started research project on sustainability of the Swedish built environment towards climate changes. The project is conducted at Chalmers University of Technology, Sweden, in cooperation with the climate research unit Rossby Centre of the Swedish Meteorological and Hydrological Institute.*

## **1. Introduction**

The impact of climate in general, expressed in the form of precipitation, wind, temperature and exposure to the sun, causes extensive degradation and damage to the built environment every year. Not only the climate parameters themselves, but also their interaction is critical for this impact, i.e. a change in one parameter affects the others and, therefore, the whole situation. The impacts of climate that can be predicted can be successfully managed by an adequate construction practise. Some combinations of building materials and designs show better performance and durability than the others. However, possible deviations in predicted loads and especially of the long-term ones may change the designed response of a building.

Projections from climate models point to a warmer climate with an intensified hydrological cycle in the future (IPCC, 2007). Such changes have been already observed, both globally and regionally. In Sweden, for instance, the last 10-15 years have been mild and wet compared with previous periods. This trend in the recent Swedish warming is in line with climate change scenarios. The climate projections include changes in both average conditions and in the frequency and magnitude of extreme events.

The goal of the recently started research project on sustainability of the Swedish built environment towards climate changes (Nielsen et.al, 2007) is to define and study critical parts of the existing buildings, e.g. constructions, assemblies or certain types of buildings, whose hygro-thermal performance may be significantly affected by climate changes. The project is conducted at Chalmers University of

technology, Sweden, in cooperation with the climate research unit Rossby Centre of the Swedish Meteorological and Hydrological Institute.

This work is focused on the future energy consumption for heating and cooling in buildings. Regional climate change scenarios, developed at the Rossby Centre, are presented and evaluated in the first part of the work. The assessment of the future energy use for heating and cooling is done numerically for one selected climate scenario and for one town - Gothenburg, Sweden. The energy results can be found in the second part of the paper.

## 2. Climate scenarios

### 2.1 Global climate models

Climate model experiments can be carried out using coupled atmosphere-ocean general circulation models (AOGCMs). These models are applied with different external forcings as changing greenhouse gas concentrations, changes in solar intensity, etc. The response of a climate system to changes in forcing depends on the climate sensitivity of the AOGCM. On the other hand, the climate sensitivities vary between AOGCMs as the latter differ in how the details of the climate system are described. As an example, the general circulation models may include different feedback mechanisms related to, for instance, land-surface processes, the carbon cycle, or the atmospheric composition.

A common feature in most of climate change scenarios, together with future increases in greenhouse gas concentrations, is the increase of the global mean temperature. By the end of the century this increase may be between 1.8 and 4.0°C depending on the chosen emissions scenario (IPCC, Intergovernmental Panel on Climate Change 2007). In addition to these central numbers acquired with the emissions scenarios, the uncertainties associated with models widens this range to 1.1-6.4°C, according to the latest IPCC report that takes into account more than 20 AOGCMs.

As the state-of-the-art AOGCMs have a rather coarse spatial resolution (often 100-300 km), so they do not fully represent the details on a regional scale. A commonly used approach to improve the resolution (and thereby provide the more useful scenario results to end-users) is to use a regional climate model (RCM) for downscaling the results from the AOGCM. In such an experiment, the RCM takes lateral boundary conditions, sea surface temperatures (SST) and sea-ice conditions from the AOGCM at a certain time interval and calculates its own state in the model domain.

### 2.2 Regional climate model at the Rossby Centre

RCA3 is the latest version of the Rossby Centre regional atmospheric model, which includes a description of the atmosphere and its interaction with the land surface. RCA3 has been run on a rotated latitude-longitude grid with a spatial resolution of 0.44°, corresponding to 49 km. The time step used for the calculation is 30 minutes. In terms of forcing, some parts are identical between the simulations: the land surface (forest, open land and snow) is initiated from HIRLAM climatology (Undén et al., 2002), aerosols are kept constant throughout the simulations and the solar constant is held constant at 1370 W/m<sup>2</sup>. Other external forcings are: greenhouse gases and sea surface temperatures (SST). Further documentation of RCA3 can be found in Kjellström et al. (2005).

RCA3 has been used extensively for several climate change experiments. In the present study results from two experiments are used:

**Hindcast** covers the 45-years period 1961 - 2005. Lateral boundary data and SSTs are taken from the European Centre of Medium range Weather Forecast (ECMWF) ERA40 data set for the time period until August 2002. Thereafter data is taken from the operational analysis at the ECMWF. In terms of the greenhouse gas forcing, a linear increase with time in carbon dioxide (CO<sub>2</sub>) is imposed, 1.5 ppm per volume and year. In the remainder of the text, this experiment is denoted as S1.

**Scenario** covers the 140-years period 1961-2100 with lateral boundary conditions and SSTs originating from AOGCM ECHAM4/OPYC3, developed at the Max-Planck Institute for Meteorology in Hamburg. Greenhouse gases and radiative effect of sulphur aerosols is accounted for in terms of the equivalent CO<sub>2</sub> concentration following the A2 emission scenario from the Special Report on Emission Scenarios (SRES) by the Intergovernmental Panel on Climate Change (IPCC). In the scenario, the equivalent CO<sub>2</sub> concentration increases as shown in Table 1. In the remainder of the text, this scenario is denoted as S2.

TABLE 1: Equivalent CO<sub>2</sub> concentration (in ppm per volume and year) following the A2 emission scenario from the Special Report on Emission Scenarios (SRES) by the IPCC

Year	1960	1990	2000	2010	2020	2030	2040	2050	2060	2070	2080	2090	2100
A2	313	353	373	403	426	470	532	602	702	823	963	1123	1316

### 2.3 Small-scale validation of the predicted climate parameters for building energy simulations

Air temperature is one of the most influencing climate parameters for energy consumption in buildings and also among the most important input data in building energy simulations. Figure 1 shows the measured and the calculated monthly mean temperatures for the two years 1991 and 2004 when detailed observational data for the test site in Gothenburg are available.

The most obvious differences between the data originate from the models used. In the hindcast (S1), which complies well with the measurements, the global model at the ECMWF assimilates observations (from weather balloons, synoptic stations, etc) forcing it to stay close to the real state of the climate system. One evident bias in these years is too low temperatures during parts of the summer. As a contrast, the boundary conditions used in the calculations of S2 are taken from an AOGCM, which simulates the climate by using the external forcing only (greenhouse gas concentration, aerosol concentration, solar constant, etc). Therefore, the AOGCM driven simulation does not necessarily follow the actual day-to-day or even year-to-year variations. But, in a long-term perspective it should capture multi-year annual and seasonal averages as well as higher order variability. The particular AOGCM used shows a too zonal atmospheric circulation in the 20<sup>th</sup> century. This implies that westerly winds bringing mild air in over northern Europe in winter are too strong and too frequent which in turn leads to too high temperatures and too much precipitation during winter and slightly too low temperatures during summer.

In addition, downscaling to smaller spatial resolution (e.g. from a 100 km grid to a 50 km grid) also introduce differences between the data. Compared to the ERA40 data, RCA3 does not include any data assimilation. This means that RCA3 is relatively free to develop its own state in the interior model domain. In some situations this state may deviate from the ERA40 data making it difficult to compare actual time series to each other. Instead comparisons to observational data should be performed in a climatological way, by comparing multi-year monthly and annual means as well as their temporal variability. One-year time series are too short to evaluate the performance of a climate model but the general features of these seasonal cycles presented in Figure 1 are seen also for longer (30-year) time series (Kjellström et al., 2005).

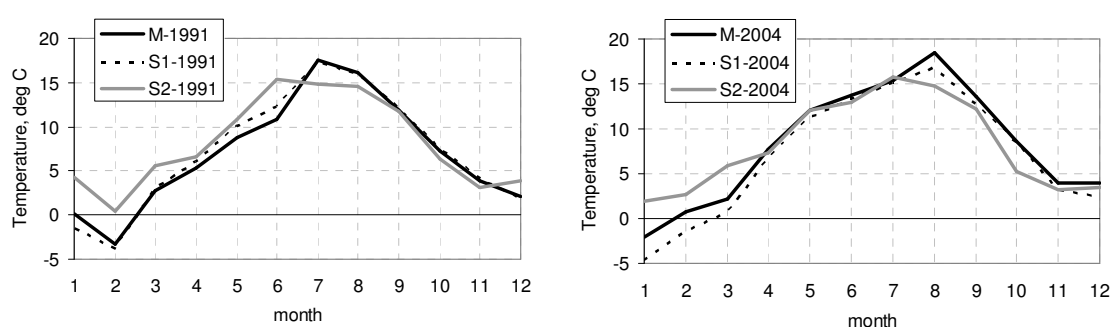

FIG. 1: Monthly mean temperature in Gothenburg in 1991 (to the left) and 2004 (to the right). M=measured data, S1=hindcast and S2= scenario.

### 3. Energy calculations

As given in Sanders (1996), external data for building simulations should be recorded at the building under investigation, whenever possible. This is because the variations in the intensity of the climate parameters are clearly projected on the results of the calculations. To illustrate this, the annual energy consumption for heating and cooling for a test house located in Gothenburg, is calculated by using the measured and the simulated climate data from the climate scenarios 1 and 2 (in further text S1 and S2).

### 3.1 Test building

The test building originates from the testing procedure known as “BESTEST” (Judkoff and Neymark, 1995) that provides methodology for a systematic testing of simulation programs. The method comprises a series of test case buildings that progress systematically from simple to fairly realistic ones. The building used in this work is based on the qualification test case 600, which refers to the building with a lightweight construction.

The building is simple in shape – a rectangular zone with no interior partitions as shown in Figure 2, and thermally almost decoupled from the ground by thick floor insulation. The ventilation flow rate is constant, 0.5 1/h, as well as the intensity of internal gains, 200 W. Two double-glazed windows are placed in the southern wall. The indoor air temperature is kept strictly within the limits of 20°C - 27°C by the heating and cooling systems with infinite capacity.

Regarding the present insulation standard in Sweden in which the overall U value of the building envelope should be less than 0.3 W/m<sup>2</sup>K, it is obvious that the test building, with the overall U value of 0.51 W/m<sup>2</sup>K, is not the representative one for the given locality. As the focus of the present work is on the trends in energy consumption for heating and cooling in future, the simple geometry of the test building, together with the simple material specification and also the popularity of the test, are assumed suitable for the given purpose.

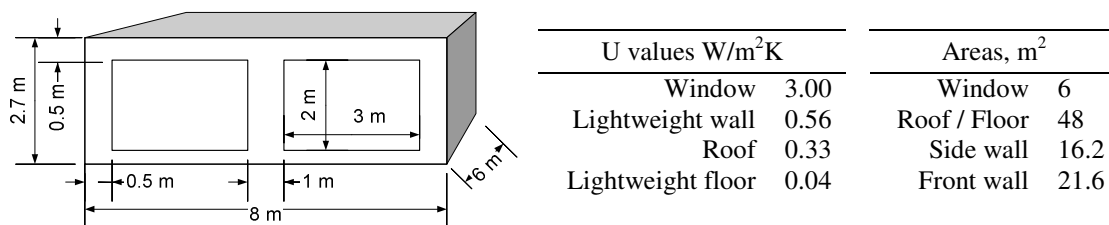

FIG. 2: Geometry and thermal properties of the test building.

### 3.2 Computer programme

Calculations presented here have been accomplished by HAM-Tools, the numerical programme developed at Chalmers University of Technology, (Sasic, 2004). In HAM-Tools, the heating energy demand of a building is calculated directly from a system of energy balance equations for all components involved. The transient heat transfer through walls is calculated as a one-dimensional process and the indoor air is treated as well mixed. The numerical solution is based on the control volume technique. The programme has been validated on several benchmark tests including the BESTEST, (IEA Annex 41, 2007).

### 3.3 Model for solar radiation calculations

Global and diffusive horizontal radiation and the beam intensity are necessary inputs in HAM-Tools for the calculation of solar irradiance on sloped surfaces and through windows. The weather data from the Rossby centre include the global solar radiation on a horizontal surface. The direct and the diffusive parts of the solar radiation are then found from the global radiation data using the model of Taesler and Andersson (1984).

In this model, the intensity of direct radiation is calculated by integrating the mean value of spectral radiation in a specific wavelength range. By taking into account the effects of cloudiness and absorption of radiation by water vapour, the amount of direct normal radiation or beam that hits the ground is found. Direct solar radiation on a horizontal surface is then found by multiplying the sinus of the solar height to the beam. Finally, by subtracting the direct horizontal component from the global, the diffusive horizontal radiation is obtained.

## 4. Future changes in energy consumption

Estimation of the future energy consumption for heating and cooling is based on the climate data from the scenario S2. Figure 4 shows the evolution of yearly mean temperatures in Gothenburg for the time period 1961-2100. According to S1, the time period 1990-2005 was warmer than the reference period 1961-1990. S2 is even warmer than S1 for these years. For the future temperature S2 is increasing

throughout the century with some decadal variability. Such decadal variability is common to climate scenarios as it is related to internal variability of the climate system. The year-to-year variability is even larger and has been filtered out here for clarity.

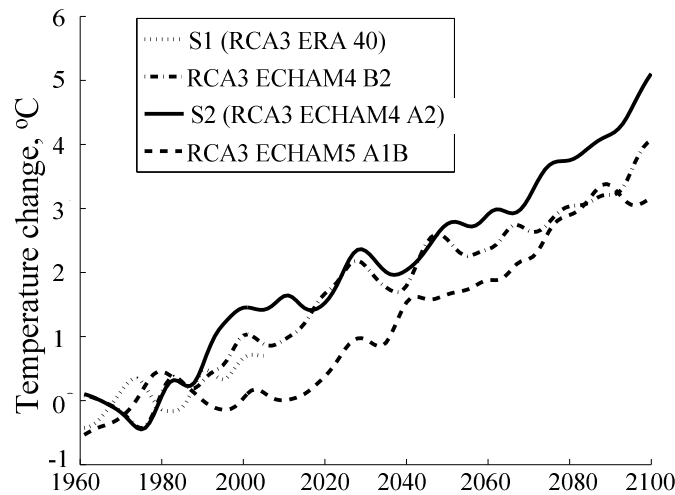

FIG. 4: Yearly mean temperatures anomalies compared to the 1961-1990 mean according to: the hindcast (S1), the climate scenario S2 and two additional climate scenarios for the 1961-2100 time period. The abbreviations are RCA3 for the regional climate model, ECHAM4/ECHAM5 for the global model and B2, A1B and A2 for three different emission scenarios. Data has been filtered with a Gaussian filter to remove variability on time scales shorter than 10 years.

#### 4.1 Reference results based on the energy consumption in the period 1991-2000

The energy needed for heating and cooling in the period 1991-2000, according to the scenario S2, is chosen as the reference for the analysis of future energy consumption. The values, 99 kWh/m<sup>2</sup>floor/year for heating and 34 kWh/m<sup>2</sup> floor/year for cooling, are found as the averages of the annual demands in the selected years. The specific values are plotted in Figure 5. The results based on the hindcast S1 are also shown in Figure 5, with the purpose of illustration of the differences in the climate data.

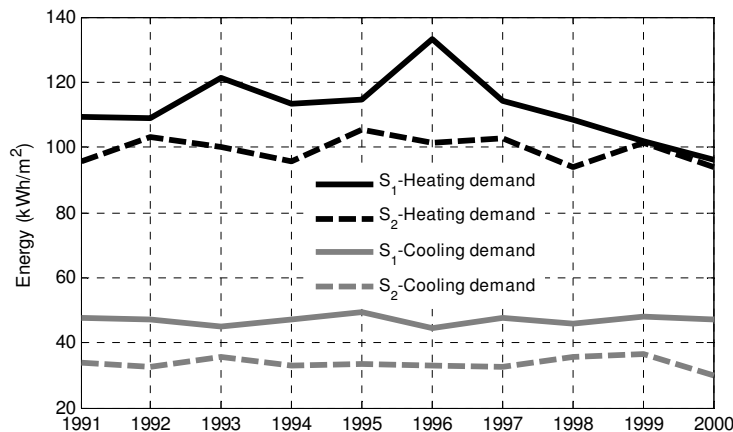

FIG. 5: Reference results: energy consumption for heating and cooling in the test building in the period 1991 - 2000.

#### 4.2 Future energy demand - results for years 2000-2100

Figure 6 illustrates the future energy use for heating and cooling in the test building, based on the climate data from the scenario S2. The results are given in two forms: as absolute values in kWh/m<sup>2</sup>floor/year and as the differences from the reference values for the period 1991-2000. Each result



presents a 10-year average. The error-bars in the upper figure denote the standard deviation of the results within each decade.

According to these calculations, there is an obvious decrease in energy need for heating – by 2100, it could be 30 % less than in the reference period. At the same time, the simulations show an increase in the cooling energy demand by 47 %.

Note, however, that these values should be taken with caution since they present one possible outcome of the climate change.

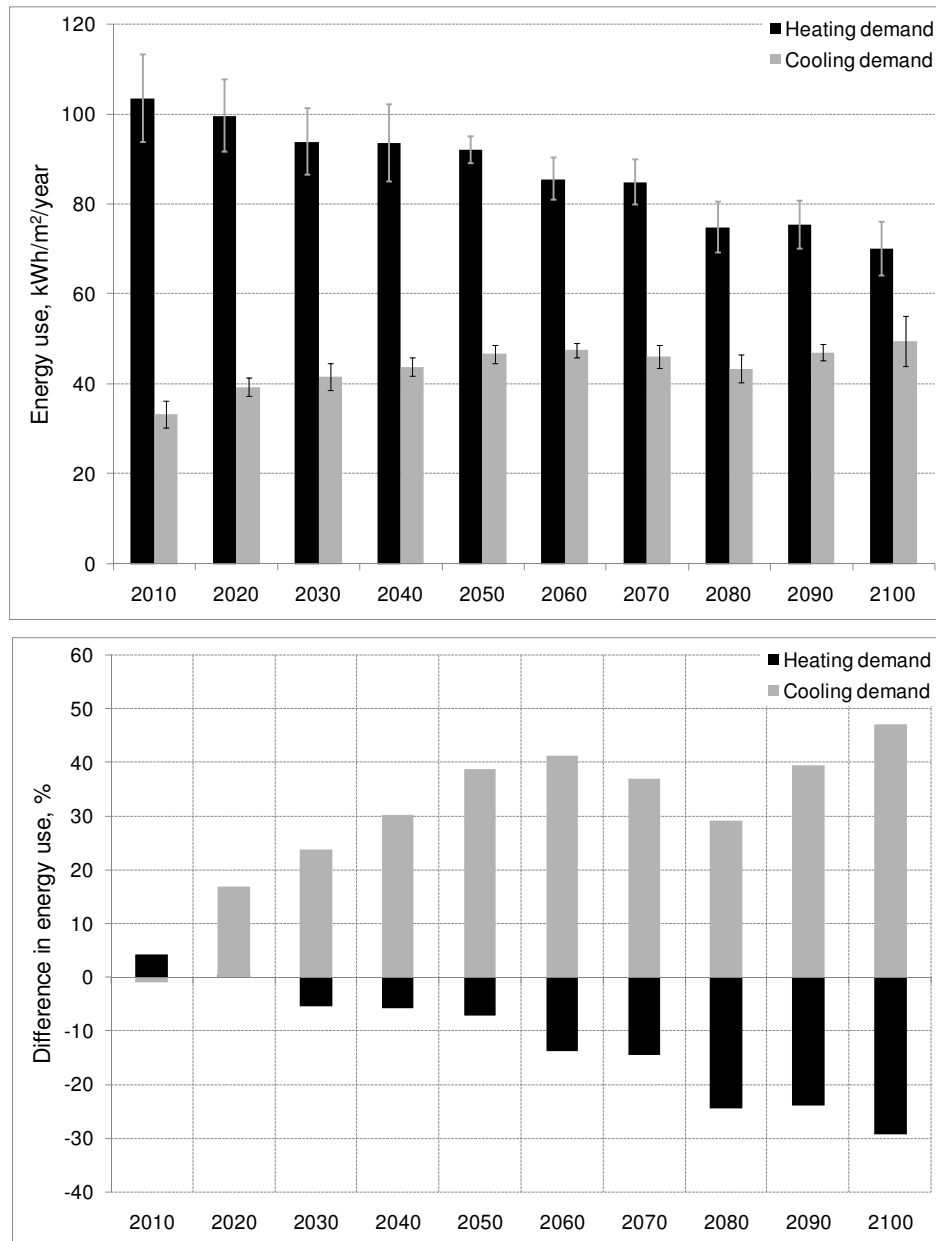

FIG. 6: Future energy consumption for heating and cooling in the test building according to the climate scenario S2. The bars denote the averages over decades.

## 5. Conclusions

Climate change scenarios for the future, which all together point to an increase in global temperature, are built on emissions scenarios and on climate model simulations. There is a considerable variability in this parameter from year to year reflecting the natural variability of the climate. Other than that, there are also variations on longer time scales, for example decades. These features are partly due to natural variability but are also caused by other factors.

One future scenario for Sweden is presented in this work. The simulated future air temperature is evaluated against the measured data for two arbitrarily selected years from the past.

Based on the data from one of the climate scenarios, the energy consumption for heating and cooling in a test building have been calculated numerically. According to the calculations, the energy need for heating could be decreased by 30 % by year 2100, in comparison to the reference period 1991-2000. Given the same conditions, the energy need for cooling could be increased by 47 %.

The results presented are the first ones from the recently started research project on sustainability of the Swedish built environment towards climate changes. In continuation, the research will focus on the development of the reference climate design data for simulations of present and future climatic impact on buildings. Based on that, an update of the principal solutions for building structures in Sweden will be proposed.

An important part of all work that is related to future climate change is to address the uncertainties in the climate scenarios. Figure 4 gives a hint of some of the uncertainties related to this as different climate change scenarios show different temporal trends and variability.

## 6. References

- IEA-EXCO, Annex 41. 2003-2007. Whole building heat, air and moisture response (MOIST-ENG). International Energy Agency (IEA) – (EXCO) Energy Conservation in Buildings and Community Systems. Reports from the project are available from the second half of 2008.
- IPCC. 2007. Climate Change 2007: The Physical Science Basis. Summary for Policymakers. Contribution of Working Group I to the Fourth Assessment Report of the Intergovernmental Panel on Climate Change.
- Judkoff R., Neymark J. 1995. *Building Energy Simulation Test (BESTEST) and Diagnostic Method*. IEA International Energy Agency. National Renewable Energy Laboratory, Golden, Colorado.
- Kjellström, E., L. Barring, S. Gollvik, U. Hansson, C. Jones, P. Samuelsson, M. Rummukainen, A. Ullerstig, U. Willén, and K. Wyser. 2005. A 140-year simulation of European climate with the new version of the Rossby Centre regional atmospheric climate model (RCA3). SMHI Reports Meteorology and Climatology No. 108, SMHI, SE-60176 Norrköping, Sweden, 54 pp.
- Nielsen, A., Kjellström E., Sasic Kalagasidis A. 2007. Sustainability of the Swedish built environment towards climate change. Hygro-thermal effects and design criteria for buildings with respect to future climate scenarios. 10<sup>th</sup> International Conference on Performance of the Exterior Envelopes of Whole Buildings, 2007, Clearwater Beach, Florida.
- Sanders, C. 1996. IAE Annex 24, Final Report, Volume 2, Environmental conditions. K.U.Leuven, Belgium: Laboratorium Bouwfysica, Departement Burgerlijke Bouwkunde.
- Sasic Kalagasidis A. 2004. HAM-Tools. An Integrated Simulation Tool for Heat, Air and Moisture Transfer Analyses in Building Physics. Doctoral Thesis. Department of Building Technology, Chalmers University of Technology, Gothenburg, Sweden. ISBN 91-7291-439-4.
- Taesler R., Andersson C. 1984. A method for solar radiation computations using routine meteorological observations. *Energy and Buildings*, Vol. 7 (4), p 281-378. Swedish Meteorological and Hydrological Institute, Norrköping, Sweden.
- Undén P., L. Rontu, H. Järvinen, P. Lynch, J. Calvo, G. Cats, J. Cuxart, K. Eerola, K. Fortelius, J.A. Garcia-Moya, C. Jones, G. Lenderlink, A. McDonald, R. McGrath, B. Navascues, N.W. Nielsen, V. Ødegaard, E. Rodrigues, M. Rummukainen, R. Rööm, K. Sattler, B.H. Sass, H. Savijärvi, B.W. Schreuer, R. Sigg, H. The, and A. Tijn, 2002. HIRLAM-5 Scientific Documentation. HIRLAM Report, SMHI, SE-601 76 Norrköping, Sweden, 144 p.



## Proposal for a Building Energy Efficiency Certificate

*Hans-Peter Leimer, Prof. Dr.-Ing.,  
BBS INSTITUT – Germany  
University of Applied Sciences and Arts - HAWK Hildesheim - Germany  
Hefei University - Anhui - China  
www.building-physics.net*

**KEYWORDS:** *Building, Energy, Certificate, Standard of Buildings*

**SUMMARY:** *The objective for the next years must be a significant reduction of energy consumption, together with an increasing awareness for the continuing rise of energy costs, increasing population and the need to save energy in order to reduce emissions. In a first step, it is essential to avoid not only an extreme increase of energy demand for heating and cooling, but also extreme peak loads, which can lead to a supply shortfall. Correct consideration of the requirements while planning the building's envelope, especially the façade is essential. Therefore, a planning and control instrument including a certification system will be developed, which will enable both the architect and the authorising authority to apprise and assess the energetic behaviour of buildings using average technical expertise and at reasonable cost. For this, it is vital that the basic physical structure of buildings be considered exclusively in respect to regional climatic conditions. Calculations must be based solely on the results of thermal balance equations. The assessment must be made unaffected by political and lobby influences, which often play a role: e.g. primary energy sourcing. This of course includes economic considerations, in which the investment costs for additional insulation are set against operating and maintenance costs.*

*The planning tool –LowEnergyCertificate- LEC provides architects and engineers to describe the energy demand for heating (only), heating and cooling and cooling (only) for different kind of buildings (residential, office and commercial buildings; new and existing buildings). Therefore they have the possibility to optimize the building envelope during the planning stage for the regional climatic conditions (actual available climate data are Europe, Turkey, USA, Russia, China; more climatic regions are in preparation). Additionally, a world wide comparability of the building energy standard is now possible by using LEC.*

### 1. The need for BEEs (Building Energy Efficiency Certificates)

The urgent need for buildings resulting from economic development has led to impressive and remarkable forms of architecture, many of which have been designed and planned by architects with the regional perspectives.

Even so, it is often the case that neither prevailing climate conditions nor the availability of particular building materials have been properly accounted for.

This often stands in sharp contrast to the traditional development of structural design and construction methods, which are adapted to end use, locally available construction materials and building traditions.

Important aspects of housing and living traditions may be completely ignored. People often aspire to western models in terms of quality of life and lifestyle. This also applies to their living space and the architectural environment.



FIG. 1: Architecture and lifestyle in China

Problematically, the possibilities for the realisation of buildings and apartments differ.

Though buildings may conform externally to western models, they lack essential elements which account for the quality and serviceability of a building or apartment.

Often flats and offices are sold in a basic configuration, frequently without taking into account functionally important details such as

- adequate moisture proofing,
- sufficient drainage of roofs and façades,
- thermal insulation adapted to the climate conditions,
- measures to limit overheating in summer,
- a 100 % airtight building envelope,
- adequate sound insulation, especially for structure-borne sound,
- acoustic damping in rooms.

An example may help to illustrate this: according to western tradition, it is expected that a house, apartment or office will be equipped with central heating and can be cooled if necessary. In China, however, the installation of technical systems for heating and cooling is the responsibility of the tenant/buyer.

Thus individual, decentral air-conditioning units are generally used, and both heating and cooling are powered by electricity only, leading to extremely high peaks in power consumption.

The eyesores resulting from construction had done too hastily and under pressure also reveal substantial flaws in the quality of planning and execution. Energy-saving thermal insulation is often not taken into account or cannot be taken into consideration because of a lack of calculation models, which can be applied pragmatically.

Energy-saving thermal insulation ultimately helps to reduce energy demand for heating and cooling to an economically acceptable level.

With regard to operational costs, two objectives need to be addressed:

- energy demand for heating and cooling must be minimised (kWh price)
- it is vital to avoid extreme demand peaks (costs of providing capacity for peak usage)

The energy demand for heating and the connection capacity requirement are mainly influenced by:

- heat loss by transmission through the building's envelope
- ventilation heat loss due to air exchange (airing of rooms)
- heat losses due to air leakage through gaps in the building's envelope

The energy and connection power required for cooling of a building are influenced by:

- internal loads
- heat gain by transmission
- solar heat gain
- latent heat due to condensation in the air-conditioning unit

One must bear in mind that inappropriate use can substantially increase demand and power required.

The objective for the next years must be a significant reduction of energy consumption per capita, together with an increasing awareness for the continuing rise of energy costs, increasing population and the need to save energy in order to reduce emissions.

The United Nations Framework Convention on Climate Change of 1992 [1], and the Kyoto Protocol to the United Nations Framework Convention on Climate Change of 1998 [2] are the groundwork for the reduction of greenhouse gases in CO<sub>2</sub>-equivalents for

- |  |                      |
|--|----------------------|
| - industrialized countries ('Annex B countries') | at least 5 %         |
| - EU-15  | 8 %                  |
| - Germany (EU burden sharing)                    | 21 % by 2008 - 2012. |

The year of reference for CO<sub>2</sub>, CH<sub>4</sub>, N<sub>2</sub>O, is 1990; for CFC, HCFC and CF<sub>6</sub>, it is either 1990 or 1995.

A further reduction of the emissions of greenhouse gases in CO<sub>2</sub>-equivalents by 2020 compared to 1990 is expected as a result of the follow-up agreement to the Kyoto Climate Protocol of the UN conference of Copenhagen in 2009.

This step was politically implemented by the on the total energy efficiency of buildings. In this time, different Building Energy Efficiency Certificates are used. For example:

LEED [3] - certificates by Platinum, gold, silver Levels. Basis is the Evaluation of buildings based on a credit system. The focusing on energy efficiency based on ASHRAE [4], with building guidelines but no calculation. The main focus is based on water and waste management, building materials, etc.

EnEV [5] - certificates by Energy Passport. This Certification system is used in Germany for the promotion of energy efficiency in buildings based on the guideline 2002/91/EG of the European Parliament and Council dealing with energy efficiency of buildings. The calculation tool is based on DIN 18599 [6], uses German climate conditions and regards the energy consumption of heating and cooling by HVAC Systems and lighting. A noticeable strengthening of requirements over EnEV 2001 is already being discussed. The requirements expected in EnEV 2009 are expected to be 30 % under those of EnEV 2007.

Based on experience, it is shown that the highly complex approach of the evaluation methodology involves extensive calculation work and, in the meantime, requires very specific knowledge in the fields of building physics and mechanical services.

In the process, the relation with the building and the optimisation of the building's envelope are often forgotten.

According to EnEV 2007, the energy balance for new buildings must be established first. From this, energy demand for the heating and cooling of rooms is determined. This process must take into account the efficiencies of heating, cooling and ventilation systems along with hot water provision and lighting. These calculations result in a figure for the building's power demand. Taking into account energy production with respect to CO<sub>2</sub> emissions per kWh, this energy demand is declared to be the building's annual primary energy demand  $Q_{p,vorh}$  and is compared with the maximum permissible annual primary energy demand  $Q_{p,max}$ .

It's difficult for users, architects and engineers to ascertain directly possible improvements from the multitude of input parameters and to derive energetically and economically appropriate modifications.

What improvements are needed?

In a first step, it is essential to avoid not only an extreme increase of energy demand for heating and cooling, but also extreme peak loads, which can lead to a supply shortfall. Correct consideration of the requirements while planning the building's envelope, especially the façade is essential.

So a new planning and control instrument including a certification system will be developed, which will enable both the architect and the authorising authority to apprise and assess the energetic behaviour of buildings using average technical expertise and at reasonable cost. Nevertheless, this is definitely not possible by using the actual existing Building Energy Efficiency computer programs.

For this, it is vital that that the basic physical structure of buildings be considered exclusively in respect to regional climatic conditions. Calculations must be based solely on the results of thermal balance equations. The assessment must be made unaffected by political and lobby influences, which often play a role: e.g. primary energy sourcing.

This of course includes economic considerations, in which the investment costs for additional insulation are set against operating and maintenance costs.

An established method of verifying, ensuring and if necessary improving the quality and durability of buildings including building services is the use of quality control systems, which should include:

- Step 1. Exclusively the building's envelope
- Step 2. Exclusively the HVAC equipment
- Step 3. Assessment of the quality of planning
- Step 4. Assessment of the quality of execution

For the assessment and optimisation of the building's envelope (Step 1), a possible assessment system is proposed below, which comparatively easily, yet relatively accurately reflects the energetic quality of the building with respect to heating and cooling.

## 2. Low energy Certificate - Proposal for an Energy Certificate for buildings

The assessment for the heating period is based on a comparison with reference buildings built according to the standard of the 'eighties. Assessment of the cooling period is made by a comparison with an optimal façade, for which the criterion 'zero energy façade' has been defined.

Then, taking into account specified rating criteria, the results of the assessment of the energy demand for heating and cooling are summarised and attested. The certification of a building is in the form of a simplified star rating system.

An increasing number of stars, analogue to the assessment criteria for hotels and gastronomy, instantly visualises the energetic quality of the building.

TABLE. 1: Certification - Standard of Buildings

1 *	Standard: very poor upgrades for Energy consumption in winter and/or summer obligatory
2 **	Standard: poor upgrades for Energy consumption in winter and/or summer necessary
3 ***	Standard: good upgrades for Energy consumption in winter and/or summer recommended
4 ****	Standard: very good Standard according to Building Standard in Europe 2007
5 *****	Standard: excellent Standard according to <i>Low Energy Buildings</i> in Europe 2009

## 3. The certification procedure

TABLE. 2: certification procedure

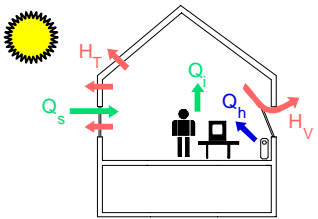
<b>Object</b>	 <p>Proof of the energy efficiency of buildings</p>
<b>Calculated parameters</b>	Service energy demand $Q_p$ - Energy demand of a building, needed to maintain the specified thermal conditions (heating, heating and cooling, cooling). The energy demand is a parameter of the building solely influenced by its structure and use, without consideration of the building services.
<b>Assessment criteria</b>	$q_h$ - normalised thermal heat demand of the building $q_{fc}$ - normalised energy demand of the building for cooling
<b>Boundary conditions</b>	Bases: DIN 4108 [7] – parts 2 + 6 and DIN V 18599 [6], with - climate (reference climate of the world climate regions) - geographic position (azimuth, surface normal) - use - construction method - thermal balance model with reasonable simplifications

Here, the energy balance of the building must be established, taking into account whether the building is heated only, heated and cooled, or cooled only.

TABLE . 3: *boundary conditions*

<b>Type of building</b>	Residential building; office and commercial buildings; other buildings
<b>Age of the building</b>	New buildings; existing buildings
<b>Size of the building</b>	$V_e$ – Volume of the building – exterior dimensions
<b>Construction</b>	Lightweight construction: Buildings with suspended ceilings, lightweight partitions, hollow floors. This includes rooms with at least four of the six limiting surfaces (walls/floor/ceiling) separated from massive structural elements by cladding. Heavy construction: Buildings with solid concrete ceilings, heavyweight partitions, screed floors without cladding. This includes rooms mainly without cladding of the heavy internal structural elements. Structural elements, such as solid concrete ceilings, heavy partitions and screed floors must be in direct contact with the ambient air.
<b>Air exchange</b>	Residential buildings: venting day and night Office and commercial buildings: day venting with or without night venting
<b>Construction materials</b>	Construction materials are chosen according to Standards with respect to their density and thermal conductivity, with special consideration of their absorption, thermodynamic storage capacity, absorption, reflection and transmission behaviour with respect to radiation (transparent elements of the building's envelope)
<b>Energy systems</b>	Heating; heating and cooling; cooling
<b>Climate Regions</b>	Europe, Turkey, USA, Russia, China

## 4. Thermal calculations for the building under consideration

### 4.1 Annual thermal heat demand

In the calculation of the annual thermal heat demand, the balance between heat losses and heat gains over the heating period (HP) is established.

A balance of the following energies is drawn up:

Heat losses:

- transmission heat losses through the building's envelope
- venting losses

Heat gains:

- solar heat gains
- internal loads

#### 4.1.1 Certification procedure Low Energy Certificate – heating period

The assessment of the considered building is made on the basis of a specified reference building. Geometry, climate region, orientation, azimuth, surface normal and use of the reference building correspond to those of the considered building, and to the Chinese building standard of the 'eighties with respect to structural design and construction elements.

For assessment and certification, the reduction of energy demand for heating is calculated from the difference between the annual thermal heat demands of the considered building and the reference building.



## 4.2 Annual energy demand for cooling

### 4.2.1 Estival temperature behaviour inside buildings

Requirements concerning thermal protection in summer aim at being able, as far as possible, to do without building services for cooling in non air-conditioned living and working spaces, and/or to reduce as far as possible the energy demand for cooling in rooms air-conditioned because of their utilisation. In particular, it should be ensured that the ambient temperature in non air-conditioned rooms does not significantly exceed physiologically bearable ambient air temperatures.

The comfort level defined for the summer in the German Standard DIN 4108-2 has proven to be sensible and reflects the region of barely tolerable indoor climate in the summertime very well.

The estival thermal protection implies high construction requirements, especially with regard to the type and size of façade glazing, and the shielding quality of shading devices. The so-called solar gain factor  $S'$  is used to assess the estival thermal protection of a room.

TABLE 4: Solar heat gains in Rooms

$S' = A_G \cdot g \cdot F_C$	$S'$ ... = solar gain factor $A_G$ ... = glazed surface area $g$ ... = total energy transmission coefficient of the glazing $F_C$ ... = reduction factor for the shading
------------------------------	---

### 4.2.2 Certification procedure Low Energy Certificate – cooling period

The assessment and certification of the estival behaviour of buildings is based on a simple method derived from the requirements of the German Standard DIN 4108-2 and specifically developed for China.

The criterion 'zero cooling energy' is defined for façades. A façade construction is described, whose interacting size of window, glazing properties, shading devices and glare shield limit the time in which given maximum temperatures are exceeded to a few hours per year. Increased internal loads and the possibility of reducing ambient air temperature by increased venting are not considered.

The threshold values were determined bearing in mind that this criterion should not lead to too great a reduction in daylight due to an unacceptably small area of window or reduced light transmission coefficients of special anti-sun glass.

A 'zero cooling energy' façade thus ensures that the rooms behind them do not overheat when not in use and therefore need not be cooled whether they are in use or not.

The product of the temperature excess and the corresponding time is used as a criterion for the threshold value for the ambient temperature (cf. DIN 4108 T2).

At this, one must bear in mind that in regions with low outside temperatures, e.g. the Harbin region, due to low nocturnal temperatures, cooling down, and therefore a lower mean daily temperature are more easily achieved than in regions with more constant climate, such as the Guangzhou region, where daytime and night-time temperatures are nearly equal.

The following parameters are calculated for a reference room, using a dynamic climate simulation. This is done with by a raddy state computermodel , for the calculation of heating and cooling performances and air temperatures..

TRNSYS [8] is a modular simulation software and can account for dynamic effects, for which the data can be taken from actual records. Special attention is paid to the ambient temperature resulting naturally, i.e. under the sole influence of inner and outer thermal influences, without heating and cooling. These form primarily an rating criterion for the thermal design of buildings with respect to energy saving and climate adapted building techniques.

#### 4.2.2.1 Procedure

With this simulation model, the cooling energy demand for rooms that just meet the threshold criteria without cooling is determined for different solar gain factors:  $S'$ , lightweight and heavyweight constructions, all four cardinal directions and each climate region in China.

The result of the calculations is the optimum solar gain factor  $S'_{opt}$ , parameter for the "zero cooling energy" façade.

The certificate is based on the factor  $S'_{opt}$ . An optimal design can be realised with its help.

Further, the specific energy demand for cooling per unit area respectively the specific cooling power per unit area required to dissipate solar heat gains can be determined from the difference between the actual  $S'_{act}$  value of the building and the optimal  $S'_{opt}$  values for the individual façades

#### 4.2.2.2 Energetic assessment and/or classification of façades with respect to the total energy demand for cooling

The energetic quality of a façade is assessed using the following parameters:

- Specific energy demand for cooling of the façade per unit area ( $q_{FC}$  in kWh/am<sup>2</sup>)
- Max. specific cooling power/connection power of the equipment, per unit area ( $\dot{q}_{FC}$  in kWh/m<sup>2</sup>)

Energy demand for cooling and the cooling power are determined for different solar gain factors by a parameter study performed with the simulation model.

From these calculated values, a function describing  $q_{FC}$  and  $\dot{q}_{FC}$  as a nearly linear function of the difference  $S'_{act} - S'_{opt}$  can be derived for the different climate regions of China and varying façade orientations. The gradient of this function is called  $L$  in the following. A negative factor  $L$  reduces the thermal storage behaviour of the building and, subsequently, the cooling energy demand in rooms with high internal loads.

Assessment of the building according to the Low Energy Certificate

Assessment is made for

- thermal insulation standard for winter
- estival thermal insulation

TABLE. 5: Standard of Buildings – Winter

1 *	= Energy consumption for heating	MAX 100 – 69 %
Building Standard before BEE - Requirements		
2 * *	= Energy consumption for heating	70 - 49 %
3 * * *	= Energy consumption for heating	50 - 31 %
4 * * * *	= Energy consumption for heating	30 - 21 %
Building Standard Europe 2007		
5 * * * * *	= Energy consumption for heating	MIN ≤ 20 %
Low Energy Building Standard Europe 2009		

TABLE. 6: Standard of Buildings – Summer

1 *	= Energy consumption for cooling	MAX ≥ 170 %
2 * *	= Energy consumption for cooling	150 - 169 %
3 * * *	= Energy consumption for cooling	130 - 149 %
4 * * * *	= Energy consumption for cooling	115 - 129 %
5 * * * * *	= Energy consumption for cooling	MIN ≤ 110 - 114%
Standard Europe 2007/2009		

Both standards are given in a summary and in the certificate.

Duration of heating and cooling periods is not considered here. This is done to avoid that, for example, a building with a poor standard for the cooling period gets a negative assessment although the cooling period is very short compared with the heating period.

TABLE. 7: Assessment - Standard of Buildings

Heating period	$Q_G$ in $\frac{\text{kWh}}{a}$
Cooling period	$Q_{FC}$ in $\frac{\text{kWh}}{a}$

TABLE. 8: Certification - Standard of Buildings

Certification - Result Example	Standard of Buildings Winter	Standard of Buildings Summer	
3 * * *	3 * * *	4 * * * *	
3 * * * etc.	5 * * * * *	3 * * * *	

In arriving at the annual standard for the building, the lowest assessment / number of stars for the heating period and cooling period is decisive! The evaluation is done with interactive software.

### 5. Conclusion

The planning tool –LowEnergyCertificate- LEC provides architects and engineers to describe the energy demand for heating (only), heating and cooling and cooling (only) for different kind of buildings (residential, office and commercial buildings; new and existing buildings). Therefore they have the possibility to optimize the building envelope during the planning stage for the regional climatic conditions (actual available climate data are Europe, Turkey, USA, Russia, China; more climatic regions are in preparation). Additionally, a world wide comparability of the building energy standard is now possible by using LEC.

### 6. References

- [1] United Nations Framework Convention on Climate Change of 1992 - <http://unfccc.int/resource/docs/convkp/conveng.pdf>
- [2] Kyoto Protocol to the United Nations Framework Convention on Climate Change of 1998 - <http://unfccc.int/resource/docs/convkp/kpeng.pdf>
- [3] LEED – by U.S. Green Building Council (USGBC) - <http://www.usgbc.org/Default.aspx>
- [4] ASHRAE - American Society of Heating, Refrigerating and Air-Conditioning - <http://www.ashrae.org/>
- [5] EnEV – 2001, 2007, coming 2009; Energieeinsparverordnung
- [6] DIN V 18599 – 07/2005; Energetische Bewertung von Gebäuden,
- [7] DIN 4108 - Wärmeschutz im Hochbau
- [8] TRNSYS - Transient Energy System Simulation Tool, Solar Energy Laboratory (SEL) at the University of Wisconsin – Madison

# The effect of micro air movement on the heat and moisture characteristics of building constructions.

*A.W.M. (Jos) van Schijndel, assistant professor  
Eindhoven University of Technology,  
Email: A.W.M.v.Schijndel@bwk.tue.nl*

**KEYWORDS:** *Construction, heat, moisture, transfer, air movement, modeling.*

## **SUMMARY:**

*The research focuses on the effect of air movement through building constructions. Although the typical air movement inside building constructions is quite small (velocity is of order  $\sim 10^{-5}$  m/s), this research shows the impact on the heat and moisture characteristics. The paper presents a case study on the modeling and simulation of 2D heat and moisture transport with and without air movement for a building construction using a state-of-art multiphysics FEM software tool. Most other heat and moisture related models don't include airflow or use a steady airflow through the construction during the simulation period. However, in this model, the wind induced pressure is dynamic and thus also the airflow through the construction is dynamic. For this particular case study, the results indicate that at the internal surface, the vapor pressure is almost not influenced by both the 2D effect and the wind speed. The temperatures at the inner surface are mostly influenced by the 2D effect. Only at wind pressure differences above 30 Pa, the airflow has a significant effect. At the external surface, the temperatures are not influenced by both the 2D effect and the wind speed. However, the vapor pressure seems to be quite dependent on the wind induced pressure. Overall it is concluded that air movement through building materials seems to have a significant impact on the heat and moisture characteristics. In order to verify this statement and validate the models, new in-depth experiments including air flow through materials are recommended.*

## **1. Introduction**

The reduction of energy consumption related to buildings is of great importance. In order to calculate the energy consumption of a building, the heat transfer modeling of constructions is important. Moreover, some software tools also simulate moisture transport simultaneously to improve the design of building constructions (U.S. Department of Energy 2008). If we look more closely to these combined heat and moisture models, the effect of air movement inside the construction is not taking into account by almost all models (IEA Annex 41 2008). The main reasons are twofold: First, in practice it seems to have only a minor effect on the energy consumption. Second, the modeling and simulation of the air movement is quite complicated and probably therefore only occasionally implemented in heat, air and moisture (HAM) models. Experimental studies that include air movement through building materials seem to be quite rare. Hens et al. (1996) and Janssens (1998) show that the effects of airflow are substantial and often more significant than the effects of variations in material properties. During the IEA Annex 41 project the problem of the effect of air movement in constructions was encountered at Subtask 1. Starting point of the research is the earlier work of van Schijndel (2006). This paper presents a first modeling guide for the modeling and simulation of up to full 3D dynamic Heat, Air & Moisture (HAM) transport of building constructions using COMSOL. Furthermore, all modeling files and results are public domain (HAMLab 2008). The changes in this research, compared to the reference HAM2D model of van Schijndel (2006) were twofold: First, the internal and external boundary conditions of temperature and humidity are now based on a typical Dutch climate instead of the more or less extreme climate of Denver. Second, in the reference model the wind induced pressure was steady, thus also the airflow through the construction was steady during the simulation period. However, the model in this paper also includes a dynamic wind induced pressure and thus also a dynamic airflow through the construction. The research approach was to study the effect of (micro) air movement through materials on the heat and moisture characteristics of building constructions using the latest multiphysics modeling tools (van Schijndel 2007). The method of research for was as follows: First, a selection of a common building construction type which was also used at the several Common exercises of the Annex 41. Second, the modeling of the 2D heat and moisture transport each with and without air movement based on the selected construction. The used internal and external boundary conditions (i.e. temperature, humidity and wind induced pressures) were based on a typical Dutch climate. Third, the simulation of both models and comparison of the different results.

## 2. Background and description

As already explained, the starting point of this case is the earlier work of van Schijndel (2006). The HAM2D construction model of (van Schijndel 2006) is presented in Figure 1.

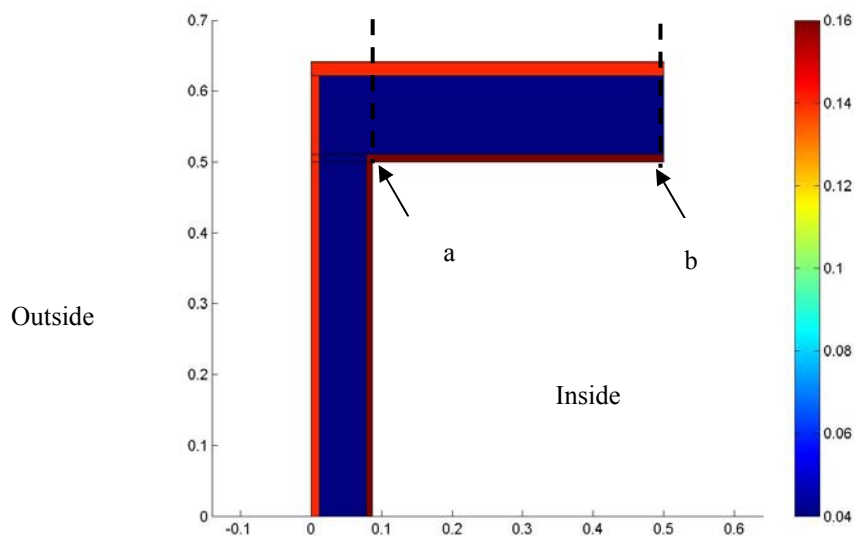

FIG. 1: The 2D construction.

The material properties (partly also used at common exercises of IEA Annex 41 (IEA Annex 41 2008)) are provided at Table I and II.

Table I. Material properties part 1

	$\lambda$	$d$	$U$
	W/mK	m	W/m <sup>2</sup> K
Exterior wall (inside to outside)			
Int. surf. coeff.			8.29
Wood panels	0.160	0.012	13.333
Cellulose ins.	0.040	0.066	0.606
Wood siding	0.140	0.009	15.556
Ext. surf. coeff.			29.300
Total air-air			0.514
Roof (inside to outside)			
Int. surf. coeff.			8.29
Wood panels	0.160	0.010	16.000
Cellulose ins.	0.040	0.1118	0.358
Roof deck	0.140	0.019	7.368
Ext. surf. coeff.			29.300
Total air-air			0.318

Table II. Material properties part 2

	$R$	$\rho$	$C_p$	$K$
	m <sup>2</sup> K/W	kg/m <sup>3</sup>	J/kgK	kg/msPa
Exterior wall (inside to outside)				
Int. surf. coeff.	0.121			
Wood panels	0.075	395	1880	10 <sup>-9</sup>
Cellulose ins.	1.650	55.0	1880	5.510 <sup>-5</sup>
Wood siding	0.064	530	900	10 <sup>-9</sup>
Ext. surf. coeff.	0.034			
Total air-air	1.944			
Roof (inside to outside)				
Int. surf. coeff.	0.121			
Wood panels	0.063	395	1880	10 <sup>-9</sup>
Cellulose ins.	2.794	55.0	1880	5.510 <sup>-5</sup>
Roof deck	0.136	530	1880	10 <sup>-9</sup>
Ext. surf. coeff.	0.034			
Total air-air	3.147			

Where  $\lambda$  is the heat conduction coefficient;  $d$  the thickness;  $U$  the U-value;  $R$  the heat resistance;  $\rho$  the density;  $C_p$  the heat capacity;  $K$  the air permeability.

The internal and external conditions are provided in figure 2.

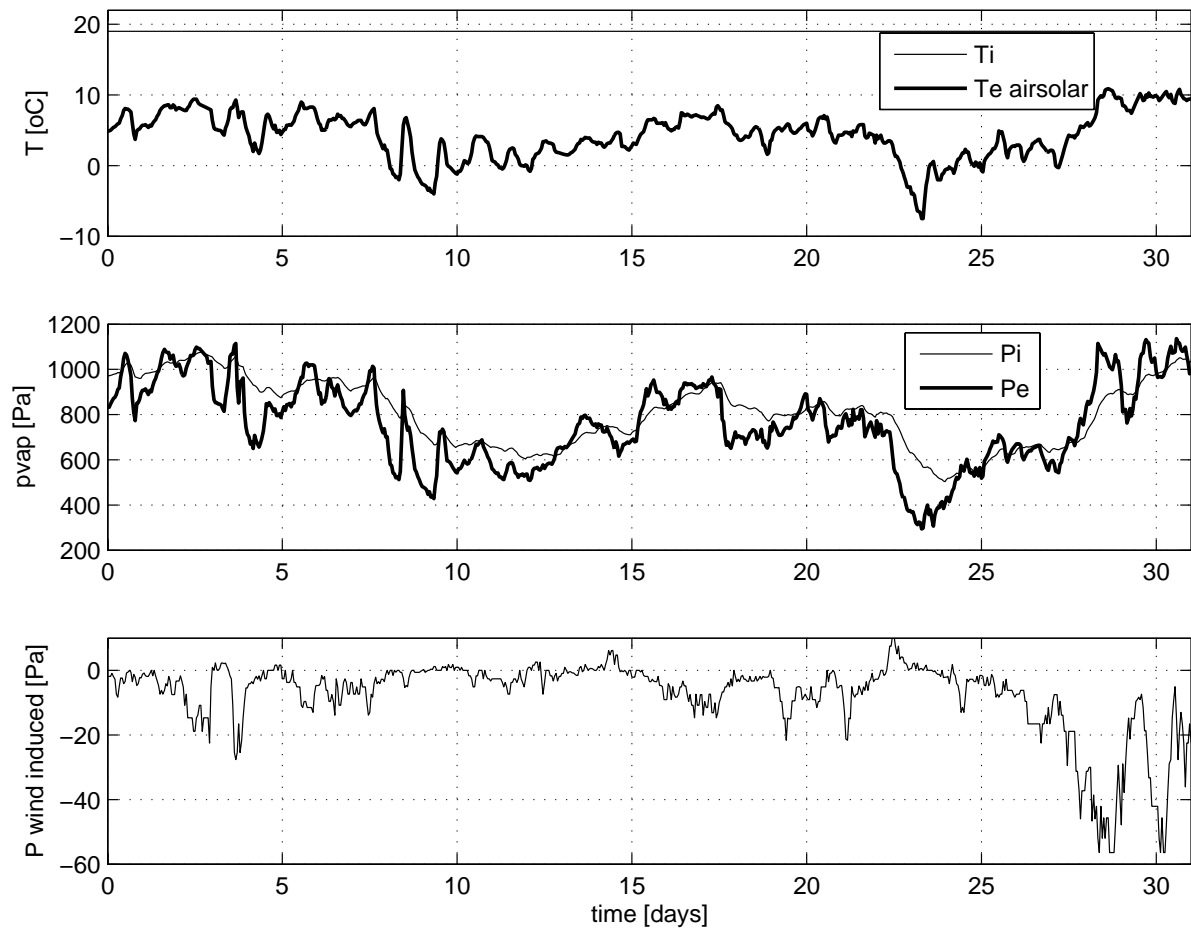

FIG. 2: Top: Indoor and outside air temperatures; Middle: Indoor and outside air vapor pressures; Bottom: The wind induced pressure; Horizontal All: number of days after January 1

The changes compared to the reference HAM2D model of van Schijndel (2006) were twofold:

- (1) Internal and external boundary conditions (figure 2) are now based on a typical Dutch climate instead of the more or less extreme climate of Denver;
- (2) In the reference model (van Schijndel 2006) the wind induced pressure was steady, thus also the airflow through the construction was steady during the simulation period. However, in this paper, the wind induced pressure is dynamic (figure 2, bottom)) and thus also the airflow through the construction.

### 3. Modeling

#### 3.1 The PDEs

The Partial Differential Equations (PDEs) are:

$$\begin{aligned}
 \text{Heat} : \rho C_p \frac{\partial T}{\partial t} + \nabla \cdot (-\lambda \nabla T) + \rho C_p \mathbf{u} \cdot \nabla T &= 0 \\
 \text{Air} : \frac{\partial P}{\partial t} + \nabla \cdot (-K \nabla P) = 0; \mathbf{u} = K \nabla P & \quad (1) \\
 \text{Moisture} : \frac{\partial p_v}{\partial t} + \nabla \cdot (-D \nabla p_v) + \mathbf{u} \cdot \nabla p_v &= 0
 \end{aligned}$$

Where  $\mathbf{u}$  is air velocity [m/s];  $P$  is (scaled) atmospheric pressure [Pa];  $p_v$  is vapor pressure [Pa];  $D$  = diffusion coefficient [m<sup>2</sup>/s] equals  $(p_{vsat} \cdot \delta_a) / (\mu \cdot \zeta)$ ;  $p_{vsat}$  is saturation vapor pressure [Pa];  $\delta_a$  is vapor permeability coefficient (1.8 10<sup>-10</sup> s);  $\mu$  is vapor diffusion resistance factor [-];  $\zeta$  is specific moisture capacity related to RH [kg/m<sup>3</sup>];  $K$  = permeability [kg m<sup>-1</sup> s<sup>-1</sup> Pa<sup>-1</sup>]. In figure 3 the sub-domains are presented. Table III provides the PDE coefficients of the sub-domains.

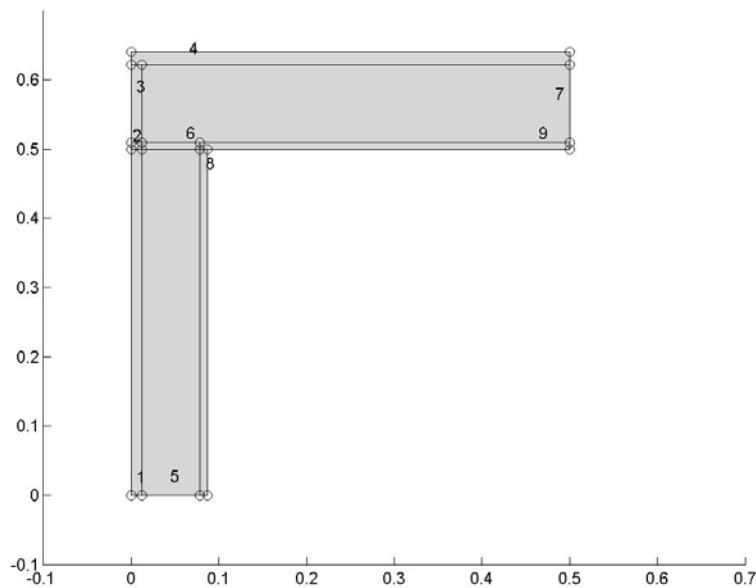

FIG. 3: Sub-domains & numbering

TABLE. III: Sub domain PDE coefficients

Sub-domain	1-4	5-7	8-9
$\lambda$	0.14	0.04	0.16
$\rho$	530	55	395
$C_p$	1880	1880	1880
$D = (p_{vsat} \cdot \delta_a) / (\mu \cdot \zeta)$	psatf(T)*1.8e-10/(120*95)	psatf(T)*1.8e-10/(14*1.4)	psatf(T)*1.8e-10/(101*2.1)
$K$	1e-9	5.5e-5	1e-9

### 3.2 The boundary values

The boundary values are:

$$\begin{aligned}
 \text{Heat : Flux : } \mathbf{n} \cdot (\lambda \nabla T) &= h(T_{\text{inf}} - T); \text{ Insulation : } \mathbf{n} \cdot (\lambda \nabla T) = 0 \\
 \text{Air : Pressure : } P &= P_0; \text{ Insulation : } \mathbf{n} \cdot K \nabla P = 0 \\
 \text{Moisture : Flux : } \mathbf{n} \cdot (D \nabla p_v) &= \beta(p_{v\text{inf}} - p_v); \text{ Insulation : } \mathbf{n} \cdot (D \nabla p_v) = 0
 \end{aligned}
 \tag{2}$$

Where  $\mathbf{n}$  is normal vector of surface [-];  $h$  is surface coefficient of heat transfer [W/m<sup>2</sup>K];  $\beta$  is surface coefficient of vapor transfer [s/m]. In figure 4 the boundaries are presented. Table IV provides the boundary coefficients.

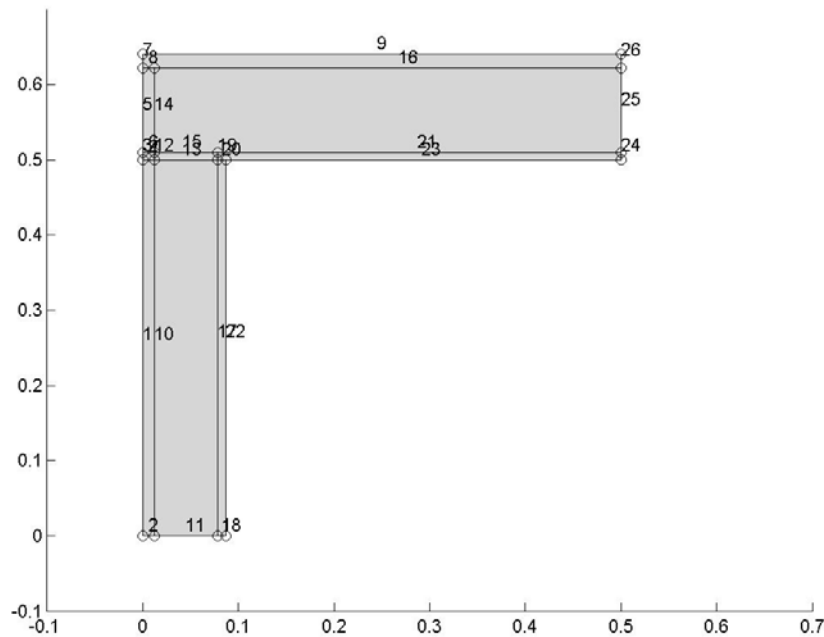

FIG.4: Boundary values & numbering

TABLE IV. Sub domain boundary value coefficients

Boundary	1, 5, 7, 9	2-3, 11, 18, 24-26	22-23
Type	Flux	Insulation	Flux
Heat ( $h$ )	29.3	0	8.29
Heat ( $T_{\text{inf}}$ )	$T_e$ airsolar	-	$T_i$
Moisture Inward flux	$8e-8 \cdot (p_e - p_v)$	0	$2e-8 \cdot (p_i - p_v)$
Air Pressure ( $P_0$ )	$P_{\text{wind}}$	0	0

Where  $T_i$ ,  $T_e$  airsolar,  $p_i$ ,  $p_e$  and  $P_{\text{wind}}$  are time dependent input signals as provided in figure 2.



## 4. Simulation results

Three cases are considered, each with different wind induced pressure difference between internal and external ( $\Delta P$ ):

- (1)  $\Delta P = 0$  (reference case)
- (2)  $\Delta P = P_{\text{wind}}$  (see figure 2 Bottom) and
- (3)  $\Delta P = -P_{\text{wind}}$

The simulation results are visualized in two ways:

- Firstly, movies (downloadable from <http://sts.bwk.tue.nl/hamlab/>). This probably the best way to analyze the results.
- Secondly, time series at six locations: Two points at the inner surface (figure 5), two points at the inside wood-insulation surface (figure 6) and two points at the outside wood-insulation surface (figure 7)

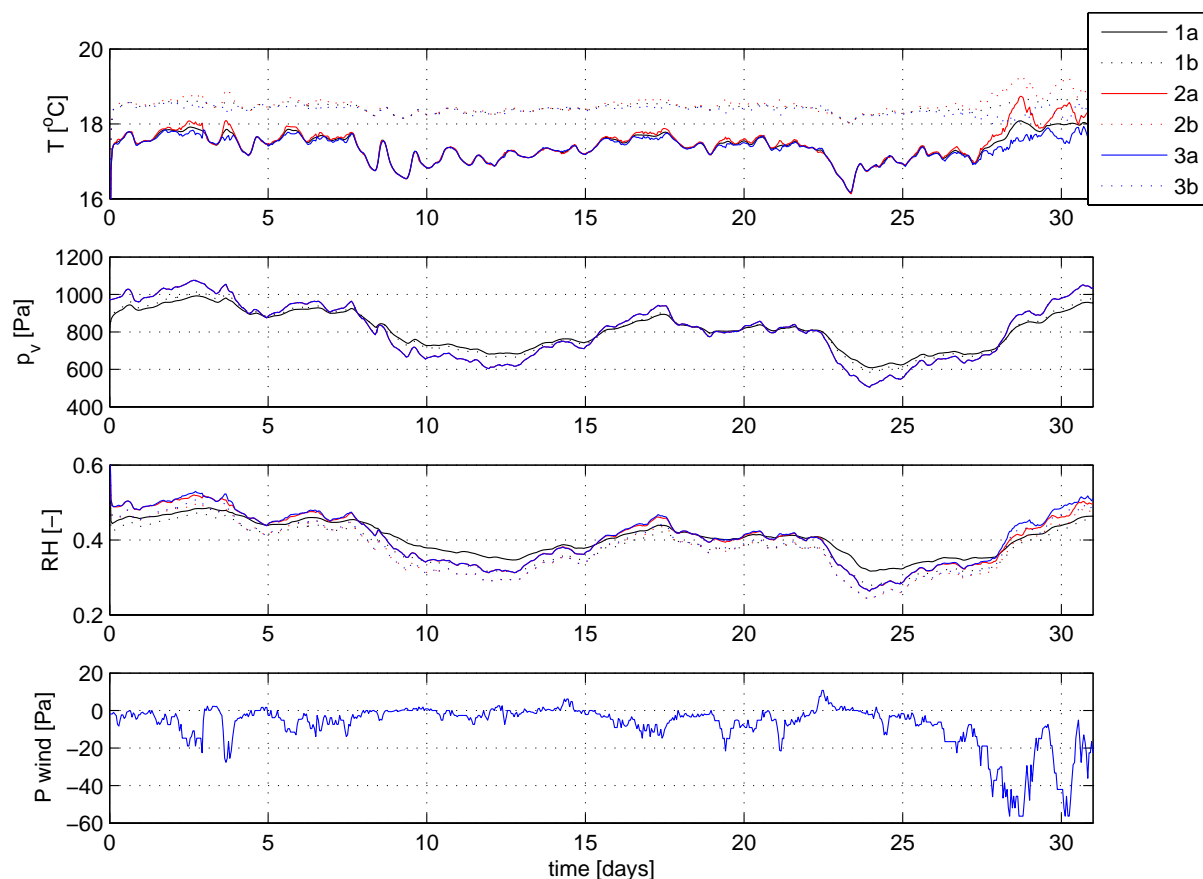

FIG. 5: Time series at inner surface (This figure relies on color: see digital version of paper; pos a (continuous lines) & b (dotted lines) see fig.1; explanation see below).

The first three sub-figures each show six variants (two positions, each with 3 different wind induced pressures at the external boundary) of temperature (top), vapor pressure (second) and RH (third). The sub-figure at the bottom shows the wind induced pressure. The results of indoor surface temperatures (figure 5 top) show a quite steady difference of about 1 °C between the continuous lines representing position a, and the dotted lines representing position b. This is due to the (corner) thermal bridge effect. Only at high wind induced pressure differences (for example day 28) the airflow due to the wind has some significant effect on the temperatures. This means that thermally, at the internal surface the multi-dimensional effect is far more dominant than the effect of airflow through the construction. The results of the surface vapor pressures are very different. The vapor pressures are almost not influenced by both the 2D effect and the wind speed (four curves: 2a; 2b; 3a & 3b coincide during the whole simulation period). The RH has roughly the same shape as the vapor pressure.

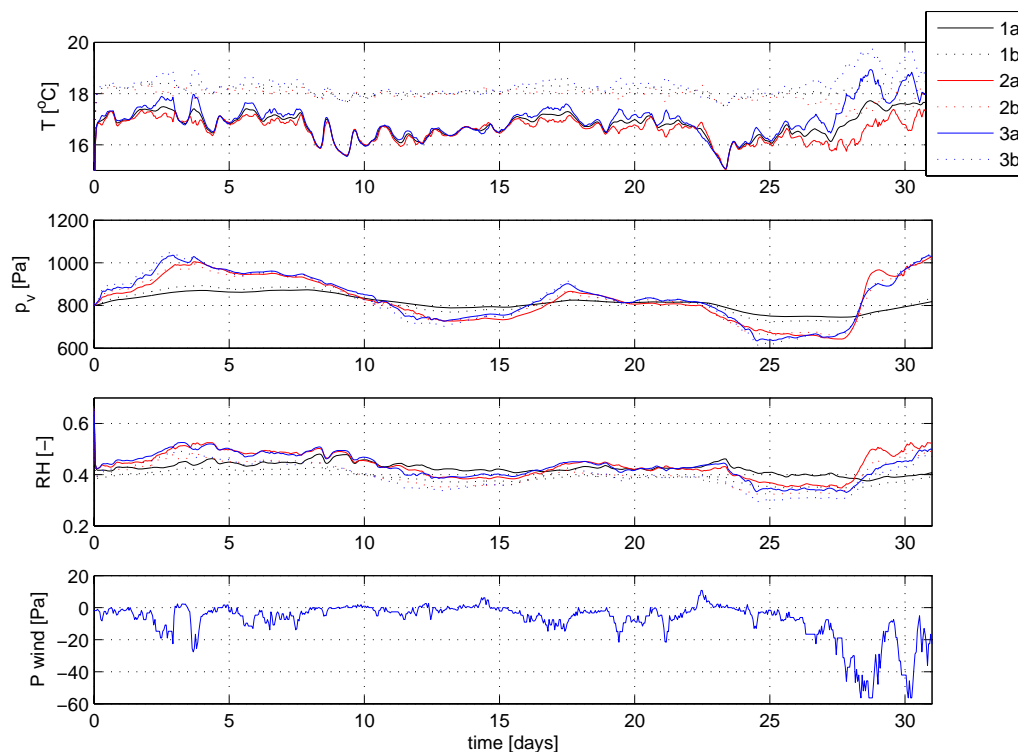

FIG. 6: Time series at inside wood-insulation surface (This figure relies on color: see digital version of paper; pos a & b see fig.1; explanation see below).

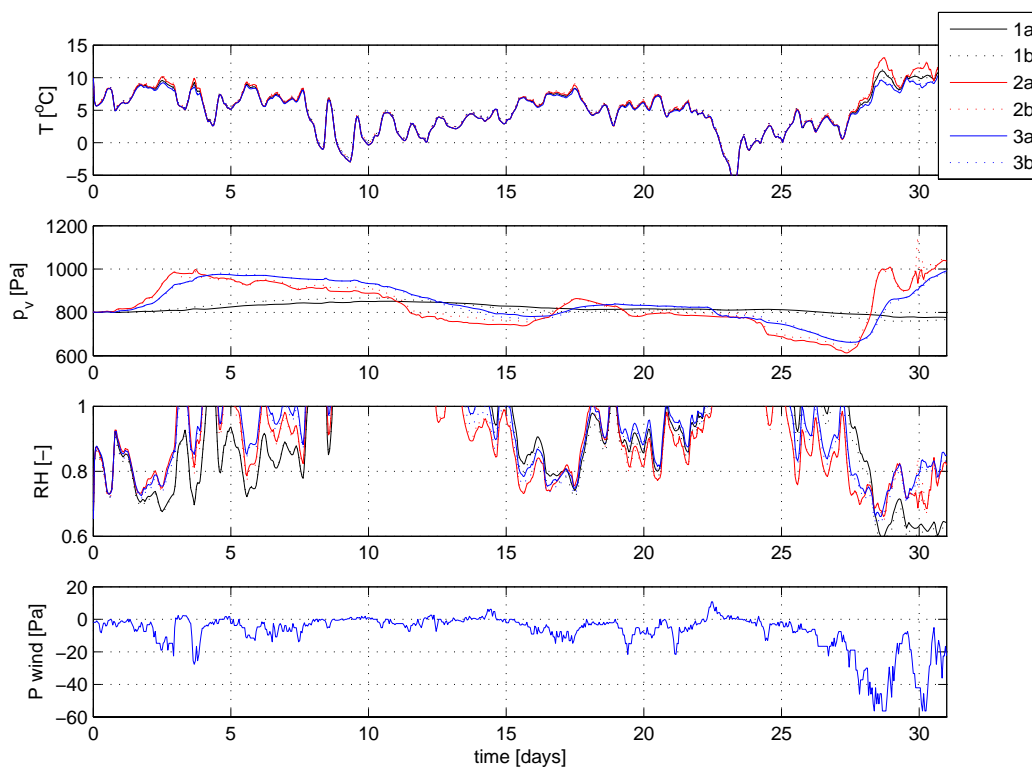

FIG. 7: Time series at outside wood-insulation surface (This figure relies on color: see digital version of paper; pos a & b see fig.1; explanation see below).

Figure 6 (at inside wood-insulation surface)

The temperatures of figure 6 (top) show the same pattern as figure 5. However the vapor pressure (second sub-figure) is influenced by the wind induced pressures (see difference between 1a, 2a & 3a). This clearly shows the effect of air movement. Again, the RH (third sub-figure) has roughly the same shape as the vapor pressure.

Figure 7 (at outside wood-insulation surface)

The temperatures profiles of figure 7 (top) are almost the same (all curves coincide). Thus there is no effect of airflow. The vapor pressures of figure 7 (second) have roughly the same shapes as the previous figure 6, again showing clearly the effect of air flow. The RH (third sub-figure) shows the dependency of the temperature as well as the air flow.

## 5. Discussion

The moisture transport is based on vapor transport, so for example rain penetration and condensation are not included (yet). This means that the results are not accurate for RH above 90%. Currently we are working on a model which also includes these phenomena. Furthermore (experimental) results are needed to confirm or contradict our computational findings on the impact of airflow.

## 6. General Conclusion

Multiphysics FEM software can be used to simulate 2D (and in principle also 3D) full dynamic HAM models of building constructions. Our simulation results indicate, for this particular case, that air movement through building materials seems to have significant impact on the heat and moisture characteristics. In order to verify this statement and validate the models, new in-depth experiments including air flow through materials are recommended.

## 7. References

- HAMLAB (2008), Heat Air and Moisture Laboratory, <http://sts.bwk.tue.nl/hamlab/> (visited April 2008)
- Hens, H. (1996), Heat, air and moisture transfer in insulated envelope parts, *IEA Annex 24. Final report*, vol 1. Acco Leuven
- Janssens, A. (1998), reliable control of interstitial condensation in lightweight roof systems . *PhD thesis*, Leuven University of Technology, ISBN: 90-5682-148-2, 217 pages
- IEA Annex 41 (2008). <http://www.ecbcs.org/annexes/annex41.htm> (visited April 2008)
- Roels, S. (2005), Modelling exercise on dynamic response of gypsum board, *IEA Annex 41 Subtask 2: Second common exercise*. Instruction document November 2005
- Schijndel A.W.M. van (2007a), Integrated Heat Air and Moisture Modeling and Simulation, *PhD thesis*, Eindhoven University of Technology, ISBN: 90-6814-604-1, 200 pages
- Schijndel, A.W.M. van (2007b), Impact of airflow through a 2D envelope, a case study, *IEA Annex 41 research paper no: A41-T1-NL-07-2*.
- Schijndel, A.W.M. van (2007c), Additional Multiphysics modeling & analysis on Test 1 of ST2/ME2 using COMSOL, *Annex 41 research paper no: A41-T1-NL-07-1*.
- Schijndel A.W.M. van (2006a), Heat, Air and Moisture Construction modeling using COMSOL with MatLab, Modeling guide version 1.0, *Proceedings of the COMSOL Users Conference 2006 Eindhoven*
- Schijndel A.W.M. van (2006b), HAM Construction modeling using COMSOL with MatLab, Modeling guide version 1.0, *IEA Annex 41 resesarch paper no: A41-T1-NL-06-6*.
- U.S. Department of Energy, <http://www.eere.energy.gov> (visited April 2008)

# Air Transport in Building Envelope and Construction Process

**Claes Bankvall**

*Chalmers University of Technology, Gothenburg, Sweden*

[claes.bankvall@telia.com](mailto:claes.bankvall@telia.com) [claes.bankvall@chalmers.se](mailto:claes.bankvall@chalmers.se)

**Eva Sikander**

*SP Technical Research Institute of Sweden, Borås, Sweden*

[eva.sikander@sp.se](mailto:eva.sikander@sp.se)

**KEYWORDS:** *Air transport, building envelope, construction process, modelling, measurement, information*

## **SUMMARY:**

*This research programme, dealing with air transport in and through the building envelope, is ongoing. This presentation summarises the work that has been done, describes current activities and invites communication input from third parties. The programme, which partly has been presented previously, has three parts:*

- 1. Modelling of convective processes in building components,*
- 2. Systems modelling and analysis of air transport in and through the building envelope, as part of a whole building, and*
- 3. Airtightness of the building process, including demonstration of results and their application for practical use.*

*A major aim of the programme is to develop predictive modelling tools and to analyse problems of relevance to the building process. This has included site inventories, modelling of typical situations and laboratory testing for input data and validation. The objective has also been to develop tools to help design and evaluation of building elements, and to provide a basis for estimating the convective transport of heat and moisture in and through the envelope. The programme is a joint activity between SP Technical Research Institute of Sweden, Chalmers University of Technology, and the building industry. It has been found that many types of damage and problems are caused by poor airtightness, that airtightness is seldom given proper consideration, and that there is a major need for information on the effects of poor airtightness. The conclusions are that it is important to ensure that developers/clients treat airtightness more seriously, making them (more) aware of the potential damage that can be caused by poor airtightness, and that they should understand the “cost” of this and specify and monitor airtightness requirements more clearly.*

## **1. The R&D Programme**

Air movements within structures and materials have an impact on the flow of moisture and heat in a building and thereby on the balance of moisture and dryness in the building envelope. They may also carry emissions from building materials, a factor that is of significance to indoor air quality. Consequently, this is an important part of a professional building physics design - that is, of actions in the building process that contribute to the construction of buildings with good indoor climate, low energy consumption and durability, and ensure that the building is not damaged by moisture, air or temperature effects.

Areas of previous results of interest in the available literature fall roughly into the following categories:

- theoretical descriptions, modelling and simulation of air leaks and airflow,
- leakage details,
- airtightness in whole buildings,
- wind pressure on buildings,
- natural and forced convection in permeable materials,
- dynamic insulation
- others, such as life cycle performance, prefabricated construction, HVAC systems, moisture transport, certification etc.

There is an increase in interest in practical solutions related to energy conservation and intended to prevent moisture and air quality problems. Nevertheless, an overall systems approach, building physics design, building process and workmanship are still mostly missing. Lately, however, a certain increase in understanding the

importance of air transport and airtightness aspects can be felt. This is due to energy conservation, particularly in passive housing, and to moisture problems and poor air quality and the realisation that more carefully designed, and better controlled, airflow can help to solve such problems. The different building regulations treat the matter only to some limited extent, or very little at all.

A building is a complex system. To predict the distribution of air movements requires an analysis of components and an analysis of the building as a system, accounting for the interaction of components, both in terms of air leakage and heat and mass transfer. Different models are used: this project uses mainly CFD/Fluent and HAM-Tools. To be able to use the models in practice, it is necessary to have relevant measured data of leaks of interest in the building envelope. Some leakage data has been found in the literature, but much is missing, and the data is normally from idealised and perfect workmanship. It is therefore necessary to perform a number of measurements of “elementary leaks” in the building envelope. For validation of the models, it is also of interest to perform a number of full-scale measurements on the building envelope and parts of the building envelope, both in the laboratory and in the field. Measurements have been made on a number of leaks and also of some complete wall designs, including connections between window and wall, installations in the building envelope etc. A catalogue of airtightness information is being built up, covering construction details and their leakages characteristics (e.g. Johansson, 2004, Sandberg, Sikander, 2004, Mattsson, 2007).

Our national R&D programme is ongoing, dealing with air transport in and through the building envelope. It has three main parts,

- I Modelling of convective processes in building components
- II Systems modelling and analysis of air transport in and through the building envelope as part of a whole building
- III Airtightness of the building process, transformation and demonstration of results for practical use

## 2. Modelling of Convective Processes, Part I

Part I of the programme is concerned with the development of models and instruments analyse air movements and to model different types of air leakages through the building envelope and its components. The models are used to estimate the influence of air transport on heat transfer, temperature fields, moisture situations and ventilation.

The use of computational fluid dynamics (CFD) has become more common in various building physics simulations in recent years. This type of programme has traditionally been used to model aerodynamic problems. In principle, the advantages are greater modelling possibilities than are available in simpler programmes. Of special interest is the ability to include different types of boundary conditions, models for radiation, air flow through porous materials and natural convection. However, the ability to compute moisture condensation and moisture transport in materials must be done by modifying or by using other models. The work so far has shown, as in many other cases, that much of the necessary input data is missing. Measurements are therefore made in order to provide relevant information and input data for analyses, and also used to validate the models.

### 2.1 Application

The following are examples from the work.

Figure 1 shows the additional heat loss due to convective processes in a wall with dimensions 2.5 m x 0.3 m, with sill and top plate and design heat loss of 0.138 W/(m<sup>2</sup>K). Insulation is by mineral wool (10 kg/m<sup>3</sup>, 0.034 W/(mK), 6e-9/10e-9 m<sup>2</sup> (permeability in two directions)). Air flow occurs in the insulation due to natural convection and/or a pressure drop at the surface of the insulation, e.g. due to a wind with a higher velocity at the top of the wall. Wind protection of gypsum board, mounted tightly (Sikander, Olsson-Jonsson, 1997) or non-tightly at the sill and top plate, and with imperfections in the fitting of the insulation (illustrating varying workmanship), and compared to no wind protection.

Studies on Building Air Leakage (Björn Mattsson, 2007) describes a transient pressurisation method for air leakage measurements. It can be applied, for example, to a wall section with well-defined leakage paths through gaps and holes in plywood boards, and to ventilation opening below the eaves, of common Swedish design. Air leakage through these paths is simulated with the CFD tool, Fluent.

The use of CFD simulations in cases of well-defined geometry of leakage paths gave good agreement with measured values in cases without porous insulation in the structure, and where the edges of the leakage paths are sharp. A case involving porous materials is illustrated in Figure 2, showing how even a small void in the insulation near an inlet or outlet opening may have a considerable impact on the air leakage rate. This underlines that, in practice, the most difficult part is to determine the geometry of gaps and cracks in the structures. This is a main reason why detailed modelling of the airtightness of individual leakage paths is difficult in practice.

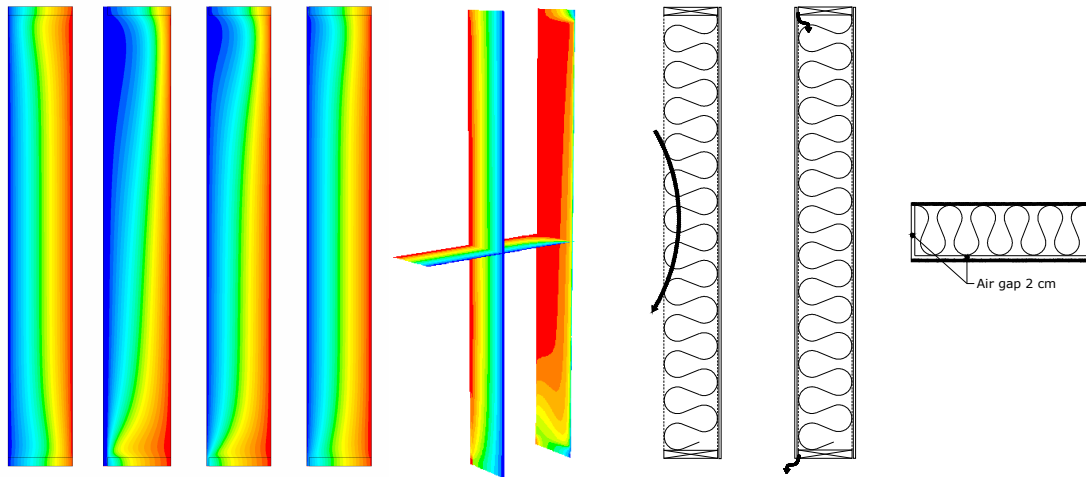

FIG. 1: Temperature fields in the wall, from left to right:  
 1) only natural convection; adds 0.002 at  $\Delta T$  50 °C., at 30 °C 0.001 W/(m<sup>2</sup>K) at 30 °C,  
 2) without wind protection and pressure drop; 10 Pa/m from top to bottom,  
 3) with un-tight wind protection and pressure drop 10 Pa/m from top to bottom,  
 4) with tight wind protection and pressure drop 10 Pa/m from top to bottom,  
 5) only natural convection (with wind protection) and with imperfections in the insulation installation (2 cm air-crack at one edge of the insulation and 2 cm air-space at the warm side). This adds 0.091 W/(m<sup>2</sup>K) to the design heat loss at  $\Delta T$  30 °C and 0.097 at  $\Delta T$  50 °C.

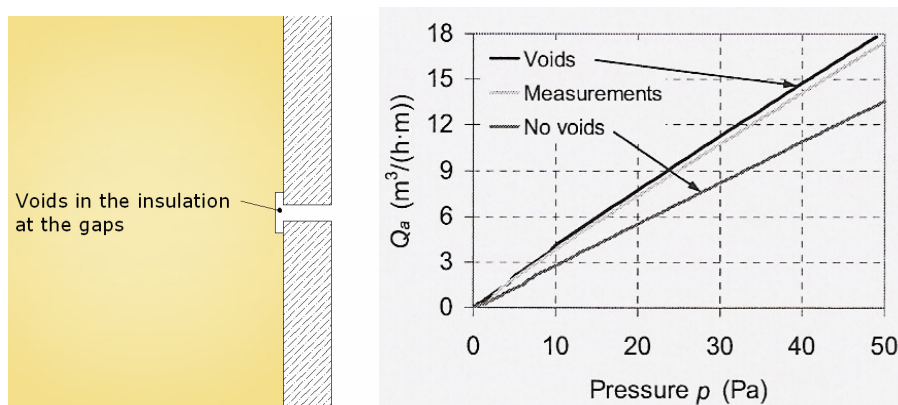

FIG. 2: The drawing to the left shows the modelled void in the insulation next to the gap in the inside plywood sheet. The diagram shows the results from modelling with and without voids together with the result from measurements.

### 3. Systems Modelling and Analysis, Part II

Part II of the programme is concerned with modelling and analysis of air transport in and through the building envelope as part of a whole building. This is done by combining information on the building envelope with models for ventilation systems and information on the pressure/wind situation. The main model used in this case

is designed in the Simulink graphical programme language, which is a part of the Matlab calculation tool. A special calculation tool, HAM Tools, has been used. The following functions can be modelled:

- One-dimensional transient heat, air and moisture (HAM) transfer through the building components, which can be combined into a 3D building enclosure
- transient HAM balance of an enclosed (fully mixed) air space
- multi-zone HAM calculations
- modelling of external and internal HAM loads, radiation heat exchange, wind and temperature-induced air flows through intentional and unintentional openings, rain, HVAC equipment, occupants, appliances, and with variable intensities and control strategies.

The main purpose of this tool is simulation of transfer processes related to building physics, e.g. heat and mass transport in buildings and building components in operating conditions. This is a research and educational tool, with modelling based on present knowledge in this area. It is used for the investigation of the mechanism of transport processes and the degree of their correlation when they are linked. This programme differs from other existing regulations in this area by providing linked HAM simulations for the whole building, and by its modular structure.

### 3.1 Application

The HAM Tools whole model (e.g. simulations of the building or the building section as a whole) has been validated against measurements of experimentally investigated cold attics, with six different ventilated and insulated compartments. The programme has shown good predictive accuracy of internal climate conditions (indoor temperature and relative humidity) for all six compartments, when compared with field results. Details can be found in “An Integrated Simulation Tool for Heat, Air and Moisture Transfer” (Sasic Kalagasidis, 2004).

The occurrence of high moisture levels in cold attics has been treated in “Simulations as the way of bridging the gaps between desired and actual building performance” (Sasic Kalagasidis, 2007). This is a common moisture problem in Swedish houses, where ventilation of the attic by outdoor air has been proposed by building authorities as a remedy. The role of the attic ventilation is analysed by comparing attics with different air infiltration rates from the dwelling below them. By using advanced simulations, (HAM Tools) a number of conclusions can be drawn from these virtual experiments in a fairly easy and inexpensive manner. Some of the conclusions are known from the experimental studies but, for example, the role of the house ventilation system and the airtightness of the house cannot be easily determined without simulations. This is because such details introduce many unknown parameters in field studies, not only because of their number, but mostly because of their high correlation.

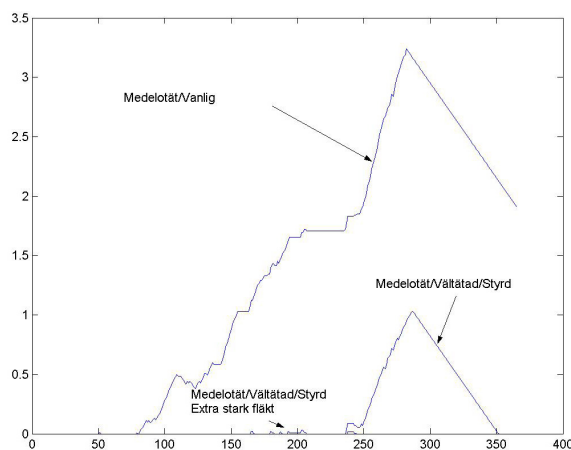

FIG: 3: Variation in mould growth index over time, from one summer to the next, for the north side of a cold attic. Three situations are shown: (1) normal, (2) with increased airtightness and controlled airflow, and (3) increased airtightness/controlled airflow and extra powerful fan.

The HAM Tools program has also been used to study a method with more airtight cold attics and controlled ventilation to improve the moisture safety. Calculation results for moisture and temperature show a clearly reduced or eliminated risk of mould growth with controlled ventilation (Figure 3). Poor airtightness can partly be compensated for by increased ventilation. The best results are achieved in buildings with good building envelope airtightness. Mechanical exhaust ventilation is somewhat less critical than balanced ventilation (Hagentoft, 2007).

The problems presented show that it is very important to develop calculation tools which can treat the hygro-thermal response of buildings in sufficient detail. The ability to perform parametric studies and systematisation of results is an important advantage of numerical investigations over field studies.

In this context it can be noted that a number of practical moisture problems are treated in “få bukt med fukt” (roughly “get the better of moisture”) (Samuelson, Arfvidsson, Hagentoft). In most cases, the analysis includes modelling and calculations to explain the situation and remedies used. Many of the cases involve air transport, and also the use of a very sophisticated airtightness and airflow system to solve problems in wall and flooring.

## 4. The Building Process and Airtightness in Practice, Part III

A major aim of the programme is to find and analyse problems of relevance to application for the building process. Therefore Part III of the programme deals with design and practical work situations that are critical, i.e. where knowledge and technical solutions have to be developed. This part of the work includes an inventory and the modelling of typical situations and as an important part - as it has turned out - the preparation and transfer of knowledge.

For the inventory, knowledge and experience were recorded through interviews with a number of persons in the building process (such as architects, consulting engineers, site engineers, foremen, carpenters and damage investigators), to ascertain their relation to airtightness and its perceived causes and consequences. A number of specific questions were used and the answers were analysed. A number of buildings sites were visited.

In parallel with this, air flows due to normal deficiencies in airtightness and the consequences of these airflows have been investigated. This provides overall information on the airtightness problem, and a foundation for recommendations concerning designs, methods, education and special quality considerations at the building site.

### 4.1 Perception of airtightness

When investigating the importance of airtightness in the construction process, it was found that many types of damage and problems were caused by poor airtightness, that airtightness was seldom given the proper consideration that it deserved, and that there was a major need for information on the effect of poor airtightness. One of the conclusions was that it is important to get developers/clients to treat airtightness more seriously (Sandberg, Skander, 2004 and 2005).

The following are summarised comments from persons in the building process:

*Attitude:* Most respondents think that airtightness is important. They also indicate that their colleagues have the same attitude. However, the immediate superior seldom has any viewpoints or requirements. “It's not his job.”

*At the building site:* Drawings and descriptions are not good enough. 50 % of the details have to be worked out at the building site. Airtightness is seldom discussed or commented on at site meetings, and is seldom mentioned in checklists or quality plans.

*Information/education:* Nearly everyone sees a need for information/education. “Gladly half a day of information and demonstration.” Comment: Those not motivated need to be educated on the importance of airtightness. Those motivated need information on how to accomplish airtightness. Much knowledge is lacking. In many cases, it is difficult to distinguish between airtightness, resistance to moisture diffusion or thermal resistance. “It is so well insulated with mineral wool that it should be airtight.”

*New materials and methods:* Some of the respondents pointed out the need to develop better materials and methods. Others said that the special solutions that are available are not used because they are too expensive or there is no time to order them.

*Reasons for poor airtightness:* Most common: Inadequate design, drawings or descriptions. “How can they think it is possible to obtain an airtight layer, right through a lattice beam?” Sometimes: Shortage of time, carelessness



and/or insufficient knowledge (the latter most often relates to building services systems). Seldom: materials or intentional negligence.

*Critical details:* Many different suggestions, of which the main ones are: lead-throughs and penetrations (for example, electricity and HVAC), joints against steel and concrete, windows, floor structures.

*Consequences:* Most often mentioned at the building site are energy loss and draughts. Others, such as damage investigators, are of course more detailed in their replies, and in addition mainly mention moisture problems, although also carry-over of odours, poorly functioning ventilation systems, freezing pipes and noise problems.

*Measurements and control methods:* Most feel that airtightness is seldom tested. Those with experience from the blower door method think that it works well. A few see the need to be able to measure local air leakages.

*New and old buildings:* Those who were active in the seventies state that airtightness questions were given priority. This priority has since been lost. The questions that are given priority today are moisture problems and how to lower costs.

## 4.2 Cost of poor airtightness and quality

The objective of this part of the programme is to make developers/clients (more) aware of the damage that can be caused by poor airtightness, together with the cost of this in a life-cycle perspective, so that they see the need to specify and monitor airtightness requirements. Therefore tools and methods are developed for informing developers/clients of the importance of good airtightness, and of the resulting extra costs that are incurred from paying insufficient attention to airtightness.

The most important reason why good airtightness is not sufficiently prioritised is most likely that the damage/trouble caused by these deficiencies seldom show themselves in a distinct manner. Poor construction or workmanship leads to direct costs (remedial work) and indirect costs (for goodwill/loss of goodwill, complaints, health etc). Stricter demands from the developer/client for an improvement in airtightness should stimulate an increase in effort from the consultants, contractors and the material manufacturers for better airtightness.

A project financed by SBUF (the Development Fund of the Swedish Construction Industry) and Byggekostnadsforum (Forum for Building Costs) was started in 2006 to investigate the status of these questions, and was completed in 2007. The starting point of the project has been that we often find ourselves at Position A as shown in Figure 4. It would be beneficial to increase airtightness to, for example, Position B in Figure 4.

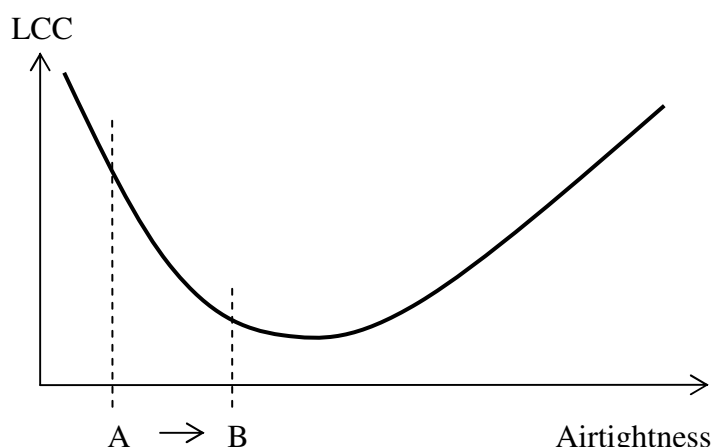

FIG. 4: Life cycle cost (sum of the cost of creating airtightness + the cost of poor airtightness) as function of airtightness.

The most serious negative consequences of poor airtightness are: increased energy use, reduced thermal comfort, reduced air quality and moisture damage. In many cases, the consequences are so diffuse that it is possible to describe them only in qualitative terms. This does not mean that they are not essential, but that the client/developer must set a value to them with respect to the individual project's requirements. The consequences that have been easiest to quantify are increased energy use, and for the others, help will be provided to estimate a value where it is possible. The cost calculations show that the developer/client would benefit in most cases from an increased standard and follow-up on airtightness. We have projected the work with three different levels of

ambition: 0.2, 0.4 and 0.6 l/m<sup>2</sup>s (at 50 Pa pressure difference), and believe that the optimal airtightness lies somewhere in the region of these values, depending on the building's use and equipment.

A part of the project was to develop tools to help developers/clients. These tools have many similarities with those that have been produced for moisture safety during construction, and cover:

- Checklists for the developer's work, including levels of requirement, allocation of responsibility, competence and follow-up.
- The developer's level of requirement with respect to airtightness. In addition, there can be requirements for checks on construction solutions, durability (of materials), education, self-checking and verified measurements/surveys.
- A simple developer's project control checklist.
- Example of checking plan for airtight construction.
- Example of verification and measurement method.

An important aspect in practice is that requirements should be verified. Alternative methods to evaluate the airtightness of the building envelope are needed. An ongoing project is aimed at developing complementary methods for evaluating the airtightness of a building component at an early stage, and also at evaluating representative parts of a large building.

### 4.3 Information, developers-clients and designers-contractors

The results need to be presented in such a fashion that they draw attention and encourage developers to specify clear airtightness requirements. The results are "packaged" as follows:

- Scientific report, describing the work done, references, results and conclusions
- Book, written in a popular scientific style, "Airtightness manual – problems and possibilities", interesting enough to be read by a considerable number of people in the building sector
- PowerPoint presentation, with the most important results from the project
- Flyer, evening paper-style, with some striking results from the project and guidance on how to obtain further information. This flyer is disseminated to the building sector through all available channels.
- Poster with the message that air leaks will cause increased energy use, and that buildings must breathe through the ventilation system and not through the building envelope.

The results are also used in the nationwide educational programme "Bygga bo dialogen", a voluntary agreement between the building sector and the government to improve awareness of energy conservation, indoor climate and the environment.

In a current project, similar activities are being developed for designers and contractors. Knowledge of how to design and implement robust airtight solutions is often inadequate. A key question in this case is communication between designer and contractor.

## 5. In conclusion

The research program is ongoing, steadily adding data and validating the modelling work. Critical details related to the air leakages are tested and modelled. This provides information on air transport in building components and the building envelope, and forms the basis for information on temperature fields, heat flow, moisture transport etc. in the building. These results are analysed to give answers to questions concerning the influence of specific factors on moisture, thermal performance and ventilation problems, as well as to questions such as:

- what details are the most critical ones and the most difficult ones to perform to achieve sufficient airtightness?
- why do a number of designs turn out to have poor airtightness, even if they are constructed in accordance to guides and good experience?
- need for improved designs leading to robust solutions when implemented.

Experience from the building sector has shown that, to begin with, questions regarding poor airtightness were not of great concern and the consequences of poor airtightness were little known. Lately, however, a certain increase in awareness of the importance of air transport and airtightness has been noticed. This is due to energy conservation, especially in passive housing, and to moisture problems and poor air quality and greater emphasis

on control of air flow to solve such problems. A professional building physics design element as part of overall design is still missing. The different building regulations give very little attention to the matter. Unless the implementation and application of the results are considered from the beginning, their impact on the building process will be very slight. A number one priority is:

- need for further information/education and training

## 6. References (in relation to research programme, international references can be found in these)

- Bankvall, Claes, Mattsson, Björn & Sasic Kalagasidis, Angela. (2004). Air transport in and through the building envelope. Proceedings of Performance of Exterior Envelopes of Whole Buildings IX, Florida, USA
- Hagentoft, Carl-Eric et al. (2007). The influence on performance and cost of controlled ventilation in attics (in Swedish). SBUF-project 11871. Building Technology, Building Physics, Chalmers University of Technology, Gothenburg, Sweden.
- Johansson, Mikael. (2004). Airtightness in buildings – Design and practical workmanship of construction details of the air barrier in the building envelope. Publication E-04:4 (in Swedish). Diploma work: Building Technology, Building Physics, Chalmers University of Technology, Gothenburg, Sweden.
- Mattsson, Björn. (2007). Studies on Building Air Leakage – a transient pressurisation method, measurements and modelling. Doctoral thesis, 2639. Building Technology, Building Physics, Chalmers University of Technology, Gothenburg, Sweden.
- Samuelson, Ingemar, Arfvidsson, Jesper & Hagentoft, Carl-Eric. (2007). Få bukt med fukt. T3:2007 Forskningsrådet Formas, Stockholm
- Sandberg, Per Ingvar & Sikander, Eva. (2004). Consideration of airtightness in the construction process - Knowledge audit, laboratory measurements and simulations in order to determine the need for technical solutions and training (in Swedish). SP Report 2004:22
- Sandberg, P.I. & Sikander, E. (2005). Airtightness issues in the building process. Proceedings of the 7<sup>th</sup> Symposium on Building Physics in the Nordic Countries, Reykjavik, Iceland
- Sandberg, Per Ingvar, Sikander Eva, Wahlgren, Paula & Larsson, Bengt. (2007). Consideration of airtightness in the construction process – Technical consequences and profitability assessments (in Swedish). SP Report 2007:23. SP Technical Research Institute of Sweden, Borås, Sweden.
- Sandberg, Per Ingvar, Bankvall, Claes, Sikander Eva, Wahlgren, Paula & Larsson, Bengt. (2007). The effect and cost impact of poor airtightness - information for developers and clients. Proceedings of Performance of Exterior Envelopes of Whole Buildings X, Florida, USA
- Sasic Kalagaidis, Angela. (2004). HAM Tools. An Integrated Simulation Tool for Heat, Air and Moisture Transfer. Analyses in Building Physics. Doctoral thesis, 2121. Building Technology, Building Physics, Chalmers University of Technology, Gothenburg, Sweden.
- Sasic Kalagasidis, Angela. (2007). Simulations as the way of bridging the gaps between desired and actual building performance. 10<sup>th</sup> International Building Performance Simulation (IBPSA) Conference, Beijing, China.
- Sikander, Eva & Olsson-Jonsson, Agneta. (1997). Airtightness in buildings with wooden structure with and without plastic sheet (in Swedish). SP Rapport 1997:34. SP Technical Research Institute of Sweden, Borås,
- Sikander, E. et al (2004). The building developer's requirements, management and verification to ensure dry buildings by moisture control. Proceedings of Performance of Exterior Envelopes of Whole Buildings IX, Florida, USA.

# Airtightness of single-family houses and apartments

*Minna Korpi, M.Sc.,  
Department of Civil Engineering, Tampere University of Technology;  
minna.korpi@tut.fi*

*Juha Vinha, Dr.Tech.,  
Department of Civil Engineering, Tampere University of Technology;  
juha.vinha@tut.fi*

*Jarek Kurnitski, Dr.Tech.,  
Laboratory of Heating, Ventilating and Air-Conditioning, Helsinki University of Technology;  
jarek.kurnitski@tkk.fi*

**KEYWORDS:** airtightness, air leakage, single-family houses, apartments, field study.

## **SUMMARY:**

*Airtightness of Finnish single-family houses and apartments have been studied during the past five years in two large-scale research projects by the Department of Civil Engineering at Tampere University of Technology and HVAC-laboratory at Helsinki University of Technology. The mean air change rate at 50 Pa, measured with fan pressurisation method, was in 100 timber-framed houses 3.9 1/h, in 10 houses built from AAC blocks 1.5 1/h, in 10 houses built from LWAC blocks 3.2 1/h, in 10 houses built from bricks 2.8 1/h, in 10 houses built from shuttering concrete blocks 1.6 1/h, in 10 houses built from concrete elements 2.6 1/h and in 20 log houses 6.0 1/h. The mean  $n_{50}$ -value of 20 apartments in multi-storey houses built from concrete elements was 1.6 1/h. In concrete-built multi-storey houses, in which the intermediate floor was cast on site, the mean  $n_{50}$ -value of 23 apartments was 0.7 1/h. 16 apartments in timber-framed multi-storey houses had a mean  $n_{50}$ -value 2.9 1/h. Different factors (construction method and the insulation material in timber-framed houses, seam insulation material in log houses, ceiling structure in heavyweight houses among others) were noticed to have an effect on the average values of air change rates. Most important result, however, is that good airtightness was reached with all house types and with all kind of structures and methods of construction.*

## **1. Introduction**

The Department of Civil Engineering at Tampere University of Technology and HVAC-laboratory at Helsinki University of Technology have carried out a co-operation project “Airtightness, indoor climate and energy efficiency of residential buildings”, in which the indoor and outdoor climates, indoor moisture excess, ventilation performance, energy consumption and airtightness in 70 Finnish heavyweight single-family houses and 56 apartments were studied. This research project is closely related to a previous study “Moisture-proof healthy detached house”, in which the same field measurements were carried out in 100 timber-framed dwellings.

In this paper the measurement results of 70 heavyweight single-family houses and 59 apartments are presented. In addition, a comparison to the results from 100 timber-framed houses is presented. The results from timber-framed houses have been presented previously and more detailed by Korpi et al. (2004). The results are and will be published in Finnish by Vinha et al. (2005) and (2008).

## **2. Studied houses**

### **2.1 Timber-framed single family houses**

The 100 timber-framed houses measured were chosen to be a wide selection of different timber-framed dwellings. The whole group of houses is not a random sample of Finnish houses because the purpose was to gather proper subgroups of different types of houses. Dwellings differed from each other, for instance, as to age, ventilation type and structural solutions. Three of the dwellings were not detached (one semi-detached, two terrace houses) and some of the two-storey houses had a first storey built of concrete or LWAC blocks. 48 percent of the houses had only one storey. 60% of the houses had a mechanical supply and exhaust ventilation

system with heat recovery. 30% houses had a mechanical exhaust ventilation system and 10% had passive stack ventilation. Half of the houses were constructed on site, one fourth of the houses were built from large prefabricated elements and the rest of the houses were built from either small prefabricated elements or with pre-cut -method.

Most of the buildings were built in the recent years. The mean age of the dwellings was five years, and the median was three years. Half of the houses were situated in the Tampere region, and half in the Helsinki region. Measurements were done in two sets, in the summers of 2002 and 2003.

## 2.2 Heavyweight single-family houses

The group of 70 heavyweight houses consists of 20 log houses, 10 houses built from blocks of autoclaved aerated concrete (AAC), 10 houses built from lightweight aggregate concrete (LWAC), 10 houses built from bricks (5 from calcium silicate brick, 5 from burnt clay brick), 10 houses built from shuttering concrete blocks and 10 houses built from concrete elements. The material named above describes the main exterior wall material used. Three log houses were built with inner and one with external supplementary insulation. In all the rest of the log houses and AAC houses the external wall was of a solid material. Rest of the houses had a thermal insulation layer between the inner and outer shell. In houses made from LWAC and shuttering concrete blocks the insulation layer was in blocks themselves.

In most of the two-storey log houses upper storey was timber-framed. Also some of the two-storey houses had a first storey that was against ground and built from different material. The ceiling assembly in most of the cases was timber-framed. Only most of the AAC houses (9 out of 10) had a ceiling assembly made of reinforced AAC. Three houses with shuttering concrete block walls, two houses with concrete element and one house with LWAC exterior walls had a concrete hollow core slab as a ceiling structure.

The measured houses were received mainly from the databases of manufactures of the houses. Some of the houses were found by delivering brochures to the dwellers of suitable looking houses. The houses were situated mainly in the Tampere and Helsinki region. Nearly all of the houses had a mechanical supply and exhaust ventilation system with heat recovery. A few of the houses had a mechanical exhaust ventilation system. 44 percent of the log houses and 31 percent of the rest of the houses had only one storey. The average internal volume used in pressurisation test results was in log houses  $483 \text{ m}^3$  and in the rest of the houses  $554 \text{ m}^3$ . All of the houses were relatively new; the oldest house was built 10 years prior to measurements. The mean age of the houses was 3 years and the median 2 years. Measurements were done in two sets, in the years 2005...2007.

## 2.3 Apartments

Apartments measured in this study represent three different types of multi-storey buildings. In concrete element buildings the external walls were of concrete element and the intermediate walls of hollow core slab. One group of apartments were in buildings, in which the intermediate floor was concrete cast on site. In most of these buildings exterior walls were of concrete element. The only exception was building number 6200 which also had non-bearing timber-framed external walls. Third group of apartments were in timber-framed multi-storey houses.

Three to five apartments were chosen to be studied from the same building. When possible, the apartments were chosen from different stories so that one apartment was from the ground floor, one from the upper stories and one from a storey in between. Altogether 59 apartments were measured in 17 buildings. Studied buildings were mainly built a couple of years ago. Nearly all of the apartments had mechanical supply and exhaust ventilation system with heat recovery. A few apartments had mechanical ventilation system. The average floor area of the apartments was  $72 \text{ m}^2$ , range from  $35 \text{ m}^2$  to  $138 \text{ m}^2$ .

## 3. Pressurisation method

The airtightness of the houses was tested using a fan pressurisation method (described in European standard EN 13829 2000). The fan pressurisation method is a widely used method and a relatively simple way of getting a comparison value of airtightness. Tests were done with a commercial computer-controlled blower-door system. During a blower-door test, all openings in the envelope are closed and sealed when needed. A fan is mounted tight on one of the building's door or window frames. The pressure difference between the inside and the outside and the airflow through the fan, which is needed to maintain a certain pressure difference, are then measured.

As a result of the pressurisation test, a series of pressure differences and the corresponding airflows through the fan are received. A so-called building leakage curve, where  $Q$  is the airflow required to maintain a pressure difference  $\Delta p$  and  $C$  and  $n$  are coefficients, is then fitted to these results. In the blower-door equipment the curve was fitted to the results automatically by the blower-door software. Airflow corresponding to a pressure difference of 50 Pa can be divided by the inner volume of the measured building. This quantity is called air change rate at 50 Pa (or air leakage rate at 50 Pa, ACH50,  $n_{50}$ -value), and by using it, the airtightness values of different buildings can be compared. Airflow measured in a pressurisation test can also be normalised by the area of the envelope (air permeability at 50 Pa, also called air leakage index and  $q_{50}$ -value). The latter has also become a common way of reporting airtightness, especially in Europe. The results in this paper are mainly reported as air change rates, although both values were calculated.

The inner volume of a house was calculated including the partition walls, fixture and fittings but excluding the intermediate floors. In apartments the intermediate walls were not included to the volume. The area of the building envelope was calculated using also the measures from the inside of envelope assemblies. This internal surface area included walls, ceiling and floors.

The results of single-family houses are given as the mean value of depressurisation and pressurisation tests. Airtightness of the apartments is the result of depressurisation test. The results are expressed to an accuracy of one decimal even though the accuracy of the measurements might not quite reach that level. A former Swedish standard estimates the accuracy of final result of a pressurisation test to be within  $\pm 10\%$  (SIS 1987). The EN-standard estimates that in most cases in calm conditions the overall uncertainty will be less than  $\pm 15\%$  and in windy conditions  $\pm 40\%$  (EN 13829 2000).

## 4. Results and discussion

### 4.1 Single-family houses

Distribution of the results from timber-framed houses is presented in Figure 1. The mean air change rate of the houses was 3.9 1/h and the standard deviation 1.8 1/h. The lowest value was 0.5 1/h, and the highest 8.9 1/h. The mean air permeability at 50 Pa was 1.1 L/sm<sup>2</sup>.

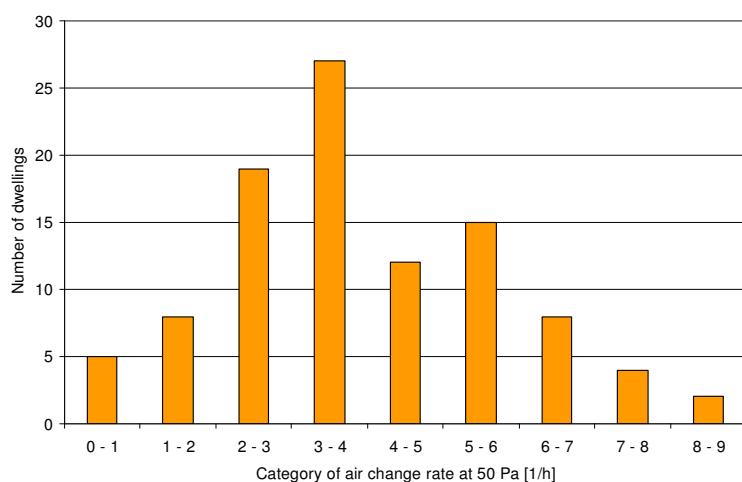

FIG. 1: Distribution of  $n_{50}$ -values [1/h] of 100 timber-framed single-family houses.

Timber-framed houses constructed on site (avg 4.5 1/h) were not as airtight as houses built from timber-framed prefabricated elements (large elements 3.3 1/h, small elements 3.2 1/h, pre-cut 3.5 1/h). The group of houses in which the thermal insulation was polyurethane were on average more airtight than houses with other insulation materials or vapour barriers. In this study the one-storey houses (average 3.7 1/h) didn't appear to be significantly tighter than the two-storey houses (average 4.1 1/h). The volume of the dwellings didn't have an effect on the results. In addition, no clear correlation between the energy consumption of the houses and air change rate at 50 Pa was found.

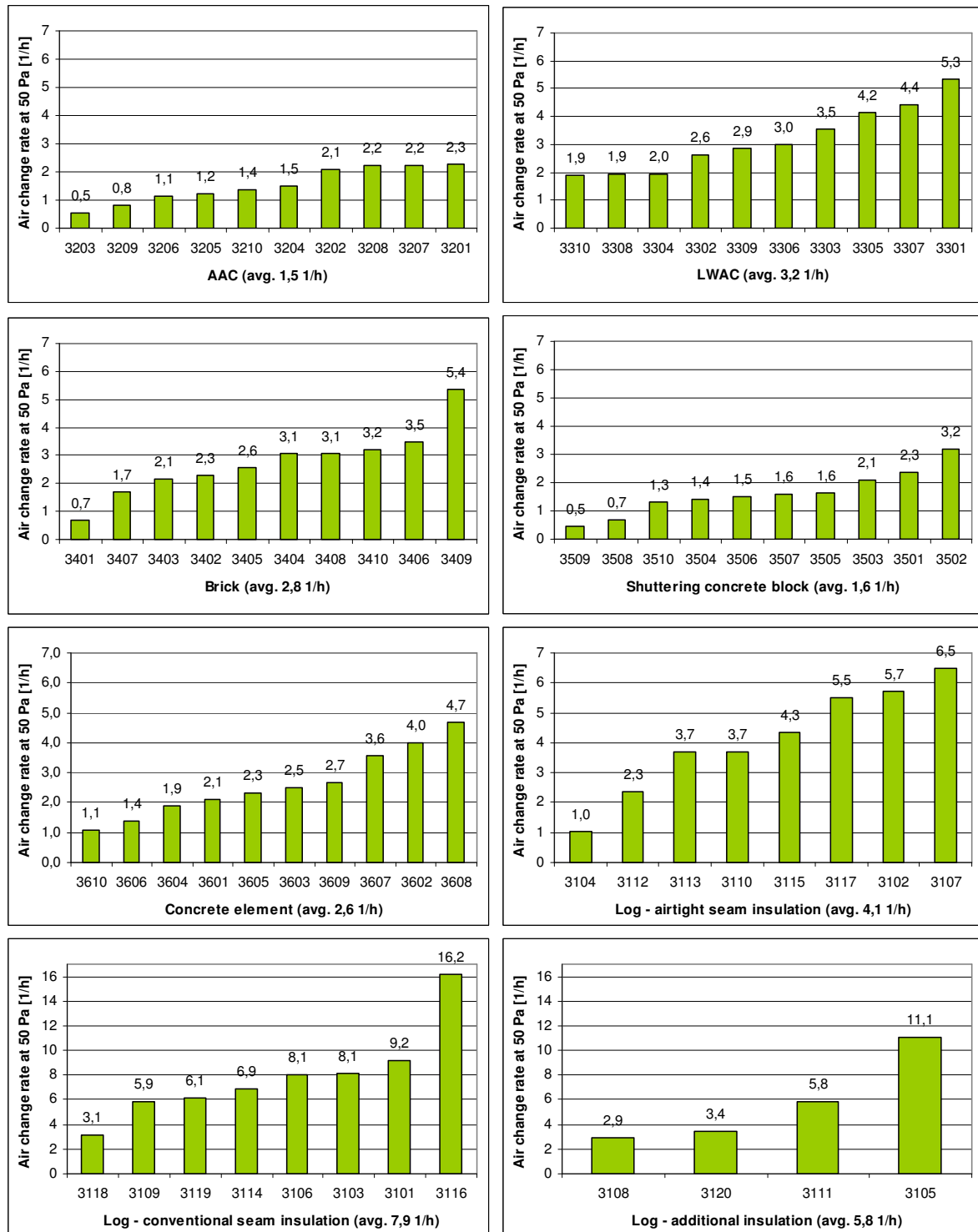

FIG. 2: Results of air change rate at 50 Pa [1/h] grouped by the type of house. The four-digit number is the code of the studied house. Notice different scale in the two lowest graphs.

Figure 2 shows the results of measured air change rates at 50 Pa in heavyweight houses. In the group of log houses different kind of seam insulation materials were used. The seam insulation materials were grouped to conventional and to airtight. Group of conventional seam insulation materials included for example mineral wool, polypropylene and flax insulation. To the group of airtight seam materials different erectile seam insulation materials and cellular rubber seam insulations were included. House was included to the group of

houses with airtight seam insulation, if airtight insulation was used between the logs either in the wall part or in the corner structure or in both. On average, houses with airtight seam insulation were clearly more airtight than houses with conventional seam insulation materials (Figure 2). In three of these log houses (3104, 3113 and 3115) polyurethane insulation was used in ceiling structure, which also might have affected to lower  $n_{50}$ -value. Log house 3108 had external additional insulation, while the rest of the log houses with additional insulation had interior insulation layer.

The ceiling structure of the houses seems to have an effect on the results. Infra-red camera measurements in this project reveal that the joint between exterior wall and ceiling is the most common source of air leakage. The joint between solid wall and the thin air barrier layer in timber-framed ceiling is difficult to make airtight. In Table 1 the results of house-groups, in which houses with both concrete and timber-framed ceiling structure occurred, are shown. In all of the groups the amount of houses in different subgroups is very low, but still the average air change rate of houses with concrete element slab as ceiling structure is a bit lower than the ones that have timber-framed ceiling structure. In the group of all block and concrete element houses, the difference in air change rates between houses with concrete or timber-framed ceiling structure was significant.

TABLE. 1: Air change rates at 50 Pa [1/h] of houses with concrete or timber-framed ceiling structure.

	Houses with concrete ceiling structure			Houses with timber-framed ceiling structure		
	Amount of houses	Average $n_{50}$ -value [1/h]	Average $q_{50}$ -value [l/sm <sup>2</sup> ]	Amount of houses	Average $n_{50}$ -value [1/h]	Average $q_{50}$ -value [l/sm <sup>2</sup> ]
Autoclaved aerated concrete	9	1,5	0,45	1	2,3	0,57
Shuttering concrete block	3	1,2	0,45	7	1,8	0,61
Concrete element	2	1,2	0,45	8	3,0	0,84
Lightweight aggregate concrete	1	1,9	0,67	9	3,3	1,06

Figure 3 shows the summary of the results of single-family houses. The air change rate of combined group of masonry and concrete element houses (2.3 1/h) had a lower  $n_{50}$ -value than timber-framed (3.9 1/h) and log (6.0 1/h) houses. In Figure 3 the airtightness of the houses is compared with both  $n_{50}$ - and  $q_{50}$ -values. In a comparison with  $q_{50}$ -values the log and timber-framed houses perform better than in the comparison with  $n_{50}$ -values. This is because the relation between the volume and the area of building envelope is on average higher with masonry and concrete element houses than log and timber-framed houses. The group of masonry and concrete element houses were also larger by their volume (554 m<sup>3</sup>) than log (483 m<sup>3</sup>) and timber-framed houses (405 m<sup>3</sup>). With timber-framed houses the  $n_{50}$ -value had no correlation to the volume of the house, but weak correlation to the volume was found with both log and the group of masonry and concrete element houses. Figure also shows that there is variation in the results with the same kind of houses and that good airtightness was achieved in all house groups.



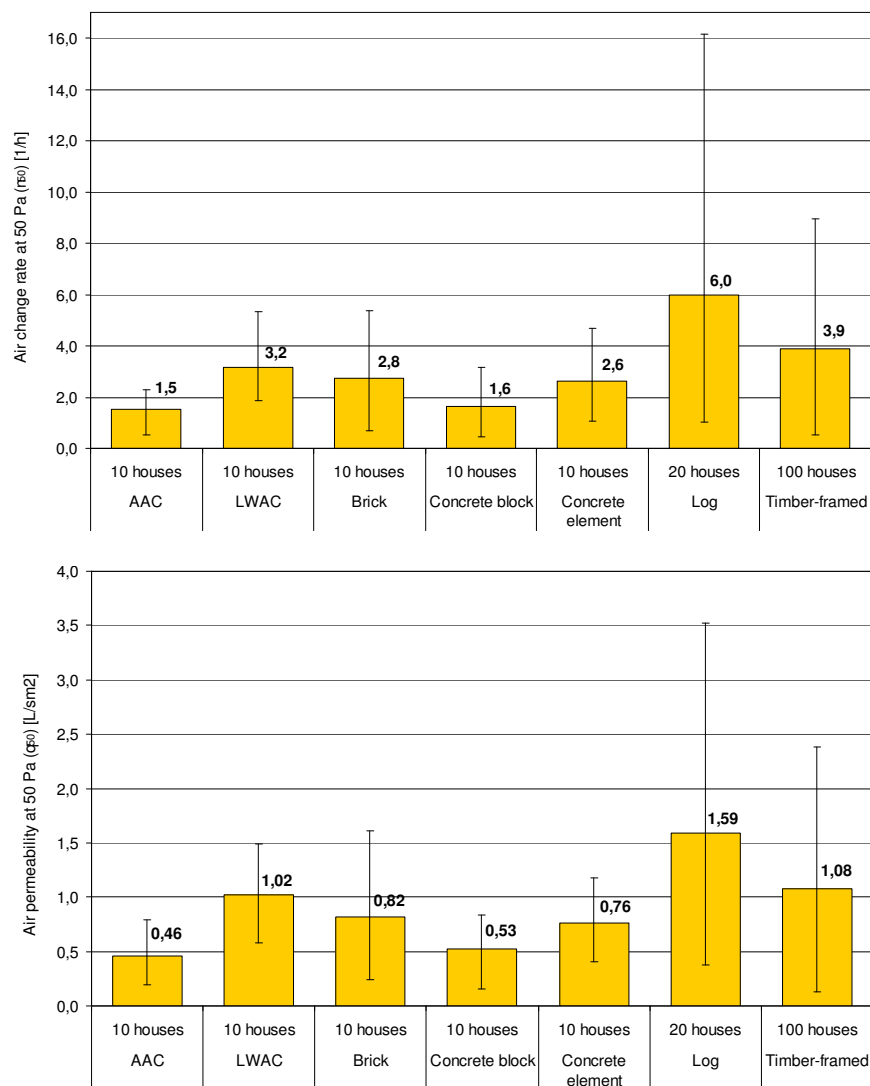

FIG. 3: Air change rates at 50 Pa [1/h] upper graph, air permeability rates at 50 Pa [L/sm<sup>2</sup>] lower graph. (Average result and the range of results)

## 4.2 Apartments

The airtightness of apartments was better than that of single-family houses. Average air change rate at 50 Pa of all apartments was 1.6 1/h and range from 0.3 to 5.3 1/h. In 49% of the dwellings the  $n_{50}$ -value was lower than 1 1/h.

The airtightness of the apartments categorized by the building type is shown in Figures 4, 5 and 6. The lowest average  $n_{50}$ -values were received in concrete built houses with intermediate floors cast on site (0.7 1/h). The average  $n_{50}$ -value of apartments in concrete element houses was 1.6 1/h and in timber-framed multi-storey houses 2.9 1/h.

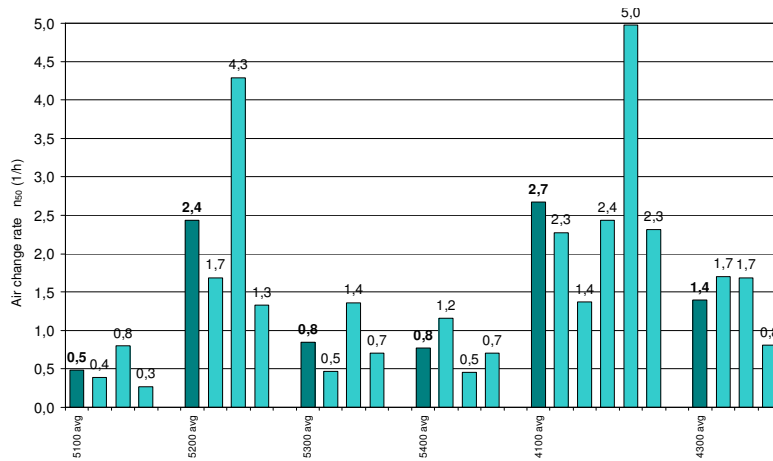

FIG. 4: Air change rates at 50 Pa [1/h] of apartments in concrete element multi-storey houses. The darkened column is the average of all apartments in the same building.

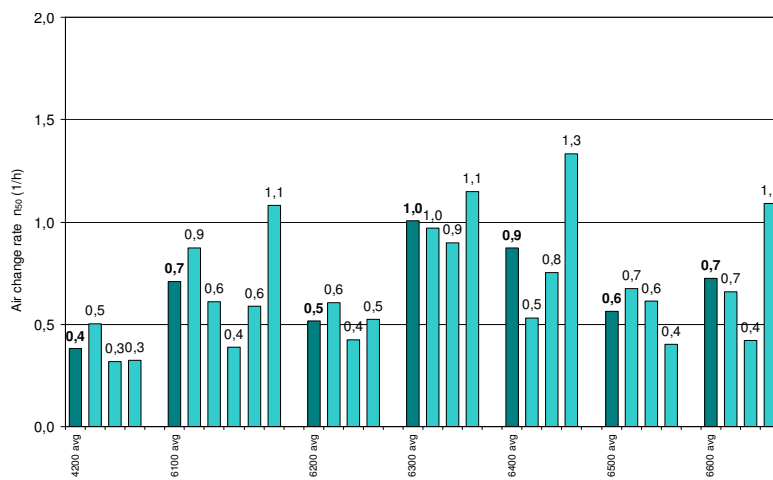

FIG. 5: Air change rates at 50 Pa [1/h] of apartments in concrete-built multi-storey houses, in which the intermediate floor is cast on site. The darkened column is the average of all apartments in the same building.

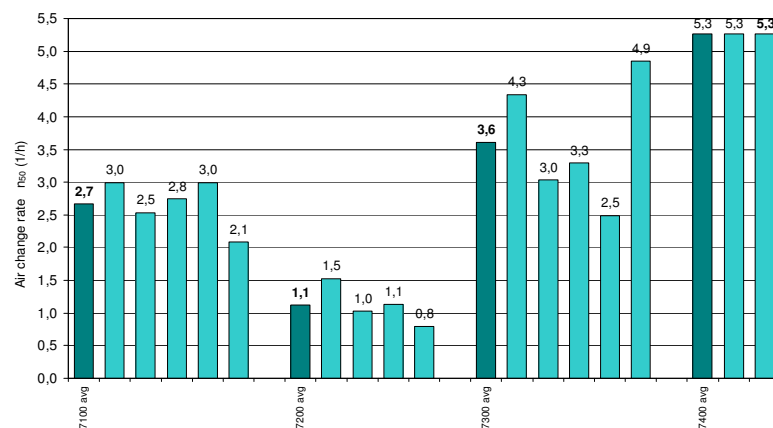

FIG. 6: Air change rates at 50 Pa [1/h] of apartments in timber-framed multi-storey houses. The darkened column is the average of all apartments in the same building.

## 5. Conclusions

Studies done during the past five years give a good conception of the level of airtightness in new Finnish single-family houses and apartments. The mean air change rate at 50 Pa in 100 timber-framed houses was 3.9 1/h, in 10 houses built from AAC blocks 1.5 1/h, in 10 houses built from LWAC blocks 3.2 1/h, in 10 houses built from bricks 2.8 1/h, in 10 houses built from shuttering concrete blocks 1.6 1/h, in 10 houses built from concrete elements 2.6 1/h and in 20 log houses 6.0 1/h. The mean  $n_{50}$ -value of 20 apartments in houses built from concrete elements was 1.6 1/h. In concrete-built multi-storey houses, in which the intermediate floor was cast on site, the mean  $n_{50}$ -value of 23 apartments was 0.7 1/h. 16 apartments in timber-framed multi-storey houses had a mean  $n_{50}$ -value of 2.9 1/h. Although it must be noticed, that the group of houses are not necessary a random sample because the purpose was to gather proper subgroups of different types of houses (for example the ceiling structure, seam insulation material in log houses and the insulation material in timber-framed houses).

The air change rate of combined group of masonry and concrete element houses (2.3 1/h) had a lower  $n_{50}$ -value than timber-framed (3.9 1/h) and log (6.0 1/h) houses. Timber-framed houses constructed on site were not as airtight as houses built from timber-framed prefabricated elements. The group of timber-framed houses in which the thermal insulation was polyurethane were on average more airtight than houses with other insulation materials or vapour barriers. On average, log houses with airtight seam insulation were more airtight than houses with conventional seam insulation materials, although other factors might have affected the good airtightness too. 15 of the measured houses had a concrete ceiling structure. In these houses, even though the number of them is relatively small, the airtightness was a bit better than in houses with timber-framed ceiling structure. Most important result, however is, that good airtightness was reached with all house types and all kind of structures and methods of construction. This emphasises the importance of construction quality in reaching good airtightness.

## 6. Acknowledgements

This study is part of two larger field research projects carried out by Department of Civil Engineering at Tampere University of Technology and HVAC-Laboratory at Helsinki University of Technology. The researches have been financed by TEKES (National Technology Agency of Finland) and Finnish companies and associations. We extend our thanks to all assisting people, residents of the houses studied, and financiers of the research for their co-operation during the study.

## 7. References

- EN 13829 2000. Thermal performance of buildings - Determination of air permeability of buildings - Fan pressurization method (ISO 9972:1996, modified). European committee for standardization.
- Korpi M., Vinha J., Kurnitski J. (2004). Airtightness of Timber-Framed Houses with Different Structural Solutions. Proceedings of IX international Conference on Performance of Exterior Envelopes of Whole buildings. Session XIB, 6 p. (CD), Florida, USA.
- SIS. (1987) SS 02 15 51 1987. Buildings – Determination of airtightness. The Standardization Commission in Sweden. Sweden.
- Vinha, J., Korpi, M., Kalamees, T., Eskola, L., Palonen, J., Kurnitski, J., Valovirta, I., Mikkilä, A., Jokisalo, J. (2005) Puurunkoisten pientalojen kosteus- ja lämpötilaolosuhteet, ilmanvaihto ja ilmatiiviys. Research report 131. Tampere University of Technology. (In Finnish)
- Vinha, J., Korpi, M., Kalamees, T., Jokisalo, J., Eskola, L., Palonen, J., Kurnitski, J., Salminen, K., Aho, H., Salminen, M. (to be published in 2008) Asuinrakennusten ilmanpitävyys, sisäilmasto ja energiatalous. Research report 140. Tampere University of Technology. (In Finnish)

# Implementation of airtight constructions and joints in residential buildings

*Hanna Aho, M.Sc.,  
Department of Civil Engineering, Tampere University of Technology;  
hanna.aho@tut.fi*

*Juha Vinha, Dr.Tech.,  
Department of Civil Engineering, Tampere University of Technology;  
juha.vinha@tut.fi*

*Minna Korpi, M.Sc.,  
Department of Civil Engineering, Tampere University of Technology  
minna.korpi@tut.fi*

**KEYWORDS:** *airtightness, air leakage, air barrier, residential buildings, design recommendations*

## **SUMMARY:**

*Airtightness is mainly a property of the building and not the structure. The basic recommendation is that air barriers must be continuous between adjacent structures and sealed around the supplementary construction elements and penetrations. A critical stage in achieving an airtight building is the quality of work at the construction site. Careful designing does not help if the solutions are unfeasible or difficult to execute and therefore are not realized at the site. Updated information of how to ensure building envelope's airtightness with constructional details has not been available in Finland. As a part of the research project "Airtightness, indoor climate and energy efficiency of residential buildings" the department of Civil Engineering at Tampere University of Technology decided to publish a guide book of airtight constructions and joints. This paper presents the development work and structure of the guide book and also some recommended solutions for airtight constructions as presented in the guide book. The objective of this part of the research project is to give practical instructions to designers and other construction professionals of how to achieve sufficiently airtight buildings for Finnish climatic conditions.*

## **1. Introduction**

### **1.1 Airtightness of residential buildings in Finland**

In recent years the research group of Building Physics at the department of Civil Engineering at Tampere University of Technology has conducted two major research projects which were concerning airtightness of residential buildings in Finland. During the first study, "Moisture-proof healthy detached house", TUT and the HVAC-laboratory at Helsinki University of Technology measured the airtightness of 100 timber-framed dwellings. In the second research project, "Airtightness, indoor climate and energy efficiency of residential buildings", the participants measured the airtightness of heavyweight single-family houses and apartments. Measured buildings were for the most part recently constructed so the result describes quite well the situation in Finland today. The results of these measurements revealed that most Finnish single-family houses do not reach the  $n_{50}$ -value recommended in the National Building Code of Finland. The recommended value of building envelope's airtightness, in respect of the functioning of the ventilation system, should be close to the value of  $n_{50} = 1,0$  1/h (RakMK C3). The  $n_{50}$ -value 1,0 1/h means that one volume of air in the building is flowing through the building envelope in an hour when the pressure difference between the inside and outside air is 50 Pa.

The average  $n_{50}$ -value measured from 100 single-family timber-framed houses was 3,9 1/h. The mean value of log-houses was 6,0 1/h, measured from 20 houses, and the average  $n_{50}$ -value of other heavyweight single-family houses was 2,3 1/h. The group of other heavyweight houses consisted of 10 houses built from blocks of autoclaved aerated concrete (AAC), 10 houses of lightweight aggregate concrete (LWAC), 10 brick houses (of these 5 were calcium silicate and 5 burnt clay bricks), 10 houses built from shuttering concrete blocks and 10 concrete element houses. The average measured  $n_{50}$ -value of apartments was 1,5 1/h, consisted of data from 57

apartments. (Korpi, et al. 2007). Generally apartments were tighter than single-family houses and block, masonry and concrete element houses achieved better  $n_{50}$ -values than timber-framed or log houses. During the measurements it was also discovered that it is possible to achieve an airtight building with an  $n_{50}$ -value around 1,0 1/h with all construction types. This requires that both the designing of details as well as the work at the site are executed carefully. Because there was no up-to-date information available of how to achieve this, TUT decided to publish a guide book of how to design and execute airtight constructions and joints in residential building envelopes.

## 1.2 Benefits of building envelope's airtightness

Previously there has been a widespread belief in Finland that airtight buildings incur unsatisfactory indoor climate or moisture damages to the structures. One reason to this belief is the so-called "bottle-house" from the 1970's. These houses might have been airtight but they lacked adequate ventilation or had severe structural defects. Almost all new residential buildings in Finland have mechanical ventilation so the indoor climate is better controlled and easily adjustable. The knowledge on hygrothermal performance of structures has also improved. On this account, there is an explanation about the advantages and correct functioning of airtight constructions in the beginning of the guide book.

Uncontrolled exfiltration of humid indoor air through the building envelope can also inflict on a major local moisture accumulation to constructions. This can then create moisture problems such as mould or decay of timber structures. Air leakage from outside especially through the floor structures can also introduce airborne pollutants or radon gas into the indoor air.

Airtightness can affect on building's heat energy consumption. It has been suggested that for a detached house in a sheltered suburban area in the climate conditions of Helsinki the increase of one unit of the building leakage value  $n_{50}$  can give a rise to an increase of approximately 6% in the heat energy consumption of the zones and the ventilation system and the increase in total heat energy consumption is about 4% (Jokisalo, et al. 2007). Also infiltration can deteriorate the indoor climate by creating the feeling of draught, which is usually compensated by an increase of the indoor temperature.

Since the beginning of 2008 energy efficiency certificates are required from all new buildings. With the new regulations it is possible to use good airtightness as a compensation for lower U-values in certain structures. This is enabled by the calculation of the buildings heat losses. The  $n_{50}$ -value used in reference calculation is 4,0 1/h and if the buildings actual  $n_{50}$ -value is lower than this, the compensation is possible. (RakMK D3.) This option is significant for example to massive log external walls which do not meet the required U-values with commonly used thicknesses. Of course, it is not recommended to minimize the thermal insulation thickness in all cases. The main objective is that new buildings reach a better energy efficiency class than the one suggested by the reference calculation.

## 2. Development of the guide book

As a part of the research project "Airtightness, indoor climate and energy efficiency of residential buildings" the department of Civil Engineering at Tampere University of Technology decided to publish a guide book of airtight constructions and joints, which is focused on typical Finnish constructions. Solutions were developed by a group of researchers from different fields of engineering. The participants were professionals in structural engineering, building physics, renovation, fire safety or site practice. The group had several meetings during 2006-2008 in which the designs were first developed and then revised. Solutions have also been commented by the construction industry professionals in the executive group of the research project.

The guide presents both detailed plan drawings for the designers and working instructions for the construction site. The examples are planned for concrete element, block, masonry, wood-framed and log structures. The guide book concentrates on residential single-family houses but the solutions can be adapted to other buildings as well. The details are planned so that their scope is as wide as possible. It was not practical to take into account all different variations so the recommendations should be modified to specific end-use applications by the designer of the building. Although the air barrier in the structure is often functioning as a moisture-barrier too, the publication does not concern the hygrothermal performance of structures.

### 3. Design recommendations

#### 3.1 General

Airtightness is mainly a property of the building and not the structure. The basic demand is that air barrier should remain continuous in structural joints e.g. the junction between the external wall and roof structure. The sealing of joints to supplementary construction elements, such as windows, should also be well planned and executed. Typical places of air leakages in Finnish residential buildings are around and through windows and doors, in the junction of roof structure or intermediate floor with the external wall as well as penetrations through the air barrier system (Kalamees et al. 2007). Penetrations can be for example electric wall sockets or chimneys and air pipes. At some cases it has been evident that the basic structure of a window or door itself can also incur an air leakage. The airtightness of these structures should be a target for development to the manufacturers.

In some constructions the main air barrier is a separate layer such as a plastic or paper based foil or a plaster coating. The first one is common in layered timber-framed structures and the latter is used with permeable block constructions e.g. LWAC. With timber-framed constructions the air barrier is most commonly also used as a vapour barrier and it is therefore located near the internal surface. Because the guide book does not cover the hygrothermal performance of the structures we only use the term air barrier instead of vapour barrier.

Some structural elements, e.g. concrete elements and AAC blocks, are functioning as an air barrier without a separate layer. However, with these structures the joints to adjacent elements or blocks and penetration seals should also be carefully executed to achieve an airtight building envelope. Similarly massive log walls do not have a separate air barrier layer. Therefore the gap between the logs must be sealed with joint strips and the shape of the log profile and corner details should be carefully considered. Log structures also tend to sag after construction, which should be considered with joint detailing. Also other recommended solutions should endure the life expectancy.

#### 3.2 External walls, roofs and base-floors

In timber-framed external walls the air barrier is usually a foil of plastic or paper-based product. The use of thicker rigid polystyrene or polyurethane thermal insulation boards has also been suggested. The advantage of these boards is relatively easy jointing and sealing with polyurethane foam. The board can also be regarded as a part of thermal insulation which may thin down the required construction thickness. The foil air barrier can be located slightly deeper inside the thermal insulation layer (FIG 1, left), this enables concealed electric wiring behind the interior board and easier assembly of electric wall sockets without piercing the air barrier. The assembly space is equally recommended with rigid thermal insulation board air barriers (FIG 1, right). Depending on other constructional details, e.g. the thermal insulation material, the air barrier must have adequate water vapour resistance for ensuring the hygrothermal performance of the wall structure.

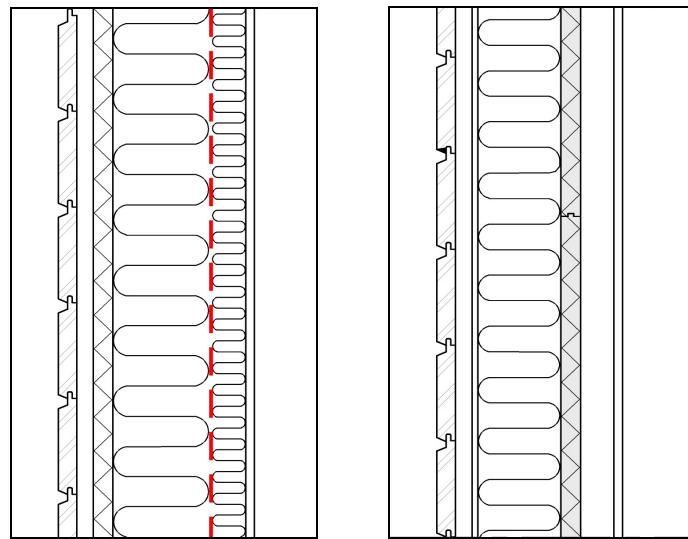

*FIG 1. Air barrier in timber-framed external wall constructions. On the left plastic or paper based foil, on the right rigid thermal insulation board. Structure is from left to right: external cladding and ventilation gap, wind shield board, thermal insulation, air barrier, installation gap and interior board.*

When the air barrier layer is also the vapour barrier the internal thermal insulation (FIG 1, left) should be installed only after the high moisture load work phases such as concrete pourings are done. The vapour barrier must not be taken too close to the exterior surface. Otherwise there is a risk of moisture condensation. A general rule is that  $\frac{3}{4}$  of the insulation thickness should be on the outside of the vapour barrier (Vinha J. 2007).

When plastic or paper-based foil is used as the air barrier the adjacent foils should be overlapped ( $> 150$  mm) and compressed together or taped with a product that has adequate long-term durability for the extensions to stay airtight. The first alternative, overlapping and compression with wooden lath, is presented in figure 2. This is the recommendation for the external wall structure presented in FIG 1, left. The maximum limit between fixing screws is 300 mm so the compression is continuous. The recommendation for overlapping and compression or taping is equally valid for plastic or paper-based foil air barriers in roof structures. In horizontal constructions the air barrier foil must be adequately supported from below so that the weight of the thermal insulation does not cause damage to the foil. If possible, both the taping and compression can be used simultaneously to ensure the tightness of the extension in horizontal structures.

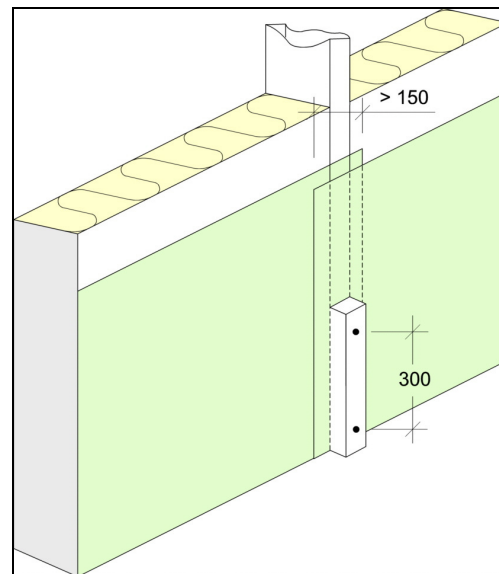

FIG 2. Plastic or paper-based foil air barrier's extension in timber-framed external wall construction.

Some block wall structures need a separate air barrier layer because the blocks themselves are air permeable. The layer is usually a plaster coating in the internal surface. Plastering should in these cases extend continuous the whole wall height and also behind suspended ceilings etc.

As a roof structure concrete or AAC elements are rare in residential single-family houses but as mentioned before they are in themselves airtight. The most critical places for air leakage are joints with external walls, seams between elements and penetrations e.g. chimney junction.

Base-floors can consist of a concrete slab (slab-on-ground or crawl-space construction) or timber beams and boards (crawl-space). Generally a concrete slab is in itself airtight but poorly sealed penetrations can cause air leaks. In timber-framed base-floors the boards are usually also the air barrier. The most critical air leakage is usually the junction between base-floor and external wall, which often is also a thermal bridge (Kalamees et al. 2007). An air leak along the floor can cause a feeling of draught and act as an entrance route for radon gas or airborne pollutants to the indoor air.

### 3.3 Joints and penetrations

With slab-on-ground structures the most effective way to obstruct air leakage and at the same time the radon gas from entering the indoor air is to use elastic (SBS modified) bitumen felt strip in the joint. There are multiple possibilities for mounting the felt and the best one for each case depends on the foundation structure as well as the external wall structure. If the foundation wall and external wall are sufficiently airtight or their tightness has been otherwise assured the elastic bitumen felt strip can be attached to the foundation wall and folded under the concrete slab (FIG 3, left (2)). It should be noticed that in this example the plaster coating extends to the whole height of the block wall structure in both surfaces and so it ensures the airtightness of the wall structure. The gap between the wall and the slab is sealed with polyurethane foam or putty (1). With timber-framed external walls the felt may extend under the longitudinal timber at the bottom of the wall structure to hinder capillary flow from foundation wall to the timber structure (FIG 3, right (2)). In this picture the air barrier foil of the external wall is folded under the slab (1) which of course is possible only when the wall is erected prior to casting of the concrete slab.



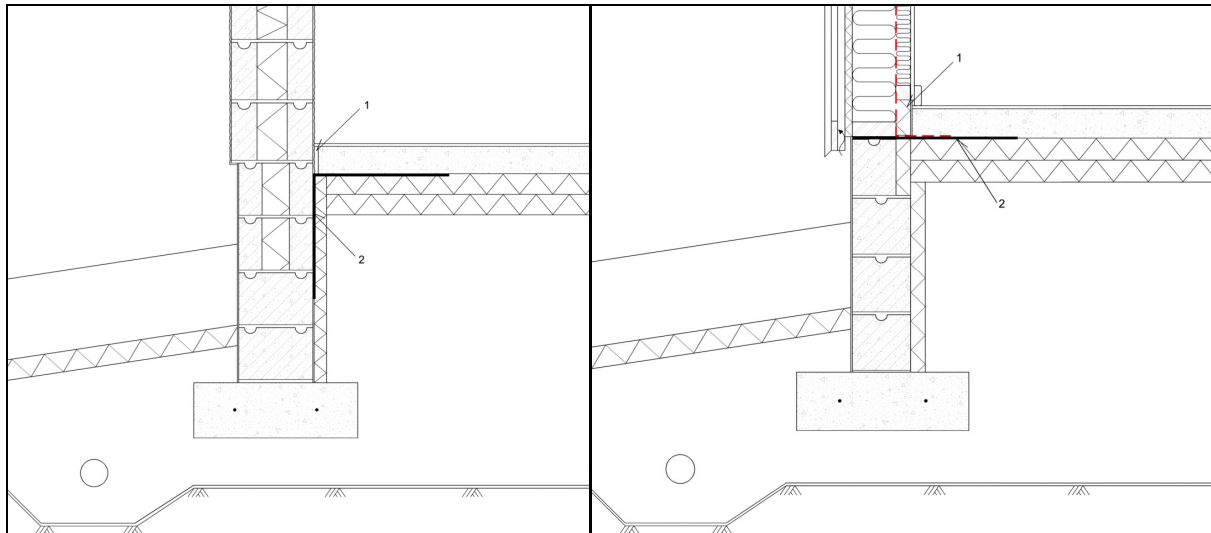

FIG 3. Examples of airtight junctions between a slab-on-ground structure and external wall.

Timber-framed roof structures with plastic or paper based foil air barriers are very common in Finnish single-family houses even when the external walls are made of blocks or bricks. With timber-framed external walls it is possible to overlap the joining air barrier foils (FIG 4, left (2)) and then compress them with a wooden lath and dense screw fixation (1). When the wall structure does not have a separate air barrier foil the junction is more difficult to execute (FIG 4, right). One possibility is to compress the air barrier of the roof structure between the longitudinal timber on the top of the block wall and suspending lath (2). The gap between the longitudinal timber to which the roof truss is attached to and the block wall is then sealed with polyurethane foam or putty (1). These examples are a combination of different sealing methods and demand a certain working order. Therefore it is very important to give good instructions for the execution to the site.

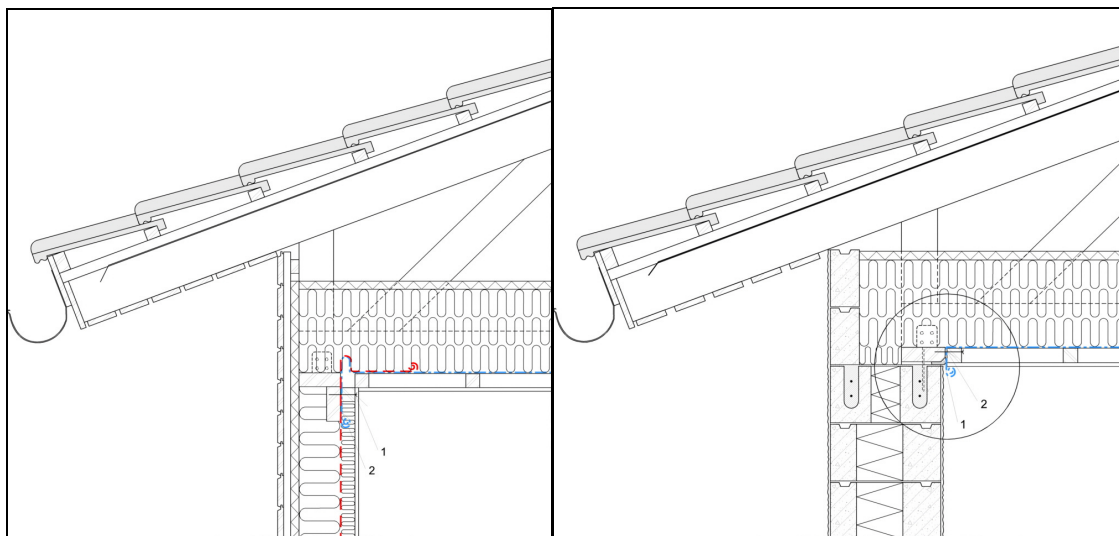

FIG 4. Examples of airtight junctions between a wood-framed roof structure and external wall.

In wood-framed external walls with foil air barrier the junction of the intermediate floor often creates a discontinuity to airtightness. The problem can be avoided by using a rigid plastic thermal insulation board between the intermediate floor beams (FIG 5, (1)). The board is fixed with polyurethane foam to the wall structures above and below and also to the beams. The air barrier foils are again compressed with dense screw fixation (2). The detail is actually easier to execute in practise as the traditional way of folding the foils around the beam-ends.

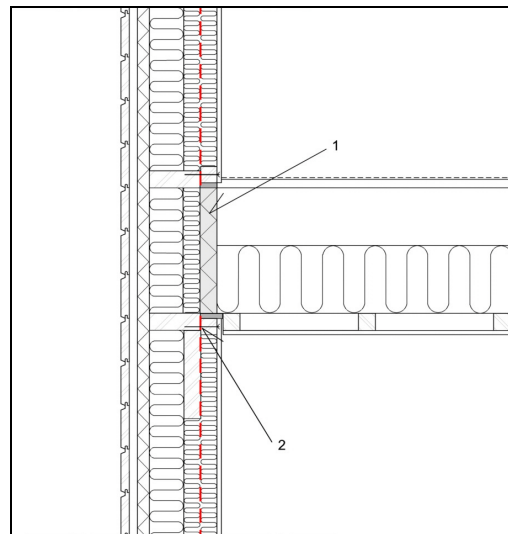

FIG 5. Example of continuous air barrier in a timber-framed external wall at the junction of an intermediate floor.

The details presented above are only an example of the recommendations in the guide book. In addition to these junctions and their modifications to other construction materials, the guide book has examples for window and door joints, chimney and ventilation pipe penetrations and some specific details for designing structures of spaces with high moisture exertion such as steam rooms.

#### 4. Implementation of airtight building envelopes

The most critical stage of achieving an airtight building is at the construction site. The benefits of an airtight building envelope should be evident to the workers as well as the supervisors at the site so the motivation for careful execution of details is present at all times. Thoughtfully designed details will not be efficient if they are not executed correctly. Even though the details planned for airtight structures are often somewhat different from custom and sometimes even slightly more demanding the designer must ensure that they are feasible or they will not be realized at the site. Most of the airtight details are combinations of different sealing methods so the work phases and their order need to be clearly instructed.

Detail planning that concentrates on airtightness is at the moment uncommon in residential buildings. If we wish to improve the airtightness of new buildings the detailing should be done by professional designers. By improving the airtightness of the building envelope we also improve the energy efficiency and indoor air quality of residential buildings and avoid local moisture damages to structures.

#### 5. Conclusions

The objective of this part of the research project “Airtightness, indoor climate and energy efficiency of residential buildings” is to give practical instructions to designers and other construction professionals of how to achieve sufficiently airtight building envelopes for Finnish climatic conditions. For this purpose, the department of Civil Engineering at Tampere University of Technology decided to publish a guide book of implementation of airtight constructions and joints. The guide book is scheduled to be published in the autumn of 2008. It is expected to raise knowledge of the importance of building envelope’s airtightness relative to the correct functioning of structures, the energy efficiency of the building and achievement of good indoor air quality.

#### 6. Acknowledgements

This study has been financed by National Technology Agency of Finland and Finnish companies and associations. The recommendations were developed by a group of researchers from the department of Civil Engineering at Tampere University of Technology. The detailed images were also evaluated by the executive

group of the project “Airtightness, indoor climate and energy efficiency of residential buildings”. We would like to thank all participants of their contribution.

## 7. References

- Jokisalo J., Kurnitski J., Vinha J. (2007). Building leakage, infiltration and energy performance analysis for Finnish detached houses. Proceedings CLIMA 2007 – Wellbeing Indoors, 10-14 June Helsinki, pp 8.
- Kalamees T., Korpi M., Eskola L., Kurnitski J., Vinha J. 2007. Kylmäsiltojen ja ilmavuotokohtien jakauma suomalaisissa pientaloissa ja kerrostaloasunnoissa. (The distribution of the air leakage places and thermal bridges in Finnish detached houses and apartment buildings.) Tampereen teknillinen yliopisto, Rakennetekniikan laitos. Seminaarijulkaisu 1. Rakennusfysiikka 2007. (in Finnish).
- Korpi, M, Vinha J., Kurnitski J. 2007. Pientalojen ja kerrostaloasuntojen ilmanpitävyys (Airtightness of single-family houses and apartments). Tampereen teknillinen yliopisto, Rakennetekniikan laitos. Seminaarijulkaisu 1. Rakennusfysiikka 2007. (in Finnish).
- RakMK C3. 2007. (The National Building code of Finland Part C3, Thermal insulation in a building). Ympäristöministeriön asetus rakennuksen lämmöneristyksestä. Suomen rakentamismääräyskokoelma, Ympäristöministeriö, Asunto- ja rakennusosasto. (in Finnish)
- RakMK D3. 2007. (The National Building code of Finland Part D3, Energy management in buildings). Ympäristöministeriön asetus rakennusten energiatehokkuudesta. Suomen rakentamismääräyskokoelma, Ympäristöministeriö, Asunto- ja rakennusosasto. (in Finnish)
- Vinha J. 2007. Hygrothermal Performance of Timber-Framed External Walls in Finnish Climatic Conditions. A Method for Determining the Sufficient Water Vapour Resistance of the Interior Lining of a Wall Assembly. Doctoral Thesis. Tampere University of Technology, Publication 658. 338 p. ISBN 978-952-15-1742-6. ISSN 1459-2045.

# The influence of exterior walls on the level and stability of indoor humidity and temperature in detached houses

*Minna Korpi, M.Sc.,  
Department of Civil Engineering, Tampere University of Technology;  
minna.korpi@tut.fi*

*Targo Kalamees, Ph.D.,  
Laboratory of Heating, Ventilating and Air-Conditioning, Helsinki University of Technology;  
targo.kalamees@ttu.ee*

*Juha Vinha, Dr.Tech.,  
Department of Civil Engineering, Tampere University of Technology;  
juha.vinha@tut.fi*

*Jarek Kurnitski, Dr.Tech.,  
Laboratory of Heating, Ventilating and Air-Conditioning, Helsinki University of Technology;  
jarek.kurnitski@tkk.fi*

**KEYWORDS:** *indoor climate, humidity, temperature, field study, moisture buffering.*

## **SUMMARY:**

*This paper is based on field measurements conducted in 69 heavyweight detached houses. The temperature and relative humidity were continuously measured in bedrooms of each house at 1-h interval for a period of one year. In order to analyse the relative and absolute humidity in single-family houses, the houses were divided into different subgroups according to exterior wall: autoclaved aerated concrete (AAC), lightweight aggregate concrete, brick, shuttering concrete block, concrete element and, log. The results showed only minor difference in the level of relative humidity between the house groups. Some differences in the daily amplitude of humidity were shown in the comparison of different house groups. During the summer period, the group of log houses had the highest and the group of AAC houses the lowest daily amplitude of absolute humidity. In winter period houses with low ventilation rate (<0,25 1/h) had a significantly smaller amplitude of absolute humidity than houses with high ventilation rate (>0,5 1/h). The average of daily amplitude of temperature was significantly higher in log houses compared to some other house groups. Overall, the fluctuation of temperature (average values of different house groups 0.7...1.3 °C) affects the relative humidity more than the type of exterior wall. The hygroscopic mass of furniture, textiles, etc. as well as real air change rates, including window airing are factors that probably play significant roles in indoor humidity.*

## **1. Introduction**

The influences of structures and materials on indoor air humidity and quality have been investigated in many studies (f.ex. Tsuchiya 1980, El Diasty et al. 1992 and 1993, Cunningham 1994, Hagendoft 1996, Kurnitski et al. 2003 and 2006, Isetti et al. 1988, Padfield 1998, Simonson et al. 2002 and 2005,). The matter has also been widely discussed in IEA Annex 41 project. In most of these studies, the heat and moisture balance of indoor air has been either mathematically modelled, or studied by laboratory experiments. The phenomenon has not been commonly studied by wide scale field measurements. However, it is important to study the influence of structures and materials in real conditions, because modelling and laboratory experiments include some indefinites that may not be present in real life. Such factors are real ventilation especially in summer when windows are often open, and the hygroscopic mass of furnishing or interior textiles etc. Most discussion in the literature has been focussed on the influence of interior surface on the indoor climate. In this paper, the possible effect of exterior walls on indoor climate is analysed.

This paper presents the indoor climate results from a large-scale field study conducted by the Department of Civil Engineering at Tampere University of Technology and HVAC-laboratory at Helsinki University of Technology in the years 2005-2007. In that study the indoor and outdoor climates, indoor moisture excess,

ventilation performance, energy consumption and airtightness in 20 log houses, in 50 other heavyweight houses and in 56 apartments in multi-storey houses were studied. In order to analyse the relative and absolute humidity in single-family houses, the houses were divided into different subgroups according to the exterior wall type. A brief comparison to the results of the previous study, in which 100 timber-framed houses were studied, is also made. The results of the timber-framed houses have been presented by Vinha et al. (2005) and Kalamees et al. (2006).

## 2. Measurements

### 2.1 The studied houses

The group of 69 heavyweight houses were measured at varying periods from summer 2005 to summer 2007. Temperature and relative humidity (RH) were measured in the main bedrooms in nearly all of the houses during winter period 2006-2007 and summer 2007. This group of houses consisted of 19 log houses, 10 houses built from blocks of autoclaved aerated concrete (AAC), 10 houses built from lightweight aggregate concrete (LWAC), 10 houses built from bricks (5 from calcium silicate brick, 5 from burnt clay (ceramic brick)), 10 houses built from shuttering concrete blocks (CB) and 10 houses built from concrete sandwich element (CSE). The material named above describes the main exterior wall material used. Three log houses were built with inner additional insulation and one with exterior additional insulation. In all the rest of the log houses and AAC houses, the external wall was of a solid material. Rest of the houses had a thermal insulation layer between the inner load bearing and the outer cladding shell. In the houses made from LWAC and shuttering concrete blocks, the insulation layer was in the blocks themselves.

The mean age of the heavyweight houses was three years and the median two years. All of the houses had mechanical ventilation system; 93% of the houses had a mechanical supply and exhaust ventilation system with heat recovery. In most of the two-storey log houses upper storey was timber-framed. In addition, some of the two-storey houses had a first storey against ground and built from different material. The ceiling assembly in most of the cases was timber-framed. Most of the AAC houses (9 out of 10) had a ceiling assembly made of reinforced AAC. Three houses with shuttering concrete block walls and, two houses with concrete element exterior walls and one LWAC block house had a concrete hollow core slab as a ceiling structure.

The measured houses were randomly selected mainly from the databases of the manufactures of the houses. Some of the houses were found by delivering brochures to the dwellers of suitable looking houses. The houses were situated mainly in the Tampere and Helsinki region.

In the studied rooms the ceiling was usually either treated wooden boarding or plastered concrete/AAC slab or plastered/painted plasterboard. The intermediate walls were normally either block walls or timber-framed walls with plasterboard and they were normally treated with plaster or paint or covered with wall-paper. All the floors were covered with non-hygroscopic materials (mainly lacked wood or laminated parquet). The interior surface of the exterior log walls was normally treated with either lacquer, latex paint or some other kind of protective fluid. Only in two log houses the interior surface was untreated. The exterior walls of the other heavyweight houses were usually plastered and painted. In some of the houses also wall-paper was used as interior surface material. Studied bedrooms were normally furnished.

### 2.2 Measurements

Indoor temperature and relative humidity (RH) were measured with data loggers at 1-hour interval. The data logger's temperature measurement range was from  $-20$  to  $+60^{\circ}\text{C}$  with an accuracy of  $\pm 0.5^{\circ}\text{C}$  and the RH measurement range was from RH 0 to 97% with an accuracy of RH  $\pm 3\%$ . Indoor loggers were located on the separating walls in every master bedroom. The representative outdoor data was received from the Finnish meteorological institute.

To study the fluctuation of RH and absolute humidity, the amplitudes of 24 h, i.e. the difference between daily maximum and minimum values, were calculated. An average value of these daily values over the summer/winter period is considered as a measure of the fluctuation of the parameter studied.

The average ventilation air change rate was 0.39 1/h. The ventilation rate was calculated based on measured return airflows in ventilation ducts at the normal operating level of the ventilation device. These values do not include window airing. The airtightness of the houses was measured with fan pressurisation method. The mean

air change rate at 50 Pa pressure difference of houses with AAC blocks was 1.5 1/h, LWAC blocks 3.2 1/h, bricks 2.8 1/h, shuttering concrete blocks 1.6 1/h and concrete elements 2.6 1/h. The mean  $n_{50}$ -value of log houses was 6.0 1/h. Pressure difference at the operating rate of ventilation was on average -1.8 Pa. A questionnaire of the structures of the houses, type of HVAC system and its use, dwelling habits, occupants opinion on indoor air quality etc. was also conducted for each house.

### 3. Results

#### 3.1 Outdoor climate

Outdoor temperature and relative humidity during the whole measurement period is shown in Figure 1 (left). Indoor relative and absolute humidity were analysed separately during the summer and winter seasons. Analysed periods were from the measurement year from fall 2006 to summer 2007. During this period, the measurements were done in all detached houses. The analysed summer season was 01.07...31.07.2007. The selection was made according to the outdoor climate; a period in which the mean outdoor temperature was mainly above 15°C and the majority of the houses were still measured, was chosen. The analysed winter seasons lasted for three months, 01.12.2006...28.02.2007.

To give an overview of the indoor temperature conditions in studied houses, the dependence of the indoor temperature on the outdoor temperature was calculated, Figure 1 (right). Each line in Figure 1, right, represents the average value of the average daily indoor temperature at the corresponding average daily outdoor temperature. The value was calculated separately for each house group. No great differences in the indoor temperature were found between the house groups.

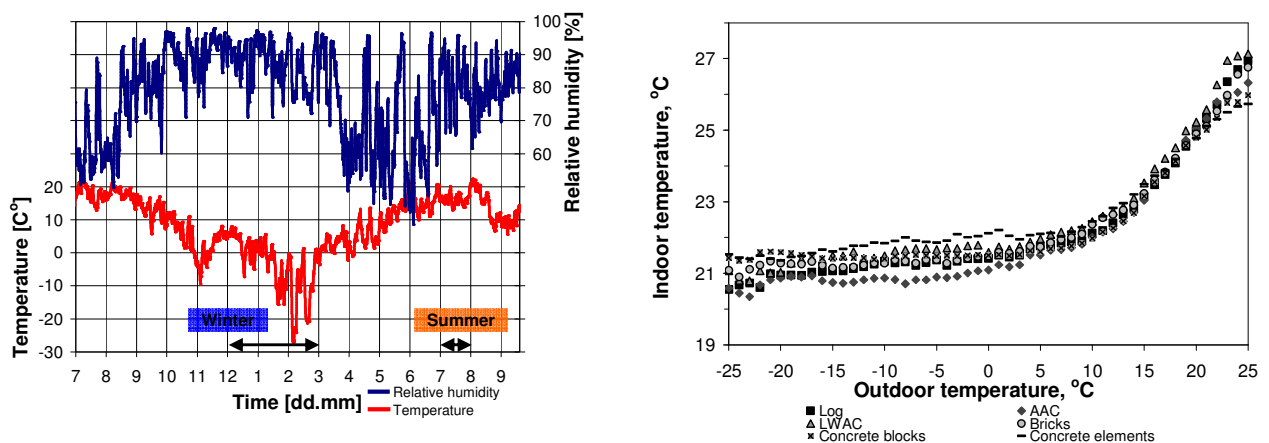

FIG. 1: The outdoor temperature and relative humidity during the measurement periods (left) and the dependence of indoor air temperature on the outdoor air temperature (right).

#### 3.2 Summer season

Figure 2 (left) shows the difference of the RH between the different house groups. Each column represents the average relative humidity of one studied house during the summer period 2007. Average indoor relative humidity of all houses during summer was 51%. To study the fluctuation of indoor RH and absolute humidity, the amplitudes of 24 h, i.e. the difference between the daily maximum and minimum values, were calculated. An average value of these daily values over the summer period is considered as a measure of the fluctuation of the parameter studied. Figure 2 (right) shows the difference between different house groups in the level of daily amplitude of indoor RH. There were no significant differences between the groups of houses in the values of relative humidities or their amplitudes.

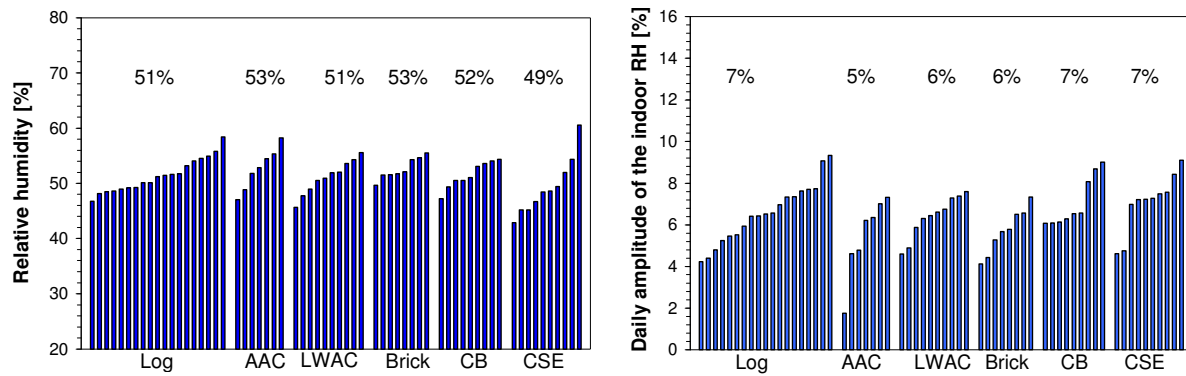

FIG. 2: The level of relative humidity (left) and the daily amplitude of relative humidity (right) during summer period 2007 (1.7...31.7.2007). Average values of different house groups are presented.

As the stability of indoor RH is affected by the stability of temperature (includes influence of outdoor climate, internal heat gains, ventilation and thermal mass of the house) and absolute humidity (includes outdoor climate, moisture production, ventilation and moisture buffering of the house), these factors should be analysed separately.

Figure 3 (left) shows the average amplitudes of absolute humidity during summer period. Houses with AAC exterior walls had significantly ( $p < 0.05$ ) minor amplitude of absolute humidity than log, shuttering concrete block (CB) and concrete element (CE) houses. Also, the difference between log and cavity brick houses was significant. Figure 3 (right) shows the distribution of average daily amplitudes of temperature in the studied houses. The daily amplitude of temperature in log houses was significantly higher than in majority of the other house groups. Thermal mass of the exterior walls might have some influence on the results.

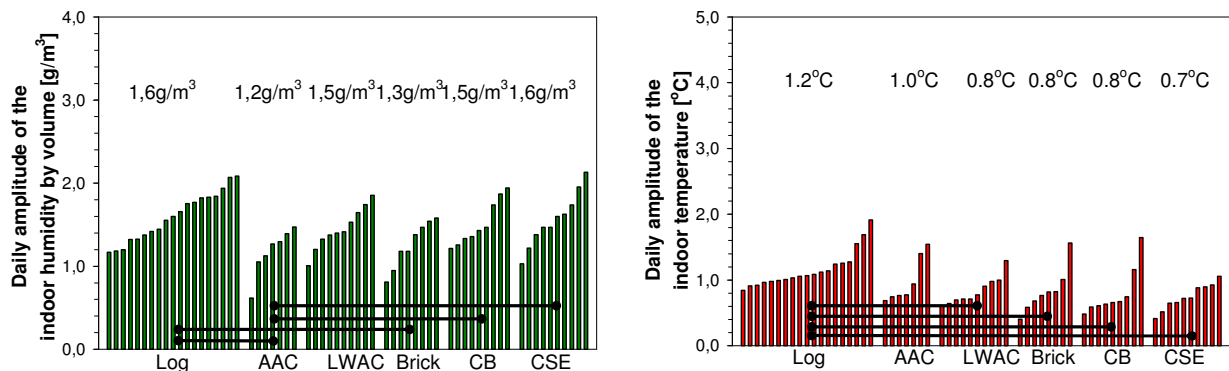

FIG. 3: The distribution of the average daily amplitudes of absolute humidity (left) and temperature (right) during summer period 2007 (1.7...31.7.2007). Horizontal lines mark significant differences between the house groups. Average values of different house groups are presented.

### 3.3 Winter season

Average indoor relative humidity during winter was 31%. The levels and daily amplitudes of relative humidities in different house groups during the winter period 2006...2007 are compared in Figure 4. Each column represents the average relative humidity/average daily amplitude during the studied winter period. Houses with concrete element exterior walls had significantly lower level of relative humidity compared to houses with autoclaved aerated concrete block, brick cavity and shuttering concrete block exterior walls. But as noticed in Figure 1 (right), the temperature in concrete element houses was also higher than in the rest of the house groups.

There were no significant differences in the average values of average daily amplitudes between different house groups

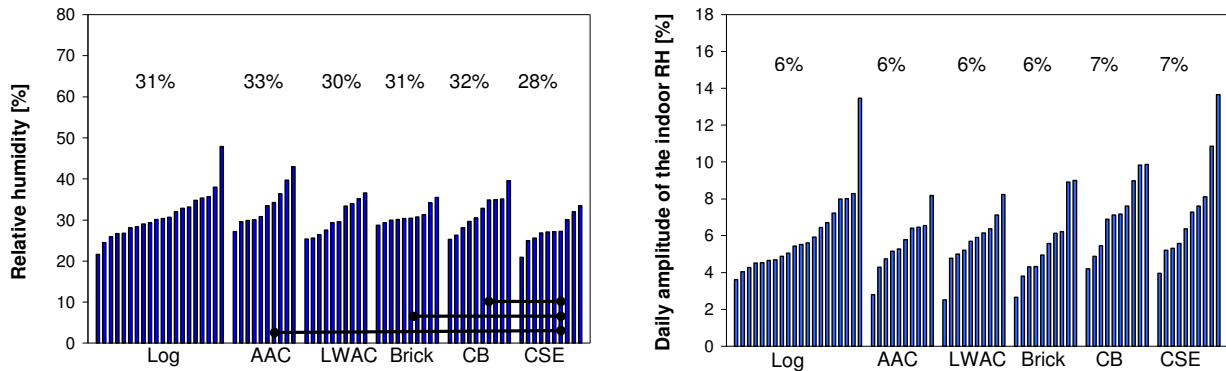

FIG. 4: The level of relative humidity (left) and the amplitude of relative humidity (right) during the winter period 2006...2007 (1.12.2006...28.2.2007). Horizontal lines mark significant differences between the house groups. Average values of different house groups are presented.

The daily average amplitudes of absolute humidity show no significant difference between different house groups during winter (Figure 5, left). In Figure 5 (right) the average value of average daily amplitude of temperature in the studied houses is compared. The log houses had significantly higher daily amplitude of temperature compared to all the other house groups except the AAC and concrete element houses. The AAC houses had significantly higher daily amplitude of temperature than the shuttering concrete block houses.

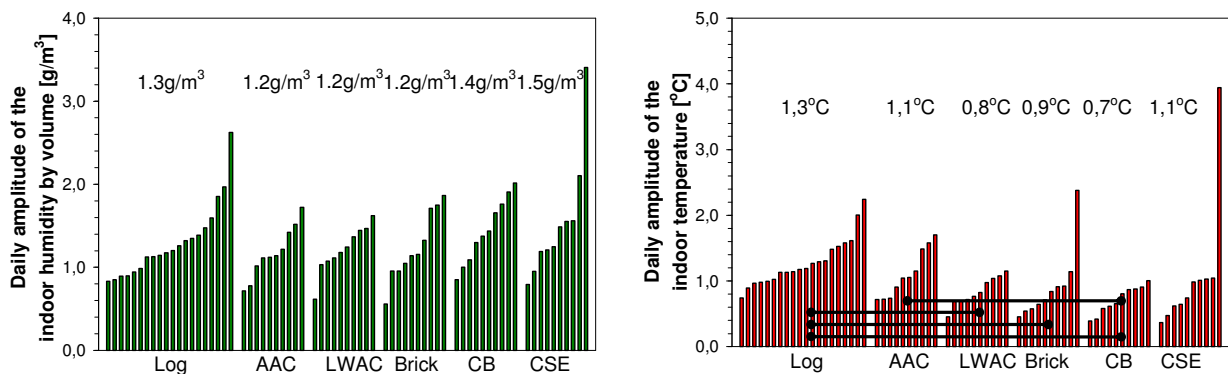

FIG.5: The distribution of the average daily amplitudes of absolute humidity (left) and temperature (right) during the winter period 2006...2007 (1.12.2006...28.2.2007). Horizontal lines mark significant differences between the house groups. Average values of different house groups are presented.

Figure 6 shows a comparison of average daily amplitudes of absolute humidity in houses with low ventilation rate (<0,25 1/h) and high ventilation rate (>0,5 1/h). The amplitude was greater in houses with higher ventilation rate.



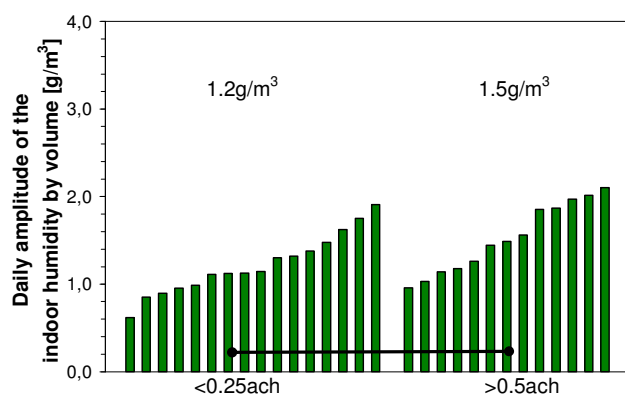

FIG.6: The distribution of the average daily amplitudes of absolute humidity during the winter period 2006...2007 (1.12.2006...28.2.2007) in houses with low and hig ventilation rate.

## 4. Discussion

In this paper, an overview on the level of relative humidity and daily amplitudes of relative and absolute humidity and temperature in real houses is made. For the indoor climate study, houses were divided into different house groups based on the main exterior wall type. Table 1 summarizes the results. The measured heavyweight houses did not have major differences in the level of relative humidity and the daily average amplitude of relative humidity. During the summer season the daily amplitude of absolute humidity in houses with AAC exterior walls was significantly minor than in log, shuttering concrete block and concrete element houses. Also, the log houses had significantly higher amplitude of absolute humidity than cavity brick houses. In winter period houses with low ventilation rate (<0,25 1/h) had significantly minor amplitude of absolute humidity than houses with high ventilation rate (>0,5 1/h). There were significant differences between the house groups in daily amplitude of temperature. Generally, log and AAC houses seemed to have higher amplitude of temperature than the rest of the house groups. The average values of average daily temperatures of the house groups varied from 0.7 to 1.3 °C. Overall, this kind of fluctuation of temperature has a more important effect on the relative humidity in the houses than the type of exterior wall.

TABLE. 1: Summary of averages of average daily amplitudes of temperature ( $T$ ), relative humidity ( $RH$ ) and absolute humidity ( $v$ ) during summer and winter period.

	Number of houses	$\Delta T$ , [°C]		$\Delta RH$ , [%]		$\Delta v$ , [g/m <sup>3</sup> ]	
		Summer	Winter	Summer	Winter	Summer	Winter
Log	19	1,2	1,3	7	6	1,6	1,3
Autoclaved aerated concrete (AAC)	10	1,0	1,1	5	6	1,2	1,2
Lightweight aggregate concrete (LWAC)	10	0,8	0,8	6	6	1,5	1,2
Brick	10	0,8	0,9	6	6	1,3	1,2
Shuttering concrete block (CB)	10	0,8	0,7	7	7	1,5	1,4
Concrete sandwich element (CSE)	10	0,7	1,1	7	7	1,6	1,5

Three years prior to the current study, a similar study in 100 timber-framed houses was made (Vinha et al. 2005, Kalamees et al. 2006). As both studies were conducted according to similar procedure, it is easy to compare the results. Envelopes of the timber-framed houses were divided into vapour tight envelope or vapour permeable envelope constructions. Vapour tight refers to an envelope where a plastic vapour barrier foil was used or polyurethane foam was used as thermal insulation. Permeable refers to a structure in which paper air barrier was used i.e. no specific vapour barrier was used (permeability of the internal surface is not taken into account in this division). In addition, a more specific classification to hygroscopic and non-hygroscopic room envelopes was made: the rooms with the hygroscopic interior surface materials and the rooms with the fully non-hygroscopic interior surface materials. For example, the rooms where the walls were covered with the hygroscopic surface material and the ceiling was covered with the non-hygroscopic material were categorized as a hygroscopic subdivision. The main hygroscopic surface material of the walls was wallpaper made of paper on the wood chipboard or on the plasterboard and wooden boarding. The major non-hygroscopic surface materials were vinyl-wallpaper and paint. The paints most commonly used on the ceilings and usually on the walls were assumed to be non-hygroscopic.

Study showed significant differences of average daily amplitudes of humidity during summer. In timber-framed detached houses with hygroscopic indoor surfaces, the average daily amplitude of the humidity by volume and RH during the first measurement period was significantly lower than in rooms with non-hygroscopic indoor surfaces (8% vs. 9% and  $1.9 \text{ g/m}^3$  vs.  $2.1 \text{ g/m}^3$ ). The ventilation, however, had a more significant role to the amplitude of daily relative and absolute humidity and temperature i.e. houses with balanced ventilation system had a lower amplitude than houses with mechanical exhaust ventilation (Vinha et al. 2005, Kalamees et al. 2006). The simulations by Kurnitski et al. (2006) showed that the permeable and hygroscopic structures improved the air quality considerably in the summer period. However, in practice the permeable and hygroscopic structures had only a minor effect on the indoor climate. This reduction was concluded to derive from window airing and furnishing that were not taken into account in simulations. The vapour tightness of the timber-framed building envelope did not show significant difference in average daily amplitudes of RH and absolute humidity.

The timber-framed houses had higher daily amplitudes of humidity and temperature than heavyweight houses. One must, although, notice that the measurement years were different.

There are many uncontrolled factors affecting the indoor climate in a field study. The orientation of the houses, architecture and surroundings were different in every case. Temperature sensors were located in the master bedroom and the orientation of this room plays an important role. As all the houses were different and situated in different areas, urban or natural surroundings, neighbouring houses or trees might directly influence the indoor conditions. Also in real houses the textiles, furniture or other furnishing may play a very important role in dampening the humidity fluctuation of indoor air. On the other hand, the influences of these factors decrease, when the number of houses is large, as in this study.

The classification of surface material properties in field test was found difficult to do (the correct paint type, the number of layers of paint and the moisture permeability of wallpapers) and for this reason only a rough classification based on exterior wall types was made and the internal surface of the envelopes was not considered. In the log houses, the interior surface of the external wall was usually treated with either lacquer, latex paint or some other kind of protective fluid. The exterior walls of the other heavyweight houses were usually plastered and painted.

## 5. Conclusions

The results of this study showed in general no major differences in the level of relative humidity between the measured house groups. However, the level of RH in concrete element houses during winter was significantly lower than in houses with autoclaved aerated concrete block, brick cavity and shuttering concrete block exterior wall, but the level of temperature in concrete element houses was also a bit higher. No significant differences in the daily average amplitude of relative humidity were found. During the summer season, the daily amplitude of absolute humidity in houses with AAC exterior walls was significantly lower than log, shuttering concrete block and concrete element houses. Also, the log houses had significantly higher amplitude than the cavity brick houses. In winter period houses with low ventilation rate ( $<0,25 \text{ 1/h}$ ) had a significantly smaller amplitude of absolute humidity than houses with high ventilation rate ( $>0,5 \text{ 1/h}$ ). There were some differences in the daily amplitude of temperature between the house groups. Generally, log and AAC houses seemed to have higher amplitude of temperature than the rest of the house groups, partly because smaller part of the walls participates

in temperature regulation. Overall, the fluctuation of temperature (average values of different house groups 0.7...1.3 °C) affects relative humidity more than the type of exterior wall.

The timber-framed houses had higher daily amplitudes of humidity and temperature than the heavyweight houses although one must notice that the measurement years were different. The hygroscopic mass of furniture, textiles, etc. as well as real air change rates, including window airing are probably factors that play significant roles in indoor humidity.

## 6. Acknowledgements

This study is part of large field research project carried out by Department of Civil Engineering at Tampere University of Technology and HVAC Laboratory at Helsinki University of Technology. The project has been financed by TEKES (National Technology Agency of Finland) and Finnish companies and associations. We extend our thanks to all assisting people, residents of the houses studied, and financiers of the research for their co-operation during the study.

## 7. References

- Cunningham M.J. (1994). Using hygroscopic damping of relative humidity and vapour pressure fluctuations to measure room ventilation rates. *Building and Environment* 1994; 29 (4): 501-510.
- El Diasty R., Fazio P., Budaiwi I. (1992). Modelling of indoor air humidity: the dynamic behaviour within an enclosure. *Energy and Buildings* 1992; 19 (1): 61-73.
- El Diasty R., Fazio P., Budaiwi I. (1993). The dynamic modelling of air humidity behaviour in a multi-zone space. *Building and Environment* 1993; 28 (1): 33-51.
- Hagentoft C.E. (1996). The effect of the building envelope on the indoor relative humidity. In: *Proceedings of the 4th symposium on Building Physics in the Nordic Countries*, Espoo: Building Physics; 1996, Vol 1, p. 27-34.
- Isetti C., Laurenti L., Ponticciello A. (1988). Predicting vapour content of the indoor air and latent loads for air-conditioned environments: Effect of moisture storage capacity of the walls. *Energy and Buildings* 1988; 12 (2): 141-148.
- Kalamees T., Vinha J., Kurnitski J. (2006). The potential of HVAC systems and building envelope on the indoor climate stability in lightweight detached houses. Annex 41 working meeting 25-27 October, Lyon, France.
- Kurnitski J., Suursoho A., Palonen J. (2003). The effect of structures on IAQ and thermal comfort. In: *Proceedings of ISIAQ 7th International Conference Healthy Buildings*, Singapore; 2003, Vol. 3, p. 375-381.
- Kurnitski J., Kalamees T., Palonen J., Eskola L., Seppänen O. (2006). Potential effect of permeable and hygroscopic lightweight structures on thermal comfort and perceived IAQ in a cold climate. *Indoor Air* 2007; 17: 37-49.
- Padfield T. (1998). The role of absorbent materials in moderating changes of relative humidity. Ph.D thesis, Department of Structural Engineering and Materials, The Technical University of Denmark., 1998.
- Simonson C.J., Salonvaara M., Ojanen T. (2002). The effect of structures on indoor humidity – possibility to improve comfort and perceived air quality. *Indoor Air* 2002; 12 (4): 243-251.
- Simonson C.J., Salonvaara M., Ojanen T. (2005). Moisture Performance of an Airtight, Vapor-permeable Building Envelope in a Cold Climate. *Journal of Thermal Envelope and Building Science* 2005; 28: 205 - 226.
- Tsuchiya T. (1980). Infiltration and indoor air temperature and moisture variation in a detached residence, *Journal of the Society of Heating, Air-Conditioning and Sanitary Engineers of Japan* 1980; 54 (11): 13-19
- Vinha J., Korpi M., Kalamees T., Eskola L., Palonen J., Kurnitski J., Valovirta I., Mikkilä A., Jokisalo J. (2005). Tutkimusraportti 131. Puurunkoisten pientalojen kosteus- ja lämpötilaolosuhteet, ilmanvaihto ja ilmatiiviys. Tampere University of Technology, Department of Civil Engineering. (In Finnish)

# Crawl space heat and moisture behaviour

*Miimu Airaksinen, Dr.,  
Technical Research Centre of Finland, VTT  
miimu.airaksinen@vtt.fi, www.vtt.fi*

**KEYWORDS:** *crawl space, moisture, evaporation from ground, ground covers, dynamic modelling*

## **SUMMARY:**

*A crawl space foundation is widely used in buildings and detached houses in northern countries. The relative humidity of the air in crawl spaces is the most critical factor concerning mould growth in the structures of a crawl space. Possible contamination in the crawl space might be transported indoors if the pressure inside the apartment is lower. The objective of the study was to find out the important properties of ground covers and the optimal air change rates for the controlling of moisture conditions in an outdoor air-ventilated crawl space in a cold climate and to estimate the acceptability of current moisture conditions in respect of material durability.*

## **1. Introduction**

A crawl space foundation is widely used in buildings and detached houses in northern countries. Basements with a crawl space have a long tradition and their worth has been proven in many old buildings. In respect of radon concentrations indoors, a crawl space is an advantageous construction. The radon concentration in leakage air through a base floor decreases remarkably if the crawl space is well ventilated (Arvela 1995)

Due to higher awareness of energy consumption, the base floor U value has decreased nowadays to  $0.2 \text{ W/m}^2\text{K}$ , which corresponds to approximately 20 cm of mineral wool insulation. The heat losses through the base floor are smaller and, thus, a lower base floor U value leads to a colder crawl space with higher relative humidity. Crawl spaces are mostly ventilated by outdoor air and ventilation is usually natural, but mechanical exhaust ventilation is also used to some extent. There is frequently a limited number of ventilation ducts and openings in the foundation walls, which leads to low air change rates.

Alternatively, crawl spaces can be ventilated mechanically with exhaust air from the building (Anderson and Samuelsson 1987, Lehtinen and Viljanen 1991, Hagentoft and Harderup 1993). In this case the crawl space should be heated by exhaust air, i.e. the crawl space is highly insulated but there is no insulation in the base floor. The crawl space can even be left unventilated if the moisture insulation is perfect (Åberg 1990). However, as these applications are relatively difficult to build and rather expensive, they have not become a common building practice.

## **2. Methods**

### **2.1 Crawl spaces studied**

The crawl spaces studied were chosen to represent typical outdoor air-ventilated crawl spaces used in Finland. Detached houses and smaller houses often have timber frames. Their base floor is wooden, with thick insulation in the base floor. The crawl spaces in these buildings are often relatively cold due to the low U value of the base floor, about  $0.2 \text{ W/m}^2\text{K}$ ; see Figure 1 (left). Apartment buildings and industrial buildings are often built from sandwich elements, and the base floor is typically made of hollow core slabs (base floor U value  $0.4 \text{ W/m}^2\text{K}$ ). The foundations of these buildings are on piles due to clay ground soil; see Figure 1 (right).

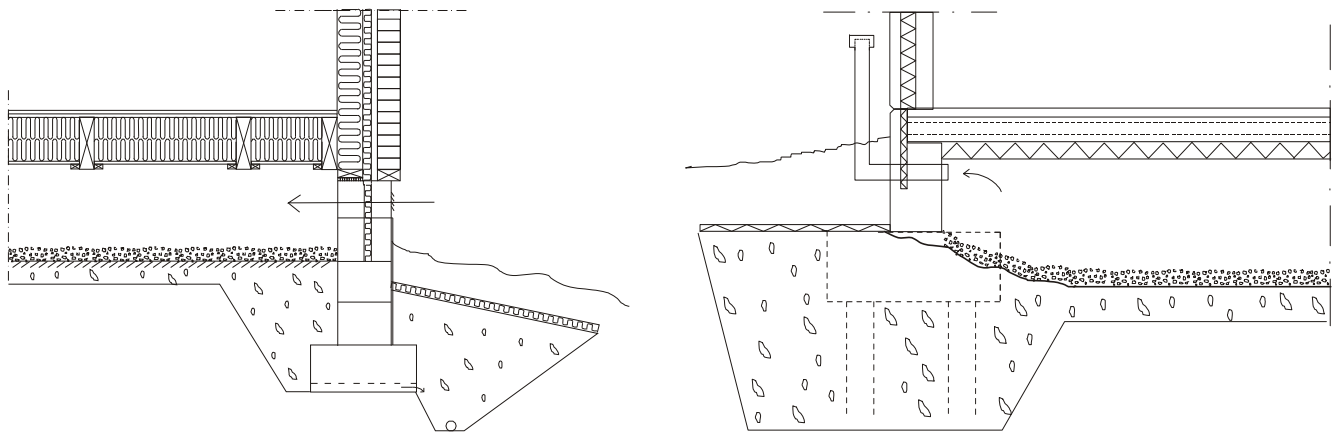

Figure 1.A wooden (left) and a concrete (right) crawl space

The crawl spaces and ground covers studied are shown in Table 1. Here a crawl space with a base floor U value of  $0.2 \text{ W/m}^2\text{K}$  is referred to as a cold crawl space and a crawl space with a base floor U value of  $0.4 \text{ W/m}^2\text{K}$  a warm crawl space.

Table 1. Crawl spaces studied

Paper	Base floor U value [ $\text{W/m}^2\text{K}$ ]	Base floor area [ $\text{m}^2$ ]	Base floor type	Ground covers used
I	0.4	95	concrete	Uncovered, PVC, <sup>1</sup> EPS
II	0.4	95	concrete	Uncovered, PVC, EPS, <sup>2</sup> LWA
	0.2	470	wooden	
III	0.4/0.2	470/100	concrete	PVC, EPS, LWA
	0.2	470	wooden	
IV	0.2	470	wooden	PVC, EPS, LWA, <sup>3</sup> CS
	0.2	117	wooden	

<sup>1</sup>EPS expanded polystyrene

<sup>2</sup>LWA lightweight clay aggregate

<sup>3</sup>CS crushed stone

## 2.2 Simulation model

The results of field measurements by Kurnitski (2000) were used to validate the modelled crawl space in the IDA simulation environment. The crawl space modelled was concrete, and a wooden crawl space was also modelled. The crawl spaces were modelled in the IDA simulation environment. IDA is a modular simulation environment which consists of a translator, solver, and modeller. The solver and physical models are separated, which makes it possible to change the mathematical formula of any component without changing the model description file. The modules are written in Neural Model Format (NMF), which serves at the same time as a readable document and a computer code. Via the translator, the modules can be used in several modular simulation environments (Sahlin 1996, Sahlin and Bring 1989, 1991).

In the RC (resistance capacity) network of heat transfer model the main simplification is to model the heat transfer of the ground soil by a semicircular flow pattern; see Figure 2.

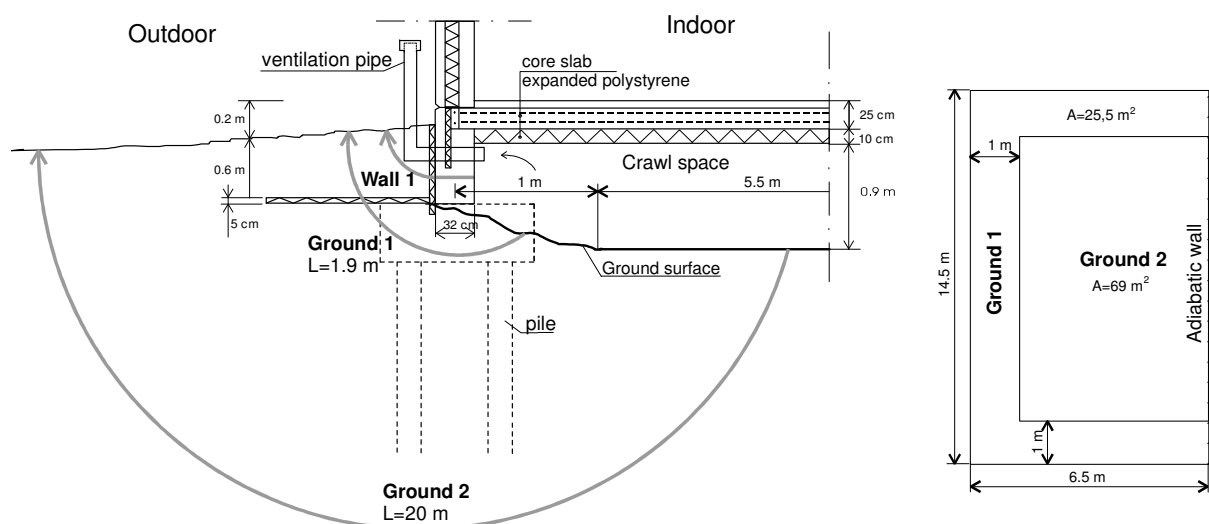

Figure 2. Heat flow patterns, Ground 1, Ground 2, and Wall 1 in the modelled crawl spaces.

### 3. Results

#### 3.1 Accuracy of simulation model

Good results were achieved both in a warm and cold crawl space when the ground moisture evaporation from the uncovered ground surface was calculated as mass transfer from the surface. In the winter, during the two last weeks of February, the outdoor air sensors were covered with snow, which explains some disagreement between the calculated and measured temperatures during this period (calculated T and RH are somewhat higher).

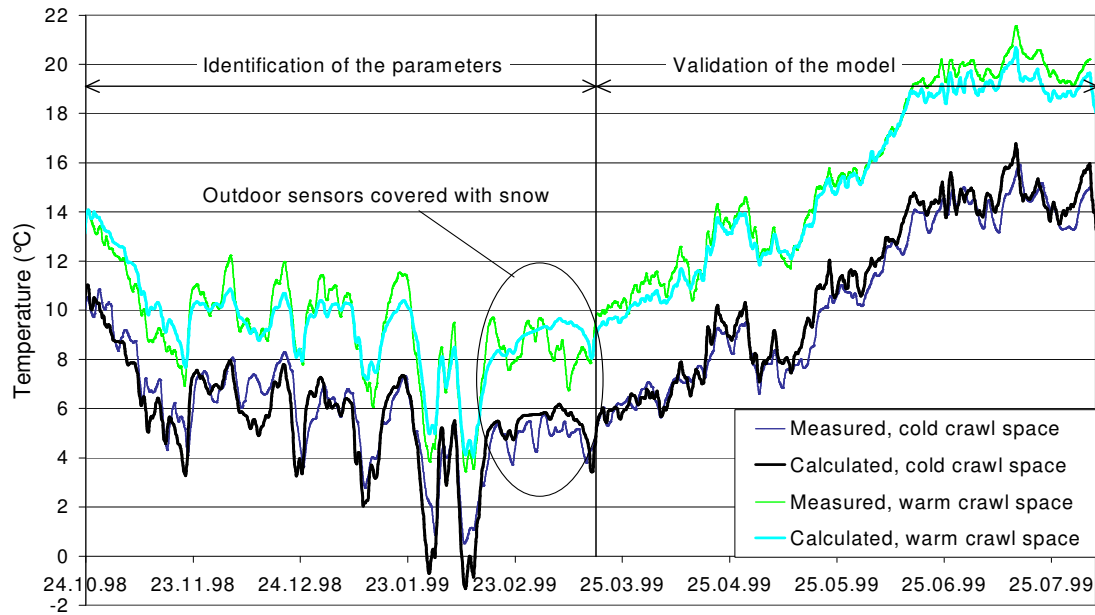

Figure 3. Calculated and measured temperatures in the crawl spaces. The air change rate in both calculations is 1.1 ach (24-hour moving averages). Ground cover in both crawl spaces was lightweight clay aggregate (15 cm in the cold and 17 cm in the warm crawl space)

### 3.2 Effect of ventilation

In a warm crawl space a high air change rate cools down the crawl space in the winter and warms it up slightly in the summer; see Figure 4. The lowest RH in the crawl space is achieved when the air change rate during the heating season is 0.2-1.0 ach. In the summer, the RH is not sensitive to the air change rate due to the crawl space being relatively warm.

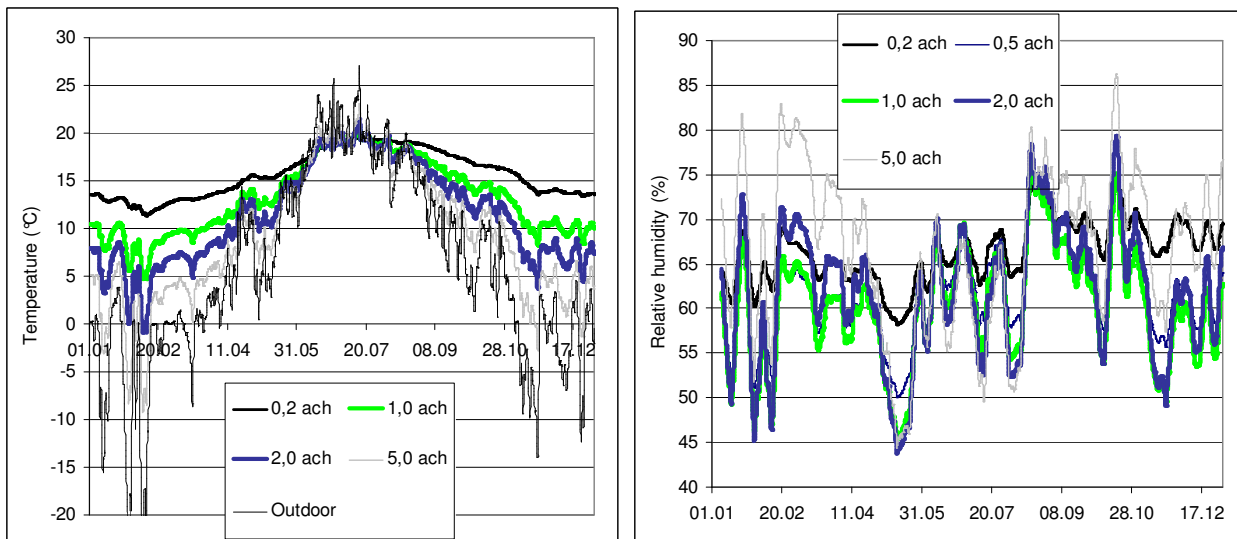

Figure 4. Temperature (left) and relative humidity (right) in a relatively warm crawl space at various air change rates. The ground is covered with 17 cm LWA (Temperature 24-hour moving averages, RH, weekly moving averages).

The crawl space of the wooden building was relatively cold throughout the year. High air change rates warm the crawl space up in the summer; see Figure 5 (left). The RH is clearly higher than in the warm crawl space - see Figure 5 (right) - exceeding 75% at the end of May. The highest air change rate, 5 ach, gives the lowest RH in the summer. In the case of higher air change rates (2.0 and 5.0 ach), a two-step air change rate was used (2.0 or 5.0 ach in the summer, May 1–September 30, and in the cold season 0.5 ach).

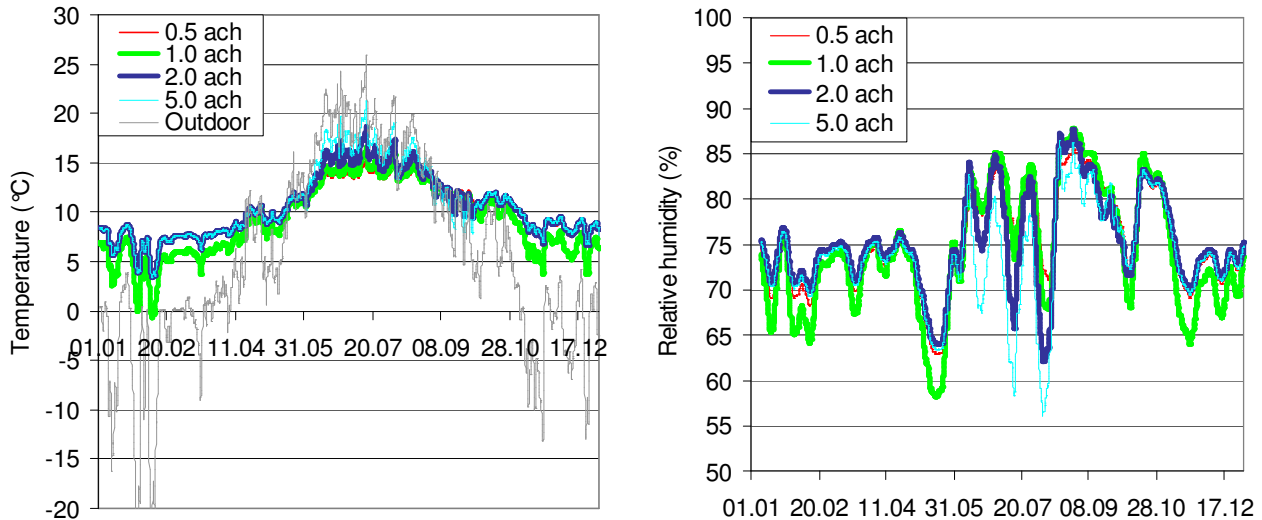

Figure 5. Crawl space air temperatures when the ground is covered with a 15-cm layer of LWA. (Temperature 24-hour moving averages, RH weekly (left) and RH (right) at various air change rates. The moving averages).

### 3.3 Different ground covers

Ground covers may have an effect in two ways; they reduce the moisture evaporation from the ground and, on the other hand, they may act as a thermal insulation.

In the relatively warm (apartment building) crawl space all ground covers reduced the relative humidity in the crawl space sufficiently. In the cold (wooden) crawl space the relative humidity varied considerably, depending on the properties of the ground cover. For the simulations an air change rate of 2 ach was used to warm up the cold wooden crawl space in the summer. Uncovered ground (sand) and that covered with a PVC sheet behaved in nearly the same way in the summer, both having a very high relative humidity; see Figure 6. This is caused by the high heat capacity, which is the same in both cases and demonstrates that the outdoor air is the main moisture source during the summer.



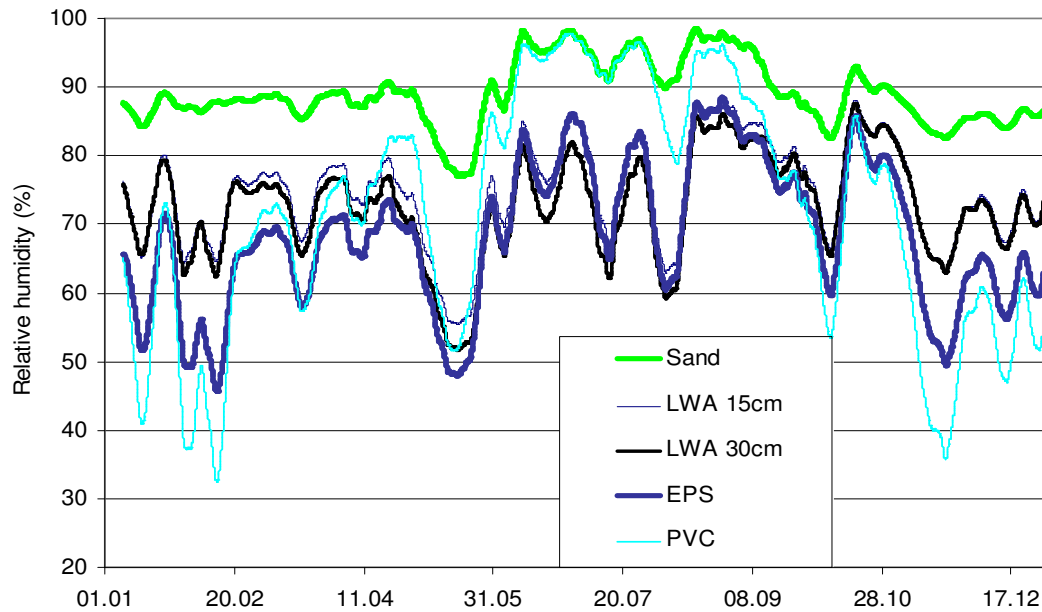

Figure 6. Crawl space air RH with different ground covers in the cold wooden crawl space (2.0 ach, 24-hour moving averages).

The uncovered ground showed the highest average evaporation rate, on average  $1.7 \text{ g h}^{-1}\text{m}^{-2}$ . Although EPS insulates far less (on average  $0.15 \text{ g h}^{-1}\text{m}^{-2}$ ) than the 15-cm LWA cover (on average  $0.74 \text{ g h}^{-1}\text{m}^{-2}$ ), there are only small differences in the relative humidity in the summer, when the risk for mould growth is highest.

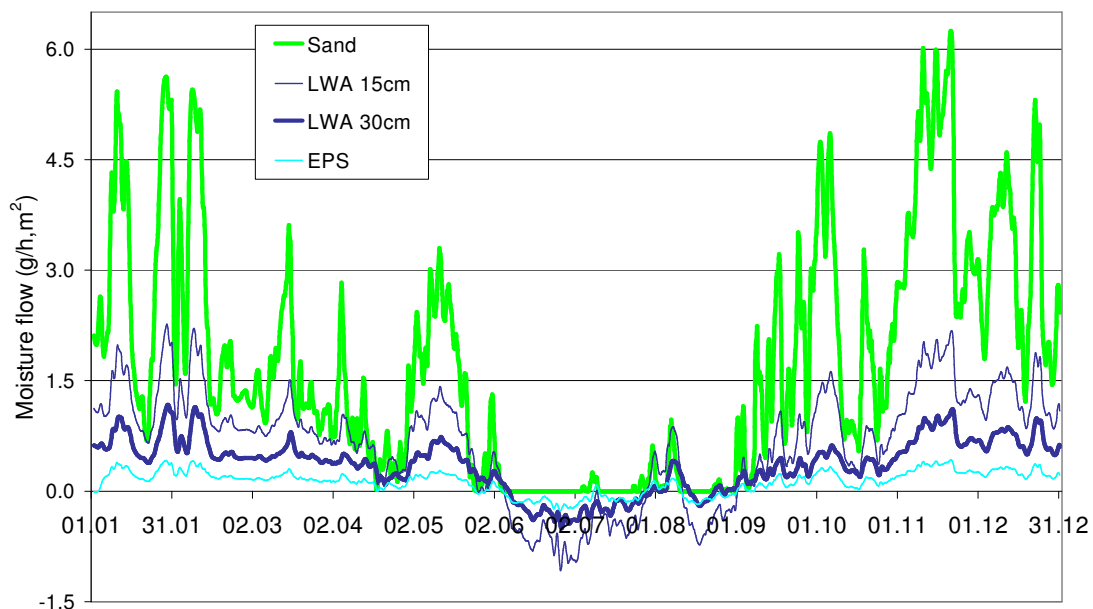

Figure 7. Moisture flow from ground (evaporation rate in the case of sand). Positive values indicate evaporation and negative values moisture flow from air to ground; in the case of sand 0 values can be interpreted as condensation (24-hour moving averages).

## 4. Conclusion

It was shown that in a relatively warm crawl space moisture problems were easy to avoid – ground soil should be covered so as to prevent moisture flow from the ground and an air change of at least 0.5 ach is enough to keep relative humidity at a low level. A relatively cold crawl space needs a ground cover with moisture and thermal resistance. A ground cover with a moderate thermal resistance, such as 15 cm lightweight aggregate, needs a higher ventilation rate, at least 2.0 ach, to warm up the crawl space in the summer. A ground cover with a high moisture capacity can stabilise the fluctuation of relative humidity in a crawl space, and thus avoid critical peaks of relative humidity in respect of mould growth. The safest ground cover solution is a thick cover with a high thermal resistance and a low air change rate of 0.5 ach; with this approach natural ventilation can be used.

## 5. References

- Andersson L. & Samulesson S., 1987, Krypgrundssystem för moderna småhus – Utvecklingsmöjligheter (*Crawl space for a modern dwelling – Development possibilities*) Träteknikcentrum, Rapport P 8704029, Stockholm, Sweden (in Swedish)
- Arvela H., 1995, Residential Radon in Finland: Sources, Variation, Modelling and Dose Comparisons, Academic dissertation, Finnish Centre for Radiation and Nuclear Safety, STUK-A124, Helsinki, Finland
- Hagentoft C.E. & Harderup L.E., 1993, Temperature and moisture conditions in a crawl space ventilated by indoor air, Building Physics '93, 3<sup>th</sup> Nordic Symposium, Proceedings, Vol 1, 261-268
- Kurnitski J., 2000, Crawl space air change, heat and moisture behaviour, *Energy and Buildings*, **32**, 1, 19-39.
- Lehtinen T. & Viljanen M., 1991, Puurakenteisen lämpöalopohjan rakennusfysikaalinen toiminta (Building physical behaviour of timber ground floor with warm crawl space), Helsinki University of Technology, Laboratory of Structural Engineering and Building Physics, Report 21, Espoo, Finland, (in Finnish)
- Sahlin P., 1996, Modelling and Simulation Methods for Modular Continuous Systems in Buildings, Doctoral Dissertation, Stockholm, Sweden
- Sahlin P., 1996, NMF Handbook, An introduction to the neutral model format, NMF version 3.02, ASHRAE RP-839, Dep. of Building Sciences, KTH, Stockholm, Sweden
- Sahlin P. & Sowell E.F., 1996, The Neutral Model Format for Building Simulation, Stockholm, Sweden
- Sahlin P., Bring A., & Sowell E.F., 1989, A Neutral format for building simulation models, In Proc. IBPSA confer. "Building Simulation '89", 273-281 Vancouver, Canada
- Sahlin P. & Bring A., 1991, IDA SOLVER – a Tool for Building and Energy Simulation, In Proc. BEPAC confer. "BEP'91", 576-582, Nice, France
- Åberg O., 1990, The unventilated crawl space foundation, Heat and moisture transfer in buildings – research papers 1990, Lund Institute of Technology, Report TVBH-3016, Lund, 1991, 41-45



# Simple climate control in archives is hindered by too strict standards

*Tim Padfield*  
*tim@padfield.dk*

**KEYWORDS:** *archive, BS5454:2000, humidity, temperature, buffer.*

## **SUMMARY:**

*There is now abundant built evidence that archives can sustain a moderate relative humidity and temperature by warming, or by dehumidifying. Four examples of museum storage buildings, of diverse purpose, size and location, show adequate climatic stability without air conditioning. However, it is not possible without air conditioning to conform with the strict temperature limits recommended in the widely used British Standard BS5454:2000, which, though an advisory standard, is often used as a building specification. The strictness of this standard is not supported by evidence for chemical or physical damage if its limits are exceeded, yet deference to it hinders the building of low energy archives which are tolerant of loss of power and neglect.*

## **1. Introduction**

There are many specialised buildings that require a degree of climate control that is not considered necessary in ordinary houses, or even in offices and factories. Museums and archives in particular are expected to have a constant climate, in both temperature and relative humidity, and to have pure air.

One might think that the environmental requirements for these exotic buildings, always a tiny proportion of the total stock, are only of interest to a few specialists. However, one can argue that a detailed study of these buildings provides valuable lessons for the construction of buildings for other purposes. In particular, this study illustrates the arbitrary limitations to energy efficiency set by standards of doubtful quality, and the physical limitations set by current building technology.

## **2. The tyranny of the standard**

A serious constraint encountered by the designer of an archive or museum is the specified indoor climate. I take as an example the British standard for archives BS5454:2000 [British Standard 2000]. This is an influential document. Obeying it is obligatory for British archives [National Archives 2004]. It has also been invoked in projects outside the UK, for example the storage building of the Royal Library in Copenhagen. It is also common for standards developed in temperate climates to be considered applicable in exotic climates, such as the Egyptian desert (St. Catherine's Monastery library, Sinai). The widespread use of the British standard is because the international standard, ISO 11799:2003, is not prescriptive, giving only general guidance which cannot be used as a specification because it contains no exact numbers. It is the didactic nature of the British standard which has made it so influential. But is it right?

Unlike scientific articles, the standard is anonymous - its authors shelter behind the prestigious names of the participating organisations. Yet it claims to be based on scientific principles and findings. In its favour, the standard does not assert that the climate must be as it advises, but in practice the standard is used as a specification, with legal force. The standard recommendation is unattainable without air conditioning. I illustrate this assertion later, but first I describe the recommended climate and try to understand why it is so tightly constrained.

"The temperature set point must be between 16°C and 19°C with a tolerance of 1°C on either side, but ranging neither below the minimum nor above the maximum."

This is tricky to achieve in any building, anywhere, even with air conditioning.

"Relative humidity should be at a fixed point between 45% and 60% with a tolerance of 5% on either side, but ranging neither below the minimum nor above the maximum."

Amazingly, this is easy to achieve in an archive, provided it is full of paper and cardboard boxes which buffer the relative humidity, and provided the air exchange rate is low. Demonstrating a constant relative humidity in an empty archive room, which is necessary to persuade the client to take over the building, is another matter, considered in a later section.

The standard furthermore demands that "The air within the repository should not be stagnant". That forces the use of fans and consequently activates another demand: "If a mechanical ventilation system is provided it should be designed to reduce pollutant concentration by introducing a proportion of fresh air".

Given that the temperature and RH are already so strictly defined, air movement surely has no significance. Air movement itself has no reported effect on biological growth but it is customarily invoked as an indirect defence against fungal growth. Moving air serves to transport heat to cold surfaces, typically in corners of outside walls, where local low winter temperature results in a raised local RH. If the RH is as specified throughout the building, there is no need to avoid stagnant air. Indeed many archived papers are kept in boxes, thus ensuring stagnant air. A method of achieving the specified climate is elevated by the standard to an independent requirement.

The argument for introducing a portion of fresh air is unconvincing. Clean air is a rare commodity, unknown in cities, where most archives are built, so pollutants are pumped into the archive. Pollution generated within the archive through outgassing from the furniture, and from the archived material, is a well known threat in museums. Morten Ryhl-Svendsen [Ryhl-Svendsen 2007a, 2007b] has shown that at least two air changes per hour is necessary materially to reduce the threat from internally generated pollutants, while it is possible to attain the same purity by recirculating the air through a carbon filter, without importing pollutants generated outside. Two exchanges with outside air per hour will destroy the humidity buffering performance, which only works effectively at less than one air change every ten hours.

The strict limits for temperature are designed to minimise the risk of condensation when papers are brought from the archive to a reading room at a congenial temperature for people. According to the standard, the narrow temperature range is "In order to avoid the need for acclimatization when documents move from storage to reading room and back,..."

The upper temperature limit is still below the temperature of most reading rooms, so one need only consider the worst case, the archive lower limit at 16°C with a reading room in summer at 22°C and 60% RH. The RH in the layer of air immediately adjacent to the cool object will rise momentarily to 87%, which would cause a considerable migration of water from air to object, and then back again as the object re-equilibrates to the room climate. In reality, the first molecules absorbed into the paper will release heat of condensation. So the paper will warm up quickly and the theoretical water content in equilibrium with 87% RH will never be reached.

The standard allows seldom used items to be stored at a fixed point between 16°C and 13°C, with the same one degree tolerance. One wonders how the standard committee decided on this lower limit, and its containment within a two degree window.

### 3. The damage caused by the environment

Archives contain materials of different durability. Only paper, parchment and cellulose acetate film have been studied thoroughly. Paper and parchment are so durable compared to the human life span that accelerated ageing has to be employed in scientific studies. Extrapolation according to the activation energy concept is then applied to predict durability at low temperature, from degradation rates typically measured at 60 - 100°C. There are many published studies, one of the latest is by [Balažic 2007]. Rag paper is notably more durable than paper made from ground wood pulp, so only relative deterioration rates are quoted for the archives which are described in this article. The deterioration rate is based on a fictitious, but typical, hydrolysis reaction with an activation energy of 100KJ/mol. The calculation is described in [Padfield 2004].

There is no evidence which suggests a low temperature limit for safe storage. Calhoun [Calhoun 1952] found no damage to photographic film from cold storage. Colour film and acetate base film is now stored at low temperature, down to -20°C, in many archives. Mecklenburg and co-workers [Mecklenburg 2005] show that some materials become brittle at low temperature but that does not necessarily damage their durability if they are not disturbed.

The safety of low temperature exposure is attested by the practice of some museums to put objects returning from exhibition through a sudden exposure to  $-30^{\circ}\text{C}$  for one day, to kill bugs that may be hitching a ride into the store. The National Museum of Denmark has reported one object damaged, among tens of thousands that have been subjected to this extreme temperature. [Jensen 2008].

It is conceivable that *variation* in temperature can cause deterioration additional to that caused by the steady temperature advocated by the standard. Bigourdan and Reilly [Bigourdan 2002] assert that the damage done to paper by daily temperature cycling between  $60^{\circ}\text{C}$  and  $80^{\circ}\text{C}$  was indistinguishable from that which would be caused by steady exposure to the two temperatures in sequence. Henry Wilhelm [Wilhelm 1993] quotes Kodak sources stating that repeated cycling of film between cold store and ambient does no damage. On the other hand Bogaard, and Whitmore [Bogaard 2002] have shown that RH cycling between 25% and 75% every two hours, at constant temperature, does damage paper, through mechanical disruption of the polymer molecules. However, constant RH is easy to achieve in a passively controlled archive.

The condensation danger inherent in transferring materials between cold storage and reading room is discussed by Padfield [Padfield 2002] who shows that slow temperature change is safe, provided the temperature gradient does not exceed  $7^{\circ}\text{C}$  within the object and its immediate enclosure. The relative humidity within a close fitting enclosure will remain nearly constant, unaided.

This brief survey of the evidence for temperature effects on artifacts suggests that the two degree window allowed by the standard is based on the principle that the best achievable constancy cannot be bad, rather than on quantitative evidence that it provides significant benefit. The consequent expense and complexity remain a problem for the building operator. A gentle annual cycle in temperature is not allowed. The possibility of increasing the lifespan of materials by storage below  $13^{\circ}\text{C}$  is not allowed. The standard provides no evidence to back its stringency and its logic is faulty in several paragraphs, particularly those concerning the need for ventilation.

#### 4. Archives without air conditioning

There are several archives and museum stores which do not use air conditioning and which deviate, often surprisingly little, from the BS5454 prescription. In the temperate zone there are two basic ways of controlling the climate in a museum store. The store can be heated to maintain about 50% RH, which means that it should hover about  $7^{\circ}\text{C}$  above the ambient temperature. Selective pumping of outside air can reduce the average temperature excess and humidity buffering can remove the need for excess temperature in summer. Alternatively the store can be dehumidified to 50% RH, while its temperature is allowed to follow the running average outdoor temperature. In favoured climates, it may not be necessary to heat or to dehumidify. I describe one example of each of these alternatives.

An example of an archive heated to maintain approximately 50% RH is the Arnemaghaean archive at Copenhagen University. The heat leaks in from the continuously heated office area, at a rate corresponding to about 5kWh per cubic metre per year. Heat leaks out through two thinly insulated outer walls, so that the temperature of the archive hovers midway between the constant  $22^{\circ}\text{C}$  of the building interior and the outside temperature with an annual cycle from about zero to  $19^{\circ}\text{C}$ . The too low temperature in summer is compensated by the humidity buffering, aided by selective pumping of outside air. The building is shown in figure 1 and the interior and exterior climate is shown in figure 2. The RH varies between 50% and 57%, within the BS limits, but the temperature cycles from  $16^{\circ}\text{C}$  in winter to  $22^{\circ}\text{C}$  in summer. The relative deterioration rate is 1.46, compared with the minimum BS5454 rate ( $17^{\circ}\text{C}$  at 50% RH) taken to be unity.



FIG. 1: The archive of the Arnemaganaean Institute of Copenhagen University is concealed behind the windowless area of the building (left). The archive, sectioned in the right hand picture, is insulated against both the internal and the outdoor temperature, so that its temperature is always about half way between the constant 22°C of the building and the variable outdoor temperature.

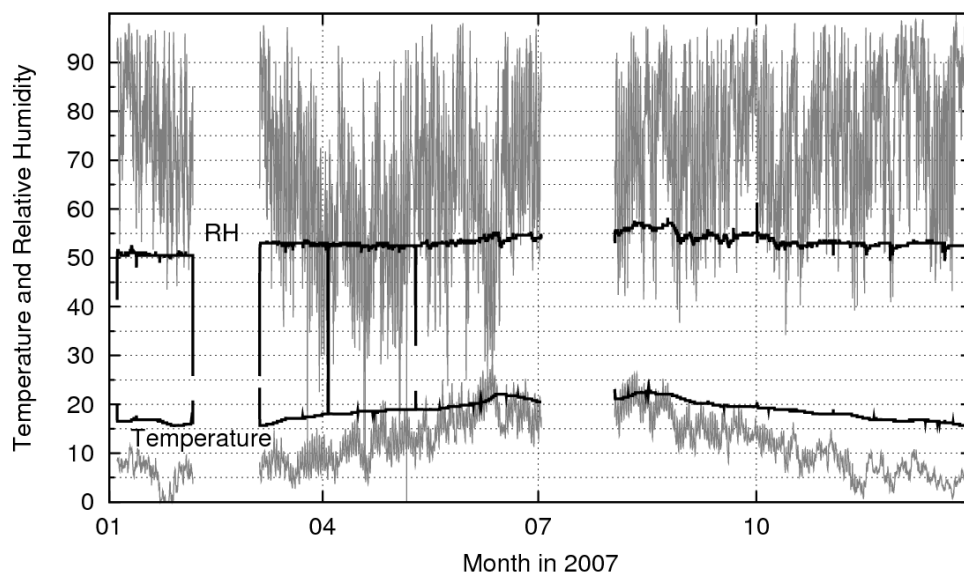

FIG. 2: The climate in the Arnemaganaean archive during 2007 (bold traces), compared with the outdoor climate (the jagged grey traces). [Jakobsen 2008]

An example of a dehumidified museum store is the Vejle storage building, described in detail by [Rasmussen 2007]. The interior climate is shown in figure 3. The temperature is a heavily buffered annual cycle from 8°C to 18°C, probably mainly moderated by the uninsulated concrete floor. The annual energy use is 2kWh per cubic metre, entirely spent on dehumidification. The relative deterioration rate is 0.67. The temperature cycle, however, wanders far outside the BS limits.

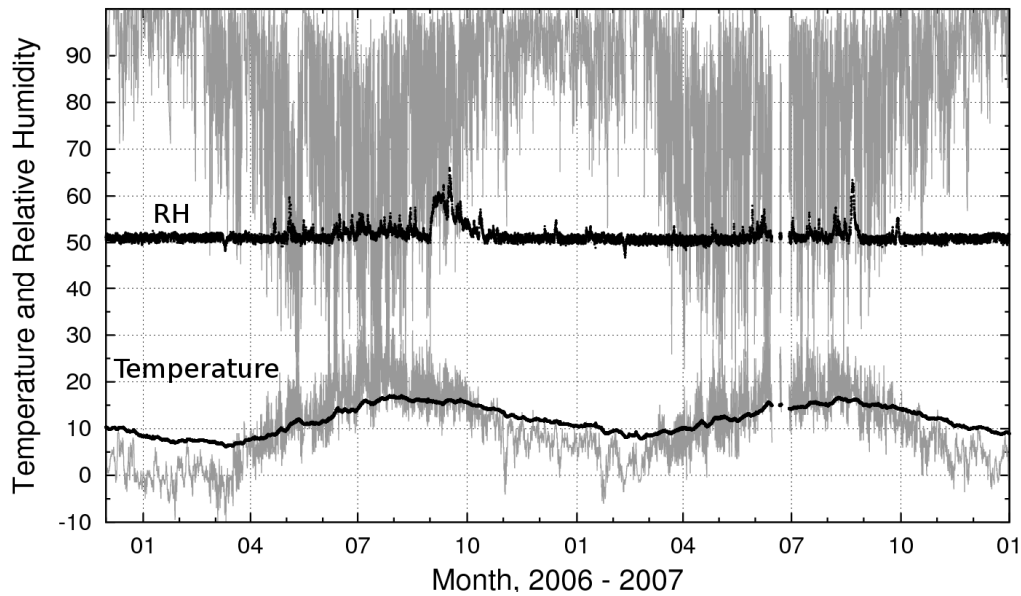

FIG. 3: Temperature and relative humidity outside (jagged grey) and within (bold lines) the Vejle storage building.

Finally, a very economical library is in St Catherine's Monastery, high in the mountains of Sinai, Egypt. Its climate is shown in figure 4. The energy consumption is zero and the relative deterioration rate is, astonishingly, 0.97. The temperature cycle is from 8°C to 30°C, but the low relative humidity compensates for the high summer temperature. Low RH, particularly the 15% reached in summer, worries conservators, but the library contains some of the oldest paper and parchment in existence, reaching back to the fourth century AD. The present library building dates from 1947 but the books must have been stored in a similar, natural climate during the 1500 years of the library's existence.

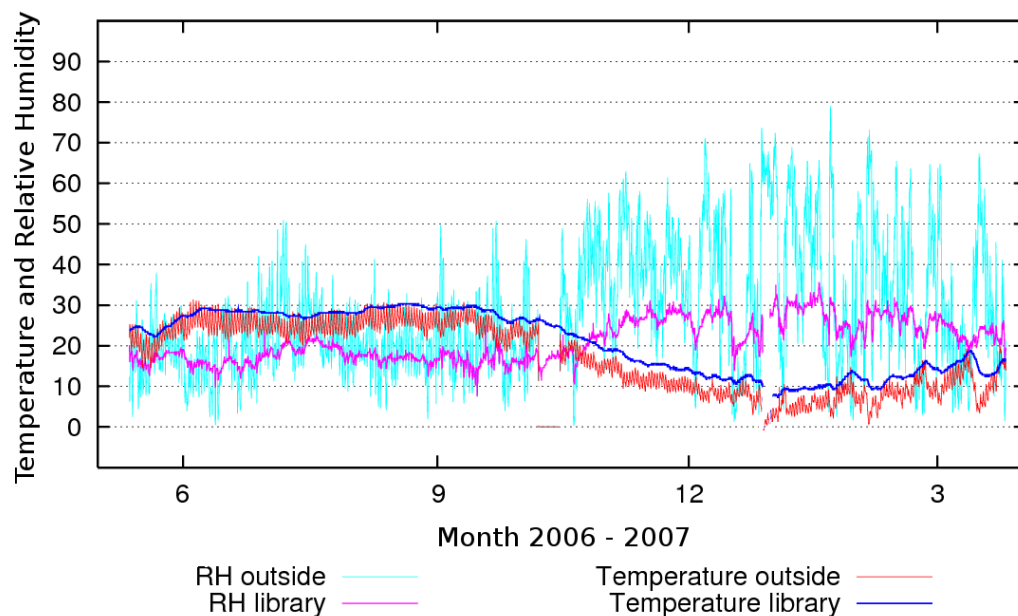

FIG. 4: The climate in the library of St Catherine's Monastery, Sinai, Egypt. [Justin 2007]



For comparison, the annual energy consumption of the recently built store of the Royal Library in Copenhagen is 30kWh per cubic metre [Bruun 2007]. Its relative deterioration rate is unity, because it conforms to BS5454.

One has to question whether air conditioning to BS5454, with the associated expense of constant surveillance by skilled engineers, is justified by greater durability of the stored items. Unstable materials such as film are already stored in cool rooms, beyond the scope of this article. The durable materials such as paper and parchment, which have long been stored in ordinary rooms with an annual cycle of temperature and relative humidity hardly need the extravagant constancy of the BS5454 climate.

## 5. Stabilising temperature and relative humidity

Buffering a room against the variation of outside temperature requires both a massive construction and also thermal capacity in the stored materials. The slow response of both the Arnemagnæan archive and the Vejle store shows that considerable buffering is possible, but it is impossible completely to flatten the annual temperature cycle. In contrast, the annual variation in RH can be nearly entirely eliminated. The stability of the relative humidity in the Arnemagnæan archive is not exceptional. There are several archives which show the same stability, without mechanical intervention. This is due to the immense water vapour sorption capacity of the stored material, combined with an air exchange rate less than once in ten hours.

Figure 5 shows, for example, the climate in the Suffolk record office, in Ipswich UK. This was heated by radiators to 16°C in winter. Because the temperature of the upper floor rose to 25°C in summer, air conditioning has now been installed to give the BS5454 recommended climate. The deterioration index for the lower room was 1.26. This hardly justifies the change to air conditioning. The error - a too high summer temperature - would not endanger items moved to the reading room.

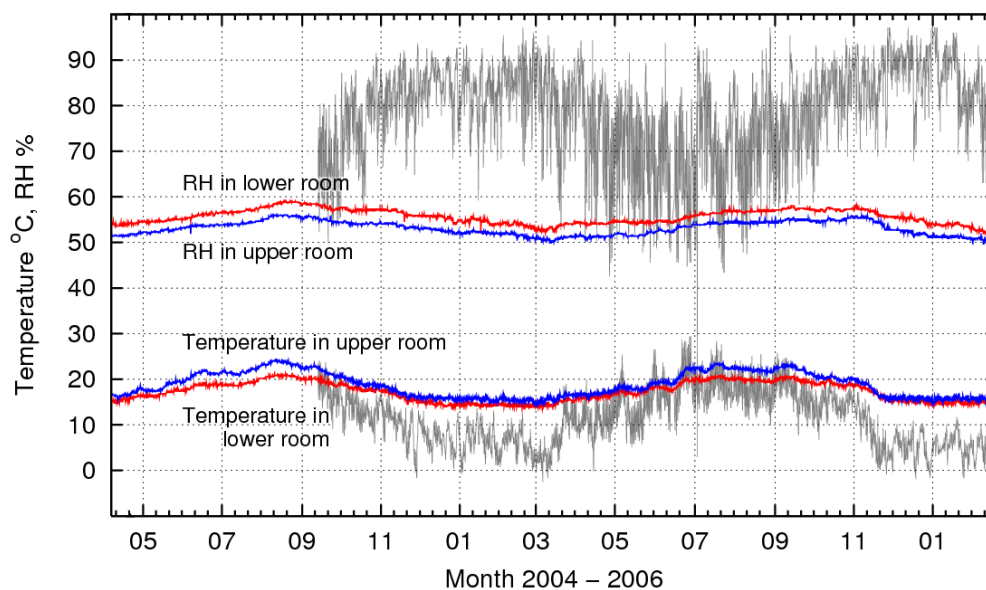

FIG. 5: The climate in the Suffolk record office. The outside climate is the jagged grey traces. [Wall 2007]

## 6. Discussion and conclusion

Low energy climate control in archives and stores is a demonstrable success. In addition to the examples given here there are other archives which function satisfactorily without air conditioning, and whose climate has been recorded. The military archive in the citadel of Segovia, Spain is described by [Ryhl-Svendson and co-workers 2003]. The state archive of Schleswig-Holstein, Germany is described in [Padfield 1999]. There are also less successful archives. One in Brede, Denmark is described in [Padfield and Larsen 2004]. It turned out to have a

fundamental flaw in its RH control by pumping air into the store. There are archives which claim to be passively controlled but which are reluctant to release the climate data. The Jersey archive has climate control by semi-passive means designed by [Twinn 1997] and further described by [Pritchard 2001].

Climate control by heating, by dehumidification, or by pumping in outside air when by chance it is beneficial, gives huge savings in the costs of both fuel and expert surveillance of complicated equipment, without materially reducing the durability of the stored materials and, in the dehumidified building, considerably enhancing the durability index. However, building simple yet effective archives is seriously hampered by deference to a standard which has no scientific justification for asserting a narrow climatic range that is only attainable with air conditioning.

Another significant hindrance to the acceptance of such climate control is that the empty archive does not show particularly good RH stability. There are currently no materials or constructions which give sufficient humidity buffering. Massive earth walls have enough exchangeable water, but diffusion to the surface is slow. A labyrinthine structure, like the ancient Roman hypocaust, will be necessary to give sufficient surface exchange of moisture. Progress in developing humidity buffering materials and constructions should be encouraged by the recent appearance of two standards for describing the buffer capacity. These are reviewed by [Roels and Janssen 2006]. If progress can be made in humidity buffering, and the climatic standard is relaxed, archive design will progress towards the ultimate aim of making them resistant to inevitable periods of power failure and neglect, seen in the perspective of centuries.

## 7. Acknowledgements

I thank my colleagues at the National Museum of Denmark: Poul Klenz Larsen, Lars Aasbjerg Jensen and Morten Ryhl-Svendsen. This work is a part of our continuing collaboration to reduce the energy use and the technical complexity of museums and archives.

## 8. References

- Balažic A, Habicht S, Smoldis M, Kolar J and Strlič M. (2007). Extending the useful life of paper - an evaluation of the effect of various preservation actions, *Museum Microclimates*, (Padfield T and Borchersen K. editors), National Museum of Denmark, Copenhagen, 39 – 41. ISBN 978-87-7602-080-4.
- Bigourdan J and Reilly J. (2002). Effects of fluctuating environments on paper materials — stability and practical significance for preservation, *La Conservation à l'Ère du Numérique, Actes des Quatrièmes Journées Internationales d'Études de l'ARSAG*, Paris, May 2002, (Paris: Association pour la Recherche Scientifique sur les Arts Graphiques, 2002), 180-192.
- Bogaard J and Whitmore P. (2002). Explorations of the role of humidity fluctuations in the deterioration of paper, *Works of art on paper: books, documents and photographs: techniques and conservation*, Contributions to the Baltimore Congress of the International Institute for Conservation, 2-6 September 2002, 11-15.
- British Standard. (2000). Standard 5454:2000, Recommendations for the storage and exhibition of archival documents, [www.standardsuk.com/](http://www.standardsuk.com/)
- Bruun C. (2007). Personal communication from the Head of Department, The Royal Library - Building Services, Copenhagen.
- Calhoun J. (1952). Cold Storage of Photographic Film. *Photographic Science and Technique*, PSA Journal 18B, No. 3, Oct. 1952.
- Jakobsen M. (2008). Climate data provided by Mette Jakobsen, conservator for the Arnamagnæan Institute, Copenhagen University.
- Jensen L. (2008). Personal communication, Lars Aasbjerg Jensen, Conservation Department, The National Museum of Denmark.
- Justin (2007). Climate data provided by Father Justin, St Catherine's Monastery, Sinai, Egypt.
- Mecklenburg M, Tumosa C and Erhardt D. (2005). The changing mechanical properties of aging oil paints

*Materials Issues in Art and Archaeology, Materials Research Society Proceedings*, Vol. 852.

- National Archives (UK). (2004). Standard for Record Repositories, First edition.  
<http://www.nationalarchives.gov.uk/archives/standards-framework.htm>
- Padfield T. (1999). The role of absorbent building materials in moderating changes of relative humidity, Ph.D. thesis, Department of Structural Engineering and Materials, Technical University of Denmark, Report R-54 1999. ISBN 87-7740-256-1. [www.padfield.org/tim/cfys/phd/phd-indx.php](http://www.padfield.org/tim/cfys/phd/phd-indx.php)
- Padfield T. (2002). Condensation in film containers during cooling and warming, Proceedings of the conference *Preserve, then Show*, The Danish Film Institute, Copenhagen, December 2001, 67-77.  
[www.padfield.org/tim/cfys/coolfilm/coolingfilm.pdf](http://www.padfield.org/tim/cfys/coolfilm/coolingfilm.pdf)
- Padfield T. (2004). The Preservation Index and the Time Weighted Preservation Index,  
[http://www.padfield.org/tim/cfys/twpi/twpi\\_01.php](http://www.padfield.org/tim/cfys/twpi/twpi_01.php) (accessed 2008-1-30).
- Padfield T and Larsen P. (2004). Designing museums with a naturally stable climate, *Studies in Conservation* vol.49, 131-137. An extended version is at: [www.padfield.org/tim/cfys/musdes/musdes.pdf](http://www.padfield.org/tim/cfys/musdes/musdes.pdf)
- Prichard D and Twinn C. (2001). An integrated design: the Jersey Archive, *Architectural Research Quarterly*, 5, 210-228
- Rasmussen M. (2007). Evaluation of the climate in a new shared storage facility using passive climate control. *Museum Microclimates* (Padfield T. & Borchersen K., editors), National Museum of Denmark, Copenhagen, 207 – 212. (Later climate data by personal communication).
- Roels S and Janssen H. (2006). A Comparison of the Nordtest and Japanese test methods for the moisture buffering performance of building materials, *Journal of Building Physics*, 137-161.  
DOI10.1177/1744259106068101
- Ryhl-Svendsen M, Padfield T, Smith V and De Santis F. (2003). The indoor climate in historic buildings without mechanical ventilation, *Healthy Buildings 2003*, 278-283.  
[www.padfield.org/tim/cfys/ppubs/indclim.pdf](http://www.padfield.org/tim/cfys/ppubs/indclim.pdf)
- Ryhl-Svendsen M. (2007a). Air quality in museum storage buildings, Phd thesis, The Royal Danish Academy of Fine Arts, School of Conservation, Copenhagen.
- Ryhl-Svendsen M. (2007b). The role of air exchange rate and surface reaction rates on the air quality in museum storage buildings. *Museum Microclimates* (Padfield T and Borchersen K, editors), National Museum of Denmark, Copenhagen, 221 – 226. ISBN 978-87-7602-080-4
- Twinn C. (1997). Passive control of relative humidity to  $\pm 5\%$ , CIBSE National Conference 1997. More easily available at: [www.kanut.ee/arh/asjad/pdf/Twinn\\_Chris-Passive\\_Control\\_of\\_RH-Jac10cibse.pdf](http://www.kanut.ee/arh/asjad/pdf/Twinn_Chris-Passive_Control_of_RH-Jac10cibse.pdf)
- Wall D. (2007). Climate data provided by Dominic Wall, Suffolk Record Office, Ipswich, UK.
- Wilhelm H. (1993). *The permanence and care of color photographs*. p 700. ISBN 0-911515-00-3.  
[www.wilhelm-research.com/book\\_toc.html](http://www.wilhelm-research.com/book_toc.html)