

Understanding energy technology developments from an innovation system perspective

Borup, Mads; Gregersen, B.; Tanner, Anne Nygaard

Published in:
Energy solutions for sustainable development. Proceedings

Publication date:
2007

Document Version
Publisher's PDF, also known as Version of record

[Link back to DTU Orbit](#)

Citation (APA):
Borup, M., Gregersen, B., & Madsen, A. N. (2007). Understanding energy technology developments from an innovation system perspective. In L. Sønderberg Petersen, & H. Larsen (Eds.), Energy solutions for sustainable development. Proceedings (pp. 206-213). Risø National Laboratory. (Denmark. Forskningscenter Risoe. Risoe-R; No. 1608(EN)).

DTU Library

Technical Information Center of Denmark

General rights

Copyright and moral rights for the publications made accessible in the public portal are retained by the authors and/or other copyright owners and it is a condition of accessing publications that users recognise and abide by the legal requirements associated with these rights.

- Users may download and print one copy of any publication from the public portal for the purpose of private study or research.
- You may not further distribute the material or use it for any profit-making activity or commercial gain
- You may freely distribute the URL identifying the publication in the public portal

If you believe that this document breaches copyright please contact us providing details, and we will remove access to the work immediately and investigate your claim.

Energy Solutions for
Sustainable Development
Proceedings
Risø International Energy Conference
2007

Edited by Leif Sønderberg Petersen and Hans Larsen

Risø-R-1608(EN)



Risø National Laboratory
Technical University of Denmark
Roskilde, Denmark
May 2007

Author: Edited by Leif Sønnerberg Petersen and Hans Larsen
Title: Energy Solutions for Sustainable Development
Proceedings
Risø International Energy Conference 2007
Department: Systems Analysis

Abstract (max. 2000 char.):

The Risø International Energy Conference took place 22 - 24 May 2007. The conference focused on:

- Future global energy development options
- Scenario and policy issues
- Measures to achieve low-level stabilization at, for example, 500 ppm CO₂ concentrations in the atmosphere
- Local energy production technologies such as fuel cells, hydrogen, bio-energy and wind energy
- Centralized energy technologies such as clean coal technologies
- Providing renewable energy for the transport sector
- Systems aspects, differences between the various major regions throughout the world
- End-use technologies, efficiency improvements and supply links
- Security of supply with regard to resources, conflicts, black-outs, natural disasters and terrorism

The proceedings are prepared from papers presented at the conference and received with corrections, if any, until the final deadline on 14 May 2007.

Risø-R-1608(EN)
May 2007

ISSN 0106-2840
ISBN 978-87-550-3603-1

Contract no.:

Group's own reg. no.:
(Føniks PSP-element)

Sponsorship:

Cover :

Pages:
Tables:
References:

Information Service Department
Risø National Laboratory
Technical University of Denmark
P.O.Box 49
DK-4000 Roskilde
Denmark
Telephone +45 46774004
bibl@risoe.dk
Fax +45 46774013
www.risoe.dk

Contents

Preface	4
Sessions overview	5
Programme	6
Programme committee	12
Local committee	13
Session 1 - Future Global Development Options	14
Session 2 - Scenarios and Policy Options	32
Session 3 – Clean Coal Technologies	55
Session 4 – Bioenergy	81
Session 5 - Renewable Energy for the Transport Sector	106
Session 6 – Wind	134
Session 7 – Solar and Wave Energy	160
Session 8 – Systems with High Level of Renewable Energy	185
Session 9 – End Use Technologies and Efficiency Improvements	214
Session 10 – Systems Aspects – Distributed Production	229
Session 11 – Low Level CO ₂ Strategies for Developing Countries	258
Session 12 – Carbon Capture and Storage Contribution to Stabilization	294
Session 13 – Hydrogen Economy	326
Session 14 – Fuel Cells	346
Session 15- R&D Priorities	371
List of Participants	398

Preface

Energy Solutions for Sustainable Development

The world is facing major challenges in providing energy services to meet the future needs of the world and in particular the growing needs of the developing countries. These challenges are exacerbated by the need to provide energy services that take account of economic growth, security of supply and sustainability, including the expected future Kyoto Protocol targets for significant reductions in CO₂ emissions. Hence, the conference aims to identify new energy solutions which can lead to a lowlevel stabilization of CO₂ concentrations in the atmosphere within the next 50 years.

The conference focused on the scientific development of new technologies, their market perspectives, and realistic contributions to achieving a low-level stabilization of CO₂ concentrations in the atmosphere at, for example, 500 ppm. What is required of new technologies, and what are their perspectives in a future supply system consisting of a mix of central units and a variety of local units? In addition, the conference addressed the challenge of increasing the share of renewable energy in the coming decades – in particular, increasing the share of renewable energy in the power system and the transport sector.

The conference focused on

- Future global energy development options
- Scenario and policy issues
- Measures to achieve low-level stabilization at, for example, 500 ppm CO₂ concentrations in the atmosphere
- Local energy production technologies such as fuel cells, hydrogen, bio-energy and wind energy
- Centralized energy technologies such as clean coal technologies
- Providing renewable energy for the transport sector
- Systems aspects, differences between the various major regions throughout the world
- End-use technologies, efficiency improvements and supply links
- Security of supply with regard to resources, conflicts, black-outs, natural disasters and terrorism

Target group

The target group for the conference was researchers, policy makers, energy sector decision makers, funding organizations, as well as international organizations, e.g. the EU, IEA, UN

Risø International Energy Conference was sponsored by DONG Energy, Danish Energy Authority and UNEP.



Risø International Energy Conference – Sessions overview

Tuesday 22 May 2007		Wednesday 23 May 2007		Thursday 24 May 2007	
08:30-09:30	Coffee and registration				
Room	Big lecture hall	Big lecture hall	Small lecture hall	Big lecture hall	Small lecture hall
09:30-10:30	Opening Session	09:00-10:30 Session 4 Bioenergy	Session 7 Solar and Wave Energy	09:00-10:30 Session 10 Systems Aspects – Distributed Production	Session 11 Low Level CO ₂ Strategies for Developing Countries
10:30-11:00	Break	10:30-11:00 Break		10:30-11:00 Break	
11:00-12:30	Session 1 Future Global Development Options	11:00-12:30 Session 14 Fuel Cells	Session 5 Renewable Energy for the Transport Sector	11:00-12:30 Session 8 Systems with High Level of Renewable Energy	Session 12 Carbon Dioxide Capture and Storage Contribution to Stabilization
12:30-13:30	Lunch	12:30-13:30 Lunch		12:30-13:30 Lunch	
13:30-15:00	Session 2 Scenarios and Policy Options	13:30-14:30 Session 3 Clean Coal Technologies	Session 13 Hydrogen Economy	13:30-14:00 Summary, Main Findings and Key Questions to the Panel	
15:00-15:30	Break	14:30-15:00 Break		14:00-15:00 Panel Discussion: What Actions are needed Now to achieve Low Level Stabilization of CO ₂ at 500 ppm?	
15:30-17:30	Session 15 R&D Priorities	15:00-16:30 Session 6 Wind	Session 9 End Use Technologies and Efficiency Improvements		
17:30-18:30	Reception			15:00 – 15:15 Closing Remarks	
		19:00 Conference Dinner			

Programme

Tuesday 22 May 2007

08:30 – 09:30 **Coffee and registration**

09:30 – 10:30 **Opening Session**

Chairman: Hans Larsen, Risø National Laboratory, Denmark

Welcome by Jørgen Kjems, Managing Director, Risø National Laboratory, Denmark

Key notes:

Mitigation of Climate Change: the Contribution of Working Group III to the IPCC Fourth Assessment Report

Bert Metz, Netherlands Environmental Assessment Agency, the Netherlands

10:30 – 11:00 **Break**

11:00 – 12:30 **Session 1 - Future Global Development Options**

Chairman: Anil Markandya, University of Bath, UK

Key note:

Energy Efficiency - achieving more with less

Stefan Denig, Siemens AG, Germany

Energy Implications of Climate Mitigation Policies

Massimo Tavoni, FEEM, Italy

Lessons Learned from Recent Promotion Strategies for Electricity from Renewables in EU Countries

Reinhard Haas; Gustav Resch; Thomas Faber; Claus Huber, Energy Economics Group, Vienna University of Technology, Austria; Anne Held, FHG ISI, Karlsruhe, Germany

12:30 – 13:30 **Lunch**

13:30 – 15:00 **Session 2 - Scenarios and Policy Options**

Chairman: Barry Worthington, United States Energy Association, USA

Perspectives of the Energy Year 2006 Project under the Danish Society of Engineers

Per Nørgård, Risø National Laboratory, Denmark

Integrated European Energy RTD as Part of the Innovation Chain to Enhance Renewable Energy Market Breakthrough

Peter Lund, Helsinki Univ. of Technology, Finland

Impacts of High Energy Prices on Long-term Energy-economic Scenarios for Germany

Volker Krey; Dag Martinsen; Peter Markewitz, Forschungszentrum Jülich, Systems Analysis and Technology Evaluation, Germany; Felix Chr. Matthes, Oeko Institut, Inst. for Applied Ecology, Germany; Manfred Horn, DIW, German Inst. for Economic Research, Germany

15:00 – 15:30 **Break**

15:30 – 17:30 Session 15- R&D Priorities

Chairman: Uwe Hermann, Siemens AG, Germany

Overview of the U.S. Department of Energy's Coal Research, Development & Demonstration Programs - Clean and Secure Energy from Coal

Scott Smouse, International Coordination Team Leader, U.S. Department of Energy, National Energy Technology Laboratory.

The UK Energy Research Atlas: A Tool for Prioritising and Planning Energy R&D

Jim Skea, UK Energy Research Centre, UK

European and Global Perspectives for CO₂ Capture and Storage

Martine Uytterlinde, ECN Policy Studies, The Netherlands

Solar Energy - Status and Perspectives

Peter Ahm, PA Energy A/S, Denmark

17:30 – 18:30 **Reception**

Wednesday 23 May 2007

Big lecture hall

09:00 – 10:30

Session 4 – Bioenergy

Chairman: Pedro Maldonado, Universidad de Chile, Chile

Bioenergy in 2007 - where will it be in the Future?

Gustavo Best, FAO, Rome

Optimal Use of Organic Waste in Future Energy Systems - the Danish Case

Marie Münster, Dept. of Develop. and Planning, Aalborg Univ., Denmark

Sustainable Bioenergy Production Combining Biorefinary Principles and Cereal-legume Intercropping

M.H. Thomsen; H. Haugaard-Nielsen; A. Petersen; A.B. Thomsen and E.S. Jensen, Risø National Laboratory, Denmark

10:30 – 11:00 Break

11:00 – 12:30

Session 14 – Fuel Cells

Chairman: Knud Pedersen, DONG Energy, Denmark

Use of Alternative Fuels in Solid Oxide Fuel Cells

Anke Hagen, Risø National Laboratory, Denmark

Solid Oxide Fuel Cell Development at Topsoe Fuel Cell A/S and Risø

Søren Linderøth, Peter H. Larsen; Peter V. Henriksen, Mogens Mogensen, Risø National Laboratory, Denmark; Niels Christiansen; John B. Hansen; Helge Holm-Larsen, Topsoe Fuel Cell, Denmark

Fuel Cell-Shaft Power Packs

Sten Frandsen, Teknologisk Institut, Denmark

Small lecture hall

Session 7 – Solar and Wave Energy

Chairman: Ulla Röttger, Amagerforbrænding A/S, Denmark

Wave Energy - Challenges and Possibilities

Per Resen Steenstrup, Wave Star Energy, Denmark

Plastic Solar Cells - Technology, Production and Market

Frederik Krebs, Risø National Laboratory, Denmark

Session 5 - Renewable Energy for the Transport Sector

Chairman: Kim Pilegaard, Risø National Laboratory, Denmark

Co-ordination of Renewable Energy Support Schemes in the EU

Poul Erik Morthorst, Risø National Laboratory, Denmark

Bioethanol

Charles Nielsen; Jan Larsen; Christian Morgen, DONG Energy, Denmark

REFUEL: A European Road Map for Biofuels

Henrik Duer, COWI, Denmark; Marc Londo, Emiel van Sambeek, ECN Energy Research Centre, Netherlands; Günter Fischer, IIASA, Austria; André Faaij, Utrecht Univ., the Netherlands; Göran Berndes, Chalmers Univ. of Technology, Sweden; Magdalena Rogulska, EC-Baltic Renewable Energy Centre, Poland; Kurt Könighofer, Joanneum Research, Austria

12:30 – 13:30 Lunch

13:30 – 14:30

Session 3 – Clean Coal Technologies

Chairman: Henrik Bindsvlev, Risø National Laboratory, Denmark

Polygeneration

Thomas Rostrup-Nielsen; Finn Joensen; Jørgen Madsen; Poul Erik Højlund Nielsen, Haldor Topsoe A/S, Denmark

Development of PF Fired High Efficiency Power Plant (AD700)

Rudolph Blum, DONG Energy, Denmark

Session 13 – Hydrogen Economy

Chairman: Søren Linderøth, Risø National Laboratory, Denmark

Durability of Solid Oxide Electrolysis Cells for Hydrogen Production

Anne Hauch, Risø National Laboratory, Denmark

The HyApproval Project

Marieke Reijalt, H2IT, Italy

14:30 – 15:00 Break

15:00 – 16:30

Session 6 – Wind

Chairman: Erik Lundtang Petersen, Risø National Laboratory, Denmark

UpWind - A Wind Energy Research Project under the 6th Framework Programme

Peter Hjuler Jensen, Risø National Laboratory, Denmark

Wind Power Costs in Portugal

Carla Saleiro, University of Minho, Dept. of Biological Engineering, Portugal; Madalena Araújo; Paula Ferreira, University of Minho, Dept. of Production and Systems, Portugal

Economic and Financial Feasibility of Wind Energy - Case Study of Philippines

Jyoti Painuly, Risø National Laboratory, Denmark

Session 9 – End Use Technologies and Efficiency Improvements

Chairman: Jens Peter Lynov, Risø National Laboratory, Denmark

A Cooling System for Buildings using Wind Energy

Hamid Daiyan, Islamic Azad Univeristy, Semnan Branch, Iran

Patterns of Energy Demand - the Effects of Substitution and Productivity

Nico Bauer, Fondazione ENI Enrico Mattei (FEEM), Italy

New LED Light Sources and Lamps for General Illumination

Carsten Dam-Hansen; Birgitte Thestrup; Henrik Pedersen; Paul Michael Petersen, Risø National Laboratory, Denmark

19:00 Conference dinner at the Tycho Brahe Planetarium, Gl. Kongevej 10, Copenhagen.

Thursday 24 May 2007

Big lecture hall

09:00 – 10:30

Session 10 – Systems Aspects – Distributed Production

Chairman: Lars Landberg, Risø National Laboratory, Denmark

A Model for a Common Energy Future

Peter Markussen, DONG Energy, Denmark; Anders Kofoed-Wiuff; Jesper Werling, Ea Energy Analysis, Denmark; Kenneth Karlsson, Risø National Laboratory, Denmark; Mette Behrmann; Jens Pedersen, Energinet.dk, Denmark

Vanadium Flow Batteries - Initial Results from Characterisation Measurements

Henrik Bindner, Risø National Laboratory, Denmark

Centralized and Distributed Control: A Power System Point of View

Oliver Gehrke, Philippe Venne and Stephanie Ropenus, Risø National Laboratory, Denmark

10:30 – 11:00 Break

11:00 – 12:30

Session 8 – Systems with High Level of Renewable Energy

Chairman: Bjarke Fønnesbech, IDA, Denmark

Realisable Scenarios for a Future Electricity Supply based 100% on Renewable Energies

Gregor Czisch Inst. for Electrical Engineering/ Univ. of Kassel, Germany; Gregor Giebel, Risø National Laboratory, Denmark

Operational Costs induced by Fluctuating Wind Power Production in Germany and Scandinavia

Peter Meibom, Risø National Laboratory, Denmark; Christoph Weber, University Duisburg-Essen; Rüdiger Barth and Heike Brand, IER, University of Stuttgart, Germany

Understanding Energy Technology Development from an Innovation System Perspective

Mads Borup; Anne Nygaard Madsen, Risø National Laboratory, Denmark; Birgitte Gregersen, Aalborg University, Denmark

Small lecture hall

Session 11 – Low Level CO₂ Strategies for Developing Countries

Chairman: Mark Radka, UNEP, Paris

Assessing the Role of Energy in Development and Climate Policies in Large Developing Countries

Amit Garg; Kirsten Halsnæs, Risø National Laboratory, Denmark

Sustainable Transport Practices in Latin America

Jorge Rogat and Miriam Hinojosa, Risø National Laboratory, Denmark

Session 12 – Carbon Capture and Storage Contribution to Stabilization

Chairman: John M. Christensen, Risø National Laboratory, Denmark

CO₂ Capture and Utilization for Enhanced Oil Recovery

Charles Nielsen; Poul Jacob Wilhelmsen; William Harrar; Jan Reffstrup, DONG Energy, Denmark

Geological Storage of CO₂ from Power Generation

Niels Peter Christensen, Geological Survey of Denmark and Greenland (GEUS), Denmark

Environmental Analysis of Coal-based Power Production with Amine-based Carbon Capture

J. Nazarko; W. Kuckshinrichs; A. Schreiber, Forschungszentrum Jülich, Systems Analysis and Technology Evaluation, Germany

12:30 – 13:30 Lunch

13:30 – 14:00

Summary, main findings and key questions to the panel

Richard Bradley, IEA, Paris

14:00 – 15:00

Panel discussion: What actions are needed now to achieve low level stabilization of CO₂ at 500 ppm?

Participants:

Jørgen Kjems, Risø National Laboratory, Denmark

Richard Bradley, IEA, Paris

Mark Radka, UNEP, Paris

Barry Worthington, United States Energy Association, USA

Uwe Hermann, Siemens AG, Germany

Bert Metz, Netherlands Environmental Assessment Agency, the Netherlands

Knud Pedersen, DONG Energy, Denmark

Anders Stouge, Danish Energy Industries Federation, Denmark

Moderator: Jørgen Henningsen, Denmark

15:00 – 15:15

Closing remarks

Jørgen Kjems, Managing Director, Risø National Laboratory, Denmark

Programme Committee

Richard Bradley, Head of Division Energy and Environment, IEA, Paris
Jørgen Henningsen, former principal advisor, European Commission, DG Energy and Transport, Brussels
Uwe Hermann, Siemens AG, Germany
Hans Larsen, Risø National Laboratory, Denmark (Chairman)
Pedro Maldonado, Programa de Estudios e Investigaciones en Energia, Universidad de Chile, Chile
Anil Markandya, Dept. of Economics & International Development, University of Bath, UK
Burt Metz, IPCC WGIII, Milieu en Natuur Planbureau, The Netherlands
Lars Bytoft Olsen, IDA, Denmark
Knud Pedersen, DONG Energy, Denmark
Mark Radka, UNEP, Division of Technology, Industry and Economics, Paris
Ulla Röttger, Amagerforbrænding A/S, Denmark
Hans Jürgen Stehr, Danish Energy Authority, Denmark
Anders Stouge, Danish Energy Industries Federation, Denmark
Barry Worthington, United States Energy Association, USA

Local Committee

Henrik Bindslev

John M. Christensen

Erik Steen Jensen

Lars Landberg

Hans Larsen (Chairman)

Søren Linderøth

Jens-Peter Lynov

Allan Schrøder Pedersen

Erik Lundtang Petersen

Leif Sønderberg Petersen

Kim Pilegaard

Session 1 - Future Global Development Options

Chairman: Anil Markandya, University of Bath, UK

Do Forests Have a Say in Global Carbon Markets for Climate Stabilization Policy ?

Massimo Tavoni¹, Brent Sohngen² and Valentina Bosetti¹

¹ FEEM (Fondazione Eni Enrico Mattei)

² Dept. Of Agr., Env., and Dev. Economics, Ohio State University

While carbon sequestration was included in the Kyoto Protocol, its potential scope as a mitigation activity has been highly debated in subsequent negotiations. Notwithstanding the widespread research suggesting that biological sequestration of carbon can play an important role for reducing greenhouse gases emissions (see for example, Metz et al., 2001), the nations in the Kyoto Protocol have so far only haltingly incorporated forestry measures, for a variety of reasons. One set of concerns revolved around the validity of measuring and monitoring land-based activities to prove that they provided additional carbon storage, as for example error bounds for measuring and monitoring carbon in forests are fairly large (e.g., Phillips et al., 2000, Somogyi et al., 2007). A second reason for the setbacks to forest sequestration regarded whether carbon sequestration would reduce carbon prices and consequently the quantity of abatement provided by the energy sector. Only the energy sector, after all, can ensure permanent reductions in CO₂ emissions. This concern implies that forest carbon sequestration could be large enough to influence carbon prices in a global carbon market. Clearly, if prices are lower the deployment of low carbon measures and technologies could be delayed, for example by reducing incentives for technological evolution. Yet, enriching the mitigation portfolio with forestry could bring a significant contribution. Global policies meant to stabilize greenhouse gas concentrations in the future will arguably require a vast bundle of measures to meet ambitious targets (Pacala and Socolow, 2004).

The first set of concerns has been widely addressed in a range of publications, including those of the Intergovernmental Panel on Climate Change (see Watson et al., 2000; Metz et al., 2001; Penman et al., 2003). Remarkably less attention has been devoted to the second set of concerns¹. In this article we try to fill the gap by analyzing the impact biological carbon sequestration has on a policy to stabilize carbon emissions. In doing so we are able to evaluate a potentially attractive mitigation option like carbon sinks accounting for the influence the inclusion of this option could bear on the carbon market and technology development in the energy sector.

Analysis

As outlined in the recently released IPCC 4th Assessment Report (Intergovernmental Panel on Climate Change, 2007), there is reinforcing evidence about the effect of human activities on global warming and on the potential damages it can spur. This has strengthened the need for concerted action to stabilize carbon concentration by the end of this century. We analyze an international climate policy that stabilizes CO₂ concentrations at 550 ppmv by 2100 (excluding other GHG gases). In the context of our model, this translates into cutting cumulative emissions in half from the baseline during

¹ Only recently have integrated assessment models begun to incorporate carbon sinks (for ex. van Vuuren *et al.*, 2007)

this century. We assume an international trading market of carbon permits is active, resulting in a single global price of carbon.

In order to assess the optimal response of the carbon market to carbon sequestration we couple two global -regionally disaggregated- models. An energy-economy-climate model for the study of climate policies (Bosetti *et al.*, 2006) is linked with a detailed forestry and land-use model (Sohngen and Mendelsohn, 2003) to provide the optimal, intertemporal (100 yr) abatement strategy. The two models are coupled by exchanging carbon sequestration quantities in each region and global carbon prices, until convergence is reached.

Burying Carbon in Forests

There are numerous opportunities for carbon sequestration in forests. Almost immediately, sequestration can be accomplished by extending rotations in managed forests, and emissions reductions can be accomplished with avoided deforestation. In the longer term, forestry can contribute through biomass growth on lands where afforestation occurs, and changes to management to increase the carbon on each hectare. Our modeling approach accounts for these short- and long- term responses within a global context, and measures their impact on global carbon prices set in a market with an overall cap on emissions.

The largest source of sequestration by 2040 occurs in developing regions and the transition economies (Figure 1A). Emission reductions from avoided deforestation constitute the most important activity occurring in tropical countries. Current estimates of emissions from deforestation in these regions amount to 0.9-2.2 Pg C yr⁻¹ in (DeFries *et al.*, 2002; Potter *et al.*, 2003; Achard *et al.*; 2002; Houghton, 2003), or 10-25% of global GHG emissions. Our emission reductions from avoided deforestation in the next 20 years in tropical regions are estimated to average 0.7 Pg C yr⁻¹. The baseline assumes that deforestation continues through much of the century although it slows over time, so that reductions in deforestation continue to be important sources of emissions reductions throughout the century. Afforestation in tropical regions also contributes to abatement efforts over time, as revealed by the peak in sequestration in 2050 in East Asia in panel A of Figure 1.

In contrast to the tropical regions, temperate and boreal countries provide very modest flows initially, mainly by extending rotation ages and setting aside low-value timberland from production (Figure 1B). Low initial carbon prices in the combined energy-forestry policy, however, limits the contribution of extending rotation ages, and limits the contribution of afforestation, at least initially. Countries in these regions have their largest contributions to carbon sequestration after the middle of the century, after afforestation efforts have been intensified. Over the next 20 years, temperate and boreal countries provide an average of 0.1 Pg C yr⁻¹. By the period 2042-2062, they provide 0.3 Pg C yr⁻¹.

One exception for temperate and boreal countries is the Transition Economies region, which is shown in Panel A of Figure 1. This region includes Russia, where large potential near term sequestration can occur through setting aside boreal forests from timber production. Russian timber harvests in the baseline are expected to rise over the next several decades following the slow down of the 1990s. Given relatively high carbon

intensities in boreal forests, reducing these harvests can enhance global carbon sequestration.

In total, forestry actions amount to 21 Pg of cumulative (undiscounted) sequestration or avoided emissions by 2020 and 65 Pg C by 2050. For the first half of the century, our results show that forestry contributes 1/3 of cumulative mitigation efforts necessary to achieve the 550ppmv stabilization target. After 2050, although forestry continues to provide abatement services, the share of forestry in total abatement declines as the emission target becomes more stringent and permanent emission cuts in the energy sector are necessary.

Figure 1: Annual emissions reduction or carbon sequestration above the baseline by region and year (2002 – 2082).

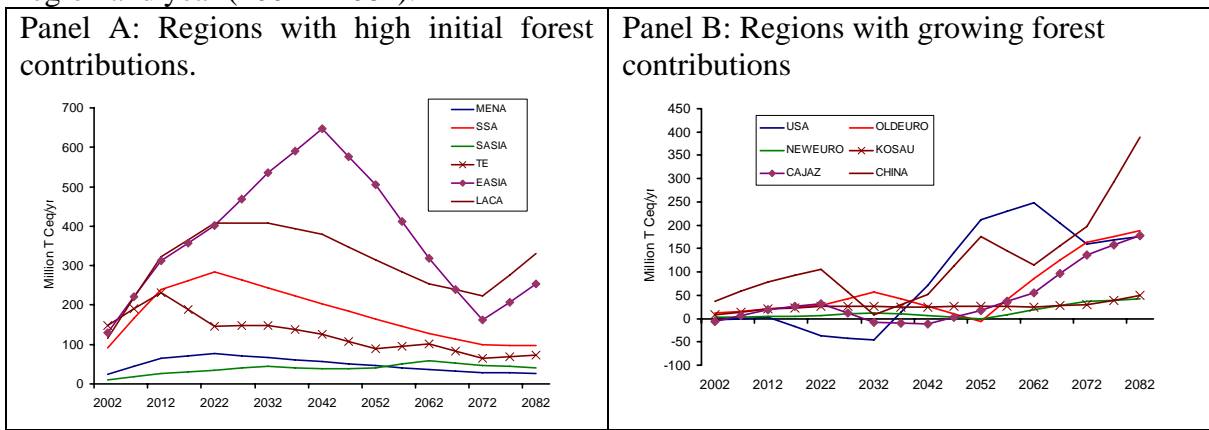

Regions: MENA=Middle East/North Africa; SSA = Sub-Saharan Africa; SASIA = South Asia; TE= Transition Economies; SEASIA=Southeast Asia; LACA = Latin and Central America; USA = United States; OLDEURO = Old Europe; NEWEURO = New Europe; KOSAU = Korea, South Africa, and Australia; CAJAZ = Canada, Japan, New Zealand; CHINA = China.

Global Implications: The Carbon Market

The scale of sequestration implied by our model will have dramatic effects on the carbon market if forest policy mechanisms are fully exploited. In particular, we calculate that reduced emissions from avoided deforestation and carbon sequestration substantially reduce the costs of meeting the 550 ppmv carbon target. Carbon prices fall by 40% relative to carbon prices that would exist if carbon sinks are not a policy option. This contrasts with Sohngen and Mendelsohn (2003) who suggest that forest sequestration would have little effect on carbon prices. Their study, however, examined a substantially less stringent policy, and consequently achieves less sequestration.

The net present value cost of the stabilization policy without carbon sequestration is a loss of 0.2% of gross world product, and 0.1% with carbon sequestration. The carbon sequestration program provides a net present value savings of \$3 trillion. We calculate the present value costs of the carbon sequestration program to be \$1.1 trillion. Our model does not account for transactions costs associated with setting up and running a fund to provide real, additional carbon through sequestration or avoided emissions, however, as long as these costs are less than \$1.9 trillion, or not larger than 170% of the costs of the carbon itself, forestry remains an efficient solution in abatement policy. All in all, carbon sinks make the policy costs similar to a 600ppmv policy, i.e., they efficiently allow society to achieve an additional 50ppmv, which is equivalent to ¼ °C in 2100, at no extra cost.

Regarding the “where” distribution of costs, two competing effects are at stake: the inclusion of forestry reduces costs for permit buyers but reduces revenues for permit sellers. Ultimately, the distributional effects will depend on the emissions allocation scheme adopted in the policy. For example, assuming that emissions are allocated based on an “equal per capita” rule, we find that carbon sequestration would reduce costs for developed countries buyers (to 1/3) but also, though by less extent, reduce revenues for developing countries sellers (to 3/4). It is worth noting that a different allowances allocation scheme would have changed the distributional results, though it would not have any impact on the carbon prices as they are determined by the world marginal abatement costs.

Energy abatement and policy induced technological change

One of the policy relevant, albeit disregarded, questions is the danger that forestry might allow the emissions constraint on the energy system to be relaxed too much. By reducing carbon prices, forestry might delay the investments in innovation that are needed to make new technologies competitive and the deployment of clean technologies that can reduce emissions permanently. Given the low turnover of energy capital stock, as well as the lengthy process before commercialization of advanced technologies, it is important to understand what effects the inclusion of a full set of forestry options may have on the energy sector.

Our results do show that forestry crowds out some energy abatement over the next 30 years. Reductions in energy intensity of the economy stimulated by the climate policy are diminished by the inclusion of the carbon sequestration (Figure 2A). However, our results also show that this effect diminishes over time. The gap in energy intensity between the forestry and no-forestry cases is mostly manifest in the first 30 years of the century, and is reduced afterwards in order to meet the stabilization target. Deployment of low carbon technologies in the energy sector such as carbon capture and sequestration and nuclear power are postponed by 10 - 20 years, but they cannot be postponed forever and eventually converge as shown in Figure 2B. Yet, cumulatively to 2050 power generation CCS without forestry is twice as that with forestry. Policy induced technological change through energy research and development, and Learning-by-Doing in renewables, is shown to weaken, although not dramatically.

Figure 2: World Energy Intensity and Carbon Captured and Stored in power plants.

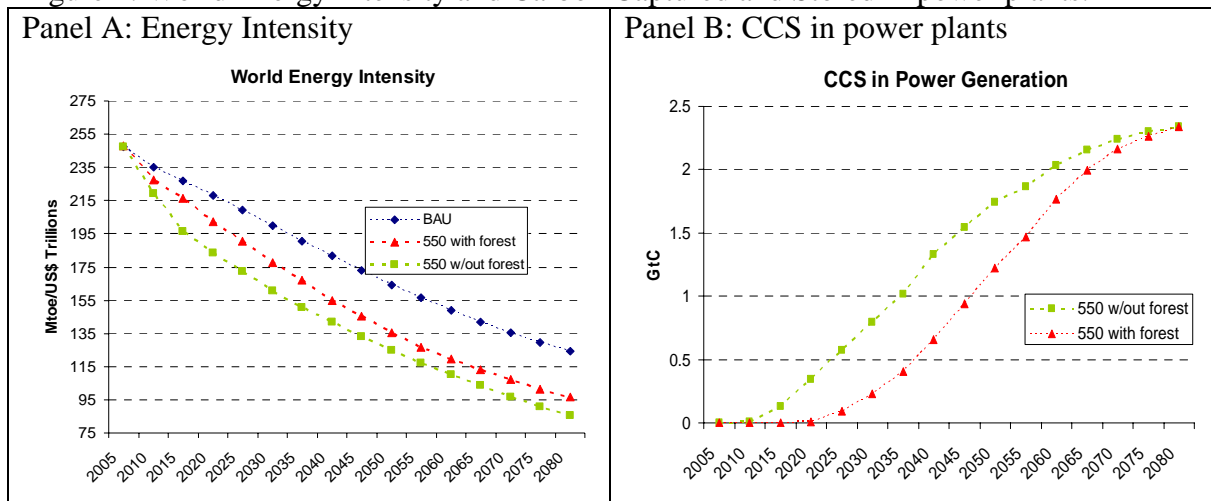

Conclusion

This study highlights a significant role for forestry in contributing to a climate stabilization policy, in terms of mitigation potential and cost reductions. While we agree with the widely held belief that forests can provide short-term abatement relief, our results suggest that the short-term under the stabilization carbon price path is dominated by reduced deforestation. Afforestation provides benefits, but these benefits largely arise after 2040. Using these results, one can ask, "what kinds of forestry actions today and in the future would be consistent with an optimal stabilization policy?" Our results suggest that initially, reductions in deforestation and the avoided emissions are the most important aspect, potentially provided 0.7 Pg C yr^{-1} in emissions reductions. Temperate countries would undertake modest afforestation efforts initially to be consistent with these policies, but some countries (e.g., the U.S.) should not expect large internally generated flows of sequestration benefits until later in the century.

References

Achard, F., Eva, H.D., Stibig, H.J., Mayaux, P., Gallego, J., Richards, T., Malingreau, J.P., 2002. "Determination of deforestation rates of the world's humid tropical forests". *Science*. 297, 999-1002.

Bosetti V., C. Carraro, M. Galeotti, E. Massetti and M. Tavoni, 2006. "WITCH: A World Induced Technical Change Hybrid Model", *The Energy Journal*, Special Issue. Hybrid Modeling of Energy-Environment Policies: Reconciling Bottom-up and Top-down, 13-38.

DeFries, R.S., Houghton, R.A., Hansen, M.C., Field, C.B., Skole, D., Townshend, J., 2002. "Carbon emissions from tropical deforestation and regrowth based on satellite observations for the 1980s and 90s". *Proceedings of the National Academy of Sciences* 99, 14,256-14,261.

Houghton, R.A., 2003. "Revised estimates of the annual net flux of carbon to the atmosphere from changes in land use and land management: 1850-2000", *Tellus Series B-Chemical and Physical Meteorology*, 55 (2), 378-390.

Pacala, S. and R. Socolow 2004. "Stabilization wedges: solving the climate problem for the next 50 years with current technologies" *Science* 305, 968

Penman J., M. Gytarsky, T. Hiraishi, T. Krug, D. Kruger, R. Pipatti, L. Buendia, K. Miwa, T. Ngara, K. Tanabe, and F. Wagner (eds). 2003. "Good Practice Guidance for Land Use, Land Use Change and Forestry." IPCC/OECD/IEA/IGES, Hayama, Japan. Available from <http://www.ipcc-nggip.iges.or.jp/public/gpplulucf/gpplulucf.htm>.

Intergovernmental Panel on Climate Change (IPCC). 2007.

Phillips, D.L., S.L. Brown, P.E. Schroeder, and R.A. Birdsey. 2000. "Toward error analysis of large-scale forest carbon budgets". *Global Ecology and Biogeography*. 9(4): 305-315.

Potter, C., Klooster, S., Myneni, R., Genovese, V., Tan, P.N., Kumar, V., 2003. "Continental-scale comparisons of terrestrial carbon sinks estimated from satellite data and ecosystem modeling 1982-1998". *Glob. Planet. Change*. 39(3-4), 201-213.

Richards, K., and C. Stokes, 2004. "A Review of Forest Carbon Sequestration Cost Studies: A Dozen Years of Research", *Climatic Change*, 63 (1-2), 1-48.

Rose, S., H. Ahammad, B. Eickhout, B. Fisher, A. Kurosawa, S. Rao, K. Riahi, and D. van Vuuren, 2006. "Land in climate stabilization modeling," Energy Modeling Forum Report, Stanford University, <http://www.stanford.edu/group/EMF/home/index.htm>

Somogyi, Z., E. Cienciala, R. Mäkipää, P. Muukkonen, A. Lehtonen, and P. Weiss. 2007. Indirect methods of large-scale forest biomass estimation. *European Journal of Forest Research* 126:2, 197

Sohngen, B., R. Mendelsohn, 2003. "An optimal control model of forest carbon sequestration", *American Journal of Agricultural Economics* 85 (2) 448-457.

van Vuuren, D., M. den Elzen, P. Lucas, B. Eickhout, B. Strengers, B. van Ruijven, S. Wokink and R. van Houdt, 2007 "Stabilizing greenhouse gas concentrations at low levels: an assessment of reduction strategies and costs", *Climatic Change*, 81:119-159

LESSONS LEARNED FROM RECENT PROMOTION STRATEGIES FOR ELECTRICITY FROM RENEWABLES IN EU COUNTRIES

Reinhard Haas¹, Anne Held², Gustav Resch¹, Mario Ragwitz², Thomas Faber¹, Claus Huber³

¹Energy Economics Group, Vienna University of Technology, Gusshausstrasse 27-29/373-2, A-1040 Vienna, AUSTRIA, Fax. ++43-1-58801-37397, Tel. ++43-1-58801-37352, E-mail: Reinhard.Haas@tuwien.ac.at

²FHG ISI, Karlsruhe

³EGL Austria

Abstract

To increasing the share of renewable energy for electricity generation is a major target in the EU. To meeting this target in recent years, a wide range of strategies has been implemented in different countries. This paper evaluates the success of different regulatory strategies assessing effectiveness of deployment and costs of support. The most important conclusions of this analysis are: (i) a well-designed (dynamic) feed-in tariff system ensures the fastest deployment of power plants using Renewable Energy Sources at the lowest cost to society; (ii) promotion strategies with low policy risks have lower profit requirements for investors and, hence, cause lower costs to society; (iii) regardless of which strategy is chosen, it is of high importance that there is a clear focus on the exclusive promotion of newly installed plants.

1 Introduction

To increasing the share of renewable energy for electricity generation (RES-E) is a major target in the EU. The Directive on the promotion of RES-E, published by the European Commission (2001/77/EC), sets challenging targets to increase the share of RES-E in the electricity mix of the EU-25 countries from 12 % in 1997 to 21 % by 2010, EC(2002). A more recently accepted target is 20% RES of total primary energy consumption by 2020. Yet, to bring about a breakthrough for RES, a series of barriers has to be overcome and proper strategies have to be implemented. Currently, a wide range of strategies is applied in different countries. Yet, which of the different instruments is most effective for increasing the dissemination of RES-E is still a topic of very controversial discussions. Within the wide range of applicable strategies most important is the discussion whether feed-in tariffs or tradable green certificates based on quotas are preferable.

The major objectives of this paper is to evaluate the performance of various strategies in the last years with special focus on the EU member states. The analysis is based on the outcomes of projects like GREEN-X, FORRES and OPTRES. Finally, the lessons learned from recent promotion strategies for electricity from renewables are presented. In detail the efficiency (costs per kWh new RES-E) and the effectiveness (kW deployed per year and capita) of different promotion strategies like Tradable Green Certificates, Bidding strategies and Feed-in tariffs are depicted for the EU-countries.

In the literature, reviewing the effectiveness and efficiency of various promotion strategies for RES-E has attracted increasing attention in recent years. The most important papers to be considered are Meyer (2003), Van der Linden et al. (2005), Haas et al. (2004), Mitchell et al. (2006) and Butler and Neuhoff (2004).

2 Survey on current policies

Figure 1 shows the evolution of the main support instrument for every EU-15 country. Only 8 out of the 15 countries did not experience a major policy shift during the period 1997-2005. The current discussion within EU Member States focuses on the comparison of two opposed systems, the FIT system and the quota regulation in combination with a TGC-market. The latter has recently replaced existing policy instruments in some European countries such as Belgium, Italy, Sweden, the UK and Poland. Although these new systems were not introduced until or even after 2002, the announced policy changes caused investment instabilities prior to this date. Other policy instruments such as tender schemes are not yet used in any European country as the dominating policy scheme. However, there are instruments like production tax incentives and investment incentives, which are frequently used as supplementary instruments. Only Finland and Malta apply them as their main support scheme.

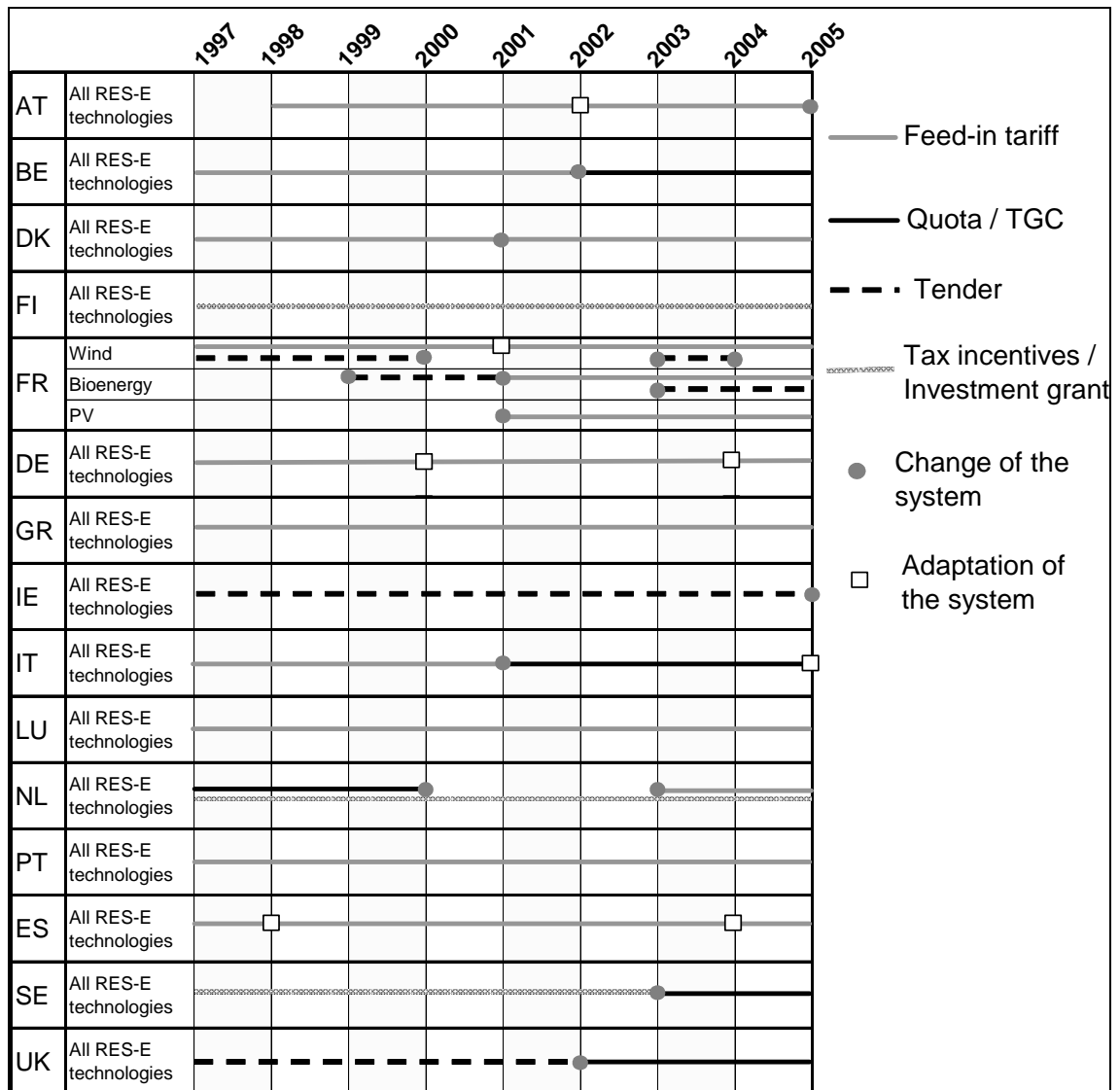

Figure 1 Evolution of the main policy support scheme in EU-15 Member States (Source: Ragwitz et al 2007)

3 Effectiveness and efficiency of promotion policies

Reviewing the programmes and instruments described above the core question is whether these programmes have been successful or not. To assess the success the most important criteria are:

- *Effectiveness: Has the programmes led to a significant increase in deployment of capacities from RES?*
- *Economic efficiency: What was the absolute support level and what was the trend in support over time?*

Further major performance criteria of interest are: credibility for investors and the reduction of costs over time.

Table 1 provides a summary on the specific / relevant performance parameters. In the following sub-chapters these criteria are discussed in detail. Needless to say, resource endowments of RES as well as existing power systems vary depending on countries; therefore, the further considerations are needed to observe actual effects of policy instruments.

3.1 Effectiveness of policy instruments

First the effectiveness of policy instruments is analyzed looking at the quantities installed. To make the performance between different countries comparable the figures are related to capita. Moreover, we look at all new RES in total as well as on wind and PV in detail.

Figure 3 depicts the policy effectiveness for electricity generation from all “new” RES for 1998-2004 measured in the incremental amount of RES-E per year and capita. Clearly, it was highest in Denmark with about twice as high renewable electricity deployed than the next ranked countries Finland, Sweden, Spain and Germany. It should be noticed, however, that since 2003 the net increase in wind power capacity has been close to Zero in Denmark. It is of interest that among these countries quite different promotion schemes exist: a quota-based TGC system in Sweden, investment incentives in Finland and FITs in the other countries. In the Nordic countries cheap electricity from biomass plays a considerable role. Note, that progress was generally much slower in new Member States than in the old EU-15 countries. Of the former, Hungary and Latvia showed the highest relative growth in the period considered.

Looking at wind onshore only – Fig. 3 – the EU countries with the highest policy effectiveness during the considered period, Denmark, Germany, and Spain, applied fixed feed-in tariffs during the entire period 1998-2005 (except a system change in Denmark in 2001). The resulting high investment security as well as low administrative barriers stimulated a strong and continuous growth in wind energy during the last decade. As can be observed from a country like France, high administrative barriers can significantly hamper the development of wind energy even under a stable policy environment combined with reasonably high feed-in tariffs.

Table 1. Summary of the specific relevant performance parameters

	Period of time analysed	RES quantity deployed (W/cap yr)	Magnitude of absolute support level	Decrease in support over time?	Risk for investors	Other important aspects
FIT&premium:						
Denmark	1992-1999	high	low	No	low	
Germany	1998-2005	high	medium	Yes	low	
Spain	2002-2005	high	low (fixed option); medium (premium)	Yes	low	
Austria	2002-2005	high	Medium	No	low	Support level to high because of parallel investment subsidies
Portugal	2002-2005	high	Low	No	low	
France	2002-2005	low	Medium	No	low	High administrative barriers
RPS and quota-based TGC:						
UK (RO)	2003-2005	low (quota not met)	High	Yes	Medium/high	Penalty too low
Italy	2003-2005		High	No	high	Time of validity of RES plants for certificates too low (8 years)
Sweden	2003-2005	high (quota met)	Low	Constant	medium	Windfall profits due to some old capacities also qualifying for certificates
Belgium	2003-2005	low (quota not met)	High	No	Medium/high	low penalty, Windfall profits due to some old capacities also qualifying for certificates
Tendering						
:						
UK (NFFO)	1990-1998	low	Low	Yes	Low after selection	Capacities to low

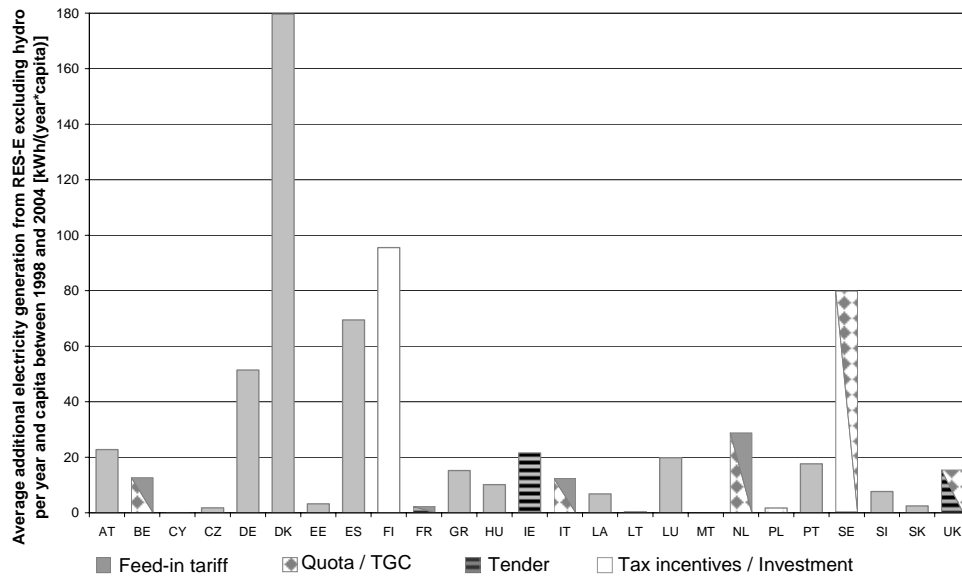

Figure 2. Policy effectiveness of support measures for electricity from “new” RES (excl. hydro) measured in additional kWh per year and capita for the period 1998-2004 in the EU, the US and Japan (Sources: EUROSTAT (2006), IEA (2006b), METI (2007), Black & Veatch (2006))

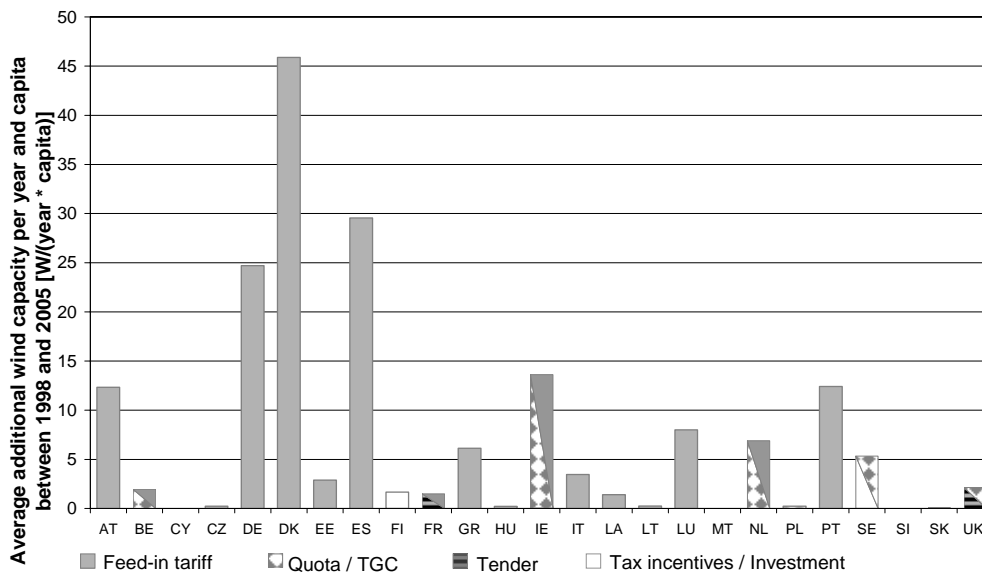

Figure 3. Policy effectiveness of wind onshore electricity support measured in additional capacity per year and capita in the period 1998-2005 in the EU, (Sources: EUROSTAT (2006))

With respect to PV – still one of the most expensive RES technologies – the depicted examples of Germany and Japan had the highest policy effectiveness along with Luxemburg who’s small population is not really representative (Fig. 4). Obviously, generous FITs – as in Germany, Luxembourg, and Japan (voluntary net metering) – have played an important role to promote PVs.

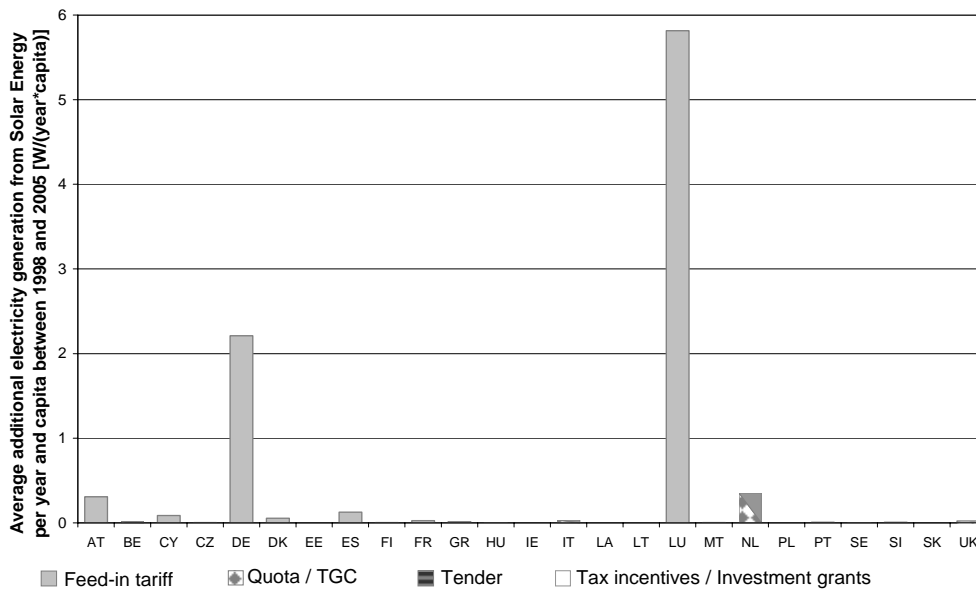

Figure 4. Policy effectiveness of PV electricity support measured in additional capacity per year and capita in the period 1998-2005 in the EU-25 countries (Source: EUROSTAT (2006))

3.2 Economic efficiency

Next we compare economic efficiency of the described support programs. In this context three aspects are of interest: absolute support levels, total costs to society and dynamics of the technology. As an indicator in the following the support levels are compared for wind power in the EU-15 specifically¹.

Fig. 5 shows that, for many countries, the support level and the generation costs are very close. Countries with rather high average generation costs frequently show a higher support level.

A clear deviation from this rule can be found in the three quota systems in Belgium, Italy and the UK, for which the support is presently significantly higher than the generation costs. The reasons for the higher support level expressed by the current green certificate prices may differ. Main reasons are risk premiums, immature TGC markets, and too short validity times of certificates (Italy, Belgium).

For Finland, the level of support for wind onshore is too low to initiate any steady growth in capacity. In the case of Spain and Germany, the support level indicated in Fig. 26 appears to be above the average level of generation costs. However, the potentials with rather low average generation costs have already been exploited in these countries due to the recent successful market growth. Therefore a level of support that is moderately higher than average costs seems to be reasonable even if it results in windfall profits for some wind power owners. In an assessment over time also the potential technology learning effects should be taken into account in the support scheme.

¹ A comparison of all new RES would provide too broad ranges for generation costs as well as for support measures.

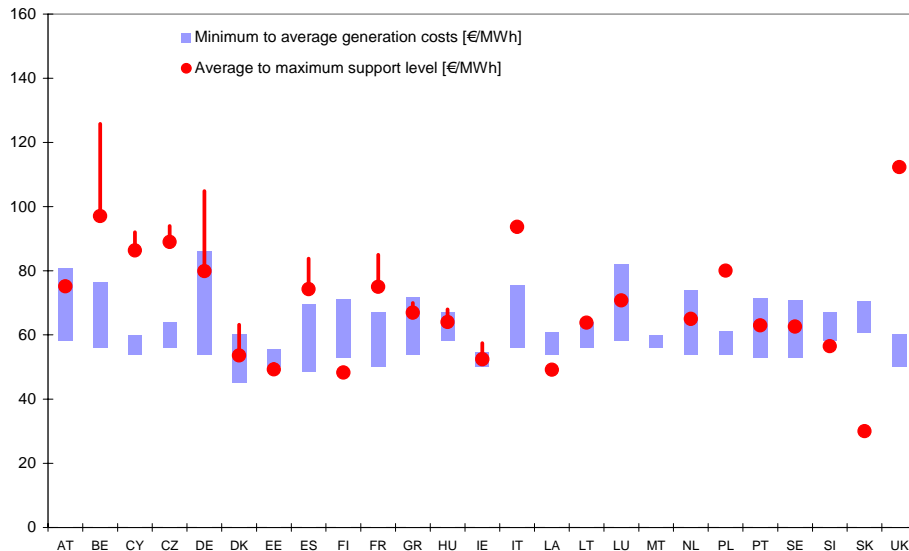

Figure 5. Example wind onshore: Support level ranges (average to maximum support) in EU countries in 2005 (average tariffs are indicative) compared to the long-term marginal generation costs (minimum to average costs). Source: Adapted from Ragwitz et al (2007).

3.3 Quantities vs costs of support

Next the relation between quantities deployed and the level of support is analysed. It is often argued that the reason for higher capacities installed is a higher support level. Although it should be noted that the resource endowments of RES vary depending on each country, as can be seen from Fig. 6 actually the opposite is true. The countries with highest support levels – Belgium and Italy – are among those with the lowest specific deployment. On the other hand, high FITs especially in Germany are often named as the main driver for investments especially in wind energy. However, the support level in Spain and Germany is not particularly high compared with other countries analysed here.

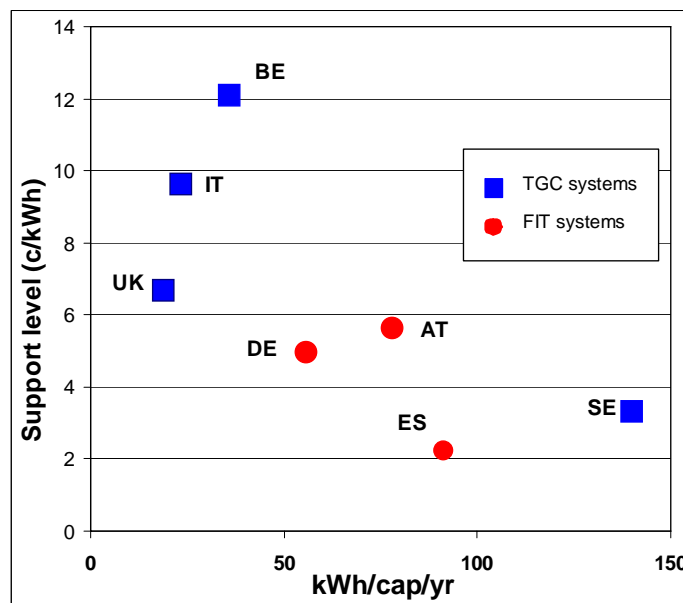

Figure 6. Effectiveness vs costs of promotion programmes for electricity from RES in selected countries (2002-2004)

The following additional character of TGC/quota instrument should be considered to explain the poor performance of this system in Europe. While it is supposed to be a quantity-driven instrument, that should reflect a higher likelihood of target achievement by comparison to a FIT system, in fact it is a hybrid instrument of control by quantity and price due to inclusion of a (relatively low) buy-out price. In the case where a government sets the buy-out price near the cost of the marginal project, the respect for the decided quota could be ruined. In such a case, renewable capacity development could be slowed down, stay far below the quota and thus miss the original target, as illustrated by the British experiment of the ROC system. The TGC/quota system thus needs refining in order to fulfil the targets in practice.

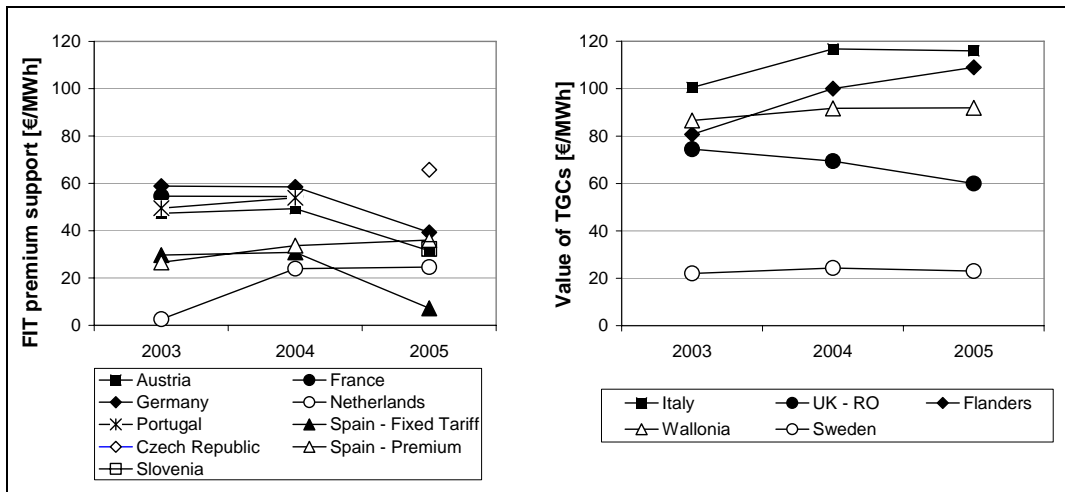

Figure 7. Comparison of premium support level: FIT-premium support vs. value of TGCs. The FIT-premium support level consists of FIT minus the national average spot market electricity price

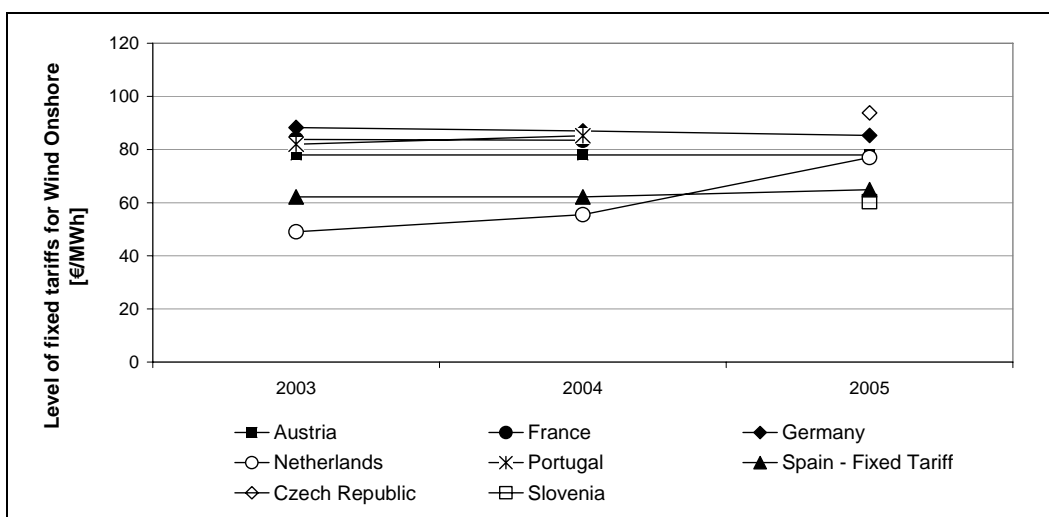

Figure 8. Development of fixed feed-in tariffs for wind onshore in different countries over time

Finally, it is of interest to analyse the dynamics. Figure 7 shows the premium support level in selected countries whereas Figure 8 depicts the overall FIT. In Figure 7, the requirement of a noticeable dynamic decrease in the promotion costs is not met for TGCs. However, the promotion costs of FIT-systems decreased in 2005 due to an

increase in electricity spot market prices. The overall remuneration provided by FIT-systems, including the value of the common electricity price shown in Figure 8, does not show a clear decrease.

4 Conclusions

The general conclusions of the analysis are:

- It is important for a promotional system to place a strong focus on new capacities and not mix existing and new capacities.
- The dissemination effectiveness of energy policy instruments depends significantly on the credibility of the system for potential investors. It must be guaranteed that the promotional strategy, regardless of which instrument is implemented, persists for a specified planning horizon. Otherwise the uncertainty for potential investors is too high and it is likely that no investments will take place at all.
- With respect to the investors' perspective, it is important to state that, at low risk (the case of FITs), the profitability expected is much lower and, hence, so are the additional costs finally paid by all customers.

Regarding the comparison of the different support schemes, the investigated FIT systems are effective at a relatively low producer profit. Hence a well-designed (dynamic) FIT system provides a certain deployment of RES-E in the shortest time and at lowest costs for society. It is preferable to national green certificate trading schemes for three reasons: (a) they are easy to implement² and can be revised to account for new capacities in a very short time; (b) administration costs are usually lower than for implementing a national trading scheme. This fact is especially important for small countries where a competitive national trading scheme is difficult to implement; (c) a clear distinction is possible between the non-harmonised strategy for existing capacities (the stepped feed-in tariff) and the harmonised strategy (international trade) for new capacities. This is very important to avoid uncertainties and backlashes in a conceivable period in which the framework conditions for a possible new harmonised system are being negotiated. The most important design criteria for FITs are: (i) a carefully calculated starting value; (ii) a dynamic decrease of the FIT that takes learning into account; (iii) the implementation of a stepped and technology-specific tariff structure (see also Haas et al (2004)).

At present, quota-based TGC systems show a low effectiveness although comparably high profit margins are possible. Market mechanisms seem to fail in TGC-systems, but, why should competition work in a TGC market if it does not function in the conventional European electricity market? In addition, it is hard to imagine that a European-wide TGC market disconnected from the large incumbent generators will work. The large incumbent utilities favour TGC, since this scheme gives them the chance to hedge risks and therefore prefer higher profitability. However, we must emphasise that these quota systems are comparatively new instruments in all the

2 Of course, this requires an understanding of the marginal costs of the various technologies and a follow-up of the individual plants.

countries using them. Therefore the behaviour observed might still be characterised by significant transient effects. The most important issues for the specific design of TGC-markets are a high penalty, the possibility of banking, a clear focus on new capacities and, to a certain extent, a technology-specific approach.

Finally, a primary question is whether a fully harmonised EU-wide promotion scheme should be pursued. The major conclusion here is: It is not likely that a European-wide harmonised scheme will emerge soon because the objectives of the various governments with respect to a promotion scheme are quite different. However, we also have to bear in mind what happens in the mid-term (after the first wave of investments comes to the end of their depreciation periods). In the light of the dynamic development in the RES-E market (e.g. wind turbine manufacturers, biomass plant developers, photovoltaic system component producers) and in the conventional electricity market (increasing prices due to rising demand and capacities becoming scarce, highly volatile natural gas prices and highly volatile prices for CO₂-emission certificates), it is of course necessary to improve and further develop the promotion schemes for RES-E. Currently, competition exists between the different types of promotion scheme. This should lead to a future development in which the best elements of the different promotion schemes are established and the different systems then gradually converge into an optimal strategy consisting of these best features. Of course, the most important accompanying features of this process are continuity of development as well as adequate credibility for investors. Joint efforts for similar framework conditions such as, e.g. depreciation times, could be a first step in this direction. In other words, the validity of certificates and the duration period for which a FIT is guaranteed should eventually be the same in each country. Furthermore, joint initiatives or lessons-learned clusters for the several categories of instruments could contribute to significant progress in designing the promotion instruments. Such an initiative has already been started for FITs by the Spanish and German governments (The International Feed-In Cooperation). We believe such an approach would be very important for quota-based TGC systems as well and an important step towards a more efficient and effective promotion of RES-E in the future.

Acknowledgements

The work presented in this chapter was financed within the scope of projects of the European Commission (GREEN-X, OPTRES) and the German Ministry for the Environment (BMU). Of course, the views expressed here are the sole responsibility of the authors not these institutions.

REFERENCES

- Butler, L.; Neuhoff, K. (2004): Comparison of feed-in tariff, quota and auction mechanisms to support wind power development. Working Paper, University of Cambridge, United Kingdom.
- European Commission [EC] (2001): *Directive 2001/77/EC of the European Parliament and of the Council of 27 September 2001 on the promotion of electricity produced from renewable energy sources in the internal electricity market.*
- European Commission [EC] (2005): *The support of electricity from renewable energy sources* . COM(2005) 627 final.

- Haas, R.; Eichhammer, W.; Huber, C.; Langniss, O.; Lorenzoni, A.; Madlener, R.; Menanteau, P.; Morthorst, P.-E.; Martins, A.; Oniszk, A. (2004): *How to promote renewable energy systems successfully and effectively*. In: *Energy Policy*, 32 (6), 833-839.
- Held, A.; Haas, R.; Ragwitz, M. (2006): On the success of policy strategies for the promotion of electricity from renewable energy sources in the EU. In: *Energy & Environment*, 17 (6), p. 849-868.
- Meyer, N.I. (2003): *European schemes for promoting renewables in liberalised markets*. In: *Energy Policy*, 31 (7), 665-676.
- Mitchell, C.; Bauknecht, D.; Connor, P.M. (2006): *Effectiveness through risk reduction: a comparison of the renewable obligation in England and Wales and the feed-in system in Germany*. In: *Energy Policy*, 34 (3), 297-305.
- Ragwitz, M.; Held, A.; Sensfuss, F.; Huber, C.; Resch, G.; Faber, T., Haas R.; Coenraads, R.; Morotz, A.; Jensen, S.G.; Morthorst, P.E.; Konstantinaviciute, I.; Heyder, B. (2006): OPTRES - Assessment and optimisation of renewable support schemes in the European electricity market.
- van der Linden, N.H.; Uytterlinde, M.A.; Vrolijk, L.; Nilsson, J.; Khan, K.; Astrand, K.; Ericsson, K.; Wiser, R. (2005): *Review of international experience with renewable energy obligation support mechanisms*. Petten, Netherlands. ECN-C-05-025.

Session 2 - Scenarios and Policy Options

Chairman: Barry Worthington, United States Energy Association, USA

Integrated European Energy RTD as Part of the Innovation Chain to Enhance Renewable Energy Market Breakthrough

P.D. Lund
Helsinki University of Technology
P.O.Box 4100, FIN-02015 TKK (Espoo), Finland
Email : peter.lund@tkk.fi

Abstract

Integrated energy RTD strategies considering the whole innovation chain is discussed and applied to renewable energy. Commercialization and diffusion processes and their link to policy instruments are crucial elements in this context. The results show that the distance from cost breakeven point affects the optimal balance between technology push and market pull actions and the mix of instruments the total public support needed.

1 Introduction

All major energy sources face severe restrictions related to environmental, safety or economic factors. Major R&D will therefore be necessary to find acceptable solutions for their future use. Huge financial resources will also be required to bring new energy solutions in a sustainable way to a major market breakthrough.

The Advisory Group on Energy for the European Commission (FP6 AGE 2002-2006) has dealt with important strategic questions concerning European energy policy, in particular the role of energy technologies in solving our common energy challenges. The AGE work comprised both “vertical” technology specific and “horizontal” common RTD issues /1, 2/. Key messages from the high-level experts were that present energy technologies could be significantly improved and their bottlenecks resolved through more concerted actions and if the financial resources were significantly increased. Conversely, the major treats are the low funding levels and dispersed efforts which may jeopardize European leadership in many energy technologies.

In its recent Communication from January 2007 on an integrated energy policy, the European Commission urged to look on the whole innovation process of energy technologies. The Commission adapted several of the AGE recommendations in its policy communication “Towards a European Strategic Energy Technology Plan” /3/.

Above plans relate closely to the necessity to achieve major commercial breakthroughs in several sectors in the coming years, notably renewable energy, to fulfill EU’s ambitious quantitative goals in GHG emission reduction, energy intensity improvement, and renewable energy targets for year 2020 and beyond.

The starting point of this paper is the Advisory Group of Energy’s recommendations and concerns on energy R&D from 2006 and the EU’s Energy Communication from 2007 which are expanded into an innovation environment. The paper starts with a discussion of the innovation chain and commercialization process of energy technologies followed by the methodology used to investigate RTD and innovation strategies. Finally the link of policies and renewable energy penetration is analyzed.

2 Energy technology innovation chain

When forming broader energy technology R&D strategies as part of the innovation chain, three different aspects are useful to be considered, namely:

- the commercialization process of new innovations or improvements of energy technologies that precede the more massive market penetration and which is very development intensive and needs strong public support
- the technology diffusion process that describes the market share of the new technology over time once the ‘take-off’ has occurred after market introduction and the new technology is becoming competitive against the prevailing ones;
- the policies and instruments that enhance above processes to enable full commercial market breakthrough; this includes also the overall policy needed to master the whole commercialization process.

All three elements are present in an integrated RTD strategy. In particular the interface between the commercialization process and technology diffusion is often vague and overlapping. The public measures and support may also extend to the diffusion phase.

2.1 Technology diffusion process

The market penetration often follows the classical technology diffusion pattern illustrated in Fig. 1. One of the main challenges is encountered when moving from R&D to the market. Getting a foot-hold on market and reaching adequate volume to enable further continued growth may require substantial public support. The diffusion is also strongly linked to decision making processes.

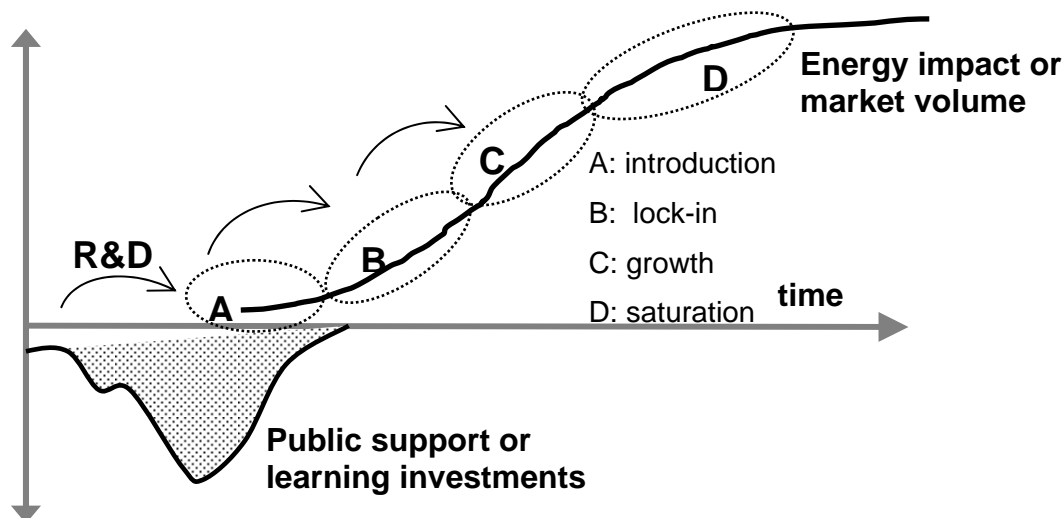

Figure 1. Schematic illustration of the technology diffusion process.

The long investment cycles of energy production systems and the inertia of infrastructures have traditionally meant long lead times for energy sources to reach significant shares on global scale. This important observation implies a few things for an integrated RTD strategy:

- impacts from R&D efforts in energy need to be viewed over a longer time period than traditionally in technology, which also implies continuity and adequate resource levels as the cumulative efforts over time seem to matter for success (cf. R&D efforts in nuclear power in OECD countries since 1949);

- it may also be highly motivated to invest R&D in areas and technologies that could provide impacts on a much shorter time scale, which could be found closer to the end-use side of the energy chain, e.g. distributed energy systems or efficient energy end-use products, where the investment cycles may be shorter /4/.

2.2 Commercialization process

The commercialization process is illustrated in Fig. 2.

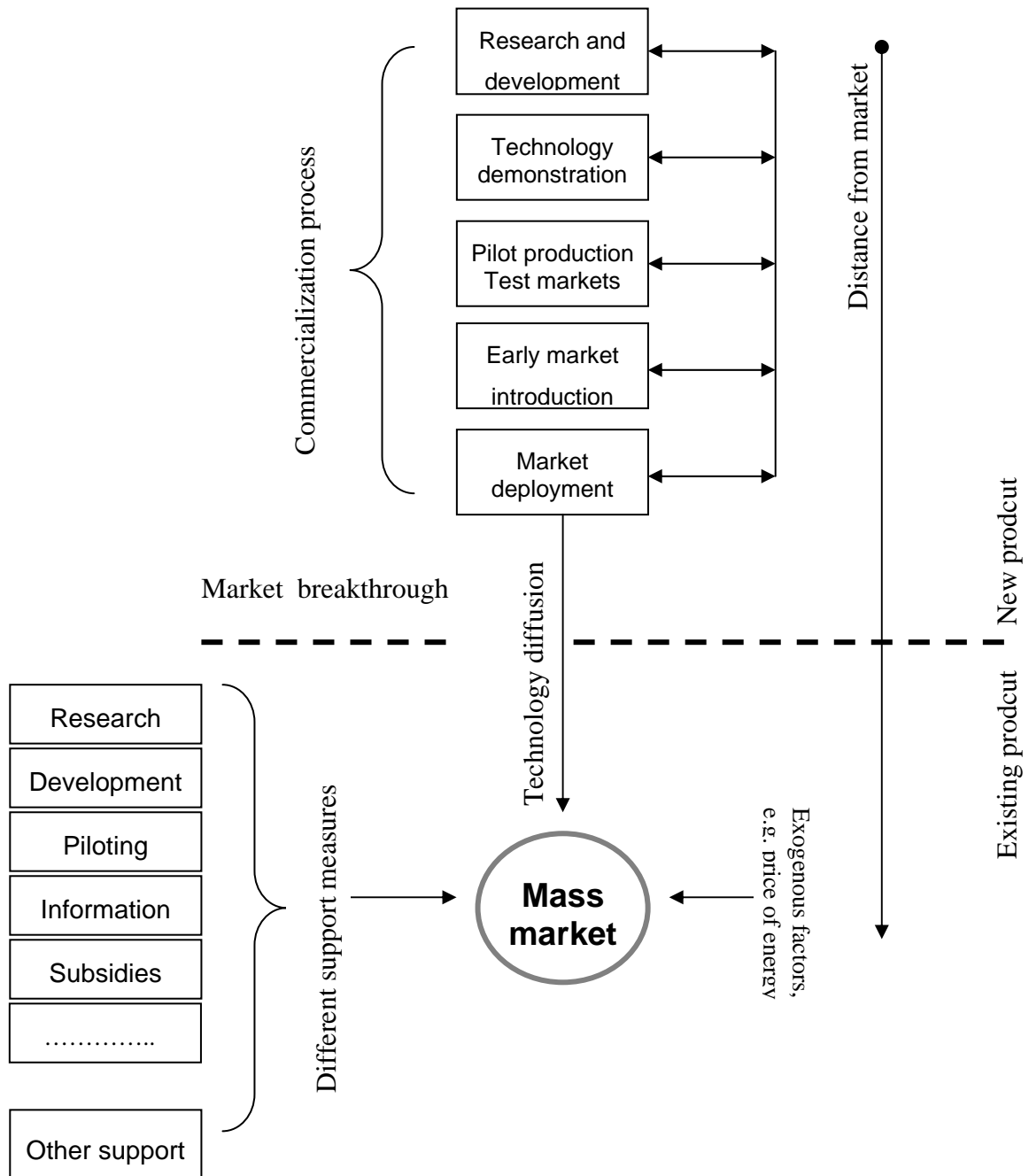

Figure 2. Schematic of the commercialization process and its stages.

It should be observed that the process is different in case of a new technology not well established in the market (upper part of the illustration) than if speaking of an existing

product and integrating new improvements into it (lower part). In both cases public support may be necessary and motivated, but in case of the new technology a range of additional stages are needed upstream to enter the market. Thus, for incremental improvements the channel to market through existing products is much shorter than for more radical innovations not having an established market. The latter corresponds more to the classical definition of the commercialization chain with so-called technology push and market pull measures.

The different stages of the commercialization process (upper part in Fig. 2) may be strongly interactive and go in parallel. Once being established on the market, the new technology may need continued support if cost-effectiveness is not reached. Different exogenous factors such as energy price, market size or non-energy factors may affect the outcome and impacts as well. The amount of public support and time needed for penetration correlates to the distance from the market. The distance from the market can be characterized e.g. by price or market share.

2.3 Policy instruments

The key of an integrated RTD strategy will be embracing the whole innovation process described above, i.e. from research to market take-up and facilitating platforms for effective commercialization. The primary target is a market breakthrough, which in turn leads to increasing volume and cost reductions. (cf. learning by doing and learning by using). The public expenditure associated into the whole process can be viewed as a kind of learning investment.

In traditional thinking the technology push instruments such as R&D and demand pull instruments are separated whereas in modern approaches these are closely interlinked under a common strategy. Those instruments that relate directly to the commercialization process, i.e. bringing innovations to the market rather than focusing on a specific product, are highly relevant here. Such approaches employ market mechanisms and forces and combine flexibly a variety of measures over time to facilitate breakthroughs. Examples of market based instruments are technology procurement, competition enhancing actions, employing purchasing power, etc. The public support acts here as a catalyzing agent. Whereas traditional product focused support have a strong volume character, i.e. size of impact is directly proportional to the amount of subsidy. Catalyzing integrated policy instruments turn out to be more cost-effective than traditional volume-based /5/.

The technology development is handled in the EU programmes through a variety of instruments such as the Framework Programmes, Joint Technology Initiatives, Technology Platforms but also through different infrastructure related funding, e.g. EBRD or Structural Funds. The market pull is on the other hand mainly provided through a range of directives. The European Strategic Energy Technology Plan (SET-Plan) calls for a more integrated approach to match the most appropriate set of policy instruments to the needs of different technologies at different stages of the development and deployment cycle.

3 Methodological approach

3.1 Combined diffusion and learning model

For basic commodities such as energy, the price is one of the main factors that determine the success on the market. The society may impose different quality or sustainability requirements on the products, which also influence the commodity price. For this reason, we chose the cost of energy produced as the main criteria that determine the commercial breakthrough and full-scale penetration of the new technology on the market. Renewable

energies face different barriers for large-scale exploitation such as technical inadequacies and institutional hurdles, but we assume that even these can be described as a cost factor.

The central objective is to overcome the higher costs of the new energy technology over the traditional energy and to boost the market introduction. The instruments in hand are technology push and market pull instruments that need to be exercised in an optimal way. The key questions encountered will be the scale and timing of efforts which in turn depend often on how close to competitiveness or how well established the new technology is on the market.

To analyze optimal strategies for renewable energy in a more quantified way and to shed light on trade-off between R&D and market deployment actions, an analytical framework describing the penetration process was employed for the analyses in this paper. The tool combines price-conditioned and segmented technology diffusion with an endogenous learning model /6/. The mathematical model consists of three parts: 1) calculation of the production cost of energy, 2) estimation of the market volume increase and 3) cost reduction, respectively. All three factors are interlinked. The first step is to calculate the leveled unit costs of produced energy over life-time:

- production cost of renewable energy C = annualized cost of investment + O&M + fuel +[risk premiums] + [public subsidy] \pm [system integration cost] \pm [CO₂ cost] divided by annually produced energy;
- investment is split between the core technology and the balance of system;
- market penetration occurs if $C \leq$ reference cost of energy. If the new technology is uncompetitive, penetration can assured by adjusting the subsidy level.

The speed of market penetration is described by a diffusion model that accounts for the inertia of the social and energy system. The volume of the new technology increases with an amount of dV_t during an interval of dt as follows:

$$- \frac{dV_t}{dt} = \beta \cdot \frac{V_t}{V_\infty} \cdot (V_\infty - V_t) ; V_t = V_0 + \sum_t dV_t \quad (1)$$

where $\beta = \beta(V_t)$ is the penetration rate of the new technology

The increase in the capacity of the new technology leads to cost reductions through endogenous learning, i.e. learning by doing and by using and economies of scale /7/. The cost reduction is modeled with a learning curve and progress ratio (P). The unit cost of the new technology falls by 1-P for each doubling of the cumulative capacity (V_t). The learning curve is of the form

$$- C_v = C_0 \cdot \left[\frac{V_0}{V_t} \right]^{\frac{\ln 2}{\ln P}} \quad (2)$$

The cost reduction from an incremental volume increase dV_t is then obtained by differentiating the learning curve

$$dC_v = -C_v \cdot \frac{\ln 2}{\ln P} \cdot \frac{dV_t}{V_t} \quad (3)$$

The learning process is split into core, O&M and BOS parts each having their own progress ratio. The total volume for the new technology is divided into N market segments each having its own characteristics in terms of size, energy price, etc.

The market penetration will lead to increased volume of the new technology which in turn reduces the unit costs and the subsidy needs. When the C drops below the reference price of energy, a breakthrough occurs and the penetration proceeds thereafter market-based. Sufficient public support or directives can enable market growth also when the new technology is price-wise not competitive.

3.2 Linking the model to policies and strategies

The end purpose of technology push and market pull activities is to improve the economic competitiveness of the new technologies (C) over the traditional energy and to influence the penetration rate (β) which leads to increased market volume (V).

The policy influence can be easily demonstrated through the learning curve in Eq(2). Figure 3 illustrates a range of cases that are explained shortly in the next:

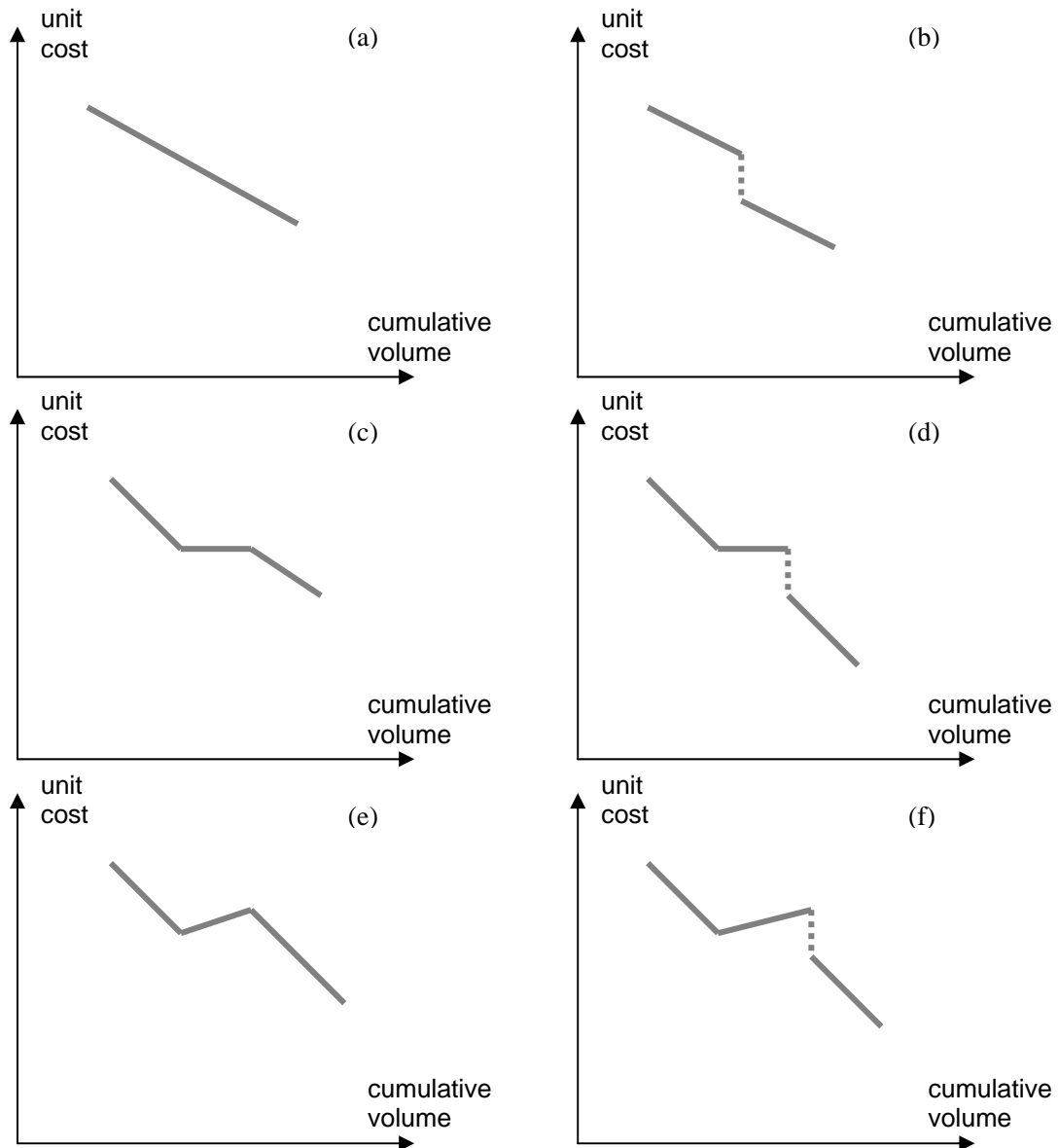

Figure 3. Examples of different learning curve typologies.

(a) shows the classical learning curve where unit cost decreases typically 10-25% for each doubling of cumulative volume. Steady market penetration caused by adequate market deployment efforts could result in such a curve.

(b) shows an abrupt drop in the unit costs, i.e. a new technology innovation or breakthrough that cause a discontinuity in the learning curve. This may be a typical outcome from a strong R&D effort.

(c) shows a phase of saturation in the unit cost albeit increasing volume which may result in case demand exceeds supply of the new technology, too high subsidies, supply bottlenecks are encountered, insufficient competition, etc.

(d) shows a saturation phase in unit cost albeit increasing volume as in case (c) but followed by a sudden drop. This could be a result of solving the reasons for saturation, for example technology/process improvements or increased competition.

(e) shows a temporary increase of the unit price albeit increasing volume which may result e.g. when demand exceeds greatly supply of the new technology, or similar reasons as in case (d). This could be an outcome of fast growing markets caused by over-subsidizing.

(f) shows a temporary increase of the unit price albeit increasing volume as in case (e) but then a sudden cost reduction. This could be a result of quick and efficient problem solving, e.g. new supply capacity, important technology improvements, etc.

4 Optimization of the commercialization process

Integrated RTD approaches for photovoltaics and wind power was investigated in the next using the combined diffusion & learning model.

4.1 Case PV – effects of large R&D efforts

PV is still expensive and necessitates strong public support to become competitive. The price of PV electricity ranges from 250 to 500 €/MWh within EU which is 2-4 fold compared to the consumer electricity price. In the model, 4 market segments were used representing grid-connected PV in south Europe, central Europe and ROW, and stand-alone PV in developing countries. Basic input parameters were the following: 5.5€/Wp for grid-connected PV at $t=0$, $\beta_0=0.2$, $\partial\beta/\partial V < 0$, 18% learning curve, interest rate 5% and economic life-time 25 years.

The prevailing public policy for PV in Europe is feed-in-tariffs which is also used here in the base case – the tariff is adjusted so that grid-PV is always competitive compared to EU consumer electricity prices. As PV is still far away from the commercial breakthrough, the second case studied is a strong RTD effort leading to a 30% cost reduction (a 10 years time horizon may be realistic to achieve a major technology breakthrough through a strong European R&D effort).

The main results for a period of 30 years are shown in Figure 4. PV could globally contribute 1% of world electricity or around 400 TWh/yr in the RTD case at $t=30$ years.

Figure 5 shows the investments and subsidies required for the penetration in Fig. 4. A focused R&D effort leading to a 30% cost reduction (e.g. cheaper solar grade Si, mass produced thin-films or third generation PV), saves 150 billion € in investments over the 30 years time period and 33 billion € of public support compared to the base case without any major technology jump. The cost-effective market breakthrough is shortened by 5 years.

The economic reward for a stronger R&D effort over market deployment instruments alone is thus most evident when being far from commercial breakthrough. This would speak strongly for using the new EU instruments such as the JTI or technology platforms for PV (also for other embryonic technologies such as fuel cells).

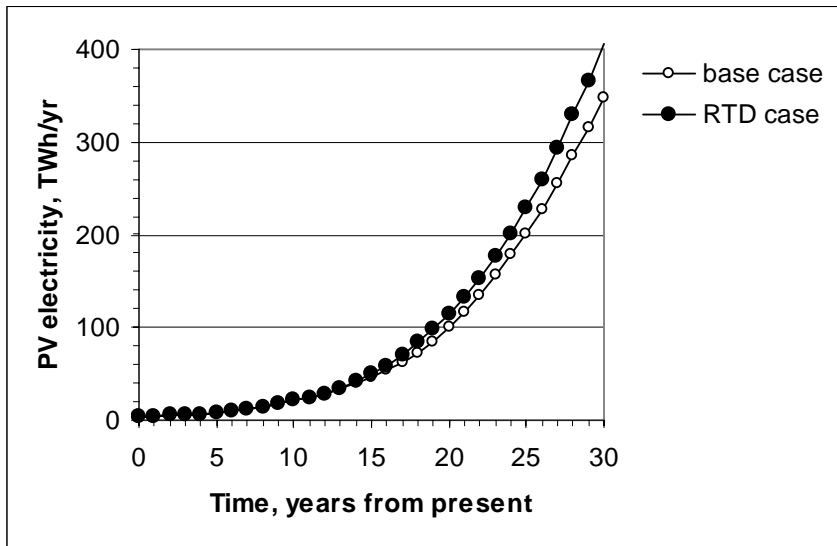

Figure 4. PV penetration on a global scale.

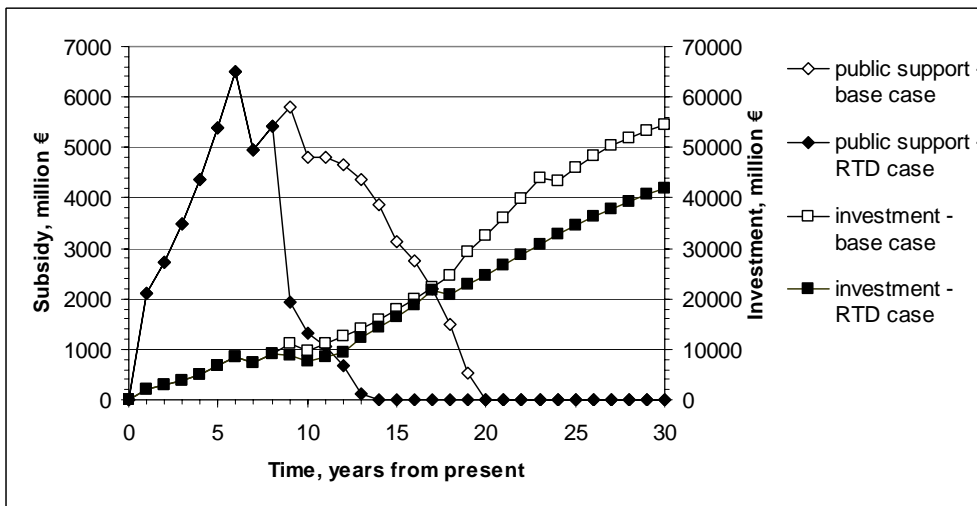

Figure 5. Investment and subsidy levels in two different cases (base and RTD).

4.2 Case wind power – effects from market disturbances

Wind power is one of the fastest growing electricity production forms in Europe. With a capacity of 74,000 MW (2006) wind produces world-wide around 1% of all electricity. The yearly sales volume has increased by 20-30% yearly for several years and in 2007 demand seems to exceed the supply of new turbines.

The cost of on-shore wind at $t=0$ is 50 and for off-shore 65 €/MWh. Feed-in-tariffs are employed to ensure penetration, but with decreasing compensation. The model predicts that wind power cost is halved in 30 years (30-36€/MWh) and non-subsidy penetration starts at $t=10$ years in EU-onshore and at $t=20$ years in EU offshore segments.

The base case scenario is illustrated in Fig. 6 predicting 3500 TWh/yr wind electricity globally in 30 years, or 10% of all electricity then. In Europe, the wind would raise to a 20% share of all electricity. Viewed by segment in Europe, on-shore wind would start to saturate around $t=15$ years and the growth would shift to off-shore.

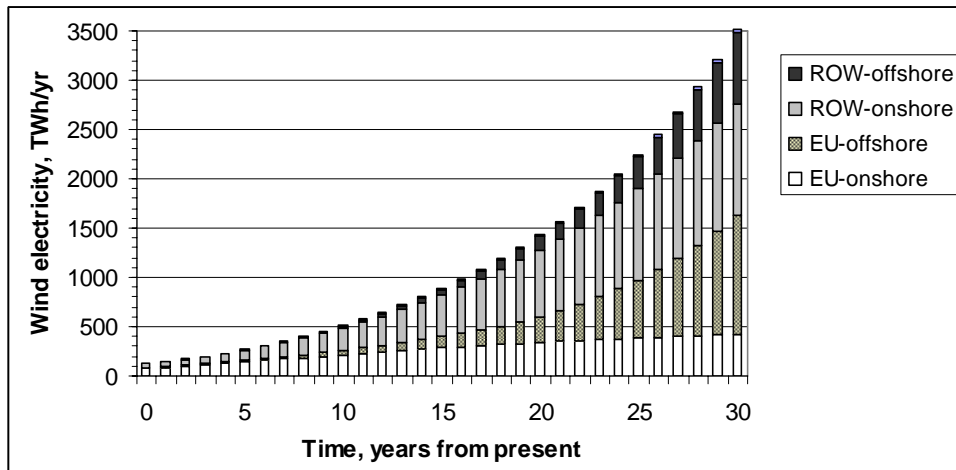

Figure 6. Wind energy penetration in different market segments in base case.

Next effects from short disturbances were analysed. Firstly, the cost of wind was assumed to increase by 5%/yr due to strong demand. Secondly, the cost reduction vs. volume was assumed to stagnate. In both cases the disturbances occurred at $t=3$ years and lasted for 2 years. Figure 7 summarizes the outcome on investments and subsidies.

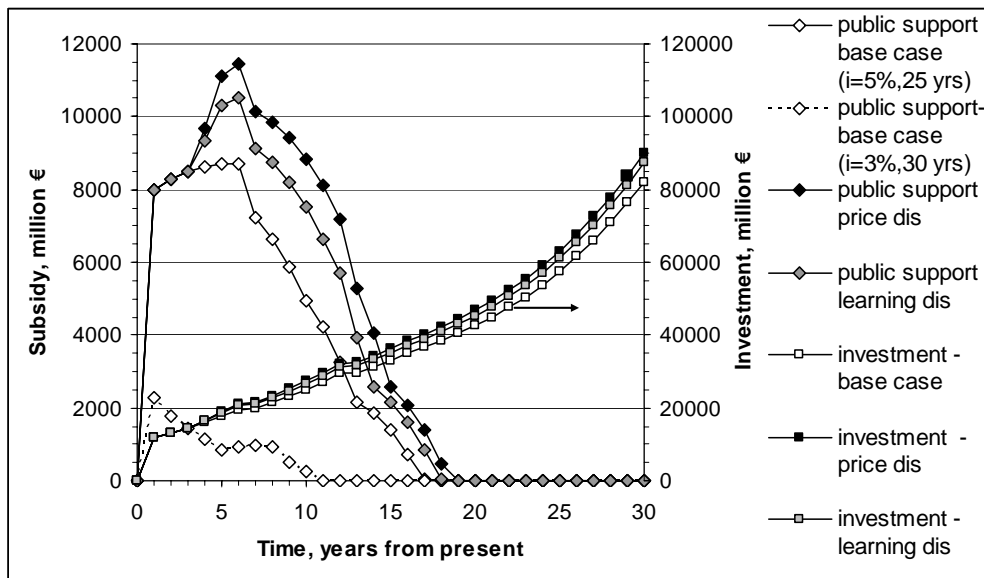

Figure 7. Investment and subsidy levels for wind power in different cases.

Compared to the base case, the learning stagnation causes a 30 billion € extra subsidy need and the cost disturbance 37 billion € respectively. The effect in the private investments is around 100 billion €

Another important factor that affects the amount of market support is the discount factor of the investment, i.e. the interest level and life-time, for which we used 5% and 25 years, respectively. If investments could be backed by low-interest loans e.g. in EU through the EBRD or EIB yielding 3%/30 yrs, would drop the subsidy requirement dramatically. For example, in the wind case in Fig.7, the commercialization could be achieved with 85% lower public support than in the base case, or saving 70 billion €

5 Conclusions and discussion

Integrated European RTD has been investigated in the whole innovation chain. Both the commercialization and diffusion processes and their links to policy instruments were addressed. An analytical framework was employed for more detailed elaborations.

The results clearly show that the distance from the cost breakeven point has a major effect on the optimal balance between technology push and market pull actions. For energy technologies still far away from the commercial breakthrough, focused R&D efforts to enable technology jumps could be more advantageous than pure market deployment actions. When market pull instruments are strongly employed to accelerate market growth even short negative disturbances in cost reduction trends could be quite costly to the support needed, for example if demand exceeds supply of the new technology or the learning effects saturate.

The case example for PV indicates a market potential of 1% of global electricity in 30 years. Introducing a strong R&D effort to reduce the core technology cost by 30% could save 30 billion € of public support for market deployment. This would strongly speak for joint European R&D in the field.

The case example for wind power indicates a market potential of 10% of global electricity in 30 years. The public support needed to reach a full cost-effective breakthrough is very sensitive to cost disturbances. For example a few years temporary cost increase of 5%/yr could require over 30 billion € more public subsidies. This in turn stresses careful planning of the subsidy levels on a European level to balance possible supply/demand bottlenecks.

6 References

1. Heather Greer (Ed.), Angelo Airaghi, Roger Ballay, Niels Busch, William d'Haeseleer, Wolfgang Dönitz, Cesar Dopazo Garcia, Alain Gerard, Gerd Eisenbeiss, Gerhard Faninger, Frederick Mariën (EC), Peter Lund (chair), Odisseas Panopoulos, Frantisek Pazdera, Carlos Pimenta, Derek Pooley, Erich Tenckhoff, Iacovos Vasalos, Transition to a sustainable energy system for Europe - The R&D perspective .European Commission Report EUR 22394, 2006, FP6 Advisory Group on Energy. http://ec.europa.eu/research/energy/gp/gp_pu/article_1100_en.htm
2. Derek Pooley (Ed.), Niels Busch, Gerhard Faninger, Roger Ballay, Angelo Airaghi, William d'Haeseleer, Wolfgang Dönitz, Cesar Dopazo Garcia, Alain Gerard, Heather Greer, Gerd Eisenbeiss, Frederick Mariën, Patrick Lederman, Peter Lund (chair), Odisseas Panopoulos, Frantisek Pazdera, Carlos Pimenta, Erich Tenckhoff, and Iacovos Vasalos, Further tasks for future European Energy R&D -A second set of recommendations for research and development by DG-RTD's Advisory Group on Energy. European Commission Report EUR 22395, 2006.
3. European Commission, A European Strategic Energy Technology Plan (in An Energy Policy for Europe). Communication, Brussels, January 2007.
4. Peter Lund, Market penetration rates of new energy technologies. *Energy Policy*, 34, 3317-3326, 2006.
5. P.D. Lund, Effectiveness of policy measures in transforming the energy system. *Energy Policy*, 35, 627-639, 2007
6. Peter Lund, Analysis of energy technology changes and associated costs. *Energy Research*, 30, 967-984, 2005.
7. C.O. Wene, Experience curves for energy technology policy. International Energy Agency, Paris, 2002.

Impacts of high energy prices on long-term energy-economic scenarios for Germany

Volker Krey¹, Dag Martinsen¹, Peter Markewitz¹, Manfred Horn², Felix Chr. Matthes³,
Verena Graichen³, Ralph O. Harthan³, Julia Repenning³

- 1) Research Centre Jülich, Institute of Energy Research - Systems Analysis and Technology Evaluation (IEF-STE), 52425 Jülich, Germany
- 2) DIW Berlin, Königin-Luise-Str. 5, 14195 Berlin, Germany
- 3) Öko-Institut, Novalisstr. 10, 10115 Berlin, Germany

Abstract

Prices of oil and other fossil fuels on global markets have reached a high level in recent years. These levels were not able to be reproduced on the basis of scenarios and prognoses that were published in the past. New scenarios, based on higher energy price trajectories, have appeared only recently. The future role of various energy carriers and technologies in energy-economic scenarios will greatly depend on the level of energy prices. Therefore, an analysis of the impact of high energy prices on long-term scenarios for Germany was undertaken.

Based on a reference scenario with moderate prices, a series of consistent high price scenarios for primary and secondary energy carriers were developed. Two scenarios with (i) continuously rising price trajectories and (ii) a price shock with a price peak during the period 2010-15 and a subsequent decline to the reference level are analysed. Two types of models have been applied in the analysis.

The IKARUS energy systems optimisation model covers the whole of the German energy system from primary energy supply down to the end-use sectors. Key results in both high price scenarios include a replacement of natural gas by hard coal and renewable energy sources in electricity and heat generation. Backstop technologies like coal liquefaction begin to play a role under such conditions. Up to 10% of final energy consumption is saved in the end-use sectors, with the residential and transport sector being the greatest contributors. Even without additional restrictions, CO₂ emissions significantly drop in comparison to the reference scenario.

The ELIAS electricity investment analysis model focuses on the power sector. In the reference scenario with current allocation rules in the emissions trading scheme, the CO₂ emissions decrease relatively steadily. The development is characterised by the phase-out of nuclear energy which is counterweighted by the increase of renewables. In the high price scenario, the CO₂ emissions temporarily rise around 2020 as a result of the diminishing attractiveness of electricity produced by natural gas in comparison to coal-fired power plants (especially lignite). In the case of the implementation of an ideal emissions trading scheme with full auctioning of EU allowances to new entrants, the emission abatement is significantly higher in the reference scenario. In the high price scenario, emission reductions are significantly lower and are comparable to the high price scenario under current allocation rules.

1 Introduction

Prices of oil and other fossil fuels on global markets have reached a high level in recent years. These levels were not able to be reproduced on the basis of scenarios and prognoses that have been published in the past (e.g. (EIA 2005; EU Commission 2003; EWI/Prognos 2005; IEA 2004)). New scenarios, based on higher energy price

trajectories have appeared only recently (EIA 2006b; EWI/Prognos 2006; IEA 2006). However, the future role of various energy carriers and technologies in energy-economic scenarios will greatly depend on the level of energy prices. This is particularly true of scenarios that are developed with the help of energy models. Therefore, an analysis of the impact of high energy prices on long-term scenarios for Germany has been undertaken. For this purpose a series of three energy price scenarios has been developed which constitutes the basis for the analysis using two different models. Whilst a normative optimisation of the whole energy system in Germany was carried out using the IKARUS energy systems model (Martinsen et al. 2006), the ELIAS model (Matthes et al. 2006) was used to analyse the trends emerging from microeconomic investment decisions in the electricity industry.

2 Energy Price Scenarios

In 2003, the price of crude oil started to increase sharply and reached about 80 US \$/bbl in the summer of 2006. In nominal terms this constituted a new historical price peak. If corrected by price increases arising from general inflation, the price was not as high as that at the end of the 1970s. Accounting for productivity and respective income increases during the last 35 years, the increase of working time needed to buy one barrel of oil is still moderate. Higher energy efficiency additionally dampened the impact of higher oil prices. Macroeconomic effects due to the oil price shock were also dependent on the behaviour of central banks. They did not react with sharp interest rate increases on this occasion, because the inflation path did not lead to a wage price spiral. Central banks - especially in Japan and the USA - may even have contributed to the recent oil price shock by means of their low interest rate policy. The created liquidity thus moderated the crisis of the stock markets after 2000. Therefore, three years of high prices did not initiate a worldwide recession as happened after the price shock at the end of the 1970s. Economic growth remained high, especially in Asia and the USA. In Europe - even in Germany - growth recovered after five years of stagnation in 2006. This dampened the effects of high oil prices on economic growth and on oil demand worldwide. If oil supply growth really lagged behind demand, oil prices would temporarily increase until a level is reached which triggers the reduction of oil demand that would be necessary to balance global demand and supply – if necessary by a recession. Such a development has not taken place to date. After a peak in the summer of 2006, the oil price dropped to below 60 US \$/bbl in the autumn of 2006, then recovered and dropped again substantially at the end of the year. One reason for this may be that the US central bank raised interest rates and that economic growth in the United States has started to slow down. To prevent a further drop of prices, OPEC countries reduced their production for the first time since the autumn of 2003 (by 1.2 mbd) and announced that they would reduce it further in February 2007 (by 0.5 mbd). Nevertheless, the prices continued to fall at the beginning of 2007.

More remarkable than the moderate effect of past oil price increases on world economic growth has been its effect on long-term oil price forecasts. Before the price started to explode at the end of 2003, the aim of the OPEC was to stabilise the oil price at about 25 US \$/bbl. For most analysts this was an ambitious target, since the marginal costs of oil production and the benchmark of oil companies for new projects was far below that level. Past predictions by some geologists that oil production would peak some years from now or had just peaked were not taken seriously by most policy makers. This has changed as a result of the price shock. Now most analysts and politicians interpret the oil price shock not as a temporarily peak of a long-term price fluctuation as in the past, but as a signal of a fundamental change in the oil markets induced by the higher than projected demand (especially by China) and a limited supply (due to a lack of sufficient resources or investments in major producer countries). By the end of 2005, the EIA changed its price assumptions dramatically; in 2006 the IEA did the same. The reasons offered by both the EIA and IEA to explain these changes in their price assumptions were investments in oil exploration and production facilities being lower than previously

assumed, and were not changed assumptions of recoverable resources. In its world energy outlook of 2006, the IEA projects crude oil prices of about 60 US \$₂₀₀₅ in 2030.

There is no certainty about the development of oil prices in the coming months and years or as to whether they will rise or fall moderately or sharply. Our knowledge of technological and political development, elasticities of demand during different stages of economic development, the amount of recoverable resources, the long-term effectiveness of OPEC and, last but not least, the interdependence of spot and future markets make it nearly impossible to predict oil prices with an appropriate degree of accuracy. Therefore, it is more helpful to refrain from making such predictions. If assumptions about oil prices are necessary, scenarios of possible developments can be sketched.

High oil and energy prices may have important effects on the level and structure (by energy carriers) of energy consumption and production and thus on CO₂ emissions. To explore these effects in detail up to 2030, the German Federal Environment Agency (Umweltbundesamt) contracted Öko-Institut, the German Institute for Economic Research (DIW) and Forschungszentrum Jülich. In a first step of this study, we sketched three possible price scenarios: a reference scenario with a moderate price development, a scenario with high prices and a scenario with a sharp price peak. As we assume that oil will remain the most important energy carrier worldwide up to 2030 and oil prices will therefore remain the best indicator of the world energy situation, our scenarios start with assumptions of oil price developments (in US \$/bbl) which are then translated into import and consumer prices for crude oil and energy products in Germany in Euro. Based on crude oil prices in US dollars, the development of the cross-border import prices in Euro for crude oil, natural gas, hard coal and mineral oil products were determined from an analysis for the last 30-35 years of currency relations between US dollars and Euro (1.1 US\$/€) and price relations of mineral oil products, natural gas and hard coal as compared to crude oil. This analysis justifies the simple assumption of long-term constant relations for the future.

Scenario	2000	2005	2010	2015	2020	2025	2030
Reference	28.4	48.7	28.0	30.0	32.0	34.0	37.0
High prices	28.4	48.7	54.1	63.7	73.3	77.9	82.5
Spike	28.4	48.7	105.0	105.0	62.0	34.0	37.0

Sources: (EIA 2006b; EWI/Prognos 2005; Goldman Sachs 2005)

Table 1: Scenarios of crude oil price developments up to 2030 in US \$₂₀₀₀/bbl

As a reference, the moderate price development according to EWI/Prognos is used (EWI/Prognos 2005). EWI/Prognos assumes that overall low cost conventional and unconventional oil reserves and resources are ample enough to dampen oil prices until 2030. Accordingly, they assume that crude oil prices will fall to 28 US \$₂₀₀₀/bbl by 2010 and will only moderately increase thereafter to 37 US \$₂₀₀₀/bbl in 2030. Nevertheless, even if enough oil reserves and resources exist, the question remains as to whether enough capital will be invested to exploit that potential so that supply and demand will be balanced in the period up to 2030. Political instability in important oil producer countries (especially in Nigeria, Iraq, Iran and Venezuela), and also a growing resource nationalism in other countries (e.g. Russia) could result in lower investments in the oil sector than were assumed some years ago. The result could be an ongoing supply shortage as well as high oil prices and further increases therein – as assumed in the high price scenario (EIA 2006a; EIA 2006b). A political crisis in an important oil producer country could drive prices even higher than is assumed in the high price scenario. Goldman Sachs sketched such a spike scenario (Goldman Sachs 2005). In this scenario it is assumed that prices rise until demand is reduced so that capacity reserves in oil production and in the refinery sector result. We assume that in such a case the high risk

premiums incorporated in oil prices today will shrink to a normal level and oil prices will fall to the moderate price level in the reference scenario.

3 Analysis using the IKARUS Energy Systems Model

3.1 Model Description

The IKARUS bottom-up model (Martinsen et al. 2006; Martinsen et al. 2003) is deployed in our research project in order to examine the effects of different price scenarios. The IKARUS model is a time-step dynamical linear optimisation model which maps the energy system of Germany in terms of cross-linked processes from primary energy supply to energy services. A large number of technological options are included along with the corresponding emissions and costs as well as possible networks of energy fluxes. In addition, general political set-ups are considered.

Within the model, the energy system is mapped in such a way that the demands for energy services are fulfilled; equilibria are formed on various intermediate conversion levels (partial equilibrium model). Its time horizon is divided into five-year intervals. Each time interval is optimised by taking into account the past stock change resulting from all previous periods in a separate dynamic program module. Thus, the model does not follow a perfect foresight approach, where the model in principle “knows” all the future parameters and boundary conditions. Perfect foresight models can react on exogenously given future changes in advance of these changes taking place (e.g. prices of energy carriers, climate gas reduction policy). Well-known energy systems models that employ a perfect foresight optimisation approach are MARKAL (Fishbone et al. 1983; Loulou et al. 2004) and MESSAGE (Messner et al. 1996). The time-step model is, however, myopic and does not take into account future changes in each optimisation step. It is thus a model in which prognosis and projection have a more realistic character. Due to its myopic character, the model is well-suited to examine reactions on various energy price scenarios, including sudden changes like a price shock.

The consistent socio-economic data on which the scenarios are based were compiled as part of the IKARUS project (Markewitz and Stein 2003). Besides limitations on quantities of imported energy carriers like coal, other restrictions based on domestic potentials for fossil and renewable energy carriers and the political framework set by the Federal Government form part of the model (e.g. the phase-out of nuclear energy). The transport sector has received special attention in our analysis and has therefore been treated differently. In contrast to the other sectors, fuel taxes at the current level have been included in the transport sector to account for the correct relation of consumer and import prices. In addition, an elastic demand for transport has been incorporated. A more detailed description of all the assumed demands and general data can be found in (Martinsen et al. 2006) and (Matthes et al. 2007).

3.2 Scenario Results

In the scenario analyses using the IKARUS model, high increases in the prices of mineral oil, natural gas and imported hard coal lead to a significant reduction in primary energy consumption (see Figure 1). Whilst primary energy consumption decreases by 19% in the period from 2000 to 2030 in the reference price scenario, it drops by 24% (high price scenario) and 20% (spike scenario) in the price scenarios within the same time period. In comparison to the reference price scenario, this corresponds to a reduction of about 7% and 2% respectively. The decrease in the reference scenario is due to socio-economic data (e.g. population decline), sector-specific structural change in the industry and in the commercial sector as well as autonomous technological progress that leads to an increase in energy efficiency. However, there is also a systematic effect due to the accounting of TPES according to the physical energy content method (OECD/IEA/Eurostat 2005). The phase-out of nuclear power and the simultaneous

increase of the share of renewables result in a reduction of TPES. The differences between the two price scenarios can above all be traced back to the relaxation effect in the spike scenario, whereby the implementation of measures which conserve primary energy markedly decreases following the subsidence of the price shock after 2015. The degree of freedom for adaptation and in particular for the observed relaxation effects depends largely on technical lifetimes which differ for the different sectors.

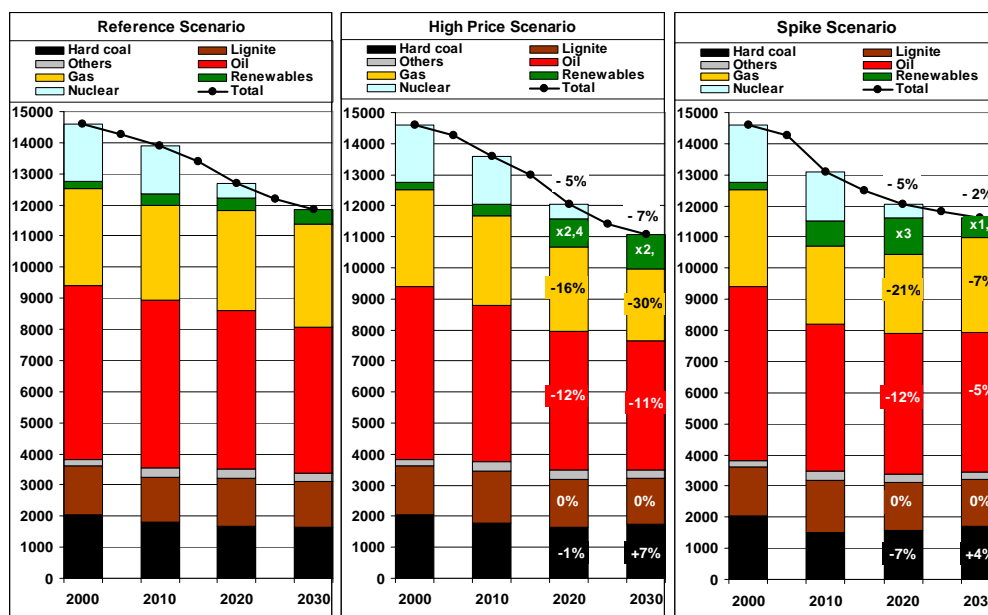

[Figure 1: Total primary energy supply \(PJ\) in the reference, high price and spike scenario](#)

In comparison to the reference scenario, there is a significantly reduced application of oil products and especially natural gas (up to -30%) in the price scenarios. The use of domestic lignite temporarily increases with increasing import prices. However, at the end of the time horizon it equals the level of the reference scenario again, as a result of the limited availability of lignite whose potential is already fully utilised in the reference scenario in 2030. In spite of price increases, the use of hard coal rises up to 7% in the period 2030. Even domestic hard coal, which is currently not competitive and is highly subsidised, is used again to a limited extent in the price scenarios. An interesting feature of the price scenarios is that domestic lignite is not only used in the conversion sector for electricity production, but also for coal liquefaction, serving as a backstop technology after 2010, corresponding to a break-even price of crude oil of approximately 54 US \$₂₀₀₀/bbl. However, the share of coal liquefaction remains relatively small (about 90 PJ of lignite corresponding to about 1 million tons of oil products).

An important aspect of higher prices for fossil energy carriers is the impact on emissions, in particular carbon dioxide. In the reference price scenario CO₂ emissions fall by almost 100 million tons per year in the period from 2000 to 2030 (this corresponds to a reduction of about 11%). The following effects on the abatement of CO₂ emissions result from the scenario analyses using the IKARUS model (see Figure 2):

- The CO₂ emissions in the industry sector are generally inelastic with regard to both energy price levels.
- High energy prices produce significant emission abatements, above all in the residential, transport and commercial sectors.
- In contrast, high energy prices in the electricity production sector only produce comparatively low CO₂ abatements. These can predominantly be attributed to the systematic increase in electricity production from renewable energy sources (mainly wind and biomass), although they are partly compensated by an

increasing trend towards coal-fired electricity production. Electricity production from natural gas is strongly reduced at the same time.

- High energy prices lead to an increase in the share of renewable energies within TPES (see Figure 1). In the high price scenario, this enhancement is in particular the result of a substantial use of biomass and wind, and, to a lesser extent, an increase in biofuels in the transport sector. In the spike scenario, the use of renewable energy carriers triples in comparison to the reference scenario and reaches a level of about 1100 PJ in the period to 2015. The energetic use of biomass (mainly in heating and CHP plants) plays an important role in this scenario.

The trends that vary between sectors also need to be emphasised. High energy prices lead to significant emission abatements, above all in the residential, transport and commercial sectors. In the residential and commercial sectors this reduction of CO₂ emissions is due to technical measures only; in the transport sector it includes effects from an elastic demand as well. It should be noted that the two high price alternatives affect measures in very different ways over time. The annual emission savings in 2030 are markedly higher in the high price scenario than in the spike scenario. Greater emission savings are, however, temporarily achieved in the spike scenario; cumulatively, these lead to a significantly higher reduction of CO₂ emissions in the spike scenario (1690 Mt) than in the high price scenario (1340 Mt), since they are realised sooner.

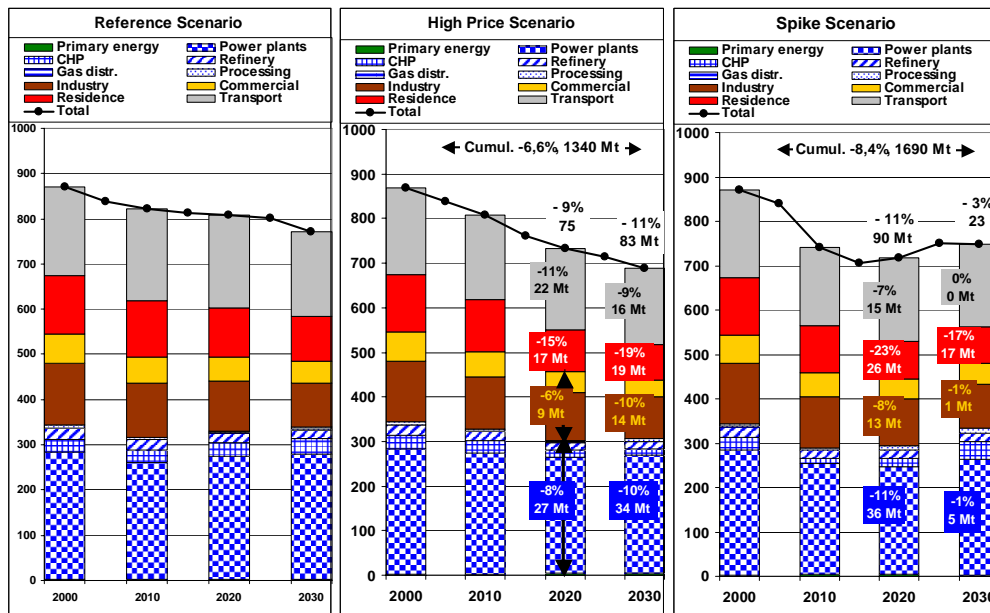

Figure 2: CO₂ emissions (Mt) in the reference, high price and spike scenario

The energy savings in the end-use sectors are somewhat higher (up to -10%) than for the primary energy consumption (up to -7%) in the two price scenarios (see Figure 3). In particular, the use of natural gas and oil products decreases as a result of the higher price levels.

The contribution of each sector to final energy savings shows sizeable differences. In general the residential sector contributes the most to these savings followed by the transport, commercial and industry sectors. Again, the reduction of final energy consumption is due to technical measures and in addition an elastic demand for transport. The lifetime of technical measures is an important criterion of whether the energy saving will persist in the long run or whether corresponding relaxation effects will occur. In the spike scenario, the final energy consumption of industry and transport adjusts to the reference scenario again up to 2030 on the one hand. On the other hand, the savings remain preserved in the household sector and partly so in the commercial sector. This is

mainly due to improvements to the thermal insulation of buildings whose technical lifetimes are beyond 30 years and show therefore a corresponding long-term effect.

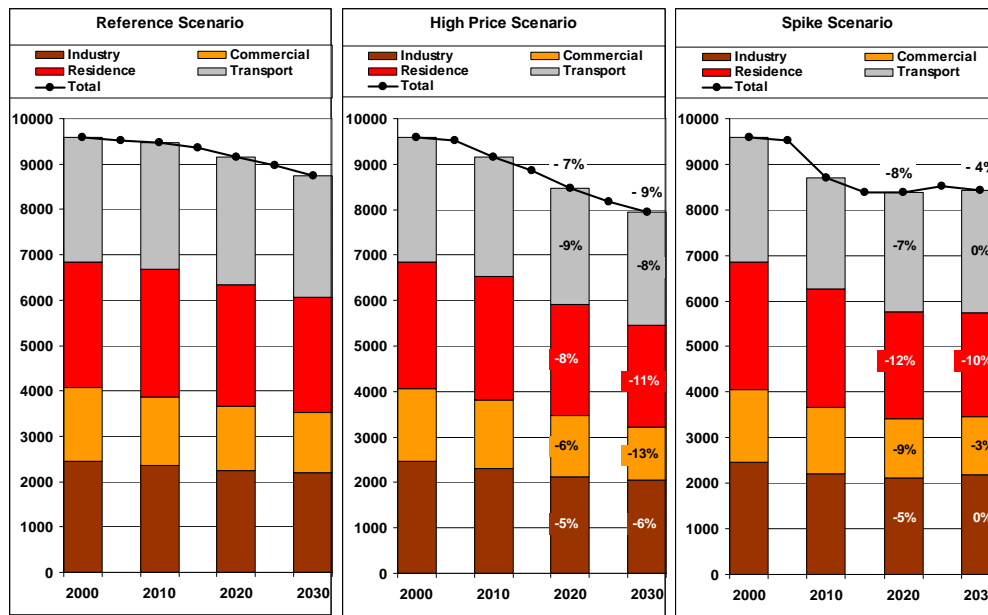

Figure 3: Final energy consumption (PJ) in the reference, high price and spike scenario

The additional thermal savings in the residential sector lead to a decrease in useful energy demand of about 150 PJ in the high price scenario in 2030. This corresponds to a decline of approximately 10% compared to the reference scenario. In the spike scenario, the reduction of useful energy consumption in the residential sector occurs more quickly and its impact on the demand for useful energy is also greater (-170 PJ in 2030).

4 Analysis using the ELIAS Electricity Sector Model

Complementary to the normative model analysis in the IKARUS model, a sector analysis of electricity production was undertaken using the ELIAS model. ELIAS is based on microeconomic considerations determining the investments of economic subjects. These include, for instance, the implementation of the emissions trading scheme or the German Renewable Energy Act (EEG).

4.1 Model Description

The ELIAS (Electricity Investment Analysis) model focuses on the electricity sector, since this sector contributes substantially to overall emissions and major investments are necessary in the years ahead due to the nuclear phase-out as well as the decommissioning of old power plants. The power sector is characterised by a long-living capital stock; today's investments will significantly influence future emissions. ELIAS allows for the evaluation of political instruments which influence the future technology mix in the power sector. Political instruments can be represented in great detail to enable the comparison of diverse design options, e.g. different allocation rules within the emissions trading scheme.

The ELIAS model calculates the amount of new capacity to be added in the electricity sector on the basis of a stock-exchange approach, identifying power plants which will come to the end of their useful life and the expected development of the electricity demand. The ensuing capacity gap is covered by investment in new power plants. It is assumed that the economic subjects invest in the technologies with the lowest average electricity production costs. The calculation of electricity production costs takes into

account fixed and variable costs, fuel prices as well as costs and benefits resulting from political instruments such as the emissions trading scheme or the German CHP Act (KWKG).

In the real world, investment is not limited to the one cheapest technology; to avoid the so-called penny-switching effect, the construction of power plants that do not constitute the cheapest option are also contained within the model, with decreasing capacities depending on the electricity production cost difference to the cheapest option. The construction of certain technologies may be restricted within the model. This is the case, for example, in hydro energy or lignite mining, which are limited by available resources. It is assumed that no new nuclear power plants will be built in Germany.

The reference and the high price scenarios have been modelled using the ELIAS model. Since ELIAS is a model based on *perfect foresight*, the spike was not modelled since it would not lead to meaningful results.

4.2 Scenario Results

It is assumed that the systematic increase of electricity production from renewable energies will follow the goals discussed (politically) up to now and that the corresponding support measures are adapted in the course of time to increase the electricity production from renewable energies to almost 190 TWh in 2030. The development of CO₂ emissions in all scenarios is largely characterised by this increase of renewables in combination with the nuclear phase-out.

- In the reference price scenario when it is assumed that allocation to new entrants continues according to the approach adopted in the first trading period (2005-2007) in Germany in the allocation of carbon credits (fuel-specific allocation and long-term allocation guarantees), CO₂ emissions decrease relatively steadily over time. In 2020, the level of CO₂ emissions is around 75 million tons under the value of 2000 (see Figure 4).
- In the high price scenario, CO₂ emissions decline by around 6 million tons by 2010, rising again by 18 million tons by 2020 – caused by the phasing-out of nuclear energy and the diminishing attractiveness of natural gas-fired electricity production – and declining once again after that by around 55 million tons in the period up to 2030 (this corresponds to an overall emission reduction of 43 million t CO₂ in comparison to 2000).

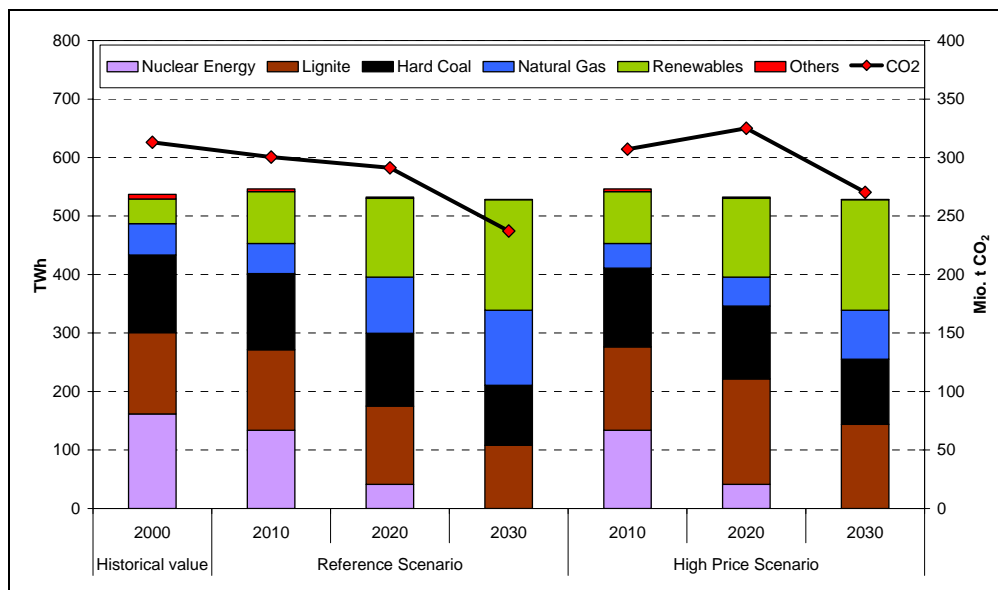

Figure 4: Net electricity generation and CO₂ emissions for the reference and high price scenario assuming current ETS allocation provisions

- In the reference price scenario when an ideal type of emissions trading scheme is assumed in which emission allowances for new entrants is auctioned, CO₂ emissions fall by around 90 million t CO₂ in the period up to 2030 vis-à-vis the year 2000 (see Figure 5).
- In the high price scenario emission reductions are significantly lower (roughly 50 million t CO₂) and comparable to the high price scenario under current allocation rules.

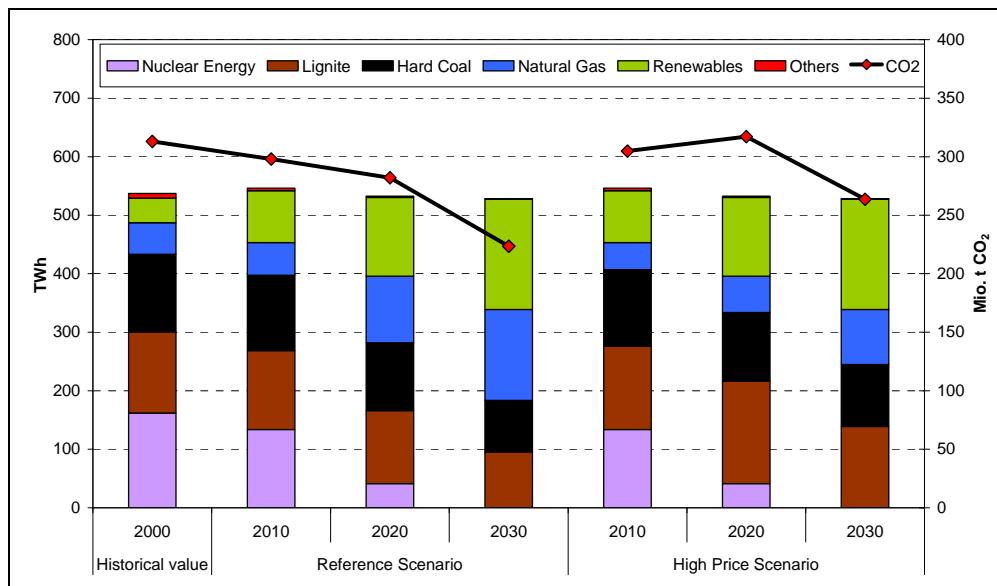

Figure 5: Net electricity generation and CO₂ emissions for the reference and high price scenario assuming an ETS with full auctioning

Changes in the levels of emissions are essentially due to the economic situation of coal- and natural gas-fired electricity production on the one hand and the economic attractiveness of cogeneration on the other hand.

In the high price scenarios, the economic attractiveness of natural gas-fired electricity production declines markedly. Electricity production from natural gas doubles in the reference price scenario when the allocation model is applied that is currently used, and triples when auctioning is introduced. Yet natural gas-fired electricity production only slightly increases in the high price scenarios, even when full pricing of CO₂ emissions takes place.

In contrast, the share of electricity produced via CHP increases when energy prices rise and full CO₂ pricing occurs; its share in terms of the total electricity production expands to significantly more than 20% in 2030.

Against the background of the fact that the result structures of the IKARUS model calculations (for the sub-segment of electricity production) are partly very similar to, and partly diverge markedly from, the ELIAS calculations with regard to the basic alternatives, a series of sensitivity calculations were carried out to reduce such differences and to quantify the effect of different parameters on the results.

The first sensitivity analysis for the purpose of the ELIAS model calculations addresses the differences in imputed interest rates. Whilst an entitlement to an interest rate of 10% or more must be applied in microeconomic analyses, macroeconomic model calculations are based on imputed interest rates of around 5%. Variations of these parameters lead to deviant results in the range of +/-10 million t CO₂ in 2030.

A second sensitivity analysis concerns the development of electricity production from renewable energies, when that production is not exogenously determined, but rather subordinated to microeconomic considerations, of which the support mechanism of the

German Renewable Energy Act (EEG) continues to be the most important general condition. Given that EEG compensation rates are orientated to the costs of electricity production from renewable energies, there is only a marginal difference in such an approach between the total level of electricity production from renewable energies in the reference price scenario and the high price scenario, when the CO₂ costs of new entrants - as in the current German allocation model - are largely ignored in investment decisions.

This situation is fundamentally changed when the attractiveness of investments in new fossil-fuelled power stations is significantly diminished due to full CO₂ pricing. The production level of regenerative power plants significantly increases as a result.

5 Conclusions

We have analysed the impact of high energy prices on the German energy system using the IKARUS energy systems model and the ELIAS electricity sector model. For this purpose, three scenarios of oil price development were elaborated as a basis for the analysis. In the reference price scenario, oil prices fall to a level of about 30 US \$/bbl by 2015 and rise thereafter to around 37 US \$/bbl by 2030. In the high price scenario, an oil price level of 54 US \$/bbl in 2010 is reached, rising from then onwards to almost 82 US \$/bbl by 2030. In the spike scenario, oil prices increase to a level of 105 US \$/bbl by 2010 and falling after 2015 to the level of the reference scenario.

The analysis using the IKARUS model shows that high energy prices produce significant emission abatements, above all in the residential, transport and commercial sectors. In contrast, the electricity production sector only produces comparatively low CO₂ abatements. These can predominantly be attributed to the systematic increase in electricity production from renewable energy sources, although they are partly compensated by an increasing trend towards coal-fired electricity production. From an oil price of around 54 US \$/bbl the use of backstop technologies, such as coal refinement for example, can become economically feasible - a trend that can also be found in the literature (e.g. (EIA 2006b)).

We find relaxation effects in the spike scenario, whereby the implementation of energy-saving measures decreases following the subsidence of the price shock after 2015. However, the sooner and more drastic realisation of measures in the spike scenario cumulatively leads to a significantly higher reduction of CO₂ emissions than in the high price scenario.

In the high price scenarios, the economic attractiveness of natural gas-fired electricity production declines markedly. The investigation using the ELIAS model exhibits a significant influence of the applied allocation rules within the emissions trading scheme. Electricity production from natural gas doubles in the reference scenario when the allocation model is applied that is currently used, and triples when auctioning is introduced. Yet natural gas-fired electricity production only slightly increases in the high price scenarios, even when full pricing of CO₂ emissions takes place. In contrast, the share of electricity produced via CHP increases when energy prices rise and full CO₂ pricing occurs, thus helping to reduce GHG emissions. In general, CO₂ emissions are higher in the high energy case than in the reference scenario, but a reduction in comparison with the base year is still achieved as a result of the share of renewables.

To sum up, although high energy prices lead to significant emission abatements in the residential and transport sectors, only slight emission abatements ensue in the power sector. This is especially the case when the support mechanism of the EEG, which is aligned to the costs of electricity production from renewable energies, is taken into account. By contrast, the power sector reacts very sensitively to the pricing of CO₂ emissions. The high energy prices can – at least in certain model calculations – be partly cushioned by cogeneration.

Acknowledgements

This research project was funded by the German Federal Environment Agency (UBA) under the research contract no. 205 46 434. The authors wish to thank Vanessa Cook (Öko-Institut) for improvements of the English version.

6 References

- EIA (2005) "International Energy Outlook." Energy Information Administration, U.S. Department of Energy, Washington DC, July.
- EIA (2006a) "Annual Energy Outlook." Energy Information Administration, U.S. Department of Energy, Washington DC, February.
- EIA (2006b) "International Energy Outlook." Energy Information Administration, U.S. Department of Energy, Washington DC, June.
- EU Commission (2003) "European Energy and Transport - Trends to 2030." EU Commission, Brussels.
- EWI/Prognos (2005) "Energy Report IV: Study The Trend of Energy Markets up to the Year 2030 - Reference Forecast for the Energy Sector (Energierport IV: Die Entwicklung der Energiemärkte bis zum Jahr 2030 - Energiewirtschaftliche Referenzprognose)." EWI at the University of Cologne/Prognos AG, Köln/Basel, April 2005.
- EWI/Prognos (2006) "Implications of higher Oil Prices for Energy Supply and Demand - Oil Price Variant of the Reference Forecast for the Energy Sector 2030 (Auswirkungen höherer Ölpreise auf Energieangebot und -nachfrage - Ölpreisvariante der Energiewirtschaftlichen Referenzprognose 2030)." EWI at the University of Cologne (EWI)/Prognos AG, Köln/Basel, August 2006.
- Fishbone, L. G., Giesen, G., Goldstein, G., Hymmen, H. A., Stocks, K. J., Vos, H., Wilde, D., Zöcher, R., Balzer, C., and Abilock, H. (1983) "User's Guide for MARKAL." IEA Energy Technology Systems Analysis Programme, July.
- Goldman Sachs (2005) "US Energy: Oil -Super spike period may be upon us." Goldman Sachs Global Investment Research, March 30, 2005.
- IEA (2004) "World Energy Outlook 2004", OECD/IEA, Paris.
- IEA (2006) "World Energy Outlook 2006", OECD/IEA, Paris.
- Loulou, R., Goldstein, G., and Noble, K. (2004) "Documentation for the MARKAL Family of Models." IEA Energy Technology Systems Analysis Programme, October.
- Markewitz, P., and Stein, G. (2003) "The IKARUS-Project: Energy Technology Perspectives for Germany (Das IKARUS-Projekt: Energietechnische Perspektiven für Deutschland)." Series Environment, Forschungszentrum Jülich GmbH, Jülich.
- Martinsen, D., Krey, V., Markewitz, P., and Vögele, S. (2006) "A Time-Step Energy Process Model for Germany - Model Structure and Results." *Energy Studies Review*, 14(2006)1.
- Martinsen, D., Markewitz, P., Müller, D., Vögele, S., and Hake, J.-F. (2003) "IKARUS-Energy Scenarios until 2030 (IKARUS - Energieszenarien bis 2030)." The IKARUS-Project: Energy Technology Perspectives for Germany (Das IKARUS-Projekt: Energietechnische Perspektiven für Deutschland), P. Markewitz and G. Stein, eds., Forschungszentrum Jülich GmbH, Jülich, 31-47.
- Matthes, F. C., Graichen, V., Harthan, R. O., and Repenning, J. (2006) "Implications of various allocation rules on investments in the electricity market (Auswirkung verschiedener Allokationsregeln auf Investitionen im Strommarkt)." Öko-Institut, Berlin.

- Matthes, F. C., Graichen, V., Harthan, R. O., Repenning, J., Markewitz, P., Martinsen, D., Krey, V., and Horn, M. (2007) "Effects of High Energy Prices on Scenarios for Greenhouse Gas Emissions (Auswirkungen hoher Energieträgerpreise auf Szenarien für den Klimaschutz)." Öko-Institut/FZ Jülich-STE/DIW Berlin, Berlin/Jülich.
- Messner, S., Golodnikov, A., and Gritsevskii, A. (1996) "A Stochastic Version of the Dynamic Linear Programming Model MESSAGE III." *Energy*, 21(1996)9, 775-784.
- OECD/IEA/Eurostat (2005) "Energy Statistics Manual." OECD/IEA, Paris, 2005.

Session 3 – Clean Coal Technologies

Chairman: Henrik Bindslev, Risø National Laboratory, Denmark

Polygeneration – Integration of Gasoline Synthesis and IGCC Power Production Using Topsoe’s TIGAS Process

Thomas Rostrup-Nielsen, Poul Erik Højlund Nielsen, Finn Joensen, Jørgen Madsen, Haldor Topsøe A/S, Nymøllevej 55, 2800 Kongens Lyngby, Denmark

Abstract

Coal is becoming an increasingly important raw material for power and chemicals production. Attractive synergies can be obtained by combining power and chemicals production. In an Integrated Gasification Combined Cycle (IGCC) plant, power is produced by burning synthesis gas produced by gasification in a gas turbine. This synthesis gas is also an excellent raw material for chemicals production such as methanol, DiMethyl Ether (DME), gasoline, Synthetic Natural Gas (SNG), hydrogen, ammonia and Fischer Tropsch (FT) diesel. By combining IGCC power production with chemical production, the plant becomes less sensitive to changes in the power price because alternative products may be produced. Some of these may be stored and used as fuel to accommodate peak loads where the power price is good.

Substituting suitable biomass for coal, results in an efficient way of meeting future power and transportation fuel requirements from renewable energy sources. Due to the concern for the possible effect of carbon dioxide (CO₂) on the global climate it is necessary to analyse the effect of CO₂ capture on the integration schemes. Many studies have looked at the options for CO₂ sequestration from IGCC plants.

This paper will present examples of attractive systems obtained by combination of power and chemicals production, as well as options for CO₂ capture

1 Introduction

The interest in gasification of coal and heavy residues such as petcoke has increased dramatically due to the very high oil and natural gas prices. Whereas it is anybody’s guess as to what extent that interest will continue, it remains a fact that in coal-rich countries like the US and China, the interest in gasification is very high and a number of chemical plants are being built using coal and petcoke as feedstock.

Power production is another interesting area for gasification. Coal based Integrated Gasification Combined Cycle (IGCC) plants can achieve efficiencies higher than what can be obtained in conventional coal fired power plants. However, the IGCC technology is expensive and has had a reputation of low availability. Recent studies have shown that the track record of IGCC plants is improving, and that the reasons for down time seldom is related to the gasifiers, but rather to process issues, which can be alleviated with resulting improved on stream performance.

With the high investment in the gasification unit, it is desirable to be able to maximise its utilisation and the value of the product. In the case of IGCC power production, the producer is faced with changing power prices and varying power demand, resulting in a less than perfect situation. However the synthesis gas produced by the gasification is, after appropriate clean up, an excellent feedstock for chemicals production. It is thus feasible to combine an IGCC plant with a chemicals production plant – Polygeneration. In this way the producer can always fully load the gasification unit, while producing the combination of products providing the best revenue. Many such combinations have been proposed with chemicals such as methanol, DME, ammonia, and fuels like FT diesel.

This paper will discuss the integration of an IGCC plant with Topsoe's Integrated Gasoline Synthesis (TIGAS) developed by Haldor Topsoe A/S.

2 IGCC Plant and Polygeneration

An IGCC plant comprises three key steps as illustrated schematically in Figure 1. A range of materials such as coal, refinery residue, biomass and some wastes can be gasified creating a synthesis gas rich in hydrogen and carbon monoxide, which after cleaning is a suitable fuel for a gas turbine in a combined cycle power generation scheme.

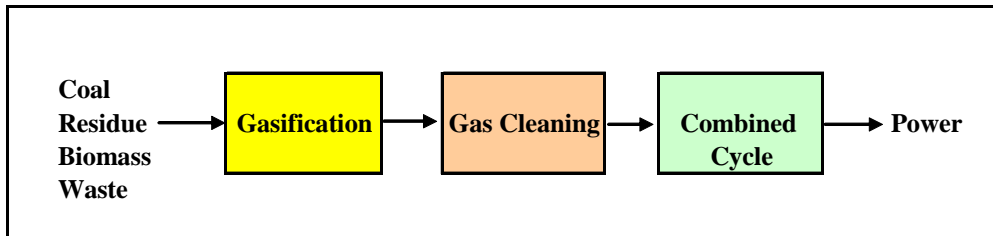

Figure 1. Schematic of an IGCC power plant (Integrated Gasification Combined Cycle)

One scheme for integrating chemicals production with the IGCC power plant, providing the producer with operational flexibility is shown in Figure 2. In this scheme all or part of the cleaned synthesis gas can be directed to the chemicals synthesis, whereby the distribution between power and chemicals production can be varied. Unused synthesis gas and process off-gases from the chemicals synthesis is used as fuel in the combined cycle plant, and waste heat generated in the synthesis is sent as steam to the combined cycle for power generation [1,2].

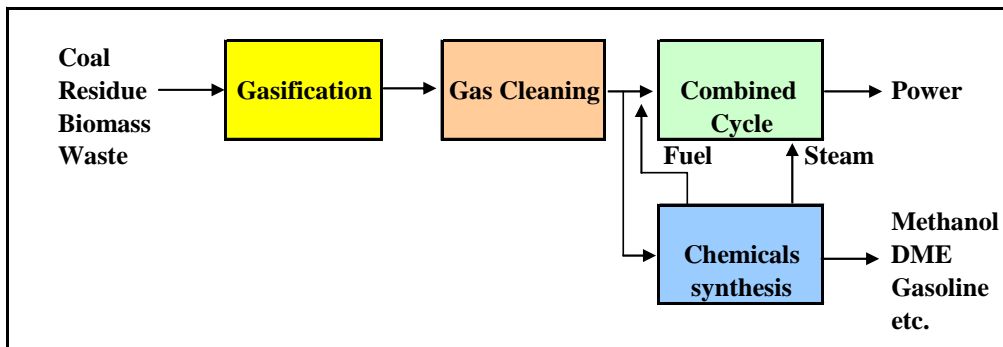

Figure 2. Schematic of integration of chemicals synthesis with an IGCC power plant

3 Gasoline Synthesis Process - TIGAS

Synthetic gasoline may be produced with high efficiency from synthesis gas by the methanol-to-gasoline (MTG) process [3,4]. The MTG process is a two step process in which synthesis gas first is converted to methanol and stored before in a second step being converted to gasoline after having established the methanol to DME reaction equilibrium, as illustrated in Figure 3.

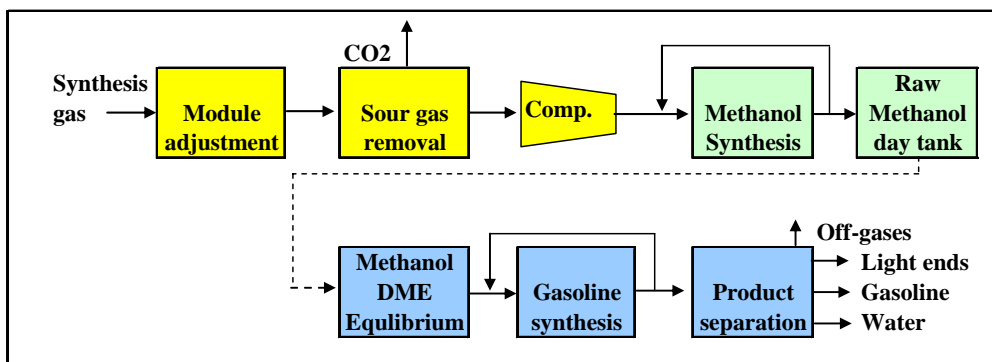

Figure 3. The Methanol-to-gasoline (MTG) process. Two steps via raw methanol

In an extended version of the methanol-to-gasoline process, the Topsøe integrated gasoline synthesis (TIGAS) converts synthesis gas into gasoline in a single-loop process, thus eliminating the requirement for upstream methanol production and intermediate storage [5,6,7,8].

The basic principle in the TIGAS process is the integration of a methanol/dimethyl ether synthesis and the subsequent conversion into gasoline in a single synthesis loop, i.e., without the isolation of intermediate MeOH. Due to the flexibility of the MeOH/DME synthesis a variety of synthesis gas compositions may be applied. The process is illustrated in Figure 4.

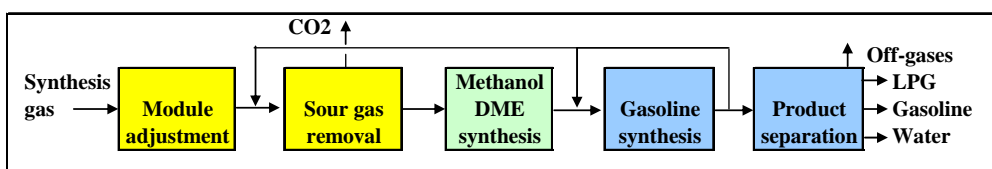
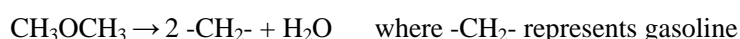
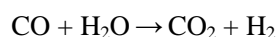
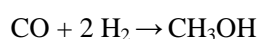
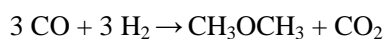

Figure 4. The Topsøe Integrated Gasoline Synthesis (TIGAS) process. The methanol / DME synthesis is integrated into a single loop with the gasoline synthesis, thus eliminating the intermediate production and storage of methanol as done in the MTG process

The key chemical reactions in the TIGAS process are:



For the DME synthesis the resulting net reaction at $\text{H}_2/\text{CO} = 1$ is:



And for the overall gasoline synthesis the net reaction at $\text{H}_2/\text{CO} = 1$ is:



A key difference between the MTG process and the TIGAS process is that the MTG process needs to synthesise methanol, while the TIGAS process lets the methanol react further to form DME immediately. Besides saving on process equipment the equilibrium conversion of the synthesis gas is greatly favoured by the TIGAS approach reducing the requirement for reaction pressure and unconverted synthesis gas recycle. The equilibrium conversions are shown in Figure 5 for a $\text{H}_2/\text{CO} = 1$ synthesis gas.

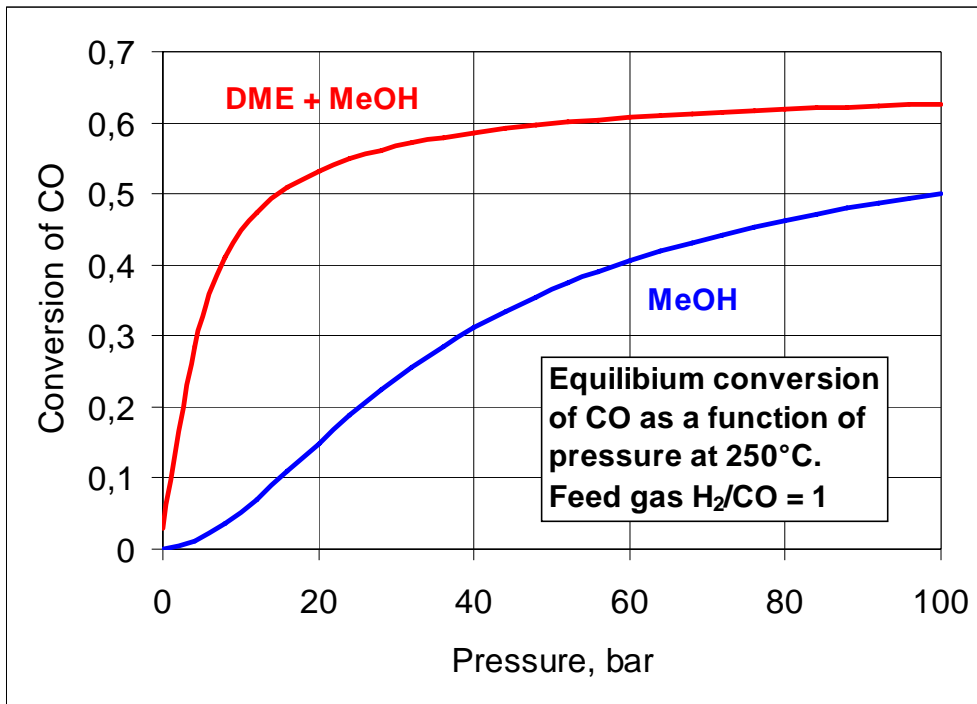

Figure 5. The equilibrium conversion of synthesis gas to methanol is greatly influenced by process pressure and only reaches 40% conversion at 60 bar. However, for the combined methanol / DME synthesis, as used in the TIGAS process, a conversion of 40% is reached already at 8 bar, and more than 60% conversion is reached at 50 bar

The equilibrium conversion of synthesis gas to methanol is greatly influenced by process pressure and only reaches 40% conversion at 60 bar. However, for the combined methanol / DME synthesis, as used in the TIGAS process, a conversion of 40% is reached already at 8 bar, and more than 60% conversion is reached at 50 bar.

For the combined methanol / DME synthesis the conversion and product distribution also depends on the synthesis gas composition. Figure 6 shows the effect of the H₂/CO ratio on the product distribution. The figure clearly shows that a H₂/CO ratio of 1 provides the highest per pass DME yield. Also the methanol and water by-products are relatively limited.

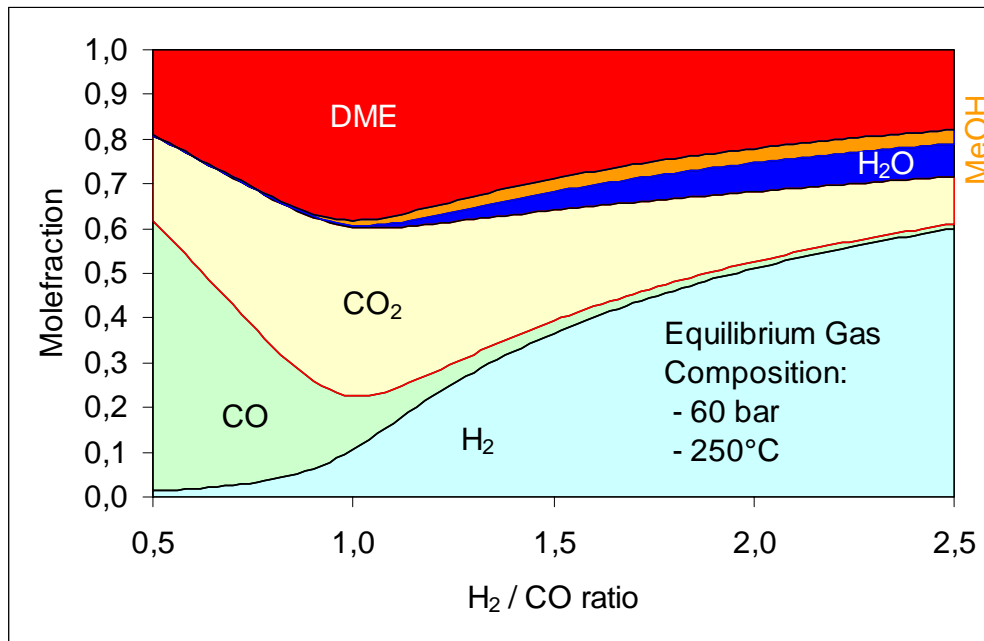

Figure 6. Effect of the synthesis gas H₂ / CO ratio on the product distribution for the combined methanol / DME synthesis. A H₂ / CO ratio of 1 provides the highest per pass conversion.

For CO-rich gases as obtained by gasification of coal, coke or biomass the integrated TIGAS process offers a particular advantage due to the high efficiency that may be obtained in the synthesis of the MeOH/DME intermediate at the low H₂/CO ratios (< 1) characteristic to gasification. As opposed to methanol synthesis, where a module – the effective H₂/CO ratio – adjustment to 2 is required, the ideal stoichiometry with respect to the combined MeOH/DME synthesis is at H₂/CO = 1, making DME by far the dominant intermediate. In addition to improving the conversion efficiency less steam is required for module adjustment. Finally, CO₂ removal as well as module adjustment may be carried out inside the synthesis loop, minimizing the recycle of unconverted synthesis gas. Recent developments warrant significant improvements in overall process efficiency leading to substantial reduction in investment cost and improved energy efficiency.

Haldor Topsøe A/S demonstrated the TIGAS technology at its Houston Texas process demonstration unit (1983-1986). The feed to the process was based on reforming of natural gas. The process demonstration unit is shown in the photo below.



Haldor Topsøe A/S TIGAS process demonstration unit in Houston Texas.

Haldor Topsøe A/S is currently entering into a technology demonstration program sponsored by the Danish government together with a number of other companies. This PSO project will allow Haldor Topsøe A/S to demonstrate the TIGAS process with new improvements and adapted to IGCC integration, based on a synthesis gas from a coal gasifier. A gasifier could also operate with biomass and waste as part of the feed, without changing the basic process being demonstrated, as shown in figure 7.

4 Integration of IGCC and TIGAS - Case study

A case study has been carried out investigating the impact of different configurations of the methanol / DME synthesis on the performance of an integrated IGCC and TIGAS plant. The six cases included in the study are:

IGCC plant	IGCC	Figure 1
TIGAS plant	TIGAS	Figure 4
4 integration schemes	I1, I2, I3 & I4	Figure 7

The four integration schemes have different reactor configurations for the methanol / DME synthesis as well as recycle around the gasoline reactor. The key difference is the equilibrium temperature achieved for the methanol / DME synthesis, as indicated in Table 1. The lower the equilibrium temperature is the higher the yield of DME and subsequently of gasoline becomes. The scheme is illustrated in Figure 7. The case study considers the processes from downstream the Gas Cleaning, assuming a clean synthesis gas as feed.

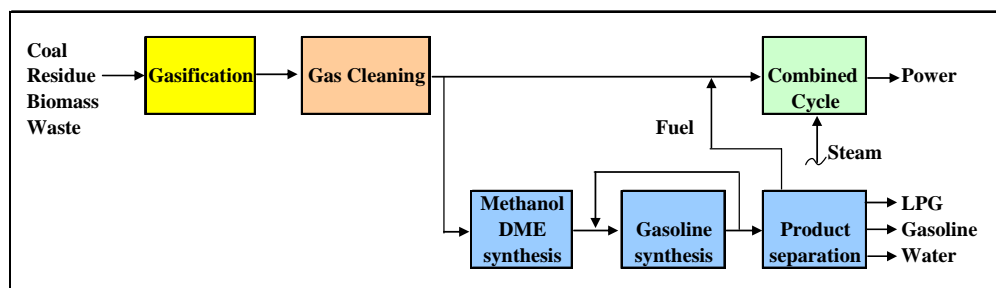

Figure 7. Integration of an IGCC plant with the TIGAS gasoline synthesis.

The basis for the study is summarised in the following. The Synthesis gas was selected to represent a slurry gasifier with the following composition, and pressure:

Pressure	65 bar
H ₂	37.7%
CO	45.6%
CO ₂	16.0%
H ₂ O	0.1%
Inerts	0.6%

The amount of synthesis gas was chosen such that the combined cycle of the IGCC plant produced 1100 MW, not accounting for parasitic power consumption (e.g. air separation plant). The following assumptions were made for the gas turbine in the combined cycle:

Turbine inlet temperature	1350°C
Turbine inlet pressure	29.3 bar g
Turbine outlet pressure	0.06 bar g
Polytropic compressor efficiency	90%

Isentropic expander efficiency 90%

The thermal efficiency of the different cases has been calculated using the following definition:

$$\text{Efficiency} = (\text{Energy of products, Power+Gasoline+LPG, LHV}) / (\text{Energy in synthesis gas, LHV})$$

The processes have been optimised by pinch analysis, to ensure the highest possible efficiency in each case. Performance figure for the six cases are shown in Table 1.

Table 1 Summary of the study cases

Case		IGCC	I1	I2	I3	I4	TIGAS
MeOH / DME	T eq, °C	-	341	331	317	270	270
Power	MW	1103	981	941	868	524	140
Gasoline, LHV	MW (ton/h)	0 (0)	144 (12)	206 (17)	305 (25)	723 (60)	1080 (90)
LPG, LHV	MW (ton/h)	0 (0)	4 (0.25)	7 (0.5)	16 (1.3)	105 (8)	270 (21)
Total	MW	1103	1128	1154	1190	1352	1490
Feed, LHV	MW	1885	1885	1885	1885	1885	1885
Thermal efficiency		59%	60%	61%	63%	72%	79%

The achieved process efficiencies are shown in Table 1 and in Figure 8. The thermal efficiency of the combined cycle is 59% while a dedicated TIGAS plant can make gasoline, LPG and some power with a thermal efficiency of 79%. The integration cases fall in between on a straight line depending on their relative gasoline production.

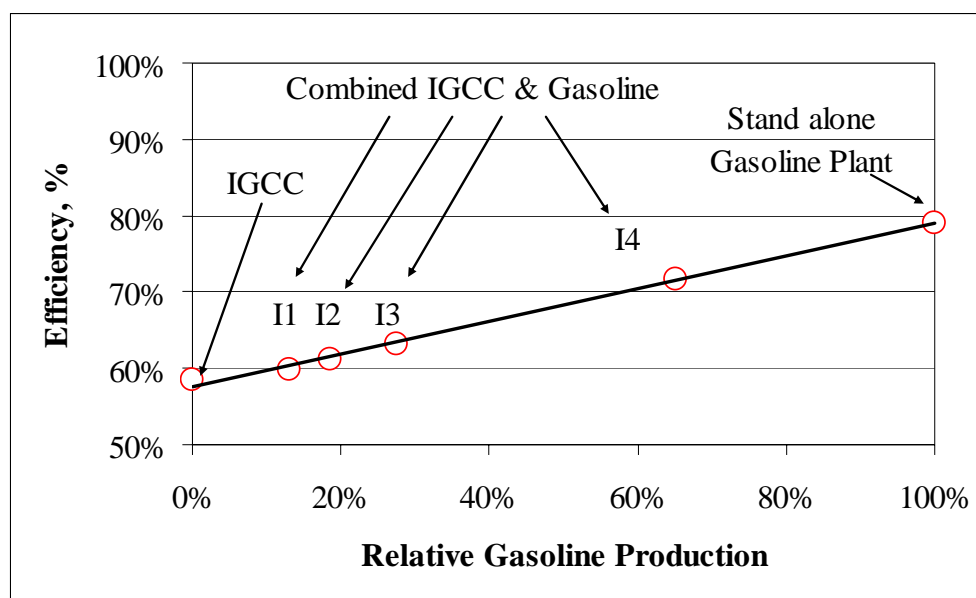

Figure 8. Thermal efficiencies of the six cases as a function of the relative gasoline production

5 Process Economics

With the production figures shown in Table 1 for the six cases it is possible to calculate the annual value of the products by assuming product values. This is shown in Figure 9 assuming a value of 2 USD/gal for gasoline and valuating LPG on LHV basis at 80% relative to gasoline. The figure shows that the annual revenue is about the same for all cases at a power value of about 8.4 c/kWh. This is because a gasoline value of 2 USD/gal corresponds to 6.2 c/kWh LHV gasoline, which due to the higher efficiency of the gasoline production (79%) relative to power production (59%) translates into a break even power value of $6.2 * 79/59 = 8.4$ c/kWh. Figure 10 shows this break even relationship as a function of power value. Figure 10 can then be used as a guideline in determining what kind of plant may be the best to build: IGCC, Polygeneration or TIGAS. If the value a producer can receive for gasoline is substantially higher than the break even value for power, then a dedicated TIGAS plant will be the most economical. Likewise if the value of power is high then an IGCC plant will be most economical. However, if the product values are relatively close to the line, a polygeneration plant is optimal.

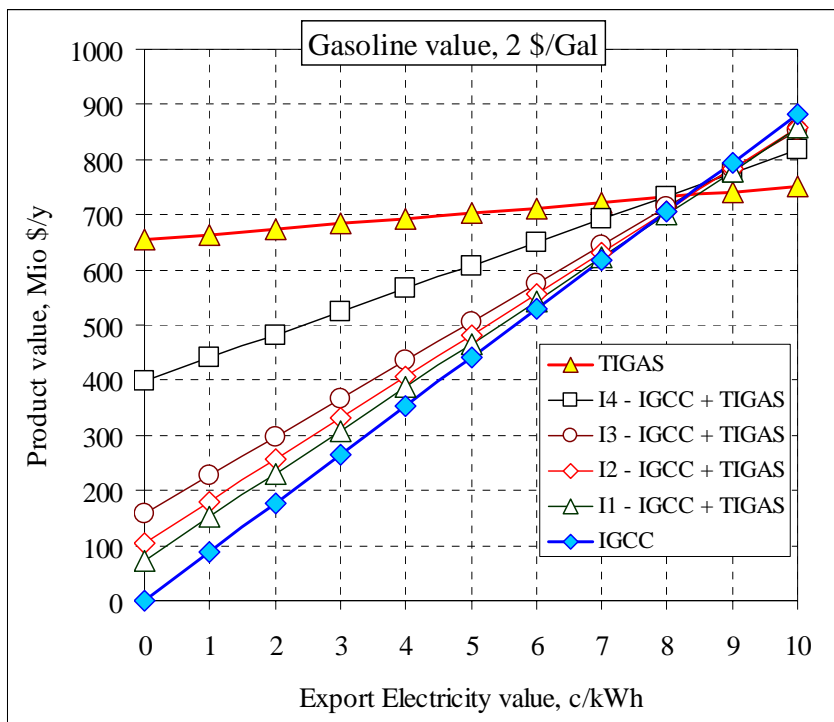

Figure 9. Annual product value as a function of power value assuming 2 USD/gal for gasoline and LPG at 80% on LHV basis relative to gasoline

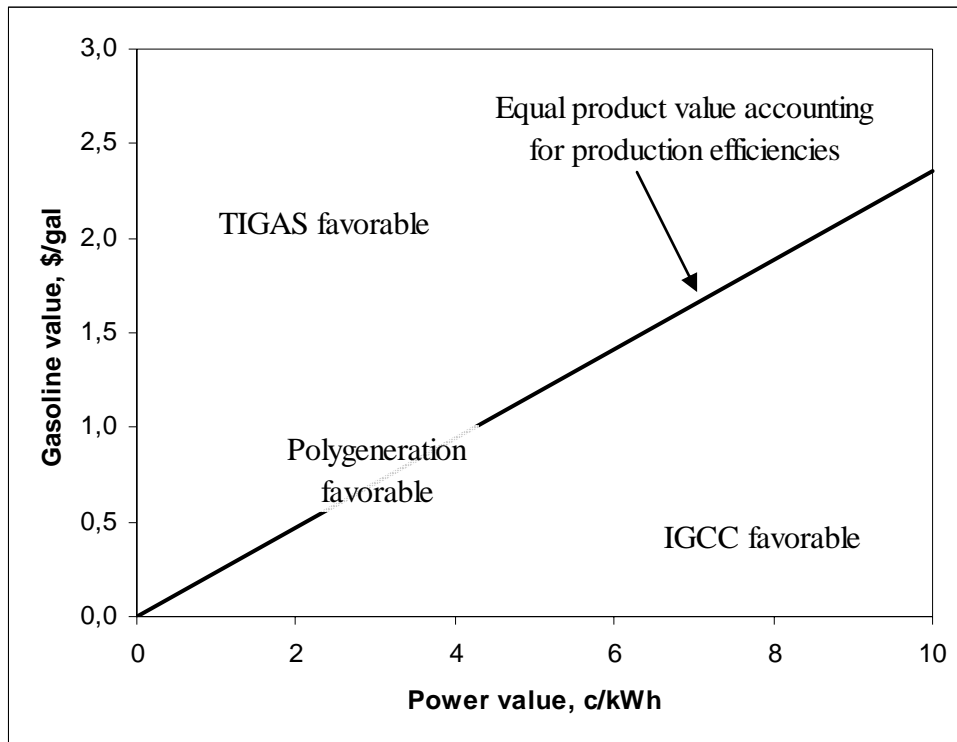

Figure 10. Choice of plant type based on relative product values. The line represents equivalent revenues taking the different efficiencies of gasoline and power production into account.

By making a few simplifying assumptions it is possible to assess the economics of a TIGAS add on to an IGCC plant allowing polygeneration. The assumptions are:

- Base case is the IGCC plant from Table 1
- Polygeneration case is case I4 from Table 1
- Only cost of TIGAS add on is considered (i.e. cost of gasification and combined cycle is assumed to be the same for both cases)
- Investment cost for TIGAS add on is based on an assumption of 10,000 USD/bbl/d (gasoline + LPG) leading to an investment of USD 145 M
- LPG is valued at 80% of gasoline value (LHV basis)

Based on these assumptions the pay-back time for the TIGAS add on unit can be determined by dividing the investment cost with the additional annual revenue generated by having the TIGAS add on unit. The additional annual revenue can be seen in Figure 9 as the difference between the I4 line and the IGCC line. The resulting pay-back times is shown in Figure 11 as a function of power value and gasoline value. The figure shows that the pay-back time is very short (half to two years), as long as the power value is about 1 to 1.5 c/kWh less than the equal product value line shown in Figure 10.

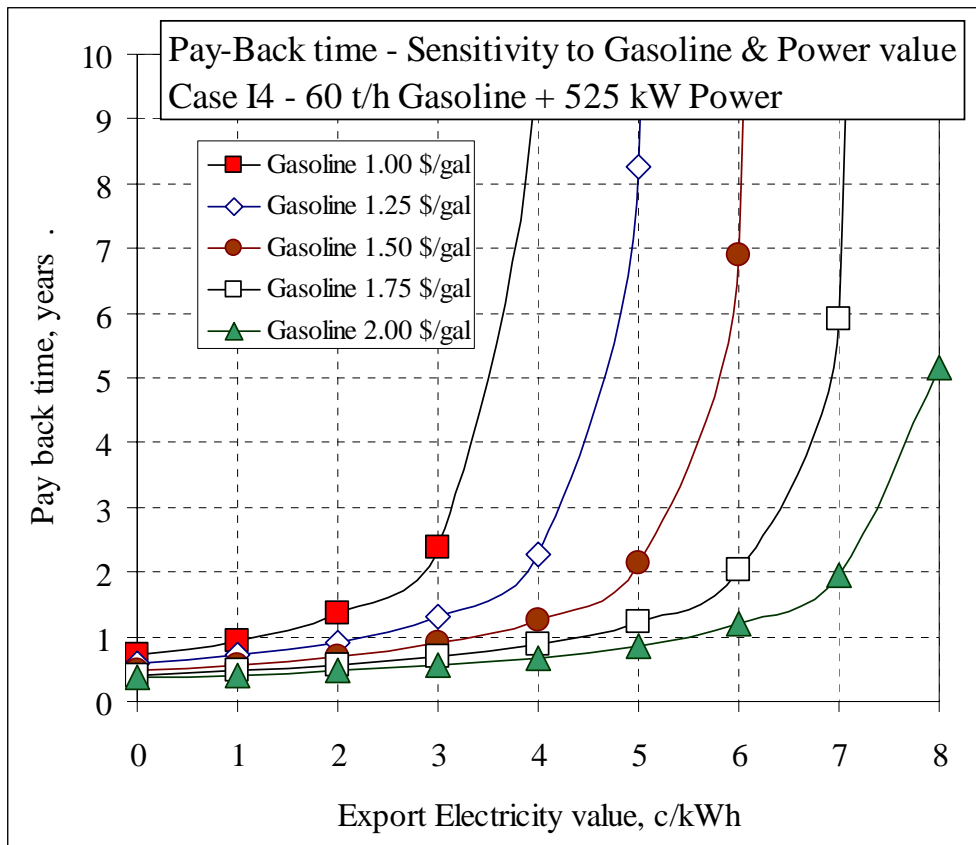

Figure 11. Pay-back time for the TIGAS add on unit as a function of gasoline value and power value

For simplicity it was assumed that the gasification and combined cycle units in the two cases above are the same. However, the polygeneration case I4 produces a smaller amount of power than the IGCC case, and thus a smaller combined cycle unit could have been used.

In the analysis above the power value represents an average value. However, power producers are faced with changing power values. The operational flexibility of the polygeneration plant will allow the plant to increase and decrease the power production by by-passing the TIGAS unit. This flexibility makes the revenue benefit obtained by the polygeneration plant larger than what is indicated in Figure 9 and used to calculate pay-back times in Figure 11. The following example will illustrate the additional benefit. By assuming that the TIGAS add on unit can be operated at 25% of maximum capacity, 75% of the synthesis gas can by-pass the TIGAS add on unit and be sent directly to the combined cycle unit. For polygeneration case C4 the gasoline and LPG production is thus reduced to $\frac{1}{4}$ (15 and 2 ton/h respectively), while the power production is increased from 524 to 957 MW, as determined by pinch analysis. The economic analysis is based on the following assumptions:

- Gasoline value 2 USD/gal and 1.3 USD/gal
- Power value 5c/kWh average based on:
 - 10 c/kWh 20% of the time
 - 3.75 c/kWh 80% of the time

Three cases are compared:

- A. IGCC case
- B. Polygeneration case I4 operated without by-pass

- C. Polygeneration case I4 operated with by-pass 20% of the time allowing maximum power production when the power value is high

Table 2. Benefit of Polygeneration, when the power value varies, analysed at two different gasoline values

Case		A IGCC	B I4	C1 I4 25%	C2 I4 100%	C _{total} C4
Feed to TIGAS						
Power value	c/kWh	5 avg	5 avg	10 20% of time	3.75 80% of time	
Power	MW	1103	524	957	524	
Gasoline, LHV	MW (ton/h)	0 (0)	723 (60)	181 (15)	723 (60)	
LPG, LHV	MW (ton/h)	0 (0)	105 (8)	26 (2)	105 (8)	
Total	MW	1103	1352	1164	1352	
Gasoline value 1.3 USD/gal						
Revenue	USD/y	441	468	166	332	498
Revenue benefit	USD/y	na	27			57
Pay-back time	years	na	5.4			2.5
Gasoline value 2.00 USD/gal						
Revenue	USD/y	441	616	173	451	624
Revenue benefit	USD/y	na	175			183
Pay-back time	years	na	0.83			0.79

The results presented in Table 2 shows that for a gasoline value of 1.3 USD/gal (which is close to the line of equal product value) the pay-back time for case B is 5.4 years, while the pay-back time can be reduced to 2.5 years, by taking advantage of the operational flexibility of the plant, as represented by case C. When the gasoline value is 2 USD/gal the pay-back time is reduced to only 0.8 years. However, there is not much benefit in using the plants flexibility, case B and C have about the same pay-back time. This is because the combination of 5 c/kWh and 2 USD/gal is so far from the equal product value line in Figure 9 that it may begin to be optimal to build a dedicated TIGAS plant with minimum power production.

6 Options for CO₂ Abatement

Due to the concern for the possible effect of carbon dioxide (CO₂) on the global climate it is necessary to analyse the effect of CO₂ capture on the integration schemes. Many studies have looked at the options for CO₂ sequestration from IGCC plants [9]. In an IGCC plant it is possible to recover CO₂ from the high pressure synthesis gas. If steam is added to the synthesis gas it is possible over a shift catalyst to convert most of the CO to CO₂ and H₂, obtaining a H₂-rich fuel after CO₂ removal. Two of the key CO₂ removal technologies are based on washing the gas stream with a liquid into which CO₂ is either chemically bound or physically absorbed. This liquid is subsequently regenerated liberating the CO₂. These processes are driven by CO₂ partial pressure. Studies have shown that it is much less costly to recover the CO₂ at high pressure as available in an

IGCC plant as compared to removing the CO₂ from atmospheric flue gas stemming from a conventional coal based power plant.

The stand-alone TIGAS process (Figure 4) already has a built-in CO₂ removal unit, so by far most of the carbon that does not end up in the product is recovered as CO₂. For the polygeneration plant as shown in Figure 7 the CO₂ removal unit is not included. However, the plant could be considered carbon capture ready, because a CO₂ removal system relatively easily could be implemented as indicated in Figure 12.

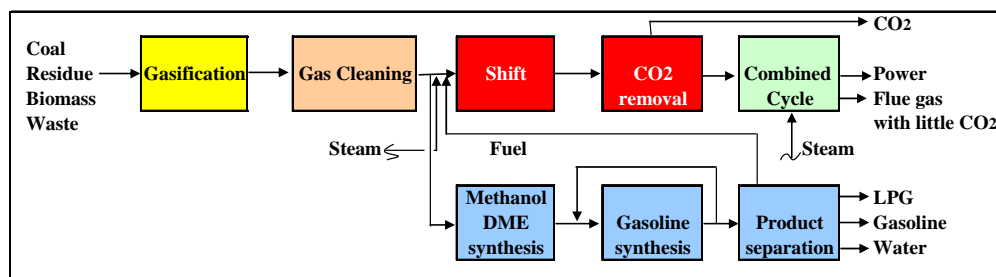

Figure 12. Polygeneration of power and gasoline with CO₂ sequestration

7 Conclusion

This paper has presented Topsoe's Integrated Gasoline Synthesis (TIGAS) process as a viable candidate for a polygeneration plant integrated with power production. For realistic values of power and gasoline an analysis has shown that the additional revenue generated by adding a TIGAS capability to an IGCC plant allows for a fast pay-back time of the additional investment. The integrated plant also offers operational flexibility. The gasoline production can be cut to about ¼ while at the same time the power production is nearly doubled.

The TIGAS process was demonstrated in the 1980s in a process demonstration unit making 1 ton gasoline per day based on natural gas generated synthesis gas, and Topsoe is now preparing to demonstrate an improved version of the TIGAS process integrated into an IGCC scheme through a Danish government sponsored PSO project.

The TIGAS plant inherently has CO₂ recovery, while the polygeneration plant does not need to have a CO₂ recovery unit. However, the polygeneration plant is easily made carbon capture ready. Also the gasifier allows the use of biomass and some wastes as a raw material, and as such provides an interesting option for generation of transportation fuel from renewable energy sources.

8 References

- [1] J. Bøgild Hansen, K. Aasberg-Petersen, I.D. Sigurdardottir, P.E. Højlund Nielsen: Chemicals as Peak Shaving Agents in IGCC-based Power Plants, Proceedings of the 15th Annual Int. Pittsburgh Coal Conf., Pittsburgh, 1998
- [2] N.R. Udengaard, J. Bøgild Hansen, H. Christiansen, P.E. Højlund Nielsen, P. Rudbeck: Co-Production of Electric Power and Chemicals, 12th Annual EPRI Conference on Coal Gasification Power Plants, San Francisco, 1993
- [3] C.D. Chang: Hydrocarbons from Methanol, Catalysis Reviews, vol 25, No 1, 1983
- [4] Y. Yurchak: Development of Mobil's Fixed-Bed Methanol-To-Gasoline (MTG) Process, Methane Conversion, 1988
- [5] J. Topp-Jørgensen: Topsøe Integrated Gasoline Synthesis – The TIGAS Process, Methane Conversion, 1988

- [6] J. Topp-Jørgensen, J.R. Rostrup-Nielsen: Integrated Process Offers Lower Gas-to-Gasoline Investment, Oil & Gas Journal, May 19, 1986
- [7] F. Joensen, H. Kiilerich Hansen, J.R. Rostrup-Nielsen, A. Skov, J. Topp-Jørgensen: Conversion of Synthesis Gas to High Octane Gasoline, Proc. 6th Int. Symp. on Large Chemical Plants, Antwerp, Belgium 1985
- [8] Process for the Preparation of Hydrocarbons, US Patent No 4,481, Date: Nov 6, 1984
- [9] N. Holt, G. Booras, D. Todd: A Summary of Recent IGCC Studies of CO₂ Capture for Sequestration, The Gasification Technologies Conference, San Francisco, October 2003

Development of a PF Fired High Efficiency Power Plant (AD700)

Rudolph Blum, Sven Kjær and Jørgen Bugge
DONG Energy Generation, Kraftværksvej 53, 7000 Fredericia, Denmark

Abstract

European efforts to start substantial improvements of the performance of well established supercritical coal-fired power technology named the AD700 project began in 1998. Major targets were development of austenitic materials and nickel-based superalloys for the hottest sections of boilers, steam lines and turbines. Other targets were development of boiler and turbine designs for the more advanced conditions and finally economic viability of the AD700 technology has been investigated. The project has been very successful and 40 partners from the European power industry have worked together in several projects cofunded by the European Commission for nearly years. Procurement of mature and commercially optimised AD700 plant could take place around 2015.

The investigated nickel-based materials have shown very high creep strengths but they have also shown to be very hard to manufacture, and more efforts to define new machining lines are being started. Ongoing tests indicate that the developed austenitic material will fulfil its creep strength target and is now ready for commercialisation.

Development works on boiler and turbine designs for the advanced steam conditions have also been successfully completed but they also clearly indicate that further development work on improved ferritic steel for furnace walls is important.

Conventional development of the steam cycles is based on new improved materials, which open for higher steam temperatures and efficiencies whereas other thermodynamic tools are only slowly being accepted. However, in the present paper a proposal for steam cycle improvements not based on higher steam temperatures is presented. The improved cycle is named the Master Cycle (MC) and it is based on a revision of the double reheat steam cycle where the bleeds of the IP turbines have been moved to a feed pump turbine bleeding on the first cold reheat line. Elsam has established protection of a patent for the MC in a number of countries.

At constant main and reheat steam temperatures, the MC offers solid heat rate improvements of ~3.5% compared with single reheat cycles and a seawater-cooled plant based on the Master Cycle could reach a net efficiency of 50%. This would mean robust improvement of competitiveness, less CO₂ per MWh being generated and a more sustainable use of the coal resources. In the future, the net efficiency will continue to increase and a sea-water-cooled 800 MW AD700 power plant to start commercial operation around 2020 might reach a net efficiency around 55% based on the MC. This is a perfect match to the future demand for achievable zero emission power plant.

1 Introduction

Coal reserves are significantly more abundant and much more widely and evenly dispersed than other fossil fuels. Coal is the invisible man powering 40% of the global electricity and at current consumption rates over 160 year's worth is available. The European Commission has recognised the importance of coal in improving Europe's security of energy supply and in the coming 7th Framework Programme (FP7) a role for coal has been found, which is well in line with former working programmes. But future

coal-based power plant must demonstrate the highest possible efficiency and be foreseen for CO₂ capture.

The 1990s was a green decade with strong focus on environmental issues and sustainability and coal was banished as a strong CO₂ emitter. Therefore, in 1994 a large group of European power generators and equipment manufacturers started to establish a joint European R&D project named “The Advanced Pulverised (700 °C) PF Power Plant” or shortly the AD700 power plant which should convert coal to power with an efficiency of > 50% (50%+). The group wanted to create a strategic and technological platform, which should make the public [politicians, media, non-governmental organisations (NGO’s), etc.] aware of how an advanced use of coal like the AD700 technology can contribute to large reductions of CO₂ emissions from coal-based power plant in Europe and world wide and at the same time enhance European security of energy supply by keeping coal in the portfolio of fuels for European power generators.

The technological target of the AD700 project was a phased development and demonstration of an advanced ultrasuper critical (USC), pulverised coal-fired (PF) power plant technology, operating at net efficiencies of 50%+ while remaining operationally flexible and competitive in the power pools. Two main items were addressed:

- Development of new high temperature materials to expand the limits for steam parameters.
- Thermodynamic improvements of cycle and component designs to reduce the efficiency gap between the ideal reversible Carnot cycle and the real existing water/steam cycles.

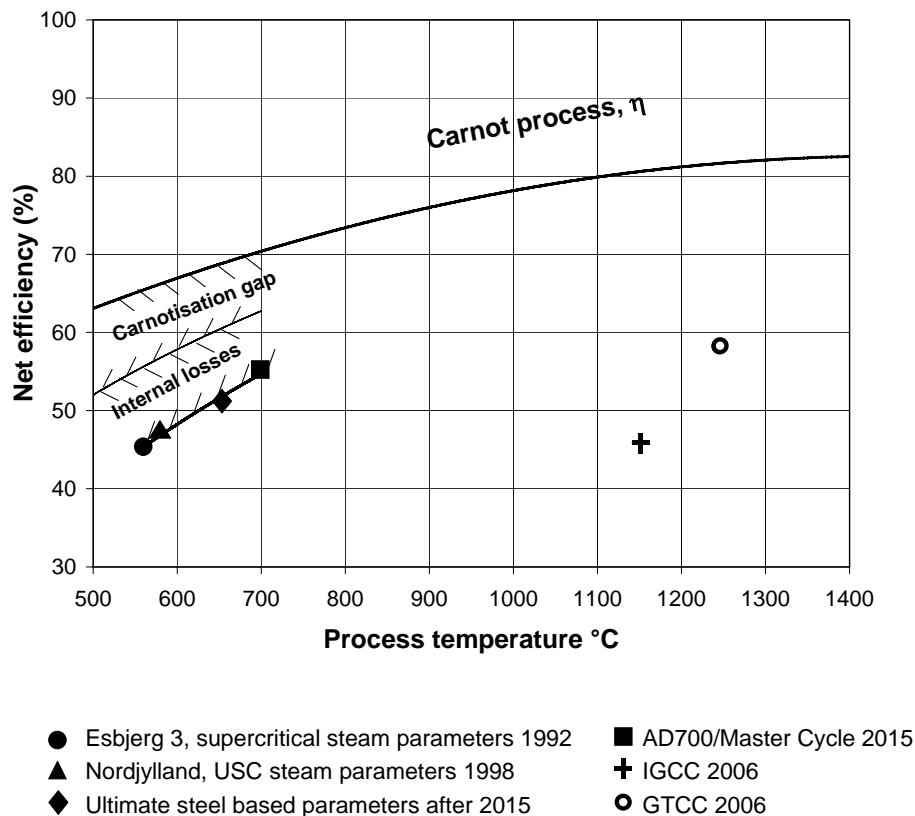

Figure 1 Efficiencies of seawater-cooled power plant fired by coal or gas

The two development activities are illustrated in Figure 1, which shows the Carnot cycle efficiency versus maximum process temperature and some examples of contemporary high efficiency power plant. The figure shows how higher process temperatures (established through better materials) drive the Carnot cycle and the existing cycle efficiencies upward along the temperature axis. The present proposals for the AD700 technology mainly focus on developments along the temperature axis.

Furthermore, Figure 1 shows how the lack of completeness of the existing water/steam cycles and their main components creates an efficiency gap between the Carnot cycle and the real existing water/steam cycles. The efficiency gap is made up of internal losses and a gap, which we have named the Carnotisation gap to illustrate lack of completeness of the water/steam cycle itself. Figure 1 also shows that even after the first AD700 plant starts there still seems to be a large potential for efficiency improvements of ~15%-points, which can be exploited through the establishment of the second development track to reduce internal losses (through improved turbine blade and sealing technologies, higher boiler efficiencies, less auxiliary power, etc.) and enhance carnottisation of the water/ steam cycles by higher steam pressures, higher feed water temperatures, double reheat, less pressure loss, etc.

Surging energy prices have given coal a strong impetus in the European power market. Fortunately, this impetus has come at a time when new and improved steels for all crucial sections of boiler, steam lines and turbine have been qualified in time for a number of new European 650-1100 MW power plants with USC steam parameters.

Most of these installations are built at inland locations with a wet cooling tower and achieve net efficiencies of ~46%. If they had been built at coastal locations in Northern Europe and based on the Master Cycle to be described at the end of the present paper, net efficiency would be ~50% (these plants are not shown in Figure 1).

The remaining sections of this paper will focus on AD700 history and outlook, considering materials for the AD700 technology and finally will offer an example of a revised water/steam cycle in which carnottisation is improved.

2 AD700

Maximum steam temperatures of the AD700 project would be around 700 °C, which means that development and demonstration of new high temperature materials, and boiler and turbine designs were crucial to the success of the project. Four major phases have been foreseen:

- I. Material development and demonstration
- II. Fabricability of materials
- III. Component demonstration
- IV. Construction and operation of a full scale AD700 power plant

The whole project would last for ~20 years from the idea was launched in the mid 1990s until it would be commercially mature around 2015. From the beginning it has been very important for the ~40 partners to obtain political acceptance of the project by the European Commission through financial engagement. The work of phases 1 and 2 was split among boiler, turbine and process groups; the boiler and turbine groups mainly worked on development and demonstration of new materials and the impact of advanced steam parameters on boiler and turbine design. The third group was a balance of project group named the process group, which took care of those issues not dealt with by the boiler and turbine groups and in particular investigated the economic viability of the AD700 technology.

Phase 1 of the AD700 project started in 1998 and ended in 2004. It was carried out within the Commission's 4th framework programme under the contract SF/01001/97/DK¹. DG TREN and the Swiss and British governments were financial cosponsors.

One of the main issues was identification and selection of appropriate materials and testing of these as described later. Parallel to that, the optimum thermodynamic cycle should be defined and corresponding designs should be developed for boiler and turbine. Thorough studies of fuel options, slagging and fouling, and emission control were carried out to find the right design parameters for the boiler. The possibility for cofiring with biomass was also studied.

As the nickel-based alloys are extremely expensive, the concept of compact design was studied. The aim of this is to limit the amount of these materials – e.g. by making the steam lines as short as possible. The outcome of phase 1 demonstrated that an AD700 plant is technically feasible and it will have a competitive advantage over the current internationally accepted generation of coal-fired power plants.

The second phase of the AD700 project started in 2002 and will end in 2006. It was carried out within the Commission's 5th Framework Programme under the contract ENK5-CT2001-00511². DG RTD and the Swiss government was a financial co-sponsor.

One of the main tasks in this phase has been to design, manufacture and test various components. For the boiler an evaporator panel, a superheater panel and welding of thick walled pipes were considered. A very thorough study was made of the horizontal boiler identified in phase 1 as a solution which would allow a very compact design. The study shows that this design also has potential for reduction of the boiler price in general.

For the turbine, a turbine inlet valve, forged rotor, welded rotor, moving blades, stationary blades, bolting and welding of pressure containment parts were considered. Also innovative designs with the aim of reduced need for the nickel-based alloys have been studied.

Considerable effort has been made to establish business plans for a full-scale demonstration plant (phase 4). The studies included a detailed risk assessment and a new check on the feasibility taking the latest material strength values and prices in consideration. The technology is still feasible even when a moderate price for CO₂ quotas is used.

Another target was to establish plans for a component test facility which would allow testing of components on a larger scale and for a prolonged period.

Several plans have been on the table and one included the high pressure part of a full scale 400 MW turbine to be built in connection with Elsam's 580 °C double reheat plant Skaerbaek 3. However, as the EU's framework programme 6 did not allow support for fossil fuels, it was not possible to finance it (budget was 150 M€). Instead plans were made for a less ambitious CTF mainly testing boiler components (phase 3).

Phase 3 of the AD700 project covers the component demonstration programme and it started in July 2004 with a component test facility (CTF) at the Scholven power station in Gelsenkirchen. The acronym of the project is COMTES700 and the Commission's Research Fund for Coal and Steel is co-sponsor together with a group of major European power generators named the Emax group.

The facility includes test of an evaporator and a superheater panel mounted in the boiler of Scholven F together with the necessary steam line and valves. It also includes a high pressure bypass valve, a safety valve and a turbine inlet valve (budget 25 M€). The CTF went in operation in August 2005 and will be in operation until mid 2009 followed by six months of materials investigations.

If the outcome of phase 3 is positive, phase 4 of the AD700 project could start around 2010 with the construction of a 400 MW Full-Scale Demonstration Plant (FSDP) somewhere in Europe. Some 3.5 years would be needed for construction and commissioning and afterwards two years of operation would be needed to pick up operational experiences. If everything goes well, the AD700 technology would be commercially ready around 2015.

If a FSDP is to be ordered in 2010, a planning period of two years to prepare bid specifications and to negotiate with the bidders should be foreseen. Therefore considerations concerning participation and creation of an owner's consortium with all its agreements would have to begin in 2007.

The FSDP is a big investment so it is foreseen that a consortium of power generators would be created to share the risk of construction and operation of the FSDP in co-operation with the European Commission. At present it seems that the Commission's 7th Framework Programme (FP 7) would be an excellent instrument to provide the essential political support for the FSDP but it is important to note that support from FP 7 would foresee demonstration of CO₂ capture in combination with the FSDP.

3 Materials

The realisation of the AD700 power plant called for development and qualification of appropriate materials including nickel-based superalloys for the most severely exposed components. In phase 1, ambitious targets regarding the creep rupture strength were set up for the development of ferritic, austenitic and nickel-based materials to meet the AD700 requirements. Besides creep rupture strength, these materials should also meet other requirements such as flue gas corrosion resistance, steam oxidation resistance, resistance to thermo-mechanical cycling and of course the ability to be manufactured and welded in thick section.

3.1 Materials for furnace walls

Three newly developed steels were selected as candidate materials for furnace panels. The highly alloyed 12%Cr tube steel HCM12 and the low alloyed 2.5%Cr tube steel HCM2S, both developed by Sumitomo Metal Industries and Mitsubishi Heavy Industries, and the Mannesmann developed 2.5%Cr tube steel 7CrMoVTiB1010.

HCM12 was chosen due to its excellent creep strength and oxidation and corrosion resistance. Furthermore, owing to its duplex microstructure of approximately 30% δ -ferrite and 70% tempered martensite, it is possible to weld this steel without preheat and post-weld heat treatment (PWHT)³. The two low alloyed 2½%Cr tube steels HCM2S and 7CrMoVTiB1010 had sufficient high temperature strength and also a metallurgy which makes it possible to omit PWHT^{4, 5}. The chemical composition and mechanical properties for all three steels are given in table 1 and figure 2 respectively.

Testing of HCM12, HCM2S and 7CrMoVTiB1010 is in progress in Europe to establish practical experience with the handling of these steels. In the furnace panels of an existing subcritical once-through boiler, test sections of all three steels have been installed, and service under cycling conditions has been tested for several years. For the HCM2S and 7CrMoVTiB1010 tube materials, no problems have been encountered during the production of the test panels or during operation at steam temperatures up to 500 °C. Test panels of HCM12 have been service exposed with steam temperatures up to 530 °C under cycling conditions.

Within the AD700 project phase 3 both 7CrMoVTiB10 10 and HCM12 are being tested in the CTF evaporator panel at Scholven power station in Gelsenkirchen.

Unfortunately, it was later realised that a major reduction in long-term creep rupture strength at temperatures above 550 °C must be foreseen for many of the 10–12%Cr steels, including HCM12. Systematic microstructure investigations of different 10–12%Cr steels showing sigmoidal creep behaviour have demonstrated that precipitation of the complex Z-phase nitride [Cr(V,Nb)N] takes place in the steels at the expense of the strengthening MX carbonitrides, which dissolve⁶. This mechanism is responsible for the reduction in creep strength, and it seems that high Cr steels are more prone to Z-phase formation than low Cr steels.

The presence of Z-phase with its detrimental effect on the long-term microstructural stability of the new generation of 9–12%Cr steels constitutes a serious challenge for the development of a cost effective AD700 power plant. New routes for the development of iron-based materials for furnace walls must be sought, otherwise the only alternative would be to use nickel-based superalloys like alloy 617 for the hottest part of the furnace wall. The fact that alloy 617 tubes cost roughly 10 times more than HCM12 and call for a far more expensive fabrication means that the whole boiler economy must be carefully considered before such a choice of material is taken.

3.2 Materials for superheater tubes

For superheater tubing, the aim is to develop an improved austenitic tube material with sufficient strength and flue gas corrosion resistance to operate at steam temperatures around 650 °C, and to develop a nickel-based superalloy to fill the gap up to 700 °C steam temperature. Intensive development work is continuing in the AD700 project to demonstrate a suitable austenitic tube material with 100,000 h rupture strength of ~100 MPa at 700 °C and a nickel-based tube material with 100,000 h rupture strength of 100 MPa at 750 °C - both materials have to demonstrate a flue gas corrosion resistance better than 2 mm metal loss during an exposure of 200,000 h.

Table 1 Nominal chemical composition, wt%

	C	Cr	Mo	W	Others
HCM2S	0.06	2.25	0.3	1.6	V, Nb, N, B
7CrMoTiB10 10	0.07	2.4	0.3		V, Ti, N, B
MCH12	0.1	12	1	1	V, Nb

Table 2 Nominal chemical composition, wt%

	C	Cr	Ni	W	Cu	Nb	Others
Alloy 174	0.08	22	25	3.5	3	0.5	Co, N
NF709	0.08	20	25	-	-	0.25	Mo, Ti, N
Super 304H	0.10	18	9	-	3	0.45	N

For the development of a new austenitic stainless steel, 30 trial melts were manufactured based on different alloy design principles. After two screening tests of up to 15.000 h of testing, the alloy 174 showed the best overall material properties and was selected to be tested further as an AD700 candidate material. The chemical composition and creep properties are shown together with some of the best commercial austenitic superheater tube alloys in table 2 and figure 2.

In figure 2 the improvement in creep rupture strength as compared to the other austenitic materials is obvious and continuing steam oxidation and flue gas corrosion tests demonstrate properties comparable with or slightly better than those obtained for a large variety of 22-25% Cr austenitic superheater steels. So far all targets are fulfilled.

Long-term creep rupture properties for base material as well as cross-weld specimens and microstructural stability test are continuing and will complete the characterisation of this super austenite which will be launched in the market by Sandvik under the name Sanicro 25.

Regarding candidate materials for the nickel-based tubing, a literature survey concluded that the existing alloy NIMONIC® alloy 263 had adequate strength to meet the creep requirement, but the literature survey also showed that its corrosion resistance might be inadequate. Therefore, >30 trial compositions based on alloy 263 were produced. Improvement of the coal ash corrosion resistance of the alloy was developed in a series

of coal ash corrosion tests at different temperatures employing samples with a systematic variation in alloy constituents.

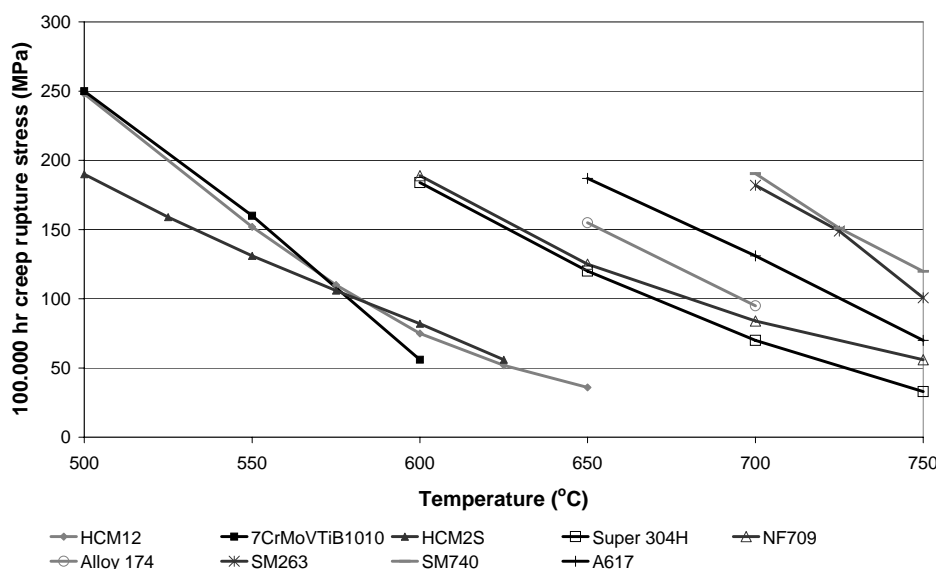

Figure 2 Creep rupture strength of candidate materials for the AD700 power plant

The resultant optimised chemical composition which was selected is given in table 3, together with two other nickel-based candidate materials. The new alloy INCONEL® alloy 740 is a nickel-chromium-cobalt alloy which is age hardenable by γ prime precipitation but also benefits from solid solution hardening.

Table 3 Nominal chemical composition, wt%

	C	Ni	Cr	Mo	Co	Al	Ti	Nb	Mn	Fe	Si
Alloy 740	0.03	Bal	25.0	0.5	20.0	0.9	1.8	2.0	0.3	0.7	0.5
Alloy 617	0.07	Bal	21.5	9.0	11.5	1.0	0.35	-	0.25	1.0	0.25
Alloy 263	0.06	Bal	20.0	5.8	20.0	0.5	2.1	-	0.3	0.35	0.2

A large creep test matrix is presently underway for both alloy 263 and alloy 740 covering two major test temperatures, 725 and 775 °C, with some shorter term tests at 700, 750 and 800 °C. Test durations up to 65,000 h are being targeted. From the results obtained so far estimations on the 100,000 h creep rupture strength are depicted in Figure 2 based on 20,000 h data.

In the frame of Emax, fabrication trials of superheater sections partly made of Sanicro 25 and alloy INCONEL® alloy 740 leading to in-plant exposure testing have been finished successfully. In-plant tests taking these superheater tube materials to temperatures above 700 °C began in September 2004 at the power plant Esbjergværket⁷ and in July 2005 at the power plant Scholven.

3.3 Thick section components and steam piping

For thick section boiler components and steam lines there are two goals for the materials development. In order to lower the cost of an AD700 power plant, it would be desirable to expand the present temperature range for the ferritic/martensitic 9-12% Cr steels up to

~650 °C; above 650 °C, a nickel-based superalloy with 100,000 h rupture strength of 150 MPa at 700 °C is needed to allow construction of outlet headers and main steam lines with acceptable wall thicknesses.

The task of improving the 9-12%Cr steels on top of the impressive developments in the last two decades has proved to be very difficult. In the last five years, worldwide research has resulted in a large number of new alloys being announced, and from short-term tests they seemed very promising. However, in long-term tests the steels show sigmoidal creep behaviour and so far no ferritic alloy has demonstrated long-term creep strength better than steel P92. In AD700 attempts were also made to improve the creep rupture strength of 9-12%Cr steels. Of the seven melts manufactured six turned out to be weaker than P92 and only one melt, a 9%Cr5Co2WVNbN, showed creep rupture strength similar to P92. In parallel, tests were made on steel NF12. Short-term data demonstrated a major improvement, but longer term data showed a dramatic drop in strength also for this steel. These dramatic decreases in strength have all been ascribed to the precipitation of Z-phase as described above for the furnace wall material HCM12.

Alloy 263 or an improved version of alloy 617 may meet the demands for outlet headers and steam lines at 700 °C steam temperature. In the AD700 context, focus was put on alloy 263 as its strength would enable constructions with smaller wall thicknesses which in turn would lead to a reduction in costs when building an AD700 power plant.

A vital demonstration of the viability of this alloy in the context of the AD700 programme was achieved with the manufacture of a thick section pipe. A two-ton ingot has been produced in alloy 263 and this has been put through the normal pipe production route to produce 4.5 m steam pipe with dimensions 310 mm o.d. x 66 mm wall thickness. Welding trials have been successfully performed and long-term creep rupture data for base material as well as cross-weld specimens and microstructural stability test are continuing and will complete the characterisation of this nickel alloy. Furthermore, long-term creep tests on commercially available 15 mm diameter bar are continuing. All creep rupture data obtained so far suggest that the alloy will easily meet the creep criteria. More thick section pipes have been produced to enable a full qualification of alloy 263 to be used with all its strength potential for steam pipe application.

3.4 Materials for the turbine

As for the boiler and for the steam lines it has been necessary to qualify materials for the hottest part of the turbine, e.g. inlet valves inlet part of the HP- and IP-turbine, first rows of blades and bolts. A special group within AD700 has been working with this qualification. Materials were selected from the large variety of nickel-based alloys well known from the gas turbine industry. The task was to qualify these materials to be used in a temperature and pressure regime and environment different from what is known from the gas turbines.

During the first six years materials for turbine castings and forgings bar material were selected and qualified for the construction of a high temperature steam turbine. In table 4 the nominal chemical compositions of these materials are given.

Table 4 Nominal chemical composition, wt%

	Ni	Cr	Mo	Co	Al	Ti	Nb	Mn	Fe	Si	B
Alloy 617	Bal	21.5	9.0	11.5	1.0	0.35	-	0.25	1.0	0.2	
Alloy 625	Bal	22.0	9.0	-	0.2	0.2	3.5	-	-	-	
Alloy 718	Bal	19.0	3.0	-	0.5	1.0	5.0	-	18.0	-	
Alloy 263	Bal	20.0	5.8	20.0	0.5	2.1	-	0.30	0.35	0.2	
Waspalloy	Bal	20.0	4.0	14.0	1.4	3.0	3.5	-	-	-	0.005
N 105	Bal	15.0	4.0	20.0	4.5	1.2	3.5	-	-	-	0.005

Alloy 617 and 625 are foreseen to be used for turbine castings and forgings, whereas alloy 718 and 263 will only be considered for forgings. Waspalloy and N 105 are to be used for bar material applications like blades and bolts. Test components of valve bodies and steam chest of materials alloy 617 and 625 and full scale rotor forgings of materials alloy 617, 625, 718 and 263 have been produced. As the use of a welded rotor construction is foreseen in future AD700 power plants heavy section rotor weldings have been demonstrated. Mechanical testing on samples taken from all these product including the weldments are in progress ⁸.

In COMTES700 a full scale turbine inlet valve is part of the component test facility.

4 Master Cycle

The improvements of steel as described above also meant remarkable progress concerning main and reheat steam temperatures which increased from the 540-560 °C range to the 600-610 °C and they will continue to increase as AD700 technology becomes commercially mature within ten years. Basically higher steam temperatures also mean higher efficiencies but a more detailed analysis of the water/steam cycle shows that superheating of the bleed steam for the regenerative feed-water heaters also continues to increase, which is thermodynamically disadvantageous. Therefore, in modern water/steam cycles the efficiency gain through higher main and in particular reheat steam temperatures disappears for that part of the reheat steam that is later on used as strongly superheated (above ~250 K) bleed steam for the feed-water heaters.

In this section it will be shown how the conventional water/steam cycle can be improved by a slight change, which reduces super heat of the bleed steam. The improved cycle was invented by Elsam and is named the Master Cycle (MC). Patent protection has been established in Australia, Europe, Canada, India, South Africa and the USA. Using the wording of the section "Introduction", it might be said that the carnotisation gap of a conventional cycle is further reduced with the MC. The MC works on both single and double reheat cycles and on both USC and AD700 steam parameters but - independently of steam parameters - it works most effectively on double reheat cycles.

The major change of the MC is the removal of the steam bleeds for the regenerative feed water heaters from the IP turbine(s) to a separate turbine named the tuning turbine or the T-turbine. With the T-turbine installed, both the reheat and regenerative feed water preheating processes are decoupled and can be optimised (tuned) independently. Tables 5 and 6 show the superheat of the four top bleeds of a number of single and double reheat cycles. The tables clearly show that in particular the first bleeds (marked with a *) after re-heating are very hot for the conventional cycles and table 6 also shows how effectively the MC reduces the superheat of the bleed steam of the double reheat cycles.

Figure 3 illustrates the principles of the Master Cycle with double reheat.

Table 6. Super heat of the four top bleeds of three double reheat cycles including the Master Cycle

Heater	Top heater		Top heater – 1		Top heater – 2		Top heater – 3	
	P _{Bleed}	Super heat	P _{Bleed}	Super heat	P _{Bleed}	Super heat	P _{Bleed}	Super heat
Steam parameters	bar	K	bar	K	bar	K	bar	K
285 bar/580/580/580/ 300 °C	78.1	77	* 41.6	* 232	20.66	166	* 13.8	* 337
285 bar/580/580/580/ 300 °C, MC	77.5	75	40.8	35	19.9	Wet	11.0	Wet
375 bar/700/20/720/ 350 °C	123.0	172	* 78.8	* 354	29.8	250	* 17.7	* 432
375 bar/700/720/720/ 350 °C, MC	132	179	85.4	144	32.2	70	17.2	28

* The first bleeds

The T-turbine is a separate turbine bleeding on the first cold reheat line downstream of the check valves and as steam for the T-turbine starts expansion from relatively cold

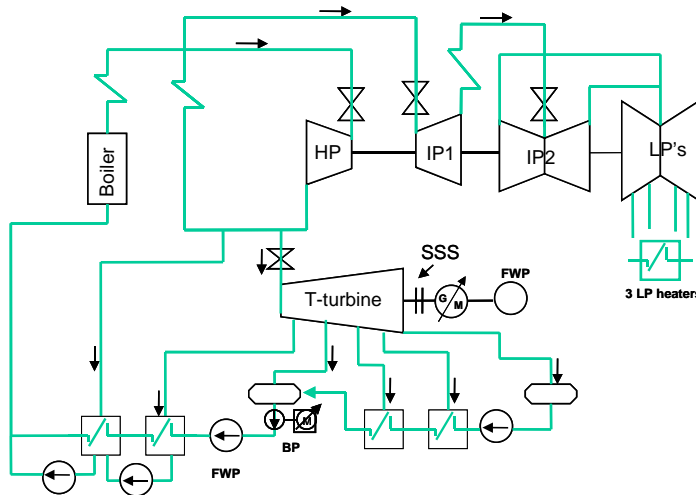

Figure 3 Principles of the Master Cycle with double reheat

conditions, the super heat is rapidly reduced. This also means that bleed steam from the T-turbine is very cold and the final bleeds of the T-turbine steam might even be slightly wet.

As steam is being extracted constantly along the steam path of the T-turbine, the volume low only increases slowly and the T-turbine needs to rotate at ~5000 rpm to achieve good stage efficiencies. After the T-turbine, the steam exhausts into a regenerative heater, so no expensive T-turbine condenser is needed. The T-turbine also drives a 100% feed pump and a generator, both running at the same speed as the turbine. The generator balances the power being generated and it could be added to the main transformer through separate primary coils. During start and stop, the T-turbine stops by opening the SSS clutch and the generator switches into motor operating mode to drive the feed pump. This also means that no separate start up pump is needed.

Good efficiency of all stages of the T-turbine is paramount to the success of the MC, which means that design of the T-turbine becomes easier as plant output increases. Therefore, the continuing trend to increase the output of coal-fired plant to the 800 - 1000 MW range is very beneficial for the MC.

IP turbine design becomes simpler and cheaper with the MC as all bleeds disappear and the extraction lines with their check and shut-off valves also can be designed for much lower temperatures and cheaper materials. More bleed steam is needed as superheat of the T-turbine bleeds is reduced, which also means that more main steam is needed to improve cooling of the furnace walls and efficiency of the HP turbine through longer blades.

Removal of bleed steam from the IP-turbines to the T-turbine also means that steam flow through the reheaters of the MC is reduced by some 20-25% creating large reductions and savings of reheat steam lines and reheater surface in the boiler. Preliminary investigations indicate that the MC boiler price would come close to the price of a conventional single reheat boiler.

Cycle studies of the MC show that in total there is a heat rate gain (in kJ/kWh) around 3.5% for the MC compared with a conventional single reheat cycle and a seawater-cooled power station based on the MC could reach a net efficiency of 50%. Further, MC decoupling of the reheat and regenerative feed water preheating systems offers more freedom to optimise these systems, which is very advantageous for the cycle designer in his efforts to reduce investment cost.

It may be concluded that the MC seems to bring a competitive advantage of ~3.5% on specific heat rate compared with a conventional single reheat cycle and the net present value of coal savings and CO₂ reductions is worth about 70 M€ for an 800 MW plant. These savings can be achieved at roughly constant investment cost.

Finally, in conventional cycles a minimum heat rate always appears as final feed water temperature increases but with the MC the situation seems different and thermodynamically more advantageous as the heat rate continues to fall. No conclusion on this phenomenon, which improves carnotisation of the cycle, exists at present but further investigations are being started.

5 Conclusions and outlook

Since the erratic price increases of primary energy started a few years ago and the gas supply crisis this year, coal has made a strong comeback in the European power market. Fortunately, the comeback appears at a time when new and improved steels for all crucial sections of boilers, steam lines and turbines have already been qualified in time for a number of new 650-1100 MW power plant with USC steam parameters.

Furthermore, improved nickel-based materials are being developed and qualified and they will be the basis for a new generation of advanced power plant operating at rated steam temperatures of 700 °C. Construction of an advanced 400 MW AD700 power plant could start around 2010 and be ready for operation around 2012.

Based on new steels, the net efficiency of contemporary power plant technology demonstrates robust improvement meaning improved competitiveness, less CO₂ per MWh being generated and a more sustainable use of the coal resources. In the future, the net efficiency will continue to increase and a seawater-cooled 800 MW AD700 power plant to start commercial operation around 2020 might reach a net efficiency around 55% based on the MC. The MC was invented by Elsam and is a slight modification of the double reheat cycle offering 3.5% improvement of heat rate compared with a single reheat cycle. Patent protection has been established in a number of countries.

However, pressure on energy resources and demand for zero emission power plant will continue and even grow in future, so there is indeed a need for more effective and sustainable power station. AD700 is a relevant answer to these requests. A coal-fired boiler allows co-firing with biomass and fractions of waste which reduces the CO₂-emission. The ultimate efficiency makes it economically feasible to install CO₂-capture after such a plant.

-
- ¹ Sven Kjær, F. Klauke, R. Vanstone, A. Zeijseink, G. Wiessinger, P. Kristensen, J. Meier, R. Blum and K. Wieghardt: *The Advanced Supercritical 700 °C Pulverized Coal-fired Power Plant*, Powergen, May 2001, Brussels
 - ² J. Bugge, S. Kjær and R. Blum: *High Efficiency Coal-fired Power Plants, Development and Perspectives*, Proc. Conf. ECOS 2003, The Technical University of Denmark, Copenhagen, Denmark, June-July 2003, 1349-1353
 - ³ Iseda, Y. Sawaragi, H. Teranishi, M. Kubota, Y. Hayase: *Development of New 12%Cr Steel Tubing (HCM12) for Boiler Application*, The Sumitomo Search, 1989 (40), 41-56
 - ⁴ F. Masuyama, T. Yokoyama, A. Sawaragi and A. Iseda: *Development of tungsten strengthened low alloy steel with improved weldability*, Materials for Advanced Power Engineering 1994, October 3-6, 1994, Liège, Kluwer Academic, 173-181
 - ⁵ W. Bendick, M. Ring, K. Haarmann and M. Zschau: *Stand der Entwicklung neuer Rohrwerkstoffe für den Kraftwerksbau in Deutschland und Europa*, VGB-Konferenz Werkstoffe und Schweißtechnik im Kraftwerk 1996, 8.-9. Oktober 1996, Cottbus, Germany
 - ⁶ J. Hald: *Creep resistant 9-12% Cr steels - long-term testing, microstructure stability and development potentials*, 1st International Conference on Super-High Strength Steels, 2-4 November 2005, Rome, Italy, Associazione Italiana di Metallurgia
 - ⁷ Q. Chen, G. Stamatelopoulos, A. Helmrich, S. Kjaer and C. Stolzenberger: *Investigations on oxidation and corrosion characteristics of the advanced boiler materials at steam temperatures up to 720 °C*, 1st International Conference on Super-High Strength Steels, 2-4 November 2005, Rome, Italy, Associazione Italiana di Metallurgia
 - ⁸ R. Blum, R.W. Vanstone: *Materials development for boilers and steam turbines operating at 700 °C*, Materials for Advanced Power Engineering 2006. Proceedings of the 8th Liege Conference, 18-20 September 2006, Liège

Session 4 – Bioenergy

Chairman: Pedro Maldonado, Universidad de Chile, Chile

Optimal Use of Organic Waste in Future Energy Systems – the Danish case

Marie Münster*, Henrik Lund
Department of Development and Planning
Aalborg University, Aalborg, Denmark

Abstract

This paper presents a comparative energy system analysis of different technologies utilizing organic waste for heat, power and fuel for transport production. Technologies included in the analysis are 2nd generation bio-fuel production, gasification, fermentation (biogas production) and improved incineration. It is argued that it is important to assess energy technologies together with the energy systems they are part of and influence. The energy system analysis is performed using the EnergyPLAN model, which simulates the Danish energy system hour by hour. The analysis shows that most fuel is saved by gasifying the organic waste and using the syngas for CHP production. On the other hand least greenhouse gases are emitted if biogas is produced from organic waste and used for CHP production.

1 Introduction

In Denmark 27% of the waste produced in 2004 was incinerated for heat and power production. Of the remaining amounts, 64% was recycled and only 8% land filled. [1]

In the EU municipal waste is at present disposed of through landfill (49%), incineration (18%) and recycling and composting (33%) [2]. EU has, however, introduced aims, which significantly reduce the amounts of biodegradable waste, which may be landfilled. According to them, the amount of biodegradable waste deposited at landfills must not in 2014 exceed 35% of the amount of biodegradable waste produced in 1995 [3]. Consequently, at EU level there is great activity with regard to finding alternatives to landfilling for biodegradable waste.

In Denmark the 34 Danish waste incineration plants contribute with 4% of the Danish electricity production and 18% of the heat production. 75% of the waste resource incinerated is biodegradable waste. The approximate 70 Danish biogas plants contribute with a mere 1% of the electricity production and 1% of the heat production. [4]

In January 2007 the Danish Government presented its vision for the Danish energy sector towards 2025. According to the vision the aim is to reach a level of 30% of energy consumption supplied by means of renewable energy in 2025 compared to 14% today and to have 10% biofuel in the transport sector in 2020 [5]. Comparisons with similar European aims show an increase in the level of renewable energy in the EU as a whole from less than 7% today to 20% by 2020 and a minimum of 10% biofuels [6]. Utilisation of waste for energy can contribute to these goals.

* Corresponding author. Tel.: +45 46775166. E-mail address: mynster@plan.aau.dk (M. Münster)

Furthermore, several trends make it interesting to use the waste resources in a different manner:

- Waste amounts are increasing all over Europe. Recent analysis project the amount of waste generated in Denmark to increase in the future. In these analyses incinerable waste is projected to rise with 30% up to year 2020 and food and wood waste with each 40%. [1]
- The Danish waste incineration capacity is becoming too low for the growing amounts.
- The energy system needs flexibility to integrate more wind.
- The demand for transport continues to increase [7]. As the sector currently runs on fossil fuels, CO₂ emissions from the sector continue to increase. This may be decreased by producing transport fuels from waste.
- A new building code makes it mandatory to reduce the energy consumption in houses, which may result in an overall decrease in the demand for heat [8]. Already, waste incineration plants have insufficient heat markets and periodically need to cool off heat.

New technologies make it possible to utilize organic waste in a new way to achieve higher power efficiency, to store energy or to produce fuels for transportation. Interesting technologies include 2nd generation bio-fuel production, gasification/pyrolysis, fermentation (biogas production) and improved incineration.

A number of LCA and Well-To-Wheel studies have been performed which illustrate the environmental effects - particularly the greenhouse gas emissions - of different technologies utilizing renewable energy including biomass for transportation purposes such as [9;10]. Likewise LCA studies have been performed on uses of waste for energy e.g. [11-13]. These studies compare strings of technologies from e.g. production of biofuels, upgrading, distribution to utilization of the fuels in vehicles. However, the studies do not analyze the technologies and their advantages and disadvantages seen from an energy system perspective or their influence on the energy system in which they exist.

It is therefore important also to perform Energy System Analysis to support decision making as done in the present analysis, as opposed to only focusing on the technologies detached from the energy systems of which they will be part.

In this Energy System Analysis of the Danish energy system it is assessed how utilization of 10 TWh waste used for incineration, fermentation or gasification producing electricity, heat and transport fuel may best contribute to reduce the dependency of fossil fuels and to reduce greenhouse gas emissions.

In Chapter 2 the Energy System Analysis model is explained and the analyses made are presented. In Chapter 3 the results are illustrated and recommendations are made for the future use of organic waste in the Danish energy system. Finally in Chapter 4 conclusions are drawn with respect to the use of the model for the purpose of evaluating the different technologies and suggestions are made for future analysis.

2 Methodology

In the following sections first the model, which was used for the analysis is described and subsequently the technical alternatives analysed.

2.1 The EnergyPLAN Model

The Energy System Analysis was made using the EnergyPLAN model, which is developed at Aalborg University and available for free together with documentation

online [14]. A brief description of the model is presented below. For more thorough explanations consult [14;15].

The EnergyPLAN model is a deterministic input/output simulation model.

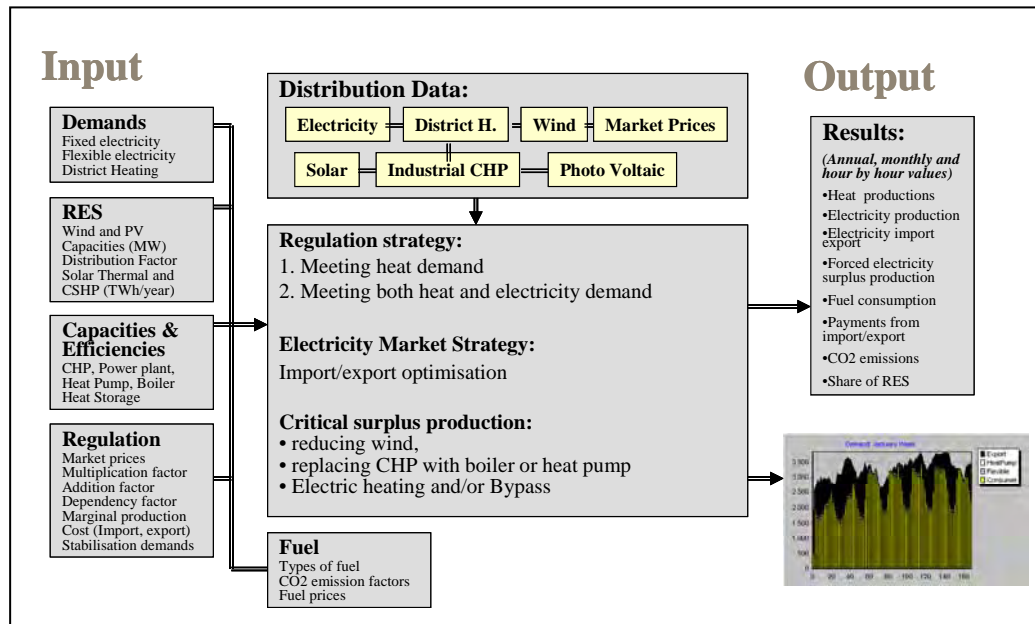

Figure 1 EnergyPLAN model 6.0 [16]

The inputs may be divided into five sets of data, which are fed into the model:

- Demands for electricity, heat, cooling, industry, individual house holds and transport
- Renewable Energy Supply
- Capacities and efficiencies of a.o. CHP and power plants
- Technical limitations and definition of external power market
- Fuel costs and CO₂ emission factors

The fluctuating demands, production and prices are fed in as hourly distributions over a year. The input data are regulated by a number of strategies illustrating e.g. how CHP plants are operated on the market and how critical excess electricity production is reduced.

Results are among others heat and power production, import/export of electricity, forced excess electricity production, fuel consumption, CO₂ emissions and share of renewable energy in the system.

The model is a simplified model in which the energy system is divided into three groups:

1. District Heating Plants
2. Decentralised CHP Plants
3. Centralised CHP Plants

The model can both simulate a closed system with no electricity exchange and an open system. It is interesting to evaluate whether the energy system can utilize the energy produced at a given hour in order to ensure an efficient system, which in turn can facilitate that trade of electricity takes place when the Danish actors want it and not when they are forced to.

Likewise the model can perform either a technical optimization focusing on improving the fuel efficiency of the system or a market optimization focusing on improving the financial output of the individual plant owners.

Previously waste has been treated in the model as a fuel along with biomass resources. However, as a part of this study, the utilization of waste in the EnergyPLAN computer model have been made more detailed and is now conducted in the way described below.

The following input has to be given to the model:

- The waste resource divided on the three types of district heating systems mentioned above.
- Efficiencies specifying the energy output in the following 4 energy forms: Heat for district heating, electricity, fuel for transportation and fuel for CHP and boilers.
- An hour by hour distribution of the waste input (and hence heat and electricity output)
- Moreover one can specify an additional non energy output (such as animal food) which will then be given an economic value in the feasibility study.

Basically the model assumes that waste cannot be stored but has to be converted in accordance with the specified hour by hour input. Consequently the energy outputs are treated in the following way:

Heat production for district heating is given priority along with solar thermal and industrial waste heat production. If such input cannot be utilized because of limitations in demand and heat storage capacity, the heat is simply lost.

Electricity production is fed into the grid and given priority along with renewable energy resources such as wind power. Other units such as CHP and power plants will adjust their production accordingly if possible (given the specified regulation strategy), and if this cannot be done, excess electricity production will be exported.

The amount of transport fuel produced is calculated and the user can subtract it from the total use of the relevant fuel in the reference and at the same time adjust for differences in car efficiencies if any exist.

Fuel for CHP and boilers is automatically subtracted in the calculation of fuel in the relevant district heating groups.

2.2 Technical alternatives

Eight different scenarios illustrating different ways of utilizing waste for energy are modelled. The scenarios focus on incineration, biogas and gasification technologies:

- **NoWaste.** Waste is not used for energy but either landfilled or composted
- **WasteHeat.** Waste is used only for heat in new plants with 2004 efficiencies
- **WasteCHP (today).** Waste is incinerated in today's plants, where 96% are CHP plants and just 4% produce only heat [17].
- **WasteCHP (new).** Waste is incinerated in new plants with 2004 efficiencies
- **BiogasCHP.** An organic fraction of 1 TWh is used to produce biogas, which is used for CHP production. 0.6 TWh manure is added to the organic fraction with a distribution of 80% manure to 20% organic waste. The biogas is produced in large scale centralised biogas plants with a capacity of 800t/d. When fermented the biomass is separated and the fibre fraction is burned in a waste incineration plant.

- **BiogasTransport.** Again the organic fraction produces biogas, but the biogas is upgraded to natural gas quality and used in natural gas vehicles. Manure is added as above
- **SyngasCHP.** The Syngas scenarios use the planned REnescence process as case [18]. 1 TWh organic fraction is gasified and used for CHP production. The waste is first liquefied by non-pressurised heat treatment and subsequently gasified in an entrained flow gasifier with 25% organic waste and 75% coal. The syngas is then used in a single cycle gas turbine.
- **SyngasTransport.** Again the waste is gasified and then converted into petrol and used in petrol vehicles

The total amount of waste considered equals 10 TWh, which is the amount of waste used for energy purposes in Denmark in 2004.

For the biogas and the syngas scenarios 1 TWh is used in the plants. This amount is comparable to the total amount of organic waste from households [12]. The remaining waste fraction of 9 TWh is incinerated in new plants with 2004 efficiencies.

The amounts and efficiencies used are illustrated in the table below.

Technical alternatives	Waste incineration				Biogas or gasification				Source
	Mixed waste fraction	Electric efficiency	Heat efficiency	Heat only efficiency	Organic waste fraction	Electric efficiency	Thermal efficiency	Fuel efficiency	
	TWh	%	%	%	TWh	%	%	%	
NoWaste	0				0				[19]
WasteHeat	10			85.5	0				[19]
WasteCHP (today)	10	14.4	70.9	75.0	0				[17]
WasteCHP (new)	10	19.5	65.4	85.5	0				[19]
BiogasCHP	9	19.5	65.4	85.5	1.6*	18.6	17.5		[19]
BiogasTransport	9	19.5	65.4	85.5	1.6*			38.6	[20]
SyngasCHP	9	19.5	65.4	85.5	1	36.6	35.0		[18]
SyngasTransport	9	19.5	65.4	85.5	1	11.0	10.5	54.4	[18]

Table 1 Efficiencies and amounts used for the scenarios.*Including 0.6 TWh manure

The electric efficiency increases from 14.4% of today's average to 19.5% of new plants as can be seen in the table above. In comparison the efficiency of heat only incineration plants increases from 75% to 85.5%. Biogas plants have a lower efficiency than gasification plants but have the advantage of facilitating the use of manure in the energy system.

The CO₂ content of the waste related to fossil parts is assumed to be 33.3 kg/GJ [21]. The table below illustrates the lower heating values (LHV) and the biogas yields assumed.

Fuel	LHV	Biogas output
Mixed waste	10.5 MJ/kg [7]	

Organic waste	5.7 MJ/kg [22]	108 Nm ³ /t [22]
Manure	0.9 MJ/kg* [23]	21 Nm ³ /t [19]
Fibre fraction from biogas plant	3.8 MJ/kg [24]	
Biogas	23 MJ/m ³ [19]	

Table 2 Lower heating values and biogas output. * Based on LHV of dry matter content in the manure

2.3 Reference Energy System

The reference energy system, in which the technologies are used, is the Danish energy system in 2004. Compared to other countries Denmark has a energy efficiency with a high level of CHP (55% of the thermal electricity production and 82% of district heating) and a high percentage of wind (18.5% of total electricity production) [7]. For all scenarios the same amount of electricity, heat and transport fuel is supplied at the same hours throughout the year.

The system is analyzed with no transmission to neighbouring countries and a technical optimization is chosen, where the model seeks to find solutions with the lowest fuel consumption. In order to ensure this, CHP plants operate according to both the heat and the electricity demands.

3 Results

Some differences exist concerning fuel consumption and CO₂ emissions when utilizing the waste in different ways. In this chapter fuel consumption is regarded first, followed by CO₂ emissions.

3.1 Fuel consumption

Below the Danish Gross Energy consumption is illustrated for the different scenarios.

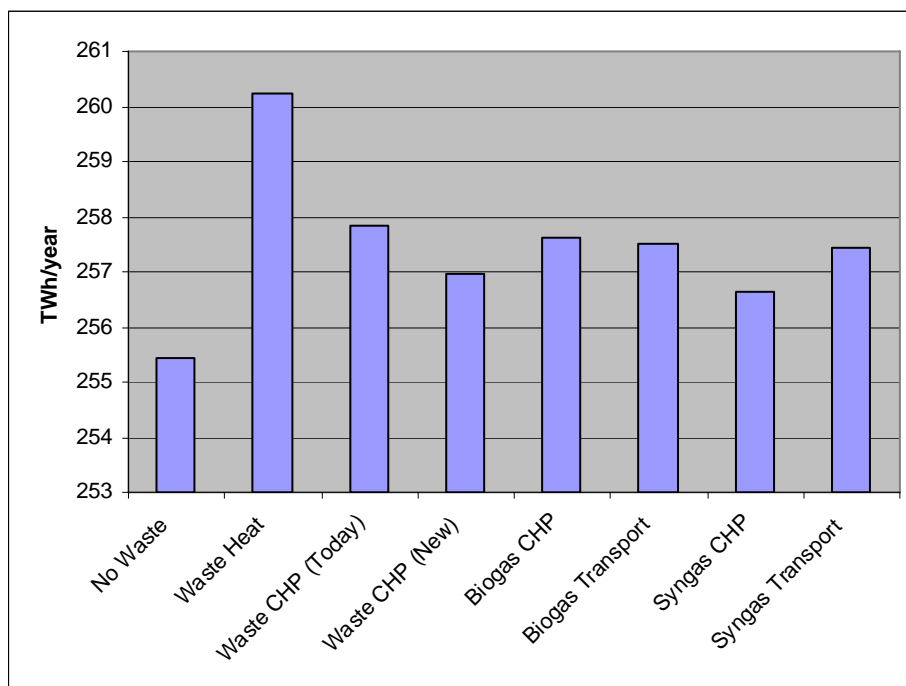

Figure 2 Gross Energy Consumption with the different scenarios

The lowest energy consumption arises when waste is not used for energy. This is due to the fact that the technologies utilizing waste are less energy efficient than the technologies using fossil fuels. Other reasons however exist for still choosing to utilize the waste for energy. The prime reason is that other fuels are substituted when using waste in the energy system. It is therefore interesting to evaluate which utilization provides the biggest fuel saving in the system. This is illustrated in the figure below.

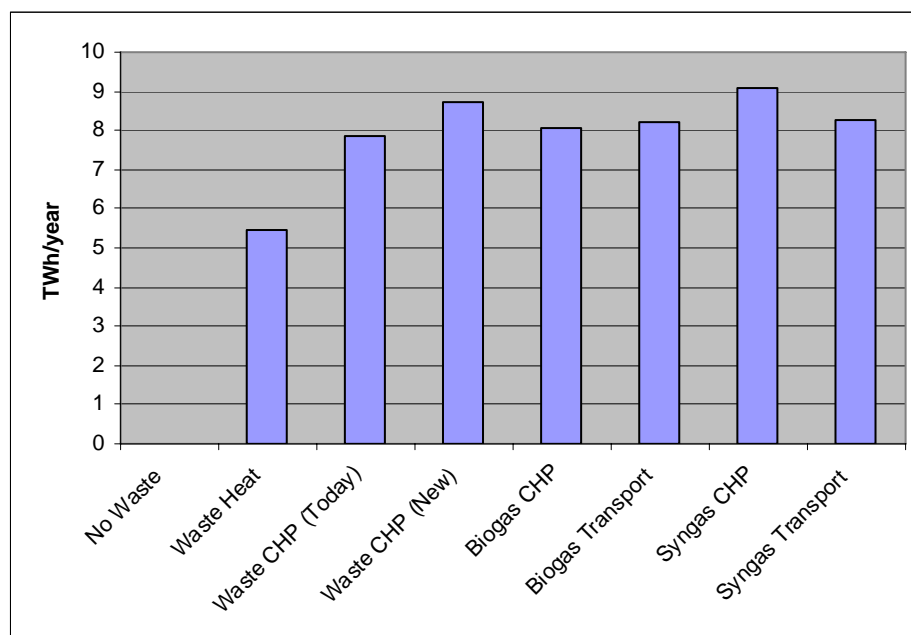

Figure 3 Primary Energy substituted when using 10 TWh waste per year. Including 2.5 Mt manure for biogas and 3 TWh coal for syngas. The top part of the columns illustrate savings due to use of 1 TWh organic waste in the different technologies

The lowest fuel substitution of around 5.5 TWh occurs when utilizing the waste only for heat. This is due to the fact that the produced heat to a large extent substitutes heat produced at CHP plants. Consequently, the heat demand is satisfied and it is necessary to produce electricity in condensing power plants producing only electricity with a low total efficiency. The remaining scenarios achieve similar savings of between 7 to 9 TWh per 10 TWh waste fed into the system. In the biogas scenarios use of 2.5 Mt manure is facilitated and in the syngas scenarios a demand of 3 TWh coal is induced to run the gasifier.

The highest substitution occurs when using syngas for CHP production where more than 9 TWh are substituted. The second highest fuel substitution occurs when upgrading the waste CHP incineration plants.

However, some of the primary energy substituted may be renewable energy. The figure below illustrates the fossil fuel substituted with waste in the various scenarios.

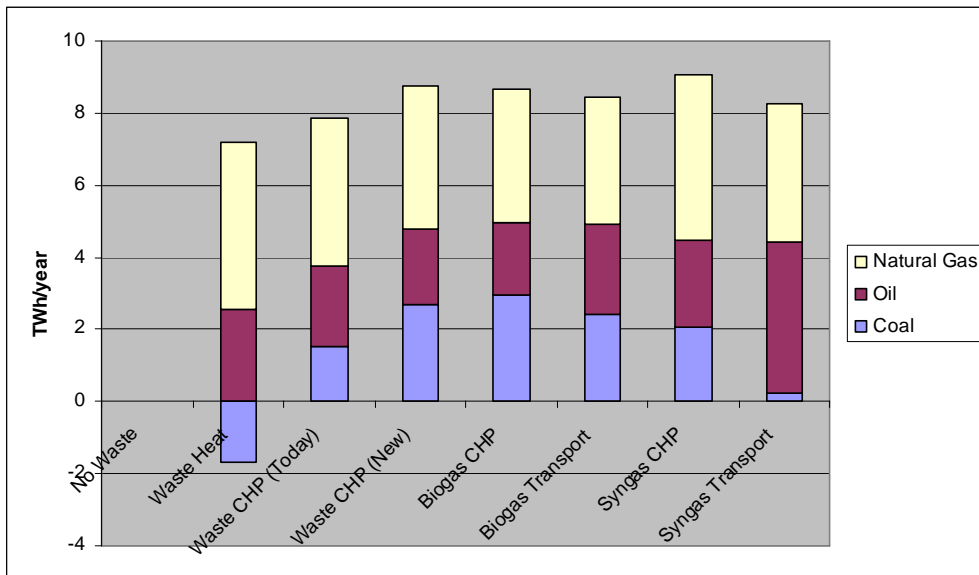

Figure 4 Fossil fuel substituted when utilizing 10 TWh waste per year. Including 2.5 Mt manure for biogas and 3 TWh coal for syngas

In the Waste Heat scenario a consumption of coal is induced for electricity production. The remaining scenarios do not induce fossil fuel consumptions, but rather substitutes around 8-9 TWh fossil fuel each.

The scenario that reduces the fossil fuel consumption most is the syngas CHP scenario. The new waste CHP scenario and the biogas scenarios come next. The Syngas Transport scenario substitutes most oil, whereas the Waste Heat scenario substitutes most natural gas and the Biogas CHP scenario substitutes most coal.

3.2 CO₂ emissions

Utilizing waste in the energy system results in reduced CO₂ emissions from energy conversion in the Danish energy system as illustrated in the figure below.

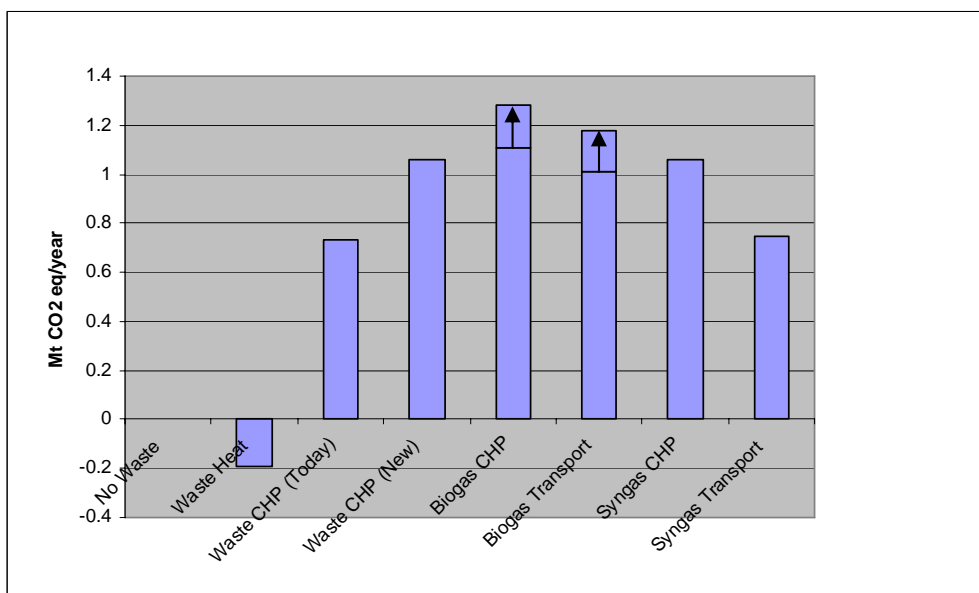

Figure 5 Reduced CO₂ emissions from energy conversion in the various scenarios and arrows indicating reduced CH₄ and N₂O emissions due to digestion of manure

Utilizing waste only for heat results in increased CO₂ emissions. The second worst solution is not utilizing waste for energy purposes. It may be seen that today's use of waste for energy saves the Danish society of approximately 700.000 t CO₂ eq every year.

The lowest CO₂ emissions occur when utilizing the organic waste in biogas plants and then produce CHP closely followed by the new Waste CHP, Syngas CHP and Biogas Transportation scenarios.

If seen in a lifecycle perspective the main differences in emission of greenhouse gases between the scenarios, which are not already accounted for, are that more methane will be emitted in the NoWaste scenario and less methane and N₂O will be emitted in the biogas scenarios.

If waste is e.g. landfilled in the NoWaste scenario, methane emissions from landfill sites should be added to the emissions and not using waste for energy would come out even worse.

The reduced methane and N₂O emissions in the biogas scenarios occur because digested manure is used on the fields as opposed to raw manure. An increase in transport is expected but an emission from this is heavily outweighed by the reduced methane and N₂O emissions [25].

If the biogas scenarios are credited for further net reduced greenhouse gas emissions, the biogas columns can be increased to the level indicated by the arrows. This results in the Biogas CHP scenario coming out even better and the second best solution being the Biogas Transport scenario.

4 Conclusion and discussion

The results of the Energy System Analysis are useful in two respects:

1. Supporting decision making directly, when the focus is on dependence of fossil fuels
2. Supplying input to further environmental assessment e.g. using LCA methodology regarding both CO₂ emissions from conversion in the energy system and fuel consumption

The clearest conclusion from the analysis is that waste should be used for energy purposes and not incinerated to produce only heat. Furthermore, if the main political aim is to reduce dependence of fossil fuels the best solution is to produce syngas for CHP scenario closely followed by upgrading the CHP incineration plants. The worst solution is to use the waste for heat production. Reduction of oil dependence is best achieved by using syngas for transport.

If, on the other hand, the main political aim is to reduce greenhouse gas emissions, then the best solution is to utilize the organic waste for biogas production and subsequently to use the biogas for CHP production. The worst solutions are incinerating the waste for heat production or not utilizing the waste for energy.

It would be interesting to perform further Energy System Analyses with open borders facilitating trade with electricity and to assess the economy of the various scenarios. Furthermore, it would be interesting to assess the performance of the technologies in energy systems with more wind power. Finally, to give full credit to the flexibility of the systems choosing between producing electricity and heat or transport fuels it would be interesting to develop the model further to reflect these features.

Acknowledgement

We would like to thank staff from Swedish Gas Centre, Waste Centre Denmark and DONG Energy for contributing with data to the analysis.

Furthermore, thanks are extended to Poul Erik Morthorst, Kenneth Karlsson and Christian van Maarschalkerweerd from Risø National Laboratory, Tore Hulgaard from Rambøll, Thilde Fruergaard from Danish Technical University as well as Brian Vad Mathiesen and Georges Salgi from Aalborg University for valuable and inspiring discussions and comments to the paper.

Reference List

- [1] F. Møller Andersen and H. V. Larsen, "A Model for Projection of Isag Data – FRIDA," Roskilde: Risø National Laboratory, 2006.
- [2] European Commission, "Taking sustainable use of resources forward: A Thematic Strategy on the prevention and recycling of waste," Brussels: 2005.
- [3] Council Of The European Union, "Council Directive 1999/31/EC of 26 April 1999 on the landfill of waste," 1999, pp. 0001-0019.
- [4] Danish Energy Authority, "Energy Statistics 2004," Copenhagen: Danish Ministry of Transport and Energy, 2005.
- [5] Danish Government, "A Visionary Danish Energy Policy," Copenhagen: 2007.
- [6] European Commission, "An Energy Policy For Europe," Brussels: 2007.
- [7] Danish Energy Authority, "Energy Statistics 2004 (In Danish)," Copenhagen: 2005.
- [8] Danish Government, "Law about increasing energy savings in buildings (in Danish), LOV no 585 of 24/06/2005," Copenhagen: 2005.
- [9] EUCAR, CONCAWE, and Joint Research Centre of the EU Commission, "Well-To-Wheels Analysis Of Future Automotive Fuels And Powertrains In The European Context - WELL-to-WHEELS Report Version 2c," Joint Research Centre of the EU Commission, 2007.
- [10] C. N. Hamelinck and A. P. C. Faaij, "Outlook for advanced biofuels," *Energy Policy*, vol. 34, no. 17, pp. 3268-3283, 2006.
- [11] G. Finnveden, "Methodological aspects of life cycle assessment of integrated solid waste management systems," *Resources, Conservation and Recycling*, vol. 26, no. 3-4, pp. 173-187, June 1999.
- [12] A. Baky and O. Eriksson, "Systems Analysis of Organic Waste Management in Denmark," in *Environmental Project no. 822, 2003* Copenhagen: Danish Environmental Agency, 2003.
- [13] J. T. Kirkeby, H. Birgisdottir, T. L. Hansen, T. H. Christensen, G. S. Bhandar, and M. Hauschild, "Evaluation of environmental impacts from municipal solid waste management in the municipality of Aarhus, Denmark (EASEWASTE)," *Waste Management & Research*, vol. 24, no. 1, pp. 16-26, 2006.
- [14] H. Lund, "EnergyPLAN, Advanced Energy System Analysis Computer Model version, Documentation version 7.0.," Aalborg: Aalborg University, 2007.
- [15] H. Lund and E. Munster, "Modelling of energy systems with a high percentage of CHP and wind power," *Renewable Energy*, vol. 28, no. 14, pp. 2179-2193, 2003.

- [16] H. Lund, "EnergyPLAN," in *Computer Model for Energy System Analysis* Aalborg: Department of Development and Planning Aalborg University, 2006.
- [17] ISWA, "Energy from Waste State-of-the-Art-Report," 5th Edition August 2006 ed Copenhagen: ISWA Working Group on Thermal Treatment of Waste, 2006.
- [18] DONG Energy, "Personal Communication regarding REnescience," Skærbæk: 2007.
- [19] Danish Energy Authority, ElkraftSystem, and Eltra, "Technology Data for Electricity and Heat Generating Plants," Copenhagen: Danish Energy Authority, 2005.
- [20] M. Persson, "Assessment of upgrading techniques for biogas (In Swedish)," in *Rapport SGC 142* Svenskt Gastekniskt Center, 2003.
- [21] Waste Centre Denmark, "CO₂ in waste - personal communication," 2007.
- [22] Danish Environmental Protection Agency, "Status on organic municipal waste (in Danish)," in *Orientation from the Environmental Protection Agency No. 4 2003* Copenhagen: 2003.
- [23] H. B. Moller, S. G. Sommer, and B. Ahring, "Methane productivity of manure, straw and solid fractions of manure," *Biomass & Bioenergy*, vol. 26, no. 5, pp. 485-495, 2004.
- [24] K. Hjort-Gregersen and J. Christensen, "Burning of fibre fraction from separated manure - Corporate and socio-economic analyses (In Danish)," Copenhagen: Institute for Food and Economy, 2005.
- [25] L. H. Nielsen, K. Hjort-Gregersen, P. Thygesen, and J. Christensen, "Socio-economic Analysis of Centralised Biogas Plants - with technical and corporate economic analysis (In Danish)," Report no. 136 ed Copenhagen: Institute of Food and Resource Economics, 2002.

Sustainable bioethanol production combining biorefinery principles and intercropping strategies

Thomsen, M.H.; Hauggaard-Nielsen, H; Petersson, A.; Thomsen, A.B. and Jensen, E.S. Biosystems Department, Risø National Laboratory Risø, Technical University of Denmark, Frederiksborgvej 399, DK-4000 Roskilde, Denmark

Abstract

Ethanol produced from pretreatment and microbial fermentation of biomass has great potential to become a sustainable transportation fuel in the near future. First generation biofuel focus on starch (from grain) fermentation, but in the present study that is regarded as a too important food source. In recent years 2nd generation technologies are developed utilizing bulk residues like wheat straw, woody materials, and corn stover. However, there is a need for integrating the biomass starting point into the energy manufacturing steps to secure that bioenergy is produced from local adapted raw materials with limited use of non-renewable fossil fuels.

Produced crops can be transformed into a number of useful products using the concept of biorefining, where no waste streams are produced. An advantage of intercropping is that the intercrop components composition can be designed to produce a medium (for microbial fermentation) containing all essential nutrients. Thereby addition of *e.g.* urea and other fermentation nutrients produced from fossil fuels can be avoided.

Intercropping, defined as the growing of two or more species simultaneously on the same area of land, is a cropping strategy based on the manipulation of plant interactions in time and space to maximize growth and productivity. Cereal-legume intercropping data from field trials show the possibility to improve the use of nitrogen resources, because the non fixing species (*e.g.* wheat) efficiently exploits soil mineral N sources while at the same time atmospheric N from the N₂-fixing species (*e.g.* pea) enter the cropping system reducing the need for N fertilizer application. Nitrogen fertilization is responsible for more than 85 % of the greenhouse gas emissions from wheat grain production in Denmark. Increase of fertilizer N supply promotes the growth of wheat and results in a decreased pea N accumulation and a different proportion of intercrop components. Intercropping introduce a dynamic change of plant species interactions as a response to the actual growing conditions observed which is not achieved with sole cropping of one species/cultivar. It is also concluded that when growing pea as a sole cropping available soil mineral N reduce N₂ fixation and the full potential of symbiotic nitrogen fixation is not exploited which is regarded as an overall inefficient use of N sources.

Using clover-grass intercropping raw materials, as another potential species combination with equivalent field responses to *e.g.* pea-wheat intercropping, conversion yields obtained in laboratory experiments show that wet oxidation is an efficient method for fractionating clover, grass, and clover-grass mixtures into a convertible solid cellulose fraction and a soluble hemicellulose fraction. The highest yield of fermentable sugars after enzymatic hydrolysis is achieved in clover-grass (mixed 1:1) pretreated at 195°C for 10 minutes using 12 bar oxygen. The optimum pretreatment conditions for clover, grass, and clover-grass mixtures is not significantly different from that of wheat, which indicates that wheat straw and clover-grass (from intercropping) could be pretreated in one step. The produced sugars were converted into ethanol by *Mucor indicus* giving good ethanol yields $Y_{E/TS, Aerobic} = 0.37$ and $Y_{E/TS, oxygen\ limited} = 0.41$. It is also concluded that fructans from unheated clover-grass juice can be co-converted into ethanol by natural enzymes and yeast increasing the ethanol production significantly.

Using field data and biomass conversion yields obtained in laboratory experiments a decentralized biorefinery concept for co-production of bioethanol and biogas is described with strong emphasis on sustainability, localness and recycling principles.

1 Introduction

Bioethanol produced from pretreatment and microbial fermentation of biomass has great potential to become a sustainable transportation fuel in the near future (Thomsen et al., 2003). Brazil and the United States are the largest producers of ethanol for transport, accounting for about 90 percent of world production. Both countries currently produce about 16 billion liters per year with a displacement of 40% of gasoline use in Brazil but only 3% in the United States with sugarcane (*Saccharum L.*) and corn (*Zea mays L.*) as the primary feedstock, respectively (Hazell and Pachauri, 2006). In 2005 Europe produced only about 2.6% of the world bioethanol production, but with a bioethanol sector growing with 70.5% between 2004 and 2005 primarily in Germany and Spain but with new producer countries like Hungary and Lithuania coming up (Euroobserver, 2006).

Recently a 10% binding minimum target was decided to be achieved by all EU Member States for the share of biofuels in overall EU transport petrol and diesel consumption by 2020 (EU 2007). In the U.S. President George W. Bush signed in to law the Energy Policy Act of 2005 creating a national renewable fuel standard (RFS) boosting the bioethanol sector (RFA, 2006). The character of such political activities is appropriate subject to production of biomass being sustainable - in the present study defined as the ability of a farm to produce indefinitely, without causing irreversible damage to ecosystem health.

Intercropping, defined as the growing of two or more species simultaneously on the same area of land (Willey, 1979), is an old traditional practice still widespread in the tropics and common in developed countries before the 'fossilization' of agriculture (Crews and Peoples, 2004). This cropping strategy is based on the manipulation of plant interactions in time and space to maximize growth and productivity (Hauggaard-Nielsen et al., 2006). Cereal-legume intercropping data from field trials show the possibility to increase input of leguminous symbiotic nitrogen (N) fixation into cropping systems reducing the need for fertilizer N applications (Jensen, 1996). Moreover, less need for pesticides are obtained due to improved competition towards weeds (Hauggaard-Nielsen et al., 2001; Liebman and Dyck, 1993) and less general damages on intercropped species by pest and disease organisms (Trenbath, 1993). Intercropping is a more adaptive management practice as compared to the present arable crop rotations consisting mainly of sole crops (monocrops, pure stands).

Beside bioethanol produced from sugar cane primarily in Brazil (producing more than twice the amount of the second largest producer India) the rest of the world production originates from starch fermentation (cereal grains), first generation technology. However, that is regarded as a too important food source in the present study. The emphasis is towards a food and energy approach using second generation technologies developed in recent years and cropping systems where the grain is utilized for food and feed and the remaining residues (straw, undersown grasses, catch crops etc.) is utilized for bioethanol production.

Apart from cellulose (40%), hemicellulose is a main sugar component (25-35%) in the lignocellulosic materials used for 2. generation bioethanol. However, these carbohydrates are closely bound together with lignin in the plant cell wall. Pre-treatment of the lignocellulose is necessary in order to open the structure and make carbohydrates susceptible to enzymatic hydrolysis and bioethanol fermentation. Aqueous pre-treatment at elevated temperature (such as wet-oxidation and steam explosion) result in an insoluble cellulose rich fraction (C-6 sugars) and a soluble fraction containing hemicellulose (C-5 sugars) and degradation products. (Bjerre et al. 1996; Tengborg et al. 2001). After pretreatment sugar polymers can be converted into fermentable sugars by enzymatic hydrolysis. An advantage of intercropping is that the intercrop components

composition can be designed to produce a medium (for microbial fermentation) containing all essential nutrients. Thereby addition of e.g. urea and other fermentation nutrients produced from fossil fuels can be avoided.

Biorefineries represent a technology for utilization of renewable resources and natural compounds in form of crops such as ryegrass, alfalfa, clover, and immature cereals from extensive land cultivation and vegetable residues e.g. different kinds of straw and fibres (maize, grain, rape, hemp, flax, etc.), potato and vegetable industry wastes and molasses where all parts of the biomass is transformed into useful products, and no waste streams are produced (Thomsen et al, 2005). In the biorefinery concept crops are converted by means of mechanical and biotechnological methods into useful materials such as food and feed products and additives, as well as materials, organic chemical compounds, and bioenergy. Biotechnology offers several advantages compared to chemical synthesis e.g. high product specificity, low production temperature, and low energy consumption. As a result fermentation is becoming increasingly important in the production of commodity chemicals such as enzymes, antibiotics, biodegradable plastics, organic acids, alcohols, and amino acids.

Using field data and biomass conversion yields obtained in laboratory experiments a decentralized biorefinery concept for co-production of bioethanol and biogas is described with strong emphasis on sustainability, localness and recycling principles.

2 Materials and methods

The intercrop experiment was carried out on a sandy loam on the Experimental Farm of The Royal Veterinary and Agricultural University, Denmark (55°40'N, 12°18'E) in 2002. In spring field pea (*Pisium sativum* L.) and spring wheat (*Triticum sativum* L.) were established as 100% sole crops (SC) and in a 50% pea + 50% wheat intercrop (IC) according to recommended sole crop sowing densities of 90 pea plants and 400 wheat plants m⁻². Spring wheat SC and pea-wheat IC were grown at three levels of N supply in the form of urea, i.e. 0 (N0), 4 (N4) and 8 (N8) g N m⁻² whereas pea SC was only grown at N0 and N4 due to the ability of pea to fix N₂ from the air. Microplots were placed in all fertilized plots and labelled with ¹⁵N-urea and used for calculating the proportion of plant N derived from fixation (%Ndfa), fertilizer (%Ndff) and soil (%Ndfs) according to standard procedures (Chalk, 1998). For further information see Ghaley et al. (2005).

The clover-grass mixture (1:1) were cultivated in the experimental fields of Risø National Laboratory, Denmark. The material was harvested and for samples of pure clover and grass - and 1:3 clover-grass mixture - the material was separated by hand. The samples were dried at 50°C to constant weight and milled to a size of less than 2 mm prior to pretreatment and further analysis. Fresh clover-grass juice was produced by pressing of newly harvested clover-grass in a kitchen fruit-press.

Wet oxidations were performed in a loop autoclave constructed at Risø National Laboratory using 6% dry matter (DM) (Bjerre et al., 1996). After the wet oxidation the pretreated material was separated by filtration into a solid filter cake (containing fibers and lignin) and a liquid fraction (containing soluble sugars and various degradation products). Pretreated liquids were stored at -20°C until further analysis and use, and the filter cakes were dried and kept in a climate cabinet at 20°C and 65% relative humidity.

To quantify the sugar polymers in the raw material and the solid fraction after wet oxidation a two step acid hydrolysis was performed. The first hydrolysis step was performed at 30°C for 60 min. with 1.5 ml of H₂SO₄ (72%) for 0.16 g DM. Then 42 ml water was added and the second step was performed at 121°C for 60 min. The hydrolyzate was filtered and the dried filter cake subtracted for ash content is reported as Klason lignin. In order to quantify the sugar content in the liquid fraction a weak hydrolysis was performed at 121 °C for 10 min using 4% H₂SO₄, in duplicate. The amounts of released sugar monomers in the hydrolyzate as well as concentrations of ethanol, malic acid, succinic acid, glycolic acid, formic acid and acetic acid were

determined by HPLC (Shimadzu) using a Rezex ROA column (Phenomenex) at 63°C and 4 mM H₂SO₄ as eluent at a flow rate of 0.6 ml/min. A refractive index detector (Shimadzu Corp., Kyoto, Japan) was used.

The enzymatic hydrolysis was carried out at 50°C, pH 4.8 and with 2% DM and an enzyme load of 30 FPU/g DM. The enzyme used was Cellubrix L, (Novozymes, Denmark) and the amounts of hydrolyzed sugars were determined by HPLC as described above. The experiments were carried out in triplicates for each solid pretreatment fraction.

Shake-flask fermentations of clover-grass with *Mucor indicus* were run in 250-ml erlenmeyer flasks containing 100 ml of clover-grass enriched with glucose to obtain a total of 16 g glucose/litre. One ml of a spore suspension in sterile water was inoculated in the medium and the flasks were incubated at 30°C with shaking (130 rpm). Oxygen-limited fermentations were run in 32-ml flasks containing 30 ml of medium and equipped with cannulas for sampling and CO₂ removal. Fermentation of fresh clover-grass juice was also performed in 250-ml erlenmeyer flasks containing 100 ml of medium. 0.5 g of dry commercial yeast (Malteserkors tørgær, De Danske Spritfabrikker A/S, Denmark) was added to the flasks together with the clover-grass, no nutrients were added. Glucose, xylose, and ethanol in fermentation broths were analysed by HPLC as described above. Flasks were incubated at 30°C with shaking (130 rpm).

3 Results and discussions

Biomass cultivation

Wheat SC significantly increased dry matter (DM) production at increased rates of fertilizer nitrogen whereas pea-wheat IC and pea SC did not respond to fertilizer N (Figure 1). In N0 plots, pea SC and the pea-wheat IC produced more than twice the amount of DM as compared to wheat SC. With N4, no significant difference was observed between wheat and pea SC and total intercrop DM yield. However, doubling the fertilizer N rate (N8), sole cropped wheat accumulated significantly higher amounts of DM. In general, growing N₂ fixing species like pea as sole crops is considered an inefficient way of utilizing soil N resources, as the legume is able to fix N₂ and may only need a small amount of soil inorganic N in the establishment phase to overcome any N-deficiency after seed-N sources have been exhausted.

Land Equivalent Ratio (LER) can be used as a measure of the crop stands ability to capture environmental resources for growth (Mead and Willey, 1980). When using the total crop dry matter production in the calculation (Figure 1) the highest LER value was 1.26 in IC N0 indicating that 26% more land would have to be used when sole cropping in order to obtain the same yield, if each sole crop was allocated to 50% of land. Thus, in a future with availability of cultivated land as a potential limiting resource such increasing efficiencies in local resource use are of high importance. Increasing fertilization decrease LER to 0.97 (N4) and down to 0.85 (N8) indicating more efficient utilizations of environmental resources for growth by sole crops than by intercrops. Improving N supply by fertilization stimulates the wheat component, which thus suppresses the growth of the legume and indirectly the interspecific complementarity.

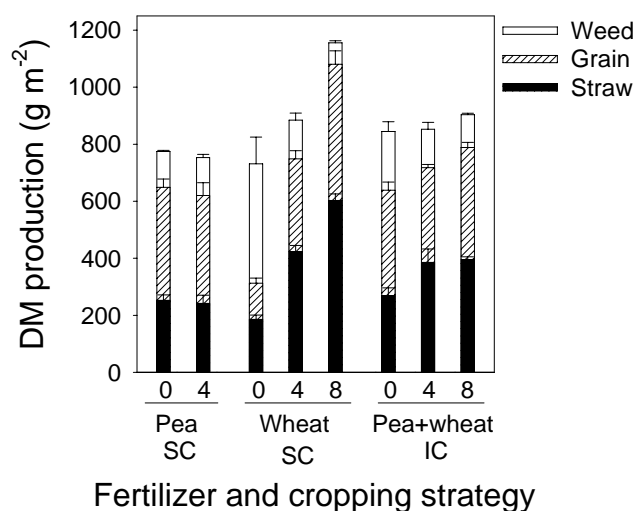

Figure 1. Average straw, grain and weed aboveground dry matter (DM) production in sole crops (SC) and intercrops (IC) of pea and wheat without (0) and with 4 and 8 g N m⁻² application, respectively. Values are the mean (n=3) ± S.E. From Ghaley et al. 2005

Improved competition with weeds has been emphasised as one of the benefits of intercrops (Liebman and Dyck, 1993) because of increased interspecific competition as compared to sole cropping (Willey, 1979) assumed to result in a more dynamic crop response to a variety of growth conditions including temporal and spatial heterogeneity in growth of weeds throughout a growing season. When including weeds in the total DM production the variability comparing treatments (Figure 1) is rather limited with a coefficient of variation (CV) averaging 15% - also when taking into account the general availabilities included in every field study. Thus, for future cropping systems reducing external inputs any part of the soil surface that is not occupied by the crop plants is potentially subject to invasion by weedy species. When combining appropriate crop species within an intercrop instead of sole crops increased efficiency in utilising environmental sources for plant growth can be achieved improving the competitive ability towards weeds using soil N and other important growth resources for crop dry matter production instead of weed biomass.

Looking at the entire ethanol production cycle, biomass production and thereby management is a very prominent source of GHG emissions independent of whether it is first or second generation technologies with 60-70 % of total LC emissions for wheat grain ethanol and 30-45 % for wheat straw based ethanol when utilizing the Danish IBUS concept (Maarschalkerweerd, 2006). Nitrogen fertilization is responsible for the main part of GHG emissions from wheat grain production in Denmark primarily caused by energy intensive production of N-fertilisers and soil emissions of N₂O (LCA Food 2006).

When intercropped, the N derived from fertilizer in intercropped wheat was significantly higher (10 - 21%) than in intercropped pea (1-3%). In SCs with fertilizer N, soil N accounted for 62-78% of the total N in wheat and 17% in pea. With N₀, the total amount of soil N accumulation was significantly higher in the pea sole crop (7.9 g N m⁻²) compared to wheat (2.9 g N m⁻²) and the combined intercrop (6.7 g N m⁻²) (Figure 2). However, with fertilizer N, sole and intercropped wheat accumulated a greater amount of soil N compared to pea. As the fertilizer N input increase the percentage of N derived from N₂-fixation in pea both when sole cropped and intercropped peaked at N₄ (90%) followed by a decrease with N₈ (79%). The greatest amount of N₂-fixation was achieved in pea SC (10.3 g N m⁻²) with N₄ followed by the pea IC and pea SC with N₀. The amount of fixed N₂ by pea IC was similar to pea SC when no N was applied. When increasing fertilizer N inputs, there was proportionate decrease in the amount of fixed N₂ in the intercrop due to the reduction of the pea intercrop proportion.

When developing sustainable plant production systems with a limited use of external inputs the present pea-wheat intercrop study show how crop interactions change dynamically over time, due to the species ability to exploit different resources and thereby secure capture of available plant growth resources. Cereals like wheat is strong competitors towards soil N. Pea-wheat IC without or with a low amount of fertilizer N supply offers an opportunity to maximise total DM production and on the same time increase N₂-fixation without compromising the yield levels. When enhancing fertilizer N LER decreased because the complementarity between the two species was decreased with wheat recovering up to 90% of the total intercrop fertilizer N acquisition and decreased the proportion of pea in the intercrop. A high degree of complementarity are important for resilient cropping strategies with the capacity for self-regulation to recover from biotic and abiotic stress when reducing external inputs and thereby energy use with less fertiliser and pesticide inputs.

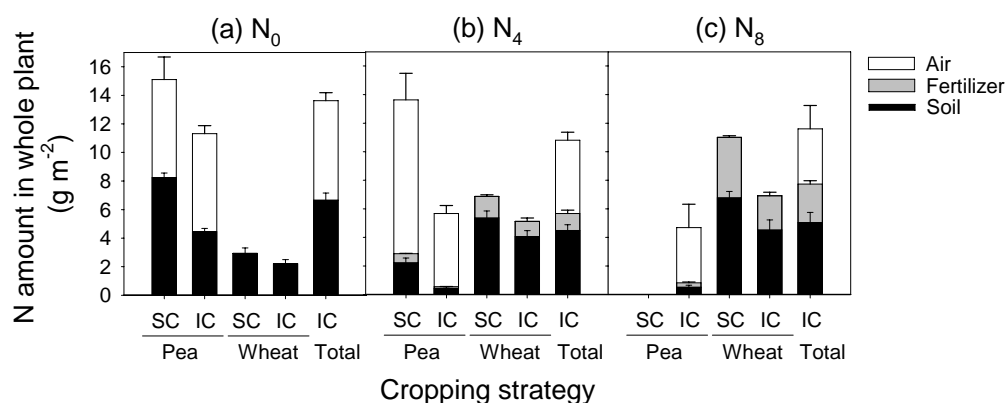

Figure 2. Amount of nitrogen (N) derived from soil, fertilizer and air in pea and wheat when grown as sole crops (SC) and as pea-wheat intercrop (IC) with 0 (N₀), 4 (N₄) and 8 (N₈) g N m⁻² application. Values are the mean (n=3) + S.E. From Ghaley et al. 2005

The growing demand for bioenergy crops may create further competition for land and water and could result in additional negative environmental pressures from cultivating bioenergy crops (EEA, 2006). The environmental impact of bioenergy production depends to a large extent on the selection of areas that are used for bioenergy production, the crops cultivated and the farming practice. There is a need for integrating the biomass starting point into the energy manufacturing steps to secure that bioenergy is produced from local adapted raw materials with limited use of non-renewable fossil fuels. Chemical quality for conversion to secure efficiency in bioethanol production needs to go hand-in-hand with the development of ecologically benign farming systems in order to fulfil the aim of sustainable bioethanol production.

Many other species than wheat and pea are potential intercrop components, each suiting different purposes and cropping conditions (Willey, 1979). Reviewing published intercropping studies Connolly et al. (2001) listed crops includes as intercrop component with the most common species first: corn (*Zea mays*), cowpea (*Vigna unguiculate* L.), groundnut (*Arachis hypogaea*), wheat, millet (*Pennisetum glaucum*), clover cultivars (*Trifolium spp.*), beans (*Phaseolus vulgaris*), pigeonpea (*Cajanus cajan*), other beans (*Vicia faba*), barley (*Hordeum vulgare*) and pea, with 80% of published intercrop research conducted in developing counties in Africa and Asia. However, increasing demand for bioenergy in Europe and United States may create new uses for e.g. grass cuttings on marginal land, new bioenergy cropping systems and perennials might also add diversity and require less pesticide or fertiliser input than in current intensive agricultural systems, like shown for the present pea-wheat intercropping example.

Biomass conversion

At present cereal straw and corn stover is the typical biomass to be used in production of 2. generation bioethanol. Pre-treatment, hydrolysis, and ethanol fermentation of these

materials are well studied and have been optimised in both laboratory scale (Bjerre et al. 1994, Schmidt & Thomsen 1998) and pilot scale (Thomsen et al., 2005). However, production of bio-ethanol in a larger scale may also require the use of alternative forms of biomasses e.g. pea, grass, or clover as described above.

Since clover and grass are rich in carbohydrates, mainly cellulose and hemicelluloses, they can be considered as substrates for bioethanol production. Clover grass pastures can be harvested several times a year and the green biomass can be collected and processed to bioethanol. Furthermore, clover grass is suitable for intercropping with wheat (just as pea in the example given above) (Thorsted et al. 2006). An interesting feature of clover grass mixtures is their high mineral, especially nitrogen, content, which is very useful in down-stream processing, since the utilisation of mineral nutrients in the fermentation step can be reduced or even avoided.

In this study clover, grass, and a mixture of clover-grass were pretreated by wet oxidation in order to examine the suitability of clover-grass to be used in bioethanol production alone or in combination with e.g. wheat straw. Table 1 shows the composition of the materials compared to wheat straw.

Table 1 Composition of raw materials.

Raw material	Cellulose (g/100 g DM)	Hemicellulose (g/100 g DM)	Lignin (g/100 g DM)
Wheat straw*	33.9	23.0	19.1
Clover	15.6	10.5	14.4
Grass	23.9	17.5	12.8

*Thomsen et al., 2006

Pretreatment of clover, grass and clover-grass mixed 1:1 and 1:3 were performed at 195°C for 10 minutes using 12 bar of oxygen pressure and 2 g/l of Na₂CO₃, which have been shown to give the optimal pre-treatment of wheat straw. Furthermore, pre-treatment of the 1:1 mixture of clover-grass were studied at 175°C and 185°C with and without addition of Na₂CO₃, and with high (12 bar) and low (3 bar) oxygen pressure. Figure 3 shows the sugar and lignin content of the fibre-fraction after pre-treatment and figure 4 shows the composition of the liquid fraction. The pretreated grass fibres have higher glucan content than clover (Figure 3), and the grass-liquid also has a higher content of hemicellulose (Figure 4), which is due to the different in the two materials (Table 1).

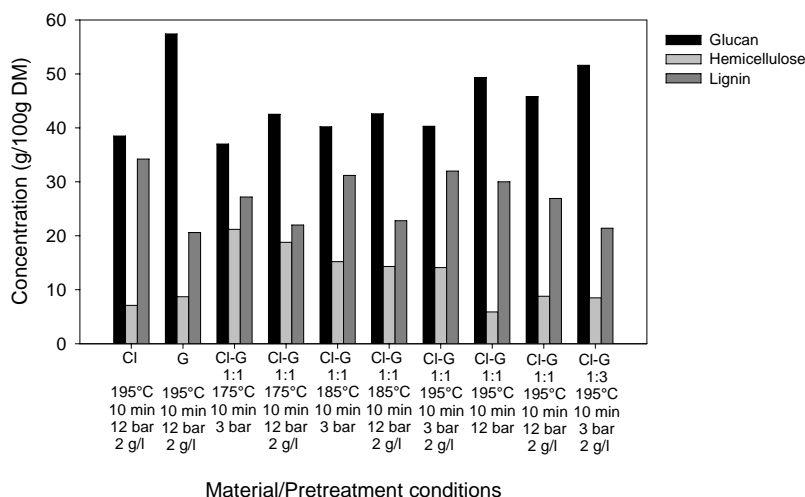

Figure 3 Glucan, hemicellulose, and lignin content in the fiber fraction of wet oxidised clover (CI), grass (G), and clover-grass mixtures (CI-G).

In turn clover has a higher content of lignin. The hemicellulose content of the fibres is dependent on the pre-treatment temperature, at higher temperatures more hemicellulose

is extracted from the fibres (Figure 3), giving a higher hemicellulose concentration in the pretreatment liquids (Figure 4). Also a high oxygen pressure seems to have an effect on hemicellulose extraction, and the three experiment with clover-grass (1:1) performed at 195°C indicates that the extraction is highest when no Na₂CO₃ is added. Clover and grass hemicellulose consist significant amount of both xylose and arabinose (Figure 4) in contrast to wheat straw hemicellulose with is 86 % xylose (Gong et al., 1981). The arabinose concentration is highest in liquid pretreated at low temperature whereas the opposite tendency is observed for xylose. This could indicate that arabinose is more susceptible to thermal degradation than xylose.

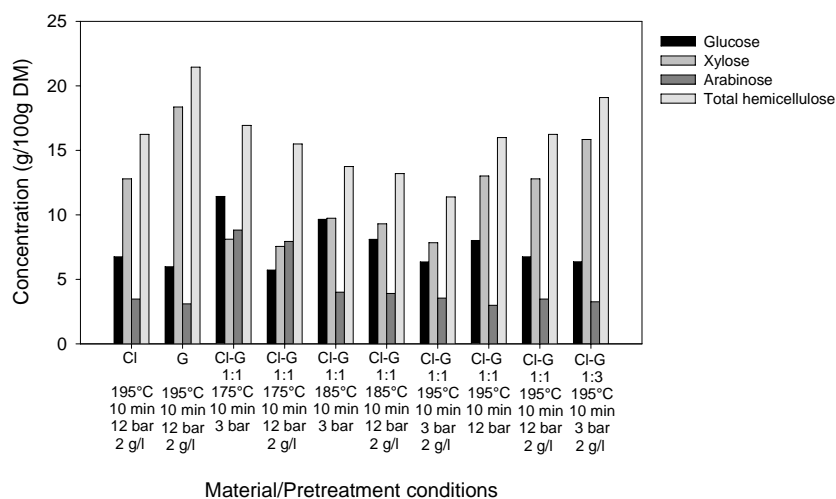

Figure 4 Glucose, xylose, arabinose and total hemicellulose content in the liquid fractions of wet oxidised clover (CI), grass (G), and clover-grass mixtures (CI-G).

Figure 5 shows the results of the enzymatic hydrolysis of the pretreated fibers. When pretreated at identical conditions (195°C, 10 min, 12 bar, 2 g/l Na₂CO₃) grass gives a higher sugar yield than clover, which could be due to the higher lignin content in clover, since lignin acts as the glue that binds the sugar polymers together in the cell wall materials (kilde). At 175°C only approximately 40% of the glucose and 30% of the xylose in the grass-clover mixture can be converted to fermentable sugars. At higher temperatures the convertibility of the fibers are significantly improved, and the optimal treatment of the clover-grass is found at 195°C using high oxygen pressure and no addition of Na₂CO₃ where the glucose yield is 94 % and the xylose yield is 66% - Arabinose?

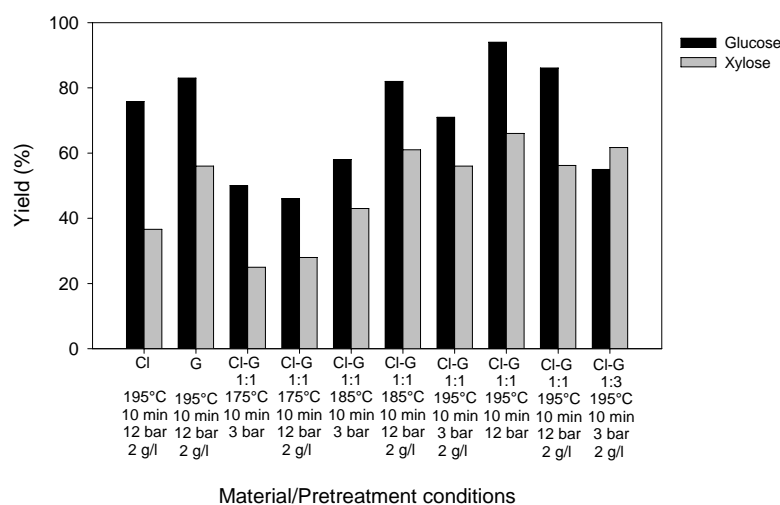

Figure 5. Glucose and xylose yield in enzymatic hydrolysis of fibers from wet oxidation of clover (CI), grass (G), and clover-grass mixtures (CI-G).

The results of this preliminary study shows that the optimum pretreatment conditions for clover, grass, and clover-grass mixtures is not significantly different from that of wheat straw (195°C, 10 min, 12 bar, 2 g/l Na₂CO₃), even though the composition of the raw material is different (Table 1). Both clover, grass, and clover-grass mixtures give glucose yields close to and above 80% when pretreated at these conditions, which indicates that wheat straw and clover-grass could be pretreated in one step if it was cultivated together in order to achieve the benefits described in the previous section about intercropping. However the effect of the Na₂CO₃ catalyst should be examined in experiments with straw and clover-grass pretreated together in order to decide if the catalyst should be added, since in the clover-grass mixture the highest yield is achieved without addition of the catalyst.

When pretreating biomass at these high temperatures some thermal degradation of sugar and lignin components is inevitable, resulting in formation of fermentation inhibitors. The fermentability of the clover-grass liquid fraction produced at optimal conditions (195°C, 10 min, 12 bar) in this study was examined by ethanol fermentation with the filamentous fungus *Mucor indicus* (Figure 6). The advantage of using *Mucor indicus*, instead of the traditional ethanol producer Bakers yeast (*Saccharomyces cerevisiae*), is that it is capable of utilising the hemicellulose sugars.

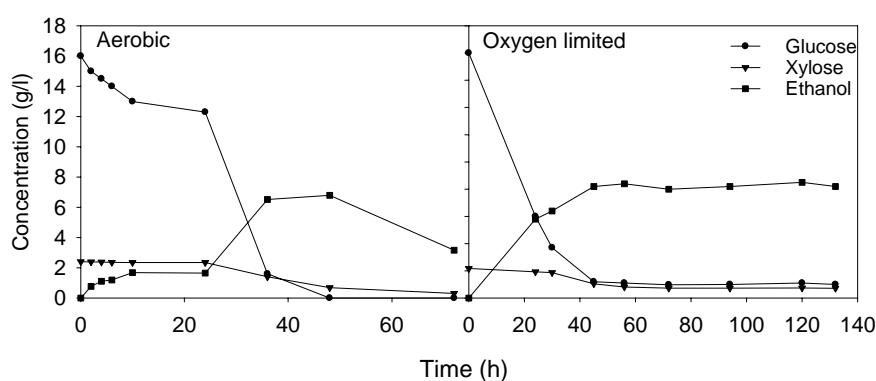

Figure 6. Ethanol formation and free sugar consumption during aerobic and oxygen-limited fermentation of a glucose enriched clover-grass hydrolysate by *M. indicus*.

Mucor indicus was successfully adapted to the clover-grass hydrolysate, showing that the inhibitor level in the hydrolysates was acceptable. Ethanol was the main product formed during fermentation, but a considerable formation of cell biomass was also detected, especially under aerobic conditions. Good ethanol yields were obtained (calculated from total sugar consumed): YE/TS, Aerobic = 0.37 and YE/TS, oxygen limited = 0.41. Glucose was completely consumed in both experiments. Xylose consumption started only when most of the glucose was consumed. 80% of the free xylose was consumed under aerobic conditions.

Biorefinery concepts

In the experiments described in the previous section clover-grass was dried before pretreatment as it would be the case if clover-grass were undersown in a wheat field and harvested and dried on the field together with the wheat straw. But when heating the material to 195°C valuable components of the clover-grass such as enzymes and free sugars are lost. Figure 7 shows the result of yeast fermentation of fresh (non-heat-sterilised) clover-grass juice. After 24 hours of fermentation all glucose present (12 g/l) in the juice is consumed, and approximately 15 g/l of ethanol is produced. From 12 g/l glucose only approx. 6 g/l of ethanol can be produced, which shows that other sugars in the juice is utilised for ethanol production.

Grass and clover contains significant amount of fructans; approx. 166 g/kg DM and 111 g/kg DM respectively (Thomsen et al., 2006). Fructans are polymeric carbohydrates consisting of variable numbers of fructose molecules with terminal sucrose. Fructans can be decomposed to free carbohydrates by enzymes in the crops that are activated after

harvesting and pressing (Hirst, 1957). Plant fructan hydrolases are reported to be most active between pH 4.5 to 5.5 and to have temperature optimum ranging from 25 to 40°C (Simpson and Bonnett, 1992), which means they could be active during yeast fermentation at 32°C and pH 4-6.

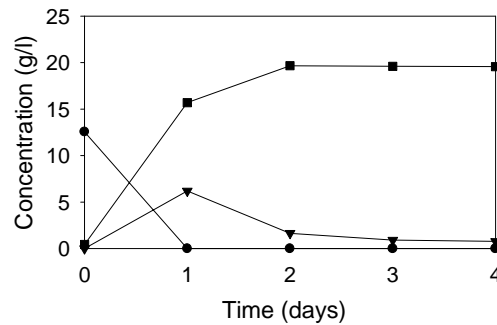

Figure 7. Yeast fermentation of fresh clover-grass juice.

This experiment shows that fructans in the un-heated juice can be converted to ethanol by natural enzymes and yeast (or maybe other microorganisms in the non-sterilised medium) increasing the ethanol production significantly. The fiber fraction from the pressing (which contains the lignocellulosic sugars) can be pretreated together with e.g. wheat straw in the biorefinery for maximum utilization of biomass components. Figure 8 shows the concept of utilization of straw and an N-fixating crop e.g. clover-grass for ethanol production in a biorefinery.

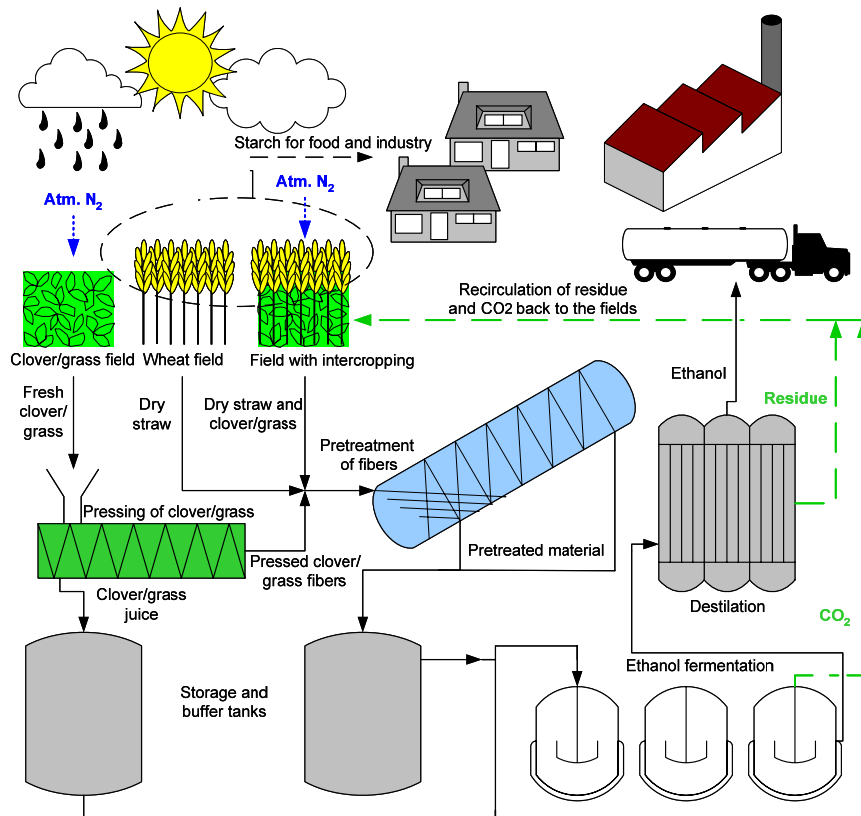

Figure 8. Biorefinery concept for utilization of N-fixating and carbohydrate rich crops.

The next step in this research would be to examine the pretreatment of clover-grass and straw in one step as well as examine co-fermentation of pretreated fibers and fresh clover-grass juice.

4 Conclusions

A legume-cereal intercrop like pea-wheat seems to be an optimal cropping strategy in relation to the use of N resources, because wheat efficiently exploits soil mineral N sources while at the same time fixed N₂ from pea enter the cropping system.

Increase of fertilizer N supply promotes the growth of wheat and results in a decreased pea N accumulation and a different proportion of intercrop components possibly influencing the conversion requirements.

Dynamic change of plant species interactions as a response to the actual growing conditions is not achieved with sole cropping of one species/cultivar. Furthermore, in the pea sole crop situation available soil mineral N reduce N₂ fixation and the full potential of symbiotic nitrogen fixation is not exploited which is regarded as an overall inefficient use of N sources.

Wet oxidation is an efficient method for fractionating clover, grass, and clover-grass mixtures into a convertible solid cellulose fraction and a soluble hemicellulose fraction.

The highest yield of fermentable sugars after enzymatic hydrolysis is achieved in clover-grass (mixed 1:1) pretreated at 195°C for 10 minutes using 12 bar oxygen.

The optimum pretreatment conditions for clover, grass, and clover-grass mixtures is not significantly different from that of wheat, which indicates that wheat straw and clover-grass (from intercropping) could be pretreated in one step.

The produced sugars were converted into ethanol by *Mucor indicus* giving good ethanol yields $Y_{E/TS, Aerobic} = 0.37$ and $Y_{E/TS, oxygen\ limited} = 0.41$.

Fructans from unheated clover-grass juice can be co-converted into ethanol by natural enzymes and yeast increasing the ethanol production significantly.

5 Acknowledgement

This work was supported by Risø DTU clover-ryegrass internal project 10025-1. We thank the Danish Ministry for Food, Agriculture and Fisheries for funding the field experimental expenses and

6 References

- Bjerre A B, Olesen A B, Fernquist T, Plöger A, Schmidt A S (1996) Pre-treatment of wheat straw using combined wet oxidation and alkaline hydrolysis resulting in convertible cellulose and hemicellulose. *Biotechnol Bioeng* 49: 568-577.
- Chalk PM (1998) Dynamics of biologically fixed N in legume-cereal rotations: A review. *Aust. J. Agric. Res.* 49, 303-316
- Connolly J, Goma HC and Rahim K (2001). The information content of indicators in intercropping research. *Agr. Ecosyst. Environ.* 87, 191-207.
- Crews TE and Peoples MB (2004) Legume versus fertilizer sources of nitrogen: ecological tradeoffs and human needs. *Agr. Ecosyst. Environ.* 102, 279-297.
- EEA (2006). How much bioenergy can Europe produce without harming the environment? Report, No. 7., EEA, Copenhagen 2006. 72 pp.
- EU (2007) Brussels European Council 8-9 March - Presidency Conclusions (<http://mediacontent.ig.publicus.com/PDF/IG35268339.PDF>)
- Euroobserver (2006) 3.9 million tons produced in 2005. *Biofuels barometer* May, pp. 57-66.

- Ghaley BB, Hauggaard-Nielsen H, Høgh-Jensen H and Jensen ES (2005) Intercropping of wheat and pea as influenced by nitrogen fertilization. *Nutr. Cycl. Agroecosys.* 73, 201-212
- Gong C-S, Chen LF, Flickinger MC, Tsao GT (1981) Conversion of Hemicellulose Carbohydrates. In: Fiechter A. *Advances in Biochemical Engineering*, vol 20 Bioenergy, Springer Verlag, Berlin-Heidelberg, 93-118.
- Hauggaard-Nielsen H, Ambus P and Jensen ES (2001) Interspecific competition, N use and interference with weeds in pea-barley intercropping. *Field Crop. Res.* 70, 101-109.
- Hauggaard-Nielsen H, Andersen MK, Jørnsgaard B and Jensen ES (2006) Density and relative frequency effects on competitive interactions and resource use in pea-barley intercrops. *Field Crop Res.* 95: 256-267
- Hazell P and Pachauri R.K. (2006) Bioenergy and agriculture, promises and challenges. 2020 Focus No. 14, November. <http://www.ifpri.org/2020/focus/focus14.asp#dl>
- Hirst, E. L., 1957, Some Aspects of the Chemistry of the Fructosans, *Proceedings of the Chemical Society*, 193-204.
- Jensen, ES (1996) Grain yield, symbiotic N₂ fixation and interspecific competition for inorganic N in pea-barley intercrops. *Plant Soil* 182: 25-38
- Liebman M and Dyck E (1993) Crop rotation and intercropping strategies for weed management. *Ecol. App.* 3, 92-122.
- LCA Food (2006) LCA Food- Webpage. Danish Institute of Agricultural Sciences, Foulum, Denmark. <http://lcafood.dk/>
- Maarschalkerweerd van C (2006) Welfare economic perspectives of Danish bio-ethanol production – a technology specific analysis of greenhouse gas savings and supply security benefits of straw and wheat grain based bio-ethanol. Master thesis. Institute of Food and Resource Economics, Royal Veterinary and Agricultural University, Rolighedsvej 25, 1958 Frederiksberg C, Denmark, 71pp
- Mead R and Willey RW (1980) The concept of 'Land Equivalent Ratio' and advantages in yields from intercropping. *Exp. Agric.* 16, 217-228
- RFA, 2006. From niche to nation. Ethanol outlook 2006. Renewable Fuels Association, Washington DC, United States. pp. 22. www.ethanolRFA.org
- Simpson, R. and Bonnet, G., 1992, Fructan exohydrolase from grasses, *New Phytol*, 123, 453-469.
- Tengborg C, Galbe M, Zacchi G (2001) Reduced inhibition of enzymatic hydrolysis of steam-pretreated softwood. *Enzyme and Microbial Technology* 28: 835-844.
- Thomsen AB, Medina C, and Ahring BK (2003) Biotechnology in ethanol production. In: Larsen H, Kossmann J, and Petersen LS. *Risø Energy Report 2*: 40-44
- Thomsen MH (2005) Complex media from processing of agricultural crops for microbial fermentation. *Appl. Microbiol. Biotechnol.* 68: 598-606
- Thomsen MH, Andersen M, Kiel P. (2006) Use of Plant Juice as Fermentation Medium. In: Kamm B, Gruber PR, Kamm M. *Biorefineries – Industrial Processes and Products*, Wiley-VCH, Weinheim, Germany.
- Thorsted MD, Olesen JE, Weiner J. (2006) Width of clover strips and wheat rows influence grain yield in winter wheat/white clover intercropping. *Field Crops Research* 95, 280-290.
- Willey RW (1979) Intercropping - Its Importance and research Needs. Part 1. Competition and Yield Advantages. *Field Crop Abstracts* 32, 1-10

Session 5 - Renewable Energy for the Transport Sector

Chairman: Kim Pilegaard, Risø National Laboratory, Denmark

Co-ordination of Renewable Energy Support Schemes in the EU

Stine Grenaa Jensen¹ and Poul Erik Morthorst²

Risø National Laboratory, Frederiksborgvej 399, DK-4000 Roskilde, Denmark

¹ E-mail: stine.grenaa@risoe.dk, Tel: +45 4677 5113, Fax: +45 4677 5199

² E-mail: p.e.morthorst@risoe.dk, Tel: +45 4677 5106, Fax: +45 4677 5199

Abstract

This paper illustrates the effect that can be observed when support schemes for renewable energy are regionalised. Two theoretical examples are used to explain interactive effects on, e.g., price of power, conditions for conventional power producers, and changes in import and export of power. The results are based on a deterministic partial equilibrium model, where two cases are studied. The first case covers countries with *regional power markets* that also regionalise their tradable green certificate (TGC) support schemes. The second, countries with *separate national power markets* that regionalise their TGC-support schemes. The main findings indicate that the almost ideal situation exists if the region prior to regionalising their RES-E support scheme already has a common liberalised power market. In this case, introduction of a common TGC -support scheme for renewable technologies will lead to more efficient sitings of renewable plants, improving economic and environmental performance of the total power system. But if no such common power market exists, regionalising their TGC-schemes might, due to interactions, introduce distortions in the conventional power system. Thus, contrary to intentions, we might in this case end up in a system that is far from optimal with regard to efficiency and emissions.

1 Introduction

Economically efficiency in markets is an important criterion for the design of the power systems (Stoft, 2002). Co-existence of different support schemes along with divergence in level of harmonisation (some systems are regional and some national) could generate as well positive as negative effects on the effectiveness in power systems including both thermal and renewable power production. In the traditional textbook, harmonisation is efficient even if only small differences in the systems exist. Though significant transaction costs often exist in power markets, and therefore, the gain also has to exceed the level of these costs. In general, the ultimate goal is to have common harmonised markets in order to gain from the existing synergies, i.e., aim at a common power market and common support scheme.

In a communication from the European Commission on Support for Electricity from Renewable Energy Sources, the Commission stresses that because of the “varying

potentials and developments in different Member states regarding renewable energies, a harmonisation seems to be very difficult to achieve in the short term” (EU, 2005). Nevertheless, “Intensified co-ordination between countries in the form of “**cooperation**” could be useful for the development of the different support systems within Europe. The emerging cooperation between the feed-in tariff systems in Germany, Spain and France, or on the Iberian market and the new planned common Swedish-Norwegian green certificate system can set examples for others. Member States with systems with a sufficient degree of similarity could then later be sub-harmonised” (EU, 2005)¹. Accordingly, there is a need to analyse advantages and disadvantages of regionalising support schemes in Europe.

Thus, the focus in this paper is how we in the most efficient way can regionalise our RES-E support systems. This, in turn, shows up to depend heavily on the starting point for the power system, where we are considering two cases: 1) *A common liberalised power market* comprising more member states, that are fairly strong interconnected and where power prices in general are determined in common for the region. 2) *A system of separate national power markets* that are interconnected only to a moderate extent and where power prices are determined in the individual countries.

Using these two power system cases as starting point we analyse the effects of introducing a regional RES-E support system, exemplified by the instrument of tradable green certificates, because this instrument is able to exemplify how the different interactions arises. Presently, this is also one of the dominating support schemes in the EU along with feed-in tariffs, which are analysed in Morthorst and Jensen (2006). Regionalising RES-E support schemes in this section means that support conditions for establishing renewable technologies are identical in the considered countries. In the case of a green certificate scheme each country will determine its own certificate quota² and cross-border trade will equalise the certificate price for the chosen region. Of course, the natural given conditions for renewable technologies will differ between countries (wind regime or growth of biomass) as might the conditions at the power market. The deployment of RES-E in all cases will take place according to the profitability of the plants. The importance of the interactive effects are illustrated on, e.g., the deployment of RES-E, the price of power, conditions for conventional and RES-E power producers, regulation costs, and the price of CO₂-allowances. Additionally, the interactions with other support schemes such as an international emission allowance scheme are addressed.

The analytical setup is a deterministic partial equilibrium model where two countries are considered, trade between the two countries are only possible in the case, where the power market are common between the two countries. This leads to a model where three types of actors (consumer, thermal producer, renewable producer) are interacting on three different markets (power, RES-E certificates, emission

¹ Observe that a common Swedish-Norwegian green certificate system is no longer discussed.

² Expectedly in a close dialog between the participating countries.

allowances). These interconnections lead to an interaction between the different price determinations, and it is this interaction that leads to the interesting results in this paper. The analysis of co-ordination shows both advantages, as well as, disadvantages. To know whether a common support scheme is an advantage for the renewable energy producers, compared to national systems, this will depend on the situation in the participating countries, especially at the power market.

2 Model Description

In this section, a model is formed in order to analyse the effect of co-ordination of support schemes between two countries. This model is a deterministic partial equilibrium model, where two countries are considered. Trade between the two countries are only possible in the case, where the power market is common between the countries. The only commodity included is electricity, which single-handedly generates utility for the consumers. There are one representative consumer, two representative thermal power producers, and two representative renewable power producers in each country. The model is developed from Jensen and Skytte (2002) with the same certificate market design. Following, we delimit the model only to describe the case with tradable green certificates.

m	number of countries ($m=A,B$)
j	number of thermal power producers ($j=t1,t2$)
k	number of renewable power producers ($k=r1,r2$)
D_m	consumption of electricity in country m
$U_m(D_m)$	utility from consumption of D_m
c_m	constant used to describe $U_m(D_m)$, indicates intercept with q-axis
d_m	constant used to describe $U_m(D_m)$, response of demand to changes in price
$qT_{j,m}$	production from thermal power plant j in country m
$cT_{j,m}(qT_{j,m})$	cost function for thermal power plant j in country m
$a_{j,m}$	constant used to describe $cT_{j,m}(qT_{j,m})$, intercept with p-axis
$b_{j,m}$	constant used to describe $cT_{j,m}(qT_{j,m})$, change in marginal cost in response to $qT_{j,m}$
$\varepsilon_{j,m}$	emission factor for producer j in country m , i.e., dependent on type of technology
$qR_{k,m}$	production from renewable power plant k in country m
$cR_{k,m}(qR_{k,m})$	cost function for renewable power plant k in country m
$a_{k,m}$	constant used to describe $cR_{k,m}(qR_{k,m})$, intercept with p-axis
$b_{k,m}$	constant used to describe $cR_{k,m}(qR_{k,m})$, change in marginal cost in response to $qR_{k,m}$
PP_m	power price determined from market clearing of the power market
PC_m	certificate price determined from market clearing of the certificate market
PE_m	emission allowance price determined from market clearing of the emission allowance market
Q_m	quota for renewable energy consumption for each country m
K	common quota for emission level

Table 1: Legend and some functional relationships

<i>Consumers</i>	$D_m \geq c_m + d_m (PP_m + Q_m PP_c)$	$c_m \geq 0$ $d_m \geq 0$
	$cT_{j,m} = a_{j,m} \cdot qT_{j,m} + (b_{j,m}/2) \cdot qT_{j,m}^2$	
<i>Thermal producers</i>	$\frac{\partial cT_{j,m}}{\partial qT_{j,m}} = a_{j,m} + b_{j,m} \cdot qT_{j,m} \Rightarrow$	$qT_{j,m} \geq 0$
	$a_{j,m} + b_{j,m} \cdot qT_{j,m} \geq PP_m - PE \cdot qT_{j,m}$	
	$cR_{k,m} = a_{k,m} \cdot qR_{k,m} + (b_{k,m}/2) \cdot qR_{k,m}^2$	
<i>Renewable producers</i>	$\frac{\partial cR_{k,m}}{\partial qR_{k,m}} = a_{k,m} + b_{k,m} \cdot qR_{k,m} \Rightarrow$	$qR_{k,m} \geq 0$
	$a_{k,m} + b_{k,m} \cdot qR_{k,m} \geq PP_m + PC_m$	

Table 2: Demand and supply defined as linear functions from the first order conditions from the model

Three market balances for respectively, power, certificates, and emission allowances, substitutes the equilibrium conditions in the model and are given in Table 3 for the different cases to be analysed. These three balances are general to the problem and can be used with other assumptions on demand and supply than indicated in Table 2.

	National	Regional
Power market	$\sum_j qT_{j,m} + \sum_k qR_{k,m} \geq D_m$	$\sum_{j,m} qT_{j,m} + \sum_{k,m} qR_{k,m} \geq \sum_m D_m$
<i>Complementary variable</i>	$PP_m \geq 0$	$PP \geq 0$
Certificate market	$\sum_k qR_{k,m} \geq Q_m D_m$	$\sum_{k,m} qR_{k,m} \geq \sum_m Q_m D_m$
<i>Complementary variable</i>	$PC_m \geq 0$	$PC \geq 0$
Emission allowance market	$\sum_{j,m} \varepsilon_{j,m} \cdot qT_{j,m} \leq K$	$\sum_{j,m} \varepsilon_{j,m} \cdot qT_{j,m} \leq K$
<i>Complementary variable</i>	$PE \geq 0$	$PE \geq 0$

Table 3: Market balances for power, certificates, and emission allowances, and complementary variable clearing each market. Notice that the emission allowance balance is equal in the two cases.

The combination of regional and national markets for the power and certificate markets determines the equilibrium conditions in the different cases of which markets that are regionalised. Each of the market balances has a complementary variable that clears the market. The price is zero when there is an excess supply.

The demand and supply functions are defined with respect to different prices. The demand is determined both from the power price and the certificate price. The renewable power producer production is determined both from the power price and the certificate price. The thermal power production is determined from the power price and the emission allowance price. Therefore, we obtain an equilibrium in which all prices interact. This means, an interaction of three to five prices depending on how many markets are regional, and since the emission allowance market is regional in all cases, there will always be some interaction between all the prices. At the same

time, this interdependency between all markets results in a possibility for the regulator to speculate in how to design the support scheme.

Consequently, given the assumptions from Table 1, Table 2, and Table 3, solutions can be illustrated in a two dimensional graph with linear demand and supply functions. However, the three markets cannot be illustrated in the same graph as the market clearings lead to prices that are depended on the other markets. Following, the interaction between all three markets gives non linear dependencies between the prices.

In the model, we consider two different countries with different energy systems and conditions for renewable technologies. Conditions are chosen to be differing because this is a prerequisite for achieving efficiency gains in co-ordination or harmonisation.

For simplicity in the discussions only wind power is considered as an example of renewable technologies, but the results are applicable to other technologies as well. This is incorporated in the equilibrium model under the constants of the renewable energy producer. The two countries used in the discussions are characterised in the following ways:

- **Country A:** Good conditions for wind power. Also the conventional power production is efficient, with high energy-efficiency, low production costs and low CO₂-emissions.
- **Country B:** Medium conditions for wind power. The conventional power production is less efficient, characterised by older power plants with low energy-efficiency, high production costs and high CO₂-emissions

3 Regional Support Scheme and Regional Power Market

The first case to be considered is when countries participating in a regional power market change the support schemes from national ones to a common regional one. Therefore, the starting point is two countries with already interacting power systems and a common power price determined by the liberalised market. This is illustrated in Figure 1.

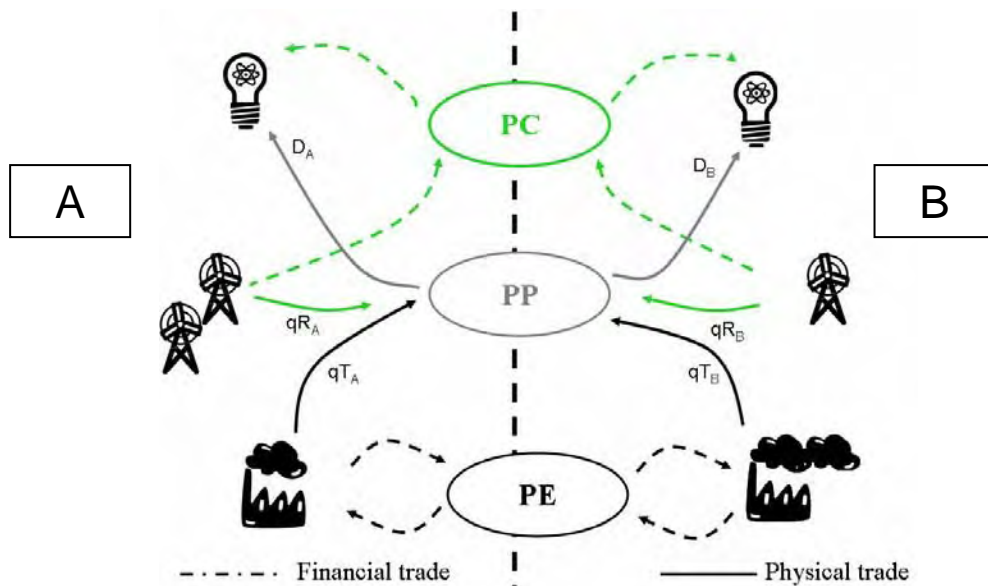

Figure 1: Interaction between Country A and Country B through markets and actors with common power and certificate markets.

In a TGC-scheme the deployment of renewable energy depends on the total TGC-quota set for the region as a whole, while the individual TGC-quotas set in each of the participating countries determine the burden sharing for consumers in each country. The RES-E plants will be located according to resources/efficiency and the long-term marginal costs of new renewable capacity will equal the TGC-price plus the power spot price. The TGC-quotas determine the development of the quantity of RES-E, costs given by market conditions, while the feed-in system determines the costs (level of feed-in), market conditions giving the quantity of RES-E developed.

In the context of the equilibrium model presented in Section 2, this case is represented by the market balances presented in Table 4. Following, the market clearing prices are independent of countries, and hence, equal for all actors in the market.

	Regional
Power market	$\sum_{j,m} qT_{j,m} + \sum_{k,m} qR_{k,m} \geq \sum_m D_m$
<i>Complementary variable</i>	$PP \geq 0$
Certificate market	$\sum_{k,m} qR_{k,m} \geq \sum_m Q_m D_m$
<i>Complementary variable</i>	$PC \geq 0$
Emission allowance market	$\sum_{j,m} \varepsilon_{j,m} \cdot qT_{j,m} \leq K$
<i>Complementary variable</i>	$PE \geq 0$

Table 4: Market balances for power, certificates, and emission allowances, and complementary variable clearing each regional market

The solution to the model results in three market clearing prices which are equal for both countries. Including the emission price in the supply curve for the thermal power producer then gives us the opportunity to look at the changes in production of

thermal and renewable power, and the level of import and export. This is illustrated in Figure 2 for Country A and Figure 3 for Country B.

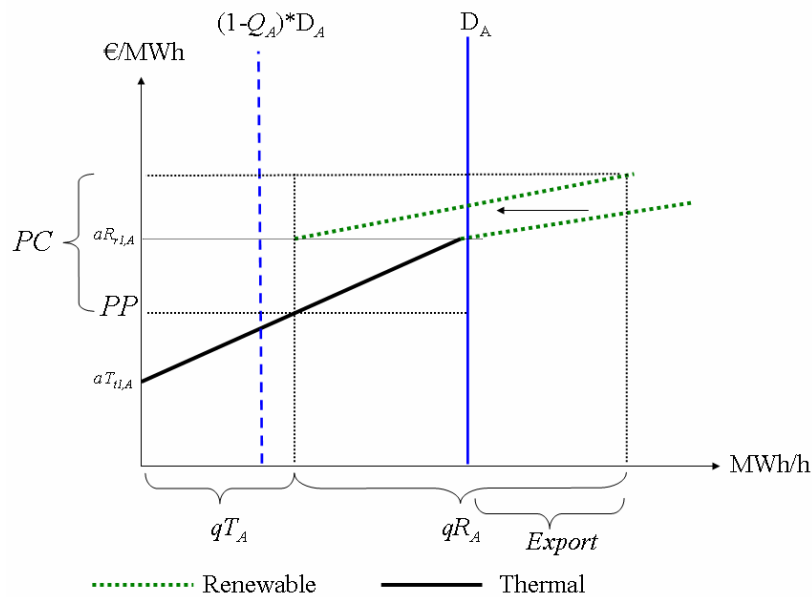

Figure 2: Country A: Determination of production shares (qT_A and qR_A), with regional power price (PP), and regional certificate price (PC). For illustrative purposes demand is here constant, i.e., $d_A=0$.

Figure 2 shows that thermal production has increased from $(1-Q_A)D_A$ to qT_A caused by a more efficient thermal power production than in Country B. If Country A had been isolated the production share given to thermal power production would equal $(1-Q_A)D_A$. Likewise, renewable power production has increased from $Q_A D_A$ to qR_A , wherefore, Country A exports a large share of their power production to Country A.

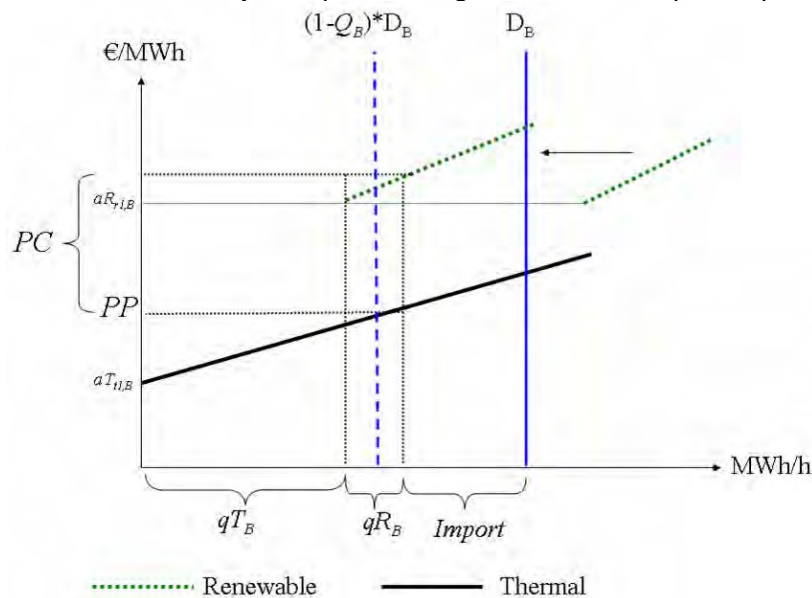

Figure 3: Country B: Determination of production shares (qT_B and qR_B), with regional power price (PP), and regional certificate price (PC). For illustrative purposes demand is here constant, i.e., $d_B=0$.

Figure 3 shows the solution for Country B. Here thermal production has decreased from $(1-Q_B)D_B$ to qT_B caused by an more inefficient thermal power production than in Country A. Likewise, renewable power production has decreased from $Q_B D_B$ to qR_B , wherefore, Country B imports the additional power from Country A.

Following, in this example with Country A and B, the case would be a significant increase of renewable power production units in Country A and lesser in Country B, cf. Figure 2 and Figure 3. The RES-E production will capture a certain share of the power market and less will be available for conventional producers. Assuming that the RES-E is prioritised in production, then, in a common power market, RES-E production will always replace the most inefficient conventional power plants in the region, no matter where the RES-E is produced. Thus, in general, we will see that the RES-E plants are located in the most resource efficient areas, while those thermal plants with the highest costs are pushed out of the market.

The impact of the green certificate system on the spot price of power would be similar to a national development of RES-E. That is, a decrease in the power price, if there is a net increase in the amount of renewable energy, and vice versa for a decrease (Jensen and Skytte, 2002). This effect is caused by the decrease in production from thermal power plants, the most inefficient power plants are replaced at the power market, and hence, the power price must be assumed to decrease with increasing supply curves. Since, the power price is common for Country A and B, we can observe the same decrease in the power price in both countries. Most often, the price of power for consumers are to increase, as a result of an increase in renewable energy production.

In general, how the common certificate system will influence the trade of power between the participating countries will totally depend on the location of the RES-E plants and the marginal conditions for the conventional power plants at the power market. Thus, no general conclusions can be drawn on the issue of trade between the participating countries. For intermitting renewable resources, e.g., wind power and photovoltaic, the green certificate scheme might require a further development of transmission capacity between countries and more resources used for regulation, as the renewable power from wind and solar is fluctuating and not necessarily produced in the most demanding areas. Furthermore, it is important to recognise the costs owing to increased regulation needs. That is, in general the country with the highest share of renewable energy also will bear a higher regulation cost. However, this problem could be solved by including the regulation cost in the discussion of burden sharing between the participating countries.

At a common liberalised power market the CO₂ reductions induced by increased RES-E will be shared among all those countries participating in the power market, the distribution solely depending on the marginal conditions for conventional power. This means, that one country can be the host of implementing RES-E, while the replaced conventional power plant can be located in another country, having the benefit of the lower CO₂ emission. In a regional power market and regional support

scheme, the CO₂ emission allowance price will decrease, as the most inefficient thermal power plants are pushed out of the power market.

The consequences of introducing a certificate market in two countries sharing a common regional power market almost adds up to an ideal case. New renewable plants are located in the most efficient way, while the most inefficient power plants are replaced. The more different the participating countries are, the more beneficial a common support scheme will be. The burden sharing of additional costs as regulation costs could be handled by introducing a common fund, financed by the participating countries e.g. according to their total power consumption (the same power price in all countries). A final barrier is the distribution of the reduced CO₂ emission that will only take place in those countries where power plants are replaced, but this is a general problem of all common power markets.

4 Regional Support Scheme and National Power Market

In this case, we will look at the consequences when a common regional support scheme is introduced into a power system consisting of national entities without strong interconnectors. Thus, focus is on how a common regional support scheme for RES-E interacts with separated national power systems. This is illustrated in Figure 4.

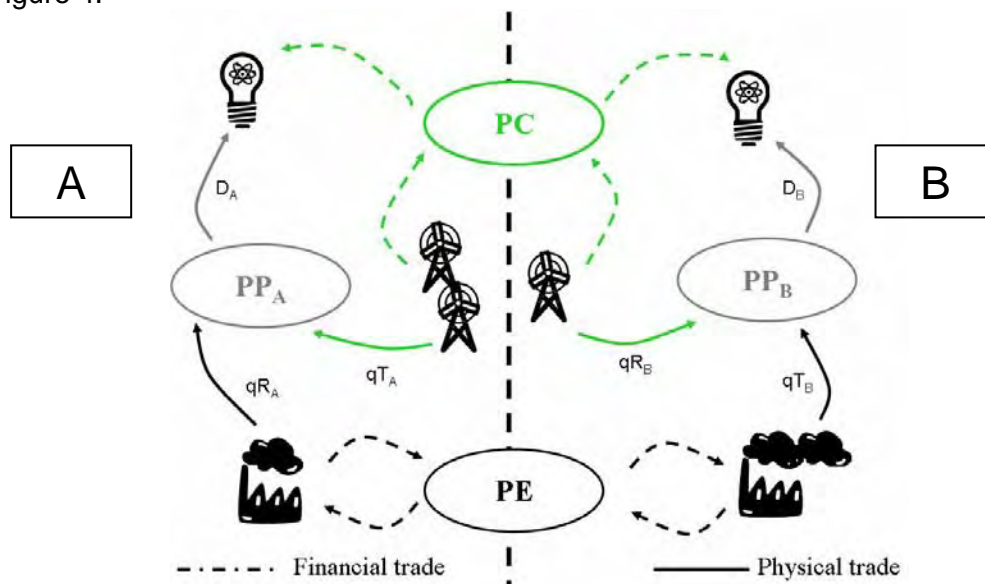

Figure 4: Interaction between Country A and Country B through markets and actors with common certificate market and national power market.

In the case of a TGC-market the deployment of renewable energy will only depend on the level of the common quota for the region. Production of renewable energy will equal the quota, and price of certificates will through trade be equalised for the region (cf. Figure 4). Deployment of RES-E will take place at the most *economic* efficient places, thus, e.g., wind turbines will not necessarily be put up in the windiest

sites, but where *total income* is highest for wind turbine owners. Therefore, a combination of price and wind resources will determine where turbines are located. Only if power prices are the same in all the participating countries, the RES-E plants will be established where it is most efficient. But if efficiency of renewables is the same RES-E plants will be established where power prices are highest. This implies that countries with a fairly low efficiency for renewables might be chosen for development because of an inefficient conventional system with high power prices. This might lead to a non-optimal allocation of renewable resources, biased because of deficiencies in the existing conventional power system.

The consequences of introducing a common green certificate scheme in our example with two countries having separate national power market are illustrated in Figure 5 and Figure 6, and commented on in the following.

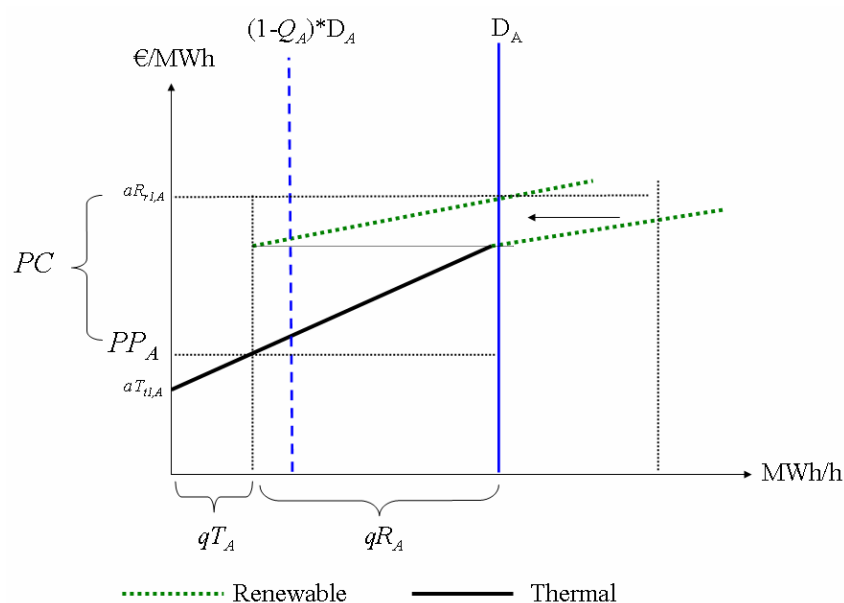

Figure 5: Country A: Determination of production shares (qT_A and qR_A), with national power price (PP_A), and regional certificate price (PC). For illustrative purposes demand is here constant, i.e., $d_A=0$.

Figure 5 shows the equilibrium solution for Country A. Here thermal production has decreased from $(1-Q_A)D_A$ to qT_A , contrary, the situation with common power markets. The effect is caused by a more efficient renewable power production in Country A that leaves a smaller part of the power market to thermal power plants. Following, renewable power production has increased from $Q_A D_A$ to qR_A , wherefore, Country B imports certificates from the TGC-market.

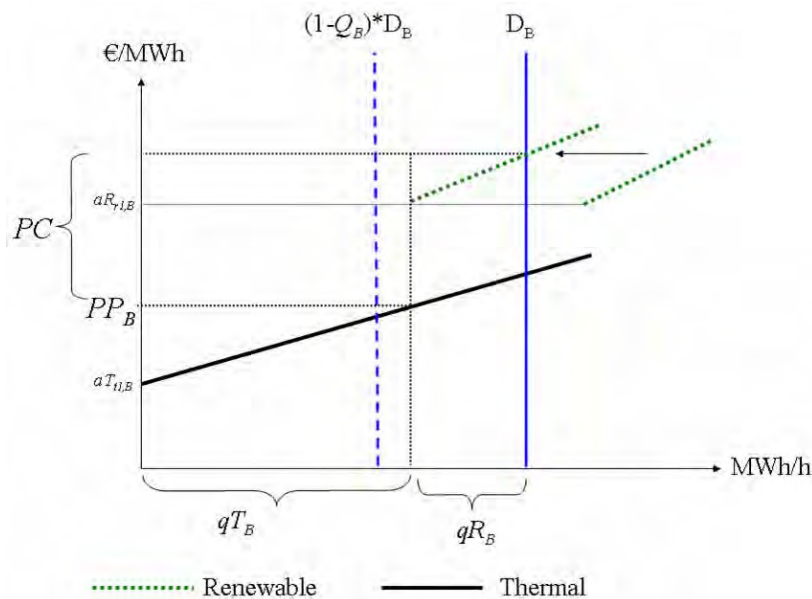

Figure 6: Country B: Determination of production shares (qT_B and qR_B), with national power price (PP_B), and regional certificate price (PC). For illustrative purposes demand is here constant, i.e., $d_B=0$.

In Figure 6, we see a decreased renewable power production in Country B as result of the good resource conditions in Country A. This leaves a larger share of power production to the thermal power producers, i.e., production of thermal power increased from $(1-Q_B)D_B$ to qT_B . As a result, the inefficient thermal power production in Country B benefits from the regional support scheme, and hence, we can also observe an increase in total emissions.

The deployment of RES-E will decrease power prices and this will have two effects: First, in a country with large RES-E deployment the decrease in power prices will also decrease the income for the renewable producer, and hence, lower incentives to establish new RES-E plants. This effect will decrease the problem of concentrating the RES-E production in specific countries. Second, if a country has a very inefficient thermal power production, and thus, has high power prices this will be an incentive to develop RES-E which in the longer term will decrease power prices.

Regarding conventional power production the most inefficient conventional plants will be replaced within each of the countries, but it does not ensure that the most inefficient power plants *within the region* are replaced. Consequently, well functioning production capacity could be pushed out of the market, with a total social loss for the region. This implies that reduction of CO_2 will be less than optimal, and therefore, a higher price of CO_2 allowances will prevail. The increased RES-E will in this case only lead to CO_2 reductions in those countries where the RES-E is implemented. And because of the two above-mentioned price effects it is even more difficult in this system to know how much the RES-E development will help them in achieving their national CO_2 reduction targets.

In a system with separate national power markets, the green certificate system aims at achieving an optimal economic solution at the given conditions, while an optimal resource allocation is not the goal. Thus, neither are the RES-E technologies located in the most resource efficient areas, nor are the most inefficient power plants in the region being replaced, but given the separate markets the income of RES-E owners and conventional power producers are optimised. At the given conditions the green certificate market ensures an economic optimal distribution of plants. Distribution of regulation costs might be a problem and also in this case a general barrier is the distribution of the reduced CO₂-emission that will only take place in those countries where power plants are replaced.

5 Conclusions

Concerning the introduction of common regional RES-E support schemes two conclusions are drawn from the present analyses: 1) The almost ideal situation exists if the region prior to regionalising RES-E support schemes already has a common liberalised power market and strong interconnections. In this case the introduction of a common support scheme for renewable technologies will lead to more efficient sitings of renewable plants, improving economic and environmental performance of the total power system. 2) If no such common power market exists regionalising RES-E support schemes might due to interactions introduce distortions in the conventional power system. Consequently, in contrary to the intentions we might in this case end up in a system that is far from optimal with regard to efficiency and emissions. Thus, the analysis clearly points out that efficiently liberalised power markets ensuring competition on the conventional market are a crucial precondition for effectively functioning RES-E markets. Furthermore, if one wants to create co-ordinated or common RES-E markets between member states sufficient transmission capacities, including the existence of necessary economic incentives to utilise the interconnections, are a prerequisite.

6 References

EU, COM(97), 599 final: White Paper: *Energy for the future - renewable sources of energy*, 1997

EU, COM(2005), The Communication from the Commission on Support for Electricity from Renewable Energy Sources, 2005.

Jensen, S.G.; Skytte, K., *Interactions between the power and green certificate markets*, Energy Policy, 2002, 30 , 425-435.

Morthorst, P.E.; Jensen, S.G., *Co-ordinated renewable energy support schemes*, Energy and Environment, 2006, 17 , 869-884.

Stoft, S., *Power System Economics –Designing Markets for Electricity*, IEEE Press Wiley Interscience, First Edition, 2002.

Bioethanol

Charles Nielsen; Jan Larsen; Kristian Morgen, DONG Energy, Kraftsværksvej 53, 7000 Fredericia, Denmark

Abstract

Security of supply, sustainability and the market are controlling parameters for developing the energy system. Bioethanol is part of the solution to the question about security of supply and the demand for a sustainable development, and all over Europe 1st generation bioethanol plants are being established.

Market demands on existing power plants and the simultaneous wish for establishing a capacity for the production of bioethanol with at first 1st generation technology and starchy biomass and then with 2nd generation technology and lignocellulose is the reason for DONG Energy's development of the concept IBUS (Integrated Biomass Utilisation System). In the IBUS concept the production of bioethanol with 1st and 2nd generation technology has been joined and integrated with the power and heat production of the central power plant.

Until the summer of 2006 the IBUS straw plant at Skærbækværket was established by means of a €15 mill. EU project. In addition to being a demonstration facility the plant is being upscaled to a 4 tonne straw per hour plant in preparation for demonstrating the process at a size which forms the basis of upscaling to fullscale – 20 tonne per hour in 2008.

The process includes continued hydrothermal pre-treatment, enzymatic hydrolysis at high dry matter concentrations, fermentation and distillation. The raw materials are wheat and maize straw.

The perspective for DONG Energy is that the IBUS concept, in which bioethanol and CHP production are to be joined, is a step towards materialising the vision that a central power plant can be developed into an energy refinery.

The presented development work within 2nd generation bioethanol technology will be carried out in cooperation with leading international players and Danish universities and knowledge centres – Risø National Laboratory, The Royal Veterinary and Agricultural University, Technical University of Denmark (DTU) and Novozymes.

DONG Energy was established on 1 July 2006 through a merger between the companies DONG, Elsam, Energi E2, Nesa, Frederiksberg Forsyning og Københavns Energi. The company thus covers the whole value chain from oil and gas fields in the North Sea to power and heat production to sale of power, heat and gas. The company has 4000 employees and a yearly turnover of DKK 33bn.

1. Introduction

The market, society and the owners make great demands on the central energy production plants of tomorrow. The market demands an efficient production with fast load following, and society demands a sustainable production, economy, environment and security of supply. The owners demand profitability. All these demands cannot be fulfilled immediately at the present production plants, which have all been established at a time when power plants were designed for base load and one fuel type. Environmental requirements could be met by flue gas and wastewater cleaning plants.

This paper outlines how DONG Energy for a number of years has aimed at increased efficiency and high environmental performance at the coal-fired plants with material development and by increasing fuel flexibility through co-firing of fossil fuel and straw or wood pellets. The next step is today's development work focusing on integrating the production of bioethanol with the energy production at power plants.

Security of energy supply, sustainability and the market are control parameters for developing the energy system. Bioethanol is part of the solution to the question about security of supply and the demand for a

sustainable development. Throughout Europe there is a rapid expansion in the production facilities for 1st generation bioethanol based on the conversion of sucrose and starch from tubers and cereals. Market demands on existing power plants and the simultaneous wish for establishing a capacity for the production of bioethanol are the reasons for DONG Energy's development of the IBUS concept. In the IBUS concept the production of bioethanol from 1st and 2nd generation technologies has been joined and integrated with the power and heat production of the central power plant. Integration of 1st and 2nd generation bioethanol technologies at CHP plants enables the power plants to process agricultural raw materials immediately. Thus further cost reductions will be possible in production, handling and supply of the agricultural raw material.

The cost reduction obtained by integration of the ethanol process with the power plant and the demand for transport fuel will increase the value of the agricultural residues worldwide.

DONG Energy has been the coordinator of the EU funded (5th framework programme) IBUS project from 2002 – 2006. Sicco K/S (DK), TMO Biotech (UK), Research centre Risoe (DK), The Royal Veterinary and Agricultural University (DK) and Energía Hidroeléctrica de Navarra SA (E) were partners in the project. The overall objective of the project was to develop cost and energy effective production systems for co-production of bioethanol and electricity. The IBUS project led to a very promising process in which wheat straw in a low-energy consuming process is converted into bioethanol, feed (molasses) and solid biofuel. The process is partly demonstrated in the scale of up to 1 tonne straw per hour and it is expected to be scaled up to full production scale in less than 5 years.

The total perspective is a completely new role for the power plant – an energy refinery in which fuel flexibility enables a simultaneous supply of electricity, heat and transport fuel based on a mix of fossil fuel and local energy sources.

2. Increased efficiency and co-firing of fossil fuel and biomass

Reduced emissions of CO₂ from fossil fuel-based power production have been achieved by DONG Energy by increasing the efficiency of power plants and co-firing with biomass.

Increased electrical efficiency of fossil fuel fired power plants has been obtained by material development and improved plant design. Danish power plants are in the forefront of the development of ultra super critical power plants. The newest plants in Denmark have steam temperatures of 580-600 °C and electrical efficiencies of more than 45 %. DONG Energy is now participating in the development of the next generation of advanced coal-fired power plants with steam temperatures of 700 °C and electrical efficiencies of around 50 %. DONG Energy also supplies large amounts of district heating from the power plants. Hereby a high total energy efficiency is obtained.

By co-firing with biomass in fossil fuel-fired power plants, significant amounts of biomass can be utilised for power production with high electrical efficiency, low emissions and low investments costs. Two methods for large scale co-firing of biomass have been implemented by DONG Energy: Co-firing of straw and pulverised coal and co-firing of wood pellets, oil and gas.

Co-firing of straw in pulverised coal fired boilers was developed and demonstrated by DONG Energy in 1992-97. Due to the high content of potassium chloride in straw, much attention was given to assess the risks of increased deposit formation, super heater corrosion, deactivation of catalysts for NO_x-reduction and deterioration of the fly ash quality. It was proven that co-firing with straw is a technically and economically feasible concept and that the main obstacle for commercial operation was lacking opportunities for utilisation of fly ash from co-firing. This problem was later solved by revised requirements for use of fly ash in cement and concrete, and commercial straw co-firing was established at the 350 MWe coal-fired power plant Studstrup Unit 4 in 2002. A few years later, co-firing at the sister plant Studstrup Unit 3 was added. The annual consumption of straw for co-firing in these plants is 150,000 tonnes.

Co-firing of wood pellets, oil and gas was implemented by DONG Energy at the 590 MWe Avedoere power plant Unit 2. This unit has three parts – a gas turbine, a straw-fired boiler and the main boiler in which co-firing takes place. The plant is equipped with SCR-catalysts for NO_x-reduction and wet flue gas desulphurisation. By co-firing of wood and oil, the produced ash contains alkali sulphate and alkali vanadate, which contribute to super heater corrosion and catalyst deactivation. However, it has been demonstrated that adding coal ash to the boiler significantly reduces these problems. The annual consumption of wood pellets is 300,000 tonnes.

3. The IBUS concept

Integrated Biomass Utilisation System (IBUS) is a concept that integrates utilisation of lignocellulose and starch or sugar feedstocks with the aim of producing transport fuel in the form of bioethanol. Furthermore, the concept integrates production of electricity and bioethanol by benefiting from low-value steam from the power plant using it to cover the steam consumption of the bioethanol process.

The ethanol plants of the future have to produce at least 150,000 m³/year to be profitable. 500,000-750,000 tonnes of straw per year are required for this purpose if straw alone has to be the raw material source. This will be logistically unrealistic in Denmark and many other countries – therefore the integration of 1st and 2nd generation technologies is necessary.

Production of bioethanol from starch (1st generation technology) also results in production of animal feed, but consumes fossil fuels. As for 2nd generation technology, lignocelluloses are converted into bioethanol, feed and solid biofuel. The solid biofuel contains more energy than is required for processing the lignocellulose. The surplus of energy can be used for processing the starch.

Furthermore, compared with co-firing with for instance straw, the solid biofuel from the 2nd generation technology is a high quality biofuel as the heating value is increased and the content of corrosion components, such as potassium and chloride, is reduced to less than 90 % of this content in straw.

IBUS is a sustainable and environmentally friendly concept as plant nutrients, micronutrients and soluble non-fermentable substances from the biomass are recirculated to the soil through the animal feed, and the process is based on zero discharge of wastewater.

Based on wheat as an energy crop in Denmark, a life cycle analysis of the IBUS concept has shown an energy output/input ratio of 1.5 when constructed as a Greenfield plant. If the IBUS plant is integrated with a power plant the ratio is increased to 2.0. This means that the IBUS concept produces twice as much energy than has been used for cultivating and processing of the energy crop.

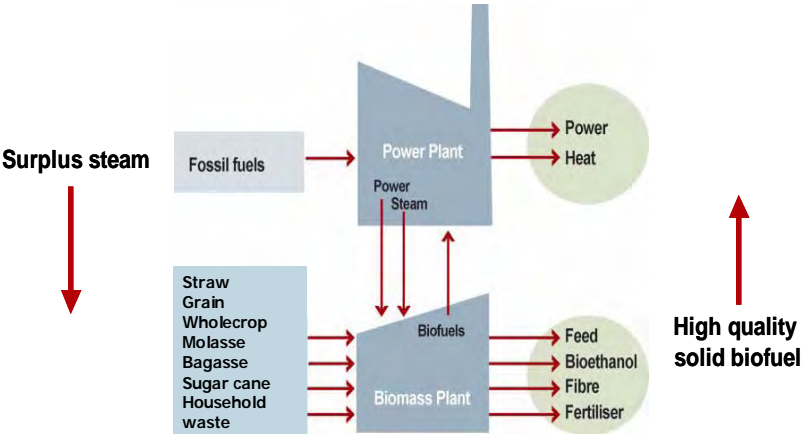

Figure 1. The IBUS concept.

4. Feasibility study

The IBUS concept comprises wholecrop harvesting and transportation to the power plant in which the biomass is processed in a bio-refinery. All possible synergies between power plant and bio-refinery are exploited.

1st generation technology exists and factories appear worldwide. On the other hand we have the 2nd generation technology, which is not commercial yet. Based on the obtained experimental data and knowhow in the IBUS project, constructing equipment for the IBUS process, a feasibility calculation has been prepared.

The main conclusion of the study is that the production costs of bioethanol can be reduced by 10-15 % because of synergy advantages when integrating the bioethanol production with a power plant. Another important conclusion is that the production price for bioethanol seen isolated in the IBUS process for converting of lignocellulose is already reduced to below the EU sale price by means of the technological progress obtained from the IBUS project. The main costs in converting lignocellulosic biomass into bioethanol are costs for biomass, enzymes and steam. By developing a process with a highly efficient use of enzymes and energy integration, most of the bottlenecks have been eliminated. The price of the biomass depends to a great extent on the local conditions.

The production price for bioethanol produced in the IBUS concept based on handling of 150,000 tonnes of straw per year and 370,000 tonnes of grain per year was estimated at EUR 0.42 per litre. If only 1st generation technology is used, the production price amounts to EUR 0.38 per litre. The calculations are based on plants installed in Denmark.

5. The IBUS process for converting wheat straw into bioethanol, feed and solid biofuel

The objective of the IBUS project was to develop cost and energy effective production systems for co-production of bioethanol and electricity from lignocellulosic biomass. The project has succeeded in developing a new and economical process that it is possible to scale up to full production scale.

The major technical bottlenecks have been eliminated in the IBUS project, in which equipment for continuous pressurised heat treatment and enzymatic liquefaction of unground wheat straw has been developed, designed, produced and optimised. In the same time, 2001-2005, the US Department of Energy (DOE) sponsored a multi-million dollar research project to develop a technology platform for producing ethanol from biomass. Part of this project was to develop cost-effective cellulases – cellulose degrading enzymes. Both Novozymes and Genencor succeeded in reducing the enzyme costs by a factor 15-30.

Cost-effective technology and enzymes are gathered in the IBUS process, which is based on hot water and enzymes, and new technological and energy efficient solutions. The technical solutions emphasize a unique way of converting biomass into bioethanol at a very high dry-matter content of 20-40 %. This covers all process steps from hydrothermal pre-treatment of large particles over enzymatic liquefaction and hydrolysis to fermentation.

The IBUS process benefits from:

- 1) Simple process with few process steps based only on water and enzymes.
- 2) Very high dry-matter content in all process steps.
- 3) Integration with a power plant (energy savings).

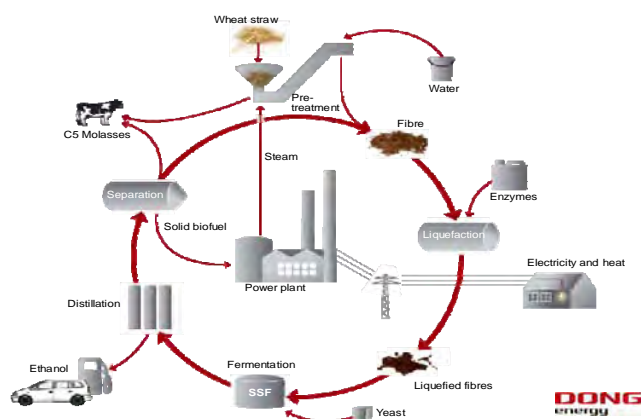

Figure 2. The IBUS process.

A pilot plant has been installed in which up to 1 tonne of wheat straw per hour can be pre-treated continuously in a hydrothermal process where salts and parts of the hemicellulose are washed out in a counter current way. The liquid fraction containing hemicellulose and salts is evaporated and sold as a feed product (molasses). The pre-treated fibres containing mainly cellulose and lignin are liquefied, enzymatically hydrolysed and fermented in a patented process that is able to handle the fibres at very high dry-matters (25-40 % dry-matter). The high dry-matter concentration is important for reaching a high concentration of ethanol in the fermentation broth. In this process we have reached more than 9 vol % ethanol by converting 85 % of the cellulose to ethanol by means of baker's yeast. The fermentation broth is distilled and the fibre stillage can be separated into a solid biofuel, mainly consisting of lignin and a thin stillage. The thin stillage can be partly recirculated to the liquefaction step, as it still contains active enzymes, and partly incorporated in the feed (molasses) produced.

1 tonne of straw produces 150 kg of bioethanol, 315 kg of solid biofuel and 315 kg of feed. If a xylose fermenting micro-organism is included in the process, the bioethanol production can be increased to 220 kg, the amount of solid biofuel will remain unchanged, and the produced amount of feed will be reduced to 175 kg.

6. Demonstration of the IBUS process

The 1-tonnes per hour pilot plant has been an important milestone in the IBUS development. The next 2-3 years will be used to verify the IBUS process before it can be up-scaled to production at a CHP plant. Within this time frame, a complete IBUS demonstration plant will be designed and built.

The demonstration plant will have a capacity of 4 tonnes wheat straw per hour. In the pilot plant major technical bottlenecks were eliminated. The aim of the demonstration plant is to verify the total IBUS process. The verification will include continuous operation, mechanical stability, mass and energy balances, recirculation of process streams, reduction of wastewater and product quality.

In parallel with the building of this demonstration plant, DONG Energy will continue R&D work with universities and companies to develop high value products that can be added to the product list of the IBUS bio-refinery.

REFUEL: an EU road map for biofuels

M. Londo¹, E. Deurwaarder and S. Lensink, ECN policy Studies, the Netherlands

G. Fischer, S. Prieler and H. van Velthuizen, IIASA, Austria

M. de Wit and A. Faaij, Copernicus Institute, Utrecht University, the Netherlands

G. Berndes and J. Hansson, Chalmers University of Technology, Sweden

H. Duer and J. Lundbaek, COWI, Denmark

G. Wisniewski, Institute for Renewable Energy (EC BREC IEO), Poland

K. Könighofer, Joanneum Research, Austria

Abstract

A successful mid-term development of biofuels calls for a robust road map. REFUEL assesses inter alia least-cost biofuel chain options, their benefits, outlines the technological, legislative and other developments that should take place, and evaluate different policy strategies for realisation. Some preliminary conclusions of the project are discussed here. There is a significant domestic land potential for energy crops in the EU, which could supply between one quarter and one third of gasoline and diesel demand by 2030 if converted into advanced biofuels. A biomass supply of 8 to 10 EJ of primary energy could be available at costs around or below 3 €/GJ. However, the introduction of advanced biofuel options may meet a considerable introductory cost barrier, which will not be overcome when EU policy is oriented to the introduction of biofuels at least cost. Therefore, conventional biodiesel and ethanol may dominate the market for decades to come, unless biofuels incentives are differentiated, e.g. on the basis of the differences in greenhouse gas performance among biofuels. The introduction of advanced biofuels may also be enhanced by creating stepping stones or searching introduction synergies. A stepping stone can be the short-term development of lignocellulosic biomass supply chains for power generation by co-firing; synergies can be found between advanced FT-diesel production and hydrogen production for the fuel cell.

1 Introduction

In view of climate change and fossil fuel supply security issues, biomass-based fuels for transport meet an ever-increasing attention. The EU has established a specific biofuels target for 2010 and has agreed upon a new target for 2020, and many commercial

¹: Corresponding author. ECN Policy studies, PO Box 56890; NL-1040 AW Amsterdam, the Netherlands. Tel +31 224 568253; fax +31 224 568339, e-mail londo@ecn.nl. www.refuel.eu.

stakeholders from different parts of the biofuels chain are now actively finding new business opportunities. But on the longer term, this future is not yet clarified: will biodiesel and conventional bio-ethanol still dominate in 2020, or will advanced synfuels and ethanol from wood and straw be the most cost-effective options by then? Or will gaseous biofuels such as SNG and hydrogen take over, in anticipation of a hydrogen economy? These questions call for an analysis of the developments to be expected in the coming decades, as well as for a robust biofuels strategy stimulating the best options.

The European REFUEL project is addressing these issues today. In the project, a consortium of seven renowned partners in the biofuels field is developing a biofuels road map until 2030. The two-year project started January 1st, 2006 and is commissioned by the EU in DG-TRENs Intelligent Energy Europe programme. The road map will identify the least-cost biofuel chain options, assess the benefits they have, outline the technological, legislative and other developments that should take place, and evaluate different policy strategies for realisation.

This paper shortly describes the project's key objectives, and discusses methodology and preliminary results on three topics: feedstock assessment, biofuels assessment and the some ingredients for a biofuels development strategy.

2 REFUEL key objectives and projected results

Given the current rapid developments in the biofuels sector in the EU, a focus on the optimal development route for biofuels has become only more relevant. This is exactly what REFUEL intends to do. To stay in travelling terms, the project aims to deal with issues such as:

- *The destination:* An ambitious, yet realistic target for biofuels in EU 2030, including intermediate targets, with a baseline scenario for e.g. developments in transport, agriculture and other relevant sectors
- *The route:* A cost-effective mix of biofuels reaching this target, including corresponding biofuel chains, conversion technologies, feedstocks, and other parts of the supply chain
- *The purpose of the journey:* An impact assessment, including greenhouse gas emissions, security of supply, socio-economics, impacts on the whole energy system, and other environmental and land use issues.
- *At the wheel:* An analysis of required actions from stakeholders, in terms of technological innovations, learning, and market introductions, and corresponding implementation options and barriers
- *Paving the way:* Required policies on related fields, such as agriculture, energy, technology development and trade, to reduce barriers and create incentives for stakeholders to act.

Projected results of the project have been specified in the REFUEL Preliminary Road Map [1]. Key results of the project will be:

- A quantitative development pathway for biofuels, including applied fuels and feedstocks, costs, and impacts, as illustrated in Figure 2
- Accompanying integrated sets of policy measures, specified in their spatial and temporal time frames, based on barrier and solution analyses, and reflected upon by the relevant stakeholders.

3 Feedstock assessment

The availability of biofuels feedstock obviously is one of the key factors affecting the further penetration of biofuels. Therefore, an extensive part of the project applies to this issue. Figure 1 depicts the followed method for the assessment of land potential. Key elements of the methodology are:

- An extensive analysis of soil, climate and other factors affecting land suitability for cropping systems, resulting in a land suitability classification for food, feed and energy crops.
- Allocation of land: Land use for other purposes, such as food production, forestry, nature conservation, infrastructure, etc. will prevail over land use for biofuels. Therefore, only 'surplus' land, not needed to meet other demands, will be available for biomass feedstock production. A detailed assessment was made of demand for food, feed and other land use-related products and services. The prime assumption was that Europe will maintain its current (period 2000-02) level of self-sufficiency for food and feed crops as well as for livestock products. Thus the land becoming available for biofuel production is a result of future consumption and technological progress. The latter was achieved mainly by reasonable yield increases. This can be interpreted as the land that becomes available without compromising food and feed production.
- Agricultural development: For the Western European Countries, modest crop productivity increases are predicted, based on statistical analyses of past developments. In the Central and Eastern European Countries, agricultural productivity is assumed to increase more strongly. In the baseline, it is assumed that CEEC intensity levels will converge with WEC levels by the year 2050, taking into account differences in physical productivity factors such as climate and soil quality.

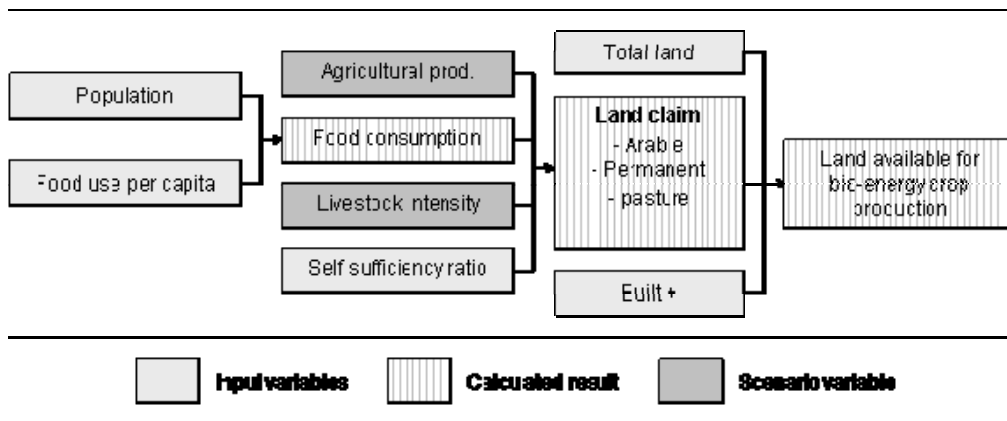

Figure 1: methodology for land potential assessment.

3.1 Land availability for energy crops

Figure 2 and Figure 3 show the amount of land that becomes available for energy cropping by the year 2030, with 'bases case' assumptions on the input variables. On arable land, approximately 60 Mha of land could become available; on pasture land this is another 25 Mha. In terms of the share of total arable land, the potentials in the EU12

(i.e. the Central and Eastern European member states) and the Ukraine are more than 50%. Note, however, that with such shares of bioenergy crops, the insertion of these crops, particularly annuals, into a farmer's rotation system may become a limiting factor.

Current pasture land could be opened up for herbaceous energy crops like perennial grasses. This potential is smaller than on arable land but still significant, again especially in the EU12 and Ukraine. Four types of grassland were identified:

1. Pasture area required for feeding ruminant animals (FEED)
2. Pasture area becoming available due to technological progress in agricultural production (i.e. the change in feed area required for ruminant livestock production between the base period and the future) (BioCrops-I)
3. Pasture area not required for livestock feed and not restricted by slope and nature conservation concerns (BioCrops-II)
4. Pasture area not required for livestock feed and reserved for reasons of nature conservation (Natural Grassland)

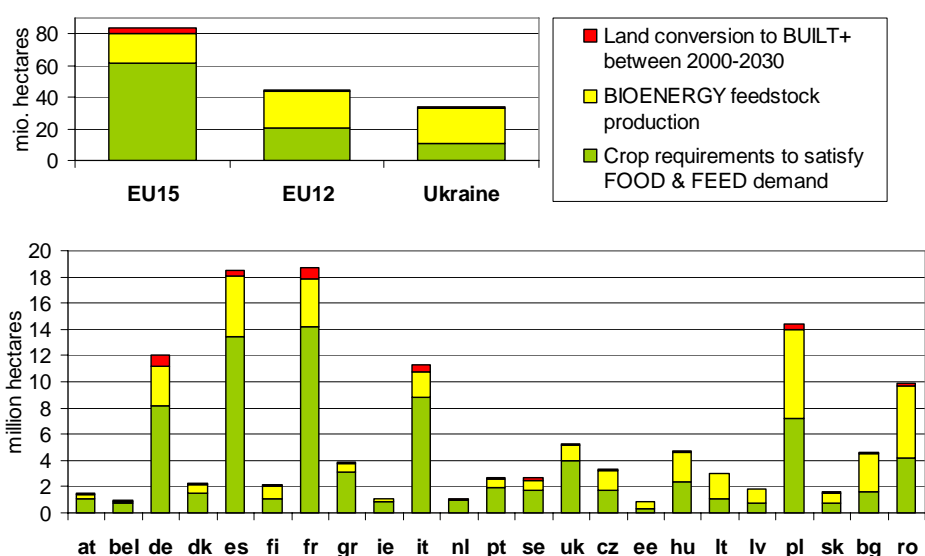

Figure 2: Energy crop potential from arable land in the EU15, EU12 and Ukraine, and per EU member state. Built+ stands for land converted into built-up area.

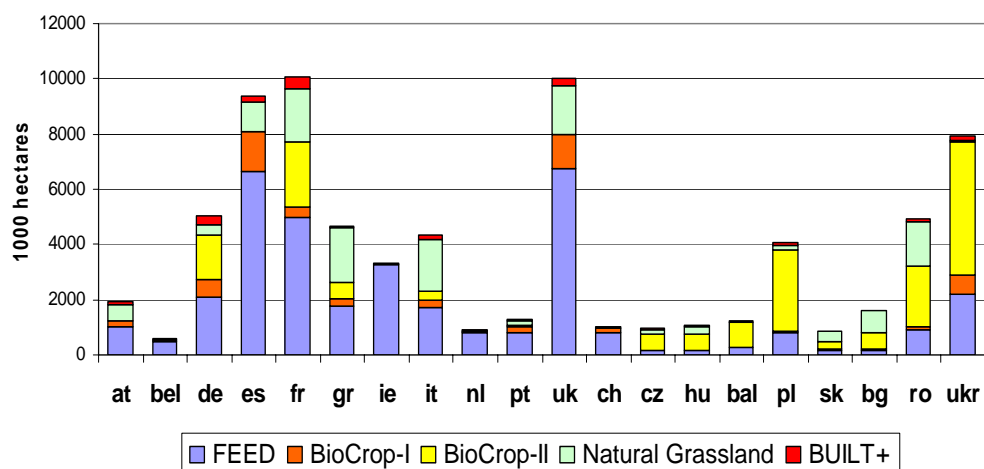

Figure 3: Energy crop potential from pasture land in the EU15, EU12 and Ukraine in the baseline scenario. For specification of categories, see text.

In order to give an impression of the bioenergy potential of the amounts of land: When planted with the most high-yielding energy crops (woody crops or perennial grasses), the total land potential in the EU27 and Ukraine could add up to a biomass supply potential of the size of circa one sixth of EU27 primary energy demand in 2030 (as predicted in the PRIMES 2006 baseline), or one tenth when only production in the EU27 is taken into account. When entirely converted into biofuels, this supply could cover one third of total fuel demand in the transport sector by 2030, or half of gasoline/diesel demand. The EU27 potential supply could cover about one quarter of EU energy demand for transport, or about one third of gasoline/diesel demand.

These potentials strongly depend on several assumptions, of which those on future trends in EU agricultural productivity are the most influential. For example, if increases in per hectare yields levels are set lower, e.g. due to an increased share in organic farming, total land potential decreases by tens of percents. On the other hand, if increases are set higher, e.g. due to the introduction of GMOs, land potential increases by tens of percents.

3.2 Biomass supply costs

The assessment of land availability and energy crop supply potentials was accompanied by cost calculations. In this, production cost for feedstock were calculated as a function of factor costs (capital, land and labour) and non-factor costs (fertiliser, seeds, etc.). Two cost variables, viz. land prices and labour wages, were taken as (sub)scenario inputs, since these costs can change significantly in the EU12 transition economies in the coming decades.

Figure 4 shows the cost-supply curve if all land for energy crops would be used for herbaceous perennials. This curve does not (yet) include the potential and cost of agricultural residues. It indicates that up to 10 EJ/yr could be produced by these energy crops in the EU27 by they ear 2030 at costs around or below 3 €/GJ. The grey bars illustrate the significant band with that occurs when other assumptions are made on land and labour costs. Note, however, that this methodology is based on cost assessment, not on the dynamics of price formation in markets in which energy cropping and agriculture for food compete.

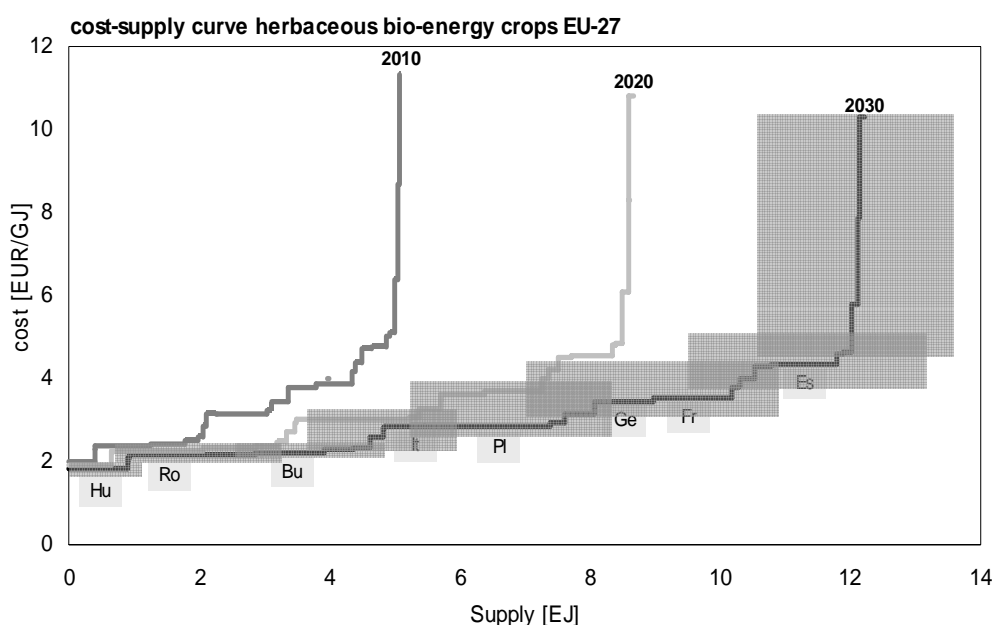

Figure 4: cost-supply curve for herbaceous energy crops in the EU27.

4 Fuel mix assessment

The Biotrans model, introduced in VIEWLS and further developed in REFUEL, generates full-chain costs of all proposed biofuel chains, specified in feedstock, conversion, distribution, etc. On this basis, the model calculates an optimal, least-cost mix of biofuels, at given biofuel target shares, based on full-chain cost data of all possible fuels, related feedstock and regions of production. Compared to earlier versions of the model, it now better describes technological learning of conversion technologies and updated costs for all parts of the production chain. Below we present some preliminary results. It should be noted, however, that these may be subject to changes in their final form.

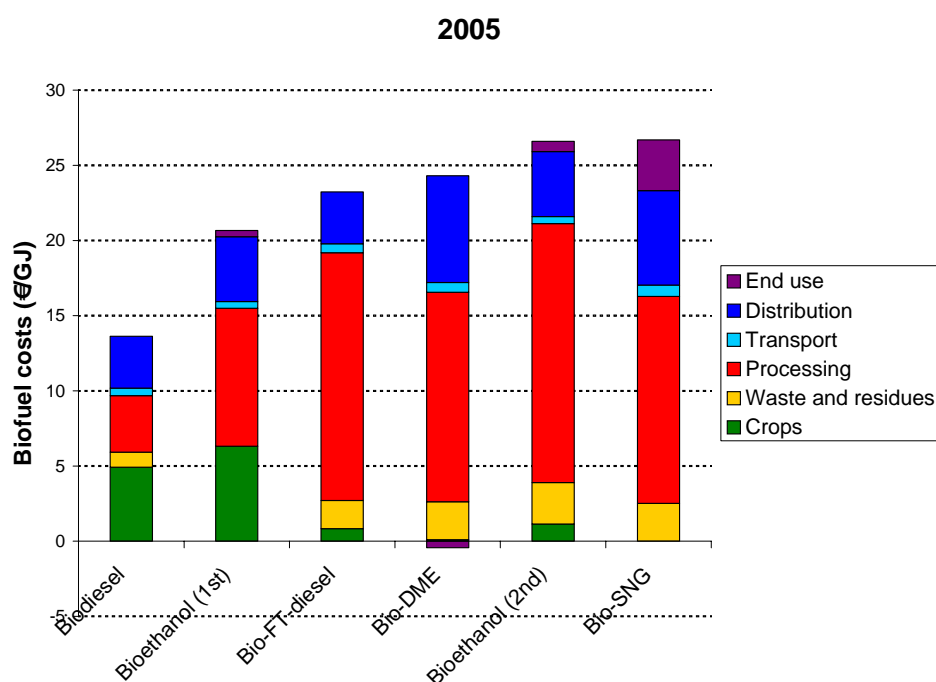

Figure 5: 2005 costs build-up for the six key biofuels in Biotrans.

Figure 5 shows the initial costs of the six key biofuels in the model. The two first-generation fuels (biodiesel and bioethanol from sugar or starch crops) are the least-cost options, with biodiesel being the cheapest option. This is also because in the 2005 situation in the model, a significant part of this feedstock can be provided by residues (e.g. animal fats). Note, however, that this cost build-up is based on production *costs* of biofuel feedstock, not on current or future market prices. Based on current *market prices*, with rape seed prices above €500/tonne (or ca 15 €/GJ), biodiesel costs would be significantly higher.

Preliminary runs with the full-chain model until 2030 provide the following indications. Diesel substitutes may dominate the market when a purely least-cost approach is adopted. Cost differences with bio-ethanol, however, are relatively minor in the longer term, and therefore both options may still enter the market.

Forcing gasoline substitutes into the market, the market penetration of bio-ethanol may lead to lower full chain costs on the long term. However, preliminary results indicate a friction between total full chain costs of biofuel production and the biofuels' potential to reduce GHG emissions.

The introduction of 2nd generation FT-diesel may meet a significant barrier due to high initial cost, resulting in a relatively long dominance of 1st generation options in the diesel substitute segment. 2nd generation options have a stronger cost reduction potential, since they are innovative and learning effects will have stronger impacts than for conventional, 1st generation options. However, it may take considerable time before 2nd generation fuel chains become more attractive than 1st generation options when only taking least cost into account. Basically, there are two situations in which advanced technologies will take over more easily:

- When the higher greenhouse gas reduction impact of 2nd generation fuels is taken into account. When expressed in terms €per tonne avoided CO₂ equivalent, the ratio between advanced and conventional fuels may be quite different than on a €/GJ biofuel basis. This will be illustrated by additional Biotrans calculations.
- At high biofuel target levels, the availability (and cost) of feedstock for conventional biodiesel and ethanol becomes a limiting factor, forcing advanced biofuels on the basis of lignocellulosic feedstock into the market. However, in the Biotrans base runs this effect only occurs at biofuel target levels above 20%. However, since REFUEL works with feedstock production cost, not with market prices, this effect may be stronger on real prices and thereby lead to better chances for 2nd generation technologies.

On the basis of these results, it seems that advanced biofuel technologies will meet severe difficulties in entering the market without any specific policy incentives. This could be shaped either by creating a specific subtarget for 2nd generation options, or by including the external advantages of advanced biofuels part of the target.

Feedstock availability for biofuels, and their costs, will also be influenced by developments in the stationary energy sector, which uses biomass for power and heat generation. Competition for biomass between the stationary and transport sectors, as well as prospects for synergies, will be analysed based on Biotrans runs in conjunction with modelling using another model available in REFUEL: PEEP, which includes both the stationary and transport sectors. Some examples of relevant analyses are given further below

5 Strategies for 2nd generation biofuels

One of the key issues in the future development of biofuels is the proposed shift from 1st generation biofuels to 2nd generation biofuels. Apart from technology development, this shift meets several barriers. For example, while 1st generation fuels use conventional feedstocks, currently available, lignocellulosic biomass feedstocks (e.g. fuel wood) require new supply chains to be set up. Furthermore, especially for synfuels such as FT-diesel, conversion technologies depend on biomass gasification, which needs to be introduced on a large scale, creating an investment barrier. Finally, biofuels are often considered an intermediate step for the transport sector, with the hydrogen-fed fuel cell penetrating the market later on. In REFUEL, these strategic issues are reviewed, and strategies are developed to overcome these barriers by the introduction of stepping-stones or bridging options.

In this paper, we shortly dwell on two strategic issues. First, the possible synergies between lignocellulosic biomass application in power/heat and for biofuels. Second, we go into some possible synergies and conflicts between biofuels and the introduction of hydrogen and fuel cells.

5.1 Setting up lignocellulosic supply chains

As for the first issue, an example was elaborated in Johnson et al [2] in a case study for Poland. This study proposes short-term co-firing of woody biomass in existing (coal-based) power plants as a supply chain step-up for wood-based advanced biofuels. It matches the regional availability of woody biomass with the currently available capacity of coal-based power plants. Essential conclusions are:

- Co-firing of biomass in existing power plants is a low-cost early option to increase the share of renewable resources in the electricity mix., with a potential of ca 3% of total electricity demand in Poland by 2010.
- As a significant part of the existing power generation capacity will be decommissioned after 2010, biomass co-firing will not lead to a technology lock-in: in the period after 2010, the biomass supply chain can be used either in power plants to be newly developed, or in new installations for the production of advanced biofuels. This makes short-term development of co-firing an interesting bridging option towards new biomass-based energy applications, either for fuels or for electricity. As a consequence, a development pathway for co-firing in existing plants in the coming decades could look like in Figure 6.
- The medium to long term prospects for biomass co-firing with coal will depend on the development of C prices, since despite the use of biomass these plants still emits large volumes of fossil CO₂, which may be too costly at high C prices. It also depends on whether technology development allows for an increasing share of biomass in the fuel mix in retrofitted or new plants (as a response to increasing C prices). Future plants may also co-produce biofuels: one possible pathway could be a gradual development towards polygeneration plants using biomass/coal as feedstock for the production of transport fuels, heat and electricity. Especially in a combination with carbon capture and storage, such plants may play an important role in a world with ambitious climate targets.

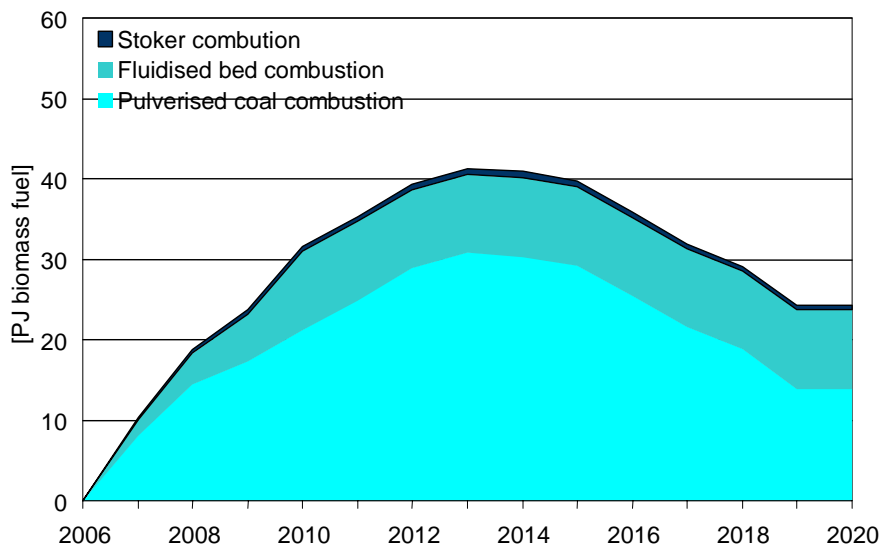

Figure 6: Potential development pathway for biomass cofiring in existing plants in Poland. After 2012-2014, the available existing capacity of coal-fed power plants for cofiring decreases, leaving the possibility to use the existing biomass supply chain either for new power generation plants or for 2nd generation biofuel production.

5.2 Biofuels and hydrogen: synergies, conflicts

Biofuels (on the short term) and hydrogen (on the longer term) are generally considered to be two major options for a more sustainable transportation sector. However, since both options require the development of new technologies, the question is to what extent the development of both leads to conflicts and lock-in situations, or to potential synergies in technology development. Therefore, we compared the preliminary outcomes of two road mapping projects (ref): REFUEL for biofuels (with a focus on advanced biofuel options) and Hyways for hydrogen (see www.hyways.de for further information).

Some conclusions from this comparison:

- The only apparent conflict lies in the competition for biomass resources, which can be used for both the production of hydrogen and of biofuels. However, in case biomass resources are limited with the evolvement of a manifold of biobased energy options, a hydrogen/fuel cell combination on the basis of biomass offers major advantages over biofuels with conventional engines due to its higher efficiency in terms of kilometres driven per ha of biomass plantation. Another argument for aiming at hydrogen use is that from the coal-based competitors of both fuels – Coal to Liquid and coal-based hydrogen respectively – the latter is preferable as it allows for CO₂ capture and storage at the production site, retaining the option of zero-emission vehicles.
- As a consequence, biofuels and their use in an internal combustion engine might be regarded as transition options rather than the final solution for sustainable passenger transport. However, for heavy duty trucks, this situation is different. Here, hydrogen and fuel cells do not provide similar benefits, because the efficiency advantage of the fuel cell is much less with high continuous loads, and the fuel storage potentials are a drawback for application in long-distance transport. Therefore, freight transport could provide a lasting and sizable market for the second generation of biofuels. Together with the application in passenger cars for the period until hydrogen in fuel cell cars has become affordable, this justifies the current efforts in developing (second generation) biofuels. A consistent development pathway of biofuels and hydrogen might therefore look like Figure 7.

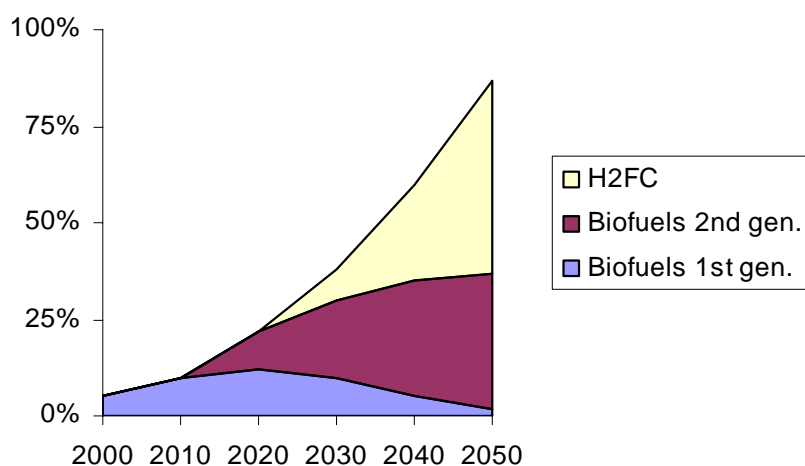

Figure 7: Proposed development pathway for biofuels and hydrogen

- Consequently, the long-term objective could be to deploy hydrogen in passenger cars and advanced biofuels in trucks. If this is pursued, major synergies can be achieved in the 2nd generation FT-diesel (BtL) production chain, because it is based on a gasification process route that can also be used for hydrogen production. Note, however that dramatic progress of plug-in hybrids and range-extended electric vehicles may strongly reduce the need for transportable fuel.

6 Conclusions

Current REFUEL results indicate that:

- There is a significant domestic land potential for energy crops in the EU, which could supply between one quarter and one third of gasoline and diesel demand by 2030 if converted into advanced biofuels. A biomass supply of 8 to 10 EJ of primary energy could be available at costs around or below 3 €/GJ.
- The introduction of advanced biofuel options may meet a considerable introductory cost barrier, which will not be overcome when EU policy is oriented to the introduction of biofuels at least cost. Therefore, conventional biodiesel and ethanol may dominate the market for decades to come, unless biofuels incentives are differentiated among biofuels, e.g. on the basis of the differences in their external benefits.
- The introduction of advanced biofuels may also be enhanced by creating stepping stones or searching for synergies. A stepping stone can be the short-term development of lignocellulosic biomass supply chains for power generation by co-firing; synergies can be found between advanced FT-diesel production and hydrogen production for the fuel cell.

References

- [1]: Londo, M., X. van Tilburg, E. van Thuijl, E. Deurwaarder, A. Wakker, G. Fischer, H. van Velthuizen, A. Faaij, I. Lewandowski, M. de Wit, G. Jungmeier, K. Könighofer, G. Berndes, J. Hansson, H. Duer and G. Wisniewski: A Preliminary Road Map for Biofuels; Approach, basic ingredients and assumptions for the REFUEL biofuels road map for the EU25+ until 2030. ECN, Petten 2006. Available at www.refuel.eu.
- [2]: Johnsson, F., G. Berndes, G. and M. Berggren (2006). Cost competitive bioenergy: linking lignocellulosic biomass supply with co-firing for electricity in Poland. World Bioenergy 2006. Conference and exhibition on biomass for energy, Jönköping, Sweden May 30 – June 1, 2006.
- [3]: Uytendinck, M., M. Londo, P. Godfroid and H. Jeeninga: Long-term developments in the transport sector –comparing biofuel and hydrogen roadmaps. Accepted for the ECEEE 2007 Summer Study, Côte d’Azur, France, 4–9 June 2007.

Session 6 – Wind

Chairman: Erik Lundtang Petersen, Risø National Laboratory, Denmark

UpWind

Wind Energy Research Project under the 6th Framework Programme
Peter Hjulær Jensen, Risø National Laboratory,
Denmark

1. Abstract.

The paper presents the until now largest EU wind energy research project. The paper presents the project objectives, project organization, the participants, the start up of the project and dissemination of results.

2. Objectives

UpWind develops and verify substantially improved models of the principle wind turbine components, which the industry needs for the design and manufacture of wind turbines for future very large-scale applications, e.g. offshore wind farms of several hundred MW. The wind turbines needed will be very large (>8-10 MW and rotor diameter > 120 m). Present design methods and the available components and materials do not allow such up-scaling. In order to achieve the necessary up-scaling before 2020, full understanding of external design conditions, innovative materials with a sufficient strength to mass ratio, and advanced control and measuring systems are essential.

In order to achieve this up-scaling in the most efficient way the following critical areas have been identified to be addressed in this Integrated Project. Aerodynamics, aero-elasticity, structural and material design of rotors, critical analysis of drive train components and support structures (for offshore applications), remote sensing measurements, control concepts, new concepts for condition monitoring, models for wind in wind farms and grid design issues, are to be analyzed, and new design approaches and concepts developed, as well as supporting technology.

As the characteristics of present monitoring and measuring techniques, and control concepts are insufficient the project will improve those techniques with the focus on large wind turbine structures.

New developments in the field of wind farm lay out, control, and grid connection constraints will be translated into design requirements for new wind turbines.

Another important feature is controlling the wind turbine as a whole and being able to use the different partial design packages in such a way that a balanced cost reduction divided over all wind turbine components will become possible.

Control systems are essential to implement "invisible" improvements in conditioning monitoring signals, power output optimization on wind park level and load mitigation.

External circumstances need to be understood accurately in order to design a wind turbine structure as critical as possible, again with the aim to save on material and in the final costs.

The objective for UpWind is to develop accurate, verified tools and component concepts the industry needs to design and manufacture this new breed of turbine.

UpWind focus on design tools for the complete range of turbine components. The project address the aerodynamic, aero-elastic, structural and material design of rotors. Critical analysis of drive train components will be carried out in the search for breakthrough solutions.

In 2006, European companies supplied 85% of the global market for wind power technology. UpWind will help maintaining that position and help realizing EU renewable electricity targets for 2020, and to attain the main objective of the Lisbon Agenda. The UpWind Project brings together the most advanced European specialists and experience relevant for the wind energy sector and thereby is UpWind a very strong forum the most of the central actors in the wind energy field and a platform for performing more efficient research in the European research laboratories in the wind energy field. .

UpWind looks towards wind power tomorrow; towards the design of very large turbines (5-10-20MW) standing in wind farms of several hundred MW, both on- and offshore.

The challenges in the creation of such power stations requires the highest possible standards in design; complete understanding of external design conditions; the design of materials with extreme strength to mass ratios and advanced control and measuring systems all geared towards the highest degree of reliability, and, critically, reduced overall turbine mass.

Wind turbines greater than 5MW and wind farms of hundreds of MW requires the re-evaluation of the core unit of a wind energy power plant, the turbine itself, for its re-conception to cope with future challenges.

3. Organization

The project has **8** so called “**Basic Research Work Packages (WP)**”. Each WP stands on its own in the sense that they only contribute in part to the central objectives of the project.

The results from these Basic Research packages are needed for use in the “**Integration**” work packages, whose objectives are fully aligned with the central objectives of the project. There are two types of Integration WP: the first covers science integration, and the second technology integration.

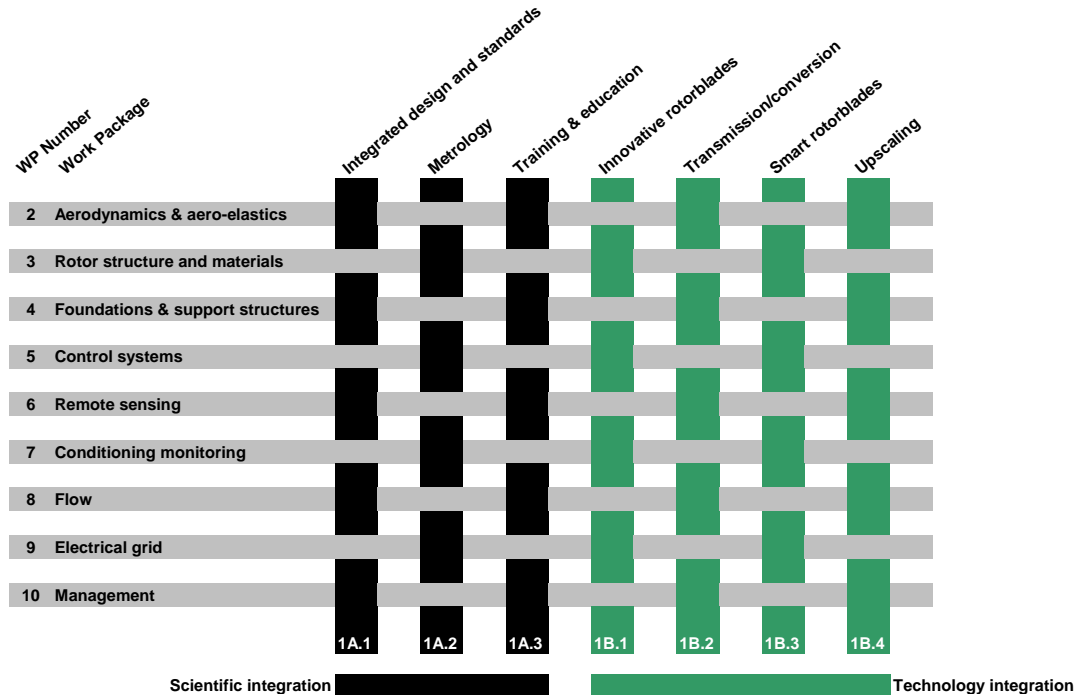

Figure 1. *Project matrix structure. Horizontal work packages are “scientific work packages and vertical are “integration tasks“, gathered in work package 1. The integration tasks have their own budgets and it is planned that in average 60% of the activity in each scientific work package is aimed directly at supporting the (cross-cutting) integration tasks.*

The main technical and scientific components of the program have been fully integrated through a visionary organizational structure, which will ensure that scientific research answers industry needs. This has been achieved by organizing the project in such a way that the (industrial) integration work packages will guide the scientific work to a great extent (vertical integration).

3. Upvind partners

The first project year 4 new partners were incorporated in the project, Risø National Laboratory were merged with the Technical University of Denmark. The result is that after one year UpWind consists of 43 partners. The partners in UpWind are:

Universities:

- Technical University of Denmark,
- Forskningscenter Risoe, Danmarks Tekniske Universitet
- Aalborg University
- Delft University National Technical
- University of Athens of Technology
- University of Patras
- Universitaet Stuttgart
- Institut fuer Solare Energieversorgungstechnik Verein an der Universität Kassel
- Werkzeugmaschinenlabor, Aachen University
- University of Edinburgh
- Lulea University of Technology
- Vrije Universiteit Brussels
- University of Salford
- Ustav Termomechaniky Akademie Ved Ceske Republiky

Research institutes

- Energy research Centre of the Netherlands
- Stichting Kenniscenrum Windturbine Materialen en Constructies
- Centre for Renewable Energy Sources
- VTT Technical Research Centre of Finland
- Instytut Podstawowych Problemow Techniki PAN
- Council for the Central Laboratory of the Research Councils
- Fundacion Cener-Ciemat

Certification Agencies

- Germanischer Lloyd WindEnergie GmbH
- Det Norske Veritas, Danmark A/S

Developers:

- Dong Energy A/S
- Shell

Consultants.

- Garrad Hassan and Partners Ltd.
- Ramboll Danmark A.S.
- Fundacion Robotiker
- SAMTECH S.A.”

Manufactures and component suppliers

- GE Global Research, Zweigniederlassung der General Electric Deutschland Holding GMBH
- Gamesa

- Repower Systems AG
- Ecotècnia S.C.C.L.
- Vestas Asia Pacific A/S
- LM Glasfiber A.S.
- Lohmann und Stolterfoht GmbH (member of the Bosch Rexroth group)
- Smart Fibres Ltd
- QinetiQ Ltd.

Industry Associations

- European Wind Energy Association

4. Start up and Dissemination.

The findings of the project will be disseminated through a series of workshops and through the dedicated website www.UpWind.eu to the widest possible audience by EWEA which represents members from over 40 countries, and 220 companies, including 98% of manufacturing industry, organizations and research institutions (*activity integration*).

In the first year the main emphasis has been on starting up the project, the organization of the project and developing the integration activities in the project. The start up of the project has been very successful.

At the Kick up meeting the integration activities were kick started. All work package's did make agreements' with other work package's concerning integration deliverables. The partners did on the kick off meeting agree on specific formulations' on the deliverables. On the following work package leader meetings these appointments' between the work packages were confirmed. And it seems that the cross work package deliverables will be delivered on time and in accordance with the agreed content.

The first years work has now been reported and public available reports will in the near future be available on the UpWind website www.upwind.eu.

Wind power costs in Portugal

Saleiro, Carla

Department of Biological Engineering, University of Minho, Portugal

carlasaleiro@gmail.com

Araújo, Madalena

Department of Production and Systems, University of Minho, Portugal

mmaraujo@dps.uminho.pt

Ferreira, Paula

Department of Production and Systems, University of Minho, Portugal

paulaf@dps.uminho.pt

Abstract

In a way to reduce the external energy dependence, increasing also the investments in renewable energy sources and aiming for the concretization of the European renewable objectives, the Portuguese government defined a goal of 5100 MW of installed wind power, up to 2012. If the drawn objectives are accomplished, by 2010 the wind power share may reach values comparable to leading countries like Denmark, Germany or Spain. The Portuguese forecasts also indicate a reinforcement of the natural gas fired generation in particular through the use of the combined cycle technology, following the European tendency.

This analysis sets out to evaluate the total generating cost of wind power and CCGT in Portugal. A life cycle cost analysis was conducted, including investment costs, O&M costs, fuel costs and external costs of emissions, for each type of technology. For the evaluation of the externalities ExternE values were used.

The results show that presently the wind power production cost is higher than the CCGT one, at least from the strictly financial point of view. CCGT costs increase significantly when charges for externalities are included. However, they only reach levels higher than the equivalents for wind power for high externality costs estimations. This partially results from the low load factor of the wind farms in Portugal and also from the low emission levels of the gas fired technology used in the comparison.

A sensitive analysis of the technical and economical parameters was also conducted. Particular attention was given to the natural gas prices due to the possible increase over time. The fuel escalation rate is the parameter that has larger effects on the final costs. It was verified that the total cost of wind plant is more influenced by the load factor than the total cost of CCGT.

Keywords: Wind power, energy costs

1 Introduction

The European Union is committed under the Kyoto Protocol to reduce greenhouse gas emissions (GHG) by 8% from 1990 levels by 2008 – 2012. Portugal, as an EU member state should limit the increase of their GHG emissions to 27% in the same period.

According to the National Climate Change Plan 2006 (NCCP), in 1990 the energy sector contributed with 67% of the total GHG emissions and it is expected to increase to 75% of the national total of emissions by 2010. Still with in the same sector, and in 1990, there are the most contributing activities to this problem - activities related with the electricity and heat industry – 35% (estimates of 30,3% in 2010).

The increase of renewable energy sources (RES) contribution for electricity production is an important element of the package of measures necessary to comply with the Kyoto Protocol, under the United Nations Framework Convention on Climate Change, and it is also fundamental for the achievement of the Directive 2001/77/EC objectives.

Under the Directive on Renewable, Portugal must achieve a target of 39% of its electricity production from RES in terms of gross electricity consumption in 2010. This percentage essentially corresponds to electricity production from RES in 1997, in which the major electricity production was originated from hydroelectric power stations. Portugal assumed that the Electricity System Expansion Plan will proceed with the construction of new hydroelectric power plants with an installed power rating of more than 10 MW, and that another type of renewable capacity will increase at an annual rate eight times higher than the recent developments.

With the Resolution of the Ministers Council n.º 63/2003 the Portuguese Government reinforced the promotion of hydroelectric resources and the support to the development of renewable energy resources, such as wind, mini-hydro, biomass, photovoltaic and waves.

Portugal is strongly dependent on external energy sources, special oil, accounting for almost 85% of the primary energy, higher than the UE average. Although the natural gas sector has grown considerably over the past few years, this is a fossil fuel that also contributed for GHG, in spite of being in a more reduced form. The only national resources came from the renewable sources, specially the hydro sector.

The large hydro is the most important source for electricity production, but it is dependent on the climatic conditions. In a dry year, like 2005, it is necessary another energy source, namely the thermal production. Besides, this sector has been facing serious environmental obstacles (BCG, 2004) and, consequently, showing a lower expansion than expected.

With the marginal contributions of the remaining energy sources and the difficulties foreseen in the hydroelectric sector, it is expected that the wind power sector will be very important for the objectives fulfilment. This source presents a high potential, but its growth depends on several factors namely the enterprising and financial capacity, the long period for the licensing requests or the access to the grid.

2 Portuguese electric power system

2.1 Portuguese electricity system

There are two electricity systems in Portugal, the Public and the Independent. The Public Electricity System (PES) is regulated in order to ensure power supply for the whole national territory. The Independent Electricity System (IES) includes a Non-binding

Electricity System (NES) and the Special Regime Producers (SRP) – cogeneration and renewable plants.

The production of electric energy in Portugal is dominated by hydro and thermal production, with the latter being resourced by coal, natural gas and fuel-oil. According to *Rede Eléctrica Nacional, SA (REN, 2004, 2005)* the total installed power reached in 2005 about 10,4 GW in PES and NES and almost 2,4 GW in the Special Regime Producers.

The SPR reached 18,5% of the total installed power and is expected to increase considering the new goals for the renewable sources of energy - 2000 MW for the cogeneration systems (in 2010) and 5100 MW for wind energy (in 2012).

In 2005 the hydroelectric production was very low, requiring an increase in thermal power production (especially fuel/oil power plants). The deliveries of the Special Regime Producers grew 47%, to which contributed significantly the wind power and cogeneration plants. These producers represent almost 14% of the total electric production.

2.2 Wind power sector

Figure 1 illustrates the evolution of installed and cumulative wind power, in Portugal. Between 1999 and 2005 the average annual rate was 67%, but the great evolution happened in 2004 and 2005, with growth rates of 112% and 94%, approximately.

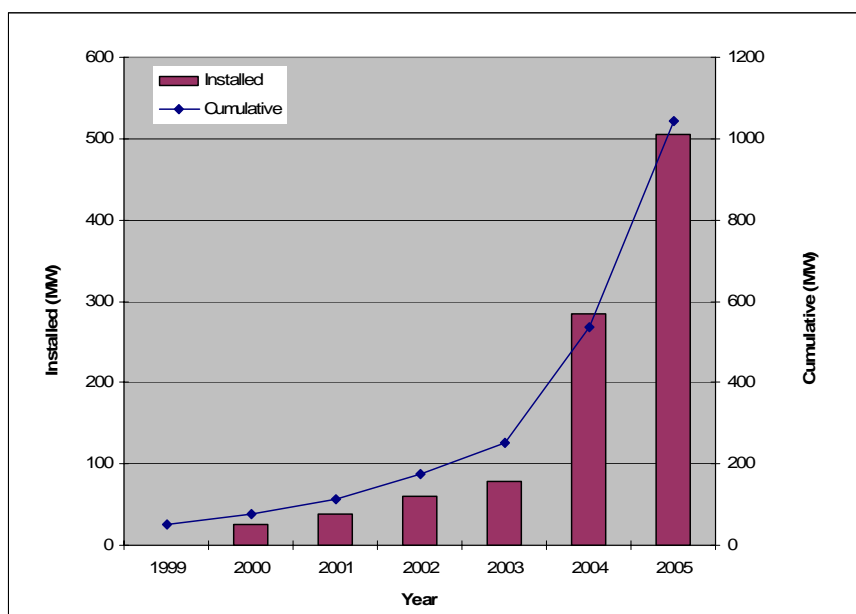

Figure 1. Installed and cumulative wind power, in Portugal (Source: DGGE, 2006).

Although presenting an impressive rising trend, wind power levels for Portugal are still distant of the European leaders, namely from Germany that reached 18 GW of total installed capacity in 2005, from Spain which crossed 10 GW on that year, and even from Denmark, with more than 3 GW.

According to the Energy and Geology Directorate General of (DGGE) data (DGGE, 2006), by the end of 2005 this source of energy represented about 20% of the renewable electricity production, and only 3,3% of the total electricity production. The DGGE forecasts expected that wind energy would contribute for 12,2% of the total electric

production by 2010, an ambitious goal when compared with the three European leading countries in wind power capacity.

Considering the wind power capacity in 2005 and the national objectives, an average of 732 MW should be installed per year, 47% more than in 2005, reaching a value of 12% of the total electricity production, higher than the contribution of this source in countries as Spain (6%) and Germany (5%) and close to the contribution in Denmark (19%).

Although the wind sector presents a great potential some barriers exist to its development, namely the delays in the licensing processes (especially associated with the environmental approval) and the difficulties on the access to the grid (BCG, 2004). Particularly important is the improvement of interconnection capacity as a key requirement for ensuring the security of supply and to proceed with the planned hydro schemes in order to avoid possible situations of operational reserve deficit (Ferreira et al, 2007).

3 Costs analysis of electricity generation systems

Different methods can be used to compare the cost of project alternatives and to determine which provides the best value. The most often used is life cycle cost (LCC), an economic evaluation technique that determines the total cost including all expenses, incurred over the entire life of the system.

Typical costs for a system may include capital, operation, fuel and decommissioning costs. A complete life cycle cost analysis may also include other costs, as well as other financial elements (such as discount rates, interest rates, depreciation, etc).

The equation used to calculate, for each power plant, the levelized electricity generation cost (EGC) is the following (NEA, 2005):

$$EGC = \sum [(I_t + M_t + F_t + X_t) (1+r)^{-t}] / \sum [E_t (1+r)^{-t}] \quad (\text{eq. 1})$$

where: EGC – Average lifetime levelized electricity generation cost

I_t – Investment expenditure in the year t

M_t – Operations and maintenance expenditure in the year t

F_t – Fuel expenditure in the year t

E_t – Electricity generation in the year t

r – Discount rate

The future costs were converted into a present value considering the period of time and the discount rate.

This analysis depends on the values of the investment costs, operation and maintenance costs, fuel costs and external costs. It is sensible to the load factor and thermal efficiency of the system (for natural gas) and is influenced by economic parameters, such as discount rates, growth rates, inflation and interest rates.

3.1 Data sources

In this study the total generating costs of wind power and combined cycle natural gas (CCGT) have been determined. The data and system characteristics necessary for economic evaluation are given in Table 1.

Table 1. Data and system characteristics used in economic evaluation for wind farm and CCGT.

	Wind	CCGT
Installed capacity	20 MW	1200 MW
Load factor	22%	85%
Thermal efficiency	-	57%
Life time	20 years	25 years
Investment costs	1206.20 €/kW	514.19 €/kW
O&M annual costs	15.37 €/kW	23.59 €/kW
Fuel costs	-	22.23 €/MWh

Levelised costs were calculated assuming constant pricing and based on the 2005 value. A discount rate of 5% and 10% was used in the analysis.

The external costs depend on several factors, like the type and age of the central, the fuel, the efficiency of control and treatment emissions systems, etc. In life cycle analysis emissions from materials production (for example materials for the turbines and materials used for the electrical transmission equipment) are also included. In the case of wind fuel cycle, it is in this phase that most emissions are produced.

The estimates for the external costs (from effects of GHG emissions) used in this analysis are derived from the ExterneE Program studies for wind and natural gas fuel cycle – emissions from wind parks installed in Denmark, United Kingdom, Germany and Spain and a combined cycle installed in Portugal. Damages have been calculated for a range of different assumptions – four different values of CO₂ emissions – varying with each adopted discount rate (1, 3 and 5%) and within the 95% confidence interval. The estimates to 1% discount rate correspond to a scenario where impacts occur for a longer period.

Table 2. External costs for different damage estimates (Source: European Commission, 1998a).

External costs	Wind (€/MWh)	CCGT (€/MWh)
Low	0.02 – 0.07	1.93
Mid 3%	0.11 – 0.31	9.41
Mid 1%	0.29 – 0.81	24.02
High	0.87 – 2.44	72.54

3.2 Results

With the technical characteristics of the power plants presented in Table 1 and with the economic assumptions, the annual levelized costs - €/MWh of electricity produced - have been calculated for the two technologies. The results are shown in Table 2.

This approach does not incorporate several aspects, like the need of backup capacity to compensate wind intermittency and fluctuations, or the need to reinforce the distribution and transmission systems, or the feed-in tariffs.

Table 3. Annual levelized costs for the two technologies.

Costs	Wind		CCGT	
	(€/kW)	(€/MWh)	(€/kW)	(€/MWh)
1. Investment				
r = 5%	1206.20	50.23	514.19	4.90
r = 10%		73.52		7.61
2. O&M				
r = 5%	15.37	7.98	23.59	3.17
r = 10%		7.98		3.17
3. Fuel				
r = 5%	--	--	22.23 €/MWh	38.98
r = 10%	--	--		38.98
4. External				
low		0.02 – 0.07		1.93
mid 3%		0.11 – 0.31		9.41
mid 1%		0.29 – 0.81		24.02
high		0.87 – 2.44		72.54
Total cost (no external)				
r = 5%		58.21		47.05
r = 10%		81.50		49.76
Total cost (with external)				
r = 5%				
low		58.23 – 58.28		48.98
mid 3%		58.32 – 58.52		56.46
mid 1%		58.50 – 59.02		71.07
high		59.08 – 60.65		119.59
r = 10%				
low		81.52 – 81.57		51.69
mid 3%		81.61 – 81.81		59.17
mid 1%		81.79 – 82.31		73.78
high		82.37 – 83.94		122.30

From the LCCA, the obtained total production costs for wind technology were 58.21 €/MWh and 81.50 €/MWh, for 5% and 10% discount rates, respectively. In the first case,

investment costs represented about 86% of the total cost, and in the second case, this share was near 90%. The remaining costs correspond to O&M values. Including external costs, the total costs are expected to be in the range of 58.23 – 60.65 €/MWh, for the lowest discount rate, and 81.52 – 83.94 €/MWh, for the highest discount rate. The environmental costs represent about 0.03 – 4.02%, for the 5% discount rate and 0.02 – 2.91%, for the 10% discount rate.

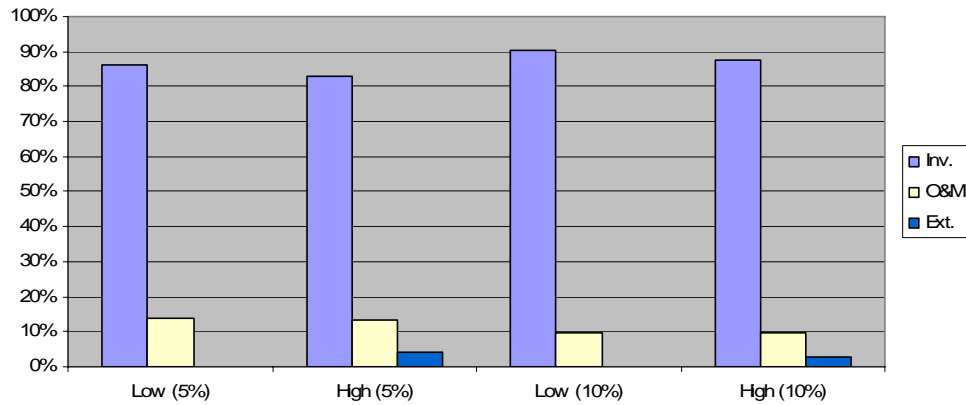

Figure 2. Estimated cost structure for wind plant (5% and 10% discount rate).

For the CCGT system the annual levelized costs, without the environmental costs, reach 47.05 €/MWh, for the 5% discount rate and 49.76 €/MWh, for the 10% discount rate. About 10% and 15% of these costs represent investment costs, respectively. For this technology the major share of costs results from the gas consumption - close to 83% and 78%. The range of values obtained, including the environmental costs, is 48.98 – 119.59 €/MWh and 51.69 – 122.30 €/MWh, respectively for 5% and 10% discount rates. For the low external cost estimations, fuel cost represents the predominant share of the total costs. However, for high external cost estimations environmental costs overcomes fuel cost values.

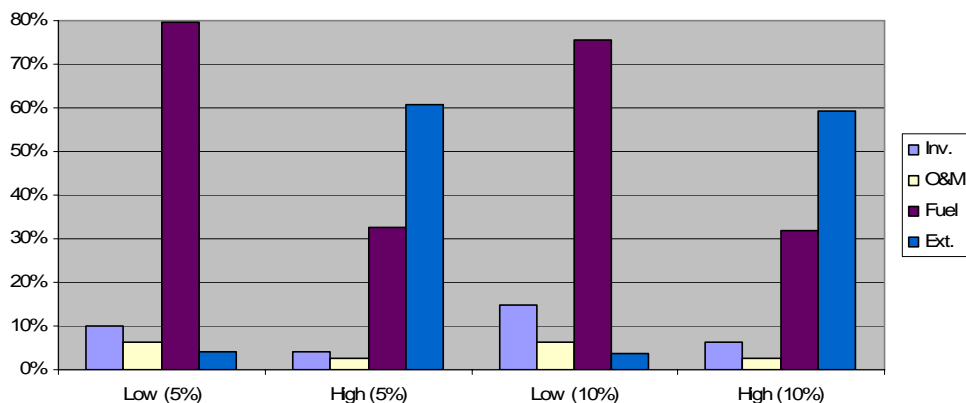

Figure 3. Estimated cost structure for CCGT (5% and 10% discount rate).

4 Discussion of the results

Although being a renewable energy source without fuel consumption costs, the investment costs of wind power plants are considerably higher than the gas technology investment values. This results in higher production costs (€/MWh) for wind plants (when external costs are not included).

From the analysis, it was possible to verify that, in order for the total uniform costs of the two technologies (without environmental costs) become similar, the investment cost of the wind system would have to reduce almost by a 22% factor (for a 5% discount rate) or by half (for a 10% discount rate), of the current value.

Other aspects can significantly affect the results obtained. For instance, the increase of the natural gas price (as verified in recent years) or the reduction of the wind farms' O&M costs.

Given the current concerns about GHG emissions, their effects and the European emissions trading schemes, it is also important to analyse the emissions market effects on the total costs of the two technologies.

The total costs, of the two technologies when including the environmental costs, are similar for high and 1% medium estimates of the external costs. For this scenario, the total costs of the gas technology increase significantly and its production costs become twice as high as the wind electricity production costs.

5 Conclusions

In this study, the total generating costs of wind power and CCGT, in Portugal were analysed. A life cycle analysis for each system was performed. Grid costs associated with the distribution and transport systems and the compensation costs in the case of the wind energy (with the storage or backup units) were not included.

From the results for the Portuguese case, it can be concluded that the CCGT is still more attractive than the wind energy when only financial aspects are accounted for. Wind energy presents higher investment and O&M costs than the CCGT that are not yet compensated by the inexistence of fuel costs. In addition the wind energy load factor in Portugal (22%) is low when compared with the adopted for CCGT (85%)

When external costs are considered, the electricity generation costs for the two technologies are similar. However, for high estimates (of GHG emissions) the wind system reaches more attractive values. For this case, environmental costs dominate the cost structure of the CCGT.

The results were obtained assuming constant values. However, an increase on conventional systems costs may be expected, in result of the resources depletion, as well as of the environmental politics (when considered environmental costs). The price of the natural gas has been presenting a significant growth between 2003 and 2005 (almost 84%) and, therefore, in a short time the inversion of the obtained results may be verified, creating a competitive advantage for wind power.

At the same time, the costs of the renewable systems should decrease due to the development and diffusion of these technologies. The analysis showed that the uniform costs of the two technologies (without environmental costs) would be similar if the investment costs of wind energy were reduced by almost 22% (for 5% discount rate) or by half of the current value (for 10% discount rate).

For the expansion of the renewable technologies a strong support from governmental institutions is fundamental. The reduction of the atmospheric emissions must be a

priority and the inclusion of the external costs in the economic analysis, should be generally implemented for the evaluation of energy projects.

The sensitivity analysis showed that the increase of the discount rate causes an increase of the investment costs and consequently an increase of the total costs. As the combined cycle has lower investment costs the effects of this parameter in this technology is less significant.

The increasing of fuel escalation rates is the parameter that originates larger effects in the final costs. Even when considered this escalation rate the CCGT system presents lower levelized costs (without environmental costs) than the renewable system for the discount rates and load factors adopted (only exceed for fuel escalation rates superior to 5%).

The total costs (without environmental costs) of a wind farm are more influenced by the load factor than the CCGT system.

The expectations and incentives around the wind energy are comprehensible. Besides, being a renewable energy source, the expected development and the consequent reduction of the costs will turn this technology even economically attractive to the investors. If the life cycle is analysed and the external costs for the wind energy are included it can become more advantageous than the conventional systems.

The expansion of the wind technology in Portugal will influence significantly the energy system costs, but it is fundamental for the execution of the European and national goals in the renewable electricity production, and to contribute for the GHG reduction. Wind power presents the obvious advantage of having operational costs invulnerable to fuel and emissions markets volatility. This represents a clear advantage in an electricity system highly dependent of external energy sources as it is the case of Portugal.

References

- BCG, 2004. O caminho para o desenvolvimento sustentado da PRE em Portugal. Setembro de 2004.
- El-Kordy, M.N., Badr, M.A., Abed, K.A., Ibrahim, Said M.A., 2002. Economical evaluation of electricity generation considering externalities. *Renewable Energy* 25, 317-328.
- European Commission, 1997a. ExternE National Implementation Germany. Novembro, 1997.
- European Commission, 1997b. ExternE National Implementation Denmark. Dezembro, 1997.
- European Commission, 1997c. ExternE National Implementation Spain. Dezembro, 1997.
- European Commission, 1998a. The National Implementation in the EU of the ExternE accounting framework – Implementation in Portugal of the ExternE accounting framework. Janeiro, 1998.
- European Commission, 1998b. Power generation and the environment – a UK Perspective. Junho, 1998.
- European Commission, 1998c. ExternE – Externalities of energy – Methodology Annexes.
- European Commission, 2003. External Costs – Research results on socio-environmental damages due to electricity and transport. Luxembourg, 2003.
- European Commission, 2004. Externe – Externalities – Methodology 2005 Update. Luxembourg, 2004.

- EWEA, 2003a. Wind energy – The facts. (www.ewea.org).
- Ferreira, P., Araújo, M., O’Kelly, M.E.J., 2006. An overview of the Portuguese wind power sector. *International Transactions in Operational Research*, 14, 39-54.
- Nuclear Energy Agency, International Energy Agency, Organization for Economic Co-Operation and Development, 2005. Projected costs of generating electricity: 2005 update
- REN, 2004b. Relatório técnico 2001-2003 (www.ren.pt).
- REN, 2005a. Dados técnicos 2005 (www.ren.pt).
- Sevilgen, S.H., Erdem, H.H., Akkaya, B.C.A.V., Dağdaş, A., 2005. Effect of economic parameters on power generation expansion planning. *Energy Conversion & Management* 46, 1780-1789.

Economic and Financial Feasibility of Wind Energy - Case Study of Philippines

Jyoti Prasad Painuly
UNEP Risoe Centre, Risoe National Laboratory
Technical University of Denmark, Roskilde-4000, Denmark
jpainuly@risoe.dk

Abstract

The financial viability of a 30 MW wind farm proposed to be set-up in St. Ana in Philippines was examined. It was found that project is viable if established by a company with a low hurdle rate (8.68%) and good reach to avail low cost financing from domestic financial institutions, who may have such packages for low-risk customers. Most of the private sector investors however have higher discount rates due to high financing costs, and higher risk premiums charged by financiers. The viability was an issue at risk adjusted discount rate of 13.2%, a typical rate for private sector investors in Philippines. Scenarios for variation in base parameters as well for a variety of financial packages, including revenues from CDM were run. Although CDM revenues improve attractiveness of the project, viability remains an issue. A financing package, that may have a grant component (as with the Danida package in the past), can help project make viable in this case.

1 Introduction

Wind energy has been one of the most promising renewable energy with an installed capacity of 74,223 MW at the end of 2006, spread across 70 countries¹. Market has been growing at more than 30% despite supply constraints with Euro 18 billion investment in generating equipments in 2006. Although most of the installed capacity is in developed countries, some developing countries such as India and China are also among the high growth markets., indicating viability of wind energy for entrepreneurs in developing countries as well.

There are varying estimates of wind energy potential in Philippines; from 7400 MW² to 76600 MW³. The Department of Energy, Philippines identified areas with strong winds, which can contribute a capacity of 345 MW, and invited investors to set up wind energy

1 GWEC, 2007. **Global wind energy markets continue to boom – 2006 another record year**, Global Wind Energy Council.
http://www.gwec.net/index.php?id=30&no_cache=1&tx_ttnews%5Btt_news%5D=50&tx_ttnews%5BbackPid%5D=4&cHash=7a562a4d4e

2 Biota Filipina, March 2006, WWF.
<http://www.wwf.org.ph/downloads/biota/Mar2006.pdf>

3 Elliott, D., Schwartz, M., George, R. Haymes, S., Heimiller, D., Scott, G., McCarthy, E. (February 2001). **Wind Energy Resource Atlas of the Philippines**, National Renewable Energy Laboratory, USA. (NREL/TP-500-26129;
<http://www.nrel.gov/wind/pdfs/26129.pdf>).

farms. Subsequently, a 25 MW wind power plant in Luzon, first wind energy plant in Philippines, was commissioned in 2005. Renewable energy projects find it difficult to access to finance, particularly in developing countries and wind energy is not an exception to this. Although Philippine Government provides incentives through Wind Power Investment Kit to promote wind energy, funding from external sources has been key to development of wind energy in Philippines so far. Besides first plant in Luzon, which was funded by Danish Agency for Development Assistance (DANIDA), some other projects are in early stages of discussions for funding by other donors. Financial assistance from the United Nations Development Programme-Global Environment Facility (UNDP-GEF) in project preparation and loan guarantee for the project is one of the options for development of wind energy in Philippines. Domestically, loan guarantees have been given to some wind projects by Philippine Export and Import Bank, and Development Bank of the Philippines also has its own Wind Energy Financing Program. Since wind energy may find it difficult to compete with low grid tariffs, it becomes important to carry out Economic and Financial Analysis to determine the level of support needed through grants and / or soft loans for specific wind energy projects. This paper is an attempt in that direction; it discusses various possible options to make wind energy projects viable in St. Ana, a potential location for wind energy farm in Philippines.

2 Financial Analysis of Sta. Ana Wind Energy Project

2.1 St. Ana- Location and Technical Assessment

Philippines is made up of hundreds of islands with three main island groups Luzon, Visayas, and Mindanao. From the wind resource perspective these islands can be divided in three zones; zone 1 up to maximum air velocities as high as 70 m/s, zone 2 with maximum wind velocities up to 55 m/s, and zone 3 up to 35 m/s. Sta. Ana falls in the first zone and is located in the northern tip of Philippines in the Cagayan region. Philippine is a typhoon prone zone; maximum wind speeds pose a challenge for design of wind turbines and increase their costs. Site selection for turbines was made by Philippines experts using standard criteria and they also carried out wind measurements at the selected site. Technical assessment of the wind farm was carried out by the Wind Energy, Risø with the help of local experts, and using wind data measurements between September 2005 to April 2006. The technical data from the assessment was used in the analysis. Wind measurements are normally required for longer durations to guard against random short time variations, and to increase reliability. Such measurements can also be verified for reliability using data from other available studies.

Sta. Ana has been proposed as a 30 MW wind energy farm. The results of the technical assessment for Sta. Ana indicated a mean wind speed of 4.9 m/s, and a maximum of 18 m/sec, with mean power at 132 W/m². According to the technical analysis, generation can be expected to be 60 GWh / year, using 2 MW V66/ 67 m wind turbines. Generation however goes up to 80 GWh /year using 2 MW V80 / 67 m wind turbines⁴. Expected investment for this was indicated at US\$30 million in the plant and machinery.

2.2 Financial Analysis

The analysis has been carried out for the proposed 30 MW Wind Farm at St. Ana. Analysis has been carried out only for 80 GWh, since viability was an issue even at 80 GWh.

4. The generation depends on the location of wind turbines at the site, and type of wind turbines, varying from 43- 61 GWh/y for 2 MW V66 /67 m wind turbines to 57-79 GWh / y for 2 MW V80 / 67 m wind turbines.

From the analysis, concessional financing and / or the CDM come out important for project viability, if normally acceptable internal rate of return (IRR) to private investors (at a minimum 13.2%) is considered. Since St. Ana does not seem to be viable without concessional financing, it can be considered a good candidate for the CDM.

Project financial feasibility was assessed by calculating net present value (NPV), and IRR of the project. Impacts of the expected CDM revenues by selling certified emissions reduction credits (CERs) on NPV and IRR of the project were also calculated. Two set of sensitivity analyses were carried out; the first set for variation in project parameters such as expected investment, electricity generation, and O & M costs, and the second set for a set of financial packages that may be available to investors. The project was evaluated for its lifetime of 20 years. All costs and benefits data used in the analysis are based on 2006 prices.

2.21 Data and Assumptions

Data and the assumptions made in the analysis are included Annexure 1. The data was provided by local experts. Some of the data are discussed below.

Total Investment: Estimated total investment for the wind farm was US\$51.77 million including for feasibility study, site and project development, plant and equipment, engineering and installation, and other miscellaneous expenses. Investment is made in 2007, but no escalation was considered.

Annual Operation & Maintenance (O & M) Costs: Estimated at US\$1.1 million per year (2.1% of investment), these include land lease, property taxes, personnel, insurance, spare parts, equipment repairs, travel, administrative costs, contingencies etc. O & M costs starts occurring only from 2008 (first year of plant operation), but no escalation in the prices is considered until first year of operation (2008). O & M costs are assumed to increase by 3% every year, over the previous year's costs.

Estimated annual energy output: It is assumed that the plant achieves 80 GWh level of generation in the first year of the operation itself, and the level is maintained over the 20 year life of the plant. Transmission losses to point of sale to distribution company are taken at 7%. Therefore power available for sale is 93% of the above generation.

Electricity sales price: Projected rate of power purchase by the distribution utility was taken as Philippine Peso (Php or P) 4.91 per unit (KWh) in 2006. It was taken to increase by 3% every year (over the previous year's price).

Financing Plan: The required investment is planned to be funded through 20% equity contribution, and the rest 80% through a loan. In the base case, loan is assumed to be from domestic sources (such as DBP in Philippines), the term being 15 years, with a (GP) period of six years, and an interest rate of 8%. The loan disbursement is done during the construction period, which is assumed to be one year (first year). Entire loan is assumed to be disbursed in the first year at the end of the year (and hence does not incur any interest costs during the first year). If we were to assume that disbursement of loan is in the beginning of the first year, interest for one more year will need to be paid, which could be paid at the end of the first year. In reality, disbursement may occur in a phased manner, or towards second half of the year, resulting payment of some interest costs in the first year also.

No amortization of the interest and principal payments has been done to arrive at equated installments (quarterly, or half yearly, or yearly). Principal repayments are assumed annual, and divided equally over the term. Principal repayments (and interest payments) are assumed to be made at the end of the year. So interest is paid for the full year on outstanding principal at the beginning of the year.

Revenues from the CDM: The combined margin emission factor was applicable in this case. It was 0.655 t CO₂ eq. / MWh in the case the case of Northwind Power Plant, proposed in Philippine, but has come down slightly since then. It was taken as 0.625 t CO₂ eq. / MWh, as calculated by Mercapto, one of the project partners. CER prices can

vary- a range of \$5 to \$20 per ton has been observed in the past. CER prices of \$6 per ton and \$10 per ton were considered for the base case.

Revenues from sale of CERs are assumed to occur for the entire life of the plant. The CDM rules currently permit two terms; 10 year, or 14 year with a requirement to revise baseline after 7 years. This could change the available CERs and hence revenue from the CDM. Price of the CERs may also be different after 7 years. Also, CDM (or a similar mechanism) could continue beyond current time frame, once negotiations on this issue are over at the international forums. Prices of CERs then may go up. For simplicity, no change in baseline and CER prices were considered; instead CERs revenue at these rates were assumed for entire plant life.

2.22 Methodology

As already mentioned, NPV and IRR were used as indicators to determine financial viability.

Net Present Value (NPV): NPVs were calculated at the discount rate (or hurdle rate) corresponding to the cost of the finance and spread needed by typical investors in Philippines (based on information provided by experts). Typical discount rate for the given financial plan of the project in the base case worked out to 8.68%.

Calculations of discount rate consisted of calculation of weighted average cost of capital (wacc) derived from the financing option available to the investors. The data for this was provided by the local experts in Philippines. The wacc⁵ was calculated as follows;

$$W_C = (E/TC) * R_E + (D/TC) * R_D * (1-T)$$

Where; W_C is weighted average cost of capital, E is the equity contribution, D is the debt, TC is the total cost (D+E), R_E is the required return on equity, R_D is required rate of return on debt, and T is the tax rate

The required rate of return on equity was taken as 11%.

Required rate of return on debt was calculated as follows;

R_D = Rate of interest on debt + 1.5% (exchange risk, in case of foreign loans) + 2% guarantee fee (in case of foreign loans to private sector; it is 1% for loans to government in Philippines, and between 1.5 to 2.5% for others).

The discount rate (or hurdle rate) then is taken as W_C + 2% spread (for real IRR, and 5% for nominal, taken by some investors in Philippines).

Thus, the wacc in the base case (with 20% equity, and 11% R_E , 80% domestic loan at 8% interest rate, and tax rate of 30%) is;

$$= 0.20 * 11 + \{(8+0 \text{ (forex risk cost)}+0 \text{ (guarantee cost)}\} * 0.80 * (1-0.3) = 6.68\%$$

And discount rate = 6.68+2 = 8.68 %

NPV was also calculated at a discount rate of 13.2%, which was considered risk adjusted discount rate for their wind energy projects in Philippines by Northwind, which was registered as a CDM project. According to available information, most of the private investors may require an IRR of 17-18% (in nominal terms) for the project to be considered viable.

⁵ wacc does not remain constant throughout the project life. As the debt is repaid, contribution of debt to wacc will reduce and that of equity increase. Therefore, considering that cost of equity is more than debt, wacc will increase over period of time. But it is very difficult to calculate a weighted wacc from year-wise wacc. To increase the accuracy of the NPV calculations, what is done is that these wacc values are used to discount corresponding cash flows in the respective years to calculate the NPV. This has not been done here due to complications involved. Therefore, NPV values obtained can be said to be somewhat overestimates.

Internal Rate of Return: Following types of IRRs were calculated;

(a) **Financial IRR for the project entity**, based on operation-oriented cash flows of the project.

(b) **Modified financial IRR for the project.** IRR assumes re-investment of cash flows, as well as re-finance (in case of intermediate negative cash-flows) at the same rate as IRR. Re-investment and re-finance rates for the intermediate cash flows can be provided in the modified FIRR. These were taken as 6% for reinvestment, and 10.5% for re-finance (same as short term loan for working capital in Philippines).

(c) **Financial IRR for the investor** based on cash flows of the investor. It only considers cash flows of the investor. This could be interest to the shareholders, who invest in the project.

Impact of carbon financing: Base case was extended to include impact of carbon financing (as a CDM project) on the above indicators (NPV and IRRs). Two CER prices; \$6 and \$10 per ton/ CO₂ eq. were considered.

2.23 Base case variations

Following variations of the base case were considered, after discussions with the Philippine partners, reflecting their perception on uncertainty in the data;

- (a) Electricity sales price is 10% higher
- (b) Investment in the wind farm is 20% higher
- (c) Electricity generation from the plant is 20% lower
- (d) Annual O & M costs are 20% higher

2.2.4 Financing Scenarios

This included analysis of a variety of possible financing options,. Discount rates were calculated from these options and a spread-sheet model simulated to find impact of the options on various indicators. The financing scenarios are indicated in Table 1, along with their discount rates.

Table 1; Financing Scenarios

S.No.	Financing scheme	Discount rate
B	Base case; Domestic loan at an interest rate of 8%, 15year term with a grace period of 6 years	8.68
F1	Loan, financed through ODA at 0.3% for 20 years, with a grace period of 10 years.	6.33
F2	JBIC ODA at 0.90% for 20 years and a grace period of 6 years (untied, as applicable to Philippines; http://www.jbic.go.jp/english/oec/standard/)	6.66
F3	OECD commercial loan at 5% for 10 years, with a grace period of 1 year (construction period).	8.96
F4	Danida financing; 35% grant and balance 65% as loan at 7%, 10 year term	9.80

Note: Loan amount is 80% of the total investment in all the scenarios. Balance 20% is equity contribution by the Investor. Data for scenarios 1 to 5 is based on common knowledge of these available loans. These may also change from time to time. Foreign exchange risk cost is taken as 1.5% and guarantee fee as 2% (as applicable to private investors in Philippines), except for Danida (1.5%).

2.2.5 Results

Base case and variations: The results of the base case and its variations for Sta. Ana are given in Table 2.

It can be seen that the project has positive NPV in the base case even without the CDM. This is because discount rate is only 8.68%. But if risk adjusted discount rate of 13.2% were considered, NPV is negative even with CDM (with CER at \$10/t). IRR of the project is below 10% without CDM, and marginally above 10% with CDM. MIRR is below 8% even with the CDM, indicating need for concessional finance. It is because of the assumption that intermediate cash flows from the project can be invested only at 6%, and intermediate investment (- ve cash flows) incur 10.5% interest rate. As can be expected, all the variations, except electricity tariff increase, further reduce the attractiveness of the project. Of the three variations- investment increase by 20%, electricity generation less by 20%, and O & M cost increase by 20%- electricity generation reduction has the most adverse impact on the project, indicating importance of reliable wind measurements.

Table 2; Base Case and variations (NPV in million P)

Indicator	Base case	Elect Tariff +10%	Investment +20%	El. Gen. - 20%	O&M costs +20%
NPV 8.68% (hurdle rate)	243	614	-230	-385	138
With CDM; \$6/t	379	750	-95	-276	273
With CDM \$10/t	469	840	-5	-204	364
NPV 13.2%	-553	-278	-1052	-1020	-632
With CDM; \$6/t	-453	-178	-951	-939	-531
With CDM; \$10/t	-386	-110	-884	-885	-464
IRR	9.83%	11.53%	7.75%	6.79%	9.33%
With CDM; \$6/t	10.46%	12.14%	8.30%	7.33%	9.97%
With CDM; \$10/t	10.87%	12.54%	8.66%	7.69%	10.39%
MIRR	7.56%	8.16%	6.75%	6.35%	7.37%
With CDM; \$6/t	7.78%	8.36%	6.97%	6.58%	7.61%
With CDM; \$10/t	7.93%	8.50%	7.11%	6.72%	7.76%
IRR-Investor	14.03%	21.08%	7.28%	4.71%	12.26%
With CDM; \$6/t	16.47%	23.93%	8.89%	6.13%	14.57%
With CDM; \$10/t	18.19%	25.89%	10.02%	7.11%	16.20%

Increase in electricity purchase price by 10% increases the attractiveness of the project, indicating importance of price reforms for viability of renewable energy projects. Although IRR improved, it was still below 13.2%, the rate which reflects risk and higher cost of finance for a majority of private developers. Addition of CDM revenues in these cases makes project marginally better.

Financing scenarios results: These can be seen in Table 3.

Since all loans are concessional, they impact hurdle rate of the project developer, and consequently discount rate for NPV. ODA loan is obviously best option from the NPV perspective when discount rate for the scenario was considered, which is lowest at 6.33%. But IRR of this option is marginally lower than the others, mainly because tax paid is higher (due to lower interest charge). But IRRs are below 13.2% in all cases except the one with 35% grant (F4; Danida loan).

Table 3; Financing Scenarios**(NPV in million P)**

Indicator	Base case DBP 8%;15 yr, GP 6 yr	F1 ODA 0.3%;20yr, GP 10 yrs	F2 JBIC 0.90%;20 yr, GP 6 yrs	F3 OECD 5%;10 yr, GP 1 yr	F4 Danida 7%;10 yr (grant 35%), No GP
NPV 13.2%	-553	-616	-610	-609	66
With CDM; \$6/t	-453	-516	-510	-508	167
With CDM;\$10/t	-386	-448	-443	-441	234
Hurdle rate	8.68%	6.33%	6.66%	8.96%	9.80%
NPV	243	753	667	103	567
With CDM; \$6/t	379	915	824	236	692
With CDM;\$10/t	469	1023	930	324	776
IRR	9.83%	9.41%	9.45%	9.46%	13.76%
With CDM; \$6/t	10.46%	10.05%	10.09%	10.10%	14.60%
With CDM;\$10/t	10.87%	10.47%	10.51%	10.52%	15.15%
MIRR	7.56%	7.40%	7.41%	7.41%	8.81%
With CDM; \$6/t	7.78%	7.63%	7.65%	7.65%	9.06%
With CDM;\$10/t	7,93%	7.78%	7.80%	7.80%	9.22%
IRR-Investor	14.03%	50.73%	45.17%	13.32%	21.33%
With CDM; \$6/t	16.47%	53.50%	48.20%	14.71%	23.24%
With CDM;\$10/t	18.19%	55.34%	50.19%	15.67%	24.54%

3 Conclusions

Sta. Ana project is viable in the base case, when assumed a favourable domestic financing package, which reduces the discount rate for the project to 8.68%. CDM in this case adds to the attractiveness of the project. However, if favourable domestic financing package is not available, and risk adjusted discount rate of 13.2% is used (applicable for most developers- 13% to 18% discount rate), NPV of the project turns negative. CDM makes only marginal impact on project viability. Electricity tariff increase (by 10%) can make project attractive but the IRR at 12.5 % (with CDM) still remains below 13.2%. As expected, all other variations- investment increase, electricity generation decrease etc. make project unattractive.

Special financing packages, that include a variety of ODA low interest loans, increase the project attractiveness, but IRRs remain below risk adjusted discount rate of 13.2%,

making the NPV negative at this discount rate. CDM impact is only marginal, and does not change project viability status. However, one of the financing package, that includes grant (Danida, with 35% grant) is able to address the issue of viability, as IRR increases to 13.8, and goes up to 15.2% with CDM.

It needs to be noted that the results in the study correspond to the assumptions made, and are sensitive to changes in that. It is therefore important to check the assumptions for correctness, and revise if necessary, before arriving at a conclusion. It also needs to be noted that discount rates used in the study are based on a variety of financing options, most of which are low cost. Most developers, especially small investors may not have access to these concessional and favourable financing packages. In that case, appropriate discount rate (which will be higher) will need to be used. Further, risk adjustment has not been made (except for foreign exchange risk) in the discount rates used. Spread (or the loan- return above cost of loan) has also been taken only 2%, and required return on equity only 11%. All these may vary across developers; may be low for public sector and high for private sector. When all these factors are included, required IRR will be higher-expected to be between 13 to 18%. Project is not viable at discount rates higher than 11% in case of Sta. Ana in the base case (even with a favourable financing package), indicating need for further financial support.

Acknowledgement:

The paper is based on the work carried out for the project *Feasibility Assessment and Capacity Building for Wind Energy Development in Cambodia, the Philippines and Vietnam* - a project co-financed by EU-ASEAN Energy Facility. I would also like to thank other project partners, especially Samuel D. Hernando, Tess Marichie R. Lugue, and Anaflor L. Candelaria and Jimmy Villaflor from PNOC (Philippines), Niels Erik from Risoe- Wind Energy (Denmark), Emmanuel Huard from IED (France), and Bernt Frydenberg from Mercapto Consult (Denmark) for their help during the work.

Annexure 1; Data and assumptions for Sta. Ana

(2006 prices)

1. Debt - Equity ratio	80: 20
2. Total investment \$51766254 ; (excludes investment in transmission lines for grid connectivity) (1\$=52 P)	2691845208 P
3. O & M costs per year \$1059526	55095352 P
4. Rate of increase of O & M costs	3% per year
5. Grid Access charges	0.80 P/ KWh
6. Electricity Production (assumed to reach 100% capacity utilization in the first year of operation)	80 GWh
7. Losses in transmission to point of sale to distribution company	7%
8. Plant life	20 years
9. Tax rate	(i) Nil for first 6 years (ii) 30% after 6 years of operations. ⁶
10. Sale price of electricity (2006)	4.91 P / KWh
11. Rate of increase of electricity sales price	3%
12. GHG saving coefficient of the power for CDM	0,625 CO2 eq./MWh
13. CER prices used for CDM revenue calculations (1CER= 1 ton of CO2eq.)	\$6 and \$10 per CER
14. Discount rate (Calculated based on financing packages)	8.68% base case; 13.2% risk adjusted minimum needed by private developers
15. Re-investment rate of the cash flows	6%
16. Re-finance rate (if needed; which is interest rate for intermediate negative cash flows i.e. short-term loans)	10.5%
17. Rate of depreciation (for tax purposes)	5% assumed

Other assumptions:

1. Construction period has been taken as one year. After construction period, year plant comes in full operation (at 100% capacity).

2 The investment is done in the first year (beginning), and cash flows from sale of electricity start from the next year (year-end).

3. Principal loan amount is assumed to be paid equally over the life of the loan. Interest for the full previous year on the outstanding amount is paid in the current year. Amortization of the loan and interest can be done for equated installments, but has not been done here.

4. MIRR is an improvement over IRR. This is because IRR assumes that intermediate cash flows can be invested at the same rate (as IRR), whereas, actually possible re-investment rate can be specified in the MIRR. A re-investment rate of 6% was taken here.

⁶ From the data, although tax is 35% currently, it is 30% from 2009.

5. Impact of tax holidays for renewable energy (for first six years) on wacc was not considered.
6. Depreciation has been taken on the entire investment at 5% per year.
7. Terminal value (or salvage value) at the end of plant life of 20 years was taken as 10% of the original investment.

Session 7 – Solar and Wave Energy

Chairman: Ulla Röttger, Amagerforbrænding A/S, Denmark

Wave Energy – challenges and possibilities



By: Per Resen Steenstrup
www.WaveStarEnergy.com

Wave energy is an old story....



The first wave energy patent is 200 years old.

Over the last 100 years more than 200 new wave energy devices have been developed and more than 1.000 patents have been issued.

Over the last 30 years more than 400 million EUR have been spent on demonstrators in the sea, with little or no success.

Only in the last 5 years the practical solutions have started to show, with real chances of commercialisation.

Main features for success:

- Simple storm protection concept.
- Proven technology in the sea.
- Simple and reliable concept, with simple power take off system.
- Scalable to big MW systems in the future.
- Low weight per MW - potential for future cost reductions.



Wave energy concepts World wide, which have been tested in the sea

Oscillating water coloum – floating or fixed coastal installation. Air based Wells turbines as power take off.

Over topping waves into a reservoir, with low head turbines as power take off.

Articulating tubes with hydraulic power take off.

Point absorber, with either water pumps, linear generators or hydraulic power take off systems.

Multi point absorbers, with hydraulic power take off.

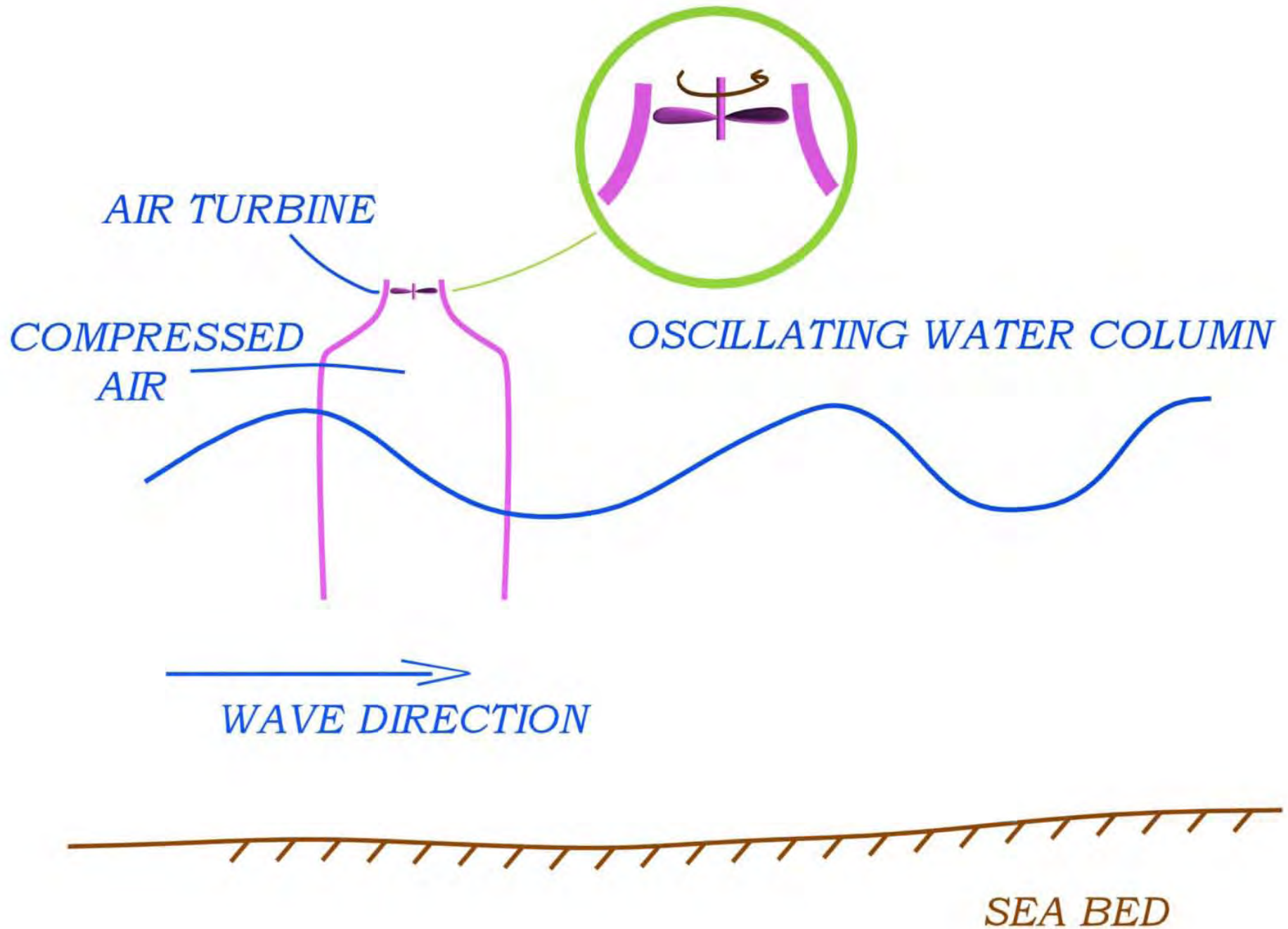

OVER TOPPING RESERVOIR

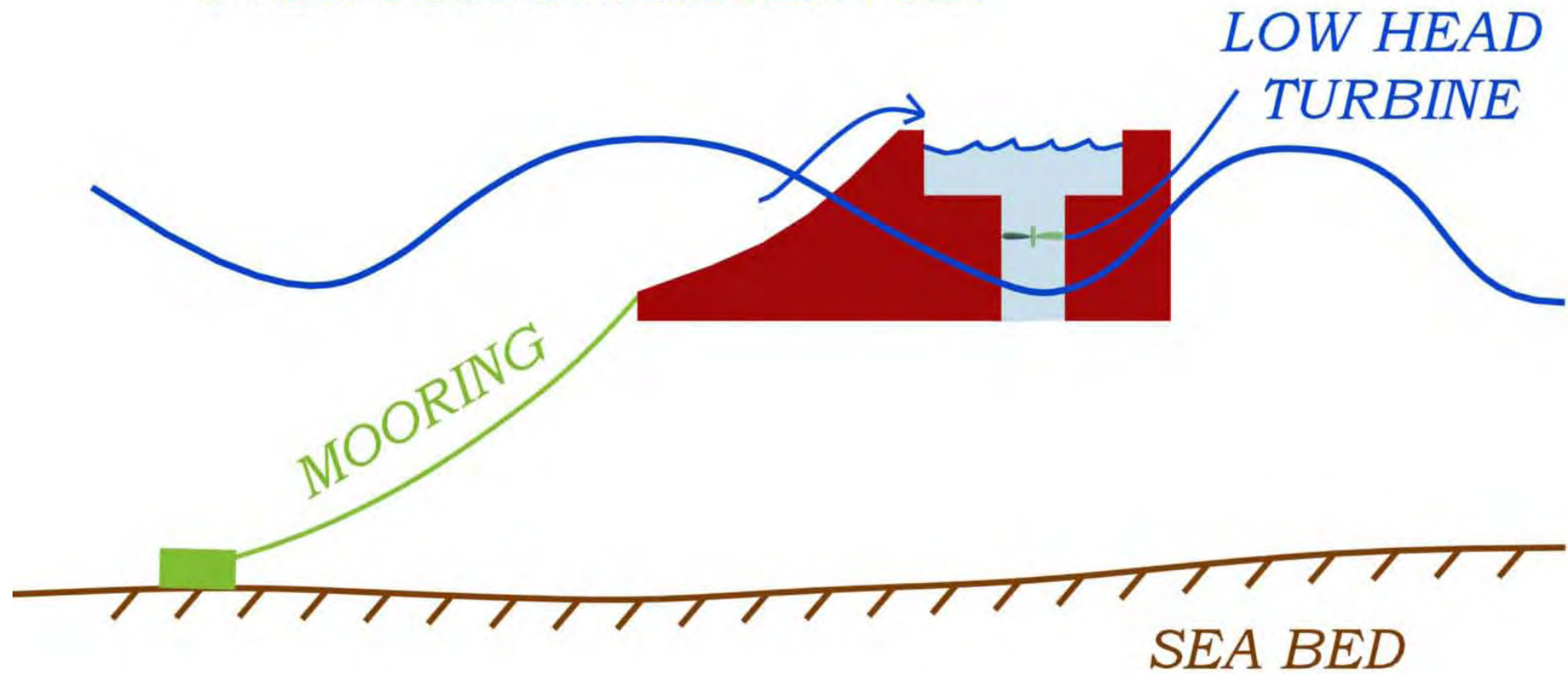

ARTICULATING TUBES WITH HYDRAULIC JOINTS

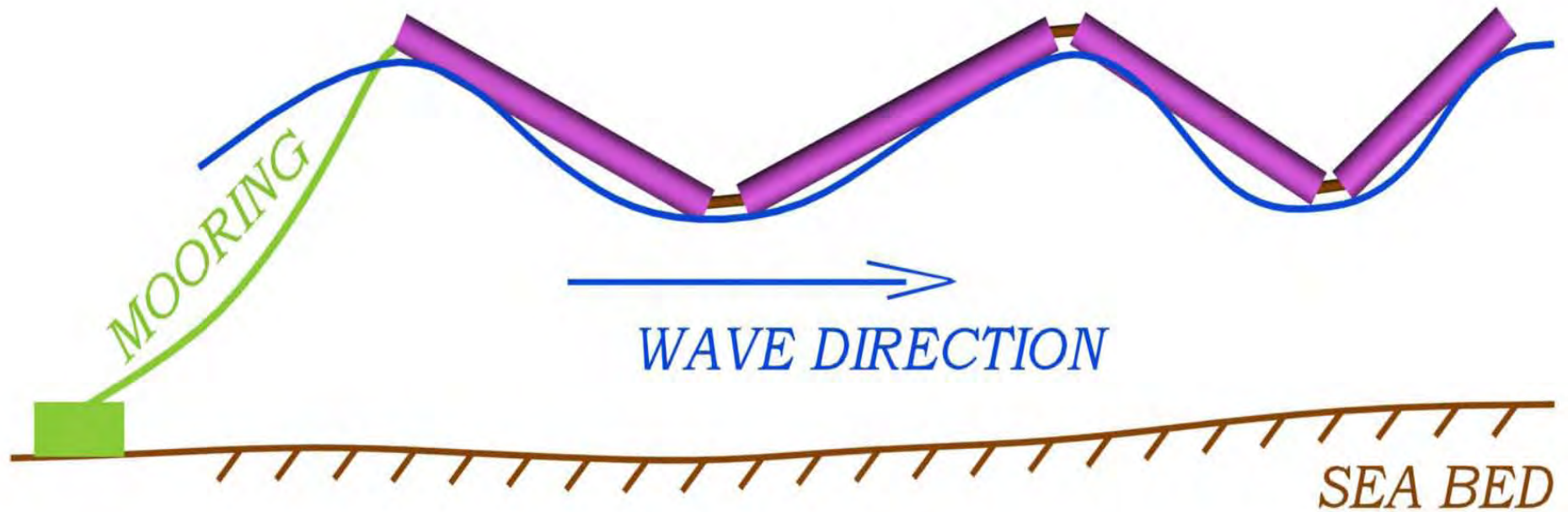

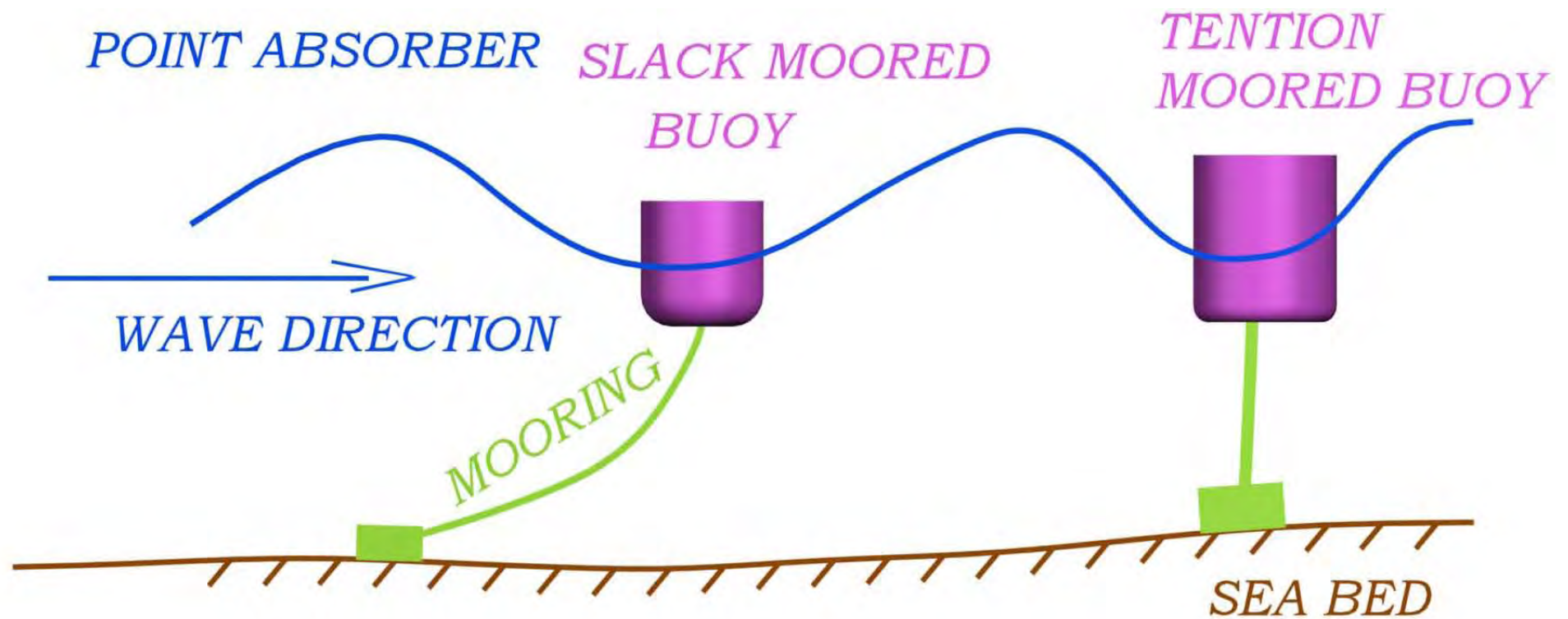

MULTI POINT ABSORBER

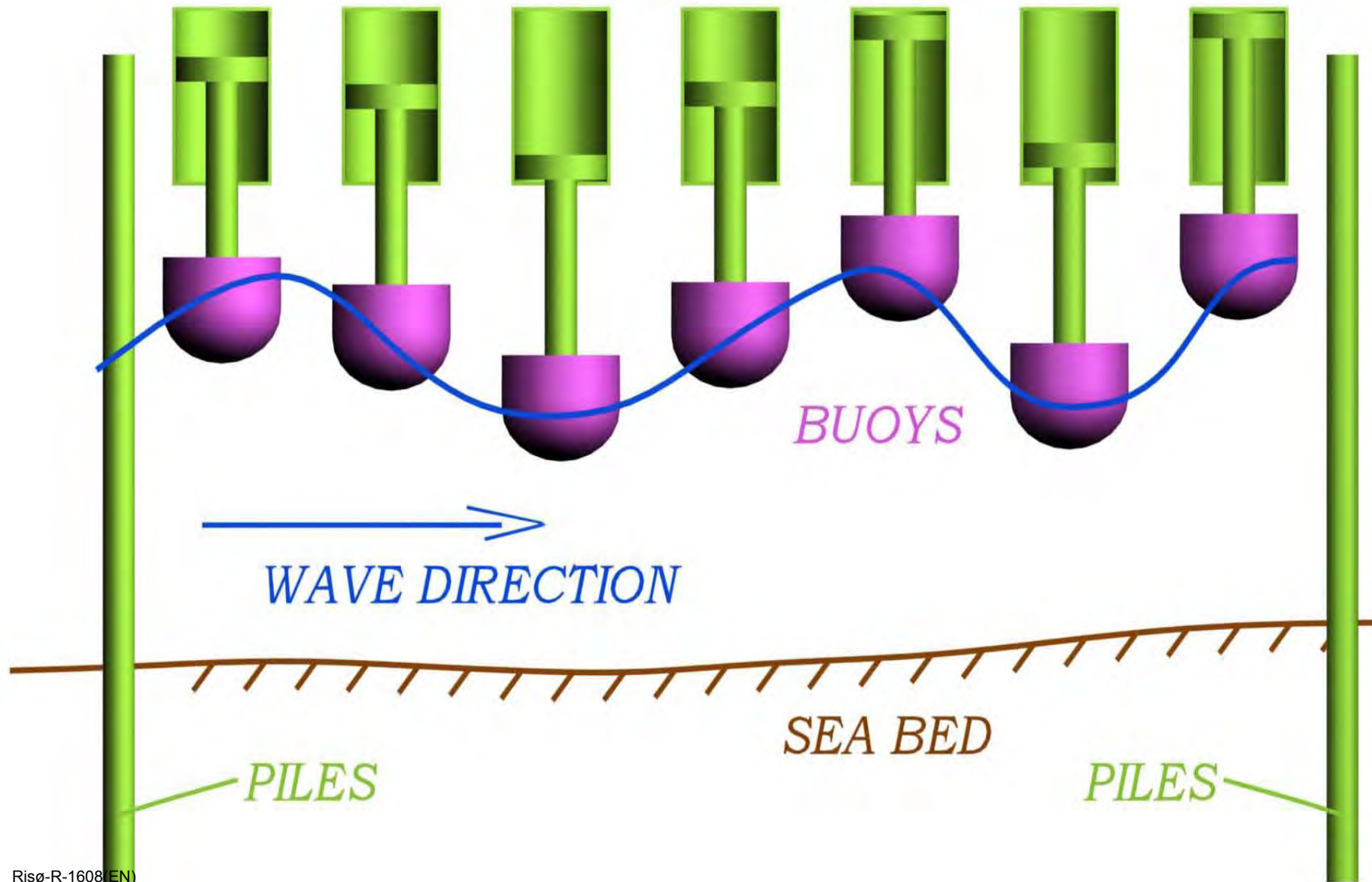

Wave Star's back ground in head lines.



Wave Star Energy was established October 1st 2003, with the sole purpose of commercialising wave energy.

Over a period of 10 months in 2004 a scale 1:40 converter was extensively tested in regular as well as irregular waves, to document the configuration, optimize the power output and document dynamic behavior compared to a hydro dynamic model.

Based on the extensive tank testing a scale 1:10 converter was designed and built during 2005 and deployed in the sea on April 6th 2006 at Nissum Bredning (DK). The converter was built and instrumented to the same high standard as a full scale converter.

After initial testing of all sub systems the converter was grid connected and put into unattended operation on July 24st 2006.

It has been in operation since then and logged more than 6.000 hours.



What is special about the Wave Star concept?

It is a simple reliable design, which can be storm protected. It sits on piles, just like an offshore structure.

All moving parts are above water and are well protected from the sea environment.

It is only based on standard components and standard offshore - and wind turbine technology.

It is scalable into multi MW converters.

Price and electric production per MW makes it realistic to become commercial over time, and supplement wind turbines on a big scale.

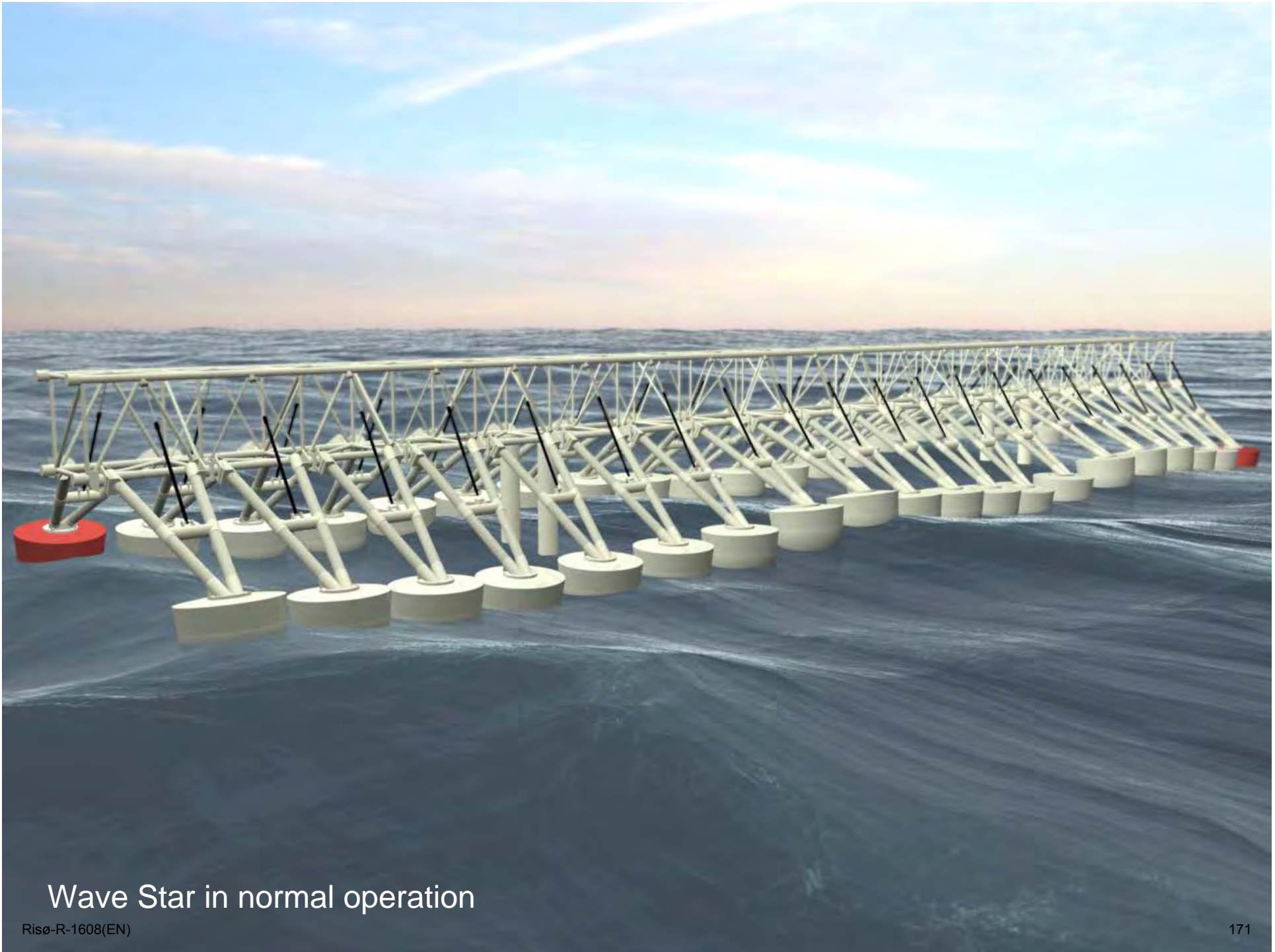

Wave Star in normal operation

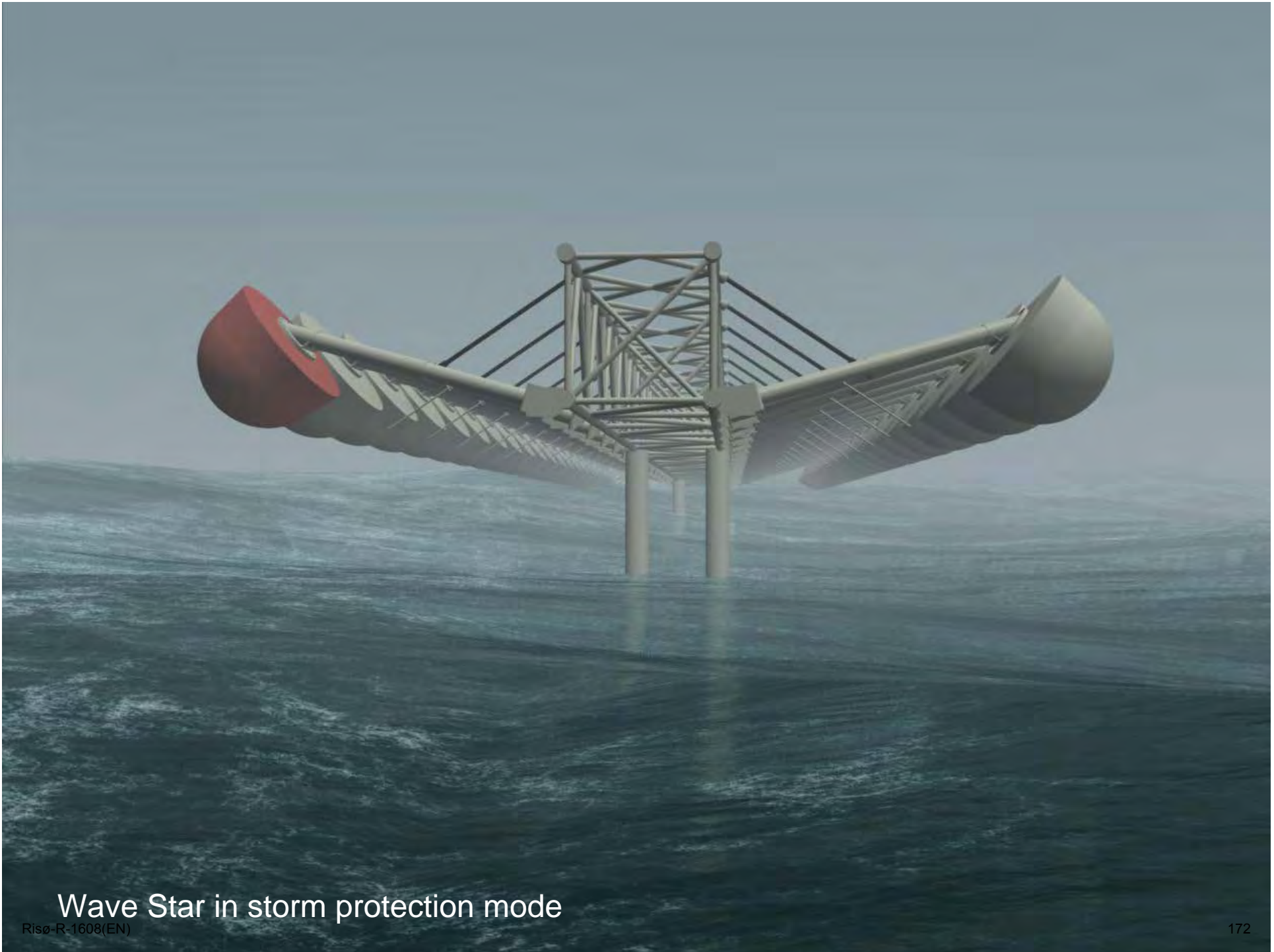

Wave Star in storm protection mode

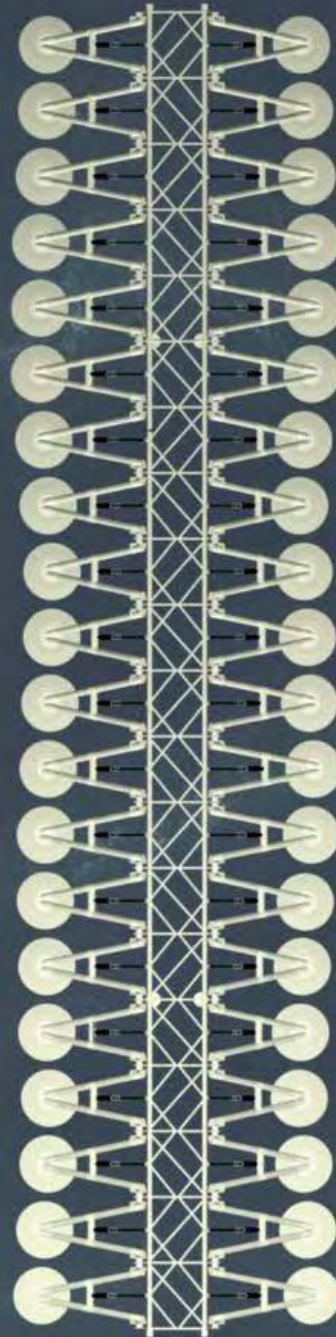

*Dominant
Wave Direction*

Birds view





Normal operation



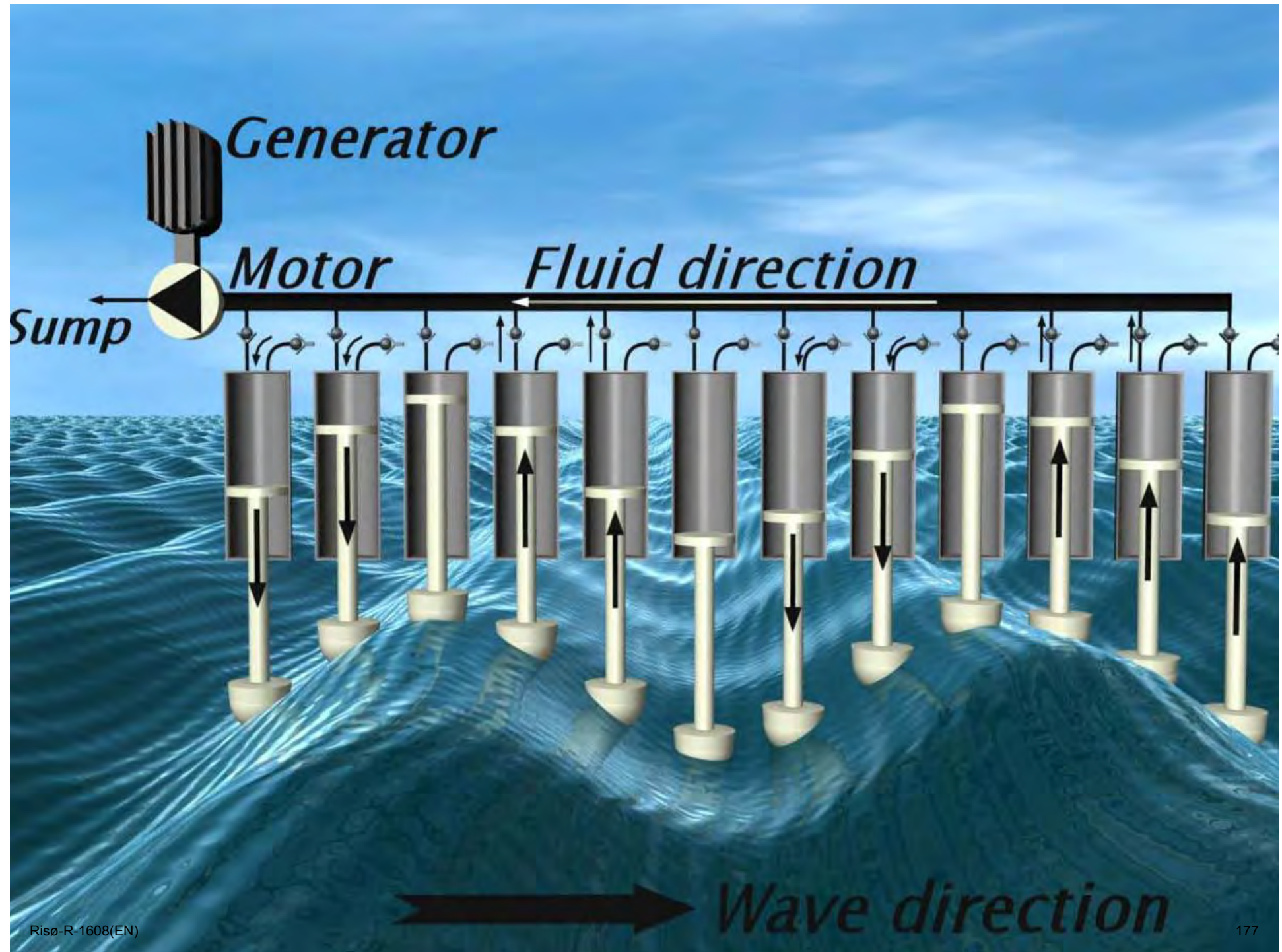



How does the power scale with size?

The test converter in Nissum Bredning is a scale 1:10 converter. It is 24 m long with 40 floats of each \varnothing 1m, and operates in 2 m of water. In **0,5 m Hs** the power output is **1.800 W** electric power.

The scale 1:2 converter is 120 m long with 40 floats of \varnothing 5 m and operates in 10 m of water depth. In **2,5 m Hs** the power output is **500 kW**.

The scale 1:1 converter is 240 m long with 40 floats of each \varnothing 10 m and operates in 20 m of water. In **5,0 m Hs** the power output is **6 MW**.

The scale 1,5 :1 converter is 360 m long with 40 floats of each \varnothing 15 m and operates in 30 m of water. In **7,5 m Hs** the power output is **24 MW**.



What are the plans for the future?

The scale 1:10 converter in Nissum Bredning will continue to operate until August 2008. The goal is to optimize the energy production and obtain long term working experience.

Design and build a scale 1:2, 500 kW converter for Horns Rev in the North Sea during 2007 / 2008 .

Arms and floats for the 500 kW converter will be installed and tested at a pier in the North Sea in 2008.

The scale 1:2, 500 kW will be pre installed at the North of Lolland at Onsevig i 2008 / 2009.

Later transferred and installed at Horns Rev (North Sea) in 2009.

Section of 500 kW machine will be installed here



Roshage Pier



500 kW Wave Star machine

Horns Rev installation



What are the major challenges for Wave Star in reaching a commercial break through?

Install and operate the first commercial 500 kW Wave Star Energy machine at Horns Rev i 2009 /2010, without any major technical problems or short commings.

Through cost engineering, in the early development phase of the 500 kW machine, bring the kWh cost down to less than 20 EUR cent, even when the machine is operated in 10 m of water depth and in a low wave climate of only 4 kW / m, in average.

Improve realiability of the first 500 kW machine, to make it the most reliable machine in the market.

Scale the machines in small steps to minimize risk.
500 kW, 1,5 MW, 3,0 MW, 6MW, 10 MW, 15 MW , 20MW etc.



Nissum Bredning test system

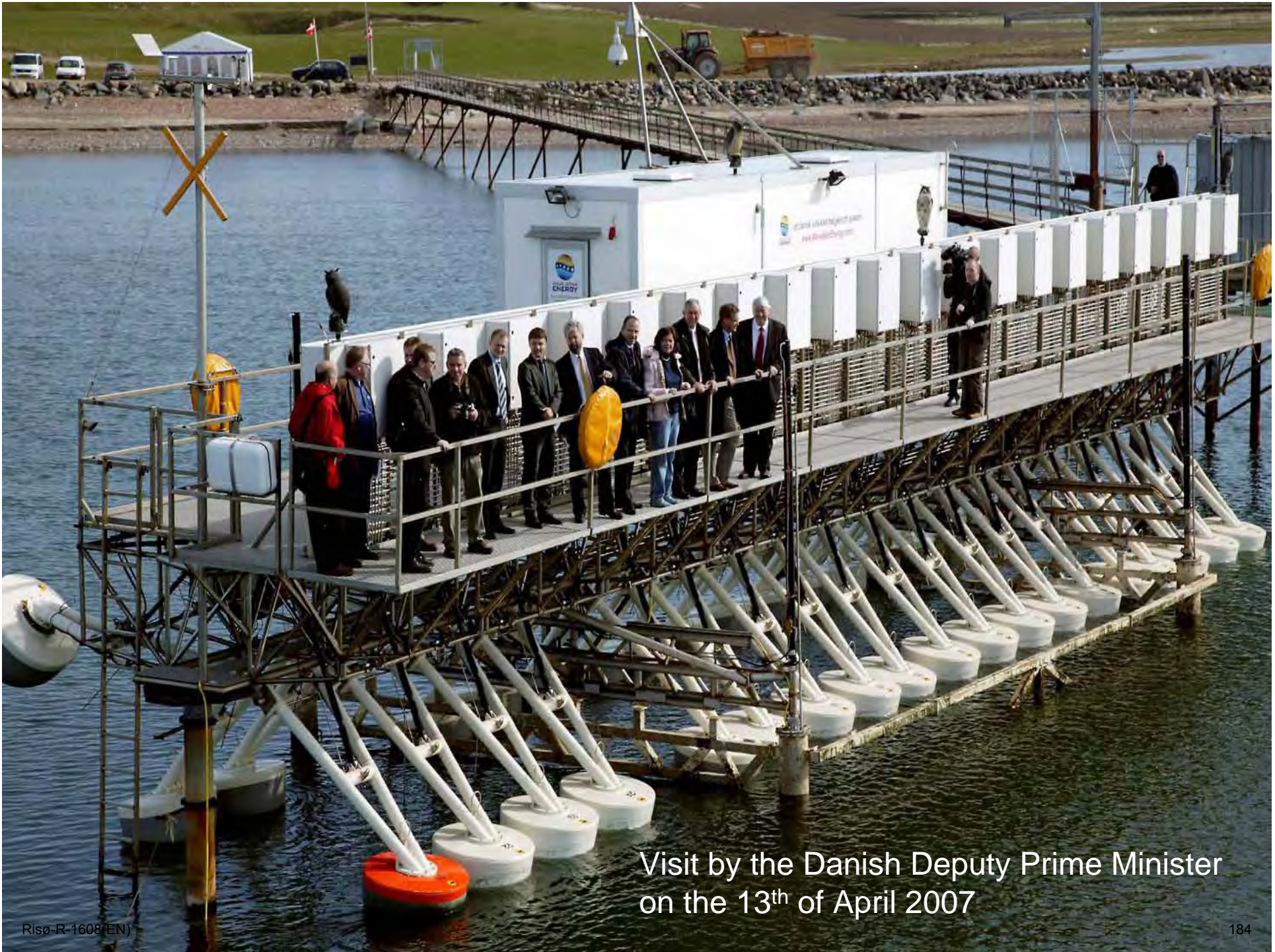

Visit by the Danish Deputy Prime Minister
on the 13th of April 2007

Session 8 – Systems with High Level of Renewable Energy

Chairman: Bjarke Fønnesbech, IDA, Denmark

Realisable Scenarios for a Future Electricity Supply based 100% on Renewable Energies

Gregor Czisch, Institute for Electrical Engineering – Efficient Energy Conversion
University of Kassel, Germany, Phone/Fax: (+49) 561-804-6377/6434, E-Mail:
gczisch@uni-kassel.de

Gregor Giebel, Risø National Laboratory, Technical University of Denmark

Abstract

In view of the resource and climate problems, it seems obvious that we must transform our energy system into one using only renewable energies. But questions arise how such a system should be structured, which techniques should be used and, of course, how costly it might be. These questions were the focus of a study which investigated the cost optimum of a future renewable electricity supply for Europe and its closer Asian and African neighbourhood. The resulting scenarios are based on a broad data basis of the electricity consumption and for renewable energies. A linear optimisation determines the best system configuration and temporal dispatch of all components. The outcome of the scenarios can be considered as being a scientific breakthrough since it proves that a totally renewable electricity supply is possible even with current technology and at the same time is affordable for our national economies. In the conservative base case scenario, wind power would dominate the production spread over the better wind areas within the whole supply area, connected with the demand centres via HVDC transmission. The transmission system, furthermore, powerfully integrates the existing storage hydropower to provide for backup coequally assisted by biomass power and supported by solar thermal electricity. The main results of the different scenarios can be summarized as follows:

- A totally renewable electricity supply for Europe and its neighbourhood is possible and affordable.
- Electricity import from non-European neighbour countries can be a very valuable and substantial component of a future supply.
- Smoothing effects by the use of sources at locations in different climate zones improve the security of the supply and reduce the costs.
- A large-scale co-operation of many different countries opens up for the possibility to combine the goals of development policy and climate politics in a multilateral win-win strategy.

To aid implementation, an international extension of the ideas of the German energy feed law (or similar other schemes around the world) is proposed for the follow-up treaty to the Kyoto climate accord.

1 Introduction

At the first Risø Energy Conference in 2003 [GiebelEtAl 2003] we have shown that the large-scale transport of renewable energy, in particular wind energy, via HVDC (High-Voltage Direct Current) is possible from some wind-rich regions around Europe to the centre of Europe with reasonable cost and with large development benefits for the installing countries. At the second Risø Energy Conference in 2005 [GiebelEtAl 2005] we presented calculations showing that due to the large differences in resources, it can be cheaper to use better wind resources further away (in this case, Egypt) than to use just

average resources in Northern Europe, even factoring in the transport over large distances. Meanwhile, since the first Risø Energy Conference in 2003, the evidence both scientific and from personal impression of climate change and the human contribution to it has grown significantly.

In this paper we want to present a framework for the implementation of the ideas shown in the previous papers, and the clear benefits of the large-scale distribution and transport of energy with a HVDC overlay grid. Using such a grid on top of the existing high-voltage grid on the continental scale enables Europe and the surrounding region to create all of its electricity solely from renewable sources. An optimisation procedure shows that the overall cost for the new system is comparable to the old one. Wind energy then creates about 70% of the overall generation, with hydropower and biomass making up the remainder.

2 The International Energy Feed Law

The German energy feed in law was one of the biggest success stories for new renewable energies in the world. To worldwide extend this success an international feed in law would be very helpful and if carefully arranged would conceivably promote the use of renewable energies more than any other measure. One possibility for Germany would be to extend the existing EEG (Energieeinspeisegesetz, energy feed-in law) to an agreement which can be ratified by other nations or to bring a similar arrangement on the international agenda coming into operation as soon as two countries have signed the agreement.

The EEG commits the utilities in Germany to accept any feed in of electricity from wind power and other renewable sources into the electrical net. It furthermore commits the utilities to provide an appropriate electricity network, sufficient to take the renewable electricity. Additionally, the EEG commits the utilities to pay a definite minimum feed in tariff for the renewable electricity – dependent on the kind of renewable source used for its production. The total payment is distributed accordingly to the end users electricity consumption of the utility's customers. One of its outcomes was the rapid growth of electricity production from wind energy which made Germany the world leading wind energy nation despite its mostly mediocre resource. Other countries with good success of wind power installations all have a similar law, e.g. Spain, Denmark (although there the success stopped after the drastic reductions in payments the new centre-right government 5 years ago), or Austria. Most other support schemes did not have the success that some form of feed in law has. This effect is most notable in Great Britain, where despite the great resource there was little wind energy activity for many years.

The international energy feed law is to be used further as a component of the energy policy and its effect should be improved. Essentially, either the EEG should be extended or a new set of rules should be created that promotes the development of renewable energies in form of an international agreement, which interested states can accede to by ratification. Together these states follow the aim to develop a rapid growth of the use of renewable energies and commit themselves on a long-term basis to change to a sustainable CO₂-neutral electricity supply. The financing of cost of electricity is to be distributed, as with today's EEG, proportionately according to the respective electricity consumption of the final customers within each country. Deviating from the German EEG, more like the Spanish feed in regulation, it seems sensible that only extra costs above a certain minimum are to be paid by the new community of responsible states. This minimum is to be agreed upon with each country signing the agreement.

This international feed in law should, at least in the longer run, contain three steps to create an appropriate internationally effective instrument. The first step is to pay for the electricity fed into the electricity network of each country. Therefore it might be necessary to agree within that treaty that the costs of extension of the national electricity network are also included into the feed in tariff if e.g. the good resources are far away from the existing network and if the country might not be able to easily afford the

expenditures. The feed in tariff has to be built in such a manner that the energy specific tariff is lower at better sites but still stimulates the search for the best sites. The second step should allow to produce the renewable electricity within one country and consume it in neighbouring countries, whereas the third step would allow for renewable electricity to be transported across third countries. This would involve developing rules for third party access in non-signatory states. This third step aims to stepwise erect an international renewable electricity supply system. Following these three steps it can be ensured that large favourable potentials of renewable energies can be used also in countries, which have small energy consumption or are economically not easily able to afford the use of their renewable potentials. In this way these potentials can be placed into the service of the climate and the resource policy understood as an international task. This form of “EEG” can thereby either be started bilaterally between Germany and other states, or on the European level, or most preferable as an international agreement, whereby in particular an anchorage in the UN appears expedient. However, the time is ripe to start pushing this idea into the follow-up treaty to the Kyoto treaty. In 2009, the potentially decisive Conference Of the Parties is going to be here in Copenhagen. We propose therefore this mechanism to be developed as a new variant of the CDM, or as a third instrument besides JI and CDM.

Such an international “EEG” could become a kind of development assistance for states in the south and the east of the European Union and world wide, which simultaneously would be of advantage by the use of highly economical potentials and thus cheap renewable electricity for the richer industrialised countries involved. Thereby a substantial effect of an international “EEG” should be to open for the use of particularly favourable locations for different renewable energies to include them into an international system acquiring more economical solutions for climate protection than could be found with single-handed national attempts.

International co-operation in the field of electricity production and transmission opens up the possibility of a sustainable electricity supply using only renewable energies which would, even if only current technologies were used, be only slightly more expensive or even cheaper than our current electricity supply. The underlying calculations are based on today's relatively high renewable technologies prices [Czisch 2005]. In the case of an approximately optimal use of the renewable resources and available techniques, costs of electricity from renewable energies would probably lie under the current prices of comparable electricity from new fossil fired power plants. Thus a conversion to renewable energies could most likely lead to economical savings, which become continually larger as the renewable electricity generation becomes cheaper due to further techno-economic progress. For example, the learning curve parameter of wind energy is between around 15%, which means that for every doubling of the installed capacity (at current rates, this happens every few years), the price of wind power drops 15%. Keep in mind that the price of most renewable power generation is pretty much fixed once the initial investment has been taken. The same cannot be said for any power generation option including a fuel price risk.

To describe the advantages of a large-scale exchange of renewable energy arising from the implementation of the international EEG in Europe and surroundings is the scope of the next section.

3 100% Renewables: a realisable Vision

Both the resources problem and the extent of the looming climate change make a change of course in humankind's use of energy sources appear inevitable. Independent of the question of the level on which energy consumption can be stabilized, clarification of the technical and economic possibilities for the future energy supply is necessary. Promising options exist in the use of renewable energies in their whole variety.

[Czisch 2005] concentrates on the technical aspects of the electricity supply as a partial aspect of the energy supply. Electricity supply is increasingly gaining in importance and can be seen as a key to a sustainable energy supply; Worldwide electricity production is currently responsible for 10.5 GtCO₂ or almost 45% of the total anthropogenic CO₂ emissions from fossil fuels stem from big power plants with an annual exhausts of more than 0.1 Mt CO₂ [IPCC 2005]

In his study the possibilities of a largely CO₂ neutral electricity supply for Europe and its closer neighbourhood were examined on the basis of different scenarios, whereby the scenario area actually covers about 1.1 billion inhabitants and an electricity consumption of about 4000 TWh/a. The focus was the question of how the electricity supply should be developed to lead to the most economic solution. This question was considered, for example, for scenarios based only on techniques available today. Also examined was the possible influence which the use of some new technologies – in so far as they are still under development – could have on the future options of the electricity supply, on the basis of some examples. The conception of the future electricity supply was aimed to meet criteria of the greatest possible objectivity, to provide genuine comparability of different resulting scenarios.

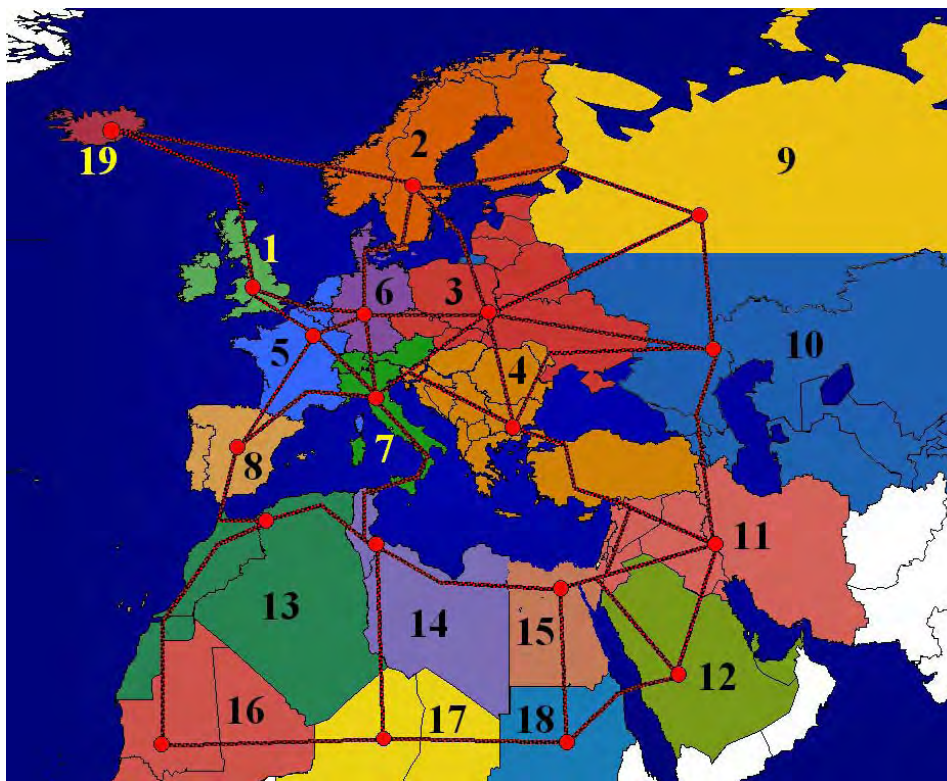

Figure 1: Possible electricity supply area divided into 19 regions with schematic representation of potential electricity transmission paths using HVDC to the geographic population centres of the regions.

To achieve this aim a mathematical optimization approach was implemented. The target of the optimization was to find the ideal system of power plants and transmission systems to provide the least cost solution for a realistic electricity demand close to the current demand. As options for the electricity production the use of renewable energies with hydro-electric power plants, wind energy converters, energy towers [ABZ 2004], biomass power stations as well as solar and geothermal power stations are considered amongst others. Dependent on the selected conditions, this resulted in different scenarios establishing a broad basis for future political decisions. The scenarios present options for a future organization of the electricity supply and point out the impact of different - also political conditions.

Before calculating the scenarios, the different potentials of renewable energies and their characteristics had to be determined in high temporal and spatial resolution. This set up a reliable data basis allowing answers to the questions associated with a spacious renewable electricity supply, without resorting to unverified assumptions. The characteristics of the different systems for energy conversion and transport also had to be studied and are discussed together with their associated costs and the potentials within the dissertation.

The starting point is a conservative base case scenario. It is a scenario for an electricity supply relying entirely on renewable energies, all of which are based on technologies available today and calculated with today's costs of all components. This base case scenario can accordingly be understood as a kind of conservative Worst Case estimation for our future options of a renewable electricity supply.

As a result of the optimization for the base case scenario, the largest proportion of the electricity production is from wind energy. Biomass and currently existing hydropower take over the predominant part of the back-up function within the supply area which is interlinked with powerful HVDC (high voltage direct current) transmission. The calculated costs of electricity production and HVDC transmission are about 4.65 €/kWh and therefore relatively close to the current costs of electricity produced with conventional technologies.

They are actually lower than today's prices on the electricity stock exchange in Germany (The monthly average price for the cheap Cal-08 in 2007 always was roughly between 5.2 and 5.6 €/kWh [EEX 2007].). In all scenarios - except the relatively expensive restrictively "decentralized" ones which exclude cross-national electricity transport via HVDC - the electricity transport plays an important role. It is used in order to realize smoothing effects of the weather-dependent electricity production from renewable sources, to make the best production sites accessible for common use and to enable the use of hydropower as well as the decentralized biomass with its inherent storage capability for common duties within the supply area. Thus electricity transport proves to be one of the keys to an economical electricity supply. This again can be interpreted as a recommendation for action for political decision-makers, who thus should deliberately pursue international co-operation in the field of renewable energy use and include in particular the issue of international electricity transmission.

The scenarios constitute a detailed and reliable basis for crucial political and technological decisions about our future electricity supply. They show that - even under conservative assumptions - an exclusively renewable electricity supply is possible with international cooperation and could be realized without any significant economic problems. This places the responsibility for future action in the field of policy. A substantial task of the policy-makers would be to organize the necessary international co-operation and to develop legal and economic instruments like the international EEG for a transformation of our electricity supply. Thereby, not only a reasonable path to a CO₂-neutral electricity supply would be taken, but beyond that excellent perspectives for the development of poorer neighbour states of the European Union and Europe could be opened.

4 Detailed Results from the Scenario Studies

Various concepts have been studied for providing renewable electricity to Europe and neighbouring regions. This process has taken into account reanalysis data from ECMWF (European Centre for Medium-Range Weather Forecasts) as the meteorological basis and the population density as a restrictive factor for the wind energy potentials or estimated roof areas in all countries within the shown regions for determining the roof top photovoltaic potentials, combined with data on solar irradiation from ECMWF and National Centers for Environmental Prediction (NCEP) and the National Center for Atmospheric Research (NCAR), wind speeds, and also temperatures used e.g. for photovoltaic electricity production and for solar thermal electricity production [ERA-15]

[NCEP 1999]. Moreover other renewable resources such as biomass and hydropower have been investigated or included at the level of current knowledge. All this has been fed into mathematical optimisation routines which have been applied to the question of which renewable resources with their individual temporal behaviour at different sites and with different yields should be used, and how selection should be made to achieve optimum cost performance. A linear optimisation with roughly 2.45 million restrictions and about 2.2 million free variables was employed to find the best combination in each scenario. The optimisation takes into account the temporal behaviour of the combined consumption of all countries within every individual region (shown as well in Figure 1) as all requirements imposed by resource-constrained production. Both sets of data, electricity demand and temporal behaviour of the possible production, have been compiled for optimisation (using time series with three-hour intervals) for all of the 19 regions which are to be supplied with electricity. The optimisation process ensures that supply will meet demand at any time, while determining if and to which extent any potential source is to be used, and how every part of the supply system will operate, including the dimensioning and operation of a HVDC grid that is superimposed on the current grid infrastructure. The criterion of optimisation is the minimization of overall annual costs of electricity when fed into the regional high-voltage grids, enabling these costs to be compared directly with those from regular power stations feeding into the conventional AC-high-voltage grid. However, the economic optimisation of all power plant operations for a time frame greater than, or equal to, three hours has simultaneously been included using sets of time series extending over one year.

4.1 Base-Case Scenario 100% Renewables

The promising results for the base-case scenario – which assumes an electricity supply system implemented entirely with current technology using only renewable energies at today's costs for all components (see [Czisch 2001] and [Czisch 2005] for more detailed information on underlying assumptions) – indicate that electricity could be produced and transported to the local grids at costs below 4.7 €/t/kWh, which hardly differs from the case of conventional generation today. (At gas prices in 2006 of about 3.5 €/t/kWh for industrial consumers in Germany [EC 2007], electricity from newly erected combined-cycle gas power stations had already reached a significantly higher level of 7 - 8 €/t/kWh_{el}.) In the resulting optimal configuration for this scenario, nearly 70% of the power originates from wind energy produced from wind turbines with a rated power of 1040 GW. A HVDC (High Voltage Direct Current) transmission system connects the good wind sites with the centres of demand while also powerfully integrating existing hydropower storage facilities, thus providing backup capacities that are enhanced by regional biomass power and given additional support by solar thermal electricity production. Electricity is generated from biomass at 6.6 €/t/kWh_{el} after proceeds from heat sales have been factored in. This result lies significantly above the average price level, yet the backup capability is essential to reduce the overall cost of the entire system. About 42% of the electricity produced is interregionally transmitted via the HVDC-System whereby the total transmission losses sum up to 4.2% of the electricity produced. Another 3.6% loss is production which neither can be consumed at the time it is produced nor be stored for later use within the pumped storage plants and therefore is produced in excess. These two losses may be considered quite acceptable for an electricity supply only using renewable energies.

4.2 Scenario with Transport Restrictions

By contrast, if interregional transmission is not allowed in a restrictive decentralised scenario, excess production increases significantly to 10% of the production, and additional backup power as well as backup energy employing other resources becomes necessary within individual isolated regions to meet the demand, leading to great additional expenses. In one scenario, fuel cells powered with renewable hydrogen produce electricity at about 20 €/t/kWh_{el} (which is already quite optimistic if the hydrogen is produced from renewable energies), raising the net electricity costs to over 8 €/t/kWh_{el} on the average. For Region 6 (Germany and Denmark), this restrictive

“decentralized” (insular) strategy would lead to costs of electricity higher than 10 €/kWh.

It is also possible to fix the minimum amount of electricity which has to be produced locally without restrictions in transport. One scenario was calculated where each region had to produce 50% of its yearly demand within its own borders. While not an actual being a restriction on transport, this mandate only relatively slightly reduces the total transmitted amount of electricity to 36% of the total production. The cost of electricity is 8.6% above the one of the base case scenario. The generation mix changes hereby to more offshore wind energy and less solar thermal production.

4.3 Scenarios with Reduced Costs for Individual Components

The effect of cost changes for individual technologies and components was also investigated in particular scenarios. One aim was to find the costs at which PV could cost-effectively contribute to the supply. Therefore a series of scenarios has been calculated where the PV costs again and again have been divided by two. As a result PV has not been chosen by the optimisation until costs fell to one-eighth of its current cost. This major cost reduction for PV was found to enable this technology to provide a significant contribution to the electricity supply. If all other costs remained the same, the reduction to just above 12% (one-eighth) of current PV costs would enable an economically viable 4% contribution to overall electricity generation to be provided. The generation would nevertheless be limited to the southernmost regions – particularly to Saudi Arabia and the southern Saharan countries or the regions 12, 16, 17 and 18. If the cost were only one-sixteenth of present levels, PV technologies could account for about 22% of all electricity generation, reducing generation costs compared with the base-case scenario by about 10% to 4.3 €/kWh. Even in this case, however, photovoltaic technologies would not be used in the northern regions 1, 2, 3, 6, 9, and 19, because they could not contribute to overall cost reductions.

If the costs of the mirror fields of solar thermal power plants were reduced by half – as is anticipated in the near future – solar thermal plants would already constitute about 13% of all electricity generation. In this case, the overall electricity costs are 4% below those of the base-case scenario. Reducing the costs of the collector array to 40% and simultaneously lowering storage costs to two-thirds of current levels (still clearly above achievable storage costs according to recent research mentioned in [CS 2004]) would increase their contribution to 28% of the electricity produced, while the electricity generation costs would – compared to the base-case scenario - fall by about 10% to 4.3 €/kWh. These examples illustrate that solar thermal generation presents an economically attractive perspective for the future that can be realized fairly easily in view of minimal cost regression factors.

4.4 Scenario with Hydropower at Inga in the Democratic Republic of Congo

The construction of a large hydroelectric power plant at an extremely favourable location in the Democratic Republic of Congo near Inga was also investigated for one proposed scenario (s. also [Kan 1999]). The construction of a hydropower plant with a capacity of 38 GW was the decision resulting from computational optimisation. This would lower the costs of electricity by 5.3% compared to the base-case scenario due to more economic generation and incidental system benefits. A primary reason for the low costs of the electricity produced at Inga is the high average load of the hydropower plant of about 6900 FLH and the relatively low anticipated investment costs at this very advantageous site. Two-thirds of the electricity produced at Inga is transmitted over a HVDC system with 26GW capacity, connecting the generating station with Region 17 (Chad and Niger), with the remainder conducted in equal amounts over two HVDC systems with a combined capacity of 12 GW, joining Inga with Regions 16 and 18.

4.5 Scenarios with Technologies Under Development

Since the implementation of the base case and similar scenarios will take many years, an attempt has been made to include some promising power generation technologies already on the horizon. A somewhat speculative scenario includes the use of energy towers (see [ABZ 2004] and [ACGZ 2006]). Should the assumptions used for energy towers hold true, especially the economic ones, then – according to the optimisation - those power plants would dominate with a generation equivalent to 49% of the total annual electricity consumption in the scenario area. The overall generation cost is with just below 4.1 €/kWh about 12% less than in the base case scenario. Solar thermal generation is completely replaced by the optimisation, but also large shares of wind power as well as a minor shares of biomass use. This scenario shows that further development of this technology might be worth while. Therefore research into the technology is needed, aiming to reduce the financial risk involved with building such a type of power plant and focussing on everything necessary to build a prototype of this kind of power plant which has not yet been tested. Generally, one can derive from that result that there should be more research grants and more venture capital devoted even to speculative ideas, which might have the potential to deliver energy at low prices and from different renewable sources.

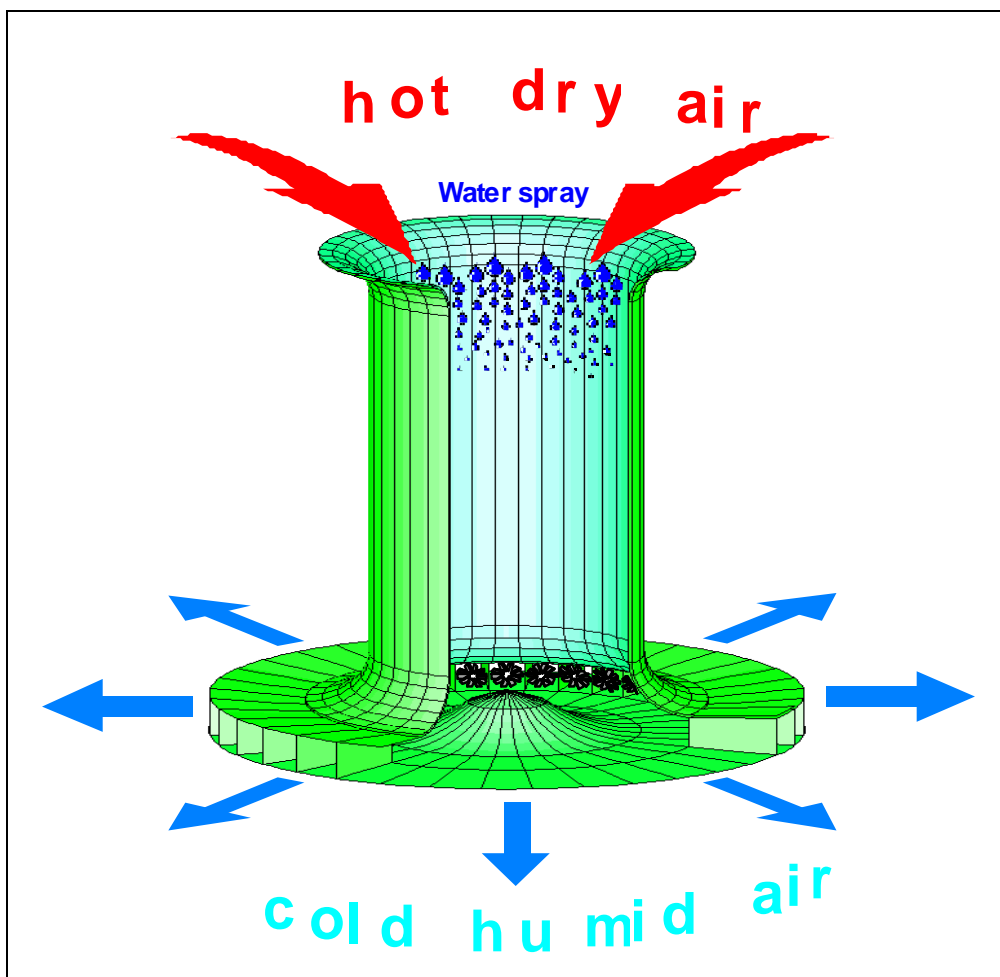

Figure 2: The principle of the energy tower. Hot air streams from above into a large tube, water is injected to cool the air, which falls down and drives some turbines at the bottom of the shaft.

4.6 Electricity Transmission within the Scenarios

In all scenarios – with the exception of the restrictive and expensive insular configurations – electricity transmission is of significant importance. The necessary converter capacity (AC⇌DC) for the HVDC grid reaches values of over 750 GW in some cases. This level corresponds to about one-half of the installed generation capacity of all production facilities in the scenario regions. The grid is used to achieve smoothing effects among different resource-dependent generation capacities using renewable energies, and to provide access to hydroelectric plants and to distributed biomass power plants both with their intrinsic storage capacities for wide-area backup applications. In the base-case scenario, for instance, about 42% of the electricity generated is transmitted via the HVDC system between the regions within the supply area. Measured against the total electricity costs the cost of the transmission system amounts to 7% of which the main part of 5% is contributed by the transmission lines and cables. HVDC transmission has a higher intrinsic system stability than AC lines. Furthermore the transmission system of the base-case scenario is highly redundant due to the fact that the thermal limit of the transmission lines is about twice the rated power and due to the fact that between almost all regions two or more systems are designed to be built in parallel. But nevertheless if further redundancy was seen as desirable this could be achieved relatively inexpensively. A somewhat extreme idea would be to erect two whole systems of transmission lines in parallel. This would mean that the costs of transmission lines and cables would double but at the same time the losses would decrease due to the doubled cross section and thus the overall cost increase would only be about 3% ensuring a degree of immunity against faults, which is by far higher than stipulated that for today's systems.

5 The International EEG as Implementation Vector in Kyoto II

In the largest part of the paper, we have shown that it is possible to supply all of "Greater Europe's" electricity needs solely with the use of renewable energy and large-scale transmission of that electricity. This would create a large zone of mutual interdependence, as the EU creates an economic interdependence amongst the European states which can be considered as stabilising factor. On the other hand this kind of interdependence has some similarity with the dependencies in the current fossil fuel based system. But with significantly more different renewable sources from many different countries and therefore with higher intrinsic stabilising diversification the dependency from single partners is clearly relieved if compared to the fossil driven system. With the gradual depletion of fossil sources the amount of sources declines in the fossil system. On the contrary the sources for renewable production become more and more and therefore potentially more distributed with technological progress. Furthermore, due to the nature of renewable energy, which is much more distributed and creates many more local jobs, the wealth created is more spread out in the population. If this large-scale implementation of renewable energy could be managed, it would therefore be for the benefit of larger parts of the countries involved and of larger parts their population than oil revenues typically are.

In the current Kyoto protocol, there are two main mechanisms for international carbon avoidance: the Clean Development Mechanism CDM and Joint Implementation JI. While the CDM is between developed countries and developing ones, JI describes the modalities of joint carbon projects between developed countries. The International EEG would be both between developed countries themselves and developing countries, therefore it is hard to see for the authors whether it should be anchored in one of the two tools or whether it should become its own tool in the coming round of negotiations. The probably decisive Conference of the Parties will be held 2009 in Copenhagen, on invitation of the Danish Ministry of the Environment. We launch this idea now to allow

for thorough discussion of the idea, and to allow time for preparative diplomacy before the conference itself.

6 References

- [ABZ 2004] A. Arbib, M. Beyth, D. Zaslavsky; ENERGY TOWERS for Producing Electricity and Desalinated Water without a Collector, Technion. Haifa, Israel, 2004.
http://www.iset.uni-kassel.de/abt/w3-w/projekte/ET-Brochure_Zaslavsky_200407.pdf
- [ACGZ 2006] T. Altman, G. Czisch, R. Guetta, D. Zaslavsky; Evaluation of the potential of electricity and desalinated water supply by using technology of "Energy Towers" for Australia, America and Africa, Special Project Interim Report, ECMWF, Reading, UK, 2006
<http://www.iset.uni-kassel.de/abt/w3-w/projekte/ECMWF-IR-SPDEGPET200605.pdf>
- [CS 2004] G. Czisch, J. Schmid; Low Cost but Totally Renewable Electricity Supply for a Huge Supply Area – a European/Transeuropean Example –, WWEC 2004 – The 3rd World Wind Energy Conference Renewable Energy Exhibition – The 2nd Win Power Asia, Peking, October/November 2004,
<http://www.iset.uni-kassel.de/abt/w3-w/projekte/WWEC2004.pdf>
- [Czisch 2001] G. Czisch; Global Renewable Energy Potential - Approaches to its Use
<http://www.iset.uni-kassel.de/abt/w3-w/fohlen/magdeb030901/overview.html>
- [Czisch 2005] G. Czisch; Szenarien zur zukünftigen Stromversorgung - Kostenoptimierte Variationen zur Versorgung Europas und seiner Nachbarn mit Strom aus erneuerbaren Energien, Dissertation, University of Kassel, 2005
<https://kobra.bibliothek.uni-kassel.de/handle/urn:nbn:de:hebis:34-200604119596>
- [EC 2007] EC, Directorate-General Energy and Transmission; Energy & Transport in figures - Statistical pocket book 2006, Brussels, Belgium 2007
http://ec.europa.eu/dgs/energy_transport/figures/pocketbook/2006_en.htm
- [EEX 2007] European Energy Exchange; German Baseload Year Futures (Cal-08), 14.05.2007, <http://www.eex.de>
- [ERA-15] ERA-15, ECMWF Re-Analysis (ERA) Project; EZMW, Reading, United Kingdom 1996, <http://www.ecmwf.int/research/era/>
- [GiebelEtAl 2003] G. Giebel, N.G. Mortensen & G. Czisch; Effects of Large-Scale Distribution of Wind Energy in and around Europe. In: Risø International Energy Conference, Risø (DK), 19-21 May 2003 p. 115-124
<http://www.risoe.dk/rispubl/SYS/ris-r-1405.htm>
- [GiebelEtAl 2005] G. Giebel, M. Nielsen & B. Hurley; Is least cost wind power always local in Europe? A balancing act between more transmission and lower load factor. Paper on the 2nd Risø International Energy Conference, Risø (DK), 23-25 May 2005
http://www.risoe.dk/rispubl/SYS/syspdf/energconf05/session10_giebel.pdf
- [IPCC 2005]. IPCC Special Report on Carbon dioxide Capture and Storage, Intergovernmental Panel on Climate Change (IPCC),
<http://www.ipcc.ch/activity/srccs/index.htm>
- [Kan 1999] K-W. Kanngießner; Nutzung regenerativer Energiequellen Afrikas zur Stromversorgung Europas durch Kombination von Wasserkraft und Solarenergie in: Strom für Europa durch Fernübertragung elektrischer Energie, hrsg. v. Brauch H.-G., Czisch G., Knies G., AFES-PRESS, Mosbach (1999)
- [NCEP 1999] NCEP/NCAR CDAS/Reanalysis Project, 1999
<http://wesley.wvb.noaa.gov/reanalysis.html>

Operational costs induced by fluctuating wind power production in Germany and Scandinavia

Peter Meibom¹, System Analysis Department, Risoe National Laboratory, Technical University of Denmark, Denmark

Christoph Weber, Chair of Energy Management, University Duisburg-Essen, Germany

Rüdiger Barth & Heike Brand, Institute of Energy Economics and the Rational Use of Energy, University of Stuttgart, Germany

Abstract

Adding wind power generation in a power system changes the operational patterns of the existing units due to the variability and unpredictability of wind power production. For large amounts of wind power production the expectation is that the operational costs of the other power plants will increase due to more operation time in part-load and more start-ups. The change in operational costs induced by the wind power production can only be calculated by comparing the operational costs in two power system configurations: with wind power production and with alternative production having properties like conventional production, i.e. being predictable and less variable. The choice of the characteristics of the alternative production is not straight forward and will therefore influence the operational costs induced by wind power production. This paper presents a method for calculating the change in operational costs due to wind power production using a stochastic optimization model covering the power systems in Germany and the Nordic countries. Two cases of alternative production are used to calculate the change in operational costs namely perfectly predictable wind power production enabling calculation of the costs connected to unpredictability, and constant wind power production enabling calculation of the operational costs connected to variability of wind power production. A 2010 case with three different wind power production penetration levels is analysed in the paper.

1 Introduction

Due to global warming and increased competition for the usage of fossil fuel resources especially oil and natural gas, alternatives to electricity production based on fossil fuels have to be introduced in large scale in future power systems. Hydropower is an excellent electricity producing technology in terms of operational characteristics, but large-scale hydropower resources in Europe are to a large extent already developed. After hydropower, wind turbines and thermal power production based on biomass are presently the most mature and cost effective kind of electricity producing technologies based on renewable energy sources. Therefore a significant growth of installed wind power capacity in Germany, Spain and Denmark has taken place the last couple of years (BTM consult, 2005).

Wind power production is fluctuating i.e. it varies a lot and is only partly predictable. Large scale introduction of wind turbines in a power system will therefore influence the day to day operation of the power system and the future development of the portfolio of power plants and transmission lines in the power system. On the operational side the variability and unpredictability of wind power production will on average cause the other

¹ To whom correspondence should be addressed. Email: peter.meibom@risoe.dk

power producing units to change production levels more frequently and with shorter notice, which implies more part-load operation and/or more frequent start-ups.

On the investment side increased wind power production will often lead to an increased need for transmission capacity from locations with good wind resources to load centres (DENA, 2005). Furthermore wind power production decreases power prices on the day-ahead power markets (e.g. Elspot market on Nord Pool) in that wind power production is bid to the market with very low short-term marginal costs, and it increases the prices for regulating power due to a larger demand for regulating power caused by the wind power production prediction errors (Meibom et al, 2006a). These changes in power price levels will in the long term cause a shift in the selection of future optimal power plant investments, such that relatively to a situation without introduction of wind power, there will be less future investment in base-load plants characterised by high efficiency and high investment cost and more future investments in peak-load or balancing power plants with lower efficiency, higher operational flexibility and lower investment costs.

These changes in the operation and the development in the power system will to some extent decrease the value of wind power expansion for society. The increase in operation and investment costs due to the expansion of wind power, evaluated relatively to some kind of reference case with the wind power production being replaced with more conventional power production are often summarised under the general term of “integration costs”.

The objective of this paper is to provide a detailed assessment of the integration cost using the stochastic system model WILMAR Planning Tool, which has been developed to analyse issues of wind power integration in the Nordic countries and Germany. Correspondingly the paper is organised as follows. Section 2 provides a short overview of the WILMAR Planning tool. Section 3 then discuss how integration costs of wind power can be assessed in this framework. Section 4 and 5 describe an application of this methodology for the power systems in Germany and the Nordic countries. Section 4 presents the cases analysed and section 5 presents the results. Finally section 6 concludes.

2 The Model

A Planning tool enabling model based analysis of wind power integration issues has been developed in the Wilmar project (www.wilmar.risoe.dk). An overview of the sub-models and databases constituting the Planning tool is given in Figure 1.

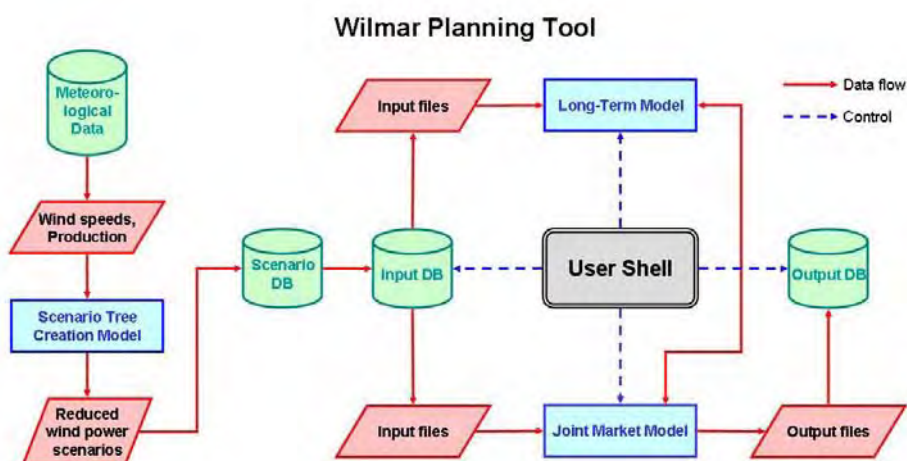

Fig. 1. Overview of Wilmar Planning tool. The green cylinders are databases, the red parallelograms indicate exchange of information between sub models or databases, the blue squares are models. The user shell controlling the execution of the Wilmar Planning tool is shown in black.

The Joint Market model is a linear, stochastic, optimisation model with wind power production forecasts as the stochastic input parameter, hourly time-resolution and covering several regions interconnected with transmission lines. It has been tested on German and Nordic data. The Joint Market model is documented in detail in (Meibom et al, 2006b; Brand et al, 2004). A model generating scenario trees representing wind power production forecasts has been developed (Barth et al, 2006). Treatment of large hydropower reservoirs requires optimisation of the use of water over a yearly or longer time horizon. Therefore the Joint Market model is combined with another stochastic, optimisation model that focus on calculating the option value of stored water dependent on the time of year and reservoir filling (Ravn, 2006).

2.1 Calculation of integration costs of wind power

The general term of *integration costs* is coined to designate additional costs of integrating something new into a pre-existent system. In the context relevant here, the pre-existent system is a power system, which consists basically of generators, transmission lines and consumers, distributed over a certain geographical area. The new things are novel generation technologies, based on other than conventional energy transformation processes. In principle integration costs could also be calculated for non-renewable technologies, be them novel or conventional (cf. also Söder 2005) – yet this is not the object of this paper.

General Approach

For a precise definition of integration costs, it is essential to distinguish them from additional system costs caused by the imposition of a certain amount of renewables generation (cf. Weber 2006). Integration costs are commonly understood as the difference between some expected cost savings through renewables and the actual ones. Yet this not operational as long as the cost savings “which would be expected” are not precisely defined.

Along the lines taken by Weber (2006) we therefore define integration costs as the difference in the cost savings induced by the renewables in the conventional system compared to the cost savings through some alternative (new) generation. Thereby for both technologies, investment costs are disregarded (or assumed to be of same height).

This can be written formally:

$$C_{Int} = C_{Add, Ren}^* - C_{Add, Alt}^* \quad (1)$$

Thereby $C_{Add, Ren}^*$ designates the optimal system costs for the system including wind power (or generally renewables). Analogously $C_{Add, Alt}^*$ refers to the optimal costs for the system including the alternative generation technology instead. Here reference is made to an optimal system, because the system has in general possibilities to adapt to new requirements (c.f. Weber 2006). E.g. with the introduction of wind energy, gas turbines may be used more frequently to compensate for fluctuations in wind. In the context of WILMAR, only adaptations in the operation of the generation technologies are considered here.² Adaptation of the remaining generation park, e.g. through increased investment in flexible gas-fired technologies is not considered here.

² Price-flexible demand is foreseen in the WILMAR model, but is not used in this application.

Obviously the integration costs are in this setting always dependent on the definition of a hypothetical technology alternative and will depend on the choice of the reference technology.

Put in another way:

$$C_{Add, Ren}^* = C_{Int} + C_{Add, Alt}^* \quad (2)$$

The additional system costs resulting from imposing a renewables target can be decomposed in the so-called integration costs and the additional costs when targeting the same objective with an alternative technology.

Among the integration costs, different categories can be distinguished (cf. Auer 2004, Weber 2006). Notably grid connection and grid extension cost arise as a consequence of the uneven spatial distribution of wind power production (cf. also DENA 2005). Yet these shall not be considered in detail in the following. Rather the focus is on the costs related to the fact that wind power, similarly to solar energy, is fluctuating by nature. These fluctuations cause additional costs for increased reserves, higher shares of part-load operations etc. Correspondingly the integration costs may be derived by comparing wind power integration to the integration of a (hypothetical) technology, which provides the same energy output but at a constant rate over all the year.

For further insights, two categories of integration costs may be distinguished:

- Costs of unpredictability (or partial predictability)

These are the additional costs occurring when comparing the system with wind to one with a hypothetical technology having same, time-varying output but perfect predictability. These costs, taken with the opposite sign, correspond to the value of perfect information, commonly referred to in the stochastic programming literature (e.g. Birge, Louveaux 1997). Formally they may be written

$$C_{Unpred} = C_{Add, Ren}^* - C_{Add, Pred}^* \quad (3)$$

Thereby the costs $C_{Add, Pred}^*$ are the costs associated with a system with time-varying wind input but without uncertainty about the future wind input.

- Costs of variability

These are then the costs associated with the fact that wind power generation is varying over time and that this will require increased use of expensive generation technologies to compensate for wind drops etc, even if wind generation were perfectly predictable. It is thus computed by comparing the costs of the system with the predictable wind power with the costs of the system with a hypothetical technology delivering the same energy output at a perfectly constant rate:

$$C_{Variab} = C_{Add, Pred}^* - C_{Add, Const}^* \quad (4)$$

$C_{Add, Const}^*$ are here the optimal costs associated with time-varying wind input but without uncertainty about the future wind input.

Overall we get for the integration costs:

$$C_{Int} = C_{Variab} + C_{Int} = C_{Add, Ren}^* - C_{Add, Const}^* \quad (5)$$

For computing the integration costs and its components it is hence necessary to make three model runs:

1. A model run with stochastic wind power feed-in and corresponding uncertainty, delivering $C_{Add, Ren}^*$
2. A model run with deterministic but time-varying wind power feed-in, delivering $C_{Add, Pred}^*$

3. A model run with constant equivalent power feed-in, delivering $C_{Add,Const}^*$

If wind power is the only source of uncertainty in the model, the second and third model run are deterministic ones, limiting consequently considerably the computational burden.

Calculating Integration costs by region

Besides computing wind power integration costs for the overall system, also a decomposition by region is of interest – especially in order to analyse whether and to what extent the integration cost depend on regional specificities – e.g. the share of hydro power.

The difficulty is that the overall system costs are not the sum of independent system costs for the different regions. Rather the regions are interconnected through interconnection capacities and the system costs occurring in one region depend on the power flows to neighbouring regions. When doing the model runs for computing integration costs, these power flows may be dependent on the type of model run carried out. If no correction for changing interregional flows is done, integration costs may rapidly become negative in regions which are increasing their net imports in the stochastic modeling compared to the deterministic versions.

In order to avoid such difficulties an approximative approach is taken, which is illustrated in the following for the most simple setup: two regions (r and r') connected with one transmission line.

i : model run index, $i \in (Ren, Pred, Const)$

r, r' : region index

t : hour index

$p_i(r, t)$: price on the intraday-market in region r and hour t .

$x_i(r, r', t)$: export of power from region r to region r' in hour t .

The intraday-market power price in region r in hour t is equal to the variable production costs on the marginal power plant in the region (or in the case of price flexible demand, either the marginal production costs or the willingness-to-pay of the marginal consumer). A lower bound on the saved operational costs due to net import in a region is the intraday-power price times the net import in MWh, because the import replaces power production within the region having marginal production costs that are higher or equal to the intraday-market price. Likewise an upper bound on the increase in operational costs due to net export in a region is the intraday-market price times the net export, because the net export is produced on power plants with marginal production costs lower or equal to the intraday-market price.

When comparing two cases it is important to clarify, that it is only the change in power flow from one case to the other that is to be taken into account. E.g. if in two cases the import into region r in hour t is 6000 MW, no correction of the operational costs of the region should be made although the intraday price can be different between the two cases. The reason is twofold:

As the import is the same in the two cases, the difference in operational costs between the two cases already reflects the integration costs of wind power for a region with a specific transmission capacity available.

Intraday prices are marginal values, i.e. in theory they only apply for very small changes from the present situation. Therefore we should only use them on the difference in transmission between two cases.

When the net export from region r is higher in case i_1 than in case i_2 , the operational costs in case i_1 have to be decreased by the increase in net export from case i_1 to case i_2 valued at the average of the intraday-power price in the two cases (corresponding to the average of the marginal production costs in the two cases). The use of the average of the

power price in the two cases has the advantage that the correction provides the same results (with opposite sign) if case i_1 is subtracted from i_2 than if i_2 is subtracted from i_1 .

Likewise when the net import into region r is higher in case i_1 than in case i_2 , the operational costs in case i_1 should be increased with the increase in net import from case i_1 to case i_2 times the average of the intraday-power price in the two cases.

The correction to the operational costs in each region can be summarized as follows:

Net exports are higher in case i_1 than in case i_2 , i.e.

$$x_{i1}(r,r',t) - x_{i1}(r',r,t) > x_{i2}(r,r',t) - x_{i2}(r',r,t)$$

⇒ Operational costs of region r in case i_1 are decreased by:

$$\frac{1}{2} * (p_{i1}(r,t) + p_{i2}(r,t)) * (x_{i1}(r,r',t) - x_{i1}(r',r,t) - (x_{i2}(r,r',t) - x_{i2}(r',r,t)))$$

Net imports are higher in case i_1 than in case i_2 , i.e.

$$x_{i1}(r',r,t) - x_{i1}(r,r',t) > x_{i2}(r',r,t) - x_{i2}(r,r',t)$$

⇒ Operational costs of region r in case i_1 are increased by:

$$\frac{1}{2} * (p_{i1}(r,t) + p_{i2}(r,t)) * (x_{i1}(r',r,t) - x_{i1}(r,r',t) - (x_{i2}(r',r,t) - x_{i2}(r,r',t)))$$

The approach is easily generalised to a region with transmission lines to several surrounding regions by summing over r' in the expressions above. In this study the approach is used to separate integration costs between countries. Therefore only changes in transmission between regions belonging to different countries are corrected for.

2.2 Case descriptions

The power system configuration taken as basis here is a projection of the present power system configuration in Germany and in the Nordic countries to 2010 by introducing investments in power plants and transmission lines that are already decided today and scheduled to be online in 2010, and by removing power plants that have been announced to be decommissioned before 2010.

The 2010 system also includes planned transmission lines between Eastern and Western Denmark (Storebælt), Finland and Sweden (Fennoskan2) and North East and North West of Germany. Power plant investments are mainly gas in Germany and Norway, nuclear and wood in Finland, upgrade of existing nuclear power plants in Sweden, and very little investment in Denmark.

This base scenario for the development of the power system until 2010 is supplemented with three scenarios for the development in installed wind power capacity in 2010:

1. Base: For all countries a “most likely” forecast of wind power capacities in 2010 is used based on estimations by the authors and estimations in (DENA, 2005; BTM consult 2005).
2. 10%: For Denmark and Germany: Forecasted wind power capacities for 2015 (equal to cover approximately 29 % and ca. 11 % of the annual electricity demand, respectively). For Finland, Norway and Sweden: Wind power capacities equal to cover 10 % of the annual electricity demand.
3. 20%: For Denmark and Germany: Same development as the 10% wind case. For Finland, Norway and Sweden: Wind power capacities equal to cover 20 % of the annual electricity demand.

The Base wind case expresses a reasonable growth in installed wind power capacity until 2010, where as the 10% and 20% wind cases represent unrealistic strong growth rates of installed wind power capacity in Norway, Sweden, and Finland in the period 2005-2010, and a high growth scenario but still more plausible amount of wind power in Denmark and Germany. Although not plausible developments within this short time period, the 10% and 20% wind cases are interesting when studying the change in operational costs

due to large-scale wind power integration. Figure 6 shows the installed wind power capacity per region in each of the wind power capacity development scenarios. The wind profiles used are based on 2001 wind power production and wind speed data.

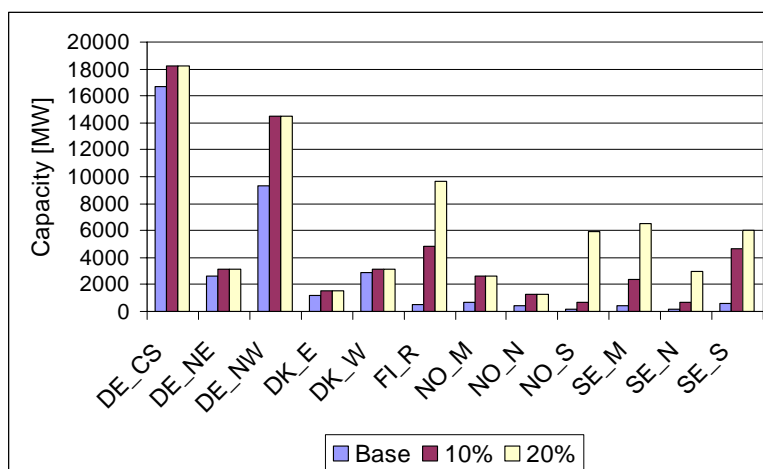

Fig. 2. Installed wind power capacity in each region in the three wind power capacity development scenarios.

CO₂ allowance price is set to be 17 €/MWh. The fossil fuel price scenario implies a continuation of the present high price levels with fuel oil, natural gas and coal prices being respectively 6.16, 6.16 and 2.25 Euro2002/GJ. All countries share the same fuel prices. The assumptions behind the base power system scenario in 2010 are documented in (Meibom et al 2006 c).

The operational integration costs of wind power production disregarding investments are analysed using the three wind power case mentioned above, but running the Wilmar Planning tool for five selected weeks. These five weeks are selected using a scenario reduction technique with the hourly wind power production, electricity demand and heat demand taken as input parameters, because these input parameters are judged as the most important for the variation in wind power integration costs between weeks. The selected weeks are supposed to be the best representative weeks of a year with regard to the variation in these input parameters. It is necessary to use selected weeks due to the long calculation times associated with stochastic optimization.

As discussed in section 3, the integration costs are divided into two groups:

1. System operation costs due to forecast errors, which are analysed by comparing the system operations costs in the stochastic simulation with the system costs in a Wilmar Planning tool simulation with perfect foresight, i.e. perfectly predictable wind power production.
2. System operation costs due to variability, which are analysed by comparing the system operations costs in the perfect foresight simulation with the system costs in a Wilmar Planning tool simulation with constant wind power production within each week.

3 Results

Figure 7 shows the results for the three wind power cases and aggregated over all countries. The results are not entirely comparable between the cases due to the uncertainty introduced by only using five selected weeks. The main conclusion is that wind power integration costs are increasing with increasing share of wind power production capacity in the power systems as expected. The base wind case has very low

costs associated with partial predictability and negative costs associated with variability. The negative costs express that in the base case, the wind power variations are positively correlated with the electricity demand. The results for wind case 10% and 20% show that the costs of being variable is larger than the costs connected to being partially unpredictable. So the time periods with low loads and large amounts of wind power production generate more costs than the balancing costs due to forecast errors. One reason for this is that the regulating hydropower production has very low balancing costs, and that the modeled balancing market is extremely efficient (in effect the perfect balancing market). In reality balancing costs would be higher due to transaction costs and in some cases market power.

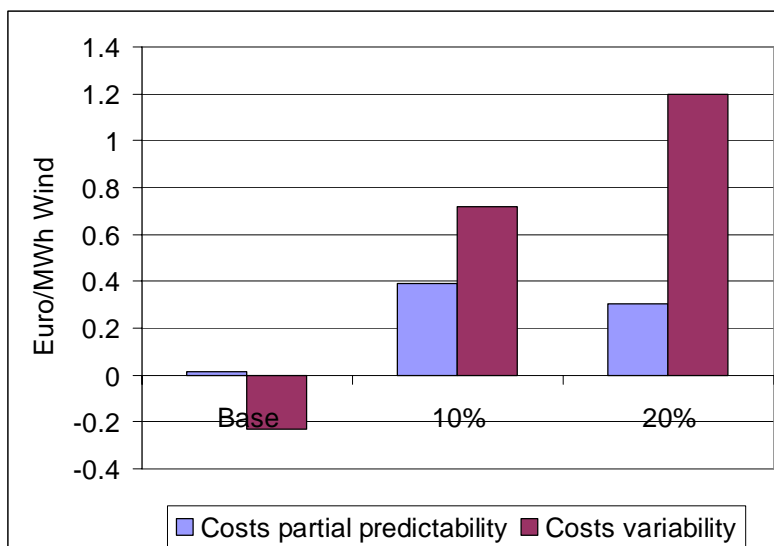

Fig. 3. Increase in system operation costs per MWh wind power production when comparing system cost in a model run with constant weekly average wind power production with a perfect foresight model run (Costs variability), and when comparing system costs in a stochastic model run with a perfect foresight run (Costs partial predictability).

Figure 8 shows the wind power integration costs (sum of costs due to partial predictability and costs due to variability) divided on countries for each of the three wind cases. The division on countries has been done by making corrections to the system operation costs when the net export between two countries changed between model runs as explained in section 3.2. Obviously wind integration costs are highest in the thermally dominated German system, whereas they are lowest in the hydro dominated Norwegian system.

Inspired by an approach suggested by Lennart Söder, the ratio between average wind power production and the sum of transmission capacity to other model countries and the average power demand has been determined, as shown in Table 1. This so-called wind power impact ratio is interpreted as an indicator of how much wind power production is present in each country, because wind power production has to be either consumed domestically or exported to other countries in the model.

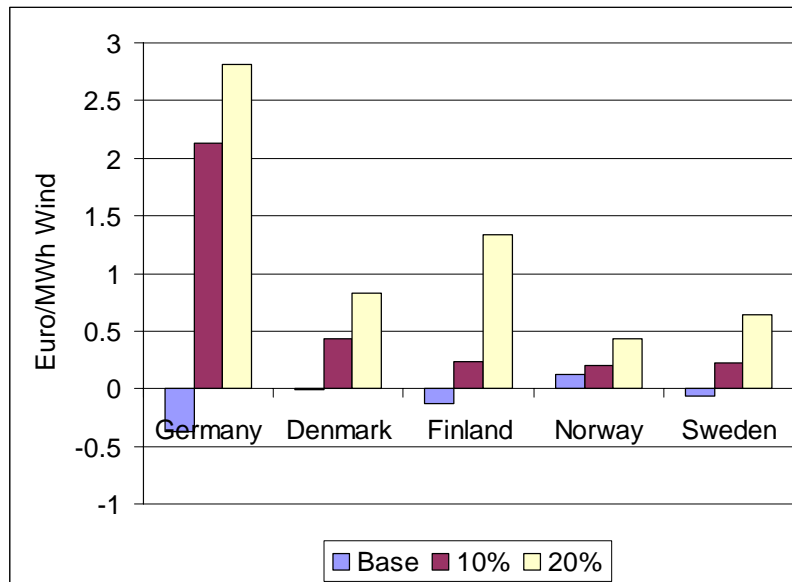

Fig. 4. Increase in system operation costs per MWh wind power production for the three wind cases and divided on countries.

Table 1. The ratio between the average wind power production in each wind case and the sum of the transmission capacity to other countries included in the model and the average power demand.

Country	Transmission capacity to other model regions [MW]	Base	10%	20%
Denmark	5050	0.12	0.11	0.09
Finland	2300	0.01	0.11	0.21
Germany	1720	0.08	0.09	0.09
Norway	4220	0.02	0.09	0.15
Sweden	8110	0.01	0.06	0.11

Combining the information in Figure 8 and Table 1 the following observations can be drawn:

1. The wind power integration costs are lower in hydro dominated countries (especially Norway) compared to thermal production dominated countries (Germany, Denmark). The reason is that hydropower production has very low part-load operation and start-up costs and that hydro-dominated systems are generally not constrained in regulating capacity.
2. The wind power integration costs increases when a neighboring country gets more wind power. Germany and Denmark have the same amount of installed wind power capacity in wind case 10% and 20%, but because the export possibilities become less attractive, due to the increased amounts of wind power capacity in Finland, Norway and Sweden, the integration costs of Germany and Denmark increase from wind case 10% to 20%.
3. Germany has the highest integration costs although their ratio in Table 1 is among the lowest. The reason is that the wind power capacity is very unevenly distributed within Germany with the model region North-western Germany having a wind impact ratio of 0.31 in wind case 10% and 20% (not shown in Table 1).

4. Denmark has the highest share of wind power among the countries, but also excellent transmission possibilities to neighboring countries compared with e.g. Finland. Therefore the wind power integration costs of Denmark are lower than those of Finland in wind case 20%.

4 Conclusions

This paper discusses the issues related to the calculation of wind power integration costs and pinpoints that wind power integration costs always depend on the choice of a reference case to which the system costs with wind power are compared. The choice of the characteristics of the reference case is not straightforward. A methodology for calculation of integration costs by comparison of three different model runs: with stochastic wind power, with perfectly predictable wind power, and with constant wind power production has been proposed. The method distinguishes between integration costs related to partial predictability and to variability.

A linear, stochastic optimisation model covering the Nordic countries and Germany has been presented. The model is able to quantify the integration costs related to variability and to partial predictability. The latter is only possible in models treating wind power production as a stochastic input parameter. Only operational integration costs can be calculated with the model, i.e. integration costs related to grid extensions and changes in a future power generation portfolio are not included in the study.

A base scenario for the power system configuration in 2010 in Germany and the Nordic countries has been supplemented by three wind power capacity cases, and country-wise wind power integration costs have been calculated for each case. Results confirm expectations, i.e. integration costs are lower in hydro dominated systems compared to thermally dominated, and integration costs are higher in power systems having a relatively larger ratio between wind power production and the sum of average power demand and transmission capacity to neighboring regions. Interestingly integration costs increase in countries with constant wind power production when neighboring countries experience increased wind power capacities.

References

- Auer et al. (2004): Cost and Technical Constraints of RES-E Grid Integration. Report for WP 2, EU-project GreenNet. Downloadable at <http://www.greennet.at/downloads/WP2%20Report%20GreenNet.pdf>.
- Barth, R., Söder, L., Weber, C., Brand, H., Swider, D., 2006, Deliverable D6.2 (b) – Documentation Methodology of the Scenario Tree Tool, Institute of Energy Economics and the Rational Use of Energy (IER), University of Stuttgart, available from www.wilmar.risoe.dk.
- Brand, H., Weber, C., Meibom, P., Barth, R. and Swider, D.J., 2004, A stochastic energy market model for evaluating the integration of wind energy, *6th IAEE European Conference*, Zurich.
- BTM Consult, 2005, International Wind Energy Development – World Market Update 2004.
- DENA, 2005, Planning of the grid integration of wind energy in Germany onshore and offshore up to the year 2030 (dena grid-study), Deutsche Energie-Agentur, www.dena.de.
- Meibom, P., Barth, R., Norheim, I., Ravn, H., Sørensen, P., 2006a, Final technical report in the Wilmar project, available from www.wilmar.risoe.dk.
- Meibom, P., Barth, R., Brand, H., Larsen, H., Woll, O. Weber, C., 2006b, Wilmar joint market model documentation, Deliverable 6.2 (b), available from www.wilmar.risoe.dk.
- Meibom, P., Barth, R., Holttinen, H., Weber, C., 2006c, Base configuration and case studies, available from www.wilmar.risoe.dk.
- Ravn, H., 2006, The Wilmar long-term model, Deliverable D6.2 (c), available from www.wilmar.risoe.dk.
- Söder, L., 2005, Modelling Approach Impact on Estimation of Integration Cost of Wind Power, 7th European IAEE Conference Bergen.
- Weber, C., 2005, Uncertainties in the Electric Power Industry: Methods and Models for Decision Support, vol. I. New York, Berlin, Heidelberg: Springer.
- Weber, C., 2006, Integrating electricity production from fluctuating sources – valuation of variability and unpredictability. Working Paper for the GreenNet EU27 project, WP 2.

Understanding energy technology developments from an innovation system perspective

Mads Borup¹, Birgitte Gregersen², Anne Nygaard Madsen¹

1) Risø National Laboratory, Technical University of Denmark, Systems Analysis Department

2) Aalborg University, Department of Business Studies

Contact: mads.borup@risoe.dk

Abstract

With the increased market-orientation and privatisation of the energy area, the perspective of innovation is becoming more and more relevant for understanding the dynamics of change and technology development in the area. A better understanding of the systemic and complex processes of innovation is needed. This paper presents an innovation systems analysis of new and emerging energy technologies in Denmark. The study focuses on five technology areas: bio fuels, hydrogen technology, wind energy, solar cells and energy-efficient end-use technologies. The main result of the analysis is that the technology areas are quite diverse in a number of innovation-relevant issues like actor set-up, institutional structure, maturity, and connections between market and non-market aspects. The paper constitutes background for discussing the framework conditions for transition to sustainable energy technologies and strengths and weaknesses of the innovation systems.

1 Innovation systems and their dynamics

Innovation system studies have shown that the conditions for development and innovation are not identical across geographical and political-administrative borders but differ according to the specific constitution of the knowledge production, learning and institutional set-up in different countries and industrial sectors. Differences between the competitive and innovative strengths of countries and regions can be ascribed to differences in the learning dynamics and the specific organisation of the knowledge production.

The system character of innovation systems refers to the fact that development and innovation appear in interplay between different actors e.g. companies, their customers and suppliers, research and educational institutions, authorities, interest organisations etc. It is not only dependent on the capabilities and resources of individual actors. Learning is the central, general activity in innovation systems. Thus an innovation system can be defined as “the elements and relationships, which interact in the production, diffusion and use of new and economically useful knowledge” (Lundvall 1992). Conditions for the developments are influenced by labour markets, educational systems, industrial structure, competition, regulation, collaboration patterns, etc.

In addition to formal knowledge production in e.g. universities, research departments, innovation system studies have pointed to the importance of informal knowledge production (Polanyi 1966), e.g. knowledge gained through practical experiments (learning-by-doing), and interaction with users (learning-by-using (Lundvall 1992), lead markets, lead-users (von Hippel 1988)). Learning-by-interaction is in general important.

A number of branches within innovation system studies have appeared. Among these are the general, national IS approach (Lundvall 1992, Edquist 1997), the sectoral approach (Malerba 2002), and the technology-specific approach (Jacobsson & Bergek 2004, Hekkert et.al. 2006). Figure 1 illustrates in a simple way the overlap between general energy sector conditions and the more technology and innovation specific conditions for development. Technological systems are to a larger extent defined in terms of knowledge

or competence flows rather than flows of ordinary goods and services. They consist of dynamic knowledge and competence networks including both national and international connections.

Figure 1: Illustration of the overlap between general conditions of the energy area and innovation-specific conditions for energy technology development.

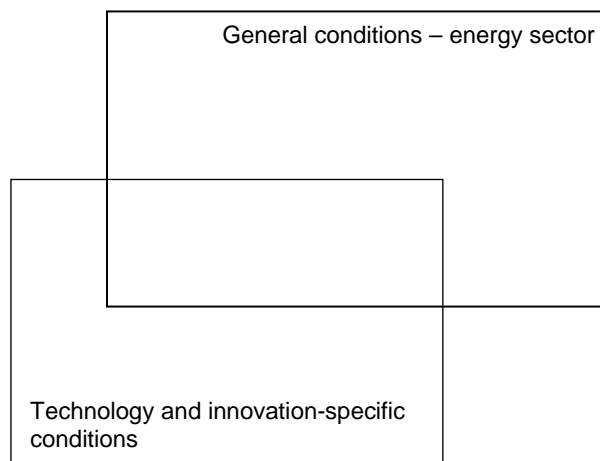

Actors, networks, and institutions are main elements in technology-specific innovation systems. An important part of the actor set-up is the ‘advocacy coalitions’ of actors working for the development and use of the technology. Maturity of the systems has been pointed to as an important issue as there are significant differences in the characteristics of mature and immature systems (Jacobsson & Bergek 2004, Foxon et.al. 2005). Two overall situations can be identified:

1. Formative character
2. Market dissemination character

While the former situation is usually characterised by relatively few actors and no or only limited niche application of the technology, the latter has relatively many types of actors and involves application on larger markets. In this situation, industrial companies are often central actors. Transformation from one situation to another is complex and often long-lasting processes.

A number of ‘functions’ that are essential in development of new technology areas are identified (Jacobsson & Bergek 2004):

- 1. Knowledge production and dissemination;** including learning and entrepreneurial experimentation
- 2. Guiding of the direction of search processes;** visions, strategies, policies and legitimization
- 3. Formation of markets;** i.e. definition, development, institutionalisation and regulation of markets; includes niche markets
- 4. Mobilisation of resources;** competences, labour and financing
- 5. Creation of positive external economies;** includes e.g. establishment of supporting consultancy businesses, development of sub-supplier networks etc.

The functions generally appear in the development of new technology area, at least if they shall become of any significance, be successful, get widespread application and,

maybe, ultimately, change the existing technology regimes of the sector. The specific interactions and development can within these functions take on many shapes.

2 Energy innovation - an economic field

The energy area has undergone considerable change in the recent decades. Like in a number of other countries, there has in Denmark been an increasing focus on the energy area as an important economic field and area of employment and innovation. Export of energy technology from Denmark was in 2005 38.7 billion DKK (Ahm et.al. 2006). It has increased considerably over the last 10 years and now makes up around 7% of the total Danish export.

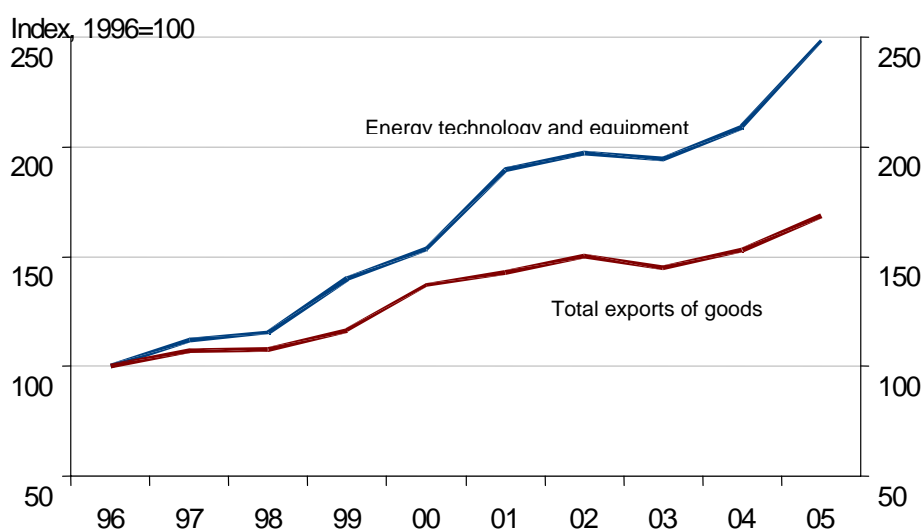

Figure 2: Development in Danish exports of energy technology and equipment compared to the general export development (Ahm et al. 2006; Energiindustrien and Energistyrelsen, building on Eurostat figures).

The growth in Danish exports from 1996 to 2005 is around 150% and thus considerably higher than most other EU countries (EU15 average is 72%). The export is dominated by the fast growing wind energy area (70%) with energy efficiency technology as the second most important area (18%). Export of combined heat & power products has decreased since the mid 1990s and now constitutes only 3%.

3 Comparison of energy technology areas

Neither solar cells, wind energy, hydrogen technology, energy efficient end-use technologies nor bioenergy are completely new subjects in the energy area. Activities and discussions about them have taken place for many years and they have all with larger or smaller weight been part of the strategic considerations about the development in the energy sector. On national level in Denmark, four of the areas have for more than a decade been among the areas prioritised for support through research and development programmes. Hydrogen technology and the idea of building a hydrogen-based infrastructure partly in replacement of oil and electricity appeared as priority area in the

beginning of the new millennium. However, analytical and technical development activities has occurred also earlier, e.g. through the closely connected area of fuel cells.

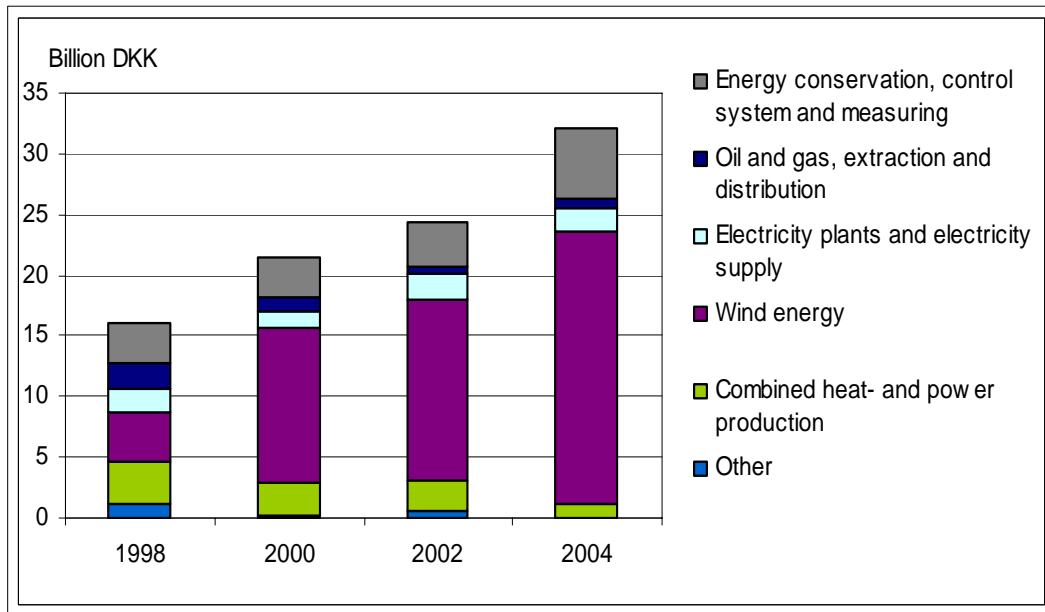

Figure 3: Danish export of energy technology (Energistyrelsen 2006).

Figure 4: Public R&D programmes – development in the budget in selected technology areas (Energistyrelsen 2006).

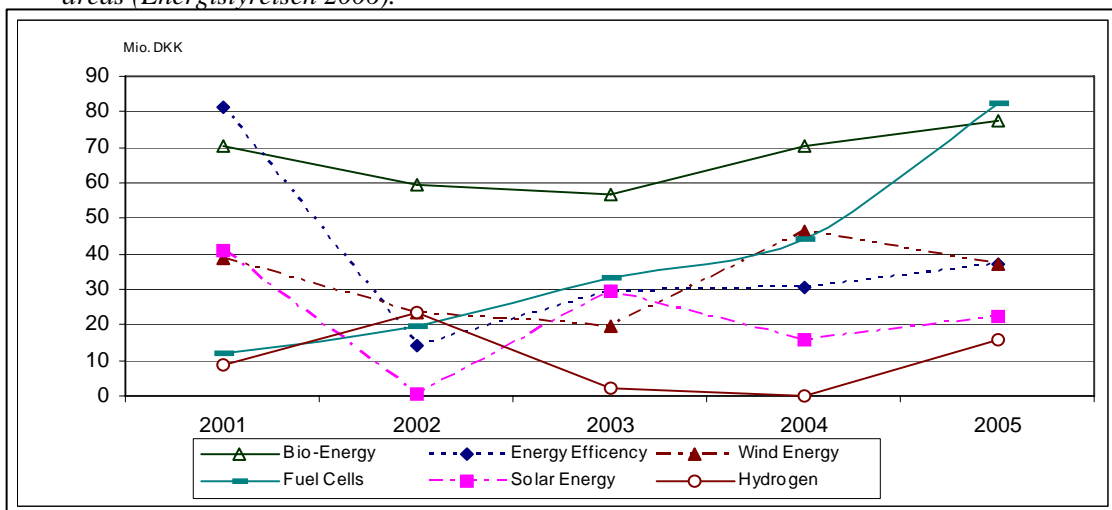

Figure 4 shows that the public R&D spending on alternative energy technologies was turbulent after 2001 where the liberal-conservative government took over. Except for fuel cells all other areas experienced severe cuts, but are now recovering and reaching the 2001 level.

Bioenergy is closely related to the traditional actors of the energy systems: the power plant companies and network operators. Many of the development activities, experimentations and demonstration projects take place in connection to the existing plants and facilities. In addition to power plant companies, consultancy companies and (often relatively small) companies within the engine industry characterize the area. Also

companies and research institutions within biotechnology, agriculture/forestry and mechanical engineering appear. A renewed focus on bio fuels for transport has occurred. This is relatively independent of the existing bioenergy field, though some research actors and biotechnology companies are the same. The leading actors are here the European Union and gasoline companies.

The hydrogen area is the smallest area with respect to number of actors involved (see Table 1). The coalition of actors leading this field consists in policy actors on national level (in parallel to initiatives in USA, EU, etc.), regional level and from the wind energy industry plus some of research actors (public and private) in the fuel cell area. Demonstration projects constitute a significant part of the activities so far. Actual application on commercial basis is not established. The hydrogen area clearly has formative character.

In the Danish context the solar cells area is only in a formative stage in the sense that the price pr kW is still relatively high - although declining, the domestic market is limited and mostly dominated by demonstration projects with some public support. Despite a growing public interests and promising export markets (especially Germany and Japan) solar energy is not given priority in the newest national energy strategy. The Danish solar energy strategy follows the overall EU minimum goal, corresponding to 1% of total energy consumption in 2010.

The Danish wind energy area counts between 200-300 actors centred around 3 large companies. Innovation activities to a large extent take place in a well-developed value chain between the large producers of wind turbines and a multitude of suppliers forming a complex knowledge-base (Andersen & Drejer 2006). The innovative capability of the industry has developed through a complex interrelationship between demands from users and NGOs, companies, research institutions and public policies. The Danish industry is among the leaders in the world market with market shares above 40 % through the last decades. A number of foreign wind turbine manufactures have established development units in Denmark and on many points the area appears as an industrial cluster. Globalisation and establishment of production plants in different parts of the world have been a part of the developments in the recent years.

The area of energy efficient technology is a large and broad area that covers a wide range of activity areas, products and techniques meant for use within three main areas: industrial production, buildings, and private households. The activities are institutionalised in a number public programmes and regulations including information services and campaigns, energy labelling systems, regulations in specific sectors e.g. the building code, an Electricity Saving Trust, cleaner production programmes, standardisation and R&D programmes. The national Energy Plan and Energy Saving Act are the overall frames for the efficiency programmes and regulations and the Government is a central actor for the area. Industrial companies are involved in large parts of the activities, as are also electricity companies, research institutions, technology service institutes, consumer organisations, and NGOs. The innovation activities in the area are characterised by being problem-oriented and focused on applications and immediate reductions in the energy use.

Table 2 summarizes elements of systemic interplay in the five technology areas including key public instruments for contribution to market formation. The systemic interplay in the energy innovation consists in both formal and firmly-structured collaborations and in more loosely coupled networks and forums.

We will point to that the informal interaction and the many active interest organisations ensure a qualified understanding of the needs. They also contribute to the broader understanding of the technologies in the population. This can be seen from the fact that there is relatively high awareness in the population about the energy area compared to many other countries (Euro Barometer 2007). The share of people in the population supporting solar cells technology, wind technology and bio energy is in top of the EU member countries (no figures on hydrogen, fuel cells). Also awareness and support of energy efficiency and renewables are high.

Table 1: Central actors and maturity in the technology areas – overview

	Bioenergy	Energy Efficiency	Hydrogen	Solar cells	Wind
Actors					
Key actors	Government Utility companies Consultants Biotech research and companies (Biofuels: EU Gasoline companies)	Government Public authorities Industry Research institutions	Government (Public policy and R&D efforts) Regional authorities Wind industry	Government (Public policy and programmes) Utility companies NGOs Industry Universities TSI Consultants Consumers	Industry Government NGOs
Number of actors	30-50	150-200	30-40	40-60	200-300, centred around 3 large companies
Maturity					
Application	A little	Application. Practice focus in development activities.	No. (Demonstration projects)	Some (through support programmes)	Widespread application
Market dissemination	No	Dependent on subfield; considerable in some; limited in others	No	Limited – no well-established Danish market Demonstration projects	Considerable dissemination, growing markets
International vs. domestic market	No export	Considerable international markets in some subfields	-	Expanding int. markets for DK subcontractors (Germany, Japan etc.)	Int. markets. Leading Danish market applications, but stagnation in recent years
Niches	Bioenergy from waste and manure	Integration in other fields e.g.: - refrigeration - ventilation - insulation	Fuel cell technology	Silicium Planning and installing Building integration System integration Materials	Mainstream (off shore wind)
Industrial maturity	Partly developed networks	Integrated in other industries	Not developed	Scattered networks, int. subcontractor networks	Developed industry; strong wind power cluster, developed producer and user associations
Change in maturity last 5 years	No	No clear tendency; rise in business focus in some subfields	Only small steps	Declining prices pr kW (“learning curve”)	Internationalisation, globalisation of production
Formative or market ‘stage’	Formative	Market	Formative	Formative, partly	Market

The communication between the use side and the development side also consists in market-mediated interaction, enabling the kind of efficiency and competition in the mutual integration of needs and opportunities that appear through this. The technology areas differ with respect to inclusion of market-based and non-market based interaction dynamics. Market supporting policy instruments are used in the wind area and within energy efficient technology primarily. Explicit focus on commercialisation and business development is not a major element in the public efforts in relation to the energy efficiency area.

Table 2: Elements of systemic interplay in the technology areas

	Bioenergy	Energy Efficiency	Hydrogen	Solar cells	Wind
Main mediation channels for demands and needs	Policy	Application, Policy	Policy	Policy, int. markets, application experiments	Markets, application, policy
Interplay btw. market and non-market dynamics	No	Yes	No	Some	Yes
Debate and communication (information campaigns, workshops etc.)	Workshops, interest org.	Information, campaigns, Workshops, interest org.	Workshops	Various activities (organized by different stakeholders), interest org.	Workshops, interest org.
Education and training	Scattered	Some	No	Scattered	Some
Public efforts (techn specific):					
Market support	No	Yes, e.g. labelling systems	No	No.	Yes, feed in tariffs
Support of integration in energy system	No	Some	No	Some, special netto tariff system	Yes
Commercialisation emphasis in efforts	Partly	No	Yes	Yes	Yes
Energy Strategy Plan	Some emphasis (biofuels)	Some emphasis	Some emphasis	DK follows the EU strategy: 1% of total energy consumption in 2010	Emphasis
Public procurement (general and strategic)	No	Yes	No	No special action	No
R&D (mill. DKK, 2005)	77,7	37,1	15,7 (fuel cells 82,1)	22,1	37,0
Other central public efforts		Regulations, standardisations		Building regulations Quality assurance system for solartechnology systems	Certification system

Source of the public R&D figures: Energistyrelsen.

There are limited educational activities on the individual technology areas. Education in wind energy has to some degree been developed in recent years. Also in the area of energy efficient technology there are some higher education activities, while in the other areas it is relatively scattered. The findings are similarly scattered concerning general energy educations.

4 Conclusions

The main result of the analysis is that the energy technology areas are quite diverse in a number of innovation-relevant issues like actor set-up, institutional structure, maturity, and connections between market and non-market aspects. Though there also are similarities, the analysis shows that a discussion of dynamics and conditions of innovation in the energy area needs to be sensitive to the specific technology areas. The connection to the local environment (industry, knowledge networks, energy systems and policies) is important.

The high degree of diversity between the different technology areas implies that an efficient innovation and energy policy has to take into account these differences. The policy must reflect the variation in maturity. In areas like solar cells, where the market is formative, qualified demand – for instance in the form of strategic public procurement – is central for the technology to develop further. In areas like energy efficiency, where there are considerable markets within selected fields, indirect public policy support in form of for instance information campaigns may be very effective.

The existing use and combination of different policy instruments varies considerable between the various energy technology areas. There is a need for a higher degree of coordination between the different policy initiatives. Synergy can be obtained by a strategic combination of different instruments (market and non-market based).

5 References

- Ahm, P., Frederiksen, K., Morthorst, P.E.; Holst-Nielsen, J. 2006: Solceller – betydningen af udbredelse til reduktion af pris behov og konsekvenser for operationelle mål, Malling: PA Energy
- Andersen, Poul Houman & Ina Drejer 2006: Danmark som Wind Power Hub – mellem virkelighed og mulighed, København: Vindmølleindustrien
- Edquist, Charles 1997: Systems of Innovation. Technologies, Institutions and Organizations, London: Pinter
- Foxon et al. 2005: "UK innovation Systems for new and renewable energy technologies: drivers, barriers and systems failures", Energy Policy 33, 2123-2137
- Hekkert, M.P., R.A.A. Suurs, S.O. Negro, S. Kuhlmann, R.E.H.M. Smiths 2007: Functions of innovation systems: A new approach for analysing technological change, in Technological Forecasting & Social Change, Elsevier
- Jacobsson, Staffan & Anna Bergek 2004: Transforming the energy sector, the evolution of technological systems in renewable energy technology, in Industrial and Corporate Change, vol. 13, no. 5, pp.815-849
- Lundvall, Bengt-Åke (ed.) 1992: National systems of innovation - toward a theory of innovation and interactive learning, Pinter, London,
- Malerba, Franco 2002: Sectoral systems of innovation and production, in Research Policy 31, pp. 247-64
- Polanyi, Michael 1966: The Tacit Dimension, New York: Anchor Books
- von Hippel, Eric 1988: 'The Sources of Innovation', New York: Oxford University Press

Session 9 – End Use Technologies and Efficiency Improvements

Chairman: Jens Peter Lynov, Risø National Laboratory, Denmark

A COOLING SYSTEM FOR BUILDINGS USING WIND ENERGY

Hamid Daiyan

Islamic Azad University - Semnan Branch, Iran

hamid.daiyan@semnaniau.ac.ir

Abstract

In Iranian historical architecture wind tower is used for cooling and ventilation. Wind tower is a tall structure that stands on building. Wind tower is used in dry land, and only uses wind energy for conditioning.

Its technologies date back over 1000 years. Wind towers were designed according to several parameters, some of the most important of which were building type, cooling space volume, wind direction and velocity and ambient temperature.

This paper studies wind towers and characterizes airflow route and explains how to decrease temperature.

To confirm, the quality of the wind tower, some experiments in a case study shows it can decrease room temperature on comfort range and room temperature is almost constant on during day.

Keywords: Architecture, Cooling system, Wind energy, Temperature



Fig.1 Wind tower of Doulat-Abad garden of Yazd with its altitude is 33 meters and 80 centimeter. It is highest wind tower in Iran. It has built in 1750. This wind tower has octagon plan. It can receive wind from eight directions and conduct it inside of room.



Fig.2 a new building equipped in wind tower in Semnan

Function of Wind Tower

Function of wind tower basically constructed method of utilization from blowing of wind to take pleasant air in to building and use from its reflection energy to suck for drive away hot and polluted weather.

Dry weather that wind tower receives path above of little pool and fountain it becomes cool by method of evaporation and goes into the room.

Below shape shows path of wind current of wind tower.

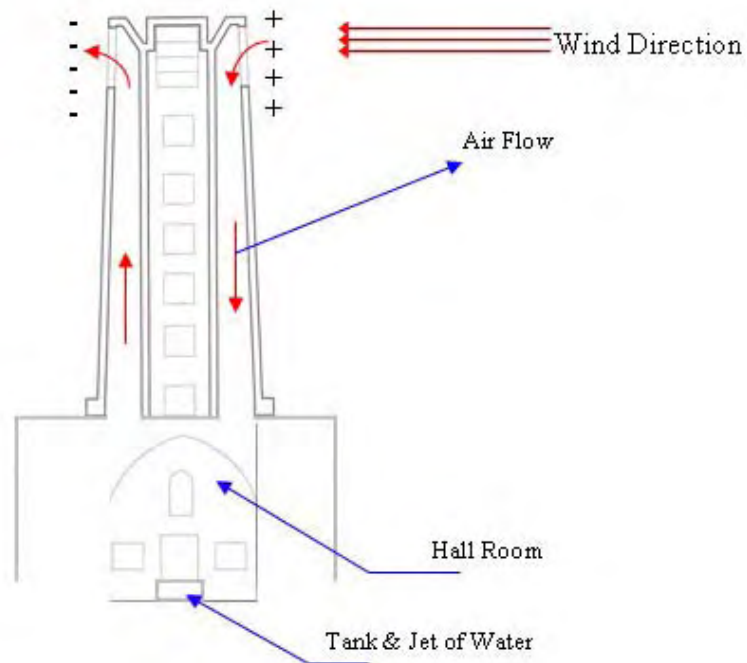

Fig.3 Direction of wind path in a wind tower



Fig.4 Room of under wind tower with small pool to moisture of weather

Wind tower has different kinds and normally built with due to climate condition and direction of wind.

1) Square and octagon wind tower is suitable for regions that direction of pleasant wind is various, specially in the warm seasons that some times pleasant wind blows from north to south and some times from east to west.



Fig.5 An octagon wind tower in Yazd

2) Rectangular wind tower has built in the area that direction of wind is from north-east to south-west. For this reason architectures make it in front of big surface of outward appearance.

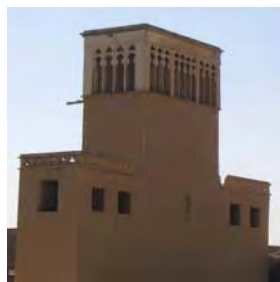

Fig.6 a rectangular wind tower in Semnan

3) In the villages of edge of desert and villages of inside of desert to avoid harm of whirlwind and storm architectures make it only direction, it has made north-east and other sides have been closed. Its direction is to the mountain breeze.

Case Study

This section indicates conclusion of inside and outside temperature of building that has equipped wind tower in one of summer hot day. This specimen ventilation has been made about 135 years ago in south of Semnan it's high is 20 meters. It is highest wind tower of Semnan.



Fig.7 Rajabi wind tower is highest wind tower in Semnan and its altitude is

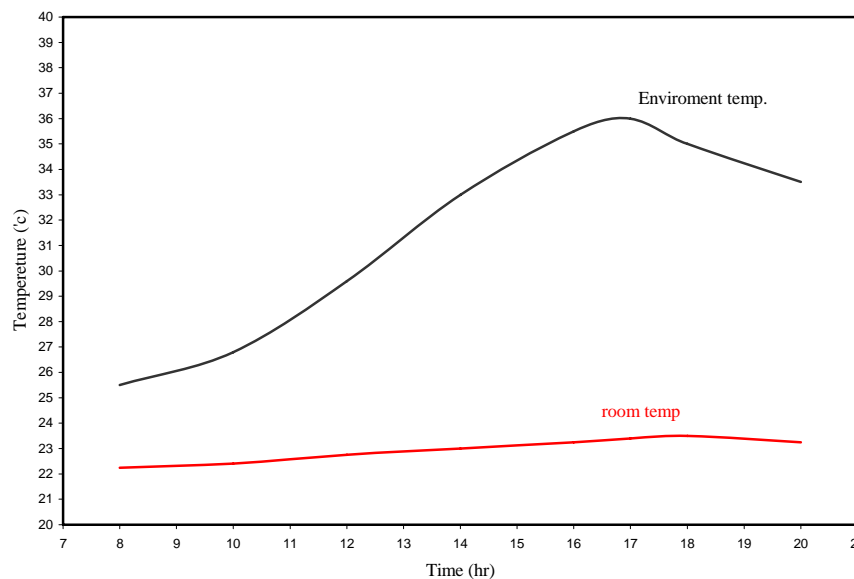

Fig.8 Room temperature comparison

Conclusion

As shown in above graph wind tower can moderate weather of room. Other important point is fixing temperature of room and keeps it in suitable situation. Above graph shown average degree of environment in the outside is 32 centigrade and average temperature of room is 23° c . It is desirable weather in the warm area.

References

Bahadori, M. N., 1978, "Passive Cooling Systems in Iranian Architecture," *Scientific American*, 2:144-154

Saberi, O, Sanei, P., 2002, *Low Energy Architecture*, Tehran: NEGAHE SHARGHI SABZ Press

Meamarian, G., 1996, *Iranian Architecture*, Tehran: University of Science and Technology Press

<http://www.persianguardeb.ir> Accessed on June 10, 2005.

<http://www.warterhistory.org> Accessed on June 21, 2005.

New LED light sources and lamps for general illumination

Carsten Dam-Hansen, Birgitte Thestrup, Henrik Pedersen and Paul Michael Petersen

Risø DTU, Optics and Plasma Research Department, DK-4000 Roskilde, Denmark

Abstract

Research and development within Light Emitting Diode or LED-technology is progressing at such a speed that today single high-power LEDs exist, which can provide luminous flux of several hundreds of lumens. And that is, with efficacies that have surpassed that of incandescent bulbs and is close to the efficacy of compact fluorescent tubes. There is no doubt that LED-technology is the future lighting technology and already today LED lighting is attractive from an energy savings perspective. However, in order to take advantage of the potential energy savings it is crucial that the light quality of these new LED light sources and lamps is very high and comparable to that of incandescent light. Here we describe the results of a research and development project on new LED light sources and lamps. The project is carried out in an interdisciplinary collaboration between designers, lamp producers and researchers. We demonstrate a new LED light source with variable color temperature combined with very good color rendering properties. The design of new lighting fixtures and LED lamps is equally important and our collaboration with several designers has resulted in several new LED lamps for general illumination in residential houses.

Introduction

The successful application of solid state lighting devices such as LEDs is forecasted to provide significant economic and environmental benefits. Recent estimates suggest that under the U.S. Department of Energy accelerated schedule, solid-state lighting could displace general light sources such as incandescent and fluorescent lamps by 2025, decreasing energy consumption for lighting by 29 percent and saving 3.5 quadrillion BTUs. In Denmark ELFORSK, which is under the Danish Energy Association, supports research and development within efficient power consumption. LED lighting has been an area of particular interest since 2004. Risø has headed and participated in three research and development projects, in cooperation with Danish industry, including established lighting companies like Louis Poulsen Lighting and Nordlux, industrial designers, LED lighting companies like Lumodan and RGB Lamps and energy distribution companies. The aim of these projects has been to design and develop new high quality LED light sources and LED lamps for replacement of traditional light sources and lamps for specific applications. The energy efficiency and light quality combined with modern design of new lamps has been of primary interest in these projects. Results shown here are obtained in the project 337-068 *Development of new LED light sources and lamps*, which was completed in December 2006¹.

Physically, the LED is a completely different type of light source compared to traditional light sources like incandescent bulbs and fluorescent tubes. The LED is a semiconductor component, which is very compact, robust and features a very long lifetime. Lifetimes of more than 50.000 h are achievable. That is more than 50 times the lifetime of an incandescent bulb. LEDs emit colored light with a narrow spectral band of 20-30 nm, colors covering the spectral range from the UV the IR is achievable. Today LEDs can be found in many applications requiring colored light, such as e.g. signs, traffic signals and automobile back and brake lights.

For general illumination, however, there is a need for new white light sources of very high light quality that can match the light quality of traditional light sources. The color temperature and color rendering properties must be comparable or better than those of incandescent bulbs and fluorescent tubes. White LED light can be obtained in two different ways; either from white LEDs or by using RGB-technology, i.e. mixing of primary colors. A description of these technologies is given and the properties of a demonstration LED light source, developed at Risø, are presented.

For the consumers, acceptance of this new lighting technology requires high energy efficiencies and high light quality. However, equally important for the consumers are the design of new lamps. This was concluded in two questionnaires carried out in connection with public presentations of the LED lamps developed in the project. The project was carried out in close collaboration with lamp designers, who was given a thorough theoretical and practical education within LED lighting technology at Risø. Some of the new designs of LED lamps resulting from this project are presented at the end of this paper.

White LED light sources

A white LED is a blue LED which is coated with wavelength converters, e.g. phosphors, which absorb the light emitted by the blue LED and re-emits light with longer wavelengths in the green, yellow and red spectral range, i.e. at 500-700 nm. With this technology white LEDs are produced with color temperatures in the range from 2700 K corresponding to the warm light from incandescent bulbs, to 10.000 K, corresponding to a cold or bluish white that can be found in certain phases of daylight. Cold white LEDs are the most efficient and Nichia has reported² an efficacy of 150 lm/W at low operation currents. Lumileds has reported³ a high-power LED which emits 136 lm with an efficacy of 115 lm/W. These efficacies are obtained under laboratory conditions. Realistic efficacies that can be achieved using commercial white LEDs are in the range 30-60 lm/W depending on the operating conditions. The color rendering properties of commercial white LEDs are relatively good and characterized by color rendering indices (CRI) of 75 for cold white LEDs and around 80 for warm white LEDs.

The CRI describes the color rendering of a light source, i.e. the effect the source has on the color appearance of objects in comparison with their appearance under a reference light source. The reference source must have the same color temperature as the test source. For warm white light source a black body radiator and for cold white light sources a phase of daylight is used as a reference source. If the spectral distribution of the test and reference light sources are identical then CRI = 100, if they differ the CRI will be lower than 100. The CRI of incandescent bulbs is thus very close to 100 since their spectra are very close to that of a black body radiator. The CRI of compact fluorescent tubes is approx. 75-80, which is the same as for white LEDs. However, the spectrum of white LEDs is continuous and covers all colors in the visible spectrum, which is not the case for the discrete spectrum of compact fluorescent tubes. Therefore the color rendering of white LEDs is expected to be superior to the color rendering of compact fluorescent tubes, regardless of the fact that they have the same CRI.

The other method of producing white light from LEDs is the RGB-technology in which one uses the mixing of the primary colors; red, green and blue, to produce white light. With this type of LED light source, one has a unique possibility to control the spectral distribution of the light and hence the color temperature and the color rendering properties of the light source. In principle, higher efficacies than can be obtained with RGB-technology than with white LEDs, since no wavelength conversion process is used as for the white LEDs.

We have developed a new LED light source based on RGB-technology and used it in an anglepoise desk lamp as a replacement for an incandescent light bulb. The lamp is going to be used for demonstration purposes and has therefore been developed so that the spectral distribution can be controlled via computer control. In this way the color

temperature and the color rendering properties of the light source can be controlled by the user. The LED light source consists of seven different types of LEDs with colors covering the visible spectrum. Here, we will examine two very different settings of the light source corresponding to white light as we know it from daylight and from incandescent bulbs, respectively.

Fig. 2 shows an example of a measured spectral distribution from the light source. Here one can see the distinct peaks but broad peaks from blue, green, red-orange and red LEDs. The relative intensity of these peaks is observed to decrease from the blue, over the green to the red spectral range. This spectral distribution of the light yields a correlated color temperature of 6300 K and corresponds to a phase of daylight with a spectral distribution which is also shown on the graph. The color rendering of the LED light source in this daylight setting is given by a measured CRI index of 91.1. This indicates a very good color rendering that is superior to what can be obtained using white LEDs.

A very different spectral distribution of the same LED light source is shown in Fig. 3. Here, the relative intensity of the peaks from the different types of colored LEDs are changed, so that the red spectral range is dominating and the intensity of the peaks decreases towards the blue part of the spectral range. The correlated color temperature has been measured to be 2880 K. This is close to the color temperature of a 60 W incandescent light bulb, which has a spectral distribution that is also shown on the graph. The CRI is measured to 86.6 for this incandescent setting of the new LED light source.

The colorimetric measurements of color temperature and CRI-index have been performed in Risø's new LED light laboratory. We use calibrated spectroradiometers with large specially designed integrating spheres. With these setups it is possible to measure the total flux from these new LED light sources and hence also the efficacy.

The efficacy of the developed LED light source has been measured to be 46-51 lm/W, depending on the actual setting of the spectral distribution. With this efficacy, the new LED light source can, with a power consumption of 5-6 W, replace a 25-40 W incandescent light bulb, which has an efficacy of 9-11 lm/W.

The wall plug efficiency of this LED lamp is somewhat lower, since power is used for control and cooling electronics. Furthermore, the light source is dimensioned to a maximum wattage of 60 W. A wall plug efficiency of up to 36 lm/W has been measured, which is better than results of similar measurements on LED light products in a test by the US Department of Energy⁴. These tests results on warm white LED lamps shows wall plug efficiencies of below 20 lm/W and CRI indices of only around 70.

With this demonstration light source it is possible, for a given application, to adjust the power and the color temperature to a desired value over a large range and at the same time maintain very good color rendering properties given by a high CRI-index.

The ability to maintain the desired color temperature over a long time and under different ambient conditions is a problem with RGB-based LED light sources. Research and development is therefore concerned with passive and active control and stabilization of RGB-based light sources.

LED lamp designs

High energy efficiency and high light quality is necessary for a successful implementation of this new LED lighting technology with danish consumers. The design of fixtures and lamps is, however, equally important. Therefore, nine Danish designers were engaged in the present project to give their ideas to new fixtures and lamps using LEDs. In order to give the designers the best background for working with LED-technology in new lamp designs, Risø held a course on light and LED technology specially developed for the designers.

This resulted in many new design ideas and four of these ideas were chosen to be further developed within the project due to promising technical and design aspects. The four designs were developed in a close collaboration between designers and researchers at Risø. Functional models of the new LED lamps were produced; two LED pendants, a LED table lamp and a chair with LED lighting. Photos of the developed LED lamps taken at an exhibition at Risø are shown in Fig. 4 and 5.

One of the LED pendants is called the waterlily, and is inspired by leaf of waterlilies. It is designed by Jesper Olsen and Jacob Rudbeck. It consist of five leafs as seen in Fig. 4. Each leaf centre has a functional white LED lighting illuminating the table. The rim of the leafs is illuminated by several RGB-LEDs which can change in color over time or be fixed at a certain color. A wall plug efficiency of up to 36 lm/W has been measured for this LED lamp. These two designers also designed the Cluster and Flip-Flop LED lamps seen in the photos as well. The chair with LED lighting is a whole new way of thinking light into our houses, and is designed by Christian Flindt.

The new LED lamps were presented to the public in October 2006, at an exhibition at Illums Bolighus in Copenhagen, a shopping centre in design, fashion and interior decoration. At the opening of the exhibition people were asked what they thought of the new type of lamps through a questionnaire. In November 2006 a LED seminar was arranged at Risø, where 150 people participated covering designers, engineers, scientists, architects and many others. Here the developed LED light sources and LED lamps were presented through talks, workshops and an exhibition. The photo in Fig. 1 is from the workshop where people had a chance to test the new light sources and lamps. A user test was conducted through a questionnaire.

The two questionnaires showed a very positive response from people, that could see the new LED lamps as replacements of the lamps the use today. The attractive feature of dimming the light and controlling the color temperature of a LED lamp was recognized and appreciated by people, but the most important feature was the design of the lamp.

Acknowledgement

We appreciate the financial support of the project no. 337-068 *Development of new LED light sources and lamps* from ELFORSK under the Danish Energy Association.

Conclusion

We have described the results of an interdisciplinary project, where designers, lamp producers and researchers have worked together on developing new LED light sources and LED lamps. A new LED light source, with a wattage of 5-6 W, that can replace a 25-40 W incandescent light bulb has been developed. Besides the high efficacy the demonstration LED light source has a color temperature that can be controlled over a large range corresponding to going from incandescent light to daylight. This is achieved with a very good color rendering given by a CRI-index of approx. 90. This demonstration LED light source is still a laboratory model, but illustrates some unique possibilities with LED technology for general illumination.

New LED lamps developed in close collaboration between designers and researchers, has been presented. Measurements have shown wall-plug efficiencies up to 36 lm/W. User tests through exhibitions, workshops and questionnaires have shown a very positive response for the possible replacement of traditional light sources and lamps. These tests also showed that design is the most important parameter when buying a new lamp.

In the use of LED technology, we have shown that it is possible to combine the high efficacy of LEDs with high light quality and design in new fixtures and lamps, thus paving the way for a integration of this new lighting technology for general illumination purposes.

Figure captions



Figure 1 Demonstration of Risø's new computer controlled LED light source used in an anglepoise desk lamp at an LED seminar held at Risø on the 30th of November 2006. The user was able to control both the luminous power and color temperature and an identical lamp with a 60 W incandescent bulb is used for comparison.

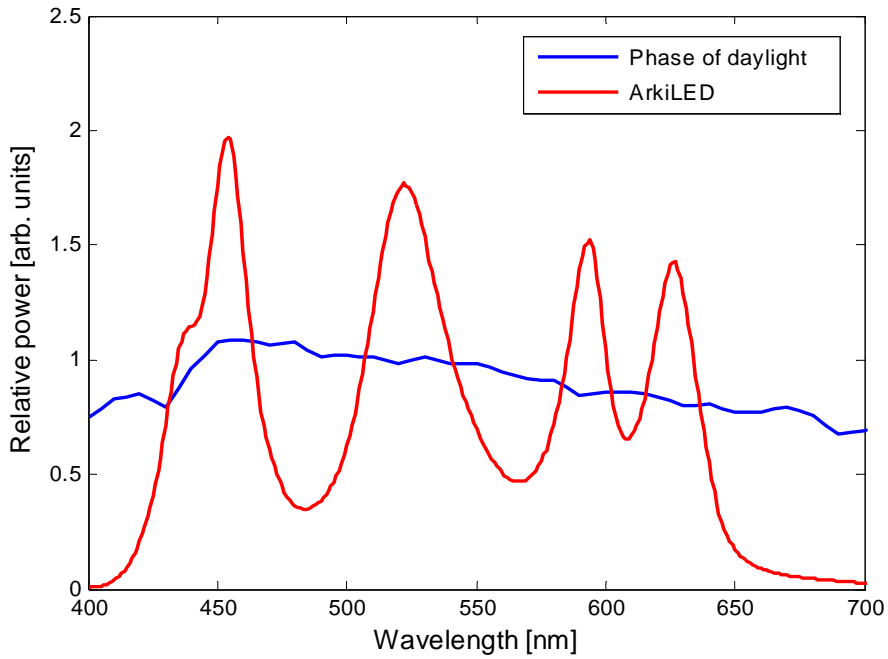

Figure 2 Measured spectral distribution of the LED light source (ArkiLED) in a daylight adjustment. The correlated color temperature has been measured to be 6300 K and the CRI-index to be 91.1. The black line shows the spectral distribution of a phase of daylight with the same color temperature of 6300 K.

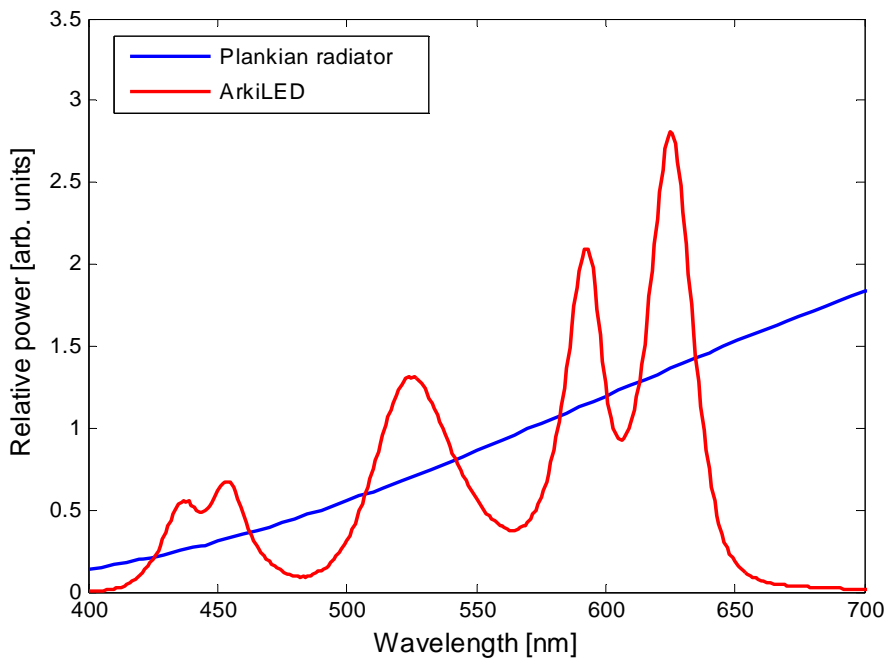

Figure 3 Measured spectral distribution of the LED light source (ArkiLED) in an incandescent adjustment. The correlated color temperature has been measured to be 2880 K and the CRI-index to be 86.6. The black line shows the spectral distribution of a Plankian radiator or in principle an incandescent lamp with the same color temperature of 2880 K.



Figure 4 Photo of the exhibition of new LED lamps at the LED seminar held at Risø in November 2006. Close to the wall is two chairs with LED lighting, in the back on the tables are two Flip-Flop LED table lamps and in the front are the Waterlily LED lamp hanging over the tables.



Figure 5 Cluster LED lamp show at the exhibition at Risø in November 2006.

References

- ¹ Carsten Dam-Hansen, Paul Michael Petersen, Birgitte Thestrup, Jørn Scharling Holm, Jakob Munkgaard Andersen, Hans Falleboe, Jesper Olsen og Christian Flindt, *Slutrapport for PSO 337-068 Udvikling af LED lyskilder og lamper*, Risø-R-1606(DA), ISBN 978-87-550-3598-0, (2007)
- ² <http://ledsmagazine.com/news/3/12/19/1>
- ³ <http://www.ledsmagazine.com/news/4/1/23>
- ⁴ Commercial Product Testing Program, Summary of Results: Pilot Round of Product Testing, DOE Solid-State Lighting, U.S. Department of Energy, December 2006, http://www.netl.doe.gov/ssl/comm_testing.htm

Session 10 – Systems Aspects – Distributed Production

Chairman: Lars Landberg, Risø National Laboratory, Denmark

STREAM: A Model for a Common Energy Future

Anders Kofoed-Wiuff, EA Energianalyse; Jesper Werling, EA Energianalyse; Peter Markussen, DONG Energy; Mette Behrmann, Energinet.dk; Jens Pedersen, Energinet.dk; Kenneth Karlsson, RISØ

Abstract

In 2004 the Danish Board of Technology initiated the project: The future energy system. Its purpose was to lay down objectives and possible futures of the Danish energy system together with Danish politicians from the Parliament (Folketinget) and interested parties within the Danish energy sector.

To start the discussion a working group was established with the task of making a simple energy flow model ensuring coherence between production of energy services and consumption and to give an indication of the financial costs. The model was made in a unique cooperation between Energinet.dk, Risø National Laboratory, DONG Energy and Ea Energianalyse.

The model consists of three parts: an energy consumption model, an optimisation model for power and heat production and consumption and finally a model gathering fuel consumption, production and final consumption and economy assessment.

For consolidation of the model calculations of more complicated energy plan and energy optimisation models have been made subsequently, and these have proven the sturdiness of the model.

The broad cooperation and the simple model ensured a continuous overview and contribute to the constructive dialogue between interested parties and politicians about objectives.

The purpose of this article is to describe the model and the final technology scenario. Thus the article can work as an inspiration for similar and future projects about the future of the energy system.

1 Why STREAM?

In spring 2004 the Danish Board of Technology¹ started a 2½ years endeavour into examining possible paths for the future development of the Danish energy system. The keystone in the project is a “Future Panel” with representatives from all parties in the Danish Parliament. A Steering Group of experts and stakeholders within the energy sector assist the Future Panel.

Throughout the project four public hearings have been held with great attendance. The hearings have been chaired by members of the parliament and have dealt with the future challenges facing the energy sector and measures to deal with these challenges on the supply side as well as on the demand side. In the spring 2007 further workshops on key instruments and measures has been established.

¹ The Danish Board of Technology is an independent body established by the Danish Parliament (the Folketing). The Board is supposed to promote the ongoing discussion about technology, to evaluate technology and to advise the Danish Parliament (the Folketing) and other governmental bodies in matters pertaining to technology.

As part of the project a number of possible developments or scenarios for the Danish Energy System in 2025 have been developed. The overall objectives of the scenarios are: to improve security of supply to deal with environmental issues particularly climate change; to ensure economic competitiveness; and to contribute to global sustainability.

The project shows that by combining different measures in a so-called “combination scenario” both targets can be fulfilled. In the combination scenario focus is on energy savings, increased use of wind power and domestic biomass in the energy sector and electric/hybrid vehicles and biofuels in the transport sector.

In the project, the *Sustainable Technology Research and Energy Analysis Model* (STREAM) has been developed to qualify the scenarios. It is often a problem that numerous actors have differing approaches and use complex models that are not always transparent for an outsider. Therefore, relatively simple models have been developed for use with the project that help to give all relevant actors better insight into the analyses.

The modelling tools are in three different ways rather unique. First of all the model is developed with the purpose to enhance the complete energy flow from fuel exploration, conversion and energy use across all sectors in the society. Many other models only focus on different parts of the energy system. Secondly, the model is developed in cooperation among a university, an energy company, a transmission system operator and consultants. This gives the model a high degree of credibility and keeps focus on problem solving and results in the dialogue with other interests. Thirdly, the simple models make it possible to conduct new analyses relatively quickly – for example during a meeting. This enhances the knowledge basis for intelligent decisions.

Further the model consists of a large amount of input data. In the data procurement process we have benefited from being a part of a project supported by the energy policy politicians making it easy to engage experts, the knowledge from the members of the steering committee and the participants in the public hearings and other workshop.

The next section describes the modelling tool. The third part describes how the modelling tool has been used to develop the combination scenario and discuss the quality of the results and compares the results with other analysis made on more complex models. Finally we conclude and discuss the perspectives of the modelling tool.

With this article we would also like to thank all the persons who have helped us in the development of the model and the procurement of data.

2 Description of the modelling tool

The modelling tool consists of three Excel spreadsheet models:

- *The energy savings model*
- *The time series model*
- *The energy flow model*

The models are based on a bottom-up approach. This means that the user defines the input to the models, e.g. MW wind turbines in the electricity sector or per cent bio-ethanol in the transport sector, and on this basis, a financial output is calculated. The model does not perform an economic optimisation specifying exactly which set of measures are the most advantageous to combine under the given conditions.

The coherence of the different tools are shown in figure 1

Figure 1. The STREAM model

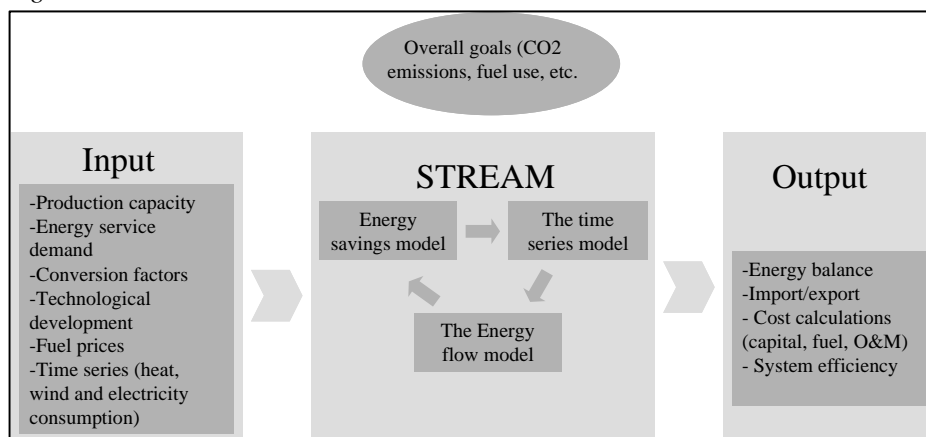

The result of a model never gets better than the data used for the modelling. Besides building the model a lot of time has been used on finding public accessible data for the model. During the development phase the limitations of data has been decisive for the structure of the model.

In the following parts of this section the model is described in more detail and with special focus on origin of data and the advantages and disadvantages of our approach.

2.1 The energy savings model

By means of the so-called *energy savings model*, the demand for energy services in the given year is projected. The demand for energy services is assumed to increase with the economic growth multiplied by an energy intensity factor reflecting the fact, that not all economic growth is translated into increased demand for energy services (partly due to structural changes within the sectors).

For Denmark, the demand for energy services and consequently the end consumption of energy are calculated for four areas: trade and the service sector; industry; households; and transport.

Within each of these areas, different types of end uses are indicated (lighting, cooling, pumping etc.) as well as savings potentials and related costs.

For the transport sector the starting point is the amount of person kilometres pr. Year, which then are allocated on different transport methods and fuel combinations. It is also possible to examine transport mode changes.

Origin of data

Data on energy consumption comes from the Danish Energy Savings plan and from a special assigned working group with representative from key stakeholders dealing with energy savings: SBI, The Electricity Saving Trust, Universities, The confederation of Danish Industries.

Data on energy savings are mainly from public studies and members from the Steering committee and more experts in Denmark have validated the input.

Advantages and disadvantages

The main advantage of the savings model is the focus on energy services and not just energy use. This makes it possible to analyze the benefits of increased energy efficiency in electronic devices, transportation, etc.

The disadvantage of the energy savings model is that it does not include costs for changing human behavior, the necessary investments in infrastructure or technological development due to the changes in energy demand and efficiency. This both include heat, electricity and gas infrastructure as well as potential extensions of harbors, stations, railroads, use of new fuels for transport etc.

2.2 The time series model

The purpose of *the time series model* is to analyse correlations in the Danish electricity and CHP system at an hourly level. The analyses made by the time series model form the basis for the input to the overall energy flow and economy calculations in the energy flow model - for example, the expected number of operation hours at the various energy production facilities. In the model, an energy system is set up in which national production plant is able to meet the demand for electricity and district heating. International exchange is not included. It is, however, possible to calculate the size and value of exported electricity surplus due to large wind power production.

The time series model is built up on historical time series (hourly values) for electricity and heat consumption. In each scenario, the historical time series are scaled to the actual consumption. The supply side is modelled as a large combined heat and power plant, large heat storage, a large heat pump and a large heat only boiler as well as four types of wind turbines (an off-shore and an on-shore wind turbine in both Eastern and Western Denmark). Denmark is analysed as one interconnected system without any national transmission constraints, neither for district heating nor for electricity.

Like the production data, the annual production of the wind turbines is established on the basis of historical time series and scaled to the selected level of wind power production in the scenario.

Its is also possible to include assumptions on demand response and energy savings in the model as well as increased used of electricity for the transport sector either directly or through the use of hydrogen.

Origin of data

The time series for consumptions are from the website of the Danish Transmission System Operator, Energinet.dk. The wind and heat profiles are from Balmorel.

Advantages and disadvantages

With the use of the time series the model indicates the coherence between electricity from wind and combined heat and power production. The model does not take transmission constraints and limitations in Denmark or to the neighbouring countries or market optimisation into account. Normally the optimisation of electricity production, heat, consumption under transmission constraints and market optimisation is the challenging and time consuming part of other energy models.

The time series model cannot be compared to advanced electricity sector optimisation models. Comparisons of results from the time series model with more advanced models show however, that the model gives a satisfactory representation of the general energy system. Further analyses of the benefits of different measures in the electricity system will however benefits from using a partial equilibrium model like for example the Balmorel model, see section 4

The time series mirrors the current infrastructure and does not take account of new infrastructure developments and how the infrastructure may be used in the future.

2.3 The energy flow model

The purpose of *the energy flow model* is to create an overview of CO₂ emissions, use of national energy resources, fuel consumption and conversion to energy products and services in the energy system. The model also contains assumptions as regards investment and operation costs of the technologies used to convert fuels into energy services, which enables it to compute the costs of investing in production facilities. It is possible to break down the fuel consumption by end consumption of energy services or by sectors.

The energy flow model is a static model assessing and arranging the total energy system in a given year. The input to the energy flow model comes from the energy savings model (final energy demand) and the time series model (system correlations).

The model also contains the possibility to establish comparisons with a given reference year or other scenarios.

Economic modeling

The economic costs of the various scenarios are determined as the annual costs of running the system in one scenario year, e.g. 2025.

The costs, which are computed in the project, are the system costs from a technical perspective. The study does not examine what concrete policy measures are the most appropriate to implement the required changes in the energy system, nor does it address the distribution of costs among stakeholders. The latter will depend on the concrete instruments preferred by policy makers.

Costs include capital costs, fuel costs, operation costs and maintenance costs. Cost of energy savings are worked out as the relative extra cost of measures in the reductions scenarios compared to the reference and maintenance and investment costs of energy supply technologies are computed to reflect the duration time of the applied production machinery. Investments in machinery and equipment (power plants, energy saving measures, vehicles etc.) are converted to annual capital cost using a discount rate of 6 per cent. This is in line with the guidelines from the Danish Ministry of Finance.

Origin of data

Data for economic modeling are from the Technology catalogue published by the Danish Energy Authority. Where information on new technologies are missing these are supplemented by information from private companies or other research projects.

The assumptions on fuel and CO₂ allowance prices are based on the public expectations, when the scenarios were constructed. This is further described in the next chapter.

Advantages and disadvantages

The simplicity of the model makes it easy to evaluate the consequences of different energy systems developments compared to other scenarios or a reference and where to optimize.

The disadvantage is the necessary manual transfer of results from the other models and many variables. The assessment of infrastructure use and bottlenecks and the consequences of market optimization are not reflected in the results.

As a general point, it should be stressed, that there are significant uncertainties associated with forecasting the future costs of different technological development paths. For example some energy producing technologies may become more expensive than expected (and others less expensive) and fuel prices may differ significantly from basic

assumptions. To take account of this a range of sensitivity analyses has been prepared using different key assumptions. It should also be mentioned that the methodology of looking at the scenarios in only one year implies some limitations in the economic analyses. For example it is not possible to examine the replacement of power plants in detail over time.

3 The combination scenario

The combination scenario is the combination of energy savings, wind energy and biomass.

The quantitative targets of the project were to:

- Reduce CO₂ emissions by 50% in 2025 compared to 1990 levels (52 ⇒ 26 mil t CO₂).
- Reduce oil consumption by 50% in 2025 compared to 2003 levels (290 ⇒ 145 PJ).

Furthermore, issues such as global responsibility and the national economy have been accounted for in the development of these scenarios.

Basic assumptions and overall results are shown in table 1. Numbers in brackets are figures from the reference year 2003.

Table 1. Overall assumptions and results for Combination scenario (real 2006 prices)

Assumptions		Results	
Oil	50\$/bbl	CO ₂ -emissions	19 mio. t. CO ₂
Natural gas	39 DKK/GJ	Net energy demand	304 PJ (423 PJ)
Coal	55\$/t	Gross energy demand 493 PJ (808 PJ)	
Biomass	32 DKK/GJ	Oil	143 PJ (284 PJ)
CO ₂ prices	150 DKK/t CO ₂	Coal	20 PJ (238 PJ)
Electricity price (for export of surplus wind power)	150 DKK/MWh	Natural gas	100 PJ (169 PJ)
		Renewable Energy	229 PJ (117 PJ)

The results shown below are only fragments. For more in depth description of assumptions and results, necessary investments and technological development you can find more information on www.tekno.dk.

3.1 The energy savings model

The energy savings in the industry are mainly reached through changes in fuel use and energy products, whereas the changes in the transport sector, service sector and households come from efficiency improvements. The assumptions on the efficiency improvements in the transport sector and electronic apparatus are very decisive for the final results and to some extent dependent on a global improvement of standards for energy use in cars, refrigerators, light pulps, etc.

In table 2 the assumptions necessary to estimate future demand for energy services and final energy demand.

Table 2. Economic growth and energy intensity factors

	Trade /service	Industry	Household /electricity	Household /heat	Transport (growth in transport service)
Economic growth (Yearly growth)	1,6%	1,5%	1,9%	1,9%	1%
Energy intensity factors	0,75	1	0,9	0,26	1,0
Decrease in demand in 2025, PJ (%), compared to a frozen efficiency development	55%	44%	70%	40%	30%

3.2 The time series model

The assumptions in table 3 on the fuel and technology distribution in the electricity and heat system are used in the combination scenario.

Table 3. Share of fuel used for electricity production and separate collective heat production.

	Oil	Coal	Natural gas	Biomass	Biogas	Waste	Wind	Heat pumps
Electricity and CHP	1%	8%	10%	7%	16%	8%	50%	-
Heat, separate	0%	0%	35%	30%	0%	25%	0%	15 PJ

With the assumptions on the total energy service demand from the Energy Savings Model a durations curve for heat and power consumption is created. With assumption on the use of heat pumps the Time series model calculates the amount of heat from combined heat and power and separate heat production as the residual, se figure 2

Figure 2. Duration curves for heat demand and heat production from heat pumps, separate heat, storage and heat from combined heat and power production.

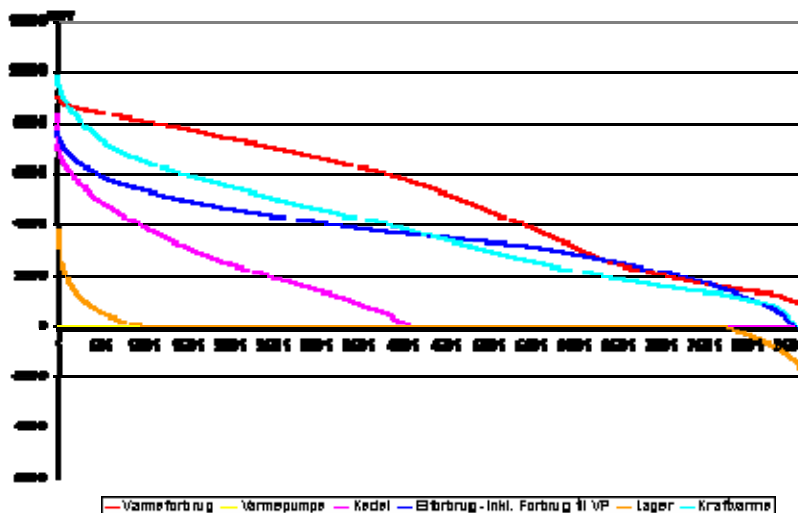

The consumption time series is deducted with the wind production and the remaining is allocated in 500 MW segments of power productions or necessary exports. In the Energy Flow model the technologies are attached to the segments dependent on their production costs and give priority to some technologies or fuels as waste or biomass in the electricity system, see figure 3

Figure 3. Duration curve with electricity demand time series deducted with the wind production.

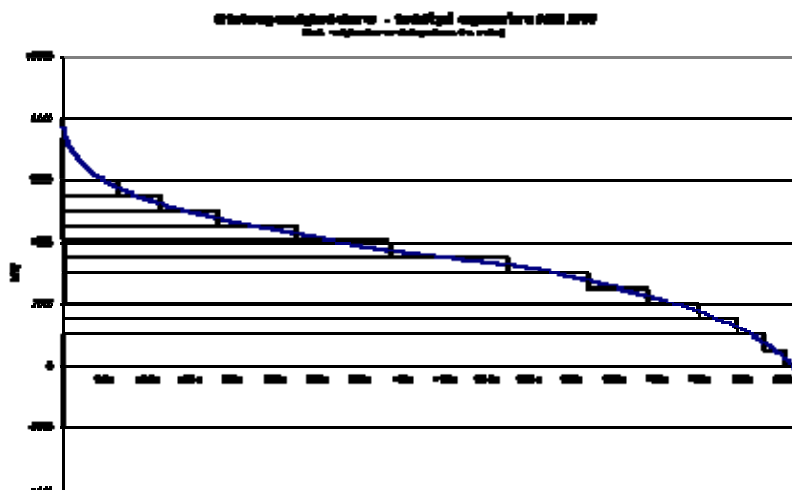

In the model it is possible manually to change the amount of flexible demand in different time periods or to include e.g. the production of hydrogen from electrolyses. It is assumed 250.000 MWh of flexible demand and 83.000 MWh used for hydrogen.

3.3 The energy flow model

The energy balance

With the information on the demand for energy products (electricity, separate heat, combined heat, transport, etc.) the Energy flow model calculates the gross energy demand with its assumptions on conversion factors and the costs in the energy system with the financial data.

In this scenario, the final level of energy consumption by end-users excl. transport in 2025 is 304 PJ. This is equal to a solid 1/3 fall in consumption when compared with 2003 levels, see table 1. Gross energy consumption also falls leading up to 2025 by approximately 45% compared to 2004, while the share of gross consumption that is covered by renewable energy rises to 45% from 15%.

The combined Danish wind power capacity will be in total, approximately 4900 MW, of which 3000 MW are provided by land-based windmills and 1900 MW by sea-based windmills. To compare, the total wind-power capacity in 2004 was approximately 3100 MW.

Oil consumption is halved in comparison to 2003. This is connected to measures in the transportation sector, where there are efficiency improvements and the substitution of oil with bio-fuels and electricity (assuming electric cars and/or hybrids). Furthermore, major reductions occur in the consumption of oil in individual houses and industry. In the transportation sector, a 25% improvement of efficiency in the vehicle fleet and the replacement of oil with other fuels such as bio-fuels and electricity are assumed.

CO₂ emissions are reduced by at least 60% from 1990 to 2025. This is primarily attributed to reduced energy consumption and the growing share of alternative energy on the supply side.

Import and export balance

The major reduction in energy consumption reduces both the need for, and subsequently the dependency upon imported fuels. Regardless of the efforts, it will still be necessary to import some coal and natural gas. The imported gas is primarily used for balancing the fluctuating production abilities of windmills. Coal consumption is derived from heat production.

Costs

Compared to the fuel, operation and maintenance and capital costs of the reference the Combination scenario reduce the costs for fuel with more than 13 billion DKK. On the other hand the O&M are 1 billion DKK higher and investments costs are almost 13 billion DKK higher than the reference making the combination scenario around 2 billion DKK more expensive than the reference.

The additional annual costs per capita to realise the targets set forth in the combination scenario (as opposed to the reference scenario) is assessed to be approximately 200 DKK in 2025.

3.4 Consolidation of the model

The two most important arguments against the results of model are the simplification of the Danish heat and electricity system and the lack of market optimization.

With the use of the partial equilibrium model SIVEAL from Energinet.dk the consequences of the simplifications has been assessed.

The simplification of the heat and electricity system might have as a consequence, that the amount of electricity from combined heat and power production is underestimated. The modeling on SIVAEL confirms this. The excess electricity production in STREAM model is 2 PJ, but in the SIVAEL modeling it amounts to 7-10 PJ. This has to be compared with the total production of 105 PJ of electricity. Increasing the amount of demand flexibility in the electricity or heat system can reduce the excess production, but compared to market flexibility this is an expensive measure.

With market optimization and the possible exchange of electricity to neighboring is a cheap way of increasing flexibility in the energy system. With market exchange the export increases to 40-50 PJ

The consequences of introducing power exchange and a market optimization is large seen from an economic perspective.

The future initiative will be directed towards consolidating the models and the challenges consists on the hand of the improvement of the model without making it too detailed and on the other side making it more user friendly.

4 Conclusion and perspectives

We have through the cooperation of a broad range interests in the energy sector succeeded in developing a transparent and simple model and create relative proof results with public available data.

These characteristics have secured an effective and sound dialogue and public debate among politicians, the energy industry and other organizations with interest in the Danish Energy System. Further the results in the Combination scenario has shown that it is possible achieve large reductions in CO₂ and fossil fuel dependency at relative low costs.

The common understanding of the challenges of the Danish Energy System has created a reference for a continued ambitious, innovative and sustainable development of the Danish energy supply. There still is a need for developing policy instruments and including a wider group of interested parties and politicians in the assessment of targets for the future energy system and how they can be reached. This will happen only through the active cooperation of relevant actors.

Although the project concentrates on the Danish energy system, it should be noted that a number of the needed resources depend on developments globally. The results from the project should serve as input for the current negotiations about the future Danish energy strategy, and should be subsequently used as a strong Danish contribution to the European deliberations on EU energy policies, which could again be source of development for Denmark. The European Parliament has already been decided to establish a similar project as a part of STOA (Scientific Technology Options Assessment) where STREAM will be used as the basic tool in the discussions.

References

Litterature

The Danish Energy Savingsplan, Potentiale vurdering, Energibesparelser i husholdninger, erhverv og offentlig sektor, Birch og Krogsboe, December 2004, www.ens.dk.

Fremtidens danske energisystem, Teknologirådet 2007, www.tekno.dk

Homepages

Balmorel, www.balmorel.dk

The Confederation of Danish Industries, www.di.dk

The Danish Board of Technology, www.tekno.dk

The Danish Electricity Savings Trust, www.elsparefonden.dk

The Danish Energy Authority, www.ens.dk

DONG Energy, www.dongenergy.dk

Ea Energianalyse, www.ea-energianalyse.dk

Energinet.dk, www.energinet.dk

Risoe, www.risoe.dk

SBI (Statens Bygningsinstitut), www.sbi.dk

Vanadium redox-flow batteries – Installation at Risø for characterisation measurements

Henrik Bindner, Wind Energy Department, Risø National Laboratory, DTU,
henrik.bindner@risoe.dk

Peter Ahm, PA Energy A/S, ahm@paenergy.dk

Ove Ibsen, OI-electric A/S, oi@oi-electric.dk

Abstract

Vanadium based redox-flow batteries hold a great promise for storing electric energy on a large scale. They have many attractive features including independent sizing of power and energy capacity, long lifetime, high efficiency and fast response. They also have the potential of relatively low cost, investment as well as operational costs.

It is essential that these features get documented in a close to real world environment. A project with just that aim has been initiated with support from the Danish system operator, Energinet.dk. The objective of the project is to characterise a vanadium battery as a system component.

The vanadium battery will be installed as a component in SYSLAB which is the lab facility established at Risø for testing and investigating distributed power systems. SYSLAB consists of two wind turbines, a pv-array, a diesel genset, different types of load and an office building with intelligent load control. SYSLAB also includes a distributed control system.

The tests on the vanadium battery will include specific tests on the battery alone such as response tests, efficiency tests at different levels of SOC etc. and tests and measurements while it provides different services to grid including smoothing of wind turbine output, load balancing and similar services. A key point for the investigations is comparison between laboratory test performance and performance during normal operation.

The unit is currently being factory tested and will be installed at Risø in August 2007.

Power systems with high penetration of Wind energy/Renewable energy

Renewable energy technologies are being installed at an increasing rate in many countries and regions in order to increase the sustainability of the electricity supply. In some power systems is the level of penetration so high that the renewable energy production has a very significant impact on the operation of the system. The impact is on both voltage and frequency of the system. The main challenge in the future power system is to increase the level of penetration of renewable energy while maintaining the quality of the power system in terms of security of supply and power quality.

The frequency control of the power system is divided into several time scales to facilitate simple and economic operation. On the short time scale, seconds to minutes, the generation capacity online should be adequate to take up changes in load as well as changes resulting from faults in generators or in the transmission. On the medium time scale, hours to days, generation plans ensure economic operation of the system i.e. commitment of plants available. On the long time scale adequacy of generation capacity for supply of the load in the time horizon of years is the issue. This include generation

capacity mix, environmental issues etc. In many power systems the functions of generation planning and operation are implemented through various power markets.

The stochastic nature of wind energy production which reduces the dispatchability of the production has an influence on the requirements of control of the frequency both on short time scales, on medium time scales, as well as on long time scales. On the short time scale the fast variations requires that the rest of the system is fast and flexible enough to compensate for the fluctuations. On the medium time scale the limited predictability adds to the uncertainty which has to be taken in account when other types of generation is committed and scheduled. On the long time scale, large amounts of wind energy has a very significant impact on which types of generation that economically ensures adequate installed capacity of appropriate types.

The current trend in wind energy is to install wind turbines in large wind farms connected to a single point in the grid. This concentration of the wind turbines results in less so called spatial averaging which means that the fluctuations are higher than from the same amount of installed capacity installed in a larger geographical area [1]. The result is that the impact on the power system is larger due to the higher requirements of the rest of the system to absorb the power fluctuations.

The wind power fluctuations as well as their limited predictability [2] also has an impact on the operation of the power system in the hours to days time scale. Due to the long time constants and high start up costs of conventional thermal power plants it is very important for the economic operation of the power system that the number of starts is minimised but that the capacity of the spinning capacity is always adequate and not too large to supply the load when the uncertainties in load and production is considered.

There is a large effort to develop wind power technology to have a higher degree of controllability [3]. Most of the modern types of wind turbines include some form of power electronics. This enables the wind turbines to participate in the voltage control of the system because the power electronics give control over the reactive power. During recent years the grid codes of many system operators have been developed to include active power control requirements. These requirements include limiting the output power of the wind farm at a specified level set by an external signal, specifying the ramping rates up and down of the output power, and a so called delta control mode where the output power of the wind farm is control in such a way that it stays a specified amount below the potential output that can be activated for frequency support. Despite these efforts the direct dependency on the current wind speed limits the possibilities for wind farms to provide power station behaviour without supporting technologies.

There also a development in many countries towards a system with a more distributed generation of energy from especially CHP plants situated at industrial sites or smaller plants for office buildings or individual houses.

In the future it can be expected that the components of the power system will be much more intelligent and connected to a communication network. This will contribute to make demand response more feasible.

More and more of the operation of the system will be done via markets e.g. as the Nordel area [4] which include a spot market and the so called Elbas market with different clearing times and different activation methods.

Many of these developments can benefit from using energy storage as the glue to increase the flexibility and controllability of the system in order to increase security of operation and reduce the financial risks.

Applications of energy storage and energy storage technologies

As pointed out in the previous section there are many potential applications of energy storage in future power systems. These functions are related to the technical functioning of the grid or to interaction with various markets. There are also many storage technologies as well as pseudo storage technologies.

Functions of energy storage include

- Very short term power quality improvement
- Uninterruptible power supplies
- Reduction of short term fluctuations in renewable energy production
- Reduction of spinning reserve
- Reduction of standing reserve
- Daily smoothing
- Seasonal storage
- Energy arbitrage

There are also a number of technologies available. The major technologies are in Table 1 which includes their applications. An overview on energy storage technologies can be found in Sauer [5], and in the EU-supported project, Investire [6], a state of the art for most of the technologies has been prepared.

Table 1 Major energy storage technologies with applications

Technology	Power/Energy Range	Applications	State of development
Supercapacitors, superconducting magnetic energy storage	High power Low energy	UPS, power quality	Pre-mature
Flywheels	High Power Low Energy	Power quality	Mature
Batteries: lead acid, lithium, natrium-sulphur, nickel	Medium power Medium Energy	UPS, RE fluctuation reductions	Pre-mature – mature
Redox-flow batteries: Vanadium, Br-S, Zn-Br	Medium power High Energy	RE fluctuation reduction, spinning/standing reserve	Pre-mature
Pumped hydro	High Power Very High Energy	Spinning/standing reserve, energy arbitrage	Mature
Compressed air	High Power Very High energy	Spinning/standing reserve, energy arbitrage	Mature
Hydrogen	Medium Power High Energy	RE fluctuation reduction, spinning/standing reserve	Prototype
Thermal	-	RE fluctuation reduction, spinning/standing reserve	Mature
Demand response	-	RE fluctuation reduction, spinning/standing reserve	Pre-mature

As can be seen there are a large number of storage technologies, however, most of them are either not mature or very expensive or both. Pumped hydro storage is a very attractive technology, but it is only relevant where the necessary height difference is available. Compressed air storage can be implemented using underground cavities, but has the best efficiency in combination with gas turbines. Most of the battery technologies are not applicable in large systems. Lithium-based batteries have the potential, but are still too expensive and not yet matured for large systems. Redox-flow batteries have the potential for large systems since they have a high efficiency and a high energy capacity. Especially the all-vanadium technology holds promise.

Vanadium batteries

The vanadium battery is a so-called redox-flow battery. In Figure 1 is a schematic overview of the vanadium battery. The electrolyte in both reservoirs is vanadium dissolved in sulphuric acid and the two half cells are separated by a membrane that is permeable for ions. The electrolyte is pumped through the cell stack where the energy conversion takes place. The material of the electrode is not participating in the energy conversion.

The electrochemical processes for the two half-cells are

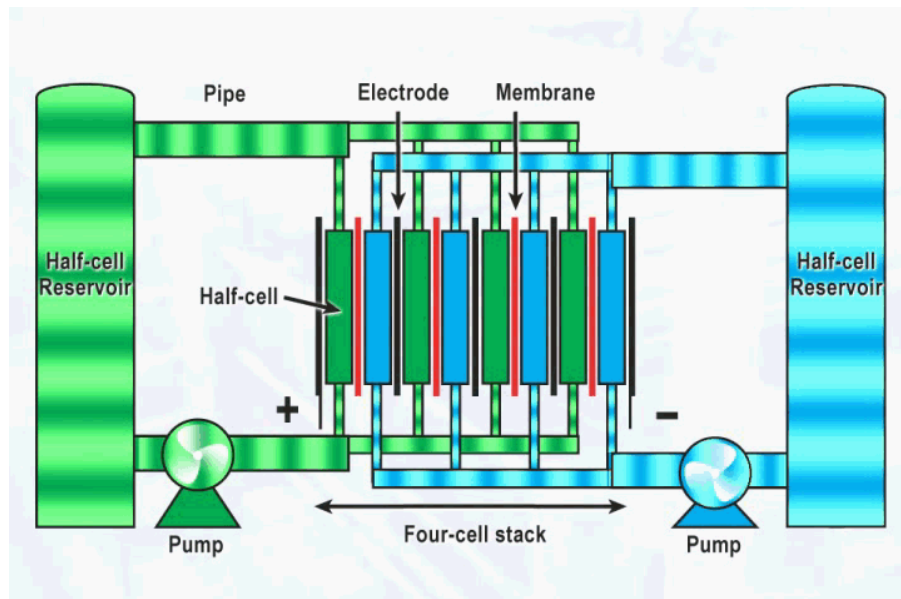
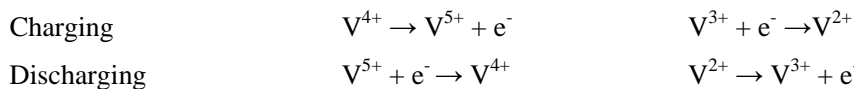

Figure 1 Schematic overview of vanadium battery

The vanadium battery has many features that makes it interesting in a large scale RE integration context. These include

- Separate sizing of power and energy capacity
- Long lifetime: more than 10 years
- Good efficiency: >75%
- Deep cycling capability: more than 10000 cycles
- Low self-discharge

The cost is still relatively high at ~500\$/kWh for a 250kW/8h plant, but there is a potential for cost reductions as the production of the cell stacks is being automated.

Vanadium battery as part of SYSLAB

Risø has acquired a vanadium battery from VRB power systems. It has the following main features:

- 15kW/120kWh
- Four quadrant power electronics
- Operation in grid connected as well as island mode
- Flexible control: active/reactive power, frequency/voltage, external set points

The battery will be installed at Risø in august 2007. In Figure 2 is drawing of the battery as it will be installed at Risø. Visible are the cell stacks, piping and the electrolyte tanks. Each of the cell stacks are 5kW. The total foot print of the installation will be 7m x 7m.

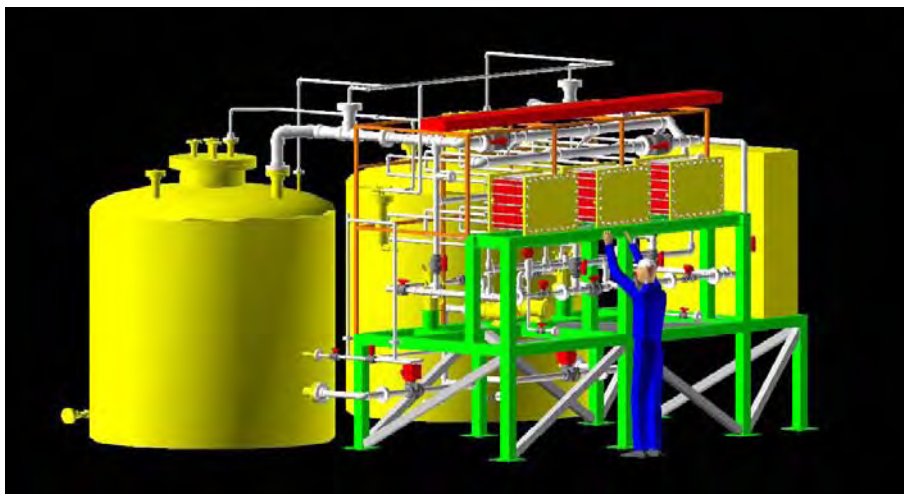

Figure 2 Drawing of vanadium battery installation at Risø

The battery will be part of the distributed energy systems test and research facility, SYSLAB, which has been established to conduct research in components and control of distributed energy systems. The facility is outlined in Figure 3. The facility consists of three sites that are interconnected via a LV network. The distances from the middle site to the two others are 300m and 700m. The system makes it possible to study the behaviour and control of high penetration power systems. The focus during the design of the system has been renewable energy, distributed control and component testing. The facility include an office building in which the heaters and airconditioners can be individually controlled for flexible load control, pv-panels and wind turbines, vanadium battery, vehicle2grid car as well a diesel generator and several loads (resistive, inductive and capacitive).

The system also includes a computer network. Each of the components in the system has a dedicated control computer on which part of the system control can be executed and local measurements can be logged. This forms a control platform on which control schemes can be investigated.



Figure 3 Outline of SYSLAB distributed energy systems test facility

The installation of the vanadium battery serves three purposes:

- Gain operating experience with the technology
- Performing tests for characterization of the battery for modelling
- Investigate system behaviour and interaction with other types of generation

Experience from other battery technologies will provide the basis for many of the test to be performed on the unit. Of main interest are system efficiency and response time. Since it will be exposed to many small cycles at different levels of discharge the performance during such operating conditions is very important. Investigation on operational requirements like need for complete charging is also of interest.

The purpose of the tests is to provide the basis for establishing a model of the battery that can be included in system performance models. This means that the testing should cover the operational range of the unit including things such as

- Cycling at different amplitudes and frequencies
- Operation at different states of charge
- Performance when the unit is close to being fully discharged or fully charged
- Response time

The investigations will include performance measurement of the cell stack, the power conversion unit and the auxiliary power consumption. The auxiliary power consumption is significant for a vanadium battery due to the pumping of the electrolyte.

Summary and current status

Future power systems with a high penetration of renewable energy require a very flexible system for balancing power. The flexibility can be provided by many different technologies. These include the renewable sources themselves, other types of generation, demand response of different forms as well as energy storage systems. As penetration

increases it will be necessary to utilize them all to ensure secure operation and power quality of the power system. One of the more promising storage technologies are vanadium redox-flow batteries because they can add flexibility, independent sizing of power and energy capacity, long lifetime, and good efficiency.

A vanadium battery will be installed at Risø for testing in order to characterize the unit and to investigate how it can be integrated in a distributed power system with a high penetration of wind and solar power. A range of tests will be performed on the unit and a model applicable for system modeling in IPSYS [8], a dispatch system model developed specifically for analysis of distributed power system with a high penetration of renewable energy.



Figure 4 15kW vanadium battery for Risø during factory test

The unit is currently (May 2007) under test at the manufacturer, VRB Power Systems. The test will be concluded during June and the unit will be installed August 2007 at Risø.

Acknowledgement

The support by Energinet.dk for the project “Characterisation of Vanadium Batteries” under contract DM5-6555 is acknowledged.

References

- [1] Poul Sørensen, Nicolaos Antonio Cutululis, Antonio Viguera-Rodríguez, Leo E. Jensen, Jesper Hjerrild, Martin Heyman Donovan, Henrik Madsen, “Power Fluctuations from Large Wind Farms”, to be Publisher in IEEE Transactions on Power Systems
- [2] Henrik Madsen, Pierre Pinson, George Kariniotakis, Henrik Aa. Nielsen and Torben S. Nielsen, “Standardizing the Performance Evaluation of Short-Term Wind Power Prediction Models”, Wind Engineering, Vol. 29, No. 6, 2005

- [3] Jesper R. Kristoffersen, Peter Christiansen, "Horns Rev offshore windfarm: its main controller and remote control system", *Wind Engineering* Vol. 27, No. 5, 2003
- [4] www.nordpool.com
- [5] Dirk Uwe Sauer, "The demand for energy storage in regenerative energy systems", First International Renewable Energy Storage Conference, October 30 and 31, 2006 Gelsenkirchen/Germany
- [6] http://www.itpower.co.uk/investire/storage_tech.htm (complete project reporting)
- [7] syslab.dk
- [8] <http://www.risoe.dk/vea-ves/projects/ipsys/>

Distributed Energy Resources and Control: A power system point of view

Oliver Gehrke, Stephanie Ropenus, Philippe Venne

Abstract

The power grid is currently facing tremendous changes in the way the energy is produced, transmitted and consumed. The increasing number of actors and the demand for more and more complex services to be provided by the grid exceed the capabilities of today's control systems. This paper gives an overview of the changes that the power system is undergoing and how these affect the aspects of communication, ancillary services, demand response, the role of the control room and market participation.

Introduction

Since the beginning of the large restructuring effort of the power grid, which started in the early 1970s [1], many new tasks have been added to the workload of the power system controller. The vertically integrated power system that was centrally controlled is now an open infrastructure on which producers, consumers and network owners are dependent in order to exchange power according to bilateral agreements, market dynamics and grid constraints. This new context, characterized by complex regulations, an increasing number of actors and the services that they require, asks for more intelligent control systems that can manage both the electrical and financial operation of the grid and new interactions between grid participants.

Many different visions have been proposed for future power systems. Each of these visions depends on equipment, regulations, legal structures, environmental factors and many more, all with specific control needs. Key assumptions like the generation mix [3] or the adoption of specific technologies [4] are defining factors for these visions.

In this paper, we will begin with an introduction to the historical and the present context of the power system, followed by a brief overview of the visions that are proposed for its future. Then we discuss how changes in the power system affect different design parameters.

Definitions

Before we go forward and start discussing power systems, a few definitions on commonly used terms will help to clarify our argument. There is a whole galaxy of misunderstanding, full of buzz words.

The terms for three general types of control - centralized, distributed and decentralized – are frequently used in an ambiguous way. They are distinguished by the flow of information between the location of data acquisition, the location of decision making and the location where an action is performed [6].

In a fully centralised control system, data acquisition, decision making and the enactment of decisions are concentrated in a single location. [Figure 1]. In a centralised controller, data from all parts of the controlled system needs to be sent to the central unit for processing.

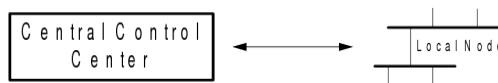

Figure 1: Centralised control

A distributed control system refers to a collection of independent devices that appears to its users to be a single system [2]. One could imagine a distributed controller as centralized control with a decentralized execution stage. The difference is in the flow of information. In a distributed controller, data may be processed and e.g. reduced locally, supervised or remote-controlled by a central control unit [Figure 2].

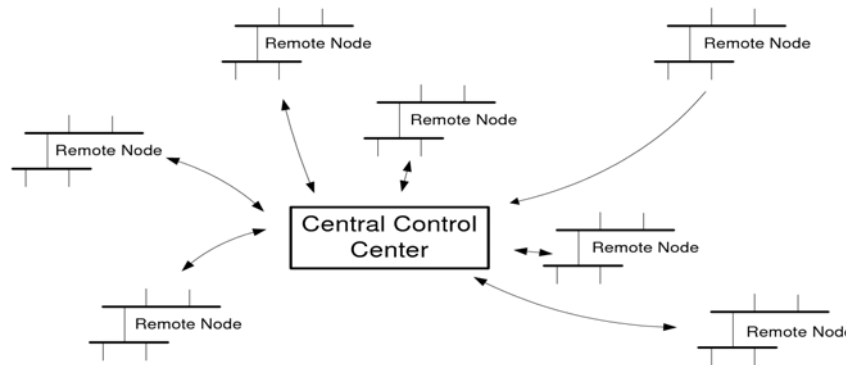

Figure 2: Distributed control

In a decentralized controller, a problem is split into smaller ones that are solved locally, using local data. Then, information is shared between local distributed control centers to solve the larger problem [Figure 3] [5].

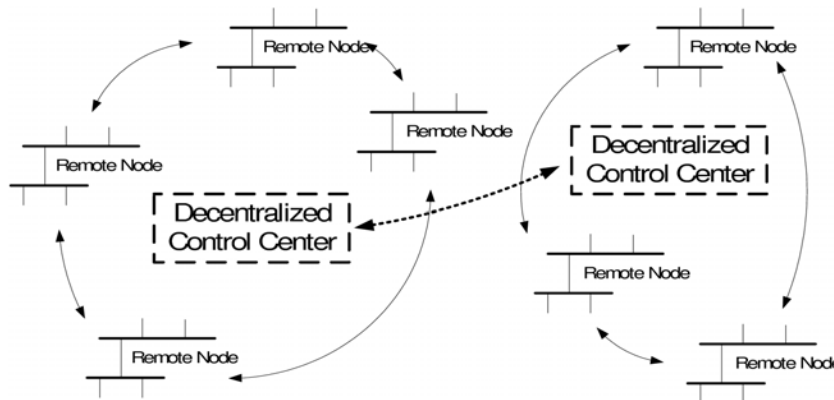

Figure 3: Decentralized control

Even though the term “Distributed Generation” (DG) has been in mainstream use for a number of years, no generally accepted definition seems to have emerged. Usage differs, sometimes just by nuances, between countries, continents or research disciplines. It is often used synonymously with “Embedded Generation”, “Dispersed Generation” or “Decentralised Generation”, none of which has a more precise definition. This paper will use the unrestrictive definition given by [7]:

“*Distributed generation* is an electric power source connected directly to the distribution network or on the customer side of the meter.” where “anything that is not defined as transmission network in the legislation, can be regarded as *distribution network*.”

In a similar fashion, multiple definitions exist for the term “Distributed Energy Resources” (DER). Many publications use it synonymously with DG, others expand it to include, for example, managed loads. We will use a definition from [8]:

“*Distributed energy resources* are demand- and supply-side resources that can be deployed

throughout an electric distribution system to meet the energy and reliability needs of the customers served by that system. Distributed resources can be installed on either the customer side or the utility side of the meter.”

This includes generation, (managed) loads as well as energy storage systems, and while DG focuses on a device's ability to deliver active power, this definition of DER also covers ancillary services, such as reserve provision, black-start capability and reactive power management.

Context

In the past, power systems were owned and operated by monopolists, often under the control of governments. The segments of electricity generation, transmission, distribution and supply were integrated within individual electric utilities. This made the operation of the grid less complicated because the system operator had full knowledge of the grid status and total control over it.

Liberalization and deregulation of the industry led to the introduction of competition in the segments of generation and supply. In transmission and distribution, the natural monopoly element has been maintained subject to network regulation [15].

Electricity exhibits a combination of attributes that make it distinct from other products: non-storability (in economic terms), real time variations in demand, low demand elasticity, random real time failures of generation and transmission, and the need to meet the physical constraints on reliable network operations [15]. One of the consequences of liberalization is the new way in which the now separated entities interact with each other.

The “electricity market” is in fact not *one* market, but rather consists of a set of submarkets that operate both sequentially and in parallel. Except for the real-time market, all electricity markets are financial markets: the delivery of power is optional and the seller’s only real obligation is financial. Typically, market participants conclude contracts through **bilateral trading** already weeks or months in advance. Thereafter, they trade on institutional markets (power exchanges or pools) to balance their portfolios. The former usually comprise a day-ahead market, an hour-ahead market, and a real-time or balancing market. The **day-ahead market** takes the form of an auction. Generators, traders, retailers and large industrial customers submit bids specifying price/volume pairs of electricity they will sell or buy for each of the 24 hours of the following delivery day. The bids are “frozen” at a fixed deadline on the trading day and prices are determined according to the rules of the power exchange or pool. Finally, accepted bids are settled at the calculated prices.

The **hour-ahead market** allows market participants to improve their physical electricity balance after gate closure of the day-ahead market through continuous trading until one hour before delivery. In the hour of actual operation, the balancing of power is either done on the basis of bilateral contracting or by means of a **balancing or real-time market**.

In order to ensure instantaneous balancing of supply and demand, real-time markets are run as centralized markets, even in fully deregulated systems. The system operator acts as a Single Buyer and is responsible for upward and/or downward regulation, which may be done via regulating bids under an exchange or pool approach.

Economic decisions are made individually by market participants and system-wide reliability is achieved through coordination among parties belonging to different companies [2]. In other words, in the past all grid participants pursued the same goal: the objectives of the individual entities were congruent with the objectives of the system. This has changed: today, the multitude of independent agendas does not necessarily guarantee decisions that are effective and sustainable for the power system as a whole. Coordination is therefore necessary.

In addition to the provision of active power, **ancillary services** are required to maintain a sufficient level of system reliability and power quality. At present no uniform definition exists of the individual ancillary sub-services to attain these system objectives [9].

Commonly, frequency control (often subdivided into primary, secondary and tertiary control), voltage control, spinning and non-spinning reserve, black-start capability, islanding support and remote automatic generation control are comprised in the definition of ancillary sub-services [12;21;9]; however, the sub-services included in the definition even vary between countries [12]. Four major methods through which system operators procure ancillary services can be distinguished: compulsory provision, bilateral contracts, tendering, and via a spot market [18]

With the increasing pressure of the newly created market to increase productive efficiency and minimize cost, electric utilities are looking for ways to increase profit for their stake holders [1]. Asset management at the core of a new management strategy, combined with deregulation, has the consequence of increasing the stress on existing grid components and to reduce investments in new infrastructures. This new way of operating the power grid closer to its physical limits certainly generates more profit, but it also reduces the stability of the grid, making it more prone to blackouts. This poses a challenge to the current design and regulation of electricity networks.

When the electrical power system was conceived in the way it is today, the grid was based on large-scale generation facilities. In most countries, the topology of the transmission grid reflects the locations of these large power plants, and the large load centers. Liberalisation coincided with an increasing awareness for environmental concerns, technological progress, security of supply considerations as well as an increased need for reliable and high-quality power.

All these factors have been the drivers for an increase in distributed generation (DG) in Europe [13] and North America [14], With the help of political incentives and due to the rise in energy costs, small energy producers have begun to emerge: wind farms, solar and geothermal plants, fuel cells and micro turbines, often operated in the countryside and far away from the main transmission corridors. These small-scale producers feed the energy directly into the distribution grid.

The traditional way of controlling the grid has become more and more of a corset which restricts the capacity of the power system as a whole [6].

- Higher penetration of DER requires more communication capabilities to coordinate the bidirectional flow of power in the distribution grid and to participate in the economic dynamics of the power market.
- Size requirements for access to power market promotes aggregation of small DER. The aggregation process requires coordination among participating DER and therefore more communications capabilities in the grid.
- Participation of DER in ancillary services markets in order to access a second revenue stream requires more computations to maintain local voltage stability and more communications with neighbouring DER.
- A level playing field for all market participants necessitates control systems to allow complex interactions between independent actors in a private way.
- Asset management and reduced stability margins require more simulation computational power in order to ensure the safe operation of the grid.

For all these reasons, control systems in the power sector need to become more decentralized and more intelligent.

Future power grids

It has become widely accepted consensus within the last few years that, in order to live up to the new demands – increased power generation from renewables and CHP, fair market access for all participants, high security of supply and power quality at low cost, and, possibly, reduced vulnerability to terrorist attack – the control mechanisms used for the operation of the power system play a central role. The grid and its energy resources will have

to be controlled in a more flexible and intelligent way, and this intelligent control will have to integrate the bulk of passive, “egocentric” and “deaf-mute” participants.

The present power system control architectures, with the SCADA system at its center, largely represent the state of the art of 1970's industrial automation [2], where all data and information is collected and concentrated at one physical location for taking decisions. The results, in the shape of commands and actions, are afterwards disseminated back the same way. This model has three main critical weaknesses:

- Scalability: The amount of data to be shifted around the system and the complexity of the decision-making process grow with the number of participants in the control system.
- Flexibility: The all-in-one-place control model assumes an all-in-one-place business structure and a power system structure which is static in the short and medium term.
- Interoperability and access: While open standards for device communication are now emerging with industry support, the control center services themselves are largely based on proprietary hardware and software, effectively creating a closed system.

The consensus no longer exists with regard to the question how a future power grid should be controlled, or what should be intermediate steps towards that direction. A new research area is currently forming on the border between electrical power engineering, industrial automation, control engineering, energy economics, communications technology and intelligent systems. The first large research projects in this area have already been launched on both sides of the Atlantic.

A variety of different concepts have been developed, most of which can be assigned to one of these three categories [13]:

- Microgrids: Small electrical distribution systems which connect multiple customers to multiple distributed sources of generation and storage)
- Active networks: Extend the connectivity of the grid to provide multiple, controllable paths between supply and demand entities. The network interacts directly with the consumers.
- Internet model: Every supply point, consumer and switching facility forms a node that acts autonomously under a global protocol. The level of control is the level of the nodes themselves.

However, none of these concepts is too sharply defined either, because all of them involve innovation across a very wide spectrum, giving many design parameters to set.

Design parameters

To provide insight into some of the major changes the power system is undergoing, in the following the impact of these developments on five design parameters will be illustrated. The five areas chosen are communication, ancillary services, demand response, control room and market participation requirements. Both the technical and economic factors inducing the changes are discussed.

Communication

In the present grid, all communication links needed for data acquisition, signalling and control in the power system are dedicated connections, typically owned by the system operator. The high cost of establishing and operating such connections is one major reason why small DER do not currently participate in the control of the power system. Without direct communication, DER can only react to events if their occurrence can be derived from locally observable variables (“intrinsic communication”): a generating unit could increase its

output if the system frequency dropped below a certain limit, or a grid interface could turn to island operation upon changes in the local grid impedance. There is no way for the system operator to influence the behaviour of the controlled resources, or to even know this behaviour in advance, except from statistical data.

Undifferentiated one-way communication is relatively cheap to implement, for example via radio broadcast. It can be used to transmit setpoints, commands or other data – e.g. a price signal - to large groups of DER, but does not permit a differentiated response, for example to a local disturbance. Individual one-way communication can solve this, but may be costly and of very limited use without the possibility to feed local observations back to the control system.

Full two-way communication links add the possibility of negotiation and coordination between DER units. It also allows the system controller to know the anticipated reaction of DER to a particular system condition to a much higher degree.

The cost of provision and maintenance of dedicated communication links to small DER is critical. The modest revenue DER can expect from offering services such as demand response[24;23], will only be attractive if it is not being diminished by the high cost of a dedicated two-way communication link. Sharing existing infrastructure – i.e. residential broadband and the public internet – would come at marginal cost, but requires accepting that for many small DER, the standards for communication reliability cannot be as high as for large, traditional power plants.

Role, provider and control of ancillary services

Compared to large, fossil-fueled power plants, small generation units connected to the distribution grid will typically have a lower capacity factor, i.e. a higher ratio of peak to average generation. The reasons for this are either properties of the primary energy source – intermittent production from wind turbines and photovoltaic arrays – or operational and economical constraints, such as the heat-bound limitations of combined heat-and-power (CHP) plants.

With their share of peak capacity growing even faster than the share of energy production, DER will have to participate in the provision of ancillary services to the grid to ensure reliable system operation. Functions traditionally done at transmission level will have to be provided where these DER are connected [25], i.e. within the distribution grid itself: primary, secondary and tertiary reserve, voltage/var control, black start and islanding capability.

The underlying rationale for the creation of markets for ancillary services is to achieve the procurement of these services at least cost through the extension of competition between providers of active power and loads to this segment. For loads and generators of active power this implies the opening up of a second revenue stream. Ancillary services encompass a wide range of services with different characteristics; e.g., voltage control has to be supplied locally whereas frequency control is a system-wide service. Also, due to their diversity, different market arrangements may be chosen for the individual services. In their comparative analysis, Rebours et al. [18] illustrate that there are many variations in ancillary services market design across countries¹ with regard to the procurement methods applied. Yet, their survey reveals some common features as to the kind of procurement method preferred: being a differentiated product, primary frequency control is usually traded via pay as bid policies whereas secondary frequency control is always remunerated and often traded through a spot market. Concerning voltage control, no spot market has been erected so far and it is at least partly compulsory [18].

The capability for the delivery of ancillary services is strongly dependent on the type of generation technology. The analysis conducted by Lopes et al. [16] suggests that the value of

¹ The power systems they covered in their survey are those in Australia, France, Germany, Great Britain, New Zealand, PJM, Spain and Sweden.

most feasible ancillary services provided by DG will be low and thus only provide incremental revenue opportunities. The incentives to invest in DG to exploit this second revenue stream are thus rather small.

Demand response

From the perspective of a household customer, the current power system is a closed society selling low-voltage power with a certain reliability. The small-sized electricity customer has no particular obligations (except for paying his bills) and may extract any amount of power (within the limitations of his residential installation) at any time, leaving the issue of energy balancing to the system operator.

A well-functioning market for demand response requires not only a sufficient amount of competition on the supply side, but also effective consumer response to price changes. However, the short-run demand elasticity for electricity is very low, and supply gets very inelastic at high demand levels due to capacity constraints [15]. Electricity demand is characterized by two demand-side flaws [19]: first, present-day electricity meters are sum counters, i.e. they do not provide the necessary temporal resolution to correlate consumption with time. Second, there is a lack of real-time control of power delivery to specific customers, i.e. a load can simply be connected to the grid at any time, even without the conclusion of prior contractual arrangements.

The first demand-side flaw leads to demand inelasticity whereas the second prevents the physical enforcement of bilateral contracts so that the system operator serves as the default supplier [19]. In many national electricity markets, due to a high degree of concentration in the generation segment, there are still tight price controls on the prices charged to end-consumers. This is, e.g., perceived as a major obstacle in the EU [11]. However, at the same time, it deprives consumers of the possibility to react to price spikes and deprives them of incentives to get rewarded for reducing their electricity consumption when this improves the system balance.

There are different methods for achieving a price-responsive demand: real-time pricing, time-of-use pricing, and critical peak pricing. Under real-time pricing, different retail electricity prices are charged for different hours of the day and for different days. However, it has not been widely implemented. The implementation of time-of-use prices has been extensive; here, the retail price varies in a preset way within certain blocks of time [10]. Other approaches of demand participation are interruptible electricity rates, critical peak pricing, and demand reduction programmes. For the incentive for demand participation to be effective, the final customers have to face unregulated electricity prices so that they are exposed to the volatility of the market and will act accordingly.

Different classes of demand response systems can be differentiated. In one type of system, all actions are taken by the user (“user-in-the-loop”) based on information presented by the system. Simple variants of these systems, with a tariff indicator lamp as the only user interface, have been in operation for more than two decades, more sophisticated ones have been tested in recent years. Experience [24] shows that the dependency on user motivation is high.

Automated systems, which are able to control energy resources in households, allow for faster, unattended and more reliable response to system conditions.

Role of the control room

Increased DG penetration lets the average size of energy sources drop, and their number soars. At the system operator's control room, this increase in complexity affects the ability of operational staff to understand the state of the power system as well as the consequences of a control action at any moment in time.

In case of a system disturbance, control room personnel have to decide about countermeasures, sometimes within a few seconds. If their perception of the system state is

not correct, a major blackout can be the consequence. This has last been demonstrated during the major European blackout on 4th of November 2006, one of whose major causes has been the misassessment of system security margins[22]. It appears slightly paradoxical that many slower-moving tasks like load-frequency control are already automated to a quite high degree, whereas emergency response still depends on the ability of a human operator to get a very fast and very good overview of the situation at hand.

To reduce the complexity, which will appear especially in the distribution grid, there are two general types of tools: Aggregation, which groups units together to make several smaller units appear as one larger entity, bundling their services and improving the combined reliability of the group. This is essentially the point behind Virtual Power Plants or Virtual Utilities.

Delegation takes this concept one step further and breaks the strict hierarchy of supervisory control by making certain control tasks a service that can be provided by the grid itself. This would change the role of the control center towards setting operational policies for an automatic system which keeps itself within the physical and operational limits, rather than directly controlling its parts.

Market participation requirements

Market access on equal terms is a prerequisite for the establishment of a level playing field between large-scale generation and DER. Current electricity market design does not take into account the specific characteristics of DER in several respects, thereby delimiting the realisation of its potential contribution in terms of active power provision and the provision of ancillary services.

The participation on power exchanges and in ancillary service markets is frequently conditional upon a minimum rating or capacity size. This is detrimental to the deployment of small-scale DG. Also, demand-side participation is often inhibited by complex bidding rules and requirements so that short-term reaction of loads to higher prices is very limited [9]. A change in market rules to allow the aggregation of small individual generators to one larger entity participating on the markets may constitute a preliminary solution to this problem.

Another obstacle to direct market participation of DER are trading fees. Their composition and amount varies considerably across markets set up in different countries. Generally, trading fees consist of an annual fixed fee for market participation paid up front and a variable trading fee dependent on the actual trade volume. High fixed participation fees pose a barrier to DG [21; 9] as this fee may be substantial in relation to the smaller trade volumes. However, in some markets new trading regimes have been introduced which take account of small-scale market participants. E.g., participants in Nord Pool's markets Elbas and Elspot incur an annual fee of EUR 12,500 and a variable trading fee of 0.03 EUR/MWh in Elspot and of 0.08 EUR/MWh in Elbas respectively. Small direct participants are provided the possibility to waive the annual fee and pay a higher variable fee of 0.13 EUR/MWh [17]. Another means to mitigate this barrier for small-scale participants, both on the production and demand side, is the use of aggregators.

Conclusion

So far, different concepts for the design of the future power grid have been developed, yet none of them can be sharply defined at this point in time as they involve changes across a wide spectrum. To provide some insight on the implications of the current changes on system design, we discussed how they challenge and change different aspects of the technology and economy of the power system. These aspects are interdependent which implies that the effects of progressing in one area will not happen in isolation but in turn impact the other areas. On the whole, the trend goes towards more decentralized structures and an increase in complexity due to a higher number of market participants.

References:

- [1] R. Brown, B. Humphrey: *Asset management for transmission and distribution*, IEEE Power and Energy Magazine, p.39-45, Vol. 3, 2005.
- [2] F.F. Wu, K. Moslehi, A. Bose: *Power System Control Centers: Past, Present, and Future*, Proceedings of the IEEE, p.1890-1907, Vol. 93, No. 11, November 2005.
- [3] G. Strbac, N. Jenkins, T. Green, D. Pudjianto: *Review of Innovative Network Concepts*, Imperial College London and University of Manchester, 2006.
- [4] S. Pullins, J. Westerman: *San Diego Smart Grid - Final Report*, The Energy Policy Initiatives Center - University of San Diego School of Law, 2006.
- [5] B. Tyagi, S. Srivastava: *A decentralized automatic generation control scheme for competitive electricity markets*, IEEE Transactions on Power Systems, p. 312-320, Vol. 21, 2006.
- [6] M. Shahidehpour, Y. Wang: *Communication and Control in Electric Power Systems: Applications of Parallel and Distributed Processing*, Book, Wiley-IEEE Press, 2003.
- [7] T. Ackermann, G. Andersson, L. Söder: *Distributed generation: a definition*, p. 195-204, Electric Power Systems Research Vol. 57, Elsevier 2001
- [8] D. Moskovitz: *Profits and Progress Through Distributed Resources*, published by the Regulatory Assistance Project (www.rapmaine.org), Maine, USA, February 2000
- [9] T. Ackermann: *Distributed Resources in a Re-Regulated Market Environment. Doctoral Dissertation*, Royal Institute of Technology, Department of Electrical Engineering, Stockholm, Sweden, 2004.
- [10] S. Borenstein, M. Jaske, A. Rosenfeld: *Dynamic Pricing, Advanced Metering and Demand Response in Electricity Markets*, CESM WP 105, University of California Energy Institute, Berkeley, California, 2002.
- [11] European Commission: *Communication from the Commission to the Council and the European Parliament. Prospects for the internal gas and electricity market*, COM 841 final, 2006.
- [12] EURELECTRIC – Union of the Electricity Industry: *Ancillary Services. Unbundling Electricity Products – an Emerging Market*, Thermal Working Group, Brussels, Belgium, February 2004.
- [13] European Commission: *New ERA for electricity in Europe. Distributed Generation: Key Issues, Challenges and Proposed Solutions*, Office for Official Publications of the European Communities. EUR 20901, Luxembourg 2003.
- [14] M. Johnson: *Current Solutions: Recent Experience in Interconnecting Distributed Energy Resources*, Sentech Inc. Bethesda, Maryland. NREL. Golden, Colorado, USA, 2003.
- [15] P. Joskow: *Electricity restructuring: Lessons Learned*, Latin American Economic Review, p. 548-558, No. 121, December 2003.
- [16] P.J.A. Lopes et al.: *Integrating distributed generation into electric power systems: A review of drivers, challenges and opportunities*. Electric Power Systems Research, doi: 10.1016/j.epsr.2006.08.016, 2006.
- [17] NordPool: <http://www.nordpoolspot.com/trading/Trading-fees/>
- [18] Y. Rebours, D.S. Kirschen, M. Trotignon, S. Rossignol: *A Survey of Frequency and Voltage Control Ancillary Services – Part II: Economic Features*, IEEE Transactions on Power Systems, p. 358-366, Vol. 22, No. 1, February 2007.
- [19] S. Stoft: *Power System Economics. Designing Markets for Electricity*, IEEE Press, Piscataway, New Jersey, USA, 2002.
- [20] K. Skytte, S. Ropenus (eds.) et al.: *Regulatory Review and International Comparison of*

EU-15 Member States, DG-Grid Report D1 (<http://www.dg-grid.org>), 2005.

[21] K. Skytte, S. Ropenus (eds.) et al.: *Assessment and Recommendations. Overcoming in Short-Term Grid System Regulatory and Other Barriers to Distributed Generation*, DG-Grid Report D2 (<http://www.dg-grid.org>) , 2005.

[22] UCTE: Interim Report: System disturbance on 4 November 2006, UCTE (www.ucte.org) 2006

[23] F.M. Andersen et al.: Analyses of Demand Response in Denmark, Risø report R-1565, Risø National Laboratory, EA Energy Analyses and RAM-løse edb, Denmark 2006

[24] M. Klobasa, T. Erge, A.S. Bukvic-Schäfer, M. Hollmann: *Demand Side Management in dezentral geführten Verteilnetzen (Erfahrungen und Perspektiven)*, Proc. 11th ISET Symposium on Energy System Technology, Kassel 2006

[25] B.M. Buchholz, P. Palensky: Kommunikation als Schlüssel für künftige Effizienz der Netzführung, Proc. 11th ISET Symposium on Energy System Technology, Kassel 2006

Session 11 – Low Level CO2 Strategies for Developing Countries

Chairman: Mark Radka, UNEP, Paris

Assessing the Role of Energy in Development and Climate Policies in Large Developing Countries

Amit Garg and Kirsten Halsnæs, UNEP Risø Centre, Denmark

Abstract

The paper discusses a number of key conceptual issues related to the role of energy in development and its potential synergies and tradeoffs with climate change. The relationship between economic development and energy over time is discussed and illustrated by data from Brazil, China, India and South Africa. It is concluded that energy plays an important role as a productivity enhancing factor in economic development and in human well being and several policy goals related to sustainable development (SD), energy and climate can be integrated. However, meeting all these policy goals requires a special effort and can imply costs.

An analytical approach that can be used to assess development, energy and climate policies is introduced and empirical indicators of Sustainable development trends for the period 2000-2030 are presented. In a pragmatic way, it is proposed to use indicators of economic, social, and environmental SD dimensions such as costs, employment generation, energy access, local and global emissions, income distribution, and local participation in the evaluation of specific policies. The approach is developed and tested as part of the Development, Energy, and Climate project which is international project cooperation between the UNEP Risø Centre and teams in Brazil, China, India and South Africa.

The results demonstrate that there is a huge potential for energy efficiency improvements in the energy systems in these countries and thereby cost savings and reduced emissions intensity. However, the implied greenhouse gas emissions depend on fuel and technology compositions and reduction will imply that specific policies are put in place.

1. Introduction

Energy is central to development. It has a key role in economic development through its role as a production input, and as a direct component in human well being. There are several ways in which increased availability or quality of energy could augment the productivity and thus the effective supply of physical and/or human capital services. The transmission mechanisms are likely to differ across the stages of development - for more advanced industrialised countries, increased energy availability and flexibility can facilitate the use of modern machinery and techniques that expand the effective capital-labour ratio as well as increase the productivity of workers. Whereas supply-side energy changes in less advanced countries economize on household labor, here energy availability can augment the productivity of industrial labor in the formal and informal sectors.

Human activities and most sustainability issues are closely linked to energy use. World (humans, systems and environment) can be easily visualized as a flow of and linked through energy. Energy is a critical component in factor productivity (capital, labor, land), can constrain well being, missing energy imposes time and labor burden on households. Most important sustainability issues (poverty alleviation, health, education, economic development) as well as climate change issues directly relate to production and use of energy. Even some of the other important sustainability issues (freshwater, landuse, atmospheric integrity, agriculture) are directly/indirectly related to production and use of energy.

The general conclusion that arrives both at macro level and at household level about the relationship between economic development and energy consumption is that increased energy availability disproportionately could affect economic development. Toman and Jemelkova (2002) identify the following factors behind this as:

- Reallocation of household time (especially by woman) from energy provision to improved education and income generation and greater specialization of economic functions.
- Economics of scale in more industrial-type energy provision.
- Greater flexibility in time allocation through the day and evening.
- Enhanced productivity of education efforts.
- Greater ability to use a more efficient capital stock and take advantage of new technologies.
- Lower transportation and communication costs.
- Health related benefits: reduced smoke exposure, clean water, and improved health clinics through electricity supply.

In addition to energy's potential for supporting economic growth disproportionately, there can also be a tendency to see decreasing energy/GDP intensity with economic development, as a consequence of increasing energy efficiency with the introduction of new energy technologies.

Schurr et al. (1982) identify more flexible energy forms (like electricity) and higher energy conversion efficiency as major factors in productivity increases for non-energy production factors. A consequence of this is that energy/GDP intensities tend to increase or to be stable in earlier phases of industrialization, while they later tend to

decrease. This suggests that economic development, energy consumption, and in some cases¹ pollution can be decoupled from economic development. This tendency is subsequently illustrated with data for some developing countries in this paper.

In less advanced countries larger and cleaner energy provision can support human wellbeing through several channels including increasing opportunities for income generation activities and a number of benefits in relation to education, health, decreased time for household chores, and increased leisure time. The magnitude of these benefits has been assessed in detailed studies for a number of developing countries, and some results are presented in this paper.

In many developing countries policies that are sensible from an energy perspective can emerge as side-benefits of sound development programmes and can support climate friendly development. In the energy sector, for example, price reforms, sector restructuring, and the introduction of energy efficiency measures and renewable energy technologies - all undertaken without any direct reference to climate change - can mitigate climate and other environmental risks while achieving their main goal of enhancing economic and social development. The present paper employs an integrated energy modeling framework to assess the role of energy in aligning sustainable development (SD), energy and climate change (CC) priorities in large developing countries. It also proposes and quantifies sustainable development indicators (SDI) to capture the level and extent of this alignment.

2. Mapping sustainable development, energy and climate change through sustainable development indicators

Energy is closely linked to provision of sustainable development and causes climate change through emission of greenhouse gases during conversion and use of energy, especially fossil fuels. Table 1 demonstrates these linkages for India. The paper proposes to quantify the role of energy in aligning SD, energy and CC priorities in large developing countries. The approach adopted is to identify some indicators to capture the extent and level of this alignment, and then quantify these using an appropriate modelling framework. We term these indicators as sustainable development indicators (SDI).

Typical energy model parameters are energy balance (share of various fuels, sectoral consumption, energy supply and demand), energy conversion (power sector generating capacities, generation profiles, T&D, refineries), sectoral energy consumption (fuel-technology mix, energy efficiency of production), emissions (global e.g. CO₂, local e.g., SO₂, mitigation analysis), and investments.

Typical parameters to capture climate change concerns (from emissions and mitigation dimensions) are greenhouse gas (GHG) emissions, mitigation efficiency (across regions, sectors, gases) for various technologies and fuels, mitigation cost curves, stabilization targets and analysis, and investment needed. It may be noted here that energy is the prominent sector for GHG emissions. It contributes over 85% of total GHG emissions for OECD countries, over 60% in India and 70% in China.

¹The local and global pollution associated with increasing energy consumption depend on the structure of energy supply, whether this goes in a more pollution intensive direction or if cleaner fuels are introduced.

Table 1: Linkages between SD and energy

Millennium development goals and global targets	India's national development targets	Energy sector implications	Implications for bottom-up energy modeling
<p><u>Goal 1: Eradicate extreme poverty and hunger</u> <u>Target 1:</u> Halve, between 1990 and 2015, the proportion of people whose income is less than \$1 a day <u>Target 2:</u> Halve, between 1990 and 2015, the proportion of people who suffer from hunger</p>	<ul style="list-style-type: none"> • Double the per capita income during 2002-2012 • Reduction of poverty ratio by 5 percentage points during 2002-2007 and by 15 percentage points during 2002-2012 • Reduce decadal population growth rate to 16.2% between 2001–2011 (from 21.3% during 1991–2001) 	<ul style="list-style-type: none"> • Energy for increased production and consumption • Energy for local enterprises and machinery • Energy and electricity to facilitate income generation • Energy for providing family planning and health services 	<ul style="list-style-type: none"> • Population and GDP projections • Sectoral demand projections consistent with the above • Reflect/capture inputs needed for increased health services etc in sectoral demand projections. • Energy needed for the above using sectoral/ national models

Global indicators for SD have been constantly updated by United Nations Commission for Sustainable Development (UNCSD) in 1996, 2001 and 2006. The latest report in 2006 created a new set of 15 themes and 50 core indicators, which are a part of a larger set of 98 SDI. The core indicators are as below;

- Poverty (6 core indicators) (income, inequality, living conditions)
- Governance (2)
- Health (6); Education (4); Demographics (2)
- Natural hazards (1); Atmosphere (3); Land (2); Biodiversity (2)
- Freshwater (3); Oceans, seas and coasts (3)
- Economic development (8); Global economic partnership (2); Consumption and production patterns (6)

We propose a smaller set of SDI structured in a way, so that they capture the evaluation of economic, social, and environmental impacts of energy sector policies recognising the models and analytical tools that are available to the countries. The focal output is to produce SD indicators that are classified into the following themes;

1. National macro indicators
2. Energy use indicators
3. Energy access indicators
4. Energy investment indicators
5. Environmental indicators
6. Energy affordability indicators

The first four categories capture the economic aspects of energy policy impacts on sustainable development and are in-turn directly linked to the climate change indicators. Social impacts of energy policies are captured through energy affordability and per capita energy consumption indicators. A detailed list is presented in the next section (figure 1).

3. Methodological framework

We have used an integrated energy modelling framework in the present study to estimate the role of energy in addressing the sustainable development and climate change concerns of a country. This offers a consistent, comparable and transparent framework for future projections. The projections are made until 2030 for Brazil, China, India and South Africa. The energy modelling framework has certain advantages over purely economic and/or environmental frameworks. The economic frameworks are not robust at including climate change parameters such as greenhouse gas (GHG) emission estimation. The environmental frameworks on the other hand do not consider the broad macro-economic linkages. The energy modelling framework provides a possibility to estimate future energy flows and most of the proposed sustainable development indicators. The framework allows a consistent consideration of relationships between various dimensions of sustainability, it can project and compare across alternative development pathways and across different countries (if due care is taken), and can even compare SD and CC impacts of competing technologies.

Figure 1 shows the integrated energy modeling framework and its linkages with various SDI. This framework is able to capture most of the proposed SDI. Some indicators depend upon input to bottom-up energy models, e.g. population, GDP, energy prices, and end-use sectoral demands. Some indicators are direct output of model runs, e.g. primary energy consumption in energy/monetary units, sectoral final energy consumption, energy efficiency of sectoral (and economy wide) production, CO₂ emissions (fuel-technology, sectoral, economy-wide), and local pollutant emissions (SO₂, PM etc). Some indicators on the other hand are to be derived from a combination of model outputs. For instance, share of renewable fuels (e.g. ethanol) in transport sector fuels (e.g. gasoline), share of primary renewable energy in total primary energy consumption, share of renewable sources in power generation, share of clean commercial fuels (and technologies) in residential sector energy consumption. Some indicators are to be derived as a combination of model inputs and model outputs, e.g. per capita energy and/or power consumption, and per capita CO₂ emissions.

Figure 1: Integrated energy modelling framework and corresponding sustainable development indicators (SDI)

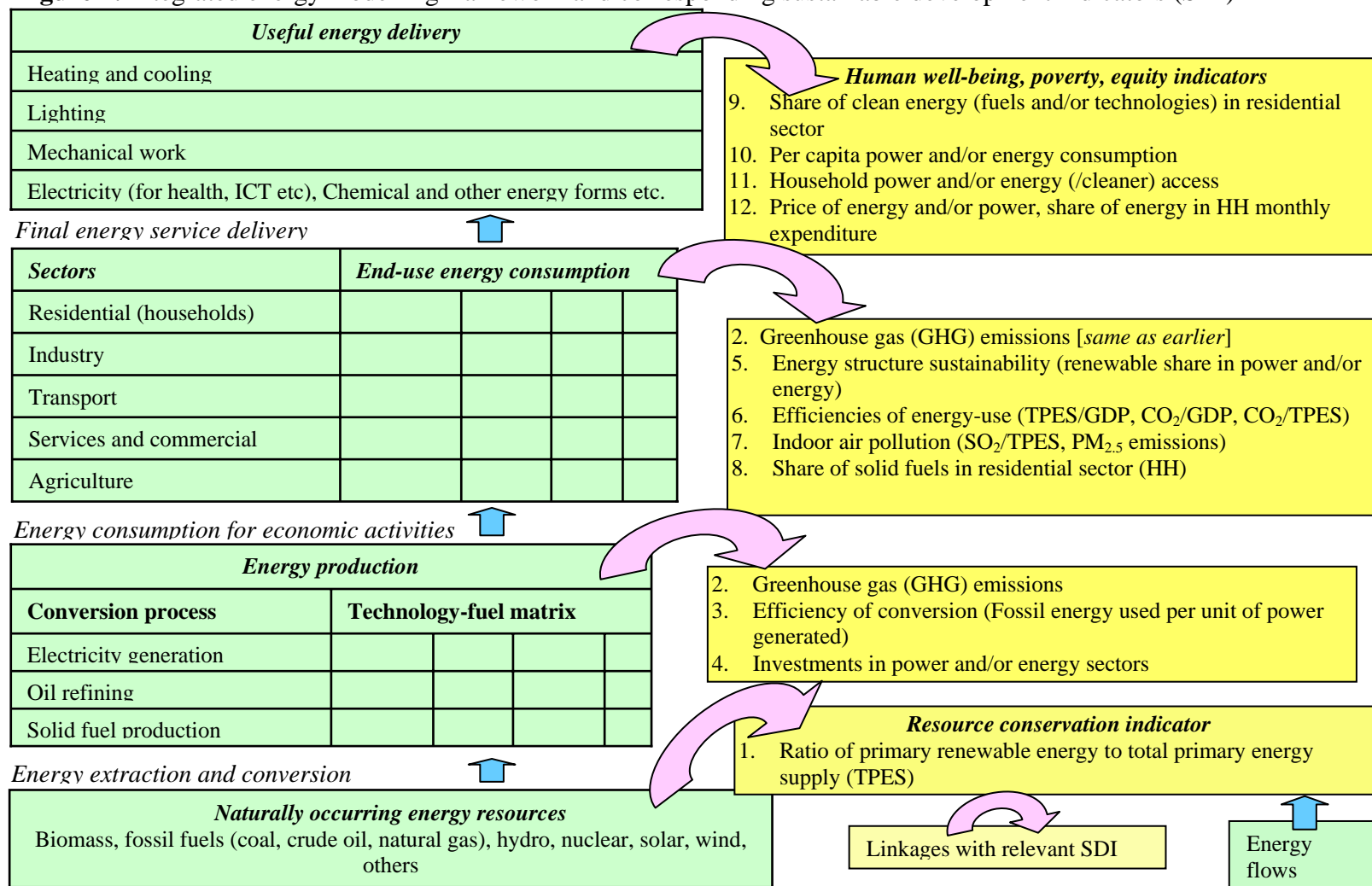

Sources: Halsnaes et al., 2006; Kemmler and Spreng, 2007

4. Cross-country comparative results

We have projected the future under a reference scenario for all the four large developing countries, using a consistent modelling protocol. The national reference scenarios by definition take policies and measures that are already under implementation into account. The economic growth and population assumptions that have been used in the country studies are reflecting official national development goals of the countries as well as expert judgments (Tables 2 and 3). Official projections typically are available for shorter time horizons such as up to 10 years, while 20-30 years and further ahead are only covered in specific energy sector planning activities.

Table 2: Economic growth assumptions (average annual GDP growth rates, %)

Country	1971-1990	1990-2004	2004-2015	2015-2030	2004-2030
Brazil	4.7	2.6	4.2	4.1	4.1
China	7.8	10.1	8	6.6	7.2
India	4.6	5.7	6.2	6	6.1
South Africa	2.1	2.2	2.4	2.8	2.6
Bangladesh	3.4	4.2	6.0	6.2	6.1
Senegal	2.4	2.8	5	7	6.2

Source: Halsnaes and Garg, 2006

Table 3: Resultant population projections (Millions)

Country	2000	2010	2020	2030
Brazil	171	198	221	241
China	1267	1380	1460	1530
India	997	1159	1290	1393
South Africa	44	48	47	49
Bangladesh	129	150	170	187
Senegal	10	13	17	22

Source: Halsnaes and Garg, 2006

4.1 Intensities related with energy use

The trend in energy intensity of the gross domestic product (GDP) and related CO₂ emissions from the energy sector are in the following illustrated for the period 1990 to 2030 for Brazil, China, India, and South Africa. The data is based on IEA statistics for the period until 1999 and on national scenario projections from 2000 to 2030. The scenarios are baselines where no specific climate policies are assumed to be implemented.

Figure 2 shows the trend in total primary energy supply (TPES) intensity of the GDP indexed from 1990 to 2030. As it can be seen the energy/GDP intensity is decreasing in the whole period for China, India, and Brazil. The picture is a little bit different in South Africa, where the energy/GDP intensity increases marginally from 1990 to 1995, where after it decreases. Some of the countries such as China and India are expected to have a very large decrease in energy/GDP intensity from 1990 to 2030 of as more than 80% in the case of China, and about 70% in the case of India. GDP becomes less energy intensive for all 4 countries during 1990-2030 (figure 2), while

less CO2 intensive for only China and India (figure 3). South Africa's economy is becoming more carbon efficient this century while Brazil is projected to move in a reverse direction for some years, mainly due to higher share of coal in the energy mix which is hydro dominant presently. The decoupling rates between GDP and energy, their timings and extent are however different for different countries, and sectoral variations exist in each country.

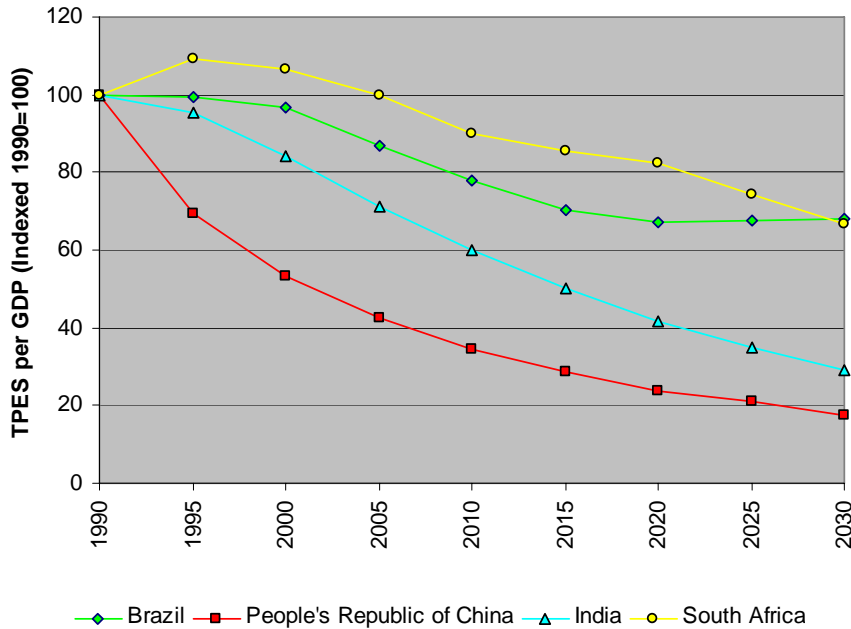

Figure 2: Total Primary Energy Supply Intensity of GDP indexed

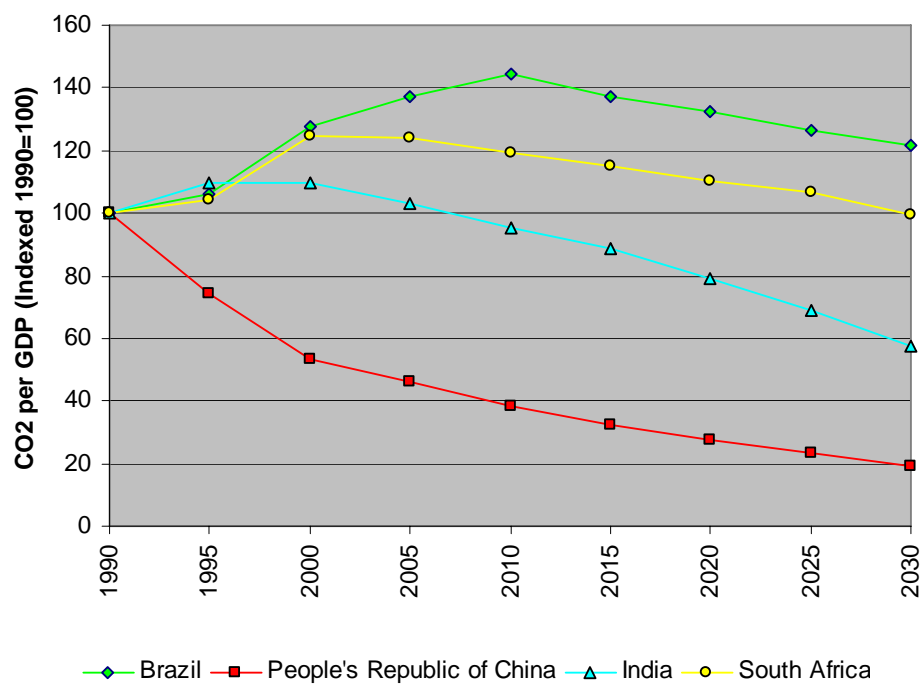

Figure 3: CO2 intensity of GDP

Energy does not however decouple from carbon (figure 4) as all these economies continue to rely heavily on domestic fossil resources for their energy needs – mainly driven by energy security concerns. Coal is the dominant resource for China, India and South Africa. Brazil’s energy system had traditionally been hydro dominant, which makes it climate friendly. The high penetration of biofuels over the last 30 years has only strengthened this friendliness. The initial rise in average carbon intensity of Brazilian energy system in figure 4 is due to increasing coal use for power generation. However its effects are overshadowed by much higher shares of carbon-neutral energy around 10 years from now, and then the carbon intensity of Brazilian energy system declines.

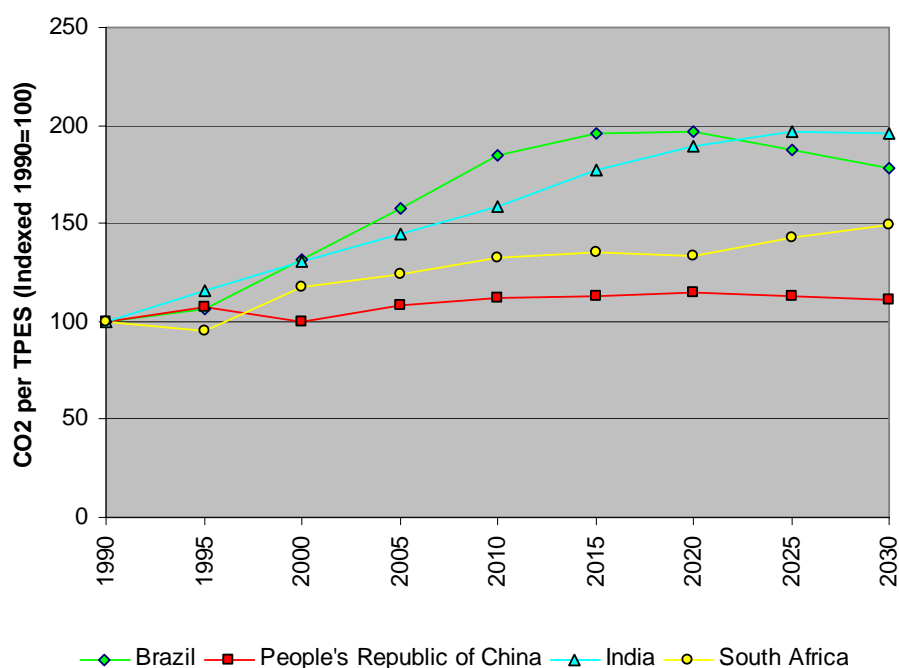

Figure 4: CO₂ Intensity of TPES in Brazil, China, India and South Africa

4.2 Energy access and affordability

Reducing energy poverty and enhanced electricity access (figure 5) for meeting the national developmental goals is projected to increase electricity requirements during 2007-2030 for all the 4 countries. Per capita electricity consumption also increases as incomes rise and power access improves (figure 6). Coal based power is projected to remain the primary source - mainly due to energy security considerations. Coal use becomes cleaner, but not clean enough. Therefore CO₂ emissions would continue to rise.

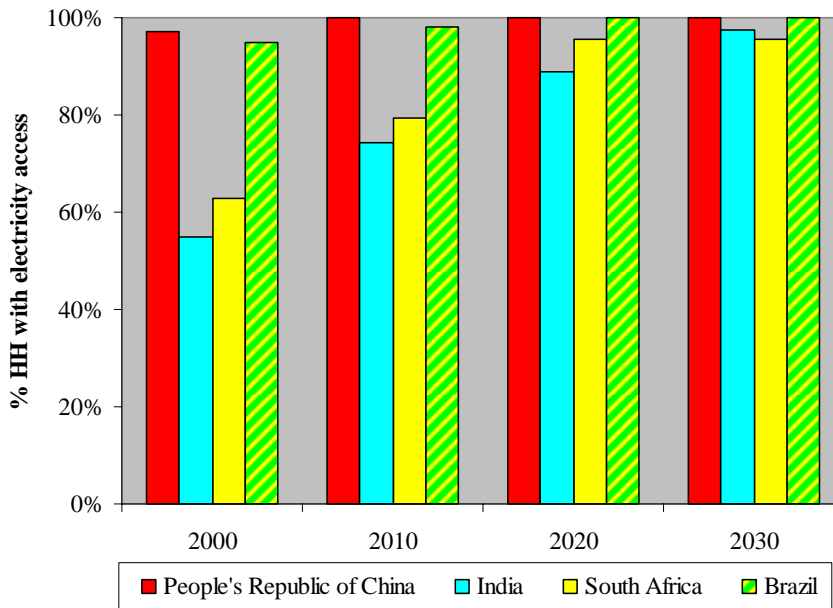

Figure 5: Energy access projections for Brazil, China, India and South Africa

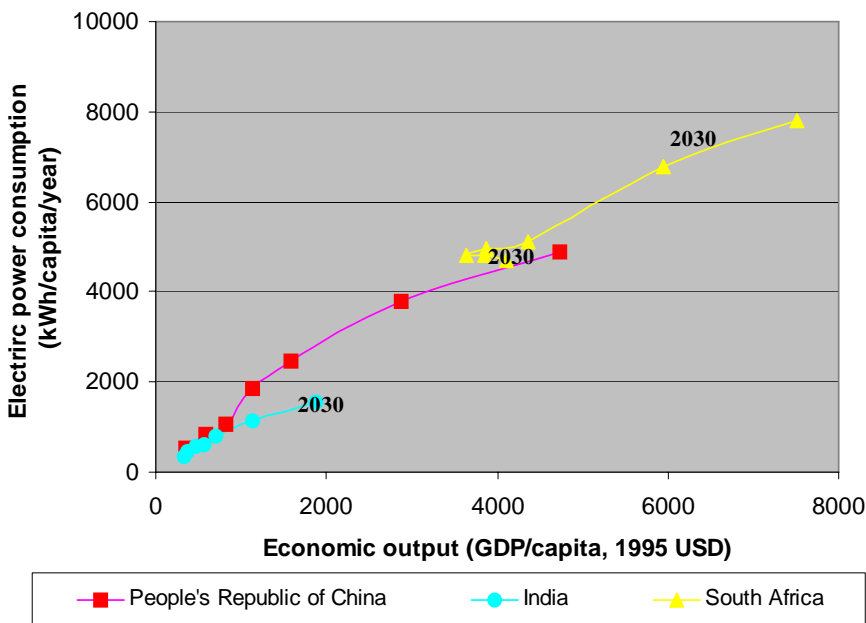

Figure 6: Electricity consumption versus per capita GDP

Electricity consumption is strongly correlated with economic output. Figure 6 shows GDP per capita and electricity consumption per capita for China, India, and South Africa in the period 1990 to 2030. It can here be seen that the countries expect to move upwards almost along a common line, where increases in income per capita is followed by a very similar increase in electricity consumption across the countries.

Energy access also differs significantly across income groups. Tables 4 and 5 below show the household expenditures on energy consumption for different income groups. The share of the household budget that is spent on energy shows a number of

similarities in India and China according to Table 4. Energy expenditures decrease with increasing income and the share of the household budget spend in India and China for urban households similarly vary between more than 10% for the poorest incomes down to around 5% for highest income households.

It should be noted that even the poorest households spend as much as 10% of their income on energy despite they must be assumed also the use non-commercial fuels in addition. This highlights the key role of energy as a basic need. We have not projected the change in share of energy expenditure in monthly household expenditure in the present paper; however the per capita estimates indicate that it marginally declines for all countries, since per capita GDP rises much faster than per capita electricity consumption. There is an increase in average price of electricity during 2000-2030. However this is off-set by per capita GDP increases, which are much higher, especially in China and India.

Table 4: Household Expenditure on Energy for Indian Households in 2000 and Chinese Households in 2004

HH income category	India rural, 2000		India urban, 2000		China urban, 2004	
	Absolute expenditure (USD, 2000 prices)	% share of total HH expenditure	Absolute expenditure (USD, 2000 prices)	% share of total HH expenditure	Absolute expenditure (USD, 2000 prices)	% share of total HH expenditure
Poorest 0-5%	0.46	10.2%	0.65	10.9%	3.00	10.3%
0-10%	0.51	10.1%	0.80	10.7%	3.33	9.8%
10-20%	0.62	9.0%	1.04	10.5%	4.10	8.7%
20-40%	0.73	8.7%	1.46	10.1%	4.79	7.9%
40-60%	0.97	8.9%	1.73	9.6%	5.57	7.2%
60-80%	1.15	8.6%	2.13	8.9%	6.55	6.6%
80-90%	1.44	8.1%	2.67	7.8%	7.67	6.0%
Top 90-100%	1.79	7.2%	4.01	5.7%	10.10	5.0%

Note: Fuel and light expenditure for India, Water, oil and electricity expenditure for China

Sources: NSSO, 2001 (India); China Statistics Yearbook 2005 (visit www.stats.gov.cn)

Table 5 gives more details about the distribution of energy expenditures among different energy forms for Indian households. According to the statistics given in this table, the expenditures on electricity are a major category in electricity expenditures for urban households and for high income rural households. Solid fuels are the dominant energy source for cooking in rural areas and for low income families in urban areas, while gas is introduced as a major source for cooking in urban areas for medium and high income households. One of the conclusions that can be drawn from Table 5 is that electricity access and income levels in particular are important in relation to lighting, but not so important for cooking, where electricity plays a less important role for household with access and higher incomes.

Table 5: Household (HH) Expenditures on different Energy forms for Indian Households in 2000 (all in %)

HH category	% of HH	Lighting			Cooking					% of monthly HH expenditure
		Liquid	Electricity	Others	Solid	Liquid	Gas	Electricity	Others	
Low rural	33.5	66	33	1	93	1	1	0	6	9.4
Medium rural	52.7	47	52	1	89	2	5	0	3	8.7
High rural	13.8	19	80	1	62	8	28	0	2	7.2
Low urban	28.6	19	73	0	62	17	14	0	6	10.6
Medium urban	40.2	4	94	0	22	24	50	0	3	9.6
High urban	31.2	5	98	0	4	13	72	0.1	11	7.1

Source: NSSO, 2001

4.3 Efficiencies of energy conversion

Figure 7 gives a comparison of average CO₂ emissions per unit of electricity generated from coal and coal products in the 5 top-most coal users in the world and these are compared with Denmark, which has one of the best efficiency of energy conversion. China where coal consumption is rising phenomenally is almost at par with the USA in carbon efficiency of power generation. India, the other fast growing developing country also relies on coal as the dominant energy resource. But her per unit CO₂ emissions are much higher, providing immense opportunities for improvement and mitigation.

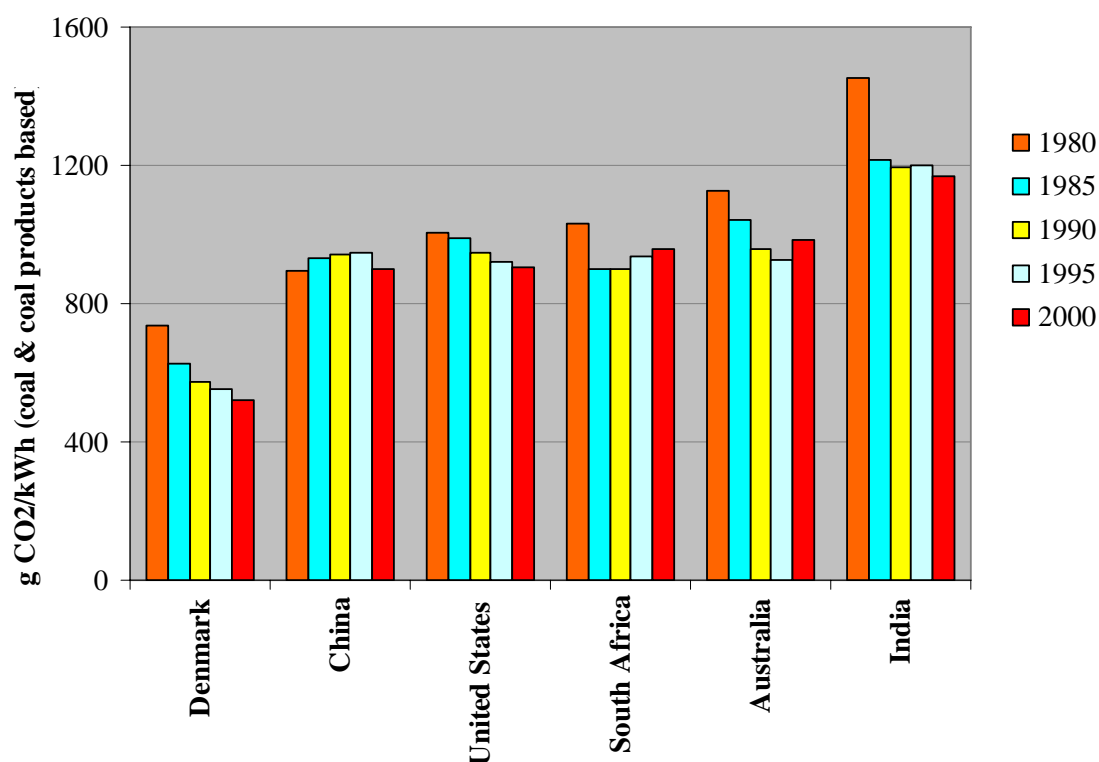

Figure 7: CO₂ emissions to generate one unit of power from coal products

Figure 8 projects the efficiency of power generation from fossil fuels in China, India and South Africa. These 3 countries together consume over 40% of global

coal annually at present. About 2/3rd of this coal is used for power generation in these countries. Therefore even marginal improvement in efficiency of power generation would result in large reductions in total CO₂ emissions. Current efficiency of production is relatively lower; however it is projected to improve in future. Clean coal technologies such as super critical pulverized coal and IGCC are projected to increase their share in power-mix in these countries from the present very low or almost nil shares.

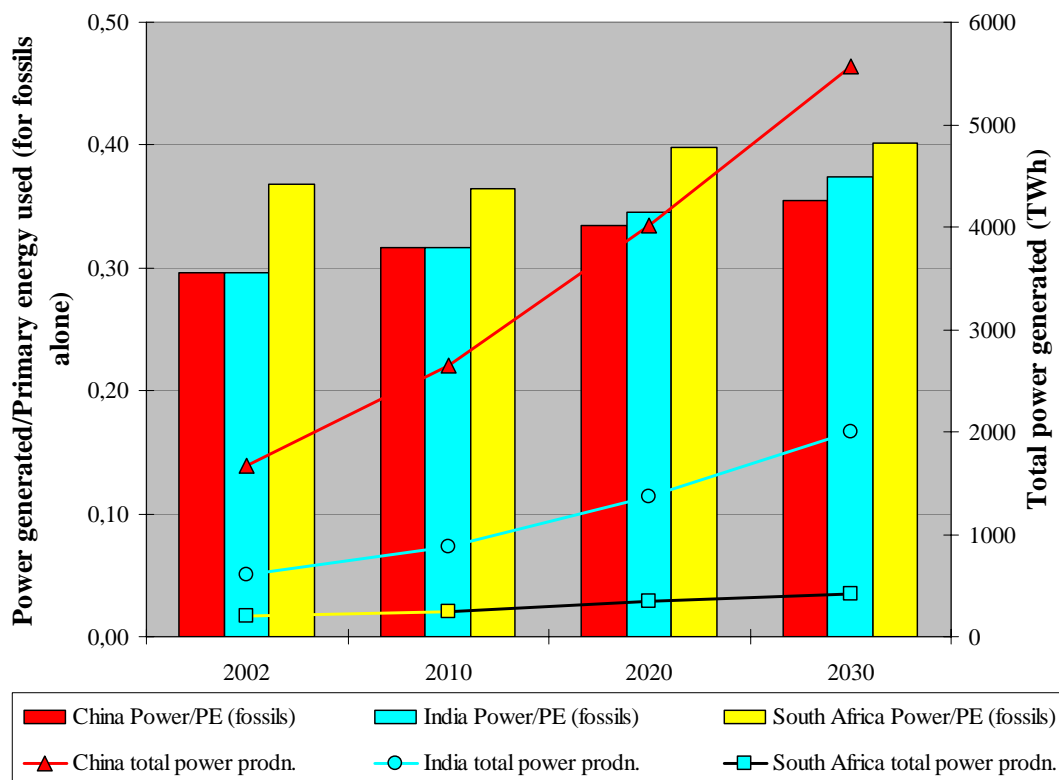

Figure 8: Efficiency of power generated from fossil fuels

4.4 CO₂ and local pollutant emissions

Large developing countries are projected to add considerable fossil fuel based capacities during 2007-2030. CO₂ emissions are projected to grow as a result. Figure 9 gives the CO₂ emissions for various countries under the reference scenario and their share of the global CO₂ emissions measured in relation to IEA's WEO 2005 (IEA, 2005). During 2005-2030, India emissions are projected to grow with 3.6% per year, 2.8% per year in China, 2.7% per year in Brazil, and 2% per year in South Africa. The countries cumulative CO₂ emissions are projected to increase from being 22% of global emissions in 2000 to 33% in 2030. Coal consumption in China, India and South Africa is the predominant driver of this emission growth, although the CO₂ intensity of coal use improves considerably in these countries due to efficiency improvements from 2005-2030.

Figure 10 shows the corresponding SO₂ emission projections for the countries.

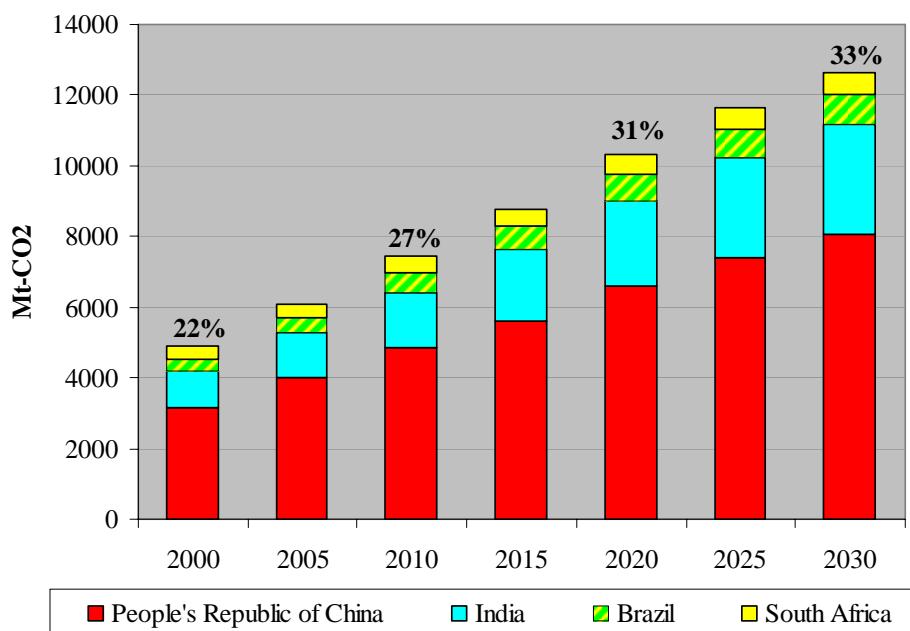

Figure 9: CO₂ emission projections under the reference scenario for Brazil, China, India and South Africa. The percentages above the bars are their cumulative share of the global CO₂ emissions (refer reference scenario in IEA, 2005b).

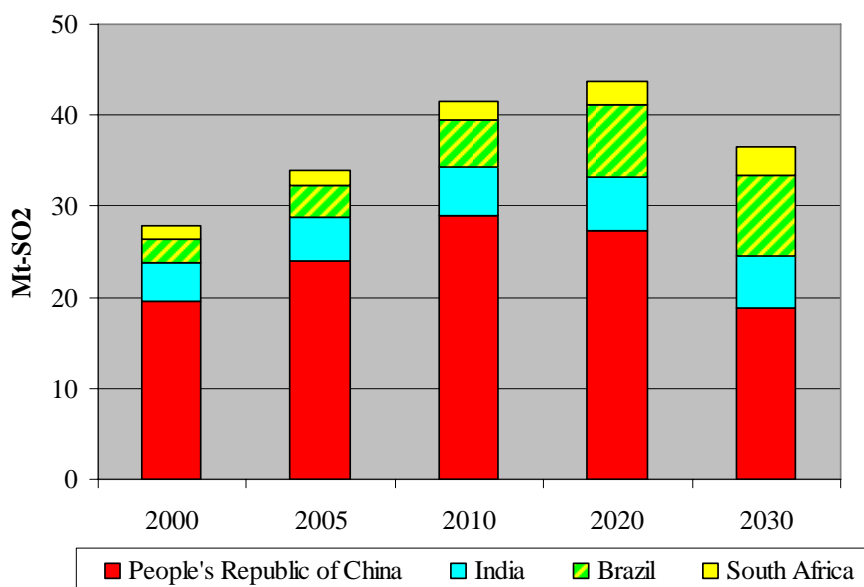

Figure 10: SO₂ emission projections under the reference scenario for Brazil, China, India and South Africa.

A key issue related to integrated development, energy and climate policies is whether it is possible to combine local and global environmental policies in a way, where countries while pursuing high priority local environmental concerns, for example in relation to local air quality, also can support CO₂ emission reduction policy objectives.

It should here be recognized that CO₂ and SO₂ emission control policies have various interesting links and disjoints. Starting from SO₂ emission control as the major policy priority, it can in many cases be cheaper to install various cleaning techniques that control SO₂ emissions rather than to implement general efficiency improvements or fuel switching that both reduce SO₂ and CO₂ emissions. Contrary, starting with CO₂ emission reduction as the major policy priority will often suggest a number of cost effective options that jointly reduce the two types of emissions. However, such policies seen from the SO₂ reduction perspective alone deliver more expensive local air pollution control than cleaning systems. The conclusion is that integrated local and global emission reduction policies in many cases will require special attention to the global aspects.

The relationship between CO₂ and SO₂ emission development is shown in Figure 11 below for Brazil, China, India and South Africa for 2000-2030 under the reference scenario. CO₂ and local pollutant emissions (e.g. SO₂, NO_x and particulates) decouple. Elasticity of mitigating CO₂ as a side-benefit of SO₂ mitigation policy is lower (0.1-0.01 in 2020 for India) than elasticity of mitigating SO₂ as a side-benefit (1.2 to 1.4 in 2020 for India) from a direct CO₂ mitigation policy. Same is the case for CO₂ and particulates emissions. Similar trends are projected for China as well. These have strong policy relevance and investment implications. The domestic governments, in absence of any binding commitments to mitigate GHG emissions, would by the cheaper and direct policy routes to mitigate only the local pollutants. However there are considerable conjoint mitigation opportunities that could be explored, but may be more expensive, e.g. fuel switching from coal to gas.

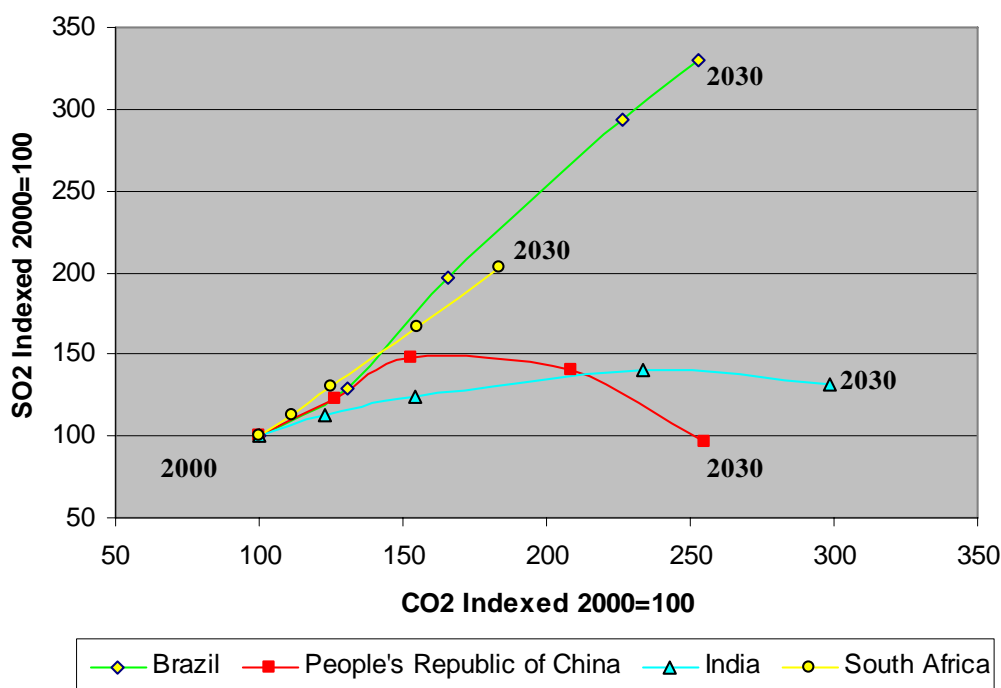

Figure 11: Links and disjoints in CO₂ and SO₂ emissions in Brazil, China, India and South Africa 2000 to 2030 (The emissions are indexed separately for each country to maintain comparability; and dots show the time namely, 2000, 2005, 2010, 2020 and 2030)

5. Sustainable development indicators

Based on the approach explained earlier, SD indicators have been applied to the reference scenario country study results for Brazil, China, India and South Africa in order to reflect energy efficiency, supply structure, per capita electricity consumptions, and local and global pollution. The results of this assessment are shown in figures 12-15 for 2000-2030 for Brazil, China, India and South Africa. These figures are structured as “web-diagrams”, where the development trends for the chosen SD indicators are shown for the period 2000-2030 (defined as index values with 2000=100). The SD indicators include variables where low index values are considered to be supporting SD, and other variables, where high index values support SD². Variables that are considered to have a positive impact on SD if the index value is **low** are:

- SO₂ intensity of energy consumptions (SO₂/TPES).
- Energy intensity of GDP (TPES/GDP).
- CO₂ intensity of GDP (CO₂/GDP).
- CO₂ intensity of energy (CO₂/TPES).

While variables that are considered to have a positive impact on SD if the index value is **high** are:

- HH electricity access
- Per capita electricity consumption.
- Efficiency of electricity generation (fossil).
- Investments in new power plants.
- Renewable share in power production.

² A low index value for the period 2000 to 2030 implies that the variable is decreasing or only slowly increasing, which for example is positive for CO₂ emission. Contrary a high index value shows a large increase over time, which for example can be positive in terms of per capita electricity consumption.

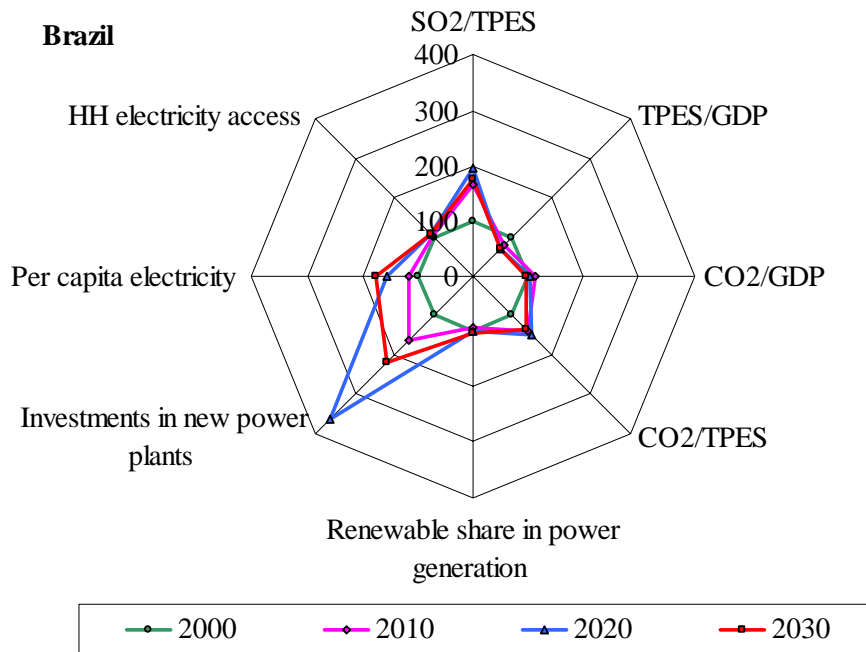

Figure 12: Sustainable development indicator projections for Brazil

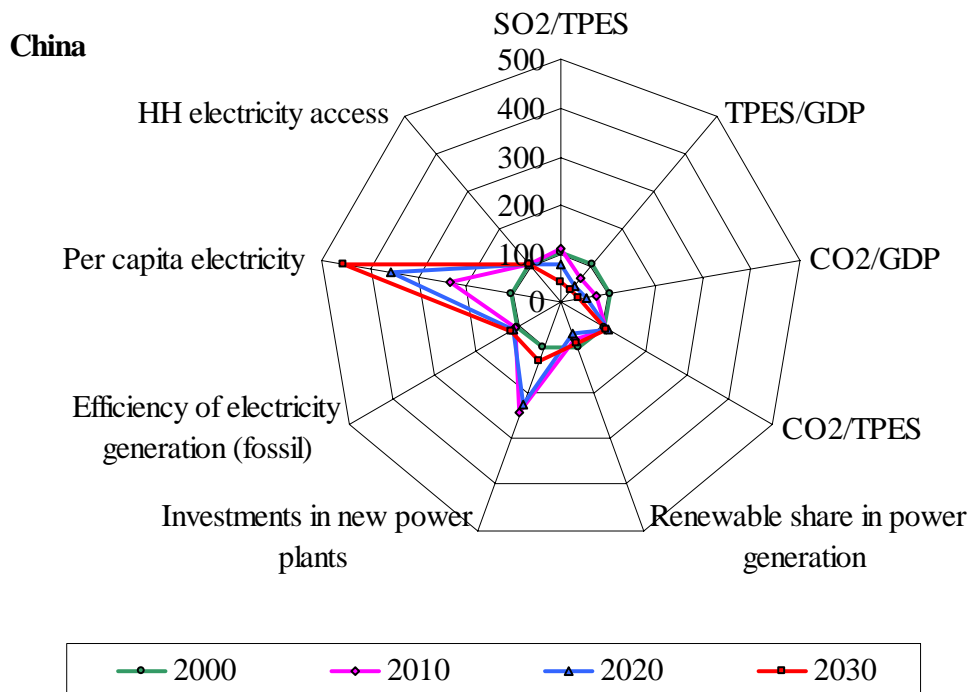

Figure 13: Sustainable development indicator projections for China

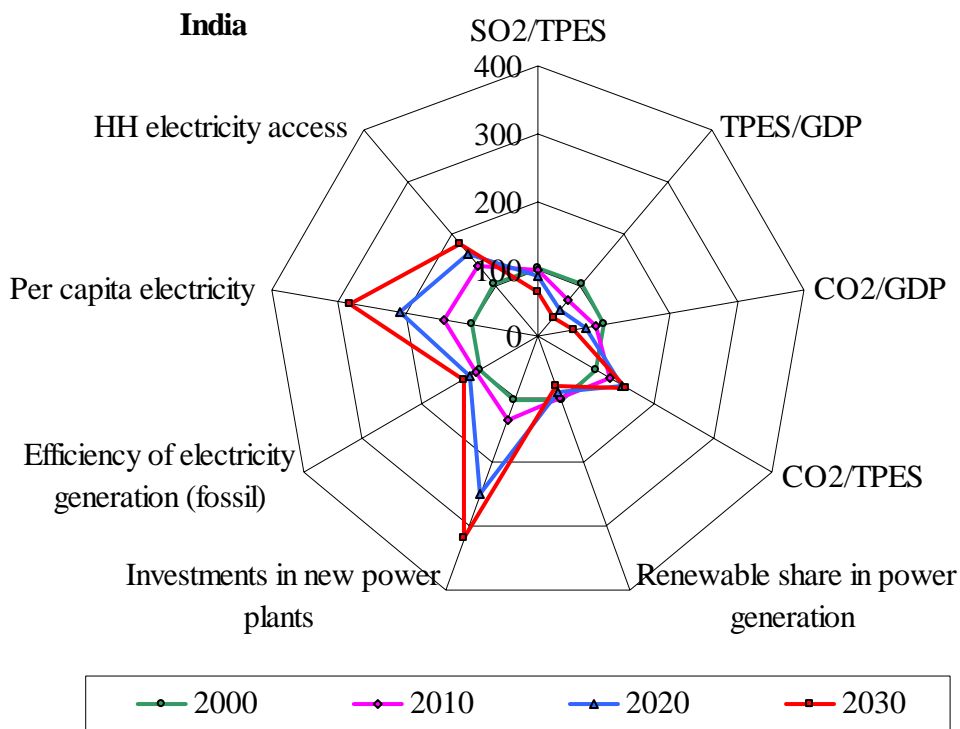

Figure 14: Sustainable development indicator projections for India

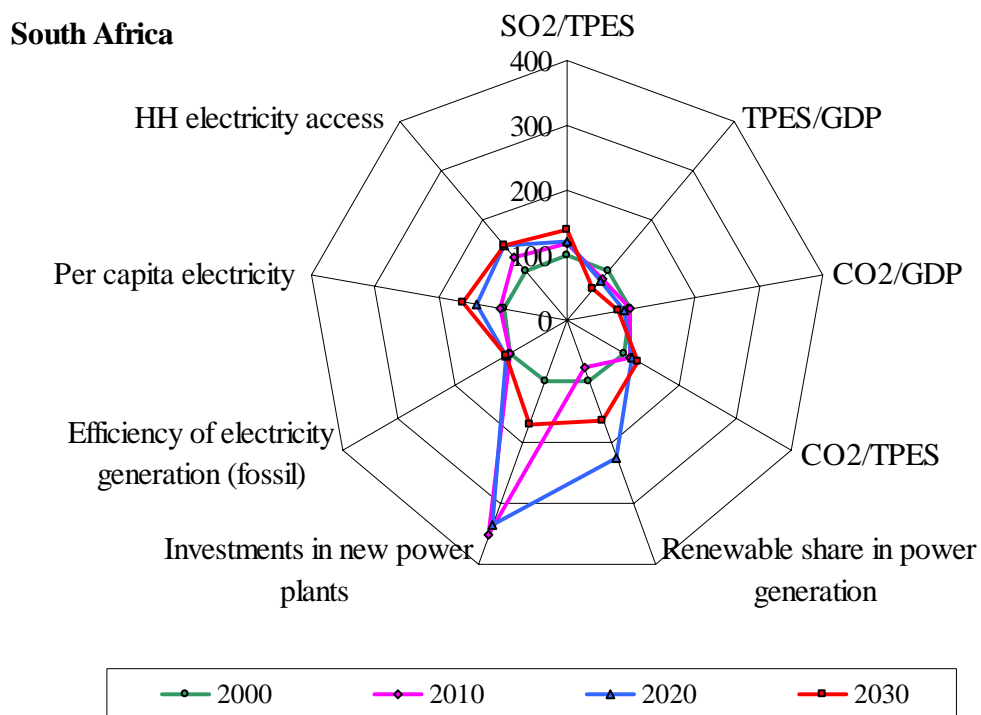

Figure 15: Sustainable development indicator projections for South Africa

The Brazilian baseline development trends from 2000 to 2030 are characterized by a large increase in power sector investments and increasing CO₂ and SO₂ intensity of

energy consumption. The share of renewable energy increases slightly and there is a relatively small increase in per capita electricity consumption.

The baseline scenario for China for 2000 to 2030 implies an increasing share of renewable energy and a very large increase in per capita electricity, while the CO₂ and SO₂ emission intensities of energy are kept very close to the 2000 levels (Figure 13). There is also a high growth in power plant investments, and the efficiency of power production increases with about 20%.

In India, there is a growth in the CO₂ emission intensity of energy consumption, while the SO₂ intensity is decreasing from the 2000 level (Figure 14). The energy intensity of GDP is also decreasing in the period. The per capita electricity consumption is increasing about three times, and this is also the cause for power sector investments.

Finally, South Africa in particular has a high growth in power sector investments from 2000 to 2030 and also some growth in the share of renewable energy in power generation (Figure 15). The CO₂ intensity of GDP is almost constant in the period, while the energy GDP intensity is decreasing slightly. Per capita electricity consumption is expected to have a relatively modest increase like in the case of Brazil.

All together, the common conclusions that can be drawn from Figures 12-15 are that there generally is a tendency for CO₂ and SO₂ emission intensities of energy and GDP to develop slowly in the countries in their 2000 to 2030 baseline cases. Investments in the power sector are expected to grow fast in the period, and in particularly in China and India this implies a large growth in per capita electricity consumption. It is here worth recognizing that none of the countries expect very large increases in the renewable share of electricity production in the period, however the absolute levels of renewable energy is projected to increase considerably in all the countries.

6. Conclusions

The paper discusses a number of key conceptual issues related to the role of energy in development and its potential synergies and tradeoffs with climate change. The relationship between economic development and energy over time is discussed and illustrated by data from Brazil, China, India and South Africa. It is concluded that energy plays an important role as a productivity enhancing factor in economic development and in human well being and several policy goals related to sustainable development (SD), energy and climate can be integrated. However, meeting all these policy goals requires a special effort and can imply costs.

The 1990 to 2030 time frame studies for Brazil, China, India, and South Africa show that there is a tendency to decouple economic growth and energy consumption over time. Energy consumption, however seems to have a stable or increasing CO₂ intensity, so all together CO₂ emissions tend to grow with about the same or a lower rate than GDP in most countries.

The power systems of all the countries except Brazil are dominated by coal and this supply structure will continue in the future. This also implies high growth rates in CO₂ emissions of between 3.6% and 2% per year from 2005 to 2030. As a result of

this, the four countries are expected to contribute as much as one third of total global CO₂ emissions in 2030.

Local air pollution in terms of SO₂ emissions will also grow in the period, but there is a tendency to introduce significant control measures 10 to 15 years from now, which implies much smaller growth in this area in the future. However, CO₂ emissions do not automatically drop as a consequence of these local air pollution control measures.

Energy access is a major priority in all the countries studied, and the official development and energy policies assume almost full household access to electricity in 2030. More detailed studies of income levels and energy expenditures however show that energy is a relatively high budget burden for the poorest households. Energy expenditures contribute more than 10% of the household budget for poor households in China and India today, while the level is between 5% and 7% for high income families.

The results demonstrate that there is a huge potential for energy efficiency improvements in the energy systems in these countries and thereby cost savings and reduced emissions intensity. The application of SD indicators indicates that the reference scenarios do not deliver high GHG emission reductions and is also only including small increases in renewable energy, so it is clear that a promotion of specific policy objectives in these areas requires special attention and policy options beyond baseline scenario perspectives. However, the implied greenhouse gas emissions depend on fuel and technology compositions and reduction will imply that specific policies are put in place.

References

China Statistics Yearbook 2005. China Year Book 2005, State Statistical Bureau, China Statistical Publishing House, Beijing. (visit www.stats.gov.cn)

Halsnæs, K. and Garg, A. (2006). *Sustainable Development, Energy and Climate: Exploring synergies and tradeoffs*. A research publication of UNEP Risoe Centre, Denmark. ISBN 87-550-3542-6.

Halsnæs, K., Garg, A., Denton F. and Olhoff, A. (2006). *Practical Guidance Material for the Development, Energy and Climate Country Studies*. A research publication of UNEP Risoe Centre, Denmark. ISBN 87-550-3543-4.

Kemmler, A. and Spreng, D. (2007). Energy indicators for tracking sustainability in developing countries. *Energy Policy* 35, 2466-2480.

NSSO, 2001. *Differences in Level of Consumption among Socio-Economic Groups 1999-2000*. National Sample Survey Organization, Ministry of Statistics and Programme Implementation, Government of India, New Delhi. Report No. 472 (55/1.0/10).

Schurr, S. H., 1982. Energy Efficiency and Productive Efficiency: Some Thoughts Based on American Experience. *Energy Journal* 3(3):3-14.

Toman, M. and Jemelkova, B., 2002. Energy and Economic Development: An Assessment of the State of Knowledge. *Resources for the Future*. Discussion Paper Series DP 03-13.

Sustainable Transport Practices in Latin America

Jorge Rogat and Miriam Hinostrroza
UNEP Risoe Centre, Energy Climate and Sustainable Development
Roskilde, Denmark

E-mail: Jorge.rogat@risoe.dk
miriam.hinostrroza@risoe.dk

Abstract

The rapid growth of Latin American cities beginning in the 70s has led to, among other things, growing mobility and demand for transportation. The lack of efficient, reliable and safe public transport systems has promoted the switch away from buses and trains towards private cars. Some of the impacts of a steadily increasing car fleet have been increased congestion, number of accidents and environmental deterioration. Recognising the potential implications of such a development, policy makers and officials found it necessary and went ahead to reformulate transport policies with the aim of providing safe, cost-effective and environmental-friendly public transport systems. Bus rapid transit (BRT) became the answer in a number of Latin American cities. The successful experiences of Curitiba in Brazil and Bogotá in Colombia have served as the source of inspiration for other cities in Latin America, Asia, Europe and the USA. Thus, the BRT represents a unique example of South-South, South-North technology transfer. This paper presents some of the Latin American experiences and discusses their achievement and drawbacks.

1 Introduction

The rapid growth of Latin American cities beginning in the 70s has led to, among other things, growing mobility and demand for transportation. The lack of efficient, reliable and safe public transport systems has promoted the switch away from buses and trains towards private cars. Some of the impacts of a steadily increasing car fleet have been increased congestion, number of accidents and environmental deterioration. From 1970 to 1990, the Latin American car fleet increased by approximately 250%, reaching 37 million vehicles (Wright, 2001). Many of these cars were imported used cars, which emit more pollutants than new cars, hence causing a heavy strain on both the local and global environment. The transport sector is currently one of the most rapidly increasing sources of green house gases (GHG) and in some Latin American countries - it accounts for nearly a third of the total GHG emissions (Rogat, 2007).

Recognising the potential implications of such a development, policy makers and officials found it necessary and went ahead to reformulate transport policies with the aim of providing safe, cost-effective and environmental-friendly public transport systems. Bus rapid transit (BRT) became the answer in a number of Latin American cities. Curitiba in Brazil was in 1973 the first city in the world to introduce a BRT system. Several years later, in 2000, Bogota in Colombia introduced another BRT system in the region. These two examples have served as the source of inspiration for other cities in Latin America, Asia, Europe and

the USA. BRT systems are operational or under construction in Mexico City, Mexico; Sao Paulo, Brazil; Santiago, Chile; Guatemala City, Guatemala; Guayaquil, Ecuador; Jakarta, Indonesia; Beijing, China; Bangkok, Thailand; Nantes, France; Glasgow, Scotland; Eindhoven, Netherlands, and in Boston and Orlando in the USA. Thus, it represents a unique example of South-South, South-North technology transfer.

One likely explanation for the wide BRT acceptance is that it can provide high quality services similar to other mass rapid transit (MRT) systems like light-rail or rail-based metro, but at a fraction of the cost. Experience from implementations in Latin America shows that the construction cost of a BRT system may vary between 1 and 5 million US\$ per kilometre, while the cost of a light rail train may be around 30 million US\$ per kilometre. The cost of rail-based metro, which is by far the most expensive, may vary between 65 and 200 million US\$ per kilometre (GTZ, 2002).

The BRT system works in a similar way to light-rail trains or rail-based metros, but operates along corridors on dedicated busways at street level. Articulated buses with a carrying capacity of between 150 and 185 passengers, or bi-articulated buses with a carrying capacity of around 270 passengers are normally used. These buses are supplemented by feeder buses which carry passengers to interchange terminals. Modal integration is another feature of BRT systems, which in some cases complement rail-based metro systems, with feeder buses connecting both buses and metro. One such example is the BRT system recently launched in Santiago, Chile. Here, the BRT system operates as a complement to the metro, covering areas not served by the metro with feeder buses connecting both transport systems. A well designed BRT system can carry around 35,000 passengers per hour and direction, which is half what metro systems can carry, but as mentioned earlier, this at a fraction of the cost. Other features of the BRT system are established stops; rapid boarding, and pre-boarding fare collection. Most of the BRT systems operating in Latin America are managed by a public-private partnership, where the government fund the required infrastructure, while private bus operators provide the buses. The government or the corresponding transport authority set the regulatory framework for private bus associations to operate. The BRT systems implemented in Latin America are not subsidised and are, despite relatively low fares, financially sustainable¹.

This paper analyses two of the most well known old BRT experiences and some of the new ongoing experiences in the region, focusing on the benefits and drawbacks encountered so far. The two well-known experiences are famous because of their success in terms of acceptance and performance. The new ongoing experiences are more difficult to assess and have shown varying degree of success.

¹ BRT fares in Latin America vary between US\$0.15 as in the case of Guatemala City, to US\$0.80 in Santiago, Chile.

2 Successful practices

2.1 Curitiba's Integrated Transport System

Curitiba, the capital city of the Brazilian State of Paraná, has been successful in innovating the transport system over the past 40 years by challenging conventional wisdom: favouring public transport over private automobiles, selecting appropriate rather than capital-intensive technologies, and pursuing strategic principles rather than rigid master plans (Santoro & Leitman, 1996). It started with the Agache Plan in 1943, when Alfred Agache, a French urban planner, developed the first urban plan for the city². Due to financial constraints in carrying out the plan; and to the pressure of rapid population growth³, planners had to reconsider the plan and in a process that matured during 20 years of institutional development, they created a forward-looking, flexible Master Plan that was approved in 1966⁴.

In proposals with several innovative solutions relying on an organised, non subsidised and privately owned investment in infrastructure, the Master Plan established guidelines that changed the city's radial configuration of growth to a linear model of urban expansion. The basis of the Master Plan was a tripod principle: the integration of land use, road network and transportation planning. These elements were the key tools for guiding and coordinating socio-economic and territorial growth of the city. The first step after approval of the plan was the creation of the Institute for Research and Urban Planning in Curitiba (IPPUC). The institute introduced zoning laws and design for the city in compliance with the urban plan. In 1969, Mayor Omar Sabbag developed the preliminary mass transportation plan. In 1971 the plans for mass transit terminals and pedestrianisation of the city centre were developed under Architect Jamie Lerner's first appointed mayoral term.

Revisions of the Master Plan were done along with the evolution of needs for transport and priorities of city planners. The most significant changes in the transport system were taken in 1974 with the creation of the road hierarchy and land control system (Rabinovitch & Hoehn, 1995)⁵. The key innovations that have been bolstered by continued political support across municipal administrations are: conscientious integration of land use planning, road design, and public transport; joint public-private operation; capacity-expanding measures and emphasis on equity and affordability.

2 The plan assumed the dominance of the automobile and the principal approach was massive infrastructure investments, including construction of circular boulevards and major radial arteries

3 Due to agricultural mechanisation from the 1950s to the 1980s, cities across Brazil experienced rapid growth with the migration of people from rural areas to urban areas. Curitiba experienced some of the highest growth in the country with population increases reaching an estimated 5.7% a year during those decades. This uncontrolled increase in population presented challenges that demanded effective city planning in areas ranging from social services, housing and sanitation, to environment and transportation..

4 The Master Plan was designed by several Brazilian architect firms in cooperation with city planners

5 One important element of Curitiba's road system is the concept and use of "road hierarchies." Each road is assigned a function in relation to its location and importance. There are the "structural" roads along the five axes described above and "priority" roads that connect traffic to the structural roads. "Collector" streets have commercial activity along them with all forms of traffic, and "connector" streets link the structural roads to the industrial area. These four types of roads form the structure of Curitiba's road network.

The current Curitiba Integrated Transportation Network (ITN) encompasses transfer terminals, thirteen express routes, direct routes using boarding tubes, feeder and inter-district routes supplemented by city centre routes, neighbourhood routes, night routes, special student routes, and pro-park routes which collectively make up Curitiba's Mass Transit System (MTS). Through carefully planned tube or terminal connections, passengers can pay one fare and travel throughout the system. Passengers can identify a specific route by the colour and type of the bus used. The Integrated Transport System is made up of 340 routes that utilise 1,902 buses to transport 1.9 million passengers per day. The entire network covers 1,100km of roads with 60km of it dedicated to bus use. There are 25 transfer terminals within the system and 221 tube stations that all allow for pre-paid boarding. In addition, the integrated system has 28 routes with special buses dedicated to carrying students and disabled people (Rabinovitch, 1995; IPPUC⁶).

Curitiba's public transport system carries nearly 1.5 million passengers daily, or about 75% of the total number of passengers, thus being the highest carrier among all Brazilian public transport systems. Affordable fares make it possible for the average low-income family to spend only around 10% of its income on transportation, which is relatively low in Brazil. The efficient system improves productivity by speeding the movement of people, goods, and services⁷.

The implementation of the urban transport system has had to overcome a number of obstacles: rapid growth; the threat to long-term transport planning posed by short-term political decisions; and the lack of finance. In overcoming these obstacles, several important lessons were learned. (Santoro & Leitman, 1996):

- even during a period of rapid growth, cities can guide physical expansion through integrated road planning, investment in public transport, and enforcement of complementary land use planning;
- the capacity and expertise needed to support innovation should be institutionalised to enhance guidance and stability over time;
- creativity, public-private partnerships, resource conservation, and external support can overcome financial constraints;
- authorities should involve stakeholders in innovations and provide them with transparent and up-to-date information.

The implementation of the Master Plan through integrating the road network, public transport, and land management has resulted in a more energy-efficient, cost effective and environment friendly city. Positive environmental changes are directly linked to urban management in the transport sector. Although there are more than 500,000 private cars in the city, three quarters of commuters take the bus (Urbanização de Curitiba, SA). Twenty-eight percent of direct route bus users previously travelled by car. The increased use of public transport has helped save up to 25% of fuel consumption citywide, with related reductions in automotive emissions. Curitiba's public transport system is directly responsible for the city having one of the lowest levels of air pollution in Brazil (Santoro, 1996).

6 Urbanização do Brasil S.A (URBS) http://www.ippuc.org.br/pensando_a_cidade/index_projetos.htm
– Cd-Rom Curitiba: Planejamento um Processo Permanente

7 http://www.curitiba.pr.gov.br/pmc/a_cidade/Solucoes/Transporte/index.html

2.2 Bogota's TransMilenio

While the source of inspiration for Curitiba's Master Plan was urban development, for TransMilenio the stimulus came from the need for a solution to a typical chaotic transportation problem of a mega-city like Bogota. Though the system was developed taking into consideration Curitiba's experience, it was a reform of an existing urban transport system. The objective of TransMilenio has been to establish an efficient, safe, rapid, convenient, comfortable and effective modern MRT system ensuring high ridership levels. The long-term goal is to ban the use of all private vehicles during peak hours starting 2015. TransMilenio is a high quality and sustainable transport solution, at a very low cost for the tax payers and direct users.

TransMilenio is a BRT system that has been carefully designed and developed taking into consideration the specific circumstances applying to Bogotá. The system was designed and developed under the following principles based on respect to the passenger:

- respect to life: reduce fatalities due to traffic accidents and reduce harmful emissions;
- economise users' travel time: reduce average trip time by 50%;
- respect to diversity: full accessibility to young, elderly and handicapped.
- quality and consistency: use of advanced transit technologies, providing a world class system city wide;
- affordability: possibility for the government to afford infrastructure costs, for the private sector to recover costs of buses acquisition and operations from fares (without public subsidies), and for the users to pay the fares.

As one component of the Mobility Strategy, TransMilenio is part of a structural change in the transit system of Bogotá. To initiate a structural change under prevailing transportation conditions, the local administration set forth an integral mobility strategy aimed to promote non-motorised transportation, reduce automobile use, and encourage public transportation. Actions include recovery of public spaces and construction of pedestrian walkways and malls, building of 400 Km bikeways network, a city wide vehicle restriction in peak periods, increase in parking prices, day-long automobile ban, and development of a bus rapid transit system (Sandoval & Hidalgo, 2002)⁸

TransMilenio encompasses specialised infrastructure for bus rapid transit, including dedicated busways for high capacity articulated buses. It also includes an efficient privately provided operations scheme, a state-of-the-art fare collection system, and a new public company in charge of planning, development and control of the system. Infrastructure, planning, development and control of the system are provided by public entities, while operations and fare collection are provided by private companies through concession contracts.

The TransMilenio system is the result of a successful public-private partnership as well. Apart from an adequate financial support for infrastructure development, factors such as strong political will, the commitment of an enthusiastic technical

⁸ TransMilenio started operations in December 2000. By May 2001 it moved 360,000 passengers/day in 20 Km exclusive busways, 32 stations; 171 articulated buses, and 60 feeder buses operating 26 Km routes. By the end of 2001 it carried 800,000 passengers/day in 41 Km busways, 62 stations, 470 articulated buses and 300 feeder buses operating 125 Km routes. Extensions will continue in the upcoming 12 years to cover 85% of the daily trips in the city.

team and the support of local agents, were strong components for successful implementation of the project in only thirty six months. Nowadays, the system's productivity is very high compared to traditional public transport. Fulfilment of the objectives is underway, and achievements are already evident, namely, a 92% reduction in fatalities, a 32% decrease in average journey time, a 98% acceptance level among the public, and an affordable fare (US\$0.40). The BRT system is managed by TRANSMILENIO S.A, which is the company in charge of planning, development and control of the system.

TransMilenio contributes to improvement of the environment and resource efficiency in the transport sector. It replaced the conventional transport system by one which, apart from providing improved transport services for passengers, reduces in a significant way emissions per passenger (14% emission reductions in 1992 and 45% expected for 2015⁹). Though buses are diesel-powered, emission reductions are basically the result of systematic improvements plus a modal shift towards public transport. Emission reductions are the result of the following changes: renewal of bus fleet, increased capacity of buses (the articulated buses have a capacity of 150 passengers); improved operating conditions for buses¹⁰; centralised bus-fleet control, which allows for the optimisation of the load factor of buses leading to lower emissions per passenger transported; mode shift; introduction of pre-paid fare technology thus streamlining the boarding process and reducing idling buses GHG emissions. Indirectly, TransMilenio also reduces GHG emissions of other vehicles circulating in the area of TransMilenio due to improved traffic conditions as a result of an elimination of interference from buses competing for passengers with other vehicles.

3 New initiatives

3.1 Guayaquil's Metrovía

The BRT system Metrovía of Guayaquil was designed by a unit within the Municipality of Guayaquil specially established for that purpose. The Metrovía was considered to be the most appropriate solution to the transport problems affecting the city and is one of the main components of the massive urban transport programme (MUTP) of Guayaquil. The main objectives of the MUTP are:

- to improve the quality of public transport services and its accessibility to the 84% of the population not having access to own transportation;
- to decrease the time spent on travelling by public transport users through introduction of articulated buses circulating along dedicated busways (corridors);

9 Entrevistas Transmilenio, STT, Circuitos de Transporte Público: "efectos sobre la calidad del aire"

10 Confined, segregated bus lanes together with bus-priority traffic signals allow buses on the route to operate more efficiently and without interference from other traffic thus reducing fuel consumption and GHG emissions. The conventional system is based on competition for passengers between buses on the same route without having segregated lanes for public transport.

- to decrease bus operation costs by providing an organised traffic with established stops and constant speeds;
- to efficiently use the capacity of buses and;
- to decrease travel expenses for commuters who have been paying high fares due to the current disintegrated system.

Before the implementation of Metrovía, other MRT systems like light rail and rail-based metro were also considered, but shelved because of a much higher cost. Like Transantiago, Metrovía uses 18.5 metres articulated buses with a carrying capacity of between 165 and 185 passengers. Urban buses with a carrying capacity of between 70 and 80 passengers will serve as feeder buses. Like most of the BRT systems implemented in the region, fare collection is through prepaid card, which increases efficiency and decrease the risk of driver assaults; the last being an issue of concern in many cities. The first corridor of Metrovía was operational in July 2006 and it has already meant a significant improvement for the inhabitants of Guayaquil in terms of increased travel speed, increased reliability and improved air quality as a result of less but also newer and cleaner buses. The first corridor has 72 articulated buses and 69 feeder buses which together will transport around 140,000 passengers per day and will serve people from 11 areas of the city. The fare price is US\$0.25, which has been calculated as the necessary fare to cover all the running costs of the system (Plan de Transporte Publico Masivo, 2004).

Metrovía, although smaller, is essentially a replication of the BRT system implemented in Bogotá. It is managed by a public-private partnership composed of the municipal government and a private association. The municipal government sets the regulatory framework and the private association is in charge of the management of the BRT system. One of the reasons for the creation of this partnership is to implement a financially sustainable transport system, which doesn't need to be subsidised by the government.

Prior to the implementation of Metrovía, the bus transport system of Guayaquil was characterised by inefficiency, insecurity and by being subjected to an unregulated market. This situation gave rise to the so called "Guerra del Centavo" (War of the cents) which is the result of bus drivers competing for passengers at stops. Prior to Metrovía, there were 5000 private busses known as colectivos, of which 250 were replaced by the first line of Metrovía. In 2001, 114 bus routes out of a total of 164 were concentrated in the central district of Guayaquil, thus giving rise to crowded and unsafe roads. This considerably reduced safety, and was one of the main reasons for many traffic accidents, with 30% of the accidents blamed on the colectivos. It is planned that in 2020, when the whole BRT system is in place, 7 corridors will be operational.

3.2 Guatemala City's *Transmetro*

The BRT system implemented in Guatemala City, Transmetro, is the first replication of the well known BRT systems of Curitiba and Bogota in Central America. It is one of the components of the Urban Mobility Plan (UMP) for 2020, which is in turn part of the development plan of Metropolitan Guatemala (DPMG). The main goal of the DPMG is to provide reliable and safe transport services to its inhabitants. In this context, the public transport system is considered essential in achieving that goal. The main objective of the UMP for 2020 is to provide "an efficient, safe and equitable transportation system, which is an integral component of the economic competitiveness of the metropolitan

area, being at the same time environmentally sustainable and socially just.” The DPMG will thus address the impacts from an inefficient transportation system, which are environmental degradation, and high social and economic costs. Many of the objectives laid out by the UMP will be directly addressed by the implementation of Transmetro, namely:

- decreased congestion;
- reduced vehicle operational costs;
- decreased average time spent on travelling;
- reduction in energy consumption;
- decreased traffic-related local emissions;
- reduction of stress levels for all road-users and;
- reduction of life losses, medical costs, and property damage resulting from traffic accidents.

The UMP has three major objectives, which are part of the national policy, and where the implementation of a BRT system is the one having the highest priority. The BRT system Transmetro will relate directly to the policy of emissions control, as it (1) uses higher capacity buses; (2) introduces newer and cleaner buses (3) substitutes 4 to 5 high polluting old buses by a new bus; (4) has fewer stops on its route; and (5) it is not affected by congestion that drives pollution levels up. Like the other BRT systems previously implemented in the region, 18.5 metres articulated buses with a carrying capacity of around 160 passengers will run on dedicated busways, thus decreasing time spent on travelling, congestion, and thereby, air pollution. Transmetro will transport approximately 180,000 passengers daily and is the first corridor of a large system that, when completed by the year 2020, will consist of 12 corridors. Despite the fact that the first corridor of Transmetro was officially launched only a few months ago (February 2, 2007), some of the benefits can already be observed, including increased security (due to constantly safeguarded buses) and decreased time spent on travelling. In contrast to the acceptance level observed during the introduction of Transantiago in Santiago, Chile, the level of acceptance among the population during the introduction phase of the first corridor of Transmetro has been very high. This is very important in that it creates a positive attitude among users, which may in turn increase the tolerance level for all the obstacles the system may have during its inception phase.

The implementation of Transmetro is expected to significantly improve the situation affecting the public transport of the capital, which has been characterised by inefficiency, and unreliable and unsafe transport services. Until recently, 68% of the trips made in the City were made by bus while 23% made by private motorisation. However, the 23% using private cars were occupying 76% of the roads, leaving the rest for the public transport¹¹. Due to the excessive number of buses, this created extremely crowded roads, high competition among bus drivers for the passengers, and along with it, increased traffic accidents and high air pollution. In addition to this, an inefficient organisation among bus operators, this gave rise to unreliability and infrequency in bus services.

¹¹ Information from several sources, among them: Global Info Group (1999), Municipality of Guatemala City, study from 2001, and Metropolitan Transportation Agency (EMETRA), 2003.

3.3 Santiago's *Transantiago*

The BRT system *Transantiago* is one of the components of a comprehensive public transport programme (PTP) designed by the government of Chile in 1995. It is currently being implemented by the government through its various ministries, such as, the ministry of transport and telecommunications and the sub secretariat of transport. The PTP, which is seen as the answer to the problems affecting the public transport of Santiago, has five main objectives. These are:

- to maintain the current share (49.5%) of the public transport as a mode of transportation;
- to provide a public transport system able to meet the demand for it;
- to develop a technologically modern, environmentally clean and economically efficient public transport system (PTS);
- to operate a reliable, safe and affordable PTS for all the citizens and;
- to provide a PTS which responds to the needs of all the citizens including disabled, elderly and low-income people.

The PTP is a unique example in that it means a complete restructuring of the public transport system which integrates the new BRT system *Transantiago*, the already existing network of urban and interurban trains and the rail-based metro system known as *Metro*. For that purpose, the distance covered by the *Metro* has been doubled from 40 to 81 kilometres. Although a bicycle network to be integrated with *Transantiago* and the *Metro* is not yet in place, it is included in the plans. The implementation of the PTP has also meant a complete reorganisation of bus operators' associations, including a reduction of these from around 300 to 16 associations, owning between 200 and 700 buses each. As the result of the use of articulated buses, the total number of buses will be reduced from 7,500 to 4,600 out of which 1,200 are new buses complying with Euro III standards¹². Old buses complying with Euro I and Euro II standards have been equipped with particle filters, which will reduce emissions considerably. The buses are diesel powered and comply with emission standards of 50ppm of sulphur oxides (*Transantiago*, 2005). *Transantiago* will use 18.5 metres articulated buses with a carrying capacity of 160 passengers and 12 metres buses with a carrying capacity of 80 passengers. In addition to the trunk buses, 8 metres buses with a carrying capacity of 40 passengers will serve as feeder buses for *Transantiago*, as well as for the *Metro*. The articulated buses will run on dedicated busways (corridors) along the capital covering the areas not covered by the *Metro*. Fare collection is through smart electronic prepaid cards, with differentiated fares. It allows passengers to transfer between the various modes paying a differentiated fare depending on the number of transfers made. However, regardless of the number of transfers, there is a maximum fare which is 400 pesos (approximately US\$0.80).

The average route distance travelled by buses will be reduced from 62 to 25 with trunk buses travelling on average 36 kilometres and feeder buses 19 kilometres. All this means a significant improvement in terms of decreased congestion and air pollution, but also significant fuel savings. When the whole BRT system is in place, the new articulated buses will run along 5 corridors of dedicated busways. *Transantiago* is managed by a public-private partnership with 60% of the funding

¹² EU emission standards EURO I to EURO III (g/kWh) for diesel engines > 85 kWh were introduced in 1992, 1996 and 2000 respectively. EURO I: CO 4.5; HC 1.1; NO_x 8.0; PM 0.36, EURO II: CO 4.5; HC 1.1; NO_x 7.0; PM 0.25, EURO III: CO 2.1; HC 0.66; NO_x 5.0; PM 0.10.

being private investment (through concessions), and the rest being government investment.

4 The Benefits of Sustainable Transport Solutions

The introduction of BRT systems has brought considerable benefits to the cities where these systems have been implemented. Before BRTs implementation, these cities were characterised by high levels of congestion, large number of traffic accidents and severe air contamination. This picture was, to a large extent, the result of inefficient and poorly managed public transport services unable to meet the increasing demand for transportation, which promoted the switch away from public to private motorised transportation. The consequences were poorly managed public transport services in combination with high municipal debts, which forced officials and municipal planners to look for cost-effective solutions. The answer to this dilemma was to find out a new transport paradigm such as the BRT system.. By relying on the concept of moving people rather than cars, they challenged cultural barriers in the cities, and brought to them, significant benefits for the environment, the economy and society. However, it is worthwhile mentioning that many factors need to be considered for a well designed BRT implementation, which has been the case, perhaps with a few exceptions, in most of the cities where BRT systems have been Implemented.

Environmental benefits

Mass rapid transit systems like BRT use clean high capacity articulated buses able to replace 4 to 5 conventional buses by one articulated bus. This means in itself a significant reduction in fuel consumption, and thereby, in levels of emissions. One such example is the BRT system of Curitiba, where a 25% reduction in fuel consumption, gave rise to equivalent emission reductions. Similarly, in the case of TransMilenio, the level of emissions per passenger was reduced by 14% in 1992, and it is expected to be further reduced (45%) by 2015. One of the main reasons for the environmental improvements, which the implementation of BRT systems has brought about, is that most of the articulated buses are new buses with improved technology using fuel more efficiently¹³. Another reason is that BRT implementations often require, and are therefore normally, coupled with comprehensive restructuring of the transport sector, which indirectly brings a series of environmental benefits. For instance, the restructuring usually involves the construction of bikeways that further promotes and facilitates changes in transport mode. For example, in the case of TransMilenio, 400 kilometres of bikeways were constructed in the city of Bogotá; and this has increasingly validated the use of the bicycle as a mode of transportation. Another measure that has been included in these transport sector reforms is the introduction of car-free days, where private cars are banned from city centre. A modal change, particularly from motorised to non-motorised transportation – is directly reflected in positive effects for the environment (because of less pollution), for the economy (because of decreased congestion) and for society (because of improved health due to cycling).

13 The TransMilenio system has reported some pollutant levels for 2000 and 2001 from a monitoring station close to Av. Caracas Busway. It showed a reduction of 43% in Sulfur Dioxide SO₂, 18% in Nitrogen Dioxide, and 12% in particulate matter (less than 10 micras) (Sandoval, 2005)

Reductions in local emissions, contributes also to reductions in global emissions. There is an increasing consensus that the most effective way of achieving greenhouse gas emission reductions in the transport sector is by the combination of a number of measures aimed at promoting and facilitating the shift to lower-emitting modes of transportation. Ideally, measures addressing aspects such as mode share, land use planning and technology innovations should be implemented in an integrated manner.

Economic benefits

BRT systems are low cost compared to other MRT systems. The Latin American experience shows that BRT systems have been delivered at a cost of between US\$1 million and US\$5.3 million per kilometre while, for instance, the cost for rail-based metro systems have been between US\$65 million and US\$207 million per kilometre (GTZ, 2002). Another advantage of BRT systems is that they are normally self-financed despite low fares, ranging from US\$0.15 as in the case of Transmetro, to US\$0.80 as in the case of Transantiago.

High congestion poses significant costs on the economy; it decreases traffic speed, which in turn increases time spent on travelling, fuel consumption, and operating costs. For example, according to estimations made for Santiago, Chile, an increase in the average speed of private car journeys by 1 km/hr and that of public transport by 0.5 km/hr would give a reduction in journey time and operating costs worth the equivalent of 0.1% of the GDP (Bull, 2003). The benefits of decreased journey time can already be observed in Guatemala City. Recent interviews conducted in Guatemala City show that after just a few months of Transmetro's introduction, travelling time from city outskirts to the city centre has been reduced by nearly 80%; with an express service, less number of stops, and by 60% of the regular service¹⁴. Although not of the same magnitude, reductions in journey time have also been observed in Bogotá. Six years after TransMilenio's introduction, journey time has been reduced by 32%. In this context, the on-time performance of the system is crucial. A good example is the BRT system Metrovía, which 7 months after implementation, showed an on-time performance of 97%. Reductions in journey time give considerable benefits for the population and for the economy as well, which have not yet been accounted for.

Well implemented BRT systems have shown a series of benefits in most of the cities where these have been implemented. The bad implementation of a BRT system can however give the opposite results. One example is the implementation of Transantiago in Santiago, Chile, where according to recent interviews, 75% of the passengers using the public transport system have experienced an increase in journey time of between 20 to 30 minutes¹⁵. This has meant a direct economic cost for both passengers in some cases (because of salary deductions), and for the economy (because of lost productivity).

Traffic accidents mean significant cost to society in terms of medical treatment and lost lives. In the case of TransMilenio, for instance, a comparison of statistics between before and after system implementation indicates an important reduction in the number of accidents in the system corridors for 1999 and 2001. According to Sandoval (2002), the Transport and Transit Secretariat of Bogotá (STT) and Metropolitan Police Department have reported a 92% reduction in fatalities, and 75% in injuries resulting from traffic accidents, and a reduction of 79% in collisions for that period.

14 Information provided by the Vice Mayor of the Municipality of Guatemala City and main responsible for the implementation of Transmetro, Enrique Godoy, on March 30, 2007).

15 Information presented in the newspaper El Mercurio, March 17, 2007.

Social benefits

BRT is a way of providing high quality and capacity transport services. The Latin American experience shows that BRT is attractive to urban travellers since it reduces journey time providing at the same time high capacity services. The fact that BRT systems provide distinctive, frequent but limited stop services, generally operating on roads with transit priority at traffic lights, makes it faster and more efficient. BRT systems also offer increased safety for passengers in waiting areas. For instance, in the case of Curitiba these areas are tubes and in many cases waiting areas are roofed and strengthened with more powerful public lighting. It has also been observed that this safety effectiveness encourages higher income people to start using the public transport system in Curitiba, which also applies for Bogota. Similar results have been observed in Guatemala City, where assaults and robberies to passengers have disappeared almost completely.

BRT offers opportunities for public-private-partnerships which are specially needed for transport reforms. Regulation (by local authorities) and investment (by private companies) need to go hand in hand to effectively achieve the goals of adopting BRT under a wider program of public transport reforms. For instance, Bogotá has dramatically reformed its control on parking; on-street parking has been eliminated from many streets and converted instead into attractive public spaces. Likewise, Curitiba dramatically improved its allocation of public space to pedestrians and commercial areas, with major car-free areas in the city centre. The pedestrian zones also act as feeder services to the BRT system by easing pedestrian movements towards stations. This would, most likely, have been more difficult to implement without private sector involvement. Private sector involvement is also crucial for the well functioning of BRT systems. Although publicly operated bus authorities continue to exist in Latin American mega-cities, they are rapidly losing passengers to private formal and informal transit operators. In most developing country cities, bus operations are now entirely in private hands. In Quito, Bogota, and Curitiba, the most famous examples bus operators were, from the very beginning, fully incorporated in the planning.

5 Conclusions

Well planned and implemented BRT systems have proven to be the right transport option for cities which have suffered the negative impacts that poorly managed transport services give rise to. The success of Curitiba, the first city in the world to implement a BRT system, has served as the source of inspiration for many cities in Latin America and all over the world. Today, TransMilenio is perhaps the most well known BRT system, and it is most likely the example that has inspired other Latin American cities the most. These two examples have meant significant improvements to their cities for the environment, the economy and society. Curitiba stands out as pioneer and an example of success for integrated transport policy planning aimed at restructuring bus systems which use energy more efficiently; reduce congestion, air pollution and journey time, and that increase safety. Similarly, with some innovation and adaptation to the country's circumstances, Guayaquil's Metrovía, and Guatemala City's Transmetro are considered successful examples for sustainable transport practices. Metrovía was, as a matter of fact, awarded the 2007 Sustainable Transport Award at the TRB (Transport Research Board) 86th annual meeting held in Washington, D.C., in January 2007. Some of the commonalities for these examples are:

- A high degree of political willingness reflected in continued local transport policy aimed at favouring the use of public transport. Both Curitiba and TransMilenio have benefited from highly committed and enthusiastic mayors who made public space and public transport a priority. Due to the influence of Bogota and Curitiba, new BRT systems are already in operation in other regions of the world. Beijing in China, Jakarta in Indonesia, Leon in Mexico, and Seoul in South Korea are some of the examples.
- Urban planning, compatible with innovative public transport solutions. This has been another contributing factor for success achieved by these cities, and something that particularly applies to relatively underdeveloped cities, or in an early stage of economic development.
- Highly synergistic implementation approach reflected in integrated transport planning and network building accompanied by regulation, promotional measures and educational campaigns. For example in Bogota each weekday the city bans 40% of all vehicles entering the city during peak periods (06.00 to 09.00 hours and 16.30 to 17.30 hours). The city also actively promotes the use of non-motorised transport modes.
- Participatory approach. This has proven to be fundamental in the implementation of Guatemala City's Transmetro, where the responsible for the implementation of the BRT system, held regular consultation meetings with the various local stakeholders such as bus operators, students, households and the media. This is in order to, from early stages, design and plan a system which could take into consideration and incorporate the needs of the citizens. In contrast to Transmetro, officials in Santiago adopted a top-down approach, designing and planning Transantiago without the participation of the population. This issue might have been one of the reasons for its lack of acceptance and troublesome implementation.
- Gradual changes in passengers' habits. Experience shows that public transport restructuring which is introduced gradually has a greater chance of being accepted and incorporated by the population. Guatemala City's Transmetro and Guayaquil's Metrovía are successful experiences. The opposite applies to Santiago's Transantiago, where a comprehensive public transport restructuring was introduced overnight.

References

Bull, A. (Compiler). Traffic Congestion. The problem and how to deal with it. ECLAC, 2003.

GTZ. Bus Rapid Transit, Module 3b. Sustainable Transport: A sourcebook for Policy-makers in Developing Cities". Eschborn, 2002.

Metrovia, Plan de Transporte P Masivo de la Ciudad de Guayaquil: Informe Técnico, Marzo, 2004.

Rabinovitch, J. "A Sustainable Urban Transportation System Energy for sustainable development. Volume II No. 2, July 1995.

Rabinovitch, J, Leitman, J. "Urban Planning in Curitiba, A Brazilian City Challenges Conventional Wisdom and Relies on Low Technology to Improve the Quality of Urban Life." Scientific American, 1996.

Rogat, J. "The Politics of Fuel Pricing in Latin America and their Implications for the Environment". Energy & Environment. Volume 18 No. 1, 2007.

Santoro, R., Leitmann, J. "Innovative Urban Transport in Curitiba, Brazil. A Successful Challenge to Conventional Wisdom" Manuscript. May 1996.

http://ippuc.org.br/servindo/index_produtos.htm

Sandoval, E., Hidalgo, D. TransMilenio: A High Capacity – Low Cost Bus Rapid Transit System developed for Bogotá, Colombia. Manuscript, 2002.

http://www.transmilenio.gov.co/transmilenio/frameset_gneral.htm

Transantiago, Informe de Avance No 1: Evaluación Ambiental Estrategica Programa de Transporte Publico, 2005).

Wright, L. "Mass Transit Options, Sustainable Transport: A sourcebook for Policy Makers in Developing Countries", Module 3a. (Eschborn: GTZ). 2002

Wright, Lloyd. "Latin American Busways: Moving People Rather than Cars". Reprint from Natural Resources Forum, JNRF 25:2, May 2001.

Session 12 – Carbon Capture and Storage Contribution to Stabilization

Chairman: John M. Christensen, Risø National Laboratory, Denmark

CO₂ Capture and Utilization for Enhanced Oil Recovery

Poul Jacob Vilhelmsen¹, William Harrar², Jan Reffstrup², Willy van Well¹ -and Charles Nielsen¹

¹ DONG Energy Generation

Elsam Skærbæk

Kraftværksvej 53, Skærbæk

7000 Fredericia

Denmark

² DONG Energy Exploration and Production

Agern Alle 24-26

2970 Hørsholm

Denmark

1 Abstract

CO₂ is an international theme and the cap-and-trade systems under implementation will lead to significant alterations in the energy market and in the energy system altogether. A possible technical step to reduce atmospheric emissions is CO₂ capture and the utilisation of the CO₂ for Enhanced Oil Recovery (EOR). CO₂ capture is to some extent a known technology but has not yet been optimised and commercialised for power plant utilisation. Correspondingly CO₂ utilisation for EOR is a known method in other areas of the world where the reservoir conditions are different from those of the North Sea.

For several years Elsam and Energi E2, part of DONG Energy, have worked on reducing CO₂ emissions through increased efficiency at the coal-fired power plants, and this work has now been extended to also include capture and utilisation of CO₂. DONG E&P within DONG Energy has started work on the utilisation of CO₂ for EOR at the company's fields in the North Sea.

Based on DONG Energy's interest in working through the whole value chain from power plants to EOR utilisation in the North Sea, this paper describes our experience with CO₂ capture at the trial plant CASTOR at Esbjerg power plant and the actual work of investigating and preparing the pilot test of CO₂ for EOR in the North Sea. The paper also illustrates the perspectives of retrofitting the existing fleet of super critical coal-fired power plants close to the North Sea with CO₂ capture and the utilisation of the CO₂ for EOR in the North Sea. DONG Energy's perspective is that CO₂ for EOR can contribute to materialising the vision that the central power plant can be developed into an energy refinery.

The development work presented will be carried out in cooperation with leading international players and Danish universities and knowledge centres – Technical University of Denmark (DTU), The Danish Geotechnical Institute (GEO) and Geological Survey of Denmark and Greenland (GEUS).

DONG Energy was established on 1 July 2006 through a merger between the companies DONG, Elsam, Energi E2, Nesa, Frederiksberg Forsyning og Københavns Energi. The company thus covers the whole value chain from oil and gas fields in the North Sea to

power and heat production to sale of power, heat and gas. The company has 4000 employees and a yearly turnover of 33 billion DKK.

2 Introduction

Energy supply security and climate change are two of the largest challenges faced by our society today. Oil production from reservoirs in the North Sea has peaked and will accordingly decline in the future. The current thoughts in the industry are that the major oil fields in the North Sea have already been found and there is little expectation of finding new fields to replace the declining reserves and ensure a continued supply in the future. At the same time, the countries around the North Sea have ratified the Kyoto-agreement and thus have committed to reduce CO₂ emissions. Power and heat producers as well as other energy intensive industries will be affected financially through anticipated lower CO₂ quota allocation. The subsurface storage of CO₂ captured from the flue gas of power plants is gaining attention as a technique to reduce CO₂ emissions to the atmosphere (1). One option is to inject the CO₂ into mature or depleted oil reservoirs. This is attractive because the geological setting of oil reservoirs is typically well documented, which minimises the study effort needed for site selection. Furthermore, the trapping of oil and gas in reservoirs over geological time is indicative of the capability of the caprocks that seal the reservoirs to inhibit leakage (2). The injection of CO₂ into mature oil reservoirs not only reduces atmospheric emissions, but also has the potential to increase oil production, which reduces the cost of CO₂ storage and benefits energy security by making residual oil left in the structure by conventional methods producible.

DONG Energy is working proactively on the development and implementation of a range of techniques to generate energy while minimising CO₂ emissions. These efforts include the development of methods to simplify and maximise the capture of CO₂ emitted from power plants and the injection of CO₂ in offshore oil reservoirs with the objectives of storing the CO₂ and increasing oil production. This paper presents a summary of DONG Energy's work on optimising post-combustion CO₂ capture for retrofitting existing power plants and enhanced oil recovery (EOR) through the utilisation of CO₂.

3 Carbon dioxide capture

There are three main techniques to capture carbon dioxide from the flue gas of a power plant: post-combustion capture, oxyfuel combustion and pre-combustion capture. The power plants designed and operated by DONG Energy have some of the world's highest thermal efficiencies and a substantial remaining lifetime. It is therefore important for DONG Energy to develop technologies that can be applied (retrofitted) to the existing power plants. Post-combustion capture and oxyfuel combustion are technologies that are well suited for retrofit, while pre-combustion capture is not. This last technology does not build on a simple combustion of coal or other fuels, but on the gasification of the fuel. This gasification results in synthetic gas: a mixture of carbon monoxide and hydrogen. The carbon monoxide and water are converted to hydrogen and carbon dioxide through the water-gas-shift reaction. The capture of carbon dioxide takes in this technology place before the hydrogen is combusted in a gas turbine.

3.1 Post-combustion capture

Post-combustion capture is the simplest capture technology in the sense that it does not affect the power plant combustion process. A block-diagram of the post-combustion method from a coal-fired power plant is presented in Figure 1.

Carbon dioxide has been produced by CO₂-capture for several decades, by means of an absorption process using monoethanol amine (MEA). The carbon dioxide from the flue gas is absorbed in a solution of about 30% MEA in water at 30-40°C. The CO₂-rich stream from the absorber goes to the stripper where CO₂ is desorbed from the solution at 120-140°C. The two streams from the stripper are a CO₂ stream and a CO₂-lean liquid stream, which is returned to the absorber (1).

The energy consumption of the MEA-based capture process did not receive much focus in the past. However, the energy consumption of the capture process is one of the most important issues in the Carbon Capture and Storage (CCS) concept. Therefore, the CASTOR project was started in order to reduce the costs of post-combustion capture by development of an absorption solvent with lower energy requirements, and by optimizing the integration of the absorption plant into a modern power plant. CASTOR is an integrated project that is funded by the European Commission and has over 25 partners from 11 countries. A major element of the CASTOR project is the construction and operation of a CO₂ absorption pilot plant that operates on coal derived flue gas. The former companies, ENERGI E2 and Elsam which are now part of DONG Energy, carried out the engineering, purchasing, installation and commissioning of the absorption pilot plant, as well as planning and conducting tests at the facility. The CO₂ absorption pilot plant is located at the DONG Energy's power plant in Esbjerg at the West coast of Denmark. The pilot plant, which was commissioned in the end of 2005, treats 0.5% of the flue gas from the 400 MW power plant and produces 1 ton of CO₂ per hour (2). A flow diagram of the pilot plant is presented in Figure 2.

The first year of operations was used to test the pilot plant and to operate the plant with a reference solvent of 30% MEA. The goal for the pilot plant has been to capture 90% of the CO₂ in the flue gas. One of the important tests during the first year was to determine how the CO₂ absorption pilot plant copes with boiler load changes. The flow rates of the flue gas to the absorber and the solvent were systematically lowered in order to simulate changes in the boiler load. The results of the test are presented in Figure 3, and show that the CO₂ removal efficiency remains above 90%, even when the flue gas flow is decreased from full load (4500 Nm³/h) to 25% load (1100 Nm³/h).

After the successful first year of operation, the pilot plant is now used for testing new solvents. These solvents have been developed by a systematic method of testing and screening conducted by several industrial and university partners within the CASTOR project. The work within the CASTOR project has attracted considerable international attention and has renewed the interest for post-combustion capture.

The energy consumption of the capture process can potentially be reduced by about 15% by optimisation of the heat integration between the absorption plant and the power plant. Work on the process integration has been initiated in the CASTOR project and is currently continued within the EU-supported CAPRICE project. A sophisticated description of the thermodynamics of the absorption process is crucial for obtaining good heat integration. Therefore, thermodynamic models for MEA and other amine-based absorption processes were developed by the IVC-SEP research group at the Danish Technical University in Copenhagen.

The absorption processes on MEA or related amines are at the moment the only commercial available post-combustion capture technologies. There are a number of alternative post-combustion capture technologies that are under development at the moment. The ones closest to commercialisation are other absorption processes based on ammonium or potassium carbonate. Besides absorption processes, membranes, solid sorbents and cryogenic methods are under consideration for post-combustion processes. However, these alternative technologies are less developed than the absorption processes.

3.2 Oxyfuel combustion

All post-combustion capture methods suffer from the fact that the concentration of carbon dioxide in the flue gas is relatively low (at most 15%). As a consequence, large flows consisting mainly of nitrogen have to be treated. The volume of the flue gas can be decreased substantially if the nitrogen is removed before the combustion of the fuel takes place. This is the concept of oxyfuel combustion: the fuel is combusted in an atmosphere of oxygen and recycled flue gas (consisting of carbon dioxide and water). Figure 4 shows a block-diagram that illustrates the oxyfuel process. Typically about 66% of the flue gas is recycled, and the resulting flue gas consists of approximately 65 volume % carbon dioxide and 30 volume % water with the balance made up of impurities from the coal. The impurities are removed in the flue gas clean-up processes, while the water can be removed by simple cooling. Several studies have indicated that oxyfuel combustion could be an economic attractive alternative to post-combustion capture (3).

Combustion under oxyfuel conditions is fundamentally different from air combustion. This opens up for new possibilities and presents some new challenges. The concentration of oxygen can be adjusted in oxyfuel combustion giving an extra degree of freedom. However, in the case of applying oxyfuel combustion to an existing power plant, the combustion conditions should not be too different from air combustion. Several investigations indicate that the oxygen concentration should be increased to 27-30 volume % in order to obtain a good flame stability and the same adiabatic flame temperature as in air combustion.

Before oxyfuel combustion can be applied at full-scale, a fundamental understanding of the process is required. DONG Energy is therefore involved in a number of international and national projects that address these fundamental aspects. One of them is a PSO project in cooperation with the CHEC (Combustion and Harmful Emission Control) research group at DTU, the Department of Manufacturing Engineering and Management (IPL) at DTU, and Vattenfall A/B. In this project, oxyfuel combustion is studied on a laboratory and pilot-plant scale. The project also addresses the influence of oxyfuel combustion on the emission of pollutants and the quality of the fly ash. These are very important issues, as Denmark has some of the cleanest power plants and all by-products (fly ash and gypsum from the desulphurisation process) are utilized. Sulphur will be the biggest challenge in this context. It would be economically attractive to recycle the flue gas before the desulphurisation unit, however this means that the sulphur level is increased by a factor 3 to 4 in the furnace. This might result in increased sulphur levels in the fly ash, which could be problematic for its utilisation. At most Danish power plants the removal of SO₂ from the flue gas takes place through wet desulphurisation processes, where SO₂ is dissolved in slurries of limestone or burnt lime. The high concentration of carbon dioxide will probably influence these processes, since carbon dioxide dissolves in these types of solutions.

Corrosion under oxyfuel conditions is a third aspect to be studied. The corrosion will be influenced by the higher level of pollutants like chlorine and sulphur due to the recycling of the flue gas. The high concentration of carbon dioxide and the subsequent increased carbon monoxide concentration, will also affect the corrosion. The corrosion will also be influenced by the difference in thermodynamic and fluid dynamic properties under oxyfuel conditions. These properties will be studied in the project by fluid dynamic modelling.

The PSO project also includes co-firing of biomass with coal under oxyfuel conditions. Biomass is regarded as a CO₂ neutral fuel, and co-firing is at the moment an important means for DONG Energy to reduce emissions of CO₂. Applying co-firing with biomass within the concept of Carbon Capture and Storage would therefore result in a power plant with below zero CO₂-emissions.

4 CO₂ Enhanced Oil Recovery

4.1 Background

Traditional production methods recover only about 25% of the oil in reservoirs located in the Danish Sector of the North Sea, leaving the potential for additional production using EOR techniques. One method involves the injection of CO₂ into the subsurface in the form of a liquid-like fluid that can dissolve and “wash” oil out of the reservoir. Industry experience indicates that the injection of CO₂ can increase oil recovery by an additional 8 to 15% (6). If CO₂ EOR is successful in the Danish Sector of the North Sea it could potentially increase oil production by about 10%. The increase in production is also accompanied by an increase in the lifetime of the oilfields. However, industry experience has also shown that the technique works in some, but not all oil reservoirs (7).

Furthermore, until now the technique has only been used in on-shore reservoirs. Whereas there are no major technical differences between the injection of CO₂ into onshore and offshore reservoirs, the capital investments required for offshore operations are much greater than those for onshore projects. The higher costs are associated with both the transportation of CO₂ to the offshore reservoirs and the installation of specialised equipment on the offshore platforms for the handling and injection of CO₂. Such large investments are not likely to be made unless the associated project risks can be identified and the uncertain projects are precluded.

4.2 Established CO₂ EOR Projects

The majority of established CO₂ EOR projects are located in the United States and Canada, where the technique has been used for more than 30 years to increase oil production. The CO₂ is obtained from both natural and manufacturing sources, and is transported by pipeline to onshore oil fields where it is injected into oil reservoirs. The CO₂ mixes with oil, causing the oil to be thinner and easier to extract. The earliest CO₂ EOR projects are located in the Permian basin in west Texas, where the technique is currently used in about 42 reservoirs. The total oil production by CO₂ EOR in the United States and is approximately 200, 000 barrels/day (8). The oil production by CO₂ injection in the Weyburn field in Canada is presently about 10,000 barrels/day (9). It is estimated that CO₂ EOR will extend the economical life of the Weyburn field by more than 25 years and yield an incremental recovery of 13 to 19%. Results from the Weyburn field show that there is a correlation between the performance of water flooding and CO₂ flooding, indicating that water flooding performance can be used as a screening tool for predicting the performance of CO₂ flooding (10). A review of the design and performance data from sixteen CO₂ huff'n puff projects in oil field located in Trinidad and Tobago indicates that CO₂ injection improves well productivity due to oil viscosity reduction, oil swelling and removal of near well bore damage (7). Furthermore, the results show that CO₂ EOR projects can be economically optimised for specific conditions of operating pressure, permeability and oil viscosity. Experience with CO₂ injection in the North Sea is limited to the Sleipner gas field, where CO₂ is captured at the offshore platform from the produced gas and injected in a saline aquifer above the gas reservoir for storage.

4.3 DONG Energy's CO₂ EOR Activities

A time line of DONG Energy's activities in CO₂ EOR is presented in Figure 5. Work on CO₂ EOR began in 2002 with an in-house study of CO₂ injection in chalk reservoirs in the Danish sector of the North Sea. This study included the numerical simulation of CO₂ EOR in a North Sea Chalk reservoir with the objective of evaluating the recovery efficiency. The well field configuration in the modelling study consists of a central CO₂ injection well and two producing wells. Traditional production was simulated for a 10-year period followed by 10-years of continuous CO₂ injection. Oil saturations in the reservoir at the end of the 10-year CO₂ injection period are presented in Figure 6. The

results show a pronounced decrease in the oil saturations in the vicinity of the injection and producing wells, indicating that CO₂ injection can be quite effective in increasing oil production. Modelling results also show that CO₂ injection increased recovery by about 5% compared to water flooding.

DONG Energy has also been an active partner in international research projects on the effectiveness of CO₂ EOR and has funded Ph.D. projects on EOR at the Danish Technical University (DTU). Current CO₂ EOR activities include funding of a research project at the International Research Institute of Stavanger (IRIS) to improve the macroscopic sweep efficiency of CO₂ flooding. The Danish National Advanced Technology Foundation and DONG Energy are co-sponsors of a research project, entitled “Enhanced Oil Recovery through CO₂ Utilisation”. The project partners include the Technical University of Denmark (DTU), The Geological Survey of Denmark and Greenland (GEUS), the Danish Geotechnical Institute (GEO) and HESS DK. The main goal of the project is to develop systematic procedures for assessing the feasibility of increasing oil recovery by injecting CO₂ into offshore reservoirs in the North Sea. The potential for the permanent storage of CO₂ in these fields will also be assessed. The approach used in assessing the effects of CO₂ injection will be generalised. This will ensure that the results will be valid for general offshore applications in the Danish sector and elsewhere, while fulfilling the overall goal of being able to accurately predict project risks.

DONG Energy is currently working on the design of a large-scale, low cost generalised pilot project that will allow for the testing of selected reservoirs in preparation for the full-scale project. The design concept is based upon the use of existing CO₂ capture technologies and onshore facilities and offshore facilities and wells. The plan is to transport CO₂, which is captured at the Esbjerg Power Plant, via a ship in pressurized and insulated containers to an offshore platform. A single well or “Huff & Puff” pilot project will be designed, which consists of injecting a slug of CO₂ into a mature oil reservoir, allowing it to soak for a period of time, and then placing the well back on production. This method has been used as a CO₂ EOR technique, but in this project will be developed for use as a testing technique. The objectives of the design study are to optimise the size of the CO₂ slug, the injection rates and the duration of the soak period in order to gain as much knowledge as possible for use in assessing the feasibility of CO₂ EOR in offshore reservoirs and assess the potential for permanent offshore storage of CO₂. Methods will also be developed to upscale the results from the pilot project to design and forecast the performance of a full-scale project.

The research partners in the project (DTU, GEUS and GEO) are currently working on investigating specific technical issues related to CO₂ EOR in order to increase our understanding of subsurface processes and improve our ability to evaluate and forecast CO₂ EOR performance in North Sea oil reservoirs. Laboratory studies are in progress to investigate the effects of CO₂ flooding on porosity, pore-geometry, wettability and rock strength; and to establish relationships between geophysical and flow/mechanical properties. Multiphase CO₂ flooding experiments under reservoir conditions are being prepared in order to obtain direct measurements of the amount of additional oil that it is possible to produce at the core scale. These experiments will also provide information concerning mineral dissolution and/or precipitation during CO₂ flooding. Laboratory and modelling studies are also being conducted to investigate the complex phase equilibria in mixtures of brine, oil and CO₂ in order to better understand the effect of CO₂ on fluid properties. This will better our understanding of recovery processes and improve forecasting capabilities. The results of the research projects will be incorporate into the pilot project as they become available.

5 The Potential for CO₂ EOR in North Sea Oil Reservoirs

Traditional production methods in the Danish Sector of the North Sea leave about 75% of the original oil in place behind in the reservoirs. The recovery of even just some of these volumes represents a significant step in securing the supply of energy. The most widely used EOR techniques in North Sea oil reservoirs are water flooding and hydrocarbon gas injection (11). The evaluation of the performance of onshore CO₂ EOR projects has shown that oil reservoirs that respond well to water flooding will most likely also respond positively to CO₂ EOR, indicating that North Sea oil reservoirs are well suited for CO₂ EOR.

The utilisation of CO₂ for offshore EOR projects not only has the positive benefit of the potential to produce more oil without additional exploration costs, but can also contribute to a decrease in atmospheric emissions of CO₂ due to subsurface storage. As part of our long-term strategy planning, DONG Energy is examining the potential of gathering CO₂ captured at our coal-fired power plants with the purpose of transporting it through pipelines for use in CO₂ EOR in North Sea oilfields. Preliminary calculations show that the parameters having the greatest effect on the economy of such projects are the hydrocarbon tax, the recovery efficiency of the CO₂ EOR technique and the oil price.

6 Summary

The post-combustion capture of CO₂ combined with the injection of CO₂ in offshore reservoirs presents the potential to reduce CO₂ emissions to the atmosphere, while at the same time increase oil production from mature reservoirs. DONG Energy owns and operates power plants with some of the world's highest thermal efficiencies and has been working on improving the efficiency of CO₂ capture technologies to retrofit existing power plants. DONG Energy's CO₂ absorption pilot plant, located in Esbjerg along the West coast of Denmark treats 0.5% of the flue gas from the 400 MW power plant and produces 1 ton of CO₂ per hour. A pilot project is underway to evaluate the effectiveness of CO₂ storage and EOR in offshore reservoirs. The plan is to transport CO₂, which is captured at the Esbjerg power plant to an offshore platform. A single well test will be designed, which consists of injecting a slug of CO₂ into a mature oil reservoir, allowing it to soak for a period of time, and then placing the well back on production. The objectives of the design study are to optimise the size of the CO₂ slug, the injection rates and the duration of the soak period in order to gain as much knowledge as possible for use in assessing the feasibility of CO₂ EOR in offshore reservoirs and assess the potential for permanent offshore storage of CO₂. An overview of DONG Energy's present EOR activities in the CO₂ process line is presented in Figure 7.

7 References

1. Intergovernmental Panel on Climate Change (IPCC). Carbon Dioxide Capture and Storage: Summary for Policymakers and Technical Summary.
2. C. Scharf and T. Clemens. CO₂ -Sequestration Potential in Austrin Oil and Gas Fields, SPE 100176, 2006.
3. J.N. Knudsen, P.J. Vilhelmsen, J.N. Jensen, O. Biede, Proceedings 8th International Conference on Greenhouse Gas Control Technologies, 19-22 June, Trondheim, Norway

4. J.N. Knudsen, P.J. Vilhelmsen, O. Biede, J.N. Jensen, Power Tech, 87, 57-61, 2007
5. R. Tan, G. Corragio, S. Santos, H. Spliethoff, Report for the International Flame Research Foundation, 2005.
6. K. Morsi, J. Leslie and D. Macdonald. CO₂ Recovery and Utilisation for EOR, SPE 88641, 2004.
7. L. Mohamed-Singh, S.K. Singhai, S. Sim. Screening Criteria for Carbon Dioxide Huff 'n' Puff Operations, SPE 100044, 2006.
8. D. Hughes, SPE Petroleum Engineering and Reservoir Management Seminar, Bergen, Norway, 26 April 2006.
9. K. Thambimuthu, IEA Weyburn CO₂ Monitoring and Storage Project, IEA, 2004.
10. K. Asghari, M. Dong, J. Shire, T. Coleridge. Development of a Correlation Between Performance of CO₂ Flooding and the Past Performance of Waterflooding in Weyburn Oil Field. SPE 99789, 2006.
11. A.R. Awan, R. Teigland, J. Kleppe. EOR Survey in the North Sea. SPE 99546, 2006.

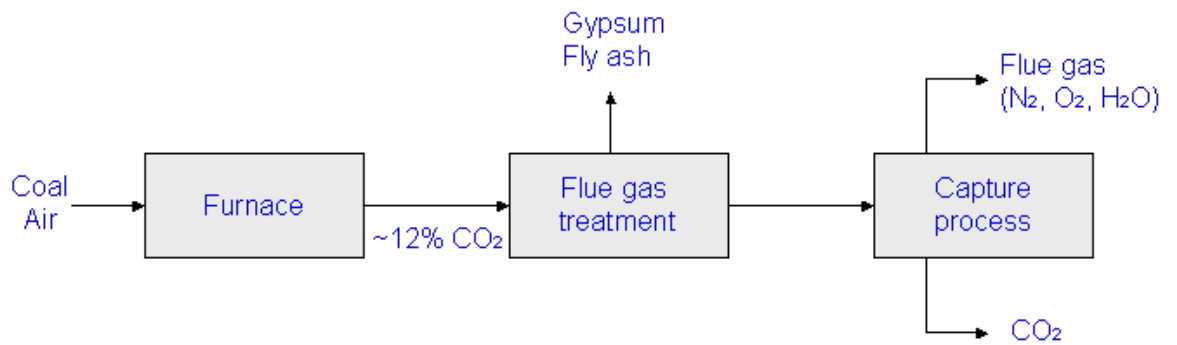

Figure 1: Illustration of post-combustion capture

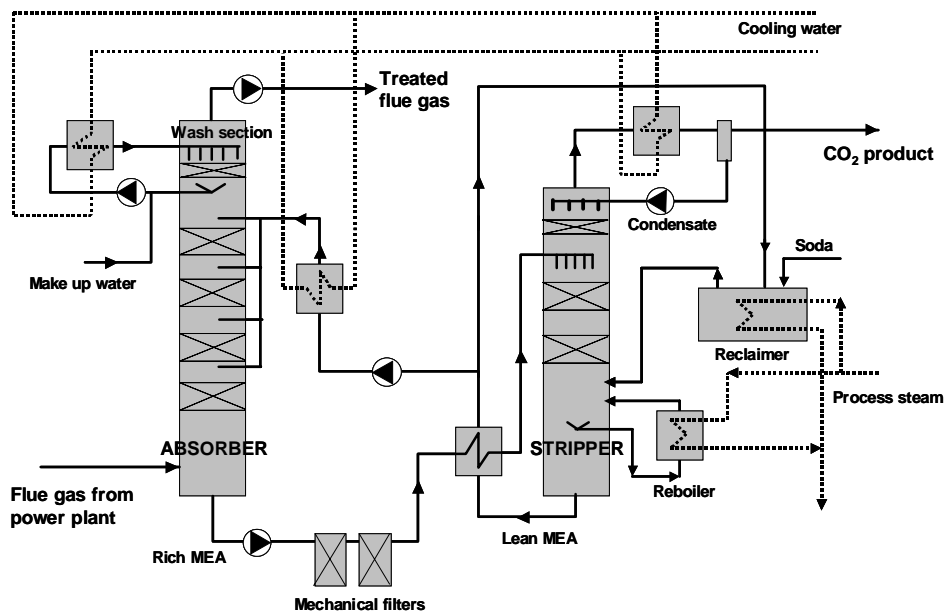

Figure 2: Flow diagram of the CASTOR pilot plant at the Esbjerg power plant

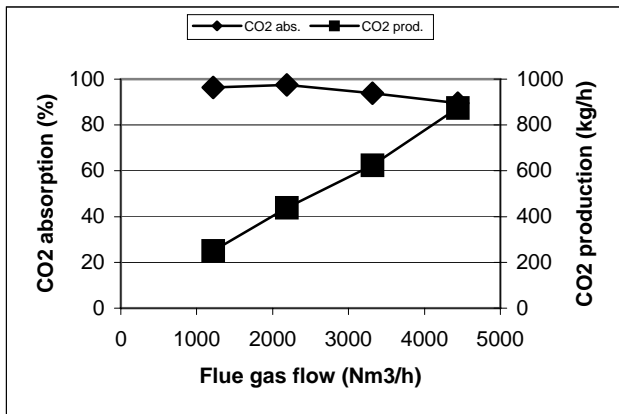

Figure 3: Test of load change: CO₂ absorption and production with different flue gas flow (adapted from ref. 1)

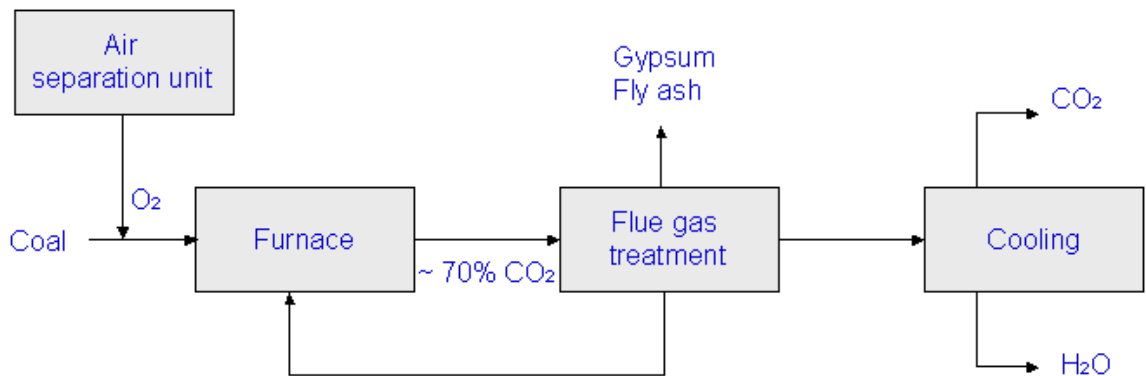

Figure 4: Illustration of oxyfuel combustion

DONG Energy's CO₂ EOR Activities and Plans

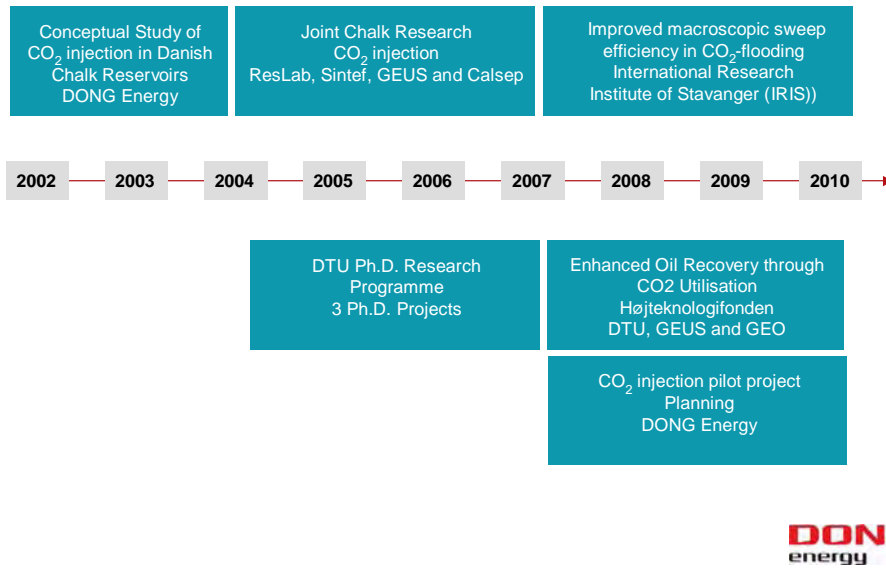

Figure 5. Time line of DONG Energy's CO₂ activities and plans.

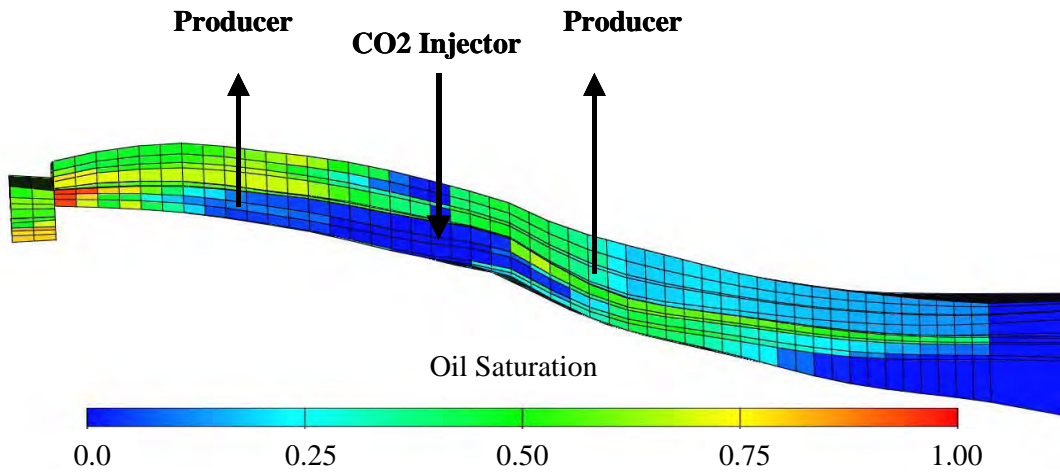

Figure 6. Simulated oil saturations after 10-years of continuous CO₂ injection.

DONG Energy's Present EOR Activities in the CO₂ Process Line

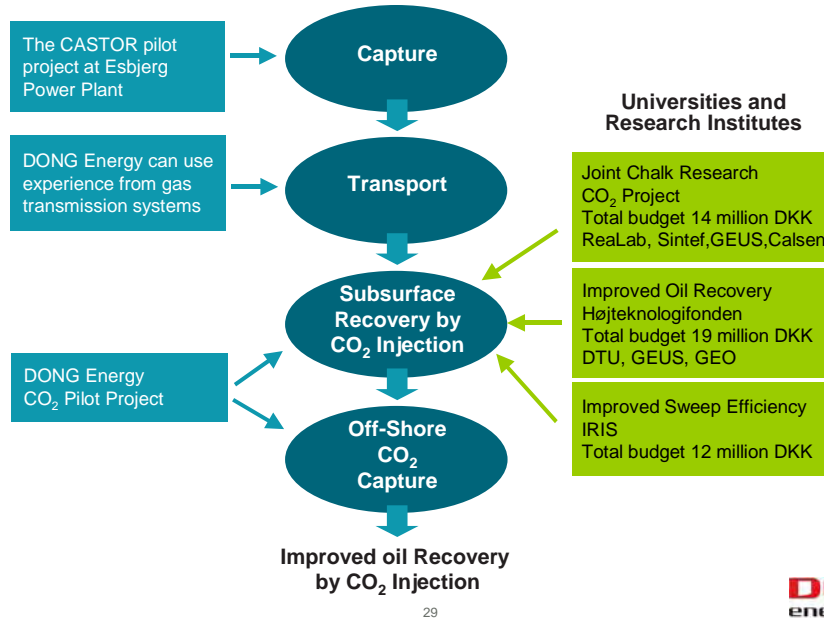

Figure 7. DONG Energy's EOR activities in the CO₂ process line.

Geological Storage of CO₂ from Power Generation

Niels Peter Christensen, Geological Survey of Denmark and Greenland (GEUS)

Abstract

Carbon Capture and Storage (CCS) is capable of contributing significant CO₂ emission reduction in the near to medium term. When fully deployed, CCS in Europe alone is estimated to be able to deliver reductions of up to 1 GT (giga tonnes) of CO₂ annually – equivalent to 1/3 of Europe's current anthropogenic emissions of CO₂. CCS could thus be a powerful supplement to European policy on energy efficiency and the longer-term goal of increasing the share of renewable energies. A European Technology Platform within Zero Emission Power (ZEP) has been established. In cooperation with the member states and a wide range of stakeholder, the EC and the ZEP are jointly working to establish the necessary regulatory and economical boundary conditions for the further development and deployment of CCS. The ZEP has recommended the urgent implementation of 10-12 integrated, large-scale CCS demonstration projects Europe-wide. This recommendation has been adopted by the EU.

Background

Energy is the main factor in climate change, accounting for some 80% of the EU's greenhouse gas emissions. It has been estimated that, without real efforts to reduce emissions, there is an increasing probability that global temperatures will rise by several degrees, dramatically altering the world's landscape, climate and the way we live. There is also mounting evidence that as atmospheric CO₂ levels rise, our oceans will acidify in response, damaging many marine life forms.

EU Climate and Energy policy

The EU has agreed to limit global warming to within 2°C, which means progressively reducing overall greenhouse gas emissions by up to 80% by 2050 (EC COM 2007/2), but the EU's present energy practice will result in increasing them by 5% by 2030. The EU's current energy and transport policies are not sustainable. In February 2007 Europe's national leaders agreed to adopt a 20% emission reduction target by 2020 for the EU, increasing to 30% if the USA agrees to deploy similar targets and enter a post-Kyoto global agreement. With respect to these aims, Europe has proposed a new Energy policy

(COM 2007/1) which amounts to a new industrial revolution. It recognises that in the EU over the next 25 years, around €900 billion will be needed to invest in new coal- and gas-fired power plants, along with renewable energy infrastructure. There is also a need to increase generating capacity. Electricity demand continues to mount by around 1.5% each year, but existing infrastructure and electricity plants are reaching the end of their useful life. It is also important that the EU can utilise its indigenous energy resources, such as coal - the EU's largest reserve of fossil fuel - as much as is economically feasible, rather than be over-reliant on imports. Low carbon emitting technology for fossil fuels is badly needed, not just for Europe but worldwide, as coal use in electricity generation is set to rise globally.

EU Power and CCS policy

With respect to power generation the EC recommends that 10-12 large-scale demonstration plants need to be promoted (EC Memo 07/08) and demonstrated by 2015. The EC wishes to have all new fossil-fuelled generation plant built by 2020 onwards fitted with capture, and existing plant then progressively retrofitted (EC COM 2006/843). The Zero Emission Power Technology Platform (ZEP) estimates that at least 1GT of CO₂ per annum (= 1000 Sleipners or 250 GW of coal-fired power generation capacity) could be captured and stored via CCS in Europe before 2050. This falls within DG TREN's expectations that coal –fired generating capacity could be at around 250- 280GW by 2050 (about a third of expected EU electricity generation capacity) if near-zero emissions is achieved. If CCS is not deployed and new conventional plant is not allowed to be built so that all that remains is existing plant with extended lifetimes, there will only be 120GW capacity left, yet it will still emit around 480Mt of CO₂ annually.

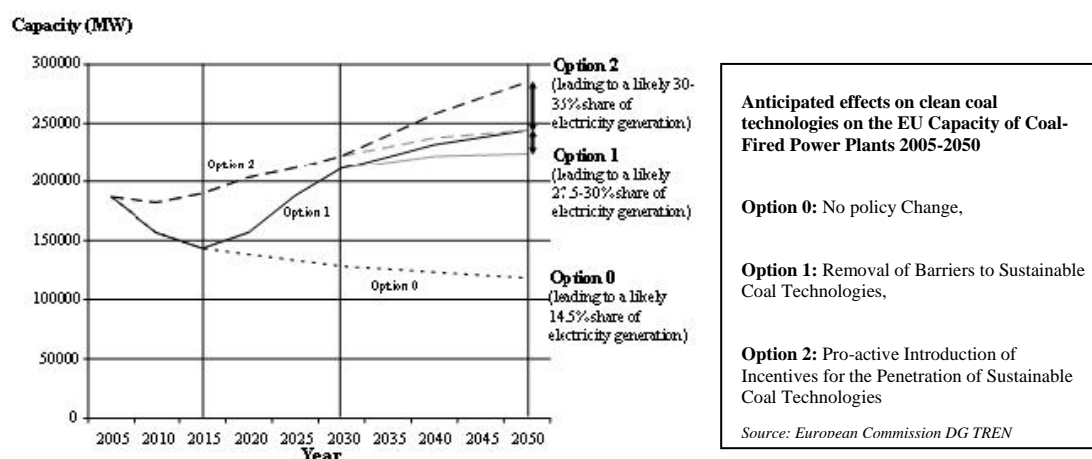

Because of early investment in renewable energy technological development the European Union is already the global leader in that sector. Europe has the potential to lead even more in the rapidly growing global market for low carbon energy technologies. Europe's determination to lead the global fight against climate change creates

an opportunity to drive the global research agenda. This applies to CO₂ capture and storage, just as in renewables. Even though Europe has led the world through the world first demonstration of CO₂ storage in a saline aquifer at Sleipner (since 1996), Europe now risks being overtaken in developing CCS technology, as concern over emissions grow in other developed countries such as the USA and Australia, who are increasingly resourcing and accelerating technological development.

To provide global leadership, the EU must provide a clear vision for the introduction of CO₂ capture and storage within its borders, establish a favourable regulatory framework for CCS development, invest more effectively in research, as well as taking international action. The EU Emissions Trading System will also need to incorporate capture and storage in the future and this will require significant regulation, including permitting of CCS operations and qualification criteria for such permits.

Potential for CO₂ storage

It is now well accepted that CO₂ capture and storage (CCS) is technically feasible, but it still remains to provide viable solutions for large-scale power generation from fossil fuels. If persistent obstacles such as the cost of capture are currently under considerable progress, the recognition of CO₂ storage in geological formations as an safe and effective approach in a long-term perspective (over 1000 years) is still largely unachieved. If in fact CCS is to be widely available for deployment by 2020, considerable urgency exists toward further R&D on CO₂ storage in deep saline aquifers. This option has by far the largest capacity and the more widespread geographical distribution.

The relative order-of-magnitude potential of the various storage methods may be expressed, very simply, as follows:

- 1000 Deep saline aquifer storage (porous rocks)
- 100 Oil/gas field use and storage
- 10 Deep un-mineable coal bed use and storage
- 1 Mineral sequestration

Deep saline aquifers have the largest storage potential globally (IPCC 2005), but are the least well explored and researched as, up till now, they have not had any economic potential (unlike hydrocarbon fields). We therefore need to build a more comprehensive dataset of their geological characteristics through considerable research and larger-scale injection projects.

Earlier research projects have already begun the task of identifying regional deep saline aquifers that are accessible to large CO₂ emissions sources, both on land and close to the shore. Although we

believe these formations hold the most promise, we need to demonstrate storage in a variety of types and settings in order to realise the full potential of this medium. It means exploring as many countries as possible, especially those with few hydrocarbon deposits, where saline aquifers will be the only feasible CO₂ storage medium.

Ten years of injection into an aquifer at Sleipner and monitoring of the CO₂ have improved the confidence in aquifer storage. For example, the Utsira Sand Formation at Sleipner is a large, regional deep saline aquifer which has been used by Statoil since 1996 to store CO₂ removed from gas production at an injection rate of about 1Mt/annum. This world class pioneering project has been researched by a succession of joint EU/industry projects and is the best understood large scale aquifer CO₂ injection in the world. The Utsira Sand Formation has an area of over 26,000 km² and according to the ZEP (2006), it potentially is capable of storing up to 600Gt of CO₂. To put this into perspective, this is equivalent to all the CO₂ emissions from all the power stations in Europe for the next 600 years. Sleipner's injection rate is equivalent to the emissions of a 250MW coal fired plant, or a 500MW gas fired one. Europe's largest coal burning plant at Drax in the UK is 4GW, which if captured and stored would require an equivalent injection rate of 16 Sleipners. There are many power plants in the 1-2GW range across Europe.

Apart from Sleipner the only large scale injection in the world into a saline aquifer is beneath the Algerian Sahara. Operated by BP this has been injecting around a million tonnes of CO₂ per annum. The reservoir is much thinner than Sleipner, and contrasts in having low permeability/porosity, and more complex heterogeneity. The other saline aquifer injections around the world so far conducted are relatively small, experimental operations, at the 10-100kt scale. Significant are Frio (Texas USA) and Nagoaka (Japan). At the European CO₂Sink flagship project at Ketzin injection will start in June 2007 – injecting up to 60 000 tonnes of CO₂ over the next two years.

The European Zero Emission Power Technology platform (ZEP)

Climate change is one of the most serious single challenges faced by humankind today. Probably one of the greatest impacts in reducing CO₂ emissions will be made by the introduction of Zero Emission Fossil Fuel Power Plants including carbon dioxide capture and storage. Therefore, the European Commission, the European energy industry, research community and non governmental organisations have together established a European Technology Platform on Zero Emission Fossil Fuel Power Plants (ETP ZEP) to unite all key stakeholders in this field.

***To enable European fossil fuel power plants
to have zero CO₂ emissions by 2020.***

ZEP vision statement, September 2006

ZEP confirms the EU's continued commitment to its leadership role in reducing CO₂ emissions and the immense challenge of keeping the average global temperature increase below 2 degrees Centigrade relative to pre-industrial level. The platform plays a crucial role in enabling the EU to fulfil this commitment: its goal is to develop and deploy new competitive options for Zero Emission Fossil Fuel Power Plants within the next 15 years and hence help European industry to compete effectively on world markets.

Experts agree that CO₂ capture and storage technology (CCS), together with improved energy conversion efficiency, is a near-term solution to reducing carbon dioxide emissions from fossil fuel power generation on a massive scale. Its immediate deployment is therefore vital if we are to avoid the catastrophic consequences of climate change we are facing today. Yet despite most of the technology elements being available, CCS is still not deployed for two key reasons:

1. The costs and risks still outweigh the commercial benefits
2. The regulatory framework for CO₂ storage is not sufficiently defined.

Following the priority given to “zero emission power generation” in the Sixth Framework Programme (FP6), industrial stakeholders and the research community therefore united to form the European Technology Platform for Zero Emission Fossil Fuel Power Plants (ZEP). The aim of the ZEP is to identify and remove the barriers to creating highly efficient power plants with zero emissions, which would drastically reduce the environmental impact of fossil fuel use, particularly coal. In the autumn of 2005, the Advisory Council and Coordination Group – along with the Working Groups and Mirror Group – were established. The Technology Platform was officially launched in December and a Vision Paper was published the following May. In August 2006, the Technology Platform then published two key documents – the Strategic Deployment Document (SDD) and the Strategic Research Agenda (SRA). While the SDD outlines how we can accelerate the market for deployment, the SRA describes a collaborative programme of technology development for reducing the costs and risks. This Strategic Overview is a summary of both documents, providing key highlights and recommendations on concrete actions required to realise the ZEP Vision.

ZEP Deployment Strategy

1. **Kick-starting the CO₂ value chain with urgent short- and long-term commercial incentives:** inclusion in EU Emissions Trading Scheme (EU ETS), guidelines for State Aid, create early mover funding mechanisms to support the development of 10-12 large-scale CCS demonstration projects, mechanisms to supplement EU ETS.
2. **Establishing a regulatory framework for the geological storage of CO₂:** amend existing EU legislation concerning waste and water, implement new EU guidelines for Member States permitting geological storage projects.
3. **Gaining public support via a comprehensive public information campaign:** Generic EU-wide multi-media and local, focused outreach in support of early mover CCS projects.

ZEP Research Agenda

- **Urgently implementing 10-12 integrated, large-scale CCS demonstration projects Europe-wide:**
- **Developing new concepts already identified, but not validated, for demonstration by 2010-2015 and implementation beyond 2020, e.g.**
- **Supporting long-term exploratory R&D into advanced, innovative concepts for implementation of next-generation technology, e.g.**
- **Maximising cooperation at national, European and international level:**

With a view to addressing the legal and regulatory issues associated with CCS, the European Commission (DG Environment) is currently developing an enabling legal framework for CCS in Europe. This development takes place in dialogue and consultation with national member states as well as the stakeholders in the field of CCS. The following preliminary timetable is envisaged by DG Environment:

- Draft impact assessment and legislative proposal by end July
- Internal procedures July-November 2007
- Adoption by Commission by November 2007

Danish CCS potential

The possibilities for underground storage of CO₂ in Denmark has previously been evaluated in two regional studies, Joule II and GESTCO including storage potential in depleted hydrocarbon fields and deep saline aquifers. In the Joule II report the total storage capacity for CO₂ in Denmark in unconfined onshore aquifers of Triassic and Jurassic age was estimated to 47 Gt based on a general assumption that 2% of the entire pore volume of the mapped formations was filled. Restricting the storage capacity to confined traps reduced the estimated total storage capacity to 5.6 Gt. Using experiences from natural gas storage facilities in Denmark, Germany and France the GESTCO study assumes that 40% of the total pore volume within a defined trap may be filled with CO₂. In the GESTCO project eleven well-defined closures all located in the central part of the Danish Basin were mapped from seismic surveys and their storage potential was evaluated using data from existing deep wells. Initial calculations suggest that these structures alone may provide storage for at least 16 Gt CO₂. The different storage capacity estimates between the Joule II and GESTCO projects illustrates the principle of "less storage capacity with better confidence" and it is anticipated that the site characterization process developed in the CO2STORE project will increase the amount of knowledge, but also reduce the estimate of total storage capacity within the countries. In the site selection phase four stratigraphic Jurassic and Triassic intervals were considered for potential storage in deep saline aquifers. The sandstones of the Jurassic Gassum Formation are known from a number wells (porosity 18-27%, maximum 36% and permeability up to 2,000 mD) and acts as reservoir for storage of natural gas at Stenlille and as geothermal reservoir at Thisted. The aquifer storage of CO₂ is dependent not only on the properties of the reservoir but also on the integrity of the sealing formation. The primary sealing unit for the Gassum Formation is marine mudstones of the Lower Jurassic Fjerritslev Formation characterised by a relatively uniform succession of marine slightly calcareous claystones. The formation is present over most of the Danish Basin with a varying thickness of up to 1,000 m. It is the sealing formation at the Stenlille natural gas storage site and has proven tight to natural gas stored in the Gassum reservoir below. A possible secondary seal is formed by carbonate rocks of Late Cretaceous-Danian age and chemical reactions between dissolved CO₂ and the carbonate rock.

References

European Technology Platform ZEP: www.zero-emissionplatform.eu

Larsen, Bech, Bidstrup, Christensen, Biede & Vangkilde: Kalundborg Case study, a feasibility study of CO₂ storage in onshore saline aquifers, GEUS Report 2007/379 pp (can be downloaded from www.geus.dk/co2)

DG Environment: Stakeholder Consultation Meeting, Brussels 8 May 2007

Environmental Analysis of the Coal-based Power Production with Amine-based Carbon Capture

J. Nazarko¹⁾, A. Schreiber²⁾, W. Kuckshinrichs²⁾, P. Zapp²⁾

Forschungszentrum Jülich

1) Institute of Energy Research, Fuel Cells (IEF-3)

2) Institute of Energy Research, Systems Analysis and
Technology Evaluation (IEF-STE)

D-52425 Jülich, Germany

Abstract

CO₂ capture and storage (CCS) is gaining an increasing importance and is being regarded as an option to mitigate CO₂ in order to protect our climate. Although several possible technical options for CCS exist, their potential for electricity generation still has to be demonstrated, and other options are still in the R&D phase. Nevertheless, an extensive application of CCS for the electricity generation is not expected before 2015-2020. On the other hand, there will be new fossil fuel power plants installed before, for which post combustion retrofit might be an attractive option.

Even though it is clear that CCS results in net reduction of CO₂ emissions compared to the same technology routes without CCS, a broader environmental analysis is necessary. Depending on the type of the carbon capture technology reduction of CO₂ emissions is different, as well as the additional material flows.

Based on LCA methodology the study examines the operation of six coal power plants, which differ in the year of installation and in the ability and efficiency to capture CO₂. The plants are characterized by the expected efficiency parameters for the year 2020:

- (1) Coal plant₂₀₀₅: pulverized coal power plant already operating in 2005
- (2) Coal plant₂₀₁₀: pulverized coal power plant installed in 2010
- (3) Coal plant₂₀₂₀: pulverized coal power plant installed in 2020
- (4) MEA_{retrofit1}: Coal plant₂₀₀₅ + MEA₂₀₂₀ retrofitted in 2020
- (5) MEA_{retrofit2}: Coal plant₂₀₁₀ + MEA₂₀₂₀ retrofitted in 2020
- (6) MEA_{greenfield}: Coal plant₂₀₂₀ + MEA₂₀₂₀ installed in 2020

The analysis regards the retrofit of coal power plants with MEA to be a general option in 2020. Under which circumstances and for which plant parameters utilities are willing to invest in retrofit with MEA is not in the focus of the analysis. For a comparative ecological inventory of six coal power plants material and energy balances for all relevant inputs and outputs on the level of single processes as well as for the process chain are calculated.

1 Introduction

One of the most important sources of global carbon dioxide emissions is the combustion of fossil fuels for power generation. To capture carbon dioxide from fossil fuel power plants and to store it in geological formations (CCS) is regarded to be one of the most promising future options to significantly reduce CO₂ emissions.

Since a few years ago CCS has become an object of intensive R&D activities. So far studies concentrate on the estimation of the technical potential, the development of capture techniques, the assessment of storage reservoirs and the economic analysis. Along the same lines the environmental analysis concentrated only on net reduction of CO₂. Although first studies on material and energy flows caused by CCS are available (Nazarko et al., 2006), (Fischedick et al., 2007) the environmental assessment of CCS is just at the beginning.

From an electricity generator's perspective the amine based carbon capture offers some advantages:

1. The technology is proved already in other industries, e.g. chemistry, and is expected to be commercially available in mid-term. Therefore, it can be deployed as a competing capture technology in advance.
2. Except for connecting facilities to enable CO₂ wash the conventional power plant generation process keeps unchanged, so that well-established generation technology can be further used.
3. Under certain conditions the retrofit of existing capacities is easily done from a technical point of view.

Nevertheless, there remain some drawbacks:

1. With an efficiency reduction of 10-15% points the energy penalty is very high which results in additional primary energy demand.
2. Electricity generating costs may rise by 50% due to carbon capture and storage so that amine-based carbon capture is unattractive against competing technologies.
3. From an environmental perspective the reduction of CO₂ emissions may be accompanied by an increase of other environmental impacts.

The focus of the paper is on the environmental aspects excluding the analysis under which conditions a plant is attractive for retrofit measures. The material and energy flows due to amine-based carbon capture have to be quantified for a comprehensive technology assessment and comparison with the conventional coal-based power generation.

2 Scope of the Analysis

The study examines power generation using coal-based steam power plants in 2005, 2010 and 2020 with and without carbon capture. Up-stream activities, e.g. coal mining and materials provision, as well as down-stream activities, e.g. transport and storage of CO₂, are not included.

“Conventional” power plants without carbon capture are characterized as following:

1. Coal plant₂₀₀₅: pulverized coal power plant already operated in 2005; data for power plant parameters are taken from existing coal power plants in Germany;
2. Coal plant₂₀₁₀: pulverized coal power plant installed and operated in 2010; data for power plant parameters are taken from publicly available literature for power plants under construction.
3. Coal plant₂₀₂₀: pulverized coal power plant installed and operated in 2020; data for power plant parameters are estimated, e.g. for efficiencies.

Post combustion carbon capture using mono-ethanolamine (MEA) wash is chosen for the study due to data availability and comparability. This comprises the following alternatives:

4. MEA_{retrofit1}: pulverized coal power plant constructed in 2005 or earlier, operated in 2020 and retrofitted in 2020 by carbon capture using MEA wash;
5. MEA_{retrofit2}: pulverized coal power plant constructed in 2010, operated in 2020 and retrofitted in 2020 by carbon capture using MEA wash;
6. MEA_{greenfield}: pulverized coal power plant with integrated carbon capture by MEA wash, constructed and operated in 2020.

More detailed information and important parameters with respect to the technologies are given in the subsequent sections.

3 Technical Aspects and Important Parameters of the Power Plants

3.1 Power plant without CO₂ capture

The performance data for the coal plant₂₀₀₅ are taken from existing coal power plants in Germany. The net efficiency amounts to 43 % (Wegerich et al., 2006).

The performance characteristics for the coal plant₂₀₁₀ are taken from public literature for power plants under construction. The net efficiency is assumed to be 46 percent (VDEW e.V., 2006), (Meier and Stolzenberger, 2006), (Wegerich et al., 2006).

For the coal plant₂₀₂₀ the net efficiency will increase by 3 points up to 49 percent. This advancement will be achieved by raising steam temperature up to 700 °C as well as other optimization measures (Linssen et al., 2006), (Wegerich et al., 2006).

The operating procedures do not vary for the three power plants without capture. Due to the environmental accounting of the material and energy flows the power plants are subdivided into five main process steps (Figure 1). The process “coal conditioning“ includes delivery and conditioning of hard coal. The „power generation“ contains combustion, steam generation, the steam power process, cooling and condensate conditioning. The “NO_x removal” is carried out through NO_x wash using ammonia. The “dust removal” is arranged by electrical precipitator. The “desulphurisation” is accomplished through SO₂ wash using limestone. Additionally, it is assumed that the power plants meet the emission threshold values according to BImSchV (13. BImSchV, 20.07.2004), which distinguish the new from the old plants.

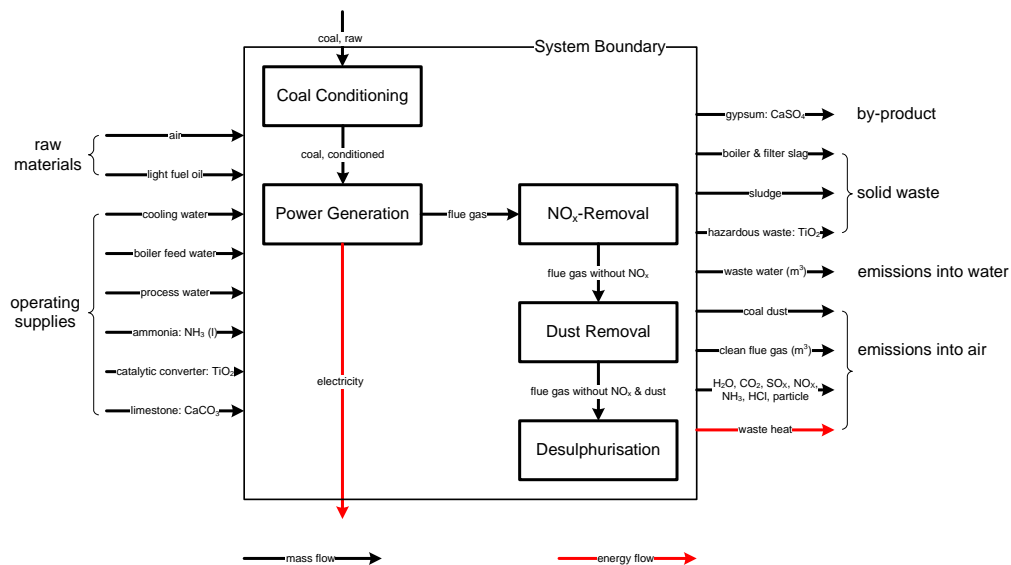

Figure 1: Processes and material and energy flows of a coal plant without CO₂ capture (case 1 – 3)

3.2 Power plant with CO₂ capture through MEA wash

MEA wash is a gas separation technique using chemical absorption. For the separation of acid gases the aqueous solutions of mono-ethanolamine are widely accepted (Kohl and Nielsen, 1997). The MEA wash concept is a classical end-of-pipe solution and could be available for large-scale use for electricity generation within the next 10 years. Thus it would be an option for observing mid-term CO₂ mitigation targets competing with the other CO₂ capture technologies if available. It is assumed that the conventional power plants are easily retrofitted by MEA wash (Burchhardt and Jentsch, 2004), (Kather and Plass, 2005), (Fischedick et al., 2006). The effect on the power plant availability by using MEA wash is relatively marginal. The reduction of availability of electrical generation is specified to approximately 0.75 percent (Smelser et al., 1991). This means that the power generation can be continued during a temporary breakdown of CO₂ capture facilities.

Figure 2 shows the main process steps of the power plants including CO₂ capture using MEA wash and CO₂ compression.

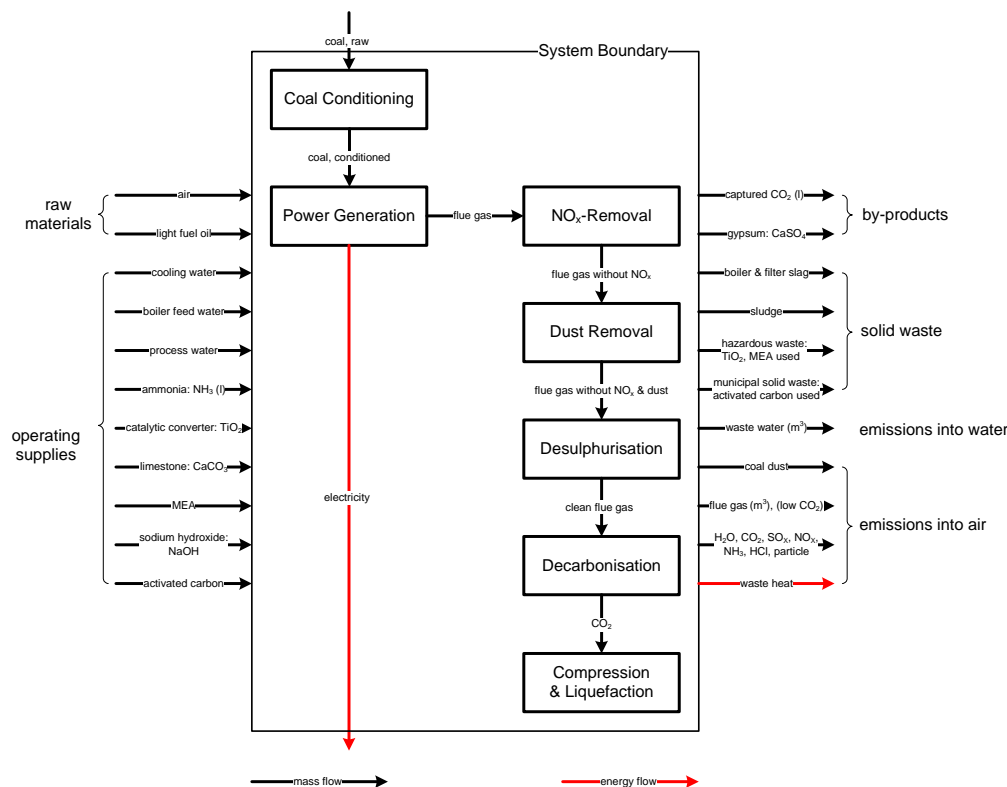

Figure 2: Processes and material and energy flows of a coal plant with CO₂ capture (case 4 – 6)

After desulphurisation the flue gas containing CO₂ and the MEA solution circulates at counter flow in the absorber. The flue gas is cleaned due to the strong chemical reaction between CO₂ and MEA. Afterwards the MEA solution containing CO₂ is carried to a regenerator. In the regenerator the CO₂ is retrieved through heating by low pressure steam. Accordingly, the MEA solution is pre-treated by filtration, adsorption and if necessary by refilling. After that the MEA solution can be reused. The low pressure steam used for regeneration of MEA solution is taken from the steam power process and is no longer available for electricity generation. Thereby the power output of the steam turbine and the electricity yielded decrease. The electrical equivalence factor describes this loss. An increasing electrical equivalence factor denotes an increasing energy demand as well as increasing losses of power output of the steam turbine or rather net efficiency. The electrical equivalence factor is especially affected by the quality of the connecting facilities between the power plant and the capture technique. After MEA wash the separated carbon dioxide is liquefied by compression.

The environmental assessment of the power plants with CO₂ capture requires the analysis of special operating parameters. These parameters concern CO₂ as well as MEA, i.e. CO₂ output factor, CO₂ absorption capacity or CO₂ purity and MEA concentration or MEA losses, respectively. Thereby the loss of MEA is caused by irreversible interactions of flue gas components, oxidation, polymerisation and evaporation. Additionally, energetic parameters also affect the material and energy balance of the electricity generation process. These are energy and steam used for regeneration, flue gas blower and diverse pumps. Furthermore, operating supplies like sodium hydroxide, activated coal and MEA are considered.

Table 1 shows the important performance and flue gas parameters of the power plants with and without CO₂ capture.

	unit	Coal plant ₂₀₀₅	Coal plant ₂₀₁₀	Coal plant ₂₀₂₀	MEA _{retrofit1}	MEA _{retrofit2}	MEA _{greenfield}
<i>Plant parameters</i>							
combustion capacity	MW _{th}	1164.0	1200.0	1423.5	1164.0	1200.0	1423.5
gross capacity	MW _{el}	550.0	600.0	750.0	478.9	526.7	706.5
net capacity	MW _{el}	500.5	552.0	697.0	378.6	426.5	592.0
gross efficiency	%	47.3	50.0	52.7	41.1	43.9	49.6
net efficiency	%	43.0	46.0	49.0	32.5	35.5	41.6
auxiliary power (sum)	MW _{el}	49.5	48.0	52.5	100.3	100.2	114.5
<i>Flue gas parameters after FGD</i>							
sulphur dioxide concentration	mg/m ³	150	150	150	150	150	29
nitrogen oxide concentration	mg/m ³	185	185	185	185	185	185
particles	mg/m ³	20	20	20	20	20	20
<i>CO₂ capture parameters</i>							
purity of CO ₂	%	----	----	----	99	99	99
rate of retention	%	----	----	----	90	90	90
MEA concentration	mass %	----	----	----	30	30	30
electrical equivalence factor	----	----	----	----	0.20	0.20	0.10
extracted low pressure steam	MW _{th}	----	----	----	355.5	350	430
auxiliary power for CO ₂ capture	MW _{el}	----	----	----	12.6	12.8	15.2

Table 1: Technical parameters of the six power plants

The calculations are based on the following assumptions: hard coal Pittsburgh no. 8 with 5.5 mass % moisture, combustion in moistly atmospheric air with 18 % (2005) or 15 % (2010, 2020) excess air (λ 1.18; 1.15). The combustion capacity keeps unchanged if CO₂

capture proceeds, whereas the gross and net capacities and the efficiencies are calculated. The SO₂ concentration will be reduced up to 10 ppm due to the addition of increased amount of limestone for the power plants in 2020 (Chapel et al., 1999), (Koss, 2005), (Rao et al., 2004). The electrical equivalence factor is decreased from 0.20 for the power plants in 2005 and 2010 to 0.10 for MEA_{greenfield} in 2020 due to improved connecting facilities between the power plant and the capture technique. Consequently, the steam energy will be better utilised. At the best still 30 % of the combustion capacity has to be used for capture.

4 Environmental Inventory of MEA-based CO₂ Capture

4.1 Methodical Aspects of Life Cycle Assessment (LCA)

LCA addresses the environmental aspects and potential impacts (e.g. resource use and environmental consequences of releases) throughout the life cycle of a product/technique from raw material acquisition through production, use, end-of-life treatment and disposal (i.e. from cradle to grave) (ISO 14040, 2006). It shall assist decision-makers in research, industry, governmental or non-governmental organizations in strategic planning, priority setting, product or process design or redesign. The procedure of a Life Cycle Assessment is defined in the International Standards ISO 14040 and 14044 (ISO 14040, 2006), (ISO 14044, 2006). Figure 3 depicts the rough classification of LCA in the four phases of goal and scope definition, inventory analysis, impact assessment and interpretation and their interrelations.

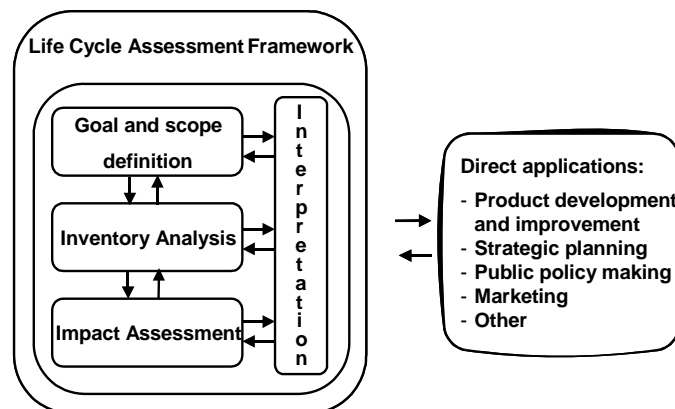

Figure 3: Phases of an LCA (ISO 14040, 2006)

Core element of every LCA is the inventory. In fact, it is the most objective part of an LCA and describes the investigated system by its inputs and outputs from and to the environment quantified and calculated in a model. The main outcome is an inventory table of the results for inputs and outputs, which is then either used to carry out the impact assessment or interpret itself according to the goal and scope.

The smallest portion of a product or service system for which data are collected when performing a life cycle assessment is called a unit process. Figure 4 specifies the main input and output categories, which must be considered in a unit process and for which data must be collected. The different unit modules are then combined to a flow diagram.

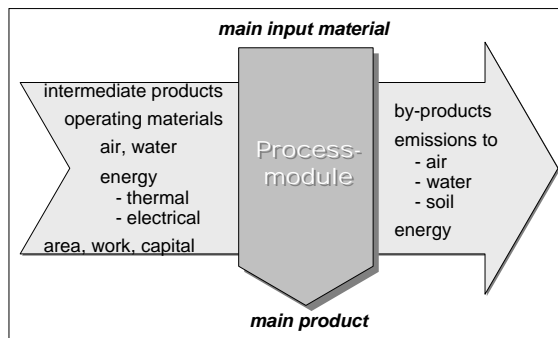

Figure 4: Input and output categories of a unit process

In the impact assessment the results of the inventory are translated into the contributions to selected impact categories, such as climate change, acidification, ozone depletion, etc. The contributions are calculated using characterisation models, in which relevant environmental processes are modelled to so-called category endpoints. For example, the climate change impact category represents emissions of greenhouse gases (LCI results) using infrared radiative forcing as the category indicator.

In the interpretation phase the results (of either LCI or full LCA) and all choices and assumptions made during the analysis are evaluated in terms of soundness and robustness. Finally, overall conclusions are drawn and recommendations are given considering the goal and scope of the study.

In this study LCA is used to compare on an environmental basis coal power plants without and with CO₂ capture using MEA wash concept.

4.2 Results of the Life Cycle Inventory

The process chains are modelled using GaBi 4.2, a well-known software for environmental calculation of products or services. All processes are described within GaBi by their energy and material flows. Correlations between process parameters or in- and outputs are expressed by mathematical equations.

The results of the six process chains are shown in Table 2. All data are relating to the functional unit 1 kWh_{el} (3600 kJ) electricity produced (for consumption). Table 2 and Table 3 present the main material and energy flows summarized along the process chains. The increased amount of hard coal and the involved increased mass of air, boiler feed water and cooling water are caused by the decreasing of efficiency (Table 2). The notable rise of cooling water for the MEA plants is mainly due to cooling down the MEA solution after regeneration (Table 2). The produced auxiliary power, the use of steam and the involved waste heat are clearly enhanced for the MEA plants due to the CO₂ capture facilities (Table 3). The same applies to the increased amounts of gypsum, sludge and waste. The hazardous waste contains the MEA residues. After the compression of the captured CO₂ approximately 700 g liquid CO₂/kWh_{el} is received (Table 3).

	Coal plant ₂₀₀₅	Coal plant ₂₀₁₀	Coal plant ₂₀₂₀	MEA _{retrofit1}	MEA _{retrofit2}	MEA _{greenfield}
<i>material g/kWh_{el}</i>						
hard coal	282	264	247	373	341	291
air	3346	3049	2862	4424	3946	3372
cooling water	1398	1222	1077	2126	1834	1389
boiler feed water	50	47	44	66	61	52
water	82	77	72	108	99	87
light fuel oil	1.0	0.9	1.0	1.4	1.2	1.1
titan oxide	0.04	0.036	0.036	0.06	0.05	0.04
ammonia	0.63	0.58	0.54	0.84	0.75	0.64
lime stone	23	22	20	30	28	24
MEA	0	0	0	2.3	2.1	1.1
sodium hydroxide	0	0	0	0.12	0.11	0.09
activated carbon	0	0	0	0.07	0.06	0.05

Table 2: Material inputs for the power plants per kWh_{el} produced

	Coal plant ₂₀₀₅	Coal plant ₂₀₁₀	Coal plant ₂₀₂₀	MEA _{retrofit1}	MEA _{retrofit2}	MEA _{greenfield}
<i>energy g/kWh_{el}</i>						
electricity	3600	3600	3600	3600	3600	3600
waste heat	590	552	518	1179	1076	920
auxiliary electricity	288	253	219	376	321	258
steam	4028	3398	2995	5914	5102	3864
<i>material g/kWh_{el}</i>						
waste water	120	113	106	159	146	126
slag	0.003	0.003	0.003	0.004	0.004	0.003
gypsum (FGD)	40	37	35	52	48	42
sludge	0.9	0.85	0.79	1.19	1.09	0.96
carbon dioxide (liquid)	0	0	0	841	769	658
waste	0	0	0	0.07	0.06	0.05
hazardous waste	0	0	0	3.46	3.07	1.22

Table 3: Material and energetic outputs of the power plants per kWh_{el} produced

Table 4 presents the major emissions into air and water. As expected the results demonstrate a strong decrease of the CO₂ emission from about 770 g/kWh_{el} down to 95 g/kWh_{el} and even 81 g/kWh_{el} for the MEA_{retrofit} and MEA_{greenfield} plants, respectively. These results are coincident with other studies (Göttlicher, 1999), (Brand, 1996), (Briem et al., 2004), (Fischedick et al., 2007). In contrast to the remarkable reduction for CO₂ all other emissions, except for SO₂, increase. The SO₂ emissions decrease due to the expected improvement of desulphurisation if MEA wash is used.

	Coal plant ₂₀₀₅	Coal plant ₂₀₁₀	Coal plant ₂₀₂₀	MEA _{retrofit1}	MEA _{retrofit2}	MEA _{greenfield}
<i>emissions in air g/kWh_{el}</i>						
carbon dioxide	769	706	662	106	95	81
sulphur dioxide	0.46	0.43	0.40	0.08	0.07	0.06
sulphur trioxide	0.18	0.17	0.16	0.24	0.22	0.19
nitrogen oxide	0.54	0.49	0.46	0.69	0.62	0.53
carbon monoxide	0.07	0.07	0.06	0.08	0.07	0.06
ammonia	0	0	0	0.19	0.17	0.15
polycyclic aromatic hydrocarbons	0.07	0.07	0.06	0.08	0.07	0.06
particles	18	17	16	24	22	18
heavy metals	2.4	2.3	2.1	3.2	2.9	2.5
<i>emissions in water g/kWh_{el}</i>						
inorganic emissions (sum) thereof:	2.5	2.4	2.2	3.4	3.1	2.7
heavy metals	6.0E-04	5.6E-04	5.3E-04	8.0E-04	7.3E-04	6.3E-04
biochemical oxygen demand (BSB)	6.2E-04	5.8E-04	5.4E-04	8.1E-04	7.4E-04	6.5E-04
chemical oxygen demand (CSB)	1.8E-02	1.7E-02	1.6E-02	2.4E-02	2.2E-02	1.9E-02
particles	2.5	3.4	3.2	3.4	4.5	3.9

Table 4: Important emissions in air and water per kWh_{el} produced

4.3 Results of the Life Cycle Impact Assessment and Interpretation

Following, the results of the inventory (Table 4) are translated to contributions to selected environmental impact categories for the impact assessment (Figure 5). The contributions are calculated using the characterisation model CML 2001 (Guinée, 2001) within GaBi.

Figure 5 presents five selected impact categories and the related contributions of the six electricity generating concepts. As expected the greenhouse gas potential for the MEA plants is much lower than for concepts without CO₂ capture and is lowest for MEA_{greenfield}. The same applies to the photochemical oxidation potential due to the reduction

of sulphur dioxide (SO₂) emissions in order to protect the MEA solution. In contrast to this the acidification and human toxicological potentials are slightly enhanced for the MEA concepts due to ammonia (NH₃) emissions in air and heavy metal emissions in water, respectively. For both impact categories, the MEA_{greenfield} concept is superior to MEA_{retrofit}, but inferior to “conventional” electricity generation. The noticeable increase of the eutrophication potential results from the increase of nitrogen oxides as well as of ammonia for all three MEA concepts. Again, MEA_{greenfield} is superior to MEA_{retrofit}.

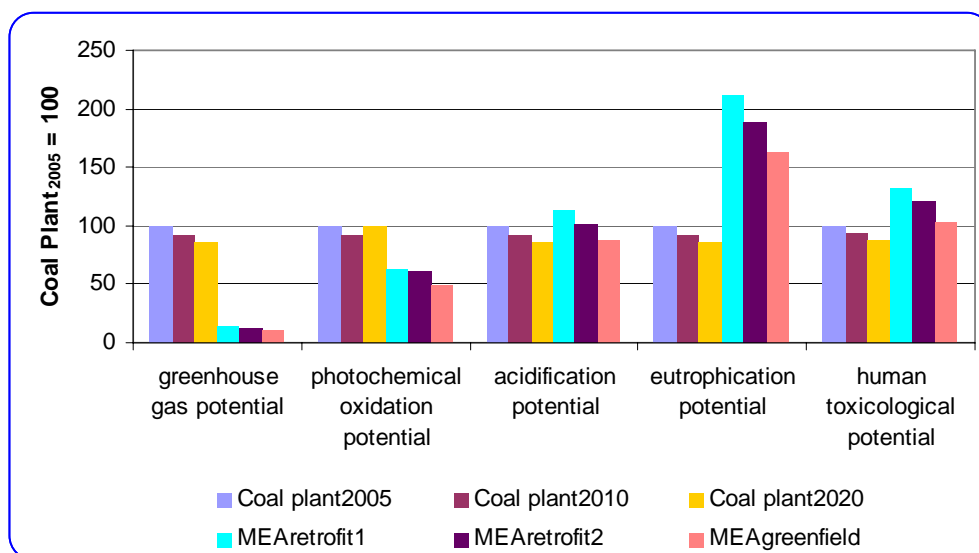

Figure 5: Normalized impact categories

5 Summary and Outlook

This study analyses the environmental impacts of coal-based power production without and with amine-based carbon capture. The results point out that the reduction of carbon dioxide emissions to air is achieved at the expense of increasing other emissions like ammonia or nitrogen oxides. Subsequently, the eutrophication potential is much higher for MEA-based carbon capture. This means that the implementation of new techniques can change the environmental assessment and thus positive and negative effects have to be compared and weighed up against each other.

This study concentrates on the process chains of six power plants without involved upstream processes like production and transport of raw materials and operating supplies (e.g. coal, sodium hydroxide, limestone, extra light fuel oil) and downstream processes, e.g. transport and storage of CO₂. According to the experiences the inclusion of upstream processes results in additional material and energy flows to about ten percent (Fischedick 2007). Due to the different specific needs of primary energy and due to different amounts of CO₂ for downstream processing, this assumption should be carefully checked for these power plant concepts.

As there exist several possible technical options for CCS further studies are necessary to compare competing capture concepts such as pre combustion and oxyfuel technologies. Some options are still in the R&D phase like carbon capture using gas separating membranes.

6 Literature

13. BIMSCHV (20.07.2004) Verordnung über Großfeuerungs- und Gasturbinenanlagen – 13. BImSchV.
- BRAND, V. (1996) Rückhaltung von Kohlendioxid in Kombikraftwerken mit integrierter Kohlevergasung. Düsseldorf, VDI Verlag.
- BRIEM, S., BLESLE, M., FAHL, U., OHL, M., MOERSCHNER, J., ELTROP, L., VOß, A., VIEBAHN, P., KREWITT, W., GÜRZENICH, D., TRYFONIDOU, R., WAGNER, H.-J., CORRADINI, R. & RICHTER, S. (2004) Lebenszyklusanalysen ausgewählter zukünftiger Stromerzeugungstechniken. Düsseldorf, VDI-Verlag.
- BURCHHARDT, U. & JENTSCH, N. (2004) Das CO₂-freie Kohlekraftwerk – Eine Übersicht von möglichen Konzepten zur mittelfristigen Anwendung. XXXVI. Kraftwerkstechnisches Kolloquium - Entwicklungspotentiale für Kraftwerke mit fossilen Brennstoffen. Dresden, Technische Universität Dresden, Institut für Energietechnik, Lehrstuhl für Kraftwerkstechnik.
- CHAPEL, D. G., MARIZ, C. L. & ERNEST, J. (1999) Recovery of CO₂ from Flue Gases: Commercial Trends. *Canadian Society of Chemical Engineers* Saskatoon, Saskatchewan, Canada.
- FISCHEDICK, M., SCHÜWER, D., ESKEN, A., SUPERSBERGER, N., PASTOWSKI, A., NITSCH, J., VIEBAHN, P., BANDI, A., ZUBERBÜHLER, U. & EDENHOFER, O. (2007) Ökologische Einordnung und strukturell-ökonomischer Vergleich regenerativer Energietechnologien mit anderen Optionen zum Klimaschutz, speziell der Rückhaltung und Speicherung von Kohlendioxid bei der Nutzung fossiler Primärenergien. Wuppertal, Stuttgart, Potsdam. <http://www.wupperinst.org/de>.
- FISCHEDICK, M., SCHÜWER, D., GÜNSTER, W., FAHLENKAMPF, H., MEIER, H.-J., NEUMANN, F., OELJEKLAUS, G., RODE, H., SCHIMKAT, A. & BEIGEL, J. (2006) CO₂-Abtrennung im Kraftwerk. Ist eine Nachrüstung für bestehende Anlagen sinnvoll? . *VGB PowerTech* 4/2006 108-117.
- GÖTTLICHER, G. (1999) Energetik der Kohlendioxidrückhaltung in Kraftwerken. Düsseldorf, VDI Verlag.
- GUINÉE, J. B. (2001) Life Cycle Assessment an operational guide to the ISO standard.
- ISO 14040 (2006) Environmental management -- Life cycle assessment -- Principles and framework. Deutsches Institut für Normung e. V.
- ISO 14044 (2006) Environmental management -- Life cycle assessment -- Requirements and guidelines. Deutsches Institut für Normung e. V.
- KATHER, A. & PLASS, L. (2005) Drei Technologierouten eröffnen Möglichkeiten zur CO₂-Abtrennung in fossil gefeuerten Kraftwerken. IN RWE (Ed.) *Power: Perspektiven 2005. Innovationen zur Klimavorsorge in der fossil gefeuerten Kraftwerkstechnik*. Essen, Köln, Abt. Unternehmenskommunikation, Firmenschrift
- KOHL, A. L. & NIELSEN, R. B. (1997) *Gas Purification*, Houston, Gulf Publishing Company.
- KOSS, U. (2005) Kraftwerkslinien und Abscheideoptionen - Eine Diskussion der grundlegenden Strategien zur CO₂-Abscheidung in CCS-Kraftwerken. IN KUCKSHINRICHS, W., MARKEWITZ, P. & HAKE, J.-F. (Eds.) *CO₂-Abscheidung und -Speicherung: Eine Zukunftsoption für die deutsche Klimaschutzstrategie?* . Jülich, Forschungszentrum Jülich, Systemforschung und Technologische Entwicklung.
- LINSSEN, J., MARKEWITZ, P., MARTINSEN, D. & WALBECK, M. (2006) Zukünftige Energieversorgung unter den Randbedingungen einer großtechnischen CO₂-Abscheidung und Speicherung. Jülich, Forschungszentrum Jülich, Programmgruppe Systemforschung und Technologische Entwicklung

- MEIER, H.-J. & STOLZENBERGER, C. (2006) Entwicklung der 700°C-Dampfkraftwerkstechnologie. IN TECHNISCHE UNIVERSITÄT DRESDEN, I. F. E. (Ed.) *Kraftwerksbetrieb unter künftigen Rahmenbedingungen*. - 38. *Kraftwerkstechnisches Kolloquium* -. Dresden, Technische Universität Dresden, Institut für Energietechnik.
- NAZARKO, J., KUCKSHINRICHS, W., SCHREIBER, A. & ZAPP, P. (2006) Umweltauswirkungen von CO₂-Abtrennung und -Speicherung als Komponente einer ganzheitlichen Technikbewertung. 9. *Symposium Energieinnovation. Dritte Energiekrise – Anforderungen an die Energieinnovation*. Graz, Österreich, TU Graz.
- RAO, A. B., RUBIN, E. S. & BERKENPAS, M. B. (2004) An integrated modelling framework for carbon management technologies. Volume 1 – Technical Documentation: Amine-Based CO₂ Capture and Storage Systems for Fossil Fuel Power Plant Pittsburgh, Carnegie Mellon University, Centre for Energy and Environmental Studies / Department of Engineering and Public Policy.
- SMELSER, S. C., STOCK, R. M., MCCLEARY, G. J., BOORAS, G. S. & STUART, R. J. (1991) Engineering and Economic Evaluation of CO₂ Removal from Fossil-Fuel-Fired Power Plants.
- VDEW E.V. (2006) Stromwirtschaft investiert in Versorgungssicherheit. VDEW e.V.
- WEGERICH, S., TELÖKEN, I. & TSCHAFFON, H. (2006) COMTES700 – Auf dem Weg zum Kohlekraftwerk mit 50 % Wirkungsgrad. IN TECHNISCHE UNIVERSITÄT DRESDEN, I. F. E. (Ed.) *Kraftwerksbetrieb unter künftigen Rahmenbedingungen*. - 38. *Kraftwerkstechnisches Kolloquium* -. Dresden, Technische Universität Dresden, Institut für Energietechnik.

Session 13 – Hydrogen Economy

Chairman: Søren Linderøth, Risø National Laboratory, Denmark

Durability of Solid Oxide Electrolysis Cells for Hydrogen Production

Anne Hauch, Søren Højgaard Jensen, Sune Dalgaard Ebbesen, Mogens Mogensen

Fuel Cells and Solid State Chemistry Department

Risø National Laboratory, Technical University of Denmark

P.O. box 49, DK-4000 Roskilde

Abstract

In the perspective of the increasing interest in renewable energy and hydrogen economy, the reversible solid oxide cells (SOCs) is a promising technology as it has the potential of providing efficient and cost effective hydrogen production by high temperature electrolysis of steam (HTES). Furthermore development of such electrolysis cells can gain from the results obtained within the R&D of SOFCs. For solid oxide electrolysis cells (SOEC) to become interesting from a technological point of view, cells that are reproducible, high performing and long-term stable need to be developed. In this paper we address some of the perspectives of the SOEC technology i.e. issues such as a potential H₂ production price as low as 0.71 US\$/kg H₂ using SOECs for HTES; is there a possible market for the electrolyzers? and what R&D steps are needed for the realisation of the SOEC technology?

In the experimental part we present electrolysis tests results on SOCs that have been optimized for fuel cell operation but applied for HTES. The SOCs are produced on a pre-pilot scale at Risø National Laboratory. These cells have been shown to have excellent initial electrolysis performance, but the durability of such electrolysis cells are not optimal and examples of results from SOEC tests over several hundreds of hours are given here. The long-term tests have been run at current densities of -0.5 A/cm^2 and -1 A/cm^2 , temperatures of 850°C and 950°C and $p(\text{H}_2\text{O})/p(\text{H}_2)$ of 0.5/0.5 and 0.9/0.1. Long-term degradation rates are shown to be up to 5 times higher for SOECs compared to similar SOFC testing. Furthermore, hydrogen and synthetic fuel production prices are calculated using the experimental results from long-term electrolysis test as input and a short outlook for the future work on SOECs will be given as well.

1 Perspectives

Whether or not there is a market for efficient electrolyzers for production of hydrogen and/or synthesis gas (a mixture of CO and H₂ which is a “precursor” for synthetic fuels such as methane and methanol) is closely related to the following two conditions: 1) restriction of fossil fuel consumption by political means and thereby an increase in energy supply from renewable energy sources and increased interest in hydrogen related energy technologies and 2) if the energy price for fossil fuels is significantly higher than the price for energy from alternative energy sources such as renewable energy from wind, solar and hydropower. Regarding condition 2), economic estimates of production prices for hydrogen and synthetic fuel by high temperature electrolysis is important in order to map the potential of SOECs for hydrogen and synthesis gas production. Furthermore, the economic estimates are closely related to 1) the electricity price and 2) the characteristics of the state-of-the-art (SoA) SOEC especially the following 3 parameters: A) cost of the cells/stacks, B) performance of the SOECs and C) durability of the SOECs.

First, we address the economic assessment of the SOEC technology. Given the assumptions in Table 1 and the initial cell performance shown in Figure 1, the H₂ production cost was found to be 71 US¢/kg H₂, equivalent to 30 \$/barrel crude oil using the higher heating value (HHV) [1]. The CO production cost was found to be 5.6 US¢/kg equivalent to 34 \$/barrel crude oil using the HHV.

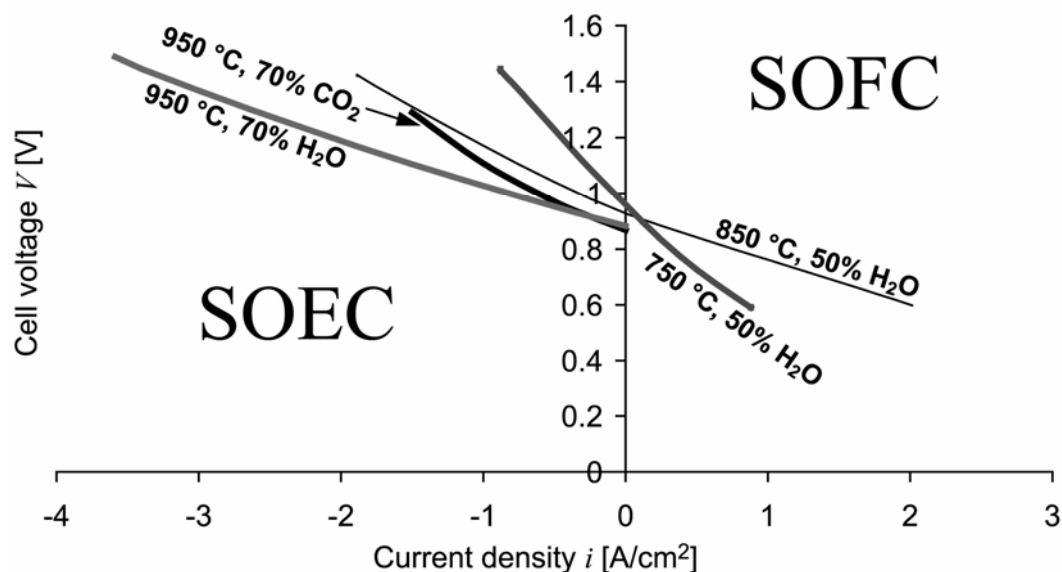

Figure 1: Kinetics of a Risoe SOC working as an electrolyser cell (negative current densities i) and as a fuel cell (positive current densities i) at different temperatures and steam or CO₂ partial pressures in the inlet gas to the cell [1].

Table 1: Cost estimation input parameters

Electricity price	1.3US¢/kWh (3.6US\$/GJ)
Heat price	0.3US¢/kWh
Investment cost	4000 US\$/m ² cell area
Demineralised Water cost	2.3 US\$/m ³
CO ₂ cost	2.3 US\$/ton
Interest rate	5%
Life time	10 years.
Operating activity	50%
Cell temperature	850 °C
Heat reservoir temperature	110 °C
Pressure	0.1 MPa
Cell voltage (H ₂ O electrolysis)	1.29 V
Cell voltage (CO ₂ electrolysis)	1.47 V
Energy loss in heat exchanger	5%
H ₂ O or CO ₂ concentration in inlet gas	95%
H ₂ O or CO ₂ utilization	95%

If heat for steam generation can be provided from a waste heat source, the production price can be lowered even further. For synthetic fuel production, some reduction in the production price may be achieved by utilizing the heat from the catalysis reaction for steam generation. The main part of the production cost for both H₂ and CO is the electricity cost [1]. In Figure 2 is shown the estimated H₂ production cost vs. electricity price at various investment costs.

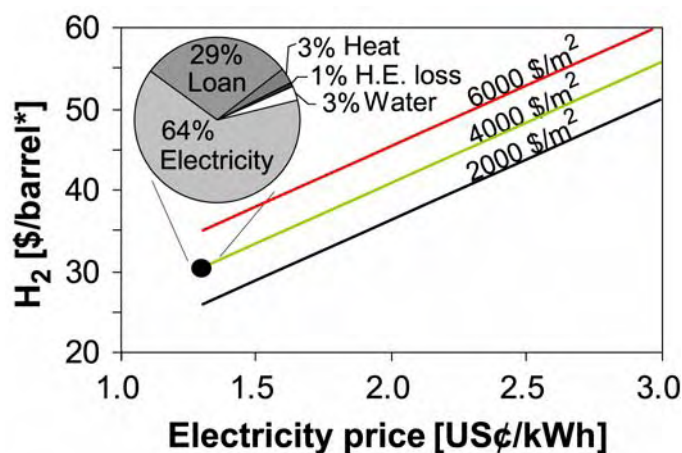

Figure 2: H₂ production cost vs. electricity price at various investment costs. Details on the assumptions for the calculation are specified in Table 1 and Figure 1. The pie diagram shows the parts of the production price. *Production price in equivalent crude oil price per barrel, using the HHV.

In Figure 3 is shown the estimated CO production cost vs. electricity price at various investment costs.

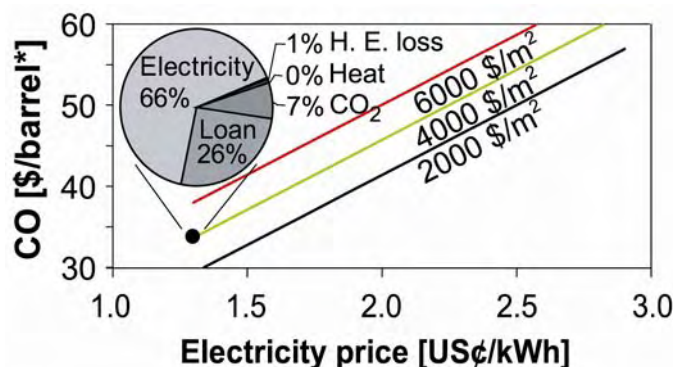

Figure 3: CO cost vs. electricity price at various investment costs. Details on the assumptions for the calculation are specified in Table 1 and Figure 1. The pie diagram show the parts of the production price. *Production price in equivalent crude oil price per barrel, using the HHV.

The H₂O and CO₂ electrolysis reactions becomes increasingly endothermic with temperature, and at 850 °C, 25% and 34% of the energy demand is heat for the H₂O and CO₂ electrolysis reaction, respectively. For this reason, the efficiency from electricity to fuel is more than 90% in the presented calculation, since the Joule heat produced in the SOEC is utilized in the endothermic electrolysis reaction. The calculation does not include heat loss to the surroundings. However, the loss is expected to be limited if properly insulated by cheap materials, such as mineral wool, is used

Secondly, within recent years a huge rise in the number of abnormal weather events has occurred. Meteorologists agree that these exceptional conditions are signs of a Global Climate Change. Scientists agree that the most likely cause of the changes are man-made emissions of the so-called greenhouse gases that trap heat in the earth's atmosphere. Although there are six major groups of gases that contribute to the global climate change, the most common is carbon dioxide (CO₂). For this reason there are much research in sequestration of CO₂ from power plants and other point sources for storage and removal of CO₂. Using SOECs for recycling or reuse of CO₂ from energy systems (or CO₂ capture from air) would therefore be an attractive alternative to storage of CO₂ and would provide CO₂ neutral synthetic hydrocarbon fuels.

Capture of CO₂ for recycling can be achieved by absorption processes employing amines or carbonates as absorbents. The regeneration includes heating of the absorbent; therefore reduction of the energy requirement becomes a determining factor for realizing CO₂ recycling. From the viewpoint of energy saving in regeneration of the absorbent, carbonates are preferable to amine solutions, since the energy requirement for CO₂ removal in the carbonate process is about half of that of the amine process [2]. However the rate for CO₂ absorption and desorption with carbonates is slow, but for CO₂ capture/recycling from air, the absorption and desorption rate may not be a determining factor.

Mineral carbonation has been recognized as a potentially promising route for permanent and safe storage of carbon dioxide, and thereby also a promising route for recycling of CO₂. Both the potentially large CO₂ sequestration capacity and the exothermic nature of the carbonation reactions

involved have contributed to an increasing amount of research on mineral carbonation in recent years [3; 4]. A number of different carbonation process has been reported, of which aqueous mineral carbonation route was selected as the most promising in a recent review [3]. Calcium carbonate is a well known CO₂ absorbent [3]. Also the less known magnesium carbonate or calcium magnesium carbonate can be employed. The required energy for regeneration is a determining factor. Thermodynamic equilibrium calculations (calculated using Factsage 5.5 Software [5] at 1 atm) show that CO₂ capture/recycling using magnesium carbonate can be operated at approximately 400 °C lower than the case for calcium carbonate. A carbon neutral energy cycle utilizing CO₂ capture from air with magnesium carbonate in combination with a fuel cell is sketched in Figure 4. Magnesium carbonate is abundant in nature as calcium magnesium carbonate. A carbonate cycle for CO₂ capture with calcium magnesium carbonate can be operated between 250 °C and 400 °C utilizing magnesium carbonate only. Using only magnesium carbonate from calcium magnesium carbonate, higher amount of minerals would have to be mined and transported.

A carbonate cycle for CO₂ capture/recycling is definitively technically feasible, but the practical and economic aspects regarding calcium carbonate, magnesium carbonate or calcium magnesium carbonate have to be assessed to determine the most suitable absorbent for CO₂ capture/recycling.

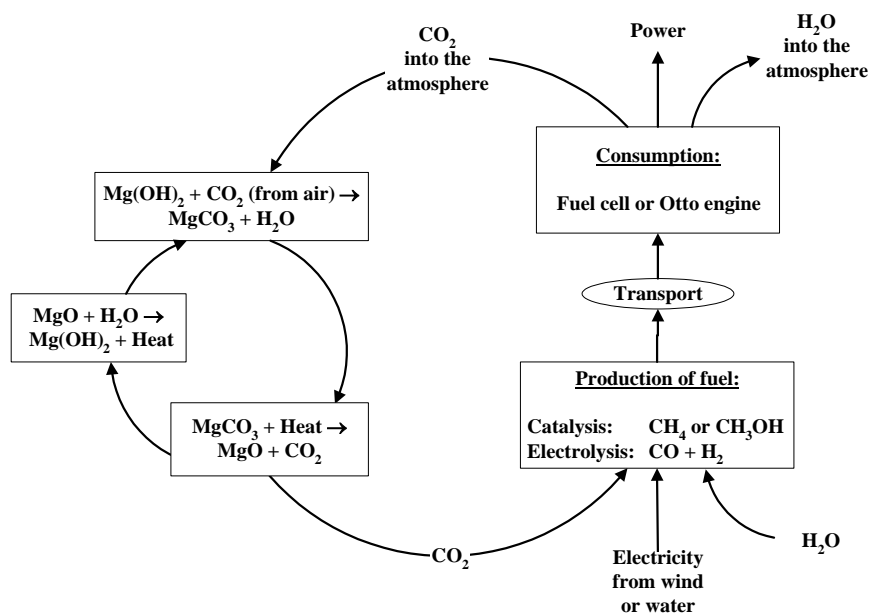

Figure 4: Carbon dioxide neutral energy cycle utilizing CO₂ capture from air with calcium carbonate in combination with a Solid Oxide Electrolysis Cells (SOEC).

Thirdly, the realization of the SOEC technology will depend greatly on the price and performance of SOECs as this in turn influences the hydrogen/synthetic fuel production price. The SOCs produced on a pre-pilot scale at Risoe National Laboratory can be used both as fuel cells and electrolysis cells and can be considered inexpensive due to 1) inexpensive production methods such as tape casting and robot spraying are use [6] and 2) no expensive materials such as noble metals are used for the

cells. Furthermore, the Risoe SOECs have been shown to have an excellent initial performance [1; 7] i.e. a low internal resistance in the cells which in turn contribute to minimize hydrogen/synthetic fuel production prices. The high initial performance of the SOECs clearly shows the potential of the cells. Nevertheless, high initial performance of the cells is a necessary but not sufficient characteristic of the SOECs. The cells need to be long-term stable i.e. keep the high performance (low cell resistance) over thousands of hours of testing. At the time being the durability issue is the critical point for the Risoe SOECs and the topic for further R&D. In the “experimental/result/discussion” sections of this paper results from long-term testing of Risoe SOECs will be given.

2 Theoretical background

The basic operational principle for a SOFC is shown in part A and for a SOEC in part B of Figure 5. In SOFC mode the cell is used to produce electricity by converting the chemical energy in the fuel (H_2) directly to electrical energy. In SOEC mode the input to the cell is steam and electrical energy from an external power supply in order to split water into hydrogen and oxygen. The SOEC also has the capability to electrolyse a mixture of steam and carbon dioxide i.e. it can split CO_2 into CO and O_2 .

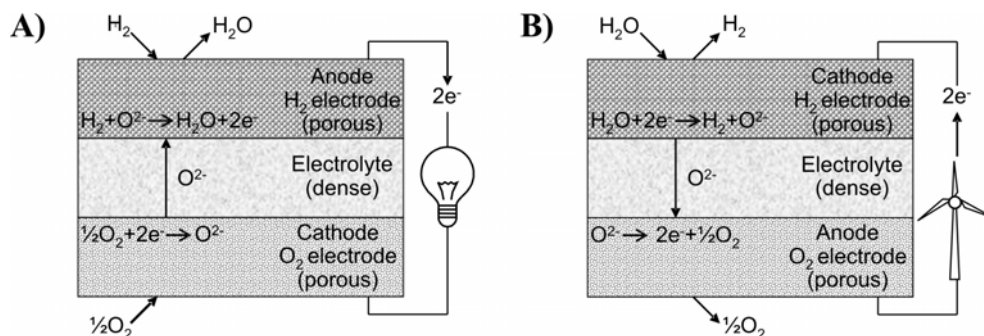

Figure 5: Sketch of the basic operational principle for the SOFC (part A) and the SOEC (part B).

For endothermic reactions such as H_2O and/or CO_2 electrolysis it is, from a thermodynamic point of view advantageous to operate at high temperature as a part of the energy required for water splitting is obtained in the form of high temperature heat e.g. heat from solar concentrators or waste heat from nuclear power plants [8-10]. The high temperature electrolysis using SOEC can therefore be performed with a lower electricity consumption compared to low temperature electrolysis cells [11; 12]. Furthermore, the reaction kinetics is speeded up at high temperature and this in turn lead to a decreased internal resistance of the cell and thereby increased efficiency i.e. lowering the necessary electrical energy consumption to produce a certain quantity of hydrogen or synthetic fuel. Even though it is, from a thermodynamic and electrode kinetic point of view, advantageous to operate the SOECs at high temperature, material durability issues makes an upper limit for the operation temperature. SOEC tests are typically performed in the temperature range from $750^\circ C$ to $950^\circ C$.

3 Experimental

Ni/YSZ supported DK-SOFC cells were used for the electrolysis tests. The cells are full cells produced at Risoe National Laboratory [6; 13]. The SOCs are planar $5 \times 5 \text{ cm}^2$ cells with an active electrode area of 16 cm^2 . Detailed description of the setup and the start-up procedure i.e. heating up and reduction of NiO is given elsewhere [7; 14; 15]. The steam is produced by burning of O_2 and H_2 in the inlet tubing to the cell. The results presented here originate from two electrolysis durability tests that were run galvanostatic. The test conditions are given in Table 2. DC characterization was performed by recording polarization curves (iV-curves) for each of the cells before and after the long-term electrolysis tests. AC characterization was performed by recording electrochemical impedance spectra (EIS) using a Solartron 1260 frequency analyzer [16].

Table 2: Test conditions for long-term galvanostatic electrolysis tests using SOECs.

Test no	Test time (h)	Temp. ($^{\circ}\text{C}$)	$p(\text{H}_2\text{O})/p(\text{H}_2)$	i (A/cm^2)	Steam utiliza.
A	620	950	0.9/0.1	-1.0	53%
B*	1510	850	0.5/0.5	-0.5	27%

*) The glass sealing was pre-treated by leaving test B for 12 days at 90% steam at 950°C prior to reduction of the cell and electrolysis testing.

4 Results

It has been shown previously that the hydrogen electrode supported SOC produced at Risoe National Laboratory have excellent and reproducible initial performance [1; 7]. Two examples of cell voltage curves recorded during electrolysis durability testing of such Risoe cells are shown in Figure 6. The both test an increase in the cell voltage during testing was observed. For SOECs an increase in the cell voltage correspond to an increase in the internal resistance of the cell i.e. a decrease in performance of the SOEC.

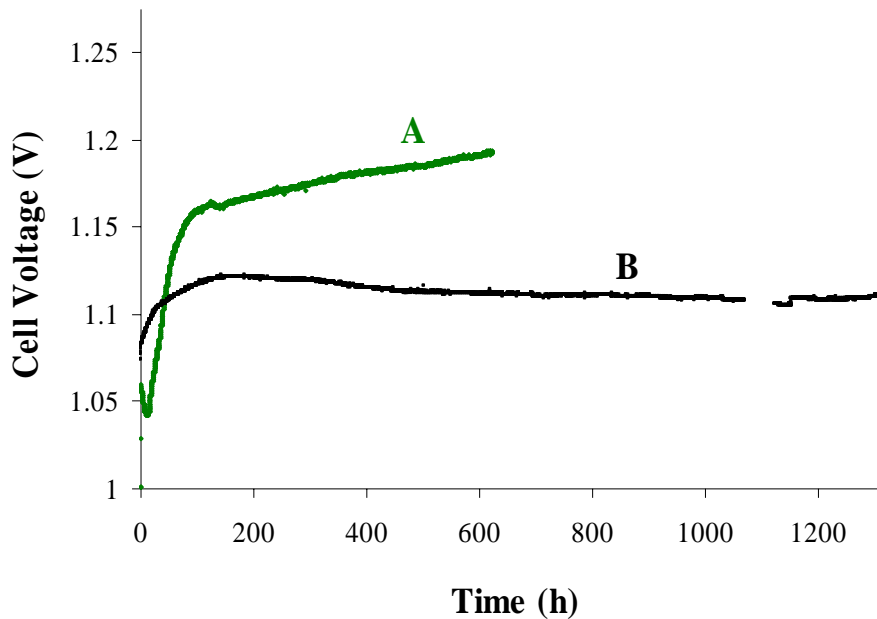

Figure 6: Development of cell voltage during two long-term galvanostatic electrolysis tests. Operation conditions are given in Table 2 and development of the internal cell resistances during electrolysis testing are in Table 3.

For test A the cell voltage increased 134 mV over 620 h of testing and for test B an increase of 35 mV over 1510 h of testing was observed. For test A the internal resistance of the cell increased from $0.22 \Omega\text{cm}^2$ to $0.45 \Omega\text{cm}^2$ but only from $0.26 \Omega\text{cm}^2$ to $0.36 \Omega\text{cm}^2$ for test B (Table 3). The passivation history for test A consists of three parts: 1) a relatively fast initial passivation of more than 100 mV within approx. 100 h, 2) a few mV of activation of the cell i.e. a decrease in cell voltage and 3) a long-term degradation of 65 mV/1000 h. The glass sealing used for test B was pre-treated with 90% H_2O at 950°C for 12 days prior to electrolysis testing and this significantly changed the cell voltage curve of test B compared to test A. An electrolysis test applying the same test conditions as for test B but without pre-treating the glass sealing showed the same general trends as for the cell voltage curve of test A, that is: 1) an initial passivation of cell within the first few hundred hours, 2) a reactivation of the cell and 3) subsequently a long-term degradation (20 mV/1000 h), see [12] for details. For the last 300 hours of test B a degradation of ~ 30 mV/1000 h was observed.

Table 3: Development of cell resistances during long-term galvanostatic electrolysis testing. Resistances were obtained from EIS during electrolysis operation of the cells.

Test no	Time (h)	i (A/cm ²)	Resistance (Ωcm^2)*
A	1	-1.0	0.22
A	610	-1.0	0.45
B	1	-0.5	0.26
B	1510	-0.5	0.36

* The resistances are the sum of the ohmic and polarization resistance obtained by impedance spectroscopy during electrolysis operation of the cells. For both tests only the polarization resistance increased during electrolysis testing.

Examples of polarization curves (iV-curves) before and after the 1510 hours of electrolysis testing for test B is shown in Figure 7. This illustrates the development of the area specific resistance (ASR) of the cell that has occurred as an effect of the 1510 hours of electrolysis testing. Fuel utilization corrected ASR [17] at 0.7 V was 0.17 Ωcm^2 before testing and 0.22 Ωcm^2 after testing for the fuel cell iV-curve recorded with 5% H₂O and 95% H₂ to the hydrogen electrode.

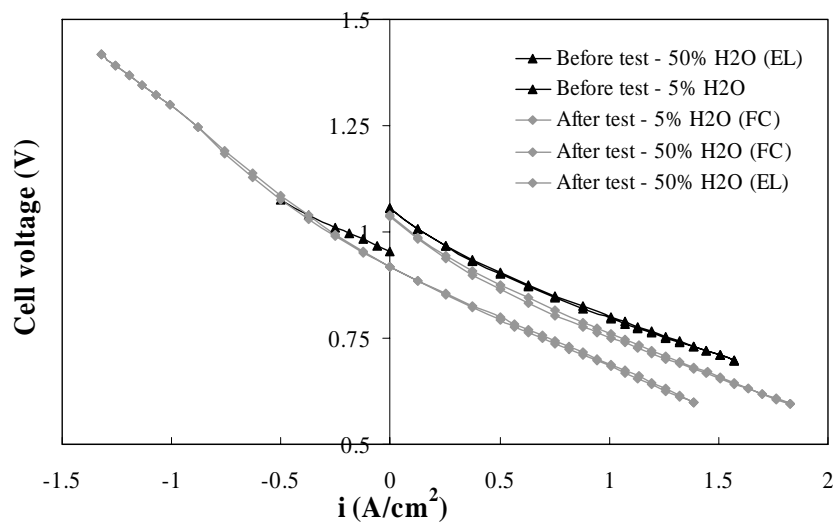

Figure 7: Polarization curves (iV curves) before and after test B at different $p(\text{H}_2\text{O})/p(\text{H}_2)$ ratios. Negative current densities correspond to electrolysis operation of the cell and positive current densities to fuel cell operation of the cell.

The cell performance results obtained during the long-term test B are relevant input data for calculation of the H₂ production price using state-of-the-art SOEC at conditions at which the SOEC has been operated for more than 1500 h. Using Table 1, but with a cell voltage of 1.15 V and 50% H₂O inlet concentration (corresponding to 0.5 A/cm² in the calculation) the H₂ production cost is estimated to be 108 US¢/kg equivalent to 46 \$/barrel crude oil using the HHV.

5 Discussion

In general increasing the $p(\text{H}_2\text{O})$ will speed up the time constant for the “initial” passivation process for the electrolysis tests and increasing the current density – i.e. a higher overpotential - seems to increase the degree of the long-term degradation. The effect of increasing the $p(\text{H}_2\text{O})$ has also been reported in [18] upon changing from 30% to 70% steam as inlet gas and is confirmed by comparison with test A. Seen from a technological point of view it is relevant to notice that tests applying up to 98% of steam has been performed successfully for these SOECs [8; 19]. It has been argued that the significant passivation within the first ~100-200 h of electrolysis testing could be related to silica impurities in the hydrogen electrode and that these impurities can originate from the glass sealing used in the cell test set-up [18]. This was the reason for the pre-treatment of the glass sealing for test B. There is no doubt that the changes for the glass sealing significantly changed the passivation course of the SOEC though a full understanding of the effect of the glass sealing on the passivation history is still a topic for ongoing investigations. Even if we consider the initial “fast” passivation of the SOEC as a sealing related problem and view this as a practicable problem, the long-term degradation of 65 mV/1000 h (~5%/1000 h) and 30 mV/1000 h (~3%/1000 h) for test A and B respectively, obtained from the cell voltage curves for test A and B in Figure 6, are still significantly higher than the degradation obtained for similar cells used for SOFC testing. In SOFC mode the cell degradation at 850°C was below 1%/1000 h measured over 1500 h of test at current densities up to 1 A/cm² [13]. The overall decrease in the cell performance of the SOEC after test is also seen from the ~30% increase in the ASR calculated from the iV-curves recorded before and after test. The long-term degradation mechanism (Figure 6) is not yet understood and a substantial R&D effort is needed for the investigation of this phenomenon to obtain the goal: SOECs that are not only initially high performing – we already have such SOECs – but also high performing in the long-term i.e. for thousands of hours of electrolysis operation!

The durability issue for the SOECs is closely related to the production prices for H₂ and synthetic fuel. For lifetimes above 3-4 years the H₂ production price starts to become relatively independent of the life time [12]. For the CO production price this is about 6 years. The Risoe cells do not yet meet these lifetimes, but reasonable stability for more than 1000 h has been achieved (see Figure 6) and our ongoing research is in this field. Generally, durability seems to be decreasing with increasing current densities, but a quantitative measure is still to come.

6 Conclusion

Economic estimates of production prices for hydrogen and synthetic fuel by high temperature electrolysis of steam and/or carbon dioxide using SOECs give very promising results. Prices down to 4.8 US\$/GJ or 71 UScent/kg H₂ using the HHV of H₂ and the excellent initial electrolysis performance at 950°C for Risoe SOECs as experimental input for the calculations. The long-term

testing of SOECs presented here show a degradation for the SOECs that is approximately 5 times larger than the one for similar cells tested as SOFC at the same temperature and current density. The long-term degradation of the SOECs is ~2-3 times larger for test A (950°C, 90% H₂O, -1 A/cm²) compared to test B (850°C, 50% H₂O, -1/2 A/cm² with and without pre-treatment of the glass sealing prior to test). Using the long-term test results, the H₂ production cost is estimated to be 108 US¢/kg equivalent to 46 \$/barrel crude oil using the HHV.

7 Outlook

Comparing the present world market oil prices with the estimated hydrogen production prices based on our experimental SOEC results, it is clear that the SOEC technology has the potential for price competitive hydrogen and synthetic fuel production; especially where inexpensive electricity from for instance renewable energy sources such as wind energy (e.g. Denmark) or hydro power systems (e.g. Iceland and Norway) is available or in combination with nuclear power plant where excess high temperature heat is available (e.g. France, Belgium, USA).

To realize the obvious potential of the SOEC technology a substantial R&D effort is necessary. The SoA Risoe SOECs are initially high performing and inexpensive production methods are used; however the durability of the cells needs to be increased significantly and this is the focus in the present SOEC work. Furthermore, work on SOEC stacks has been initiated and in a longer perspective, if the interest of today in hydrogen and renewable energy technologies is maintained for the next ~10 years, R&D work will be needed to integrate the SOEC stacks into the existing energy grid for instance in order to optimize the efficiency of and energy supply from wind energy.

Acknowledgement

The authors acknowledge the EC for the financial support via the project Hi2H2 (contract no FP6-503765).

Reference List

1. Jensen, S. H., Larsen, P. H., and Mogensen, M. *International Journal of Hydrogen Energy*; (In press) (2007).
2. G.Astarita, D.W.Savage and A.Bishio. *Gas Treating with Chemical Solvents*, John Wiley & Sons, (1983).
3. W.J.J.Huijgen and R.N.J.Comans. *Carbon dioxide storage by mineral carbonation*, Cheltenham, United Kingdom, (2005).
4. B.Metz, O.Davidson, H.de Coninck, M.Loos and L.Meyer. *Carbon capture and storage*, Cambridge University Press, Cambridge, United Kingdom and New York, NY, USA., (2005).

5. C.W.Bale, P.Chartrand, S.A.Degterov, G.Eriksson, K.Hack, R.Ben Mahfoud, J.Melançon, A.D.Pelton and S.Petersen. *FactSage Thermochemical Software and Databases*, CRCT - Center for Research in Computational Thermochemistry École Polytechnique (Université de Montréal), Box 6079, Station Downtown, Montréal, Québec, CANADA and GTT-Technologies, Kaiserstrasse 100, 52134 Herzogenrath, GERMANY, (2002).
6. Larsen, P. H., Bagger, C., Linderoth, S., Mogensen, M., Primdahl, S., Jorgensen, M. J., Hendriksen, P. V., Kindl, B., Bonanos, N., Poulsen, F. W., and Maegaard, K. A. *Proceedings - Electrochemical Society*; **2001-16** (Solid Oxide Fuel Cells VII), p. 28-37 (2001).
7. Hauch, A, Jensen, S. H., Mogensen, M., and Ramousse, S. *Journal of the Electrochemical Society*; **153** (9), p. A1741-A1747 (2006).
8. A.Hauch. L.Soenderberg Petersen and H.Larsen. *Risoe International Energy Conference 23-25 May 2005*; (2005). Roskilde, Denmark, Risoe National Laboratory. 23-5-2005.
9. Yidiz, B. and Kazimi, M. S. *International Journal of Hydrogen Energy*; **31** (1), p. 77-92 (2006).
10. J.E.O'Brien, C.M.Stoots, J.S.Herring, P.A.Lessing, J.J.Hartvigsen, and S.Elangovan. *Proceedings of ICONE12, 12th International Conference on Nuclear Engineering*; (2004). Virginia, USA.
11. M.Mogensen, S.H.Jensen, A.Hauch, I.Chorkendorff, and T.Jacobsen. *Proceedings 7th European SOFC Forum*; (2006). Lucerne.
12. Jensen SH. *Solid oxide electrolyser cell* (Thesis). Risoe National Laboratory, Denmark, 2006. ISBN 1399-2236
13. Hagen A, Barfod R, Hendriksen PV, Liu YL and Ramousse S. *Journal of the Electrochemical Society*, **153**, p. A1165-A1171 (2006).
14. R.Barfod. S.Koch, Y.-L.Liu, P.H.Larsen, and P.V.Henriksen. *SOFC VIII*; p. 1158-1166 (2003). Pennington, NJ, USA, The Electrochemical Society Inc. PV 2003-07. S.C.Singhal and M.Dokiya.
15. M.Mogensen and P.V.Henriksen, in *High temperature solid oxide fuel cells - Fundamentals, design and applications*, p. 261-289. Elsevier, London (2003).
16. J.Ross Macdonald and E.Barsoukov. *Impedance Spectroscopy. Theory, Experiment, and Applications*, John Wiley & Sons, Inc., Hoboken, US (2005).
17. Mogensen M and Hendriksen PV, in *High temperature solid oxide fuel cells - Fundamentals, design and applications*, edited by Singhal SC and Kendall K. p. 261-289. Elsevier, London (2003).
18. Hauch, A, Jensen, S. H., Mogensen, M., and Bilde-Sørensen, J. B. *Journal of the Electrochemical Society*; **154** (7), p. A619-A626 (2007).
19. A.Hauch. S.H.Jensen and M.Mogensen. *Proceedings of the 26th Risoe International Symposium on Materials Science*; (2005). Roskilde, Denmark, Risoe National Laboratory. S.Linderoth.

HYAPPROVAL – HANDBOOK FOR THE APPROVAL OF HYDROGEN REFUELLING STATIONS – FIRST PRELIMINARY ACHIEVEMENTS

Reinhold Wurster – Ludwig-Bölkow-Systemtechnik GmbH

Guy Vandendungen – Hydrogenics Europe N.V.

Jérôme Guichard – Air Liquide Division des Techniques Avancées

Menso Molag – Netherlands Organisation for Applied Scientific Research (TNO)

James Barron – Shell Hydrogen B.V.

Marieke Reijalt – Federazione delle Associazioni Scientifiche e Tecniche (FAST)

Horst Jürgen Hill – GM/Adam Opel GmbH

Hubert Landinger – Ludwig-Bölkow-Systemtechnik GmbH

Corresponding author: Reinhold Wurster, Ludwig-Bölkow-Systemtechnik GmbH,
Daimlerstrasse 15, 85521 Ottobrunn, Germany
e-mail: wurster@lbt.de
tel.: +49/89/608110-33

Number of Tables: 1

Number of Figures: 2

Abstract

The EU-funded project HyApproval [www.hyapproval.org] aims at developing a universal Handbook to facilitate the approval process of Hydrogen Refuelling Stations (HRS) in Europe. The main goal of the HyApproval partnership with 22 partners from Europe and one each from China, Japan and the USA is to provide a Handbook of technical and regulatory requirements to assist authorisation officials, companies and organisations in the safe implementation and operation of HRS.

Achievements during the first 15 months: analyses of HRS technology concepts and of equipment and safety distances/ Intermediate Design Paper/ Regulations, Codes & Standards (RCS) review and comparison/ first Handbook draft and first review sessions with HySafe experts/ safety matrix/ identification of accident scenarios/ agreement on safety documentation/ critical review of reliability data from collections and risk studies/ risk assessment (RA) criteria definition and RA/ matrix of acceptability and awareness levels/ database of Fire Associations & First Responders/ calendar of hydrogen events/ general description of CGH₂ interfaces.

Introduction

Hydrogen already plays a significant role in the world's energy economy, but this role is almost exclusively as a raw material for the chemical industry; hydrogen is rarely used as a fuel - except in space programs. The use of hydrogen as a fuel in the utility and transportation sector faces hurdles that need to be overcome in the transition to a hydrogen utilising energy economy. Besides the lack of a hydrogen supply infrastructure, neither simplified and harmonised approval procedures for HRS nor a uniform "guidance" for their approval exist.

Wider scale application of hydrogen technologies for automotive applications will most likely not gain momentum beyond single demonstration activities before 2010-2012 on a world scale. Therefore the coming years can be utilised to efficiently develop the necessary regulatory framework and industry standards in parallel to the emerging hydrogen technologies and to make them available in a timely manner.

A widespread HRS network will require that layout, installation, approval and operation of HRS are simplified and harmonised. This includes the development of compatible regulations, codes (e.g. minimum safe set-back distances) and standards (e.g. the same couplings for dispensing the same type of fuel).

The objectives of HyApproval are

- to finalise the HRS draft guideline document started under EIHP2 (European Integrated Hydrogen Project) and to be pursued under ISO TC197, WG 11 addressing global recommendations to the technology providers and representing the initial basis for developing a Handbook for the approval of HRS, and
- to come up with a Handbook which assists all gas technology companies, fuel retailers/ HRS operators and the relevant approval authorities in laying out, installing, approving and operating HRS for CGH₂ and/or LH₂ on an EU-wide level, with the potential to also apply it to non-EU regions.

The HyApproval Handbook Approach

Intermediate Design Paper (IDP): The intention is to have a uniform structure of IDP and Handbook in order to identify gaps, which will not be covered by the IDP. These gaps need to be filled after the first revision of the draft Handbook which will be circulated back to WP 1. Based on that work, the final design paper (FDP) will be worked out and handed back to WP 2 for writing the second and final version of the Handbook. The design paper contains the following chapters: Executive summary, Introduction, Recommendation for an EU25 unified approval process of HRS, Terms and definitions, Properties of hydrogen, Basics of hydrogen dispensing, HRS design and construction requirements, Recommended technical and safety requirements concerning HRS layout, Codes and standards affecting design, installation, operation & maintenance of an HRS, Safety methodologies relevant to HRS approval, Vehicle requirements, Case study: uniformly accepted (virtual) HRS design and layout and Country specific issues.

The Handbook: The HyApproval project aims to develop a uniform approach to install and approve HRS all over Europe as well as trying to find an acceptable unique definition of a “European” refuelling station, which could be installed without modifications in most of the EU25 countries.

In order to achieve these goals an EU wide approach has to be implemented first by developing an EU draft guideline (which was initiated during the EIHP2 project – see above reflected in the IDP) and then by compiling recommendations, good practices and showcases in a Handbook which could serve as a working document to help and support authorities to deliver permits to install HRS in Europe. The main effort of this exercise will be to ensure that the different countries where the “generic” HRS are installed can converge towards a uniform approach on how to approve an HRS or a uniform acceptable technical solution (safety distances, technical layout, operation etc.). This will allow infrastructure companies in the future to develop non-country specific products and at least an EU uniform HRS layout to install them. The Handbook will ensure the technical coordination between the different analysed implementation settings considered once the definition of the HRS is finalised, and will take care that essential parts of the layout are uniform, whatever the country. This coordination will be made with the support of the country “leaders” in France, Spain, The Netherlands, Germany and Italy. The Chinese specific issues will also be presented. Potential gaps between the HRS approval processes in the various countries will be analysed in the final version of the Handbook.

The development of the Handbook in a first step will not include country specific requirements, but only “good engineering practices” from the partners, which are recognised experts in refuelling stations and hydrogen. The first results of the safety WP will be used to justify the different choices made for technology, design and safety distances of each single showcase. The Handbook will be first circulated for comments amongst the partners. The Handbook furthermore will undergo review sessions with experts of the EC co-funded project HySafe. The consolidated Handbook integrating these findings then will be distributed to local authorities in charge of delivering permits of installation of HRS for comments. The results obtained from the interview protocols will be summarised and integrated in the last version of the Handbook to be delivered at the end of the HyApproval project.

Safety Related Issues of Hydrogen Refuelling Stations

Agreement on risk assessment approach: *The risk assessment methodology used can be divided into five main steps:*

1. preliminary work where HyApproval WP 4 Partners agreed on the study basis and different parameters to be taken into account, the main components of an HRS and the HRS size,
2. risk analysis to identify scenarios and to highlight safety measures,
3. scenario ranking according to severity and probability,
4. quantification of selected scenarios:
 - The quantified evaluation of non-mitigated scenarios will enable the assessment of the hazards potential of HRSs’ as well as the usefulness of the proposed safety equipment.
 - The quantified evaluation of mitigated scenarios will contribute to demonstrate that residual risks are tolerable.and finally
5. the agreement on risk acceptance criteria and acceptable scenarios.

Critical review of reliability data from collections and risk studies: Availability of relevant, high quality reliability data is important for risk studies and consequently for cost efficient installation, operation and general risk management of hydrogen installations and applications. When relevant reliability data is lacking, this increases the uncertainty and decreases the accuracy of risk studies. This is relevant as hydrogen installations in many ways behave differently compared to ‘conventional’ and well known installations. Good reliability data is also very useful to determine and optimise maintenance schedules for safe operation of installations.

As a general conclusion, the identification and review of databases for reliability data showed that reliability data for hydrogen applications are lacking. Hence, it was suggested to initiate a project for this purpose in line with what has been done for non-hydrogen equipment and systems. Details of the suggested approach are outlined in (1).

Risk assessment objectives and scope: The risk assessment objective is to identify dangerous situations, to assess their probability and severity to rank them, but above all, to point out prevention and protection means to control risks.

The risk assessment methodology is based on a preliminary risk analysis. Causes and consequences based on the identification of hazardous situations (defined as situation, if not monitored, that can lead to dangerous phenomena and damage to targets) were listed.

The accident scenarios for compressed gaseous HRS (CGH₂) and liquid HRS (LH₂) were identified during workshops gathering HyApproval partners. The HRS was divided into several functional components related to the main equipment of a CGH₂ or an LH₂ station. The complete station was also addressed to consider potential external constraints on the HRS.

Risk assessment and safety matrix: Safety functions were identified for each accident scenario and the associated technical and/or organisational barriers to be implemented in prevention and/or protection were listed as well. The occurrence probability of each cause and the consequence severity of each accident scenario, without and with considering the prevention and protection means, were ranked according to agreed ranking scales taken from the EIHP2 project (2). The severity was ranked according to the release hole size, the quantity of hydrogen released and also the type of dangerous phenomena involved. The pair probability / severity enabled to determine the risk levels of the different accident scenarios. The risk level associated with an accident helps to decide whether further mitigation is necessary. Both severity and probability tables cover range wide enough to rank both high frequency / low severity scenarios (internal safety, customer safety) as well as low frequency / high severity (external safety, land use planning).

Identification of accident scenarios: The main hazardous phenomena for a CGH₂ and an LH₂ station are:

- an explosion in case of late ignition (it requires gas to accumulate inside a container),
- a jet flame in case of an early ignition (when for example, release temperature is above auto-ignition temperature) and
- a burst of a pressurised equipment where flammable gas is processed.

The main specific hazardous phenomena when handling liquid hydrogen are:

- Boiling Liquid Expanding Vapour Explosion (BLEVE) of the above ground storage,
- pressurisation of the inner and/or outer vessel,
- catastrophic inner/outer vessel burst and
- explosion or fire of the storage vessel.

Among all the scenarios that were identified, some of them were selected to be modelled, especially to assess the benefit and the sufficiency of some proposed safety barriers in terms of hazard potential reduction. The selection of scenarios relevant for external safety and customer safety issues was based on the following criteria: release orifice / hole size class, pressure at release orifice, quantity of product potentially released, location of the release.

Consequently, the following scenarios to be modelled were selected for the external safety and for the customer safety.

Type of scenarios to be modelled	Type of HRS	Equipment	Scenario
External safety	Compressed gas	H ₂ production	Rupture of the NG feed line
		H ₂ storage	Rupture of H ₂ buffer storage output line
			Burst of hydrogen tank
		Dispenser	Rupture of dispensing line (flexible hose)
	Liquid	H ₂ delivery	Trailer hose disconnection during refilling
		H ₂ storage	Below ground storage failure (with vault)
Dispenser		Shear of the hose line	
Customer safety	Compressed gas	Dispenser	Leakage inside the dispenser enclosure
			Hole in dispensing line
			Leakage at nozzle during refuelling
	Liquid	Dispenser	Leakage at nozzle during refuelling

Table 1: Selected scenarios for modelling

Risk assessment (RA) criteria definition and RA: The document on *Risk Analysis of Hydrogen Refuelling Station – Assumptions and Study Basis* (3) comprises a compilation of the main assumptions made as part of the Risk Analysis of an HRS performed as part of the HyApproval project. The validity of the input compiled in this document will have large impact on the results of the Risk Analysis, and as such was intended to be verified by the HyApproval project during the assessment.

The document *Guidance for Safety Aspects of Hydrogen Infrastructure Projects* (4) outlines on 'Required and Preliminary Safety Plans' including

- 'Identification of Safety Vulnerabilities (ISV)' and 'Safety Risk Assessment',
- 'Outline of the Risk Mitigation Plan' (description of how safety performance will be measured and monitored/ description of method to establish and maintain safety documentation/ description of standard operating procedures/ description of employee training/ description of procedures to ensure equipment integrity/ description of an emergency response plan) and
- 'Outline for the Communications Plan',

as well as on 'Safety Plan Preparation' including

- 'Identification of Safety Vulnerabilities'/ risk assessment studies (FMEA, "what if" analysis, HAZOP, checklist analysis, fault tree analysis, event tree analysis, probabilistic risk assessment),
- 'Risk Mitigation Plan' (safety performance measurement and management of change reviews/ employee training/ procedures to ensure equipment integrity) and
- 'Communications Plan'.

General description of CGH₂ and LH₂ interfaces: In the IDP the interfaces and construction requirements for gaseous and liquid hydrogen supply systems were condensed by WP 1. This includes requirements with regard to electrical installations, pipelines, venting, material selection criteria, insulation, instruments and emergency conditions.

This covers underground, above ground as well as canopy mounted systems, to allow end-users to get a clear understanding of the requirements for an HRS.

The interfaces that need to be considered between the HRS and the vehicle are also discussed and outlined, but need to be further elaborated in the Final Design Paper (FDP).

In contrast to conventional refuelling stations HRS require hermetically sealed interfaces between tank, dispenser, and vehicle storage tank. This affects e.g. the dimensioning of the receptacles, the filling procedures, and the processes. Examples are:

- For CGH₂ a temperature monitoring of the vehicle tank is necessary either due to the use of composite tanks (limitation of operating temperature) and/or due to the aim of achieving a maximum fill-up. Fast-fill as well as non-communication refuelling scenarios need to be considered.
- For LH₂ (cryogenic refuelling) the gaseous back-flow from the vehicle tank must be enabled to ensure a fast-fill process within a closed system when no pressure increase during refuelling is allowed.

Together with the partners involved the interface descriptions, data exchange and refuelling procedures for LH₂ and CGH₂ vehicles were validated in order to come up with a standardisation for the data interface and the receptacle (receptacle geometry defines also the nozzle geometry).

Standards were written for the CHG₂ 35MPa receptacle. The document SAE J2600 is available and harmonized.

For 70MPa refuelling a technical information report (TIR) specifying a guideline for the hardware requirements considering refuelling of a hydrogen vehicle with 70MPa is also available. This SAE TRI J2799 is intended to be utilized for hydrogen field evaluations until substantial information could be gathered enabling a standardisation process.

The receptacle section of this TIR has to be re-evaluated in approx. 2 years utilizing international field data and subsequently superseded by J2600 in the 2009 timeframe. The communication section of this TIR has also to be re-evaluated utilizing field data and also subsequently superseded by J2600. It is anticipated that communication protocol and hardware could be standardized in 2009.

timeframe mentioned above. The SAE TIR J2799 is supported by all OEM's.



Figure 1: 70MPa coupling

For LH₂ refuelling a SAE TIR J2783 is available. SAE TIR J2783 applies to design, safety and operation verification of Liquid Hydrogen Surface Vehicle (LHSV) refuelling connection devices. This document is to be re-evaluated utilizing international field data. It describes the receptacle geometry design and therefore also defines the nozzle geometry. The SAE TIR J2783 is going to be standardized within a 2 years timeframe.



Figure 2: LH₂ coupling

Analyses of HRS technology concepts, equipment and safety distances: WP 1 has performed a review of some of the already existing and operated HRS's. The technology concepts of the stations have been compared (equipment, technology, location, area, dispensing capacity etc.).

Also, the safety features of the station (overall approach, safety distances, safety equipment, applied approval procedure, applied standards, shut down philosophy, physical safety features) have been collected and summarized. Finally, the safety distances arising from various standards have been compared (NFPA 50 A, EIGA IGC 15/05, GB 4962-85) and their impact has been analysed.

Review of available Regulations, Codes & Standards and Industry Best Practices for HRS: For the purpose of satisfying public safety issues, existing HRS's have been built to a number of different RCS, primarily based on specific national and local requirements. Some RCS have been derived from experiences with CNG industry. International RCS (e.g. ISO) are presently still under development.

WP 4 has undertaken a review of existing RCS and relevant technical references or guidelines that make use of recognised Industry Best Practices to set safety standards to design and construct HRS's and have identified the following as applicable:

- EU Regulations e.g. Pressure Equipment Directives, ATEX Directives
- Hydrogen ISO standards/ drafts related to hydrogen
- Guidance documents e.g. NASA Safety Standard for Hydrogen and Hydrogen Systems

- International/ national/ industry codes of practice related to HRS safety e.g. NFPA, EIGA, EIHP2, ENAA Technical Guideline for HRS

There are a number of existing RCS and that are applicable and relevant to be considered for the HyApproval Project. WP 4 activities will continue to monitor the ongoing development of RCS, industry best practices and safety studies and input to the Handbook development as applicable.

Interaction with Fire Associations & First Responders

In order to improve the format of the dissemination activities and the Handbook itself, WP 5, responsible for dissemination, prepared an additional question on suggested formats which was inserted into the questionnaire developed in WP 3 addressed to authorisation officials, fire brigades and first responders.

During the first year of the project, several preliminary workshops at fire brigade events were organised to present the project and to ask for feedback. HyApproval conducted presentations in 2006 and 2007 to the "Einsatz Taktika", organised annually in February in Salzburg by the Hamburg fire brigade for German speaking fire brigades in Europe. As a result of the presentations the German fire brigades have created a platform to train fire brigades in the handling of hydrogen. A seminar was conducted at the H2Expo in Hamburg on 26 October 2006 that addressed an audience of more than 25 fire and emergency response officials. A dedicated seminar was organised on 30 November 2006 for the Belgian authorities and meetings with the Belgian Ministry of the Interior are planned to present the final draft of the Handbook with suggestions for possible action. On 09 February 2007 a workshop was held for Italian fire brigade officials in which the first draft of the Handbook was presented and specific feedback on Italian authorisation needs was requested. In collaboration with national association members of the European Hydrogen Association preliminary workshops to present the draft Handbook are planned for France, Germany, UK, Norway, Sweden, Portugal, Spain, Hungary and Poland.

Conclusions

HyApproval for the first time tries to come up with a Europe-wide harmonised Handbook enabling a uniform approval process for HRS's. Consulted authorities and technology and safety experts/companies support this approach through their involvement in drafting respectively in commenting the Handbook. Also the refuelling interfaces and processes will be harmonised via consideration of the requirements of global automotive industry. Through the involvement of Chinese, Japanese and U.S. partners a global outreach of this endeavour will be ensured.

References

1. HyApproval Deliverable D4.4 (Public): Identification and Review of Databases for Reliability Data, 18 May 2006 by DNV (Funnemark, E.; Eldor, J.E.; Haugom, G.P.) with contributions from HSL, Hydro and JRC
2. Risk assessment of hydrogen refuelling stations concepts base on onsite production, S. Nilsen et al, EIHP2 project
3. HyApproval Deliverable D4.9 (Internal): Quantitative risk assessment of hydrogen refuelling stations with on-site production (WP4, ST3), Appendix A: Risk Analysis of Hydrogen Refuelling Station – Assumptions and Study Basis, 23 February 2007 by DNV (Holmefjord, K.; Haugom G.P.)
4. HyApproval Deliverable D4.7 Safety documentation for Handbook & Deliverable D4.10 Agreement on safety documentation (Public): Guidance for Safety Aspects of Hydrogen Infrastructure Projects, 24 November 2006 by Shell Hydrogen B.V. with contributions from ENI and Hydro

Acknowledgement

HyApproval is a Specific Targeted Research or Innovation Project (STREP) funded by the European Commission (EC) under the 6th Framework Programme [contract N° 019813].

Session 14 – Fuel Cells

Chairman: Knud Pedersen, DONG Energy, Denmark

Use of Alternative Fuels in Solid Oxide Fuel Cells

Anke Hagen

Fuel Cells and Solid State Chemistry Department, Risø National Laboratory, Technical University of Denmark

Frederiksborgvej 399, DK-4000 Roskilde, Denmark, anke.hagen@risoe.dk

Abstract

A future sustainable energy system will certainly be based on a variety of environmentally benign energy production technologies. Fuel cells can be a key element in this scenario. One of the fuel cells types – the solid oxide fuel cell (SOFC) – has a number of advantages that places them in a favorable position: high efficiency, parallel production of electricity and high value heat, prevention of NO_x emission, flexibility regarding usable fuels, and certain tolerance towards impurities. It is thus a natural option, to combine such a highly efficient energy conversion tool with a sustainable fuel supply.

In the present contribution, the use of alternative compared to conventional fuels in SOFCs was evaluated. Regarding carbon containing, biomass derived fuels, SOFCs showed excellent power output and stability behavior during long-term testing under technologically relevant conditions. Moreover, ammonia can be used directly as fuel. The chemical and structural properties of the SOFC anode makes it even possible, to combine a chemical conversion of the fuel, for example methane into synthesis gas via steam reforming and decomposition of ammonia into hydrogen and nitrogen, with the electrochemical production of electricity in one step.

1 Introduction

Fuel cells convert the chemical energy bound in a fuel directly into electrical energy, which allows for a higher efficiency than that of conventional power generation systems, for example combustion engines. Solid oxide fuel cells (SOFCs) are one type of fuel cells, where the electrolyte is a solid oxide. The operating temperatures for the currently most developed SOFCs are around 800 °C. The working principle is schematically shown in Fig. 1. Oxygen from air is reduced to oxygen ions at the cathode that are transported through the ceramic electrolyte. At the anode side they combine with the

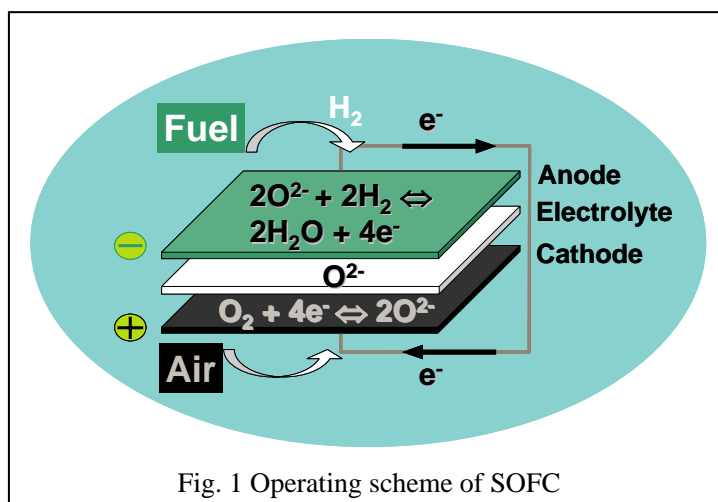

oxidized fuel ions (e.g., protons from hydrogen to give water) thereby producing heat. The freed electrons travel through an outer circuit back to the cathode.

In SOFC technology, the usability of the surplus heat gives an extra increase of the total efficiency. In addition, the high operating temperatures around 800 °C make SOFCs more flexible with regard to potential fuels and more tolerant against impurities; for example CO, which is a poison for proton exchange membrane (PEM) fuel cells working around 100 °C, is a fuel for SOFCs. Consequently, SOFCs can operate on carbon based fuels as well, e.g., synthesis gas derived from either conventional sources such as natural oil and natural gas or from alternative sources such as biomass. Furthermore, methane can be used directly as fuel as the anode of the SOFC acts as reforming catalyst, producing synthesis gas inside the cell, in parallel with the production of electricity and heat.

The application of SOFCs can decrease the emission of CO₂ as the system uses carbon based fuels more efficiently. In addition, the concentrated formation of CO₂ at the anode side of the SOFC makes CO₂ sequestration an option.

The current energy supply system is still mainly based on conventional – fossil - fuels. There are, however, a number of environmental, political, and economic driving forces towards more sustainability such as the limited natural resources, the increasing prices of fossil fuels, environmental impacts, and the security of energy supply. Here the use of fuels derived from sustainable sources (alternative fuels), for example from biomass conversion, is an attractive option. Such fuels rise of course new challenges due to their variety and variation of compositions.

In the following presentation, the focus will be on the use of alternative fuels - understood as the counterpart to conventional fuels based on fossil natural resources – in SOFCs. Biomass derived fuels are interesting options as they provide a closed CO₂ circle. A number of technologies have been developed yielding different potential fuels for an SOFC (see Fig. 2 for some suggestions). From this variety of options, biosyngas, and bioethanol were selected and will be subject in this presentation. Furthermore, ammonia will be considered as well.

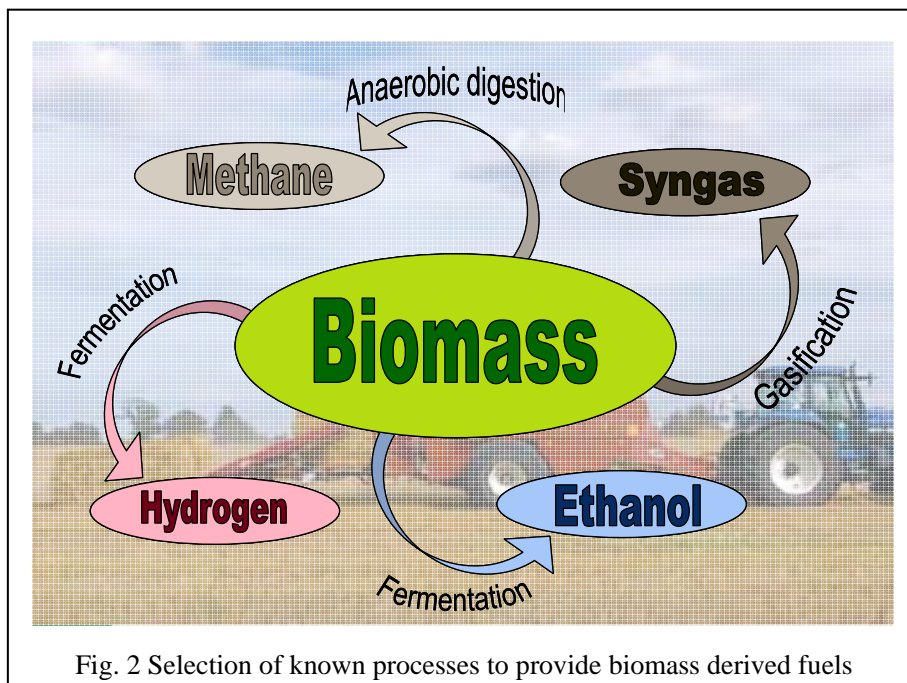

Fig. 2 Selection of known processes to provide biomass derived fuels

2 Experimental

The SOFCs used for these studies were anode supported, planar SOFCs based on a Ni/YSZ (YSZ: yttria stabilized zirconia) anode support and active anode, a YSZ electrolyte, and a LSM/YSZ (LSM: lanthanum strontium manganite) cathode. The layers are ca. 300, 10, 10, and 20 μm thick, respectively (see Fig. 3). These cells are currently fabricated at Risø at about 12000 cells per year.

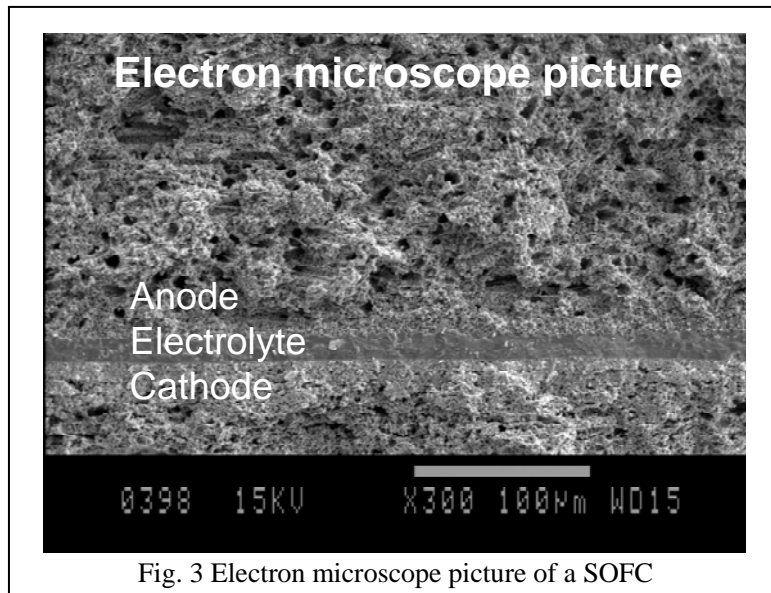

Fig. 3 Electron microscope picture of a SOFC

For testing, the cells were placed in a ceramic testing house and sandwiched between gas distribution and current collection layers as schematically shown in Fig. 4. Air is provided at the cathode side and a fuel at the anode via mass flow controllers. Glass ceramic seals prohibit direct mixture of air and fuel in the test house compartment and thus a lowering of the power output. The testing house is equipped with probes for measuring the cell voltage, current, temperature, and partial oxygen pressures of the incoming and outgoing fuel. In order to analyse gas compositions, a mass spectrometer was connected to fuel inlet or outlet. The effect of impurities in the fuel was studied by adding hydrogen sulfide to the fuel in varying amounts.

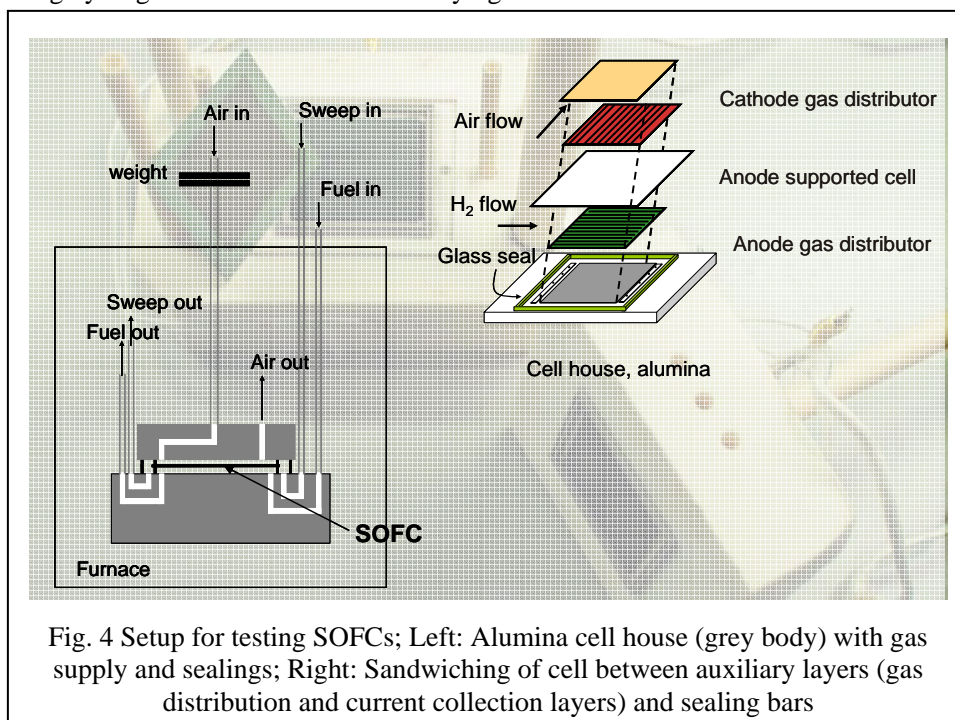
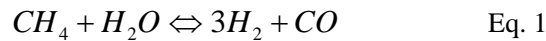

Fig. 4 Setup for testing SOFCs; Left: Alumina cell house (grey body) with gas supply and sealings; Right: Sandwiching of cell between auxiliary layers (gas distribution and current collection layers) and sealing bars

3 Results and Discussion

3.1 Carbon containing fuels in SOFCs

Fuels derived from organic sources usually contain a mixture of methane or other hydrocarbons, water, hydrogen, and carbon oxides. Two of these compounds can be regarded direct fuels for a SOFC: hydrogen - H_2 and carbon oxide - CO . The others are diluents (CO_2) or can be converted to H_2 and CO , for example via reforming of hydrocarbons with steam. If it is possible to accomplish reforming or partial oxidation, no general limits regarding useable hydrocarbons exist. Reforming is a well established process, which is usually performed on nickel containing catalysts. The main reaction under steam reforming is:



The SOFC anode also contains nickel and is known to catalyze reforming similar to the industrial catalytic process. The catalytic activity of the SOFC was tested by analyzing incoming and outgoing fuel gas composition by a MS spectrometer (see Fig. 5). Before entering the SOFC anode (at the inlet) methane is detected, whereas hydrogen and carbon oxide were found at the outlet. The reforming reaction (Eq. 1) proceeds thus entirely during passage over SOFC anode and not already in the heated pipes before the fuel cell. It is thus possible, to use hydrocarbon/water mixtures directly, with no extra – pre-reforming step or alternatively with pre-reforming if that solution complies better with the overall SOFC-system design.

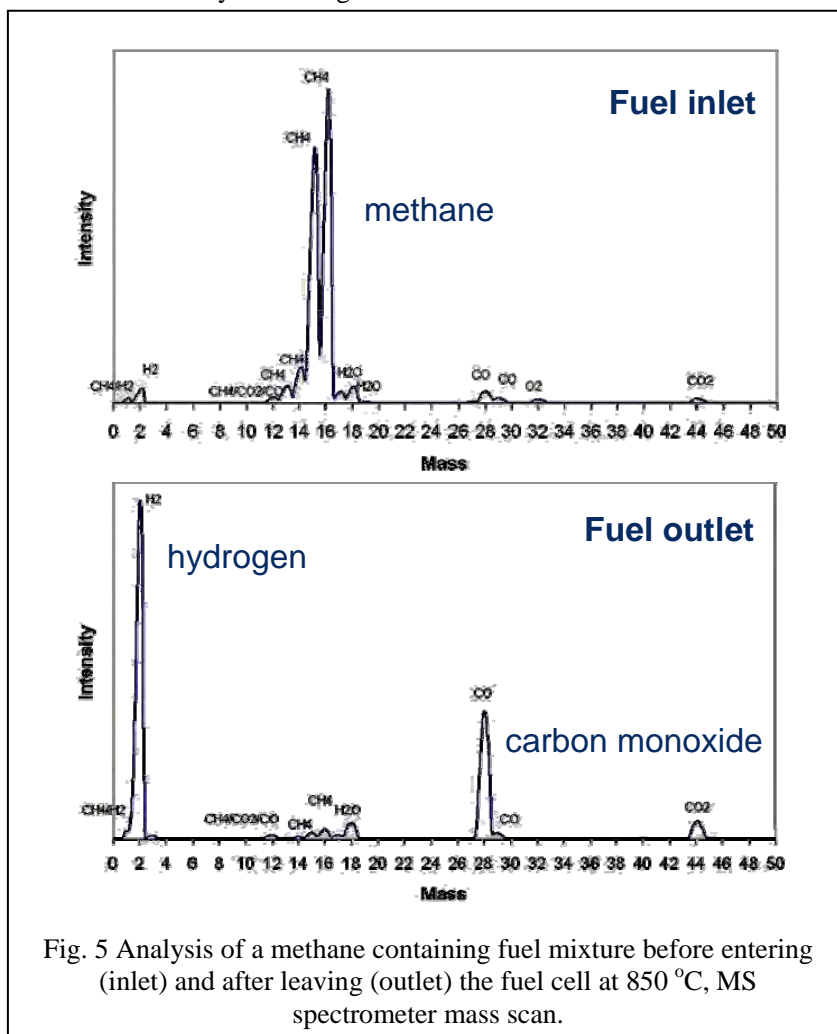

Fig. 5 Analysis of a methane containing fuel mixture before entering (inlet) and after leaving (outlet) the fuel cell at 850 °C, MS spectrometer mass scan.

3.2 Biomass derived fuels

As already mentioned, there are a number of established processes to convert biomass into fuel mixtures. In this presentation, the products of two selected technologies: gasification of biomass – biosyngas – and of enzymatic conversion – bioethanol – are considered as fuels for SOFCs.

The gasification of biomass is a thermochemical process that produces a gas mixture, with hydrogen and carbon monoxide being the main components. It is often used for the combined production of heat and power in, e.g. combustion engines or gas turbines. Another option are fuel cells. For this application, the biosyngas mixture can be regarded a similar fuel as syngas obtained from for example reforming of natural gas. The difference is the ratio of CO to H₂, which varies significantly depending on the origin of the biomass and also compared to reformed natural gas. A selection of compositions is shown in Tab. 1. The main differences in compositions are due to the gasification method: air or steam gasification, which produce a nitrogen rich and a hydrogen rich mixture, respectively.

Tab. 1 Two selected compositions of gasification gas (in %) derived from wood biomass as source

Source	N ₂	CO	H ₂	CH ₄	H ₂ O	Heavy HCs	CO ₂	Ref.
Wood	45-54	18-25	13-15	3-5	10-15	0.2-0.4	10-15	[1]
Wood	2	20-35	37-43		14-31		7-10	[2]

The production of ethanol via fermentation from organic sources by enzymes is a well-established technology [3]. The process can be based on energy crops such as starch and sugar (1st generation bioethanol), whereas crops such as cellulose or lignin are used in the 2nd generation technology that is under development, thus providing the attractive option to use organic waste materials instead.

When ethanol is used directly as fuel in an SOFC one has to be aware of decomposition reactions leading to carbon formation and deposition under heating (already in heat exchangers). In Fig. 6 it is shown, how the carbon formation from ethanol depends on the temperature. In order to suppress this undesired carbon formation and deposition, it is necessary to mix the ethanol with additives like oxygen or water to accomplish partial oxidation or reforming. By adding steam, ethanol can be reformed and carbon formation suppressed (see Fig. 6). When ethanol and water are mixed in a ration of 1/4, no carbon is formed the temperature range from 400 to 900 °C.

In order to evaluate the application of bioderived fuels, a number of long-term tests of SOFCs were performed. As all the hydrocarbon containing fuels undergo reforming over the SOFC anode as shown previously, it is sufficient to provide a mixture of hydrogen, carbon oxide, and water with the corresponding composition.

One long-term test was accomplished using a mixture of CO, H₂O, and H₂ as expected from wood gasification (see Tab. 1, 2nd example). In another test, a synthesis gas mixture corresponding to the reforming product of ethanol and water at a ratio of 1/1.5 was used. The tests were carried out under technologically relevant operating conditions with respect to temperature, power output, and fuel utilization and the degradation rates over 1500 hours test were compared to results obtained using a synthesis gas mixture as expected from methane reforming (see Fig. 7).

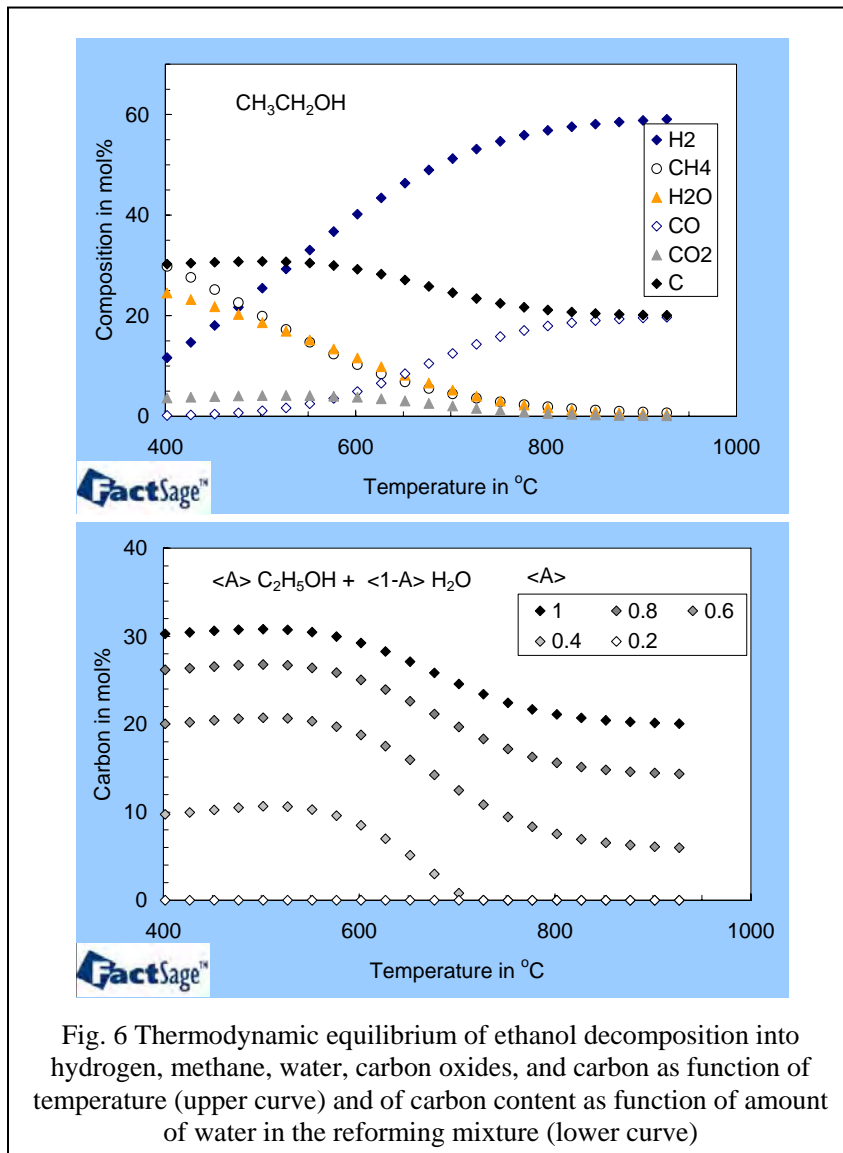

Fig. 6 Thermodynamic equilibrium of ethanol decomposition into hydrogen, methane, water, carbon oxides, and carbon as function of temperature (upper curve) and of carbon content as function of amount of water in the reforming mixture (lower curve)

The degradation of the power output was very low in all three cases, between 1 and 2% over 1500 hours. Consequently, synthesis gas mixtures derived from all types of biomass-conversion technologies are equally suited for application in SOFCs.

3.3 Ammonia

Ammonia – NH₃ – is the second largest synthetic product in the world and for example used as refrigerant, as intermediate for the production of fertilizers, plastics, pharmaceuticals and other chemicals. The handling and safety aspects are therefore well-known. The main synthesis route to ammonia goes via the Haber-Bosch-Synthesis, where H₂ and N₂ are combined on iron-containing catalysts at elevated temperatures (350 – 550 °C) and pressures above 100 bar. ‘Alternative’ regarding ammonia, can be the way the hydrogen is produced, for example by electrolysis using excess electricity produced by wind mills or nuclear power stations. Ammonia becomes liquid at slightly elevated pressure (8 bar) and has a high power density by weight and volume (comparable to petrol). The use of ammonia in a SOFC is potentially simple as no pre-reaction or pre-mixing is required, for example in order to prevent carbon deposition as in the case of hydrocarbon containing fuels; ammonia can simply decompose and release hydrogen that is used in the SOFC. During production of electricity in the SOFC, no CO₂ is released, which could be advantageous in some applications. Another attractive feature is

the possible storage either as liquid at slightly elevated pressures or in the solid state, for example in metal ammine complexes [4].

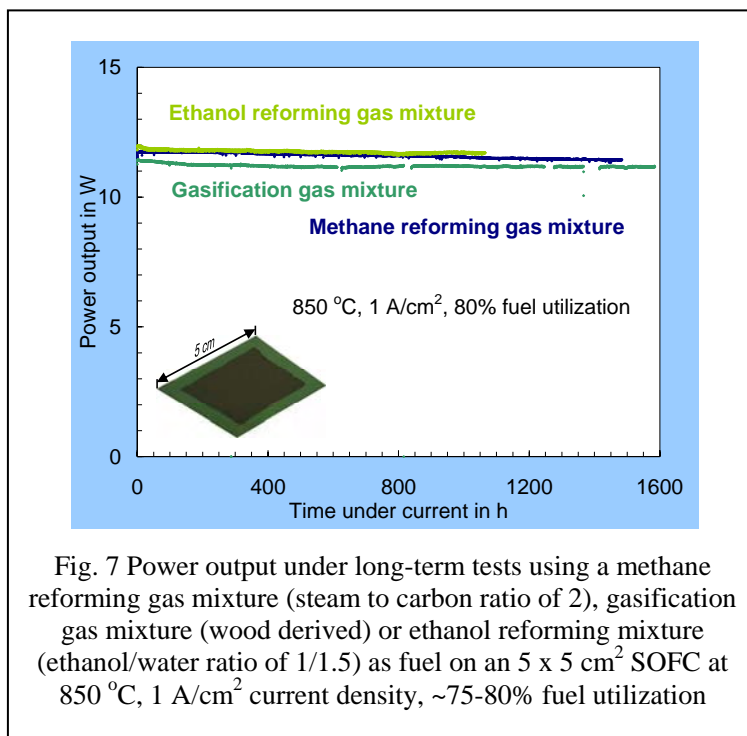

When considering ammonia as fuel for SOFCs, questions about the thermodynamics and kinetics of decomposition, formation of side products such as nitrous oxides, the performance compared to pure hydrogen, and the long-term stability have to be considered.

In Fig. 8, the ammonia decomposition is shown as a function of the temperature. At the operating temperatures of the SOFC, i.e. 850 °C, about 90 ppm ammonia are present at conditions of equilibrium and thus the decomposition reaction is nearly complete.

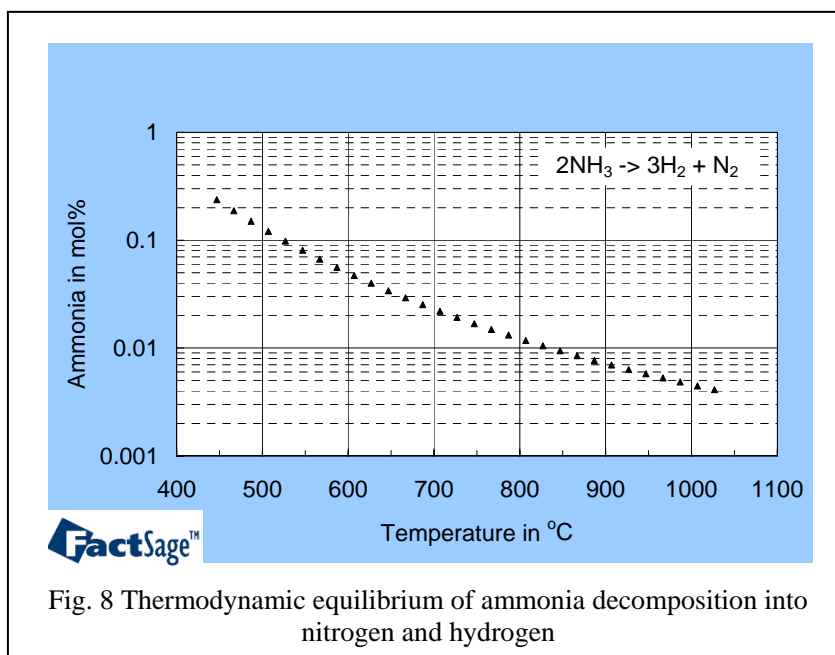

Further, the kinetics of ammonia decomposition was considered: are the operating temperatures sufficient to facilitate decomposition or is a catalyst needed. The nickel

containing anodes of SOFCs are known to be reforming catalysts, i.e. they catalyze the reaction of hydrocarbons with steam towards carbon monoxide and hydrogen (vide supra). They might also be able catalyze ammonia decomposition. By analyzing the composition of the fuel at 850 °C just before entering and after leaving the SOFC compartment with an MS spectrometer, it was indeed found that the major part of ammonia is first decomposed over the anode (see Fig. 9 for reaction scheme). The formation of nitrous oxides (NO, NO₂, N₂O) was never observed at 850 °C.

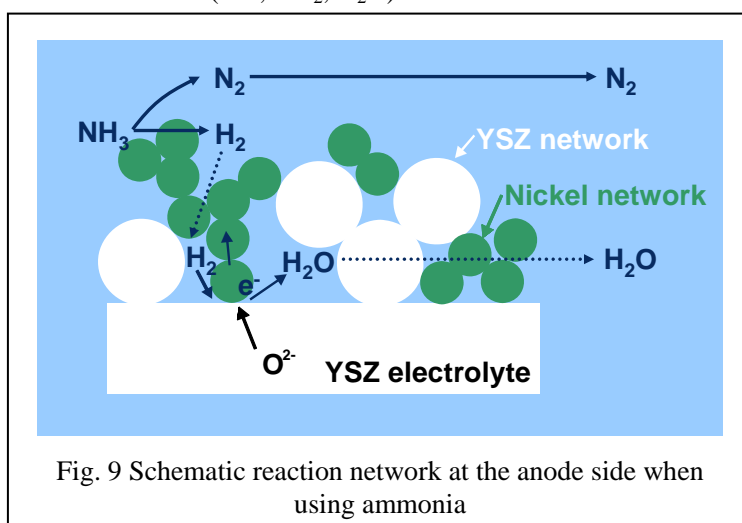

Electrochemical tests of SOFCs using pure ammonia or a hydrogen/nitrogen mixture of the same ratio were performed (see Fig. 10). The initial performances in terms of area specific resistances and power densities were the same in ammonia and in a hydrogen/nitrogen mixture. At 850 °C, the maximum power density was around 1 W/cm² representing a significant value.

A long-term test was carried out using pure ammonia as fuel. The power output over 1500 hours was observed and compared to the results obtained using a simulated reforming gas mixture (see Fig. 11). The degradation of the power output was 7% for ammonia vs. 2% for the synthesis gas mixture. The larger degradation rate in case of the ammonia fuelled SOFC could be due to thermal effects caused by the endothermic ammonia decomposition over the fuel cell anode. Thus, the stability when using ammonia was promising at technologically relevant operating conditions, but has to be further improved.

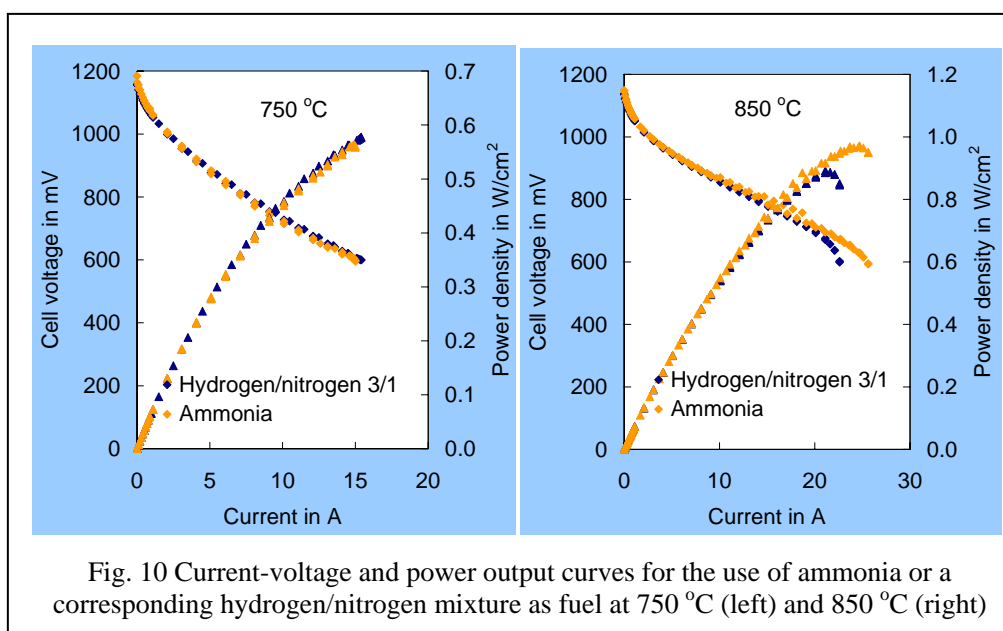

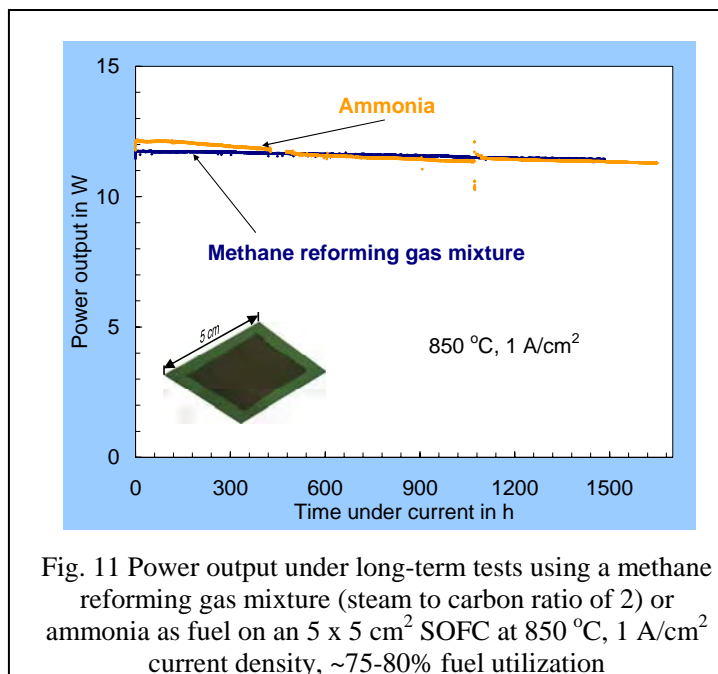

4 Effect of impurities in alternative fuels

Model mixtures can only demonstrate general feasibility. As in all real mixtures, whether they are derived from fossil or alternative sources, the challenge lies in the presence of minor constituents or impurities. A well-known impurity that is found in natural gas and oil and also can be part of biomass derived fuels is sulphur. Sulphur chemisorbs on catalytically active sites and thus blocks them efficiently from for example reforming [5]. Sulphur can affect the electrochemical reaction itself as well. When a hydrocarbon fuel is used directly in the SOFC, both, the reforming and the electrochemical activity might be affected by the presence of sulphur impurities. The change of the electrochemical performance of a SOFC in terms of power output upon the addition of different amounts of H₂S into hydrogen fuel is shown in Fig. 12. The power output dropped suddenly, followed by a

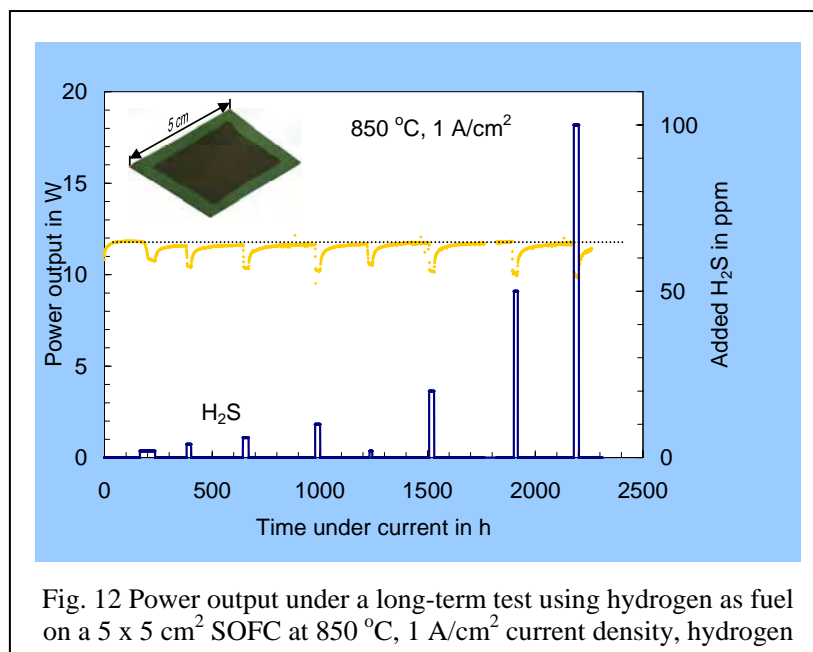

faster degradation during the period of sulphur addition. However, after removal of the sulphur from the fuel gas, the cell performance recovered up to a level of ca. 100 ppm H₂S in the fuel. The overall degradation rate (dotted line in Fig. 12) was very small. If the

degradation becomes sufficiently severe to endanger the cell performance, sulphur removal technologies can be considered, which are well-known from petro chemical processes (e.g., [6]).

5 Summary

The versatile application of fuels derived from alternative sources to fossil reserves on SOFCs was demonstrated for three examples. Carbon containing fuels derived from biomass by gasification or anaerobic digestion and ammonia were used in SOFCs. Both, performance and long-term stability proved to be promising and similar to those cases where the fuel was derived from fossil sources.

In order to design SOFC systems based on alternative fuels successfully, the effects of characteristic impurities have to be studied further.

SOFC systems have the potential to be operated with a number of fuels and can thus be used in different energy scenarios.

Acknowledgement

The work has been financed by PSO projects: Evaluation and optimization of Danish solid oxide fuel cells (5302) and Evaluation and optimization of Danish solid oxide fuel cells – Generation 2.5G and 3G (5849) and the VTU project: Efficient Conversion of Renewable Energy using Solid Oxide Cells. The author is thankful to J. Rasmussen for the studies on H₂S poisoning and the MS analysis under reforming. The technical support by M. Davohdi, H. Henriksen, O. Hansen, and S. Koch is gratefully acknowledged.

References

- [1] T.V. Ramachandra, N.V. Joshi, D.K. Subramanian, *Renewable and Sustainable Energy Reviews*, 4 (2000) 375-430.
- [2] A. Norheim, J.E. Hustad, *Proc. Science in Thermal and Chemical Biomass conversion*, Vancouver Island, BC, Canada, Aug./Sept. 2004 and Doctoral thesis at NTNU, 2005.
- [3] A.B. Thomsen, C. Medina, B.K. Ahring in *Risø Energy Report 2*. ISBN 87-550-3262-1. 2003. 40-44.
- [4] C.H. Christensen, R. Zink Sørensen, T. Johannessen, U.J. Quaade, K. Honkala, T.D. Elmøe, R. Køhler, J.K. Nørskov, *J. Mater. Chem.*, 15 (2005) 4106 – 4108.
- [5] J. Rostrup-Nielsen, J.K. Nørskov, *Topics in Catalysis*, 40(1–4) (2006) 45-48.
- [6] R. Prins, V.H.J. de Beer, G.A. Somorjai, *Catal. Rev. Rev.-Sci. Eng.* 31 (1989) 1; H. Topsøe, B.S. Clausen, F.E. Massoth, in: J.R. Anderson, M. Boudart (Eds.), *Hydrotreating Catalysis, Science and Technology*, vol. 11, Springer, Berlin, 1996; T. Kabe, A. Ishihara, W. Qian, *Hydrodesulfurization and Hydrodegeneration, Chemistry and Engineering*, Wiley-VCH, Kodanska, 1999.

Solid Oxide Fuel Cell Development at Topsoe Fuel Cell A/S and Risø National Laboratory

N. Christiansen^a, J. B. Hansen^a, H. Holm-Larsen^a, S. Linderoth^b, P. H. Larsen^b,
P. V. Hendriksen^b and A. Hagen^b

^aTopsoe Fuel Cell A/S, Nymøllevej 55, DK-2800 Lyngby, Denmark

^bRisø National Laboratory, DTU, DK-4000 Roskilde, Denmark

ABSTRACT

Topsoe Fuel Cell A/S (TOFC) and Risø National Laboratory (Risø) are jointly carrying out a development programme focusing on low cost manufacturing of flat planar anode-supported cells and stacks employing metallic interconnects. The consortium of Topsoe Fuel Cell A/S and Risø has up-scaled its production capacity of anode-supported cells to about 1100 per week. TOFC has an extended program to develop the SOFC technology all the way to a marketable product. The road to a successful SOFC technology is first and foremost governed by the ability to produce reliable and cost-effective cells and stacks. Multi stack modules consisting of four 75 cell stacks have been tested for more than 4000 hours with pre-reformed natural gas and modules consisting of twelve stacks are under development. The degradation rate has been reduced to below 0.5% per 1000 hours, especially by improvement of metal alloy interconnects and coatings. In collaboration with Wärtsilä, a 24-stack prototype based on natural gas is being tested. For methanol based systems the methanol is methanated upstream the anode using a Haldor Topsoe catalyst. The range of fuels has further been extended to include ethanol and coal syn-gas by development of a new coke resistant catalyst suitable for future SOFC technology.

CELL DEVELOPMENT AND PRODUCTION

The TOFC/Risø pilot plant production facility for the manufacture of anode-supported cells, 2G (see Figure 1), has recently been further up-scaled with an automated continuous spraying process and an extra sintering capacity resulting in a weekly production capacity exceeding 1100 12x12 cm² cells. Introduction of new processes

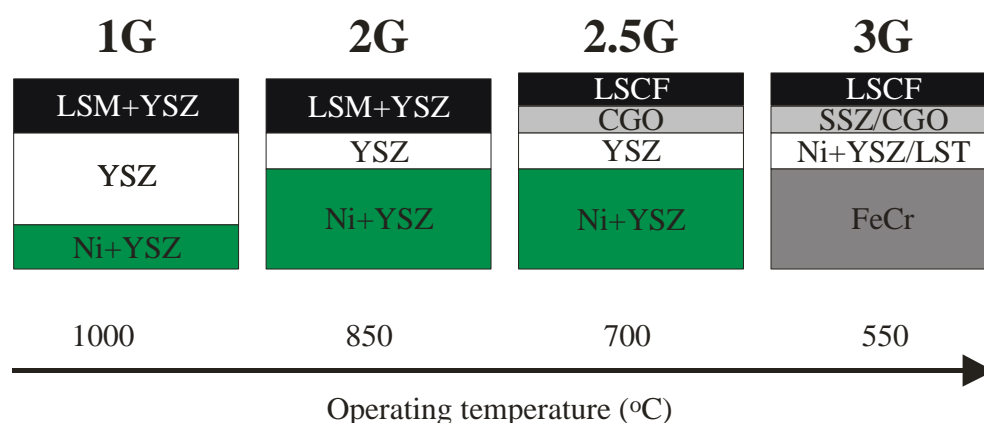

Figure 1. Various cell generations being developed and produced in the TOFC/Risø consortium.

has enabled a further reduction of cell area specific resistance, ASR [1]. The ASR of 2G cells at 850°C are currently $0.18 \pm 0.03 \text{ } \Omega\text{cm}^2$. The standard cell size is currently being increased to $18 \times 18 \text{ cm}^2$. The largest cell size that has been manufactured so far is $22 \times 52 \text{ cm}^2$.

STACK DEVELOPMENT AND PRODUCTION

Due to the very compact stack design including thin plate metallic interconnects (figure 2), a stack volume power density of 2.4 kW per litre stack volume has been obtained in cross-flow configuration with hydrogen fuel at an area specific power density of 0.35 W/cm^2 . Standard stacks have been tested successfully for more than 13000 hours with a degradation rate of about 1% per 1000 hours including nine full thermal cycles. Post-mortem analysis has revealed the dominating degradation mechanisms. Recently, the degradation rate has been reduced to below 0.5% per 1000 hours by introduction of improved stack component materials including improved metallic interconnects and improved ceramic coatings. These coatings have proved to protect the cathodes from chromia poisoning at the same time as a low area specific contact resistance of the protected steel of $2\text{-}3 \text{ m}\Omega\text{cm}^2$ is obtained.

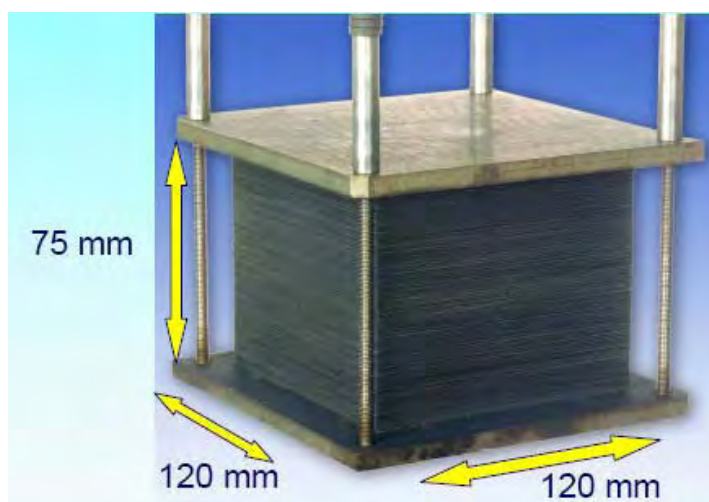

Figure 2. Compact design of a 75 cell stack with $12 \times 12 \text{ cm}^2$ cells.

Several 50 or 75-cell stacks in the 1+ kW power range have been tested successfully on methane rich reformat gas at a fuel utilisation up to 92%. Stack and system modelling including cost optimisation analysis has been used to develop and optimize 5-25 kW stack modules for operation in the temperature range 700-850°C. Figure 3 shows the I/V performance of a 75-cell single-stack ($12 \times 12 \text{ cm}^2$) with counter flow configuration for such a stack system module.

In order to further enhance the cost efficiency of the stacks a special effort is focused on manufacturing and testing of larger anode-supported cells and stacks with a foot print of $18 \times 18 \text{ cm}^2$. Figure 4 shows the performance of a seven-cell stack with $18 \times 18 \text{ cm}^2$ cells operated at 800°C. It is seen that at a steady state current of 45 A the degradation rate is below the detection limit after 500 hours for both H_2 and CH_4 fuel.

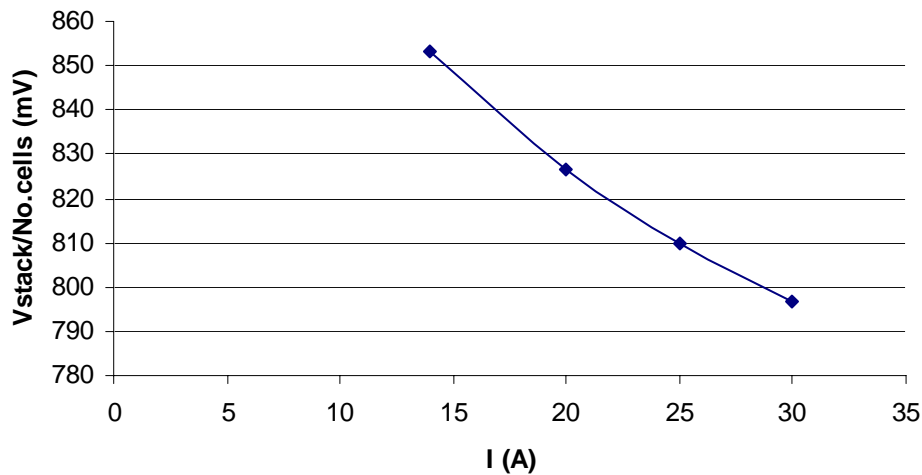

Figure 3. I/V performance of a 75-cell (12x12 cm²) counter flow at 800°C, 65% fuel utilisation with pre-reformed natural gas.

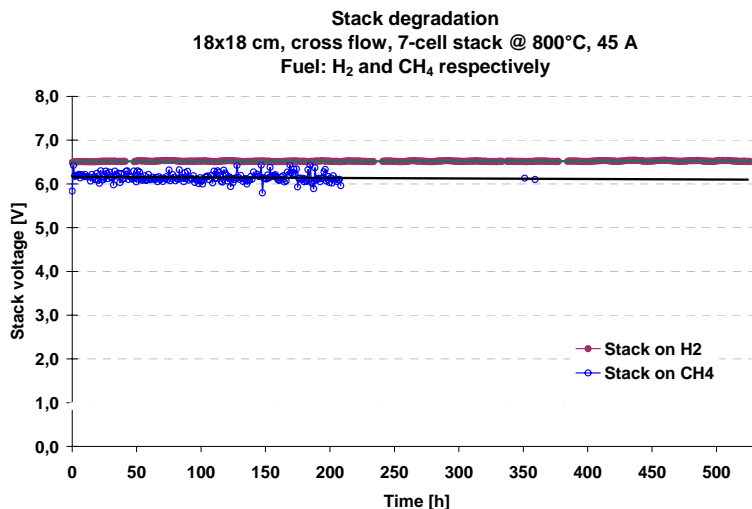

Figure 4. Degradation curves for 18x18 cm² cell stack, H₂/N₂ fuel (upper curve) and CH₄/H₂O (lower curve), steady state current 45 A.

2G CELL DURABILITY

The 2G cells manufactured in the production line are generally very durable at high temperature (850 °C) even at very high current loads [2]. The degradation rate increases with increasing polarization. At a current density of 0.25 Acm⁻² (operating voltage ~ 850 mV) the voltage degradation rate is less than 0.25 %/1000 hours and at 1 Acm⁻² (corresponding to an operating voltage ~ 750 mV) the degradation is below 0.6 %/1000 hours (See also figure 6, upper curve). Operating the cells at 750 °C also provide excellent durability when operating at normal polarisation levels. However, under severe operating conditions at 750 °C, i.e. exposed to a strong polarization, a marked degradation is observed. This degradation has been identified to mainly originate from the cathode/electrolyte interface. Efforts are being devoted to develop cells that are also capable of long term operation under these conditions, to enhance

the window of operation of the technology. Recently, progress has been achieved in this field. The introduced modification of the cathode effectively results in stable operation, even under these severe conditions, after an initial degradation occurring over the first 500 hours (see Figure 5).

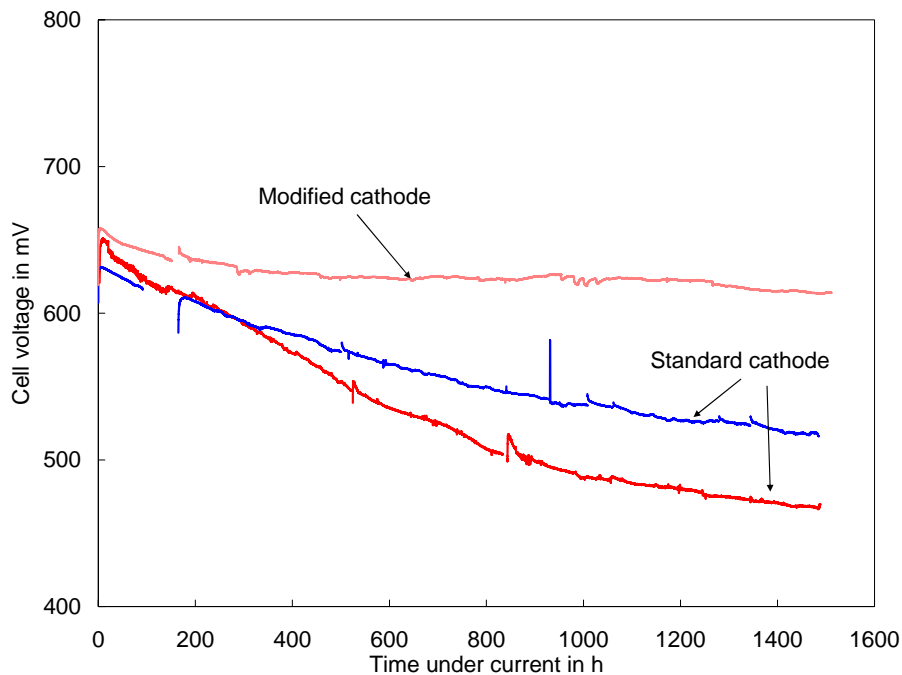

Figure 5. Stability of modified LSM cathodes in accelerated aging test (“low temperature, high polarization”). The temperature was 750 °C, the current density was 0.75 A/cm², and the cells operated on a syn-gas mixture with a fuel utilization of ~80 %.

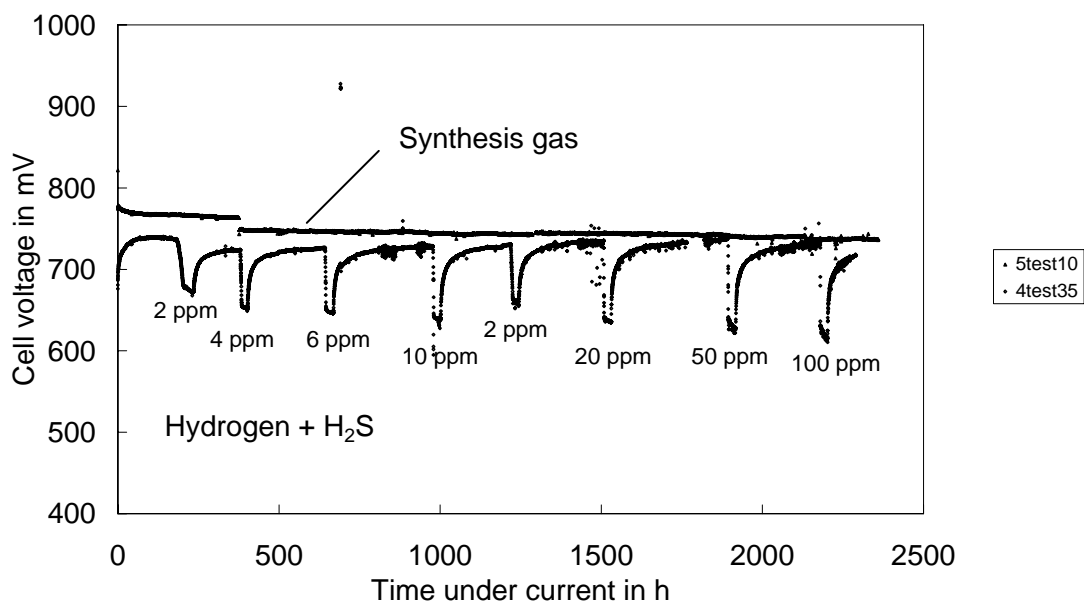

Figure 6. Cell durability at 850 °C, 1Acm⁻². The upper curve is for a cell operated in syn-gas with a fuel utilization of 75 %. The lower curve is for a cell operating at the same temperature and current load but in hydrogen with various amounts of H₂S added periodically.

When using fuel derived from biomass in SOFCs, one must be aware of trace amounts of different impurities which may act as poison for the electrochemical processes. One such impurity is H₂S, which is also used as odorant in natural gas lines. The sulphur tolerance of the anodes is currently studied. The effect of small amounts of H₂S in hydrogen on the performance and durability of a “standard” 2G cell was studied at 850 °C and 1 Acm⁻² (see figure 6). The cell voltage decreased and the degradation rate increased during the periods under H₂S. However, these changes were completely reversible up to the studied concentration of 100 ppm H₂S. Turning off the sulphur addition results in a recovery of the cell performance over a period of ~250 hours, and the overall degradation tracked over 2000 hours is less than for the reference case. Thus, it is concluded that the sulphur reduces the reaction rate by passivation of reaction sites by adsorption.

NEXT GENERATION CELL AND STACKS

The SOFC program comprises development of next generation cells with metallic support for operation at lower temperature in the range 600-750 °C. As shown in Figure 1 the material choice for this cell type differs from previous cell generations in that porous ferritic steel is used as a ductile, robust cell support and the electrolyte is based on scandia doped zirconia with increased durability, lower cost, and high mechanical robustness. Furthermore, the metal supported cells offer a significantly improved tolerance towards red-ox cycling and improved temperature distribution during cell and stack operation. The next generation stack design under development is based on these cost effective metal supported cells. The stack concept includes a further efficient integration of the individual stack components and more reliable seals leading to lower weight, lower cost and maximal robustness.

FUEL PROCESSING AND SYSTEM DEVELOPMENT

A range of fuels have previously been studied including natural gas, LPG, methanol, DME, diesel and ammonia. The studies predict system electrical efficiencies from 50-56% (AC out/LHV fuel in), depending on the fuel used and the size of the system. The range of fuels have now been extended to include ethanol and coal syn-gas [3] by development of a new coke resistant ethanol reforming/methanation catalyst and leveraging the catalyst know-how of HTAS involved in high temperature methanation of coal gas respectively.

TOFC has collaborated with Wärtsilä since 2002 on the development of SOFC systems in the 200+ kW class, primarily for power generation and marine application. Since late 2004 Wärtsilä has operated the SOFC test system with planar SOFC stacks developed and manufactured by TOFC. During spring 2006 four stacks were installed, each having a nominal power of 1 kW. The system has been in continuous operation providing an average power of 3.6 kW at 55 – 60 % fuel utilisation (FU), this being a valid reference point for further system development and up-scaling. The in total 4000 hours of operation indicates very good reliability of the used stack and system technologies. The power curve combined with average FU for the four stacks is presented in figure 7 [4].

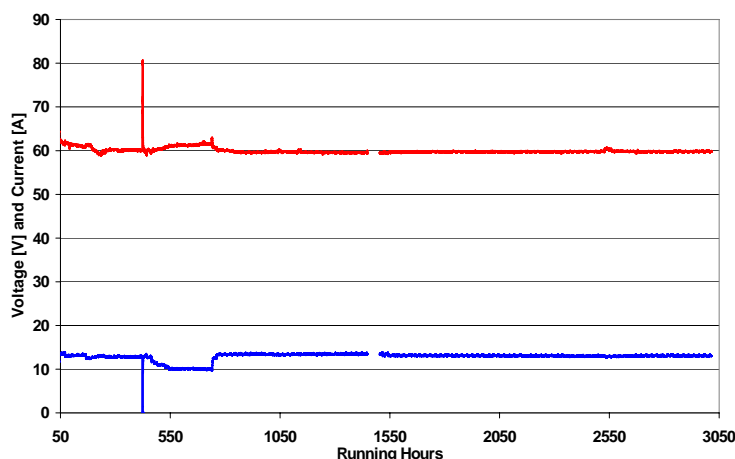

Figure 7. Average stack voltage (upper curve) and current (lower curve) of 75-cell stacks in a four stack system.

In collaboration with Wärtsilä, a detailed design for a 24-stack prototype based on natural gas has been finalised and 24 stacks of the 75 cell ($12 \times 12 \text{ cm}^2$) type are being delivered to Wärtsilä by TOFC. Another 24-stack prototype, now based on methanol as the fuel, is also under construction by Wärtsilä. The methanol is methanated upstream the anode, using a newly developed, proprietary Haldor Topsoe catalyst.

Two Danish projects in the PSO program supported by the Danish Utilities have been initiated. One is aiming at demonstrating a 1 kW_e micro-CHP unit and the other is a 10 kW_e stack demonstration facility including fuel processing and power conversion located at a power station in Copenhagen, Denmark.

REFERENCES

- [1] N. Christiansen, J.B. Hansen, H. Holm Larsen, S. Linderoth, . P.V. Hendriksen, P.H. Larsen, M. Mogensen, European SOFC Symposium, Lucerne, 2006.
- [2] A.Hagen, R. Barfod, P.V. Hendriksen, Y.-L. Liu and S. Ramousse, J. Electrochem. Soc. 153, A1165-A1171 (2006).
- [3] J. Hansen, T. Rostrup-Nielsen and J. Pålsson, to be published at SOFCX, 2007
- [4] E. Fontell, T. Kivisaari, K. Åström, J.B. Hansen and N. Christiansen, Fuel Cell Seminar, Honolulu, 2006.

ACKNOWLEDGEMENTS

Energinet.dk, PSO F&U projects, Danish National Advanced Technology Foundation: “Robust, environmentally friendly and cost efficient fuel cell systems for future power production”.

Fuel Cell-Shaft Power Packs (FC-SPP)

Frank Elefsen, Centre Manager, Ph.D., and Sten Frandsen, Head of Section
Renewable Energy and transport, Danish Technological Institute

Abstract

Danish companies will be able to obtain a unique international competitive position by combining our leadership in renewable energy with a focused and dedicated effort in hydrogen technology. The purpose of the present consortium is to establish the foundation for producing small hydrogen-based motor units. The consortium develops the technology in three concrete projects within two areas: small transportation equipment and mobile units. This assures that the research is directed towards specific market segments and that a synergy is obtained between technology development and market demand. Furthermore, the consortium involves developing concepts and tools for commercializing the technology and employing user-driven innovation. The consortium includes a number of innovative SME's in close interaction with larger established companies. The large companies are primarily component suppliers, thus assuring that the necessary components are developed and produced. The participating SME's are both component and system suppliers, thus assuring that the products developed will also be carried to the market. Ultimately, the projects may contribute to the start of a new industrial success story similar to the Danish wind power industry, which would simultaneously lead to exports and an improved environment.

1 Fuel Cell-Shaft Power Packs (FC-SPP)

A. Background

In line with the growing global and national concern with a stable and sustainable solution to the energy supply of the future, hydrogen technology is receiving a great deal of attention. Hydrogen and fuel cells have the potential to replace a large fraction of the current energy production, which is largely based on fossil fuels. Particularly in the transportation sector, there is a need for alternative solutions, as the current system is almost entirely based on oil. Hydrogen technology could make it possible to increase the share of Danish energy supply from renewable sources. Furthermore, hydrogen can create a better coherence between electricity production and the transportation sector. To promote this synergy, there is a strong need to illustrate hydrogen and fuel cell applications through R&D and demonstration projects. By focusing on products where the use of hydrogen technology provides substantial benefits to the user, the foundation for future production of hydrogen technology in Denmark will be greatly enhanced. History has shown how Danish SME's are particularly good at adapting to new technologies. In the future, these companies could enter both as component suppliers and system builders for products using hydrogen technology.



Figure 1
Traditional combustion engine

The focus of the present consortium is to provide an alternative to the common combustion engines (see Figure 1). The small combustion engines contribute significantly to the total Danish air pollution. The incomplete combustion in the engine leads to emissions of hydrocarbons, harmful fine and ultra fine particles, NOX and greenhouse gasses. A report elaborated by the Danish Institute of Environmental Assessment finds that mopeds driven by small two-stroke engines contribute to about 7% of the total hydrocarbon pollution from the Danish auto fleet even though they only constitute 0.5% of the mileage driven. Furthermore, the noise pollution from these engines can be highly disruptive. Thus, there is a particular need to find new solutions in this area.

The new alternative consists of a hydrogen storage unit, a fuel cell, and an electrical motor (Fuel Cell-Shaft Power Pack). The hydrogen will mostly come from renewable energy sources, thus contributing to a sustainable and reliable energy system.

At present, the market for fuel cell stacks and systems consists primarily of prototypes and few commercial products. At present, there is no solution on the market that gathers the electric motor, hydrogen storage unit and the fuel cell in a single compact system. In Denmark, we have a unique position for entering this market by exploiting the flexibility of the Danish small and medium-sized enterprises. The consortium therefore aims to develop and define this market, building on systematic methods for market penetration and user-driven innovation. The consortium helps focusing the efforts on the Danish SME's in this area. One of the tasks of the consortium is to uncover the possibilities for using Danish suppliers of components for the FC-SPP. In Denmark, we have a large population of flexible sub-suppliers, many of them SME's, who could supply components for the product and thus create Danish growth in the area.

The Concept

Traditionally, small portable applications use gasoline, diesel oil or batteries as energy sources. A concept frequently used in garden power tools, for instance, is shown in Figure 2. The fuel is poured into a tank that feeds a two-stroke or four-stroke combustion engine, which in turns creates mechanical energy in a rotating axel that drives the equipment.

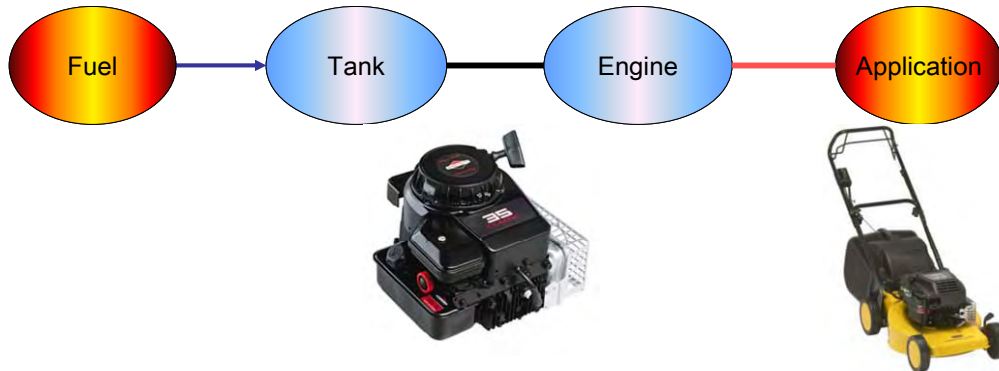

Figure 2
Traditional application

This concept is widely applied due to the simple handling and technology and the low cost of producing it. However, a two-stroke combustion engine produces a disproportionate amount of air and noise pollution. By using hydrogen and fuel cell technology in this application, these drawbacks can be avoided and at the same time, greater flexibility and user friendliness is achieved. This concept is shown in Figure 3.

The concept strives to retain the simple user interface. To the user, it should be at least as easy to use an FC-SPP. This puts great demands on the development of the concept, since hydrogen and fuel cell technologies are complicated and require further technical development.

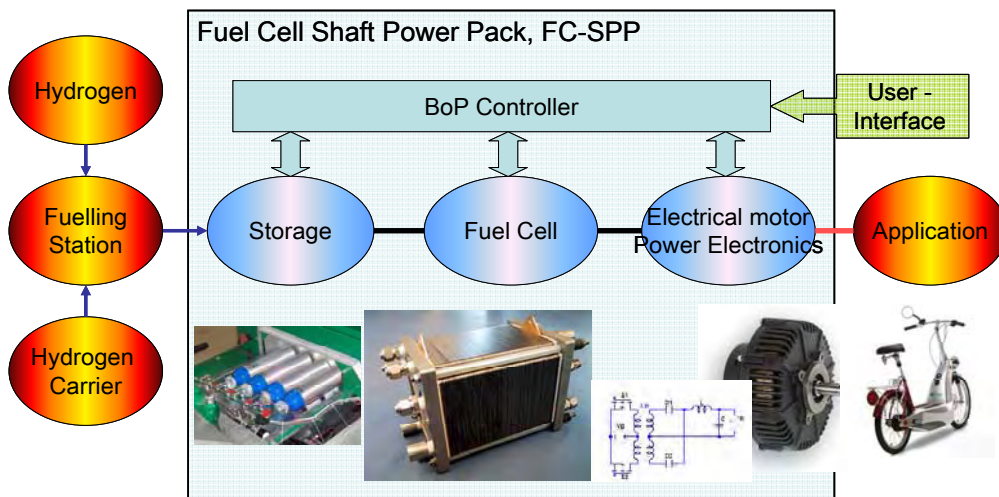

Figure 3
The new concept — A Fuel Cell-Shaft Power Pack

Furthermore, the concept must go through a continuous revision so that the product at all times represents the latest knowledge and technology in the area. This anchoring of knowledge will be realized, among other things, through three technical research projects. In order to offer the user the best solution, it is essential that the product is dynamic and evolves along with the technological progress in the area. Therefore, the project is subject to a continuous technological assessment. However, it is not enough to develop a

user-friendly and environmentally sound product with good technical characteristics. Commercial success also requires that the product can be produced, distributed and serviced in a way that allows the participating companies an adequate economic return. This requires research into development of new marketing channels and sales vehicles for new products. Furthermore, it requires investigation and development of value-creating networks among the companies involved.

2 Purpose

The specific purpose of the consortium is to establish a product company to manufacture and market Fuel Cell-Shaft Power Packs. More generally, the ambition of the project is to spread the use of hydrogen and fuel cell technology in Denmark and in this way contribute to the foundation for a new industrial success story, similar to the emergence of the Danish wind power industry. A third purpose is to build and compile knowledge of compact fuel cell systems, both in terms of thermal properties, control and regulation, and motor technology. Hydrogen and fuel cell technology should be made available for small and medium-sized enterprises via the consortium and subsequently through a technological service function. Finally, it is the intention to uncover the commercial potential of these new technologies through an analysis of both cost structures and sales channels, which is best done with a basis in concrete projects and the networks of companies needed to realize them.

3 Academic Basis

At the overall level, the research in the consortium is divided into a technical and a commercial task, with an interdisciplinary coordination between these academically distinct areas. In addition, the project involves an initial technology investigation in order to determine the technological base and the overall structure of the system.

Technology Investigation

Initially, the consortium conducts an analysis of the current development level of the different technologies involved – a state-of-the-art analysis. For instance, the alternative energy sources for the applications in the consortium will be mapped. Moreover, the overall framework for the activities of the consortium will be determined, including joint activities across applications.

Technical Research

The technical research basis for the concept sketched in Figure 3 is divided into three basic areas: (1) *Fuel cells*, where the stack design is determined and the stacks constructed that fulfill the demands specified by the applications involved. (2) *Motor and power electronics*, involving the interaction between motor and fuel cell in order to determine the best type of engine and control system. (3) *Balance-of-Plant (BoP)*, which focuses on the system as a whole in order to develop computational models that to diagnose and analyze fuel cell systems. The BoP research area is strongly interdisciplinary in nature, building upon the knowledge of the other two areas. The hydrogen storage unit is not a separate research focus and is included as a part of the BoP area. A common aim of the three technical projects is to develop and collect the knowledge necessary to design and construct fuel cell driven engine modules for different applications. This knowledge is lodged in a modeling and design tool set for fuel cell stacks, power drive system, power electronics, and overall BoP. In connection with system design there are several different central criteria, such as efficiency, weight, volume, shaft performance and price.

The knowledge base and build-up of competences is lodged in a Ph.D. project for each of the three technical research areas.

T1: Fuel cells

In this technical project, the basis for design and construction of the fuel cell stacks is developed, giving demands on parameters such as pressure loss, form factor, current and voltage levels. The aim is to create design rules and develop modeling tools that can be used in the design phase. Furthermore, a number of fuel cell stacks is constructed for calibrating the computational tools and demonstrating their use for the knowledge users. The models should assure that the knowledge created can be transferred to different applications, considering demands for such factors as stack lifetime and working environment. A design is developed for the bipolar plates, seals and the stack manifold. The process includes choices of material in order to reduce weight, since the stack will be involved in mobile applications where weight is an important issue. Another area of investigation closely connected to choice of materials is surface treatment of components in order to reduce electrical resistance in the stack. Moreover, methods of large-scale production of fuel cell stacks will be investigated.

The intended applications all have different power needs, making it necessary to create a fuel cell that is scalable or can be combined in modules for increased power. The fuel cell stack is constructed with as few components as possible and adapted to be a component part of the entire system. This involves new compact concepts for controlling the stack water balance. Another central issue to be analyzed is the flow distribution, in particular the pressure drop on both the anode and cathode side of the stack. From the Balance-of-Plant perspective, this is crucial for the choice of fan/compressor for air and fuel supply and, consequently, for the overall system efficiency. The entire system, including the stack, must be able to sustain external stresses such as dust, shocks and vibrations during use.

T2: Power electronics

The overall aim of this technology project is to develop a basis for designing and dimensioning the motor control system, including power electronics, and the motor, for any given input voltage from the fuel cell and a desired shaft performance. The project initially investigates suitable configurations for converting electrical power to shaft power. This involves an inverter, a motor, and possibly a mechanical gear. Depending upon input voltage and the application, demands may vary greatly. In some cases, a large shaft torque and slow speed is desired, indicating that a mechanical gear may be required. Alternatives would be a transverse-flux engine or a multi-polar motor. In other cases, a high speed without gearing is required. Next, will be an investigation of what power inverter topologies would be most suitable for converting the fuel cell energy to a three-phase alternating current used for controlling the motor. It may be a two-step solution (DC-DC, DC-AC) or a one-step solution (DC-AC). A design tool based on mean value models is developed for this purpose. A similar design tool is developed for the motor, which will have permanent magnets with either few or many poles, allowing the tool to be used in a wide range of applications. The tools are also able to handle thermal design on the macro scale, since some applications only require full torque for brief periods. A control strategy for the motor will be developed to achieve a desired torque and speed. This may imply special demands for the fuel cell, possibly including a small energy storage unit if the dynamic need is greater than the power output of the fuel cell. This is researched in close cooperation with technology project T3. The control strategy can be with or without a mechanical sensor. An experimental system is constructed to test the design tools, models and control methods developed. Finally, the activity is completed by minimizing the number of sensors involved in order to reduce costs. The reduction in sensors is based on the results of the BoP project.

T3: Balance-of-Plant

This technology project investigates different concepts for *Balance-of-Plant* for the FC-motor module. Basically, this involves adjustment of the components in the system (compressor, humidifier, heat exchanger, etc.) for optimal overall system performance. Thus, the focus is on the total system characteristics and not just optimizing individual components. The aim is to use existing products to the extent possible and to mature specialty components.

The analysis builds upon models for the stack, power electronics and drive system developed in projects T1 and T2, with additional modeling tools for the overall systems with alternative BoP components. An overall control strategy for the FC-motor module is developed which takes due account for demands for robustness and the fact that the unit should be operated by non-technical users. Among other things, this requires a simple start-up and shut-down procedure. The control approach involves integrating advanced diagnostics in the module's power electronics and using this technology in the overall monitoring system. In order to reduce system costs, the complete system must be as simple as possible, including a minimum of sensors, which in turn puts great demands on the control system. Low weight and volume, particularly in portable applications, in turn requires a high level of system integration. For instance, one might imagine that several BoP components could be integrated in the end plates of the stack, which would also have built-in channels for distributing different flows to the stack itself, such as anode and cathode supply. It would be an obvious step to build in valves, pumps and fans in a single unit which, combined with channels for flow distribution, would yield a very compact system that would also carry a lower price and would be easy to assemble. Developing this integrated unit requires a detailed analysis of both the thermal and fluid dynamic properties in order to provide the necessary operating conditions for the stack.

Business Research

This research focuses on the economic and managerial challenges involved in establishing new application areas for hydrogen technology in the form of two Ph.D. projects, which both employ an industrial networks perspective to the issues. This perspective stands in contrast to the main part of exiting research in innovation that employs the single firm as the unit of analysis. Experience from 25 years of research in industrial (B2B) markets has shown that networks of relationships between customers, suppliers, distributors and cooperative partners have a crucial influence upon the firm's supply, sales and innovation processes. The network extends in several dimensions: as bonds between different players (companies, departments, persons, institutions etc.), through ties between resources (capital, knowledge, labor, competencies, brands, etc.), and through links between activities (purchasing, logistics, production, order processing, service, sales, etc.). Thus, development, production and selling new products, not least for the small and medium-sized companies in the innovation consortium, must be realized through networks. In a network perspective, traditional methods in managerial economics, strategy, marketing and project management are too limited. Instead, approaches will be more appropriate from e.g. inter-organizational accounting and control (activity-based costing, Kaizen costing, target costing, etc.); project management in loosely coupled systems, relationship-based and network-based marketing and supply chain management.

The purpose of the two projects is, with departure in such approaches, to investigate the problems and their solutions both internally (company behavior, competences, resources) and externally (company interactions with customers and suppliers). The perspective is to achieve both a broad and a deep understanding of the challenges of commercializing hydrogen technology by combining the general research in the Ph.D. projects with concrete applications that arise from the other activities in the consortium. In other words, the intention is that the concrete application projects and the general business research can mutually reinforce each other: Experience and knowledge from the general theoretical research can provide the application projects knowledge of how to commercialize the product in the best way. Conversely, the application projects serve as a focus and case

example for the general research, as a basis for assessing or modifying existing analytical methods or for developing new concepts and methods that shed better light on the problems encountered. Within this common framework, the two projects focus respectively on the "downstream" market structures involved in selling the applications and the "upstream" business structures involved in their production.

M1: Market Structures

Value-based marketing is a common concept today. It entails making value creation for the customer the cornerstone element that dictates all marketing activities. The premise is that value creation is a necessary condition for long term viable profits of the firm's activities. The challenge then, is for the company to mobilize and coordinate its resources and activities to maximize value creation for the customer for any given input, and to communicate this value effectively to relevant decision-makers at the customer end. It is far from a trivial matter to uncover value creation, not least because the sale and use of the products often involve many diverse actors. For instance, electric mopeds for PostDanmark (the Danish postal service) would involve the users (postmen), the producer, public authorities (occupational health and safety, energy policy etc.), service providers (maintenance, operation and repair), fuel providers and distributors, parts suppliers, etc. To positioning and marketing the product effectively requires an understanding for the different preferences and requirements of the actors and the roles they play at different stages in the purchasing decision. Both the composition of actors and their needs may vary widely from product to product. In this respect, for instance, wheelchairs for hospitals and lawn mowers for homeowners are completely different markets even though the power units of the two applications may be quite similar. Thus, there is a need in the consortium for a thorough knowledge of the methods and principles involved in value-based marketing.

M2: Business Structures

What are the opportunities open to Danish companies for developing hydrogen-based applications? What are the technical options and what are the current and potential future capabilities presenting? The project is of a technical-commercial applied nature and it aims to identify possible areas of application for existing or nearly-existing competences in hydrogen technology. The challenges inherent in exploiting this technology are not only within the technical core (fuel cells) but also within the associated components, systems and services necessary for creating maximal value for the end user. Inevitably, this involves a large network of sub-suppliers and service partners, creating a need to analyze whether Danish industry contains sufficient competencies for entering such a network (e.g. within areas like control systems, power electronics, sensors, etc.). The focal company must take into account at an early stage in product development who will supply the components that will be part of the final production – often the availability of a reliable supplier is the most significant determinant of design choices, rather than the technologically optimal solution.

4 Project Team

Research Partners

- Danish Technological Institute, (administrator),
Kongsvang Allé 29, DK-8000 Aarhus C
- Institute of Energy Technology, Aalborg University (AAU)
- Hydrogen Innovation & Research Center (HIRC)
- Copenhagen Business School (CBS).

Corporate Partners

- Dantherm Airhandling
- Migatronic
- kk-electronic
- H2 Logic
- CYKELLET
- GMR Maskiner
- Trans-Lift
- Parker Hannifin Denmark
- ACE Xperion
- Falsled Højtryk
- EGJ Udvikling.

Session 15- R&D Priorities

Chairman: Uwe Hermann, Siemens AG, Germany

THE UK ENERGY RESEARCH ATLAS: A TOOL FOR PRIORITISING AND PLANNING ENERGY R&D

Prof Jim Skea
UK Energy Research Centre¹

ABSTRACT

The UK Energy Research Centre has created an innovative “Energy Research Atlas” which maps out energy-related research, development and demonstration (RD&D) activities and capabilities in the UK and relates these to wider international developments. The Atlas has two main purposes: a) to allow members of the energy research community to locate themselves within what has been, until recently, a very fragmented research landscape; and b) to provide an evidence base for prioritising and planning RD&D activities. The Atlas follows the International Energy Agency research nomenclature. The Atlas also covers energy R&D roadmaps, focusing initially on a meta-analysis of existing roadmaps. The paper focuses on the design and structure of the Atlas, the processes through which the content was derived, including peer review and stakeholder consultation. The paper illustrates the content with examples from the marine renewables sector and ends by highlighting some of the uses to which the Atlas has been put.

INTRODUCTION AND RATIONALE

In many countries, the twin concerns of energy security and climate change are stimulating a resurgence of interest in energy-related research and development after some years of falling investment. As Figure 1 shows, declines in R&D budgets have been particularly pronounced in Europe since the mid-1980s.

It is agreed in a number of countries (e.g. UK², Canada³) that the declining level of energy R&D was also associated with a greater fragmentation of effort. Researcher funding programmes were less co-ordinated than had been the case in the 1970s and early 1980s. Furthermore, the energy R&D community itself was less well-organised and not “self-aware”.

As a matter of strategic priority, individual countries, bodies such as the European Union and administrations at the sub-national level are re-investing in energy R&D. In the EU Seventh Framework Programme (FP7) for R&D⁴, energy research has a distinct budget line whereas under FP6 energy was subsumed within environment and sustainable development. In the UK, energy R&D expenditure has now turned the corner, having risen considerably since 2003 (Figure 2).

With this increased volume of effort, and an increasing number of bodies supporting energy R&D, there is a need to plan and co-ordinate efforts in order to establish priorities, ensure that the best use is made of scarce resources, avoid unnecessary

¹ UK Energy Research Centre, 58 Prince's Gate, London SW7 2PG; Tel +44 205 1594; jim.skea@ukerc.ac.uk

² Chief Scientific Adviser's Energy Research Review Group, *Recommendations to Inform the Performance and Innovation Unit's Energy Policy Review*, Office of Science and Technology, London, <http://www.dti.gov.uk/files/file25485.pdf>, last accessed 11 May 2007

³ National Advisory Panel on Sustainable Energy Science and Technology, *Powerful Connections Priorities and Directions in Energy Science and Technology in Canada*, Office of Energy Research and Development, Natural Resources Canada, Ottawa, http://www.nrcan.gc.ca/eps/oerd-brde/report-rapport/preface_e.htm, last accessed 11 May 2007

⁴ European Commission, *Work Programme 2007: Cooperation: Theme 5 Energy*, C(2007) 560, Brussels, 26.02.07

duplication of effort and take account of any bottlenecks in terms of research capacity. In the UK for example there have been a number of significant innovations in the last three years alone including the UK Energy Research Centre (UKERC), the Energy Research Partnership (ERP)⁵, the Energy Technologies Institute (ETI)⁶ and the Environmental Transformation Fund⁷. There is a potential risk of overlap between the activities of these bodies.

With this in mind the UK Energy Research Centre has been developing a new web-based tool, the UK Energy Research Atlas. The original goals of the Atlas as conceived in 2004 were to:

- give each member of the UK energy research community an insight as to the context of their research, both within their immediate community and in respect of competing and complementary technologies; and
- identify the sequence of research problems to be overcome before new technologies can be commercially viable.

Subsequently, it has become apparent that the Atlas could make a key contribution to the evidence base for energy R&D planning in the UK. This paper describes the scope of this effort, the structure of the Atlas, the methods used for gathering information, the management of the process and uses to which the Atlas has been put so far. The marine renewables sector is used as an example of the type of information that has been gathered.

METHODS AND STRUCTURE

The scope of the Atlas is energy R&D activity in which the UK has an interest. It does not pretend to be a comprehensive account of international activities, or even those at the EU level. It covers basic research, applied R&D and demonstration activities as shown in Figure 3. It does not extend to “market-pull” policies and mechanisms promoting technology deployment, such as the UK’s Renewables Obligation. The Atlas has three components, two of which are aimed at characterising current and recent energy R&D activities, and the third of which is concerned with forward R&D needs. These are:

Research Landscape⁸. This characterises energy-related research activities and capabilities at the *programme* level, covering both funding programmes and R&D providers.

Research Register⁹. An on-line searchable database of energy-related awards and projects.

Research Roadmaps¹⁰. These identify the sequence of R&D (and other) problems to be overcome before new technologies can be commercially viable.

⁵ <http://www.energyresearchpartnership.co.uk/erp.php>, last accessed 11 May 2007

⁶ Department of Trade and Industry, *Energy Technologies Institute: Prospectus*, London, September 2006, <http://www.dti.gov.uk/files/file34010.pdf>, last accessed 11 May 2007

⁷ <http://www.defra.gov.uk/news/2006/060629a.htm>, last accessed 11 May 2007

⁸ <http://ukerc.rl.ac.uk/ERL001.htm>, last accessed 11 May 2007

⁹ <http://ukerc.rl.ac.uk/ERC000.html>, last accessed 11 May 2007

¹⁰ <http://ukerc.rl.ac.uk/ERR001.html>, last accessed 11 May 2007

An early decision was taken to structure the Atlas according to the International Energy Agency's R&D nomenclature¹¹. The EU and the IEA spent a considerable amount of effort revising this scheme in 2003 and 2004 to reflect the modern energy R&D landscape. The new scheme was eminently fit for purpose and would allow comparison with international data.

There were however some implementation issues. IEA areas and sectors are designed around technology areas and energy supply chains, e.g. coal production, processing, transport and conversion. There is now a great interest in "systems" approaches to energy research that the IEA nomenclature does not readily lend itself to. A particular challenge was how to accommodate cross-cutting research, for example underpinning basic science on materials, or work on environmental impacts. After some experimentation, we decided to embed descriptions of basic science and environmental science in each of the technology-based IEA sectors. In practice, most energy-related materials science was found, for example, to have been conducted with a specific technology, e.g. fuel cells, in mind. Social science as embodied in energy systems models is however accounted for separately.

The IEA nomenclature, at the level used by UKERC, is shown in Table 1. Sectors not yet covered by the Atlas are shown in brackets.

Research Landscape

Each sector covered in the landscape is broken down into the following sections:

1. Overview, characterising the field and identifying key research challenges
2. UK Capabilities Assessment
3. Basic and Applied Strategic Research
4. Applied Research
5. Development and Demonstration Funding
6. Research Facilities and other Assets
7. Networks
8. UK Participation in EU Activities
9. International Initiatives

In general, each section includes factual information in tabular format supplemented by brief interpretative text. Sections 1 and 2 necessarily rely more on subjective judgments. Sections 3 – 5 include information on both funding streams and research providers. The inclusion criteria used for research providers has been a key issue. It has become very evident that barriers to entry and the scale of activity needed for critical mass vary greatly from one sector to another. We used the qualitative criterion that providers are making a "material contribution" to the UK's energy R&D effort. There is an illustration of the research landscape for marine renewables in a subsequent section.

Research Register

The Research Register is a searchable database of publicly funded energy R&D projects in the UK. It operates at a greater level of detail than the Research Landscape and contains financial information on each award. As with the Research Landscape, the IEA R&D nomenclature is used as the basis for classification. The Register also distinguishes between: Basic and strategic applied research; Applied Research and Development; and Final stage Development and Demonstration.

¹¹ European Commission, *Energy R&D Statistics in the European Research Area*, EUR 21453, Brussels, 2005

The development of the Research Register has been carried out by the Rutherford Appleton Laboratory (RAL), one of the UKERC partners. The intention has been to “mine” data automatically, as far as possible, from key research funders and accumulate the information in a specially designed database. The Register has not therefore required the extensive networking inside and outside UKERC needed to assemble the Research Landscape. In practice, arranging access to funders’ records has proved far more difficult than setting up the database itself.

Priority has been given to acquiring information from the Engineering and Physical Sciences Research Council, the Department of Trade and Industry (DTI) and the Carbon Trust. As of May 2007, the database contains 418 grants made by EPSRC, 137 by DTI and 86 by the Carbon Trust. The next organisations to be included are the Natural Environment and Economic and Social Research Councils. The final aim is to include government departments such as environment (DEFRA), transport (DfT) and communities and local government (DCLG). We will also attempt to cover the Regional Development Authorities in England and the Devolved Administrations in Scotland and Wales.

Research Roadmaps

At this stage, the Research Roadmaps section of the Atlas consists mainly of a series of characterisations of existing roadmaps, based on a common template. As with the Research Landscape, the roadmaps are classified by IEA sector. The characterisation template covers:

- Bibliographic information, i.e. how to access the roadmap
- The nature of the output (report, website, software)
- “Architecture” (timescales, trends and drivers, performance targets)
- Process used to derive the roadmap (desk study, stakeholder consultation)
- Nature of the actions identified and a brief summary

The set of characterisations is currently less complete than the set of research landscapes. In the view of the Atlas Advisory Group (see below) further work is now required to synthesise the conclusions of the separate roadmaps for each IEA sector. A set of “questions” to guide the synthesis has been established and these are being tested on the Marine Renewables sector.

UKERC is starting to develop research roadmaps of its own where gaps in existing knowledge are identified. The general pattern is for a two-day workshop engaging academic researchers, industry and government to be followed up by extensive email consultation leading to a final draft put out for peer review. So far, roadmaps on photovoltaics and marine renewables are furthest advanced while workshops have taken place for bio-energy and carbon capture and storage. The PV roadmap is currently out for peer review.

GATHERING INFORMATION

This section focuses on the Research Landscape, describing current energy R&D activities at the programme level. UKERC is a “distributed centre”, meaning that it is a collaboration between different centres of excellence round the UK. Each has competences in its own part of the energy field. This provides an excellent network of expertise for accumulating the information necessary to characterise the research landscape.

A “topic leader” within each of UKERC’s themes has assumed responsibility for an IEA sector. A common template for data collection and an associated guidance document was developed by the UKERC headquarters. The following sequence was followed:

- Draft template for data collection developed
- Template tested on trial sector (transport)
- Template revised and guidance drafted
- Draft templates and guidance issued to those responsible for gathering content
- First drafts reviewed by headquarters and guidance modified
- Iterative process of revising content/commentary by headquarters
- draft sector documents uploaded to a closed “demonstration” website for internal review
- Landscape documents launched
- Three month review period involving invited peer review plus open invitation to comment.

UKERC received external assistance in certain areas. Some sectors were not adequately covered through UKERC expertise. The British Coal Utilisation Research Association was commissioned to carry out the work relating to coal combustion and conversion. The Culham Laboratory and the Dalton Institute at Manchester University voluntarily carried out the task for the nuclear fusion and fission sectors respectively.

For “UK Participation in EU Activities”, we established a separate arrangement with the Energie Helpline, the UK National Contact Point for the energy aspects of the EU Framework Programme. With support from the DTI, they provided us with comprehensive data on EU projects in which UK players were involved.

THE RESEARCH LANDSCAPE: AN EXAMPLE FROM THE MARINE RENEWABLES SECTOR

To give a flavour of the content of the Research Landscape, sample information from the marine renewables sector is presented. The full document is available online.¹²

Section 1 provides an overview of the sector. It starts by characterising the field in the UK:

“Marine renewables cover wave energy and tidal stream energy. The potential for offshore wave energy in the UK has been estimated to be 50 TWh/year with nearshore and shoreline wave adding another 8 TWh. The UK tidal stream potential is 18 TWh. Taken together, approximately 15-20% of UK electricity demand could in principle be met by wave and tidal stream. However, the marine industry in the UK is at a very early stage, probably 20-30 years behind the current wind industry.”

It also highlights research challenges:

“Marine renewable energy research tends to be multi-disciplinary covering a range of challenges: resource modelling; fundamental hydrodynamic modelling; engineering design of devices; tank testing; electrical systems and grid connection; environmental issues; economics; and impacts of climate change. Issues include: survivability, economics, installation, operation and maintenance and rapid prototype development.”

¹² <http://ukerc.rl.ac.uk/ERL0303.html>, last accessed 11 May 2007

Section 2 contains an assessment of how the UK's research capabilities compare to those of other countries. This is a subjective assessment and is a critical area for peer review. Table 2 shows the current assessment of capabilities. When considering the division of capabilities into "high", "medium" and "low" the authors were given this guidance:

High should indicate that the UK is among the world leaders in the area concerned; ***medium*** that the UK is at a typical level for a developed country; and ***low*** that the UK lags well behind the world leaders. It is difficult to be precise but, in making these judgments, the UK's peers should be considered to be the G7 countries (US, Canada, Japan, Germany, France, Italy) plus any other countries considered to be particularly well-advanced in a particular field"

Sections 3 –5 contain more factual information on basic (university-led) research, applied R&D (industry-led) and demonstration. Each follows a similar format. Figure 4 shows the major funding streams for basic marine research in the UK. Figure 5 shows a subset of the main research providers. In both cases the documents contain a comprehensive set of weblinks which lead to organisation and project websites, allowing immediate access to comprehensive information on research activity.

Finally, Figure 6 shows the format in which we have captured information on UK participation in the EU Framework Programmes.

From the evidence in the Atlas it is possible to conclude that for UK marine renewables players, R&D funding at the national level is currently by far the more important. About £1m per year is going into basic R&D plus several £m going into applied R&D and demonstration activity. At the EU level, the UK has so far had a share in rather smaller projects.

MANAGEMENT

The development of the Atlas is being directed from UKERC headquarters. The Rutherford Appleton Laboratory (RAL), one of the organisations participating in UKERC, designed and hosts the website containing the Atlas.

The overall process for developing and maintaining the Atlas benefits from guidance from an Advisory Group. This comprises key UKERC personnel engaged in developing the Atlas plus external people representing users, or those who have had previous experience of taking forward similar initiatives. The external organisations represented include the Department of Trade and Industry, the Office of Science and Innovation, the Engineering and Physical Sciences Research Council, an electric utility and the Environment Research Funders Forum. Among the topics on which the Group has provided advice are: peer review/quality control; inclusion criteria; and potential uses of the atlas.

The research landscape material was reviewed internally by UKERC before being placed online. However, we have recently run an external peer review process to test the validity of the material. We invited peer reviews of each sector from three people: a UK-based academic; a UK-based "user" from industry or government; and someone from outside the UK. The reviewers were invited to comment on the accuracy and completeness of the factual information in the landscape material and the appropriateness of the interpretive elements. Peer review comments have been received and are now being responded to by the authors of the landscape documents.

USING THE ATLAS

The Energy Research Atlas is being used for a variety of purposes. UKERC's extensive network of contacts, plus the active engagement of members of the Advisory Group,

ensures that awareness of the Atlas round the UK energy R&D community is high. The specific uses have included:

- Providing background information and statistics for presentations on the UK energy research scene
- Providing information on the activities of local research organisations for regional development authorities and the devolved administrations
- Providing evidence for the Energy Research Partnership in developing criteria for the work programme of the new Energy Technologies Institute
- Helping to characterise patterns of research activity for the International Science Panel on Renewable Energy recently established by the International Council for Science (ICSU).
- Helping identify partners for establishing consortia for EU Framework Programme bids.

It is evident that the Atlas is a flexible tool. Plans for taking the Atlas forward include:

- Putting the Research Landscape documents, which are most complete, on to a six-monthly revision cycle which will be reviewed in 2009.
- Filling in the small number of missing landscape documents
- Completing and developing new research roadmaps relevant to the UK
- Extending the number of funding organisations covered by the Research Register
- Improving the suitability of both the Research Register and the Research Landscape for statistical analysis of funding patterns and other measures of activity.

Table 1 The IEA Energy RD&D Nomenclature as Used by UKERC

Area	Sector
ENERGY EFFICIENCY	Industry Residential and Commercial Transport (Other)
FOSSIL FUELS: OIL, GAS AND COAL	(Oil and Gas) Coal CO2 Capture and Storage
RENEWABLE ENERGY SOURCES	Solar Energy Wind Energy Ocean Energy Bio-Energy (Geothermal Energy) (Hydropower) (Other Renewables)
NUCLEAR FISSION AND FUSION	Nuclear Fission Nuclear Fusion
HYDROGEN AND FUEL CELLS	Hydrogen Fuel Cells
OTHER POWER AND STORAGE	(Electric Power Conversion) Electricity Transmission and Distribution (Energy Storage)
OTHER CROSS-CUTTING TECHNOLOGIES AND RESEARCH	Energy System Analysis (Other)

TABLE 2: UK MARINE ENERGY R&D CAPBILITIES

UK Capability	Area
High	<ul style="list-style-type: none"> • Wave device development • Tidal stream device development • Electrical system design • Tank & Offshore testing • Resource Assessment • Device Installation • Manufacturing • Grid connection • System demonstration (EMEC & WAVEHUB) • R&D
Medium	<ul style="list-style-type: none"> • Environmental monitoring
Low	<ul style="list-style-type: none"> • Materials design and development for marine

Figure 1: IEA Energy R&D Spend

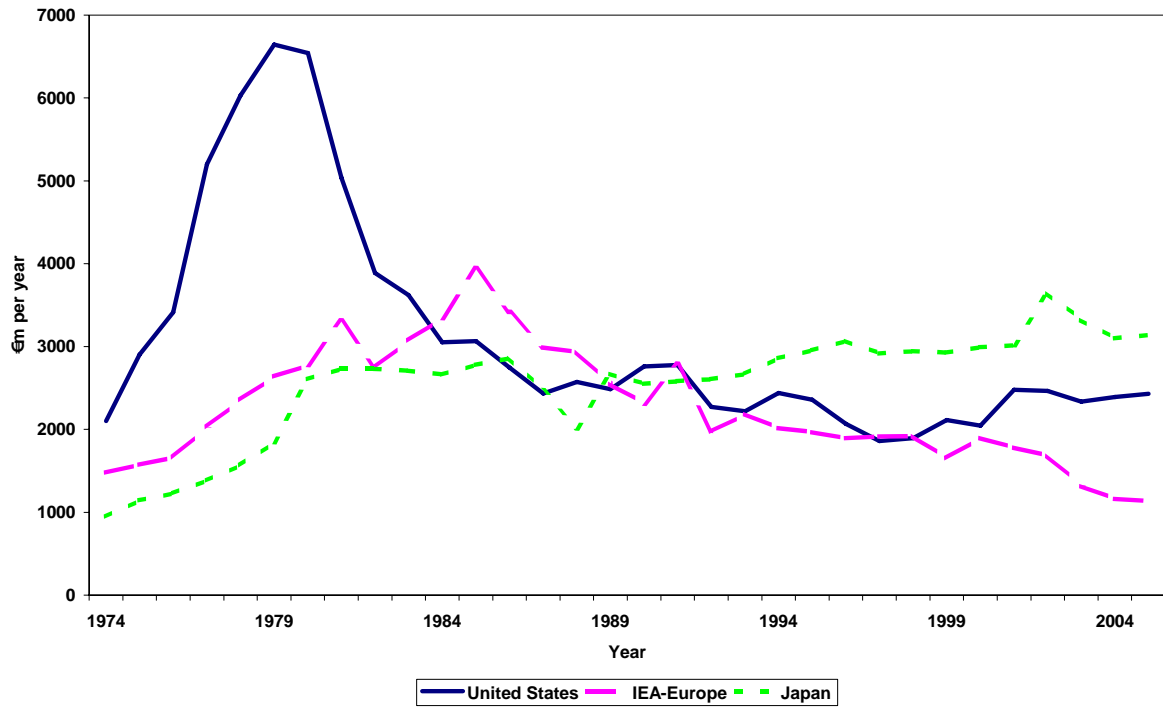

Figure 2: UK Energy R&D Spend

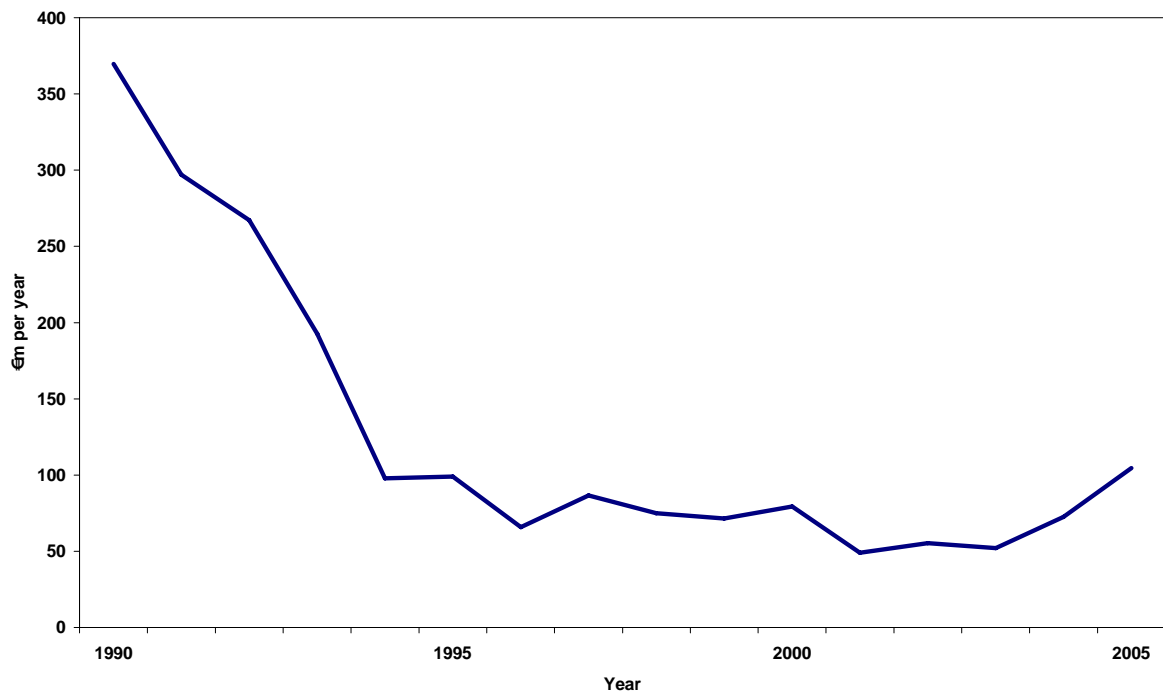

FIGURE 3: ENERGY INNOVATION PROCESS

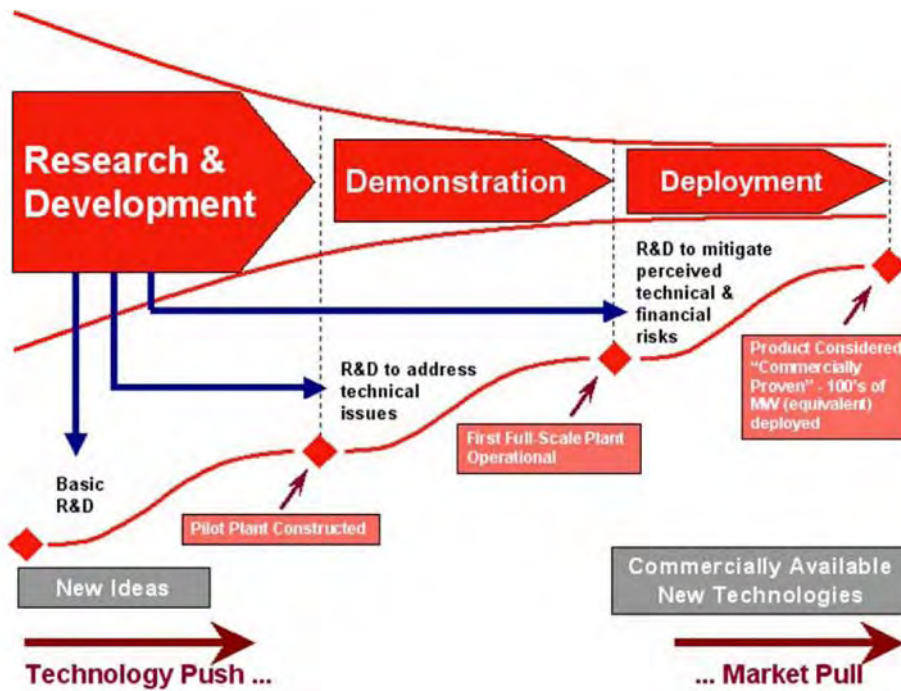

FIGURE 4: MAJOR FUNDING STREAMS IN BASIC MARINE ENERGY RESEARCH

Table 3.1: Research Funding

Funding Stream	Funding Agency	Description	Committed Funds	Period	Representative Annual Spend
SUPERGEN - Marine	EPSRC	Generic research to reduce risk & uncertainty for marine energy development. A consortium of 5 Universities: Edinburgh, Heriot Watt, RGU, Lancaster & Strathclyde.	£2.6m	2003-2007	£650k
UK Energy Research Centre	NERC	Coordinators of the National Research Network and developing roadmap documents for renewable energy technologies, including marine renewables (£170k)	£170k for Marine Network	2005-2009	£40k
Responsive Mode	EPSRC	Research grants awarded to institutions for marine energy research.	£2.8m	2000-	£560k
TOTAL			£5.6m		£1.12m

FIGURE 5: SOME RESEARCH PROVIDERS –MARINE ENERGY

Name	Description	Sub-topics covered	No of staff	Field
Institute for Energy Systems, University of Edinburgh	Multidisciplinary research institute formed from the Wave Energy Group and the Energy Systems Group. Focus is on marine renewables and networks. Involved in three SUPERGEN consortia: Marine, Networks and Infrastructure. Recently formed a Joint Research Institute with Heriot-Watt University	<ul style="list-style-type: none"> • wave energy • tidal stream • tank testing • hydrodynamic modelling • design of electrical power take off systems • design of novel electrical machines • renewable resource modelling • impact of climate change on the resource • chemical conversion using renewables 	12 faculty, 7 researchers, 20 PhD students	<ul style="list-style-type: none"> • Electrical and electronic engineering • Chemical engineering • Civil Engineering • Mechanical engineering
Sustainable Energy research Group, University of Southampton	Cross departmental grouping covering technical and social issues of all aspects of renewable energy	<ul style="list-style-type: none"> • hydrodynamics of marine current turbines • tidal stream resource 	8 faculty (2 visiting, 6 working in marine) 6 researchers (4 in marine) 5 PhDs (1 in marine)	<ul style="list-style-type: none"> • Electrical and electronic engineering • Civil Engineering • Mechanical engineering • Economics and econometrics
Hydraulics Research group, Queens' Belfast	Marine activity is based in the Civil Engineering Dept. Tank test facilities available. Recently Established a research centre: Environmental Engineering Research Centre . Also work closely with the Power Group in Electrical Engineering	<ul style="list-style-type: none"> • tank testing • device development • hydrodynamic modelling • power take off design • Wells turbine design • Hydraulics • Structural engineering • Environmental • Coastal engineering 	16 faculty, 9 researchers, 28 PhDs	<ul style="list-style-type: none"> • Electrical and electronic engineering • Civil Engineering • Mechanical engineering • Environmental sciences
LUREG, Lancaster University	Part of general engineering department. Focussed on development of two devices: PS Frog and Frond.	<ul style="list-style-type: none"> • Tank testing. • Hydrodynamic modelling. • Power take off design. • Control of wave devices 	6 faculty, 5 researchers,	<ul style="list-style-type: none"> • Electrical and electronic engineering • Civil Engineering

FIGURE 6: EXAMPLE OF EU PROJECTS IN WHICH UK MARINE RESEARCHERS PARTICIPATE

Project	Objectives	Action Line	Type of Action	UK Participants	Co-ordinator and partners	Total Funding	EU Funding	Duration	Annual spend
CA-OE -Co-ordinated Action on Ocean Energy	To develop a common knowledge base to bring a coordinated approach within key areas of ocean energy research and development, to provide a forum for longer term marketing of promising research deliverables. Revise and implement standards related to monitoring performance and presentation of results, safety on structural and electrical system design.	FP6: SUSTDEV-1.2: M-L Research activities having an impact in the medium and longer term	Coordinated Action	University of Southampton University of Strathclyde Robert Gordon University IT Power Aquaenergy Development Ltd Lancaster University Queen's University Belfast University of Edinburgh Mr Christopher Day Ocean Power Delivery	Ramboll Denmark 41 partners	€1.58m	€1.5m	September 2004 – December 2007	€0.5m
Coordinated Action on Ocean Energy (CA-OE) and its European Thematic Network on Wave Energy	Workshop 5 is on Environmental, Economics, Development Policy and Promotional Opportunities. Workshops every 6 months. 2003 Wavenet Report , including social, planning and environmental impacts. 2004		Coordinated Action	8 UK Partners	Kim Nielsen +45 4598 8441 Environment: SPOK ApS, Denmark Hans Chr. Sorensen consult@spok.dk www.spok.dk			2004 – present?	

European and Global Perspectives for CO₂ Capture and Storage

Heleen Groenenberg, Martine Uyterlinde, ECN Policy Studies, The Netherlands

Abstract

CO₂ capture and storage (CCS) is increasingly mentioned as one of the options in the portfolio to mitigate climate change. CCS involves the capture of CO₂ from a large point source, compression, transport and subsequent storage in a geological reservoir, the ocean, or in mineral carbonates. This paper will provide results of the scenarios analysed using 10 advanced energy models. Two policy approaches are compared in order to address the question how to achieve significant CO₂ emission reductions through the application of CCS technologies. The analysis shows that CCS can provide an important contribution to mitigating climate change. Up to 30% of global CO₂ emissions could be captured in 2050, while for Europe, due to a more limited growth of the power sector than in some other world regions, this would amount to some 22% of total CO₂ emissions. The CCS policies not only induce the large-scale introduction of CCS systems in the electricity sector, but they also accelerate the penetration of renewable energy sources and nuclear. Policies that provide flexibility, for instance through emission trading, are more cost-effective than those obliging CCS to be installed with all new fossil power plants. Therefore, it is recommended to employ mixes of the different CO₂ emission reduction options available, also depending on regional circumstances. The uncertainties, particularly in storage capacities, are large. Being a new technology, the actual deployment of CCS will also depend on public perception and on how legal and regulatory aspects related to risks and liabilities are addressed.

1 Introduction

CO₂ capture and storage is increasingly mentioned as one of the options in the portfolio to mitigate climate change. CCS involves the capture of CO₂ from a large point source, compression, transport and subsequent storage in a geological reservoir, the ocean, or in mineral carbonates.

This paper analyses the role of CO₂ capture and storage technologies in the power sector, and provides an overview of the main results from a number of models used in the CASCADE MINTS project (Uyterlinde et al, 2006). The models used are: POLES, MARKAL and TIMES-EE for the European impacts, GMM, MESSAGE, ETP, DNE21+ and PROMETHEUS to illustrate global developments, the global economic model NEWAGE-W, and finally NEMS for the US. The models do not take into account non-economic aspects of CCS that may inhibit the deployment, such as public acceptance, risks and safety regulations and upstream environmental impacts.

Two policy approaches are compared in order to address the question how to achieve significant CO₂ emission reductions through the application of CCS technologies.

- Case 1: 'CCS standards' requires that from 2015 onwards, all new power plants have to be equipped with a CO₂ capture facility. These standards are not applied to peaking plants with a utilisation rate of 20% and small CHP-plants.
- Case 2: 'CO₂ emission cap' takes the emission level from the Standards case as an upper bound for the overall emissions. No other policies are assumed.

The scenarios are compared to a common, harmonised baseline scenario, characterised by a moderate economic and demographic growth, and based on the IPCC B2 scenario¹. Oil prices reflect assumptions of low to moderate resource availability. In the period 2000-2050, the world oil price is projected to increase from ca. 26 to 38 US\$₉₅/barrel (4.2 to 6.2 €/GJ), which is relatively low compared to current prices. Natural gas prices within Europe, although not explicitly harmonised among the models, are projected to increase from on average 2.3 to 5.4 €/GJ in 2000-2050. Finally, some representation of climate policy or emission trading for the region of Europe has been included, reflected in a generic carbon tax of 10 €/tonne CO₂ from the year 2012 onwards.

Most models have applied approximately the same set of capture technologies. Post-combustion systems, that separate CO₂ from the flue gases after combustion, are generally coupled to supercritical pulverised coal (PC) plants, or to natural gas combined cycle power plants (NGCC). Pre-combustion systems, which extract the CO₂ and combust or use the resulting hydrogen, are used in combination with an integrated coal gasification combined cycle plant (IGCC), or with a biomass gasification plant. Oxyfuel combustion, which is still in a demonstration phase, has not been modelled. Some models have also included CO₂ capture in hydrogen production processes (gas steam reforming or coal partial oxidation) and in industry, in the production of cement, cokes, and ammonia.

There are differences in how transportation and storage of CO₂ is modelled. Some models have a wide array of storage options with capacities whereas others have a generic storage technology with infinite capacity. This does have an effect on the results, since for some models, the revenues related to hydrocarbon recovery greatly contribute to making CCS viable. The modelling of transportation costs also varies.

2 Regulatory CCS standards compared to a global CO₂ emission cap

Under the assumption of the regulatory CCS standards, 16% to 30% of global CO₂ emissions can be captured in 2050, as illustrated in Figure 1. According to the different global models used, this corresponds to a range of 7 to 19 Gton CO₂ captured and stored in 2050. For Europe, due to a more limited growth of the power sector than in some other world regions, this would amount to some 21%-23% of total CO₂ emissions.

One of the factors underlying this range is the large variation in emissions projections among the models, which is related to the differences in the projected primary energy mix, particularly the share of fossil fuels. Other important explanatory factors are the assumptions related to technology learning and future costs of CCS technologies and renewables, as well as the growth constraints or potentials of the main carbon-free energy sources, nuclear and renewables.

The CCS standards not only induce the large-scale introduction of CCS systems in the electricity sector, but they also accelerate the penetration of nuclear and renewable energy sources. This 'substitution effect' is due to the fact that the application of CCS makes electricity generation more expensive and therefore other options become more competitive. For this reason, the emission reduction compared to the baseline is even larger, up to 40%, in most models. Generally, it more than compensates the 'energy penalty', e.g. the energy use and related emissions due to the additional energy needed for the CO₂ capture and storage processes themselves. However, one of the models (MESSAGE) points out that imposing CCS standards within the power sector may lead to a considerable shift ('leakage') of emissions to other sectors. The increase of biomass

1 More information on the models and on key assumptions, 'business as usual' trends and developments for Europe can be found in the CASCADE MINTS baseline report (Uyterlinde et al., 2004).

use for power production, for instance, induces more use of fossil methanol instead of bio-ethanol in the transport sector.

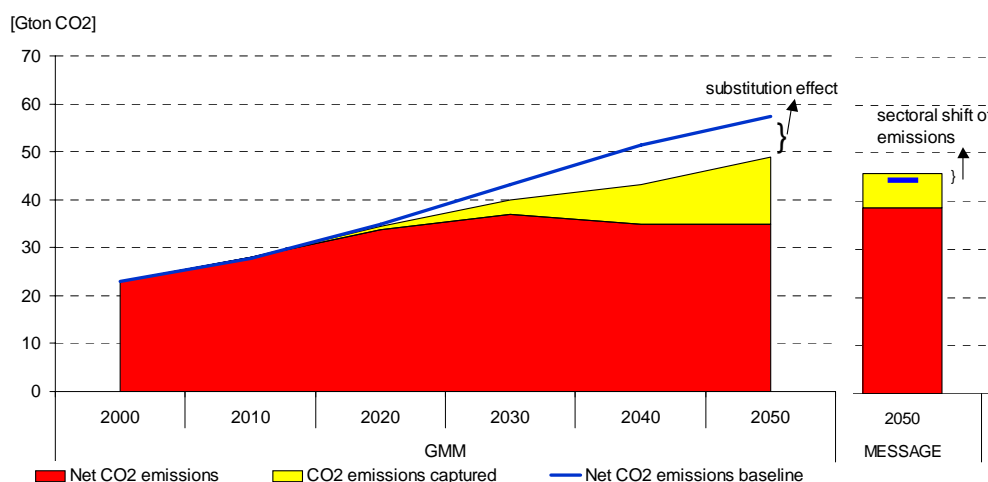

Figure 1 Global net CO₂ emissions and amount of CO₂ captured in the CCS Standards case compared to net CO₂ emissions in the baseline

A global CO₂ emission cap results in a lower penetration of CCS technologies, but reaches the same emission reduction at lower costs. Generally, this policy instrument induces a stronger increase in the contribution of renewable energy sources and nuclear power. There may also be a shift towards natural gas power plants instead of coal capacity. There are clear differences between the models concerning the timing and extent of CCS penetration, related not only to the differences in projected fuel mix, but also to the severity of the CO₂ cap, which is derived from the emission reduction realised in the CCS standards case.

3 Sufficient storage capacities towards 2050

There is an ongoing scientific debate on how the CO₂ storage capacity should be estimated. Any site needs a detailed geological survey in order to make a reliable estimate of the suitability of the reservoir for storage of CO₂. Although acknowledging the controversies in the scientific literature on this issue, the CASCADE-MINTS project used conservative estimates in line with the IPCC Special Report, and arrives at the conclusion that the availability of storage capacity does not impose limits to the amount of CO₂ stored in the time frame to 2050.

Figure 2 presents the cumulative amounts of CO₂ stored under the different policy cases, for three world models. These models report that under the CCS standards policy for new fossil power plants, the global, cumulative amount of CO₂ captured and stored in 2020-2050 is in the range of 170 - 260 GtCO₂. Acknowledging that the power plants built towards 2050 will need enough storage capacity for the decades to come, this still seems well below IPCC estimates (IPCC, 2005) of 675-900 GtCO₂ of cumulative potential for CO₂ storage in global gas and oil fields. Also in Europe, storage potentials appear to be sufficient. There are differences among the models in what kind of reservoirs are used. These differences are closely related to the uncertainties in storage potentials as a result of the huge variety in local geological circumstances.

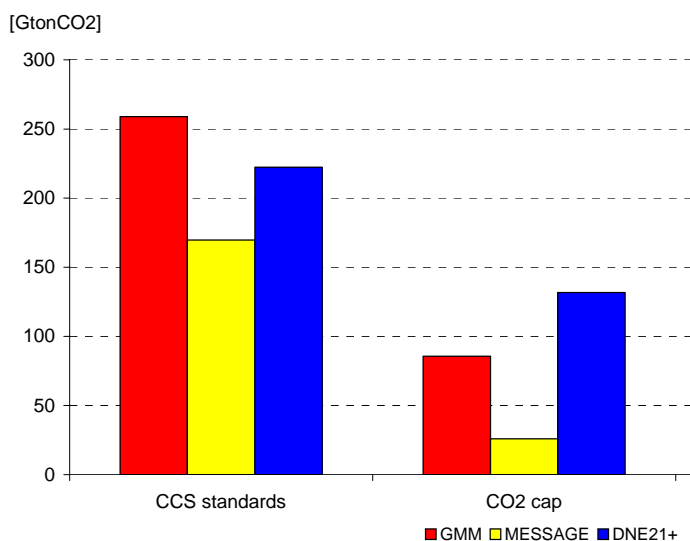

Figure 2 Cumulative amount of CO₂ stored in 2020-2050

4 Conclusions

From a comparison of the policy cases, a number of conclusions can be drawn. The most general observation is that the models investigated are broadly in agreement: they confirm that CCS is likely to play a role in cost-effectively reducing CO₂ emissions. However, the actual deployment of CCS not only depends on its technical and economical characteristics, as taken into account by the models, but also on several other important aspects, such as the importance of the availability of reservoirs near a point source of CO₂ was already mentioned. The potential and characteristics of CO₂ storage reservoirs remain uncertain, although several studies aim at reducing this uncertainty. Furthermore, several legal and regulatory issues, related to risks and liabilities still need to be dealt with, and not much is known yet about public acceptance. Finally, CCS has not yet established itself in the climate change negotiations, and it needs an accepted accounting methodology in the Kyoto regime.

The first policy instrument analysed, which obliges new fossil power plants to install CCS technologies as of 2015, shows that 16% to 30% of global CO₂ emissions could be captured in 2050. These amounts could be regarded indicative of the maximal CCS penetration achievable by 2050, as the more flexible global CO₂ emissions cap induces a much lower CCS uptake, while at the same time there are several mechanisms limiting the effectiveness of any policy focusing exclusively on CCS.

First, the inertia in the power sector will slow down the penetration of CCS technologies, as plants built before the introduction of the standards regime are allowed to operate until the end of their lifetime. Secondly, imposing a strict standard requirement on one sector alone leads in some cases to moving the carbon intensive fuels to sectors where no such requirements are imposed. Third, it is difficult to target such a policy well, as it may easily provide an incentive for fossil-based technologies not covered by the standard, such as peak-load gas plants. Finally, the introduction of a CCS standards policy is often much more costly than imposing a CO₂ cap that reaches the same emission reduction.

5 References

IPCC (2005): Special Report on Carbon Dioxide Capture and Storage. Cambridge University Press, 442 p.

Uyterlinde, M.A., G.H. Martinus, E. van Thuijl, N. Kouvaritakis, L. Mantzos, V. Panos, M. Zeka-Paschou, K. Riahi, G. Totsching, I. Keppo, P. Russ, L. Szabo, S. Kypreos, P. Rafaj, C. Böhringer, A. Löschel, I. Ellersdorfer, M. Blesl, P. Le Mouél, A.S. Kydes, K. Akimoto, F. Sano, T. Homma and T. Tomoda (2004): *Energy trends for Europe in a global perspective: Baseline projections by twelve E3-models in the CASCADE MINTS project*. ECN-C--04-094, December 2004.

Uyterlinde, M.A.; Rösler, H.; Coninck, H.C. de; Zwaan, B.C.C. van der; Keppo, I.; Kouvaritakis, N.; Panos, V.; Szabó, L.; Russ, P.; Suwala, W.; Rafaj, P.; Kypreos, S.; Blesl, M.; Ellersdorfer, I.; Zürn, M.; Fahl, U.; Kydes, A.; Martin, L.; Sano, F.; Akimoto, K.; Homma, T.; Tomoda, T.; Gielen, D. (2006b): *The contribution of CO2 capture and storage to a sustainable energy system. Volume 4 in the CASCADE MINTS project*. ECN-C--06-009, September 2006.

6 Acknowledgements

The CASCADE MINTS project is funded by the EU under the Scientific Support to Policies priority of the Sixth RTD Framework Programme.

Solar Energy – Status and Perspectives

Peter Ahm, Director

PA Energy A/S (Ltd.)

Snovdrupvej 16, DK-8340 Malling

Phone: +45 86 93 33 33; Fax: +45 86 93 36 05; e-mail: ahm@paenergy.dk

Abstract

Solar energy in terms of thermal Solar Hot Water systems and electricity producing Photovoltaics contribute at present only to the global energy supply at a fraction of 1 %. However, the potential for solar energy is immense: the earth receives in 1 hour from the sun the equivalent of the present annual global energy supply.

Solar energy is one of the emerging renewable energy technologies still not competitive, but exhibiting both technical and economic potential to be so inside 10-15 years. There is basically no necessary “technology jumps” as prerequisites, but such a development will demand a favorable political climate.

Growing political awareness, driven partly by environmental concerns partly by concerns about security of energy supply, of the need to promote solar energy and renewables, e.g. on global level spurred on by the recent UN/IPCC report and on an EU level by the EC commitment to reach 20 % renewables in the electricity supply by 2010 and 20 % renewables in the overall energy production by 2020, appears to ensure the necessary future political support for renewables, but not necessarily for solar energy technologies, in particular photovoltaics’s, which is still not yet competitive to other renewables although exhibiting a tremendous potential.

1 Introduction

The potential for solar energy is very high – about one hour sunshine on the surface of the earth corresponds to the present annual global energy consumption. However renewable and solar energy still plays a very minor role in the global energy supply. The IEA statistics¹ as shown in Fig. 1 illustrates this fact very well.

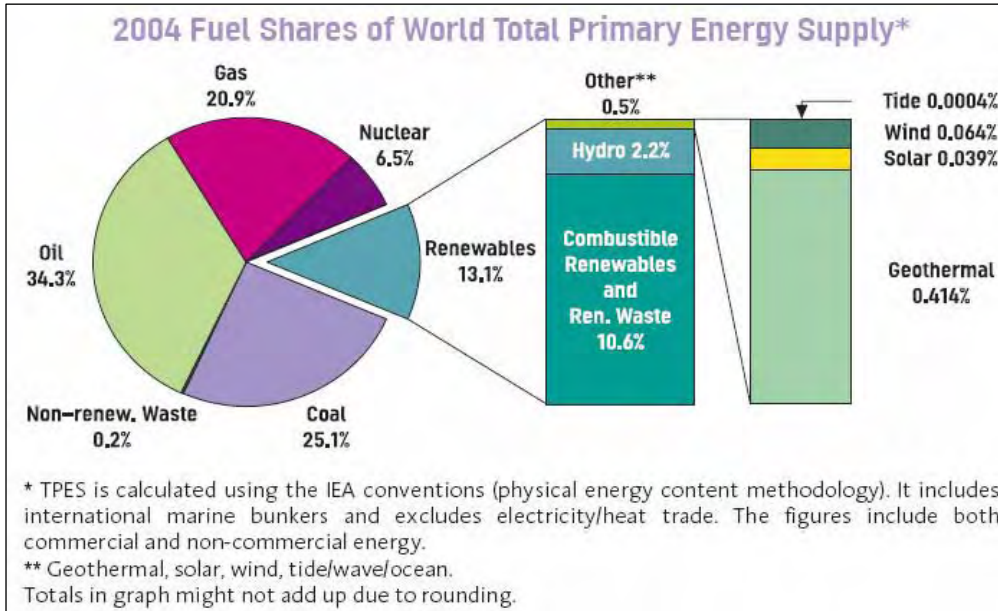

Fig. 1: Fuel shares in 2004.

Although the contribution of solar energy to the global energy supply is quite small at present, less than 0,05 percent, the growth rate of solar energy has been relatively high, albeit from a very low starting point. Again with reference to IEA statistics and as

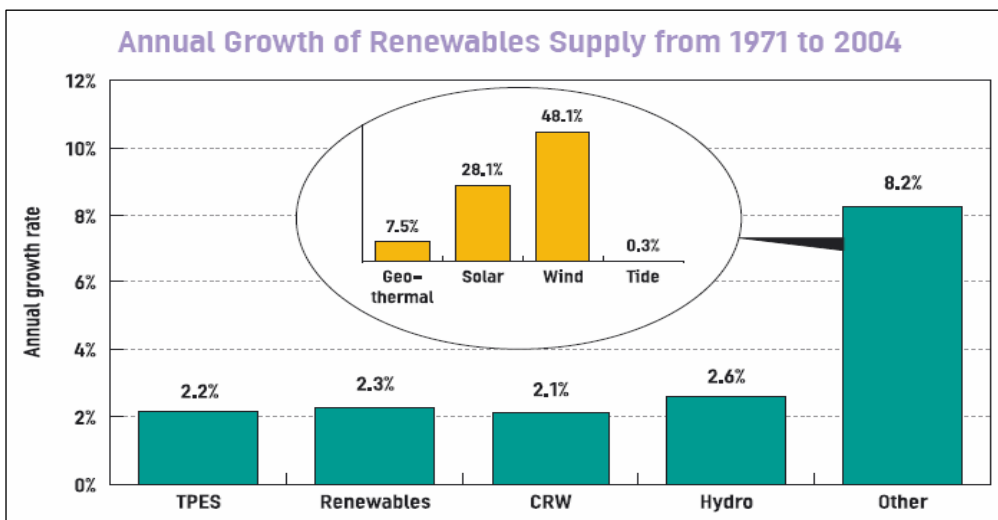

Fig. 2: Annual growth rates of renewables

illustrated in Fig. 2 renewables as such have in the period 1971 to 2004 exhibited an annual growth rate of 2,3 percent, almost on par with the growth rate of the global energy supply, whereas solar energy in the same period grew by almost 30 % per year in average with higher growth rates in the recent years.

¹ Source: Renewables in Global Energy Supply, September 2006, the International Energy Agency.

Being an emerging market segment, solar energy as other renewables is still dependent on political support. Growing political awareness, driven partly by environmental concerns partly by concerns about security of energy supply, of the need to promote solar energy and renewables, e.g. on global level spurred on by the recent UN/IPCC report and on an EU level by the EC commitment to reach 20 % renewables in the electricity supply by 2010 and 20 % renewables in the overall energy production by 2020, appears to ensure the necessary future political support for renewables, but not necessarily for solar energy technologies, in particular photovoltaics's, which is still not yet competitive to other renewables although exhibiting a tremendous potential.

Status and perspectives for solar energy in terms of solar hot water systems (SHW) and photovoltaics (PV) will be discussed in the following chapters, which have been prepared based on recent work done in connection with the Sustainable Energy Catalogue compiled by the Danish Board of Technology.

2 Solar Hot Water Systems

2.1 Technology information

Solar thermal technology converts part of the energy content of the insolation into heat. Sub-technologies include flat plate collector systems² typically for domestic hot water and other low temperature applications such as space heating or large scale district heating, parabolic troughs/evacuated tube collectors for higher temperature applications such as industrial process heat, and central thermal power stations with heliostats³ concentrating the insolation from a large area on a small receiver, in this way obtaining high temperatures and capacities suitable for operating steam turbines.

Typical solar thermal conversion efficiencies range from about 25-60%. The two first mentioned sub-technologies are fully commercial and in operation in many countries all over the world.

A solar heating system transforms the energy of the sun to heat, typically in a single, closed circuit. The solar collector consists of a black plate, which picks up the energy of the sun and heats up a mixture of water and antifreeze, which is pumped to a special hot-water tank in the house, where it emits the heat and runs back to the solar collector. Solar collectors are typically used for heating up domestic water, but more and more people also use solar-heated water for floor heating and other space heating. The system is adapted to the size of the house and the heating requirements.

Furthermore, a new and promising use of solar heating is being developed – solar cooling. By attaching a solar collector that can heat water to 80 to 100 degrees to an absorption cooler, it is possible to create refrigeration, which for example can be used in air-conditioning systems. As the world uses more energy on cooling than on heating, great energy-saving perspectives in the solar cooling area become available.

By the end of 2004, about 110 million m² of solar collectors were installed worldwide. The energy contribution from this technology can be calculated using the IEA adopted conversion factor of 1 m² = 0.7 kW_{TH}. As to technology, about 25 pct. is unglazed collectors, mainly serving swimming pools, and 75 pct. is flat-plate and evacuated-tube collectors, predominantly for preparing hot water and for space heating. The average market growth rate has been 17-20 pct. in recent years. The most dynamic market areas are China and Europe. By 2004, China shows about 65 million m² installed capacity

² Thermo siphon's or with forced circulation

³ A Heliostat is a device that tracks the movement of the sun.

corresponding to 50 m²/1000 inhabitants. The EU exhibits about 14 million m² installed capacity with wide variation from country to country.

The presently installed solar thermal capacity provides around 0.15 pct. of the overall EU requirements for hot water and space heating. Used predominantly for hot water and space heating, solar thermal collectors are typically mounted on roofs of buildings, and as solar thermal installations are quite visible, this has led to an ongoing process of both technological and architectural development. The aesthetics of a building is one of the most important aspects when solar collectors are “integrated” into the building envelope, the main trend being to try to make the solar collectors as invisible as possible. However, architects have started to use solar thermal installations in order to enhance the aesthetic appeal of a given building, but much more research and development seems to be needed in this field.

In general, system costs decrease with the size of the system. Therefore, solar thermal systems connected to a district heating network are more cost-effective than systems for single family houses. Traditionally, short term storage is included in a solar thermal system in the range of 50-75 liters per m² collector. Seasonal storage in the range of 2000 liters per m² collector area has been investigated, but is still very much a research and development issue.

2.2 Best available technology

Today (2006), vacuum tube solar collectors are the best with regard to performance. The somewhat higher price of these systems, compared to other product types, is usually compensated for by the better performance.

2.3 Supply potential

A solar collector that covers an area of 4-5 m² can typically cover 60-65% of the annual energy consumption of hot water for a family of 3-4 people. During the summer months, a facility like this will even cover the hot water need 100%. An average system that is targeted at space heating as well as hot domestic water can typically cover 30-40% of the annual heat consumption of a household depending on the geographical region. As mentioned, the EU has an objective⁴ that there should be 0.25 m² solar collector per citizen in the member countries in 2010, which corresponds to a total of approx. 100 million m². However, with the present market trends, only about 40-50 million m² is likely to be reached by 2010. In 2005, Germany installed about 950.000 m² totalling 4.700 million m² (3.300 MW_{TH}). About 4 % of German homes use SHW in 2005. Also in 2005, Austria installed about 240.000 m², Spain almost 1 million m² and France about 120.000 m².

2.4 Environmental impact

A solar heating system does not emit any CO₂ or any other harmful substances to the atmosphere. An amount of power that corresponds to a light bulb is used for the system's control function and pump. Most solar heating manufacturers take worn-out systems back and reuse some of the parts. The radiator coolant used is non-toxic. The energy used to produce a solar heating system corresponds to the energy that is produced by the system during approx. 9 months of operation.

2.5 Technology lifetime

An average solar heating system with a life span of at least 20 years, which is installed by a workman in a home with electrical heating, will have paid for itself through saved energy costs within 7-8 years. If the system is installed in a home with oil/gas heating, the investment will have paid for itself within 12-15 years in Northern Europe. The annual operating costs of a solar heating system make up approx. 1% of the system price.

⁴ EU White Paper on Renewable Energies, COM(97)599, 26.11.97; EU Directive 2001/77/EC.

Operating costs consist primarily of the power consumption of the pump that keeps the system running.

2.6 Economy

A typical single family household SHW system of 4-5 m² collector areas and 200-300 litres of storage tank ranges from 2-4000 € but this depends considerably on the country and brand of manufacture.

2.7 Interaction with the energy system

It appears from the EU's White Paper containing, amongst others, solar heating⁵ that solar heating is assessed to have a good chance of becoming a profitable type of energy in connection with large, central heat and power stations. In 2004, the large solar heating systems that are attached to district heating stations are close to becoming a competitive alternative to gas and oil. It is advantageous to combine solar heating systems with biofuel systems (such as wood pellet burners), which can supply heat during the winter, when the solar heating system is less active. At the same time, it is an advantage to be able to turn off the boiler – typically during the summer. A biofuel boiler burns poorly at low load operation, which results in low efficiency and thus poor heating economy.

When fuelling with biofuels, it is possible to use a highly efficient boiler with an attached storage tank, where the heated water is stored for use during the day and night. It is a good idea for the supply of hot water to the storage tank to come from a boiler as well as a solar heating system, as it reduces the need for continuous stoking in the boiler. Whether this method is financially attractive depends on the price of firewood.

2.8 Geographical parameters

Leaders in the EU are Cyprus with 680 m²/1000 inhabitants followed by Greece and Austria with some 260 m²/1000 inhabitants, to Denmark with about 60 m²/1000 inhabitants. Israel probably has the highest penetration of solar thermals with about 740 m²/1000 inhabitants. In absolute terms, the European solar thermal market is dominated by Germany (50 %) followed by Greece and Austria (each 12 %). On a global level and in absolute numbers China leads with about 10 mill. m² collector areas installed per year.

2.9 Advantages

- A solar heating system does not emit any CO₂ or other harmful substances to the atmosphere.
- When a solar heating system has been paid through savings on the heating bill, the sun supplies free heat year after year.
- A frequent criticism is that solar collectors disfigure buildings with their unattractive appearance. However, today, systems have been developed that are integrated into the roof surface in a harmonious way.

2.10 Disadvantages

- A solar heating system in Europe can typically not stand alone, but has to be supplemented by another type of energy, because the sun exhibits considerable seasonal variation.
- Solar heating is presently in general more expensive than fossil energy.

2.11 Timeline

- 2006: the technology is fully developed and ready. Continuous smaller efficiency improvements are expected. The technology is adequately covered in terms of norms and standards.
- 2004-2010: intermediate period for solar heating. Scattered distribution of inexpensive systems.
- 2005-2010: possibility of some distribution of cooling through solar heating of buildings.

⁵ EU White Paper on Renewable Energies, COM(97)599, 26.11.97; EU Directive 2001/77/EC.

- 2010-: good possibility of growing distribution to houses and buildings, in particular due to the EU Directive on Energy Consumption in Buildings. Presupposes subsidy scheme or rising oil and gas prices.
- 2015: 100 million m² installed⁶.
- ESTIF has primo 2007 published a Solar Thermal Action Plan for Europe looking up to 2020 with a potential target of 1 m² collector area/inhabitant, corresponding to about 320 GW_{TH}.

3 Photovoltaic Systems

3.1 Technology information

Photovoltaic (PV) power systems convert light directly into electricity without any moving parts or any emissions, which means PV systems can normally – unless very little physical space is available – be implemented directly at the site of the electric load to be supplied, one of the great advantages of PV technology (on-site generation). R&D of PV technology has since the early 1970's been supported both on the EU level and by the EU member states, and the EU constitutes presently a centre of excellence in the field of PV technology. Although not yet competitive with other sources of electricity, PV is widely regarded as a significant contributor to the future electricity supply of Europe, and to stimulate this evolution, a PV Technology Platform was established in 2005 encompassing all important EU stakeholders.

Typical conversion efficiency for a Silicon PV module is 14-16 %, the best commercial modules exhibiting 20-21 % efficiency.

PV modules and systems are much better documented and tested than most other industrial products. The reason for this is that the technology was originally developed for space travel and military purposes, where it had to meet very strict requirements. Today, the main market is PV systems connected to the electric grid, but there is also a considerable market for stand-alone systems, in particular for remote professional applications such as signalling and telecom, water pumping, cathodic protection and similar. In developing countries, small stand-alone systems (Solar Home Systems) are used for household electrification outside the grid coverage.

The global market for traditional photovoltaics (PV) has in the last 5 years seen an annual rate of growth of about 40%. In 2004, the growth was more than 60%, and in 2005 about 43%; the estimate for 2006 is 40 %. Even if the base in terms of energy production is quite small, the global PV market in 2005 exhibited a value of more than 10 billion €. The market is mainly traditional Silicon-based crystalline cells and modules. In 2005, almost 90% of the PV modules produced were based on crystalline Silicon technology, with poly-crystalline Silicon modules constituting about 60%. Since 2004, lack of Silicon feed-stock has led to an increase in PV module cost and a slight increase in system cost and this has established a real “sellers market”. Since 2005, the Silicon industry has invested heavily in increased production capacity and this feed-stock bottleneck is expected to be cleared during 2007-8. Crystalline Silicon cells and modules are expected to dominate the market in the coming 10-15 years and only after about 20 years are they expected to cover less than 50 pct. of the global PV market.

The EU has in 2005 launched a PV Technology Platform and regards PV as a significant future energy technology for the Union. The EU goal of reaching 3 GW installed PV capacity by 2010 (1% of the EU electricity consumption) is presently expected to be exceeded, as 4.5-5 GW installed capacity is regarded as realistic by 2010.

3.2 Best available technology

⁶ Estimated by ESTIF – European Solar Thermal Industry Federation (www.estif.org) – with support of active policies.

A typical system for a one-family house that is self-sufficient with regard to electricity is of 15-35 m², which corresponds to a power of 2-5 kW (depending on PV cell type). In northern Europe, a PV system can produce approx. 850-900 kWh/year for each kW of generating capacity; in southern Europe, almost the double. Recently, PV modules with efficiencies of more than 20% have been introduced onto the market – which means that the necessary solar cell area can be significantly reduced. On the installation side, there are now also so-called “plug-and-play” systems, which are plugged directly into the socket and thus displace purchased electricity.

Traditional PV technology has a learning curve typically showing a learning rate of some 20% , signifying a reduction in cost of 20% every time the volume is doubled. This trend is expected to continue for the next 10-15 years, as a combination of reduced material (Silicon) consumption and improved production technology will make this possible without any demand for “new technology”.

Thin film PV module types with strongly reduced manufacturing costs are slowly gaining ground and will probably take a prominent position in the future. However, they still exhibit lower efficiency and lower stability compared to crystalline PV modules.

3.3 Supply potential

A number of scenarios⁷ have been developed for future PV penetration in the EU and in the individual member countries. Maximum penetration foreseen up to 2040 ranges from between 20-40% of all electricity consumed, corresponding to 60-120 GW installed capacity. However, these forecasts are inherently very uncertain and depend very much on energy policies, raw material supplies, manufacturing capacities and in particular price developments.

It is relatively easy to forecast the production of electricity from PV systems and to integrate the electricity into a given electricity grid system. The main area of application in Europe appears to be building integrated PV systems (BIPV), where the PV technology can be applied in urban areas, not taking up new space, can easily be connected to the grid, is close to the actual consumption of electricity and can fulfil “multi-functions” in a building, e.g. be an integral part of the building envelope as well as produce electricity.

3.4 Environmental impact

PV modules do not have any impact on the environment during operation. The total cradle-to-grave environmental impact of typical PV Silicon modules is very limited. Recycling of PV modules and the associated electronics is well-known and the possibilities are continuously being improved. Health and environmental issues related to PV technology are being studied and investigated internationally, e.g. in the framework of the International Energy Agency (IEA).

The consumption of energy for manufacturing a PV module will usually be produced by the module within approx. 3-4 years. The economic lifetime is typically 30 years or more. This means that the solar cells produce almost ten times as much energy as the amount of energy used for manufacturing and operating the solar cell system. If solar cells replace other building materials, the energy balance can become even better.

3.5 Technology lifetime

The economic lifetime of present typical state-of-the art PV systems in Europe is 30 years. However, the PV modules themselves can be expected to last longer. On the other hand, PV technology develops quite quickly, and old installations may be considered obsolete earlier due to this technical progress.

⁷ For example: EPIA & Greenpeace: Solar Generation; The EU PV Technology Research Advisory Council: A Vision for PV Technology; Photon International Magazine.

3.6 Economy

The cost of electricity from PV systems has to be reduced significantly to become a real alternative to electricity supply based on fossil fuels and thereby achieve a break-through in the energy sector. Since the beginning of the 1980s, the price of solar cell modules has been halved every 7 years. In Europe, the present cost of electricity from PV systems is around 0.3-0.4 €/kWh in northern Europe and half of that for the best systems in southern Europe. These costs can be reduced by increasing the efficiency of PV systems or by reducing the overall costs – both happen continuously through research and development in materials, processes, design, etc. At the same time, growing production volumes also lead to falling prices. The global PV industry exhibits a very non-transparent relationship between prices and cost.

At present, PV systems are reported to be competitive as peak-load shaver in southern Europe. In general terms, PV systems are expected to be competitive in Europe inside 8-12 years.

3.7 Interaction with the energy system

There seems to be little in terms of technical constraints even for a large-scale penetration of PV technology into a given grid system. There is normally good correlation between PV production and the need of electricity and PV production is relatively easy to forecast accurately. Many investigations have shown that modern inverter technology does not impair power quality – on the contrary.

3.8 Geographical parameters

Europe exhibits considerable differences in insolation – in yearly average, a factor 1:2 from northern to southern Europe and, more importantly, a seasonal variation in the north of 1:10 compared to 1:4 in the south.

Besides the resource variations, the value of PV produced electricity differs considerably across Europe, depending on factors such as load profiles, type and operation of generators, feed-in tariff structures and cost of fuel.

3.9 Advantages

- PV systems do not have any environmental impact during operation.
- PV systems constitute a robust and reliable type of energy production with few operating costs and a long lifespan.
- Power is produced during the day, when the demand is largest.
- PV systems are scale neutral in efficiency – small systems are as energy efficient as large systems
- A PV system consists of individual solar modules and can be expanded to MW or GW in system size – like building blocks, more solar modules can be put together to create a system theoretically with no limit in size⁸.
- PV systems are easy to adapt to the electrical power network, as decentralised as well as central production.
- There are good possibilities for integrating PV systems into the urban environment and into buildings.

3.10 Disadvantages

- The price of a PV system is still relatively high, and the technology is not yet competitive with the alternatives supplying the electrical grid systems. However, prices are expected to fall continuously for quite a considerable time in the future and to reach competitiveness in about 10 years.

⁸ Very Large Scale Photovoltaic Power Generations Systems (VLS-PV) are examined by IEA-PVPS <http://www.iea-pvps.org/tasks/task8.htm>

Timeline

- 2005-2010: solar cells are more and more being architecturally integrated into buildings (BIPV), a trend also expected to be stimulated by the EU energy & building directive.
- 2010: Standard Silicon based PV module cost a < 1,5 €/W; increased area of competitiveness for PV electricity
- 2010: commercial break-through for third generation solar cells. This will result in integration of inexpensive solar cells in windows and many other building and consumer goods.
- 2015: standard Silicon PV module cost < 1€/W. PV systems play an important role in connection with solving peak load problems of the electrical power network.
- 2015-2020: solar cells are expected to be directly competitive to alternative electricity producing technologies.
- The EPIA & Greenpeace scenario (see footnote 7) shows, that by 2025 PV on global level may produce about 590 TWh corresponding to an installed capacity of about 430 GW. The EU₂₅ would have 20 % of its electricity coming from PV.

2025: emergence of solar cells that have an integrated electrolysis function and can therefore produce hydrogen for use as a propellant in fuel cells.

Risø International Energy Conference 2007

Energy Solutions for Sustainable Development

22-24 May 2007

List of Participants

Finn Aaberg	Albertslund Kommune	Denmark
Peter Ahm	PA Energy	Denmark
Jesper Damtoft Andersen	Aalborg University	Denmark
Per Dannemand Andersen	Risø National Laboratory	Denmark
Thomas Astrup	Technical University of Denmark	Denmark
Christian Bang-Møller	DTU/MEK	Denmark
Nico Bauer	Potsdam-Institute for Climate Impact Research	Germany
Janet Jonna Bentzen	Risø National Laboratory	Denmark
Gustavo Best	FAO - Food and Agriculture Organization of the United Nations	Italy
Matteo Biancardo	Risø National Laboratory	Denmark
Henrik Binder	Risø National Laboratory	Denmark
Henrik Bindselev	Risø National Laboratory	Denmark
Rudolph Blum	DONG Energy Generation	Denmark
Claire Boasson	Caisse des Depots	France
Mads Borup	Risø National Laboratory	Denmark
Richard Bradley	IEA	France
Tobias Caluori	Risø National Laboratory	Denmark
Henrik Carlsen	MEK-DTU	Denmark
John M. Christensen	UNEP Risø Centre	Denmark
Niels Peter Christensen	GEUS	Denmark
Niels-Erik Clausen	Risø National Laboratory	Denmark
Hamid Daiyan	Islamic Azad University	Iran
Carsten Dam-Hansen	Risø National Laboratory	Denmark
Stefan Denig	Siemens AG	Germany
Stefan Döge	Wilhelm-Ostwald Gymnasium	Germany
Hélène Dornier	French Embassy, Communication dept.	Denmark
Henrik Duer	COWI A/S	Denmark
Sune Dalgaard Ebbesen	Risø National Laboratory	Denmark
Helge Elbrønd	DTU	Denmark
Frank Elefsen	Danish Technological Institute	Denmark
Torben Engsig	Siemens A/S	Denmark
Paula Ferreira	University of Minho	Portugal
Bjarke Fønnesbech	IDA Ingeniørforeningen i Danmark	Denmark
Alexandre Fontana	Risø National Laboratory	Denmark
Thilde Fruergaard	Technical University of Denmark	Denmark
Amit Garg	UNEP Risø Centre	Denmark
Annemette Geertinger	FORCE Technology	Denmark
Oliver Gehrke	Risø National Laboratory	Denmark
Tania Georgieva	BioCentrum DTU	Denmark
Gregor Giebel	Risø National Laboratory	Denmark
Christopher Graves	Columbia University	USA
Birgitte Gregersen	Aalborg University	Denmark

Heleen Groenberg	ECN Policy Studies	The Netherlands
Anke Hagen	Risø National Laboratory	Denmark
Reinhard Hass	Technische Universität Wien	Austria
Anne Hauch	Risø National Laboratory	Denmark
Wei He	Norsk Hydro	Norway
Jørgen Henningsen		Denmark
Uwe Hermann	Siemens AG	Germany
Claus Hermansen	Danmarks Eksportråd	Denmark
Per Holmgård	DONG Energy	Denmark
Mads Iversen	Embassy of Denmark Beijing	Denmark
Walter J. Sanchez	Roskilde University	Denmark
Erik Steen Jensen	Risø National Laboratory	Denmark
Jens Christian Jensen	Danmarks Eksportråd	Denmark
Peter Hjuler Jensen	Risø National Laboratory	Denmark
Stein Bjørnar Jensen	Det Norske Veritas	Norway
Ebbe Johansen	Embassy of Denmark, Berlin	Denmark
Birte Holst Jørgensen	Nordic Energy Research	Norway
Jeanette Møller Jørgensen	Energinet.dk	Denmark
Grant Kirkman	UNFCCC	Germany
Stig Kjeldsen	Danish Environmental Protection	Denmark
Jørgen Kjems	Risø National Laboratory	Denmark
Frederick Krebs	Risø National Laboratory	Denmark
Volker Krey	Forschungszentrum Juelich	Germany
Igor Kunze	Wilhelm-Ostwald-Gymnasium	Germany
Lars Bytoft Landberg	Risø National Laboratory	Denmark
Hans Larsen	Risø National Laboratory	Denmark
Bent Lauritzen	Risø National Laboratory	Denmark
Adrian Lema	Risø National Laboratory	Denmark
Hans Lilholt	Risø National Laboratory	Denmark
Søren Linderoth	Risø National Laboratory	Denmark
Nadja Lönnroth	Risø National Laboratory	Denmark
Peter Lund	Helsinki University of Technology	Finland
Søren William Lund	Risø National Laboratory	Denmark
Jesper Lund-Larsen	3F	Denmark
Jens-Peter Lynov	Risø National Laboratory	Denmark
Anne Mette Madsen	Embassy of Denmark, Washington	Denmark
Anne Nygaard Madsen	Risø National Laboratory	Denmark
Pedro Maldonado	Universidad de Chile	Chile
Narcis Margall	Trade Commission of Denmark, Barcelona	Denmark
Radka Mark	UNEP	France
Anil Markandya	University of Bath	United Kingdom
Peter Markussen	DONG Energy Generation	Denmark
Peter Meibom	Risø National Laboratory	Denmark
Bert Metz	IPCC WGIII	The Netherlands
Niels I. Meyer	BYG-DTU	Denmark
Alam Mohammad Monzurul	DTU	Denmark
Allan Mortensen	Embassy of Denmark, Warszawa	Denmark
Henrik Hilleke Mortensen	MEK-DTU	Denmark
Poul Erik Morthorst	Risø National Laboratory	Denmark
Rasmus Mosbæk	DTU	Denmark
Vivi Nymark Morsing	Risø National Laboratory	Denmark
Lykke Mulvad Jeppesen	Environmental Assessment Institute	Denmark

Marie Münster	Risø National Laboratory	Denmark
J. Nazarko	Forschungszentrum Jülich GmbH	Denmark
Camilla Nellemann	Embassy of Denmark, Moscow	Denmark
Charles Nielsen	DONG Energy A/S	Denmark
Karsten Nielsen	Risø National Laboratory	Denmark
Lise Skovsgaard Nielsen	Environmental Assessment Institute	Denmark
Per Nørgård	Risø National Laboratory	Denmark
Kjeld Nørregaard	VE-Net, Danish Tech. Inst.	Denmark
Bent Sundby Olsen	Siemens A/S	Denmark
Lise-Lotte Pade Hansen	Environmental Assessment Institute	Denmark
Jyoti Painuly	Risø National Laboratory	Denmark
Aksel Hauge Pedersen	DONG Energy	Denmark
Bruno Lund Pedersen	Danfoss	Denmark
Knud Pedersen	DONG Energy	Denmark
Niels Falsig Pedersen	Ørsted DTU	Denmark
Åge Bjerg Petersen	HNG I/S	Denmark
Erik Lundtang Petersen	Risø National Laboratory	Denmark
Leif Sønderberg Petersen	Risø National Laboratory	Denmark
Ole Carlo Petersen	Viden om på DR2	Denmark
Steffen Petersen	BYG-DTU	Denmark
Kim Pilegaard	Risø National Laboratory	Denmark
Marieke Reijalt	H2IT	Italy
Per Resen Steenstrup	Wawe Star Energy	Denmark
Jorge Rogat	Risø National Laboratory	Denmark
Birte Røgen	MEK-DTU	Denmark
Stephanie Ropenus	Risø National Laboratory	Denmark
Thomas Rostrup-Nielsen	Haldor Topsøe A/S	Denmark
Ulla Röttger	Amagerforbrænding A/S	Denmark
Hanne Roulund	VE-Net / Danish Energy Industries Federation	Denmark
Eva Ryberg	VE-Net, Danish Tech. Inst.	Denmark
Carla Saleiro	University of Minho	Portugal
Agne Sandberg	Swedish Rescue Services Agency	Denmark
Jim Skea	UKERC	UK
Ioannis Skiadas	BioCentrum DTU	Denmark
Steffen Skjoldager	Consulate General of Denmark, São Paulo	Denmark
Scott Smouse	U.S. Dept. of Energy National Energy Technology Laboratory	USA
Cecilia Steck	Risø National Laboratory	Denmark
Hans Jürgen Stehr	Danish Energy Authority	Denmark
Anders Stouge	Energi Industrien, Dansk Industri	Denmark
Massimo Tavoni	FEEM	Italy
Kristian Thomsen	Embassy of Denmark Stockholm	Denmark
Mette Hedegaard Thomsen	Risø National Laboratory	Denmark
Rasmus Traberg	Embassy of Denmark, London	Denmark
Willy van Well	Dong Energy Generation	Denmark
Phillip Venne	Risø National Laboratory	Denmark
Hubertus von Dewitz	Siemens AG	Germany
Martin Wittrup Hansen	DONG Energy	Denmark
Barry K. Worthington	United States Energy Association	USA
Erika Zvingilaite	Risø National Laboratory	Denmark
Hanne Østergård	Risø National Laboratory	Denmark

Risø's research is aimed at solving concrete problems in the society.

Research targets are set through continuous dialogue with business, the political system and researchers.

The effects of our research are sustainable energy supply and new technology for the health sector.