



**Learner
Support
Services**

The University of Bradford Institutional Repository

This work is made available online in accordance with publisher policies. Please refer to the repository record for this item and our Policy Document available from the repository home page for further information.

To see the final version of this work please visit the publisher's website. Where available, access to the published online version may require a subscription.

Author(s): Benkreira, H., Patel, R., Gale, M. and Butterfield, R.

Title: Replication of mixing achieved in large co-rotating screw extruder using a novel laboratory 10-100g minimixer

Publication year: 2008

Journal title: *Plastics, Rubber and Composites: Macromolecular Engineering*

eISSN: 1743-2898

Publisher: Maney Publishing

Publisher's site: <http://www.maney.co.uk/>

Link to original published version:

http://www.ingentaconnect.com/search/article?author=benkreira&year_from=2000&year_to=2008&database=1&pageSize=20&index=1

Copyright statement: © 2008 Maney Publishing. Reproduced in accordance with the publisher's self-archiving policy.

REPLICATION OF MIXING ACHIEVED IN LARGE CO-ROTATING SCREW EXTRUDER USING A NOVEL LABORATORY 10-100G MINIMIXER

H.Benkreira*, R.Butterfield, M.Gale and R.Patel

* School of Engineering, Design & Technology, IRC in Polymer Engineering, University of Bradford, BD7 1DP, UK
H.Benkreira@bradford.ac.uk

Abstract - When compounding polymers with additives to develop materials at specifications (colouring plastics is the simplest example), the difficulties is in getting the formulation right the first time. Also, when developing completely new materials such as in nanotechnology applications, there is a need to do the initial trials safely and with as small quantities as possible to enable a wide range of experimentation. With traditional applications, often the initial compounding formulation is done using small single or twin screw extruders but with machines that have a fair output to instruct the large scale operation. This step is costly in material wastage and time but more importantly it often does not provide the right formulation which in turn results in bigger wastage cost at the industrial scale before the right formulation is eventually obtained. With the very new material formulations, any reduction in cost of development is always essential. With these aims in mind, we have developed a new minimixer capable of handling tiny quantities of order 10-100g but the minimixer is capable of reproducing the very high mixing conditions experienced in large machines. This invention provides a new opportunity to develop new products quickly, safely and cheaply. The application is not restricted to polymers and can be extended to other soft materials. It has also other spin-offs as a research tool for studying mixing and developing new, more efficient, mixing flows. In this paper we explain the principle of operation we have engineered to produce such intense mixing. Basically, the device is based on combining two opposing flows: a single screw extruder circulation flow with a twin screw extruder mixing flow. The mixing is carried out as a batch but on its completion, the single screw extruder flow is reversed and becomes co-current with the twin extruder flow to enable the discharging of the batch through a die. In the paper we present mixing data obtained with various polymer-additive combinations tested in the minimixer under various conditions of screw speeds, mixing times and temperatures and at the larger scale to underpin the operation of this novel mixer. The quality of mixing of the extrudate was measured using a variety of methods depending on applications: using image analysis of microtome sections of the extrudate or of blown film samples produced from the formulations or measuring electrical properties.

Introduction

In the processing industries with or without chemical reaction, good and efficient mixing is the key to good and efficient production. Good mixing is a pre-requisite for product properties uniformity and efficient mixing is a pre-requisite for economic production. With low viscosity fluids and dispersed solids, achieving this is relatively easy, turbulence and diffusion being effective drivers. When viscous like polymer melts are mixed with tiny amounts (~1%) of non-dispersed solid agglomerates such as pigments and other additives of micron and nano sizes the situation is quite different. Turbulence cannot be achieved and the mixers must develop flows, which distribute and dispersed the additives components throughout the viscous mass. These mixers are generally bulky [1], demand high power and perform their tasks using very narrow gaps with high shear and elongation rates and stresses. The extruder, single or twin is the typical tool for continuous operation; roller mills and the Banbury mixer are the typical tools for batch operation. All these equipment however require large quantities (kilogram size and larger) of the materials to be processed and it would be desirable for research purpose as well as economy and health safety (especially when handling nano-additives) to develop laboratory equipment at the gram scale. Such mini-mixers would be very useful as a research tool to study dispersive mixing and its scale-up to larger machines and would give the opportunity to develop new products quickly and cheaply at the laboratory prior to testing at the larger extruder scale. The main obstacle is however how to duplicate mixing which occurs in the large machines to the mini-mixer scale. Current practice is to “er on the safe side” by carrying out the lower scale work using smaller mixers but which are “closer to the larger scale”. These small scale mixers become either too large and thus expensive for research or industrial formulation studies or too small to duplicate the kind of mixing created in large machines. Here we propose a new mini-mixer design capable to operate at the gram levels yet delivering the types (distributive and dispersive) and extent (stresses and time) of mixing developed in the large industrial scale machines. We describe the rationale for the design and underpin the operation of the mixer by experimental data and compare this data with data obtained in larger scale machines.

Design Rationale

The use of co-rotating twin screw compounding extruders with a combination of intermeshing screws and mixing cams for providing good and continuous mixing of viscous fluids has been established for sometimes now [1-3] and such machines principles of operation and application for distributive and dispersive mixing of additives into viscous masses are widely disseminated [4-7]. Miniature versions of these machines, producing samples which are similar to

production materials and in a form suitable for testing, would be ideally suited for laboratory research and formulation work. However, to duplicate mixing in the larger scales, these miniature machines must be relatively large in size and thus expensive and need significant amounts of material to fill the barrel, between consuming. The smaller versions (see Figure 1) which combine twin screw extrusion mixing with batch mixing using a re-circulating channel [8-9] do not replicate the actual flow conditions. This is because in the re-circulating channel, viscous fluids such as molten thermoplastics will experience very low velocity at the channel surface so that this material may experience very little exposure to the screw mixing and may even stagnate and thermally degrade. Also, the material remaining in the channel when mixing has been completed will require manual removal.



Figure 1: Current Mini-Mixer Design

In our design, we circumvent the need for a recirculation channel by incorporating a third screw positioned axially and tangentially with the mixing elements of the co-rotating intermeshing twin screw. Axial movement of the material required for uniformity of mixing is thus achieved. This simple but effective mean of re-circulating the material is at the heart of this new design. It then enables us to reduce the size of the whole apparatus down to a very small device holding typically 10 to 100g of material whilst as we will explain retaining the ability to discharge the mixed material as one or more strands or as a strip for testing.

Mini-Mixer Design

As can be inferred from the design rationale, the principle of operation of this new mixer is based on combining two opposing flows: a single screw extruder circulation flow with a twin screw extruder mixing flow. When considering mixing, it is important at the outset to distinguish between distributive and dispersive mixing and the flow and deformation conditions, i.e. the equipment required to achieve them. Dispersive mixing is particularly important in the preparation of masterbatches. Hence twin screw compounding extruders are widely used as they are particularly good for this operation; being able to give good dispersion with many additives that have a tendency to form agglomerates, as well as readily accepting and conveying powders. Single screw extruders have a poor dispersive mixing performance.

In the case of this new mini-mixer, by duplicating the mixing elements of a twin screw compounding extruder the dispersive mixing of such a machine can be reproduced. The addition of an interacting in-line screw ensures there is good distributive mixing. The mixing is carried out as a batch but on its completion, the single screw extruder flow is reversed and becomes co-current with the twin extruder flow to enable the discharging of the batch. If a die is fitted, then the material can be extruded as a strand or a strip, suitable for rheological testing, colour matching, fire testing, etc. The operation allows for a quick change over to a new product by purging with a new virgin mass. The materials can be feed as liquids, pastes or solids, which can be softened or melted by heating the barrel housing the screws. This new device has very wide applications and can be used as a tool to:

- observe and study the mechanisms of dispersive mixing in different major-minor systems,
- test new screw geometries and develop more efficient ones which can then be scaled up,
- test new material formulations and optimise properties prior to full-scale production.

Figures 1-3 describe three designs of the prototype. The mixer occupies a space less than 30cm x 50cm x 30cm and the barrel housing the mixer is typically 7cm in diameter and 10cm long. The mixer is driven with a variable speed control and reversing switch, via a gearbox which has three output shafts, one for each of the two mixing rotor shafts and one for the screw. The mixer drive is connected to the mixer with a torque-measuring device. Torque measurement during mixing will provide a measure of work input which can be related to degree of dispersion. The mixing elements are in the form of lobe cams, cylinders with eccentric centres or any combination, which provides good dispersive mixing. In all the designs, material enters the mixer through the hopper and feed pipe and is assisted by a piston, which also closes the feed during mixing. The barrel housing the mixer can be heated to a controlled temperature.

In the first design (Fig. 2), the screw conveys the material away from the entry point and the die. As it is fed, the material is continuously transferred between the intermeshing chambers and the conveying screw. Eventually with assistance from the piston, the mixer will be completely filled and the material being mixed contained within the barrel by the piston. The rotational speeds can then be increased to give the level of deformation required. The screw may

rotate at a faster, equal or slower speed than the rotors but a faster speed is preferred to maximise drag flow conveying. When mixing is completed the screw and mixing elements direction is reversed and the screw conveys the mixed material to the outlet and extrudes it out through the die. During this emptying period, the rotating cams transfer material from the intermeshing chambers to the channel of the screw. In the second design (Fig. 3), the screw is nominally the same length as the mixing chambers and the screw chamber is terminated with a valve which is opened to allow discharge of material when mixing is complete without reversal of the direction of the screw. For this arrangement the hopper and feed pipe are positioned at the opposite end to the valve and die. In both above designs, the conveying screw can have a channel section typical of the type used in single screw extruders. However, to optimise particles conveying during mixer filling and material conveying (with screw reversed) during emptying, the screw channel depth may be varied across its width and its flank radius. In the third design (Fig. 4), the single screw is replaced by two intermeshing screws to provide more positive pumping and complete emptying of the mixer.

Figures 2, 3, 4: The Various Design of the Minimixer.

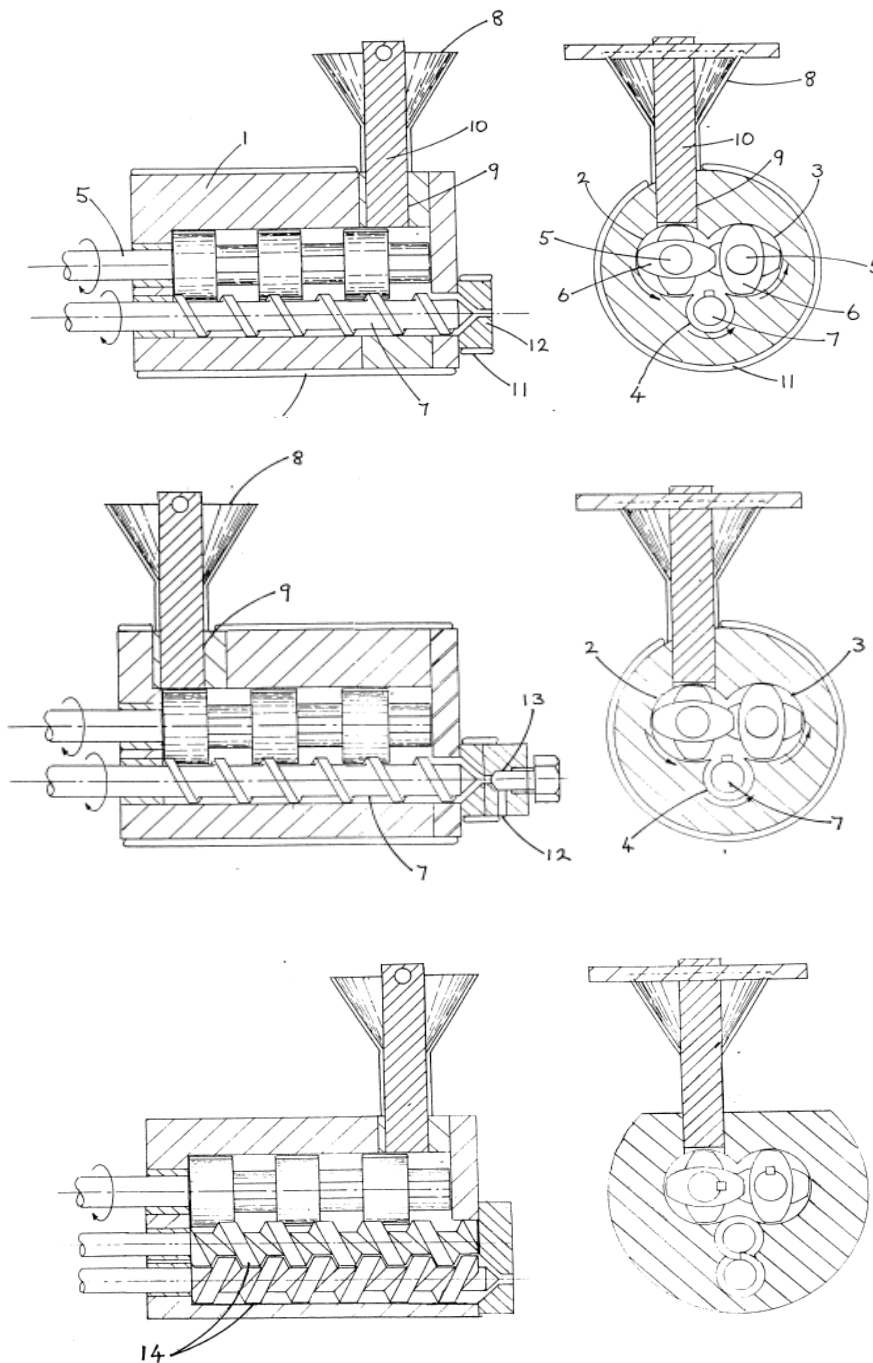

Experimental Evaluation

We report in this paper testing with the first and recommended design of this mixer (Fig.2). Figure 5 shows a picture montage of the prototype we built, the overall size of which does not exceed 15cm. The top photo shows the assembled kit, the middle photo the mixing chamber itself and the bottom photo the mixer open by activating the rack and pinion mechanism.

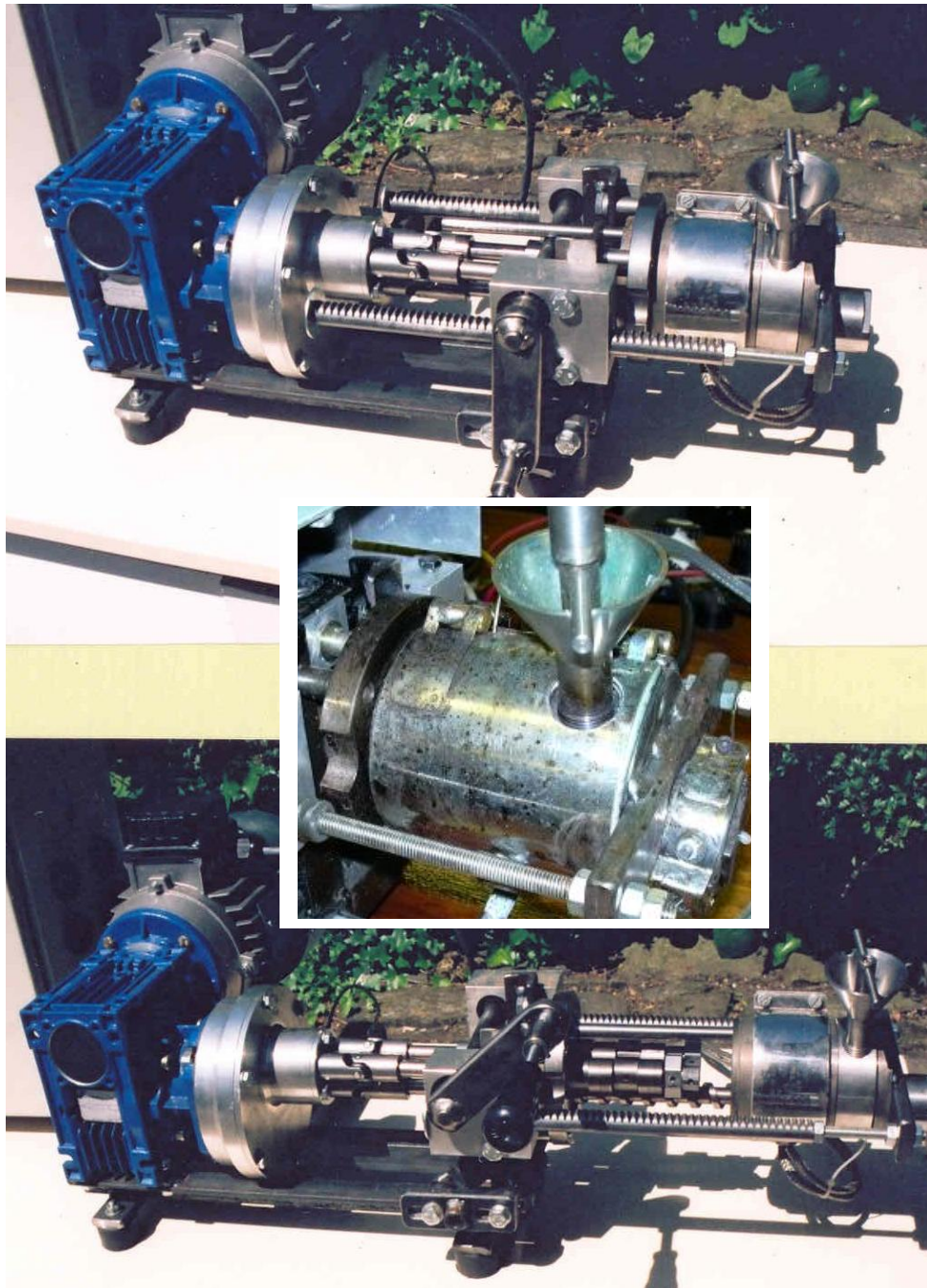

Figure 5: Various views of the minimixer showing the chamber (middle photo) and a rack and pinion to open.

We then used this prototype to carry out a number of experimental programmes including producing specified colour polymer masterbatches, dispersing in various polymers masterbatches rated as “very difficult” to disperse, and producing carbon black dispersed polymers with a range of conductivities. In the evaluation of colour, we produced masterbatches with the minimixer and tested in industrial scale film blown line. In order to carry out a full evaluation we also built a mini-blown film line (see Figure 6) to produce film sample and analyse mixing. A photo the mini-blown film line is shown below. It deliver a flow rate of 2-3kg/hr of film in the tickness range 25-500microns. It consists of a single screw extruder with a cavity transfer mixer attached at the end to ensure full mixing and a 24 mm annular die.

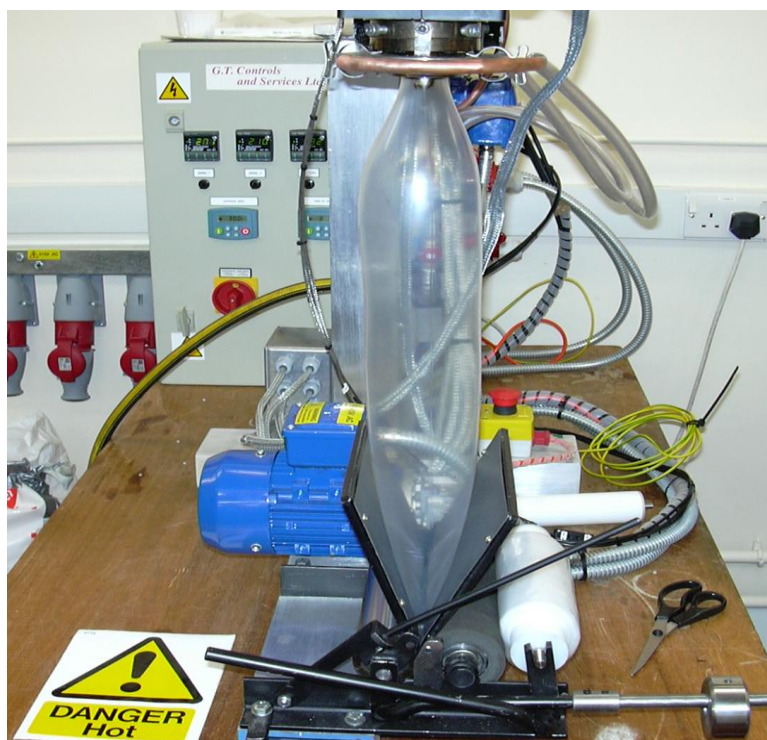

Figure 6: Mini-Blown Film Line used in conjunction with the minimixer and masterbatch production

In order to quantify a comparative study with a normal base line device, data with carbon black mixing experiments were compared with data obtained with twin screw extrusion machines at two different scales. In this paper, we describe the quantitative and important results obtained with the carbon black additive whose dispersion in polymers (we used here Ketjenblack EC-300J carbon black and a high MF polypropylene, HG385MO PP Homo Borealis) is critical to electrical properties. The changes in electrical resistance of semi-conducting and antistatic compounds are very sensitive to changes in the degree of dispersion and unless the same degree of dispersion that can be achieved in the larger machines is achieved in the laboratory scale devices, the formulation exercise in the laboratory will be off-specifications.

The experimental mixing procedure, essentially the preparation of semi-conducting polypropylene samples containing up to 10% carbon black in a high MF polypropylene was as follows. First the heater mini-mixer was set at a low temperature of about 60°C. The mixer screws and elements all linked by a common drive were then set in motion at a set speed and the polymer pellets were charged. The splitter gearbox gives rotor speeds of 3.5 times the screw speed and being nearly double the diameter of the screw the rotors impose much higher shear rates than the screw. The set speed is that of the screw, typically in the range 20-60 rpm and a polymer charge of 25 g would be used. The carbon black was then added at the required proportion Here in the range (2-8%) and the temperature set point was increased to the required test temperature whilst keeping the screws running at the set speed. The experiment continued until the set temperature was reached (here 170°C) and a further mixing period followed. For a given recipe, the variables are thus temperature, speed and mixing time, all of which can be varied. At the end of the experiment, the material was discharged with the elements running at the fixed speed. (The AC inverter drive has ramp time adjustment so that on switching screw direction it steadily reduces speed to zero in typically 10 seconds and then accelerates over 10 seconds to reach the original speed but in the opposite direction). The discharged mix was in the form of a long cylindrical strand of a few mm in diameter. The rates of discharge and the torque consumed under the different conditions tested were noted as these are indicative of the rheology of the mix and the magnitude of the stress developed. These are useful comparative mixing indicators when formulating a particular polymer-additive combination.

Having extruded the mixture in strands form, these were cut in samples of length 6cm for the measurement of electrical resistance using a Keithley Instrument 610C Solid State Electrometer with two probes pushed into contact with the sample extremities which were coated with conductive silver paint to ensure good contact. The results are presented in Figure 4 which shows how the mix develops conductivity as the carbon content is increased. The sensitivity in the change is remarkable. From 2.5 % and up to 5% carbon content, the polymer remains non-conductive¹. A jump in the conductivity is observed when the carbon content is increased to 6% with little change thereafter when the content is

¹ Conductors / Semi Conductors / Insulators resistivity in ohms is respectively $\sim 10^{-8}$, $\sim 10^{-5}$ - 10^4 and $\sim 10^8$ - 10^{15}

increased to 6.75% and 7.5%. Effectively our experiments have shown that 6-7% carbon content is sufficient to impart semi-conductivity to this particular polymer.

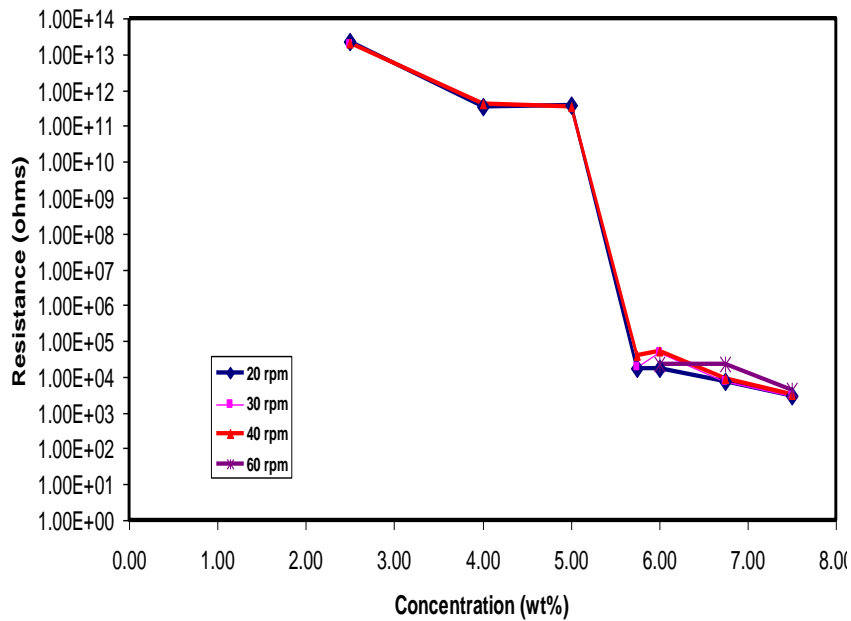

Figures 4: Changes in Resistivity with Carbon Black Concentration

The question now is would a twin screw extruder on the production line duplicates this observation? Or would it show semi-conductivity at much lower carbon content? If it does then our claim that the mini-mixer is capable of duplicating the kind of mixing that occurs in the larger machine is unfounded. To test this, we carried out experiments on two co-rotating twin extruder at scales (APV MP19TC 19mm, L/D 25:1, speed range 80-400rpm and a Betol BTS 40mm, L/D 29:1, speed range 10-200 with a closely intermeshing trapezoidal flight design) at various level of carbon concentration and measured the conductivity using the same technique described above. The data in Figure 5 shows that the minimixer outperforms the APV19. Figure 6 shows the comparisons with the Betol 40 which only reaches the performance of the minimixer when it is operated above 5kg/hr.

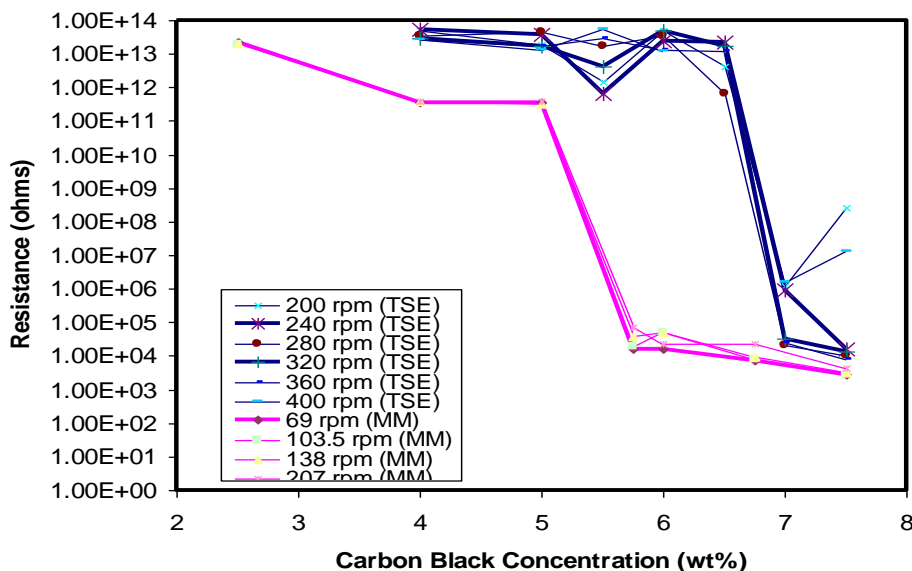

Figures 5: Comparison of Performance of the minimixer and the APV19

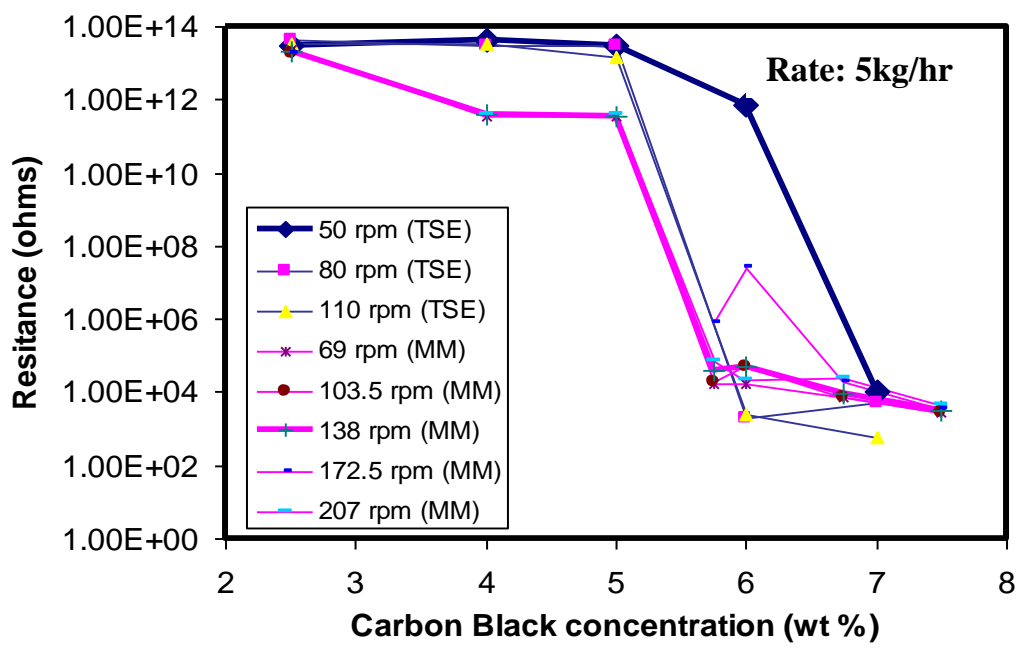
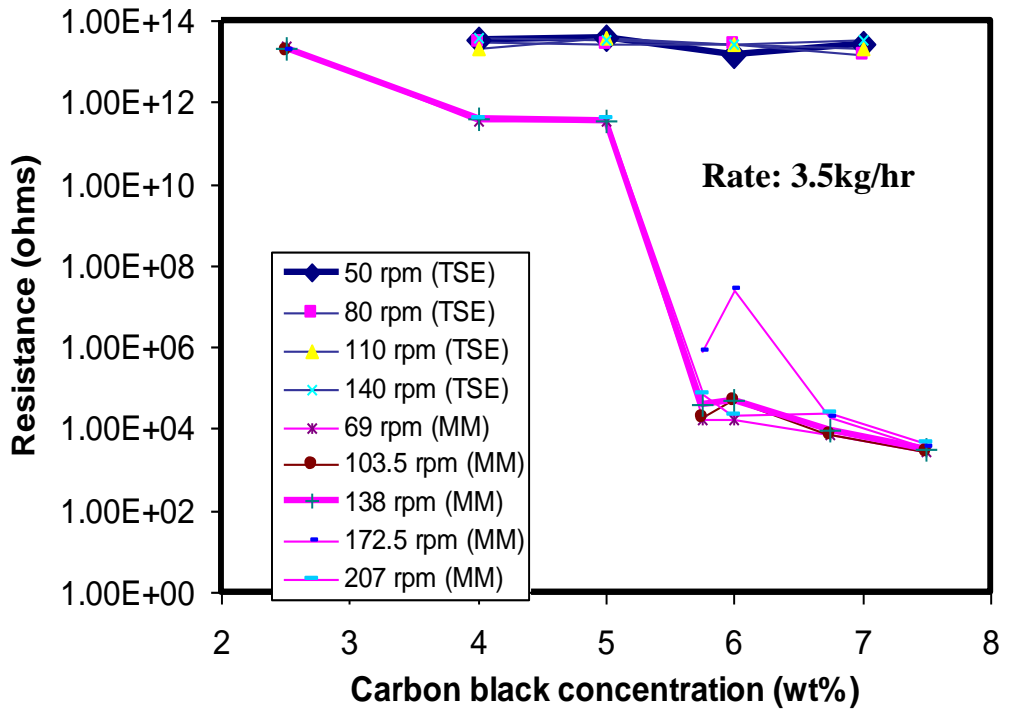

Figures 6: Comparison of Performance of the minimixer and the Beto140 at 3.5 and 5kg/hr

Conclusions

A new mini-mixer has been developed and proven to be effective at replicating mixing which occurs in large twin screw compounding extruders. The mixer has proved easy, convenient and safe to use as a research tool to study dispersive mixing and as a formulation tool to develop new products in which the distribution-dispersion of an additive is key to properties. Completed work indicates that the size of this mixer could be increased, or more likely, decreased to accept smaller, more economic, batch sizes with very costly nano-additives.

References

1. Nelson, W. K., US 1,868,671 (1932)
2. Erdmenger, R., US 2,670,188 (1954)
3. Erdmenger, R., US 2,814,472 (1957)
4. Manas-Zloczower, I. and Tadmor, Z., Editors, 'Mixing and compounding of polymers; Theory and practice', Hanser, Cincinnati, OH (1994)
5. Eise, K., 'Recent developments in extrusion and processing machinery', in *Advances in Polymer Technology* 3:2 113-116 (1983)
6. Wang, Y., 'Compounding in co-rotating twin screw extruders', *Rapra Review Report* 116, 10:8 (2000)
7. Benkreira, H. and Britton, R.N., 'The optimisation of masterbatch formulations for use in single screw machines' *Intern. Polymer Processing* 3, 1330-1307 (1994)
8. DSM ResearchBV, Geleen, The Netherlands 'Twin screw mini-extruder'
9. http://www.rheologysolutions.com/rheo_pdfs/haake1.pdf 'Minilab microrheology compounder'

Acknowledgements

We acknowledge the support of EPSRC UK in the research leading to the development of the minimixer.