

# Aniline effect on concrete steel rebar degradation in saline and sulfate media

Omotosho O.A., Loto C.A., Ajayi O.O. and Okeniyi, J.O.,

Department of Mechanical Engineering, Covenant University, P.M.B. 1023, Ota, Nigeria

Email: <sup>1</sup> [akinloto@yahoo.com](mailto:akinloto@yahoo.com), <sup>2</sup> [oluseyi.ajayi@covenantuniversity.edu.ng](mailto:oluseyi.ajayi@covenantuniversity.edu.ng); +234-8036208899

<sup>3</sup> [joshua.okeniyi@covenantuniversity.edu.ng](mailto:joshua.okeniyi@covenantuniversity.edu.ng)

\* Corresponding Author: [olugbenga.omotosho@covenantuniversity.edu.ng](mailto:olugbenga.omotosho@covenantuniversity.edu.ng); +234-8033382752

## ABSTRACT

Electrochemical potential monitoring experiments were performed on mild steel rebars embedded in concrete admixed with aniline inhibitor and fixed amount of sodium chloride salt partially immersed in sulfuric acid and sodium chloride solution. The open circuit potential corrosion monitoring technique was employed and potential readings were taken in accordance with ASTM C 876. Repressive attribute and consistency of the inhibitor was then estimated by the Weibull probability density distribution as an extreme value statistical modeling approach to study performance effectiveness and predict the most efficient inhibitor concentration in each media. Aniline effect on the compressive strengths of the reinforced concrete samples was also investigated and reported. Varying concentrations of the inhibitor were used and its performance improved as concentration changed in NaCl medium, while no particular order of performance was noted in sulfuric medium. In the statistically analyzed experimental results for each of the inhibitor concentrations employed, 0.34 and 0.41 M aniline admixed samples are identified as exhibiting the best inhibiting quality in sodium chloride while 0.14 M aniline was predicted as showing the lowest probability of corrosion risk in sulfuric acid medium. The overall effective inhibitive performance in sulfuric acid was less when compared to the sodium chloride medium. Concrete sample admixed with 0.41 M aniline had the highest improvement in compressive strength in both media.

**Keyword:** Potential, concrete steel rebar, aniline, compressive strength, Weibull distribution, Kolmogorov–Smirnov statistics, marine/microbial media.

## 1. INTRODUCTION

Steel-reinforced concrete is one of the most widely used materials of construction due to its versatility and acceptability. Manufacturing plants, highway infrastructure and waste water system utilize concrete as an item of construction (Bavarian and Reiner, 2006). These infrastructures, in some instances find usage in the coasts or soils of the Niger Delta of Nigeria which is characterized by high water table levels (Burubai and Dagogo, 2007) and microbial environments due to animal farms and sewage treatment facilities (Hewayde et al., 2006 and Parande et al., 2006). Though the alkaline environment of the concrete protects the embedded steel from corrosion, the normally passive steel can begin

to corrode when the concrete is subjected to either chloride, sulfate or carbonation attack through the ingress of chloride/sulfate ions and carbon dioxide (Yongmo et al., 2004; Richard, 2002; Schiegg et al., 2000; NEA, 2002 and Bertolini et al., 2004). The resulting corrosion products have two or four times the volume of the original steel, with the subsequent stresses produced causing the concrete to crack (Daily, 2000 and Loto, 1992). This finally leads to delamination and spalling, and the destruction of the integrity of the concrete structure. In some instances such damage results in the collapse of the concrete structure.

Decreasing steel rebar corrosion in concrete is achievable through the reduction in the permeability and porosity of the concrete by adding a selected pulverized fuel ash as well as the use of coatings that have been developed to protect reinforced concrete structures in the splash zones (Loto, 1992). Furthermore, protection of reinforced steel from corrosion is also achieved by adding an inhibitor to the concrete. Experimental studies on the use of inhibitors in concrete have been reported by various authors (Berke, 1989; Griffin, 1975; Loto and Odumbo, 1989; Afolabi, 2008; Craig and Wood, 1970 and Treadway and Russel, 1968). Among the group studied so far, only calcium nitrite is known to be used commercially (Berke, 1989). These studies have focused attention on sodium nitrite, potassium dichromate, sodium benzoate and sodium sulphide, with little or no attention given to aniline as an inhibitor in chloride and sulfate media. There is also paucity of the use of the Weibull probability distribution to statistically analyze potential readings arising from such studies due to fluctuations that make interpretation difficult. In this work sodium chloride was used to simulate marine corrosion environment while sulfuric acid is used to simulate bacterial or microbial environment. Sodium chloride was added to the concrete mix to accelerate the corrosion of the embedded steel by providing increased chloride ions in the matrix and particularly around the reinforcing steel rebars, while the amounts of aniline admixed in the concrete samples was varied.

The focus of this investigation is on the use of aniline since much work has not been done with this inhibitor. This work seeks to discern the true nature of the corrosion mechanism and also goes ahead to provide more insight in the corrosion protection of steel-reinforcement in concrete. The attendant difficulty in ranking inhibitor performance with regards to concentration and establishing the most effective inhibitor concentration as a result of the fluctuating nature of the corrosion potential readings necessitated the use of Weibull probability distribution following the procedure employed by Omotosho et al., 2010. Furthermore the compressive strength of the concrete samples admixed with and without inhibitor was also determined. Attempts were also made to establish if a relationship existed between varying concentration of inhibitor and compressive strength.

## **2. EXPERIMENTAL PROCEDURE**

### **2.1 Preparation of concrete block samples:**

Concrete blocks used for the experiment were made of water and a mixture of Portland cement, sand, and gravel in a mix ratio of 1:2:4. The formulation used for the reinforced

concrete specimens in  $\text{kg/m}^3$ , was cement-320, water-140, sand-700, and gravel-1150. The water/cement (w/c) ratio was 0.44 (Loto, 1992).

Two groups of blocks were made. The first group consists of seven sets of block comprising several specimens, which were cast with varying inhibitor concentration, admixed with fixed amount of sodium chloride. The percentages quoted below for each of the admixed inhibitors and the sodium chloride was computed based on every 10 kg weight of the concrete from which the blocks were made. All the chemicals used were AnalaR grade. The sets were prepared as presented in Table 1 and Set 1 in the table was the control sample. The steel rebar used for the reinforcement has the chemical composition of: 0.3%C, 0.25 %Si, 1.5%Mn, 0.04%P, 0.64%S, 0.25%Cu, 0.1%Cr, 0.11%Ni, and the rest Fe. The rebar was cut into several pieces each with a length of 160mm and 10mm diameter. An abrasive grinder was used to remove any mill scale and rust stains on the steel specimens before embedded in each concrete block. The remaining 20mm protruded at one end of the block, and was painted to prevent atmospheric corrosion (Figure 1). This part was also used for electrical connection. The test media used for the investigation were; 3.5% NaCl solution and 0.5M dilute sulfuric acid.

Table 1. List of Inhibitor Admixtures with fixed amount of NaCl in concrete.

S/N	Concrete sample	Aniline Concentration
	Concrete admixed with 0.1M NaCl	
1	(control)	None
2	Concrete admixed with 0.1M NaCl	0.07M (1 ml)
3	Concrete admixed with 0.1M NaCl	0.14M (2 ml)
4	Concrete admixed with 0.1M NaCl	0.21M (3 ml)
5	Concrete admixed with 0.1M NaCl	0.27M (4 ml)
6	Concrete admixed with 0.1M NaCl	0.34M (5 ml)
7	Concrete admixed with 0.1M NaCl	0.41M (6 ml)

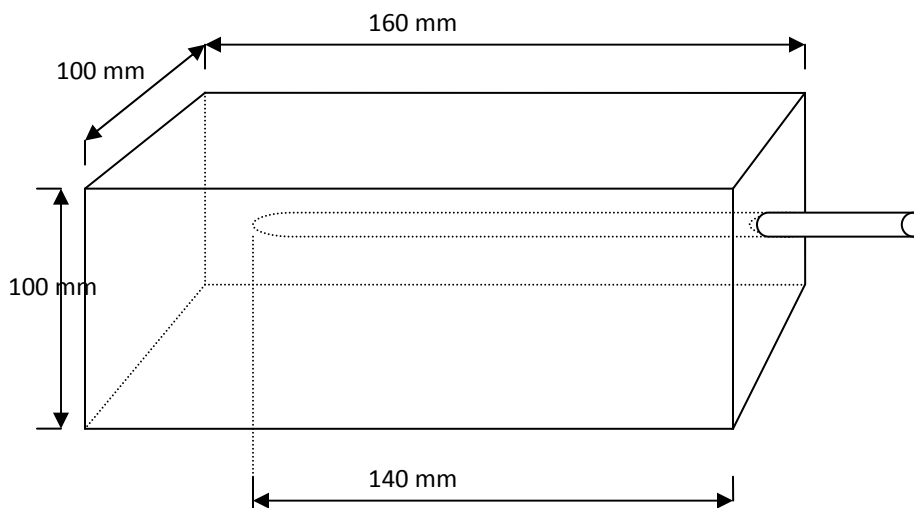

Figure 1. Sample of concrete block (drawing is not to scale).

The second group consisted of two concrete blocks without any admixed inhibitor, which were purposely made for determining strength under different curing conditions. One of the concrete blocks in the second group was cured in air for two weeks, and the other was cured in water for the same period (Loto, 1992).

## 2.2 Potential Measurement:

Each concrete block was partially immersed in their respective test medium such that the liquid level was just below the exposed part of the reinforcing steel to avoid direct contact. Corrosion potential or open circuit potential (OCP) readings were obtained by placing a copper/copper sulfate electrode (CSE) firmly on the concrete block (Figure 2). One of the two lead terminals of a digital multimeter was connected to the copper sulfate electrode and the other to the exposed part of the embedded steel rebar to make a complete electrical circuit. The readings were taken at three different points on each concrete block directly over the embedded steel rebar (Berke, 1989; Loto and Odumbo, 1989; Loto and Okusanya, 1989; Franciskovic et al., 2006 and Omotosho et al., 2010). The average of the three readings was computed as the potential reading for the embedded rebar in 2-day intervals for a period of 32 days. All the experiments were performed under free corrosion potential and at ambient temperature.

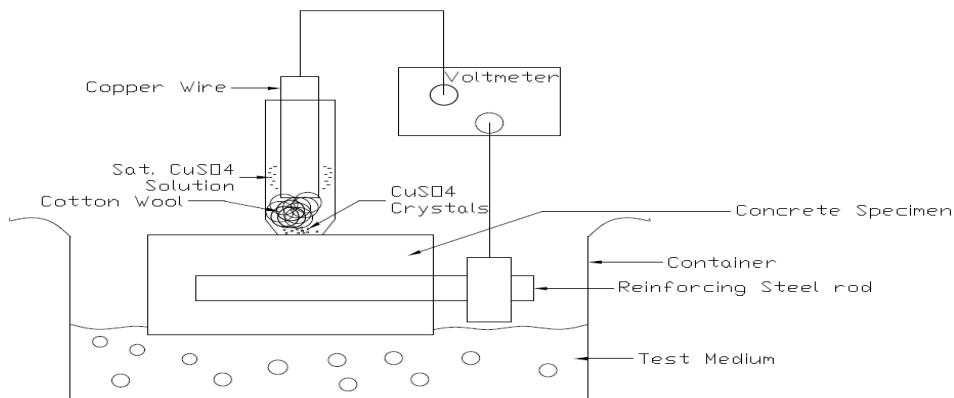

Figure 2. Schematic diagram of experimental set up.

## 2.3 Data Assessment

The analysis of data obtained during the experiments was performed using the approach adopted by Omotosho et al., 2010. This involved the use of a two-parameter Weibull distribution function given by Equation 1.

$$F(x) = 1 - \exp\left(-\left(\frac{x}{c}\right)^k\right) \quad (\text{Equation 1})$$

Where k and c is the shape and scale parameter respectively.

The quality of the data was also measured by a Weibull prediction of the mean  $\mu$  (Omotosho et al., 2010):

$$\mu = c\Gamma\left(1 + \frac{1}{k}\right) \quad (\text{Equation 2})$$

Where  $\Gamma(\cdot)$  is the gamma function of  $(\cdot)$

A goodness of fit test was also carried out to determine the compatibility of the OCP data to Weibull distribution, through the Kolmogorov-Smirnov (K-S) test (Omotosho et al., 2010). The K-S test measures the difference between the empirical  $F^*$  and the theoretical distribution function  $F(x)$  (Omotosho et al., 2010)

$$d = d(x_1, \dots, x_n) = \sqrt{n} \sup_{-\infty < x < \infty} |F^*(x) - F(x)| \quad (\text{Equation 3})$$

Where  $n$  is the number of the examined data points.

Consequently, at a significant level of  $\alpha=0.05$ , the P-value of the K-S test is subjected to the test of hypothesis:

$$\begin{aligned} T_0: P \geq \alpha \\ T_A: P \geq \alpha \end{aligned} \quad (\text{Equation 4})$$

Where  $T_0$  is the null hypothesis such that the OCP data follow the two-parameter Weibull distribution and  $T_A$  is the alternative hypothesis such that the OCP data does not follow the two-parameter Weibull distribution.

## 2.4 Determination of the compressive strength of the test specimens

The effect of aniline inhibitor on the compressive strength of the concrete test samples was determined using the concrete samples in the second group of specimens mentioned earlier. After the potential monitoring period, the original steel-reinforced concrete test specimen were removed from their respective test media and allowed to air harden for seven days. Then each of the concrete blocks was carefully weighed, placed on a compressive fracture machine lengthwise and loaded until the concrete blocks failed (Loto, 1992).

## 3. RESULTS AND DISCUSSION

### 3.1 Test samples in sulfuric acid medium

The curves of mean potential versus time for the control sample and sample admixed with 1 ml aniline and 0.1M NaCl are presented in Figure 3. Potential reading of steel in the control specimen moved from the active region at -623mV (CSE) to the passive region at -310mV (CSE) on the 6<sup>th</sup> day. This could be due to the fact that the sulfate ions in the medium had not reached the steel surface because of the protection provided by the alkaline pore solution of the concrete. From about the 7<sup>th</sup> day to the 14<sup>th</sup> day, steel

potential was in the active region, it then drifted towards the passive region until the 20<sup>th</sup> day. The sulfate ions in the medium had probably succeeded in destroying the alkaline barrier; hence the active corrosion potential observed. Afterwards, the corrosion products stifled the corrosion reaction and this resulted in the passive potential. Steel potential after the 20<sup>th</sup> day, however, became active until the end of the experiment. This again, could be as a result of the dissolution of the corrosion products which exposed the steel surface.

Steel rebar concrete sample admixed with 1ml aniline in the H<sub>2</sub>SO<sub>4</sub> medium in Figure 3 showed initial active corrosion as the potential reading moved from 420mV (CSE) to 580mV (CSE) in the first 14 days of the experiment. This was followed by a drift towards passive corrosion state from the 16<sup>th</sup> to the 18<sup>th</sup> day. The inhibitor at the amount used might have succeeded in gradually building a passive film on the steel rebar during the period of passive potential readings. The aggressive nature of the H<sub>2</sub>SO<sub>4</sub> medium resulted in active potential readings as the steel rebar showed active corrosion condition after 20<sup>th</sup> day until end of the experiment. The concentration of the inhibitor used was also not able to reduce corrosion effectively in the H<sub>2</sub>SO<sub>4</sub> medium.

For the first six days of the exposure period, it was observed that the steel rebar concrete sample admixed with 2ml aniline in the H<sub>2</sub>SO<sub>4</sub> medium in showed active corrosion condition with a potential reading of less than -569mV(CSE) as shown in Figure 3. This was probably due to the sulfate ions in the acidic medium. The potential of the steel rebar gradually drifted, though with fluctuations, towards the passive region until it reached a value greater than -100mV (CSE) on the 16<sup>th</sup> day. This passive reading was maintained until the 20<sup>th</sup> day of the experiment, this condition could be attributed to the higher inhibitor content in the test sample when compared to the previous sample. The breakdown of passive film, therefore resulted in active corrosion condition of about -540mV (CSE) at the end of the experiment.

The sample admixed with 3ml aniline and partially immersed in H<sub>2</sub>SO<sub>4</sub> medium is shown in Figure 3. The potential reading moved gradually though with fluctuations from the active (-530mV CSE) to the passive region (-280mV CSE) for the first 12 days of the experiment indicating that the inhibitor was effective when compared to the control sample during the same time frame. The potential drifted into the active region with a mean value of -560mV (CSE) from the 22<sup>nd</sup> day to the 32<sup>nd</sup> day, as the inhibitor became less effective. The effectiveness reduced from the 22<sup>nd</sup> day until the end of the experiment as the aggressive medium destroyed the barrier created by the inhibitor.

The potential reading of the steel rebar concrete sample admixed with 4ml aniline and partially immersed in H<sub>2</sub>SO<sub>4</sub> medium in Figure 3 showed a behavior of initial active corrosion from the beginning to the 14<sup>th</sup> day of the experiment. Steel rebar potential then moved into the passive region from the 16<sup>th</sup> to the 18<sup>th</sup> day of the experiment, and afterwards drifted into the active region from the 20<sup>th</sup> day till the end of the experiment indicating that higher concentration of the inhibitor did not effectively reduce corrosion activity.

Initial potential reading of steel rebar concrete sample admixed with 5 ml aniline and partially immersed  $H_2SO_4$  medium as shown in Figure 3 drifted from the active to the passive region but not as low as what was observed in the previous sample in the first 14 days of the experiment. This is perhaps an indication of initial effectiveness of the inhibitor at the concentration used. The potential reading attained a value of less than -100mV (CSE) on the 16th day, however the shift downwards, from the 18<sup>th</sup> day to the 20<sup>th</sup> day of the experiment into the active corrosion region, was probably due to the breakdown of the passive film.

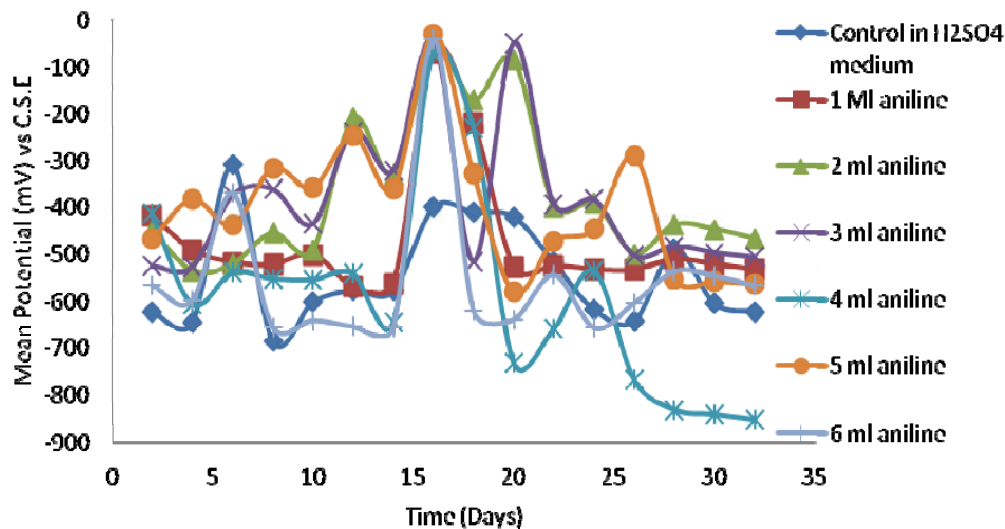

Figure 3. Variation of corrosion potential with time for mild steel reinforcement in concrete admixed with varying amount of aniline in  $H_2SO_4$  medium.

Though passive activity was once again displayed after the 22<sup>nd</sup> day it was short-lived as the passive film was once again destroyed resulting in active potential readings until the end of the experiment.

Potential records from the start moved sharply from the active to the passive region on the 6<sup>th</sup> day of the experiment as shown in Figure 3. This initial spike was immediately followed by a return to the active state for about 8 days which is again followed by persistent and frequent spikes varying in amplitude from a unit of a millivolt to more than 100 mV. These spikes are probably an indication of the persistent contest between passivation in the highly alkaline pH of hydrated cement and corrosion in the acidic pH of active anodes caused by sulfate ions. However, steel potential readings remained in the active region (-620mV CSE) until the end of the experiment, probably due to the aggressive nature of the acidic medium.

### 3.2 Test samples in sodium chloride medium

The potential reading of the control test sample in the NaCl medium in Figure 4 moved from the passive region of -350mV(CSE) to the active region of -600mV(CSE) in the first 4 days of the experiment. After the 4<sup>th</sup> day, potential readings increased gradually to -400mV (CSE) on the 16<sup>th</sup> day showing that the alkaline barrier between steel rebar and the chloride ions in the matrix was still able to prevent corrosion. This potential reading was maintained till the end of the experiment except for the fluctuation on the 24<sup>th</sup> day.

The curve for the steel concrete sample admixed with 1 ml aniline and partially immersed in the NaCl medium is shown in Figure 4. Though the potential was drifting towards the active region, in the first 6 days, it was observed that the chloride ions initiating this action were not strong enough to allow a sharp shift into the very active corrosion region. Perhaps the inhibitor also forestalled this downward drift at the concentration used, since the trend of the potential readings was gradually moving into passive region though with fluctuations until the 14<sup>th</sup> day of the experiment. However, it seemed the inhibitor became less effective afterwards as the potential readings remained in the active region until the end of the experiment.

The curve of the mean potential versus time for steel rebar sample admixed with 2ml aniline partially immersed in NaCl medium is shown Figure 4. The recorded potential reading showed upward fluctuation from -450mV (CSE) to -220mV (CSE) from the start to the 12<sup>th</sup> day, indicating that the inhibitor was effective during this time frame. However, frequent spikes were also displayed after the 12<sup>th</sup> day until the 20<sup>th</sup> day indicating that the inhibitor was still effective since the fluctuations were in the passive region. Subsequently, after the 20<sup>th</sup> day the passive film of the inhibitor was destroyed as the potential readings of the steel rebar drifted into the active region, thus indicating that the inhibitor was not effective at the concentration used, though overall readings were better when compared to the control experiment in NaCl medium.

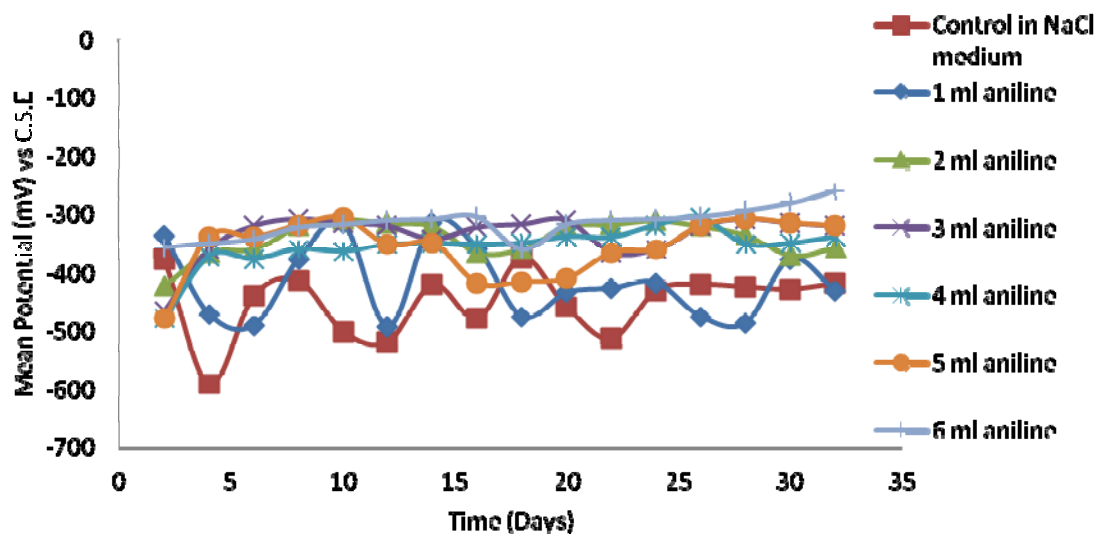

Figure 4. Variation of corrosion potential with time for mild steel reinforcement in concrete admixed with varying amount of aniline in NaCl medium.



In the first 20 days of the experiment, steel rebar concrete sample admixed with 3 ml aniline and partially immersed in NaCl medium, Figure 4, showed a gradual and consistent shift towards the passive region. Potential reading of -310mV (CSE) which was achieved on the 8<sup>th</sup> day of the experiment and maintained until the 20<sup>th</sup> day could be as a result of the inhibiting action of the inhibitor at the concentration used. Apart from the 22<sup>nd</sup> and 24<sup>th</sup> day of the experiment, where the readings plunged briefly, potential values for the remaining experimental days were in the near passive region. This probably indicates an increase in the effectiveness of the inhibitor at the concentration used when compared to the control and the former (2 ml aniline).

The mean potential versus time curve of concrete test sample admixed with 4 ml aniline and partially immersed in NaCl medium is shown in Figure 4. The steel rebar potential showed a trend in the upward direction from -500mV (CSE) in the beginning to -360mV (CSE) at the end of the experiment. This could be as a result of the increase in the concentration of the inhibitor which was able to suppress the action of the chloride ions throughout the experimental period.

The potential of the concrete test sample admixed with 5 ml aniline and partially immersed in sodium chloride media showed initial shift towards the passive region for the first 10 days in Figure 4. This indicates that the inhibitor was effective for this period. However, the trend changed direction and drifted downwards after the 10<sup>th</sup> day until the 20<sup>th</sup> day after which the readings gradually moved upwards into the passive region indicating that the chloride ions in the matrix and medium could not destroy the barrier created by the inhibitor throughout the experimental period.

Figure 4 shows the curve obtained the concrete sample premixed with 6 ml aniline and partially immersed in NaCl medium. The record of the potential readings show that the steel rebar potential was in the passive region throughout the experiment. The potential reading was -350mV (CSE) at the beginning and it gradually increased to -280mV (CSE) at the end of the experiment. No fluctuation spikes were shown apart from that of the 18<sup>th</sup> day throughout the experimental period. The records of the potential readings suggest clearly the effectiveness of the inhibitor throughout the experimental period.

### **3.3 Overall picture of increasing inhibitor concentration on concrete steel rebar corrosion in sulfuric acid and sodium chloride media**

Potential vs time curves for steel rebar embedded in concrete premixed with varying amounts of aniline immersed in H<sub>2</sub>SO<sub>4</sub> and NaCl media respectively are presented in Figures 3 and 4. These also show the overall picture of the comparison of the effectiveness of increasing the amounts of aniline used. In H<sub>2</sub>SO<sub>4</sub> medium (Figure 3), aniline showed some level of initial effectiveness (passivating initial potential) after which it fluctuated throughout the experimental period; even with the use of higher concentration of the inhibitors. However, most of the potential readings were in the passive region ranging between -100mV and -400mV (CSE). The fluctuations could be due to the aggressiveness of the H<sub>2</sub>SO<sub>4</sub> medium that tends to breakdown the inhibitors passive film intermittently. In the NaCl medium (Figure 4), aniline was more effective as inhibitor for the steel reinforcement in concrete. The mean potential throughout the

experimental period was in passive range of -300 and -420 mV (CSE). The best performance was obtained when 6ml of aniline was used. At this concentration the steel showed increasing order of passivation throughout the experimental period, except for the 16<sup>th</sup> and 18<sup>th</sup> day.

### 3.4 Weibull result and analysis

Observing Figures 3 – 4, it is obvious and quite clear that potential readings fluctuated throughout the experiments. These fluctuations made data interpretation difficult hence the need for a tool with resultant analytical ability. Employing a statistical tool to determine the quality and the reliability of inhibitions in the respective medium, subsequently gave a clear interpretation of the inhibitions in the test media, regardless of the fluctuations displayed by the admixed inhibitor. Therefore, Weibull distribution fittings to the OCP measurements for the admixed inhibitor were made. The suitability and reliability of the fittings were then investigated using the K–S goodness of fit test in a bid to determine the consistencies of the OCP measurements for each admixed inhibitor with the Weibull distribution fittings. The results obtained are presented in Table 2.

Table 2. Weibull distribution fitting results of inhibitor admixtures in reinforced concrete samples

S/N	Admixture	Medium	k	c	$\mu$	Prob( $\mu$ )	P-value (K-S) test
1	Control	NaCl	8.72	475.48	449.62	0.456	0.3556
2	1 ml	NaCl	7.05	445.54	416.93	0.465	0.8521
3	2 ml	NaCl	11.29	357.15	341.45	0.452	0.2766
4	3 ml	NaCl	7.97	357.00	336.14	0.461	0.0589
5	4 ml	NaCl	9.84	374.25	355.80	0.456	0.1635
6	5 ml	NaCl	13.05	327.35	314.65	0.449	0.5214
7	6 ml	NaCl	13.05	327.35	314.65	0.449	0.5214
8	Control	H <sub>2</sub> SO <sub>4</sub>	4.98	595.69	546.85	0.479	0.5719
9	1 ml	H <sub>2</sub> SO <sub>4</sub>	1.72	593.03	528.65	0.560	0.0135
10	2 ml	H <sub>2</sub> SO <sub>4</sub>	1.58	448.40	402.60	0.570	0.2084
11	3 ml	H <sub>2</sub> SO <sub>4</sub>	1.26	489.81	455.21	0.598	0.0564
12	4 ml	H <sub>2</sub> SO <sub>4</sub>	1.68	716.18	639.54	0.563	0.1922
13	5 ml	H <sub>2</sub> SO <sub>4</sub>	1.41	512.11	466.22	0.584	0.1047
14	6 ml	H <sub>2</sub> SO <sub>4</sub>	1.24	763.82	712.19	0.600	0.0045

Table 3. Estimated Corrosion Condition

S/N	Concrete Admixture	Medium	$\mu$	Predicted corrosion condition
1	6 ml	NaCl	314.65	Intermediate corrosion condition
2	5 ml	NaCl	314.65	Intermediate corrosion condition
3	3 ml	NaCl	336.14	Intermediate corrosion condition
4	2 ml	NaCl	341.45	Intermediate corrosion condition
5	4 ml	NaCl	355.80	Intermediate corrosion condition
6	2 ml	H <sub>2</sub> SO <sub>4</sub>	402.60	High (90% risk of corrosion)
7	1 ml	NaCl	416.93	High (90% risk of corrosion)

8	Control	NaCl	449.62	High (90% risk of corrosion)
9	3 ml	H <sub>2</sub> SO <sub>4</sub>	455.21	High (90% risk of corrosion)
10	5 ml	H <sub>2</sub> SO <sub>4</sub>	466.22	High (90% risk of corrosion)
11	1 ml	H <sub>2</sub> SO <sub>4</sub>	528.65	Severe corrosion
12	Control	H <sub>2</sub> SO <sub>4</sub>	546.85	Severe corrosion
13	4 ml	H <sub>2</sub> SO <sub>4</sub>	639.54	Severe corrosion
14	6 ml	H <sub>2</sub> SO <sub>4</sub>	712.19	Severe corrosion

The value of  $k$ , in Table 2 for all the inhibitor amounts indicated that the data spread exhibits good consistency with relatively small scatter. Most of the samples satisfy the null hypothesis confirming that the OCP data came from a two-parameter Weibull distribution based on the P-value of the K-S test from ( $P \geq 0.05$ ). The null hypothesis was however, not satisfied for specimens 9 and 14 in Table 2. This could have resulted from the sharp increase in negative corrosion potential in the first 14 days of the experiment, which may have eventually led to pitting corrosion occasioned by the presence of sulfate ions since the specimens were partially immersed in sulfuric acid.

Furthermore the mean values obtained from the Weibull analysis is appropriate for estimating the level of corrosion according to ASTM C 876 standard of classification with reference to CSE as presented in Table 3.

However, the performance ranking of inhibiting quality of the reinforced concrete samples with admixed inhibitor is presented in Figure 5 and it is based on the prediction by the Weibull mean. From Figure 5, specimen number 1 and 2 as shown in Table 3 with 6 and 5 ml aniline admixture partially immersed in the NaCl medium have the maximum Weibull mean evaluation of -314.65 mv (CSE) each. The reliability of this predicted mean value stands at a probability of 52.14% for each sample. Following after this are specimens admixed with 3, 2 and 4 ml aniline partially immersed in NaCl medium having Weibull mean values of -336.14, 341.45 and -335.80 mV (CSE). The reliability of this predicted value stands at probability of 46.1, 45.2 and 45.6% respectively. This is indicative of the existence of some kind correlation between the concentration of aniline and its inhibiting qualities.

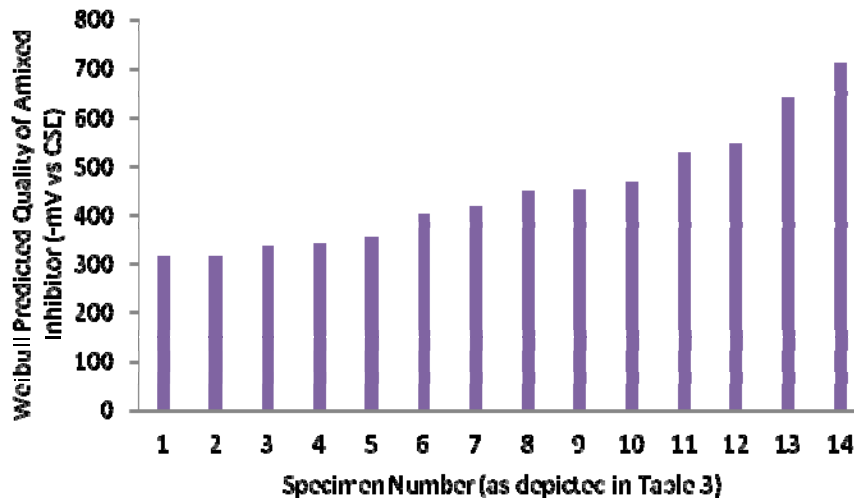

Figure 5. Performance ranking of inhibiting quality of admixed inhibitor based on prediction by the Weibull distribution.

The admixed inhibitors identified as exhibiting optimal qualities still show better inhibition effectiveness when compared to the control specimen though they are in the intermediate corrosion risk range according to ASTM C 876 (Haynie, 2005), as indicated by their predicted values of  $\mu$  in Figure 5.

Further examining Figure 5, the predicted Weibull mean values can be used to clearly identify specimens 1,2,3,4,5,6 and 7 as exhibiting positive inhibiting qualities in descending order as compared to specimen 8 (the control specimen) partially immersed in NaCl medium. Also specimens 9, 10 and 11 had better inhibiting qualities when compared to control specimen partially immersed in H<sub>2</sub>SO<sub>4</sub>.

### 3.4 Compressive strengths of concrete test sample

The analysis of compressive fracture load data for steel-reinforced concrete samples immersed in NaCl and H<sub>2</sub>SO<sub>4</sub> medium are presented in Figures 6 and 7 respectively. The strengths of all reinforced concrete specimens used in the experiments and partially immersed in H<sub>2</sub>SO<sub>4</sub> and NaCl media were higher than those of the specimen cured in water for two weeks. This indicates that the admixed inhibitor had no adverse effect on the concrete samples used. The reason for the higher compressive strength in the admixed samples than in the sample cured in water could probably be due to the relative chemical reactions hardening effect of the inhibitor with the concrete. In addition the specimens used for the monitoring experiments were partially immersed in H<sub>2</sub>SO<sub>4</sub> and NaCl media. The other halves were exposed to the air throughout the experimental period. This dual

hardening method might also account for the higher strength associated with the partially immersed specimens.

The values of the compressive strengths, obtained for the 7 specimens used for the monitoring experiments and partially immersed in  $H_2SO_4$  and NaCl media did not follow a particular trend when compared with the compressive strength values of the concrete specimens cured in air. Specimens 1, 3, 4 and 5 in the  $H_2SO_4$  medium (as depicted in Table 1) gave a loss in compressive strength when compared with specimens cured in air. However, specimens 2, 6 and 7 in the  $H_2SO_4$  medium and specimens 1, 2, 3, 4, 5 and 6 in the NaCl medium gave increases in the compressive strengths. Therefore the inference here is that the admixture of specimens 1, 3, 4 and 5 in  $H_2SO_4$  medium when used in concrete block making will cause a loss in compressive strength of the blocks. The control sample without inhibitor in the NaCl medium showed an increase in compressive strength while it displayed reduced strength in the  $H_2SO_4$  medium showing that sulfuric acid had a deleterious effect on the strength of concrete. In Figure 6, the addition of certain quantities of aniline improved the compressive strength of some of the concrete samples immersed in  $H_2SO_4$  medium while in Figure 7 aniline was able to improve the compressive strength of all the concrete samples in the NaCl medium.

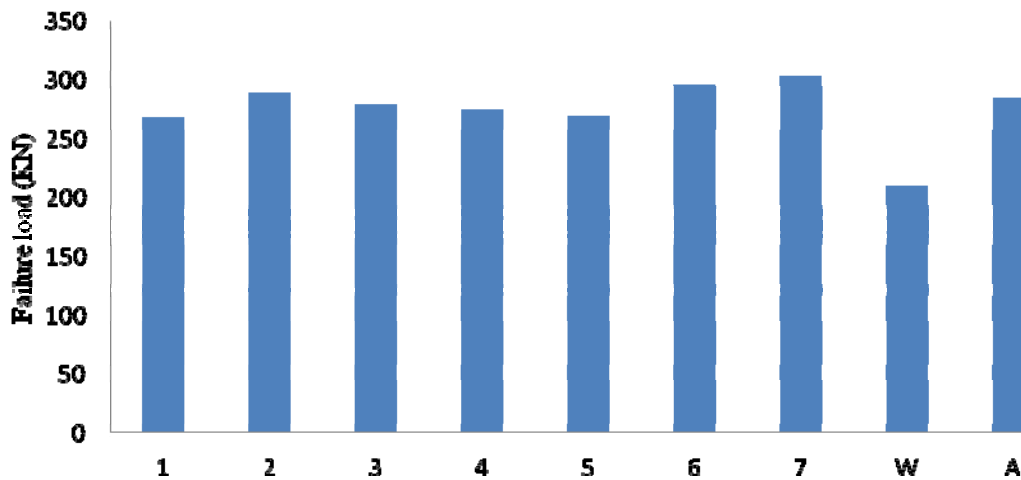

Figure 6. Histogram of the compressive failure load for the reinforced concrete specimens immersed in sulfuric acid. W=concrete specimen cured in water, A= concrete specimen cured in air. Numbers 1 to 7 represents the list of concrete specimen described previously in Table 1.

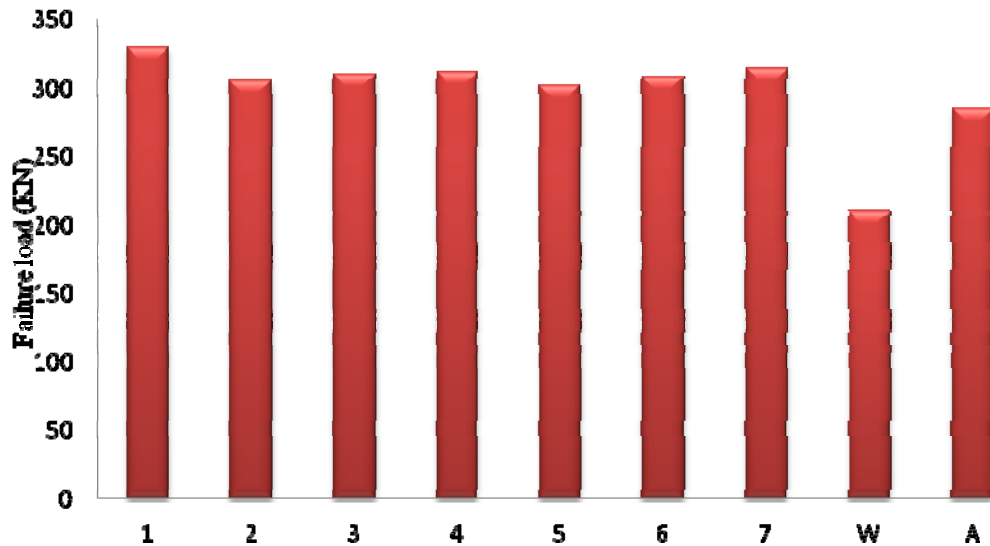

Figure 7. Histogram of the compressive failure load for the reinforced concrete specimens immersed in NaCl medium. W=concrete specimen cured in water, A=concrete specimen cured in air. Numbers 1 to 7 represents the list of concrete specimen described previously in Table 1.

#### 4. CONCLUSION

The study investigated the effect of aniline on concrete steel rebar corrosion in saline and sulfate media using the electrochemical potential measuring method, while the resulting fluctuating potential readings were statistically analyzed using the Weibull probability distribution. The investigation also determined the compressive strength of concrete test samples. The experimental result showed that aniline proved more effective in its inhibiting ability in the NaCl medium than the sulfuric acid medium when admixed with the concrete in increasing concentration.

Weibull distribution has modeled statistical-based performance evaluation of aniline on the corrosion of steel rebar in concrete. Twelve of the samples were well fitted based on K-S goodness of fit test, while two had outliers. Rebar concrete samples admixed with 6 and 5 ml aniline inhibitor with Weibull  $\mu = -314.65$  mV (CSE) at a probability of 52.14% is predicted as exhibiting optimum inhibiting quality in NaCl medium, while the 2 ml aniline admixture was predicted as showing the lowest probability of corrosion risk in sulfuric acid medium. Weibull mean values of corrosion potential obtained for all concrete samples made the interpretation of the data using ASTM C 876 possible.

The compressive strength of concrete sample admixed with 6ml aniline improved tremendously in both the sulfuric acid (303KN) and NaCl media (315KN). The concrete sample with the best compressive strength was the control sample in the NaCl medium. Hence from the results aniline with concentration of 6ml aniline is recommended as an

inhibitor for concrete structures in saline environment, since it showed the highest resistance to corrosion and highest improvement in compressive strength.

### References

Afolabi, A.S. 2008. Synergistic inhibition of Potassium Chromate and Sodium Nitrite on Mild Steel in Chloride Sulphide media. Available on the web at [[http://lejpt.academicdirect.org/A1/143\\_154.htm](http://lejpt.academicdirect.org/A1/143_154.htm) accessed 7/18/2008]

Bavarian, B. and Reiner, L. 2006. Current Progress in Corrosion Inhibition of Reinforcing Steel in Concrete Using Migrating Corrosion Inhibitors. Available online at [<http://www.cortecvci.com/Publications/Papers/MCITechPapers/06347.pdf> accessed 28/12/2010]

Berke, N.S. 1989. Corrosion Inhibitors in Concrete. *Corrosion 89. Paper 445, NACE*, Houston, Texas:1–10.

Bertolini, L., Elsener, B., Pedferri, P. and Polder, R.P. 2004. Corrosion of Steel in Concrete: Prevention, Diagnosis, Repair. *WILEY-VCH Verlag GmbH & Co, Weinheim*.

Burubai, W. and Dagogo, G. 2007. Comparative Study of Inhibitors on the Corrosion of Mild Steel Reinforcement in Concrete. *Agricultural Engineering International: The CIGR Ejournal*. Manuscript BC 06 008, vol. IX.

Craig, R.J. and Wood, L.E. 1970. Effectiveness of corrosion inhibitors and their influence on the physical properties of Portland cement mortars. *Highways Rese. Rec.* 328:77–78.

Daily, S. 1997-2000. Understanding Corrosion and Cathodic Protection of Reinforced Concrete Structures, *Corrpro Companies, Inc.* Available online at [[http://www.estig.ipbeja.pt/~pdnl/Subpaginas/Conservacao%20de%20edificios\\_files/Documentos/Material%20de%20apoio/Betao/corrosao.pdf](http://www.estig.ipbeja.pt/~pdnl/Subpaginas/Conservacao%20de%20edificios_files/Documentos/Material%20de%20apoio/Betao/corrosao.pdf) accessed 26/12/2010].

Franciskovic, J., Miksic, B., Rogan, I. and Tomcic, M. 2006. Protection and repair of reinforced concrete structures by means of mci-inhibitors and corrosion protective materials. In Proc. *Structural Engineering Conferences: International Conferences on Bridges*: 554. Available on the web at [<http://www.cortecvci.com/Publications/Papers/057%20Protection%20and%20repair%20of%20reinforced%20concrete.pdf> accessed on 3/26/2010].

Griffin, D.F. 1975. Corrosion of Metals in Concrete. *American Concrete Institute, Detroit, MI*: 65.

Haynie, F.H. 2005. Statistical treatment of data, data interpretation, and reliability. In: Baboian, R. (ed.) *Corrosion Tests and Standards— Application and Interpretation*, 2nd edn, pp. 83–88. *ASTM International, West Conshohocken, PA*.

Hewayde, E., Nehdi, M.L., Allouche, E. and Nakhla, G. 2007. Using concrete admixtures for sulfuric acid resistance. In Proc. *Institution of Civil Engineers, Construction Materials*. 160 Issue CM1: 25–35.

Loto, C.A. 1992. Effect of inhibitors and admixed chloride on electrochemical corrosion behavior of mild steel reinforcement in concrete in seawater. *NACE Corrosion prevention and control* 48 (9): 759-763.

Loto, C.A. and Odumbo, E.T. 1989. Electrochemical potential monitoring of corrosion and coating protection of mild steel reinforcement in concrete. *Corrosion* 45(7): 535.

Loto, C.A. and Okusanya, A. 1989. The influence of clay addition on the electrochemical corrosion behavior of mild steel in concrete. *Corros. Prev. Control J.* 36(4):105.

Nuclear Energy Agency/Committee on the Safety of Nuclear Installations (NEA/CSNI). 2002. Electrochemical techniques to detect corrosion in concrete structures in nuclear installations. *Organisation for Economic Co-operation and Development (OECD), Technical note*.

Omotosho, O.A., Okeniyi, J.O. and Ajayi, O.O. 2010. Performance evaluation of potassium dichromate and potassium chromate inhibitors on concrete steel rebar corrosion. *J Fail. Anal. And Preven.* 10(5):408-415.

Parande, A.K., Ramsamy, P.L., Ethirajan, S., Rao, C.R.K. and Palanisamy, N. 2006. Deterioration of reinforced concrete in sewer environments. In Proc. *Institution of Civil Engineers, Municipal Engineer*. 159 Issue ME1: 11–20.

Richard, R.L. 2002. Leading the Way in Concrete Repair and Protection Technology. *Concrete Repair Association, Costa Rica* Vol. 1.

Schiegg, Y., Hunkeler, F. and Ungricht, H. 2000. The Effectiveness of Corrosion Inhibitors - a Field Study. *16th Congress of IABSE* Paper 234, Lucerne.



Treadaway, K.W.J. and Russel, A.D. 1968. The inhibition of the corrosion of steel in concrete. *Highways Public Works* 36:40.

Yongmo, X., Hailong, S. and Miksic, B.A. 2004. Comparison of inhibitors MCI and  $\text{NaNO}_2$  in carbonation-induced corrosion. *Mater. Perform.* 43: 42–46.