

PhD. 25775

*THE IMPACT OF THE ARAB CONQUEST
ON LATE ROMAN SETTLEMENT IN EGYPT*

VOLUME 2: ILLUSTRATIONS

ALISON GASCOIGNE
DARWIN COLLEGE, CAMBRIDGE

Fig. I.1

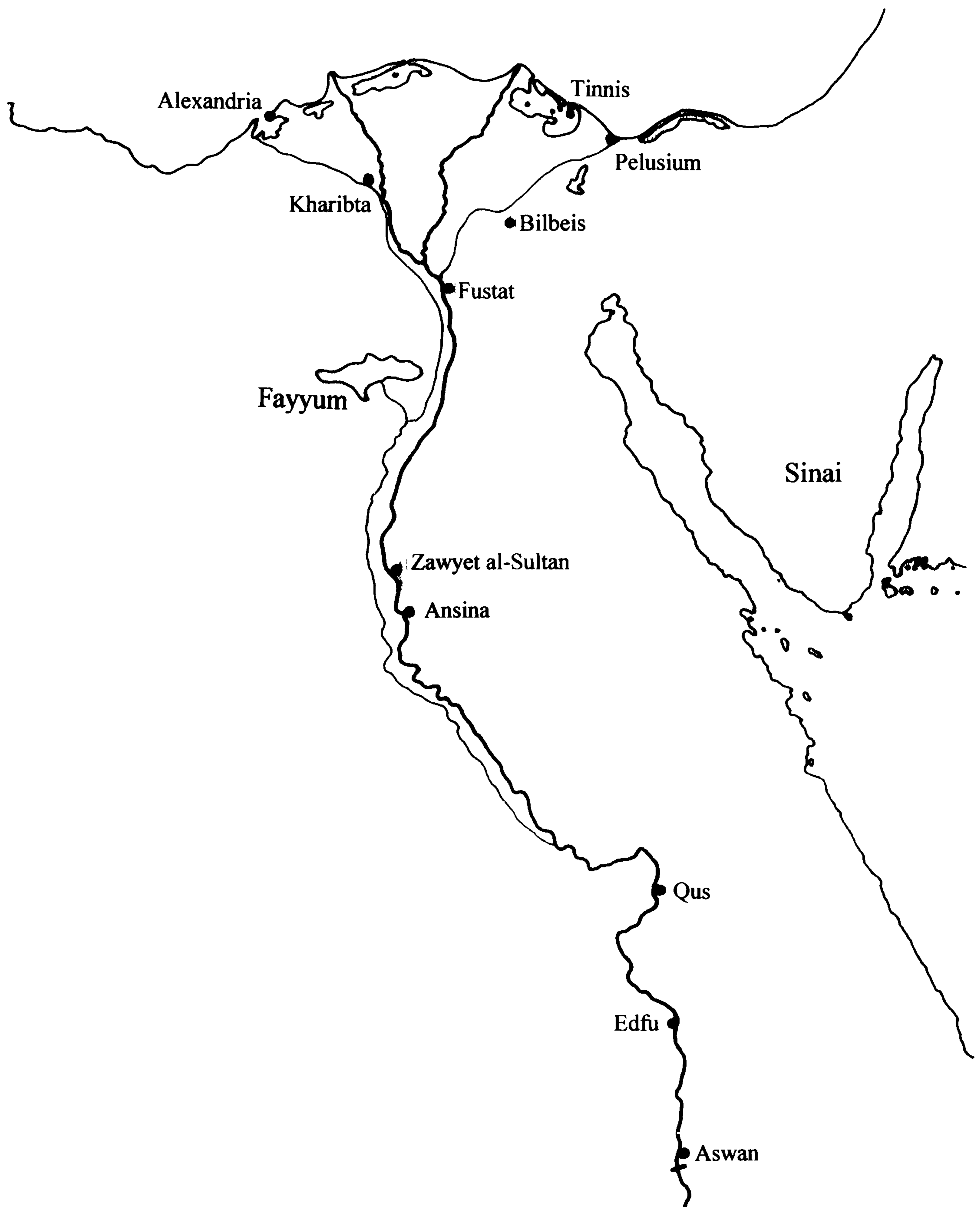

Map of Egypt marking sites discussed in the text.

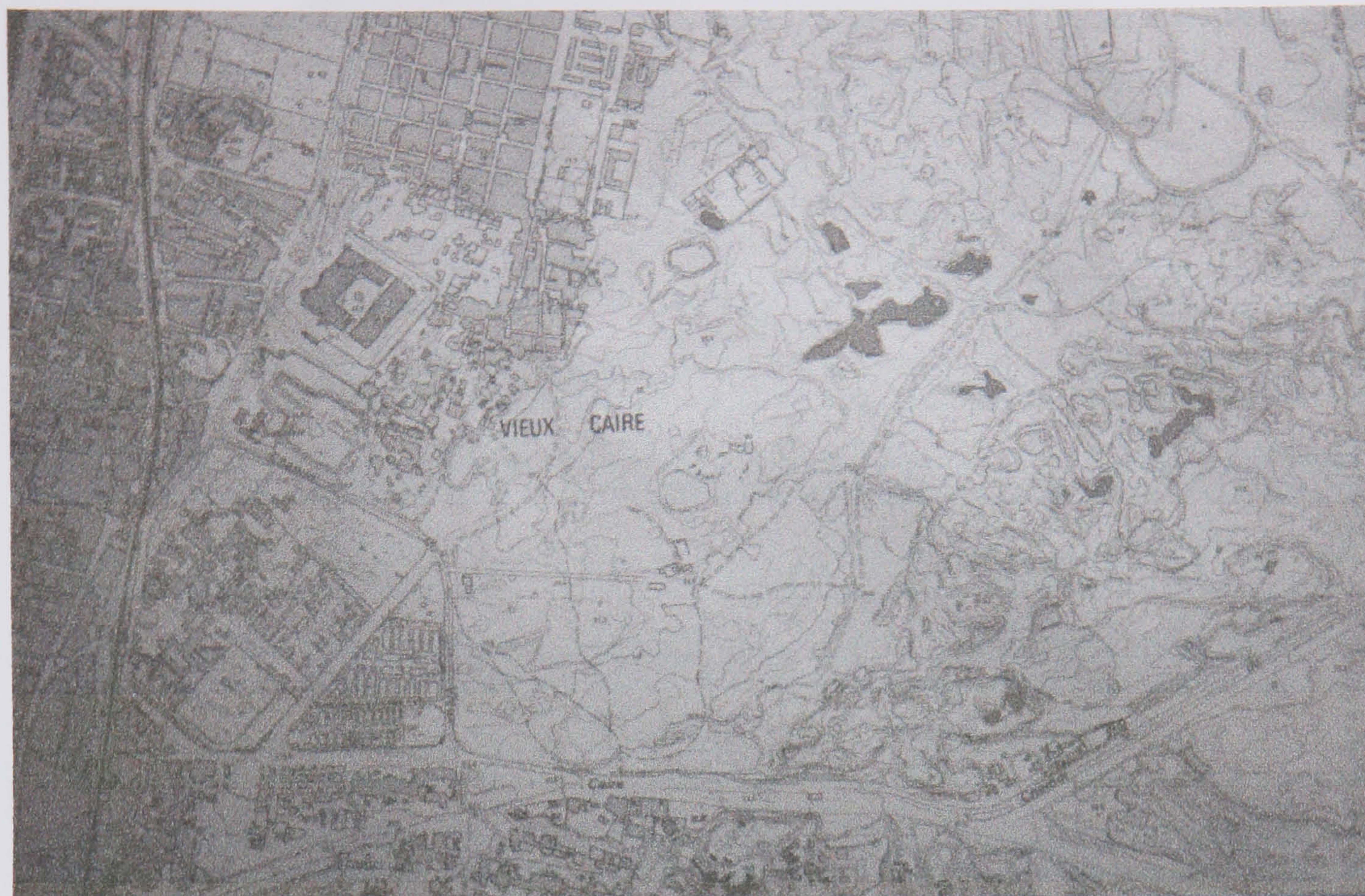

A: Survey map of Old Cairo, with Babylon and the Mosque of Amr to the west and the mounds of Fustat to the east.



B: The 1999 excavations of the *Khittat Ahl al-Raya* (photo by Peter Sheehan).

Fig. I.3



A: The south gate of the fort of Babylon.

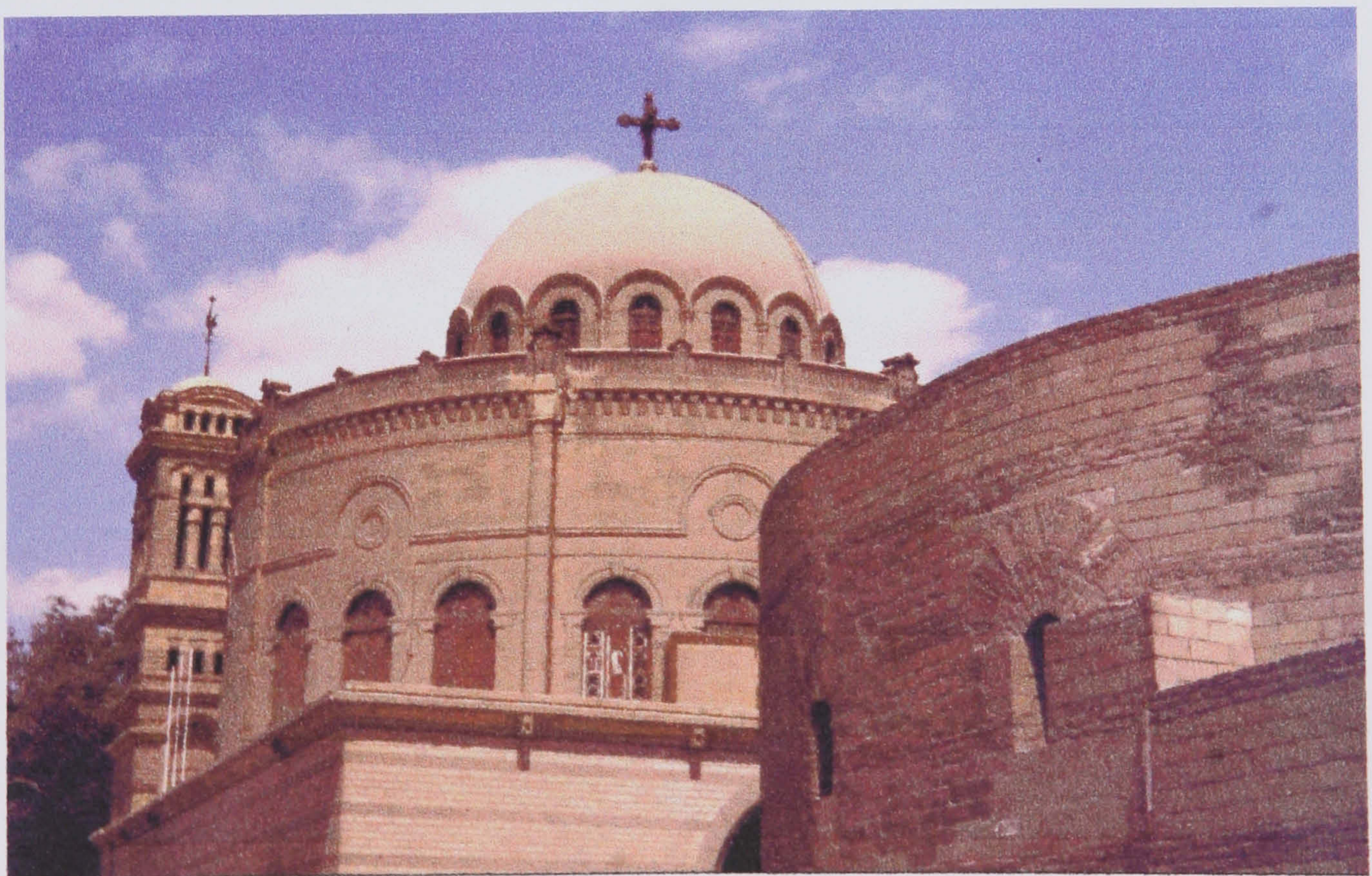

B: The round towers of the west gate of Babylon; the Greek Orthodox church of St. George is built over the northernmost tower.

Fig. I.4

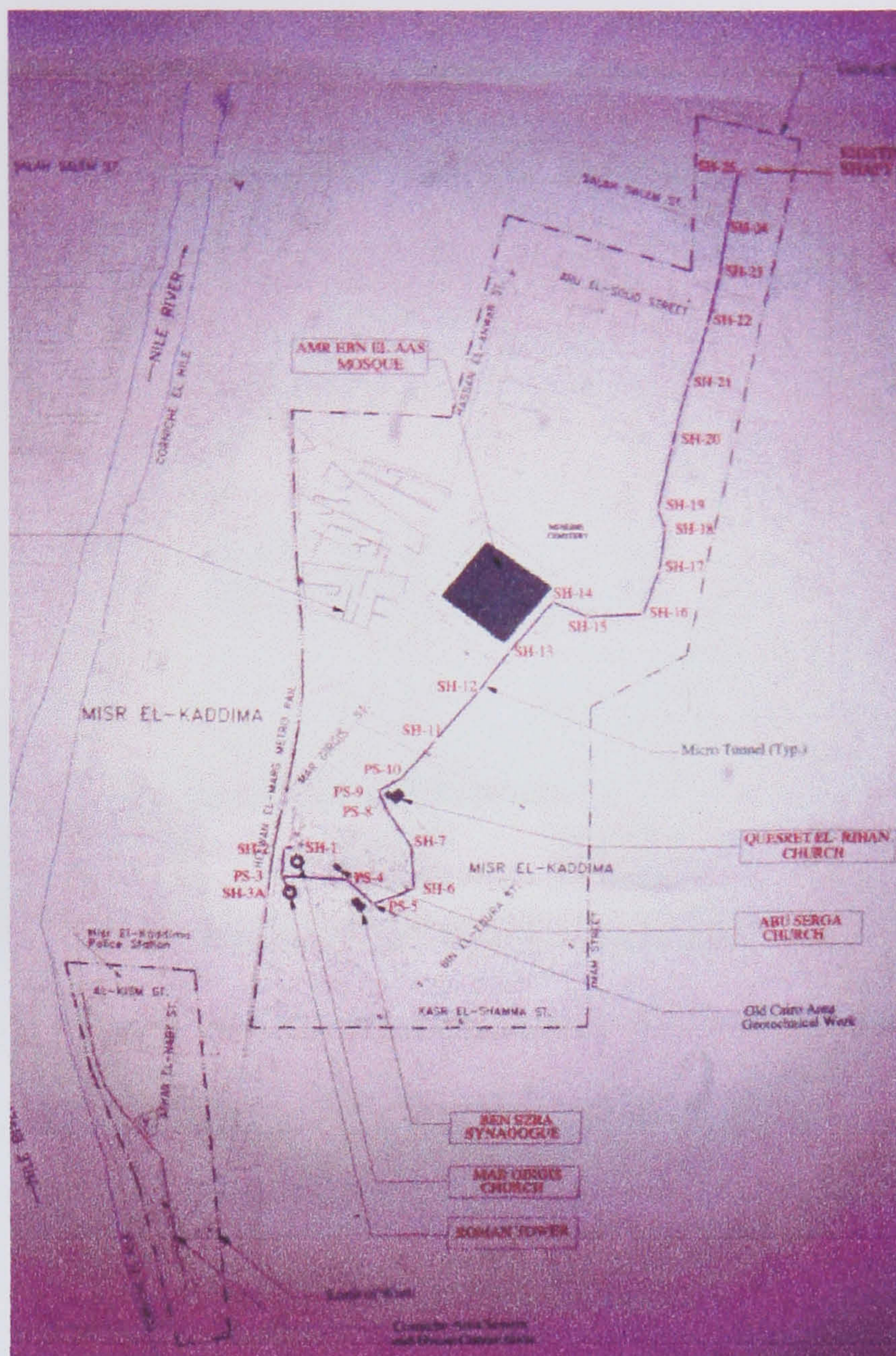

A: Plan of the shafts sunk during the Old Cairo Wastewater Project.



B: View of shaft 6 with the wall of the Mosque of 'Amr in the top left corner.



A: The handle of a Rhodian amphora stamped with the maker's name ΣΩΚΡΑΤΕΥΣ.



B: Two imported (Cypriot?) unguentaria.

Fig. II.1

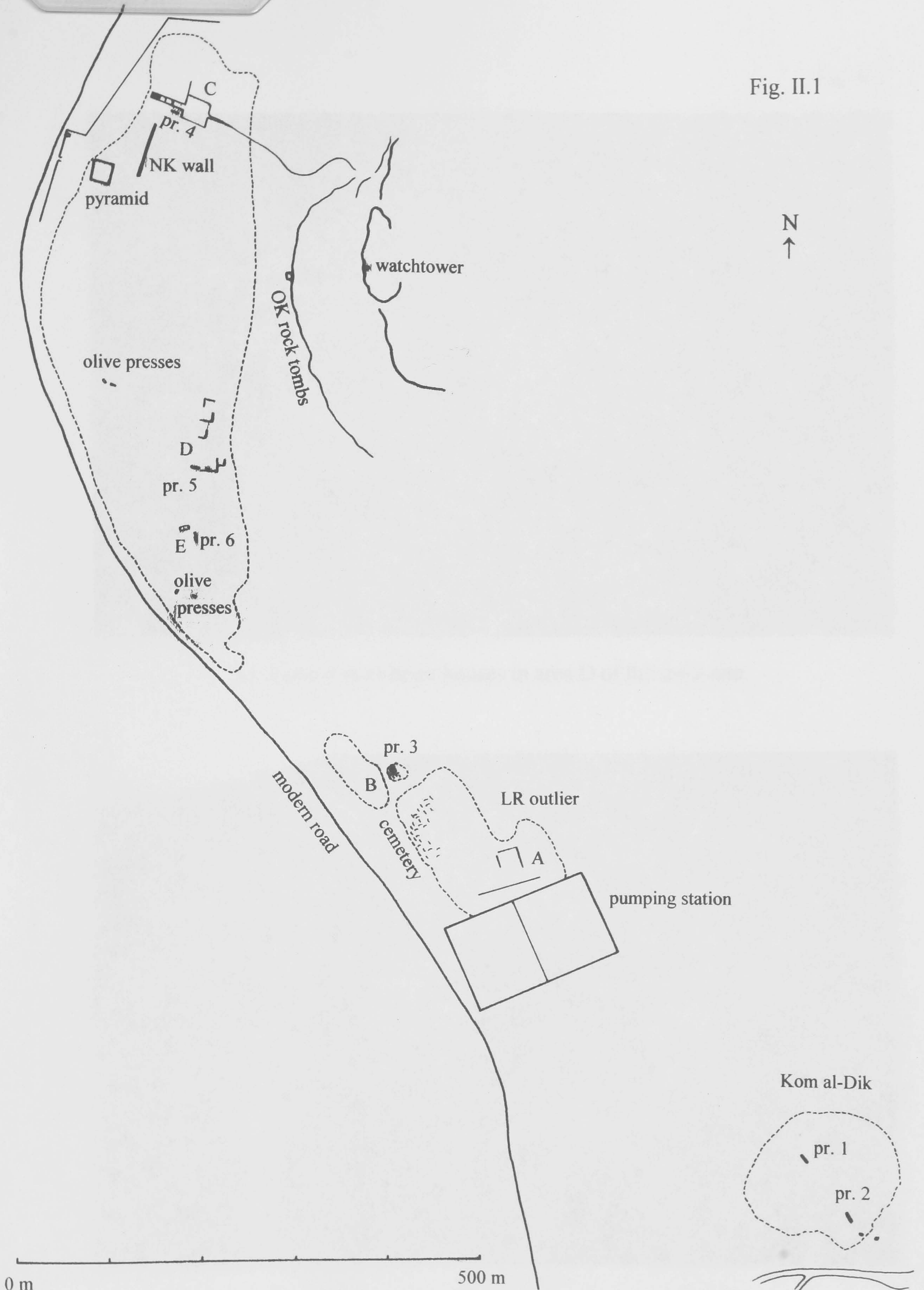

Sketch map of the site of Zawyet al-Sultan in Middle Egypt.



A: Burned mud-brick houses in area D of the main site.



B: Rock cut hermitage in the cliffs at the southern end of the main site.



A: Blocks from Roman oil presses on the surface of the main site.



B: View south-west across the sherd heaps of area C, the NK temple platform, towards the NK wall.

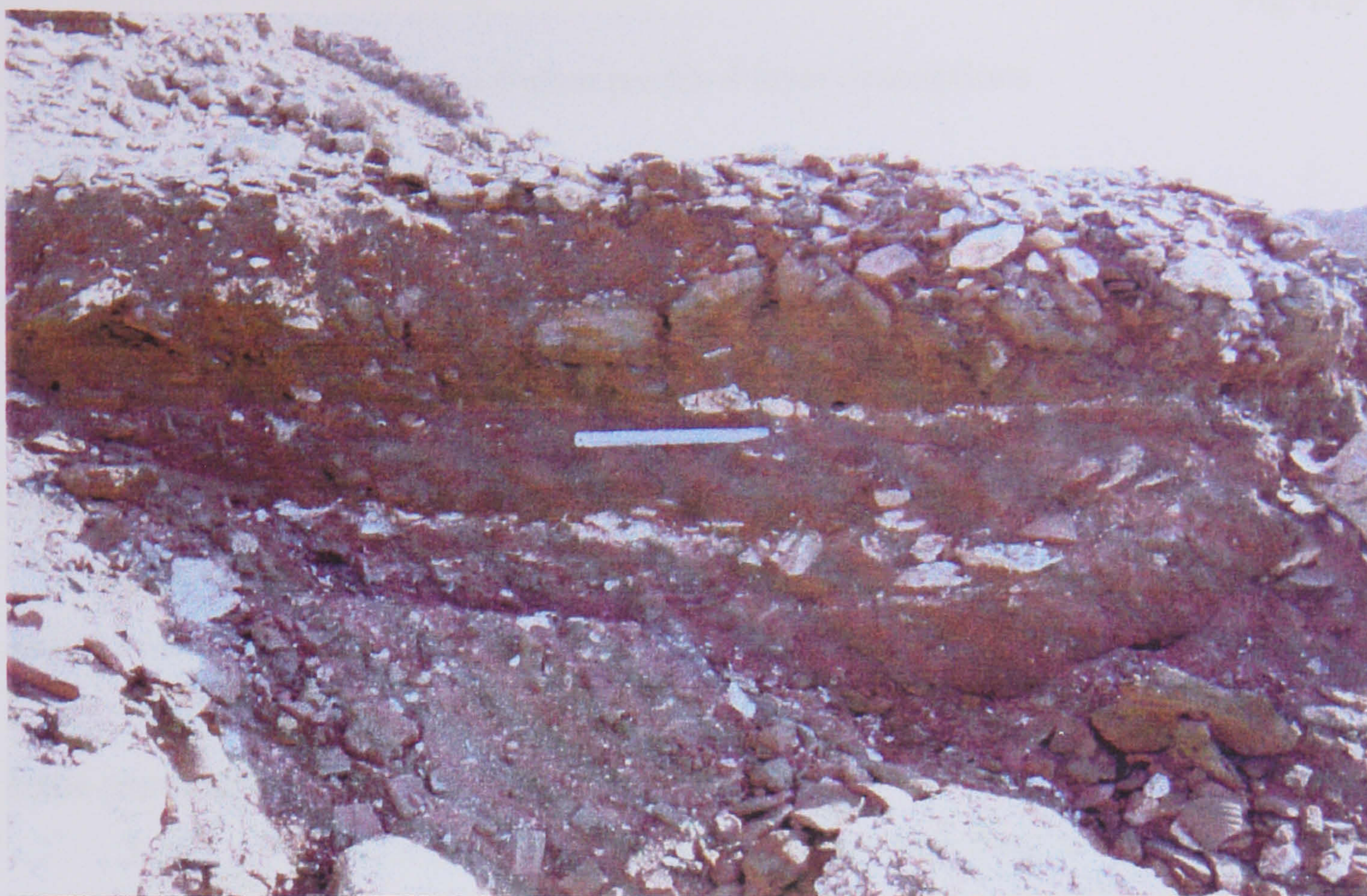

A: Profile 4, area C (photo Nadine Moeller).

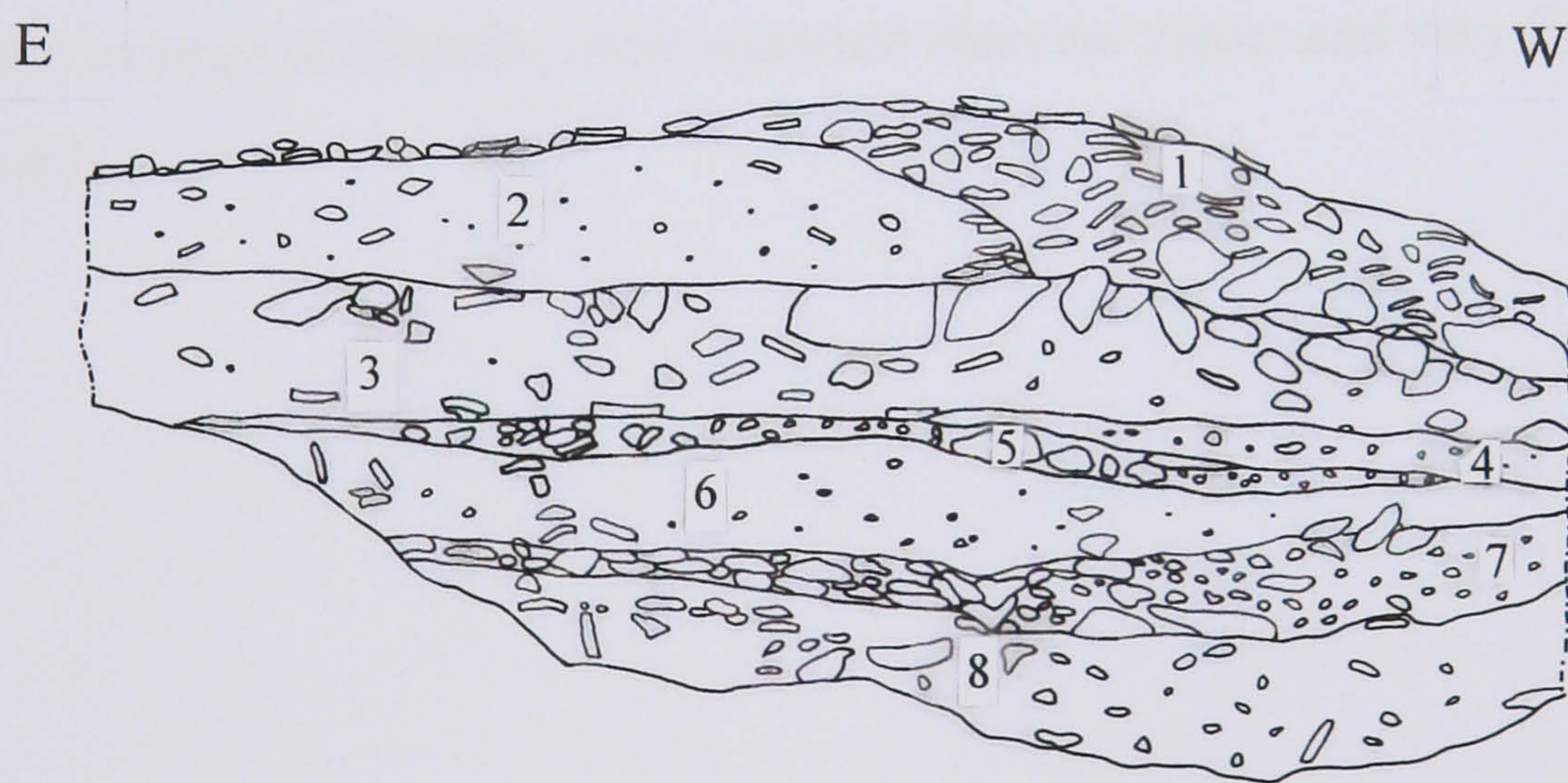

B: Drawing of profile 4 at 1:20.

Zawyet al-Sultan profile 4 layer descriptions

All profiles are drawn at 1:20.

Area C: The New Kingdom temple platform

Layer 1: large overburden of sherds and stones left by *sebbakhin*.

Layer 2: fine organics, including abundant fine straw, plant remains, goat droppings, a few pieces of charcoal, small sherds and stones.

Layer 3: straw and manure mixed with decomposed mud bricks with a high straw content, larger sherds, a few stones and abundant plant remains.

Layer 4: fine sandy layer with a few small stones, a very few, small sherds, some plant remains and straw with goat droppings.

Layer 5: limestone chippings and very fine limestone dust; at eastern end, many medium sherds and sandy soil with fine limestone chips.

Layer 6: sandy matrix with abundant organics including straw, some charcoal, goat droppings, as well as a few small stones and very scarce pottery (4–6 cm).

Layer 7: compact layer of angular limestone chippings, looser towards western end, with smaller stones in sandy soil.

Layer 8: deposit of sand and organic material, with a few small stones, medium to large pot sherds, some scattered charcoal pieces and very fine straw particles.

Area C: profile 4 pottery

See fig. II.24 for ceramic terminology.

Layer 1

1. *Fabric: M1. Surfaces: resinated interior, rocker-stamped herringbone decoration on exterior.*
2. *Fabric: LRA 7.*
3. *Fabric: M1. Surfaces: uncoated. Diameter: 18 cm.*

Layer 5

4. *Fabric: (VC)M1. Surfaces: uncoated. Diameter: 16 cm.*

Layer 6

5. *Fabric: VCM1. Surfaces: uncoated, single line of string-marks around exterior. Diameter (base): 12 cm.*

Layer 7

6. *Fabric: M1. Surfaces: uncoated. Diameter: c. 22 cm.*

Layer 8

7. *Fabric: M2. Surfaces: good red slip inside, exterior unslipped with rough finish. Perhaps New Kingdom? Diameter: 20 cm.*
8. *Fabric: M2. Surfaces: uncoated. Diameter: c. 24 cm, but stance and diameter uncertain. Perhaps New Kingdom?*
9. *Fabric: M2. Surfaces: uncoated. Diameter: 22 cm.*
10. *Fabric: M1. Surfaces: uncoated. Diameter: 24 cm. Stance uncertain.*
11. *Fabric: M1. Surfaces: uncoated, embossed line of finger-marked decoration around exterior. Diameter: c. 38 cm, but stance and diameter very uncertain.*
12. *Fabric: VCM1. Surfaces: traces of white slip on exterior, marks of rough finger-shaping on interior. Diameter (base): 28 cm.*
13. *Fabric: M2. Surfaces: uncoated. Diameter: 16 cm.*
14. *Fabric: M1. Surfaces: uncoated. Diameter: 14 cm. Stance uncertain.*

1

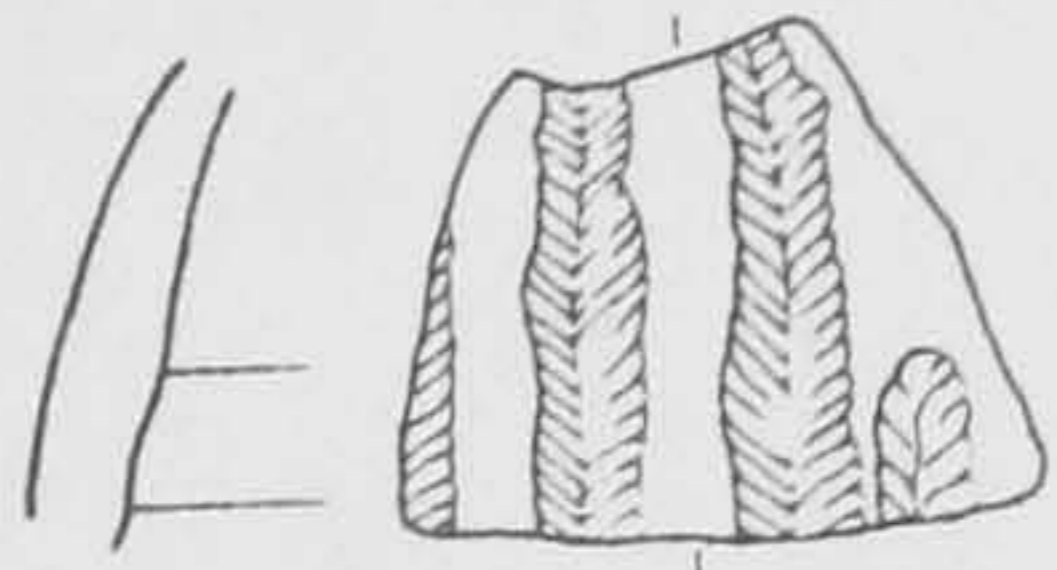

2

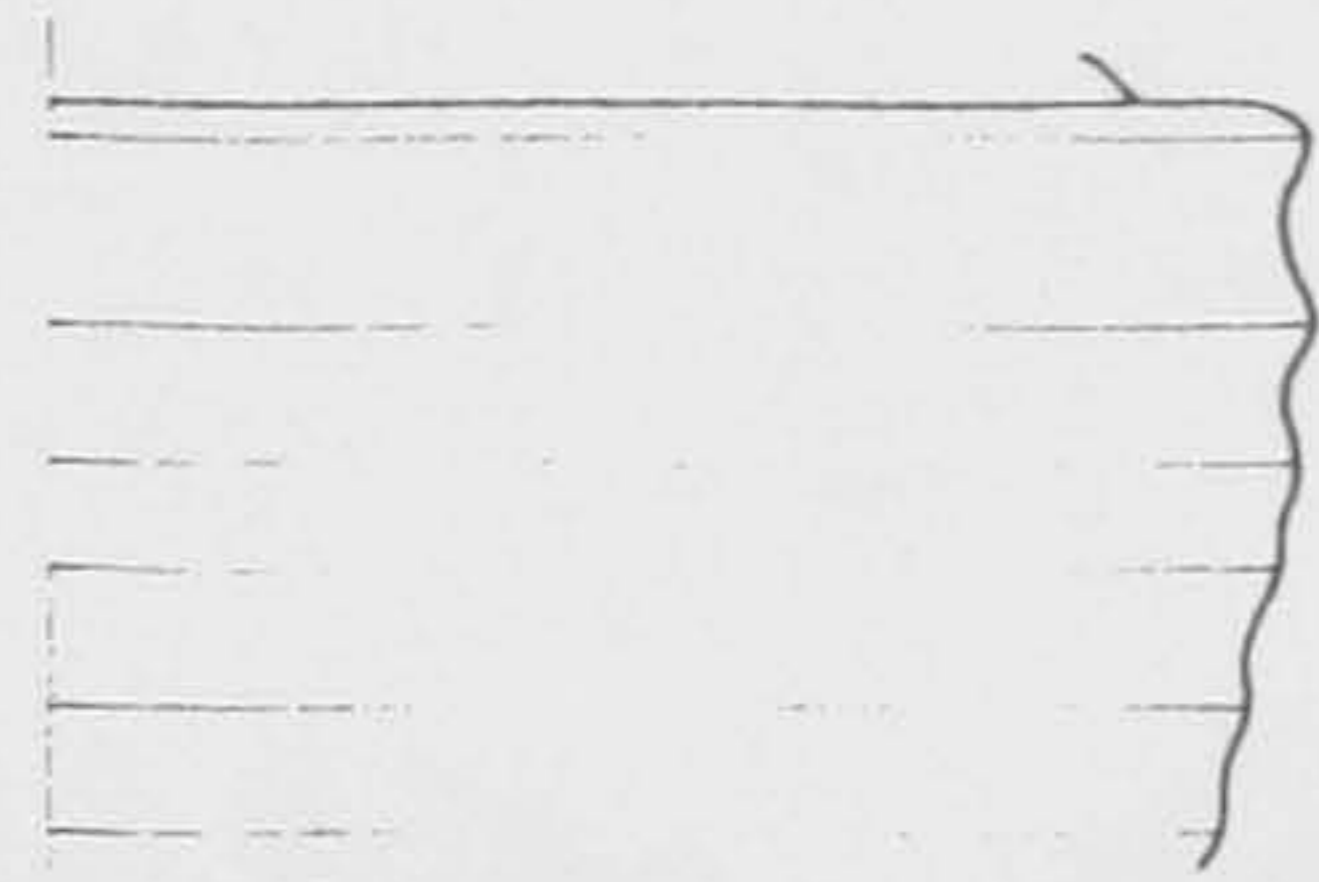
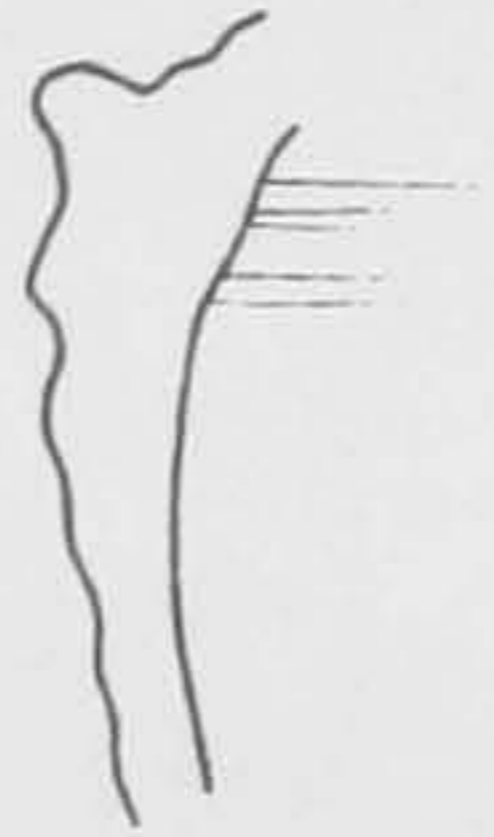

3

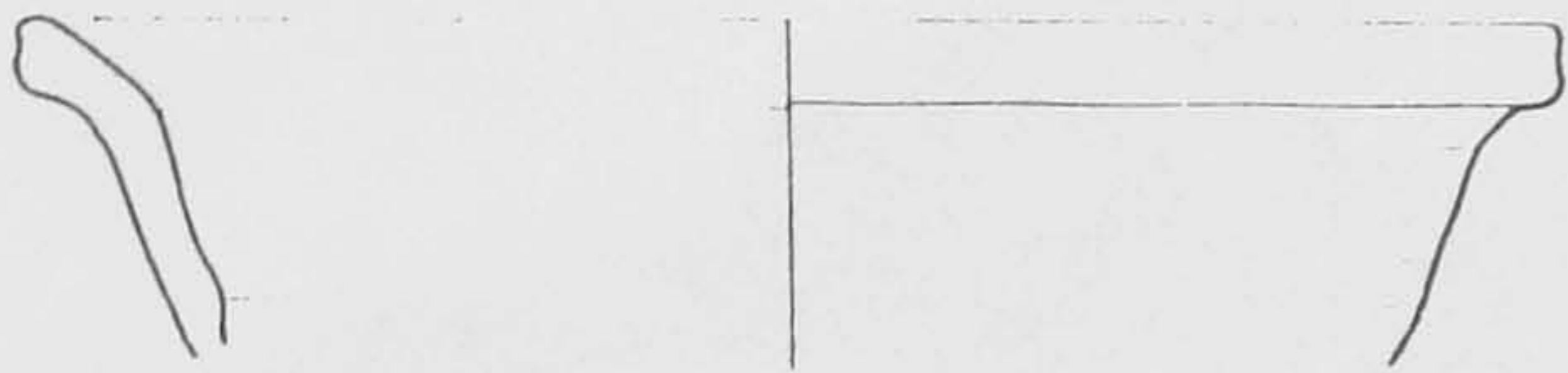

4

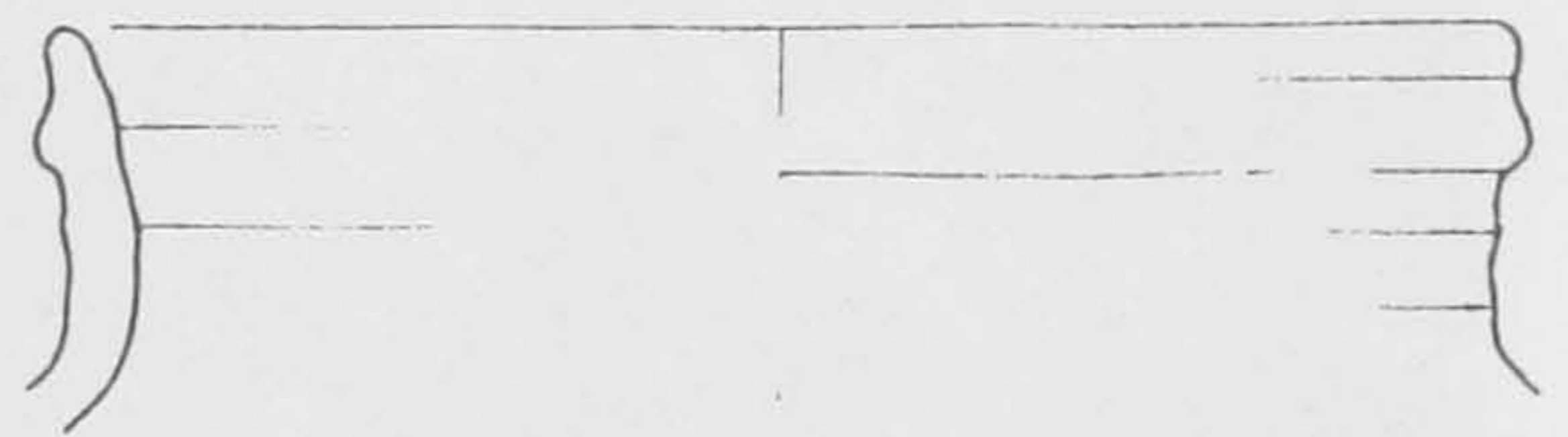

5

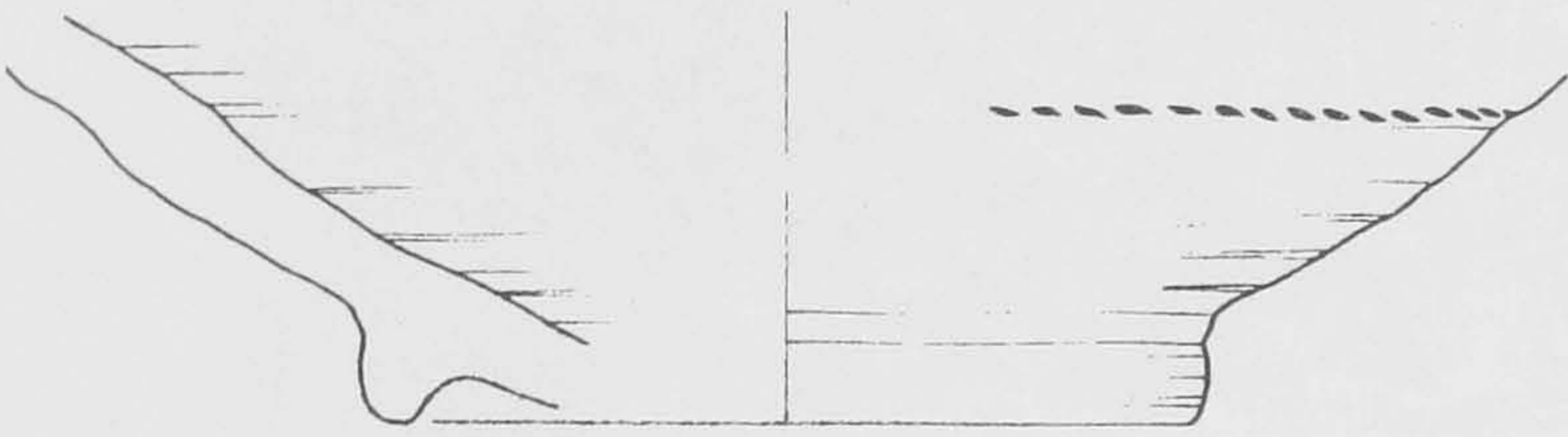

6

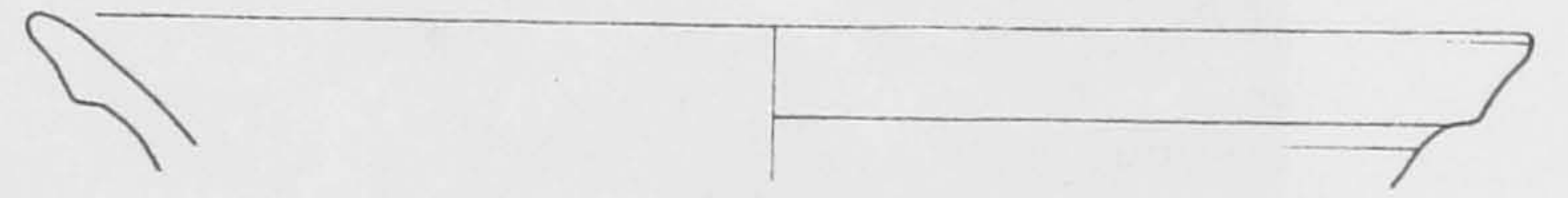

7



8



9

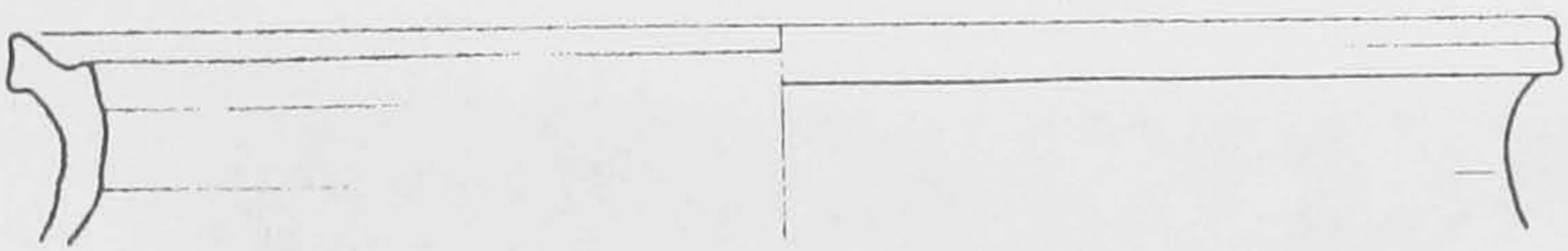

10

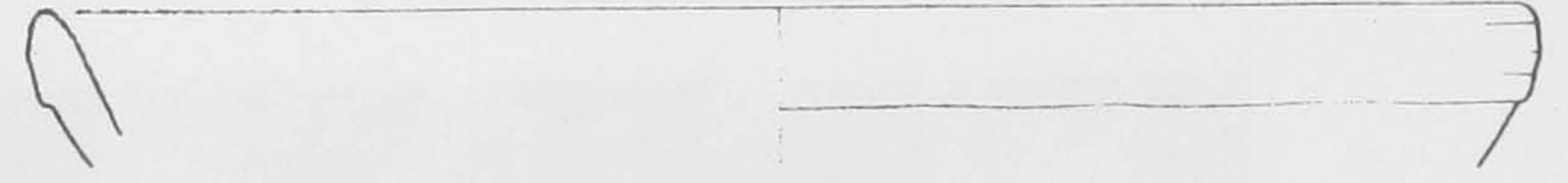

11



12

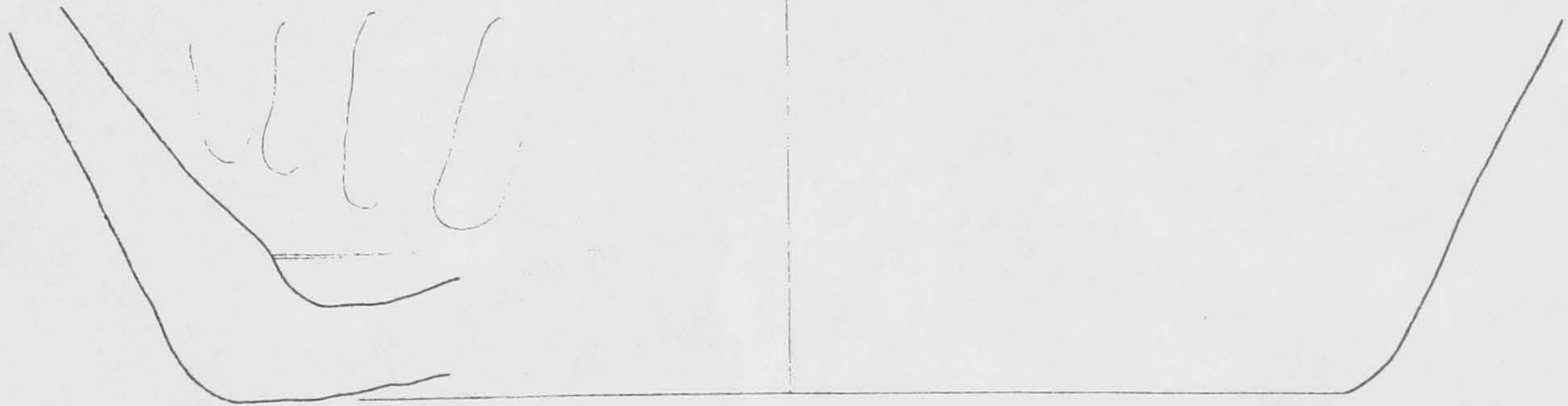

13



14



Pottery from profile 4 at 1:3.



A: House walls in area D of the main site.



B: Profile 5, area D.

Fig. II.9

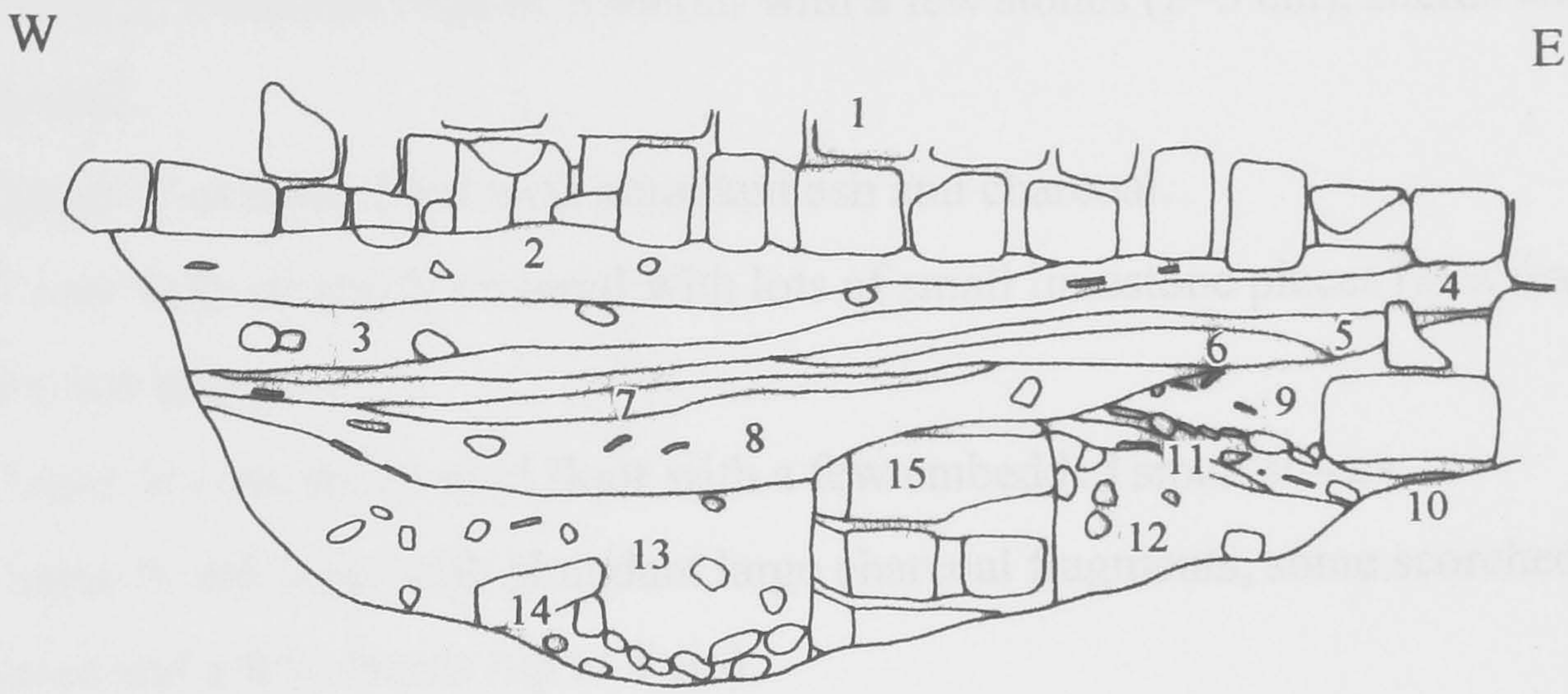

Drawing of profile 5, Zawyet al-Sultan area D at 1:20.

Zawyet al-Sultan profile 5 layer descriptions

Area D: The late Roman houses

Layer 1: late Roman house wall.

Layer 2: abundant organic material with a few stones (2–5 cm), sherds and a little charcoal.

Layer 3: as layer 2 but with abundant ash and charcoal.

Layer 4: loose sandy material with lots of small limestone pieces (less than 1 cm) and a few sherds.

Layer 5: compacted mud floor with a few embedded small stones.

Layer 6: ash layer with abundant large charcoal fragments, some scorched brick pieces and a few sherds (up to 4 cm).

Layer 7: powdered limestone mixed with sand, small stones and a little charcoal.

Layer 8: loose, sandy deposit with abundant charcoal, some straw and other organic material, some stones (up to 6 cm) and a few small sherds.

Layer 9: sandy layer with a few very small stones and a single fragment of wood.

Layer 10: compact sherd layer mixed with limestone and mud brick pieces, some large charcoal and straw.

Layer 11: as layer 9 but with some small sherds (less than 1 cm).

Layer 12: yellowish, powdery limestone fill with larger angular chippings (2–5 cm); no sherds or organics.

Layer 13: brick tumble mixed with limestone fragments and powder.

Layer 14: brick tumble with a few stones; perhaps upper part of wall (layer 15)?

Layer 15: remains of mud brick wall (brick size 33×11×16 cm).

Area D: profile 5 pottery

Old Kingdom material:

Layer 4

1. *Fabric:* fine red silt with moderate grey, black and white particles. *Surfaces:* burnished red slip all over. *Diameter:* uncertain.

New Kingdom material:

Layer 7

2. *Fabric:* I.1. *Surfaces:* uncoated. *Diameter:* 14 cm.

Layer 9

3. *Fabric:* I.1. *Surfaces:* matte red slip all over, darker red rim stripe. *Diameter:* 28 cm.

Layer 10

4. *Fabric:* I.1. *Surfaces:* matte red slip all over, darker red rim stripe. *Surfaces:* uncoated. *Diameter:* 26 cm.
5. *Fabric:* I.1. *Surfaces:* uncoated. *Diameter:* 20 cm. Bread mould.

Layer 11

6. *Fabric:* III.1. *Surfaces:* matte red slip inside, unslipped outside, black-painted rim ticks. *Diameter:* 24 cm.

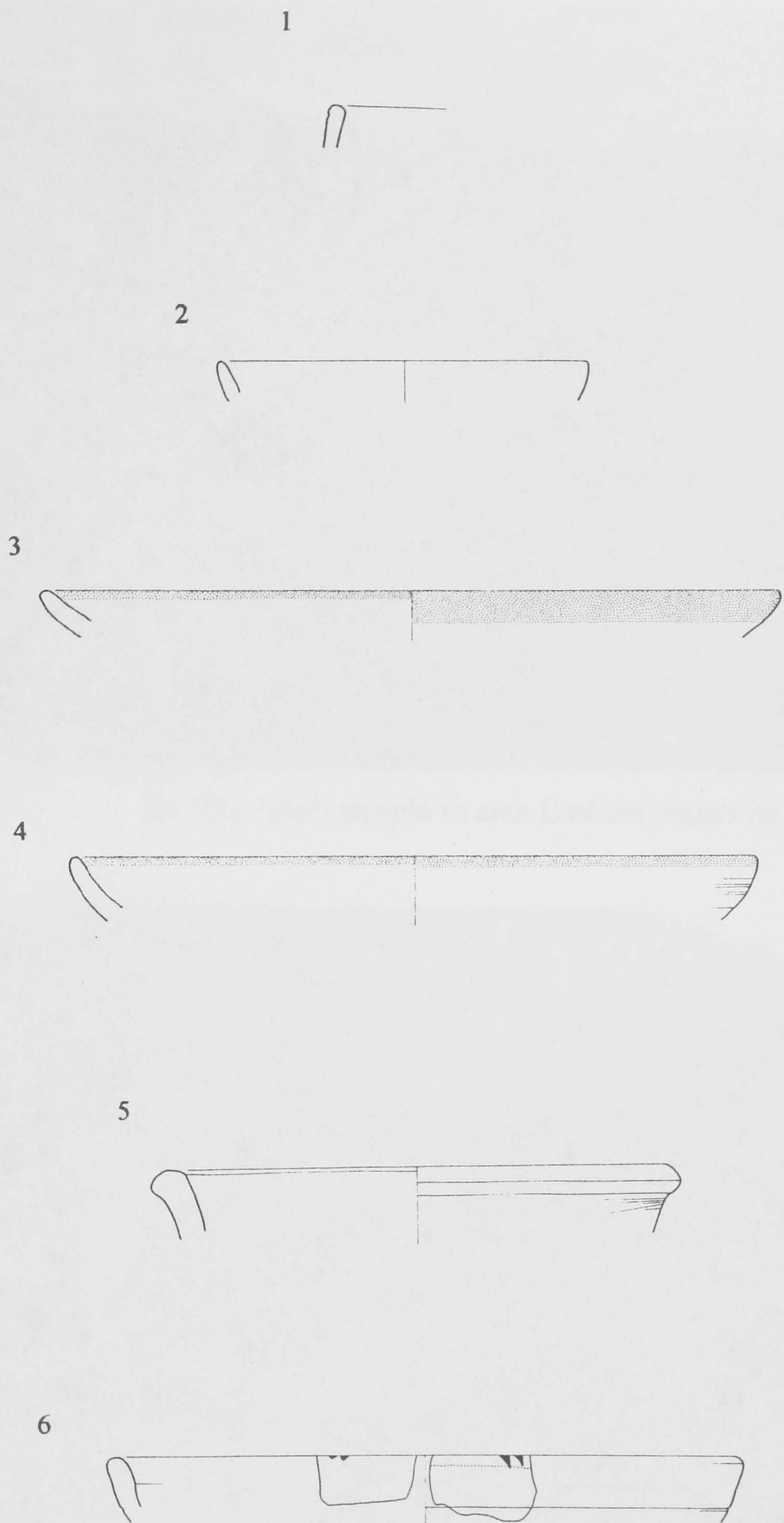

Pottery from profile 5 at 1:3.



A: The small temple in area E of the main city.



B: Profile 6, area E.

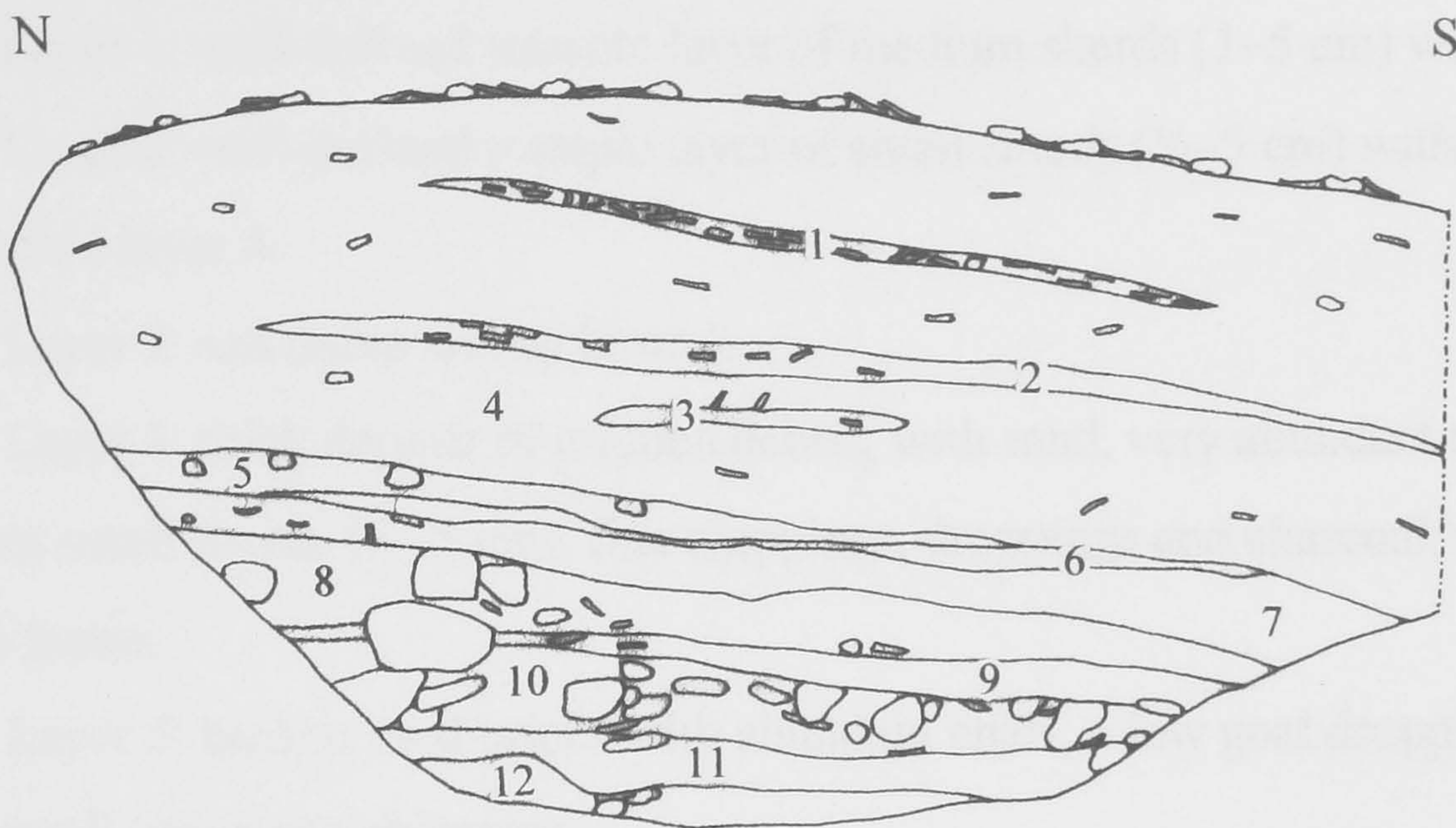

Drawing of profile 6, Zawyet al-Sultan area E at 1:20.

Zawyet al-Sultan profile 6 layer descriptions

Area E: the small temple area

Layer 1: well-defined trample layer of medium sherds (1–5 cm) within layer 4.

Layer 2: well-defined trample layer of small sherds ($\frac{1}{4}$ –5 cm) with abundant chaff within layer 4.

Layer 3: ash dump within layer 4.

Layer 4: thick deposit of midden debris, with sand, very abundant chaff, abundant small sherds ($\frac{1}{4}$ –5 cm), fine chippings, droppings and charcoal; many trample layers.

Layer 5: broken mud bricks with abundant chaff, a few goat droppings and scarce small limestone chippings.

Layer 6: fine yellow sandy layer as 9 but with more chaff and fewer chippings.

Layer 7: another dark layer with abundant chaff, sheep wool and droppings; also some small sherds (1–7 cm) and a single piece of shell.

Layer 8: decomposed mud bricks, a few medium sized sherds (3–10 cm), rounded limestone chippings, bone and chaff in dark sandy matrix.

Layer 9: layer of sand and fine limestone chippings, signifying a period of abandonment.

Layer 10: tumble layer of large stones (5–20 cm) set in a matrix of sand and fine limestone chippings, with a little chaff, a few sherds and abundant fly pupae.

Layer 11: compacted limestone powder, like a gypsum cement, with a few large stones (3–10 cm) embedded in upper surface; perhaps laid down by flooding.

Layer 12: wind-blown fine sand with a small amount of organic material.

Area E: profile 6 pottery

Layer 2

1. *Fabric*: sandy M1. *Surfaces*: uncoated.
2. *Fabric*: brown silt with abundant, fine to coarse, pale to dark brown round or angular sand, scarce fine limestone and rare traces of chaff, hereafter 'sandy amphora'. *Surfaces*: resinated interior below rim, patches on exterior.
Diameter: 12 cm. *Parallels*: perhaps Dendara, Middle Egyptian brown silt amphorae of the first to third century (Marchand and Laisney 2000, figs. 95–103).
3. *Fabric*: sandy amphora. *Surfaces*: resinated as above. *Diameter*: 13 cm.

Layer 4

4. *Fabric*: sandy M2. *Surfaces*: uncoated, rough finish. *Diameter*: 14 cm.
5. *Fabric*: sandy amphora. *Surfaces*: uncoated. *Diameter*: 16 cm.
6. *Fabric*: sandy M2. *Surfaces*: uncoated. *Diameter*: 14 cm.
7. *Fabric*: very sandy M4. *Surfaces*: uncoated. *Diameter*: 18 cm.
8. *Fabric*: M1. *Surfaces*: uncoated. *Diameter*: 28 cm.
9. *Fabric*: sandy amphora. *Surfaces*: uncoated, but drips of resin.
10. *Fabric*: sandy amphora. *Surfaces*: uncoated.
11. *Fabric*: sandy amphora. *Surfaces*: uncoated, small patch of resin.
12. *Fabric*: sandy amphora. *Surfaces*: patches of resin inside and out. *Diameter*: 12 cm.
13. *Fabric*: M4. *Surfaces*: uncoated. *Diameter*: 12 cm.
14. *Fabric*: sandy amphora. *Surfaces*: uncoated. *Diameter*: 12 cm.
15. *Fabric*: M1. *Surfaces*: uncoated, blackened. *Diameter*: 13 cm.
16. *Fabric*: sandy amphora. *Surfaces*: uncoated except for patches of resin inside and out. *Diameter*: 11 cm.
17. *Fabric*: sandy M1. *Surfaces*: uncoated.
18. *Fabric*: sandy M1. *Surfaces*: uncoated.

Layer 8

19. *Fabric*: sandy amphora. *Surfaces*: uncoated.
20. *Fabric*: sandy amphora. *Surfaces*: uncoated.

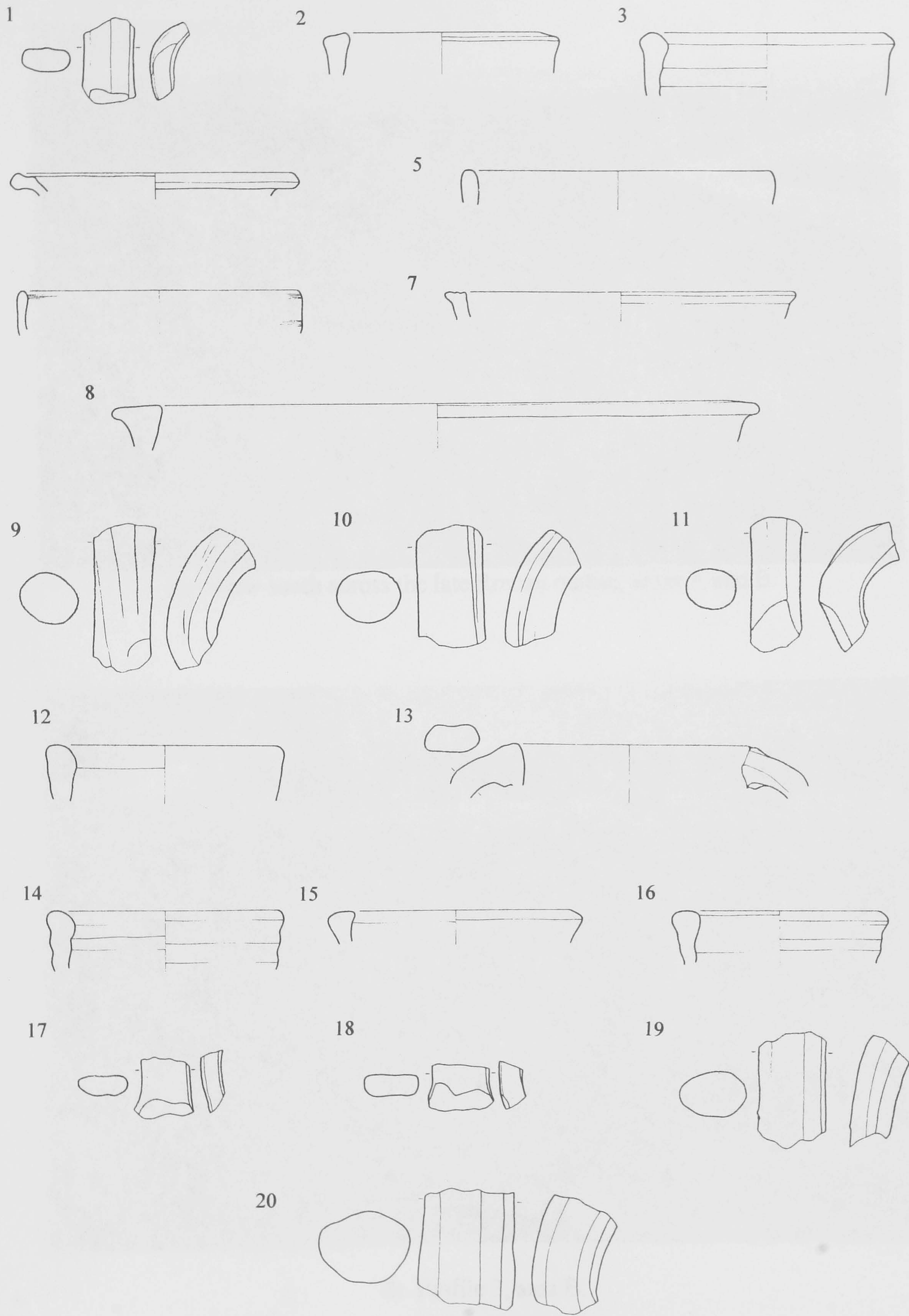

Pottery from profile 6 at 1:3.



A: View south across the late Roman outlier, areas A and B.



B: Profile 3, area B.

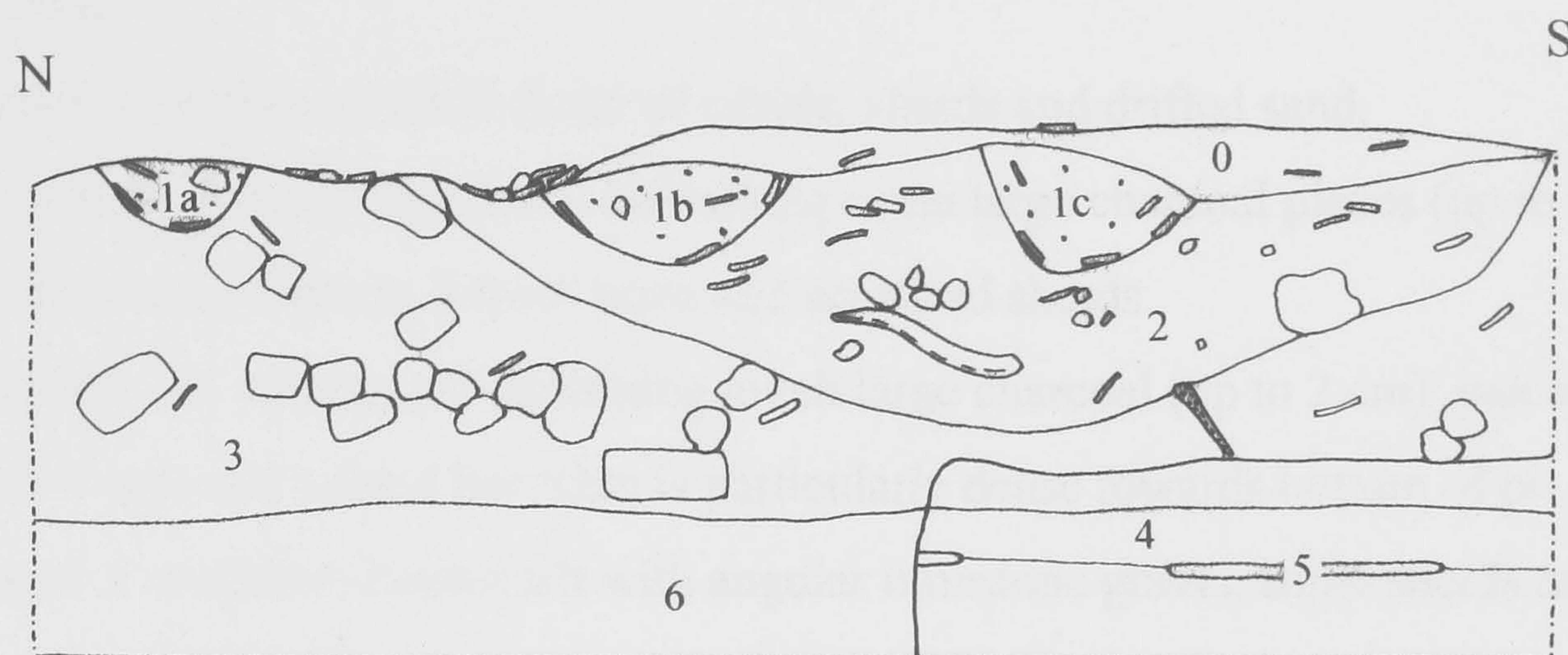

Drawing of profile 3, Zawyet al-Sultan area B at 1:20.

Zawyet al-Sultan profile 3 layer descriptions

Area B: the late Roman outlier

The layer descriptions for profiles 3 (area B), 1 and 2 (Kom al-Dik) were made by Dr Paul Buckland.

Layer 0: post-excavation dump of rubble, sherds and drifted sand.

Layers 1a, b and c: small pits containing some large charcoal pieces (up to 2 cm) and much burned straw, burned bone and scorched sherds.

Layer 2: fill of large pit containing much large charcoal (up to 2 cm); calcined bone (up to 4 cm) and animal hair/skin is particularly dense towards bottom of pit.

Layer 3: moderate brown silt with angular limestone gravel, some sherds and evident large charcoal fragments.

Layer 4: wadi deposit as layer 6 with fragments of mud brick and chippings of limestone (up to 10 cm).

Layer 5: hard packed floor of moderate brown silt with much angular small to medium limestone gravel, some small pot sherds (not Pharaonic or late Roman).

Layer 6: poorly sorted limestone gravel with some angular fragment (up to 10 cm) and *Nummulites*, natural fill of wadi.

Area B: profile 3 pottery

New Kingdom material (from inside brick near cow):

1. *Fabric:* III.6. *Surfaces:* cream exterior up to slightly below rim. *Diameter:* 24 cm.

Pit 1a

2. *Fabric:* M4. *Surfaces:* uncoated.

Pit 1b

3. *Fabric:* LRA 7. *Surfaces:* resinated inside and over rim. *Diameter:* 13 cm.
4. *Fabric:* M2. *Surfaces:* thick, matte, dark red slip all over. *Diameter:* 13 cm.
5. *Fabric:* M1. *Surfaces:* uncoated. *Diameter:* 14 cm.
6. *Fabric:* M1. *Surfaces:* uncoated. *Diameter:* 12 cm.
7. *Fabric:* M2. *Surfaces:* uncoated. *Diameter:* 16 cm. Main city catalogue bowl form 16 (see fig. II.25).
8. *Fabric:* very pale green/clear glass, few bubbles. *Diameter:* 7 cm.

Pit 1c

9. *Fabric:* M1. *Surfaces:* red slip all over. *Diameter:* 16 cm. Main city catalogue bowl form 16.
10. *Fabric:* M2. *Surfaces:* uncoated. *Diameter:* 18 cm.
11. *Fabric:* LRA 7. *Surfaces:* traces of resin inside, drips down outside of rim. *Diameter:* 12 cm.
12. *Fabric:* LRA 7. *Surfaces:* worn. *Diameter:* 13 cm.

Layer 2 (upper)

New Kingdom material:

13. *Fabric:* Cypriot base-ring ware (c. 1600–1400 BC; Jones 1986: 528–9). *Diameter (base):* 5 cm. From inside a brick fragment.
14. *Fabric:* I.1. *Surfaces:* burnished red slip all over. *Diameter:* 34 cm.
15. *Fabric:* I.1. *Surfaces:* red-slipped all over. *Diameter:* 38 cm.

Roman material:

16. *Fabric:* sandy M2. *Surfaces:* uncoated. *Diameter:* 16 cm.
17. *Fabric:* M1. *Surfaces:* uncoated. *Diameter:* 23 cm.

18. *Fabric:* M4. *Surfaces:* uncoated. *Diameter:* 18 cm.
19. *Fabric:* dirty light brown marl with lighter beige core, containing moderate fine brown particles, a little fine, light red grog and a few large lumps of white and scarce mica. *Surfaces:* uncoated. *Diameter* (base): 3.5 cm.
20. *Fabric:* LRA 7. *Surfaces:* resinated interior and over rim and upper part of handle. *Diameter:* 12 cm.
21. *Fabric:* M1. *Surfaces:* uncoated. *Diameter:* 16 cm.
22. *Fabric:* M1. *Surfaces:* uncoated. *Diameter:* 14 cm.
23. *Fabric:* M4. *Surfaces:* uncoated. *Diameter:* 18 cm.
24. *Fabric:* M2. *Surfaces:* thin, matte, dark red slip. *Diameter:* 17 cm. Main city catalogue bowl form 16.
25. *Fabric:* M1. *Surfaces:* uncoated. *Diameter:* 15 cm.
26. *Fabric:* M1. *Surfaces:* uncoated interior, exterior white-slipped with red painted decoration.

Layer 2 (lower)

New Kingdom material:

27. *Fabric:* III.5. *Surfaces:* burnished cream slip all over. *Diameter:* 16 cm.

Roman material:

28. *Fabric:* LRA 7. *Surfaces:* traces of resin on interior, and exterior of rim. *Diameter:* 13 cm.
29. *Fabric:* M2. *Surfaces:* uncoated, blackened. *Diameter:* 17 cm.
30. *Fabric:* M2. *Surfaces:* uncoated, blackened interior. *Diameter:* 16 cm.
31. *Fabric:* M1. *Surfaces:* gypsum coating on interior, otherwise uncoated. *Diameter* (base): 15 cm.

Layer 3

Old Kingdom material?:

32. *Fabric:* fine, dense red-brown silt with no visible inclusions. *Surfaces:* burnished bright red slip. *Diameter:* 13 cm. The thin walls and surface finish of this sherd are reminiscent of certain Old Kingdom wares.

Roman material:

33. *Fabric: M4. Surfaces: uncoated. Diameter: 26 cm.*
34. *Fabric: M4. Surfaces: uncoated, scorched interior. Diameter: 24 cm.*
35. *Fabric: M1. Surfaces: uncoated. Diameter: 13 cm.*
36. *Fabric: M4. Surfaces: uncoated, scorched exterior. Diameter: 32 cm.*

Fig. II.22

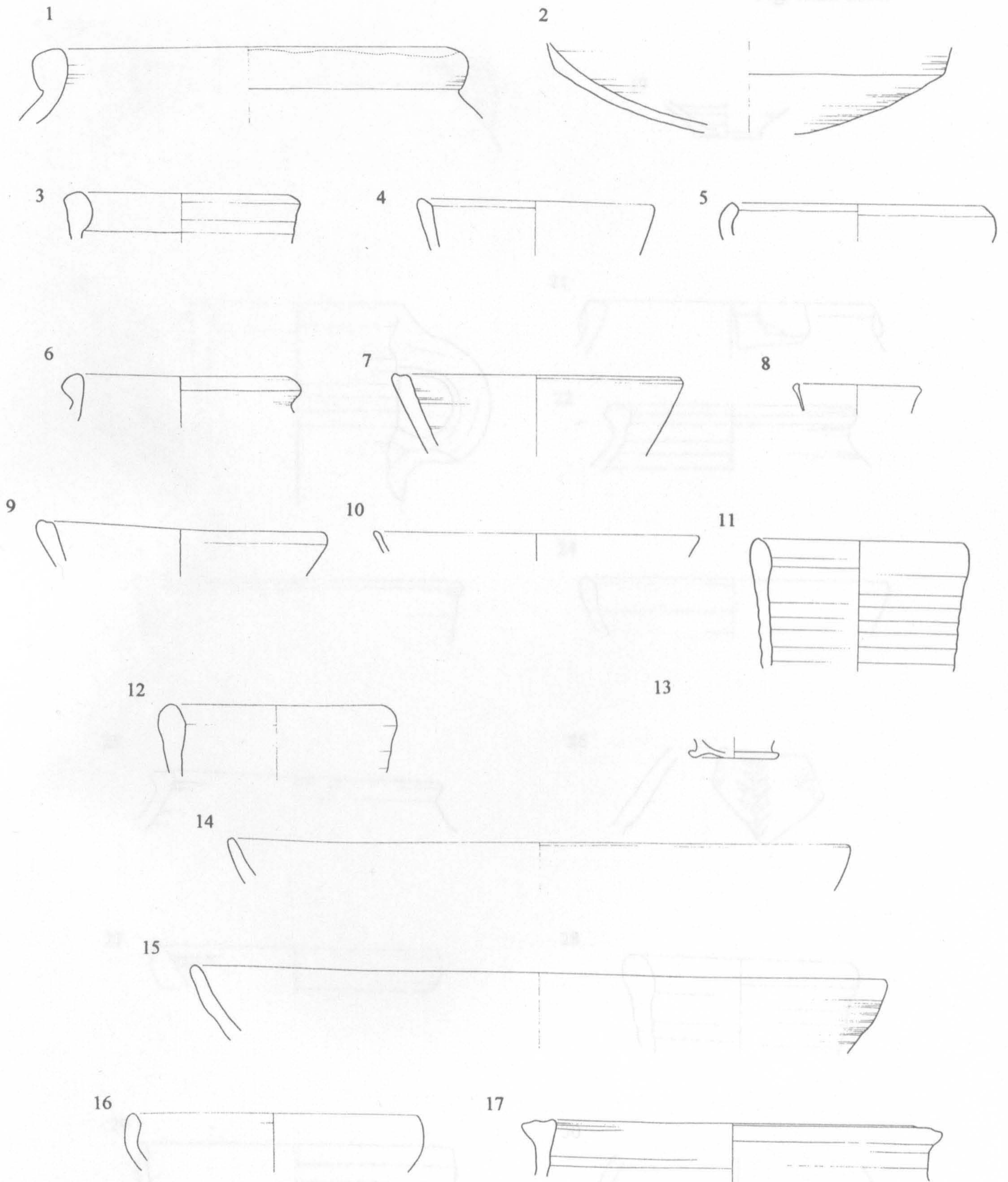

Pottery from profile 3 at 1:3.

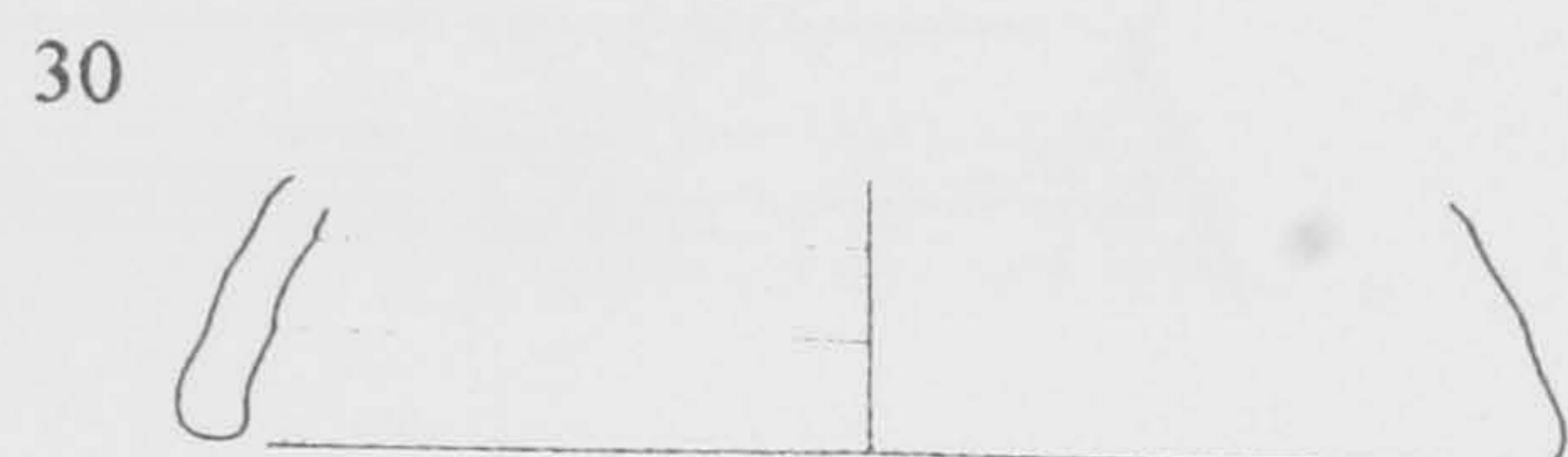
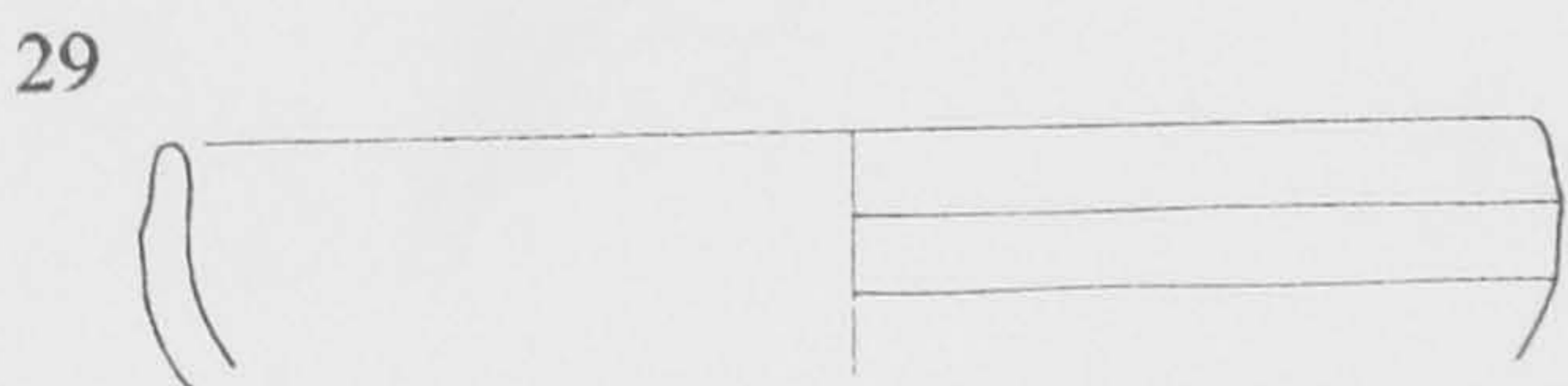
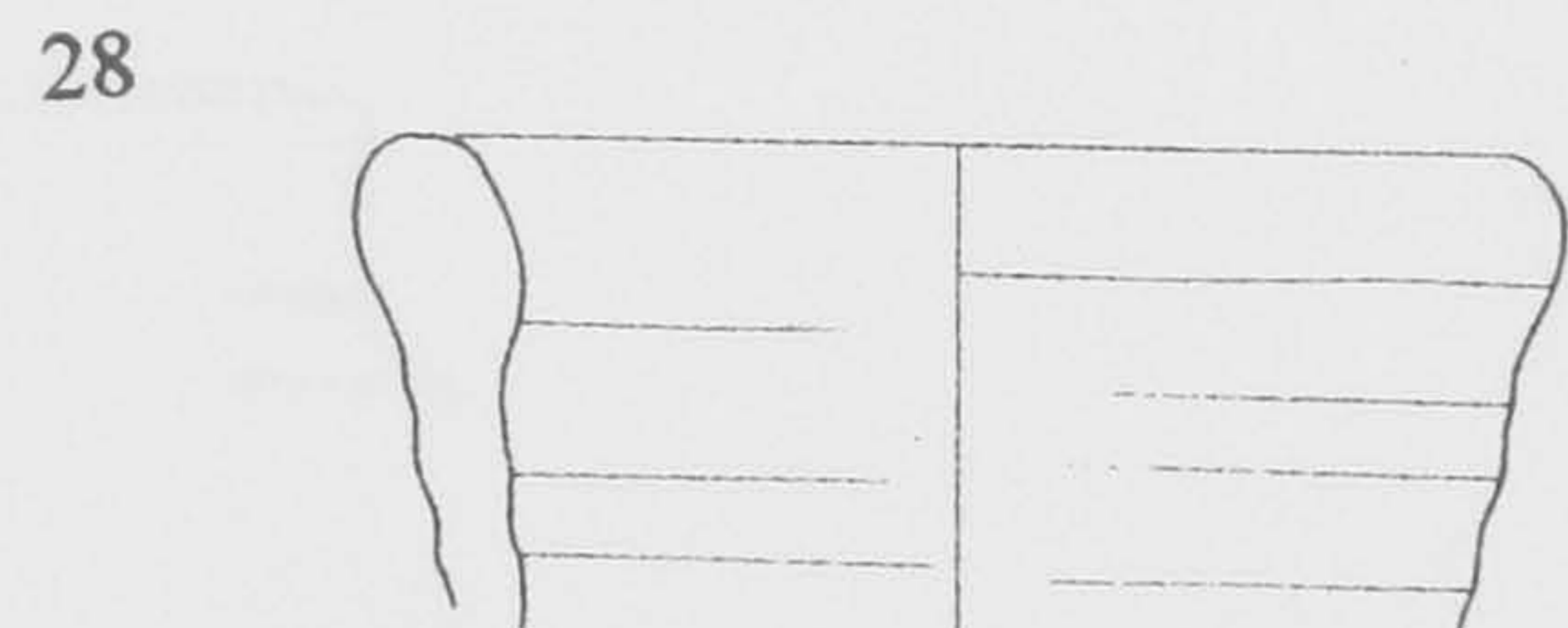
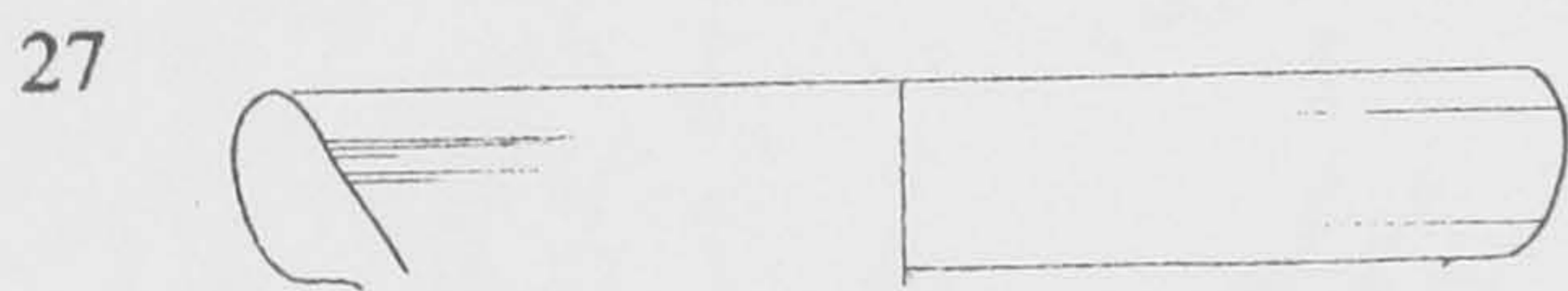
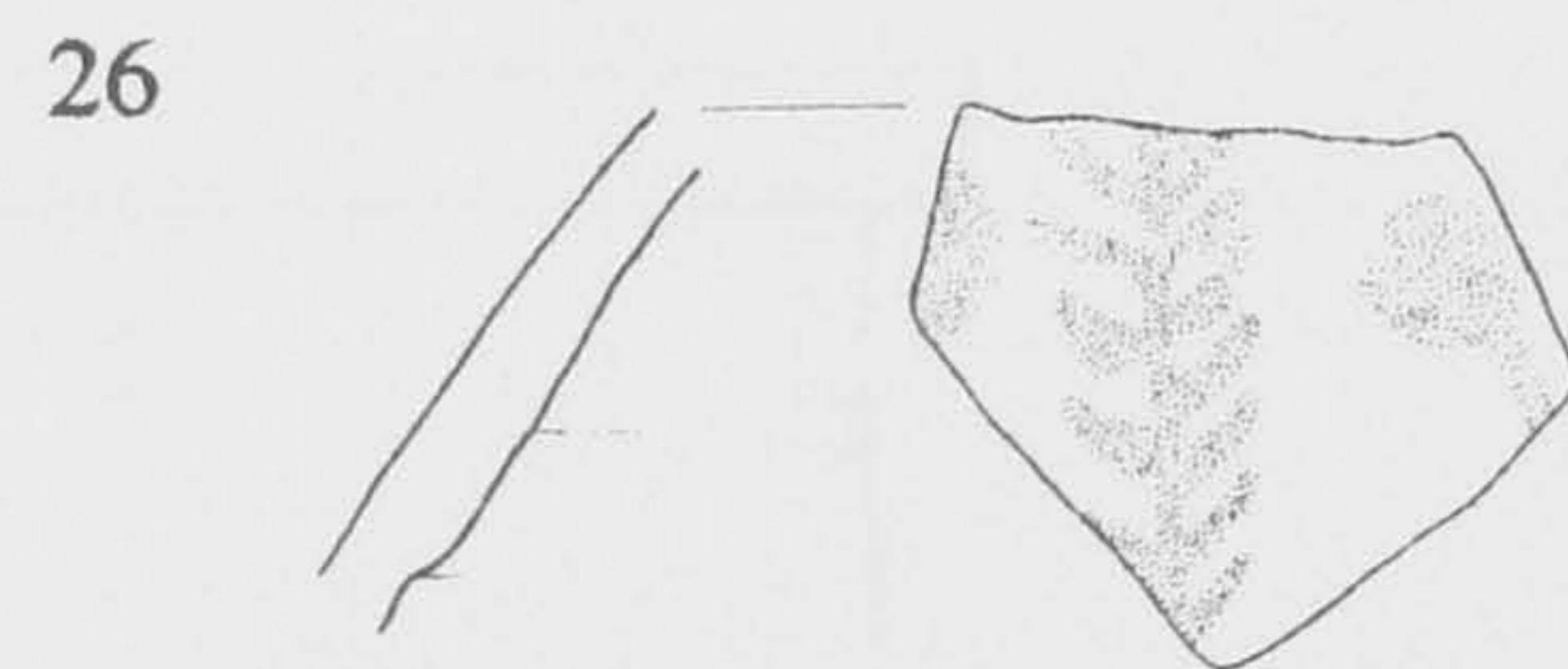
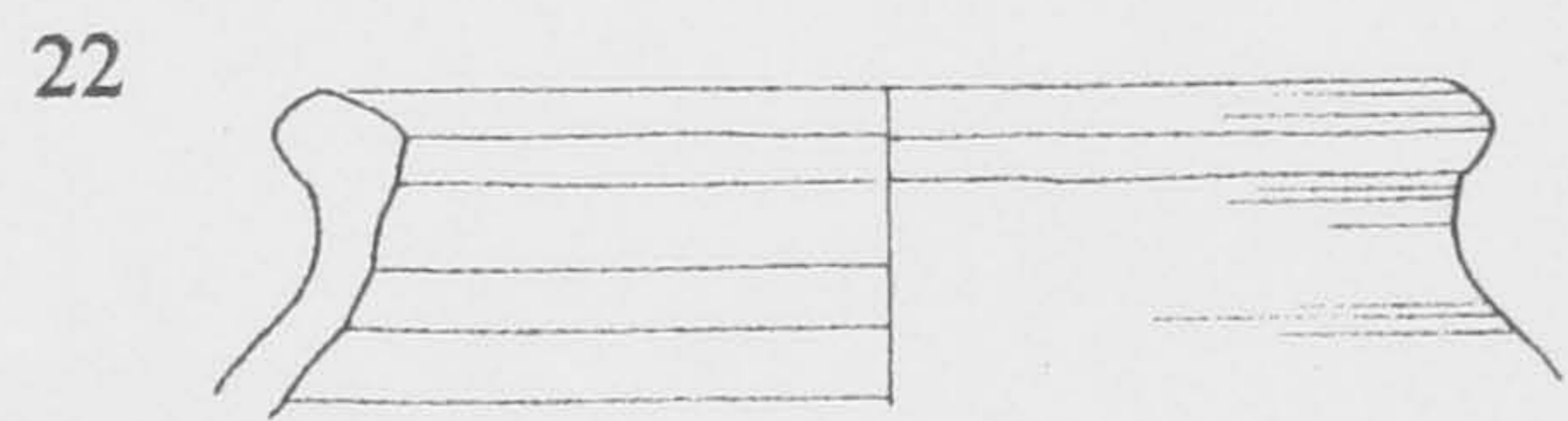
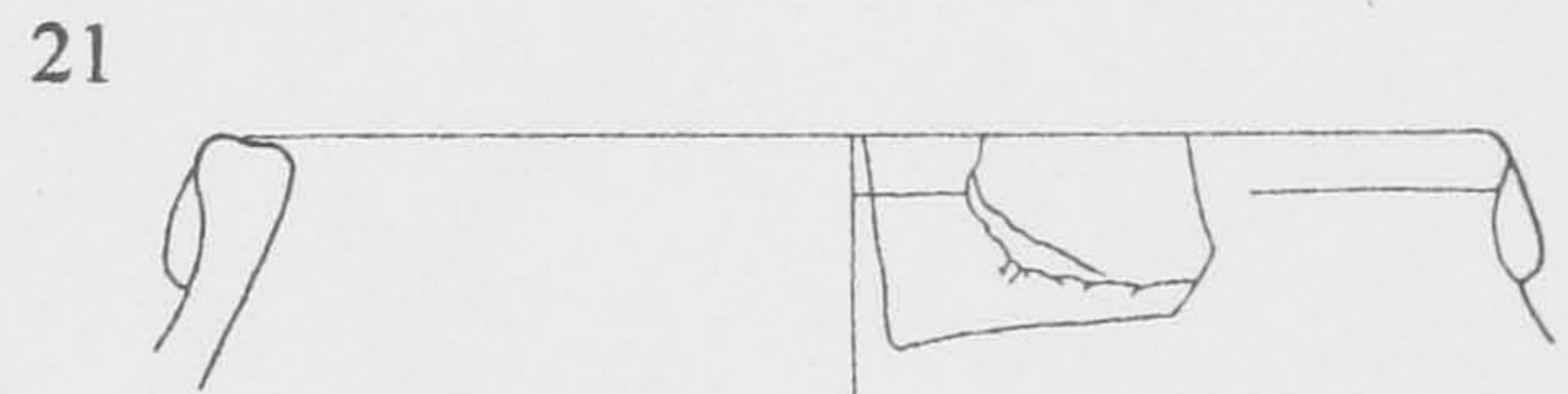
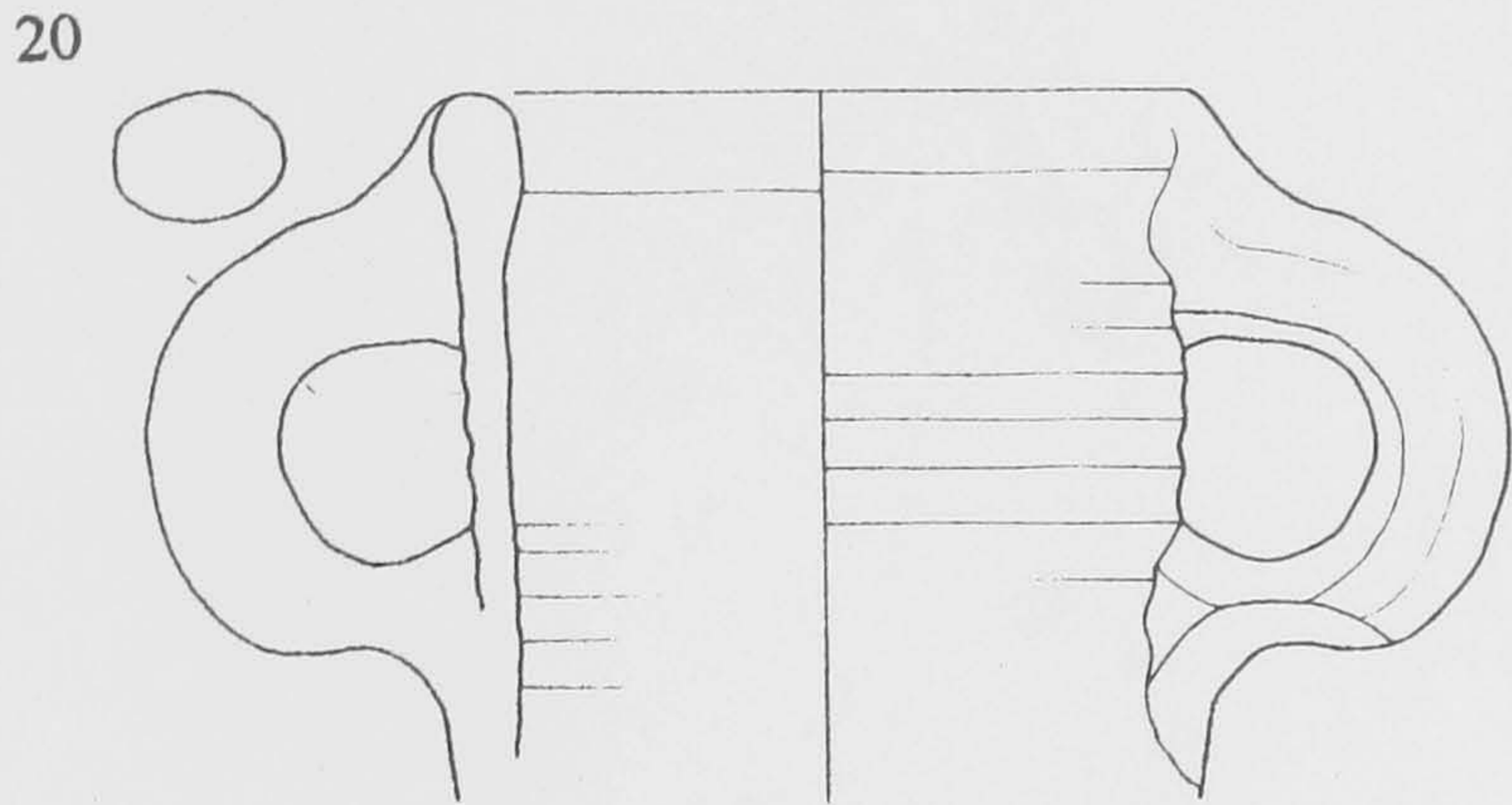
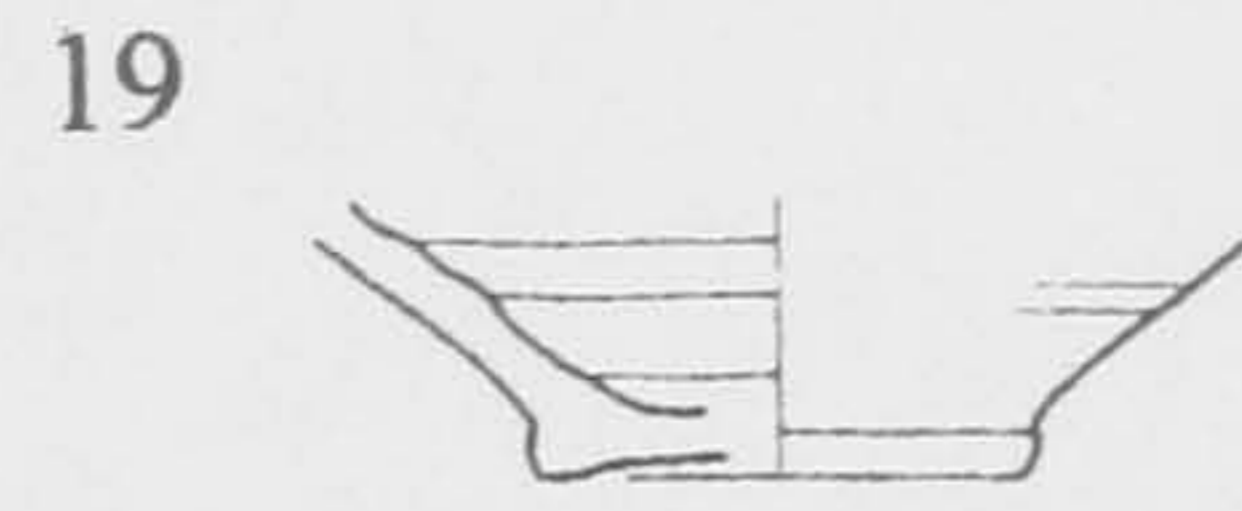
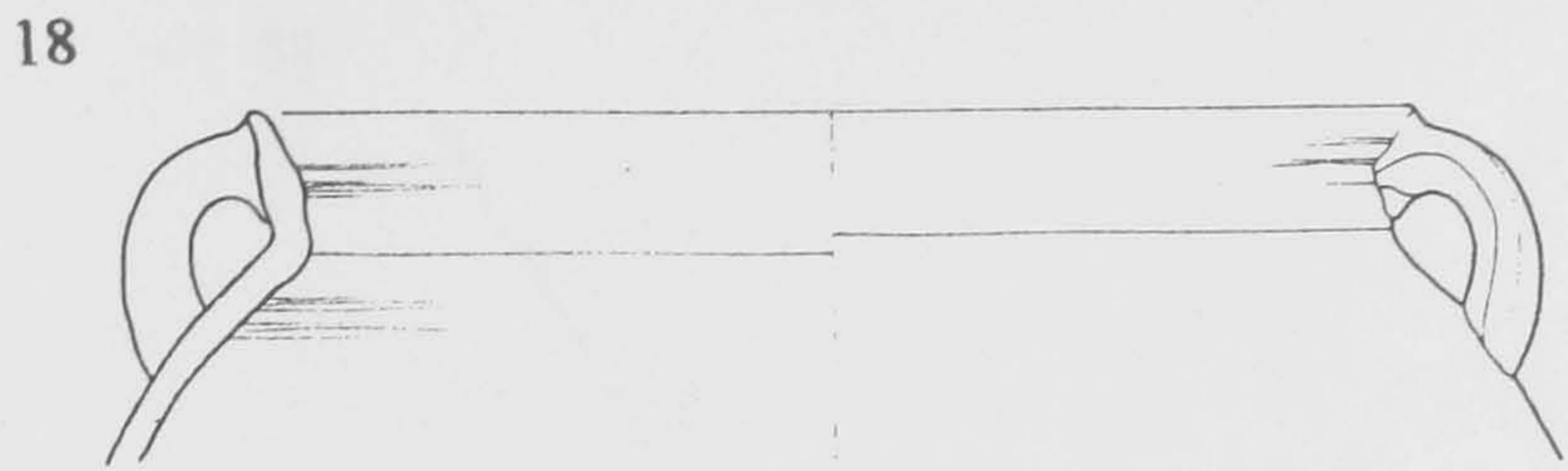

Pottery from profile 3 at 1:3.

31

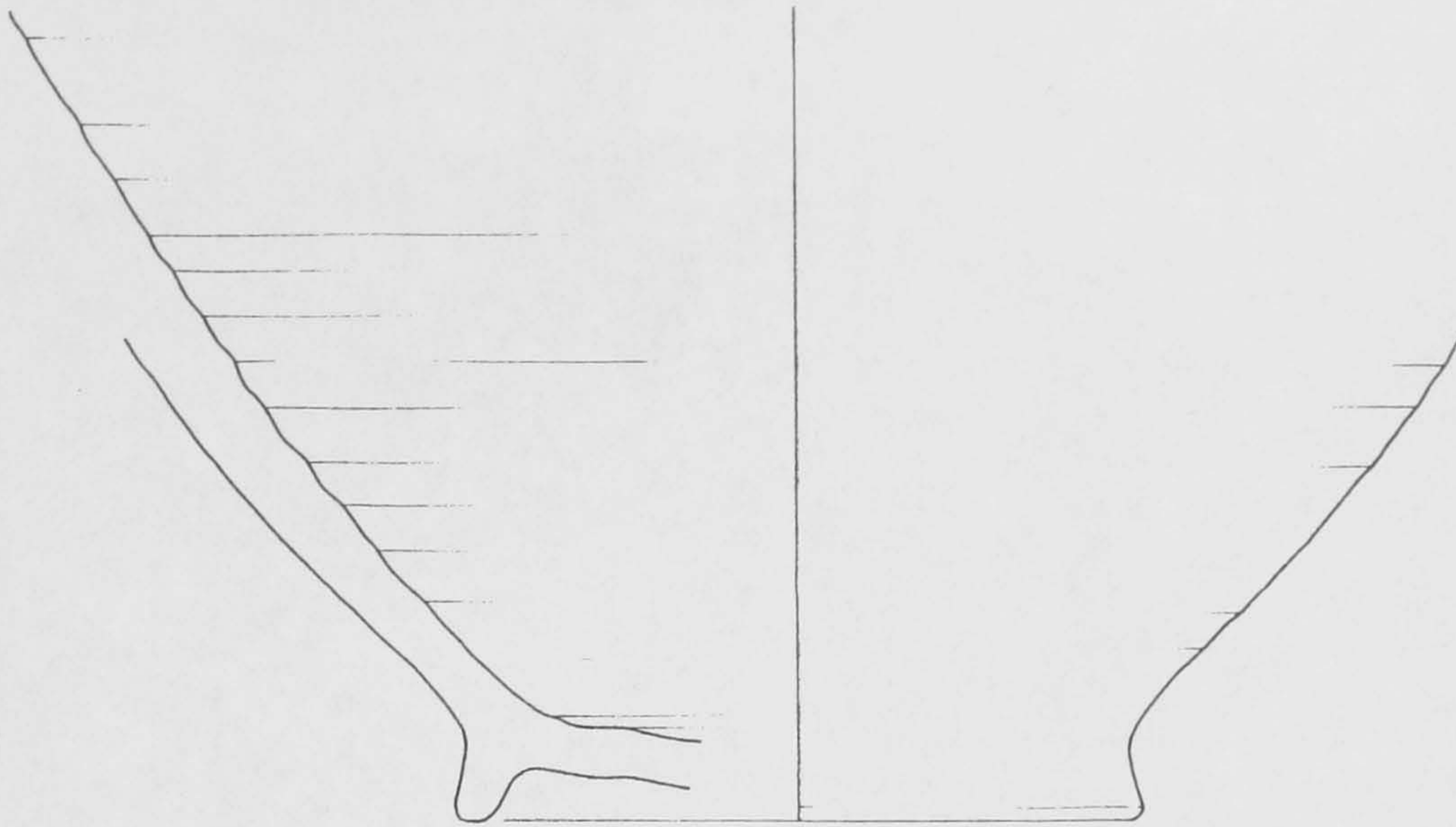

32

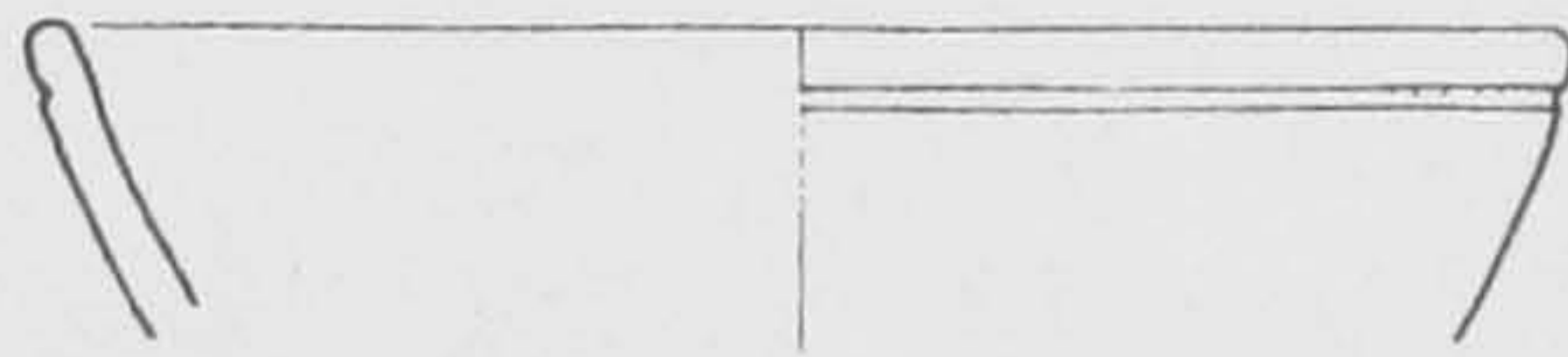

33

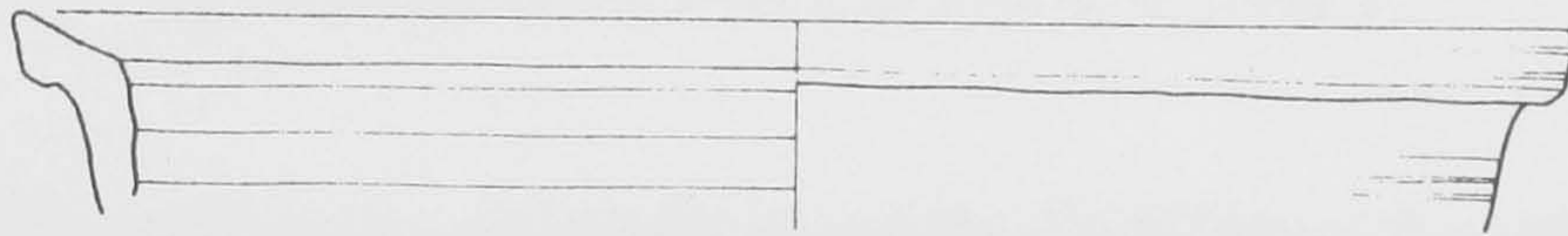

34

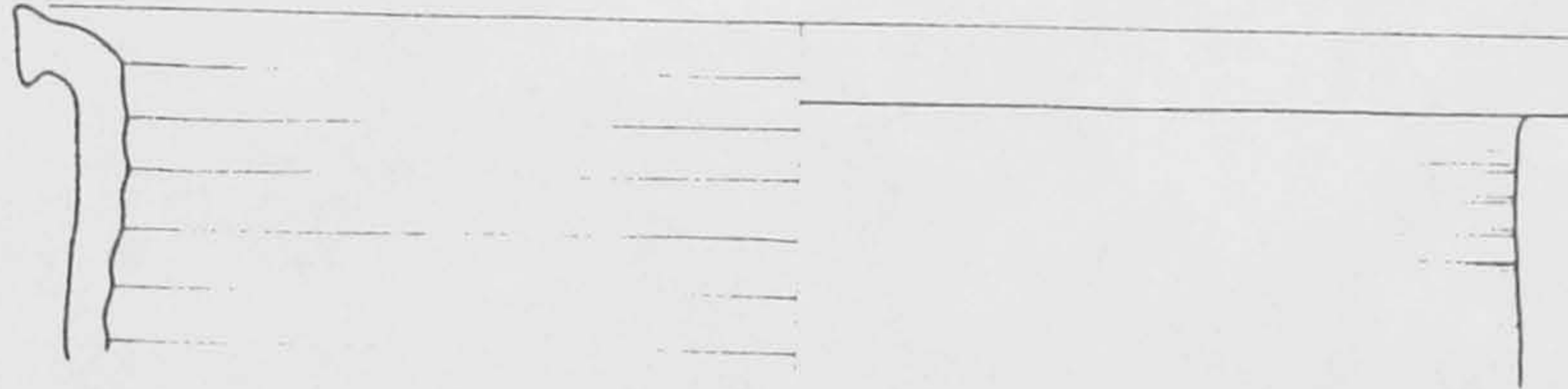

35

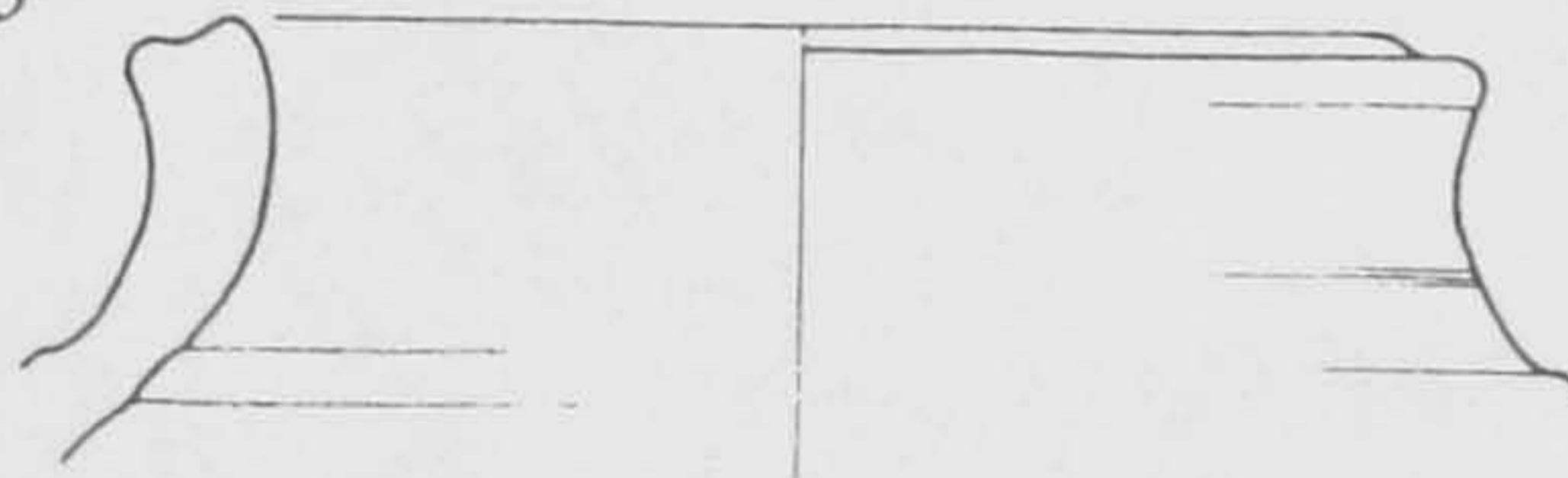

36

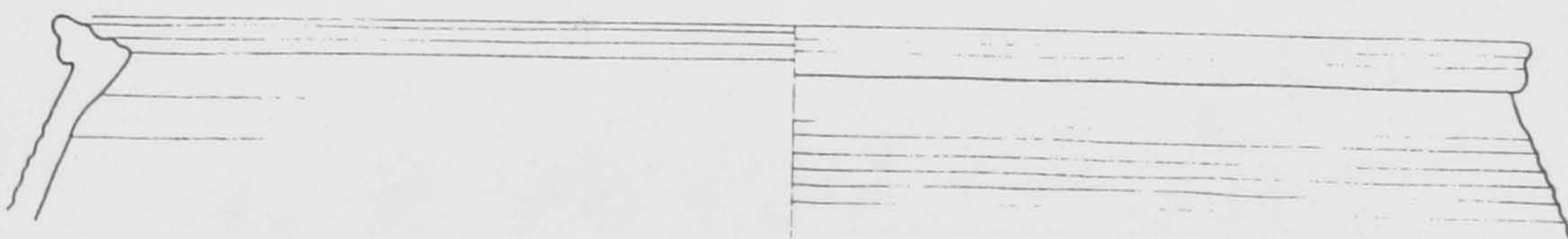

Pottery from profile 3 at 1:3.

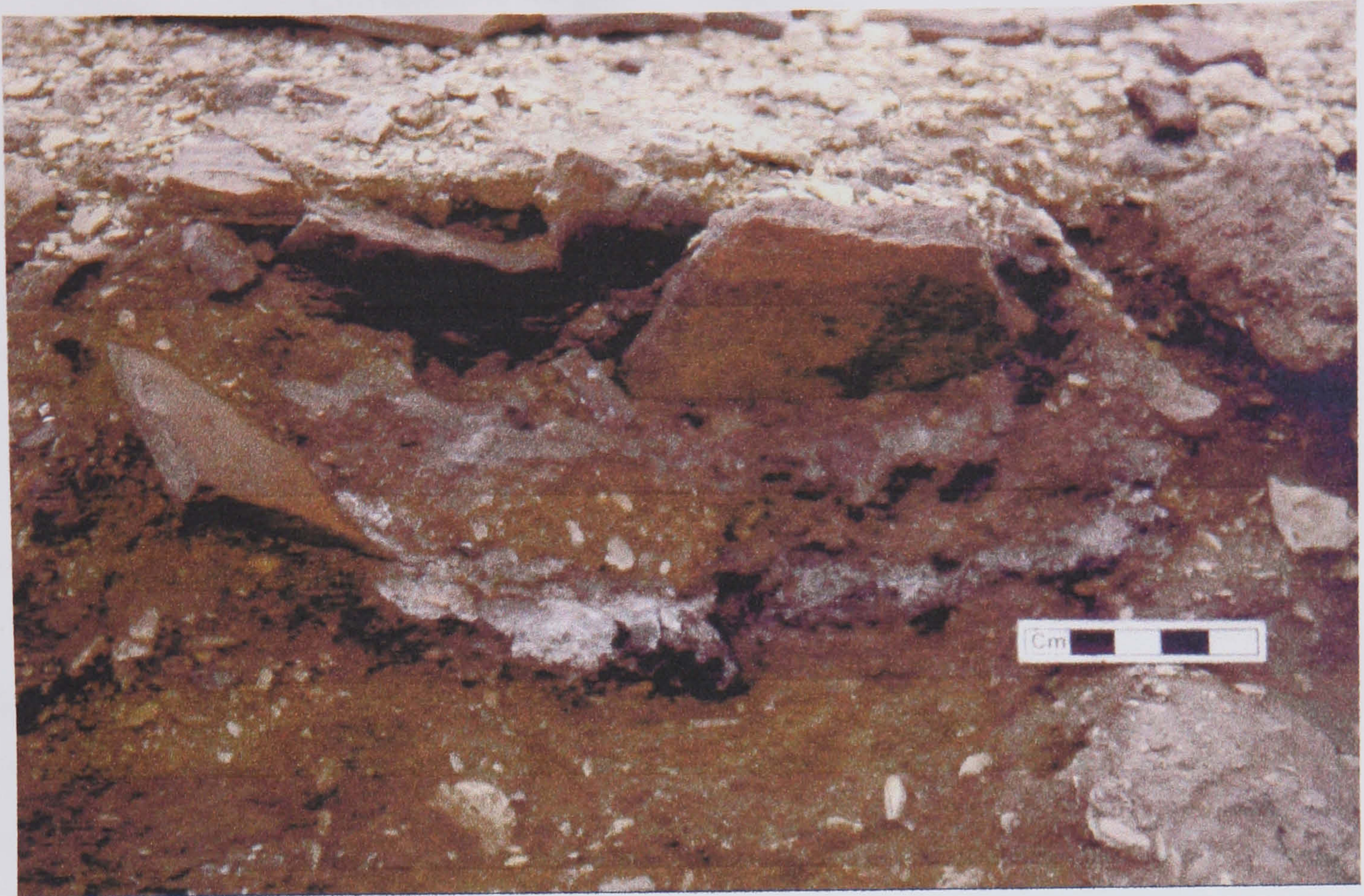

A: One of the pits in the top of profile 3.



B: Looking north across the cow burial behind profile 3.

Conventions for pottery catalogue

Drawings are at 1:3 unless otherwise stated. Normal painting conventions are: black=black; close stipple=red; sparse stipple=white. However, the difficulty of representing intricate patterns in stipple, and the presence of multi-coloured glazes has frequently necessitated a deviation from this system, clearly marked in the catalogue entries.

Fabric and ware descriptions

Pharaonic fabrics

The fabrics of New Kingdom material from Zawyet al-Sultan have been classified according to Nicholson and Rose's Amarna system (1985).

Late Roman/early medieval fabric series

No further description or details are offered for the following well documented wares except in the case of unusual or variant fabrics.

African red slip ware (ARS): see Hayes 1972.

Cypriot red slip ware: see Hayes 1972.

'Late Roman C' ware: see Hayes 1972.

Aswan wares: see Adams 1986; also known as ERS A (Hayes 1972),

Rodziewicz groups O and W (1976).

Late Roman amphorae (LRA) 7: see Riley 1979; 1981; Peacock and Williams 1986 (classes 52 and 53); Adams 1986, 567–8 (U4); Bailey 1998, 125–135; Egloff 1977 (types 172 to 179); Hayes 1992 (Saraçhane type 12).

LRA 1: see Riley 1979; 1981; Peacock and Williams 1986 (class 44), Adams 1986, 580–1 (U3); Bailey 1998, 121–2; Egloff 1977 (type 164/6); Hayes 1992 (Saraçhane type 5); Ballet and Picon 1987.

Gaza Jar: see Riley 1979; 1981; Peacock and Williams 1986 (class 49).

LRA 5/6: see Riley 1979; 1981; Peacock and Williams 1986 (class 46).

For the silt wares, I am grateful for permission to use relevant parts of Faiers's classification system, quoted below, which is itself based on an unpublished system used by Bourriau at Saqqara (Faiers in press).

Finewares:

M5: also known as ERS B (Hayes 1972, 397–8). Soft and crumbly, very fine and dense. Uniform brown on surface and in section. Matrix includes mica, sand, fine chaff and limestone inclusions. Red slipped. Clumsy technique with thick walls and carelessly applied decoration.

M6: also known as ERS H (Spencer, Bailey and Burnett 1983, 27; Bailey 1998, 38). Dense, hard fabric containing some mica in small particles. Dark pink core with a thin outer layer orange in colour but the surface, where unslipped, has a reddish-brown appearance. The slip is of an Indian red colour, fairly matt; more often than not applied to the inside of the vessel and the outside of the rim only.

Coarsewares:

VCM1: hard, very porous and 'corky', very coarse, Nile silt fabric. Quantities of straw, large particles of limestone and other inclusions visible. Usually showing a wide carbon streak in section. Usually confined to very large, hand-made vessels.

M1: hard, very porous and 'corky', coarse Nile silt fabric. Quantities of straw, large particles of limestone and other inclusions visible. Usually showing a wide carbon streak in section.

M2: hard, medium to fine, Nile silt fabric. Usually well and evenly fired. Red-brown with a thin red, rarely black core in section. Vessel walls vary from 0.4–1 cm in thickness.

M4: hard, if not brittle, due to repeated heating during cooking. Very fine, Nile silt fabric, containing sand, mica, small particles of charcoal (?), and black and white particles. Yellowish-brown 10 YR 5/4 to 2.5 YR 5/6, commonly ribbed and stained black/sooted, with a red or violet (never black) core. Pottery in this fabric often has very thin walls.

Medieval fabrics

Fustat fabric: soft and porous beige to greenish-grey clay with common dark red particles, coarse round sand, and finer black and white particles. Although it is possible not all 'Fustat ware' was made in Fustat, it has been found there in large quantities; modern Fustat potters still use a similar clay today, which they mine from the village of Tabine, south of Cairo. Fustat clay is found both glazed and unglazed.

Although Faiers's silt ware designations are used for medieval pottery, the later wares tend to contain greater quantities of mica and less organic material than their Roman equivalents. Examples of fabric VCM1 from Tinnis tended to be tempered with limestone rather than straw; of course this may have geographical rather than chronological significance.

Glazed wares

Glazed Aswan wares: see Bailey 1998, 112–3; Engemann 1988, 1989; Rodziewicz 1983; Whitcomb 1989.

Fustat Fatimid Sgraffiato: see Scanlon 1999.

Wares with FG numbers come from the unpublished catalogue from Old Cairo: see Gascoigne forthcoming.

Zawyet al-Sultan main city surface pottery

Surface ceramic material from the main city has been divided up by fabric and form rather than by area, although the provenance of each piece is noted. The collection from Kom al-Dik is listed separately towards the end of the catalogue. Form parallels have been sought in the first instance from sites in Middle Egypt, and afterwards from further afield, although few, if any, parallels have been listed for coarse wares such as cooking pots, which have great variety on all sites and add little to discussions of dating. Although some sherds clearly dating from pre-Roman times were collected, limited space has not allowed their inclusion in this catalogue. The original drawings of 7, 11, 13, 14, 15 and 17 were made by Amanda Dunsmore, 46, 47, 76, 105, 110, 113, 114, 124 and 130 by Dr Kate Spence and 39 by Nadine Moeller.

Faience

Small faience body sherds were noted on all areas of the site, including Kom al-Dik; these are apparently all Roman in date.

Form 1

Parallels: Memphis (Petrie 1909, pl. 50, 6–7); Baqaria, Bucheum (Mond and Myers 1934, pl. 83, fig. 5); Quseir al-Qadim, first to early third century (Whitcomb and Johnson 1982, pl. 68a, b, d); Dendara, first and second centuries (Marchand and Laisney 2000, nos 114–5); Cairo Museum (Bissing 1902, 87, no. 3982); Middle Egypt (Kurth and Rößler-Köhler 1987, pl. 82).

1. *Provenance:* area B. *Diameter:* 10 cm.
2. *Provenance:* area D. *Diameter:* 16 cm.

Form 2

Parallels: Memphis (Petrie 1909, pl. 50, 1); Quseir al-Qadim, first to early third century (Whitcomb and Johnson 1982, pl. 68c).

3. *Provenance:* area B. *Diameter (base):* 12 cm.
4. *Provenance:* area E. *Diameter:* 16 cm.

ARS

The form typology used here is from Hayes's 1972 study of late Roman fine wares.

Form 50 (mid-third century–c. 400)

5. *Provenance*: area B. *Diameter*: 24 cm.

Form 61, B (c. 400–450)

6. *Provenance*: circle, area E. *Diameter*: >40 cm.

7. *Provenance*: exact provenance unknown. *Diameter*: c. 40 cm.

Form 67 (c. 360–470)

8. *Provenance*: area C. *Diameter*: 32 cm.

9. *Provenance*: area D. *Diameter*: 34 cm.

10. *Provenance*: area D. *Diameter*: 38 cm.

11. *Provenance*: exact provenance unknown. *Diameter*: c. 40 cm.

12. *Provenance*: circle, area E. *Decoration*: stamped decoration in style Aii–iii (c. 350–470). *Diameter* (base): 15 cm.

13. *Provenance*: exact provenance unknown. *Diameter*: 38 cm.

14. *Provenance*: exact provenance unknown. *Decoration*: stamp type 78, style Aii (late fourth century). *Diameter* (base): 16 cm.

Form 84 (c. 440–500)

15. *Provenance*: exact provenance unknown. *Diameter*: 24 cm.

Other examples of this common form were collected from areas C, E (two) and west of area D.

Form 91, A/B (A: mid- to late fifth century; B: c. 450–530)

16. *Provenance*: area E. *Diameter*: 16 cm.

17. *Provenance*: exact provenance unknown. *Diameter* (base): 7.5 cm.

Form 99, B (c. 530–580)

18. *Provenance*: area E. *Diameter* (base): 8 cm.

19. *Provenance*: area E. *Diameter* (base): 9 cm.

Aswan wares

Aswan sherds are divided into the ware groups defined by William Adams in his 1986 study of medieval Nubian pottery.

Group AI (c. 100–475)Ware R37 (c. 350–475)

20. *Provenance*: area C. *Fabric*: pink with abundant grog. *Surfaces*: badly preserved; would originally have exhibited painted decoration typical of this ware. *Diameter*: 46 cm. *Parallels*: Ashmunein, C97–110, fifth century or earlier (Bailey 1998), or c. 390–460 (Bailey 1996, pl. 4, 23); Elephantine, T106, first quarter of fourth century to sixth century (Gempeler 1992), or second half of fifth century (Grimm 1975, 74, fig. 11g); Ehnasya, fourth century (Petrie 1905, pl. 30, no. 4); Gurna, 1288–91, c. 395–640 (Myśliwiec 1987); Armant, pap.1–2, form 101 C–102 D, fourth century (Mond and Myers 1940, 154, pl. 25 and 75); Royal Ontario Museum, late fourth to early fifth century (Hayes 1976, no 107–8, pl. 14); Tod, fourth and fifth (not sixth) century (Pierrat pers. com to Bailey 1998, 13; Pierrat 1996, 22, 79–81; see also 1995 for further museum examples); Karnak, fourth to early fifth century (Azim 1980, fig 12, pl. 31a); Esna, H11, post-550 (Jacquet-Gordon 1972); Dendara, exs 172–5, fourth to sixth century (Marchand and Laisney 2000); Monastery of Epiphanius (Winlock and Crum 1926, pl. 33B); Medinet Habu, U18 (Hölscher 1954, pl. 48); Fitzwilliam Museum, no. 185, fifth to sixth century (Bourriau 1981); Luxor Museum catalogue entry 299 (Egyptian Antiquities Organisation 1979). See also fig. II.37, vessels 5 and 6 below.

Group AII (c. 400–850)Ware R4? (c. 550–850; Bailey (1998, 24) suggests some vessels in this group may date from as early as c. 400.)

21. *Provenance*: area D. *Surfaces*: red-slipped interior and exterior, black rim stripes. *Diameter*: 21 cm. *Parallels*: Elephantine T210a, second quarter fourth century to c. second quarter sixth century (Gempeler 1992); Ashmunein C388–428, second quarter fourth century to well into sixth century (Bailey 1998); Gurna 1274–85, c. 395–640 (Myśliwiec 1987); Tod, end of fifth to mid-seventh century (Pierrat 1995, 35–6 and 1996, pl. 8, figs. 115–6).
22. *Provenance*: area D. *Fabric*: brown-fired and coarser than standard Aswan clay; contains same inclusions as well as more decomposed calcitic material

than usual. Other examples of this fabric variant found at Edfu (see fig. V.6, vessels 7 and 8 below). *Surfaces*: red-slipped. *Parallels*: form resembles Hayes ARS form 67, late fourth to fifth century; see also Elephantine, T211, second half of the fourth to mid-sixth century (Gempeler 1992); this form also appears as a silt ware: see below, bowl form 1.

Ware W3 (c. 650–850)

23. *Provenance*: area E. *Surfaces*: primary black and secondary red decoration over cream slip. *Diameter*: 50 cm. *Parallels*: Elephantine T354, mid-sixth to eighth century (Gempeler 1992); Ashmunein, C573–82, seventh to ninth century (Bailey 1998); Tod, c. 650–950 or later (Pierrat 1991, fig. 55f); similar large W3 dishes from Kellia (e.g. type 260) date from c. 630 to the mid-eighth century (Egloff 1977).

Other kaolinitic wares

Ware U?

24. *Provenance*: area D. *Fabric*: very sandy beige-cream. *Surfaces*: cream-slipped below rim on exterior. *Diameter*: 6 cm. *Parallels*: Dakhla oasis, late third/fourth century (Hope and Eccleston 2000). This keg rim is apparently an example of Hope's fabric B23, not a true Aswan clay, but distinguishable only by microscopic analysis.

Marl wares

25. *Provenance*: area E. *Fabric*: pink calcitic marl not unlike Aswan clay, but coarser, with more white and no black pieces. *Surfaces*: cream slip over all surfaces, stamped decoration inside base (corresponding to Hayes style Aii, stamps number 4k and 24, c. 350–420, but whether dating of ARS stamps can be applied reliably to other wares is doubtful). *Diameter* (base): 14 cm.
26. *Provenance*: area B. *Fabric*: sandy marl with abundant fine black particles. *Surfaces*: white firing surface decorated with red spots and rim stripe. *Diameter*: 13 cm. *Parallels*: similar form, without fabric description, from Dakhla, 'Roman' (Hope 1981, pl. 23r).

Silt Bowls

To avoid the artificial division between fine and coarse wares, bowls are here presented together. Forms are ordered as far as possible from the most well-made first, to the roughest last. However, different quality examples of the same form have been placed together. The finish of each vessel should be clear from their catalogue entries. The division of the vessels into form numbers is purely practical; each of these groups contains considerable variation.

Bowl form 1: M5 vessels with bipart rim

This ERS B form, which resembles Hayes ARS form 67 (c. 360–470), has been found at Ashmunein in contexts dating from the late fourth to eighth centuries (Bailey 1998, 51, D442–7), or to c. 400–550 (Spencer, Bailey and Burnett 1983, E80.1). At Kom al-Nana, an example of this bowl is probably from the sixth century (Faiers in press, no. 141); an Aswan example was found in area D (vessel 22) and Gempeler records another from Elephantine, dating from the second half of the fourth to the mid-sixth century (1992, T211). Parallels to individual vessels are given below.

27. *Provenance: area D. Fabric: M5. Surfaces: thick, burnished red-slipped interior, slightly darker-slipped exterior. Diameter: 31 cm.*
28. *Provenance: area D. Fabric: M5. Surfaces: thick, burnished red slip all over. Diameter: 44 cm.*
29. *Provenance: circle, area E. Fabric: M5. Surfaces: matte dark red slip all over. Diameter: 18 cm.*
30. *Provenance: area C. Fabric: M5. Surfaces: burnished dark red slip on interior surface, thinner on exterior. Diameter: 36 cm.*
31. *Provenance: area C. Fabric: M5. Surfaces: matte red slip all over. Diameter: 22 cm. Parallels: Kom al-Nana, sixth century (Faiers in press, types 92 and 106).*

Bowl form 2: M5 flanged bowls

This form contains a variety of related shapes. Some examples of this group resemble Hayes ARS form 91, a long-lived bowl manufactured c. 450–650. Górecki's insistence that the silt varieties must be later in date than the ARS form is not necessarily valid (1989–93, 232). The low-rimmed form with wide flange (as 36 and

38) is paralleled at Ashmunein, D299–313, late fourth to mid-sixth century (Bailey 1998), and at Kom al-Nana, type 83–4, c. 400–550 (Faiers in press). The more common tall-rimmed type with medium flange resembles Ashmunein, D314–35, fifth to sixth century (Bailey 1998, 46) and the fifth to sixth century Kom al-Nana type 86 (Faiers in press). The abundance of this form at Zawyet al-Sultan is due to its local manufacture: Ballet, Mahmoud, Vichy and Picon found multiple wasters at a kiln site in the north of the town (1991). Occasional further parallels for individual vessels are given below.

32. *Provenance*: area A. *Fabric*: M5. *Surfaces*: burnished red slip over interior, and exterior of rim, matte slip below flange. *Diameter*: 20 cm.
33. *Provenance*: area A. *Fabric*: coarse M5 with coarse limestone pock-marking surface. *Surfaces*: as above. *Diameter*: 14 cm.
34. *Provenance*: circle, area C. *Fabric*: M6. *Surfaces*: red slip over interior and exterior, thinner below flange. *Diameter*: 16 cm.
35. *Provenance*: area D. *Fabric*: M5. *Surfaces*: matte dark red slip all over. *Diameter*: 15 cm. *Parallels*: Kom al-Nana, GP600, fifth to sixth century (Faiers and Pyke forthcoming); Deir el Naqlun (Godlewski 1988, fig. 4).
36. *Provenance*: area D. *Fabric*: M5. *Surfaces*: burnished red-slipped interior and exterior, thinner below flange. *Diameter*: 31 cm. *Parallels*: Kom al-Nana, GP487, fifth to sixth century (Faiers and Pyke forthcoming); Alexandria, K15, fifth to late sixth/early seventh century (Rodziewicz 1976); Monastery of Epiphanius (Winlock and Crum 1926, fig. 37q).
37. *Provenance*: circle, area D. *Fabric*: M5. *Surfaces*: burnished red slip. *Diameter*: uncertain.
38. *Provenance*: area E. *Fabric*: M5. *Surfaces*: burnished red slip over all surfaces; roughly finished. *Diameter*: 20 cm.
39. *Provenance*: area D. *Fabric*: M5. *Surfaces*: burnished red slip all over. *Diameter*: 22 cm.

Bowl form 3: M5 bowl with everted rim

This form is paralleled at Ashmunein from contexts dating from the late seventh to eighth century, but Bailey notes that, as the contexts are residual, the form is probably

much earlier (1998, 48, D90–97). Hayes ARS forms 93 and 94 are close in shape, and date from the late third to early sixth century; from the Aswan workshops a similar form, T242 at Elephantine, is probably of sixth century date (Gempeler 1992).

40. *Provenance*: area C. *Fabric*: M5. *Surfaces*: smoothed, matte, dark red slip on all surfaces. *Diameter*: 26 cm.
41. *Provenance*: area E. *Fabric*: M5. *Surfaces*: red-slipped inside and out. *Diameter*: 16 cm. *Parallels*: Kom al-Nana, type 95, sixth century (Faiers in press).
42. *Provenance*: area E. *Fabric*: M5. *Surfaces*: glossy red slip inside and upper half of exterior, matte lower half. *Diameter*: 26 cm.

Bases

Although these bases are not particularly diagnostic, they belong with the finer wares and have thus been placed here.

43. *Provenance*: area A. *Fabric*: M5. *Surfaces*: red-slipped interior, thinner slip on exterior. *Diameter* (base): 9 cm.
44. *Provenance*: area E. *Fabric*: M6. *Surfaces*: red-slipped interior with faint stamped decoration (perhaps a single bird?) related to Hayes (1972) stamps 182–210, style E, c. 480–600); unslipped exterior. *Diameter* (base): 9 cm.

Bowl form 4: M6 with everted grooved rim

Paralleled at Alexandria, K4, mid-third to mid-fifth century (Rodziewicz 1976).

45. *Provenance*: area C. *Fabric*: M6. *Surfaces*: burnished red-slipped interior and exterior of rim. *Diameter*: 32 cm.
46. *Provenance*: area C. *Fabric*: M6. *Surfaces*: all surfaces red-slipped. *Diameter*: 32 cm.
47. *Provenance*: area C. *Fabric*: M6. *Surfaces*: red-slipped all over. *Diameter*: 19 cm.

Bowl form 5: M6 with plain grooved rim

Paralleled at Ashmunein, D484, fifth to seventh century (Bailey 1998, but white-slipped); Buto, fourth to eighth century (Ballet and Von der Way 1993, fig. 2, 4).

48. *Provenance*: area B. *Fabric*: M6. *Surfaces*: glossy red slip all over. *Diameter*: 20 cm.

49. *Provenance*: circle, area E. *Fabric*: M6. *Surfaces*: matte dark red slip interior and exterior of rim. *Diameter*: 18 cm.

Bowl form 6: M6 plain-rimmed bowl

50. *Provenance*: area C. *Fabric*: M6. *Surfaces*: burnished dark red slip all over. *Diameter*: 24 cm.

Bowl form 7: M6 carinated bowl

This distinctive form dates from the fifth to sixth century at Ashmunein (Bailey 1998, D519–671) and at Old Cairo (Gascoigne forthcoming). It is most commonly found with painted decoration in black and white (Myśliwiec 1987, 1177 (unpainted) and 1557 (painted); see also example from profile 2, Kom al-Dik, below).

51. *Provenance*: area D. *Fabric*: M6. *Surfaces*: matte red-slipped interior and exterior of rim. *Diameter*: 22 cm.

Bowl form 8: M6 shallow dish with ledged interior

52. *Provenance*: circle, area B. *Fabric*: M6. *Surfaces*: dark red slip showing traces of burnishing on inner surface. *Diameter*: 28 cm.
53. *Provenance*: area B. *Fabric*: M6. *Surfaces*: red slip on interior only. *Diameter*: 24 cm.

Bowl form 9: M6 platter with outturned rim and rope marks

54. *Provenance*: area C. *Fabric*: M6. *Surfaces*: thick burnished red slip on all surfaces. *Diameter*: 40 cm.

Bowl form 10: M6 platter with upright rim and rope marks

Paralleled at Ashmunein, D297–8, fifth century (Bailey 1998); Middle Egypt (Kurth and Rößler-Köhler 1987, 249, pl. 6, no 1; 259, pl. 16, no. 35); also similar to an example from Tod, end of the fourth–end of the fifth century (Pierrat 1996, pl. 4, fig 45).

55. *Provenance*: area D. *Fabric*: M6. *Surfaces*: burnished red slip on interior and rim, thin wash below carination; rope marks on exterior. *Diameter*: 46 cm.

Bowl form 11: M6 plain-rimmed bowl

Paralleled at Ashmunein, D72, c. 600–700 (Bailey 1998); Kom al-Nana, type 165, found with coin dating to 578–82 (Faiers in press); Alexandria, K1, mid-third to mid-

fifth century (Rodziewicz 1976). However, parallels are possibly not very useful for the dating of such an undistinctive rim shape.

56. *Provenance*: circle, area D. *Fabric*: M6. *Surfaces*: burnished red slip interior, red wash on exterior. *Diameter*: 26 cm.

Bowl form 12: M6 'triple-rimmed' bowl

Paralleled at Deir el-Naqlun, end of the seventh to the first half of the eighth century (but found in a redeposited rubbish dump along with fifth- and sixth-century ARS).

This is not an exact match, the diameter of the Deir el-Naqlun examples being considerably larger (Górecki 1989–93, I.a, fig. 13).

57. *Provenance*: area C. *Fabric*: M6. *Surfaces*: thick dark red slip all over, white swag on exterior. *Diameter*: 30 cm.

Bowl form 13: coarse thick-walled, everted-rimmed bowl

Paralleled at Ashmunein from a context dated c. 400–550 (Bailey 1998, D415).

58. *Provenance*: area A. *Fabric*: M2. *Surfaces*: uncoated. *Diameter*: 19 cm.
59. *Provenance*: area B. *Fabric*: M6. *Surfaces*: red-slipped interior, unslipped exterior. *Diameter*: 19 cm.
60. *Provenance*: circle, area B. *Fabric*: M6. *Surfaces*: matte, dark red slip all over. *Diameter*: 20 cm.
61. *Provenance*: area D. *Fabric*: M6. *Surfaces*: matte, dark red slip on interior, rough red wash on exterior; interior has punctate decoration in loops and triangular patterns. *Diameter*: 40 cm.

Bowl form 14: coarse, uneven, plain-rimmed bowl

This bowl form was extremely abundant at Zawyet al-Sultan, but few examples have been recorded from elsewhere; it may be a locally manufactured form of the early to mid-Roman period. The closest example is from Mons Claudianus, dating from the first to third or fourth century (Tomber 1992, fig. 3, 9). Ashmunein, D80 (from a context dated to the late fourth to the eighth century) and D139 (with rouletting; context date c. 375–450) are also similar (Bailey 1998). An example from Buto is better-finished but is similar in form to the Zawyet al-Sultan example; it dates from the fourth to the eighth century (Ballet and Von der Way 1993, fig. 2, 8).

62. *Provenance*: area A. *Fabric*: M2. *Surfaces*: traces of red slip all over.
Diameter: 18 cm.
63. *Provenance*: area A. *Fabric*: M1. *Surfaces*: traces of red slip all over.
Diameter: 20 cm.
64. *Provenance*: area A. *Fabric*: M1. *Surfaces*: red-slipped all over. *Diameter*: 16 cm.
65. *Provenance*: circle, area B. *Fabric*: overfired M2. *Surfaces*: red slip carelessly applied to interior and upper part of exterior; the edge of the slip on the exterior is not an even line and the unslipped surface is rough and carelessly finished. *Diameter*: 18 cm.
66. *Provenance*: circle, area B. *Fabric*: M2. *Surfaces*: red-slipped all over, exterior of lower wall roughly finished. *Diameter*: 22 cm.
67. *Provenance*: circle, area B. *Fabric*: M2. *Surfaces*: matte, dark red slip all over.
Diameter: 18 cm.
68. *Provenance*: circle, area B. *Fabric*: M1. *Surfaces*: matte, dark red slip all over.
Diameter: 18 cm.
69. *Provenance*: circle, area C. *Fabric*: M2. *Surfaces*: thick matte red slip all over.
Diameter: c. 26 cm.
70. *Provenance*: area D. *Fabric*: M2. *Surfaces*: matte red slip all over. *Diameter*: 18 cm.
71. *Provenance*: area A. *Fabric*: M1. *Surfaces*: uncoated. *Diameter*: 24 cm.
72. *Provenance*: area B. *Fabric*: M2. *Surfaces*: uncoated. *Diameter*: 24 cm.
73. *Provenance*: area B. *Fabric*: M2. *Surfaces*: uncoated. *Diameter*: 22 cm.
74. *Provenance*: circle, area B. *Fabric*: M1. *Surfaces*: uncoated. *Diameter*: 18 cm.
75. *Provenance*: area C. *Fabric*: M2. *Surfaces*: uncoated. *Diameter*: 18 cm.
76. *Provenance*: circle, area C. *Fabric*: M2. *Surfaces*: uncoated. *Diameter*: 16 cm.

Bowl form 15: coarse, deep bowl with 'double' rim

Examples from Tell Fara'on near Qantir in the Delta dated to Ptolemaic period (base only; Gascoigne in press).

77. *Provenance*: area B. *Fabric*: M1. *Surfaces*: uncoated. *Diameter*: 18 cm.

78. *Provenance*: area B. *Fabric*: M1. *Surfaces*: red-slipped all over. *Diameter* (base): 8.5 cm.
79. *Provenance*: circle, area D. *Fabric*: M2. *Surfaces*: unslipped, lower part of outside scraped. *Diameter*: 18 cm.

Bowl form 16: coarse, deep bowl with indented rim

Paralleled at Ashmunein from a context dated to c. 375–450 (Bailey 1998, N36–8); also Kom al-Nana (Faiers and Pyke forthcoming, GP 649 and 647).

80. *Provenance*: circle, area B. *Fabric*: M2. *Surfaces*: matte, dark red slip all over. *Diameter*: 16 cm.
81. *Provenance*: circle, area C. *Fabric*: M2. *Surfaces*: all red-slipped. *Diameter*: 16 cm.
82. *Provenance*: circle, area E. *Fabric*: M1. *Surfaces*: red-slipped all over, carelessly finished. *Diameter*: 19 cm.
83. *Provenance*: circle, area E. *Fabric*: M1. *Surfaces*: all red-slipped. *Diameter* (base): 4 cm.
84. *Provenance*: circle, area B. *Fabric*: M2. *Surfaces*: matte, dark red slip all over. *Diameter* (base): 7 cm.

Bowl form 17: coarse, deep, plain-rimmed bowl

Paralleled at Ashmunein from a context dated to c. 375–450; vessel date late fourth to mid-fifth century (Bailey 1998, N70).

85. *Provenance*: area A. *Fabric*: sandy M2. *Surfaces*: uncoated. *Diameter*: 20 cm.
86. *Provenance*: circle, area E. *Fabric*: M2. *Surfaces*: matte, orange-red slip all over. *Diameter*: 13 cm.
87. *Provenance*: area B. *Fabric*: M2. *Surfaces*: uncoated. *Diameter*: 12 cm.
88. *Provenance*: circle, area C. *Fabric*: M2. *Surfaces*: red-slipped all over. *Diameter*: 15 cm. *Parallels*: variant with slightly everted rim similar to an example from Ashmunein, late fourth to fifth century (Bailey 1998, D341–2).

Bowl form 18: coarse, shallow bowl with outturned rim

An example from Ashmunein, context date c. 375–450, is similar, if not an exact match (Bailey 1998, N13).

89. *Provenance*: area A. *Fabric*: M2. *Surfaces*: unslipped, roughly scraped exterior. *Diameter*: 12 cm.

Bowl form 19: 'frying pan'

Vessels similar to this form have been recorded from other sites, but few are well-dated. See, for example, Kom al-Nana, types 130 and 131, c. 400–500 (Faiers in press); also Ashmunein, E1.8 or E1.5 (Spencer, Bailey and Burnett 1983); other parallels below.

90. *Provenance*: circle, area C. *Fabric*: M1. *Surfaces*: matte red slip inside and out. *Diameter*: 22 cm. *Parallels*: Elephantine, K118, date uncertain (Gempeler 1992); Kom al-Nana, GP 574 (Faiers and Pyke forthcoming).
91. *Provenance*: circle, area B. *Fabric*: M2. *Surfaces*: uncoated, roughly finished base. *Diameter*: 15 cm. *Parallels*: Elephantine, K120a, date uncertain (Gempeler 1992).

Bowl form 20: chaffy painted bowl

'Copto-byzantine' example from Buto (Kom el-Matiur) has a similar fabric and form, although the decorative pie-crust rim and red slip are quite unlike the red paint on white slip of the Zawyet al-Sultan piece (Ballet and Von der Way 1993, number 28).

92. *Provenance*: area D. *Fabric*: M1. *Surfaces*: cream slip, red ticks inside and outside rim, not lining up at top edge. *Diameter*: 21 cm.

Silt Cooking Pots

Utility wares are not particularly useful for dating purposes, so few parallels have been sought, and only from Middle Egyptian sites. As above, the division of the vessels into separate form groups is for convenience only and is not significant. Few of the cooking pots recorded appeared to be ribbed.

CP form group 1: with tall, plain rims

Tall-rimmed examples of this common form are also found at Ashmunein, dating from the fourth to the sixth century (Bailey 1998, E192–6), and at Kom al-Nana, from c. 400–550 (Faiers in press, types 215–7).

93. *Provenance*: circle, area B. *Fabric*: M2. *Surfaces*: uncoated. *Diameter*: 10 cm.
94. *Provenance*: circle, area B. *Fabric*: M2. *Surfaces*: uncoated. *Diameter*: 18 cm.

95. *Provenance*: circle, area B. *Fabric*: M4. *Surfaces*: uncoated. *Diameter*: 14 cm.
96. *Provenance*: circle, area D. *Fabric*: M1. *Surfaces*: uncoated. *Diameter*: 13 cm.
97. *Provenance*: circle, area E. *Fabric*: M2. *Surfaces*: uncoated. *Diameter*: 12 cm.
98. *Provenance*: circle, area E. *Fabric*: M2. *Surfaces*: uncoated. *Diameter*: 14 cm.
99. *Provenance*: circle, area E. *Fabric*: M1. *Surfaces*: uncoated. *Diameter*: 13 cm.
100. *Provenance*: circle, area B. *Fabric*: M4. *Surfaces*: uncoated. *Diameter*: 19 cm.

CP form group 2: straight-walled pots with everted rims

101. *Provenance*: circle, area B. *Fabric*: M4. *Surfaces*: uncoated. *Diameter*: 24 cm.
102. *Provenance*: circle, area D. *Fabric*: M4. *Surfaces*: uncoated. *Diameter*: c. 24 cm.
103. *Provenance*: circle, area D. *Fabric*: M4. *Surfaces*: uncoated. *Diameter*: 20 cm.
104. *Provenance*: circle, area D. *Fabric*: M4. *Surfaces*: uncoated. *Diameter*: 20 cm.
105. *Provenance*: circle, area D. *Fabric*: M2. *Surfaces*: red-slipped exterior and upper interior. *Diameter*: 16 cm.

CP form group 3: square-rimmed pots

The squared section of the rims of these vessels closely resembles those of examples from Ashmunein, of mainly fifth and sixth century date (Bailey 1998, E286–338).

106. *Provenance*: circle, area B. *Fabric*: M4. *Surfaces*: uncoated. *Diameter*: 18 cm.
107. *Provenance*: circle, area B. *Fabric*: M4. *Surfaces*: uncoated. *Diameter*: 20 cm.
108. *Provenance*: circle, area C. *Fabric*: M2. *Surfaces*: uncoated. *Diameter*: 18 cm.

CP form group 4: with everted, slightly thickened rim

109. *Provenance*: circle, area B. *Fabric*: M2. *Surfaces*: uncoated. *Diameter*: 16 cm.
110. *Provenance*: circle, area D. *Fabric*: M2. *Surfaces*: cream rim spots on unslipped walls. *Diameter*: 19 cm.

CP form group 5: open form with everted rim

111. *Provenance*: circle, area C. *Fabric*: M1. *Surfaces*: uncoated. *Diameter*: 40 cm.

Silt Jars

No attempt has been made to group these forms together, as no multiple examples of a recognisable type were noted. Due to the undiagnostic nature of these wares, parallels have been given only for a few distinctive examples.

112. *Provenance*: circle, area B. *Fabric*: M1. *Surfaces*: uncoated. *Diameter*: 16 cm.
113. *Provenance*: circle, area C. *Fabric*: M1. *Surfaces*: uncoated. *Diameter*: 19 cm.
This sherd is perhaps not Roman in date, being reminiscent of medieval forms; it may be intrusive.
114. *Provenance*: circle, area C. *Fabric*: M1. *Surfaces*: uncoated. *Diameter*: 12 cm.
115. *Provenance*: circle, area C. *Fabric*: M1. *Surfaces*: uncoated. *Diameter*: 16 cm.
116. *Provenance*: circle, area E. *Fabric*: M1. *Surfaces*: uncoated. *Diameter*: 17 cm.
117. *Provenance*: circle, area B. *Fabric*: blackened M1. *Surfaces*: uncoated.
Diameter: 16 cm.
118. *Provenance*: circle, area B. *Fabric*: M1. *Surfaces*: uncoated. *Diameter*: 18 cm.
119. *Provenance*: circle, area E. *Fabric*: M1. *Surfaces*: uncoated. *Diameter*: 18 cm.
120. *Provenance*: circle, area E. *Fabric*: M2. *Surfaces*: uncoated. *Diameter*: 10 cm.
121. *Provenance*: circle, area B. *Fabric*: M1. *Surfaces*: uncoated. *Diameter*: 14 cm.
Possibly a *qadus* rim.
122. *Provenance*: circle, area E. *Fabric*: M1. *Surfaces*: uncoated except white swags on exterior. *Diameter*: 24 cm.
123. *Provenance*: circle, area C. *Fabric*: M1. *Surfaces*: uncoated. *Diameter*: 32 cm.
124. *Provenance*: circle, area D. *Fabric*: poorly-mixed M1. *Surfaces*: cream-slipped exterior with red swags, interior uncoated. *Diameter*: 38 cm.
125. *Provenance*: area E. *Fabric*: M2. *Surfaces*: deep, rocker-stamped decoration on unslipped outside surface. *Parallels*: rocker-stamped decoration is to be found on sherds from Ashmunein: O68, from context date c. 650–800+ (Bailey 1998), one undated (Roeder et al 1937, pl. 17c), and one from a seventh-century pit (Spencer, Bailey and Burnett 1983, fig. 18, no 1). Similar decoration is also found on a piece from Kom al-Nana, type 421, fifth to sixth century (Faiers in press). See also Apa Jeremias, monastery date late fifth to mid-ninth century (Quibell 1912, pl. 49, 2); north of Asyut (the authors suggest that some of these examples are of Abu Mina ware, although there appears to be at least one rocker-stamped silt ware; Kurth and Rößler-Köhler 1987, pl. 98, bottom right); Armant (Mond and Myers 1940, pl. 49, 2); Kellia,

type 324 (Egloff 1977, 165, pl. 87, 3 and 88, 4); Esna hermitages, N20, c. 500–Arab conquest. At Esna, Jacquet-Gordon notes, this kind of decoration ‘apparaît sous forme de coups de gouge verticaux sur les pichets et les bouteilles, ou sous forme d’un réseau recouvrant les amphores’ (Jacquet-Gordon 1972, 19). See also fig. II.37, vessel 50 and the incised sherd from profile 4 (fig. II.6, vessel 1).

Silt Qulla

126. *Provenance*: area D. *Fabric*: M1. *Surfaces*: dirty cream slip over exterior and inside of neck to slightly below filter. *Diameter*: 7 cm.

Silt Lids

‘Food cover’

Lid-form V8 from the Esna hermitages (c. 500–Arab conquest) has a very similar rim shape to the examples below; the fact that vessel 128 is slipped only on the exterior would confirm that this piece, at least, must have been a lid. (Bowl N34 from Ashmunein may also be a lid of this type, from context date fifth to seventh century; Bailey 1998.)

127. *Provenance*: area A. *Fabric*: M2. *Surfaces*: wet-smoothed interior and rougher exterior, all unslipped. *Diameter*: 24 cm.
128. *Provenance*: circle, area B. *Fabric*: M2. *Surfaces*: thin, matte red slip on outside, unslipped inside. *Diameter*: 28 cm.
129. *Provenance*: circle, area B. *Fabric*: M2. *Surfaces*: red-slipped all over. *Diameter*: 24 cm.

Coarse lid

130. *Provenance*: circle, area D. *Fabric*: VCM1. *Surfaces*: orange-brown slip. *Diameter*: 21 cm.

Silt Potstands

131. *Provenance*: circle, area C. *Fabric*: M1. *Surfaces*: well-finished with matte, dark red slip; surprisingly little wear around inner surface of rim. *Diameter*: 22 cm.
132. *Provenance*: circle, area D. *Fabric*: VCM1. *Surfaces*: uncoated. *Diameter*: 17 cm.
133. *Provenance*: circle, area E. *Fabric*: M1. *Surfaces*: uncoated. *Diameter* (base): 14 cm.

Lamp

134. *Provenance*: area D. *Fabric*: hard silt with no visible inclusions. *Surfaces*: unslipped. *Decoration*: mould-made erotic (?) scene on upper surface.

Torch?

135. *Provenance*: circle, area B. *Fabric*: M1. *Surfaces*: uncoated. *Diameter* (base): 8 cm.

Imported Amphorae

Late Period?

136. *Provenance*: circle, area C. *Fabric*: well-mixed beige marl with scarce fine white limestone, black and brown bits. *Surfaces*: uncoated. *Diameter*: 18 cm.

LRA 1

(Early fifth to mid-seventh centuries)

137. *Provenance*: circle, area C. *Diameter*: 9 cm.

Peacock and Williams class 10 (1986): Koan Amphora

(First century BC to second century AD)

138. *Provenance*: area D. *Fabric*: Catalan; marl with lots of inclusions, including large limestone pieces, sparkly quartz sand, abundant red-purple pieces, some grog, a little brown round stuff and silver mica. *Surfaces*: green-fired. *Diameter*: c. 12 cm.

Peacock and Williams class 46 (1986): Palestinian Amphora

(Fifth to sixth century)

139. *Provenance*: circle, area E. *Fabric*: fairly dense orange-brown fabric with common very coarse round light brown or grey sand, coarse sub-angular black particles, coarse round white limestone and moderate golden mica. *Surfaces*: ribbed on exterior, the lines in discrete groupings; this does not conform exactly to Peacock and Williams's description.

Peacock and Williams class 42? (1986)

The form of this vessel is a good match for class 42, although the fabric does not exactly match the description. Many amphora types were, however, produced at multiple production centres. Class 42 dates from the early third to late fourth at Ostia.

140. *Provenance*: circle, area C. *Fabric*: very fine, dense clay with a little white and black material. *Surfaces*: smoothed. *Diameter*: unknown.

Peacock and Williams class 47? (1986)

141. *Provenance*: area C. *Fabric*: red clay with lots of calcitic material, some burned-out, and a little coarse-grained, red-brown matter; zoned, with wide brown core. *Surfaces*: cream-fired.

Unidentified

142. *Provenance*: circle, area C. *Fabric*: dark brown marl with abundant limestone, some large pink pieces, a little round sand and a very little mica. *Surfaces*: uncoated. *Diameter*: 14 cm.
143. *Provenance*: area D. *Fabric*: dense green marl with lots of large grey, black and red particles. *Surfaces*: uncoated. *Diameter*: 14 cm.

Egyptian Amphorae: LRA 7

The relative dating of the two forms of this amphora is uncertain. Peacock and Williams restrict their class 53 to between the late fourth and the mid-sixth century while giving the dates of class 52 as the late fourth to the sixth or seventh century. Bailey (pers. com. to Pollard, 1998, 155) suggests that the larger form (class 53) was in use from the first to the early fifth centuries, and the smaller (class 52) from the late fourth to the sixth century, a variant with a squat neck continuing into the eighth

century. Both these end dates may be a little early. Adams (1986) records the presence of ware U4 (which includes this amphora) up to c. 1000 in Nubia. While class 52 certainly continued in use later than class 53, the two forms clearly coexisted for a significant length of time. Bailey (1998) suggests that during this period, the distribution of the two forms is related to geographical more than chronological differences, and this does indeed seem to be the case. At the fifth and sixth century site of Kom al-Nana in Middle Egypt, for example, class 52 is abundant while class 53 is altogether absent (Faiers in press; Pyke pers. com.). Equally, in Old Cairo, a far greater number of class 52 than class 53 has been retrieved (Gascoigne forthcoming), while all examples of LRA 7 published by Gempeler from Elephantine fall into class 52 (1992). A recent survey of an area of the east Delta, however, recovered large numbers of class 53 amphora bases (Gascoigne in press). This pattern must be produced by local variation in the type of amphora most commonly made, the exceptions perhaps being imported from elsewhere in the country.

Class 53

- 144. *Provenance*: circle, area B. *Diameter*: 12 cm.
- 145. *Provenance*: circle, area B.
- 146. *Provenance*: circle, area B. *Diameter*: 12 cm.
- 147. *Provenance*: circle, area B. *Diameter*: 12 cm.
- 148. *Provenance*: circle, area B. *Diameter*: 11 cm.
- 149. *Provenance*: circle, area B. *Diameter*: 13 cm.
- 150. *Provenance*: circle, area B. *Diameter*: 14 cm.
- 151. *Provenance*: circle, area B. *Diameter*: 14 cm.
- 152. *Provenance*: circle, area B. *Diameter*: 11 cm.
- 153. *Provenance*: circle, area D. *Surfaces*: resinated interior. *Diameter*: 14 cm.
- 154. *Provenance*: circle, area E. *Diameter*: 13 cm.
- 155. *Provenance*: circle, area E. *Diameter*: 13 cm.
- 156. *Provenance*: circle, area E. *Diameter*: 14 cm.
- 157. *Provenance*: circle, area E. *Diameter*: 13 cm.

Class 52

- 158. *Provenance*: circle, area D. *Diameter*: 10 cm.

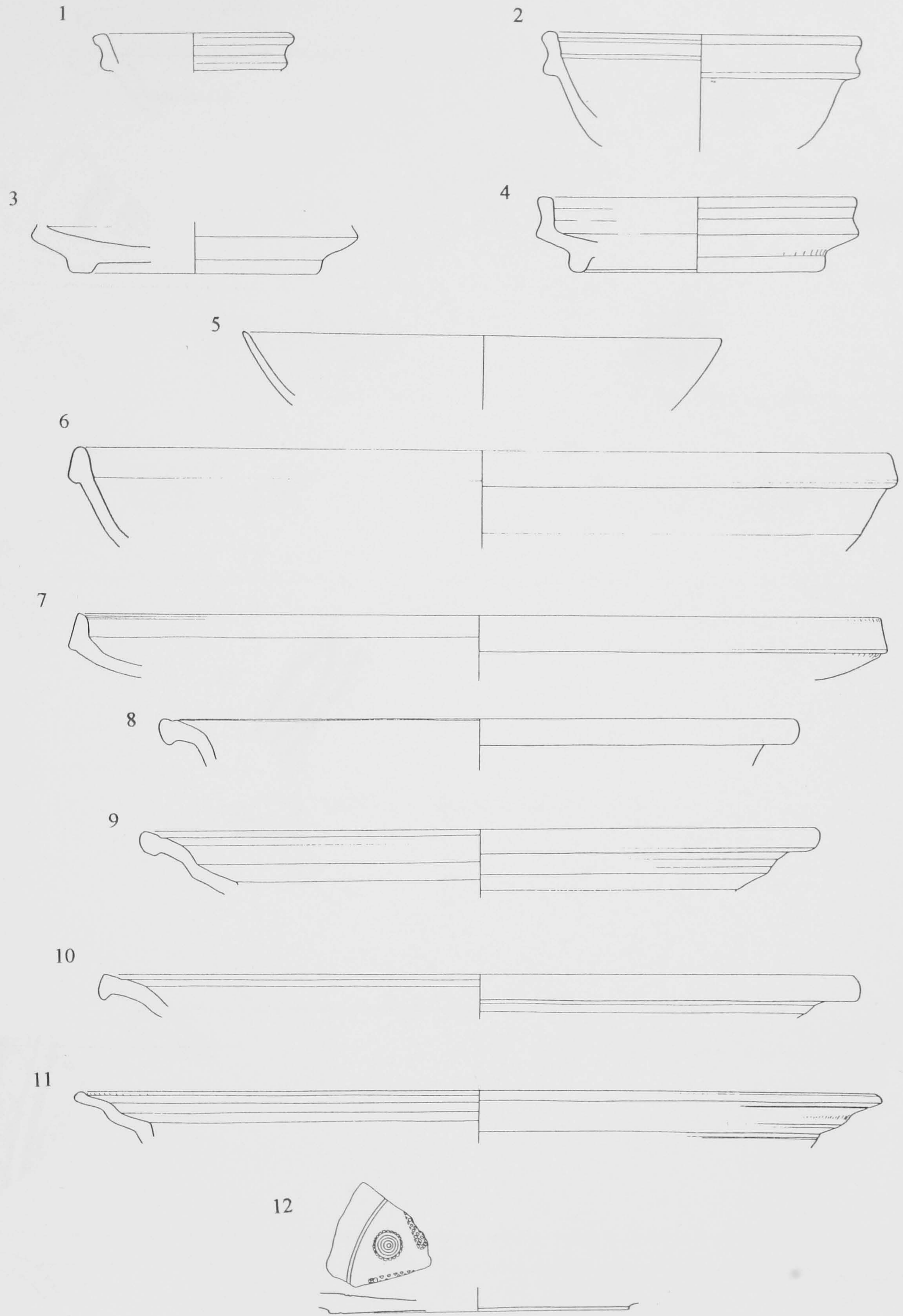

Pottery from surface collections on the main site at 1:3.

Fig. II.26 cont.

13

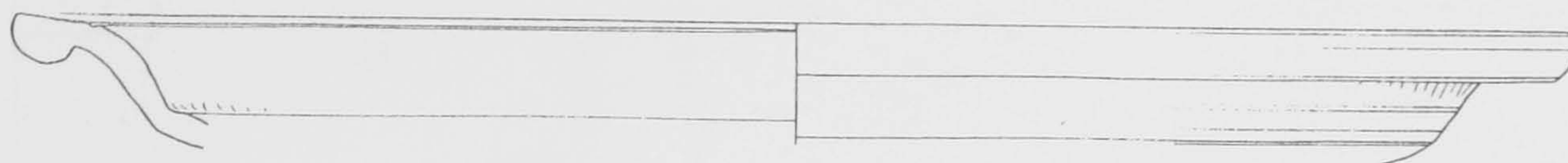

14



15

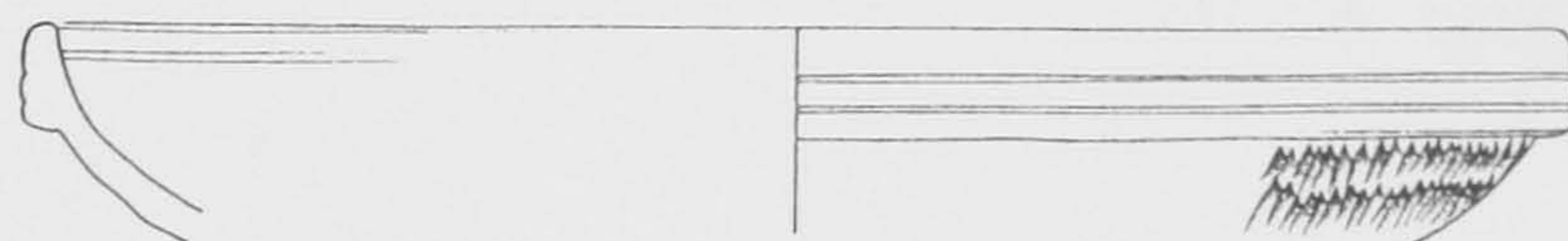

16

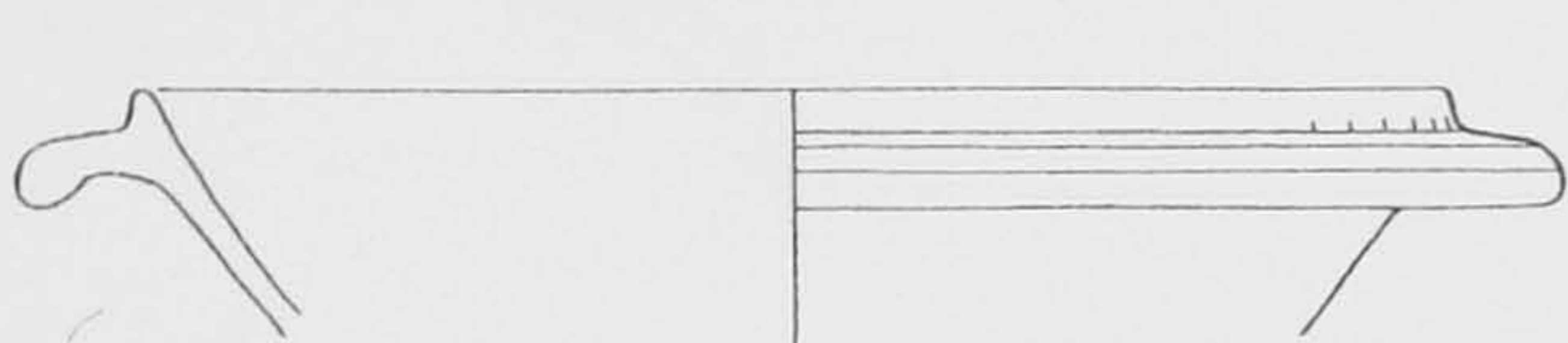

17

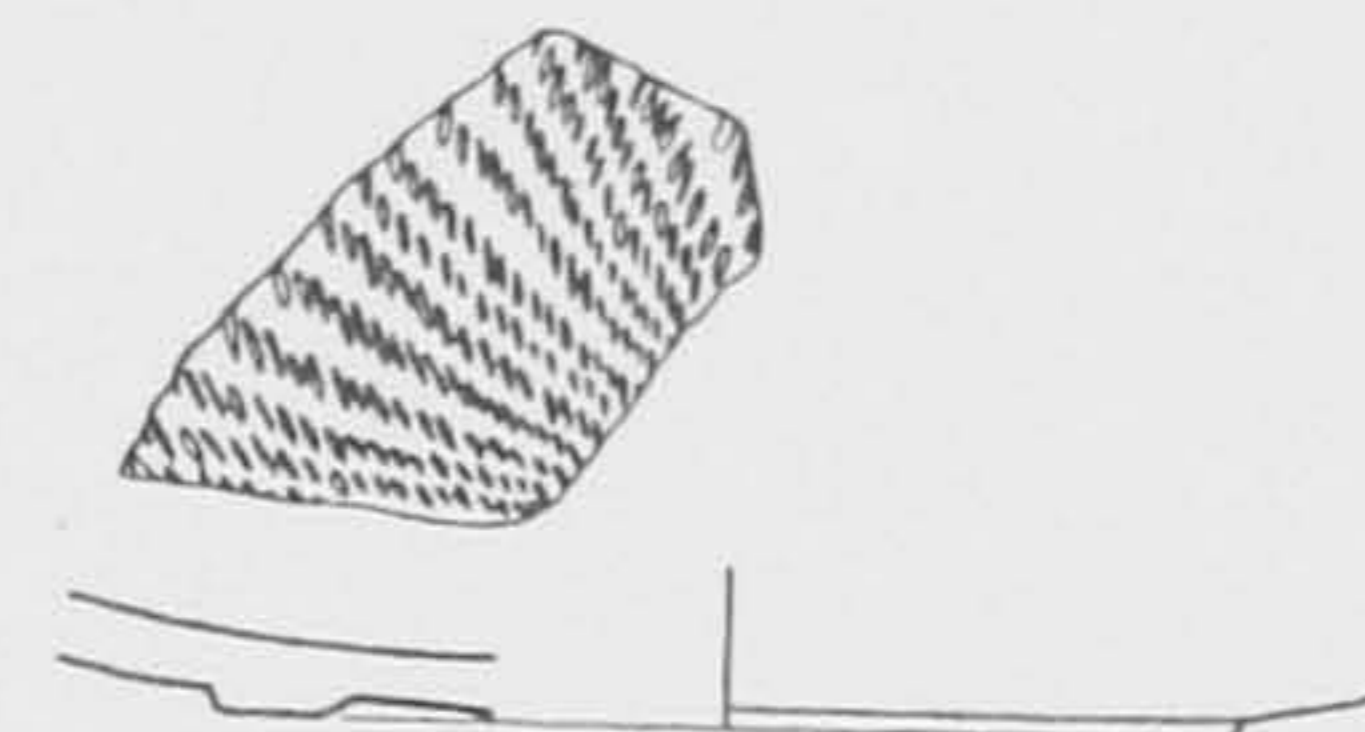

18

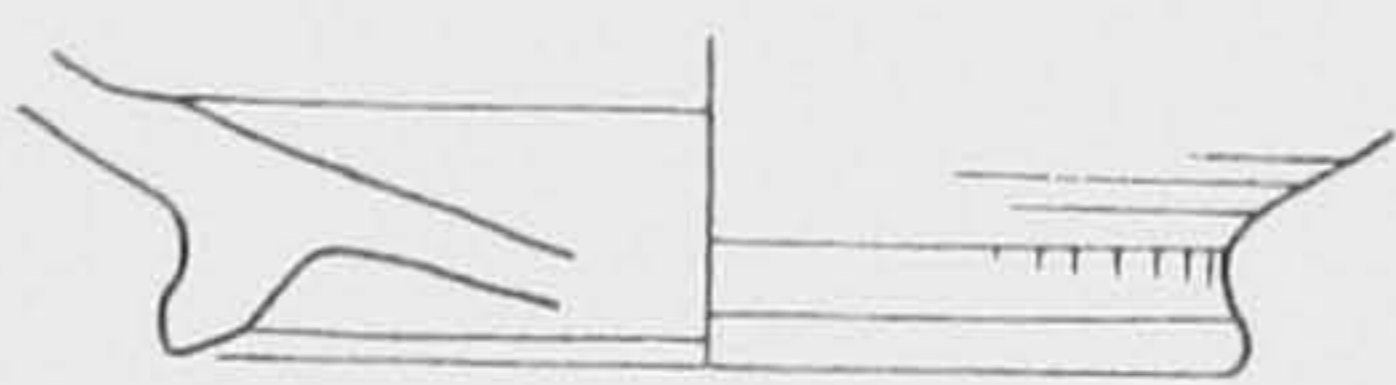

19

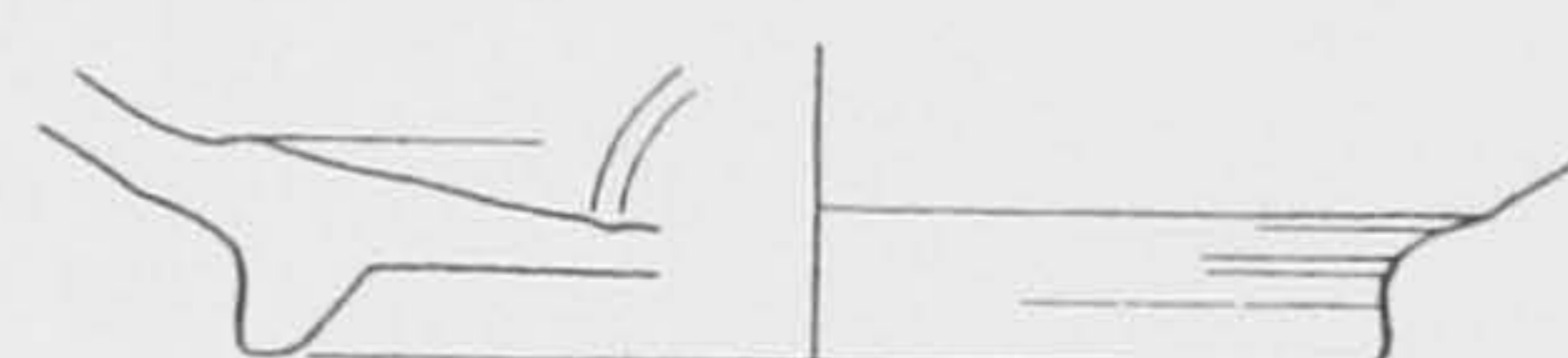

20

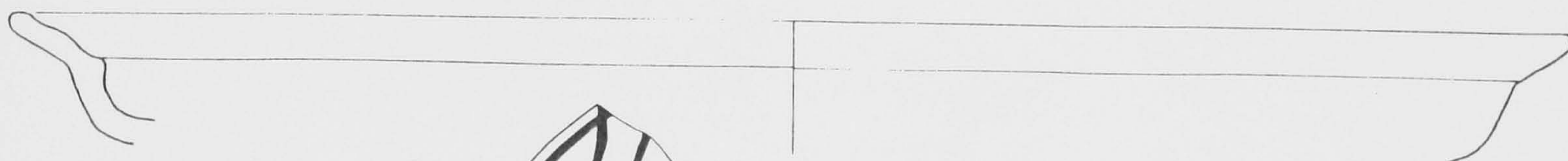

21

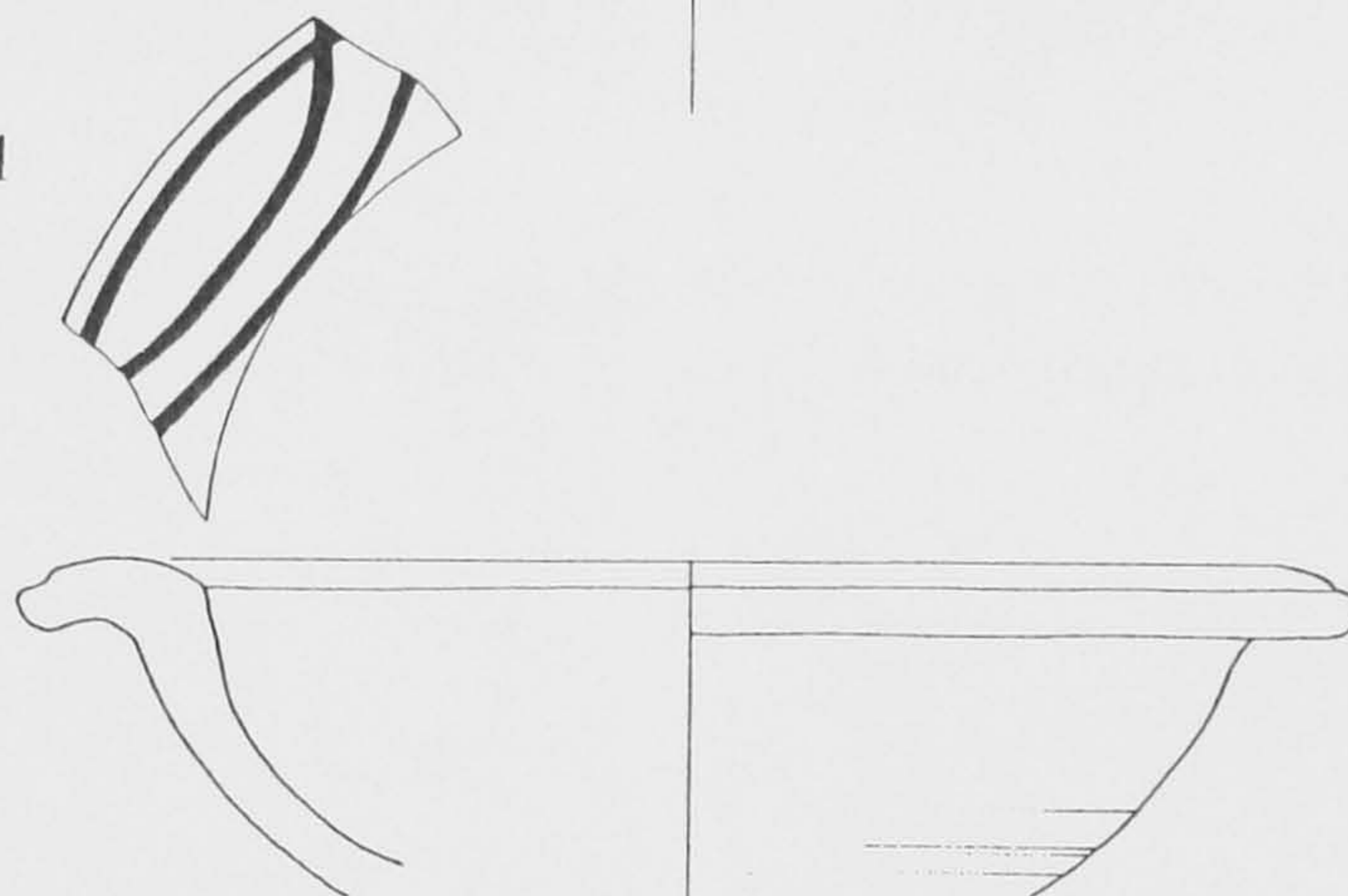

23

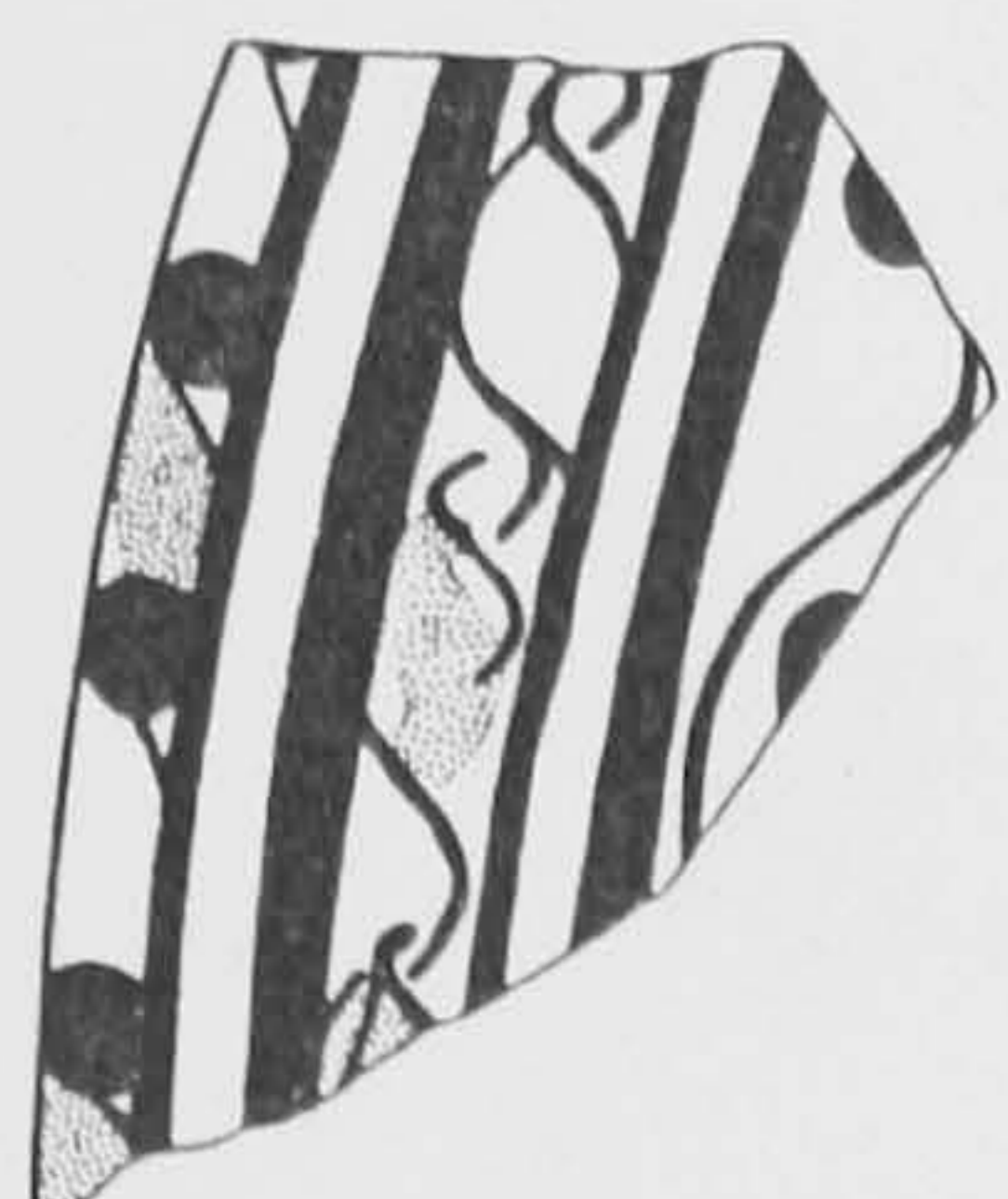

22

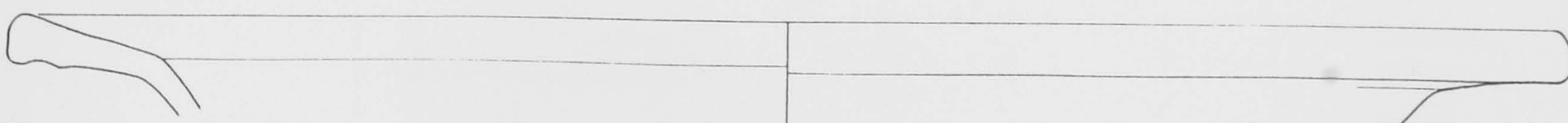

Pottery from surface collections on the main site at 1:3.

24

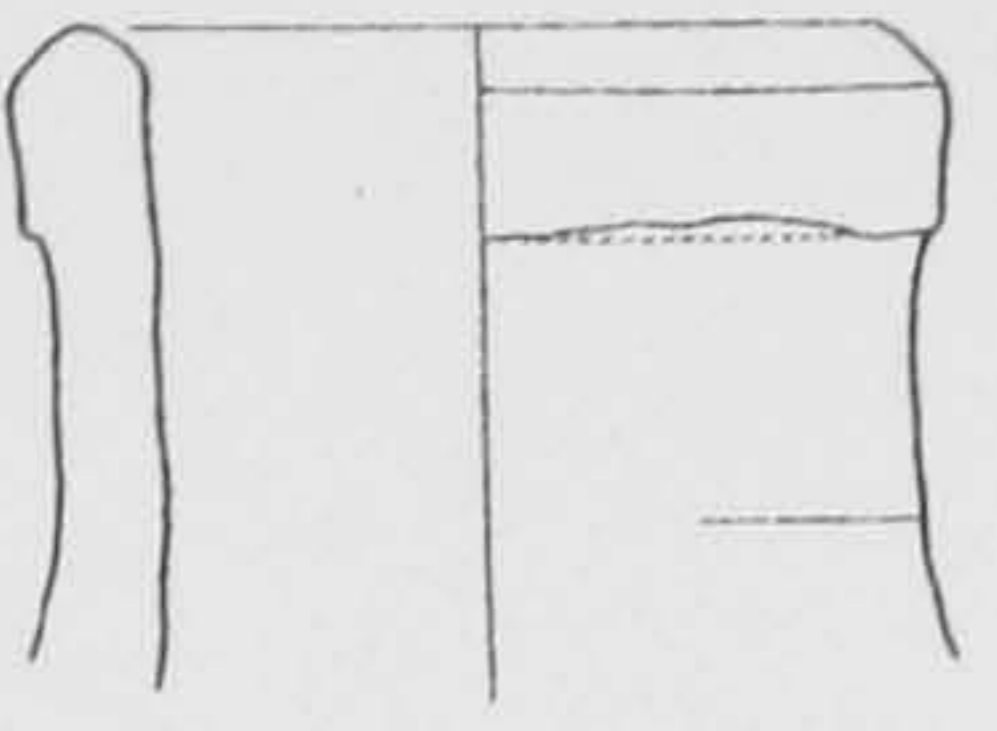

25

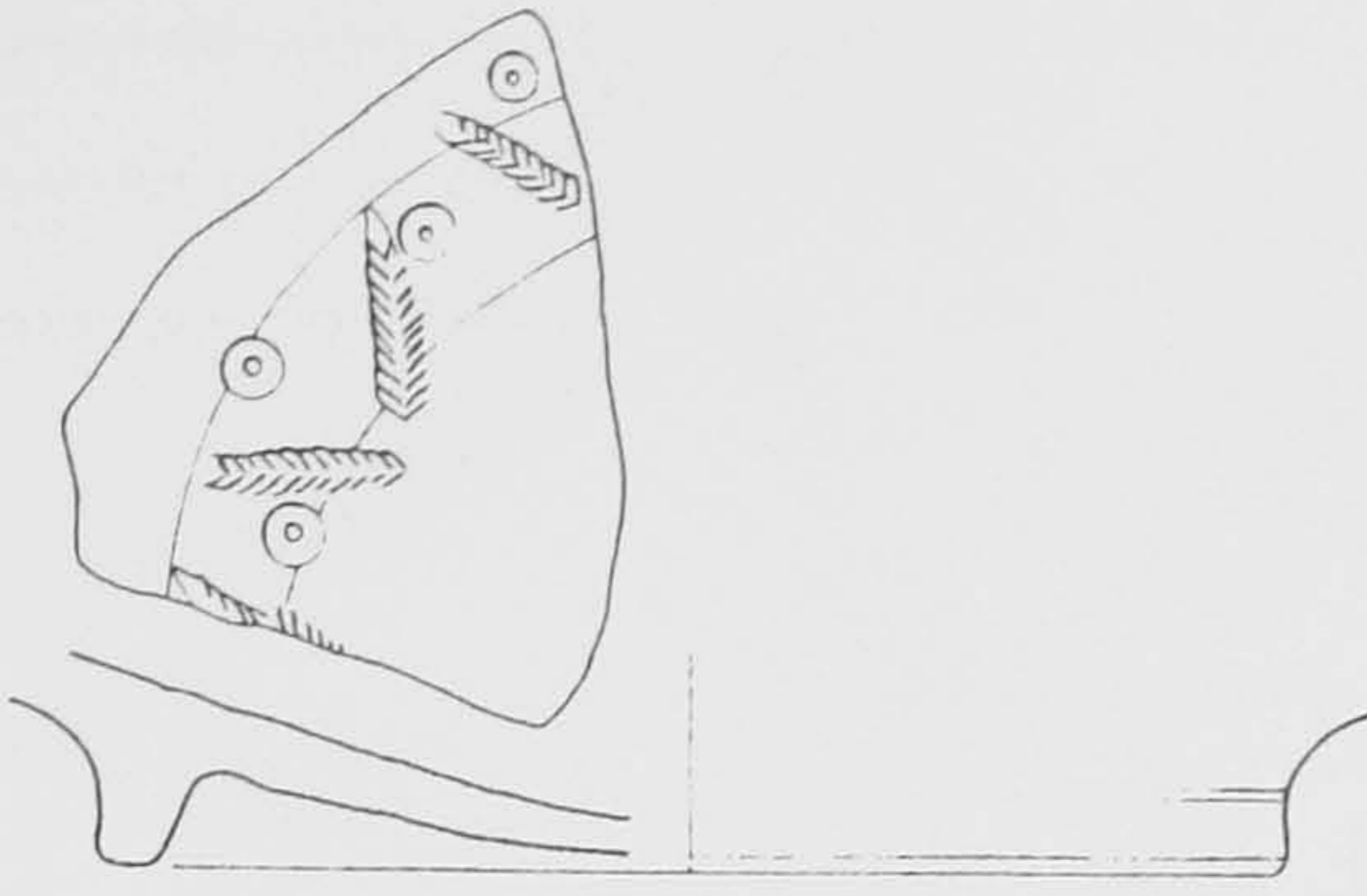

26

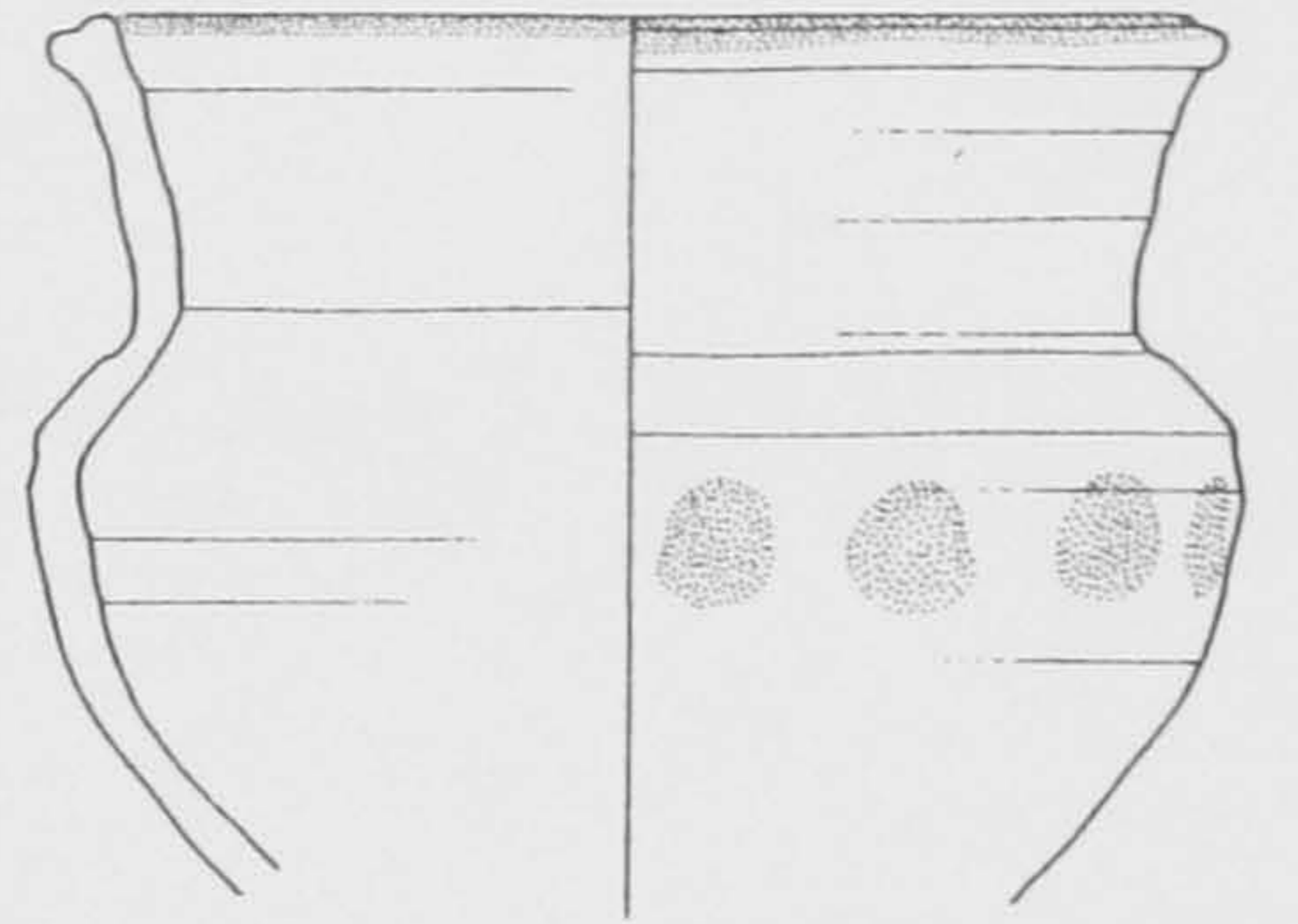

27

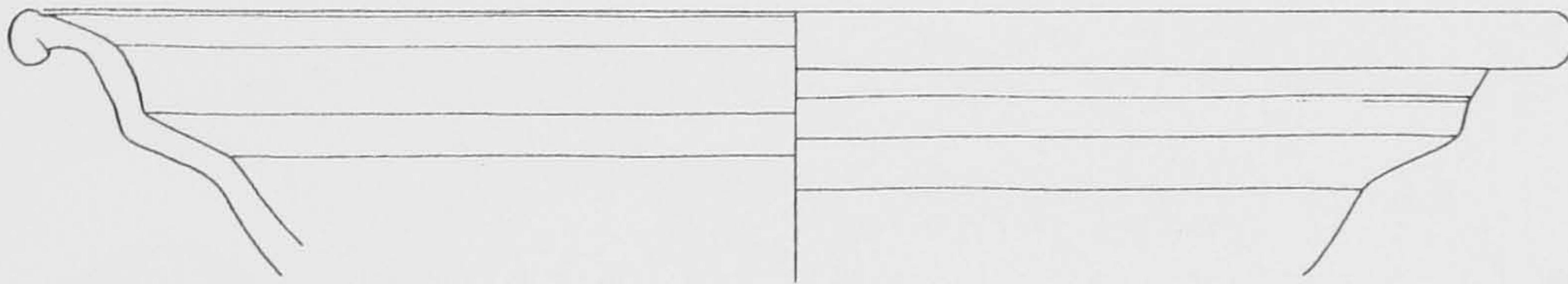

28

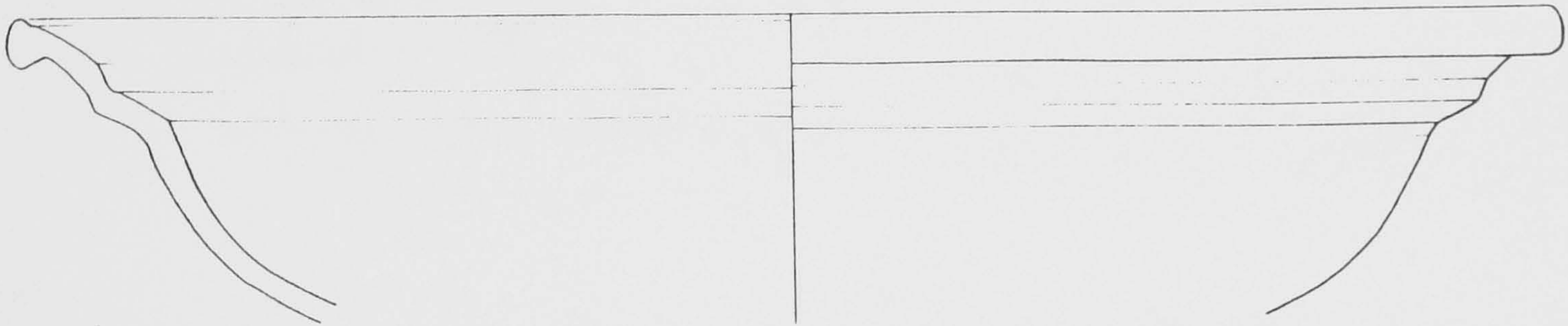

29



30



31



32

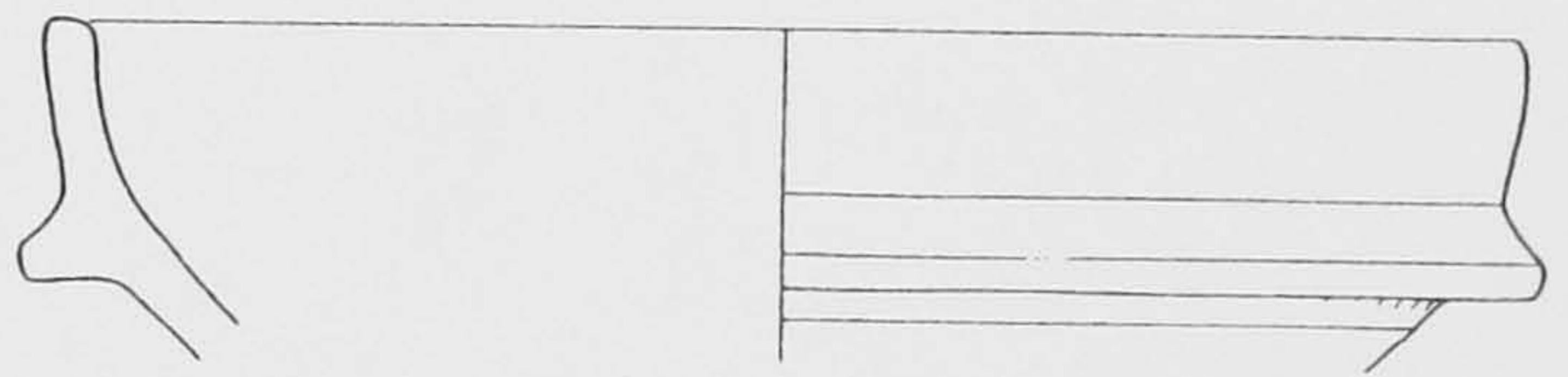

33

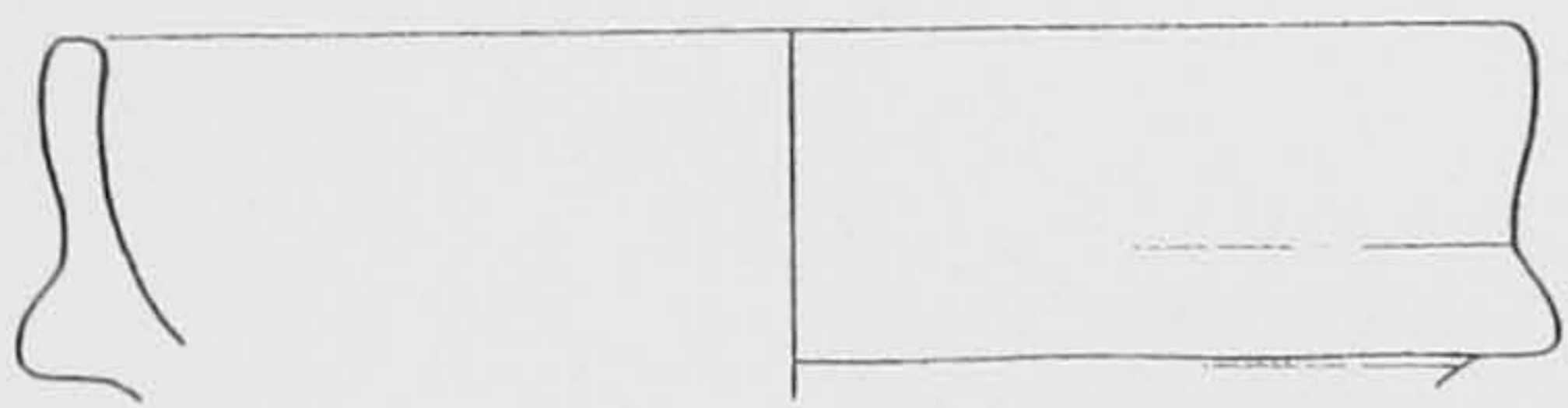

34

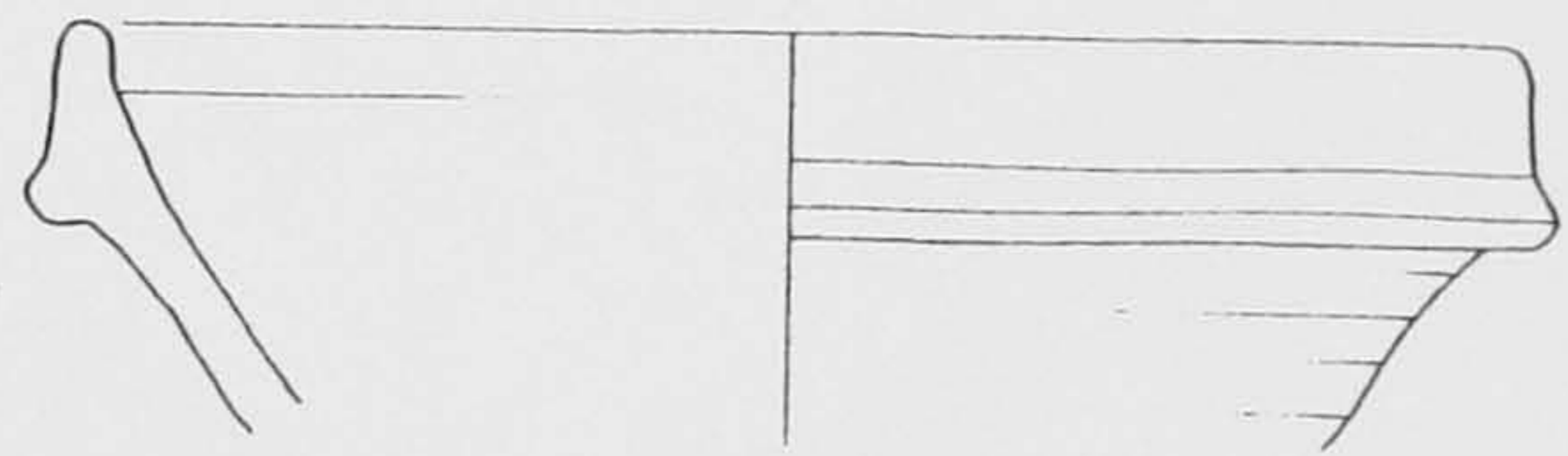

35



36

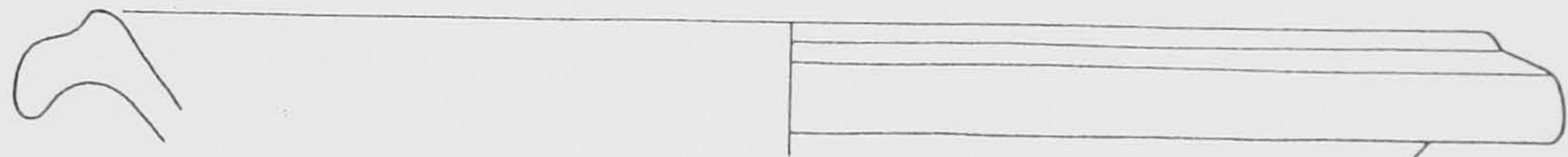

37



38

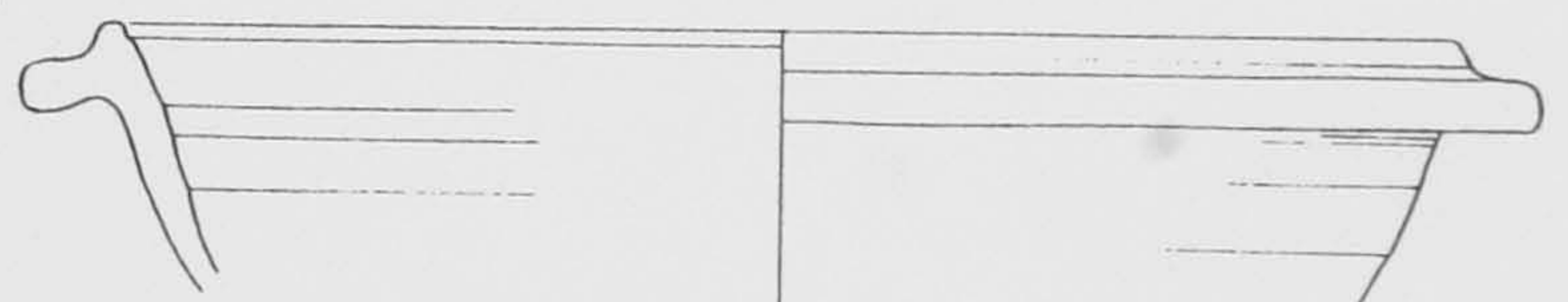

Pottery from surface collections on the main site at 1:3.

39

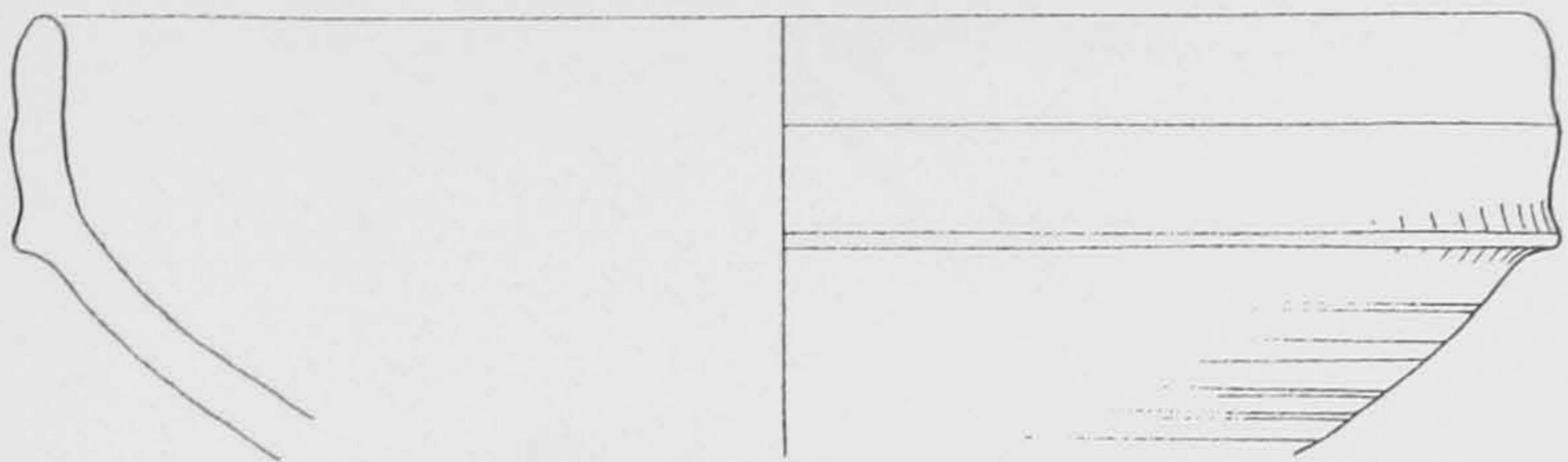

40

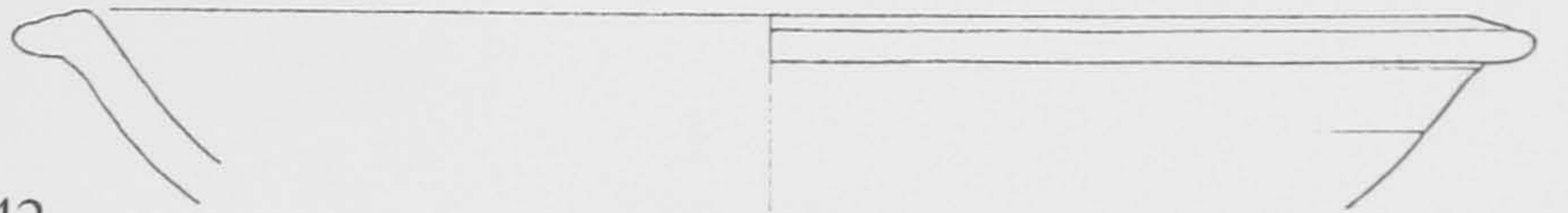

41



42



43

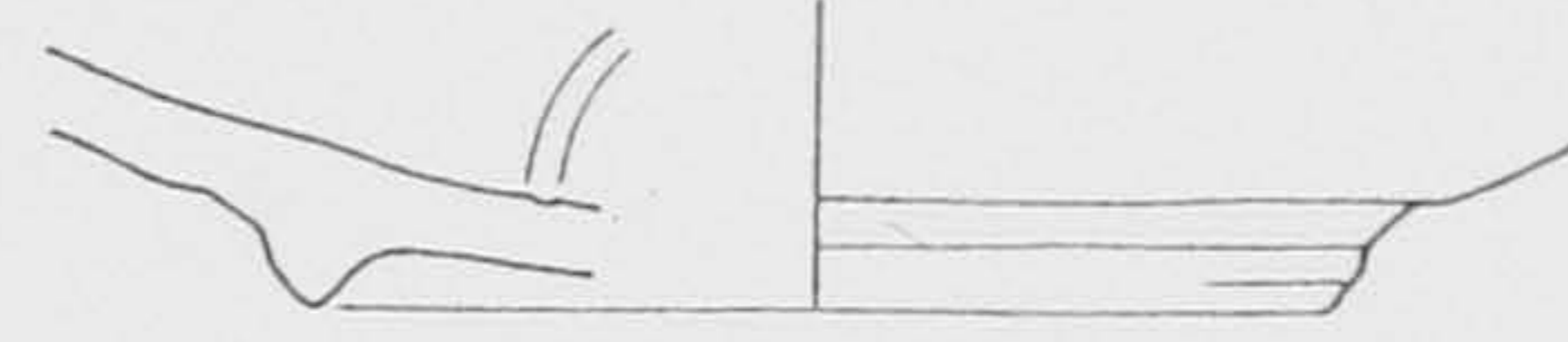

44

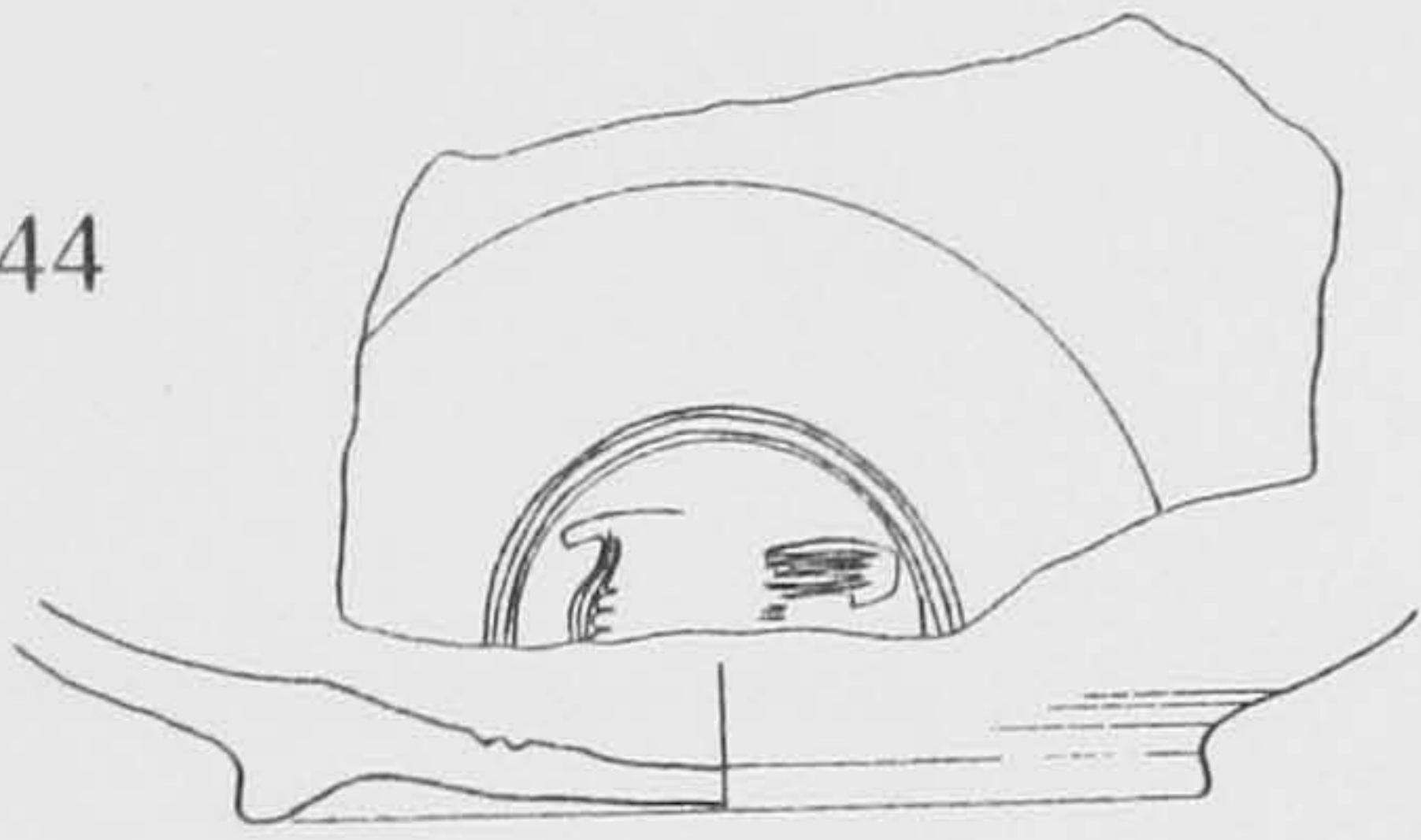

45

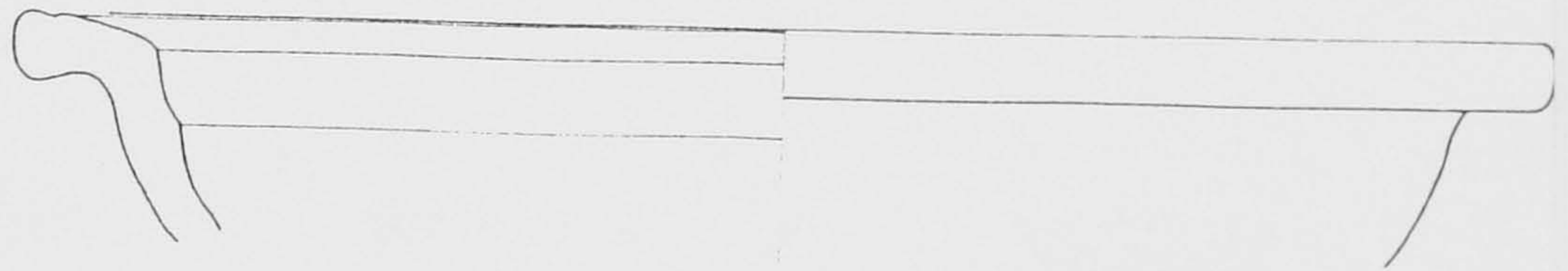

46

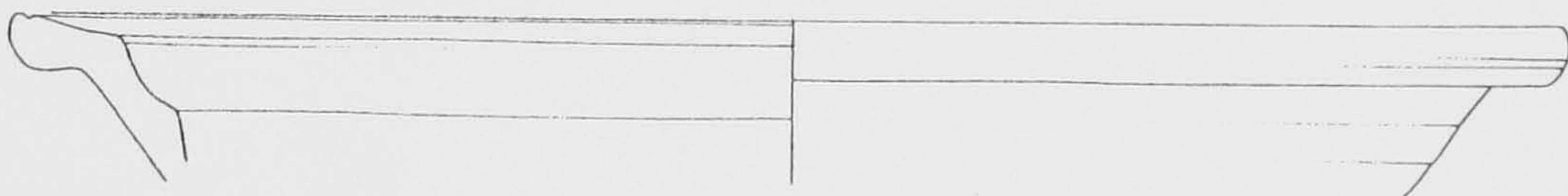

47

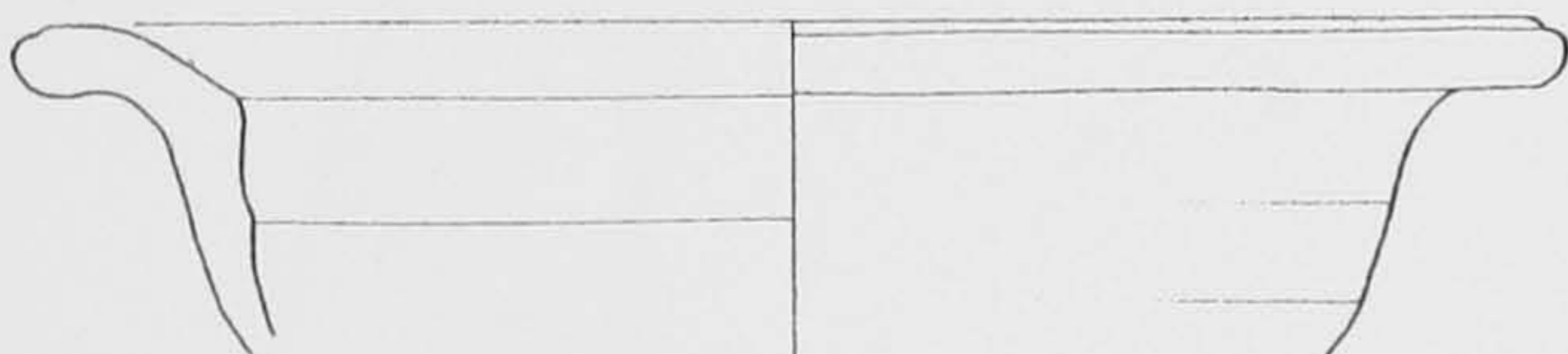

48

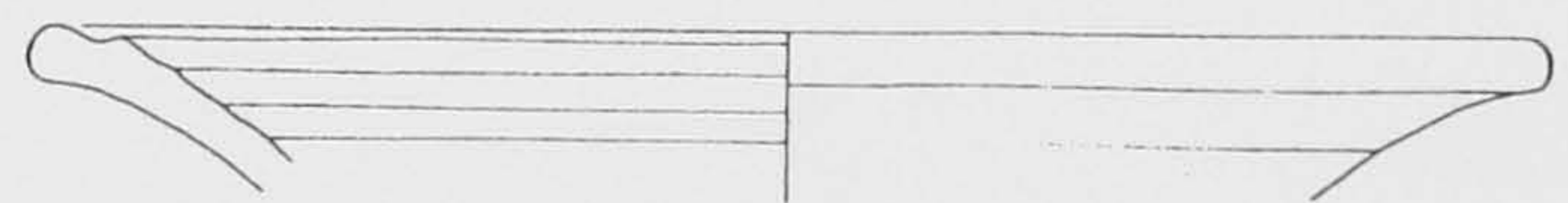

49

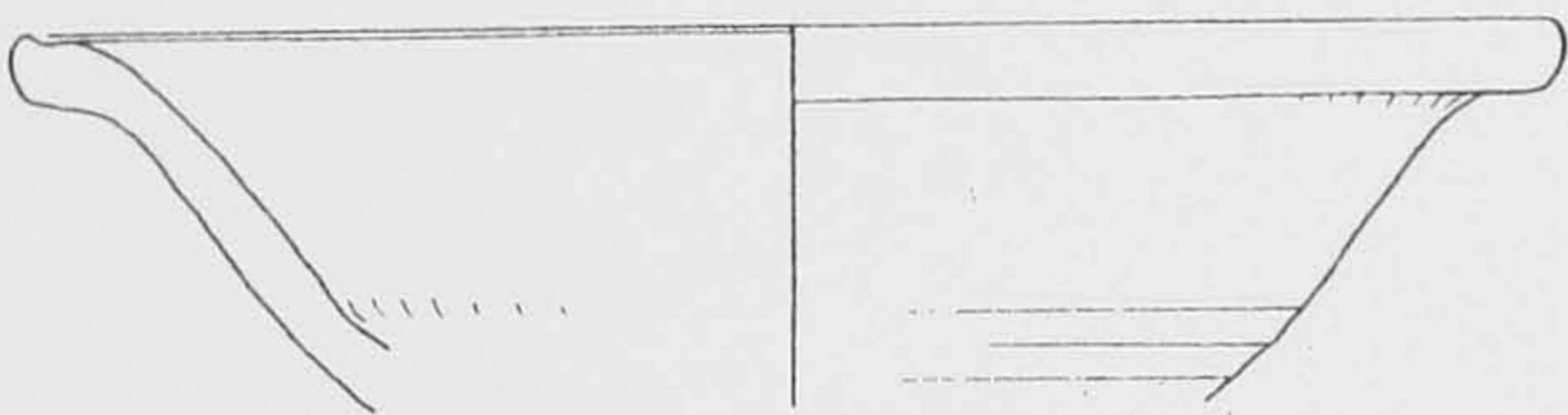

50

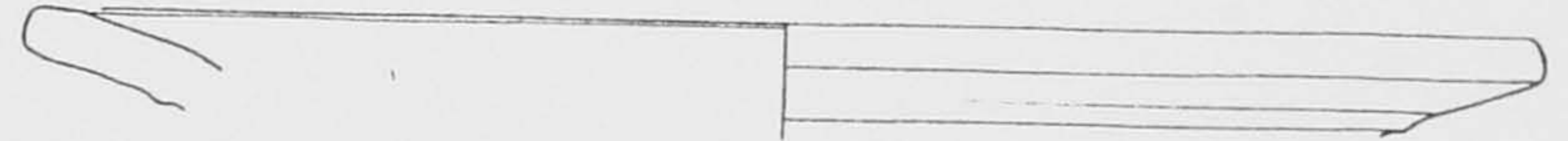

51

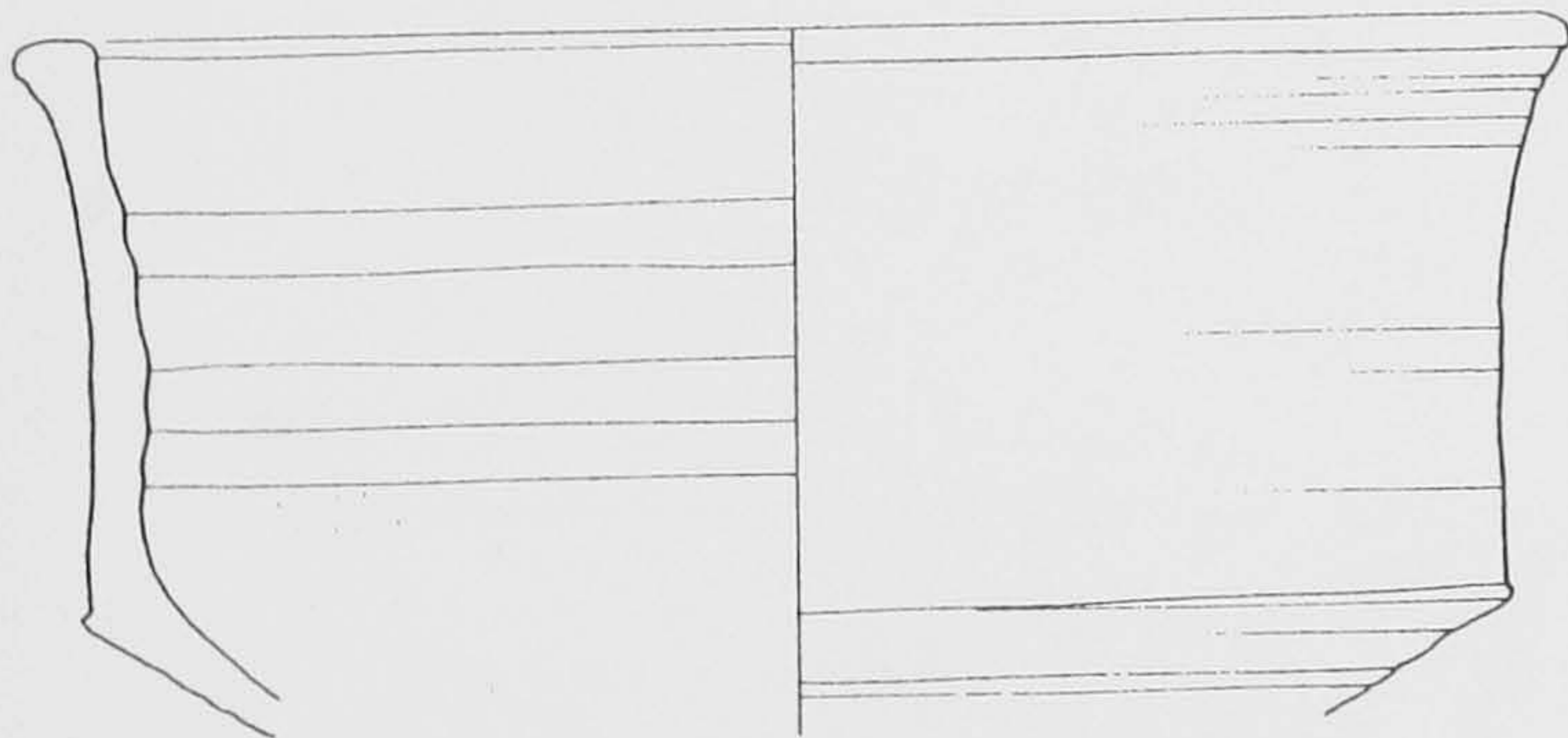

52

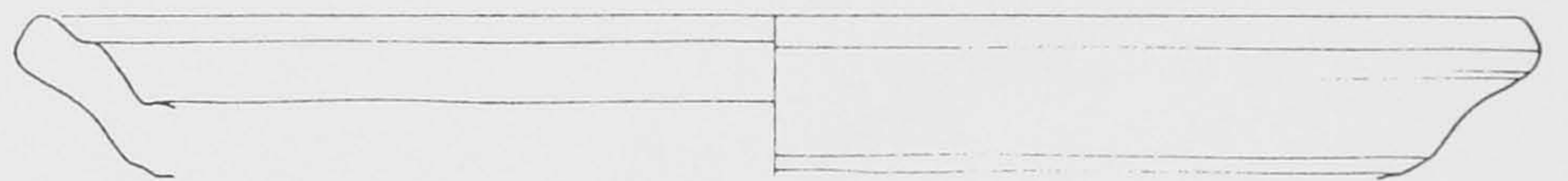

53

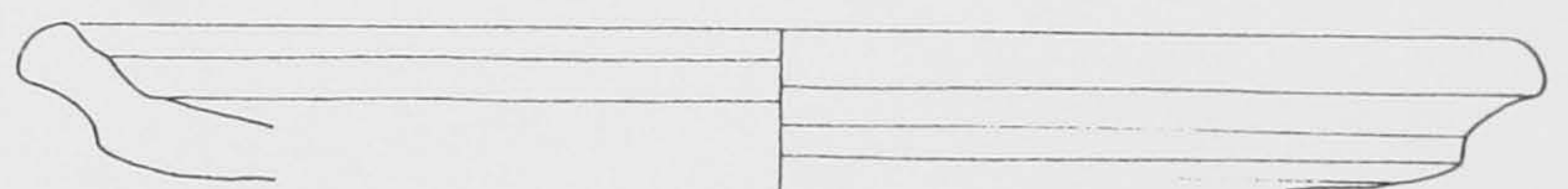

54



55

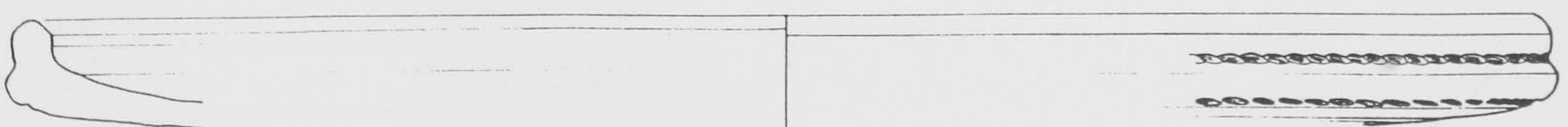

Pottery from surface collections on the main site at 1:3.

56

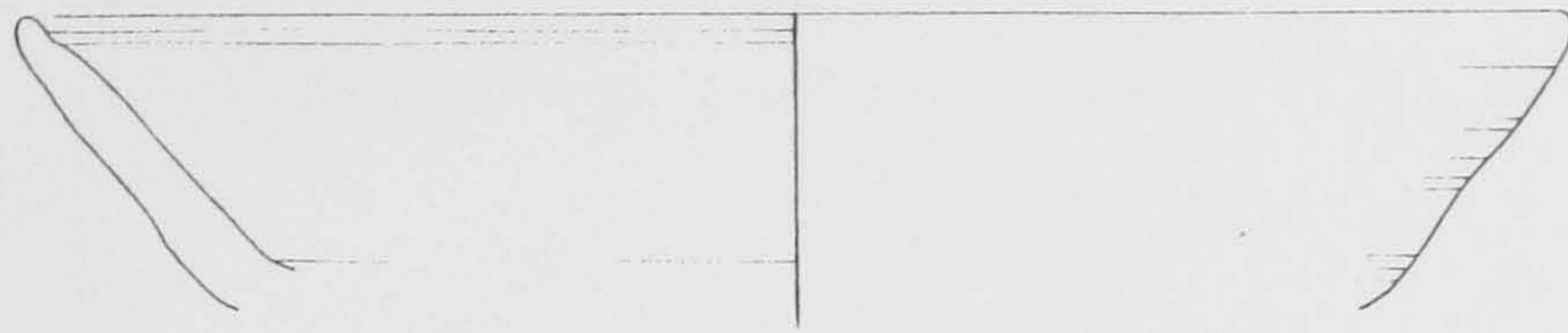

57

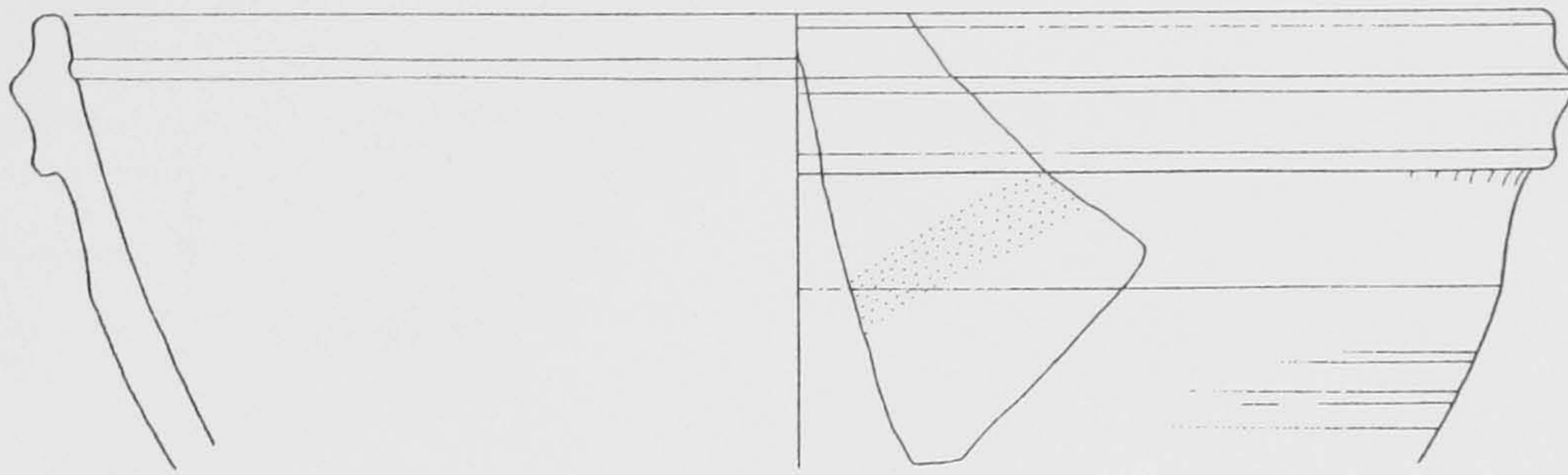

58

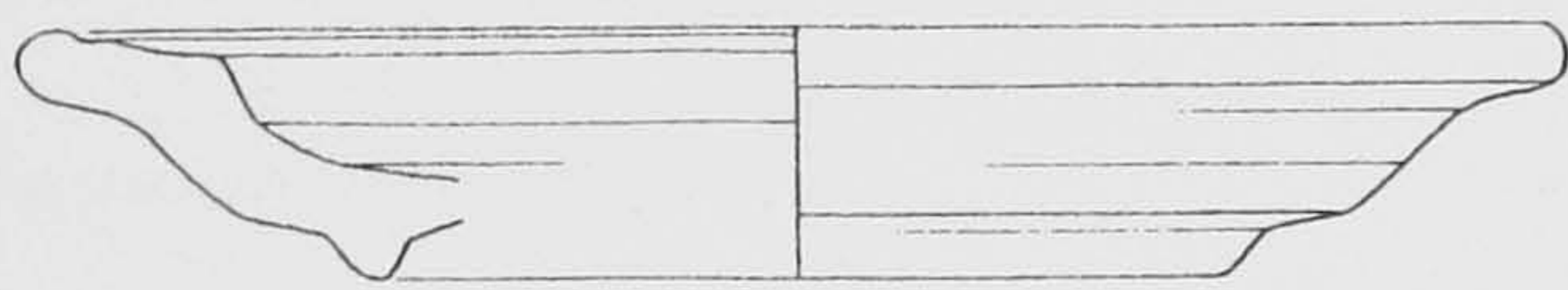

59

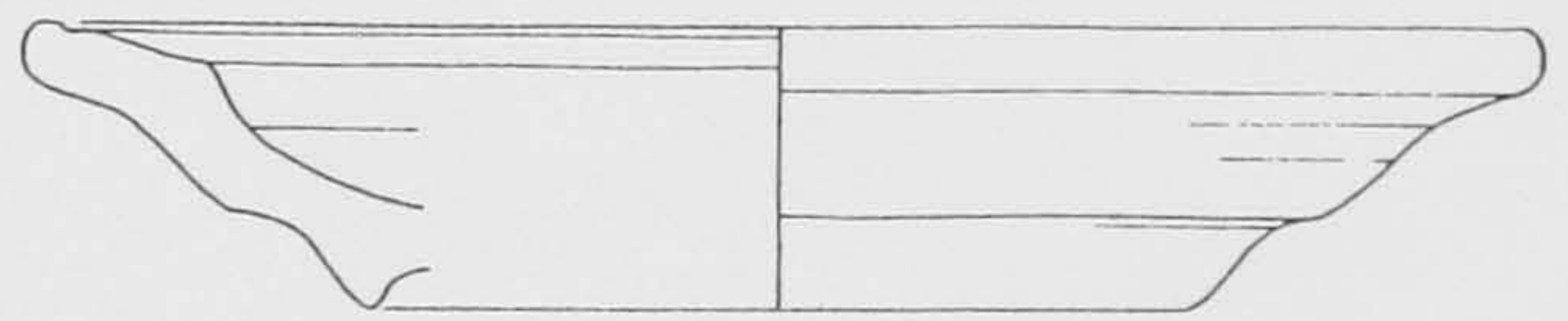

61

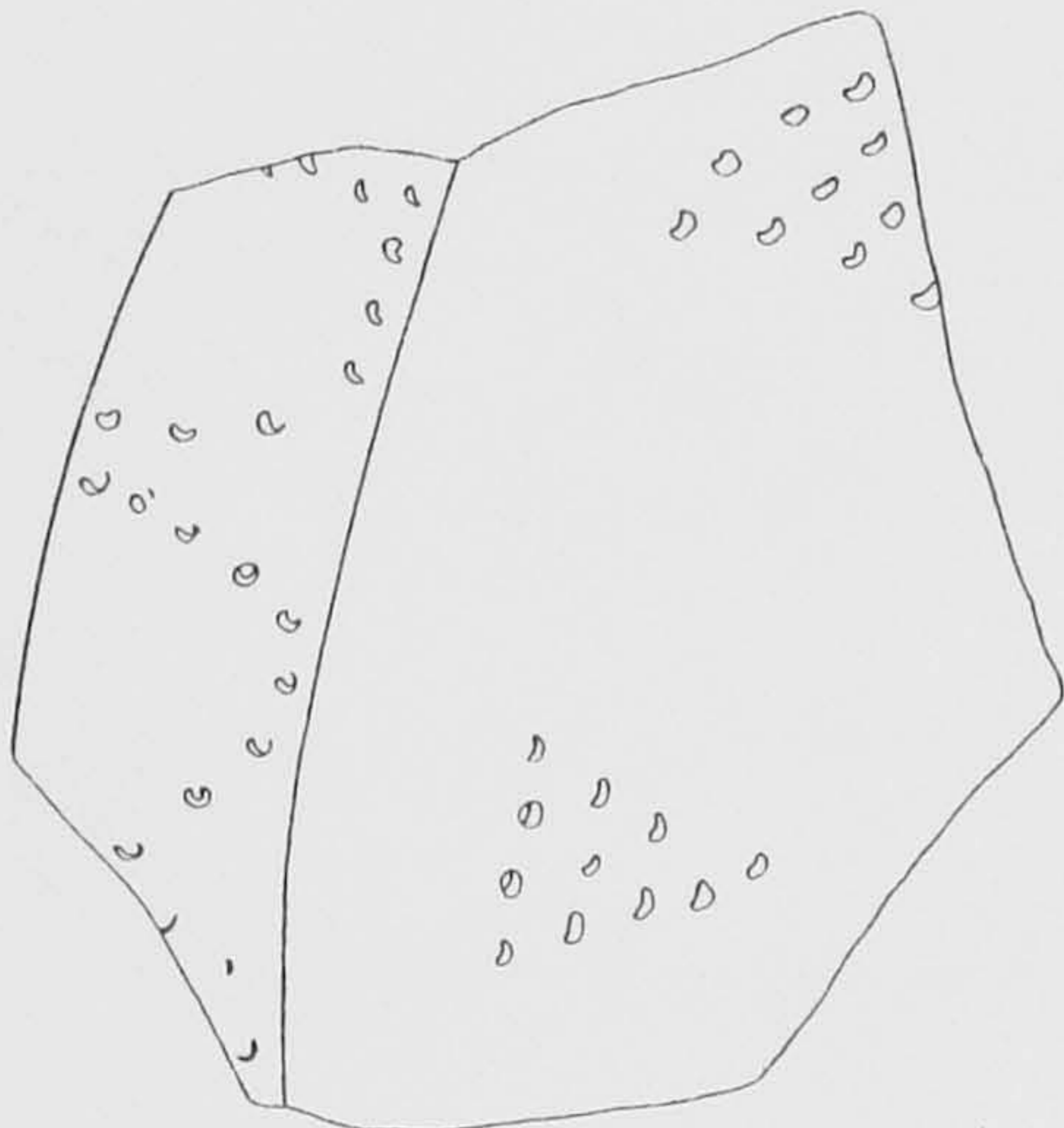

60

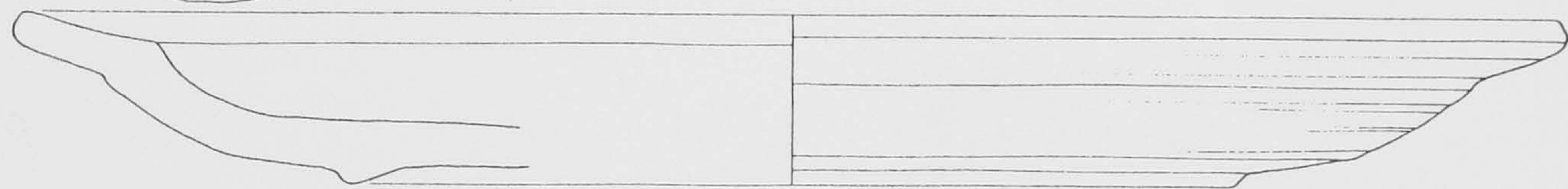
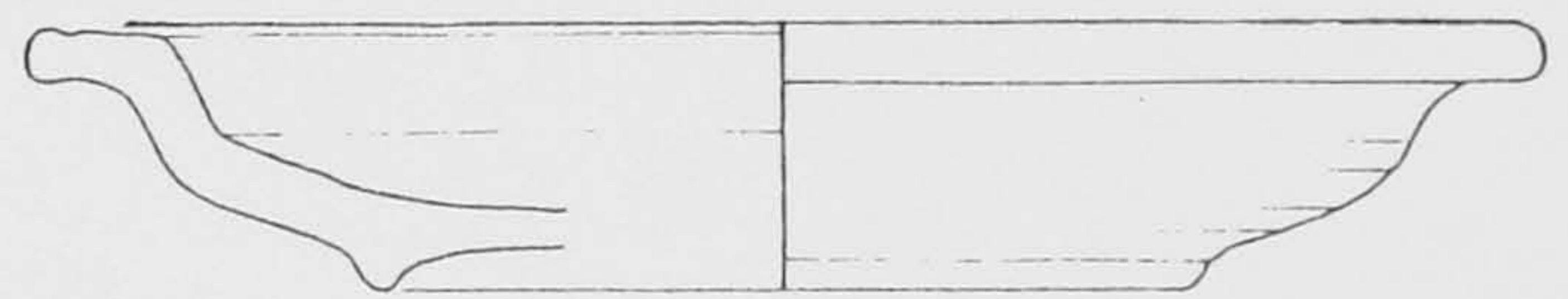

62

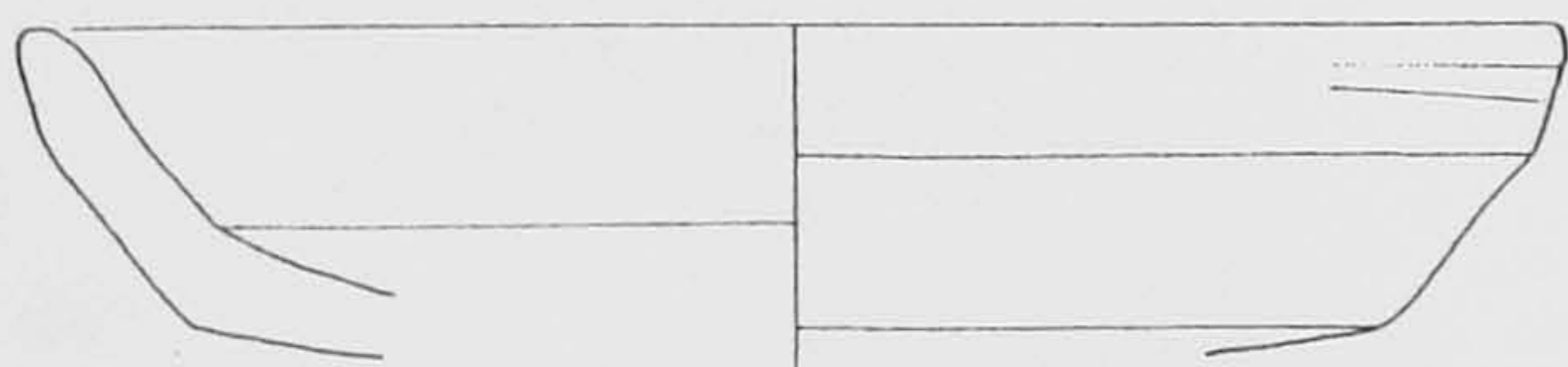

63



64

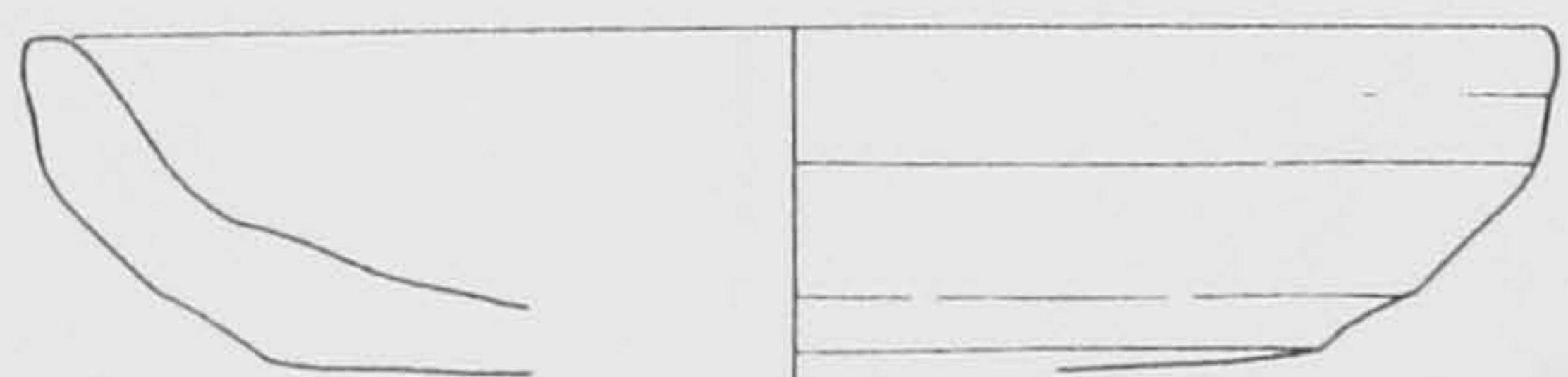

65



66

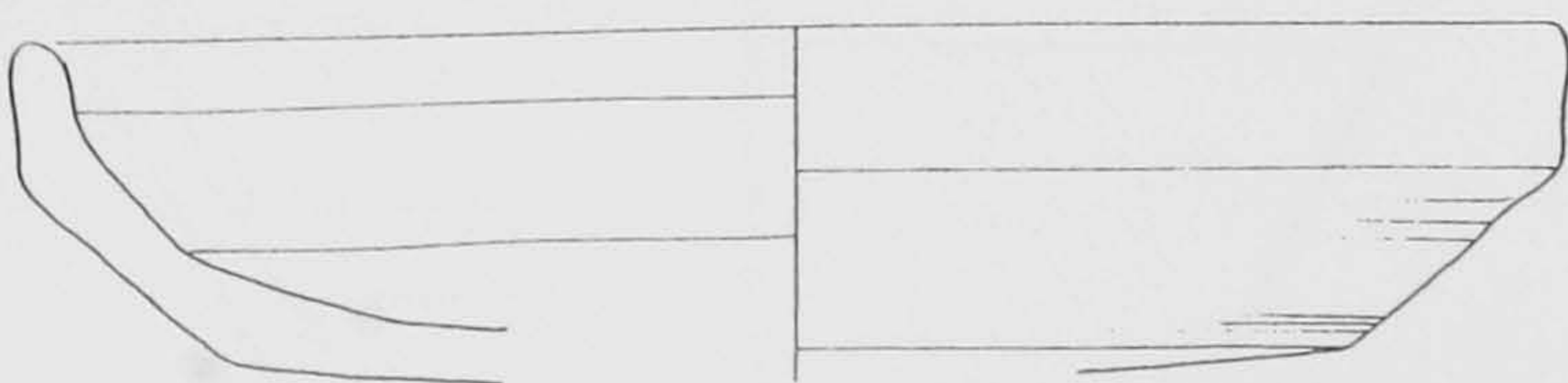

67

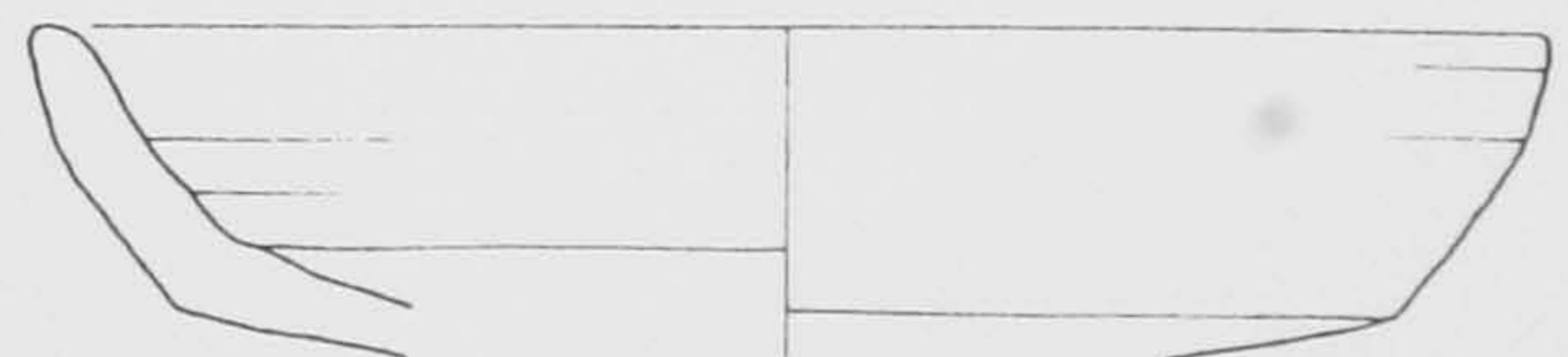

Pottery from surface collections on the main site at 1:3.

68



69

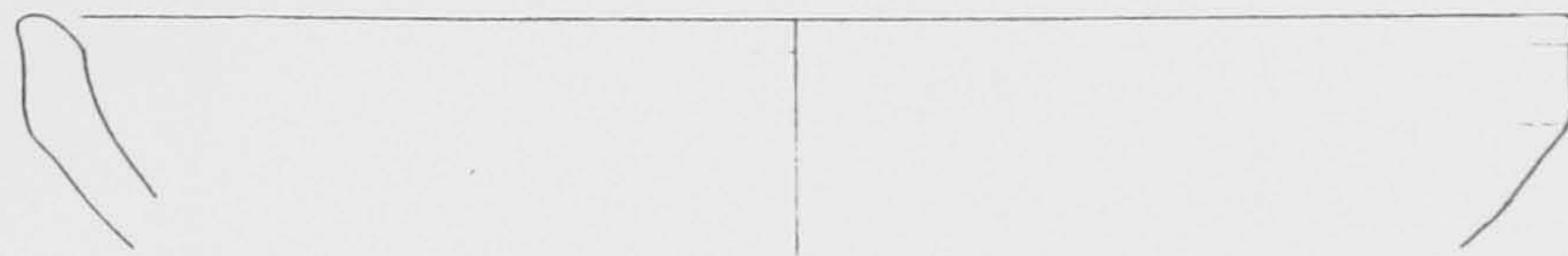

70

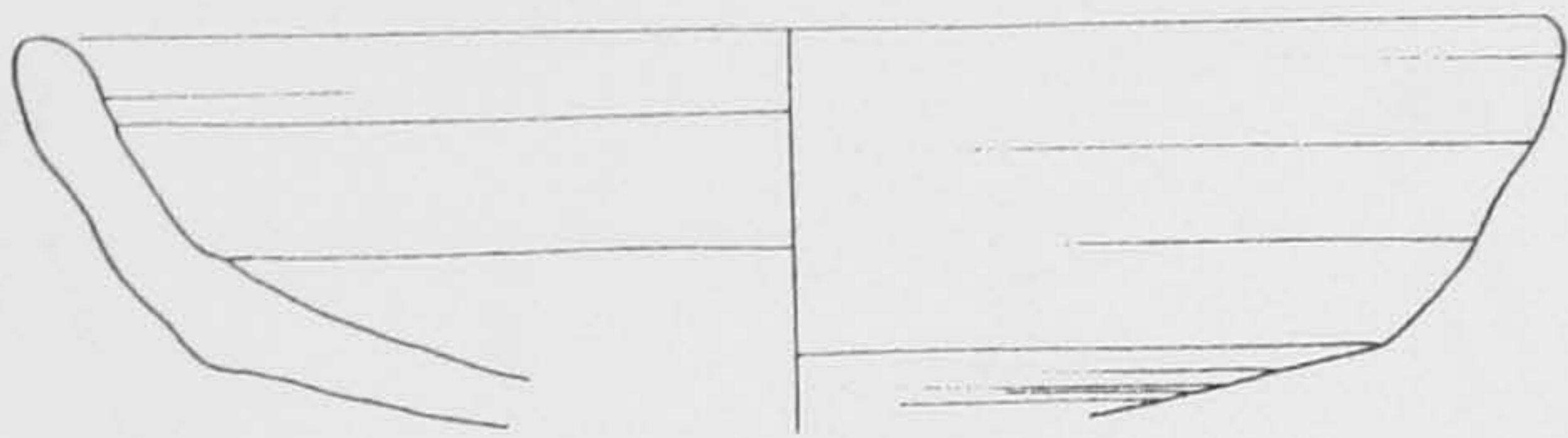

71

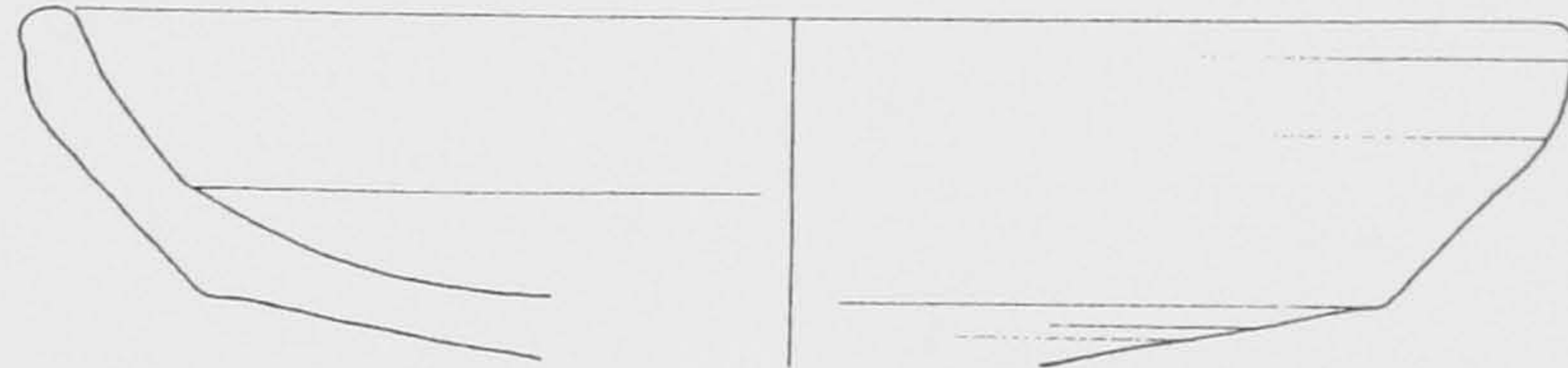

72

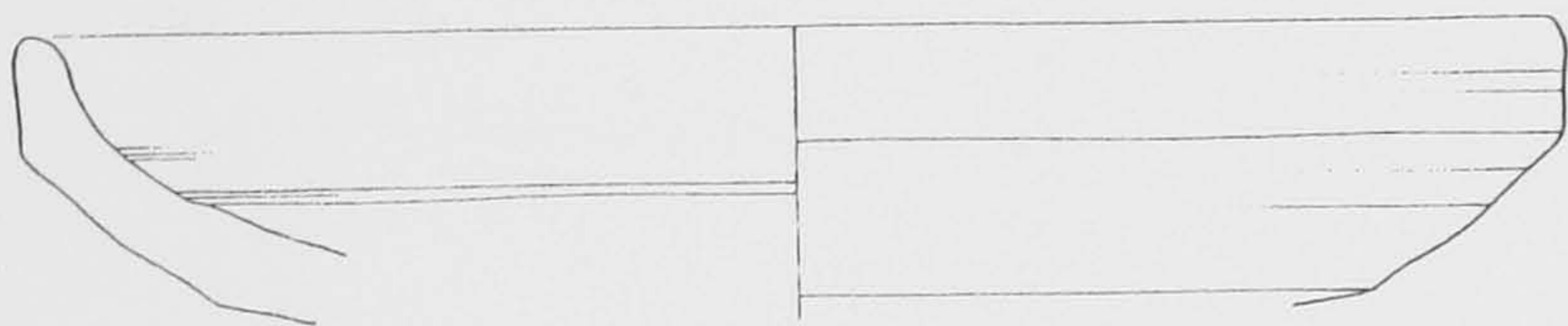

73

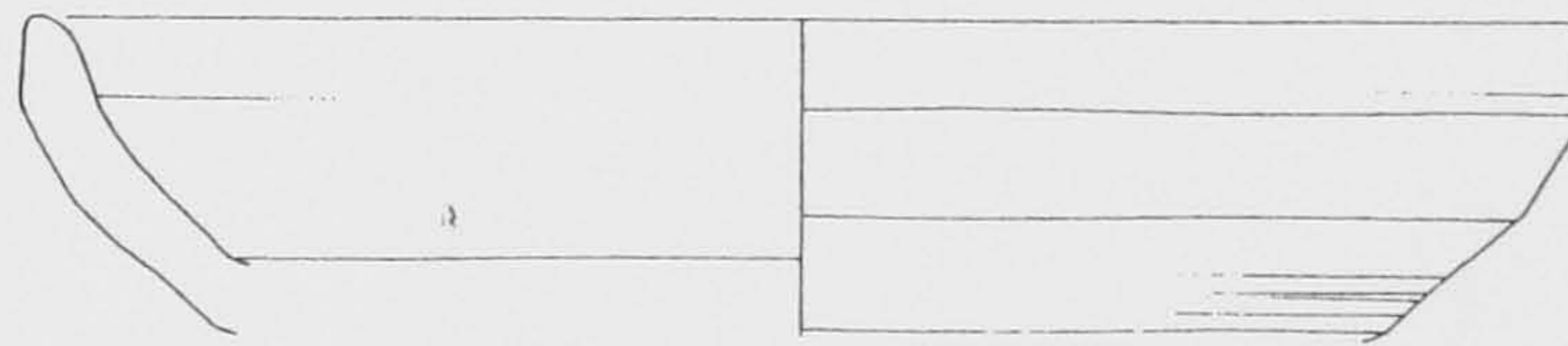

74

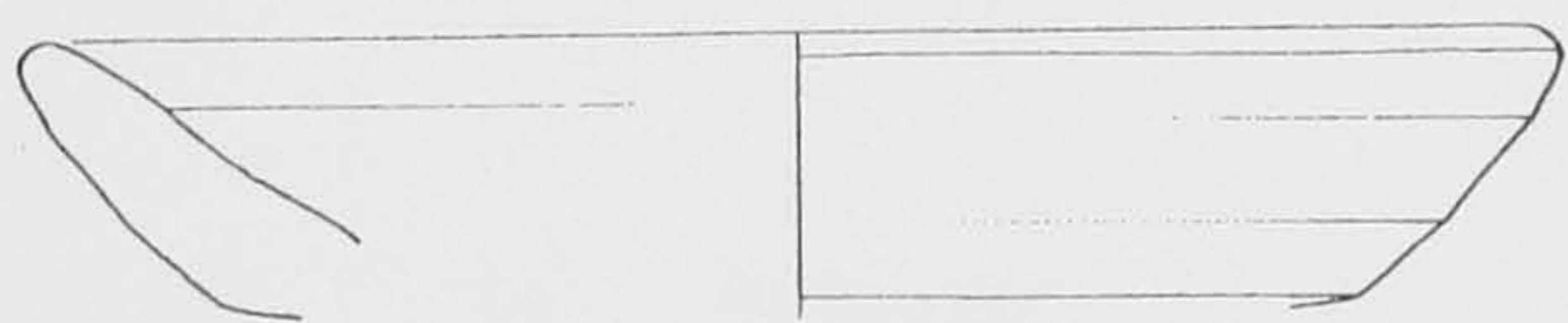

75



76



77

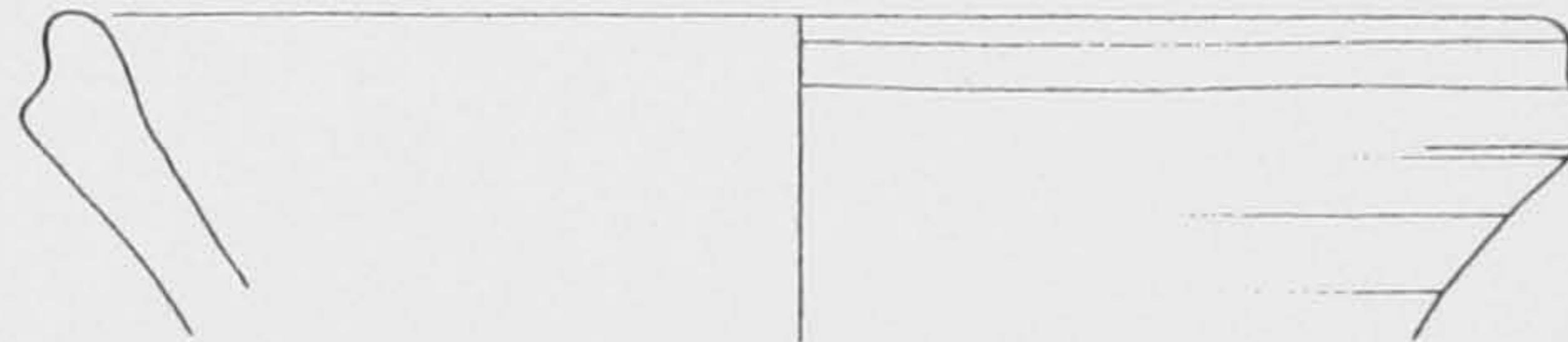

78

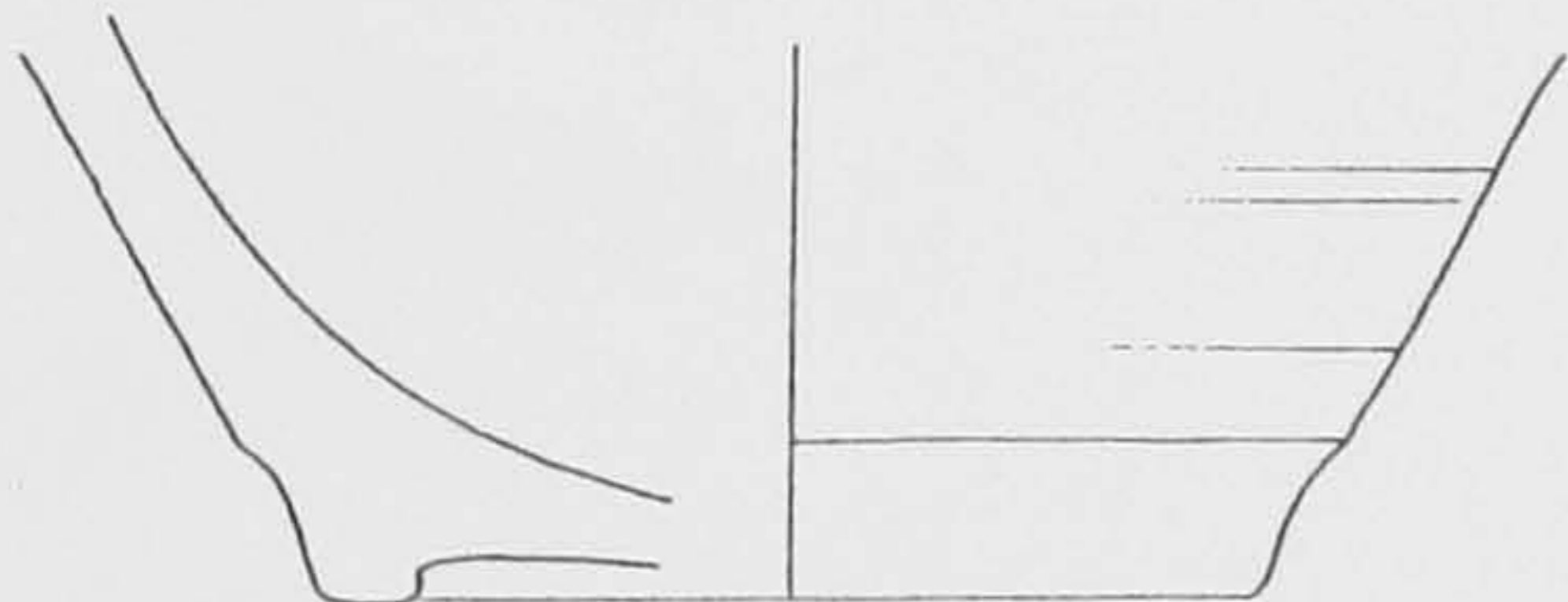

79

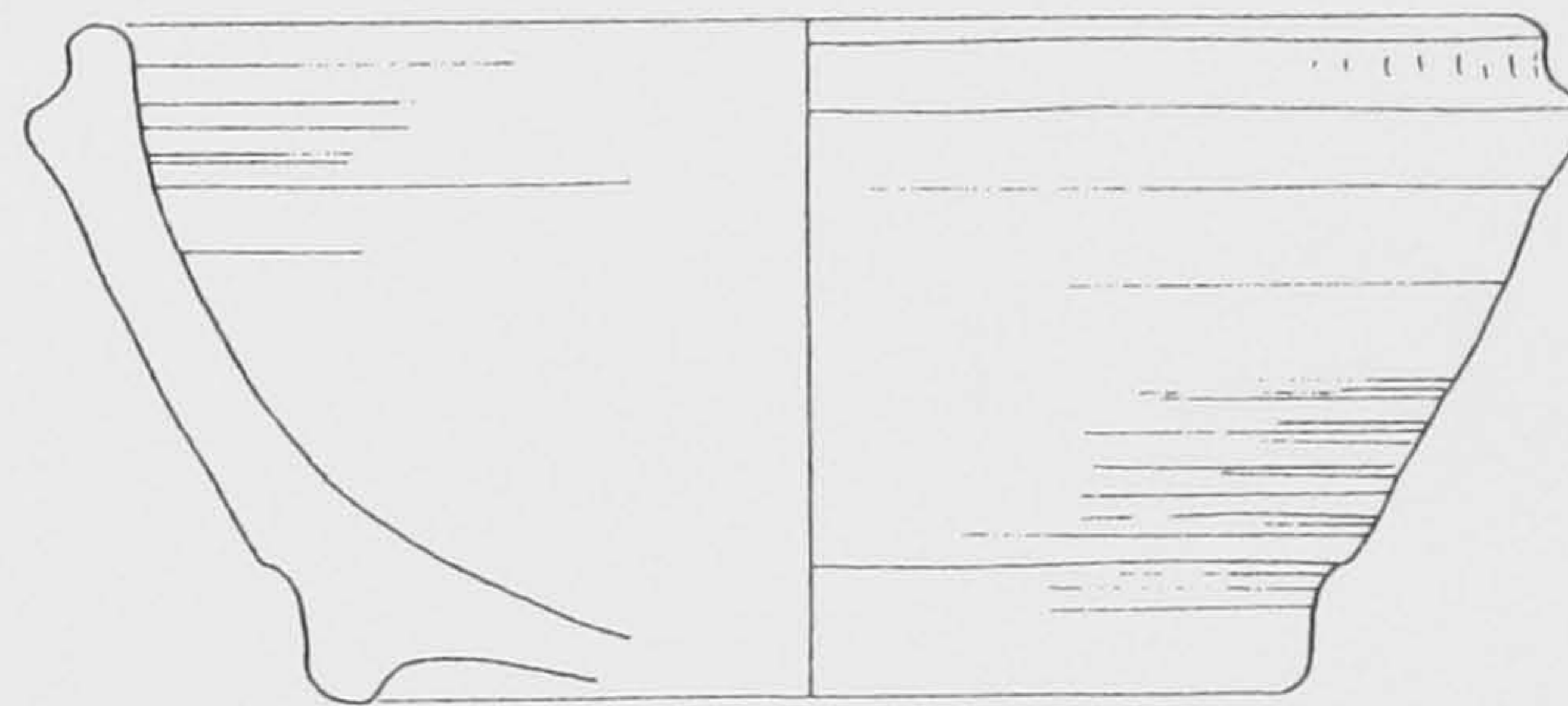

80

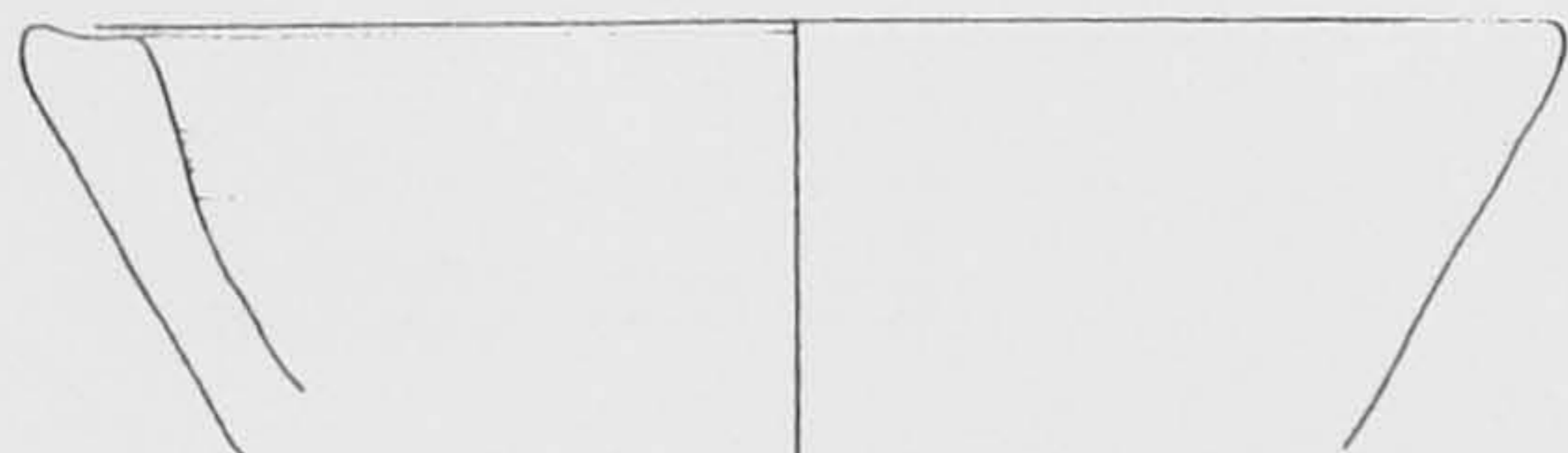

81



82



83



Pottery from surface collections on the main site at 1:3.

Fig. II.26 cont.

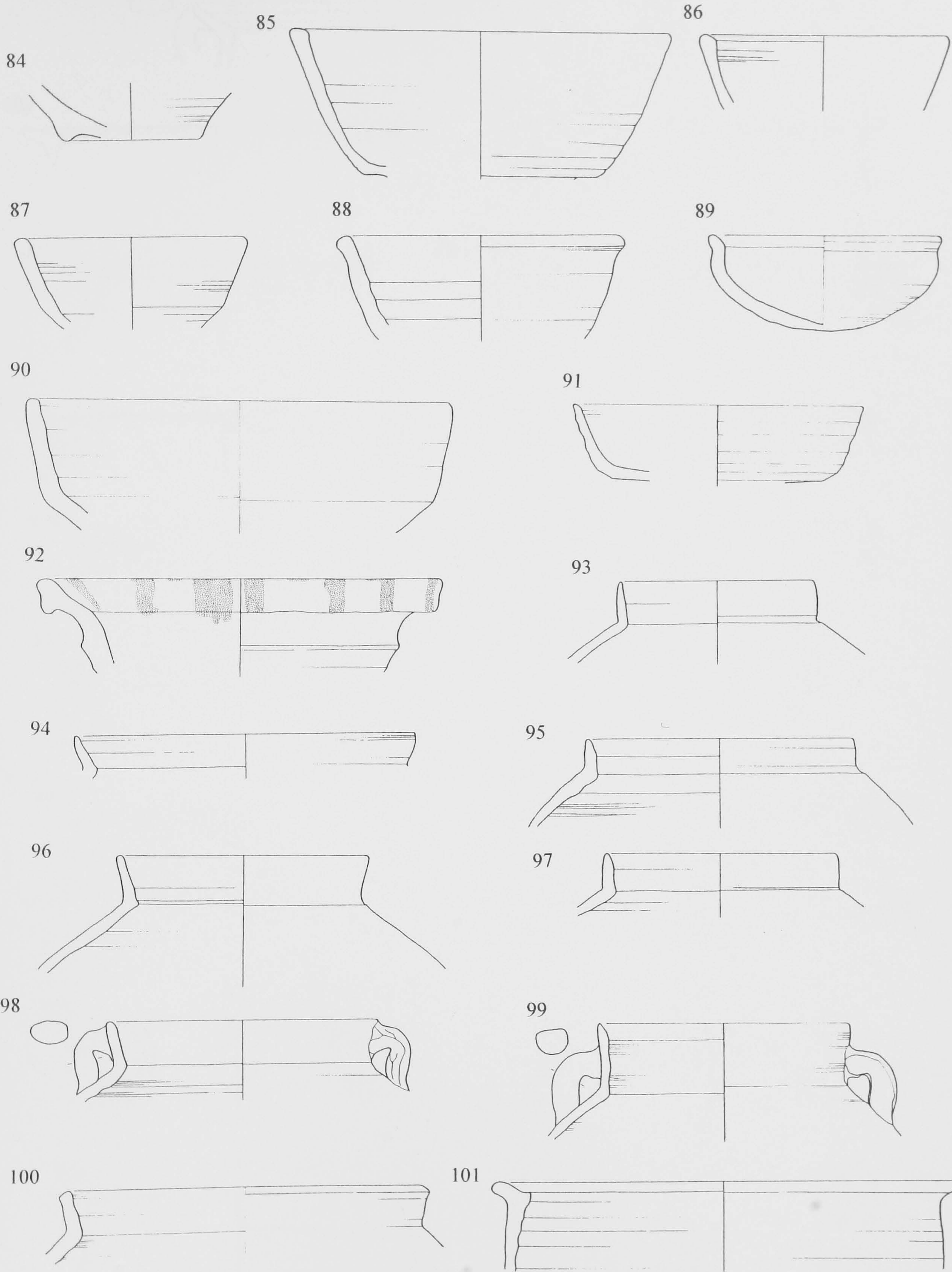

Pottery from surface collections on the main site at 1:3.

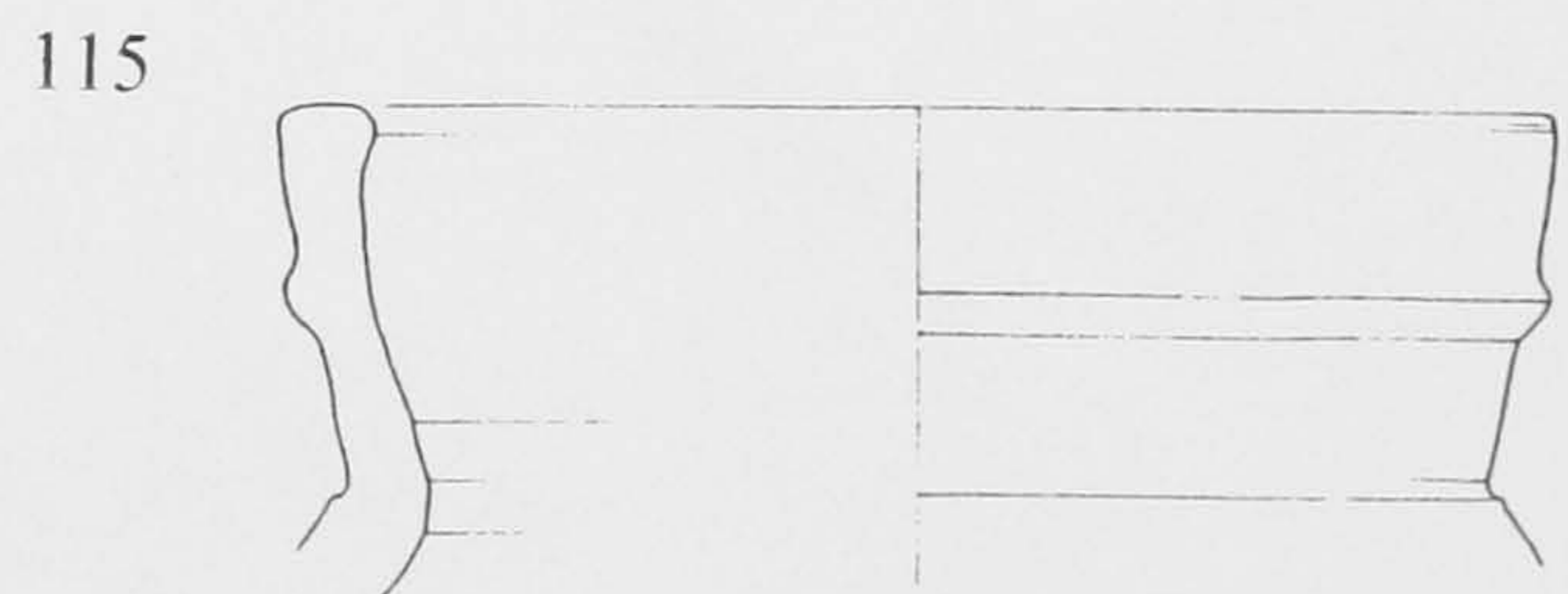
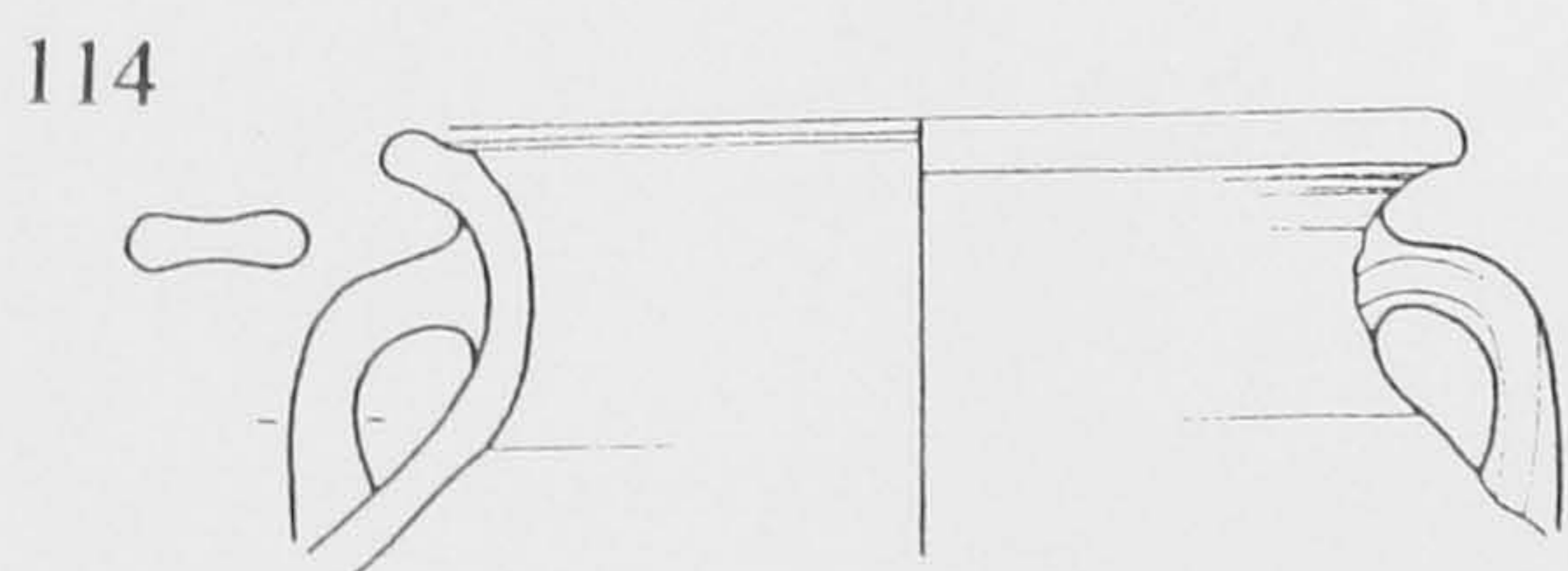
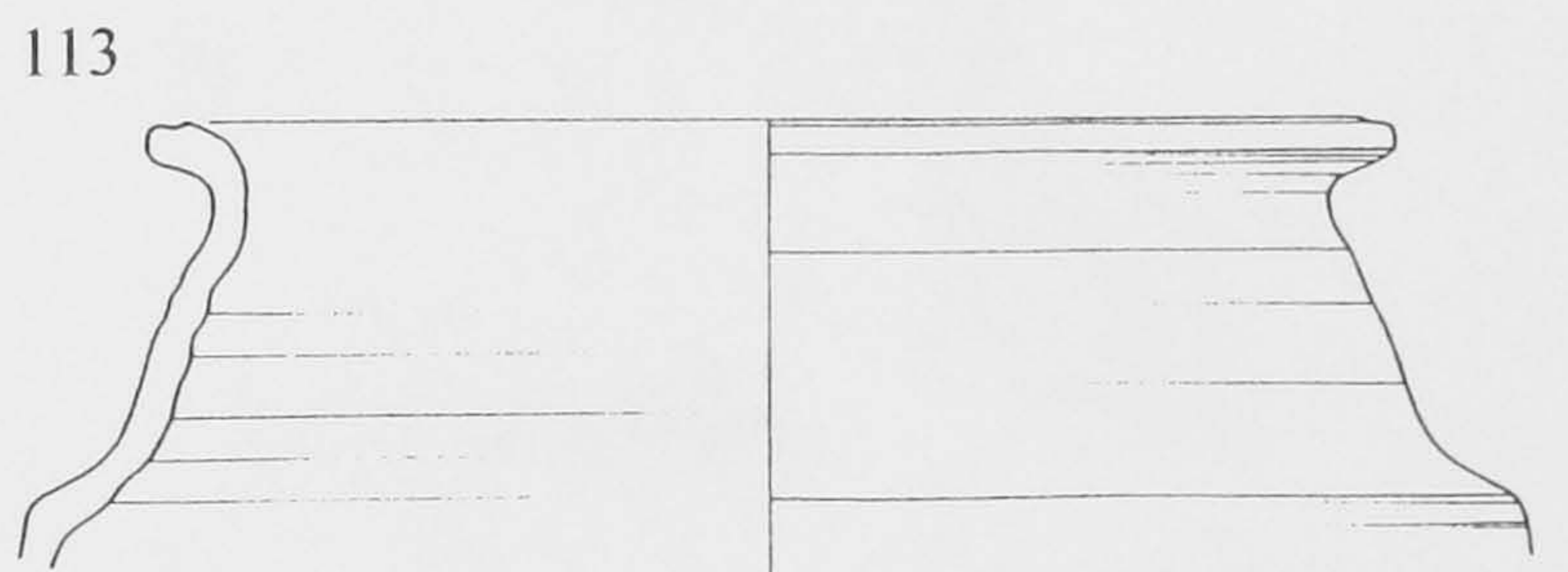
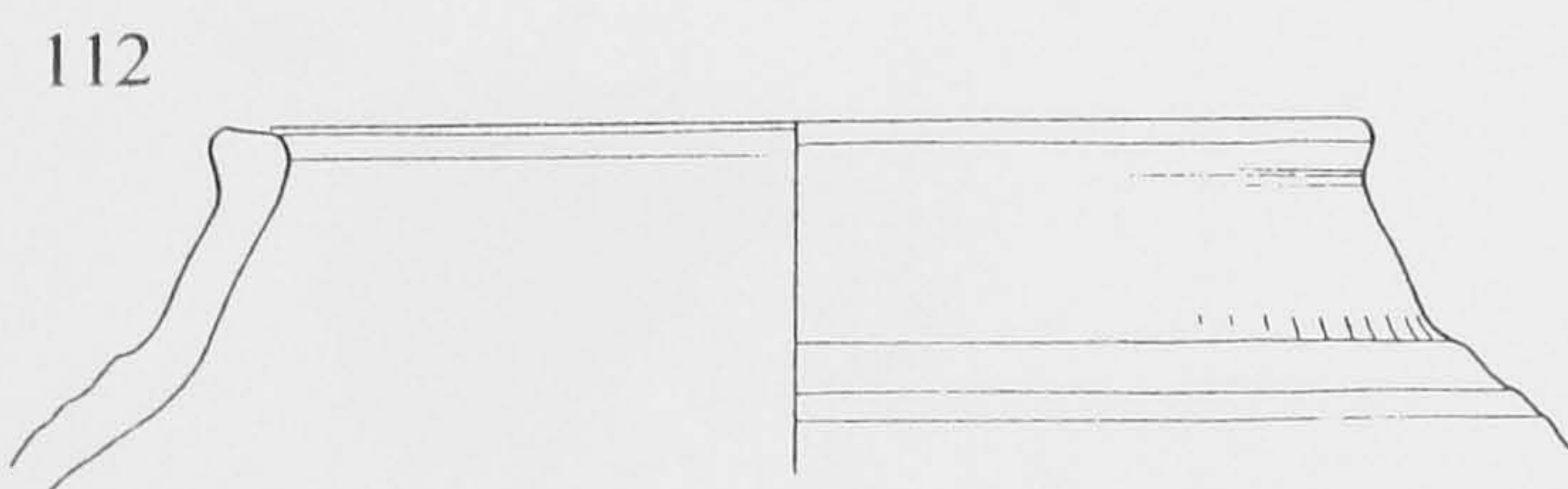
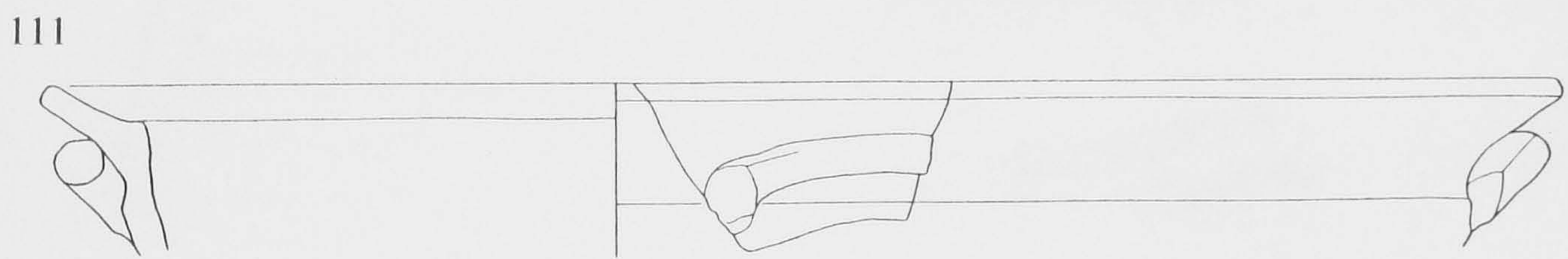
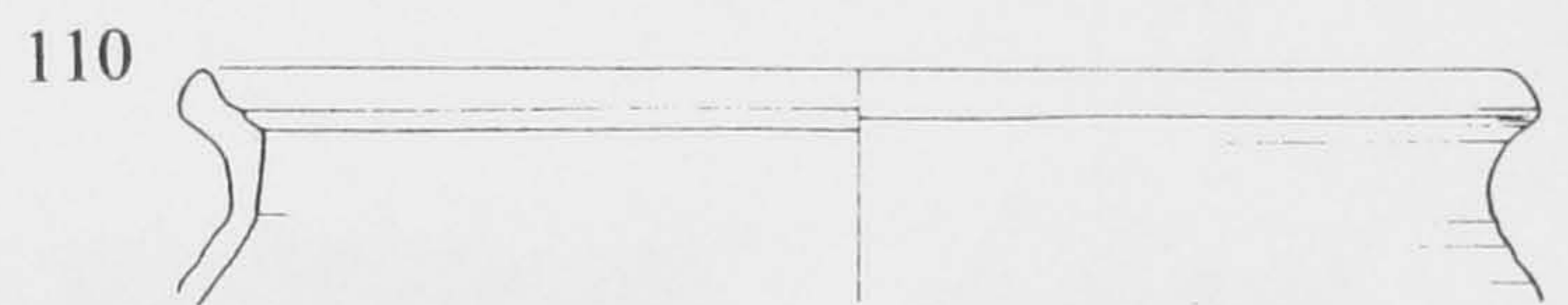
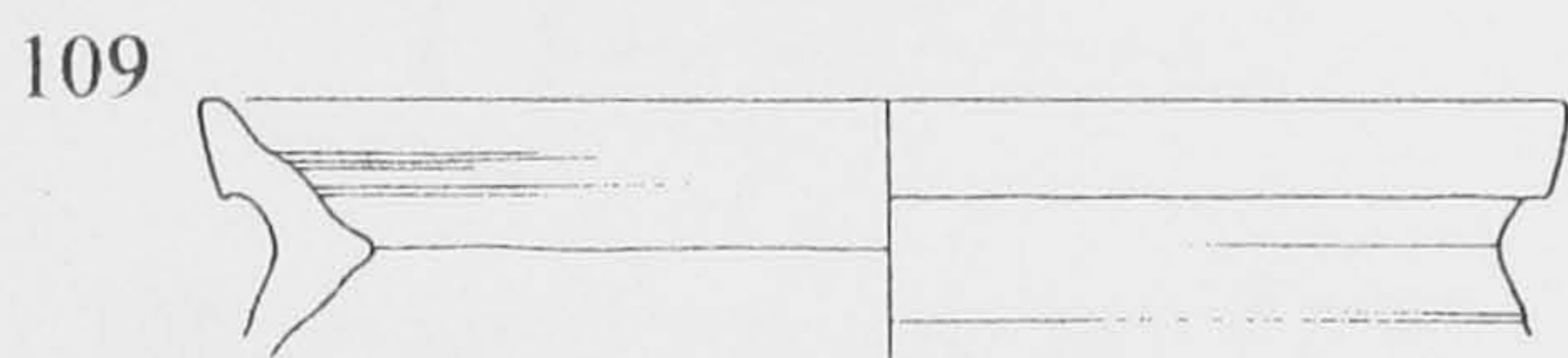
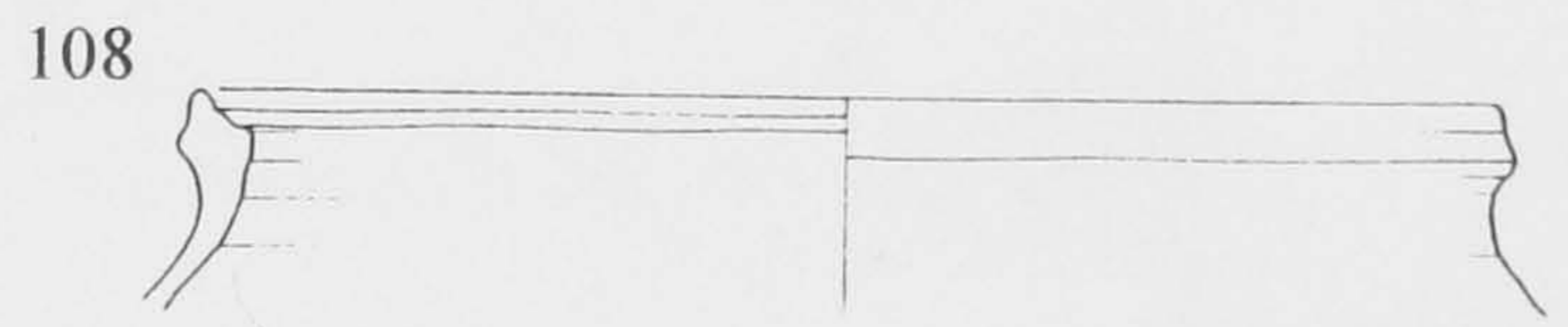
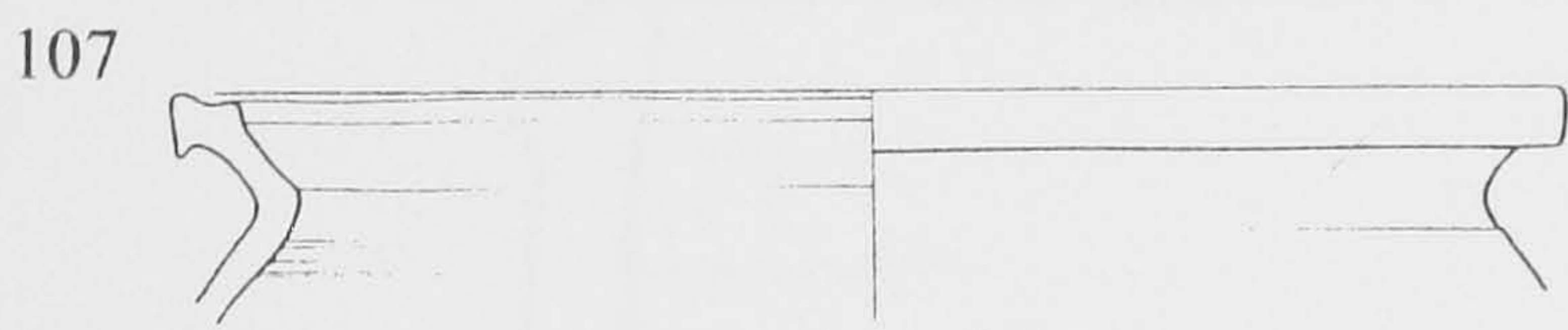
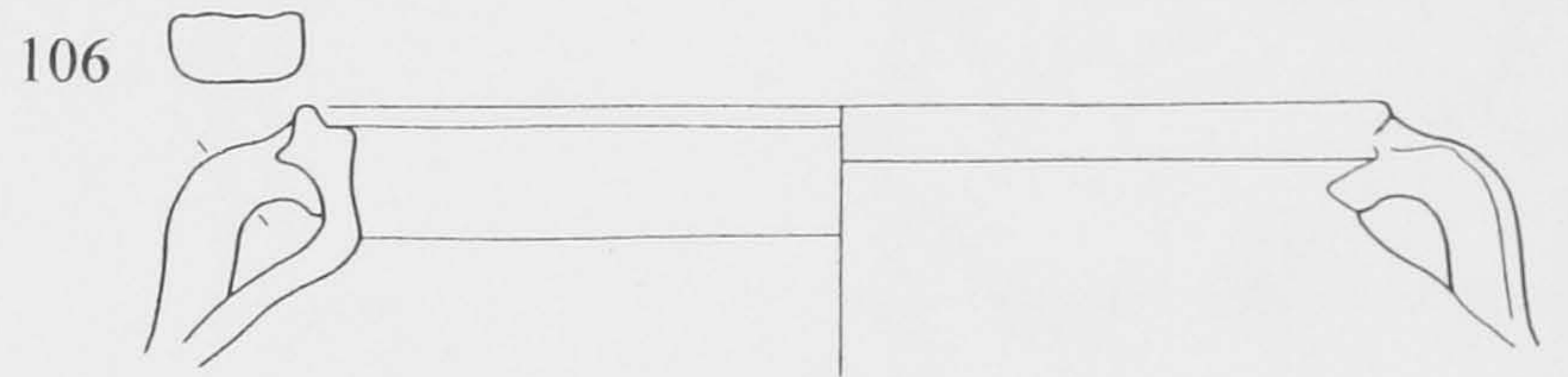
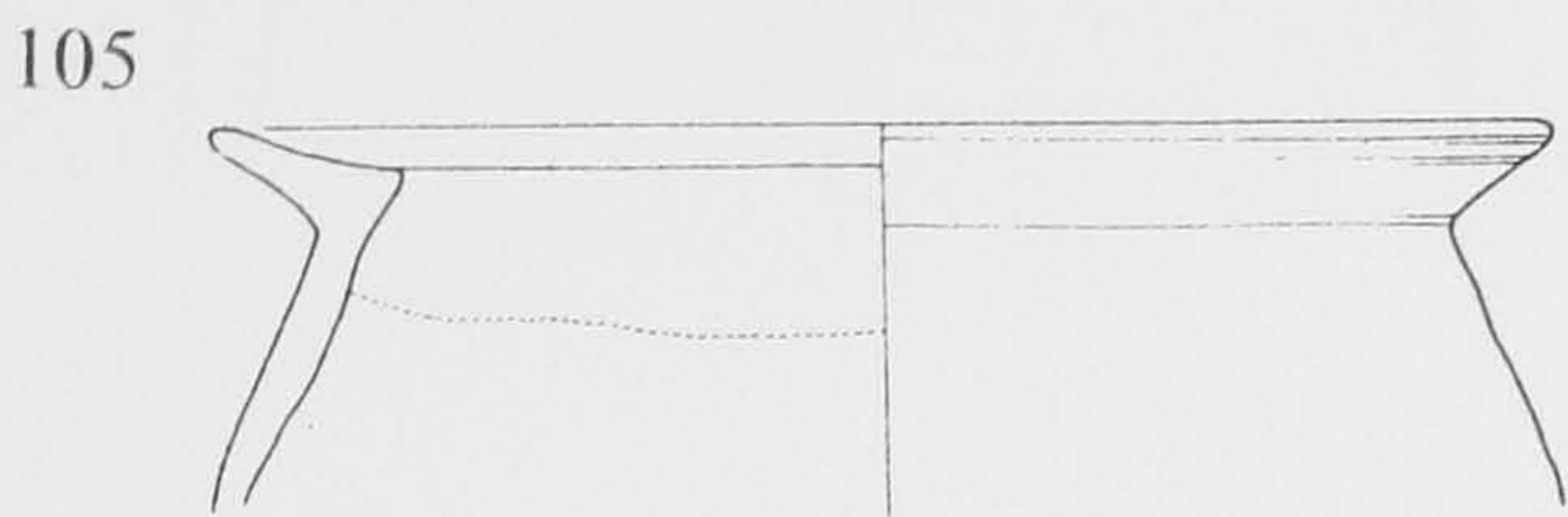
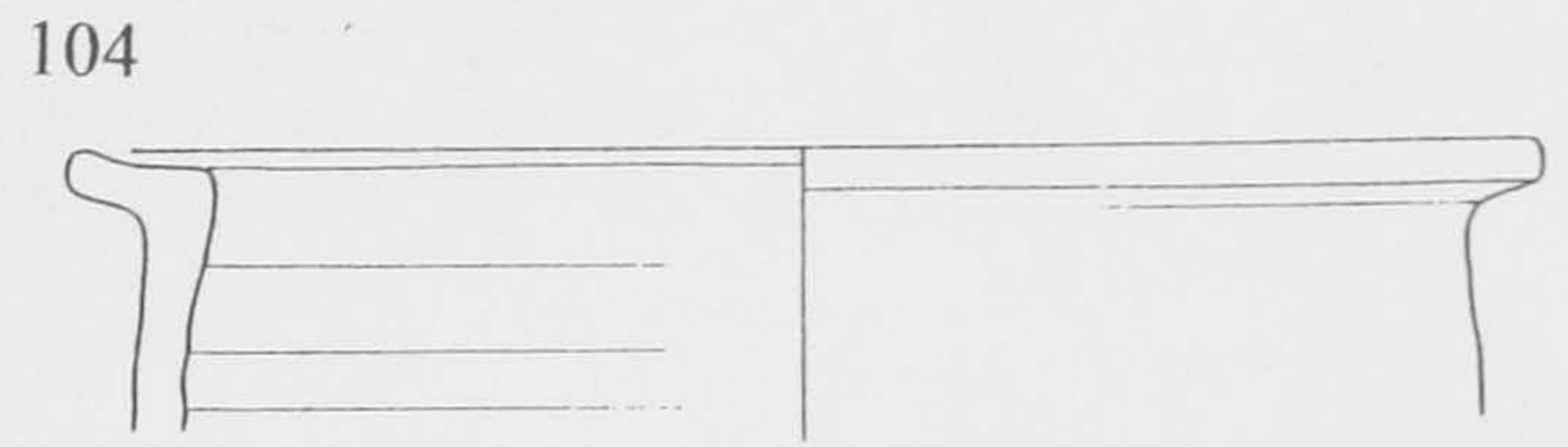
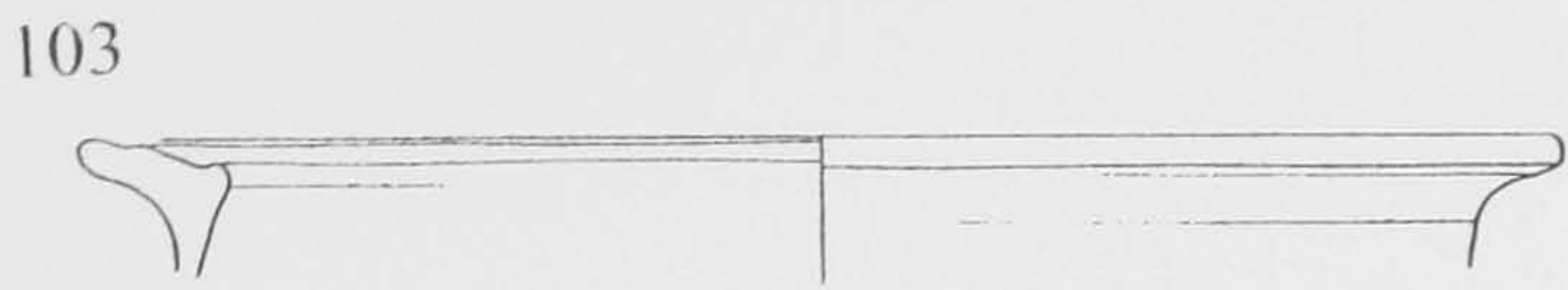
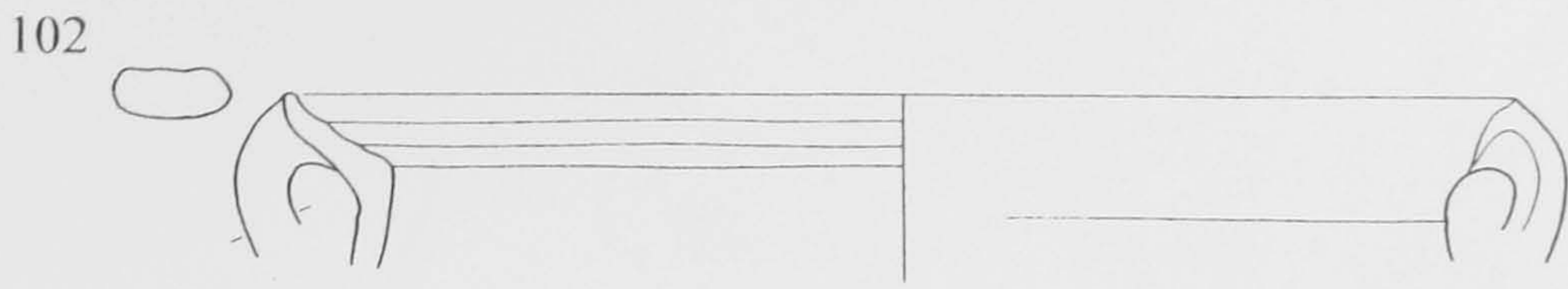

Pottery from surface collections on the main site at 1:3.

118



119

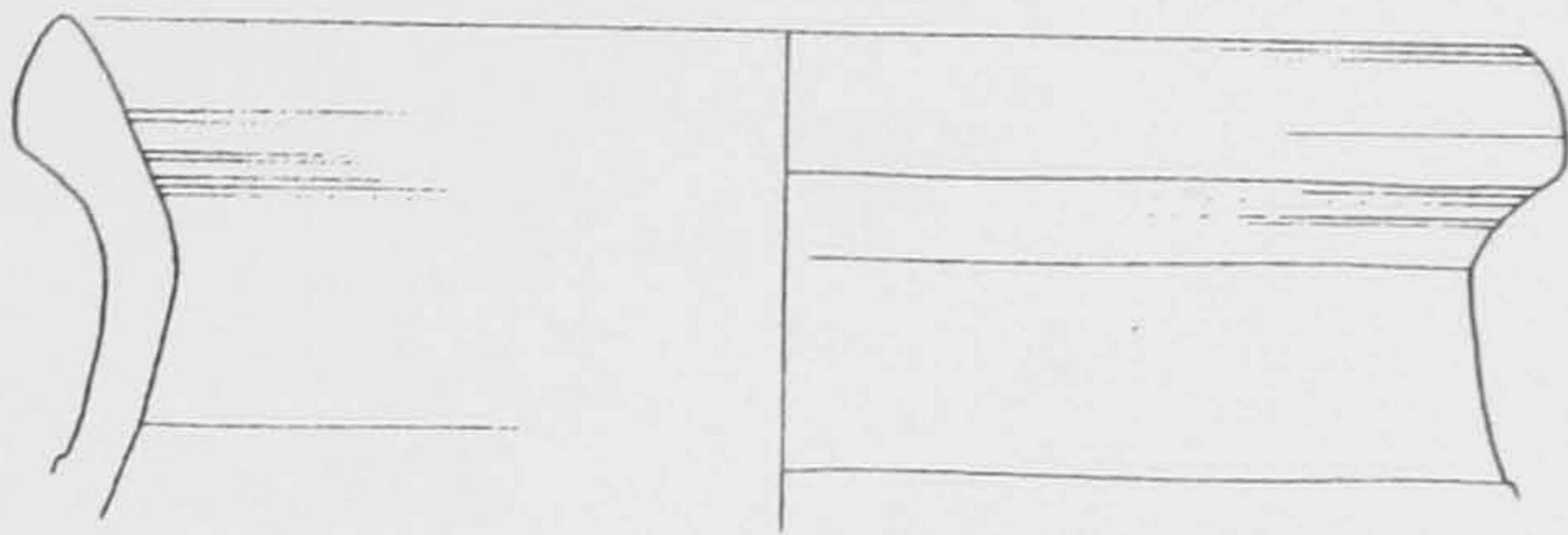

120

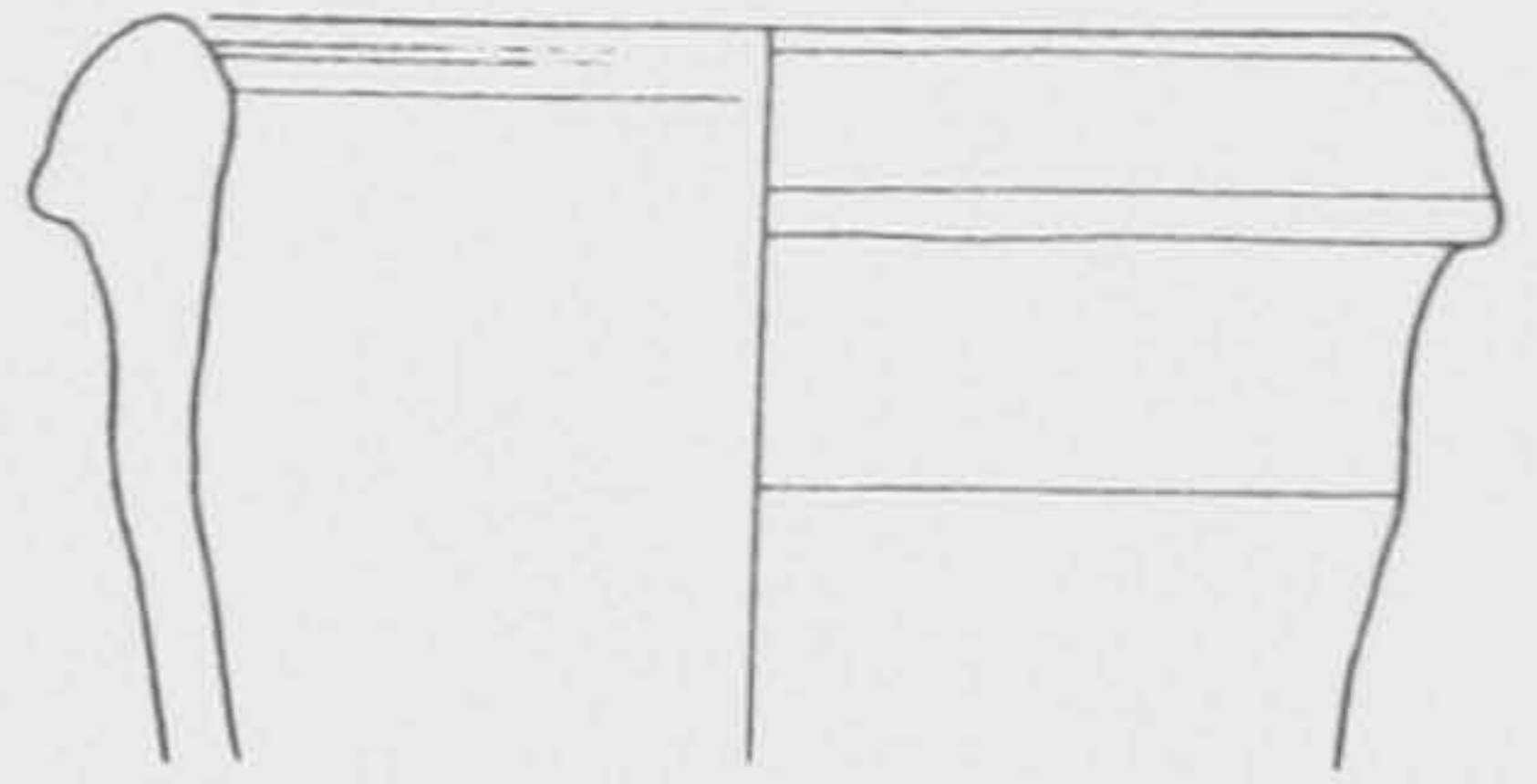

121



122

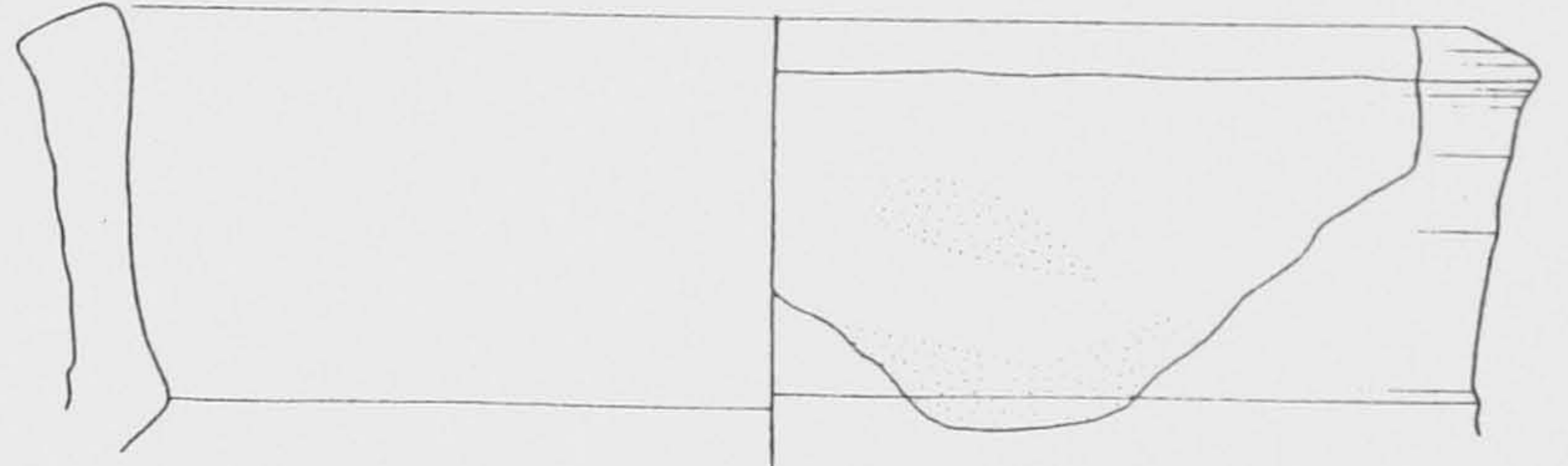

123

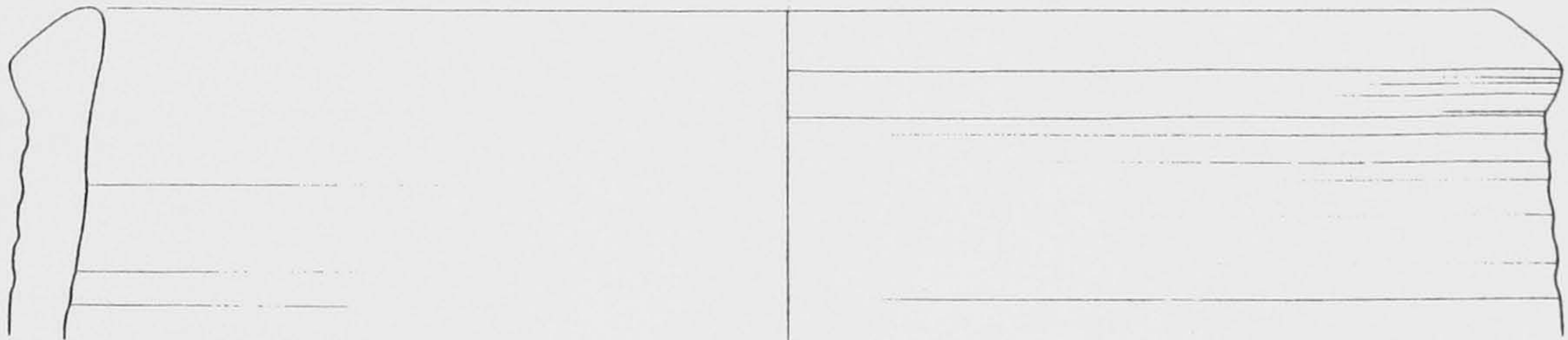

124

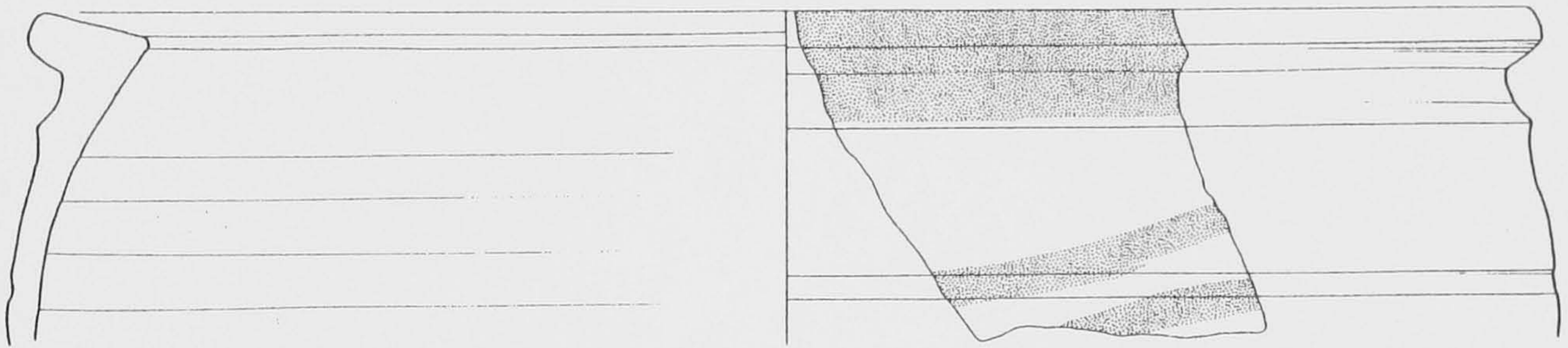

125

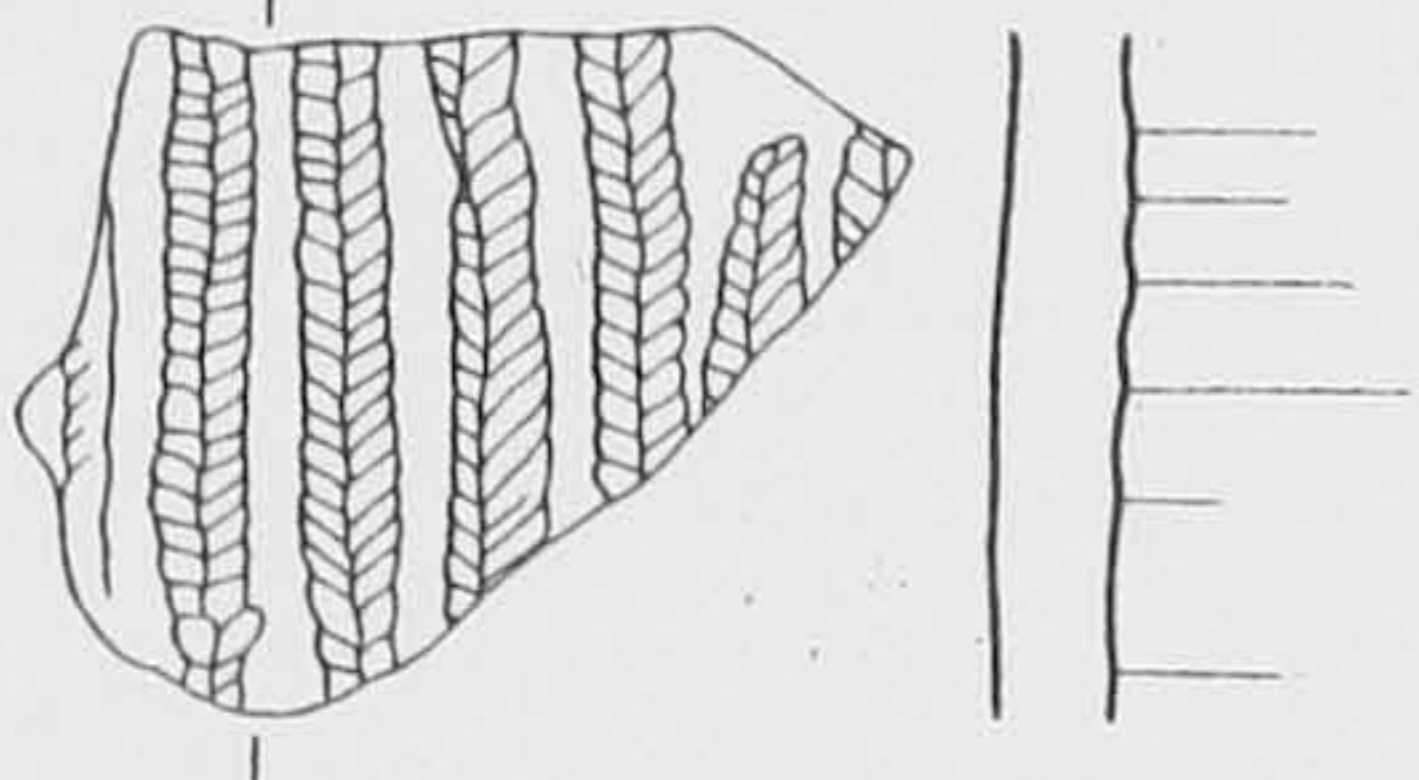

126

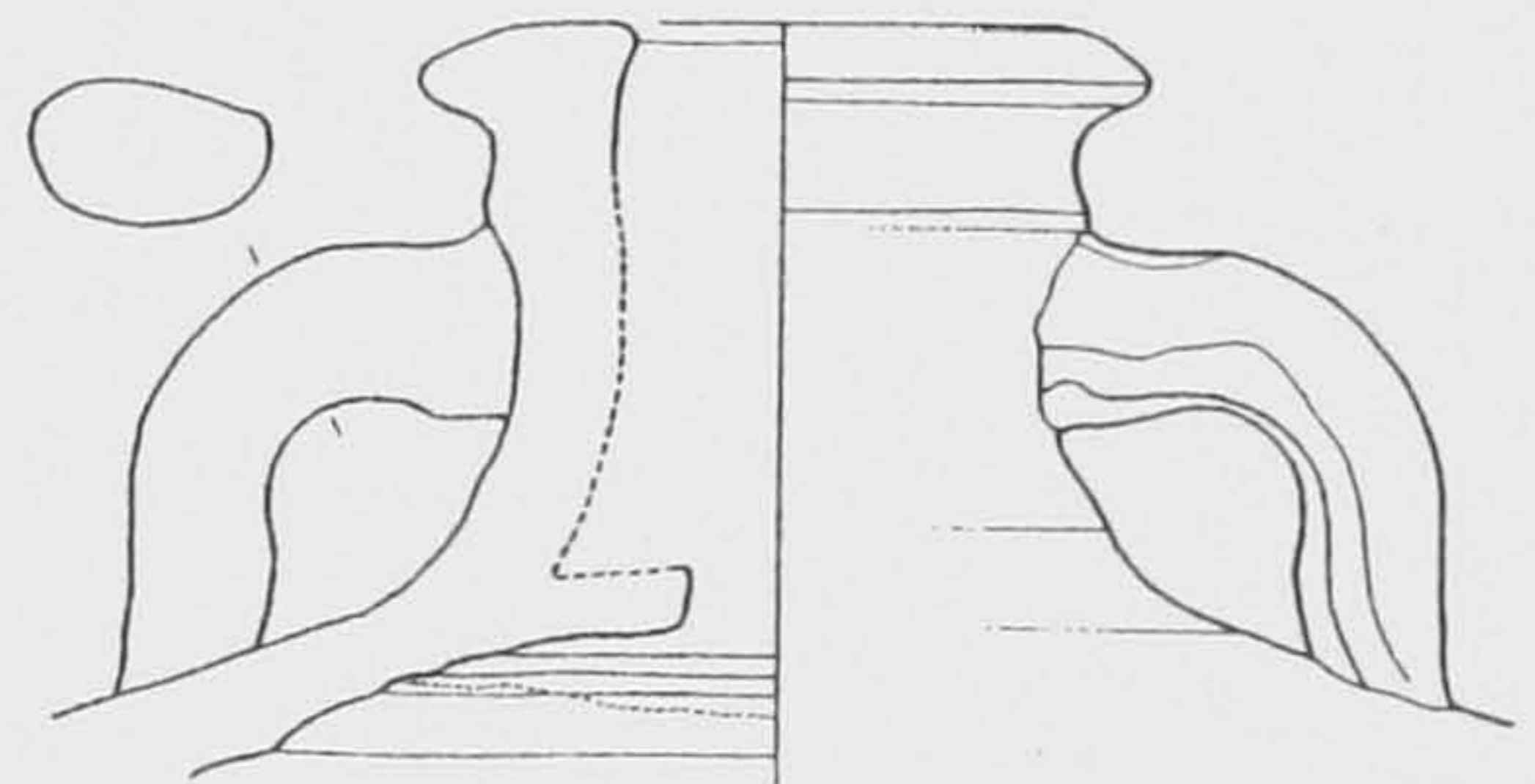

127



128

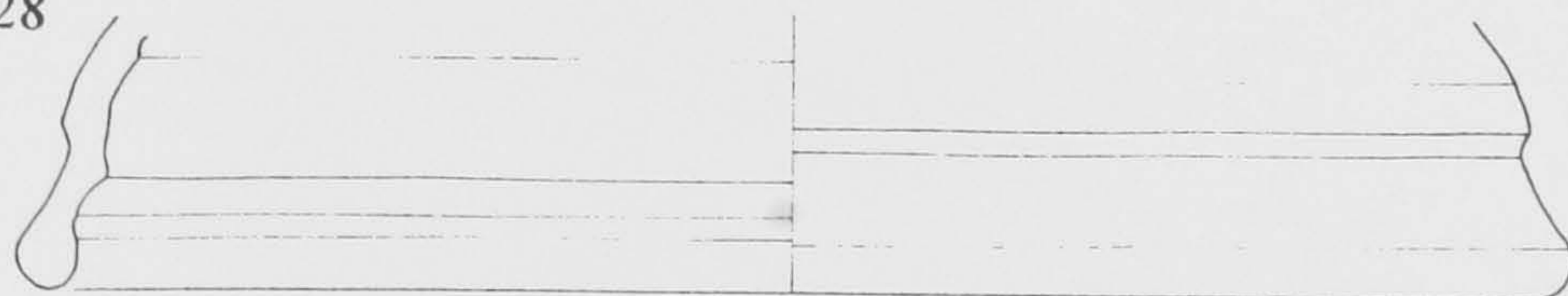

Pottery from surface collections on the main site at 1:3.

Fig. II.26 cont.

129

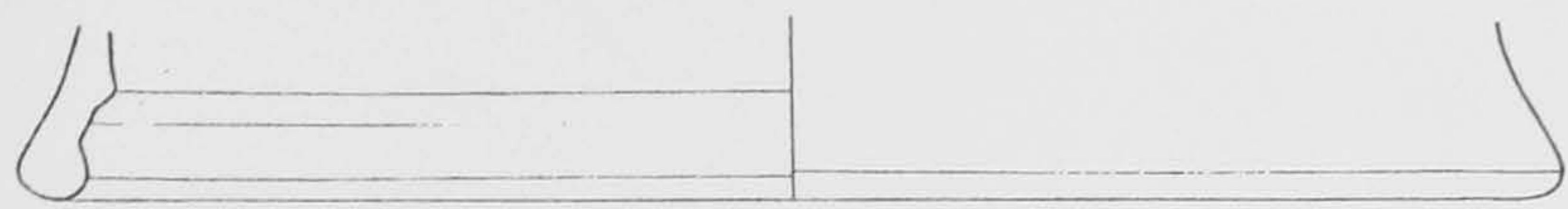

130

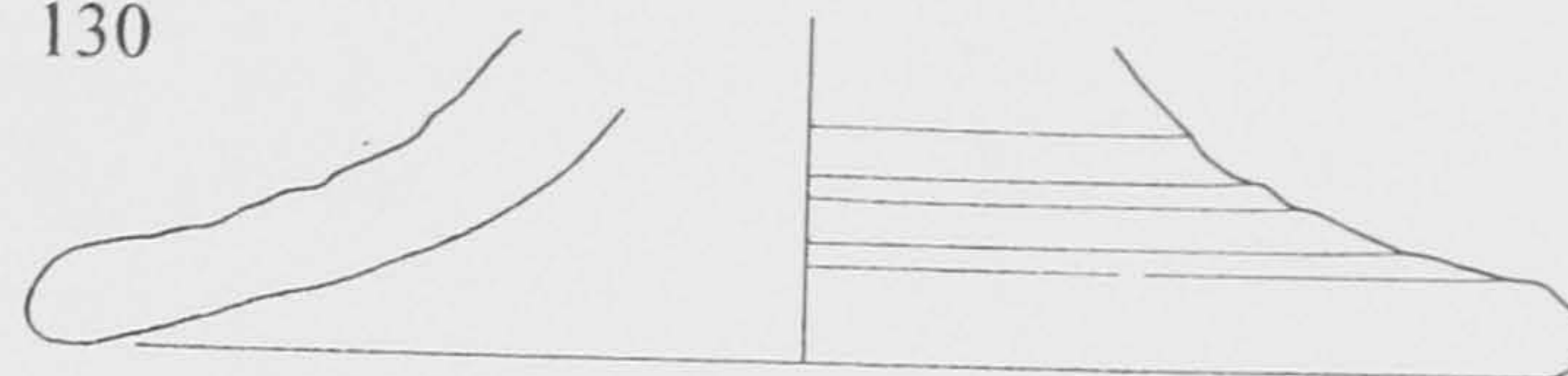

131

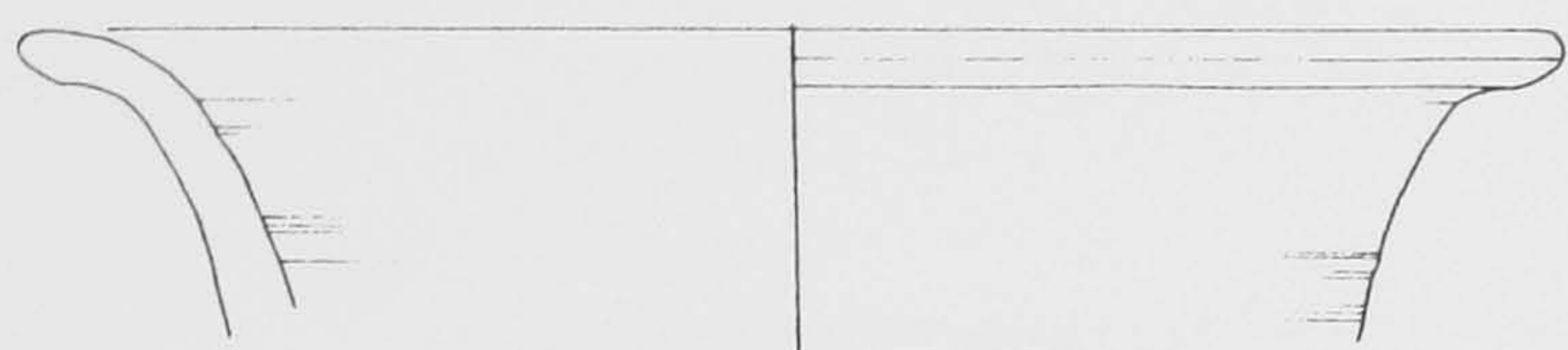

132



133

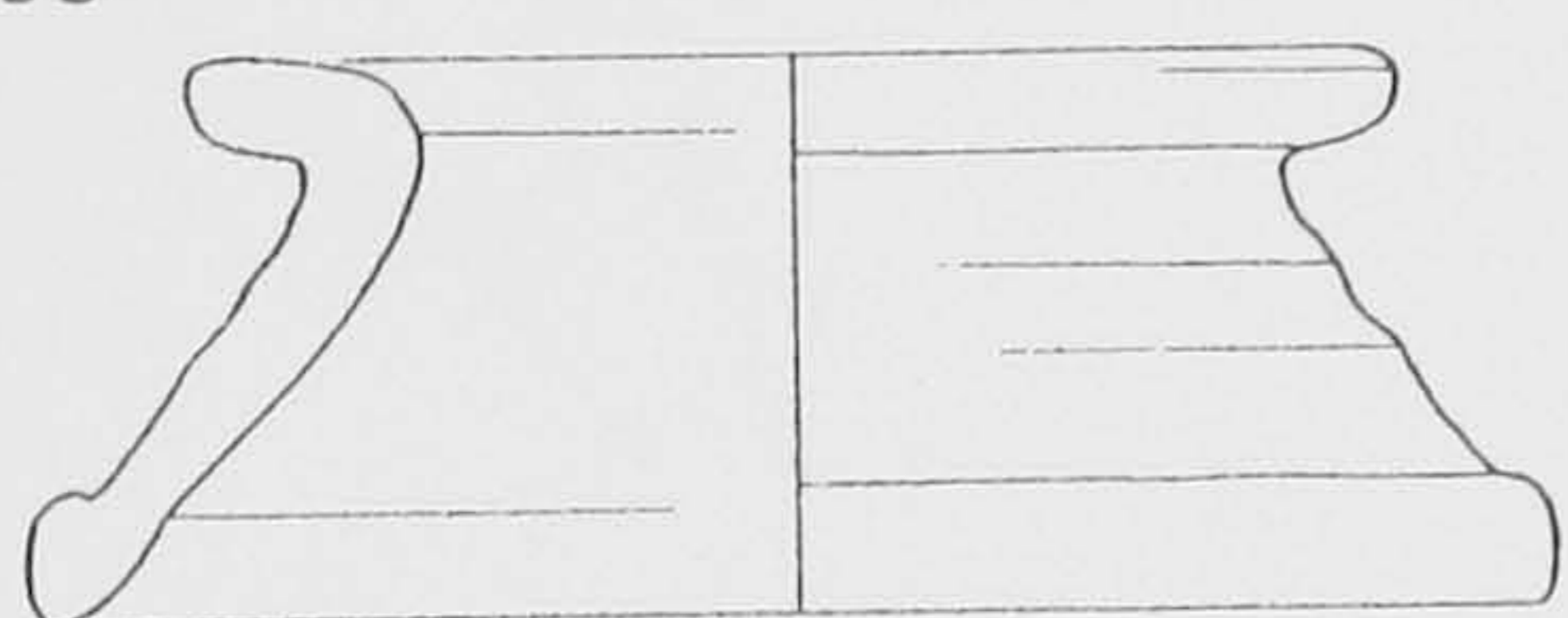

134



135



136

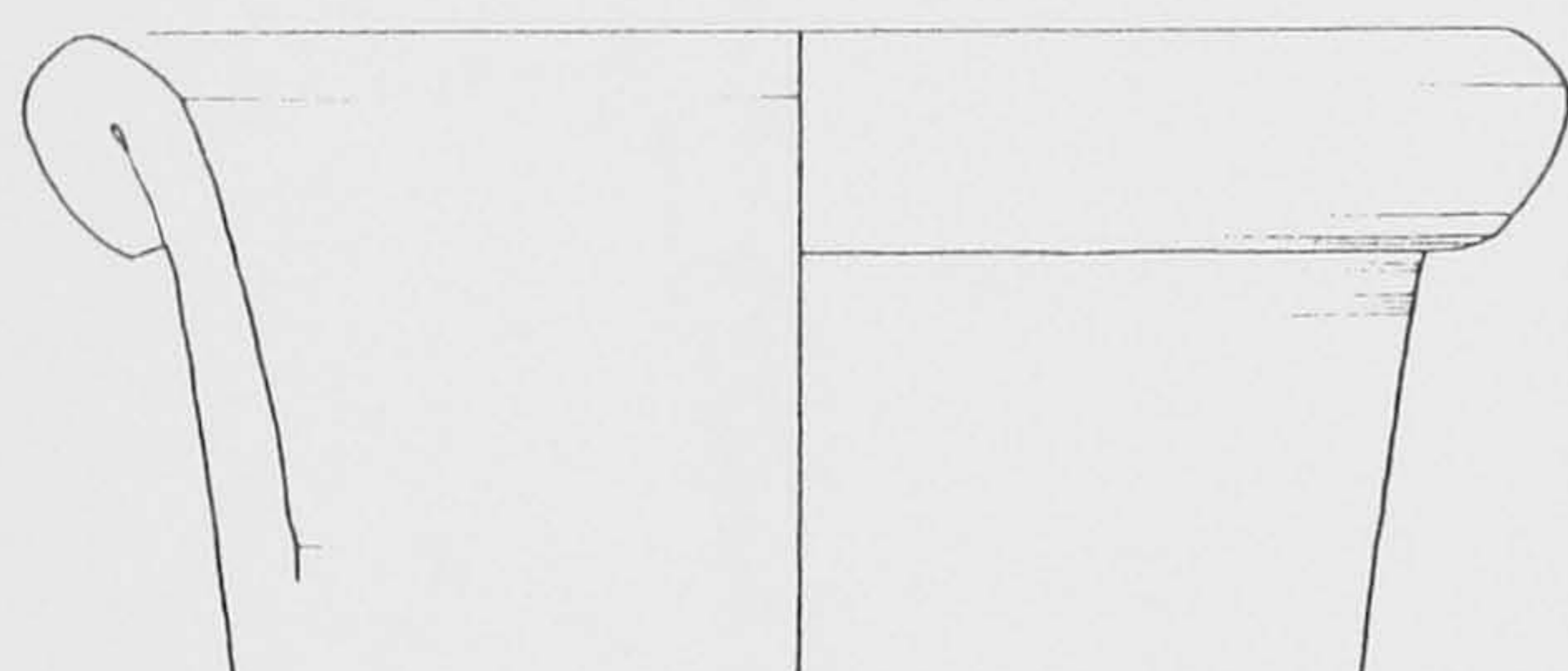

137

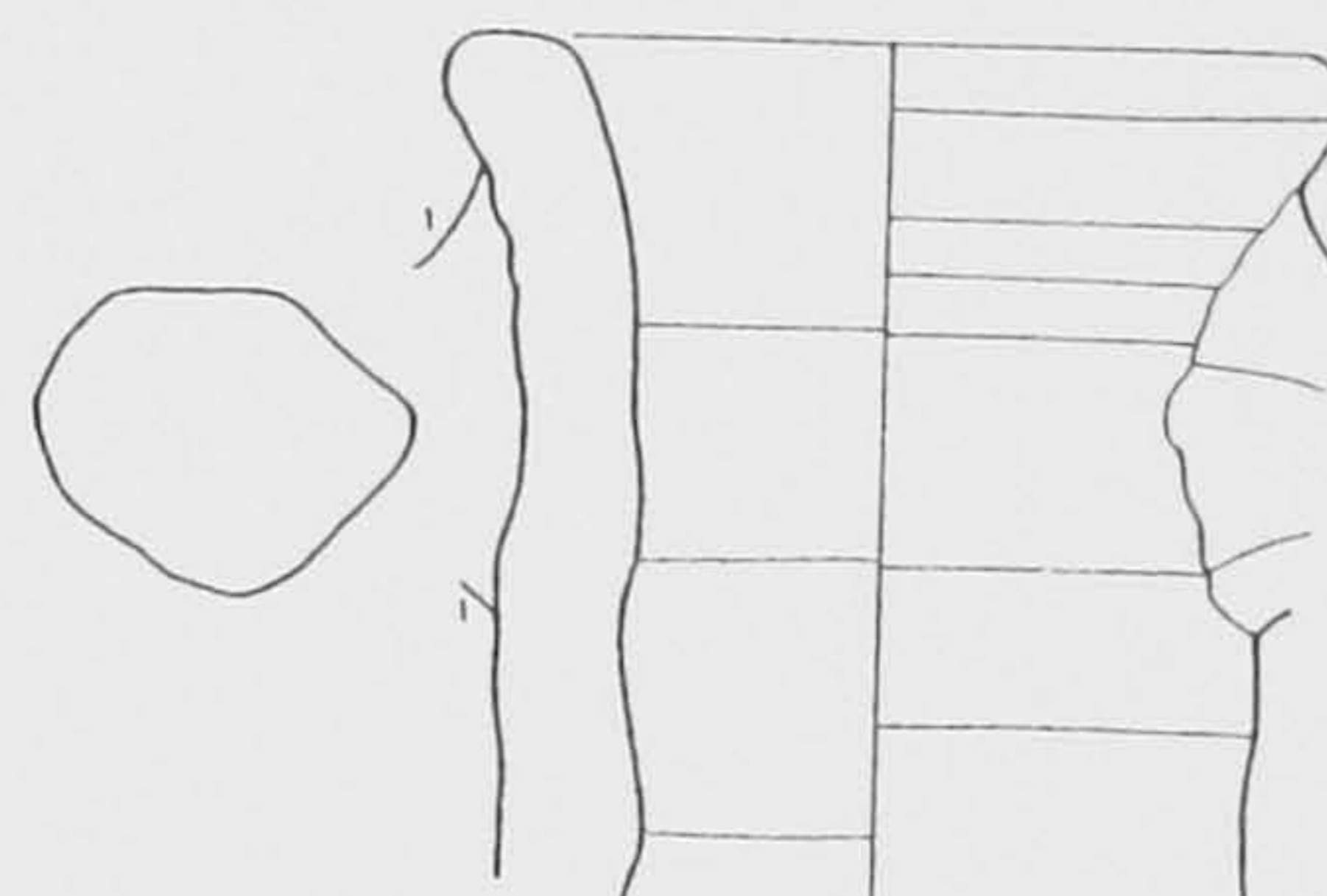

138

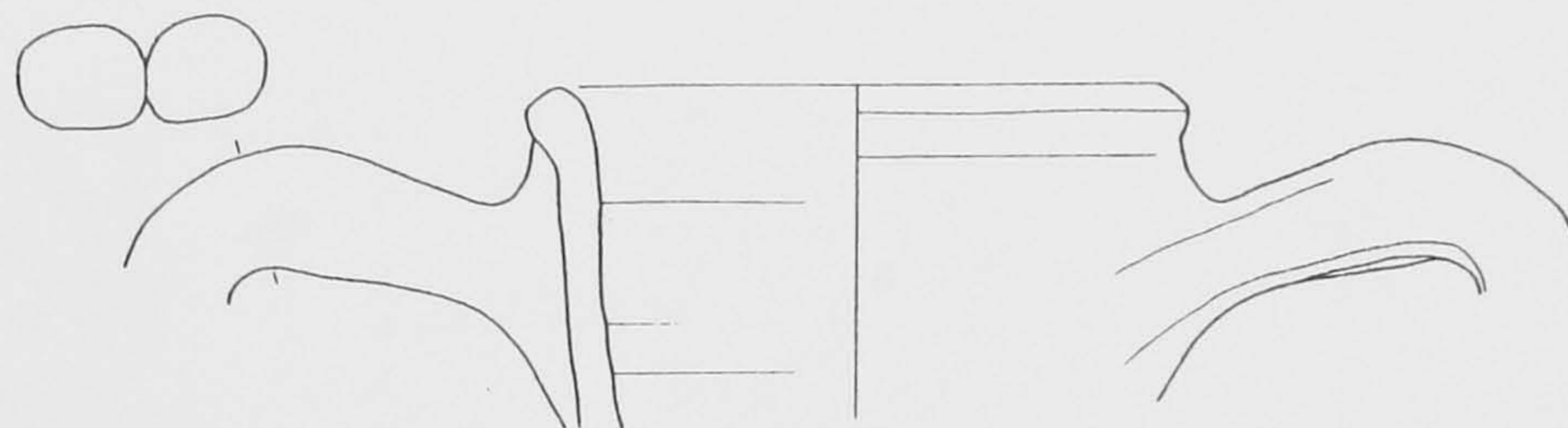

139

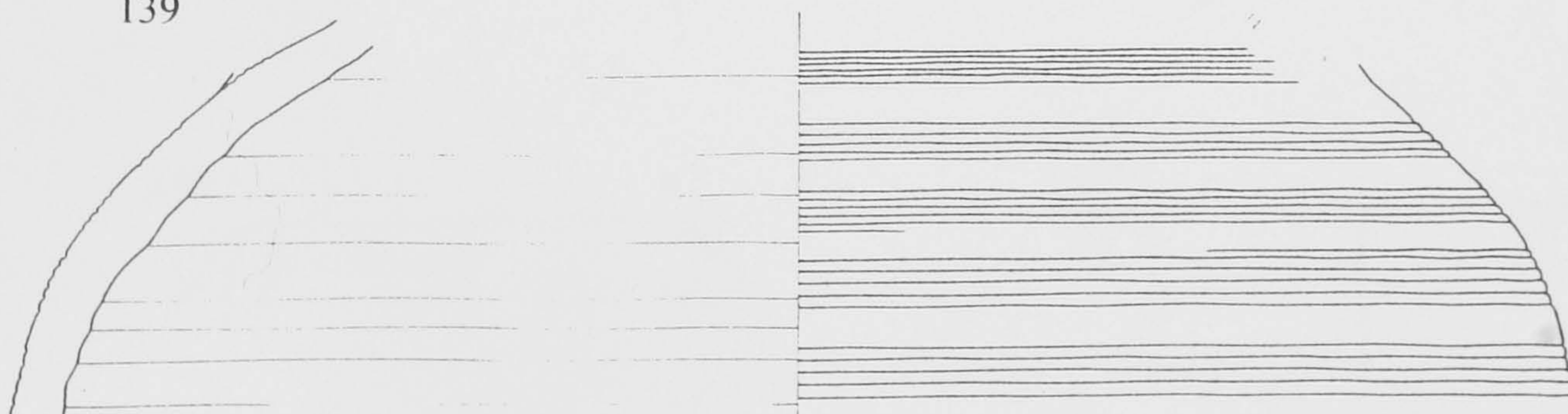

Pottery from surface collections on the main site at 1:3.

140



141

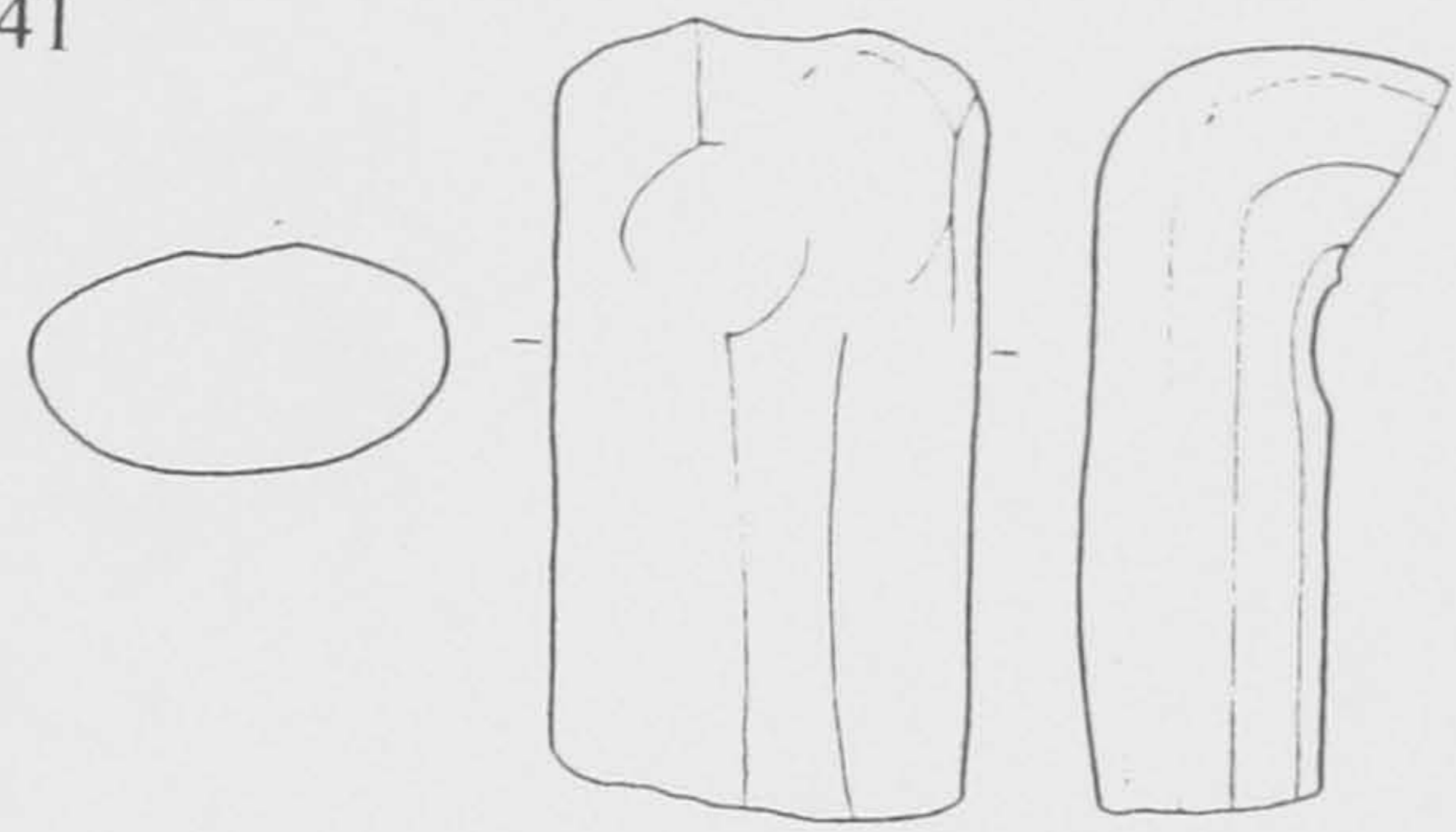

142



143

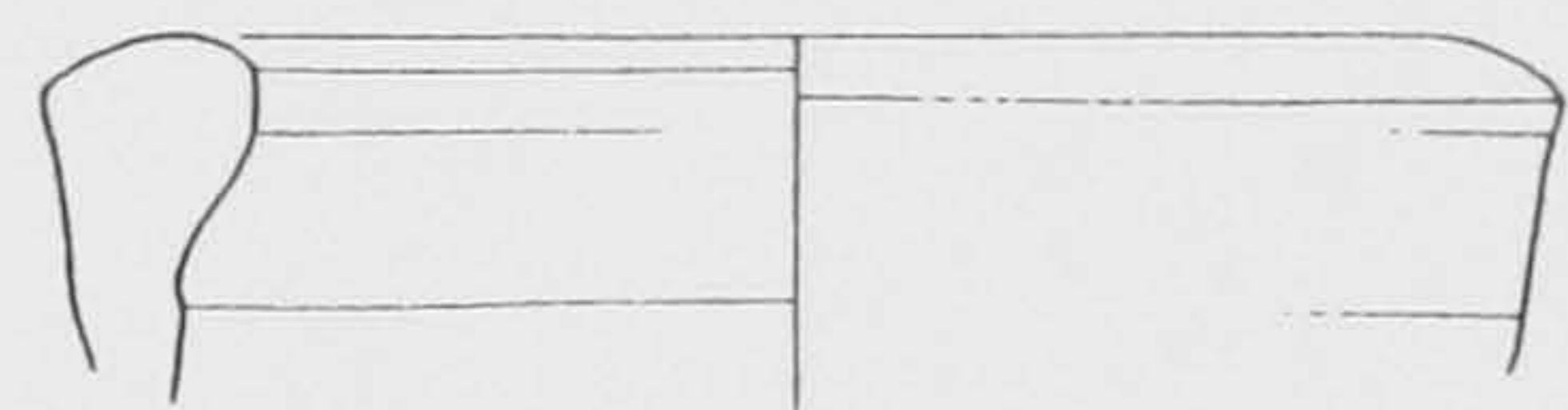

144

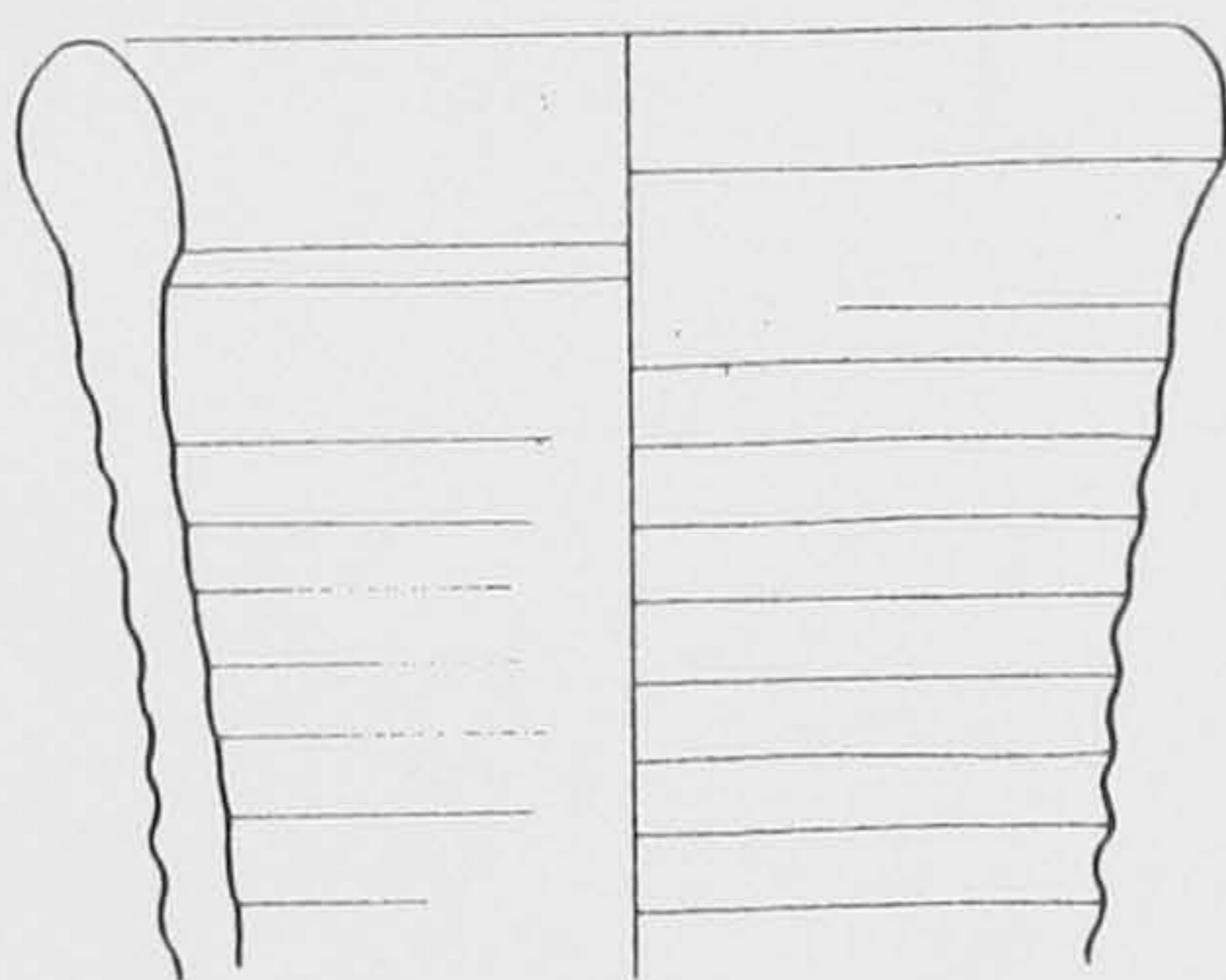

145

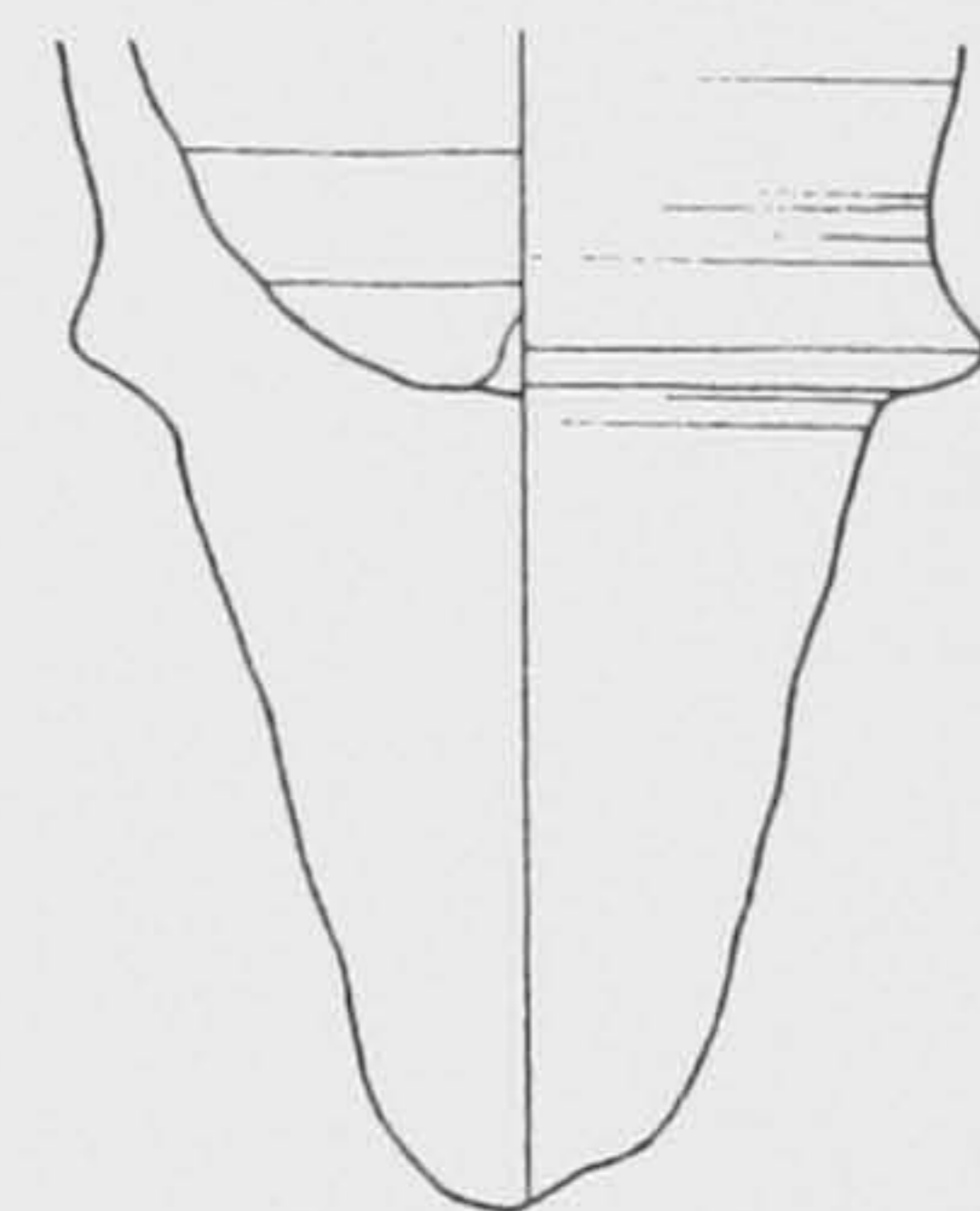

146

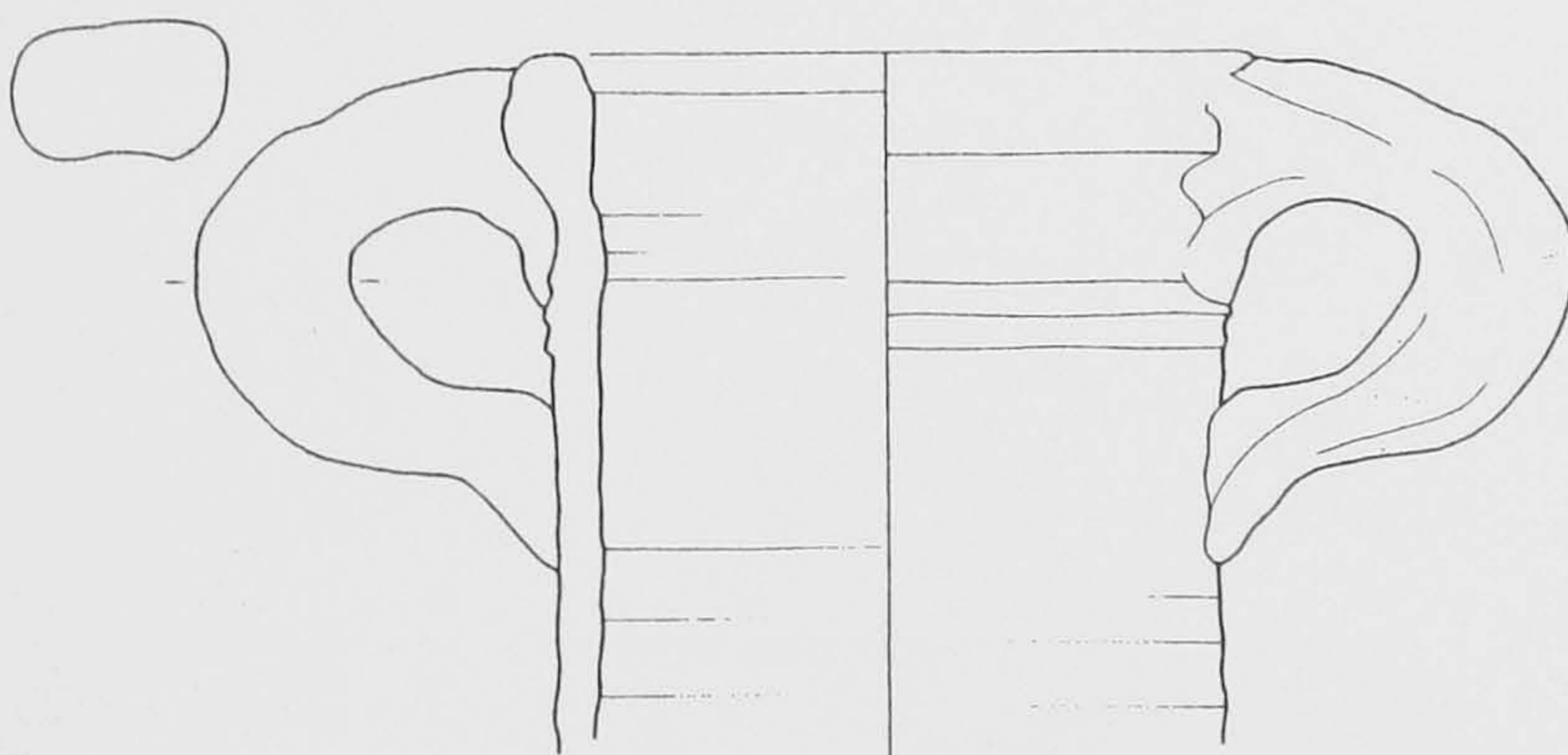

147

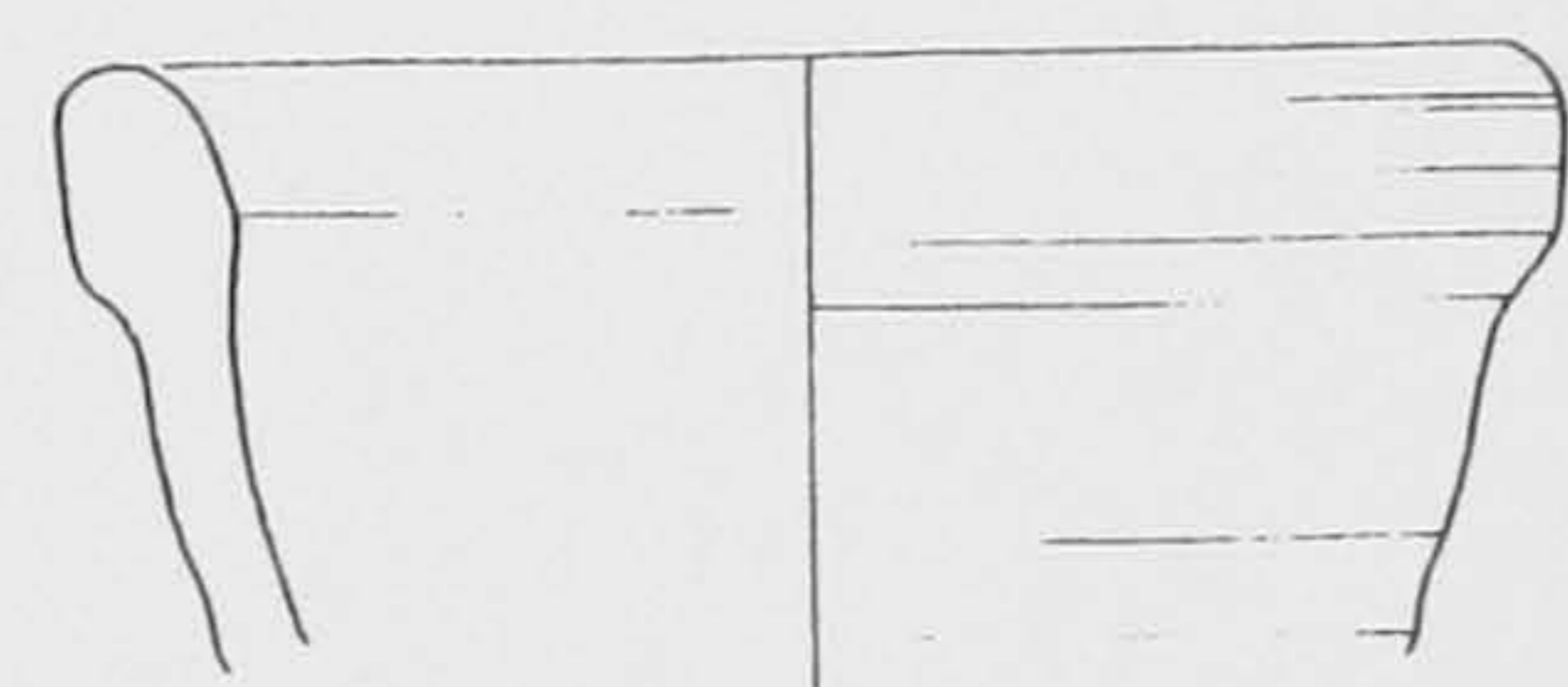

148



149

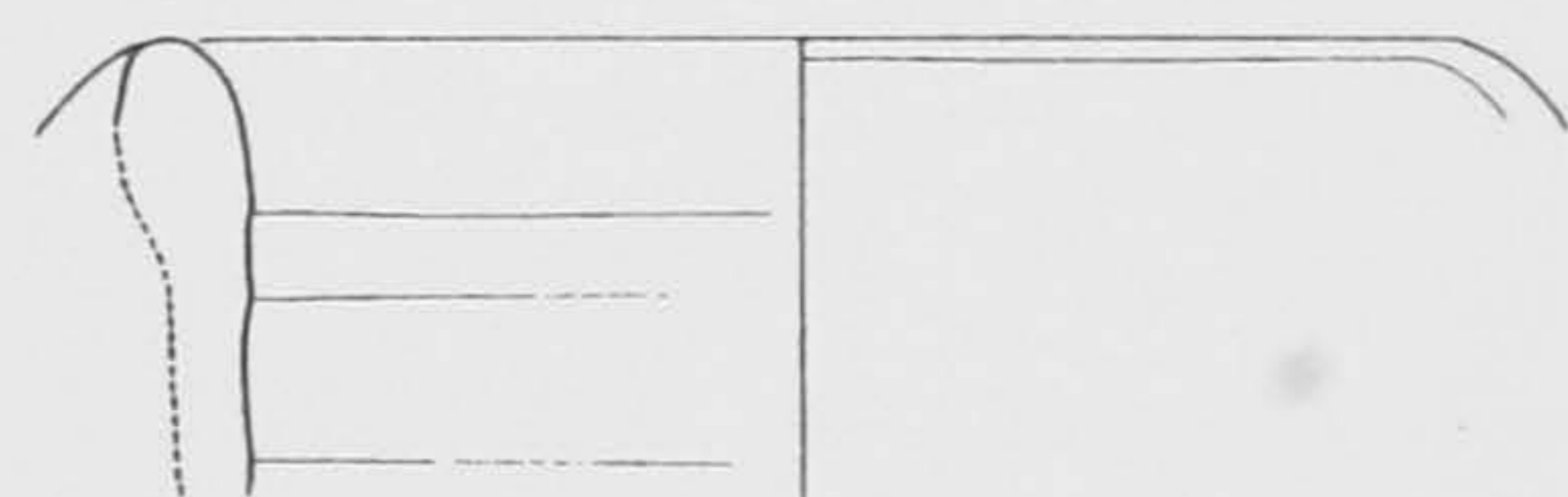

150

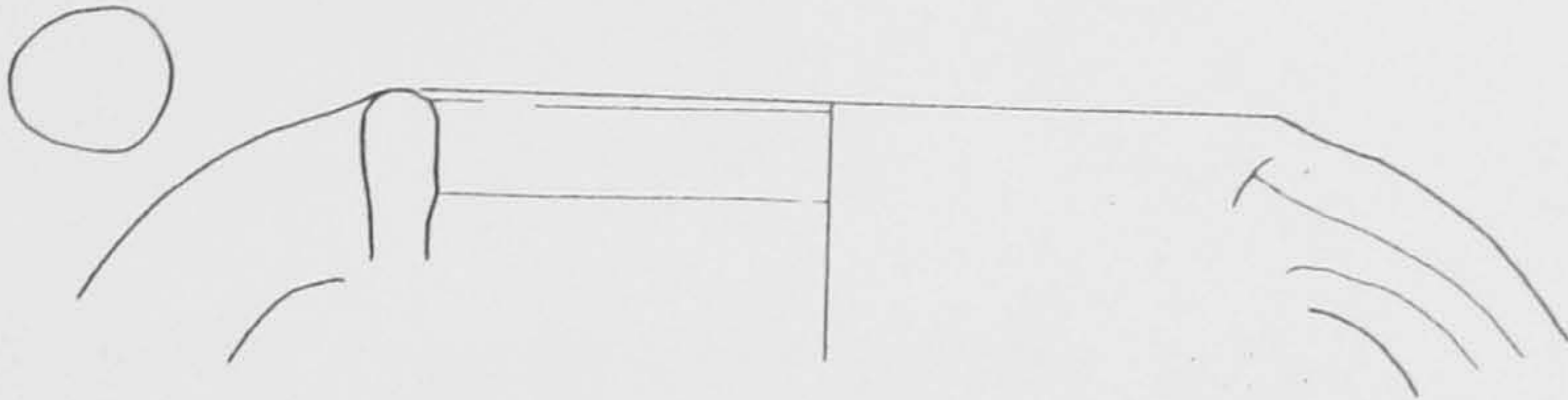

151

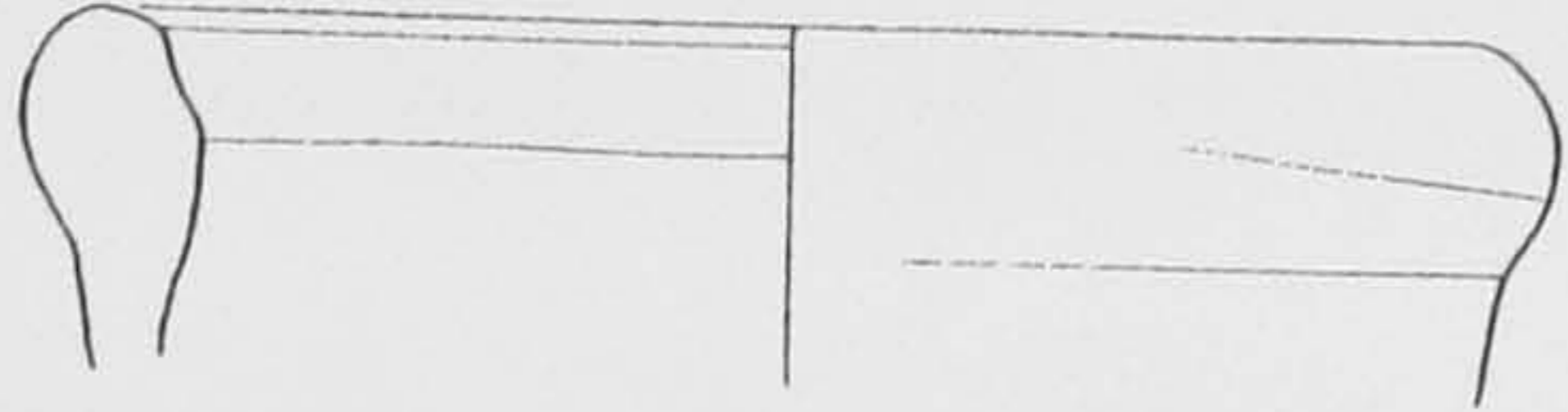

152



153

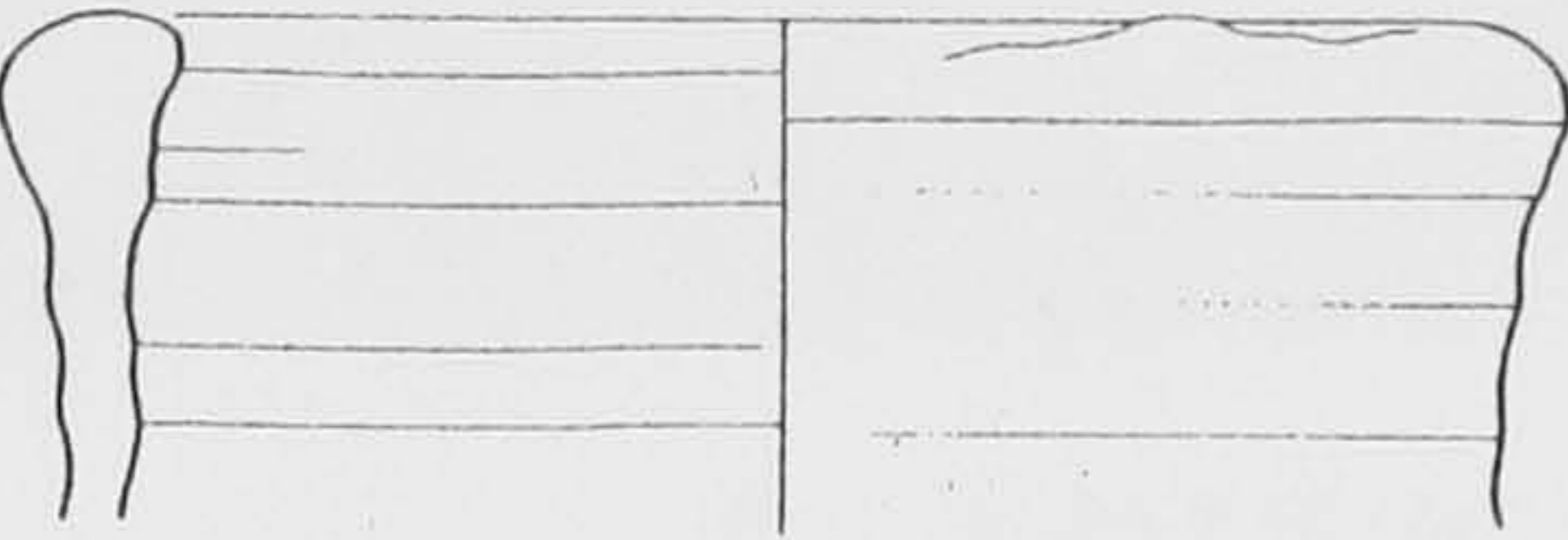

154

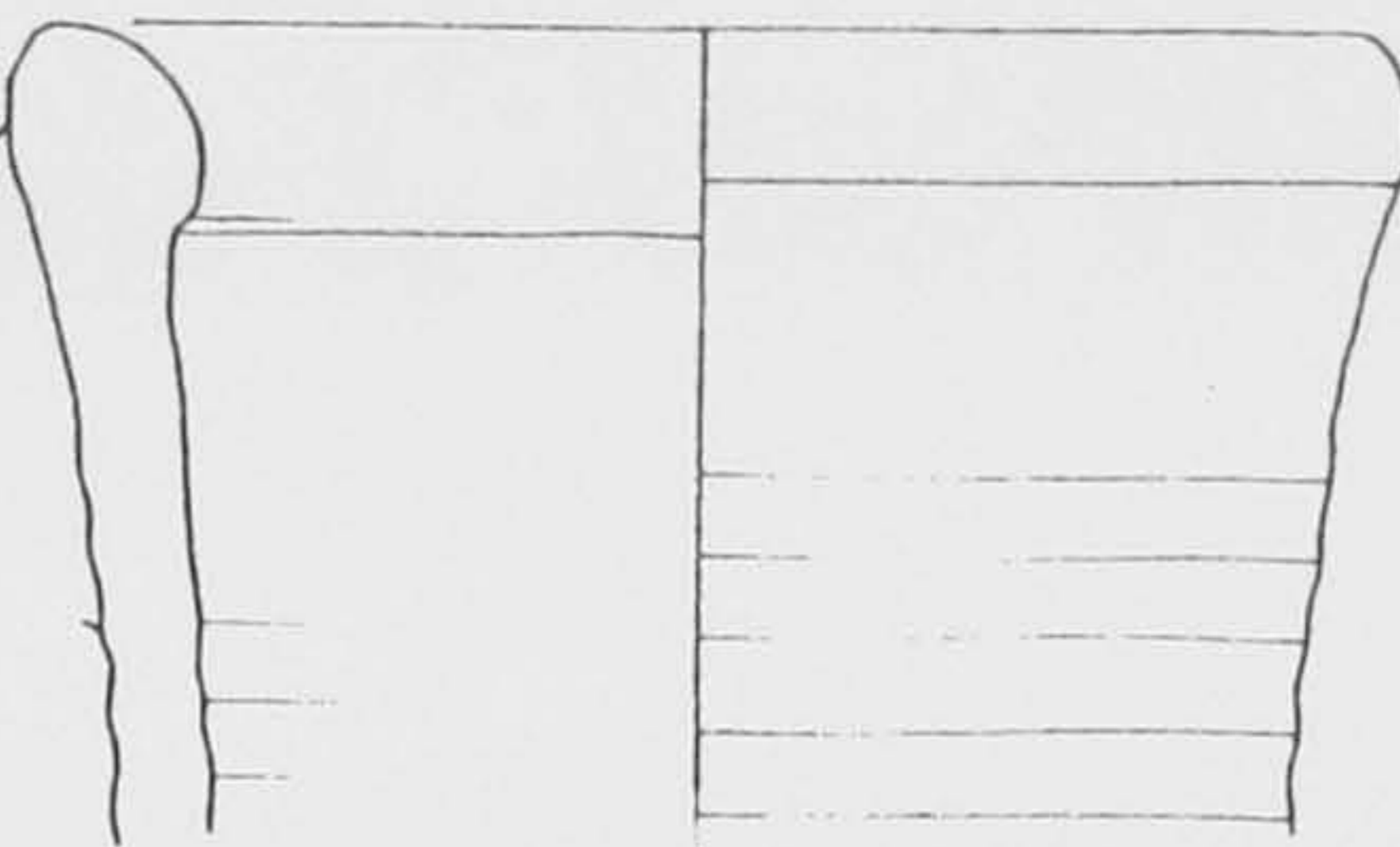

155

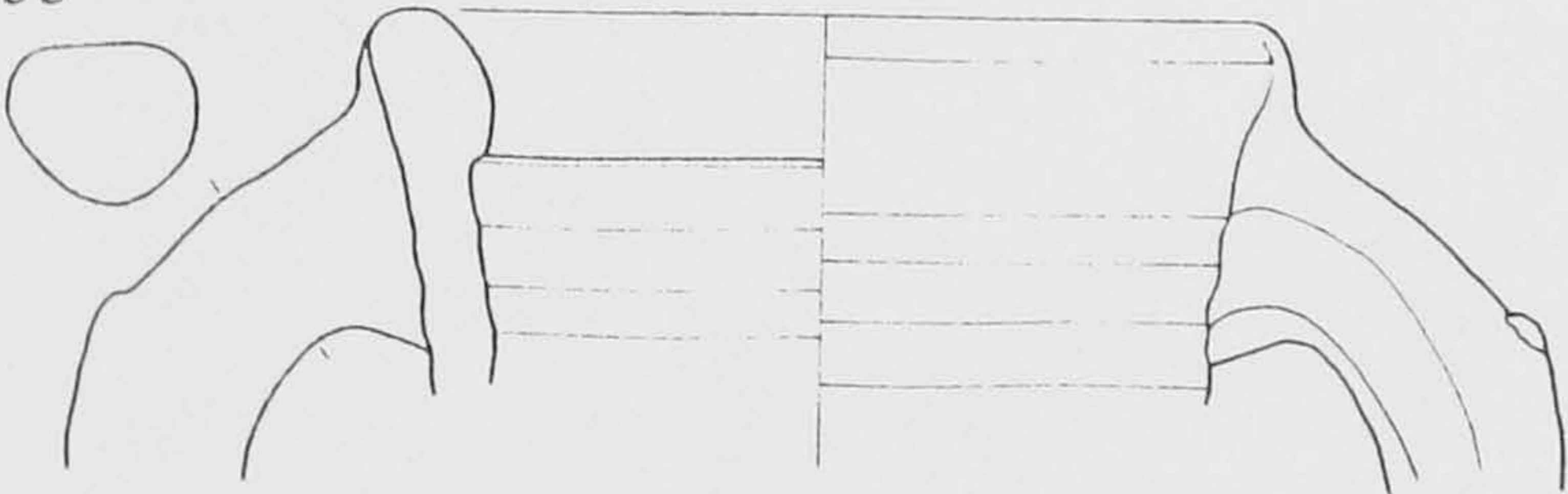

156

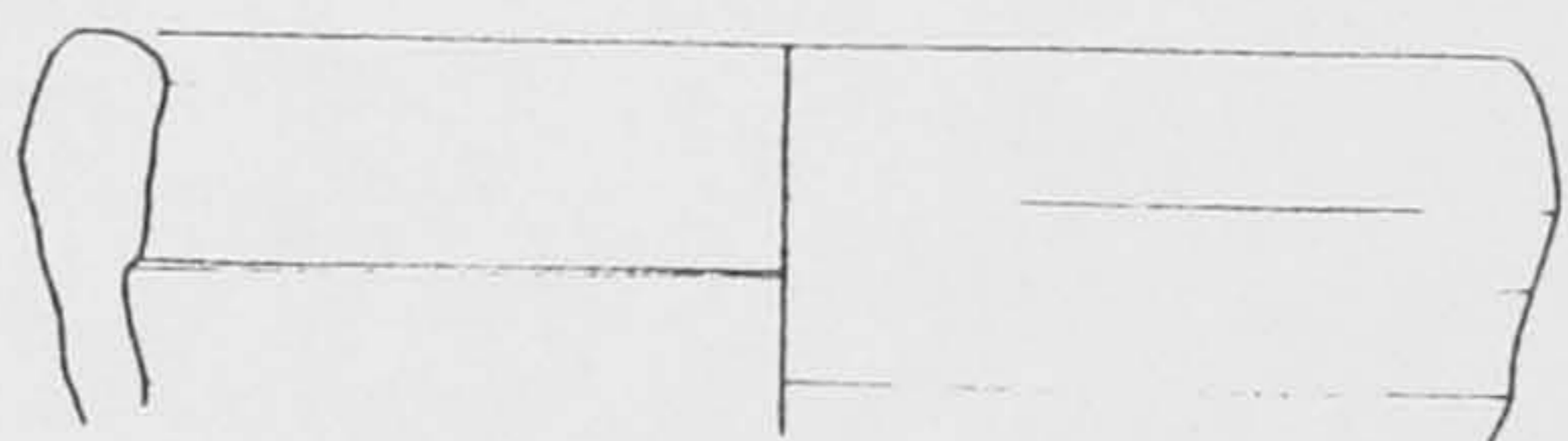

157

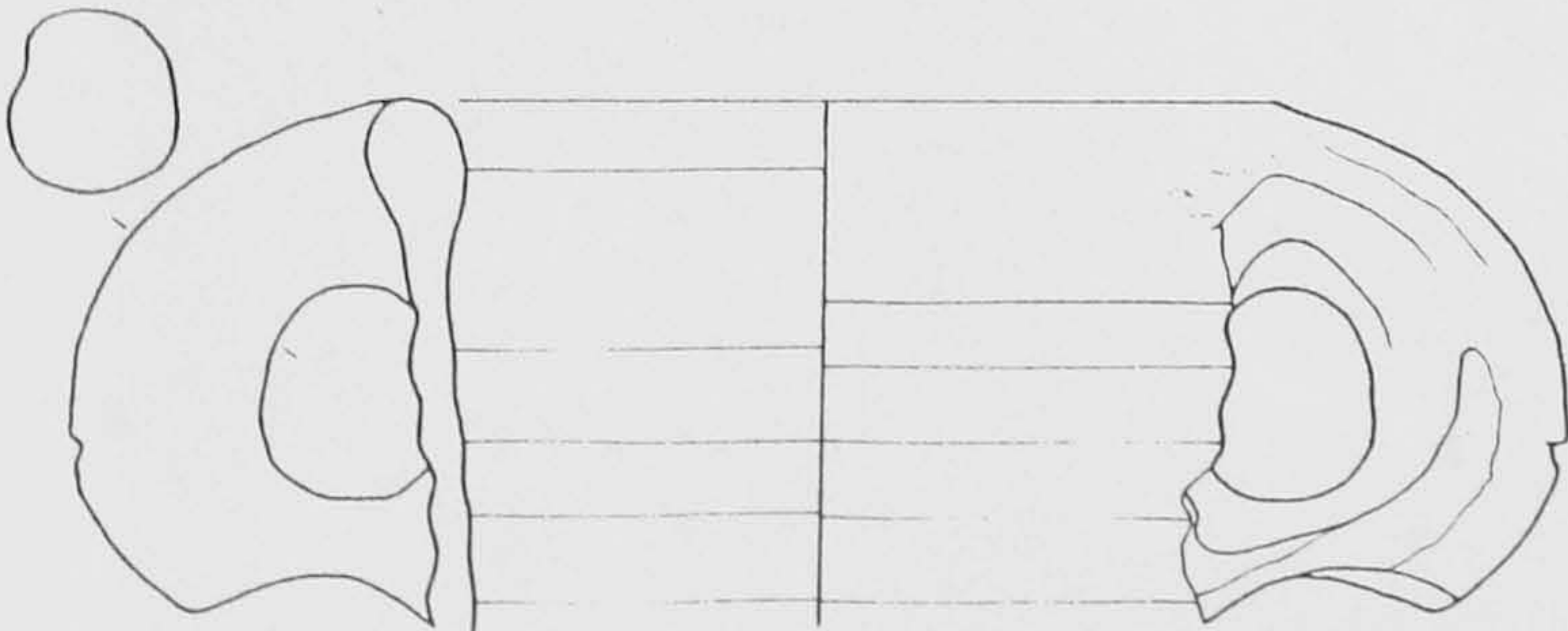

158

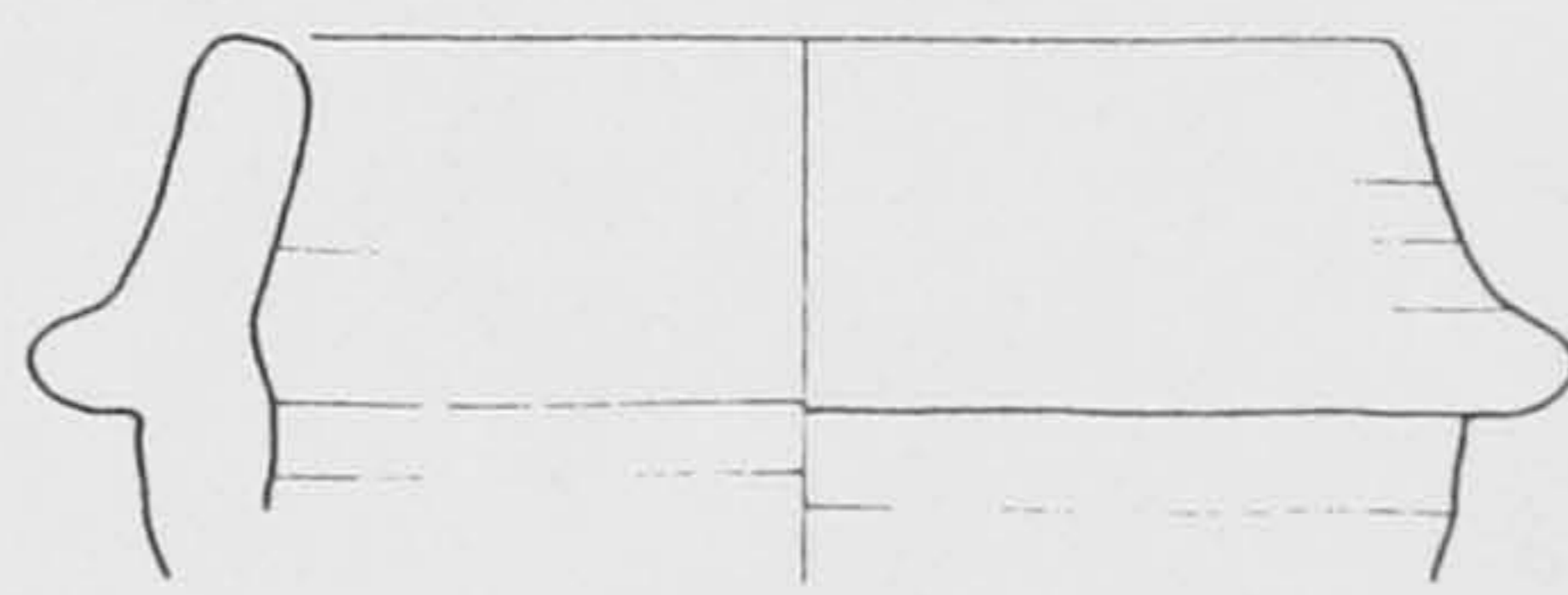

Pottery from surface collections on the main site at 1:3.



A: View south from cliffs towards Kom al-Dik



B: Profile 1, Kom al-Dik.

Fig. II.28

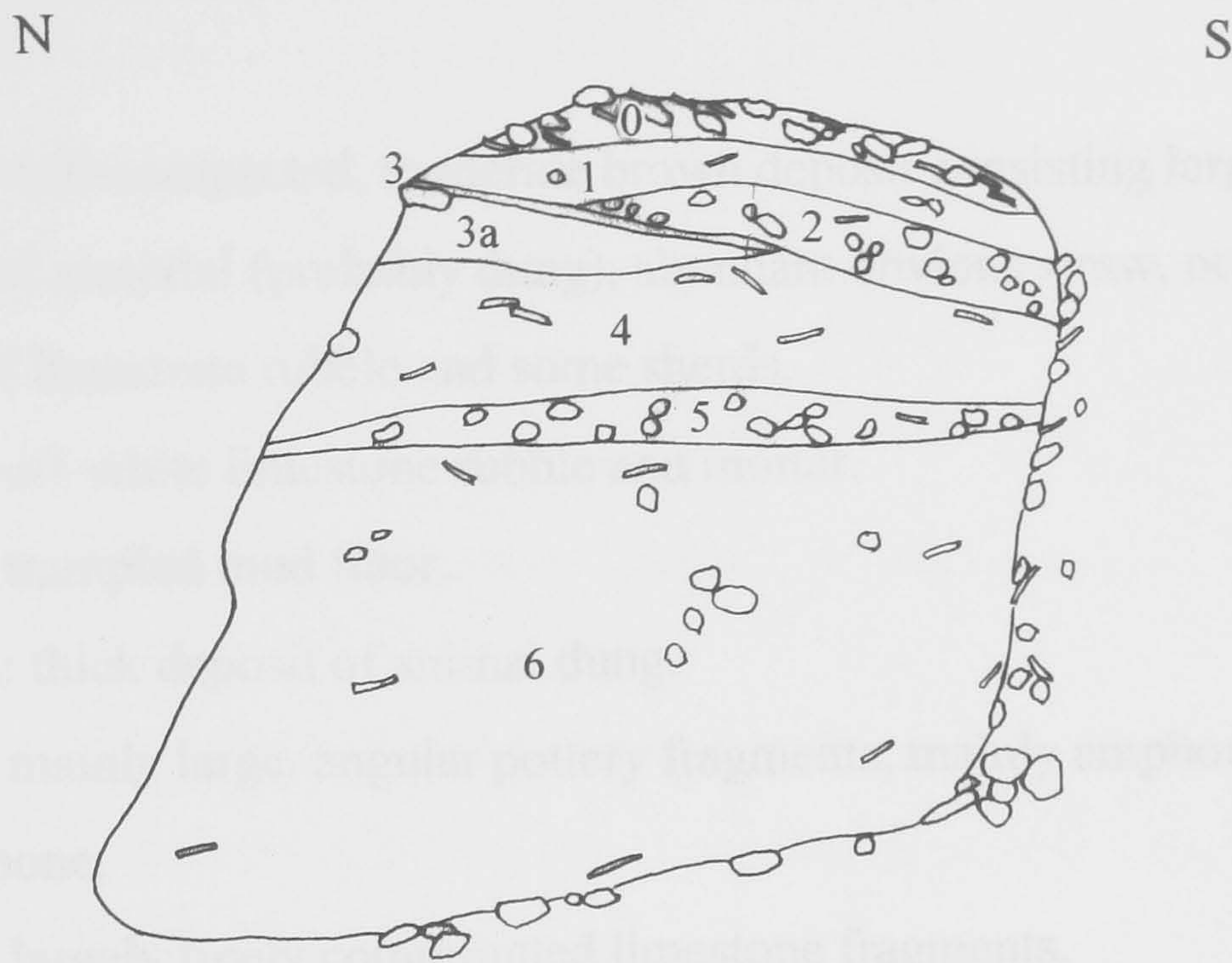

Drawing of profile 1, Kom al-Dik at 1:20.

Kom al-Dik profile 1 layer descriptions

Layer 0: rubble of fired brick (12×6 cm) and pottery, mainly large amphora fragments.

Layer 1: well-compacted, moderate brown deposit consisting largely of comminuted plant material (probably dung), abundant obvious straw, occasional angular pieces of limestone rubble and some sherds.

Layer 2: off-white limestone rubble and mortar.

Layer 3: trampled mud floor.

Layer 3a: thick deposit of animal dung.

Layer 4: mainly large, angular pottery fragments, mainly amphorae, with some fired brick and bone.

Layer 5: largely finely comminuted limestone fragments.

Layer 6: Very silty deposit with copious plant debris and angular sherds, mainly amphorae.

Kom al-Dik: profile 1 pottery

Layer 1

1. *Fabric: M5. Surfaces: burnished red slip all over. Diameter: 22 cm.*
2. *Fabric: Aswan ware R13. Surfaces: thin red slip all over, careless finish. Diameter: 22 cm.*
3. *Fabric: M1. Surfaces: cream slip on exterior, finger indents all around inside of neck.*

Layer 2

4. *Fabric: M4. Surfaces: uncoated. Diameter: 20 cm.*

Layer 4

5. *Fabric: M1. Surfaces: uncoated. Diameter: 26 cm.*
6. *Fabric: M1. Surfaces: traces of red slip inside, apparently unslipped outside. Diameter: 30 cm.*
7. *Fabric: M1. Surfaces: burnished red slip inside and over upper part of outside, rougher finish to slip on lower outside walls. Diameter: 40 cm.*
8. *Fabric: LRA 1. Diameter: 12 cm.*
9. *Fabric: M2. Surfaces: uncoated. Diameter: 14 cm.*
10. *Fabric: gypsum plaster jar stopper over twig strengtheners, impressed with Coptic letters ϣ†. Parallels: similar jar stoppers have been found at Kom al-Nana (Faiers in press, type 431); Kellia, c. 450–500, some with Coptic letters and religious devices (Egloff 1977, type 353, pl. 20); Monastery of Apa Jeremias, Saqqara, and Monastery of Epiphanius, Thebes, made of mud and straw rather than gypsum, but impressed with religious symbols and Coptic letters (Quibell 1912, pl. 46–7; Winlock and Crum 1926: 79–81).*

Layer 5

11. *Fabric: LRA 7. Diameter: 8 cm.*

Layer 6 (upper)

12. *Fabric: M6. Surfaces: red-slipped interior, exterior scorched. Diameter: 20 cm.*

Layer 6 (middle)

13. *Fabric: M5. Surfaces: good red slip all over, scorched exterior. Diameter: c. 20 cm.*
14. *Fabric: M5. Surfaces: burnished red slip, slightly rougher finish on exterior. Diameter: 24 cm.*

Layer 6 (lower)

15. *Fabric: LRA 7. Diameter: 8 cm.*
16. *Fabric: M5. Surfaces: burnished red slip all over. Diameter: unknown.*
17. *Fabric: (VC)M1. Surfaces: uncoated. Diameter: 20 cm.*

Fig. II.31

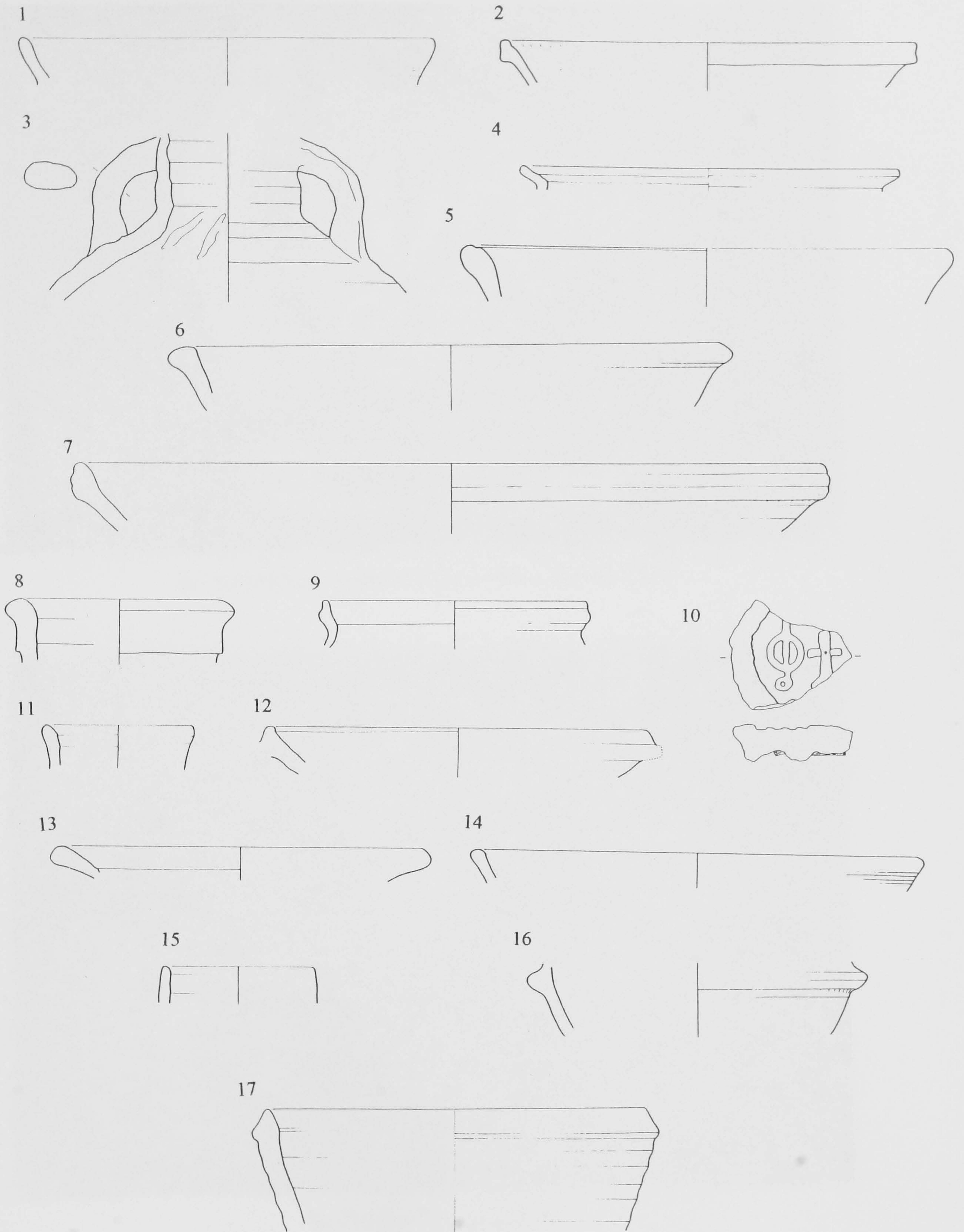

Pottery from profile 1, Kom al-Dik at 1:3.



A: Gypsum jar stopper from profile 1, Kom al-Dik.

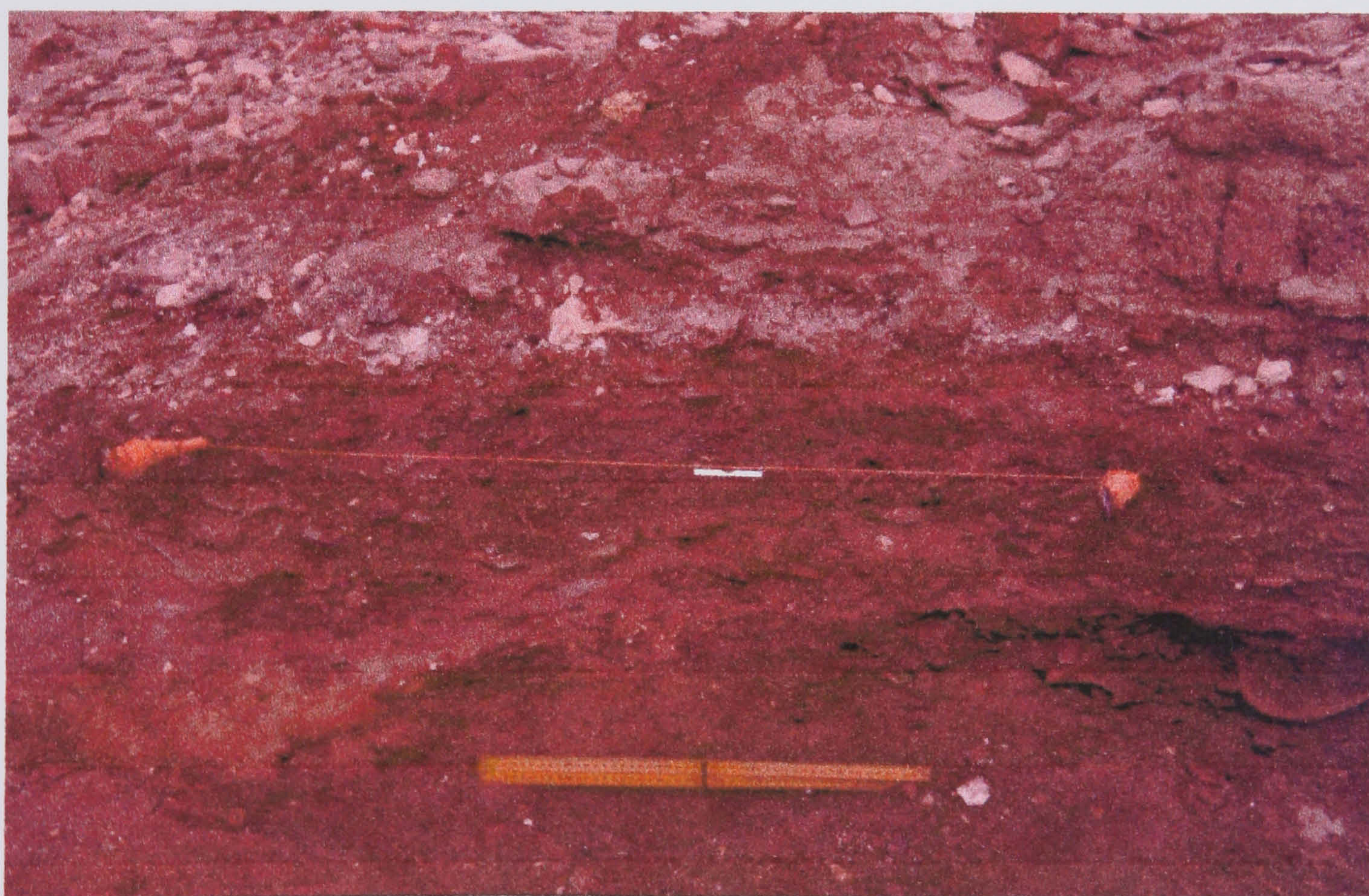

B: Profile 2, Kom al-Dik.

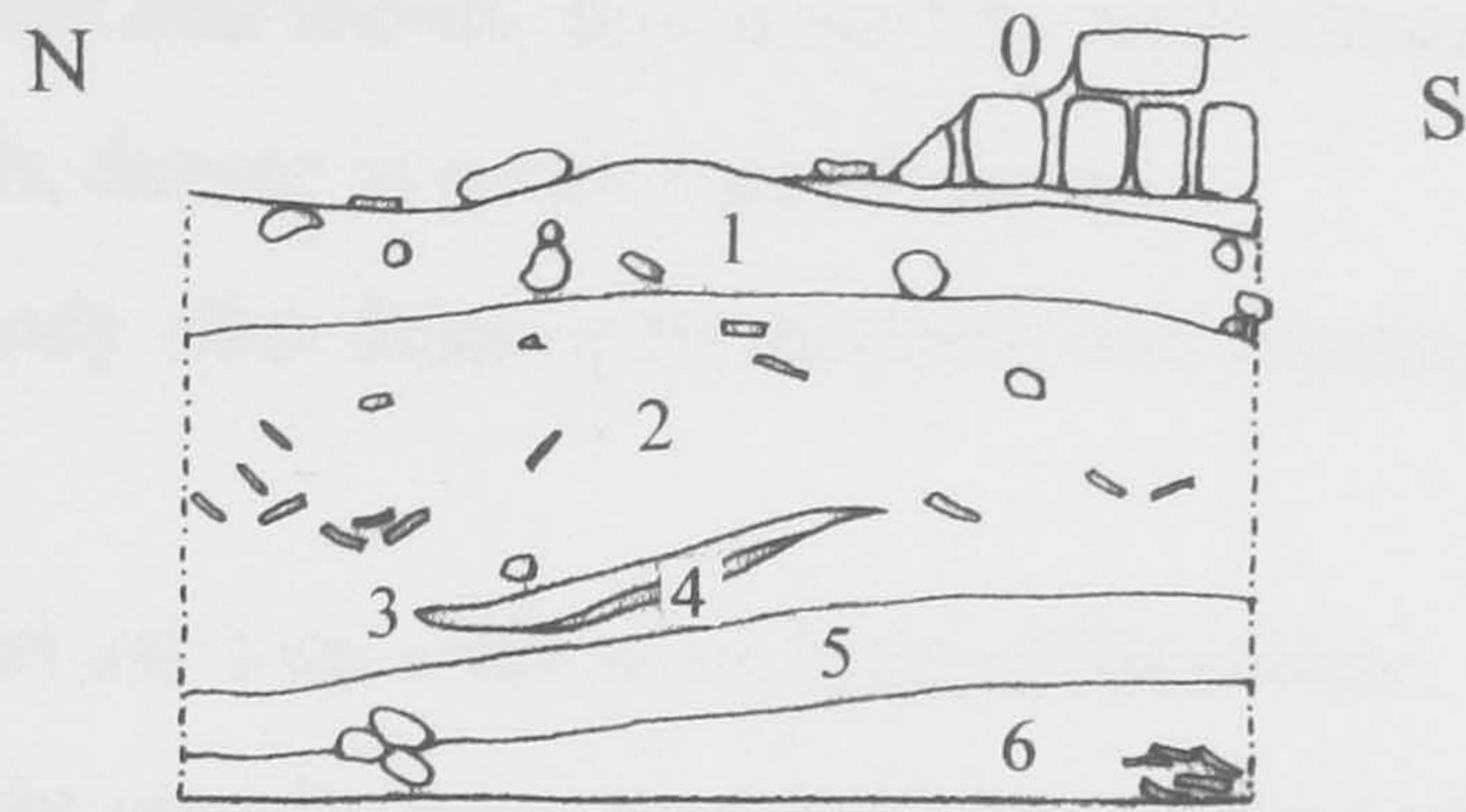

Drawing of profile 2, Kom al-Dik at 1:20.

Kom al-Dik profile 2 layer descriptions

Layer 0: mud-brick wall.

Layer 1: ashy rubble with abundant angular limestone fragments, pottery, mudbricks and much charcoal; topped with loose light brown sediment with large number of date stones.

Layer 2: chaff and sherds, dominated by well-preserved plant debris and scattered pot sherds, denser in south side of deposit.

Layer 3: sandy silts, dipping northwards and running out southwards into deposit above.

Layer 4: thin ash lens with some burned limestone.

Layer 5: light grey-brown comminuted limestone with occasional larger limestone fragments, dipping northwards.

Layer 6: as layer 2.

Kom al-Dik: profile 2 pottery

Layer 1

1. *Fabric: (VC)M1. Diameter: 22 cm.*

Layer 2

2. *Fabric: M5. Surfaces: burnished red slip all over. Diameter: 24 cm.*
3. *Fabric: M5. Surfaces: burnished red slip, matte and rougher below flange. Diameter: 20 cm.*
4. *Fabric: M2. Surfaces: uncoated. Diameter: 28 cm.*
5. *Fabric: M5. Surfaces: burnished red slip all over, rougher on lower exterior surface. Diameter: 28 cm.*
6. *Fabric: M5. Surfaces: burnished red slip all over, blackened and rough on lower exterior. Diameter: 28 cm.*
7. *Fabric: M5. Surfaces: burnished red slip, matte and rough below flange. Diameter: 12 cm.*
8. *Fabric: M5. Surfaces: burnished red slip, matte and rough below flange. Diameter: 12 cm.*
9. *Fabric: M5. Surfaces: burnished red slip, matte and rough below flange. Diameter: 12 cm.*
10. *Fabric: M2, some burned out. Surfaces: burnished red slip on interior and exterior of rim, matte and rough below flange. Diameter: 12 cm.*
11. *Fabric: M2. Surfaces: burnished red slip, matte and rough below rim. Diameter: 14 cm.*
12. *Fabric: M4. Surfaces: uncoated. Diameter: 14 cm.*
13. *Fabric: M4. Surfaces: uncoated. Diameter: 14 cm.*
14. *Fabric: M4. Surfaces: uncoated. Diameter: 16 cm.*
15. *Fabric: LRA 7. Surfaces: resinated interior, drips of resin on exterior. Diameter: 8 cm.*
16. *Fabric: pink-brown marl with light greenish-beige core, containing fairly abundant fine to medium black angular particles, round, light brown sand and common mica. Surfaces: uncoated.*

Layer 5

17. *Fabric*: pale green glass with a few bubbles. *Diameter*: 6 cm.

Layer 6

18. *Fabric*: olive green glass with a few bubbles. *Diameter*: 12 cm.
19. *Fabric*: M5. *Surfaces*: burnished red slip inside and out with black painted decoration around top of rim. *Diameter*: 18 cm.
20. *Fabric*: M5. *Surfaces*: burnished red slip all over. *Diameter*: 20 cm. *Parallels*: Ashmunein, fifth to first half of sixth century, D5–59 (Bailey 1998).
21. *Fabric*: M1. *Surfaces*: cream slip with black and red painted fish decoration on exterior; interior uncoated. *Parallels*: Tell Atrib, second half of sixth to the mid-seventh century or later (Górecki 1988).
22. *Fabric*: blackened M4. *Surfaces*: uncoated, exterior smoothed. *Diameter*: 18 cm.
23. *Fabric*: M5. *Surfaces*: burnished red slip inside and out, black swags and white spots on exterior; shallow indents below carination. *Diameter*: 22 cm. *Parallels*: Ashmunein, fifth and sixth century, D519–671 (Bailey 1998).

Fig. II.36

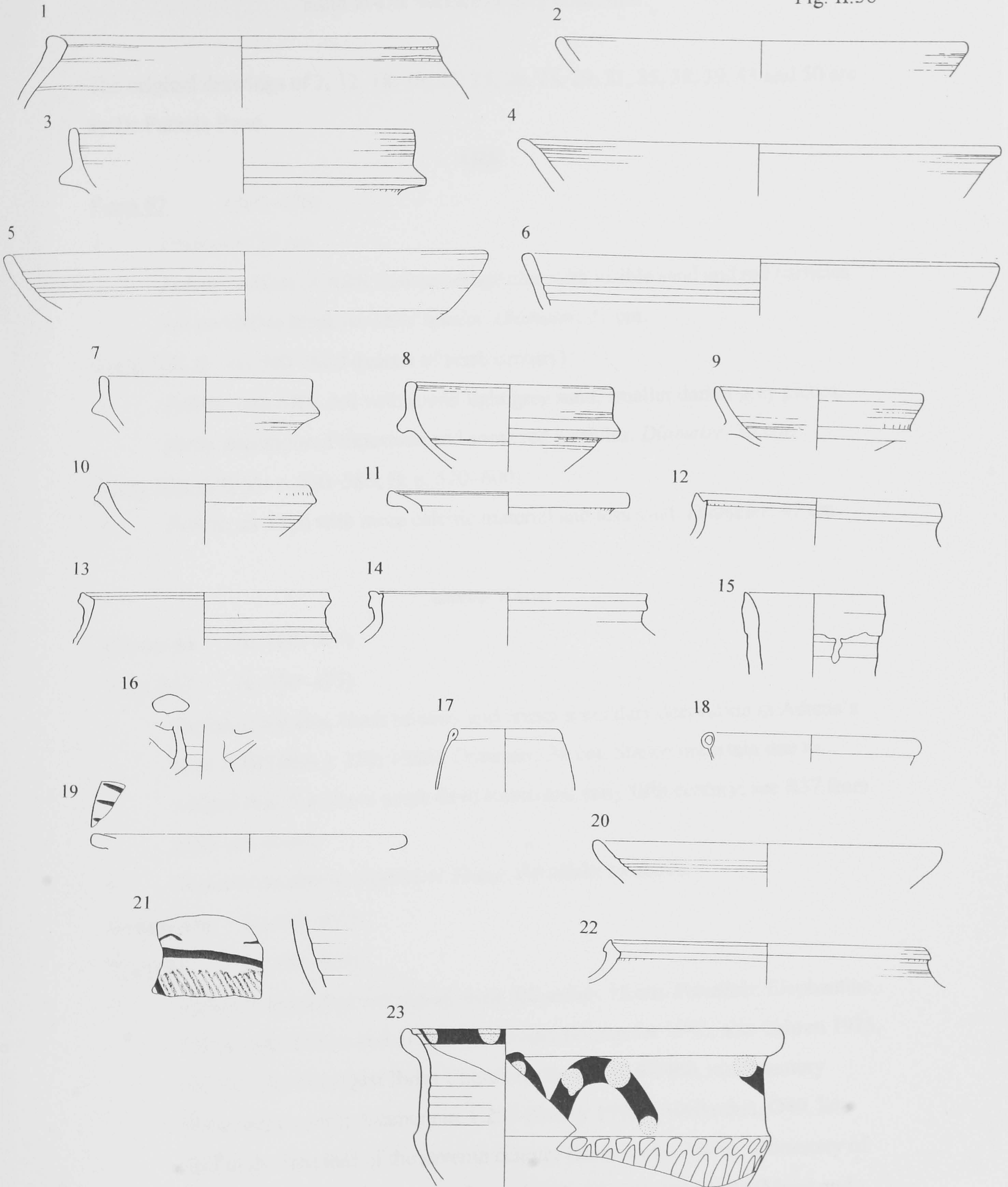

Pottery from profile 2, Kom al-Dik at 1:3.

Kom al-Dik surface pottery collection

The original drawings of 2, 12, 18, 19, 22, 25, 26, 28, 29, 31, 35, 38, 39, 43 and 50 are by Dr Pamela Rose.

ARSForm 67 (360–470)

1. *Diameter: 29 cm.*
2. *Fabric: variant of ARS, coarse orange clay with visible sand and red particles but no visible black or white specks. Diameter: 27 cm.*

Form 103, B (c. 500–third quarter of sixth century)

3. *Fabric: late ARS, red with round light grey sand, smaller darker grey pieces, partly decomposed limestone and some red particles. Diameter: 30 cm.*

Form 104, A/B (A: c. 530–580; B: c. 570–600)

4. *Fabric: as 3 but with more calcitic material and less sand. Diameter: 42 cm.*

Aswan wares**Group AI** (c. 100–475)Ware R37 (c. 350–475)

5. *Surfaces: red slip, black primary and cream secondary decoration in Adams's style A.IB (after c. 350; 1986). Diameter: 38 cm. Stance uncertain due to warped rim. Parallels: many from fourth and early fifth century; see R37 from main city above.*
6. *Surfaces: as above. Diameter: 32 cm. Parallels: as above.*

Group AII (c. 400–850)Ware R4 (c. 550–850)

7. *Surfaces: burnished red slip all over. Diameter: 15 cm. Parallels: Elephantine, T324a, mid-fifth to end of seventh century (Gempeler 1992, also Grimm 1975, 74, 11c, 78, 15a); Qasr Ibrim Church on the Point, 97/400, ninth century (Rose, pers. com.); Ashmunein, C257 (Bailey 1998); Alexandria, O40, late fifth to the first half of the seventh century (Rodziewicz 1976); Monastery of Epiphanius, 37k (Winlock and Crum 1926); Armant, type 138c (Mond and*

Myers 1940, pl. 55); Cyprus Museum, late sixth to seventh century (Hayes 1972, fig. 85e); Nubia, D74 (Adams 1986).

8. *Surfaces*: thin slip, not covering lower part of exterior. *Diameter*: 16 cm. *Parallels*: as above.
9. *Provenance*: circle A. *Surfaces*: thick, burnished slip on interior, thinner slip on exterior. *Diameter*: 50 cm. *Parallels*: Elephantine, T261a, second quarter of sixth to first half of seventh century or later (Gempeler 1992); Alexandria, O18, early seventh century (Rodziewicz 1976).
10. *Fabric*: sandy. *Surfaces*: burnished red slip on interior and upper exterior, coarser finish and thinner slip on lower exterior. *Diameter*: 19 cm. *Parallels*: Elephantine, T359c, second half of sixth to eighth century (Gempeler 1992); Alexandria, O20, fifth to second quarter of seventh century (Rodziewicz 1976); Monastery of Epiphanius, third to sixth century (Winlock and Crum 1926, fig. 37q).

Ware W3 (c. 650–850)

11. *Provenance*: circle A. *Surfaces*: thick, burnished orange-cream slip all over, rouletted decoration on exterior. *Diameter*: 27 cm. *Parallels*: Elephantine, T222, second quarter of fifth to early seventh century (Gempeler 1992); Qasr Ibrim Church on the Point, 96/164 (without rouletting), ninth century (Rose, pers. com.).
12. *Surfaces*: glossy cream slip all over. *Diameter*: c. 40 cm or less; possibly a compartmentalised dish? *Parallels*: Elephantine, T254, late sixth to first half of seventh century, or later (Gempeler 1992); Ashmunein, C615–7, sixth to seventh century (Bailey 1998).

Group AII/AIII

Ware R4/R13 (transitional vessels, ninth to tenth century)

This group includes certain vessels exhibiting characteristics of both ware R4 (glossy red slip, forms typical of the sigillata tradition) and of ware R13 (careless surface finish with thin wash, string-marked rim, different forms). Form parallels are given where found, but may be of different date: for example, the form of 14 is comparable with those of Ware R4, but the surface finish apparently indicates a later date.

13. *Surfaces*: burnished red slip all over. *Diameter*: 24 cm. *Parallels*: Elephantine, T412a, second quarter of seventh to ninth/tenth century (Gempeler 1992); Qasr Ibrim Church on the Point, 97/545, late ninth to mid-tenth century (Rose pers. com.).
14. *Provenance*: circle B. *Surfaces*: thin red wash all over, vessel carelessly finished. *Diameter*: 18 cm. *Parallels*: for form, Elephantine, T344c, sixth to seventh/eighth century (Gempeler 1992); Theban tomb 99, 98/68 (Rose/Pyke pers. com.).
15. *Surfaces*: thin red slip all over, fired darker red on rim. *Diameter*: 14 cm. *Parallels*: for form, Elephantine, T324a/b, mid-fifth to seventh century (Gempeler 1992).
16. *Provenance*: circle A. *Surfaces*: thin, watery red slip all over, rough finish, faint impressed decoration around inside of base. *Diameter*: 18 cm. *Parallels*: for form, Elephantine, T324c, decoration similar to T324b, first half of sixth to the end of sixth/start of seventh century (Gempeler 1992, pl. 39, 17).
17. *Surfaces*: thin red slip all over. *Diameter*: 24 cm. *Parallels*: for form, Elephantine, T230b, first half of sixth to seventh century (Gempeler 1992); Theban tomb 99, 98/121 (Rose/Pyke pers. com.).

Group AIII (c. 850–1100)

Ware R12? (c. 850–950)

The decorative programme of this sherd does not conform closely to any of Adams's ware descriptions, nor have good parallels been found from other sites.

18. *Surfaces*: matte, dark red slip all over, black-painted decoration on exterior. *Diameter*: 20 cm. *Parallels*: form as Elephantine, T511 (ware W12), probably eighth/ninth century or a little earlier (Gempeler 1992).

Group AIII/IV

Ware R13: (c. 850–1250)

19. *Surfaces*: thin, matte, pink wash all over, slight traces of smoothing in places. *Diameter*: 28 cm. *Parallels*: Elephantine, T227, possibly late sixth or early seventh century (Gempeler 1992).

20. *Provenance*: circle B. *Fabric*: fairly coarse-grained. *Surfaces*: thin slip all over. *Diameter*: 35 cm. *Parallels*: perhaps Elephantine, T231b, seventh century (Gempeler 1992); Ashmunein, C112–5, sixth to seventh century (Bailey 1998).
21. *Provenance*: circle B. *Surfaces*: red wash on interior and upper exterior. *Diameter*: 34 cm. *Parallels*: Elephantine, T270–1, sixth to eighth/ninth century (Gempeler 1992).
22. *Surfaces*: matte, washy red slip all over. *Diameter*: c. 26 cm. Stance uncertain. *Parallels*: as above.
23. *Surfaces*: thin, matte red slip all over. *Diameter*: 22 cm. *Parallels*: as above.
24. *Provenance*: circle B. *Surfaces*: matte, dark red slip all over, chiselled decoration on exterior. *Diameter*: 19 cm. *Parallels*: Elephantine, T409/410a, late sixth to seventh century or a little later (Gempeler 1992).
25. *Surfaces*: matte, dark red slip on upper exterior only, two lines of chiselled decoration on exterior wall. *Diameter*: 24 cm. *Parallels*: Elephantine, T410a, late sixth to seventh century or a little later (Gempeler 1992).
26. *Surfaces*: slip and decoration as above. *Diameter*: c. 18 cm. *Parallels*: as above. Stance uncertain.

Ware R13 var?

Ware R13 does not have painted decoration; this sherd does not conform exactly to any of Adams's wares.

27. *Provenance*: circle A. *Surfaces*: thin red slip with darker red rim stripe and vertical string-mark on rim, coarse finish. *Diameter*: 10 cm. *Parallels*: for form, Elephantine, T372, end of sixth to eighth/ninth century (Gempeler 1992).

Group AIV (c. 950–1500)

Ware R13 (c. 850–1250)

These sherds are a continuation of the previous group, containing examples of ware R13 with a fabric fitting Adams's group AIV.

28. *Surfaces*: thin red slip on interior and upper exterior. *Diameter*: 10 cm. *Parallels*: the form is clearly related to bowls of Adams's ware W12.

29. *Surfaces*: thin, streaky, red wash all over. *Diameter* (base): 12 cm.
Ware W12 (c. 950–1300; probably from the late ninth century in Egypt; Pierrat 1992)
30. *Provenance*: circle A. *Surfaces*: dirty cream slip, primary black and secondary red decoration. *Parallels*: Elephantine, T509a, decoration as pl. 67, 6, seventh to tenth century (Gempeler 1992); Esna hermitages, G4 (Jacquet-Gordon 1972, 60, pl. 223); G4, post-650 (Adams 1986).
31. *Fabric*: pinky-orange. *Surfaces*: white slip all over, red rim band and black decoration (decorative scheme does not conform exactly to Adams's ware W12). *Diameter*: c. 16 cm. *Parallels*: Elephantine, T375, pl. 58, 1, seventh to eighth/ninth century; also T373 a or b, pl. 56, 20 and 25, seventh to ninth/tenth century (Gempeler 1992); Ashmunein, C716 (with larger diameter), ninth century (Bailey 1998).

Glazed Wares

The appearance of glazing technology in Egypt probably dates from the early eighth century, at which point so-called 'Coptic Glazed Ware' (glazed Aswan ware) and certain types of 'Fayyumi ware' came into existence (Bailey 1998, 112–3; Engemann 1988 and 1989; Rodziewicz 1983; Whitcomb 1989). Engemann observed from his material at Abu Mena that 'Fayyumi ware' glazed turquoise or with black radiating patterns on a grey-white base were apparently earlier than those with more complex patterns in yellow or manganese brown (quoted in Bailey 1998, 112). The material from Kom al-Dik is glazed in shades of blue or green, with occasional stripes or spots of black or purple; no examples of yellow or brown glazed wares were found. The glazed sherds from Kom al-Dik thus appear to be fairly early in date.

The fabrics of these vessels are all light beige marls of medium porosity, with moderate amounts of medium-sized, round sand or white quartz and scarce fine black and red particles, similar to Fustat fabric. The widespread glazing of silts seems to be largely a later phenomenon. Bailey suggests a local origin for much of the early glazed material from Ashmunein; further investigation of desert clay sources may shed some light on this issue.

32. *Surfaces*: interior glazed a thick aquamarine, exterior has thin, dull, gritty glaze, bright mint-green in colour. *Diameter*: 18 cm. *Parallels*: Ashmunein, R19 has the same pattern of thicker glaze inside and over rim giving way to a thinner coating on the exterior; R26 is glazed in comparable colours, eighth to ninth century; the form is closest to R13, and Bailey suggests it was manufactured in Egypt from the ninth century (1998: 114).
33. *Surfaces*: thick aquamarine glaze as interior of vessel 32 all over. *Diameter* (base): 9 cm. *Parallels*: Ashmunein, R12 has comparable glaze, eighth to tenth century (Bailey 1998).
34. *Surfaces*: unglazed exterior, interior has green (stippled) and black diagonal stripes on a pale green background glaze. *Parallels*: Ashmunein, R1 ('brown clay'), ninth to tenth century, or R2–3 ('cream clay'), ninth century (Bailey 1998); Fustat, ninth to tenth century (Scanlon 1974, pl. 18, 6); Old Cairo, ware FG16, ninth to tenth century (Gascoigne forthcoming); Abu Mina, eighth to ninth century (Engemann 1989, fig. 8); Dakhla, thirteenth century (date far too late; Keall 1981, fig. 1, no. 15); Benaki Museum, tenth to twelfth century (these dates are also too late; Philon 1980, fig. 94); a complete bowl of this ware is on display in the Islamic ceramics room of the Fitzwilliam Museum, Cambridge (accession number C151–1946); it is labelled 'Veramin Ware' but an Egyptian origin seems certain.
35. *Surfaces*: exterior has a cream slip, interior pale green with blue-green (stippled) and purplish-black streaky lead glaze. *Diameter*: 16 cm. *Parallels*: as above.
36. *Provenance*: circle A. *Surfaces*: interior glazed a thick, glassy pale green with slightly raised spots of black glaze, exterior has a thin coating of pale green. *Diameter* (base): 10 cm.
37. *Surfaces*: pale-green glaze all over, somewhat vitrified. *Diameter* (base): 12 cm.
38. *Fabric*: soft cream marl with fine and slightly coarser sand, many voids, also burned-out calcitic particles; zoned, with some areas of very pale pinkish colouration in section. Light in weight, it could be from Fustat, though it is not

as granular as typical Fustat ware. *Surfaces*: lead-glazed only on interior, pale green with aubergine stripe. *Diameter*: c. 24 cm.

39. *Surfaces*: interior green-blue glazed, exterior slipped the same colour, the glaze extending over the rim and dripping down the outside unevenly. *Diameter*: 10 cm. *Parallels*: Ashmunein, R22, ninth to tenth century (Bailey 1998); Benaki Museum (Philon 1980, 50, fig. 100).
40. *Surfaces*: slightly bluish bottle-green glaze on interior and exterior surfaces, with incised grooves around outside of rim using FFS technique to create darker stripes. *Diameter*: 17 cm. *Parallels*: Fustat (Scanlon 1984, fig. 20); Edfu surface finds (see fig. V.6, vessel 9 below).

Marls

41. *Provenance*: circle A. *Fabric*: Fustat. *Surfaces*: green-fired. *Diameter*: 5 cm. *Parallels*: Ashmunein (Ballet, Mahmoud, Vichy and Picon 1991, fig. 13); Kellia (Egloff 1977, type 199–200).

Black-painted white ware

A decorative programme of black concentric circles and spots on a white background seems to be a Middle Egyptian tradition: a high density of similar ceramics (both pale-coloured marl clays and cream-slipped silts) were observed during a visit to the site of Ansina. Parallels for the latter may also be found in sherds J60, J125, J135 and possibly J181 from Ashmunein, where they come from contexts dated to between the fifth and eighth centuries (Bailey 1998).

42. *Fabric*: greenish-beige marl, quite porous with round sand, grog, lots of small black particles and a little chaff and mica. *Surfaces*: dirty cream firing surface with black-painted decoration faded to dark brown in places. *Diameter*: 7 cm.

Lamp

43. *Fabric*: pale yellowish-green marl containing fine red and black sand, no obvious calcitic particles or chaff. Too dense for traditional Fustat ware. *Surfaces*: cream or self-slipped exterior.

Oasis ware

44. *Fabric*: fine beige-brown marl with large cream lumps of unmixed clay, a small amount of round grey sand and a few dark red bits (P26 in the Dakhlah oasis corpus; Dunsmore pers. com.). *Surfaces*: uncoated, but some resin drips on interior and exterior. *Diameter*: 5.5 cm.

Silt BowlsFlanged bowls

See fig. II.25 bowl form 2 from main city. These vessels are probably of fifth- or sixth-century date.

45. *Fabric*: M2. *Surfaces*: thin cream slip on all surfaces, shallow rouletted decoration on exterior. *Diameter*: 16 cm.
46. *Provenance*: circle A. *Fabric*: M5. *Surfaces*: thick matte red slip interior and exterior, scraped on exterior below flange. *Diameter*: 13 cm. *Parallels*: as for fig. II.25, vessel 35.

Stamped base

47. *Fabric*: M6. *Surfaces*: red-slipped interior with stamped decoration, unslipped under base. *Diameter* (base): unknown.

Wide Rope-marked Dish

(Related to main city form 11)

48. *Fabric*: M5. *Surfaces*: burnished red slip on interior, thinner and matte on exterior with 2 lines of rope marks and scraped lower parts. *Diameter*: 35 cm.

Flange-rimmed bowl

49. *Provenance*: circle B. *Fabric*: M6. *Surfaces*: thin red slip all over, rough finish. *Diameter*: 18 cm.

Coarse bowl

50. *Fabric*: M2. *Surfaces*: red-slipped interior and exterior, rocker stamped decoration deeply incised into exterior. *Diameter*: 18 cm. *Parallels*: for rocker decoration, see fig. II.25, vessel 125. Especially relevant is sherd O68 from Ashmunein, which seems to have been decorated in the same pattern as this piece. See also Deir al-Naqlun, sixth century? (Godlewski 1988, fig. 8).

Silt Cooking Pots

Square-rimmed pots

51. *Provenance: circle A. Fabric: M4. Surfaces: uncoated. Diameter: 16 cm.*

52. *Provenance: circle B. Fabric: M4. Surfaces: uncoated. Diameter: 22 cm.*

Round base

53. *Provenance: circle B. Fabric: M1. Surfaces: uncoated.*

Lids

54. *Provenance: circle B. Fabric: VCM1. Surfaces: uncoated, blackened interior.*

Diameter: 22 cm.

55. *Provenance: circle B. Fabric: M1. Surfaces: uncoated, blackened interior.*

Diameter: c. 20 cm. Stance uncertain.

56. *Provenance: circle B. Fabric: M1. Surfaces: uncoated, blackened interior.*

Diameter: 24 cm.

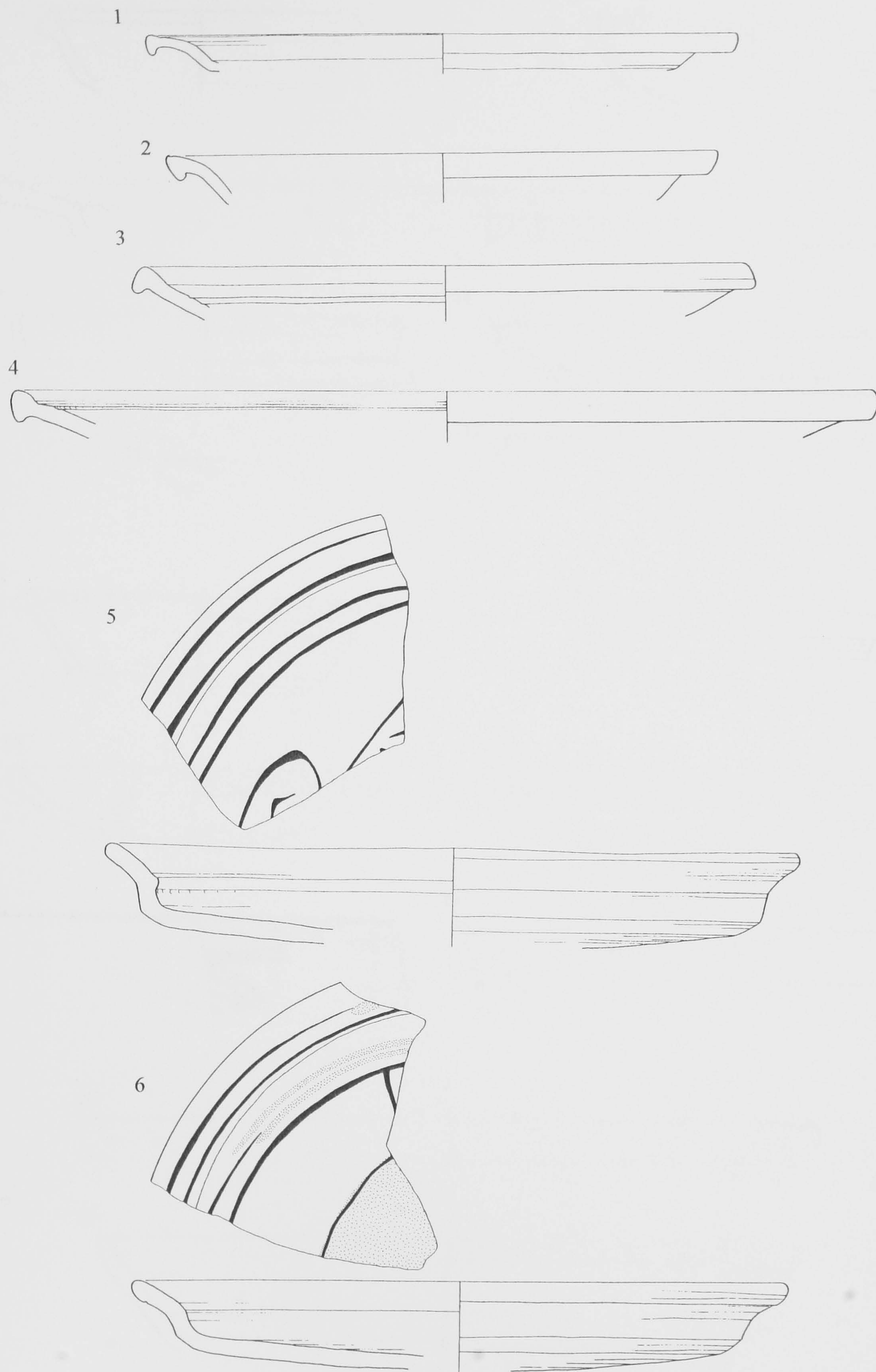

Pottery from the surface collection on Kom al-Dik at 1:3.

7

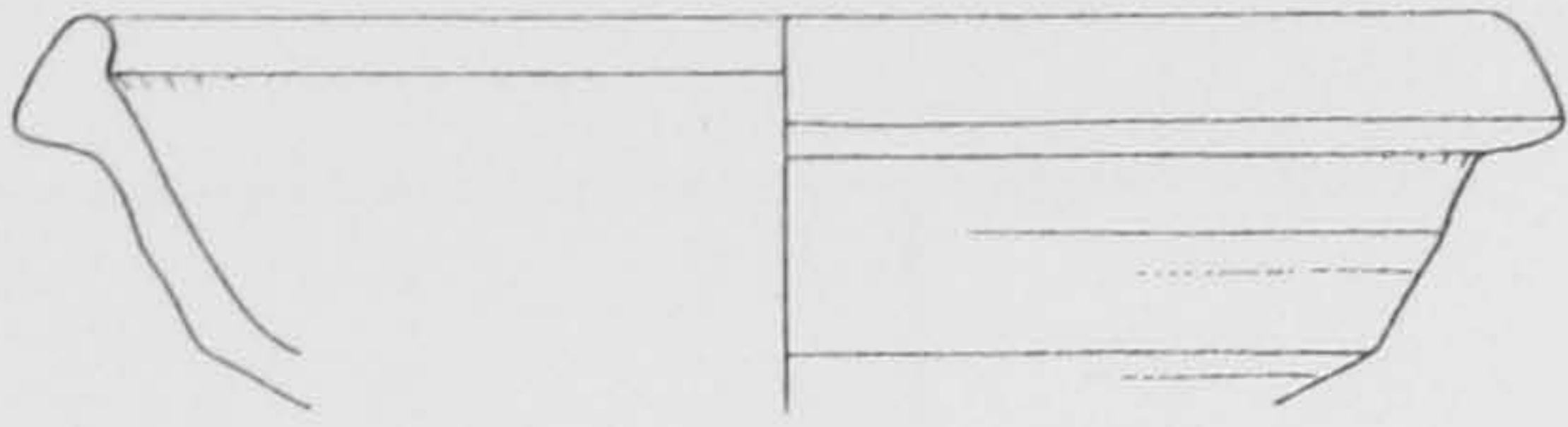

8

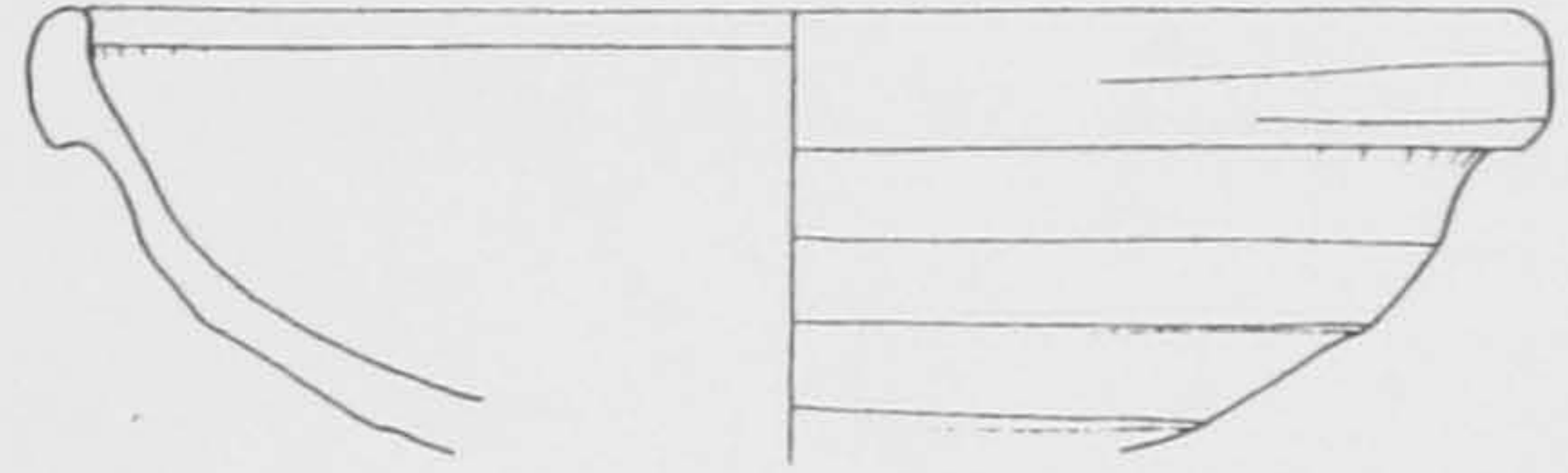

9

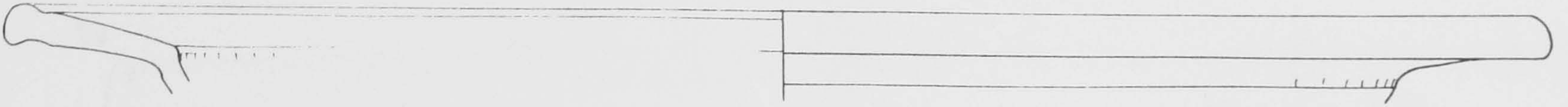

10

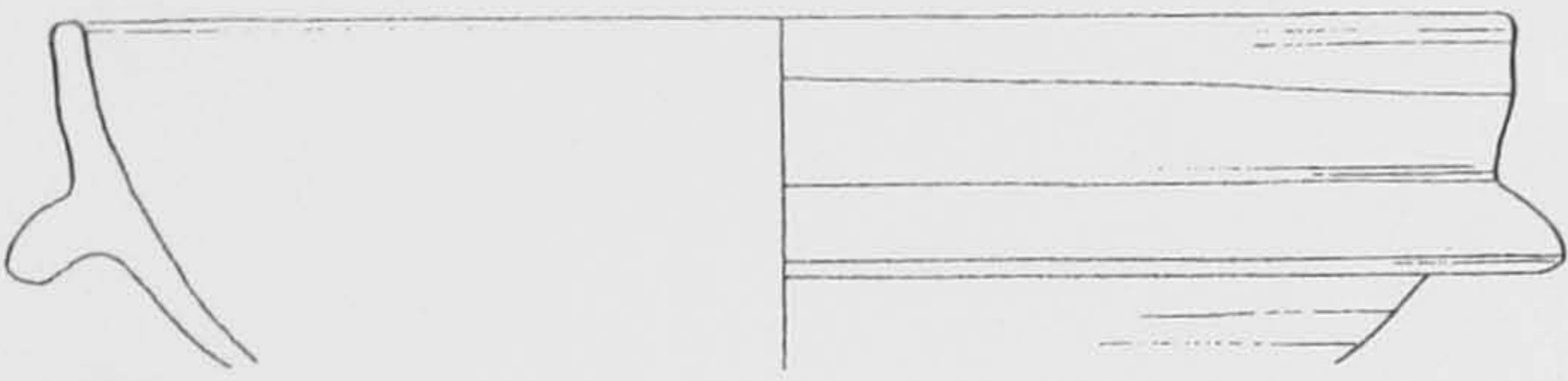

11

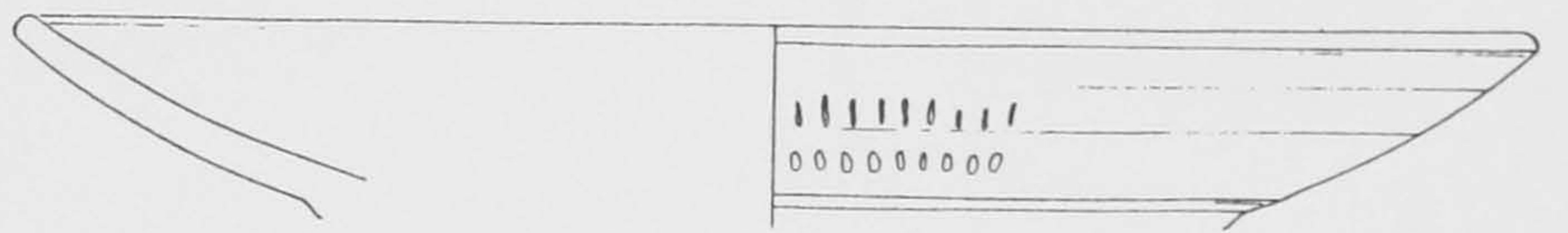

12



13



14

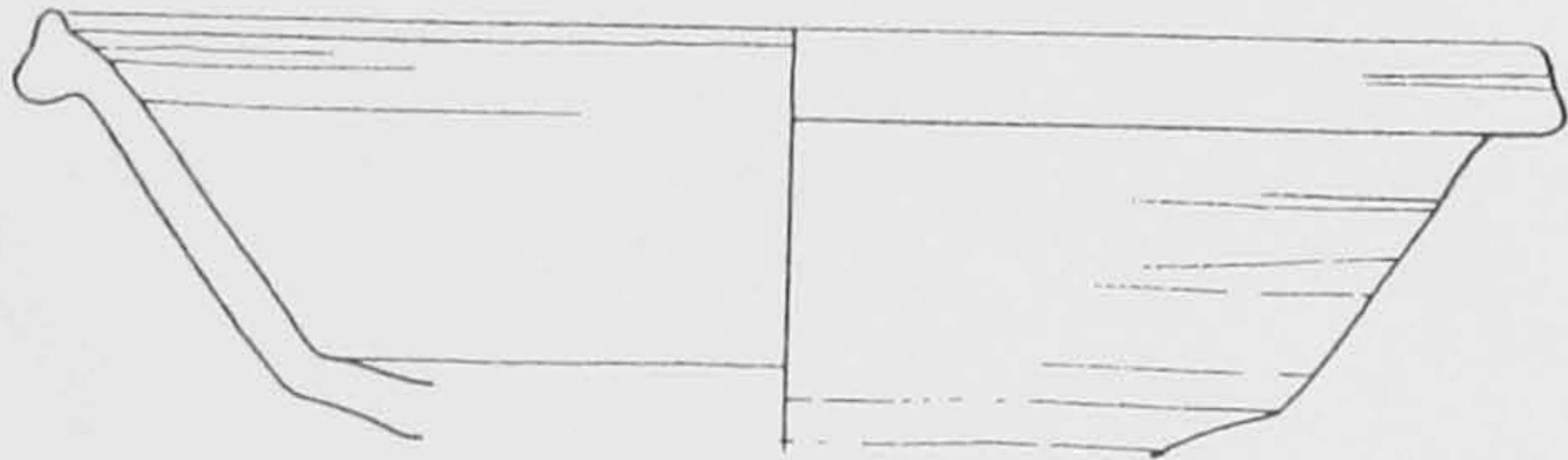

15



16



17

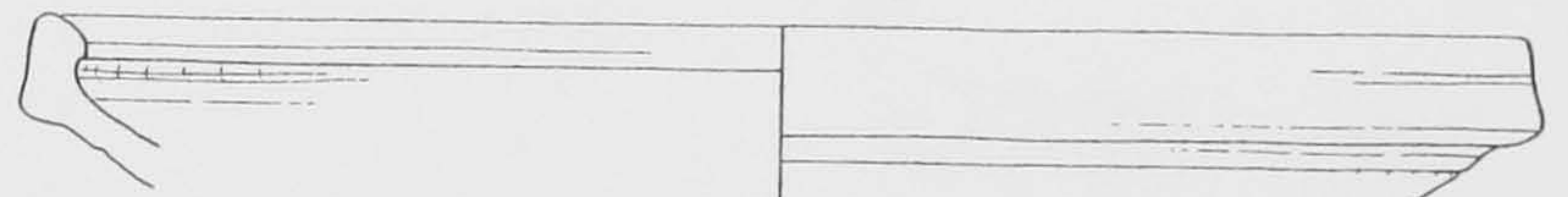

18

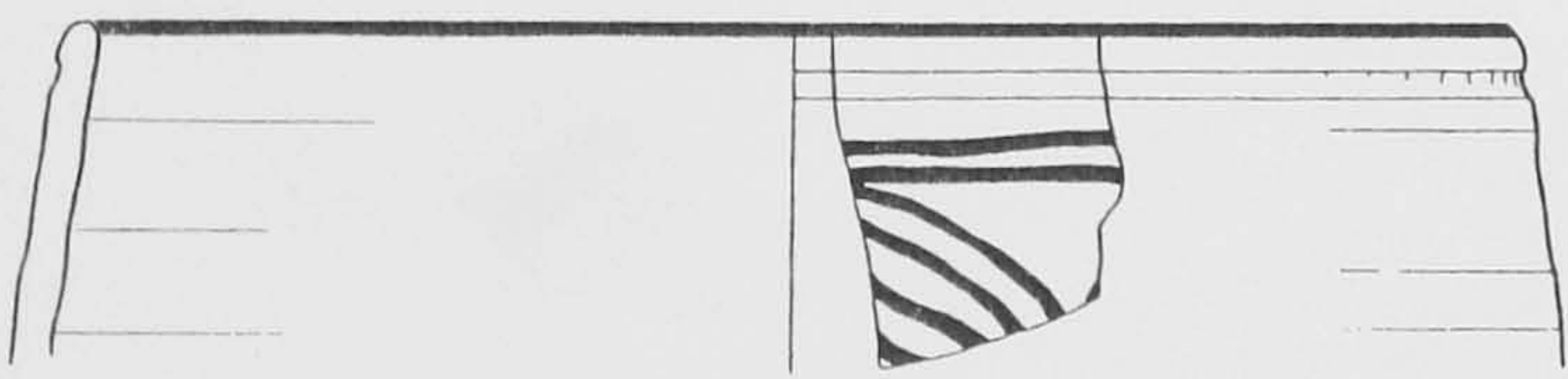

19

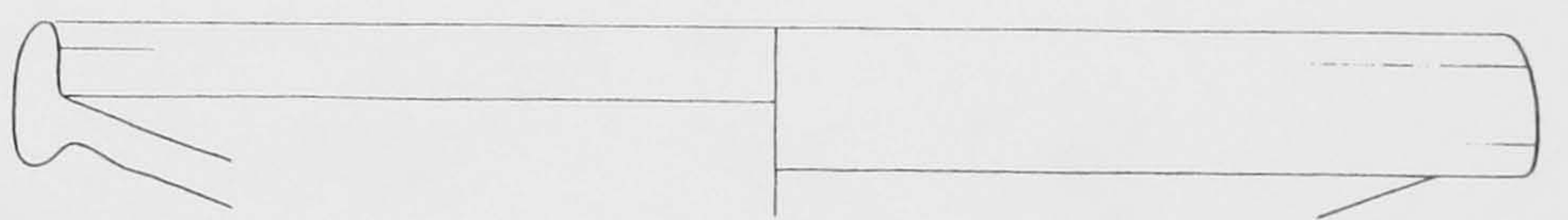

20

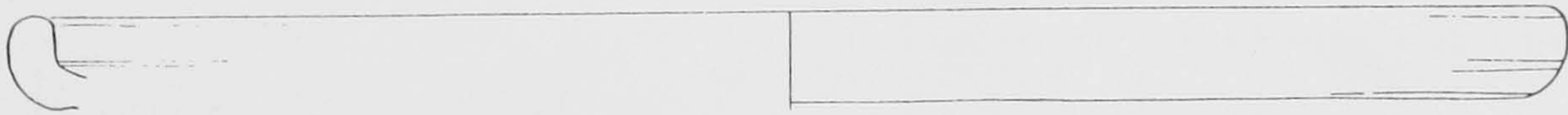

21

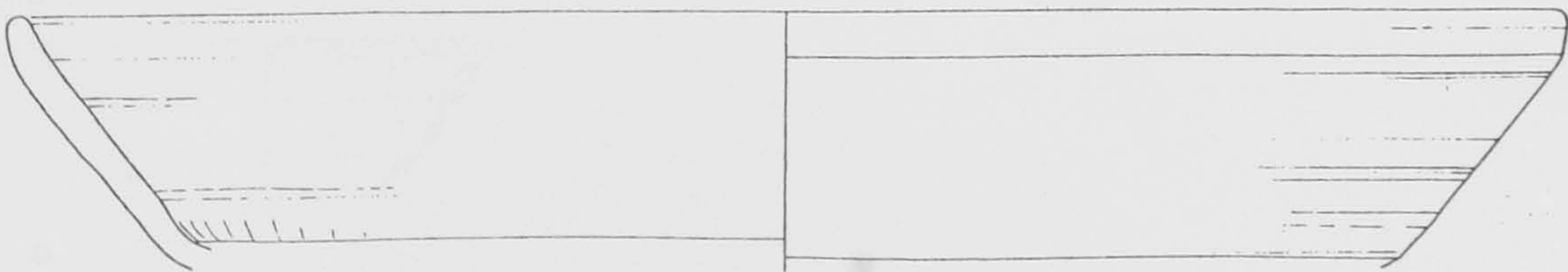

Pottery from the surface collection on Kom al-Dik at 1:3.

Fig. II.38 cont.

22

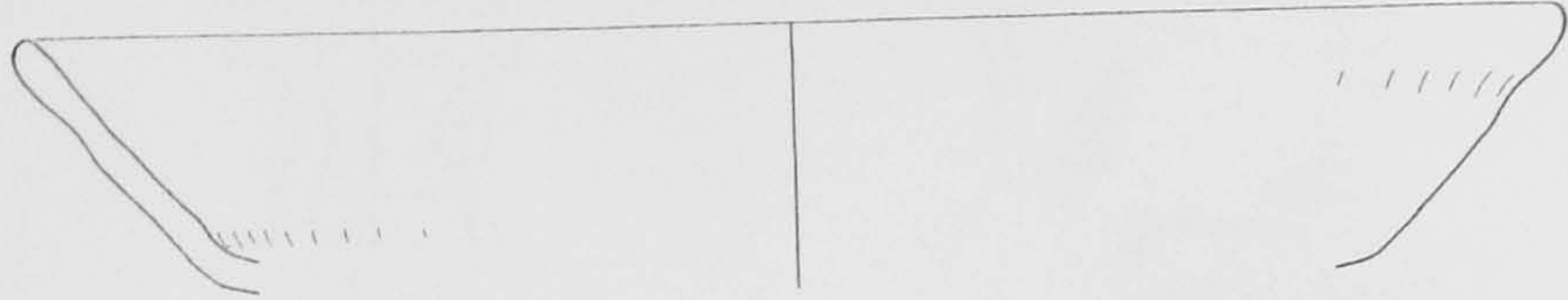

23



24

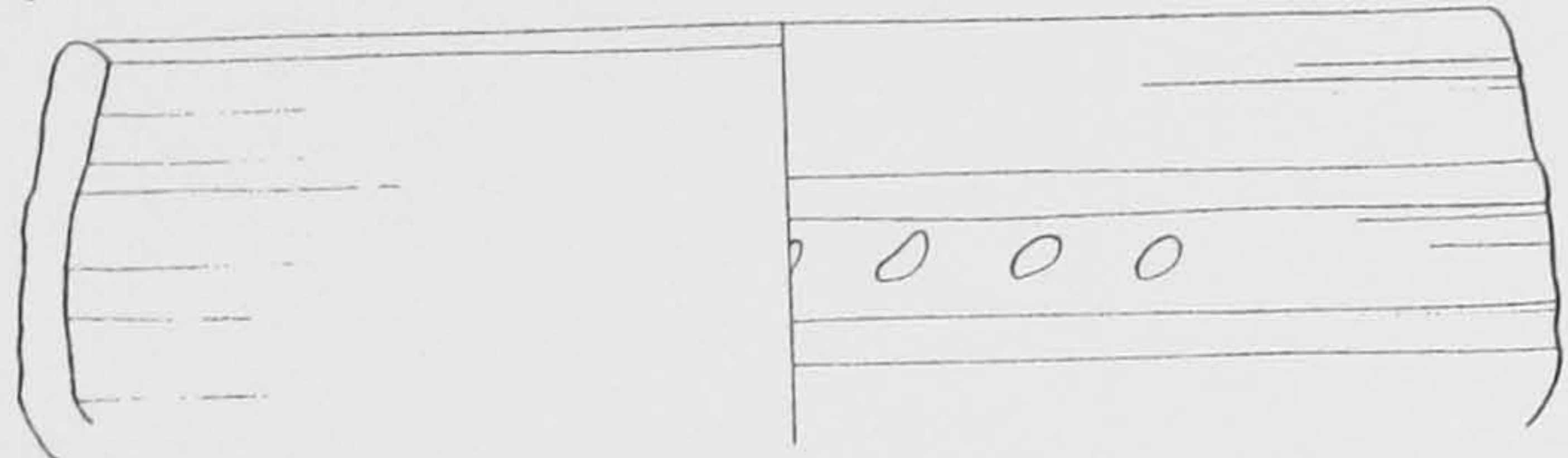

25



26

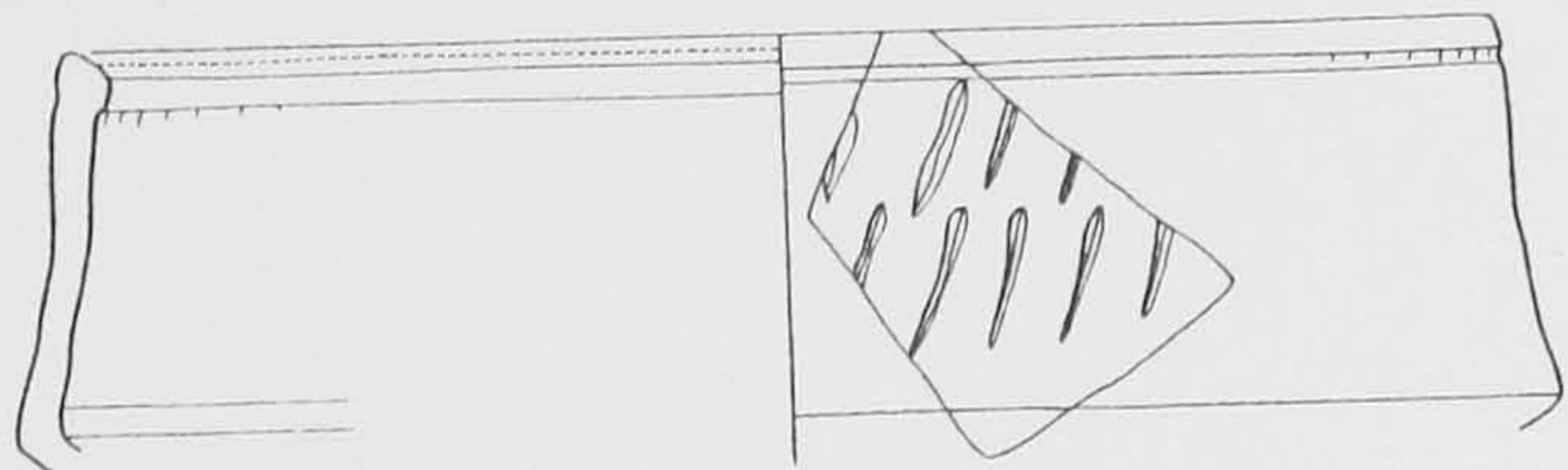

27

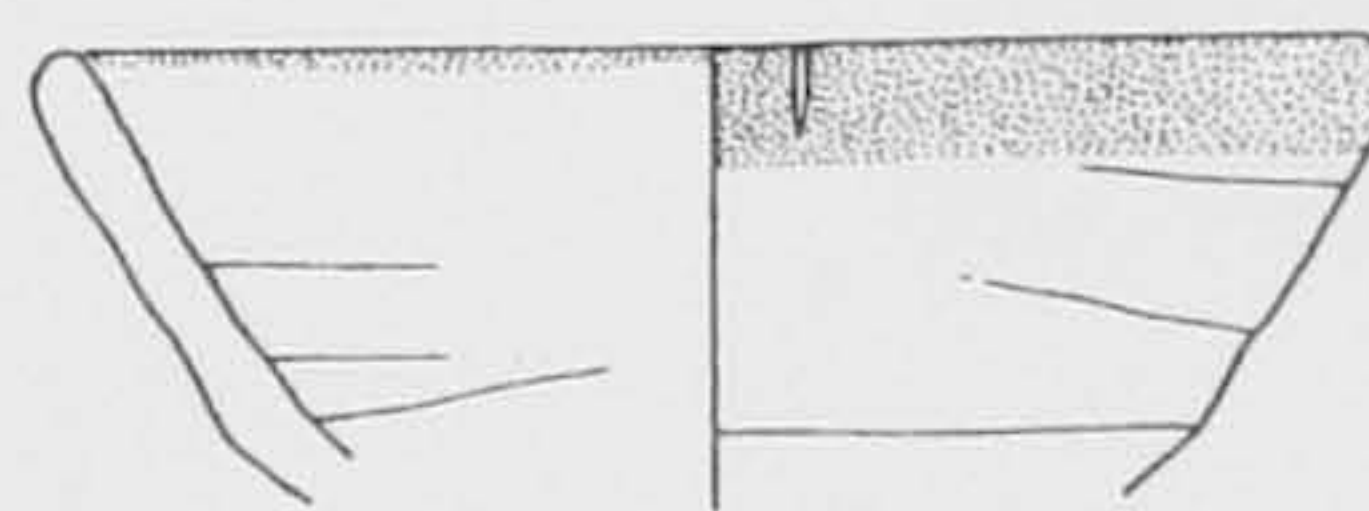

28



29



30

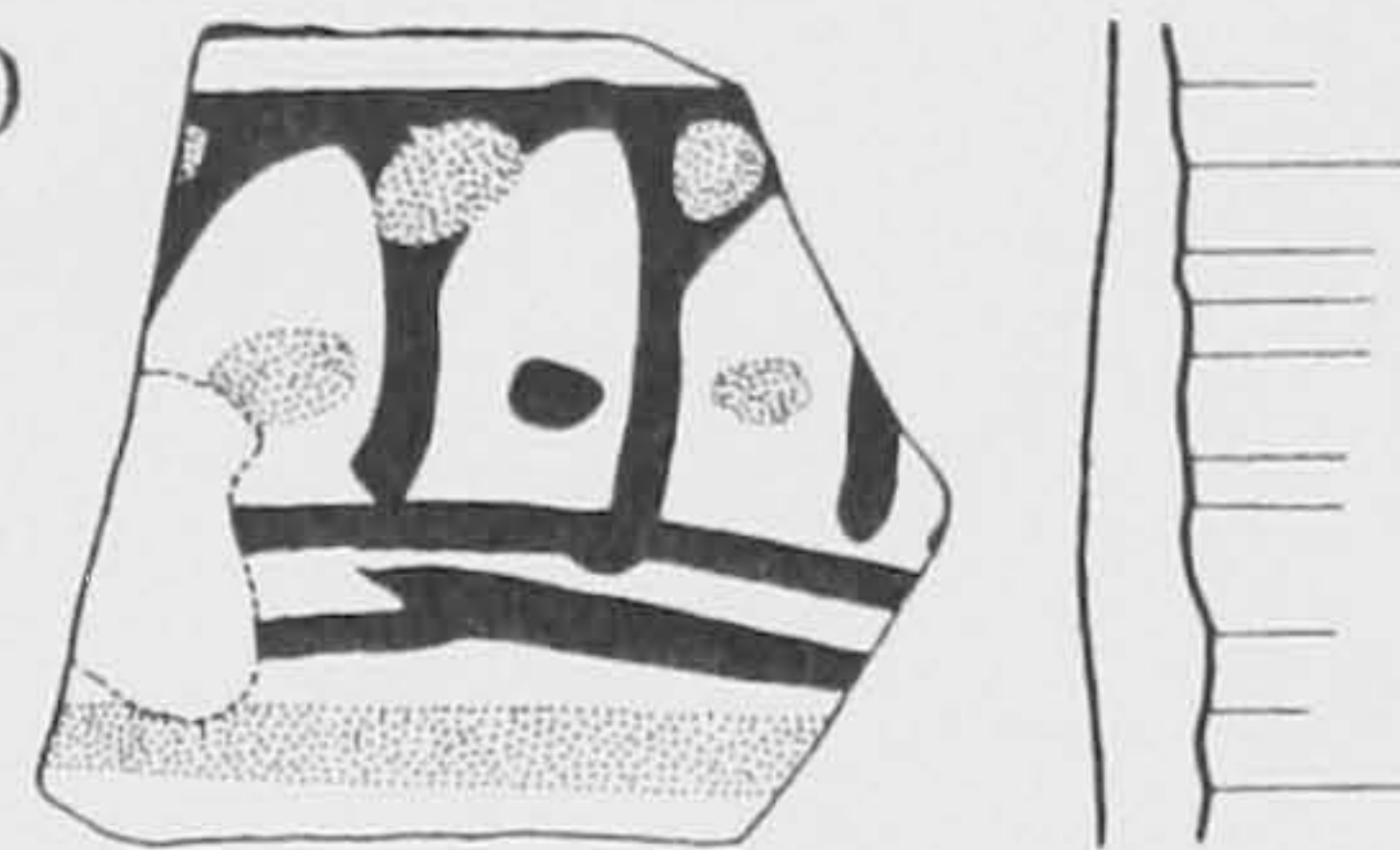

31



32

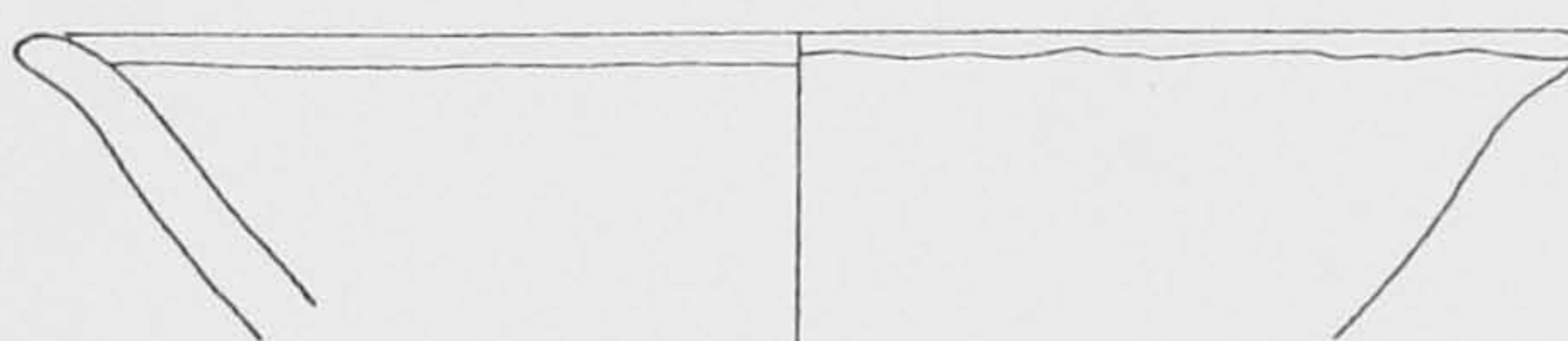

33

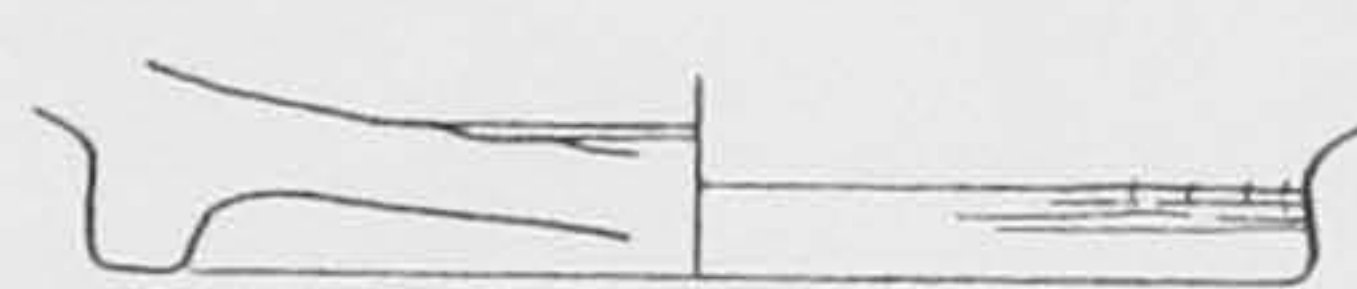

34

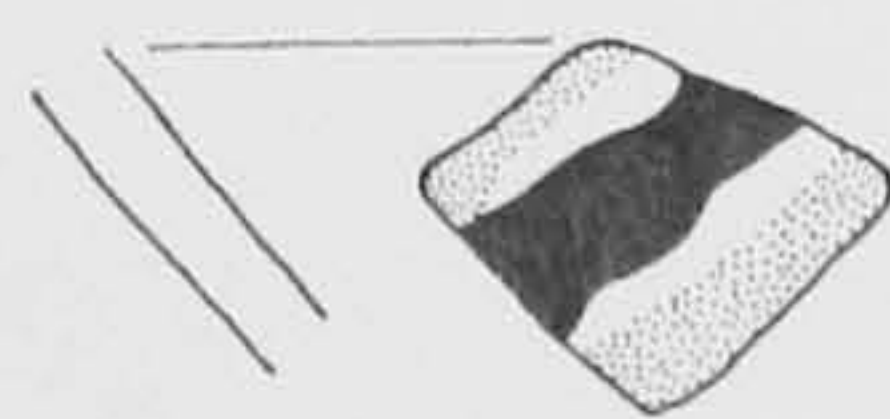

35

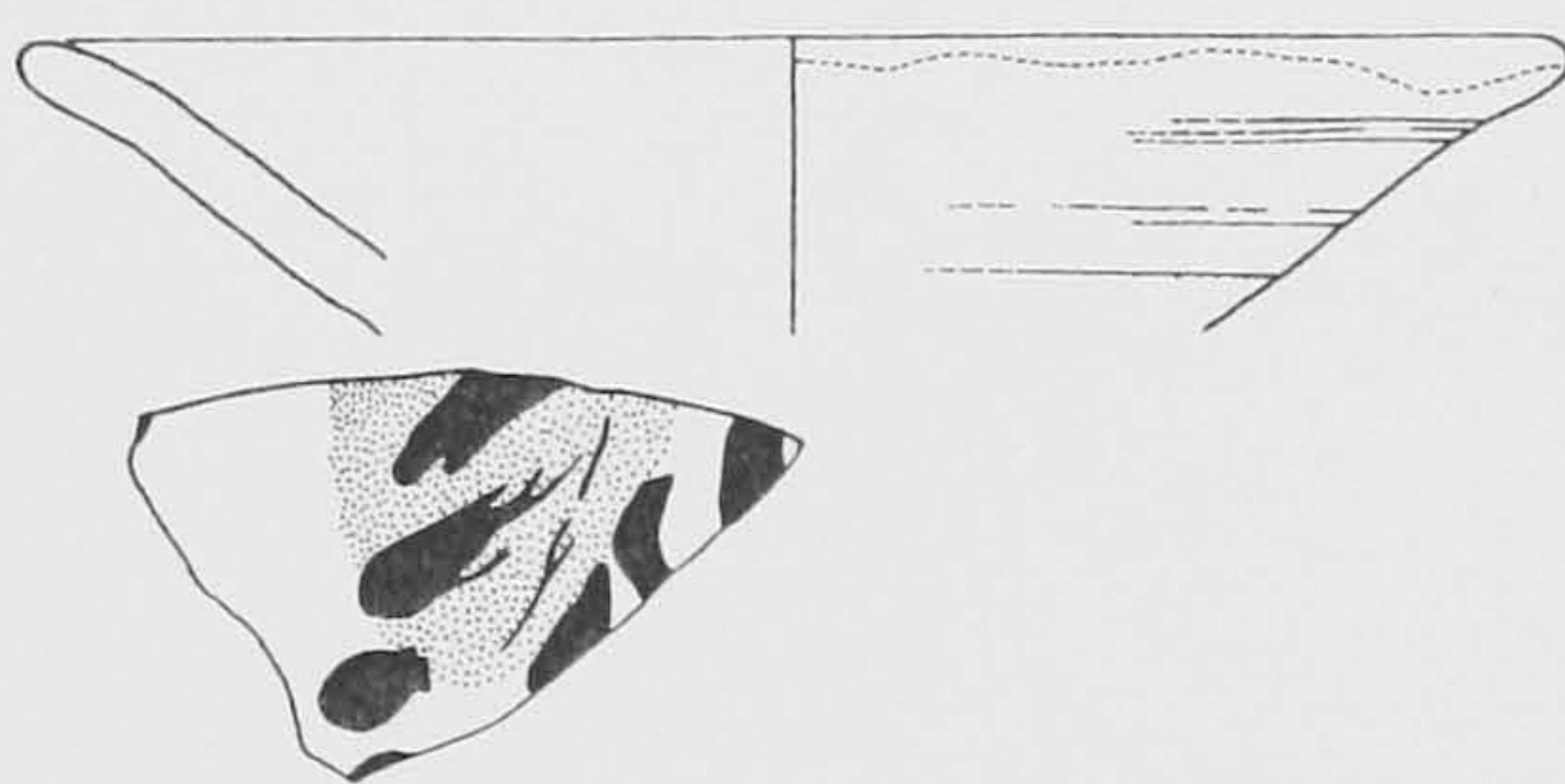

36

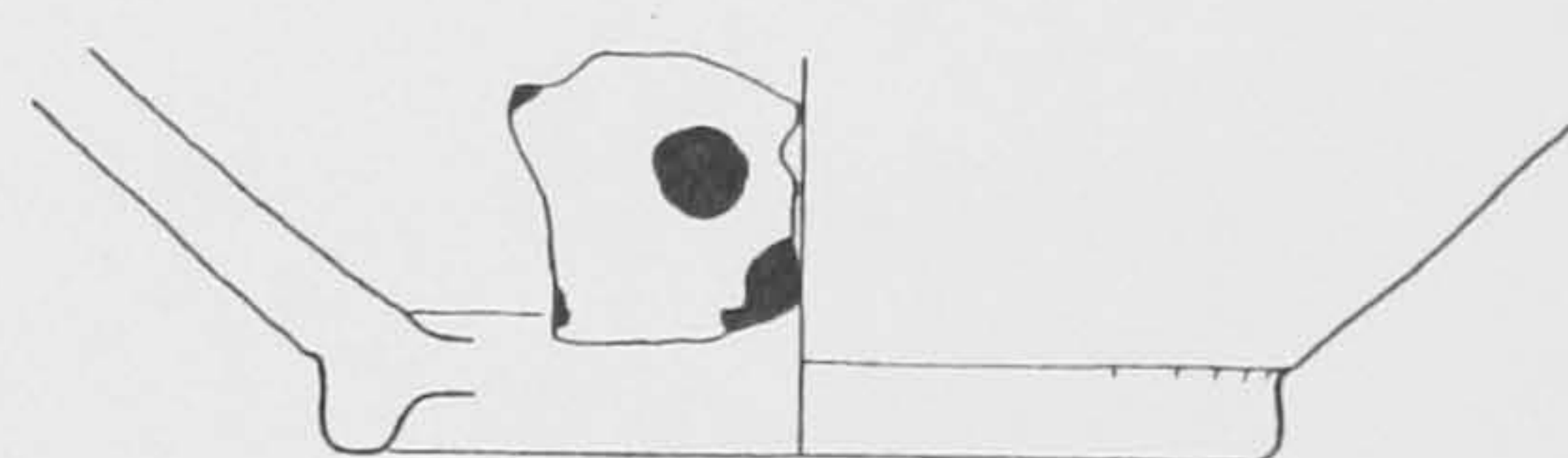

37



38

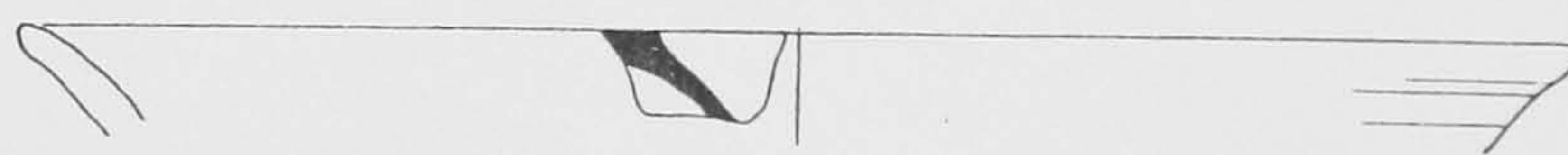

39

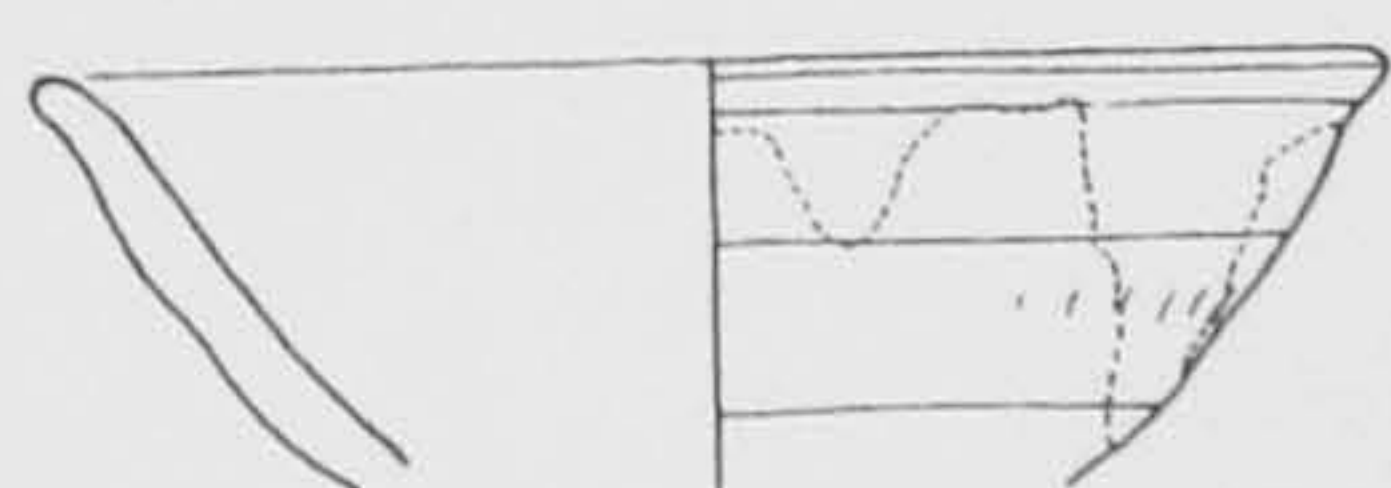

40

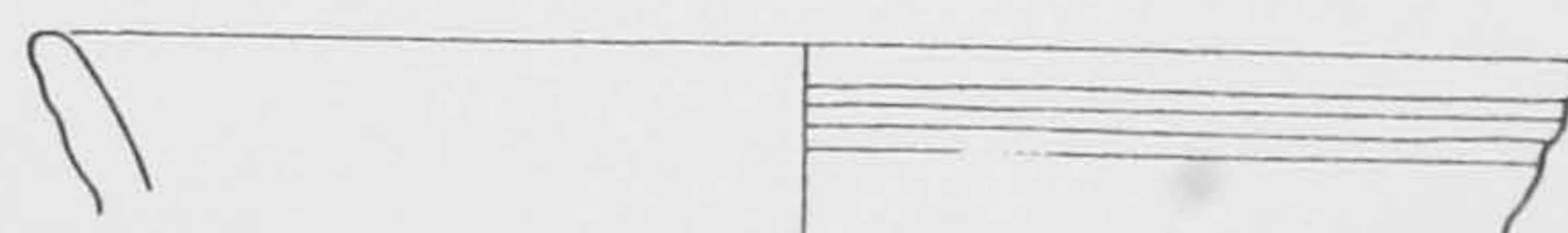

Pottery from the surface collection on Kom al-Dik at 1:3.

Fig. II.38 cont.

41

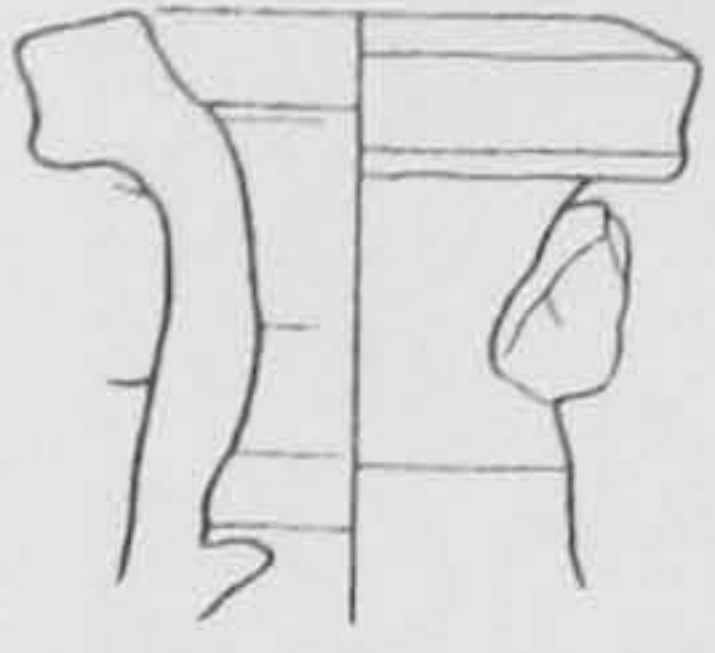

42



43



44

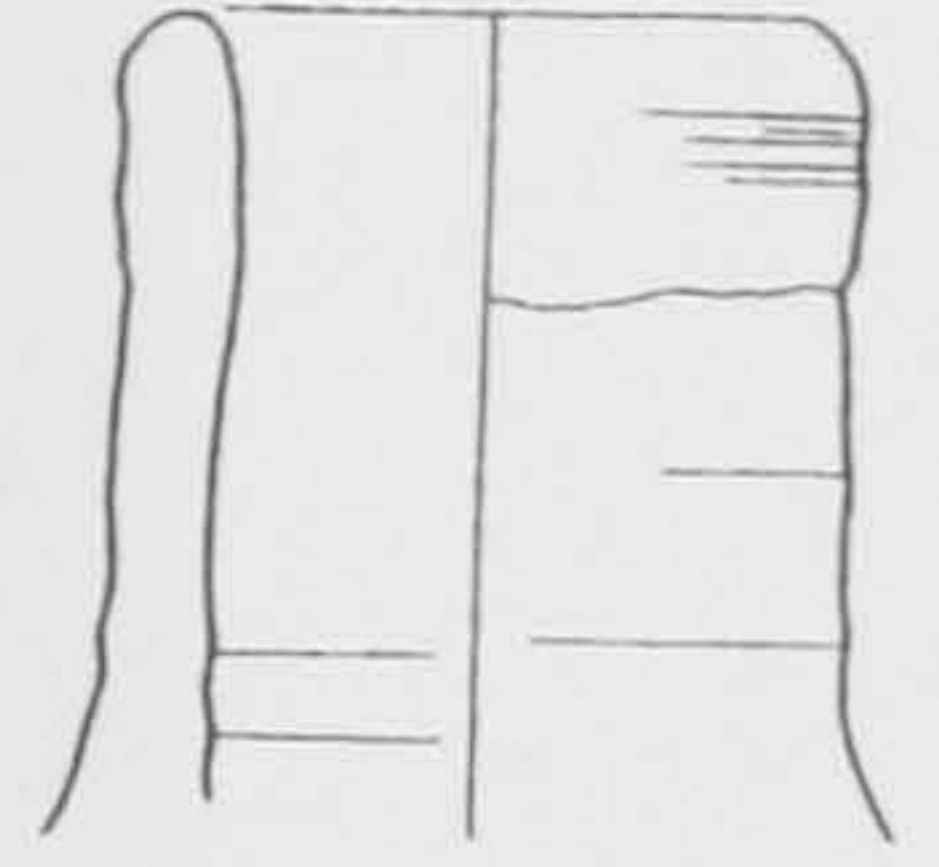

45

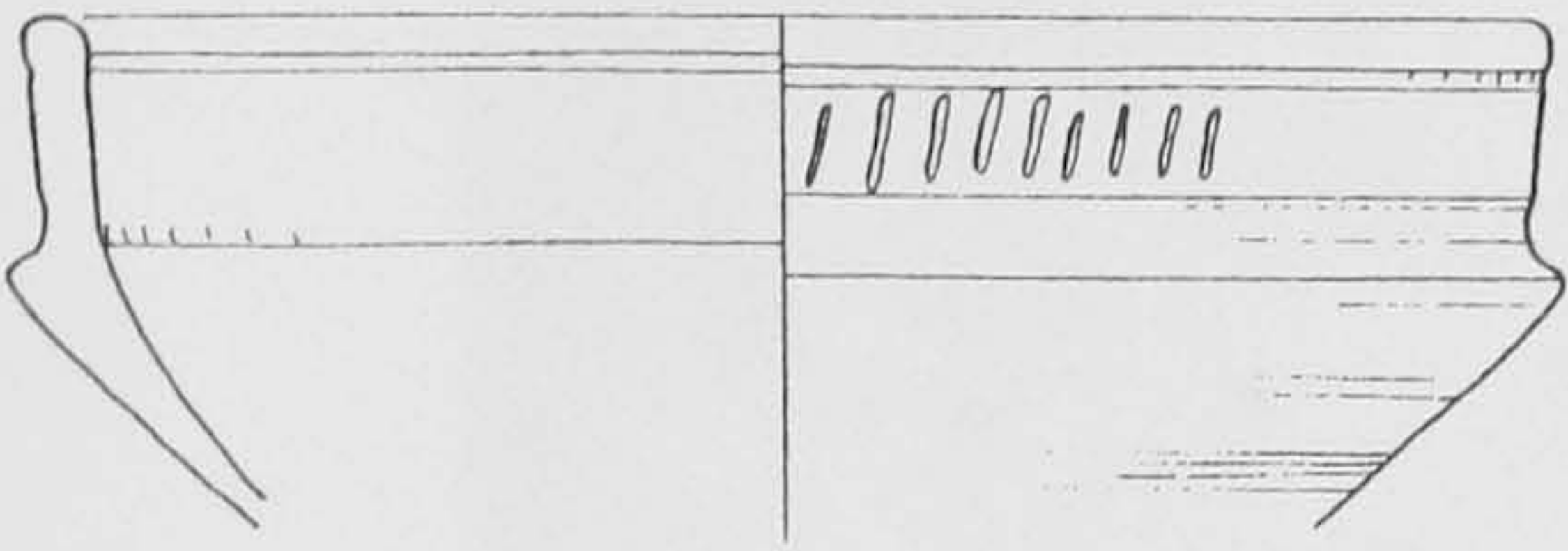

46

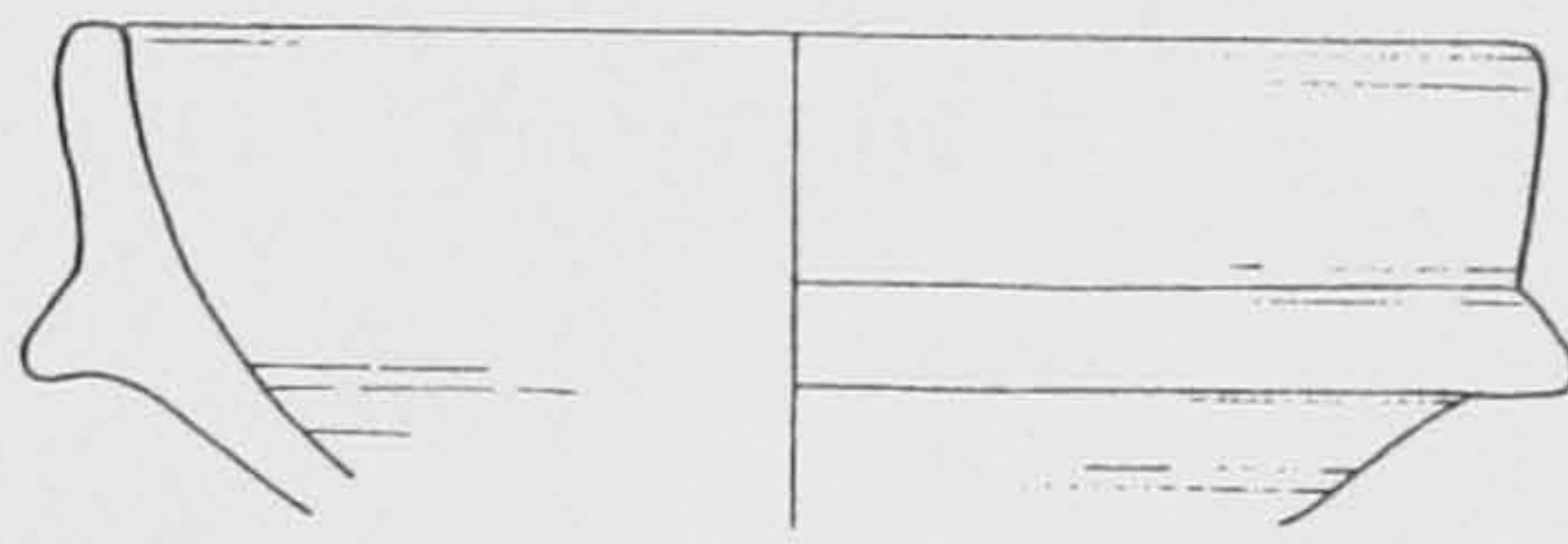

47

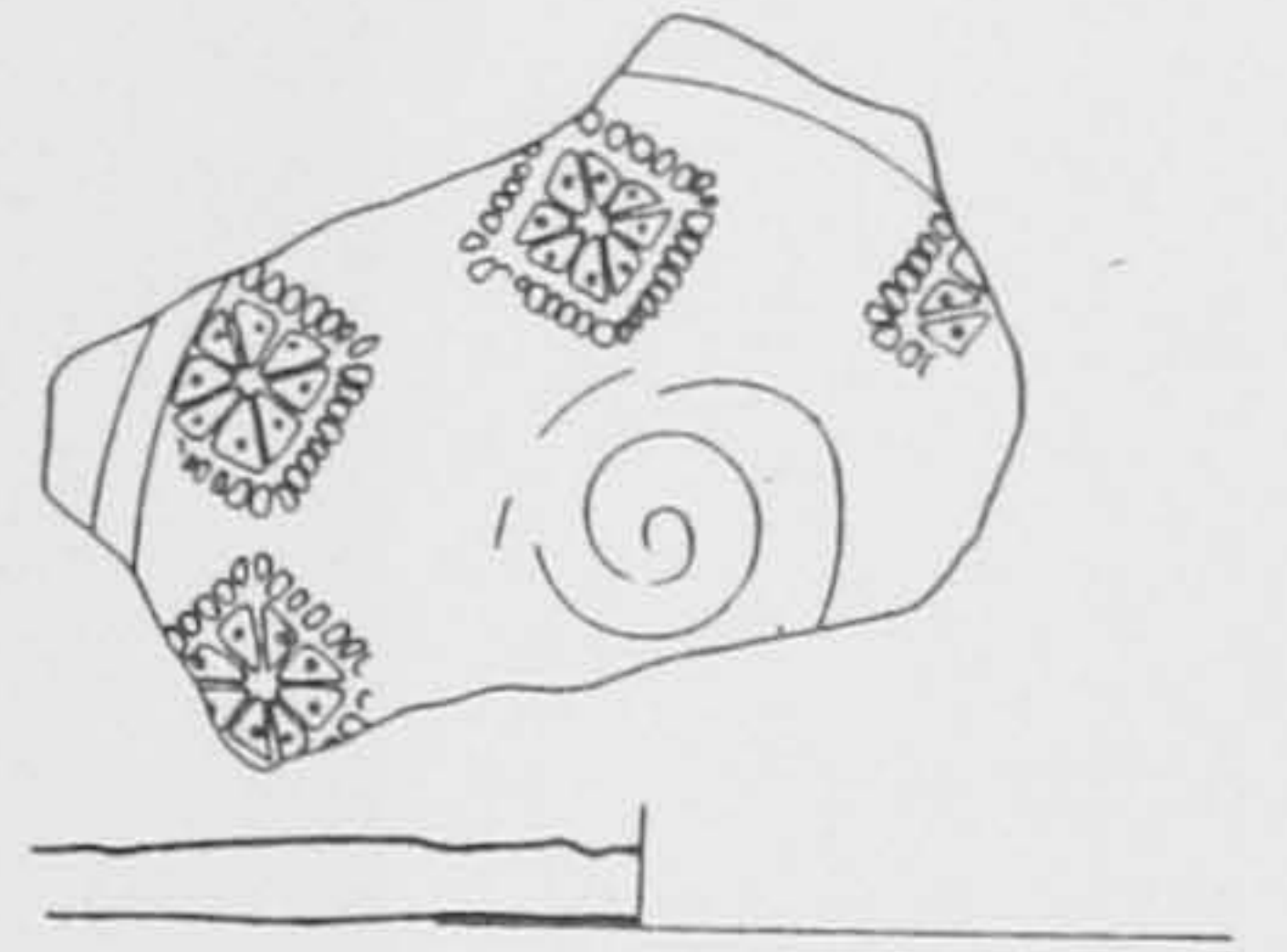

48

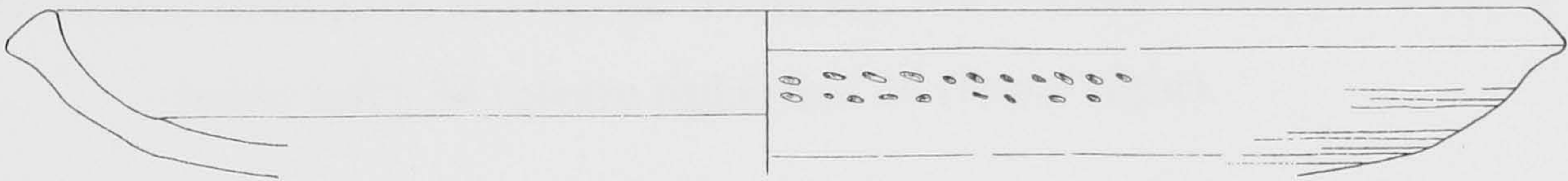

49



50



51

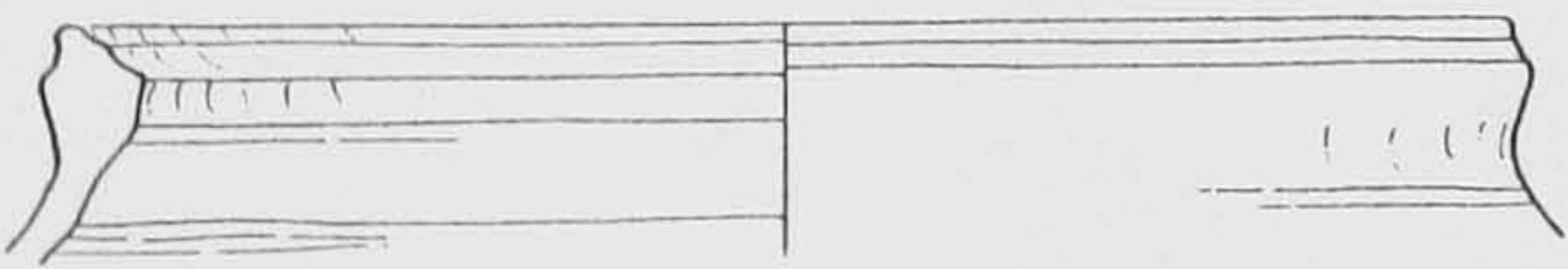

52

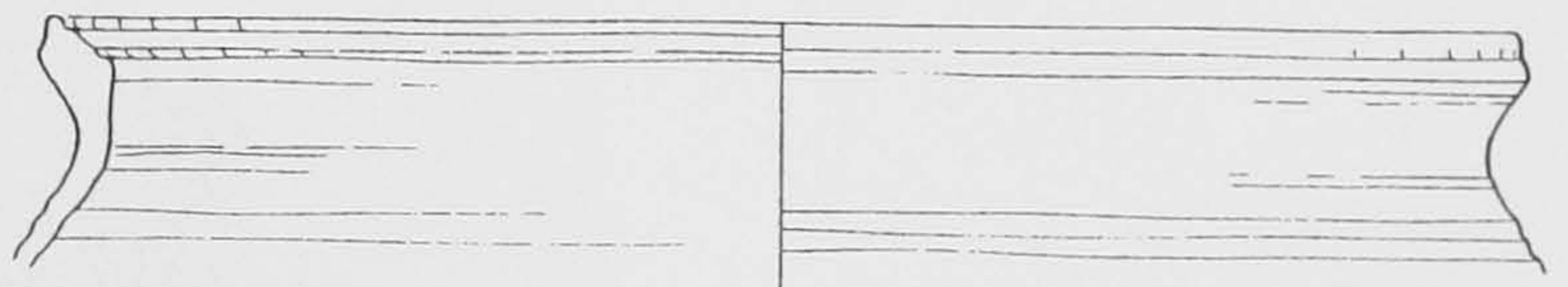

53



54

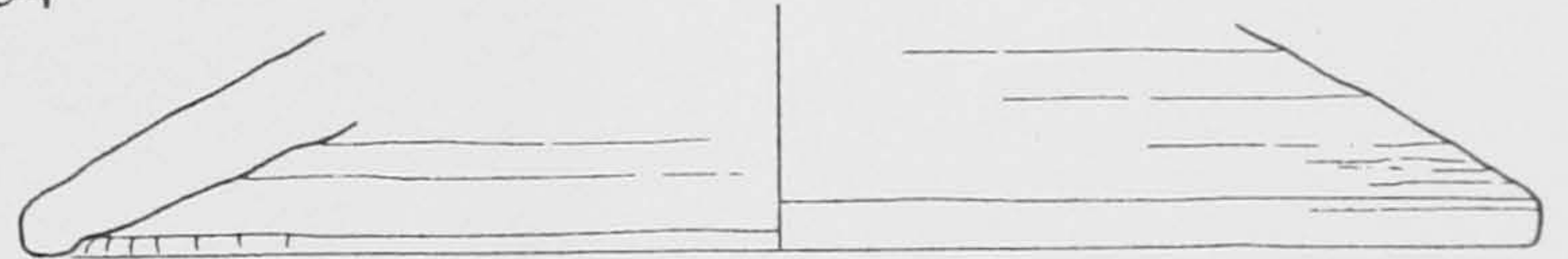

55



56



Pottery from the surface collection on Kom al-Dik at 1:3.



A: Glazed sherds from Kom al-Dik, including fig. II.37–8, nos 32 (upper left), 33 (lower left), 34 (centre right) and 36 (lower right).



B: View of watchtower, looking north.



A: Interior of watchtower.



B: View north along cliffs to watchtower.

Fig. II.41



Rough stairway cut into the southern end of the cliff.

Fig. III.1



Map of Tinnis based on survey maps and satellite photographs.



Map of the SCA excavation at Tinnis, compiled by Inspector Said 'Agami 'Arafa at 1:200
(additions have been made in the north-west corner)

N ←



A: The line of the town walls across the north edge of the site, looking north-east.



B: Traces of horseshoe towers on the south-east side of the town, looking north-east.



A: Intact brickwork of town wall to south-west of site, looking north-east.



B: View south-west across small fort to north-west of site.



A: View south-west across the southernmost 'Sheikh's tomb'.



B: View north-west across the westernmost 'Sheikh's tomb'.

Tinnis surface pottery and glass catalogue

'Late Roman C' ware

1. *Provenance: circle 1. Diameter: 22 cm.*

Aswan ware R4

2. *Provenance: circle 1.*

LRA 1

3. *Provenance: circle 1.*

LRA 7

4. *Provenance: circle 2. Diameter: 12 cm.*
5. *Provenance: circle 1.*

Moulded, early lead-glazed ware

6. *Provenance: SCA excavations. Fabric: clean break not seen. Decoration: moulded geometrical design inside and under base, covered in brown lead glaze. Diameter (base): 5 cm. Parallels: see Scanlon 1984a.*

Glazed Aswan ware

7. *Provenance: circle 2. Decoration: traces of dark green glaze over rim; presumably originally glazed all over. Diameter: 30 cm.*

FFS

8. *Provenance: circle 2. Decoration: bottle green glaze all over, with incised straight lines inside and out. Diameter: 20 cm.*
9. *Provenance: circle 1. Decoration: mustard yellow glaze, lighter and thinner on outside, incised lines on interior. Diameter: 12 cm.*
10. *Provenance: circle 2. Decoration: mustard yellow glaze, incised pattern on interior. Diameter: 24 cm.*
11. *Provenance: circle 2. Decoration: olive greeny-yellow, incised pattern on interior.*

Porcelain

Most of the true porcelain found at Tinnis appears to be Ch'ing Pai ware, which was manufactured in Kiangsi Province during the eleventh and twelfth centuries (Ayers

1968). Other wares are also described below. Parallels have not been sought for porcelain as there appear to be few archaeological studies available.

12. *Provenance*: circle 1. *Fabric*: hard, pure white porcelain with thick, even pure white glaze. *Diameter*: 21 cm.
13. *Provenance*: circle 2. *Fabric*: hard, pure white porcelain with thick, even pale greenish glaze. *Diameter* (base): 8 cm.
14. *Provenance*: circle 1. *Fabric*: as above. *Decoration*: lotus petal moulding of exterior. *Diameter* (base): 8 cm.
15. *Provenance*: circle 2. *Fabric*: as above. *Decoration*: incised floral (?) design.
16. *Provenance*: circle 2. *Fabric*: as above. *Decoration*: raised design: head of animal.
17. *Provenance*: circle 1. *Fabric*: as above. *Decoration*: incised floral pattern (peonies?).
18. *Provenance*: circle 1. *Fabric*: as above. *Diameter* (base): 10 cm
19. *Provenance*: circle 2. *Fabric*: hard, white porcelain. *Decoration*: turquoise glaze over incised pattern. *Diameter*: 32 cm.
20. *Provenance*: circle 2. *Fabric*: dense pink-beige clay with abundant, fine black and sparkly white particles and moderate coarse, round mauve inclusions. Perhaps not true porcelain, but clearly imported. *Decoration*: black underglaze painted pattern. *Diameter*: 18 cm.

Imitation Porcelain

21. *Provenance*: circle 1. *Fabric*: light pink-beige with moderate red-brown inclusions (Persian??). *Decoration*: lotus petal moulding of exterior covered in a white glaze. *Diameter*: 24 cm.
22. *Provenance*: circle 2. *Fabric*: similar to above but with fine black inclusions, white glazed. *Diameter* (base): 6.5 mm.
23. *Provenance*: circle 2. *Fabric*: pink-beige sandy Fustat ware, glazed white on the inside only, with thick drops of glaze over edge of rim. *Diameter*: 30 cm.

Polychrome-glazed marl wares

24. *Provenance*: circle 1. *Fabric*: Fustat. *Surfaces*: bottle green glaze on interior, traces over rim on exterior but surface flaked away lower down. Patches of black on interior. *Diameter*: 18 cm.
25. *Provenance*: circle 1. *Fabric*: Fustat. *Surfaces*: glazed in bottle green (close stipple), black (black) and light green (sparse stipple). *Diameter*: 12 cm.
26. *Provenance*: circle 2. *Fabric*: Fustat. *Surfaces*: glazed in purple (close stipple), black (black), dark green (hatched), blue (sparse stipple) and white (white), interior plain olive green.
27. *Provenance*: circle 1. *Fabric*: Fustat. *Surfaces*: glazed bottle green (stipple) and dark purple-brown (black) over light mustard, exterior and under base green. *Diameter* (base): 10 cm.
28. *Provenance*: circle 2. *Fabric*: Fustat. *Surfaces*: glazed with black stripes on olive green. Interior too vitrified to detect glaze. *Diameter* (base): 10 cm.
29. *Provenance*: circle 2. *Fabric*: Fustat. *Surfaces*: yellow glaze with small patch of lime green on interior. *Diameter* (base): 8 cm.
30. *Provenance*: circle 2. *Fabric*: Fustat. *Surfaces*: glazed purple-brown (stipple) and mustard yellow, exterior olive green.
31. *Provenance*: circle 1. *Fabric*: Fustat. *Surfaces*: cream-slipped interior with patch of red paint, spot of mustard yellow glaze (black) which presumably originally covered the interior; exterior scorched.

Plain-glazed marl wares

32. *Provenance*: circle 2. *Fabric*: Fustat. *Surfaces*: glazed bottle green. *Diameter* (base): 7 cm.
33. *Provenance*: circle 1. *Fabric*: Fustat. *Surfaces*: glazed bottle green. *Diameter* (base): 5 cm.
34. *Provenance*: circle 2. *Fabric*: Fustat. *Surfaces*: glazed olive green. *Diameter*: 18 cm.
35. *Provenance*: circle 1. *Fabric*: Fustat. *Surfaces*: glazed grass green, slightly darker on exterior. *Diameter*: 25 cm.

Plain-glazed silt wares

36. *Provenance*: circle 2. *Fabric*: M1. *Surfaces*: glazed bottle green. *Diameter*: 18 cm.
37. *Provenance*: circle 1. *Fabric*: M1. *Surfaces*: powdery yellow underglaze inside and out (ware FG8; see Gascoigne forthcoming). *Diameter* (base): 10 cm.
38. *Provenance*: circle 1. *Fabric*: M1. *Surfaces*: as above. *Diameter*: 14 cm.
39. *Provenance*: circle 1. *Fabric*: M1. *Surfaces*: as above. *Diameter*: 22 cm.

Lamps

40. *Provenance*: circle 2. *Fabric*: Fustat. *Surfaces*: glazed pale green all over.
41. *Provenance*: circle 2. *Fabric*: Fustat. *Surfaces*: glazed bottle green inside and out but no under base.

'Sphero-conical vessels'

See Ghouchani and Adle 1992.

42. *Provenance*: circle 2. *Fabric*: hard, dark grey paste with abundant black, shiny particles. *Surfaces*: glossy brown (slip?).
43. *Provenance*: circle 1. *Fabric*: hard, reddish-brown with abundant black and grey inclusions. *Surfaces*: blackened exterior.

Marl wares

44. *Provenance*: SCA excavations. *Fabric*: pink marl with black inclusions (no fresh break). *Surfaces*: greenish-cream fired exterior. *Diameter*: 6 cm.
45. *Provenance*: circle 2. *Fabric*: dark pink marl with coarse black inclusions. *Surfaces*: lighter pink fired. *Diameter*: 8 cm.
46. *Provenance*: circle 2. *Fabric*: hard green-fired marl. *Decoration*: trace of red paint.
47. *Provenance*: circle 2. *Fabric*: sandy grey-beige marl. *Surfaces*: fired grey-green. *Diameter* (base): 7 cm.
48. *Provenance*: circle 1. *Fabric*: beige marl with a few white particles. *Surfaces*: green fired. *Diameter* (base): 5 cm.
49. *Provenance*: circle 1. *Fabric*: fine beige marl, few inclusions. *Surfaces*: cream fired. *Decoration*: red painted spot on interior. *Diameter*: 17 cm.

50. *Provenance*: circle 2. *Fabric*: porous, green-grey Fustat. *Surfaces*: grey fired.
Diameter: 20 cm.
51. *Provenance*: circle 1. *Fabric*: Fustat. *Surfaces*: worn; originally glazed?
Diameter: 26 cm.

Silt wares

52. *Provenance*: circle 1. *Fabric*: M2. *Surfaces*: untreated. *Diameter* (base): 7.5 cm.
53. *Provenance*: circle 2. *Fabric*: M1. *Surfaces*: untreated. *Diameter* (base): 5 cm.
54. *Provenance*: circle 2. *Fabric*: M2. *Surfaces*: untreated. *Diameter* (base): 3.5 cm.
55. *Provenance*: circle 2. *Fabric*: M1. *Surfaces*: untreated. *Diameter*: 12 cm.
56. *Provenance*: circle 1. *Fabric*: M1. *Surfaces*: matte red slip inside. *Diameter*: 13 cm.
57. *Provenance*: circle 1. *Fabric*: M1. *Surfaces*: untreated. *Diameter*: 22 cm.
58. *Provenance*: circle 2. *Fabric*: M1. *Surfaces*: untreated. *Diameter*: 12 cm.
59. *Provenance*: circle 1. *Fabric*: M1. *Surfaces*: red-slipped all over. *Diameter* (base): 7 cm.
60. *Provenance*: circle 2. *Fabric*: hard M1. *Surfaces*: untreated. *Diameter* (base): 7 cm.
61. *Provenance*: circle 2. *Fabric*: M1. *Surfaces*: traces of red-brown slip all over. *Diameter*: 38 cm.
62. *Provenance*: circle 1. *Fabric*: M1. *Surfaces*: untreated. *Diameter*: 38 cm.
63. *Provenance*: circle 1. *Fabric*: M1. *Surfaces*: worn, apparently untreated. *Diameter*: 26 cm.
64. *Provenance*: circle 2. *Fabric*: M1. *Surfaces*: untreated. *Diameter* (base): 5 cm.
65. *Provenance*: circle 1. *Fabric*: M1. *Surfaces*: untreated. *Diameter*: 12 cm.
66. *Provenance*: circle 2. *Fabric*: VCM1. *Surfaces*: untreated. *Diameter*: 34 cm.
67. *Provenance*: circle 2. *Fabric*: M1. *Surfaces*: untreated.
68. *Provenance*: circle 1. *Fabric*: VCM1. *Surfaces*: untreated; pre-firing horizontal grooves across bottom of handle.

Glass

- G1. *Provenance*: SCA excavations. *Colour*: very dark purple. *Diameter* (base): 5 cm.
- G2. *Provenance*: circle 2. *Colour*: clear. *Decoration*: three red stripes of glass around outside of rim. *Diameter*: 20 cm.
- G3. *Provenance*: circle 1. *Colour*: pale pink. *Diameter*: 8 cm.
- G4. *Provenance*: circle 1. *Colour*: light olive green. *Diameter* (base): 3 cm.
- G5. *Provenance*: circle 1. *Colour*: light blue. *Decoration*: thin white painted zigzag around outside of rim. *Diameter*: c. 3 cm.
- G6. *Provenance*: circle 1. *Colour*: very pale mauve, almost clear. *Diameter*: 3.3 cm.
- G7. *Provenance*: circle 1. *Colour*: clear. *Diameter*: 3 cm.
- G8. *Provenance*: circle 2. *Colour*: light olive green. *Diameter*: 1.6 mm.
- G9. *Provenance*: circle 1. *Colour*: light green. *Diameter*: 16 mm.
- G10. *Provenance*: circle 2. *Colour*: light blue-green. *Diameter*: 2 cm.
- G11. *Provenance*: circle 1. *Colour*: light blue-green. *Decoration*: indented sides. *Diameter* (base): 2.5 cm.
- G12. *Provenance*: circle 2. *Colour*: pale green-blue. *Diameter* (base): 3.5 cm.
- G13. *Provenance*: circle 2. *Colour*: very dark purple. *Decoration*: incised geometrical designs on exterior.
- G14. *Provenance*: circle 1. *Colour*: very light green. *Diameter* (base): 5 cm.
- G15. *Provenance*: circle 1. *Colour*: light green. *Diameter* (base): 6 cm.
- G16. *Provenance*: circle 2. *Colour*: light blue. *Decoration*: fine incised line on outside of rim. *Diameter*: c. 10 cm.
- G17. *Provenance*: circle 2. *Colour*: light purple. *Diameter*: 6 cm.
- G18. *Provenance*: circle 2. *Colour*: light purple. *Decoration*: lustre-painted gold patterned interior. *Diameter*: 10 cm.
- G19. *Provenance*: circle 1. *Colour*: light green. *Decoration*: embossed circles and prunts. *Diameter*: 5 cm.

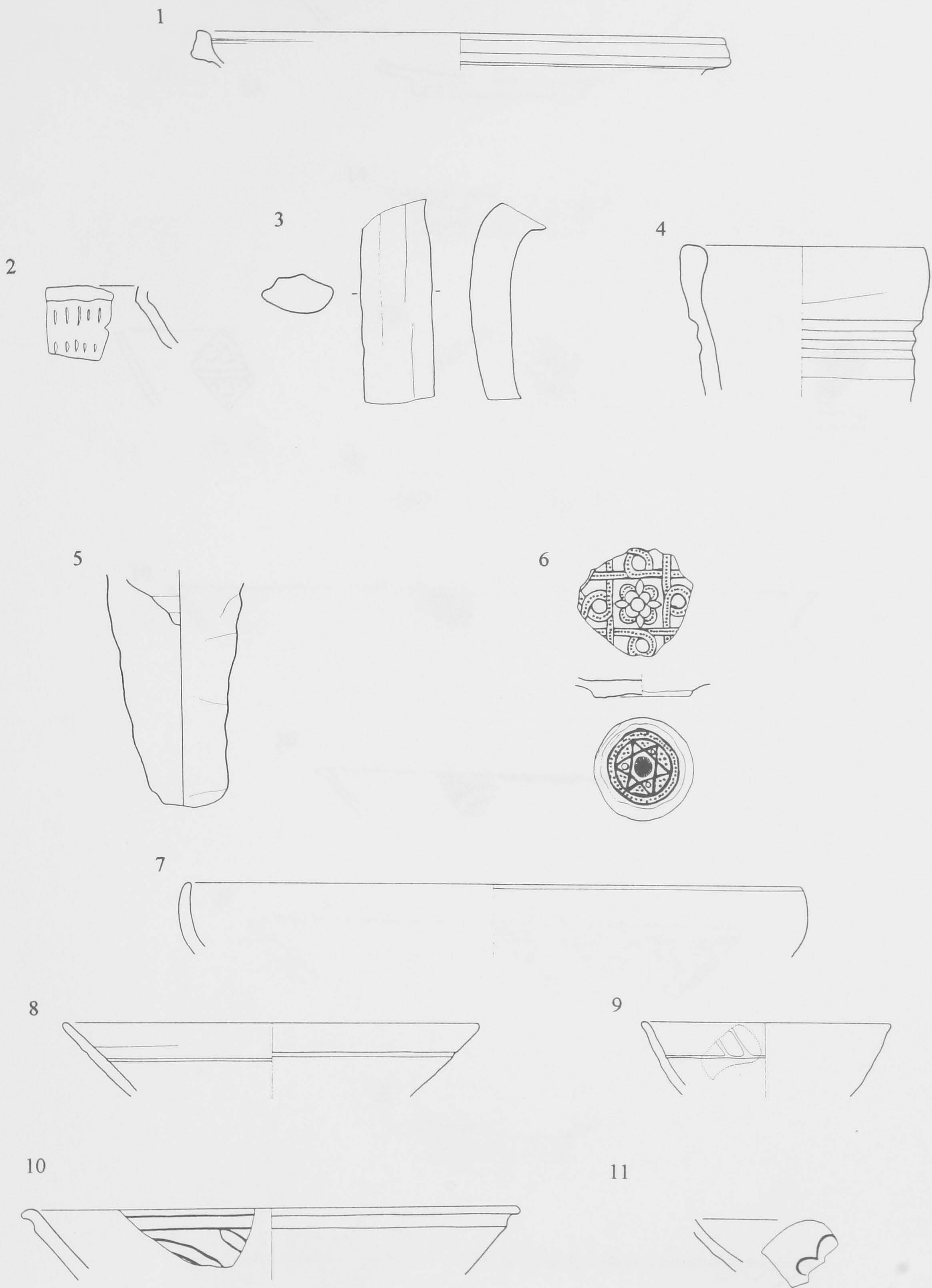

Pottery from surface collections on Tell Tinnis at 1:3.

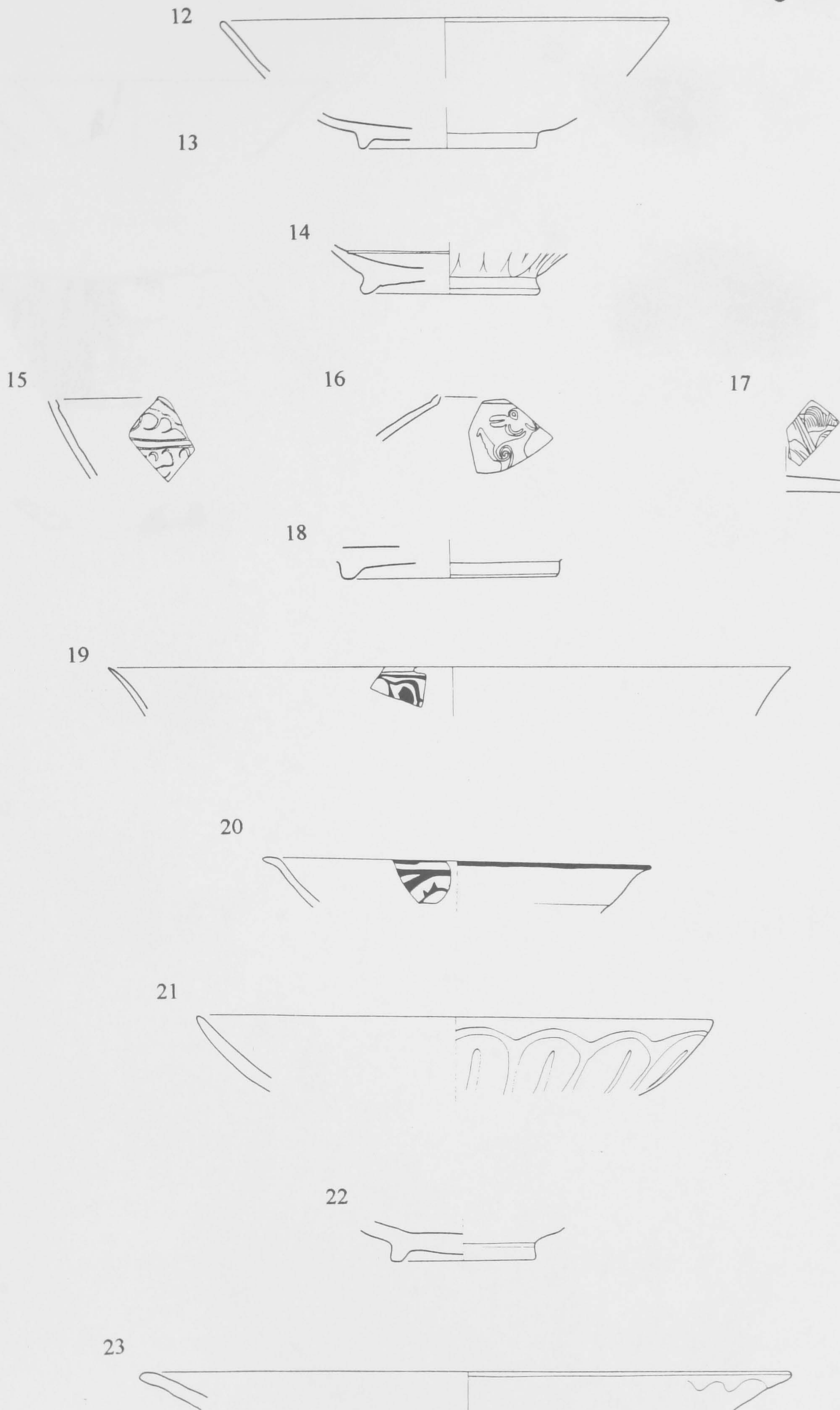

Pottery from surface collections on Tell Tinnis at 1:3.

24



25

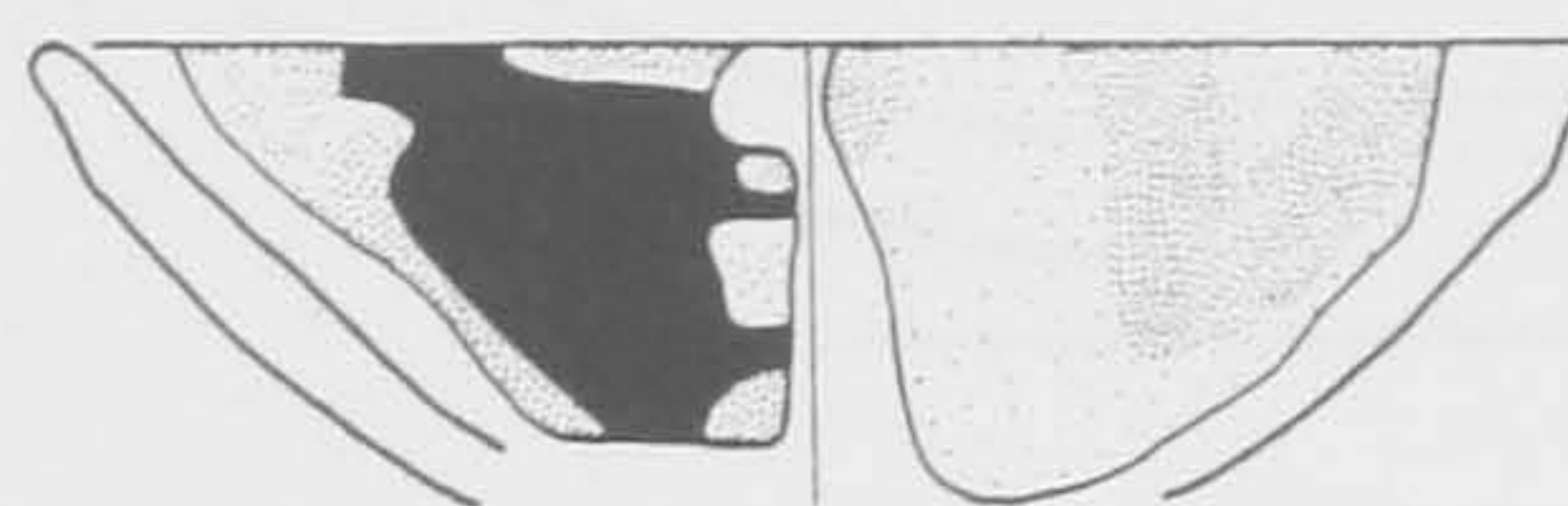

26

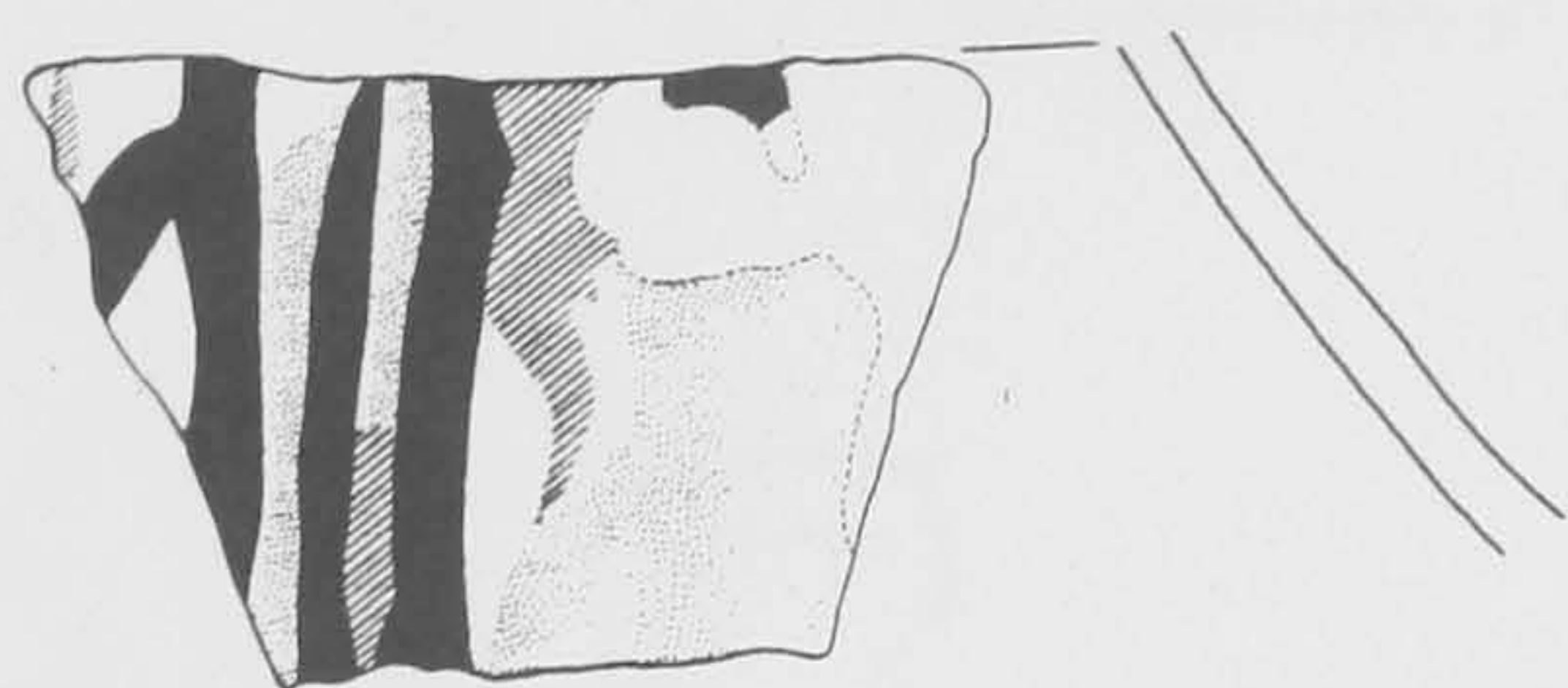

27

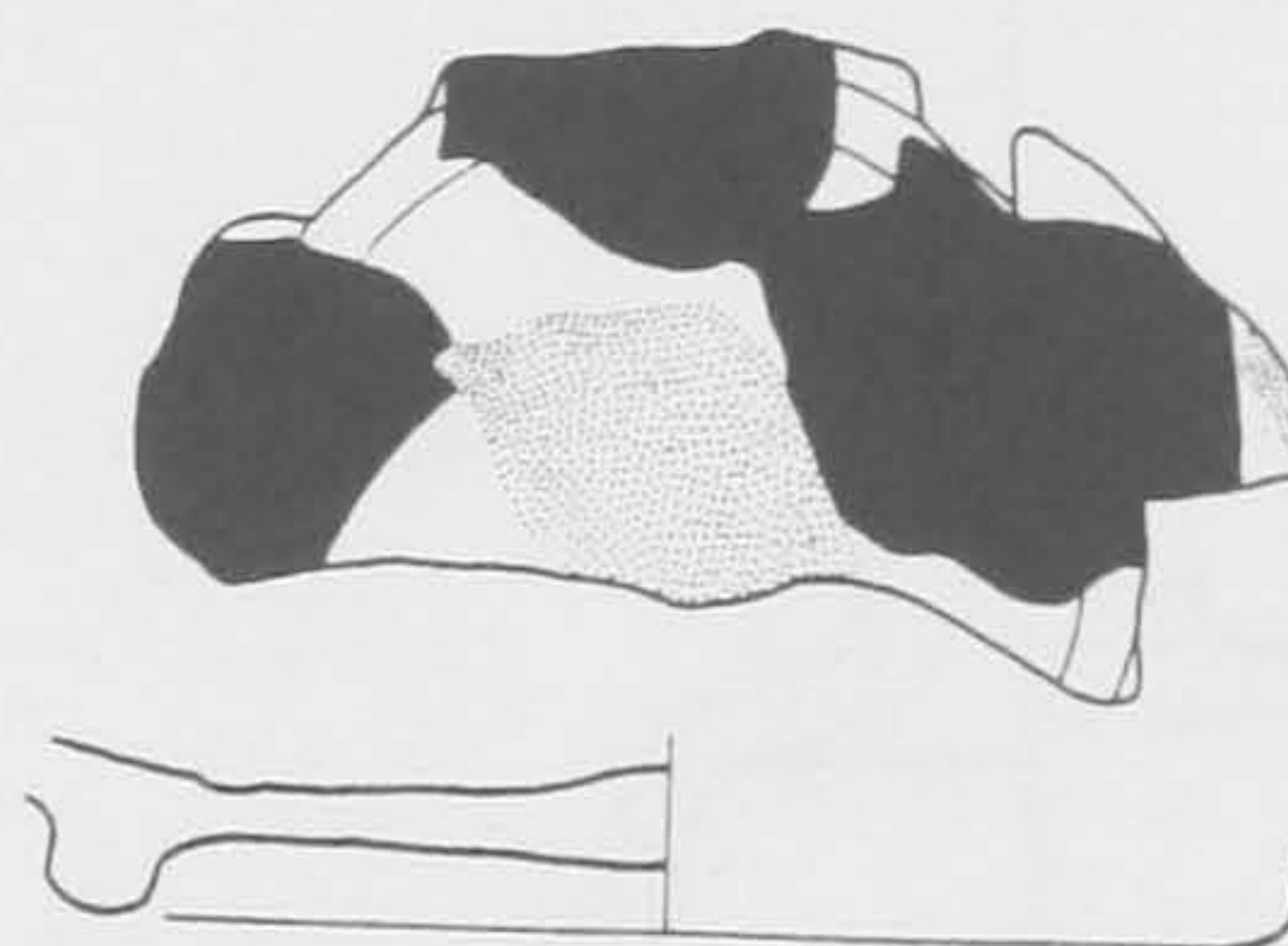

28



29

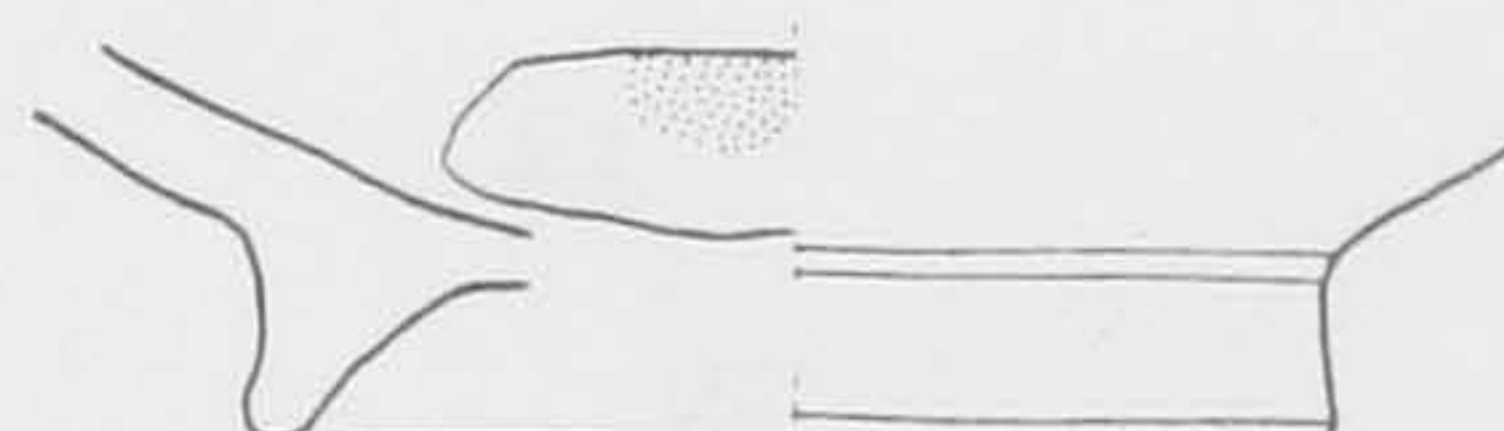

30

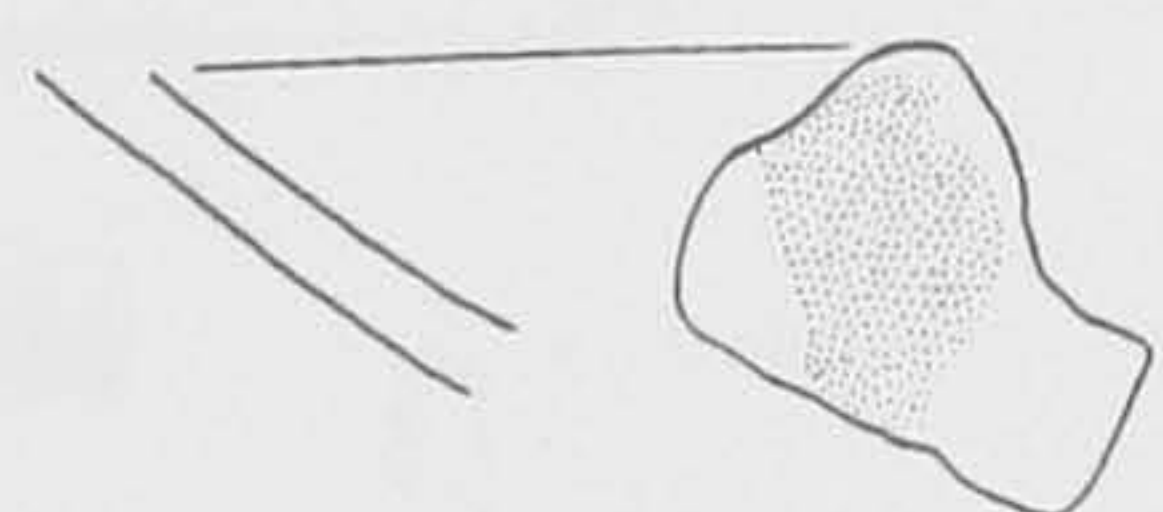

31

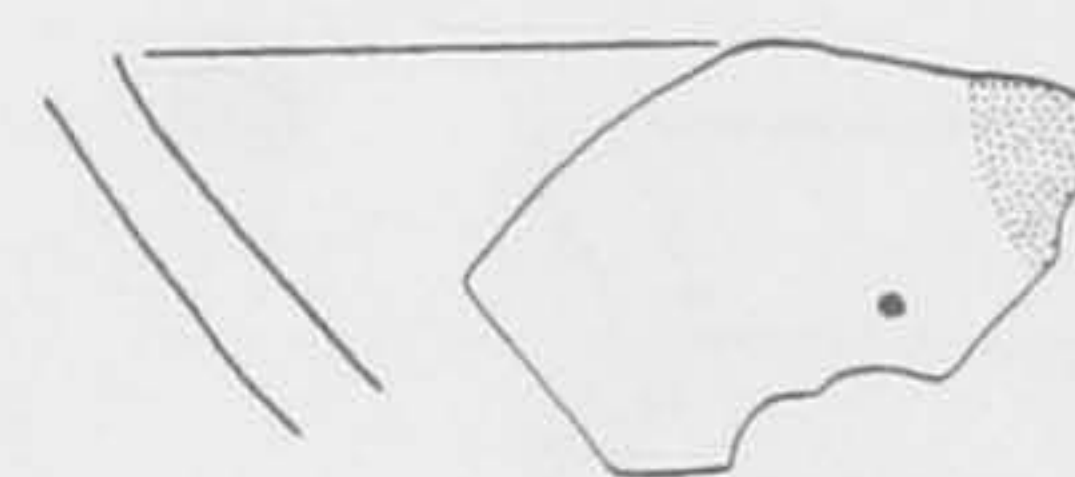

32



33

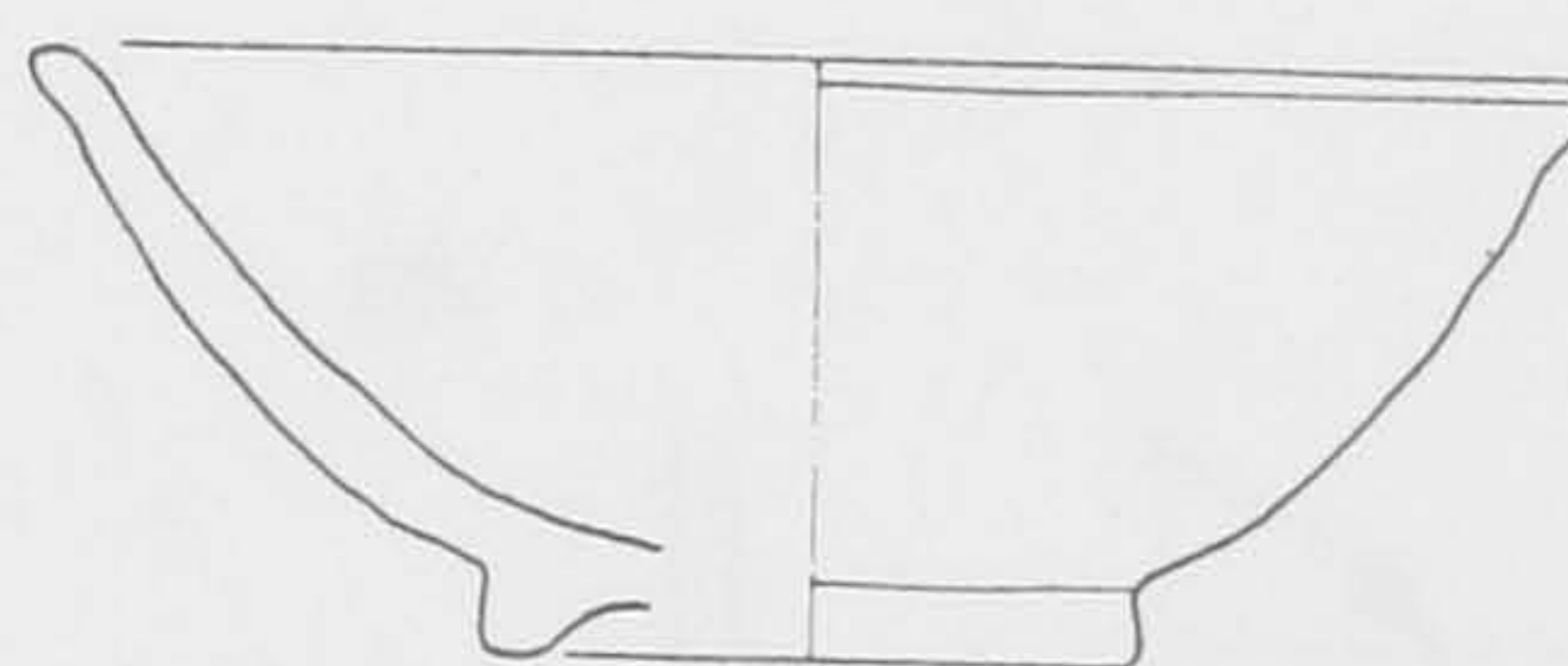

34

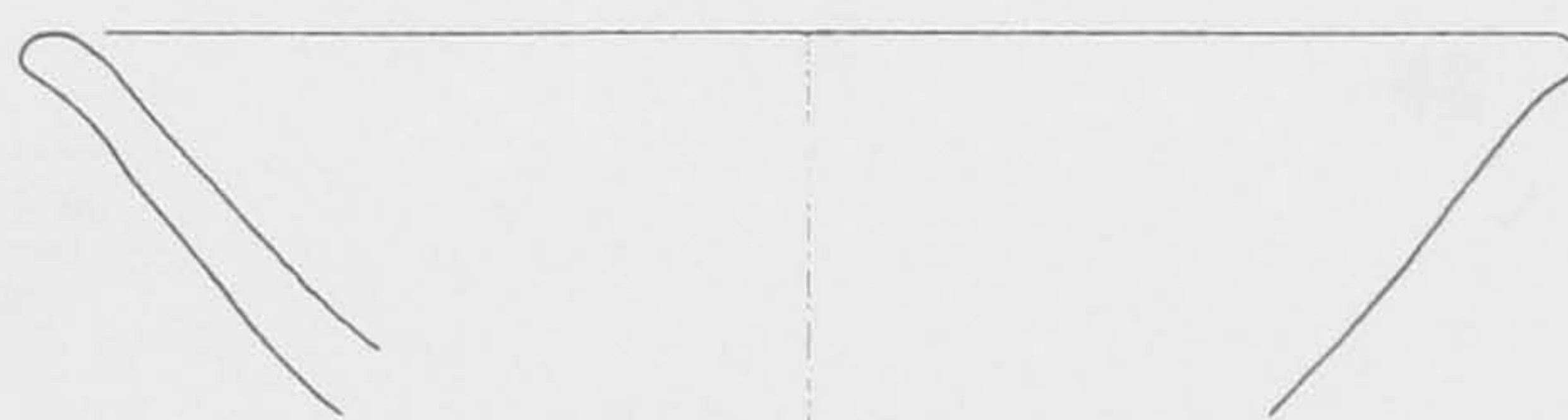

35

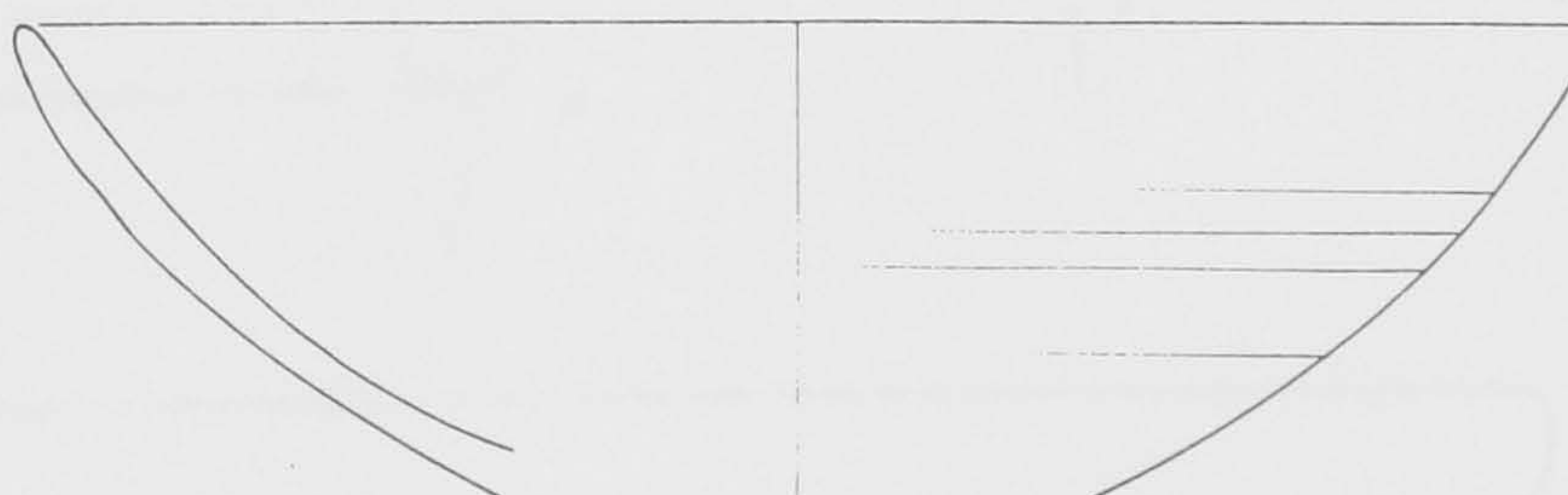

36

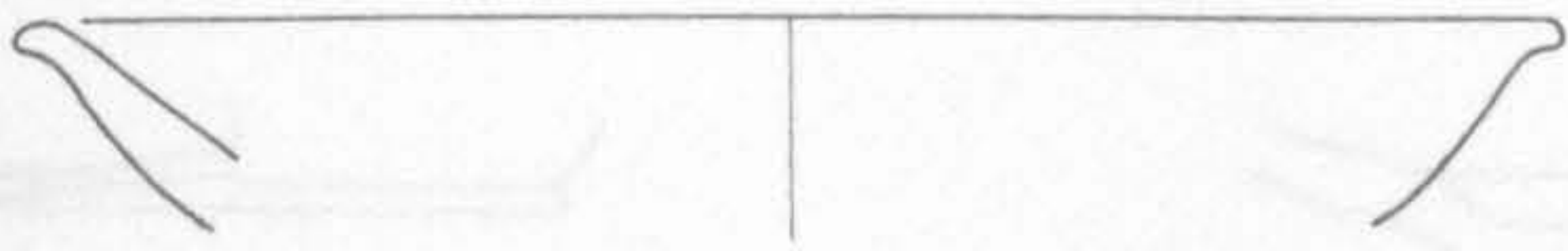

37

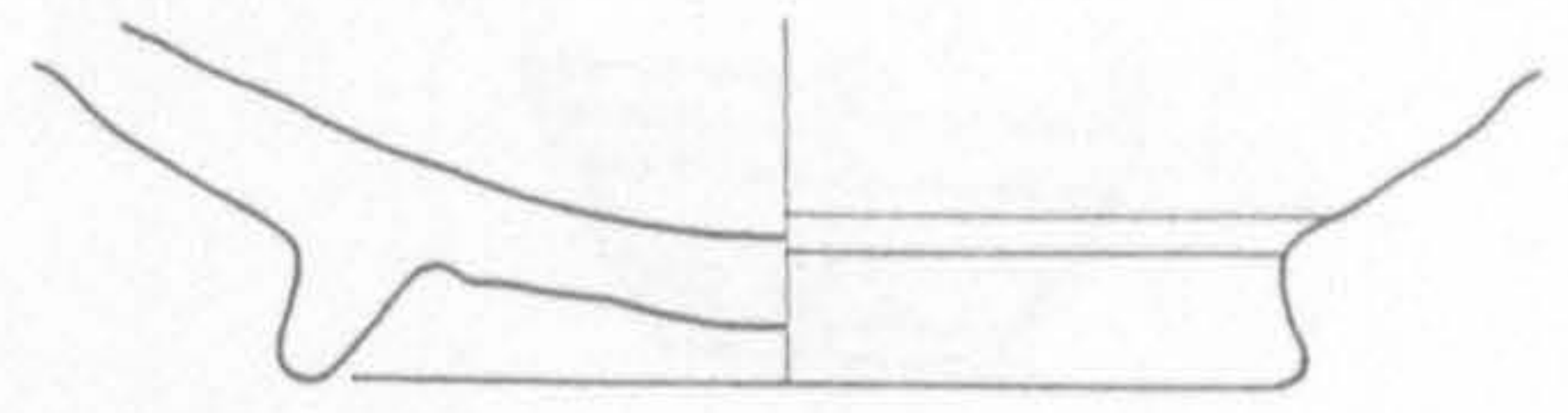

38

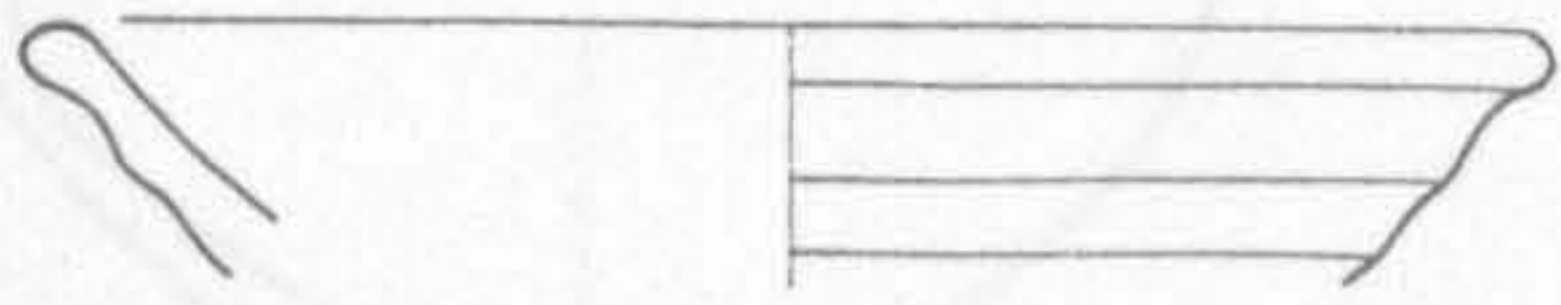

39

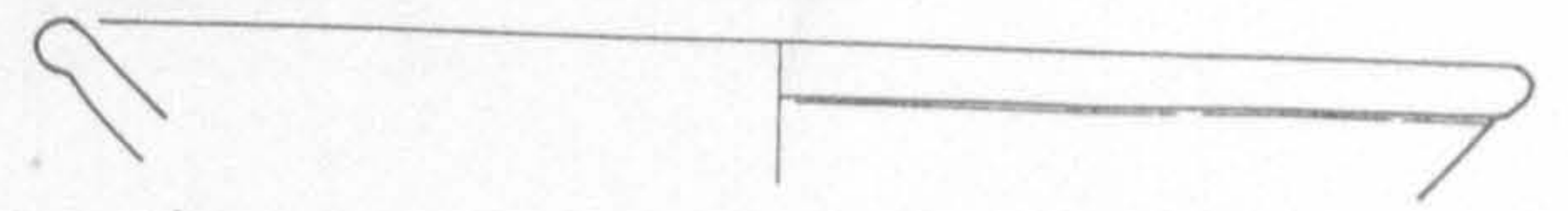

40

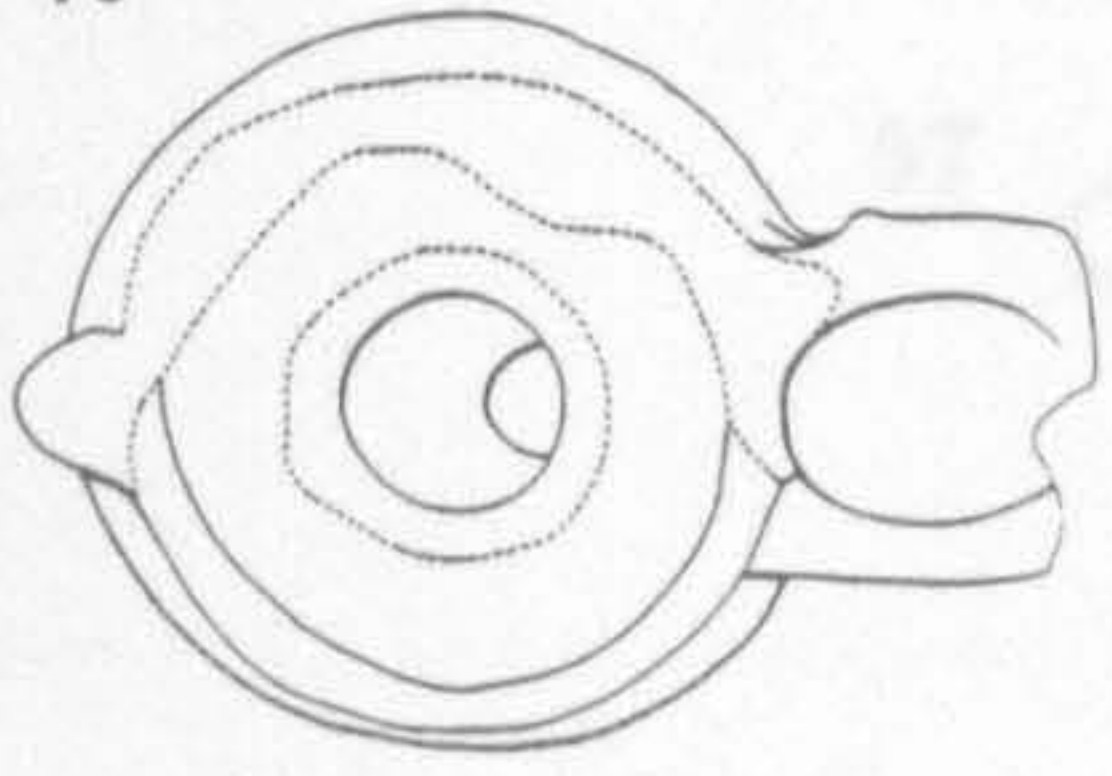

41



42

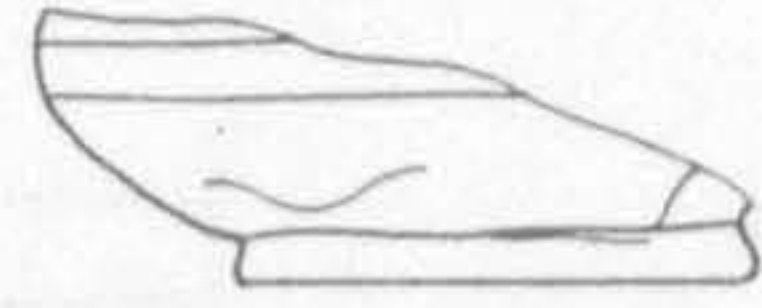
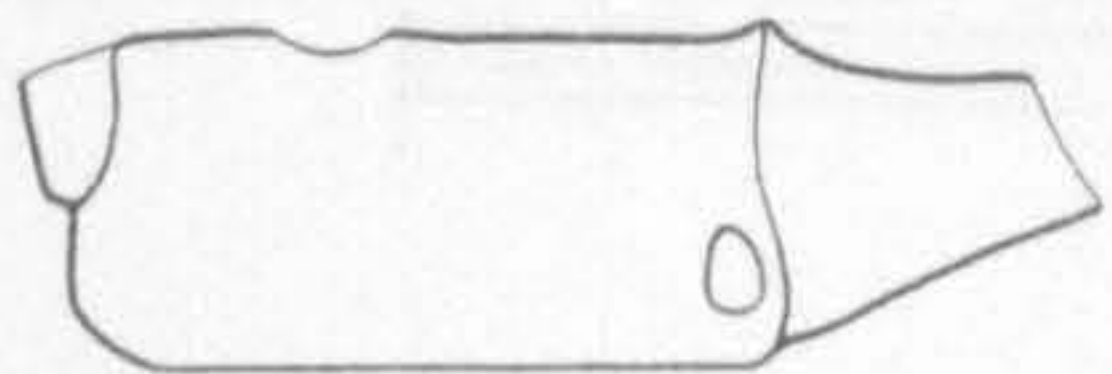
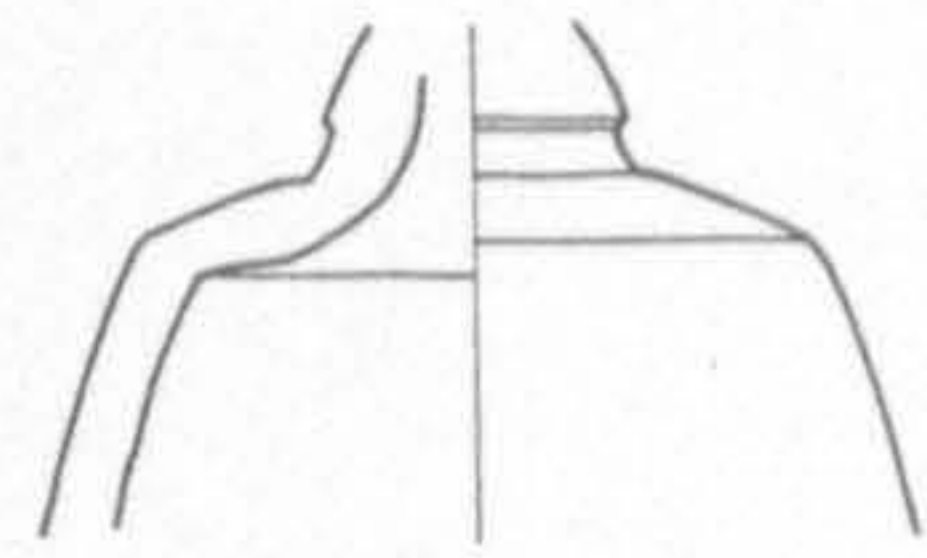

43

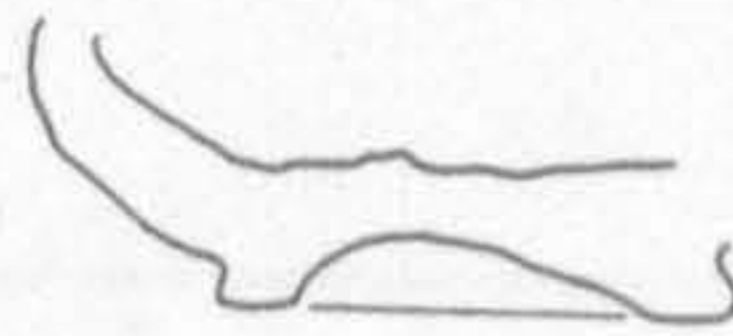
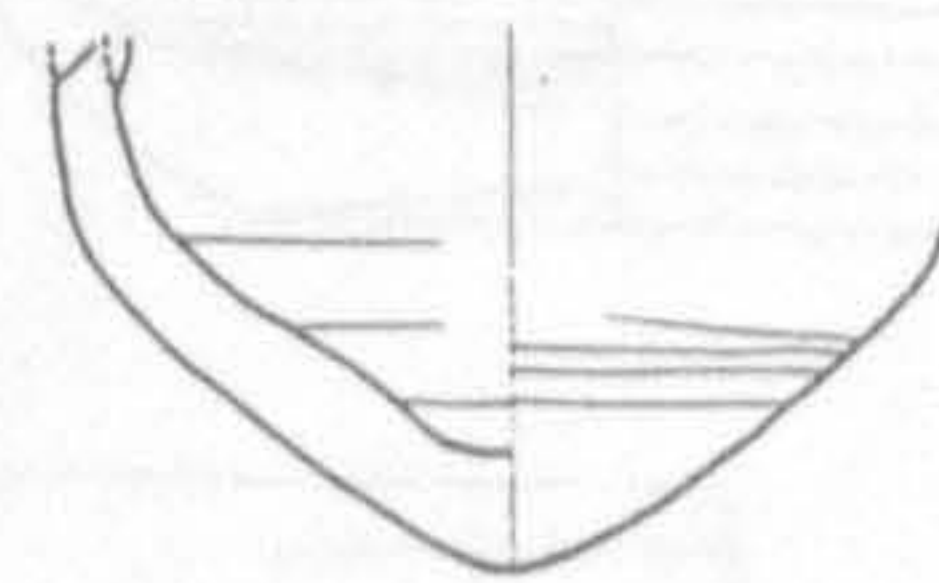

44

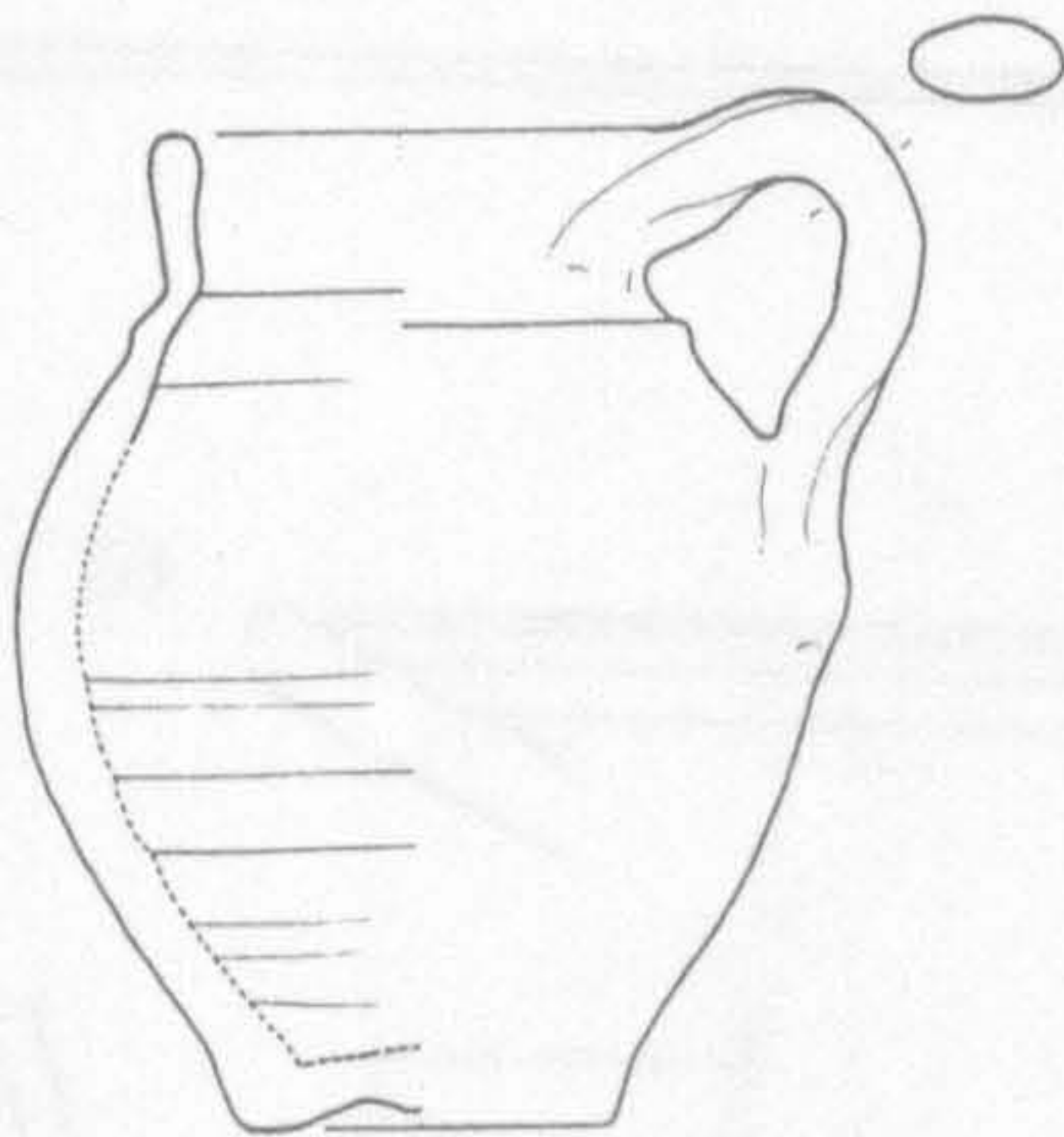

45

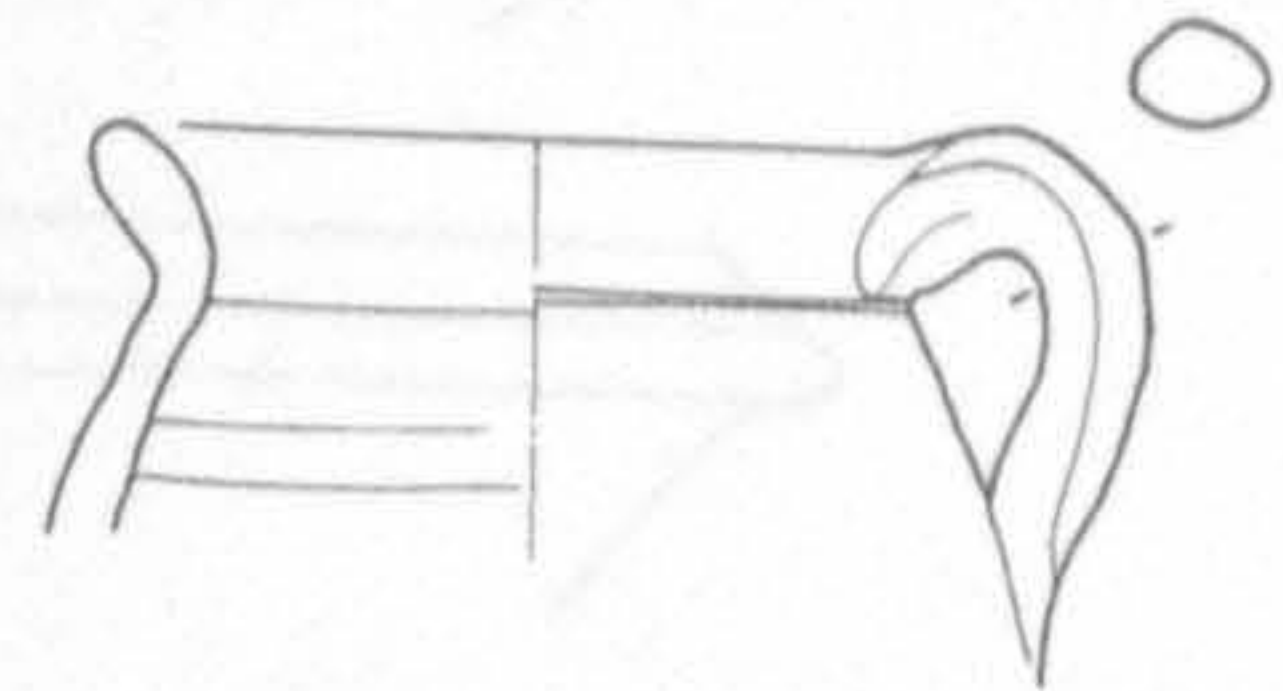

47

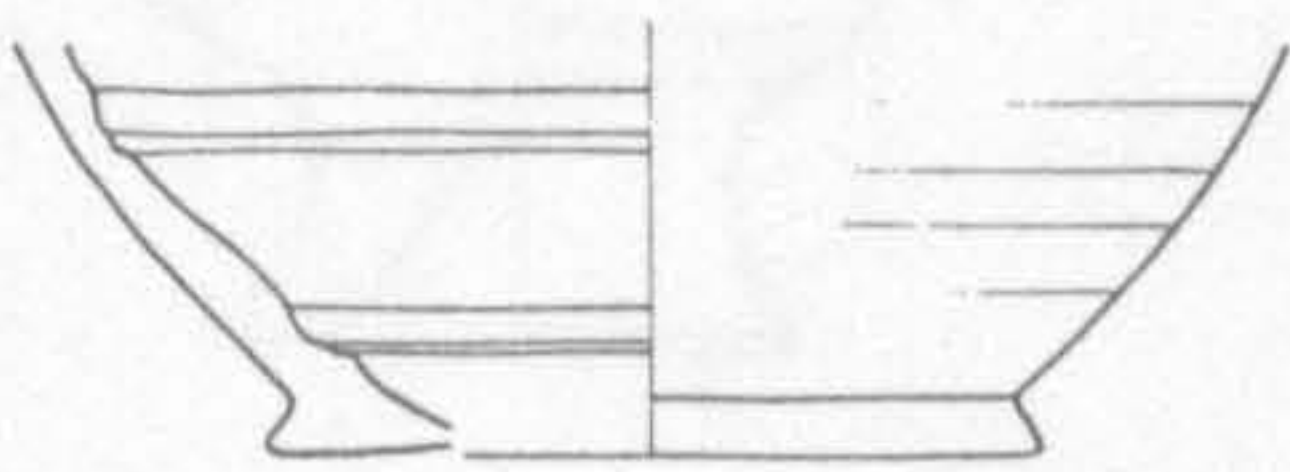

46

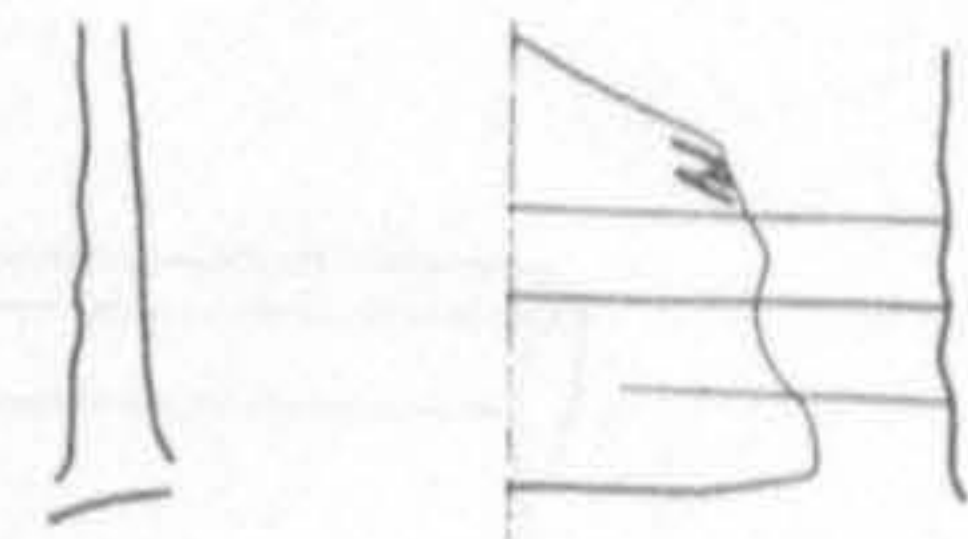

48

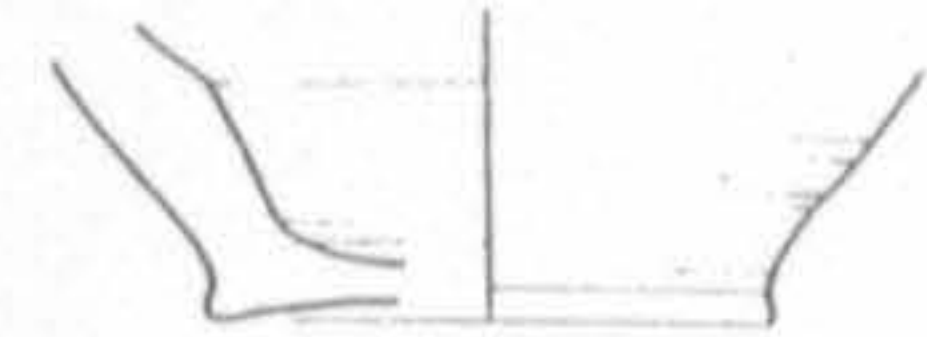

49

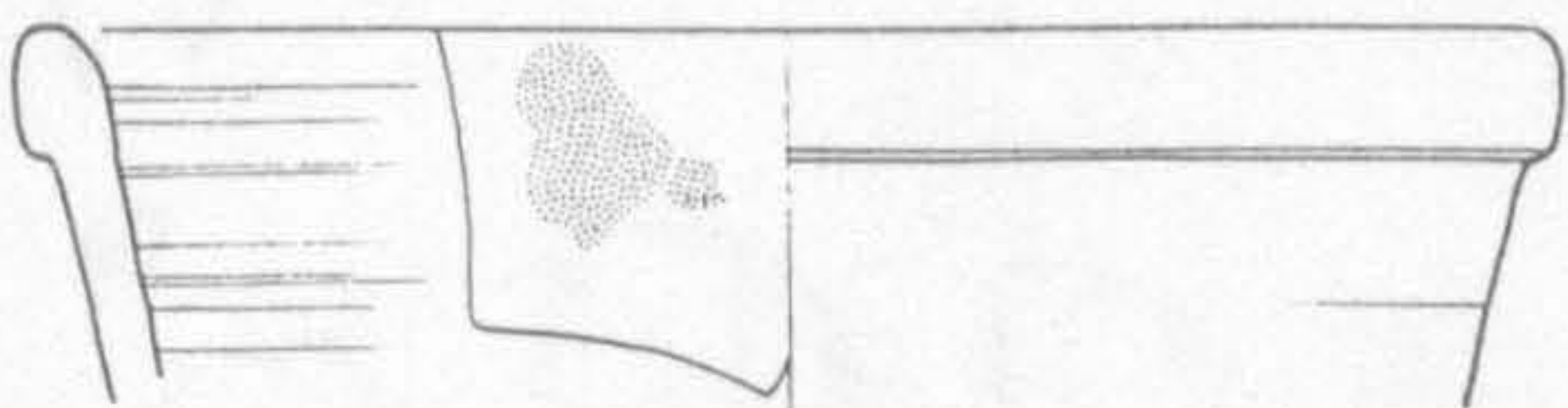

50

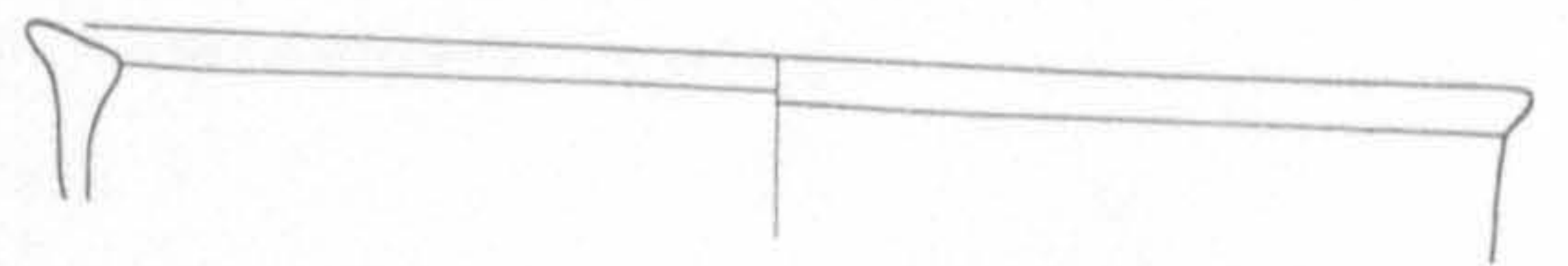

51



Pottery from surface collections on Tell Tinnis at 1:3.

Fig. III.7 cont.

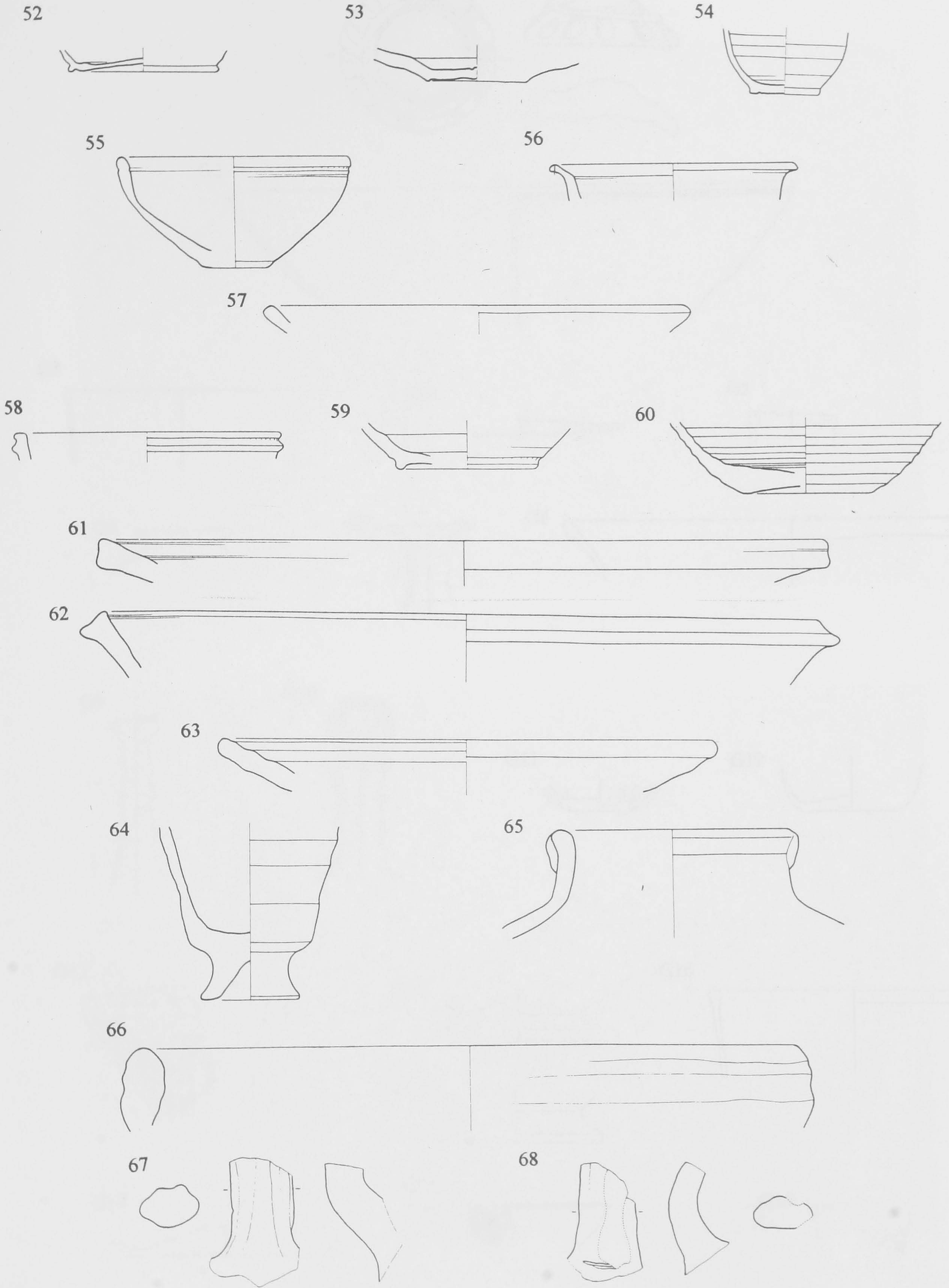

Pottery from surface collections on Tell Tinnis at 1:3.

Fig. III.7 cont.

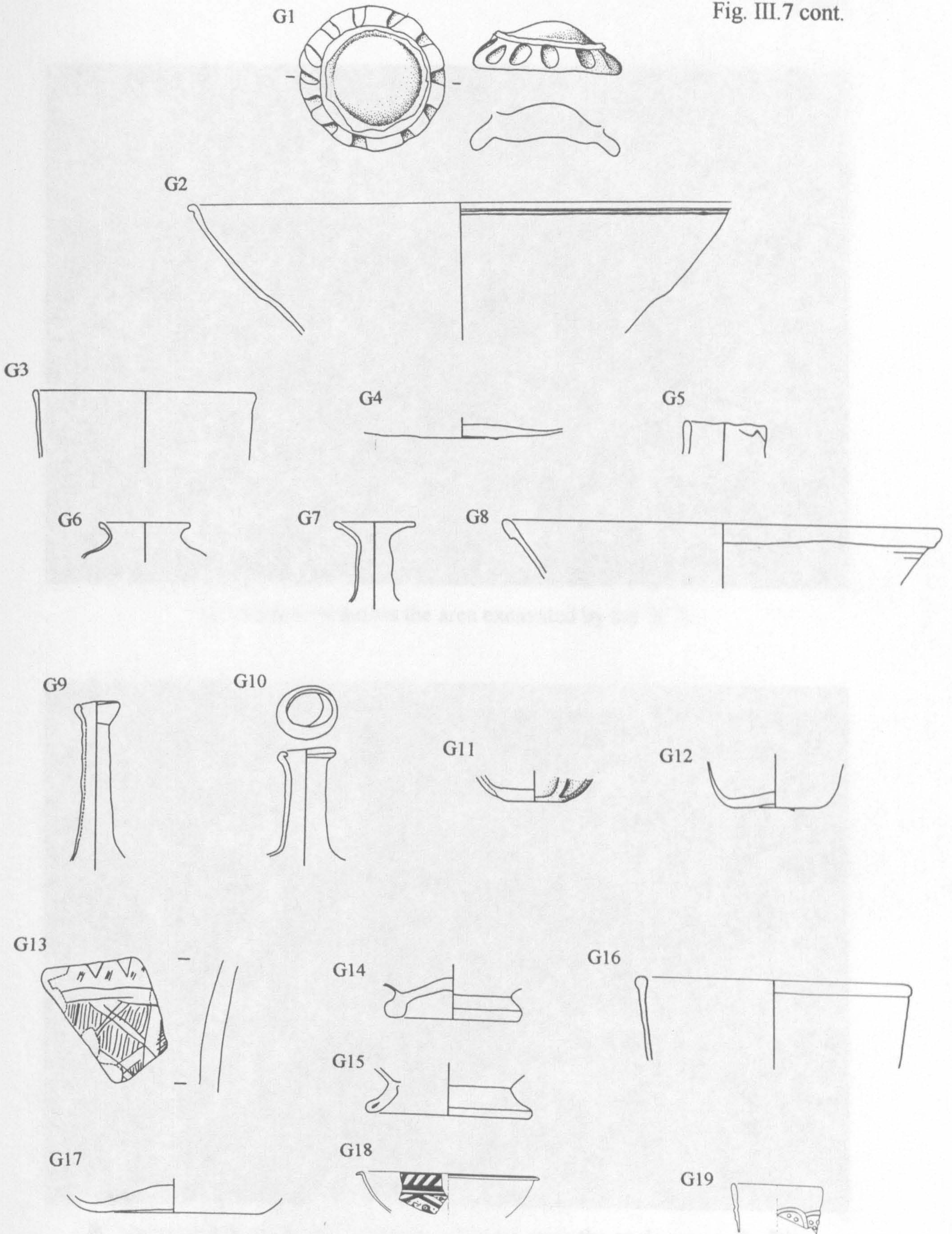

Glass from surface collections on Tell Tinnis at 1:2 (G1-17) and 1:3 (G18-9).



A: View west across the area excavated by the SCA.



B: The cistern beneath the 'Governor's house', with the enclosure wall of the complex in the foreground.



A: Marble stela from the 'Governor's house' now in Port Said Museum, reading:

... له بركة
... زه الدار لعبد
العزیز بن الوزیر
الجروي القاءد



B: Polygonal pool behind profile 1; the raised wall behind is layer 1 of the profile.

Fig. III.10



View of the conjunction of profiles 1 and 2 against the side wall of the 'Governor's house' complex.

Matrix for 'Governor's house' complex

Profile 2

Profile 1

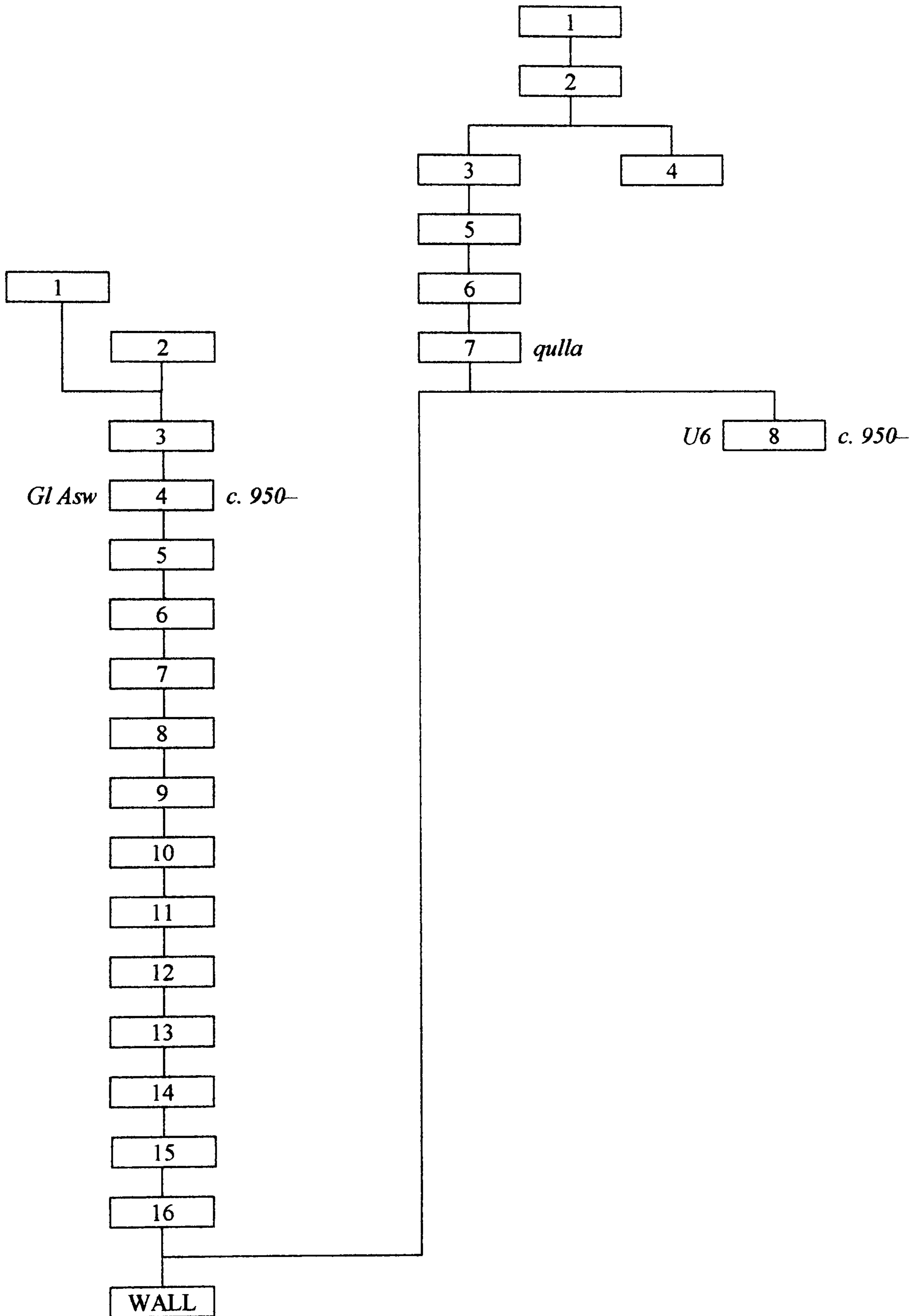

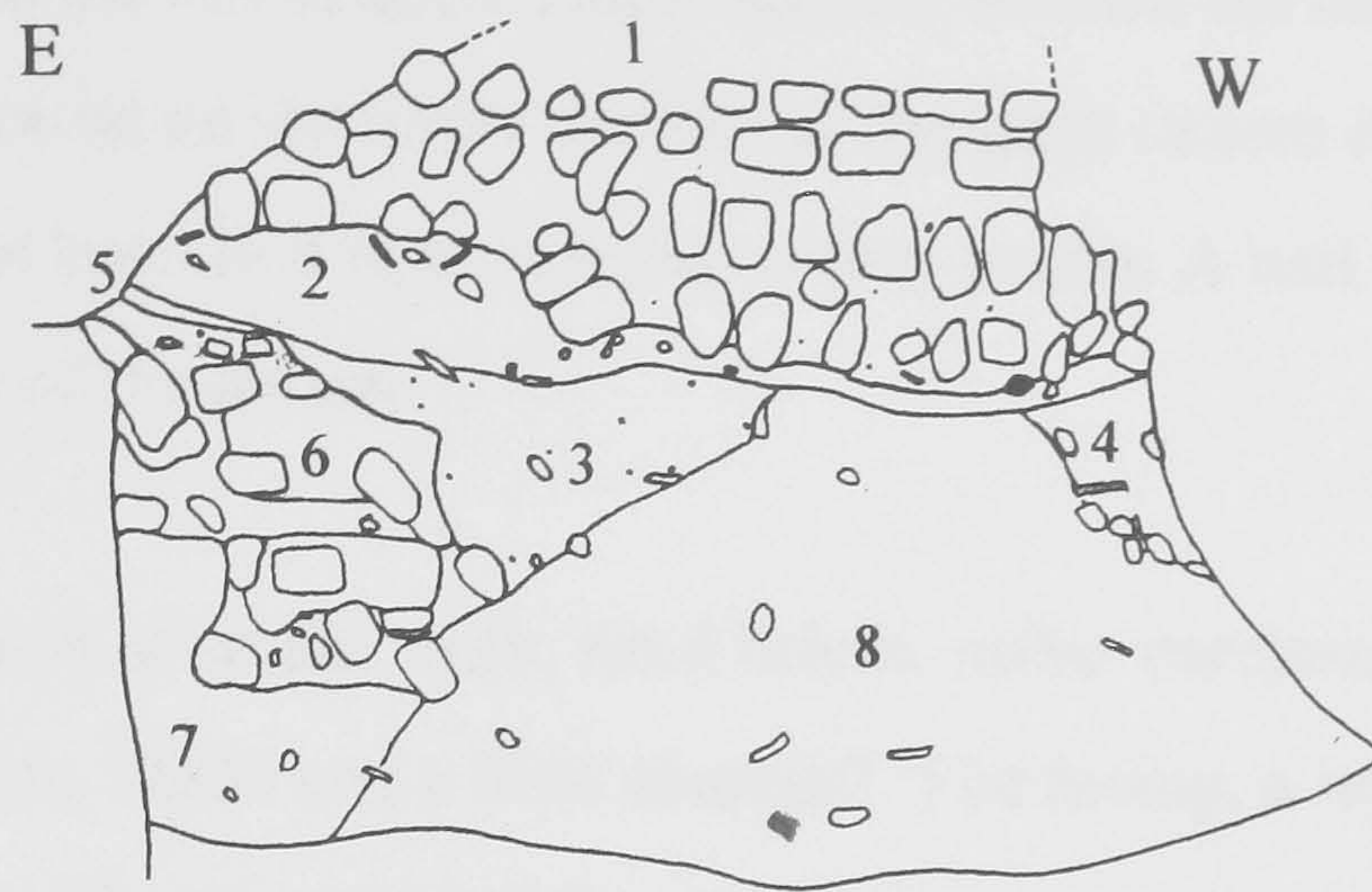

Drawing of profile 1, Tinnis at 1:20.

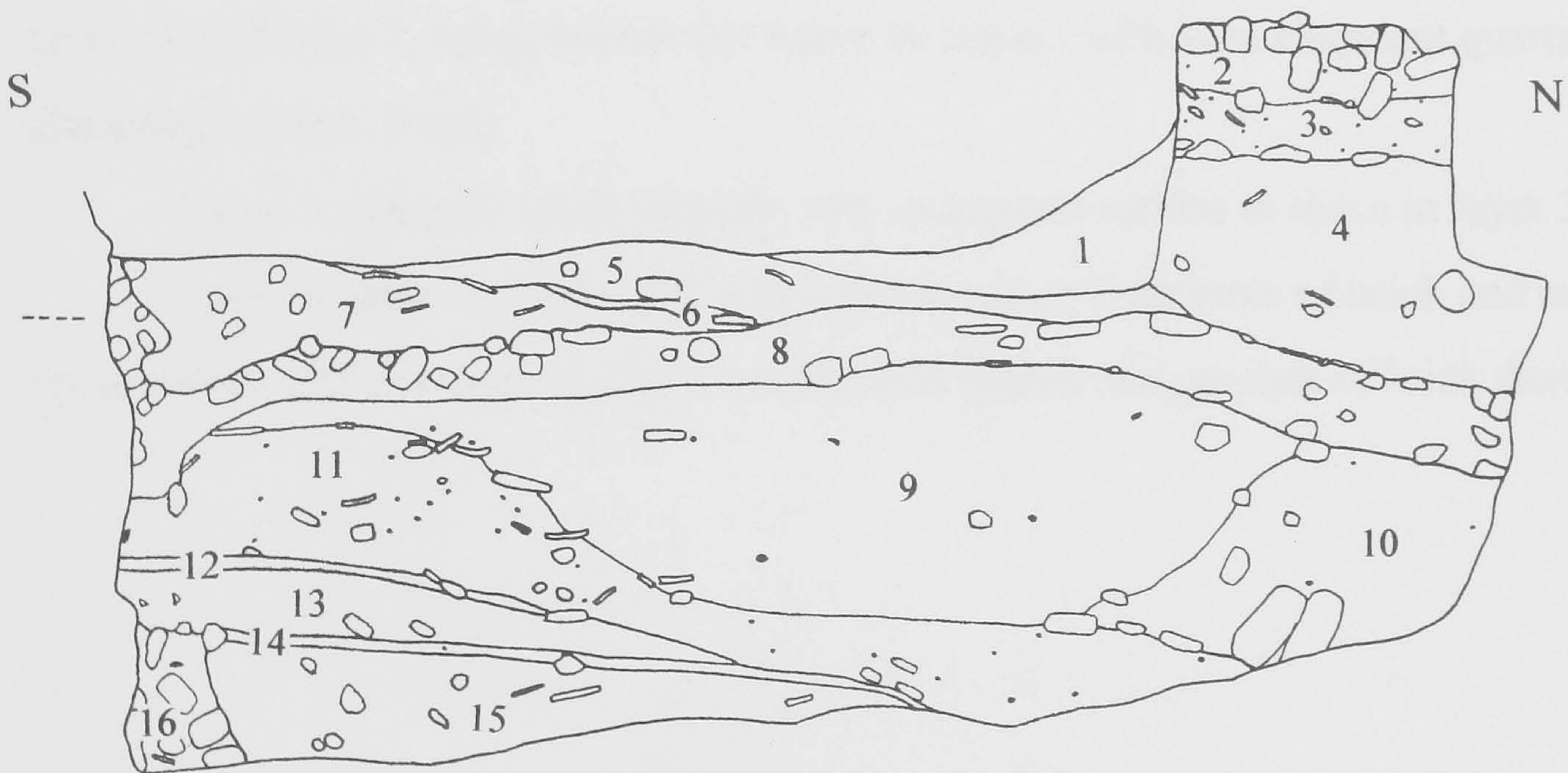

Drawing of profile 2, Tinnis at 1:20.

Tinnis profile 1 layer descriptions

The dotted lines to the left of each Tinnis section indicate the datum height. The datum point is located on the upper surface of the great cistern on the south-west corner, but has not been tied in to external survey points. A nail was left in situ to mark the position of the datum.

Layer 1: wall of small, worn, fired bricks, rather carelessly laid in pink mortar with crushed quartz, shells and a little charcoal. The facing, a layer of more carefully laid brickwork, is only preserved at the west end.

Layer 2: foundation/levelling layer of sand with abundant, medium quartz fragments (3–8 cm), shell pieces and a few sherds.

Layer 3: loose sandy fill with moderate stone fragments (1–4 cm), abundant shell and charcoal and a few fired-brick fragments.

Layer 4: fired-brick and mortar rubble pieces (2–5 cm) in shelly sand with abundant small quartz pieces (1–3 cm).

Layer 5: hard cement surface topping masonry of layer 5.

Layer 6: rubble of fired brick and mortar in large pieces. The mortar differs from that of layer 1, being harder and white in colour, with very abundant quartz chippings (2 mm–2 cm).

Layer 7: granular sandy deposit with inclusions similar to those in layer 3.

Layer 8: dark silty material with a few medium fragments of brick and mortar, some sherds and charcoal, moderate small shell pieces and patches of brick dust.

Tinnis profile 2 layer descriptions

Layer 1: modern wind-drifted material which has built up since the excavation of the area. Fine, sandy silt with lots of salt crystals, a few fine quartz chippings (1 mm–1 cm).

Layer 2: wall of fired brick running perpendicular to the section, which cuts through it. The bricks are carelessly laid and scorched as if the building had burned. The mortar resembles the pink mortar of profile 1, layer 1.

Layer 3: a foundation layer of rubble and mortar, heavily encrusted with salt. Contains moderate sherds, abundant mortar fragments (1–5 cm) and crushed shell.

Layer 4: fine, powdery silt with a few sherds, moderate brick fragments (1–8 cm), some large shell pieces (1–3 cm), a little fine charcoal and large lumps of white mortar with quartz fragments (as that of profile 1, layer 6).

Layer 5: loosely-packed silt with abundant fish bones and insect remains, a few medium brick fragments (3–8 cm) and pink mortar pieces (1–3 cm), occasional sherds, fairly abundant shell, some quartz chippings and patches of brick powder.

Layer 6: ash lens with abundant large charcoal pieces (1–4 cm).

Layer 7: coarse rubble in a sandy deposit. Abundant large brick and mortar pieces (2–7 cm), fairly common crushed shell and moderate sherds, lots of fish bones and insect remains and a little fine charcoal.

Layer 8: tumbled masonry of fired brick in white mortar with quartz pieces, as well as fragments of pink mortar. Towards the north, the rubble is less dense.

Layer 9: sandy material with abundant white mortar fragments (1 mm–3 cm), many large charcoal pieces, some decomposed brick and a few sherds.

Layer 10: fired-brick and white mortar rubble in sandy deposit with much decomposed brick powder and some charcoal.

Layer 11: sandy deposit with large shell pieces, brick and pink mortar fragments, abundant large sherds (3–10 cm), charcoal and some bone.

Layer 12: ash lens with fine charcoal.

Layer 13: as layer 11 but with more powdered brick and no sherds or charcoal. Some fragments of plain green glass (1–2 cm) and fine white particles (shell/stone/mortar).

Layer 14: very visible pink powdery layer of decomposed mortar.

Layer 15: sandy material with brick and pink mortar pieces (3–7 cm), some large sherds and moderate white particles as layer 13 above.

Layer 16: brick and white mortar rubble, the mortar containing charcoal.

Tinnis profile 1 pottery

1. *Provenance: layer 1. Fabric: M1. Surfaces: untreated.*
2. *Provenance: layer 2. Fabric: Fustat. Surfaces: pale green glaze inside and under base.*
3. *Provenance: layer 7. Fabric: fine, hard, green-fired marl. Surfaces: untreated.*
4. *Provenance: layer 8. Fabric: Aswan. Ware: U6. Surfaces: black painted stripe across inside of rim, partly under dark olive green glaze below rim.*
5. *Provenance: layer 8. Fabric: M1. Surfaces: untreated.*

Tinnis profile 2 pottery

1. *Provenance: layer 4. Fabric: Aswan. Surfaces: mustard-yellow glaze all over with two spots of olive green on interior.*
2. *Provenance: layer 4. Fabric: Aswan (group AIV). Surfaces: dark olive glaze over rim, clear glaze drips over outside of rim and on inside.*
3. *Provenance: layer 11. Fabric: M1. Surfaces: untreated.*
4. *Provenance: layer 11. Fabric: M1. Surfaces: untreated.*

Profile 1

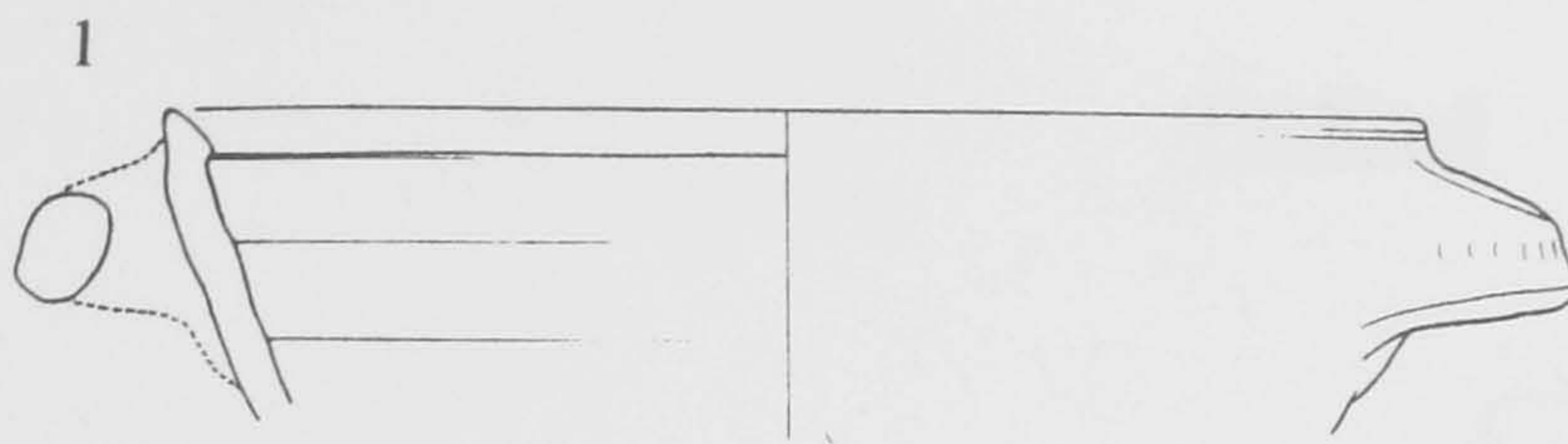

2

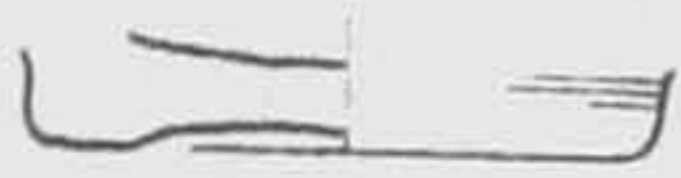

3

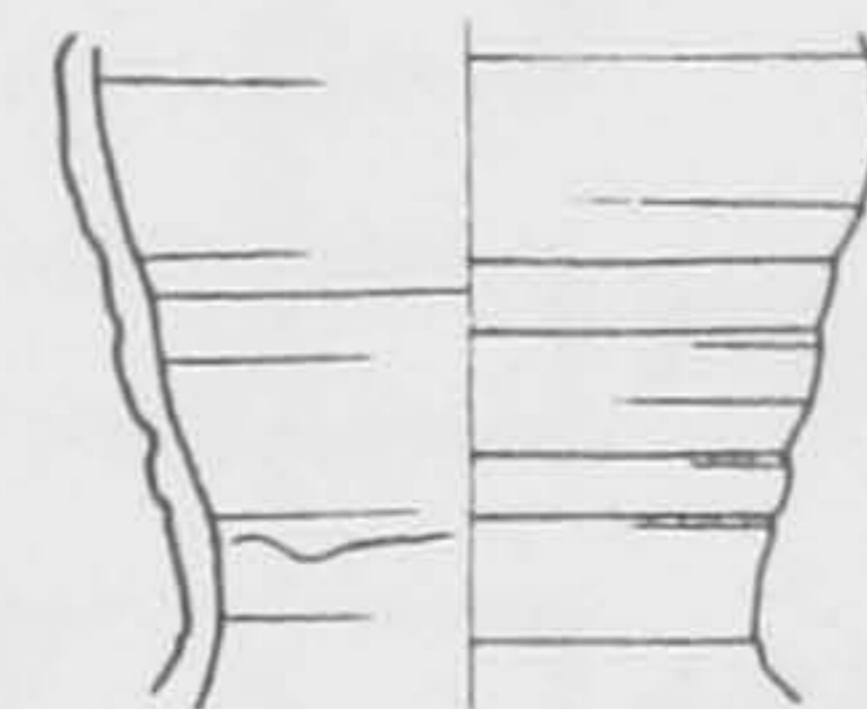

4

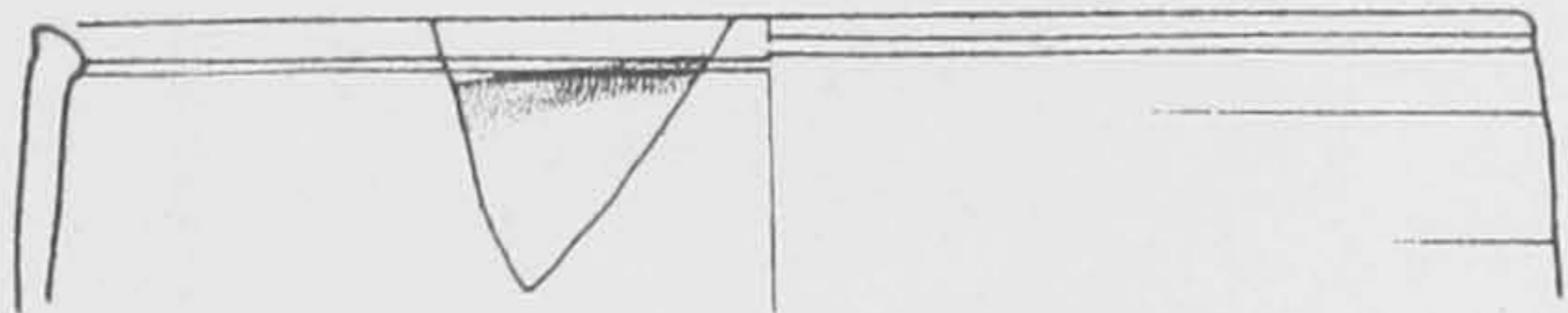

5

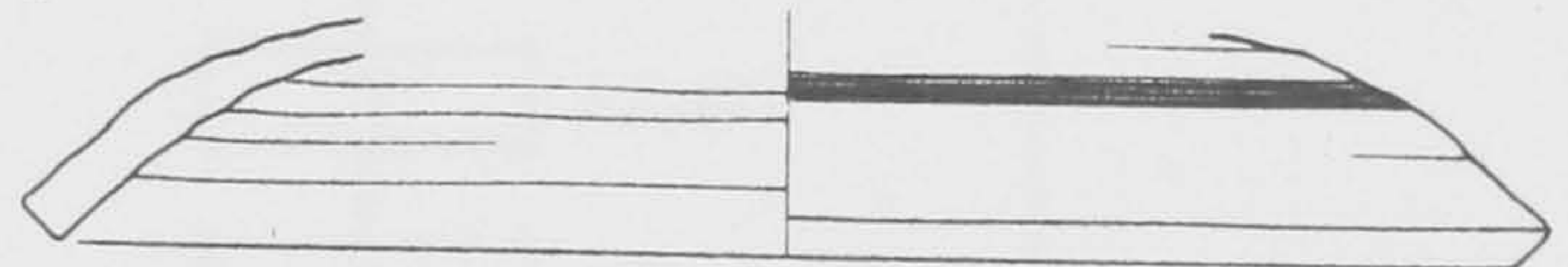

Profile 2

1

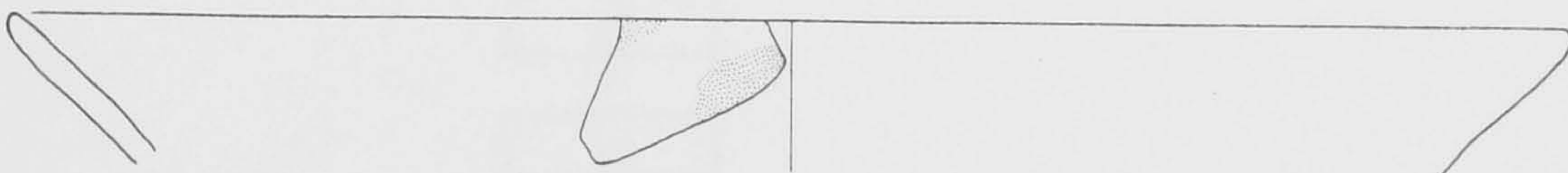

2



3

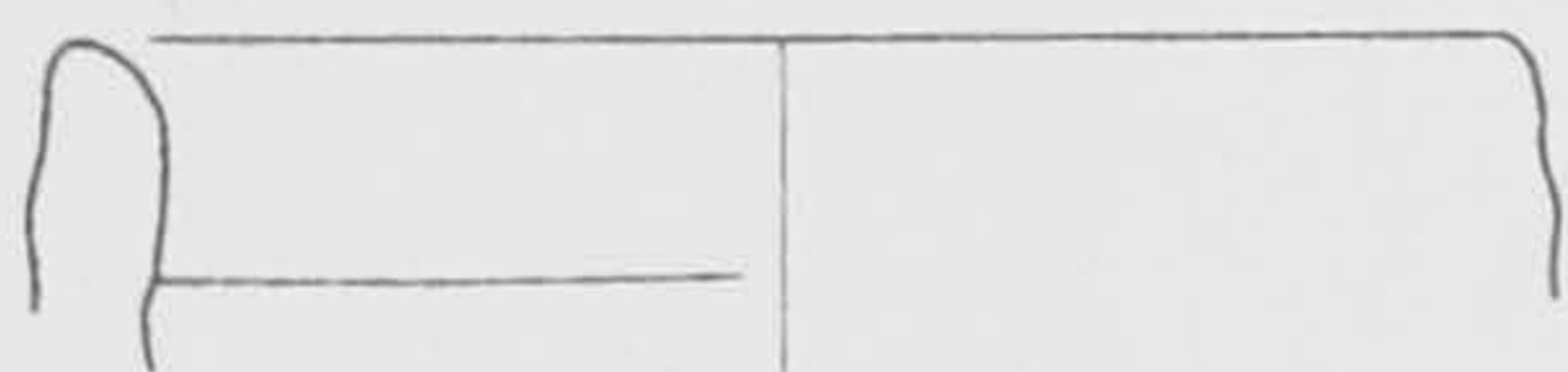

4



Pottery from profiles 1 and 2, Tinnis at 1:3.

Matrix for water installation

Profile 3

Profile 4

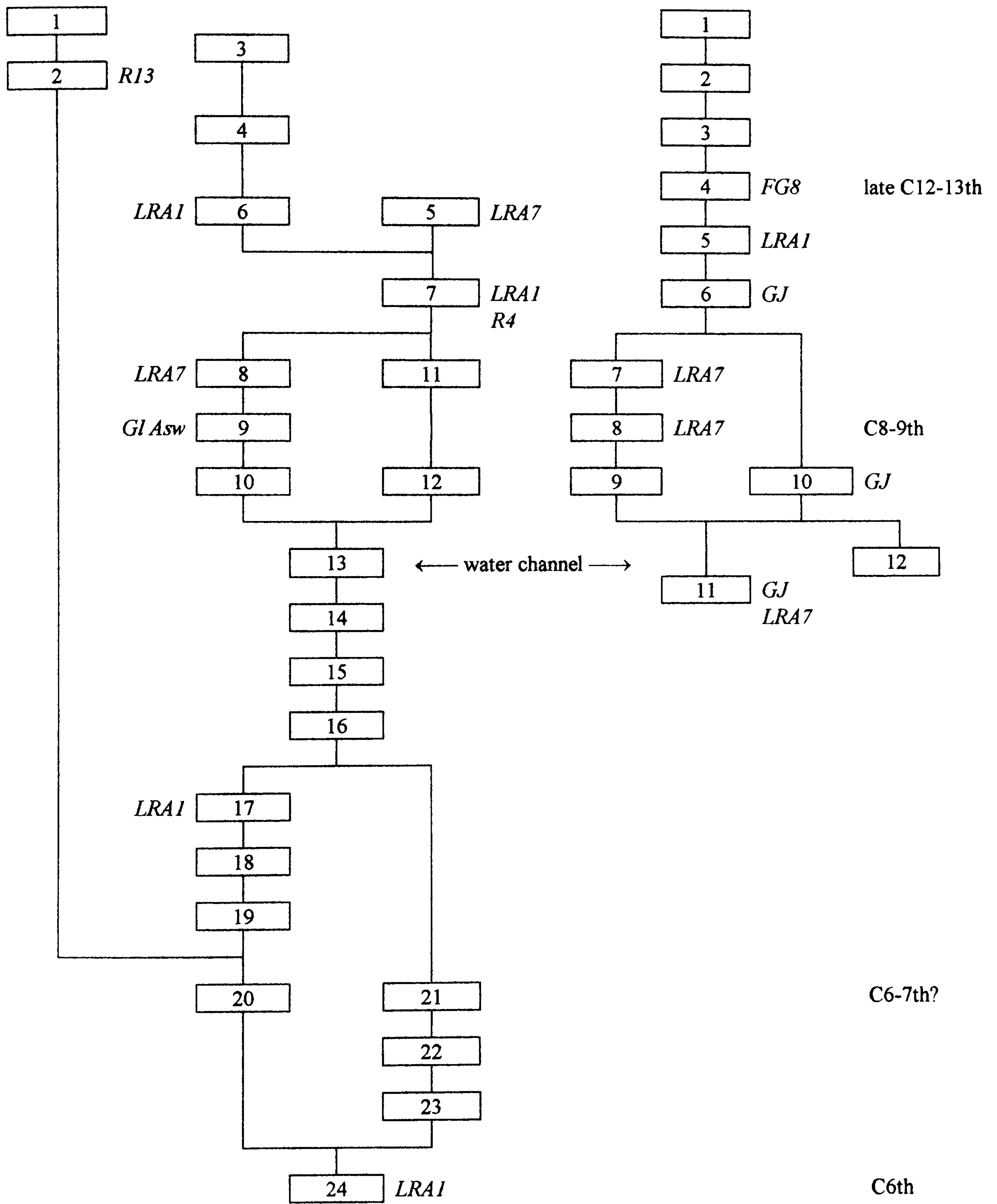



A: Profile 3, Tinnis.



B: Profile 4, Tinnis.

Fig. III.19

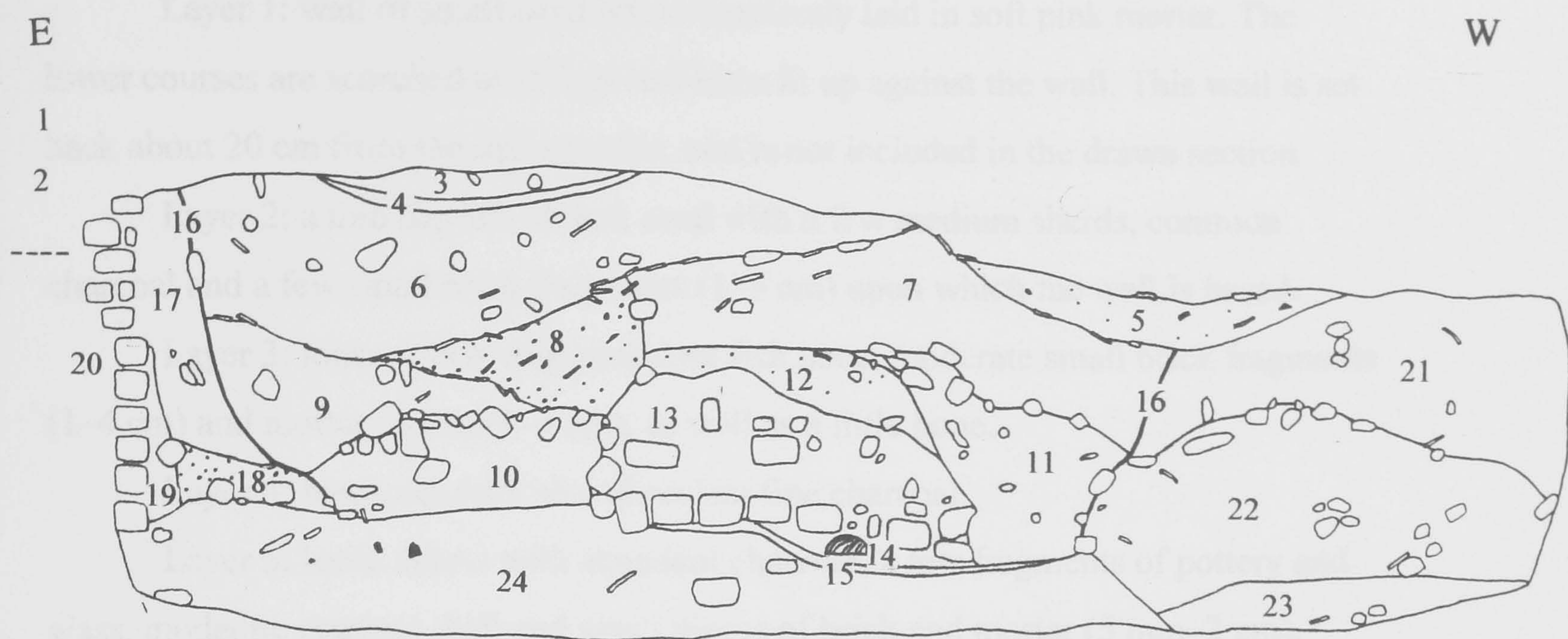

Drawing of profile 3, Tinnis at 1:20.

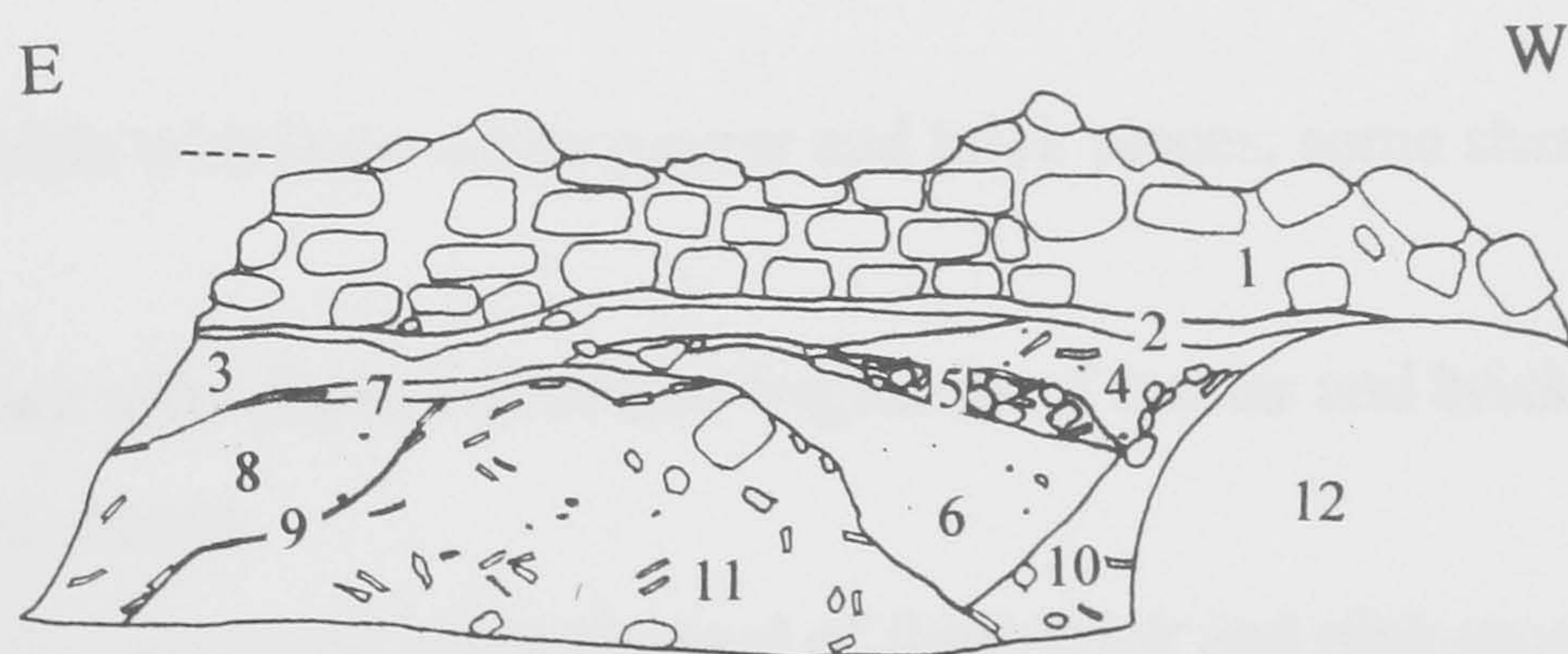

Drawing of profile 4, Tinnis at 1:20.

Tinnis profile 3 layer descriptions

Layer 1: wall of small fired bricks carelessly laid in soft pink mortar. The lower courses are scorched as if fires had been lit up against the wall. This wall is set back about 20 cm from the main profile, and is not included in the drawn section.

Layer 2: a thin deposit of dark sand with a few medium sherds, common charcoal and a few small brick fragments (1–3 cm) upon which the wall is based.

Layer 3: loose debris with abundant fish bone, moderate small brick fragments (1–4 cm) and mortar pieces (1–3 cm), as well as a little bone.

Layer 4: black ash lens with abundant fine charcoal.

Layer 5: loose debris with abundant charcoal, a few fragments of pottery and glass, moderate crushed shell and small pieces of brick and mortar (5 mm–2 cm).

Layer 6: silt with moderate large charcoal pieces, a little crushed brick and mortar (both pink and white) and crushed shell.

Layer 7: rubble with abundant large sherds (1–8 cm), large brick and pink mortar fragments, finer pieces of white mortar, some charcoal and shell.

Layer 8: blackened deposit with very abundant coarse charcoal, loosely packed, and many sherds (2–5 cm).

Layer 9: deposit with abundant white mortar chippings with brick fragments (up to 10 cm), some sherds and medium charcoal pieces.

Layer 10: rubble of brick and pink mortar fragments with smaller white mortar pieces.

Layer 11: rubble with large white mortar and brick pieces, some sherds and a little charcoal.

Layer 12: black ashy deposit with fine fragments of mortar and brick (1 mm–2 cm), some blackened sherds.

Layer 13: badly preserved water channel of fired-brick and pink mortar which has collapsed in on itself.

Layer 14: dense clay residue from water pipe with abundant fine charcoal and decomposed brick powder.

Layer 15: crushed shell foundation layer.

Layer 16: cut of a deep trench dug for the construction of the water channel.

Layer 17: silt with some charcoal and a few small brick fragments (1–2 cm).

Layers 17, 18 and 19 are very similar and may in fact be the same deposit.

Layer 18: silt with large charcoal pieces, some sherds, pink mortar and brick fragments.

Layer 19: blackened silt with scarce fine charcoal.

Layer 20: wall with fired-brick water channel running into it. The brickwork has traces of burning, which perhaps accounts for the scorching of the silt in layer 19.

Layer 21: silt with abundant brick and mortar rubble, sherds, some fine charcoal and crushed shell.

Layer 22: rubble deposit with pink and white mortar, some charcoal and sherds and a little bone.

Layer 23: silt with abundant crushed shell similar to material used as wall foundations, but no traces of brickwork are preserved.

Layer 24: dense, wet clay sterile apart from scarce large brick pieces and sherds, and a little charcoal.

Tinnis profile 4 layer descriptions

Layer 1: wall of small, carelessly laid, fired bricks bedded in sandy grey mortar containing shell fragments and a little charcoal.

Layer 2: foundation of crushed shell under the brickwork.

Layer 3: reddish powdery layer of decomposed brick dust, with some small fragments of brick.

Layer 4: sandy material with crushed shell, a little charcoal and a few small sherds.

Layer 5: deposit of blackened rubble, including large pieces of brick, stone, slag and sherds.

Layer 6: as layer 4.

Layer 7: ash lens.

Layer 8: heavy clay with large sherds, crushed shell, quartz fragments and some medium charcoal pieces.

Layer 9: cut.

Layer 10: fine silt with a few fragments of brick, stone and sherds.

Layer 11: heavy silt with many sherds, brick and mortar fragments, some charcoal and crushed shell.

Layer 12: marble column running underneath layer 1, and perpendicular to the exposed section.

Tinnis profile 3 pottery

1. *Provenance:* layer 2. *Fabric:* Aswan (group AIV). *Surfaces:* red-slipped interior, uneven black rim stripe.
2. *Provenance:* layer 5. *Fabric:* M1. *Surfaces:* untreated.
3. *Provenance:* layer 9. *Fabric:* M1. *Surfaces:* untreated.
4. *Provenance:* layer 9. *Fabric:* VCM1. *Surfaces:* untreated.
5. *Provenance:* layer 21. *Fabric:* M1. *Surfaces:* untreated.

Tinnis profile 4 pottery

1. *Provenance:* layer 8. *Fabric:* Gaza Jar (Majcherek's form 4, sixth and seventh centuries).
2. *Provenance:* layer 10. *Fabric:* Gaza Jar (Majcherek's form 4, sixth and seventh centuries).
3. *Provenance:* layer 11. *Fabric:* Gaza Jar (Majcherek's form 3 or 4, late fifth to seventh centuries).
4. *Provenance:* layer 11. *Fabric:* Gaza Jar (Majcherek's form 3 or 4, late fifth to seventh centuries).
5. *Provenance:* layer 11. *Fabric:* unidentified import.
6. *Provenance:* layer 11. *Fabric:* M5. *Surfaces:* traces of burnished red slip all over.

Profile 3

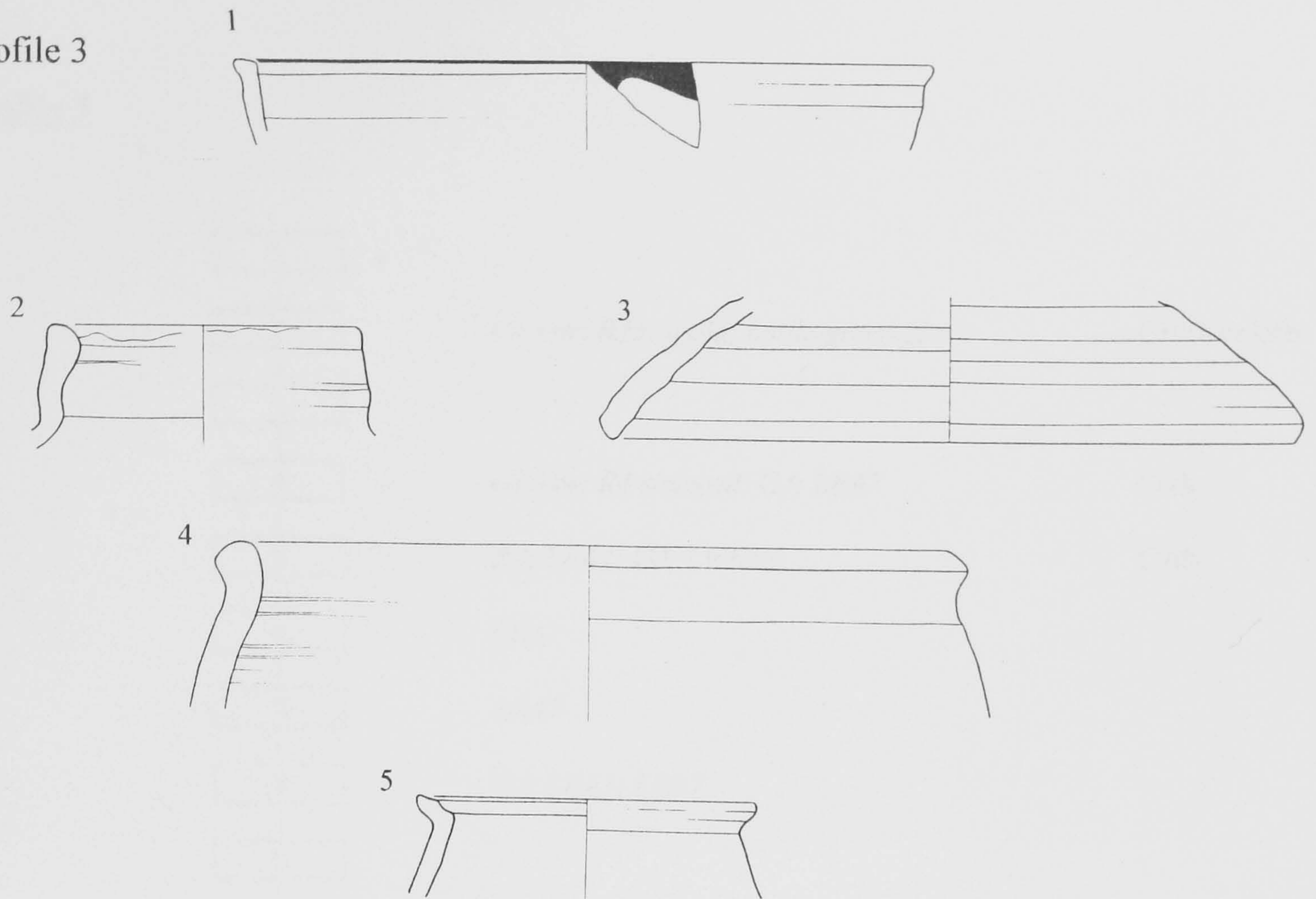

Profile 4

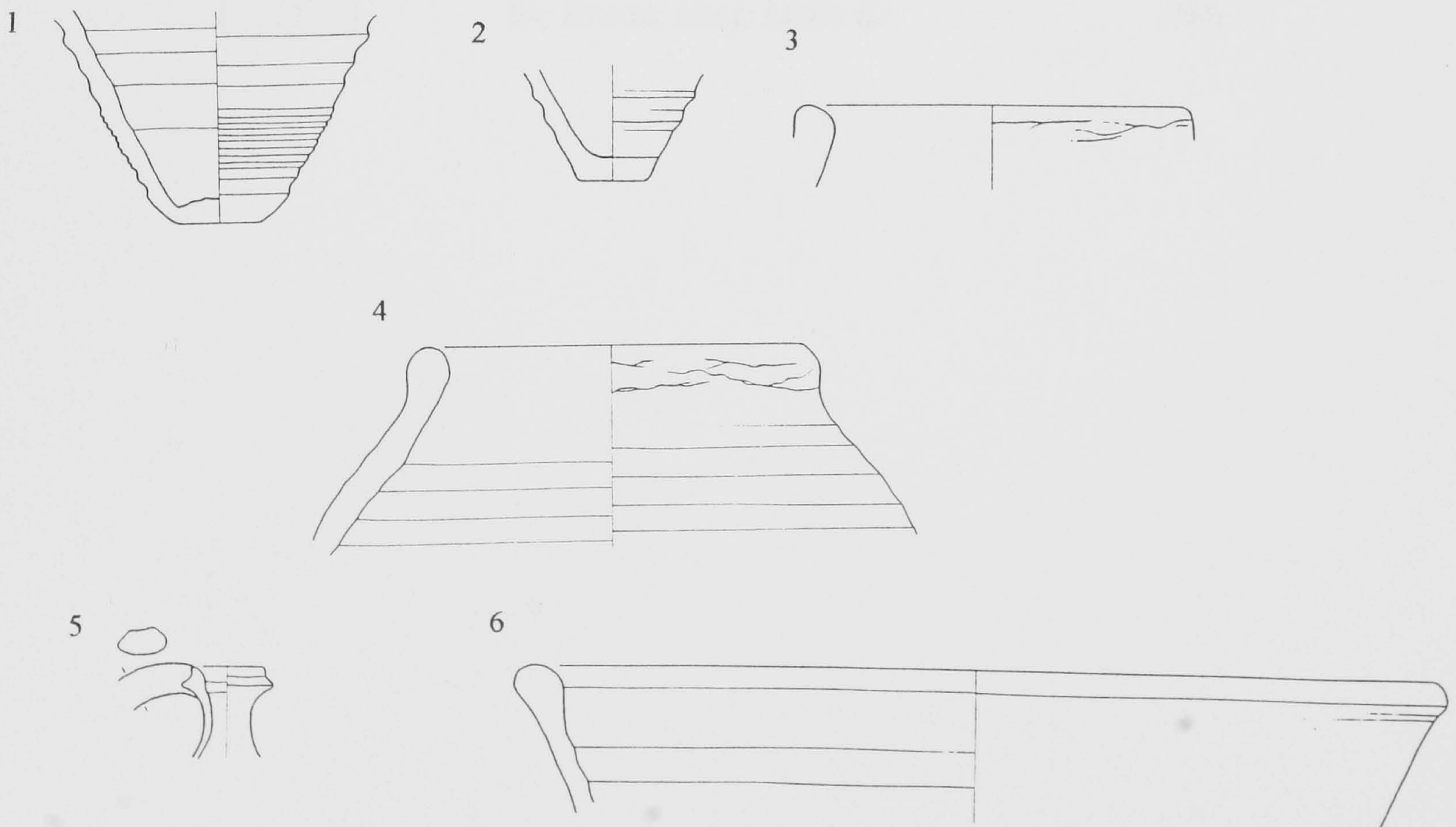

Pottery from profiles 3 and 4, Tinnis at 1:3.

Matrix for cistern cut

Profile 5

1		
2	<i>Gl Asw; R13; qulla; bottle-green gl silt</i>	C10th or later
3		
4	<i>Gl Asw; R4 stamped; GJ; LRA7</i>	C8th
5	<i>R4; LRA1; GJ; LRA5/6</i>	C7th
6	<i>LRA7</i>	
7	<i>LRA7</i>	
8	<i>GJ; LRA1; LRA7</i>	
9		
10	<i>Cypriot ware</i>	C6th
11		
12	<i>R4; W24/32; LRA1; LRA7; GJ</i>	C6th

Fig. III.25



Profile 5, Tinnis.

Fig. III.26

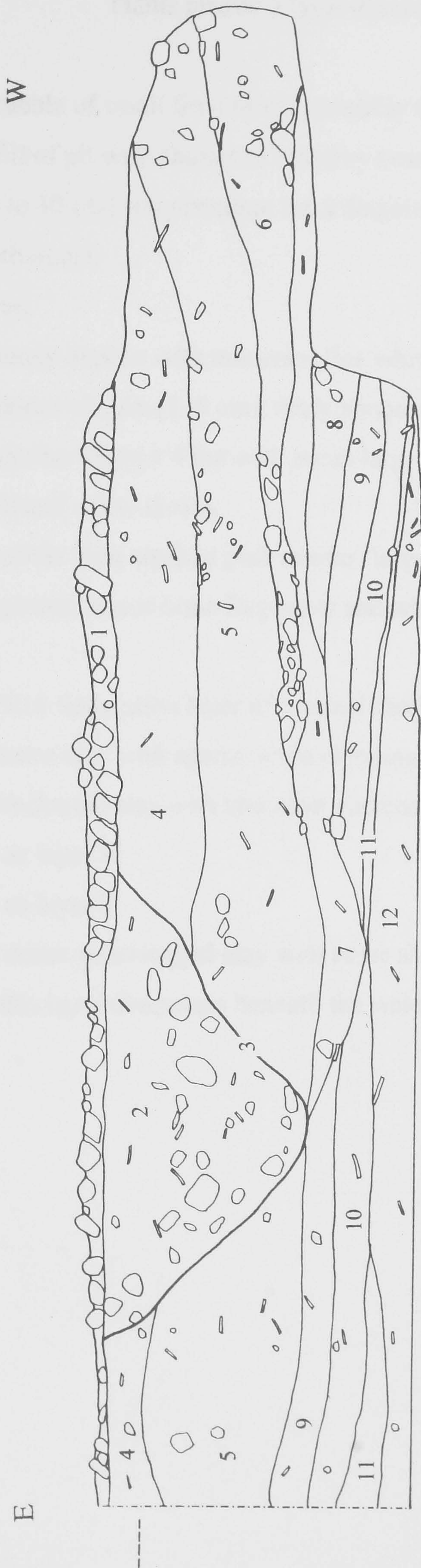

Drawing of profile 5, Tinnis at 1:20

Tinnis profile 5 layer descriptions

Layer 1: rubble of small fired bricks, possibly the remains of a destroyed wall.

Layer 2: fill of pit with chunks of masonry comprising large pieces of pink and white mortar (up to 10 cm) and abundant brick fragments (2–7 cm); also sherds, some shell and a little charcoal.

Layer 3: cut.

Layer 4: sandy deposit with moderate fine white chippings (from decomposed mortar?), some mortar chunks (1–5 cm), fairly abundant sherds and moderate bone.

Layer 5: similar to layer 4 but with much larger white chippings (1–5 cm), moderate charcoal and a few sherds.

Layer 6: rubble with crushed pink mortar (larger pieces to east end of profile), with small brick pieces, scarce bone fragments and white chippings, some crushed shell.

Layer 7: thick foundation layer of crushed shells with a few sherds.

Layer 8: dense clay with sparse white chippings and scarce sherds.

Layer 9: blackened clay with abundant charcoal and scarce sherds.

Layer 10: as layer 8.

Layer 11: as layer 9.

Layer 12: dense waterlogged clay with some sherds, fairly abundant bone and a little charcoal; this layer disappears beneath the water.

Tinnis profile 5 pottery

1. *Provenance:* layer 2. *Fabric:* Aswan. *Surfaces:* yellow glaze over rim, wide stripe of bottle-green glaze over middle of interior, two black painted stripes below bottom edge of green glaze; cream-slipped exterior.
2. *Provenance:* layer 2. *Fabric:* fine, hard, green-fired marl. *Surfaces:* untreated.
3. *Provenance:* layer 4. *Fabric:* Aswan. *Surfaces:* olive-green glaze on interior, exterior surface worn away.
4. *Provenance:* layer 4. *Fabric:* M5. *Surfaces:* remains of red slip all over.
5. *Provenance:* layer 4. *Fabric:* M5. *Surfaces:* remains of red slip all over.
6. *Provenance:* layer 4. *Fabric:* LRA 7 (Peacock and Williams class 53).
7. *Provenance:* layer 4. *Fabric:* M1. *Surfaces:* untreated.
8. *Provenance:* layer 4. *Fabric:* M1. *Surfaces:* untreated.
9. *Provenance:* layer 4. *Fabric:* Aswan. *Ware:* R4. *Surfaces:* remains of red slip inside and out, stamped decoration on interior.
10. *Provenance:* layer 5. *Fabric:* LRA 5/6.
11. *Provenance:* layer 9. *Fabric:* M1. *Surfaces:* untreated; blackened interior.
12. *Provenance:* layer 10. *Fabric:* Cypriot red slip ware. *Surfaces:* burnished red slip all over, rouletted exterior.
13. *Provenance:* layer 11. *Fabric:* M1. *Surfaces:* blackened, apparently untreated.
14. *Provenance:* layer 12. *Fabric:* M1. *Surfaces:* untreated; blackened interior.
15. *Provenance:* layer 12. *Fabric:* Aswan. *Ware:* R4. *Surfaces:* burnished red slip all over.

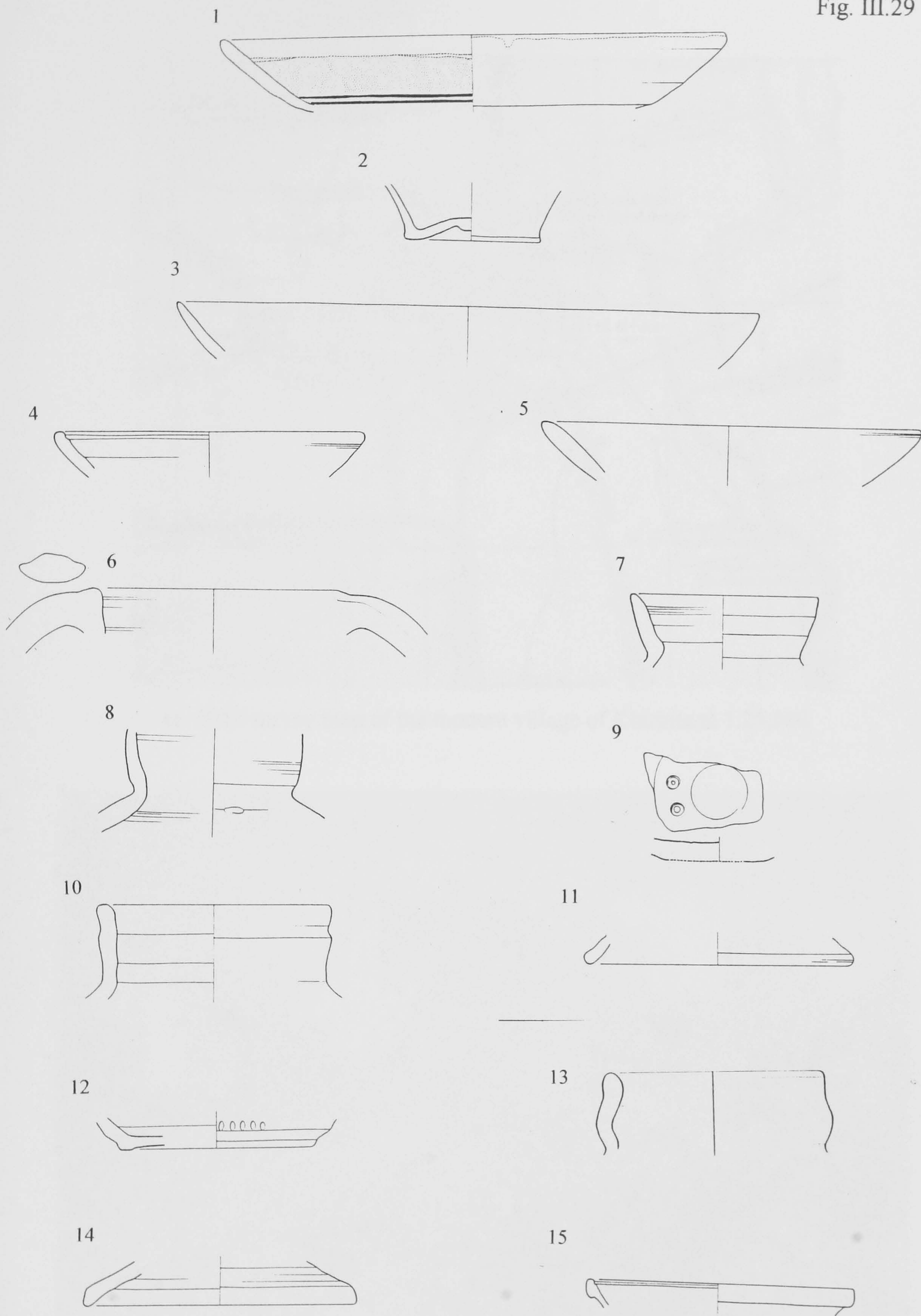

Pottery from profile 5, Tinnis at 1:3.

Fig. IV.1



A: 1942 survey map of the modern village of Khirbita at 1:25,000.



B: The edge of the cemetery at Tell al-Krum, Kharibta.

Kharibta surface pottery catalogue

Cypriot red slip ware

Form 1–3 late fourth to mid-sixth century (Hayes 1972).

1. *Diameter* (base): 6 cm.

LRA 1 early fifth to mid-seventh century.

2. *Diameter*: 10 cm.
3. *Diameter*: 9 cm.
4. *Diameter*: 10 cm.

LRA 7 see fig. II.25 for discussion of dating.

5–8.

Silt bowls

9. *Fabric*: M5. *Surfaces*: burnished red slip all over. *Diameter*: 30 cm. *Parallels*: Ashmunein, D 421, c. 320–420 (Bailey 1998); similar to ARS form 59, c. 320–420 (Hayes 1972).
10. *Fabric*: M2. *Surfaces*: untreated. *Diameter*: 14 cm. *Parallels*: related to Lahun, Ptolemaic (Petrie 1923, pl. 61, 1–34, no. 6); Medinet Habu, late third century (Hölscher 1954, pl. 48); Bucheum, c. 275–395 AD (Mond and Myers 1934, pl. 136–7); Armant, third to fourth centuries (Mond and Myers 1940, pl. 58).
11. *Fabric*: M1. *Surfaces*: untreated. *Diameter*: 20 cm. *Parallels*: Naukratis, ‘echinus’ bowls, Ptolemaic (Coulson 1996, 39–40, fig. 18).
12. *Fabric*: M1. *Surfaces*: untreated. *Diameter*: 32 cm.
13. *Fabric*: VCM1. *Surfaces*: untreated. *Diameter*: 36 cm. *Parallels*: Kellia, fifth century (Egloff 1977, type 272).
14. *Fabric*: M1. *Surfaces*: untreated. *Diameter*: 18 cm.

Silt potstands

15. *Fabric*: VCM1. *Surfaces*: untreated. *Diameter* (base): 19 cm.

Silt qullas

16. *Fabric*: M1. *Surfaces*: wet-smoothed. *Diameter* (narrowest point of neck): 4 cm.

Silt jars

17. *Fabric: M1. Surfaces: untreated. Diameter: 10 cm.*
18. *Fabric: VCM1. Surfaces: untreated. Diameter: 24 cm.*
19. *Fabric: M1. Surfaces: untreated. Diameter: 26 cm.*
20. *Fabric: VCM1. Surfaces: untreated. Diameter: 28 cm.*
21. *Fabric: M1. Surfaces: untreated. Diameter: 36 cm.*
22. *Fabric: M1. Surfaces: untreated. Decoration: roughly-moulded scalloping on outside of rim. Diameter: 31 cm.*
23. *Fabric: M1. Surfaces: untreated. Diameter: 21 cm.*
24. *Fabric: M4. Surfaces: untreated. Diameter: 16 cm.*
25. *Fabric: M1. Surfaces: untreated. Diameter: 26 cm.*
26. *Fabric: M1. Surfaces: cream-slipped exterior, untreated interior. Diameter: 24 cm.*
27. *Fabric: hard, fine-grained silt with fine black and white inclusions, red-brown with brighter margins to break. Surfaces: worn, possible traces of cream slip. Diameter: 21 cm. Parallels: similar to, but larger than, Qantir, vessel 2484, 20th/21st dynasty (Aston 1998).*
28. *Fabric: M1. Surfaces: untreated. Diameter: 14 cm.*
29. *Fabric: M1. Surfaces: thick cream slip all over. Diameter: 20 cm.*

Fig. IV.3

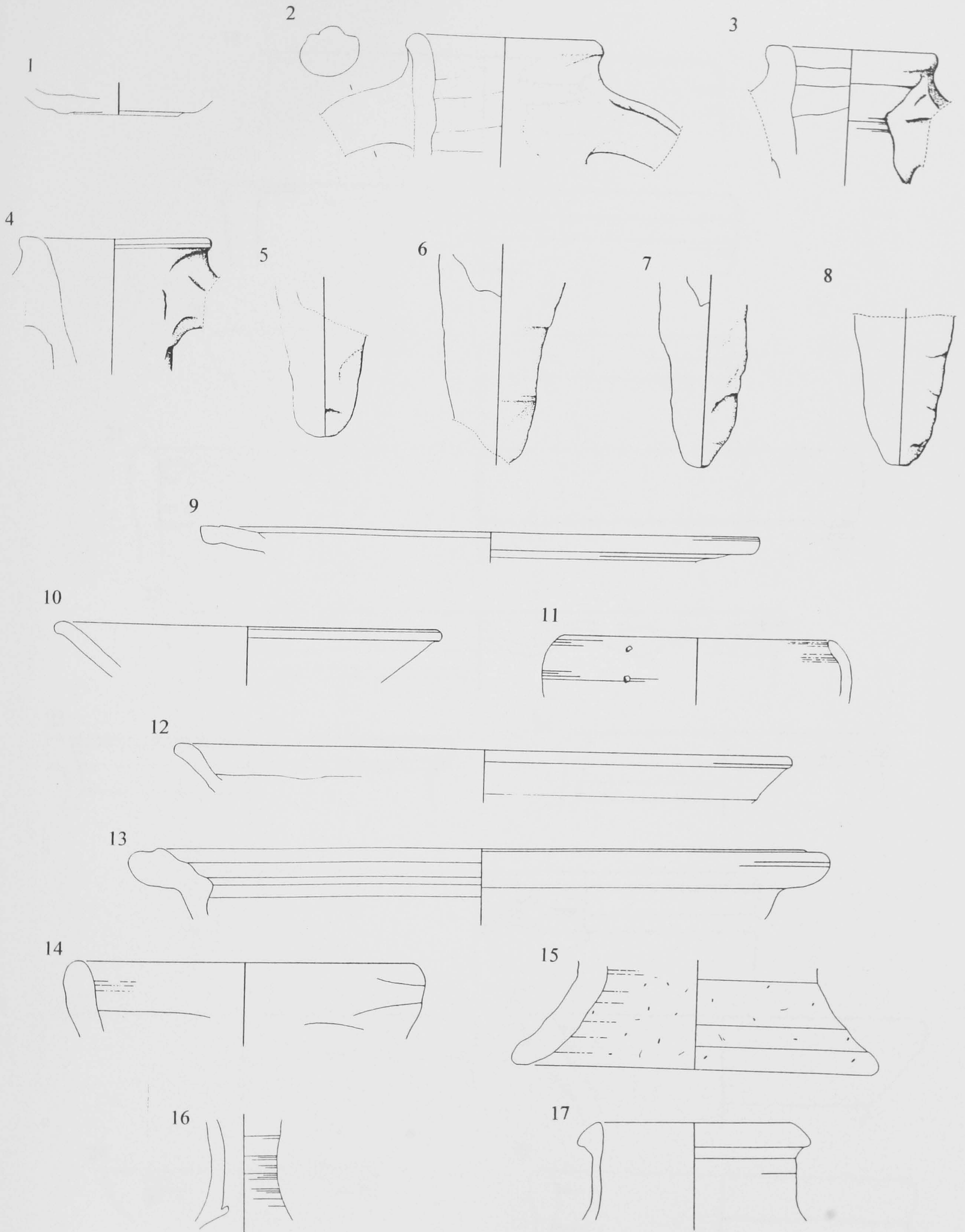

Pottery from surface collections on Tell al-Krum, Kharibta at 1:3.

18

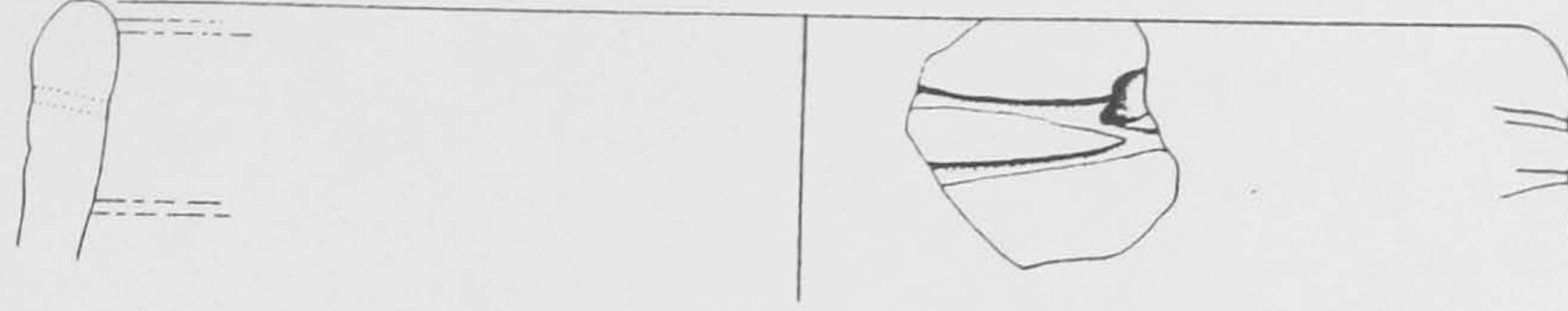

19

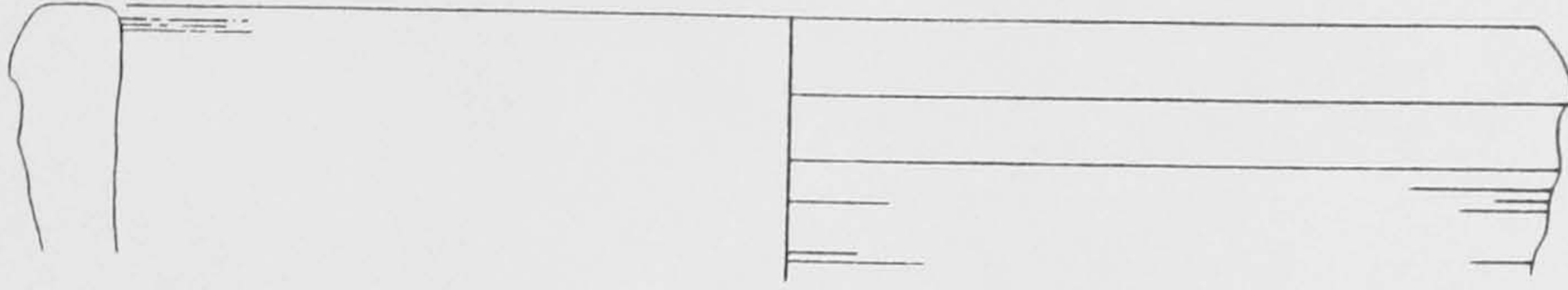

20

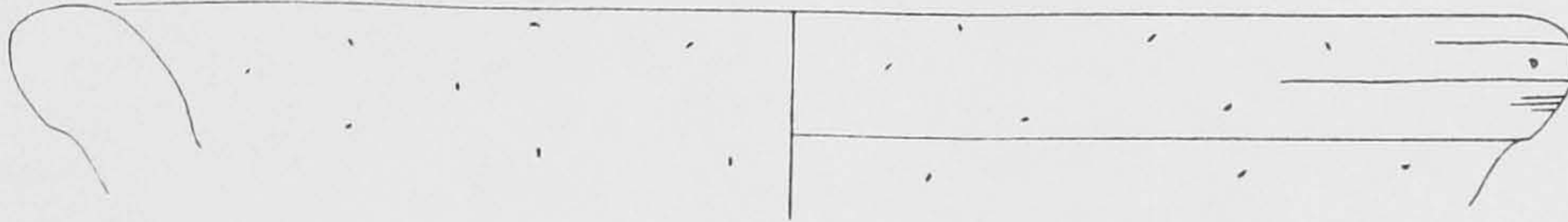

21

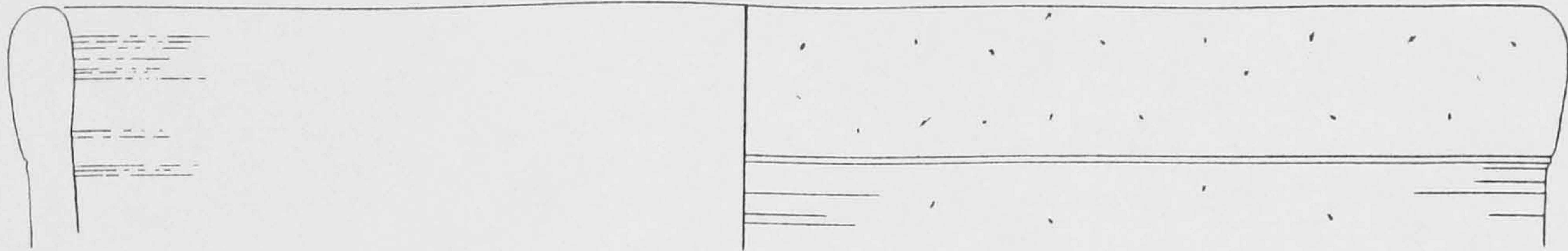

22

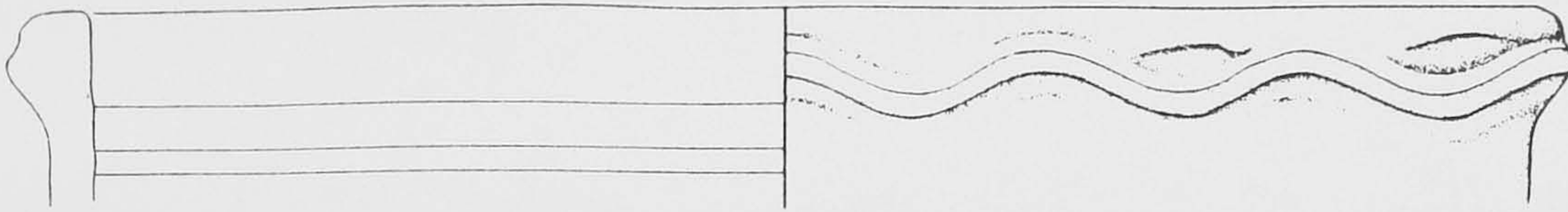

23

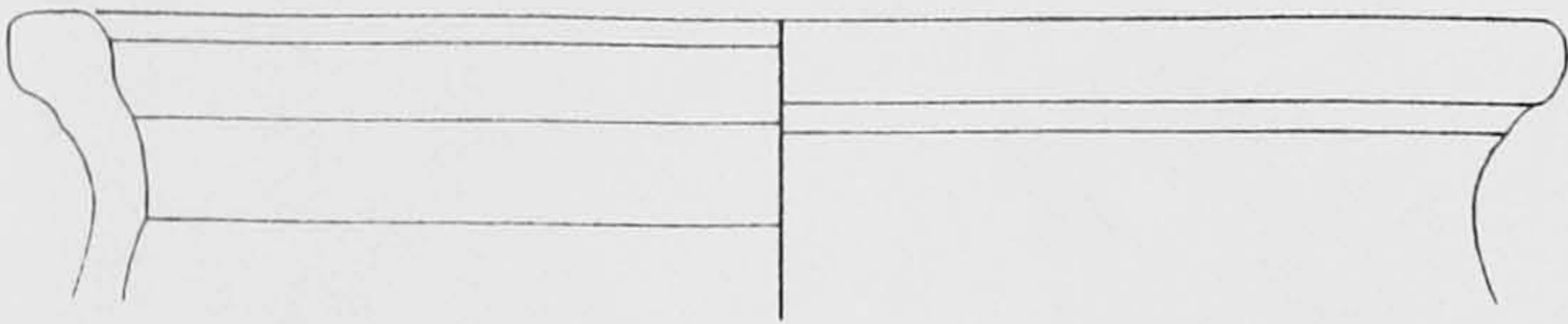

24

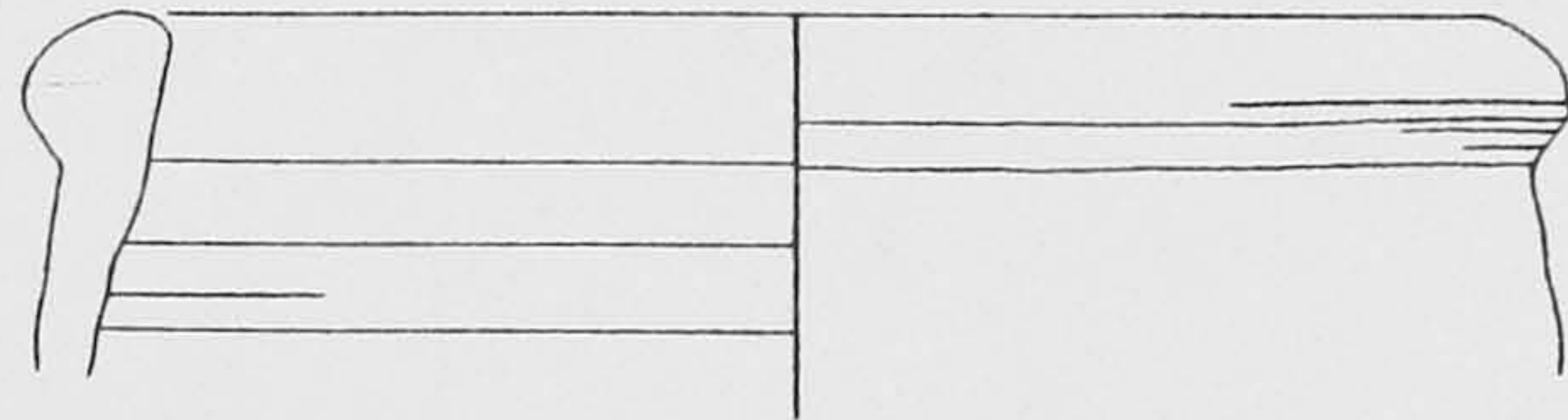

25

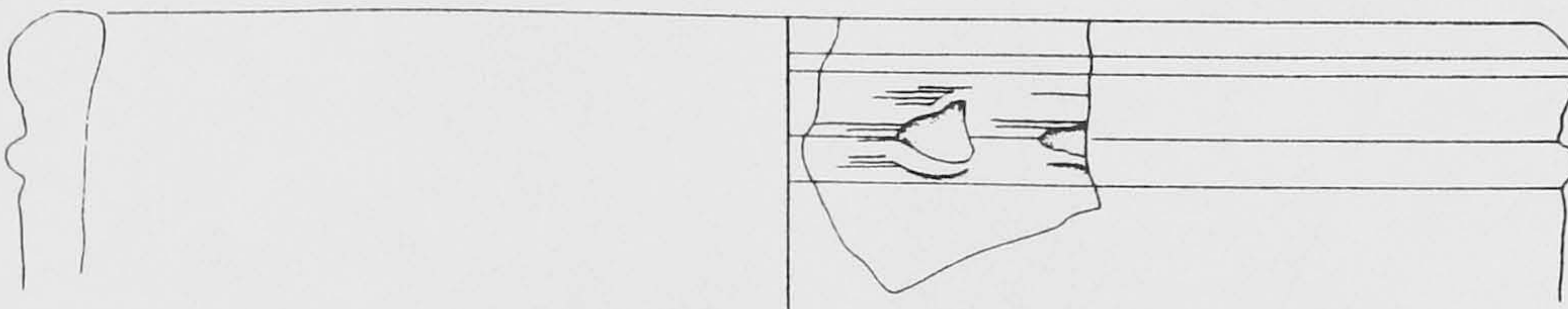

26

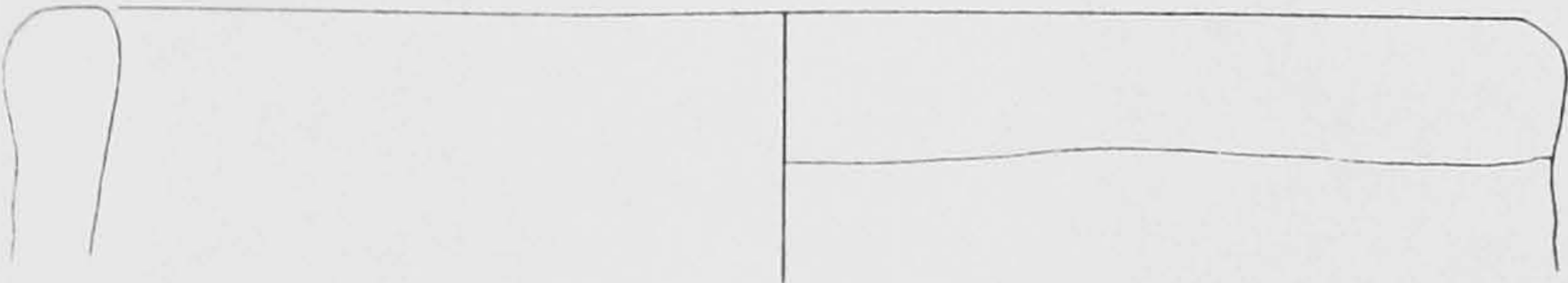

27

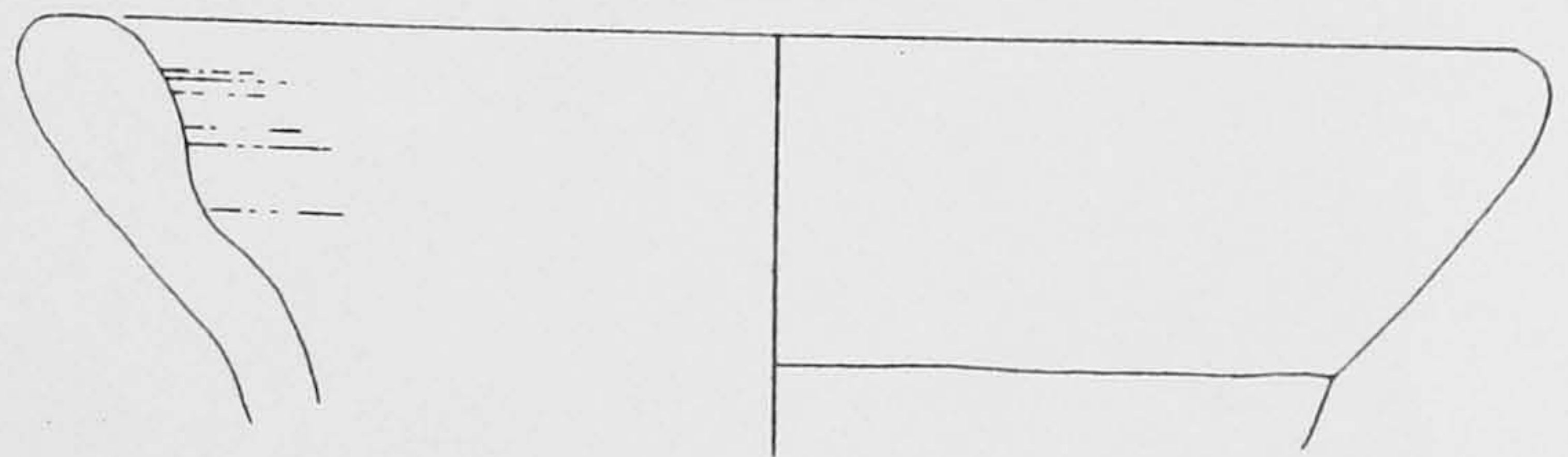

28

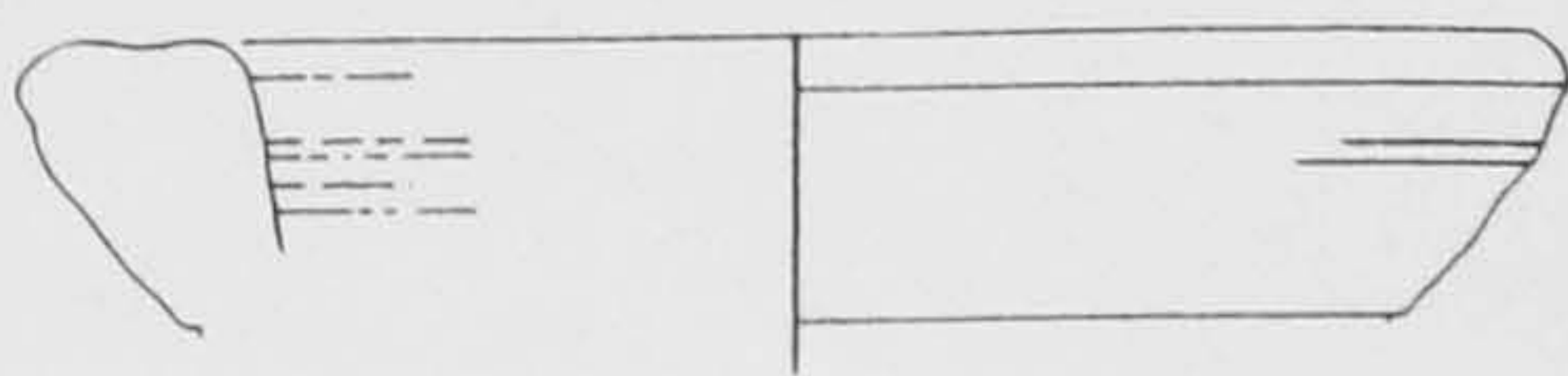

29

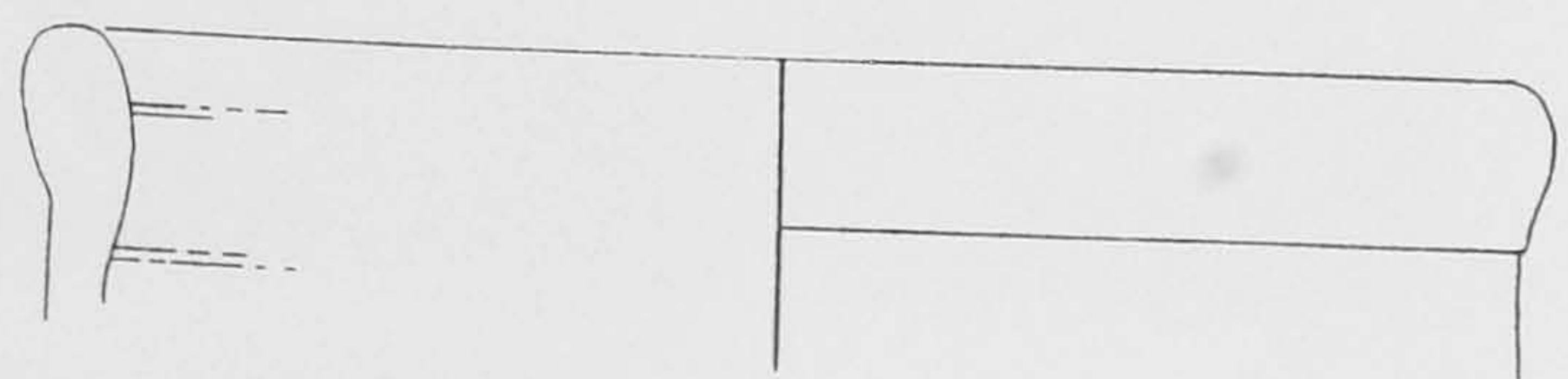

Pottery from surface collections on Tell al-Krum, Kharibta at 1:3.

Fig. IV.4



A: Bare ground between Tell al-Krum and the cultivation, Kharibta.



B: Profile 1, Tell al-Krum, Kharibta.

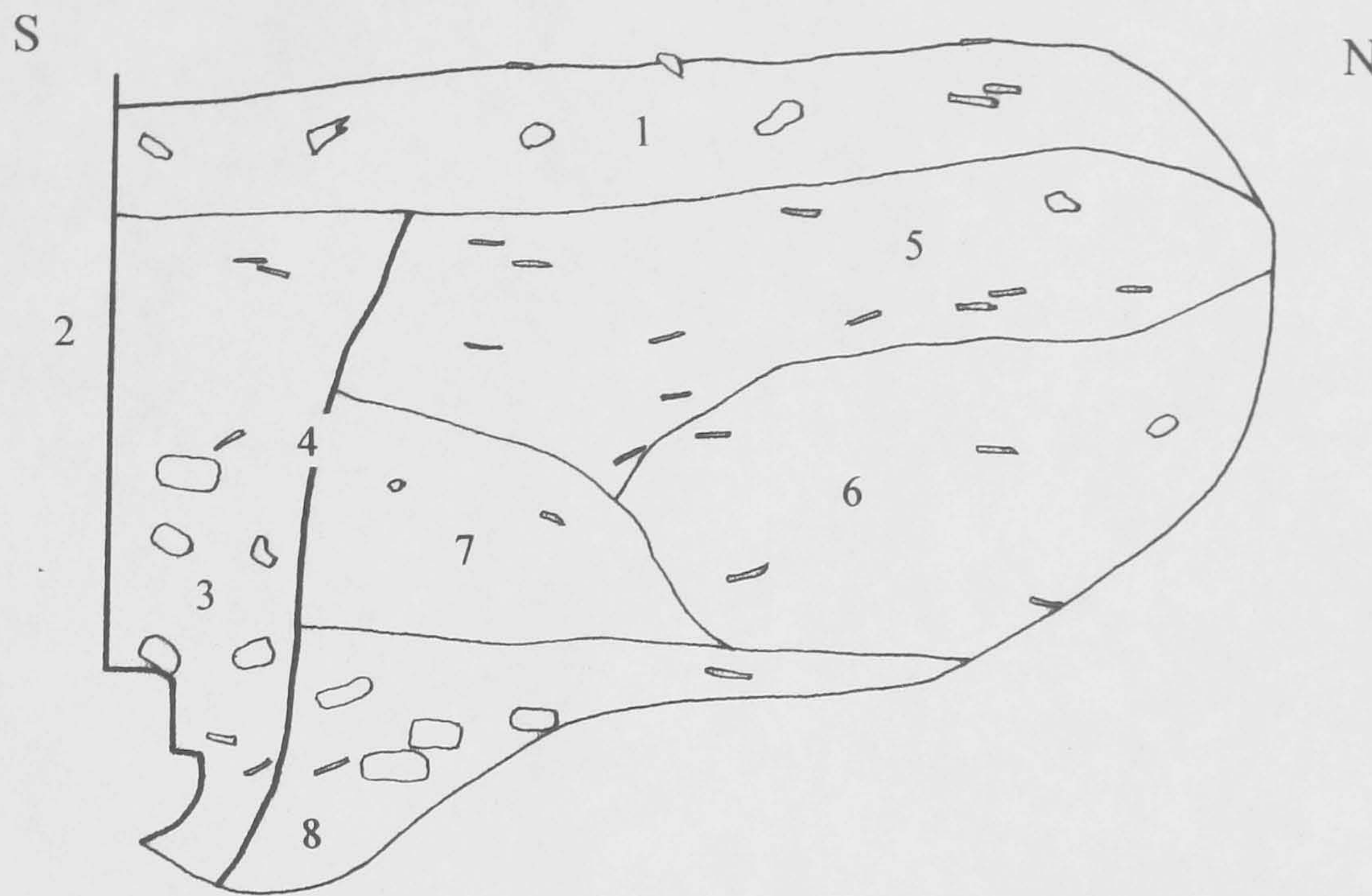

Profile 1, Tell al-Krum at 1:20.

Kharibta: profile 1 layer descriptions

Layer 1: modern overburden of fired-brick rubble, straw and pottery and glass fragments.

Layer 2: modern concrete tomb structure.

Layer 3: silt with large mud-brick fragments, fine limestone chippings and organic material (fill of tomb foundation trench).

Layer 4: cut.

Layer 5: silt with abundant small sherds, fine charcoal, organic material and limestone chips.

Layer 6: heavier silt with scarce small sherds and some coarse charcoal.

Layer 7: silt with abundant white limestone chippings, larger stone fragments and scarce fine sherds.

Layer 8: heavy wet clay with a few decomposed sherds and (?) mud-brick fragments.



Profile 2, Tell al-Krum, Kharibta.

Kharibta: profile 2 layer descriptions

Layer 1: compacted silt deposits containing many plant root-clumps.

Layer 2: silt with abundant fine stone chippings and a few larger fragments.

Layer 3: dump of small sherds, stone chippings and a little charcoal.

Layer 4: compacted heavy silt with a little charcoal, a few small sherds and some organic remains.

Layer 5: thin layer of ash and charcoal.

Layer 6: sterile sand.

Layer 7: as layer 4.

Layer 8: as layer 3.

Layer 9: heavy, wet clay containing a few small sherds and stone fragments.

Layer 10: deposit of very fine gravel and decomposed sherds, scarce stone fragments.

Layer 11: as layer 9.

Layer 12: compacted wet sand (decomposed sandstone?).

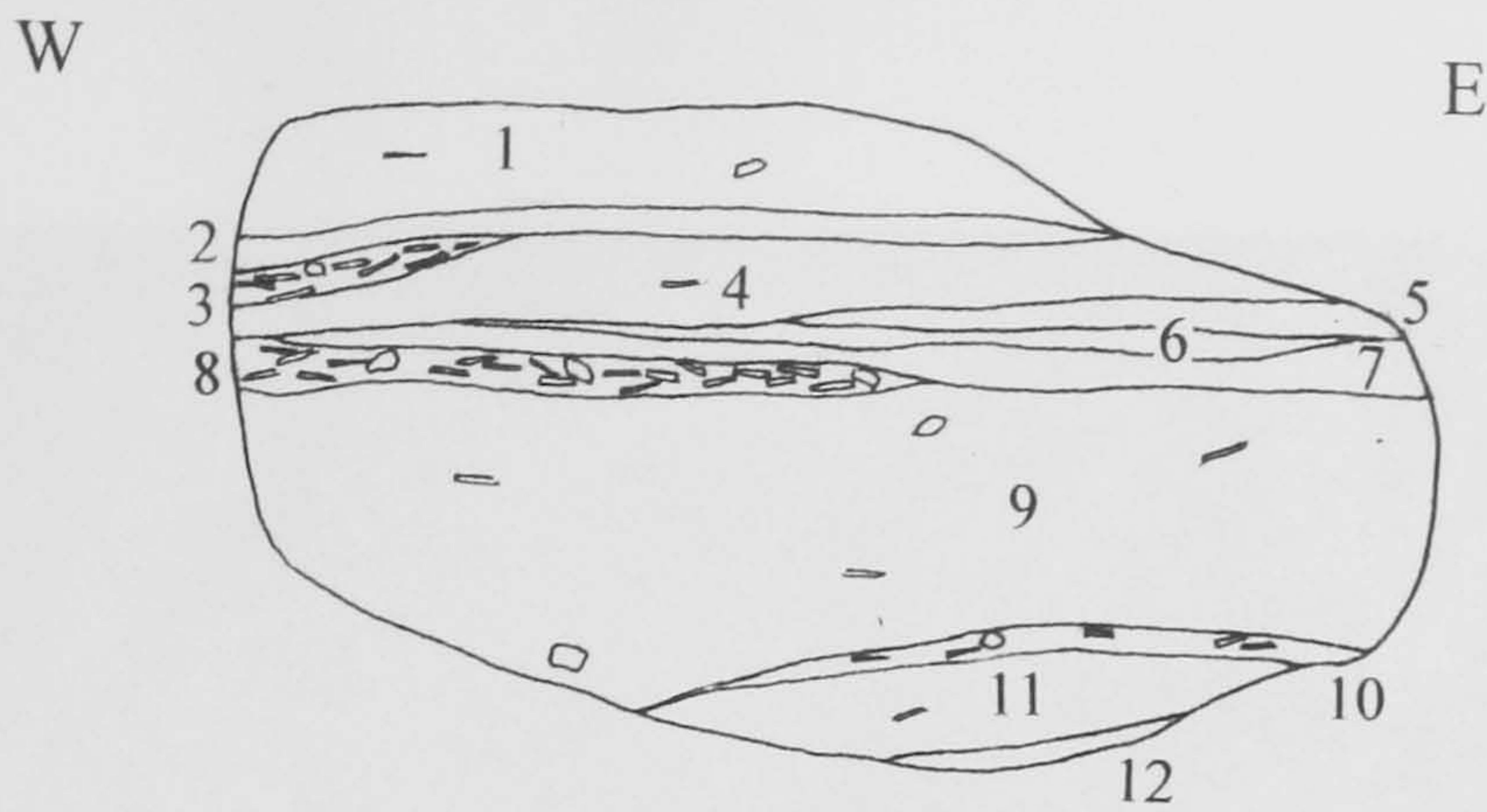

Profile 2, Tell al-Krum at 1:20.

Pottery from profile 1:

- 1-3. *Provenance:* layers 3, 5 and 8. *Fabric:* LRA 1.
- 4. *Provenance:* layer 5. *Fabric:* M1. *Surfaces:* untreated. *Diameter:* 26 cm.
- 5-6. *Provenance:* layers 6 and 8. *Fabric:* LRA 7.

Pottery from profile 2:

- 7-11. *Provenance:* layers 3, 8, 8, 9 and 11. *Fabric:* LRA 1.
- 12-3. *Provenance:* layers 1 and 10. *Fabric:* LRA 7.
- 14. *Provenance:* layer 9. *Fabric:* Gaza Jar.

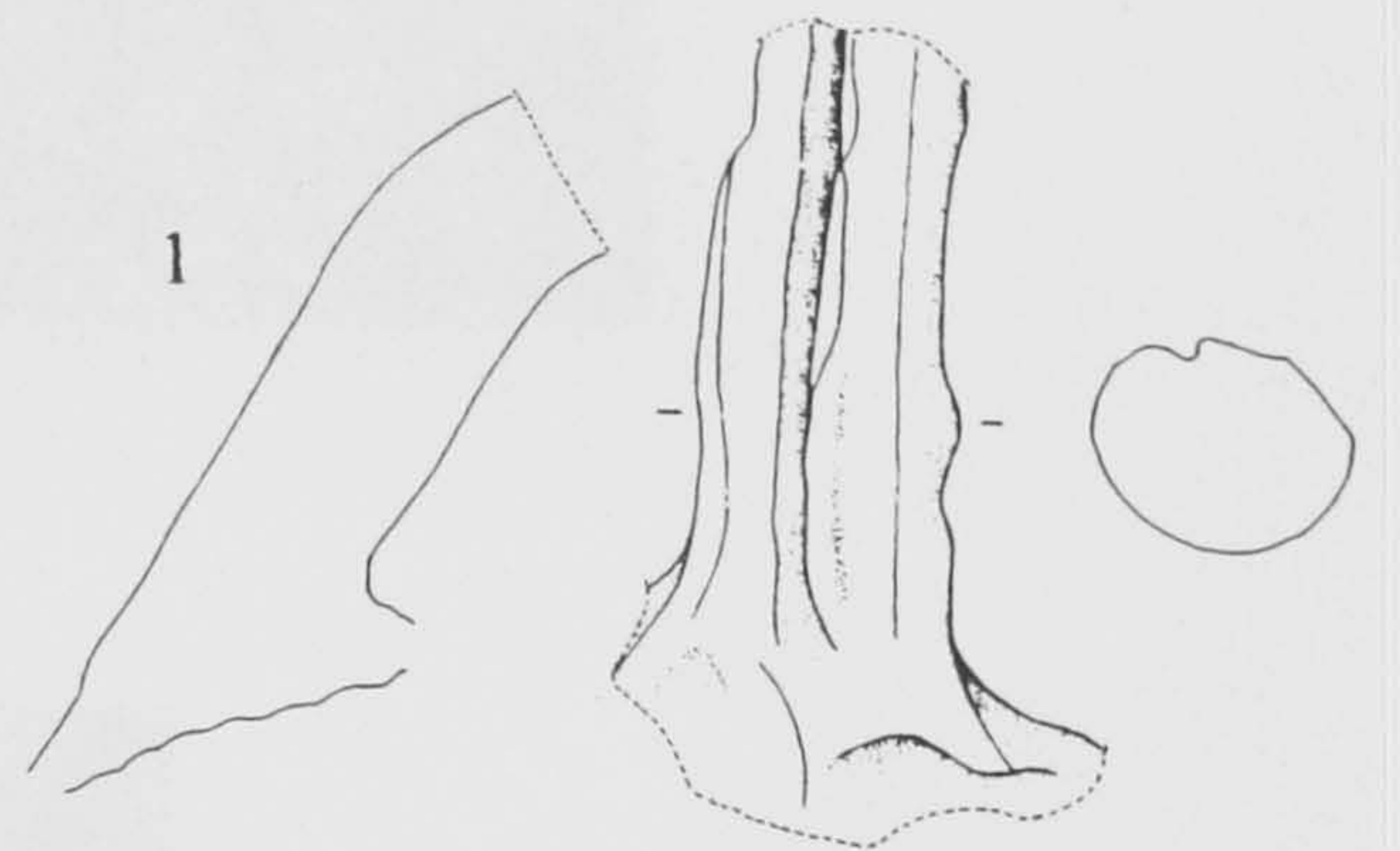

Pottery from profiles 1 and 2, Kharibta at 1:3.

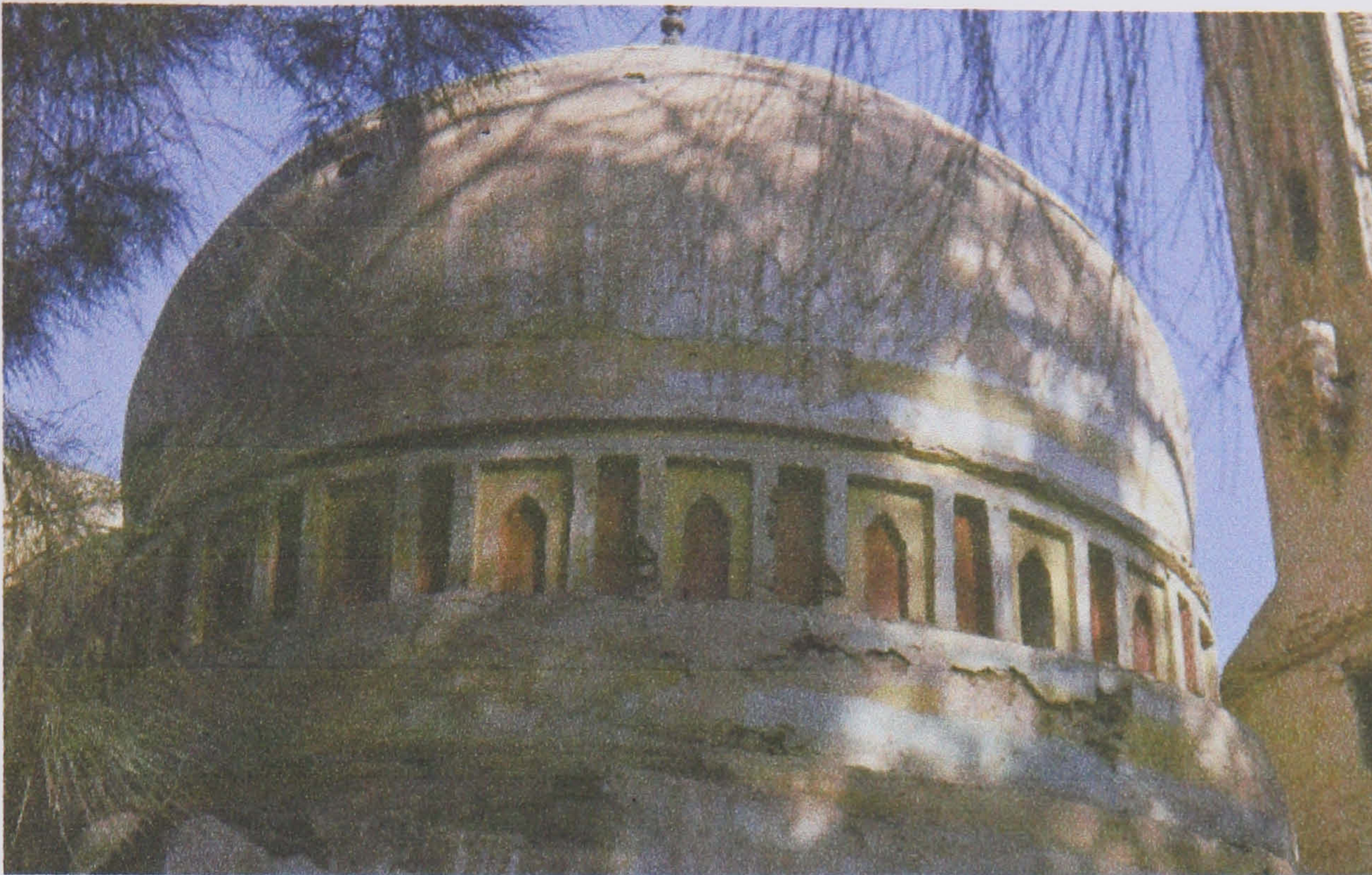

A: The tomb of Abu al-Hawl, Kharibta.

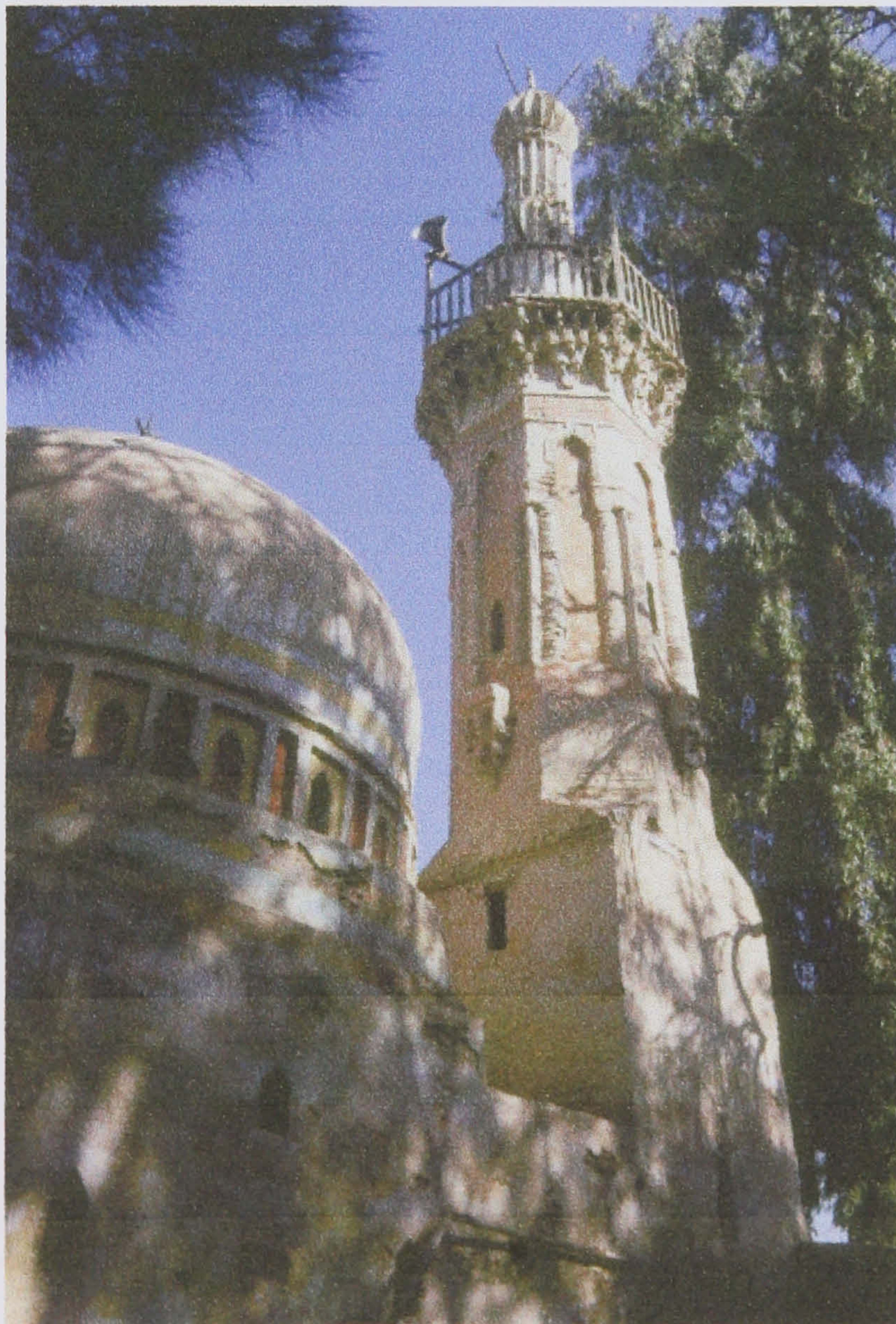

B: The minaret of the tomb of Abu al-Hawl, Kharibta.

Fig. IV.9



A: Some of the column pieces dug up from the courtyard of Abu al-Hawl mosque.



B: Granite column protruding from the ground outside al-Arba'in mosque.



A: The *mihrab* in the outer wall of al-Arbaʿin mosque, Kharibta.

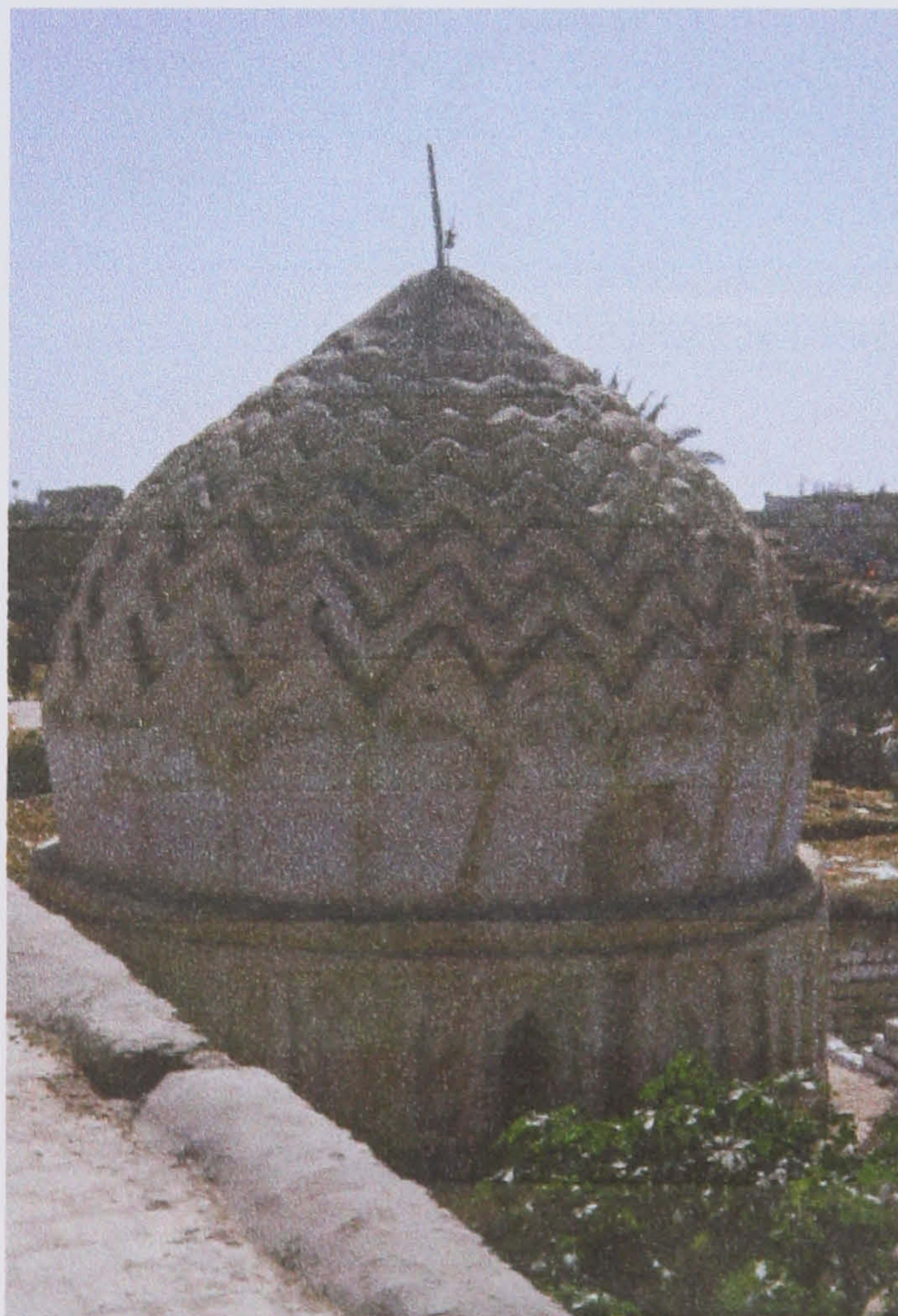

B: The tomb of Ahmad al-Sinawy, Kharibta.

Fig. V.1



Map of Tell Edfu, after Ziermann.

Fig. V.2



A: Stela concerning the administration of the *iqta'* of Edfu.



B: Pottery and artefacts from SCA excavations stored in the pylon of Edfu temple.

Fig. V.3



A: Area A, Tell Edfu.



B: Area B, Tell Edfu.

Area A surface pottery

ARSForm 82 (c. 430–475)

1. *Decoration*: traces of small stamped cross, probably the later phase of Hayes's style D (c. 440–500). *Diameter* (base): 14 cm.

Aswan waresWare R4 (c. 500–850)

2. *Surfaces*: matte red slip all over, darker-fired rim. *Diameter*: 22 cm. *Parallels*: Adams's form D74.
3. *Surfaces*: matte red slip all over, blackened towards base from use over fire. *Decoration*: rouletting above and below flange on exterior. *Diameter*: 20 cm. *Parallels*: Adams's form D53.
4. *Surfaces*: burnished red slip inside, matte on outside. *Decoration*: stamped cross typical of Adams's 'Early Christian' Aswan wares (c. 650–850).
5. *Surfaces*: red slip all over, matte except on rim. *Diameter*: 20 cm. *Parallels*: Adams's form D69.

Wares R4/13 (transitional)

6. *Surfaces*: matte red slip all over, surfaces carelessly finished with finger-marks on interior. *Decoration*: string-marked rim. *Diameter*: 28 cm.

Ware R13

7. *Surfaces*: thin red wash over interior and upper exterior surfaces, poorly finished. *Diameter*: 11 cm.

Fig. V.5

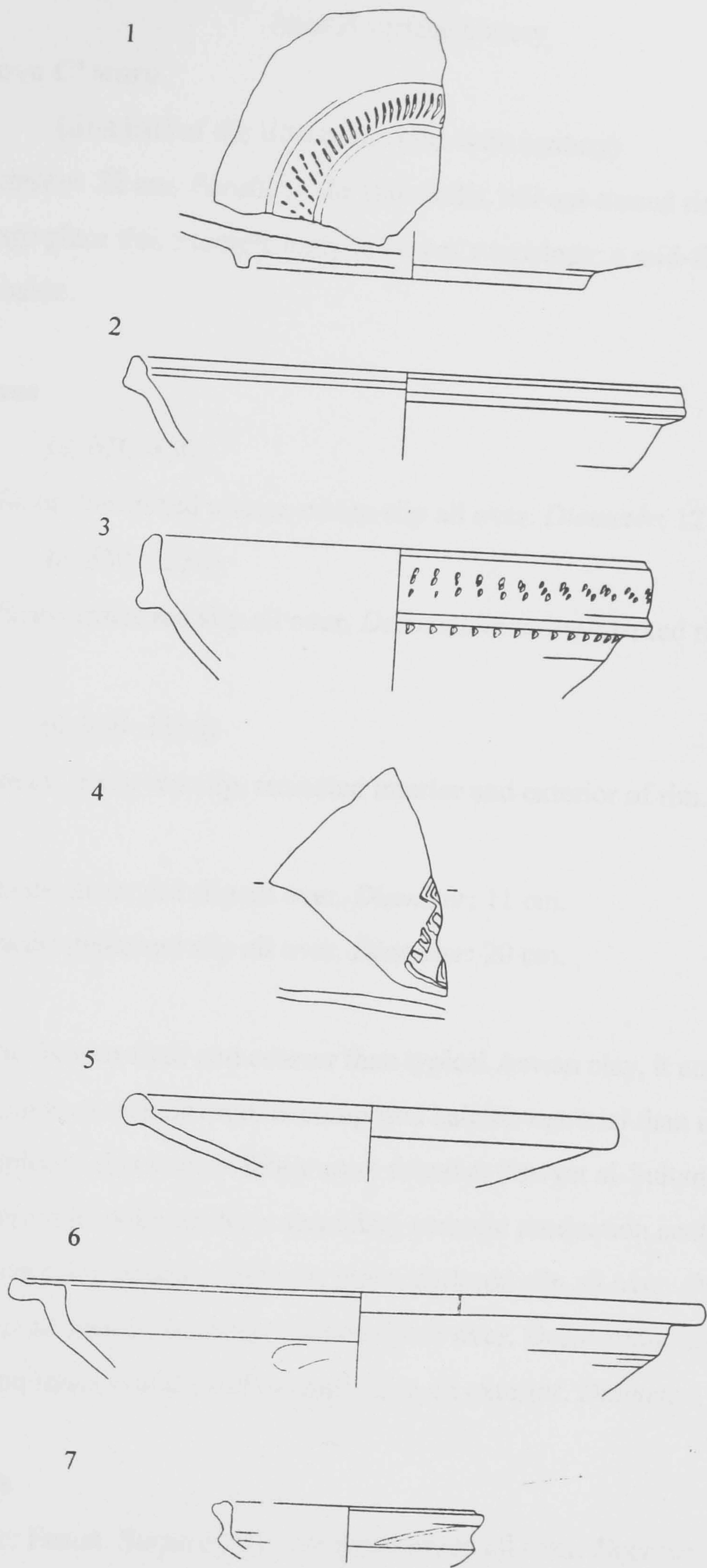

Surface pottery from area A at 1:3.

Area B surface pottery

'Late Roman C' ware

Form 3 (first half of the fifth to the mid sixth century)

1. *Diameter: 22 cm. Parallels: the thin-walls, tall out-turned rim and narrow flange place this example early in Hayes's typology; a mid-fifth century date is probable.*

Aswan wares

Ware W3 (c. 650–850)

2. *Surfaces: burnished orange-cream slip all over. Diameter: 12 cm.*

Ware R13 (c. 850–1250)

3. *Surfaces: matte red slip all over. Decoration: string-marked rim. Diameter: 30 cm.*

Ware U8 (c. 850–1100)

4. *Surfaces: matte red slip, resinated interior and exterior of rim. Diameter: 11 cm.*
5. *Surfaces: matte red slip all over. Diameter: 11 cm.*
6. *Surfaces: matte red slip all over. Diameter: 20 cm.*

Ware ?

7. *Fabric: brown-fired and coarser than typical Aswan clay, it contains the same inclusions as well as more decomposed calcitic material than usual. Other examples of this variant fabric were found at Zawyet al-Sultan. These pieces may provide evidence for a secondary ceramic production centre in southern Egypt outside Aswan. Surfaces: matte dark red slip all over. Diameter: 28 cm.*
8. *Fabric: as above. Surfaces: cream slip all over. Decoration: black painted lines on interior and exterior; rouletting on exterior. Diameter: 10 cm.*

Glazed wares

9. *Fabric: Fustat. Surfaces: glazed bottle green all over. Decoration: parallel incised grooves inside rim in FFS technique. Diameter: 14 cm. Parallels: an example from Kom al-Dik, Zawyet al-Sultan; see also vessel 4 from area D, Edfu.*

Fig. V.7

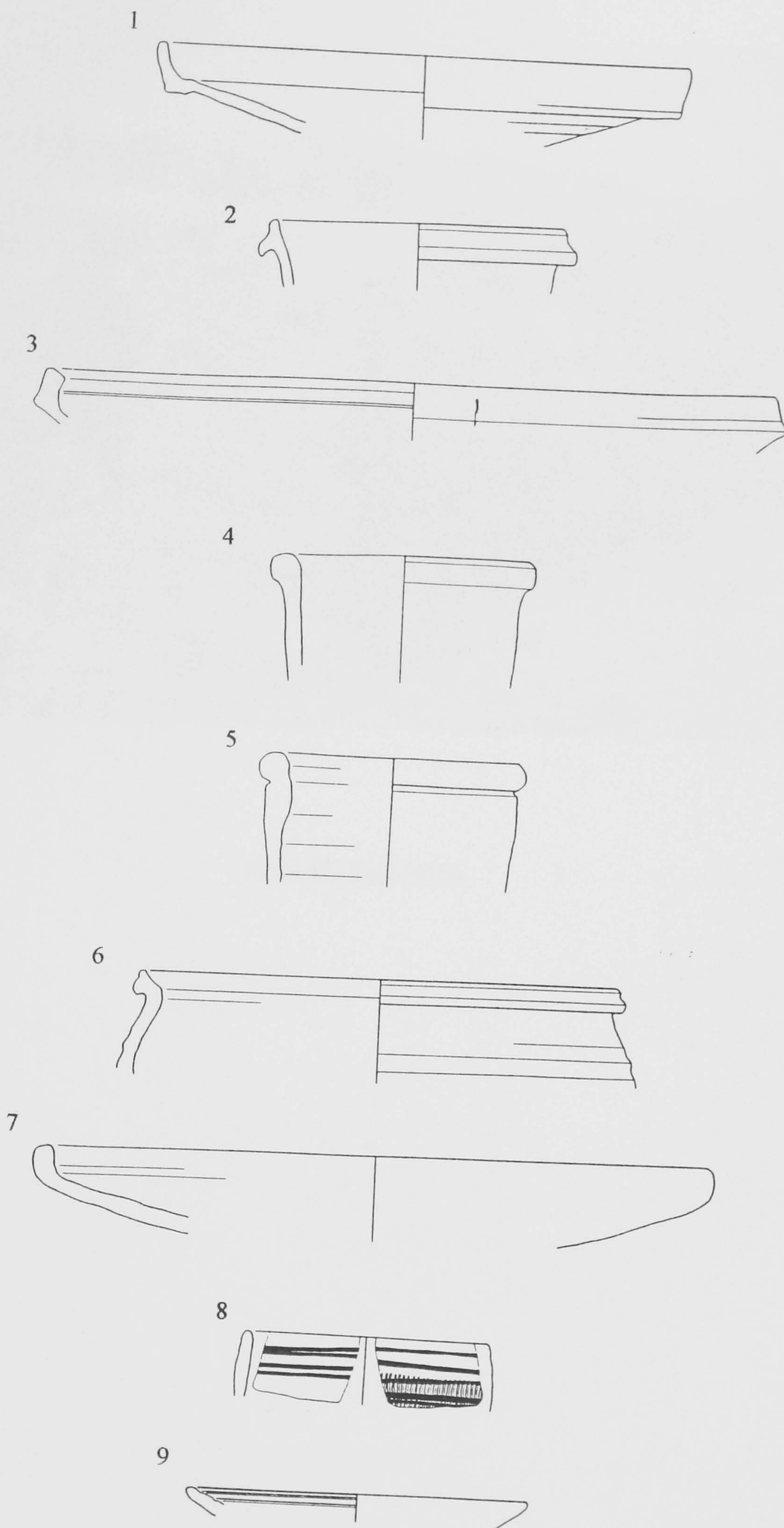

Surface pottery from area B at 1:3.

Fig. V.8



Area C, Tell Edfu.

Area C surface pottery

Aswan waresWare W32 (c. 400–500)

1. *Surfaces*: cream slip all over. *Decoration*: two painted black stripes inside rim. *Diameter*: 12 cm.

Ware R4 (c. 550–850)

2. *Surfaces*: burnished red slip all over. *Decoration*: rouletted exterior, interior with grooves and stamped motifs. *Diameter* (base): 10 cm.

Ware R4/R13 transitional

3. *Surfaces*: thin, unevenly applied, burnished red slip on interior; gritty wash on exterior. *Diameter*: 26 cm.

Ware R13?

4. *Surfaces*: glossy brown-slipped interior, thinly red-slipped exterior. *Diameter* (base): 6 cm. *Parallels*: similar to examples dating from the eleventh or twelfth centuries from Qasr Ibrim (Rose pers. com.).

Ware W12 (c. 950–1300)

5. *Surfaces*: dirty cream slip all over. *Decoration*: painted designs in black and red. *Diameter*: 10 cm.
6. *Surfaces*: dirty cream slip all over. *Decoration*: painted designs in black and red. *Diameter*: 13 cm.

Marl ware

7. *Fabric*: fine, green-fired marl. *Surfaces*: lightly striated, uncoated. *Diameter* (base): 6.5 cm. *Parallels*: Ashmunein, S 2–16, ninth to eleventh century (Bailey 1998).

Glazed wareImitation celadon (c. 1200 to the mid-fifteenth century; Scanlon 1971)

8. *Fabric*: Fustat. *Diameter*: 22 cm.

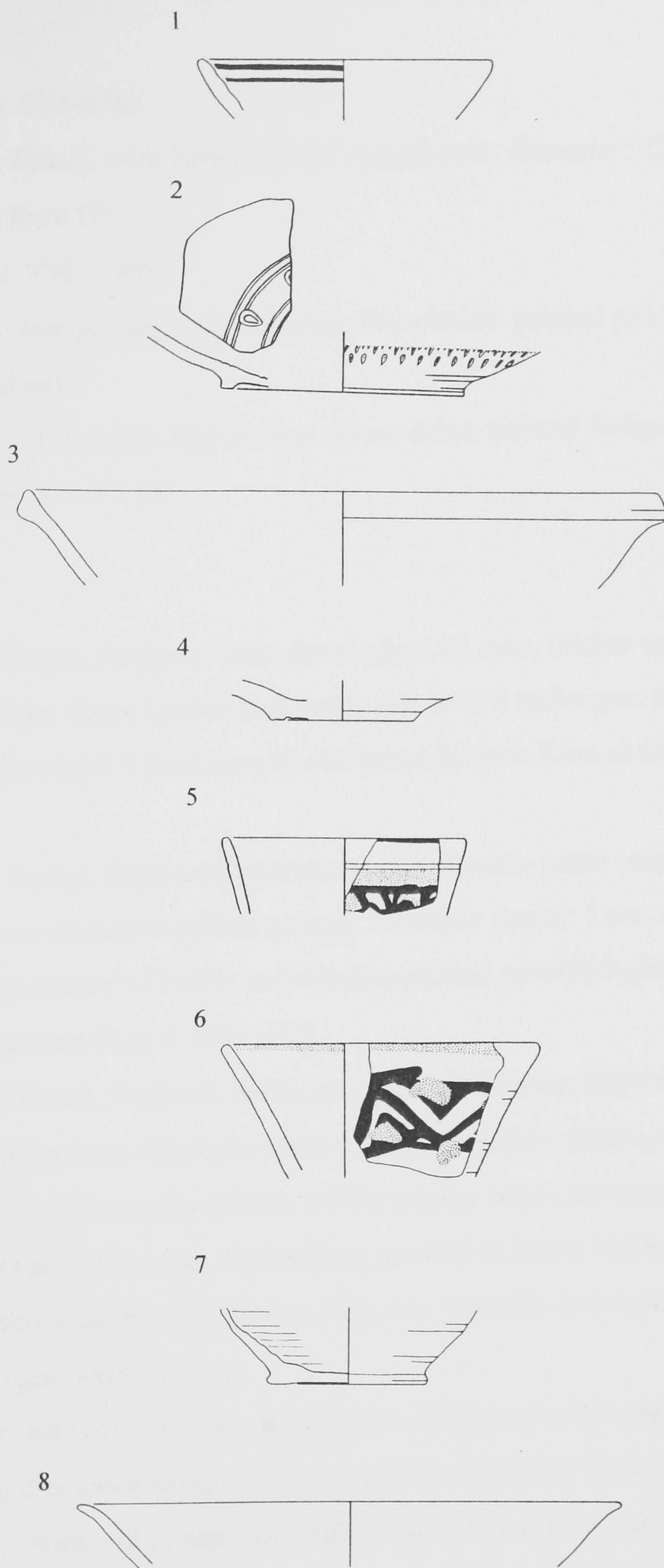

Surface pottery from area C at 1:3.

Area D surface pottery

Aswan waresWare R4 (c. 500–850)

1. *Surfaces*: flaked, with burnished red slip all over. *Diameter*: 22 cm. *Parallels*: Adams's form D81.

Ware W12 (c. 950–1300)

2. *Surfaces*: orange-cream slip all over. *Decoration*: painted geometric pattern in black and red.
3. *Surfaces*: dirty cream slip all over. *Decoration*: painted design in black and red. *Diameter*: 7.5 cm.

Glazed wares

4. *Fabric*: Fustat. *Surfaces*: olive-green glaze all over, thicker on interior. *Decoration*: single incised line inside rim in FFS technique. *Diameter*: 24 cm. *Parallels*: vessel 9 from area B, and example from Kom al-Dik, Zawyet al-Sultan.
5. *Fabric*: Fustat. *Surfaces/Decoration*: glazed bottle green (stipple) and brown (black) on a mustard yellow ground. *Diameter* (base): 5 cm. *Parallels*: probably Mason's (1997) 'polychrome-painted opacified-glaze' type, manufactured from c. 975–1075.
6. *Fabric*: Fustat. *Surfaces*: bottle green-glazed interior, unglazed exterior except drops under base. *Diameter* (base): 7 cm. *Parallels*: Ashmunein, R11–31, eighth or ninth century (Bailey 1998); similar wares are found in Fatimid deposits at Istabl Antar, Fustat (I am grateful to Lucie Vallauri for allowing me to see this material); Old Cairo, FG4, late Mamluk to Ottoman period (Gascoigne forthcoming).
7. *Fabric*: silt with fine limestone temper. *Surfaces*: bottle-green glazed interior, unglazed exterior except drops under base. *Diameter* (base): 7 cm.
8. *Fabric*: brick-red modern silt with abundant limestone temper. *Surfaces/Decoration*: thick, uneven pale turquoise glaze with dark purple stripes (stipple) running vertically down interior. *Diameter*: 28 cm.

Ottoman smoking pipe

9. *Fabric*: fine-grained, hard, grey silt with some fine white particles. *Surfaces*: burnished. *Decoration*: punctate design.

Fig. V.12

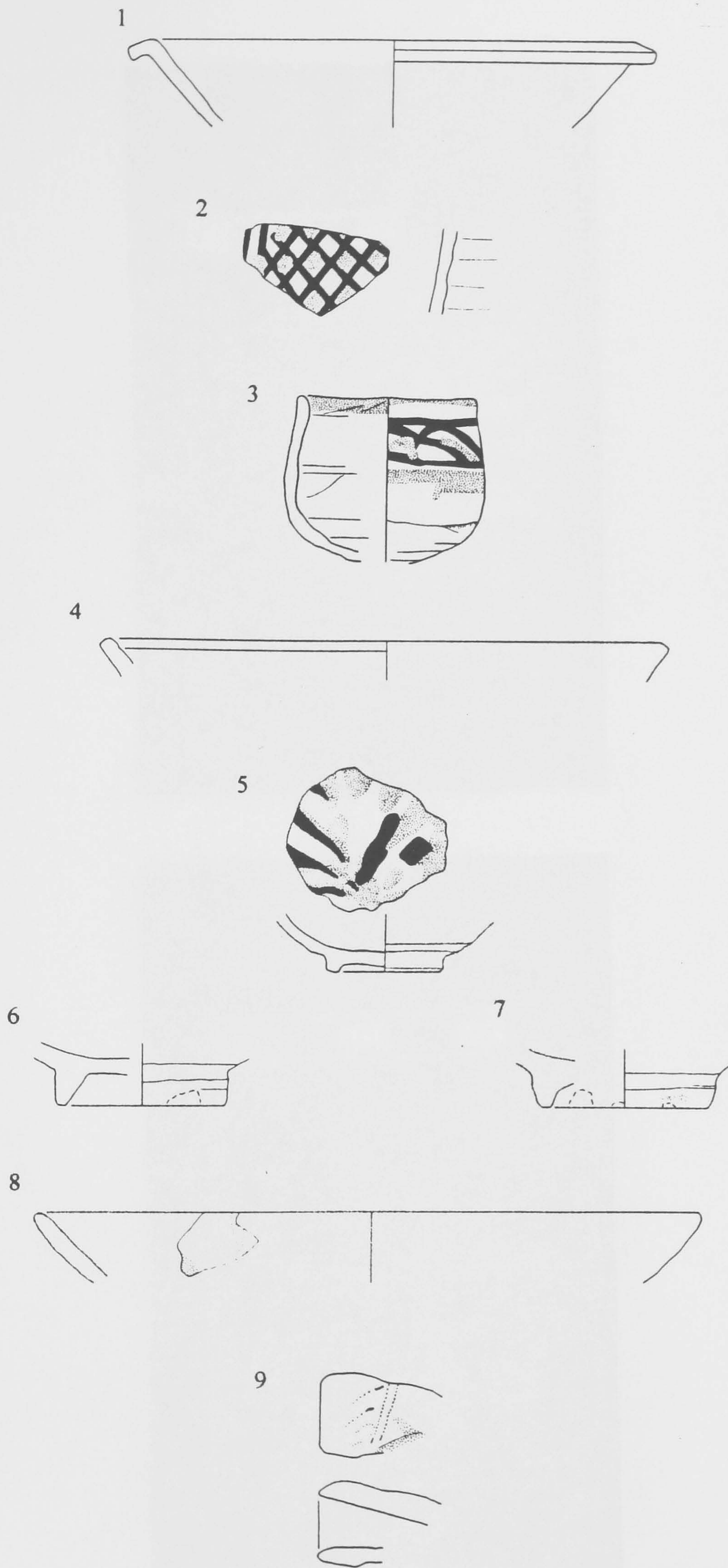

Surface pottery from area D at 1:3 (pipe at 1:2).

Fig. V.13



Ostraka from the pot cache, south quarry, Tell Edfu.



A: Ostrakon from the pot cache, south quarry, Tell Edfu.



B: Sandstone block inscribed with Semitic characters from pot cache, south quarry, Tell Edfu.

Pot cache, south quarry

ARSForm 91A (second half of the fifth century)

1. *Surfaces*: very worn, interior lost completely. *Diameter*: 25 cm.

Aswan waresWare R30 (c. 100–475)

2. *Surfaces*: red-washed all over. *Diameter* (base): 6 cm. *Parallels*: Adams's form Z5, the typical amphora of Meroitic Nubia (c. 200–400).

Ware R4/R13 transitional

3. *Surfaces*: matte red slip all over, darker red rim. *Decoration*: string-marked rim, rouletted interior. *Diameter*: 25 cm.

Ware W22 (c. 850–950).

4. *Surfaces*: cream-slipped all over. *Decoration*: red-painted design (outlined in illustration as pattern too fine for stippling alone). *Diameter*: 16 cm.

Glazed waresGlazed Aswan ware

5. *Surfaces/Decoration*: pale mustard-yellow glaze inside and over rim, black underpainted stripe on exterior. Interior glaze over brown lines (black) and bottle green swags (stipple). See fig. V.17a. *Diameter*: 22 cm. *Parallels*: eighth or ninth century (Rodziewicz 1983); 'semi-glazed class' (Mason 1997); Saba' Bannat, Fustat, Abbasid period (pers. obs.).

FG16 (ninth and tenth centuries)

6. *Fabric*: Fustat. *Surfaces/Decoration*: glazed with green and black loops over very pale green background. *Diameter*: 32 cm. *Parallels*: as for fig. II.37, vessel 36.

FFS (late tenth to end of twelfth century)

7. *Surfaces/Decoration*: bottle-green glaze over incised design. *Diameter*: 26 cm. *Parallels*: apparently an example of either group 2 or 3 in Mason's typology (1997), manufactured during the twelfth century.

Slip-underpainted ware (Mamluk period; Scanlon 1971)

8. *Fabric*: soft, sandy Fustat. *Surface/Decoration*: dark blue painted pattern beneath pale green glaze. *Diameter*: 22 cm.

Imitation celadon (c. 1200 to the mid-fifteenth century; Scanlon 1971)

9. *Fabric*: Fustat. *Diameter* (base): 10 cm.

Late Mamluk to Ottoman wares

10. *Fabric*: bright red silt, few inclusions. *Surfaces/Decoration*: decomposed yellow glaze with a spot of dark green (stipple) and brown zigzags or triangles (black). *Diameter* (base): 6 cm.
11. *Fabric*: grey-fired Fustat. *Surfaces*: glossy bottle-green glazed all over. *Diameter* (base): 7 cm. *Parallels*: Old Cairo, FG4 (Gascoigne forthcoming).
12. *Fabric*: hard, reddish-fired marl (Fustat?). *Surfaces*: thick, pale blue glaze on interior and exterior, except for a few missed patches towards base on outside. *Diameter* (base): 7 cm. *Parallels*: Old Cairo, FG6 (Gascoigne forthcoming).
13. *Fabric*: Fustat. *Surfaces*: thick, glassy apple-green glaze on interior and upper parts of exterior. *Decoration*: faint incised lines on interior, perhaps from method of manufacture? *Diameter* (base): 9 cm. *Parallels*: Old Cairo, FG9 (Gascoigne forthcoming).

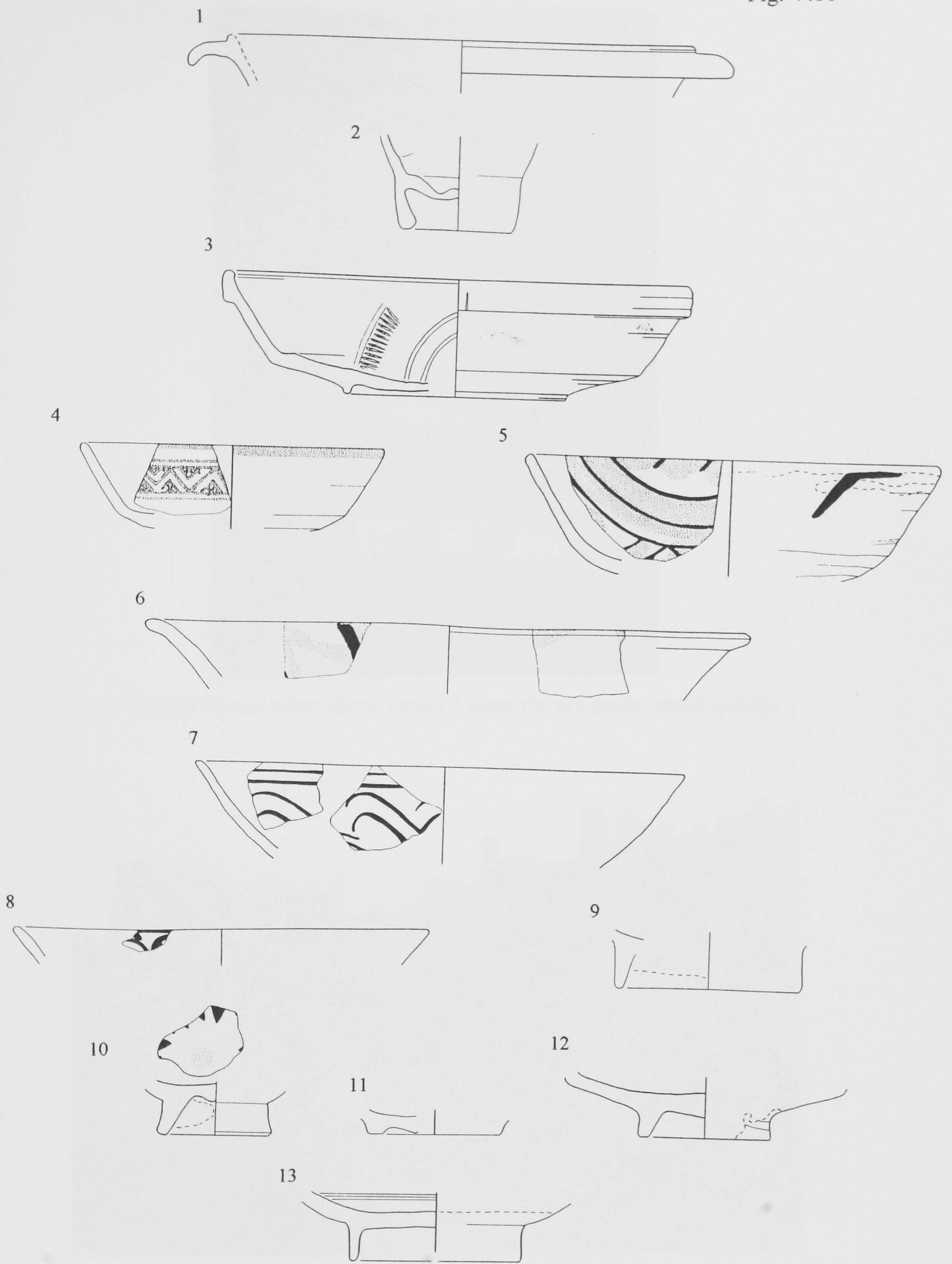

Surface pottery from the pot cache, south quarry at 1:3.

Fig. V.17



A: Glazed Aswan ware sherd, vessel 5 from the pot cache, south quarry.



B: Slope south of the temple and the main mound and west of the modern town.

Fig. V.18

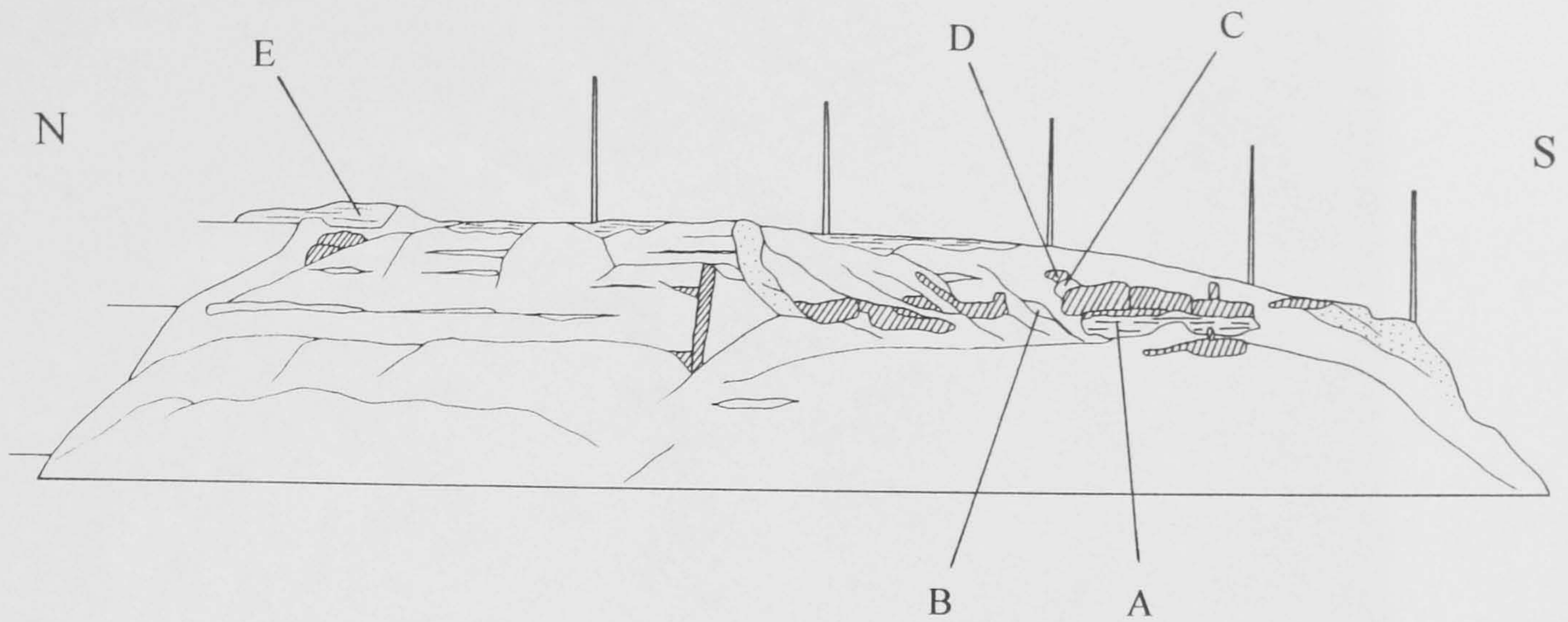

A: Sketched outline of the south slope, Tell Edfu.

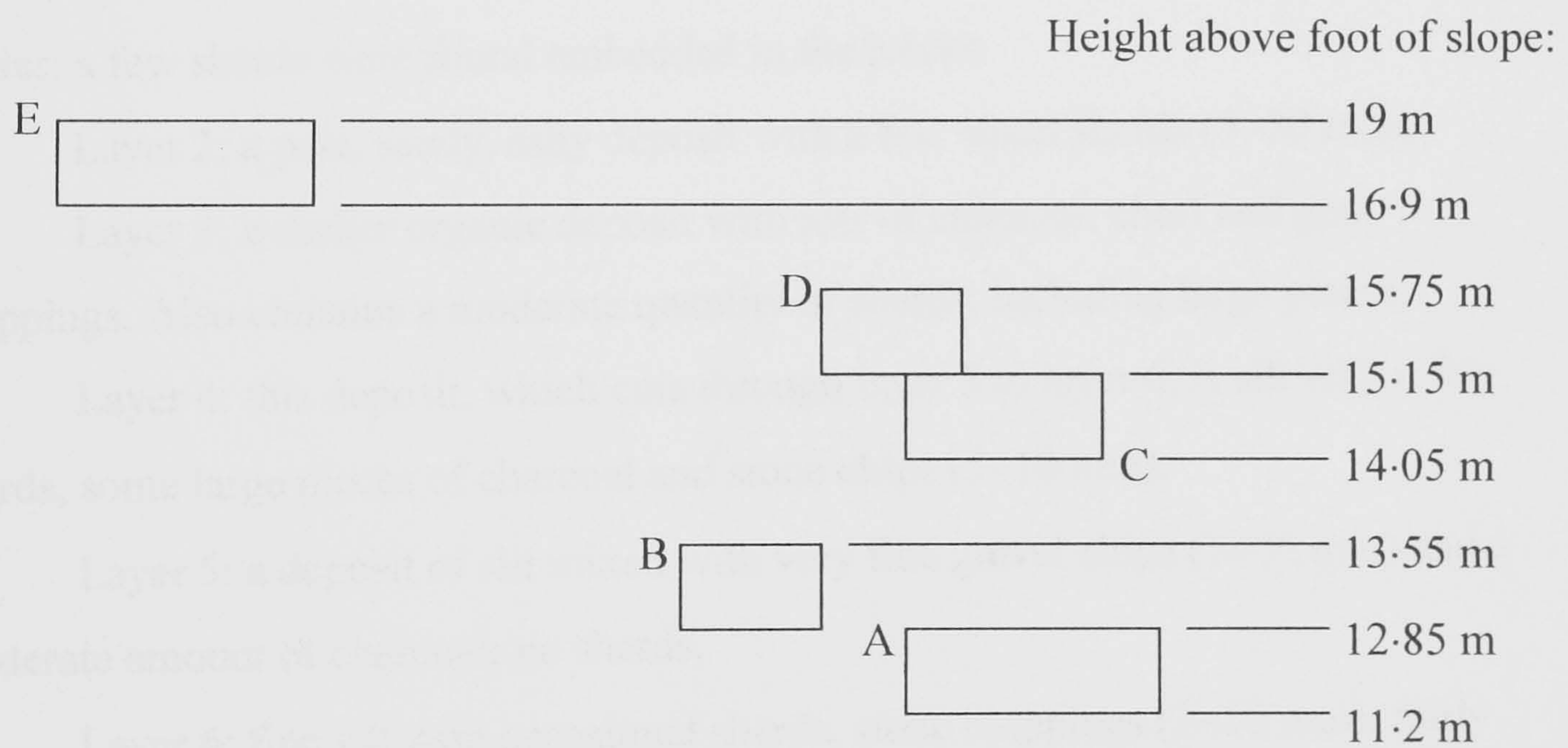

B: The relative locations of recorded profiles on the south slope (not to scale).



Edfu profile A layer descriptions:

Layer 1: a construction level of mud-brick walls butting together. The dimensions of the bricks are $32 \times 11 \times 16$ cm, probably indicating a Ptolemaic date or earlier; a few sherds were found embedded in the bricks.

Layer 2: a pale, sandy, ashy deposit with a few small sherds (5–30 mm).

Layer 3: a darker organic deposit with lots of charcoal, chaff and goat droppings. Also contains a moderate quantity of sherds, including large pieces.

Layer 4: this deposit, which cuts through layer 5 to layer 6, is silt with a few sherds, some large pieces of charcoal and stone chips (5–10 mm).

Layer 5: a deposit of silt mixed with very fine gravel chips ($\frac{1}{4}$ – $\frac{1}{2}$ mm) and a moderate amount of charcoal; no sherds.

Layer 6: fine silt with occasional sherds, stone chippings (2–10 mm), fairly abundant charcoal and a few small bone fragments.

Layer 7: similar to layer 6 but the stone chips are larger; the layer is topped by a clear line of trampled sherds.

Layer 8: tumble of large mud-brick fragments including some whole bricks, apparently of the same large dimensions of those in layer 1. A piece of sandstone and a few sherds were present among the bricks.

Edfu profile A pottery

Layer 3

1. *Fabric*: blackened silt with sparse organic temper. *Surfaces*: interior highly burnished all over, exterior burnished in narrow horizontal lines. *Diameter*: 24 cm. *Parallels*: similar to Spencer's (1996) 'Memphis black ware', apparently manufactured in the Delta between the third and first centuries BC: examples have also been found in the Nile Valley as far south as Qasr Ibrim (Grataloup 1991; Adams unpublished). Grataloup's vessel 13 is very similar in form and diameter to the Edfu sherd.
2. *Fabric*: M1 with fine limestone temper. *Surfaces*: untreated. *Diameter*: 16 cm.

Layer 4

3. *Fabric*: VCM1. *Surfaces*: untreated, with three lines of rope impressions round exterior. *Diameter*: 46 cm. *Parallels*: similar to a group of vessels which date from c. 1000–700 BC (considerably earlier than the previous deposit), for example Elephantine, vessel 1295 (Aston 1999); Ashmunein, type A3 (Spencer 1993, 44).

Layer 6

4. *Fabric*: M1. *Surfaces*: interior smoothed, uncoated. *Diameter*: 20 cm. *Parallels*: third and second century BC pieces from many sites, for example Elephantine, vessels 2928 and 3089 (Aston 1999); Aswan, vessels 21 and 22 (Jaritz and Rodziewicz 1994); Athribis (Myśliwiec 1987, fig. 4c, listing many further parallels); Naukratis (Coulson 1996, pl. 19, type A).
5. *Fabric*: M1. *Surfaces*: untreated. *Diameter*: 7 cm. *Parallels*: Elephantine, late third to second century BC, vessels 3053–7 (Aston 1999).

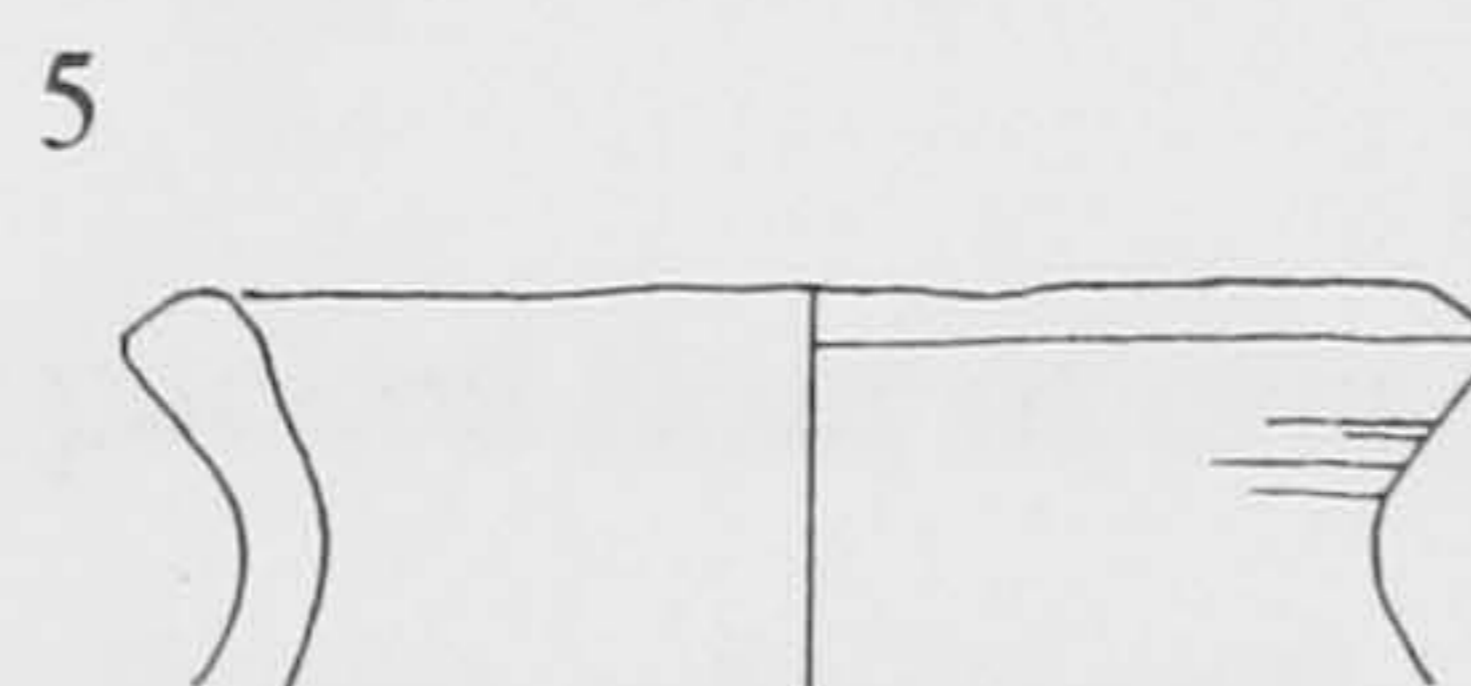
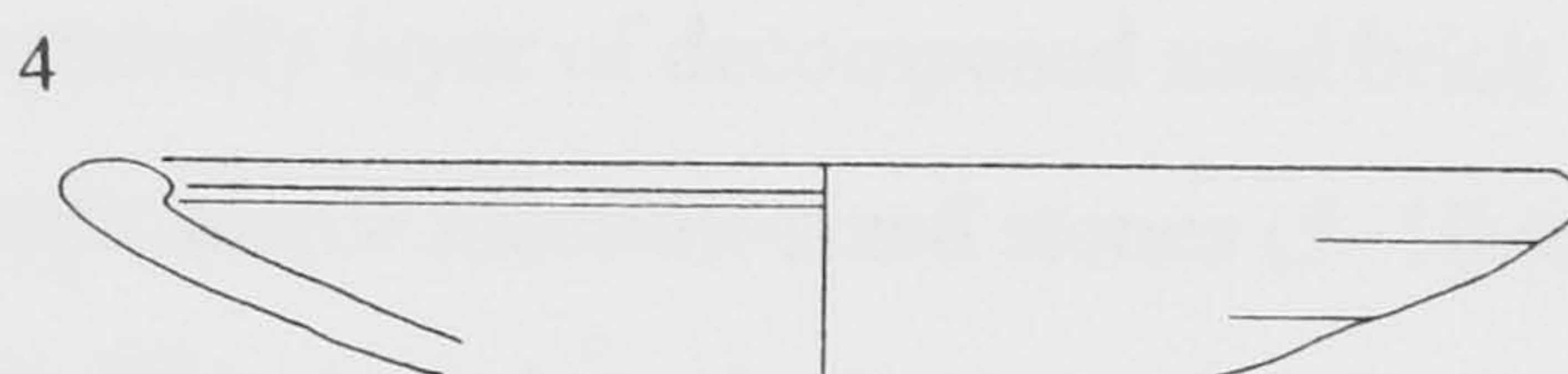
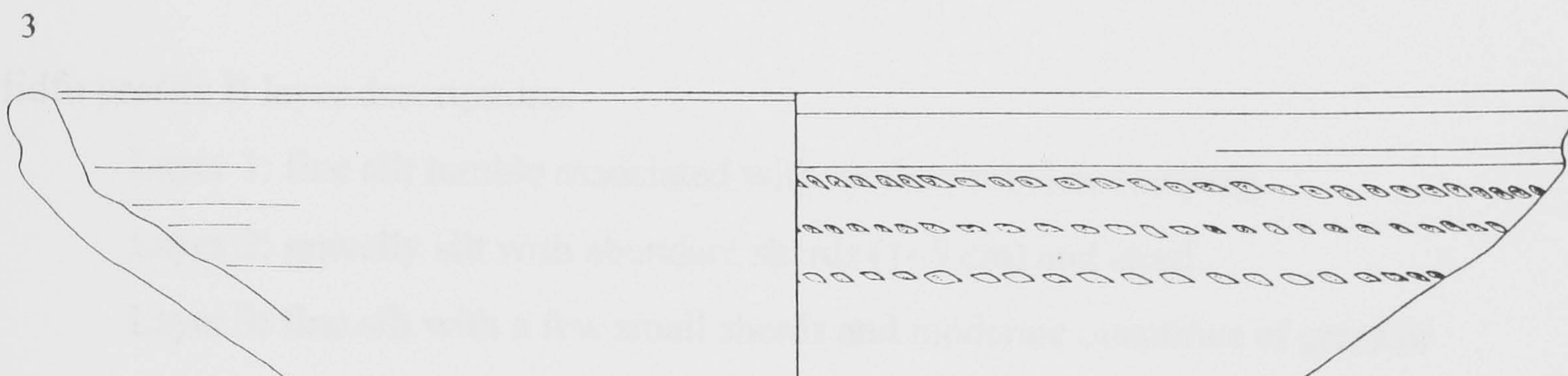
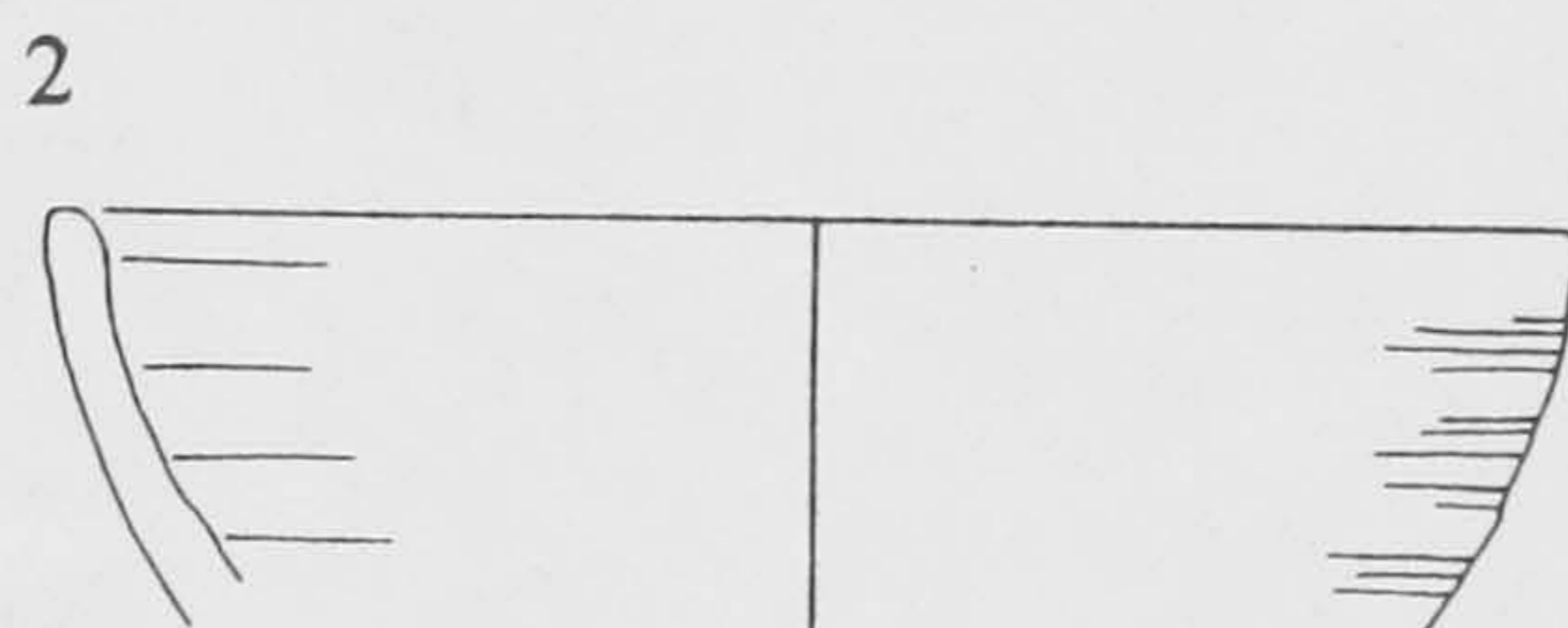
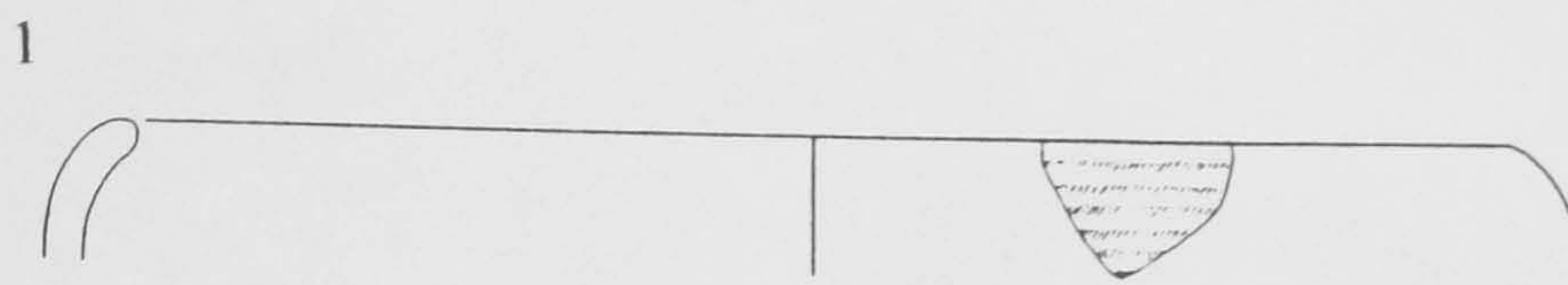

Pottery from profile A, Tell Edfu at 1:3.

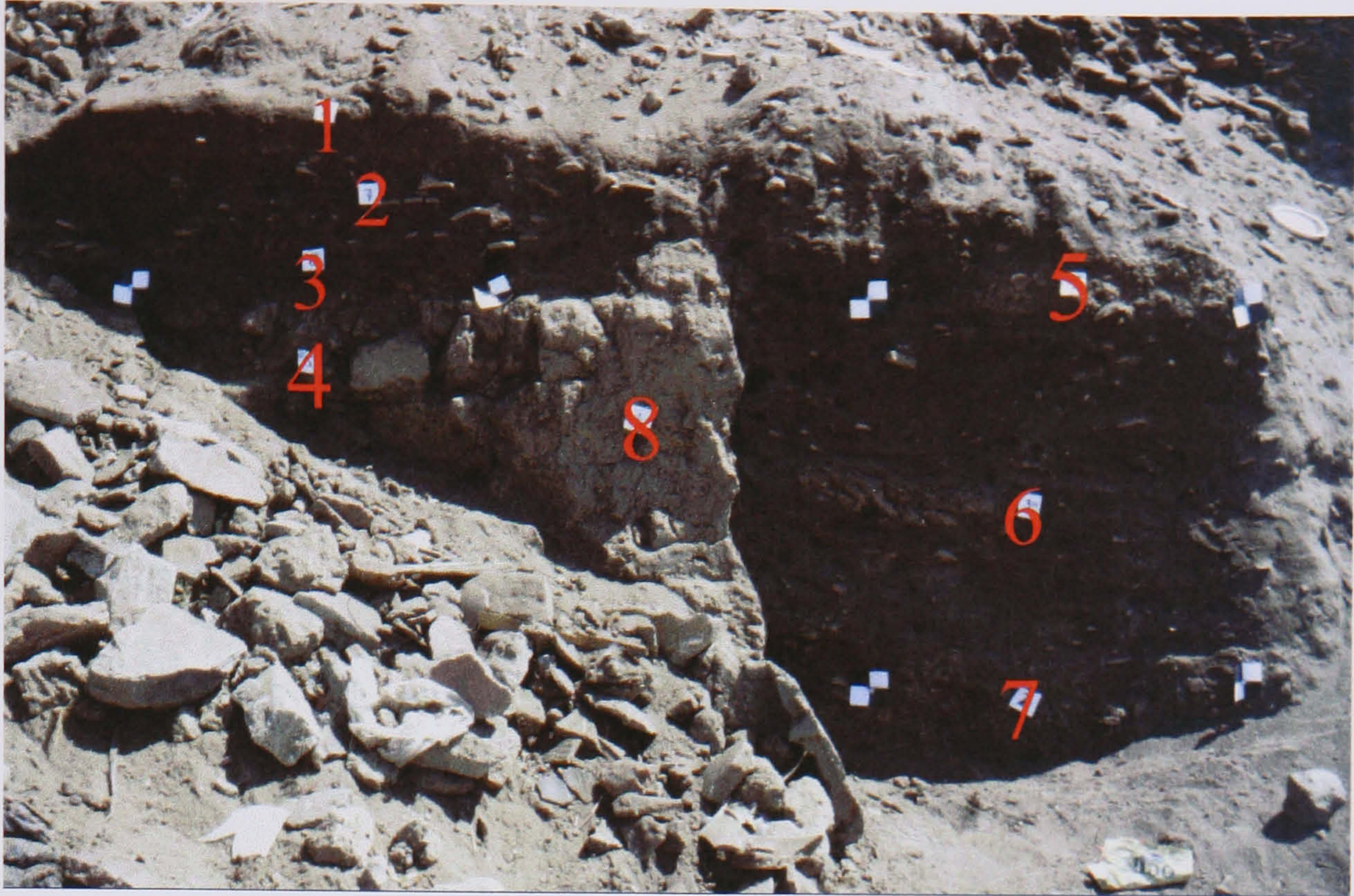

Edfu profile B layer descriptions:

Layer 1: fine silt tumble associated with modern rubbish dumping.

Layer 2: gravelly silt with abundant sherds (1–5 cm) and chaff.

Layer 3: fine silt with a few small sherds and moderate quantities of grass or straw, equivalent to layer 6 south of the wall.

Layer 4: mud-brick tumble north of the wall, from the higher levels of which it is probably derived.

Layer 5: a sterile, gravelly layer of decomposed mud brick overlying layer 6.

Layer 6: fine silt with scarce medium-sized stones (5–10 mm) and moderate amounts of gravel ($\frac{1}{2}$ mm). This deep deposit also contains some sherds (1–3 cm) and a single decomposing mud brick. A small quantity of organic material, mainly straw and goat droppings, is also present. This layer is the fill of the area enclosed by the wall (layer 8).

Layer 7: south of the wall, a packed floor of crushed mud-brick pieces (1–5 cm), moderate large bone pieces ($\frac{1}{2}$ –3 cm), a few medium-sized sherds (1–3 cm) and some gravelly silt. The top of this layer is a hard-packed, chaffy, floor surface.

Layer 8: a mud-brick wall running perpendicular to the profile, the south surface being coated with rough mud plaster. Brick dimensions are 25×7×11 cm, noticeably smaller than those in profile A, layer 1.

Edfu profile B pottery

Layer 2

1. *Fabric:* Aswan (ware R30). *Surfaces:* resinated all over. *Diameter:* 11 cm.

Layer 6

2. *Fabric:* Aswan (ware R30). *Surfaces:* red-washed all over, partly coated in resin. *Diameter:* 28 cm. *Parallels:* Adams's form D5 or D10.

1

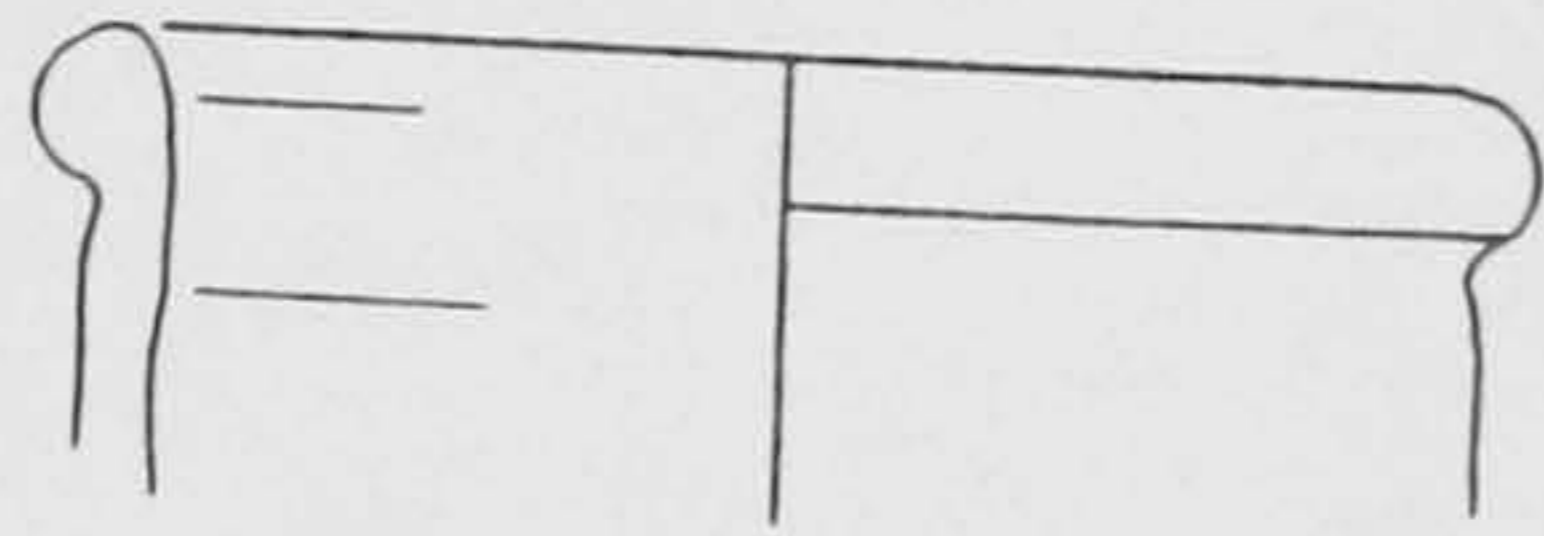

2

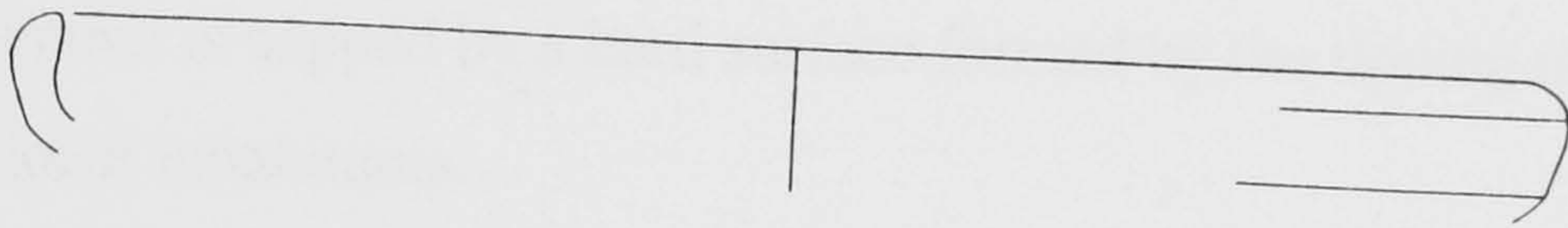

Pottery from profile B, Tell Edfu at 1:3.



Edfu profile C layer descriptions:

Layer 1: modern rubbish and tumble falling over the edge of the exposure, including abundant organic material, feathers, glass, sherds and modern textile pieces. The whole deposit is capped by a hard surface formed by the tipping of water down the slope by local inhabitants.

Layer 2: silt with a little organic material, a few small stone pieces ($\frac{1}{2}$ mm) and sherds.

Layer 3: decomposed remains of a mud-brick wall with a few sherds packed between the bricks. The dimensions of the bricks are fairly large (? \times 11 \times 17 cm).

Layer 4: another dump of sherds (1–10 cm) with some mud-brick rubble.

Layer 5: silt deposit with abundant organic material including charcoal, textile fragments, chaff and bone. A few sherds and gravel chippings are also present.

Layer 6: a loose dump of small sherds, separated from layer 8 only at the south end of the profile; the dumps run into each other to the north.

Layer 7: silt with moderate organic material as layer 5; only visible at the south end of the exposure.

Layer 8: a loose dump of sherds including some large fragments; this level also contains bone and some pieces of rope and cord.

Layer 9: a rubble layer of sherds and large fragments of small mud bricks.

Edfu profile C pottery

Layer 1

1. *Fabric: M5. Surfaces: red-slipped all over, blackened exterior. Diameter: 24 cm. Parallels: as for fig. II.25, 90–1.*

Layer 2

2. *Fabric: LRA 7.*
3. *Fabric: M1. Surfaces: untreated.*

Layer 4

4. *Fabric: Aswan (ware R30). Surfaces: red wash all over. Diameter: 24 cm.*
5. *Fabric: LRA 7. Diameter: 7 cm.*
6. *Fabric: LRA 7. Diameter: 8 cm.*
7. *Fabric: M1. Surfaces: untreated. Diameter: 22 cm.*
8. *Fabric: M1. Surfaces: untreated. Diameter: 16 cm.*
9. *Fabric: M1. Surfaces: untreated. Diameter: 20 cm.*
10. *Fabric: M1. Surfaces: white slip on exterior and interior of rim. Diameter: 28 cm.*
11. *Fabric: black glass.*

Layer 5

12. *Fabric: Aswan (ware W32). Surfaces: dirty cream slip. Decoration: two black-painted stripes around interior of rim. Diameter: 13 cm.*
13. *Fabric: Aswan (ware ?). Surfaces: burnished pink slip on interior, pinkish wash on exterior. Diameter (base): 8 cm.*
14. *Fabric: Aswan (ware R4?). Surfaces: burnished red slip all over. Decoration: black and white stripes around top of rim. Diameter: 28 cm. Parallels: as fig. II.25, 21.*
15. *Fabric: LRA 7. Diameter: 6 cm.*
16. *Fabric: M1. Surfaces: untreated, blackened. Diameter: 24 cm.*
17. *Fabric: M1. Surfaces: untreated, blackened. Diameter: 24 cm.*
18. *Fabric: VCM1. Surfaces: untreated. Diameter: 44 cm.*
19. *Fabric: clear glass. Diameter: 36 cm.*

Layer 6

20. *Fabric:* Aswan (ware R30). *Surfaces:* flakey, with dark red wash on exterior and uncoated interior. *Diameter:* 10 cm.
21. *Fabric:* Aswan (ware W32). *Surfaces:* cream-slipped all over. *Diameter* (base): 4 cm.
22. *Fabric:* Aswan (ware R30?). *Surfaces:* traces of red slip (stipple). *Decoration:* traces of black paint. *Diameter* (base): 5 cm.
23. *Fabric:* Aswan (ware R30). *Surfaces:* red wash all over. *Diameter:* 28 cm.
24. *Fabric:* Aswan (ware R30?). *Surfaces:* burnished red slip all over. *Diameter* (base): 8 cm.
25. *Fabric:* Aswan (ware R30?). *Surfaces:* burnished red slip all over. *Decoration:* painted with black and white (stipple) spots and stripes. *Diameter* (base): 34 cm.
26. *Fabric:* Aswan with a little organic temper (ware ?). *Surfaces:* cream slip on exterior. *Decoration:* red and black painted geometric designs.
27. *Fabric:* M1. *Surfaces:* untreated. *Diameter:* 12 cm.
28. *Fabric:* M4. *Surfaces:* untreated. *Diameter:* 22 cm.
29. *Fabric:* M4. *Surfaces:* untreated, blackened. *Diameter:* 22 cm.
30. *Fabric:* M4. *Surfaces:* untreated, blackened. *Diameter:* 18 cm.
31. *Fabric:* M4. *Surfaces:* untreated. *Diameter:* 20 cm.
32. *Fabric:* M4. *Surfaces:* untreated, blackened. *Diameter:* 21 cm.
33. *Fabric:* M4. *Surfaces:* white slip on exterior, traces of same on interior. *Diameter:* 16 cm.
34. *Fabric:* M1. *Surfaces:* untreated. *Diameter:* 22 cm.
35. *Fabric:* M1. *Surfaces:* untreated. *Diameter:* 32 cm.
36. *Fabric:* M1. *Surfaces:* untreated. *Diameter:* 20 cm.
37. *Fabric:* LRA 7. *Diameter:* 8 cm.
38. *Fabric:* LRA 7. *Diameter:* 8 cm.
39. *Fabric:* LRA 7. *Diameter:* 7 cm.
40. *Fabric:* LRA 7. *Diameter:* 8 cm.
41. *Fabric:* LRA 7. *Diameter:* 7 cm.

Layer 7

42. *Fabric*: soft, green, chaff-tempered marl. *Surfaces*: green-fired. *Diameter*: 8 cm.

Layer 8

43. *Fabric*: Aswan (ware R4?). *Surfaces*: red slip all over, blackened exterior. *Diameter*: 26 cm. *Parallels*: as fig. II.25, 21.
44. *Fabric*: Aswan (ware R30). *Surfaces*: red slip all over, rougher on exterior. *Diameter*: 18 cm.
45. *Fabric*: Aswan (ware R30). *Surfaces*: thin red wash on exterior, interior apparently untreated. *Diameter*: 12 cm.
46. *Fabric*: Aswan (ware W32). *Surfaces*: dirty cream slip all over. *Decoration*: faded black-painted stripes around interior of rim. *Diameter*: 12 cm.
47. *Fabric*: Aswan (ware W32). *Surfaces*: white slip all over. *Decoration*: faded black-painted stripes around interior of rim. *Diameter*: 14 cm.
48. *Fabric*: Aswan (ware ?). *Surfaces*: burnished red slip all over. *Decoration*: traces of black-painted motif.
49. *Fabric*: Aswan (ware R30). *Surfaces*: thin red wash on exterior. *Diameter* (base): 7 cm.
50. *Fabric*: LRA 7. *Diameter*: 8 cm.
51. *Fabric*: LRA 7. *Diameter*: 10 cm.
52. *Fabric*: Aswan (ware R30). *Surfaces*: thin red wash. *Diameter*: 10 cm.
53. *Fabric*: Aswan (ware R30). *Surfaces*: red wash on exterior, resinated inside. *Parallels*: Adams's form J3?
54. *Fabric*: M4. *Surfaces*: untreated, blackened. *Diameter*: 17 cm.
55. *Fabric*: M4. *Surfaces*: untreated, blackened. *Diameter*: 14 cm.
56. *Fabric*: M4. *Surfaces*: untreated, blackened. *Diameter*: 20 cm. *Parallels*: Ashmunein, E261 and E274, fifth-century (Bailey 1998).
57. *Fabric*: M4. *Surfaces*: untreated. *Diameter*: 18 cm.
58. *Fabric*: M1. *Surfaces*: untreated, blackened. *Diameter*: 20 cm.
59. *Fabric*: VCM1 with limestone temper. *Surfaces*: untreated. *Diameter*: 22 cm.
60. *Fabric*: M1. *Surfaces*: untreated, blackened.

61. *Fabric:* VCM1. *Surfaces:* untreated. *Diameter:* c. 50 cm.
62. *Fabric:* M1. *Surfaces:* untreated. *Diameter:* 36 cm.
63. *Fabric:* M1. *Surfaces:* smoothed brown slip all over. *Diameter:* 40 cm.

Layer 9

64. *Fabric:* Aswan (ware R30). *Surfaces:* matte dark red slip all over. *Diameter:* 10 cm.
65. *Fabric:* M1. *Surfaces:* blackened. *Diameter:* 28 cm.
66. *Fabric:* VCM1 with limestone temper. *Surfaces:* untreated. *Diameter:* 44 cm.

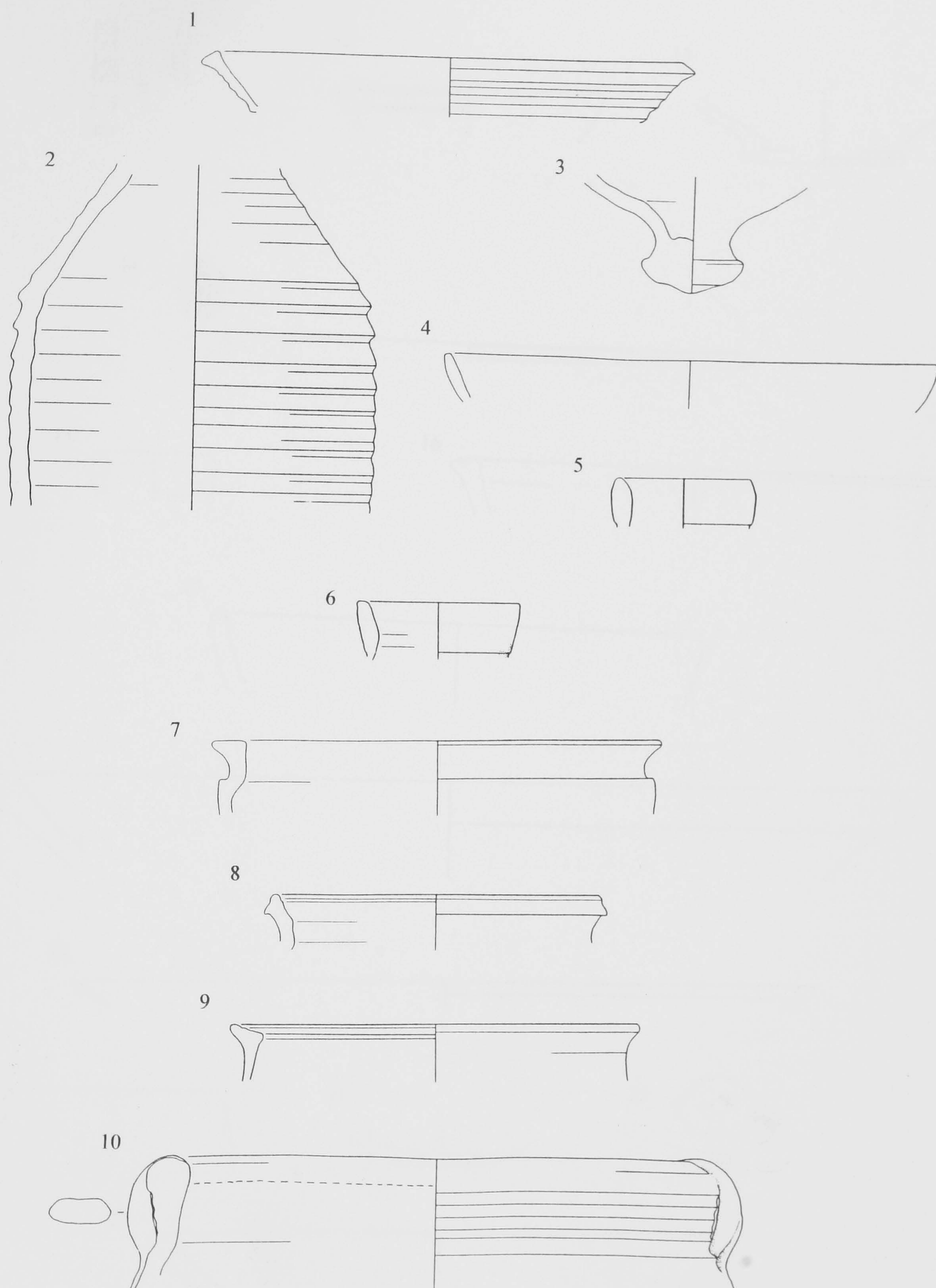

Pottery from profile C, Tell Edfu at 1:3.

11



12

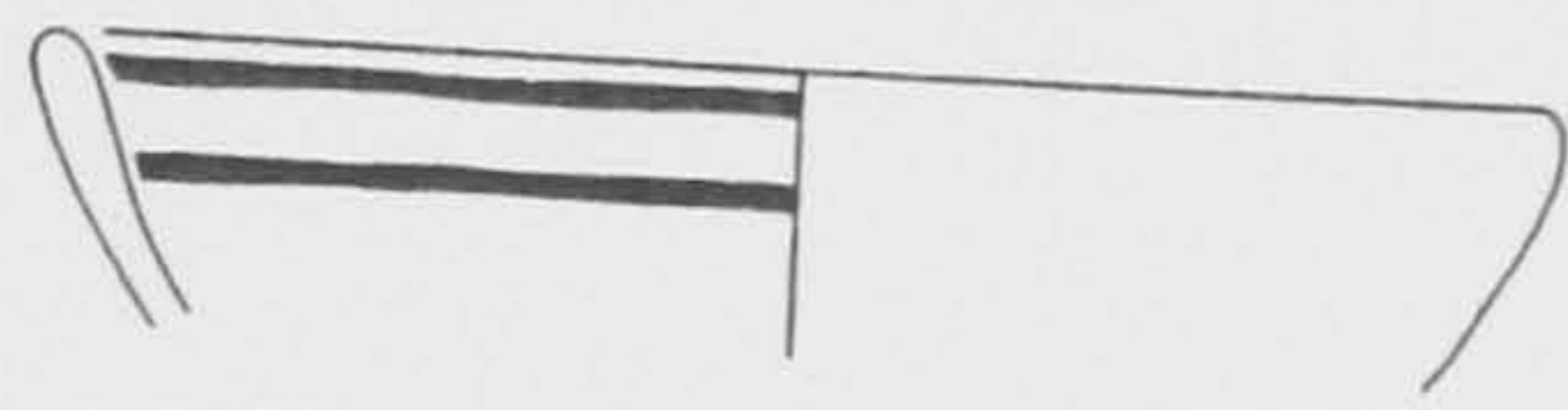

13



14

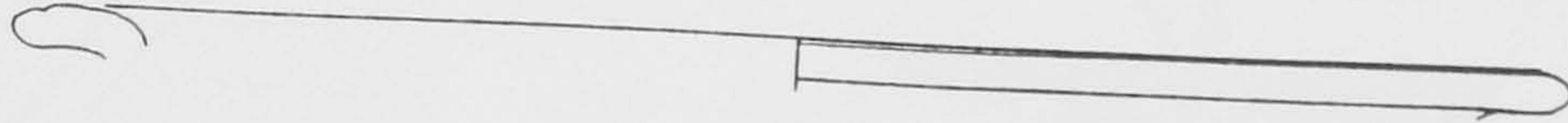

15

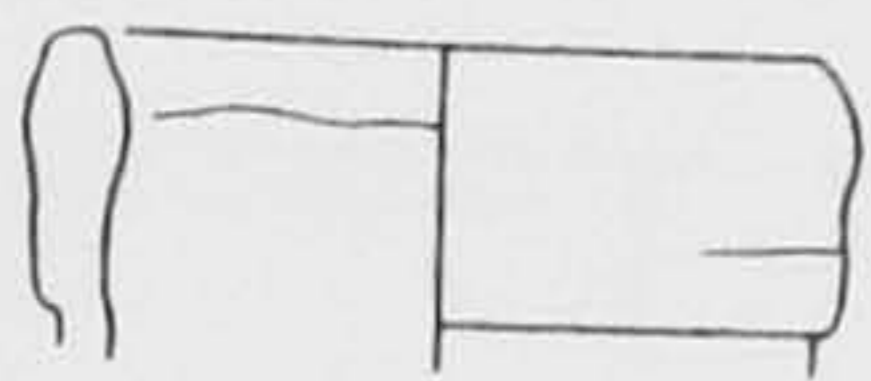

16

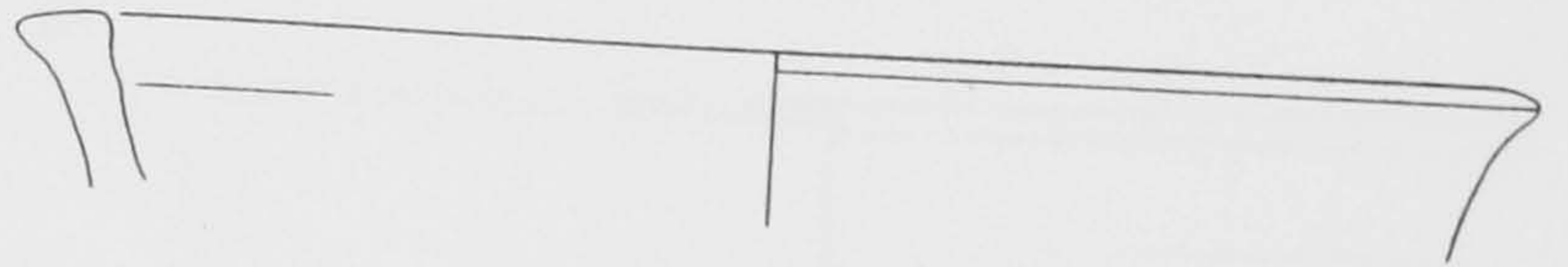

17



18

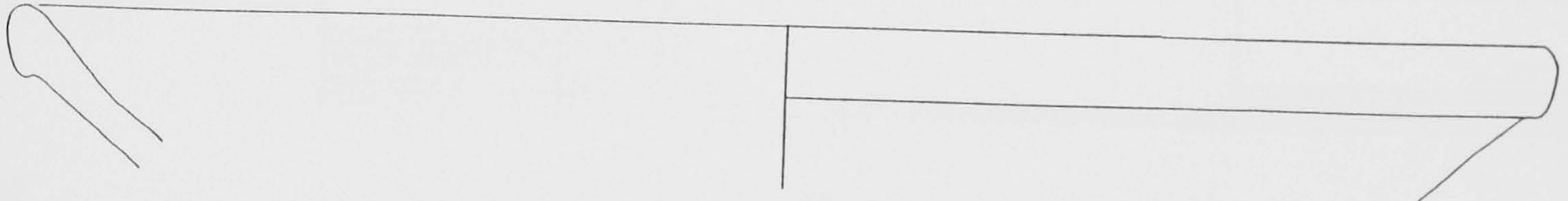

19

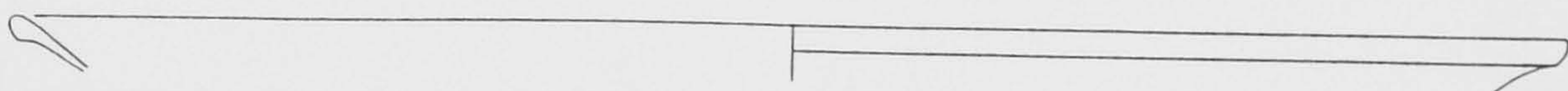

20

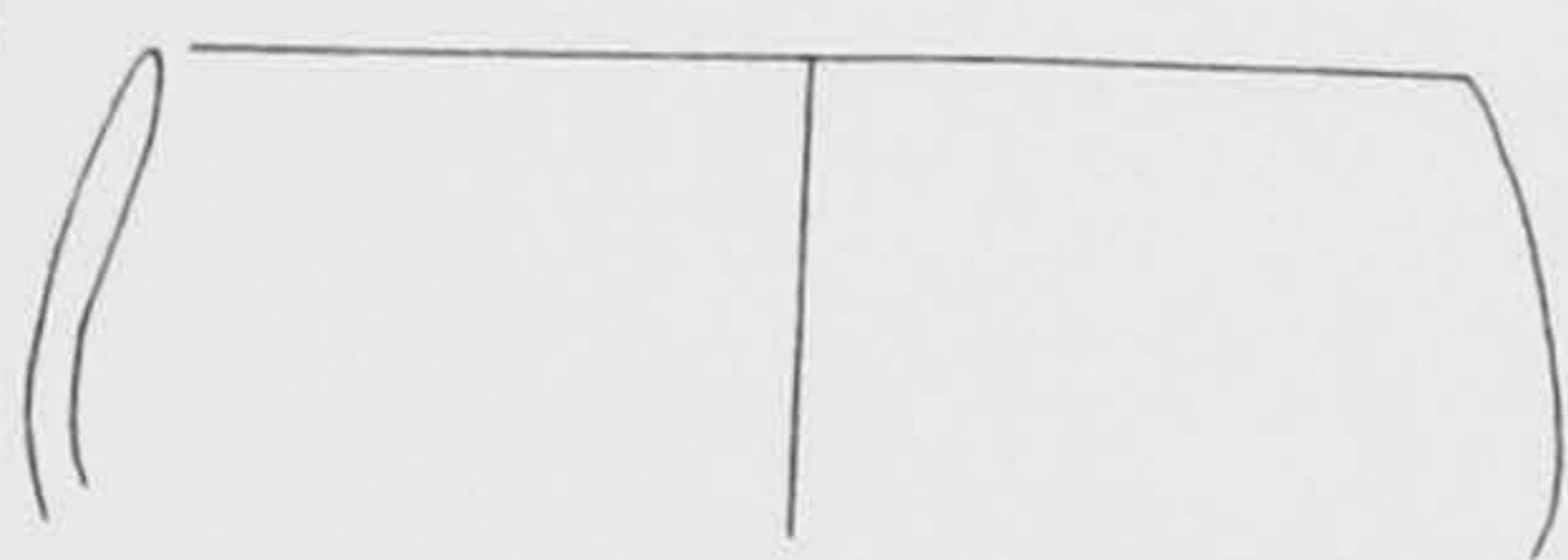

21

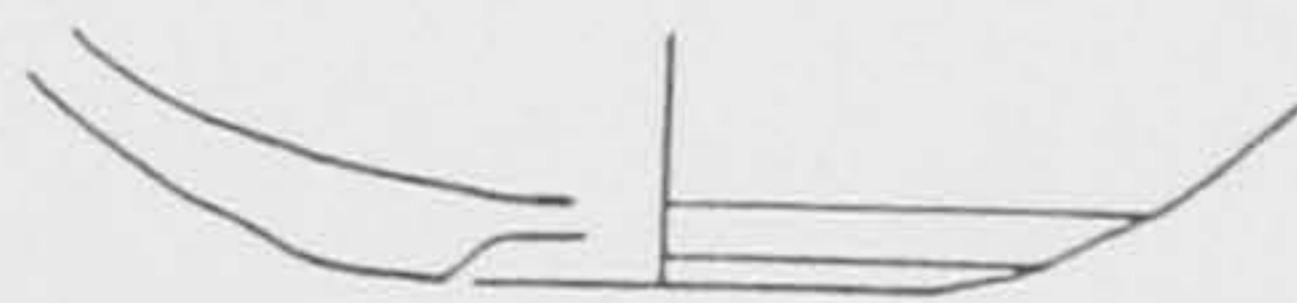

22



23

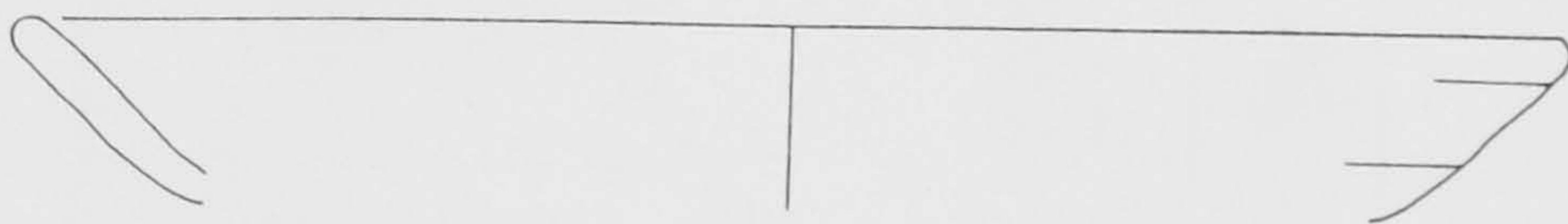

Pottery from profile C, Tell Edfu at 1:3 (bracelet at 1:2).

24

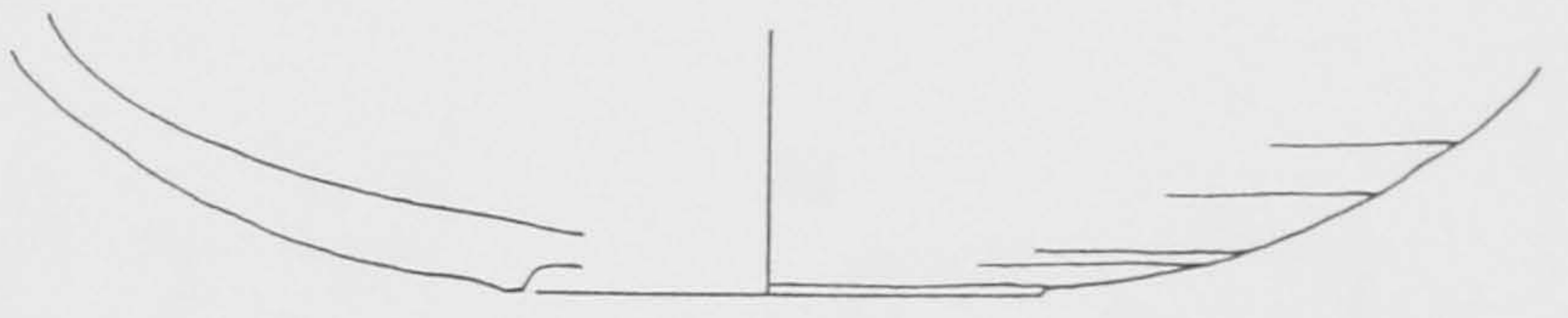

25

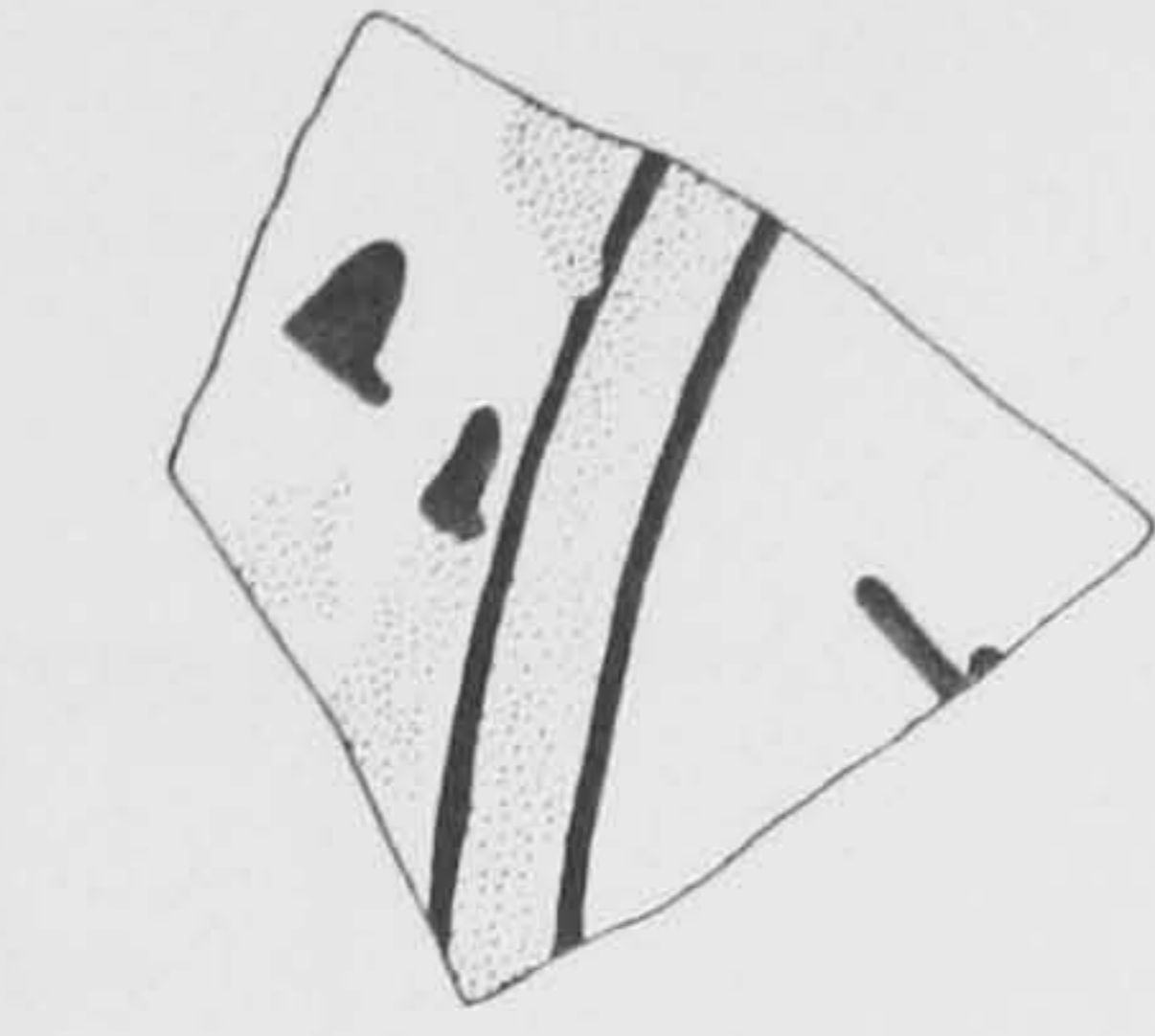

26

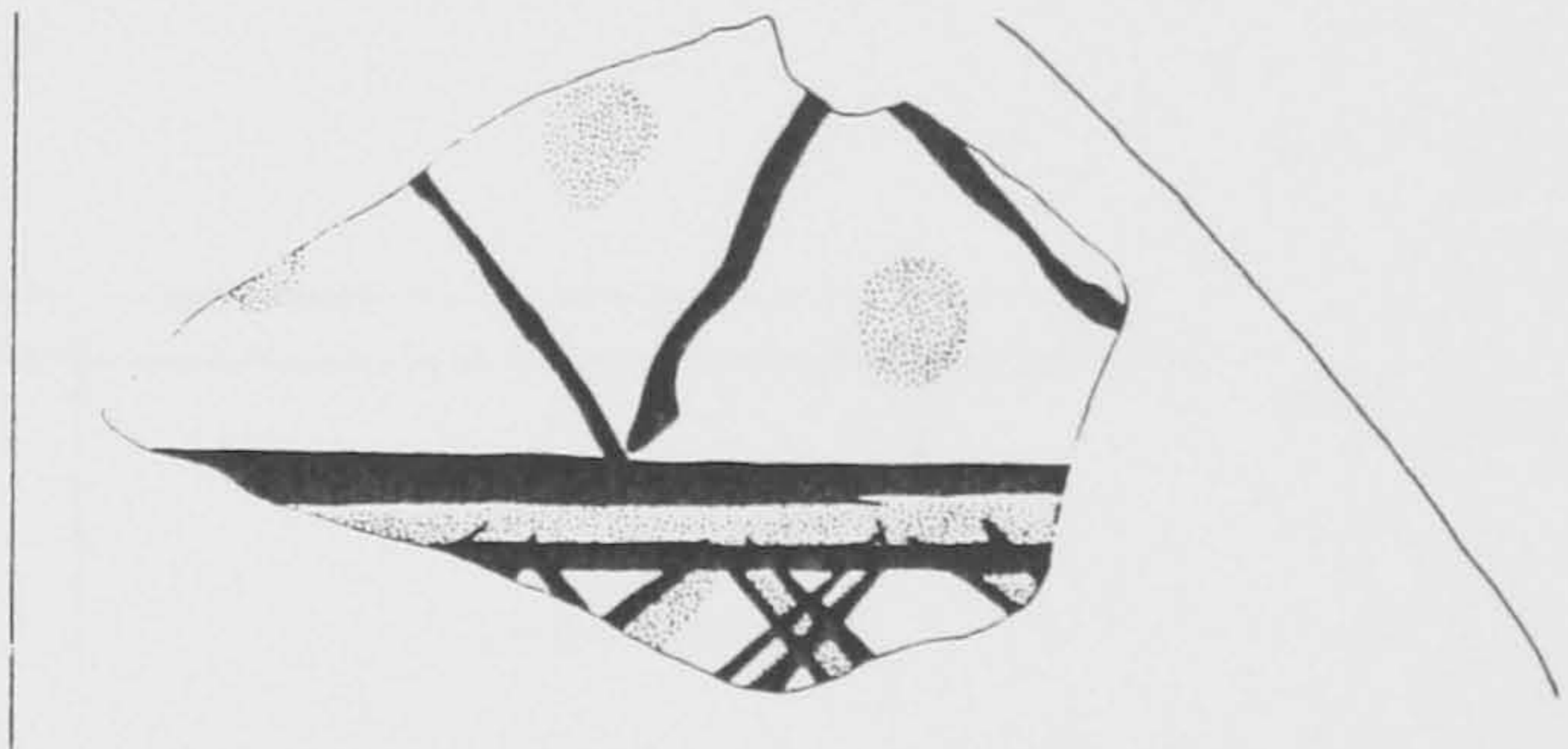
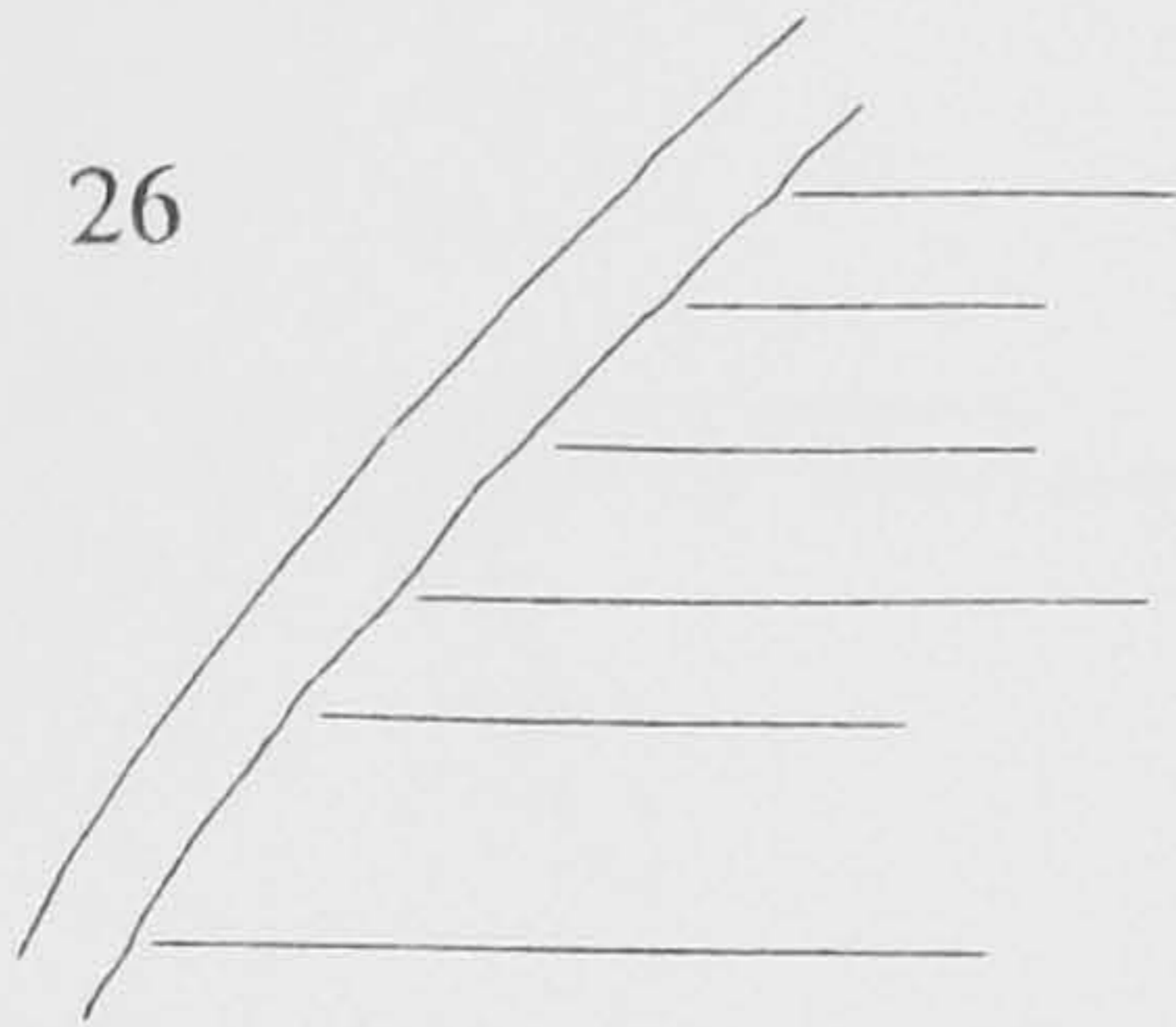

27

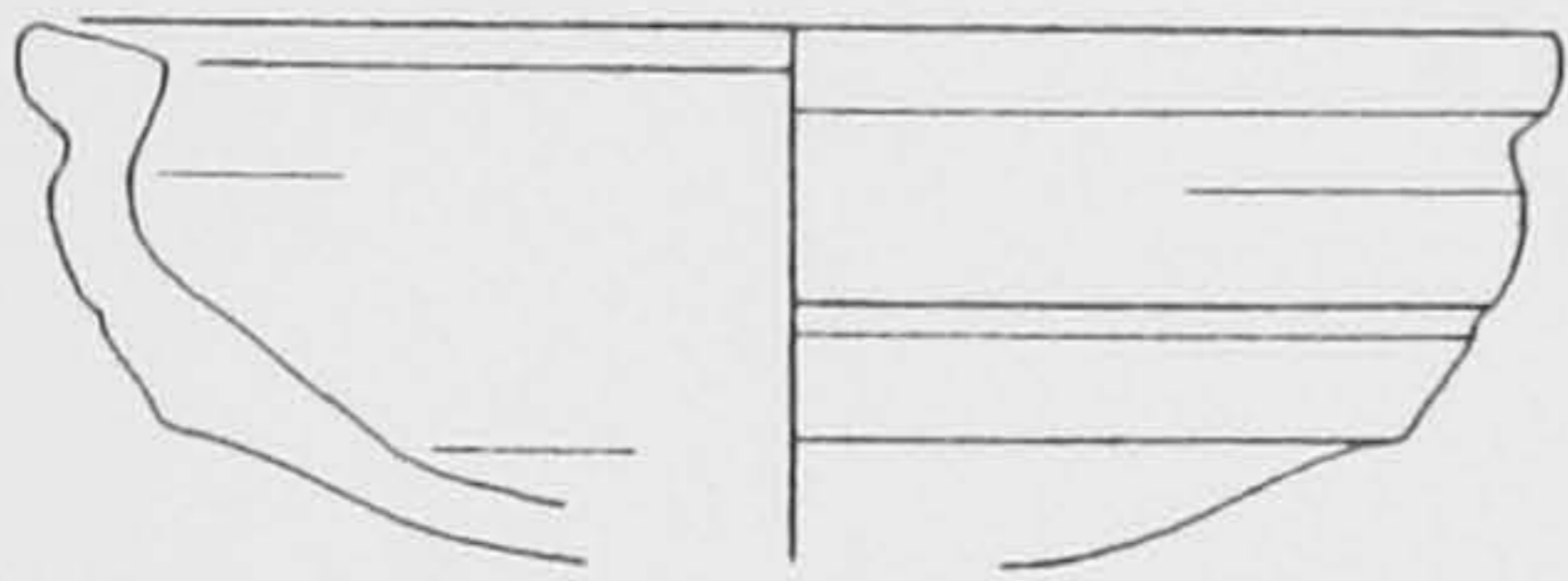

28

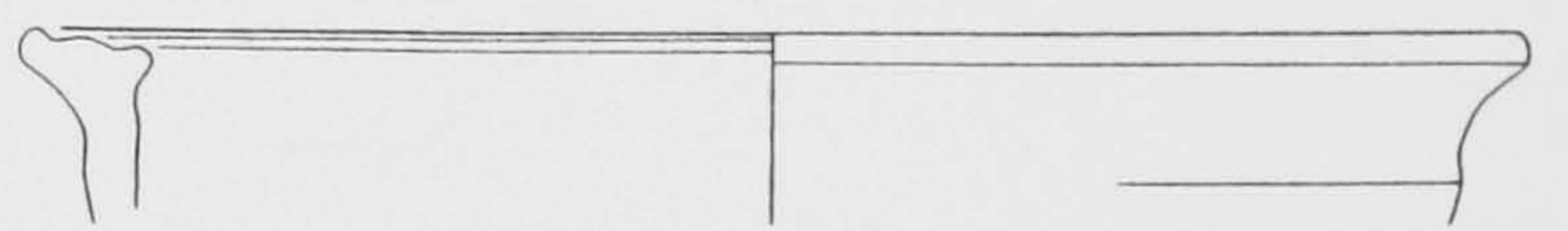

29

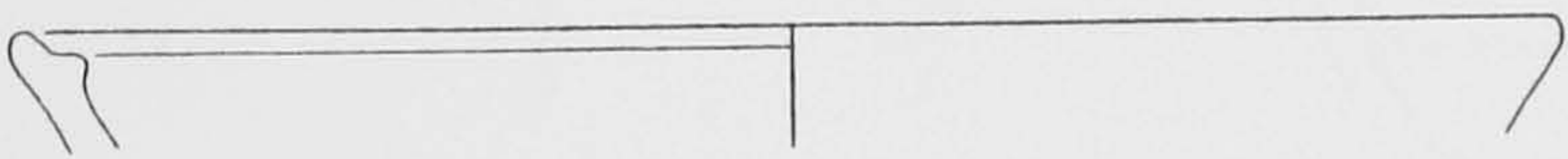

30



31

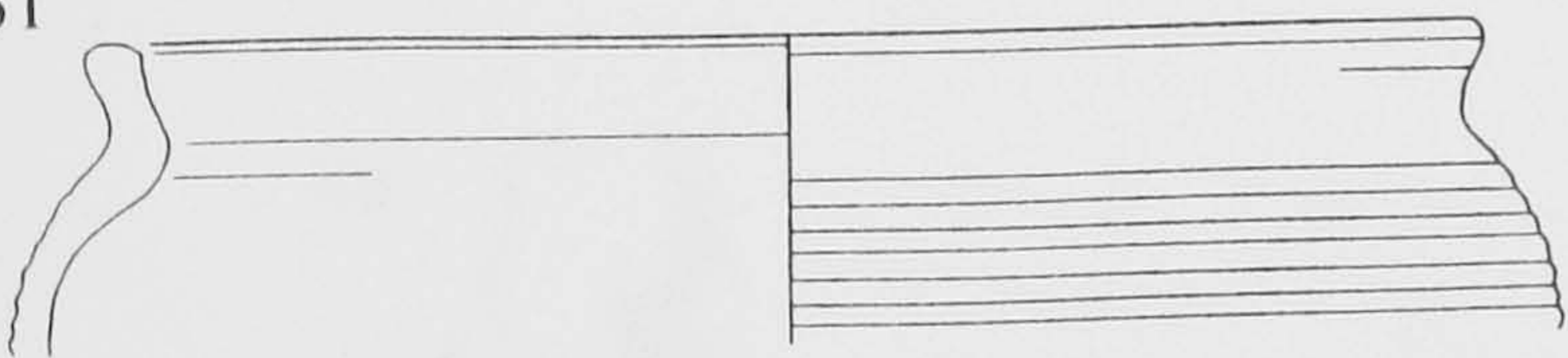

32

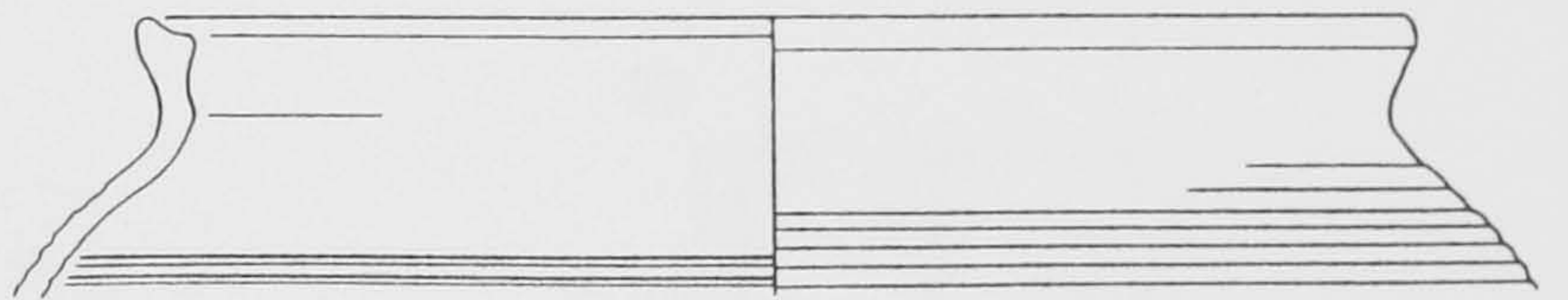

33

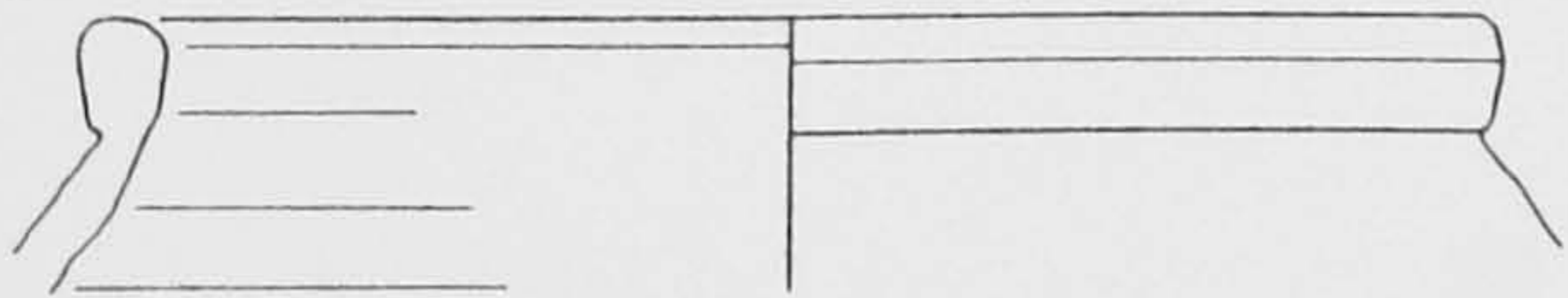

34

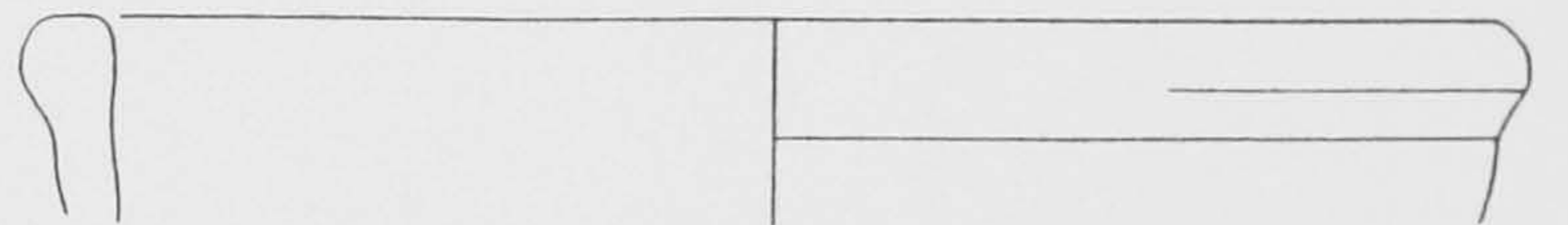

35

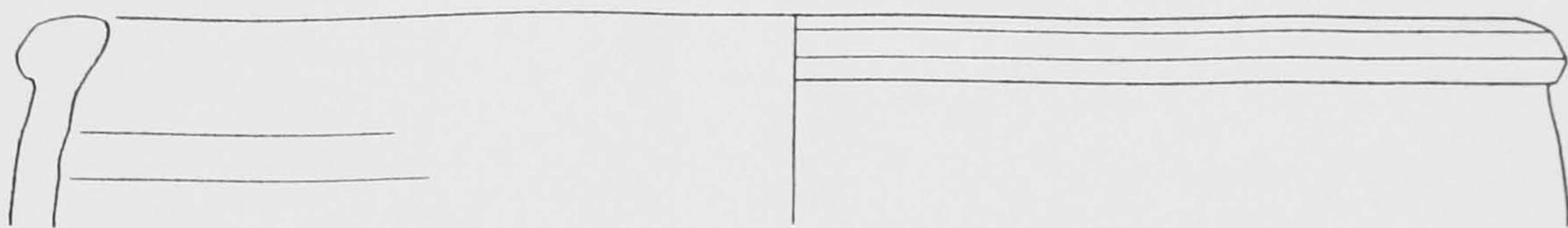

36

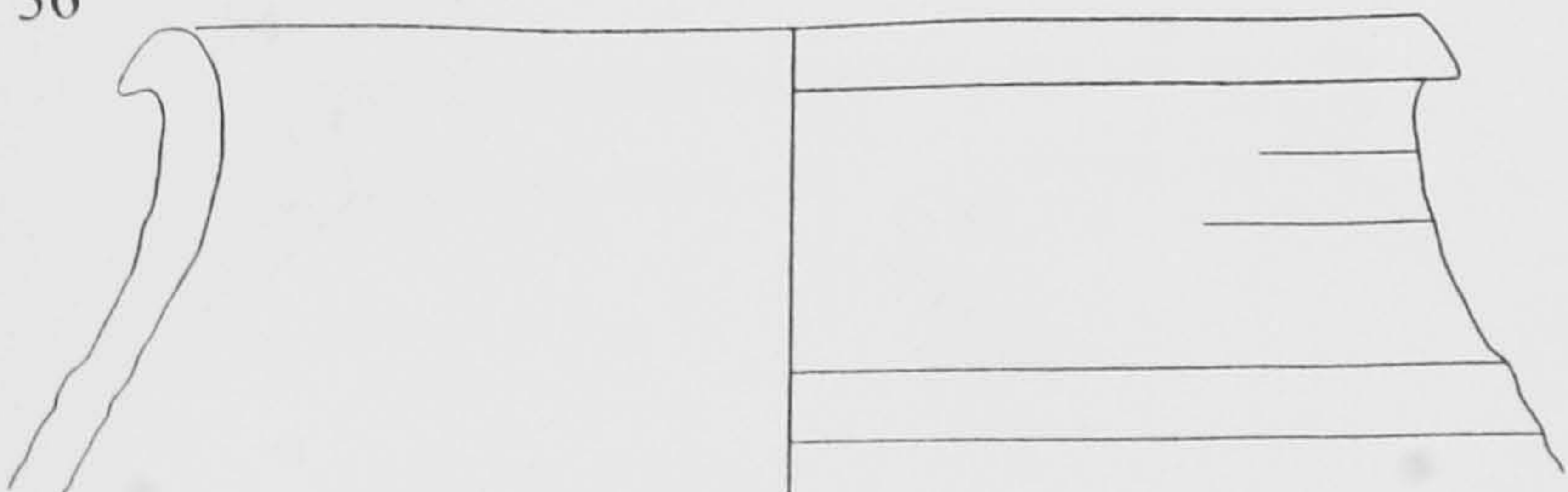

37

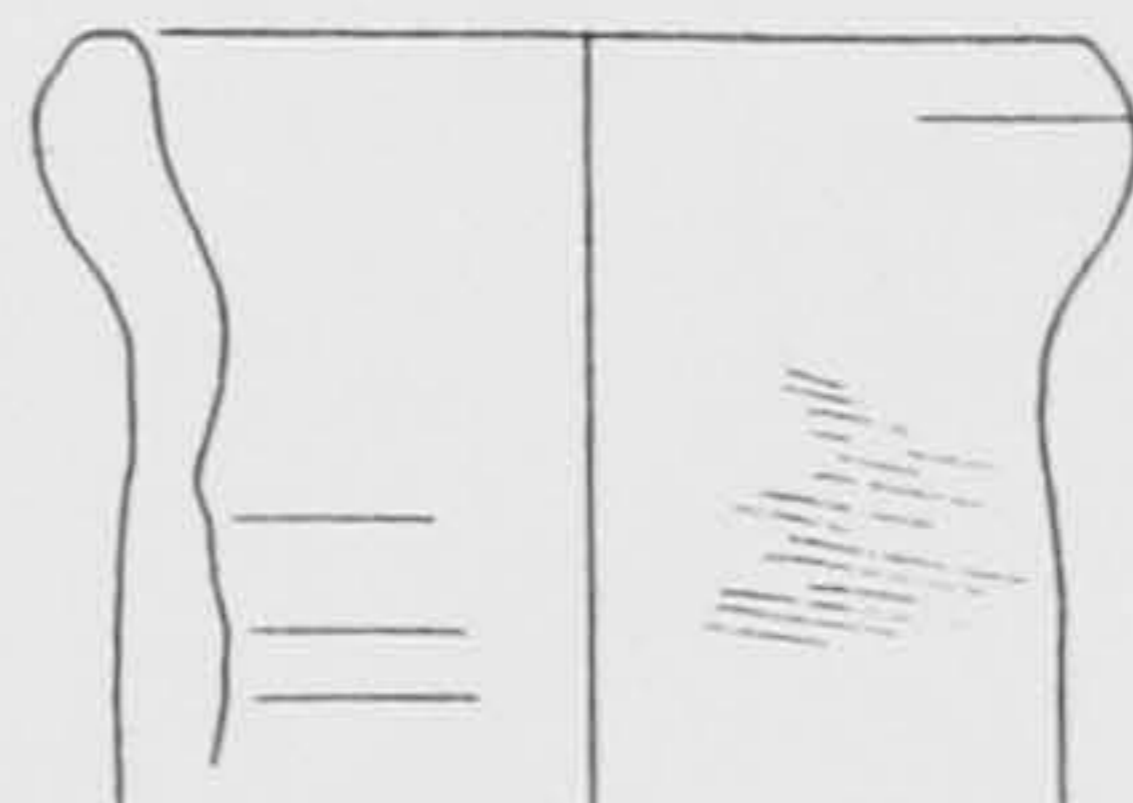

38

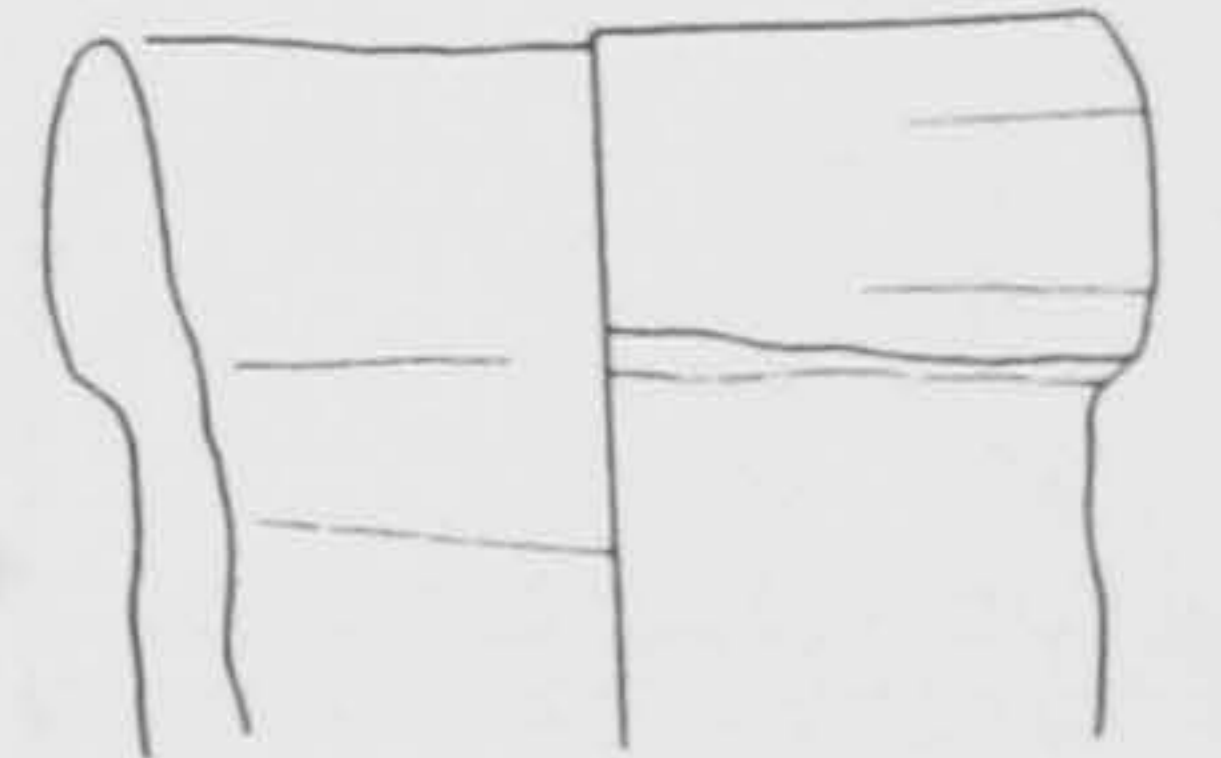

Pottery from profile C, Tell Edfu at 1:3.

Fig. V.27 cont.

39

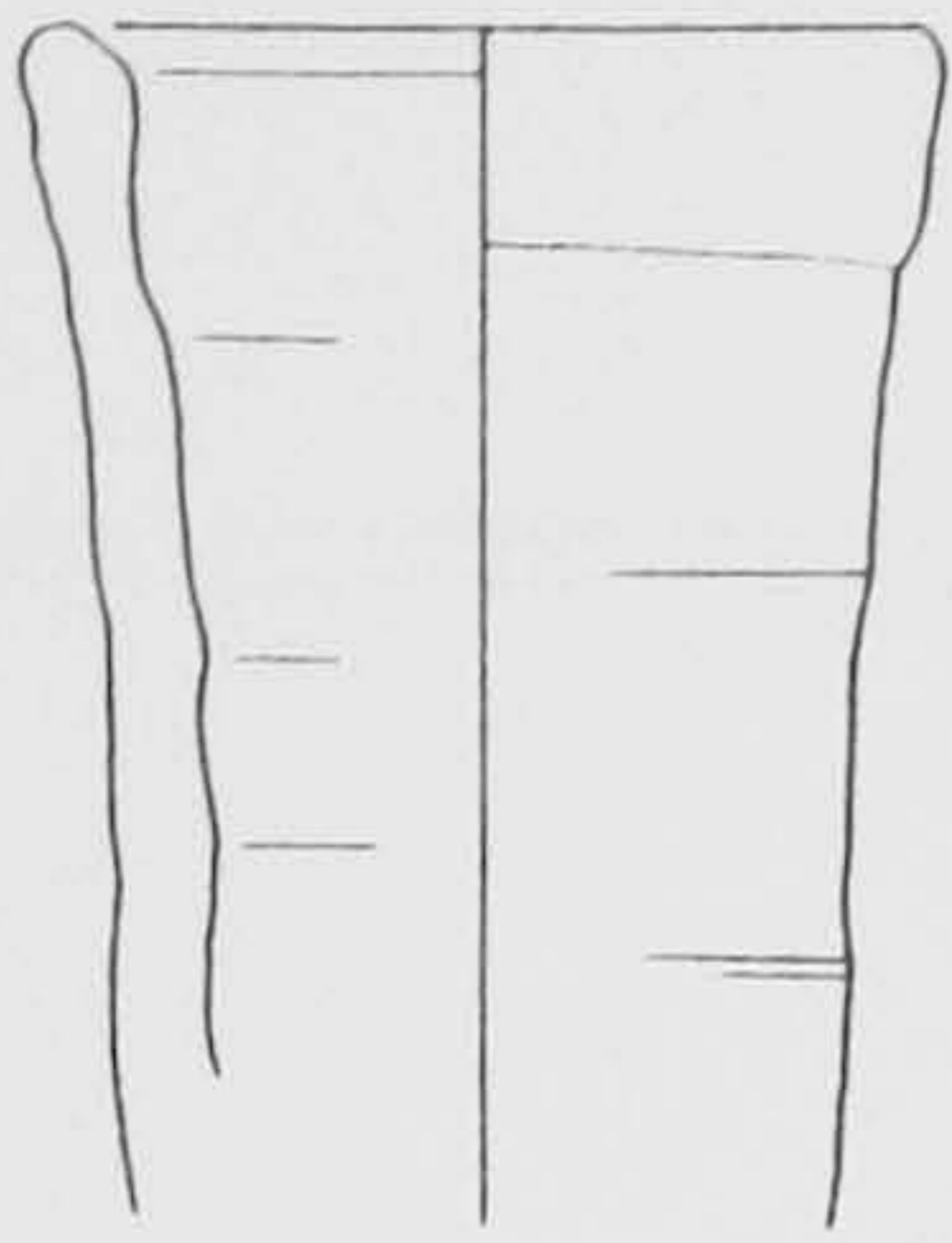

40

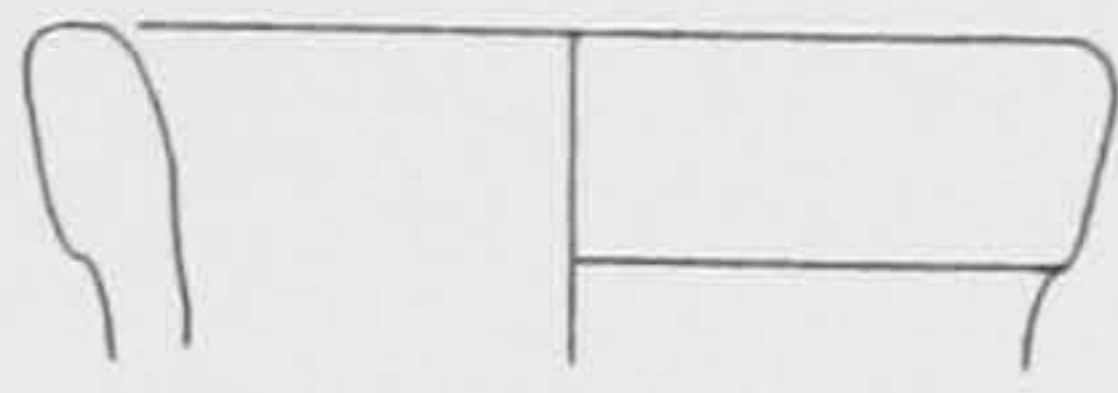

42

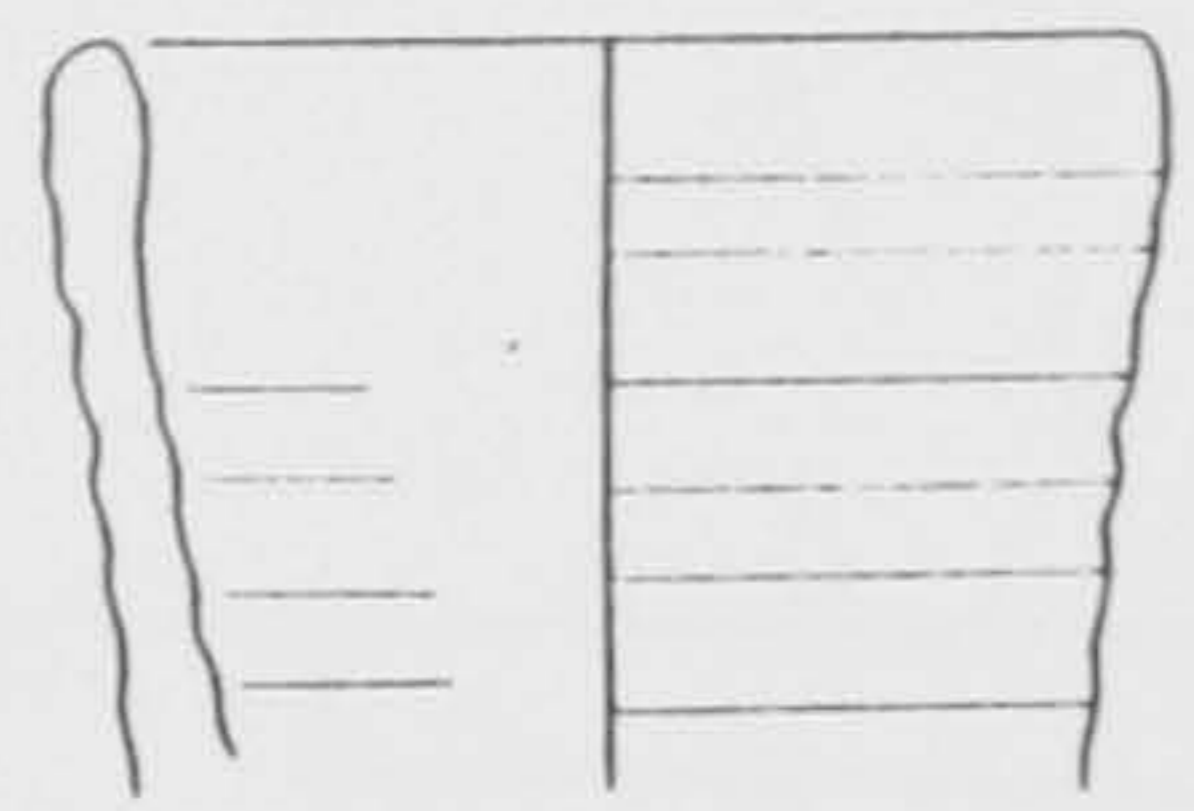

41

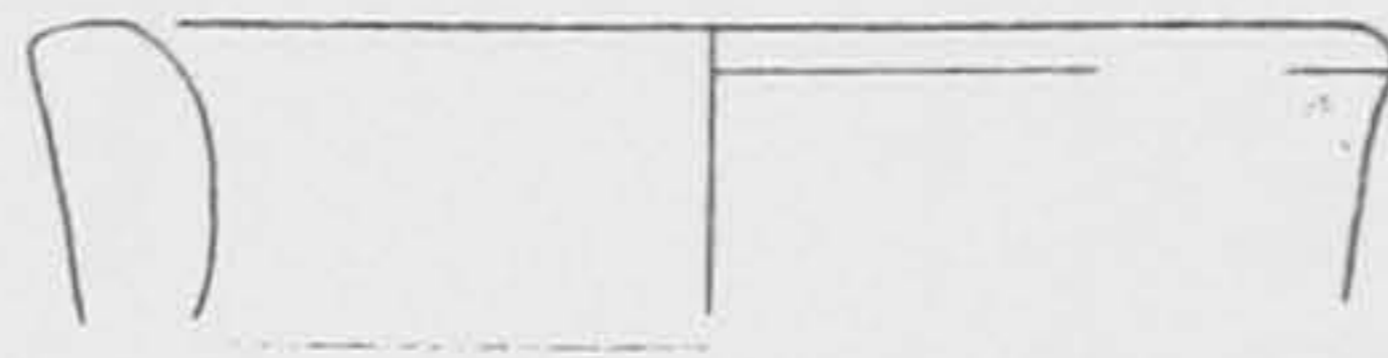

43

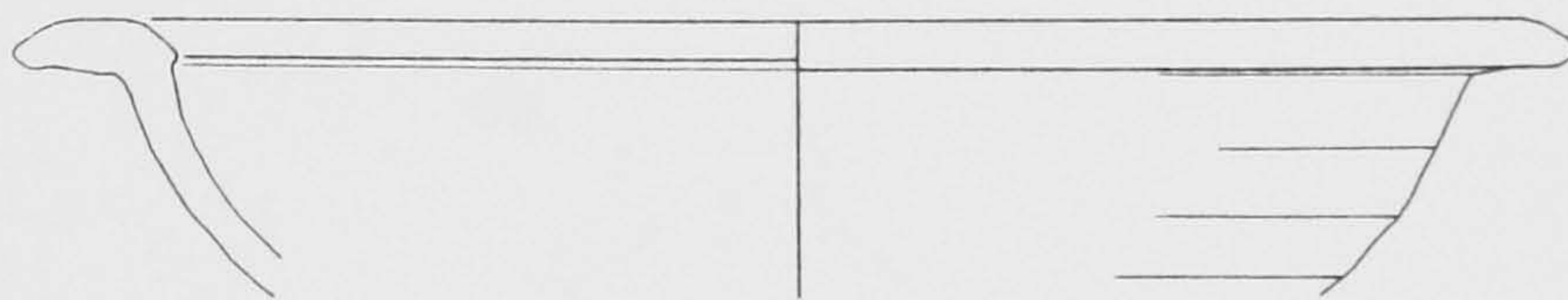

44

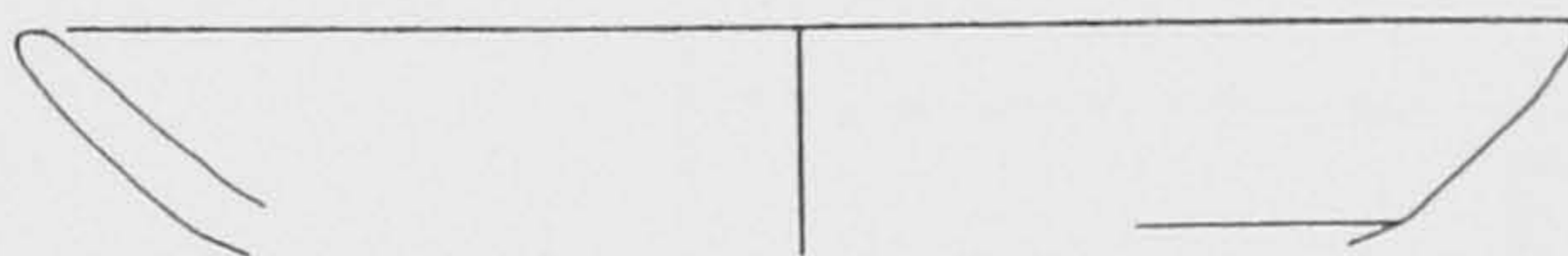

45

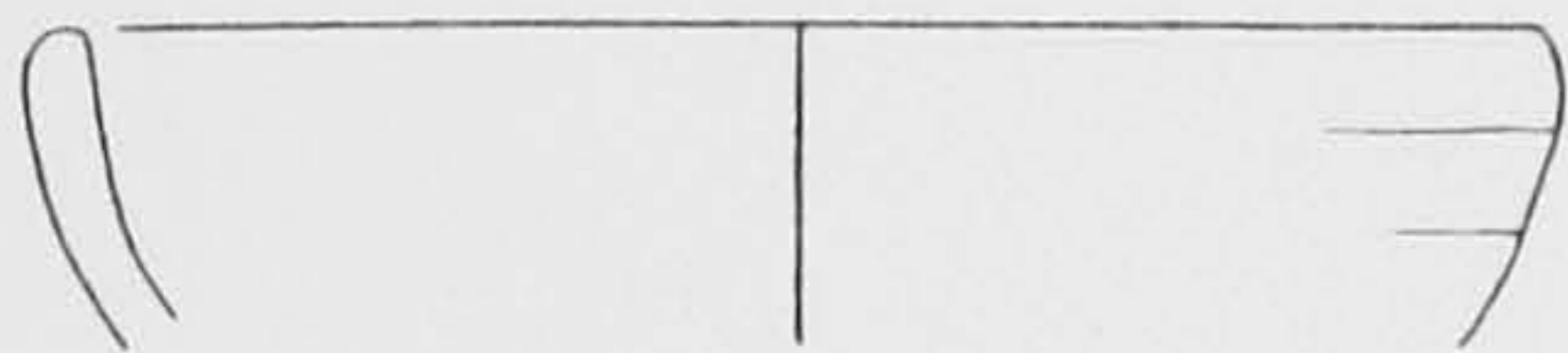

46

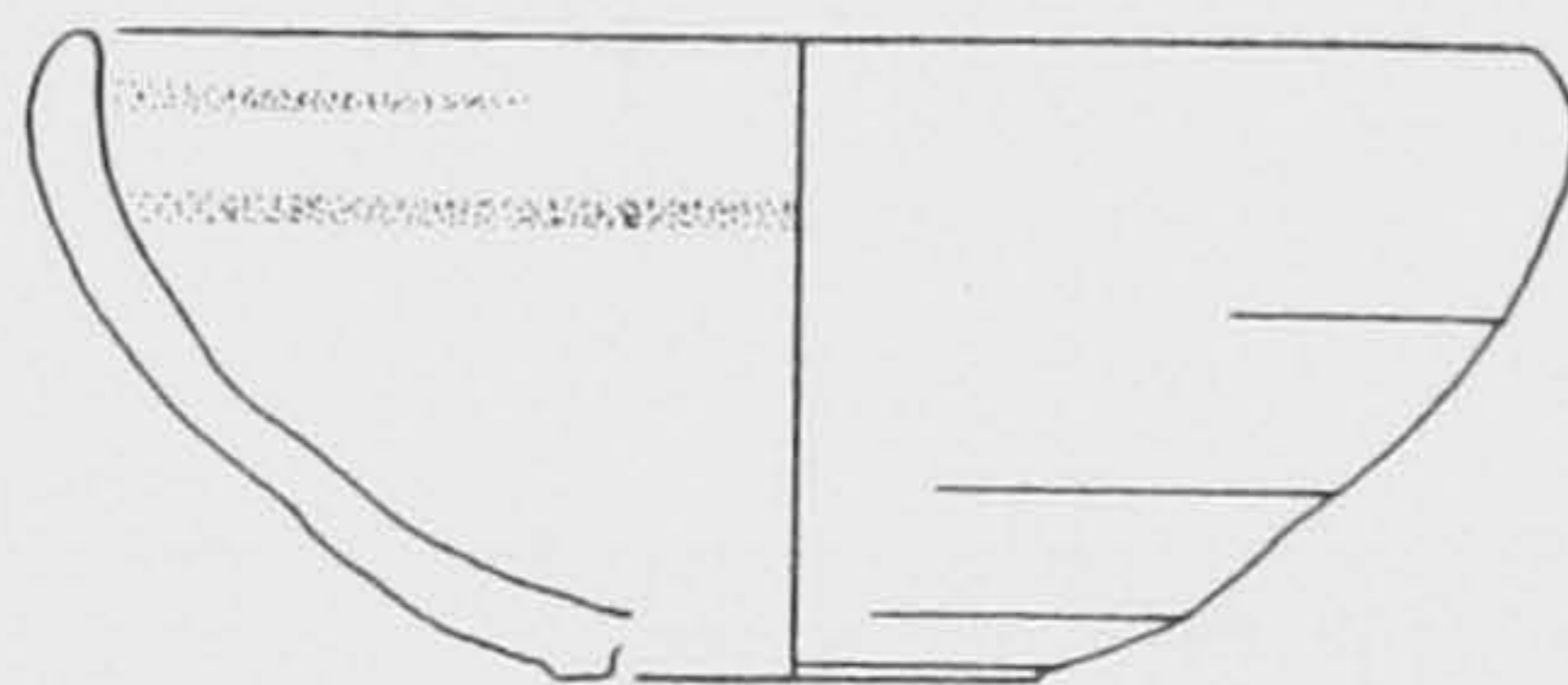

47

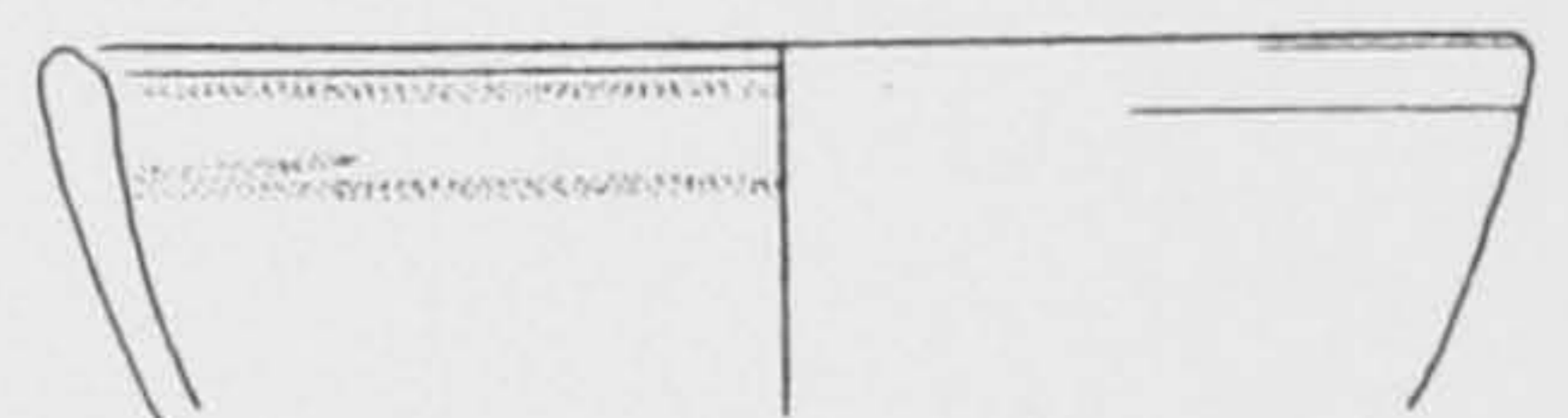

48



49

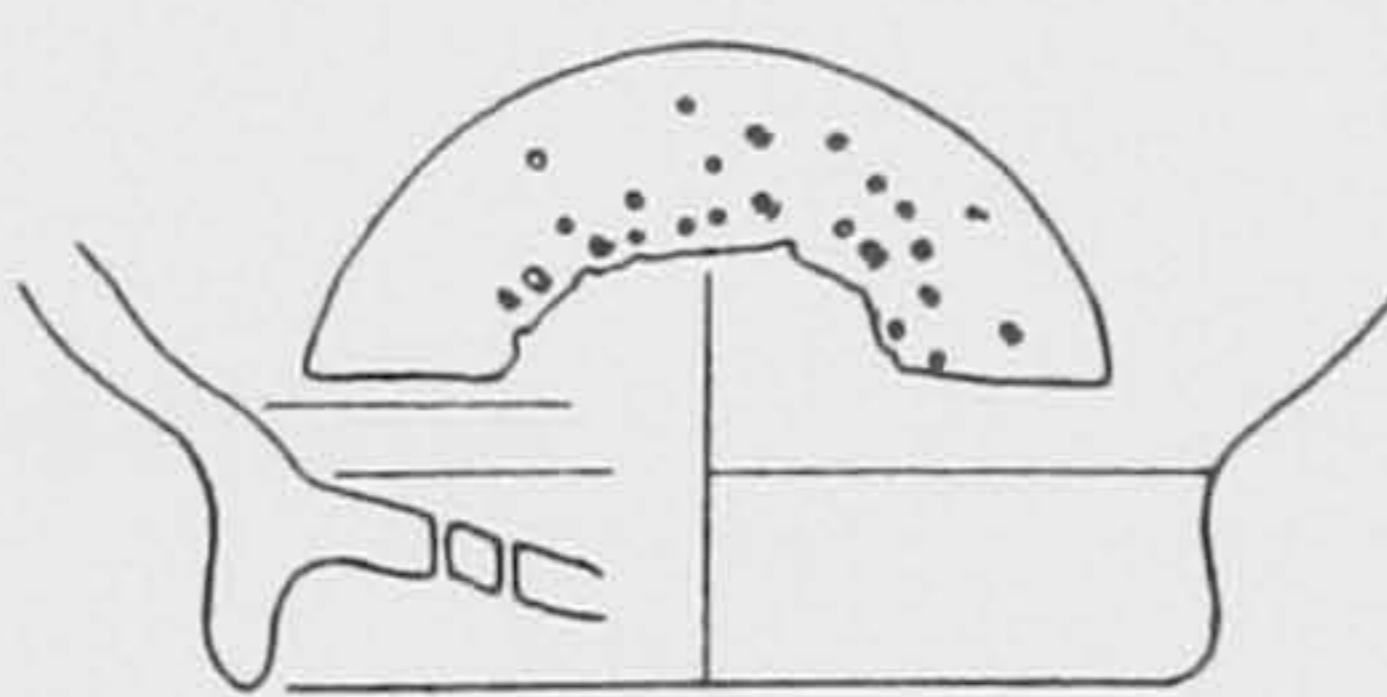

50

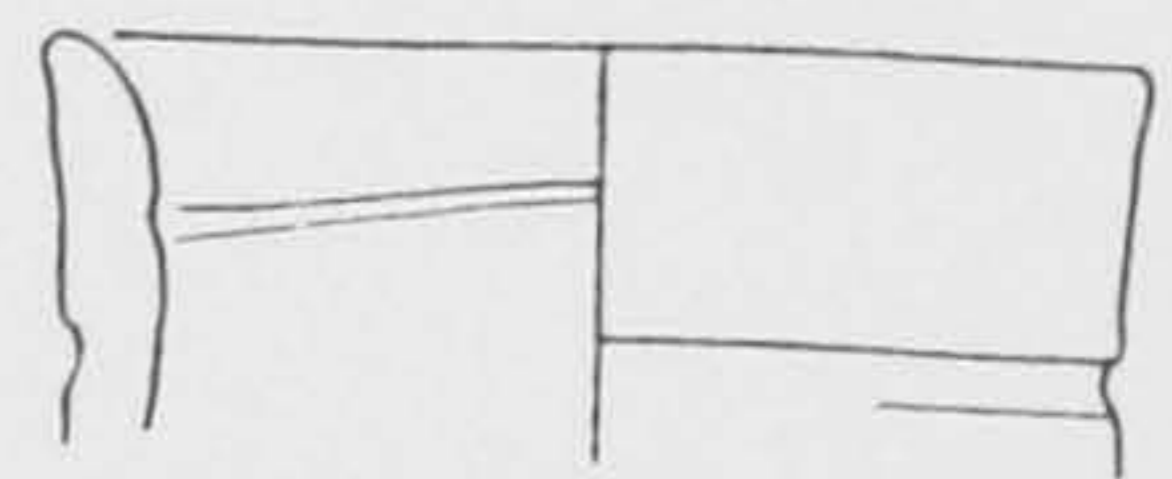

51

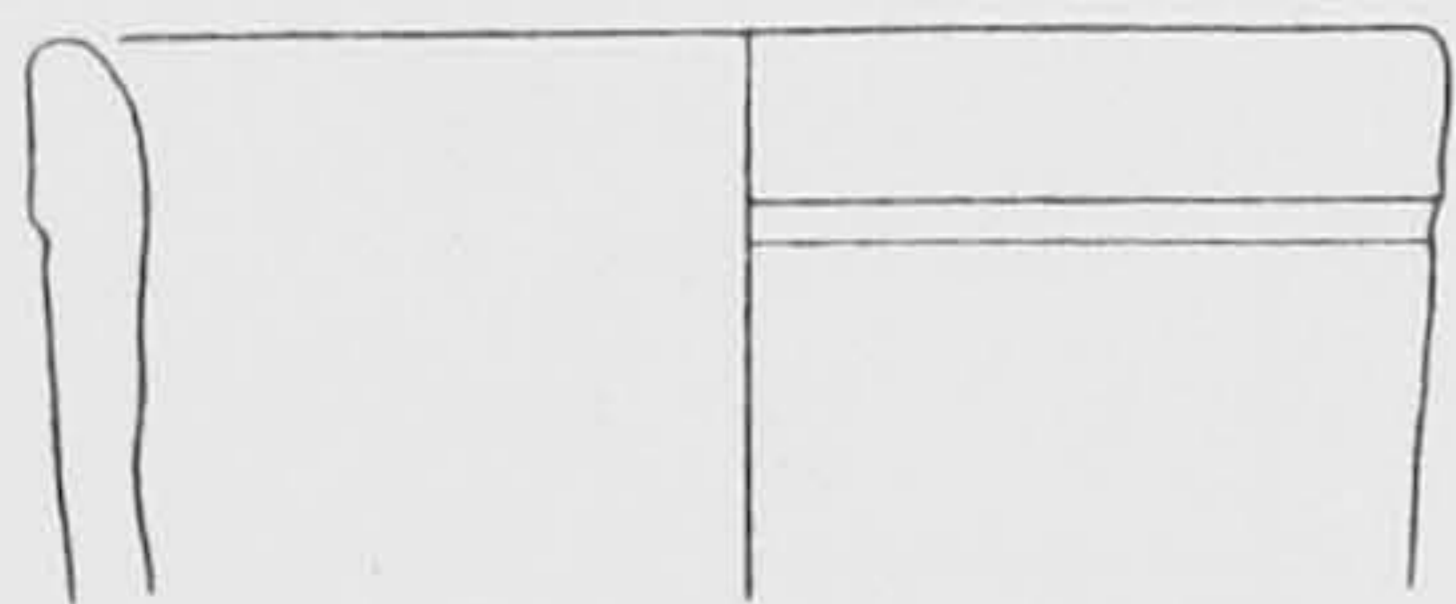

52

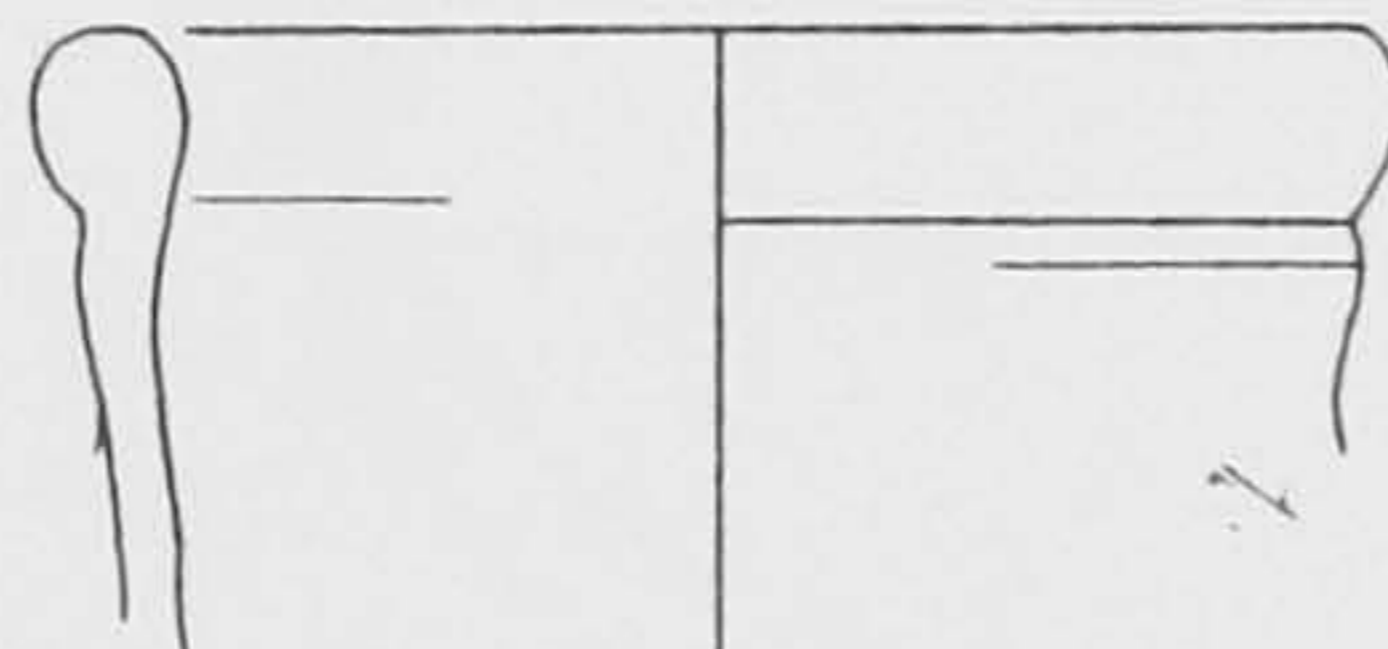

53

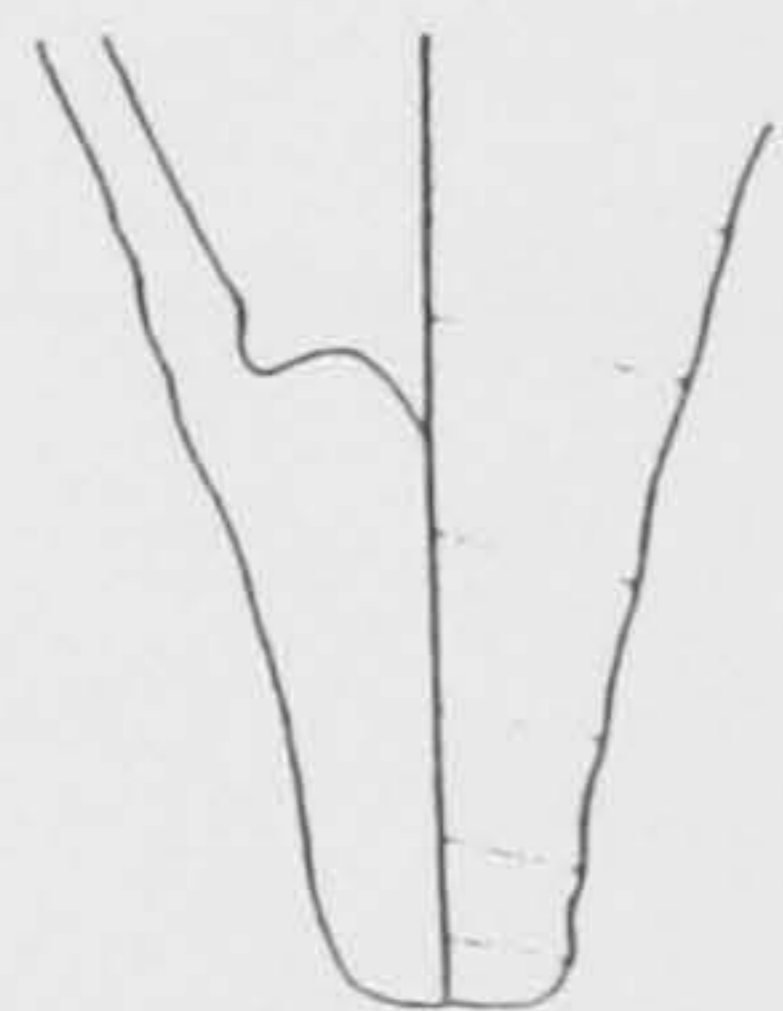

54

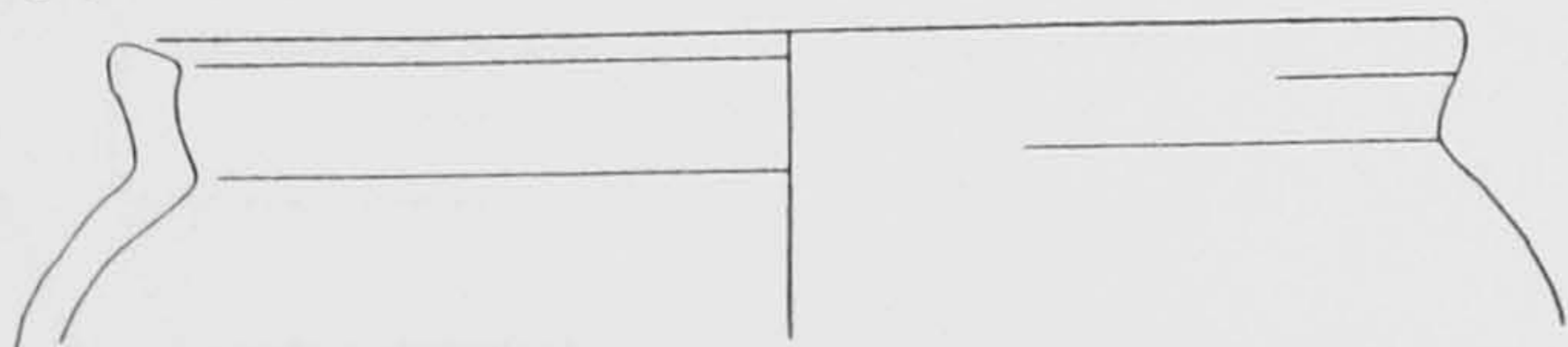

55



Pottery from profile C, Tell Edfu at 1:3.

Fig. V.27 cont.

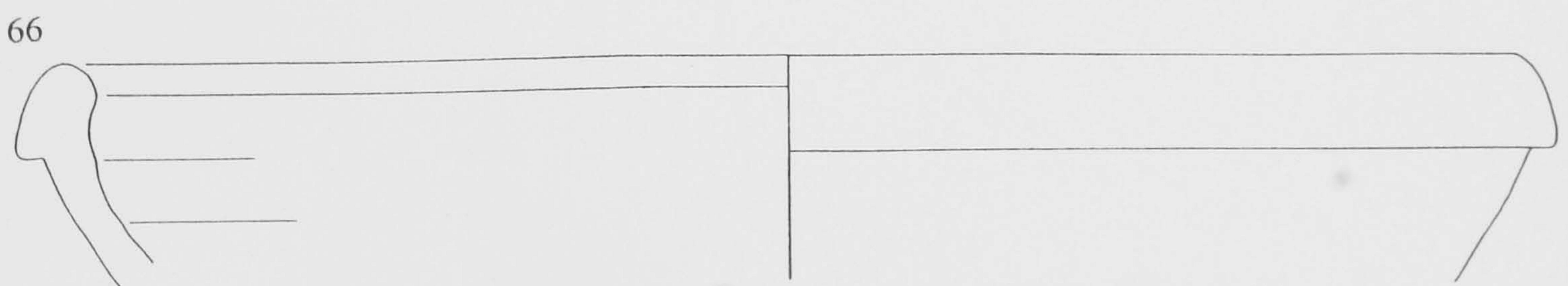
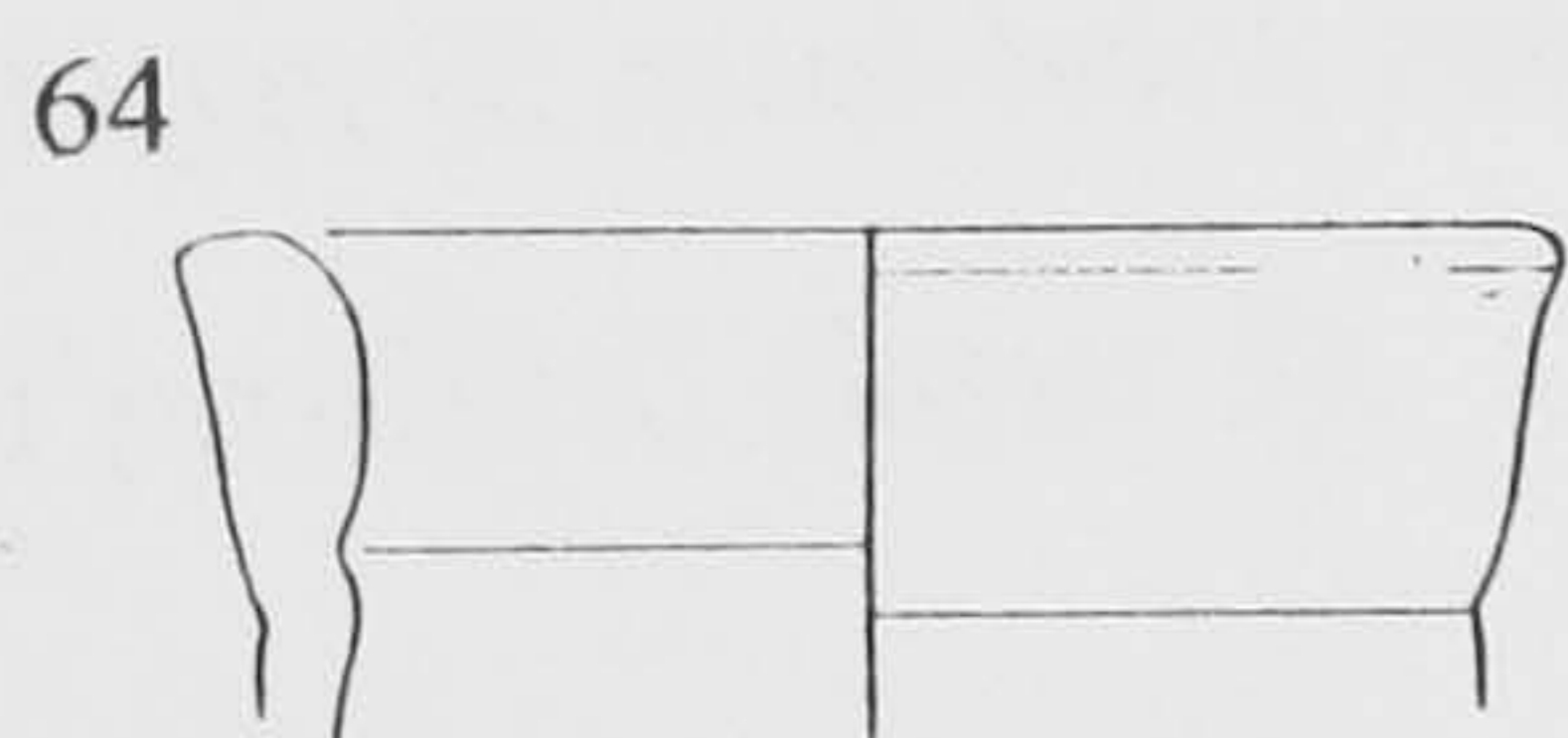
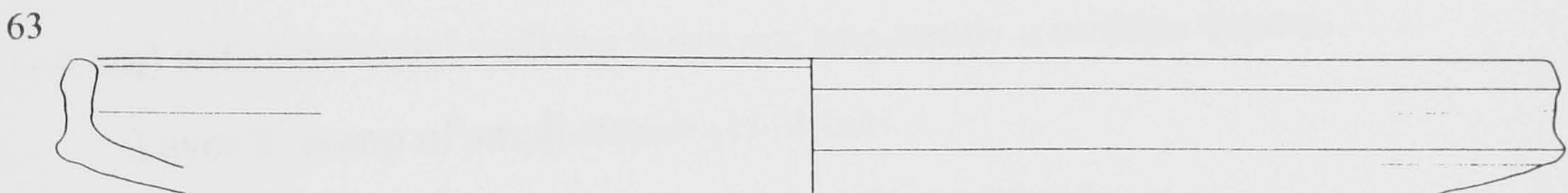
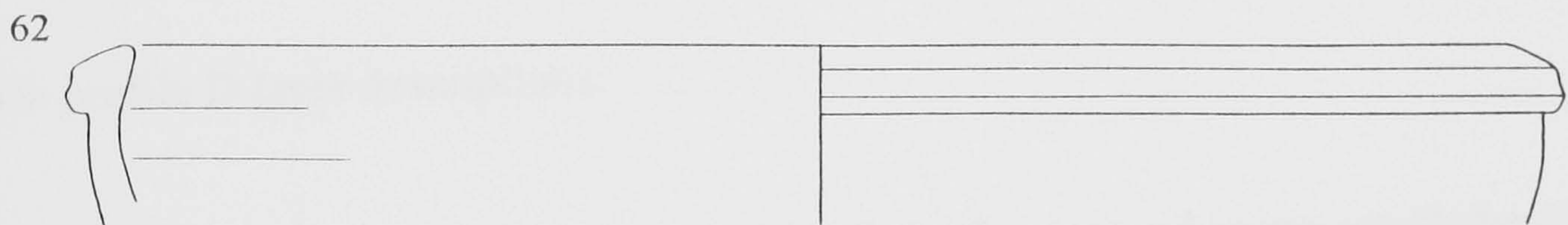
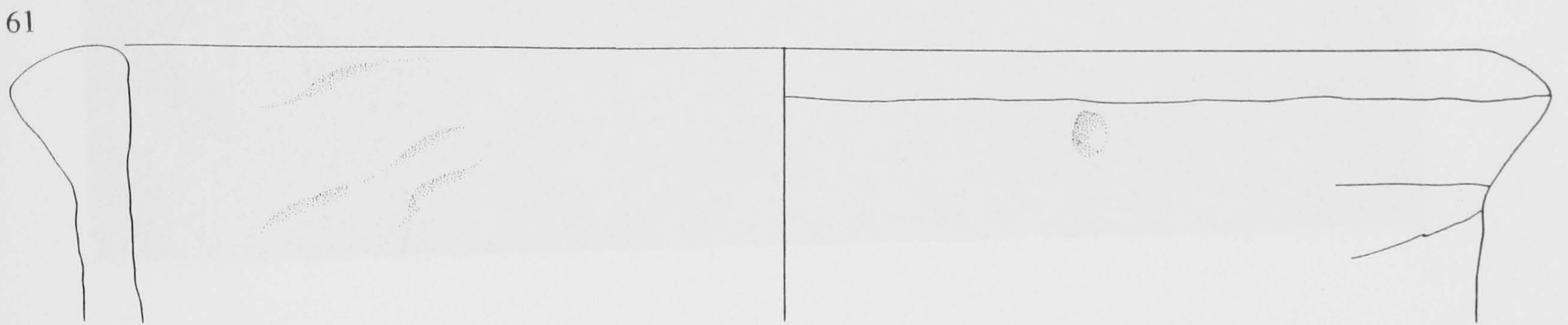
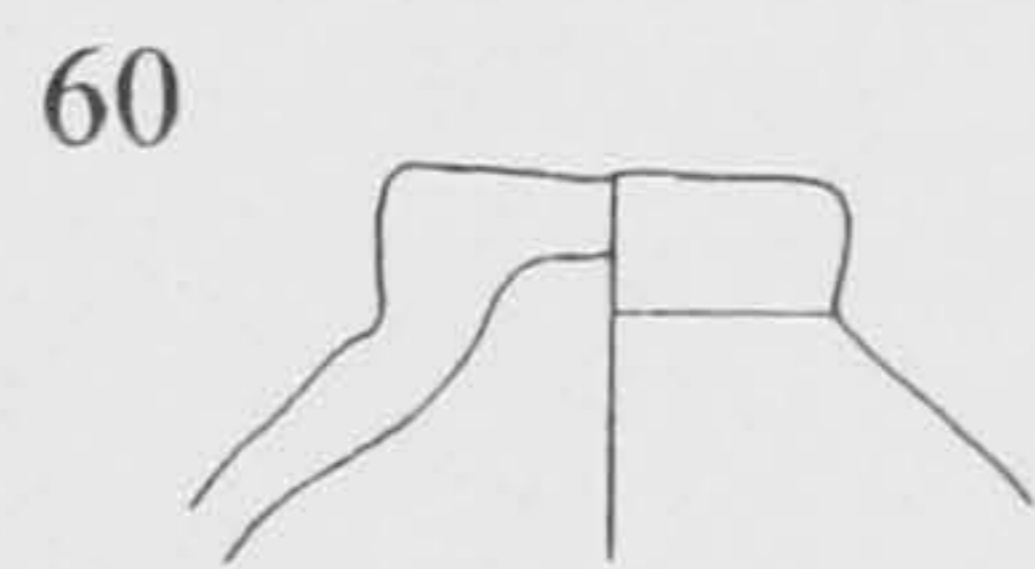
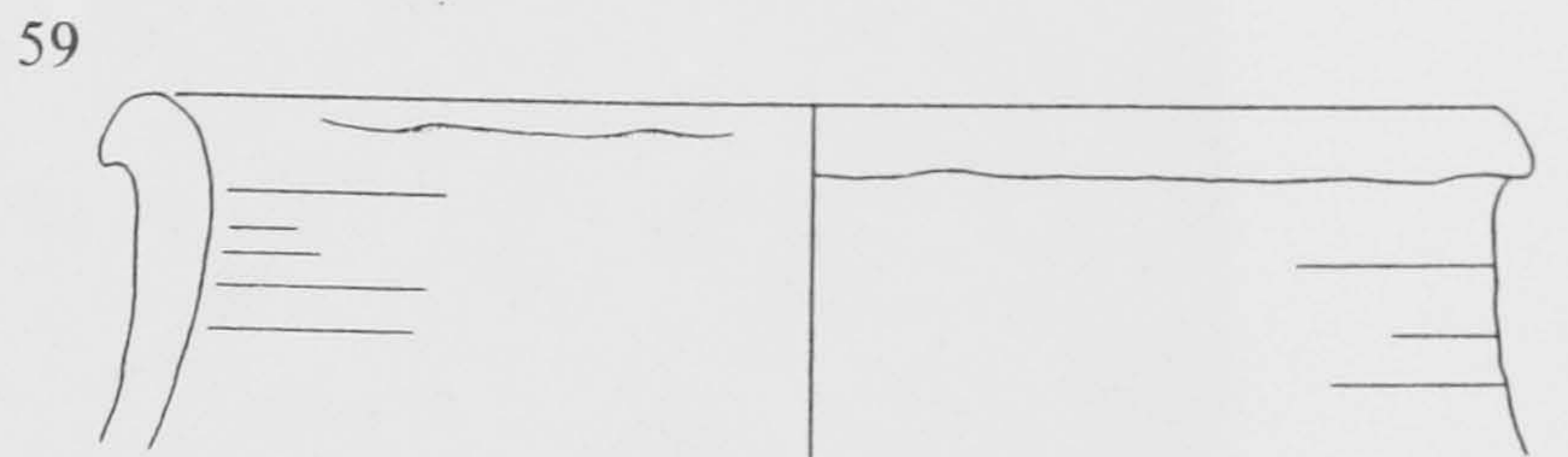
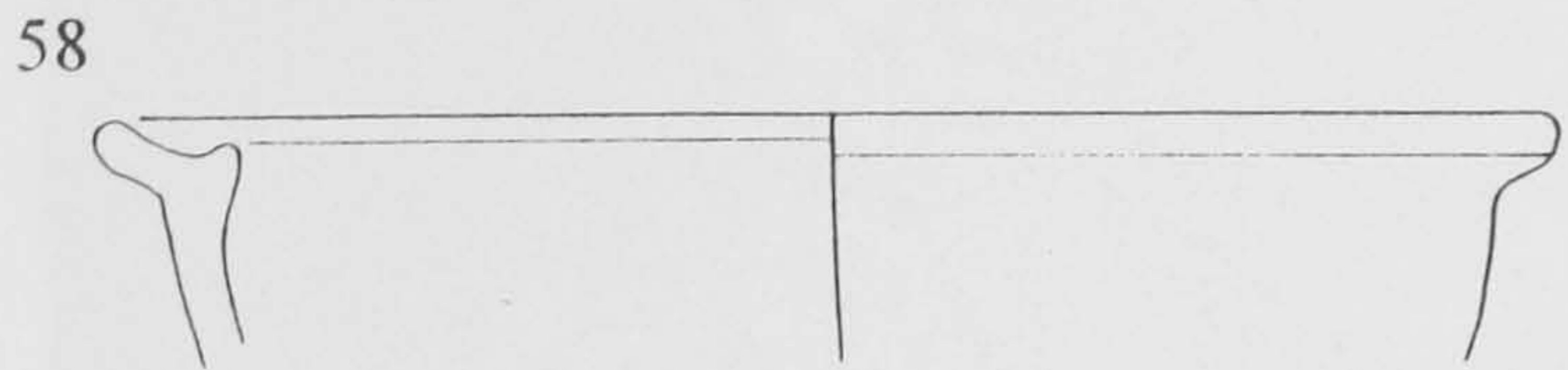
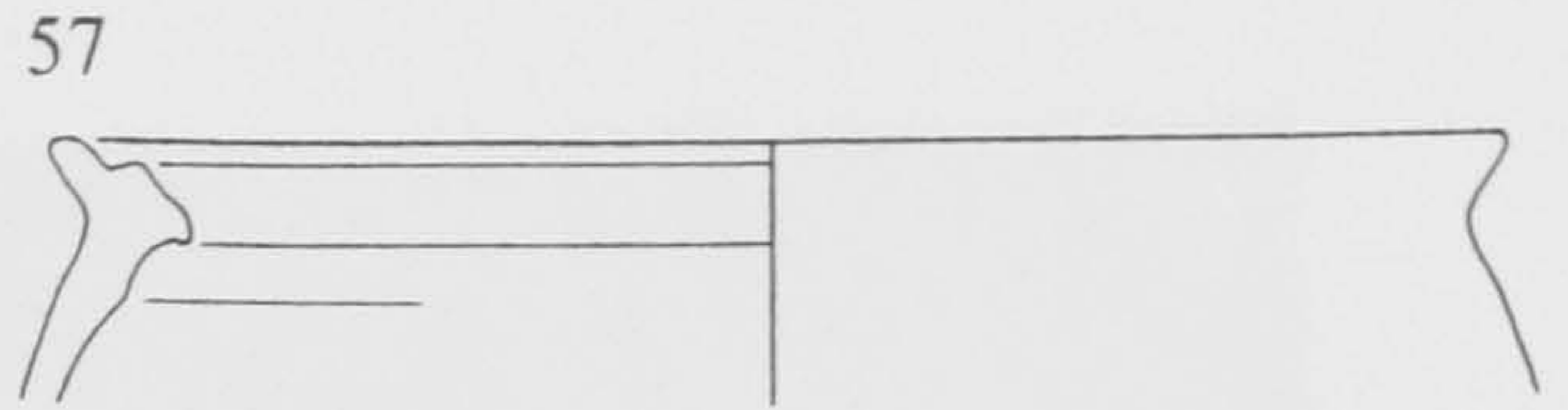
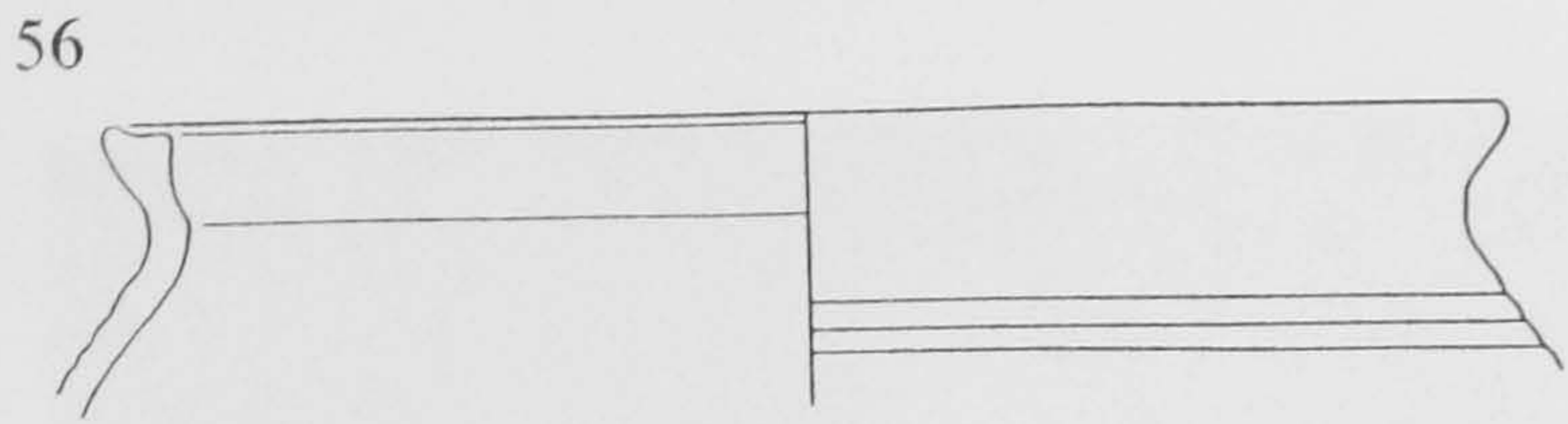

Pottery from profile C, Tell Edfu at 1:3.



Edfu profile D layer descriptions:

Layer 1: fine silt with coarse gravel, a little charcoal and scarce small sherds (1–4 cm) with horizontal walking horizons; apparently a midden deposit.

Layer 2: dump of small sherds ($\frac{1}{2}$ –4 cm).

Layer 3: midden deposit as layer 1 but finer grained.

Layer 4: mud-brick rubble and large sherds (2–10 cm) immediately above wall at top of profile C (layer 3).

Edfu profile D pottery

Layer 1

1. *Fabric: M1. Surfaces: untreated. Diameter: 22 cm.*
2. *Fabric: M1. Surfaces: untreated. Diameter: 16 cm.*
3. *Fabric: M1. Surfaces: untreated. Diameter: 24 cm.*

Layer 2

4. *Fabric: M2 (Adams's ware R1 or R25?). Surfaces: red-slipped all over.
Decoration: black-painted vertical stripe on exterior. Diameter: 10 cm.
Parallels: Qasr Ibrim, fifth century (Rose pers. com.).*
5. *Fabric: M1. Surfaces: untreated, blackened. Diameter: 20 cm.*
6. *Fabric: M1. Surfaces: untreated. Diameter: 16 cm.*
7. *Fabric: VCM1. Surfaces: untreated.*
8. *Fabric: LRA 7. Diameter: 7 cm.*
9. *Fabric: VCM1. Surfaces: untreated. Diameter: 28 cm.*

Layer 3

10. *Fabric: VCM1. Surfaces: untreated. Diameter: 34 cm.*

Layer 4

11. *Fabric: VCM1. Surfaces: dirty white slip on exterior, untreated interior.
Diameter: 16 cm.*
12. *Fabric: porous grey-green marl. Surfaces: uncoated but carefully finished.
Diameter: 8 cm.*
13. *Fabric: VCM1. Surfaces: untreated. Diameter: 33 cm.*

Fig. V.30

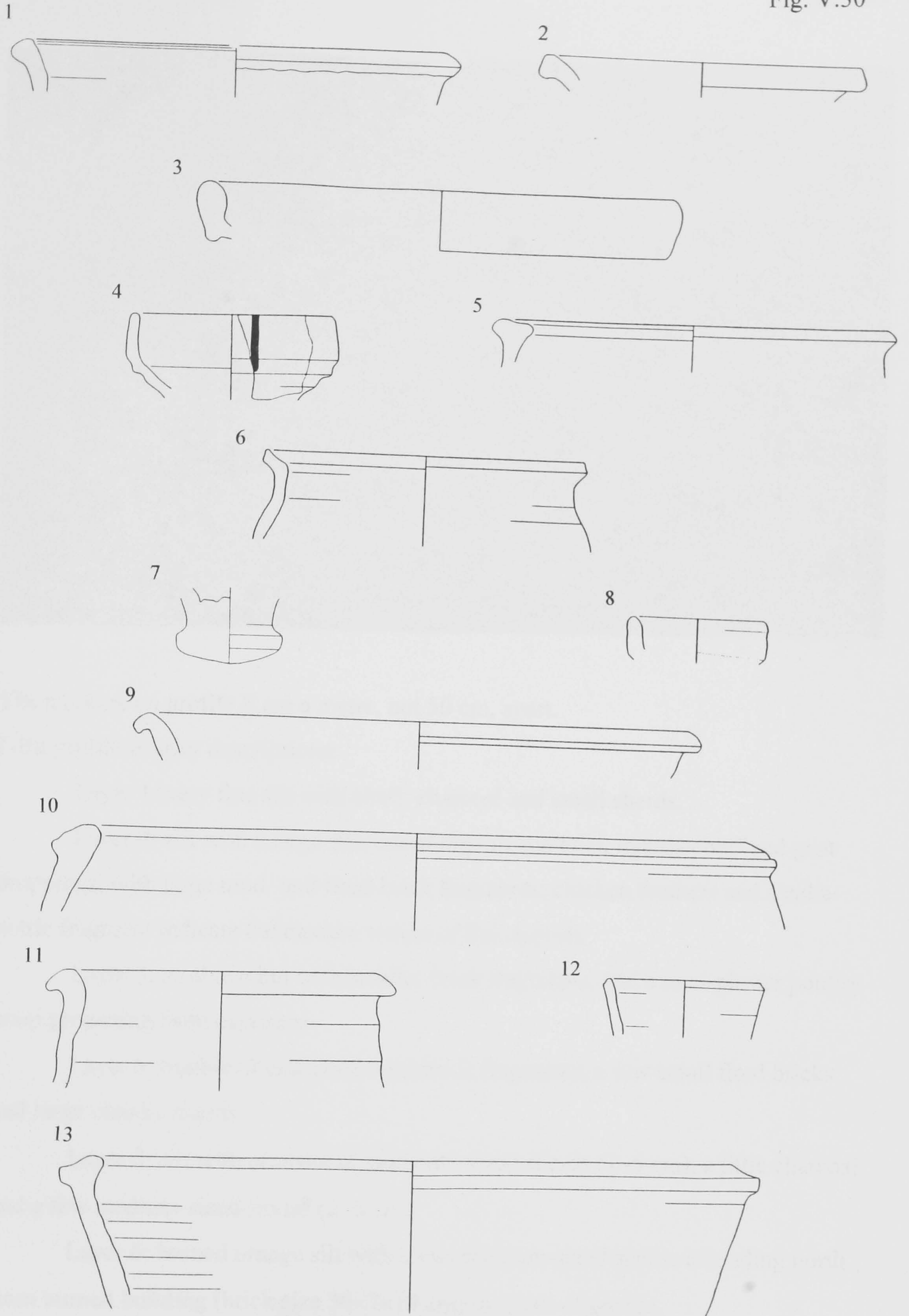

Pottery from profile D, Tell Edfu at 1:3.



The markers on profile E are a metre, not 50 cm, apart.

Edfu profile E layer descriptions:

Layer 1: very fine silt with chaff, charcoal and small sherds.

Layer 2: silt with a large amount of organic material, mainly chaff and goat droppings, with large mud- and fired-brick fragments; chicken feathers and a coke-bottle fragment indicate the modern nature of this deposit.

Layer 3: as above but with smaller brick fragments, and a mud-plaster poultry coop projecting from exposure.

Layer 4: tumble of collapsed mud-brick fragments, a few small fired bricks and large chunky sherds.

Layer 5: silt with occasional moderate-sized sherds (1–5 cm), a little charcoal and a few medium-sized stones (2–6 cm).

Layer 6: burned orange silt with a few medium-sized sherds extending north from burned building (brick size 30×7×14 cm) to south of profile.

Edfu profile E pottery

Layer 3

1. *Fabric*: handmade M1. *Surfaces*: burnished light red slip. *Decoration*: black-painted geometric designs. *Diameter*: 32 cm. *Parallels*: Tod, Lp 5, c. 1000–1200 (Pierrat 1991, 169). Related wares, decorated in red over unslipped or cream-slipped surfaces, have been found at: TT99, ware HW2, tenth century (Rose in Strudwick and Strudwick 1996); TT41, nos 23–34, undated (Assmann 1991); TT296, nos 203, 228 and 231, undated (Feucht 1985); Gurna, vessels 2130–50, eighth century or later (Myśliwiec 1987).

Surface of south slope

Further examples of the red-and-black painted ware were collected from the surface of the south slope and are included here to increase the available corpus of this little-known type of pottery.

2. *Fabric*: handmade M1. *Surfaces*: burnished light red slip. *Decoration*: black-painted geometric designs. *Diameter*: 16 cm.
3. *Fabric*: handmade M1. *Surfaces*: burnished light red slip. *Decoration*: black-painted geometric designs. *Diameter*: 28 cm.
4. *Fabric*: handmade M1. *Surfaces*: burnished light red slip. *Decoration*: black-painted geometric designs. *Diameter*: 24 cm.
5. *Fabric*: handmade M1. *Surfaces*: burnished light red slip. *Decoration*: black-painted geometric designs. *Diameter*: 18 cm.

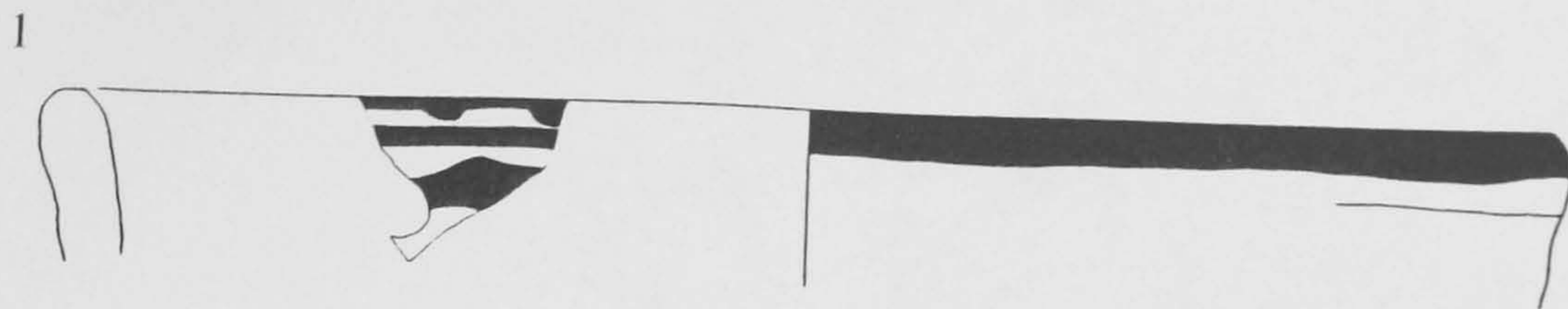



A: Red-and-black painted ware from the south slope (fig. V.33, nos 2–5).



B: Exposed archaeological material east of the *mammisi*, Edfu temple.



A: View of the Fatimid minaret from the temple pylon.

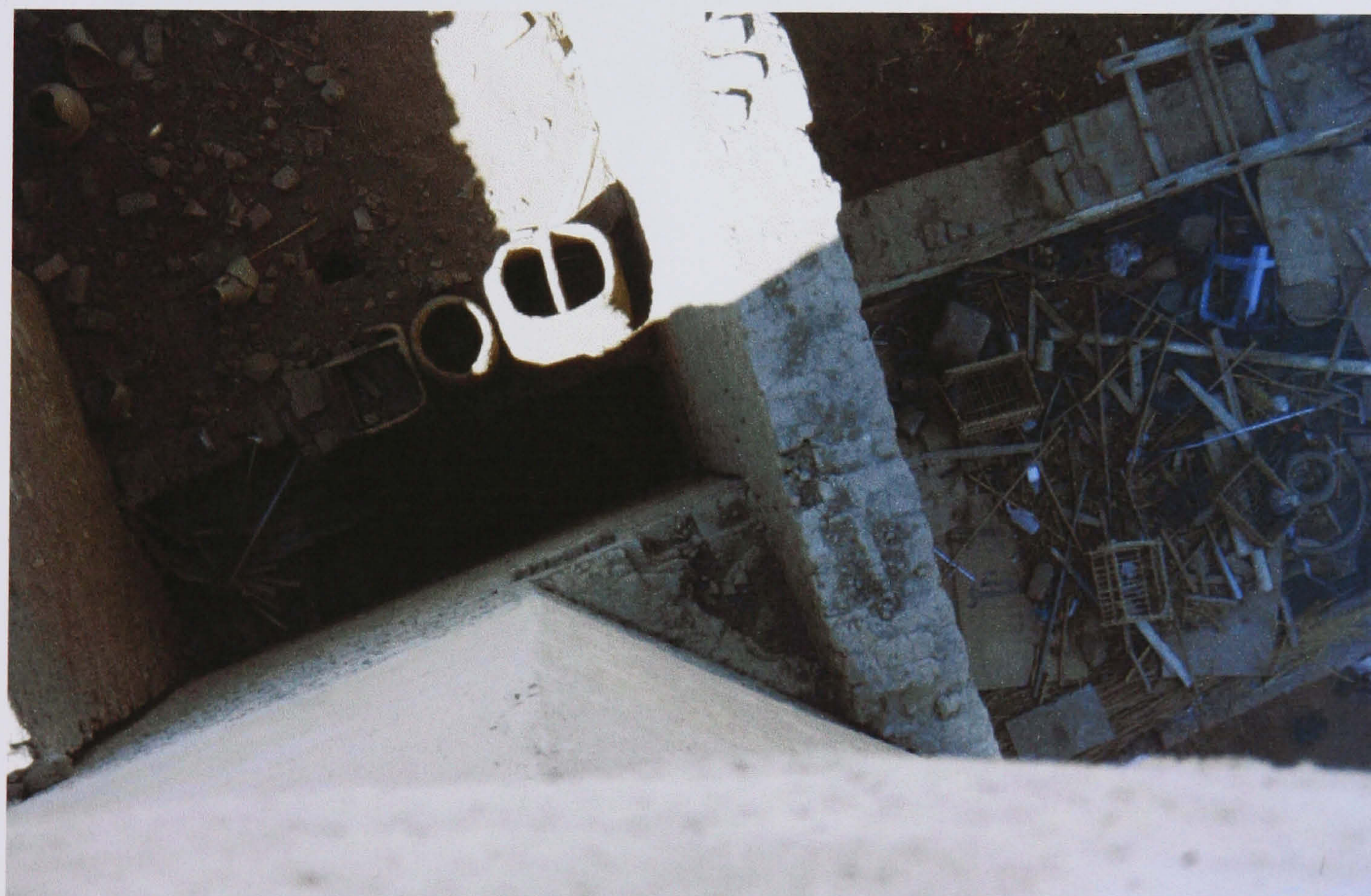

B: Base of minaret from above, showing the structure's square base, separate from and not aligned with the later mosque building (photo Candice Hatherley).



The Fatimid minaret, Edfu.



Model of settlement development at Edfu, demonstrating how a gradual shift in occupation, combined with clearance of certain areas, can give a false impression of dislocation during the early Islamic period despite continuous occupation of the town.

CAMBRIDGE
UNIVERSITY LIBRARY

Attention is drawn to the fact that the copyright of this dissertation rests with its author.

This copy of the dissertation has been supplied on condition that anyone who consults it is understood to recognise that its copyright rests with its author. In accordance with the Law of Copyright no information derived from the dissertation or quotation from it may be published without full acknowledgement of the source being made nor any substantial extract from the dissertation published without the author's written consent.