

A MODEL STRUCTURE FOR COLOURED OPERADS IN SYMMETRIC SPECTRA

JAVIER J. GUTIÉRREZ AND RAINER M. VOGT

ABSTRACT. We describe a model structure for coloured operads with values in the category of symmetric spectra (with the positive model structure), in which fibrations and weak equivalences are defined at the level of the underlying collections. This allows us to treat R -module spectra (where R is a cofibrant ring spectrum) as algebras over a cofibrant spectrum-valued operad with R as its first term. Using this model structure, we give sufficient conditions for homotopical localizations in the category of symmetric spectra to preserve module structures.

1. INTRODUCTION

In a series of papers [BM03], [BM06], [BM07], Berger and Moerdijk studied the homotopy theory of operads and coloured operads in monoidal model categories from an axiomatic point of view. For any cofibrantly generated monoidal model category \mathcal{V} satisfying certain conditions, they described a model structure for the category of C -coloured operads (for a fixed set of colours C) in which the fibrations and the weak equivalences were defined at the level of the underlying collections. The model structure was, in fact, transferred from the model structure on the category of C -coloured collections $\text{Coll}_C(\mathcal{V})$ via the free-forgetful adjunction

$$F: \text{Coll}_C(\mathcal{V}) \rightleftarrows \text{Oper}_C(\mathcal{V}) :: U.$$

This model structure is very useful for proving general results concerning constructions with coloured operads. In this way, one can define, for an operad P , the notion of homotopy P -algebra as an algebra over a cofibrant resolution of P . One can also define a generalization of the W -construction of Boardman-Vogt in monoidal model categories equipped with an interval [BM06]. Berger and Moerdijk also proved a generalization of the homotopy invariance property of algebras over cofibrant operads, extending results of [BV73].

The conditions imposed by Berger and Moerdijk on \mathcal{V} concern the cofibrancy of the unit of the monoidal structure, the existence of a symmetric monoidal fibrant replacement functor, and the existence of a coalgebra interval with a cocommutative comultiplication [BM07, Theorem 2.1]. These conditions hold for

2000 *Mathematics Subject Classification.* 18D50, 55P43, 55P60.

Key words and phrases. Coloured operad; Symmetric spectra; Localization.

the categories of simplicial sets, compactly generated spaces and chain complexes over any commutative ring. However, they do not hold for (symmetric) spectra. In the category of symmetric spectra with the positive model structure, the unit spectrum S is not cofibrant and the existence of a monoidal fibrant replacement functor is not known. In fact, by an argument of Lewis, no monoidal model category of spectra can simultaneously have a cofibrant unit and a symmetric monoidal fibrant replacement functor [Lew91].

One can try to avoid the cofibrancy condition on the unit by enriching the base category over another monoidal model category in which the unit and the intervals are nicer [Kro07, Theorem 2.4]. In his work, Kro considered the category of orthogonal spectra with the positive model structure enriched over compactly generated topological spaces and he proved that the categories of (one-coloured) reduced operads and positive operads in the category of orthogonal spectra admit a transferred model structure. We cannot expect to apply his argument to the category of symmetric spectra, since a symmetric monoidal fibrant replacement is still needed and Kro's functor for orthogonal spectra is not valid for symmetric spectra [Kro07, Remark 3.4].

Here we propose an alternative approach suitable for the category of C -coloured operads with values in symmetric spectra, where C is any set of colours. Given a symmetric monoidal category \mathcal{V} , operads in \mathcal{V} act on any monoidal \mathcal{V} -category \mathcal{E} . For a fixed set of colours C and any monoidal \mathcal{V} -category \mathcal{E} , we describe a coloured operad in \mathcal{V} acting on \mathcal{E} whose algebras are C -coloured operads in \mathcal{E} . The category of symmetric spectra with the positive model structure is a monoidal model category enriched and tensored over the model category of simplicial sets. Combining this with the fact that for any coloured operad P in simplicial sets acting on symmetric spectra there is a model structure on the category of P -algebras [EM06, Theorem 1.3], we produce a model structure for the category of C -coloured operads in symmetric spectra in which fibrations and weak equivalences are defined at the level of the underlying collections.

We use this model structure to prove that enriched homotopical localizations in the category of symmetric spectra preserve algebras over cofibrant operads. In particular, they preserve R -module spectra, where R is a cofibrant ring spectrum. Our proof simplifies considerably the one given in [CGMV10, Theorem 6.1] (which used a coloured operad with two colours in the category of simplicial sets acting on symmetric spectra), since we are now allowed to use spectrum-valued operads. More concretely, for any ring spectrum R there is an operad P_R with $P_R(1) = R$ and 0 otherwise, whose algebras are the R -modules. This operad is cofibrant if R itself is a cofibrant ring spectrum. Thus, if L is an enriched homotopical localization functor in the category of symmetric spectra and M is an R -module, where M is cofibrant (as a spectrum) and R is a cofibrant ring spectrum, then LM has a homotopy unique R -module structure such that the localization map $M \rightarrow LM$ is a map of R -modules.

2. COLOURED OPERADS AND ALGEBRAS IN ENRICHED CATEGORIES

Coloured operads may be defined in any symmetric monoidal category \mathcal{V} and algebras over them make sense in any symmetric monoidal category \mathcal{E} enriched over \mathcal{V} . In this first section, we review some terminology of enriched categories [Bor94, §6], [Hov99, §4.1], [Kel82], and recall the definition of coloured operads and their algebras [BV73], [EM06, §2], [Lei04].

Throughout the paper, \mathcal{V} will denote a cocomplete closed symmetric monoidal category with unit I and tensor product \otimes . We will denote by 0 an initial object of \mathcal{V} .

A functor $F: \mathcal{V} \rightarrow \mathcal{V}'$ between symmetric monoidal categories is called *symmetric monoidal* if it is equipped with a unit $I_{\mathcal{V}'} \rightarrow F(I_{\mathcal{V}})$ and a binatural transformation $F(-) \otimes_{\mathcal{V}'} F(-) \rightarrow F(- \otimes_{\mathcal{V}} -)$ satisfying the usual associativity, symmetry and unit conditions. A symmetric monoidal functor is called *strong* if the structure maps are isomorphisms.

2.1. Enriched categories. A *category enriched over \mathcal{V}* is a category \mathcal{E} together with an enrichment functor

$$\mathrm{Hom}_{\mathcal{E}}(-, -): \mathcal{E}^{\mathrm{op}} \times \mathcal{E} \rightarrow \mathcal{V}$$

and, for every X, Y and Z in \mathcal{E} , composition morphisms

$$\mathrm{Hom}_{\mathcal{E}}(Y, Z) \otimes \mathrm{Hom}_{\mathcal{E}}(X, Y) \rightarrow \mathrm{Hom}_{\mathcal{E}}(X, Z)$$

satisfying the associativity law, and morphisms

$$I \rightarrow \mathrm{Hom}_{\mathcal{E}}(X, X)$$

which are left and right identities for the composition morphisms.

A \mathcal{V} -*module category* \mathcal{E} is a category enriched and tensored over \mathcal{V} , i.e., equipped with a functor

$$- \otimes -: \mathcal{V} \times \mathcal{E} \rightarrow \mathcal{E}$$

such that the following two conditions hold:

(i) There are natural isomorphisms

$$(2.1) \quad A \otimes (B \otimes X) \cong (A \otimes B) \otimes X, \quad I \otimes X \cong X$$

for every A and B in \mathcal{V} and every X in \mathcal{E} , rendering certain coherence diagrams commutative (see [Hov99, §4.1] for details).

(ii) There are natural isomorphisms

$$\mathcal{E}(A \otimes X, Y) \cong \mathcal{V}(A, \mathrm{Hom}_{\mathcal{E}}(X, Y))$$

for every X and Y in \mathcal{E} , and every A in \mathcal{V} .

In particular, when $A = I$, the condition $\mathcal{E}(X, Y) \cong \mathcal{V}(I, \mathrm{Hom}_{\mathcal{E}}(X, Y))$ holds for all X, Y .

A *monoidal \mathcal{V} -module category* \mathcal{E} is a symmetric monoidal category that is also a \mathcal{V} -module category and such that the \mathcal{V} -action commutes with the monoidal product of \mathcal{E} . That is, there are natural isomorphisms

$$(2.2) \quad A \otimes (X \otimes Y) \cong (A \otimes X) \otimes Y$$

for every X and Y in \mathcal{E} and every A in \mathcal{V} ; see [Fre09, §1.1.2, §1.1.12]. We will refer to monoidal \mathcal{V} -module categories as *monoidal \mathcal{V} -categories*. Any closed symmetric monoidal category \mathcal{V} is enriched over itself and a monoidal \mathcal{V} -category.

Lemma 2.1. *If \mathcal{E} is a monoidal \mathcal{V} -category, then the functor from \mathcal{V} to \mathcal{E} sending every object A in \mathcal{V} to $\tilde{A} = A \otimes I_{\mathcal{E}}$, where $I_{\mathcal{E}}$ denotes the unit of the monoidal structure of \mathcal{E} , is strong symmetric monoidal.*

Proof. Using the natural isomorphisms (2.1) and (2.2), we have that $\tilde{I} \cong I_{\mathcal{E}}$ and that

$$\begin{aligned} \tilde{A} \otimes \tilde{B} &\cong (A \otimes I_{\mathcal{E}}) \otimes (B \otimes I_{\mathcal{E}}) \cong A \otimes (I_{\mathcal{E}} \otimes (B \otimes I_{\mathcal{E}})) \cong \\ &A \otimes (B \otimes I_{\mathcal{E}}) \cong (A \otimes B) \otimes I_{\mathcal{E}} \cong \widetilde{A \otimes B} \end{aligned}$$

for every A and B in \mathcal{V} . □

2.2. Coloured operads. Let C be any set, whose elements will be called *colours*. A *C -coloured collection* K in \mathcal{V} consists of a set of objects $K(c_1, \dots, c_n; c)$ in \mathcal{V} for each $(n+1)$ -tuple of colours $(c_1, \dots, c_n; c)$ equipped with a right action of the symmetric group Σ_n by means of maps

$$\alpha^* : K(c_1, \dots, c_n; c) \longrightarrow K(c_{\alpha(1)}, \dots, c_{\alpha(n)}; c),$$

where $\alpha \in \Sigma_n$ (if $n = 0$ or $n = 1$, then Σ_n is the trivial group).

A *morphism* of C -coloured collections $\varphi : K \longrightarrow K'$ is a family of maps

$$\varphi_{c_1, \dots, c_n; c} : K(c_1, \dots, c_n; c) \longrightarrow K'(c_1, \dots, c_n; c)$$

in \mathcal{V} , ranging over all $n \geq 0$ and all $(n+1)$ -tuples $(c_1, \dots, c_n; c)$, and compatible with the action of the symmetric groups. The category of C -coloured collections in \mathcal{V} is denoted by $\text{Coll}_C(\mathcal{V})$.

Definition 2.2. A *C -coloured operad* P in \mathcal{V} is a C -coloured collection equipped with unit maps $I \longrightarrow P(c; c)$ for every $c \in C$ and, for every $(n+1)$ -tuple of colours $(c_1, \dots, c_n; c)$ and n given tuples

$$(a_{1,1}, \dots, a_{1,k_1}; c_1), \dots, (a_{n,1}, \dots, a_{n,k_n}; c_n),$$

a *composition product* map

$$\begin{array}{c} P(c_1, \dots, c_n; c) \otimes P(a_{1,1}, \dots, a_{1,k_1}; c_1) \otimes \cdots \otimes P(a_{n,1}, \dots, a_{n,k_n}; c_n) \\ \downarrow \\ P(a_{1,1}, \dots, a_{1,k_1}, a_{2,1}, \dots, a_{2,k_2}, \dots, a_{n,1}, \dots, a_{n,k_n}; c), \end{array}$$

compatible with the action of the symmetric groups and subject to associativity and unitary compatibility relations; see, for example, [EM06, §2].

Remark 2.3. Alternatively, one can replace the composition product in the definition of a C -coloured operad by the \circ_i -operations

$$\begin{array}{c} P(c_1, \dots, c_i, \dots, c_n; c) \otimes P(a_1, \dots, a_m; c_i) \\ \downarrow \circ_i \\ P(c_1, \dots, c_{i-1}, a_1, \dots, a_m, c_{i+1}, \dots, c_n; c) \end{array}$$

for every $(n+1)$ -tuple (c_1, \dots, c_n, c) , every m -tuple (a_1, \dots, a_m) , and all $1 \leq i \leq n$. The \circ_i -operations are compatible with the action of Σ_n and are subject to the usual associativity and unitary compatibility relations; see, for example, [Lei04, §2.1]. We will make use of both definitions in the next section.

A morphism of C -coloured operads is a morphism of the underlying C -coloured collections that is compatible with the unit maps and the composition product maps (or the \circ_i -operations). The category of C -coloured operads in \mathcal{V} will be denoted by $\text{Oper}_C(\mathcal{V})$. There is a free-forgetful adjunction

$$(2.3) \quad F: \text{Coll}_C(\mathcal{V}) \rightleftarrows \text{Oper}_C(\mathcal{V}): U$$

where U is the forgetful functor, and the left adjoint is the free coloured operad generated by a collection.

2.3. Algebras over coloured operads. Algebras over operads can be defined in any monoidal \mathcal{V} -category \mathcal{E} , as follows. Let \mathcal{E}^C denote the product category $\prod_{c \in C} \mathcal{E}$ indexed by the set of colours C . For every object $\mathbf{X} = (X(c))_{c \in C} \in \mathcal{E}^C$, the *endomorphism C -coloured operad* $\text{End}(\mathbf{X})$ in \mathcal{V} associated with \mathbf{X} is defined by

$$\text{End}(\mathbf{X})(c_1, \dots, c_n; c) = \text{Hom}_{\mathcal{E}}(X(c_1) \otimes \dots \otimes X(c_n); X(c))$$

where $X(c_1) \otimes \dots \otimes X(c_n)$ is meant to be the unit of the monoidal category \mathcal{E} if $n = 0$. The composition product is ordinary composition and the Σ_n -action is defined by permutation of the factors.

Definition 2.4. Let P be any C -coloured operad in \mathcal{V} . An *algebra over P* or a *P -algebra* in \mathcal{E} is an object $\mathbf{X} = (X(c))_{c \in C}$ of \mathcal{E}^C together with a morphism

$$P \longrightarrow \text{End}(\mathbf{X})$$

of C -coloured operads in \mathcal{V} .

Equivalently, a P -algebra in \mathcal{E} can be defined as a family of objects $X(c)$ in \mathcal{E} for all $c \in C$, together with maps

$$P(c_1, \dots, c_n; c) \otimes X(c_1) \otimes \dots \otimes X(c_n) \longrightarrow X(c)$$

for every $(n+1)$ -tuple (c_1, \dots, c_n, c) , compatible with the symmetric group action, the units of P , and subject to the usual associativity relations.

A map of P -algebras $\mathbf{f}: \mathbf{X} \rightarrow \mathbf{Y}$ is a family of maps $(f_c: X(c) \rightarrow Y(c))_{c \in C}$ in \mathcal{E} such that the diagram of C -coloured collections

$$\begin{array}{ccc} P & \longrightarrow & \text{End}(\mathbf{X}) \\ \downarrow & & \downarrow \\ \text{End}(\mathbf{Y}) & \longrightarrow & \text{Hom}(\mathbf{X}, \mathbf{Y}) \end{array}$$

commutes, where the top and left arrows are the P -algebra structures on \mathbf{X} and \mathbf{Y} respectively, and the C -coloured collection $\text{Hom}(\mathbf{X}, \mathbf{Y})$ is defined as

$$\text{Hom}(\mathbf{X}, \mathbf{Y})(c_1, \dots, c_n; c) = \text{Hom}_{\mathcal{E}}(X(c_1) \otimes \dots \otimes X(c_n), Y(c)).$$

The arrows $\text{End}(\mathbf{X}) \rightarrow \text{Hom}(\mathbf{X}, \mathbf{Y})$ and $\text{End}(\mathbf{Y}) \rightarrow \text{Hom}(\mathbf{X}, \mathbf{Y})$ are induced by \mathbf{f} by composing on each side.

If the category \mathcal{V} has pullbacks, then a map \mathbf{f} of P -algebras can be seen as a map of C -coloured operads

$$P \rightarrow \text{End}(\mathbf{f}),$$

where the C -coloured operad $\text{End}(\mathbf{f})$ is obtained as the pullback of the diagram of C -coloured collections

$$\begin{array}{ccc} \text{End}(\mathbf{f}) & \dashrightarrow & \text{End}(\mathbf{X}) \\ \vdots \downarrow & & \downarrow \\ \text{End}(\mathbf{Y}) & \longrightarrow & \text{Hom}(\mathbf{X}, \mathbf{Y}). \end{array}$$

The C -coloured collection $\text{End}(\mathbf{f})$ inherits indeed a C -coloured operad structure in \mathcal{V} from the C -coloured operads $\text{End}(\mathbf{X})$ and $\text{End}(\mathbf{Y})$, as observed in [BM03, Theorem 3.5]. We will denote the category of P -algebras in \mathcal{E} by $\text{Alg}_P(\mathcal{E})$.

For any monoidal \mathcal{V} -category \mathcal{E} , the functor from \mathcal{V} to \mathcal{E} sending each object A in \mathcal{V} to $\tilde{A} = A \otimes I_{\mathcal{E}}$ is strong symmetric monoidal (Lemma 2.1). Hence, it sends C -coloured operads in \mathcal{V} to C -coloured operads in \mathcal{E} . Moreover, if P is a C -coloured operad in \mathcal{V} , then an object \mathbf{X} of \mathcal{E}^C is a P -algebra if and only if it is a \tilde{P} -algebra.

3. COLOURED OPERADS AS ALGEBRAS

The following is an example of a coloured operad whose algebras are C -coloured operads for a fixed set of colours C . It is initially constructed in the category of sets, but can be transported to an arbitrary symmetric monoidal category via the strong symmetric monoidal functor that sends a set to a coproduct of copies of the unit of the monoidal category (indexed by the elements of the set). The description of this operad is made in terms of trees, so we need to introduce some terminology on them first.

3.1. Trees. A *tree* T is a connected finite graph with no loops. We denote the set of vertices of T by $V(T)$ and the set of edges of T by $E(T)$. Edges are directed. There are two different types of edges: the ones with a vertex at both ends, called *inner edges*, and the ones with a vertex only at one end or with no vertices, called *external edges*. A *rooted tree* is a tree where each vertex v has exactly one outgoing edge denoted by $\text{out}(v)$ and a set $\text{in}(v)$ of incoming edges whose elements are called *inputs* of v (note that $\text{in}(v)$ can be empty). The cardinality of $\text{in}(v)$ is called the *valence* of v . Consequently, in our trees there is a unique external edge leaving a vertex; we call it the *root* or *output edge* of T . The other external edges form the set $\text{in}(T)$ of *input edges* or *leaves* of T .

A *planar rooted tree* is a rooted tree T together with a linear ordering of $\text{in}(v)$ for each vertex v of T .

When drawing rooted trees in the plane, we represent them as oriented towards the output, drawn at the bottom, with the canonical orientation from the leaves towards the root. In this case, the linear order appears from reading the incoming edges from left to right.

Definition 3.1. Let C be any set. A *planar rooted C -coloured tree* is a planar rooted tree T together with a function $c_T: E(T) \rightarrow C$, called a *colouring function*.

3.2. The coloured operad S^C in sets. Let C be a set of colours. We define a D -coloured collection S^C in *Sets*, where

$$D = \{(c_1, \dots, c_n; c) \mid c_i, c \in C, n \geq 0\}.$$

This collection can be endowed with a D -coloured operad structure whose algebras are C -coloured operads in *Sets* as follows. We use the following notation for the elements of the set D :

$$\bar{c}_i = (c_{i,1}, \dots, c_{i,k_i}; c_i) \text{ and } \bar{a} = (a_1, \dots, a_m; a).$$

For each $(n+1)$ -tuple of colours $(\bar{c}_1, \dots, \bar{c}_n; \bar{a})$, the elements of $S^C(\bar{c}_1, \dots, \bar{c}_n; \bar{a})$ are equivalence classes of triples (T, σ, τ) , where:

- (i) T is a planar rooted C -coloured tree with m input edges coloured by a_1, \dots, a_m , a root edge coloured by a , and n vertices.
- (ii) σ is a bijection $\sigma: \{1, \dots, n\} \rightarrow V(T)$ with the property that $\sigma(i)$ has k_i input edges coloured from left to right by $c_{i,1}, \dots, c_{i,k_i}$ and one output edge coloured by c_i .
- (iii) τ is a bijection $\tau: \{1, \dots, m\} \rightarrow \text{in}(T)$ such that $\tau(i)$ has colour a_i .

Two such triples (T, σ, τ) , (T', σ', τ') are equivalent if and only if there is a planar isomorphism $\varphi: T \rightarrow T'$ such that $\varphi \circ \sigma = \sigma'$, $\varphi \circ \tau = \tau'$ and φ respects the colouring, i.e., if e is an edge of T of colour c , then the edge $\varphi(e)$ in T' has colour c too.

Example 3.2. If $C = \{a, b, c\}$, then an element of

$$S^C((a, b; c), (b, b; a), (\ ; a), (c, a, a; b); (b, b, a, c; c))$$

is represented, for example, by a tree

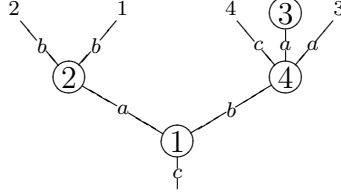

Any permutation $\alpha \in \Sigma_n$ induces a map

$$\alpha^*: S^C(\bar{c}_1, \dots, \bar{c}_n; \bar{a}) \longrightarrow S^C(\bar{c}_{\alpha(1)}, \dots, \bar{c}_{\alpha(n)}; \bar{a})$$

that sends (T, σ, τ) to $(T, \sigma \circ \alpha, \tau)$. That is, $\alpha^*(T)$ is the same tree as T but with a renumbering of the vertices given by α .

Let α be any element in Σ_m and $\bar{a}_1 = (a_{\alpha(1)}, \dots, a_{\alpha(m)}; a)$. Then the set $S^C(\bar{a}_1; \bar{a})$ can be identified with the subset of elements of Σ_m that permute the element $(a_{\alpha(1)}, \dots, a_{\alpha(m)})$ into (a_1, \dots, a_m) . In particular, if $\bar{a} = \bar{a}_1$ then the set $S^C(\bar{a}; \bar{a})$ can be identified with the (opposite) subgroup of Σ_m that leaves the colours a_1, \dots, a_m invariant.

Proposition 3.3. *The D -coloured collection S^C admits a D -coloured operad structure in *Sets*.*

Proof. There is a distinguished element $1_{\bar{a}}$ in $S^C(\bar{a}; \bar{a})$ corresponding to the tree

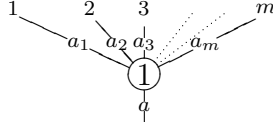

for every $\bar{a} \in D$. These elements will be the units of the coloured operad S^C .

The composition product on S^C is defined as follows. Given an element (T, σ, τ) of $S^C(\bar{c}_1, \dots, \bar{c}_n; \bar{a})$ and n elements $(T_1, \sigma_1, \tau_1), \dots, (T_n, \sigma_n, \tau_n)$ of

$$S^C(\bar{d}_{1,1}, \dots, \bar{d}_{1,k_1}; \bar{c}_1), \dots, S^C(\bar{d}_{n,1}, \dots, \bar{d}_{n,k_n}; \bar{c}_n)$$

respectively, we obtain an element T' of

$$S^C(\bar{d}_{1,1}, \dots, \bar{d}_{1,k_1}, \bar{d}_{2,1}, \dots, \bar{d}_{2,k_2}, \dots, \bar{d}_{n,1}, \dots, \bar{d}_{n,k_n}; \bar{a})$$

in the following way:

- (i) T' is obtained by replacing the vertex $\sigma(i)$ of T by the tree T_i for every i . This is done by identifying the input edges of $\sigma(i)$ in T with the input edges of T_i via the bijection τ_i . The $c_{i,j}$ -coloured input edge of $\sigma(i)$ is matched with the $c_{i,j}$ -coloured input edge $\tau_i(j)$ of T_i . (Note that the colours of the input edges and the output of $\sigma(i)$ coincide with the colours of the input edges and the root of T_i .)

- (ii) The vertices of T' are numbered following the order, i.e., first number the subtree T_1 in T' ordered by σ_1 , then T_2 ordered by σ_2 and so on.
- (iii) The input edges of T' are numbered following τ and the identifications given by τ_i .

This composition product is associative and compatible with the units and the action of the symmetric group. \square

Example 3.4. Let $C = \{a, b, c\}$ as before and let T be an element of

$$S^C((a, b; c), (c, b; a), (a, a, a; b); (c, b, a, a, a; c))$$

represented by the tree

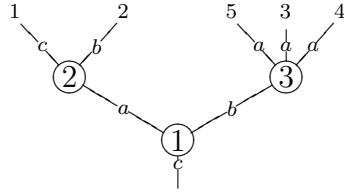

and T_1, T_2 and T_3 be elements of

$$S^C((a, b; c), (c; c); (a, b; c)), S^C((b, b; a), (c; b); (c, b; a)),$$

$$\text{and } S^C((a, a; c), (a, c; b); (a, a, a; b))$$

respectively, represented by the trees

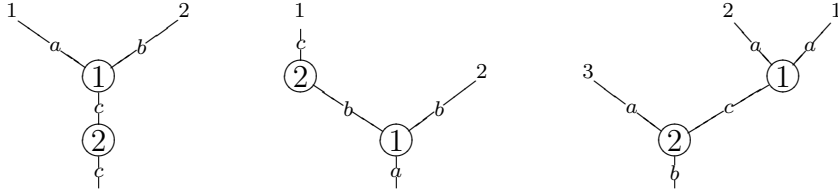

Applying the composition product, we get an element in

$$S^C((a, b; c), (c; c), (b, b; a), (c; b), (a, a; c), (a, c; b); (c, b, a, a, a; c))$$

that is represented by the following tree:

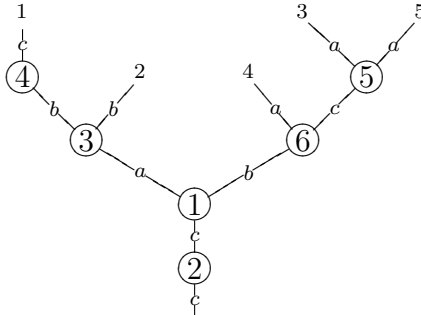

Proposition 3.5. *An algebra over S^C is a C -coloured operad in $\mathcal{S}ets$ and conversely.*

Proof. Recall that the set of colours of S^C is

$$D = \{(c_1, \dots, c_n; c) \mid c_i, c \in C, n \geq 0\}.$$

Thus, an S^C -algebra is given by a family of sets

$$P = (P(c_1, \dots, c_n; c))_{(c_1, \dots, c_n; c) \in D}$$

together with a map of D -coloured operads $S^C \longrightarrow \text{End}(P)$, i.e., maps of sets

$$\Phi: S^C(\bar{c}_1, \dots, \bar{c}_n; \bar{a}) \longrightarrow \mathcal{S}ets(P(\bar{c}_1) \times \dots \times P(\bar{c}_n), P(\bar{a})),$$

where $\bar{c}_i = (c_{i,1}, \dots, c_{i,k_i}; c_i)$ and $\bar{a} = (a_1, \dots, a_m; a)$. In particular, the maps

$$S^C(\ ; (c; c)) \longrightarrow \mathcal{S}ets(*, P(c; c))$$

give the units of P . If $\alpha \in \Sigma_n$, then the right action

$$\alpha^*: P(c_1, \dots, c_n; c) \longrightarrow P(c_{\alpha^{-1}(1)}, \dots, c_{\alpha^{-1}(n)}; c)$$

is defined by taking $\Phi(T)$, where T is the tree

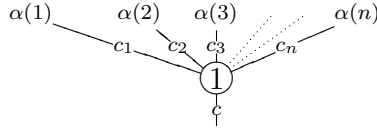

The \circ_i -operations

$$\begin{array}{c} P(c_1, \dots, c_i, \dots, c_n; c) \times P(a_1, \dots, a_m; c_i) \\ \downarrow \circ_i \\ P(c_1, \dots, c_{i-1}, a_1, \dots, a_m, c_{i+1}, \dots, c_n; c) \end{array}$$

of P are defined as the image under Φ of the element

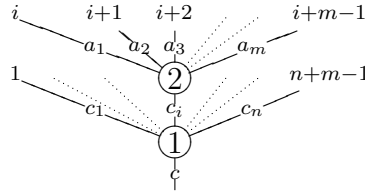

in $S^C((c_1, \dots, c_n; c), (a_1, \dots, a_m; c_i); (c_1, \dots, c_{i-1}, a_1, \dots, a_m, c_{i+1}, \dots, c_n; c))$.

Conversely, if Q is a given C -coloured operad, then any triple (T, σ, τ) in the set $S^C(\bar{c}_1, \dots, \bar{c}_n; \bar{a})$ acts on an element $(e_1, \dots, e_n) \in Q(\bar{c}_1) \times \dots \times Q(\bar{c}_n)$ by labeling the vertex $\sigma(i)$ of T by e_i , and then using the coloured operad structure of Q to compose (e_1, \dots, e_n) along the tree T to obtain an element $e \in Q(\bar{a})$, and then applying the right action by τ to this element. \square

3.3. The coloured operad S^C in monoidal categories. The operad S^C can be transported to any closed symmetric monoidal category \mathcal{V} to obtain a coloured operad in \mathcal{V} whose algebras are C -coloured operads in \mathcal{E} , where \mathcal{E} is any monoidal \mathcal{V} -category. More precisely, if \mathcal{V} is any closed symmetric monoidal category, then the strong symmetric monoidal functor $(-)_\mathcal{V}: \mathbf{Sets} \rightarrow \mathcal{V}$ defined as

$$A_\mathcal{V} = \coprod_{x \in A} I$$

for every set A sends coloured operads to coloured operads. Hence, by applying this functor to the coloured operad S^C in \mathbf{Sets} , we obtain another coloured operad $S_\mathcal{V}^C$ in \mathcal{V} whose algebras in \mathcal{V} are precisely C -coloured operads in \mathcal{V} .

If \mathcal{E} is a monoidal \mathcal{V} -category, then coloured operads in \mathcal{V} act on \mathcal{E} . Thus, $S_\mathcal{V}^C$ is a coloured operad in \mathcal{V} whose algebras in \mathcal{E} are C -coloured operads in \mathcal{E} .

Remark 3.6. We will use $S_\mathcal{V}^C$ to obtain a model structure for coloured operads in symmetric spectra. There is an alternative approach: the category of C -coloured collections is strictly monoidal [BM07, Appendix] and the monoids in this category are the C -coloured operads, i.e., a C -coloured operad is an algebra over the non-symmetric operad encoding monoid structures. We have chosen the present way for two reasons. Firstly, we believe that the operad $S_\mathcal{V}^C$ is of interest in its own right. Secondly, we cannot directly use the results of Berger and Mordijk [BM03, BM07], who only work in *symmetric* monoidal categories, since the category of C -coloured collections is *not* symmetric monoidal.

4. COLOURED OPERADS WITH VALUES IN SYMMETRIC SPECTRA

We recall from [BM07] the basic properties and terminology of a model structure for the category of coloured operads in a symmetric monoidal model category. We assume that our model categories have functorial factorizations, as in [Hov99] and [Hir03].

4.1. Enriched model categories. A *monoidal model category* \mathcal{V} is a closed symmetric monoidal category with a model structure satisfying the following conditions:

- (i) *Pushout-product axiom.* If $f: A \rightarrow B$ and $g: U \rightarrow V$ are two cofibrations in \mathcal{V} , then the induced map

$$(4.1) \quad (A \otimes V) \coprod_{A \otimes U} (B \otimes U) \rightarrow B \otimes V$$

is a cofibration that is trivial if f or g is trivial. A direct consequence of the pushout-product axiom is that tensoring with a cofibrant object preserves cofibrations (and trivial cofibrations), and that the tensor product of two cofibrations with cofibrant domains is again a cofibration.

(ii) *Unit axiom.* The natural map

$$q \otimes 1: QI \otimes A \longrightarrow I \otimes A$$

is a weak equivalence in \mathcal{V} for every cofibrant A , where Q denotes the cofibrant replacement functor of \mathcal{V} . The unit axiom holds trivially if the unit of \mathcal{V} is cofibrant.

Let \mathcal{V} be a monoidal model category. A *model category enriched over \mathcal{V}* is a category \mathcal{E} enriched over \mathcal{V} with a model structure such that the enrichment $\mathrm{Hom}_{\mathcal{E}}(-, -)$ satisfies an analog of Quillen's (SM7) axiom for simplicial categories; namely, if $f: X \longrightarrow Y$ is a cofibration in \mathcal{E} and $g: W \longrightarrow Z$ is a fibration in \mathcal{E} , then the induced map

$$(4.2) \quad \mathrm{Hom}_{\mathcal{E}}(Y, W) \longrightarrow \mathrm{Hom}_{\mathcal{E}}(Y, Z) \times_{\mathrm{Hom}_{\mathcal{E}}(X, Z)} \mathrm{Hom}_{\mathcal{E}}(X, W)$$

is a fibration in \mathcal{V} that is trivial if f or g is trivial.

Recall from [Hov99, Definition 4.2.18] that a *\mathcal{V} -module model category* is a \mathcal{V} -module category \mathcal{E} with a model structure such that:

- (i) The functor $- \otimes -: \mathcal{V} \times \mathcal{E} \longrightarrow \mathcal{E}$ is a Quillen bifunctor, that is, the pushout-product of a cofibration in \mathcal{V} and a cofibration in \mathcal{E} is a cofibration in \mathcal{E} .
- (ii) The map $q \otimes 1: QI \otimes X \longrightarrow I \otimes X$ is a weak equivalence in \mathcal{E} for every cofibrant object X in \mathcal{E} .

A *monoidal \mathcal{V} -model category* is a \mathcal{V} -module model category \mathcal{E} that is also a monoidal model category and such that the \mathcal{V} -action commutes with the monoidal product of \mathcal{E} (see [Fre09, §11.3.3, §11.3.4]), i.e., there are natural coherent isomorphisms

$$A \otimes (X \otimes Y) \cong (A \otimes X) \otimes Y$$

for every X, Y in \mathcal{E} and every A in \mathcal{V} . Any monoidal model category \mathcal{E} is a monoidal \mathcal{E} -model category.

4.2. Model structures for coloured operads. For any cofibrantly generated monoidal model category \mathcal{V} , the category of C -coloured collections $\mathrm{Coll}_C(\mathcal{V})$ admits a cofibrantly generated model structure in which a morphism $K \longrightarrow L$ is a weak equivalence or a fibration if for each $(n + 1)$ -tuple of colours $(c_1, \dots, c_n; c)$, the map

$$K(c_1, \dots, c_n; c) \longrightarrow L(c_1, \dots, c_n; c)$$

is a weak equivalence or a fibration, respectively, in \mathcal{V} . This model structure can be transferred along the free-forgetful adjunction (2.3),

$$F: \mathrm{Coll}_C(\mathcal{V}) \rightleftarrows \mathrm{Oper}_C(\mathcal{V}): U,$$

to provide a model structure on the category of C -coloured operads in \mathcal{V} , if any sequential colimit of pushouts of images under F of the generating trivial cofibrations of $\mathrm{Coll}_C(\mathcal{V})$ yields a weak equivalence in $\mathrm{Coll}_C(\mathcal{V})$ after applying the forgetful functor (cf. [Cra95, §3], [Hir03, Theorem 11.3.2]). In this model

structure, a morphism of C -coloured operads $f: P \rightarrow Q$ is a weak equivalence or a fibration if and only if $U(f)$ is a weak equivalence or a fibration of C -coloured collections, respectively.

Although this assumption is usually hard to verify, it is satisfied if we assume that the unit of \mathcal{V} is cofibrant, the existence of a symmetric monoidal fibrant replacement functor for \mathcal{V} , and the existence of an interval with a coassociative and cocommutative comultiplication [BM07, Theorem 2.1]. Recall that a *symmetric monoidal fibrant replacement functor* in \mathcal{V} is a fibrant replacement functor F that is symmetric monoidal and such that for every X and Y in \mathcal{V} the following diagram commutes:

$$\begin{array}{ccc} X \otimes Y & \xrightarrow{r_{X \otimes Y}} & F(X \otimes Y) \\ r_X \otimes r_Y \downarrow & \nearrow & \\ FX \otimes F(Y), & & \end{array}$$

where $r: \text{Id}_{\mathcal{V}} \rightarrow F$ is the natural transformation associated with the fibrant replacement.

The categories of simplicial sets or k -spaces (with the Quillen model structure), among others, satisfy the conditions above.

4.3. Coloured operads in symmetric spectra. We denote by $\mathcal{S}p^{\Sigma}$ the category of symmetric spectra. When we refer to its model structure, we will understand it as the *positive model structure*, as described in [MMSS01] or in [Shi04]. The weak equivalences are the usual stable weak equivalences, and positive cofibrations are stable cofibrations with the additional assumption that they are isomorphisms in level zero. Positive fibrations are defined by the right lifting property with respect to the trivial positive cofibrations. With this model structure, the category of symmetric spectra is a cofibrantly generated proper monoidal model category.

However, the assumptions required in [BM07, Theorem 2.1] are not satisfied for this category. In the category of symmetric spectra with the positive model structure, the unit spectrum S is not cofibrant, and the existence of a symmetric monoidal fibrant replacement functor is not known. In fact, by an argument of Lewis [Lew91], no symmetric monoidal model category of spectra can simultaneously have a cofibrant unit and a symmetric monoidal fibrant replacement functor. In this section we show how we can avoid this problem by using the coloured operad described in Section 3.

Let \mathcal{E} be a monoidal \mathcal{V} -model category and P any C -coloured operad in \mathcal{V} . Then there is an adjoint pair

$$F_P: \mathcal{E}^C \rightleftarrows \text{Alg}_P(\mathcal{E}): U_P,$$

where F_P is the free P -algebra functor defined as

$$F_P(\mathbf{X})(c) = \coprod_{n \geq 0} \left(\prod_{c_1, \dots, c_n \in C} P(c_1, \dots, c_n; c) \otimes_{\Sigma_n} X(c_1) \otimes \cdots \otimes X(c_n) \right)$$

for every $\mathbf{X} = (X(c))_{c \in C}$ in \mathcal{E}^C , and U_P is the forgetful functor. Following the terminology of [BM07], we say that a C -coloured operad P in \mathcal{V} is *admissible* in \mathcal{E} if the model structure on \mathcal{E}^C is transferred to $\text{Alg}_P(\mathcal{E})$ along this adjunction. Thus, if P is admissible, then $\text{Alg}_P(\mathcal{E})$ has a model structure where a map of P -algebras $\mathbf{f}: \mathbf{X} \rightarrow \mathbf{Y}$ is a weak equivalence or a fibration if and only if

$$f_c: X(c) \rightarrow Y(c)$$

is a weak equivalence or a fibration, respectively, in \mathcal{E} for every $c \in C$.

The category of symmetric spectra $\mathcal{S}p^\Sigma$ with the positive model structure is a monoidal *sSets*-model category, where *sSets* denotes the category of simplicial sets with the usual model structure. We recall the following admissibility result from [EM06, Theorem 1.3]:

Theorem 4.1. *If we consider the positive model structure in $\mathcal{S}p^\Sigma$, then any coloured operad P in simplicial sets is admissible in $\mathcal{S}p^\Sigma$. \square*

Using the coloured operad of Section 3, we obtain a model structure for coloured operads in symmetric spectra.

Corollary 4.2. *Let C be a fixed set of colours. Then the category of C -coloured operads in symmetric spectra admits a model structure in which the weak equivalences are the colourwise stable equivalences and the fibrations are the colourwise positive stable fibrations of symmetric spectra.*

Proof. Consider the coloured operad S_V^C of Section 3, where \mathcal{V} is now the category of simplicial sets. The category of C -coloured operads in $\mathcal{S}p^\Sigma$ is the category of S_V^C -algebras in $\mathcal{S}p^\Sigma$, and the latter has a model structure by Theorem 4.1. \square

Remark 4.3. Recall that if \mathcal{E} is a cocomplete category and \mathcal{I} is a set of maps in \mathcal{E} , then the subcategory of relative \mathcal{I} -cell complexes is the subcategory of maps that can be constructed as transfinite compositions of pushouts of elements of \mathcal{I} . The admissibility of every coloured operad with values in simplicial sets in the category of symmetric spectra is based on the fact that every relative $F_P(\mathcal{J})$ -complex is a stable equivalence, where \mathcal{J} is the set of generating trivial cofibrations of \mathcal{E}^C with $\mathcal{E} = \mathcal{S}p^\Sigma$ (see [EM06, Lemma 11.7]). In fact, Theorem 4.1 and its corollary remain valid for any cofibrantly generated monoidal \mathcal{V} -category \mathcal{E} with this property.

Remark 4.4. In a recent paper [Kro07], Kro proved that the category of reduced operads and the category of positive operads in orthogonal spectra with the positive model structure admits a transferred model structure, by constructing a symmetric monoidal fibrant replacement functor. Recall that an operad P in a

monoidal category \mathcal{V} is *positive* if $P(0) = 0$, and it is *reduced* if $P(0) = I$, where I is the unit of \mathcal{V} .

In fact, he extended the results of [BM03] to reduced and positive operads in a monoidal \mathcal{V} -model category \mathcal{E} where the unit is not necessarily cofibrant (although the symmetric monoidal fibrant replacement functor assumption is still needed), but \mathcal{V} has a nice unit and Hopf intervals (see [Kro07, Theorem 2.4] for an explicit statement). Observe that we cannot apply the result of Kro in our case, since we do not have a symmetric monoidal fibrant replacement functor, and his candidate for orthogonal spectra is not valid for symmetric spectra (see [Kro07, Remark 3.4]).

5. LOCALIZATION OF MODULE STRUCTURES

5.1. Enriched homotopical localization. Let \mathcal{E} be a \mathcal{V} -module model category as in Section 4.1. For all X and Y in \mathcal{E} , we define

$$\mathrm{hom}_{\mathcal{E}}(X, Y) = \mathrm{Hom}_{\mathcal{E}}(QX, FY),$$

where Q denotes a functorial cofibrant replacement and F denotes a functorial fibrant replacement. We call the object $\mathrm{hom}_{\mathcal{E}}(-, -)$ a *homotopy \mathcal{V} -function complex*. Note that $\mathrm{hom}_{\mathcal{E}}(-, -)$ is always fibrant in \mathcal{V} by (4.2). A morphism $X \rightarrow Y$ and an object Z in \mathcal{E} are called *\mathcal{V} -orthogonal* if the induced map

$$\mathrm{hom}_{\mathcal{E}}(Y, Z) \rightarrow \mathrm{hom}_{\mathcal{E}}(X, Z)$$

is a weak equivalence in \mathcal{V} .

The following definition extends [CGMV10, Definition 4.1].

Definition 5.1. An *enriched homotopical localization* in a \mathcal{V} -module model category \mathcal{E} is a functor $L: \mathcal{E} \rightarrow \mathcal{E}$ that preserves weak equivalences and takes fibrant values, together with a natural transformation $\eta: \mathrm{Id}_{\mathcal{E}} \rightarrow L$ such that, for every X in \mathcal{E} , the following hold:

- (i) $L\eta_X: LX \rightarrow LLX$ is a weak equivalence in \mathcal{E} .
- (ii) η_{LX} and $L\eta_X$ are equal in the homotopy category $\mathrm{Ho}(\mathcal{E})$.
- (iii) For every X in \mathcal{E} , the map $\eta_X: X \rightarrow LX$ is a cofibration such that the induced map

$$\mathrm{hom}_{\mathcal{E}}(LX, LY) \rightarrow \mathrm{hom}_{\mathcal{E}}(X, LY)$$

is a weak equivalence in \mathcal{V} for all Y in \mathcal{E} .

If L is an enriched homotopical localization, then the fibrant objects of \mathcal{E} weakly equivalent to LX for some X are called *L -local*, and the maps f such that Lf is a weak equivalence are called *L -equivalences*. L -local objects and L -equivalences are \mathcal{V} -orthogonal. In fact, a fibrant object is L -local if and only if it is \mathcal{V} -orthogonal to all L -equivalences, and a map is an L -equivalence if and only if it is \mathcal{V} -orthogonal to all L -local objects.

The main source for enriched homotopical localizations comes from enriched left Bousfield localizations [Bar10]. Enriched left Bousfield localizations are similar to Bousfield localizations, but defining the class of local objects by means of \mathcal{V} -orthogonality instead of simplicial orthogonality. As proved in [Bar10, Theorem 4.46], the enriched left Bousfield localization with respect to a set of morphisms always exists in a \mathcal{V} -model category \mathcal{E} , provided that the category \mathcal{E} is cotensored over \mathcal{V} , left proper and combinatorial, and the category \mathcal{V} is combinatorial. This is the case, for example, of the category of symmetric spectra enriched over itself or enriched over simplicial sets.

The following theorem is our main result on the preservation of algebras over operads in monoidal \mathcal{V} -categories. For simplicity, we state it for coloured operads with only one colour, but it can be generalized to C -coloured operads by using ideals on the set of colours C ; cf. [CGMV10, Theorem 6.1].

Theorem 5.2. *Let (L, η) be an enriched homotopical localization on a monoidal \mathcal{V} -model category \mathcal{E} such that the category of operads in \mathcal{V} admits a transferred model structure. Let P be a cofibrant operad in \mathcal{V} and let X be a P -algebra such that X is cofibrant in \mathcal{E} . Suppose that, for every $n \geq 1$, the map*

$$(5.1) \quad \eta_X^{\otimes n} : X \otimes \cdots \otimes X \longrightarrow LX \otimes \cdots \otimes LX$$

is an L -equivalence. Then LX admits a homotopy unique P -algebra structure such that η_X is a map of P -algebras.

Proof. The map $\eta_X^{\otimes n}$ is a cofibration for every $n \geq 1$, since it is a tensor product of n cofibrations with cofibrant domains in a monoidal model category. Hence the induced map

$$\begin{array}{c} \mathrm{Hom}_{\mathcal{E}}(LX \otimes \cdots \otimes LX, LX) \\ \downarrow \\ \mathrm{Hom}_{\mathcal{E}}(X \otimes \cdots \otimes X, LX) \end{array}$$

is a trivial fibration for every $n \geq 1$. Indeed, it is a weak equivalence because LX is L -local and $\eta_X^{\otimes n}$ is an L -equivalence by assumption, and it is also a fibration by (4.2). Thus, the morphism of collections

$$\mathrm{End}(LX) \longrightarrow \mathrm{Hom}(X, LX)$$

induced by η_X is a trivial fibration.

Now consider the endomorphism operad $\mathrm{End}_P(\eta_X)$ associated to η_X . It is obtained as the following pullback of collections:

$$(5.2) \quad \begin{array}{ccc} \mathrm{End}(\eta_X) & \xrightarrow{\alpha} & \mathrm{End}(LX) \\ \beta \downarrow \scriptstyle \dots & & \downarrow \\ \mathrm{End}(X) & \longrightarrow & \mathrm{Hom}(X, LX). \end{array}$$

The operad P is cofibrant by hypothesis, and the map β is a trivial fibration since it is a pullback of a trivial fibration. Therefore, there is a lifting

$$\begin{array}{ccc} & \text{End}(\eta_X) & \\ & \nearrow & \downarrow \\ P & \longrightarrow & \text{End}(X) \end{array}$$

where $P \longrightarrow \text{End}(X)$ is the given P -algebra structure of X . The P -algebra structure on LX is obtained by composing this lifting with the upper morphism α in (5.2), and with this structure η_X is a map of P -algebras.

To prove uniqueness, suppose that we have two P -algebra structures on LX , denoted by $\gamma, \gamma': P \longrightarrow \text{End}(LX)$, and assume that η_X is a map of P -algebras for each of them, i.e., γ and γ' factor through $\text{End}(\eta_X)$. Now let $\delta, \delta': P \longrightarrow \text{End}(\eta_X)$ be such that $\gamma = \alpha \circ \delta$ and $\gamma' = \alpha \circ \delta'$, with α as in (5.2). Since $\beta \circ \delta = \beta \circ \delta'$ and β is a trivial fibration, it follows that δ and δ' are left homotopic. Since P is cofibrant and $\text{End}_P(LX)$ is fibrant, we obtain that, in fact, $\gamma \simeq \gamma'$; see [Hir03, 7.4.8]. \square

Remark 5.3. The displayed condition (5.1) holds automatically when $\mathcal{V} = \mathcal{E}$, that is, when \mathcal{E} is a monoidal model category and the localization is enriched in \mathcal{E} .

5.2. Localization of module spectra. Let \mathcal{E} be a monoidal \mathcal{V} -model category. Recall that the operad $\mathcal{A}ss$ in \mathcal{V} whose algebras in \mathcal{E} are the associative monoids is defined by $\mathcal{A}ss(n) = I[\Sigma_n]$ for $n \geq 0$, where $I[\Sigma_n]$ denotes a coproduct of copies of the unit I indexed by Σ_n on which Σ_n acts freely by permutations. Suppose that the operad $\mathcal{A}ss$ and the coloured operad $S_{\mathcal{V}}^C$ in \mathcal{V} , with C a set with one element, are admissible in \mathcal{E} . Then, the category $\text{Mon}(\mathcal{E})$ of monoids in \mathcal{E} and the category $\text{Oper}(\mathcal{E})$ of (one-coloured) operads in \mathcal{E} have a transferred model structure, since they are categories of algebras over $\mathcal{A}ss$ and $S_{\mathcal{V}}^C$, respectively. These two categories are related by a pair of adjoint functors

$$P_{(-)}: \text{Mon}(\mathcal{E}) \rightleftarrows \text{Oper}(\mathcal{E}): (-)(1),$$

where the left adjoint sends a monoid R to the operad P_R defined by

$$P_R(n) = \begin{cases} R & \text{if } n = 1, \\ 0 & \text{otherwise,} \end{cases}$$

and the right adjoint sends any operad Q to the monoid $Q(1)$. In fact, this adjoint pair is a Quillen pair, since the right adjoint preserves fibrations and weak equivalences.

The following result is an application of Theorem 5.2 to the preservation of module structures under enriched homotopical localizations.

Theorem 5.4. *Let (L, η) be an enriched homotopical localization on a monoidal model category \mathcal{E} such that the category of operads in \mathcal{E} and the category of*

monoids in \mathcal{E} admit a transferred model structure. Let R be a cofibrant monoid in \mathcal{E} and let X be an R -module such that X is cofibrant in \mathcal{E} . Then LX admits a homotopy unique R -module structure such that η_X is a map of R -modules.

Proof. If R is a monoid in \mathcal{E} , then an R -module is the same as an algebra over the operad P_R . Note that, if R is a cofibrant object in $\text{Mon}(\mathcal{E})$, then the operad P_R is also cofibrant in $\text{Oper}(\mathcal{E})$, since $P_{(-)}$ is a left Quillen functor. The result now follows from Theorem 5.2, since the operad P_R is concentrated in valence one and considering \mathcal{E} itself as a monoidal \mathcal{E} -category. \square

Now we make this result explicit for module spectra in the category of symmetric spectra $\mathcal{S}p^\Sigma$ with the positive model structure. We will consider enriched homotopical localizations in $\mathcal{S}p^\Sigma$ viewed as a monoidal $\mathcal{S}p^\Sigma$ -category, i.e., using the enrichment given by the internal hom.

Corollary 5.5. *Let (L, η) be an enriched homotopical localization on the category of symmetric spectra (enriched over itself). Let M be a module over a cofibrant ring symmetric spectrum R and assume that M is cofibrant as a symmetric spectrum. Then LM has a homotopy unique module structure over R such that $\eta_M: M \rightarrow LM$ is a morphism of R -modules.*

Proof. The category $\mathcal{S}p^\Sigma$ is a monoidal $s\text{Sets}$ -category, where $s\text{Sets}$ denotes the category of simplicial sets and any coloured operad in $s\text{Sets}$ is admissible in $\mathcal{S}p^\Sigma$ by Theorem 4.1. Thus, the category of operads in $\mathcal{S}p^\Sigma$ and the category of ring symmetric spectra both admit a transferred model structure. The result now follows directly from Theorem 5.4. \square

REFERENCES

- [Bar10] C. Barwick, On left and right model categories and left and right Bousfield localizations, to appear in *Homology Homotopy Appl.*
- [BM03] C. Berger and I. Moerdijk, Axiomatic homotopy theory for operads, *Comment. Math. Helv.* **78**(4) (2003), 805–831.
- [BM06] C. Berger and I. Moerdijk, The Boardman-Vogt resolution of operads in monoidal model categories, *Topology* **45**(5) (2006), 807–849.
- [BM07] C. Berger and I. Moerdijk, Resolution of coloured operads and rectification of homotopy algebras, in: *Categories in Algebra, Geometry and Mathematical Physics (Street Festschrift)*, Contemp. Math. vol 431, Amer. Math. Soc., Providence, 2007, 31–58.
- [Bor94] F. Borceux, *Handbook of Categorical Algebra 2. Categories and Structures*, Encyclopedia of Mathematics and its Applications, 51. Cambridge University Press, Cambridge, 1994.
- [BV73] J. M. Boardman and R. M. Vogt, *Homotopy invariant algebraic structures on topological spaces*, Lecture Notes in Math., 347, Springer, Berlin-New York, 1973.
- [CGMV10] C. Casacuberta, J. J. Gutiérrez, I. Moerdijk, and R. M. Vogt, Localization of algebras over coloured operads, *Proc. London Math. Soc.* (3) **101** (2010), 105–136.
- [Cra95] S. E. Crans, Quillen closed model structures for sheaves, *J. Pure Appl. Algebra* **101** (1995), 35–57.
- [EM06] A. D. Elmendorf and M. A. Mandell, Rings, modules, and algebras in infinite loop space theory, *Adv. Math.* **205**(1) (2006), 163–228.

- [Fre09] B. Fresse, *Modules over operads and functors*, Lecture Notes in Math., vol. 1967. Springer-Verlag, Berlin-New York, 2009.
- [Hir03] P. S. Hirschhorn, *Model Categories and Their Localizations*, Math. Surveys and Monographs, vol. 99, Amer. Math. Soc., Providence, 2003.
- [Hov99] M. Hovey, *Model Categories*, Math. Surveys and Monographs, vol. 63, Amer. Math. Soc., Providence, 1999.
- [Kel82] G. M. Kelly, *Basic Concepts of Enriched Category Theory*, London Math. Soc. Lecture Notes, vol. 64, Cambridge University Press, Cambridge-New York, 1982.
- [Kro07] T. A. Kro, Model structure on operads in orthogonal spectra, *Homology Homotopy Appl.* **9(2)** (2007), 397–412.
- [Lei04] T. Leinster, *Higher Operads, Higher Categories*, London Math. Soc. Lecture Notes, vol. 298, Cambridge University Press, Cambridge, 2004.
- [Lew91] L. G. Lewis, Is there a convenient category of spectra? *J. Pure Appl. Algebra* **73(3)** (1991), 233–246.
- [MMSS01] M. A. Mandell, J. P. May, S. Schwede, and B. Shipley, Model categories of diagram spectra, *Proc. London Math. Soc.* **8(2)2** (2001), 441–512.
- [Shi04] B. Shipley, A convenient model category for commutative ring spectra. in: *Homotopy Theory: Relations with Algebraic Geometry, Group Cohomology, and Algebraic K-Theory*, Contemp. Math., vol. 346, Amer. Math. Soc., Providence, 2004, 473–484.

JAVIER J. GUTIÉRREZ
 CENTRE DE RECERCA MATEMÀTICA
 08193 BELLATERRA, SPAIN
E-mail address: `jgutierrez@crm.cat`

RAINER M. VOGT
 UNIVERSITÄT OSNABRÜCK
 FACHBEREICH MATHEMATIK/INFORMATIK
 ALBRECHTSTR. 28
 49069 OSNABRÜCK, GERMANY
E-mail address: `rainer@mathematik.uni-osnabrueck.de`