



UTS
ePRESS

Construction
Economics and
Building

Vol. 17, No. 4

December 2017



© 2017 by the author(s). This is an Open Access article distributed under the terms of the Creative Commons Attribution 4.0 International [CC BY 4.0] License (<https://creativecommons.org/licenses/by/4.0/>), allowing third parties to copy and redistribute the material in any medium or format and to remix, transform, and build upon the material for any purpose, even commercially, provided the original work is properly cited and states its license.

Citation: Singh, M.M., Sawhney, A., and Sharma, V. 2017. Utilising Building Component Data from BIM for Formwork Planning. *Construction Economics and Building*, 17:4, 20-36. <http://dx.doi.org/10.5130/AJCEB.v17i4.5546>

ISSN 2204-9029 | Published by UTS ePRESS | ajceb.epress.lib.uts.edu.au

RESEARCH ARTICLE

Utilising Building Component Data from BIM for Formwork Planning

Manav Mahan Singh¹, Anil Sawhney^{2*}, Vaishnavi Sharma³

¹Department of Architecture, KU Leuven, Box-2431, Kasteelpark Arenberg 1, Leuven, 3001, Leuven, Belgium

²Department of Built Environment, Liverpool John Moores University, Byrom Street, Liverpool, L3 3AF, United Kingdom

³Risk Consulting, KPMG UK LLP, KPMG, 1 Snow Hill Queensway, Birmingham, B4 6GH, United Kingdom

***Corresponding author:** Anil Sawhney, Department of Built Environment, Liverpool John Moores University, Byrom Street, Liverpool, L3 3AF, United Kingdom; A.Sawhney@ljmu.ac.uk

DOI: <http://dx.doi.org/10.5130/AJCEB.v17i4.5546>

Article History: Received 23/05/2017; Revised 27/09/2017; Accepted 10/11/2017; Published 07/12/2017

Abstract

Advancements in the computing realm have assisted the Architecture, Engineering, and Construction (AEC) industry to progress significantly by automating several design tasks and activities. Building Information Modelling (BIM) authoring tools have played a significant role in automating design tasks and reducing the efforts required by the designer in redundant, repetitive or production-oriented activities. This paper explores one such approach that, with the help of BIM authoring tool and its Application Programming Interface (API), reduces the efforts expended on formwork design for concrete structures. The paper utilises the concept of using BIM data as input to compute the quantity of formwork, and generate visualisations and schedule of formwork. The developed approach first takes data input from semantic BIM to the API environment for computation and design of formwork systems, which is then placed within the BIM model, to generate visualisation and prepare schedules. The research work utilises a structural concrete wall as an example to demonstrate the presented approach. The approach will be influential in streamlining the formwork design process in the BIM environment and reducing efforts required by the designer and the planning engineer. Since the formwork elements are generated as 3-Dimensional (3D) solids and smart BIM elements, the generated model of formwork can be used for resolving clashes, scheduling, and resource planning.

DECLARATION OF CONFLICTING INTEREST The author(s) declared no potential conflicts of interest with respect to the research, authorship, and/or publication of this article. **FUNDING** The author(s) received no financial support for the research, authorship, and/or publication of this article.

Keywords

Formwork Design, BIM, Parametric Modelling, Design Automation, Formwork Visualisation.

Introduction

The design process in Building Information Modelling (BIM) environment generates useful and informative data which can be used for several downstream activities such as analysis of alternatives (Langroodi and Staub-French, 2012) and virtual construction (Popov et al., 2010). Previously research has been carried out to use BIM data for energy analysis (Ahn et al., 2014; Tse, Wong and Wong, 2005), structural analysis (Cavieres, Gentry and Al-Haddad, 2011; Lopez, 2011), sustainability analysis (Azhar et al., 2011; Jalaei and Jrade, 2015; Wu and Issa, 2012), facility management (Kang and Choi, 2015; Lin, Su and Chen, 2014; Becerik-Gerber et al., 2012) and many similar activities (Yalcinkaya and Singh, 2015). The use of BIM data reduces the efforts to remodel data in an analysis application, while significantly reducing errors and coordination issues (Sawhney and Maheswari, 2013). The BIM data can also be used for automating design evaluation and code compliance checks (BCA, 2013; Sanguinetti et al., 2012; Cheng and Das, 2014; Sinha et al., 2013). Approaches have been developed to perform rule checking for acoustical design (Pauwels et al., 2011) and many more performance evaluation activities. The latest trends in the domain include the use of BIM data for automating construction tasks such as site planning (Kumar and Cheng, 2015; Kannan and Santhi, 2013) and preparing a layout for construction safety (Zhang et al., 2013; Azhar and Behringer, 2013; Ding, Zhou and Akinci, 2014). Moreover, BIM authoring tools can also be used for generation of design alternatives based on available constraints (Abrishami et al., 2014). The BIM authoring tools have the potential to advance the Architecture, Engineering and Construction (AEC) industry by automating redundant and repetitive design tasks and calculations. These approaches allow designers to expend more efforts on decision-making tasks (Sawhney, 2014).

Formwork design and planning is a crucial activity for the construction of concrete structures (Kannan and Santhi, 2013). The cost of temporary construction accounts for a major component of concrete work (Smith and Hanna, 1993) on construction sites. The calculation of formwork is mostly done on lump-sum basis either based on the built-up area of the building or surface area of concrete works (Building How, 2015). It requires tedious efforts to design the formwork and document it, in order to convey the design intent. In addition, the process requires information on cast in-situ concrete elements, such as dimensions of structural elements, the material used and connections between them (Hanna, Willenbrock and Sanvido, 1992), which can be modelled in the BIM environment during the design process. The automation of formwork design and preparation of formwork three-dimensional (3D) model and quantity schedule of formwork elements (Tah and Price, 1991) can facilitate construction planning process using BIM data. In addition, it will reduce the errors and inconsistencies in formwork design by reusing the already modelled data in the BIM environment.

The proposed framework in this research paper demonstrates how BIM data can be used to calculate the quantity of formwork, with further extension to visualisation and preparation of quantity schedule of formwork elements. Research activities in the domain of BIM are evolving, and the focus is shifting from adoption, standardization, perceived benefits, and similar broader issues to concentrated topics of design, collaboration, interoperability, and downstream use of BIM (Zhao, 2017; Santos, Costa and Grilo, 2017; Yalcinkaya and Singh,

2015). Motivated by this research trend, the proposed framework will be influential in increasing attention to the use of BIM data for construction planning activities.

Context setting

The essence of BIM process and its authoring tools is to provide a specialised platform for generating information about building components that can be stored, reused, exchanged and shared for production-oriented repetitive tasks such as documentation, visualisation and quantification (Vanlande, Nicolle and Cruz, 2008; Monteiro and Poças Martins, 2013). The BIM authoring tools generate the data of building elements not only in the form of 3D solid objects but also associate useful semantic information with it (Goes and Santos, 2011). The object-oriented nature of BIM and its ability to capture information beyond 3D geometry makes it a unique facilitator for utilising the same information for downstream activities (Borrmann and Rank, 2010). The re-use of BIM data for downstream analysis and design activities – such as structural analysis (Shin et al., 2011), construction planning (Kumar and Cheng, 2015) or cost-estimation (Lee, Kim and Yu, 2014; Staub-French et al., 2003) – has the potential to minimise errors which are prevalent in traditional design processes (Christiansson, 2004). Due to its object-driven and model-centric core, BIM has the potential to positively distribute the efforts expended by designers, from production-oriented, low value-adding tasks, to decision-making tasks (Singh, Sawhney and Borrmann, 2015; Sawhney, 2014). Also, BIM has proven to be instrumental in increasing collaboration, coordination and effective data management through several design activities (Isikdag, Underwood and Aouad, 2008). This research builds upon these fundamental concepts while utilising existing BIM data to automate the laborious task of formwork planning, through Application Programming Interface (API) development.

Utilising features of BIM authoring tool, its API development platform, and parametric modelling capabilities, the research presents an approach to automate the process of formwork calculation, its 3D representation, and preparation of a quantity schedule. The authors have selected cast in-situ structural walls to demonstrate the utility of proposed approach with the help of BIM authoring tool *Autodesk Revit* for modelling, visualisation and quantification of formwork elements.

Literature review

The approach presented in the research work requires background study of three subject areas – BIM and usefulness of semantic parametric modelling capabilities of BIM, utilising BIM for decision making, and use of BIM in construction phase of projects.

PARAMETRIC MODELLING CAPABILITIES OF BIM

Parameters are the variables, defined in the BIM environment, to store data about the modelled element (Autodesk Inc., 2014a). These variables contain useful data and information such as visual, thermal, mechanical or geometric properties attributed to a particular building element. Such parameters facilitate parametric modelling in a BIM authoring tool that allows designers to use the mathematical and logical relationship to define geometrical constraints (Eastman, Sacks and Lee, 2004) and include domain-specific information (Lee, Sacks and Eastman, 2006). Dimensional constraints such as length, separation etc. can be defined using parameters (Bergin, 2011), which guide the regeneration of building geometry in the BIM environment (Sacks, Eastman and Lee, 2004). Parametric modelling capabilities of the BIM authoring tools allow users to model complex building systems with consistency

(Eastman et al., 2010; Cavieres, Gentry and Al-Haddad, 2011). It facilitates the process of solid modelling and automates the generation and updating of building information while reducing the time and effort required by professionals (Lee and Ha, 2013). Technical flaws and modelling errors can also be reduced by defining rules through parametric constraints (Singh, Gu and Wang, 2011). Information - such as relationship among neighbouring elements (Oosterhuis, 2012) - can be stored using parameters, and is useful for three-dimensional modelling. Four features of 3D parametric modelling - editing, updating, interoperability, and information management - are crucial for construction planning (Aram, Eastman and Sacks, 2013; Jeong et al., 2009; Tse, Wong and Wong, 2005). The work presented in this paper, utilises the parametric modelling feature of BIM authoring tool, for visualising formwork elements in the 3D environment and for generating quantity schedules.

UTILISING BIM FOR DECISION MAKING

Compared to Computer-Aided Design/Drafting (CADD) tools, BIM authoring tools have several advantages, such as object-oriented modelling, coordination with multiple views, parametric solution, internal relational database, cost estimation, and simulation tools (Eadie et al., 2013; Arslan et al., 2014). With various perceived benefits, AEC industry has witnessed significant utilisation of BIM solutions in recent years (McGraw Hill Construction, 2014). BIM provides an enabling platform for this research work, as data input required for the presented approach will be generated during building design process, followed by tasks such as visualisation and quantity estimation of formwork elements. The model generated using BIM tools can be defined as a data-rich, object-oriented, intelligent, parametric and digital representation of building facilities (The Associated General Contractors of America, 2006). Use of BIM authoring tool as a facilitator for information creation, collaboration, and sharing during the planning of concrete works has been shown to enhance the efficiency by providing richer and more accurate information, and integrating and reusing the data generated during the design phase (Aram, Eastman and Sacks, 2013). Use of BIM has proven its utility in decision-making tasks during the construction phase of building life-cycle (Schade, Olofsson and Schreyer, 2011; Lu, Won and Cheng, 2016).

API for BIM authoring tools allows the user to access the data stored in the BIM database (Edwards, Li and Wang, 2015; Lin, Su and Chen, 2014), and perform computational design tasks on it. API tools can be used to interact with BIM elements and access information associated with them (Autodesk Inc., 2014b). Researchers have developed API programmes for automation of analysis and design activities. This approach allows the user to automate design activities for which an algorithm can be developed. API also allows the user to combine several commands available in Graphical User Interface (GUI), thus reducing multiple inputs required for several commands. The introduction of API with BIM authoring application allows individual users, product manufacturers, designers, and other project participants to develop and automate design activities. It facilitates embedding domain-specific expertise into BIM application such as energy analysis (Bank et al., 2010; Wu and Issa, 2012), structural design (Lopez, 2011), interactive modelling (Lee and Ha, 2013), facility management (Motamedi and Hammad, 2009; Lin, Su and Chen, 2014) and other similar analysis tasks.

USE OF BIM IN CONSTRUCTION PHASE OF PROJECTS

Innovation in design-construction processes, and analysis of design alternatives, through the implementation of BIM, have been prime areas of interest among researchers in the domain

of construction and civil engineering (Yalcinkaya and Singh, 2015). Its potential to distribute the efforts to the initial stages of design (MacLeamy, 2004), to create digital database of information (NIBS, 2012), and to automate redundant design activities (Singh, Sawhney and Borrmann, 2015) has captured the interest of the scholarly community (Bhatt et al., 2013). BIM has been perceived as a tool which can increase coordination (Goes and Santos, 2011), increase the efficiency of AEC industry (Moreau and Back, 2000), and help progress towards lean building design and construction solutions (Arayici et al., 2011). The quick availability of building design data through digital platforms improves the quality of construction work (Chen and Luo, 2014; Davies and Harty, 2013). The benefits of deploying BIM in construction planning include early detection and resolution of clashes and constructability issues by providing visualisation (Chambers, 2010; Zhang and Hu, 2011). Also, the research works addressed the issues relevant to temporary construction and importance of its planning (Chi, Hampson and Biggs, 2012; Mansuri et al., 2017). Furthermore, information for quantity estimates can be prepared by extracting detailed quantity information from the exact 3D model with consistency (Kim et al., 2013), also easing the process of resolving conflicts and site logistics using 4D simulation (Hartmann, Gao and Fischer, 2008; American Institute of Architects, 2009).

Conceptual framework for automating design tasks in BIM

BIM authoring tools provide a GUI for creating 3D geometry and element data that can be used for several activities such as visualisation and schedule of quantities. Whereas proprietary BIM tools provide predefined building elements to generate building data, they can also be used to create parametrically constrained specialised elements such as doors, windows or formwork elements, also known as BIM objects (Hjelseth, 2010; Sawhney and Maheswari, 2013). As technology progresses ‘increasingly detailed and complex domain-specific semantics and knowledge’ (Lee, Sacks and Eastman, 2006) can now be embedded in the model. As BIM usage becomes more pervasive in the industry the requirement to query, extract, modify, and catalogue the data and information present in the model will continue to increase. A framework that can provide this ability will be needed. The API environment can provide access to an information-rich database of BIM for computational design and analysis tasks. Hence, design activities, particularly those that depend on iterative analysis, can be automated if there is well-defined logic that can be captured using mathematical formulas and logical conditions. As explained in Figure 1, the BIM environment provides functionality to store building data, to parametrically constraint modelling, use object-orientation, perform visualisation, and link scheduling data. The API development environment provides an integrated environment to develop new applications for automation of repetitive tasks using logic. The API is capable of accessing building element information required to perform computations in the API development environment and subsequently update the BIM database with new elements or information. The building element data, which is populated during the design development phase of the building lifecycle and updated during the construction planning stage, can be used to provide inputs for API programme that supports the analysis requirements of the downstream activities. For performance analysis tasks such as energy or structural analysis, dimensional and spatial data, along with structural and thermal properties, are translated into input for performance analysis engines. The analysis engines compute performance attributes of the design solution based on input from BIM, which helps in the analysis of several design alternatives with ease. This similar approach can be extended to generate BIM elements after performing a calculation on the BIM input.

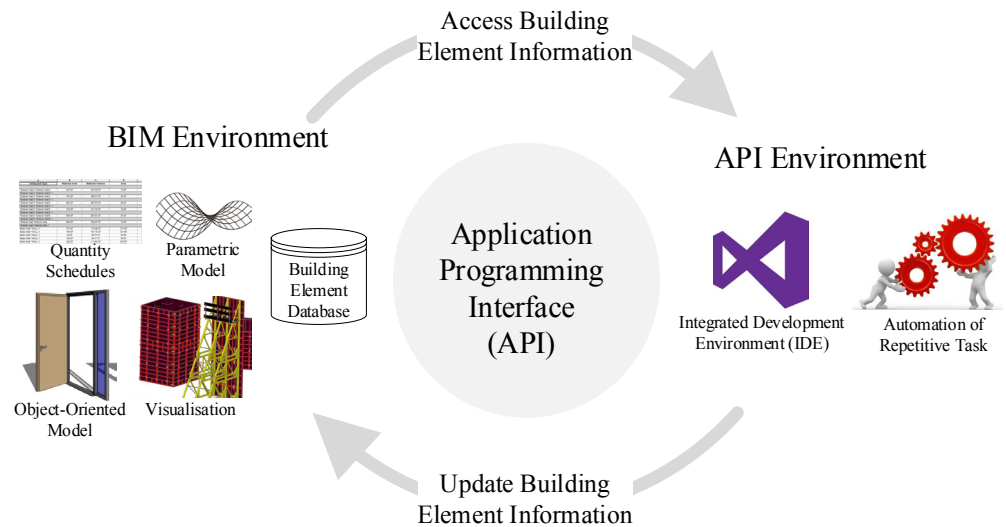

Figure 1 Information exchange between BIM authoring tool and API development environment

To highlight the envisioned approach, authors have developed a plug-in using the API of a BIM authoring tool (namely *Autodesk Revit*) and object-oriented programming in C#. Authors have selected cast in-situ wall elements to demonstrate the developed framework. A system of traditional formwork for walls consisting of sheeting, studs, wales and tie rods has been used in this research. API programme performs design computations and generates the information, using that formwork elements are created in the model. Formwork elements are developed as parametrically constrained objects whose size, the number of sub-elements, and alignment, can be adjusted using dimensional parameters. After computing dimensional information in the API environment, formwork elements are placed along the wall length and are adjusted using the calculated parameters. These formwork elements are information-rich BIM elements/objects. The information associated with them can be utilised further for visualisation and developing schedules of quantities.

Development of the approach to BIM-based formwork design

In the presented approach, an API programme provides access to BIM data and collects shape and dimensional information about the walls or other concrete cast in-situ elements. The dimensional data can be used to compute number, size, and span for various formwork elements. As explained in Figure 2, the first part of the programme queries the BIM database for walls, including their dimensional and location properties. The second part of the programme utilises this data - along with inputs for other construction parameters added using user input - for calculation of formwork elements. This calculates the spacing between elements, their adequacy to sustain bending and shear stresses, in addition to the deflection criteria for formwork. For more information, Indian Standard IS 14687 Falsework for Concrete Structures – Guidelines, can be referenced. These calculations are done based on the

predefined formulae within the API program. The output of the calculations can be used to place a formwork object in the BIM authoring tool alongside the original model.

A parametric line based object is modelled as the formwork for wall elements. This is placed in the project environment after adjusting its parameters according to the calculations from the previous step. Once the formwork object is updated in the BIM environment, it can be used for visualisation as well as preparing quantity schedule. As it can be noticed, with the help of the API and existing BIM data, the users are able to perform formwork design quickly without tedious, iterative, and manual calculations.

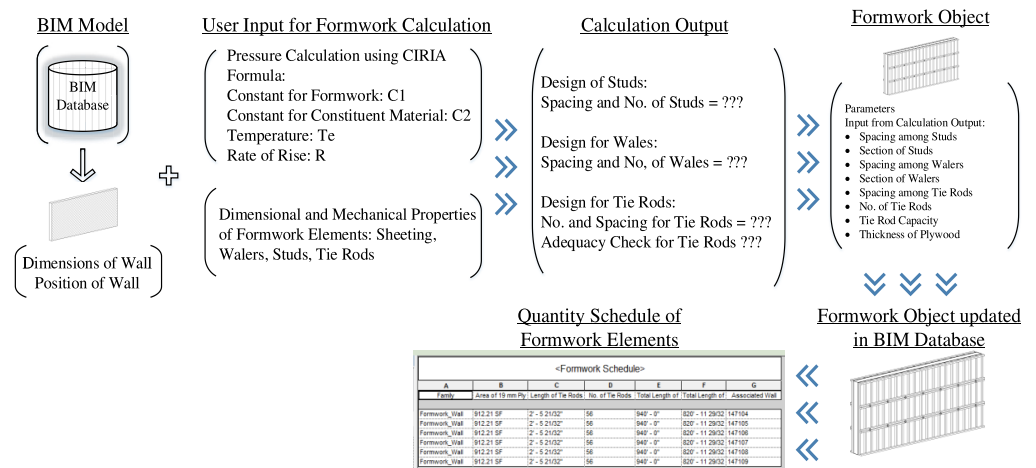

Figure 2 Framework for automating formwork layout for wall using BIM

DATA COLLECTION FROM BIM

First, the API programme queries the BIM database for cast in-situ wall elements for which the formwork needs to be generated. Once these are specified to the plug-in, it starts collecting data for each wall elements one-by-one for calculations, and proceeds to place the formwork elements. The centreline of a wall is required for placing the formwork object at the particular location. Dimensional data such as length, height, and thickness of the wall are required to calculate the size, spacing, and a number of formwork elements. As shown in Figure 3, the program collects the dimensional and positional information about each wall element individually, to perform further calculations.

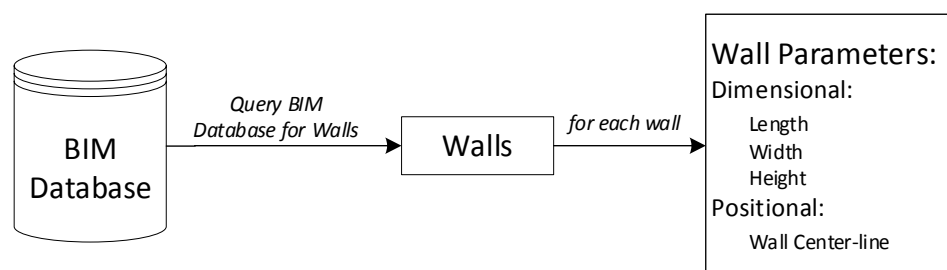

Figure 3 Dimensional and positional data collection for wall elements from BIM

CALCULATION OF FORMWORK ELEMENTS

Once the inputs required for calculation of formwork elements have been collected from the model, there are several methods available to compute the lateral pressure due to wet concrete on the formwork elements. For the proposed approach, maximum pressure, i.e. P_{max} is calculated using Construction Industry Research and Information Association (CIRIA) formula (Jha, 2012). As shown in Figure 4, there are various inputs – such as coefficients C_1 and C_2 , the rate of pouring, temperature, and density of concrete – required for calculation of P_{max} . This additional information can be added using a user input form.

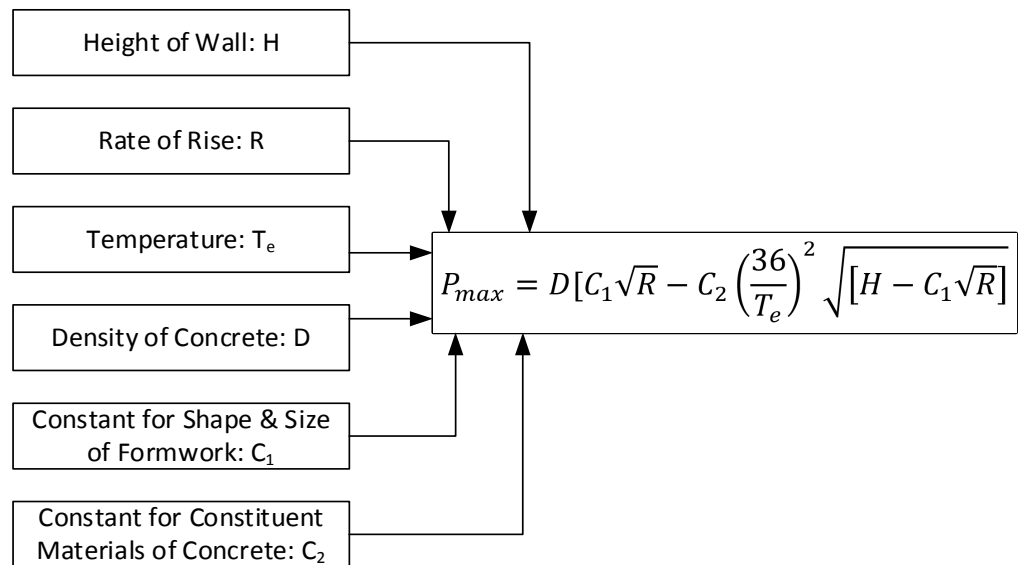

Figure 4 Calculation of maximum pressure on formwork

The developed programme calculates the number and spacing of various formwork elements, i.e. sheeting, studs, wales, and tie rods while considering their adequacy to carry the load. As shown in Figure 5, for studs, the programme checks the maximum possible span based on three criteria – allowable bending stress, allowable shear stress and permissible deflection. The lowest of these three values is selected for calculation of spacing for any element.

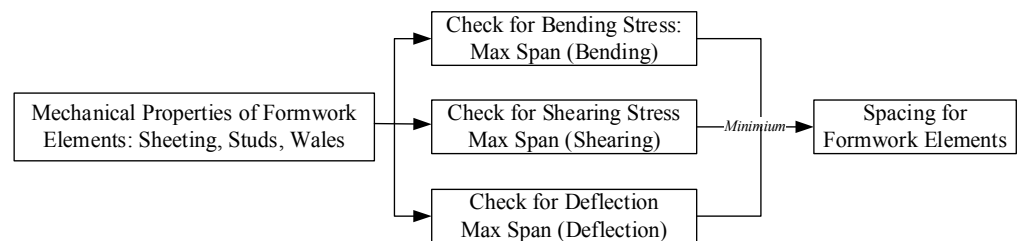

Figure 5 Design calculation for studs

Since tie rods are provided at a specified location of the formwork system, the load on the tie rods is determined by the spacing between the formwork elements. Hence, its tensile strength must be more than the load exerted by the concrete in that region. As shown in Figure 6, the

programme checks whether the tie rod will be able to take the tensile load applied to it. If not, it will prompt a warning message to the designer to increase its capacity.

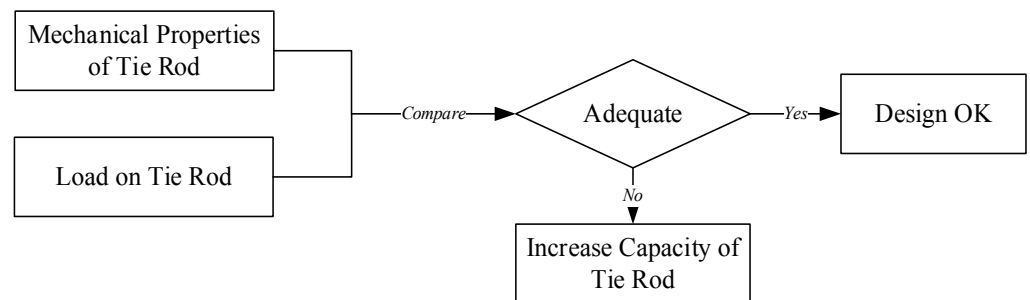

Figure 6 Warning message for inadequate capacity of tie rods

DEVELOPMENT OF PARAMETRIC MODEL OF FORMWORK COMPONENTS

The approach described in previous sections performs the computation of formwork elements, but utilising full capabilities of BIM authoring tool; formwork elements must be generated in the BIM itself. To ease the process, authors have utilised parametric modelling capabilities of BIM authoring tool to generate geometrically constrained formwork components. As shown in Figure 7, a line based set of objects (*Autodesk Revit* line based object) is developed that includes sheeting elements, studs, wales on both faces of the wall, and tie rods to hold both sides of formwork elements. The numbers and spacing among these objects can be appropriately adjusted using parameters.

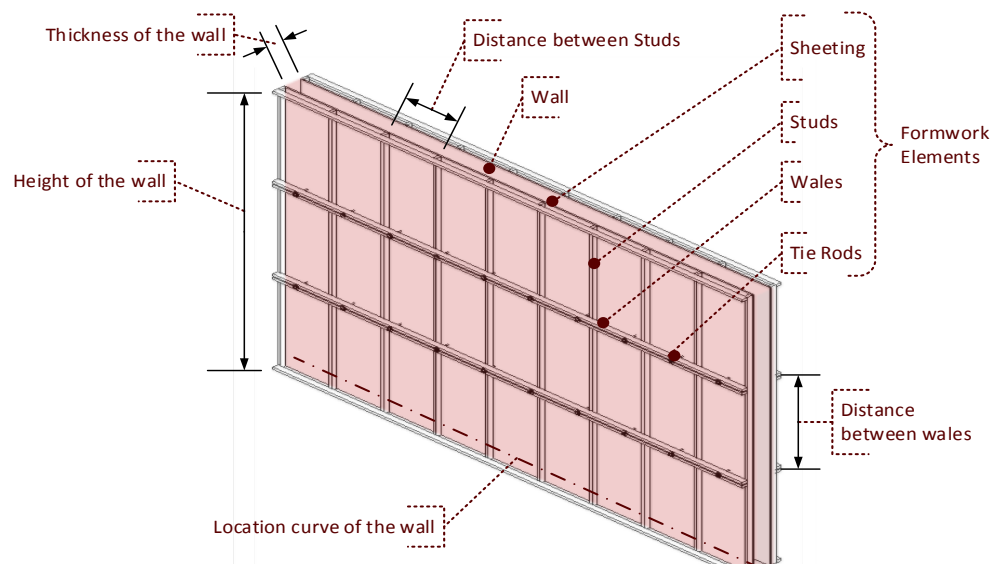

Figure 7 Geometrically constrained and parametrically adjustable formwork object for walls

Several instance parameters have been developed for formwork object shown in Figure 7. These parameters are required for various purposes such as preparing quantity schedules,

to control spacing and number of formwork elements, etc. Furthermore, after placing the formwork object instance, its properties can be modified using these parameters according to the associated wall. As shown in Figure 8, geometrical parameters have been defined - such as wall thickness, height, and a number of formwork elements - to control the geometry and structure of the formwork instance.

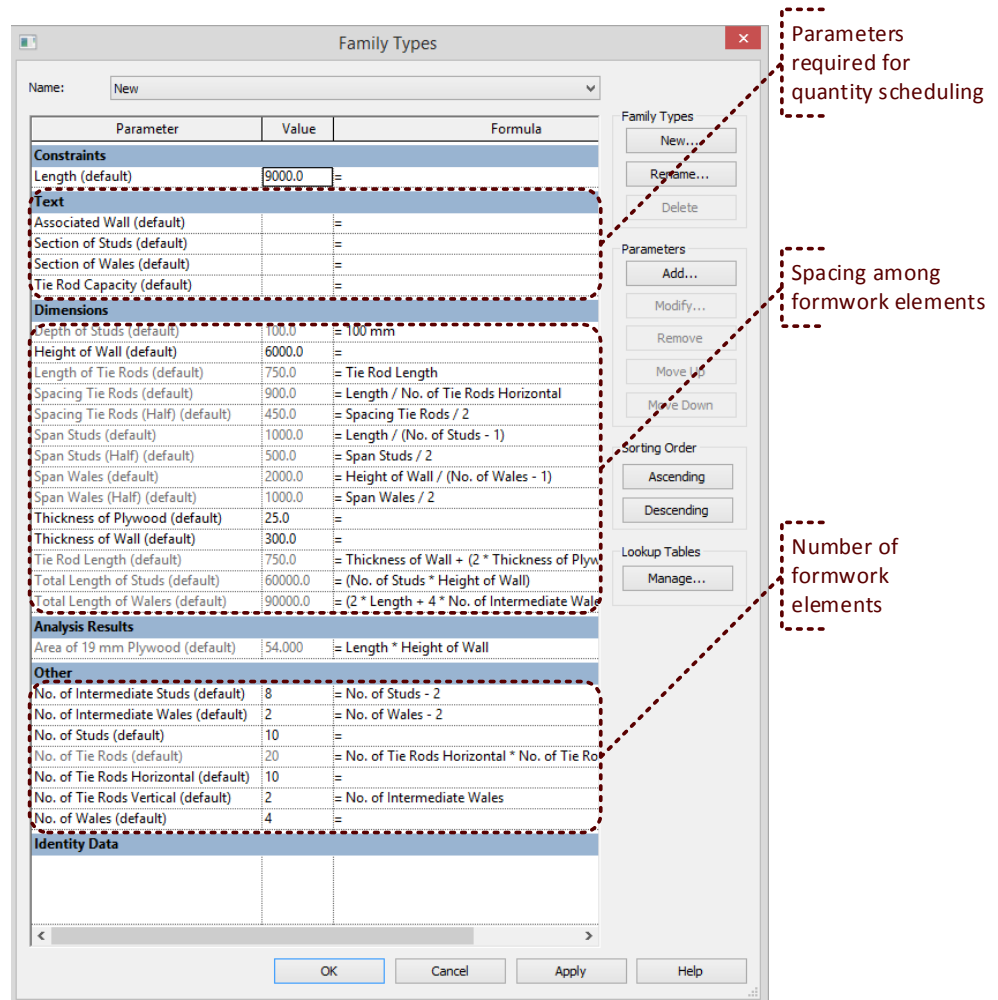

Figure 8 Various instance parameters required to adjust the formwork object

INSERTION OF MODEL ELEMENTS FOR VISUALISATION AND SCHEDULING OF FORMWORK

To create or insert any objects or to make any change in the BIM database, a transaction command needs to be initiated in the API environment. As described in Figure 9, the object created in the previous section can be placed as an instance in the model and its parameters can be adjusted as per the calculations. Various parameters such as the number of formwork elements, their sizes, and wall dimensions, need to be adjusted to place the formwork instance in the BIM. As shown in Figure 9, for placing a particular instance of the line-based object, the inputs required are - centreline, thickness and height of the wall. After placing an instance, its parameters have been adjusted based on the results of the calculated output.

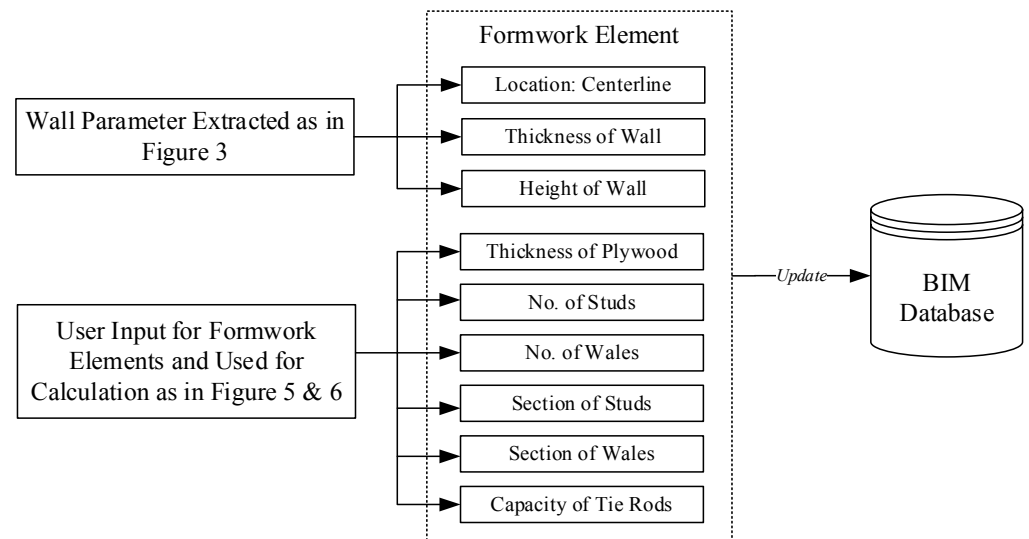

Figure 9 Insertion of object instance and parameter adjustment

After placing formwork objects in BIM, they can be used for visualisation, as only the 3D geometry is required. For quantity scheduling activity, associated shared parameters can be used which are created while modelling parametrically constrained formwork elements. As shown in Figure 10, quantity information about all the formwork elements is extracted from the model, after their generation and visualisation from the processes described previously.

<Formwork Schedule>						
A	B	C	D	E	F	G
Family	Area of 19 mm Ply	Length of Tie Rods	No. of Tie Rods	Total Length of Studs	Total Length of Wales	Associated Wall
Formwork_Wall	3660.00 SF	2' - 5 21/32"	224	3740' - 0"	3294' - 0"	155077
Formwork_Wall	1170.00 SF	2' - 5 21/32"	72	1200' - 0"	1053' - 0"	155127
Formwork_Wall	460.00 SF	2' - 5 21/32"	28	460' - 0"	414' - 0"	155174
Formwork_Wall	720.00 SF	2' - 5 21/32"	44	740' - 0"	648' - 0"	155233
Formwork_Wall	670.00 SF	2' - 5 21/32"	40	680' - 0"	603' - 0"	155286

Figure 10 Generation of quantity schedules after automating formwork layout

The proposed framework does not only compute the formwork element but extends the designer's capability to visualise it in 3D model also. The features of BIM authoring tools such as 3D element modelling, visualisation and quantity take-off will be helpful in construction planning activities. Moreover, connecting site inventory information or logistical data can expand the capabilities towards automation of decision-making tasks (Yoon and Chin, 2011).

Conclusion

Initially, BIM gained popularity for streamlining design activities, which is now extending towards the downstream processes such as construction and facility management. With several useful applications of BIM during the entire project lifecycle now available (Langroodi and Staub-French, 2012), use of BIM is gaining acceptance in the pre-construction planning tasks also (Karan and Irizarry, 2015). The proposed framework focussed on formwork planning by

automating design tasks, provides significant opportunities to harmonise the pre-construction planning activity. It's potential to generate the quantity schedule for formwork is beneficial for formwork planning during the construction phase. The generated formwork can be visualised in a 3D environment, hence visual checks become easier to perform. Although the authors have demonstrated the framework for generating formwork elements only for cast in-situ walls, this concept can be extended to other cast in-situ elements such floor slabs, columns and beams. Moreover, the site inventory database for formwork elements can be linked with the design process to automatically select the available elements for formwork or to inform the construction team about the requirement of extra formwork elements and automate decision-making tasks (Yoon and Chin, 2011). The limitations of the proposed system are that it relies on proprietary BIM format of the adopted BIM authoring tool. This limitation can be removed by connecting the system to the Industry Foundation Classes (IFC) compliant BIM model. As part of future work, there is also a need to study the time-savings that can be accomplished by the proposed system.

References

- Abrishami, S., Goulding, J., Rahimian, F.P., Ganah, A. and Sawhney, A., 2014. G-BIM Framework and Development Process for Integrated AEC Design Automation. *Procedia Engineering*, 85, pp.10-17. <https://doi.org/10.1016/j.proeng.2014.10.523>.
- Ahn, K.-U., Kim, Y.-J., Park, C.-S., Kim, I. and Lee, K., 2014. BIM interface for full vs. semi-automated building energy simulation. *Energy and Buildings*, 68(PART B), pp.671-78. <https://doi.org/10.1016/j.enbuild.2013.08.063>.
- American Institute of Architects, 2009. *ALA 2009 BIM Awards Category B: Design/Delivery Process Innovation using BIM*. [online] Available at: <http://www.aia.org/aiaucmp/groups/aia/documents/pdf/aia081608.pdf>.
- Aram, S., Eastman, C. and Sacks, R., 2013. Requirements for BIM platforms in the concrete reinforcement supply chain. *Automation in Construction*, 35, pp.1-17. <https://doi.org/10.1016/j.autcon.2013.01.013>.
- Arayici, Y., Coates, P., Koskela, L., Kagioglou, M., Usher, C. and O'Reilly, K., 2011. Technology adoption in the BIM implementation for lean architectural practice. *Automation in Construction*, 20(2), pp.189-95. <https://doi.org/10.1016/j.autcon.2010.09.016>.
- Arslan, M., Riaz, Z., Kiani, A.K. and Azhar, S., 2014. Real-time environmental monitoring, visualization and notification system for construction H&S management. *Journal of Information Technology in Construction*, 19(September 2013), pp.72-91.
- Autodesk Inc., 2014a. *Autodesk Revit 2014|Help*. [online] Available at: <http://help.autodesk.com/view/RVT/2014/ENU/?guid=GUID-D927E0DC-F720-4F7D-AACD-8B06787793CB>.
- Autodesk Inc., 2014b. *Revit 2014 Platform API Developers Guidelines*.
- Azhar, S. and Behringer, A., 2013. A BIM-based Approach for Communicating and Implementing a Construction Site Safety Plan. *49th ASC Annual International Conference Proceedings*. California Polytechnic State University (Cal Poly), San Luis Obispo, CA. 10-13 April 2013. California: Cal Poly.
- Azhar, S., Carlton, W., Olsen, D. and Ahmad, I., 2011. Building information modelling for sustainable design and LEED® rating analysis. *Automation in Construction*, 20(2), pp.217-224. <https://doi.org/10.1016/j.autcon.2010.09.019>.

- Bank, L.C., McCarthy, M., Thompson, B.P. and Menassa, C.C., 2010. Integrating BIM with System Dynamics as a Decision-Making Framework for Sustainable Building Design and Operation. In: *First International Conference on Sustainable Urbanization (ICSU 2010)* Hong Kong, 15-17 December 2010. Hong Kong: PolyU.
- Becerik-Gerber, B., Jazizadeh, F., Li, N. and Calis, G., 2012. Application Areas and Data Requirements for BIM-Enabled Facilities Management. *Journal of Construction Engineering and Management*, 138(3), pp.431–442. [https://doi.org/10.1061/\(asce\)co.1943-7862.0000433](https://doi.org/10.1061/(asce)co.1943-7862.0000433).
- Bergin, M.S., 2011. *Architecture Research Lab|History of BIM*. [online] Available at: <http://www.architectureresearchlab.com/ar/2011/08/21/bim-history/> [Accessed 10 Jan 2017].
- Bhatt, M., Borrmann, A., Amor, R. and Beetz, J., 2013. Architecture, computing, and design assistance. *Automation in Construction*, 32(29), pp.161–164. <https://doi.org/10.1016/j.autcon.2013.01.001>.
- Borrmann, A. and Rank, E., 2010. Query support for BIMs using semantic and spatial conditions. *Handbook of Research on Building Information Modeling and Construction Informatics: Concepts and Technologies*, pp.405–450. <https://doi.org/10.4018/978-1-60566-928-1.ch018>.
- Building and Construction Authority, 2013. *Singapore BIM Guide*. Singapore: BCA Academy of the Built Environment.
- Building How, 2015. *Formwork quantity take-off*. [online] Available at: <http://www.buildinghow.com/en-us/Products/Books/Volume-A/Quantity-Cost-estimation/Formwork-quantity-take-off>.
- Bureau of Indian Standards, 1999. *IS14667:1999 Falsework for Concrete Structures – Guidelines*. New Delhi: BIS.
- Cavieres, A., Gentry, R. and Al-Haddad, T., 2011. Knowledge-based parametric tools for concrete masonry walls: Conceptual design and preliminary structural analysis. *Automation in Construction*, 20(6), pp.716–28. <https://doi.org/10.1016/j.autcon.2011.01.003>.
- Chambers, D., 2010. The Sutter Health Prototype Hospital Initiative. In: *Improving Healthcare through Built Environment Infrastructure*. [online] Oxford, UK: Wiley-Blackwell, pp.102–108. Available at: <http://doi.wiley.com/10.1002/9781444319675.ch7>.
- Chen, L. and Luo, H., 2014. A BIM-based construction quality management model and its applications. *Automation in Construction*, 46, pp.64–73. <https://doi.org/10.1016/j.autcon.2014.05.009>.
- Cheng, J.C.P. and Das, M., 2014. A BIM-Based Web Service Framework for Green Building Energy Simulation and Code Checking. *ITcon—Journal of Information Technology*, 19(January), pp.150–68.
- Chi, S., Hampson, K. and Biggs, H., 2012. Using BIM for Smarter and Safer Scaffolding and Formwork Construction: A Preliminary Methodology. In: *CIB W099 International Conference on Modelling and Building Health and Safety*, 10–11 September 2012. Singapore: CIBW.
- Christiansson, P., 2004. *IT Building Education Overview*. [online] Available at: <http://www.it.civil.aau.dk/it/education/overview.html>.
- Davies, R. and Harty, C., 2013. Implementing ‘Site BIM’: A case study of ICT innovation on a large hospital project. *Automation in Construction*, 30, pp.15–24. <https://doi.org/10.1016/j.autcon.2012.11.024>.
- Ding, L., Zhou, Y. and Akinci, B., 2014. Building Information Modeling (BIM) application framework: The process of expanding from 3D to computable nD. *Automation in Construction*, 46, pp.82–93. <https://doi.org/10.1016/j.autcon.2014.04.009>.

- Eadie, R., Browne, M., Odeyinka, H., McKeown, C. and McNiff, S., 2013. BIM implementation throughout the UK construction project lifecycle: An analysis. *Automation in Construction*, 36, pp.145-51. <https://doi.org/10.1016/j.autcon.2013.09.001>.
- Eastman, C., Sacks, R. and Lee, G., 2004. Functional modeling in parametric CAD systems. [online] Available at: <http://citeseerx.ist.psu.edu/viewdoc/summary?doi=10.1.1.93.398>.
- Eastman, C.M., Jeong, Y.-S., Sacks, R. and Kaner, I., 2010. Exchange Model and Exchange Object Concepts for Implementation of National BIM Standards. *Journal of Computing in Civil Engineering*, 24(1), pp.25-34. [https://doi.org/10.1061/\(asce\)0887-3801\(2010\)24:1\(25\)](https://doi.org/10.1061/(asce)0887-3801(2010)24:1(25)).
- Edwards, G., Li, H. and Wang, B., 2015. BIM based collaborative and interactive design process using computer game engine for general end-users. *Visualization in Engineering*, 3(1), p.4. <https://doi.org/10.1186/s40327-015-0018-2>.
- Goes, R.H.T. and Santos, E.D., 2011. Design Coordination with Building Information Modeling: A Case Study. In: *Proceedings of the CIB W78-W102 2011: International Conference –Sophia Antipolis, France*. 26-28 October 2011.
- Hanna, A.S., Willenbrock, J.H. and Sanvido, V.E., 1992. Knowledge Acquisition and Development for Formwork Selection System. *Journal of Construction Engineering and Management*, 118(1), pp.179-98. [https://doi.org/10.1061/\(asce\)0733-9364\(1992\)118:1\(179\)](https://doi.org/10.1061/(asce)0733-9364(1992)118:1(179)).
- Hartmann, T., Gao, J. and Fischer, M., 2008. Areas of Application for 3D and 4D Models on Construction Projects. *Journal of Construction Engineering and Management*, 134(10), pp.776-85. [https://doi.org/10.1061/\(asce\)0733-9364\(2008\)134:10\(776\)](https://doi.org/10.1061/(asce)0733-9364(2008)134:10(776)).
- Hjelseth, E., 2010. Exchange of Relevant Information in BIM Objects Defined by the Role- and Life-Cycle Information Model. *Architectural Engineering and Design Management*, 6(4), pp.279-87. <https://doi.org/10.3763/aedm.2010.idds5>.
- Isikdag, U., Underwood, J. and Aouad, G., 2008. An investigation into the applicability of building information models in geospatial environment in support of site selection and fire response management processes. *Advanced Engineering Informatics*, 22(4), pp.504-19. <https://doi.org/10.1016/j.aei.2008.06.001>.
- Jalaei, F. and Jrade, A., 2015. Integrating building information modeling (BIM) and LEED system at the conceptual design stage of sustainable buildings. *Sustainable Cities and Society*, 18, pp.95-107. <https://doi.org/10.1016/j.scs.2015.06.007>.
- Jeong, Y.-S., Eastman, C.M., Sacks, R. and Kaner, I., 2009. Benchmark tests for BIM data exchanges of precast concrete. *Automation in Construction*, 18(4), pp.469-84. <https://doi.org/10.1016/j.autcon.2008.11.001>.
- Jha, K.N., 2012. *Formwork for Concrete Structures*. New Delhi: Tata McGraw Hill Education Private Limited.
- Kang, T.-W. and Choi, H.-S., 2015. BIM perspective definition metadata for interworking facility management data. *Advanced Engineering Informatics*, 29(4), pp.958-70. <https://doi.org/10.1016/j.aei.2015.09.004>.
- Kannan, R. and Santhi, H., 2013. Automated Construction Layout and Simulation of Concrete. *The 4th International Conference of EACEF (European Asian Civil Engineering Forum)*, National University of Singapore, Singapore, 26-28 June 2013.

- Karan, E.P. and Irizarry, J., 2015. Extending BIM interoperability to preconstruction operations using geospatial analyses and semantic web services. *Automation in Construction*, 53, pp.1-12. <https://doi.org/10.1016/j.autcon.2015.02.012>.
- Kim, H., Anderson, K., Lee, S. and Hildreth, J., 2013. Generating construction schedules through automatic data extraction using open BIM (building information modeling) technology. *Automation in Construction*, 35(July 2015), pp.285-95. <https://doi.org/10.1016/j.autcon.2013.05.020>.
- Kumar, S.S. and Cheng, J.C.P., 2015. A BIM-based automated site layout planning framework for congested construction sites. *Automation in Construction*, 59(November 2015), pp.24-37. <https://doi.org/10.1016/j.autcon.2015.07.008>.
- Langroodi, B.P. and Staub-French, S., 2012. Change Management with Building Information Models: A Case Study. In: *Construction Research Congress 2012*. Reston, VA, VA: American Society of Civil Engineers. <https://doi.org/10.1061/9780784412329.119>.
- Lee, G., Sacks, R. and Eastman, C.M., 2006. Specifying parametric building object behavior (BOB) for a building information modeling system. *Automation in Construction*, 15(6), pp.758-76. <https://doi.org/10.1016/j.autcon.2005.09.009>.
- Lee, S.-K., Kim, K.-R. and Yu, J.-H., 2014. BIM and ontology-based approach for building cost estimation. *Automation in Construction*, 41, pp.96-105. <https://doi.org/10.1016/j.autcon.2013.10.020>.
- Lee, S. and Ha, M., 2013. Customer interactive building information modeling for apartment unit design. *Automation in Construction*, 35(November 2013), pp.424-30. <https://doi.org/10.1016/j.autcon.2013.05.026>.
- Lin, Y.-C., Su, Y.-C. and Chen, Y.-P., 2014. Developing Mobile BIM/2D Barcode-Based Automated Facility Management System. *The Scientific World Journal*, 2014, pp.1-16. <https://doi.org/10.1155/2014/374735>.
- Lopez, J.M.S., 2011. *Calculation and representation of structural reinforcement in Building Information Models using Revit Structure and SOFiSTiK*. Munich: Technische Universitat Munchen.
- Lu, Q., Won, J. and Cheng, J.C.P., 2016. A financial decision-making framework for construction projects based on 5D Building Information Modeling (BIM). *International Journal of Project Management*, 34(1), pp.3-21. <https://doi.org/10.1016/j.ijproman.2015.09.004>.
- MacLeamy, P., 2004. *MacLeamy Curve* [online] Available at: <http://www.msa-ipd.com/MacLeamyCurve.pdf> (Accessed 29 Sep 2015).
- Mansuri, D., Chakraborty, D., Elzarka, H., Deshpande, A. and Gronseth, T., 2017. Building Information Modeling enabled Cascading Formwork Management Tool. *Automation in Construction*, 83, pp.259-72. <https://doi.org/10.1016/j.autcon.2017.08.016>.
- McGraw Hill Construction, 2014. *The Business Value of BIM for Construction in Major Global Markets: How contractors around the world are driving innovation with Building Information Modeling* [online] Available at: https://www.icn-solutions.nl/pdf/bim_construction.pdf [Accessed 30 Jan 16].
- Monteiro, A. and Poças Martins, J., 2013. A survey on modeling guidelines for quantity takeoff-oriented BIM-based design. *Automation in Construction*, 35(November 2013), pp.238-53. <https://doi.org/10.1016/j.autcon.2013.05.005>.
- Moreau, K. and Back, W.E., 2000. Improving the design process with information management. *Automation in Construction*, 10(1), pp.127-40. [https://doi.org/10.1016/s0926-5805\(99\)00057-6](https://doi.org/10.1016/s0926-5805(99)00057-6).

- Motamedi, A. and Hammad, A., 2009. Lifecycle management of facilities components using radio frequency identification and building information model. *Journal of Information Technology in Construction (ITCON)*, 14, pp.238-62.
- National Institute of Building Sciences, 2012. *National BIM Standard – United States TM Version 2*. United States: NIBS Building SMART Alliance.
- Oosterhuis, K., 2012. Simply complex, toward a new kind of building. *Frontiers of Architectural Research*, 1(4), pp.411-20. <https://doi.org/10.1016/j.foar.2012.08.003>.
- Pauwels, P., Van Deursen, D., Verstraeten, R., De Roo, J., De Meyer, R., Van de Walle, R. and Van Campenhout, J., 2011. A semantic rule checking environment for building performance checking. *Automation in Construction*, [online] 20(5), pp.506-18. <https://doi.org/10.1016/j.autcon.2010.11.017>.
- Popov, V., Juocevicius, V., Migilinskas, D., Ustinovichius, L. and Mikalauskas, S., 2010. The use of a virtual building design and construction model for developing an effective project concept in 5D environment. *Automation in Construction*, [online] 19(3), pp.357-67. <https://doi.org/10.1016/j.autcon.2009.12.005>.
- Sacks, R., Eastman, C.M. and Lee, G., 2004. Parametric 3D modeling in building construction with examples from precast concrete. *Automation in Construction*, 13(3), pp.291-312. [https://doi.org/10.1016/S0926-5805\(03\)00043-8](https://doi.org/10.1016/S0926-5805(03)00043-8).
- Sanguinetti, P., Abdelmohsen, S., Lee, J., Lee, J., Sheward, H. and Eastman, C., 2012. General system architecture for BIM: An integrated approach for design and analysis. *Advanced Engineering Informatics*, 26(2), pp.317-33. <https://doi.org/10.1016/j.aei.2011.12.001>.
- Santos, R., Costa, A.A. and Grilo, A., 2017. Bibliometric analysis and review of Building Information Modelling literature published between 2005 and 2015. *Automation in Construction*, 80, pp.118-36. <https://doi.org/10.1016/j.autcon.2017.03.005>.
- Sawhney, A., 2014. *International BIM implementation guide*. [online] *RICS Professional Guidance Note*. Available at: <http://www.rics.org/us/knowledge/professional-guidance/guidance-notes/international-bim-implementation-guide-1st-edition/>.
- Sawhney, A. and Maheswari, J.U., 2013. Design Coordination Using Cloud-based Smart Building Element Models. *International Journal of Computer Information Systems and Industrial Management Applications*, 5, pp.445-53.
- Schade, J., Olofsson, T. and Schreyer, M., 2011. Decision-making in a model-based design process. *Construction Management and Economics*, 29(4), pp.371-82. <https://doi.org/10.1080/01446193.2011.552510>.
- Shin, H.M., Lee, H.M., Oh, S.J. and Chen, J.H., 2011. Analysis and Design of Reinforced Concrete Bridge Column Based on BIM. *Procedia Engineering*, 14, pp.2160-63. <https://doi.org/10.1016/j.proeng.2011.07.271>.
- Singh, M.M., Sawhney, A. and Borrmann, A., 2015. Modular Coordination and BIM: Development of Rule Based Smart Building Components. *Procedia Engineering*, 123, pp.519-27. <https://doi.org/10.1016/j.proeng.2015.10.104>.
- Singh, V., Gu, N. and Wang, X., 2011. A theoretical framework of a BIM-based multi-disciplinary collaboration platform. *Automation in Construction*, 20(2), pp.134-44. <https://doi.org/10.1016/j.autcon.2010.09.011>.

- Sinha, S., Sawhney, A., Borrmann, A. and Ritter, F., 2013. Extracting Information from Building Information Models for Energy Code Compliance of Building Envelope. In: *Proceedings of the RICS COBRA Conference 2013*. New Delhi, India, 10-12 September 2013. New Delhi, India: RICS.
- Smith, G.R. and Hanna, A.S., 1993. Factors influencing formwork productivity. *Canadian Journal of Civil Engineering*, 20(1), pp.144-53. <https://doi.org/10.1139/193-015>.
- Staub-French, S., Fischer, M., Kunz, J., Ishii, K. and Paulson, B., 2003. A feature ontology to support construction cost estimating. *AI EDAM*, 17(2), pp.133-54. <https://doi.org/10.1017/s0890060403172034>.
- Tah, J.H.M. and Price, A.D.F., 1991. Interactive computer-aided formwork design. *Computers & Structures*, 41(6), pp.1157-67. [https://doi.org/10.1016/0045-7949\(91\)90253-i](https://doi.org/10.1016/0045-7949(91)90253-i).
- The Associated General Contractors of America, 2006. *The Contractors' Guide to BIM*. [online] Available at: <http://www.agcnebuilders.com/documents/BIMGuide.pdf>.
- Tse, T.C.K., Wong, K.D.A. and Wong, K.W.F., 2005. The utilisation of Building Information Models in nD modelling: A study of data interfacing and adoption barriers. *Electronic Journal of Information Technology in Construction*, 10, pp.85-110.
- Vanlande, R., Nicolle, C. and Cruz, C., 2008. IFC and building lifecycle management. *Automation in Construction*, 18(1), pp.70-78. <https://doi.org/10.1016/j.autcon.2008.05.001>.
- Wu, W. and Issa, R.R., 2012. Leveraging cloud-BIM for LEED Automation. *Electronic Journal of Information Technology in Construction*, 17(July), pp.367-84.
- Yalcinkaya, M. and Singh, V., 2015. Patterns and trends in Building Information Modeling (BIM) research: A Latent Semantic Analysis. *Automation in Construction*, 59, pp.68-80. <https://doi.org/10.1016/j.autcon.2015.07.012>.
- Yoon, S.-W. and Chin, S.-Y., 2011. An RFID and BIM based Simulator for Construction Material Logistics and Progress Management. *Korean Journal of Construction Engineering and Management*, 12(5), pp.46-54. <https://doi.org/10.6106/kjcem.2011.12.5.46>.
- Zhang, J.P. and Hu, Z.Z., 2011. BIM and 4D-based integrated solution of analysis and management for conflicts and structural safety problems during construction: 1. Principles and methodologies. *Automation in Construction*, 20(2), pp.155-66. <https://doi.org/10.1016/j.autcon.2010.09.013>.
- Zhang, S., Teizer, J., Lee, J.-K., Eastman, C.M. and Venugopal, M., 2013. Building Information Modeling (BIM) and Safety: Automatic Safety Checking of Construction Models and Schedules. *Automation in Construction*, 29, pp.183-95. <https://doi.org/10.1016/j.autcon.2012.05.006>.
- Zhao, X., 2017. A scientometric review of global BIM research: Analysis and visualization. *Automation in Construction*, 80, pp.37-47. <https://doi.org/10.1016/j.autcon.2017.04.002>.
- Ahn, K.-U., Kim, Y.-J., Park, C.-S., Kim, I. and Lee, K., 2014. BIM interface for full vs. semi-automated building energy simulation. *Energy and Buildings*, 68(Part B), pp.671-78. <https://doi.org/10.1016/j.enbuild.2013.08.063>.