



15 x 200 Gbit/s 16-QAM SDM transmission over an integrated 7-core cladding-pumped repeatered multicore link in a recirculating loop

Castro, Carlos; Jain, Saurabh; Man, Erik De; Jung, Yongmin; Hayes, John; Calabro, Stefano; Pulverer, Klaus; Bohn, Marc; Alam, Shaif-UI; Richardson, David

Published in:
Journal of Lightwave Technology

Link to article, DOI:
[10.1109/JLT.2017.2741495](https://doi.org/10.1109/JLT.2017.2741495)

Publication date:
2017

Document Version
Peer reviewed version

[Link back to DTU Orbit](#)

Citation (APA):
Castro, C., Jain, S., Man, E. D., Jung, Y., Hayes, J., Calabro, S., ... Rosenkranz, W. (2017). 15 x 200 Gbit/s 16-QAM SDM transmission over an integrated 7-core cladding-pumped repeatered multicore link in a recirculating loop. *Journal of Lightwave Technology*, 36(2), 349 - 354. <https://doi.org/10.1109/JLT.2017.2741495>

General rights

Copyright and moral rights for the publications made accessible in the public portal are retained by the authors and/or other copyright owners and it is a condition of accessing publications that users recognise and abide by the legal requirements associated with these rights.

- Users may download and print one copy of any publication from the public portal for the purpose of private study or research.
- You may not further distribute the material or use it for any profit-making activity or commercial gain
- You may freely distribute the URL identifying the publication in the public portal

If you believe that this document breaches copyright please contact us providing details, and we will remove access to the work immediately and investigate your claim.

15 × 200 Gbit/s 16-QAM SDM Transmission over an Integrated 7-Core Cladding-Pumped Repeated Multicore Link in a Recirculating Loop

Carlos Castro, Saurabh Jain, Erik De Man, Yongmin Jung, John Hayes, Stefano Calabrò, Klaus Pulverer, Marc Bohn, Shaif-ul Alam, David John Richardson, Katsuhiko Takenaga, Takayuki Mizuno, Yutaka Miyamoto, Toshio Morioka, and Werner Rosenkranz

Abstract—We investigate a realistic integrated multicore system consisting of directly spliced components: homogeneous trench-assisted 7-core fiber with a length of 60 km, cladding-pumped 7-core amplifiers, integrated 7-core isolators, and fiberized fan-in/fan-out couplers. We analyze the performance of an in-line repeated multicore transmission system in a recirculating loop by transmitting a 200 Gbit/s 16-QAM test channel and 14 × 100 Gbit/s QPSK neighboring channels between the wavelengths of 1558.58 nm and 1564.27 nm in a 50 GHz grid. For every position of the test channel within the considered band we demonstrate transmission distances over 720 km.

Index Terms—Multicore fiber (MCF), optical fiber communications, space-division multiplexing (SDM), recirculating loop, in-line multicore transmission system, cladding-pumped multicore amplifiers, multicore optical isolators, multicore fiber transmission.

I. INTRODUCTION

MULTICORE fibers (MCFs), consisting of several optical waveguides encompassed by a single cladding structure [1], were introduced in 1979 as a special type of space-division multiplexing (SDM). After being almost forgotten by the research community, they recently profited from the renaissance of SDM technologies driven by the continuously increasing data demands. Lately, MCFs have experienced significant progress and are now regarded as a viable technology to realize optical SDM telecommunication systems. The most important achievements in the field of MCFs include low inter-core crosstalk levels [2], capability to support long-haul transmission [3], and high core count [4]. In particular the last point aims at maximizing the economical benefit by utilizing the largest possible area of the cladding, while keeping the cladding diameter below 250 μm to minimize the mechanical failure probability of the fiber [5].

C. Castro and W. Rosenkranz are with the Christian-Albrechts-Universität zu Kiel, 24143 Kiel, Germany (e-mail: ccas@tf.uni-kiel.de)

S. Jain, Y. Jung, J. Hayes, S-ul. Alam, and D.J. Richardson are with the Optoelectronics Research Centre, University of Southampton, Southampton, SO17 1BJ, UK.

E. De Man, S. Calabrò, K. Pulverer, and M. Bohn are with Coriant R&D GmbH., 81541 Munich, Germany.

K. Takenaga is with Fujikura Ltd., 285-8550 Chiba, Japan.

T. Mizuno and Y. Miyamoto are with NTT Network Innovation Laboratories, NTT Corporation, 239-0847 Kanagawa, Japan.

T. Morioka is with the Technical University of Denmark, DK2800 Kgs. Lyngby, Denmark.

Manuscript received , 2017; revised , 2017.

MCF communication systems are conceived to employ state-of-the-art per-core digital signal processing (DSP). Therefore, inter-core crosstalk is usually minimized by fiber design rather than canceled via power-hungry signal processing. The main approaches to reduce crosstalk are maximizing the intercore distance, e.g. by arranging the cores according to efficient lattice layouts (hexagonal, square, etc.), incorporating artificial structures such as air holes and trench-indexed layers around the cores of the MCF [6], and using different refractive index profiles for different cores or groups of cores within the cladding [7].

In addition to the fiber, a critical component for the realization of integrated MCF system are multicore amplifiers. In the last few years, both core-pumped and cladding-pumped amplifiers have been demonstrated. The latter approach shows particular promise in enabling cost-effective MCF systems. The use of a single multimode pump laser to simultaneously amplify all cores offers the possibility to cut complexity and costs in comparison to single-mode and core-pumped repeated systems. Initially, core-pumped 7-core amplifiers have been designed using conventional erbium doping, to achieve performance close to that of conventional single-core erbium-doped fiber amplifiers (SC-EDFA). Lately, even 19 cores have been amplified using this core-pumping scheme [8]. In case of cladding-pumping, ytterbium co-doping is generally used to improve the cladding absorption. Recently, a cladding-pumped high-density 32-core amplifier using 2 multimode pumps has been demonstrated [9].

In this paper, we expand on our previous investigation regarding a fully-spliced 7-core integrated in-line repeated C-band system in a recirculating loop [10]. The transmission link is composed of two cladding-pumped multicore amplifiers, a 60-km MCF, and fan-in/fan-out devices to couple and de-couple the individual signals. We demonstrate the feasibility of MCF under realistic conditions by transmitting a 200 Gbit/s 16-QAM test channel over 720 km.

II. INTEGRATED MULTICORE LINK

A multicore link, consisting of integrated multicore elements was built by splicing together the components to produce an in-line repeated 7-core system. The integrated multicore link (IML) is composed by one homogeneous trench-assisted 7-core MCF with a total length of 60 km, two 7-core

erbium-ytterbium-doped fiber amplifiers (MC-EYDFAs), and fan-in/fan-out couplers. While being realistic, an integrated repeated system makes it impossible to directly measure power levels and crosstalk at arbitrary link stages, since the components are spliced together and the active fiber in the amplifiers is highly absorbing within the operating transmission band.

A. Homogeneous Trench-Assisted 7-Core Multicore Fiber

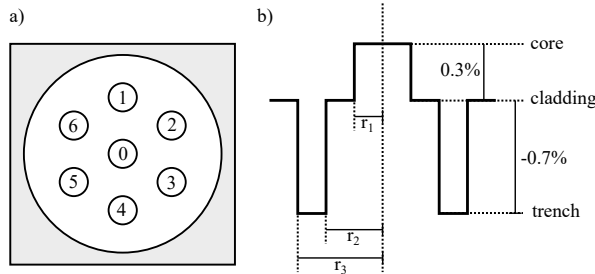

Fig. 1. a) Hexagonal waveguide layout and core identifiers of the 7-core MCF used in the experiments. b) Refractive index profile of the 7-core MCF.

In our experiment, we utilize a step-index homogenous trench-assisted 7-core MCF with a total length of 60 km, whose structure and refractive index profile are shown in Fig. 1. The cores of the MCF have an average pitch distance of 49.3 μm , a radius of 5.11 μm (r_1) and a relative difference of 0.23% in refractive index with respect to the cladding. The trench structures around the cores reduce the crosstalk by confining the power within each waveguide. They have inner and outer radii of 10.5 μm (r_2) and 16.6 μm (r_3), respectively, and their refractive index is 0.7% lower than that of the cladding. In addition, the 7-core fiber sports a cladding diameter of 195 μm and a coating diameter of 316.2 μm .

For the inner core, taking into account the overall interaction of the six neighboring cores, the inter-core crosstalk was measured to be -58.5 dB; whereas for the outer cores, overall crosstalk is \sim -61 dB. Table I reports the main parameters of the MCF.

TABLE I

Characteristics of the MCF at 1550 nm. Inter-core crosstalk in this table is measured as the interaction between any given pair of cores after 60 km.

MCF parameters	Min.	Max.
Attenuation [dB/km]	0.191	0.199
Chromatic dispersion [ps/nm/km]	20.5	20.8
Mode field diameter [μm]	11.6	12.0
Effective area [μm^2]	106.6	113.1
Polarization mode dispersion [ps/ $\sqrt{\text{km}}$]	0.031	0.068
Pairwise inter-core crosstalk [dB]	-68.0	-64.6

B. Integrated Erbium-Ytterbium-Doped Fiber Amplifier

An active 7-core MC-EYDFA was developed by a standard stack-and-draw method using an erbium-ytterbium-doped preform.

The preform was fabricated using a modified chemical vapor deposition technique with solution doping. Afterward,

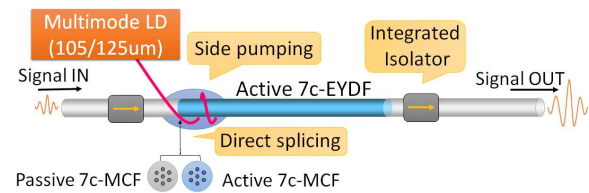

Fig. 2. Schematic diagram of the internal structure of a MC-EYDFA. The position of the integrated isolator in the MC-EYDFA depends on the role of the amplifier in the system. A pre-amplifier has the isolator at the input of the MC-EYDFA, whereas a post-amplifier has it placed at the output.

the cladding area of the preform was etched in Hydrofluoric acid bath in order to obtain the core/cladding ratio required to match the core pitch of the passive 7-core MCF, while ensuring single-mode operation. The core and cladding diameters of this EYDF are 5 μm and 195 μm , respectively. These dimensions ensure that the waveguides in the active fiber act as single-mode waveguides, since the erbium-ytterbium doping causes the numerical aperture of the cores in the active fiber to be larger than in the passive MCF.

Subsequently, the resulting preform was drawn into 7 thin rods, which were then stacked along with pure silica (F-300 Suprasil) packing rods in a hexagonal arrangement to obtain the final preform for the active 7-core erbium-ytterbium-doped-fiber (EYDF) matching the geometrical disposition of the cores of the transmission fiber. Compared to the passive 60-km MCF, where rings with different refractive indices (trenches) around the cores are used to lower inter-core crosstalk, for ease of fabrication the active 7-core EYDF only displays a simple homogeneous step-index core arrangement. Afterwards, both ends of the 7-meter-long EYDF were spliced to 1.5-meter-long 7-core MCFs.

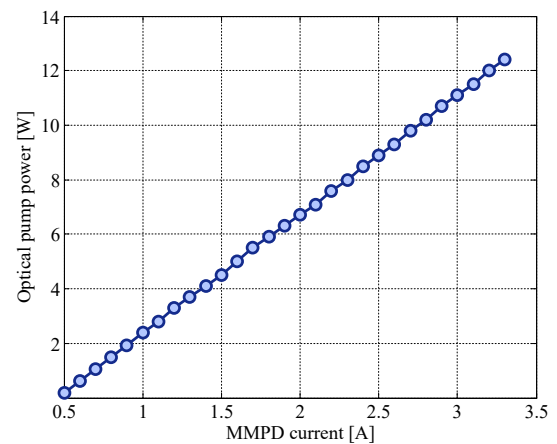

Fig. 3. Relation between the diode current and the optical pump power produced by the MMPD in the amplifiers.

We use a multimode pump laser diode (MMPD) operating at a wavelength of 975 nm, whose output fiber, which exhibits a numerical aperture of 0.22 and a core/cladding diameter of 105/125 micrometers, was adiabatically tapered down to a diameter of 15 μm and coiled around the active EYDF and passive MCF splice point to produce the pump coupler. The

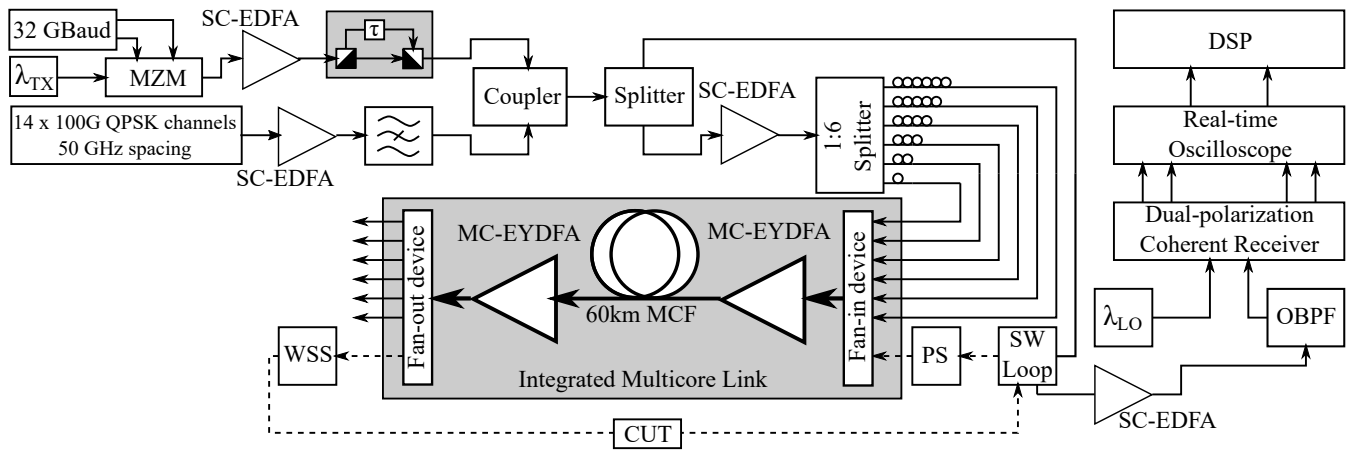

Fig. 4. Experimental setup of the multicore fiber system. SW Loop refers to the optical switches used to let the signal in and out of the recirculating loop. This setup analyzes the transmission performance of a given core of the MCF, while the remaining cores act as sources of inter-core crosstalk.

schematic diagram of the MC-EYDFA used in our experiment is shown in Fig. 2

At the pump wavelength, the cladding absorption, measured using a white light source, was found to be 9 dB/m. The pump coupling efficiency was observed to be about 65%, which was obtained by first developing pump couplers with short active fiber lengths, where the output power from the active fiber was measured.

Additionally, Fig. 3 displays the measured optical pump power of the MMPD as a function of the diode current, which is the externally tunable parameter of the MC-EYDFAs.

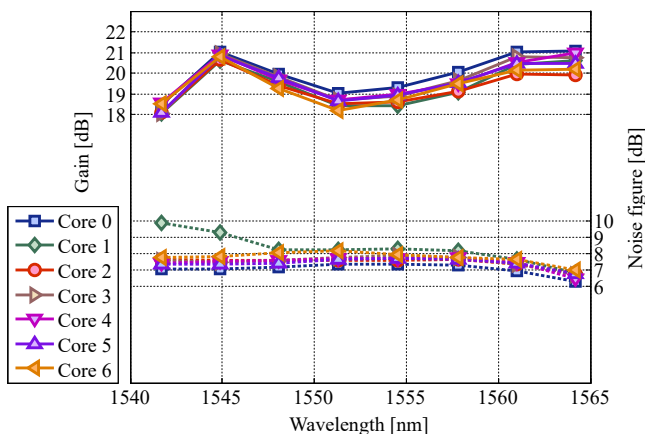

Fig. 5. Approximate gain spectrum and noise figure of the 7-core MC-EYDFA for an MMPD current of 2 A. The gain spectrum takes into account the average insertion loss of one integrated multicore isolator.

Figure 5 illustrates the gain spectrum and noise figure of an individual 7-core MC-EYDFA with integrated multicore isolators on both ends. The amplification bandwidth is approximately 22 nm in the C-band (wavelengths between 1542 nm and 1564 nm). In this spectral range, we have observed that there is a maximum gain variation of ~ 1.3 dB among cores and that the noise figure varies up to ~ 2.8 dB at the lower end of the analyzed spectral region due to an increased level of amplified spontaneous emissions.

To avoid undesired behavior such as reflections and lasing,

which might affect the overall performance of the device, we have inserted integrated 7-core isolators in the multicore amplifier structure. The insertion loss was measured to be around 4 dB per isolator pair. To minimize unnecessary losses, we decided to place just one isolator in each MC-EYDFA, since we assume that the transmission MCF acts as an isolator at one end of the MC-EYDFAs.

III. EXPERIMENTAL SETUP

Fig. 4 illustrates the multicore experimental setup comprising 15 WDM channels per core. The WDM signal consists of one 200 Gbit/s 16-QAM signal and 14 de-correlated 100 Gbit/s QPSK neighboring channels between 1558.58 nm and 1564.27 nm in a 50 GHz channel grid. The same WDM arrangement is simultaneously used for all the cores in the MCF system.

At the transmitter, the in-phase and quadrature samples of one polarization of the 16-QAM test channel, including pilot symbols and constant-amplitude zero-autocorrelation sequences, are generated offline and loaded into the memory of a digital-to-analog converter working at 88 GSamples/s. The resulting periodic 32 GBaud signal is then fed to a Mach-Zehnder modulator (MZM) to generate an optical signal that is boosted by a SC-EDFA before entering a polarization-multiplexing emulation (PME) stage.

To generate the neighboring channels, we use a laser comb corresponding to the different channel positions comprised in the WDM spectrum and couple them into a single multi-frequency signal, where a gap is left for the test channel. A second MZM, driven by a different 32 GBaud electrical signal than that used for the test channel, modulates simultaneously the whole laser comb. The signal is then amplified and fed into a wavelength-selective switch (WSS), which de-multiplexes the different channels and sends them over delay lines of various lengths for de-correlation purposes. Afterwards, a second WSS re-couples all channels into a single WDM signal. Finally, before adding the test channel via a passive coupler, we suppress the noise in the gap via a tunable notch-filter.

To produce optical signals for all the cores, a splitter generates two duplicates of the original WDM signal: one

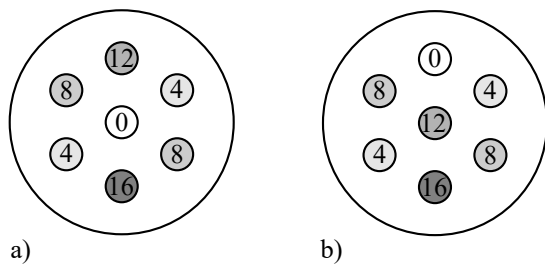

Fig. 6. Relative delay lines in meters with respect to a given core to de-correlate signals between optical waveguides: a) with respect to the middle core, and b) with respect to one of the outer cores.

is used for the core-under-test (CUT) and the other, for the remaining cores. The latter duplicate is amplified and further split, resulting in 6 signal copies, which are then de-correlated by using delay-lines of various lengths (4 m, 8 m, 12 m, and 16 m). The length of the used delay-lines is shown in Fig. 6. The variation of the total power among the cores at the input of the integrated multicore link remains within 2 dB.

The signal of the CUT is transmitted over a recirculating loop, which consists of a low-speed polarization scrambler (PS), the IML, and a WSS to equalize the power of the WDM channels. The signals of the neighboring cores, which act just as sources of interference, only pass once through the IML before being terminated. After the recirculating loop, a SC-EDFA amplifies the signal before the receiver and an optical bandpass filter (OBPF) extracts the test channel from the WDM spectrum. A coherent receiver and a real-time oscilloscope provide the digital samples for offline processing.

The captured waveforms are re-sampled to 2 samples per symbol. Then, bulk chromatic dispersion is compensated in the frequency domain. The carrier frequency offset and the coefficients of the 2-by-2 butterfly equalizer are estimated using the training sequences and pilot symbols. Clock recovery is performed after equalization according to the squarer algorithm. Subsequently, carrier phase estimation is implemented using the Viterbi-Viterbi algorithm for m-QAM modulation formats. In the end, the demodulated symbols are de-mapped to bits and the bit-error rate (BER) is estimated via error-counting.

We assume soft-decision forward error correction (FEC) with 15%-overhead irregular repeat-accumulate low-density parity-check codes [11]. By running several long-term simulations with 20 decoding iterations we determined the FEC threshold to be $2.4 \cdot 10^{-2}$.

IV. RESULTS

A. Per-Core Analysis

Inter-core crosstalk and MC-EYDFA gain vary from core to core, with core 0 experiencing both the highest inter-core crosstalk and the best gain spectrum (Fig. 5) [12]. Also the overall insertion loss along the IML due to fan-in/fan-out couplers, multicore isolators, and attenuation in the optical fiber exhibits a slight core-dependence.

To compare the transmission performance of the individual cores over the considered band, we evaluated the BER of the

test channel at the 5 wavelengths 1559.39 nm, 1560.61 nm, 1561.83 nm, 1563.05 nm, and 1564.27 nm for various transmit distances. The average BER measurements per core are displayed in Fig. 7, where the dashed line represents the average over all cores.

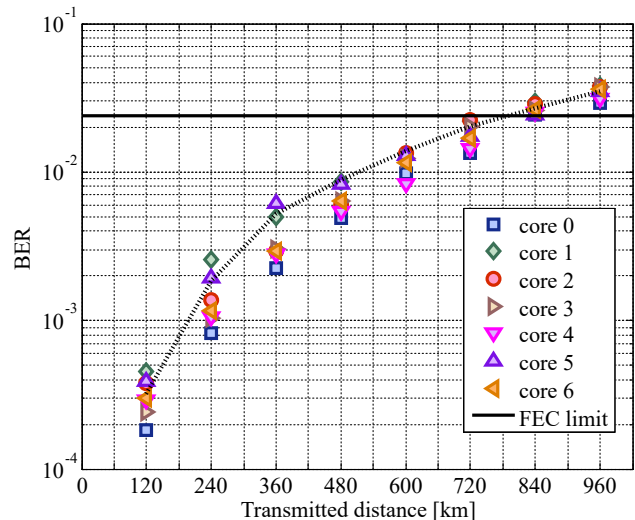

Fig. 7. Average BER measurements for the 200 Gbit/s 16-QAM test channel at 5 different wavelengths within the WDM spectrum for all cores in the MCF system. The dashed line represents the averaged BER of the 7-cores.

Since Fig. 7 shows that all cores perform similarly, we conclude that the different effects, in particular cross-talk and MC-EYDFA gain, tend to compensate each other and result in a balanced performance.

B. Reach Estimate

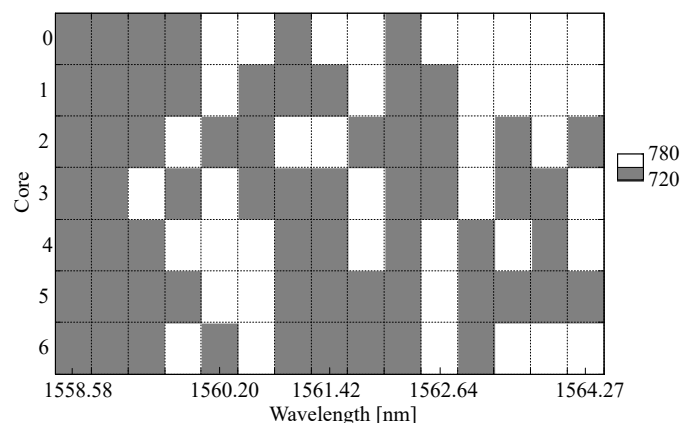

Fig. 8. Maximum achievable distance of the 200 Gbit/s test channel over all 15 channels per core before crossing the assumed FEC threshold of $2.4 \cdot 10^{-2}$.

To estimate the overall reach of the 7-core system, defined as the maximum transmitted distance before crossing the FEC threshold, we have measured the BER of the test channel for all 15 possible spectral positions in all the cores (in total, $7 \times 15 = 105$ channels) as a function of the transmission distance.

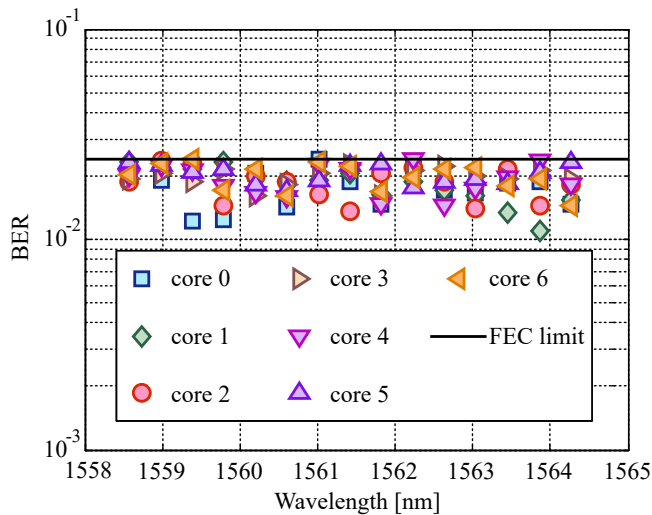

Fig. 9. BER of the 200 Gbit/s 16-QAM test channel over all 15 channels per core after a transmission distance of 720 km.

As shown in Fig. 8, about 61% of channels (64/105) have a reach of 720 km, whereas 39% (41/105) manage to achieve a transmission distance of 780 km.

Fig. 9 shows the measured BER of the 200 Gbit/s 16-QAM test signal for the 7 cores and the 15 wavelengths. Obviously, after a transmission distance of 720 km, all 105 channels perform below the assumed FEC threshold of $2.4 \cdot 10^{-2}$.

C. Link Impairments

To estimate the impact of the link impairments affecting the MCF system, we compare the results achieved over the recirculating loop with the optical back-to-back (B2B) performance of transmitter and receiver in the presence of noise loading.

Since we have shown that the performance is nearly uniform over wavelengths and cores, we restrict this analysis to a single channel in core 0 at a wavelength of 1564.27 nm.

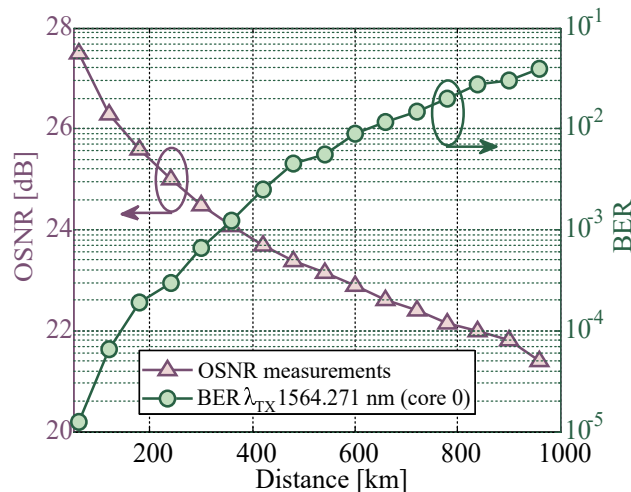

Fig. 10. OSNR (left vertical axis) and BER (right vertical axis) of a test channel at 1564.27 nm for the MCF transmission system.

Fig. 10 reports for the system of Fig. 4 the BER and the measured optical-signal-to-noise ratio (OSNR) in a resolution bandwidth of 0.1 nm as a function of the transmission distance.

Fig. 11 shows the BER vs. OSNR curve for the MCF transmission, obtained by mapping the data points of Fig. 10 in a one-to-one correspondence, and a reference curve obtained by loading noise in an optical B2B configuration.

At high OSNR levels, which correspond to short transmission distances, the two curves are quite close. However, as the distance increases, the curve corresponding to the MCF transmission experiment starts to diverge from the reference curve.

From the comparison shown in Fig. 11 it can be stated that for distances up to 360 km, the OSNR penalty remains approximately within ~ 1 dB, whereas for larger distances inter-core crosstalk and additional impairments acquired within the loop setup accumulate faster than optical noise, resulting in a degraded transmission performance.

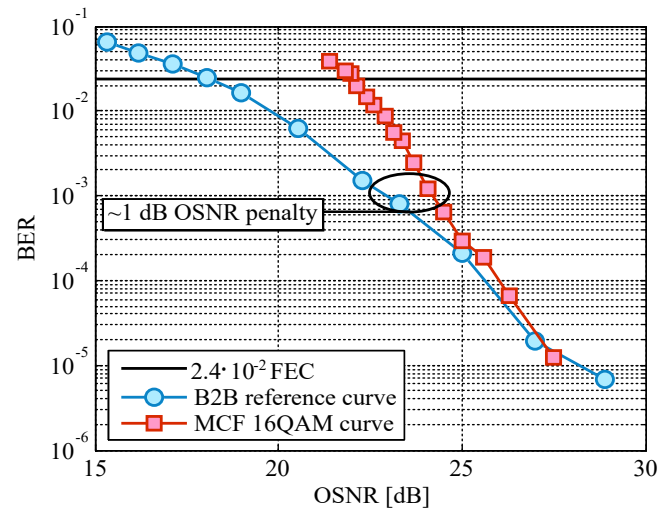

Fig. 11. BER vs. OSNR comparison between the optical B2B reference curve and the mapped points from Fig. 10

V. CONCLUSION

We have demonstrated MCF transmission over a fully-spliced integrated multicore link in a recirculating loop using C-band cladding-pumped multicore amplifiers, a 60-km homogeneous trench-assisted 7-core fiber, and fiberized couplers. To evaluate the system performance, we have transmitted in each core a WDM signal that comprises one 200 Gbit/s 16-QAM test channel alongside 14 100 Gbit/s QPSK neighboring channels in a 50 GHz channel grid.

We compared the average performance of the individual cores in the MCF and determined the overall highest achievable transmission distance. Extensive BER measurements show the performance of the test channel over all 15 channel positions in the spectrum and all 7 cores to fall below the FEC limit of $2.4 \cdot 10^{-2}$ after 720 km. Finally, we compared the BER vs. OSNR performance over the recirculating loop with a reference curve obtained in optical back-to-back configuration and we estimated the impact and accumulation of crosstalk-induced penalty.

ACKNOWLEDGMENT

The authors would like to thank Coriant R&D team for their support. This project was supported by the EU-Japan coordinated R&D project on “Scalable And Flexible optical Architecture for Reconfigurable Infrastructure (SAFARI)” commissioned by the Ministry of Internal Affairs and Communications (MIC) of Japan and EC Horizon 2020.

REFERENCES

- [1] S. Inao, T. Sato, S. Sentsui, T. Kuroha, Y. Nishimura, *Multicore optical fiber*, Proc. OFC, Paper: WB1, Washington D.C. (1979).
- [2] T. Hayashi, T. Taru, O. Shimakawa, T. Sasaki, E. Sasaoka, *Ultra-Low-Crosstalk multi-Core Fiber Feasible to Ultra-Long-Haul Transmission*, OFC Post Deadline, Paper: PDPC2, Los Angeles (2011).
- [3] K. Takeshima, T. Tsuritani, Y. Tsuchida, K. Maeda, T. Saito, K. Watanabe, T. Sasa, K. Imamura, R. Sugizaki, K. Igarashi, I. Morita, M. Suzuki, *51.1-Tbit/s MCF Transmission over 2,520 km Using Cladding Pumped 7-core EDFAs*, Proc. OFC, Paper: W3G1, Los Angeles (2015).
- [4] Y. Sasaki, K. Takenaga, K. Aikawa, Y. Miyamoto, T. Morioka, *Single-Mode 37-Core Fiber with a Cladding Diameter of 49.3 μm* , Proc. OFC, Paper: Th1H2, Los Angeles (2017).
- [5] T. Sakamoto, T. Matsui, K. Saaitoh, S. Saitoh, K. Takenaga, T. Mizuno, Y. Abe, K. Shibahara, Y. Tobita, S. Matsuo, K. Aikawa, S. Aozasa, K. Nakajima, Y. Miyamoto, *Low-loss and Low-DMD Few-mode Multicore Fiber with Highest Core Multiplicity Factor*, OFC Post Deadline, Paper: Th5A2, Anaheim (2016).
- [6] T. Hayashi, “Multi-Core Optical Fibers” in *Optical Fiber Telecommunications VIA: Components and Subsystems*, I. P. Kaminow, T. Li, and A. E. Willner, Academic Press, 2013, pp. 321-352.
- [7] Y. Amma, Y. Sasaki, K. Takenaga, S. Matsuo, J. Tu, K. Saitoh, M. Koshihara, T. Morioka, Y. Miyamoto, *High-density Multicore Fiber with Heterogeneous Core Arrangement*, Proc. OFC, Paper: Th4C4, Los Angeles (2015).
- [8] J. Sakaguchi, W. Klaus, B. J. Puttnam, J. M. Delgado Mendunuea, Y. Awaji, N. Wada, Y. Tsuchida, K. Maeda, M. Tadakuma, K. Imamura, R. Sugizaki, T. Kobayashi, Y. Tottori, M. Watanabe, R. V. Jensen, *19-core MCF transmission system using EDFA with shared core pumping coupled via free-space optics*, Optics Express, Vol. 22, No. 1, pp. 90-95, January 2014.
- [9] S. Jain, T. Mizuno, Y. Jung, Q. Kang, J. R. Hayes, M. N. Petrovich, G. Bai, H. Ono, K. Shibahara, A. Sano, A. Isoda, Y. Miyamoto, Y. Sasaki, Y. Amma, K. Takenaga, K. Aikawa, C. Castro, K. Pulverer, Md. Nooruzzaman, T. Morioka, S.U. Alam, D. J. Richardson, *32-core Inline Multicore Fiber Amplifier for Dense Space Division Multiplexed Transmission Systems*, ECOC Post Deadline, Paper: Th3A1, Düsseldorf (2016).
- [10] C. Castro, S. Jain, Y. Jung, E. De Man, S. Calabrò, K. Pulverer, M. Bohn, J. Hayes, S.U. Alam, D. J. Richardson, K. Takenaga, T. Mizuno, Y. Miyamoto, T. Morioka, W. Rosenkranz, *200 Gbit/s 16QAM WDM Transmission over a Fully Integrated Cladding Pumped 7-Core MCF System*, Proc. OFC, Paper: Th1C2, Los Angeles (2017).
- [11] M. Yang, W. E. Ryan, Y. Li, *Design of efficiently encodable moderate-length high-rate irregular LDPC codes*, IEEE Trans. Commun., Vol. 52, No. 4, pp. 564-571, 2004.
- [12] C. Castro, S. Jain, E. De Man, Y. Jung, J. Hayes, S. Calabrò, K. Pulverer, M. Bohn, S.U. Alam, D. J. Richardson, K. Takenaga, T. Mizuno, Y. Miyamoto, T. Morioka, W. Rosenkranz, *100-Gb/s Transmission Over a 2520-km Integrated MCF System Using Cladding-Pumped Amplifiers*, IEEE Photonics Technology Letters, Vol. 29, No. 14, pp. 1187-1190, July 2017.

Authors' biographies not available at time of publication