

Storage of agricultural products

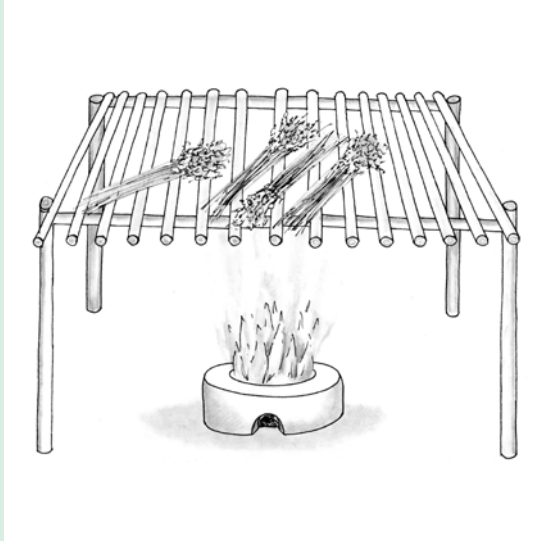
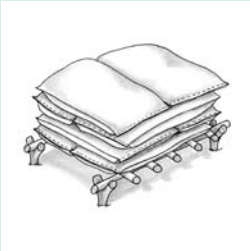

Agrodok 31

**Storage of agricultural
products**

Piet Scheepens
Rik Hoervers
Francis Xavier Arulappan
Gerard Pesch

This publication is sponsored by: ICCO

© Agromisa Foundation and CTA, Wageningen, 2011.

All rights reserved. No part of this book may be reproduced in any form, by print, photocopy, microfilm or any other means, without written permission from the publisher.

First edition: 1995

Fifth (completely revised) edition: 2011

Authors: Piet Scheepens, Rik Hoevers, Francis Xavier Arulappan, Gerard Pesch

Illustrators: Marinette Hoogendoorn, Jaap Uittien

Translation: Catherine de Kat-Reynen (language editing)

Printed by: Digigrafi, Veenendaal, The Netherlands

ISBN Agromisa: 978-90-8573-123-8

ISBN CTA: 978-92-9081-443-6

Foreword

This booklet in the Agrodok series is a major revision of Jelle Hayma's edition from 1995. As post-harvest losses of crops are still a major issue for small-scale farmers in the tropics, we needed no further stimulation to work on the update.

The intention of this revision was to place less emphasis on all the technical facilities available to store agricultural products, and instead provide more background information on how and why products deteriorate, and how this can be delayed or reduced.

Rather than focusing only on storage of the most important staple foods (grains and pulses, root and tuber crops), a whole chapter in this edition has been devoted to fruits and vegetables. These products are not only important in the diet of a farmer's family: they can also contribute to the farmer's income when brought to the market in good condition.

During the preparation of this booklet we received comments from several people on how to improve the manuscript. We want to acknowledge especially the valuable input of Dr. Peter Fellows, who was simultaneously in the process of writing *Agrodok 50: Packaging of Agricultural Products*.

The authors, Wageningen, 2011

Contents

1	Introduction	6
1.1	Reasons for a farmer to store agricultural products	6
1.2	Outline of the booklet	7
2	How to retain the quality of stored agricultural products	9
2.1	The product to be stored determines its shelf life	9
2.2	Why the quality and quantity of stored agricultural products decline	11
2.3	Prevention of storage losses	12
2.4	Storage principles	13
3	Storage of seeds	16
3.1	Introduction	16
3.2	Challenges in the storage of seeds	17
3.3	Harvesting seeds and drying in the field	19
3.4	Further drying and storage	25
3.5	Additional protection against insects	33
3.6	Additional protection against rats and mice	40
4	Storage of roots, tubers and bulbs	44
4.1	Introduction	44
4.2	Challenges in the storage of roots and tubers	44
4.3	Operations in the field	45
4.4	Storage of roots, tubers and bulbs	49
4.5	Specific measures to increase shelf life	52
5	Storage of vegetables and fruits	56
5.1	Introduction	56
5.2	Challenges in the storage of vegetables and fruits	57
5.3	Operations in the field and in a warehouse	60
5.4	Storage of vegetables and fruits	62

Appendix 1: Measuring relative humidity of the air	69
Appendix 2: Measuring the moisture content of seeds	72
Further reading	74
Useful addresses	76
Glossary	78

1 Introduction

1.1 Reasons for a farmer to store agricultural products

This booklet discusses how agricultural products are harvested and stored by farmers. In most cases, the products are stored without further handling for a shorter or longer period. Unfortunately losses of 25 percent for stored grain crops and 40-50 percent for vegetables are not unusual in the tropics. For the farmers, these products fulfil various needs:

Seed for planting

Part of the harvest is used as propagation material for the next crop. If seeds or tubers are not stored well, some will not germinate (grow) when planted, which means the farmer will have to plant many more to get enough plants. The seed grains may also grow at different speeds, which will cause problems for cultivating and harvesting the crop.

Food for the family

It is important to have enough food, but to stay healthy it is also important to have food that is of good quality. Farmers and their families can clearly see whether they will run out of grain to eat before the next harvest, but loss of food quality is more difficult to measure. Some insects eat out the best parts of the grain, which contain the vitamins and minerals that make the food nutritious. Farmers may not see this loss, and therefore need to know how to prevent it. Lack of nutritious food can lead to many problems, including sickness and malnutrition.

Income

Farmers have to buy or barter for things they need but do not produce themselves. Most farmers sell the products they do not use for food or planting to earn money, or they trade their own products for the things they need. If farmers have only poor drying and storage facilities, they cannot keep their products safely for any period of time and are forced

to sell the products soon after harvest. The prices are low at this time because no one needs grain. Everyone is harvesting, and there is plenty of grain available. If the farmers can dry and store the products safely, they may be encouraged to grow more than they need for their families. Good grain storage can thus lead to more food, more money, better planting material, and a better future.

With this practical manual we wish to encourage small-scale farmers to improve their storage methods for grains, roots and tubers, fruits and vegetables.

1.2 Outline of the booklet

In this booklet we discuss the storage of different agricultural products. We will present storage not as a single measure, but in the context of other post-harvest activities. In the first chapter we discuss why it is important for farmers to store agricultural products.

Chapter 2 is divided into several sections. The first section (2.1) discusses how agricultural products start to deteriorate after harvesting, which makes them unsuitable for long-term storage. The maximum storage period varies per product, but in general it is longest for seeds, intermediate for most roots and tubers and shortest for some fruits and vegetables. Section 2.2 explains why the quality of harvested products quickly declines. Section 2.3 describes ways to stop or reduce these losses. Section 2.4 summarises the principles for product storage and how these can depend on the type of products to be stored and the outside conditions.

Chapters 3 – 5 are devoted to the storage of specific crops, including seeds (Chapter 3), roots, tubers and bulbs (Chapter 4) and fruits and vegetables (Chapter 5). These chapters start with an overview of the products that belong to each group of crops discussed, followed by the greatest challenges in storing these products. The third section of each chapter describes the activities that take place in the field before storage, and for some products storage in the field. The fourth section of

each chapter is devoted to preparation of storage space inside a building, the storage itself and transport to and from the storage space.

2 How to retain the quality of stored agricultural products

2.1 The product to be stored determines its shelf life

Agricultural products cannot be stored indefinitely. The maximum storage duration (the shelf life) of agricultural products varies and can be only a few days for some fruits and vegetables, a couple of months for most tubers and bulbs, and over a year for dried food grains or other seeds (Figure 1).

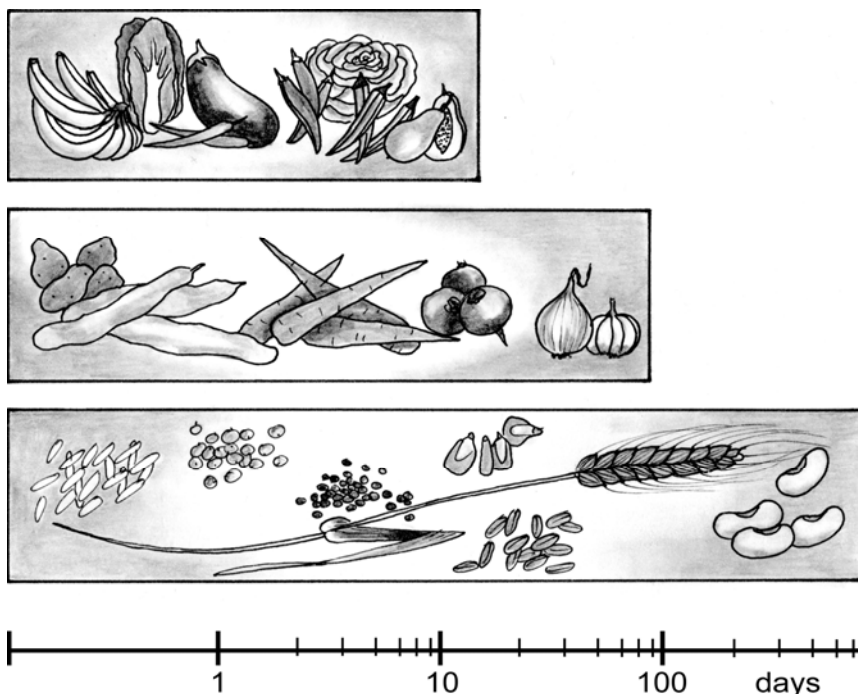

Figure 1: The shelf life of agricultural products depends, first of all, on the product itself. Upper bar: fruits and vegetables; middle bar: tubers and bulbs; lower bar: seeds.

You can extend the shelf life of some fresh agricultural products by cooling, but this is expensive and it is not described in detail in this booklet. For all crops, the most important thing is that they remain edible during storage. Most fruits and vegetables should also keep their attractive appearance. A wrong colour, wrinkles, etc., make them less attractive to consumers.

For each product there are numerous factors that pose a threat to their shelf life. These threats are present not only during storage, but during the whole pipeline from food production to consumption or marketing (see Figure 2). Each step can have an impact on the quality and quantity of the products. This booklet deals with the first steps of the pipeline. The processing and marketing steps are described in the references in 'Further reading'.

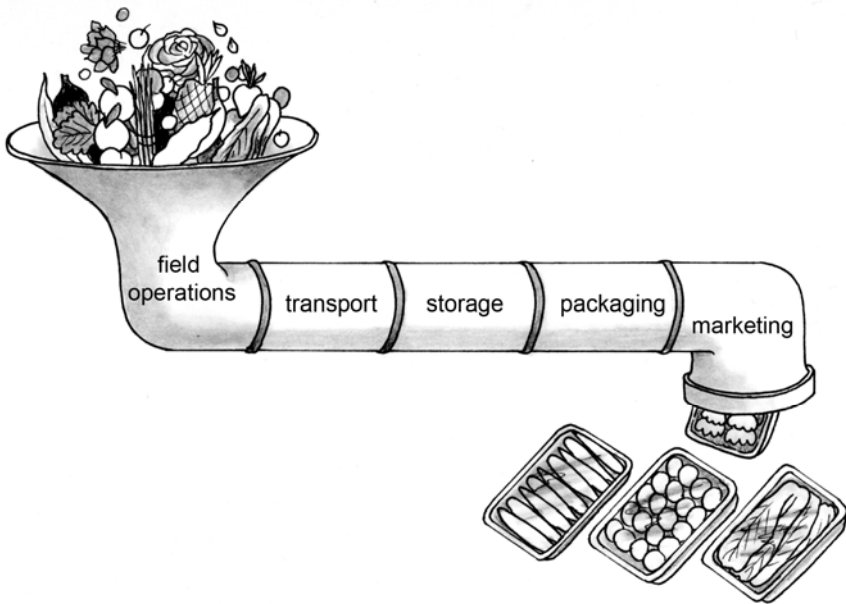

Figure 2: Food pipeline from harvest to consumption

If proper storage is not possible and a product is likely to spoil before it can be consumed, the best solution is often to preserve it. Preservation means modifying a product so that its properties change and it can be kept longer. Examples are drying fruits, making flour from cassava tubers, or mash from tomatoes. In this way, new products with different properties are made that are still edible. Information on preserving products can be found in Agrodok 3: **Preservation of fruits and vegetables**.

2.2 Why the quality and quantity of stored agricultural products decline

Internal factors

Agricultural products are still alive and their life processes continue after the harvest. All products respire (breathe). They use oxygen from the air to burn their reserves. The products thus become thinner, and they produce carbon dioxide and heat. Another continuing process is ripening. Fruits often change colour as they ripen, and their tissue gradually becomes softer. Eventually the fruit becomes overripe and is then unsuitable for consumption. Fruits and vegetables, and to a slightly lesser degree tubers, tend to lose water as they get older. The product becomes wrinkled and is less attractive to consumers.

Respiration, ripening and water loss are internal factors that determine the quality of stored products.

External factors

External factors, which also play an important role in the loss of product quality and quantity, include:

➤ *Mechanical injury*

Seeds, roots and tubers are easily injured during harvest. Fresh fruits and vegetables are particularly susceptible to cuts and bruises owing to their tender texture and high moisture content. Poor handling, unsuitable packaging and improper packing during

transportation are the causes of bruising, cutting, breaking, impact wounding, and other forms of injury in fresh fruits and vegetables.

➤ *Fungi and bacteria*

After harvesting, the natural defence mechanisms of agricultural products rapidly decline. Roots, tubers, fruits and vegetables are then easily infected by bacteria and fungi. Most fungi have thread-like structures. These are also called moulds. Bacteria and fungi cause rotting of the products, if the products are wet enough to support the growth of these micro-organisms. Seeds are generally less vulnerable, provided that they are stored under dry conditions.

➤ *Insects, rodents and other animals*

All these pests like to eat seeds and other stored agricultural products, and can thus be the cause of large losses.

2.3 Prevention of storage losses

In the following chapters, we will discuss how to optimise storage conditions in order to prevent losses of agricultural products. In general, prevention is focused on controlling the different internal and external factors that are responsible for losses of quality or quantity.

Aging, respiration and loss of water all make products deteriorate. These processes can be slowed down by chilling the products. Tubers, with the exception of cassava, can be kept in a state of dormancy (see Chapter 4), and as long as this state is maintained, they will remain fresh and will not get wrinkled. Loss of water in roots and tubers can be prevented by storing them in a humid environment, for instance in wet soil. On the other hand, seeds are best stored in a dry environment, because life processes including respiration are then slowed down. Harvesting when still unripe can be a good option for prolonging the shelf life of some fruits.

Mechanical injury has to be prevented before or during the harvest, for instance by carefully threshing seeds or using protective packaging

during transport of fruits and vegetables. Sometimes, special varieties of a crop are available that are less susceptible to injury, like ‘Roma’ tomatoes.

Some rotting of fruits, vegetables, roots and tubers by fungi or bacteria can be prevented by keeping the crops healthy during the growing season. Rotting by these same micro-organisms in storage can be prevented or delayed by the same methods that delay the aging of the products. Deterioration of seeds due to micro-organisms can be prevented by drying the seeds.

Insects and rodents need to be prevented from contaminating the crop before harvest, and prevented from entering the storage facility.

2.4 Storage principles

Most agricultural products are not consumed immediately after harvest for reasons given in Chapter 1, but have to be kept in storage for some time. The challenge in storing agricultural products is to prevent them from deteriorating and losing quality. The following points should be considered:

- 1 Sometimes not picking or harvesting products until they can be consumed is an option for tuber and bulb crops (Chapter 4) and for some vegetables and fruits (Chapter 5). Most products, however, need to be harvested right away at maturity, to prevent their quality from decreasing too much and to reduce the chances of infestation by pests and diseases or theft.
- 2 Leaving the products in the field after harvesting is possible and desirable in some cases, but it is always risky because the conditions (weather and presence of pests and diseases) are uncontrollable. For some products this would even be disastrous, because exposure to direct (tropical) sunlight would ruin them. This is particularly true for sowing seed (Chapter 3), which cannot tolerate temperatures above 40-45 °C, and for vegetables and fruits (Chapter 5).

For tubers and bulbs it may be beneficial to leave them for some time (not too long) in the field at high temperatures. Seeds need to be dry for safe storage, so in periods of dry weather drying could very well be done in the field.

- 3 During transportation and storage, some products are easily bruised or injured. This must be prevented by careful harvesting, but also by ensuring proper packaging and careful driving of the transport vehicle.
- 4 If seeds cannot be dried in the field, they have to be dried inside a building. If the weather is mostly dry, they can be dried in a well-ventilated building. Once dry, they can be kept in this ventilated building or packaged and stored elsewhere. If the weather is mostly humid, they have to be dried artificially by using a fan and a current of warm air. The temperature should not become too high because the seeds may then die.
- 5 The products are stored until consumed by the farmer and his or her family or until they are transported to the market. The optimal conditions may vary per product.
 - In all cases temperature is important. Generally, the lower the temperature, the longer the storability. Refrigeration is suitable for some products, but for economic reasons it is mostly used only with expensive products that come in small volumes. Some tropical fruits are injured by low temperatures.
 - Products that respire should not be stored airtight, so not in plastic, closed containers or warehouses without ventilation.
 - Products that do not breathe (dry seeds) can be stored in airtight containers or spaces.
 - Products that contain a lot of moisture must be stored in relatively humid conditions. These conditions are also favourable for the growth of fungi and bacteria, so care should be taken to store only products that are free from fungi and bacteria. Seeds that are still too wet to be stored under airtight conditions need to be stored in spaces with only very small holes to keep insects, rats

and mice out, but on the other hand also need good ventilation to further the drying process.

- Fruits that produce ethylene gas during ripening (Chapter 5) cannot be stored together with many other fruits and vegetables, because ethylene gas causes aging.
- Regular (daily) inspection is important to detect product deterioration and attack by rodents and insects as early as possible.

6 If the volume of product harvested is greater than that needed for family consumption, part of the production could also be preserved to increase its shelf life (see Agrodok 3: **Preservation of fruits and vegetables** and references in Further Reading).

3 Storage of seeds

3.1 Introduction

Seeds are the natural means for a plant species to propagate and spread. They also enable the species to survive during the period between growing seasons when weather conditions are unsuitable to support plant growth. Plant seeds are thus built for survival. They consist of (Figure 3) an embryo, a store of food to enable the embryo to grow and a coat to protect the embryo and food reserve. Under suitable conditions, the embryo germinates and grows into a new plant. The growing embryo then exhausts the food reserve. Water is the most important factor that triggers growth of the embryo. If seeds are dry, and as long as they remain dry, no life processes take place, and the seeds remain intact and viable (ready to grow).

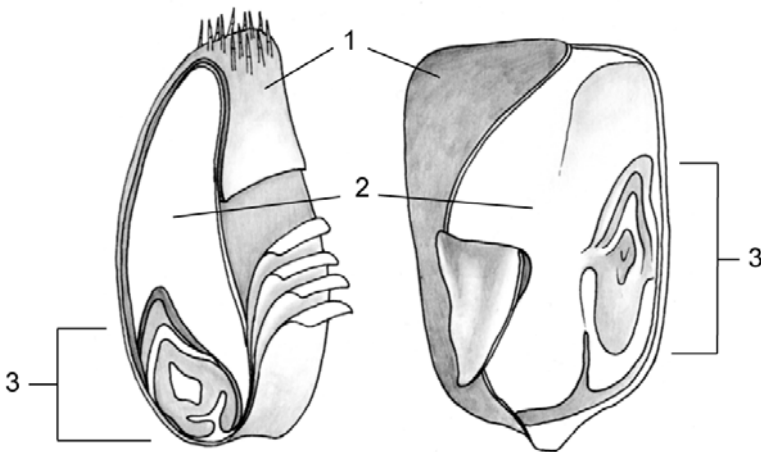

Figure 3: Seed structure of wheat (left) and maize (right), with 1: seed coat, 2: food reserve, and 3: embryo

Many crops are propagated by seeds (grains). If you are a farmer, seeds are important for establishing a crop at the beginning of each growing season. If you plant them in wet soil, they will germinate and

grow into crop plants. Seeds are also an important source of food and feed. Cereal grains and pulses are important staple foods. Cereals belong to the grasses family and pulses are annual legumes that are grown for their seeds. Oil-containing seeds are used for direct consumption (groundnuts, soybeans, sesame and coconut) or for the extraction of oil. Nuts represent a special category of oil-containing seeds as they can be used in cooking, eaten raw, sprouted or roasted as a snack food. They are also very nutritious.

Whether seeds are used for planting or as a source of food, it is important to be able to store them for a period of at least several months.

3.2 Challenges in the storage of seeds

The first challenge in the storage of seeds is to properly dry them. Drying seeds has a double purpose. In the first place it nearly stops respiration. If seeds to be used for food continue to respire, they will lose nutritional value. Seeds for planting will lose the ability to germinate. However, if seeds are dry enough, they will not respire and can be kept in storage for quite a long time. Depending on the plant species, this period can vary from several months to more than a year.

The second purpose of drying seeds is to prevent spoilage by bacteria and fungi. If seeds are too wet when put into storage, they provide an ideal food source for bacteria and fungi. The activity of these storage pests raises the temperature in the storage area, and within quite a short time the seeds will be totally spoiled, both by direct damage (rotting and feeding by insects and other animals) and by destruction of the germination capacity through the high temperature.

For storage of food grains, the moisture content should therefore be no more than 13 percent, for pulses it can be around 2 percent higher. This is called the 'safe moisture content' because below this point the seeds will no longer support growth of bacteria and fungi (See Annex 1 for a further explanation). Seeds for planting can be stored longer if they are dried a few percent more. Very dry legume seeds pose another

problem though: they become very brittle and are easily damaged when handled.

Assessing the moisture content of seeds is often one of the largest problems faced by the small-scale seed producer. There is no accurate method to judge moisture other than by using a small electronic moisture meter (see Appendix 2), which can be quite expensive. However, if you can afford to buy one, it would definitely be a worthwhile investment. Some experienced farmers and seed handlers can judge seed moisture content by biting the seed. If the seeds crack, rather than break, they are dry enough for storage. Another low-cost alternative is to use salt that has been sun-dried for a couple of days. The salt is mixed with the seeds in a clean, dry glass jar and shaken for a minute. If the salt sticks to the glass then the seeds probably contain more than 15 percent moisture and should be dried further. If the salt does not stick then the seeds are dry enough to be put into storage.

Some oil-containing seeds are especially at risk of being damaged by micro-organisms, because some fungi and bacteria can grow on them even when they have a very low moisture content. For instance groundnuts have to be dried to below 8 percent moisture to prevent growth of some fungi that produce substances (aflatoxins) that are toxic to people. Stored oilseeds can also become rancid (develop an unpleasant odour or flavour).

Seeds are a preferred food source for several insects, rodents and birds. For that reason seeds cannot be kept very long in the field after the harvest. Insects and rodents can also be notorious pests for stored seeds. The second challenge is therefore to prevent insects and rodents from entering the seed store. An even greater challenge is to do this without the use of pesticides. Many pesticides are also poisonous for humans and domestic animals.

For seeds that are to be used for planting, a third challenge is to prevent them from being destroyed by too much heat. Temperatures dur-

ing harvest, drying and storage should not exceed 40 °C for grains and 35 °C for pulses.

3.3 Harvesting seeds and drying in the field

Harvesting time and method

The keyword for harvesting seeds is timeliness. Harvesting must not take place too early, nor too late. Too early means that a high moisture content will make dry storage of the seeds impossible. Too late will result in losses through disease and insect infestation, birds, shattering or spoilage through rain. Too late will also increase the brittleness of the seeds, which makes them more likely to break when the crop is handled.

Because of the higher value of a seed crop, it can be worth the extra trouble to harvest a little early and dry the seed artificially. This will eliminate most of the dangers mentioned. When you investigate drying methods that have not been specifically designed for seed, bear in mind that too much heat is the surest way to kill the seed! A well-ventilated place in light shade is best, and the seed should be regularly turned. You should also be careful to stop in time, and not let the seed get too dry. If you want to rely on field drying, you must have planned your planting time so that harvesting can take place in the dry season.

In most crops, the seed reaches maturity a while before normal harvesting time. The grain has been filled, the embryo is complete, and all that happens from then on is loss of water. We say that the seed is then *physiologically mature*. In theory, it can be harvested any time after this point, provided you are equipped to deal with the high moisture content.

In most pulses, physiological maturity is reached when the pods start to change colour. The plants can then be pulled up and put in windrows or on racks to dry. This helps to ensure that all pods are ready for threshing at about the same time. In cultivars with a long flowering period and pods of widely differing ages, you will have to compro-

mise between losing seeds from the oldest pods due to shattering, and harvesting the youngest pods too early. The first set pods are usually of the best quality, so it is usually better to save them rather than the youngsters.

Groundnuts do not allow for simple inspection of the pods. There is no alternative to digging up a few plants when you think the time is nearing, and checking if the seeds are free in the pod, and if the skin on the seeds (in the case of peanuts) has turned colour.

In maize, physiological maturity is reached when the black layer is formed. You can see the black layer by breaking a seed off the cob, removing the bits of fibrous and papery tissue at the top, and looking as it were into the seed from the point where it was attached. The crop could be harvested at this point and will yield very good quality seed.

Physiological maturity is not a useful indicator in rice and other short straw cereals (wheat, barley, rye and oat). It already occurs at around 50 percent moisture, which is far too early to harvest. The best time to harvest is, as with pulses, when the ears change colour.

If you have selected plants from which you want to collect seed for planting, remember to harvest them first, before the rest of the crop is harvested.

Drying seeds

As explained in Appendix 1, dry weather with some wind is ideal for drying seeds. Too-high drying temperatures cause the kernels of some grains to break and may kill the seed embryo. Therefore drying of most sowing seeds is best done at a maximum temperature of 35 °C. Only cereals can withstand temperatures of 40-45 °C. That is why seed for planting is not dried in full sunlight, but in the shade. It is disastrous for dry seeds to become wet again. Therefore, seeds have to be dried indoors when harvested in a rainy period (see section 3.4). If there is only an occasional shower, seeds might still be dried in the field. In that case, spread seeds on a plastic or canvas sheet and tie a

rope across the middle (Figure 4). In the event of rain, the sheet can be folded over the rope to protect the seeds.

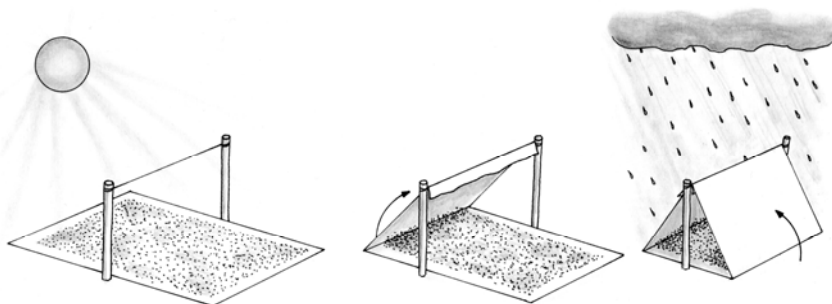

Figure 4: Seeds are dried in the sun on a sheet (left) that can be folded (middle) over a rope in the event of rain (right)

Cereals and pulses are often dried in the field with the seeds still attached to the plants. Figure 5 shows several types of racks on which the plants can be dried.

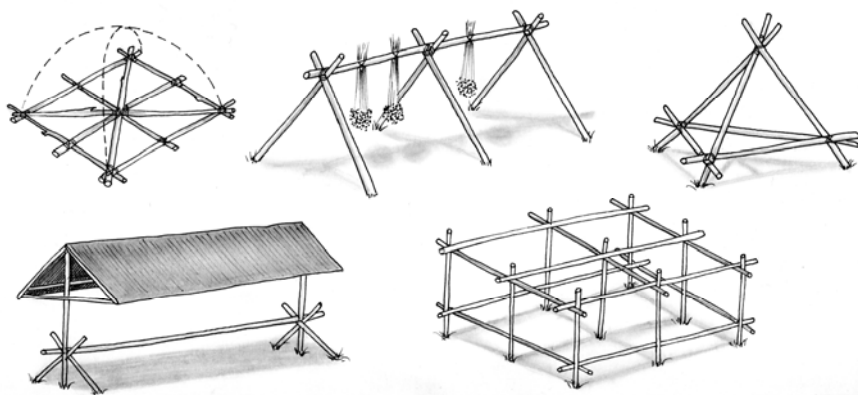

Figure 5: Different types of racks to dry cereals and pulses. Upper row, from left heap of branches, rack to hang bundles of plants, hay rack. Lower row: roofed rack (left), platform (right)

Pulses are often left lying on the ground before mounting the plants on racks, to let the leaves die off. This process is called windrowing. However, windrowing works less well if the soil is heavy and remains moist for a long time. Groundnuts are also dried in the field in windrows, in stacks or on racks.

If some rain is expected, it is important to protect the seeds of cereals or the pods of pulses and groundnuts from becoming wet. This is achieved by piling the crop onto racks or tripods with the seeds or pods on the inside and the leaves on the outside. The leaves form a kind of thatch on which the water runs off, like the thatch of a house. A small piece of tarpaulin or plastic on top of a tripod (like a hat) additionally protects the seeds or pods from rain.

Maize will have to be dried when the seeds are still on the cob. The reason is, that the seeds are still too wet to be threshed, and thus they must be dried before they can be threshed. Maize cobs are often dried in specific buildings (see Figure 6 in section 3.4).

During this pre-storage drying period, and sometimes even before harvesting, the seeds may easily become infested with insects. This should be avoided by adequate pest management during the growing season.

When the products have reached the safe moisture content, the stems and foliage can be removed and the pulses can be stored in containers that take up less space. Often they will be threshed first. Even if the product is still too moist, it can be stored, provided that it can dry further during storage.

The oil-containing groundnuts, soybeans and sesame are first dried in the field with the foliage still attached. They are dried to a moisture content of no less than 15 percent. At a lower moisture content, too many seeds will be broken during further handling. And broken seeds will also increase the incidence of infection by fungi and invasion by insects. Afterwards they are threshed or picked by hand. A moisture

content of 15 percent seems to be the most suitable for picking by hand and threshing with flails or simple stripping machines. The latter methods give a high percentage of broken groundnuts. When threshing mechanically, it is possible to thresh at a higher moisture content, which results in less damage.

Palm kernels are very difficult to store without loss of quality and have to be dried very well. For prolonged storage of coconuts the coconut meat should be dried from the original moisture content of about 50 percent to about 6 percent. The nuts are cut in half and are dried in the sun or artificially or by a combination of both (see section 3.4). For sun-drying 60-80 hours of sunshine are required; if it takes longer than 10 days the coconut will spoil. They are covered at night against dew formation and during rain, or the drying racks can be stored under a roof. The meat is removed from the shell after about 2 days and 3-5 days are then necessary to complete the drying.

Threshing

Methods of threshing are more or less the same for all kinds of seeds. It takes place when the seeds have almost reached the desired moisture content. This may be when they are still in the field or after additional drying inside a building. There are few, if any, specific threshing methods for seed. We just have to ensure that the local standard method is used as gently as possible, to avoid breakage.

Pulses are especially sensitive. Here the value of harvesting a little early will be especially noticeable, as seed with a slightly higher moisture content is easier to handle. However, too wet is not right either, since handling can then cause internal damage. Additional drying should take place after threshing, but before winnowing and cleaning.

If the crop is field dried, remove the windrowed or sheaved crop from the field early in the morning, when there will be a bit of dew on the pods or ears, or dampness in the air, which will limit shattering. Threshing can begin later in the day. The simplest way of threshing pulses for seed is by stuffing the pods in bags and hitting these with

sticks. Do not trample pods or run vehicles over them, as that is likely to cause too much damage.

The groundnuts are again an exception: first, because they are better stored in the pod until planting time, and second because for use as planting seed there is no good alternative to threshing (shelling) by hand.

Threshing of cereals for seed is done with the same methods as when harvested for food. If you have enough space and suitable storage facilities, maize seed can also be kept very well on the cob. Small quantities of cobs can be bundled and hung indoors, but for larger quantities a crib must be built.

Threshed seed will generally need to be cleaned of soil, stones, chaff and other pieces of plants, as well as insects and weed seeds. Smaller quantities can be cleaned by hand, through winnowing, sieving and/or sorting. But if you have large quantities of seed, this will soon become a job that will have to be mechanised. A wide range of machinery is available, from simple to very advanced.

Whether sorting by hand or by machine, pay special attention to weed seeds and to crop seeds that do not look healthy. This may include discoloured, broken, stained, shrivelled or malformed seeds, and seeds attacked by insects. Even though many of these may already be taken out during winnowing or sieving, visual inspection and if necessary a last hand sorting before putting the seed into storage must always be done.

Groundnuts, soybeans and sesame are threshed when they have a moisture content of about 15 percent. Alternatively, the pods are picked by hand. This decreases the number of broken seeds and thereby also the risk of fungal growth and possible building up of aflatoxins.

3.4 Further drying and storage

If the weather conditions do not allow the crop to become dry in the field, wet or partially field-dried seeds must be further dried indoors. Drying may be done in the same place where the seeds will be stored, or in another place. Very moist seeds need lower temperatures during drying than drier seeds. It might be safer to dry them in several steps rather than in one step.

For most seeds it is sufficient to dry them to the safe moisture content, to be sure that no bacterial and fungal growth will occur. Seed for planting is usually dried a bit further. Every percent that the moisture goes down below the safe moisture content doubles the time that the seed can be kept in storage. The choice of drying method depends on the type of product to be dried, on the weather during the harvest period and on available equipment.

The effectiveness of drying depends on the humidity of the air and the air movement in the area concerned. Air-dried seeds that are dried in the rainy season still contain about 13 percent moisture, while the safe limits for sowing seed are 10 percent for cereals (rice, maize, sorghum etc.), 8 percent for pulses and 6 percent for vegetable seed.

Drying and storing in a ventilated building

If it is raining every now and then, it is too risky to further dry the product outside. If the relative humidity drops below 70 percent for longer periods every day, the product can be dried naturally while being stored in a well-ventilated building. If the crop is still not threshed, it may be hung in the same type of racks as in the field. In this way the air can move around the seeds.

The maize crib, such as the design shown in Figure 6, is an example of a naturally ventilated building that is suitable for the storage and continued drying of maize cobs in the humid and dry tropics. Outside air is allowed to blow as much as possible through the loosely packed maize cobs. Ideally, the crib should be placed with the long side perpendicular to the prevailing wind direction. The crib is built on poles,

which can be protected with baffles to prevent rodents and other thieves from entering. For protection against insects the ventilation openings must be covered with a fine mesh.

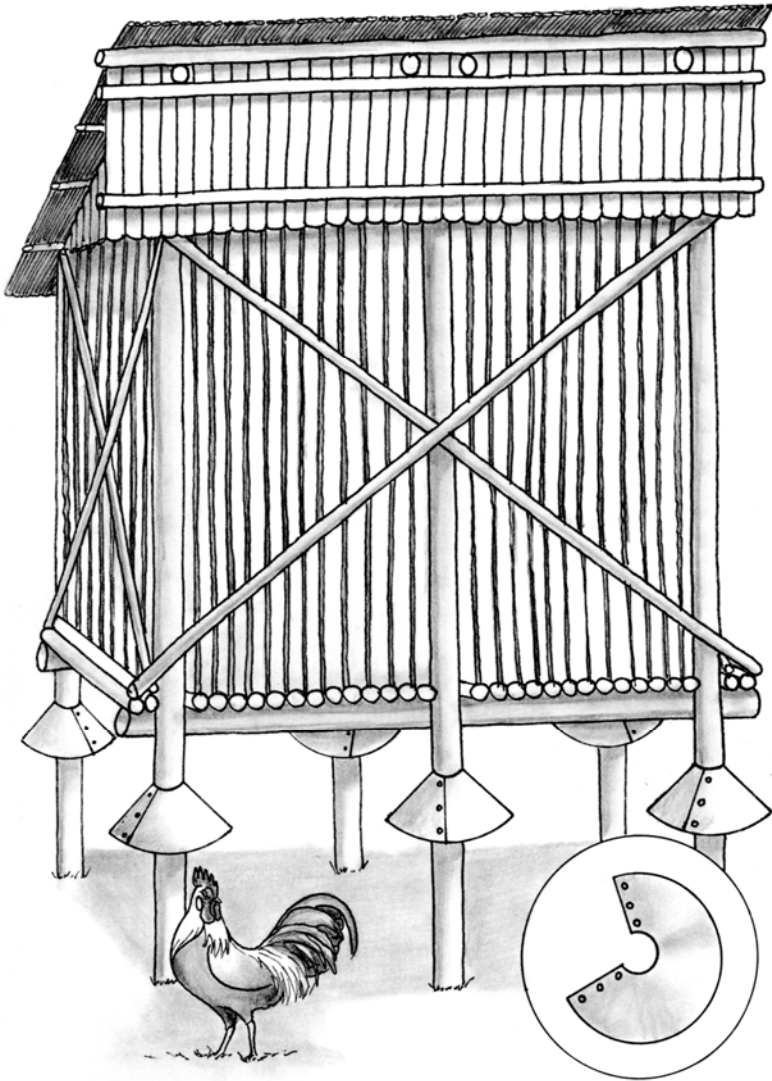

Figure 6: Maize crib made of bamboo

After the kernels on the cobs have reached the safe moisture content, they may be shelled and stored as a smaller volume. For this purpose, sacks and baskets made from plant fibres are useful. In the humid tropics baskets and sacks should not be placed on the ground, but should be raised off the ground on a platform. This is shown for a pile of sacks in Figure 7. Some people protect the product against insects by plastering the outside of a basket with mud or dung. However, it is better not to do this before the product is thoroughly dry, otherwise it will rot quickly.

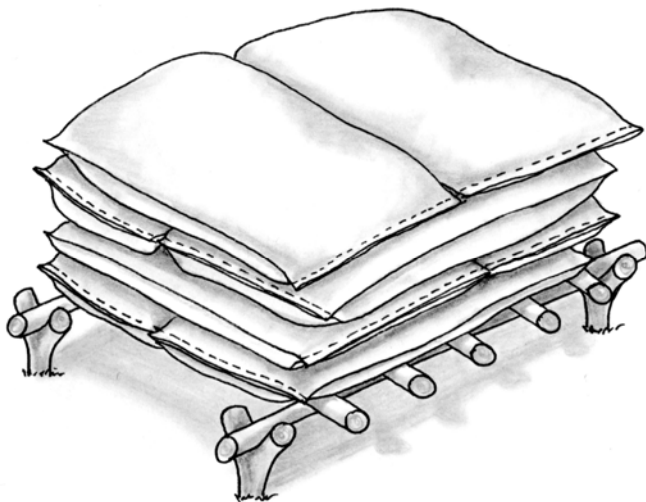

Figure 7: Pile of sacks on a pallet. Enough space is left between pallets to ensure good ventilation.

Drying above the fireplace

Warm air will move upward by itself. Seeds or other products to be dried can be placed on an airy platform above a fire in such a way that the smoke and hot air can move easily through the product (Figure 8). Take care that seed for planting is not heated above 40 °C and watch out for flames coming too high. Also, the product might get a smoky flavour. But the method works quite well and the costs are low.

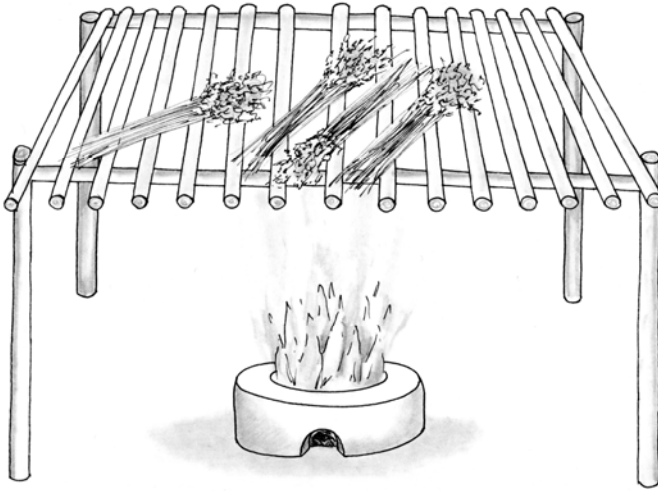

Figure 8: Drying on a platform above a fire

Dryers for agricultural products

A faster and more reliable way of drying is to bring artificially heated air in contact with the seeds to be dried. Such dryers can also be used to dry other agricultural products. They further have the advantage of offering some protection against insects and rodents. A disadvantage is the relative high costs for construction.

Solar dryers provide faster drying than natural ventilation and require no fuel. Dryers that enclose the seeds are more efficient in retaining heat than the method of spreading the seeds out in the sun. They require little or no maintenance, and with the possible exception of plastic sheet or corrugated roofing, all the materials should be available almost everywhere. The model shown in Figure 9 can also produce hot air under the grain bed by burning fuels.

By using solar heat or by making a fire the surrounding air is heated and rises through the product to be dried, which is spread in a thin layer on a wire mesh, supported by logs. Maximum thickness of a layer of small grains, such as millet and sorghum is 5-8 cm, for shelled

maize and other grains it is 10 cm, for groundnuts 20 cm, and for maize on the cob 30 cm. As smoke may affect the taste of the product it is removed via a chimney downwind of the prevailing wind direction. The fire should be watched constantly in order to prevent too high temperatures. Limit the drying temperature for food grains to 50-55 °C. Do not dry seeds for planting in these dryers as these should not be heated above 40 °C. Do not stir the drying grain unless it is to release the heat if overheating occurs.

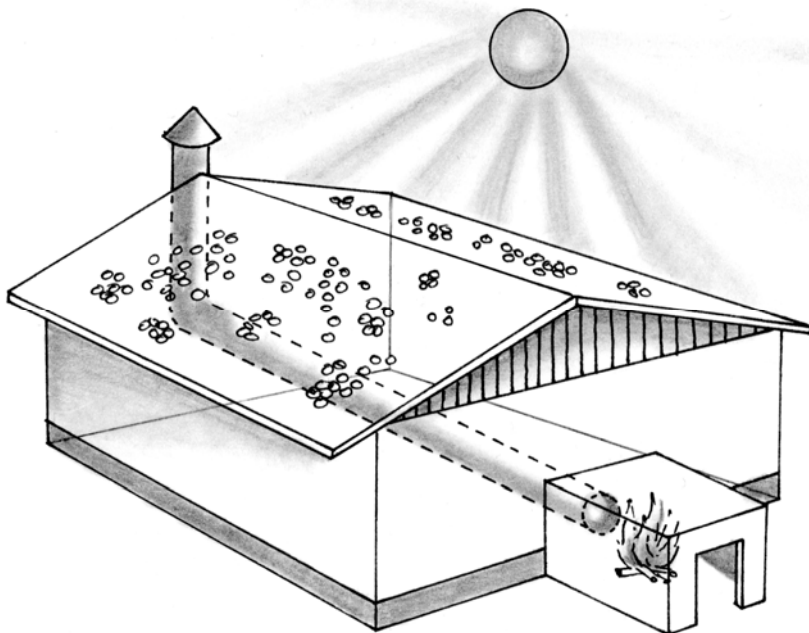

Figure 9: Dryer of agricultural products that can operate both with burning fuel and with solar heat

More advanced dryers use a fan to deliver the hot air to the seeds. They are suitable for drying cereals, pulses and oil-containing products. The fan is powered by a diesel or kerosene motor. To produce hot air, any fuel can be used. The drying capacity depends on the size of

the dryer and on the product to be dried. For example batches of 1000 kg of rice may be dried in about 5 hours with the flatbed dryer shown in Figure 10. The costs of construction and of fuel may be a constraint for the individual farmer. Therefore it is better if such a dryer can be owned and used by a group of farmers. The dryer below produces hot air by burning rice hulls. Accuracy and some technical understanding are required for construction of the dryer. Fuel is sometimes difficult to obtain, therefore drying methods have to be adapted to local circumstances: climate, technical knowledge, availability of fuels and construction materials, etc.

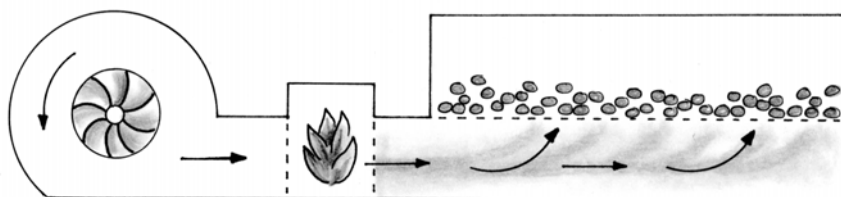

Figure 10: Cross-section of a dryer that forces hot air through seeds by a motor-driven ventilator. On the left side: ventilator; middle: furnace to burn crop residues or another fuel; to the right: container with seeds.

Storage in airtight containers

If seeds have a moisture content that is too high, they should be stored in a well-ventilated space. Once they have reached the safe moisture content, it is important to keep them dry. To prevent them from attracting moisture from the air during a wet season they must be stored in airtight containers. These may be plastic bags, clay pots, metal or stone silos or pits in the ground. Buildings or containers must be built on well-drained ground, so they do not get flooded.

In pits or silos that will not be opened for several weeks, a candle may be placed inside and lit. When the pit or silo is closed, the candle uses up all the remaining oxygen and replaces it with carbon dioxide. This will kill any insects present in the seeds.

A common feature of pits and silos is a small opening to collect seeds for daily use. The advantage of airtight containers is that they also prevent infestation by insects and rodents. A water-absorber (desiccant) may be added to the stored seeds to keep them extra dry. Cheap and locally available materials like charcoal, dried rice or clay will do the job.

Pits and silos can be made of different materials, all of which have advantages and disadvantages.

The silo shown in Figure 11 is made of 1 mm thick sheet metal that is welded together at the seams. It has two openings, one to fill it at the top, and one to empty it near the bottom. The silo can best be placed on poles to prevent the bottom from becoming wet. Metal silos offer good protection against fungi, insects and rodents, but require some specific skills to build and are relatively expensive. Silos should not be placed in complete shade and never in the full sun.

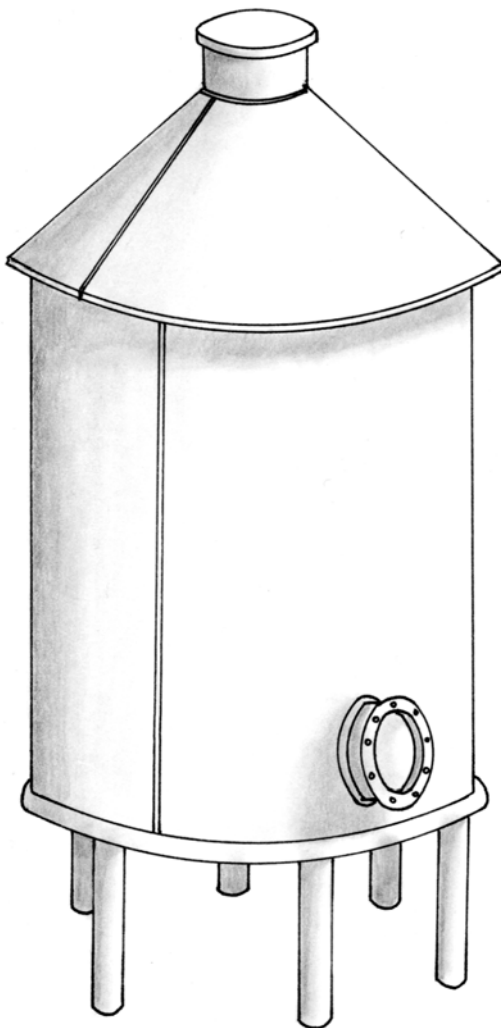

Figure 11: Metal silo; see text for details

Pit stores can be made everywhere, provided there is a sufficient depth of workable soil. The walls of the pit are traditionally lined with grass, straw, maize stalks or other plant materials, and plastered with clay or cow dung. The pits are closed and sealed also with plant material.

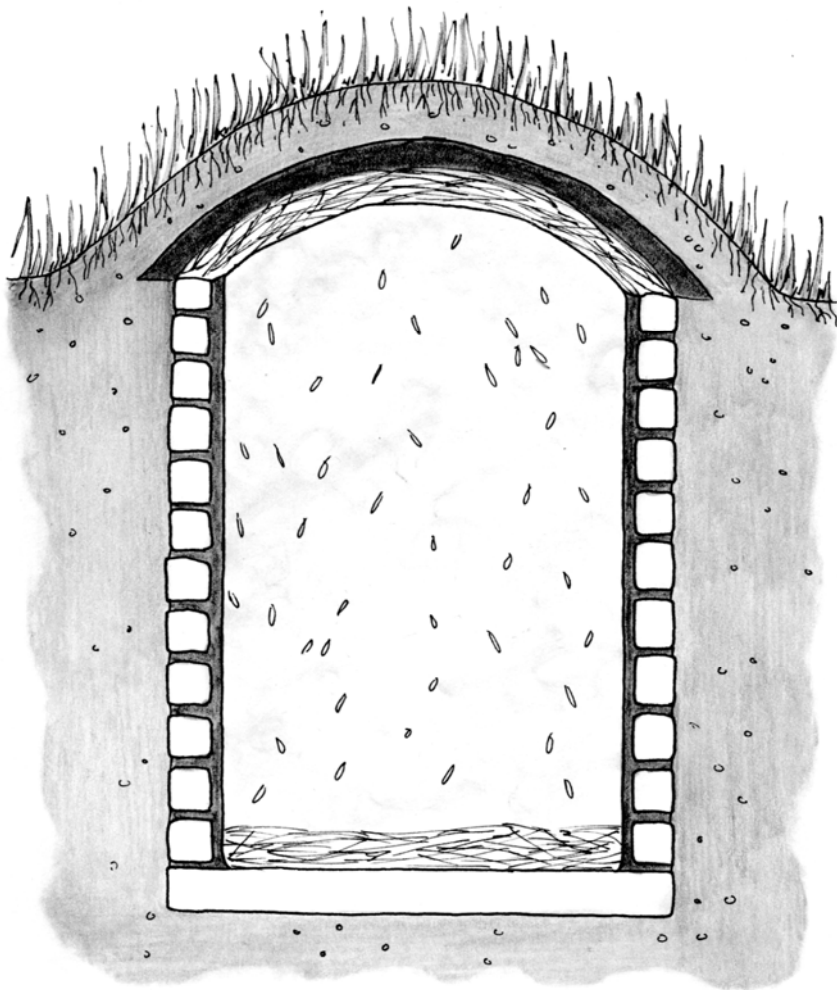

Figure 12: Traditional underground pit

If the husks or pods of maize, paddy and legumes are undamaged during harvest, it is best to not remove them from the seeds before storing the crop. The reason is that they offer some protection against insect attack.

3.5 Additional protection against insects

The most common insects found in stored food are beetles and moths. Both groups of insects have worm-like larvae that are very different from their parents (see Figure 13). Among moths, only the larvae actively damage seeds, while among beetles, both the larvae and adults may be active.

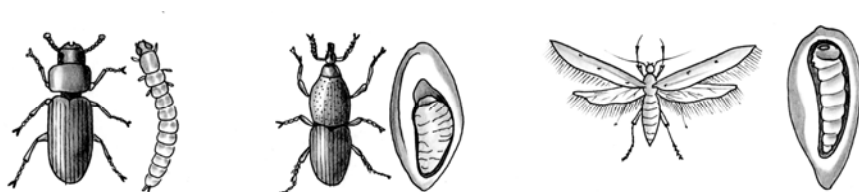

Figure 13: Two beetles (left and middle) and a moth that feed on grain seeds. Each adult is accompanied by its worm-like larva.

In this booklet we emphasise the use of preventive measures to combat storage insects. We believe that most problems involving storage insects can be prevented. As many accidents still happen due to incorrect use of pesticides, we discourage the use of pesticides in the storage of seeds, especially seeds that will eventually be used for food. For use as a last resort, Table 1 provides information on plant extracts that have insecticidal properties. It is important to note, however, that some of these extracts, like *Datura*, are poisonous to people. Some vegetable oils like castor bean oil are also poisonous to people. We already addressed some measures that can be taken against insects when we discussed the construction of buildings and containers for storage earlier in this chapter. The following paragraphs present other possible preventive measures.

Choice of variety

Modern high-yielding maize varieties often have open cob husks, which allow insects and birds to easily attack maize in the field, whereas some traditional varieties have closed husks, which effectively protect the crop from insect attack. Similar mechanisms exist for other crop seeds as well. Where no cash markets are available, farmers often choose seeds based on their pest- and disease-resistance properties, and thus better storage characteristics, rather than just on their yield.

Choosing harvest time

Cultivating new high-yielding and early-ripening varieties can mean that the harvest falls in the wetter part of the year, and this creates new storage problems. Some insects infest pulses and grains in the field only when the crop is almost dry. A timely harvest can therefore ensure that the weevils are not carried into the store along with the pulses. Do not leave crops too long in the field after they are harvested. This increases the chances of infestation by some storage pests.

Drying

Heat used for drying the products will also help to kill larvae and chase away adult insect pests.

Sorting and cleaning

Check whether stored produce is infested by taking samples. Pay particular attention to cracks and gaps in the storage container or building where insects may hide. If the produce is infested, ensure that it is stored separately (in quarantine) and treated with one or several measures mentioned below in order to prevent the pests from infesting clean produce. In the event of heavy infestation, discard the produce. If the produce is only slightly attacked, heating it to no more than 50 °C can kill moths and weevils. Removal of infested grains or cobs and pests can be done by hand, sieving, winnowing or moving the grain (shaking, restacking). If you merely separate the pests from the stored produce, ensure that the pests are killed to avoid reinfestation.

Store location

Site stores away from any potential source of infestation and away from growing crops. Grain and tuber moths are good flyers and adults from infested stores often infest growing crops in the field. Separating stores from fields may therefore help to reduce the risk of attack.

Characteristics of store

Keep the temperature and humidity as low as possible through controlled ventilation. Avoid large variations in temperature, as this can cause condensation of water in the store. Prevent the entry of pests by sealing the store (windows, doors, ventilation facilities) with insect-proof gauze. In conditions with low humidity, airtight storage gives good protection against storage pests. To avoid fungal growth, care should be taken to ensure that the produce stays dry (i.e. no condensation forms inside the container). This is particularly important for long-term storage in warm, dry areas. It is advisable, however, not to store seed for planting for more than a few months. A small amount of seeds can be stored in a strong airtight container with a close-fitting lid (glass, ceramic or strong plastic). Ceramic pots that do not have lids must be covered very carefully or topped up with dry soot, ashes or fine dry soil. In conditions where the relative humidity is high, airtight storage is not recommended due to the risk of fungal growth.

Storage hygiene

Always keep the store and its surroundings clean. The broom is an important, economic and effective tool for storage hygiene. Before newly harvested crops are stored, the store should be carefully prepared well ahead of time. Old stored products should be removed and the room completely cleaned. The walls, roof and floor should be both watertight and rat proof, and small holes and cracks, which are potential breeding places for storage insects, should be sealed.

The site chosen for a good seed store must be airy, shady, cool and dry. Temperature variations should be as small as possible, because these encourage condensation of water, which in turn promotes fungus

development. The whole building should be well aired and if possible fumigated (see store fumigation).

Inspecting the store

Periodic inspection (weekly to fortnightly) and removal of any infested produce is essential. Check for droppings and footprints of birds and rodents. Look for flying moths at dusk. Brush stacks of bags with a stick or broom to disturb and discover resting moths. Lift bags in order to detect moth cocoons along the line where bags touch each other. When looking for beetles, pay particular attention to cracks, bag seams and ears where they often hide. Empty individual bags in a thin layer onto a sheet and examine the contents for beetles and larvae. This should be done in the shade so that the insects do not flee immediately. Insects can also be sieved out using a box sieve with a mesh of 1-2 mm. Identify the insects found in order to choose the correct treatment.

By inspecting in these ways, it should be possible to prevent the breeding of carry-over insects from former crops. The surroundings should also be cleared to discourage easy re-infestation by insects and rodents.

Infection with fungi can be detected by the mouldy smell, which is noticeable even before any visual changes to the product can be seen. Pay attention to water marks on bags. They indicate that the crop may have become wet. Even if the bags have dried, the crop can become mouldy.

Store fumigation

Farmers in the Philippines and Benin light fires in which powdered chilli pepper is burnt underneath grain stores once a month to keep away storage pests. One disadvantage is that the smoke is very uncomfortable for the eyes and respiratory system of humans.

Store disinfection

After the store has been cleaned completely and all old deposits of dust (that could contain insect eggs) have been removed, it is good practice to dust the whole store with diatomaceous earth, lime or ashes as a further preventive measure. If the wood in the construction has been attacked by larger grain borers, it should be treated with any of the approved wood preservatives or thoroughly sprayed with kerosene or an oil mixture to get rid of any surviving grain borers.

Physical and biological methods

Mineral substances such as fine sand, clay dust, lime and wood ash can be mixed with seeds, as this causes invisible injuries to food pests, leading eventually to their dehydration. These substances also fill the spaces between the grains, making it difficult for the pests to move and respire. The amounts of these substances required ranges from 50-100 g per kg of stored product, except for sand, which has to be added in larger amounts.

Wood ash

Mixing seeds with wood ash, either alone or together with powdered chilli pepper, is an efficient method of pest control. However, it does not control the larger grain borer, and ash may have an effect on the taste of the crop. The success of this method depends on the amount of ash added. 2-4 percent ash by weight of grain is said to give 4-6 months protection if the moisture content of the grain is below 11 percent. Ash from casuarinas, derris, mango and tamarind wood is particularly suitable. Any other ash mixed with powdered pyrethrum, Mexican marigold or syringe seeds will increase the protection against insects.

Lime

Mixing seeds with 0.3 percent lime (calcium oxide) has given good results in weevil control.

Sand

In areas where fine sand is easily available it can be used to protect stored products. It is best used with bigger seeds, the intention being that all the spaces between the larger seeds should be filled by sand, which can easily be removed by sieving. The more sand used the better, but at least equal amounts of sand and seed should be used.

Diatomite

Diatomaceous earth (DE) is mined in several African countries and can be obtained at a very reasonable price. DE consists of tiny fossil diatoms whose skeletons are made mostly of silica and form the diatomite deposits. DE is a very effective and non-poisonous insect killer. As a dust it can absorb a lot of water, and it kills insects by drying them out. It has been used in South Africa for many years by organic farmers in various kinds of insect control. Farmers using as little as 75 g DE per bag of 25 kg of grain do not experience any problems with weevils and other insects.

Bacillus thuringiensis

Bacillus thuringiensis is a bacterium that is active against insects. In powder form mixed with fine sand it is effective against potato tuber moth. It may be used against grain moths as well.

Vegetable oils

Oils of coconut, castor bean, cottonseed, groundnut, maize, mustard, safflower, neem and soybean affect the egg laying, and egg and larval development of stored pests. Be careful with castor bean oil, because it is very poisonous. Some oils can go rancid during storage and cause crop spoilage. The addition of vegetable oil is particularly useful in protecting legumes against pulse beetles (Bruchids). Losses in pulses can be prevented with the addition of 5 ml oil per kg of grain/seed. To be effective the seed must be fully coated with oil.

Sunflower oil is not very effective. The effect of oil treatment decreases with time so seeds stored this way should be treated again at any new sign of infestation. Small seeds may lose some of their ger-

mination capacity after oil treatment. If neem seed oil or any other non-food oil is used the bitter taste can be removed by immersing the seed in hot water for a few minutes before food preparation.

Admixture of plant parts

Traditionally many different types of plant parts are used against storage pests.

Table 1: Examples of plant materials which help protect stored seeds

Plant names	Plant parts	Treatment
Aloe (<i>Aloe vera</i>)	Whole plant	Plants dried and ground; dust mixed with the seeds
Chilli peppers (<i>Capsicum sp.</i>)	Ripe, dried pods with ashes, dung or fine clay	Whole pods mixed with grain or dusted as powder on beans
Pyrethrum (<i>Chrysanthemum cinerariifolium</i> and <i>C. coccineum</i>)	Flower heads	Pick on hot days. Dry in the shade. Crush to powder and mix with seeds
Sun hemp (<i>Crotalaria juncea</i>)	Seeds	Mix seed between gaps in stored larger size seeds
Datura (thorn apple, <i>Datura stramonium</i>)	Leaves and stems (be careful seeds are very poisonous!)	Dry and mix with produce
Derris (<i>Derris sp.</i>)	All parts	Stored produce dusted or sprayed
Eucalyptus (<i>Eucalyptus sp.</i>)	Leaves	Layered or mixed with stored produce
Lantana (<i>Lantana sp.</i>)	Leaves	Crushed and placed among seeds
Syringa (<i>Melia Azedarach</i>)	Leaves, ripe seeds	Dried, powdered, mixed with stored grain using 2% if powder from seed, 4% if powder from leaves
Mexican Marigold (<i>Tagetes lucida</i>)	Whole plants	Add dried plants in layers, or mix in powdered plant or place 3-5 cm layer of crushed plants in base of grain bins
Spearmint (<i>Mentha spicata</i>)	Whole plant	4% leaf powder will give good protection for more than 4 months
Neem (<i>Azadirachta indica</i>)	Leaves, crushed seeds and their extracts and oils	-

The dosages of plant substances required are generally around 50 g per kg of stored product.

The addition of ash, fine sand, lime, diatomaceous earth, and mineral or vegetable oils is particularly useful for protecting a small storage area or for storing small amounts for replanting. However, this is not always practical for large quantities of seed in terms of labour required. For larger amounts of grains and seeds it is often more practical to simply mix the seed with any strong-smelling plant material available to repel insects. Some plants such as pyrethrum and derris can actually kill storage insects.

3.6 Additional protection against rats and mice

The most common rodents in and around buildings are black rat, brown rat and house mouse (Figure 14). They eat approximately the same food as man.

Keeping rodents away from stored food is the most effective prevention. In the first place, food stores should be built in a way that rodents cannot enter them. Secondly, the area in and around food stores should be swept often to keep it clean.

Once you have rodents in your store, using simple traps is often the cheapest and most effective method to remove them. Snap traps (Figure 15) are among the most effective traps for both rats and mice.

Some dogs and cats will catch and kill rats. There are few situations, however, in which they will do so sufficiently to control rat populations. Around most structures, rats can find many places to hide and rear their young out of the reach of such predators. Cats probably cannot eliminate existing rat populations, but in some situations they may be able to prevent reinfestations once rats have been controlled. Farm cats, if sufficient in number and fed supplementary food, may serve this function.



Figure 14: The three most common rodents: house mouse (above), brown rat (middle), black rat (below)

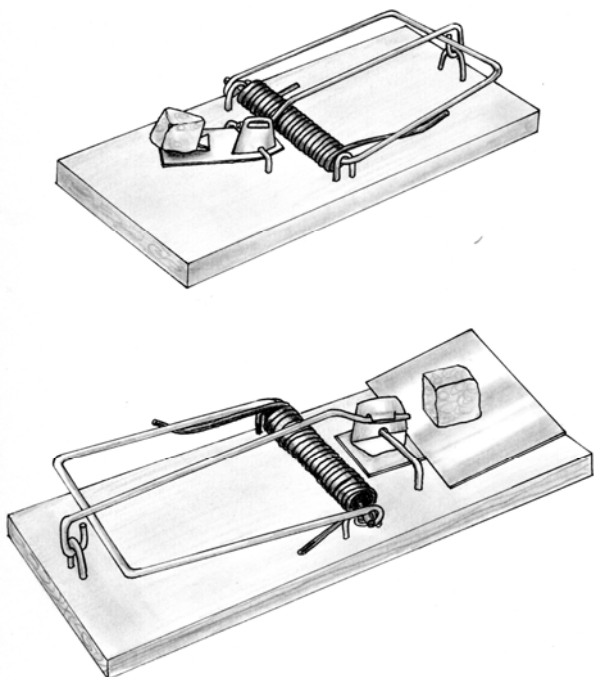

Figure 15: Snap traps in two different sizes for mice and rats

Set traps close to walls, behind objects, in dark corners, and in places where rat activity is seen. Place the traps so that when rats follow their natural course of travel (usually close to a wall) they will pass directly over the trigger. Set traps so that the trigger is sensitive and will spring easily. Effectiveness can be increased by enlarging the trigger. A great advantage of traps is that they can be used again and again.

In some situations, rats can be killed manually with a club or other implement.

Only as a last resort should you consider using poison. Unfortunately, poisons that are effective against rodents are also very dangerous for humans, domesticated animals and wildlife. Another problem is that rodents have become accustomed to many poisons. You should ask your extension worker which poisons are still effective and available

in your area. Most poisons are used in the form of bait. Use poison only inside buildings. Outside they are too dangerous for wildlife including rat and mice predators. Keep them out of reach of children and domesticated animals by using bait boxes or other type of protection.

4 Storage of roots, tubers and bulbs

4.1 Introduction

In this chapter we discuss root, tuber and bulb crops that are mostly used as staple foods and need to be stored for several months in order to be available the year around. In this booklet we focus on cassava, sweet potato, potato and yam. For practical reasons we also include bulbs such as onions, because they are usually stored for several months under similar conditions.

Tubers and bulbs have special requirements with respect to storage because of their high moisture content (60-80 percent when fresh). They must retain this high water content in storage. If they were dried like seeds, they would lose their structure.

4.2 Challenges in the storage of roots and tubers

The storage of roots, tubers and bulbs involves a particular challenge. On the one hand drying out (or 'desiccation') should be avoided. On the other hand too much humidity around the roots and tubers may cause rotting. Living tubers continue to respire (breathe) fairly intensively, and this increases with storage temperature. When high tuber temperatures are combined with airtight storage, plant tissue will die due to lack of oxygen. For example potatoes get black hearts. As the temperature of the product increases, better ventilation is therefore necessary.

During storage, chemical changes take place in the roots, tubers and bulbs which may influence their firmness and taste. Tubers of most species are dormant for a certain period, after which they start to sprout. This period varies with the crop variety and the storage temperature of the tubers. Yams can be stored for about four months at a

normal temperature without sprouting, but potatoes already start sprouting after five weeks at 15 °C. Also, tubers are often attacked by rodents during storage.

The keeping quality of tubers that are not cooled depends on the species. The keeping quality is longest for yam, then cocoyam and sweet potato, and it is shortest for cassava. The lower the temperature is, the lesser the likelihood of desiccation and rotting, lack of oxygen and sprouting, provided the temperature does not fall below freezing. In other words: keeping the temperature low during storage is the best method.

However, in practice this is usually not feasible, since refrigeration equipment is unavailable or very expensive. It is therefore usually not practised with these bulky products. The best alternative is to keep the storage room as cool as possible and well ventilated. If ventilation can be regulated, for example by using a ventilator or adjustable ventilation vents (in a barn), the area should be ventilated during the coolest time (at night) and insulated during the hottest time of the day to trap the cool air. However, this kind of temperature regulation requires a thick-walled storage room. With natural ventilation, for example in huts, the temperature is difficult or impossible to regulate.

The cooler the conditions (which will depend on, among other things, the season and altitude), the less ventilation is needed, but the chances of rotting and internal heating are higher. Yam, sweet potatoes and cassava should not be cooled below 12 °C because they are damaged by low temperatures.

4.3 Operations in the field

Harvesting when needed

Certain varieties of yam, sweet potatoes and in particular cassava can be left in the ground during the dry season without harvesting. The quality remains reasonable, though often the tubers become more fibrous.

Although this method seems very attractive, it has several disadvantages:

- The land is occupied longer, so other cultivation cannot take place during that period.
- The tubers are not harvested at the optimum time.
- The tubers are not protected against termites, rats, monkeys, thieves, etc.

Short-season cassava varieties mature as early as 6 months after planting. They cannot be left in the ground for more than 9-11 months without serious deterioration. Long-season varieties take a year or more to mature. Sometimes they can be left in the ground for 3-4 years without serious deterioration. Unfortunately, the more attractive sweet cassava often belongs to the first group, while the less tasteful bitter variety tends to belong to the second group. Leaving cassava tubers in the ground and harvesting them when needed as food or feed is the best option to 'store' them.

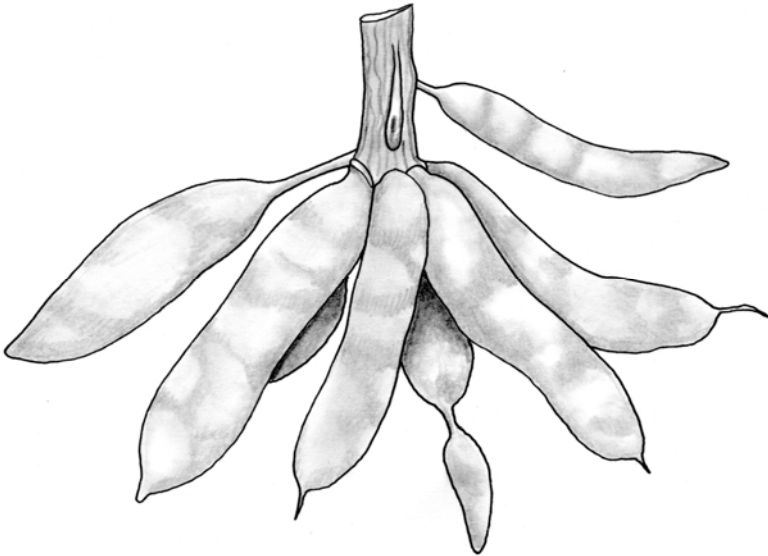

Figure 16: Cassava roots. Cassava is often left in the ground until needed.

Pre-harvest pruning

The shelf life of cassava roots is extended considerably by pre-harvest pruning of the plants. Between 4 weeks to 1 week before the harvest all the leaves are removed, leaving a stalk of approximately 20 cm in the ground. If a piece of the stalk is left attached to the roots during harvesting, the chances of rotting are less. Yam tubers are usually harvested all at once and subsequently stored. Leaving yams in the ground during the dry season may be done without appreciable loss of quality.

Preventing injuries

Rotting begins with wounds that are inflicted during harvesting and transport. Therefore harvesting should be done as carefully as possible, preferably with wooden tools. If the crop is planted in rows and in ridges, the roots and tubers can be lifted if they are not too far apart. The lifting tool should be able to pass easily underneath. More than 50 percent of tubers are often damaged, but only about 5 percent of the small ones. Damaged tubers should be consumed immediately or should be specially treated. Rubbing the damaged spots with sieved wood ashes, with lime or with chewed cola nuts and then drying them in the sun for 1 or 2 days heals the wounds and notably decreases the chance of rotting.

Curing of roots and tubers

In order to make the tubers more suitable for storage, they can undergo a special treatment, called 'curing'. Generally the tubers are stored under very warm (25-35 °C) and very humid (85-95 percent relative humidity) conditions for several days. During this time a layer of cork, a few cell layers thick, is formed around the tubers. This layer greatly reduces the desiccation process and largely prevents infection by bacteria and fungi. Although the curing process is faster in full sunshine, it is better to protect the tubers against the sun with big leaves, because otherwise the relative humidity around the tubers decreases rapidly and the strong heating of the tubers initiates processes that reduce the keeping quality.

Cassava roots are cured for 4-7 days at a temperature of 30-35 °C and a relative humidity of 80-95 percent. Wounds should be treated and left to dry. Sweet potatoes are cured for 5-7 days at about 30 °C and a relative humidity of 85-90 percent. The tubers can be left in the field in small heaps that are covered at night with straw or jute sacks if the temperature drops below 25 °C. Yam is cured for 4 days at 29-32 °C and a relative humidity 90-95 percent.

Satisfactory healing only occurs around deep wounds such as knife cuts. Bruised tubers with superficial wounds do not respond to curing. Such tubers can only be preserved by cutting off the bruised parts before curing. Curing of potatoes takes place for 5-8 days at much lower temperatures of 8-20 °C with relative humidity of approximately 90 percent. Condensation of water on tubers must be prevented by ensuring only small temperature fluctuations.

Curing of bulbs

Bulbs are cured in a hot and well-ventilated environment. Contrary to the curing of tubers it is preferably done at low humidity. This dries out the neck and the two or three outer layers of scale leaves of the bulb. The outermost layer, which may be contaminated with soil, usually falls away easily when the bulbs are cured. The dry under-layer, with a more attractive appearance, then becomes visible.

Onions are considered cured when the neck is tight and the outer scales are dried until they rustle. This condition is reached when onions have lost 3-5 percent of their weight. If onions cannot be cured in the field, they can be collected in trays, which are then stacked in a warm, covered area with good ventilation. Curing in the shade improves bulb colour and significantly reduces losses during storage. In cool, damp climates, onions are stored in bulk in ventilated rooms. They are dried with air at 30 °C blowing through the bulk. Onions can also be cured by tying the tops of the bulbs in bunches and hanging them on a horizontal pole in a well-ventilated shed.

After curing the bulbs are graded before they go into storage. Thick-necked, injured and decayed bulbs are picked out by hand and discarded. Grading may be repeated after storage to get a better price on the market. The outer dry scales usually rub off during the grading process, giving the onions a better appearance. Proper sorting and grading reduces losses in storage.

4.4 Storage of roots, tubers and bulbs

The two most common storage methods for roots, tubers and bulbs are field clamps and ventilated huts.

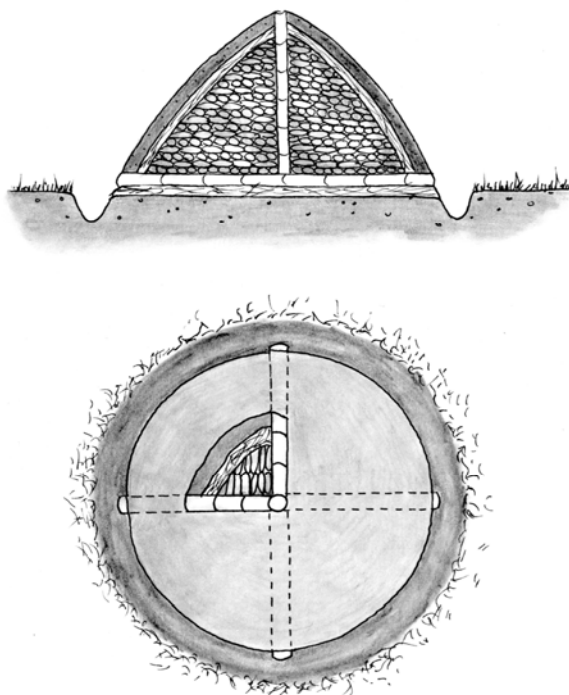

Figure 17: Two cross-sections of a field clamp to store a root crop

Storage in field clamps

Cassava and sweet potatoes are often stored in field clamps after curing as shown in Figure 17.

Depending on local conditions and type of root crop, the storage time can be 2-9 months. The basic design of these field clamps is as follows: a circular bed of straw or other material such as dried grass or sugar cane leaves is placed on suitable, well-drained ground. The layer is approximately 1.5 m in diameter and 15 cm thick after it has been compacted. The freshly harvested tubers are heaped in a conical pile of 300-500 kg on this straw bed. The pile is then covered with a similar layer of straw and the entire clamp is covered with soil to a thickness of 15 cm. The soil is then removed from around the circumference of the clamp, forming a drainage ditch.

During cool, moist periods this basic clamp design is satisfactory. In order to prevent too much exposure to the sun or damage by heavy rains, the clamp may be protected by a thatched shed or placed under a tree. In hot, dry conditions it is necessary to ensure that the internal clamp temperature does not exceed 40 °C, since tubers deteriorate rapidly at higher temperatures.

The clamp can be altered for these conditions by incorporating the following modifications:

- a thicker soil cover to reduce internal temperature
- the construction of central and base ventilators to encourage air flow within the clamp. Ventilators may be constructed from locally available materials, such as straw, hollow bamboo, drainpipes or timber (Figure 18). When base ventilators are used, precautions should be taken to prevent the entry of mice and rats, such as by covering the openings with wire netting.

In very wet conditions, precautions need to be taken to prevent the roots from becoming wet during harvesting and handling, as well as within the clamp, since wet tubers deteriorate rapidly. Frequent light rainfall tends to be advantageous after clamp construction, since mois-

tening of the soil lowers the internal temperature of the clamps. Therefore wetting the soil cover during hot, dry periods should be considered. If more than 500 kg are to be stored in one day, it is advisable that several circular clamps or a single elongated structure be built, to ensure a better internal temperature control. Likewise this reduces the chance of the whole stock rotting, and being lost.

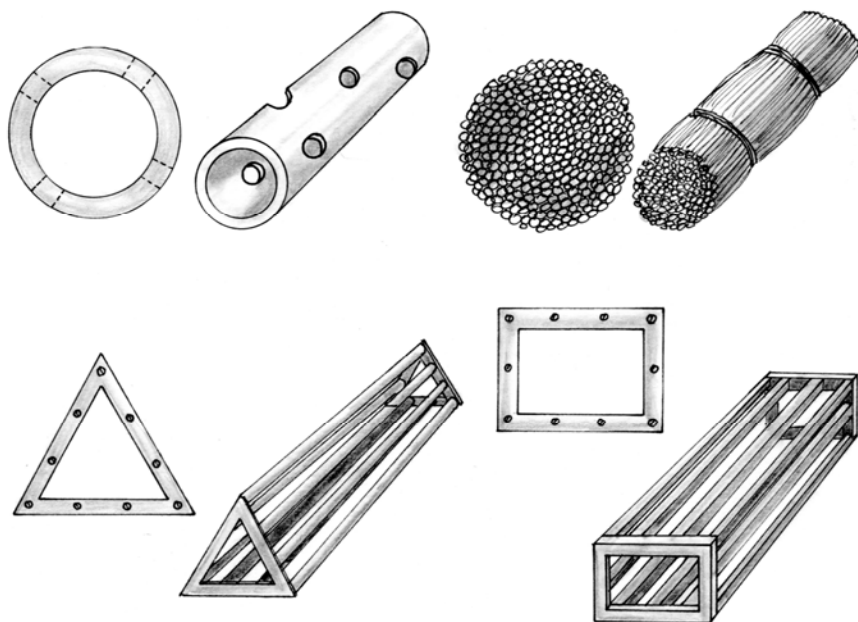

Figure 18: Ways to make ventilators for storage clamps. Upper row, from the left: hollow tube with lateral holes, straw bundle; lower row from the left: triangular frame of wood or bamboo, rectangular frame.

It should be noted that before any specific clamp storage recommendations can be made, simple trials using locally available materials may be undertaken during the required storage season in order to determine the best design and location of clamps.

For clamp storage of cassava, alternating layers with cassava leaves and/or replacing the straw cover by cassava leaves and later by coconut fronds seems to give better results.

Storage in ventilated huts

Ventilated huts can offer protection against rodents, sun heat, rain and groundwater. The ventilation can also prevent fungal growth and rotting. Locally available materials can be used for construction: bamboo, wooden boards (planks), woven mats in a wooden frame, etc. For protection against rats and termites the huts can be built on poles at least 75 cm high with rat collars fixed on them. If they are built on the ground, all holes and cracks should be closed with wire netting. If the walls are made of planks they should overlap like roof tiles with some space between them so that sunlight cannot enter but ventilation still occurs. The roof of wood or thatch should be overhanging for protection against sun and rain. Inside the hut the tubers should be piled in boxes or on shelves or racks along the wall in such a way that air can move freely between them. The contents should be checked regularly to make sure there is no rotting.

4.5 Specific measures to increase shelf life

Cassava

Freshly harvested cassava roots deteriorate rapidly starting within 1-7 days after harvesting. Simple techniques such as reburial, keeping under water, smearing with mud or stacking and daily watering suffice to preserve the tubers for a few extra days.

In field clamps the shelf life can be increased even more by storing the cassava in layers alternating with layers of sand or cassava leaves of 3-5 cm deep. In ventilated huts freshly harvested cassava tubers are packed with moist sawdust in wooden boxes. If sawdust is not available, coir-dust or peat may be used instead. Rice-husks are unsuitable. The moisture content of the sawdust packing should be about 50 percent; this maintains a high relative humidity, which promotes curing and prevents excessive moisture loss, but does not wet the roots,

which would lead to rotting. The tubers maintain a good quality during 1-2 months of storage. Cassava leaves may even be a better preservation medium than moist sawdust: alternate layers of tubers and leaves (in a 3-5 cm thick layer) in a wooden box or bamboo basket. A delay in packing after harvest will result in a lower quality.

An alternative way to extend the storage life considerably is by processing freshly harvested roots into various dried products. The tubers can be sliced and dried in the sun, with or without parboiling (which enhances the keeping quality), and may be stored for several months.

Yam

Unlike with cassava, the production of yam is very seasonal and therefore the tubers have to be stored for several months. The end of dormancy (when sprouting starts) is the main constraint to long-term storage. Removal of the young shoots extends the storage life. Optimal storage conditions for cured yam tubers are approximately 16 °C and 70 percent relative humidity. At 16 °C the tubers can be stored for 3-4 months. Uncured tubers should be stored at a relatively low humidity. Below 12 °C chilling injury occurs.

After curing the tubers can be stored in ventilated huts in heaps on the floor, in boxes or on shelves or racks in such a way that air can circulate around them. The higher the temperature and the relative humidity, the more ventilation is needed. The maize crib can also be used for storage of yams, provided the roof is large enough to protect the crop against sunlight. Small amounts of well-dried tubers can be stored in earthen silos. It is also common to find yams stored in pits or piled into heaps, protected from sun and flood water. Yams may also be stored in a 'yam barn'. The basic design is a vertical framework of 2 m or more high to which individual yam tubers are tied with a rope along cross members of lightweight timber. The yams may also be tied to the upright poles so that the tubers rest horizontally. A thatched roof of palm leaves may be constructed or the barn can be built under the dense shade of forest trees. These structures provide adequate ventilation and protection from termites, but not against theft. Also the tubers

can be inspected daily and rotting tubers cannot infect the other ones. As soon as the rainy season begins, the tubers in the yam barn begin to deteriorate rapidly.

Sweet potato

Sweet potato is difficult to store in the tropics. Optimum storage conditions after curing are 13-16 °C with high relative humidity (85-90 percent). Higher temperatures promote sprouting and increase respiration, leading to heat production and dry matter loss. Ventilation during storage is of great importance. The roots are highly susceptible to physical damage and subsequent deterioration. Red varieties seem to store better than white varieties.

Sweet potatoes can be stored in clamps. The cured roots can be stored in huts by wrapping them in newspaper or packing them in dry sawdust. The sawdust must be dry in order to minimise re-growth and rotting. They can also be stored in crates lined with plastic. Holes in the plastic allow for ventilation. During the first week curing is allowed to proceed at ambient temperature (18-31 °C). After curing, excess moisture must be removed to prevent sprouting. Pit storage is an alternative. The pits are lined with straw or bamboo and covered with a tight-fitting (wooden) cover and a roof for protection from the rain. This is only possible in areas with good drainage.

Processing the roots by peeling, slicing and drying in the sun to produce chips is an alternative way of keeping fresh sweet potato. The chips are stored as such or they can be ground into flour.

Potato

Potatoes are a sensitive product with respect to oxygen requirement, infection by bacteria and fungi, etc. The optimum storage temperature is below 10 °C and the potatoes should not be exposed to the sun for too long (maximum 1 hour). They should be stored in the dark in a dry and well-ventilated place.

Potatoes are preferably stored in ventilated huts. The ventilation takes place during the night when the temperature is lower. The huts may be built partially underground with air ducts under the tubers to let in cool night air. Storage is in bulk or, preferably, in small boxes. Potatoes may also be stored in clamps or (partially) underground pits. Because the rate of respiration is still very high in the beginning, the final layer of sand is sometimes applied to the straw after one week. In the highland tropics, the lower temperatures allow potatoes to be stored in low-cost structures for extended periods of time without serious losses. Disease- and insect-free potatoes may be stored in bulk or in containers allowing ventilation, and many existing storage containers and structures may be adapted for this purpose.

Onion

Bulbs are placed on racks with 2 or 3 layers of bulbs and stored in well-ventilated huts. The bulbs should be turned regularly and rotten, damaged and sprouted bulbs removed. Bulbs should not be stored unless they are adequately cured to prevent rotting in storage. Onions can best be stored at temperatures of 30-35 °C with a relative humidity of 65-70 percent. A temperature of 10-25 °C increases sprouting and a high humidity leads to increased rotting. Weight loss increases with a temperature above 35 °C.

5 Storage of vegetables and fruits

5.1 Introduction

A vegetable can be any part of a plant: a root, stem, leaf, flower or fruit. Fruit vegetables are often harvested and consumed when still immature. We eat these usually as a part of a hot meal, not only as a source of energy, but for their flavour and as a source of minerals and vitamins.



Figure 19: Vegetables

In referring to fruits, we generally mean the fleshy parts of plants that contain the plants' ripe seeds. We eat them because of their flavour and as a source of vitamins, usually as a dessert or between meals.

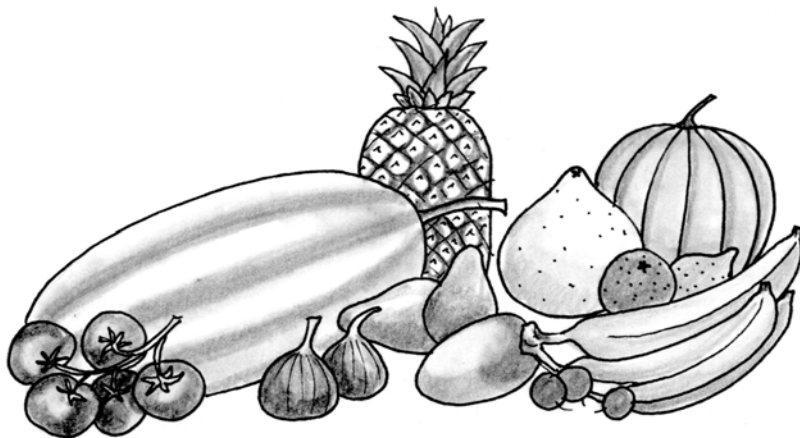

Figure 20: Fruits

Whereas seeds and root crops are often eaten year around, vegetables and fruits are not always available and consumption changes with the seasons.

5.2 Challenges in the storage of vegetables and fruits

Like the root crops discussed in the previous chapter, fruits and vegetables consist to a large extent of water. And just like for root crops, one challenge is to retain that water during storage. The shelf life of fruits and vegetables can be a couple of months for some products, but this is an exception rather than the rule. For most fruits and vegetables it varies from only a few days to several weeks.

It is important for a farmer to know which fruits and vegetables ripen in which season in order to have different fruits and vegetables available for consumption in every season. For some annual fruits and

vegetables it may be possible to plant them at several dates so that the harvest period for that fruit or vegetable is prolonged. The conditions in the field at the time of harvest differ considerably from the optimum conditions for storage. In the field it is often hot and dry. Under these conditions the products start to deteriorate and lose water as soon as they are detached from the plant. Therefore, short-lived products should either be consumed directly or put in store shortly after harvest. They should not be handled for several days before they are brought under optimum storage conditions.

All fruits and vegetables are easily bruised by carelessness during harvest, transport and other activities. Bruises may not be visible, but decay will begin under the skin. As a consequence of bruising, the already short shelf life becomes even shorter. Handling the products carefully to prevent bruises is thus very important.

Fruits and vegetables are not only an important food source for the family, they can also bring a good price if sold on the market. The costs for storage, transport and handling will pay off for products that are of the uppermost quality. Farmers should keep in mind, however, that traders tend to pay a too-low price for products with a short shelf life; selling directly to consumers will always bring a better price. It is important to remember that consumers like products that look fresh and are of uniform size and good quality.

If farmers cannot afford to pay for storage and other facilities, it may be possible to share these costs by starting a cooperative of several farmers (see Agrodok 38: **Starting a cooperative**).

It is not always possible to consume or sell all fruits and vegetables while they are still fresh. In this case, part of the harvest may be processed to preserve it for a longer period. Methods of processing fruits and vegetables are described in the references in Further reading.

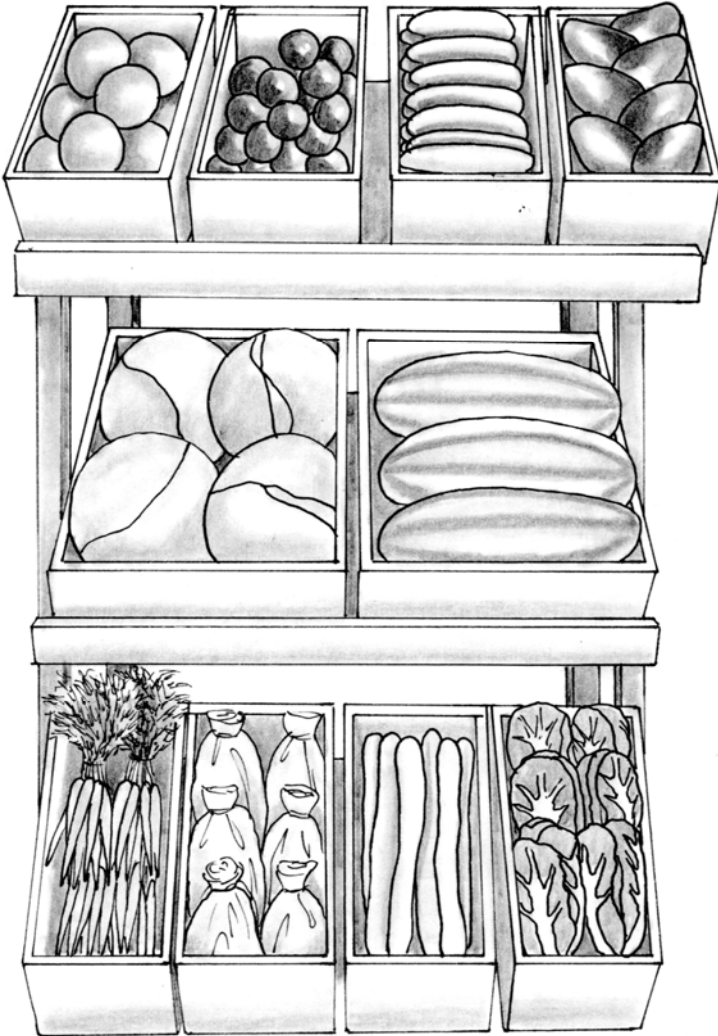

Figure 21: Customers like vegetables that are fresh and of uniform grade and size

5.3 Operations in the field and in a warehouse

Check readiness for harvest

To decide whether fruits or vegetables are ready to harvest, farmers must observe them almost every day when they are still attached to the plant. Many vegetables, like cucumbers, zucchinis, snap beans and peas, are eaten when they are still immature. They are harvested when they have reached a certain size. If they are harvested a few days later, they may be less tasty. Fruits are eaten when they are ripe, which is reflected by a certain colour and flavour. With respect to harvesting, we recognise two groups of fruits. The first group is sensitive to ethylene. Ethylene is a gas that we cannot see or smell, but it causes the fruits to ripen, even when they are already detached from the plant. Fruits that are sensitive to ethylene, for instance tomatoes, can be harvested before they reach their full ripeness. Then they are less vulnerable and can be stored longer. The second group of fruits is not sensitive to ethylene. They ripen only while attached to the plant. Among them are peppers and citrus. They must be harvested when they are ripe.

Handling during harvesting

Harvesting involves a number of activities in the field. It is recommended to harvest fruits and vegetables in the morning before the sun rises. The products will have high respiration and they will also start to lose water very quickly in the hot sun. Other fruits and vegetables should be taken to a shady place as soon as possible after harvest. Foliage and other non-edible parts can be removed while the crop is still in the field to have less weight to transport. Products with severe defects, injuries or diseases should also be left in the field. The product is further prepared for storage, consumption or selling on the market in the shade, which may be outside under trees or in a building. If needed, the heat absorbed in field can be removed by dipping the fruits or vegetables in water, or covering them with wet sacks while they are kept in the shade. Wetting the product reduces respiration rates and loss of water, which increases the shelf life – especially of leafy crops.

During the harvest, fruits and vegetables are easily wounded or bruised. Wounds (cuts and punctures) may be caused by the harvesting tools used for the removal of plants. Fungi and bacteria enter the products through wounds and cause rotting. This type of damage can be easily detected and the damaged products are usually removed. Harvesting scissors or knives should have rounded ends to prevent punctures, but be sharp enough to prevent tearing of the crop. Bruises are more common than wounds. They are less noticeable and symptoms show up several days later when the product is in the hands of the consumer. Bruises easily occur during harvest and packaging, when fruits or packed fruits are dropped onto a hard surface or rub against each other. Another possibility is that fruits or vegetables in the bottom layers of containers are bruised by the weight of the upper layers. This often occurs during storage and bulk transportation. It can also happen when weak boxes or packages collapse because they cannot withstand the weight of those piled up on top of them. Depending on the product, bruises may cause several types of damage, but they always shorten the period during which the product can be stored. To avoid bruising, harvest containers should be cushioned, smooth and free of sharp edges. Do not overfill field containers and move them carefully. Minimise drop heights when transferring produce to other containers.

Operations after harvesting

After harvest, fruits and vegetables need to be prepared for sale. Preparation for the fresh market comprises four key operations: removal of unmarketable material, sorting by maturity and/or size, grading into different quality classes and packaging. Unmarketable materials like leaves, rotted fruits, etc., are left in the field; there is no need to transport them together with the product. For the other operations, the product is first transported to a shady place or a warehouse. A warehouse or packing shed protects both the product and the workers from the weather so that processing can take place during any weather conditions. With their capacity to process large volumes, farmers associations, cooperatives, or even community organisations can take advantage of the opportunities offered by such a protected area. The

size and degree of complexity of a warehouse or packing shed depend on the following factors: crop(s) and volume to be handled, capital to be invested and objectives, such as handling of owner's production or to provide service to others. In some cases storage rooms as well as sales offices are connected to packing sheds.

Fruits are usually harvested within a range of maturity, but they need to be more uniform for sale. Also the size of fruits and vegetables can vary considerably. Fruits and vegetables of approximately the same colour and size are put together. The next step is grading, the removal by hand of bruised, rotted, mis-shaped pieces, wilted or yellow leaves. Fruits and vegetables of a lower grade are still edible, but they are less suited to store and sell fresh on the market. A better option is to make chutney or another product out of them.

Packaging should be designed to prevent physical damage to produce, and to make the products easy to handle. After sorting and grading, fruits and vegetables are packed in small units, which correspond to the weight or number that one family consumes during a certain period of time (300 g to 1.5 kg, depending on the product). There are several ways to package fruits and vegetables for sale on the market, and these are described in more detail in Agrodok 32: **Packaging of agricultural products**. For storage and transport, several packages are put together in fibreboard or wooden boxes weighing from 5-20 kg, or in even heavier bags.

5.4 Storage of vegetables and fruits

Having storage facilities eliminates the need to market the products immediately after harvest. Such facilities range from a simple heap on the ground to buildings with special equipment for cooling.

Natural or field storage

This is the most rudimentary system and is still in use for many root and tuber crops. You will find the details in Chapter 4. Crops should be left in the soil until preparation for the market. This is similar to

how citrus and some other fruits are left on the tree. Although storing products under natural conditions is widely practiced, it leaves them exposed to pests and diseases as well as to adverse weather conditions. This can have a detrimental effect on quality. Another method widely used is field storage in heaps. This method ensures that produce is free from soil humidity and is protected from the weather with straw and a layer of earth. It is a low-cost alternative for bulky crops, like pumpkins, that would otherwise require large buildings if stored inside.

Buildings with natural ventilation

Amongst the wide range of protected storage systems, buildings with natural ventilation are the most simple. They provide some protection from the external environment and natural ventilation ensures airflow around the products to remove heat and humidity generated by respiration. Produce can be placed in bulk, bags, boxes, bins, pallets, etc. Although the system is simple and easy to construct, it has some serious drawbacks:

- Large fluctuations in temperature may occur, which are unfavourable for storage.
- The buildings need wide openings for ventilation. These openings need to be fitted with screens to keep rodents and pest insects out.
- The products must be separated from each other to let air circulate around them. This reduces the storage capacity.
- Many gaps in the roof are necessary to prevent the build up of hot and humid areas, which in turn enhance the growth of bacteria and fungi.

Within certain limits, it is possible to take advantage of natural changes in temperature and relative humidity. This can be achieved by selectively opening and closing the storage ventilation. At noon, ambient temperature is higher and relative humidity lower than that of the products. During the night the opposite is true. To reduce the temperature of stored products, ventilation openings should be left open during the night. While lowering the temperature during the night, the relative humidity will go up.

Buildings with forced-air ventilation

Heat and air exchange can be improved by fans that pass air through the stored products. This system allows for more efficient use of space for bulk storage. Air conduits run under a perforated floor and air is forced through the product. Loading patterns and fan capacity should be carefully calculated to ensure that there is uniform distribution of air throughout the product. Specialised personnel should design the system based on volume and number of air changes per unit of time required.

Cooling

Controlling temperature is one of the main tools to extend post-harvest life: low temperatures slow product respiration and the activity of micro-organisms responsible for deterioration. As a result, ripening is retarded and water loss is reduced. These factors contribute towards maintaining freshness, and the nutritional value of the product is preserved. Refrigerated rooms can be built, with machines in them that keep the temperature down to close to 5 °C. Unfortunately, building and maintaining such rooms is quite expensive. Such a facility could only be financed by a group of farmers who share the costs; and this would only be possible if they can be certain of getting a good price for their products.

Evaporative cooling is a low-cost alternative for the cooling facilities mentioned above. The basic principle is that the products are cooled through evaporation. Evaporation means that liquid water turns into water vapour on a surface. When water evaporates it draws energy from its surroundings, producing a considerable cooling effect. Evaporative cooling occurs when air that is not too humid passes over a wet surface; the faster the rate of evaporation the greater the cooling. The efficiency of an evaporative cooler depends on the humidity of the surrounding air. Very dry air can absorb a lot of moisture, causing greater cooling. On the other hand, if the air is totally saturated with water, no evaporation can take place and no cooling occurs.

An evaporative cooler is made of a porous material that is fed with water. Hot dry air is drawn over the material. The water evaporates into the air raising its humidity and at the same time reducing the temperature of the air. There are many different styles of evaporative coolers. The design used will depend on the materials available and the user's requirements. Some examples of evaporative cooling designs are described below.

The basic design of an evaporative cooler consists of a storage pot placed inside a bigger pot that holds water. The inner pot stores food that is kept cool. One adaptation on the basic double pot design is the Janata cooler, developed by the Food & Nutrition Board of India (Figure 22). A storage pot is placed in an earthenware bowl containing water. The pot is then covered with a damp cloth that is dipped into the reservoir of water. Water drawn up the cloth evaporates, keeping the storage pot cool. The bowl is also placed on wet sand, to isolate the pot from the hot ground.

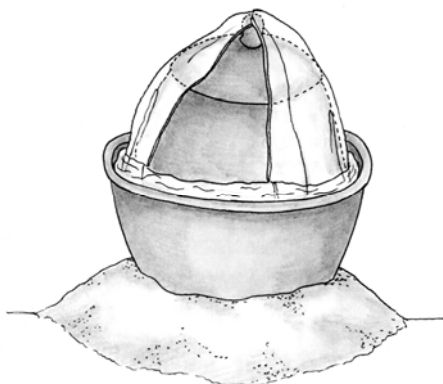

Figure 22: Janata evaporative cooler

An alternative design of this cooler consists of a 'pot-in-pot' system that uses two pots of slightly different sizes. The smaller pot is placed inside the larger pot and the gap between the two pots is filled with sand. The Indian Agricultural Research Institute has also developed a different kind of cooling chamber that has more capacity. The basic structure of the cooling chamber can be built from bricks and river sand, with a cover made from cane or other plant material and sacks or cloth. There must also be a nearby source of water.

Construction is fairly simple. First the floor is built from a single layer of bricks, then a cavity wall is constructed of brick around the outer edge of the floor with a gap of about 75 mm between the inner wall and outer wall. This cavity is then filled with sand. About 400 bricks are needed to build a chamber of the size shown in Figure 23, which has a capacity of about 100 kg.

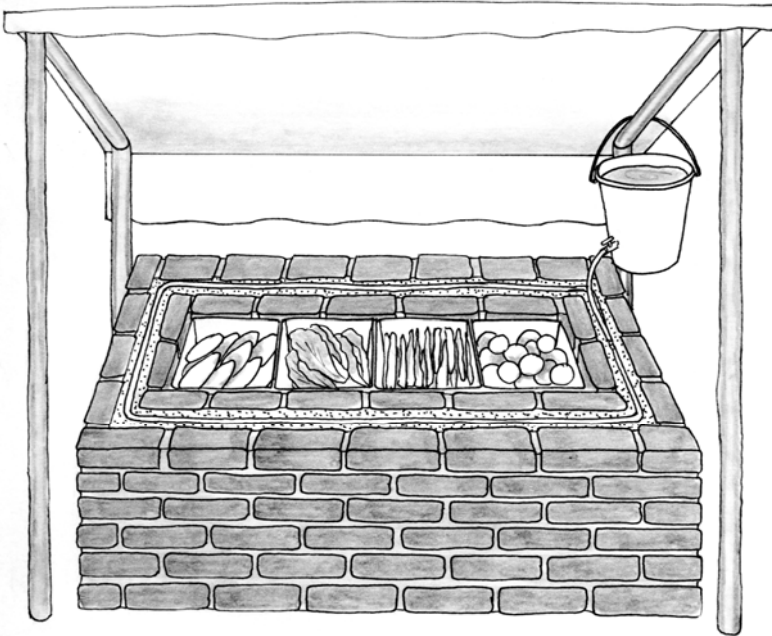

Figure 23: Evaporative cooling chamber

A covering for the chamber is made with canes covered in sacking, and mounted on a bamboo frame. The whole structure should be protected from the sun by making a roof to provide shade. After construction the walls, floor, sand in the cavity and cover are thoroughly saturated with water. Once the chamber is completely wet, a twice-daily sprinkling of water is enough to maintain the moisture and temperature of the chamber. A simple automated drip watering system can also be added as shown in Figure 23.

Storage and ethylene

Many fruits and vegetables are sensitive to ethylene. In fruit ethylene induces ripening, which is favourable in most cases, because these fruits can be harvested before they are fully ripe and when they are less vulnerable to damaging. Most of the sensitive fruits also produce ethylene, as you can see in Table 2. Some fruits are sensitive to ethylene, but do not produce it themselves. They can ripen off the plant when stored in the presence of fruits that produce ethylene.

Table 2: Common tropical fruits. Storage duration is a rough indication for fruits that are harvested ripe.

Common Name	Scientific Name	Storage temperature, °C	Storage duration, weeks
A. Fruits that ripen off the plant ¹⁾			
Sugarapple	<i>Annona squamosa</i>	15 - 20	0.5 – 1.5
Mango	<i>Mangifera indica</i>	10 - 13	1
Banana	<i>Musa sp.</i>	13 - 16	1 - 1.5
Guava	<i>Psidium guajava</i>	5 - 10	1 – 3
Passion fruit	<i>Passiflora sp.</i>	5 - 10	1 – 5
Avocado	<i>Persea americana</i>	3 - 7	2 - 4
Mangosteen	<i>Garcinia mangostana</i>	13 - 15	2 - 4
Breadfruit	<i>Artocarpus altilis</i>	13 - 15	2 – 4
Jackfruit	<i>Artocarpus heterophyllus</i>	13 - 15	2 – 4
Papaya	<i>Carica papaya</i>	13	2 – 5
Durian	<i>Durio zibethinus</i>	13 - 15	3 - 5
B. Fruits that ripen off the plant, but only in the presence of other fruits ²⁾			
Grape	<i>Vitis sp.</i>	0 - 2	2 – 8
Citrus (Lime)	<i>Citrus aurantiifolia</i>	10 - 13	6 - 8
C. Fruits that ripen only on the plant ³⁾			
Rambutan	<i>Nephelium lappaceum</i>	10 - 12	1.5 - 2
Pineapple	<i>Ananas comosus</i>	10 - 13	2 – 6
Pomegranate	<i>Punica granatum</i>	5 - 7	8 - 16
Orange	<i>Citrus sinensis</i>	3 - 8	12
¹⁾ Fruits produce ethylene and are sensitive to ethylene			
²⁾ Fruits do not produce ethylene, but are sensitive to ethylene			
³⁾ Fruits do not produce ethylene and are not sensitive to it			

Many vegetables are also sensitive to ethylene. In vegetables ethylene causes aging, which is unfavourable in most cases. Therefore, if you

want to store these vegetables for a week or more, you should not store them in the presence of ethylene-producing fruits. Some vegetables and their sensitivity to ethylene are shown in Table 3.

Table 3: Common vegetables, approximate storage duration and sensitivity to ethylene

Common Name	Scientific Name	Storage Duration, weeks	Sensitive to ethylene
Cabbage	<i>Brassica oleracea</i>	3 - 6	+
Spinach	<i>Spinacia oleracea</i>	0.5	++
Cauliflower	<i>Brassica oleracea</i>	2 - 3	+
Carrot	<i>Daucus carota</i>	1.5 - 2	+
Sweet corn	<i>Zea mays 'rugosa'</i>	0.5	-
Hot pepper	<i>Capsicum annuum 'longum'</i>	10 - 25	+
Sweet peppers	<i>Capsicum annuum 'gros-sum'</i>	2 - 5	-
Green onion	<i>Allium fistulosum</i>	2 - 4	+
Tomato	<i>Lycopersicon esculentum</i>	0.5 - 1	+
Button mushroom	<i>Agaricus bisporus</i>	0.5 - 1	+
Eggplant	<i>Solanum melongena</i>	0.5 - 1	+
Green bean	<i>Phaseolus vulgaris</i>	0.5 - 1	+
Cucumber	<i>Cucumis sativus</i>	1 - 2	+
Okra	<i>Abelmoschus esculentus</i>	1 - 1.5	+
Artichoke	<i>Cynara scolymus</i>	0.5 - 1	+

Appendix 1: Measuring relative humidity of the air

If the relative humidity (RH) is more than 70 percent, wet seeds must be artificially dried before they can be stored. At this RH, dry seeds can absorb water from the humid air. They should therefore be stored in airtight containers to prevent contact with the outside air.

The RH of the air can accurately be measured with two thermometers: a dry-bulb thermometer and a wet-bulb thermometer. The dry-bulb temperature is the temperature of the air measured by an ordinary thermometer. The wet-bulb temperature is the temperature of the air measured by an ordinary thermometer whose glass bulb is covered by a wet cloth or gauze (a cotton wick is slipped onto the bulb end of the thermometer and then dipped into distilled or rain water). Both thermometers are shown below in Figure 24. The temperatures are measured after the thermometers have been moved rapidly (by shaking or rotating them) for several seconds through the air. Some water will evaporate from the wet bulb, and as a result the temperature will go down. The drier the air, the more water will evaporate and the lower the temperature that the wet bulb thermometer will indicate. Once the temperatures of the dry and wet bulbs have been measured, the RH can be read from Table 4.

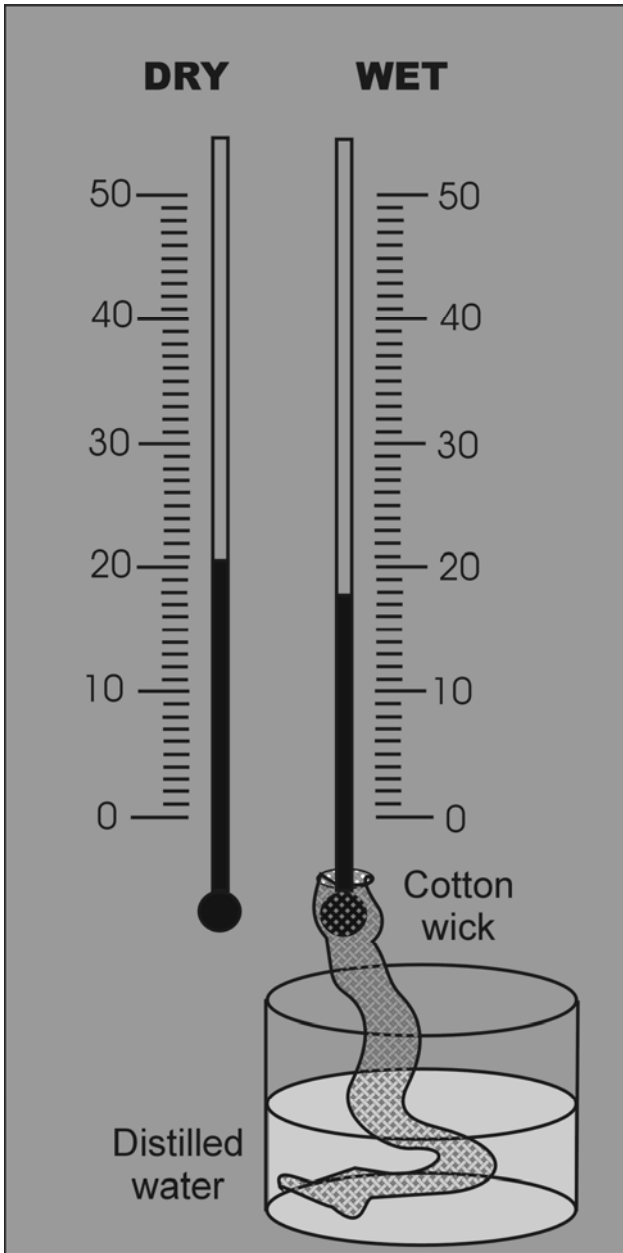

Figure 24: Dry and wet bulb thermometers

Table 4: Relative humidity of the air measured with dry and wet bulb thermometers

Td	Δt										
	0.0	1.0	2.0	3.0	4.0	5.0	6.0	7.0	8.0	9.0	10.0
5	100	86	72	58	45	33	20	7	-	-	-
10	100	88	77	66	55	44	34	24	15	6	-
15	100	90	80	71	61	53	44	36	27	20	13
20	100	91	83	74	66	59	51	44	37	31	24
25	100	92	84	77	70	63	57	50	44	39	33
30	100	93	86	79	73	67	61	55	50	44	39
35	100	94	87	81	75	69	64	59	54	49	44
40	100	94	88	82	77	72	67	62	57	53	48
Td = Dry bulb temperature											
Δt = Difference in temperature between dry and wet bulb thermometers											

Table 4 is a simplified table, which is valid for an air speed of approximately 2.5 metres per second, at normal atmospheric pressure and with no direct sunlight on the thermometers.

Appendix 2: Measuring the moisture content of seeds

Moisture Content (MC) of seeds is usually determined on a wet basis:

$MC \text{ wet} = (\text{Weight of wet grain} - \text{Weight of dry grain}) * 100 / (\text{weight of wet grain})$

$\text{Final weight of grain} = \text{Initial weight} * (100 - MC \text{ initial}) / (100 - MC \text{ final})$

Example: 1000 kg of seeds are harvested at 25 percent MC, and dried down to 14 percent M

$\text{Final weight of grain} = 1000 * (100 - 25) / (100 - 14) = 872 \text{ kg of paddy at } 14 \text{ percent}$

Method A: Weighing a seed sample before and after drying in an oven

- 1 Pre-heat the oven at 130 °C.
- 2 Weigh three seed samples of approximately 10 grams each (w).
- 3 Place the samples inside the oven.
- 4 Remove the samples after approximately 16 hours, and obtain the final weight of each sample.
- 5 Compute the MC for each sample: $MC = (W - \text{Final weight of dried sample in grams}) * 100 / W$.
- 6 Compute the average MC of three samples.

Method B: With an electronic moisture meter

There are many different types of seed moisture meters. Make sure your meter is suitable for your grain. Consult the manual to find out the correct procedure for measurement. We use the IRRI-meter as an example (Figure 25). It is relatively cheap and was originally developed for rice. Later it was adapted for coffee and other seeds. Sales in

several African countries are planned. The meter operates with a 9-Volt alkaline battery.



Figure 25: Electronic meter to measure the moisture content of seeds. The operation of the meter is described below.

Operation of the meter

- 1 Turn on the moisture meter with the on/off button.
- 2 Fill the tray of the moisture tester with seeds to the required level.
- 3 Turn the knob until the moisture reading is displayed.
- 4 Take measurements of 3 to 5 samples and compute the average moisture content.

Further reading

López, C.A.F. 2004. **Manual for the preparation and sale of fruits and vegetables** – From field to market. FAO Agricultural Service Bulletin 151. ISBN: 92-5-104991-2.

Boeke, S.J., J.J.A. van Loon, A. van Huis, D.K. Kossou, M. Dicke, 2001. **The use of plant material to protect stored leguminous seeds.** Wageningen University Papers (Netherlands), no. 2001/3, Leiden (Netherlands), Backhuys Pub., ISBN 90-5782-100-1, 108 pp., tables.

CAB International, 1997. **Post-harvest physiology and storage of tropical and subtropical fruits.** ISBN: 0-85199-210-2.

Diop, A. & D. J. B. Calverley, 1998. **Storage and processing of roots and tubers in the tropics.** FAO Agro-industries and Post-Harvest Management Service, Agricultural Support Systems Division, Rome, Italy. This document is also available in French: **Les étapes de l'après-récolte du riz et le suivi de la qualité.**

Diop, A., R. Wanzie, 1995. **Improved low-cost storage of potatoes in the North-west province of Cameroon.** Proceedings of the workshop on the African Experience on Post-harvest Technology Development. FAO, Rome, Italy.

Gwinner, J., R. Harnisch & H. Mück, 1996. **Manual on the prevention of post-harvest grain losses.** Gesellschaft für Technische Zusammenarbeit Eschborg, Germany, 2nd edition, 334 pp. Internet site: <http://nzdl.sadl.uleth.ca>

Kader, A.A. & R.S. Rolle, 2004. **The role of post-harvest management in assuring the quality and safety of horticultural produce.** FAO, Rome. www.fao.org. ISBN: 92-5-105137-2

Lebot, V., 2008. **Tropical Root and Tuber Crops: Cassava, Sweet Potato, Yams and Aroids** (Crop Production Science in Horticulture). Oxford University Press, 432 pp. ISBN: 978-1-84593-424-8.

Payne, T.S., B.C. Curtis (ed.), S. Rajaram (ed.), H. Gomez Macpherson (ed.), 2002. **Harvest and storage management of wheat**, FAO Plant Production and Protection Series (FAO) 0259-2525, no. 30, Rome (Italy). ISBN: 92-5-104809-6.

Post-harvest Management Group, 2003. **Compendium on Post-harvest Operations**. FAO-GTZ-CIRAD, Rome, Italy. Internet site: www.fao.org The Post-harvest Compendium is designed to be used through the Internet: to provide technical and updated information about how, when and what is done after production of crops in different communities around the world.

Stoll, G., 1996. **Natural crop protection, based on local farm resources in the tropics and subtropics**. Tropical Agroecology (Germany), AGRECOL, Langenbruck (Switzerland), Publisher Margraf Verlag, 188 pp. ISBN 3-8236-1113-5.

Walker, D. J. and G. Farrell, 2003. **Food Storage Manual**. Chatham, UK: Natural Resources Institute; Rome: World Food Programme, fourth edition of the Food Storage Manual, University of Greenwich/World Food Programme 2003, 247pp. ISBN: 0 85954 544 X. <http://foodquality.wfp.org>

UNIFEM, 1995. **Storage**. Practical Action Publishing, 48 pp. ISBN: 1-85339-309-6. This book focuses on the storage of staple commodities such as grains and root crops, but it also covers other major food groups such as oils, fish, fruit and vegetables.

Useful addresses

AVRDC – The World Vegetable Center

AVRDC – the World Vegetable Center is the leading international center for vegetable research and development worldwide. It is a not-for-profit research institute focused on the alleviation of poverty and malnutrition in developing countries through the improved production and consumption of safe vegetables.

Postal address: PO Box 42, Shanhua, Tainan 74199, Taiwan

Physical address: 60 Yi-min Liao, Shanhua, Tainan 74151, Taiwan

T: +886-6-583-7801, F: +886-6-583-0009 E: info@worldveg.org

Regional Center for Africa

Address: Duluti, PO Box 10, Arusha, Tanzania

T: +255(27)255-3102/3093, F: +255(27)255-3125

E: info-africa@worldveg.org, W: www.avrdc.org

GTZ (Deutsche Gesellschaft für Technische Zusammenarbeit)

GTZ is an international cooperation enterprise for sustainable development with worldwide operations. GTZ promotes complex reforms and change processes, often working under difficult conditions. Its corporate objective is to improve people's living conditions on a sustainable basis.

Postal address: Deutsche Gesellschaft für Technische Zusammenarbeit (GTZ) GmbH, Postfach 5180, 65726 Eschborn, Germany

T: +49 6196 79-0, F: +49 6196 79-1115

E: info@gtz.de, W: <http://www.gtz.de/en/index.htm>

Ileia, Center for information on low external input and sustainable agriculture

ILEIA, the Centre for Information on Low External Input and Sustainable Agriculture promotes exchange of information for small scale farmers in the South through identifying promising technologies involving no or only marginal external inputs, but building on local knowledge and traditional technologies and the involvement of the farmers themselves in development. Information about these tech-

nologies is exchanged mainly through the LEISA Magazines in English, French, Portuguese, Spanish, Indonesian and Chinese. All articles accessible on-line.

Zuidsingel 16; P.O.BOX 2067, 3800 CB Amersfoort, The Netherlands
T +31 33 4673870. F: +31 33 4632410.

E: ileia@ileia.org, W: www.ileia.org

International Forum for Rural Transport & Development

The International Forum for Rural Transport and Development (IFRTD) is a global network of individuals and organisations working together towards improved access, mobility and economic opportunity for poor and vulnerable communities in developing countries.

Address: International Forum for Rural Transport and Development
113-114 Spitfire Studios, 63-71 Collier Street,
London N1 9BE, United Kingdom

T: +44 (0) 207 713 6699, F: +44 (0) 207 713 8290

E: ifrtd@ifrtd.org, W: www.ifrtd.org

Practical Action

Practical Action helps people to use technology in the fight against poverty. Keywords are: 'practical answers to poverty, sustainable solutions and people focused'. W: www.practicalaction.org

Practical Action Southern Africa

Number 4 Ludlow Road (off Enterprise Road), Newlands, Harare, Zimbabwe

T: +263 (4) 776631-3, 776107, 2936857-60, F: +263 (4) 788157

E: practicalaction@practicalactionzw.org

Regional Headquarters (Nairobi Office)

Practical Action - Eastern Africa

AAYMCA Building,, Along State House Crescent, Off State House Avenue, Nairobi, Kenya

T: +254 (0) 20 2713540 / 2715299 / 2719313 / 2719413.

F: +254 (0) 20 2710083

E: practicalaction@practicalaction.or.ke

Glossary

<i>Aflatoxin</i>	A food poison produced by fungi belonging to the genus <i>Aspergillus</i> . Aflatoxins are toxic to humans and cause cancer.
<i>Bulb</i>	Short underground stem with buds surrounded by usually fleshy leaves that contain stored food for the shoot within
<i>Conservation</i>	Protection from change, loss or injury
<i>Evaporate</i>	To change from a liquid to a vapour
<i>External factor</i>	A factor in the environment (that causes loss of quality of stored plants)
<i>Infestation (of a stored crop)</i>	A pest (insect, fungus or bacterium) that grows on the stored crop
<i>Internal factor</i>	A factor attributed to the crop itself (causing loss of quality of stored plants)
<i>Nutrition</i>	The process by which a living organism consumes food and uses it for growth and for replacement of tissues
<i>Parboiling</i>	A cooking technique in which food is partially cooked in boiling water, but removed before it is cooked all the way through
<i>Physiological maturity (of a seed)</i>	Growth stage at which the ripening seed is fully developed and does not grow further or

store more food reserves. It is usually still too wet to thresh or to store for any length of time.

Preservation

The process of treating agricultural products to stop or greatly slow down spoilage caused by micro-organisms

Respiration

Chemical reactions by which living plants and animals produce energy from food

Seed

1-An organ formed in the sexual reproduction of plants, consisting of a protective coat enclosing an embryo and food reserves

2-A collection of seeds used by a farmer to start a new crop

Shelf life (of agricultural products)

Length of time before they are considered unsuitable for sale or consumption

Tuber

A swollen, fleshy, usually underground stem of a plant, such as the potato, bearing buds from which new plant shoots arise

Tuberous root or storage root

Modified lateral root, enlarged to function as a storage organ